

Solid state microwave leaving the lab 86
Cascading aids active-filter design 100
Revving up MOS memories 106

\$1.00 A McGraw-Hill Publication
February 17, 1969

Electronics®

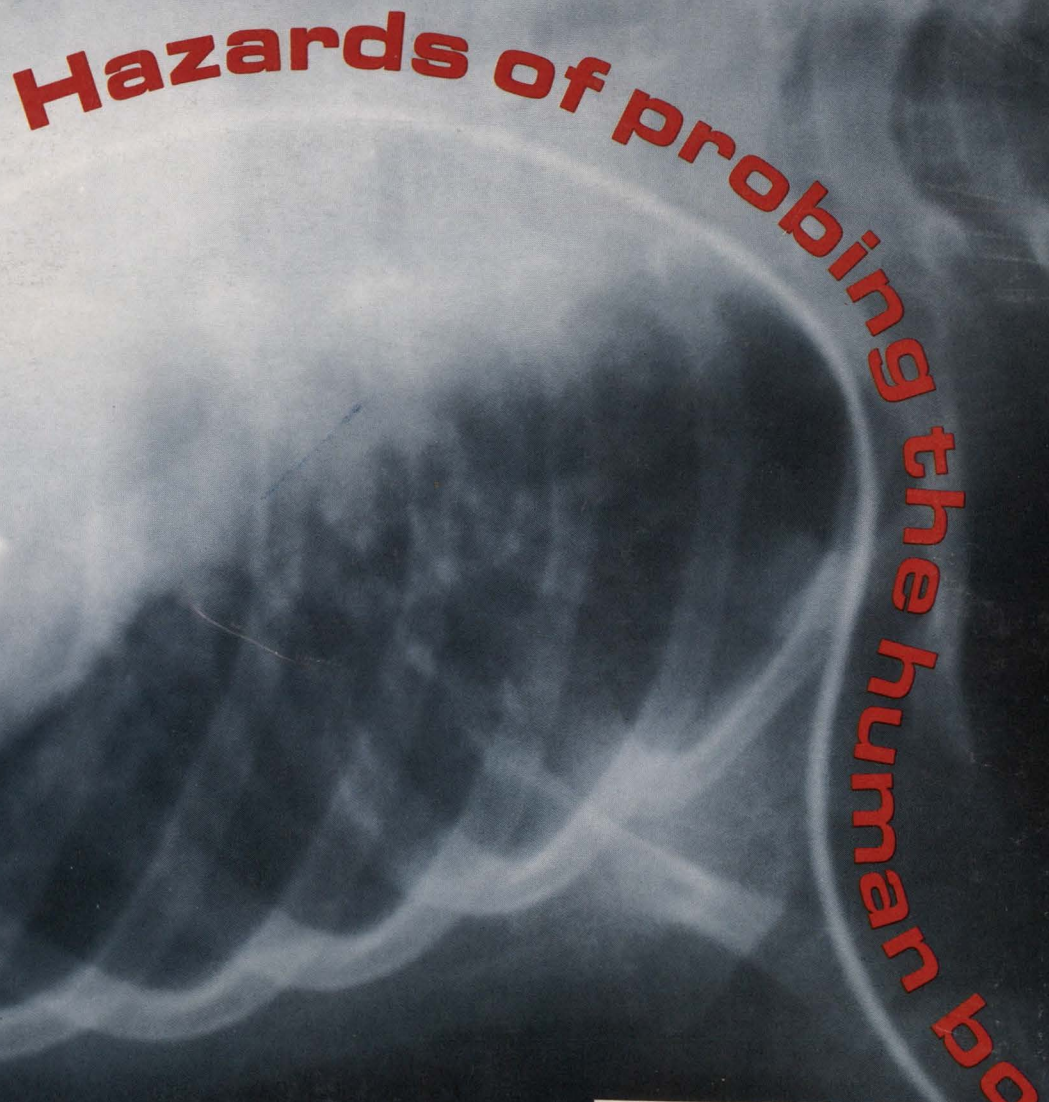

Hazards of probing the human brain



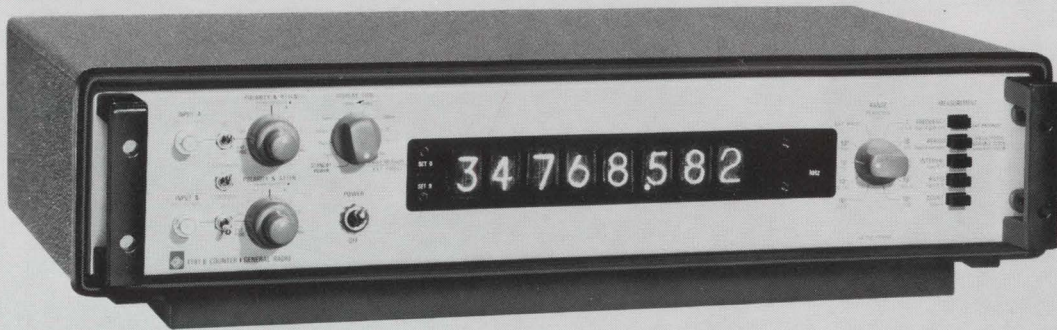

**MORE of Everything
You Want
in a Counter
... Still for only \$1340**

We have made significant improvements to the popular 1191 Counter. Now you can get more performance at the same low price. The 1191-B has:

More Frequency Range. DC to 35 MHz, direct count. The addition of an inexpensive GR scaler (now or at a later time) extends the frequency range to 100 MHz or 500 MHz.

More Sensitivity. A 10-mV signal is all that is needed to trigger the instrument up to 20 MHz. (Beyond 20 MHz, sensitivity gradually decreases, but no more than 100 mV is required up to 35 MHz.)

More Versatility. The 1191-B provides all the functions you'd expect from a high-quality counter-timer: frequency, single and multiple period (1 to 10^8 periods), time interval (10^{-7} s to 10^9 s), frequency ratio (1 to 10^8), count (to 10^8). In addition, a unique strobed-period mode (described below) affords even more performance per dollar. All functions, including secondary controls, are dc programmable.

More Useful Counting Time. A unique strobed-period mode of the

1191-B allows you to measure the period between *successive* pulses or the time between *successive* occurrences. The count-display scheme used by other counters allows measurement of every other period, at best. But the 1191-B can generate a clear and restart signal immediately upon completion of display time (which is as low as 1 μ s), so no information is lost.

More Value. The base price of the 1191-B is \$1340; this model contains a room-temperature crystal oscillator with drift $< \pm 2 \times 10^{-6}$ per month. An additional \$300 buys a high-precision oscillator with drift $< \pm 1 \times 10^{-8}$ per week. Fully buffered 1-2-4-8 BCD output at standard DTL levels can be ordered for another \$100.

For more information call your nearest GR Office. Or write General Radio, West Concord, Mass. 01781; telephone (617) 369-4400. In Europe: Postfach 124, CH 8034 Zurich 34, Switzerland.

GENERAL RADIO

What's so great about adding an HP computer to an HP signal averager?

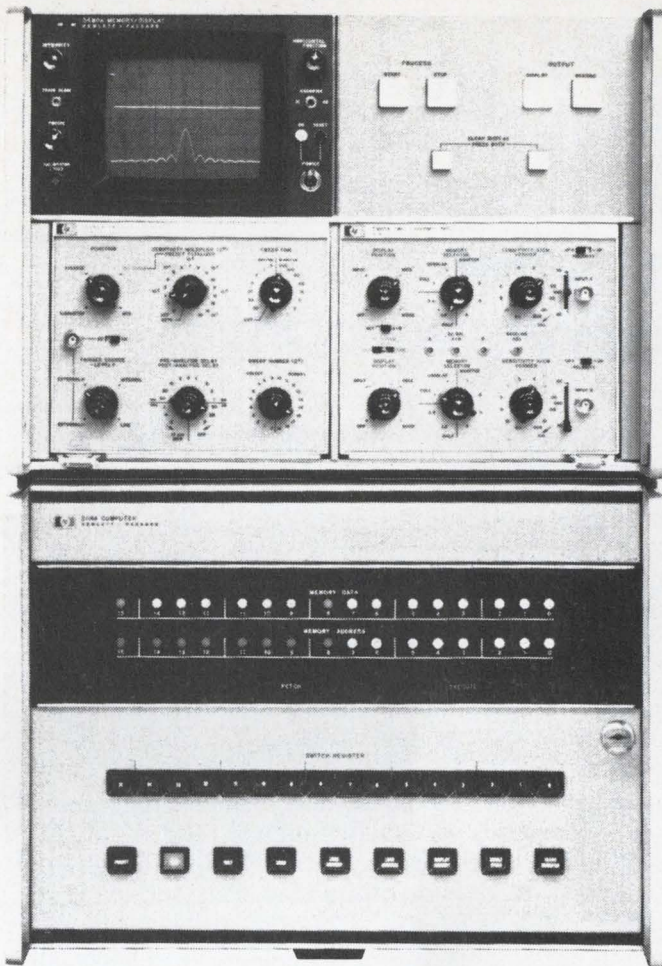

Getting Fourier Transforms in seconds.

If you want to know more about a noisy waveform than what it looks like, the combination of an HP computer and an HP signal averager is a relatively inexpensive—but speedy—solution.

The 5480A Signal Analyzer operates as an averager to extract your data signal from noise. The HP 2114A Computer then processes the waveform—say, converts it from time domain to frequency domain by Fourier transformation—and displays its real and imaginary parts, magnitude and phase, on the averager CRT.

The standard 5481A system with 4K memory will handle a 250 point, 500 point or 1000 point transform. But since it is modular, you can expand the memory to 8K or larger to give you greater power and flexibility through Executive call-up of subroutines.

A short dialog between you and the computer—you answer simple questions with yes, no, or a number—prepares the Executive tape. This tape calls up system

library subroutines or even those you may wish to write. One subroutine gives you program control of the averager for automatic data acquisition.

With the standard system you get the averager, the computer, and a teleprinter with complete interfacing and system software packages—for less than \$26,000. Or you can choose one of the larger HP computers and any of the peripherals offered with them.

The HP 5481A Signal Averager/Computer System brings practical, real-time analysis to such difficult applications as nuclear magnetic resonance spectroscopy, optical systems testing and calibration, biomedical, vibration, circuit and servo analysis. Anywhere that noise in the same frequency range is an added problem.

Ask your HP field engineer for complete information. Or write Hewlett-Packard, Palo Alto, California 94304; Europe: 1217 Meyrin-Geneva, Switzerland.

HEWLETT  PACKARD
SIGNAL ANALYZERS

THE COUNTER REVOLUTION GOES ON AT HP

Feature for feature, you can't find a better universal counter

The new Hewlett-Packard 5325B Universal Counter gives you more counting features for your money than any other counter. And its extreme flexibility lets you do all the jobs a counter can do without plug-in accessories. Measure frequency to 20 MHz, time intervals from 100 ns to 10^9 s, and period, multiple period, ratio and multiple ratio. Time interval stop and start signals can be from common or separate inputs, with separate trigger level, slope and polarity controls for each.

Only the 5325B guarantees a very narrow trigger level threshold band—less than 1.0 mV—to prevent false counts when the trigger level setting is marginal. Integrated circuits designed specifically for electronic counters simplify internal wiring and reduce primary power requirement to less than 35 watts. Therefore, the 5325B requires no cooling fan and operates from 50 Hz to 400 Hz power.

Another feature is readout blanking: it blanks all

zeros to the left of the most significant digit—simplifies and speeds readout interpretation.

Still another: it generates two types of oscilloscope markers, which not only mark the start and stop points of an interval, but also intensify the entire measured segment when desired.

One more thing. Some counters can give you wrong time interval answers when the time interval stop signal unknowingly disappears or its trigger level is set too high. The 5325B won't respond incorrectly under such conditions—it will simply keep counting and not present a new reading.

These features, together with *standard* remote programming, BCD output that's stored for recording and readout while a new measurement is made, sampling rate down to 100 μ s, 0.1 μ s—10 s gate time, and excellent time base stability make the new 5325B Universal Counter an outstanding instrument. Yet the price is only \$1300.

Call your local HP field engineer for more details. Or write Hewlett-Packard, Palo Alto, Calif. 94304; Europe: 1217 Meyrin-Geneva, Switzerland.

02828

HEWLETT  PACKARD

ELECTRONIC COUNTERS

Circle 2 on reader service card

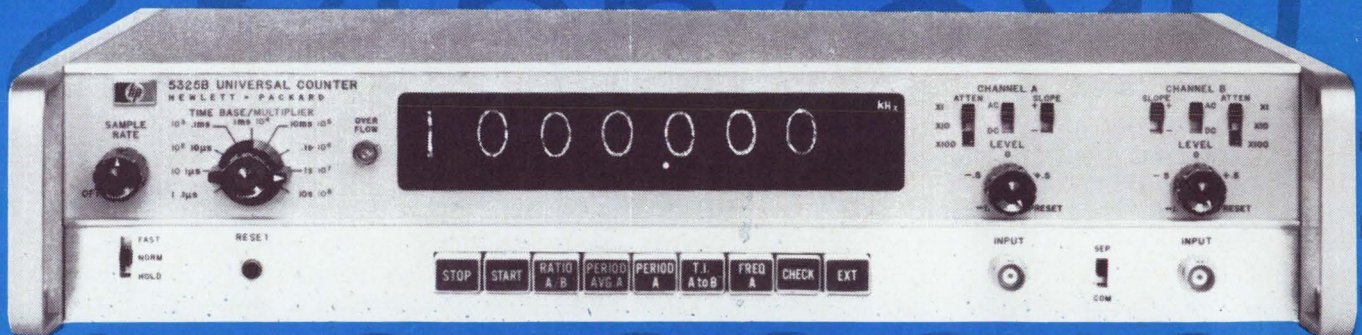

News Features

Probing the News

- 133 **Space electronics:** Intelsat plots a course for the future
139 **Markets:** To thread the maze of export rules, start at Commerce

U.S. Reports

- 53 **Space electronics:** TRW's phased-array pops up when orbit is reached
54 **Optoelectronics:** Solid state tv cameras
56 **Solid state:** Circuits outpace ECL; Fairchild returns to power transistors
58 **Consumer electronics:** Detent tuning for uhf tv gains
60 **Instrumentation:** High-speed recorder
60 **Government:** Silence shrouds military procurement report
62 **Communications:** Telegrams by pcm
64 **Advanced technology:** Cool LSA diodes
66 **Companies:** Sprague is nudged into power-transistor field

Electronics International

- 217 **Japan:** Tokyo subway tries trains with chopper control and regenerative braking that cuts power costs
218 **The Netherlands:** Monolithic IC handles tv signal processing
219 **West Germany:** System that checks surface deviations of parabolas may spur new design for large antennas; Peltier plaques cool rooms in summer and heat them in the winter
220 **International:** OECD prescribes remedy for the gap between the U.S. and Europe in semiconductor technology

New Products

- 149 **In the spotlight**
149 Semiconductor microwave sources go off-the-shelf at more makers
155 **Components review**
155 Adding capacitance by the strip
158 Digital readout with backup
161 **Instruments review**
161 Timer has plug-in IC's
164 Multimeter is built rugged
169 **Subassemblies review**
169 Logic improves tv color tests
173 **Data handling review**
173 Time-sharing of hybrid computers
178 Fourier processor filters data
183 **Microwave review**
183 Switches isolate ports by 60 db
186 Comb generators cover 3-40 Ghz
189 **Semiconductor review**
189 Low-leakage power transistors

Title R registered U.S. Patent Office; © copyright 1969 by McGraw-Hill Inc. All rights reserved, including the right to reproduce the contents of this publication in whole or in part.

Technical Articles

- Integrated electronics** 86 **Solid state microwave leaves the lab**
George F. Watson, Electronics associate editor
- Instrumentation** 92 **Designers of medical instrumentation face serious questions on safety**
Owen Doyle, Electronics assistant editor
- Circuit design** 96 **Designer's casebook**
▪ FET's tune RC oscillator over decade range
▪ FET links oscillator to TTL circuit
▪ Converted generator drives heavy logic loads
▪ Two zeners set limits of voltage range gate
- Design theory** 100 **Analog blocks ensure stable active-filter design**
Joseph Salerno, Bell Telephone Laboratories
- Memory technology** 106 **Getting more speed from MOS**
Oliver S. Saffir, American Astrionics
- 109 **COS/MOS: the best of both worlds**
Gerald B. Herzog, RCA Laboratories
- 114 **SOS brings new life to read-only units**
James A. Luisi, Autonetics

Departments

- | | | | |
|----|--------------------------|-----|--------------------------|
| 4 | Readers Comment | 41 | Electronics Newsletter |
| 8 | Who's Who in this issue | 71 | Washington Newsletter |
| 14 | Who's Who in electronics | 192 | New Books |
| 30 | Meetings | 196 | Technical Abstracts |
| 39 | Editorial Comment | 205 | New Literature |
| | 215 | | International Newsletter |

Electronics

Editor-in-Chief: Donald Christiansen

Senior staff editors

Technical: Stephen E. Scrupski
News: Robert Henkel
International: Arthur Erikson

Managing editor: Harry R. Karp
Art director: Gerald Ferguson

Senior associate editor: Joseph Mittleman
Assistant managing editors: Stanley Zarowin, Eric Aiken, H. Thomas Maguire
Senior copy editor: James Chang; **Senior staff writer:** Howard Wolff

Department editors

Advanced technology: William Bucci, Richard Gundlach
Communications: John Drummond, Raphael Kestenbaum
Computers: Wallace B. Riley, George Weiss
Design theory: Joseph Mittleman
Instrumentation: Owen Doyle, Walter Barney
Military/Aerospace: Alfred Rosenblatt, Paul Dickson
New products: William P. O'Brien
Solid state: George Watson, Stephen Wm. Fields

Domestic bureaus

Boston: James Brinton, manager; Gail Farrell
Chicago: Frederick Corey, manager
Los Angeles: Lawrence Curran, manager
San Francisco: Walter Barney, manager; Peter Vogel
Washington: Robert Skole, manager; Paul Dickson, William F. Arnold

Foreign bureaus

Bonn: John Gosch
London: Michael Payne
Tokyo: Charles Cohen

Copy editors: Larry Miller, Edward Flinn
Staff writer: Peter Schuyten

Assistant art director: Susan Hurlburt, Kenneth L. Dix
Production editor: Arthur C. Miller

Editorial research: Anne Mustain

Editorial secretaries: Lorraine Longo, Claire Goodlin, Barbara Razulls, Vickie Green

McGraw-Hill News Service

Director: Arthur L. Moore; **Atlanta:** Fran Ridgway; **Chicago:** Robert E. Lee
Cleveland: Arthur Zimmerman; **Dallas:** Marvin Reid
Detroit: James Wargo; **Houston:** Barbara LaRouax
Los Angeles: Michael Murphy; **Pittsburgh:** Louis Gomolak
San Francisco: Margaret Drossel
Seattle: Ray Bloomberg; **Washington:** Charles Gardner, Daniel B. Moskowitz, Herbert W. Cheshire, Seth Payne, Warren Burkett, William Small, William D. Hickman

McGraw-Hill World News Service

Bonn: Robert Dorang; **Brussels:** James Smith; **Hong Kong:** Wes Perry;
London: John Shinn; **Mexico City:** Gerald Parkinson; **Milan:** Ronald Taggiasco, Jack Star;
Moscow: Jack Winkler; **Paris:** Robert E. Farrell, Stewart Toy
Rio de Janeiro: Leslie Warren; **Tokyo:** Marvin Petal
Reprints: Susan Nugent
Circulation: Isaaca Siegel

Publisher: Gordon Jones

Assistant to the publisher: Wallace C. Carmichael

Electronics: February 17, 1969, Vol. 42, No. 4

Published every other Monday by McGraw-Hill, Inc. Founder: James H. McGraw 1860-1948.
Publication office 99 North Broadway, Albany, N. Y. 12202; second class postage paid at Albany, N. Y.

Executive, editorial, circulation and advertising addresses: McGraw-Hill Building, 330 W. 42nd Street
New York, N. Y. 10036. Telephone (212) 971-3333. Teletype TWX N.Y. 710-581-4235. Cable address:
MCGRAWHILL N.Y.

Subscriptions solicited only from those professionally engaged in electronics technology. Subscription rates:
qualified subscribers in the United States and possessions and Canada, \$8.00 one year, \$12.00 two years,
\$16.00 three years; all other countries \$25.00 one year. Non-qualified subscribers in the U.S. and
possessions and Canada, \$25.00 one year; all other countries \$50.00. Air freight service to Japan \$50.00
one year. Single copies: United States and possessions and Canada, \$1.00; all other countries, \$1.75.

Officers of McGraw-Hill Publications: Joseph H. Allen, President; J. Elton Tuohig, Executive Vice President;
David J. McGrath, Senior Vice President-Operations; Vice Presidents: John R. Callahan, Editorial; Paul F. Gowie,
Circulation; John R. Emery, Administration; John M. Holden, Marketing; David G. Jensen, Manufacturing;
Jerome D. Luntz, Planning & Development; Robert M. Wilhelmy, Controller.

Officers of the Corporation: Shelton Fisher, President and Chief Executive Officer; John L. McGraw, Chairman;
Robert E. Slaughter, Executive Vice President; Daniel F. Crowley, Donald C. McGraw, Jr., Bayard E. Sawyer, Senior
Vice Presidents; John J. Cooke, Vice President & Secretary; Gordon W. McKinley, Vice President & Treasurer.

Title ® registered in U.S. Patent Office; © Copyright 1969 by McGraw-Hill, Inc. All rights reserved. The contents
of this publication may not be reproduced either in whole or in part without the consent of copyright owner.

Subscribers: The publisher, upon written request to our New York office from any subscriber,
agrees to refund that part of the subscription price applying to copies not yet mailed.
Please send change of address notices or complaints to Fulfillment Manager; subscription
orders to Circulation Manager, Electronics at address below. Change of address notices
should provide old as well as new address, including postal zip code number. If possible,
attach address label from recent issue. Allow one month for change to become effective.

Postmaster: Please send form 3579 to Fulfillment Manager, Electronics,
P.O. Box 430, Hightstown, New Jersey 08520

Readers Comment

Sins of omission

To the Editor:

I note an error, or, more properly, omissions, in Designer's Casebook [Jan. 6, p. 93]. The schematic does not indicate the output for monostable 1 and monostable 2, there is no coupling between monostable 1 and monostable 2, and switch S₁, mentioned in the article, is missing.

Chester K. Bishop
Robertshaw Controls Co.
Columbus, Ohio

▪ The missing switch should have been placed between Q₄'s collector and ground. The output of monostable 1 is at the collector of Q₂; the output of monostable 2 is at the collector of Q₃. In addition, D₃ should be connected directly to the 4.7-kilohm resistor, without the connection shown to the positive supply voltage.

Interfering with noise

To the Editor:

In "High-precision preamp built from 3 transistors" [Dec. 23, 1968, p. 58], omissions and errors occurred. The noise characteristic in the figure should be "3.3 nv per square root cycle at 1 khz," not 10 hz. All capacitor values are in microfarads and all resistances in ohms except where specified. The FET low noise has nothing whatsoever to do with allowing greater feedback.

T.C. Penn
Texas Instruments
Dallas

Question of formality?

To the Editor:

An item in Washington Newsletter [Nov. 11, 1968, p. 88] is in error.

The Ryan AN/APN-182 doppler radar navigator has not been tested by the Army. Your writer says that the Army is "again considering" the system and that it has "twice flunked Army tests."

The AN/APN-182 has been pur-

Because most of the world is analog

2.8 MHz hybrid 10-bit D-to-A circuits are here to help.

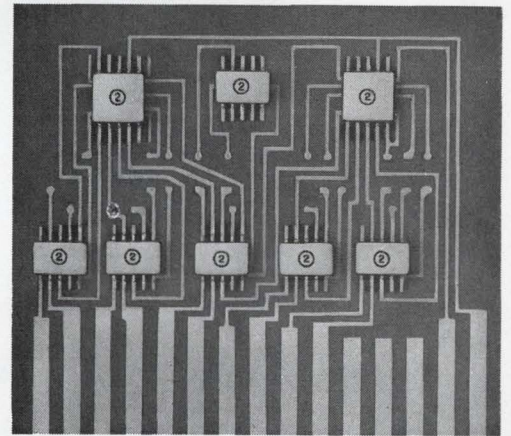

Get 10-bit accuracy at 2.8 MHz with only eight packages. You get ladder networks, ladder switches, and buffers. Just add a PC board and the fastest op amp you can find.

Only 240 mW. Save power. There's no hot speed/power trade-off with these new Sprague hybrids. And you save space, too. The D-to-A circuits are in $\frac{1}{4}'' \times \frac{1}{4}''$

and $\frac{1}{4}'' \times \frac{1}{8}''$ hermetically sealed ceramic flatpacks, rated for -55 to $+125^{\circ}\text{C}$ operation.

Three ways to go for these new D-to-A circuits. Call Dom Consorte at Sprague Worcester—(617) 853-5000, ext. 321. Or call your nearest Sprague industrial distributor. Or circle the inquiry card number for complete specification data.

455-8150



'Sprague' and '®' are registered trademarks of the Sprague Electric Co.

THE BROAD-LINE PRODUCER OF ELECTRONIC PARTS

Readers Comment

chased by Sikorsky Aircraft for use in the Navy SH-3D ASW helicopters, by the Italian Air Force for use in Italian-built Bell craft, and by Agusta, an Italian firm, for installation in Italian Navy ASW helicopters.

R.D. Fredsti

Ryan Aeronautical Co.

■ An Army spokesman said that the system was tested informally—once in a Mohawk plane—and didn't meet specifications and that Ryan has been invited to resubmit it.

No missing LINC

To the Editor:

The article about the PDP-12, "At last—a computer with a heart" [Jan. 6, p. 179], would have been more accurately headlined "At last—another article about the LINC." I can cite at least 13 articles on the LINC that have appeared since 1961, including two in Electronics: "New computer analyzes brain waves in real time" [Jan. 18, 1963, p. 8] and "For life sciences: a do-it-yourself computer" [July 26, 1963, p. 28].

E.L. MacCordy

Washington University
St. Louis

■ The PDP-12 is an offspring of the LINC and has similar input-output equipment, but it is a new machine; the processor architecture, for example, is brand-new.

The PDP-12, as a commercial computer, has much broader systems applications than the LINC, which was essentially restricted to life-sciences work.

False start

To the Editor:

In looking at your 1969 market report [Electronics, Jan. 6, p. 107], I came across a discrepancy I cannot resolve.

In the chart on the cover page indicating factory sales in billions of dollars for the years 1968 on, the ordinate side shows sales starting at 0 and then going to 9, 10, 11, etc. I am wondering if this should be 8 rather than 0; this would agree with your projections for industrial electronics made on the market's chart.

I also wonder why you show the anticipated Federal electronics and industrial-commercial electronics markets on the graph, but neglect to include consumer electronics on it.

Louis D. DeLalio

President
Deutsch Filtrors Relay Division
East Northport, N.Y.

■ Yes, that 0 should have been an 8. As to leaving the consumer market out of the illustration, the main purpose of the graph was to show that the industrial-commercial market is expected to surpass the Federal by 1972.

New from the **SPEC-TROLL!**



A LOW-COST INDUSTRIAL WIREWOUND POT WITH PREMIUM FEATURES

Welded termination—With heavy-duty ribbon taps welded to several turns of wire, the new single-turn Model 132 can better withstand high-level vibrations and short-term overloads.

Unitized design—With only 4 major subassemblies—a stainless-steel shaft and rotor, a coil, a molded housing, and a rear lid—the 132 offers a new simpler design for greater reliability, with rear terminals for better packaging.

Rugged construction—The materials used in the 132 have been selected for their ability to withstand impacts and abrasions during assembly or maintenance to assure the customer a trouble-free, serviceable pot.

Low cost—For less than \$6 (in quantity)—you can buy this precision industrial pot! Also, heavy-duty stops (8 in. lb. static) are optional at no extra cost.

For full specs, circle the reader service card. Qualified respondents requesting a sample will receive a Model 132 free of charge from their local Spectrol representative.



Spectrol Electronics Corporation
A subsidiary of Carrier Corporation
17070 East Gale Avenue
City of Industry, Calif. 91745
Phone: (213) 964-6565
TWX: (910) 584-1314

SUBSCRIPTION SERVICE

Please include an Electronics Magazine address label to insure prompt service whenever you write us about your subscription.

Mail to: Fulfillment Manager
Electronics
P.O. Box 430
Hightstown, N.J. 08520

To subscribe mail this form with your payment and check new subscription renew my present subscription

Subscription rates: qualified subscribers in the U.S.: 1 year \$8; two years, \$12; three years, \$16. Non-qualified: 1 year \$25. Subscription rates for foreign countries available on request.

CHANGE OF ADDRESS

ATTACH LABEL HERE

If you are moving, please let us know five weeks before changing your address. Place magazine address label here, print your new address below.

name _____

address _____

city _____

state _____

zip code _____

Who's Who in this issue



Doyle

"Let George do it," is an increasingly common call around *Electronics* these days. And with good reason; George F. Watson, an associate editor with a special interest in solid state, is covering a fast-moving field. With a background that includes six years in the semiconductor field and a degree from Drexel Institute, he's the author of the roundup on practical circuit applications for bulk-effect devices and avalanche diodes on page 86. In preparing this article, Watson had reporting help from most of the *Electronics* field staff—Walt Barney and Peter Vogel in San Francisco, Steve Fields in New York, Larry Curran in Los Angeles, Marv Reid in Dallas, Bill Arnold in Washington, Charlie Cohen in Tokyo, and Mike Payne in London.

Journalists are supposed to be inquisitive, but sometimes they get disconcerting answers to their questions. Owen Doyle, an assistant editor at *Electronics* and author of the medical safety article beginning on page 92, asked, in the course of his research, who maintained one hospital's electronic instruments. "We usually hire a couple of technicians," a surgeon told him. "We're not too keen on these new things—biomedical engineers." Doyle, who holds a master's degree in this discipline from



Herzog

Drexel Institute, managed to keep his cool, as well as his interest in the field.

Later this year, Joseph Salerno, who wrote the active filters article on page 100, will celebrate his 10th anniversary with Bell Labs. He joined the organization after getting his B.S. from Newark College of Engineering. At present, Salerno, who also earned a master's from the Polytechnic Institute of Brooklyn in 1966, is investigating computer-aided design of active filters using operational amplifiers.

Variety spices the background of Ollie Saffir, who wrote the MOS memory article on page 106. He's been director of engineering at American Astrionics since the firm was founded two years ago. An alumnus of Union Carbide's Electronics division and what's now Philco-Ford's Microelectronics division, Saffir has worked in the fields of microwave, filters, and communications theory.

An engineer who works with his jacket on as RCA's Jerry Herzog does is a comparative rarity. But then, so is one with such a distinguished record of accomplishment. Herzog, who wrote the article on complementary MOS on page 109, has been with RCA Labs ever since he received his master's degree

from the University of Minnesota 17 years ago.

Early in his career, he helped design and build the first transistorized television. He subsequently worked on special color reproducer systems and new applications for semiconductor devices. In 1957, he switched to the ultrahigh-speed computer field.

"A wayward control engineer" is how Jim Luisi describes himself. He became involved with microelectronics at Autonetics because he saw in it a way to implement some exciting concepts in information processing. Luisi specializes in silicon-on-sapphire technology, about which he writes on page 114, for the fabrication of high-performance memory arrays. His interest in pattern recognition has carried over from his doctoral thesis work at Purdue, and he's developed an electro-optical scanner and a special-purpose data process for detecting fingerprint minutiae.

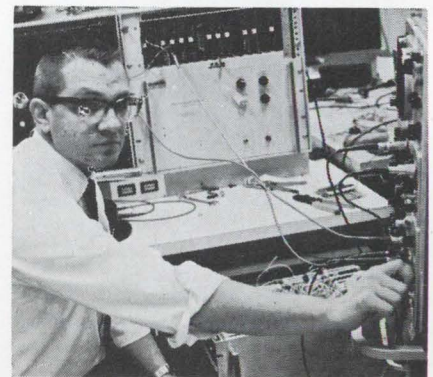

Luisi



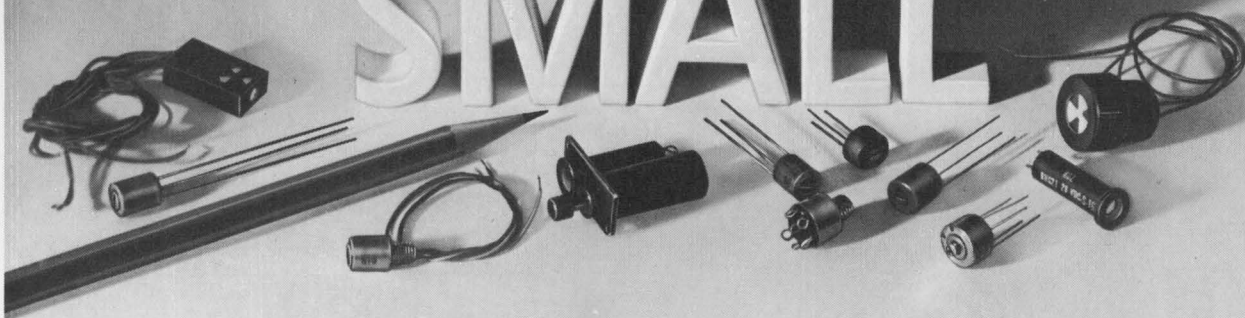

To gather material for the article on page 133 about next week's Intelsat meeting, Paul Dickson, an associate editor based in Washington, contacted a number of U.S. and foreign sources. To his chagrin, however, members of the U.S. delegation proved difficult to reach and evasive about this nation's position at the conference. By way of contrast, his first telephone call to the Soviet Embassy was put through to a press aide who immediately dug up a cooperative source in the scientific attaché's office.

THINK SMALL

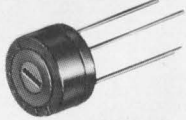

The Minelco family of small components that solve big problems. Small? **Miniature!** Trimmer Potentiometers... Rotary Selector Switches... BITE (built in test equipment) Indicators. A size, a configuration, a type for every requirement. Name your specifications, we'll supply the component. We keep it in the family.

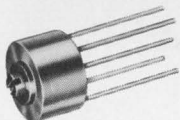
...THINK MINELCO!

 <p>NEW! MP32 5/16" dia. Pancake Trimmer Potentiometer</p>	 <p>Microminiature! MS1 1/4" dia. Trimmer Potentiometer</p>	 <p>For printed circuits! SW32 .350" dia. Rotary Selector Switch</p>	 <p>For panel mounting! SW37 .350" dia. Rotary Selector Switch</p>	 <p>Manual reset! BHGM 1/2" wide BITE Indicator</p>
 <p>Internal switching! M170 .2" x .4" x .7" BITE Indicator</p>	 <p>Electrical or mechanical reset! M151SMS 1/2" dia. BITE Indicator</p>	 <p>Tiny... bistable... highly visible! BHG21 1/4" dia. BITE Indicator</p>	 <p>Low-cost! MP2 .290" dia. Trimmer Potentiometer</p>	 <p>Infinite resolution! MF2 1/4" dia. Trimmer Potentiometer</p>

For additional information, contact:

MINELCO

a subsidiary of  **GENERAL TIME**
Progress in the World of Time

600 SOUTH STREET, HOLBROOK, MASS. 02343 / (617) 963-7717



BITE INDICATORS • ROTARY SWITCHES • TRIMMER POTENTIOMETERS • ELAPSED TIME INDICATORS • EVENTS COUNTERS

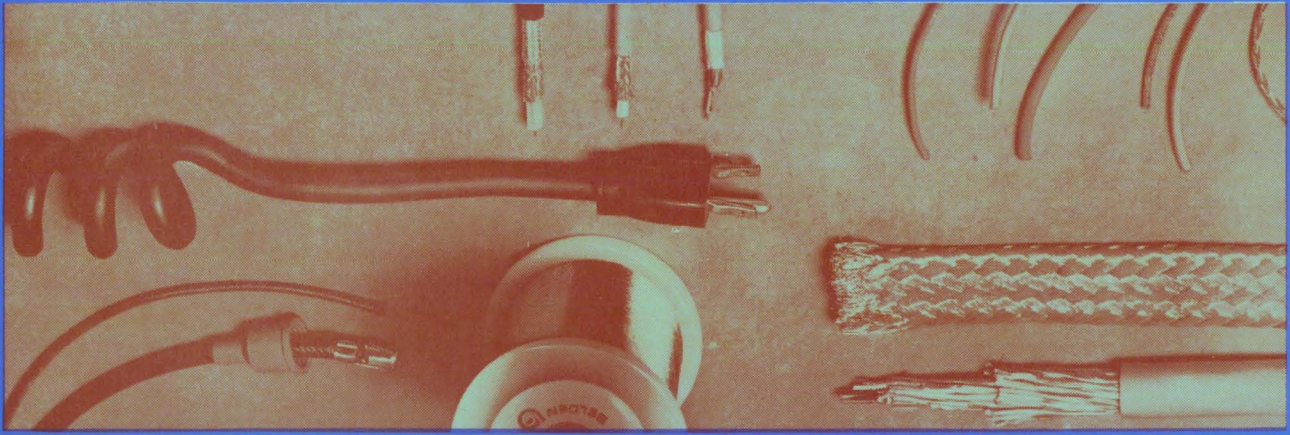

Belden's systems savvy is

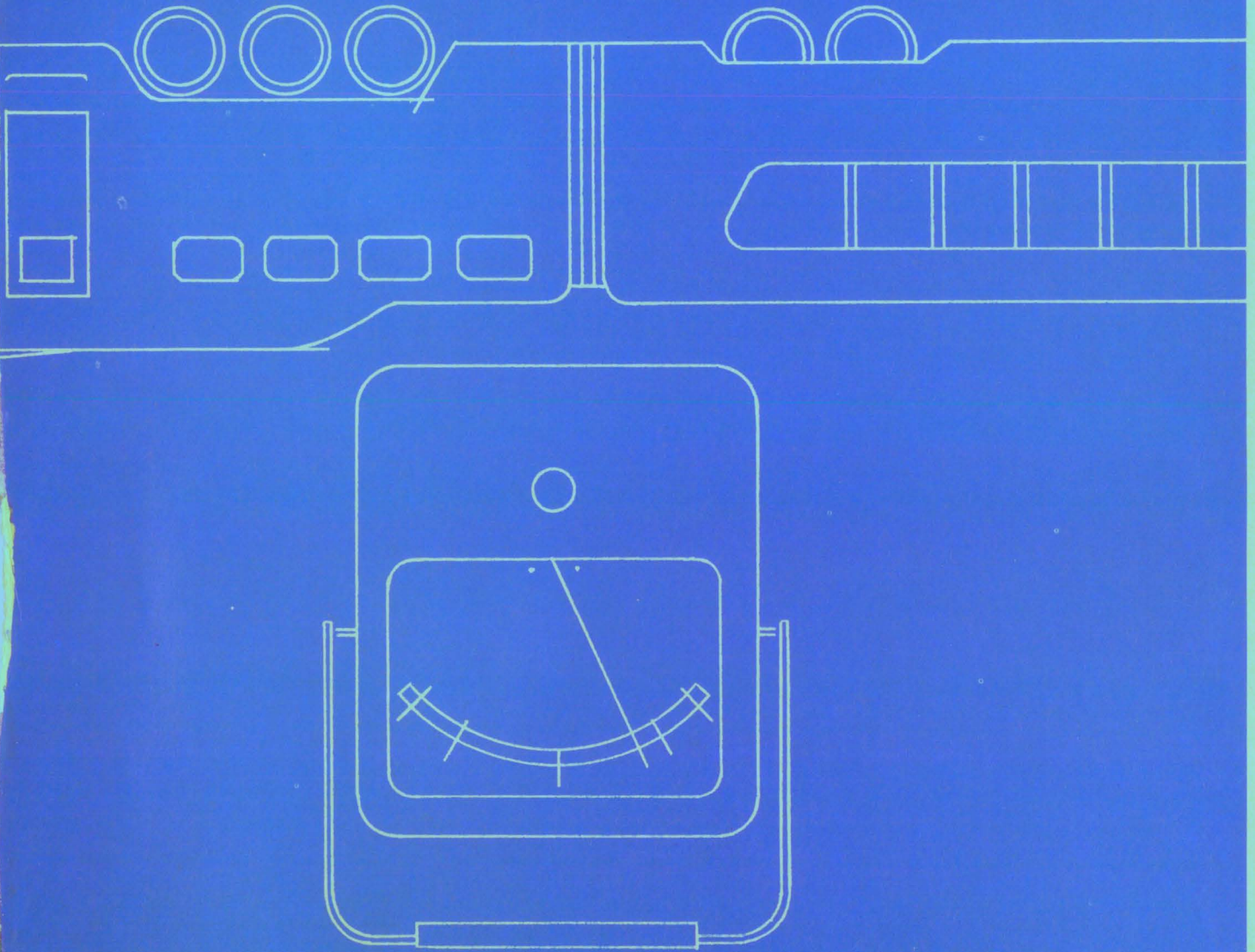

BELDEN...new ideas for moving electrical energy

no big deal

It's a lot of little deals, that add up to something big. Like lower costs. Fewer production headaches. Enhanced product reliability. By poking and probing into your product's electrical system and the way it's manufactured and used, Belden Wire Systems Specialists may be able to suggest a wire or cable that costs less. Or that lasts longer, or that takes up less space*. Or maybe they'll suggest a different put-up that saves you assembly time. Or a solution to a stripping problem. They'll also offer you one responsible source for all your wire needs. Because we're the

people who make all kinds of wire for all kinds of systems. So if you're making plans or having problems, get yourself a good deal. Call or write: Belden Corporation, P.O. Box 5070-A, Chicago, Illinois 60680. And ask for our catalog, and the reprint article, "Key Questions and Answers on Specifying Electronic Cable."*

*For example: Beldfoil® shielding in Belden cable. It isolates conductors better than anything yet. And it's thinner. You can pack more conductors into a conduit . . . hold down size and weight.

6-2-8

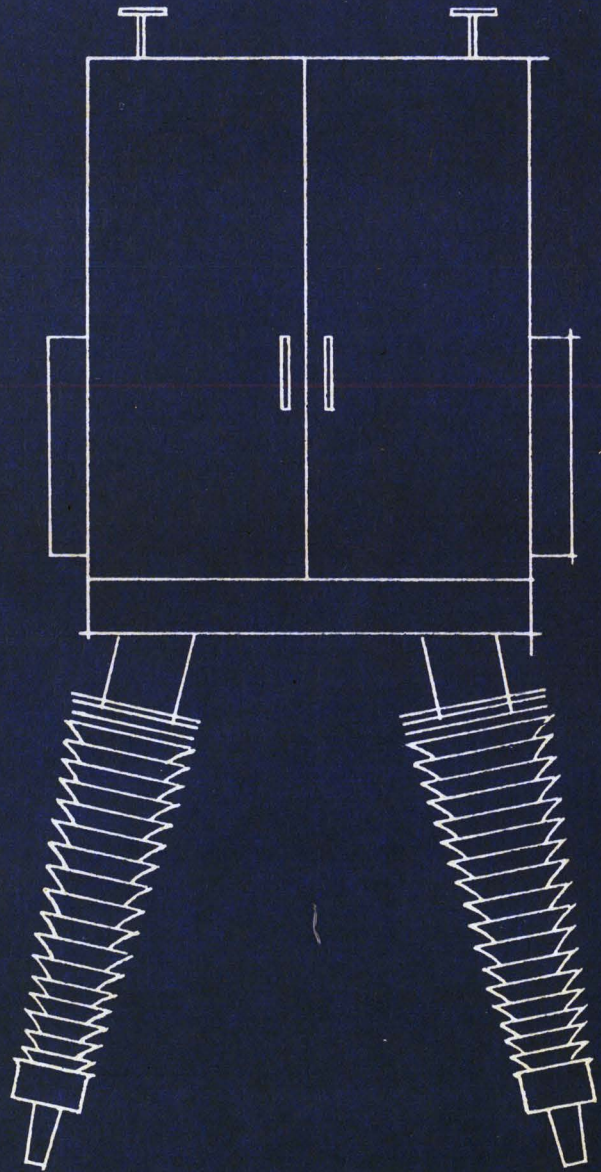
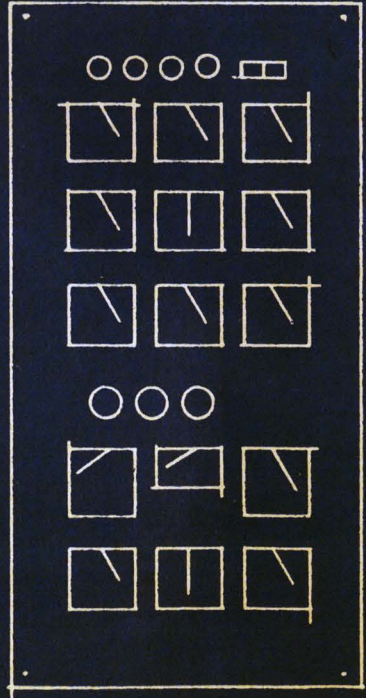
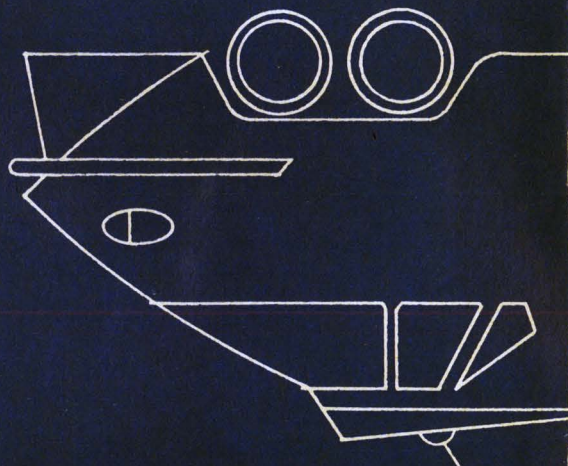

Fairchild told everyone what MSI could do.

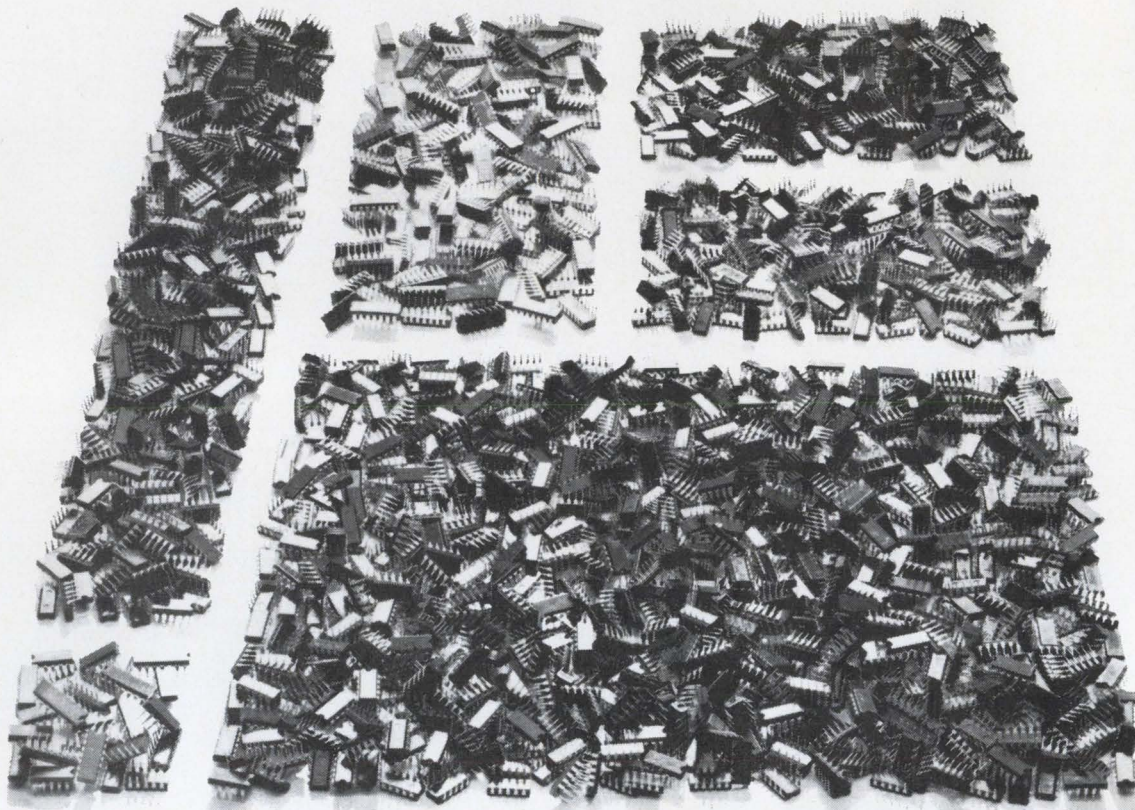

Ever since we introduced medium scale integration in 1967, we've been talking about the systems approach to computer design. Basic, compatible fundamental building blocks that do more jobs than a hundred Integrated Circuits.

Versatile circuits that function like shift

registers, counters, decoders, latching circuits, storage elements, comparators, function generators, etc. We said we had enough MSI device types to build more than half of any digital system you could design. An imaginative company in Boston took us up on it.

We're glad someone was listening.

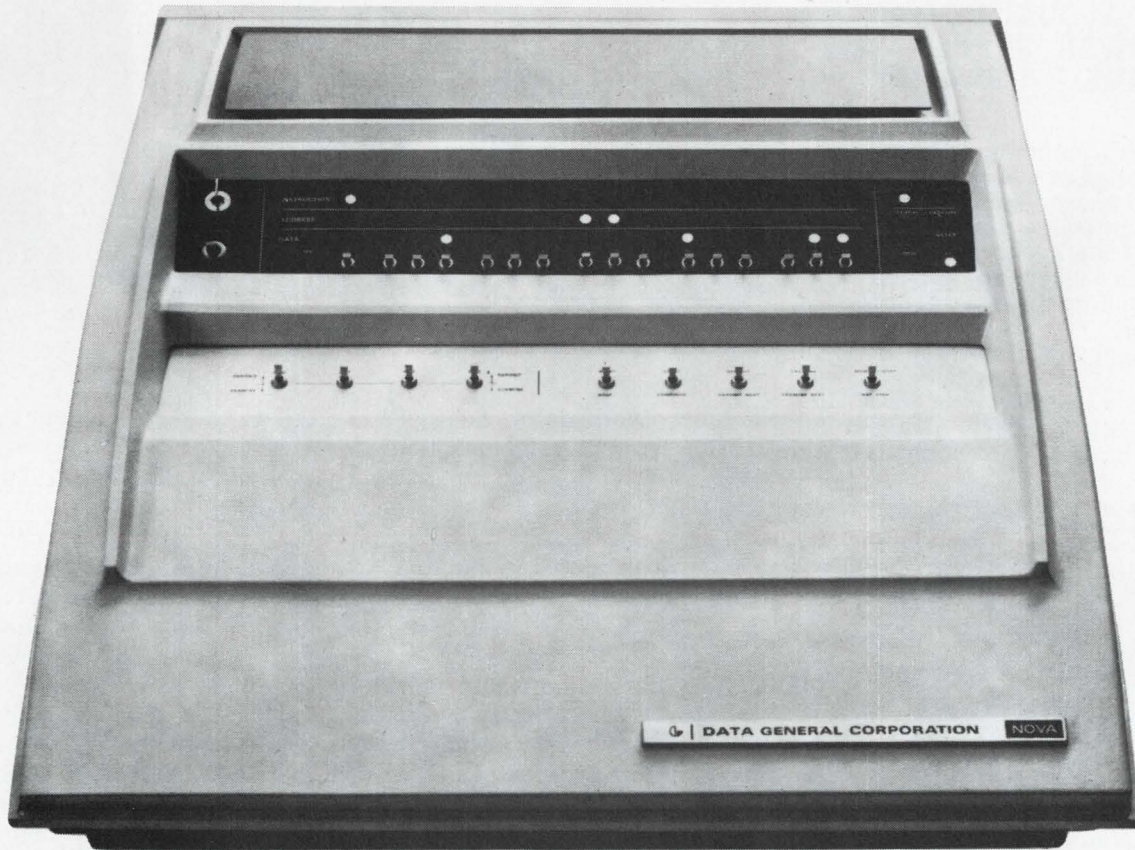

Data General Corporation built a revolutionary computer with Fairchild MSI circuits. The building block approach allowed them to design and build the whole system in six months. And put it in either a desk top console (shown above) or a 5¼-inch high standard 19-inch rack mount package. The central processor fits on two 15-inch by 15-inch plug-in circuit boards.

Another board houses a 4,096-word core memory. A fourth board provides enough space for eight I/O devices. And there's still enough room left for boards that expand the memory capability up to 16K. Any circuit board can be changed in seconds, so the computer has zero down

time. The NOVA is the world's first computer built around medium scale integration. The first general-purpose computer with multi-accumulator/index register organization. The first with a read-only memory you can program like core. The first low-cost computer that allows you to expand memory or build interfaces within the basic configuration. And the first to prove the price/performance economy of MSI circuitry: The NOVA 16-bit, 4K word memory computer with Teletype interface costs less than \$8,000.

If you'd like more information on MSI, use the reader service number on the opposite page. For specs on the NOVA, use the reader service number below.

FAIRCHILD
SEMICONDUCTOR

FAIRCHILD SEMICONDUCTOR / A Division of Fairchild Camera and Instrument Corporation ■ 313 Fairchild Drive, Mountain View, California 94040, (415) 962-5011 ■ TWX: 910-379-6435

\$31.50

**BUYS A DUAL-OUTPUT
POWER SUPPLY
IN SINGLE QUANTITY**

The 2Q15-100PC is one of a NEW series of low-cost, high-quality Power Supplies. Although primarily designed for use with operational amplifiers it may be used for any application requiring balanced supply voltages.

This compact package delivers $\pm 15\text{VDC}$ with 100 milli-ampere capability from each output with excellent regulation and ripple specifications.

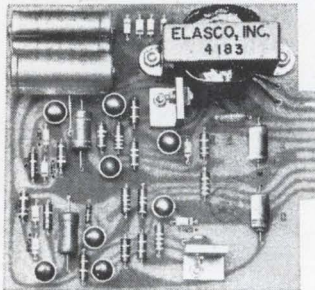

The 2Q15-100PC is designed for mounting either on a chassis or in a 5¼" IC basket. As many as 10 units can be mounted in a standard Elasco basket.

FEATURES

- TWIN OUTPUTS
- SHORT CIRCUIT PROOF
- "HANG-UP" PROOF
- 71°C OPERATION
- DELIVERY: STOCK TO 2 WEEKS

WRITE FOR BULLETIN 169 FOR
DATA ON THE 2Q15-100PC
POWER SUPPLY.



ELASCO INCORPORATED

33 SIMMONS ST., BOSTON, MASS. 02120
TELEPHONE: 617 / 442-1600

Who's Who in electronics



Gruen

A quiet profit maker, Sierra Electronics is a small operation in Philco-Ford's Communications and Electronics division that mainly sells test equipment to the communications industry. But the explosive changes in communications have shattered the quiet around Sierra. "No longer will we be known as that frequency-selective voltmeter house," says Harold Gruen, Sierra's vigorous new director. "We are dedicated to growth."

For years, Gruen explains, Sierra made equipment to measure single parameters. But IC's, by increasing the complex nature of equipment, render single parameters ineffective. The entire system must be tested to get satisfactory results. Adaptive equipment, Gruen says, such as transceiver systems that vary the carrier frequency as a function of atmospheric conditions, are essentially closed-loop systems, and the engineer gets no real information from them using a single parameter.

Built-in testing. "Systems are getting to the point where the only way to test them is to build in the test equipment," Gruen says. "Collins Radio already does this to some extent with its modems. Sierra will become the company that supplies instrumentation to check interfaces between subsystems and over-all system performance. We won't make black boxes; we will

sell as an OEM (original equipment manufacturer) to systems houses such as Collins, Philco, and Western Electric."

To implement this change in emphasis, Sierra will spend 2½ times more on research and development, plant facilities, and equipment this year than it did in 1968. Gruen says that 15% will be spent for applied research, twice as much as before. He says, "About a third of the money will go into improving our basic communications-instrumentation product line; we want to extend the selective voltmeter to 100 megahertz so that it will work with Bell Telephone's T-5 system for high-bit rate data transmission on trunk lines. The balance of the money will go into bit-error test equipment, for end-to-end testing of data modems.

Long term. "Only the voltmeter money is related to sales as early as 1970; the rest is long term," he says. "We plan on tripling the engineering staff, to around 50 or 60 persons, and doubling the marketing staff, as soon as possible. And we will want to expand our floor space by about a third." Sierra now occupies about 85,000 square feet in a one-story building in Menlo Park, Calif.

Gruen's goal is to double sales in four years and double them again in four more, while maintaining Sierra's profit margin. He

**To calibrate percent error directly
on your AC/DC, volt, or ammeters
of any type, read this meter.**

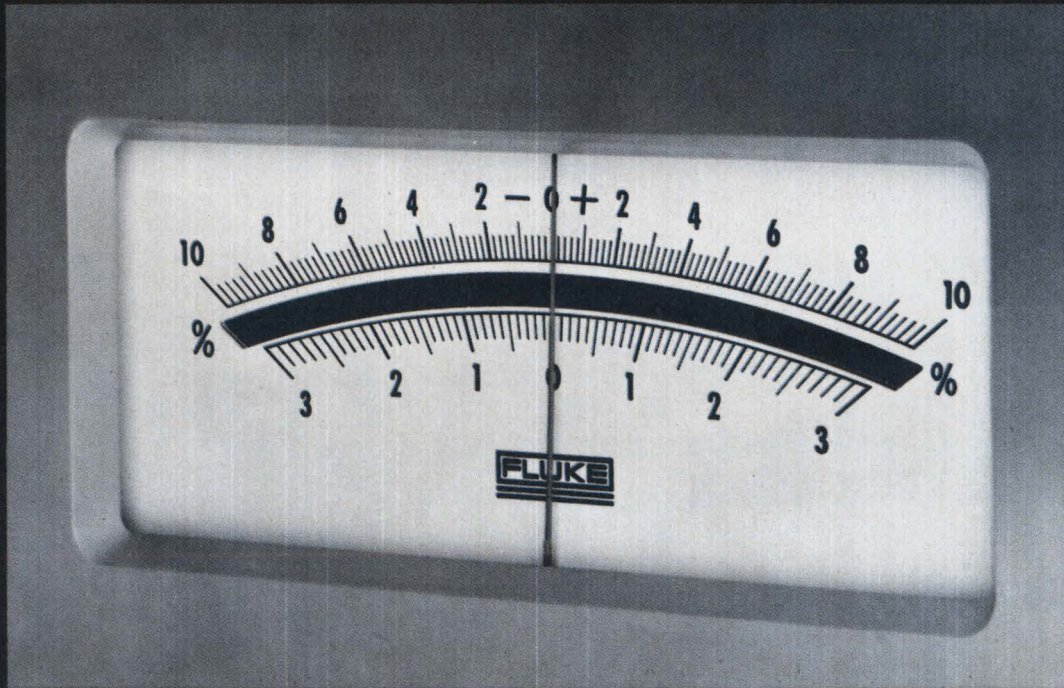

**It's on the face of the new solid state
Fluke Model 760A meter calibrator.**

And that's only one feature of the Fluke 760A which obsoletes all other meter calibrators. For instance, here's a calibration standards instrument guaranteed to stay within specifications for one full year over a wide range of environmental conditions. Further, the instrument is genuinely portable when compared to existing single units or groups of several instruments performing similar functions.

We've built the Model 760A with a minimum of controls and indicators so you



can operate the instrument simply and quickly. Dial up any parameter without range change or switching. We've put in a full complement of interlocks and other safety features so neither you nor the instruments under test are in danger. The 760A can easily be used by unskilled operators to calibrate virtually all multi-range, multi-function instruments.

A stable, low distortion oscillator is used

to provide either 60 Hz or 400 Hz. DC accuracy of the 760A is $\pm 0.1\%$ up to 1000 volts. Current range is 1 microampere to 10 amperes with an accuracy of $\pm 0.25\%$. Resistance range is 0 to 10 megohms to an accuracy of $\pm 0.1\%$. AC accuracy is $\pm 0.25\%$ from 0.001 to 1,000 volts. And the price, \$2,695, is a lot less than anything remotely comparable.

So, if meter calibration is your business, let us help make your work day shorter and easier with the new Fluke 760A Meter Calibrator. See your Fluke Sales Engineer (listed in EEM) or write or call us for full information and a demonstration.

Fluke, Box 7428, Seattle, Washington
98133. Phone: (206) 774-2211.
TWX: (910) 449-2850.



In Europe, address Fluke Nederland (N.V.),
P.O. Box 5053, Tilburg, Holland.
Telex: 844-50237. In the U.K., address
Fluke International Corp., P.O. Box 102,
Watford, Herts, England, Telex: 934583.



ELDORADO

THE LEADER IN NANOSECOND
AND FREQUENCY COUNTERS



200 Series
Crystal Time Base
Display Storage
Panel Mount
100 kHz: 4 digit \$325
15 MHz: 5 digit \$395
1 μ s Time Interval: \$395

1600 Series
Counter/Timers
with Display Storage
25 MHz: 5 digit \$ 550
25 MHz: 7 digit \$ 650
200 MHz: 6 digit \$1,050
200 MHz: 8 digit \$1,250
500 MHz: 8 digit \$1,650

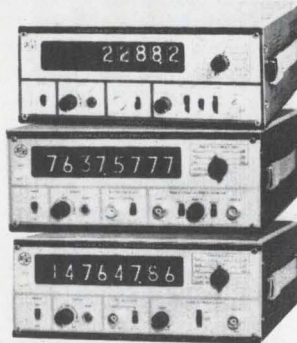

1400 Series
Universal Counter/Timers
15 MHz \$ 950
Preset \$1,050
150 MHz \$1,450
500 MHz \$1,825

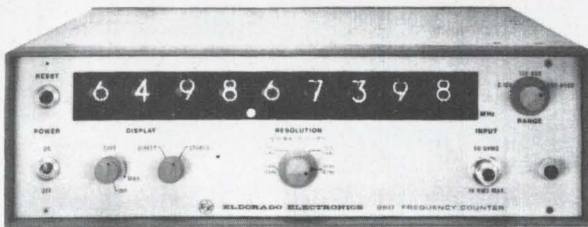
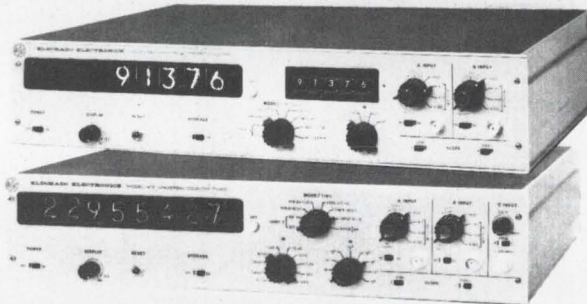

900 Series
Microwave Frequency Counters
Fast Sample, Optional Offsets
Remote Programming
6.5 GHz: 7 digit \$4,250

600 Series
Digital Delay Generator
Remote Programming
500 kHz Rep Rate
10ns Steps \$3,500
1ns Steps \$4,500

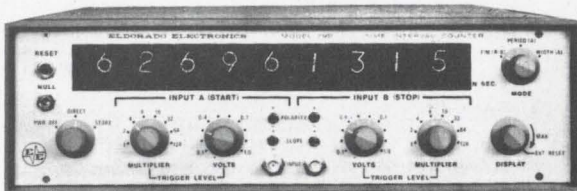
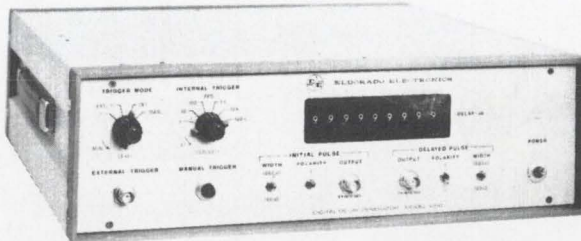

700 Series
Time Interval Counter
Full Input Conditioning
TIM, Period, Width,
Rise Time
1ns \$6,500
10ns \$1,750

Send for
Free Catalog



ELDORADO

601 Chalamar Road
Concord, California U.S.A.
(415) 686-4200

Who's Who in electronics

does concede that short-term profits will decrease, but adds, "They won't go negative."

Last autumn the Electronic Industries Association named a committee to come up with recommendations for changes in the group's organization. Their report is scheduled to be submitted this June.

Whatever recommendations are made—and several significant ones can be expected—much of the responsibility for implementing them will fall on George D. Butler, who has just been named the first salaried president of the association. He takes over June 30, succeeding James Secrest, who is retiring.

The appointment of a full-time president reflects the change of pace at the EIA. Secrest's title had been executive vice president. The current president, Mark Shepherd Jr. of Texas Instruments, will assume the title of chairman.

Background. Butler is an engineer and a businessman whose previous job was president of the Electra/Midland Corp. of Kansas City, a firm recently acquired by Transitron. The 50-year-old Butler has been active in the EIA for 10 years and has been a director for the past five. He was elected chairman of the Parts division last June. As one who has helped set the association's policy, he can be expected to make his own opinions strongly felt.

Butler has been identified as a strong proponent of trade protection, and he defends this position from the viewpoint of a parts manufacturer and the head of the parts division. But he points out that he can see the question from the other side, too.

Intramural. The protection issue is just one of many on which the association is divided. This and other controversies have led to proposals that the association reorganize itself into a loose federation of semi-independent divisions, such as parts, consumer goods, and industrial products. This is one of the questions the organization committee is now considering.

SEMICONDUCTOR NEWSBRIEFS

PUBLISHED BY MOTOROLA SEMICONDUCTOR PRODUCTS INC.

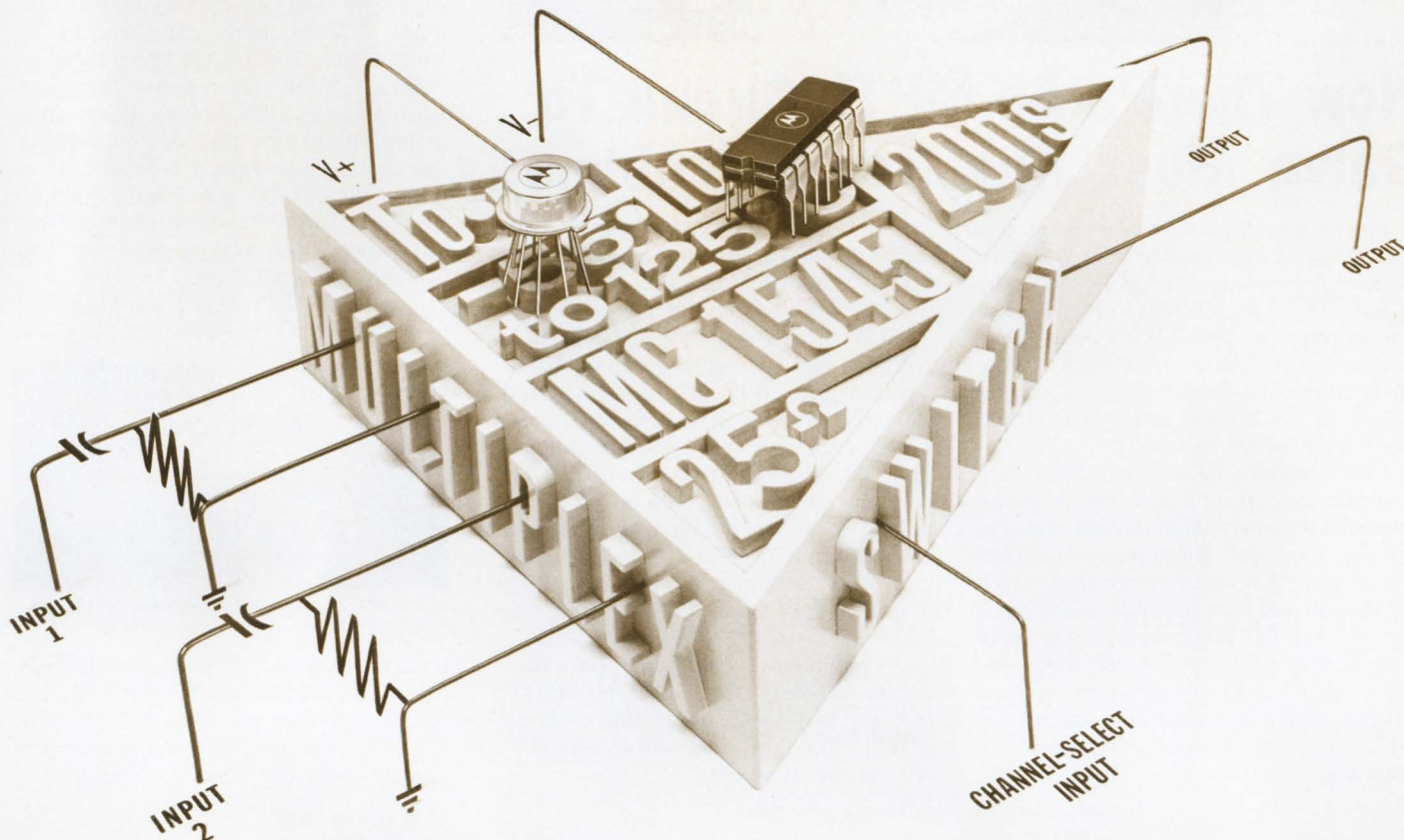

Dual-Channel Gated Wideband Amplifier Serves Most Anywhere!

Although the new MC1545 linear integrated circuit is characterized as a gated, dual-channel wideband amplifier, its range of application is seemingly endless. For example, it can be used as a video switch, sense amplifier, multiplexer, modulator, frequency-shift keying (FSK) circuit, limiter, AGC circuit, or pulse amplifier . . . to name just a few!

And, its low-cost further enhances its universal appeal for practically any linear application — just \$5.50 for the 10-pin metal-can packaged version ("G" suffix), in 100-up quantities. The MC-1545 is also available in the TO-116 14-lead ceramic dual inline ("L" suffix) and the 14-lead TO-86 ceramic flat-pack ("F" suffix). All versions operate over the -55 to $+125^\circ$ temperature range.

This versatile linear integrated circuit is particularly well suited for broad frequency range applications such as in C.A.T.V. and closed-circuit TV, due to its excellent wideband characteristics (B.W. = 75 MHz, typ) and gate-controlled, dual-channel design.

Other outstanding features include:

- 20 ns channel-select time (typ)
- Differential inputs and outputs
- High Input Impedance — 10 K Ω (typ)
- Low Output Impedance — 25 ohms (typ)

Evaluate the MC1545 now and you'll be ready to use it the next time you come up against a tough design situation.

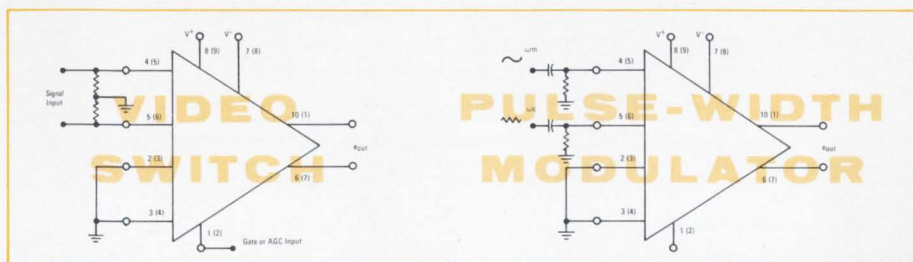

For details circle Reader Service No. 499



The transfer curves on the right illustrate the large logic swing available from MHTL compared with MDTL.

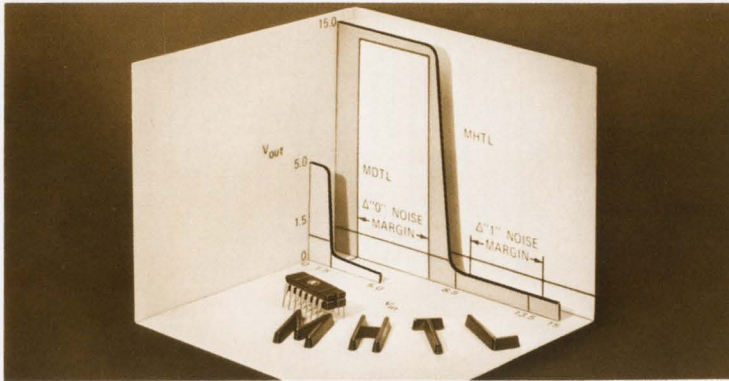

Now There's An MHTL Circuit To Solve Most Any Noise Problem!

Eleven new high-threshold integrated logic circuit functions that offer 7.5-volts (typ) noise-immunity are now available in hermetically-sealed, TO-116 dual in-line ceramic packages. With these latest additions, the designer of high noise-environment equipment now has a wide choice of 15 MHTL integrated circuit types from which to select.

For example, in addition to a full complement of multiple-input gates (with both active and passive pull-up options), several flip-flops and a line driver, the series includes two triple-level translators and a monostable multivibrator. As MHTL is pin compatible with other forms of saturated logic, these circuits can be used in high-speed system designs where economical solutions to high noise environment conditions are required.

Combining a voltage swing of 13 volts with a 7.5-volt noise margin, a wide operating temperature range of -30 to $+75^{\circ}\text{C}$, high fan-out of up to 30; and 35 mW dissipation, the MHTL family will prove an invaluable aid in industrial applications such as: numerical and supervisory control systems and computer peripheral equipment. These monolithic I/Cs can be interfaced with discrete componentry in many designs.

And, they carry the same low price tags associated with plastic encapsulated types. For example, the MC670L/671L Triple 3-Input Gates sell for as little as \$2.60 each (in 1,000-up quantities).

A comprehensive Perpetual Data Brochure, detailing the complete MHTL line, and two Application Notes covering MHTL flip-flops and noise-immunity criteria are available.

For copies circle Reader Service No. 500

New I/C Voltage Regulator Handles Up to 35-V Inputs

Now, there's a Motorola "Double-Regulated" I/C Voltage Regulator for just about any application up to 35-Volts input!

The new MC1561/1461 types are essentially the same as the recently-introduced MC1560/1460, internally-compensated voltage regulators . . . except that they have a higher input voltage capability! The new devices offer a maximum 35-Volts input, compared to 20-Volts (max) for the MC1560/1460.

The "built-in" reference-voltage regulator stage of this unique linear integrated circuit line provides characteristics that are essentially independent of output voltage (no other I/C regulator, currently available, offers this important advantage)! Yet, 100-up prices start as low as \$4.50 (MC1461G).

These new I/C regulators are available in both the "G" 10-pin metal-can and



The new MC1561/1461 voltage regulators can handle inputs of up to 35-volts.

the 9-pin TO-66 "R" package (dissipating up to 17.5-Watts). The MC1561 is a full temperature range circuit (-55 to $+125^{\circ}\text{C}$), while its MC1461 counterpart operates over the 0 to 75°C range.

For details circle Reader Service No. 510

Three More MECL II I/Cs Broaden High-Speed Design Flexibility

With the introduction of a 1.8 ns propagation delay (typ) Line/Clock Driver — the MC1026/1226 — along with the MC1034 Type "D" Flip-Flop and MC1040 Quad Latch, the designer of high-speed digital equipment has 29 different MECL II circuits from which to

choose. And, he can now exclusively use fast emitter-coupled logic functions throughout his entire system!

For example, the illustration shows how the MC1026 and MC1034 combine with three MC1027's to yield a decade counter that will operate in excess of

150 MHz. In this design, the MC1040 is used as a buffer storage for the BCD data from the counter. The MC1034, since it utilizes a true master-slave design, eliminates data "rippling-through" when the clock is in the low state.

Both the MC1034 and MC1040 are available in the 0 to $+75^{\circ}\text{C}$ temperature-range and come in the 14-pin dual in-line ceramic package. The MC1026/1226 come in either limited or full temperature versions and are packaged in both the TO-116 ceramic dual-in-line and TO-86 flat-pack.

Two application notes — one called "I/C Crystal Controlled Oscillators;" the other "High Speed Monostable Multivibrators" — along with comprehensive data sheets on these new MECL II types have just been published. Add them to your high-speed design library.

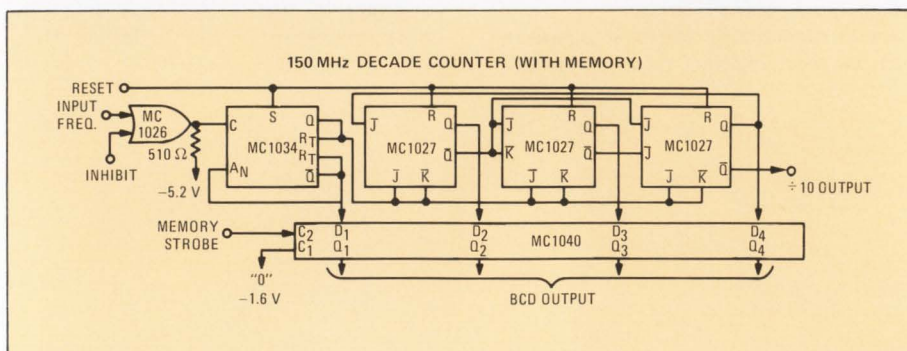

For copies circle Reader Service No. 502



XC177 Provides Ingredients For Low-Cost Custom MSI/LSI!

The recipe is really quite simple. Take the basic XC177 chip — a flexible array of 25 uncommitted TTL gates, each having 4 circuit options. Add your own circuit and logic layout for transition to two layers of intraconnecting metal. And, send to Motorola!

The result can be an inexpensive, custom, complex-circuit such as the Quad "D" Flip-Flop illustrated . . . or, any other that you can design. And, your costs can be a great deal less than for circuits of comparable complexity. For still greater complexity and functional capability, up to 100 gates may be interconnected using 4 adjacent XC177's.

Even though customizing costs normally run to \$15,000 and up, development costs for your designs with the XC177 are only \$2,500 per layer of metal; and, even then, unit costs will be in the \$15 to \$30 range, depending on the function and tests required.

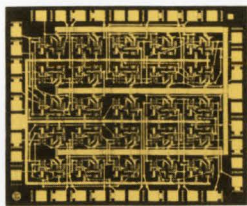

The XC177 shown formed into a universal Quad D Flip-Flop.

are drastically reduced — because of the flexibility offered through two metalization layers. So, you get custom-designed basic gates with passive pullups, for wired OR capability and low-noise; plus, almost unlimited flexibility.

The various options of the XC177 are available in five different package configurations: 14 and 16-pin dual in-line plastic, and both 14-pin and 32-pin ceramic flat packs.

For details circle Reader Service No. 503

The "how" of it is almost as simple as the recipe: By starting with a standard chip that houses 25 bipolar gates, development time and mask-making costs

Only two MC4006 Decoders and 16 MC4004/5's are needed to form a complex, yet compact system such as this 64-Word, 4-Bit Memory.

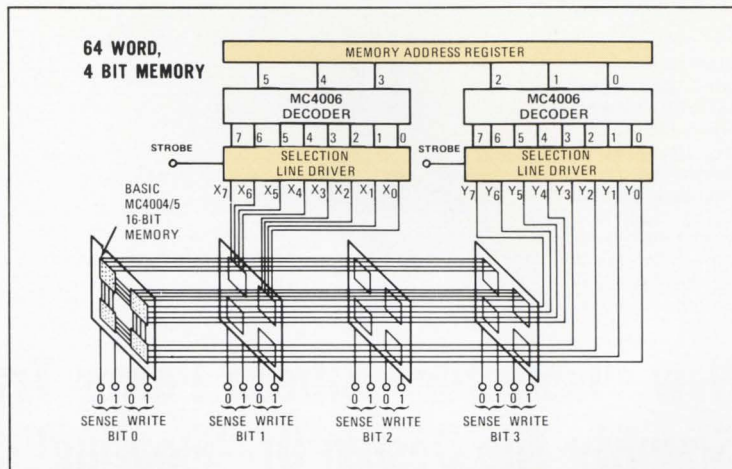

Family of 23 M TTL Complex-Element I/Cs Led-Off by Two Memories and a Decoder

Improved performance, lower system costs and inter-family (MDTL, T²L, etc.) compatibility are just three of many advantages offered by a new series of complex-element transistor-transistor logic circuits — the first introductions being two 16-bit memory circuits and a binary to one-of-eight-line decoder. *The rest of the family, consisting of twenty more types, is scheduled for release during the first half of 1969.*

The MC4004 and MC4005 16-Bit Random Access Memories can serve as "building blocks" for 100 ns scratch-pad memory systems; while the MC4006 Decoder offers greatly improved operating efficiency and a lowering of "cancout" and system costs. As shown in the illustration, these new M TTL complex-elements can be combined to form expanded memory systems.

The MC4004/05 provide 16-words of one-bit memory each, operating in the NDRO mode. Each of these units contains 16 flip-flops, arranged in a four-by-four matrix, plus two amplifiers and two "write" circuits. Eight "select" lines pro-

vide for the selection of one of the bits by applying a logic "1" level to one of the "X" and one of the "Y" select lines. After selection, information may be written into the bit by applying a logic "1" level to one of the "write" circuit inputs.

The MC4006 combines low-level, non-saturating gates with high-level gates, all on a single chip. The "enable" line provides an inhibit capability and also allows the decoder to be expanded for larger systems.

These new circuits offer the same system compatibility improvements pioneered by Motorola with its M TTL III line. That is, diode-clamped inputs and a by-pass network to improve transfer characteristics and reduce "ringing."

MC4004/05/06 are on distributor's shelves now, in the 14-lead dual in-line ceramic package and the TO-86 ceramic flat-pack. All operate over the 0 to 75°C range. 100-up prices are:

MC4004L—\$11.80	MC4004F—\$17.70
MC4005L— 9.05	MC4005F— 12.65
MC4006L— 7.50	MC4006F— 12.80

For details circle Reader Service No. 504

Now One MC1514 Can Do The Job Of Two Diff-Comparators

Why use two when one will do?

With Motorola's new MC1514 Dual Differential Comparator I/C you can replace two 710-types, thus reducing package count, system-size, costs and complexity in low-level detection, sensing and memory designs.

In addition to two separate outputs,

the MC1514 also offers a strobing capability as well as a high output current-sink — 2.8 mA (min) for each comparator! This circuit also features a propagation delay time of only 40 ns. And, its output is compatible with saturated logic forms.

It is capable of transferring differential signals directly into dc output levels —

thus making it useful in a variety of applications such as variable threshold Schmitt triggers, pulse-height discriminators, memory sense amplifiers, and high-noise-immunity line receivers.

The MC1514 comes in the 14-lead, TO-116 dual inline ceramic case and operates over the -55 to +125°C temperature range. It is 100-up priced at \$13.

For details circle Reader Service No. 505



"Isolated-collector" packaged silicon power transistors can be thermally-mounted to a heat-sink without using electrical insulation — making them ideal for critical high-wattage applications.

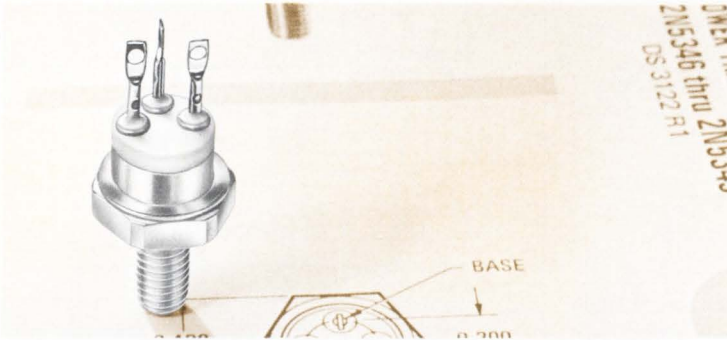

New "Isolector" Silicon Power Transistors Simplify The Design Of "Floating" Systems!

Increased system design flexibility and a decrease in hardware requirements — that's what's wrapped-up in four new NPN, TO-59 packaged, 7-Amp silicon power transistors that feature a unique isolated-collector design.

These new isolated-collector power transistors allow the designer to thermally-mount the units, but keep them electrically isolated from the heat-sink — a requirement often found in non-grounded or "floating" systems in missiles and satellites. In addition, mounting and insulating hardware are virtually eliminated.

The new 60-Watt "Isolector" series — EIA registered 2N5346-49 — has been specifically developed for power switching and wideband amplifier applications

in critical industrial and military designs where reliable performance under demanding conditions is important.

The new series features a wide spectrum of advantages such as: dc current gain spec'd at three points up to 5 Amps; excellent dc safe operating area (5 Amps at 10 Volts) and saturation voltage of only 1.2 Volts @ 7 Amps . . . plus a 200°C maximum operating temperature.

TYPE NO.	V _{CEO} (sus)	h _{FE} @ I _C (min)	SWITCHING TIME		
			t _{on}	t _s	t _{off}
2N5346	80 V	30 @ 2A 20 @ 5A	200 ns	2.0 μs	200 ns
2N5347	80 V	60 @ 2A 40 @ 5A			
2N5348	100 V	30 @ 2A 20 @ 5A			
2N5349	100 V	60 @ 2A 40 @ 5A			

@ V_{CC} = 40V / I_C = 2A (max)

For details circle Reader Service No. 506

New Si₃N₄ Dual-Gate MOSFETs Are Low-Cost, Yet Versatile

The new dual-gate MOSFETs — types MFE3007 and 3N140 — offer RF circuit designers all the basic advantages of field-effect transistors coupled with low cross-modulation distortion, more efficient AGC action and lower feedback capacitance. Cascode operation is facilitated by the series arrangement of two channels, with a separate and independent control-gate for each, thereby maintaining separation of RF-signal and AGC voltage. They are ideal for RF amplifier and mixer applications such as required in frequency converters, TV/FM tuners, AGC amplifiers, and color demodulators.

These N-Channel, TO-72 packaged dual-gate MOSFETs exhibit excellent long-term stability under both high temperature and reverse biasing conditions — due to Motorola's Silicon-Nitride passivation process. C_{rss} values are minimal, namely 0.02 pF typical for the MFE-3007 and 0.03 pF max for the 3N140, while maximum input capacitance (C_{iss}) is 5.5 pF and 7.0 pF, respectively.

Characteristics	MFE3007	3N140
G _{ps} min @ 200 MHz	18 dB	16 dB
Y _{fs} (μmhos) @ 1 kHz	10,000 min 18,000 max	6,000 min 18,000 max
NF max @ 200 MHz	4.0 dB	4.5 dB
I _{oss} (mA)	5.0 — 20	5.0 — 30
Price: (1,000-up)	99¢	98¢

For details circle Reader Service No. 507

4 Diodes, 5 Transistors Now Join Micro-T Packaged Line

Fast-Switching Diodes Offer Assortment of Configurations

Four new Micro-T silicon epitaxial diodes with typical reverse recovery times of just 3 ns are now available for



Four Micro-T diode configurations offer greater high-density design flexibility.

designers who have severe space limitations in computer, instrumentation, and military switching applications.

The MMD6050 is a single diode in a two-lead variation of the one-piece, injection-molded plastic Micro-T package. The others are dual-diodes (in the 3-leaded package). They are the MMD-6100, a common-cathode device, MMD6150 (common-anode), and the MMD7000, a series configuration.

Adding to the advantages of these fast-switching diodes are premium specs like: high breakdown voltage of 70 V (min) @ 100 μA and capacitance values as low as 2 pF (max). The power dissipation for all types is 225 mW @ 25°C; and, they operate over a wide junction temperature range of -55 to +135°C.

Ultra-Fast-Switch Heads List Of 5 New Micro-T Transistors

Take a familiar NPN silicon Annular fast-switching transistor like the 2N3960,

For details circle Reader Service No. 508

Application	Polarity	Type No.	Key Parameters
Current-Mode Logic Very Fast Switch	NPN	MMT3960A	t _{on} /t _{off} = 2.1 ns (typ) f _r = 2250 MHz (typ) @ I _C = 10 mA
Low-Noise Amplifier	NPN	MMT930 MMT2484	h _{FE} = 175 (min) @ 100 μA (MMT2484) NF = 3.0 dB @ I _C = 10 μA
DC-to-VHF Amplifier High-Speed Switch	NPN	MMT2222	f _r = 200 MHz (typ) @ I _C = 10 mA t _{on} = 16 ns (typ) @ I _C = 150 mA
General Purpose Amplifier & Switch	PNP	MMT2907	h _{FE} (range) 100-300 @ I _C = 150 mA t _{on} = 20 ns (typ) @ I _C = 150 mA V _{CE(sat)} = 0.4 V (max) @ I _C = 150 mA

speed it up even more, and improve its current-gain — bandwidth product, then package it in the Motorola Micro-T housing, and you have the best high-speed current-mode logic switch yet — the MMT3960A. And, you are afforded the flexibility of being able to use discrete devices while retaining the circuit shrinkage attributes of I/Cs.

Four other additions to the Micro-T transistor line include: two NPN low-noise amplifiers, an NPN dc-to-VHF amplifier/high-speed switch, and a PNP general-purpose transistor.



Zener Diode Chips Now Make Internally-Regulated Hybrid I/C Designs Practical

Built-in voltage regulation has just become simple and economical to achieve in hybrid microcircuit designs!

Two new MZC series of unencapsulated, 400 mW zener diodes (both high and low current-level versions) are now available for cost-cutting, assembly-simplifying applications in virtually any type of hybrid design requirements, from

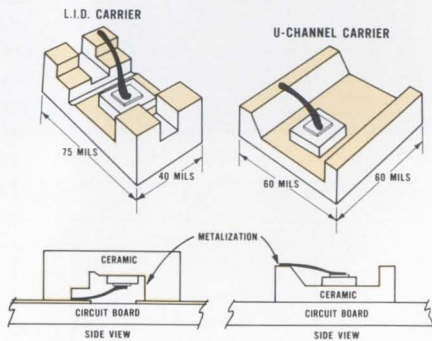

Zener diode "chips" can be supplied on metallized ceramic U-channel and L.I.D. carriers (as well as unmounted), to satisfy most any Hybrid thick or thin-film circuit mounting and fabrication requirement.

1.8 to 200 volts ... in a choice of three, compatible configurations: (1) chips only; (2) chips-on-U-channels; (3) chips-on-L.I.D.'s.

The MZC series "A" — equivalent to chips used in the popular Surmetic 1N-5221 family — has test currents which are specified at standard milliamp levels and, can be incorporated into most higher-current circuits where power drain is not a prime consideration.

For space, instrumentation and other low-current-level, battery-operated systems where power drain must be minimized, the "B" series offers test currents spec'd at only 250 μ A! These chips are closely akin to those found in the 1N4614 and 1N4099 "glass" RamRod family.

Both series are available in 5% and 10% voltage tolerances, offer anode/cathode metallization compatibility with standard wire and die-bonding techniques, and feature gold-plated bonding surfaces — to facilitate thin or thick-film assembly operations.

Chip Series No.	Voltage Range	Test Current (I _{ZT})	Leakage Current (I _L)	1N Device Equivalent
MZC "A" Series (High-Level)	2.4-200V	0.65-20 mA	0.1-100 μ A	1N5221* Series
MZC "B" Series (Low-Level)	1.8-200V	250 μ A	0.01-10 μ A	1N4099 Series 1N4614 Series

*Also equivalent to 1N4370,A thru 1N4372,A; 1N746,A thru 1N759,A; 1N964,A,B thru 1N922,A,B.

For details circle Reader Service No. 509

Mini/Micro-T Opto-Sensor Entries Make For Maxi-Visibility Arrays!

Like women's latest fashions, they're mini-sized, maxi-produced and specially-designed for optimum optical properties!

Unlike the new fashions though, they're low in cost!

We're talking about the new, clear plastic packaged, Micro-T and Mini-T optoelectronic transducers — state-of-the-art devices that clear-the-way to more economical, high-density-array punched-card and tape-readers, shaft encoders, pattern and character recognition, process inspection, counting, sorting, switching and logic circuit systems designs.

So tiny you can put more than 100 of them in a thimble without reaching the top, the Micro-T units are available with (MRD100), or without external base leads (MRD150). They can be closely spaced and mounted on the underside of PC boards, with only their active areas exposed — making it possible to design smooth, uncluttered close-contact interface configurations.

Covering the visible and near-infra-red spectral range, Micro-T's feature a sensitivity of 0.04 mA/mW/cm² (min).

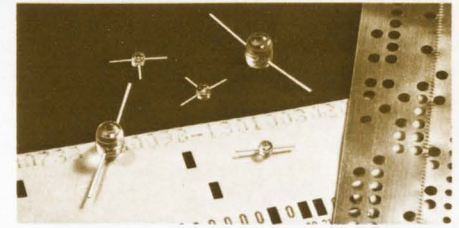

New Micro-T (2 and 3-leads) and Mini-T opto-devices expand opportunities to develop low-cost high-density/high sensitivity sensors.

The Mini-T (MRD450) exhibits an even higher radiation sensitivity — 0.20 mA/mW/cm² — due to a unique, molded lens design which concentrates more light onto the active die surface. It is especially suitable for sensing designs in inspection, production and detection equipment as well as alarm systems, SCR triggering and optical interfacing with data processing systems.

Type No.	Package Type	Dark Current	Rise Time	Fall Time	Price (100-up)
MRD 100	Micro-T	100 nA (max)	2.5 μ s (max)	4.0 μ s (max)	\$1.00
MRD 150	Micro-T				.80
MRD 450	Mini-T				1.50

For details circle Reader Service No. 510

Latest Premium Tuning Diode Line Increases Broad-Frequency-Control Design Flexibility

A new premium-performance EPICAP tuning diode series, types 1N-5461-76, can now serve to improve the design of tuning circuits for such exacting frequency control requirements as are found in ECM equipment, ground and aerospace radio and frequency synthesizers. The significant features of this line include: very high Q's — for sharp response at high frequencies; high tuning

them into matched multi-stage configurations and for continuous wide-band tuning requirements.

Their tuning ratios are closely held to indicated typical values by guaranteed min. and max. values on each type (see table). The series covers all standard nominal capacitance values from 6.8 pF to 100 pF.

These new EPICAP tuning diodes are supplied in the Motorola RamRod DO-7 "glass" case. The 100-up price for suffix A types is \$4.50 each, suffix B — \$5.80 and suffix C — \$8.00.

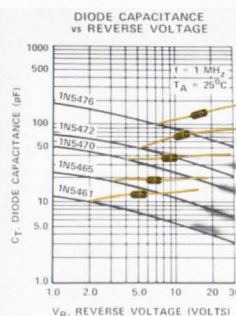

The slopes of capacitance change vs. voltage are the same for all types in the 1N5461 Epicap tuning diode series.

ratios — to facilitate tuning over broad frequency ranges; and uniform linear changes in capacitance with voltage — making it a simple matter to "gang"

Type No.	Fig. of Merit (Q) @ 4V/50 MHz	Capacitance (C ₁) @ 4V/1 MHz	Tuning Ratio C ₂ /C ₁₀ @ 1 MHz
	Min.	pF*	Typ
1N5461A	600	6.8	2.8
1N5462A	600	8.2	2.9
1N5463A	550	10.0	2.9
1N5464A	550	12.0	2.9
1N5465A	550	15.0	2.9
1N5466A	500	18.0	3.0
1N5467A	500	20.0	3.0
1N5468A	500	22.0	3.0
1N5469A	500	27.0	3.0
1N5470A	500	33.0	3.1
1N5471A	450	39.0	3.1
1N5472A	400	47.0	3.1
1N5473A	300	56.0	3.1
1N5474A	250	68.0	3.1
1N5475A	225	82.0	3.1
1N5476A	200	100.0	3.1

*Nominal capacitance tolerance of $\pm 10\%$, $\pm 5\%$, or $\pm 2\%$ indicated by suffix A, B or C, respectively.

For details circle Reader Service No. 511



NEW ULTRA-LOW-NOISE JFETs

— Feature Low-Frequency Noise-Figures Below 1.0 dB!

Three new ultra-low-noise N-Channel JFETs (2N5556-58) offer excellent noise characteristics making them exceptionally well-suited for low-signal, high impedance input circuits, such as required in electrometers and medical electronic amplifiers. For example, they exhibit a small equivalent input-noise-voltage (e_n) = 20 nV/ $\sqrt{\text{Hz}}$ typ. @ 10 Hz and a noise-figure (NF) of only 1.0 dB max. @ 10 Hz.

In addition to the specs shown in the table below, these TO-72 packaged devices exhibit a minimum breakdown voltage of 30 volts and a low I_{GSS} of just 0.1 nA max. Typical figures for C_{iss} and C_{rss} are also quite low — 4.5 pF and 1.2 pF, respectively.

Type No.	I_{DSS} (mA) Min — Max	$V_{GS(off)}$ (V) Min — Max	y_{fs} (μmhos)			Price (100-up)
			Min	Typ	Max	
2N5556	0.5 — 2.5	0.2 — 4.0	1500	3500	6500	\$9.50
2N5557	2.0 — 5.0	0.8 — 5.0				8.00
2N5558	4.0 — 10.0	1.5 — 6.0				7.50

For details circle Reader Service No. 512

TWO LOW-LEVEL PNP AMPLIFIER TRANSISTOR SERIES

— Provide High-Gain At Low Collector-Currents, Plus Low Noise-Figures!

With the availability from Motorola of two PNP silicon Annular transistor series — the 2N2604/05 and their premium versions, the 2N3798/99 — designers can now utilize low-level, high-gain amplifiers with noise figures that are typically less than 3 dB (even when operating over a wide frequency bandwidth of 10 Hz to 15.7 kHz).

While the 2N3798/3799 are premium devices by virtue of their lower capacitance, lower noise figures, higher gain, and higher collector-emitter breakdown voltage, the 2N2604/2605 have the advantage of being encased in the space-saving TO-46, low-silhouette, solid Kovar package and, they carry significantly lower price-tags (see table at right).

For details circle Reader Service No. 513



HIGHLIGHT CHARACTERISTICS	2N2604	2N2605	2N3798	2N3795
Low Noise: NF(max) @ I_c (B.W. = 10 Hz to 15.7 KHz)	4.0 dB @ 10 μA	3.0 dB @ 10 μA	3.5 dB @ 100 μA	2.5 dB @ 100 μA
High Voltage: $BV_{CEO(min)}$ @ I_c $BV_{EBO(min)}$ @ I_E	40 V @ 10 mA 6 V @ 10 μA		60 V @ 10 mA 5 V @ 10 μA	
Low Capacitance: $C_{ob(max)}$ @ V_{ce}	6 pF @ 5 V		4 pF @ 5 V	
High Gain: $h_{FE(min)}$ @ I_c	60 @ 500 μA	150 @ 500 μA	150 @ 500 μA	300 @ 500 μA
Package Type:	TO-46		TO-18	
Prices (100-up):	\$2.30	\$2.70	\$4.00	\$4.50

SIX NEW SILICON JAN TRANSISTORS

— Join Motorola's Extensive Mil-Type Availability List

Two each universal high-speed switches, general purpose medium-current high-speed switches, and high-speed switching/DC-to-VHF amplifier transistors now join over 300 Motorola semiconductors that are now available to meet MIL requirements.

Test data on the JAN/JANTX2N708 and JAN/JAN-TX2N914 NPN types is available on request. A comprehensive Designers data sheet, containing complete limit curves, covers the PNP JAN2N3467/3468 core drivers — while, the space savings provided by the low-profile TO-46 packaged PNP JAN2N3485A/3486A make them ideal for high component-density applications.

Type No.	Mil-S-19500/	Case	P_o @ 25°C	C_{ob} @ 10V	f_r @ I_c (min)	$V_{CE(sat)}$ @ I_c (max)	V_{CEO}
JAN/JAN-TX2N708	312B(USAF)	TO-18	360 mW	6 pF (max)	300 MHz @ 10 mA 300 MHz @ 20 mA	0.4V @ 10 mA 0.7V @ 200 mA	15V
JAN/JAN-TX2N914	373(USAF)	TO-18	360 mW	6 pF (max)	300 MHz @ 10 mA 300 MHz @ 20 mA	0.4V @ 10 mA 0.7V @ 200 mA	15V
JAN/JAN-TX2N3485A/86A	392(USAF)	TO-46	400 mW	8 pF (max)	200 MHz @ 50 mA	0.4V @ 150 mA	60V
JAN3467/68	348(NAVY)	TO-5	1.0 W	25 pF (max)	175/150 MHz @ 50 mA	0.3/0.35 V @ 150 mA	40V/50V

For details circle Reader Service No. 514



RADIATION-RESISTANT PNP "DIONIC" TRANSISTOR

— Especially Processed For High Neutron Tolerance Levels!

Motorola's new MM4261H PNP silicon Annular "Dionic" transistor marks the first time that a radiation-resistant device, which has also met the highest high-rel criteria, is available "off-the-shelf." Advanced processing techniques provide an exceptional tolerance to neutron radiation (h_{FE} degradation is less than 50% after exposure to 5×10^{11} neutrons/cm²) and reliability is doubly assured through testing standards which are over-and-above those specified for typical JAN-TX requirements.

Applications in ordnance, space, and wherever low-level switching or low-voltage amplifier circuits require high radiation tolerance, are natural for the MM4261H. Among its key specifications, this TO-72 four-lead metal-can packaged device features a high current-gain — bandwidth product (f_T) of 2,000 MHz (min) @ 10 mA. Input and output capacitances are both a low 2.5 pF (max), while its fast switching capability is shown by a $t_r = 0.5$ ns (typ) @ 10 mA.

For details circle Reader Service No. 515

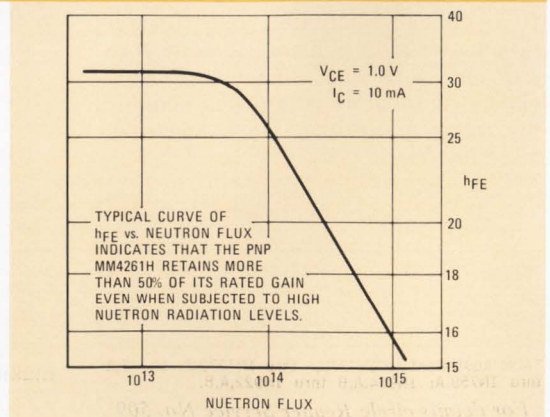

New Linear I/C HANDYLab Kit Makes Prototyping Quick and Easy



MCK1500 is the latest in a continuing series of prototype design kits, developed to give the working engineer a complete, "all-in-one" source of information and devices for evaluation and breadboarding.

This new kit contains 24 linear integrated circuits — 2 each of 12 types — representing a cross-section of Motorola's Linear I/C line. Ten of the circuits are in TO-5 metal cans and two are in 14-pin ceramic dual in-line packages. In addition, a complete library of technical data is also included in the kit. For example, data sheets for all Motorola Linear I/Cs are included, plus Application Notes that are representative of the wide range of uses for the circuits that are in the kit. In addition, an "Applications Selector Guide" for Motorola Linear I/Cs makes it possible to tell at-a-glance which is the proper circuit for your application.

The material is all contained in a sturdy, compact vinyl-covered case that will fit in a desk drawer. The MCK1500 is available now from franchised Motorola distributors for \$94.50 each. The value of the device alone, in 1-24 quantities, is \$361.00!

First RF Selector Guide Provides Applications-Oriented Device Data

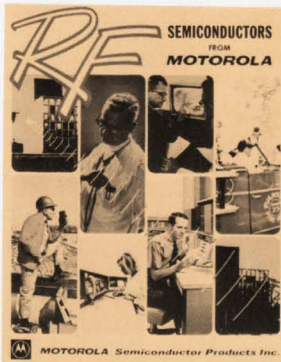

As an aid to the design of UHF and VHF circuitry, Motorola has just published a comprehensive selector guide that includes *all* types of RF characterized semiconductors — from 2 MHz to more than 10 GHz. The power and small-signal sections are further divided into three sequential selectivity levels. The first level being graphical representations of application areas covered by specific devices; the second is

in the form of charts which list the devices by their frequency of operation as related to their most pertinent parameter; while the third is an alphanumeric listing of the devices with their abbreviated specifications.

A spectrum-chart covering major areas of applications is also included.

For details circle Reader Service No. 516



LITERATURE ORDER FORM

NOTICE: Requests for literature on items described in this publication cannot be honored after July 1, 1969.

NEWSBRIEFS No. 5-69

Please circle the Reader Service number of item(s) you are interested in receiving.

E				
499	500	501	502	503
504	505	506	507	508
509	510	511	512	513
514	515	516	517	518

Please Print Clearly

NAME _____

TITLE _____

COMPANY NAME _____

DIVISION _____

DEPARTMENT _____

COMPANY ADDRESS (Street or P. O. Box) _____

CITY _____

STATE _____ ZIP CODE _____

If you wish to receive mail at a different address, fill out below:

ADDRESS _____

CITY _____

STATE _____ ZIP CODE _____

Do you wish a Motorola Representative to contact you?

VISIT

PHONE

Phone No. _____ Area Code _____

Tear Along Perforated Line and Drop in Mail (No Postage Required)

FOLD HERE

FIRST CLASS
Permit No. 2565
PHOENIX
ARIZONA

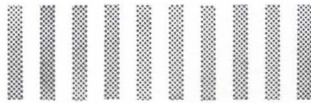

BUSINESS REPLY MAIL

No postage stamp necessary if mailed in the United States

POSTAGE WILL BE PAID BY

Semiconductor NEWSBRIEFS No. 5-69
Motorola Semiconductor Products Inc.
P. O. Box 20924
Phoenix, Arizona 85036

FOLD HERE

For Fast Action!

... on delivery of literature for items described in this publication — fill out this coupon, fold as indicated and drop in the mail.

(NO POSTAGE IS REQUIRED)

Seal Here

NEW LITERATURE BRIEFS

Over 650 Semiconductors Covered In Motorola's New Hi-Rel Catalog!

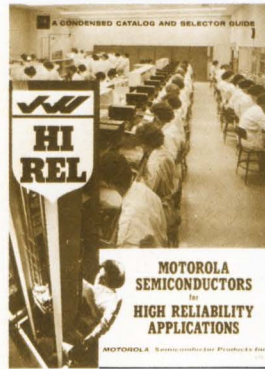

The most complete guide to semiconductors for Hi-Rel applications ever compiled, has just been published by Motorola. This 28-page, condensed catalog and selector guide describes over 650 types, in terms of their performance criteria for Hi-Rel requirements. Over 400 discrete devices that meet NASA, JAN/JAN-TX or Motorola's MEG-A-LIFE specifications are shown cross-referenced to the specific program under which they are available. In addition, condensed specifications are given for all the listed types. Process flow charts are also shown to provide details on Motorola's Hi-Rel procedures.

The listings include: Over 300 zener diodes; more than 100 germanium and silicon transistors (in both small-signal and power categories); eight thyristors and UJT's; three silicon rectifiers; over 230 digital I/C functions covering all popular families — MDTL, MECL, MTTL and MRTL — and, 24 linear I/C types, including diff-amps, op-amps, sense-amps, power and high-frequency amplifiers.

No design engineer whose work areas and interests include the Hi-Rel field should be without this new all-inclusive semiconductor catalog and selector guide.

For details circle Reader Service No. 517

Better Ideas In Custom Hybrid Microcircuits Shown In New Brochure

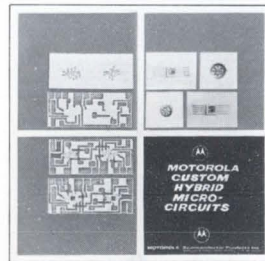

The ability to combine any of 19,000 different semiconductor chips into a virtually endless variety of custom hybrid microcircuits, at economical costs, keynotes Motorola capability — detailed in this new publication.

With more and more systems designers searching for the optimum answer to bridging the gap between sometimes-costly, sometimes-cumbersome discrete device assemblies and power and performance-limited monolithic circuits, the brochure provides much starting-point impetus to new-design thinking along custom hybrid lines.

What they are, where they fit, their advantages and graphic examples of specific, finished custom designs in thick and thin-films are shown. Quality assurance considerations (including 100% stress tests) are also treated.

If you're planning to or already working in miniaturization through microelectronics . . . you'll want this new brochure!

For details circle Reader Service No. 518

Published by Motorola Semiconductor Products Inc., P. O. Box 20924, Phoenix, Arizona 85036.

SEMICONDUCTOR
NEWSBRIEFS

©Motorola Inc. 1969

The circuitry shown external to Motorola products is for illustrative purposes only, and Motorola does not assume any responsibility for its use or warrant its performance or that it is free from patent infringement.

MHTL, MTTL, MECL II, Micro-T, Mini-T, Unibloc, Isolector, Epicap, Surtmetic, RamRod, Thermopad, Designers, DIONIC, and HANDYLab used in this publication are trademarks of Motorola Inc. Annular Semiconductors are patented by Motorola Inc.

NOTE: If coupon is missing use magazine's Reader Service numbers to order literature on items described in NEWSBRIEFS.



From Monsanto:
130,000,000
discrete frequencies
with almost perfect purity.

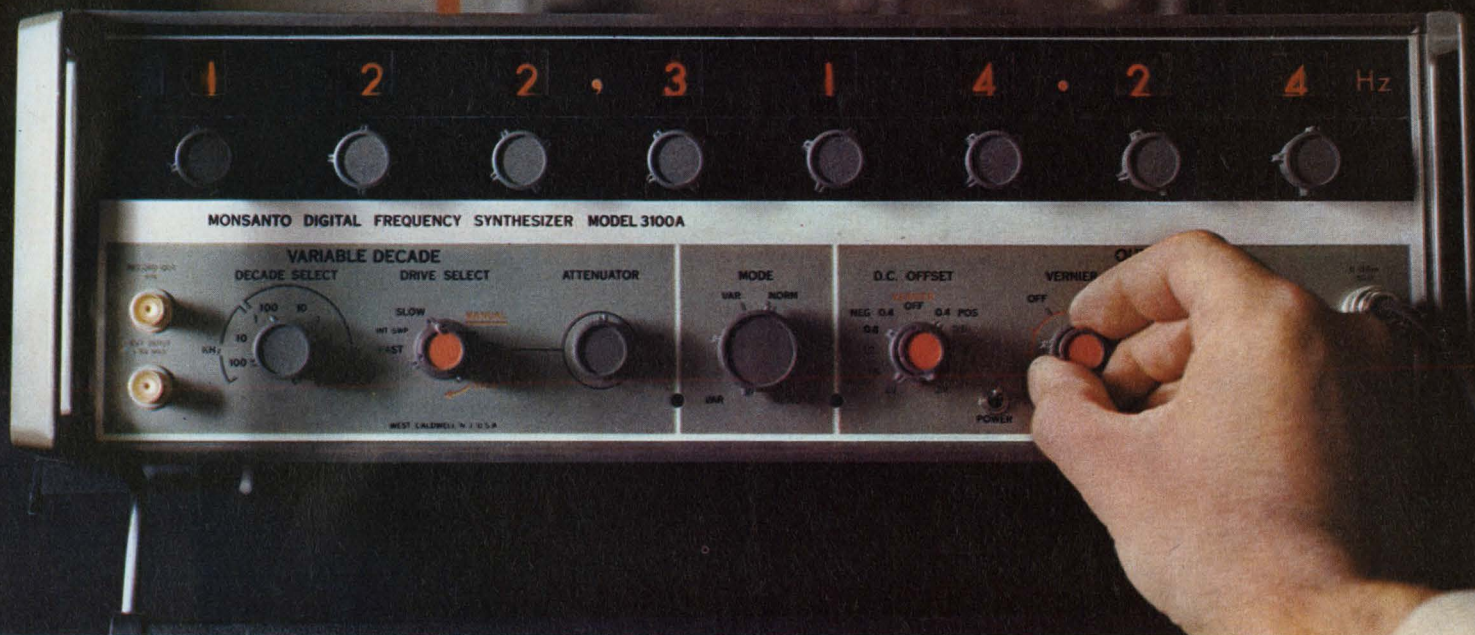

**New "4th generation"
digital frequency synthesizer achieves new level of
perfection in signal generation
with computer-aided design
and I-C construction.**

Monsanto's new Model 3100A Digital Frequency Synthesizer obsoletes just about every present concept of general purpose signal sources.

Pick your frequency from DC to 1.3 MHz in 0.01 Hz steps. The result—signal purity you can get only from Monsanto, with a stability of one part in 10^9 per day.

Other refinements include: internally supplied rapid or slow sweep and provision for external sweep; continuous control of output level over a 90 db range; provision for both amplitude modulation and frequency modulation or both, simultaneously; in the remotely programmable version, switching time is less than 20 microseconds.

You can put this *better way* of signal generation to work for you for only \$3950.00, FOB West Caldwell, N. J.

For a demonstration, or for full technical details, call your local Monsanto Field Engineer now or contact us directly at: Monsanto Company, Electronic Instruments, West Caldwell, New Jersey 07006, (201) 228-3800.

New B-D[®] cu outperforms other coppers at no extra cost that's **ANACONDABILITY**

Only Anacondability could have produced Boron Deoxidized Copper (B-D cu), the newest high performance coppermetal from Anaconda. It required the total corporate capabilities of Anaconda to develop it . . . from marketing research and advanced copper technology, to application

engineering and rigid quality control.

Today B-D cu offers almost unlimited design possibilities in areas where grain growth and embrittlement have long been problems. Possessing the high conductivity of oxygen-free copper . . . Boron Deoxidized Copper also combines the desirable properties of Deoxidized Copper.

Costing no more than other oxygen-free coppers, B-D cu is already in use in aircraft multiple disc brakes, glass-to-metal seals, composite metal coins, pinch-off tubes and welded communications cable shielding. Good reason to go with Anacondability . . . Anaconda's total capability to



improve copper alloys without increasing costs.

B-D cu is used in a new disc brake that provides a better solution to aircraft emergency braking.

Sudden emergency braking of aircraft usually resulted in burnt-out brake discs necessitating complete replacement and costly downtime.

Anaconda's B-D cu alloy is used in a new liquid-cooled

disc brake in which the temperatures are controlled so maintenance time is reduced for the brakes and the tire life is increased.

This new aircraft brake is certified on the Boeing 727.

For technical information on Boron Deoxidized Copper and other high temperature,

high conductivity copper alloys, send for Publication TP-58 on Boron Deoxidized Copper today to: Anaconda American Brass Company, 414 Meadow Street, Waterbury, Connecticut 06720. In Canada: Anaconda American Brass Limited, Ontario.

2.8.23

Think copper, think ANACONDA[®]
AMERICAN BRASS COMPANY

The better point-to-point WIRE, SPACE,

Use stranded as well as solid wire. And use less of it. Our TERMI-POINT* Technique uses 25% less wire for the connection than other techniques. Wire is not destroyed in testing, routine maintenance and circuit changes . . . can be re-used.

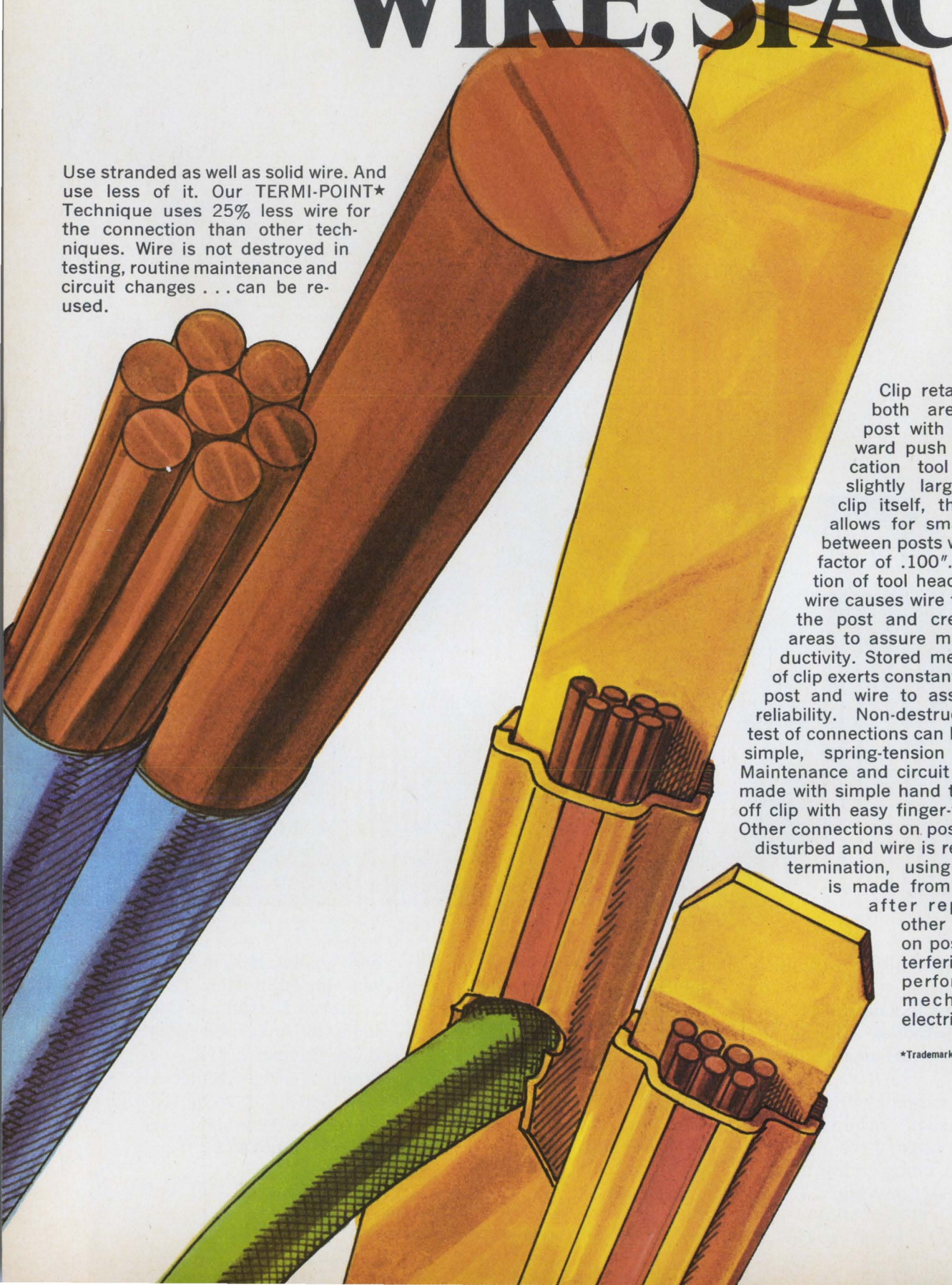

Clip retains wire and both are affixed to post with straight, forward push of the application tool head. Only slightly larger than the clip itself, the tool head allows for smaller spacing between posts with a density factor of .100". Forward action of tool head on clip and wire causes wire to wipe along the post and create "clean" areas to assure maximum conductivity. Stored memory design of clip exerts constant pressure on post and wire to assure long-life reliability. Non-destructive tensile test of connections can be made with simple, spring-tension hand tool. Maintenance and circuit changes are made with simple hand tool that flips off clip with easy finger-twist motion. Other connections on post are left undisturbed and wire is reusable. New termination, using same wire, is made from top of post after repositioning other connections on post without interfering with their performance and mechanical and electrical stability.

*Trademark of AMP Incorporated

wiring technique saves you **TIME, MONEY**

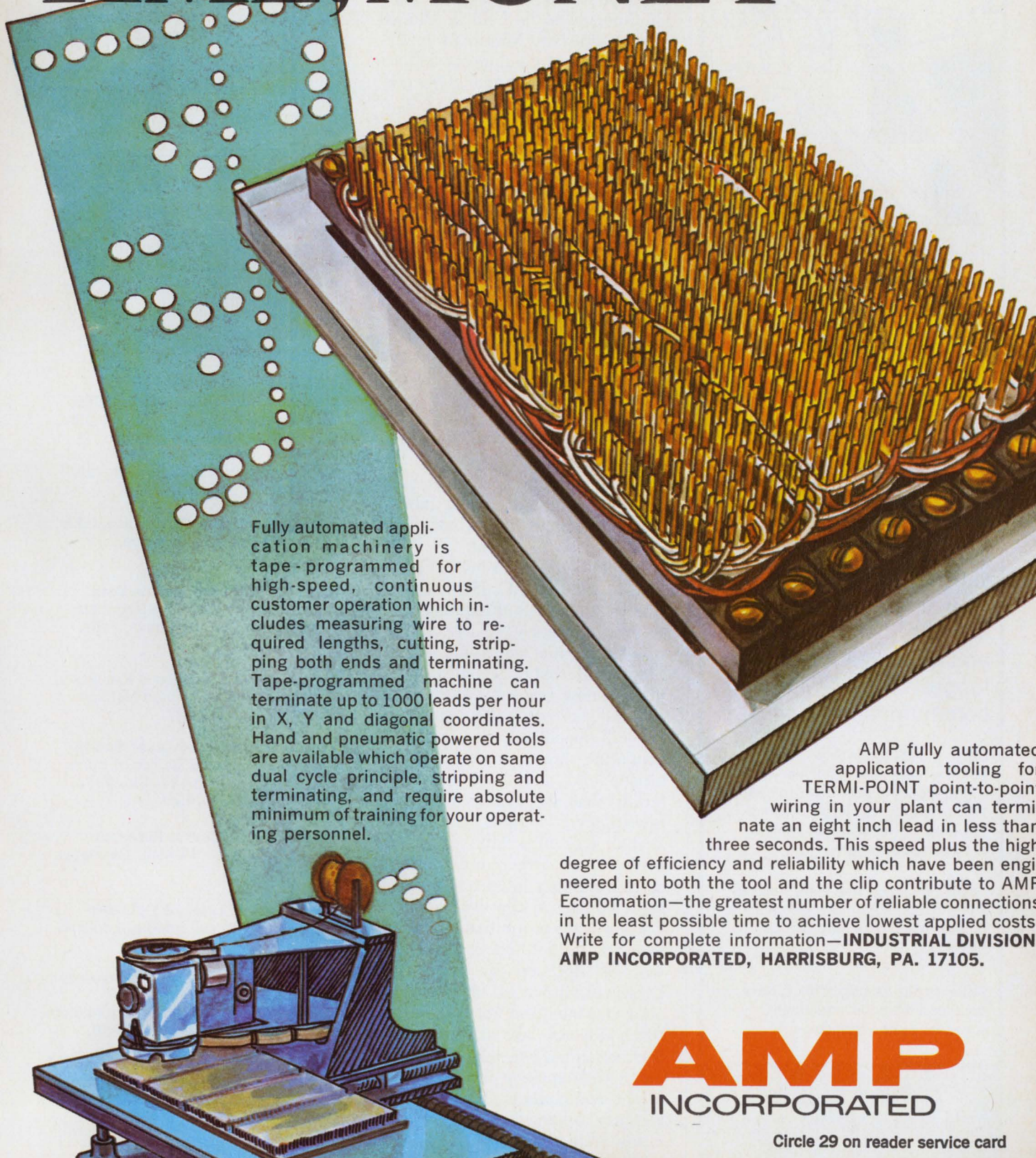

Fully automated application machinery is tape-programmed for high-speed, continuous customer operation which includes measuring wire to required lengths, cutting, stripping both ends and terminating. Tape-programmed machine can terminate up to 1000 leads per hour in X, Y and diagonal coordinates. Hand and pneumatic powered tools are available which operate on same dual cycle principle, stripping and terminating, and require absolute minimum of training for your operating personnel.

AMP fully automated application tooling for **TERMI-POINT** point-to-point wiring in your plant can terminate an eight inch lead in less than three seconds. This speed plus the high degree of efficiency and reliability which have been engineered into both the tool and the clip contribute to AMP Economation—the greatest number of reliable connections in the least possible time to achieve lowest applied costs. Write for complete information—**INDUSTRIAL DIVISION, AMP INCORPORATED, HARRISBURG, PA. 17105.**

AMP
INCORPORATED

Circle 29 on reader service card



The Alameda County Sheriff's Department

uses Farinon microwave and multiplex for reliable long-distance communications.

So do the Michigan State Police, 16 US government agencies, 33 independent telephone companies, 12 Bell telephone companies and 11 public power and light utilities . . . among 223 others.

These people serving the US public know all about Farinon performance, reliability and economy, and so can you.

Write for our catalog of microwave, radio and multiplex equipment, accessories and services.

Farinon

Farinon Electric, 935 Washington St., San Carlos, Cal. 94070

Meetings

Semiconductors: worldly view

About half of the papers at the Semiconductor Device Research Conference—to be held in Munich, West Germany, March 24 to 27—will be given by engineers and scientists from outside Germany. Thus, the meeting, the second of its kind, promises to give a broad international picture of the semiconductor field.

The conference is expected to attract semiconductor experts from the East, too: the Soviet Union, East Germany, and Czechoslovakia.

The meeting, to be held at Munich University, is sponsored by the German section of the IEEE and three national technical associations. It features a 14-session program that includes about 90 contributed and invited papers.

Invited papers will treat a variety of themes: bulk-effect devices, field-effect transistors, power devices, monolithic store units, modern techniques for mask fabrication, and application of computers to device development.

Ion implant. In an invited paper, L.N. Large and J.G. Hambleton of Britain's Services Electronics Research Laboratory will discuss their work with ion implantation. And Manfred Zerbst of Siemens AG will discuss new results with metal-insulated semiconductor transistors. He will specifically deal with new insulating layers such as silicon nitride and aluminum oxide—materials that are increasingly being investigated around the world. Zerbst will also talk about new methods of investigating charge-carrier mobility in current-conducting channels of the devices.

Microwave properties of Schottky barriers in field-effect transistors will be outlined by Karsten F. Drangeid, Simon Middlehoek, Theodor O. Mohr, and Peter Wolf from IBM's research labs at Rueschlikon, Switzerland. They will concentrate on high-frequency characteristics of the components. This team has recently achieved maximum oscillating frequencies of 12 gigahertz with these devices.

In another invited paper, Hans Ullrich, also a Siemens man, will go into computer techniques for fabricating masks for semiconductor devices.

For more information write Walter Heywang c/o Siemens AG, Balanstr. 73, Munich 8, West Germany.

Calendar

International Solid State Circuits Conference, IEEE; University of Pennsylvania and the Sheraton Hotel, Philadelphia, Feb. 19-21.

West Coast Reliability Symposium; Century Plaza Hotel, Beverly Hills, Calif., Feb. 21.

Technological Influences on Communications Conference, IEEE; Washington Hilton Hotel, Washington, D.C., Feb. 24-25.

Electric Propulsion Conference, AIAA; Williamsburg, Va., March 3-5.

Particle Accelerator Conference, IEEE; Shoreham Hotel, Washington, March 5-7.

International Colloquium on Data Transmission, Federation Nationale des Industries Electroniques; Paris, March 24-28.

International Convention & Exhibition, IEEE; Coliseum and Hilton Hotel, New York, March 24-27.

Second International Laser Safety Conference, Medical Center of the University of Cincinnati; Stouffer's Motor Inn, March 24-25.

Semiconductor Device Research Conference, IEEE; Munich, Germany, March 24-27.

Conference on Lasers & Optoelectronics, IEEE; Southampton, England, March 25-27.

Symposium on Engineering Aspects of Magnetohydrodynamics; Massachusetts Institute of Technology, Cambridge, Mass., March 26-28.

The Changing Interface: An IC Systems Seminar, Electronics/Management Center; Park Sheraton Hotel, New York, March 28.

(Continued on p. 32)

The wonderful goofproof machine.



(Model 305/360 pinpoints correct carrier levels by-the-numbers)

This is the world's first fully foolproof frequency-selective levelmeter, tracking signal generator, and spectrum display system. It combats human error with crystal-clear displays of every key measurement parameter. Each reading, each setting, each switch you push lights up. This alone makes it hard to misinterpret a reading. But for our human engineers, lighted displays were only the beginning.

Consider, for example, the direct digital frequency readouts. The frequency counter displays automatically summed outputs of both the coarse and fine-tuning oscillators. In the frequency-locked mode, the counter shows the composite frequency to the nearest 10-Hz increment. Continuous tuning gives you a three-digit display to the nearest 0.1 MHz. So you can't mistake the mode you're in.

And how are you going to misinterpret your attenuation-level settings? Bright three-digit displays on the levelmeter and generator units present automatically totalled outputs of the 10- and 1-dB per-step attenuators. Each clearly indicates level setting and polarity with reference to meter zero. Should someone absent-mindedly leave the set in calibration mode, both displays stay off.

All digital counters employ flat-plane, high-brightness displays that give you a much wider viewing angle than gas-glow tubes. The levelmeters introduce a rear-projected scale with bright, illuminated

pointer, a new metering technique that does away with parallax distortions. Switchable meter-scale expansion resolves input levels to 0.05 dB.

With a range of 1 kHz to 32.1 MHz, Model 305/360 is the only test system of its kind that covers both voice and HF bands of the frequency spectrum.

Product File 169 takes up the war on goofs in greater detail. For your set, write Philco-Ford, 3885 Bohannon Drive, Menlo Park, California 94025. Or call (415) 322-7222, ext. 329.

SUMMARY SPECIFICATIONS

Frequency Range	1 kHz to 32.1 MHz
Frequency Resolution:	
Locked Mode	10 Hz
Continuous Mode	100 kHz
Measurement Range:	
Low Sensitivity (1 kHz to 32.1 MHz)	-89 to +22 dBm
High Sensitivity (60 Hz to 32.1 MHz)	-109 to +2 dBm
Measurement Accuracy (at 1 MHz, 0 dBm)	0.2 dB
Selectivity (switch selected):	
Wideband	
3 dB bandwidth	3100 ± 200 Hz
60 dB bandwidth	8000 + 500/-1000
Narrowband	
3 dB bandwidth	250 ± 50 Hz
60 dB bandwidth	1000 ± 100 Hz



PHILCO-FORD CORPORATION
Sierra Electronic Operation
Menlo Park, California • 94025

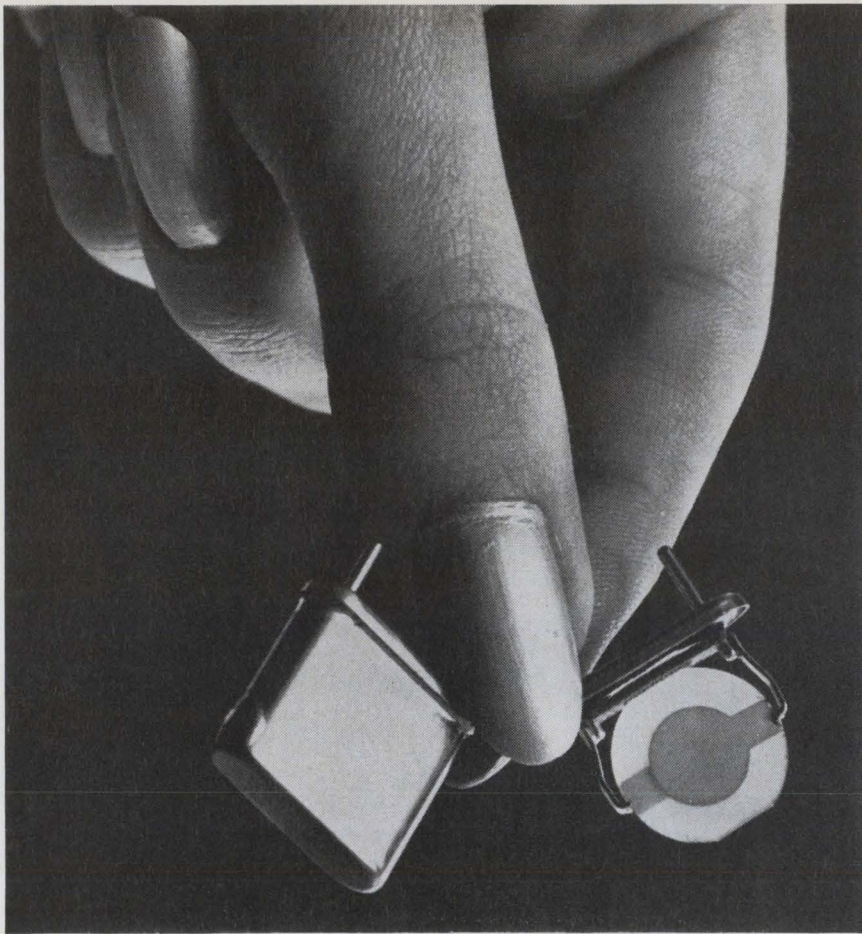

How do you get fast service on special, short-order or prototype crystals?

Tune Sherold in.

We've got the advanced crystal technology to analyze your unique crystal problems, design the solution, and manufacture a prototype or short order — quickly. And we have the facilities to put it into low-cost quantity production, too. No matter what special crystal techniques your application requires, Sherold can produce it in the .4 kHz to 175 megaHz range. Solder seal, cold weld, resistance weld or glass fusing. Custom packaging. High shock and vibration MIL specs. And we have several plants geographically located to give you this special crystal technology assistance quickly and locally. Tune us in on your problem. Send details to Sherold Crystal Products Group, Tyco Laboratories, Inc., 1510 McGee Trafficway, Kansas City, Missouri 64108. Or phone (816) 842-9792. TWX 910-771-2181.

tyco

Meetings

(Continued from p. 30)

International Components Show, Federation Nationale des Industries Electroniques; Paris, **March 29-April 2.**

Vibrations Conference, Association of Mechanical Engineers; Philadelphia, **March 30-April 2.**

Quality Control Conference, University of Rochester; Rochester, N.Y., **April 1.**

Numerical Control Society; Stouffer's Motor Inn and Convention Center, Cincinnati, **April 1-3.**

Mathematical Aspects of Electrical Network Analysis, American Mathematical Society; Providence, R.I., **April 2-3.**

International Symposium on Computer Processing in Communications, Polytechnic Institute of Brooklyn; Waldorf-Astoria Hotel, New York, **April 8-10.**

Computer Aided Design Conference, IEEE; University of Southampton, England, **April 15-18.**

Joint Railroad Conference, IEEE; Queen Elizabeth Hotel, Montreal, **April 15-16.**

International Magnetics Conference (Intermag), IEEE; RAI Building, Amsterdam, Holland, **April 15-18.**

International Geoscience Electronics Meeting, IEEE; Twin Bridges Marriott Hotel, Washington, **April 16-18.**

Conference on Switching Techniques for Telecommunications Networks, IEEE; London, **April 21-25.**

Conference and Exhibit, Temperature Measurements Society; Hawthorne, Calif., **April 21-22.**

Spring Meeting, United States National Committee, International Scientific Radio Union, IEEE; Shoreham Hotel, Washington, **April 21-25.**

Symposium on Circuit Theory, Department of Electrical Engineering and Electronics Research Center; University of Texas at Austin, **April 21-22.**

RTCM Assembly Meeting, Radio Technical Commission for Marine Services; Hollenden House, Cleveland, **April 21-23.**

National Telemetry Conference, IEEE; Hilton Hotel, Washington, **April 22-24.**

(Continued on p. 34)

LOW PROFILE

hot-molded trimmer for
close circuit board stacking

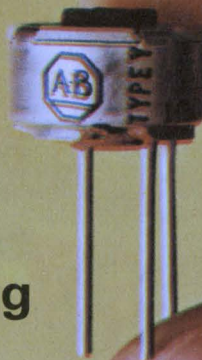

Basic Type Y unit
shown actual size



With wheel for
side adjustment



With attachment for
horizontal mounting and
wheel for side adjustment



With attachment for
horizontal mounting

New Type Y single turn trimmer is especially designed for use on printed circuit boards. It has pin-type terminals for use on boards with a 1/10" pattern. And the new low profile easily fits within the commonly used 3/8" space between stacked printed circuit boards.

For greater operating convenience, the Type Y can be supplied with an optional thumb wheel for side adjustment, or an optional base for horizontal mounting, or both. The Type Y enclosure is splash-proof as well as dust-tight, and the metal case is isolated to prevent accidental grounding.

While featuring a new low profile, this new Type Y trimmer retains the popular Allen-Bradley solid resistance element, which is produced by A-B's exclusive hot-molding technique. With virtually infinite resolution, adjustment is smooth at all times. Being essentially noninductive, the Type Y can be used at frequencies where wirewound units are inadequate. The Type Y is rated 1/4 watt at 70°C and is available in resistance values from 100 ohms to 5.0 megohms. Standard and special tapers are available.

Let us send you complete specifications on this newest addition to the Allen-Bradley line of quality electronic components. Please write: Allen-Bradley Co., 1201 South Second Street, Milwaukee, Wis. 53204. Export Office: 1293 Broad St., Bloomfield, New Jersey, U.S.A. 07003. In Canada: Allen-Bradley Canada Ltd.

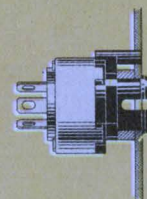

New Type Y with handy
snap-in panel mount,
supplied with spacers for use
on panels up to 1/8" in thickness



ALLEN-BRADLEY
QUALITY ELECTRONIC COMPONENTS

Comparisons are Beautiful...and Easy...

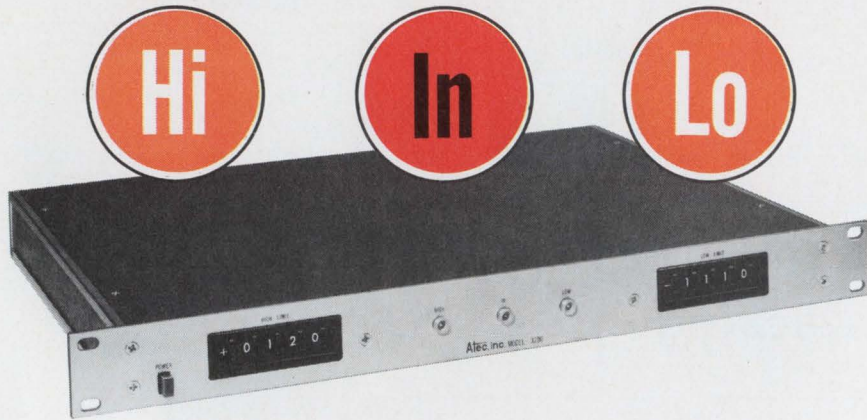

with the new Atec 3200 DIGITAL COMPARATORS!

Automation of your "Go/No-Go" or "Hi-In-Low" measurements is now made easier with greater reliability, flexibility and lower cost, with the new Atec 3200 series Digital Comparators.

Here's your own off-the-shelf-minicomputer. Measurement comparisons are made by parallel computation as opposed to coincidence logic, permitting either moving or static BCD inputs to be compared to pre-established limits. The 3200 Series is specifically designed for local or remote limit programming and occupies only 1 $\frac{3}{4}$ " of height in a standard 19" rack.

You interface with a wide variety of BCD inputs, including all the Atec 2000 and 3000 series of electronic counters, bi-directional totalizers, time interval meters, and an infinite variety of digital measuring devices.

Programming limit values? That's just as easily accomplished, again with no interface problems. Set manual limits from front panel decimal switches; or enter the limits from a complete spectrum of sources: tape and card readers, external measuring instruments—you tell us!

All logic levels for inputs and limits are standard saturated IC voltages (TTL). Choose from four models:

3200 Dual Limit, unsigned data	\$625
3201 Single Limit, unsigned data	425
3202 Dual Limit, signed data	825
3203 Single Limit, signed data	525

Like all Atec products the 3200 comparators are ruggedly constructed and feature modular plug-in assemblies using readily available IC's.

Atec sales engineers are ready to serve you. Phone, wire or write.

Atec, Inc.

1125 LUMPKIN STREET, HOUSTON, TEXAS • PHONE (713) 468-7971
MAILING ADDRESS: P. O. BOX 19426 • HOUSTON, TEXAS 77024

Meetings

(Continued from p. 32)

International ISA Pulp & Paper Instrumentation Symposium, Instrument Society of America; Vancouver, Canada, April 22-26.

Southwestern Conference & Exhibition, IEEE; Convention & Exhibition Center, San Antonio, April 23-25.

Short courses

Process analytical instrumentation, Marriott Motor Hotel, Philadelphia; June 1-6; \$250 fee.

Automatic electronic test equipment, New York University; two courses, June 16-20 and Aug. 18-22; \$265 fee for each course.

Modern circuit theory: analysis, synthesis and computer methods, University of California at Los Angeles; July 21-Aug. 1; \$375 fee.

Call for papers

Electro-optical Systems Design Conference, New York Coliseum, Sept. 16-18. **March 1** is deadline for submission of abstracts to Technical Papers Committee, Electro-optical Systems Conference, 222 W. Adams St., Chicago 60606.

International Telemetry Conference, International Foundation for Telemetry; Sheraton Park Hotel, Washington, Sept. 15-17. **March 15** is deadline for submission of abstracts to Dr. E. J. Bagdady, program chairman, ADCOM, 808 Memorial Dr., Cambridge, Mass. 02139.

International Electronics Conference, Canadian Region of the IEEE; Automotive Building, Exhibition Park, Toronto, Oct. 6-8. **March 15** is deadline for submission of abstracts to Dr. Rudi de Buda, technical program chairman, International Electronics Conference, 1819 Yonge St., Toronto 7, Canada.

Laser Industry Association Meeting and Exhibit; Los Angeles, October 1969. **March 15** is deadline for submission of abstracts to Gordon Gould, Polytechnic Institute of Brooklyn, Long Island Graduate Center, Department of Electrophysics, Farmingdale, N.Y. 11735.

Symposium on Parallel Processor Systems, Technologies and Applications, Department of the Navy; Navy Postgraduate School, Monterey, Calif., June 25-27. **March 16** is deadline for submission of papers and abstracts to L.C. Hobbs Associates Inc., P.O. Box 686, Corona Del Mar, Calif. 92625.

Hybrids from United Aircraft?

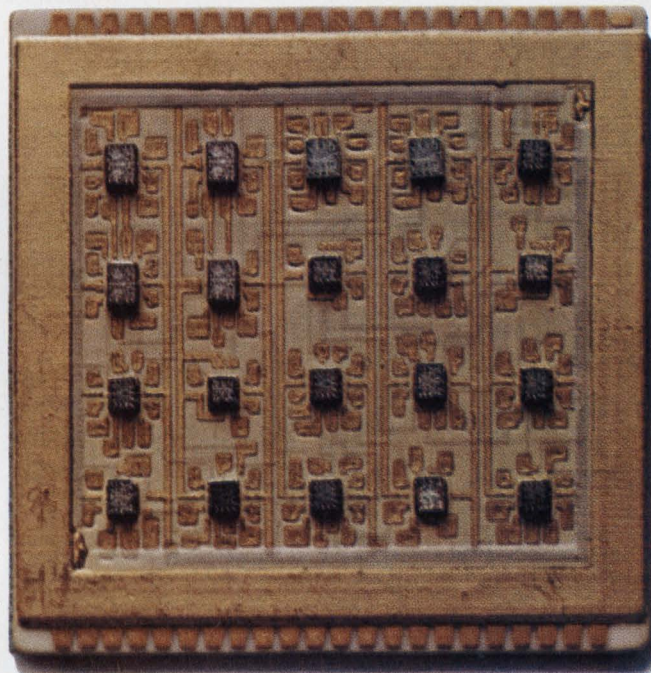

Unretouched photograph of a typical 1/4" square Multilayer MSI Module.

You'd better believe it!

Thin film. Thick film. Single layer. Multilayer. Hermetic and nonhermetic packages. Whatever you need in custom hybrid microcircuits, you can get it from us. Because—beyond engineering skills—we have proven capability in every major hybrid production and

packaging technique.

And we have a pilot line that lets you prove out designs before committing to full production.

Call our Hybrid Microcircuit Marketing Manager at (215) 355-5000. TWX 510-677-1717. Or write direct.

**Electronic
Components**

DIVISION OF

**United
Aircraft**

TREVOSE, PENNSYLVANIA 19047

In the West: 128 E. Katella Ave., Orange, Calif. (714) 639-4030

DANA SERIES 5700

The most accurate DVM there is—0.0025%. And the most stable—0.009% for a year. And the fastest—18 milliseconds for dc, 45 milliseconds for ac. It also has a 3-speed filter, and can be calibrated with just a single adjustment. The finest DVM in the world.

DANA SERIES 5500

Best DVM in the \$3000-\$4000 class. Accuracy is 0.005%. Six months stability is 0.006%. It has 5 dc ranges, 3 ac ranges, 5 ohm ranges, 3 ratio ranges, autoranging and 10% over range.

5700

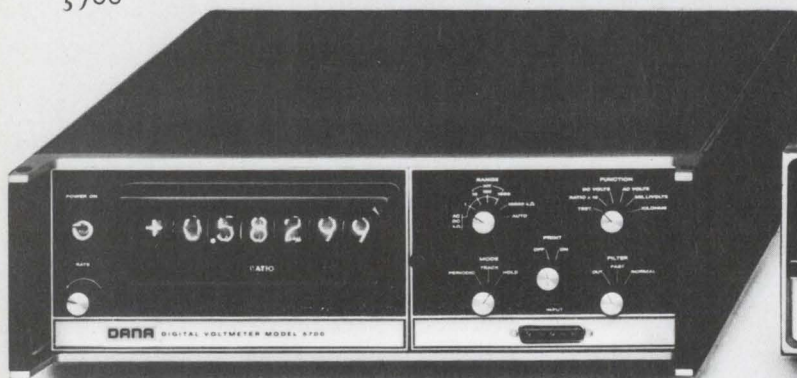

5500



Go to the head of

DANA SERIES 4400

Our newest DVM. It takes on all comers in the \$1000-\$2000 class. 90-day accuracy is 0.01%. There's a 1-volt range on ac and dc with 20% over ranging. There are plenty of integrated circuits to keep reliability honest. It even has the Dana 3-pole active filter for noise nuisance. You can choose between two rack-mount units and one portable unit. And anyone who can push buttons can operate it.

4400



DANA SERIES 5400

There's no better 4-digit instrument made. It's a multimeter. Measures ac/ac ratio. Has sample and hold, differential input, integrator and/or broadband filtering. It, too, has a 3-pole noise filter. With more than 1000 of them out in the field, it's almost a legend.

There're all in full detail in our handsome new brochure. So is the rest of the Dana line. The book is yours if you ask. Dana Laboratories, Inc., 2401 Campus Drive, Irvine, California 92664.

DANA

5400

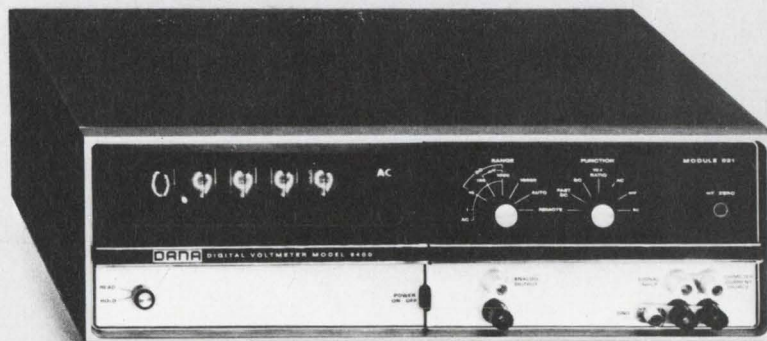

the class. Any class.

Circle 37 on reader service card



CINCH AEROSPACE CONNECTORS GO BEYOND MIL SPECIFICATIONS

Since 1963 Cinch has been a major source for these ultimate performance rack and panel connectors. America's major space and defense spacecraft use these Cinch connectors in space and on the moon...TRW's Intelsat III, OGO, Pioneer and VELA spacecraft and JPL's Mariner satellites.

Their production involves complex quality control procedures beginning with raw material selection through every stage of fabrication and "clean room" assembly. Plating QC alone involves 119 lab measurements for 4 different characteristics, on the pre-assembled contacts. The completed connector must have a maximum residual magnetism of less than 20 gamma at the magnetometer probe and be free of visible contamination under 25x microscopic examination.

Do your connector requirements involve unusual design or production problems? Cinch can help you. For more information on Cinch aerospace connectors and the Cinch capabilities available to you, write Cinch Manufacturing Company, 1501 Morse Avenue, Elk Grove Village, Illinois 60007.

C-6810

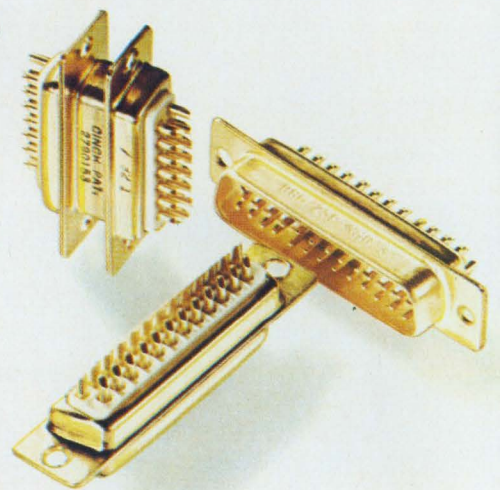

CINCH

DIVISION OF UNITED-CARR



MEMBER
THE CINCH ELECTRONICS GROUP
CONSISTING OF CINCH MANUFACTURING COMPANY, CINCH-GRAPHIK, CINCH-MONADNOCK, CINCH-NULINE, UCINITE (ELECTRONICS) AND PLAXIAL CABLE DEPT.

Circle 38 on reader service card

Editorial comment

Heading off IBM

In the interest of fairness, the Justice Department wants IBM to change its way of doing business. The company has been so faultless in the way it has planned, manufactured, and marketed computers and computer services that if it merely continues its successful practices, its competitors may be unfairly treated, the agency feels. The suit it has brought [*Electronics*, Feb. 3, p. 44] is an attempt to divert IBM from its present path.

In the opinion of many experts in antitrust procedures, the suit will go on for years and ultimately IBM and the Justice Department will come to terms outside the courtroom. One situation that must be rectified, according to Justice, is IBM's single-price policy for the sale or rental of a package comprising hardware, peripheral equipment, software, and maintenance. Yet there's reason to believe IBM would shift to separate pricing of its own accord. On the other hand, hardware and software are becoming so inextricably entwined that it's hard to envision a situation in which a customer should not at least be given the option of buying the whole package from IBM (or any company).

Another sore point is IBM's "pre-selling" of a new generation of computers. When IBM alerts its potential customers to its plans, such customers may be deterred from signing on with a competitor who presumably could deliver sooner than IBM. Yet it's hard to think of a good alternative. What

company planning to invest heavily in a future product line would not seek dialogue with its customers in order to determine their needs?

Finally, IBM has been taken to task for influencing future purchases through discriminatory pricing for colleges and universities, a practice that might well have been lauded if it were not for its cumulative impact along with the other complaints.

That the suit reflects an unbelievably complex problem can be judged by the ambivalence of competitors toward IBM. Most of them admire and strive to emulate the techniques IBM has employed to make it the giant that it is. Further, hardware and software companies alike appreciate the comfortable pricing umbrella that IBM has built—and under which they can thrive. The software people, on the other hand, are a bit tired of the "IBM gives it to us for nothing" myth. Still, they realize that if software were priced separately, IBM might toughen its pricing practices.

One real possibility is that if the Government tries to head off IBM in specific areas, the company might not be there when the justices arrive. The industry may evolve so rapidly that emphasis might shift to new markets, such as teleprocessing. Or IBM may elect to invest in new and different products or services. As *Business Week* has aptly put it, the court may have to write the rules for a game that is not yet being played. ■

IEEE needs money

When an article is published in the Proceedings of the Institute of Electrical and Electronics Engineers, the author's company is asked to pay \$50 per page to subsidize the rising costs of printing and distribution. The society carefully points out that payment is not a prerequisite for publication. Some of the IEEE Transactions have already used a similar technique. Just how does it work? An editor of one of the Transactions says, "We send the author a bill; if he doesn't pay, we forget about it." The IEEE stresses that the author's organization, not the author, is expected to foot the bill, and maybe even to tack the page charges on to the cost of Government-sponsored projects. But what of consultants or authors from small firms?

Journals of certain professional societies require that authors pay to have their articles published, but this doesn't have the ring of professionalism.

IEEE membership dues have been increased significantly over the past several years. Yet an additional subsidy of about 0.03 cent per page per member—or in the course of a year less than 75 cents per member—would seem to be a small price to pay to keep the articles published in the Proceedings above monetary considerations. This would avoid a situation that might embarrass the author or even remotely suggest that his contribution might be weighed in terms of his ability to pay for its publication, or his company's willingness to do so. ■

Well?

Gas discharge tube



Digivac S/G

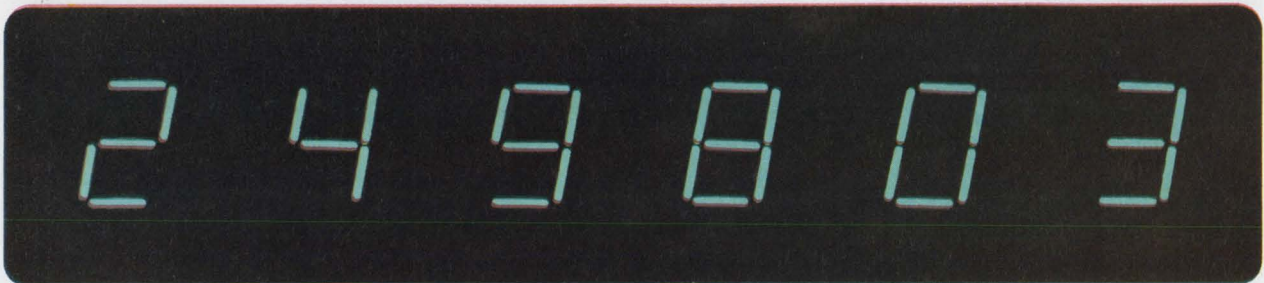

How's this for legibility?

Judge for yourself the clarity of the Tung-Sol Digivac S/G readout as compared to a gas discharge tube. Single plane, up-front display is uniformly distinct. Reading is fast and accurate, with exceptional wide-angle visibility. Characters don't "dance" as numerals change. Normal blue-green color is easier to view than the familiar "bloodshot eye." Digivac S/G can be successfully used in "time sharing" applications. □ These advantages are enhanced by the low price of Digivac S/G and matching IC logic which provides features not present in other readout devices. Get the whole story. Write for the portfolio on Tung-Sol Digivac S/G readouts.

TUNG-SOL DIVISION / WAGNER ELECTRIC CORPORATION
ONE SUMMER AVENUE, NEWARK, NEW JERSEY 07104

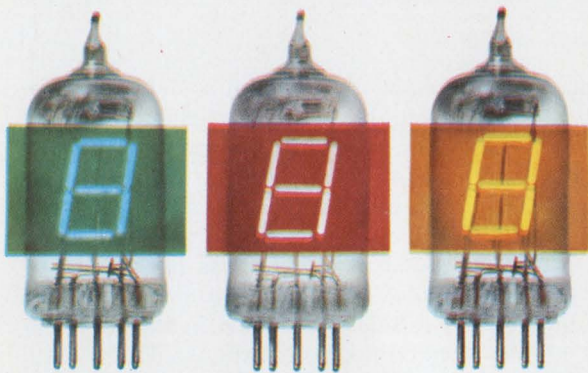

CHOICE OF COLOR WITH FILTERS
Simple filtering provides an almost unlimited choice of colors for identifying individual readout arrays.

TUNG-SOL[®]
DIGIVAC S/G[™]

...the newest state
of the readout art

Electronics Newsletter

February 17, 1969

Philco division chief quits; pending award to decide unit's fate

Emanuel Fthanakis has resigned as vice president and general manager of the Philco-Ford Corp.'s Space and Reentry Systems division (SRS) only days before the anticipated award of a contract that could affect the fate of that division. Philco is competing with Hughes and TRW for Phase 2 of the Defense Satellite Communications System, a multi-million-dollar procurement for which the last bit of contractors' data went in to the Pentagon last week. **A decision on the winner is expected before the end of the month.**

Should Philco lose out, the company may return the Space and Reentry Systems unit to the Western Development Laboratories division, out of which it was formed last September. Although SRS built the 24 birds for the Initial Defense Communications Satellite System (IDCSS), it has few large programs in house at present. **And under its new president, Robert Hunter, the parent company has been emphasizing the consumer side of its operations over the purely electronic and military.**

The dynamic Fthanakis, 40, headed SRS since its birth; prior to that, he was director of space vehicle operations at the Western Development Labs. He refused to comment on his reasons for leaving Philco or on his future plans, **but he is known to be under consideration for the presidency of a large electronics subsidiary of a major corporation.**

Edward A. Miller, who was a colleague of Fthanakis's at GE's Missile and Space division and who joined SRS last April as director of space vehicle operations, has succeeded him as head of SRS. **But Miller has not been given a vice presidency or the title of general manager.**

Changes in SST lessen the need for multiplexing

The major changes being made by Boeing in the over-all design of its supersonic transport have sidetracked, at least temporarily, the development of a multiplexing system for the plane's instrument and control signals. Detailed plans for the system, which would include four two-way multiplexers to handle about 3,000 signals simultaneously, were submitted to Boeing at the end of last year by Autonetics and Hamilton Standard. **However, the plane maker's aim in funding the development of such a system to replace heavy wiring in the aircraft was to save weight, and this goal will now be partly achieved by the over-all design changes.**

For one thing, a fixed wing will replace the heavy swing wing of the original SST design. Also, the four engines will be mounted closer to the forward end of the plane, sharply reducing the distance between the engines and the cockpit. All this will cut the weight of the necessary wiring.

Engineers had estimated that multiplexing would save about 2,000 pounds in the original design; they now feel that with the other modifications planned, it will save only 1,000 pounds. Nevertheless, Boeing engineers are trying to convince their management to proceed with a reduced version of the multiplexing system.

Under the plan being considered, the two competitors would submit formal proposals in April. One would then be selected to handle the prototype phase, which would involve the construction of about 14 multiplexers. **The trimmed system would probably have four one-way multiplexers to handle roughly half the 3,000 signals originally planned—and**

Electronics Newsletter

over a shorter coaxial data link. Price would likely be a major factor in the final competition.

Autonetics' initial version used time-division pulse-code modulation and included more than 1,000 MOS integrated circuits of six basic medium-scale integrated types.

Sentinel delay may mean little

Even though "deployment" of the Sentinel antiballistic missile system has been halted, few in Washington expect more than a quick reevaluation. Research and development continues at full tilt; the only parts of the program that have stopped are site selection and construction. Many speculate that the system will return after its short delay in a different form—possibly nothing more than a new name.

Perhaps the biggest fear of supporters is that Congress will convene open hearings. The missile backers are especially worried about hearings with full tv coverage; they know that enough hostile witnesses with good credentials (engineers, nuclear scientists, and the like) could increase national sentiment against the plan.

NASA seeks firms to study satellite for direct-cast tv

NASA is seeking potential users of direct-broadcast television satellites—including those who might share the costs of getting the craft off the ground. In a request for study proposals issued by its Electronics Research Center, Cambridge, Mass., NASA envisions the satellite as using hardware developed for Saturn 5 and the orbiting workshop. Part of the Apollo applications program, the satellite would go up in the middle of the next decade.

NASA wants the study now to help settle the specifications for the tv electronics and to line up large numbers of users by the launch date. The agency hopes user funds will help offset the cost of developing system specs.

The broadcast package would include receiver gear for an 8-gigahertz ground-to-satellite link, a frequency converter for the down link, and a 25-kilowatt uhf transmitter feeding a parabolic antenna 30 to 40 feet in diameter. The 650-megahertz down-link signal would be either black-and-white or color and could be picked up on home tv sets with a 14-decibel Yagi antenna.

Proposals are due Feb. 20, and a contractor for the 12-month study should be picked by late spring. The company will contact and catalog users and determine transmitter duty cycles, beam shaping, modulation method, and other parameters. The contractor will also help potential users work out their own receiver needs.

Addenda

Autonetics is trying to resurrect the multiplexing system it was designing for the Navy's DX destroyer program when its team was dropped from the competition. The firm is now working to get its design included in the proposal of one of the three finalists, reportedly Litton. Autonetics is running a bit late, though, as final bids on the DX are due in April. . . . The Naval Air Systems Command expects to request industry proposals in April for studies and designs of automatic calibration and maintenance consoles for the Carrier Aircraft Inertial Navigation System (Cains). The consoles, which would be both land- and carrier-based, would locate malfunctions in planes' inertial navigation systems. Specifications will be closely tied to industry concepts of the aircraft inertial systems.

Integrated Circuit

IDEAS

FROM
SYLVANIA

Oakland Athletics score with Sylvania MSI.

Million-dollar scoreboards driven by over 7,000 medium-scale integrated circuits.

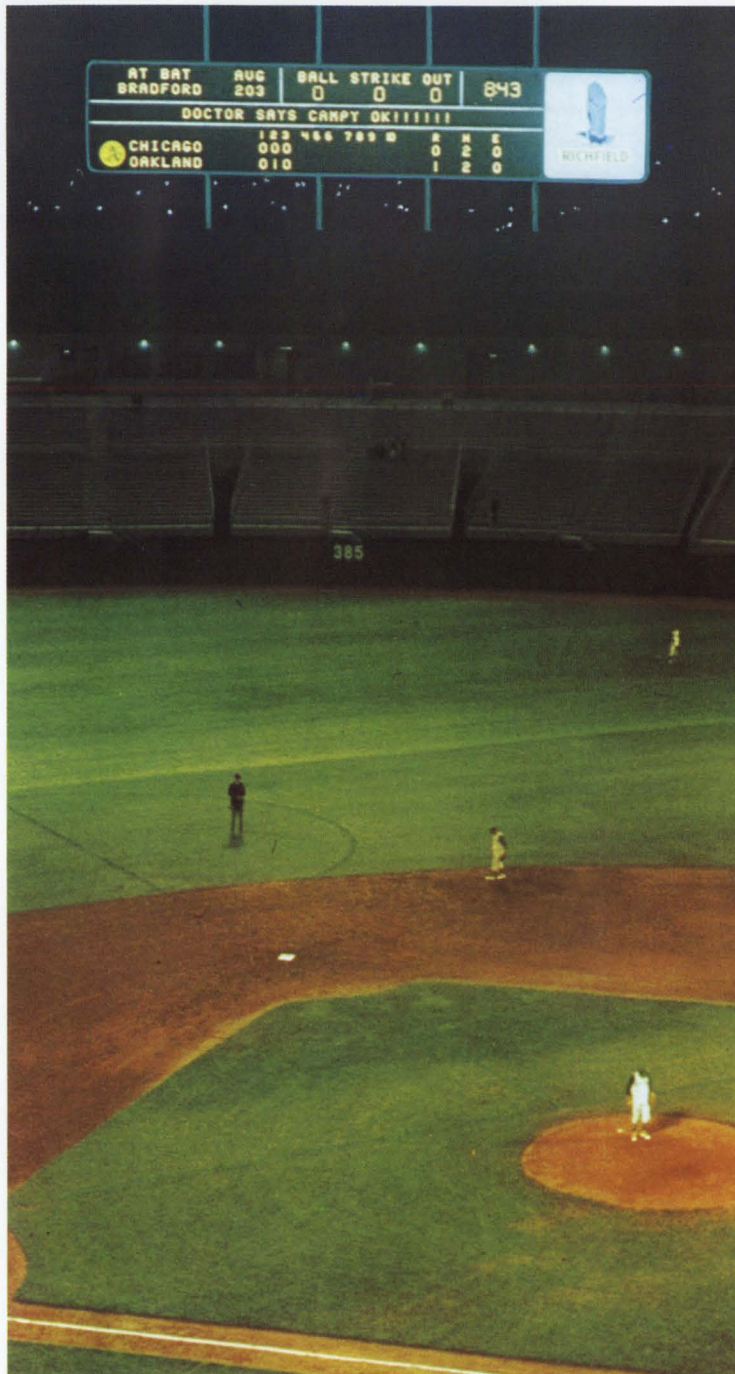

Scoreboards at Oakland Athletics' new stadium are under the control of 7,000 Sylvania integrated circuits.

When California sports fans get the score at the Oakland Athletics' new ballpark in Alameda County Coliseum, they'll be watching 7,000 Sylvania SM-70 4-bit storage registers at work. These medium-scale integrated circuits play an important role in controlling two separate scoreboards that give up-to-the-minute player and team statistics as the game progresses.

Sylvania's SM-70s are the information storage elements for the complex system. The entire scoreboard complex is under the control of an IBM 1130 computer. The output of the computer drives the SM-70s which in turn control triacs which turn the proper lamps on and off.

There were several reasons for selecting the SM-70 for this important function. One was its storage capability. Triacs, when used in an AC system, do not have the ability to store information. Thus, flip-flops or gated latch circuits were required to drive the triacs. There was also a problem of environment. The devices used had to operate as a free ambient temperature as high as 100°F, with minimum protection from high humidity and other extremes of the elements. Sylvania's hermetically sealed package solved these problems.

Another important problem lay in the drive requirements. The SM-70s had to be capable of driving anywhere from 30 to 80 feet of unshielded line having a common ground return. This required a circuit that would not be affected by noise, crosstalk, ringing or reflections. The SM-70s high noise immunity and buffered high-level output solved the problem.

Before using the SM-70s in the scoreboard the manufacturer, Datex Division of Conrac Corp., put them through a grinding test to assure their reliability. A hundred SM-70s were put under an accelerated testing program with a high power supply voltage of 6 to 6.5 volts. In the 17,000 device hours accumulated, not a single failure occurred.

It's this sort of reliability and dependability that makes Sylvania's SUHL logic system so popular for a wide variety of applications, both military and industrial.

CIRCLE NUMBER 300

This issue in capsule

IC Applications

Single-chip shift register replaces eight cans.

IC Types

The growing SUHL integrated circuit line keeps on growing.

MSI Applications

Scratchpad memory gives high-speed access.

Manager's Corner

The most often asked questions about SUHL logic.

Hybrid Circuits

High-speed clock driver matches SUHL integrated circuit speed.

Single-chip shift register replaces eight cans.

High speed and low power consumption make the SM-110 an ideal replacement for a whole set of integrated circuits.

We've packed a lot of function and a lot of flexibility into our new SM-110 4-bit shift register. It can be used for parallel and serial storage and data shifting in any type of digital system. In addition, it can be used for parallel-to-serial or serial-to-parallel conversion, storage, delay and shifting operations, and can be used as a system building block to perform key arithmetic operations such as multiplication and division.

The result is a truly universal logic element that can simplify the design of digital systems. Each SM-110 contains the equivalent of eight conventional SUHL packages. These include: two dual J-K flip-flops, two dual AND-NOR gates, one quad inverter, one dual inverter, and one AND-OR gate.

In addition to replacing eight devices, the SM-110 requires lower power (160 mW), substantially less board wiring, less board space and less clock loading than individual packages, and shift frequency can be as high as 20 MHz.

The SM-110 is designed for serial shift right. All four outputs have SUHL integrated circuit drive and logic capability. In addition, there is a mode control line which will permit parallel entry into all four bits. This data can then be shifted serially upon command. By simple wiring at the package terminals, the SM-110 can be converted to a shift register that can shift left.

As you can see from Fig. 1, each flip-flop in the SM-110 has an inverter between the J and K inputs. This means that you don't need the complement of the data. Only the data itself is required. This single data input has an AND-OR structure which permits feeding in the output of a preceding flip-flop or data from external terminals, depending on the state of the mode control. The external data terminals can be used for parallel transfer into the four bits or they can be connected to the outputs of following flip-flop to permit shifting left.

The SM-110 can perform a shift right and parallel storage operation or a shift left and a shift right, depending on the state of the mode control. However, it can't perform a shift left and store operation in conjunction with each other.

A typical application of the SM-110 as a parallel-to-serial converter is shown in Fig. 2. Here, the register is initially loaded through the parallel inputs by supplying a start pulse during the first clock period.

The start pulse raises the mode control to a high level, allowing the data on the parallel inputs to be entered into the register. By grounding the D_{p1} input in the first register, a "0" bit is placed in this position which will follow the last bit in the word being shifted. The "0" bit is followed by all "1" bits since the D_s input is maintained at the "1" level while the data is being shifted. After six pulses, all inputs of the decoder gate will be high. This raises the mode control input to a "1" level and allows new data to be transferred into the register on the following clock pulse while the last bit is being shifted out.

The SM-110 can also be used to perform the reverse operation, serial-to-parallel conversion. This is shown in Fig. 3. The initial loading of the register is accomplished by supplying a start pulse during the first clock period. This preconditions the register with a single "1" bit at B_2 and "0" bits at B_3 through B_7 . The serial data is fed into the D_s and D_{p1} inputs of the first stage during the same clock pulse. Six clock pulses later the first data bit will appear at output B_7 . The "1" bit that was set into the second stage during the first clock pulse is now at the output of the last stage.

The last stage is not used for data conversion since it is used to produce an output signal when all preceding stages of the register are filled with data bits.

This signal automatically preconditions the register again on the next clock pulse and can also be used as a control signal for parallel transfer.

By adding a two-input NAND gate, as shown in Fig. 3, the signal bit can be ANDed with an external control pulse to store the information in the register until the control pulse is removed.

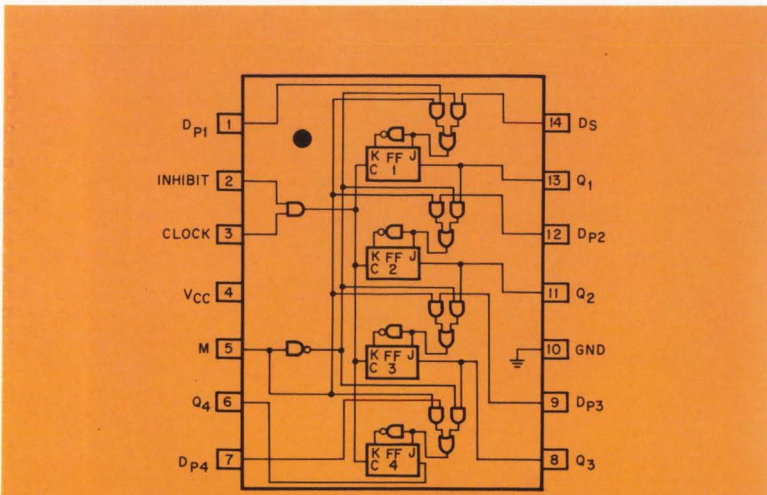

Fig. 1. Logic diagram of SM-110 4-bit shift register.

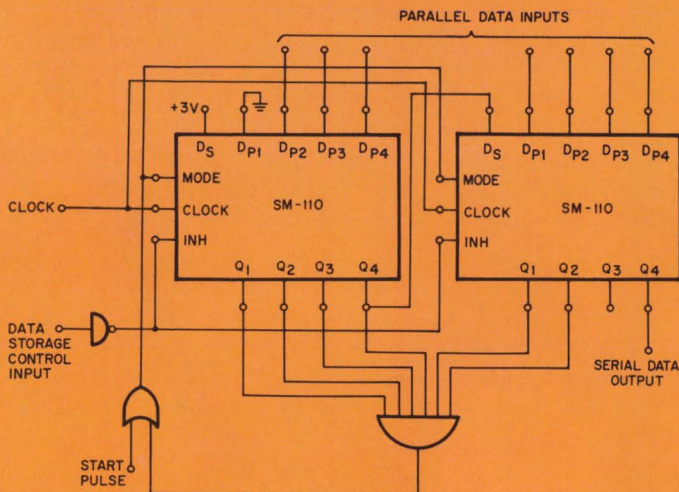
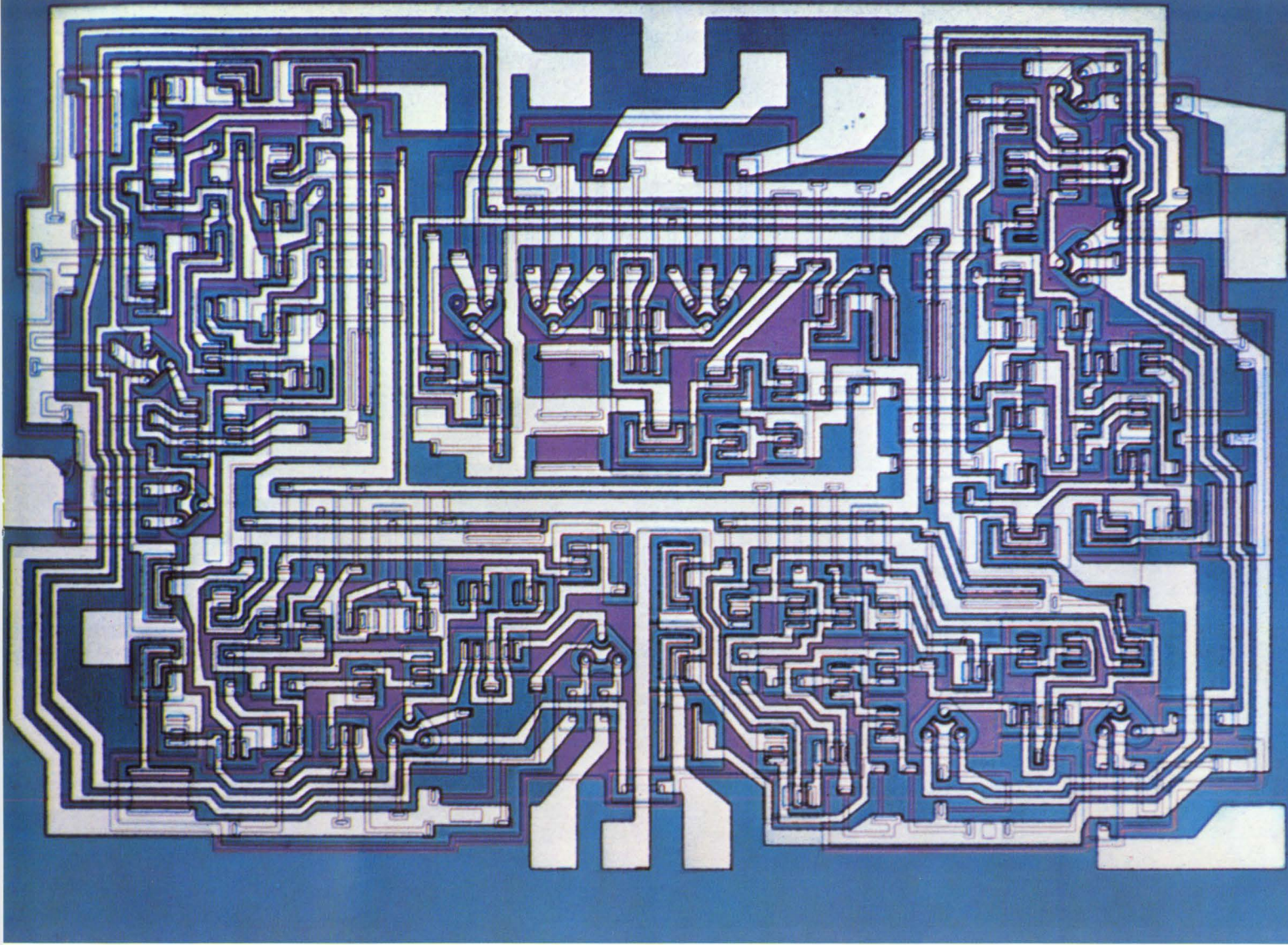

Fig. 2. Application of SM-110 as a 7-bit parallel-to-serial converter.



SM-110 four-bit shift register.

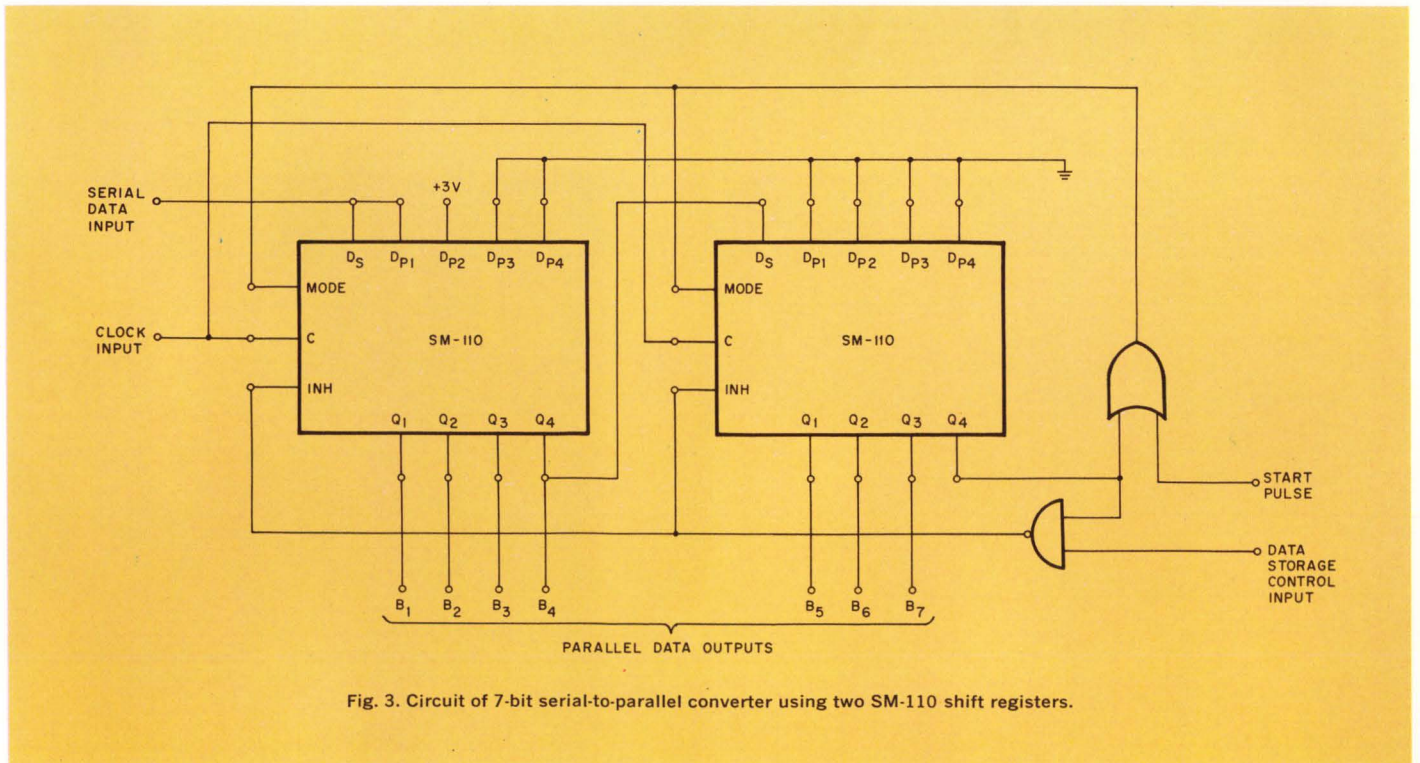
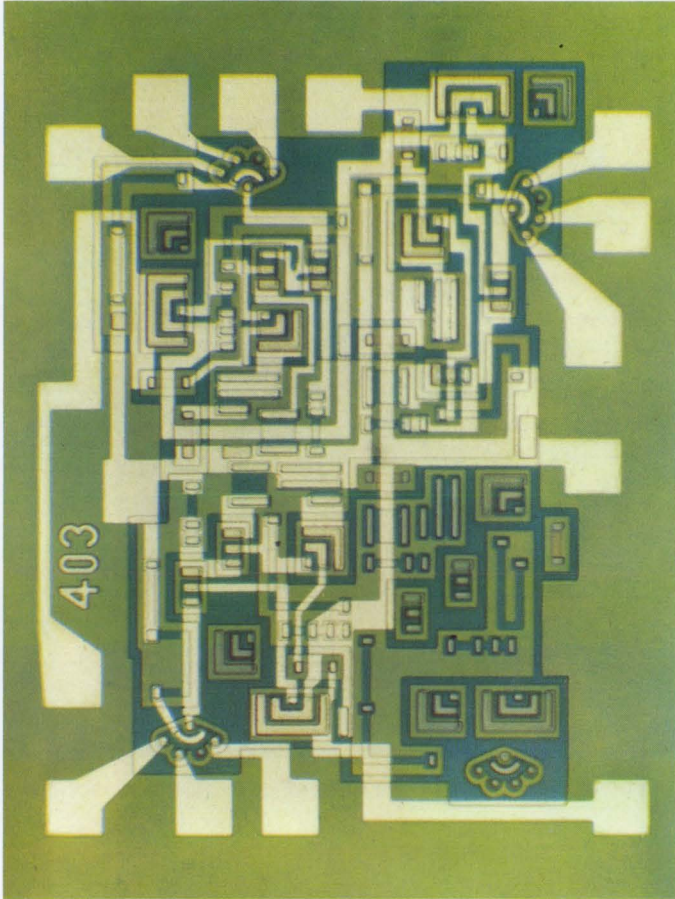

Fig. 3. Circuit of 7-bit serial-to-parallel converter using two SM-110 shift registers.

The growing SUHL line keeps on growing.

New additions to chart include a delay flip-flop and a triple 3-input NAND/NOR gate.



Logic Layout of SF-80, SF-90 dual "D" flip-flop.

Sylvania continues to add to the most complete TTL line in the industry. Two new circuits, making their appearance on the chart for the first time, are the SF-80 dual "D" flip-flop and the SG-320 series triple 3-input NAND/NOR gate.

The SF-80 flip-flop is ideally suited to the design of simple storage registers with minimum input requirements. Only a single input line is required, eliminating the need for complementary inputs. Another feature of this flip-flop is the inclusion of a clamp diode on the input line. This provides damping action to prevent ringing and allows higher system operating speeds.

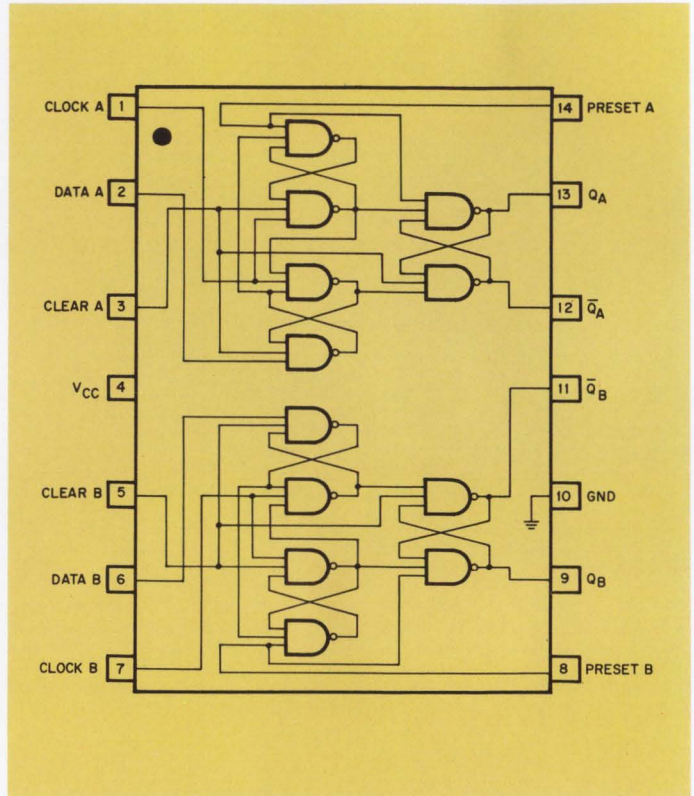

Circuit arrangement of SG-320 triple 3-input NAND/NOR gate.

Digital Functional Arrays

FUNCTIONAL ARRAYS, TYPICAL CHARACTERISTICS (+25°C, +5.0 Volts)					
Function	Type Nos.	t _{pd} (nsec)	Avg. Power (mw)	Noise Immunity +(Volts)-	Fanout
Full Adder	SM10 Series	Sum 22 Carry 10	90	1.0	1.0
Dependent Carry Fast Adder	SM20 Series	Sum 22 Carry 10	125	1.0	1.0
Independent Carry Fast Adder	SM30 Series	Sum 22 Carry 10	125	1.0	1.0
Carry Decoder	SM40 Series	2	25	1.0	1.0
4-Bit Storage Register	SM60 Series	20	30/bit	1.0	1.0
Bus Transfer Output 4-Bit Storage Register	SM70 Series	20	30/bit	1.0	1.0
Cascade Pullup Output 16-Bit Scratch Pad Memory	SM80 Series	25	250	1.0	1.0
Decade Frequency Divider	SM90/92 Series SM91/93 Series	35MHz 30MHz	125 85	1.0	1.0
4-Bit Shift Register	SM110 Series	25MHz	120	1.0	1.0
Parity Generator/Checker	SM120 Series	22	125	1.0	1.0
Comparator	SM130 Series	17	120	1.0	1.0
Programmable Binary Divider	SM140 Series	25MHz	150	1.0	1.0
Programmable Decade Divider	SM150 Series	25MHz	150	1.0	1.0
Binary Counter	SM160 Series	25MHz	135	1.0	1.0
Decade Counter	SM170 Series	25MHz	135	1.0	1.0
Binary Up/Down Counter	SM180 Series	25MHz	205	1.0	1.0
Decade Up/Down Counter	SM190 Series	25MHz	205	1.0	1.0
BCD to 7-Segment Translator	SM200 Series	85	280	1.0	1.0
Dual 4-Bit Multiplexer	SM210 Series	10-20	130	1.0	1.0
Demultiplexer	SM220 Series	9-14	225	1.0	1.0

These arrays are available in fanouts up to 15 and are completely compatible with SUHL I and SUHL II integrated circuits.

The SF-80 operates at 20 MHz. And coming soon is the SF-90 which will run at a 30 MHz rate. Both devices are single-chip monolithic silicon units.

The SG-320 triple 3-input NAND/NOR gate is the SUHL II version of our popular SG-190 SUHL I gate. That means you get high-speed operation—6 ns propagation delay is typical—along with the usual advantages of SUHL circuitry. And power consumption is low, too—typically 22 mW per gate.

The SG-320 contains three 3-input AND gates each followed by an inverting amplifier and a cascade pull-up output

network. Each gate operates as a NAND element in positive logic or a NOR element in negative logic.

Both of these new circuits are completely compatible with the entire SUHL logic line and they share all of the benefits inherent in the SUHL design. These include: high noise immunity, high logic swings and operation from a single 5-volt power supply. Both devices are available in either 14-lead flat packs or dual in-line plug-in ceramic packages.

CIRCLE NUMBER 302

SUHL Integrated Circuits

SUHL I TYPICAL CHARACTERISTICS (+25°C, +5.0 Volts)										
Function	Type Nos.	t _{pd} (nsec)	Avg. Power (mw)	Noise Immunity +(volts)—		**Military (-55°C to +125°C) Prime FO Std. FO		**Industrial (0°C to +75°C) Prime FO Std. FO		
NAND/NOR Gates										
Dual 4-Input NAND/NOR Gate	SG-40, SG-41, SG-42, SG-43	10	15	1.1	1.5	15	7	12	6	
Single 8-Input NAND/NOR Gate	SG-60, SG-61, SG-62, SG-63	12	15	1.1	1.5	15	7	12	6	
Expandable Single 8-Input NAND/NOR Gate	SG-120, SG-121, SG-122, SG-123	18	15	1.1	1.5	15	7	12	6	
Dual 4-Input Line Driver	SG-130, SG-131, SG-132, SG-133	25	30	1.1	1.5	30	15	24	12	
Quad 2-Input NAND/NOR Gate	SG-140, SG-141, SG-142, SG-143	10	15	1.1	1.5	15	7	12	6	
Triple 2-Input Bus Driver	SG-160, SG-161, SG-162, SG-163	15	15	1.1	1.5	15	7	12	6	
Triple 3-Input NAND/NOR Gate	SG-190, SG-191, SG-192, SG-193	10	15	1.1	1.5	15	7	12	6	
AND-NOR Gates										
Expandable Quad 2-Input OR Gate	SG-50, SG-51, SG-52, SG-53	12	30	1.1	1.5	15	7	12	6	
Expandable Dual Output, Dual 2-Input OR Gate	SG-70, SG-71, SG-72, SG-73	12	20/gate	1.1	1.5	15	7	12	6	
Exclusive-OR with Complement	SG-90, SG-91, SG-92, SG-93	11	35	1.1	1.5	15	7	12	6	
Expandable Triple 3-Input OR Gate	SG-100, SG-101, SG-102, SG-103	12	25	1.1	1.5	15	7	12	6	
Expandable Dual 4-Input OR Gate	SG-110, SG-111, SG-112, SG-113	12	20	1.1	1.5	15	7	12	6	
Non-Inverting Gates										
Dual Pulse Shaper/Delay-AND Gate	SG-80, SG-81, SG-82, SG-83	11	30/gate	1.1	1.5	15	7	12	6	
Dual 4-Input AND/OR Gate	SG-280, SG-281, SG-282, SG-283	11	38/gate	1.0	1.5	10	5	8	4	
AND Expanders										
Dual 4-Input AND Expander	SG-180, SG-181, SG-182, SG-183	< 1	0.9/gate	1.1	1.5					
OR Expanders										
Quad 2-Input OR Expander	SG-150, SG-151, SG-152, SG-153	4	20	1.1	1.5					
Dual 4-Input OR Expander	SG-170, SG-171, SG-172, SG-173	3	5	1.1	1.5					
Flip-Flops										
Single Phase SRT Flip-Flop	SF-30, SF-31, SF-32, SF-33	15MHz*	30	1.1	1.5	15	7	12	6	
J-K Flip-Flop (AND Inputs)	SF-50, SF-51, SF-52, SF-53	20MHz*	50	1.1	1.5	15	7	12	6	
J-K Flip-Flops (OR Inputs)	SF-60, SF-61, SF-62, SF-63	20MHz*	55	1.1	1.5	15	7	12	6	
Dual D Flip-Flop	SF-80, SF-81, SF-82, SF-83	20MHz*	48	1.0	1.5		10		10	
Dual 35MHz Flip-Flop (Separate Clock)	SF-100, SF-101, SF-102, SF-103	35MHz*	55/FF	1.0	1.5	11	6	9	5	
Dual 35MHz J-K Flip-Flop (Common Clock)	SF-110, SF-111, SF-112, SF-113	35MHz*	55/FF	1.0	1.5	11	6	9	5	
Lamp Driver										
Quad 2-Input Lamp Driver	SG-350 series	10	37	1.0	1.5	22	12	18	10	
SUHL II TYPICAL CHARACTERISTICS (+25°C, +5.0 Volts)										
NAND/NOR Gates										
Expandable Single 8-Input NAND/NOR Gate	SG-200, SG-201, SG-202, SG-203	8	22	1.0	1.5	11	6	9	5	
Quad 2-Input NAND/NOR Gate	SG-220, SG-221, SG-222, SG-223	6	22	1.0	1.5	11	6	9	5	
Dual 4-Input NAND/NOR Gate	SG-240, SG-241, SG-242, SG-243	6	22	1.0	1.5	11	6	9	5	
Single 8-Input NAND/NOR Gate	SG-260, SG-261, SG-262, SG-263	8	22	1.0	1.5	11	6	9	5	
Triple 3-Input NAND/NOR Gate	SG-320, SG-321, SG-322, SG-323	6	22	1.0	1.5	11	6	9	5	
AND-NOR Gates										
Expandable Dual 4-Input OR Gate	SG-210, SG-211, SG-212, SG-213	7	30	1.0	1.5	11	6	9	5	
Expandable Quad 2-Input OR Gate	SG-250, SG-251, SG-252, SG-253	7.5	43	1.0	1.5	11	6	9	5	
Expandable Triple 3-Input OR Gate	SG-300, SG-301, SG-302, SG-303	7	36	1.0	1.5	11	6	9	5	
Expandable Dual Output Dual 2-Input OR Gate	SG-310, SG-311, SG-312, SG-313	7	30/gate	1.0	1.5	11	6	9	5	
AND/OR Expander										
Dual 2 & 3 Input AND/OR Expander	SG-290, SG-291, SG-292, SG-293	7	15/gate	1.0	1.5					
OR Expanders										
Quad 2-Input OR Expander	SG-230, SG-231, SG-232, SG-233	2	28	1.0						
Dual 4-Input OR Expander	SG-270, SG-271, SG-272, SG-273	2	6.7	1.0	1.5					
Flip-Flops										
Dual D Flip-Flop	SF-90, SF-91, SF-92, SF-93	30MHz*	75	1.0	1.5		7		7	
Dual 50MHz J-K Flip-Flop (Separate Clock)	SF-120, SF-121, SF-122, SF-123	50MHz*	55/FF	1.0	1.5	11	6	9	5	
Dual 50MHz J-K Flip-Flop (Common Clock)	SF-130, SF-131, SF-132, SF-133	50MHz*	55/FF	1.0	1.5	11	6	9	5	
50MHz J-K Flip-Flop (AND Inputs)	SF-200, SF-201, SF-202, SF-203	50MHz*	55	1.0	1.5	11	6	9	5	
50MHz J-K Flip-Flop (OR Inputs)	SF-210, SF-211, SF-212, SF-213	50MHz*	55	1.0	1.5	11	6	9	5	

*Minimum toggle frequency **Minimum fan-out

Scratchpad memory gives high-speed access.

Sixteen-bit functional array is designed for memory systems with cycle times in the 100 ns range.

Here's a functional array that makes good use of Sylvania's ability to pack more functions into a single chip. The SM-180 16-bit memory, with an access time of 25 ns, has been designed specifically for high-speed scratchpad memory applications.

The single-chip circuit consists of sixteen set/reset flip-flops forming a four-by-four addressable memory matrix (Fig. 1). Read or write addressing is done through four X and four Y lines brought out to external terminals. Four internal amplifiers take care of the read and write functions on the chip. Two of these are sense amplifiers for "0" and "1" reading and the other two are write amplifiers for "0" and "1" writing. Each flip-flop in the four-by-four matrix is logically connected to its own unique address combination, and to the sense and write amplifiers. This design permits nondestructive readout of all sixteen bits.

When a readout command is received, the dual sense amplifiers indicate the state of the selected bit. If a "1" is stored, the sense "1" amplifier gives an output at the proper logic level, and the sense "0" amplifier remains in the unselected state.

Since the SM-80 is word organized, it is relatively simple to expand memory systems in both the word and bit direction.

Figure 2 shows examples of how the SM-80 can be used to form a 16-word parallel memory and a 64-bit memory unit. The sense outputs of the SM-80 are from a single

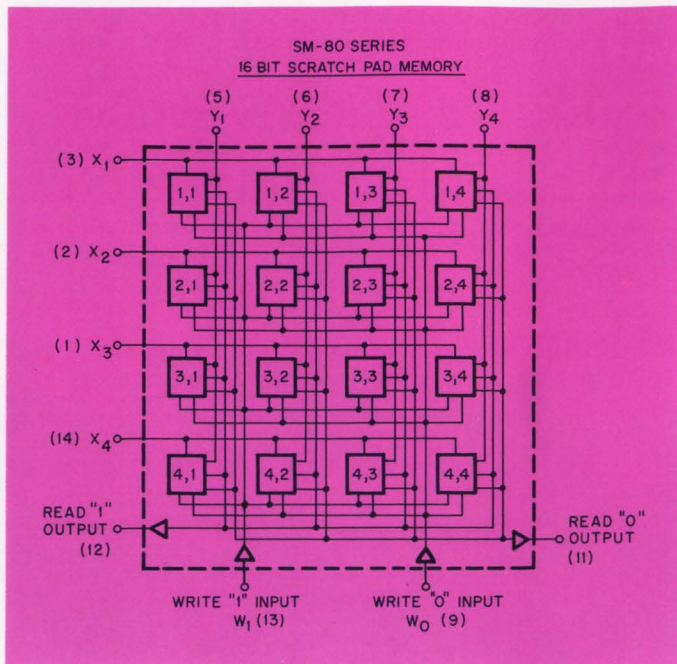

Fig. 1. Logic layout of SM-80 16-bit scratchpad memory.

transistor with no pull-up network. This means word expansion is simplified, since it permits the use of the "wired-OR" function. Such an application requires that an external resistor be used to pull up the "OR"ed collectors. The pull-up resistor can be returned to any V_{cc} less than 6 volts.

The SM-80 comes in both military and commercial temperature ranges. It is available in Sylvania TO-85 hermetically sealed ceramic flat packs or dual in-line packages.

CIRCLE NUMBER 303

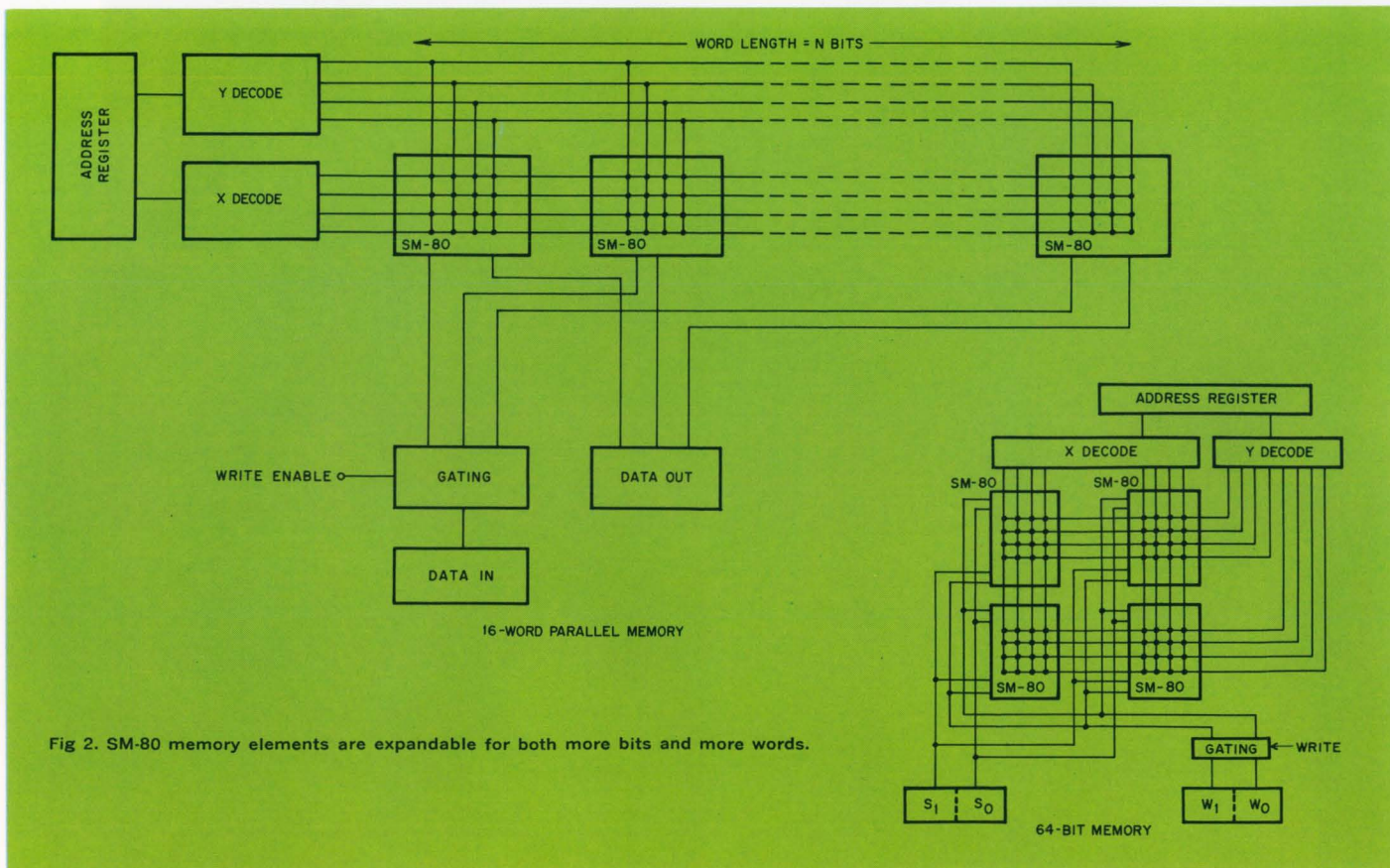

Fig. 2. SM-80 memory elements are expandable for both more bits and more words.

MANAGER'S CORNER

The most often asked questions about SUHL logic circuits.

Sylvania's SUHL logic circuits have been around for over five years. However, we still get questions about the general characteristics of our circuit. Most of these questions deal with what the user can and cannot do with SUHL circuits beyond the information given in the data sheets. Here are some of the most commonly asked questions and our answers.

Can a SUHL I circuit drive a SUHL II circuit and vice versa?
Yes. These circuits are completely compatible with regard to signal level, power supply and pin basing. Individual data sheets define the input unit loads and output current sinking capability of each device.

Will a SUHL circuit drive a DTL?
Yes. Signal swings are compatible. You can compute the number of DTL inputs that can be driven by referring to the DTL input unit load and the output current sinking capability of the SUHL circuit.

Will DTL drive a SUHL circuit?
Yes. Signal levels are compatible. When DTL is driving SUHL circuit inputs, you should keep in mind that TTL inputs have greater input leakage current than DTL inputs. This current must be allowed for when computing the DTL output logic "1" voltage level.

Can a SUHL circuit drive MECL, and conversely will MECL drive a SUHL circuit?
No. MECL requires two power supplies and the signal swing starts below ground. MECL is not compatible with either DTL or TTL.

Does Sylvania have an interface circuit?
Yes. The SG-130 and SG-160 line drivers can be used as interface circuits in many applications. The SG-170 dual 4-input OR expander can be used to translate levels compatible with RTL logic.

Can I drive long lengths of line with SUHL circuits?
Emphatically yes. One of the major features of a SUHL cir-

cuit is its ability to drive heavy capacitive loads. SUHL circuit outputs present a low impedance in the output "0" and output "1" states. SUHL circuit inputs tend to clamp at about 0.7 Volts below ground if ringing should occur and attempt to pull the input below ground. Furthermore, the SG-130 and SG-350 series can be used to drive terminated lines where the termination consists of resistors tied to B+, ground or to both. The high output capability of these devices provides the needed drive to supply these terminations.

I want to buy industrial standard for price advantage but want to use it in the military temperature range. Will this work? Will you guarantee it?

The devices will probably work. However, there are definite tradeoffs in parameter performance. You can expect threshold changes and the possibility of running out of drive capability in the output "0" state. Therefore, we can make no guarantees beyond the specifications shown on the data sheets.

Is the industrial grade circuit less reliable than the military grade circuit?

No. Sylvania circuits are made by the same process at the same time. A device is classified as industrial or military based on its resistor tolerance, primarily. Reliability does not vary from one grade to another. For example, the 10,000-hour life test results reported in our Technical Bulletin No. 7 are based on industrial grade circuits.

Do you guarantee switching times at temperature extremes?
No. There is no practical way to make 100% tests of switching times at temperature extremes on high-speed test equipment. To guarantee switching times at other than room temperature, even on a sampling basis, means special programming. And that means extra cost.

These questions and answers may take care of some of your thoughts about SUHL circuits. If you have further questions, feel free to submit them to us. We'll be glad to give you the straight answers.

John Rienzo
Manager, Applications Engineering



HOT LINE INQUIRY SERVICE

Need information in a hurry? Use Sylvania's "Hot Line" inquiry service. It's easy and it's free. Just circle the reader service number(s) you're most interested in. Then fill in your name, title, company and address. We'll do the rest and see that you get further information by return mail.

You can also get information by using the publication's inquiry card elsewhere in this issue. However, using the card shown here will simplify handling and save time.



Fold and seal with tape or glue. (Do not staple.)

Fold here.

FIRST CLASS
Permit No. 2833
Buffalo, N. Y.

BUSINESS REPLY MAIL
No Postage Stamp Necessary if
Mailed in the United States

POSTAGE WILL BE PAID BY

Sylvania Electric Products Inc.
Sylvania Electronic Components
1100 Main Street
Buffalo, New York 14209

Dept. D 2 2

High-speed clock driver matches SUHL integrated circuit speed.

Hybrid integrated circuit clock driver is designed to drive SUHL and other TTL circuits at speeds up to 50 MHz.

Here's the only 50 MHz clock driver compatible with the size and electrical characteristics of high-speed TTL circuitry. Designed in hybrid form by Sylvania, this power amplifier is capable of driving up to twenty flip-flops at speeds up to 50 MHz. Multiple ground leads, internally connected bypass capacitors, and a carefully determined pin arrangement make it easy to mount this clock driver on printed circuit boards to achieve the low-noise level clock distribution that high-speed circuitry requires.

Because the unit is self-contained (except for one power resistor), it can be conveniently mounted close to the flip-flops to be driven. Also, clock drivers can be cascaded to drive systems containing a large number of flip-flops. Two inhibit inputs, compatible with SUHL I and II logic circuits, are provided to allow for a gated clock system.

The small size of the clock driver package (0.82" x 1.70") makes it physically compatible with the use of flat packs and dual-inline packages.

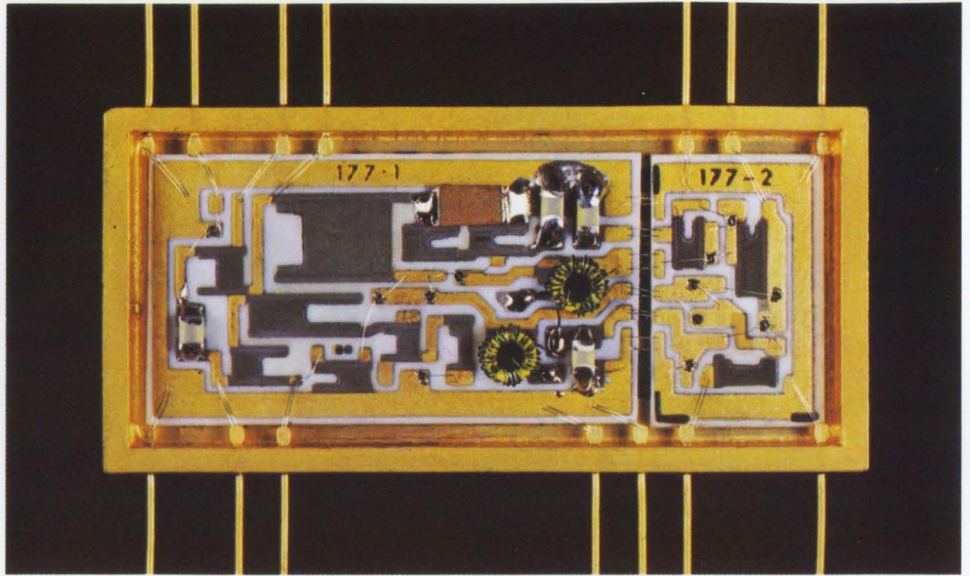

Hybrid construction of high-speed clock driver makes it compatible in size with integrated circuits.

Use of this new clock driver package brings with it a lot of extra advantages. First, its availability relieves you of the problem of designing a high-speed, fast fall time, low-noise clock source. Because we have the circuit in mass production, we can offer this driver at a cost lower than you would pay for a conventional discrete component clock driver card. Our expertise with hybrid circuits makes it easy for us to modify the clock driver to your specs at minimum additional cost. With all these advantages going for you, why not look into Sylvania's clock driver for your systems application.

CIRCLE NUMBER 304

This information in Sylvania Ideas is furnished without assuming any obligations.

SYLVANIA

A SUBSIDIARY OF
GENERAL TELEPHONE & ELECTRONICS

NEW CAPABILITIES IN: ELECTRONIC TUBES • SEMICONDUCTORS • MICROWAVE DEVICES • SPECIAL COMPONENTS • DISPLAY DEVICES

I am especially interested in ICs for following application(s) _____

NAME _____

TITLE _____

COMPANY _____

ADDRESS _____

CITY _____ STATE _____ ZIP _____

Circle Numbers Corresponding to Product Item

300

301

302

303

304

Please have a Sales Engineer call

Tired of tweaking up your oscillator level every time you change frequency?



With the HP 654A Test Oscillator you don't have to adjust the output when you change frequencies. The automatically controlled 0.5% level flatness across the entire frequency range of 10 Hz to 10 MHz eliminates repetitive output level adjustments. And, with your system input automatically controlled, you are free to concentrate on system performance measurements.

Pushbutton selection of any of the balanced outputs of 135, 150, or 600 Ω eliminates the necessity of an external balance transformer—and the error due to transformer response. You have the additional advantage of 50 and 75 Ω unbalanced outputs when required.

The combination of an expanded meter scale (-1 dBm to +1 dBm) and a sensitive output level control assures you of extremely accurate output resolution. Put all these capabilities and more into a lightweight portable instrument that combines laboratory precision with field mobility, and you have the HP 654A—the ideal general-purpose test oscillator.

For specialized television applications — Ask for information on the HP 653A. It has the inherent accuracy and ease of operation of the 654A—plus special built-in

video capabilities required for A2 type television systems measurements.

Do your part to stamp out unnecessary knob twisting and superfluous equipment—call your local HP field engineer for more information. Or, write for data sheets to Hewlett-Packard, Palo Alto, California 94304. Europe: 1217 Meyrin-Geneva, Switzerland. Prices: HP 654A, \$875; HP 653A, \$990.

099/B

HEWLETT  PACKARD

SIGNAL SOURCES



Call your logic module supplier for automated wire listing and wrapping.

Lots of luck if it isn't us.

No one else has a standard module line plus both automated services: wire listing and wire wrapping. So we're your sole source for a new way to save time, money, and trouble in building digital systems.

Fill in some simple forms defining your system. Our computerized design service will convert your design into an error-free, optimized wire list.

The computer will also program our automatic wire wrapping machines. These will lower your wiring costs at least 40% on any job worth doing. And once again you'll save a large chunk of time and money, because our computerized wiring verifier checks every connection. Finally, every board will be neatly wired, with multiple copies exactly alike — unlike the spaghetti bowl effect of hand wiring.

This is a proven system . . . not a flight of fancy. It was used for the entire family of Sigma computer products. And because we developed it for ourselves,

you'll only buy computer time, not development. Ask for our Application Bulletin No. 8 on "Automated Wire Listing."

All this and more modules too.

Our expanded J Series now has 123 low cost ways to solve digital system problems. You can choose among 76 logic modules, four power supplies, 33 cabinets and mounting cases, plus 10 solutions to cabling problems. There's even an edge lamp test assembly that lets you instantly check key points in your system. But our high performance T Series isn't a slouch. There are 73 modules to choose from plus all the hardware the J Series has to offer.

So call your logic module supplier, and if he isn't us tell him goodbye.

SDS
Scientific Data Systems,
El Segundo, California

Phased-array satellite antenna pops up when orbit is reached

TRW's helix unit delivers efficiencies of up to 65% for a straight beam and about 50% at the beam-steering extremes

Antennas on communications satellites have been a constant cause of headaches for designers. Early designs, using omnidirectional, fixed-position radiating elements, were very inefficient; because the satellite rotated, more of the beam was being radiated into space than toward the earth. Later designs turned to electrically despun antennas, but then the motor that did the despinning drained electricity from the limited supply produced by the solar panels [*Electronics*, April 1, 1968, p. 71]. But at TRW Systems Group, a team of engineers is taking a different tack: instead of despinning the antenna, it has developed a phased array of helices that can steer the beam electronically.

It consists of a helically wound flat conductor deposited inside a collapsible plastic tube that stays folded until the satellite reaches orbit; then the tube snaps out, much like a party favor when it's inflated. The difference is that no air is required to unfurl the TRW antenna element; it's stressed in folding and when the strain on the plastic tube is released, it pops out, ready for use.

Steering. "Phased arrays have been more talked about than implemented," says Klaus Schroeder, program manager in the antenna systems laboratory. He notes that the recent launching of the Hughes-built Air Force Tactical Communications Satellite will test a true phased array on a satellite for the first time. But this unit consists of five helices and is designed as a fixed earth-coverage-beam array, not a steerable one.

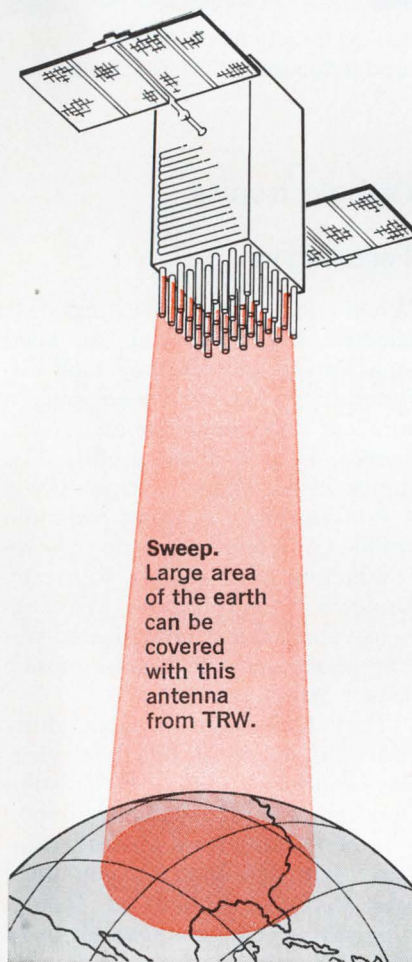

As an array, the TRW antenna will deliver efficiencies up to 65% when the beam is directed straight out, perpendicular to the array. This compares with about a 70% maximum efficiency for a Dial-guide dish antenna, developed by Radiation Inc., which is larger and heavier. And Schroeder says the best efficiency of the ordinary horn-feed antenna using a parabolic re-

flector is about 55%. But the TRW array is at its best compared with other designs at the beam extremes.

Antenna range measurements have shown that the array's efficiency in a 24° sweep is about 49%, or the equivalent of a little more than 3 decibels of loss from the peak aperture gain.

He says the efficiency of a single element in such a tube array has been measured at better than 90%, or an ohmic loss of less than 0.5 decibels.

"This is surprisingly small, for an element with an absolute gain of 15 db at 1.6 gigahertz," he says. "But what really counts is the total array efficiency. I know of no other systems with 50% efficiency at the beam-steering extremes. Some are as low as 10%," the TRW project manager points out.

Schroeder and Samuel Sensiper, manager of the antenna systems laboratory, believe their array will be best used where there's a requirement on a synchronous-orbit satellite for a beam steering angle of no more than $\pm 9^\circ$ or a total of an 18° arc.

Attractive. They envision a 36-element array mounted on one face of the spacecraft that might be about 5 feet square. With a 10-watt solid state amplifier at each element, such an array would deliver an effective radiated power from the satellite of 51.6 decibels above a watt (dbw), Schroeder calculates. That kind of performance, he maintains, will make the array attractive for a variety of satellites: for communications and navigation, television broadcasts, and



Folded up. TRW's pop-out helix antenna is planned for a communications satellite. Phased-array design has high gain and is lightweight. When satellite reaches orbit, plastic rods unfurl.

data relay applications.

In fact, a conceptual version was included in TRW's proposal to NASA in last spring's competition for its Data Relay Satellite System study and hardware development contract, ultimately won by the Airborne Instruments Laboratory division of Cutler-Hammer. But that array wasn't deployable and little performance data had been gathered.

However, TRW's Space Vehicles division is considering adapting the pop-out antenna idea for the Aeronautical Services Satellite—if that project ever gets off the ground.

At 1.6 Ghz (a frequency chosen because it appears that it will be used in a number of programs in the next five years) and using 30-inch-long elements, the array will have a 30° beamwidth. Each such element weighs just 1.58 ounces. After making a study of high-density arrays using self-steering amplifiers, TRW engineers have concluded their design will weigh only about half as much as other systems.

For example, Schroeder says one comparison shows the weight of a reflector system with an earth coverage beam using both a 5½-foot dish and a 2¾-foot dish to be 81 pounds; a 16-element array using TRW's deployable plastic-encased helix will weigh only 40 pounds.

Optoelectronics

Focusing in

When RCA and Westinghouse Electric began working on solid state image sensors they took different tacks toward developing a tubeless television camera [*Electronics*, Feb. 7, 1966, p. 46]. RCA, under an Air Force contract, chose a thin-film course, using cadmium sulfide-cadmium selenide photoconductors over a glass substrate. Under a NASA program, Westinghouse charted less complicated silicon photoconductors in a mosaic sensor array.

Their initial sensors successfully proved the concept, but the devices gave crude pictures of low resolution and sensitivity. Resolution was about 300 lines at best, compared with 525 lines in commercial television. It looked as though tubeless tv cameras would be a long time coming.

Now, however, the two companies have crossed each other's tracks in their respective efforts to produce a fleet of promising camera ideas. RCA's Princeton Laboratories is working on both thin-film arrays for the Air Force and silicon photoconductors with its own money. Westinghouse delivered a 200-by-256-element array for NASA and expects to complete a 400-by-512-element array for the space agency by November. The latter

would achieve tv-quality resolution, says E.L. Irwin, a research engineer with the company's Defense and Space Center, Baltimore.

Major problems. Also in the act is RCA's Avionics Laboratories, Burlington, Mass., which has built a 64-by-64 structure and plans to complete a 128-by-128 structure this fall, according to Dave B. Williams, technical staff senior scientist. For switching, this approach uses chemically deposited thin-film lead sulfide, with photoconductor and standard silicon technologies.

Although sensitivity of these arrays is still many times below that of commercial vidicon tubes, these efforts are so promising that researchers predict compact tubeless cameras within several years. Says Paul K. Weimer of the Princeton Labs: "The major problems right now are those of uniformity of [video] lines, cost, and sensitivity; once those are solved though, the arrays will be good for a variety of uses." He listed among these optical reading, surveillance, and monitoring. The compactness problem is already licked. The heaviest part of Westinghouse's 200-by-256 unit is the lens, and Irwin says the camera could be built in less than 2 cubic inches, including circuitry but without lens.

Solid state sensors are a newer way to do what camera tubes do: regularly and sequentially measure the differences in light falling in specific minute areas. The amount of light corresponds to a charge in the sensors. By regularly scanning at tv rates the differences in charges in the sensors—the 200-by-256 array has 51,200 sensors—the array can produce tv-like pictures. The more sensors, and the closer together they are in a matrix, the better the resolution.

Westinghouse chooses silicon planar-process, large-scale integration technology, using aluminum interconnections for its arrays because the process is well-proved, says Irwin. The major problem here is that the photoetching must be precise because a 0.0025-inch error will invalidate the whole wafer. And since a whole wafer is used for each array, breakage

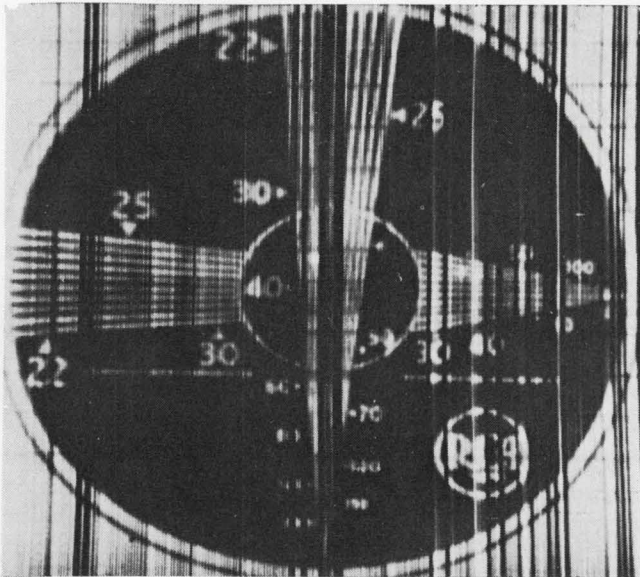

Crude proof. Although resolution and sensitivity are poor, RCA's early efforts with solid state image sensors proved the feasibility of a tubeless television camera.

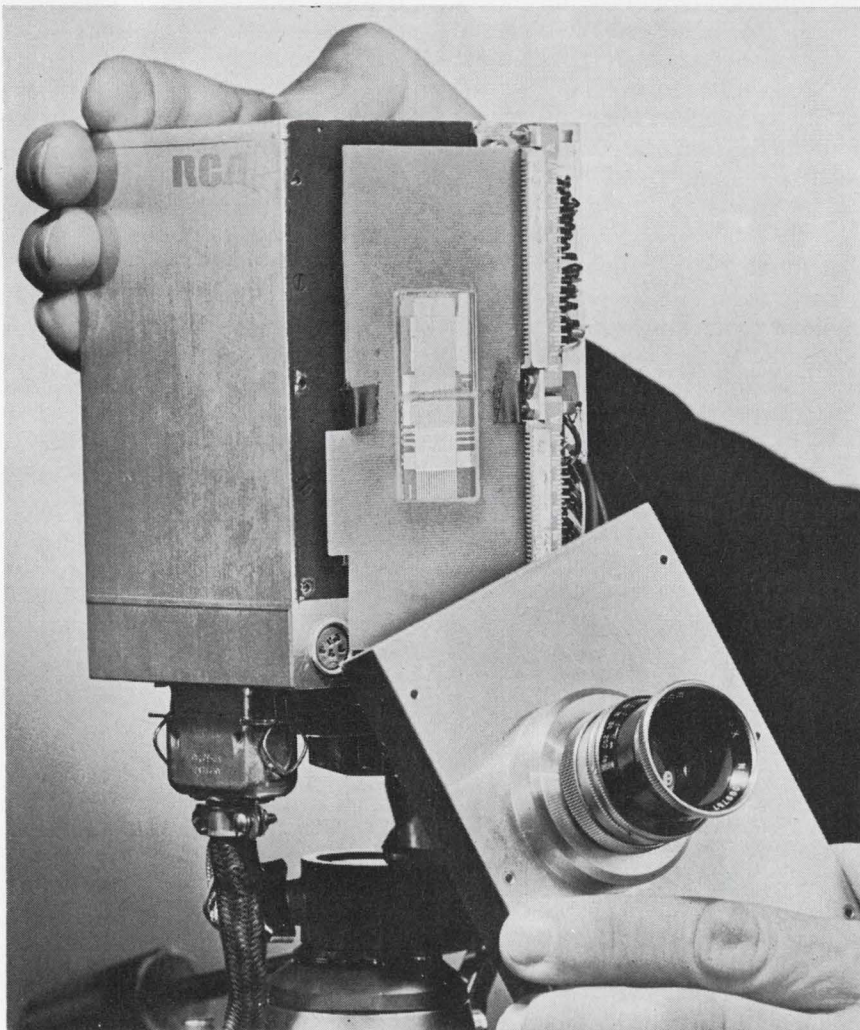

New view. Tubeless tv cameras, like this one from RCA, should eventually provide better sensitivity and resolution and require less power to operate than conventional models.

and handling are also problems.

Not lunar. The logic circuitry is made up basically of junction MOS FET switches for the emitters and the collectors of the photoconductors. Ring counters sequentially switch the pulses to an output video amplifier, notes Westinghouse's Irwin.

Irwin says he doesn't know how NASA will use the large camera, but he's sure it's not for the moon. For the larger camera, the circuitry will be incorporated on printed circuit boards around the sensing array instead of separately from the array as with the smaller ones. The array is less than an inch square.

With its dual efforts, the Princeton labs is assessing the respective strengths of the two approaches. Weimer says that while silicon technology offers greater charge storage in the photoconductor for better sensitivity, thin-film technology has the advantages of longer wavelengths—into the deep infrared. With thin film it is possible to build higher gain into the arrays to activate more electrons per photon encountered. Conversely, thin film can be unstable because it's hard to control thickness.

Weimer hints that the next step may be 360-by-360 units on 1-mil centers (typically, the sensors on all cameras are from 2 to 4 mils

U.S. Reports

apart). These should have sharp resolution.

With that one and Westinghouse's larger one, can a tubeless tv camera be far behind?

Solid state

Faster than ECL

Emitter-coupled logic is the fastest available commercially, but a small company in Lowell, Mass., plans to produce high-speed digital logic that could make ordinary ECL seem almost a slowpoke.

However, the circuits will be sold only in systems, not by themselves. This decision was made because the tunnel diodes needed for the new logic can't yet be produced monolithically. The circuits can be built in discrete and hybrid form, but the new format won't be able to take advantage of low-cost batch processing, and so couldn't compete in price with commercial monolithic ECL.

The company, Tau-Tron Inc., was formed in October by Yohan Cho and John B. Connolly, who became president and vice-president, respectively. Both have been working on ultrafast logic since 1961, first at the Mitre Corp., and then at MIT's Lincoln Laboratory.

"By 1967, we saw that there would be a market for specialized digital signal processors—like fast Fourier, for example," they say. "But we also saw that many of the higher-speed devices then envisioned couldn't be built with the logic types available."

The proof. But as early as 1963, they had been running "proof of principle" data processors that clocked at more than 100 megahertz. "We had developed a logic circuit that combined the speed of a tunnel-diode switch with the isolation of three-terminal devices," says Cho. "With this technique we figured we could go commercial."

The latest generation in their ECL/tunnel-diode development is "easily capable of toggle frequencies beyond 500 megahertz," they say. "Even in hybrid circuit formats, propagation delay runs below 0.7 to 0.8 nanosecond"—a figure achieved by commercial ECL only in monolithic form, and by the highly specialized discrete-component circuits in the Control Data 7600 computer.

Cho and Connolly won't specify how their logic works but will say that its first application is to be in a programable data generator capable of producing words up to 100 bits long; each bit would be generated at rates from one per second to 125 million per second. Later

they will produce a commercial version of their data processor.

To be used for dynamic tests of large- and medium-scale integration or sets of logic circuit boards, "it will be the fastest data generator on the market," says Connolly, "faster than most any subsystem it might encounter, even ECL types. But among its purposes is to prove publicly that our logic works well, and to help us find customers for our eventual ultrafast processors."

Future plans. Cho and Connolly expect the processor to be a new sort of peripheral device, one that would be hardwire-programed quickly to perform the repetitive multiplications or divisions characteristic of digital filtering or other advanced signal processing techniques. "This sort of operation, which is the slowest sort a data processor can do, often can make up three-quarters of a user's work load," says Cho. "By designing processors to do this kind of job at very high speed and the software needed to shunt such work into and out of the peripheral processor, we could not only speed filtering computations but also make more main-frame time available to the user."

Using a Univac 1219 scientific machine as an example, Cho says that computations that might take 50 or more memory cycles under ordinary circumstances could be done in less than a single cycle with the sort of processor envisioned by Tau-Tron.

But for now, Tau-Tron plans only data-generator sales, with introduction of the tester due sometime in March. "It's our first step in getting the word out," says Connolly.

Power grab

When C. Lester Hogan took charge of Fairchild Semiconductor late last August, one of his first directives was that the company find a way to get back into the consumer-industrial power-transistor business it had abandoned only a few months before. The problem at that time was that Fairchild's planar technology, with its many maskings and its tight registration requirements, was too expensive a



High-Speed. Logic circuits faster than ECL designs have been developed by John Connolly, standing, and Yohan Cho, of Tau-Tron.

The Honeywell 500

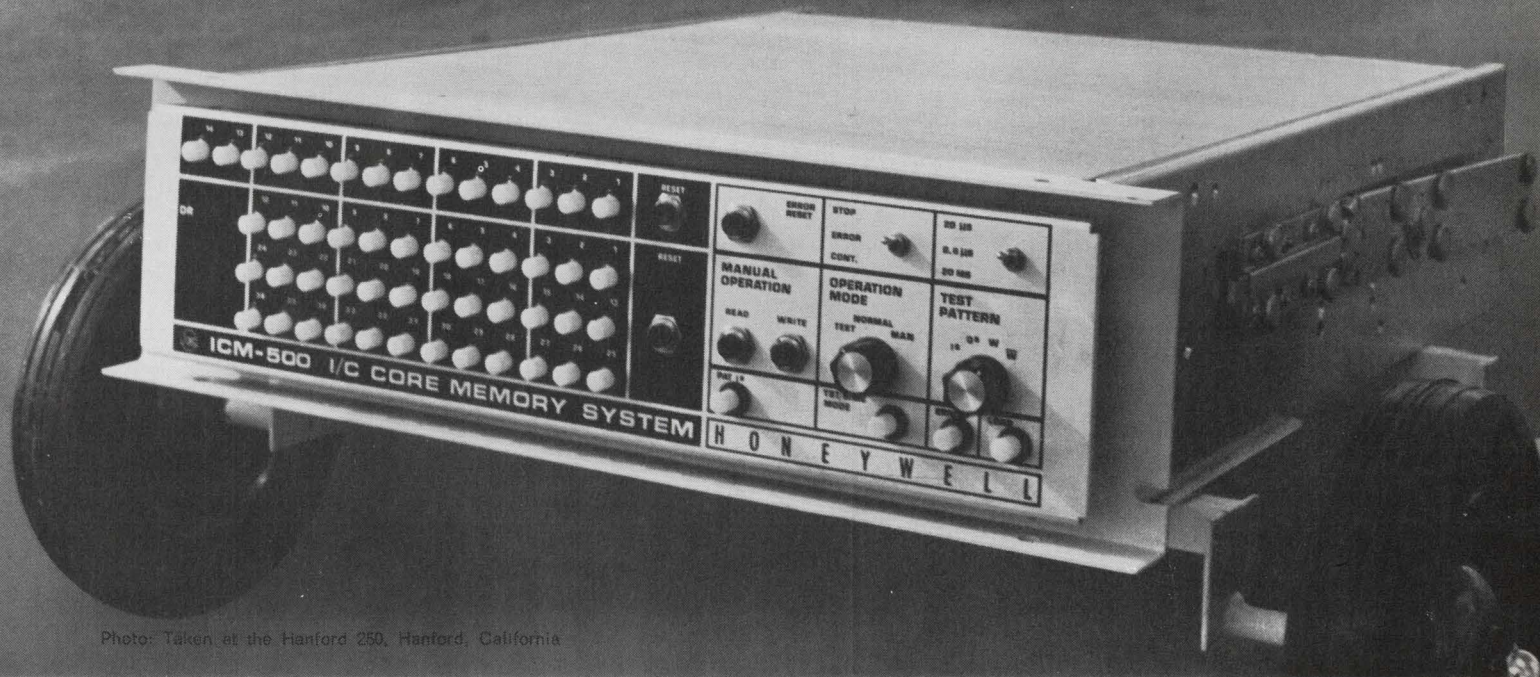

Photo: Taken at the Hanford 250, Hanford, California

Honeywell's fastest, high-performance memory system: the ICM-500. Standard model, 600 nsecs full cycle with capacity up to 32K words in a 5 $\frac{1}{4}$ " high chassis.

Overhauls are rare. The all I/C (even sensing and direct-drive selection lines) ICM-500 clocks out at 22,000 hours MTBF.

If you're looking for a winner in high-speed storage and buffering, go ICM-500. In the Honeywell Age, it's the systems man's edge. Want the track record? Write Honeywell, Computer Control Division, Dept. 500, Old Connecticut Path, Framingham, Massachusetts 01701.

Honeywell
AUTOMATION

(206) 746-9250 Ext. 2100
(212) 275-6200 Ext. 770
(213) 278-1901 Ext. 32
(214) 363-5441 Ext. 0219
(215) 835-2500 Ext. 2214
(305) 841-1570 Ext. 2400
(312) 671-1800 Ext. 73
(313) 836-7170 Ext. 7171
(314) 862-1000 Ext. 135
(315) 463-4534 Ext. 1177
(404) 875-9561 Ext. 12
(408) 732-0120 Ext. 1041
(412) 922-4422 Ext. 107
(505) 345-1656 Ext. 2954
(617) 893-2610 Ext. 2710
(703) 524-8200 Ext. 227
(713) 785-3200 Ext. 322
(714) 276-4162 Ext. 2017

U.S. Reports

method of fabrication—especially when pitted against mesa techniques with their resulting looser geometries.

"We knew we couldn't get back into the market with planar," says Thomas Ciochetti, Fairchild's marketing manager for power and special devices, "so we put a task force to work on other methods." That group came up with a hybrid technique that combines both mesa and planar methods. And Fairchild this month will begin sampling the market with the first three products. "This new process, plus an epoxy package, will put us back in the consumer business," he says.

Bigger chips. The epoxy package will come later in the year, when the company begins assembly at a new plant in Singapore. No longer bugged by big-chip problems, Fairchild plans to build devices measuring nearly 400 mils a side, devices capable of handling 100 amperes at 30 or 40 volts. The first products, however, will be devices that Ciochetti says are already popular in the consumer market—in clock radios and car radios, for instance—the 2N3054, 2N3055, and 2N5023.

Fairchild attributes the devices' power-handling capability to their two high-resistivity areas—an n layer grown epitaxially on an n+ substrate and a p layer grown epitaxially on the n layer. The substrate and the n layer form the collector while the p layer is the base. Into this p layer is diffused a small discrete n+ emitter. The emitter-base junction is thus protected in the familiar planar fashion—that is, it's beneath the surface. The mesa is formed by etching the base; the collector-base junction is thus exposed and is passivated with a silicon monoxide layer.

In the collector, the n layer provides the resistivity needed for high breakdown voltage and the n+ layer keeps the saturation voltage low. Fairchild wants to limit voltage saturation to 1 volt at 10 to 20 amperes.

The mesa construction permits high-voltage operation—up to 300 volts at 10 amps, Ciochetti says. The p region is relatively deep (exactly how deep is a Fairchild

secret), and the epitaxial growth is an inexpensive way to get a wide region for thermal gradients between emitter and collector.

Stable emitter. Fairchild claims that the diffused discrete emitter, which it has used in its power devices for several years, is the most stable type of any now offered. The emitters—as many as 250 on some devices—are connected to a bus by evaporated thin-film nichrome resistors. Any individual emitter that draws too much current is biased toward cutoff by the voltage drop across the resistor. And since a resistor may evaporate and burn out under overload conditions, failure isn't catastrophic. The company reports that up to 20% of the resistors have evaporated in tests before beta rolloff. This factor increases the safe area—the area under the current-voltage curve where a transistor will operate without going into secondary breakdown.

In summing up the effect of the innovation, Ciochetti says: "Before, we had to live with mesa prices and ship planar devices. Now it will be different." Fairchild has been strictly a planar house; before the new line of transistors, it made only one device, a microwave diode, with the mesa technique.

The company will have a whole line of power transistors on the market within six months, Ciochetti says, with the 100-amp device being the last. That one may be packaged in a 1¼-inch can with a stud; the biggest such package now available, the TO-61, measures 11/16 inch across.

And even bigger devices may be on the way. Wilfrid Corrigan, Fairchild's group director for discrete devices, told a meeting of securities analysts that the company plans to build power transistors a half-inch on a side.

Consumer electronics

Pushing buttons

A long-time champion of uhf broadcasting, Federal Communications Commissioner Robert E. Lee

tried for years to persuade television receiver manufacturers to voluntarily include detent uhf tuners on all sets. Lee feels that uhf stations aren't getting a fair break on the receiver dials.

He and fellow commissioners now propose a rule that all receivers have "comparable ease of tuning" for both vhf and uhf channels. The rule, if approved, would open up a large market for detent tuners—which work with a "lock and click" action—or for push-button tuners [*Electronics*, Jan. 6, p. 60]. The FCC says that the ideal receiver would have the same tuning method and tuning aids for both uhf and vhf. On almost all receivers now manufactured, there are two tuning controls—one for vhf and the other for uhf.

But the FCC says that industry "has the capability to reduce disparities between uhf and vhf tuning systems." It bluntly says, in announcing the proposed rule, that it doubts industry will voluntarily move toward "reducing the tuning disparities."

Lee met with industry representatives and representatives of the All-Channel TV Society—an industry group lobbying for uhf—several times last year in an effort to get makers to go along. But the meetings were unsuccessful.

Legislate progress. Manufacturers at these meetings claimed there was no acceptable device available they could use. The big problem they faced was cross-modulation [*Electronics*, Jan. 6, p. 88].

"Their big argument was that you can't legislate progress," says one FCC staff member. "Well, let's see what they say about the proposed rule. Maybe we won't have to make a ruling. Perhaps the threat will do it."

The FCC, in seeking comments on its proposed rule by March 21, asked set manufacturers for details on when they plan to introduce tuning features to eliminate disparities. The commission also wants to hear comments from makers of equipment for uhf and vhf tuning, and from set makers on how receiver prices would be affected.

All-channel receivers account for

HIGH QUALITY DATA RECEPTION IS CRITICAL

...and you can rely on Scientific-Atlanta's Model 410A Telemetry Receiver to deliver your data without distortion or interference.

LOW DISTORTION

Bessel-type IF filters are phase linear to within 3° over the entire 3 dB bandwidth. I/S ratios are less than -45 dB.

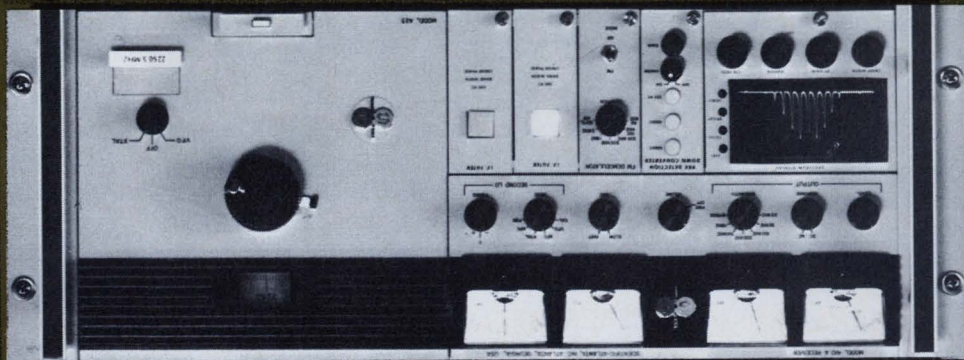

ULTRA-LINEAR DEMODULATORS

Pulse-averaging FM demodulators provide linearities of less than 1% for deviations up to 2 MHz.

MINIMIZED INTERMODULATION

Double-balanced, hot-carrier diode mixers with +10 dbm intercept points and the use of FET front-end circuitry assure extremely low intermodulation products in multiple signal environments.

DIRECT PLAYBACK DEMODULATORS

Spurious responses and data distortion resulting from up-conversion playback of predetection recorded signals are eliminated by the use of pulse averaging direct demodulators. Center frequency correction and tape speed compensation are also provided.

For complete information, contact

Bob Holman, P.O. Box 13654
Atlanta, Georgia 30324

Telephone 404-938-2930

Scientific-Atlanta

U.S. Reports

about 45% of the total now in use, compared with 16% in 1962 when the law was passed requiring sets to have both uhf and vhf tuning. The FCC expects that 75% of all receivers will be all-channel by the end of 1970.

Seeing the handwriting on the wall, the National Association of Broadcasters is studying ways to improve uhf television receivers.

Instrumentation

High-speed recording

An instrumentation tape recorder with a bandwidth of 10 megahertz and a capacity of 14 million bits per second will be developed for NASA by Ampex. By June of next year, Ampex is to deliver to the Goddard Space Flight Center in Greenbelt, Md., a prototype of an instrument that may become NASA's standard telemetry recorder.

There are no radical changes in the new instrument; the bandwidth will be increased from the present 6-Mhz limit mainly by a new tape transport and a more efficient head design, according to Robert H. Horn, senior project engineer. Like Ampex' 6-Mhz FR-900, the instru-

ment will have a rotary head and will write at 1,585 inches per second. But the new instrument will read changes in wavelengths as short as 100 microinches, compared to 170 microinches for the FR-900.

Firmly packed. Moreover, the recorder will use a new method of data redundancy that permits a much greater packing density. To prevent losses of data from "drop-outs" (dirt or scratches on the tape), the data is normally recorded twice, once by each of two sets of four heads placed at 45° angles from each other on the drum. The technique reduces the chance of error from 1 in 10⁴ to 10⁵ to 1 in 10⁸ to 10⁹.

However, it also wastes every other track. The drum in the new recorder will have only four heads—but each head will have two recording gaps, 50 mils apart. The gaps record in strips only 3.5 mils wide, on each side of a 1.8-mil guard band. The FR-900 has tracks 10 mils wide and a 2.5-mil guard band.

To save tape while recording extremely slow data, or to use the full bandwidth in recording high-speed data that must be slowed down for computer processing, the new recorder will have a speed selection ratio of 256 to 1. Present

recorders have only one speed.

NASA will use the instrument at its satellite tracking stations, but Ampex expects it to have wide application elsewhere.

Government

Silent treatment

A private unpublished study of Defense Department procurement policy was leaked to the press last month and became an instant hit. [*Electronics*, Feb. 3, p. 33]. For its assertion that the Pentagon was paying high prices for heavily electronic weapons systems that didn't meet specifications added fresh fuel to the growing controversy over defense procurement.

But as quickly as it came, it went, whisked away under a cloud of official silence. Defense Secretary Melvin Laird said he had instructed his number two man, David Packard, to study it and then instructed no one in the Pentagon to talk about it. Industry and company spokesmen declined comment. And the author himself, Richard A. Stubbing, an analyst for the Bureau of the Budget who wrote the paper as a graduate thesis, says: "I can't say anything right now. I've been told not to."

In Washington, the commonest way to kill something is to refer it for study.

Reprise. But this paper, which seems to focus on just how the Pentagon manages the funding of its huge systems, will undoubtedly be referred to—and used—at some promised Congressional probes into defense spending.

Entitled "Improving the Acquisition Process for High-Risk Electronic Systems," the study asserts that out of 13 major Air Force and Navy aircraft and missile programs since 1955, programs costing some \$40 billion, only four resulted in systems that performed satisfactorily. Satisfactory performance he defines as electronics reliability over 75% of initial contracted-for specifications.

Stubbing, noting that the electronics gear aboard military air-

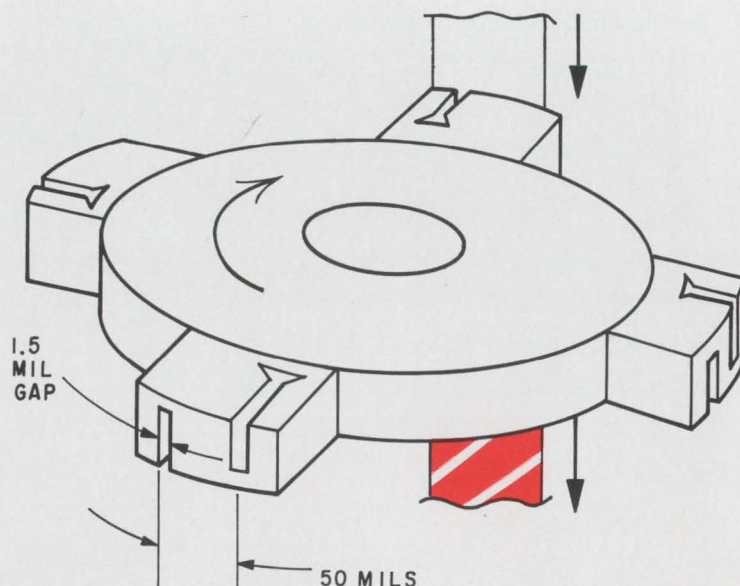

Zippering along. New Ampex instrumentation tape recorder has only four heads—instead of eight—but each head contains two recording gaps. The instrument has a bandwidth of 10 megahertz and a capacity of 14 million bits per second.

Now! High Power, High Efficiency at 225-400 MHz with New Family of RCA "overlay" Transistors

New power performance for VHF/UHF comes in RCA's new radial lead package—in a family of "overlay" transistors. For your driver, pre-driver, and output circuit requirements, RCA offers the following developmental types:

TA7344—16 W (min.) output at 400 MHz; 6 dB gain

TA7367—10 W (min.) output at 400 MHz; 8 dB gain

TA7411—2 W (min.) output at 400 MHz; 10 dB gain

These units, silicon "overlay" n-p-n transistors, are housed in a package

designed for low input and output parasitic lead inductances. And low capacitances, too. The wide leads, all isolated from the stud, are uniquely "sandwiched" between ceramic layers to provide an over-all hermetic case with exceptional mechanical strength.

TA7344, TA7367, and TA7411 can be used effectively as direct replacements for plastic stripline types. All are intended for large signal, broadband linear RF power amplifiers for military and industrial equipment operating in

VHF/UHF frequencies.

For more information on this expanded family of "overlay" types and other RCA "overlay" transistors, see your local RCA Representative or your RCA Distributor. For technical data on specific types, write:

RCA Electronic Components,
Commercial Engineering,
Section No. PN 22A,
Harrison, New Jersey 07029.

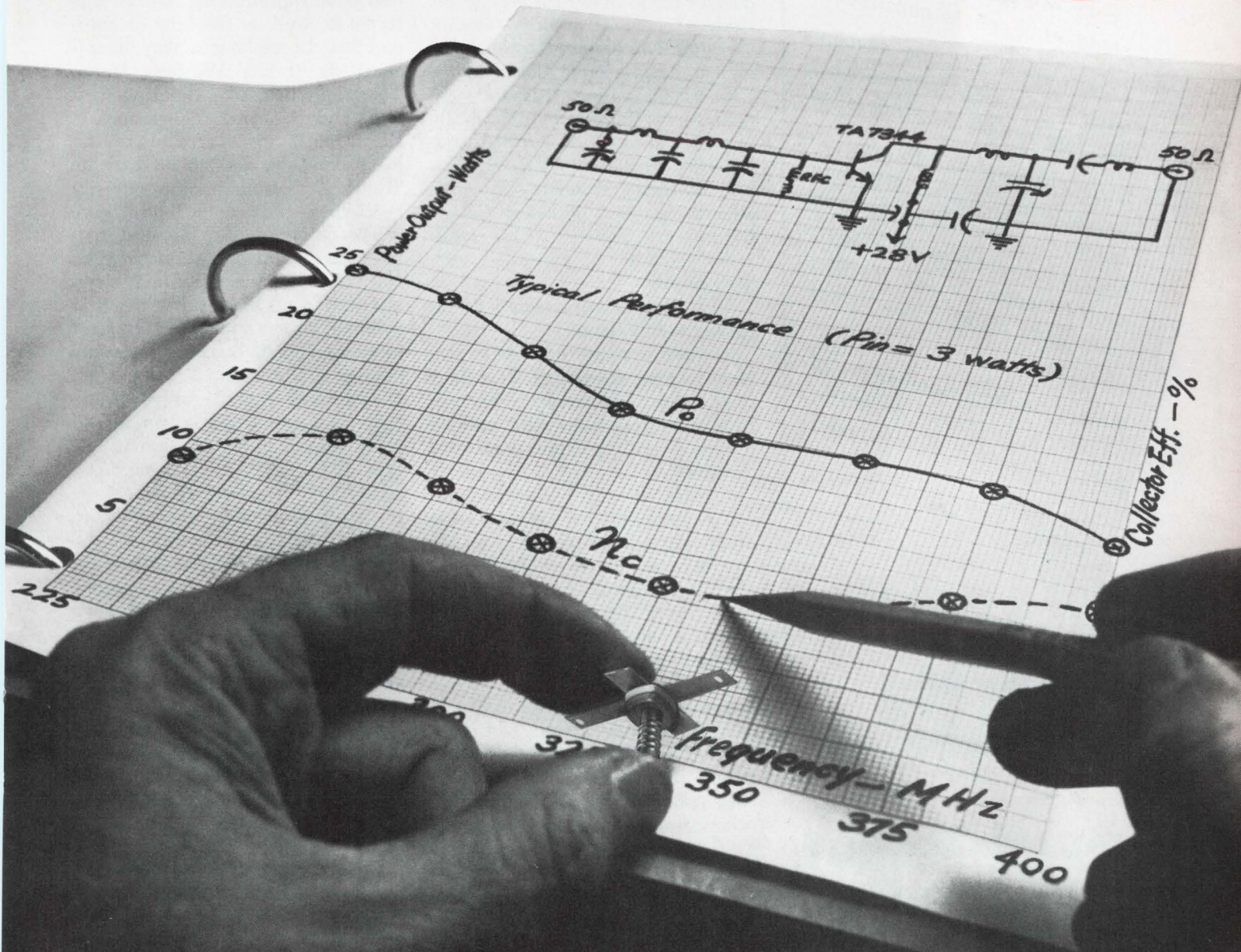

Total Capability

IN CARBON VARIABLE CONTROLS

Singles, concentric duals, tandem duals . . . with or without switches . . . All available at Mallory. Practically everything you require in standard or special construction.

Long wear, noise free elements used in all carbon controls for satisfactory trouble free operation.

Switches attached to controls available in 1, 3, 5 and 6 ampere ratings . . . Special switches for high in-rush current applications such as color TV and tungsten lamp loads made to your specifications.

Mallory Controls Company, a division of P. R. Mallory & Co. Inc., Box 327, Frankfort, Indiana 46041.

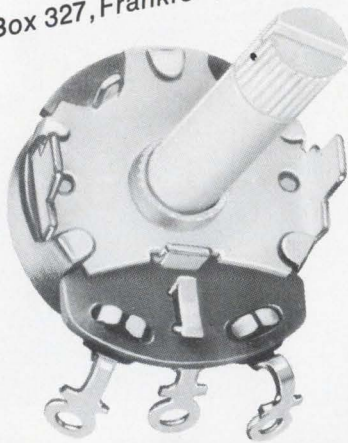

MALLORY

U.S. Reports

craft and missiles is becoming increasingly complex, charges that aerospace companies propose systems whose technologies are not yet proven in order to offer attractive designs and beat out the competition. He says the Pentagon chooses among these proposals on the basis of paper designs and can't adequately sift through all the paperwork anyway. And he further asks why there is never an electronics competition after the final airframe contractor has been selected?

Stubbing also states that electronic systems developed over a long period of time work better than those resulting from a crash program. He cites the Sidewinder missile as an example, although he doesn't name many systems in his study because of security reasons.

Payoff. In comparing profit margins among various types of industries, he finds that aerospace companies have the second highest rate of return in terms of invested capital; the drug industry heads the list. Stubbing wonders why specific companies producing below-par military systems (by his standards) seem to be rewarded with high profits.

Stubbing's recommendations include the following:

- When a plane or missile system is being developed in a short time, the electronics systems should be less innovative and be designed with a high degree of certainty.

- When advances in technological capability are the goal, the minimum development period should be five to seven years.

- The system's life cycle, concept formulation, concept definition, engineering development, and production should be kept as competitive as possible.

Before it was shrouded in official silence, Stubbing's study got some broadsides. Defense officials questioned his use of mean time between failure as the only valid criterion for assessing the reliability of electronics systems. Others contended that weapons systems should be judged not on whether they meet their contractual specifications but whether

they are better than the ones they replace. And some industry spokesmen muttered that companies couldn't afford severe competition through a system's life cycle. Some were of the opinion that such competition might wind up costing the Pentagon more.

One thing is clear: Stubbing's study has exposed some touchy nerves. And there are people in and out of Congress who look forward to a re-release.

Communications

Telegram by pcm

Traffic's a problem around the nation's metropolitan areas—message traffic as well as the flow of automobiles. In seeking a way to un-snarl its traffic, Western Union Telegraph has, like the Bell System and General Telephone & Electronics, discovered that the least expensive way to increase its "short-haul" transmission capacity is to go to pulse-code modulation.

The company now has a system in experimental operation between New York and neighboring Newark, N.J., and claims it's the first common carrier to use pcm to send teleprinter signals. The prototype system, dubbed Mini-T, has worked out so well that Western Union is now looking for a vendor to make terminals for 15 similar setups—all for use in short, local links.

Expansion. "Mini-T was developed primarily for local operation, where our circuits are most overcrowded," explains Russell DeWitt, the firm's manager of transmission systems engineering. "We expect to have pcm systems in Atlanta, Los Angeles, Chicago, and Dallas as well as New York by the end of this year."

The prototype system employs medium-scale integrated circuits, but the company won't say whose. Mini-T can transmit up to 168 200-bit full duplex channels simultaneously.

Cost cutting. On the basis of tests with the New York-Newark hookup, Western Union officials estimate that because more mes-

OUR MAGNETIC PERSONALITY GIVES US SOME OF THE BEST CONTACTS IN THE RELAY BUSINESS

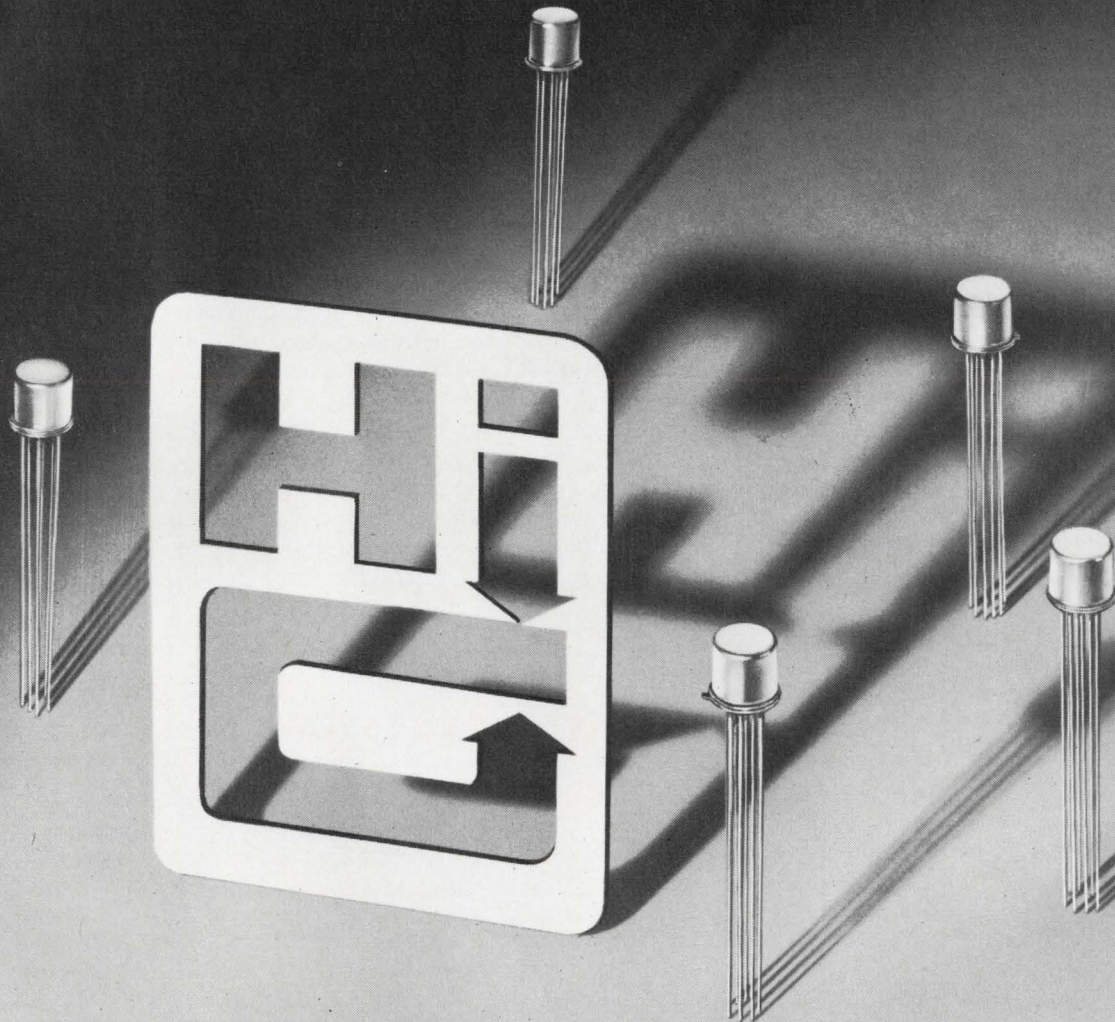

RELAY TYPE	SERIES MA & MS
Size	TO-5
Contact Arrangement	DPDT
Max. Rated Contact Current	1 amp at 32 Vdc
Construction	All Welded
Weight	
Series MA	2.9 Gms Max.
Series MS	4.5 Gms Max.

A uniquely designed and unusually efficient magnetic assembly gives our new TO-5 size relays exceptionally good contact resistance. But this isn't the only reason for great reliability in our MA-MS series.

For example, every MA-MS relay we make is miss-tested. Relays that pass our test are accepted only on the basis of *uniformity* within the acceptable maximum limits.

Relays are assembled and then subjected to a multi step cleaning process all in laminar flow chambers. All units are then out-gassed in an open state at .001 microns of mercury and over 200°C temperature. From start to finish all assembly including welding is done under a strictly controlled atmosphere.

Hi-G's concern for design and manufacturing processes gives you an ultra reliable relay that will withstand tough environmental stresses and meet all applicable portions of MIL-R-5757.

For more details write or call Hi-G for Bulletin #90. It could be one of the best contacts you've ever made.

Total Capability

IN SWITCHES

Rotary, lever and push button. Mallory has them all . . . and more. Dozens of different switches for hundreds of applications.

For prototype or production, Mallory can readily supply standard switches or custom-made units tailored to your specifications.

Terminal contacts are high quality, special alloy brass . . . silver plated. Low contact resistance is maintained by built-in self cleaning action between rotor and stator contacts.

Many switch sections are available in both phenolic and ceramic insulation.

Mallory Controls Company, a division of P. R. Mallory & Co. Inc., Box 327, Frankfort, Indiana 46041.

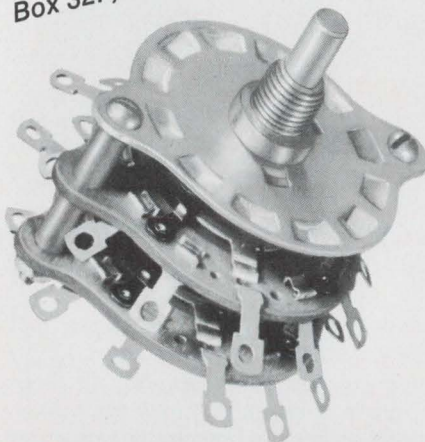

MALLORY

U.S. Reports

sages can be sent via pcm in a given time period, the new systems will reduce transmission costs by as much as 35% over a typical 8-to-10 mile route. As an added benefit, Mini-T doesn't require analog signal processing; the telegraph company's traffic is all digital.

DeWitt's group, which designed Mini-T, is now working on 2,400-bit and 50-kilobit systems for long-distance pcm transmissions.

Advanced technology

Cooler LSA diodes

Bulk-effect devices operated in the limited space-charge accumulation (LSA) mode, discovered in 1967, have yet to fulfill their promise of high power and efficiency at millimeter frequencies. It was obvious that one way to boost power was to make the diodes bigger, but increasing size and input power produced too much heat to be dissipated without making some basic design change. Bell Telephone Laboratories tackled the problem by changing the topography of the diode so that it allowed heat to be dissipated more efficiently.

Terence Riley, a Bell Labs scientist, worked out a fabricating technique in which parts of a disk-shaped piece of gallium arsenide that stands on the heat sink are etched away, forming a mesa that allows more heat to be dissipated radially.

His next step was to form three such mesas, tripod-shaped, on the heat sink. The result: a small array with even better radial heat dissipation and good mechanical stability. Many such structures have been batch-fabricated on a single wafer.

Upper limit. Riley predicts that such a tripod structure could generate up to half a watt, continuous-wave, with an efficiency of 20% at 150 gigahertz. And, he adds, an array of 17 mesas could be paralleled to generate 3 watts, c-w, at 50 Ghz; 17 mesas is about the upper limit because beyond that it would be impossible, based on the present state of the art, to match impedances.

So far, however, Bell Labs has operated the three-mesa diode in the transit-time mode only, achieving 250 milliwatts c-w with 3% efficiency at X band. Ironically enough, conventional designs have achieved 500 mw in this frequency

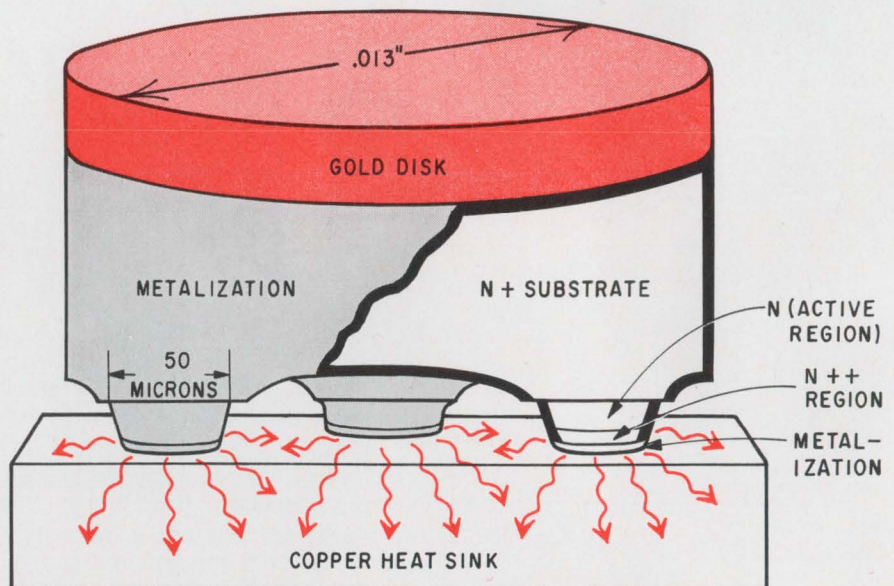

Mesa stool. To improve heat dissipation from LSA diodes for higher output powers and efficiency, Bell Telephone Laboratories etches away the face bonded to a copper heat sink. The resulting mesa shape exposes more heat-sink surface, increasing radial dissipation. The center mesa is set back from the other two, forming a tripod for easier handling and bonding.



nimo™

four decade display tube

Now, a new dimension in electronic display at a low, low price. IEE presents the Nimo™ four decade display tube at the unheard of price of \$3.50 a decade.

Single plane presentation, variable brightness, minimum power consumption, temporary data storage, but primarily *four bright legible decades*.

The new four decade Nimo™ display tube is only 1.135" in diameter with

$\frac{3}{8}$ " high characters in various colored phosphors.

We've reduced space requirements 75%, lowered the cost to compete with gas discharge tubes, and put the necessary electronics onto one circuit board boasting features like:

- 100% digital—no analog yoke control problem
- No character generation required
- All inclusive decoding and deflection

- No precision power supplies required
- Only *one* non critical adjustment
- MSI components used throughout

No wonder Nimo™ is called The Uncommon Readout, for IEE has made the unique commonplace. We've been improving on the readout art for many years and feel our four decade Nimo™ display is quite a performer. So will you... at \$3.50 a decade.

P.S. A six decade is on the way.

The uncommon readout.



Industrial Electronic Engineers, Inc.
7720 Lemona Ave., Van Nuys, California 91405
Telephone: (213) 787-0311 • TWX 910-495-1707

Total Capability

IN WIRE-WOUND RESISTORS

Vitreous enamel, fixed and adjustable. Whatever you need in wire-wound resistors, Mallory can deliver. 1 ohm to 100K ohms. 3 watts to 200 watts. Cylindrical and flat, with standard or special terminals.

Excellent resistance to thermal and mechanical shock, humidity and electrolysis. High wattage dissipation. Long life and outstanding durability. Top reliability in extreme environments. Permanently welded connections.

Whatever your needs in wire-wound resistors, Mallory can fill them.

Mallory Controls Company, a division of P. R. Mallory & Co. Inc., Box 327, Frankfort, Indiana 46041.

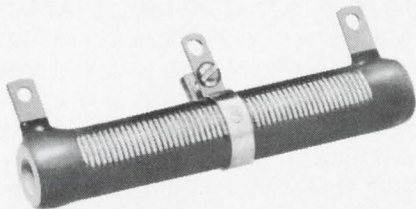

MALLORY

U.S. Reports

range. However, Riley points out that the latter experiments were done with gallium arsenide of relatively high quality. The labs has been unable to grow material with as uniform a doping profile and hasn't been able to get it from outside suppliers. So Bell has never really had a chance to test the mesa approach in the LSA mode, nor, for that matter, to evaluate it fairly in the transit-time mode.

Singles, too. In the mesa technique, the etching step removes part of the active region of the gallium arsenide, reducing power somewhat. But the improvement in heat sinking makes it possible to handle much more input power, thereby increasing the output.

The mesa structure can also be applied to single diodes, which could then be bonded near each other on a heat sink. However, forming three or more devices on the same chip greatly eases handling and bonding.

Companies

A word of advice

How does a large company like Sprague Electric develop a new line of business, like power transistors, without taking too big a financial risk? The answer, according to Sprague, was to go into partnership with "a group of well-known semiconductor specialists" to form Pirgo Electronics Inc.

But there's more to the story: among that group of well-known's are Richard Hanschen and Richard Petritz, the men who left Texas Instruments last year to form New Business Resources, a company that specializes in marrying technology and capital.

High power. As sources close to the situation tell it, Sprague consulted with New Business Resources on ways to improve its semiconductor business and Pirgo was the result. And along with obtaining some of the financial backing, it appears that Hanschen and Petritz also had a hand in recruiting some of the new firm's management, three of whom are TI alumni

—Frank Klosowosky, Pirgo president, and Gilbert Levy and Arnold Allen, vice presidents.

Pirgo, which is located in Farmingdale, N.Y., is planning to introduce, possibly by the spring, npn and pnp silicon, planar, 50-megahertz power transistors. These will be followed by single diffused devices with collector currents ranging up to 90 amps. Also on the company's agenda are power MOS FET's, and r-f power transistors.

For the record

Up in the air. Hughes Aircraft is developing a 1-watt 60-gigahertz transceiver after winning a two-year, \$200,000 Air Force contract sought by about 30 competitors. A spokesman at the Hughes Research Laboratories says the Avionics Laboratory at Wright-Patterson Air Force Base wants to study the transceiver for a satellite application. At 60 Ghz, the atmosphere severely attenuates signals from space because of oxygen absorption, which makes the frequency attractive for secure satellite-to-satellite communications.

The Hughes source says the best output for impatt diode oscillators in the V band is about 100 milliwatts. The biggest challenge will be to get the 1 watt out of the impatt diodes that will serve as the solid state driver in the system. Although the work has just begun, outputs of 20 mw have already been achieved.

Missile award. Texas Instruments has received an \$80,000 contract from Boeing to do preliminary design work on a homing device for the Advanced Surface Missile System. Boeing is the prime contractor for the Navy's ASMS program. TI's Government Products division will assemble data on the electronic target seeker and report back to Boeing this spring. This device will guide the missile during the last stage of flight.

Pacific bird. The second Intelsat 3 satellite was orbited over the Pacific this month by the Communica-

The deflection plate aligner

LOW CURRENTS:

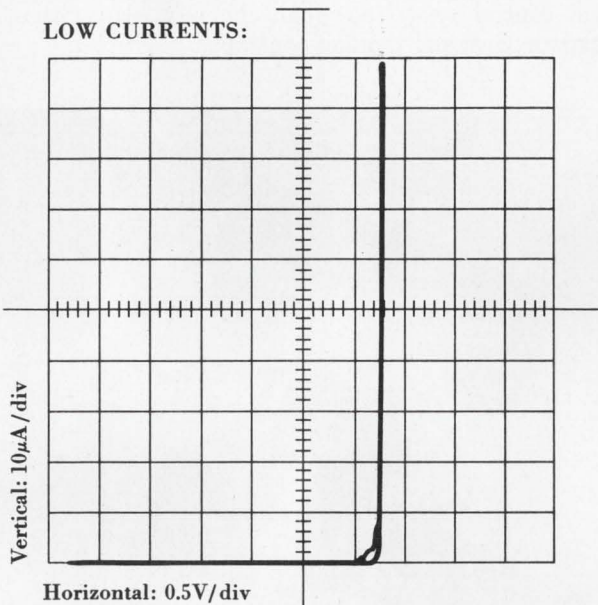

MEDIUM CURRENTS:

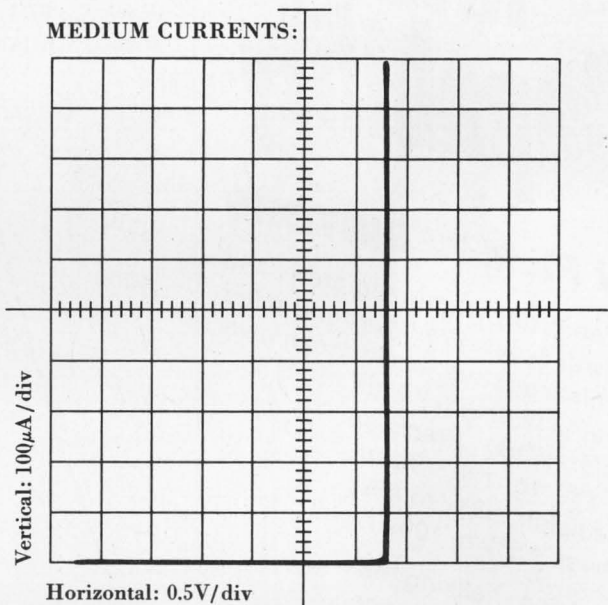

HIGH CURRENTS:

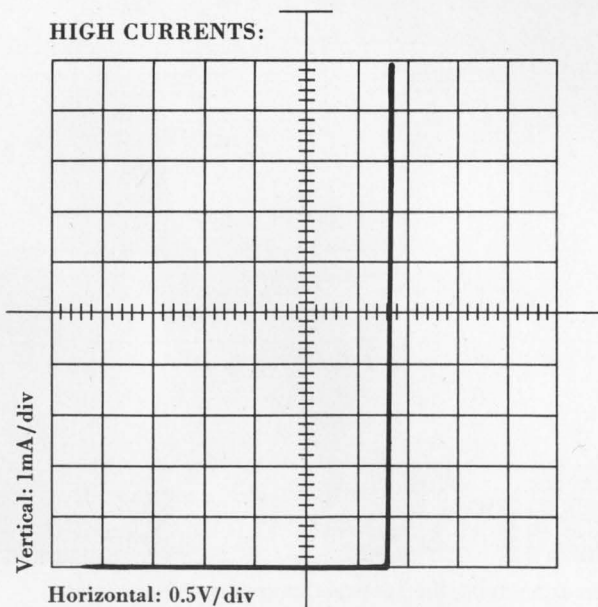

\$6.00* buys you the only integrated voltage reference that can give you these traces.

At any of ten voltages from 5.6V down to 2.4V. Or all the way down to 2.2V, 2.0V and 1.8V if you insist. And the voltage you choose will typically vary 15mV from $100\mu\text{A}$ to 1mA (or 125mV over its full $10\mu\text{A}$ to 10mA range).

Ask for it by name — the LM103.

*100 up quantities

National/Linear

National Semiconductor, 2975 San Ysidro Way, Santa Clara, California 95051 • (408) 245-4320 • TWX 910-339-9240 • Cables: NATSEMICON

Total Capability

IN FILM RESISTORS

Precision, semiprecision and power types. Whatever you need in film resistors, Mallory can give you. $\frac{1}{8}$ watt thru 7 watt. Tolerances: Precision $\pm 0.1\%$ to 1% ; Semiprecision $\pm 2\%$ to 5% ; Power $\pm 5\%$ to 10% .

Precision helixing assures tight resistance tolerances and uniform heat dissipation. Molded or conformal coating with epoxy or silicon protects resistors from moisture and environmental contaminants. Special "No Flame" coating available for power types.

Whatever your needs, Mallory can fill them.

Mallory Controls Company, a division of P. R. Mallory & Co. Inc., Box 327, Frankfort, Indiana 46041.

MALLORY

U.S. Reports

tions Satellite Corp. This brings the number of operating commercial communications satellites now in orbit to four and doubles the number of television and telephone satellite circuits across the Pacific. Plans now call for having four Intelsat 3's in orbit by year-end, with one each over the Pacific and Indian Oceans and two over the Atlantic.

Towering. The TSW-7 portable control tower designed for the Air Force's 407L tactical control system by RCA's Aerospace Systems

division is also expected to sell commercially. John McAllister, vice president and general manager of the division, explains that the system has all the communications and visual flight control capabilities required by major commercial airports.

It has room for three air controllers and includes five ultrahigh- and four very-high-frequency multichannel solid state transceivers, a radio direction finder, and communications and weather monitoring gear. There's also space for radar controls.

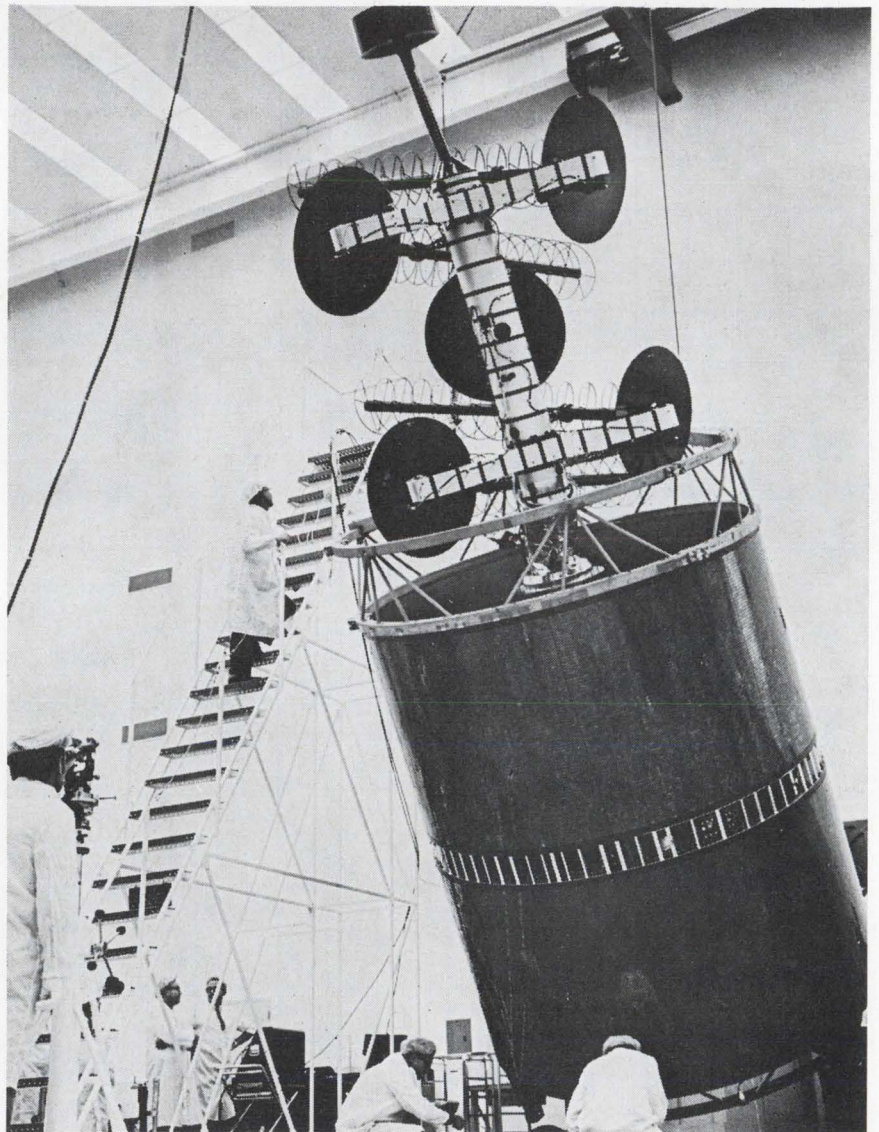

Duty bound. Officially an experiment, the Tactical Communications Satellite launched over the weekend could see duty in Vietnam relaying communications through its 10,000 two-way channels, once it passes initial testing. The Hughes-built repeater was developed under Air Force sponsorship with this end in mind and offers ultra-high, super-high, and X-band frequencies. The two-story-high, 1,600-pound vehicle is the heaviest launched by the U.S.

Our new LM 106 is the 710 and then some.

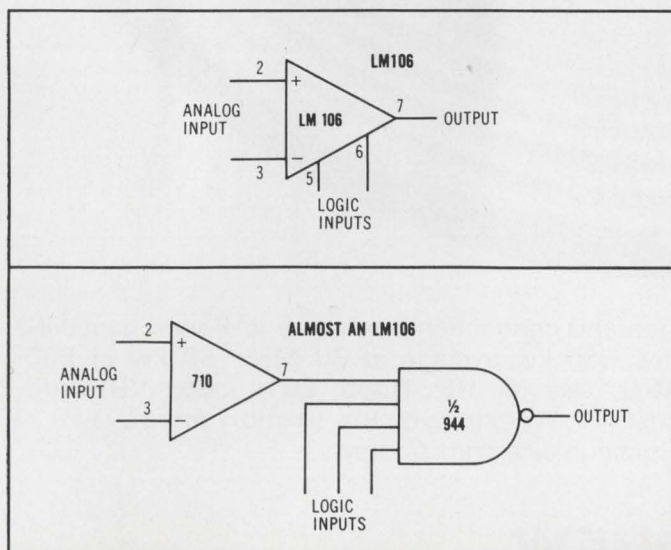

Our LM106 is a clever brute. It's a high-speed voltage comparator that is a direct plug-in replacement for the 710 in practically every application. What's more, on two pins the 710 doesn't even use, the LM106 accepts logic signals to strobe an output that drives up to 10 DTL or TTL loads. Or it switches up to 18V at 100mA to drive relays or lamps directly. The 25,000 gain makes gain error insignificant compared to the 2mV maximum offset. And it operates over a wide range of supply voltages even with symmetrical supplies. In quantities of 100 to 999, the military version LM106 is \$18.00, the LM206 for instrumentation (-25 to +85°C) is \$11.50, and the LM306 for industrial uses (0 to +70°C) is \$6.80. Write us for other clever things about the LM106. National Semiconductor, 2975 San Ysidro Way, Santa Clara, California 95051. (408) 245-4320.

National/Linear

8" HELIAX

high power without a hanger "HANG-UP"

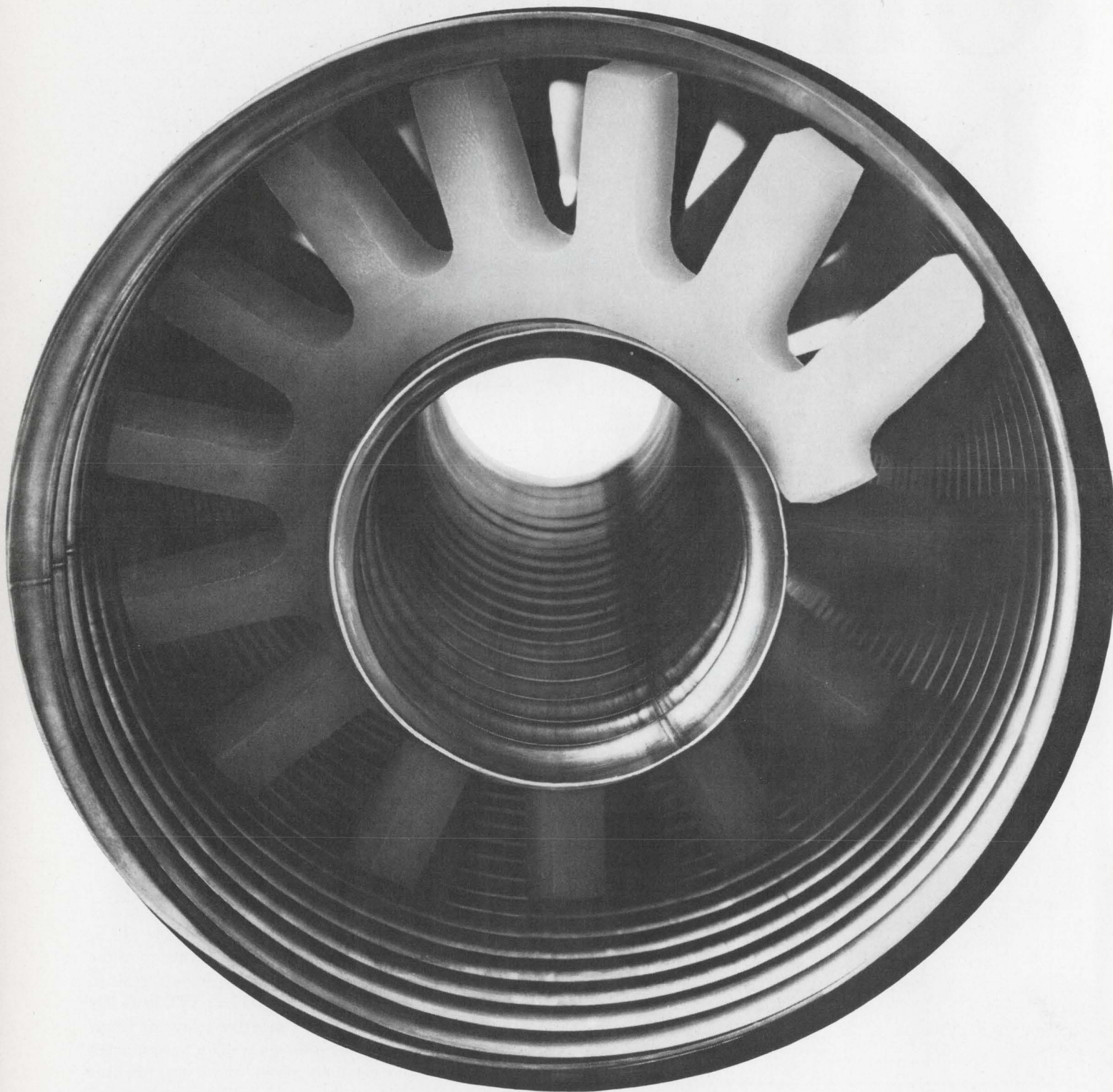

Faced with carrying a couple of hundred RF kilowatts? Need low, low attenuation? Move up to 8" HELIAX® coaxial cable. Big. Semi-flexible. Continuous lengths to 850 feet. Eliminates connector bullets and complicated hangers. Thermal expan-

sion and contraction don't faze it. Power capabilities: 300 kw average at 30 MHz; 58 kw at 600 MHz. Use for HF; Tropo; OTH radar; VHF and UHF-TV. Wouldn't you like to know more? Communicate with Andrew.

11-68

 **ANDREW**

CONTACT THE NEAREST ANDREW OFFICE OR ANDREW CORPORATION, 10500 W. 153rd STREET, ORLAND PARK, ILLINOIS 60462
Circle 70 on reader service card

Washington Newsletter

February 17, 1969

Pueblo probes may hurt sales of spy gear

One result of the Pueblo inquiries could be a **cutback in funds for electronic espionage and communications equipment for the military**. Pentagon insiders arrive at that conclusion this way: the CIA and the military's spy operation, the National Security Agency, have been feuding for years; **CIA chieftains grumble that the military intelligence agency is getting bigger than necessary** through duplication and thus is getting money that should be going to the CIA.

Now, with the CIA disclaiming any connection with the Pueblo's communications and navigation foul-ups and dumping the whole mess in the laps of the military, **the result almost certainly will be more intense investigations of the nation's total spy operation by both the Administration and the Congress**. And any probe is bound to tighten spending on spook equipment.

Crime study urges U.S. aid for R&D

The Small Business Administration's study of crime against small businesses, to be released next month, won't say **anything particularly new about electronic protection or detection devices—even though the SBA paid Stanford Research Institute \$60,000 for work on this part of the study**. What Stanford came up with is an outline of equipment and systems that are available or that can be constructed.

However, the study does urge the obvious: Federal support for research and testing of new and innovative protection equipment and systems.

NASA's Beggs gets second spot in DOT

Research and development work by NASA on a number of aviation safety and air traffic control projects may get a faster response from the Federal Aviation Administration now that **James M. Beggs, a top NASA official, has been appointed under secretary of transportation**.

Beggs headed NASA's office of advanced research and technology, which has been working on such aviation projects as the V/STOL aircraft and collision avoidance and instrument landing systems. **He's now in a position to prompt the FAA to implement this work since the agency is part of the Department of Transportation**.

Compulsory f-m will get a big push

F-m broadcasters, seeking more air time on portable and car radios, are about to launch a strong drive for a law requiring that all receivers be able to pick up both a-m and f-m. **A bill to that effect was introduced last month by Sen. Frank Moss (D., Utah), a member of the communications subcommittee of the Senate Commerce Committee**.

Similar legislation introduced in the past several years wasn't pushed by the broadcasters' lobbyists because f-m receiver sales were considered adequate.

Old programs needn't fade away

The new Administration is carefully examining ideas, programs, and studies left over by the Johnson Administration, **some of which could be important to the electronics industry**.

The Department of Labor is studying the oft-mentioned national computer job bank, Secretary of the Interior Hickel is examining the recommendations of the Commission on Marine Science, Engineering and

Washington Newsletter

Resources (which, among other things, proposed a "wet NASA" for overseas development), and Presidential science adviser Lee A. Dubridge is looking closely at the report—still not released—of the President's Task Force on Communications Policy [*Electronics*, Dec. 23, 1968, p. 40].

Meanwhile, there are other clues that the new Administration may be just as liberal as the last in seeding the scientific and engineering communities with money. Last week the President made it known that he felt it had been a "serious error" to step back in scientific spending, and proceeded to restore \$10 million of the \$40 million Congress slashed from the fiscal 1969 basic research budget of the National Science Foundation.

Congress upset by firms' hiring of retired brass

Everyone knows that defense contractors hire retired officers. But recent boldness by some firms in issuing press releases to announce the hiring of former top brass has upset some Congressmen, and they're talking about an investigation of the matter.

The House Armed Services Committee's special investigating subcommittee, whose new chairman is expected to be Otis Pike (D., N.Y.), is the group most likely to look into the question. The last time the problem was examined was 10 years ago. That probe, by the investigations panel headed by Rep. F. Edward Hebert (D., La.), produced headlines about contractor's lush entertainment of the brass and alleged influence-peddling by retired officers.

Sonar bugs blamed for sub delay

Sonar problems are apparently delaying the commissioning of the USS Narwhal, a large nuclear attack submarine. Launched in September 1967, the sub was due to be commissioned a year later. This was postponed to last month, then put off again until this summer at General Dynamics' yard in Groton, Conn.

Informal sources say the trouble revolves around Western Electric's AN/BQQ-3 sonar classification set, which is part of the BQQ-2 integrated sonar system built by Raytheon. A strange wrinkle is that the BQQ-3 is not an especially advanced system and shouldn't be causing any serious problems.

Panel to talk up more talk satellites

In the next few weeks, all the technical papers, recommendations, and panel reports of the National Research Council's Special Study Group on Space Applications will be made public. The reports will make a strong pitch for a comprehensive space applications program costing \$200 million to \$300 million a year in the coming decade.

It's known that high priorities are requested for certain communications satellite programs, including: a domestic broadcast satellite, use of satellite broadcasting for aiding underdeveloped nations, and aeronautical and maritime communications and navigation satellites.

Addendum

Although Comsat and Intelsat have approved the idea of an aeronautical services satellite, indications are that if too much time is wasted negotiating the price of the two-ocean system with the airlines, the cost of the system will go up. One reason for this, according to an official at Arinc, is that NASA is running low on Delta launch vehicles. If a decision is not made soon to go ahead with the system, perhaps in the next few months, only more powerful and expensive vehicles will be left.

The Standard Laboratory Power Supply

\$145⁰⁰

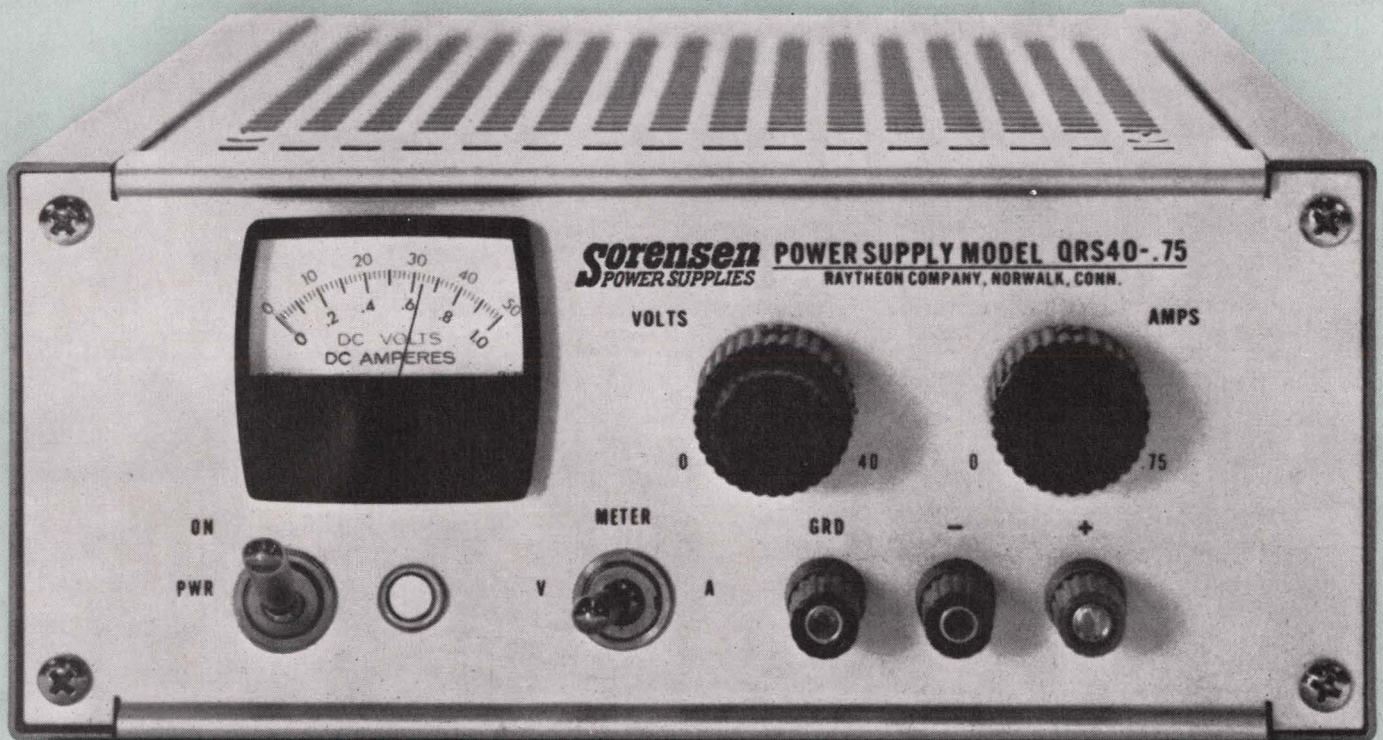

There are seven QRS models, available from stock, in this series of high performance power supplies—four 30 watt models and three 80 watt models with voltage ranges of 0 to 15, 20, 30, 40 and 60 Vdc.

Features include: ■ 0.01% or 1mV voltage regulation/current regulation with automatic crossover ■ 400 μ V rms (6mV p-p) ripple to 25MHz ■ 0.01% resolution ■ 50 μ sec. transient response ■ -20°C to +71°C operating temper-

ature ■ remote sensing/remote programming.

Single and dual mounting 19" adapters permit rack mounting a single QRS or two units side by side.

For more information contact your local Sorensen representative or; Raytheon Company, Sorensen Operation, Richards Avenue, Norwalk, Connecticut 06856.

Tel.: 203-838-6571;

TWX:710-468-2940;

TELEX: 96-5953.



RAYTHEON

Circle 200 on Inquiry Card

29 FETS FOR SWITCHES OR CHOPPERS



Applications Power*

What's your most important switch or chopper requirement?

ON resistance . . . low as 5 ohms
 Gate-to-drain capacitance . . . little as 0.25 pF
 Price . . . some low as \$2.00 (100 up)
 Somewhere in the 29 FETs listed here
 you'll find the right tradeoff for your
 switching or chopping application. Contact
 us for complete data on any or all
 of these devices!

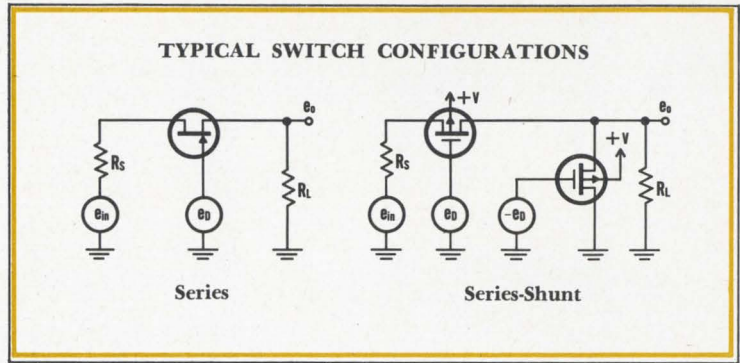

Type	r _{DS(ON)} Max. (Ohms) ⁽¹⁾	C _{gd(OFF)} (pF) ⁽²⁾	I _{D(OFF)} (pA) ⁽³⁾	V _P Max. (Volts) ⁽⁴⁾	BV _{GDS} Min. (Volts) ⁽⁵⁾	Price ⁽⁶⁾
MOS						
M105	20	9	10	—	30	\$23.50
M103	200	2.7	8	—	30	5.30
M104	1200	0.25	3	—	30	4.65
JUNCTION						
2N5432	5	9.5	40	10	25	40.00
2N5433	7	9.5	40	9	25	20.00
2N5434	10	9.5	40	4	25	33.50
U240 ⁽⁷⁾ (2N4445)	5	9.5	40	10	25	31.50
U241 ⁽⁷⁾ (2N4446)	10	9.5	40	10	25	14.25
U242 ⁽⁷⁾ (2N4447)	6	9.5	40	10	20	18.00
U243 ⁽⁷⁾ (2N4448)	12	9.5	40	10	20	11.70
2N4856	25	2.9	8	10	40	4.50
2N4857	40	2.9	8	6	40	3.80
2N4858	60	2.9	8	4	40	3.15
2N4859	25	2.9	8	10	30	4.35
2N4860	40	2.9	8	6	30	3.70
2N4861	60	2.9	8	4	30	3.00
2N4391	30	2.9	8	10	40	4.70
2N4392	60	2.9	8	5	40	3.70
2N4393	100	2.9	8	3	40	3.00
2N4091	30	2.9	8	10	40	4.35
2N4092	50	2.9	8	7	40	3.70
2N4093	80	2.9	8	5	40	3.00
2N3970	30	5.5	10	10	40	3.50
2N3971	60	5.5	10	5	40	2.60
2N3972	100	5.5	10	3	40	3.00
U200	150	5.5	20	3	30	2.35
U201	75	5.5	20	5	30	2.20
U202	50	5.5	20	10	30	2.00
2N3824	250	1.2	2.5	8	50	2.70

NOTES:

- (1) Maximum ON Channel resistance measured at V_{GS} = 0, V_{DS} = 0, for junction FETs, and V_{GS} = -20V, V_{DS} = 0 for MOS FETs.
- (2) Typical gate-to-drain OFF capacitance values measured at V_{GS} = -10V, V_{DS} = 10V for junction FETs and V_{GS} = 0, V_{DS} = -10V for MOS FETs. C_{gd(ON)} is approximately three times C_{gd(OFF)}.
- (3) Typical OFF drain current measured at V_{GS} = -10V, V_{DS} = 10V for junction FETs and V_{GS} = 0, V_{DS} = -10V for MOS FETs.
- (4) V_P max. to data sheet conditions.
- (5) BV_{DSS} for MOS FETs.
- (6) 100-999 Prices.
- (7) Identical to 2N4445 series, except for package.

*** Applications Power: An ever-expanding catalog of quality devices, plus an in-depth applications team waiting to serve you!**



Siliconix incorporated

1140 West Evelyn Ave. • Sunnyvale, Calif. 94086
 Telephone (408) 245-1000 • TWX 910-339-9216

ON CONDITION: ON error voltage is a function of FET r_{DS(ON)} value relative to source and load resistance values of the circuit. Since, for different FET geometries, lower ON resistance means larger capacitance, a good figure of merit is the r_{DS(ON)} C_{gd} product for a given V_P. The 2N5432 series has the lowest r_{DS(ON)} C_{gd} product available!

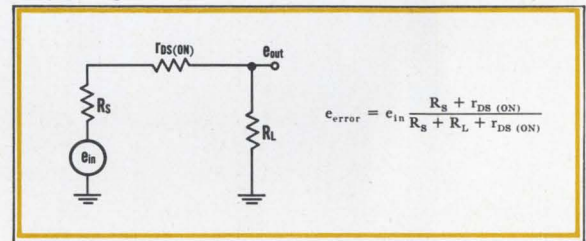

OFF CONDITION: Static OFF error voltage is extremely small due to low drain leakage current, I_{D(OFF)}. AC feedthrough is low since drain-to-source capacitance, C_{ds}, is always less than 0.4 pF.

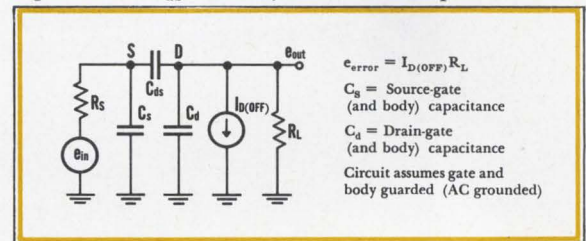

SWITCHING: Going from the ON condition to the OFF condition is generally the limiting case, and the important parameters are gate-to-drain capacitance, C_{gd}, and the output load impedance R_L and C_L. Siliconix FETs offer lower C_{gd} for a given r_{DS(ON)} and V_P.

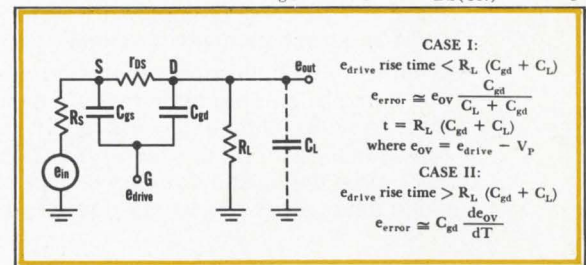

For further information and immediate applications assistance call the number below. Ask for Extension 19.

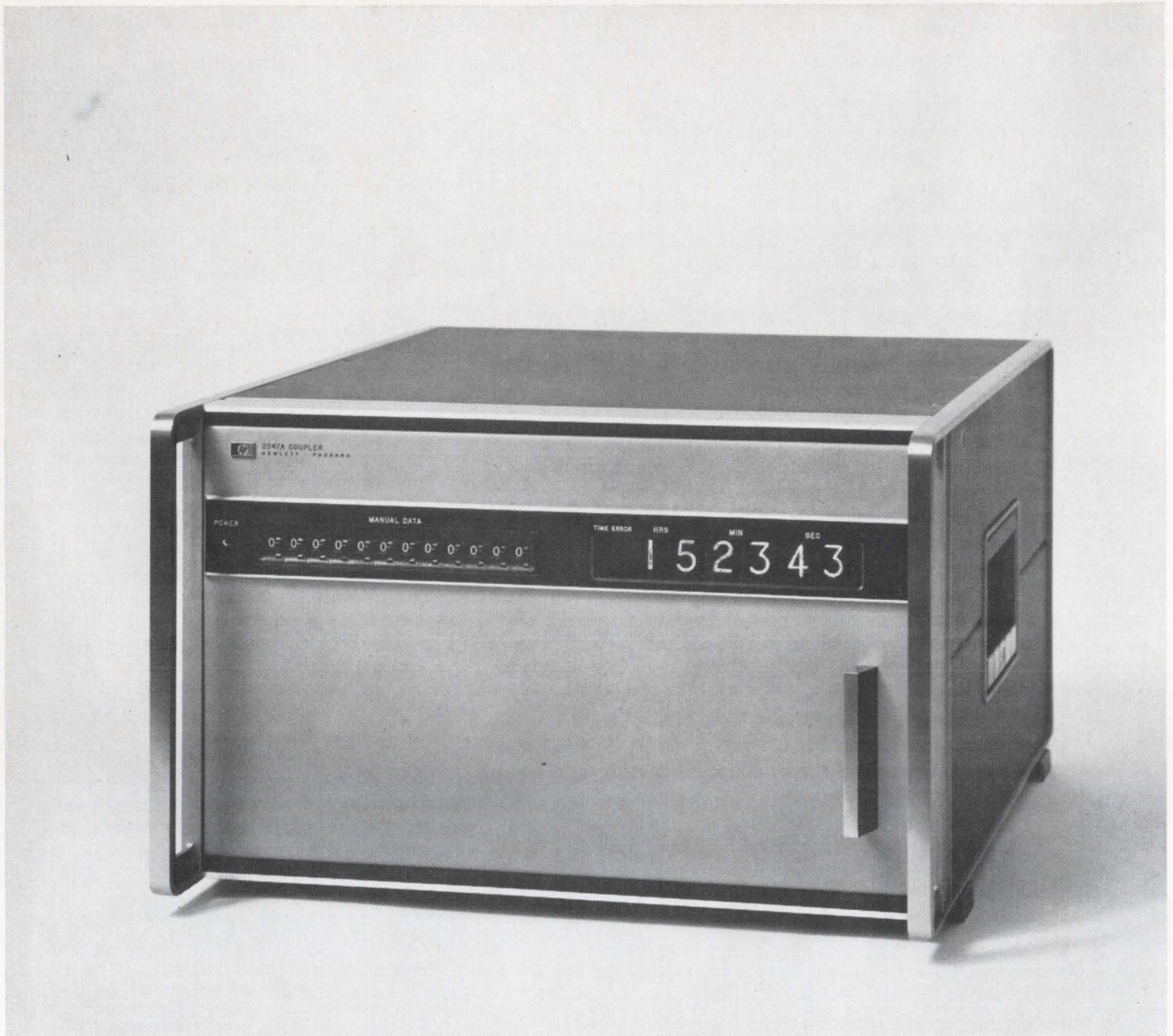

The Middle Man

This is the Hewlett-Packard 2547A Coupler—a specialist at translating digital data for recorders. It takes the place of special circuits you've been building to record your DVM and counter measurements.

Whether you have one measuring instrument or six, this coupler feeds measured data to your choice of recorder—like a tape punch, card punch, teleprinter or magnetic tape deck. And you can run a printer simultaneously to see what's going on. Later

on, if you want to change your recorder, just plug in a new card.

You can add other options any time you want: digital clock for time of day, manual data panel for entering fixed data along with measurements.

If you need a systems middle man to automate your recording, call your local HP field engineer. Or write Hewlett-Packard, Palo Alto, California 94304; Europe: 1217 Meyrin-Geneva, Switzerland.

HEWLETT  PACKARD

DATA ACQUISITION SYSTEMS

06827

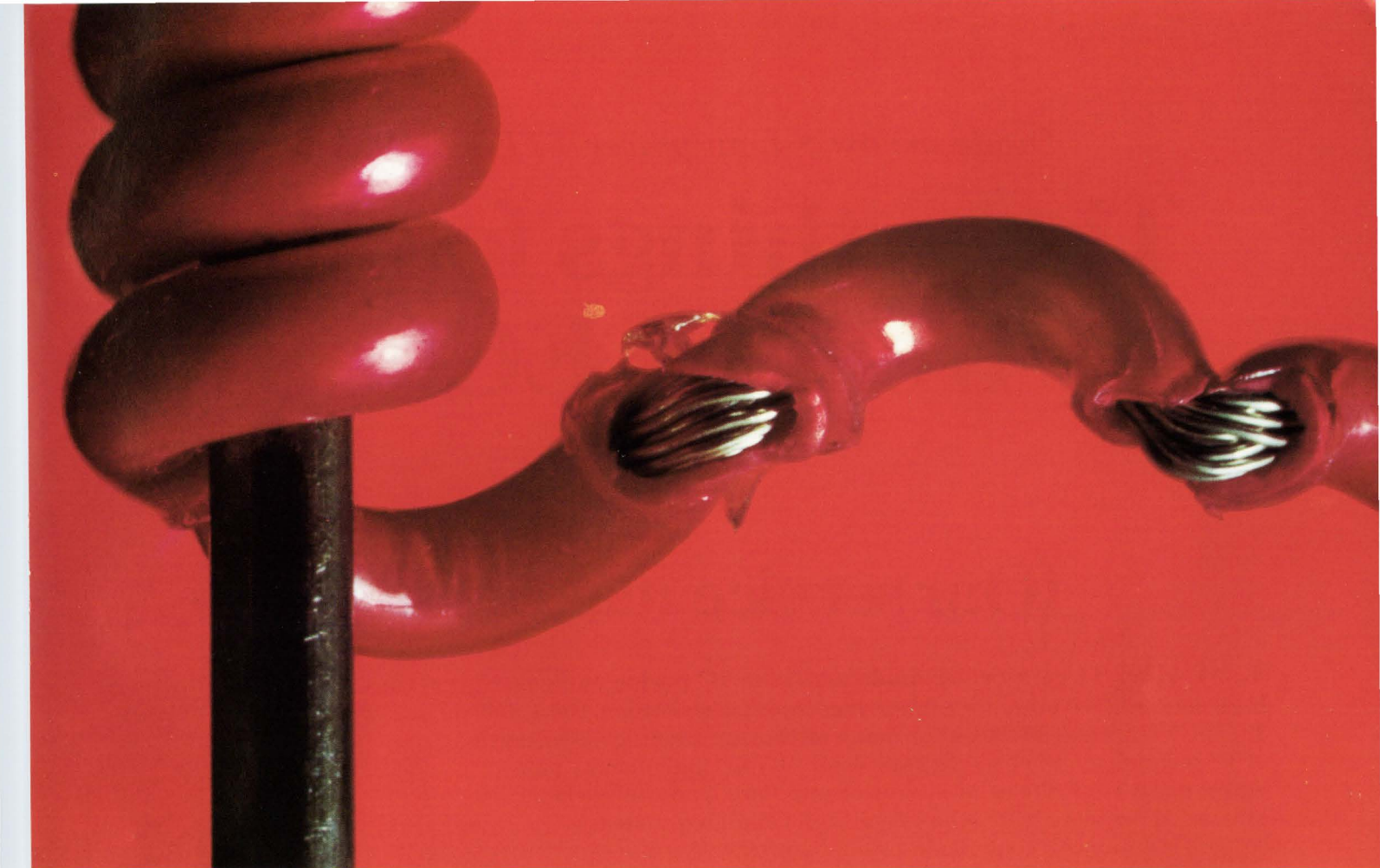

Don't risk it!

This hookup wire was wrapped around a mandrel and heat-aged for 88 hours at its rated temperature. When it was unwrapped, cracks developed and exposed the conductor.

This won't happen with insulation of Du Pont TEFLON* (TFE). At its own high rated temperature (up to 500°F, depending on the specification), TEFLON shows excellent resistance to cracking after much longer periods of heat aging.

That's only one of the reasons we call TEFLON the sure one. Among others: TEFLON is nonflammable. It's inert to virtually all chemicals and corrosives. It resists solder-iron damage. And it provides weight and space savings without sacrificing performance.

In short, when you specify insulation of TEFLON, you minimize risk.

For detailed data on the resistance of TEFLON to thermal stress cracking and other hazards, write Du Pont Company, Room 6670E, Wilmington, Delaware 19898.

*Reg. U. S. Pat. Off. for Du Pont fluorocarbon resins and film.

TEFLON®...the sure one



Better things for better living
...through chemistry

Diode arrays • Low-power TTL • MOS SRs

Three things for sure from DEECO

(Our service makes four!)

1. SURE! TI core driver diode arrays in IC packages. Featuring planar passivated junctions, high current (500 mA), low capacitance and fast switching, these 8-diode and 16-diode arrays, TID21 – TID26, TID29 and TID30, offer many of the outstanding advantages of IC technology. Such as package flexibility for high density packaging (take your choice of standard and long lead flat packs, plastic DIP and 10 lead TO-5). And high reliability (extra testing is standard: centrifuge, temperature cycle, gross and fine leak, internal visual inspection). Reduced weight and smaller size. Uniform parameters. We'll ship promptly or for more data, circle 329 on the Service Card.

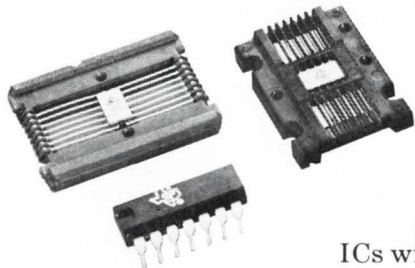
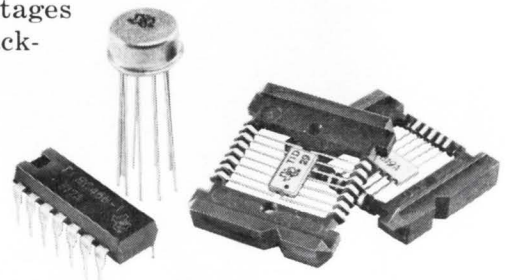

2. SURE! Low-power

TTL that's speedy. When power sources can be smaller, product size and weight can be reduced. Accomplish this *economically* by ordering TI's low-power, high-speed TTL. These 13 circuits, a full line available from us, feature power requirements less than one-tenth that of comparable standard ICs. Typically, 1 mW per gate and 3.8 mW per flip-flop. *And* they are about twice as fast as other ICs with similar power dissipations – 33 ns per gate propagation delay, 47 ns per flip-flop. For complete data, check 330 on the Service Card.

3. SURE! 200 bits in TI's economical new MOS

static SR. With this latest TI entry, you have the most bits available today in a static SR – 200 – at the lowest cost per bit – one-tenth that of bipolar registers. The new Dual 100 features a clock repetition rate ranging from DC to 1 MHz, with no minimum clock rate and an extremely low power drain – 1.5 mW per bit. The 200 bits can be connected into a system in two parallel 100-bit registers or the output of one register can be converted to the other. We'll take your order now; or for a data sheet, circle 331 on the Service Card.

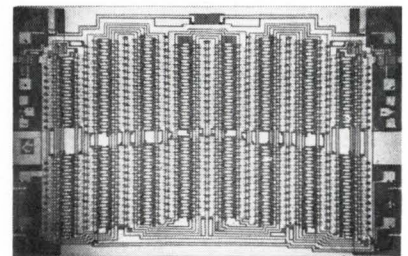

For sure service, call

DEECO  **Inc.**
DISTRIBUTORS — SERVING INDUSTRIALS EXCLUSIVELY

AUTHORIZED
DISTRIBUTOR 

2530 16th Avenue S.W. • Cedar Rapids, Iowa 52406 • Phone (319) 365-7551
Free Wide Area Telephone Service: From Surrounding States Dial: 800/553-5421 • From Within Iowa Dial: 800/332-5478

IRRAVINTM

INSULATED WIRE

Designer's new wire that production can't complain about.

Ever had to re-design because production is having problems and calling for your head as the solution? That's why we've come up with IRRAVINTM irradiation cross-linked PVC hook-up wires. You release the design knowing that wire complaints are stopped before they start.

IRRAVIN insulated hook-up wire continuously withstands temperatures up to 115°C, and higher for short periods of time. So there's no shrink back from hot solder-iron contact. Production doesn't waste time replacing wire just installed. Advantage: use higher density packaging without fear of accidental solder iron damage. And, you can specify IRRAVIN hook-up wire for applications where only costly high-temperature insulations were used before.

Consider crush and abrasion resistance. Our IRRAVIN insulation has four times the crush resistance of that other high temperature stuff. You eliminate lacing cut through, assembly damage, future

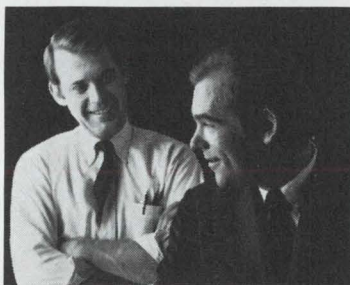

Unretouched photo of design engineer being greeted by production engineer after specifying IRRAVIN insulated hook-up wire.

breakdown from undetected cuts and other production grumbles.

Couple this with 5,000 foot lengths, pre-tinned conductors, and you can see why IRRAVIN insulated hook-up wire can be worked fast and safely through automatic processing equipment.

Or we could mention the advantage of having 27 striped and solid colors in stock. Or the 600, 1000 and 3000-volt rated wires con-

forming to MIL-W-16878 and carrying Underwriters' Laboratories, Inc. listings.

Most important, though, IRRAVIN hook-up wire costs less than half that of the other higher temperature wire. Unless you really need the additional degrees why put up with the additional price?

So, be a hero. Get a sample of IRRAVIN insulated hook-up wire and try it. Of course, it's free. Contact ITT Wire and Cable Division, Surprenant Products, International Telephone and Telegraph Corporation, Pawtucket, R.I. 02862.

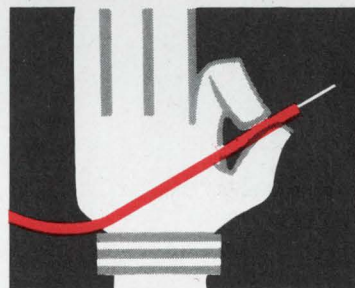

IRRAVIN—the wire
that stops the grumbles.

WIRE AND CABLE **ITT**

2½D cycle time at 3D cost!

Data Products' new 3-wire, 3D memory

...the STORE/33™

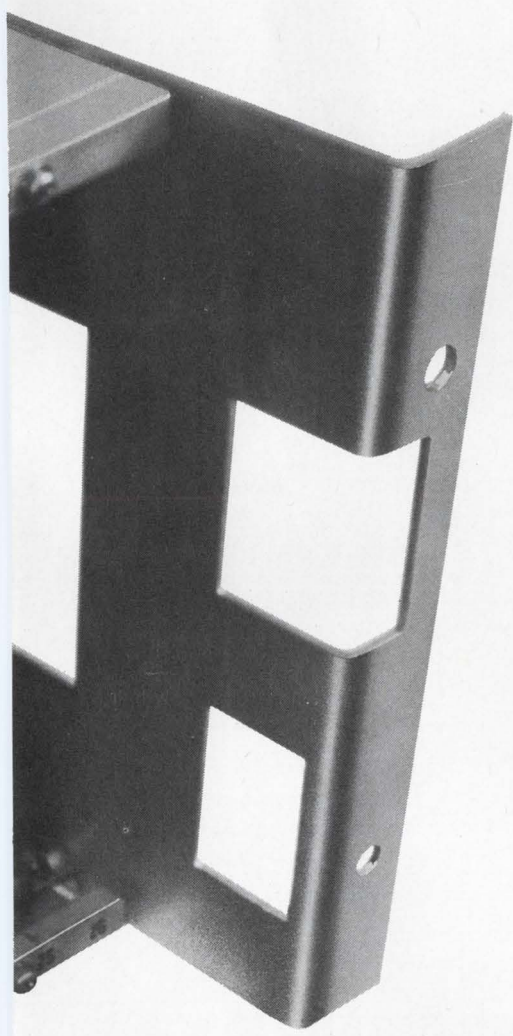

STORE/33 is in full production at Core Memories, Inc.* . . . now you can have 2½D speed at coincident-current prices! For example, the 4K x 16 version of STORE/33 uses 18 mil cores to give a full-cycle time of 650 nsec. The price? Under \$4500** in production quantities.

What makes this price breakthrough possible without a tradeoff in speed? The key, of course, is 3-wire 3D organization in which the fourth winding normally associated with coincident-current organization is eliminated. By utilizing the same winding for both sensing during reading and inhibiting during writing, assembly costs of the magnetic planes are reduced . . . But 3D organization is only part of the story.

STORE/33 employs IC electronics throughout to increase reliability, reduce power consumption and achieve more compact packaging. The basic memory uses only four types of plug-in cards. The memory stack also plugs in. This standardization of circuit card types and modular construction reduces your inventory costs and simplifies maintenance. Word capacities to 16K, interface flexibility, plus a wide range of options . . . for the full story, write Data Products Corporation, 6219 De Soto Ave., Woodland Hills, Calif. 91364.

Los Angeles, Calif. 213/887-8000 Melbourne, Fla. 305/262-4773
Bethesda, Md. 301/652-8120 Acton, Mass. 617/263-3961
Minneapolis, Minn. 612/338-4717 Dallas, Tex. 214/239-9641
Amsterdam, 020/156-297 London, 1-579-3116

*Core Memories, Inc. is a subsidiary of Data Products Corporation.

**Price does not include optional power supply.



"the peripheralists"

Data Products manufactures LINE/PRINTERS™, DISCHILES®, Core Memories, Off-Line Printer Systems, Card Readers & Punches.

Circle 83 on reader service card

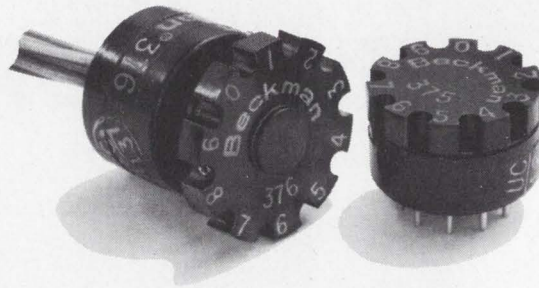

Switch to The Switchables.

Helipot's new miniature rotary switches always give you precise, positive switch settings.

Only Helipot's new rotary precision switches have rugged, positive action detent. That's why they're the Switchables ... because they always switch to the precise position you switch them to.

They come in two, single pole-10 position models. Helipot Model 376 with six-inch leads is designed for instrument panel applications. And Helipot Model 375 with 10 gold plated terminals is for direct installation on printed circuit boards. Both have a black insulated plastic housing with easy-to-read contrasting index marks, have a contact current rating of 250 ma at 28 V DC, and are the economical choices for all applications

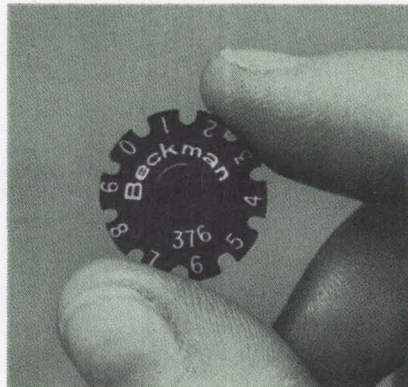

requiring rapid changes in settings such as test equipment and timing devices.

For all the details, specs and schematics, get in touch with your local Helipot Representative. He'll show you why Helipot's new miniature rotary precision switches are the Switchables.

Beckman®

INSTRUMENTS, INC.

HELIPOT DIVISION

FULLERTON, CALIFORNIA • 92634

INTERNATIONAL SUBSIDIARIES: AMSTERDAM; CAPE TOWN; GENEVA; GLENROTHES, SCOTLAND; LONDON; MEXICO CITY; MUNICH; PARIS; STOCKHOLM; TOKYO; VIENNA

February 17, 1969 | Highlights of this issue

Technical Articles

**Solid state microwave
leaves the lab
page 86**

Design engineers are getting serious about using semiconductors—bulk-effect devices and avalanche diodes—as microwave power sources. A number of practical circuits have been built now that engineers have figured out ways to tune, cool, and stabilize the devices. Even reliability presents no serious problems, although reproducibility and yields remain obstacles to widespread use.

**Medical instrumentation
faces safety questions
page 92**

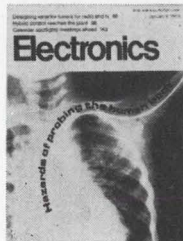

The increased use of cardiac catheters and other body probes has aggravated the problem of hospital patients' receiving often lethal electrical shocks. The article surveys the hazards involved in electronic medical instrumentation and outlines prospective remedies from the viewpoints of both design engineers and physicians. Failing development of an effective solution to the

problem, the article concludes, there's a good possibility the FDA will push for Congressional passage of the medical device safety bill, which lays down tough design standards for clinical and diagnostic instrumentation.

**Analog blocks for stable
active-filter design
page 100**

A new technique, combining integrators and inverters, offers the designer of active filters a simple, economical way to produce transfer functions. The approach trades on the engineer's familiarity with analog circuitry and the low cost of integrated-circuit operational amplifiers.

**Speed, stability, simplicity
in MOS memories
page 106**

In this fifth installment of *Electronics'* special report on computer memories, the first article considers ways and means of designing MOS units to achieve speedier data rates, the second discusses the complementary MOS techniques practiced at RCA, and the third describes read-only memories made by Autonetics with a thin film of silicon on a sapphire substrate.

Coming

**Germanium IC's presage
picosecond computer**

Circuits with per-stage delays as small as 150 picoseconds have been built. IBM, with an eye to superfast computers operating below room temperatures, is refining techniques to increase circuit packing density and further reduce delay.

Solid state microwave leaves lab

Circuits with bulk-effect devices and avalanche diodes are ready now; although most go to the military, some are commercially available; marketing success will depend on materials and fabrication advances

By George F. Watson

Associate editor

The harnessing of semiconductor sources of microwave power is now a fact of life—at least on the circuitry level. Designers around the world have at their disposal the means for tuning, stabilizing, or otherwise controlling bulk-effect devices, avalanche diodes, and related assemblies. But to secure the volume applications that appear tantalizingly within reach, designers are going to have to come up with reproducible devices that can be made available in commercial quantities. To this end, development efforts are now taking a more practical turn.

There's still a high trial-and-error content in much of the work being done. And the infighting over the comparative merits of specific devices and operating modes remains to be resolved in large measure. Finally, the task of accumulating sufficient reliability data is taxing the resourcefulness of developers. Despite all these difficulties, semiconductor microwave sources have proved their worth to the point where further investments of time and money are justified.

As is usual in the case of new componentry, the first practicable devices wind up in military systems, which are shrouded in a security blanket. But at least one piece of commercial equipment has reached the marketplace—a British-made doppler-effect burglar alarm that incorporates a bulk effect device to generate a 10.675-gigahertz signal [*Electronics*, Feb. 3, p. 177].

Probably the first problem confronting the designer is removing heat from the device. Warren Cooper, manager of the Electromagnetics Technology laboratory at Westinghouse's Defense and Space Center, notes that at 30% efficiency, the device dissipates $\frac{2}{3}$ of its power in itself. "You have to find ways to get rid of that power," he says. One of the promising ways is to mount the device on a diamond heat sink, instead of a copper one. Above 100°C, diamond has about four times the thermal

conductivity of copper.

Heat removal may call for some exotic approaches to the problem. Thomas Midford, a senior staff engineer at Hughes, knows of a military requirement calling for a black box with 2 to 3 kilowatts of output power. "This means that you've got to dissipate 25 to 30 kw of heat from that box." There are several ways to do this, but Hughes is studying a closed-cycle liquid cooling system.

Circuit designers favor microstrip mounting of avalanche diodes and bulk-effect devices, usually on an alumina substrate, because of the compactness and convenience of this method. It's necessary to connect the device in some way with the ground plane so that heat can be removed from the device.

But if the designer requires a high circuit Q to minimize noise, he'll probably avoid a stripline, since the dielectric losses and conductor losses are higher in this configuration. A coaxial circuit, or better yet, waveguide, would provide higher Q. Nevertheless with yig (yttrium-iron-garnet) tuning, the Q of microstrip circuits can be increased to respectable levels. William H. From, section head for microwave integrated circuits at Raytheon's Missile Systems division, expects to get Q of 200 to 300 in a yig-tuned avalanche-diode microstrip circuit. This will give an output 1 to 2 Mhz wide, tunable over a 10% to 15% bandwidth around a center frequency of 9.4 ghz.

The big problem, From says, was bonding the avalanche diode to the microstrip line. In a preliminary version, the unpackaged diode was soldered to the stripline, but "the solder bond was a cause of failure," he reports; the solder tended to creep up the sides of the chip and short the epitaxial layer. He hoped that ultrasonic bonding would help, but the real solution finally emerged from cooperative work with Varian's Solid State group. Raytheon and Varian found a way to bond

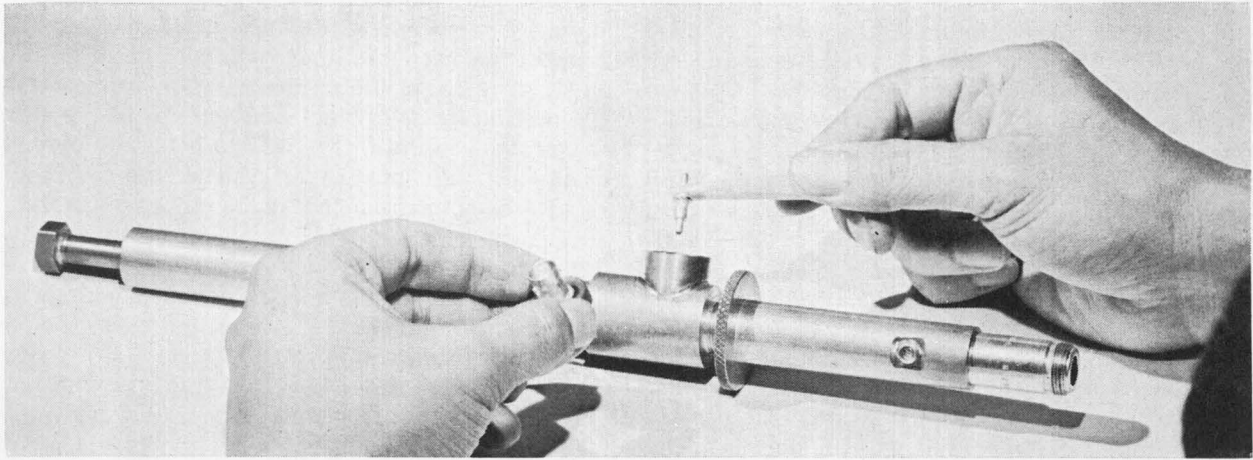

Powerful. RCA's Trapatt, or anomalous mode diode delivers hundreds of watts at 0.1% duty cycle. Here, it's being placed in a tuning circuit.

the chip in a microstrip "cavity" (actually a small hole in the ceramic substrate) with the epitaxial layer up instead of down. A dividend was more power output. The Raytheon-Varian group now gets more than 40 mw from diodes that are rated at 50 mw in an optimized waveguide mount.

High Q circuits also improve frequency stability. The Nippon Electric Co., which uses Impatt diodes and Gunn devices in systems to be sold to the Nippon Telegraph and Telephone Public Corp., says that NTT wants a frequency stability of at least 10^{-6} . Impatt diodes have an intrinsic stability of about one order of magnitude lower than this, according to Nippon Electric engineers. Gunn diodes have an intrinsic stability of about two orders of magnitude lower. This might make it seem that Impatt diodes have a clear advantage, but unfortunately, their high noise is not suited for frequency controlling circuits. The way out is to use high-Q tuned circuits with Gunn devices, although this requires some sacrifice in power output, say the Nippon Electric engineers.

One of the criticisms often leveled at limited space-charge accumulation (LSA) bulk-effect devices—the difficulty of starting oscillation—can also be overcome by proper mounting. Robert Spiwak of Bell Labs has developed a waveguide mounting that provides the delayed loading that's needed (see panel).

Yig tuning is becoming increasingly popular among circuit designers. Many see the marriage of semiconductor power sources and ferrite technology as the key to further infiltration of semiconductor devices into microwave circuits. Westinghouse's Cooper, for example, has built a receiver with a ferrite device and bonded diode chips. Because the ferrite is nonreciprocal it isolates incoming and outgoing signals. And From of Raytheon has built an amplifier with ferrite circulators arranged on a ceramic substrate to couple or isolate three amplifying stages (which use bulk-effect devices). Its pulsed output is about 13 watts at 3 Ghz; it easily

handles pulse widths of 20 microseconds. From claims that in its final form, the circuit can be packaged in a 2- by 4- by 1-inch enclosure.

Another big problem in designing circuits is lack of knowledge about the large signal characteristics of bulk effect devices and avalanche diodes. Midford of Hughes says "If you apply X volts across a diode, and you know the impedance, you can design a circuit, but you don't know the impedance without making the circuit first." Manufacturers will have to address themselves to the task of adequate characterization of these devices if they want to encourage their use by circuit designers.

Material question

Making devices with consistently good characteristics is still a problem—either because of variations in the starting material (in the case of gallium arsenide bulk-effect devices) or shortcomings in the fabrication process (in the case of avalanche diodes). This lack of reproducibility is probably not apparent to users who buy their devices from outside manufacturers, since the supplier will screen the units he ships. But houses that elect to make their own devices—for reasons of performance or economy—are painfully aware of the situation. For their bulk-effect devices, in fact, the large system houses are almost universally setting up their own facilities for preparing GaAs. A.C. Rowe, microwave marketing manager at Texas Instruments, believes that companies who intend to do well in the field are going to need a closed loop from materials through fabrication. Those who depend on outside sources of materials "have a real problem, we think. We firmly believe that improvements in the state of the art will have to come from materials improvements."

Avalanche diodes and bulk-effect devices have been available commercially for well over a year, either off the shelf or on a sampling basis. Firms like Plessey and Mullard in England, Nippon Electric in Japan, RCA, Varian, Hewlett-Packard and

Cayuga Associates, in the U.S. are selling bulk-effect devices. In avalanche diodes, there are companies like Hughes, Microwave Associates, Sylvania, Sperry, and KMC Semiconductors. Texas Instruments, which has been supplying sample quantities of Gunn oscillators for evaluation by customers, will introduce a product line at the IEEE show in March. These will operate in the X or Ku band, with power outputs of 10 to 20 milliwatts. They're intended for local oscillator applications—their modest power output will be adequate for this. "A lot of people have been in a race to get as much power as they can," says Rowe. "Rather than run this race, we have concentrated on developing products where we have found the state of the art will give us high reliability that we can deliver." The company has chosen this course, Rowe says, because it believes that there are technological limitations on power output at this stage of development.

The art of the possible

Users seem to agree with TI that it's best to concentrate on less ambitious projects at this point. Certainly, low-power circuits are closest to practical fruition. Loral Electronic Systems, for example, is designing a yig-tuned Gunn oscillator in a microstrip circuit to replace a low-power klystron in the front end of an X band receiver. The circuit produces about 1 mw of output power, and the finished product should be ready in about 6 months.

"The bulk effect device has good wideband characteristics and is electronically tunable," says Michael Dydyk, principal engineer at Loral. "We went with this device instead of an avalanche diode because the noise figures of avalanche devices are not good." The circuit is tunable over a range of 75%, and tuning is linear within 0.2 to 0.5%. It uses a Gunn oscillator made by TI, model L189B, which has a threshold of 3.5 volts.

Avalanche diode technology is much more advanced than bulk-effect device technology, simply reflecting the state of development of the materials they're made from (GaAs for the bulk devices and silicon, usually, for the avalanche diodes). Even so, the present stage of exploitation of avalanche diodes parallels that of bulk devices: they're being used in modest, low power applications.

Of course, "low" power for an avalanche diode is considerably higher than for a bulk device. Hughes Aircraft's Electron Dynamics division is about to introduce a 250 mw continuous-wave avalanche diode X-band oscillator circuit (For more on this subject, see page 149). It dissipates 15 to 20 watts average power, and is designed for mounting in a waveguide. It can be used as a local oscillator in radar or communication systems, an oscillator in test equipment, a pump source for a parametric amplifier, or as an oscillator in a transponder.

Avalanche diode application work, in fact, has now progressed to the point where there's serious talk about equipment that would probably be best

classified as "industrial electronics": police radar. Varian Associates has built a prototype impatt-powered police radar [*Electronics*, April 29, p. 37] and Eric van der Kaay, manager of applications engineering for solid state products, plans a swing around the country this winter to generate interest in an "all-solid state" radar system. Van der Kaay expects to profit from the awareness of solid-state advantages created by Motorola and others with transistorized mobile communication gear. He hopes that sales of impatt's to police radar manufacturers will blossom as soon as the cost of such diodes—with mounts—falls to \$100 to \$125. Sales may even begin sooner, since the Impatt would not only replace a small klystron tube, but would also make unnecessary much of the high-voltage, expensive power supply now part of police radars. The Impatt price would only have to equal the klystron cost plus the amount saved on the power supply to be competitive. Power of only 50 or 100 mw would be needed, and such diodes have been available commercially for more than a year. "The impatt's time may come this spring," says van der Kaay.

Some police-radar builders will want life data on impatt's before they agree to use them, however; unpredictable life expectancy is a criticism that has often been leveled at these devices. Although the transistor has made such customers eager for a semiconductor microwave source, it has also accustomed them to high—and well documented—reliability.

This data will not be easy to come by. Hughes has operated avalanche diodes for 7,000 to 8,000 hours in the lab, but is just getting ready to start formal reliability tests to support the company's marketing effort. Alex Miller, project manager for solid state microwave devices at Hughes' Electron Dynamics division (formerly the Microwave Tube division) feels that this kind of test time—in a formal program—will be enough. But it will be too expensive, he says, to gather the kind of reliability data the transistor houses can come up with. It would simply be too expensive for microwave devices, Miller says, and new techniques for arriving at reliability definitions will have to be developed.

Bulk devices, because of their unfamiliar GaAs material, have become slightly notorious when it comes to reliability. At this stage, this reputation is probably undeserved. "We think we have a reliable chip design," TI's Rowe reports. "Most problems we have encountered are associated not with the device but with the way it is mounted." The improvement in reliability is largely due to a new device structure. "In the Gunn device's most recent form the ohmic contacts are prepared by growing an epitaxial layer of GaAs on the device material; there is no high resistivity region at the interface with the active layer and efficiency is therefore higher," according to J.S. Heeks of Standard Telecommunication Laboratories in England. He says, "the life expectancy of such devices will surely exceed the 10,000 hours recorded previously." Bell Labs' John A. Copeland, supervisor of the bulk

Getting LSA started

One of the problems in designing a bulk-effect circuit to operate in the limited space-charge accumulation mode is getting the high-frequency oscillations started before a Gunn domain has a chance to form. This is done by loading the primary resonant circuit only lightly for a brief period after power is applied to the device. The idea is to allow the peak r-f amplitude to build up quickly, so that the trough of the oscillations will quickly swing below threshold to prevent domain formation. At Bell Telephone Laboratories, the circuit shown below was designed to provide this delayed loading.

Regarded. The stub and the waveguide floor can be regarded as a microstripline circuit one-half wavelength long. It's loaded at one end with the device, and the other end is open, loaded only by radiation into the waveguide. Once the device has started oscillating and the signal has traveled to the tuners and back to the device, the load on the device increases because of the impedance transformation created by the length of waveguide between the tuners (which are several wavelengths away from the device) and the resonant stub. The impedance of the stub circuit depends on the stub's width and average height above the floor.

The time that passes before the voltage drops below threshold is critical, and depends on the impedance of the stub circuit. If this time is too long—that is, if the amplitude builds up too slowly—the stub circuit will become loaded before the voltage can swing well below threshold, and the device will break into Gunn-mode oscillations at a much lower frequency, instead of LSA oscillations.

Plots. Some computer-generated plots made at Bell Labs show how the stub impedance affects starting of LSA oscillations in an unloaded circuit. In the top waveform, the stub impedance is equal to the low field resistance of the device (that is, $Z_0 = R_0$): this value is too low. The peak voltage doesn't increase fast enough, and as a result, a real circuit (one with delayed load) would become fully loaded before the amplitude fully develops.

In the middle waveform, $Z_0 = 3R_0$. This value is close to optimum. The amplitude of the LSA

oscillations builds up within a few cycles, well before the circuit would be loaded. And the oscillations drop well below threshold quickly to prevent a domain from accumulating.

The lower waveform is for a stub impedance of $10R_0$. This value is much too high, since the device oscillates at a frequency determined by the bias circuit, still in an LSA mode but at lower frequency.

These computer simulations show that the optimum impedance for the stub is 3 to 5 times R_0 .

R. R. Spiwak,
Bell Telephone Laboratories, Inc., Murray Hill, N.J.

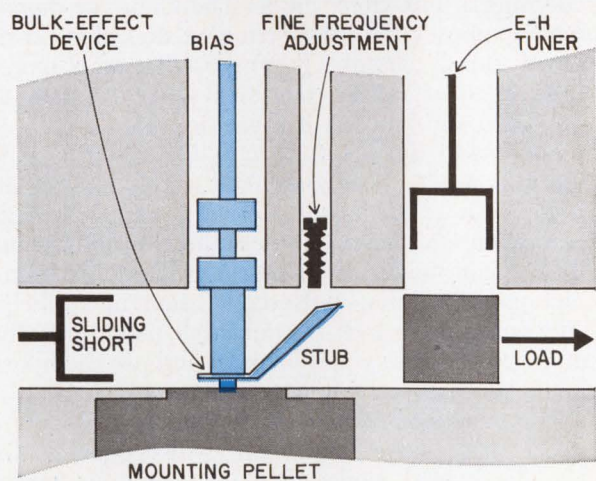

Low Load. New mounting design delays loading so that LSA oscillations can start.

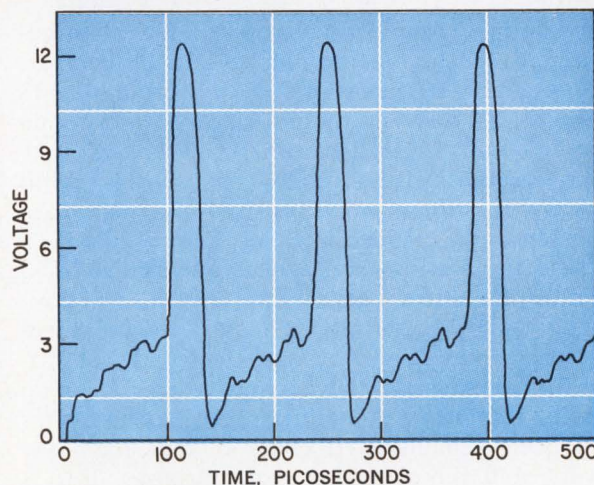
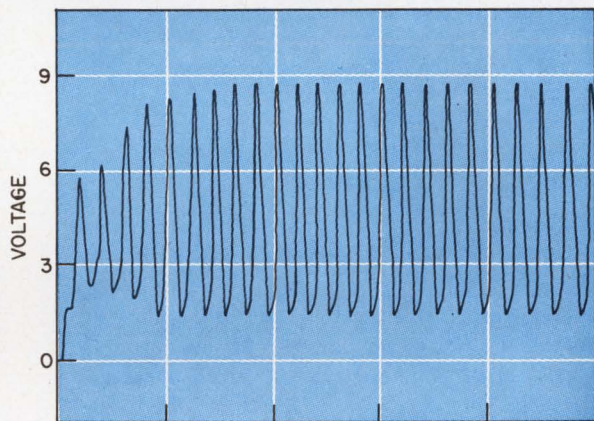
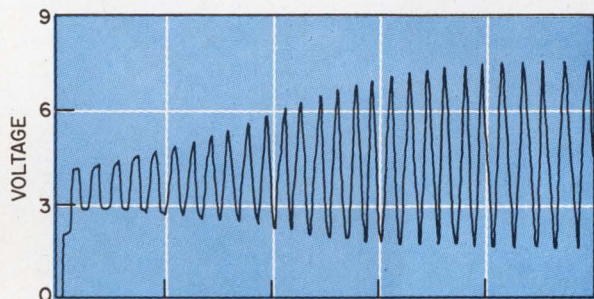

Good, better, worse. Stub impedance must be in optimum range to get waveform in middle.

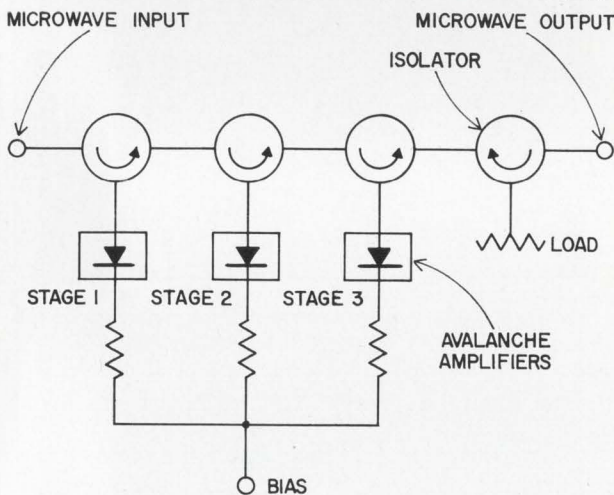
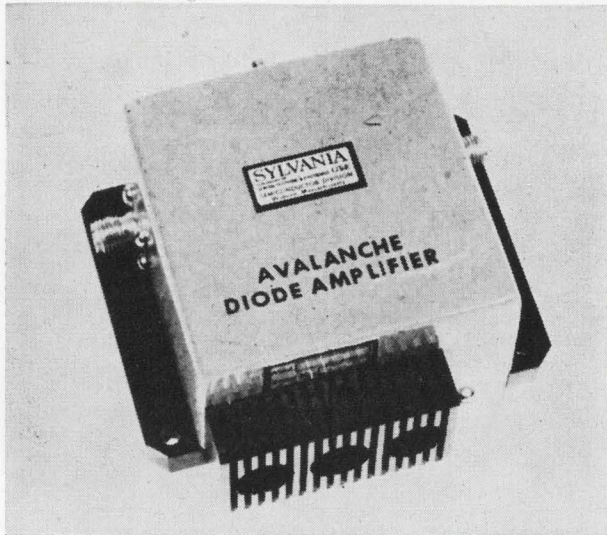

Multistage. Sylvania's Semiconductor division hopes to compete with low power traveling wave tubes with its three-stage Impatt amplifier circuit. It's about 3 inches long, and uses a single ferrite substrate for four circulators. Gain is 40 db, output is 50 mw over a relatively narrow band of 75 to 100 Mhz in X band.

effect studies group, says that for Bell System applications, the lifetime would have to be comparable to first-rate transistors—on the order of 10^8 , 10^9 hours. "We see no reason why we can't obtain that with bulk GaAs devices, but we haven't produced enough devices which consistently exhibit the same electronic properties that give us a base on which to do life testing."

The controversy over the relative merits of bulk-effect devices and avalanche diodes seems to be resolving itself—temporarily at least. "I think there are applications for both," says James W. Gewartowski, supervisor of the microwave source group at Bell Telephone Laboratories. "Avalanche diodes have been demonstrated to yield very high c-w powers, and for communication purposes, this is very desirable. At the present time we have demonstrated with an impatt device almost 5 watts at 13.5 Ghz; we've also demonstrated 0.75 watt at 35

Ghz. And these powers are greater than anything that GaAs can do, c-w, presently. So my opinion is that Impatt devices are, now, useful for many communication applications, whereas bulk GaAs devices are now useful only as local oscillators where you don't need much power." Gewartowski is quick to point out, however, that this situation may change in the future. Copeland's group at Bell Labs is investigating new geometries for LSA-mode GaAs bulk-effect devices in which heat flows out of the device transversely. This will greatly increase the area available for heat dissipation. "If this becomes practical—it hasn't as yet, but if it does—then they may be able to compete very well with the impatt," Gewartowski says.

University of Washington's Dow sizes it up this way: "Fundamentally, the avalanche diode will handle more power and be more efficient, but it's noisy. The noise advantage is heavily in favor of the bulk-effect device."

One engineer estimates that noise level in silicon avalanche diodes may be 10 to 13 decibels higher than that in GaAs bulk-effect devices. It's questionable, however, whether bulk devices will be superior to germanium avalanche diodes.

There are ways of minimizing noise generated in avalanche diodes. Designers at Hughes, for instance, try to overcome noise problems by phase locking or injection locking, or by putting the diode in a high-Q cavity. And when an avalanche diode is operated as an amplifier, rather than as an oscillator, noise is much less of a problem.

Noise in bulk-effect devices is apparently comparable to that in klystrons. In fact, Dydyk of Loral claims that the noise figure for a bulk-effect device operated in the quenched-domain mode is better than for a klystron.

The circuit designer has a choice of operating modes as well as of devices, each with its own advantages. Robert A. Ruehrweind, director of electronics R&D for the Monsanto Co., which has discovered a "hybrid" mode of operation in bulk-effect devices, says, "It's really a question of power" in choosing a bulk-effect mode. The Gunn, or domain mode, imposes the least stringent demands on the power supply circuits; getting oscillation is merely a question of raising the bias voltage above the threshold and keeping it there. It's the "most fool-proof" mode, Ruehrweind says. "On the other hand, the LSA mode gives the highest output, but it's tricky." In other words, starting and sustaining oscillation isn't easy. "For c-w local oscillator use, the domain mode would be more likely. For those high power outputs—pulsed operation, most likely—one would go to LSA. If you didn't need quite that much power, then you'd back off and use the hybrid mode because you'd be on safer ground."

The quenched-domain mode, which is closely related to the pure Gunn mode, is also popular. Unlike the hybrid mode, domains are fully formed and they traverse only part of the active region.

In avalanche diodes, too, there are different modes of operation. One of the most significant

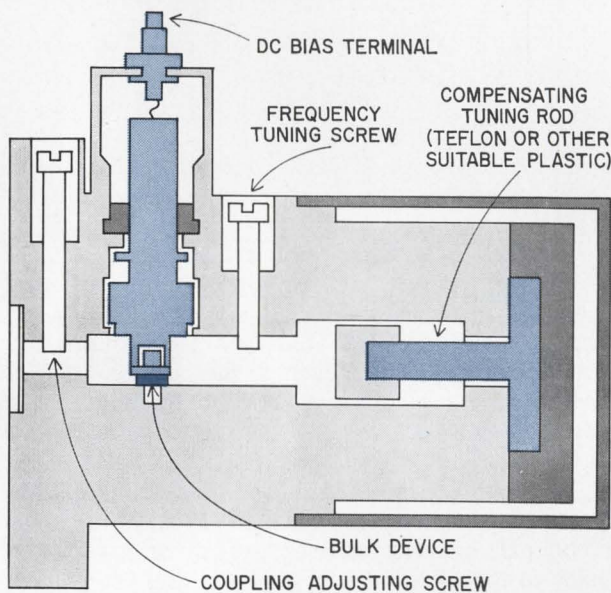
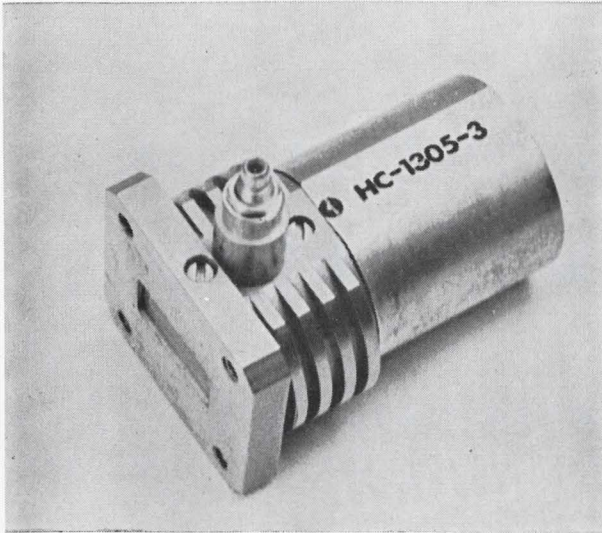

Stable. Hitachi circuit compensates for variations with temperature in a bulk-effect oscillator frequency by using a tuning rod with a large temperature coefficient of expansion. As temperature changes, length of the rod changes too, changing the cavity dimensions just the right amount to keep frequency constant. Hitachi gets a variation of only 2 or 3 Mhz over a -10 to $+50^{\circ}\text{C}$ temperature range at a nominal oscillation frequency of 12 Ghz.

impatt developments has been the discovery of the harmonic mode of operation, in which the second and third—and sometimes as high as the sixth—harmonics are used to get 30% efficiencies.

The harmonic mode was discovered during the course of studies by D. Iglesias and C.B. Swan at Bell Labs. They found that by moving a tuning slug in a coaxial avalanche diode circuit close to the diode, efficiency more than doubled. They had been getting efficiency of about 5%, but now it soared to 12%. Swan pursued the effect and found that the slug provided a localized resonance around the

diode at twice the output frequency. They were working with a 6 Ghz output, so the slug resonance was at 12 Ghz. "It turned out that allowing these 12 Ghz currents to circulate through the diode provided more favorable electronic conditions. This improved the efficiency of the avalanche process," Gewartowski explains.

The Bell researchers have since analyzed the effect in detail, and have come up with coaxial circuit configurations that have yielded even higher efficiency. The system houses are now strongly interested in the new mode, and applications should be forthcoming. Motorola's Government Electronics division, for one, expects to use the harmonic mode in its semiconductor microwave circuits (they're working on communications, guidance, and other systems).

Yet another avalanche diode mode has produced some astounding pulsed power outputs and efficiencies. This is the "anomalous" or trapatt (for trapped plasma avalanche transit time) mode, discovered at RCA's David Sarnoff Laboratories, which produces peak outputs of hundreds of watts at L band from a single diode.

RCA's Kern Chang tells the story: "We tried to look into the avalanche diode for L band—about 1 Ghz frequency. According to impatt diode theory you cannot go down that low in frequency. But we had hope of operating in some other mode at a low frequency. In a couple of months, we showed that we had found a new mode with one order of magnitude improvement in efficiency and two orders of magnitude improvement in power: 425 watts peak output with efficiency of 25 to 30%." Duty cycle was 0.1%.

As it continued its work on the new mode, RCA found that a few diodes had efficiency as high as 60%. The lab also worked on circuits for the diode and developed one that permitted continuous tuning over the whole L band, 900 Mhz to 1.5 Mhz. "I think this is a big step in solid state power generation," Chang says, "because we are able to have almost 1-octave-bandwidth tuning. And the circuit itself is so simple." It's an ordinary coaxial line with a simple lumped section; there are only two adjustments—to tune frequency and power. Chang believes that his group will be generating about a kilowatt, at 0.1% duty cycle, "in the very near future."

The potential of the anomalous avalanche diode in an L-band radar has already been demonstrated by RCA. "That particular radar happened to have a magnetron transmitter," Chang explains. "We pulled the magnetron out and we just got our diode and put it into the circuit in the transmitter. Although we had some power difference between the magnetron (which would work in the kilowatt range) and the diode (a few hundred watts), it worked. We tracked airplanes 20 or 30 miles away."

The anomalous mode is not limited to pulsed operation, Chang believes. With appropriate attention to heat dissipation, a power output of 20 watts c-w is possible, he says. ■

Designers of medical instruments face serious questions on safety

Many engineers and physicians say hospital electrocutions are increasing; the Government may step in if action isn't taken soon to improve control of leakage currents and other sources of danger

By Owen Doyle

Assistant editor

Hospital electrocutions are on the rise, according to many engineers, doctors, and others. Statistics aren't available, but the safety of electronic medical instrumentation is being questioned more and more. And instrument designers are getting part of the blame. The out-and-out dangerous instrument is rare, though not extinct. But some devices rely too much on operator skill. Others lack fail-safe protection or aren't designed to work safely with other instruments.

The problem has already reached Congress. The Medical Device Safety Act, which died in committee last session, will be introduced again this year. And if Congressmen don't see results from the efforts of instrument companies and hospitals to reduce the risks, one headline-making tragedy may be enough to get a safety act passed and bring the Food and Drug Administration into the act.

Of course, the danger of electrical shock has always been present in hospitals. But the chance of electrocution has gone up rapidly in the past decade. Ironically, the risks have risen for the same reason that the quality of some types of medical care has improved: the insertion into the body of catheters that transmit data on physiological parameters is becoming routine. And the heart, the organ most sensitive to small electrical currents, has been the organ most probed. The catheters bring vital information from the body, but they can also bring current into the body.

Before the appearance of the cardiac catheter, dangerous currents were measured in milliamperes. But when there's an open road to the heart, as little as 20 microamperes can be lethal. The problem facing physicians and engineers is to close the road to leakage but keep it open to data.

Inserting a catheter into a heart chamber is simple and painless. Usually, the physician inserts a long hollow needle into an artery or vein in the arm or leg, then feeds the catheter through the needle until the tip reaches the section of the heart where measurements are to be made. The most common parameter measured is total pressure of the blood at a specific heart site, but other types of catheters are becoming available for measurements of parameters other than pressure, such as blood pH, concentration of oxygen or carbon dioxide in the blood, and metabolic rate.

After the thin plastic tube is inserted, it's filled with a saline solution and connected to the chamber of a pressure transducer. A strain gage lies at the bottom of the chamber, so the fluid directly transmits the body pressure to the strain gage. The salt, required to make the fluid compatible with blood, also makes it an excellent conductor. A few stray millivolts between the fluid and ground can send lethal currents flowing into the heart wall.

The lack of statistics can be attributed mainly to two factors: hospitals, naturally enough, are reluctant to talk about the subject, and in many cases the evidence that death is due to shock from leakage currents is circumstantial. Patients with catheters in or probes on their bodies are often very ill. Unless the current is high enough to burn or produce sudden rigidity there is no way to prove electrocution. A small current flowing in the body does nothing that shows up in an autopsy. Dr. John Bruner, a Massachusetts General Hospital anesthesiologist, points out that death from fibrillation induced by current from a catheter is indistinguishable from death by "natural causes."

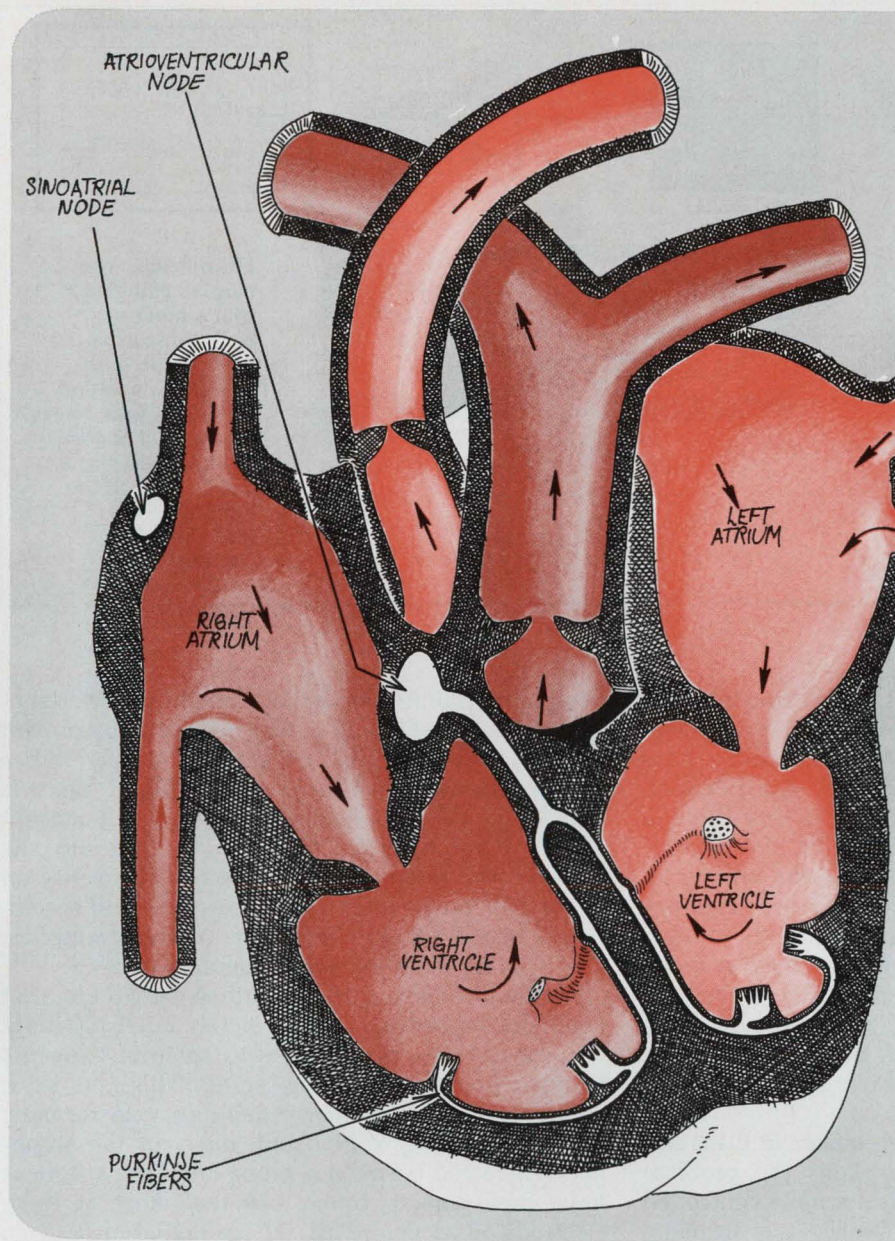

What is fibrillation?

Normally, contractions of muscle cells in the heart are controlled by a pacemaker, the sinoatrial (SA) node. Below it is another clump of specialized cells, the atrioventricular (AV) node. Strands of still other specialized cells, called Purkinje fibers, branch out from the AV node through the ventricular walls.

The pumping cycle starts when the SA node contracts, sending out electrical signals, some of which reach the AV node, then go through the Purkinje fibers, completing the cycle.

Mutiny. However, if an external current passes through a section of the heart, cells there may contract without waiting for commands from the pacemaker. And when they contract they send out signals just like those of the pacemaker. So the mutiny can spread. When muscle cells are contracting randomly and too rapidly, the heart is said to be fibrillating.

Removing the current won't restore order; once a heart starts fibrillating, it takes a large jolt of energy to resynchronize, or defibrillate, it.

Based on how currents get into the body, electrical shock can be broken down into gross and microamp types.

Gross shock occurs when the current passes through the skin. Skin resistance can run as high as 1 megohm, depending on the amount of dirt, sweat, body oil, and other substances. A patient's body is clean, however, and when electrodes are to be attached to a patient the physician usually scrapes away the layer of dead cells on the skin's surface. As a result, skin resistance under an electrode, such as the type used with electrocardiographs, is typically less than 1,000 ohms. A current of around 20 milliamps flowing through this resistance can cause fibrillation.

In a common type of ECG setup, two electrodes are placed on the patient's chest and a third, attached to the ECG's ground terminal, is placed on

his leg. If a patient with electrodes attached were to touch something above ground potential, a dangerous level of current could flow through him.

Although it usually causes fibrillation, gross shock can be lethal in two other ways. If the current comes in through the skull, it may attack the brain's respiratory control center. Elsewhere, it can paralyze the muscles used in breathing.

The lethal current that gets into a catheter is usually leakage, generated because of poor grounding. But currents can also be produced if electronic instruments are poorly designed or wrongly used, or if a component in an instrument fails. Also, some instruments, perfectly safe when operated by themselves, generate dangerous currents when used with other equipment.

In some hospitals the power ground is used as the instrument ground, says Paul Stanley, a physi-

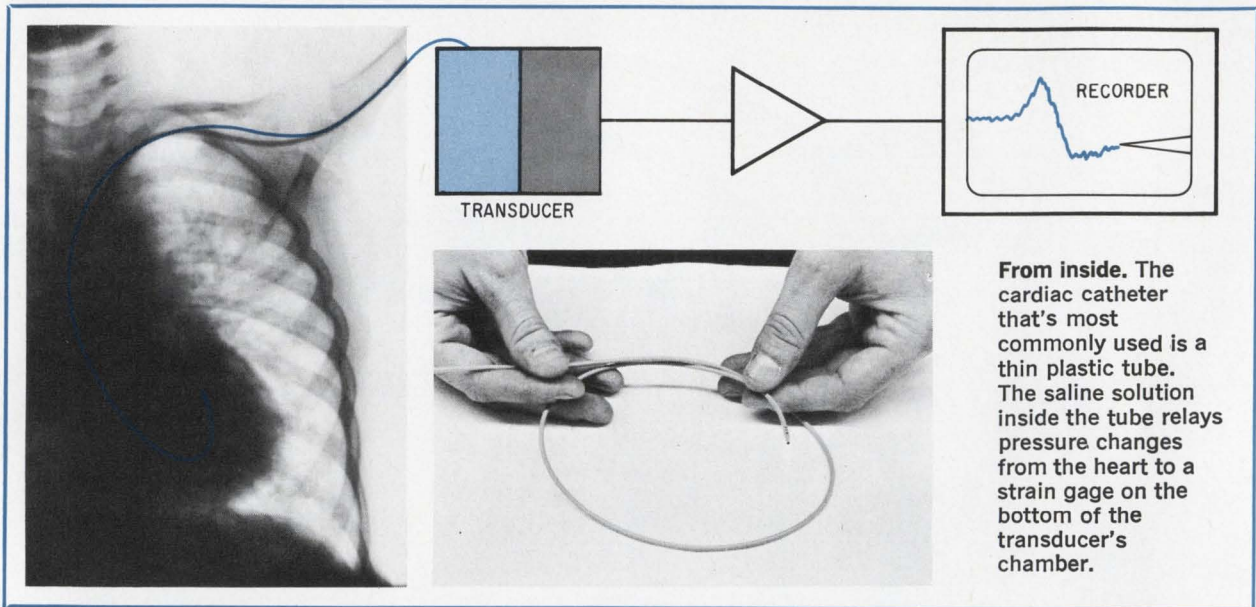

cist at Purdue University and an instrumentation-safety activist. Stanley points out that a power ground is often just a thin-walled conduit whose resistance may be as high as 0.006 ohm per foot. If, for example, 100 milliamps were to flow through this ground, the instrument end of the ground could easily be 100 millivolts above the other end.

Another reason it's dangerous to use a power ground as an instrument ground is that when there's a break in the cable's ground lead or when the ground pin snaps off the plug, the instrument continues to work, even though it can now be a source of leakage. And says Dr. Bruner: "The plugs and cords we get on instruments now are totally inadequate."

J.A. Hopps, a senior research officer in Canada's National Research Council, explains the problem this way: "Accidental current is normally controlled by grounding the equipment chassis . . . In many hospitals the existence of any sort of ground system is suspect. Older hospitals may have no ground wires at all."

The voltage that drives the leakage current can come from various sources. The electrical appliances found in hospital rooms—television sets, radios, lights, motorized beds—could be faulty. The beds seem to be the worst offenders. Many investigators have spot-checked beds in their hospitals and reported that 70% to 90% of them were poorly grounded. Says Dr. Harold Laufman, director of the Institute for Surgical Studies at New York's Montefiore Medical Center: "We don't have a good hospital bed. They can make them in French provincial, they can make them in colonial, but they don't seem to be able to make them safe."

Transient trouble

Joseph Neuland, manager of Beckman Instrument Inc.'s clinical instruments operations, points to another danger spot: the shock hazard due to

component failures in an instrument's power-supply circuit. Just about every medical instrument has either dual supplies or a single supply with a positive and negative output potential. If there is a failure, says Neuland, a large transient current can flow through the input leads and into the patient. And simply turning some instruments on or off can cause large transients. Neuland's solution is to build failure sensors into power supplies; this is being done by some manufacturers.

Neuland points out two other situations that could be hazardous. There is too much 60-hertz leakage from the power lines to some instruments in their normal operating state. This, he says, could be solved by properly shielding transformers.

And, according to Neuland, many of the amplifiers connected between a probe and an instrument have capacitors to cancel out the effect of large electrode-offset potentials. These potentials can go as high as 500 millivolts, says Neuland, so there's often a lot of energy stored by the capacitors. Under certain conditions, he says, this energy can be discharged through the patient to ground. So anyone designing blocking capacitors into an instrument, says Neuland, must make sure that the discharge current is carefully controlled.

The blame for these hazardous conditions, however, can't be placed entirely on one group. Says Hopps: "The responsibility must be shared by the equipment manufacturer, the hospital designer, and the medical user. The manufacturer's culpability generally derives from an inadequate comprehension of medical procedures and physiological factors. . . . In his desire to achieve versatility, he may unwittingly sacrifice protective features. He may assume that the user has technical competence to operate the instrument safely, and this is the most erroneous assumption . . . and a manufacturer usually considers his product a discrete unit rather than part of a patient treatment system."

Others are not so understanding about the manufacturers' efforts. Says Dr. Laufman: "There's been a lot of gimmickry and misrepresentation in this instrumentation business." Harve Hanish, president of Biocom Inc., a medical instrumentation house, is no more sympathetic. He feels that there hasn't been nearly enough improvement in medical instrumentation, and not just in the safety area, over the past few years. He charges that the instrument industry is suffering from the "Detroit syndrome." "Manufacturers appear compelled to bring out new models every year, not changing the electronics, just making the cases fancier," he says.

David Lubin, administrative engineer at Baltimore's Sinai hospital, also finds fault with the instrument makers: "Most electrical equipment purchased today is factory-equipped with grounding facilities in the power cord and attachment plug. The catch lies in the fact that too often the devices furnished with electrical equipment to provide grounding for safety are weak, easily broken, and poorly designed for rough handling. They aren't proper because they're not foolproof, not fail-safe, not reliable."

But others also come in for criticism from Lubin: "The blame cannot be placed entirely on the manufacturer or entirely on any one condition. The situation as it exists today is the result of a combination of factors that involve the newness and subtlety of the hazard, the complacency and apathy of hospitals, an almost total lack of standards relating to specific devices for specific hospital applications, confusion in some codes, and the unfortunate fact that connection devices that will work on light-duty, generally nonhazardous items such as electric clocks will also work on critical medical instrumentation."

Richard Lloyd, assistant to the president of Underwriters Laboratories Inc., proposes some immediate changes in the design of instrumentation systems. Lloyd would:

- "Require a ground-fault detector.
- Require that isolating transformers serve one patient area only and be provided with a grounding shield between primary and secondary windings.
- Restrict the size of the isolating transformer, the length of the circuit, and the type of insulation used on the conductor to keep leakage down.
- Require surge or overvoltage protection on all circuits entering or leaving the patient area.
- Require the use of double-insulated equipment where grounding doesn't provide the necessary protection.
- Consider the use of ground-fault circuit interrupters on medically nonessential circuits."

A long look

Stanley, while naturally urging immediate changes where they can be made, feels that now is the time for a sweeping attack on the problem of shock in hospitals. Says Stanley: "Committees formed by Federal agencies, professional societies, safety organizations, and industry are scrambling

to establish standards aimed at making cardiac monitors, pacemakers, defibrillators, and all kinds of still-uninvented devices safe for use in the hospital and clinic. The effort is commendable, but the word scrambling is used advisedly. Decisions reached and rules codified without careful analysis could stifle the development of new concepts if the decisions and the rules are too strict; if standards are too liberal, they provide little of the safety they are intended to ensure. And whether too strict or too lenient, codes once printed are difficult to change."

The program Stanley proposes would first involve defining the problem. "There should," he says, "be careful study to determine how real the dangers are. Are electrical fatalities caused by medical instrumentation on the increase? Is the rate of increase as large as some fear?" Once these questions are answered, says Stanley, it would be possible to make sure that safety is designed into systems, to establish adequate controls over existing problems, and to begin review programs so equipment design could be continuously brought up to date.

He also suggests re-evaluation of the body's sensitivity to electric shock, particularly in regard to maximum safe currents, and studies to determine whether the pathological heart is more susceptible to electric shock than the healthy heart and how various medications affect fibrillation thresholds.

A congressman's wife

Stanley isn't specific about who should undertake or pay for such a program, but there's a good chance the Government will enter the area of medical-instrumentation safety.

The Medical Device Safety Act would authorize the FDA to pass on the safety and efficacy of medical instrumentation and to set standards for devices that are implanted in body cavities, placed in contact with mucous membranes, or delivering energy to the body. Exempted would be devices that have been around long enough to have proved themselves, such as fluoroscopes; instruments under clinical investigation, and those custom-made for a licensed practitioner.

Whatever the chances of the bill this year, it seems likely that some kind of legislation will be adopted in the next few years. "I don't like to see the Government get involved in this," says one physician, "but I'm afraid it's going to have to happen. Hospitals and manufacturers have had their chance and just don't seem to be able or willing to do anything about the safety problem. Congress isn't under that much pressure now to pass any kind of bill. But let one congressman's wife get burnt while she's in the hospital, and we'll have our standards the next day." ■

Bibliography

J.A. Hopps, "Electrical Hazards in Hospital Instrumentation," Symposium on Reliability, IEEE, January 1969. Proceedings of the First National Conference on Electronics in Medicine, 1969; to be published.

Designer's casebook

FET's tune RC oscillator over decade range

By Kees van der Geer

Jutphaas, Netherlands

Field effect transistors acting as variable resistance devices enable an RC oscillator to be tuned over a decade range with a control voltage that varies from 4.8 to 7.2 volts. The output amplitude remains stable to within 1 decibel. Although the frequency range for the values shown is 500 kilohertz to 5 megahertz, other frequency ranges can be obtained using different capacitor values.

Two phase shifters, a phase inverter, an amplifier, and an attenuator are connected in a loop. The circuit will oscillate at a frequency in which the total phase shift is 360 degrees. At that frequency, the two identical phase shifters each yield a phase shift of 90°. The voltage-controlled phase shifter is determined by C₁ and Q₂. The frequency is de-

rived from the equation:

$$f_{osc} = \frac{-I_{DSS}}{\pi CV_p} + \frac{I_{DSS}}{\pi CV_p^2} V_{GS}$$

Thus the frequency is a linear function with slope

$$\frac{I_{DSS}}{\pi CV_p^2}$$

Q₃, Q₄, and C₃ constitute the second phase shifter which operates in a similar manner to the first one. The high input impedance of the phase shift stages eliminate the need for buffer stages. The gates of Q₂ and Q₄ are a-c grounded and hence can be connected together. Q₅ amplifies the signal.

Q₇ and R₆ make up the voltage-controlled attenuator with Q₇ acting as a variable resistor.

The amplitude detector consists of amplifier Q₆; diode-capacitor detector D₁, C₄, and C₆; and filter R₅-C₅. If the output amplitude increases, the gate of Q₇ will be driven more negative, increasing its dynamic resistance, lowering the loop gain. The dynamic range of the voltage-controlled attenuator does not need to be very broad because the phase shift stages are "all pass" filters.

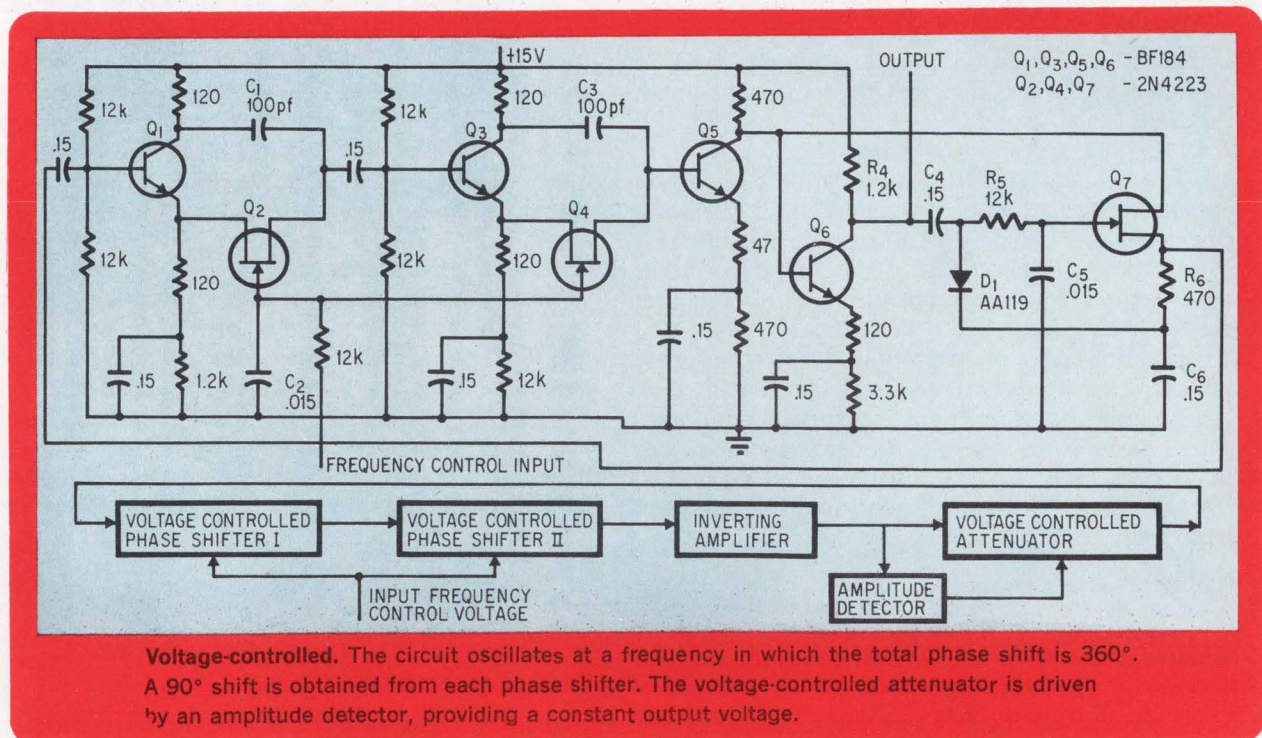

FET links oscillator to TTL circuit

By Colin S. L. Keay and Ian C. Graham

University of Newcastle, New South Wales

Coupling clock generators to TTL is simplified when a field effect transistor is used. The FET makes two or more driver stages unnecessary and allows the complete circuit to operate off the same 5-volt supply as the TTL.

The crystal oscillator provides a 4-volt peak-to-peak sine wave at a frequency of 12 megahertz. This is rectified by a shunt diode that provides a bias to the FET. C and $R_1 + R_2$ provide a relatively long time constant so that virtually the full sine wave is applied to the gate of the FET. The saturated drain current is more than enough to bring the TTL's input emitter to 0, provided the FET's drain-to-source channel resistance is low enough. It is typically 200 ohms for a 3N128. The SN7400 series requires an input emitter resistance of less than 500 ohms.

The mark-space ratio of the output waveform can be improved by changing the value of the 1.2-kilohm resistor.

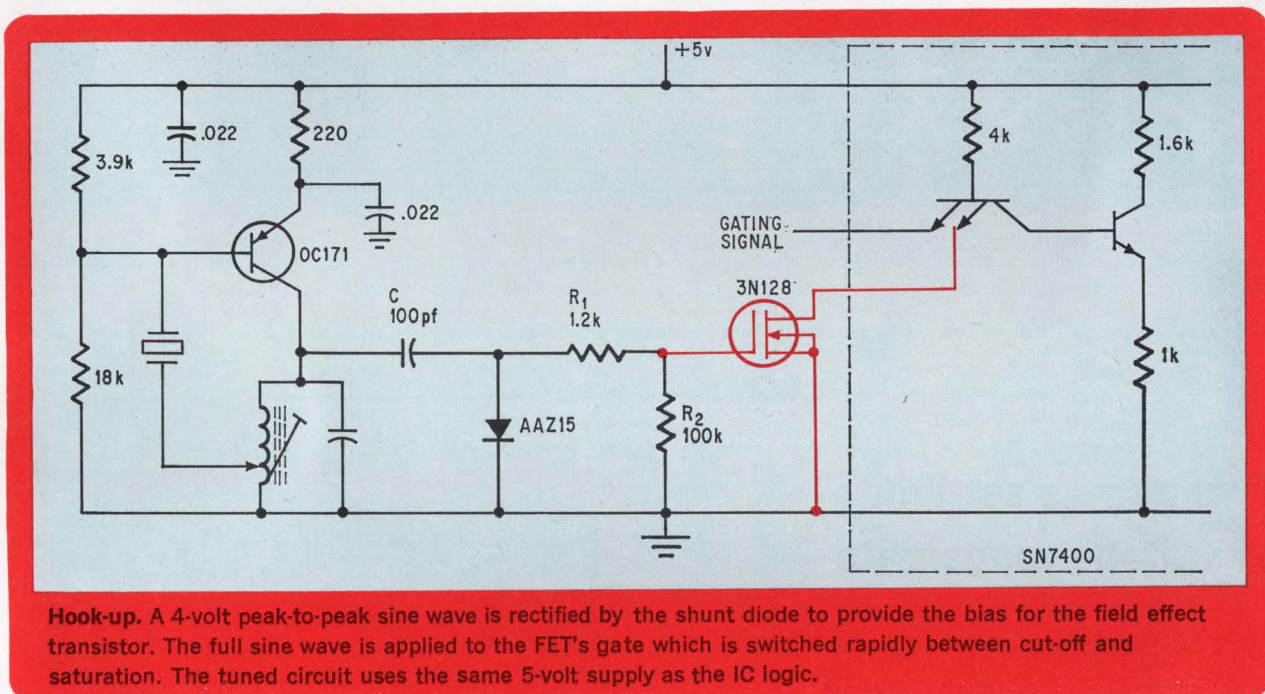

Hook-up. A 4-volt peak-to-peak sine wave is rectified by the shunt diode to provide the bias for the field effect transistor. The full sine wave is applied to the FET's gate which is switched rapidly between cut-off and saturation. The tuned circuit uses the same 5-volt supply as the IC logic.

Converted generator drives heavy logic loads

By Robert K. Underwood

Monsanto Corp., St. Louis, Mo.

The engineer must beware when attempting to drive current sinking logic (DTL, TTL, etc.) by standard laboratory signal or pulse generators. Most sine-wave and function generators produce an output waveform symmetrical about ground

which, if adjusted for sufficient amplitude in the positive direction, may exceed the ratings of the logic elements in the negative direction. Pulse generators with 50-ohm output resistance are limited to driving relatively light loads because current flowing out of the gate inputs develops a voltage across the generator's resistance that prevents the output-gate voltage from reaching ground.

In the circuit, voltage swings of ± 25 volts will cause no damage to integrated circuits.

R_1 and D_1 clamp positive input voltages to 5 volts and negative inputs to -0.7 volts. The clipped waveform is applied to the supply terminal and one of the gate inputs. During the input's positive cycle, the output is clamped to ground and capable

of absorbing 40 milliamps. While the input is positive, D_2 conducts and charges C to 5 volts.

During the negative cycle, the supply voltage

is removed from the gate and the input is clamped to ground removing the base drive to the output transistor. C acts as the supply voltage through R_2 .

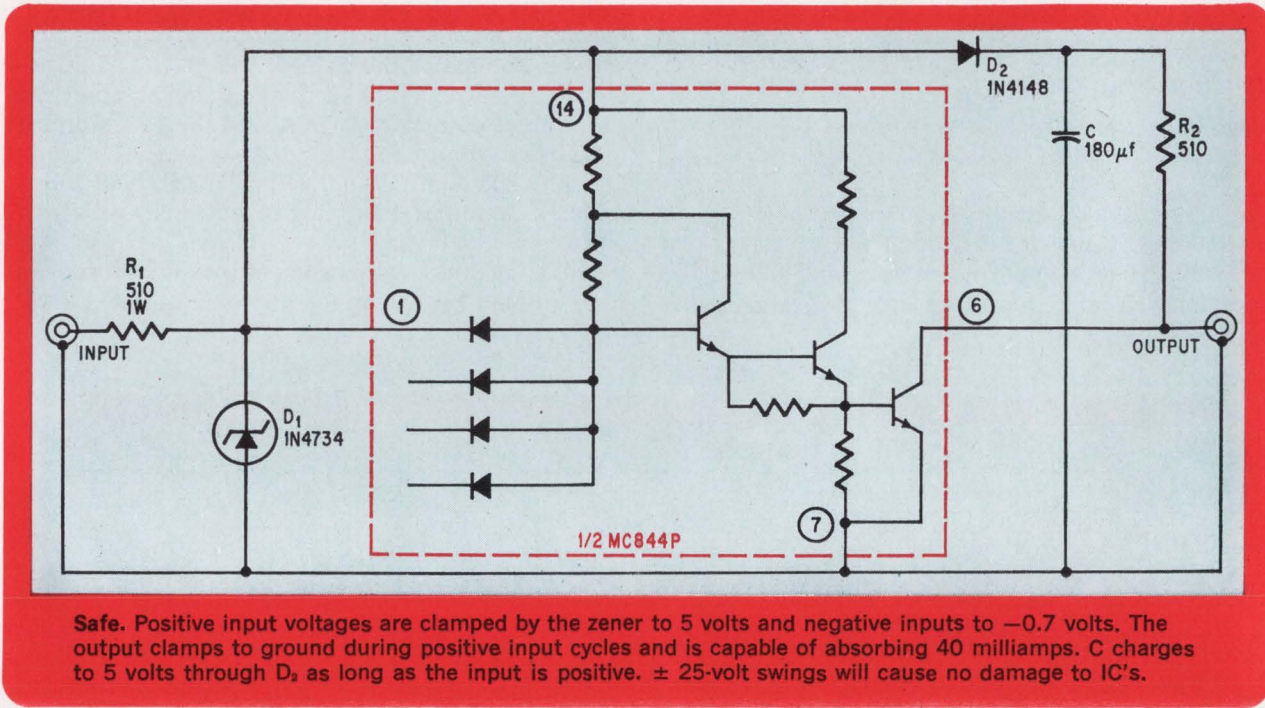

Safe. Positive input voltages are clamped by the zener to 5 volts and negative inputs to -0.7 volts. The output clamps to ground during positive input cycles and is capable of absorbing 40 milliamps. C charges to 5 volts through D_2 as long as the input is positive. ± 25 -volt swings will cause no damage to IC's.

Two zeners set limits of voltage range gate

By N.M. Buckland

Defence Standards Laboratories, Melbourne

Automatic processing equipment often requires devices to shut off testing or production when a major input parameter exceeds arbitrarily set limits. When the parameter exists as a voltage, it can be simply monitored by a zener circuit.

When the input voltage is less than the zener voltages, no current flows in the circuit. When the input voltage is less than the zener voltage of D_2 but greater than D_1 , current flows through R_1 and D_3 . Despite changes in the current through R_1 , the voltage across D_3 will remain constant even as the input voltage varies over broad limits. This voltage causes current to flow through R_3 , R_4 , and D_4 . Although the circuit works when D_4 has the same forward voltage drop as D_3 , use of a gold-bonded diode for D_4 enhances the shape of the voltage-current curve at the D_1 turn-on point.

If the input voltage exceeds D_2 's zener voltage,

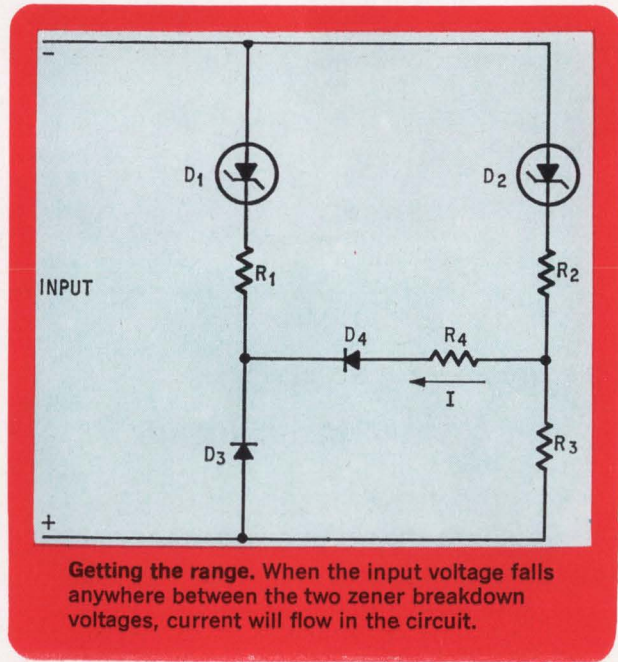

Getting the range. When the input voltage falls anywhere between the two zener breakdown voltages, current will flow in the circuit.

current will flow through R_2 and R_3 . The values of R_2 and R_3 are chosen so that at low currents the voltage across R_3 exceeds the forward voltage across D_3 and current stops flowing.

First second source

(Immediate delivery on 54/7400 IC's, even hard-to-get ones.)

Some people think 54/7400's are primarily a secondary interest with us. (New designs should be using our DCL line, of course.)

But our 54/74's are so good some people are coming to us as a second source first.

The reasons are simple:

First, we've got a good broad line. Second, we can deliver them *all*, in volume, even the hard-to-get ones.

Third, we've got a superior package, silicone instead

of epoxy. Fourth, we can guarantee the same kind of reliability you'd get in our proprietary lines.

Fifth, it's all backed by our excellent sales and service organization. And sixth, for 54/74's that makes us the first second source.

Signetics Integrated Circuits

A SUBSIDIARY OF CORNING GLASS WORKS
811 East Arques Ave., Sunnyvale, California 94086



We're the easiest place to get hard-to-get-ones

Quad 2-Input NAND	5401/7401
Dual 4-Input Power NAND	5440/7440
BCD-to-Decimal Decoder/Driver	7441
Quadruple Bistable Latch	5475/7475
Full Adder	5480/7480
8-Bit Shift Register	5491/7491

And not quite so hard-to-get-ones

Quad 2-Input NAND	5400/7400
Quad 2-Input NOR	5402/7402
Triple 3-Input NAND	5410/7410
Dual 4-Input NAND	5420/7420
Eight Input NAND	5430/7430
Dual AND-OR Invert w/Expander	5450/7450
Dual AND-OR Invert without Expander	5451/7451
Single 4 wide 2-Input AND-OR Invert Gate Expandable	5453/7453
Quad 2 AND-OR Invert Not Expandable	5454/7454
Dual 4-Input Expander	5460/7460
Single Phase J-K Flip Flop	5470/7470
Single M.S. Flip Flop	5472/7472
Dual M.S. Flip Flop	5473/7473
Dual D Flip Flop	5474/7474
Dual M.S. Flip Flop Preset & Clear	5476/7476

And there are more to come.

Call your nearest Signetic's Sales Office or distributor.

See us at IEEE, booth number 3A01 to 3A04

Active filters: part 7

Analog blocks ensure stable design

A new, quick, and straightforward cascading procedure uses integrators and inverters to produce a filter that can't oscillate and can be made of wide-tolerance components

By Joseph Salerno

Bell Telephone Laboratories, Holmdel, N.J.

Drastic reductions in the costs of active-filter designs and in the difficulty of fixing the cutoff frequency have resulted from the use of IC op amps. A technique that produces a filter's transfer function with operational amplifiers—combined to provide either an integrating or inverting function—is finally available. Frequencies are set by resistor value, eliminating the need for tight-tolerance capacitors, which aren't available in IC form.

The design minimizes the number of capacitors needed, and because the op amp is an isolator (due to its high input impedance, low output impedance, and high gain)—no additional coupling stages are needed to cascade sections. What's more, the active filter is absolutely stable, since changes in passive elements or amplifier gains don't shift the transfer function poles to the right-hand side of the complex s-plane.

In the technique, the op amp is used as an inverter or integrator—a common situation. With

these basic building blocks, the designer can construct a variety of filters. The number of capacitors in each filter equals the order of the transfer function.

Regardless of the type of filter desired, the designer must first determine the order of its normalized low-pass prototype. This is done by:

- Operating on the insertion-loss characteristics of the filter.
 - Writing the polynomial corresponding to the order of the low-pass prototype or writing it in factored form as a product of lower-order polynomials.
 - Transforming the normalized prototype to the transfer function desired—low pass, bandpass, or high pass.
 - Laying out the building block elements according to the transformed prototype, using integrators and inverters.
 - Constructing the active filter schematic.
- Use of the technique becomes clearer when one

$$\frac{V_o}{V_i} = \frac{b_n s^n + b_{n-1} s^{n-1} + \dots + b_0}{s^n + a_{n-1} s^{n-1} + \dots + a_0} \quad (1)$$

$$V_o (s^n + a_{n-1} s^{n-1} + \dots + a_0) = V_i (b_n s^n + b_{n-1} s^{n-1} + \dots + b_0)$$

$$V_o s^n = V_i (b_n s^n + b_{n-1} s^{n-1} + \dots + b_0) - V_o (a_{n-1} s^{n-1} + \dots + a_0) \quad (2)$$

$$V_o = V_i \left(b_n + \frac{b_{n-1}}{s} + \dots + \frac{b_0}{s^n} \right) - V_o \left(\frac{a_{n-1}}{s} + \dots + \frac{a_0}{s^n} \right)$$

Transfer functions. The general expression for a second-order transfer function can be written as in equation 1. By rearranging the terms the form of equation 2 is obtained. Here, the terms become integrators and inverters.

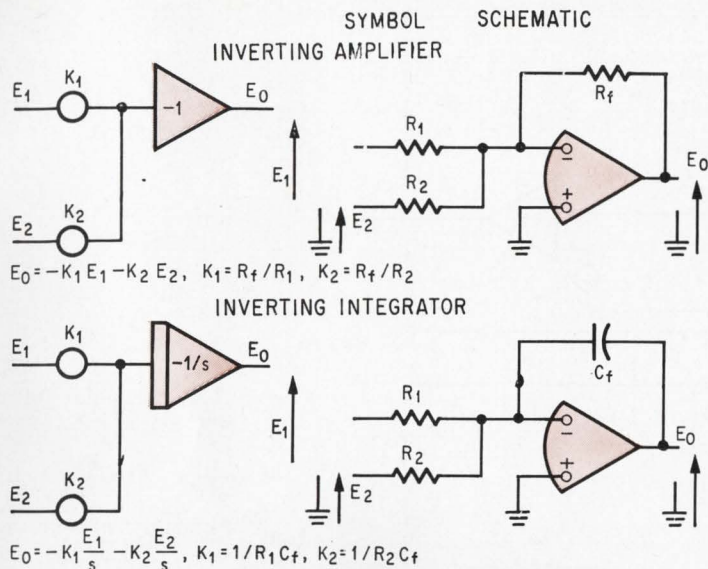

Building blocks. The inverter is represented by an op amp whose gain is -1 . A signal is integrated by an op amp whose gain is $1/s$.

examines some helpful and basic analog rules.

The analog synthesis method can be applied directly from the transfer-function relationship. To start, consider the synthesis of a general n -th order active filter, as expressed by equation 1. Here, the transfer function is the ratio of two polynomials. The numerator represents the zeros of the filter and the denominator represents the poles. Coefficients a and b are constants. The transfer function should also be rearranged as in equation 2, because each term can then be expressed by an integrator or inverter. As an example of the ease of design consider a second-order transfer function.

$$\frac{V_o}{V_i} = - \left(\frac{b_2 s^2 + b_1 s + b_0}{s^2 + a_1 s + a_0} \right)$$

If the network is a low-pass filter, coefficient $b_2 = b_1 = 0$; for a bandpass filter, $b_2 = b_0 = 0$; a high-pass filter, $b_1 = b_0 = 0$; a band-elimination filter, $b_1 = 0$. The a_1 and a_0 coefficients are always greater than zero.

Rewriting the transfer function yields the following expression in terms that can be directly implemented with integrators and inverters.

$$V_o = -V_i \left(b_2 + \frac{b_1}{s} + \frac{b_0}{s^2} \right) - V_o \left(\frac{a_1}{s} + \frac{a_0}{s^2} \right)$$

To lay out the block drawing of this equation, the designer draws two terminals. At the left is a terminal for the input voltage, V_i , and to the right one for the output voltage, V_o . The construction between these two is made on a term-to-term basis. The coefficients are represented as input signals and the s -terms by integrators. Since the lowest power of s is zero, the building block preceding V_o must be an inverting amplifier. The function is

obtained with the circuit shown at top of page 102.

The feedback elements C_1 , C_2 , R_4 , and R_7 can be chosen arbitrarily, because their values aren't critical to the circuit's operation ($C_1 = C_2 = 0.01$ microfarad, $R_4 = R_7 = 100$ kilohms are usually suitable values). The remaining resistors must be trimmed. Having chosen these component values, the designer calculates the others based on the time constant of the op amp the components are connected to and the constants a or b , as shown on page 102 to the right of drawing.

Getting started

Before a circuit diagram such as the one just described can be drawn, the designer must choose a transfer function. This is usually done from a frequency-response curve. For example, consider the design of Butterworth-type filters. The transmission-loss shape is represented by

$$\left| \frac{V_o}{V_i} \right|^2 = \frac{1}{1 + |p|^{2n}}$$

where n represents the order of the transfer function chosen, and p is the complex frequency normalized to the cutoff or center frequency, ω_0 . The plots of the transmission loss for normalized low-pass prototype filters are shown at bottom page 102.

Suppose the designer wants a filter with a rejection of 18 decibels at twice the cutoff frequency, $f/f_0 = 2$. Entering the curve at a normalized frequency of 2, the designer searches for an intersection with a transmission-loss line of 18 db. Such an intersection is made inevitable by a third-order prototype of $n = 3$. Thus, the required prototype is third order.

In general, the filter's transfer function can be written as

$$\frac{V_o}{V_i} = \frac{1}{D_n(p)}$$

where $D_n(p)$ are the Butterworth polynomials. Six terms for $D_n(p)$ are given at top of page 103 for convenience; these are usually found in a conventional Butterworth table. Since the example filter is third-order, the polynomial for $D_3(p)$ would be used.

To minimize sensitivity due to changes in component values, the designer cascades several low-order sections, each corresponding to the factor of the over-all polynomial. As a convenience in cascading such networks the Butterworth polynomials are also given on page 103 in factored form. Designing the filter by using the factors eliminates the need for the long feedback path of the unfactored polynomial design. Having one less path improves the network's parameter sensitivity, lessening the chance for instability.

Having determined the normalized transfer function for the filter, the designer next transforms this expression. The transformation from the normalized prototype to the actual transfer functions

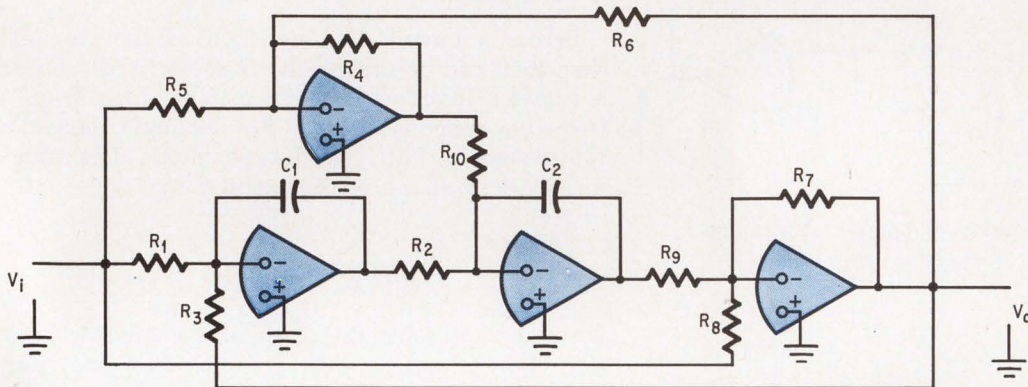
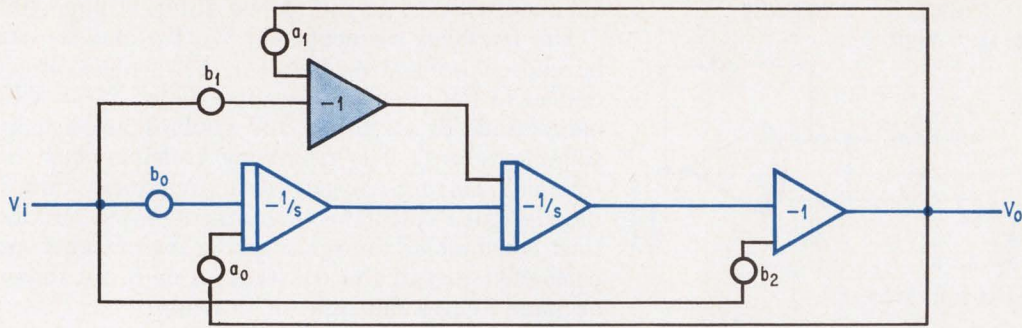

$$R_1 = \frac{1}{b_0 C_1}, \quad R_2 = \frac{1}{C_2}$$

$$R_3 = \frac{1}{a_0 C_1}, \quad R_5 = \frac{R_4}{b_1}$$

$$R_6 = \frac{R_4}{a_1}, \quad R_8 = \frac{R_7}{b_2}$$

$$R_9 = R_7, \quad R_{10} = \frac{1}{C_2}$$

Writing equations. Integrators and inverters are combined to express a mathematic equation for a transfer function. The path shown in color can be written as $V_o = b_o (-1/s) (-1/s) (-1) V_i$. Similarly, other paths between V_i and V_o can be expressed mathematically. The algebraic sum of all paths forms the mathematical relationship of the transfer function. Resistor values are expressed in coefficients and time constants.

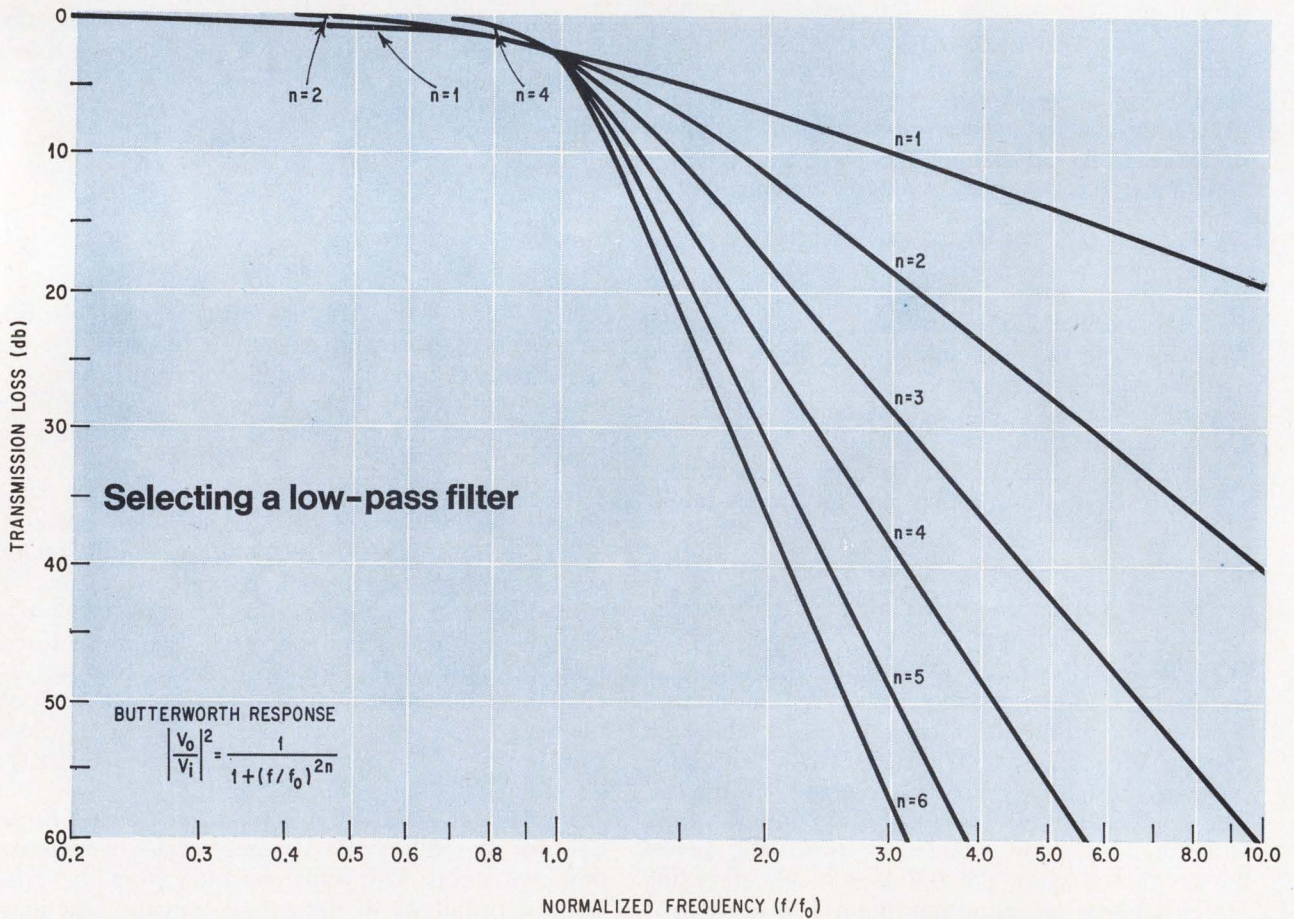

Factored Butterworth polynomials aid active-filter design

Order	Conventional form	Factored (cascaded) form
$D_1(p)$	$p + 1$	$(p + 1)$
$D_2(p)$	$p^2 + 1.41421 p + 1$	$(p^2 + 1.414 p + 1)$
$D_3(p)$	$p^3 + 2p^2 + 2 p + 1$	$(p + 1) (p^2 + p + 1)$
$D_4(p)$	$p^4 + 2.61313 p^3 + 3.41421 p^2 + 2.61313 p + 1$	$(p^2 + 0.7653 p + 1) (p^2 + 1.848 p + 1)$
$D_5(p)$	$p^5 + 3.23607 p^4 + 5.23607 p^3 + 5.23607 p^2 + 3.23607 p + 1$	$(p + 1) (p^2 + 0.6180 p + 1) (p^2 + 1.618 p + 1)$
$D_6(p)$	$p^6 + 3.86370 p^5 + 7.46410 p^4 + 9.14162 p^3 + 7.46410 p^2 + 3.86370 p + 1$	$(p^2 + 0.5176 p + 1) (p^2 + 1.414 p + 1) (p^2 + 1.932 p + 1)$

can be made as follows.

For a low- or high-pass filter the cutoff frequency is defined as ω_0 . In a low-pass transformation, then, a situation of $p = s/\omega_0$ is required; in a high-pass transformation, $p = \omega_0/s$. In the bandpass and band-elimination configurations, the low- and high-frequency cutoff edges are defined as ω_L and ω_H , respectively, with the substitution

$$\delta = \omega_H - \omega_L$$

$$\omega_0 = \sqrt{\omega_H \omega_L}$$

The actual transfer functions for these cases can be obtained by substituting

$$V_o = -V_i \frac{\omega_0^3}{s^3} - V_o \left(\frac{2\omega_0}{s} + \frac{2\omega_0^2}{s^2} + \frac{\omega_0^3}{s^3} \right)$$

By tracing paths from V_i and V_o the designer

sets up a route for each coefficient term in the transfer function. Each $1/s$ term corresponds to an integrator and each -1 term to an inverter. One circuit that satisfies this equation is directly below. Values for components C_1 , C_2 , C_3 , and R_4 are chosen arbitrarily. Thus, to maintain accuracy, close tolerance values are required on all resistors except R_4 .

As an alternative, this filter could be built by cascading two smaller sections—a first-order and a second-order design. Thus, for $n = 3$

$$D_3(p) = (p + 1) (p^2 + p + 1)$$

The transform function for the actual low-pass filter, V_o/V_i , where

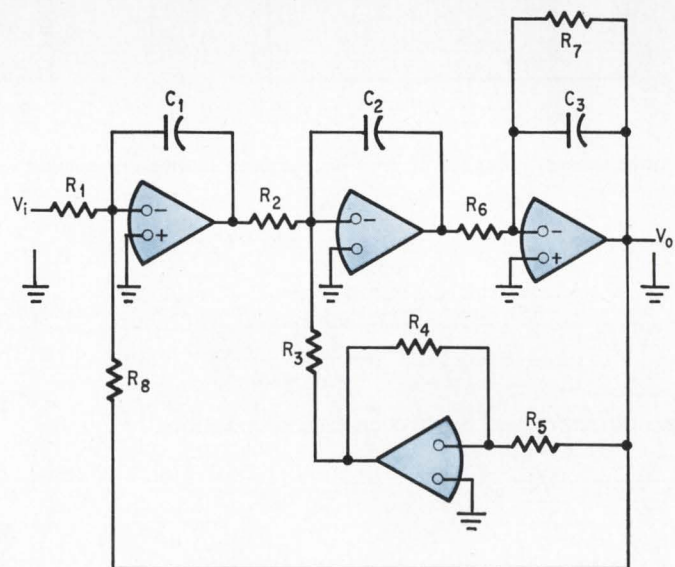
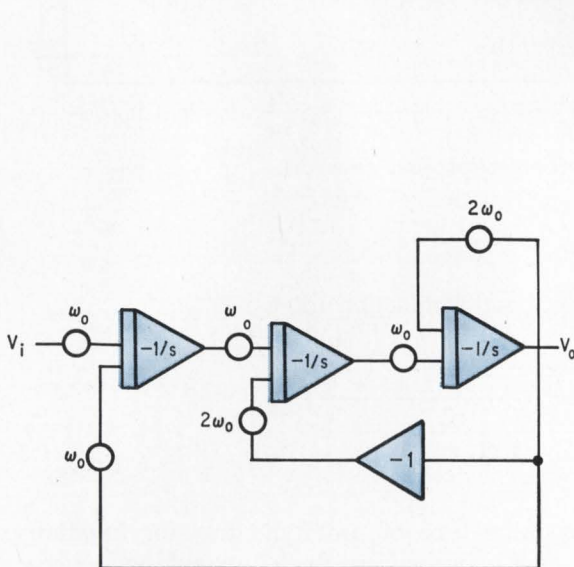

$$R_1 = R_8 = \frac{1}{\omega_0 C_1}, R_2 = \frac{1}{\omega_0 C_2}, R_3 = \frac{1}{2\omega_0 C_3}, R_5 = R_4, R_6 = \frac{1}{\omega_0 C_2}, R_7 = \frac{1}{2\omega_0 C_3}$$

Butterworth filter. The transfer function for a Butterworth filter is represented by op amp integrators and inverters.

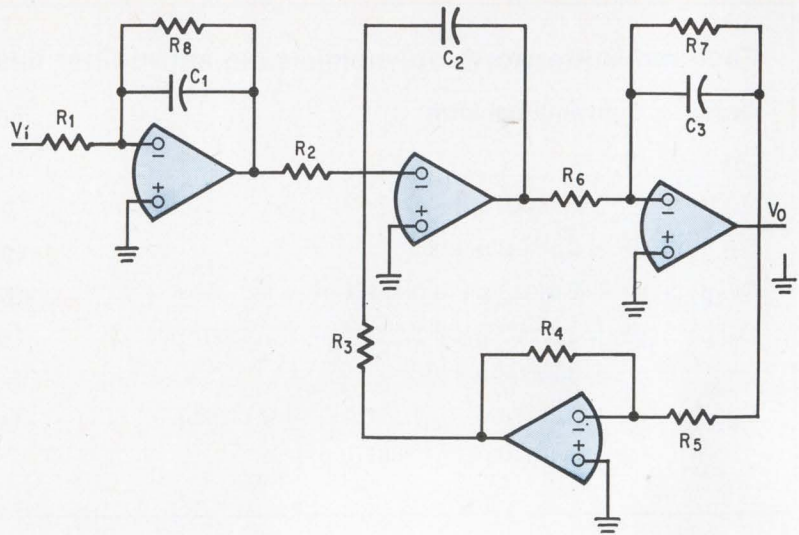
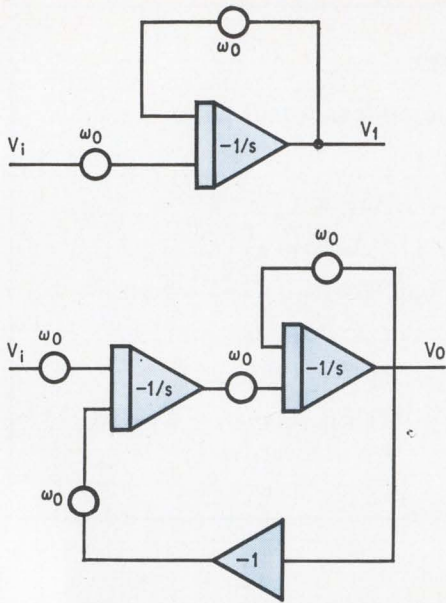

$$R_1 = R_8 = \frac{1}{\omega_0 C_1}, \quad R_2 = R_3 = \frac{1}{\omega_0 C_2}, \quad R_6 = R_7 = \frac{1}{\omega_0 C_3}, \quad R_5 = R_4$$

Cascading. To improve the sensitivity of a filter several low-order networks are cascaded. The drawing at the right shows the combination of the two sections at the left.

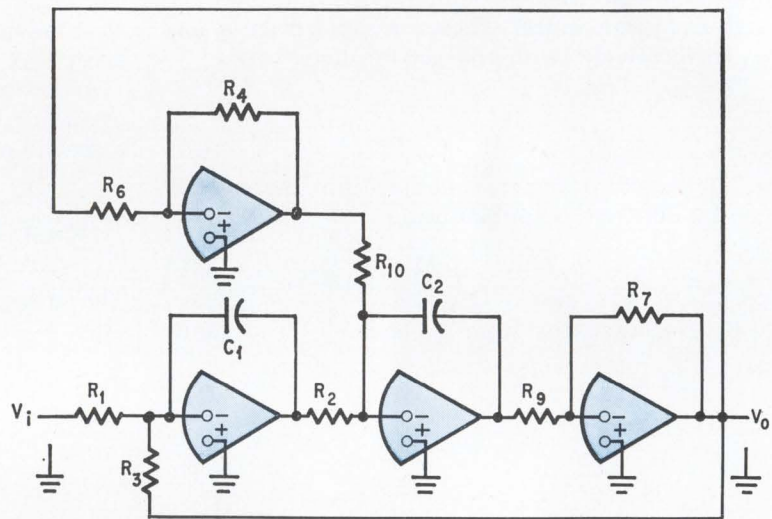
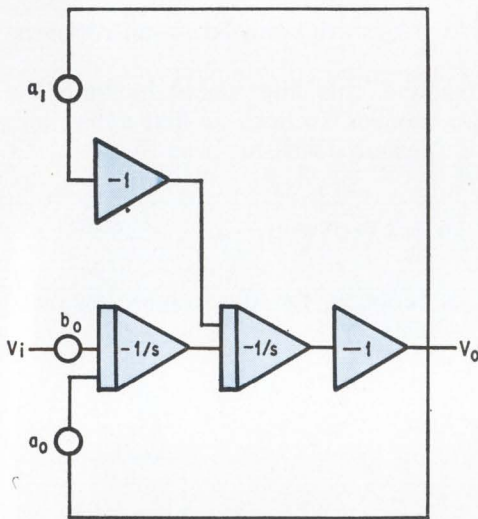

$$R_1 = \frac{1}{b_0 C_1}, \quad R_2 = \frac{1}{C_2}, \quad R_3 = \frac{1}{a_0 C_1}, \quad R_6 = \frac{R_4}{a_1}, \quad R_9 = R_7, \quad R_{10} = \frac{1}{C_2}$$

Higher orders. Filter for an $n = 4$ prototype is made of several lower-order cascaded networks.

$$\frac{V_o}{V_i} = \frac{-1}{\left(1 + s/\omega_0\right) \left(1 + \frac{s}{\omega_0} + \frac{s^2}{\omega_0^2}\right)}$$

can be expressed as two cascaded functions

$$\frac{V_o}{V_i} = \frac{V_1}{V_i} \times \frac{V_o}{V_1}$$

for the bandpass filter, and

$$p = \frac{\omega_0}{\delta} \left[\frac{\omega_0}{s} + \frac{s}{\omega_0} \right]$$

for the band-elimination filter.

$$p = \frac{1}{\frac{\omega_0}{\delta} \left[\frac{\omega_0}{s} + \frac{s}{\omega_0} \right]}$$

Any other type of prototype transfer function, such as Chebycheff or Bessel, could have been chosen, and the same transformation applied.

As an example of the complete design procedure consider a low-pass, maximally flat passband filter

with a 500-hertz cutoff frequency and a minimum attenuation of 25 db at 1,500 hz.

From the graph it can be seen that a third-order filter will meet the requirements. Thus,

$$D_3(p) = (p^3 + 2p^2 + 2p + 1)$$

Inserting for a low-pass transformation, $p = s/\omega_0$, where $\omega_0 = 2\pi(500)$, the actual low-pass transform function becomes

$$\frac{V_o}{V_i} = \frac{-1}{\frac{s^3}{\omega_0^3} + \frac{2s^2}{\omega_0^2} + \frac{2s}{\omega_0} + 1}$$

Rearranging yields

$$V_o = -V_i \frac{\omega_0^3}{s^3} - V_o \left(\frac{2\omega_0}{s} + \frac{2\omega_0^2}{s^2} + \frac{\omega_0^3}{s^3} \right)$$

each of which can be considered separately. For the first section

$$\frac{V_1}{V_i} = \frac{-1}{1 + s/\omega_0}$$

$$V_1 = -\frac{\omega_0}{s} V_i + \frac{\omega_0}{s} V_1$$

The second transfer function can be written as:

$$\frac{V_o}{V_1} = \frac{1}{1 + \frac{s}{\omega_0} + \frac{s^2}{\omega_0^2}}$$

$$V_o = \frac{\omega_0^2}{s^2} V_1 - V_o \left(\frac{\omega_0^2}{s^2} + \frac{\omega_0}{s} \right)$$

Comparing the two filter schematics shown at the top of page 104, the designer notes that element values differ because of different coefficients in the individual transfer functions. The only layout difference, however, lies in the path containing resistor R_8 . In the construction using the single transfer function, the feedback path extends from the last integrator to the first. For the two lower-order transfer-function networks this feedback path includes only the first integrator and isn't dependent on the other elements in the filter. Deriving higher-order sections yields a similar comparison of layouts. Thus, parameter sensitivity is improved by applying low-order sections.

Consider a second example, in which a design is required for a maximally flat low-pass filter with a cutoff frequency of 500 hz and a minimum of 20-db discrimination at 1 kilohertz. The graph shows that $n = 4$ satisfies the requirements. The low-pass active filter can be obtained by cascading two second-order sections. The low-pass maximally flat prototype polynomial is chosen from the But-

terworth table as

$$D_4(p) = (p^2 + 0.7653p + 1)(p^2 + 1.848p + 1)$$

First consider the network corresponding to

$$D(p) = p^2 + 0.7653p + 1$$

Using the low-pass transformation,

$$p = \frac{s}{\omega_0}$$

where $\omega_0 = 2\pi(500)$

$$D(s) = \frac{s^2}{\omega_0^2} + 0.7653 \frac{s}{\omega_0} + 1$$

The second-order transfer function can now be written as

$$\frac{V_o}{V_i} = \frac{1}{D(s)} = \frac{\omega_0^2}{s^2 + 0.7653\omega_0 s + \omega_0^2}$$

which corresponds to the configuration shown at top of page 102, with

$$b_1 = b_2 = 0$$

$$b_0 = \omega_0^2$$

$$a_1 = 0.7653\omega_0$$

$$a_0 = \omega_0^2$$

Similarly, the second of the two cascaded sections is identical except that

$$a_1 = 1.848\omega_0$$

The representation of each section is shown on the facing page. Typical values for the feedback elements are

$$C_1 = C_2 = 0.01\mu\text{f}$$

$$R_4 = R_7 = 100\text{ k}$$

Thus, all values are defined. Cascading both sections produces the required active filter characteristics. ■

Bibliography

J.L. Burchall, "The Bessel Polynomials," *Canadian Journal of Mathematics*, Vol. 3, 1951, pp. 62-68.

L. Storch, "Synthesis of Constant Time Delay Ladder Networks Using Bessel Polynomials," *Proceedings of the IRE*, November 1954, p. 1,666-1,675.

Louis Weinberg, "Network Analysis and Synthesis," McGraw-Hill Inc., 1962, pp. 485-552.

L.K. Wadkwa, "Simulation of Third-Order Systems With Double Leads Using One Operational Amplifier," *Proceedings of the IRE*, June 1962, pp. 1,538-1,539.

S.K. Mitra, "Transfer-Function Synthesis Using A Single Operational Amplifiers," *Electronic Letter*, July 1967, 3:332-3.

W.J. Kerwin, L.P. Huelsman, and R.W. Newcomb, "State Variable Synthesis for Insensitive Integrated Circuit Transfer Functions," *Journal of Solid State Circuits*, No. 3, Vol. SC-2, September 1967.

J. Tou, "Active RC Filters—A State-Space Realization," *Proceedings of the IEEE*, 1968.



Getting more speed from MOS

By Oliver S. Saffir

American Astrionics Inc., Palo Alto, Calif.

So far as speed goes, MOS and bipolar memories often appear to be in two different leagues. Actually, however, they are by no means as poorly matched as they are sometimes taken to be; in fact, metal oxide semiconductor technology is capable not only of superior packing densities and lower power dissipation but also of an unexpected turn of speed.

For example, it's generally believed that the speed of MOS circuits is limited to a few megahertz, corresponding to access times of several hundred nanoseconds. But MOS memories built by American Astrionics Inc. for use as buffers with high-speed digital conversion and processing equipment can operate at up to 50 Mhz. This figure, though well below the 120 Mhz achieved by emitter-coupled logic circuits, is comparable to the speed level of the more expensive transistor-transistor-logic circuits and ahead of the 15-to-25-Mhz rates of the cheapest ones.

The factor that limits speed in the simplest MOS designs is the transistor's resistance and capacitance, which form an RC network with an intrinsic time constant.

Speeds can be boosted by clock pulses from low-impedance sources, which charge portions of the circuit to levels that are permitted to decay through the RC network. One-, two-, and four-phase techniques have all been tried. But the highest speeds attained so far have resulted from the use of small output-signal swings in conjunction with amplifiers that restore the level required at the next stage, along with multiplexers that permit several medium-speed circuits to operate in parallel.

MOS memories are actually only long shift registers, or arrays of flip-flops; these, in turn, are combinations of simple logic blocks. A discussion of high-speed memories therefore begins with logic.

Examination of a typical MOS logic stage suggests ways to make it go faster. For example, the oldest and simplest form is the resistance-ratio logic stage shown at right, so-called because its binary 0 level is proportional to the ratio of the two resistances of its transistors. It's very slow, being constrained by its built-in resistance and by the unavoidable gate capacitance of the following stage.

In the resistance-ratio circuit shown, transistor

Previous articles in this series on memory technology appeared in the issues of Oct. 28, Nov. 11, and Dec. 23, 1968, and Jan. 20, 1969.

Q_1 , called the pull-up device, is always turned on because its gate is connected to its drain—though a separate voltage supply is sometimes used instead of the feedback connection. The transistor therefore acts like a resistor, the value of which depends on its size; the longer and narrower the transistor, the higher its resistance.

When the input signal is a binary 0 (at ground), Q_2 is turned off, and the output is a binary 1. When the input becomes negative, Q_2 turns on and the output becomes 0. The 1 level at the output is approximately the same as the supply voltage because the load draws essentially no current and there is no voltage drop across the resistance of Q_1 . But the 0 level is generally not at ground because Q_1 and Q_2 become a voltage divider when both are turned on. More precisely, the 0 level is

$$V\{1/[(R_1/R_2) + 1]\}$$

where R_1 and R_2 are the resistances of Q_1 and Q_2 , respectively. R_2 is usually much smaller than R_1

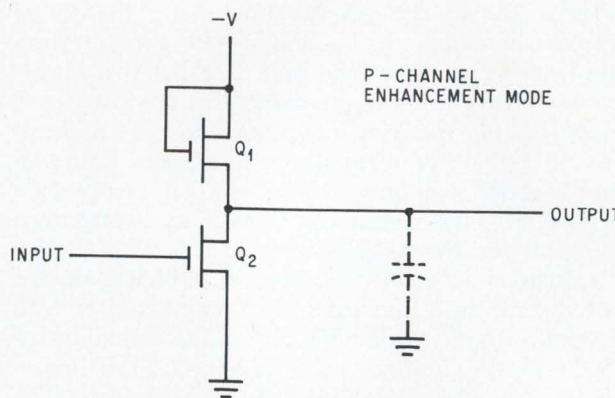

Resistance ratio. The speed of the logic stage in this simplest MOS design is limited by its size and input capacitance.

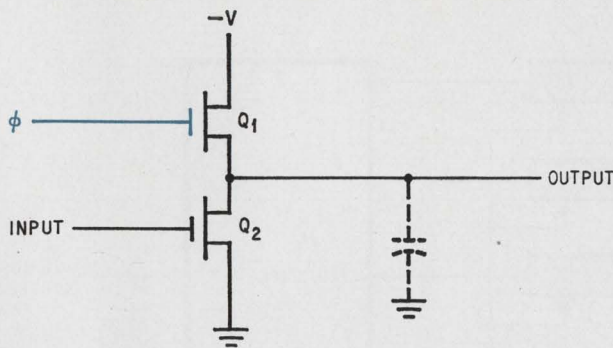

Clocked stage. The clock pulse permits some speed improvement, but the ceiling is still under 2 Mhz.

because the 0 level must be kept below the threshold that turns on the next stage; the 0 level is therefore approximately $V(R_2/R_1)$.

The output of the logic stage always sees a node capacitance—the sum of the next stage's gate capacitance, the capacitance of the line connecting the two stages, and a few other parasitic odds and ends. This node capacitance charges slowly through Q_1 when the circuit is switching from 0 to 1, and discharges quickly through Q_2 when the switch is from 1 to 0.

This difference in speed arises from the difference in the two resistances. But if the designer tries to reduce both resistances to increase speed, he must make both transistors larger, thereby increasing the capacitance at the gate and at the junction between source and substrate. He therefore soon encounters the law of diminishing returns.

In most applications, Q_2 has a resistance of about 1,000 ohms when it is on, and Q_1 of 7,000 to 10,000 ohms. Charging and discharging the node capacitance through these resistances limits the circuit's speed to about 1 or 2 Mhz.

Two early attempts to increase the speed of resistance-ratio logic involved the use of clock pulses instead of the gate-to-drain connection. In the sim-

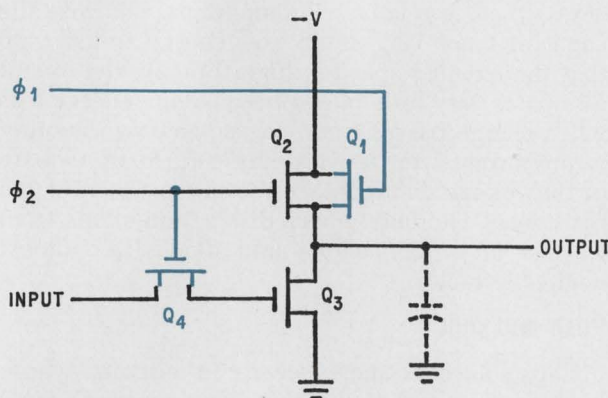

Precharge. Two alternating clock pulses set up the stage before its logic state is acquired, for further speed improvement.

pler form, shown at left, a clock pulse turns on Q_1 at regular intervals—say, once a microsecond with about a 10% duty cycle. While Q_1 is on, the output takes on a value opposite to that of the input, just as in unlocked resistance-ratio logic. Between pulses, the output tends to retain its last state, although some decay through various leakage paths may occur. This decay is of little consequence, though, since the following stage is also clocked and therefore uses the output only before the decay can begin.

The other scheme, the precharge node method, uses a two-phase clock to turn on two identical pull-up transistors alternately, as at left below. The first clock pulse connects the output directly to the supply voltage, regardless of the input state. The output thus becomes a 1, and the node capacitance charges to the level of the supply. The second pulse turns on a parallel connection and admits the input signal through Q_4 to Q_3 . If the input is 1, therefore, Q_3 turns on and the output becomes 0 as the node capacitance discharges.

This technique takes advantage of the fast transition from 1 to 0 occurring with the second clock pulse—just the time the following stage looks at the signal. The transition from 0 to 1 occurs only at the time of the first clock pulse, when no one is looking. However, the technique still doesn't produce speeds above 2 Mhz because it still leaves the circuit shackled by the restrictions of line and gate capacitance.

Four-phase or polyphase techniques are employed in some circuits to increase internal speeds without boosting power consumption or enlarging transistor size. In some circuits, all four clock phases are externally generated; in others, only one phase is external, the rest being generated within the circuit. The latter arrangement works best with low-voltage MOS circuits.

Four-phase clocking can be used with many circuit configurations and with a variety of time relationships between the phases. But with all these variations, the usual approach uses MOS transistors

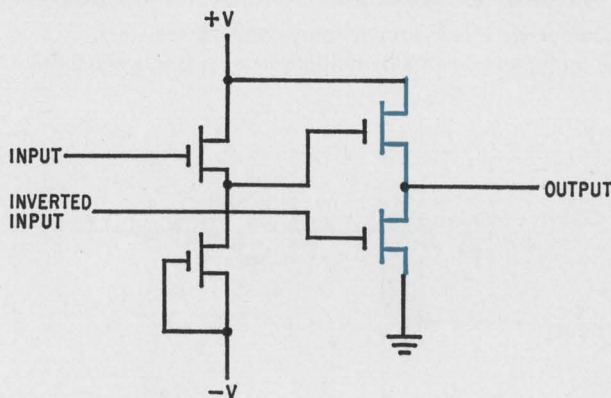

Push-pull. Driving the signal both up and down using the signal and complement overcomes the high capacitance of a load outside the chip.

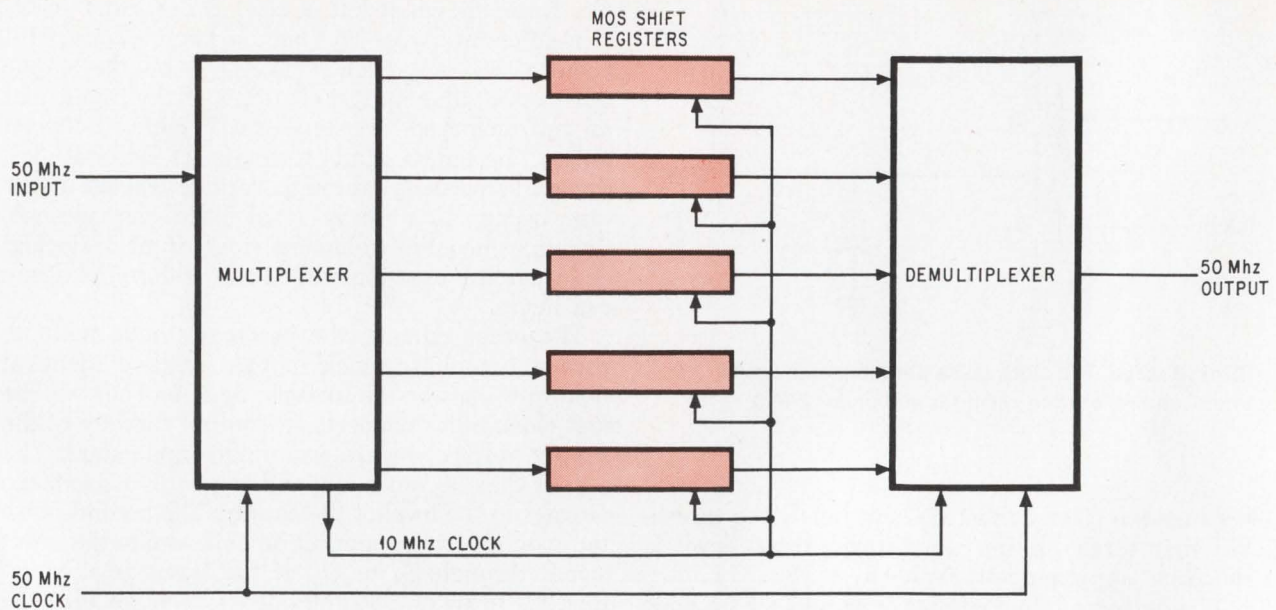

Parallel. Dividing a high-speed signal into several parts—each handled by a separate, relatively slow shift register—makes the memory appear to have high speed.

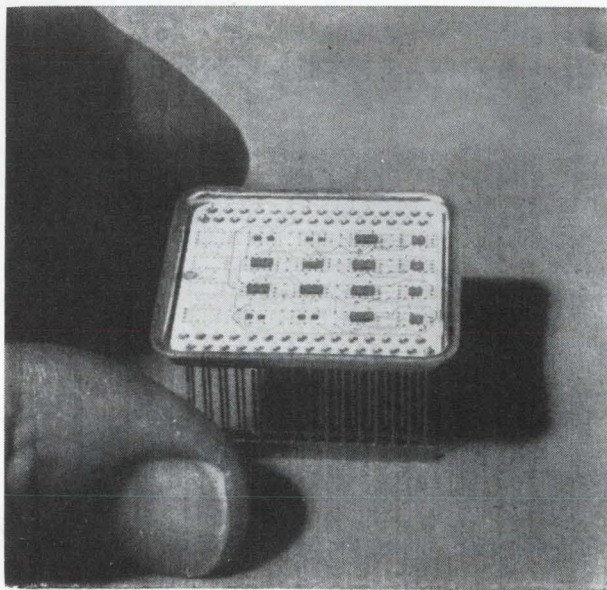

Complete. This hybrid memory contains registers, a multiplexer, and a demultiplexer on a single substrate.

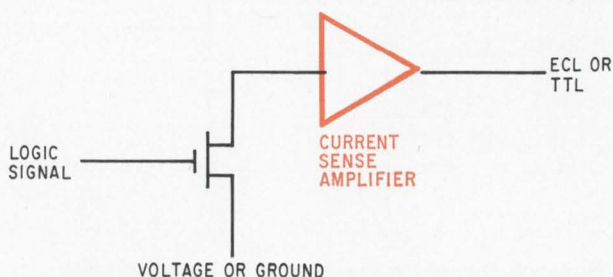

Booster. Low-level signals are intrinsically fast; an amplifier gives them the oomph to drive an external stage.

as switches to charge and discharge capacitors rather than as resistors.

In these switching designs, the input logic signals appear during the first phase and turn the gates of an isolated MOS switching network on or off. Due to the residual charge on the gate, these switches retain their states when the logic signals are disconnected.

In the second phase, another isolated switch is turned on. It stays on until the third phase arrives, at which time it discharges through the logic network established in the first phase if that network was turned on, or stays on if that network was off.

Finally, during the fourth phase, the logic network is disconnected again and the switch that was turned on during the second phase produces its new state as the circuit's output.

The transistors in a four-phase circuit can be small and thus have a high resistance. Because they charge open-circuited capacitors, the voltage drop across them is relatively unimportant. Likewise the capacitors are very small and charge quickly, so that the circuit's speed is high. Finally, the circuit dissipates very little power because the energy loss when charge passes from one capacitor to another is proportional to the capacitor and to the square of the voltage difference, but is independent of the resistance. The only power dissipation stems from leakage in the capacitors and diodes, an almost negligible factor.

Push and pull

Capacitance is most severe in circuits whose loads are external to the chip. The approach most frequently applied to these high-speed output circuits employs a push-pull stage made of two transistors of the same size, as shown at bottom right

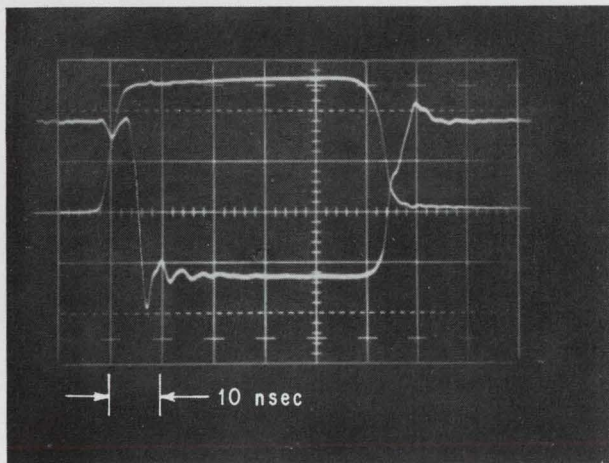
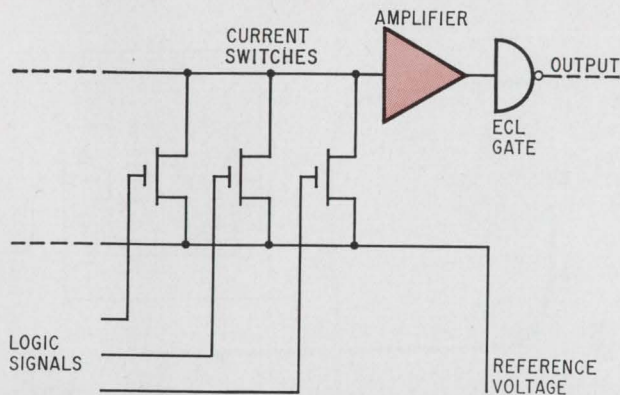

Fast. Several low-level stages driving a single amplifier put out logic signals at high speed. Rise and fall times are only a few nanoseconds, and the propagation time is less than 10 nsec.

on page 107, and therefore with the same resistance when on. This stage is faster than the simple resistance-ratio stage and it switches both ways in the same time. Both polarities of the input signal are required, but this is easily obtained with an inverter. Combining this technique with the precharge node or four-phase method yields speeds of up to 10 Mhz, or access times of 100 nsec.

And the circuits can be made to appear to operate at even higher speeds—by multiplexing several parallel circuits, for instance. A four-phase shift register with push-pull output circuits will operate as a serial dynamic storage unit at the 10-Mhz level. But five such registers can be connected in parallel, as shown at top of page 108, to the outputs of a multiplexer made from TTL or ECL circuits; their outputs are connected in turn to the inputs of a similar demultiplexer, which produces a bit stream identical to the input but delayed the length of a single shift register. Such a hybrid package containing registers, multiplexer, and demultiplexer on a single substrate is shown in the photograph opposite.

Fast random-access memories require fast access time. Multiplexing tricks don't apply here; they speed up the access rate, but not the access time.

The only answer is to make the basic MOS circuit operate faster.

The biggest roadblock in this area has been the idea that output signal swings have to be comparable to input logic levels. When this concept is set aside, significant improvements in speed are possible.

Using the MOS transistor as a high-speed switch reflects this change in concept. The output stage now used by American Astrionics [bottom, p. 108], is an amplifier that senses currents of about a half-milliamper through a current switch. The voltage swing at the input to this switch is only about a half-volt—even less than the customary ECL swing.

To demonstrate a quantitative result, the oscillogram in the photo at left shows what can be obtained from the circuit just above it. The total propagation delay of the circuit is well under 10 nsec, and the rise and fall times are only a few nanoseconds. This represents a significant improvement over the hundreds of nanoseconds required when the MOS device drives a voltage load instead of the amplifier. It also permits the fabrication of a 32-bit chip with access time of less than 150 nsec, including external address decoding and sensing time.

Additional speed can be attained by putting the address decoding right on the chip with the memory array. This reduces the number of wires and packages, and thus the amount of noise and parasitics that hold back the circuits. ■

Memories XIII



COS/MOS: the best of both worlds

By Gerald B. Herzog

RCA, Princeton, N.J.

Flip-flops built with complementary symmetry metal oxide semiconductor circuits (COS/MOS) dissipate negligible power and are stable in the presence of noise and heavy loads. These characteristics make the flip-flops excellent elements for arrays that can be used as memories with capacities of up to several hundred bits.

Furthermore, the trend to MOS memories is toward more use of complementary symmetry as techniques are perfected and as additional manufacturers begin supplying COS/MOS devices.

The low dissipation and the high stability result because the circuit has both n-channel and p-channel transistors in series. Only one of these transistors can be conducting at a time, except during a switching operation; and the non-linearity of the series combination is greater than that of

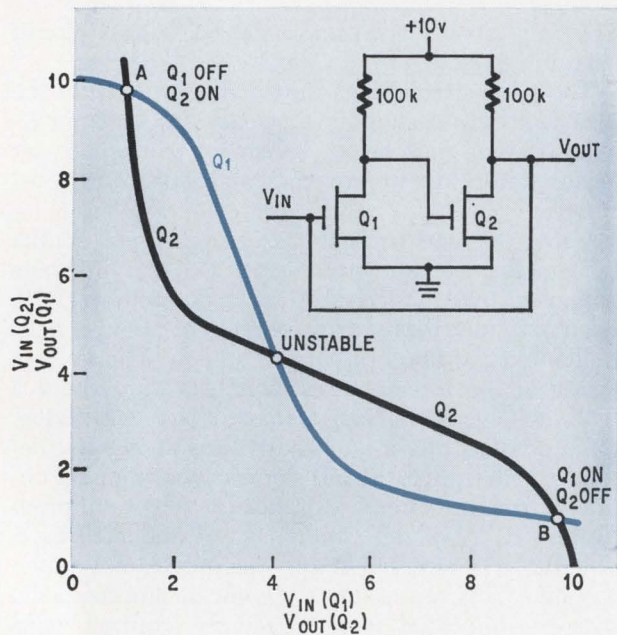

MOS characteristic. Although MOS transistors can be connected in a bistable configuration, their linearity makes the circuit only marginally reliable.

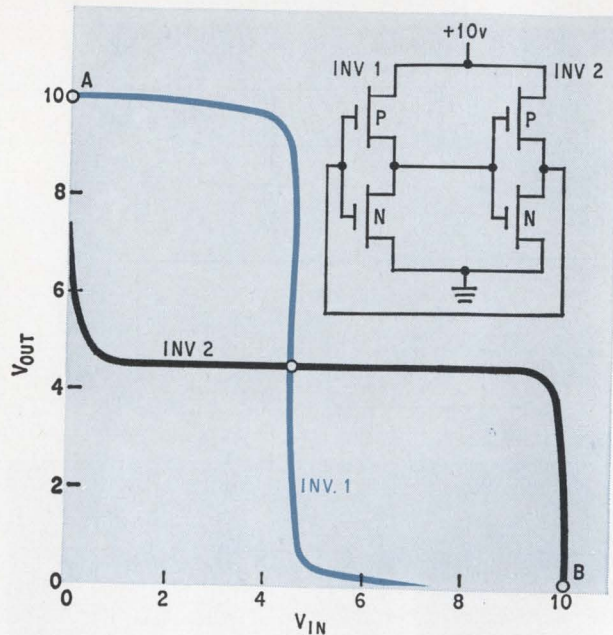

COS/MOS characteristic. Connecting opposite types of MOS transistors in series multiplies their nonlinearities, thus reducing noise sensitivity and power dissipation.

either transistor working by itself.

Only the difficulty of fabricating complementary MOS devices on a common substrate has slowed the development of these circuits so far. All the many variables involved in the dual process have to be just right at the same time; otherwise the process won't work. But recent breakthroughs in ways to make oxide and metal layers that are free of impurities have overcome the problem.

Digital circuitry requires devices whose characteristics have a particular kind of non-linearity, in which a small increase in the input over part of its range causes a much larger decrease in the output. When two such devices are cross-connected to drive each other, they form a bistable circuit. A small increase in the input of one of the devices causes a large decrease in its output and thus in the input of the other; the second device's output then saturates, strongly reinforcing the original small increase in the input.

The MOS transistor, though nonlinear in this way, is by no means ideal. Its transfer characteristic is much more nearly linear than that of a bipolar transistor—so much so that a MOS transistor is widely used in radio tuners as a mixer and r-f amplifier.

When used with a high-impedance linear load, the voltage transfer characteristic of the MOS transistor is marginally acceptable for a digital switching element. The transfer characteristics of the two cross-connected low-threshold transistors, when plotted with the appropriate relationship to one another, as shown above, indicate the stable operating points of the flip-flop. With a 10-volt supply these are approximately 1 volt and slightly

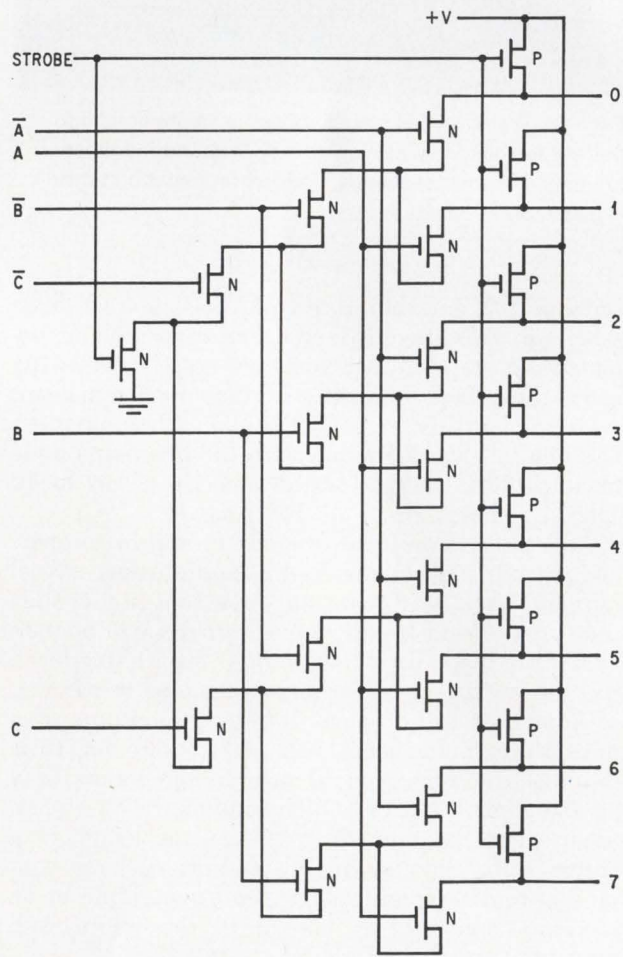

Decoder. Complementary pair at output can generate larger currents to charge circuit capacitance, thus can operate faster than single-channel circuit.

less than 10 volts. The shape of the two loops indicates the d-c stability of the circuit. The diagram is drawn for n-channel devices; that for p-channel transistors would be similar.

Noise transients, excessive loading during the readout of the flip-flop, or transients on the power supply voltage could cause the characteristics to move or change enough so that the stable intercept points would be lost and the circuit would lose its stored data.

Wide margin

When two COS/MOS inverters are connected as a flip-flop, as at top right on page 110, the characteristics of the two types of devices are effectively multiplied together, and the transfer characteristic of the two in series becomes extremely nonlinear. The cross-connection provides large noise margins, and well-defined output levels of 0 and 10 volts, for a 10-volt supply.

Since each leg of the flip-flop always contains one conducting and one nonconducting transistor, there is always a relatively low impedance path from the output terminal to either the power supply or ground, depending upon the state of the inverter. The low impedance minimizes the capacitive noise pickup. And whatever noise signal is received, has only a slight effect because the circuit has a large noise margin.

Furthermore, through this same low-impedance path, more current can be drawn from the circuit than from a flip-flop made from a single kind of transistor without disrupting the state of the flip-flop. This larger output current—available, for example, to a sense amplifier—makes sensing faster. At the same time, the nonconductive transistor lowers the COS/MOS flip-flop's standby power dissipation, because it blocks the current flow from power supply to ground.

Because MOS transistor circuits that use only one type of transistor usually operate with higher voltages, the wider voltage level translation costs time, especially if the address signals come from bipolar transistor logic. But the highly nonlinear characteristic of the COS/MOS inverters permits devices with low threshold voltages to be used; its source voltage can be well below 10 volts. With these lower voltages, compatibility with bipolar transistor logic levels can be obtained, leading to higher memory cycle speeds or lower costs for the peripheral circuitry or both.

In applications requiring more complex arrays, address decoding on the chip containing the storage elements reduces the number of leads from the package. Complementary MOS transistors in a decoder tree can also achieve higher addressing speeds than can the single-channel type, again because complementary transistor pairs are more nonlinear and have lower impedances, and thus can generate larger currents to charge circuit capacitance.

In the decoder tree shown directly opposite, all the transistors are n-channel except the output

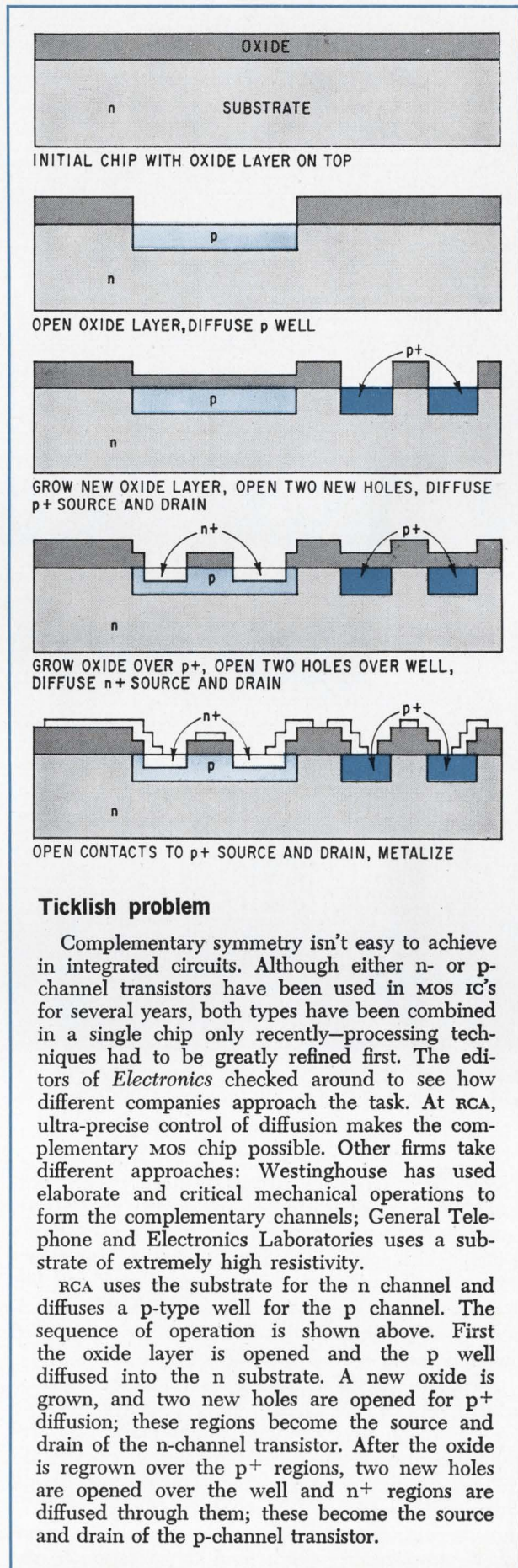

Ticklish problem

Complementary symmetry isn't easy to achieve in integrated circuits. Although either n- or p-channel transistors have been used in MOS IC's for several years, both types have been combined in a single chip only recently—processing techniques had to be greatly refined first. The editors of *Electronics* checked around to see how different companies approach the task. At RCA, ultra-precise control of diffusion makes the complementary MOS chip possible. Other firms take different approaches: Westinghouse has used elaborate and critical mechanical operations to form the complementary channels; General Telephone and Electronics Laboratories uses a substrate of extremely high resistivity.

RCA uses the substrate for the n channel and diffuses a p-type well for the p channel. The sequence of operation is shown above. First the oxide layer is opened and the p well diffused into the n substrate. A new oxide is grown, and two new holes are opened for p+ diffusion; these regions become the source and drain of the n-channel transistor. After the oxide is regrown over the p+ regions, two new holes are opened over the well and n+ regions are diffused through them; these become the source and drain of the p-channel transistor.

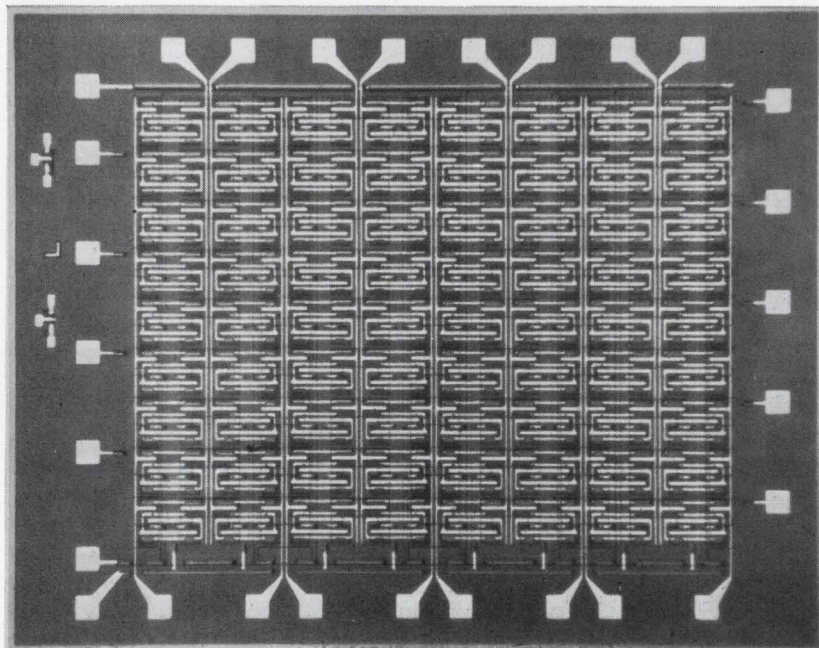

72-bit memory. This array, now in production, is the prototype of one, four times the size, that will be used in a high-speed scratchpad application.

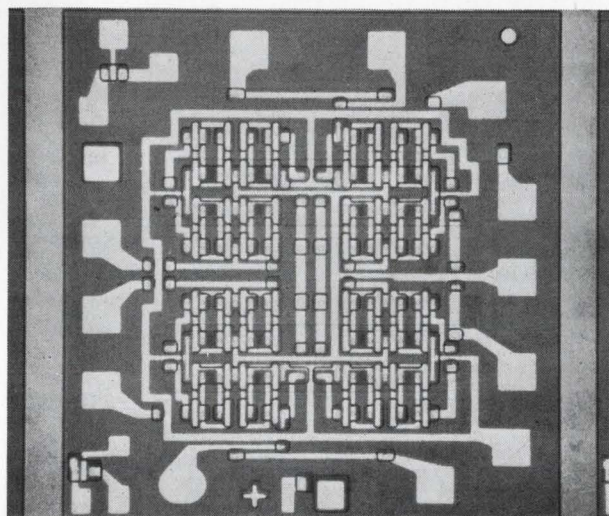

Commercial. This 16-bit array, RCA's type CD4005, is part of a 4,096-bit scratchpad with 100-nsec cycle time.

stage. The p-channel output transistors are normally kept on, except when the strobe signal goes positive; this turns them off and turns on the single n-channel master gate. When the output transistors turn off, all but one of the output lines are left floating at their positive level, while the line specified by the input address lines are grounded through the tree and the master gate.

Although circuit designers have long recognized advantages of the circuit, only recently has the process technology become commercially practical for fabricating both n- and p-channel devices on the same substrate. While the principal processing steps look easy [see "Ticklish problem," p. 111], they require exceptionally clean oxides and metal layers. Impurities, which tend to contaminate the

semiconductor material, are more deleterious in n-channel devices, which is why semiconductor engineers have swung toward p-channel devices in the past several years. With the new techniques, n-channel is coming back into favor; its carriers are more mobile, so that the devices switch faster.

Since COS/MOS uses both n- and p-type devices, the new techniques are as important here as in single-channel designs. They've made possible the memory array shown above, with 72 bits of memory and 432 MOS transistors; it's being experimentally fabricated now with modest yields—still under 10%—of perfect arrays, that is, arrays where all 72 bits are operational. This particular array is being produced for the U.S. Air Force* as part of an effort to fabricate a 4,068-bit high-speed scratchpad memory. Arrays of 288 bits with partial address decoding will be used in this memory.

More representative of what can be done in the factory is the 16-bit memory array [photo at left], which RCA is selling commercially. It operates at 10 volts and dissipates 100 nanowatts in standby; its set time is 50 nanoseconds and its read time is 15 nsec. It is the basic storage element of a scratchpad memory containing 512 bytes (4,096 bits) that has an access time of 50 nsec and a full cycle time of 100 nsec. The bipolar decoding limits these speeds, which include internal translation from and to emitter-coupled logic.

What's to come

Work on silicon-on-sapphire substrate material at RCA Laboratories promises to make available the higher speed of complementary symmetry in larger semiconductor memories. As the size of any memory is increased, the limit of its operating speed decreases because of parasitic loading ef-

* Air Force contract No. AF33(615)3491

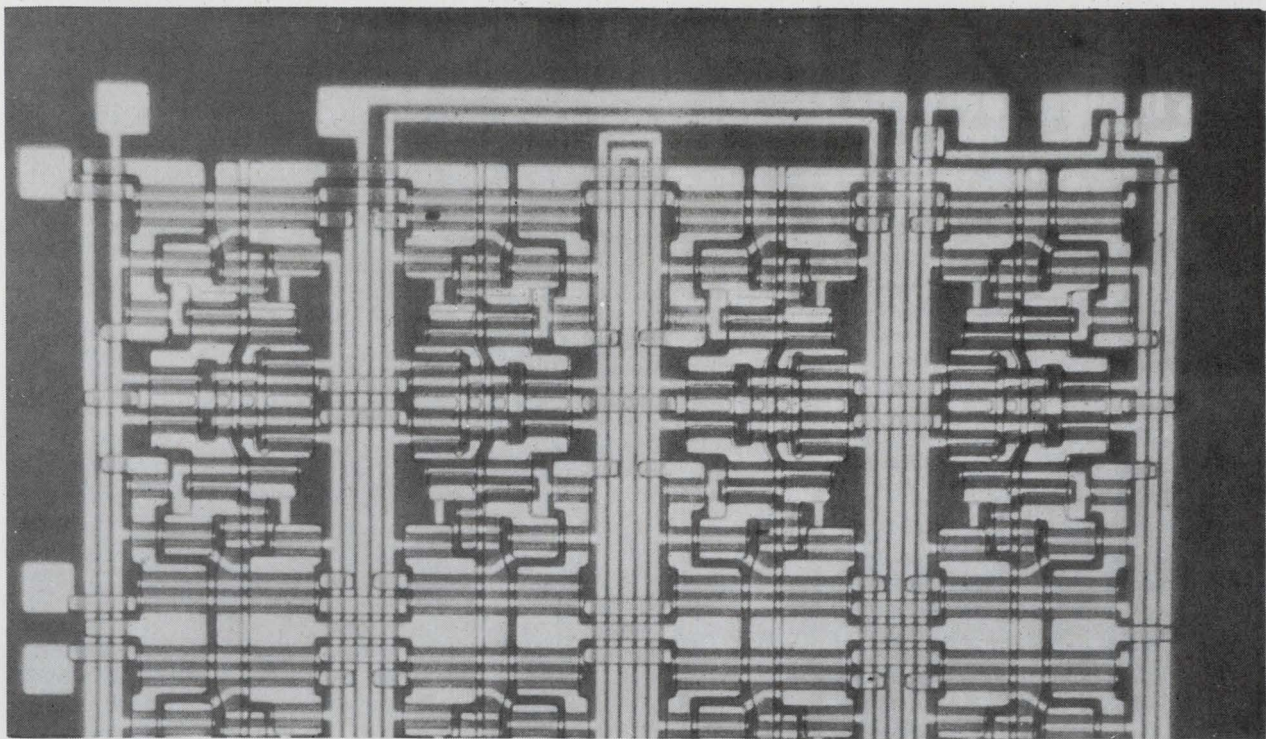

SOS. Another 16-bit array made of a thin film of silicon deposited on sapphire and then doped. Its intrinsic capacitance is very small, thus it is ultimately capable of very high speed.

fects. In COS/MOS devices fabricated in silicon on sapphire, rather than in bulk silicon, the line capacitance is closer to the free-space capacitance of a wire than to the parallel-plate capacitance of a wire over the insulator covering the relatively conductive substrate; thus the capacitance is much lower and these parasitic effects are minimized.

Fabrication of COS/MOS devices in silicon-on-sapphire films, although a more difficult materials processing problem at the present time, promises eventually to be a much simpler process. Processing complementary MOS devices in bulk silicon requires the silicon material to be converted from n-type to p-type or vice-versa for the fabrication of the opposite polarity devices; but an undoped film of silicon on a sapphire substrate can be converted either to n or to p [see following article]. Thus both kinds of devices can be fabricated in the same substrate material, both with low threshold voltages. These advantages can be achieved by novel processing techniques that require only one diffusion furnace, instead of the half-dozen or more furnaces in the bulk-silicon process.

The cost of MOS storage elements is unlikely to drop as low as that of magnetic cores operating at about one-microsecond cycle time. But a market is highly likely to develop in the few hundred nanoseconds region. At these speeds semiconductor memory elements can compete on a cost basis with magnetic memories, because high-speed drivers and sense amplifiers for magnetic memories cost more than those for semiconductor memories. Cur-

rently, small magnetic scratchpad memories cost approximately \$1.00 per bit; whereas the total system cost for a small semiconductor scratchpad memory that operates at two or three times the speed of a magnetic memory is about the same.

There seems to be every indication that complementary devices can be fabricated with as good a yield as single-channel devices. The improved performance of a COS/MOS memory offsets its slightly higher processing cost—which might well be masked by the usual engineering and overhead costs. Consequently, the advantages of COS/MOS memory arrays make them the logical choice for modules with which to build future high-speed memories of moderate to large size. ■

Bibliography

- J.R. Burns, J.J. Gibson, A. Harel, K.C. Hu, R.A. Powlus, "Integrated Memory Using Complementary Field Effect Transistors," Digest of technical papers, International Solid State Circuits Conference, February 1966.
- G.B. Herzog, "Large Arrays of Semiconductor Devices for Computer Memories," Third Annual Integrated Circuits Seminar, Stevens Institute of Technology.
- F.P. Heiman, "Thin-Film Silicon-on-Sapphire Deep Depletion MOS Transistors," IEEE Trans. on Electron Devices, December 1966.
- A. Medwin, "Fabrication of Complementary MOS Circuits," RCA reprint PE-375.
- J.F. Allison, F.P. Heiman, J.R. Burns, "Silicon-on-Sapphire Complementary MOS Memory Cells," IEEE Journal of Solid-State Circuits, December 1967.
- R.W. Ahrons, P.D. Gardner, "Interaction of Technology and Performance of Complementary Symmetry MOS Integrated Circuits," Digest of technical papers, International Solid State Circuits Conference, February 1969.



SOS brings new life to read-only units

By J. A. Luisi

Autonetics Division, North American Rockwell Corp., Anaheim, Calif.

Silicon on sapphire is a semiconductor technology particularly well-suited to diode arrays used as read-only memories. The simple structure and processing make the arrays easy to build; the low capacitance of the SOS diode's junction makes the arrays fast, and the silicon film's large sheet resistance permits resistors to be included in the array without taking up too much room. Furthermore, the arrays are highly radiation resistant.

A recently developed automatic laser micro-machining technique [*Electronics*, Dec. 23, 1968, p. 37], for custom bit-pattern encoding makes SOS technology practical by permitting fast, low-cost production of memories. This is especially helpful in speeding implementation of engineering changes. These read-only memories achieve lower cost, higher speed, larger output signals, decreased size and weight, reduced dissipated power, and better radiation hardness, both in themselves and in the equipment they're used in.

In the marketplace, the SOS read-only memory is expected to do well in the fields of process-control computers, test equipment, and input-output equip-

ment. In process control applications, special high-speed sub-routines, data tables, and microprograms can all be implemented with read-only memories. In test equipment, the read-only memory can store instructions, generate test waveforms and bit sequences, and hold the model outputs for comparison with the response of the system under test. In a remote computer terminal with a cathode-ray tube display, the memory can be used for a character generator.

The fabrication of an SOS integrated circuit begins with the growth of a thin single-crystal layer of silicon on a polished substrate of sapphire (aluminum oxide). Because silicon and aluminum oxide are different substances, the thin film must be grown heteroepitaxially. Autonetics was the first to do this successfully in 1963; RCA is apparently the only other organization to have investigated it extensively. Much of this work has been proprietary. The fabrication difficulty is probably the main reason that research and development in SOS has been limited.

After the silicon film is grown on the sapphire, it's selectively doped, using conventional oxidation, photolithographic, and diffusion processes, to form semiconductor junctions. The two diffusions—one with n dopant and one with p—need not be precisely controlled, because the dopants are driven at high concentration, through selectively exposed areas of the silicon, all the way to the silicon-sapphire interface. After these junctions have been formed, the unwanted parts of the silicon film are etched away to produce electrically isolated islands of silicon supported by the insulating sapphire substrate. A layer of oxide, grown over the remaining islands, seals them and reduces the probability of short-circuits at the crossovers. The final steps in the procedure open contact holes in the oxide, deposit

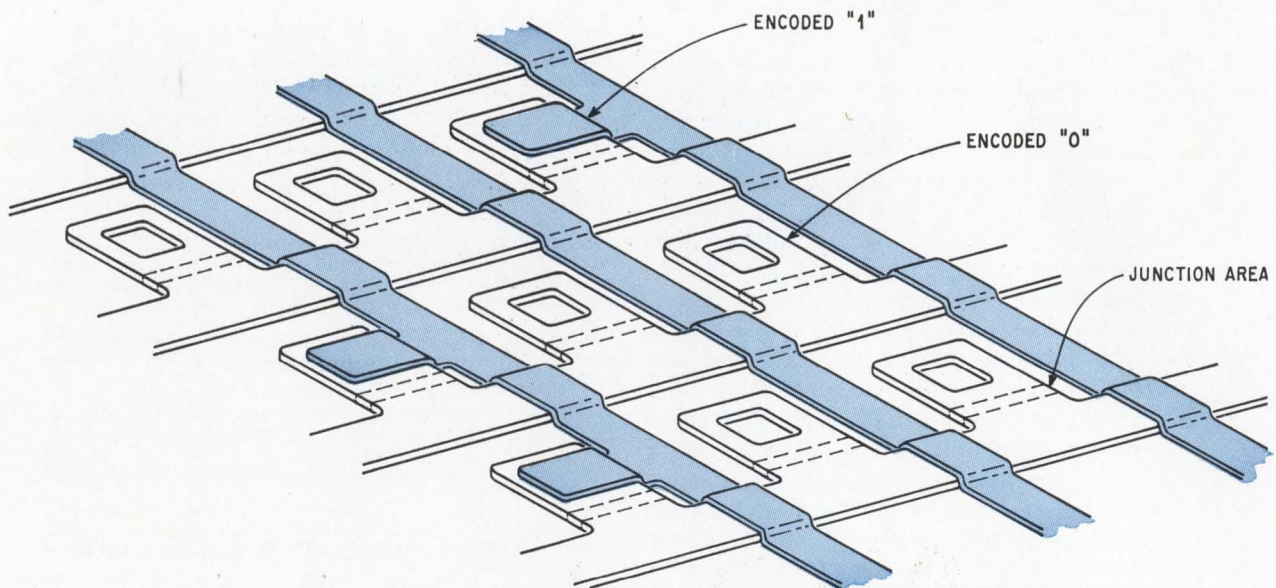

Matrix. The lower set of conductors is silicon, the upper aluminum. Tabs in silicon contain diodes; contact is made through similar tabs on the aluminum layer.

Resistant to radiation

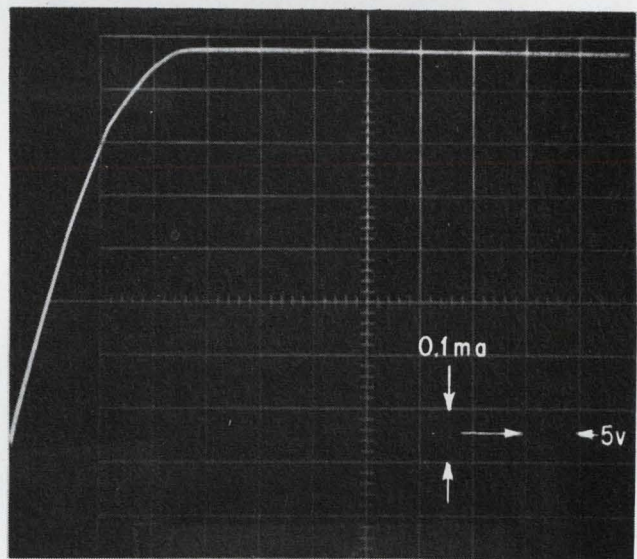
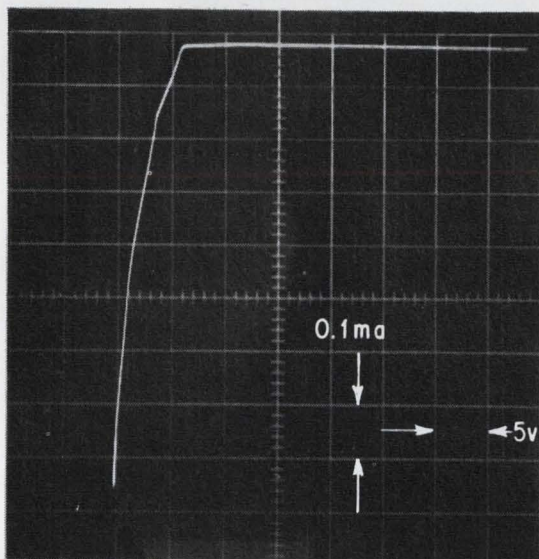
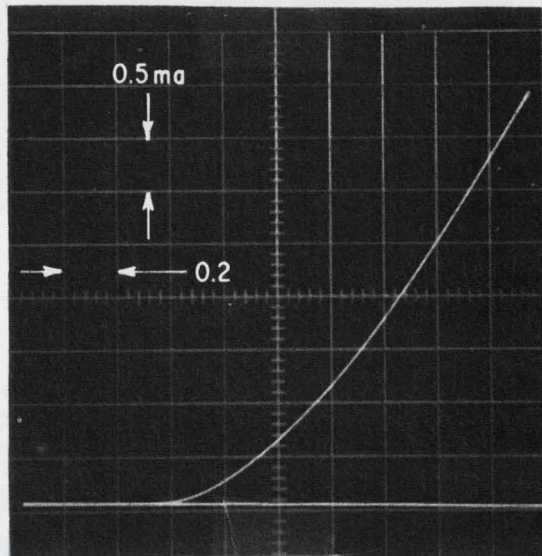
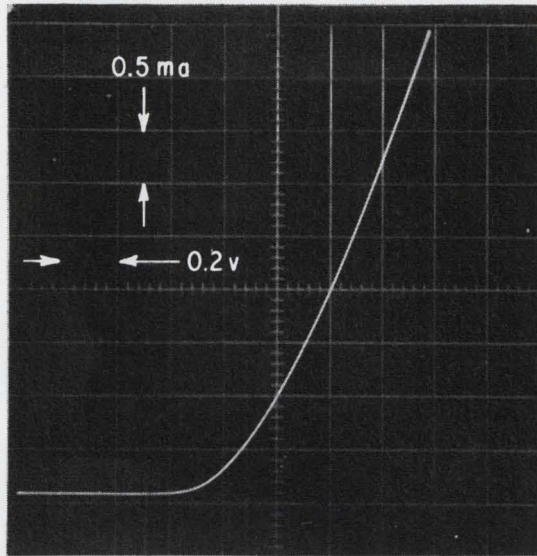

Hardy. Heavy doses of radiation have hardly any effect on SOS diodes. Upper traces show diode's forward characteristic before (left) and after exposure to neutrons; the lower traces are the reverse characteristic.

an aluminum film, and etch the metalization pattern.

In an early SOS diode array, shown opposite, the diodes are connected by a matrix consisting of two orthogonal sets of conductors [*Electronics*, Feb. 20, 1967, p. 171]. One set is formed from heavily doped silicon, the other from the vapor-deposited aluminum. An oxide layer insulates the two conductors at the crossovers in the matrix. Diodes are built into silicon tabs, extending from the silicon conductors. These diodes can be made with either the anodes or the cathodes electrically common, depending on the selected doping. Because this array is produced with just five photomasking steps, the yield is excellent.

An SOS junction is formed along a diffusion front

that advances down to the silicon-sapphire interface and laterally under the oxide. The resulting junction is sometimes called vertical because its plane is perpendicular to the substrate plane, rather than parallel to it as in other technologies. One of the dimensions of the junction area, then, is the thickness of the film—typically 1 micron, or 10^{-4} centimeter. If the tab is 2 mils wide, the area of the junction is 50 square microns, and the corresponding junction capacitance is only about 10 femtofarads (0.01 picofarad).

As a result, even large diode arrays have only a small capacitance, which is quickly charged and discharged while the array operates. For comparison, the junction capacitance of conventional diodes

Production version. Autonetics' ROM-2206 stores 1,024 bits on a chip 220 mils square.

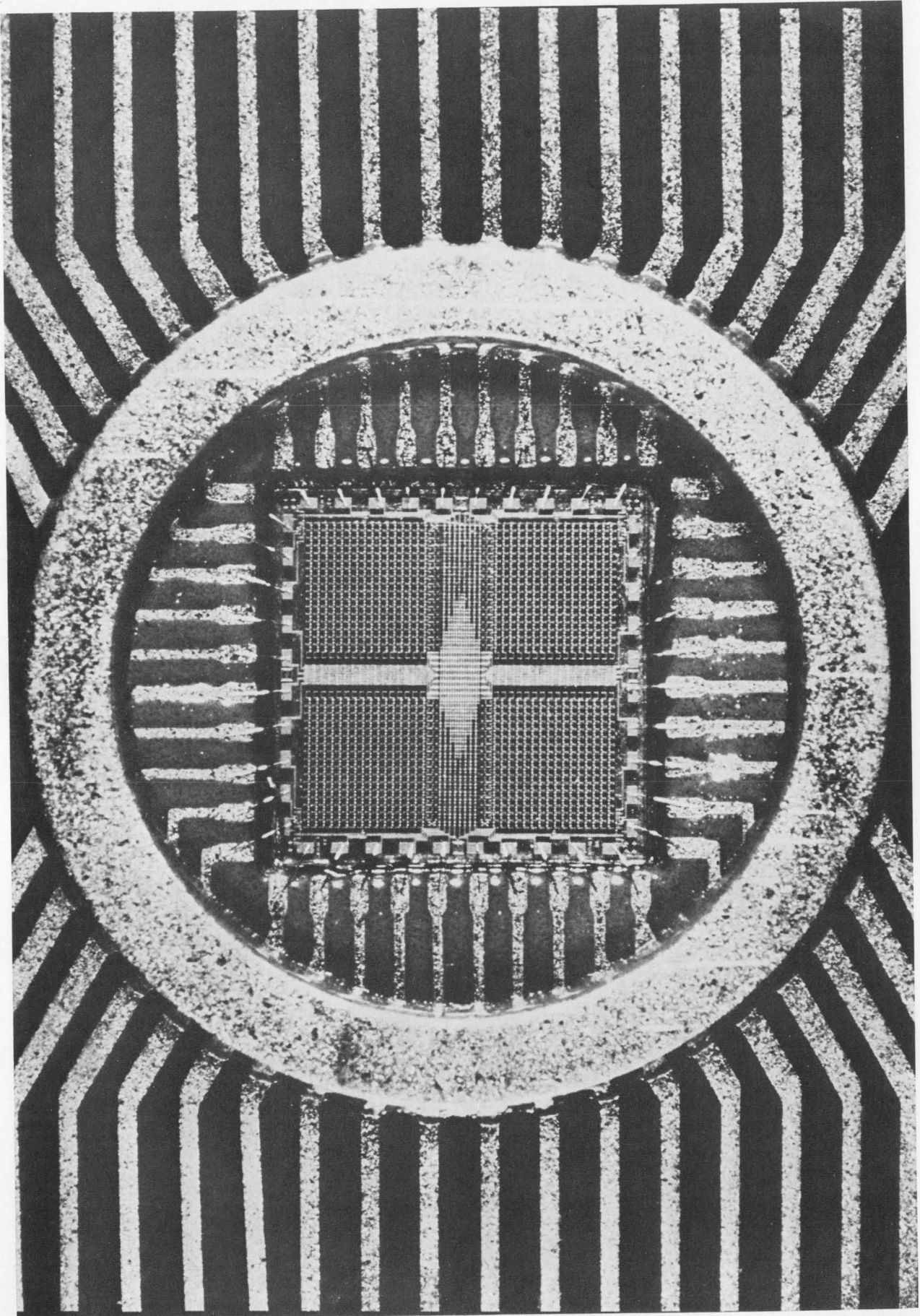

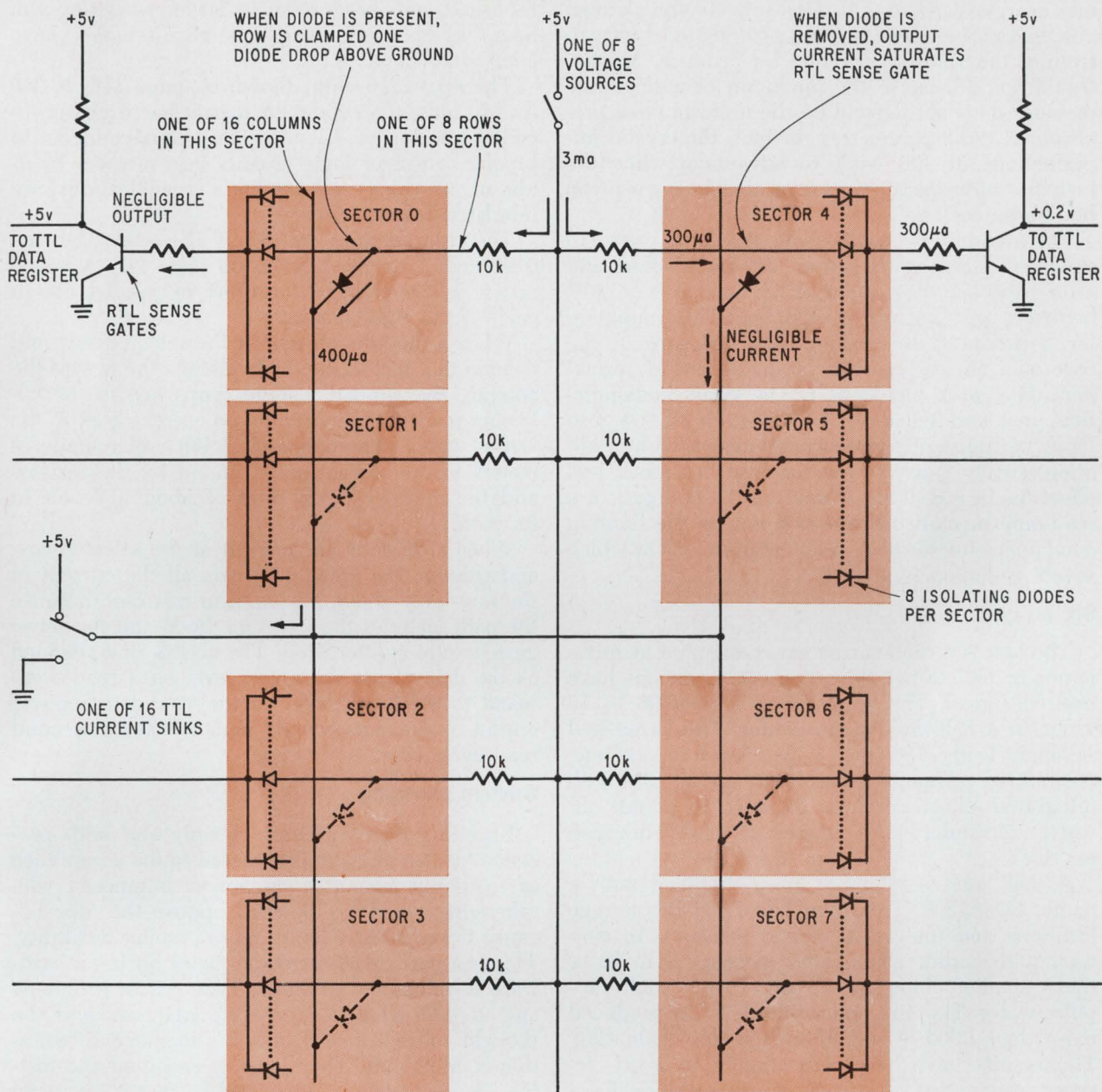

Eight in parallel. A single access selects one diode in each of eight 128-diode sectors, producing a read-out signal in 50 nanoseconds.

is on the order of 100 times greater. Thus an SOS read-only memory can achieve higher speed at any given capacity or greater memory at any given speed than arrays of other kinds of diodes.

Reducing the number of access leads on a read-only memory reduces the number of external connections, simplifying the memory's incorporation into a system and improving the latter's reliability. In SOS technology, integrating resistor-diode circuits to produce selection and sensing functions reduces the number of leads; besides that, it's quite easy.

It's easy because the thin film, besides having a small junction area, also has a large sheet resistance—the quotient of the resistivity divided by the

thickness of the film. Material of 0.5 ohm-cm produces 5 kilohms per square—more than 10 times the sheet resistance of a base diffusion in monolithic silicon.

The area on a chip occupied by resistors is a kind of "overhead" because it isn't available for memory diodes. With SOS, overhead is low, because large SOS resistances can be formed in a small area by etching; the large sheet resistance and ease of isolation permit a complex resistor-diode network to be integrated in a small area.

The crystalline quality of the silicon film material is poorer than that available in bulk silicon, and this limits the yield of certain devices, such as MOS FET IC's. But it doesn't cause significant problems in di-

ode arrays. Variations in diode reverse-breakdown voltage or in leakage current, or difficulties in controlling the value of the sheet resistance, are not troublesome because the operation of a read-only memory does not depend on the uniformity or precision of these parameters. In fact, the crystal imperfections in SOS work to advantage when the memory must operate during or after heavy neutron bombardment.

For example, the oscilloscope traces on page 115 show the characteristics of an SOS diode before and after exposure over a period of time to 5×10^{15} neutrons per square centimeter. This radiation level, produced by a 15-minute exposure in the core of a nuclear reactor, produces severe permanent damage to bipolar IC's. The small diode-junction area and the dielectric isolation of SOS also limit the transient photocurrents generated by radiation. Heavy gamma radiation also has much less effect on an SOS diode. Therefore the SOS part of a read-only memory module will not be the limiting component for survival in an environment in which severe radiation is present.

Six arrays

The first SOS diode array was fabricated at Autonetics in 1965. Since then, five other versions have been designed. The largest was a giant 96×70 array on a half-inch square wafer. This array had so many leads—166—that it was hard to package. A modified version of it was fabricated in 1967 with integrated silicon resistors included to permit on-wafer decoding. The number of leads dropped to 31.

A still later version has been dignified with a name, ROM-2206. This chip has 1,024 bit storage locations and integrated silicon resistors. In contrast with earlier whole-wafer designs, 9 to 12 of these smaller chips are obtained from each sapphire wafer. The Autonetics pilot line has produced more than 1,000 ROM-2206 circuits for evaluating. The results have been encouraging in every respect; Autonetics no longer considers the device a laboratory model. Customers' interest has been es-

tablished, and production in large quantities will begin as soon as customers' requirements have been established.

The ROM-2206 chip, shown on page 116, is 220 by 220 mils; the conductor matrix has a center-to-center spacing of 4.5 mils. This chip connects to bipolar transistor logic circuits in a memory module of 32 chips; the module's specifications are tabulated below.

The chip contains eight 8-by-16 sectors, labeled 0 through 7 in the diagram on page 117. A single access selects eight bit locations, in parallel, one in each of the eight sectors.

When a diode is present at the selected row and column in a sector, the diode clamps the row to the column, the applied voltage drops across the 10-kilohm resistor, and virtually no current goes to the sense gate. Approximately 400 microamperes passes to the current sink, limited by the resistor and the memory diode drop of about 0.7 volt in its path.

When a diode is not present at the selected row and column, the sense gate gets all the current in the row—only about 300 μ amp in this case because the path includes the isolating diode and the sense gate base-to-emitter drop. The access time, defined as the delay from the 2-volt level on a read command to the 2-volt level on the TTL data register output, is 50 nanoseconds with a 100-nanosecond read cycle time.

Custom encoding

Encoding memory chips cheaply and with precision for fast changes is essential to the acceptance of read-only memories by project engineers, who otherwise would be likely to oppose the idea because it supposedly limits reprogramming flexibility. This is a particularly sensitive point during a hardware development program. Changes in programs and in internal data stores are frequent, and the thought of repeated delays for memory substitution is intolerable. Therefore the encoding and testing process must be automated so that a read-only memory can be changed in less time than the programmer can identify the change.

The recently developed laser micromachine tool, under punched-tape control, as shown on page 119, top, meets the necessary specifications. A deck of punched cards contains the data to be stored, which can be organized as 1,024 words of one bit, 512 words of two bits, 256 words of four bits, or 128 words of eight bits. A general-purpose computer reads the cards and produces, in 30 seconds, a punched paper tape. This tape contains a list of simple instructions for custom encoding on ROM chips. These instructions are read sequentially into a special-purpose computer, which controls the motion of a precision x-y table, commands the laser to fire when a diode is to be disconnected, and immediately checks that bit location to confirm that the connection has been broken.

A small experimental neodymium-glass, water-cooled laser makes five zaps per second; commer-

Read-only SOS memory module

Capacity	1,024 words
Word length	32 bits
Access time	300 nsec
Cycle time	500 nsec
Power dissipation	3 watts*
Volume	20 cu. in.
Radiation resistance	
Neutrons	3×10^{14} n/cm ²
Transient gamma	10^8 rads/sec

* Including peripheral circuits

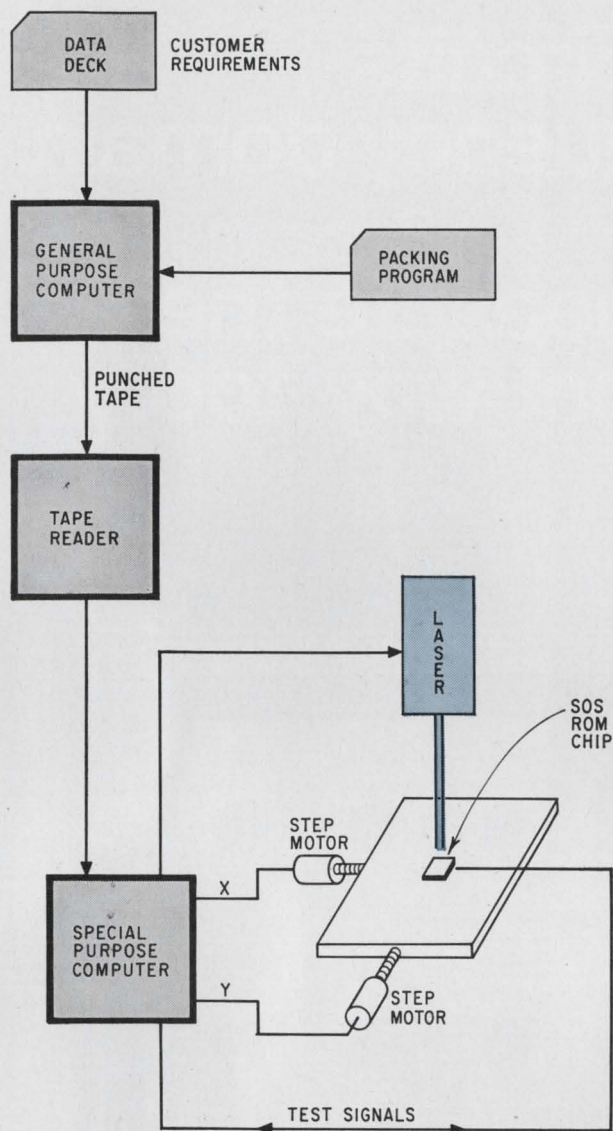

Zap machine. A laser machine tool encodes data in diode array by burning out unwanted connections.

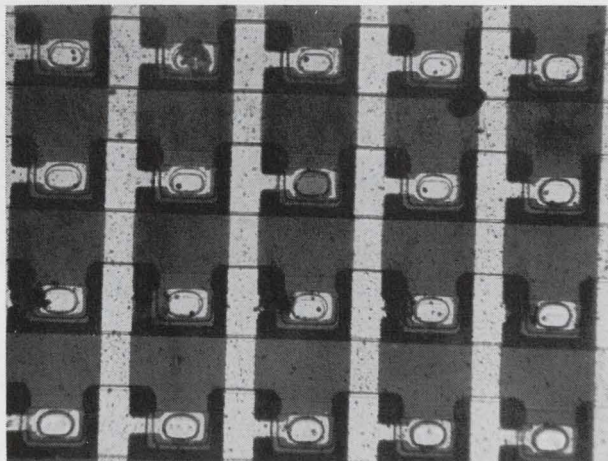

Encoder array. The laser has burned out all the diode connections in one horizontal row, where the light-colored connection is missing.

cial lasers are available that could encode 10 times as fast. The energy per zap is 10^{-3} joule, focused onto a spot about 1 mil in diameter; the pulse lasts about 30 μ sec. No redeposition of aluminum debris has been observed, either by electrical tests or by careful inspection of microphotographs at 200 \times magnification. Presumably the violent local heating changes the vaporized metal into nonconducting oxides or nitrides.

Of course, read-only memories can also be coded by chemical etching, whenever one needs a large number of identically encoded arrays—for example, trigonometric tables. If more than about 100 identical chips are required, chemical encoding would be cheaper than laser encoding.

What's coming

The developmental success of the ROM-2206 chip is expected to lead to volume production and stocking of blank SOS memories. The masks and the process will be refined first, test programs will be expanded to characterize the devices more completely, and a large number of chips will be used in a wide variety of applications.

The designers are now considering increasing the bit storage capacity by quadrupling the chip bit-density to 4,096 bits in approximately the same chip size. The device structures on ROM-2206 are crude by contemporary standards of photo-lithography and reflect the caution born of a need for success. There is no substitute for achieving the greatest bit density within the limitations of process yield when competing in a cost-sensitive market. The immediate goal is to crack the penny-per-bit sales price barrier for one-of-a-kind, custom-encoded arrays made in small quantities.

At the moment, packaging of the chips is less than satisfactory. The 40-lead flatpack in which ROM-2206 is mounted is all right for testing. However, more extreme miniaturization could be achieved by assembling uncased complex chips into functional aggregates if techniques for assembly of the machines can be developed.

In this respect, SOS has some interesting possibilities. For example, the data in an SOS memory can be established by shooting the laser through the 10-mil-thick sapphire substrate. Thus, the sapphire becomes a window in a face-down approach that might even permit laser bonding. The transparent sapphire permits registering two face-to-face metalization patterns, which can be locally heated. Experimental work in this direction is just starting; special attention is being given to the problem of chip substitution.

Work is also in progress to add active devices to the arrays. Complementary MOS circuits are being designed and fabricated to provide decoding, current-drive, and sense-gate electronics on the chip. A yield penalty is expected, and radiation effects are forcing the consideration of unconventional gate insulation, but the potential gain in speed with further reductions in size and power justifies these experimental efforts. ■

You design RF circuits in terms of frequency domain.

Now you can measure their performance that way, too.

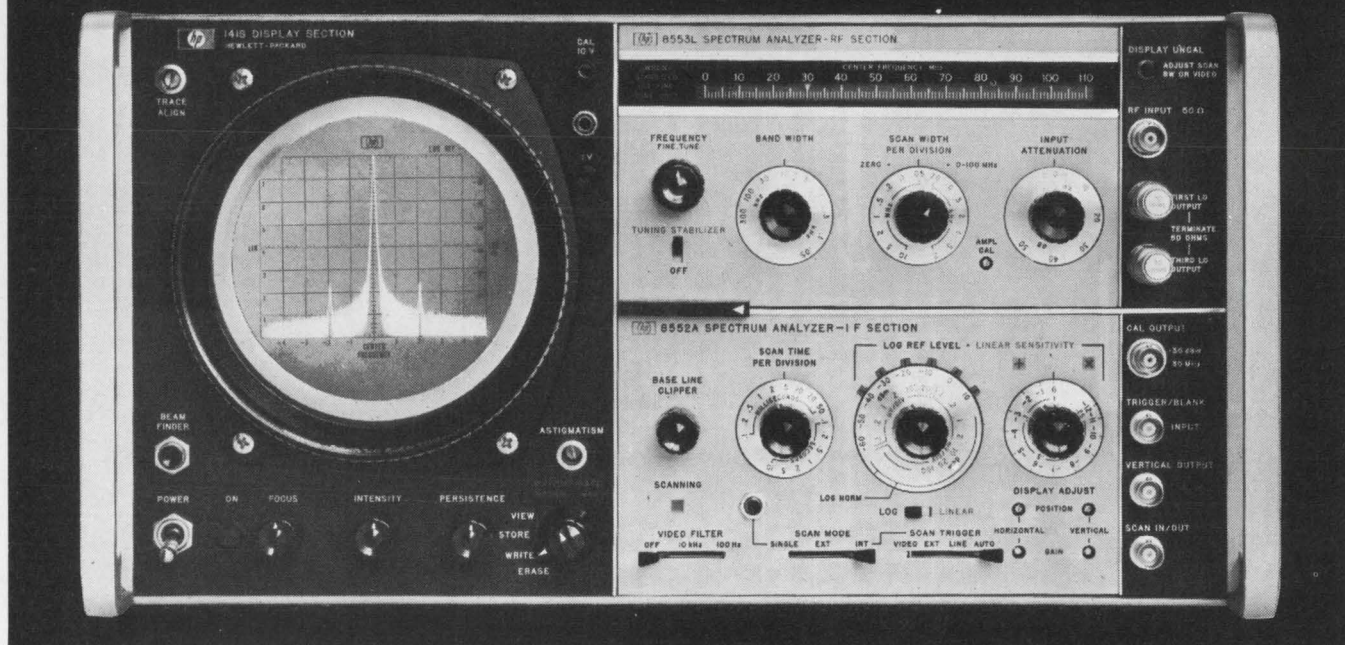

Forget all equipment limitations that used to plague signal analysis in the 1 kHz to 110 MHz range. The HP 8552A/8553L Spectrum Analyzer has all the characteristics—absolute calibration, high stability, freedom from internal distortion and spurious responses—that make it an indispensable tool for virtually every frequency domain measurement.

Absolute signal levels are displayed from -130 dBm to $+10$ dBm ($0.07 \mu\text{V}$ to 0.8 V). With the wide 100 MHz scan, you see the broad spectrum quickly, precisely. Reduce the scan width in calibrated steps (to as narrow as 2 kHz) for detailed examination of individual signals. With the analyzer's distortion-free 70 dB dynamic range and narrow 50 Hz resolution, you can characterize complex signals, even in the presence of other high-level signals.

Yours for the asking—a brochure describing how these

vital circuit performance characteristics are measured accurately and conveniently: *oscillator* spectral purity; *amplifier* response and distortion; *mixer* conversion efficiency; *modulation* index; *filter* response. Price of the full system—8553L RF section, 8552A IF section, 141S Variable Persistence Display section—\$5225.

Your HP field engineer can give you the details on how this remarkable new instrument can solve your frequency domain measurement problems, in circuit design lab or final system evaluation. Or write to Hewlett-Packard, Palo Alto, California 94304; Europe: 54 Route des Acacias, Geneva.

HEWLETT  PACKARD

SPECTRUM ANALYZERS

04807

**A "MINI-BABY"
STRIP PRINTER—
BUT WHAT A WALLOP!**

The MDS 120A Series Digital Strip Printer weighs about seven pounds, and is only 8 5/8" x 3" x 6 1/4" high . . . yet it outperforms many bigger, heavier and more expensive units.

Printing an average of 20 characters per second, the 120A offers a variety of higher print speeds. It upgrades many systems where the high cost of a multiple column printer is prohibitive.

Due to the horizontal method of printing, on a 1/2" wide paper tape, like a ticker tape . . . and with the front paper exit . . . continuous print-out of data is possible using the full 64-character font. Print-out takes place with the application of a 26V pulse. Synchronizing pulses, to individual character position, are provided by reluctance pickup.

The standard 120A is furnished ready to operate from the user's electronics and power supply. If desired, MDS will provide complete matching electronics or complete application and engineering information, so you can manufacture your own electronics.

Self-inking, impact-type impression paper is ordinarily used, but an inked roller is available as an optional extra.

Maintenance is so simple that anyone who can squirt oil from an oil can once a year and wipe away accumulated dust and lint, can be your maintenance expert.

"Down-time" is the exception, not the rule. Warranty: 120 days.

Ask for: The MDS folder-file on the 120A for more complete information.

FOR MORE — MEET YOUR MAN FROM MDS



MDS 120A DIGITAL STRIP PRINTER

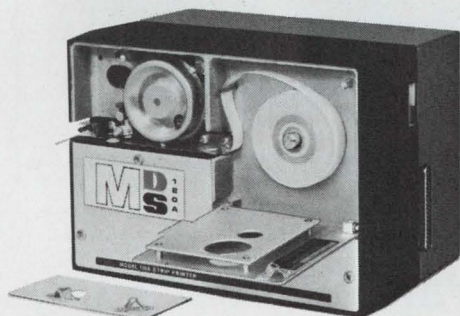

With cover panels removed, the miniaturization of the mini-baby can easily be seen.

MOHAWK MDS
DATA SCIENCES CORPORATION
OEM MARKETING

122 EAST RIDGEWOOD AVENUE • PARAMUS, N.J. 07652
Telephone 201/265-7333

Every MDS office is an OEM Marketing office

DIGITAL STRIP PRINTERS • BUFFERED TAPE UNITS
HIGH-SPEED AND LOW-SPEED LINE PRINTERS
CARD PUNCHES AND READERS
PAPER TAPE PUNCHES AND READERS

REGIONAL MANAGER OFFICES

Waltham, Mass. Tel. 617/891-4430
Jacksonville, Fla. Tel. 904/721-3422
Des Plaines, Ill. Tel. 312/827-7178
S. San Francisco, Calif. Tel. 415/761-0750

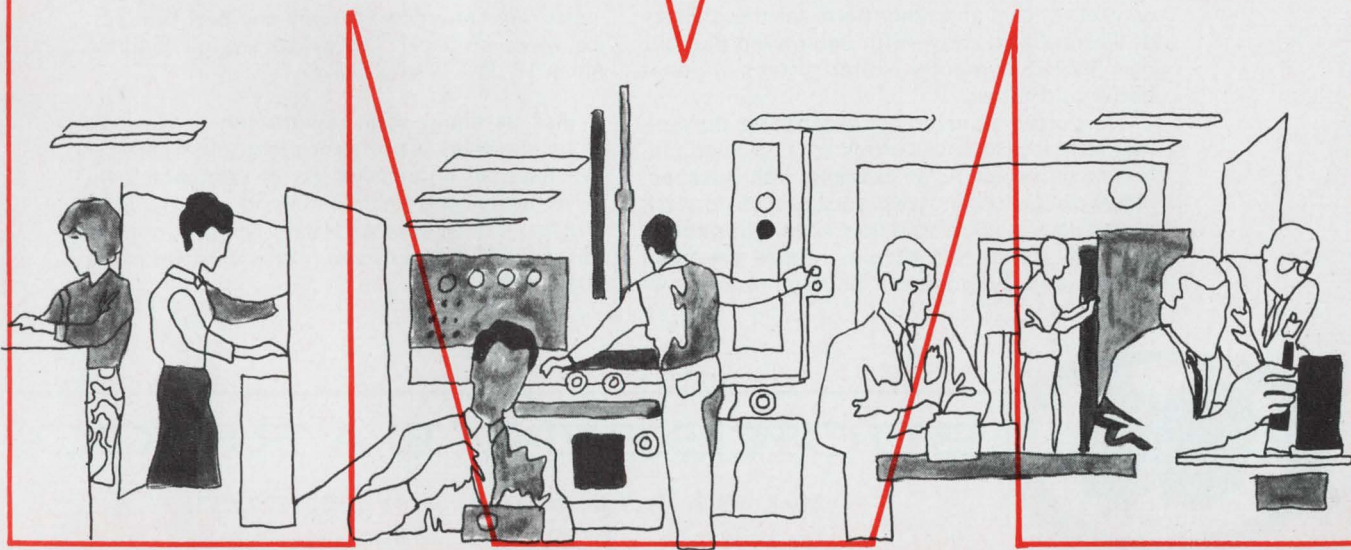

how big *is a micron?*

This page
could hold
16,914,128,443
round dots
one micron
in diameter

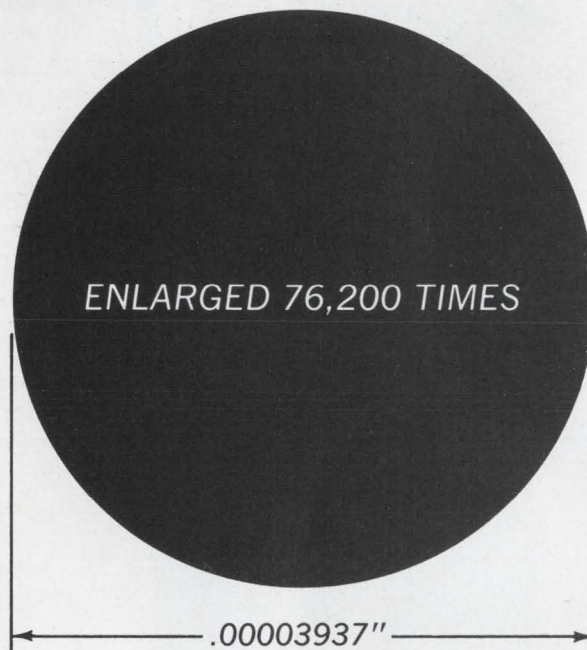

We etch metal to micron tolerances every day

Ultra-precise photomechanical reproduction of metal and glass parts is our business. We're very good at it. We've been precision etching on a quantity production basis since we made fire control reticles and other parts for the military in World War II. Now, with equipment like our new BMAPS computer-plotter system, we do it better and faster.

We picture a micron dot because we do work regularly to tolerances of microns, or even millionths of inches. As an example, with Buckbee-Mears electroforming we produce standard stock sieves down to 5 micron hole sizes, guaranteed accurate within ± 2 microns. These are shelf items, quantity produced. On hand-picked spe-

cials we can do better.

If you need a little less precision—for fewer dollars, of course—check our prices and delivery times for more routine etched metal or glass parts. We can make virtually any part that can be drawn on paper. Our prices are fair, and we think 10 days is long delivery.

Ask us about your requirements. We look upon ourselves as professional problem solvers. We have an impressive list of companies we have helped, and we'd like to add your name to the list. Call or write us today. The first man to talk to is Bill Amundson, our industrial sales manager.



BUCKBEE-MEARS CO.

245 E. 6th St., St. Paul, Minnesota 55101 / (612) 227-6371

The world leader in **precision** photomechanical reproduction

67.

New product number

3530 64-BIT STATIC RANDOM ACCESS MEMORY

The 3530 is an MOS non-destructive read-out (NDRO) random access memory organized as 64, 1-bit words. Addressing of any selected bit is through a 6-line decoder included on the chip, and access time is under $2\mu\text{sec}$. Several 3530's may be stacked for longer words.

The need for external gates is reduced by a built-in wired-OR capability. And system power needs are less (under 3mW/bit) because the chip is built with p-channel enhancement mode MOS.

The 3530 was designed to be used in military or commercial airborne, space, or ground-based systems. It is easily integrated into any data storage system, from computer peripherals and calculators to scratch pad and process control memories.

The 3530 comes in a 16-pin DIP. Write for complete specs and application notes. Or order it from stock from your Fairchild distributor.

To order the 3530, ask for:

Part No.	Temperature Range	Price		
		(1-24)	(25-99)	(100-999)
A6J353014X	-55°C to $+85^{\circ}\text{C}$	\$36.00	\$32.00	\$24.00

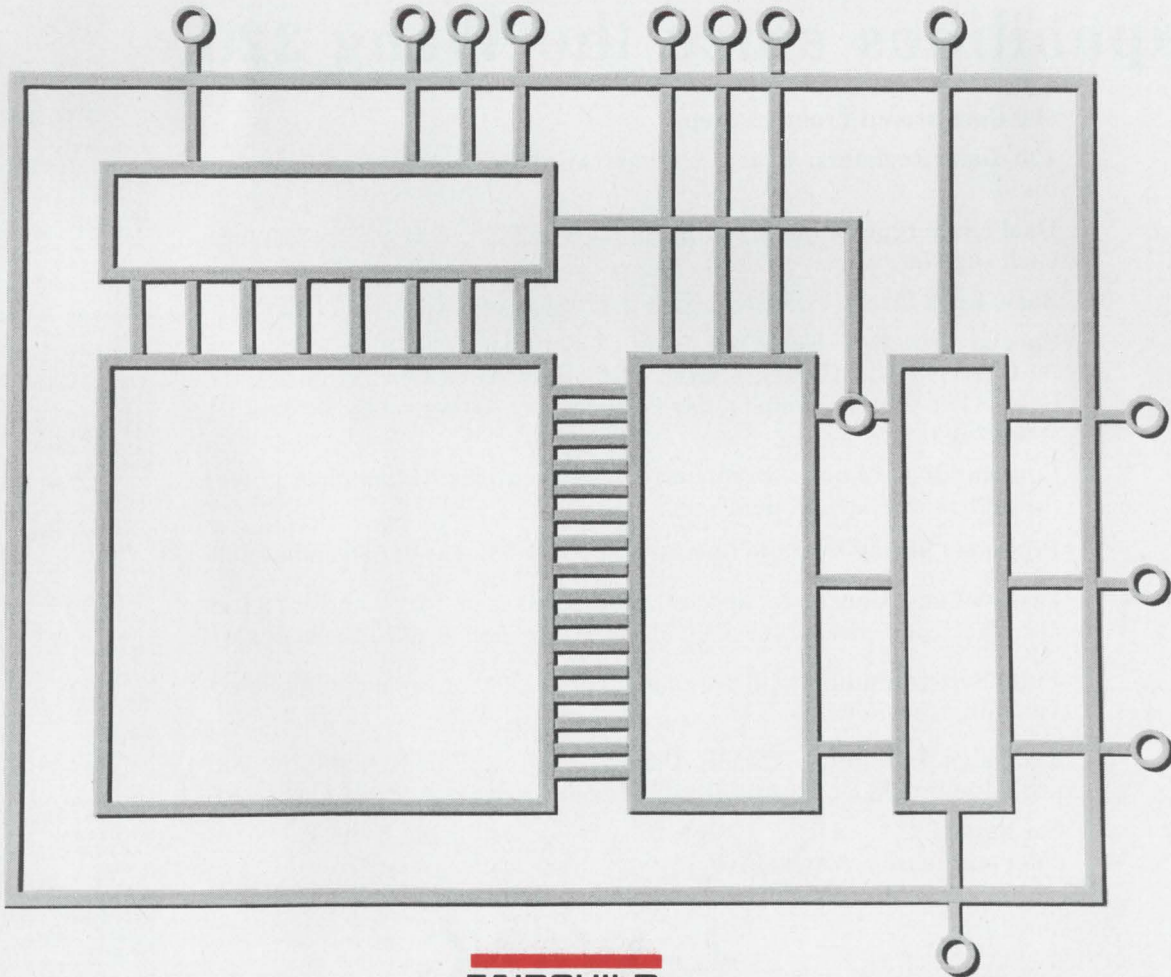

FAIRCHILD
SEMICONDUCTOR

ANNOUNCING THE WANG 700

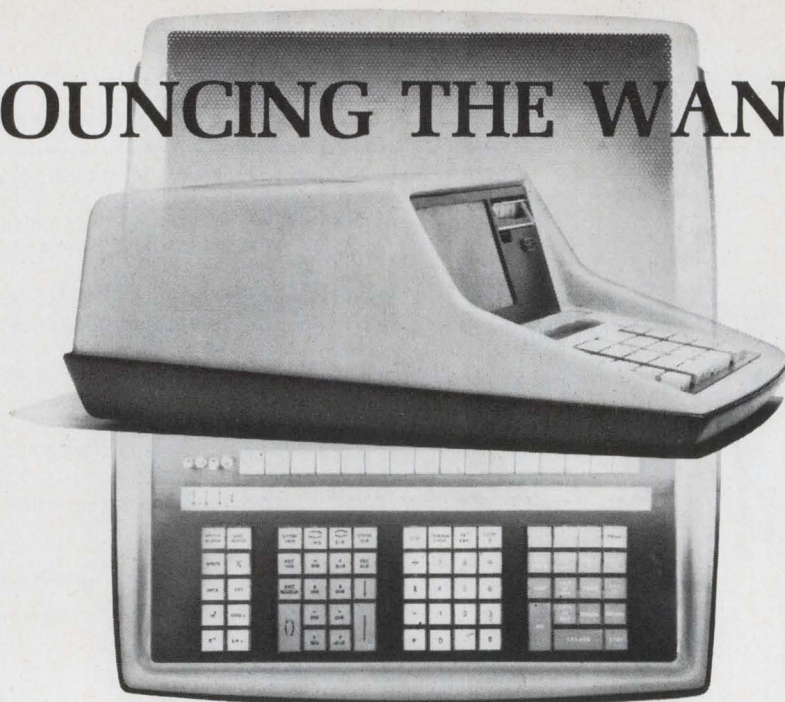

...from any angle,
the most significant advance in calculator capabilities since the Wang 320.

960 Core-stored Program Steps.

120 Data Registers. Every register can add, subtract, multiply and divide.

Dual Nixie-type Display, 12 digits plus 2-digit (-98 to +99) exponent, each register.

Basic Keys for +, -, x, ÷, \sqrt{x} , 1/x, $\text{Log}_{10}X$, Log_eX , e^x , |X|, INT(X), π .

Special Function Keys for SIN, COS, TAN, ARCSIN, ARCCOS, ARCTAN, SINH, COSH, TANH, ARCSINH, ARCCOSH, ARC TANH, Polar Conversion, Rectangular Conversion. (Others may be readily substituted.)

Commands for Loops, Branches and Subroutines. Unmatched power for matrix and array operations.

Programs Stored by Tape Cassettes; up to 10 blocks of 960 steps each.

Fastest Execution Time, approximately 300 $\mu\text{sec.}$ for + and -, 3.0 m sec. for x, 3.5 m sec. for ÷, 15 m sec. for Log A, 35 m sec. for e^A .

Fully Self-contained with rear panel connector for forthcoming Selectric output writer.

Exclusive Integrated Circuit Design. First and only high-powered programmable calculator with IC's for more performance at less cost.

For details,
call your nearby Wang office . . .

SALES/SERVICE OFFICES

Alabama (205) 595-0694	New Jersey (201) 272-7160
Arizona (602) 265-8747	New Mexico (505) 255-9042
California (415) 692-0584 (213) 776-2985 (916) 489-7326 (714) 234-5651 (805) 962-6112	New York (212) 682-5921 (716) 381-5440 (518) 463-8877 North Carolina (919) 288-1695
Colorado (303) 364-7361	Ohio (614) 488-9753
Connecticut (203) 288-8481 (203) 223-7588	Pennsylvania (216) 333-6611 (513) 531-2729
Florida (305) 841-3691 (305) 564-3785 (813) 877-6590	Oklahoma (918) 747-0018
Georgia (404) 633-4438	Tennessee (615) 524-8648 (901) 272-7488 (615) 482-3040
Illinois (312) 889-2254 (309) 674-8931	Texas (512) 454-4324 (214) 361-4351 (713) 668-0275 (817) 834-1433 (915) 772-4111
Indiana (317) 631-0909	Virginia (703) 877-5535 (703) 359-6320
Iowa (712) 286-5578	Washington (206) 622-2466
Louisiana (504) 729-6858	West Virginia (304) 344-9431
Maryland (301) 821-8212 (301) 588-3711	Wisconsin (608) 244-9261
Massachusetts (617) 851-7311	Calgary (403) 266-1804
Michigan (313) 278-4744 (616) 454-4212 (517) 835-7300	Montreal (514) 482-0737
Minnesota (612) 881-5324	Ottawa (613) 244-4554
Mississippi (601) 982-1721	Toronto (416) 364-0327
Missouri (314) 727-0256 (816) 421-0890	Vancouver (604) 685-2835
Nebraska (402) 341-6042	
Nevada (702) 322-4692	

 **WANG**
LABORATORIES, INC.

Dept. 2H, 836 North Street Tewksbury, Massachusetts 01876. Telephone: (617) 851-7311

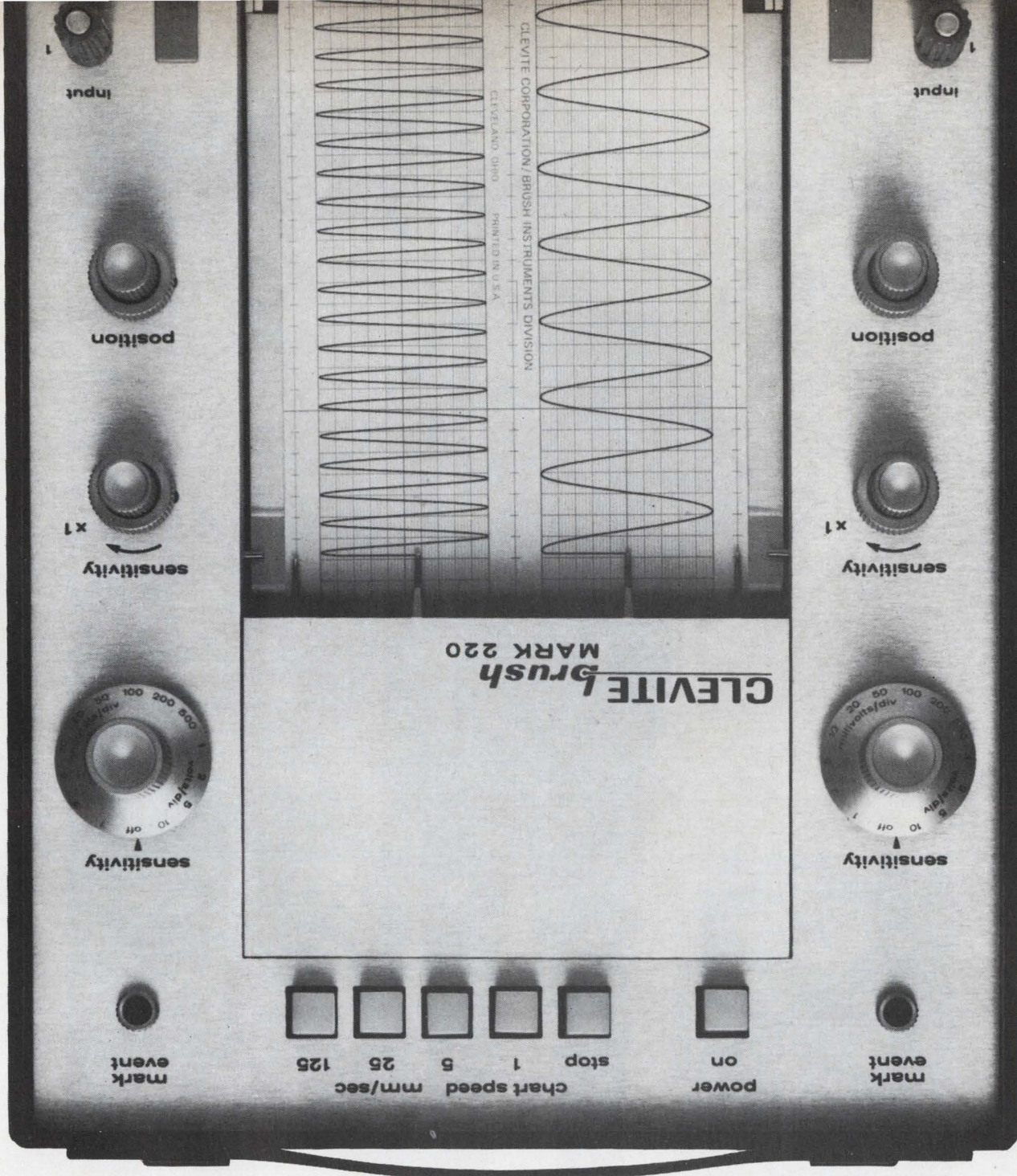

Write-side up?

Why not? New Mark 220 by Brush features pressurized-ink writing. Puts trace into the paper . . . not just on it. And you can see you don't have to pamper it! Now, anyone can take this remarkable new 25 lb. portable *anyplace*, plug it in . . . and put it in writing. And what writing! Fine, sharp traces you can read at a distance—99½% accurate! Rectilinear writing, of course, on two easy-to-read 40mm analog channels plus left and right-hand event markers. And there's enough ink in the throw-

away ink cartridge to last for about a thousand miles. There's more. Rugged, reliable solid state electronics to give you position feedback pen control . . . no springs, no strings. Pushbutton choice of chart speeds. Frequency response that's flat ($\pm 2\%$) from d-c to 40 cps at 50 div, or from d-c to 100 cps at 10 divisions. The price? Less than \$1800. For a portable chart recorder the likes of which you've never seen! Bulletin 942-1 has all the details. Call or write: Clevite Corporation, Brush Instruments Division, 37th & Perkins, Cleveland, Ohio 44114.



brush CLEVITE
INSTRUMENTS DIVISION

Circle 125 on reader service card

TELEMETRY'S
MOST
COMPATIBLE
PAIR



PC-500 IN THE FIELD

TICOR III IN THE LAB

This matched pair of Mincom Instrumentation Recorder/Reproducers are right out of the same family. Every Mincom PC-500 and every TICOR III grow up together—literally—and this proves out in their faultless cooperation in data acquisition and reduction. They are the industry's most advanced systems for their specified tasks, they share telemetry's ultimate compatibility while providing up to 2 MHz on fourteen channels. The rugged PC-500 was designed from the blackboard up to complement TICOR III's flutter suppression performance. In both systems the basic servo design thinking is identical. At the sub-assembly level, electronics and circuit design are the same. Add to this TICOR III's unmatched servo bandwidth, its low $\pm 0.4 \mu$ sec time base error, its highly successful two years of field test as Mincom's Model 32—and look no further for your complete (and compatible) data team. Write us for details and specifications.

Mincom Division **3M**
COMPANY
300 SOUTH LEWIS ROAD • CAMARILLO, CALIFORNIA 93010

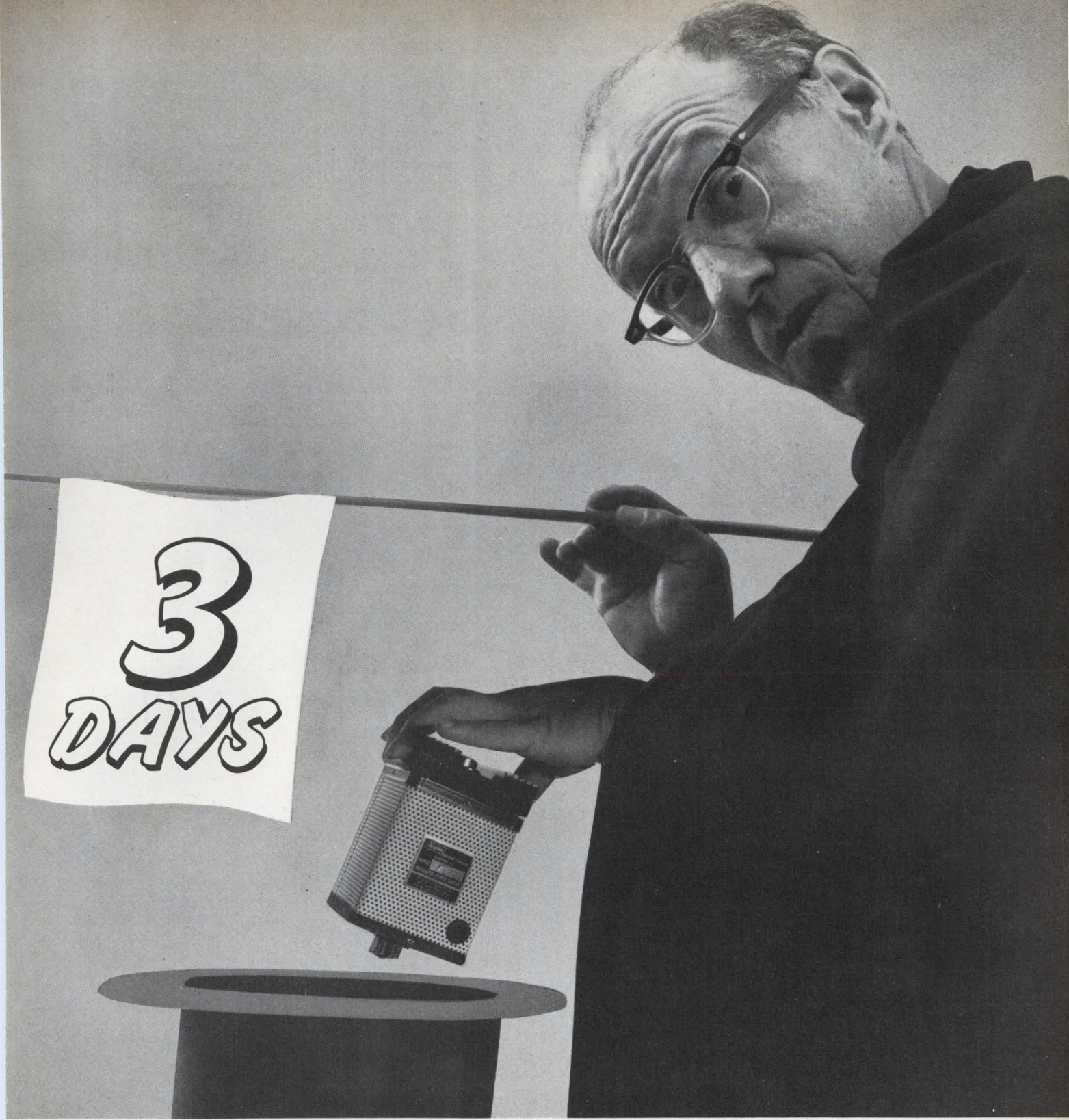

Magic... Acopian style!

We ship any of our 82,000 different AC to DC plug-in power supplies in just 3 days!

Next time you need power supplies in a hurry, contact Acopian. We offer 82,000 different AC to DC plug-in power supplies, any of which will be shipped to you in **just three days!** Choose the exact DC output you need. Singles or duals. Regulated or unregulated. Whether you need one power supply or several, your order will be shipped in just three days! That's our promise. For your copy of our latest catalog, contact your local Acopian rep, call us at (215) 258-5441, or write to Acopian Corp., Easton, Pa. 18042.



The longer you rent a time-shared computer, the more it costs — but if you buy your own, the more you use it, the less it costs.

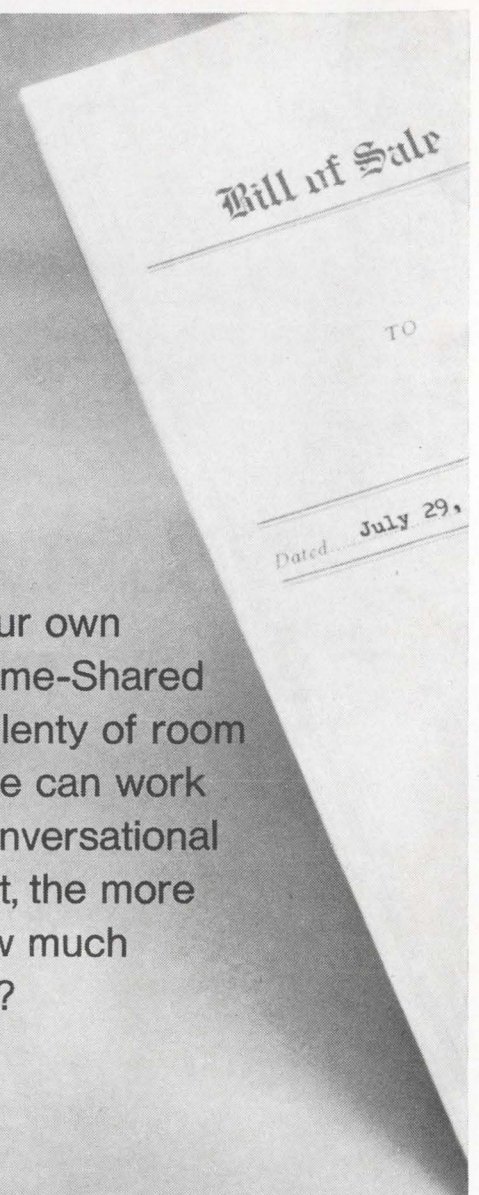
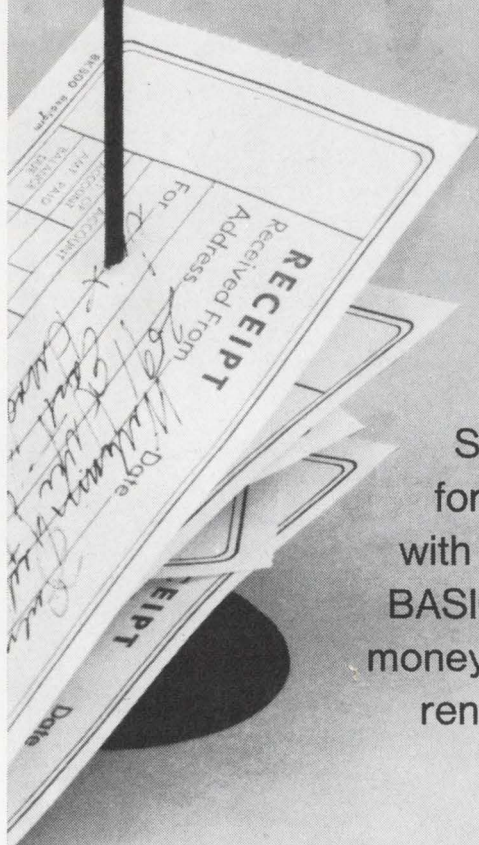

You can have your own Hewlett-Packard Time-Shared System for \$90K. And plenty of room for growth. Sixteen people can work with it simultaneously. In conversational BASIC. The more they use it, the more money it saves. Any idea how much rental \$90K can save you?

The HP 2000A Time-Shared BASIC System gives you —among other things— one HP 2116B Computer, 16K memory, expandable disc storage, a control teleprinter and proven time-share software.

The high-speed computer gives the illusion that one has the computer to himself. And integrated-circuit construction means long life without obsolescence.

Disc storage holds about 500 average-size programs, and can be expanded. The program library has two sections: public for all users to draw on, private for individual user programs. Software features include line-at-a-time compiling, extensive diagnostics, and full duplex echoing.

Terminals can be located anywhere. Direct wire connections save on phone charges. But with telephones, any number of terminals can be accommodated— within the limit of 16 at a time.

The genius of the HP Time-Shared System is its Conversational BASIC Compiler, a powerful programming language that you can learn in three to four hours. Yet the computer can also be used in the non-time-sharing mode with Assembler, FORTRAN and ALGOL Compilers, peripheral I/O devices and scientific instruments.

So, when you're tired of paying the high cost of giant time-shared systems, see what \$90K will buy for you. Call your HP field engineer, or write Hewlett-Packard, Palo Alto, California 94304; Europe: 54 Route des Acacias, Geneva.

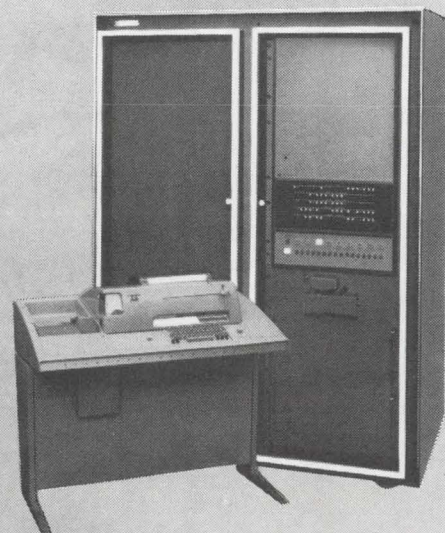

HEWLETT  PACKARD
DIGITAL COMPUTERS

06821-A

Special introductory offer to new members of the ELECTRONICS AND CONTROL ENGINEERS' BOOK CLUB

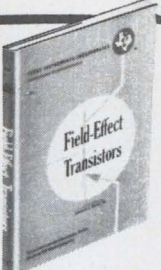

Pub. Price
\$10.00
Club Price
\$8.50

Field-Effect Transistors by L. J. Sevin.
Code #355



Pub. Price
\$18.00
Club Price
\$15.30

Pulse, Digital, and Switching Waveforms by J. Millman and H. Taub.
Code #381



Pub. Price
\$27.75
Club Price
\$23.60

Antenna Engineering Handbook by Henry Jasik.
Code #290

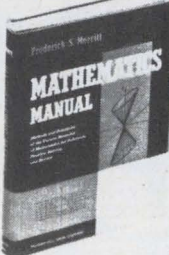

Pub. Price
\$11.95
Club Price
\$10.15

Mathematics Manual by F. S. Merritt.
Code #1509



Pub. Price
\$17.50
Club Price
\$14.95

Electronic and Radio Engineering by F. E. Terman.
Code #509



Pub. Price
\$16.50
Club Price
\$14.05

Transistor Circuit Design by the Engineering Staff of Texas Instruments, Inc.
Code #737

ANY ONE

for only **\$1.00**

VALUES FROM \$10.00 TO \$29.50

Special \$1.00 bonus book comes to you with your first club selection

SAVE TIME AND MONEY BY JOINING TODAY

MAIL THE ATTACHED POSTPAID CARD

IF CARD IS REMOVED SEND COUPON BELOW

Here is a professional club designed specifically to meet your day-to-day engineering needs by providing practical books in your field on a regular basis at below publisher prices.

HOW THE CLUB OPERATES. Basic to the Club's service is its publication, the *Electronics and Control Engineers' Book Club Bulletin*, which brings you news of books in your field. Sent to members without cost, it announces and describes in detail the Club's featured book of the month as well as alternate selections which are available at special members' prices.

When you want to examine the Club's feature of the month, you do nothing. The book will be mailed to you as a regular part of your Club service. If you prefer one of the alternate selections—or if you want no book at all for that month—you notify the Club by returning the convenient card enclosed with each *Bulletin*.

As a Club member, you agree only to the purchase of four books over a two-year period. Considering the many books published annually in your field, there will surely be at least four that you would want to own anyway. By joining the Club, you save both money and the trouble of searching for the best books.

Electronics and Control Engineers' Book Club
582 PRINCETON ROAD, HIGHTSTOWN, N. J. 08520

Please enroll me as a member of the Electronics and Control Engineers' Book Club and send me the two books indicated below. I am to receive the higher priced of the two for just \$1, and my first selection at the special Club price. These books are to be shipped on approval, and I may return them both without cost or further obligation. If I decide to keep the books, I agree to purchase as few as four additional books during the next two years at special Club prices (approximately 15% below list).

Write Code # of higher priced selection here

Write Code # of lower priced selection here

NAME _____
ADDRESS _____
CITY _____
STATE _____ ZIP _____
(Offer good in U.S. and Canada only)

E 33079

TEKTRONIX 50-MHz dual-beam oscilloscope

Type 556
delayed-sweep
7-ns risetime

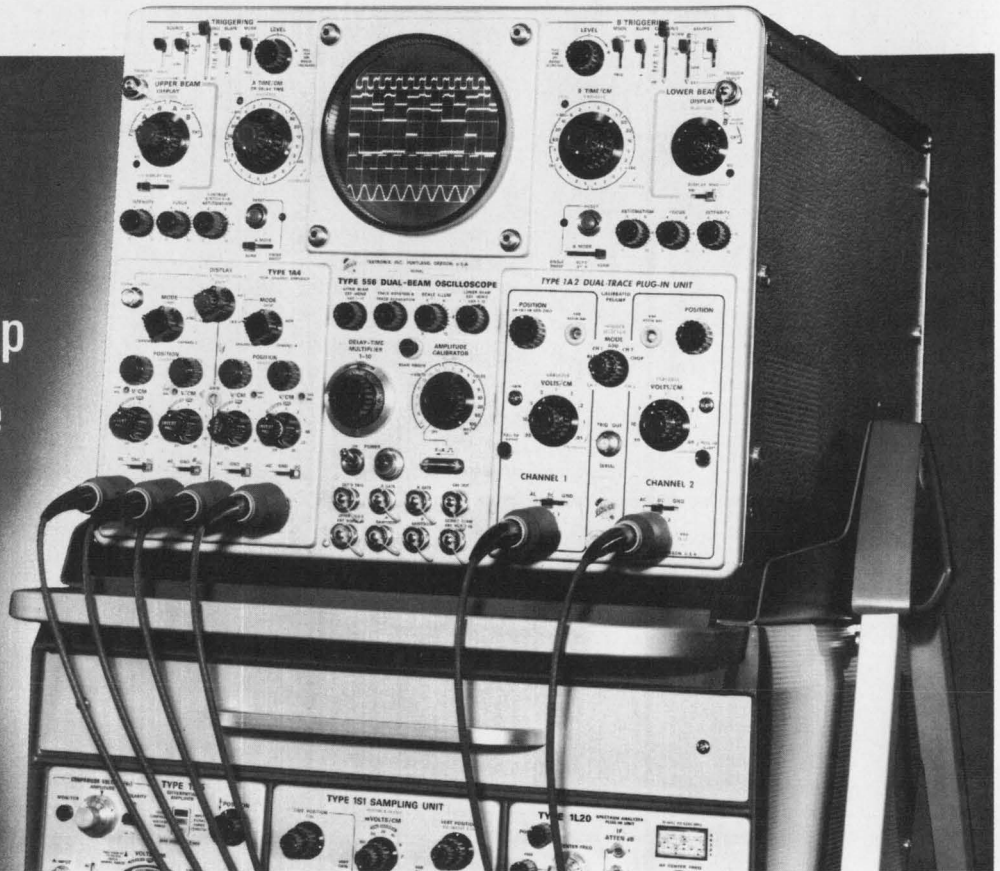

The Tektronix Type 556 Dual-Beam Oscilloscope features 50-MHz bandwidth, calibrated sweep delay, 6 x 10 cm scan per beam and dual plug-in flexibility. Using two plug-ins at a time, the Type 556 offers many display combinations, including: dual-beam single-shot; multiple-trace; sampling and real-time; frequency and time; delaying and delayed sweep. The two independent horizontal deflection systems provide full bandwidth triggering and calibrated sweep speeds from 5 s/cm to 100 ns/cm, extending to 10 ns/cm with the X10 magnifier. The calibrated sweep delay range is from 100 ns to 50 seconds.

The Type 556 with the Type 1A4 Four-Channel Plug-in and the Type 1A2 Dual-Channel Plug-in provides up to six channels, each with 7-ns risetime and DC-to-50 MHz bandwidth. (Up to eight traces with two Type 1A4 Plug-ins.) You can also select from differential plug-ins with bandwidths to 50 MHz, TDR and sampling plug-ins with 90-ps risetime, and spectrum analyzer plug-ins that cover the spectrum from 50 Hz to 40 GHz.

For a demonstration, contact your nearby Tektronix field engineer or write: Tektronix, Inc., P. O. Box 500, Beaverton, Oregon 97005.

Type 556 Dual-Beam Oscilloscope	\$3350
Type 1A2 Dual-Trace Plug-in	\$ 350
Type 1A4 Four-Channel Plug-in	\$ 825
Type 205-2 Scope-Mobile® Cart	\$ 145

U.S. Sales Prices FOB Beaverton, Oregon

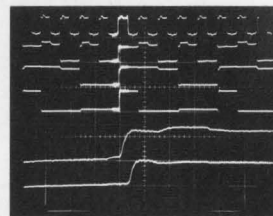

Multi-Trace

The six waveforms are time related digital pulses. The upper four displays are A Sweep (2 μ s/cm) with the Type 1A4 Four-Channel Plug-in. The lower two displays are B Sweep Delayed (100 ns/cm) with the Type 1A2 Dual-Trace Plug-in.

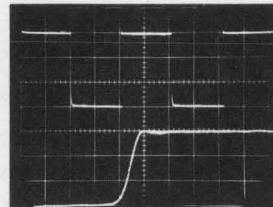

Sampling and Real-Time

The upper beam shows a square wave at 2 μ s/cm as applied to a Type 1A2 Dual-Trace Plug-in. The lower beam shows the risetime of the same pulse with the Type 1S1 Sampling Plug-in at 1 ns/cm.

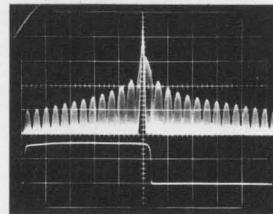

Frequency and Time

The upper beam shows the spectral output of a 200 MHz gated oscillator applied to the Type 1L20 Spectrum Analyzer; calibrated dispersion is 1 MHz/cm. The lower beam shows a real-time display of the 2.5 μ s gating pulse.



Tektronix, Inc.

committed to progress in waveform measurement

Intelsat plots a course for the future

Delegates from 80 nations, 64 of them consortium members, will meet next week in Washington to take action on questions of importance to electronics suppliers

By Paul A. Dickson

Associate editor

Early next week, the State Department will play host to delegates from most of the world's nations in what's billed as the largest international commercial meeting ever held, as well as the biggest diplomatic conclave in Washington history. The get-together, officially designated the Plenipotentiary Conference to Establish Arrangements for the International Telecommunications Satellite Consortium, will feature an agenda as long and as important as its jaw-breaking name implies.

Among the myriad of issues to be decided are many that will have a great impact upon the electronics industry. For example:

- Intelsat contracting policies for satellites, components, and research and development.

- The future of regional and domestic commercial satellite systems.

- Possible expansion of Intelsat into other commercial satellite service areas.

- The final organization of Intelsat and the position of the Communications Satellite Corp., the consortium's acting manager.

- The role of U. S. aerospace and electronics firms vis-a-vis that of overseas concerns in Intelsat programs.

In addition, a broader question will be raised as to whether the consortium can permanently establish itself as the truly universal system its directors would like it to become. For this to come about, two things must happen—the meeting must be conducted without undue fallings-out among the members, and the Soviet bloc must join the consortium. On the eve of the

meeting, the outlook on both counts appears bright.

When the Intelsat consortium was set up in 1964, 14 founding nations decided to operate under a set of interim agreements until 1969, when definite arrangements could be established. January 1970 was made the deadline for establishing the organization's final form. In the five years since Intelsat began, a lot has happened. The membership has jumped substantially to the point where there are now 64 nations on the rolls; another six have recently been approved. They're all expected to join within the next few months. Several other nations—for example, Somalia, San Marino, and Mauritania—will attend the meeting as observers with an eye to applying for membership in the near future. A Comsat official sums things up this way: "With the exception of the Soviet bloc nations and Red China there are only a very few Lichtenstein-sized nations left which are not in Intelsat."

Bustle. The consortium's activity level has risen right along with membership. Earlier this month, a second Intelsat 3 satellite was placed in orbit; the current plan is to have four such spacecraft in orbit (two over the Atlantic, one over the Pacific, and another over the Indian Ocean) by year's end. The Intelsat 3's will replace the still operational Intelsat 2's and Early Birds now in orbit. Meanwhile, work is progressing on Intelsat 4's, the next generation of communications satellites. Supporting the lineup of spacecraft are an ever-increasing total of ground stations, a wide-ranging R&D program, and

over \$100 million in cash reserves.

Many knowledgeable observers believe the very size and success of the consortium will ensure the success of the meeting. Ambassador Leonard H. Marks, a former director of the United States Information Agency and chairman of the American delegation, says: "In just a few years a global system has been set up and is working well. One must keep in mind that a successful functioning business is being reexamined in the meeting, and countries will be coming to improve that organization, not to tear it apart." Marks points out that Intelsat is the first truly international business. As a result, the mood may well be closer to that of a stockholders get-together than of a diplomatic conference.

Another factor that would tend to keep the meeting from getting out of hand centers on the fact that



Lead man. Leonard H. Marks leads U.S. delegation at Intelsat meeting.

The more you need from crystal filters, the more you need Bulova!

Today's sophisticated systems call for filters with "difficult" characteristics. Difficult, that is, for everyone but Bulova! Bulova has had so much experience with crystal filters, there's hardly anything we don't know about them.

Take single side-band filters, for example: Attenuation figures alone are not enough to adequately describe today's military communication filters. More and more filters require limitations on envelope time delay, while others must follow a precise time-delay envelope curve.

Bulova has been testing for these parameters — providing measurements both in terms of phase linearity and, in many cases, directly in envelope time-delay readings. As a result,

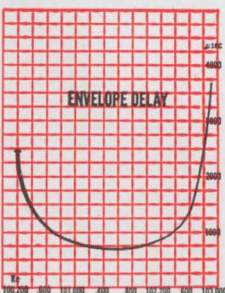

Bulova can engineer and produce to the exact measurements you specify. And at a realistic price!

Proof:
Here are the actual curves and specs for just one Bulova filter, Model 562.

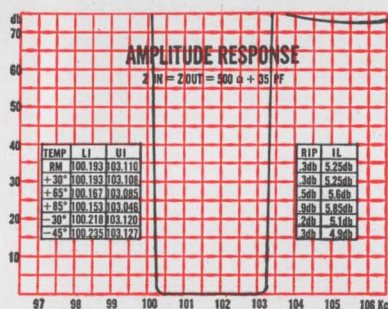

Bandwidth (1db) 100.255 to 103.035 Kc
Bandwidth (60 db) 99.990 to 103.260 Kc
Carrier frequency — is 100 Kc
Loss at carrier — 55 db min.
Ultimate attenuation — 70 db
Max. insertion loss — 6 db
Max. ripple — 1 db max.
Operating temperature — -40° to +65°C
Impedance — 500Ω (in and out)
Differential envelope time delay — 500 μsec max. over 80% of pass band

With specs like these you can see why we say — the more you need from a filter, the more you need Bulova! Call or write Dept. E-21.

Try Bulova first!

FREQUENCY CONTROL PRODUCTS

ELECTRONICS DIVISION
OF BULOVA WATCH COMPANY, INC.

61-20 WOODSIDE AVENUE
WOODSIDE, N.Y. 11377, (212) DE 5-6000

Incommunicado

On Aug. 14, 1967, President Johnson, in a message to Congress, established a star-studded panel of experts to study U.S. communications policy and offer recommendations for modifying and improving procedures in this area. The group was further specifically directed to investigate "our entire international communications posture." The report was to be submitted by August 1968—primarily to give the President time to review and release the findings well before the Intelsat meeting.

After much delay, the task force got moving in the winter of 1967; a research team was hired, contracts were let, and exhaustive studies were undertaken by such groups as the Office of Telecommunications Management, the FCC, and the Bureau of the Budget. The President's August deadline came and went, however. Finally, "working papers" prepared by the task force began to be leaked to the press last October.

By Inauguration Day, the report had still not been officially released. Nor was there, as far as anyone could determine, a final draft of the report. The task force has by now been disbanded and the report is still in limbo. President Nixon has, however, assigned a specialist to review it.

Watchdogs. Understandably, several members of Congress, including Sen. John O. Pastore (D., R.I.), are upset because the costly work of the panel seems to have gone for naught. More important, however, is the fact that the U.S. delegation to the Intelsat meeting stresses that the working paper entitled "The Future of Intelsat" is not to be considered this nation's policy regarding the organization. Ironically, some key members of the delegation (Ambassador Marks, FCC Chairman Rosel Hyde, and Director of Telecommunications Management James D. O'Connell) served on the task force.

Thus, after much planning and expense, clues to the U.S. position must be gleaned from the remarks of those delegates willing to talk on or off the record.

the governing body of the organization, the Interim Communications Satellite Committee, has carefully sounded out the member governments about their positions. The committee has assembled detailed information on each point to be negotiated at the meeting in a 115-page volume, entitled Report and Definitive Positions, that's being circulated among the members. One Comsat aide to the U.S. delegate to the committee says: "Positions have been collected and sorted into majority and minority viewpoints. There are some issues upon which there's unanimous agreement, while with others there are a variety of alternative positions. The intent of the document is to allow the member nations to know what alternatives exist." Another reason for the document is the airing of all the possibilities—no matter how radical—early in the game with an eye to preventing blockbuster proposals from taking the conference by surprise.

The Russians are coming

There's also optimism about the prospect of Communist-bloc na-

tions' joining the consortium. Last month, the Soviet Union told the U.S. State Department that it would accept the invitation made in the United Nations, offering "observer" status at the meeting to any nation "with a serious interest in the possibility of becoming an Intelsat member at a future time." Since the USSR accepted, Yugoslavia and Bulgaria have announced that they will send delegates. A source at the office of the Soviet scientific attaché in Washington says, "In all probability, there will be other socialist delegations at the meeting in addition to those that have formally announced they will attend."

Meanwhile, U.S. officials are trying to assess the possibility of Soviet membership. Marks says, "I can only hope this means that the Soviet Union wants to join Intelsat. The signs are good. We interpret the acceptance as an important advance towards joining. And we are impressed and encouraged that they are sending their deputy minister of communications." Others were openly surprised that the USSR had accepted the invitation,

considering the move a reversal of the country's announced plans to establish a communications satellite system of its own called Intersputnik.

Idea man. A possible clue to the rationale behind the Russians' decision to send observers is offered by Charles S. Sheldon, senior space and transportation specialist at the Library of Congress. Considered America's ranking expert on the Soviet space program, he says: "From what I've been able to determine, nothing has happened with Intersputnik since it was announced last year. It appears to be nothing more than a proposal to start a competing system." Sheldon considers the chances of Soviet entry good.

At Comsat, an official notes that there are those in the organization who view the Soviets as "potentially disruptive" to Intelsat, but a vast majority seem to believe that the Soviets should be encouraged to join. This source predicts: "If the ice is broken, it will probably occur when Yugoslavia applies for membership." He points out that Yugoslavia has accepted aid from Comsat in planning its own ground station, which is presumably compatible with the Intelsat system. And Yugoslavia has never publicly announced it would join Intersputnik. Some national delegations, Sweden's, for example, plan to do all they can to get the USSR and Intelsat together.

Free form

While Soviet participation will undoubtedly emerge as the major unscheduled issue of the meeting, it's difficult to determine which of the more than 100 items on the formal agenda will emerge as the most controversial or important.

According to Marks and other members of the sizable U.S. delegation, there is no position paper that clearly defines America's stance. The document issued in 1967 has been "submerged," along with the positions of other countries, in the report of the interim committee. (Positions are not labeled by national origin.) But while there are, officially, no positions at this time, national stances are discernible on a number of the major issues.

The U.S., along with a sizable

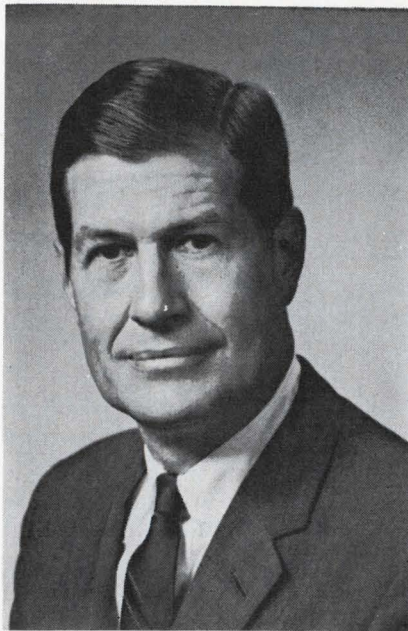

Worldwise. Comsat's John A. Johnson is a key U.S. delegate at the meeting.

number of other nations, is in favor of Intelsat's being allowed to furnish any services within the capacity of communications satellites. Aviation and maritime communications and navigation services are immediately at issue. Marks points out that his delegation will also push to have such services approved for the domestic use of one nation. The opposition, led by France, wants to limit communications services to the existing long-distance arrangements. This alternate view has already been aired in meetings of the interim committee at which France has thrown up barriers to Comsat's getting into the aeronautical services satellite business through Intelsat. France has taken the position that the aeronautical satellite proposal does not properly fall into Intelsat's purview under the terms of interim agreements. But John A. Johnson, vice president, international, for Comsat and a member of the U.S. delegation, says: "We take the position that other services, such as aeronautical services, are part of the existing agreements and should be part of final agreements."

Piece of the action. Shares in Intelsat—voting and financial—have been determined by a formula based on actual and anticipated satellite communications traffic. As the system has grown, the U.S. share has fallen to 53% from over

High
RF
power,
low
distortion



The Hewlett-Packard 230A Signal Generator Power Amplifier delivers up to 4.5 watts of low distortion power from 10 to 500 MHz. It is ideal for meeting your high RF power requirements for applications such as receiver testing, wattmeter calibration, antenna testing, filter and component testing and attenuation measurements. The amplifier may be driven with any conventional signal source and will reproduce AM, FM and pulse modulation characteristics of the driver generator with minimum distortion. The instrument employs three tuned, cascaded stages of grounded-grid amplification fed from a regulated power supply. Price: \$1350. Application Note 76 discusses high and low-level applications. For your copy of this application note or more information about the amplifier, contact your local Hewlett-Packard field engineer or write: Hewlett-Packard, Rockaway Division, Green Pond Road, Rockaway, New Jersey 07866. In Europe: 1217 Meyrin-Geneva, Switzerland.

HEWLETT  PACKARD
SIGNAL SOURCES

1082 A



Centralab gives transistor circuits longer, more reliable performance with NEW 16, 25 & 50 volt Ultra-Kaps[®]

Centralab engineers have achieved a new degree of temperature stability in semiconductor type, low voltage ceramic disc capacitors with their development of temperature-stable Ultra-Kaps. The 16 and 25 volt units can hold a maximum capacitance change of $\pm 4.7\%$; 50 volt units as little as $\pm 7.5\%$.

Ultra-Kaps also exhibit other superior performance characteristics, such as low impedance; high capacitance density; and operation to temperatures as high as 150°C, as low as -55°C. In 50v ratings average dissipation factor is as low as 1.5%; leakage resistance of 1000 megohms, min.

the stable ones

Ultra-Kaps are ideal for use in transistor circuits because they are operable to a frequency of 1 MHz. And they're still low cost units that replace more expensive mylar and "Hi-K" ceramic capacitors. On quantity orders, they're priced as low as 2½ cents each with delivery as short as 4 to 5 weeks. We can send you samples immediately for your evaluation.

Don't let your design plans melt away because of inferior capacitor performance. Get the ultimate, Centralab's stable Ultra-Kaps.

Max. Diameter	16 volt		25 volt		50 volt	
	Max. Cap. MFD	Min. I.R. Megohms	Max. Cap. MFD	Min. I.R. Megohms	Max. Cap. MFD	Min. I.R. Megohms
.290	.02	5.0	.015	65.0	.01	1000
.390	.033	3.0	.022	45.0	.015	1000
.405	.05	2.0	.033	30.0	—	—
.485	—	—	—	—	.022	1000
.515	.068	1.5	.05	20.0	.033	1000
.590	0.1	1.0	.068	15.0	.047	1000
.690	0.15	0.65	0.1	10.0	.05	1000
.760	—	—	—	—	.068	1000
.820	0.2	0.5	0.15	6.5	—	—
.920	0.3	0.33	0.2	5.0	0.1	1000

*Thickness: .156 inches maximum
 Lead spacing: Discs less than .500" diameter, nominal lead spacing is .250"
 Discs .500" and larger, nominal lead spacing is .375"

CENTRALAB

Electronics Division
 GLOBE-UNION INC.
 5757 NORTH GREEN BAY AVENUE
 MILWAUKEE, WISCONSIN 53201

M-6901

FOR MORE INFORMATION AND/OR DESIGN ASSISTANCE, WRITE CAPACITOR SALES MANAGER, CENTRALAB.



Need CENTRALAB ULTRA-KAPS® RIGHT NOW?

Your Centralab Industrial Distributor has these new products for immediate delivery at factory prices. He can furnish these and thousands of other Centralab components from stock. He will serve you promptly and efficiently.

For a complete directory of Centralab Industrial Distributors, mail coupon today.

Advertising Department	
Centralab, Electronics Division, Globe-Union Inc.	
5757 North Green Bay Ave., Milwaukee, Wis. 53201	
Name	_____
Title	_____
Company	_____
Address	_____
City	_____
State	Zip

DISTRIBUTOR PRODUCTS



CENTRALAB
Electronics Division
GLOBE-UNION INC.

5757 NORTH GREEN BAY AVENUE
MILWAUKEE, WISCONSIN 53201

DI-6908

65%. Under the interim agreements, however, the U.S. cannot go below 50% even if the actual percentage of traffic dips below this level. The premeeting consensus is that the 50% limit for the U.S. will be abandoned. Says one Comsat official: "Even the U.S. can see that the provision is unfair."

Negotiation of a new voting system will probably prove one of the hottest potatoes at the meeting. Comsat's Johnson says, "There are many different proposals in this area, making the question of representation one of the major issues of the meeting." Whatever voting scheme is adopted, there is little doubt that the U.S. share will fall below 50%; the question is how far below.

Who's in charge?

Comsat, the present manager of the consortium, would like to keep its job. Marks has this to say on the prospects of Comsat's hanging in there: "U.S. technological and managerial expertise has made Intelsat a great success. To keep momentum you must have technical ability and administrative knowledge, and Comsat has this. Almost all members agree that the company has done well. And almost everyone wants it to keep its job as manager. The only question which must be resolved is how much non-U.S. participation there is to be in management. Other nations are asking for greater participation and we welcome them."

While Marks makes diplomatic noises, others, particularly at Comsat, are frankly worried as to how serious the challenge to Comsat's role will prove. Insiders predict Comsat will keep its job—albeit with strong supporting roles for assistant managers from other nations in the consortium.

Sidesteps. The issue is very far from resolution. In the document prepared by the interim committee, the majority opinion calls for "a permanent management body" with a director-general (or international manager).

But there are no details on who the director-general might be or how the management could be staffed. Says one Comsat official, "You can read anything you want into it—retention of Comsat with a new title or a whole new scheme

of things with the company as one of the managers." However, according to Johnson, there has been no move to completely replace Comsat as manager with an organization from another nation.

Share alike. As far as the U.S. is concerned, every attempt has been made to buy a sizable percentage of satellite and ground station hardware and research abroad. Marks points out that 35% of the apparatus for the Intelsat 4 will be produced outside the U.S. However, Marks and others admit that there are rumblings from smaller nations (in Africa and South America, for example) which don't like the fact that most of the contracts wind up in Europe or Japan. The smaller nations believe that such awards amount to "subsidies" for these powers. Whether logically or not, they reason that the work should either be done in the U.S. for less money or be spread out further to include technical "subsidies" for them. Understandably, the "have" countries doing Intelsat work do not want to exclude themselves from future R&D or hardware contracts.

It appears that there is no real opposition to domestic satellites. But regional satellite systems are a different matter. The U.S. is clearly against them. Marks, for one, labels them "inefficient and impractical." The U.S. would like to keep regional satellites from competing with Intelsat, while European nations, notably France and Germany, want to keep their options open.

Housekeeping. While there are many smaller points to be thrashed out on organization, there is little doubt that Intelsat will not differ substantially from its present set-up. According to Marks, there appears to be "almost unanimous" consent to the idea of a general assembly where all members occasionally meet to iron out major issues of policy. This group would be backed by a governing board, rather like the present interim committee, which would meet regularly to conduct the routine business of the organization. This small group would include delegates from the major powers as well as from blocs of nations with less voting power. Finally, there will be a manager.

Philbrick/Nexus DC log amplifier— a slip stick in 2.65 cubic inches

Quicker than you can operate your favorite slide rule, Model 4350 Log Amplifier will calculate the logarithm of a positive voltage or current, or solve the positive antilog of an input voltage. Model 4351 performs the same functions on negative voltage or current.

The combination of two Philbrick/Nexus log amplifiers multiplies and divides. Add scaling resistors and you can compute arbitrarily selected powers and roots. Units are fully temperature compensated for use over wide temperature ranges.

Units are fully encapsulated and measure 1.4" x 2.7" x .7". They feature fast response and a wide 6-decade dynamic range. Priced well below competition at only \$95. Contact your Philbrick/Nexus sales representative for complete details and specifications. Or write, Philbrick/Nexus Research, 22 Allied Drive at Route 128, Dedham, Mass.

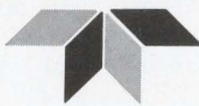

PHILBRICK/NEXUS RESEARCH

A TELEDYNE COMPANY

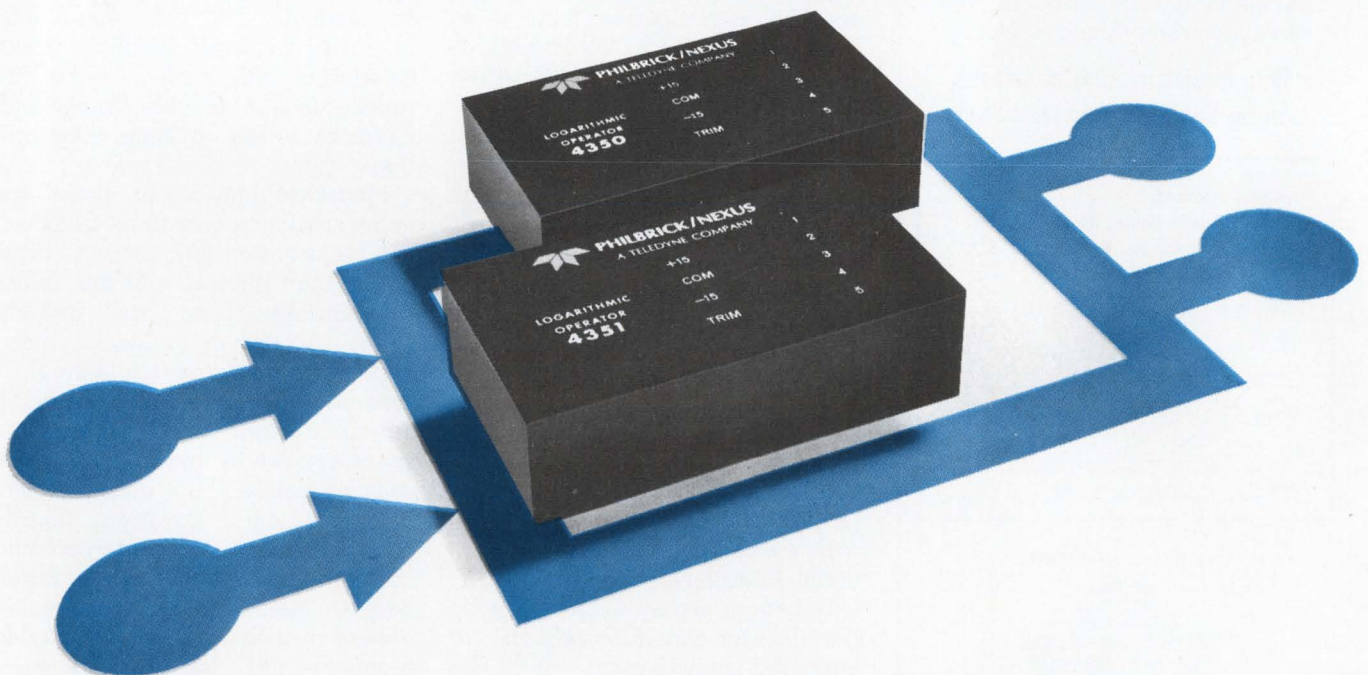

To thread maze of export rules, start at the Commerce Department

Most companies agree that the guidance offered by bureaucrats is the next best thing to relaxation of restrictions

By Howard Wolff

Senior staff writer

Consider the dilemma of the electronics industry in its efforts to sell more abroad: just about everything the field turns out is subject to export controls for security reasons of one sort or another. Nonetheless, electronics companies file more export license applications each day—about 250—with the Commerce Department's Office of Export Control than firms in any other industry. One result is that last year \$1.6 billion worth of the industry's \$23.1 billion output was shipped to customers overseas.

Underpinning these figures is accommodation—companies of almost every size and description learning to live with detailed and ever-changing restrictions. Surprisingly, the consensus of these firms is that despite frequent frustrations—and the seemingly contradictory, arbitrary, or just downright stupid rules—the Commerce Department and the OEC do a remarkably efficient job of processing export applications. The department says with some pride that 90% of all applications are processed within 10 days; those creating policy problems—such as trade with Soviet bloc nations—take longer.

The only real worry for the industry, as the Nixon Administration begins to impose its personality, is whether Commerce Department policy makers will adopt a more relaxed stance, tighten the rules, or stand pat.

Tug of cold war

The OEC was set up in 1949 under the Export Control Act "to prevent the export of strategic ma-

terials, equipment, and technical data to Sino-Soviet bloc countries where their use could be detrimental to the United States." Because the operative word is "prevent," the agency is subject to pressures from exporters, the Pentagon, and the Congress. The upshot is that the OEC has become not only a barrier to the export of material to "unfriendly" countries but also an agency that protects the domestic economy against "excessive drains" of scarce materials while furthering the nation's foreign policy.

The OEC must deal with Congressional protectionists, super-

patriots, and Pentagon hawks who want to put almost everything on the proscribed list and sharply restrict shipments of strategic materials to neutrals friendly with the Communists. On the other hand, equal pressure is applied by businessmen who want to sell their wares and by Congressmen who have those businessmen as highly vocal constituents.

By the book

To keep things more or less straight, the OEC maintains a fat loose-leaf book called the "Comprehensive Export Schedule" list-

The arcane arts

Despite the Commerce Department's willingness to help American firms obtain export licenses, its scientific naiveté sometimes gets in the way. The experience of Spectra-Physics of Mountain View, Calif., which exports lasers, provides a case in point.

The problem, says Alfred P. Hildebrand, product manager, is that "lasers are mysterious to the department. They sound strategic and the department doesn't distinguish among them. And the Commerce people have no method for differentiating between lasers for military applications and those intended for scientific use." As a result, Spectra-Physics, which exports 25% of its products, can't get a license for export to Iron Curtain countries.

In a fix. All the company's devices, complains Hildebrand, are low-power models with no destructive capability. Their application is exclusively in areas such as high-resolution measurement. "In any case," he adds, "laser technology is so well developed in Red countries that there's almost no strategic value to any laser."

The company encounters other problems when it tries to ship repair or replacement parts, which come under the same restrictions as entire lasers. But devices that move from country to country sometimes break down in a country for which the company can't get an export license. "This often results in prolonged delays and rerouting to get the part to the person who needs it," says Hildebrand. Spectra-Physics would like to see some liberalization of the rules governing the movement of such parts. However, the government is considering establishment of a license for replacement parts.

TRYGON HAS THE POWER

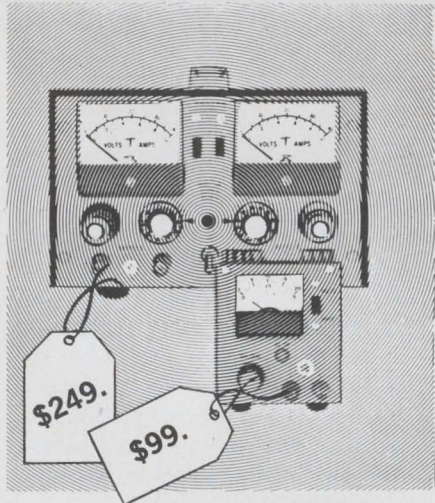

to deliver these great laboratory power supplies immediately.

Trygon's economy EAL and precision DL-series laboratory power supplies are available—right now—from 36 sales offices, nationwide. So when we say you'll have them, you can depend on it. You can also depend on them.

The versatile DL Series gives you two independent dual-range supplies (0-20V @ 1 amp or 0-40V @ 0.5 amps) in one half-pack package.

The compact EAL fits in a corner of your bench and your budget (only \$99) and comes in the four most commonly used laboratory voltage ranges.

TRYGON POWER SUPPLIES
 111 Pleasant Ave., Roosevelt, L.I., N.Y. 11575*

I need the following unit(s).

Qty.	Model	Rating
....	EAL 10-1	0-10 VDC @ 1.0 Amp
....	EAL 20-500	0-20-VDC @ 500 ma
....	EAL 32-300	0-32 VDC @ 300 ma
....	EAL 50-250	0-50 VDC @ 250 ma
....	DL 40-1	2x0-40 VDC @ 1.0 Amp

Name/Title _____
 Firm _____
 Address _____
 City _____ State _____ Zip _____

Purchase Order Attached.
 Contact us for Purchase Order.
 Please send Trygon Power Supply Handbook.

*PRICES SLIGHTLY HIGHER IN EUROPE.
 TRYGON GMBH, 8 MUNCHEN 60, HAIDELWEG 20, GERMANY.

ing products and the regulations governing their export. This volume is kept up to date by "Current Export Bulletins." The book tells which products may be exported to, for example, Poland but not to Communist China.

Other items listed in its pages may be shipped to Hong Kong only under special license because of that city's status as a doorway to mainland China. Cuba and mainland China are naturally on the no-no list for everything, but East European countries can get quite a bit of rather advanced material and technology.

One of the OEC's major headaches is determining what is strategic and what isn't. In this area the office relies on industry consultants, military experts, and members of the State Department's Arms Control Agency. In addition, there is an international body (mostly nations that are former Marshall Plan aid recipients) called the International Control System that decides what shouldn't fall into the hands of the Reds. CoCom, as it is called, requires unanimous agreement of its delegates before anything is embargoed.

Finally, the OEC investigates cases of illegal transshipment of goods. For example, an Austrian might buy strategic items and sell them to the Russians. Such transactions are generally hard to track, but every now and then a foreign businessman is put on the blacklist, meaning Americans may not sell to him.

Notwithstanding the maze of regulations, applications, and pitfalls, most companies agree with the Commerce Department that doing business overseas is easy if one keeps abreast of OEC bulletins. Says Charles Davisson, senior traffic coordinator for Page Communications Engineers of Alexandria, Va.: "I have no sympathy for companies that say they can't do this or that. They probably just haven't read the book. It's our 'Bible.'"

Which road?

James Frazier from TRW Inc. expects things to loosen up even further. Frazier, manager of domestic distributor sales and export sales of semiconductor products, thinks the new Administration will take a liberalized view of foreign

trade. Licensing, he predicts, will become easier for some products and restrictions will be eliminated for others.

Frazier points out that as free-trade barriers come down in Europe, economic and administrative obstacles should also tumble, since they're all of a piece. Major easing of U.S. controls will come, he says, as the trade objectives of the Kennedy Round and the Common Market are met.

Easing up. Charles S. Luther, vice president in charge of exports at the Raytheon Co.—which exports millions of dollars worth of products a year—agrees. He feels that restrictions on licenses have been easing right along and should continue to do so under Nixon. "The industry has had a battle for eight to 10 years with the Commerce Department to be more lenient, and some of our efforts are bearing fruit. Bulk licenses and distribution permits are among the newest developments," he says. "And a license to make repairs and supply replacements is being contemplated."

But the Raytheon executive does believe that the process required to obtain a license to sell abroad is time consuming. "It takes 10 to 12 days," he notes. "Applications must be filed in Washington, documents are required from the customer abroad, and sometimes delivery verification is necessary, so the customer must go to customs when his order comes."

Dissenter. Motorola Semiconductor, which puts export responsibility in the hands of T.J. Connors, doesn't believe a major change in policy is imminent. The department's structure is such, says the company, that though major policy decisions may be the province of the President through his Secretary of Commerce, any changes come slowly and gradually. Nor does Motorola agree unequivocally with Commerce's contention that obtaining an export license is easy. In certain areas, the company believes, that's the case only if a firm is willing to do less business. Any executive of a medium-sized company, it's said, could easily look at the maze of rules and conclude that he might as well go on doing business, and earning more money, where he already knows how. More

THIS NEW ADD-ON...

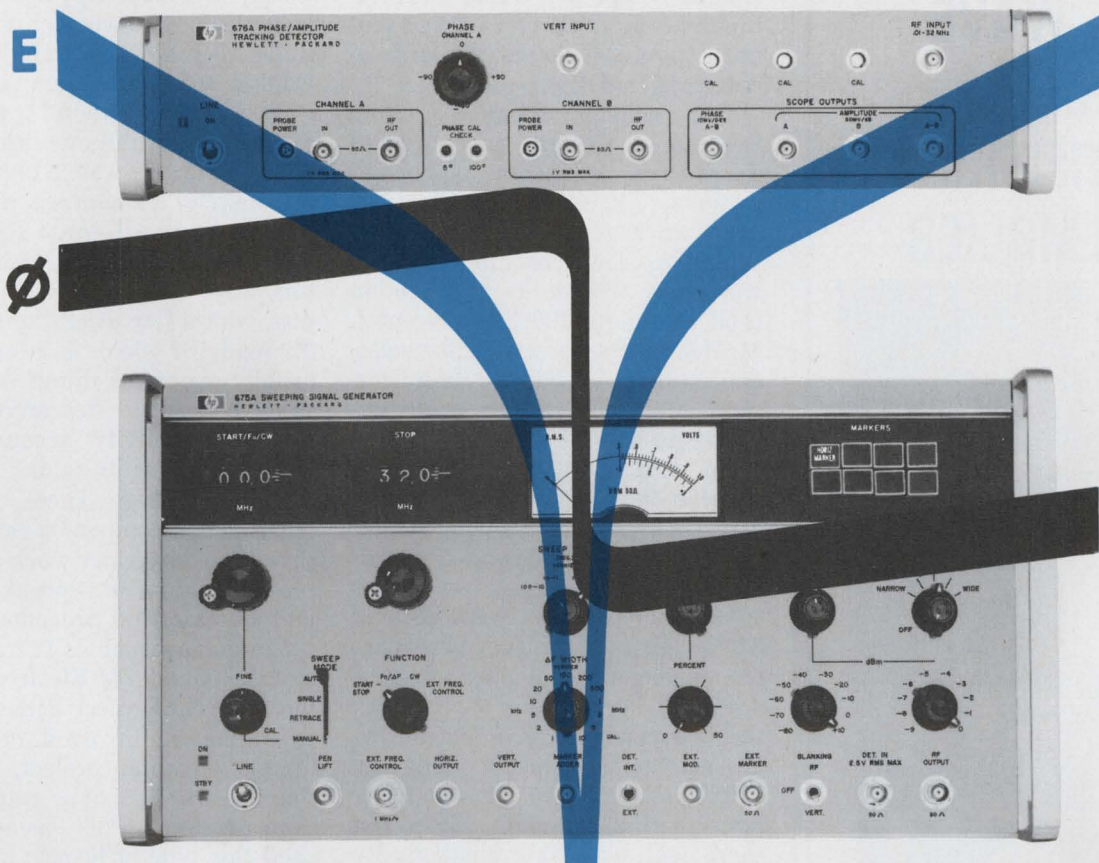

MAKES THE HP 675A SWEEPER A NETWORK ANALYZER...

Simultaneously display phase and amplitude!

Now you have *both* phase and amplitude information on a swept basis to 32 MHz. You save hours of time, see changes in phase and amplitude responses immediately as you make adjustments. This combination of instruments is oriented toward production and lab testing.

The 675A Sweeping Signal Generator has a 10 kHz to 32 MHz range with settings anywhere in this range for single or continuous sweep. The 676A Phase/Amplitude Tracking Detector adds a full 360° phase measurement capability and an 80 dB dynamic amplitude range. Combination is programmable for automatic or computerized testing.

Channel A and B outputs of the 676A provide simul-

taneous amplitude measurements of two devices for comparison. Amplitude A-B and PHASE A-B make difference measurements easy. Outputs can be easily calibrated in linear dB and linear phase on a low frequency oscilloscope or X Y recorder. New active probe (100 k Ω , 3.5 pF) augments 50 Ω input for high impedance measurements.

Check your design and production areas for the savings you can make with the new network analyzer—the combination that makes point-to-point plotting passé. Call your local HP field engineer for complete information. Or, write Hewlett-Packard, Palo Alto, California 94304. Europe: 1217 Meyrin-Geneva, Switzerland. Price: 675A, \$2250; 676A, \$1275.

HEWLETT  PACKARD
SIGNAL ANALYZERS

LOWEST COST . . . FULL WAVE BRIDGE RECTIFIERS & ASSEMBLIES

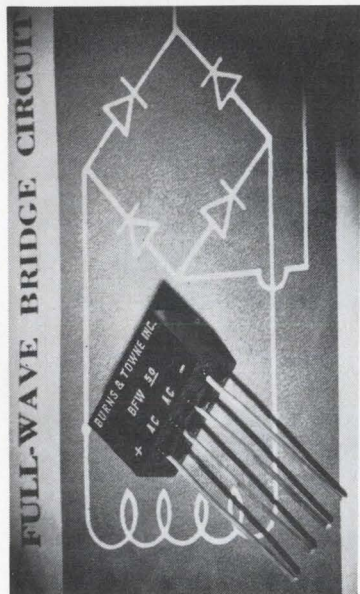

Burns & Towne pre-packaged rectifier circuits represent a significant cost savings over individual components used in multi-rectifier units. Yet, you are always assured of quality and reliability. The low cost BFW family of single phase full wave bridges . . . features high current capability of up to 2.0 amps.

Part No.	Max. PRV (volts)
BFW-50	50
BFW-100	100
BFW-200	200
BFW-300	300
BFW-400	400
BFW-500	500
BFW-600	600
BFW-800	800
BFW-1000	1000

Call or write for full specifications and price data.

BURNS & TOWNE INC.
SYSTEMS DIVISION 18-36 Granite St.
Haverhill, Mass. 01830, Tel (617) 373-1333

... "Many controls are at least obsolescent, if not obsolete" ...

smaller companies would be entering the competition for foreign profits, Motorola believes, if real free-enterprise rules prevailed.

One smaller company, Omni Spectra of Detroit, which makes microwave connectors and components, solves the problem by using an international sales representative. The concern's exports were only 6% of its \$5.4 million total volume in 1968, so Vincent J. McHenry, vice president for sales, doubts that any Nixon Administration policy adjustments could appreciably affect his firm.

Another optimistic company is Hewlett-Packard, whose international volume is growing faster than its domestic business. A decade ago, overseas sales were about 11%; last year they were 25% of \$265 million. Says Tom Christensen, manager of planning for international operations: "Nobody wanted to put his neck out during an election, especially after the Czech crisis drove all our fancy hopes underground. However, there will be a re-evaluation; we need it. If this is done, we may see a shift in restrictions on strategic goods.

"Many controls are at least obsolescent, if not obsolete, and it should be kept in mind that it's very difficult to determine what's contributing to the economic well-being of a Communist country. The Commerce Department often finds that the easiest answer to an export request is 'No.' There needs to be some revamping of controls based on a realistic appraisal of the world today. But let me make one thing clear: the department works very hard in the more constructive areas of its interests."

The way to go

Many types of licenses are available to U.S. firms. The simplest is the basic export license and its accompanying ultimate consignee/purchaser statement, which is intended to prevent products from being diverted to other uses or destinations without OEC authorization. The experience of one small company—the Vermont Research

Corp., of North Springfield, Vt.—is typical. A newcomer to foreign trade, Vermont Research decided to exhibit at a trade show in Frankfurt, where it wound up selling \$50,000 in drum memories.

The next step was to obtain, with the help of Commerce personnel, a basic license. George Rivers, the firm's sales manager, sums it up this way: "You file your application, wait a few weeks, and usually it's ready. If you're in a hurry, OEC usually expedites things." As a result, Vermont Research's 1968 European activity accounted for 10% to 12% of its sales.

Thinking big. There are two other routes companies can take to save time and paper work on multiple bulk shipments—project license and warehousing procedure.

Companies such as ITT and General Telephone & Electronics find the one-year project license handy when they're involved in a large overseas capital project, such as the construction of a communications system. For example, ITT used this type of license to build a \$2.7 million automatic telegraph relay control system for NATO in Italy. And last year ITT exported \$25 million worth of components to foreign subsidiaries and customers under project licenses. GT&E is using such permits to send Intelsat earth station equipment to Thailand, Chile, and the Philippines.

The warehousing procedure, on the other hand, is being used by GT&E to improve its European competitive position by stocking electron and microwave tubes, plus other items, with its West German subsidiary. Approved warehouses—they can be foreign subsidiaries, affiliates, or branches under full control of the parent U.S. firm—may sell goods exported under this license only to customers approved in advance by the OEC. Despite this stricture, exporters such as GT&E say the warehousing procedure helps cut licensing delays because the companies needn't file additional certification of end use and destination for each shipment to the warehouse.

John Collins, director of the

puzzled by data acquisition?

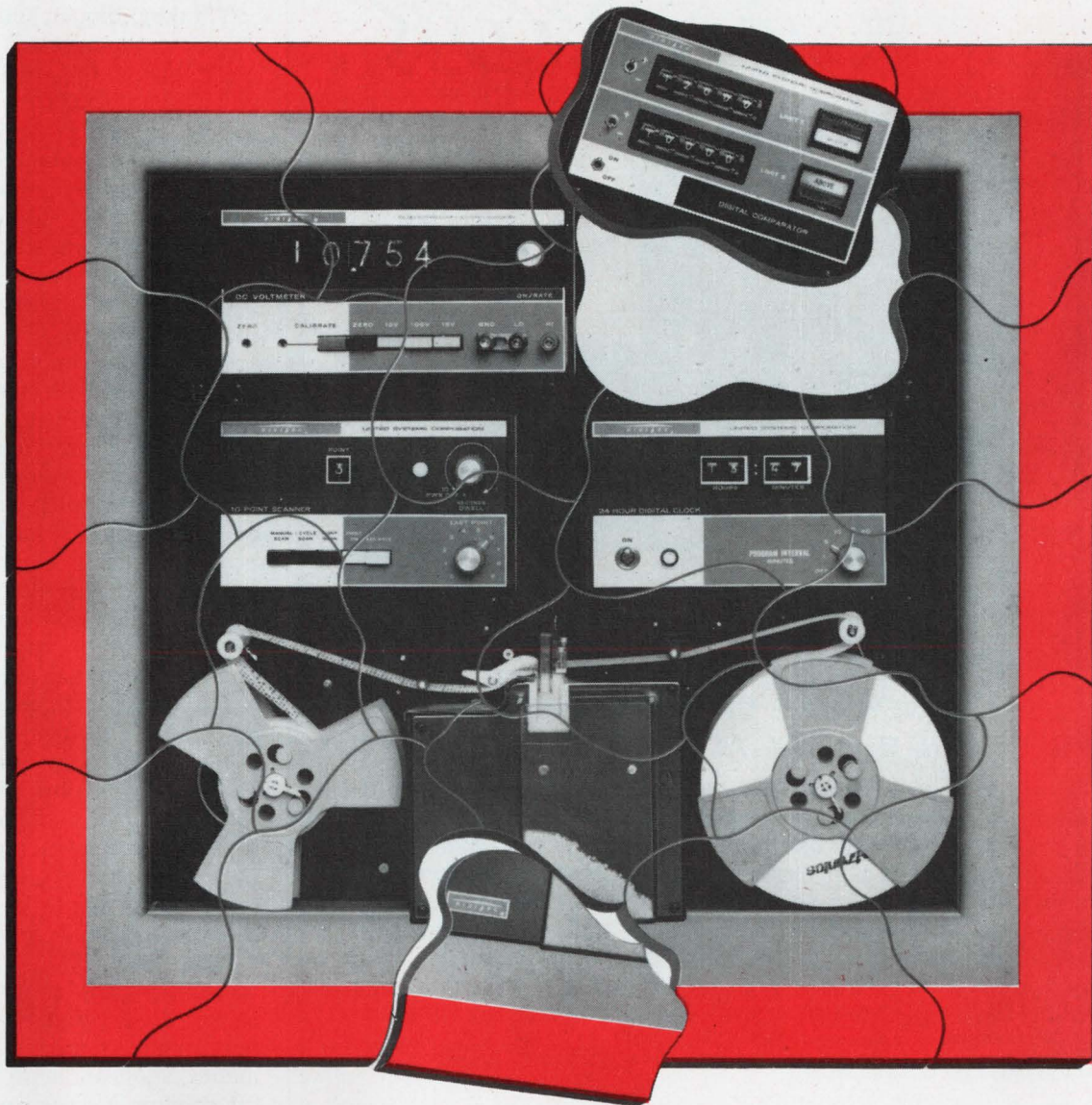

DIGITEC[®] "off the shelf" components provide the solution!

DigiTec meets your requirements with a full line of compatible voltage and temperature measuring instruments. When these are combined with DigiTec Clocks, Scanners, Digital Comparators, Event Counters, Multiplexers, Tape Punches and Printers, your data acquisition

requirements are no puzzle. In addition we can match readouts to nearly any transduced parameter. Let us show how easily you can fit the pieces together, or check us for a complete packaged system, tailored to your needs.

"SYSTEMS" is our middle name

DIGITEC[®] by **UNITED SYSTEMS CORPORATION**

918 Woodley Road • Dayton, Ohio 45403 • (513) 254-6251
Stocking Representatives Throughout the World

For Complete
Specifications
request new
catalog D69

SPECIFY **NEW** PANEL BOARD INSTRUMENTS by **HICKOK**

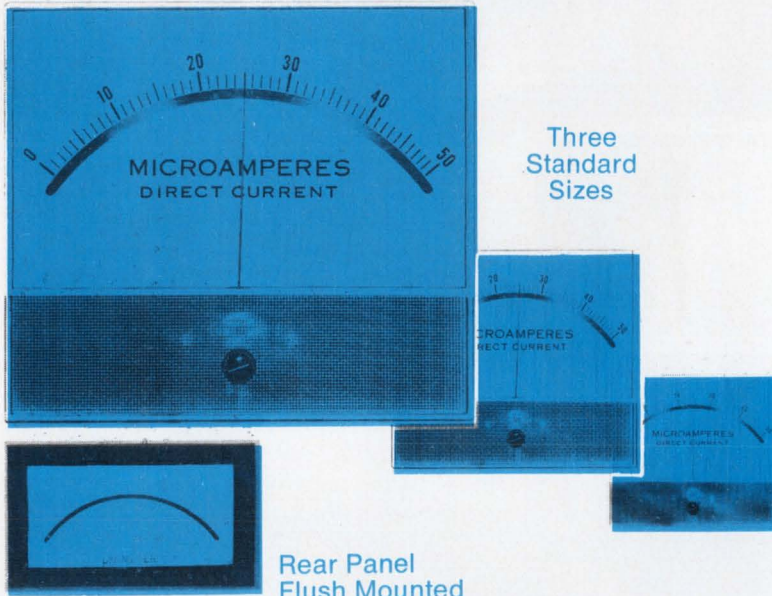

A NEW LINE OF INSTRUMENTS PRECISION QUALITY AT COMPETITIVE PRICES

Colorado Hickok Corp., Division of Hickok Electrical Instrument Co., Cleveland, announces a NEW LINE of Panel Board Instruments at highly competitive prices. Hickok Instruments can read anything in electronics—ruggedized instrumentation with pioneer-proven reliability. Fast deliveries can also be made from Hickok's factory mod department. Hickok's NEW LINE features clear acrylic plastic front cases for front or rear-of-panel mounting, available in 3½ — 4½ — 5½ inch width cases, in D-C D'Arsonval and A-C Repulsion Vane and Dynamometer Movements, CALL OR WRITE FOR ADDITIONAL INFORMATION.

- Accuracies 1.5% full-scale
- A-C Iron Vane Repulsion
- Current Range 10 milliamps — 30 amps*
- Voltage Range 5-300 volts*
- D-C Self-Shielded Core Magnet
- Pivot-Jewel or Tautband Suspension
- Current Range 10 microamps — 30 amps*
- Voltage Range 15 millivolts — 300 volts*

*Higher A-C current and voltage ranges may be supplied for use with transformers or multipliers; and with D-C shunts and multipliers.

Colorado **HICKOK**

CORPORATION

A Division of The Hickok Electrical Instrument Co. — Cleveland.
2897 North Avenue Grand Junction, Colorado 81501
Telephone — Area Code 303 / 243-2124

OEC's Scientific and Electronic Equipment division, says: "The real limitation of the warehousing procedure is that some goods, like sophisticated electronic instruments, are too expensive to store overseas awaiting customers' orders."

Thinking bigger. But perhaps the single greatest boon to the company that is already in the export picture and wants to stay there is the Commerce Department's newest and most comprehensive procedure, the distribution license. It enables a firm to ship a wide range of products to previously approved distributors or users in 12 countries. However, there are conditions:

- The U.S. exporter must have done business with those customers for at least two years.

- The company must have received 40 or more export licenses.

- The firm must have sent licensed products worth more than \$100,000 to those customers during the calendar year preceding application for the distribution license.

- And it must expect to maintain that level for the coming year.

The time and paperwork savings are obvious. Instead of describing each specific item covered by the license, the exporter simply lists them in broad commodity groups. And exports may be made from any port. However, the company must report each month on the exports made the previous month.

Open arms. The large exporters are enthusiastic about the new license. Ernest Ramsey, import-export administrator for Texas Instruments' Semiconductor group, says: "It sounds like the greatest export licensing procedure yet." And Collins Radio plans to make "extensive use of the distribution license for regular and emergency shipments of our whole product line to our subsidiaries and large customers."

Hewlett-Packard points out that the new license will make life easier for a number of international customers who won't have to obtain import certificates to buy strategic products. And ITT expects to export \$1 million to \$2 million in semiconductors alone during 1969 under distribution license, according to Kenneth J. Vigue, director of international projects and export controls. ■

new mil-performance square cermet trimmers from CTS

Now . . . with CTS Cermet Multi-Turn Square Trimmers you get Characteristic C Mil-spec performance for all military applications. All new series 165 (style RJ24) and series 175 (style RJ22) meet tough Characteristic C of Mil-R-22097C. These same environmental characteristics are available . . . at lower cost . . . for commercial and industrial applications.

Both small $\frac{3}{8}$ "-square series 165 and compact $\frac{1}{2}$ "-square series 175 trimmers assure infinite resolution over a 20 ohm to 2.5 megohm range . . . and power rating of $\frac{1}{2}$ watt @ 85°C. TC ± 150 ppm/°C for 2k ohms and above. -0 +175 ppm/°C from 50 ohms through 250 ohms and -0 +250 ppm/°C from 500 ohms through 1k ohm. All available at no extra cost.

Low cost*, proven quality, and top performance—combined with **fast distributor delivery**—make CTS your best industrial trimmer choice. Can't use one of our standard series? Ask how we can solve specific application problems. Call or write for complete details to CTS of Berne, Inc., Berne, Indiana 46711. Phone (219) 589-3111.

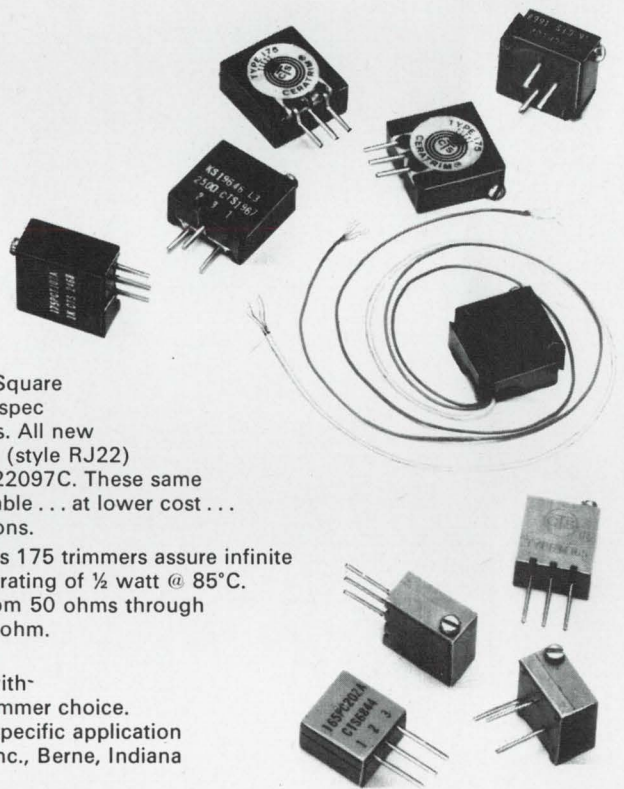







*Check these prices for 4-6 week production delivery. (Small quantities from stock)

	Series 165		Series 175	
	25-49 (each)	1000 (each)	25-49 (each)	1000 (each)
Quantity				
Commercial ($\pm 20\%$ Tol.)	\$4.55	\$3.25	\$4.20	\$2.95
MIL-type ($\pm 10\%$ Tol., Char. C)	5.30	3.80	5.10	3.65

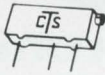

CTS CORPORATION
Elkhart, Indiana

Other CTS Cermet Trimmers include:

 Series 185 $1\text{-}\frac{1}{4}$ " x $.290$ " x $.364$ " multi-turn	 Series 190 $\frac{3}{4}$ " x $.160$ " x $.310$ " multi-turn	 Series 340 $\frac{1}{4}$ " x $\frac{1}{4}$ " square x $.270$ " high—single-turn	 Series 360 $\frac{7}{16}$ " x $\frac{1}{16}$ " x $\frac{25}{64}$ " single-turn	 Series 385 $1\frac{1}{32}$ " round x $.225$ " high—single-turn	 Series 660 $\frac{3}{8}$ " round x $\frac{1}{4}$ " high— single-turn	 Series 630 $\frac{1}{2}$ " round x $\frac{13}{32}$ " high— single-turn
--	---	---	--	---	--	--

Three new developments in filter-connectors.

They're the three different filter-pins you see in the picture. What makes them noteworthy is what they make possible—a variety of low-, mid- and high-frequency filter-connectors. There are three different types, and there are filter-pins of three different lengths to match the frequency. Naturally, the mating and mounting techniques for all three types are the same.

So are the advantages. All of which stem from the fact that each pin is surrounded by its own miniature ferrite filter to keep out EMI (electromagnetic interference).

Making the filter an integral part of the connector means that these new types—like all Bendix filter-connectors—save you space, weight and money. Because they cost considerably less than a filter-box setup. Weigh about 10 times less. And take up about 10% less space. And, these new types are available with socket contacts.

So now you've got even more ways to benefit from Bendix filter-connectors. Because Bendix already makes a wide variety. Including those intermatable with our Pygmy® Series (Mil-C-26482), JT Series, and LJT Series (Mil-C-27599 and Mil-C-38999). And if you don't see what you want, we'll design it. For details, contact: The Bendix Corporation, Electrical Components Division, Sidney, New York 13838.

Bendix

Electronics

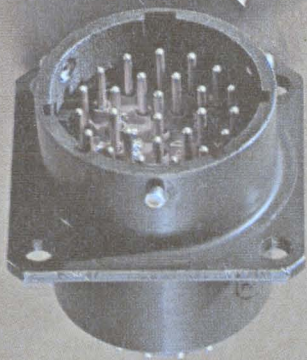

**HIGH ELECTRIC STRENGTH,
LOW FRICTION SURFACE.**

**OPERATIONAL TO +500 F.
OPERATIONAL TO -100 F.**

**USED IN OUTER SPACE,
USED IN INNER SPACE.**



TEMP-R-TAPE OF TEFLON.*

Because Teflon has one of the slipperiest surfaces known, everything slides off Temp-R-Tape. Temp-R-Tape withstands severe environmental conditions. The electrical characteristics are excellent and remain constant through a temperature range of -100 F. to +500 F. It has excellent conformability and the silicone polymer pressure-sensitive adhesive makes it easy to apply and remove.

CHR's Temp-R-Tape line offers the industry's widest variety of types and sizes of pressure-sensitive Teflon tape.

Stocked by a national network of CHR distributors capable of technical assistance and fast delivery. Look in the Yellow Pages under "Tapes Industrial" or in major industrial directories and micro-film catalogs under CHR. Or write for a free sample to The Connecticut Hard Rubber Co., New Haven, Connecticut 06509.

*TM of DuPont



Subsidiary of U.S. Polymeric, Inc.

Semiconductor microwave sources go off-the-shelf at more makers

Suppliers cut lead times to a few weeks for mounted and unmounted units as bulk-effect devices and avalanche diodes gain in popularity

The fast increase in applications for semiconductor microwave power sources has meant that more and more devices are becoming available off-the-shelf. As design engineers build bulk-effect devices and avalanche diodes into practicable circuits, it seems that manufacturers are making mounted and unmounted units more readily available [see "Solid state microwave leaves lab," p. 86].

The Electron Dynamics division of the Hughes Aircraft Co., for example, is quoting 60-day delivery on the first of a new family of avalanche diode oscillators (these are diodes mounted in a waveguide). Designed for X-band operation, the new oscillator is specified at 250 milliwatts minimum from 8 to 12.4 gigahertz.

Hughes is not alone. Varian Associates just introduced a series of silicon impatt oscillators with continuous-wave power ratings from 100 mw minimum in Ku band to as much as 500 mw in X band [*Electronics*, Feb. 3, p. 158]. And over the next three months Varian expects to improve the powers of its diodes, especially at Ku band, which is a popular frequency range for many proposed avionics programs. The company forecasts about 250 mw minimum through Ku band, and it will probably beef up its X-band ratings as well. However, Eric van der Kaay, manager of application engineering, says that although high power attracts attention, devices operating at 50 to 100 mw will develop strong markets, probably in low-power radar and surveillance systems.

Sylvania will get in on the act, too. Eugene J. Feldman, manager

of microwave products for the Semiconductor division, reports that his company will have both oscillators (diodes plus mounts) and diodes (unmounted) for sale by or during the second half of this year. They'll range from C band through X band at powers from 0.5 watt to 1 watt c-w. "These will be commercial devices operating in the normal avalanche mode," Feldman says. To back up his prediction, he notes that Sylvania has already delivered sample quantities of 900-mw, 9-GHz diodes and several 200-mw diodes that operate at only 4.6 GHz. (In the impatt mode, it's far more difficult to generate power at these low frequencies than at higher ones.)

In the spring. Microwave Associates quotes delivery in 45 days for the model MA-8000-XF2, oscillator—which has an output of 10 mw at 8 to 12.4 GHz and is mechanically tunable over a 5% band—and in 60 days for the MA-8000-XF5, which is fixed-tuned in the same frequency range with a 250-mw output. These are mounted avalanche diodes, weighing 3 ounces each. Microwave Associates plans to introduce Ku-band impatts in the spring but says that it's too soon to characterize them. Outputs will probably exceed 100 mw.

Oki Electric Industry Co. in Japan offers a line of X-band oscillators. The series ADS-10 is designed for low-noise applications such as multichannel communication systems and tv links. The f-m noise deviation can be lowered to less than 100 hertz per kilohertz of bandwidth, within the power variation of 1 db, by means of a small stabilizing cavity developed by

Oki. Power output with a vswr load of 1.2 is 60 mw for the ADS-10A and 100 mw for the ADS-10B. Frequencies from 8.2 to 12.4 GHz are available, tunable mechanically within a ± 260 MHz range. The series ADW and ADC have similar characteristics, but are waveguide and coaxial types, respectively.

Bulk-effect devices aren't being neglected. Microwave Associates has just announced two Gunn oscillators: MA-1010-XF4, 10 to 15 GHz, 4-mw output, and MA-8012-ML, 8 to 12.4 GHz, 5 mw. Delivery times are two and three months, respectively. Both are mechanically tunable over a range of a few percent, and the 5-mw unit is electronically tunable over a 0.5% band.

Varian, too, has just started mar-

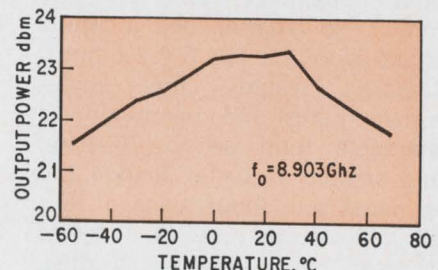
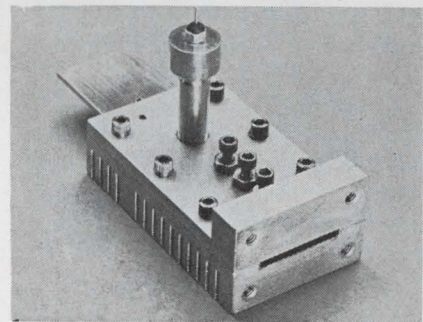

Summit. Power of the Hughes 44010H peaks at room temperature and falls off at high and low readings.



NEW UNIVERSAL HIGH IMPEDANCE DC AMPLIFIER

**This new generation lab assistant amplifies
as well as measures voltage and low level current**

Our new all solid state Model 604 is a differential input electrometer amplifier that brings new speed and convenience to laboratory measurements. It combines all the features physicists, biologists and physiologists look for in studying ion chamber currents, photocell currents, measuring biological potentials, determining pH, analyzing membrane conductivity and handling other research projects.

It offers 10^{14} ohms with 1 pf input impedance, precise gains from 1 to 10,000 and a short circuit proof 11 volt 5 ma output. Guarding insures high speed measurements and bandwidth is selectable from dc to 75 kHz. Zero stability is better than 4 mv per week and input noise of less than $20 \mu\text{V}$ rms remains constant at most gains. Besides all this, the 604 has 7 voltage ranges from 1 volt to 1 millivolt f.s.

The Model 604 becomes a pre-

cision differential input picoam-
meter when used with our 6041
Differential Current Shunt. It
extends current ranges from 10^{-6}
to 10^{-14} ampere f.s. The Model
6041 contains two high impedance
switches with matched 10^6 to 10^{11}
ohm shunt resistors on each. Complete
guarding is maintained.

The Model 604 Amplifier is only \$895, the 6041 Current Shunt \$295. Your Keithley Sales Engineer will gladly demonstrate both. Or contact Keithley Instruments, Inc. for complete details—28775 Aurora Rd., Cleveland, Ohio 44139. In Europe: 14, Ave. Villardin, 1009 Pully, Suisse. Prices slightly higher outside the U.S.A. and Canada.



**MODEL 6041
CURRENT SHUNT**



KEITHLEY

keting a Ka-band Gunn oscillator. The model VSA-9010 offers 10-mw output over any customer-selected 1-GHz band in the 26.5-to-40 GHz range. Maximum bias requirements are 6 volts and 500 milliamperes, and the oscillator can operate at ambient temperatures up to 100°C . Units are priced at \$1,500.

Big market. Texas Instruments plans to introduce a batch of unmounted Gunn-type microwave devices during the next month. These have power outputs of up to 100 mw c-w in the 4-to-12-GHz range and efficiency up to 5.3% and they're tunable over a 10% range. TI has concentrated on devices for

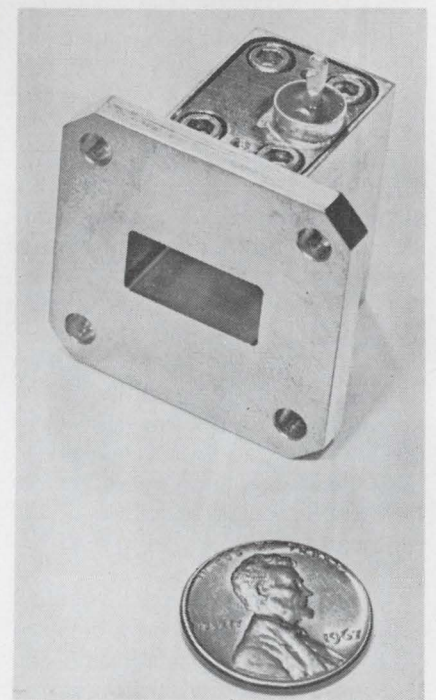

Powerpoint. Diode atop waveguide is source for Varian's Ku-band oscillator.

low-power local oscillator applications because it believes this is where the big market is for products that can be delivered with confidence at the present stage of development. At first, the company will sell only unmounted devices. Later this year, it will supply them in cavities or hybrid integrated circuits.

The price of the Hughes avalanche oscillator is not yet firm, but it will be less than \$500, and possibly less than \$400. It requires a d-c supply of 60 to 80 volts at about 100 milliamps. It's superior in this respect to most previously

micro-pakTM

Short on size, but long on life. The dot on the "i" is a life-sized picture of our newest transistor package, the Fairchild Micro-Pak. Just 80mils on a side, our Micro-Pak is the only plastic transistor in this size that passes rigid military reliability tests. Plastic, but with all the reliability of a metal can.

The high degree of shock resistance inherent in its inert single-block construction makes it ideal for warhead fuzes or missiles. Small, light and reliable, the Micro-Pak is the best way to go for applications from missiles to computers, submarines to satellites. And anything in-between.

Listed on the right are 26 popular transistor types available in the Micro-Pak. Electrical characteristics are similar to those of metal can equivalents. The transistors can operate with junction temperatures up to 175°C and dissipate up to 300mW doing it. Three radial ribbon leads make it easy to incorporate into PC board layouts, hybrid modules and other high density configurations. Write for full specifications.

Or, if you already know what you want, see your Fairchild distributor. He's got them in stock, in quantity.



PART NUMBER	PRICE (100-999)	PART NUMBER	PRICE (100-999)
FX3299	1.60	FX2894A	3.00
FX3300	2.00	FX4960	6.00
FX3962	2.40	FX918	2.20
FX3963	3.20	FX2483	2.00
FX3964	3.20	FX2484	2.40
FX3965	3.70	FX709	2.00
FX3724	4.00	FX2368	1.20
FX3725	5.00	FX914	1.20
FX4046	3.00	FX2894	2.00
FX4047	4.00	FX4034	1.60
FX3013	5.00	FX4207	3.00
FX3014	3.00	FX3502	3.00
FX2369A	1.30	FX3503	5.00



INDIANAPOLIS IS AIRBORNE

- In Indianapolis, you're just minutes by air from every important U.S. market. You can have direct air service to the East Coast, West Coast, Gulf Coast and virtually any place in between.
- Indianapolis has an ultra-modern airport, minutes from downtown . . . runways long enough for big passenger and freight jets.
- For all the airborne facts, write John Hardy, Dept. 104, Area and Market Development Director, or call collect 317 635-6868.

INDIANAPOLIS *Power & Light* COMPANY

INDIANAPOLIS, INDIANA 46206

. . . diodes being designed into test equipment . . .

available microwave oscillators, according to Thomas Midford, a senior staff engineer. He cites two other devices with lower outputs that need 75 to 90 volts at 20 to 70 ma, and 60 to 90 volts at 20 to 50 ma, respectively, as examples of the previous state of the art. "The power and efficiency of the device increase at a faster-than-linear rate," he explains, "so the harder you drive it, the more power you can get out of it." The dc-to-microwave conversion efficiency of the device, called the 44010H, is 4%.

Some officials at Hughes wish that the output power rating of 250 mw hadn't been set so conservatively. Midford says that the impatt diode will deliver 500 mw without any trouble.

Hybrid circuit. In the Hughes oscillator, the avalanche diode is mounted at the intersection of a coaxial line and a waveguide, in what Midford describes as a "hybrid circuit that is relatively well understood." He says the microwave circuit takes up less than 10% of the volume of the package; the rest is for heat dissipation. The total volume is 10 cubic inches, and the package weighs 12 ounces.

Power variation over the oscillator's tuning range is 3 decibels maximum. Amplitude-modulated noise is -130 db per hertz at 2 kilohertz, and the operating temperature range is -40 to +60°C. Midford says the temperature range can be extended to cover the extremes of military specifications -from -55 to +85°C.

The 44010H is expected to be used in test equipment, in pump sources for parametric amplifiers, and as a local oscillator in radar and communications systems. Hughes engineers envision mounting two or three impatt diodes in a similar circuit to deliver a 1-watt output, with a different package.

The impatt diode used in the 44010H is made with standard diffusion processes, but Hughes will eventually use ion implantation to form the junction. Midford says this technique is especially promising for higher-frequency oscillators -in the millimeter-wave region.

**That's right —
It's a signal generator without a dial.**

Instead, the frequency you set is displayed on a digital Nixie® display—to *four significant digits* of accuracy and resolution. We call this feature **ddc™**—direct digital calibration.

Using a unique, patent-applied-for circuit, **ddc** automatically, directly, and continuously measures the frequency to an accuracy better than 10 PPM, and displays it to 0.01% . . . 100 PPM, or about 100 times more precisely than any dial.

These frequency measurements are crystal-clock-referenced, at *all* settings, and the display is direct-reading, *always*, including decimal point and units . . . kHz or MHz. *The frequency you see is the frequency you've set—always.*

That's not all. These new all-solid-state designs provide for complete digital-system compatibility—programming of both frequency *and* amplitude, printout, computer control, etc.

Bulletin 900-10A reviews the theory and application of Series 900 signal generators from 50kHz-230MHz. To get your copy, check the reader-service number below . . . or call or write directly.

LogiMetrics

DIVISION OF SLANT/FIN CORPORATION,
100 Forest Drive, Greenvale, N. Y. 11548;
Phone: (516) 484-2600;

Notice
anything different
about this
RF signal generator?

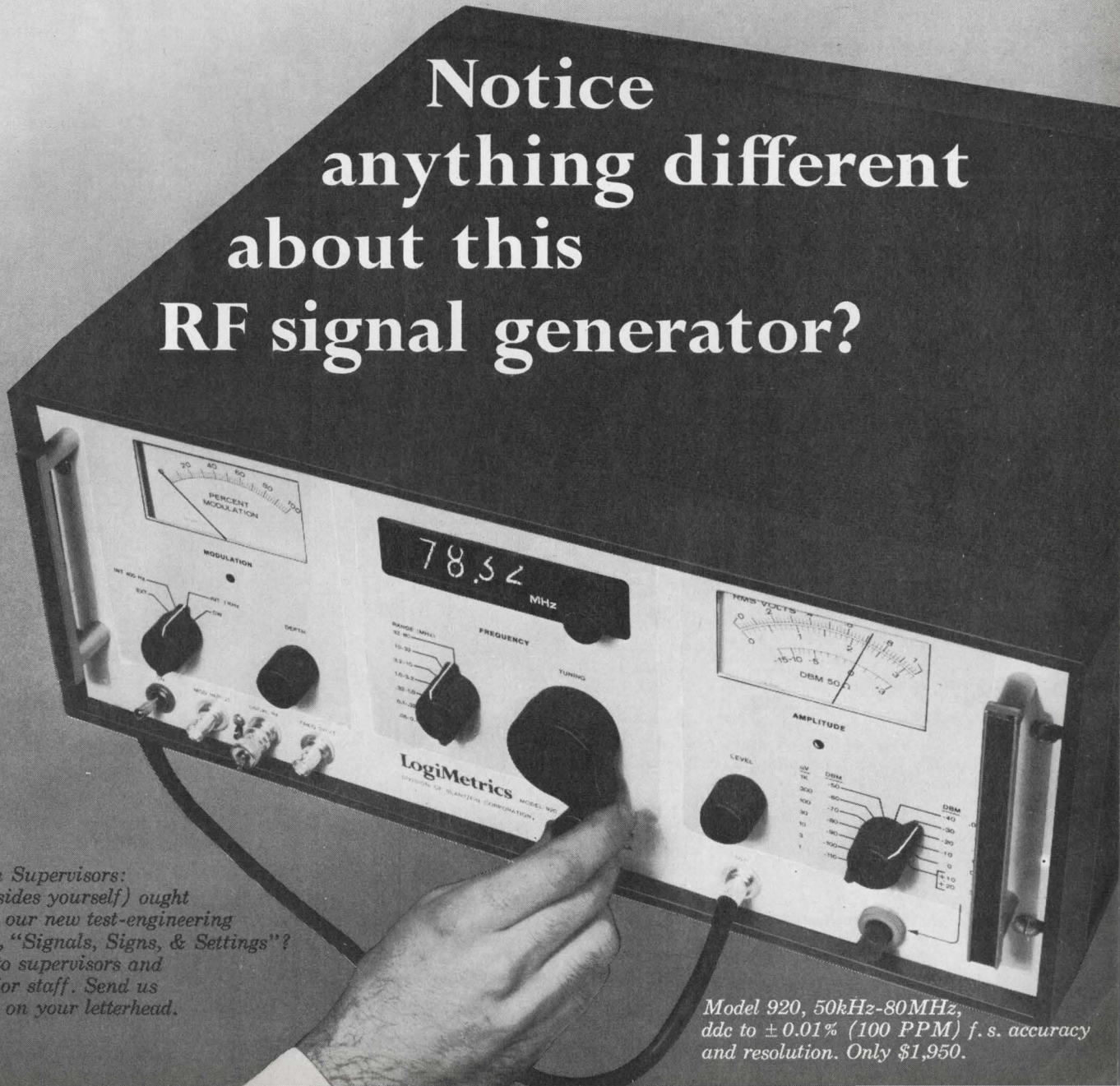

*Attention Supervisors:
Who (besides yourself) ought
to receive our test-engineering
quarterly, "Signals, Signs, & Settings"?
It's free to supervisors and
their senior staff. Send us
your list, on your letterhead.*

*Model 920, 50kHz-80MHz,
ddc to $\pm 0.01\%$ (100 PPM) f. s. accuracy
and resolution. Only \$1,950.*

CONDUCTIVE PLASTIC POTS

"From Duncan With Love"

(OR WHY EVERYONE SHOULD SPECIFY THE DUNCAN CP POTS
ENGINEERED AND QUALITY CONTROLLED WITH LOVING CARE)

DUNCAN CP POTS--
HOT OFF THE DRAWING
BOARD OF THE MOST
HIGHLY SKILLED
ENGINEERS IN
THE POT
INDUSTRY.

RESOLON®
CONDUCTIVE PLASTIC
PRECISION
POTENTIOMETERS

**ZERO
DEFECTS**

LINEAR OR NON-LINEAR FUNCTIONS

WHAT
REMARKABLE
LINEARITY AND
CONFORMITY
TOLERANCES
TO
 $\pm .05\%$

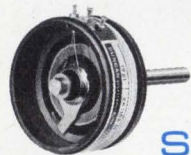

RESOLON® SPECIFICATIONS

State-of-the-art design and strict quality control provides Duncan Resolon potentiometers with these outstanding features:

- Long Life: 20 million shaft revolutions without significant change in characteristics
- Low temperature coefficient: -300 ppm/ $^{\circ}$ C max.
- Wide temperature range: -65° C to $+125^{\circ}$ C
- Conformance to all applicable MIL specs, including MIL-R-39023
- Low output smoothness: maximum of 0.1% of total applied voltage
- Linearity and conformity tolerance to $\pm .05\%$
- Single-turn/servo-mounted; available in $\frac{1}{8}$ " to 3" diameters
- Linear or non-linear functions may be provided

CALL OR WRITE TODAY FOR COMPLETE RESOLON BROCHURE

de

DUNCAN electronics, inc.

a division of Systron-Donner Corp.
2865 FAIRVIEW ROAD, COSTA MESA, CALIFORNIA 92626
TEL: (714) 545-8261 • TWX (910) 395-1128

Adding capacitance by the strip

Subminiature units for delay lines, filters, hybrid circuitry provide 50 pf each, can be connected with low-temperature solder

Getting more circuitry into smaller spaces remains a prime concern of most design engineers. As a result, some component manufacturers have added micro-sized components to their line of products. One such product is a newly developed subminiature capacitor, 0.016 square inch per 100 picofarads, made by Synchrotech, Inc.

Designated type ROC, these

capacitors are designed for application in delay lines, filters, and hybrid circuitry. Furnished in strips 0.020 inch thick, and from 1/8- to 1/2-inch wide, they are readily adapted to existing assemblies without redesign or manufacturing change.

Electrical characteristics are similar to mica components presently used in delay lines or similar

circuitry. A typical multicapacitor strip 2 inches long and 1/4-inch wide can be supplied with 40 individual 50-pf capacitors. Voltage rating is 25 volts d-c; operating temperature range is from -50°C to +125°C. Use of this type of strip capacitor is expected to help the designer gain up to 50% volume reduction when compared with mica and other discrete capac-

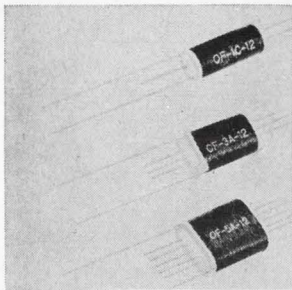

Open frame relays series OF can achieve more than 100 million cycles at low level without failure. They are electrically and physically isolated in a nylon bobbin to minimize stress, provide high sensitivity, system design flexibility, low power consumption and vibration resistance. Prices (1-9) start at \$1.86. Phipps Precision Products, 7749 Dinsmore Ave., Van Nuys, Calif. [341]

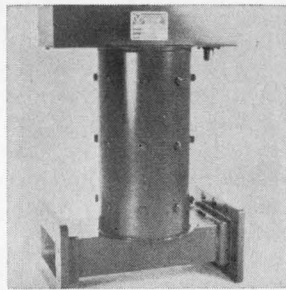

Directional filter model 0403 incorporates 3 resonators to combine or separate signals on common transmission line. Wideband input accepts any signal from 2.5 to 2.68 Ghz. Narrowband port accepts second 6-Mhz bandwidth signal on any specified channel from A1 through H3. Isolation between bands is 20 to 38 db. Vector Industries, San Antonio Rd., Palo Alto, Calif. [342]

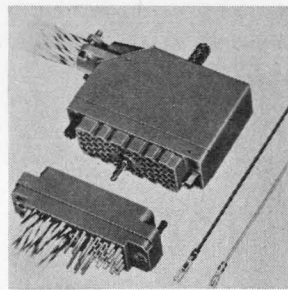

Rectangular connector series 8016 is designed for rack and panel or in-line cable applications. Available in five insulator shell sizes (20, 38, 56, 90, and 120 contacts), the connector features the Varicon hermaphroditic fork type contact that can be customer inserted into the insulator and is available with a variety of tail configurations. Elco Corp., Willow Grove, Pa. [343]

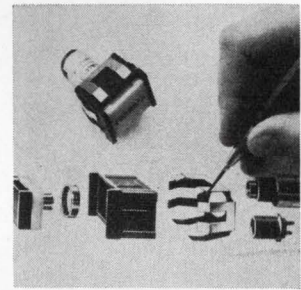

Low-profile, illuminated push-button switches series 513, due to a simplified design, are offered at 2/3 the cost of comparable momentary four-lamp units. They come in 3/4 x 1 in. rectangular and 5/8 in. round or square push-button caps. While using only one lamp, they are interchangeable with most rectangular four-lamp displays. Dialight Corp., 60 Stewart Ave., Bklyn., N.Y. [344]

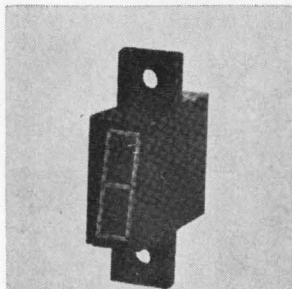

Seven-segment, high intensity digital readout light block meets MIL-STD-202 environments. It measures 0.300 x 0.625 x 0.800 in. deep. Each segment is excited with 5 v d-c at 0.020 amp. Readout is displayed on the surface of an image projected anti-parallel diffuser providing a viewing angle of 120° in any plane. Allen Aircraft Radio Inc., 2050 Touhy Ave., Elk Grove Village, Ill. [345]

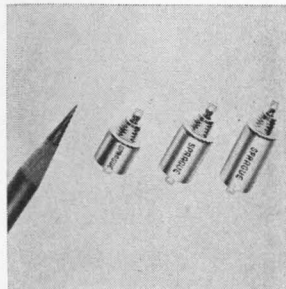

Subminiature EMI filters series JX3000 are for a-c use. They operate from -55° to +125° C without derating at 125 v a-c, 0 to 400 hz. Three circuit configurations in either of two mounting styles are available. Ratings are from 0.1 through 1.5 amps for the "L" and "PI" configurations, and 5 amps for the feed-throughs. Sprague Electric Co., North Adams, Mass. [346]

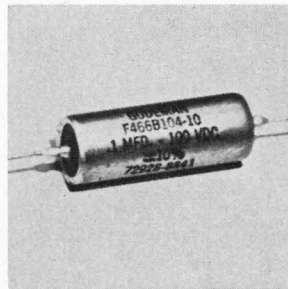

Hermetically sealed, balanced polycarbonate capacitors series 466 meet all applicable requirements of MIL-C-19978. Guaranteed maximum capacitance change for 100 v units from +25° C to +125° C is +0.5% to -0.75%. Temperature coefficient of +50, -75 ppm/° C is achieved through use of matched, compensating materials. Gulton Industries, 340 W. Huron St., Chicago. [347]

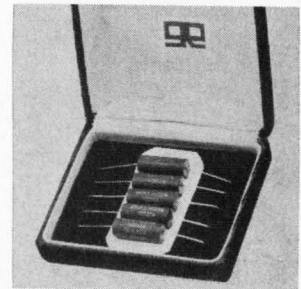

Miniature standard resistors type 12S32AZ have ohmic values of 1, 10, 100 and 200 kilohms, and 1 megohm; accuracy, ±0.0025%; power rating, 3/4 w maximum at 125° C; temperature coefficient, ±3 ppm/° C (-55° to +125° C); stability, ±25 ppm per year; dimensions, 3/8 in. diameter x 1 in. long. General Resistance Div. of Chronetics, 500 Nuber Ave., Mt. Vernon, N.Y. [348]

Put the Op Amp you're now using on this square.

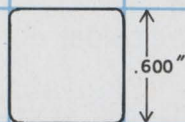

If it doesn't fit, call Data Device.

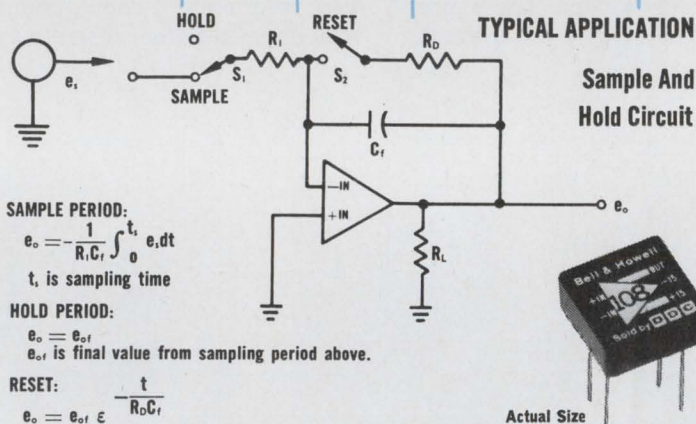

We have two new FET and bipolar series of microminiature hybrid operational amplifiers. They do everything the old fat ones did, cost about the same, and can even be inserted into existing holes on your cards.

They're internally compensated and trimmed so you don't need a lot of peripheral components. These op amps will be among the smallest devices on your board and, at 0.25" high, among the flattest.

Priced to meet your budget — in several grades of voltage and current stability; radial leads optional.

SPECIFICATION LIMITS	MODEL 008/108 FET INPUT	MODEL 009/109 COMPLEMENTARY INPUT
VOLTAGE GAIN, OPEN LOOP, DC At rated load (2K)	88 db min	83 db min
INPUT VOLTAGE CHARACTERISTICS Initial offset Drift vs. temperature	1 mV max * 5 μ V/ $^{\circ}$ C max *	0.2 mV max* 1 μ V/ $^{\circ}$ C max *
INPUT CURRENT CHARACTERISTICS Initial offset, either terminal	5 pA max *	2 nA max
RATED OUTPUT Voltage-peak at rated load Current-peak	\pm 10 V min \pm 5 mA min	\pm 10 V min \pm 5 mA min
SUPPLY VOLTAGES	\pm 10 to \pm 22 V	\pm 6V to \pm 22V
SHORT-CIRCUIT PROTECTION	Inputs & outputs	Inputs & outputs
WEIGHT	0.125 ounce	0.125 ounce
PRICE (10-25)	\$28-70	\$15-90

(* Available with less stringent specifications)

All specifications at 25 C and \pm 15 V supplies unless otherwise noted. Specifications subject to change without notice.

THE 009, & 008 HYBRID SERIES ARE MANUFACTURED FOR DDC BY BELL & HOWELL AND ARE NOW IN STOCK FOR IMMEDIATE DELIVERY



DDC has a better design

DATA DEVICE CORPORATION

100 Tec Street / Hicksville, N.Y. 11801 / (516) 433-5330

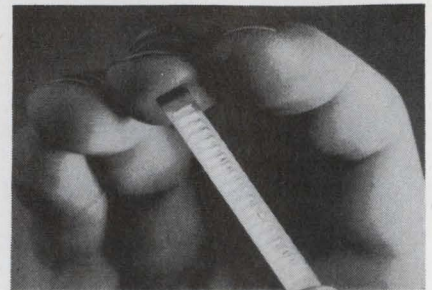

Ready. Each capacitor in strip is solder-coated for easy connection.

itor types now on the market.

Alloy center. The units are thick-film refractory oxide capacitors (ROC). The base material is a metallic alloy, and the dielectric is its refractory oxide. The base metal forms one of the capacitor plates, and solder contact is accomplished at both ends of the strip.

After the dielectric has been grown on the metal substrate surface, counter-electrodes—the other capacitor plates—are screened on either or both sides of the strip. The area of the electrode fixes the individual capacitance value.

Capacitance yield for these devices reaches a maximum of 6,250 pf per square inch. Squares can be paralleled for more capacitance or the strip cut apart and connected in series for less.

No coupling. The dielectric characteristics and the close proximity of the individual elements to the common metal substrate cause the section-to-section coupling to be negligible. At 1 megahertz, the Q of individual devices less than 500 pf is greater than 1,000.

In typical use, an assembler would normally connect end wires to the substrate terminals of the unit. The device is then positioned for assembly in respect to the tapped delay-line coil by the wires attached to the substrate. The operator then can wrap the strip around the coil and attach the coil lead wires to the individual capacitors. Since each electrode area is solder-coated, the lead wires can be attached easily with low-temperature solder and without a flux.

Units are available from stock or can be customer-specified. A typical example: 500 type ROC strips, 0.25 inch wide by 2.0 inches long, cost \$1.58 each.

Synchrotech Inc., Edgerton, Ohio 43517 [349]

RUB-OUT PROOF

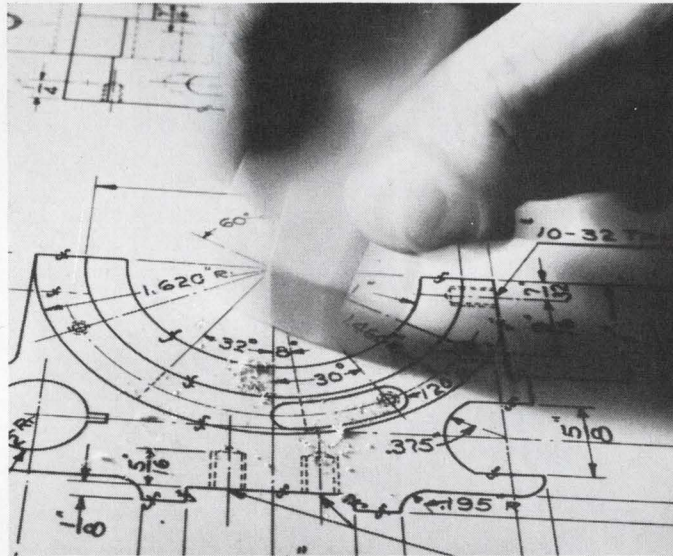

**After as many as 10 changes,
KODAGRAPH ESTAR Base Films
still won't tell on you.**

That's right. KODAGRAPH ESTAR Base Films have surface toughness that stays ahead of your eraser. This rugged matte drafting surface retains its "tooth" under repeated same-area changes, and always maintains its smooth acceptance of your ink and pencil lines.

You'll really like working with ESTAR Base Films.

They're easier to handle and correct. For example, KODAGRAPH Wash-Off Film wet-erases in seconds with a drop of water and a few swipes of your eraser. And it's so easy to process; you can count on getting your prints back faster than ever before.

KODAGRAPH ESTAR Base Films are designed by Kodak to make you and your work look good. Next time, order them from your reproduction department or blueprinter. Your local Kodak Technical Sales Representative can show you the full line this week. Or write: Eastman Kodak Company, Business Systems Markets Division, Rochester, New York 14650.

Kodak

DRAWING REPRODUCTION SYSTEMS BY KODAK

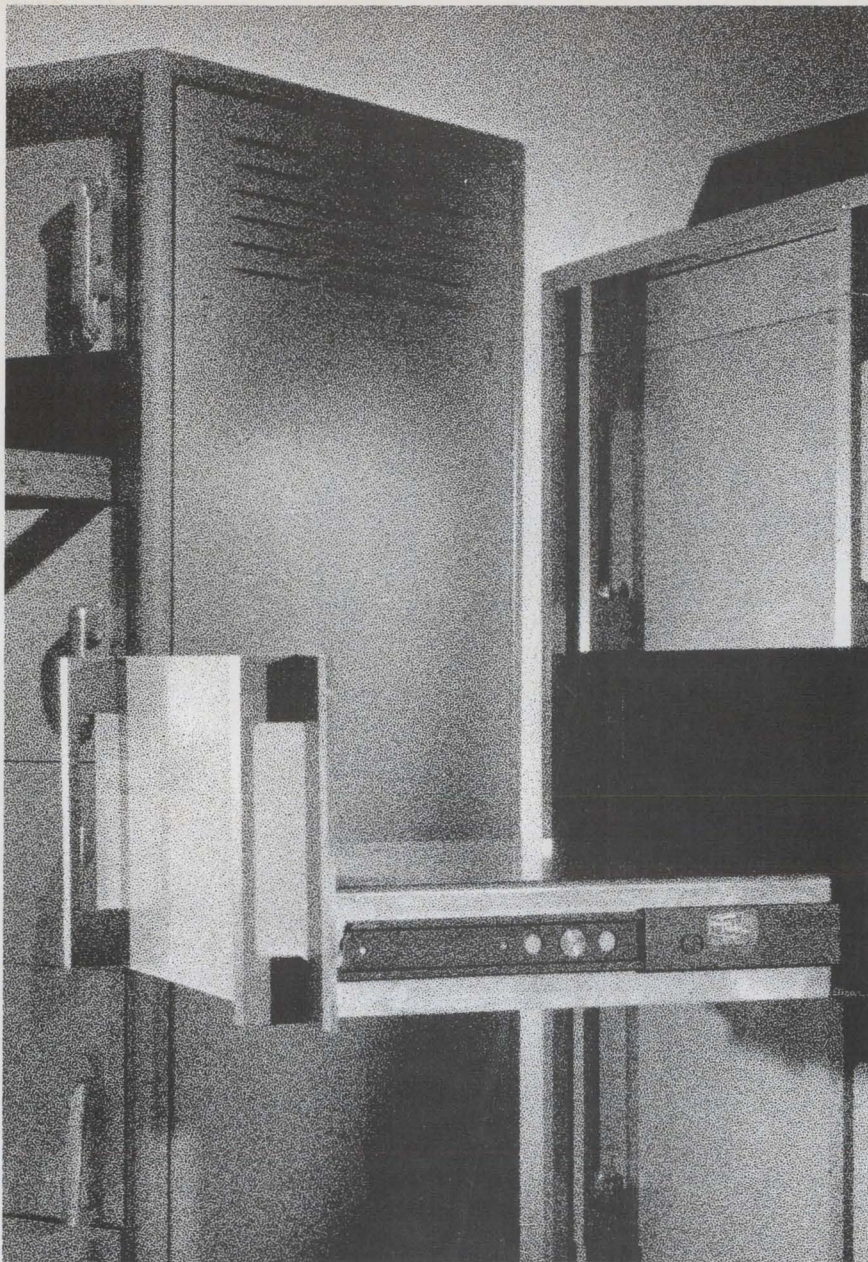

This slide is a real steel

Chassis-Trak Slides are made of hard, cold-rolled steel for maximum strength and cadmium-plated for extra corrosion resistance. Smooth operation is possible because it is coated with Poxylube 75 dry-film lubricant that actually works better the more you use it.

Chassis-Trak Slides are available in 16 models with weight capacities up to

1000 lbs. in non-tilt, tilt, and tilt-de-tent designs. Pencil-thin Chassis-Trak design permits installation of standard 17" chassis in standard 19" panel racks without modification. Chassis-Trak steel slides are available from stock for fast delivery at quotations that are something of a steal also. Let Chassis-Trak quote on your job.

See us at NepCon
BOOTH 144

A package for every Major Missile Project from . . .
525 South Webster Ave., Indianapolis, Indiana



New components

Digital readout with backup

Two separate sets
of light bars provide
cockpit-display redundancy

Where a readout can be crucial, such as in cockpit displays, design engineers often require a device with backup. Pinlites Inc. offers this added reliability in its direct-viewing, seven-segment digital readout.

Designated model M645, the hermetically-sealed unit has these features:

- Within one display head, two electrically and mechanically separate sets of seven light bars—incandescent tungsten filaments concentrically arranged for two character sizes: primary size $\frac{5}{8}$ inch, secondary size $\frac{1}{4}$ inch. If either fails, the other lights. The displayed character is voltage-controllable over a wide range of brightness.

- Both sets of filaments are uni-plane for maximum viewing angle.

- Parallel filaments are sufficiently separated for immediate mode failure indication.

- Three main operational modes are available. The user can select either primary or secondary modes, both simultaneously, or the primary display at a rated voltage between 3 to 5 volts and a secondary at derated voltage for increased life. A voltage derating of 30% increases life expectancy to more than 1,000,000 hours.

- Each set of filaments is provided with an electrically separate binary-coded decimal to seven-segment decoder.

Engineering samples are now being evaluated by aerospace companies. In quantities of 1000 and more, the readouts will sell for "under \$40 each," says Bruce Bundy, sales manager. Readouts which do not have the redundant filaments will be priced at about \$13 each, in production lots of 1000's.

Pinlites Inc., 1275 Bloomfield Ave.,
Fairfield, N.J. 07007 [350]



E-Cell* Integrator/Readout System Measures, Stores, and Retrieves the "Area Under the Curve"

"Area under the curve" is a phrase that first enters an engineer's working vocabulary in high school calculus and stays with him throughout his career. Yet, even with today's sophisticated technologies, actually *measuring* the area under the curve has until now been a lot easier said than done.

So we see good engineers and scientists resorting to the old brute force method of doing it — plotting the curve and calculating the area under it.

In a field use situation, even if basic engineering sense points to building an on-line, real time integration function into the problem solution, the researcher or designer is likely to seek another alternative approach. Why? Simply because the only tools previously available to do the job were bulky, complicated, and expensive.

But as every engineer knows intuitively, there's always got to be a "better way." Our "better way" is...

The E-CELL Integrator

Bissett-Berman's E-CELL integrator looks like a simple circuit element but does the work of a complex assembly. It can be simply connected across the output leads of a sensor unit responsive to the phenomenon to be integrated. Examples: a photoelectric cell sensing the accumulated sunlight falling on a satellite during a several months' mission; or the accumulation of RF energy output of several radars to give a warning when the total becomes dangerous to humans.

Physically, an E-CELL integrator is the size of a discrete electronic component. Inside the cell is a center electrode, which is surrounded by an electrolyte, with the case itself serving as the second electrode.

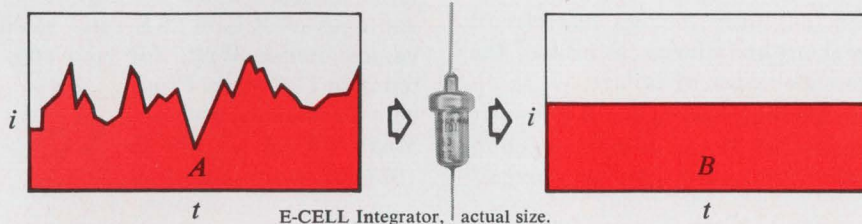

E-CELL integrator transforms irregular input signal into average integral. Area under curve A equals curve B area. Countup Mode → measures unknown input integral. Countdown Mode ← gives signal when unknown input equals pre-set value.

When connected in a circuit, the E-CELL integrator plates silver atoms onto either the center electrode or the case electrode, depending on the polarity of the integrator in the circuit and the operational mode.

The E-CELL Transform

The simple beauty of this arrangement lies in the fact that the plating process is perfectly precise. For every electron impressed on one of the electrodes, exactly one atom is plated onto the other.

The information stored in the E-CELL integrator as atoms is non-volatile, and doesn't have to be retrieved in the same way or at the same rate that it was generated in the E-CELL integrator. This means that the *input* curve can be highly irregular, have simultaneous multiple sources, and extend over a very long time period, but the transformed integrator *output* can be represented as a convenient flat curve at any chosen level of time or current.

The E-CELL integrator action is reversible, i.e. you can count up from zero or count down from a predetermined total down to zero. In the "Countup" mode you start with a bare center electrode on the integrator and accumulate a charge on it as the action proceeds. In the "Countdown" mode you start with an E-CELL integrator whose center electrode is plated with an amount of silver representing the integral in your problem solution. Then you let the integrator run until all of the silver has been transferred from the center electrode to the case. When this has occurred, the E-CELL integrator delivers a sharp voltage rise which can trigger a solid state-actuated light, alarm, or switch.

The Integrator/Readout System

Bissett-Berman has just completed development of the Model 300 EDR E-CELL Digital Readout. An E-CELL

integrator together with a Model 300 EDR Readout comprise a *data collection system* capable of measuring the "area under the curve" on-line in real time, and over periods from seconds to months.

The Model 300 EDR Readout is specifically designed to measure and digitally display total charge accumulated on the center electrode of an E-CELL integrator used in the "Countup" mode. In addition, the Model 300 EDR provides for manually pre-setting an E-CELL integrator with a precise amount of plating for operation in the "Countdown" mode.

The E-CELL Integrator/Readout system is ideally suited for: physical, medical, and agricultural research; product field testing; collection of use data, and evaluation; process monitoring and control; warranty validation — or wherever an analyst desires to measure a phenomenon that can be represented by the "area under the curve."

*Patents applied for.



For technical information on Bissett-Berman E-CELL integrators and our new Model 300 EDR Digital Readout, please send in the coupon below.

BISSETT BERMAN

COMPONENTS DIVISION
Los Angeles, California

The Bissett-Berman Corporation

Components Division
3860 Centinela Ave. A65
Los Angeles, Calif. 90066

- LITERATURE ONLY
 HAVE REPRESENTATIVE CALL

APPLICATION _____

NAME _____

COMPANY _____

DEPT. _____

STREET _____

CITY _____

STATE _____ ZIP _____

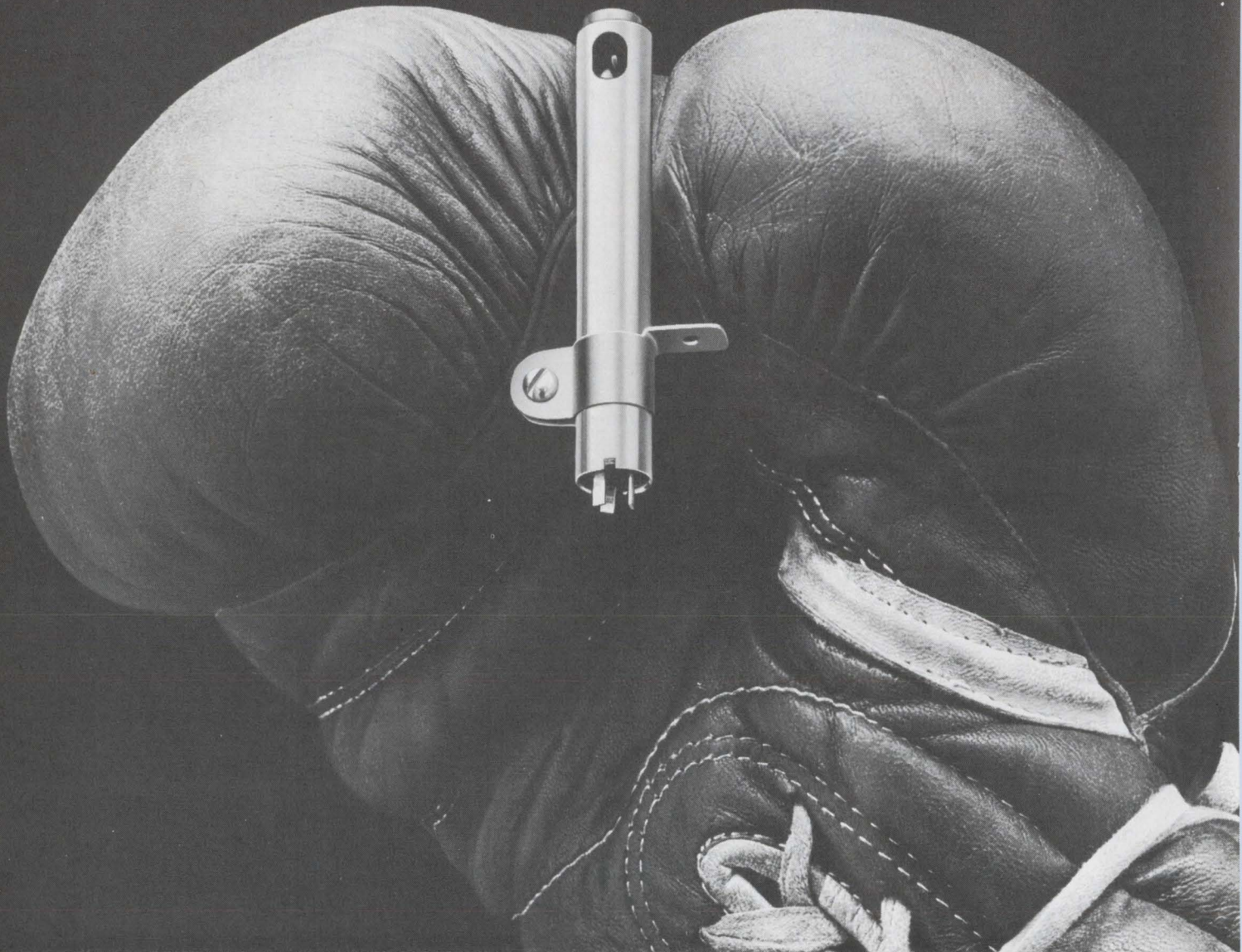

New protection for low blows!

Air flow sensing goes solid state.

TI has advanced the state of the air flow sensing art with a solid state vane switch that senses flow rates as low as 50 feet a minute. That's *ten times as sensitive as most electro-mechanical devices.*

Since our Klixon 2SE vane switch has no moving parts, it is not affected by shock, vibration, gravity, equipment orientation and air flow surges that have caused nuisance tripping in the past.

The secret of the unique sensitivity

and reliability of the 2SE is a positive temperature coefficient module in the head of the probe. Any abnormal loss of air flow or temperature rise rapidly increases the module's resistance. This change is sensed and is used to trigger an SCR or transistor. The resulting output controls auxiliary devices like circuit breakers and alarms to protect the system or warn of failure.

Our 2SE vane switches are currently protecting heat-sensitive components in power supplies, comput-

ers, aircraft and shipboard electronic systems and other military and commercial equipment. How about your air-cooled problem children?

Bulletin CIRB-37 covers specifications, design options and unique advantages of Klixon 2SE solid state vane switches. Write for your copy today to TI Control Products Division, Attleboro, Mass. 02703, or phone (617) 222-2800, Ext. 368.



TEXAS INSTRUMENTS
INCORPORATED

Timer turns back the clock

Instrument is all-IC, and all the IC's plug into circuit cards; as in the days of tubes, therefore, repairs are cheap and easy

Making repairs on electronic equipment was once a simple job. Each vacuum tube was pulled out and tested until the bad tube was found. Transistors and integrated circuits changed all that. To repair a solid state instrument today an engineer has to do a lot of soldering, throw away expensive circuit cards, or send the instrument back to its maker.

Engineers at Beckman Instruments Inc., think a return to the good old days can save instrument users time and money. And they point to the company's Model 6155 counter-timer to prove their point.

Each of the timer's more than 70 IC's plugs into its own socket; if an IC goes bad, the user pulls out the bad circuit and plugs in a new one.

Beckman points out that with this instrument, a user doesn't have to keep a costly collection of spare circuit boards—typically worth between \$50 and \$100 a piece. Instead, he can get along with a few IC's; the 6155 is made with circuits from Texas Instruments' series 74, Fairchild's series 9000 and 9930, and Motorola's series 900 and 1000. But a user of the 6155 can go to

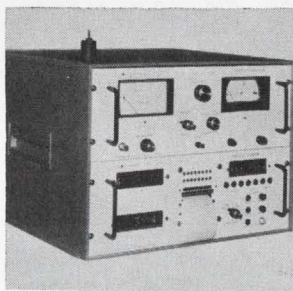

Particle analyzer/counter/printer CI-201/207 features an elliptical mirror optical sensor to detect airborne particles by the "forward light-scattering" technique. It counts, displays, and records airborne particle concentration in two size ranges (normally 0.5 micron and larger, and 5 microns and larger). Climet Instruments Inc., Birchwood Dr., Sunnyvale, Calif. 94086. [361]

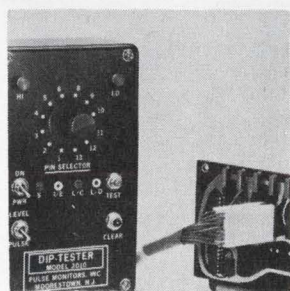

DIP tester 2010 can check dual-in-line IC's without removing them from their circuit boards. Using an integrated circuit clip, the unit selects an active pin and a red or green light indicates the level or polarity of pulses at that point. The tester obtains its nominal 5 v, 75 ma power directly from the power leads of the DIP under test. Pulse Monitors Inc., Moorestown, N.J. [362]

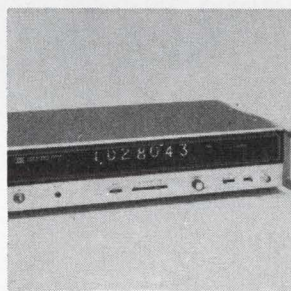

Automatic counter model 5323A has a range of 0.125 hz to 20 Mhz. It can measure the carrier frequencies of pulsed r-f or tone bursts, even those that are but a few microseconds in duration, without the use of a transfer oscillator. The unit is priced at \$2,150. Deliveries are scheduled to begin in March. Hewlett-Packard Co., 1501 Page Mill Road, Palo Alto, Calif. [363]

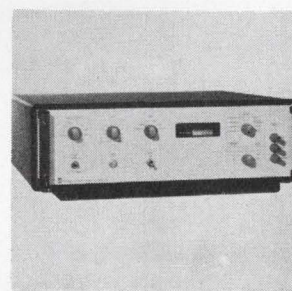

Digital voltmeter calibrator type 1822 checks out a DVM by stepping it through a programmed test sequence. It checks whether DVM readings are affected by circuit loading, by a-c superimposed on the measured d-c signal, and by common-mode a-c or d-c signals. Price is \$2,800 for the bench model; \$2,775 for the rack mounting unit. General Radio Co., West Concord, Mass. 01781. [364]

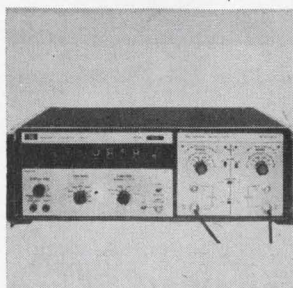

Electronic counter model 1515A has a frequency range of d-c to 70 Mhz and can totalize to 10^9 counts. Frequency ratio is 10^{-6} to 10^6 and sensitivity is 100 mv. Crystal aging rate is 1 part in 10^7 per day. Internal time base output scaled from 0.1 hz to 10 Mhz in decade steps is available at rear panel. Monsanto Electronic Instruments, 620 Passaic Ave., West Caldwell, N.J. [365]

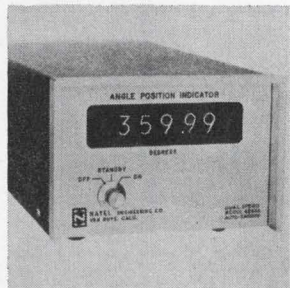

Dual-speed, automatic-ranging angle position indicator model 4062A can handle 1:36 and 1:10 two-speed synchro inputs. It offers several automatic features including 60 and 400 hz operation, 26 v and 115 v reference (rotor) amplitudes, and 11.8, 90, or 115 v rms line to line stator voltages, all available in one package. Natel Engineering Co., 7129 Gerald Ave., Van Nuys, Calif. [366]

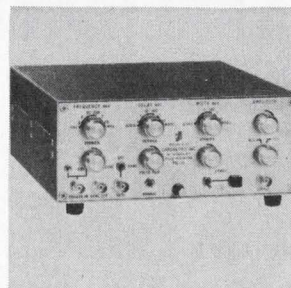

Pulse generator PG-11 provides single or double pulses, pulse pairs, pulse bursts or one-shot output. It operates over a repetition rate range from 10 hz to 20 Mhz in the double pulse mode and to 10 Mhz in the single pulse mode. Rise and fall times are 5 nsec max. at full ± 15 v output amplitude. Price is \$375. Chronetics Inc., 500 Nuber Ave., Mt. Vernon, N. Y. 10550. [367]

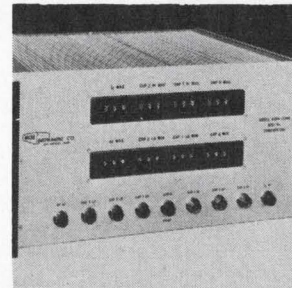

High-speed digital comparators series 6000 are for component sorting applications. They feature go-no/go decisions as short as 10 μ sec, providing both visual front panel indications and contact closures, for direct interface with BCD instruments. They come in 3 basic configurations: 3-, 4-, and 9-decision models. Micro Instrument Co., 12901 Crenshaw Blvd., Hawthorne, Calif. [368]

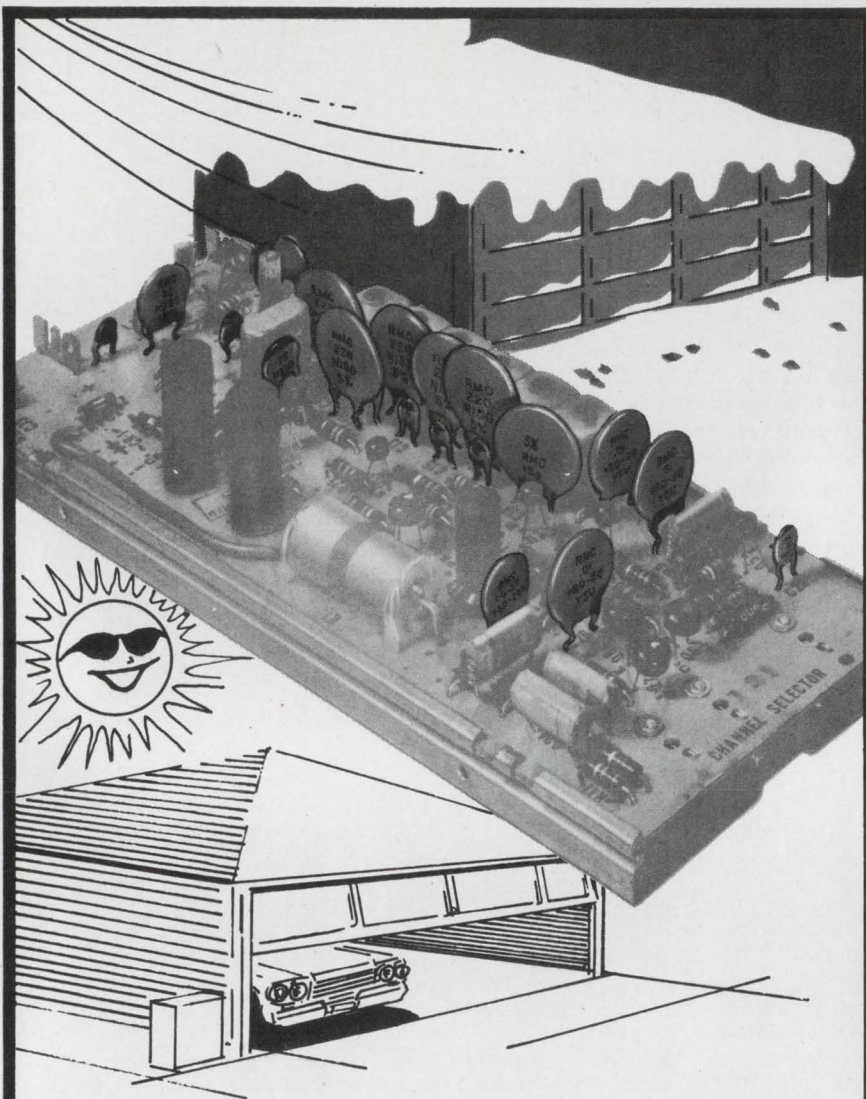

RMC DISCAPS FOR TEMPERATURE SENSITIVE APPLICATIONS

Perma-Power, a division of Chamberlain Mfg. Corp., a leading manufacturer of radio controlled garage door openers, specifies RMC DISCAPS to assure reliability under extreme environmental conditions.

RMC produces a full range of DISCAPS for temperature sensitive circuitry or applications requiring exact temperature compensation. Frequency and temperature stable types, as well as units of predictable variability, are available.

DISCAPS are produced to the highest standard of quality and may be specified with complete confidence.

If your application requires special physical or electrical characteristics, contact RMC's Engineering Department.

*Write today on your company letterhead
for your copy of the complete RMC catalog.*

DISCAP
CERAMIC
CAPACITORS



RADIO MATERIALS COMPANY
A DIVISION OF P. R. MALLORY & CO., INC.
GENERAL OFFICE: 4242 W. Bryn Mawr Ave., Chicago 46, Ill.
Two RMC Plants Devoted Exclusively to Ceramic Capacitors
FACTORIES AT CHICAGO, ILL. AND ATTICA, IND.

second sources for spare IC's.

Down time down. Now is the time for an instrument with plug-in circuits, says Beckman, because the inexpensive—around \$500—IC testers becoming available allow an engineer to quickly track down the IC that's causing trouble.

Compared to a soldered-IC device, an instrument with plug-in IC's has a 30% lower mean time between failure, says Beckman. For example, the 6155's MTBF is 39,000 hours compared with 61,000 hours for Beckman's 6148 timer. The prices of the two types of instruments are about the same. So the tradeoff is between fewer failures and shorter repair time.

The company expects that the 6155 will appeal to small companies that can't afford to keep expensive spare-parts inventories, and to users who want a quickly repairable instrument.

But Beckman engineers built the 6155 to count and to time, not to be repaired. The instrument replaces several discrete-component

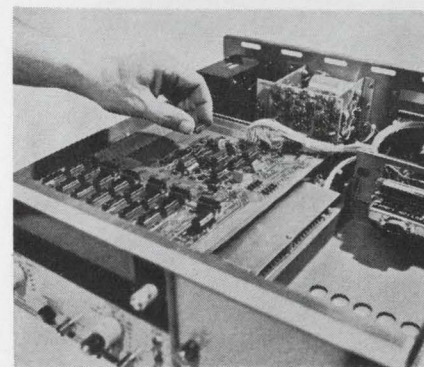

Quick change. Any of the more than 70 IC's in the counter-timer can be replaced without soldering.

timers in the Beckman line, will compete with Hewlett-Packard's model 5245L.

The 6155 measures frequency, time interval, period, half period, multiple-period average, ratio and multiple ratio. Its range is d-c to 100 megahertz, and with front-panel plug-ins can go to 12.4 gigahertz. Resolution is 10 nanoseconds and stability is 3 parts in 10^9 per day.

The counter has an eight-digit display and a BCD output.

It is the only one of the single-channel instruments that triggers



THE CHANGING INTERFACE

An IC/Systems Seminar

MARCH 28, 1969, PARK SHERATON HOTEL, NEW YORK, 9:00 AM—5:00 PM
Presented by the Electronics/Management Center

Program

Implications Of LSI On The Electronics Market: Glenn E. Penisten, Vice President, Components Group, Texas Instruments Inc., Dallas.

The Rationale For An In-House IC Capability: Alvin B. Phillips, Assistant to the President, Autonetics Division, North American Rockwell Corp., Anaheim, Calif.

The Component Maker's Responsibility In The System/Component Interface: Robert M. Walker, Supervising Engineer, Array Systems Engineering, Fairchild Semiconductor, Mountain View, Calif.

The System Builder's Responsibility In The System/Component Interface: Richard Stokes, Manager of Planning, Electronic Systems Organization, Burroughs Corp., Paoli, Pa.

The Mask And Computer-Aided Design As Interface: Wally Raisanen, Operations Manager for MOS and IC Memories, Motorola Semiconductor Products, Phoenix, Ariz.

The Testing Interface: William Dunn, Engineer-in-charge, Custom LSI, Sylvania Semiconductor Div., Woburn, Mass.

The Integrated Circuit Design Interface In Bell Laboratories: James M. Early, Director, Semiconductor Device Laboratory, Bell Telephone Laboratories, Allentown, Pa.

How IBM Deals With The Interface Problem: Paul Low, Manager of Logic Products, IBM, East Fishkill Facility, Hopewell Junction, N.Y.

Controversies And Future Trends In LSI: Donald Farina, President, ICST, Inc., Sunnyvale, Calif.

Panel Discussion

Moderator: Orville Baker, Vice President, Signetics Inc., Sunnyvale, Calif. Speakers and invited guests will join in an open forum discussion of interface problems, and will answer questions submitted from the audience.

ADVANCE REGISTRATION

"The Changing Interface" — March 28, 1969 — Park Sheraton Hotel, 7th Avenue & 56th Street, New York, N.Y.

NAME _____

TITLE _____

COMPANY _____

ADDRESS _____

CITY _____ STATE _____ ZONE _____

Registration Fee: \$65 (Fee includes all sessions, refreshments, luncheon, and a copy of the proceedings when published.)

Note: Attendance will be limited and applications will be handled on a first-come, first-served basis.

Mail registration and make checks payable to: Electronics/Management Center, An Information Service of McGraw-Hill, Inc., 330 West 42nd Street, New York, New York 10036

Ultimeter!*

A new building block for electronic derring-do

(it's not a meter-relay)

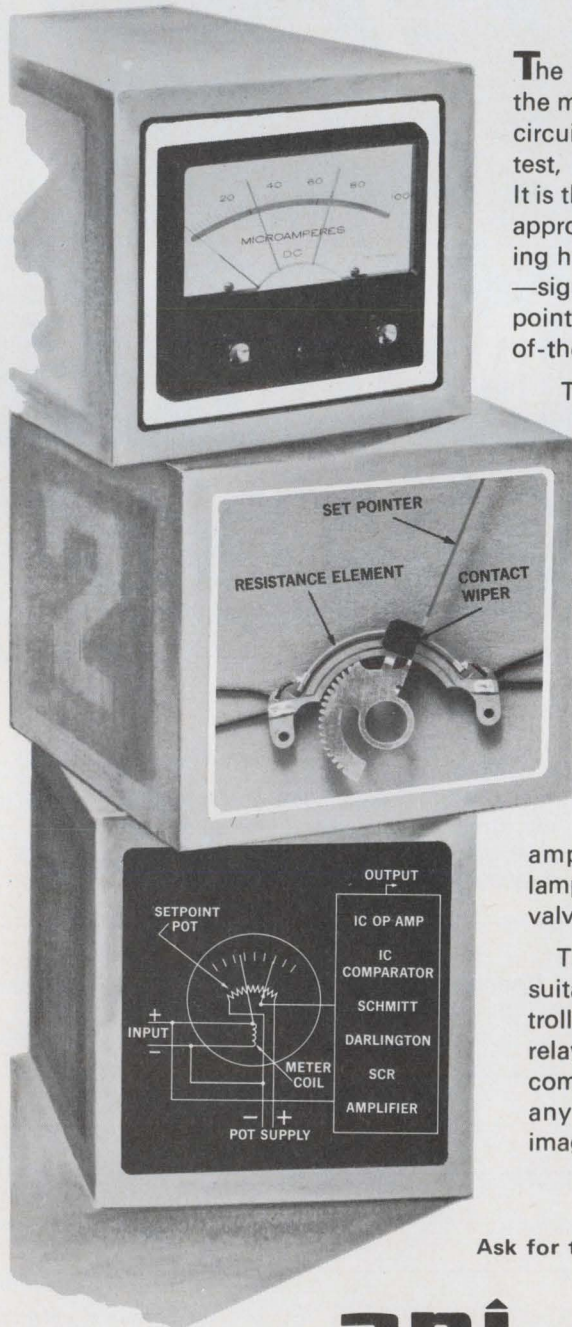

The Ultimeter helps you make the most of the latest integrated circuit techniques in control, test, or monitoring apparatus. It is the best and least expensive approach yet known for melding human engineering features—signal indication, easy set point adjustment—with state-of-the-art electronics.

The Ultimeter contains a 1 per cent linear meter movement and a 0.5 per cent linear potentiometer, both precisely calibrated to the same meter dial. Red set pointers actually operate the potentiometer contact wipers. You can readily team the Ultimeter with IC op amps, IC comparators, Schmitt triggers, Darlingtons, SCR's or amplifiers. They can drive lamps, alarms, relays, motors, valves, power SCR's, etc.

These combinations are suitable for proportional controllers, indicating solid-state relays, simple panel loaders, component testing bridges, or any other application your imagination comes up with.

Ask for the full story in Bulletin 64

IEEE Show Booth No. 2G-34

api

INSTRUMENTS CO.

Chesterland, Ohio 44026 | (216) 729-1611

Incidentally, if all you need is simple On/Off control, API has pre-packaged relay output circuitry to go with the Ultimeter. This circuitry comes in an integral controller called Compack IV.

*Pat. Pending

on positive or negative slopes, so it can measure pulse width and pulse separation.

The instrument is 5 by 19 by 17 inches and weighs 30 pounds. Its price is \$2,450 and delivery is from stock.

Beckman Instruments Inc., 2200 Wright Ave., Richmond, Calif. 94804 [369]

New instruments

Digital multimeter is built rugged

Designed for Hawk tests, it's being marketed for other military jobs

"I often felt as if I were designing an armored vehicle rather than a sensitive electronic instrument." The engineer was referring to a digital multimeter built for radar calibration and other test functions in the Hawk missile system.

The Instrumentation division of Fairchild, which made the multimeter for Raytheon, has now decided to market it "to any customer who can afford it." Fairchild declines to quote a price, but says it will run "three to four times that of a comparable nonmilitarized instrument."

The meter measures d-c voltage; a-c voltage, from 20 hertz to 30 kilohertz; a-c voltage, from 30 khz to 50 megahertz with an external r-f probe; resistance, and d-c current. The unit operates either by remote or manual commands. However, automatic programming will override manual operation. A single ground control wire from a remote programmer selects each function, but internal logic is such that the function does not change when the operation goes from remote to manual.

The front panel of the multimeter displays the function measured: four digits of data with a decimal point and an automatic-overload readout.

Since the primary design criterion was rugged field use, says

FLEXIBLE

Taylor is your only source for Riegel Monotherm® copper clad polyimide film. It offers unmatched reliability and ease of fabrication. Basic properties of the film and a high temperature thermoset adhesive permit the use of high pressure without "swimming" or rupture. Retains dimensional stability and resists normal soldering temperatures. Withstands 180° creases without cracking or separating. For specialized flexible circuit applications, Taylor can offer a wide range of dielectric films and metallic foils.

RIGID

Taylorclad FIREBAN 1011E is a premium glass-epoxy copper clad for critical circuit needs. It combines all of the basic properties of NEMA G-10, G-11, FR-4, and FR-5 grades. Heat resistant, flame retardant, it meets MIL-P-13949 and takes precision drilling, punching and shearing.

Taylor also has three other glass epoxy grades of copper clad, plus Teflon glass to meet your circuit needs.

Only Taylor offers total service for all your copper clad needs

All Taylor copper clad laminates are trouble-free for faster, easier processing.

Help you meet MIL-P-55110.

Write for data, prices and samples.

ULTRATHIN

Composites of copper foil glass epoxy laminates that save space and weight. Thicknesses range from .003 through .031 inches. GEC 550 meets NEMA G-10. FIREBAN 650 is flame retardant —meets NEMA FR-4. Both can be readily processed with standard equipment and solutions.

Taylor's controlled flow prepreg systems have low gel time—30-second range—resulting in minimal circuit displacement during the pressing cycle.

Taylor corporation

A subsidiary of Alco Standard Corporation

Valley Forge, Pa. 19481 • 215-666-0300
La Verne, Calif. 91750 • 714-593-1341
In Canada: Small Fibre Stampings, Ltd. • Scarborough, Ont. 416-593-6655

Manufacturer of Tayloron® Laminated Plastics, Taylorite® Vulcanized Fibre, Tayloron Prepregs, Taylor Fabricated Parts





Model 41A Microwattmeter with new 12.4 GHz head

SOMETHING NEW IN POWER MEASUREMENTS UP TO 12.4 GHz

Our new power detector head measures down to -60 dBm, has a dynamic range of 70 dB, and offers all these other advantages:

- No zeroing (except for fractional microwatt measurements).
- Insensitivity to shock and handling drift.
- Overload protection to 300 mW cw.
- One head for all power levels, to save you time and money.
- Accuracy to ± 0.5 dB (including power detector).
- 200 KHz to 12.4 GHz range for easy low frequency calibration and noise power measurements.
- Doubles as detector for slotted line vswr measurements.

Ask for a demonstration of our 41A Microwattmeter with the new 12.4 GHz head, or send for a data sheet.

Prices: 41A Microwattmeter — \$600; 41-4B 12.4 GHz head — \$250.

**BOONTON
ELECTRONICS**
CORPORATION

ROUTE 287
PARSIPPANY, N.J. 07054
Telephone: 201-887-5110
TWX: 710-986-8241

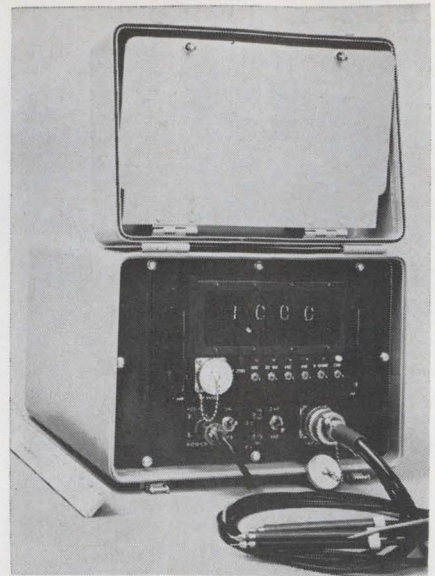

All alike. The circuit boards in the 7460 are interchangeable and plug into disposable modules.

Ron Byrne, project manager for the model 7460, field maintenance also became a design requirement. To accomplish this, all 22 circuit boards plug into disposable modules. The cards are interchangeable and the modules have Federal stock numbers so they can be requisitioned from military stock points or be purchased directly from Fairchild. A replacement involves minimal recalibration.

The Hawk missile program for the U.S. and NATO is the only field use of the model 7460 that Fairchild knows about, but Byrne says that the instrument may be in operation in other functions. Applications will certainly be broadened, says Byrne, because the instrument can be used as a universal piece of test equipment. He divides the potential market into two areas: flight-line and related test equipment, and test apparatus for transportable missile systems. Price of the instrument, he adds, depends on quantity and pre-shipment testing. Those shipped to date have undergone 500 tests; some applications might require fewer.

All d-c and a-c voltage applications offer automatic ranging, and d-c voltage and current measurements include automatic polarity readout. The instrument can run off 240 volts rms ± 20 volts or 120 volts ± 12 volts, at 400 hz ± 20 hz.

Fairchild Instrumentation Division, 974 Arques Ave., Sunnyvale, Calif., 94086 [370]

You Don't Have to See the Light... Just Look at the Data

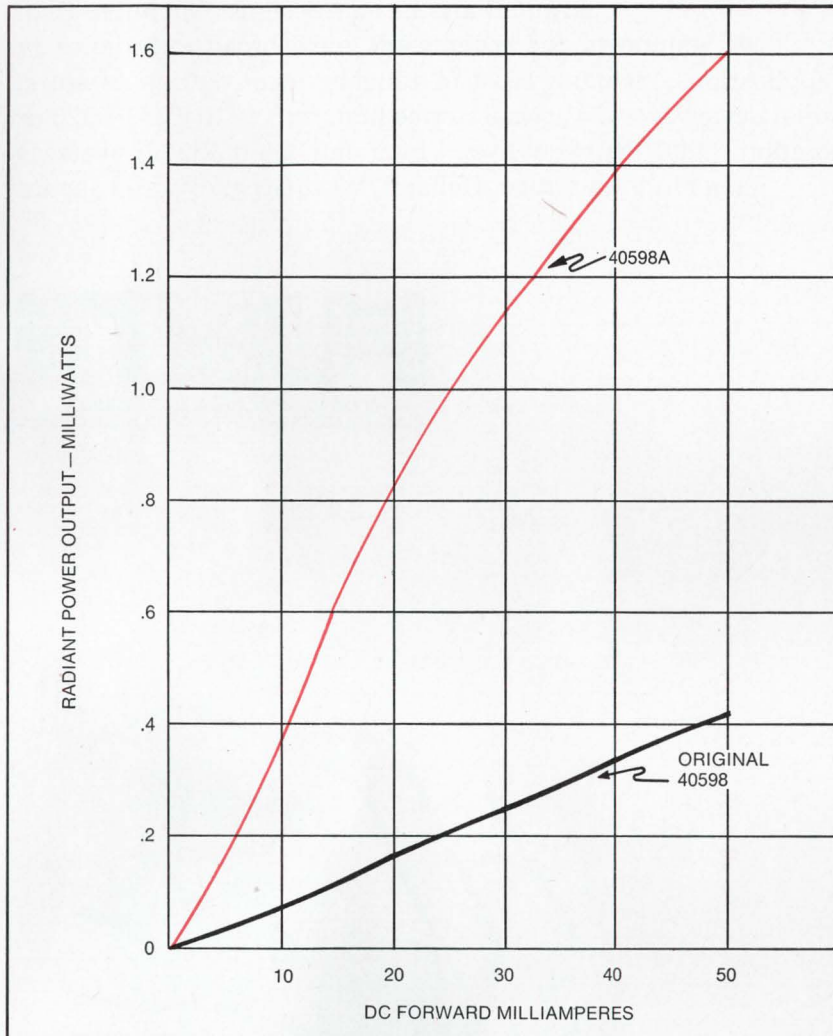

40598A — INFRARED EMITTER

- 3 X More Power Than Original 40598
- Same Drive Current—50 mA
- Same Small Package
- Same Low Price

Typical Irradiance on Photodetector

Distance from Photodetector to Emitting Diode	Punched Card	Punched Paper Tape
0.150" Separation	15 mW/cm ²	14 mW/cm ²
0.200" Separation	10.5 mW/cm ²	10 mW/cm ²

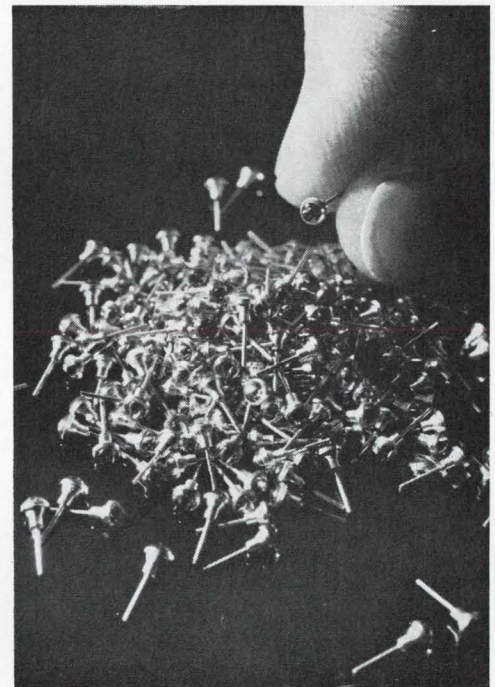

ROOM TEMPERATURE LASERS

<p>New! TA2628 and TA2628R* Single Laser Diodes</p> <ul style="list-style-type: none"> • 1 W (Min.) Peak Output • 30 A Drive Current • Pulse rate to 4 kHz <p>*Reverse Polarity</p>	<p>New! TA7438 10 Diode Series Array</p> <ul style="list-style-type: none"> • 10 W (Min.) Peak Output • 30 A Drive Current • Pulse rate to 500 Hz 	<p>Now Declassified! TA2930 Available for Industrial Use</p> <ul style="list-style-type: none"> • 50 W (Min.) Peak Output • 30 A Drive Current • Pulse rate to 1 kHz 	<p>Custom Arrays</p> <p>Devices from a few diodes to hundreds can be designed to your specifications.</p>
---	---	--	--

Immediate availability in quantity. That's the story of RCA's line of solid-state GaAs Lasers and our exceptional IR emitter. Each of these invisible light devices offers important electro-optic opportunities in secure communications, intrusion alarms, traffic control, instrumentation, ranging, and field illumination.

Call your local RCA Representative today for more information. Or see your RCA Distributor. For technical data on the new 40598A, and the developmental TA2628, TA7438 and TA2930 GaAs Lasers, write: RCA Electronic Components, Commercial Engineering, Section No. SN-2-2A, Harrison, New Jersey 07029.

LET FUSITE SOLVE YOUR COMPLEX TERMINAL DESIGN PUZZLE

For over 25 years Fusite has been engineering customers out of trouble on highly complex hermetic terminal and header designs. Our more than 40 engineers and technicians have broad experience in sealing applications, including those of a highly unconventional nature. If your terminal design is *really* special, try us first. Call (513) 731-2020 or write Fusite Corporation, 6000 Fernview Ave., Cincinnati, Ohio 45212; overseas plants in Puerto Rico, Holland, West Germany, and Japan.

FUSITE

GLASS-TO-METAL HERMETIC TERMINALS
GLASS/GLASS-CERAMIC PREFORMS & SUBSTRATES

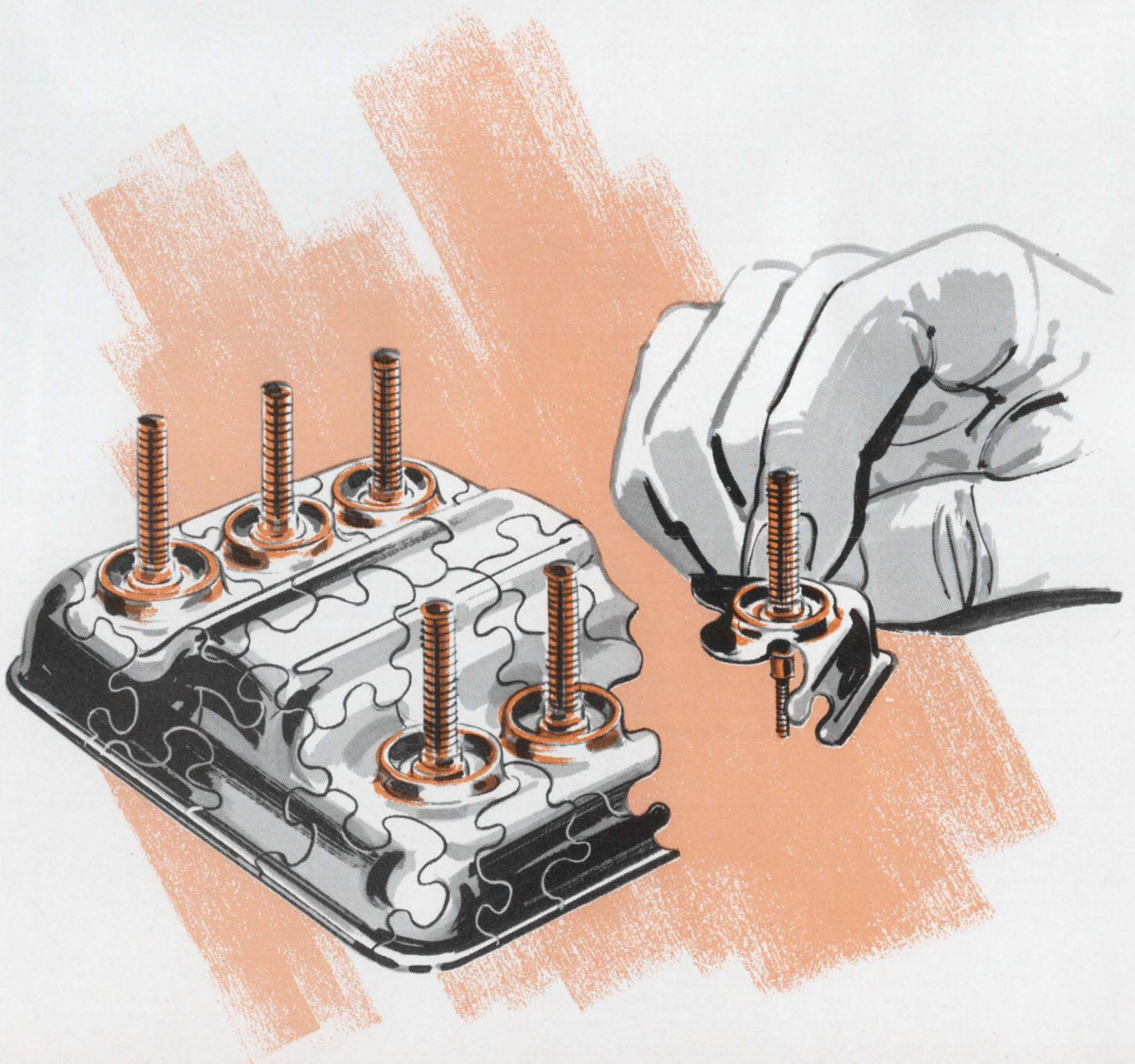

Logic circuits improve tv color mix

Bar generator creates test patterns for production-line testing, closed-circuit system maintenance, and servicing of home sets

Each new color-bar generator boasts at least one feature that makes it different. One may offer five patterns, another a three-color bar display, another front-panel sync output, and yet another integrated circuitry. Now one has appeared that not only combines almost all the features of the others but also has a brand-new one of its own: use of logic circuitry to

improve reproduction of the National Television System Committee color standards.

The new Heath IG-28 color-bar and dot generator uses combinations of logic circuits to generate the test patterns and get the proper mix of colors. Fifteen J-K flip-flops and associated gates count down from a crystal-controlled oscillator, eliminating the possibility of

divider-chain instability and the need for frequency adjustments. In all, the generator produces 13 patterns: the standard 9-by-9 color-bar displays, dot patterns, horizontal bars, crosshatches, vertical bars, and shading bars. It also provides a 3-by-3 full-screen display of all patterns and a clear raster.

The test patterns are used to adjust color tv circuitry and tri-gun



Charge amplifier type 1-308 is for use with piezoelectric transducers in general test lab applications. It operates on 24 v d-c at 7 ma and is protected against polarity reversal. Gain is 2 mv/pcmb. Frequency response is 5 to 10,000 hz $\pm 5\%$. Maximum shunt capacitance is 10,000 pf. Price is \$95. Consolidated Electro-dynamics Corp., 300 Sierra Madre Villa, Pasadena, Calif. [381]

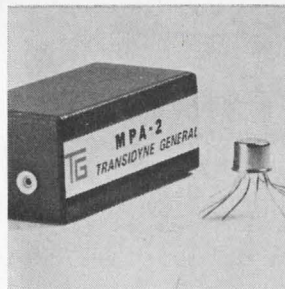

Battery-operated, high input impedance preamplifier model MPA-2 has a fixed gain of 10. It offers d-c to 100 khz response. The user can introduce a d-c offset potential at the input terminals up to ± 1 v, or adjust input impedance from 100 megohms to a theoretically infinite value. Price is \$49.50. Transidyne General Corp., 462 S. Wagner Road, Ann Arbor, Mich. 48103. [382]

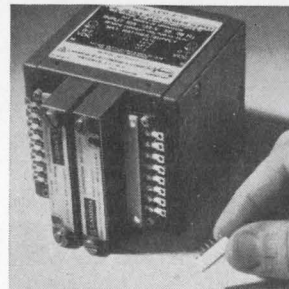

Dual-output power supply series LCD-2 uses an IC to provide the regulation system. This results in a package measuring 3 5/32 x 3 9/32 x 3 5/16 in., with over 30 discrete components eliminated. Regulation is 0.01% ± 1 mv. Temperature coefficient is 0.01% $\pm 300 \mu\text{v}/^\circ\text{C}$. Weight is 2 1/4 lbs. Prices start at \$155. Lambda Electronics Corp., 515 Broad Hollow Rd., Melville, N.Y. [383]

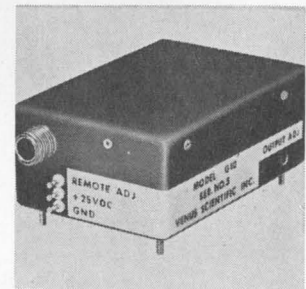

Crt power supply G10 is less than 15 cu. in. in volume and weighs 1 1/4 lbs. A screwdriver adjustment allows the output voltage to be set at any value between 8,500 and 10,500 v d-c. Both line and load regulation are $\pm 0.1\%$. Output ripple is 0.15% peak-to-peak at full load (500 μa) and less than 0.1% at 350 μa . Venus Scientific Inc., 399 Smith St., Farmingdale, N.Y. [384]

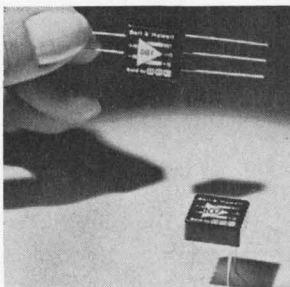

Hybrid universal operational amplifier model 107 operates over a range of supply voltages from ± 6 to ± 22 v d-c. With ± 15 v d-c supplies, output is ± 10 v at 5 ma. D-c open loop gain at rated load is 88 db; frequency for unity gain, 2 Mhz; frequency for full output, 30 khz. Voltage drifts are as low as 0.5 $\mu\text{v}/^\circ\text{C}$ max. Data Device Corp., 100 Tec St., Hicksville, N.Y. 11801. [385]



H-v power supply series 1000 is for use in crt display systems, computer output microfilming systems and nuclear instrumentation. It is available in 2 output voltage ranges: 10 to 20 kv, and 20 to 30 kv, with regulation to 0.001% for line or load variations, and a low drift of less than 0.005%/hr. Computer Power Systems Inc., 722 E. Evelyn Ave., Sunnyvale, Calif. 94086. [386]

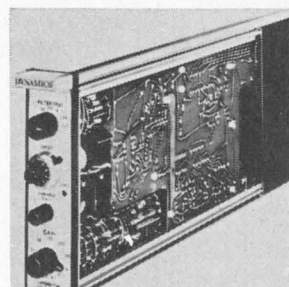

Differential d-c amplifier model 7514, A or B series, features a 20 v common-mode operating level and 18 options for maximum versatility. Key options include 6 gain step sequences, single and dual outputs (± 100 ma), 5- and 7-position selectable filters and fixed or variable current limiting settings. Dynamics Instrumentation Co., 583 Monterey Pass Road, Monterey Park, Calif. [387]

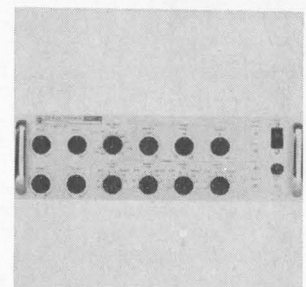

Four-phase clock pulse generator C-4 furnishes clock stimulation to MOS LSIC devices. The four amplitude controls are continuously variable to -30 v. Pulse widths are continuously variable from 50 nsec to 8 msec. Phase delays are continuously variable from 0° to 360° . Repetition rate is adjustable from 100 hz to 3 Mhz. Non-Linear Systems Inc., Box 728, Del Mar, Calif. 92014. [388]

Introducing PLUSISTOR

VECO



slayer of dragon-size heat regulation problems

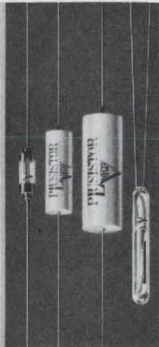

PLUSISTOR is VECO's all-new positive temperature coefficient thermistor for temperature measurement and compensation. A solid state silicon resistor, PLUSISTOR features an average coefficient of $+0.7\%/^{\circ}\text{C}$ which remains virtually constant through the range of -60°C to $+150^{\circ}\text{C}$. These small-but-stalwart heat defenders are available to you in a variety of designs—

- ¼ & ½ watt axial lead, molded design
- ¼ watt, hermetically sealed can
- ¼ watt axial lead, glass body adjacent lead, glass probe

Available in decade multiples of E.I.A. standard resistance values from 10Ω to $10\text{K}\Omega$... 10% standard tolerance or tighter tolerances and special values other than standard where required. PLUSISTOR is just one of a complete line of thermistors from VECO designed to solve the most gigantic of problems.

VECO VICTORY ENGINEERING CORPORATION
 VICTORY ROAD, SPRINGFIELD,
 NEW JERSEY 07081
 (201) 379-5900 • TWX 710-983-4430

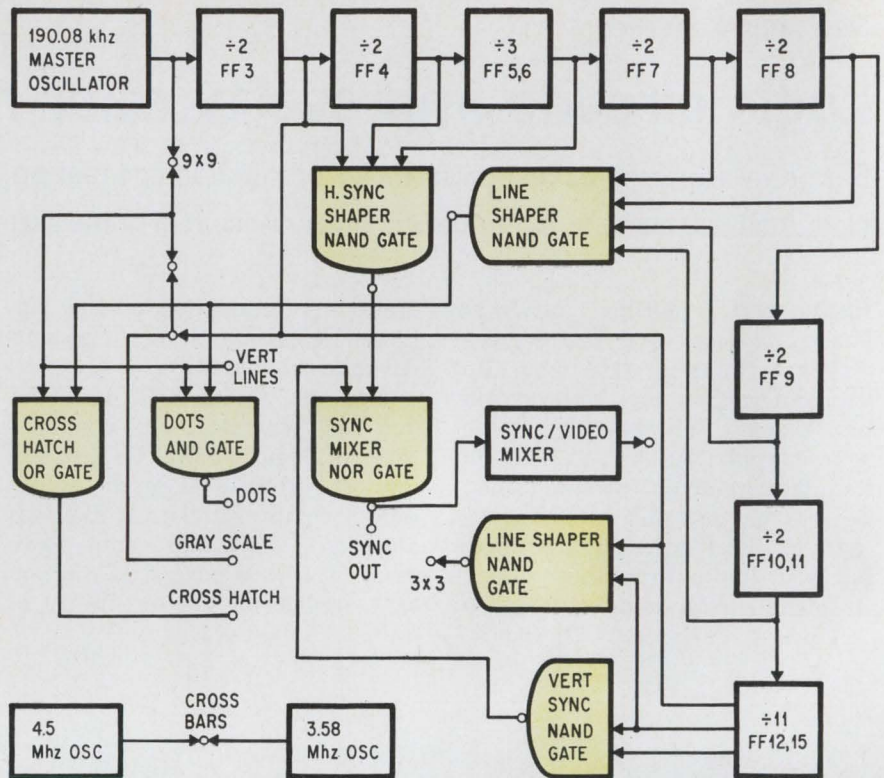

Logic flow. Thirteen test patterns are generated from a crystal-controlled oscillator countdown with frequencies selected by OR, NOR, AND and NAND gates, above, in Heath's IG-28 color-bar and dot generator, at right.

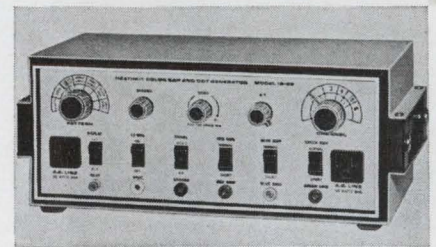

systems in development laboratories, service organizations, closed-circuit tv installations, and—principally—on the color-tv production line. The generator is Heath's first product aimed at the set manufacturers. "The greater test flexibility it affords," says Gene Fieback, the company's director of engineering, "makes it useful as a quality control instrument."

A crystal-controlled Pierce master clock oscillator starts the chain of events by generating a stable 190.08-kilohertz sine-wave signal. The signal is then passed on to a number of flip-flop multivibrator dividers that clip and shape it into a square wave, then divide it down to the appropriate frequencies. The frequency signals are picked off at various stages along the divider chain and applied to logic circuits consisting of OR, NOR, AND, or NAND gates. The logic circuits combine the proper signals to produce the desired output patterns.

All of the desired test patterns

are instantly selected by a switch on the front panel that accepts the signals from the various gate circuits and crystal-controlled oscillators and chooses the right one for the application.

Vertical lines are produced by shaping the output signal of the master clock and divider chain to produce a pulse that shows up as a narrow line on the tv screen. Combined with the sync signal in the tv receiver's video circuit, the pulses produce the desired number of vertical lines.

To produce horizontal lines, the divider chain's output is fed to a NAND gate whose output pulse produces a narrow line on the screen. The output pulses are combined with the receiver's sync signal to produce the required number of pulses for the vertical sweep duration.

The price hasn't been set but it will be about \$100.

Heath Co., Benton Harbor, Mich. 49022 [389]

with your reputation at stake, which resistor line would you specify?

take a close look—there'll be no question

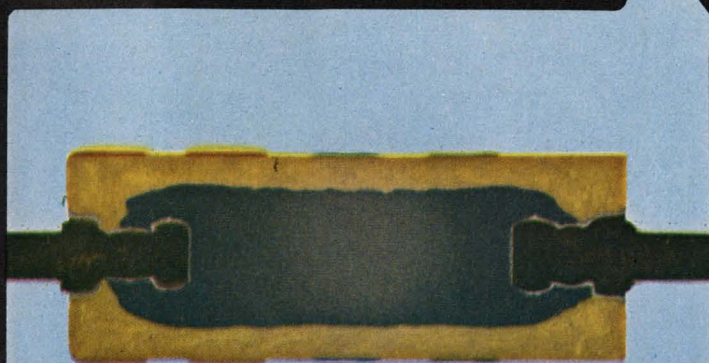

Allen-Bradley

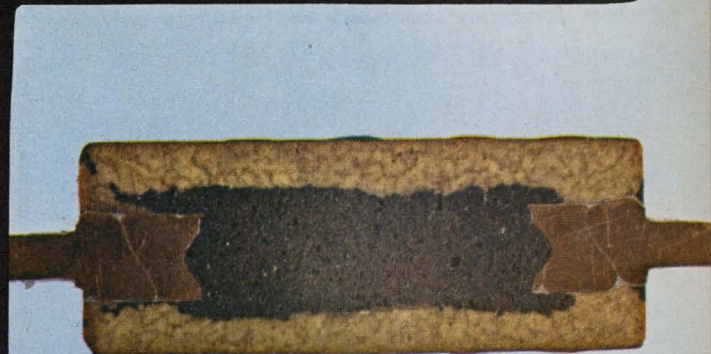

Manufacturer X



Manufacturer Y

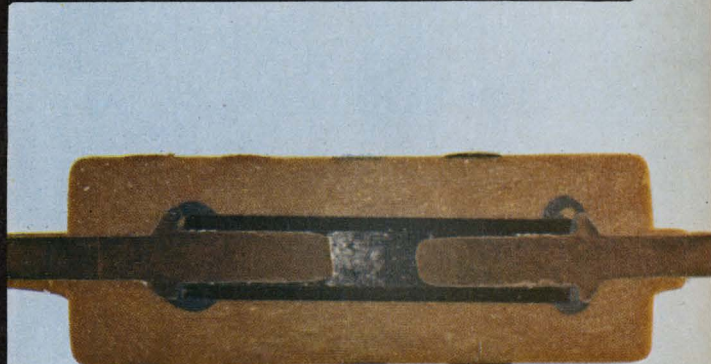

Manufacturer Z

The above illustrations are from unretouched photomicrographs taken of four $\frac{1}{2}$ -watt fixed resistors. Compare the anchoring of the leads, the seal provided by the insulating jacket at the ends, the homogeneity of the resistance material, the sharp color code bands—and decide for yourself.

For more details on Allen-Bradley hot-molded resistors, please write for Technical Bulletin 5000: Allen-Bradley Co., 1201 South Second Street, Milwaukee, Wis. 53204. Export Office: 630 Third Avenue, New York, N. Y., U.S.A. 10017. In Canada: Allen-Bradley Canada Ltd.

1067E-4

A-B hot-molded fixed resistors are available in all standard resistance values and tolerances, plus values above and below standard limits. **A-B hot-molded resistors meet or exceed all applicable military specifications including the new Established Reliability Specification.** Shown actual size.

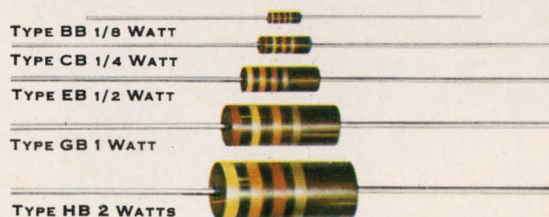

QUALITY ELECTRONIC COMPONENTS



ALLEN-BRADLEY

Circle 171 on reader service card

Who says relay specs are dull reading?

Not us. We're sure you'll find the specs of these two popular models positively fascinating. Want more info? Write: 1550 W. Carroll Ave., Chicago, Ill. 60607



GUARDIAN®

GUARDIAN ELECTRIC MANUFACTURING COMPANY

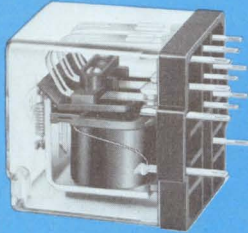

SERIES 1220

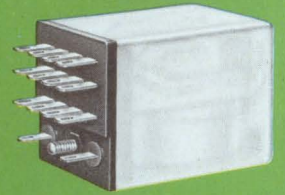

SERIES 1300



And now—time-sharing of hybrid computers

Desk-top terminal for teaching and training applications permits remote control of variables through digital logic

Mathematicians, unlike engineers, don't like to get their hands dirty. Now, with a new remote terminal connected to a large analog-hybrid computer, they won't have to; they can play around with massive systems of partial differential equations, yet never set up a patchboard or learn the difference between an op amp and a pot.

The new terminal, made by Ap-

plied Dynamics Inc., and called the Dynamics Terminal, makes time-sharing on analog-hybrid computers a possibility for the first time. Previously, only large digital systems, and, more recently, smaller digital computers could handle time-sharing. Pure analog systems solve complex problems in parallel and therefore use no memories to store data or instruction sequences.

Because of this, multiple remote access has not been tried up to now. However, the intrinsic speed of the analog system makes it as useful in discovering how parameter variation affects a solution as in obtaining a solution. To simplify this process, the larger systems have arrays of fast digital logic to vary the parameters automatically. This additional logic makes the com-

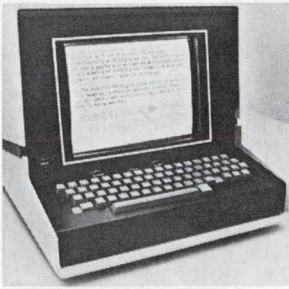

Computer-driven television display system incorporates multiple desk-top video terminals. It has the capacity of storing and simultaneously displaying up to 128 different tv pictures. The terminals, which consist of monitors and keyboards, can be used for computer data entry and retrieval as well as for data display. Data Disc Inc., 1275 California Ave., Palo Alto, Calif. [421]



Digitizer 485 is an A/D device that can digitize both lines and points simultaneously. Features include whole value and incremental operating modes, a floating origin which permits starting point location to be anywhere on the tracing area relative to point or line coordinates, and a coordinate display that sums digitized increments. Calma Co., Kifer Road, Sunnyvale, Calif. [422]



Adding machine model 708 is an input station for Data-Verter, a line of devices for recording manually on magnetic tape for subsequent computer processing. The unit has a non-add key that can be used to record non-add records e.g. reference numbers, dates, etc. It handles up to 10 columns of input and 11 of sub-totals and totals. Digitronics Inc., Albertson, N.Y. [423]

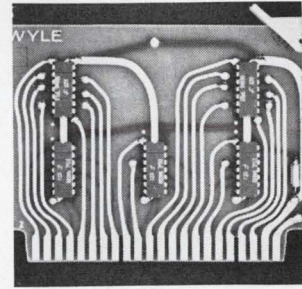

RS flip-flop card MSF-10 provides a ten set-reset or storage capability. Designed for many storage and general-purpose logic applications, the card provides for frequency, d-c to 5 Mhz, and input loading of one unit load each input. Output drive capability is 7 unit loads, and power required is $+5 \pm 0.5$ v at 75 ma, max. Wyle Laboratories, 128 Maryland St., El Segundo, Calif. [424]

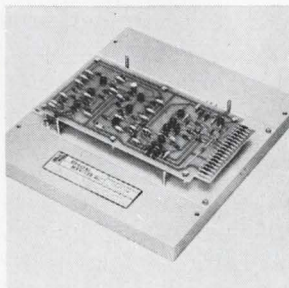

Magnetostriuctive delay line 613E-1015 has a storage capacity of 30,000 bits. Cost per bit is around one cent, in small quantities. The unit provides a 15,000 μ sec delay and a 2 Mhz data rate over the temperature range 60° to 90°F. Applications include crt displays, digital tv displays, and communications terminals. Digital Devices, 200 Michael Drive, Syosset, N.Y. 11791. [425]

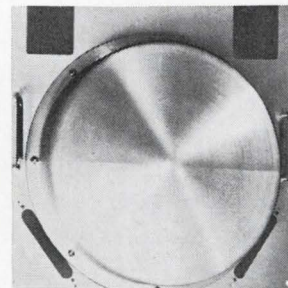

Ten-inch rotating drum memory system CLC-1 can store up to 1.2 million bits of data and has an average access time of 8.5 msec. It features four multiple pole-piece head assemblies, each containing eight write/read heads on 32 data tracks, operating at 3,600 rpm. The drum unit comes complete with digital interface. Bryant Computer Products, Ladd Road, Walled Lake, Mich. [426]

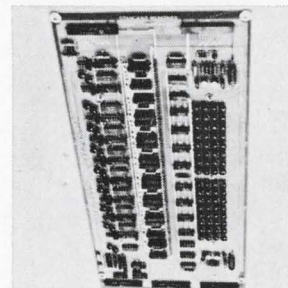

Instant memory system ECOM-S comes on a single 7.50 x 16.70 p-c board. It is for volume applications as a refresh memory for displays, a block buffer in key-to-tape, and as a small memory in process control computers. It operates in either the $\frac{1}{2}$ cycle mode at 2 μ sec or the full cycle mode at 4 μ sec. Standard Memories Inc., Ventura Blvd., Sherman Oaks, Calif. [427]

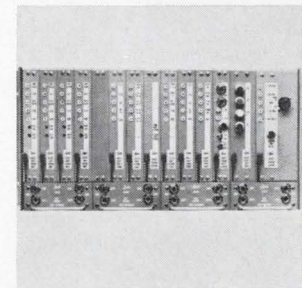

PCM wideband data terminal B313 provides accurate high speed data (0 to 256 kilobits per sec) and voice transmission over exchange type telephone cables at less cost than conventional microwave or frequency division multiplex systems. It transmits signals from digital computers and other data processing equipment. Lynch Communication Systems, 695 Bryant St., San Francisco. [428]



Cheap! Cheap!

We've just hatched the first low-priced charge amplifier. Yet the new 1-308 can crow about specs as good as (or better than) the higher priced versions.

Just look what our \$95.00 cheapie can deliver.

Higher shunt capacitance: 10,000 picofarads.

Lower noise specs: 500 microvolts at 10,000 pf.

Operating temperature: +25°F to +150°F.

Reference gain: 2 mv/pcmb \pm 2%.

Linearity: \pm 2%. Frequency response: 5 to 10,000 Hz \pm 5%.

Weight: 12 ounces maximum.

And—the 1-308 will work with virtually all piezo devices.

Obviously, we're rather proud of our "egg heads."

For all the facts, call our nearest office or write Bell & Howell, Pasadena, California 91109. Ask for Bulletin Kit 1308-X1.

CEC / TRANSDUCER DIVISION



BELL & HOWELL

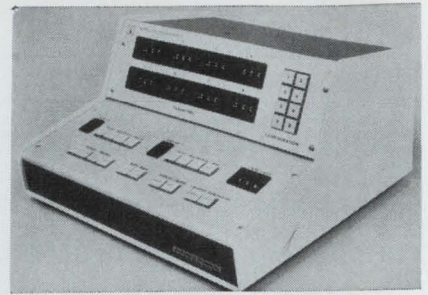

Control point. Variables of computer problem can be adjusted at terminal.

puter a hybrid; in some cases the digital portion is a full-scale computer in its own right.

Through its terminals, Applied Dynamics adds time-sharing to the digital portion of such a system.

Patched in. When the new terminals are in use, the central computer must be patched in the conventional manner. But the digital logic and the pot settings can be controlled from a distance, using thumb-wheel parameter switches and configuration buttons on the terminals. Configuration buttons are like function switches, permitting certain pre-programmed changes in the digital control logic to be cut in or out as desired.

For example, a problem well suited to analysis on an analog computer is the behavior of a new automobile suspension on a washboard road. The problem is easily reduced to the response of a mass-and-spring system to an external force, when the system includes friction and damping. In this case the mass is the automobile, damping is provided by the shock absorber, and the external force is the thumping action from the washboard. The user might want to adjust certain variables while studying the system—such as the shock-absorber characteristics, the spring constant, or the frequency of the external force, corresponding to the car's speed on the road. In a small analog computer, he'd have to look at the results for each value of each variable, then stop the machine, change the variable, and restart. By contrast in a hybrid system, he could set up the changes he wanted to study in the digital portion, then sit back and watch the output change as the variables cycled through their values.

In the time-shared system, each of these variables can be controlled

Making a ceramic tower base insulator to 9,000,000 lbs. ultimate strength isn't easy . . .

Lapp specializes in tough jobs.



That was one of our toughest. But, Lapp has designed and built hundreds of tower insulators. They range downward to 80,000 lbs. ultimate strength. In fact, Lapp insulators support most of the world's larger radio towers, both self-supporting and guyed masts.

Lapp has over 50 years of "know-how" and experience that won't cost you a cent when you bring your insulating problem to us. From drawing board to delivery you can count on Lapp to handle your tough tower . . . and antenna . . . insulating jobs.

Can we help? Lapp Insulator Co., Inc. LeRoy, N.Y. 14482.

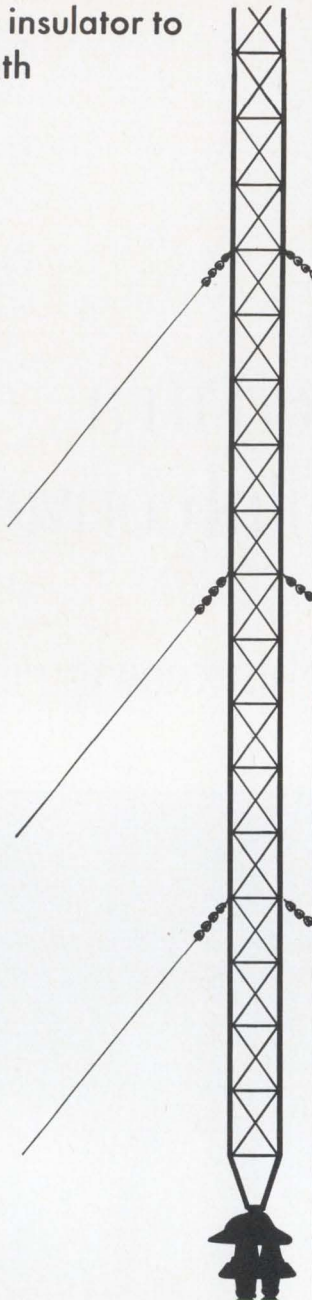

. . . terminals may widen use of hybrids . . .

from the remote terminals; different terminals can be working with different problems on the same analog computer, up to the capacity of the computer's patchboard.

Single bus cable. Up to 16 terminals can be connected to a single bus cable on the company's Applied Dynamics 4 computer. It has a capacity of four bus cables, so that as many as 64 terminals can be connected at once. An oscilloscope display comes with the terminal for displaying the output. The computer spends a millisecond with each terminal when no more than 16 are connected; the time is reduced for more than 16 to prevent the display from flickering. Of this display time a certain amount is required to re-initialize the computer; but the worst case is 100 microseconds when the output for the disconnecting terminal is at one end of the computer's ± 100 -volt range and the output for the new one is at the other extreme.

This is 10% of the display time for one of 16 terminals; it thus has a negligible effect on the displayed solution.

If the terminals are connected directly to the computer, a maximum of 100 feet of cable can be used; for greater distances, line drivers are required. The maximum distance is limited by the fact that analog signals are transmitted over lines; it's unlikely that the terminal would work satisfactorily if it were not in the same building with the central computer. After all, one doesn't expect to use miles of leads on an oscilloscope; the limitations on the terminal are the same.

The company expects its principal market to be university installations, where previously only graduate students had access to large analog computers. With the new terminal, large undergraduate classes can use such machines; they benefit from large-machine capability, but the cost is less than that of, say, 16 small analogs.

The terminal is available with either of two standard Tektronix oscilloscopes, for \$6200 or \$7400.

Applied Dynamics Inc., Box 1488, Ann Arbor, Mich. 48106 [429]

McGraw-Hill invites
you to participate in
a unique, THREE-DAY

computer-aided design seminar

MARCH 19-21, 1969 • THE PARK SHERATON HOTEL • NEW YORK, N.Y.

This intensive, all-inclusive seminar will bring you up-to-date on specific design methods and ready-to-use programs... and will give you the opportunity for actual "hands-on" experience in designing by computer. Practicing leaders in the field will explain and fully discuss all practical aspects of initiating, utilizing, and maintaining a computer-aided design activity. A number of operational design programs available from no other source will be given to all attendees.

SEMINAR OUTLINE

I. Computer Oriented Modeling And Design Procedures—Semiconductor Device Models • Optimization Techniques Automated Transistor Model Determination from Measured Data • Lumped and Distributed Circuit Elements • Mechanical Systems • Fundamentals of Numerical Analysis

II. Digital Circuit Design—Circuit Configurations • Nonlinear Circuit Analysis by Computer • Design Procedures Using Iterative Techniques

III. Automated Transistor Bias Circuit Design—Stabilization Techniques • The Method of

Constrained Singular Imbedding • On-Line Computer Program Description and Applications • Worst Case Design from Tolerance Information

IV. Automated Filter Design—Fundamentals of Filter Design • Application of Constrained Singular Imbedding to Filter Design • On-Line Computer Program Description and Applications

V. Microwave Network Design By Computer—Microwave Network Elements • Application of Indefinite Admittance Matrices to Multi-terminal Network Analysis • Automatic

Microwave Network Parameter Optimization by Computer

VI. On-Line Graphics for Circuit Layout and Interconnection—Computer Algorithms • Description of Computer Program Applications

VII. Automated Power Station Cable Routing—Fundamentals of Linear Programming • On-Line Computer Program and Applications

VIII. Information Communication by Computer—Computer Algorithms • Applications to Power Systems

Complete Seminar Materials will be provided to each registrant.

Special Computer-Aided Design Workshops

In this extension of the seminar you will help execute actual computer-aided design projects using an IBM 360, as well as terminals for remote access to time-sharing computers. An additional fee of \$10 per registrant covers these extra, optional sessions, dinner, and chartered bus transportation between facilities.

Consultants and Lecturers

Dr. Gerald J. Herskowitz, Stevens Inst. of Technology;
Dr. Marco Murray-Lasso, Case Western Reserve Univ.;
Dr. Richard C. Levine, Stevens Inst. of Technology;
Arnold Spitalny, Norden Div. of United Aircraft Corp.;
Dr. Thaddeus J. Kobylarz, Stevens Inst. of Technology;
Frederick J. Murad, Public Service Elec. and Gas Co.

FEES:

Computer-Aided Design Seminar	\$375
Two-evening Computer-Aided Design Workshops	\$10

REGISTRATION must be made in advance—
USE THE FORM BELOW. Mail it now to ensure your reservation.



John Stockwell, Seminar Manager
McGraw-Hill Book Company, 330 W. 42nd St., New York, N.Y. 10036 (212) 971-2388

Please register me in your three-day Computer-Aided Design Seminar at \$375

Also include me in the evening Computer-Aided Design Workshops for an additional \$10

Name _____

Position _____

Company _____

City _____ State _____ Zip _____

Phone (Area Code) _____ Number _____ Ext. _____

Please bill company Bill Me Check enclosed

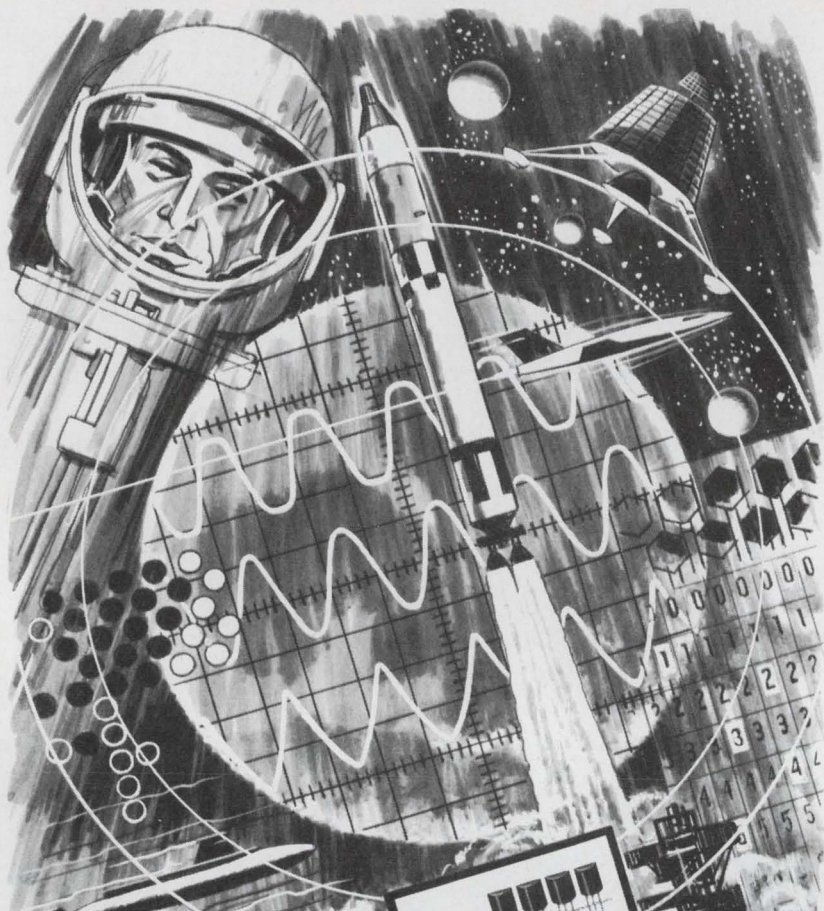

**Compatible...
Moisture Resistant...
Hysol Makes Epoxy
and Urethane Compounds
to Sink, Fly and Click
Anywhere...**

Solve your electronic component insulation and protection problems now with the same HYSOL materials that have been found to be completely compatible in space, underseas and computer components. HYSOL meets or exceeds the most rigid specifications for electronic component protection with a complete line of molding powders and liquids, coating powders and printed circuit coatings. When your program calls for epoxies or urethanes, check HYSOL. Have assurance that HYSOL recommended materials have been thoroughly tested on live components under environmental conditions defined in MIL-STD 750 and MIL-STD 202 in HYSOL's Electronic Testing Laboratory.

HYSOL®
HYSOL DIVISION
THE DEXTER CORPORATION

Write, wire or call HYSOL, Department EM-269
Olean, N.Y. 14760 for application
engineering assistance.

MOLDING POWDERS

COATING POWDERS

CASTING COMPOUNDS

PRINTED CIRCUIT COATINGS

Data handling

System speeds digital filtering

Fast Fourier transform computer moves from oil to other industrial fields

Oil exploration teams, in their perpetual hunt for new fields, wind up with a great deal of digital seismic data that must be processed quickly. A system designed by Texas Instruments to help them do that is now being marketed for application in other areas where digital filtering is needed—vibration analysis, communications, image processing (such as image enhancement of the type being done in the space program), sonar and radar, power system balancing, and airframe, wind tunnel, and biomedical data analysis.

The system, called Tiops, uses the fast Fourier transform for digital filtering of large volumes of data at high speeds. TI says it's the first production system on the market that is able to fully utilize the FFT algorithm.

That quick. The keystone of the system—indeed, its reason for being—is speed. TI uses the example of a routinely complex seismic calculation setup involving transformation of 8,192 time points. Tiops would take about 190 milliseconds (using a 12,000-bit core memory); a large scale general purpose computer (with a 32,000-bit core) would take 8 seconds—Tiops would provide, therefore, a system that is 40 times faster than conventional ones.

The system is fast, says TI, because the vector dot-product, vector complex product, and address generation that are needed to implement the FFT algorithm are wired directly in the hardware. Not only that, but speed is gained also through utilization of the pipeline logic concept for the multipliers in the FFT unit design. Finally, pre-selection of specific memory locations to store and retrieve recurring information is possible because of the data-chained direct memory ac-

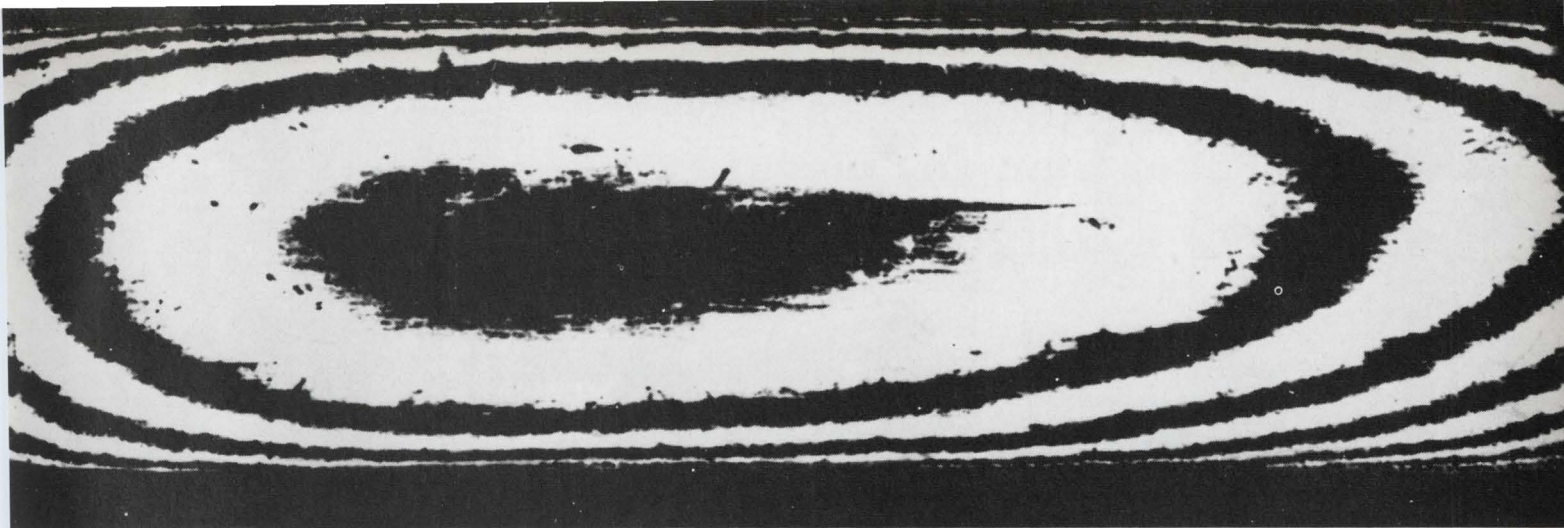

Interference photomicrograph of a gage block surface. Fringes give a clear picture of a surface dropping toward the edges.

A flatness tester with fringe benefits.

Fringe benefit

No.1: The surface you're testing is touched by nothing but light and air.

Fringe benefit

No.2: The kind of accuracy that is obtainable *only* by interference of light waves.

Fringe benefit

No.3: Fast operation, high throughputs—once the standard is in position, all samples can be checked without realignment.

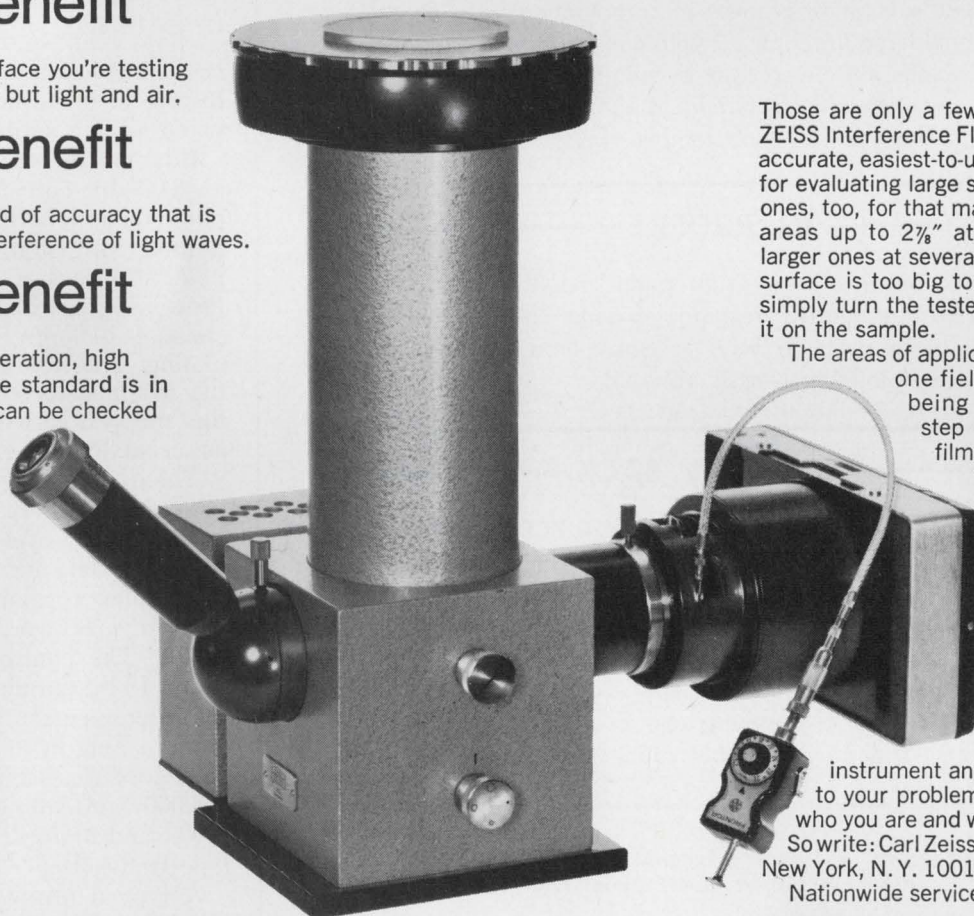

The ZEISS Interference Flatness Tester—a unique instrument.

Those are only a few of the benefits of the ZEISS Interference Flatness Tester, the most accurate, easiest-to-use instrument available for evaluating large surfaces. Or fairly small ones, too, for that matter. You can measure areas up to 2 $\frac{1}{8}$ " at a glance, and much larger ones at several glances—since, if the surface is too big to put on the tester, you simply turn the tester upside down and put it on the sample.

The areas of application are legion. In just one field, micro-circuitry, it's being used to measure the step height of photoelectric films on silicon wafers; and to test the flatness of the wafers themselves, the ceramic plates that the wafers are mounted on, and the glass slides used to project the mask pattern. And that's only one field of many.

We'd like to tell you all about this unique instrument and how it can be applied to your problem. But we need to know who you are and what your application is. So write: Carl Zeiss, Inc., 444 Fifth Avenue, New York, N. Y. 10018. Nationwide service

ZEISS
THE GREAT NAME IN OPTICS



ATLANTA, BOSTON, CHICAGO, COLUMBUS, DENVER, HOUSTON, LOS ANGELES, PHILADELPHIA, ST. LOUIS, SAN FRANCISCO, SEATTLE, WASHINGTON, D.C.

Circle 179 on reader service card

Better from any angle! by DiGiCATOR[®]



From the Front

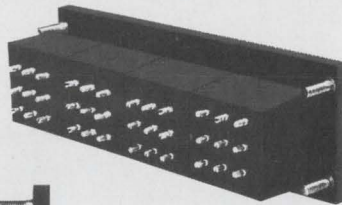

From the Back

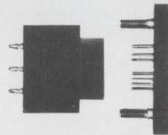

In Profile

THINLINE READOUT
SERIES 20

ULTRA-COMPACT DECODER/DRIVER
MODEL 5720

FROM THE FRONT

Character height 1 inch • Wide-angle readability to 35 feet • High brightness in combination with exceptional lamp life. 5 or 12 volt lamps • Lamps easily replaceable • Delivered as a complete assembly to your specifications, including integral bezel, screen, mounting studs . . . and lamps!

IN PROFILE

Only ¼-inch profile • Front panel mounting eliminates requirement for rectangular panel cutout • No detail piece parts to buy, assemble and mount • Occupies minimum chassis volume.

FROM THE BACK

Ultra-compact DiGiCATOR Model 5720 BCD to 7-line decoder/driver plug-in package mates with the Series 20 readout • Monolithic IC unit has integral high-current lamp drivers • Compatible with all TTL, DTL and RTL logic systems • Lamp supply circuit separate from logic supply; allows use of unregulated lamp supply and direct dimming control • Eliminates all but logic and power supply connections.

SIMPLE TO SPECIFY • SIMPLE TO PURCHASE • EASY TO DESIGN IN
EASY TO INSTALL • COMPETITIVELY PRICED

Phone or write for complete information

DISCON CORPORATION

1150 NORTHWEST 70th STREET • FT. LAUDERDALE, FLORIDA 33309
PHONE: (AREA CODE 305) 933-4551

Patents Applied For



Fast filter. System was developed for large volumes of seismic data.

cess channel in the system. That feature cuts the need for software while adding sophistication.

Bits and pieces. Tiops uses only an 8,000-bit core memory to compute data lengths up to 4,000 points; for lengths up to 8,000 points it uses a 12,000-bit core. Processing is done for up to 32 channels of input data. For manipulating data volumes greater than the available core space can handle, the system uses drum storage as an auxiliary memory.

The digital controller that's used with the basic system has a 1.5-microsecond cycle time, 16-bit words for data and instruction, and a modular core memory expandable in 4,096-word increments to 32,768. The controller's input-output is 16-bit parallel.

Options currently available include a plug-in FFT unit wired in the hardware, magnetic drum with 393,000-word storage, an a-d-a converter and multiplexer system, and tape transports.

A typical arrangement for seismic data processing—two tape transports, drum memory, controller, supplementary core memory, and the FFT feature—costs about \$150,000; leasing is about \$4,000 a month. Delivery time is 180 days.

Texas Instruments Apparatus Division,
12201 Southwest Freeway, Stafford,
Tex. [430]

For the first time you have the added dimension of variable persistence **and** storage in a low frequency scope for your dc to 500 kHz measurements. And, *only* variable persistence gives you completely flicker-free displays of all your low frequency measurements.

Four new models in the HP 1200 series have pushbuttons allowing selection of conventional, variable persistence and storage modes. Having one of these new all-solid-state scopes is like having three scopes in one!

You can select storage writing speed by pressing the STD pushbutton for >20 cm/ms. Press the FAST pushbutton for $>1/2$ cm/ μ s writing speed. Persistence is continuously variable from 0.2 second to 1 minute or longer in STD mode and

0.2 second to 15 seconds in FAST mode.

In STD mode, you can vary storage time from 1 minute to 8 hours—in FAST mode, from 15 seconds to 1 hour. And, because of the mesh storage technique used in the 8 x 10 cm internal graticule CRTs, you get bright displays without the loss of trace brightness caused by phosphor deterioration. The 1200 storage CRTs have a life expectancy comparable to HP conventional CRTs.

The new HP 1201A (cabinet) and 1201B (rack) models are dual trace storage scopes with $100 \mu\text{V}/\text{cm}$ deflection factor. Models 1207A and 1207B are single trace storage scopes with $5 \text{ mV}/\text{cm}$ deflection factor. These new scopes have single-ended or differential input on all ranges, high common mode rejection ratio,

complete triggering versatility, external horizontal input, dc-coupled Z-axis, beam finder — many of the features normally associated only with high frequency scopes.

For full details on the new HP dc to 500 kHz variable persistence and storage scopes in the 1200 series, contact your nearest HP field engineer. Or, write to Hewlett-Packard, Palo Alto, California 94304. In Europe: 1217 Meyrin-Geneva, Switzerland.

Prices: HP 1201A or 1201B $100 \mu\text{V}$ storage scopes, \$1800; HP 1207A or 1207B 5 mV storage scopes, \$1475.

HEWLETT  PACKARD
OSCILLOSCOPE SYSTEMS

089/9

Now You Can Get Flicker-Free Variable Persistence and Storage In A Low-Cost, Low Frequency Scope!

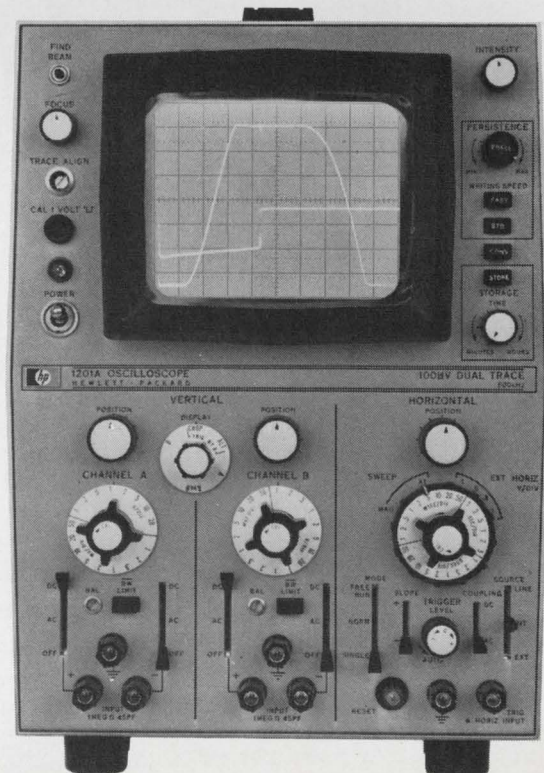
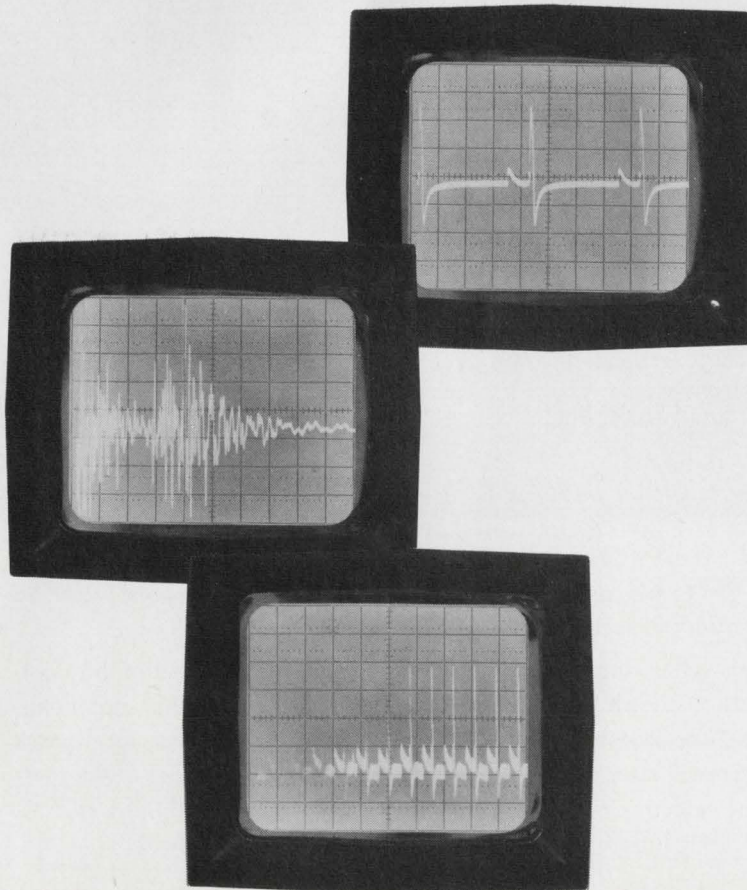

ON DISPLAY AT IEEE SHOW

Circle 181 on reader service card

Our private stock isn't private any more.



Motorola's Frequency Control Products are now on the market.

They say that if you want a thing done right, you do it yourself. And so we did. For thirty years, we've been designing and manufacturing our own

frequency control components. Because they had to be good enough to use in our own products.

We've been selfish long enough. Now our precision crystals, oscillators, filters, and tone modules are available to designers and manufacturers throughout the electronics industry. And if the mile-long list of components

isn't long enough, our designers and engineers are ready to go to work on custom projects.

For additional information on existing products and design potentials, write to Motorola Communications & Electronics Inc., 4501 W. Augusta Boulevard, Chicago, Illinois 60651. Ask for Bulletin TIC-3401.

Circle 182 on reader service card



MOTOROLA

Coaxial switches isolate ports by 60 db

Single-pole electromechanical devices handle bandwidths up to 18 Ghz; jobs seen in radar, countermeasures, and test equipment

Switching radio-frequency signals from one place to another is a much tougher job at microwave than at d-c or other low frequencies. Direct current takes the desired path if the conductors are in the proper place, but microwaves stray, inducing unwanted r-f currents which make the 'off' position on some microwave switches a relative thing.

For this reason, microwave switches are quoted as having a given isolation between input and output when off, and between ports if they are multi-pole switches.

Two new electromechanical coaxial switches from Microwave Associates seem to get around the isolation problem and handle bandwidths from d-c through 18 Ghz.

The MA-7532 is a single-pole

four-throw switch; its mate, the MA-7533, is a single-pole six-throw unit. They are about equal in performance: loss is only 0.5 decibel maximum at 18 Ghz, and well below this at lower frequencies; voltage standing-wave ratio is only 1.5 maximum at 18 Ghz, but is even better—only 1.1—at 2 Ghz.

Isolation is the key specification. Even at 18 Ghz, each port is iso-

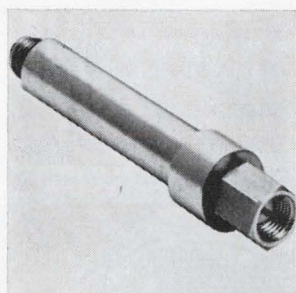

Distributed lossy line miniature attenuator covers 4 to 12.4 Ghz. Flatness over the entire band ranges from a maximum of 0.5 db to 0.2 db, depending on the value of the attenuator. Units are available in values to 6 db, in 1/2 db increments. Vswr of all units is less than 1.25. Price is \$45 each; delivery, 6 to 8 weeks. Microlab/FXR, 10 Microlab Road, Livingston, N.J. [401]

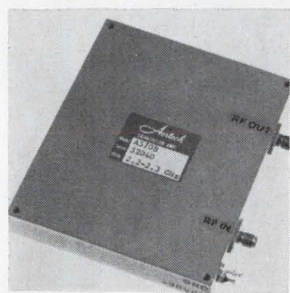

All silicon telemetry amplifier model A5708 operates over the frequency range of 2.2 to 2.3 Ghz with 20 db minimum gain and typical noise figure of 6 db. Output power for 1 db gain compression of +12 dbm gives wide dynamic range. The 7-oz unit operates over the temperature range of -55° to +71° C. Aertech Industries, 815 Stewart Dr., Sunnyvale, Calif. [402]



Lightweight coaxial balanced mixer model AM7380 is suitable for use in microwave receivers and frequency translators. It is also used in airborne, military and commercial applications. Frequency range is 0.5 to 1 Ghz; noise figure, 7.5 db typical; vswr, 1.5 maximum; local-oscillator power, 0±3 dbm. Alpha Industries Inc., 381 Elliot St., Newton Upper Falls, Mass. 02184. [403]



Coaxial attenuators series 757C meet the environmental performance requirements of MIL-A-3933B. They cover the frequency range from d-c to 12.4 Ghz and are available in attenuation values of 3, 6, 10, and 20 db. Maximum vswr from d-c to 6 Ghz is 1.20; 6 to 12 Ghz, 1.25. Price is \$45; delivery, from stock. Narda Microwave Corp., Commercial St., Plainview, N.Y. 11803. [404]

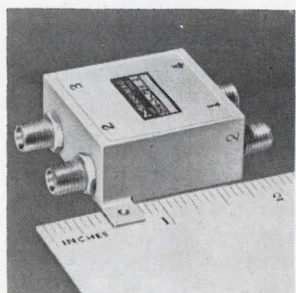

Voltage tunable magnetron oscillator BLM-1351 delivers more than 1 w over the frequency range of 5.25 to 5.90 Ghz. Heater voltage is 1.7 v; typical heater current, 3.6 amps; power variation, 0.7 db; anode voltage, 1040 to 1160 v; load impedance, 50 ohms; load vswr, 1.1:1. Over-all dimensions are 2.505 x 3.005 x 2.850 in. Varian Bomac Division, Salem Road, Beverly, Mass. [405]



Miniature quadrature hybrids using loop line networks are for applications from 200 Mhz to 2 Ghz. The QHM-3-K series consists of coaxial devices having octave bandwidths and relative output phases of 90° ±2°. Isolation is 28 db; coupling, -3 db; impedance, 50 ohms; insertion loss, 0.3 db. Merrimac Research and Development Inc., 41 Fairfield Place, West Caldwell, N.J. [406]

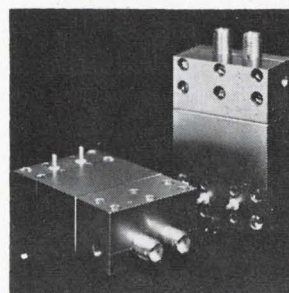

Coaxial balanced mixers feature a diode-holder design that eliminates fragile finger-contacts and provides for easy field replacement of the diodes. X-band models shown cover 8 to 12 Ghz. Over the range, noise figure is 9 db max., i-o/r-f vswr is 1.7 max., and isolation is 8 db minimum. Price is \$375. Sage Laboratories Inc., 3 Huron Drive, Natick, Mass. 01760. [407]

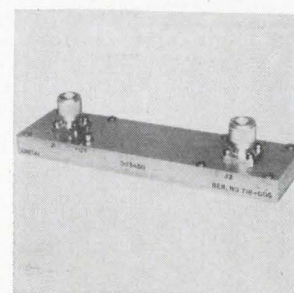

Compact and ruggedized amplifiers for use in the L and S telemetry bands offer a dynamic range as high as +7 dbm before 1 db compression at the output and have an intercept point of +20 dbm minimum. Gain variation is ±1 db max.; vswr input, 2:1 max. or less than 1.4:1 when using circulator at input. Applied Research Inc., 76 S. Bayles Ave., Port Washington, N.Y. 11050. [408]

**10 uv.
10 samples/
second.
Under \$1000.
.01%.**



Breakthrough performance at a Trymetrics breakthrough price.

You can't buy more DVM without spending hundreds of dollars more. The new Trymetrics 4250A unitized full 4-digit DVM gives you .01% accuracy, 5 DC ranges (99.99mV to 999.9V) with automatic ranging, automatic polarity indication and 20% overscale readout. Plus optional printer output capability (compatible with all popular printers); remote range selection, and dual switched inputs for instant-readout A or B or instant input-output comparisons.

Make your own comparisons. Send for detailed catalog today.



TRYMETRICS Corporation

A SUBSIDIARY OF TRYGON ELECTRONICS, INC.

204 Babylon Tpke., Roosevelt, L.I., N.Y.
Phone 516-378-2800 11575

Please send information on your 4250A DVM and your complete catalog.

Name _____

Title _____

Company _____

Address _____

City _____

State _____ Zip _____

PRICES SLIGHTLY HIGHER IN EUROPE.

lated by 60 db from every other. "The best isolation obtainable in prior designs has been about 20 to 40 db," says William G. Burt Jr., product manager for electromechanical r-f switches.

Transformation. The MA devices achieve high isolation by turning a piece of microstrip into a piece of waveguide. Many switches, by contrast, cut a conductive path.

In the "on" state a thin microstrip conductor connects the coaxial center conductor of the input port to one of the output connectors. The microstrip rests in a machined trough between the input and output connectors.

When the strip-line conductor moves, the connection breaks; a

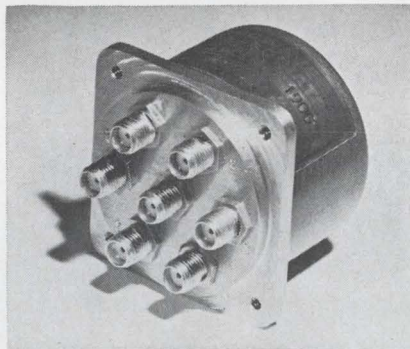

Controller. Single-pole six-throw switch, and an SP4T, provide high signal-isolation.

spring, manual push rod, or a solenoid forces it toward the top of the trough. Now, with the sides and bottom of the trough, it forms a rectangular waveguide, but one whose dimensions keep it from propagating energy below 18 Ghz.

Below this cutoff frequency, the waveguide is so lossy that signal strength falls to almost zero in a fraction of the length of the trough. The newly formed waveguide cannot conduct it.

Burt says that the switches will find most of their uses in military systems such as countermeasures or radar, but that makers of test equipment will also use them, to connect and select loads and other elements.

Price for the MA-7532 (SP4T) is \$375; the MA-7533 (SP6T) costs \$425. Delivery time is eight weeks.

Microwave Associates Inc., Northwest Industrial Park, Burlington, Mass. 01893 [409]

NEW

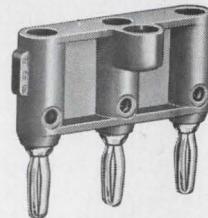

MODEL 2970 TRIPLE BANANA PLUG

Ideal for balanced line two-conductor shielded cable assemblies, and 3-terminal power supplies.

Featured in our 1968 general catalog. Write for your free copy.

POMONA

ELECTRONICS CO., INC.
1500 E. Ninth Street, Pomona, Calif. 91766

NEW



PHONO ADAPTERS

MODEL 2957 BNC RECEPTACLE TO PHONO PLUG **MODEL 1442 PHONO JACK TO DOUBLE BANANA PLUG**

Featured in our 1968 general catalog. Write for your free copy.

POMONA

ELECTRONICS CO., INC.
1500 E. Ninth Street, Pomona, Calif. 91766

How AO fiber optic light guides solve illumination problems.

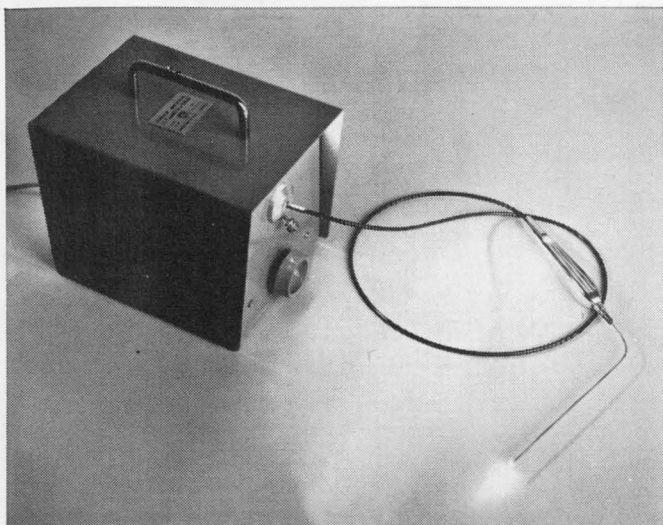

Transmit "cold" light like other forms of energy—by flexible routing to remote or inaccessible locations, hazardous areas, or any abnormal environment.

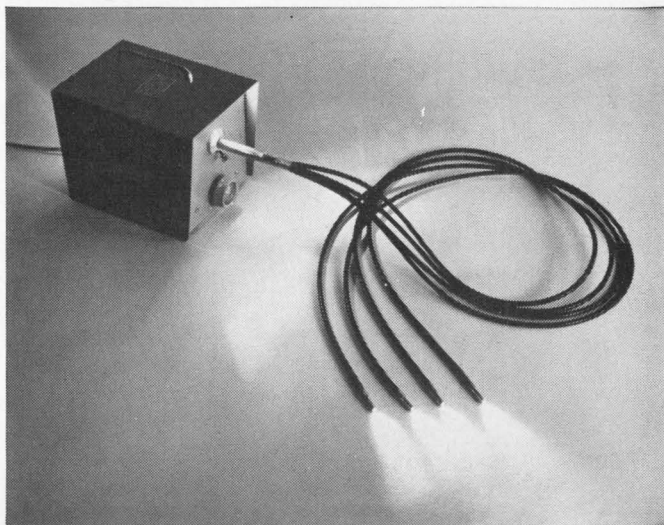

Supply multiple illumination from a single light source, with multi-branched light guides.

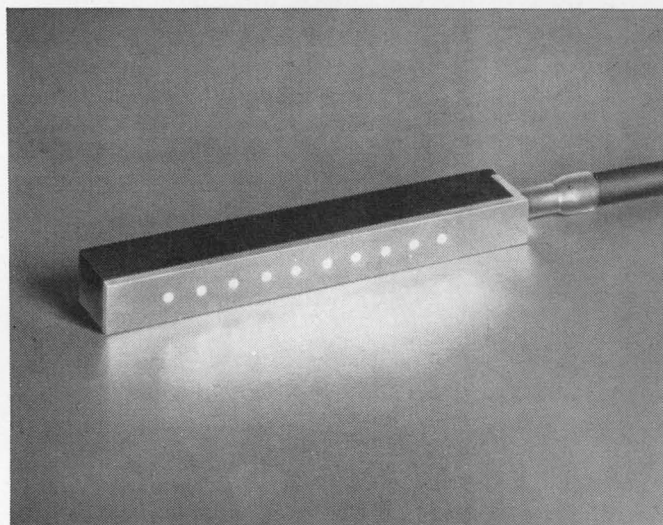

Simplify lighting problems by eliminating lens systems, multiple lamps, complex electrical circuitry.

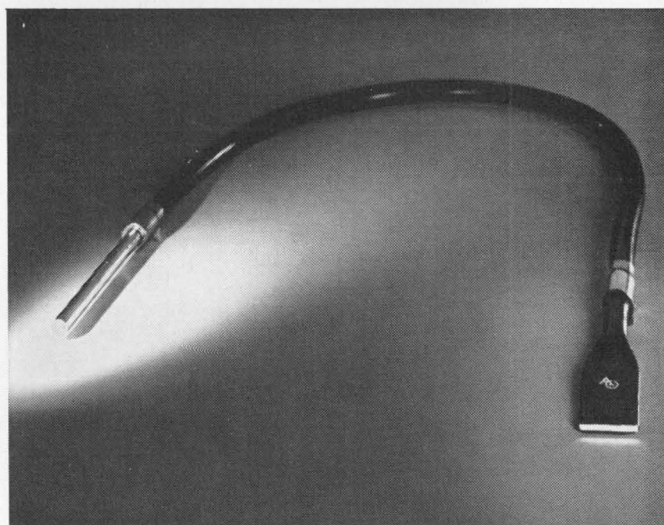

Provide input-output geometry conversions such as round-to-square, round-to-slit, etc.

These are only a few of the ways in which American Optical fiber optic light guides are used to help solve illumination problems. Specific applications range from mark sense readout to electro-optical sensing in data processing, circuit verification, fire control, null detection, light pens, spot illumination, and many others.

Simple, reliable, economical. AO fiber optic light guides are simple, passive elements which remain extremely reliable under normal vibration, temperature or humidity changes, or other environmental fluctuations. This results in long service life with minimum maintenance.

Standard and custom light guides from American Optical have light transmission ranges from 400 to 1500 millimicrons. Standard light guides are

available in bundle sizes from .020" to 1/4", with 30 to 6000 fibers, lengths up to 72", plastic or stainless steel tips, and PVC sheaths. Custom light guides can be supplied in any length desired, with special end tips, sheaths, diameters, input-output face configurations, and branchings.

A leader in optics since 1833, American Optical Company brings a great breadth of related experience to the technology of fiber optics. Our versatility in fiber optics is unmatched by any other manufacturer. In fact, AO scientists already hold more than 200 important patents or patents pending in this relatively new field.

For Fiber Optics Data Kit, send reader service card, or write to Fiber Optics Department:



AMERICAN OPTICAL COMPANY

Space-Defense Division • Southbridge, Mass. 01550

9524-B

Another superb
photomultiplier from



Dark current at
200 Amps/Lumen typically
 2×10^{-9} Amps



A rugged versatile tube utilizing the special EMI CsSb box and grid design. Typical gain of 3×10^6 at 1100 volts makes it an excellent tube for portable instruments. Variants are available with "S", S-10, and S-20 cathodes as well as with quartz windows for U.V. work.

The characteristics of the 9524-B exemplify the type of performance to be expected from the more than sixty different photomultipliers made by EMI in sizes from 1 to 12" in diameter. Most types are available from stock in the U.S.

Write for our latest catalog and the name of your local representative.

Whittaker
CORPORATION
GENCOM DIVISION
80 Express St.
Plainview, L. I., N. Y.
516-433-5900 TWX 516-433-8790
* EMI ELECTRONICS, LTD., ENGLAND

New microwave

Comb generators cover 3-40 Ghz

Off-the-shelf units
can also phase-lock
high-power oscillators

Comb generators are usually custom-made items, produced in one's and two's for in-house systems. But Varian's Solid State operation will now market them off-the-shelf. "The requests we've had from customers who see them in our lab convinces us that the demand warrants an inventory," says John C. Hieber, marketing manager.

Although similar to varactor multipliers, comb generators, instead of generating one specified harmonic of an input or modulating frequency, produce many harmonic lines, each separated by the modulating frequency.

When viewed on an oscilloscope, the generator's output is a series of vertical lines that look like the teeth of a comb.

The Varian generators are priced at \$350, which Hieber describes as relatively inexpensive. He expects that they will be used principally with spectrum analyzers, whose built-in markers are often spaced too far apart for some applications. Depending on the modulating frequency, the separation between the teeth of the comb generator varies from 2 to 500 megahertz.

If the modulating frequency is accurately controlled, any of the comb generator's spectrum lines will phase-lock the frequency of more powerful oscillators.

Varian offers six comb generators, each rated for an output of -30 dbm per comb line at an input frequency of 180 Mhz. Power can be from 50 to 100 milliwatts. Delivery from stock is 10 days. The VSS-9715A will cover 3-4 gigahertz; the VSC-9716A, 4-6 Ghz; the VSX-9717A, 8-12.4 Ghz; the VSU-9718A, 12.4-18 Ghz; the VSK-9719A, 18-26.5 Ghz; the VSA-9720A, 26.5-40 Ghz.

Varian Associates, Solid State Products Operation, Salem Rd., Beverly, Mass. 01915 [410]

FREE SAMPLE RFI GASKET ECCOSHIELD® SV

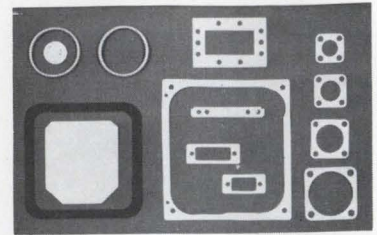

Eccoshield® SV is the flexible, compressible plastic with the conductivity of metal—available in many physical forms—for RF and hermetic seals. Insertion loss has exceeded 100 db.

Circle 491 on reader service card

ECCOAMP ELECTRICALLY CONDUCTIVE ADHESIVES & COATINGS



New four page folder describes materials from 0.0001 to 100 ohm-cm. Adhesive pastes to replace hot solder, thin liquids, silver lacquer in aerosol spray, lossy coatings, etc.

Circle 492 on reader service card

THERMAL CONDUCTIVE DIELECTRICS



Electrically insulating, thermally conductive . . . for bonding, encapsulating, coating or sealing heat sinks, components or cryogenic devices where rapid heat transfer is desired. New four-page folder describes materials and applications.

Circle 493 on reader service card

Emerson & Cuming, Inc.



CANTON, MASS.
GARDENA, CALIF.
NORTHBROOK, ILL.
Sales Offices
in Principal Cities

EMERSON & CUMING EUROPE N.V., Gevel, Belgium

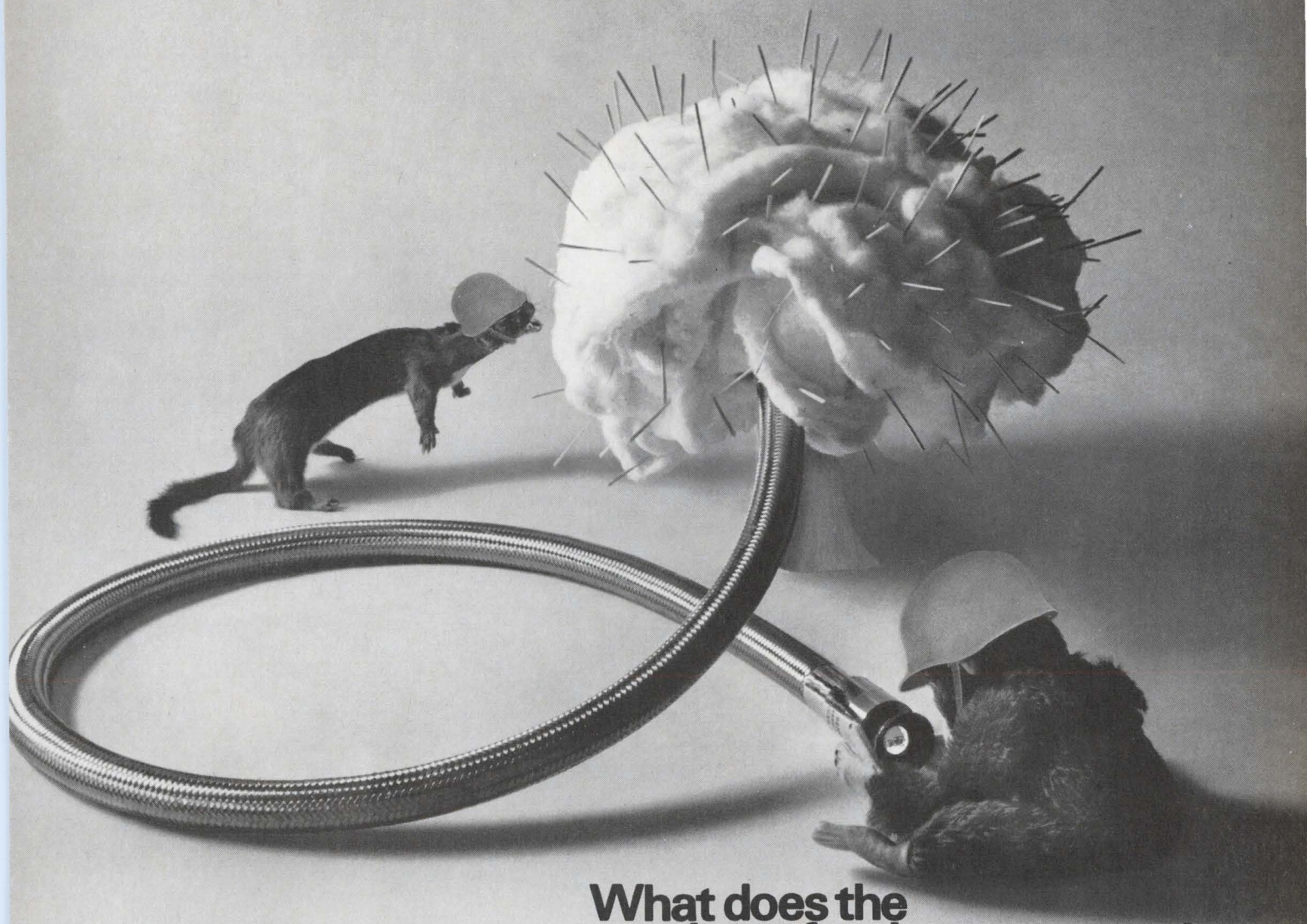

What does the monkey of today use to track the elusive weasel all around the prickly mulberry bush?

A flexible Bendix imagescope. An image transfer device that monitors remote events and inspects otherwise inaccessible areas. It doesn't beat around the bush. But beats into it . . . and under it . . . and over it. In fact, the Imagescope can bend, twist, and "weasel" its way into many hard-to-see places. And because it can be optically coupled to an image intensifier device, it can bring a picture right into the cockpit of a tank, or a helicopter, or a fighter plane. This rugged, but flexible, device can carry a picture of what's there to any lengths because it consists of a coherent bundle of glass fibers. The Imagescope breaks up an image into thousands of minute parts, conducts each separately within the individual fiber, and then reassembles them at the other end. There you can attach it to any photo-optical system: Vidicon or still camera. The Bendix Imagescope has so many uses that it can "pop" into any mulberry bush to identify any weasel.

For more information about the Bendix weasel-tracking Imagescope, call or write: Mosaic Fabrications Division, The Bendix Corporation, Galileo Park, Sturbridge, Mass. 01518 • (617) 347-9191

Bendix **Electronics**

Circle 187 on reader service card

the guaranteed electronic components

CAMBION

Standardize on

Our free catalog 700 has all the facts. Write for your copy today. See for yourself how CAMBION's Cage Jack connector can prove to be the **reliable** link in your circuit . . . time after time . . . after time. Cambridge Thermionic Corporation, 445 Concord Avenue, Cambridge, Massachusetts 02138. Phone: (617) 491-5400. In Los Angeles, 8703 La Tijera Boulevard 90045. Phone: (213) 776-0472.

And for at least another 32,607 trouble-free cycles, the fit will be exact . . . to sustain the electrical integrity of the connection. That's because this is a CAMBION Cage Jack. And even if you don't need to push it that far it's nice to know the proven reliability is always there. But despite such a positive time-after-time grip, CAMBION Cage Connectors are easy to disengage. And you can pick a style for every rugged need . . . patching, testing, breadboarding, mounting components. We make more than 1500 different connectors, available from stock in six different sizes from .025" to .080". All with compatible mating plugs.

This connector has cycled only 7,393 times



Darlington transistors offer low leakage

Manufacturing technique modifies chip design for power devices, seen leading to higher current and voltage ratings

Why would a small semiconductor manufacturer produce a line of power transistors that's already being marketed by some of the biggest names in the industry? Because it has found a way to make a significant improvement. Stanley Pessok, president of the Solid Power Corp., says "The devices that we're making have lower saturation voltages and lower leakage

currents than theirs, and we feel that we've got a process that will enable us to eventually make higher voltage and current devices."

Pessok says that EIA-registered specifications for the 2N2226 through 2N2233 series are 3.5 volts for collector-to-emitter saturation voltage and 20 milliamps for leakage current. "Our devices have a typical leakage current of 1 to 5 ma,

and a saturation voltage of about 1.5 volts," he says. "These allow for a more efficient operation so that at a given operating point, the device dissipates less heat."

The power transistors are actually Darlington amplifiers and are intended for use in inverters, converters, power supplies, and servo amplifiers. In these applications, power transistors prove to be better

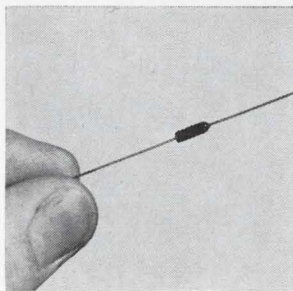

Avalanche diodes types GLA28-GLA100 have zener voltage ratings from 2.8 v d-c to 10 v d-c. Continuous power dissipation is 600 mw. Maximum noise density at 250 μ a is 4 μ v/hz. Zener voltage tolerances may be supplied at \pm 10%, \pm 5% or \pm 2%. Dynamic impedance varies from 10 to 75 ohms depending on voltage rating. Computer Diode Corp., Fair Lawn, N.J. [436]

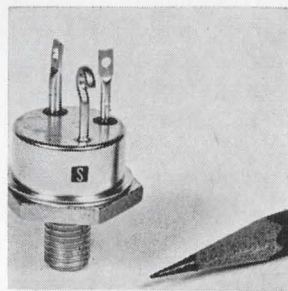

Silicon power transistors series SDT8751-8 are 20-amp devices with breakdown voltages ranging from 100 v to 200 v. They have beta ranges from 15 to 90 at a collector current of 10 amps and collector saturation voltages lower than 0.5 v. Primary uses are in high voltage, fast switching applications. Solitron Devices Inc., 1177 Blue Heron Blvd., Riviera Beach, Fla. 33404. [437]

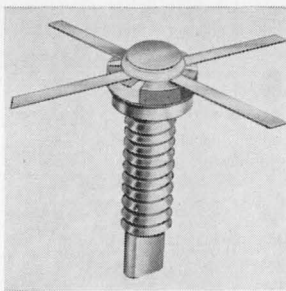

Microwave transistor PT6821 provides 20 w c-w power at 1 Ghz. It has 5 db gain, 55% efficiency operating from a 28-v source. The hermetic devices can be incorporated into microstripline amplifiers for design simplicity and economical construction. Common emitter configuration provides circuit stability. TRW Semiconductors Inc., 14520 Aviation Blvd., Lawndale, Calif. 90260. [438]

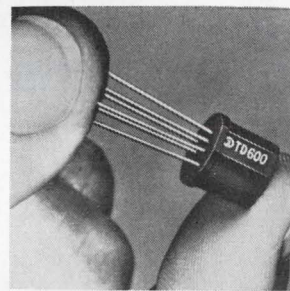

Complementary dual transistors designated the TD-600 series come in one-piece molded plastic packages. They are specified for low-level applications such as single-pole double-throw switching. Units feature low noise (2 db maximum) and high gain. Type TD-602 features a minimum gain-bandwidth product of 200 Mhz. Sprague Electric Co., 35 Marshall St., North Adams, Mass. [439]

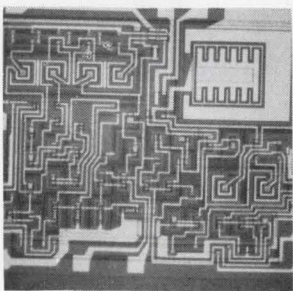

Monolithic and short-circuit-proof voltage regulator TVR2000 is a versatile unit designed for operation over the military temperature range. Absolute maximum ratings include input voltage, 40 v; input-output voltage differential, 40 v; power dissipation at 25° C (TO-100), 800 mw; load current, 150 ma. Transiltron Electronic Corp., 168 Albion St., Wakefield, Mass. 01881. [440]

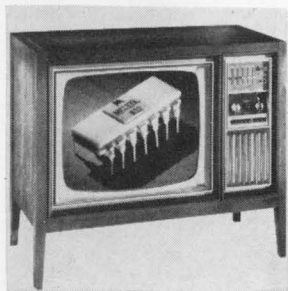

Integrated-circuit chroma demodulator MC1325 requires only the chroma signal and two reference phases to produce low-impedance color difference signals for driving the output stages directly. Temperature-compensated networks built into the chip eliminate grey-scale drift. Price in lots of 100 to 999 is \$2.50 each. Motorola Semiconductor Products Inc., Box 955, Phoenix. [441]

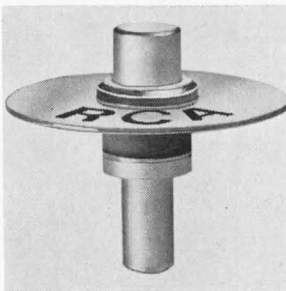

Silicon overlay transistor TA7403 is for power oscillator applications in receivers and power sources that operate in the L- and S-band ranges. A typical unit operated at 21 v can provide 0.6 w of power at 2 Ghz with 25% efficiency; and provide 100 mw at 3 Ghz. Production quantities will be available after April. RCA/Electronic Components, 415 S. 5th St., Harrison, N.J. [442]

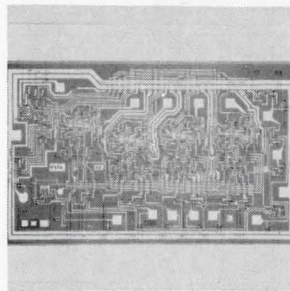

Synchronous counting for multiple stage operation in digital systems is achieved by two CCSL (compatible current sinking logic) circuits that offer versatility and speeds of greater than 15 Mhz. The 9310 BCD decade counter and 9316 binary hexidecimal counter come in dual in-line and flatpacks. Prices range from \$14 to \$46 each. Fairchild Semiconductor, Mtn. View, Calif. [443]



No monkey biz when you buy Security Filters from Captor

Captor Corporation is a specialist in the manufacture of communications, security and shielded room filters. Our goal is to satisfy the industry's long-standing needs: the need for a supplier who makes on-time deliveries... whose sales promises are fulfilled... whose products meet all applicable specifications... who gives good overall service. Captor offers one of the industry's most complete line of security filters, including units capable of carrying very large power line loads. Our security filters meet even more rigorous specifications than EMC filters, including DCA and FED-STD-222. If your requirements are unusual or unique, Captor engineers are available to evolve special filter designs. Now that you have an alternative, let Captor bid on your next security filter requirement!

Captor Corporation manufactures miniature filters... communications and security filters... custom-design filters, and other electronic components.

CAPTOR CORPORATION
APPLICATION ENGINEERING DEPT.
5040 Dixie Highway, Tipp City, Ohio 45371

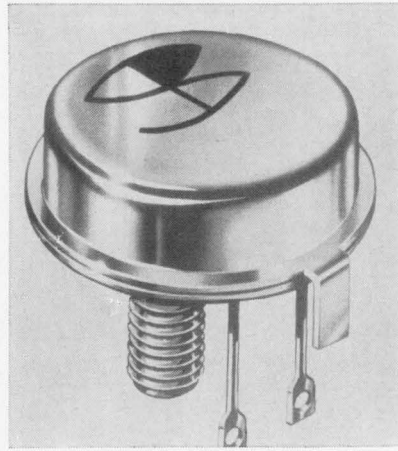

than thyristors, which have frequency limitations. Thyristors—silicon controlled rectifiers and triacs—are limited to about 400 hertz, but most power transistors can function above 10 kilohertz.

The Solid Power series consists of two groups. The first, 2N2226 through 2N2229, has a minimum current gain of 250, and the units are rated at 10 amps and from 50 to 200 volts. The second types, 2N2230 through 2N2233, have a minimum current gain of 700 and are also rated at 10 amps and from 50 to 200 volts.

According to Pessok, the improvement that lowers the saturation voltage and leakage current is due to a "modification in chip design." This proprietary configuration is what the company is counting on to enable it to produce power transistors with collector currents of up to 20 amps and voltage ratings of 250 and 300 volts.

The transistors are available in either a TO-82 or TO-63 package. Small quantities can be delivered immediately and production quantities are available in four weeks.

Specifications

Power dissipation	150 w at 75°C
Gain 2N2226-29	250 min, 2,000 max
2N2230-33	700 min, 10,000 max
Collector current	10 amps
Collector voltage	
2N2226	50 v
2N2227	100 v
2N2228	150 v
2N2229	200 v
2N2230	50 v
2N2231	100 v
2N2232	150 v
2N2233	200 v
Leakage current	1 to 5 ma typical
Saturation voltage	
V _{ce}	1.5 v typical
V _{be}	2 v typical
Gain-bandwidth product	700 khz
Price	\$25 to \$90

Solid Power Corp., 440 Eastern Parkway, Farmingdale, N.Y. 11735 [444]

We design high energy density capacitors to fit.

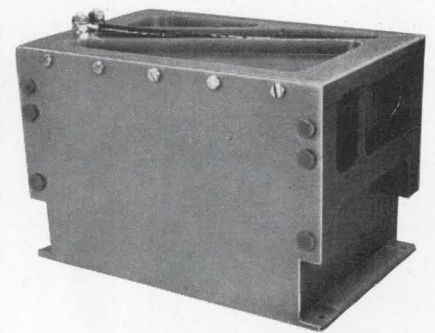

A typical AMPLIFILM* capacitor assembly. Even un-encapsulated, the exclusive dielectric construction provides moisture resistance meeting MIL-STD-202 (Method 106), making possible an energy efficiency greater than 0.6 joules per cubic inch without the encumbrance of a metal case.

- Capacitance: 0.1 μ f \pm 5%
- Voltage rating: 40,000 volts DC
- Power factor: 0.5% max.
- Temperature Range: -55°C to +100°C
- Size: 4 $\frac{1}{2}$ " x 4 $\frac{1}{2}$ " x 6 $\frac{1}{2}$ " max.
- Weight: 9 $\frac{1}{2}$ lbs.

We can supply units rated from 4,000 to 60,000 Volts DC with capacitances from 100 pf to 1.0 μ f and higher. Ask us to build you a high-energy-density capacitor that makes the best use of your available space. Call or write, today.

*Trademark of AMP Incorporated

**AMP
INCORPORATED**

CAPITRON DIVISION

155 Park Street • Elizabethtown, Pa.
717-367-1105 • TWX: 510-675-4561

VOICES IN OUTER SPACE ...



another step ahead in the development of satellite communications.

Last September K.D.D. of Japan decided on FUJITSU as the most qualified expert to develop and manufacture a new PCM-TDMA COM SYSTEM. This system employs pulse-code multiplexion with a transmission speed of 50 million bits/sec.; TASI, a time assignment speech interpolation system which increases channel capacity; a time-division multi-access controller and a phase-shift keying device.

The resulting 700 channels per band—which is more than conventional FDMA can boast—provide distortion-free voice communication, larger per-band capacity and lower per-channel charges.

For us, it's another step toward our goal of a better tomorrow for everyone. For humanity, it's another step closer to the stars.



FUJITSU LIMITED

Communications and Electronics

Marunouchi, Tokyo, Japan

MAIN PRODUCTS: Telephone Exchange Equipment Telephone Sets Carrier Transmission Equipment Radio Communication Equipment Space Electronics Equipment Data Communication Equipment Computers (FACOM) & Peripheral Equipment Automatic Control Equipment (FANUC) Telemetry & Remote Control Equipment Electric Indicators Electronic Components & Semiconductor Devices Auto-Radio & Car Stereo (TEN) Marine Radar Nuclear Measuring Equipment

A-to-D in 1 μ sec.



4 1/2" x 2 1/4" x 1"

New Pastoriza Model ADC-10F Converter combines 10-bit resolution with 1 MHz speed.

Here's the ideal mix of speed and resolution for real-time processing jobs. All elements including reference power supply, high-speed switches, resistor network, comparison amplifier, and TTL integrated-circuit logic are contained in this single plug-in module.

Applications for the ADC-10F's 1 MHz sampling capability include digital processing of radar data, high-speed analysis of radar pulses, and conversion of analog data for direct consumption by a core memory. The ADC-10F is also ideal for use with Pastoriza's SHA-II Sample-and-Hold Amplifier for strobing and converting video signals for computer use.

Write or call for prices
and full specifications.

PASTORIZA
ELECTRONICS, INC.

385 Elliot St., Newton, Mass. 02164 • 617-332-2131

New Books

A model solution

Simulation—A Dynamic Modeling of Ideas and Systems with Computers
Edited by J.H. McLeod
McGraw-Hill Book Co., 351 pp., \$15.00

John McLeod is editor of *Simulation*, journal of Simulation Councils Inc. Active for more than 25 years in one phase or another of this narrowly-understood field, editor McLeod has now put together from the magazine a large, handsome volume documenting the growth of simulation since its early pre-computer days.

As a whole, the book reflects the current state of simulation art. Systems engineers with strong mathematical backgrounds will find it instructive. While familiarity with computer synthesis methods is advisable, there are a number of tutorial articles to help the novice along.

The book is divided into three parts. In part I, McLeod, with wit and clarity, defines the oft-misinterpreted term "simulation." After suggesting such expletives as "a hopeful fake when the real thing is just too much" or "instant coffee" or "a rat's nest of multicolored test-leads spilling like viscera" from a computer's abdomen, he gets down to business by stating, cautiously, that simulation is "the act of representing some aspects of the real world by numbers and symbols which may be easily manipulated to facilitate their study." The tone of the book thus set, simulation is now traced from basics to its present implementation.

The bulk of the work, part II, consists of 30 articles by authors in various fields who are interested in computer solutions to their particular problems. Each article is preceded by a summary and introduction that describes the paper to follow and tells the reader what prompted the need for a machine solution. The contents here cover the application of the simulation technique to such areas as electronic systems, error solutions, rotating space bodies, integrated missions, time-sharing methods, iterative differential analyzers, transistor circuits under bombard-

small wonder.



LS 40 sweep generator 2-250 MHz 0.5 Vrms OUTPUT \$655.00 2 WEEK DELIVERY

The LS series of sweep generators is a new line of test instruments specifically designed for incorporation into production test systems. The use of line frequency sweep rate, limited marker capability, and specialized sweep range results in an instrument which can cover a desired band for an extremely low price. These instruments are linear, broad sweep, solid state units with exceptionally flat, low distortion outputs.

OTHER LS INSTRUMENTS

LS45

Frequency Range: 250-500 MHz
Output: 0.5 Vrms
Sweep Width: 250 MHz
Price: \$575.00

LS70

Frequency Range: 500-1000 MHz
Output: 0.5 Vrms
Sweep Width: 500 MHz
Price: \$575.00

TEXSCAN
CORPORATION

2446 N. Shadeland Avenue
Indianapolis, Indiana 46219
Telephone (317) 357-8781
TWX: 810-341-3184

NRC high production sputtering guards your most expensive raw material: Time.

Guards it by eliminating substrate loading and unloading time. Guards it by delivering the speed and consistency demanded by production line coating. And, it sputters anything to $\pm 5\%$ uniformity, including quartz and other insulating materials. The NRC multi-sided revolving

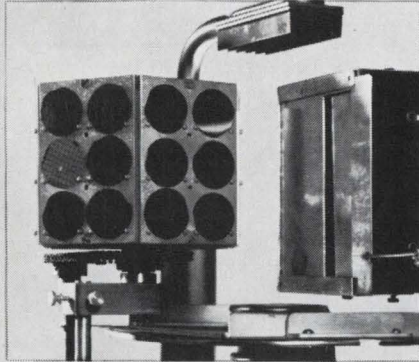

substrate holder carries wafers from 1" to 3" dia. past a dual target, to coat up to 50 1" wafers at a time. While one substrate holder is being coated, the operator loads another, so no production time is lost. The system may be equipped with a second target to sputter two materials simultaneously.

The vertical substrate position on the holder eliminates the danger of accidental sputtering of foreign objects that may enter the coater during loading.

This high capacity sputtering system may be installed on our versatile NRC 3117 vacuum coater. We designed it to readily accept 15 sepa-

rate "plug-in" modules, including electron beam guns; resistance evaporation power supplies; and two pumping systems — 1500 l/s or 2400 l/s. Any of these accessories can be installed without custom "plumbing," to save you up to \$5000 on your purchase price.



For the newest in vacuum equipment, research or industrial, look to the NRC brand. For further information, contact: Norton Vacuum Equipment Division, 160 Charlemont St., Newton, Mass.

NORTON VACUUM EQUIPMENT DIVISION

Circle 193 on reader service card

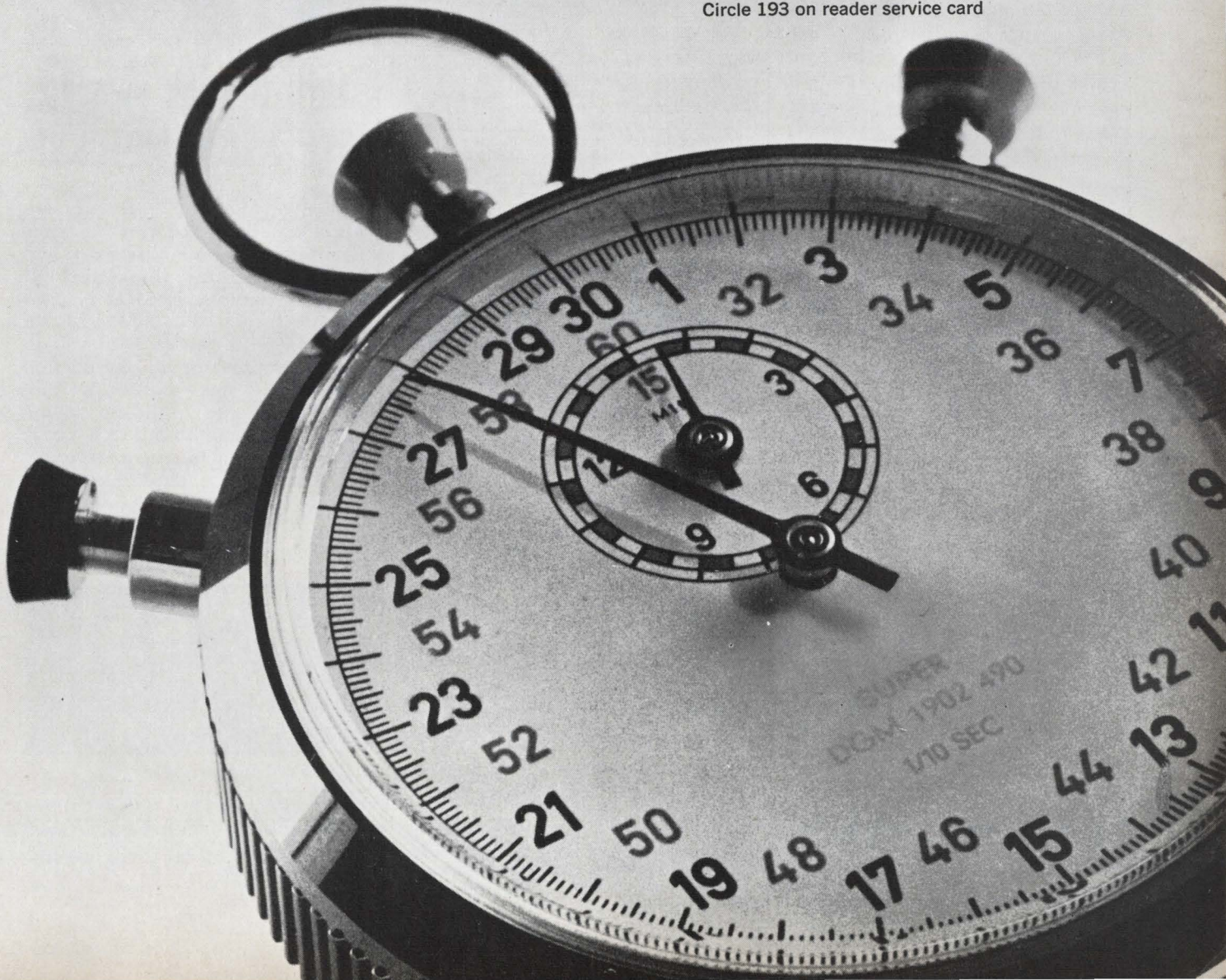



ACTUAL SIZE

DO YOU MAKE OR BUY?

\$60,000 will buy you 1000 M401 multipliers. You could spend 2/3 of that amount making just one modular unit if you designed, tested and produced your own in house. So why not order a single Intronics unit at \$95 — check it out in your system circuit — and let Intronics supply you with your quantity requirements. We can provide low cost solutions to the multiplying function for many applications including the following:

- DYNAMIC HORSEPOWER MEASUREMENT
- PHASE DETECTION
- RMS VOLTAGE MEASUREMENT
- CRT DISPLAYS
- AUTOCORRELATION
- SIGNAL MODULATION
- TRIGONOMETRIC COMPUTATION
- SOLID STATE RESOLVER

SPECIFICATIONS

Accuracy	1%
Linearity Y25%
Linearity X75%
Full output (20vp-p)	20kHz
Small signal response (-3db)	125kHz
Noise p-p wideband	3mvp-p
Gain temp. stability03%/°C
Offset temp. stability	2mv/°C
XY/10 input/output range	±10V AC or DC
Power supply requirement	±15V, 12ma
Price (1-9)	\$95.00
Delivery	Stock

intronics
 TWX 710-335-6835
 (617) 332-7350
 57 CHAPEL STREET, NEWTON, MASS. 02158

New Books

ment by nuclear particles, physiological systems, and chemical systems. The development of simulation equipment is dwelt upon, especially the computer itself.

In part III, McLeod looks into the future of simulation equipment as digital and hybrid computers become faster and more miniaturized. The technique's influence will continue to grow exponentially, he says. Hybrids will become the pre-eminent simulator as IC techniques make inroads in computer systems design. The biggest change in hybrids, forecasts McLeod, will be the realization of digitally programmed analog building blocks.

Recently published

Basic Network Theory, Paul M. Chirlian, McGraw-Hill Book Co., 624 pp., \$13.50

An introductory circuits text aimed at undergraduates, this book examines such new topics as state-variable techniques and signal flow graphs while giving full attention to basic network topology, Laplace transforms, and Fourier series. The introductory chapter on electromagnetic fields and circuit concepts provides a basic understanding, but networks are analyzed strictly from a circuits viewpoint. Classical solutions for linear differential equations are also covered.

Fortran Programming, Fredric Stuart, John Wiley & Sons Inc., 353 pp., \$7.95

Intended as both a textbook and a reference manual for Fortran. Covers such topics as input statements, flow charts, conditional branch statements, and nonexecutable statements. Problems are given at the end of each chapter for self-study.

Computation by Electronic Analogue Computers, V. Borsky, J. Matyas, American Elsevier Publishing Co., 421 pp., \$10.75

Written by two Czechoslovakian engineers and translated by mathematics department staff members at Brunel University in England. Covers linear and nonlinear problems and a series of special problems including variable coefficients, partial differential equations, wave equations, matrix inversion, and digital control. Examples include a relay servo-mechanism and a transistor oscillator.

Circuit Design of Digital Computers, Joseph K. Hawkins, John Wiley & Sons Inc., 515 pp., \$17.50

Aimed at the engineering level; includes magnetic and semiconductor elements. Basic logic schemes such as DTL and CML are treated, and magnetic core storage and magnetic surface recording, including head design, also are discussed.

Feedback Control Theory for Engineers, P. Atkinson, Plenum Publishing Corp., 434 pp., \$14.50

Undergraduate textbook that discusses control engineering with heavy emphasis on actual hardware. Many mechanical illustrations supplement the analytical approaches to the problems.



Need... FAST REVERSING ACTION?
 Need... TIMED MEASUREMENT?
 Need... to meet CHANGING PRESSURES?

turn the job over to **SYNCHRON® MOTORS!**

Any time you have any motor application that requires extreme flexibility, extreme versatility and extreme accuracy, think first of Synchron motors. Here at Hansen Manufacturing, we specialize in working with you to help you in design, engineering and production problems. Come to us for the motors, and the application experience you want. Call us—or if you're not in a hurry, write today for complete specifications on the type of motor and application you have in mind. No obligation, of course.



HANSEN REPRESENTATIVES: CAREY & ASSOCIATES, Houston and Dallas, Texas; R. S. HOPKINS CO., Sherman Oaks, Calif.; MELCHIOR ASSOCIATES, INC., San Carlos, Calif.; THE FROMM CO., Elmwood Park, Ill.; JOHN ORR ASSOCIATES, Grand Rapids, Mich.; H. C. JOHNSON AGENCY, INC., Rochester, N.Y.; WINSLOW ELECTRIC CO., Essex, Conn.; Narberth, Pa., and New York, N.Y.
 EXPORT DEPARTMENT: 64-14 Woodside Ave., Woodside, N.Y.

business trips rule out evening classes?



here's a practical way to update your knowl- edge of electronics

Are irregular hours, travel and family obligations keeping you from attending classes—even though you worry about becoming technically obsolescent? Check into the Special Programs in Electronics for Engineers developed by CREI, the Home Study Division of the McGraw-Hill Book Company.

These are not simply courses, but comprehensive programs in advanced electronics offering major electives in such fields as:

Communications Engineering, Aeronautical and Navigational, Television Engineering, Automatic Control Engineering, Missile and Spacecraft Guidance, Radar and Sonar Engineering, Nuclear Instrumentation and Control, Computers.

Industry-recognized CREI Programs make it possible for you to catch up on new developments in electronics through study in your own home, at your own pace,

your own schedule. Free book gives complete information and details of technical material covered. For your copy, mail coupon below or write: CREI, Home Study Division, McGraw-Hill Book Company, Dept. 1854H, 3224 Sixteenth St., N.W., Washington, D.C. 20010.

Founded 1927



Accredited Member of the National Home Study Council



CREI, Home Study Division, McGraw-Hill Book Company
Dept. 1854H, 3224 Sixteenth St., N.W.
Washington, D.C. 20010

Send me free brochure describing CREI Programs in Electronics for Engineers.

NAME _____ AGE _____

ADDRESS _____

CITY _____ STATE _____ ZIP CODE _____

COMPANY _____

TITLE _____

Software slowdown

Hardware design reflecting software requirements
 Saul Rosen
 Purdue University, Lafayette, Indiana

So far the promises made to computer users have not been kept; timely, useful, and meaningful results without waste of personnel and equipment time have not been obtained. Although machine hardware has developed and improved at a great rate, the capabilities of the "extended machine"—the combined hardware-software system—have lagged disappointingly. Hardware design has not done the job of analysis, debugging, and documentation of complex software systems. Many areas remain where hardware design can improve the overall performance of computer systems.

Many systems undergo a critical test when handling routine input-output interrupts. The time it takes to recognize an interrupt, to handle the functions it requires, to initiate new operations where needed, and to finally return to the interrupted program is usually an important performance parameter of any system. The execution of many instructions in response to each interrupt can cause an otherwise fast computer to become intolerably slow. Much of the supervisory programming is best kept at the elementary operation level and cannot be handled by software alone.

Advances in integrated circuits have made it more practical to handle supervisory functions by hardware rather than software programming. This includes such functions as the maintenance of input-output queues, the handling of priorities, the issuance of input-output commands, and the response to error conditions. But pitfalls will crop up. Hardware-built microprograms can become excessively long and may be difficult or even impossible to debug.

New computer hardware developments are essential before the promise of interactive time-sharing systems can be realized. Peripheral equipment will need faster channels with greater bandwidth;

PUSH-IN

NEW MICRO-KLIP

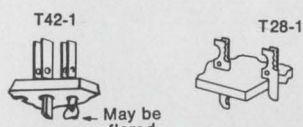

T42-1
T28-1

May be flared
Fits .042" diameter holes

T28 Mini-Klip
Fits .062" holes

TURNED TYPE

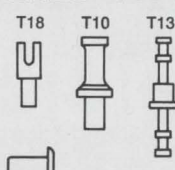

T18 T10 T13

EYELETS

For holes .042", .062", .093" diameter

CUT CONSTRUCTION DELAY

T32A

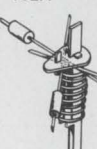

Fits .093" holes
T32A-1 fits .062" holes

T30N-2



Fits .093" holes

USE VECTOR ZIP PUSH-IN TERMINALS, INBORD PINS, CUP RECEPTACLES

Quickly installed, easy to use Vector zip push-in terminals and inbord pins cut construction time and cost in many ways while providing reliable connections. Solderable and solderless terminals are available. They are designed for versatility and accept most wire sizes used in electronics. By inverting the new T42-1 Micro-Klip terminal and inserting it in "P" Pattern Micro-Vectorbord*, it serves as a useful mounting device for D.I.P.'s. These terminals normally need no staking. Space saving Inbord Pins may be inserted in boards as required and function as component terminals or male connector pins. Hand insertion tools are available for all push-in terminals and inbord pins. Production type staking tools are available for turned type terminals. Vector also has eyelets, and hand staking tools.

Cup receptacles may be mounted anywhere and accept Inbord Plug Pins (.040"), Vector Edge-Pins, or any .040" diameter pin of proper length. Edge Pins attach to board edges to make Plug-In Cards.

INBORD PLUG PINS

For .025" and .042" dia. holes
Various lengths available



Mounting Pin
.040" diameter

Cup Receptacle



EDGE PINS
K23A & K25



* TM
K28



Vector ELECTRONIC COMPANY, INC.
 12460 Gladstone Ave., Sylmar, Calif. 91342

Circle 232 on reader service card

GRC Intermold



die cast
ZINC ALLOY

Samples Show How
NEW MOLDING PROCESS
JOINS 2 DIFFERENT
PLASTICS IN A
SINGLE SMALL PART

- Combine different colors, physical, chemical properties of different plastics in a single tiny component.
- Movable-element parts, separable parts, two-color parts, numbered and lettered parts, combination - of - materials parts.
- Saves assembly costs, enhances appearance, performance of your product.

Write today for "intermold" samples and detailed bulletin.

Coil Bobbins
Gears & Pinions

GRIES REPRODUCER CO.



Division of Coats & Clark, Inc.
 World's Foremost Producer of Small Die Castings
 151 Beechwood Ave., New Rochelle, N.Y. • (914) 633-8600
 Plants in: New Rochelle, N.Y.; Warren, R.I.; Toccoa, Ga.

196 Circle 196 on reader service card

Active Solid State Filters



NOTCH FILTERS

Compact portable filter, tuned to 60 Hz with a variable rejection band width to 1 Hz, available from stock. Higher or lower frequencies available upon request.



ACTIVE VARIABLE FILTERS

High Pass, Low Pass, Band Pass or Band Reject. Portable Filters can be set continuously in the 0.02Hz to 20KHz Range.

AP 7" Wide x 5" Deep x 4" High
Weight Including Batteries 5 lbs.

For more information write to:

A. P. CIRCUIT CORP.
 865 West End Ave., New York, N.Y. 10025
 Tel. (212) 222-0876

Circle 231 on reader service card

In the power tetrode field we're defining the state of the art by demonstrating intermodulation distortion better than any other known tubes. In 1966 we introduced the 4CX1500B, a 1.5 kW tetrode with the highest linearity then known: better than -40 dB 3rd order IM distortion. Since then we produced the 4CX600J, a 600 watt tube with -45 dB 3rd order IM products—without feedback—and later a 5 kW tetrode with the same figure. Now the latest tetrode in our program, a 15 kW tube, exhibits -40 dB 3rd order IM products. We can show IM distortion improvements from 10 to 20 dB in a practical quiescent plate current range.

Other tetrodes now under development will deliver up to 40 kW with linearity as high as -45 dB IMD, according to preliminary data. Such performance advances are part of a long range program employing computer-assisted design studies to optimize internal tube geometry—all part of our plan to insure you get state of the art products every time you buy from Eimac.



Contact your nearest Varian/Eimac distributor or ask Information Operator for Varian Electron Tube and Device Group.

**No tetrodes
with higher
linearity.**



Radar signal processing engineers:

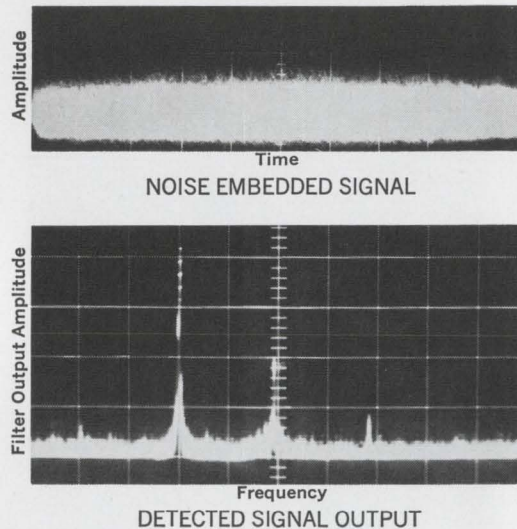

Our expansion can be your opportunity.

Today at Hughes, we're developing digital radar signal processors for a variety of important airborne applications. An engineering model of one of these processors has been developed for real-time operation. It uses the Cooley Tukey, or fast Fourier transform algorithm, to form a bank of 512 narrowband doppler filters, together with their associated detectors and threshold circuits. The scope photographs show a processor input signal 12 db

below wideband input noise, and the resulting processor output signal 15 db above rms noise in one digital filter output.

Several programs are now starting to carry this technique and others further toward operational radar systems.

It's a rapidly expanding field. And Hughes wants to grow with it. That's why qualified engineers and scientists are needed now. Particularly those with digital circuit design experience, signal processing analysis and

subsystem design experience, and microelectronic circuit applications background.

Interested? Please airmail resume today to:

Mr. Robert A. Martin
Head of Employment
Hughes Aerospace Divisions
Dept. 57
11940 W. Jefferson Blvd.
Culver City, Calif. 90230

An equal-opportunity employer
— M & F
U.S. citizenship is required



Technical Abstracts

graphical input-output consoles will require sophisticated built-in hardware.

For many years the programmer's instructions were used for the simulation of computers by computers. But the software-programed systems were so slow as to be almost useless for general computation, and were limited to special applications such as checkout. Hardware microprograms, however, easily simulate the programmer's instruction set on a computer. The instruction set is represented by a set of elementary hardware operations.

Presented at the Fall Joint Computer Conference, San Francisco, Dec. 9-11, 1968.

Power play

A highly reliable multichannel microwave amplifier
H.P. Gregor, Syracuse University Research Corp., and
A.T. Adams, Syracuse University, Syracuse, N.Y.

To develop high power at microwave frequencies, transistors are designed with a narrow base region that forms a junction with a distributed, interdigitated emitter. Unfortunately, however, this design leads to increased internal negative feedback, which limits the device's power gain.

It's possible to increase both power and gain from an amplifier by operating several channels in parallel and using two matrixes of 3-decibel stripline hybrids to split up and recombine the power.

Four- and eight-channel devices, with bandwidths of 7% and 15% at L band, respectively, were built and tested. Some of the results were as follows. Peak power was increased by a factor of N, the number of channels. The voltage standing-wave ratio was reduced significantly to a level approximating that of the stripline hybrids. The amplifying devices were found to be reliable; when an individual amplifier was deactivated, gain was reduced by a multiplier of only $(1-1/N)$, and vswr increased only slightly.

The design can be based on av-

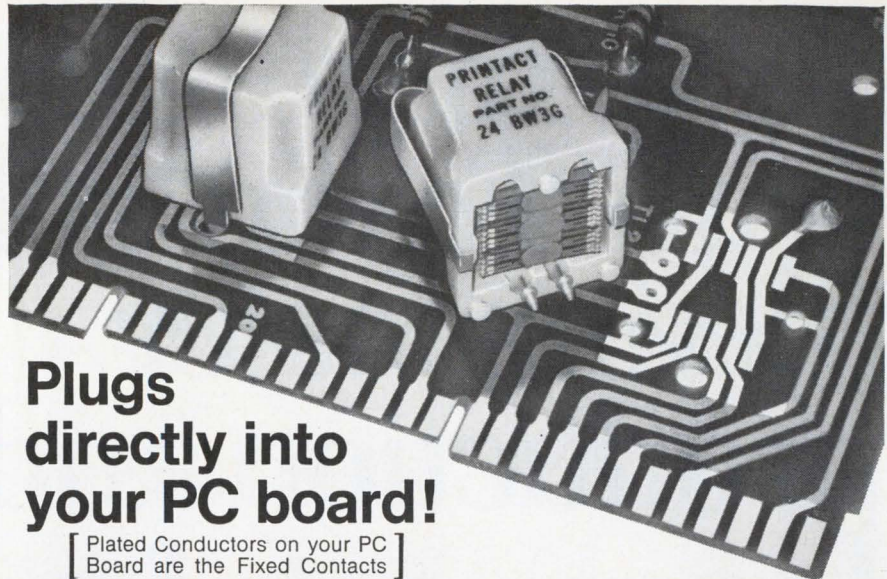

Plugs directly into your PC board!

[Plated Conductors on your PC Board are the Fixed Contacts]

Printact® Latching and Non-Latching MAGNETIC RELAYS

Designed for reliability and switching versatility, the Printact is a unique relay. The coil and ceramic magnet are encapsulated in a $\frac{7}{8}$ " cube for environmental protection. The magnet returns the balanced armature and applies contact pressure. In-line, series-break swingers afford constant impedance, low thermal EMF, and 100,000,000 cycle mechanical life.

Bifurcated contacts, gold alloy or palladium, provide low contact resistance and bounce for switching low level or up to 2 amp. PC board layouts provide up to 4 Form C or 8 pole single throw (4 Form A and 4 Form B) switching. Coils for 6, 12, 24 and 48 VDC are rated 0.5 watt.

For data write or call 212-EX 2-4800.

Printact Relay Division, Executone, Inc., Box 1430, Long Island City, N.Y. 11101

Circle 233 on reader service card

NOW...an easier way to make extra points!

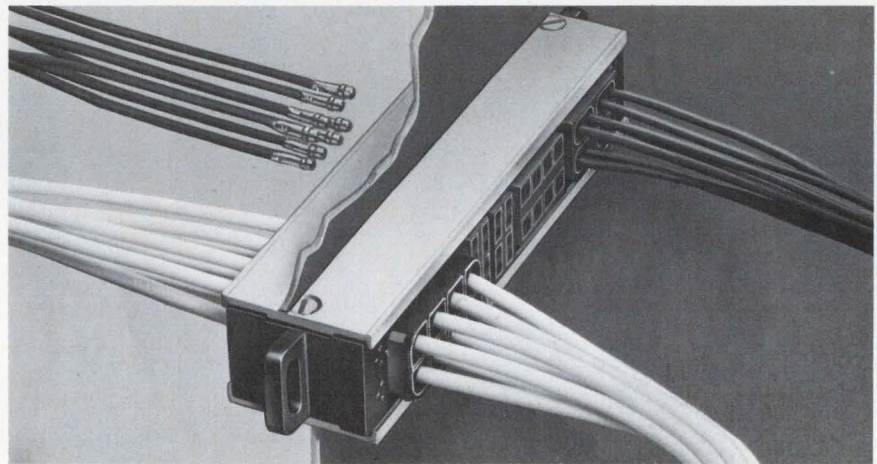

Deutsch Bulkhead Feedthru Junctions are small in size, but large in capacity. They combine the best features of busing and feedthru systems into a single modular design. Use them for busing configurations from either side of a bulkhead. Interconnect single wires or groups of wires on either side. Make changes or add-ons, checkout...in a matter of seconds. Their compact, modular design accommodates wire sizes from 12 to 26 AWG. Use **one** simple insert-removal tool. Follow **one** simple system. Sound interesting? You've heard only part of the story. Ask your Deutschman to tell you the rest. Another component of ITS... the Deutsch Integrated Termination System.



DEUTSCH ELECTRONIC COMPONENTS DIVISION

Municipal Airport • Banning, California 92220 • Telephone: Area Code 714 • 849-6701

COPYRIGHT, 1969 DEUTSCH ELECTRONIC COMPONENTS DIVISION

No drying cycle with "Freon"[®] solvents means faster production and lower costs for us.

—John Nolan, Atlas Chemical Industries

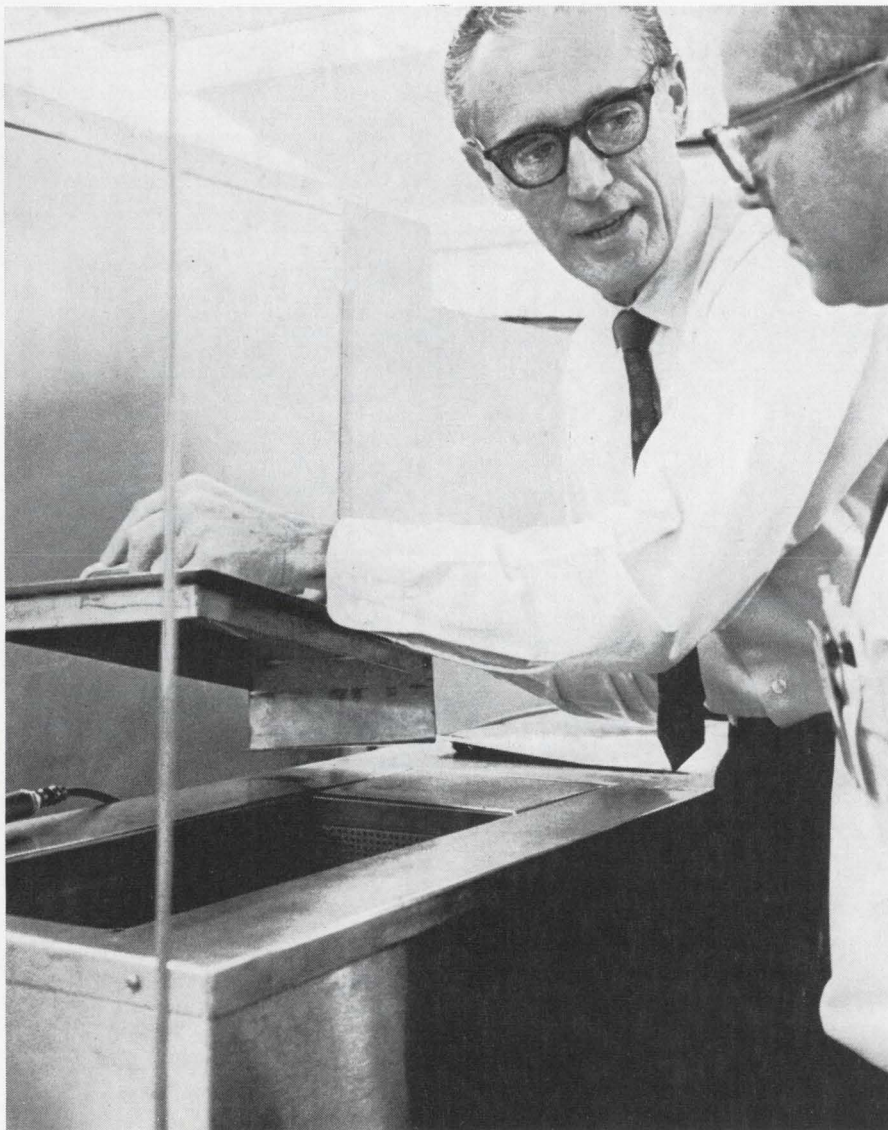

John Nolan, senior process engineer, and Stanley Brill (nearest camera), production foreman, inspecting cleaning machine.

The Aerospace Components Division of Atlas Chemical Industries manufactures parts for ultraminiature actuators. Critical tolerances in the tiny component parts make cleanliness an absolute necessity.

FREON[®] TE solvents allow them to clean these parts with greater efficiency. A direct result of this increased efficiency has been a parallel increase in production. Mr. Nolan explains:

"With FREON solvents, we don't have to go through a long drying cycle—they dry immediately upon exposure to the air. As soon as a part has been cleaned, it can go right to the next step of assembly. This has helped our production schedules."

FREON TE also eliminated the need for different types of solvents because they found that it would effectively perform just about any cleaning job, and on any type of metal. Thus they could standardize their cleaning process with the only variable being the length of time each type of metal remains in the cleaner.

Mr. Nolan added, "The lower boiling point of FREON prevents overheating of delicate parts."

The low-toxicity and nonflammability features of FREON are also decided pluses in the operation of their cleaning processes.

In summing up, Mr. Nolan said, "Our experience has been very good. We are getting a good product from Du Pont and very good technical service. We have had no cleaning problems since we started using FREON TE."

Find out how FREON solvents can help you. Write today: Du Pont Company, Room 7292, Wilmington, Del. 19898. (In Europe, write Du Pont de Nemours Int. S.A., FREON Products Division, 81, Route de l'Aire, CH-1211, Geneva 24, Switzerland.)

*Reg. U.S. Pat. Off. for Du Pont's fluorocarbon solvents.

DU PONT **FREON**[®]
REG. U.S. PAT. OFF. Solvents

Technical Abstracts

erage transistor characteristics, because the device is insensitive to individual departures from the average. The principal disadvantage of the system is its complexity.

Stability is not a serious problem because of the high isolation between amplifier channels; one channel has little or no effect on the other. This is particularly true when cross coupling between adjacent channels is less than $1/G_A$, where G_A is the individual amplifier voltage gain.

There are several ways to improve the design. Greater bandwidth could be had by using a broadband matrix and by staggering the individual amplifiers. The size of the unit could also be reduced significantly by relying on high dielectric materials in the fabrication and using electrical shortening techniques in the design.

Presented at NEC, Chicago, Dec. 9-11.

Good listening

High-performance solid-state vhf tuner
G. Wolf
N.V. Philips' Gloeilampenfabrieken
Nijmegen, Netherlands

The big drawback of most solid state vhf tuners is that they have severe cross-modulation problems that impair performance even if the gain is adequate and the noise low. However, the problem can be solved with the right design technique, r-f amplifier, and mixer transistors.

The r-f stage is the most critical. It must yield low-noise performance, be capable of high gain, have a low voltage standing-wave ratio over the entire gain range, and have good signal-handling capability. The gain can be kept high and the noise low if the r-f transistor is connected in the common-emitter mode, but this seriously impairs signal-handling capability because the transistor's input impedance is high in this particular mode.

The solution lies in connecting the transistor in the common-base mode. This reduces the input impedance, improving signal-handling.

Old English Coffee Mug

FREE! FREE! FREE!

Evaluate our Dial-A-Source Voltage Source and we'll send you an expensive Old English Coffee Mug with our compliments.

We want you to evaluate the compact Dial-A-Source for a simple and obvious reason: after you evaluate one we're pretty sure Dial-A-Source will become your standard reference source and you'll buy one . . . and another . . . and another . . .

What will you be evaluating? Specs, please:

Accuracy: $\pm(0.0025\% + 5 \mu\text{V})$

Range: 0 to ± 10 VDC

Resolution: $0.1 \mu\text{V}$ (7-decade model)

Stability: Typically ± 1 PPM/day

T.C.: 1 PPM/ $^{\circ}\text{C}$

Remote sensing; 1000 megs isolation; zero output impedance (50×10^{-6} ohms max); three models; delivery from stock; from \$875 f.o.b. Mt. Vernon, N.Y., domestic.

To get started before the coffee gets cold, write, phone or circle the number on the reply card; we'll take it from there.

*General Resistance, Division of Chronetics,
500 Nuber Avenue, Mt. Vernon, N.Y. (212)
292-1500. In Europe: 39 Rue Rothschild,
Geneva, Switzerland (022) 31 81 80.*

DIAL-A-SOURCE



Circle 234 on reader service card

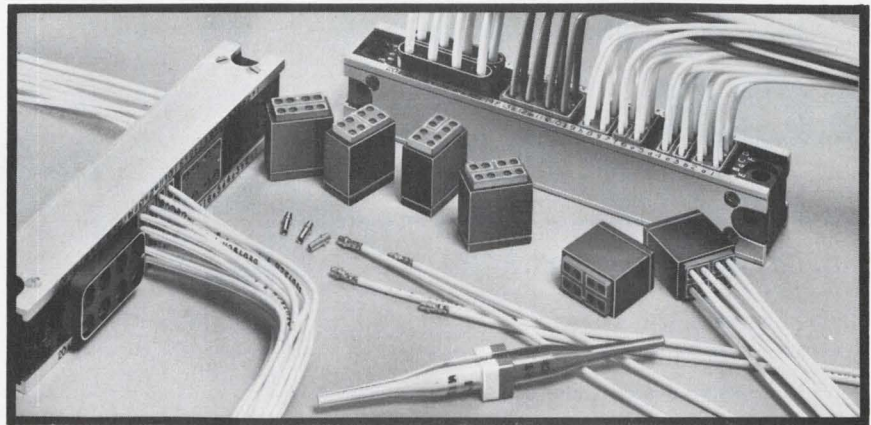

KING OF THE COMMONERS! A termination device that requires only one common assembly procedure and one common tool and that's compatible with a common integrated system makes a lot of sense. In this regard, the Deutsch Terminal Junction is the king! It's your best means of commoning, busing together, or joining two or more circuits. And look at the cost saving . . . almost two-thirds less. And look at the efficiency and versatility. No splicing, soldering, wrapping or lugging. If you want to add on, you just **do** it. Extra plugs-ins are ready and waiting. You can turn Deutsch Terminal Junctions upside down, sidewise, or what have you. Hail to the King! Still another component of ITS . . . the Deutsch Integrated Termination System.



DEUTSCH

ELECTRONIC COMPONENTS DIVISION

Municipal Airport • Banning, California 92220 • Telephone: Area Code 714 • 849-6701

COPYRIGHT, 1969 DEUTSCH ELECTRONIC COMPONENTS DIVISION

5 days

can do a lot for your next 5 years.

If you're involved in systems and equipment design, research, production or management . . . five days at one of our Seminars may make your next five years—and many more after that—much more productive.

More and more key management and high-level technical personnel from top companies all over the United States are attending RCA Institutes Seminars. Just as they are doing, you'll acquire information and techniques of immediate value in your work. You will also gain the kind of knowledge that can help build your professional standing in the years just ahead.

We believe we can increase your productivity by providing you with a firm grasp of many of the latest engineering techniques. Our experienced staff maintains constant contact with "what's happening" in industry. The texts and audio-visual materials are prepared exclusively by us for each seminar.

You can attend RCA Institutes Seminars around the country the year-round. Check your subject and send along the coupon for your brochure. Now—while you're thinking about it.

RCA

RCA Institutes, Inc. Dept. E-29

Institute for Professional Development
132 West 31st Street
New York, New York 10001

For FREE descriptive brochure, check the Seminar in which you are interested:

- | | |
|--|---|
| <input type="checkbox"/> Logic Design | <input type="checkbox"/> Management Information Systems |
| <input type="checkbox"/> Digital Systems Engineering | <input type="checkbox"/> Digital Communications |
| <input type="checkbox"/> Modern Optics | <input type="checkbox"/> Digital Electronics |
| <input type="checkbox"/> Integrated Circuits | <input type="checkbox"/> Numerical Control Systems |
| <input type="checkbox"/> Reliability of Integrated Systems | |

Name _____

Title _____

Company _____

Address _____

City _____ State _____ Zip _____



4th International Exhibition of Industrial Electronics

Basel
4-8 March 1969

440 exhibitors showing
Industrial Electronics of
700 manufacturers from
17 countries

Display of production-line
manufacture of electronic
components

Opening hours 9 a.m. – 6 p.m.

Information and catalogues:
Secretary INEL
CH-4000 Basel/Switzerland
Telephone 061.32.38.50
Telex 62.685 fairs ch

Technical Abstracts

dling capability, noise figure, and vswr. A 33-ohm resistor is placed in series with the transistor's emitter circuit and the antenna transformer secondary to noise-match the transistor while power-matching the 300-ohm antenna. The circuit losses are used to get a high input selectivity through parallel-tuned circuits. However, cross-modulation performance can be improved only at the expense of a 5-decibel decrease in gain.

In designing the mixer stage, one should select a transistor with a low base resistance to achieve a high conversion transadmittance (f_T) with low mixer noise. This combination is sometimes hard to obtain because a higher f_T means a relatively higher base resistance.

Maximizing conversion gain requires a low impedance at the input of the mixer transistor to provide a bypass for the harmonic currents in the mixer's emitter-base junction. The impedance can be kept low by putting a small capacitor—typically 10 picofarads—across the transistor's input circuit. For turret type tuners, this capacitance, in distributed form, is achieved by the proper tapings. For varactor-diode tuners, however, actual capacitors must be used.

This method of improving tuner performance cannot be directly applied to varactor-diode tuners, because the losses of the diodes may affect the gain and noise-figure performance. The fact that the diode is voltage-dependent could also represent an additional source of cross-modulation. In general, the performance of the r-f circuit of diode tuners is about the same as that of turret tuners, except for diode losses. These decrease the quality factors to the extent that at the high-frequency end of the band, the gain drops by about 1 to 2 db.

The mixer stage remains essentially unchanged in varactor tuners. However, a varactor type local oscillator requires a special provision for the tuning voltage, which must remain stable for good frequency stability.

Presented at NEC, Chicago, Dec. 9-11, 1968.

New Cord Set Kit

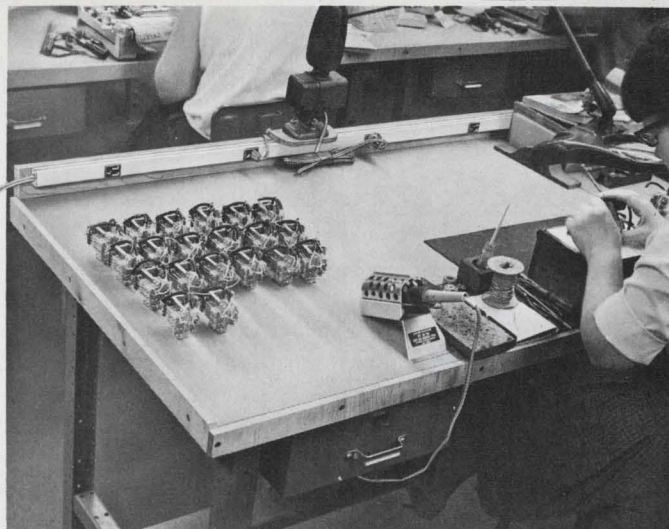

Relocation of production benches made easier!

With the new 20CSK Cord Set Kit from Wiremold, a bench-mounted run of multioutlet Plugmold® 2000 can be converted into a portable power strip, ready to move with the bench when production requirements change. Send for literature on this and the entire line of compatible Wiremold surface wiring systems designed to meet every power distribution need from panel box to outlet.



THE WIREMOLD COMPANY / HARTFORD, CONNECTICUT 06110

Circle 237 on reader service card

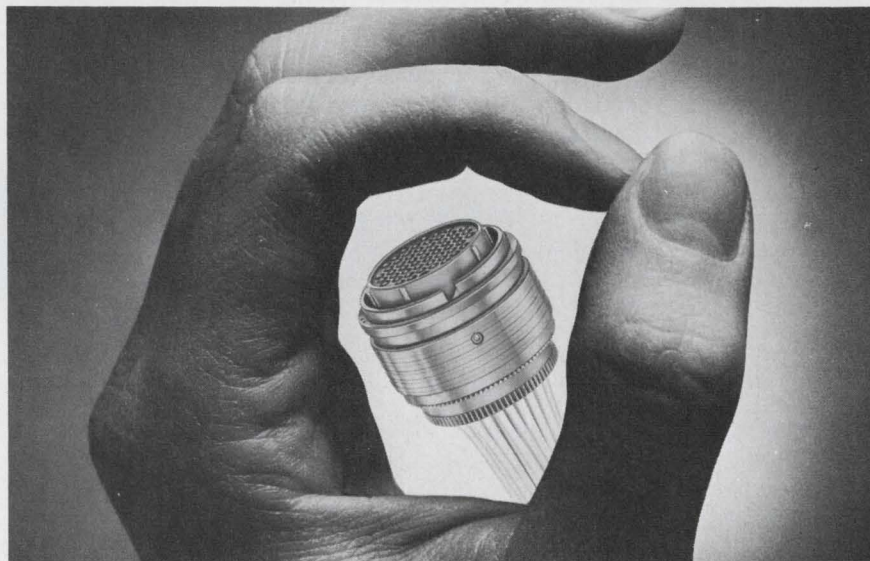

READY TO MEET YOU HALFWAY! The Deutsch 469 Push-Pull Plug is a friendly accommodating type that is ready and willing to mate with all MIL-C-26482 bayonet-type receptacles. Available in a wide range of insert arrangements and shell sizes, the 469's push-pull capability grooms it for quick disconnect in tight spots. Besides all its many other talents, it boasts rear contact insertion and removal. An agreeable fellow? You bet! Just like all the other components of ITS... the Deutsch Integrated Termination System.



DEUTSCH ELECTRONIC COMPONENTS DIVISION

Municipal Airport • Banning, California 92220 • Telephone: Area Code 714 • 849-6701

COPYRIGHT, 1969 DEUTSCH ELECTRONIC COMPONENTS DIVISION

New, press-in indicator light

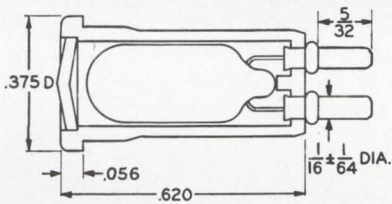
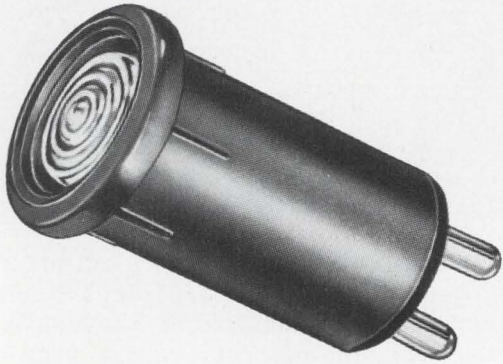

RIB-LOC™ miniature light mounts securely in .312" round hole when simply pressed into place

This new, low-cost indicating light provides the ultimate in ease of installation. It simply presses into place in a .312" diameter round hole. Mounting pressure required is minimum, yet ribs bite into sharp edges of hole to provide positive retention.

Long-life incandescent T 1 3/4 bulb rated 750 to 20,000 hours or more, depending on bulb and applied voltage. Available for operating voltages of 4-6, 10-14, and 22-28 volts. Durable polycarbonate lens in clear, red, green, amber, blue or nontransparent opal. Housing is of tough molded polyamide, color black.

Terminals are 1/16" dia. intended for solder connection or to accept mating receptacles such as AMP #61064-1 or similar types. Insulated sleeving is recommended for receptacle ends.

NEW, FREE CATALOG gives detailed specs and prices on these and other high quality E. F. Johnson electronic components. See your Johnson representative or write for your copy today.



E. F. JOHNSON COMPANY

3056 Tenth Ave. S. W., Waseca, Minnesota 56093

Providing nearly a half-century of communications leadership

Now
For The
First Time

You can completely design, layout, construct and test your most intricate new circuitry with the dynamic

elite 1

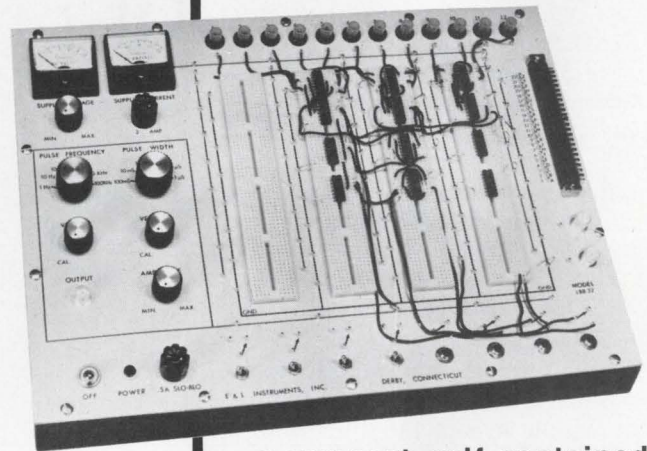

... a compact, self-contained, general-purpose Electronic Testing Laboratory for \$650.00



EL Instruments Incorporated

61 First Street, Derby, Connecticut 06418 Telephone 203-735-8774

Circle 238 on reader service card

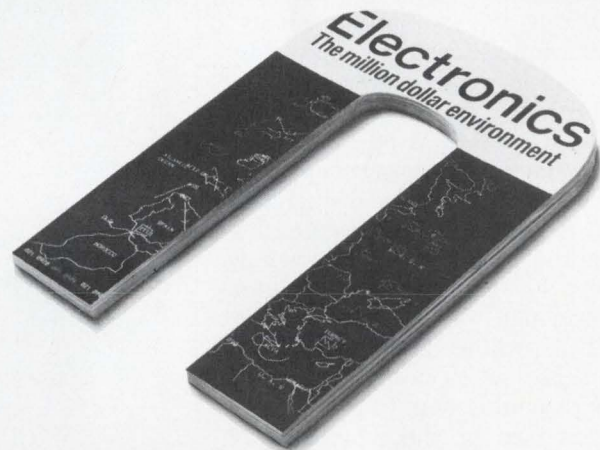

Every year, ELECTRONICS attracts requests for over 125,000 editorial reprints.

They're like interest payments on our million-dollars-a-year editorial principles.

That's how much we spend annually to produce timely, authentic, and useful articles like those listed on the reader service card as reprints currently available.

Investment and interest make both ELECTRONICS and its readers more meaningful to its advertisers.

The Material
of Unlimited Uses...



SOLDERING "UNSOLDERABLES"

...is but one of the thousands of uses for advanced low-melting-temperature alloys such as Cerroalloy® 35. Cerroalloy 35 melts between 238° and 260° F., and can be used with ordinary soldering techniques. When soldered with this versatile alloy, "toughies" such as glass-to-metal, ceramic-to-metal and metal-to-metal seals stay tight even in a deep vacuum. Other Cerro® Alloys, including specials made to your individual specs, are perfect for joining ultra-delicate parts like integrated circuits which cannot be heat-sunk during soldering. Low-temperature soldering as cool as 117° F. can also be accomplished with certain Cerro Alloys.

For detailed information contact Cerro Alloy Dept., Cerro Copper & Brass Company, Stamford, Conn. 06907...R. S. Darnell (203) 327-0550.

In Europe, contact Mining & Chemical Products Ltd., Alperton, Wembley, Middlesex, England.

CERRO®

Circle 239 on reader service card

New Literature

Laser cathodes. Philips Metalonics, 888 S. Columbus Ave., Mt. Vernon, N.Y. 10550, has published two technical bulletins on the PM-5 and PM-20 directly heated impregnated cathodes for use in gas lasers. Circle 446 on reader service card.

Remote data terminal. Wyle Laboratories, 128 Maryland St., El Segundo, Calif. 90245, has available a six-page brochure describing the features and capabilities of the Computerminal, a remote data terminal. [447]

High-vacuum gaging. Veeco Instruments Inc., Terminal Dr., Plainview, N.Y. 11803, has issued a 24-page brochure on two dozen high-vacuum gaging products. [448]

Gamma ray detectors. Nuclear Diodes Inc., P.O. Box 135, Prairie View, Ill. 60069. A 16-page manual is offered as a guide to the selection and use of lithium drifted germanium gamma ray detectors. [449]

Power control units. Magnetics Inc., Sandy Lake, Pa. 16145. A 10-page illustrated folder describes power control units featuring phase angle control or synchronous firing control that can be used as building block components. [450]

Ferrite permanent magnets. Arnold Engineering Co., P.O. Box G, Marengo, Ill. 60152. An 18-page catalog describes the company's complete line of Arnox ferrite permanent magnets. [451]

Modular cabinetry. Honeywell's Apparatus Controls Division, 2727 Fourth Ave. S., Minneapolis 55408, offers an illustrated 28-page catalog covering the series 40 Modu-Mount modular cabinetry. [452]

Programmer. Eagle Signal Division of E.W. Bliss Co., 217 Second St. N.W., Canton, Ohio 44702. Eight-page, two color bulletin 910 covers the MT sequence programmer. [453]

Electronic weighing cell. Automatic Timing & Controls Inc., King of Prussia, Pa. 19406. Four-page bulletin 6005C describes the company's recently introduced environment-protected electronic weighing cell. [454]

Serial memories. Andersen Laboratories, 1280 Blue Hills Ave., Bloomfield, Conn. 06002, has available a booklet entitled "Serial Stores Using Delay Lines" that presents the theory of operation, plus the capabilities and limitations, of glass, quartz, and wiresonic type digital stores for specific applications. [455]

Integrated laser system. Hadron Inc., 300 Shames Dr., Westbury, N.Y. 11590,

your best move

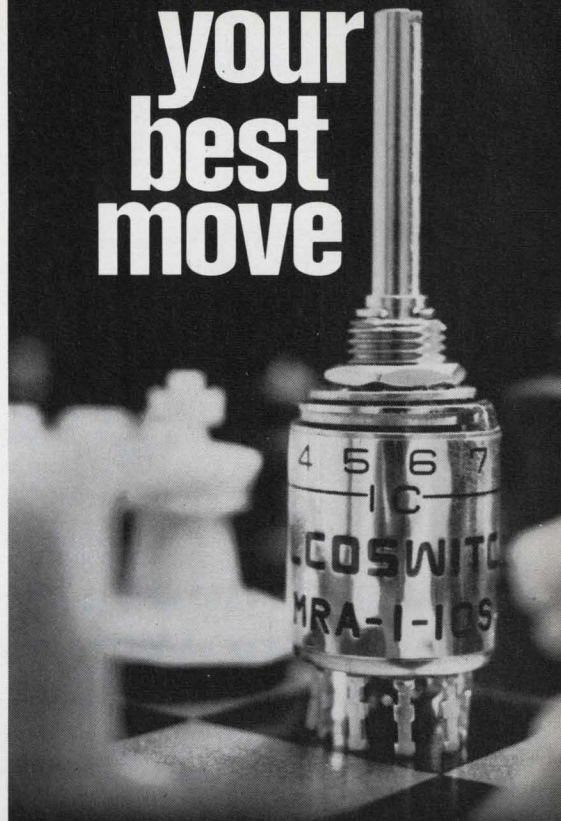

The world's first ultra-miniature 1/2" rotary switch with the invaluable feature of an adjustable stop. The MRA Series is available as 1, 2, 3, or 4 poles on a single deck with a maximum of 10 or 12 positions. You can choose the universal 1/8" diameter shaft, or a switch with its own specially mated knob. Ideal for installations where size and space limitations are a factor. Conservatively rated at 500 mA @ 125 VAC.

The MSRE waterproof rotary switch series is similar to the MRA Series, but built to meet the highest reliability standards required under any environmental condition.



LOCKING TOGGLE
World's first totally miniature toggle switches capable of being locked to safeguard against accidents. Full line available in 1-2-3-4 poles. 6 amps @ 125 VAC.

SLIDE SWITCH

The world's best mini-slide switch with a compact 1/2" case and new anti-tease design. Available in one and two pole, double throw models; 2 amps @ 120 VAC.



ALCO

ELECTRONIC PRODUCTS, INC.

Lawrence, Massachusetts 01843

Circle 205 on reader service card

Going to IC's? Or Higher IF's?

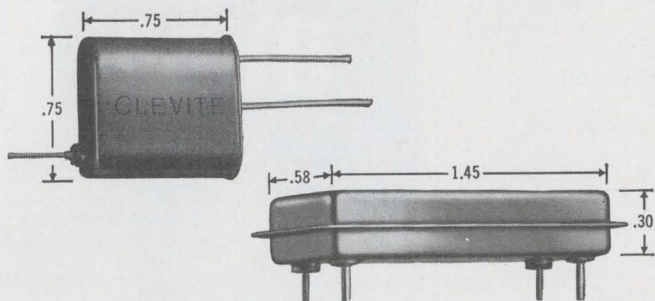

Go two ways with Monolithic Clevite Uni-Wafer Filters

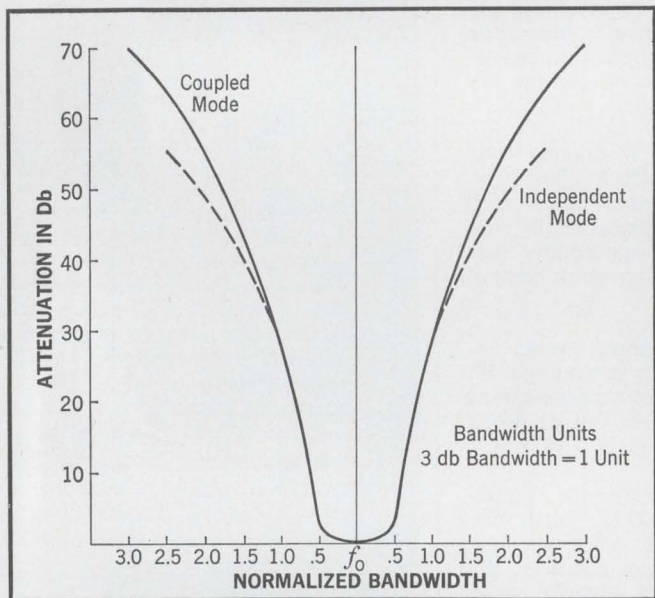

Go independent mode. Go coupled mode. You can go either mode with monolithic Clevite Uni-Wafer filters. They're smaller and more reliable (fewer interconnections) than conventional filters.

Clevite Uni-Wafer filters are ideal for matching IC circuitry in communications receivers operating in the VHF and UHF frequency ranges as well as in telemetry, radar and aerospace systems.

They are four-pole crystal filters with a choice of center frequencies ranging from 8 MHz to 75 MHz. They've been developed using Clevite's advanced engineering techniques and Clevite's original thin film approach to quartz filters. In this concept, arrays of resonators are achieved on a single quartz wafer with resonator isolation and spurious suppression controlled by the trapped energy principle.

So if you're going to IC's or higher IF's, go Clevite Uni-Wafer filters. They're available in both independent and coupled mode.

For more information and complete specification data, write: Clevite Corporation, Piezoelectric Division, 232 Forbes Road, Bedford, Ohio 44146.

CLEVITE



Get technical literature on new solid state, portable dual-beam oscilloscope. Choice of two plug-in Y-amplifiers. Features differential input, internal voltage calibration, and both signal and time delay.

Write to Motorola Communications & Electronics Inc., 4501 W. Augusta Blvd., Chicago, Ill. 60651.



MOTOROLA
Precision Instrument Products

Circle 240 on reader service card

FREE!

TA'S Instrument Case Engineering Manual

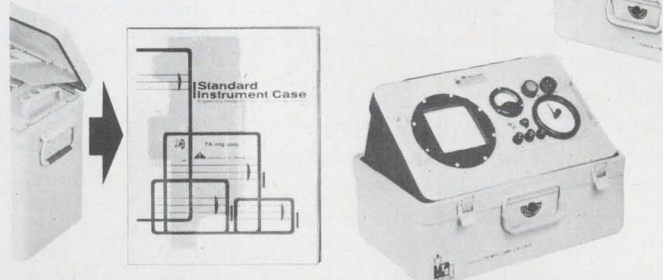

Makes you a packaging expert!

This one-of-a-kind booklet contains everything you need know to select the proper case for **your particular** packaging requirements. ■ Save money for your firm by selecting one of TA's standard cases rather than going to the expense of designing a custom case to package your product. ■ Huge warehouse stock for fast delivery at low prices... no tooling charges. All TA cases are designed to surpass Mil-Spec requirements... completely dust and waterproof. Free vellum service and panel templates. ■ Write or phone for a quotation and let us put our staff of case engineers to work for you today. Send for your free case manual now.

TA MFG CORP  A DAYCO COMPANY

4607 Alger Street, Los Angeles, California 90039 ■ Phone 213-245-3748/
TWX 910-497-2065 L. A./WUX CAT L. A., Calif.

DC In-Circuit Analyzer

For the first time — with **GUARDOHM®** — you can measure exact values of individual components *in-circuit* or out! **GUARDOHM** effectively isolates in-circuit electronic components from the effects of parallel circuitry. Checks IC's, too.

Fewer trouble-shooting frustrations. No more time delays, burnt fingers, ruined PC's nor broken components from unsolderings. Know exactly which components to replace. Prevent damage by checking semi-conductors to specifications with known currents.

GUARDOHM's solid-state design provides a rugged and reliable instrument. "Guarding" rules packed with each instrument — easy to learn and apply.

Portable — weighs only 7 pounds.

Use **GUARDOHM** on your manufacturing line, in your engineering development lab or for field service. **GUARDOHM** — with + and - leads and 2 "guard" leads — provides a selectable 13-range resistance measurement, 7-range current measurement, 9-range DC voltage measurement and generates its own DC current in 13 selectable amperages. Accuracy: $\pm 1\%$ of full scale. Cost: \$335, F.O.B. Schenectady.

For more information, write or phone . . .



Systomation Inc.

140 ERIE BLVD./SCHENECTADY, N. Y. 12305
TEL. 518/393-3638

Manufacturers of F-I-X-I-T, **GUARDOHM®**. Consultants in and manufacturers of electronic, mechanical and optical engineering products and systems. Name it; we'll automate it.



Circle 242 on reader service card

New Literature

has issued a data sheet on its LPM (Laser Precision Microfabrication) series of application-oriented lasers. [456]

TTL cards. Wyle Laboratories, Systems Division, 128 Maryland St., El Segundo, Calif. 90245. A 64-page catalog contains technical information on a line of 34 TTL cards, including schematics, manufacturer's IC specifications, and specifications of associated hardware and power supplies. [457]

Timing system. Flow Corp., 127 Coolidge Hill Rd., Watertown, Mass. 02172, has released an illustrated application bulletin entitled, "Cumulative Error in a Timing System." [458]

Frequency meters. Solid State Electronics Corp., 15321 Rayen St., Sepulveda, Calif. 91343, offers a data sheet on the series 486E expanded scale Freqmeters. [459]

MOS/LSI IC's. Fairchild Semiconductor, 313 Fairchild Dr., Mountain View, Calif. 94040, announces a 44-page brochure on MOS/LSI circuits and other recent MOS IC products. [460]

P-c connections. Molex Products Co., 5224 Katrine Ave., Downers Grove, Ill. 60515. A 20-page catalog shows a variety of p-c board problem solvers—versatile components that speed production and assembly. [461]

Electrolytic capacitors. Sangamo Electric Co., P.O. Box 128, Pickens, S.C. 29671. Axial lead, aluminum electrolytic capacitors are described in bulletins 2237 and 2239A. [462]

Solid state counters. Anadex Instruments Inc., 7833 Haskell Ave., Van Nuys, Calif. 91406, has issued a six-page catalog on its complete line of solid state counters and frequency instruments. [463]

Control systems. Computer Control Division, Honeywell Inc., Framingham, Mass. 01701, offers two brochures describing the series 16 data acquisition and direct digital control computer systems. [464]

Hydrogen thyratrons. Tung-Sol Division of Wagner Electric Corp., 1 Summer Ave., Newark, N.J. 07104. Ultrastable hydrogen thyratrons are described in booklet T128. [465]

Pyrometer. Itronics Inc., 329 Center Ave., Mamaroneck, N.Y. 10543. A two-page data sheet covers the Pacemaker 1000 series of high-temperature infrared radiation pyrometers. [466]

Klystron transmitter. Ampex Corp., 401 Broadway, Redwood City, Calif. 94063. Bulletin V164 lists features and speci-

the twisters

The twist of the fingertips tells the user that he is handling quality.

A lot of effort has gone into making these aluminum knobs the best money can buy. **ALCOKNOBS** have been painstakingly machined and anodized to a high satin finish. A wide choice of stock knobs are now available to compliment your equipment design. All are available at a reasonable cost and competitive to plastics.

Send for the new **ALCOKNOB** catalog describing a wide variety of stock knobs and with particulars whereby **ALCO** can customize knobs to create your own individual image.



ALCO

ELECTRONIC PRODUCTS, INC.

Lawrence, Massachusetts 01843

Circle 207 on reader service card

Our New Frequency Extender Wears 2 Hats . . .



. . . It's Also A Signal Monitor!

Connect the new FE-26 Frequency Extender to any of W-J's 900 Series receivers (or to any other receiver of sufficient bandwidth) and triple the frequency range. The FE-26 not only tunes the 235 to 1000 MHz range and converts the signals to a 60 MHz output, but also provides a visual display of signals throughout the entire combined range of the receiver and the extender.

Other outstanding features of the FE-26 include: ability to place in or out of operation without changing inter-connecting cables, 3 antenna inputs and 1 output, switchable automatic or manual gain control,

variable sweep rate control, MOS FET first mixer, digital automatic frequency control capability (when used with an ancillary counter), and standard 19-inch rack size.

CEI DIVISION



WATKINS-JOHNSON

6006 Executive Blvd., Rockville, Md. 20852

World's largest selection of receiving equipment for surveillance, direction finding and countermeasures.

Circle 243 on reader service card

WANTED: ELECTRONICS MANUFACTURER

who desires to fill a
dependable supply of
government contracts

Excellent opportunity for growth-minded electronics manufacturer to locate in Texas and help meet the needs of the government and the third fastest-growing state. Stable, productive labor. Incomparable tax advantages. Lowest living costs. For 1968 Texas Fact Book, write or call the:

TEXAS INDUSTRIAL COMMISSION
Central Information Source for all of Texas
Box JJ-E, Capitol Station
Austin, Texas 78711
Telephone 512/475-4331

OVER 1,000,000 SIZES MILITARY CASES COMBINATION • TRANSIT • INSTRUMENT

MIL-T-945A, T-4734, T-21200, STD-108, C-4150



Choose from over 1,000,000 variations in dimensions, proportions, metals, finishes, and custom accessories. Whatever your need, the MM (multi-measure) method gives you high production savings even on custom runs as low as 25 units. Send your print or requirements. Manufacturers representatives in all major cities. SEND FOR FREE CATALOG & DIMENSION SPECIFICATION SHEETS.

MM ELECTRONIC ENCLOSURES, Inc.
111 Bloomingdale Rd., Hicksville, N.Y. 11801 • 516-935-9400

**TRANSIENTS
IN THE AC INPUT LINE
WON'T HURT YOUR PRODUCT
DESIGNS IF YOU SPECIFY
JOSLYN AC PROTECTORS**

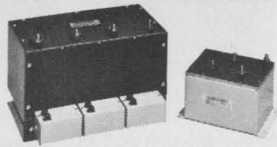

For ultra fast precision response clamping at extremely low levels any kva rating with line voltages up to 650 v rms max. life expectancy that exceeds that of your product no power interruption and no line insertion loss (exc. 1201-02).

Call or write now for full information on 1200 single-phase, 1400 three-phase 60-cycle Series Protectors. Just two of many surge arrester lines.

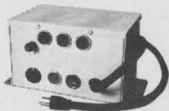

**JOSLYN
ELECTRONIC SYSTEMS**

Division of Joslyn Mfg. & Supply Co.
SANTA BARBARA RESEARCH PARK
P.O. BOX 817, GOLETA, CALIFORNIA 93017
Tel. (805) 968-3551.

Circle 245 on reader service card

THIS SPACE CONTRIBUTED BY THE PUBLISHER

**Cancer
is
sneaky.**

It doesn't announce itself loud and clear until it's often too late. Beat it at its own game. Yearly visits to your doctor are cancer's worst enemy. Help yourself with a checkup. And others with a check.

American Cancer Society

New Literature

fications of the TA-10BT klystron transmitter for uhf television stations. [467]

Phase angle voltmeter. North Atlantic Industries Inc., Terminal Dr., Plainview, N.Y. 11803, offers a data sheet describing the model 212 solid state phase angle voltmeter. [468]

Magnetic amplifiers. Airpax Electronics, P.O. Box 8488, Fort Lauderdale, Fla. 33310. Bulletin M-62 describes the PREAC high sensitivity d-c magnetic amplifiers with gains up to 10,000. [469]

Ceramic capacitors. Sprague Electric Co., 35 Marshall St., North Adams, Mass. 01247. Engineering bulletin 6201E, containing data on axial-lead, resin-coated Monolythic ceramic capacitors, is available upon letterhead request.

D-c regulators. Kepco Inc., 131-38 Sanford Ave., Flushing, N.Y. 11352, has prepared a monograph on the capabilities of modern d-c regulators for the control of voltage or current. [470]

Rotary switches. ASM Corp., 525 Truck Lane, Smithfield, N.C. 27577. A 20-page catalog describes a complete line of 1-inch-diameter enclosed rotary switches. [471]

IC test system. AAI Corp., P.O. Box 6767, Baltimore 21204, has available a 10-page brochure giving full details on the series 1000 IC test system. [472]

Telemetry modules. Solid State Electronics Corp., 15321 Rayen St., Sepulveda, Calif. 91343, offers a 52-page catalog describing a line of f-m/f-m telemetry modules. [473]

Pressure transducers. Genisco Technology Corp., 1533 26th St., Santa Monica, Calif. 90404. Pressure transducers capable of withstanding severe environments and providing the latest advances in pressure measurement technology are described in a general catalog. [474]

D-c power supply. Endeveco, subsidiary of Becton, Dickinson & Co., 801 S. Arroyo Parkway, Pasadena, Calif. 91109. A specification sheet gives detailed data on the model 4206 d-c power supply that functions as part of a portable signal conditioner system for piezoelectric transducers. [475]

P-c comparison chart. GTI Corp., P.O. Box 217, Leesburg, Ind. 46538, offers a chart comparing the technical specifications of etched and die-stamped circuitry. [476]

Instrumentation recorder. Ampex Corp., 401 Broadway, Redwood City, Calif. 94063. Bulletin D115 lists features and

**build
with
ALCOSWITCH**

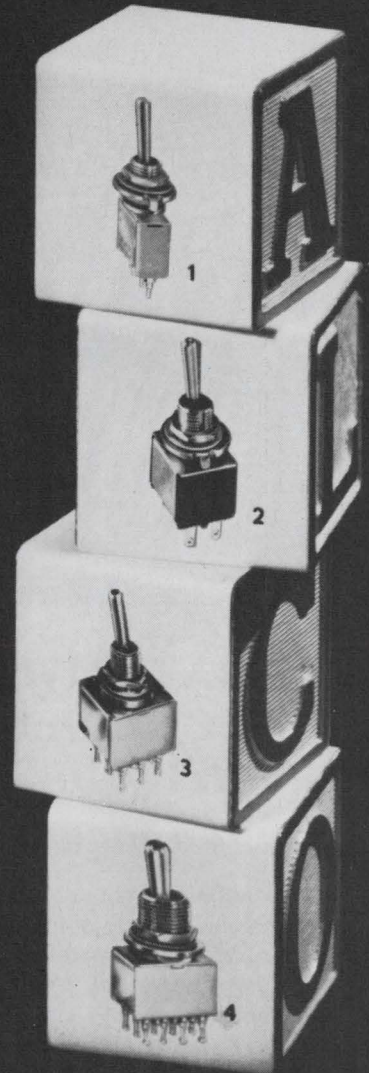

Build quality and reliability into your equipment with top performing ALCO-SWITCH® miniatures. Here are representative models from the many families of ALCOSWITCH® which you can select:

- #1 — SPDT "A" SERIES
- #2 — DPDT "MST" SERIES
- #3 — 3PDT "E" SERIES
- #4 — 4PDT "MUSTANG"

If you are looking to build a fine product you'll find the answer in the broad ALCOSWITCH® line.

There is a miniature switch to fit your particular budget and design.

ALCO

ELECTRONIC PRODUCTS, INC.

Lawrence, Massachusetts 01843

Circle 209 on reader service card

Custom
power . . .

**SPECIAL
Delivery**

ERA DELIVERS SPECIAL DESIGN POWER SUPPLIES *by the thousands*

In addition to hundreds of off-the-shelf power sources, ERA provides a complete custom design service. ERA's custom department, fully-staffed with top power-engineering experts can supply you with "instant" quotations, prompt prototype delivery, and quality production at competitive prices.

Our quotations and comments covering your requirements promptly supplied without obligation on your part.

Write ERA now for a quotation
on your special designs.



ELECTRONIC RESEARCH ASSOCIATES, INC.

67 Sand Park Road, Cedar Grove, N. J. 07009

SUBSIDIARIES:

ERA Acoustics Corp. • ERA Dynamics Corp.
Astrocom Inc. • The Magitran Company

New Literature

specifications of the FR-1900 multi-band instrumentation recorder. [477]

Brushless d-c motors. Brushless Motors Electronics Inc., 241 Lake Howell Rd., Casselberry, Fla. 32707. A four-page brochure explains the theory and operation of a line of brushless d-c motors. [478]

Junctions/connectors. Deutsch Co., Municipal Airport, Banning, Calif. 92220. Three catalogs visually itemizing the company's lines of terminal junctions, miniature and subminiature connectors, and hermetic connectors are now available to serve as quick-reference aids. [479]

Pressure switches. Fairchild Controls, 225 Park Ave., Hicksville, N.Y. 11802, offers a set of application notes for its PSF100A pressure switch and PSF/SRF100A pressure switch/solid state relay combination. [480]

Molding powders. Emerson & Cuming Inc., 869 Washington St., Canton, Mass. 02021. The Eccomold molding powder chart has been revised to include two new types of powders and to eliminate outdated types. [481]

Panel-mounted counters. ENM Co., 5306 W. Lawrence Ave., Chicago 60630, has released a four-page catalog describing a complete line of panel-mounted counters. [482]

Power supplies. Lambda Electronics Corp., 515 Broad Hollow Rd., Melville, N.Y. 11746, has available a 56-page catalog of power supplies, instruments and systems for laboratory, test equipment, and original equipment manufacturer applications. [483]

Connectors. Positronic Industries Inc., 1906 South Stewart, Springfield, Mo. 65804. A 29-page handbook features a broad line of removable contact connectors that conform to MIL-C-22857. [484]

High-pressure blower. Rotron Inc., Hasbrouck Lane, Woodstock, N.Y. 12498. A four-page technical bulletin describes the model G Centraxial blower, which is designed for cooling applications that require uniform air discharge, high pressure capability, and a right-angle flow. [485]

Switchboard instrumentation. Voltron Products Inc., 403 S. Raymond Ave., Pasadena, Calif. 91105, has available a 28-page catalog on switchboard instrumentation. [486]

Mercury film switches. Fifth Dimensions Inc., P.O. Box 483, Princeton, N.J. 08540. A description of the operation and applications of mercury film switches is contained in a five-page booklet. [487]

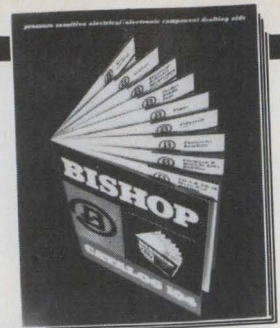

FREE CATALOG

68-page Manual of Time-Saving Problem-Solving Electrical / Electronic Drafting Aids

Featuring illustrated technical information on printed wiring artwork production techniques. Thousands of pressure-sensitive shapes, symbols and tapes for faster, more accurate master artwork.

T0-5 Patterns **T0-18 Patterns**
Flatpack Patterns **Integrated Circuit Patterns**
Pads **Connectors**
Fiducials **Tapes** **Tees**
Elbows **Letters and Numbers** and many, many more.

From Bishop, the specialist in electrical/electronic component drafting aids.



Write for free copy:

Bishop Industries Corp.

7300 Radford Avenue
North Hollywood, California 91605
Phone: (213) 982-2000

Circle 246 on reader service card

JOIN OUR PHOENIX PROFIT CLUB!

Most clubs take pride in their exclusiveness. But not ours. The only qualification for membership is a healthy profit-and-loss statement. And because we have a vigorous business climate, fast-growing markets, tax-free inventories, high worker productivity and low state income taxes, our membership is really zooming!

For our FREE 28-page brochure, "DYNAMIC PHOENIX," write Stanton Allen, Manager, Economic Development Dept., Room E-4, Chamber of Commerce, Phoenix, Arizona 85004

**dynamic
Phoenix**

PROFIT CENTER OF THE SOUTHWEST

FOR INFORMATION

about

classified advertising,
contact the McGraw-Hill
office nearest you

ATLANTA, 30309

1375 Peachtree St., N.E.
404-875-0523

BOSTON, 02116

607 Boylston St.
617-262-1160

CHICAGO, 60611

645 No. Michigan Avenue
312-664-5800

CLEVELAND, 44113

55 Public Square
216-781-7000

DALLAS, 75201

1800 Republic Nat'l, Bank
Tower
214-747-9721

DENVER, 80202

1700 Broadway, Tower Bldg
303-255-5483

DETROIT, 48226

856 Penobscot Building
313-962-1793

HOUSTON, 77002

2270 Humble Bldg.
713-224-8381

LOS ANGELES, 90017

1125 West Sixth Street
213-482-5450

NEW YORK, 10036

500 Fifth Avenue
212-971-3594

PHILADELPHIA, 19103

Six Penn Center Plaza
215-568-6161

PITTSBURGH, 15222

4 Gateway Center
412-391-1314

ST. LOUIS, 63105

7751 Carondelet Avenue
314-725-7285

SAN FRANCISCO, 94111

255 California Street
415-362-4600

CLASSIFIED ADVERTISING



SEARCHLIGHT SECTION

BUSINESS OPPORTUNITIES
USED OR SURPLUS EQUIPMENT

SURPLUS IBM EQUIPMENT

FREE catalog of powers supplies, light & switch panels, semiconductors, test equipment, IC's, optics, etc.

GADGETEERS SURPLUS ELECTRONICS, Inc.
5300 Vine St. Cincinnati, Ohio 45217

CIRCLE 970 ON READER SERVICE CARD

RADAR SYSTEMS GROUND AND AIRBORNE AUTOMATIC TRACKING ANTENNA SYSTEMS NIKE AJAX NIKE HERCULES M-33 MSO-1A MPS-19 MPS-9 SCR 584 TPS-1D TPS-28 FAA-ASR-2 AIRBORNE SYSTEMS APN-84 APN-102 APS-20 APS-27 APS-45 DPN-19 DIGITAL COMPUTERS IBM 650 IBM 704

LARGEST INVENTORY OF RADAR AND MICROWAVE EQUIPMENT IN THE WORLD.
RADIO RESEARCH INSTRUMENT CO.
45 WEST 45TH ST. N. Y. 10036 212-JU 6-4691

CIRCLE 971 ON READER SERVICE CARD

BUSINESS OPPORTUNITY

Capital Contacts—Before you try Public or Private Placements to Underwriters, Investment Banking Houses, write for free helpful information to Confidential Consultant, 817 51st St., Brooklyn, N.Y.

RATES

EMPLOYMENT OPPORTUNITIES—

\$79.00 per inch, subject to agency commission.

SEARCHLIGHT SECTION—\$39.75

per inch for equipment (Used or Resale), business opportunity, etc. advertising appearing on other than a contract basis. Contract rates on request.

UNDISPLAYED (Not available for

Equipment Advertising)—\$3.60 per line, minimum 3 lines. To figure advance payment count 5 average words to a line and 1 line for a publication box number.

Position Wanted — undisplayed rate is one-half of above rate, payable in advance.

Send New Ads or Inquiries to:

Classified Adv. Dept.

ELECTRONICS

P.O. Box 12, New York, N. Y. 10036



EMPLOYMENT OPPORTUNITIES

VIDEO ENGINEERS Color Camera and Recorder Design

International Video Corporation is currently seeking experienced circuit and servo-mechanism design engineers for its expanding line of color video equipment. IVC, located 35 miles south of San Francisco, offers an outstanding opportunity to associate with a company which recognizes and rewards outstanding individual efforts.

Qualified applicants should have a solid background in designing servo-mechanisms for electro-mechanical equipment, circuitry and packaging as related to video tape recorders and cameras.

For prompt and confidential consideration, please write, outlining your qualifications, to:

D. L. Horn
Technical Staffing



INTERNATIONAL VIDEO
CORPORATION

675 Almanor Avenue

Sunnyvale, California 94086

(415) 738-3900

An equal opportunity employer

CIRCLE 972 ON READER SERVICE CARD

ADDRESS BOX NO. REPLIES TO: Box No.
Classified Adv. Dept. of this publication.
Send to office nearest you.
NEW YORK, N. Y. 10036: P. O. Box 12
CHICAGO, IL. 60611: 645 N. Michigan Ave.
SAN FRANCISCO, Cal. 94111: 255 California St.

EMPLOYMENT SERVICES

Electronic Engineers, \$9-\$25,000. Nationwide positions available through 85 affiliate offices. Application, production, design, project & RD in circuitry, optics, instrumentation, digital circuitry, measurement systems, industrial controls, communications, solid state devices, & computers. Fees company paid. Send resume with present and desired salary with location flexibility to Leonard Personnel, 310 Empire Building, Pittsburgh, Pa. 15222.

Don't forget

THE BOX NUMBER

when answering the classified advertisements in this magazine. It's our only means of identifying the advertisement you are answering.

When Bill Attridge was a boy, training production people was no big deal.



There was no electronics elite when Bill Attridge was growing up in Boston. Designers of industrial tools were simple, practical men. Their brilliance was established on the production line, not in the laboratory.

Bill Attridge's dad was a toolmaker. A perfectionist. Bill is more of the same. At Teradyne he designs extraordinarily complex instruments to test electronic components. But he designs them to be used by mortal men and women.

To reduce costly training time and lessen human errors in production, Teradyne removes the mysteries from instrument operation. Simplicity is the keynote.

Programming controls are thoughtfully arranged. Panel markings are self-explanatory. Simple line drawings of the front panels describe accurately and completely each instrument's function. Anyone familiar with the nomenclature of component testing can use Teradyne equipment with only minimum instruction. Even the computer-operated systems built by Teradyne to test complex IC's are relatively simple to use.

Bill Attridge and his associates are succeeding in lowering the high cost of errors in testing; first, by building machines to spot rejects automatically and reliably, and second, by making these machines easy to use without long, costly training.

Outsiders may still think you're in a glamorous, blue sky business. But you know better, don't you. It's the same old story. You get good people and you give them good tools.

By making automatic test equipment easier to use, Teradyne makes your good people better. And you save a barrel of training time and money in the bargain. It's that simple at Teradyne, 183 Essex Street, Boston, Massachusetts 02111.

Teradyne makes sense.

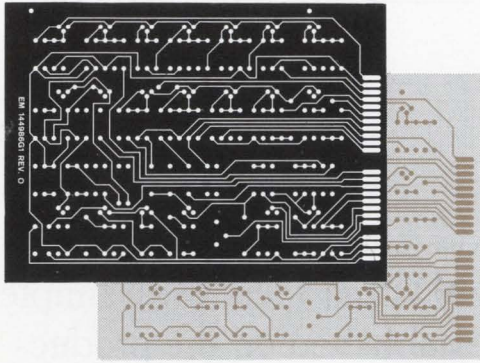

SLO-SYN® N/C POSITIONING SYSTEMS
. A VERSATILE GROUP OF
NUMERICALLY CONTROLLED MACHIN-
ERY THAT CAN BE USED INDIVIDU-
ALLY OR AS COMPLETE PRODUCTION
SYSTEMS FOR PC BOARD OR OTHER
MANUFACTURING NEEDS. CAN BE
OPERATED MANUALLY, BY PUNCHED
TAPE OR WITH DATA PROCESSING
SUPPORT FOR:

- ARTWORK GENERATION
- HIGH SPEED HOLE DRILLING
- INSERTION OPERATIONS
- WIRE TERMINATION

80% Faster

Printed circuit board sketch to etch in 8 hours or less! Pro-
vides a new consistent standard of speed and quality control.

New Technique

Easily programmed, error-free tape prepared directly from engineering
sketch gives precise 1:1 generation of film masters.

More Accurate

Table accuracy to $\pm .001''$; repeatability to $\pm .0005''$. Position-
ing resolution $.001''$; optional resolution of $.0005''$ available.

Economical

Eliminates time-consuming drafting, drastically reduces lead-time, pro-
duction time and possible error. Faster pay-off . . . increased profits.

Versatile

Also used to prepare integrated circuit masters, schematics, inspection
shadowgraphs, step and repeat printing. Additional capabilities tailored
to specific needs. Call, write or wire for literature or demonstration.



THE
SUPERIOR ELECTRIC
COMPANY

410 MIDDLE STREET
BRISTOL, CONNECTICUT, 06010

Electronics | February 17, 1969

International Newsletter

February 17, 1969

Autonetics' MOS for Hayakawa's pocket calculator

It now looks as if the Hayakawa Electric Co. will put an eight-digit pocket calculator built around large-scale arrays on the market this fall.

Hayakawa has readied a design and—perhaps more important—has lined up Autonetics as the supplier for the MOS large-scale arrays it needs to mass-produce the machine. Under a deal up for approval by the Ministry of International Trade and Industry, Hayakawa will first buy circuits and later the know-how to make them from the U.S. company. The scale of minimum royalties in Hayakawa's proposal runs from \$50,000 in 1970 to \$500,000 in 1975.

The pocket calculator, developed with a subsidy from the Japanese government, will have five types of MOS circuits in it. By 1970, Hayakawa expects to produce the circuits itself and may by then have another Japanese supplier—Mitsubishi Electric.

Mitsubishi plans to complete by April the design of six large-scale MOS circuits for a pocket calculator Hayakawa worked on before it turned to Autonetics for MOS. Mitsubishi estimates it will have to rework perhaps three of its circuits to make the six-circuit package compatible with the U.S.-made MOS.

Nippon Electric designs IC drive for desk calculators

Nippon Electric thinks it's found a way to get low-cost drive circuits for desk calculator indicator tubes—pair MOS and bipolar transistors on the same silicon chip.

In the circuit developed by the company, 34 MOS devices are used as a decoder to transform a binary input into a decimal output. The MOS decoder section controls 22 bipolar transistors that have collector-base breakdown voltages of 60 to 120 volts. This high level is needed to handle the 170 to 200 volts at which the indicator tubes are operated.

A trio of the firm's researchers will report on the circuit later this week at the International Solid State Circuits Conference in Philadelphia.

Thomson-Brandt joins group seeking Jeumont-Schneider

France's largest electronic company, Compagnie Francaise Thomson Houston-Hotchkiss Brandt, may become a reluctant partner in yet another corporate merger. It consummated two last year.

President de Gaulle apparently has roped Thomson-Brandt into a deal with two heavyweight electrical-electronics companies—Societe Alstom and Compagnie Generale d'Electricite (CGE)—to buy a majority holding in Societe Jeumont-Schneider, an ailing French-based electrical equipment maker under Belgian control.

De Gaulle is seeking to block Westinghouse Electric's plans to consolidate Jeumont-Schneider and four other European companies—all Westinghouse licensees—into a new European electrical giant under control of the U.S. firm. The five companies now have annual sales of \$65 million.

Marconi will build three-mile antenna

The 400-foot radio telescope Sir Bernard Lovell has requested for Britain's Jodrell Bank observatory apparently won't be built for several years. The government's Science Research Council has relegated the project to a secondary priority and has decided to go ahead first with a \$5 million multi-dish facility for Cambridge University. The Marconi Co. will handle

International Newsletter

this project, which is slated for completion in 1971.

The new antenna—intended mainly for quasar mapping—will be made up of eight fully steerable dishes, each 42 feet in diameter. Four will be fixed at intervals of 0.7 mile; the other four will travel on a track $\frac{3}{4}$ -mile long. The arrangement makes possible an effective diameter from nil to three miles.

Ferranti computer to steer big dish

Britain's Ferranti Ltd. has bested two other data-processing heavyweights in the competition to supply a control computer for the world's largest steerable radio telescope, a 328-foot-diameter dish now being built near Bonn. The other contenders were Siemens AG and the Control Data Corp.

The \$500,000 order solidifies Ferranti's position as a leader in the field of large-antenna control systems. The firm has also provided control computers for the famed Jodrell Bank radio telescope in Britain.

Australia demands arms-import offset

After eight months of veiled warnings, Australia's defense minister made it clear this month that there will be no more arms imports without some sort of offset arrangement. Defense spending abroad in the past fiscal year was \$385 million, slightly more than 8% of total imports.

The shift in policy seems certain to speed the flow of U.S. and British electronics companies Down Under. Companies with plants there will have an inside track for government business; procurement officials have been ordered to buy nothing abroad that can be reasonably made at home.

Dassault to open Quebec sales office

French politicians are cheering Electronique Marcel Dassault's decision to open a North American sales office for medical electronics gear. The reason: it will be located in Quebec City, the stronghold of French Canada and a center of pro-Gaullist sentiment.

The Dassault office is being set up principally to install and service the 46 heart-patient surveillance systems purchased for \$400,000 by the new Sherbrooke University Hospital south of Quebec City.

Germany may seek new NKF partners

West Germany's Defense Ministry is seriously considering asking France and the U.S. to join in the NKF project, aimed at developing a plane to replace the Luftwaffe's aging F-104G Starfighters in the mid-1970's.

The reason seems to be Bonn's apprehension lest the embryo project end up mainly British [*Electronics*, Oct. 28, 1968, p. 202]. The NKF was first proposed by two German aircraft makers, but Britain came in on the project later, and the two countries have had trouble getting together on a single version to suit both.

Addenda

Outside makers of color tv sets may be able to go it alone in Japan starting April 1. The government's Foreign Investment Council has recommended that color sets be added to the so-called "100% automatic approval" list, which applies to products that can be made by foreigners in Japan without special restrictions . . . Britain's International Computers Ltd., which has considerable excess production capacity, apparently has a big overseas sales drive in the works. Sweden seems a likely first target; the company last month took a majority holding in its distributor there, L.M. Ericsson Data AB.

Chopper control, regenerative braking to get trial on Tokyo subway trains

Varying duty cycle of SCR's controls current flow to motors; system will lower costs by generating electricity instead of heat

Tokyo's subway riders long ago resigned themselves to getting a Turkish bath as well as transportation during summer rush hours. And, as with most of the horrors of urban life, things underground figure to get worse before they get better.

The betterment for sweltering Tokyo subway riders, in fact, is at least two years off. In the spring of 1971, the system's operator—the Teito Rapid Transit Authority—plans to put trains with chopper control and regenerative braking into service on a line now under construction. Instead of generating heat and making the passengers more uncomfortable, the braking system will generate electricity, lowering operating costs. The saving works out to one-third of the power used by a conventionally braked train, Teito officials say.

And there should be savings, too, in costs of rolling stock. A test train performed so well that the authority decided to use six powered cars and four trailers in chopper-controlled trains. Normally, eight out of 10 cars are powered in Teito's trains.

What's more, the chopper-controlled rolling stock should be easier to keep rolling. Instead of switching 100 or more resistance elements to control accelerating and braking, the chopper control does the job by varying the duty cycle of silicon controlled rectifiers that control current flow to the motors. Chopper control thus avoids the problem of wear-prone arrays of contacts but provides a way to keep the traction-motor current—and as a result the train's acceleration—constant. The current flowing through a series d-c motor,

of course, drops as the motor speeds up.

The SCR's can handle very heavy currents at 1,500 volts d-c. Another key element is a circuit design that can boost the voltage generated by the motor during regenerative braking enough to put power back into the line. Another circuit consideration is ripple suppression. The power supplied to the motor by the chopper must be smooth and the power must be drawn from the line without setting up pulse noise that would interfere with the train-control signals sent over the power line.

Kicked up. Ripple is taken care of by inductive smoothing reactors in parallel between the motor and the chopper. Signal interference is done away with by operating two or more choppers phased to get an effective frequency of at

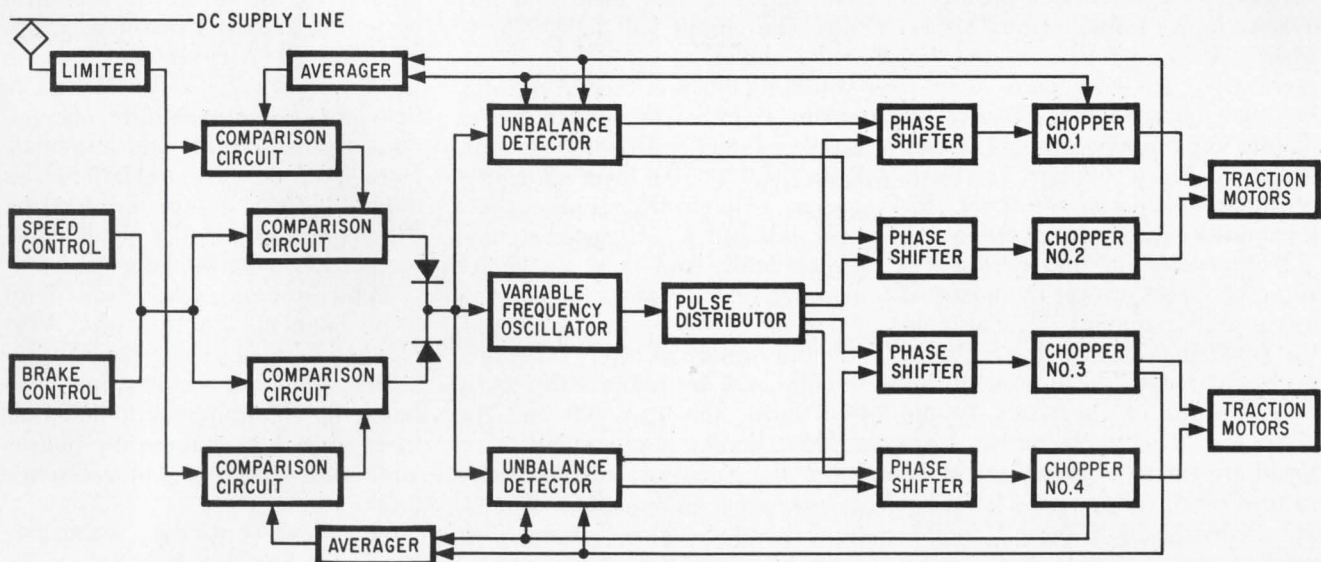

Stepping out. Continuously variable duty cycle of choppers controls speed and regenerative braking of prototype subway cars. Turn-on pulses pass through phase shifter and thus become turn-off pulses too.

least 200 hertz. And an inductive kick makes it possible to return power to the line during braking.

When the train is accelerating, the motors, chopper, and smoothing reactors are all in series across the line. When the motorman brakes, however, the connections to the fields and armatures are reversed so that the motors, smoothing reactor, and chopper form a loop when the SCR's in the chopper circuit are closed. When the chopper circuit opens, the current flowing through the inductances in the circuit is high enough to boost the motor voltage so that power returns to the line.

Yonehiko Ishihara, who's responsible for the new equipment, feels chopper control is a technique that most electric railways will adopt. Westinghouse will use choppers, for example, in the rolling stock for the Bay Area Rapid Transit.

New phase. So far, Teito has tried out two systems. One, by the Mitsubishi Electric Corp., splits the eight motors of a traction unit (two cars) into two groups. One controller rides herd on both groups of four motors, but each quartet works through a two-phase, 400-hertz chopper. The other system, by Hitachi Ltd., has a 100-hertz single-phase chopper for each motor group, but the choppers are phased so the composite frequency is 200 hz.

By May, Teito expects to take delivery on a production prototype system for a complete train. Mitsubishi will build four cars and Hitachi two. In each case, there'll be two quartets of 175-kilowatt motors in parallel, powered through one three-phase chopper. The basic frequency will be 230 hertz, for a composite frequency of 690 hertz.

Duty cycles for the current-carrying choppers are set by means of a variable-frequency oscillator in the controller. The oscillator drives a circuit that feeds turn-on pulses to the gates of the SCR's in the choppers. The same pulses, delayed by phase shifters, are used to turn off the choppers. The interval depends on SCR and motor-current phase relation and on the speed or braking setting fed into the controller by the motorman.

The Netherlands

Stacking up chips

As Philips' Gloeilampenfabrieken goes, so goes in large measure consumer electronics in Western Europe. And it's now apparent that Philips is going in strong for integrated circuits in tv sets.

Last year, the Dutch giant started producing its TAA 570 package, which combines a sound i-f amplifier and an f-m demodulator. With the TAA 570, Philips did nothing more than many others have done since RCA pioneered years ago with an IC in a tv receiver sound section.

But now Philips is poised to leap out in front of the pack. Later this week at the International Solid State Circuits Conference in Philadelphia, A. Cense and J.J. Rongen of the company's industrial IC group will introduce the TAA 700. It packs on a single chip all the functions needed to process a tv signal between the detector and the final output stages.

Philips says it will start volume production of the circuit in "a few months." The first customers will be in Britain where at least two set makers will go into production next September with sets incorporating the TAA 700. And there's a chance the circuit will turn up in an American-made set before long. Philips has negotiations under way with one U.S. set maker, at any rate. The circuit will sell for \$2.40 at the outset.

Building block. Although the chip carries 42 transistors, it still leaves a set designer with some options. With the TAA 700, there's a choice—tubes, discrete transistors, or IC's—for the tuner, i-f amplifier, and the detector. And there's a choice of tubes or transistors for the output stages, both video and sound. All the other receiver functions, though, can be taken care of by two chips, the TAA 700 and the TAA 570 sound combination.

For the signal processing there's no skimping on functions. The IC comprises a video preamplifier, automatic gain controls, a horizontal sync separator, a vertical sync separator and amplifier, plus a

noise detector and gating for agc and sync.

The input voltage supplied to the IC from the video detector has to be at least 2 volts peak-to-peak. This is amplified by three in the TAA 700's preamplifier section, which provides an impedance match between the detector and the video output stage. The agc voltages supplied by the IC range up to 8 volts.

West Germany

Well rounded

Builders of satellite-communications ground stations take great pains with their antenna dishes. Even slight distortions in the surface can raise havoc with antenna radiation patterns—and with dishes of 300-foot diameter and more there's plenty of chance for distortion.

One way to hold down distortion is to build a rigid support frame, and that's the route antenna designers have taken so far. Even better, some designers feel, would be dishes made of moveable segments that would be adjusted to offset variations in wind and temperature.

Headstart. When someone does devise a large dish with moveable segments, he won't have to hunt around for the basis of a control system to keep the segments properly aligned. A curvature-checking technique developed by Rohde & Schwarz, a Bavarian firm specializing in instruments and antennas, can spot surface deviations as minute as 0.3 millimeter. Getting the same accuracy by mechanical methods is a painstaking job.

The technique, worked out with some financial aid from the West German Ministry for Scientific Research, checks curvatures by bouncing electromagnetic fields off them and then comparing phases and amplitudes with a reference field.

To prove out the technique, Rohde & Schwarz has built a jig and mounted four segments on it to form a parabolic mirror. One of

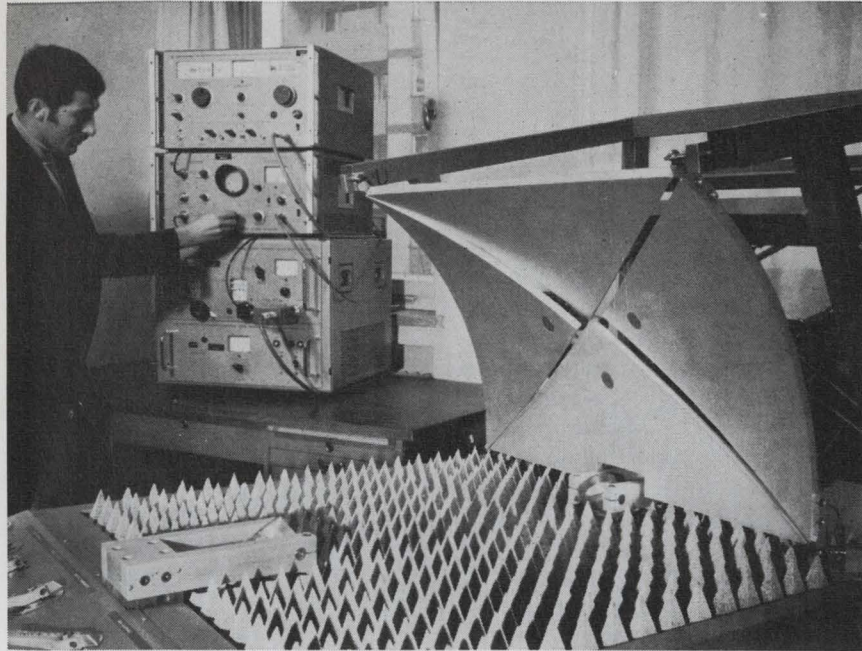

Horning in. Alignment of the four segments of this parabolic mirror can be checked to within 0.3 mm with new West German technique. Horn just below mirror and second one opposite it radiate interference patterns that are picked up by probes (dark spots) on moveable segments.

the segments is fixed; the others have hydraulic controls to move and position them.

Just below the mirror is a base plate carrying two microwave horn radiators powered by a common 10-gigahertz frequency generator. The horns put out spherical fields that always have the same phase relationship to one another.

Highs and lows. The two fields interfere with each other. At spots where the path difference is a multiple of the emitted wavelengths, the fields' energies hit a maximum value. Between these spots, though, there are zones in which the energies drop and even cancel each other entirely.

Thus, maximum and minimum energy points are established. When interconnected, they form hyperboloids of revolution. The position of these hyperboloids is a function of the location of the horns, of the applied frequency, and of the phase of the emitted waves.

Embedded in the surface of the moveable segments are slot-type receiving probes. The energy these probes pick up is applied to a comparison circuit that determines whether or not the amount repre-

sents a minimum value.

When a probe travels through a minimum, 180° phase shift occurs. And if phase shifts and energy levels at a probe are then compared with the corresponding values for a reference energy field, both the distance and direction a particular segment has been moved can be worked out.

Hot under the cooler

By applying the 135-year-old Peltier effect, a West German firm is making combination apartment heating-cooling units that use semiconductor materials as heat pumps. The units, to hit the market in about two months, are designed to replace customary separate heating and cooling equipment. Not only do the semiconductor heat pumps perform a double function, but they also control temperature better than conventional heating and air-conditioning units.

In the Peltier effect, heat is generated or absorbed in two joined pieces of different metals when a current passes through the junction. The current's direction determines whether the junction is

heated or cooled. Thus, the effect is the opposite of the Seebeck effect that's the basis of thermocouples.

Narrow use. While Peltier-type cooling has already found some applications in the consumer goods field, it's never been used for residential heat control. For example, portable cooling boxes, powered by car batteries, are being used for camping. Airlines, too, have turned to such equipment for airborne refrigeration because Peltier systems are relatively light and do not need a gas coolant. And such systems are installed on many German locomotives to keep the engineer's coffee warm and his milk cold.

The new units are being developed by August Schneider KG, a maker of air-conditioning and heating equipment in Bavaria. Siemens AG supplies the Peltier elements—the semiconductor heat pumps. The development of the units was spurred by the Rheinisch-Westfälische Elektrizitätswerke, Germany's largest electricity-generating outfit. RWE has been testing prototype units for some time in several large apartment buildings in the Ruhr area. August Schneider will introduce commercial models on April 1 during a Frankfurt trade show. Mass production will start soon after.

Through the wall. The Peltier elements, made by Siemens under the trade name of Sirigor, are cooling blocks consisting of about 40 individual Peltier cells. On each side is a heat exchanger, one for the cold side, the other for the warm side. Installation is through a room's outside wall so that the "warm" exchanger contacts the outside air and the "cold" one the inside air. The heat exchangers are essentially finned radiators like those used in air-heating systems.

The heating and cooling principles are relatively simple. For heating, the elements take heat from the outside via the outer exchanger, heat it to a higher temperature and impart it via the inner exchanger to the inside air. For cooling, the heat flow is reversed.

This method of heat pumping is very efficient, Siemens says. Depending on the difference between

the outside and inside temperatures, 1 kilowatt of electric power transfers 2 to 3 kw of heating power. The electric-to-heat power ratio can thus be as high as 1:3. With conventional electric heaters 1:1 is the best obtainable. The heat pump has a high conversion ratio because not only the electric energy but also the heat extracted from the outside air becomes effective. In other words, heat is "stolen" from the outside and classical output-over-input rules are not violated.

Heating specialists say that the new systems' heating and cooling costs will come to between \$1.25 and \$1.50 a year per square meter—approximately 11 square feet—of living area. Average four- to five-room apartments in Germany have roughly 100 square meters.

However, equipment costs are still relatively high. A Peltier system for one normal room will cost the consumer about \$825. On the other hand, the system is expected to run for years without any maintenance. Except for two ventilators to suck in or push out air, there are no moving parts in Schneider's pioneering system.

Right size. The Peltier unit is about as big as a normal water circulation radiator used in central heating systems and is powered directly from regular a-c line outlets. The line power is stepped down to about 100 volts, which is then rectified for temperature control. Thermostat principles maintain the temperature. The new system's electronic temperature control acts faster than a conventional unit.

The direction of the d-c current through the elements determines heating or cooling and values of the current determines the amount of power.

The Peltier cells consist essentially of n-type and p-type mixed crystals made from a bismuth-tellurium combination. For high heating and cooling output, cells are interconnected in a meander-like fashion. Electrically, the cells are in series; thermally, they're parallel. The cell's physical dimensions determine the current that's required for Peltier element operation.

International

Gapmanship

Western Europe's electronics executives got some new required reading this month—a primer of sorts on how to cope with the "technology gap" between the U.S. and the rest of the non-Communist world.

The primer is the work of the 22-nation Organization for Economic Cooperation and Development, which set up a multinational task force under French Science Minister Robert Galley to identify the causes of the gap—particularly in semiconductor technology—and suggest remedies.

Some of the factors cited by the OECD task force as reasons for U.S. supremacy leave European executives with little to do but wring their hands. Among them: market size, government research and development policy, and tax structures. But there are plenty of guidelines in the document for industry and government managers bent on catching up with the Americans.

Hustlers. The reports draw a familiar picture of the startup of successful American semiconductor manufacturers: shoestring operations that flourished because the engineers thought big. This portrait contrasts sharply with conditions in the European and Japanese components industries, which are largely in the hands of venerable giants.

The OECD experts feel it's no accident that relatively small U.S. semiconductor firms like Texas Instruments and Fairchild Semiconductor have supplanted traditional components suppliers like General Electric, RCA, and Westinghouse. New technology tends to be "of only marginal importance" to giant firms, says the report, because it takes so long to convert the technology into significant sales volume. But it may be the "main gamble" of a young and struggling firm.

The situation in the U.S., the OECD report maintains, is due in large part to greater manpower mobility. American engineers move freely from job to job, but German

companies have tacit agreements not to hire away each others' scientists and the British government slaps a two-year "technological embargo" and a loss of pension rights on people who resign research jobs. The report urges an end to such practices.

Aiming high. A major conclusion of the OECD report is that few components firms set their sights high enough. Although the phrase "thinking big" is an obvious platitude, the OECD's experts have come up with some impressive examples of its value.

Texas Instruments, they argue, may owe much of its success to its early practice of setting—and publicizing—high sales targets. Such targets, the panel holds, compel a company to devise strategies for achieving them. European companies seldom set sales goals, the report notes.

The size of markets and the sophistication of customers have an important effect on electronics growth. The smaller size of European markets means production runs are shorter and the output per employee is lower than in the U.S., the report observes.

The OECD experts also report that salesmen operating in Europe for three major U.S. companies handle only one-third to one-fifth the business they'd do in the U.S. The reasons: backward communications and transportation make selling harder, and the fragmentation of national markets means more firms have to be contacted per sale.

Hanging in. Despite the difficulty of narrowing the components gap, the OECD group recoils from any suggestion that the world simply buy its components from the U.S.

Instead, the OECD group suggests that each industrial nation assess its needs and abilities, and specialize in a few product types. "International trade within a group of countries could thus remedy the limited size of each national market," the report declares.

However, the experts sadly admit that the trend, especially in such "prestige-laden sectors" as integrated circuits, is in the opposite direction.

new AC/BATTERY

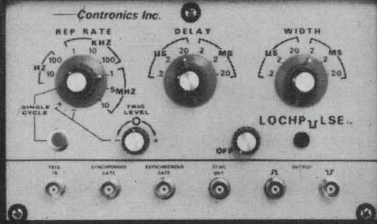

PULSE GENERATORS

Completely Self Contained Laboratory and Portable Pulse Generators with—

- 100% DUTY CYCLE
-
- 6 ns RISETIME & FALLTIME
-
- SIMULTANEOUS COMPLEMENTARY OUTPUTS
-
- 1 Hz TO 10 MHz REP RATE
-
- A/C-BATTERY
-
- VARIABLE DELAY & WIDTH
-
- SIZE—HALF RACK
-
- WEIGHT 6 LBS.
-
- FROM \$310.00
-
- DELIVERY FROM STOCK

The CONTRONICS CPG200 Series provides a new dimension in pulse generators. It is the only low cost solid state, portable pulse generator series specifically designed for use with integrated circuits.

International **Contronics Inc.**

1061 Terra Bella Avenue
Mountain View, California 94040
(415) 969-0793 TWX 910-379-6976



TA Manufacturing Corporation Bear Advertising Inc.	206
■ Taylor Corporation Gray & Rogers Inc.	165
■ Tektronix Inc. Dawson, Turner & Jenkins Inc.	132
Tempress Research Company Inc.	3rd Cover
Hal Lawrence Inc.	212, 213
Teradyne Inc. Quinn & Johnson Advertising Inc.	208
Texas Industrial Commission The Pitluk Group	
Texas Instruments Incorporated, Components Group Don L. Baxter, Div. of Albert Frank-Guenther Law Inc.	78
■ Texscan Corporation Burtton Browne Advertising	192
■ Trygon Electronics Inc. Kameny Associates Inc.	140
■ Trymetrics Corporation Kameny Associates Inc.	184
■ Tung-Sol Division Wagner Electric Corporation Feeley & Wheeler Inc.	40
Tyco Laboratories Inc., Sherold Crystal Products Group Kenyon & Eckhardt Inc. Adv.	32
United Aircraft Electronic Components Cunningham & Walsh Inc. Advertising	35
United Systems Corporation Advertising & Merchandising Inc.	143
Varian Associates, Eimac Division Botsford, Constantine & McCarty Inc.	197
Vector Electronic Company Inc. Packard Advertising Inc.	196
■ Victory Engineering Corporation A.D. Adams Advertising Inc.	170
Wang Laboratories Impact Advertising Inc.	124
Wiremold Company, The Charles Brunelle Company	203

Classified Advertising

F.J. Eberle, Manager

EMPLOYMENT OPPORTUNITIES	211
International Video Corporation	211
EQUIPMENT (Used or Surplus New) For Sale	
Gadgeteers Surplus Electronics Inc.	211
Radio Research Instrument Co.	211

- For more information on complete product line see advertisement in the latest Electronics Buyer's Guide
- Advertisers in Electronics International

Electronics Buyers' Guide

George F. Werner, General Manager
[212] 971-2310
Robert M. Denmead,
Midwest Regional Manager
[312] MO 4-5800
William A. Capuzzi,
New York, New England District Manager
[212] 971-3793
Regina Hera, Directory Manager
[212] 971-2544
Thomas M. Egan, Production Manager
[212] 971-3140

Circulation Department

Isaac Siegel, Manager [212] 971-6057

Research Department

David Strassler, Manager [212] 971-6058

Advertising Sales Staff

Frank E. LeBeau [212] 971-6464
Advertising Sales Manager

Wallis Clarke [212] 971-2187
Assistant to sales manager

Donald J. Austermann [212] 971-3139
Promotion Manager

Warren H. Gardner [215] LO 8-6161
Eastern Advertising Sales Manager

Atlanta, Ga. 30309: Michael H. Miller, 1375
Peachtree St., N.E.
[404] 892-2868

Boston, Mass. 02116: William S. Hodgkinson
McGraw-Hill Building, Copley Square
[617] CO 2-1160

Cleveland, Ohio 44113: William J. Boyle, 55
Public Square, [216] SU 1-7000

New York, N.Y. 10036
500 Fifth Avenue
James R. Pierce [212] 971-3615
John A. Garland [212] 971-3617
Michael J. Stoller [212] 971-3616

Philadelphia, Pa. 19103:

Jeffrey M. Preston
Warren H. Gardner,
6 Penn Center Plaza,
[215] LO 8-6161

Pittsburgh, Pa. 15222: Warren H. Gardner,
4 Gateway Center, [412] 391-1314

Rochester, N.Y. 14534: William J. Boyle,
9 Greylock Ridge, Pittsford, N.Y.
[716] 586-5040

Donald R. Furth (312) MO 4-5800
Midwest Advertising Sales Manager

Chicago, Ill. 60611: Kenneth E. Nicklas
Ralph Hanning, 645 North Michigan Avenue,
[312] MO 4-5800

Dallas, Texas 75201: Richard P. Poole, 1800
Republic National Bank Tower,
[214] RI 7-9721

Houston, Texas 77002: Robert Wallin,
2270 Humble Bldg. [713] CA 4-8381

Detroit, Michigan 48226: Ralph Hanning,
856 Penobscot Building
[313] 962-1793

Minneapolis, Minn. 55402: 1104 Northstar
Center [612] 332-7425

St. Louis, Mo. 63105: Kenneth E. Nicklas,
The Clayton Tower, 7751 Carondelet Ave.
[314] PA 5-7285

James T. Hauptli [415] DO 2-4600
Western Advertising Sales Manager

Denver, Colo. 80202: Joseph C. Page, David
M. Watson, Tower Bldg., 1700 Broadway
[303] 255-5484

Los Angeles, Calif. 90017: Ian C. Hill,
John G. Zisch, 1125 W. 6th St.,
[213] HU 2-5450

Portland, Ore. 97204: James T. Hauptli,
Thomas McElhinny, 218 Mohawk Building,
222 S.W. Morrison Street,
Phone [503] 223-5118

San Francisco, Calif. 94111: James T. Hauptli,
Thomas McElhinny, 255 California Street,
[415] DO 2-4600

Pierre Braude Tel: 225 85 88: Paris
European Director

Paris: Denis Jacob
88-90 Avenue Des Champs-Elysees, Paris 8

United Kingdom and Scandinavia

London: Oliver Ball, Tel: Hyde Park 1451
34 Dover Street, London W1

Milan: Robert Saldel
1 via Baracchini Phone 86-90-656

Brussels: F.I.H. Huntjens
27 Rue Ducale Tel: 136503

Frankfurt/Main: Hans Haller
Elsa-Brandstrom Str. 2
Phone 72 01 81

Geneva: Denis Jacob
1. rue du Temple Phone: 31 95 60
Tokyo: Takeji Kinoshita, McGraw-Hill
Publications Overseas Corporation,
1 Kotohiracho, Shiba, Minato-ku, Tokyo, Japan

Osaka: Akihiko Kamesaka, McGraw-Hill
Publications Overseas Corporation, Kondo
Bldg., 163, Umegee-cho Kita-ku [362] 8771

Business Department

Stephen R. Weiss, Production Manager
[212] 971-2044

Thomas M. Egan,
Assistant Production Manager [212] 971-3140

Dorothy Carmesin, Contracts and Billings
[212] 971-2908

Frances Vallone, Reader Service Manager
[212] 971-2865

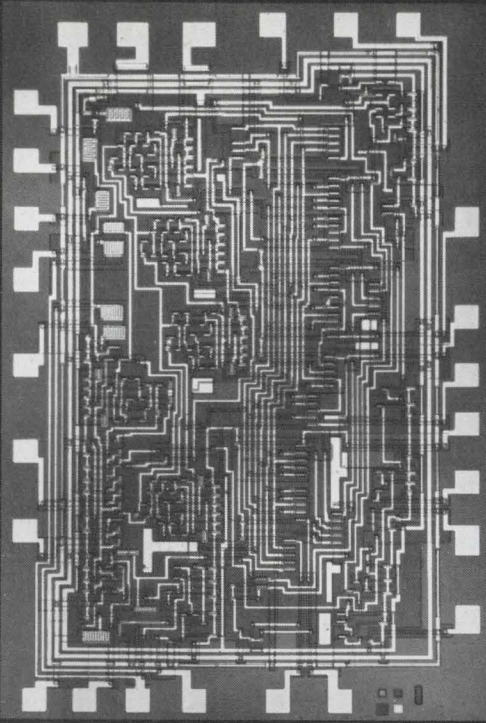

HUGHES
HUGHES AIRCRAFT COMPANY
MOSFET DEVICES

Complex LSI's have just
been assured a glorious future.
We've put them into the
Tomorrow Class.
Take the complex array in the
picture for example.
512 MOSFETs arranged as
approximately 100 logic gates.
To perform the functions of a
seven stage counter, with
decoding and a monostable
multi-vibrator.
In real life that LSI measures
0.116" by 0.082". A little smaller
than a large size fleck of pepper.
In real life it's a Tomorrow
MOSFET. With all the earmarks
of Tomorrow.
Like a two-volt threshold for
compatibility with existing bipolar
logic—with the ability to operate
at higher voltage levels.
With lower channel resistance,
We think all complex arrays
will be built that way someday.
So you'll have a freer hand in
design. So they'll operate faster.
Use up less power. And eliminate
level translators.
Tomorrow is just ahead of
schedule at Hughes.
Write Hughes MOSFETs,
500 Superior Ave., Newport Beach,
California 92663.

THE TOMORROW MOSFETS GO COMPLEX.

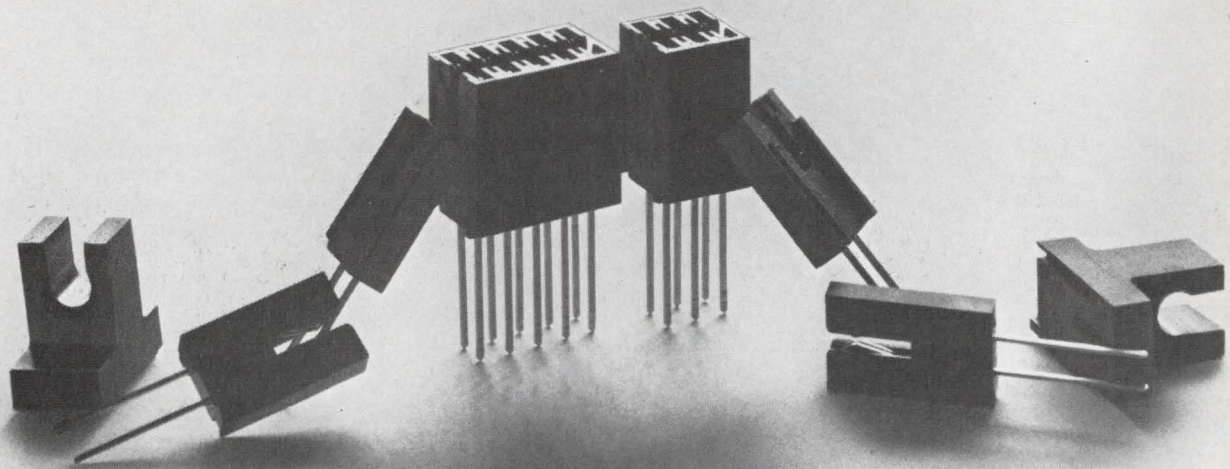

When you make a connector like this, it pays to give it away.

That's exactly what we are doing because it's such a handy design tool.

Sylvania's segmented connector gives you a building block approach to breadboarding and prototyping.

It allows you to build up exactly the single-position circuit-board connector to fit your job.

Just put together as many segments as you need.

Use it for actual circuit wiring and for mechanical layout.

When you have your final design, call Sylvania for fast production on connectors that will meet your exact specifications.

That way, you will get the benefits of Sylvania's long experience in custom connectors. Such benefits as our special gold-dot contact design that minimizes contact resistance and lowers cost.

You also get Sylvania's precision construction that puts connector terminals exactly where they're needed for programmed wiring systems.

For your own connector kit write on letterhead to M. Gustafson, Sylvania Metals and Chemicals, Parts Div., 12 Second Ave., Warren, Pa. 16365. Your kit will be sent by return mail. As a bonus, we'll throw in data sheets on our new off-the-shelf connector line.

CONNECTORS BY
SYLVANIA
A DIVISION OF
GENERAL TELEPHONE & ELECTRONICS

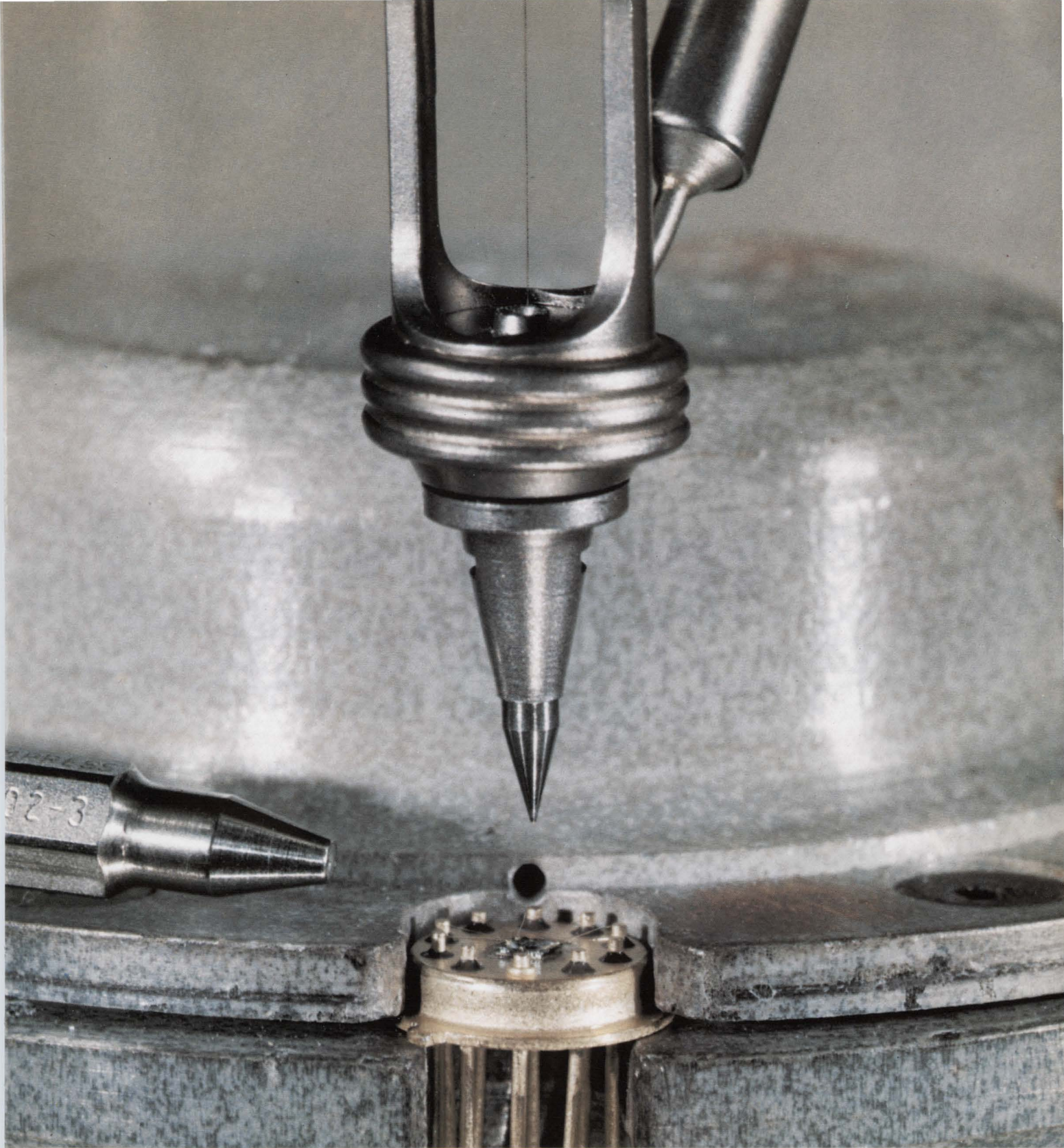

At .0008" Dia. . . . there is no second source

The tungsten carbide capillary tip and its complete family of accessories for thermal compression nailhead bonding was created and introduced by Tempress in 1963. . . . Only from this pioneering source can you purchase the entire system, designed from the beginning to give maximum efficiency: tungsten carbide capillary tip, heated shank and power supply that provides constant capillary temperature from 0° to 350°C, testing pyrometer for the tungsten carbide tip, capillary unplugging fixture and punches, and flame-off torch with sap-

phire orifice insert. Tempress also created and supplied the tungsten carbide ultrasonic bonding tool and pioneered its technology. . . . When you purchase Tempress miniature assembly tools and production equipment, you tap the ultimate source of high precision . . . the Tempress Standard of Excellence. In fields demanding high precision, such as semiconductor manufacturing, there is no second source.



TEMPRESS

Tempress Research Co., 566 San Xavier Ave., Sunnyvale, Calif. 94086

Circle 901 on reader service card

The Inside Story of Handling Current at High Speeds

Now, RCA introduces the multiple-emitter chip, a concept using RCA "overlay" techniques, in 2N5038 and 2N5039—multi-epitaxial silicon transistors for high-speed switching circuits. On the inside is the pellet with 12 discrete emitter sites, interconnected by a 12-pronged heat-conducting copper slug. The use of individual emitter sites provides the excellent 20-ampere current handling capabilities of these devices by increasing the emitter periphery. The copper slug assures good temperature and voltage distribution among the emitter sites across the pellet, and further contributes to the current handling, *while adding significantly to the forward second breakdown capability of the device.* These concepts (discrete emitters and copper slug) eliminate the non-uniform current injection normally associated with high current interdigitated transistor structures.

For the design engineer, 2N5038 and 2N5039 represent the right combination of mechanical structure and performance characteristics. They have low saturation voltage (1.0 volt max. at 12 A for 2N5038 and at 10 A for 2N5039) and fast saturated switching times (turn-on less than $0.5 \mu\text{s}$ and turn-off less than $2 \mu\text{s}$).

Available in production quantities, 2N5038 and 2N5039 are useful in a wide variety of applications including: dc-to-dc converters (at 25 KHz, 250 watts and 85% eff. may be achieved) and high frequency switching regulators (up to 50 KHz, 700 watts output, with 95% eff.). Both units make good linear amplifiers at frequencies up to 5 MHz.

Call your RCA representative today for more information or see your RCA Distributor. For technical data, write: RCA Electronic Components, Commercial Engineering, Section No. IN-2-2, Harrison, N. J. 07029.

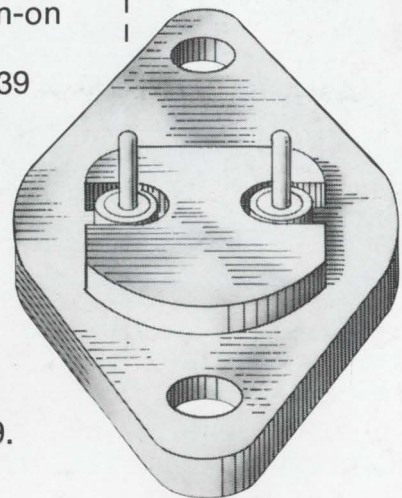
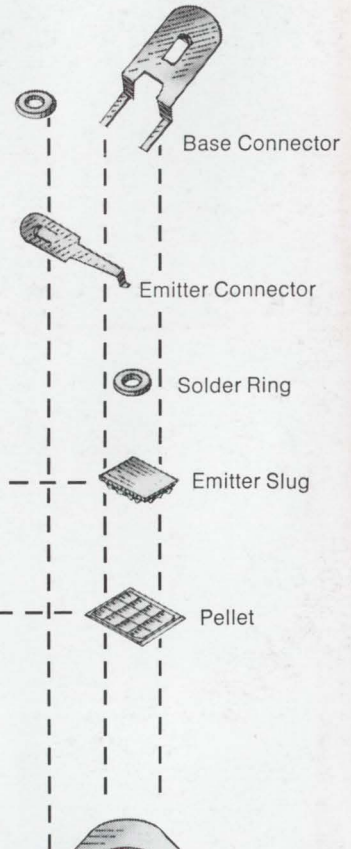

RCA