

IC tester cuts inspection costs 74

\$1.00 A McGraw-Hill Publication

Inside Bell's bubbles 83

September 1, 1969

Computer makers look East 103

# Electronics<sup>®</sup>

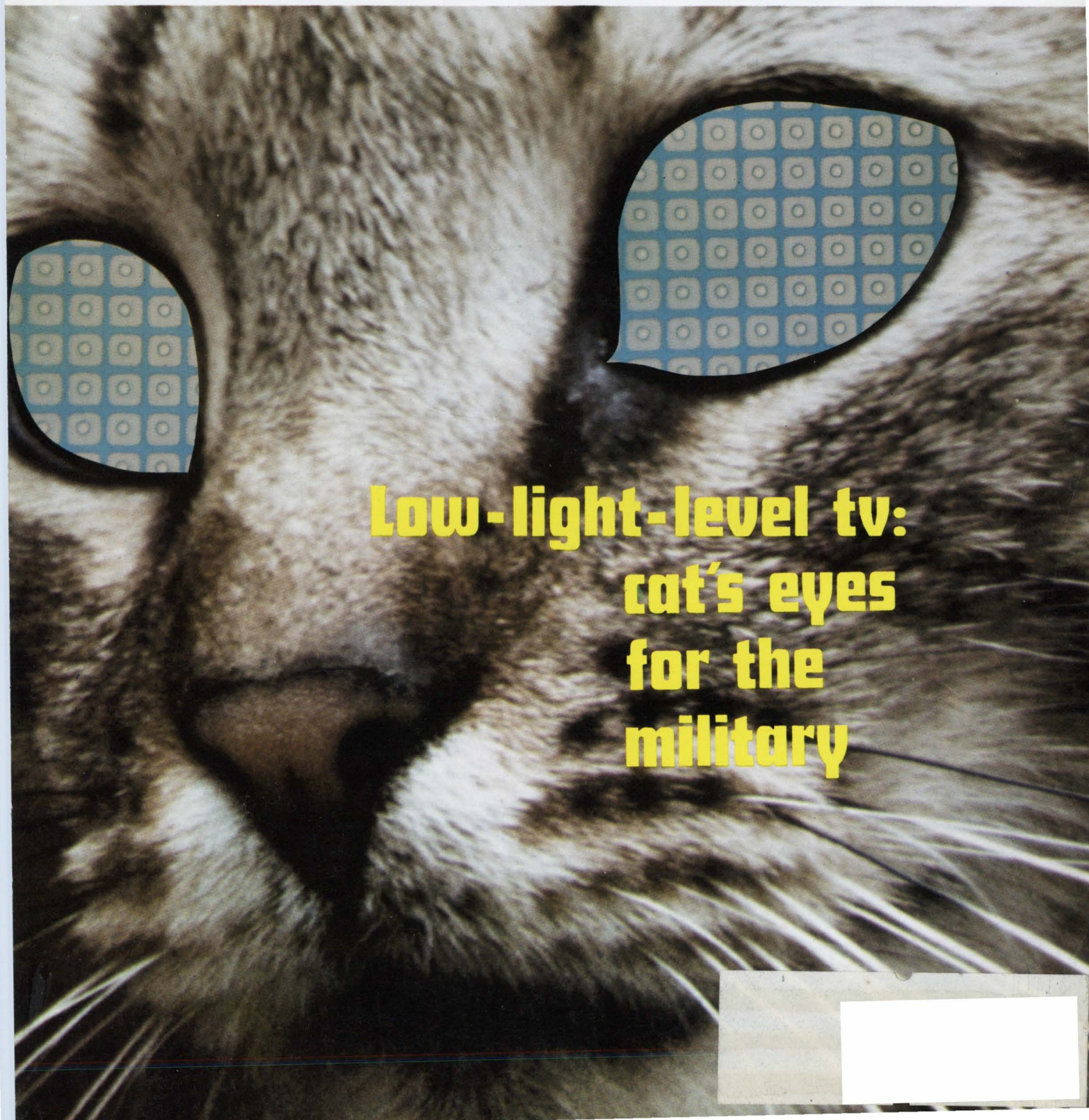

**Low-light-level tv:  
cat's eyes  
for the  
military**





# Introducing - THE AMBIDEXTROUS RECORDER

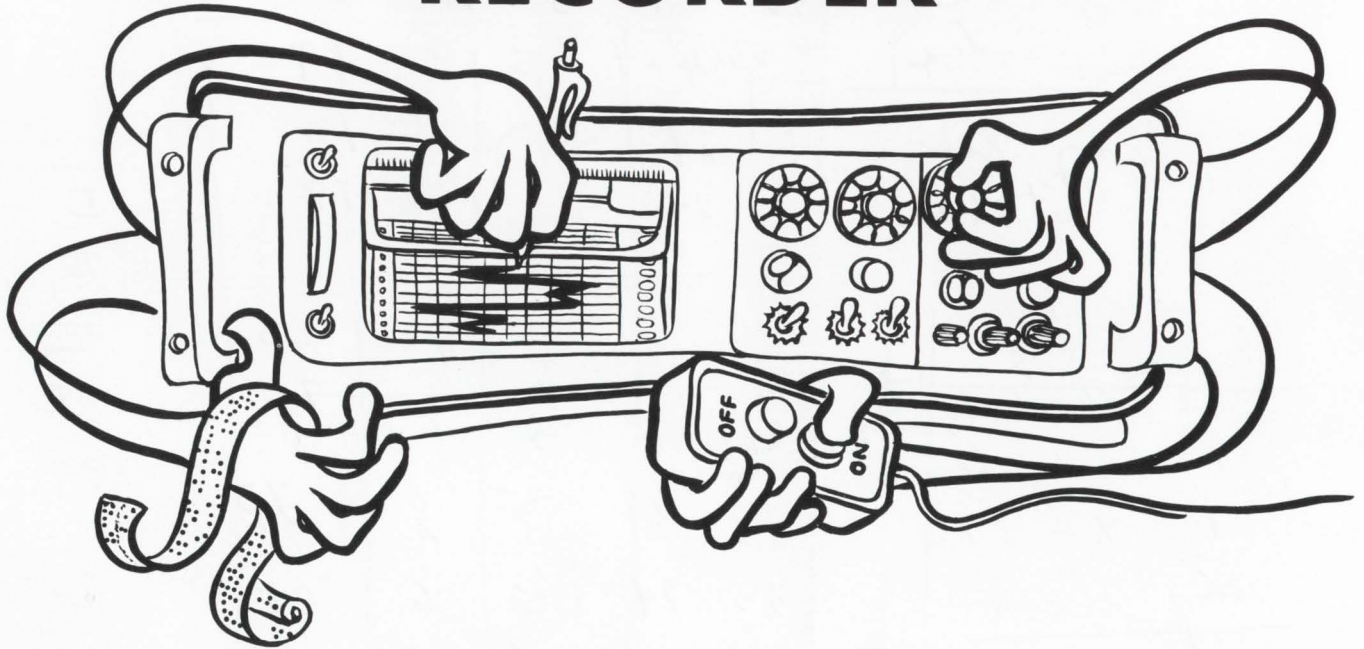

## Designed with Systems in Mind.

A high-speed dc strip-chart recorder  
... that can be remotely programmed  
... and can program itself automatically  
... and can program other devices, controls, and processes

Adding hands to this recorder couldn't have made it a more versatile and unique systems component.

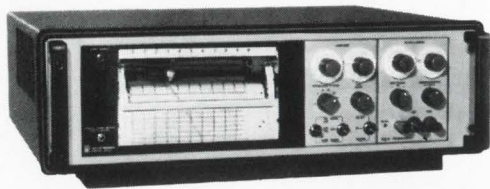

The 1522 recorder can be remotely programmed. Simple switch-closure commands will select one of 18 chart speeds, start the chart in forward or reverse and stop it; lift the pen; and actuate two event markers.

Or, the 1522 recorder can program itself. Control marks along the chart paper's edge are sensed photoelectrically for automatic internal control of any of the above recorder functions.

Or, the 1522 recorder can program other devices such as sort/select mechanisms. It can activate go/no-go systems or warning signals if plotted information exceeds preset high or low limits. It can be used to program additional test equipment and synchronize other 1522 recorders.

That's not all. The 1522 by itself is a superb dc recorder. It writes with a pen speed of 65 inches per second - it takes only 70 milliseconds for full-scale traverse. Linearity is  $\frac{1}{4}\%$  of full scale; accuracy is  $\frac{1}{2}\%$  of full scale. Eighteen paper speeds from 2 inches per second to 1 inch per day to accommodate both rapid plotting and continuous monitoring of long processes. There are 15 dc voltage ranges and 18 dc current ranges from 2 mV or  $0.2 \mu\text{A}$  per inch to 100 V or 100 mA per inch.

The 1522 adds "hands" to your system. We don't claim it to be smarter than any other machine. It's just a darn good worker and you can put the 1522 on your payroll for \$1915 in the U.S.A.

For complete information, write General Radio, W. Concord, Massachusetts 01781; telephone (617) 369-4400. In Europe: Postfach 124, CH 8034, Zurich 34, Switzerland.

GENERAL RADIO





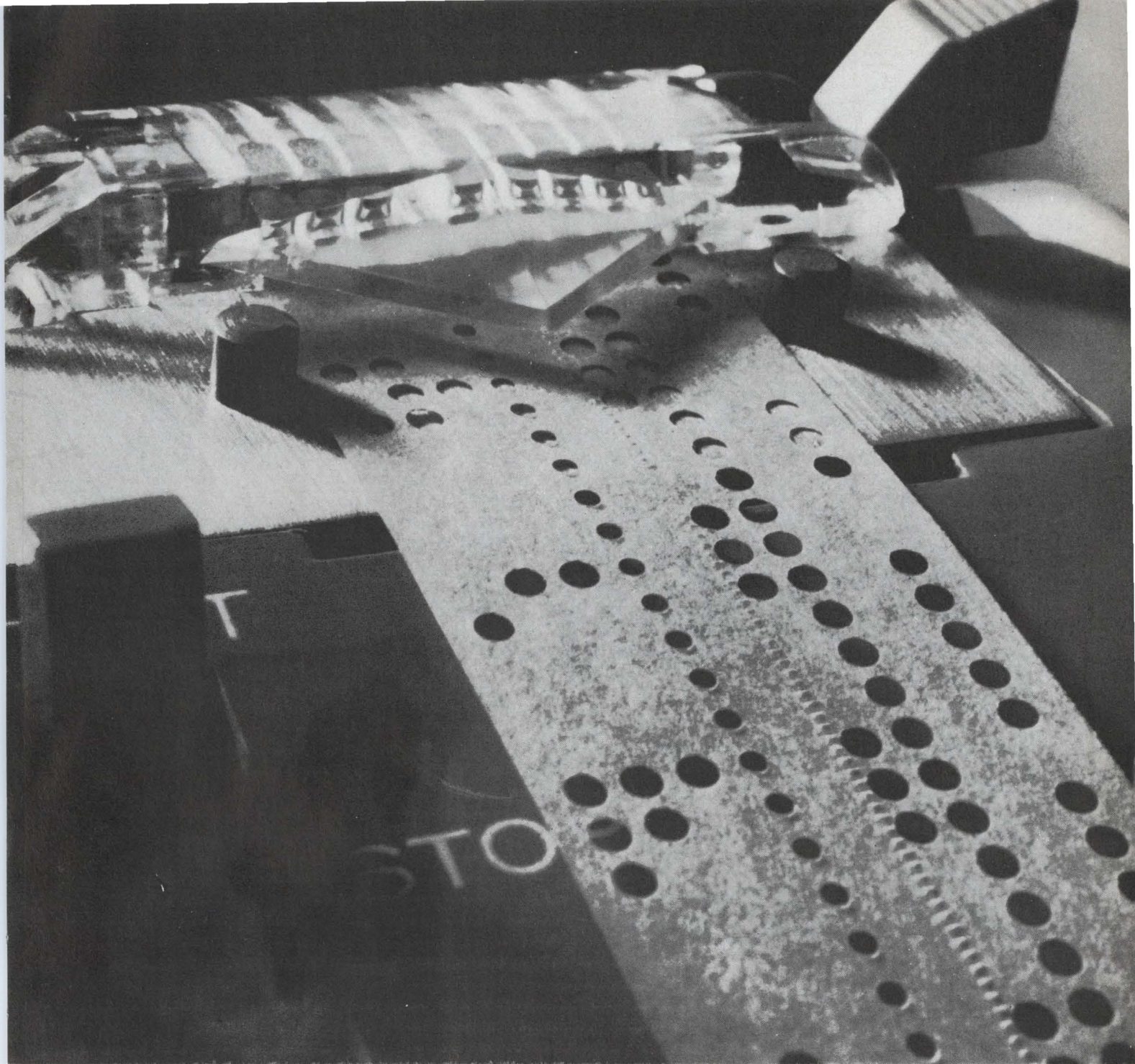

## Couple your measurements to a time-sharing terminal.

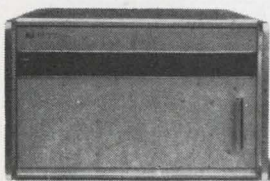

With HP's 2547A Coupler, you can record BCD outputs from your measuring instruments, ready to feed straight into your time-sharing terminal. Data from up to six instruments at a time can be recorded on ASCII-coded punched tape for immediate processing.

Simply feed the tape into your time-

sharing terminal and get back the answers you want. Now. That's a lot quicker and easier than typing in data on-line, or preparing off-line data tapes.

The 2547A Coupler works with more than 40 different HP measuring instruments — and most other instruments with BCD output.

Cost for the coupler, teleprinter and a 10-digit data input interface adds up to a reasonable \$4300. For complete information on the coupler and

time-sharing applications, contact your local HP field engineer. Or write to Hewlett-Packard, Palo Alto, California 94304; Europe: 1217 Meyrin-Geneva, Switzerland.

**HEWLETT**  **PACKARD**

**DATA ACQUISITION SYSTEMS**  
Circle 1 on reader service card



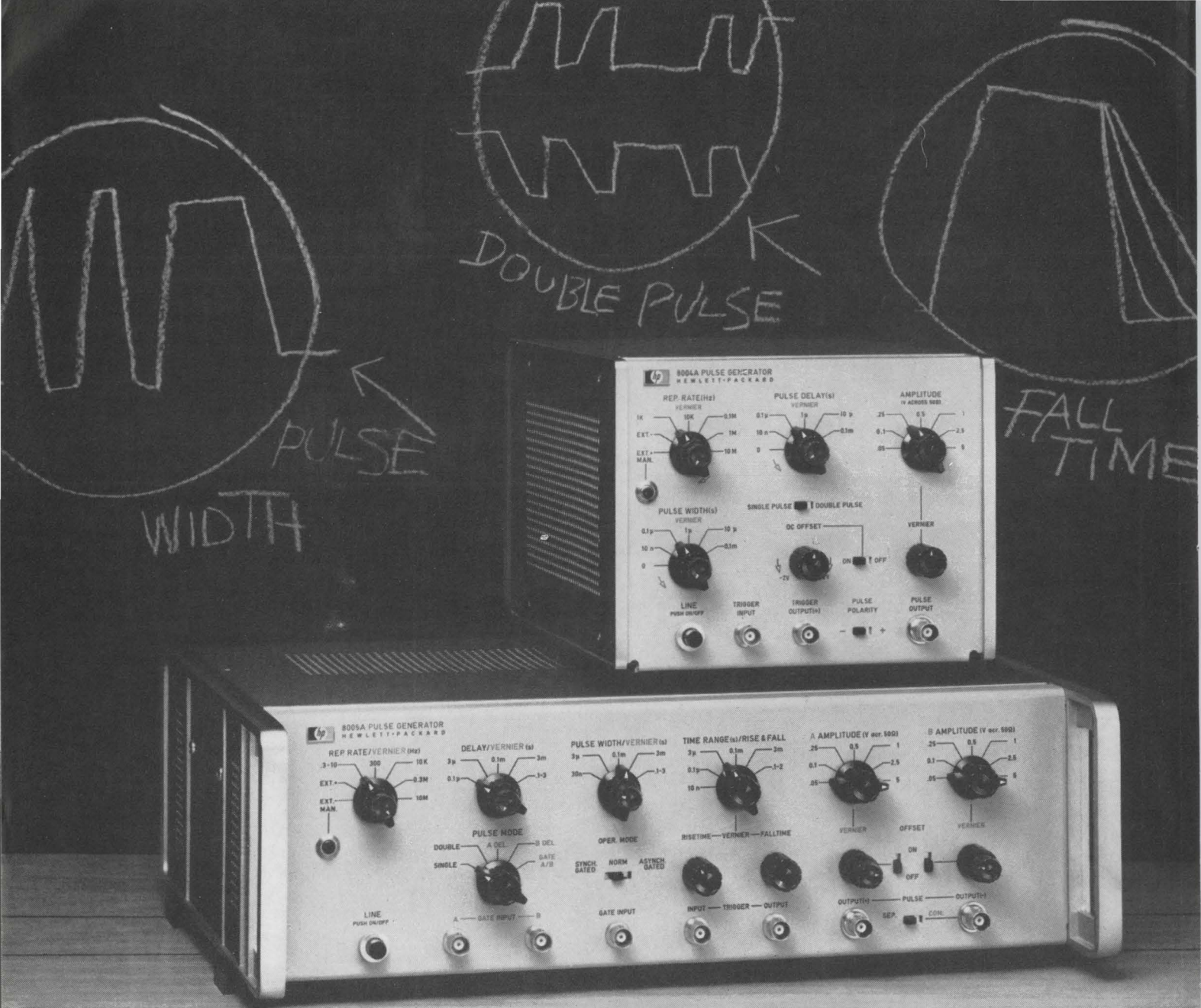

## Sculpt a test Waveform

Now you can control pulse shape four ways (rise time, fall time, width, and repetition rate) with these new HP pulse generators.

For maximum control, the 8005A gives you dual outputs — either positive or negative — with variable rise *and* fall times from 10 nsec to 2 sec, continuous attenuation of each pulse, pulse repetition from 0.3 Hz to 10 MHz, pulse width from 30 nsec to 3 sec, and 100 nsec to 3 sec delay with respect to the trigger output.

If you don't need all that versatility — just an extremely fast rise/fall time — then the 8004A is your instrument. It'll give a variety of pulse shapes with 100 Hz to 10 MHz rep rate. Pulse width is vari-

able from 0 to 1 msec in six ranges, with vernier adjustment.

Both instruments offer high linearity, versatile gating, adjustable dc offset, double-pulse mode for stimulating logic and memory circuits, and a price as low as performance is high. \$1050 for the 8005A, \$720 for the 8004A.

Call your local HP field engineer for a detailed set of specs. Or write Hewlett-Packard, Palo Alto, California 94304; Europe: 1217 Meyrin-Geneva, Switzerland.

**HEWLETT  PACKARD**

PULSE GENERATOR SYSTEMS



## News Features

### Probing the News

- 103 **Computers:** Computer makers look East  
111 **Nomenclature:** Acronyms—antic abbreviations

### U.S. Reports

- 37 **Patents:** Software, a big 'if'; Tribus asks reform  
38 **Medical electronics:** Isolating inputs  
38 **Avionics:** Satellite antenna for helicopters  
39 **Computers:** Another IBM giant  
40 **Communications:** Ma Bell's competitor  
42 **Industrial:** Meter reading by phone  
44 **Components:** Cataloging chips  
45 **Consumer:** Safety standards emerge for tv sets  
46 **Memories:** Low-cost disk for mini-computers  
46 **Manufacturing:** Hughes' back-etched flip chips

### Electronics International

- 157 **International:** British and Japanese systems centralize tv data generation  
158 **Great Britain:** High-speed camera for up to 100 million frames per second  
159 **France:** Too soon too late with 250-Mhz oscilloscope  
160 **West Germany:** Microwave yig filter built from polycrystalline material

### New Products

- 119 **In the spotlight**  
119 Supernova is much faster than the year-old Nova computer  
121 Signal generator does it all  
125 **New components**  
125 Uncased resistors and inductors are made for microwave work  
129 **New instruments**  
129 Spike detector's price is \$48  
133 **New subassemblies**  
133 Power amplifiers can be cascaded  
134 Security system relies on a register  
136 **New production equipment**  
136 Sorter handles 5,600 transistors hourly  
141 **New semiconductors**  
141 Ceramic package undersells TO-5 can

Title R registered U.S. Patent Office; © copyright 1969 by McGraw-Hill Inc. All rights reserved, including the right to reproduce the contents of this publication in whole or in part.

## Technical Articles

- Advanced technology** 64 **Cat's eyes for the military** (cover)  
Low-light-level television systems hold out great promise, but development has been painstakingly slow—and costly  
Alfred Rosenblatt, Associate editor
- Integrated electronics** 74 **Sorting IC's economically**  
Incoming inspection system executes static, dynamic, and burst tests on 2,500 IC's an hour with self-adjusting, programable signal source  
Robert A. Hughes and Blaine Belecki, Digital Equipment Corp.
- Circuit design** 79 **Designer's casebook**  
■ Touch-activated switch built with copper-plated board  
■ Asynchronous pulse gives tape's data signal  
■ Pulse modulator regulates pneumatic valve closure
- Advanced technology** 83 **Magnetic bubbles—a technology in the making**  
Developed by Bell Labs, new technique for storing and manipulating digital data appears set for exploitation by makers of computers and memories  
Harry R. Karp, Senior associate editor
- Memory technology** 88 **Memory testing is a task that comes in layers**  
Leonard Kedson and Alan M. Stoughton, Computer Test Corp.
- 90 **Computers flex their muscles**  
William R. Blatchley, Computer Test Corp.
- 93 **Exercising memory systems with worst-case bit patterns**  
Charles R. Elles, Computer Test Corp., and Ellwood A. Dance, Scientific Measurement Systems
- 95 **Boosting plated-wire yield: which knob to adjust?**  
Gary Chernow, Computer Test Corp.

## Departments

- |    |                          |     |                          |
|----|--------------------------|-----|--------------------------|
| 4  | Readers Comment          | 39  | Index of Activity        |
| 8  | Who's Who in this issue  | 49  | Washington Newsletter    |
| 14 | Who's Who in electronics | 144 | New Books                |
| 22 | Meetings                 | 145 | Technical Abstracts      |
| 31 | Editorial Comment        | 147 | New Literature           |
| 33 | Electronics Newsletter   | 193 | International Newsletter |



# Electronics

Editor-in-Chief: Donald Christiansen

## Senior Staff Editors

Technical: Stephen E. Scrupski

News: Robert Henkel

International: Arthur Erikson

Art director: Gerald Ferguson

Senior associate editors: Joseph Mittleman, Harry R. Karp

Assistant managing editors: H. Thomas Maguire, Howard Wolff, William Bucci, Richard Gundlach, Frederick Corey

Special projects editor: Roger Kenneth Field; Senior staff writer: John Johnsrud

## Department editors

Communications: John Drummond

Computers: Wallace B. Riley, George Weiss

Design theory: Joseph Mittleman

Industrial electronics: Harry R. Karp

Instrumentation: Owen Doyle

Military/Aerospace: Alfred Rosenblatt

New products: William P. O'Brien

Solid state: George Watson, Stephen Wm. Fields

## Field bureaus

Boston: James Brinton, manager; Gail Farrell

Los Angeles: Lawrence Curran, manager; Ralph Selph

New York: Peter Schuyten

San Francisco: Stephen Wm. Fields

Washington: Ray Connolly, manager; Robert Westgate, Lois Vermillion

Bonn: John Gosch

London: Michael Payne

Paris: Arthur Erikson

Tokyo: Charles Cohen

Copy editor: Edward Flinn

Assistant art director: Charles Ciatto

Production editors: Susan Hurlburt, Arthur C. Miller

Editorial research: Virginia Mundt

Editorial secretaries: Lorraine Longo, Claire Goodlin, Barbara Razulis, Vickie Green, Bernice Pawlak, Patricia Bispham

## McGraw-Hill News Service

Director: Arthur L. Moore; Atlanta: Fran Ridgway; Chicago: Robert E. Lee

Cleveland: Arthur Zimmerman; Dallas: Marvin Reid

Detroit: James Wargo; Houston: Barbara LaRoux

Los Angeles: Michael Murphy; Pittsburgh: Louis Gomolak

San Francisco: Margaret Drossel

Seattle: Ray Bloomberg; Washington: Charles Gardner, James Canan, Herbert W. Cheshire, Seth Payne, Warren Burkett, William D. Hickman

## McGraw-Hill World News Service

Bonn: Robert Dorang; Brussels: James Smith; Hong Kong: Kate Mattock

London: John Shinn; Mexico City: Gerald Parkinson; Milan: Ronald Taggiasco, Jack Star

Moscow: Jack Winkler; Paris: Robert E. Farrell, Stewart Toy

Rio de Janeiro: Leslie Warren; Tokyo: Marvin Petal

Reprints: Gail Niles

Circulation: Isaaca Siegel

Publisher: Gordon Jones

Associate Publisher: Dan McMillan

Assistant to the publisher: Wallace C. Carmichael

Electronics: September 1, 1969, Vol. 42, No. 18

Published every other Monday by McGraw-Hill, Inc. Founder: James H. McGraw 1860-1948. Publication office 99 North Broadway, Albany, N. Y. 12202; second class postage paid at Albany, N. Y. and additional mailing offices.

Executive, editorial, circulation and advertising addresses: Electronics, McGraw-Hill Building, 330 W. 42nd Street, New York, N. Y. 10036. Telephone (212) 971-3333. Teletype TWX, N.Y., 710-581-4235. Cable address: MCGRAW-HILL N.Y.

Subscriptions solicited only from those professionally engaged in electronics technology. Subscription rates: qualified subscribers in the United States and possessions and Canada, \$8.00 one year, \$12.00 two years, \$16.00 three years; all other countries \$25.00 one year. Non-qualified subscribers in the U.S. and possessions and Canada, \$25.00 one year; all other countries \$50.00. Air freight service to Japan \$50.00 one year. Single copies: United States and possessions and Canada, \$1.00; all other countries, \$1.75.

Officers of McGraw-Hill Publications Company: Joseph Allen, President; John R. Emery, J. Elton Tuohig, Senior Vice Presidents; Gordon L. Jones, Jr., Group Vice President; Vice Presidents: John R. Callahan, Editorial; Paul F. Cowie, Circulation; John M. Holden, Marketing; David G. Jensen, Manufacturing; Jerome D. Luntz, Planning & Development; Robert F. Marshall, Administration; Robert M. Wilhelmy, Finance.

Officers of the Corporation: Shelton Fisher, President and Chief Executive Officer; John L. McGraw, Chairman; Robert E. Slaughter, Executive Vice President; Daniel F. Crowley, Donald C. McGraw, Jr., Bayard E. Sawyer, Senior Vice Presidents; John J. Cooke, Vice President & Secretary; Gordon W. McKinley, Vice President & Treasurer.

Title registered in U.S. Patent Office; © Copyright 1969 by McGraw-Hill, Inc. All rights reserved. The contents of this publication may not be reproduced either in whole or in part without the consent of copyright owner.

Subscribers: The publisher, upon written request to our New York office from any subscriber, agrees to refund that part of the subscription price applying to copies not yet mailed. Please send change of address notices or complaints to Fulfillment Manager; subscription orders to Circulation Manager, Electronics at address below. Change of address notices should provide old as well as new address, including postal zip code number. If possible, attach address label from recent issue. Allow one month for change to become effective.

Postmaster: Please send form 3579 to Fulfillment Manager, Electronics, P.O. Box 430, Hightstown, New Jersey 08520

## Readers Comment

### Australian taximeter

To the Editor:

Your article "Fare enough" [July 7, p. 186] is incorrect and misleading. The electronic taximeter is a development of Sanders Enterprises Ltd., not Standard Telephones & Cables Australia Ltd. as your article states. Sanders holds the world patent rights to the taximeter, while Standard Telephones is the licensee for the Australian rights only.

Plessey Pacific Control Research Laboratory does not have any interest in or hold any license for this device whatsoever.

J. Bruce-Sanders  
Sanders Enterprises Ltd.  
Brisbane, Australia

### No agreement

To the Editor:

We were disturbed to note your report that Qantas has agreed to foot its part of the bill for the Pacific segment of the much talked of Arinc/Comsat 2 satellite proposal [May 26, p. 58].

Your information is incorrect. We have been a great advocate of the use of vhf aeronautical satellites and have participated in the National Aeronautics and Space Administration program. While we are familiar with current developments, we have never been asked to signify our agreement to foot what might be our part of the bill.

M. H. Meyers  
Communications manager  
Qantas  
Sydney, Australia

### Cool to Ray 3

To the Editor:

I think there may have been a misunderstanding regarding Ray 3 in your newsletter [July 7, p. 34]. When you say, "Fairchild is believed to be a second source," that automatically makes the product line approved by the experts—and we haven't done that.

We are very interested in super-



# Magnetic laboratory equipment

WALKER  
MAGNETIC  
GROUP



## Walker Integrating Fluxmeter and Hall Gaussmeter

A line of precision magnetic measurement instruments to accurately measure magnetic flux and produce an accurate analogue voltage proportional to the flux for recording hysteresis loops or measurement of magnetic fields. Light weight, solid state design. Fast, accurate, easy to use.

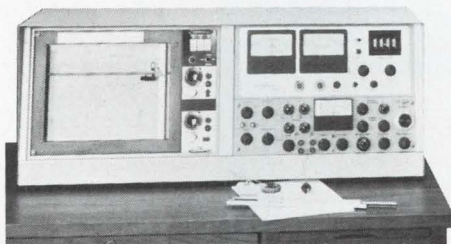

## Walker Hysteresisgraphs

A line of magnetic material test equipment including the Model MH-1 Hysteresisgraph for materials with coercivities ranging from 100 to 3000 oersteds and saturation inductance up to 18,000 gauss, the Model MH-2 Hysteresisgraph for soft magnetic material testing and the Model MC-1 Coercivity Meter.



## Walker Regulated Power Supplies

- 5, 11 and 15 Kilowatt Current Regulated Models
- One Part in 100,000 or Better Stabilities
- All Silicon Solid State Circuitry
- Ultra Stable Low Noise Input Circuitry
- Automatic Polarity Reversal (Optional)
- Electronic Sweep Circuitry (Optional)
- Impedance Matched to the Walker Line of Precision Laboratory Magnets

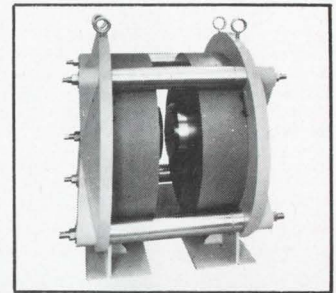

## Walker Precision Laboratory Electromagnets

Moderately priced and specifically designed for high performance with flexibility and accessibility. Five models - 4, 4V (4 inch diameter), 7, 7V (7 inch diameter) and 10 (10 inch diameter). Magnet pole cap surfaces are precision ground and polished to optical tolerances to achieve optimum magnetic uniformity. 4V and 7V models are variable gap models with continuously adjustable spans. All magnets are capable of providing a stepped variable gap by means of precision ground spacer blocks.

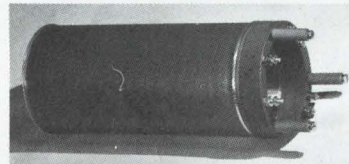

## Walker Superconductor Magnets

Available in bores up to 3" with intensities up to 65 kilogauss. Compensated solenoids are available for applications requiring high field uniformity. A complete line of accessories is available for these magnets.

## Walker Custom Coils

The O.S. Walker Company produces to customer order numerous coil systems including Helmholtz coils, air core and iron core solenoids, plasma coils and laser coils.

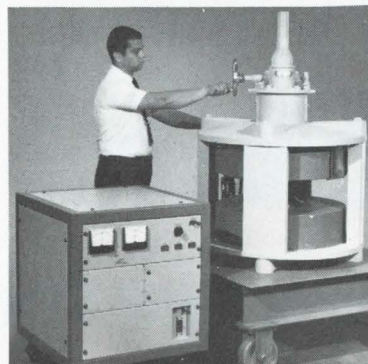
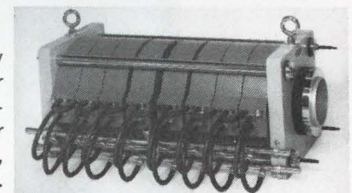

## Walker Special Magnet Systems

Typical special magnet systems, designed and produced at O.S. Walker.

**O. S. WALKER COMPANY, INC.**  
ROCKDALE STREET, WORCESTER, MASS. 01608 617-853-3232

WALKER  
MAGNETIC  
GROUP

**SCIENTIFIC DIVISION**  
TWX 710-340-7629



# FIRST again... with the largest lineup of new linear ICs

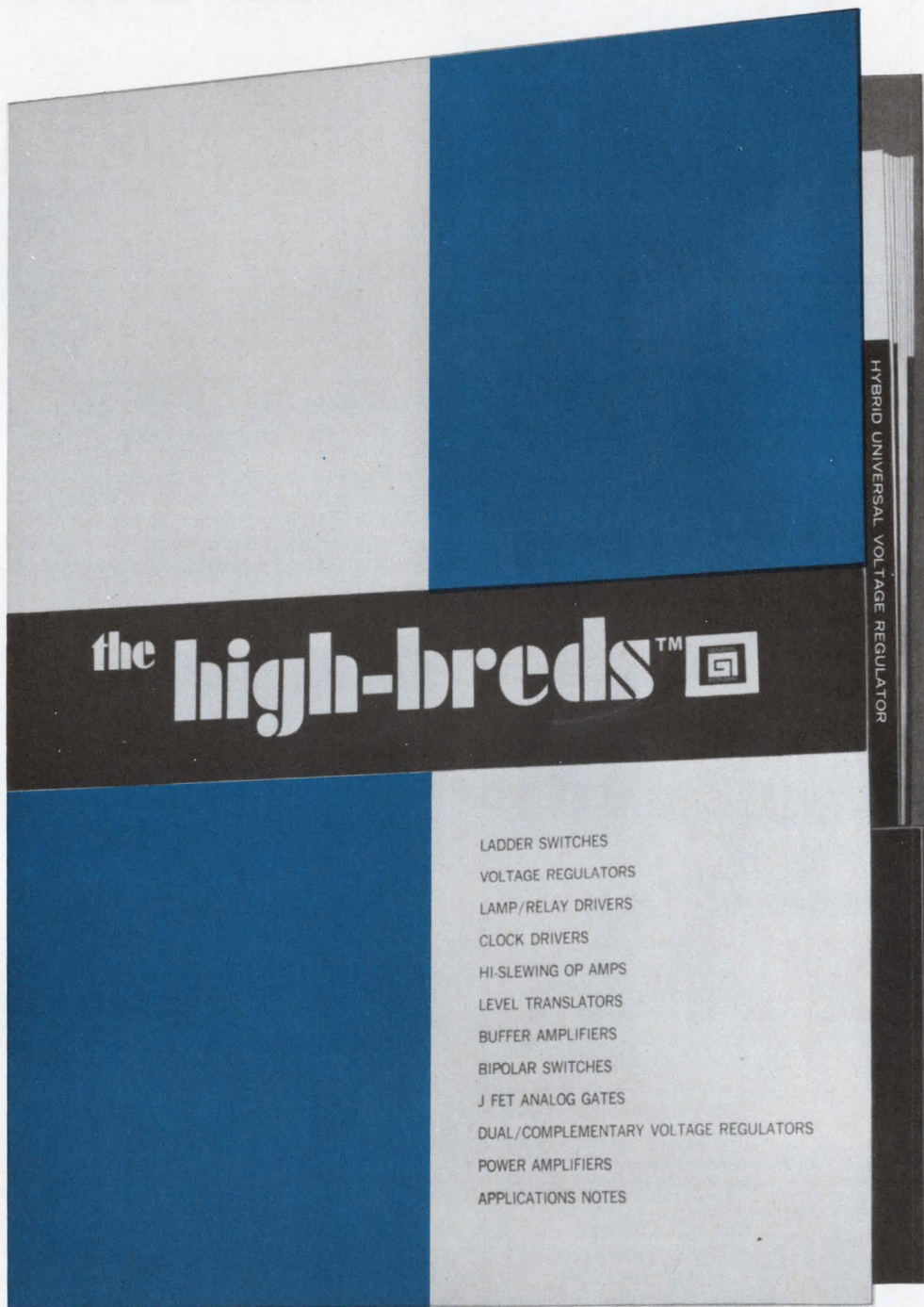

## order your free copy today!

Call 516-733-3243 or write General Instrument Corporation, Dept. H, 600 West John St., Hicksville, L.I., N. Y. 11802.





## Readers Comment

fast transistor-transistor logic, and are, in fact, considering a possible custom development for a major manufacturer. But we are not making Ray 3, nor do we intend to develop and produce a family of circuits that would be compatible, pin-for-pin, with Ray 3 for general usage.

Elliott Sopkin  
Fairchild Semiconductor  
Mountain View, Calif.

### For the record

To the Editor:

Your "For the record" item on high-speed printers [June 23, p. 60] incorrectly credits IIT as the manufacturer of the Inktronic printer. Inktronic is trademarked by the Teletype Corp., which manufactures the printer.

D.J. Zigament  
Manager, advertising & sales promotion  
Teletype Corp.  
Skokie, Ill.

### Noise monitors

To the Editor:

I read with considerable interest your article on airport noise monitoring systems [July 7, p. 183] especially since I was recently involved in a similar project for Amsterdam's Schipol Airport.

At that airport, Rohde & Schwarz GmbH, a leading West German instrumentation manufacturer, re-

cently installed a noise monitoring system. It built the monitoring equipment, which is interfaced into a Digital Equipment Corp. PDP-8L computer. The programing was done by Agrippa-Ord Systems GmbH, a West German subsidiary of the Agrippa-Ord Corp.

The Rohde & Schwarz Fluglarm is similar to the Hewlett-Packard GmbH system in its operation. Daily records are kept of the equivalent noise level (LEQ) and all occurrences of threshold violations. Reports can be obtained on demand or are automatically generated at predefined times. Threshold violations are printed immediately on a teleprinter, and information about the violation is punched on a high-speed tape punch. The system is capable of handling as many as 16 different monitoring points or stations.

Stephen D. Piner  
Vice president/systems  
Agrippa-Ord Corp.  
Carlisle, Mass.

### A matter of opinion

To the Editor:

In the June 23rd issue of *Electronics* [p. 116] the symbol  $CM_{rr}$ , common-mode rejection ratio, is most distracting. To be consistent, collector voltage would be  $C_v$ . Mr. Soanes must have had a fit!  $RR_{cm}$ , in my opinion, would have been far more plausible.

Nicholas Bodley  
New York

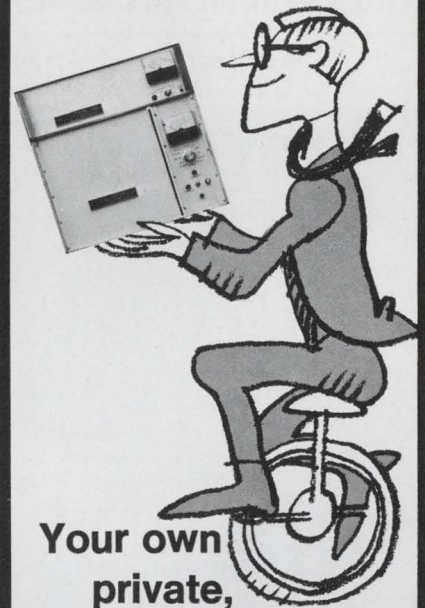

Your own  
private,  
movable  
Microwave.

Moving around? New Farinon TR-2500 microwave speeds and simplifies the extension of voice and data circuits to temporary locations. And you can take advantage of mobile licensing in the 2450-2500 MHz band. Equipment can be moved when and where you like without re-licensing.

Meeting normal industry standards for telephone or data transmission, you can operate up to 12 high-quality voice channels. A complete terminal (including multiplex) can be mounted on a portable rack or in an outdoor cabinet.

Because TR2500 is a true microwave system, you get the privacy and high quality of microwave transmission. And since TR2500 operates in a mobile band, you have the convenience of mobile licensing. Move with TR2500.

Talk to Farinon.

# Farinon

Farinon Electric, 935 Washington St., San Carlos, Cal. 94070

### SUBSCRIPTION SERVICE

Please include an Electronics Magazine address label to insure prompt service whenever you write us about your subscription.

Mail to: Fulfillment Manager  
Electronics  
P.O. Box 430  
Hightstown, N.J. 08520

To subscribe mail this form with your payment and check  new subscription  renew my present subscription

Subscription rates: qualified subscribers in the U.S.: 1 year \$8; two years, \$12; three years, \$16. Non-qualified: 1 year \$25. Subscription rates for foreign countries available on request.

### CHANGE OF ADDRESS

ATTACH LABEL HERE

If you are moving, please let us know five weeks before changing your address. Place magazine address label here, print your new address below.

name

address

city

state

zip code



## Who's Who in this issue



Chernow

Blatchley

Kedson

Stoughton

**Six men** share credit for the four articles on memory technology that begin on page 88. Gary Chernow, a staff engineer at Computer Test Corp., has been in the field for over seven years. Prior to joining CTC, U.S. patents and has seven pending. Formerly with RCA, Alan M. Stoughton has for the past couple of years headed a CTC group designing and programing computer-controlled test equipment. A co-author, who didn't quite make the picture, is Charles A. Elles, who, before signing on with CTC a year ago, racked up 11 years of experience in the test equipment and instrumentation fields. Elwood A. Dance recently left CTC for a new position at Scientific Measurement Systems Inc.

**Senior associate editor** Harry Karp, who handled the piece on Bell Labs' magnetic bubbles (page 83), is very high on this new technique for manipulating digital data. Until recently managing editor, he has decided to return to field work, specializing in coverage of industrial electronics. A 14-year veteran of technical journalism, Harry holds both BSEE and MSEE degrees from Newark College of Engineering; before embarking on an editorial career, he worked many years in industry. Harry has received two patents on control systems.

**Testing integrated circuits** economically is the subject of the article that begins on page 74; it was co-authored by Robert Hughes and Blaine Belecki of the Digital Equipment Corp. Bob, manager of component engineering at the company, is in charge of inspecting all incoming components. Before being appointed to this post, he was a senior engineer doing design work. His associate won a BSEE from the University of Manitoba in 1965. He first joined DEC in 1967 after working two years at Northern Electric's Montreal facility. Blaine started off as a design engineer. At the moment, he's employed as a software specialist in Digital Equipment's Toronto Office.

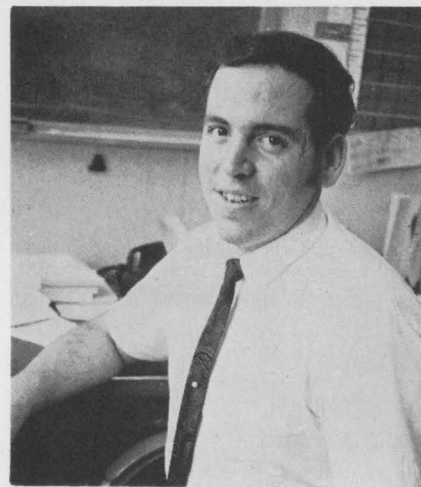

Gilder

**With the school year** about to start again, *Electronics* is saying goodbye to summer intern Jules Gilder, who's returning to the City College of New York to complete work for his BSEE. Jules, editor in chief of *Vector*, CCNY's engineering magazine, worked in a number of departments, including U.S. reports, Designer's Casebook, and Technical Abstracts, during his stay. And during July, he covered the Conference on Engineering in Medicine and Biology. He returns to school with our best wishes.



Biberman

**An applied optics** expert, Lucien M. Biberman makes a strong case for the sec tube in a special section of the cover story on low-light-level tv that begins on page 64. Now a research staff member at the Institute for Defense Analyses, he specializes in the fields of infrared and night vision. Biberman earned a BS at Rensselaer in 1940.



NEW FLAT PAK DESIGN ONLY 0.1" THICK

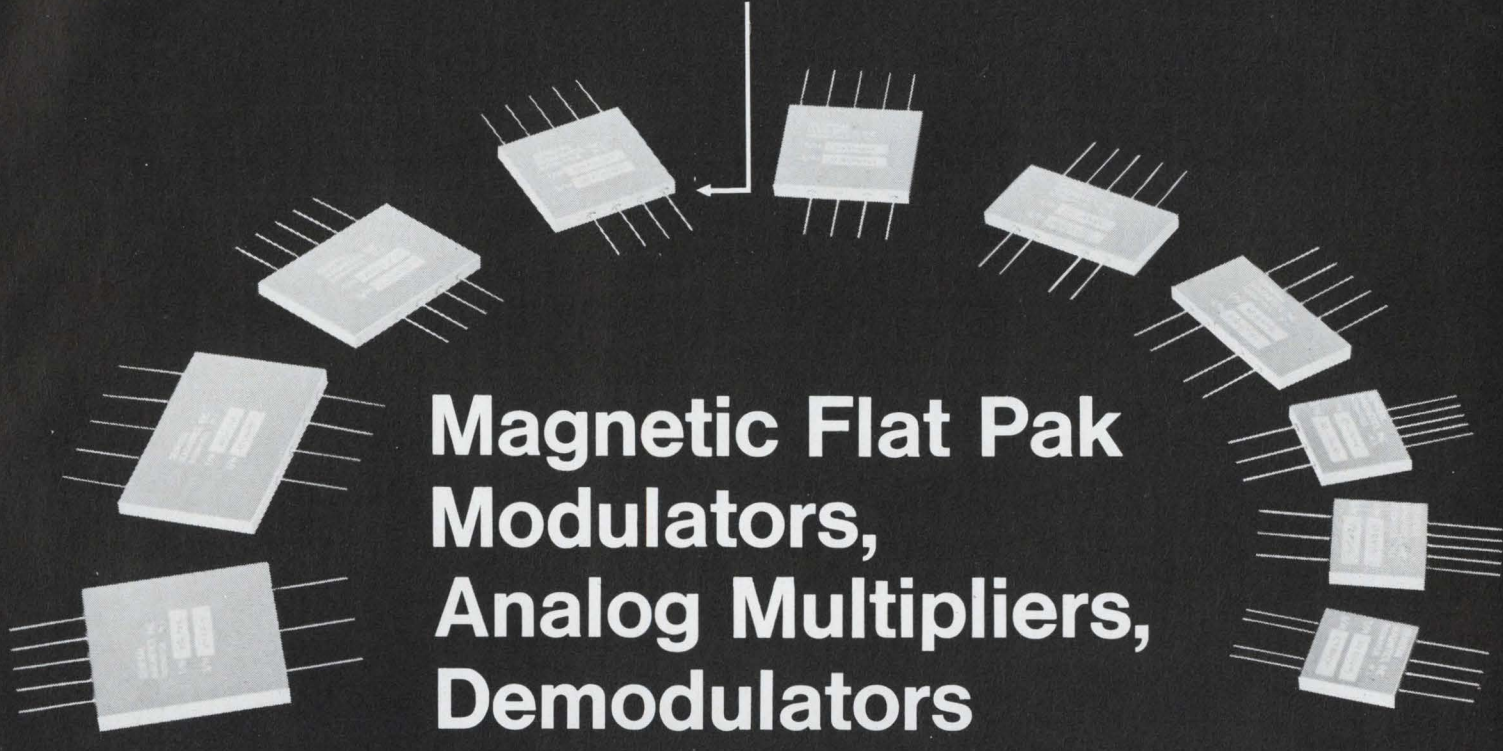

# Magnetic Flat Pak Modulators, Analog Multipliers, Demodulators mount directly on IC Cards

ACTUAL SIZES

- Hybrid assemblies mount directly on IC cards.
- Space saver design . . . typical dimensions 0.1" thick x 0.5" x 0.75".
- Rugged design, extreme reliability. MTBF design goal 0.25 per million hours.
- Extremely low drift over  $-55^{\circ}$  to  $+125^{\circ}\text{C}$  range.
- Not affected by high intensity nuclear radiation.
- Capable of operating on carrier frequencies as high as five Mhz.
- One or more isolated or floating input signals may be used for modulating, multiplying, dividing, squaring or extracting a root.
- No external nulling or offset adjustments.
- No additional components or compensation required.
- No external operational amplifiers required.
- Standard  $\pm 15$  V DC power supplier unless otherwise specified.

TYPICAL FUNCTION PERFORMED BY THESE COMPACT MODULES

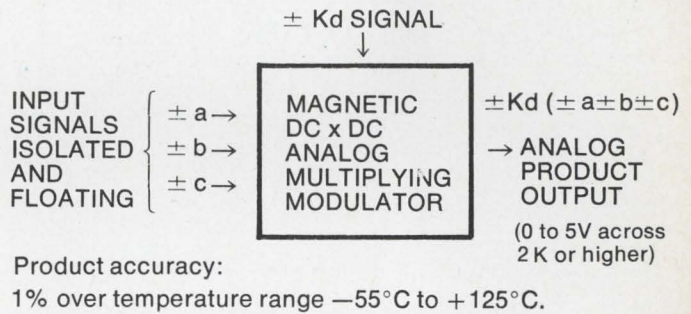

TYPE NUMBER	IMM 1199-1	IMM 1210-1	IMM 1212-1	IMM 1214-1
Reference Carrier Voltage and Frequency	10 V RMS @ 1800 Hz	10 V RMS @ 400 Hz	5 V RMS @ 25 KHz	5 V RMS @ 100 KHz
Input Control Signal Range	0 to $\pm 1.5$ ma DC	0 to $\pm 300$ ma DC	0 to $\pm 5$ V DC	0 to $\pm 10$ V DC
DC Resistance of Input DC Signal Winding	8 K ohms	30 K ohms	10 K ohms min	< 5 K
AM Phase Reversing AC Output Range	0 to 5 V RMS @ 1800 Hz	0 to 5 V RMS @ 400 Hz	0 to 5 V RMS @ 25 KHz	0 to 5 V RMS @ 100 KHz
Differential Gain RMS mv. AC Output/ua DC Sig. Input	4 mv RMS/ $\mu$ a DC	16.5 mv RMS/ $\mu$ a DC	1 V RMS/1 V DC	0.5 V RMS/1 V DC
AC Output Null (Noise Level) RMS	$\frac{1}{2}$ % f.s.	$\frac{1}{2}$ % f.s.	0.5% f.s.	0 to 5 V RMS @ 100 KHz
Output Impedance	< 50 ohms	< 50 ohms	< 50 ohms	< 50 ohms
External Load	10 K to 100 K ohms	10 K to 100 K ohms	10 K to 100 K ohms	10 K to 100 K ohms
Excitation (Carrier Winding) Impedance	4 K ohms	25 K ohms	10 K ohms	1 K ohms
Zero Point Drift over Temp. Range Referred to DC Input Terminals	0.25% f.s.	0.5% f.s.	0.5% f.s.	1% max
Hysteresis in Percent of Max. Input DC Signal	0.2% f.s.	0.5% f.s.	0.5% f.s.	0.5% f.s.
% Harmonic Distortion in Output Wave	5%	10%	< 5%	< 5%
Temperature Range	$-55^{\circ}\text{C}$ to $+125^{\circ}\text{C}$	$-55^{\circ}\text{C}$ to $+125^{\circ}\text{C}$	$-55^{\circ}\text{C}$ to $+125^{\circ}\text{C}$	$-55^{\circ}$ to $+100^{\circ}\text{C}$
Frequency Response	DC to 200 Hz	DC to 100 Hz	DC to 2.5 KHz	DC to 10 KHz
Overall Dimensions (in inches)	0.1 x 1.0 x 1.0	0.1 x 1.0 x 1.0	0.1 x .75 x .625	0.1 x .75 x .625
Type of Mounting	Flat Pak Terminals	Flat Pak Terminals	Printed Circuit Flat Pak	Printed Circuit Flat Pak

Magnetic DC x DC Multiplier

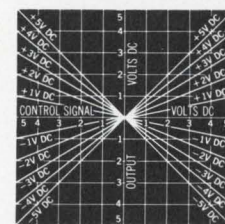

Squaring

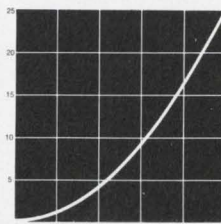

Square Root

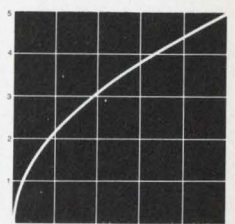

Division

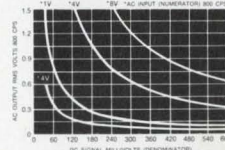

Amplitude Modulation

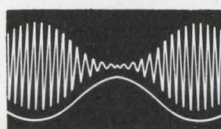

Balanced Modulator

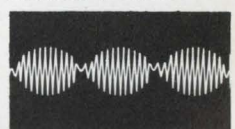

There is No Substitute for Reliability  
**GENERAL MAGNETICS, INC.**  
 135 Bloomfield Avenue,  
 Bloomfield, New Jersey 07003

Circle 9 on reader service card



**A new custom logic  
element used to cost  
about forty thousand  
dollars, months of  
design and production  
time, and endless grief  
in debugging and reliability**



# How about a thousand dollars and we'll do it from memory?

Use logic programmed into an ROM (Read Only Memory) element. With a minimum of time, we can set up the pattern your logic table dictates and have your circuits coming down the chute. Costs about a thousand dollars and there's every probability your production run circuits will cost less, too.

ROM elements are far simpler to make than a new, untried logic design. They're highly repeatable and proven reliable. No logic race conditions. All of our ROMs will directly interface with TTL or DTL logic.

We've got a memorable packet of information for logic designers. Write or call National Semiconductor. 2975 San Ysidro Way, Santa Clara, California 95051. (408) 245-4320. TWX: 910-339-9240 Cables: NATSEMICON

Product number*	Bits	Organization	Package	100 up \$
MM520	256	256 x 1	8 pin TO-5	38.00
MM521	1024	256 x 4	16 pin DIP	45.00
MM522	1024	128 x 8 or 256 x 4	24 pin DIP	60.00
MM523	2048	256 x 8 or 512 x 4	24 pin DIP	96.00

\*—25° to 70°C. Full mil temp also available.

## National/MOS



**Our computer plays  
back PM motor  
designs in seconds.**



# INDIANA GENERAL *We make it easy for the design engineer.*

30 design possibilities in about 5 minutes, to be precise. All we need from you for input data to our computer are speed vs. torque vs. current characteristics; maximum diameter and/or length (if required); and lowest temperature for stall or start (if known). We'll feed in characteristics of all the ceramic magnet materials.

From that, we'll provide virtually as many designs as will work, for both DC and rectified AC motors as well as for alnico PM motors. Parameters specified will include armature diameter and stack length. Winding data, including volume of copper. Magnetic material.

And magnet dimensions, including volume, thickness and area. Or we'll be happy to confirm your own design. However you use our computer design service, it's free.

And far more than calculating the magnetic materials to be used, we provide them, too. Our wide range of Indox® materials covers all your PM motor needs. Want additional design service, or help with prototype motors?

Fall back on IGC's design experience, with or without our computer terminal.

For design evaluation, or further details, send the coupon.



Mr. C. H. Repenn, Manager of Sales  
Indiana General Corporation  
Magnet Division  
Valparaiso, Indiana 46383

Please send me magnet and design literature, and an application form for a PM motor design evaluation.

Please calculate PM motor design possibilities, based on the attached data: Speed vs. torque vs. current; maximum diameter and/or length; and minimum temperature for stall or start.

NAME \_\_\_\_\_

TITLE \_\_\_\_\_

COMPANY \_\_\_\_\_

ADDRESS \_\_\_\_\_

CITY \_\_\_\_\_ STATE \_\_\_\_\_ ZIP \_\_\_\_\_



# DATA TRANSMISSION

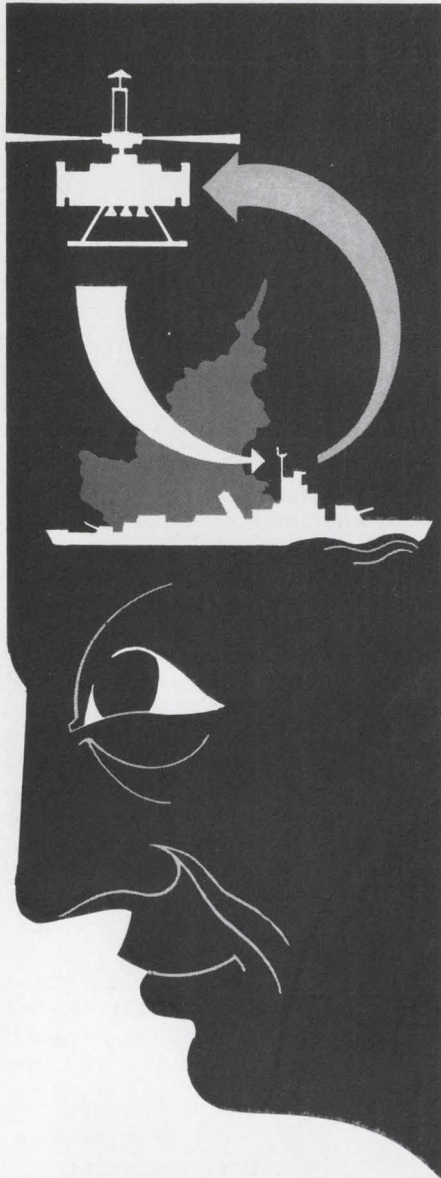

TOTAL ELECTRONIC  
SYSTEMS CAPABILITY.  
SPECIALISTS IN  
TIME/FREQUENCY,  
RADAR AND  
DATA SYSTEMS  
OFFERING RAPID  
GROWTH.



P.O. BOX 222, BUFFALO, N. Y. 14225

14 Circle 14 on reader service card

## Who's Who in electronics



Goeken

"When we started this, everyone thought we were nuts," says John D. Goeken recalling how people in the communications industry and in Washington's legal and political circles viewed his decision to challenge AT&T through a petition to the Federal Communications Commission for permission to offer private microwave service on a route between Chicago and St. Louis.

Now the former G.E. mobile radio salesman from Joliet, Ill., having won his six-year battle with AT&T, believes that his firm, Microwave Communications Inc. (MCI), is on its way to creating a new national microwave net to service commercial and industrial firms. And Goeken contends that the service will be 50% to 90% cheaper than comparable telephone company service [See p. 40].

Goeken estimates that the fight cost MCI close to \$400,000 in litigation fees over the last six years. But now he contends that a share in his privately-held communications company is worth \$4,000. This compares with a 1963 figure of \$100 and reflects a 5-for-1 stock split.

Goeken has also started another firm, Microwave Communications of America Inc. (Micom), through which he and Micom chairman William McGowan expect to provide other fledgling microwave service companies with assistance in filing FCC license applications, with

engineering expertise, with system construction and operation assistance, and with marketing services.

Thus the determination which led people to say that Jack Goeken was "nuts" six years ago is already paying off. To his friends and colleagues he has become "Jack the Giant Killer"—a nom de guerre that has been recorded for posterity on a trophy that looks like it was originally designed for an amateur bowler. But Jack Goeken, approaching 36, has become a hardened communications pro during the lean years of litigation.

Goeken is enthusiastic about the possibilities now open for the communications industry. Before his landmark FCC decision and the one on Carterfone, he recalls, "you did it AT&T's way or you didn't communicate." Throughout the 24 days of hearings, Goeken says the Bell System had 13 attorneys and 15 to 20 experts every day, at a daily expenditure of over \$20,000. "They had unlimited resources." MCI had one lawyer, and "we'd work together until 4, 5 or 6 in the morning preparing for the next day's hearings."

With one leg draped over the arm of his rocker, the Commerce Department's Myron Tribus appears to be the most relaxed man in Washington. But it would be a mistake to judge his intentions by his posture, because the 47-year-old Assistant Secretary of Commerce for Science and Technology is determined to convince the Government that the only place for a Federal Telecommunications Authority is right in the Commerce Department. The authority would manage "electospace"—newest capital buzzword for the frequency spectrum.

From his rocker, the gift of his students at Dartmouth, where he headed the Thayer School of Engineering before joining the Government, Tribus makes this case for assignment of spectrum management to Commerce: the depart-

Circle 15 on reader service card →



# ALSiMAG®

## Small Precision CERAMICS "As Fired"

Illustrated Approximately Actual Size.

### PROGRESS REPORT

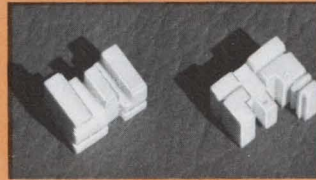

.370 ± .003  
Hole .025 ± .002

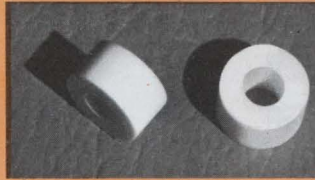

O. D. .467 ± .000  
- .005

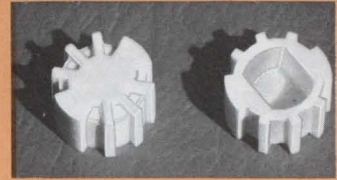

.532 ± .005



Holes .056 ± .003  
Holes .016 ± .002



Radii .171 ± .002



Slot Width .070 ± .002  
Holes .034 ± .001



O. D. .379 ± .0025  
Holes ± .003



Thickness .0165 ± .0015



Slot Width .064 ± .002  
Floor Thickness .050 ± .001



Hole .042 ± .001



O. D. .484 ± .003  
Hole .016 ± .002



O. D. .304 ± .003  
Holes ± .002



O. D. .369 — .372 ± .0015



O. D. .218 ± .0015  
Hole .094 ± .001



Holes ± .002  
Thickness ± .002

Improvements in electronic devices have been limited by the cost and time requirements of precision ceramics produced by grinding, lapping and polishing. The ability to produce ALSiMag® "as fired" ceramics to close tolerances removes the limits on quantity, speeds deliveries, favorably influences cost, and assures greater uniformity from piece to piece and lot to lot. In many cases the "as fired" surface also has more favorable electrical characteristics.

### SPECIAL FACILITIES

The volume of ALSiMag® precision "as fired" ceramics has grown steadily each year. Equipment has been refined. Skills have been upgraded. Environment and raw material controls have been strengthened. Engineering know-how has been increased. All these result from years of work on precision "as fired" ceramics.

### ALUMINA, STEATITE OR BERYLLIA

To meet the requirements of our customers, capabilities have gradually been extended to include Forsterite, cordierite, beryllia and steatite as well as the alumina

ceramics. ALSiMag® steatite ceramics have long been the leaders in the industry. They have been used for decades with marked success. These highly refined steatites, exclusive with American Lava, have favorable electrical characteristics which are not equaled by any others. They usually offer substantial cost savings, especially in large volume.

### SPECIALIZED EXPERIENCE

Today American Lava has the broadest capabilities available in precision "as fired" ceramics. The illustrations point out significant dimensional tolerances and give an idea of current production capabilities.

### HELP FOR YOU

Inquiries on close tolerance ceramics should be as detailed as possible. Please remember that the broadest tolerances permitted by the design will result in the lowest cost. Designs with tolerances "impossible" a few years ago are now practical. Tell us what you need and our technical people will be glad to make suggestions.

CODE IDENT. NO. 70371

American Lava Corporation **3M**  
A SUBSIDIARY OF COMPANY

PHONE 615 265-3411 • CHATTANOOGA, TENNESSEE 37405, U.S.A.

For service, contact American Lava representatives in Offices of Minnesota Mining and Manufacturing Company in these cities (see your local telephone directory): Boston: Needham Heights, Mass. • Chagrin Falls, Ohio • Chicago: Elmhurst, Ill. • Dallas, Tex. Indianapolis, Ind. • Laurens, S. C. • Los Angeles, Calif. • Metropolitan New York: Ridgefield, N. J. • Up-State New York and Canada: Phoenix, New York • Orange, Conn. • Philadelphia, Penna. • Roanoke, Virginia • St. Louis: Lee's Summit, Mo. South San Francisco, Calif. • International: c/o American Lava Corporation, Chattanooga, Tenn. 37405 U.S.A. TELE. 558-122

68th  
YEAR  
OF  
CERAMIC  
LEADERSHIP



# precision fix on performance.

## FP SERIES ATTENUATORS

Each attenuator pad is individually calibrated at two frequencies—30 MHz and 1 GHz—Series FP-50 and FP-75 are color coded individually in standard resistor color code. Both the 50-ohm FP-50 and 75-ohm FP-75 are available in a wide variety of connectors, or in any combination of those connectors.

### PRICES

FP-50: BNC, TNC—\$12.50; Type N, \$16.00.  
 FP-75: BNC, TNC, Type F—\$12.50; 70-ohm Type N—\$18.00.



### KEY SPECIFICATIONS

**Frequency Range:**  
 Model FP-50, DC–2 GHz  
 Model FP-75, DC–1.2 GHz

**Calibration Accuracy:**  
 Model FP-50,  $\pm 0.1$  db;  
 Model FP-75,  $\pm 0.2$  db

**Power Handling Capacity:**  
 1 watt average, 1000 watts peak

## ZM SERIES MINIMUM LOSS PADS



50/75  $\Omega$     50/93  $\Omega$   
 75/93  $\Omega$     50/600  $\Omega$

- **Frequency Range:**  
Up to 1000 MHz
  - **Connectors:**  
Any combination of BNC, TNC, Type N, or Type F
- Price: \$10.00

ALL MODELS AVAILABLE FROM STOCK, SPECIAL CUSTOMER DESIGNS SHIPPED WITHIN TWO DAYS AFTER RECEIPT OF ORDER.



*Texscan* CORPORATION

2446 NORTH SHADELAND AVENUE  
 INDIANAPOLIS, INDIANA 46219

## Who's Who in electronics

ment, unlike some other agencies, is not mission-oriented, and can thus provide the best interface for science and technology, the economy, and the society [See p. 37].

The word "electrospace," coined by one of Commerce's scientists at Boulder, embraces the frequency spectrum plus selective directionality, time, and polarity, and includes not only the spectrum but also cable communications. Tribus says no one knows at any one time how much of the electrospace is being used, or by whom, and "no one [agency] knows or will claim responsibility to find out". In addition, he says, there's a "tremendous background of technical information that's missing." For example, what happens to microwave transmission when it rains?

Commerce "has the best non-defense capability in Government" for in-house systems analysis, Tribus says. While conceding that other agencies, such as the Defense Department, NASA, and the Atomic Energy Commission have enormous in-house capabilities, he says that their specific missions could possibly interfere with judgment on telecommunications matters. But, Tribus says, "That isn't to say NASA couldn't turn around and get it".

Whichever Government group gets FTA, Tribus says, "The agency would have to serve as a coordinating agency", a sort of super-agency, of which the Federal Communications Commission, the National Bureau of Standards, possibly Comsat, and others would be a part. FTA would also manage the National Communications System [*Electronics*, Aug. 4, p. 56]. The problem of coordination now, Tribus says, is that "FCC plays in its part of the spectrum and OTM plays in its part of the spectrum," and there could be much better management if just one office decided who gets what chunk of the electrospace.

**Go to cable.** One technique he thinks would alleviate the growing congestion is to put more communications services on cables.



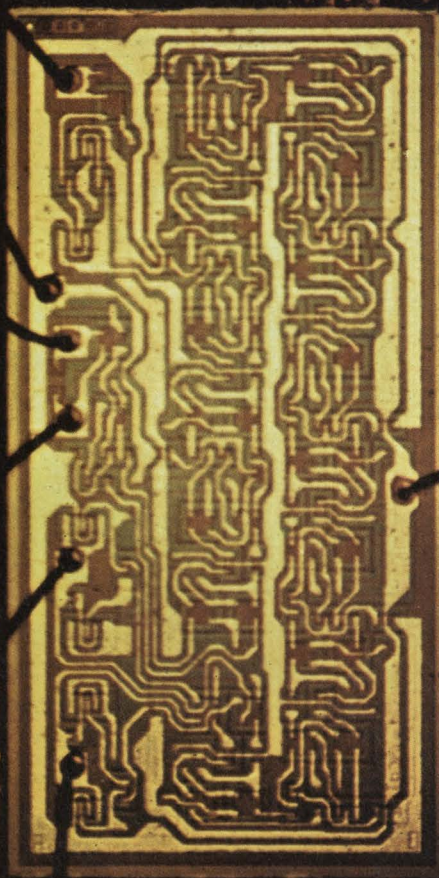

**MSI**

Sprague Series 54/74 ICs. Illustration: 54/7491 8-Bit Shift Register

## More Stuff Inside. Sprague 54/74 arrays.

Design is easier. Package count and costs go down. Equipment gets smaller, neater, simpler. Simply because you get more inside every DIP or flatpack with Sprague Series 54/74 arrays.

So buy fewer parts. And make every part count. Move into MSI. With Sprague Series 54/74 arrays. Get the straight answers on complex arrays. Types. Prices. Delivery. Call Sprague now.

Decade Counter	54/7490	4-Bit Binary Full Adder	54/7483
Divide-By-Twelve Counter	54/7492	8-Bit Shift Register	54/7491
4-Bit Binary Counter	54/7493	BCD Decoder/Driver	54/7441
Gated Full Adder	54/7480	Quad Bistable Latch	54/7475
2-Bit Binary Full Adder	54/7482		

Call Sprague Info-Central (617) 853-5000 extension 5474.

Or call your Sprague industrial distributor. He has Sprague Series 54/74 circuits on the shelf. For complete specifications, circle the reader service number below.

**SPRAGUE**  
THE MARK OF RELIABILITY

455-9132R1

Circle 17 on reader service card

Circle 19 on reader service card →



# PNP/NPN COMPLEMENTARY POWER SWITCHES

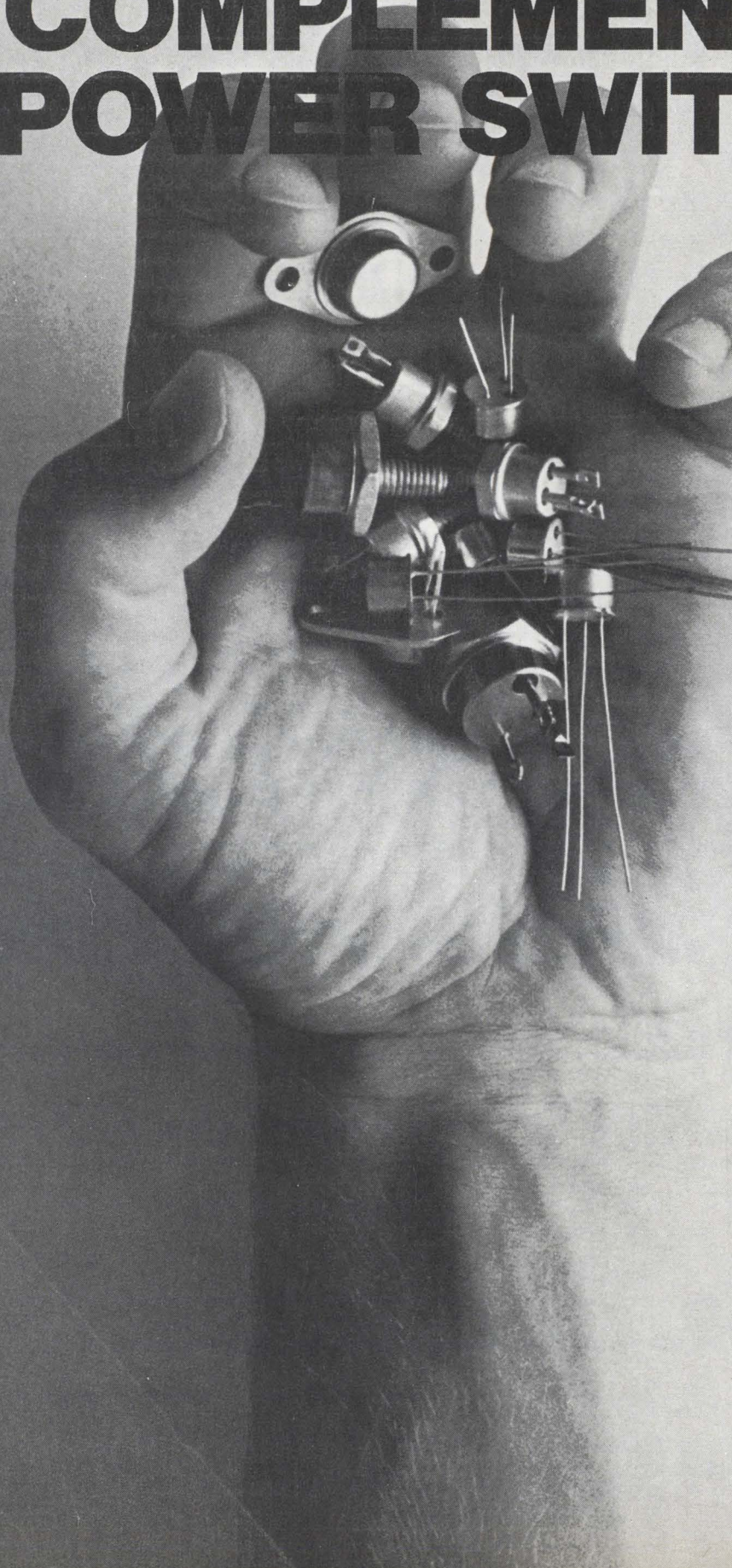

This month's power products include eight high-powered NPN/PNP complementary power switches capable of handling loads of 10 and 20 amps. They're new to the industry, so you've never seen the 2N numbers before. But you'll see a lot of them from now on.

We've built these complementary pairs with our double diffused epitaxial Planar\* technology so they don't just switch power—they switch it safely. Besides excellent reverse-biased safe area operation for handling highly inductive loads, this technology gives you faster switching times. Better overall switching characteristics. Very low  $V_{CE(sat)}$  and  $V_{BE}$ . And transistors that operate over the full  $-65^{\circ}\text{C}$  to  $+200^{\circ}\text{C}$  temperature range. At competitive prices.

**NEW:**

CURRENT	PACKAGE	NPN	PNP COMP.
10A	TO-5	2N5729†	2N5769†
	TO-59	2N5730†	2N5770†
20A	TO-3	2N5732†	2N5772†
		2N5731†	2N5771†
	TO-61	2N5313	2N5312
		2N5315	2N5314
		2N5317	2N5316
		2N5319	2N5318

†New to the industry

In case you've forgotten, we've also got some other complementary power switches you might find useful:

**NOT-SO-NEW, BUT AVAILABLE:**

CURRENT	PACKAGE	NPN	PNP COMP.
2A	TO-39	2N5148	2N5147
		2N5150	2N5149
	TO-59	2N4998	2N4999
5A	TO-39	2N5000	2N5001
		2N5152	2N5151
	TO-59	2N5154	2N5153
		2N5002	2N5003
10A	TO-61	2N5004	2N5005
		2N5006	2N5007
		2N5008	2N5009

Both the new and the not-so-new devices are on your Fairchild distributor's shelves. Grab a handful now.

\*Planar is a patented Fairchild process.



**THE  
GREAT  
FAIRCHILD  
POWER  
GRAB**



# FAIRCHILD'S POWER GRAB GOES ON!

So far in the Great Fairchild Power Grab, we've introduced our NPN Power Switches and Amplifiers. Our PNP Complementary Power Switches and Amplifiers. And our NPN/PNP Complementary Power Switches. A lot of second-source devices. And a lot of devices no one else can make.

They're all listed below. Just take your pick. You'll never have a better choice. (Until next month, when we bring out our Plastic Power Transistors.)

PACKAGE	NPN DEVICE	DATA PLEASE	PACKAGE	NPN DEVICE	DATA PLEASE	PACKAGE	PNP DEVICE	DATA PLEASE		
TO-3	2N3055	_____		2N5002	_____	TO-3	2N3789	_____		
	2N3232	_____		2N5004	_____		2N3790	_____		
	2N3233	_____		2N5346	_____		2N3791	_____		
	2N3234	_____		2N5347	_____		2N3792	_____		
	2N3442	_____		2N5348	_____		2N4398	_____		
	2N3713	_____		2N5349	_____		2N4399	_____		
	2N3714	_____		2N5477	_____		**2N5772	_____		
	2N3715	_____		2N5478	_____		TO-5	2N4234	_____	
	2N3716	_____		2N5479	_____			2N4235	_____	
	2N3771	_____		2N5480	_____			2N4236	_____	
	2N3772	_____		2N5730	_____			**2N5769	_____	
	2N3773	_____		TO-61	2N2811			_____	TO-39	2N5147
	2N4913	_____			2N2812		_____	2N5149		_____
	2N4914	_____			2N2813	_____	2N5151	_____		
	2N4915	_____			2N2814	_____	2N5153	_____		
	2N5038	_____			2N4301	_____	TO-59	2N4999	_____	
	2N5039	_____			2N5006	_____		2N5001	_____	
	2N5067	_____			2N5008	_____		2N5003	_____	
	2N5068	_____		2N5313	_____	2N5005		_____		
	2N5069	_____		2N5315	_____	**2N5770		_____		
	2N5301	_____		2N5317	_____	TO-61	2N5007	_____		
2N5302	_____	2N5319	_____	2N5009	_____					
2N5303	_____	2N5731	_____	**2N5312	_____					
2N5732	_____	TO-63	2N3597	_____	**2N5314		_____			
2N5734	_____		2N3598	_____	**2N5316		_____			
TO-5	2N3439		_____	2N3599	_____		**2N5318	_____		
	2N3440		_____	2N4002	_____	**2N5771	_____			
	2N4300	_____	2N4003	_____	TO-66	2N3740	_____			
	2N4877	_____	2N5733	_____		2N3741	_____			
	2N5336	_____	TO-66	2N3054		_____	2N4898	_____		
	2N5337	_____		2N3441		_____	2N4899	_____		
	2N5338	_____		2N3738		_____	2N4900	_____		
	2N5339	_____		2N3739	_____	**NEW THIS MONTH				
2N5729	_____	2N4910	_____							
TO-39	2N5148	_____	2N4911	_____						
	2N5150	_____	2N4912	_____						
	2N5152	_____	2N5427	_____						
	2N5154	_____	2N5428	_____						
TO-59	2N4998	_____	2N5429	_____						
	2N5000	_____	2N5430	_____						

NAME \_\_\_\_\_ ADDRESS \_\_\_\_\_

COMPANY \_\_\_\_\_ CITY \_\_\_\_\_

DEPARTMENT \_\_\_\_\_ STATE \_\_\_\_\_ ZIP \_\_\_\_\_





*For 14 months we would have said "no"*

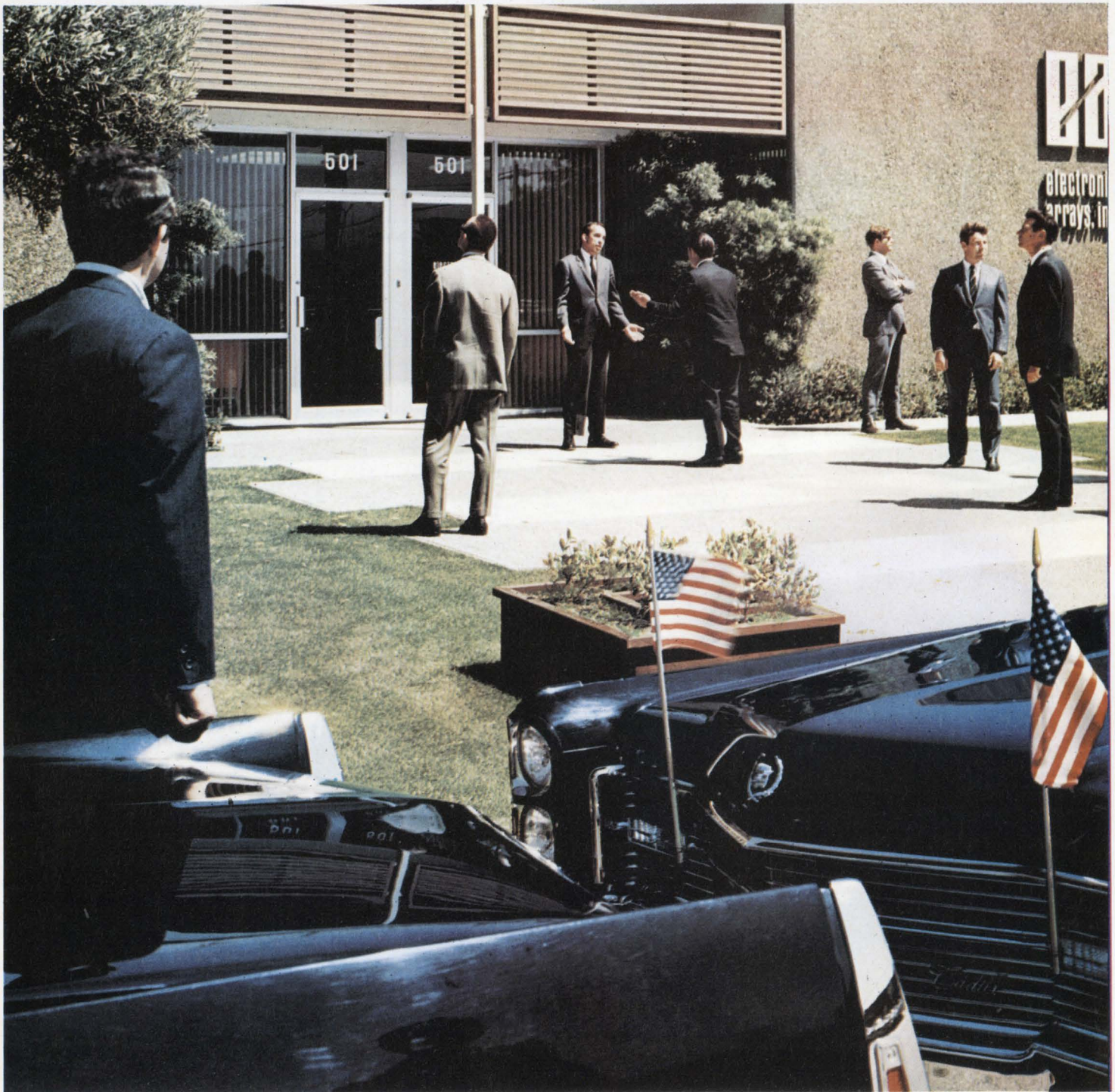



# to even the President of the United States.



"Sorry, Mr. President."

That's what we would have said.

When we got into the MOS business in 1967, we resolved not to follow the over-enthusiastic marketing practices of the industry.

So we didn't sell to *anybody* until our products were fully tested, documented, and deliverable in volume.

That's why you didn't hear from us until February of this year—14 months after we began our operations.

Electronic Arrays is a volume producer of state-of-the-art MOS products. That's all we do.

We work with no other technology.

We have the know-how to manufacture complex circuits at low cost by packing a lot of electronic function into tiny silicon chips.

Our EA 3500, a 2560 bit Read-Only Memory, for example, is made with 3000 transistors all contained in a chip of silicon .065 inches by .094 inches—about as small as the head of a pin.

Our experience with MOS integrated circuits goes way back. In fact, Gene Stephenson, our director of manufacturing operations, designed the very first MOS circuit in 1964. Others on our staff account for the next three, along with many current designs.

Our plant is already over 27,000 square feet. Production standards are impeccable. This year, we will deliver about 100,000 circuits. And next year, many times this number.

We worked a long time behind the scenes. Now we're delivering.

Address your purchase orders to Electronic Arrays, Inc., 501 Ellis Street, Mountain View, California 94040. (415) 964-4321.

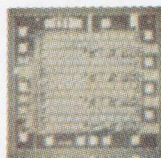

To the left is our EA 1200, the industry's only Quad 32 bit shift register. Other products include dynamic and static registers, random access read/write and read-only memories and logic arrays.



**electronic  
arrays, inc.**

**Proven MOS products delivered in volume**



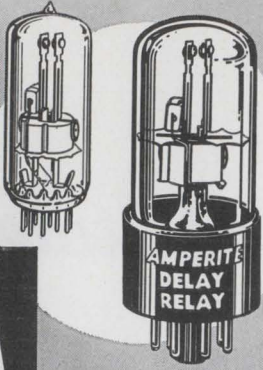

## GLASS ENCLOSED Thermostatic DELAY RELAYS

Offer true hermetic sealing.  
Assure maximum stability  
and life.

**Delays: 2 to 180 seconds**

Actuated by a heater, they operate on A.C., D.C., or Pulsating Current... Being hermetically sealed, they are not affected by altitude, moisture, or climate changes... SPST only — normally open or normally closed... Compensated for ambient temperature changes from  $-55^{\circ}$  to  $+80^{\circ}$ C... Heaters consume approximately 2 W. and may be operated continuously. The units are rugged, explosion-proof, long-lived, and inexpensive!

**TYPES:** Standard Radio Octal and 9-Pin Miniature... List Price, \$4.

Amperite Delay Relays are approved for all voltages up to and including 115V under the component regulations of Underwriters' Laboratories, Inc.

PROBLEM? Send for Bulletin No. TR-81.

## AMPERITE

### BALLAST REGULATORS

Hermetically sealed, they are not affected by changes in altitude, ambient temperature ( $-50^{\circ}$  to  $+70^{\circ}$  C.), or humidity... Rugged, light, compact, most inexpensive.

List Price, \$3.00

Write for 4-page Technical  
Bulletin No. AB-51



## AMPERITE

600 PALISADE AVE., UNION CITY, N.J. 07087

Telephone: 201 UNION 4-9503

In Canada: Atlas Radio Corp., Ltd.,  
50 Wingold Ave., Toronto 10

## Meetings

### Sounding off on Ultrasonics

The growing interest in surface and guided waves in ultrasonics is evidenced by the 1969 IEEE Ultrasonics Symposium, Sept. 24-26 at the Chase Plaza Hotel in St. Louis, Mo. Of the 12 technical sessions, four will be devoted to surface and guided waves. In addition, the other eight will include papers on biological and medical ultrasonics, physical acoustics, elasto-optic interactions, and lattice dynamics.

In the area of surface waves, M. R. Daniels of the Westinghouse Electric Corp. will present a paper dealing with the electrical equivalent circuit of an interdigital transducer and its characteristics. H. Mathews of Sperry Rand will be presenting a paper on magneto-static surface waves.

One presentation that could draw more than its share of the participants will be an overview of the status of acoustic emission

studies. The paper, "Acoustic Emission Developments and Current State of the Art," will be given by P. H. Schofield of Teledyne's materials research operation.

One paper that could attract a great deal of interest is one by Gordon Atkinson of the University of Maryland. His presentation, "Low Frequency Absorption in Water," will concern itself with the problems of transmitting ultrasonic sound through sea water. While it is known that the chemical reactions of sea water cause the absorption of high frequency ultrasonic waves, he suggests that chemical reactions are also to blame for a great deal of absorption in the low frequencies. However, he believes that these reactions are not the same as those for high frequencies.

For further information contact C.K. Jones, Westinghouse Research & Development Center, Beulah Rd., Churchill Borough, Pittsburgh, Pa. 15235.

## Calendar

**Education and Training Technology International Convention, IEE; London, England; Sept. 2-6.**

**Electrical Insulation Conference, IEEE; Sheraton-Boston Hotel & War Memorial Auditorium, Boston; Sept. 7-11.**

**European Microwave Conference, International Symposium on Man-Machine Systems, IEE; St. John's College, Cambridge, England; Sept. 8-12.**

**Convention of the Society of Logistics Engineers; Cape Kennedy Hilton Hotel, Cape Kennedy, Fla.; Sept. 9-10.**

**Petroleum & Chemical Industry Tech. Conference, IEEE; Statler Hilton Hotel, Los Angeles; Sept. 14-17.**

**International Telemetry Conference, International Foundation for Telemetering, Sheraton Park Hotel, Washington, D.C.; Sept. 15-17.**

**Conference on Trunk Telecommunications by Guided Waves, IEE; London, England; Sept. 15-17.**

**Electro-Optical Systems Design Confer-**

**ence, Industrial and Scientific Conference Management Inc.; Chicago; Sept. 16-19.**

**Solid State Devices Conference, IEE; University of Exeter, Exeter, Devon, England; Sept. 16-19.**

**Symposium on the Biological Effects and Health Implications of Microwave Radiation, Biophysics Department of the Virginia Commonwealth University, Bureau of Radiological Health, Environmental Control Administration, and U.S. Public Health Service; Richmond, Va.; Sept. 17-19.**

**Annual Broadcasting Symposium, IEEE; Mayflower Hotel, Washington, D.C.; Sept. 18-20.**

**Joint Power Generation Conference, IEEE, American Society for Mechanical Engineers; Charlotte, N.C.; Sept. 21-25.**

**Annual Intersociety Energy Conversion Engineering Conference, IEEE, American Society for Mechanical**

(Continued on p. 24)



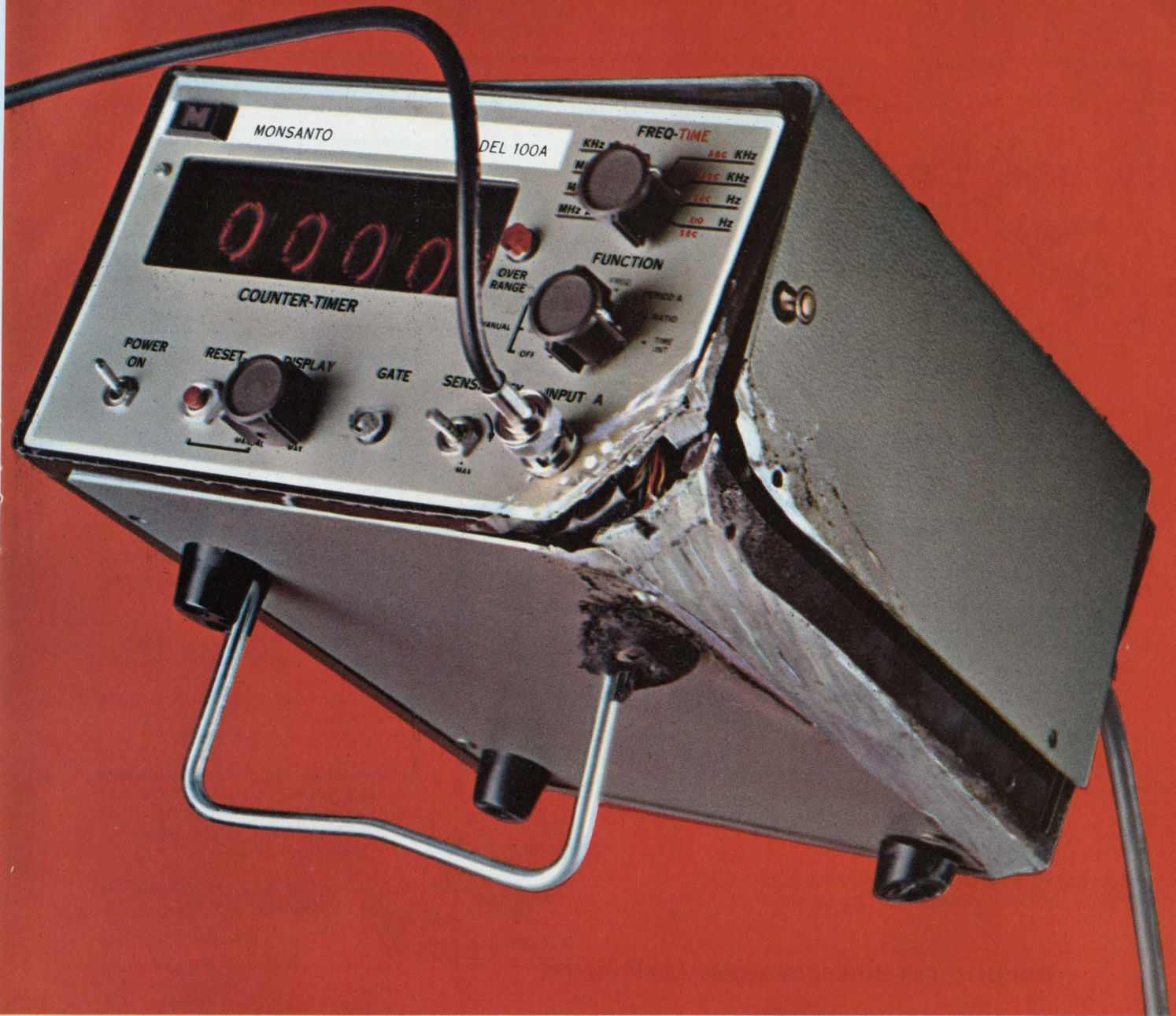

**This counter fell off a plane.  
It didn't need service  
(but when one does, we're ready).**

This Model 100A Counter-Timer was enroute to a customer. A freight handler laid it on the wing of the airplane—and forgot it. The package finally slid off as the wheels left the runway. Instantly freed of its container, the "Small Wonder," as our customers sometimes call it, chased the plane for about a hundred yards, then ground-looped.

Our nearby Service Center, bored with inaction, brightened at the thought of a real challenge when it was brought in. But they were disappointed: electrically, the "Small Wonder" picked up right where it left off in Final Inspection. (Of course, *mechanically* there were a few abra-

sions to take care of, as you can see.)

Please help us keep our 37 Service Centers with their factory-trained technicians alive and well. Call the one nearest you anytime you feel that a Monsanto instrument requires service or calibration...or even verification of its performance. In addition to their expertise and factory specified test equipment, all carry a complete stock of spare parts. If there should be a defect in materials or workmanship during the 2-year warranty period, it won't cost you anything.

Monsanto Company, Electronic Instruments, West Caldwell, New Jersey 07006.

**Monsanto**



# BETA DISPLAYS

## BETTER DISPLAYS

Remember. You can't do better than Beta. Here is a full range of high resolution CRT display system modules that have proven themselves in situations ranging from applesauce processing to creating the recently televised Apollo moon pictures. Send for Engineering Data Sheets today.

### ± 35 VOLT DEFLECTION AMPLIFIERS

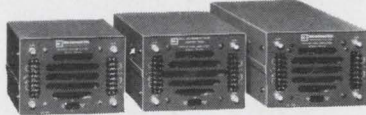

The models DA223, DA224 and DA225 are dc-coupled, all-silicon, solid-state modular packages capable of supplying up to  $\pm 2.0$ ,  $\pm 4.0$  and  $\pm 6.0$  amperes of deflection current respectively to each axis of a directly-coupled deflection yoke. A unique method of damping optimizes the amplifier for the particular yoke being used by means of an adjustable potentiometer. The amplifiers also feature extremely fast settling time and high bandwidth. The user has the choice of operating the amplifiers Class A for achieving nonlinearities of  $\pm 0.02\%$  maximum or Class AB for minimum power consumption.

### HIGH & LOW VOLTAGE CRT POWER SUPPLIES

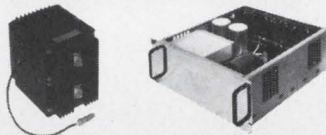

SERIES HV provides regulated high voltage outputs for CRT electrodes — anode, focus grid, G2, and filament.

Model No.	Anode Output Range
HV8	1-8 kv
HV20	5-20 kv
HV30	15-30 kv

SERIES PAK provides regulated low voltage outputs for Beta modules —  $\pm 35$  volts,  $\pm 20$  volts, G1, and filament.

Model No.	$\pm 35$ volt (deflection) Output
PAK7	7 amperes
PAK16	16 amperes

### MODULAR CRT BUILDING BLOCK COMPONENTS

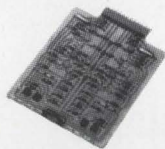

Individual, compatible plug-in circuits such as: DF2050 Dynamic Focus Generator; DF347 Electromagnetic Dynamic Focus Amplifier; DF2496 Electrostatic Dynamic Focus Amplifier; LC2656/2676 Precision Linearity Correction Circuit; LC916/918 Linearity Correction Circuit; VA2076 Video Amplifier (10 MHz); VA2075 Gamma-Corrected Video Amplifier (10 MHz); VA2769 Video Amplifier (10 MHz, 60 volt output); VA2077 Video Amplifier (30 MHz); SG1190 X-Y Sawtooth Generator; PP529 Phosphor Protection Circuit; DA341 Deflection Amplifier ( $\pm 200$  ma); DA1340 ( $\pm .75$  amperes); EDA800 Electrostatic Deflection Amplifier (350 volts plate-to-plate positive or negative); EDA1504 Electrostatic Deflection Amplifier (500 volts plate-to-plate positive or negative); FR1882 Static Focus Regulator; BA1714 Blank/Unblank Amplifier. All Beta circuitry features silicon semiconductors and temperature stable metal-film resistors throughout.

### PRECISION TUBE AND COIL MOUNTS

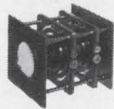

Flexible combinations of standard assemblies for the precision mounting and alignment of CRTs, yokes and coils: CRTM Basic CRT Mount includes removable bezel, rods and neck end clamps; DSTM Dual Gun Recording Storage Tube Mount, includes rods and neck clamps both ends; MCM Micro-positioner Coil Mount allows 6 independent motions and positive lock; FYM Fixed Yoke Mount for application where micropositioning is not required; FYMS Fixed Yoke Mount for servo-type mounted yokes; CCM Centering and/or Alignment Coil Mount; MS983 Magnetic Shield Enclosure.

## Beta Instrument

377 Elliot St., Newton Upper Falls, Massachusetts 02164 / Tel. 617 969-6510 / TWX 710-335-6973

## Meetings

(Continued from p. 22)

Engineers; Statler Hilton Hotel, Washington, D.C.; **Sept. 21-26.**

Aerospace Development Briefings and Fall Meeting, Air Force Association; Sheraton Park Hotel, Washington; **Sept. 22-24.**

Ultrasonics Symposium, IEEE; Chase Park Plaza Hotel, St. Louis, Mo.; **Sept. 24-26.**

International Electronics Conference, IEEE; Automotive Building, Exhibition Park, Toronto; **Oct. 6-8.**

Annual Conference of the American Institute of Ultrasound in Medicine; Winnipeg, Manitoba, Canada; **Oct. 6-10.**

Engineering Management Conference, IEEE; Montreal, Quebec, Canada; **Oct. 9-10.**

IGA Group Annual Meeting, IEEE; Statler Hilton Hotel, Detroit; **Oct. 12-16.**

Annual Symposium on Switching and Automata Theory, IEEE; Waterloo, Ontario, Canada; **Oct. 15-17.**

International Symposium on Remote Sensing of Environment, The Center for Remote Sensing Information and Analysis; University of Michigan, Ann Arbor; **Oct. 14-16.**

Thermionic Energy Conversion Specialist Conference, IEEE; Carmel, Calif.; **Oct. 21-23.**

Joint Materials Handling Engineering Conference, IEEE, American Society of Mechanical Engineers; Sheraton Motor Inn, Portland, Ore.; **Oct. 27-29.**

Winter Power Meeting, IEEE; Statler Hilton Hotel, New York; **Jan. 25-30, 1970.**

Annual Symposium on Reliability, Group on Reliability of the IEEE, American Society for Quality Control, American Society for Nondestructive Testing, and the Institute of Environmental Sciences; Ambassador Hotel, Los Angeles; **Jan. 27-29, 1970.**

## Short courses

Laser Fundamentals and Applications, Polytechnic Institute of Brooklyn; Long Island Graduate Center, Farmingdale; **Sept. 8-12.** \$275 fee.

Digital Process Control Systems, Pur-

(Continued on page 26)



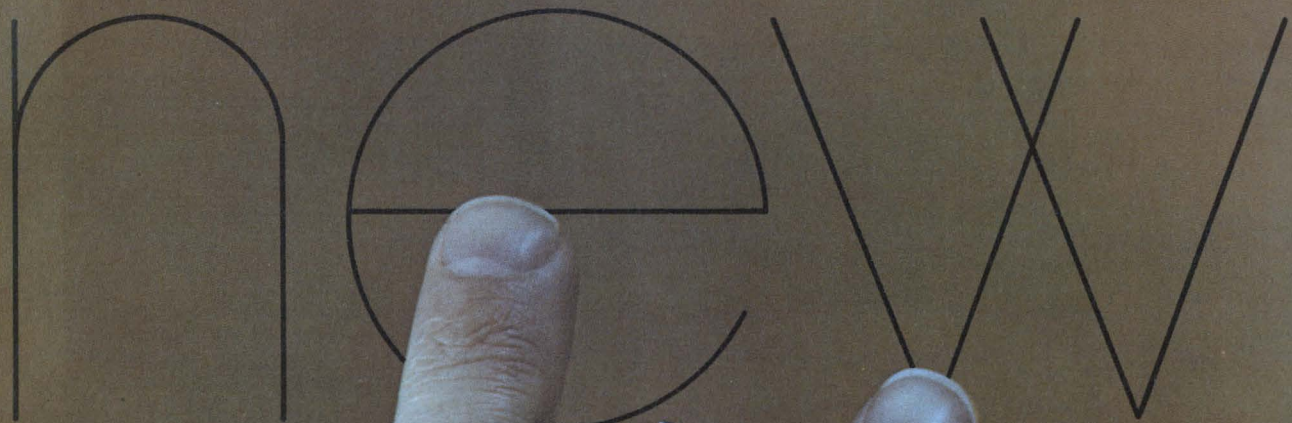

**TWO  
IN  
ONE**

*New Allen-Bradley  
hot-molded Type GD  
dual variable resistor  
shown actual size*

## **Allen-Bradley hot-molded dual variable resistor**

Here's the most compact two section variable resistor currently available—the new Allen-Bradley dual Type GD. It's one-half inch in diameter and only a fraction of an inch longer than the popular single section Type G control. The case is dust-tight as well as watertight. ■ Both resistance tracks in the dual Type GD are solid, hot-molded elements, which provide long operating life. As with the single Type G, the noise level is low initially and actually decreases with normal use. Adjustment is smooth at all times with virtually infinite resolution. And low inductance permits operation at frequencies far beyond the usable range of wirewound controls. ■ In addition to standard application, these new dual Type GD controls are ideally suited for use in compact attenuators. ■ Dual Type GD controls are available with nominal resistance values from 100 ohms to 5.0 megohms. For complete specifications on tolerances, tapers, and options, please write Henry G. Rosenkranz, Allen-Bradley Co., 1201 South Second Street, Milwaukee, Wis. 53204. Export Office: 1293 Broad Street, Bloomfield, N.J., U.S.A. 07003. In Canada: Allen-Bradley Canada Limited.







Meet the "Mite".  
Only .218" diameter. The toughest ceramic disc trimmer capacitor its size.

New from E. F. Johnson. And it's this small:   
Designed for printed circuit applications where space is at a premium. Stator of High Alumina for greater shock and vibration resistance. The rotor plate is encapsulated in ceramic for environmental stability and long life. The Q factor at 1 MHz is 500 minimum. Precision lapped bearing surfaces give you smooth linear tuning. Pick from a wide capacitance range: 1.0-3.0 pF, 2.5-9.0 pF, 3.5-20.0 pF, 5.0-25.0 pF. Designed to meet or exceed applicable requirements of MIL-C-81A.

Return the coupon today for information on Johnson's new Micro-J.<sup>™</sup> And if you have a special capacitor need, we'd like to work with you. The same engineering that made our air variable capacitors the standard of excellence goes into every new Johnson product.

E. F. JOHNSON COMPANY/3008 Tenth Ave. S.W./Waseca, Minnesota 56093

- Send product specification information on new Micro-J capacitor.
- Include information about your full capacitor line and other Johnson components.

NAME \_\_\_\_\_ TITLE \_\_\_\_\_

FIRM \_\_\_\_\_ ADDRESS \_\_\_\_\_

CITY \_\_\_\_\_ STATE \_\_\_\_\_ ZIP \_\_\_\_\_



**E. F. JOHNSON COMPANY**

## Meetings

(Continued from p. 24)

due University, Lafayette, Ind.; **Sept. 15-24.** \$250 fee.

**Aerodynamics of V/STOL Aircraft**, Pennsylvania State University, University Park; **Sept. 21-26.** \$175 fee.

**Active Filter Design: Theory and Practice**, University of California at Los Angeles; **Sept. 22-26.** \$275 fee.

**Executive Technical Development**, Polytechnic Institute of Brooklyn, New York; Gurney's Inn, Montauk, Long Island; **Oct. 6-31.** \$2,125 fee.

**Computer Manipulation of Symbolic Information**, University of California at Los Angeles; **Oct. 20-24.** \$275 fee.

## Call for papers

**Numerical Control Society's Meeting and Technical Conference**; Statler Hilton Hotel, Boston, April 8-10, 1970. **Oct. 15** is deadline for submission of abstracts to program chairman, Lawrence D. Levine, Hitchiner Manufacturing Co., Milford, N. H. 03055.

**International Solid-State Circuits Conference**, IEEE; Sheraton Hotel, Philadelphia, Feb. 18-20, 1970. **Oct. 17** is deadline for submission of abstracts and papers to Mr. L.D. Wechsler, General Electric Co., Electronics Park, Building #3, Syracuse, N.Y. 13201.

**Transducer Conference**, IEEE; National Bureau of Standards, Gaithersburg, Md., May 4-5, 1970. **Nov. 1** is deadline for submission of summaries to Dr. Robert B. Spooner, IMPAC Instrument Service, 201 E. Carson Street, Pittsburgh, Pa. 15219.

**1970 Electronic Components Conference**, Electronic Industries Association, IEEE; Statler-Hilton Hotel, Washington, May 13-15, 1970. **Nov. 15** is deadline for submission of abstracts to Mr. Burks, Sprague Electric Co., Marshall Street, North Adams, Mass. 01247.

**Geoscience Electronics Symposium**, IEEE; Washington, D.C., April 14-17, 1970. **Dec. 1** is deadline for submission of abstracts to Mr. Ralph Bernstein, Chairman, Technical Program Committee, IBM Corp., 18100 Frederick Pike, Gaithersburg, Md. 20760.

**Parametric Design of Digital Filters**, Technology Service Corp.; Miramar Hotel, Santa Monica, Calif., **Oct. 21-24.** \$275 fee.





Pretty  
nice,  
for a circuit breaker.

And you can have our Model JC in any color you want—so long as it's white or gray.

Either way, you get a hydraulic-magnetic circuit breaker that's handsome enough to put right out there on the front panel. At an attractive OEM price, too.

Heinemann hydraulic-magnetic protection, of course, has an appeal all its own. Precise current ratings from 0.020 to 30 amp. Temperature-stable trip points. Choice of time-delay (or non-time-delay) characteristics. Optional special-function internal circuits that let you use the breaker as a control element.

And don't forget our five-year warranty. We don't.

You can get more information about our rocker-handle JC breaker by writing for Bulletin 3380. Heinemann Electric Company,  
2700 Brunswick Pike,  
Trenton, N.J. 08602

**HEINEMANN**

If it's color you're after, you can code our Series JA breaker with any of nine different hues, from flash yellow to electric blue. Write us for Bulletin 3350.

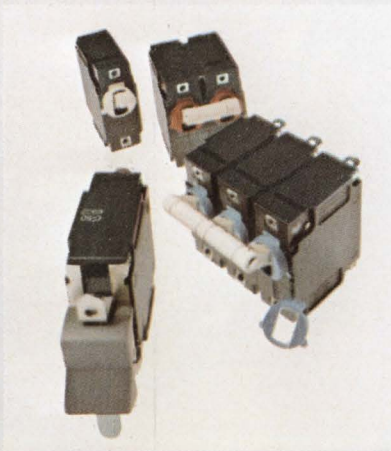



 The  
Trend  
is TTL.

 6917A  
SN74150M

 6917A  
SN74151N

 6917A  
SN74151J

 6917A  
SN 54152 F



*To help you cut the cost of multiplexing...*

## TI announces a new 16-bit and two new 8-bit MSI data selectors.

Here are three new ways to cut the cost of multiplexing and related operations. Each of these data selectors/multiplexers selects one of sixteen (or eight) data sources determined by the binary address inputs.

Each contains both inverter-drivers and AND-OR-INVERT gates in a single package.

This reduces your design time, inventory requirements and circuit costs. In addition, manufacturing costs are reduced and reliability is improved.

Applications include:

- Boolean function generation
- Random or sequential parallel-to-serial conversion
- Multiplexing from N-lines to one line (or N lines to M lines)
- Read-only memory or pulse-pattern generation.

SN54150/SN74150 are 16-bit data selectors in 24-pin plastic packages (left). SN54151/SN74151 are 8-bit circuits in either the 16-pin plastic or ceramic dual-in-line packages

shown at the left. SN54152/SN74152 are 8-bit selectors available in the 14 pin  $\frac{1}{4}$ " x  $\frac{1}{8}$ " flatpacks.

An SN7493 4-bit binary counter may be used as the select register to perform sequential selection. Or a register with parallel load capability—such as the SN7495—will provide flexibility to perform random selection and/or pulse pattern generation.

Any Boolean function of up to five variables can be implemented with the SN74150 without any external gating.

Any number of bits—and any word length—may be multiplexed by paralleling and cascading circuits. Decoding may be accomplished with SN7442 BCD-to-decimal decoders.

Propagation delay is only 10 ns from data input to output, and 20 ns total through three select levels.

Power dissipation is low...only 200 mW typical for the SN74150.

The SN54151/SN74151 features complementary outputs, while

SN54150/SN74150 and SN54152/SN74152 have inverted outputs.

SN54150/SN74150 and SN54151/SN74151 have strobe inputs to enable the data selectors. This provides maximum flexibility when cascading the circuits.

### New TTL Design Aid



These new data selectors/multiplexers take their places in industry's broadest line of TTL/MSI circuits. To tell you the full story, we have just completed a new 80-page brochure that gives valuable design information on all Series 54/74 circuits including the data selectors. Circle 195 on the Reader Service card for your copy...or write Texas Instruments Incorporated, P. O. Box 5012, MS 308, Dallas, Texas 75222.



**TEXAS INSTRUMENTS**  
INCORPORATED





## New, more versatile scribing . . . identical operation

Changes have been made in the new Model "C." Tempress Automatic Scribing Machine, but only where they matter . . . to increase operating flexibility and to incorporate improved components where they will contribute to the efficiency, dependability, or longevity of the machine. Follow the same set-up procedures; press "actuate," and you are scribing any rectangular or triangular pattern from .001" to .399", with incremental resolution to .001". How versatile? Choose a model to scribe either 1½" or 2" wafers, decimal or metric indexing, extended range, 50 or 60 cycle operation, without affecting

price. The only option for which you pay extra is a binocular optical system. Third generation of the machine that brought low-cost, automatic scribing to the semiconductor industry, the new Model "C" meets the Tempress Standard of Excellence, your assurance of precision when you purchase any member of the growing family of Tempress miniature assembly tools and production machines.



# TEMPRESS

Tempress Industries, Inc., 980 University Ave., Los Gatos, Calif. 95030



---

## Editorial Comment

---

### Japan's goals are defined

**Predictions about where Japan** is headed with its electronics industry were confirmed to a great degree by a report recently issued by the country's Electronics Industry Development Association. The upshot of the report: Japan has no intention of relaxing protectionism for its computer and IC industries.

In effect, this means that Japan intends to use the same approach in the industrial-commercial sector that proved so effective for consumer electronics. Through government subsidization and protectionism, along with private enterprise, Japan was able to build consumer electronics into a \$2.3 billion bonanza. Now, the same priority is being given the industrial-commercial sector. And Japan will rely heavily on its computer industry to propel the nation into this market in a big way.

Japan laid the groundwork for its lofty goals back in 1966, when the Agency of Industrial Science and Technology established the national research and development program—known popularly as the large-scale projects program (LSP). Of six such projects, the computer segment is getting more funding than all the others combined. Japan has

poured \$17.7 million into the project, whose charter is to develop high-performance computers that include IC's.

Japan's engineers envision computers as the backbone of their future in industrial-commercial electronics. Target performance specifications for computers under the LSP program, generated through a joint study by major computer makers, include a delay time of 1 nanosecond and add times of 50 nsec. The system is being designed to include multiaccess capability, as well as character recognition, graphic manipulation, and the ability to handle Chinese characters.

Besides the LSP program, Japan has taken other steps to promote its computer industry; tax exemptions have been granted, loans of \$120 million have been arranged to establish a private agency to buy computers from manufacturers and rent them to users, and loans have been provided to modernize computer production facilities.

In view of the success of the support it has already given its computer industry and the ambitious goals it has set, Japan is unlikely to relax its protective attitude in the near future. ■

### Radiation revisited

**The release earlier this year** of the results of tests by the Radiation Control Unit of New York's Suffolk County revealed that one of every five color-tv sets tested in consumers' homes emitted radiation greater than the recommended Federal guidelines. Specifically, 963 sets out of 4,838 tested exhibited radiation levels of more than 0.5 milliroentgens per hour at a distance of 5 centimeters from the set. During the course of the New York tests, which began in January 1968, results were relayed to the public via press releases. This led to "scare" headlines in the daily press, which were decried by industry spokesmen who felt the warnings unwarranted. The public, they said with some justification, did not appreciate the arbitrariness of the 0.5 mr/hr limit. (In fact, 550 of the 963 "defective" sets emitted X rays at a rate of less than 1 mr/hr).

Nevertheless, in-home testing continued as did publication of results. And pressure mounted for Congress to pass laws which would protect the consumer. The EIA became disenchanted with the bad publicity, and through its counsel asserted that no hazard existed. Set makers rebelled at suggestions that they perform extensive—and expensive—in-factory tests. They also noted that once sets are

installed in the home, the radiation levels can still go awry, through, for example, misadjustment by the installing technician.

The Suffolk County agency summarized its tests as follows:

- X rays were noted in some sets of all makes tested (37 brands in all).
- Emissions ranged up to 150 mr/hr.
- Radiation levels between 20 and 150 mr/hr were found in only 12 of the 4,838 sets checked.

These causes for the radiation were listed by the agency as the most outstanding:

- Manual adjustment of the high-voltage shunt regulator tube's circuitry, causing the voltage to exceed factory specifications.
- Faulty high-voltage shunt regulator tube.
- Replacement of the regulator tube with a faulty one by a repairman.

In the final analysis, set makers have been unable to design a large-screen color set which, from the standpoint of limiting radiation to some factory-specified level, is foolproof. One solution could be the replacement of the radiation-emitting vacuum tubes with solid state devices—such as voltage triplers. ■



If signal analysis from 10 Hz to 50,000 Hz is your concern, Systron-Donner's new spectrum analyzer will simplify your tasks and extend your measuring capabilities as never before.

Our 710/800 gives you absolute amplitude measurements over a 140 dB dynamic range, any 60 dB of which appears on a large 7 x 10 cm high-contrast display. Wave analysis, distortion studies, and spectral display are enhanced by a full 50 kHz scan and a narrow 10 Hz resolution. For measuring EMI and other low-level signals, you get very high sensitivity (calibrated to 30 nanovolts/cm) plus selectable input impedances of 50 ohms, 600 ohms, 10k ohms, and 1 megohm. And you get X-Y outputs, pen lift, sync and sweep inputs, plug-in versatility and many other standard features—all for \$2495.

This spectrum analyzer is truly portable. It weighs only 25 lbs.—or 30 lbs. with an optional internal battery that operates up to 8 hours before recharging.

Write for complete specifications. Ask for a demonstration. Contact Microwave Division, Systron-Donner Corporation, 14844 Oxnard St., Van Nuys, Calif. 91409. Phone: 213-786-1760.

## New spectrum analyzer covers 10 to 50,000 Hz with universal measuring capability\*

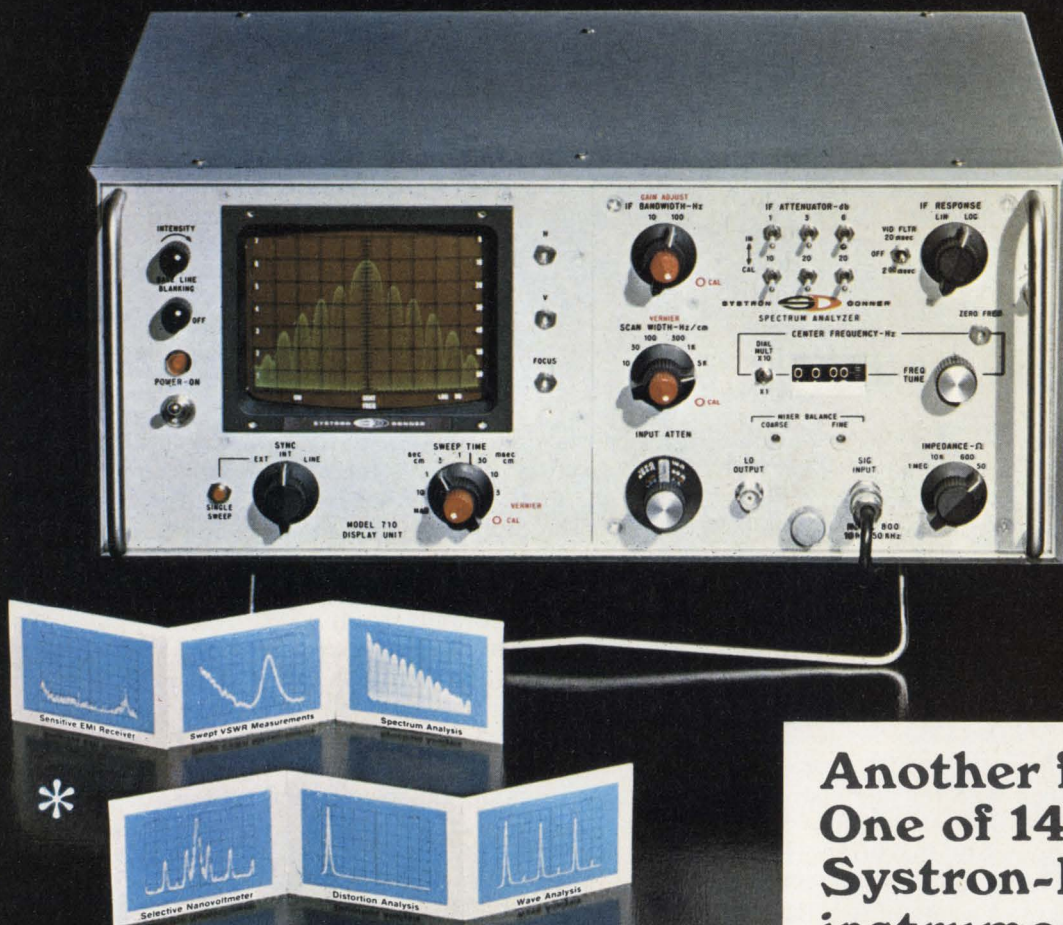

### Another first. One of 145 Systron-Donner instruments

Electronic counters	Digital voltmeters
Pulse generators	Spectrum analyzers
Microwave frequency indicators	Digital panel meters
Digital clocks	Microwave signal generators
Memory testers	Laboratory magnets
Analog computers	Data acquisition systems
Time code generators	Microwave test sets
Data generators	

Circle 32 on reader service card

SYSTRON  DONNER



---

# Electronics Newsletter

---

September 1, 1969

## Silicon Schottky diodes avalanched

Cornell University researchers have operated silicon Schottky-barrier diodes in avalanche. At X band, they've obtained 200 milliwatts of c-w power with 4% efficiency; at  $K_u$  band, the figures are 50 mw with 1% efficiency. Results were obtained at current densities of only 500 amps/cm<sup>2</sup> at X band and 1,200 amps/cm<sup>2</sup> at  $K_u$  band. **These current densities are lower than in conventional avalanche diodes, resulting in cooler junctions and improved reliability and power-handling capability.**

Schottky-barrier avalanche devices are simpler and cheaper to make than diffused types. They require no high-temperature diffusion steps, and the barrier junction is formed by a simple metal contact to the epitaxially grown n layer. Moreover, power handling is improved since there is no p layer and thermal resistance is lowered.

**The biggest obstacle to use of Schottky devices as avalanche diodes was surface stabilization.** Higher reverse breakdown voltage capability was needed to prevent premature avalanching. What happens is that ions left on the surface of the diode after it goes through the fabrication steps of etching, rinse, and baking are more likely to degrade the reverse characteristics of the Schottky-barrier than the diffused devices.

## Collins to sell customized MOS

Collins Radio has lifted the veil of secrecy from its new 200,000-square-foot facility in Newport Beach, Calif. The company will sell MOS integrated circuits—but there's a twist. **Unlike other systems makers that have marketed devices designed for in-house use, Collins will permit its customers to control design.** Chip size is limited to 160 mils on a side.

The customer will send logic equations to Collins computers in Newport Beach from six data centers around the country. A Fortran library of 300 standard cells and larger units of polycells will be available.

Collins will be able to handle 100 designs per month. Customers will pay \$8,000 to \$12,000 per design. **Collins estimates it will take about 60 days from the time it gets the logic equations until the parts are delivered.** Custom designs now cost up to \$50,000; turnaround is 90 to 120 days.

The MOS effort is one part of a three-pronged move into commercial competition for Collins. **The firm will also sell thin-film hybrid circuits and multilayer circuit boards externally, and already has a letter agreement to furnish more than \$1 million worth of thin-film hybrids to Litton's Data Systems division for use in the Navy E-2C aircraft's airborne command and control system.**

## Speech synthesizer promised for fall

The problems of making speech intelligible to a computer, and of making a computer's output resemble speech, may have been solved. Glen J. Culler, president of the Culler-Harrison Co. of Santa Barbara, Calif., **will market a speech synthesizer before year's end that may give computers unlimited vocabularies.** For the recorded words and numbers used with present aural computer outputs, Culler substitutes a microprogrammed processor and a proprietary form of real-time speech analysis to convert bit streams to words, and vice versa. The synthesizer can work at the output bus of most computers with only a few changes in mainframe software. **A microprogrammed voice input will follow the output system into the market sometime in 1970.**



---

# Electronics Newsletter

---

The first sounds generated by the Culler scheme are whispers of controversy. Culler has worked on speech synthesis for only about two years, and is far better known for work on time-sharing scientific computer systems, some dating back to about 1960. Thus, speech researchers who seem to have been making little progress for many years are skeptical. But Culler promises a public demonstration this fall.

## Fairchild discovers 3751 parameter gap

What do you do when you learn an MOS device you've been shipping for some time contains a logic error that makes it unworkable as an analog-to-digital converter at its intended accuracy without the addition of an external flip-flop? This is Fairchild Semiconductor's dilemma with its model 3751, an 8- to 12-bit a-d converter that's been shipped at a rate of about 300 a month. **One customer designed it into a hybrid thick-film a-d converter system and got to a-c testing before finding the error.**

Fairchild has offered three options: free flip-flop parts, which will prevent the race condition that develops if the customer doesn't have a 1 microsecond clock pulse; controlled clock-pulse width to prevent the race condition; or chip redesign. The customer that put the 3751 into a hybrid system can't wait four months for a redesign, and may have to settle for adding the flip-flop. **That, however, means 30 additional wire bonds in the package, which will raise the device's price.**

## Increased prices for discretes seen

Buyers of certain discrete semiconductors will probably be paying more for some of the older lines in 1970, if not later this year. Many manufacturers expect the steady downtrend to halt this year for those products, and foresee production cost increases leveling the price curve or even pointing it upward in some selected categories.

Stephen Levy, vice president and general manager of Motorola's Semiconductor Products division, looks for stabilization in metal-canned transistor prices, with the possibility of price hikes for some devices. David Cowden, diode product line manager at Sylvania's Semiconductor division, points out that diodes that sold for \$1 five or six years ago are now down to about four cents and can't go lower with materials and labor costs rising 3% to 6% a year.

## Viatron completes first prototypes

Prototypes of the much discussed and closely watched Viatron System 21 desktop microprocessor have been assembled. **This puts Viatron on its promised schedule of late 1969 delivery** [*Electronics*, June 23, p. 141] despite skepticism about whether the firm will be able to find MOS LSI suppliers for the machines, which are to rent for \$39 a month.

Meanwhile, suppliers state that Viatron lately has been demanding quick delivery of other System 21 components. While Viatron spokesmen won't comment, **the word is out that the company plans a mass delivery of System 21 processors within the next month or two.**

## Addendum

A research team from Autonetics and the NASA Electronics Research Center says a new family of plastics called parylene film may replace passivation layers now in use, and could help solve package-contamination problems. **The researchers have already developed a vacuum-deposition process that is said to be free of pinholes.**



# Granting of software patents still 'iffy'

Despite court upholding patentability of computer programs in Prater-Wei case, other unresolved legal battles will more than likely forestall anticipated boom

**Is the way clear** for the granting of software patents now that the U.S. Patent Office lost its appeal to overturn the precedent-setting Prater-Wei decision? And, if so, are the independent software firms in for an economic boom?

Don't count on either—not yet, at least—despite all the ballyhoo in the news media. Although there are those in the computer industry who believe the floodgates will open on a wave of patents as a result of the U.S. Court of Customs & Patent Appeals upholding the patentability of a program developed by two Mobil Oil Co. computer experts, Charles D. Prater and James Wei, the legal fraternity isn't quite that sure. Patent attorneys, in fact, say there are still too many "ifs."

Typical of this cautious response are the views of Irving Kayton, an engineer-turned-attorney who now directs the Computers-in-Law Institute at George Washington University's National Law Center, and David Bender, an attorney on the institute's staff.

**Other cases.** Kayton and Bender see the decision as only one of several which will affect protection of computer programs. Some of their "ifs" are:

- Pending appeals on two other cases—Wheeling and Mahony—which could decide if, as Kayton puts it, "all programable processes are statutory, and if all are not, then what criteria should be used to determine which are."

- Decisions still to come in the Government and civil antitrust suits filed against IBM this year and last which are expected to determine the legality of "bundling"—the technique by which computer manufacturers give away so-called "free" software with the purchase

or lease of computer hardware.

In the Prater-Wei decision, the court ruled that computer programs can be patentable. Kayton and Bender both point out that the court did not rule—press reports to the contrary—that computer programs are patentable per se, although Kayton believes the decision amounts to almost the same thing. Since the Prater-Wei patent package is for a program to be run on an analog computer for obtaining spectrographic data on gas, the more commonly used general-purpose digital computers are not immediately involved. Nevertheless, the court said it could see no reason why digital systems should be restricted from patentability.

**The market.** Assuming forthcoming decisions will be favorable to an estimated 500 U.S. independent software houses, Bender believes their \$250 million to \$500 million share of the annual \$6 billion software market could jump by as much as \$250 million. Bender's market analysis shows \$4.5 billion of the annual total is generated by large computer users, while hardware producers account for about \$1.25 billion in their software bundles.

Kayton and Bender consider the case so important that it is scheduled as one of the major topics for discussion at the Law of Software Conference in Washington, Oct. 8-9. "The implications of Prater and Wei for program patent protection," by Virgil Woodcock of Philadelphia, who argued the case for the appellants, is expected to highlight the session.

While Kayton believes the ultimate value to industry of the Prater-Wei ruling is still dependent on the upcoming appeals in the cases of Wheeling and Mahony, he

is sure on this point: "There is no doubt from the decision that if programable computer process and machine claims are written in the proper form, the court's view is that they are indeed protectable by patent."

## Reforms urged

While the Patent Office was losing its software court battle, it was being assailed for the lengthy and "obsolete" process still employed in granting patents. The critic was none other than Myron Tribus, the new assistant secretary of commerce for science and technology.

Tribus wants the Patent Office automated and is urging a Federal study, with industry participation, to spell out how to bring the U.S. system into the 20th Century.

**Plea for EDP.** Pending such a study, the new Nixon appointee

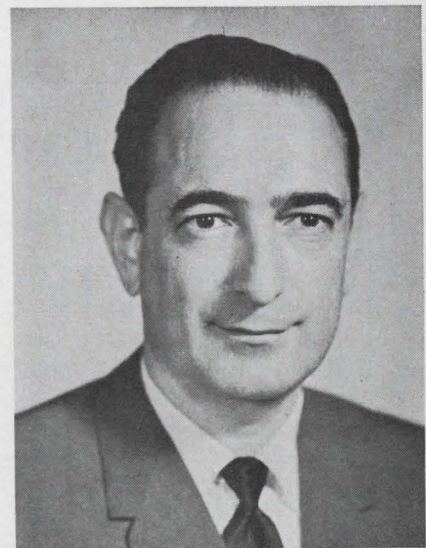

Assistant Commerce Secretary Tribus scores patent procedure as "obsolete."



## U.S. Reports

from Dartmouth College has some ideas of his own for wiping out the backlog of patent applications. He believes, for example, a workable patent office EDP system would have to be able to provide direct access to the 600 billion characters of the 3.5 million U.S. and 17 million foreign patents registered.

Off-line storage of abstracts and their 600 billion characters, says Tribus, is a "logical first step" after a study is completed. Possibilities for storage of "trillions of characters" include systems using lasers, electron beams and holographic techniques, with any interim approach allowing for complete on-line capability for patent office needs within five years.

### Medical electronics

#### Safely isolated

Doctors and hospital administrators, increasingly concerned over reports and rumors of patients electrocuted by faulty or improperly hooked-up instruments [*Electronics*, Feb. 17, p. 92], are pressing instrument makers to improve the safety of their products. Hewlett-Packard's Waltham division, in a move to satisfy these demands, is adding circuit isolation to its line of medical instrumentation.

Waltham isn't the only instrument-maker turning to circuit iso-

lation. "Not too many companies are isolating their inputs; but pretty soon they'll all have to do it," says Joseph Neuland, manager of the Clinical Instrumentation group at Beckman Instruments Inc., another company that is starting to employ the concept in its line. "More and more hospital specifications are calling for such low leakage currents that everyone will have to isolate," Neuland predicts.

The isolation technique involves eliminating any electrical path between the circuitry connected to the patient and the circuitry that's grounded. The idea is to prevent leakage currents flowing through the patient; these can flow, for example, if the patient touches something that's a few volts above ground, such as a poorly grounded lamp.

**Costly approach.** The safety provided by isolation isn't inexpensive. Dave Kelch, a product manager at Waltham, says that building in the isolation circuitry boosts an instrument's price by 10% to 15%. Waltham's isolation procedure is to amplify and chop the signal coming from a body probe, modulate a carrier with this chopped signal, and then feed the modulated signal to the ungrounded winding of a transformer. The instrument's grounded networks are connected to the transformer's other winding through a demodulator.

To ensure that the amplifier is totally isolated from ground, the

power-line signal which drives it also is passed through a transformer; the winding that looks at the power line is grounded and the one that looks at the amplifier isn't.

The division recently showed its new monitoring system, the 7807B at the American Hospital Association's Chicago convention, as well as a series of recorders, amplifiers, clocks, and ratemeters, all with isolated inputs. Waltham started to use isolation in its 1500 series of electrocardiograph machines, which was introduced last year.

### Avionics

#### Chop talk

Since the Korean war, helicopters have been called "choppers," and it couldn't be a more appropriate nickname, say the engineers designing antenna systems to enable the craft to transmit and receive via satellite relays.

If antennas are mounted conventionally on the fuselage, the rotating blades overhead chop the signals. This would require expensive and complex synchronous transmission techniques, using multiple antennas, to overcome the rotor blade modulation.

It's important that helicopters be equipped with a satellite relay antenna because of the major role that the ubiquitous craft now plays in combat operations, such as in Vietnam. Already under test are several tactical ground terminals that operate with a satellite; the terminals range from jeep-mounted units to antennas on board ships and aircraft. These tests, being conducted for the past several months with the experimental tactical communications satellite (Tacsat 1), have been very successful. So the helicopter satellite antenna system with its own special set of development problems appears to be a pacing item in the overall Tacsat program.

**Solution in sight.** Bell Aerospace, however, is now building a prototype above-the-rotor system that would eliminate the multipath,

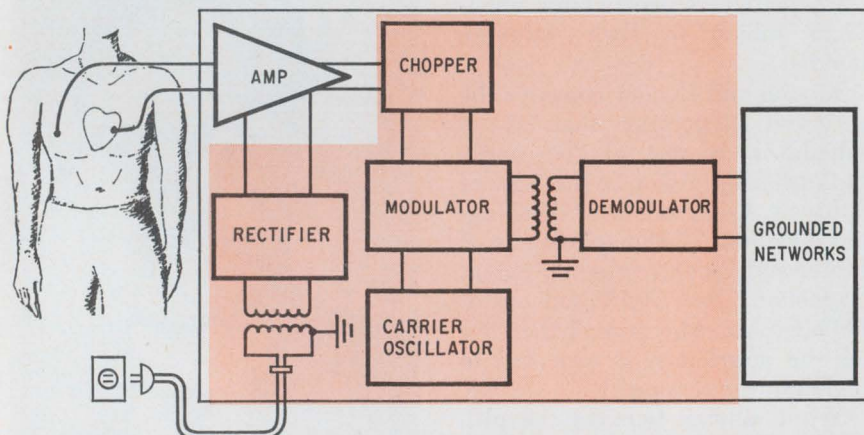

**An isolated example.** Medical instrument makers, challenged on safety of their wares, are turning to circuit isolation. Above, transformers ensure that there's no electrical path connecting the patient to ground.



September 1, 1969

# Electronics Index of Activity

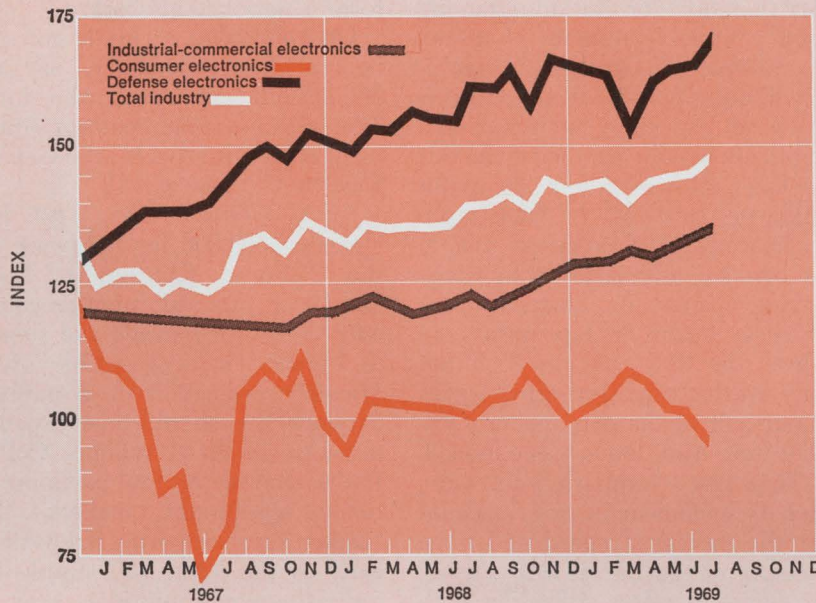

Segment of industry	July 1969	June 1969*	July 1968
Consumer electronics	96.4	101.5	100.1
Defense electronics	171.4	165.5	160.3
Industrial-commercial electronics	135.4	133.9	122.3
Total industry	148.0	145.4	138.9

July's electronics production index jumped to 148.0, the strongest monthly gain this year — up 2.6 points from the downward revised June figure of 145.4 and a substantial 9.1 points higher than the July 1968 index.

The figures were boosted by advances in both the defense and industrial-commercial electronics sectors. Defense production gained 5.9 points, its biggest monthly rise in 1969, while industrial-commercial output was up 1.5 points from June. July's consumer performance, on the other hand, showed a sharp 5.1-point decline from the previous month.

Indexes chart pace of production volume for total industry and each segment. The base period, equal to 100, is the average of 1965 monthly output for each of the three parts of the industry. Index numbers are expressed as a percentage of the base period. Data is seasonally adjusted. \*Revised.

blocking, and diffraction effects inherent in any antenna mounted below the rotor blades. The Buffalo, N.Y., firm, which had been studying the problem along with the Avionics Laboratory at Wright-Patterson Air Force Base in Ohio and the Army Communications Agency at Ft. Monmouth in New Jersey, only recently completed a feasibility study to determine such a system's aerodynamic effects as well as its stability, mechanical, and electrical problems.

In Bell's prototype, which is being built under a \$489,000 contract, a parabolic dish antenna will be mounted on a nonrotating shaft. The shaft, along with the control wiring, will pass down through the hollow rotating drive shaft of the helicopter to the cabin. The pilot will be able to control the direction and orientation of the antenna so that he can locate the satellite signal manually. Once this is done, the antenna will lock on and track

the satellite automatically regardless of any change in the helicopter's position or orientation.

Bell expects to complete the prototype late this year or early 1970, when it will be tested in a Bell UH1F. The system will operate in the superhigh-frequency range, 3-30 gigahertz.

## Computers

### Yet another shoe drops

Some people accuse IBM of being an octopus, but when it comes to letting shoes drop the company looks more like a centipede. Two weeks after telling the world about its new minicomputer [*Electronics*, Aug. 18, p. 48], it revealed some details about the most powerful computer it has ever developed.

To emphasize the magnitude of the jump it has made in speed over

the model 85, the largest in its current System/360 stable, the company went to three figures, calling the machine the model 195. Scheduled for first commercial delivery in the first quarter of 1971, the 195 will make extensive use of monolithic circuits in arithmetic and logic operations and its ASLT emitter-coupled logic circuitry as drivers in a 32,768-byte buffer memory.

For the time being, IBM has let Control Data keep the trophy for the most powerful machine. CDC's 7600 has nine separate but parallel processors in the central processing unit, a basic machine cycle time of 27.5 nanoseconds and a main storage cycle time of 275 nsec. The model 195, by comparison, has to make do with only five separate processors and pokes along at half the speed, 54 nsec. Its main storage cycle time is only a third as fast, 756 nsec.

But, industry sources suspect





**Top of the line.** System 360 now has a new member, the 54-nsec Model 195.

that a bigger machine, perhaps five times faster than the 195, will be introduced by IBM about the end of this year, after a 4-year gestation period.

And IBM may need it. Many industry observers, both competitors and impartial experts, are perplexed about IBM's latest ploy. They point out that the 195 seems to have fallen between two stools. As a commercial computer—where speed is less a factor than software, flexibility, reliability and the like—it would appear to offer a poorer bargain than purchase of two 360-65's. A user could rent a 195 CPU with a 1-megabyte memory for about \$107,800 per month or two 65's with megabyte memories for about \$52,590 each. As a scientific computer, the 195 is only half as fast as the 7600, a great drawback in an area where speed is a critical factor.

Part of the 195's trouble is IBM's need to maintain upward software compatibility in the 360 line. In so doing, the 195 comes out as part commercial, part scientific. In doing neither job perfectly, it would seem to be able to attract only those customers who want to do scientific work in the daytime and batch the payroll through at night.

"The upward compatibility that IBM touts as a feature of the 360 line is a drag on the 195. Having to use compatible software and having to fulfill commercial applications, makes the 195 less fit for scientific applications, while its speed and price are unsuited to commerce." So says an unworried competitor.

The 195 also is hitched to the system 360 operating system, and in multiprogramming applications to the MVT software package. (MVT stands for multiprogramming with a variable number of tasks.) If multiple job streams, or multiprogramming is to be done—and it is often so, especially in commercial applications—the user must use this package. However, one computer engineer calls MVT "catastrophically wasteful of processor time in its bookkeeping tasks." In transferring pages or segments out of disk, drum or tape into core where the CPU can use it, it not only wastes time, but often leaves about half of the core memory unallocated. And this is waste indeed.

Thus IBM's compatible software, and its inefficiencies, may account for the increased speed and large memory of the 195—if IBM is using hardware to offset difficulties with software.

Because of software weaknesses, many in the industry expect to see a revised and improved operating system and MVT by the end of 1969. With the unbundling, IBM's software operations are now said to be running under a separate profit and loss account, an incentive for IBM to clean out its software barn. Otherwise heads may roll out if the money fails to roll in.

## Communications

### Getting link going

Although the Bell System still can appeal the Federal Communications Commission's 4-to-3 decision granting Microwave Communications Inc.'s petition to establish a commercial microwave link between Chicago and St. Louis, MCI is proceeding apace with plans to make the route operative by July 1970 and already is buying hardware for the system.

The David-and-Goliath battle between the giant carrier and MCI has been raging for six years. But MCI president John D. Goeken is rapidly making up for lost time. In addition to going ahead on the Chicago-St. Louis route, an MCI

affiliate—Microwave Communications of America Inc. (Micom)—is moving to set up other microwave routes and interconnect them to form a national network.

**Up and going.** "This is going to be a whole new industry," says the 36-year-old executive, who formerly was a communications equipment representative for the General Electric Co. [see p. 14].

First, Goeken says, MCI will allocate \$564,000 for hardware for the 275-mile Chicago-St. Louis line, and proceed simultaneously with plans to upgrade the system to make it compatible with Micom's projection of a national network; this should raise expenditures to about \$1 million. Collins Radio, one of the few communications equipment makers that Goeken says supported his position early in the fight, will supply the radio-frequency multiplex gear.

"Mainline Electronics of Joliet, Ill., and A & E Electronics of St. Louis will handle the installation," including tower construction, he says, while MCI will negotiate for the antennas. The company plans to set up nine drop-offs along the route for customer interconnection with local phone lines—a service the FCC told the losers they must provide to complete the loop.

**New routes.** Goeken and William McGowan, Micom's chairman, say they will file for new routes between Chicago and New York, Chicago and Minneapolis, St. Louis and New Orleans and Kansas City, Kan., passing through Kansas City, Mo. Micom, they add, recently acquired control of Interdata, another special-service microwave carrier, which has filed for a New York-to-Washington link.

Goeken says MCI will offer a 75-bits-per-second, one-way data channel for five cents a mile on the Chicago-St. Louis route—bringing monthly charges to \$13.75 plus another \$16.00 for terminal costs and a local loop charge by the telephone company. He claims that users would have to pay Bell at least \$400 a month for the same service. MCI will offer capacities up to 20,000 bits per second with "a guarantee of no more than one error in 10 million bits."



# We make 95% of the most popular types of logic transistors, RF transistors, diodes and diode arrays.

## Nobody's perfect.

We've made a heap of hullabaloo lately about what we're doing in ICs. Don't infer from this we've forgotten discrete components. We're lavishing the same technological attention on them as on ICs.

**Take core drivers.** We're off-the-shelving 10 high voltage, high current or high speed NPN drivers, including the ever popular 2N3725. Soon we'll log a 1 amp version of our 2N3735 with 20 nanosecond storage time and six new PNP models. And you get them all in a panorama of packages: TO-5 or TO-46 cans, DIPs or flatpacks, all in dual or quad versions.

**And monolithic diode arrays.** We deliver 16-diode arrays in DIPs. Flatpacks are imminent. And expect a 64-diode package for your Christmas stocking.

Or RF transistors. Today our distributors stock a 1 Watt, 1 GHz 2N5108 transistor in a TO-39 package, and sell it for \$10.70 in 100 quantities. But right around the corner we have a tighter-leakage A version looming. And then a 10 Watt model. And by year's end a 1 GHz 20 Watt device.

To prove our discrete dedication we've just moved into a shiny new facility. With quick-response special products section and fully equipped applications lab. But it's that same old knowhow that keeps our more than 400 standard and high-rel transistors and 1800 diodes hustling out the back door. Because in discrete components, too, we're the company that gets the ideas and delivers the goods. Raytheon Semiconductor, Mountain View, California. (415) 968-9211.

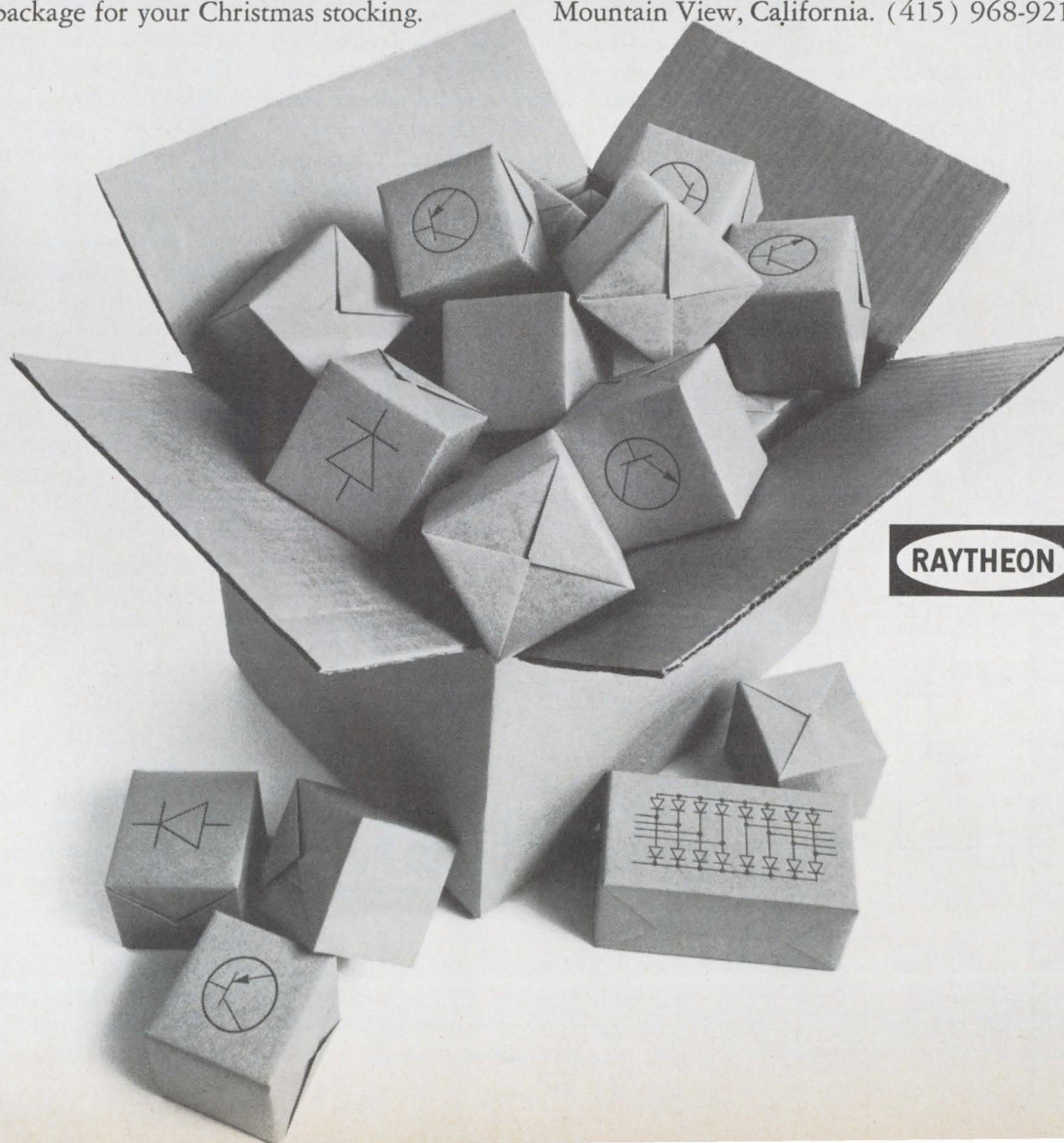



## U.S. Reports

### Industrial electronics

#### Turning on

Read utility meters by telephone? Good idea, but the trouble is that \$20 a meter, perhaps up to \$30, is about all that utility companies seem willing to pay to eliminate the cost of sending a man to do the job.

But with some 140 million utility meters in this country, 80% of them near telephone lines, the market looms large and the quest continues. For the Neptune Meter Co., an MOS chip, containing 300 transistors operating in both digital and linear modes, appears likely to provide the transponding function—reading encoded meter dials and converting readings to bits for transmission over the line. Expected price: \$20 for an integrated-circuit transponder that will service three separate meters (electric, water, gas).

Though some of its automatic meter-polling system via telephone is still under development, Neptune has practically completed design of its receiver and computer interface equipment. Results so far look good, and Neptune expects

to have a commercial system ready by mid-1971.

**Ready to call.** Having already successfully benchtested its computer-directed system at its laboratory in Long Island City, N.Y., Neptune this month puts a more comprehensive operation on trial by linking five transponders in Long Island City to a central (telephone) office at Bell Laboratories' Holmdel, N.J., facility.

The purpose is to find out what happens when transponder pulses flow through a telephone company's switching system (including a specially-designed meter reading facility) and are sent on their way to a meter-polling computer. After the tests, Neptune will get together with a utility to install transponders in 25 residences for thorough field trials.

When operational, the meter-polling system—which can handle hundreds of thousands of meters—will include an encoder for each meter, a transponder that reads up to three meters, and a special data set. An experimental version of the data set, which has been developed by the Bell System, attaches to the customer's telephone line.

The central office equipment

routes pulses to another data set, this one connected to a terminal that interfaces with the polling computer at the utility's offices. Connected to the computer is a phone company automatic calling unit (ACU) that on command from the computer dials the phone number and connects the corresponding transponder to the line.

**Decimals.** The encoder, also made by Neptune, converts the meter's mechanical dial readings to electrical equivalents by using four 10-position decimal switches. Decimal switches need 14 wires to permit readout of the four highest-value dials; binary coded decimal would take 20 wires and have more sliding contacts.

Information from the decimal switches is continuously read into the transponding encoding modulator, or transponder. The transponder reads the decimal numbers on each encoder in parallel, formats each character into an unambiguous two-out-of-six binary code, scans the registers and converts the parallel data to a string of serial pulses and modulates the pulses to two-tone audio signals by frequency shift keying. Under control of the central computer, the complete calling and readout cycle for a transponder is 7.5 seconds.

As for the heart of the transponder, the MOS chip, Thomas R. Clark, Neptune's advanced systems engineer, says he chose MOS rather than bipolar because MOS requires low power, has higher circuit density, and is less expensive. Bipolar would have taken two chips, he says.

**Deep in the heart.** Texas Instruments produced prototype units. From Clark's specs, TI engineers worked out the detailed cell arrangements on the chip, which contains such digital operations as shift registers and such linear functions as audio oscillators. Neptune paid TI \$14,000 for development and delivery of 25 prototype units.

The Bell System seems ready to agree to supply the power for equipment attached to its lines. But, says Clark, the maximum power that Bell will make available to the transponder is 100 milliwatts for 2 seconds. Clark had hoped for

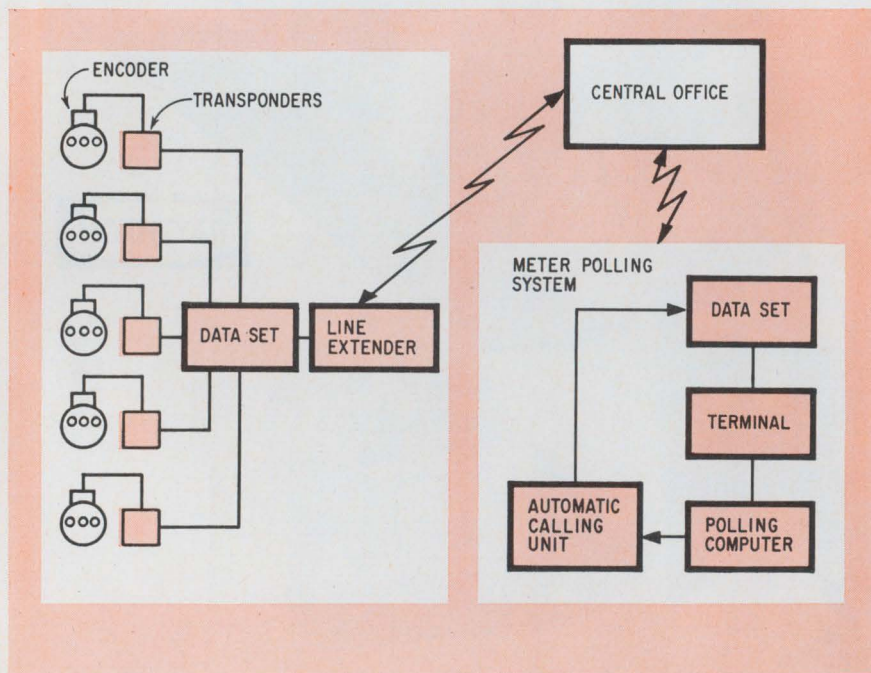

**Meter poller.** Encoded utility-meter readings are digitally conditioned in MOS transponders. Computer initiates meter callup, stores returned readings.



# R.M.S. VOLTS -- the scale says -- but what about the circuits behind that scale?

All of us have been making rms readings of ac voltages for years. We know we have, it says so right on the front of the meter.

If someone were to ask what we mean by rms voltage, we could quickly explain the concept of "root mean square." In the interest of accuracy we might add that the rms voltage indication on most meters is true only for a sinusoidal wave. Unfortunately, most measurements are not made on true sinusoidal waves. However, for many applications, average responding meters are adequate.

But it would seem logical, where accuracy is important, to use a meter that measures true rms voltage no matter what the wave shape—a true rms voltmeter.

Why isn't this done more often? Well, until recently, most true rms voltmeters were expensive, limited

in capability and rather slow responding.

Now Hewlett-Packard has adapted the thermocouple concept used in standard laboratories; added protective amplifiers to insure overload protection (800 V p-p); and reduced final-value step function response to less than 5 seconds.

When you combine these features with a low price of \$525, it adds up to the HP 3400A—the first practical true rms voltmeter for general use in the 10 Hz to 10 MHz range. And, a high crest factor (ratio of peak to rms) allows you to measure noise and other non-sinusoidal wave forms at a ratio of 10:1 full scale or 100:1 at 10% of full scale. You get accurate noise and pulse measurements — without having to make non-standard corrections.

The 3400 isn't just a fine true rms

voltmeter—although that's plenty in itself. It can also be used as an ac/dc converter and a current meter. Typical dc output accuracy is 0.75% of full scale from 50 Hz to 1 MHz. Use the HP 456A AC Current Probe (\$225) and you get quick dependable current measurements. The 456A probe has a 1 mA to 1 mV conversion allowing direct readings up to 1 amp rms.

So, if all your measurements aren't made on true sinusoidal wave shapes and if you like direct accurate rms voltage indication no matter what you're measuring, it's time to check into the HP 3400A true rms voltmeter. For more information, contact your local HP field engineer. Or, write to Hewlett-Packard, Palo Alto, California 94304. Europe: 1217 Meyrin-Geneva, Switzerland.

099/19

Circle 43 on reader service card

HEWLETT  PACKARD

ANALOG VOLTMETERS

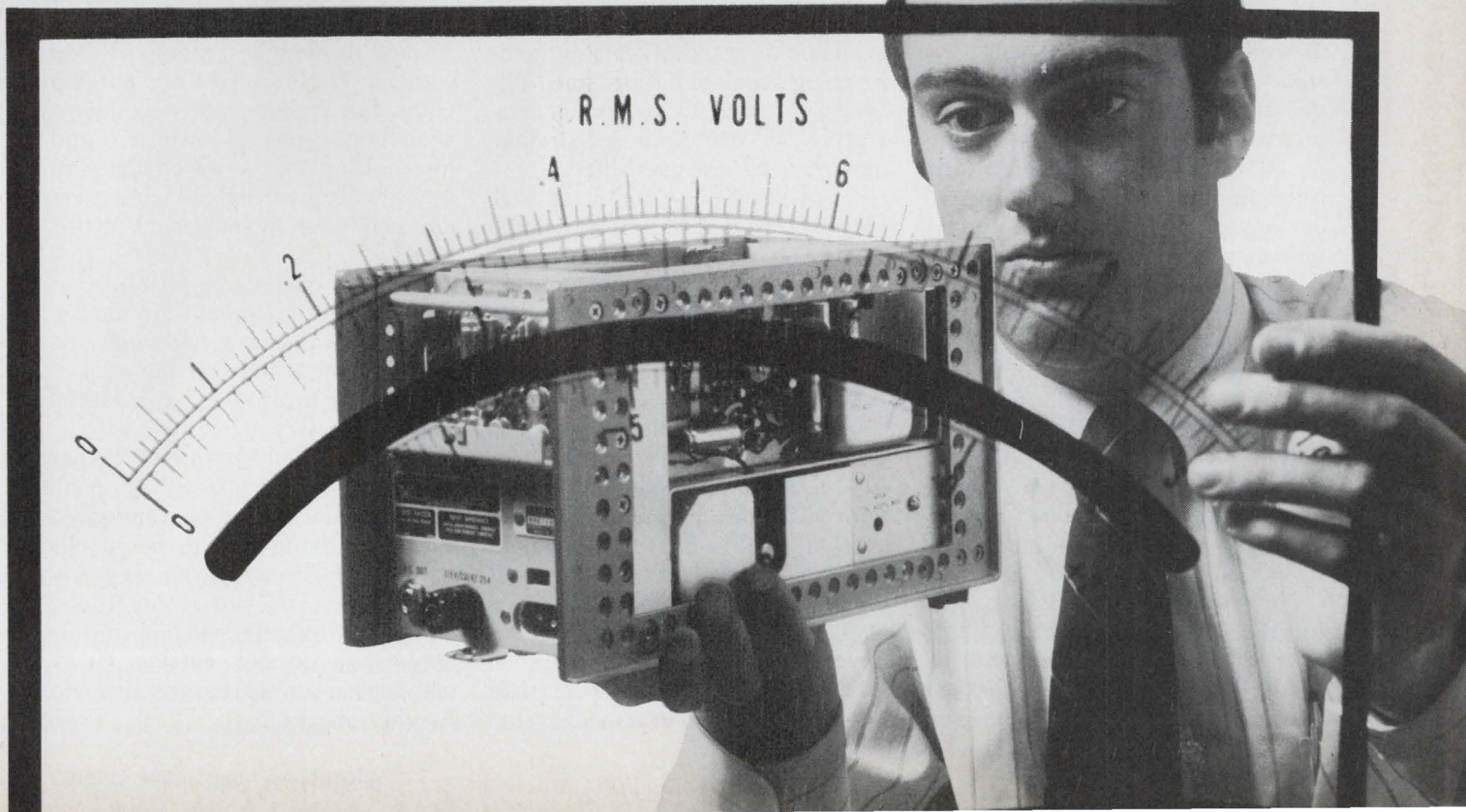



## U.S. Reports

a somewhat larger power allotment, so some MOS chips appear marginal. However, he's going for a second-generation development on the chip, and is looking for silicon nitride technology to lower the threshold levels, and hence required power, on the chip. When Neptune lets the new development contract, he says, another vendor will be involved. Fairchild Semiconductor is a likely candidate, he says.

An essential part of Neptune's automatic meter-polling system is the digital computer. Here, Clark has selected Data General's Nova computer. Working from telephone numbers stored on magnetic tape, the computer instructs the ACU to dial a phone, read the meters, and store the data on magnetic tape—which is then read out by another computer for billing. Meter polling would probably be done between midnight and 8 a.m., when telephone traffic is at its lightest and there's not much chance of a busy signal.

### Components

#### Picking up the chips

Selling unpackaged semiconductor chips, which most producers once viewed with some reluctance [*Electronics*, May 13, 1968, p. 117], is gaining in popularity as demand increases. Two companies—Motorola Semiconductor Products and Siliconix Inc.—will be putting out catalogues this month listing many new standard chip types.

While a number of firms are selling uncased discrete and IC dice to hybrid-circuit makers, none appears to be offering anything near the 85 standard chip types marketed by Motorola. Each of these will be included in its new catalog; they're all passivated and they're all discretely at this point, but unpackaged IC dice undoubtedly will be added to the catalog later on.

Nevertheless, Joe Vielock, Motorola's product marketing manager for silicon transistors, still regards the effort more as a service to customers than as a business

with big potential. He figures that in the estimated \$1.2 billion 1969 semiconductor market, chips account for \$12 million or so, just about 1% of the total. Chips amount to less than 1% of his division's business, and Vielock thinks uncased dice will never account for more than 5% of the overall semiconductor business.

**'Reluctant virgin.'** Still, customers want bare dice, and manufacturers are now somewhat less fearful of being blamed for circuit malfunctions. Hybrid-circuit manufacturers have become more adept at such processes as wire and die bonding, and packaging. "We're taking the role of the reluctant virgin," Vielock says, "but we'll supply the devices."

Motorola's 85 device types break down this way: small-signal switching and amplifying transistors, 30 devices; silicon switching transistors, 23 devices; silicon amplifying transistors, nine types; silicon power transistors with currents up to 25 amps, eight devices; silicon radio-frequency power transistors, five types, one of which puts out 8.4 watts at 400 megahertz; field-effect transistors, six devices of which four are junction devices and two are MOS FET's; and switching diodes, two devices.

To this list must be added 122 zener diodes, which have been available as standard catalog items in unencapsulated form since last spring. Most of these have equivalent 1N, or EIA diode registration, numbers; all are passivated.

A sampling of prices of the bare chips shows that Motorola's MMCS-2222A, an uncased version of the popular 2N2222A switching and amplifying transistor, sells for \$1.25 compared with \$3.25 for the packaged version in quantities of 100 or more. In the zener line, some chips also will cost less. The unpackaged price for the 1N753A is 90 cents in lots of 100, compared with \$2.05 for a hermetically sealed version of this 6.2-volt device. In some instances, however, the zener chips will cost more than a packaged part because these diodes have been redesigned to mount in leadless inverted ceramic carriers or u-shaped mountings. The chip

size has been cut from 37 mils square, and the metalization has been changed from chrome-silver-gold to plain gold to facilitate die bonding.

**Customer warning.** In specification sheets, Motorola will duplicate the direct-current characteristics of the packaged counterparts of most of the parts, but customers will be cautioned on some of the larger-size power transistor chips, which require a little more care to insure that they're properly used in circuits.

Semiconductor Product division officials expect two carriers to be their mainstays for shipping unencapsulated dice—a 400-compartment tray which has a protective cover that holds each die face up securely in its individual nest for visual inspection, and a 10-chip carrier for smaller-quantity buyers. The dice also will be available in vials.

Motorola planners anticipate the possibility of adding thyristors and varactors to their chip catalog; some of these may even have beam leads and be radiation hardened. "Our intention," says Vielock, "is to pursue customer demand for dice after showing a broad capability."

Siliconix has been offering three uncased flip-chip FET's for some time; next month it will add some 20 new devices in a standard chip catalog. These entries are not flip chips, but include radio-frequency, switching, general-purpose, and low-leakage FET's, which the firm feels will give hybrid designers any combination they need in this area.

Siliconix officials emphasize that they will sell just about any device they make uncased, although the new catalog is the first big step in attempting to attract a substantial chip business.

Fairchild Semiconductor is not now making an attempt to push standard uncased dice through a catalog, although the division sells them to its licensees, as do many others, but not to competitors. Texas Instruments, which also sells chips but doesn't catalog them, also notes an increasing demand for the devices.



## U.S. Reports

### Consumer electronics

#### Showdown for tv

After several false starts—and a lot of public clamor and private persuasion—safety standards for color television receivers have been worked out by a technical committee advising the Secretary of Health, Education, and Welfare Robert R. Finch.

The electronics industry and the bipartisan committee scored a victory in keeping the permissible radiation level at a “managable” 0.5 milliroentgen per hour. However, as an electronics industry source present during the discussions says, “. . . it’s a tough 0.5.” The standard calls for keeping the level of emission to 0.5 mr as measured 5 millimeters from the set.

**In the Act.** Under provisions of the Radiation Control for Health and Safety Act of 1968, the Government must have standards established for one electronics product by the end of this year. It looks as if the first product to be put under control will be the color tv receiver.

Standards for all products are being worked out by the HEW advisory committee working from drafts of standards submitted by HEW’s Bureau of Radiological Health. The first television draft, which called for extremely stringent standards—including a reduction in the level of permissible radiation to 0.1 mr per hour, was unanimously rejected by the committee in June [*Electronics*, July 7, p. 48].

Early in August the committee met again and has worked out standards for television which will almost certainly become law. The exact language of the standards still needs touching up before being sent to the head of the Environmental Control Administration and then on to Secretary Finch for final approval. Once the standards are approved at the top, they will be published in the Federal Register and become law 30 days thereafter.

**Controls.** Three operating procedures have been stipulated by the committee:

- Sets produced on or after Jan.

## a complete digital system

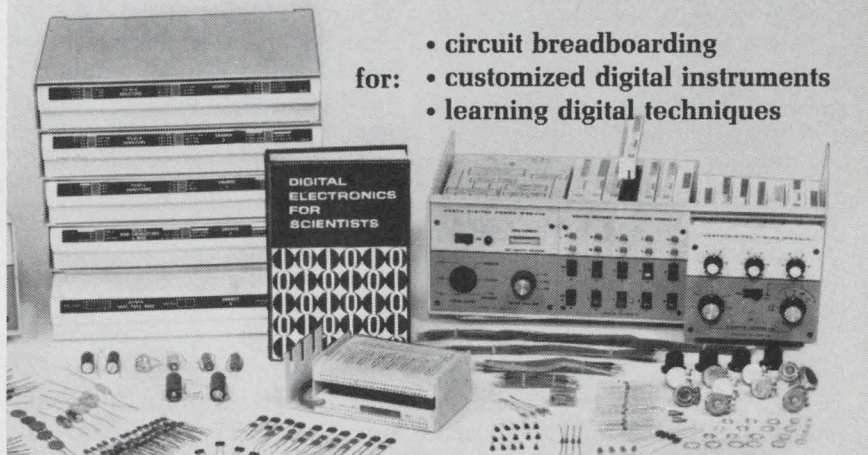

- circuit breadboarding
- for: • customized digital instruments
- learning digital techniques

## HEATH 801 Digital System...

### buy the complete system or discrete components

Now . . . A Complete System to Enable You to Get the Most Out of Digital Electronics. Here is a system that is revolutionizing instrumentation in labs and classrooms throughout the world. The basic design concepts of Professors H. V. Malmstadt and C. G. Enke combined with the engineering of Heath’s scientific instrument group have resulted in the unique 801 Analog Digital Designer (ADD) and the EU-51A breadboard and parts group. This versatile system can perform equally well in constructing high performance research-quality instruments, in performing hundreds of experiments in the teaching laboratory, in rapid testing of new digital ideas, or in interfacing to computers.

**Start . . . By Learning the New Digital Electronics.** Drs. Malmstadt and Enke have written a pioneering new text “Digital Electronics for Scientists” (published by W. A. Benjamin, Inc.) that provides a systematic introduction to the digital circuits, concepts and systems that are basic to the new instrumentation — computation revolution. The book is written for engineering and science students and for practicing engineers, scientists, and technicians so that all may effectively utilize the startling recent advances in digital electronics.

Never before have the latest “state-of-the-art” methods been made so rapidly and conveniently accessible through an integrated combination of new text and versa-

tile equipment. The experimental section of the text is written specifically for utilizing the Heath 801A and 51A to provide experience and working knowledge with hundreds of digital and analog-digital circuits, instruments and systems.

**Write . . . for Complete Information on Cards, Modules and Parts in the Heath Digital System.** The basic Analog-Digital Designer (EU-801A) contains 3 modules (power supply, binary information, and digital timing) and 13 circuit cards including TTL gates, flip-flops, monostable MVs, relays, op amps, and V-F converter. The EU-51A Experimental Parts Group is a highly flexible breadboard system for circuit design and teaching. The group includes a desk chassis, 493 components, a patch card accepting these components, and a power patch card.

The system is open-ended. New cards and modules are continuously being introduced so you can construct your own special frequency meters, counters, timers, DVMs, rate meters, and many dozens of other instruments.

**Take . . . advantage of the digital revolution** — order your Heath Digital System now.

**EU-801A**, Analog-Digital Designer . . . \$435.00\*

**EU-51A**, Experimental Parts Group . . . \$135.00\*

**EUP-19**, text “Digital Electronics For Scientists” by H. V. Malmstadt and C. G. Enke (published by W. A. Benjamin, Inc.) . . . \$9.50\*

#### FREE Heath Scientific Instrumentation Catalog



Describes these and other precision instruments for laboratory, engineering, education and R & D applications. Send for your FREE

copy now . . . just write on your school or company letterhead.

HEATH COMPANY, Dept. 586-04  
Benton Harbor, Michigan 49022

 **HEATH**  
a Schlumberger company

Please send FREE Heath Scientific Instrumentation Catalog

Name \_\_\_\_\_

Address \_\_\_\_\_

City \_\_\_\_\_ State \_\_\_\_\_ Zip \_\_\_\_\_

Prices and specifications subject to change without notice.

\*Mail Order Prices; F.O.B. Factory

EK-278



## U.S. Reports

1, 1970, must be capable of keeping radiation below the 0.5 line under conditions of excessive power source voltage with external controls available to the viewer.

▪ Sets produced on or after June 1, 1970 must be capable of complying with the standard with both external and internal receiver controls adjusted to maximize X-ray radiation.

▪ That by late in 1971 sets will be built to prevent producing 0.5 mr in the event of a circuit or component failure which would maximize radiation.

The last point was originally scheduled to go into effect at the beginning of 1971, but the committee agreed to set the date to coincide with the new television model year.

The stipulations are not going to be easy for the industry, especially the last point, but they are far easier to live with than the original 0.1 mr proposal. A spokesman for the Electronic Industries Association says that the failure provision is going to "cause a problem, but not an insurmountable one." He points out that EIA members are looking at different approaches to meeting the stipulations. These fixes range from incorporating a circuit mechanism to shut the set off if any part goes above the critical level, to going to solid state devices in areas where emission is a problem.

## Memories

### Taking the bit

Minicomputer users often are shocked to discover that their nice, little \$10,000 machine needs a \$50,000 memory to do its job. With just this dilemma in mind, Singer-General Precision Inc.'s Librascope group has come up with a 500,000-bit disk memory that promises to extend minicomputer capabilities for only \$2,750—slightly more than half a cent per bit.

Currently, the Emerson Electric Co. is evaluating the memory for use with automatic testing equipment. Other companies have ex-

pressed interest in using it as a compact memory for remote cathode-ray tube display terminals.

Designated model L107-8-4, the memory is a low-cost lineal descendant of Librascope's L598, a 65,000-bit disk memory for the military. The L107-8-4 weighs only 11 lbs., and measures 6 by 9 by 9 inches, including signal-conditioning electronics. Packing density is conservative, with 20,000 bits per track; there are 25 tracks with one flying head per track. Rotational speed is 3600 revolutions per minute, with a 1.2-megacycle transfer rate.

**Interface simplified.** The memory, which uses Signetics 6400 series transistor-transistor-logic gates, can be plugged directly into most minicomputers without additional interfacing. A circuit board containing the electronics is mounted on top of the disk for accessibility. Six screws and two soldered connections hold the board in place. There are no mechanical adjustments to compensate for variations in integrated-circuit values; one adjustment is provided in the electronics for optimizing the strobe signal, and two for setting pulse periods in the timing-track logic. IC and discrete components are used for the read and write amplifiers.

The signal-to-noise ratio is maximized by amplifying the analog signal close to the head. Magnetic interference on read-and-write functions is averted by using a 4-to-20-bit gap between bit words. To decrease vibration a duplex paired bearing is mounted at the disk instead of right at the motor.

Access time is 8.5 milliseconds average, and a coded timing track provides the index clock, block, or sector clock and master bit clock. Recording is phase modulated and is in serial format, block alterable. Data bits-per-block and blocks-per-track are set to customers' specifications.

The memory's relatively low cost—possibly well under \$2,000 in large quantities—permits expansion of minicomputer memories in small, fairly inexpensive increments, according to Librascope.

## Manufacturing

### New twist to flip chips

Hughes Aircraft has been putting bumps on semiconductor dice for face-down bonding for several years, but flip-chip sales at Hughes—and for a number of other producers for that matter—haven't really caught on in a big way. Now the company has a new system it says will give its flip-chip sales a big boost.

And in addition, to keep down its own production equipment costs, Hughes has gone to an anisotropic back etching to separate the 1-0-0 silicon chips from the wafer, rather than conventional scribing and breaking. This is how Bell Telephone Labs separates beam-lead dice from the wafer, but Jack Hirshon, manager of Hughes' Newport Beach, Calif., division, says their technique is much less complicated and should give higher yields.

Up to now the new technique has been restricted to producing wafers for discrete devices. And the process only needs one additional masking step: defining the back-etch dicing pattern. Hirshon says the back-etched flip chips along with the bonders and other associated equipment needed to handle them are being delivered to a few customers making hybrid circuits for what he describes as the "home-entertainment systems" market and the automotive market. He says Hughes hopes to get high-volume customers, including appliance manufacturers.

**Salesmanship.** "The customer has to know he can buy these chips for less than he can get plastic transistors to put into a printed-circuit board," says Hirshon, "and our studies confirm that our prices will allow us to meet these objectives." Hirshon adds, "We're aiming at people now using flip chips, so we have to provide the razor, in effect, so that the customer can buy our blades." He estimates the bonder, turret feeder and template and pantograph that go with the back-etched flip chip system will cost about \$30,000, but points out that Hughes will modify the equip-



## U.S. Reports

ment to suit the customer.

In the anisotropic etch process, with 1-0-0 silicon, the angle that results on the side of the die is about 55° because of the crystalline structure of the material. A specially designed ultrasonic bonding needle with a nest shaped to accommodate that angle is used.

The process allows etching through wafers 8 mils thick, and the dice on which it's now being used—13 types of transistors and six diodes, are about 32 mils square. Each has four silver bumps coated with silver-tin solder to facilitate face down bonding using an ultrasonic head or reflow soldering. The chip edge is the reference for precisely positioning the bumps.

**Magazine load.** After the wafer is probed and the glass-passivated dice are separated, they're automatically transferred to nests in specially designed plastic carriers about one-fourth inch square. These carriers, each containing one die, are then loaded into a magazine and the magazines are affixed to a turret on the table holding the bonding tool.

The operator uses an enlarged template of the circuit, and a pantograph to locate the point where a given die should be bonded. Logic in the system assures that the turret holding the magazines of dice brings the proper magazine into place. A feeder arm extracts the carrier-held die from the turret and places it over the substrate at a preselected point. The ultrasonic bonding head drives the die down through the carrier to the contact pads on the substrate. The bonding head is raised, the feeder arm removes the empty die carrier, and the bonding head then comes down again, this time applying energy to make the bond. The operator then moves the pantograph pointer to another template position, the turret indexes to bring the proper die magazine into place for that location, and the process is repeated.

Hirshon says the system bonds 900 dice an hour. "If our approach is right," he concludes, "the next six months should show a dramatic shift in momentum in the use of flip chips." The system was shown for the first time at Wescon.

# READ OUT THESE FOUR RECEIVERS



## WITH THIS ONE COUNTER



Four receivers with a 30-300 MHz frequency range and a 21.4 MHz IF can be read out with W-J's new Type DRO-307 Time-Shared Digital Readout.

The counter alternately samples and counts the LO signal from each of the receivers, automatically subtracts 21.4 MHz IF and stores the result in integrated circuit storage elements. The unit reads out a six-digit visual display of the tuned frequency of any one of the receivers as selected by a front panel switch. Information is updated 12.5 times each second.

Other features include simultaneous BCD output from the storage elements for all receivers and full-time digital automatic frequency control (DAFC), which locks the receivers to a desired frequency. Separate DAFC circuitry is provided for each receiver.

For details circle the Reader Service Card number, write CEI Division or contact a W-J representative.

### TYPE DRO-307 TIME-SHARED READOUT WITH DIGITAL AUTOMATIC FREQUENCY CONTROL

*World's largest selection of receiving equipment for surveillance, direction finding and countermeasures*

CEI DIVISION



WATKINS-JOHNSON

6006 Executive Boulevard, Rockville, Maryland 20852 (301) 881-3300



# 8" HELIAX

high power without a hanger "HANG-UP"

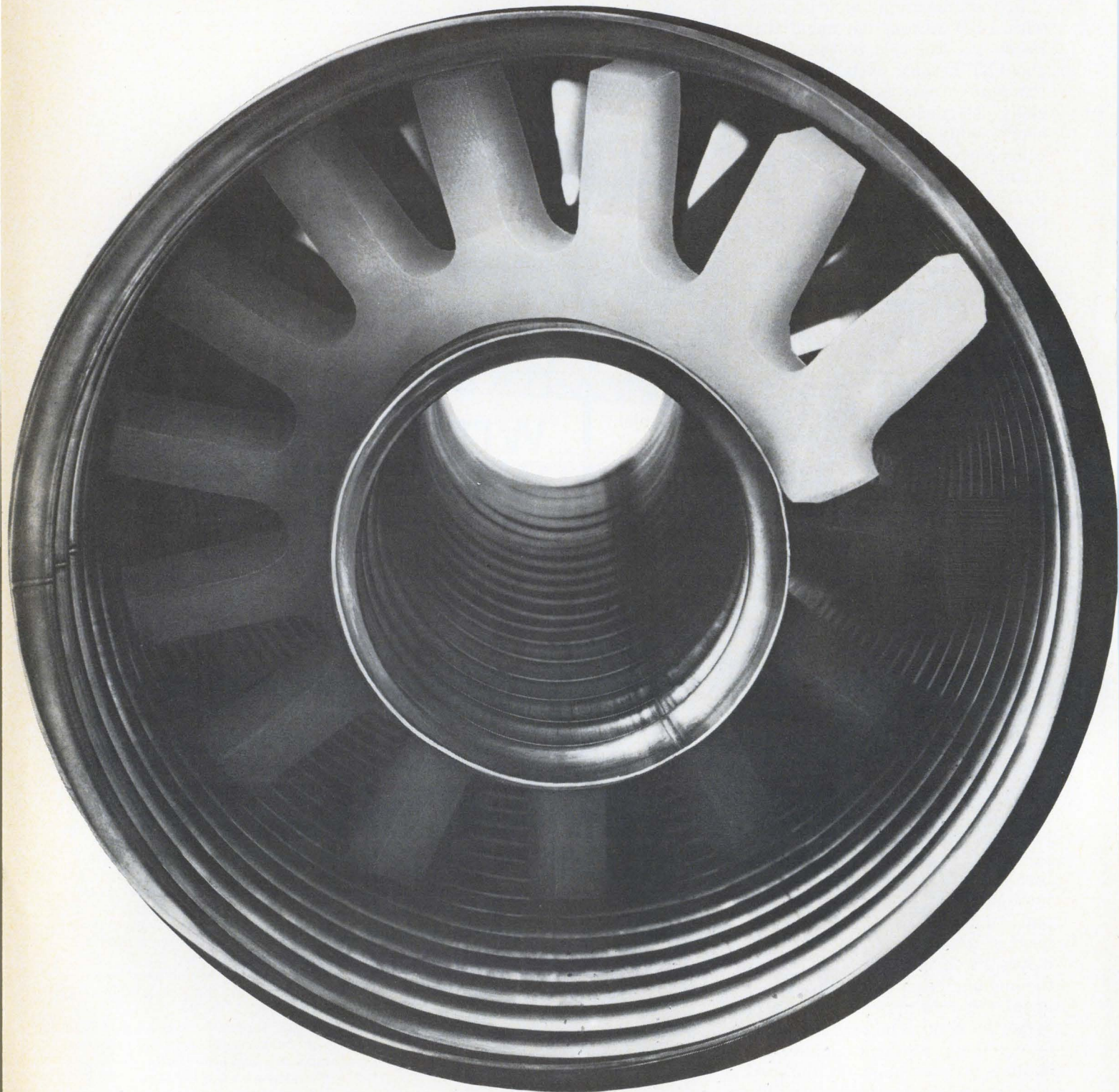

Faced with carrying a couple of hundred RF kilowatts? Need low, low attenuation? Move up to 8" HELIAX® coaxial cable. Big. Semi-flexible. Continuous lengths to 850 feet. Eliminates connector bullets and complicated hangers. Thermal expan-

sion and contraction don't faze it. Power capabilities: 300 kw average at 30 MHz; 58 kw at 600 MHz. Use for HF; Tropo; OTH radar; VHF and UHF-TV. Wouldn't you like to know more? Communicate with Andrew.

11-68

 **ANDREW**

CONTACT THE NEAREST ANDREW OFFICE OR ANDREW CORPORATION, 10500 W. 153rd STREET, ORLAND PARK, ILLINOIS 60462

Circle 48 on reader service card



---

# Washington Newsletter

---

September 1, 1969

## Army's tactical operations system to be expanded . . .

Look for the Army's tactical operations system (TOS)—presently earmarked for the field-army level—to be extended to division and battalion levels. In the works at the Army's Computer Systems Command is an expanded system called, aptly enough, DIV/TOS. According to Army sources, DIV/TOS is being kept in a "hold" status until the fiscal 1970 defense budget is finally worked out. **The Army intends to procure DIV/TOS separately from the existing TOS system, for which Control Data Corp. is prime development contractor with an estimated \$5 million in contracts to date.**

The Army's immediate problem with DIV/TOS is to get it through Rep. George Mahon's (D.-Tex.) House Appropriations Committee before stamping it approved. In addition to Control Data, Litton, RCA and Hughes Aircraft have made informal proposals to the Army on the proposed system.

One of three elements in the automatic data system for the Army in the field (Adsaf), TOS supports staff intelligence, communications, and operations via a variety of interconnected electronic data processors and displays. Vans housing the first TOS system are deployed in West Germany for configuration verification and testing, most recent of these being **Exercise Cardinal in which CDC says its system operated successfully.**

## . . . as Litton tries for a slice of the pie . . .

Litton Industries, with a \$122.2 million prime production contract for another Adsaf element—the tactical fire direction system (Tacfire)—**is working diligently to cut itself in for some of the TOS action by promoting its Tacfire computer for both DIV/TOS and TOS.** Litton had been counting on incorporating its Tacfire computer modules in TOS [*Electronics*, March 4, 1968, p. 17].

An Army official says a Tacfire-type computer "probably" will go into TOS production equipment, noting that the existing test installation now in Europe was put together with nonruggedized, off-the-shelf hardware. "The master plan calls for utilizing the ruggedized hardware from Tacfire in other elements of the Adsaf program," he says.

At this point, **Tacfire has slipped somewhat.** But under a revised timetable, Litton will deliver the first three Tacfire computers by May 1970 for eight months of engineering tests. **A production go-ahead would follow in early 1971.** When work was getting under way in early 1968 on the total-package-procurement program, Litton engineers said they hoped to get Tacfire operational by 1971.

## . . . while Control Data fields new computer

Control Data apparently isn't too worried about the competitive threat to the DIV/TOS computer business. "We'd like to see DIV/TOS go out for competitive bids," maintains a Control Data official. **The company will bid its new, miniaturized "fourth generation" computer dubbed Alpha, recently developed in an in-house program.**

The modular system is described as meeting Mil-E-5400, class 2 environmental specifications. **Built with large-scale integration, Alpha's 18-pound central processor occupies one-third of a cubic foot.** It will operate with a destruct readout core memory that has a 350-nanosecond access time with 16,384 words of memory in a 36-lb package occupying two-thirds of a cubic foot, and a non-destruct readout thin film memory with



---

# Washington Newsletter

---

comparable stores in an 18-lb package. CDC maintains Alpha is ready to go and says about 4 units have already been sold to the Canadian government for a classified application.

## House may soften Senate controls on DOD spending

When Congress reconvenes after Labor Day, it's likely that the House and its powerful Armed Services Committee will react strongly to pre-recess Senate legislation and refuse to go along with some of the stiff controls passed on military spending. For example, the Senate approved (47-46) a Defense budget amendment granting the General Accounting Office broad powers to investigate contracts is not expected to stand in its present form.

The amendment's provision that the Pentagon submit quarterly cost reports to GAO on major weapons systems may be the only section to survive the House [*Electronics*, July 21, p. 61]. This could pass since Defense Secretary Laird plans to establish a comparable system of his own. But provisions giving GAO unprecedented subpoena powers over contractor's records and the right to audit contracts where the Comptroller General believes costs are excessive or performance below par are not expected to get by hawkish House leadership.

## FCC to put Bell on the carpet

Should Western Electric be barred from all nontelephone business? And should the Bell System's hardware procurement, all of which now goes to Western Electric—Bell's manufacturing arm—be opened to competitive bidding? An inquiry the FCC will hold later this month on the Bell System-Western Electric relationship might well delve into these significant questions.

Telephone company officials are expected to be subjected to a hard line of questioning that could produce a great deal of ammunition for those in industry who would like to see Western Electric separated from AT&T.

The FCC has already given indications that it will focus its attention on the large number of service complaints lodged against Bell's manufacturing arm. Certain to be brought up are whether Western Electric has missed delivery dates for equipment and whether competition would make the company more responsive.

## Addenda

Richard P. Gifford's appointment to head General Electric's new Communications Systems division at Lynchburg Va., comes as no surprise. It agrees with earlier reports that he would not be a candidate to head the White House Office of Telecommunications Management [*Electronics*, Aug. 4, p. 69] . . . While the courts indicated that computer programs meet the criteria for patentability [see p. 37], IBM has been pushing for a registration system that would protect computer software in lieu of patents. The company is urging the enactment of "well-thought-out legislation" rather than the development of a system on a case-by-case basis in the courts . . . A White House letter asking industry for input for its domestic satellite system study indicates that other than telephone lines may be employed for ground distribution in the proposed system. Such a position is expected to be made more evident when the Administration issues its study in about two months . . . Microwave ovens are next now that standards have been agreed upon for color tv [see p. 45]. The technical committee that worked out the tv standards will turn its attention to oven interlocks at a Richmond, Va., meeting on September 16.



# High-speed programmable dc power supplies \$178<sup>00</sup>

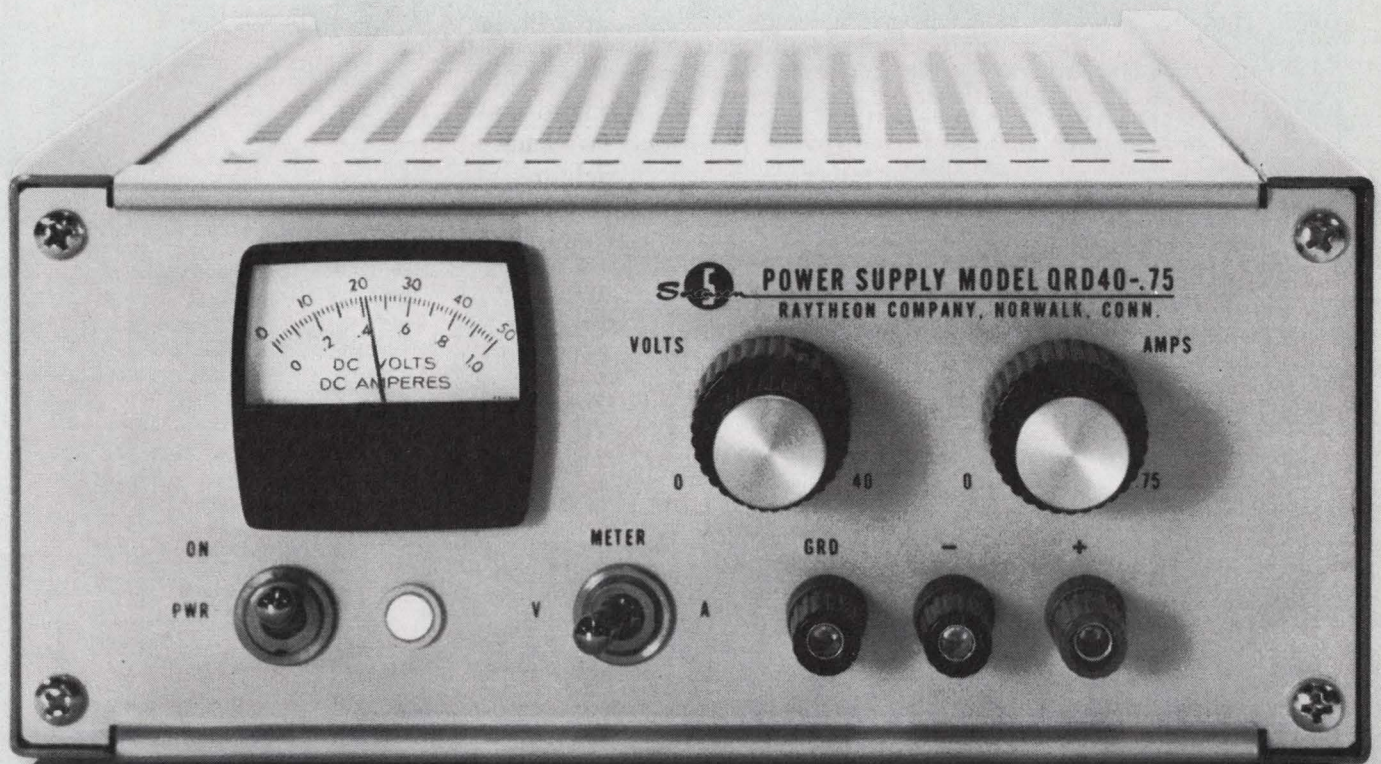

The QRD Series of precision power supplies is composed of seven off-the-shelf models covering the range of 0-60Vdc at current levels up to 4 amperes.

In the high speed programming mode the QRD's performance is unmatched — less than 10 microseconds for a step change of  $E_{max.}$  to 0! The capability of being programmed by resistance, voltage or current signals to frequencies of 100kHz makes the QRD Series unequalled in digital, microcircuit testing and servo system applications. Other features include: ■  $\pm 0.005\%$  voltage regulation ■  $200\mu V$  r.m.s (3mV p-p) ripple ■ automatic crossover between

constant voltage and constant current operation.

Send *your* high-speed programming power supply specifications to Sorensen, today, for the optimum solution of your modular, bench or rack mounted power supply problem.

For more information contact your local Sorensen representative or; Raytheon Company, Sorensen Operation, Richards Avenue, Norwalk, Connecticut 06856.

Tel: 203-838-6571;  
TWX: 710-468-2940;  
TELEX: 96-5953.

**RAYTHEON**



Circle 200 on Inquiry Card



# RCA Solid-State Data for Designers

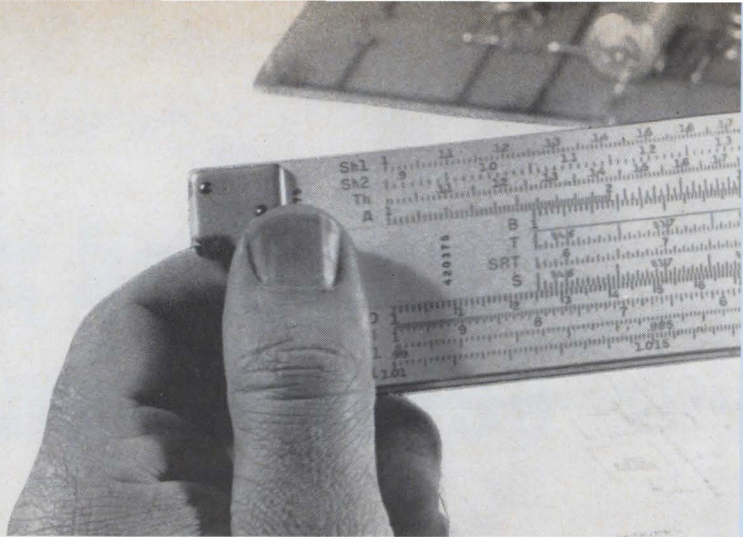

## IR Injection Lasers with Double the Output at Half the Threshold Current



Here's your answer to designing compact IR laser range finders; line-of-sight communications systems; aircraft altimeters; proximity fuzes, and intrusion alarms: RCA's new Close Confinement ("CC") GaAs infrared injection laser diodes in RCA's OP-3 coaxial-lead, stud-type package. "Close Confinement" means that the radiation is confined strictly in the junction area.

Choose from 1 to 10 watts (minimum); 2 to 13 W (typical). Peak current ratings:  $I_{th}$  from 4 amperes to 10 A;  $I_{FM}$  from 10 A to 40 A.

For technical data on RCA's new Close-Confinement GaAs lasers, circle Reader Response No. 501.

RCA OP-3 Pkg.	TA7606	TA7608	TA7610
Peak Power Output (Watts)			
Min.	1	5	10*
Typ.	2	6	13
Largest Emitting Area Dimension	3 mils	6 mils	9 mils
Amps Peak Current			
$I_{th}$	4	7	10
$I_{FM}$	10	25	40

\*Selections offering power output up to 5 W at 70°C are available.

## High Beta Values, High Dissipation Ratings, High Voltage Capabilities...

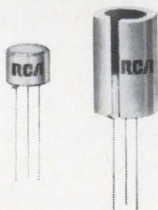

The characteristics you need for high-voltage, high-current amplifier and high-current switching applications are provided by RCA's 2N3241A family of silicon n-p-n, epitaxial, planar transistors. Fourteen types give you a

broad selection of ratings and characteristics for audio preamplifier, audio and video amplifier, computer switching and instrumentation circuits. Included in the family are transistors with integral heat-radiators which provide 50% lower thermal resistance between junction and ambient and thus twice the dissipation capability of the prototypes at ambient temperatures up to 25°C.

Take advantage of these ratings for your circuit designs:

**AUDIO PREAMPLIFIER**—NF as low as 2 dB at 10 kHz, beta values as high as 165 (min.) at  $I_C = 10$  mA.

**AUDIO AMPLIFIER**— $P_T$  ratings as high as 2 W at  $T_C$  to 75°C for types with heat radiators, high current capabilities to 300 mA max.

**HIGH CURRENT SWITCHING** applications including core drivers up to 300 mA max.

**INSTRUMENTATION**—high beta values; leakages as low as 10 nA max. at  $V_{CB} = 25$  V; saturation voltages as low as 0.1 V typ., 0.2 V max. at  $I_C = 100$  mA; breakdown voltages to 40 V  
Circle Reader Response No. 502 for detailed specs.

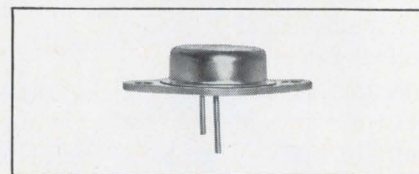
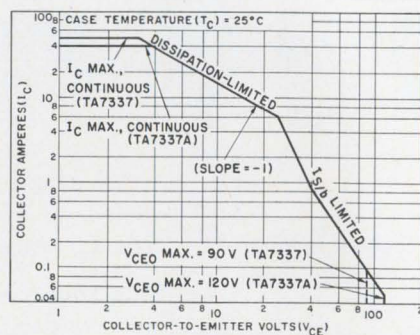

Type	$V_{CE0}$ (sus) (V)	$I_C$ (A)	$V_{CE}$ (sat)	$f_T$ (MHz)	$t_{on}$
TA7337A	120	40	1.2 V (max.) @ 40 A	50	1 $\mu$ s (max.) @ 40 A
TA7337	90	50	1.5 V (max.) @ 50 A	50	1 $\mu$ s (max.) @ 40 A

## "All Purpose" Economy For Linear IC Users

Wherever your designs call for economy—without sacrificing performance—look at the RCA-CA3053 Linear IC. CA3053 is specified to bring you important savings in a high-performance IF and general-purpose integrated circuit. It's designed to fit your plans for differential and cascode amplifiers, for limiters, detectors, mixers, modulators, converters and oscillators. You can figure on 40 dB typical cascode voltage gain, 30 dB typical differential voltage gain at 10.7 MHz.

RCA-CA3053 is offered in the hermetic TO-5 package at a 1,000 unit price of 49¢ per unit.

Circle Reader Response No. 503 for full details.

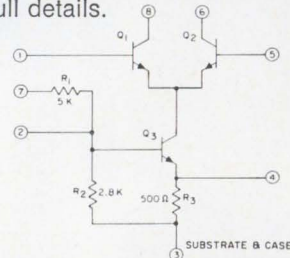

## 40 A to 50 A Performance For Your High-Speed Switching

Whatever you want to switch—control amplifiers, power gates, switching regulators, converters, or inverters—investigate RCA's new high-speed, high-current switching transistors. Other recommended applications include DC-RF amplifiers and power oscillators.

For instance, RCA developmental types TA7337 and TA7337A—silicon n-p-n types—both in modified TO-3 package (two 60-mil pins)—offer parameters like those listed below.

**Additional benefit:** These units have enhanced second breakdown capability under forward and reverse-bias conditions.

Circle Reader Response No. 508 for full details.



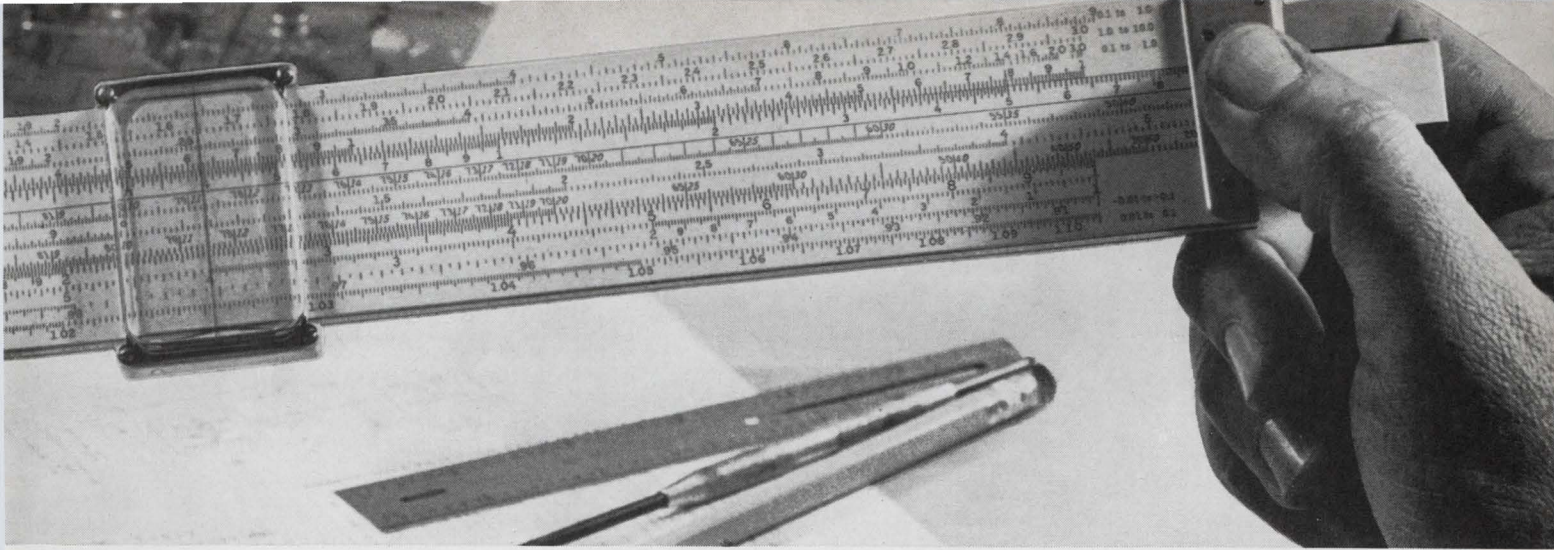

### 400 Hz 120-V Line Operation for Triacs

You can turn to triacs for all your airborne controls that you now design with electro-mechanical relays or switches!

RCA offers a cross-section of triacs—all rated at 400 Hz, with RMS currents from 0.5 A to 40 A and repetitive peak off-state blocking voltages of 200 V and 400 V. Units are available in two- and three-lead modified TO-5, press-fit and stud-type packages.

Plan around these triacs for such aircraft applications as: lighting controls for cabins and running lights; heater controls; motor controls, and hydraulic valve controls. Circle Reader Response No. 504 for help in your designs

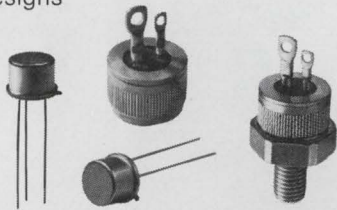

### Optimize RF Amplifier Designs to 400 MHz... And Protect Against Handling and In-Circuit Transients

RCA's new 40673 Dual-Gate MOSFET gives you all the inherent, superior performance characteristics of an MOS Field-Effect Transistor and transient voltage protection for each gate. Integrated "Transient Trappers" (back-to-back zener diodes) guard each gate of the 40673 against static discharge during handling operations and in-circuit transients. Now, you

have new assurance of dependable, high performance when you take advantage of these outstanding characteristics of the RCA-40673 to optimize your RF amplifier designs:

- Power Gain (MAG) = 20 dB @ 200 MHz
- Noise Figure (NF) = 3.5 dB @ 200 MHz
- Superior Cross-Modulation Characteristics
- Wide Dynamic Range Without Diode Current Loading
- Reduced Spurious Response
- Extremely Low Feedback Capacitance = 0.02 pF
- Excellent Gain-Reduction Characteristics
- Simplified AGC Circuitry
- Reduced Oscillator Feed-through

Furthermore, the dual-gate design of the 40673 makes it possible for you to reduce feedback capacitance by operating in the common-source configuration and AC-grounding gate No. 2. Result: Maximum gain without neutralization and reduced local oscillator feed-through to the antenna.

So, before initiating new designs for RF amplifiers, mixers or IF amplifiers (to be used in industrial, military and consumer communications equipment; aircraft and marine vehicular receivers; CATV and MATV equipment or telemetry and multiplex systems) get complete technical data on the RCA-40673 MOSFET. Circle Reader Response No. 505.

### TA7205—World's Highest Power, Gain, Efficiency Transistor For Operation at 2 GHz



The RCA-TA7205 is the latest RF power transistor featuring RCA's patented multiple-emitter "overlay" construction in a coaxial package. You can rely on its dependable performance in microwave communications, L- and S-band telemetry, microwave relay link, phased-array radar, distance-measuring equipment and collision-avoidance systems.

Packaged in a hermetically-sealed, ceramic-metal, coaxial configuration, this silicon n-p-n device is ideal for large signal applications in coaxial, stripline and lumped-constant circuits.

Specifically, the TA7205 provides a 5.8-W (typ.) output, 7.6-dB (typ.) gain and 45% (typ.) efficiency at 2 GHz in a common-base circuit. At 1.2 GHz, it offers 11-W output with 11.5-dB (typ.) gain and 60% (typ.) efficiency.

Circle Reader Response No. 506 for further details.

### High Performance At New Low Prices from RCA's COS/MOS Logic—COS/MOS Memory

Now, take advantage of the many opportunities for innovations in design, performance and application offered by RCA's unique monolithic integrated circuits using Complementary Symmetry MOS construction. These new COS/MOS integrated circuits provide:

- Nanowatt quiescent power dissipation
- Frequency capability—from DC to 5 MHz
- Noise immunity—4 V (typ.) @  $V_{DD} = 10V$
- Fanout capability up to 50
- Operation from a single power supply (6–15 V)
- Full military temperature range
- Operation with single-phase clocking

RCA has a package of bulletins for you on COS/MOS. Included in this package is a new product-line catalog which provides data on commercial and developmental COS/MOS types.

For your package of bulletins, circle Reader Response No. 507.

For price and availability information on all solid-state devices, see your local RCA Representative or your RCA Distributor. For specific technical data, write RCA Electronic Components, Commercial Engineering, Section QN9-1, Harrison, N. J. 07029.

# RCA

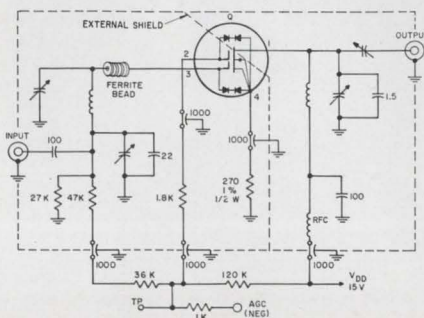



# It took us years to develop the best stereo microscope.

## Now give us a few minutes to prove it.

Let us compare our StereoStar/ZOOM to any stereoscopic microscope in your lab.

Our microscope offers high resolution, larger fields of view, greater working distance. We have as wide a magnification range as you're likely to need: a full 6 to 1 zoom range with magnifications from 3.5 X through 210 X. The zoom control knob is coupled—so that it's conveniently located on both sides, for either left or right-hand operation. And the entire head is easily rotatable through 360°.

135 years of optical excellence went into the AO StereoStar/ZOOM. Let us compare it to any stereo microscope in your lab. After all, if it's worth your money, it's worth your time.

Call your AO Representative. Or write for our convincing 24-page brochure.



**AMERICAN OPTICAL  
CORPORATION**

SCIENTIFIC INSTRUMENT DIVISION • BUFFALO, N.Y. 14215

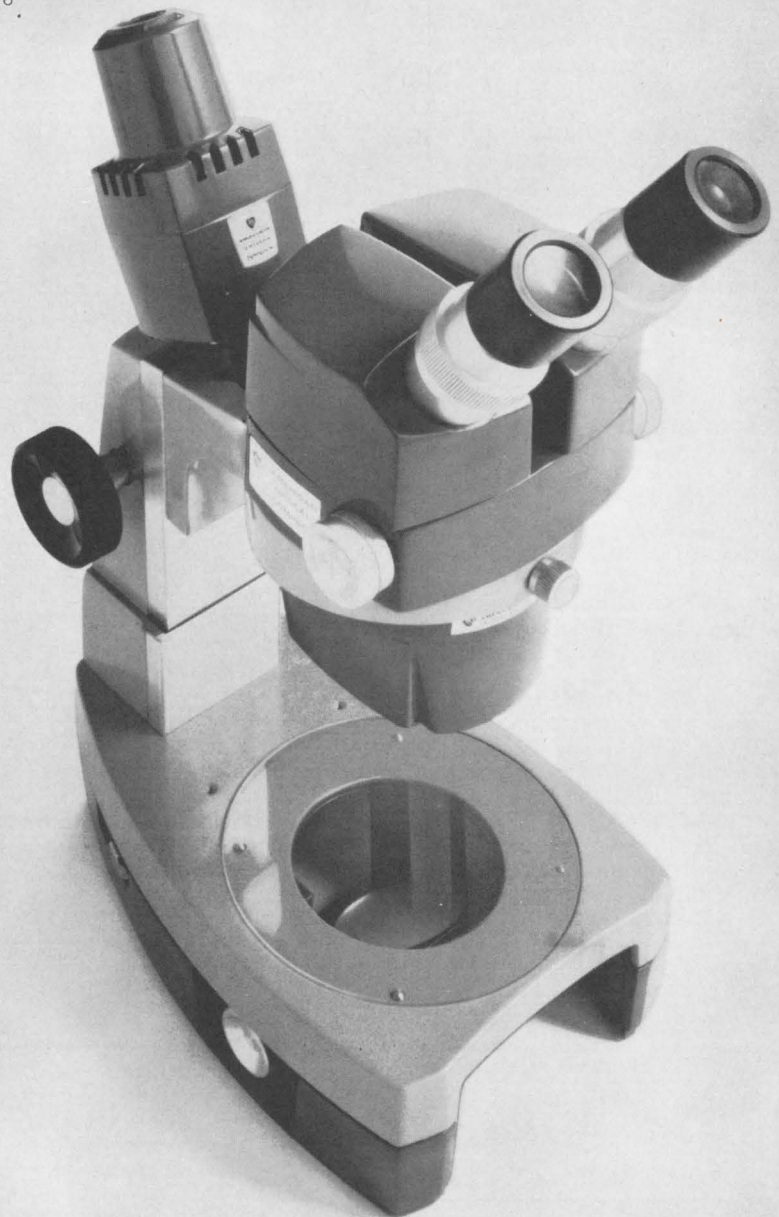



# TRW Announces Ultra-Linear RF Power Transistors... 2 to 150 MHz

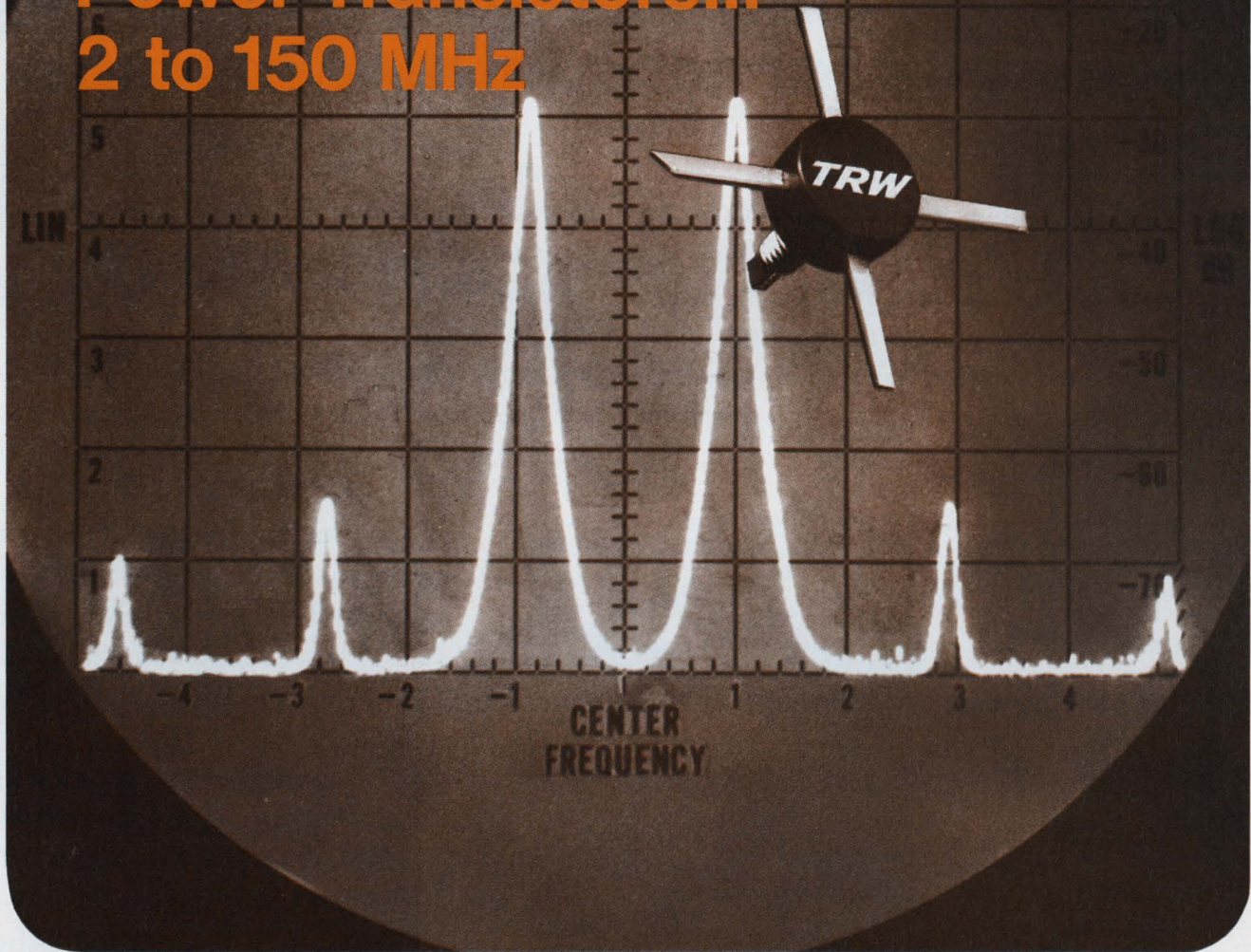

## 20 to 100 watts...- 32 dB intermodulation guaranteed

TRW offers three new 28-volt RF transistors to meet a range of output power needs in either SSB or CW. All are designed for Class A, Class AB, or Class C operation. All will withstand severe output mismatch. All are available in low profile, strip-line packages.

The 2N5707 provides 20 Watts

P.E.P. in SSB use from 2 to 30 MHz, and 30 Watts CW output to 150 MHz. The 2N5708 provides 40 to 50 Watts respectively over the same frequencies, and the 2N5709 furnishes 80 and 100 Watts in the same operating modes. All three have excellent broadband capabilities.

Contact any TRW Distributor or

TRW Semiconductors, 14520 Aviation Boulevard, Lawndale, California 90260. Phone: (213) 679-4561. TWX 910-325-6206. TRW Semiconductors Inc. is a subsidiary of TRW Inc.

# TRW®



# Gyro-tuning.

## A new, wideband, high speed tuning technique for coaxial magnetrons.

Gyro-tuning employs a ring gear which drives a set of rotating dielectric paddles within the magnetron coaxial cavity. A high speed synchronous motor drives the entire mechanism, which is external to the tube vacuum envelope. This arrangement provides a high degree of frequency tuning and reliability for coaxial magnetrons used in airborne search, navigation, terrain fol-

lowing and missile seeker radar applications. The complete tuner assembly is compact and adds only ½ pound to the basic magnetron weight.

Gyro-tuning presently achieves tuning rates of 400 Hz at frequency excursions of 250 MHz at Ku-band. It features low tuning drive power and a simple, directly driven, high voltage electrical generator readout technique to reduce local oscillator tracking problems.

Gyro-tuning is reliable. The rotary tuner mechanism provides long operating life and meets relatively stringent shock and vibration specifications. Operation outside the vacuum enhances tube life.

Gyro-tuned magnetrons are now being delivered at the 35 kilowatt level at Ku-band and 70 kilowatt level at X-band. Tubes are in development at other power levels.

For information on Gyro-tuning and other rapid tuning techniques now available or under development, contact: Electron Tube Division, 960 Industrial Road, San Carlos, California 94070. Telephone: (415) 591-8411.



**LITTON INDUSTRIES**  
ELECTRON TUBE DIVISION





## Here's technical achievement for you... better living for you and your family

We are particularly anxious to meet you if you are a Circuit Design Engineer; Packaging and Mechanical Engineer; Electron Optics, Vacuum Technology or Materials and Process Specialist. But whatever your technical strengths, if "roll-up-the-sleeves" engineering appeals to you, we'd like to hear from you.

Here you'll find an environment that emphasizes the individual, and his personal contribution to technical development—contribution by working on projects, not writing about them. Your work will benefit advanced engineering throughout the world. *You* will benefit from technical association with specialists experienced in developing state-of-the-art instrumentation, components and devices.

All Tektronix R & D—financed entirely from our annual sales of approx. \$150 million—is directed toward commercial products. Our community is prosperous, balanced, with a stability of employment not typical of every industrial center. And as for the Green Land we live in—it speaks for itself.

If you're seeking technical advancement and better living for you and your family, why not investigate Tektronix?

Write to D. A. Thompson, Tektronix, Inc., P. O. Box 500A, Beaverton, Oregon 97005, or send in the coupon.

Professional Placement Mgr., Tektronix, Inc.

P. O. Box 500A, Beaverton, Oregon 97005

Please send me your  Booklet, "Tektronix"  Application Form

NAME: \_\_\_\_\_

ADDRESS: \_\_\_\_\_

CITY: \_\_\_\_\_

STATE: \_\_\_\_\_

I am interested in: \_\_\_\_\_

**Tektronix, Inc.**

An Equal Opportunity Employer.





# The Choice is TTL.

$$Y = A \oplus B$$

## TI's new MSI SN5486/SN7486 does it fast.

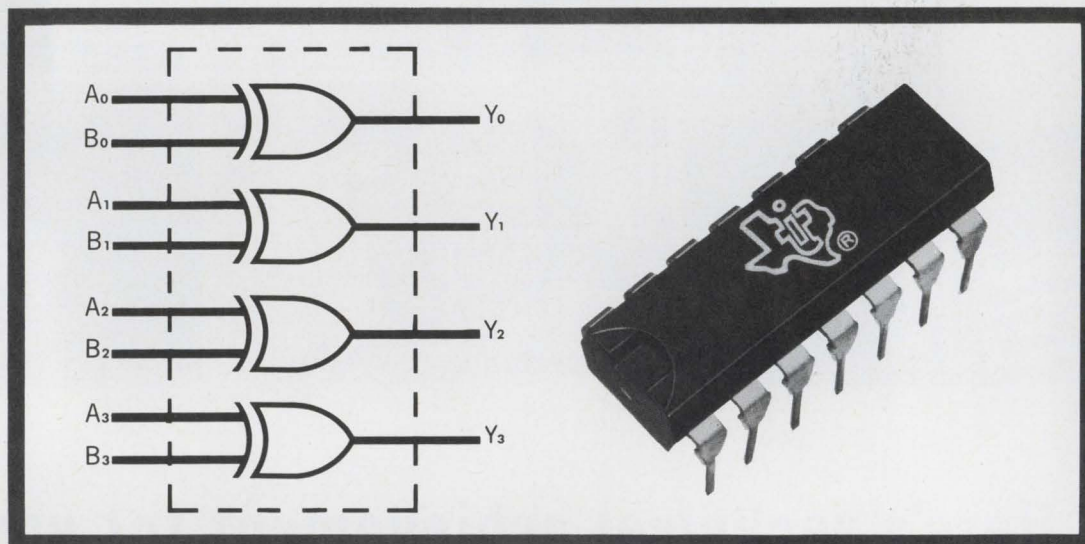

(And easy on the pocketbook.)

Typical propagation delay of this new TI monolithic quadruple 2-input exclusive-OR gate is 12 ns. Power dissipation per exclusive-OR function is only 39 mW. In 100-999 quantities, the plastic dual-in-line carries a \$3.00 price tag.

TI's low-power version, SN54L86/SN-74L86, will help ease your critical power dissipation situations. Power dissipation: 3.75 mW per exclusive-OR function. Propagation delay: 58 ns. Cost: \$3.41 for the plastic dual-in-line.

You can get both versions promptly

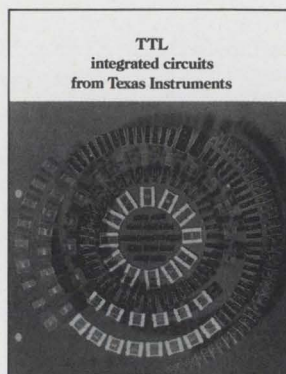

and both are fully compatible with TI's growing family of Series 54/74 integrated circuits.

For all the facts, fast and easy, get our data sheet on the SN5486/SN7486. We'll also send along our new 80-page brochure on our Series 54/74 ICs. Circle 190 on the Reader Service Card or write Texas Instruments Incorporated, P.O. Box 5012, M. S. 308, Dallas, Texas 75222. Or call your nearest authorized TI Distributor.



## TEXAS INSTRUMENTS INCORPORATED



## Choosing a Signal Processor

by DR. E.U. COHLER, *President*  
*Computer Signal Processors, Inc.*

*Signal processing systems fall into three general categories. It is important to appreciate the differences in order to make a sensible selection.*

### Function-Specific

Function-specific processors are usually designed to perform a single version of a complete processing function. These systems, when developed and debugged, very often maximize performance per dollar. Unfortunately, they often result from the observation: "It's simple; we just throw together a few integrated circuits and . . .". Sadly, the result is usually functionally rigid, obsolescent, and has cost a great deal to engineer.

### Algorithm-Specific

Algorithm-specific processors are designed to perform individual algorithms of general usefulness, such as Fast Fourier Transforms. This category really consists of partial systems, since these processors must be combined with either a function-specific processor or a computer. Thus it is clear that the algorithm-specific processor, like the function-specific processor, is an inherently rigid approach.

### General-Purpose

General-purpose processors are systems whose functions are programmed rather than wired. The most flexible of the three, they combine the advantage of standard hardware with a multiple function capability. Such a system may be used for any algorithm: Fourier transforms, digital filtering, correlations, convolutions, cepstra, amplitude histograms, signal averaging, spectral densities, or statistical analyses. It can also accomplish the many odd jobs peculiar to a non-specific environment: comparison, peripherals handling, display, threshold sets, adaptation, and decision-making.

Each category has its place and its most useful applications. Since you know your own requirements better than anyone else, it is practical to do your own evaluating. After each category has been considered against the application, selection will be nearly automatic.

Circle 59 on reader service card

# A CASE IN POINT: **CompuSignal System 3 (CSS-3)**

A general purpose signal processing system capable of performing Fast Fourier Transforms (FFT's) *in real time*, and able to acquire samples at rates up to 50 KHz. Will perform 2048-point transforms, which can be extended by option. Also provides zoom FFT, auto-correlations, cross-correlations, convolutions, averaging, histograms, digital filtering, and special application-oriented signal processing routines. Complete system, including software, for *less than \$45,000*. Sixty day delivery. Write for complete specifications: Computer Signal Processors, Inc., 209 Middlesex Turnpike, Burlington, Mass. 01803. Tel. (617) 272-6020.

**cspi** COMPUTER  
SIGNAL  
PROCESSORS, INC.

Invitational demonstrations will be held in your area.  
Write for dates and program subjects.

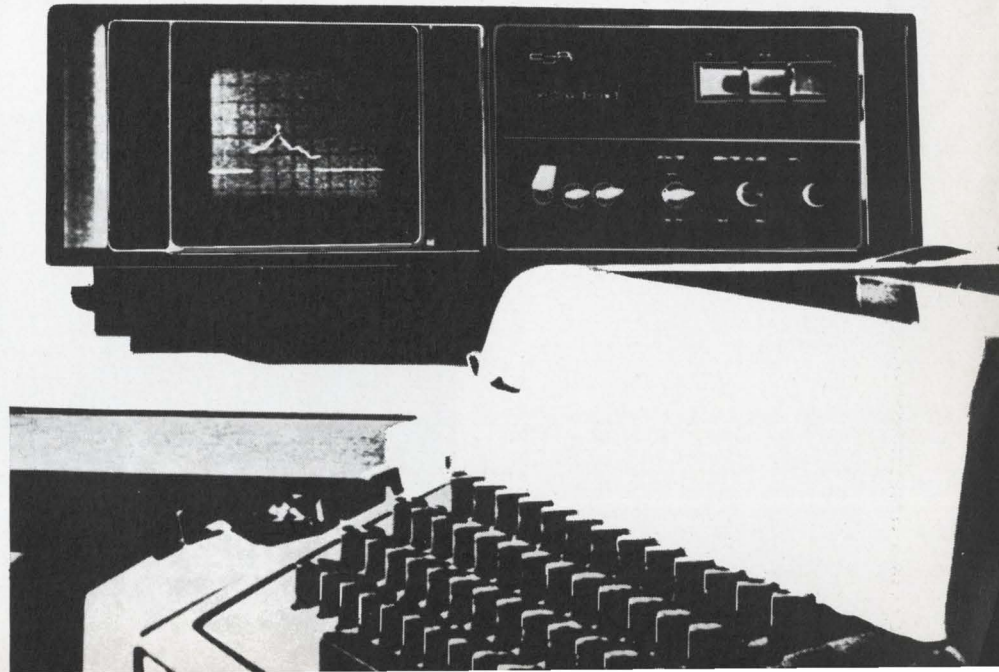



# Five generations of satellites came from Hughes.

## Join us for the sixth?

Syncom was the first synchronous communications satellite. Launched in July, 1963, and still operating.

Then Early Bird. The Intelsats. Applications Technology Satellites. And now, giant TacSat, being built for the Department of Defense.

But there's lots more history to be made. Far more sophisticated satellites. With bigger voices than ever in world communications.

Want to be in on the new generations of satellites? We need men who do. Our pioneering work in communications satellites has led to new and expanding programs with many unusual career opportunities.

### Typical openings for Space Systems Engineers

Astro Dynamicists • Dynamic Analysts •  
Spacecraft Systems Analysts • Space  
Communications Analysts • Senior Systems  
Engineers • Communications & Telemetry —  
Telecommunications Specialists • Spacecraft  
Circuit Design Engineers • Project  
Engineers • Power Conditioning Equipment  
Design Engineers •

All assignments require accredited engineering or scientific degrees, a minimum of two years of applicable, professional experience and U.S. citizenship.

For prompt consideration, please airmail your resume to:

**Mr. Robert A. Martin, Head of Employment**  
**Hughes Aerospace Divisions, Dept. 77**  
**11940 W. Jefferson Blvd.**  
**Culver City, Calif. 90230**

**HUGHES**

HUGHES AIRCRAFT COMPANY  
AEROSPACE DIVISIONS

An equal opportunity employer—M & F





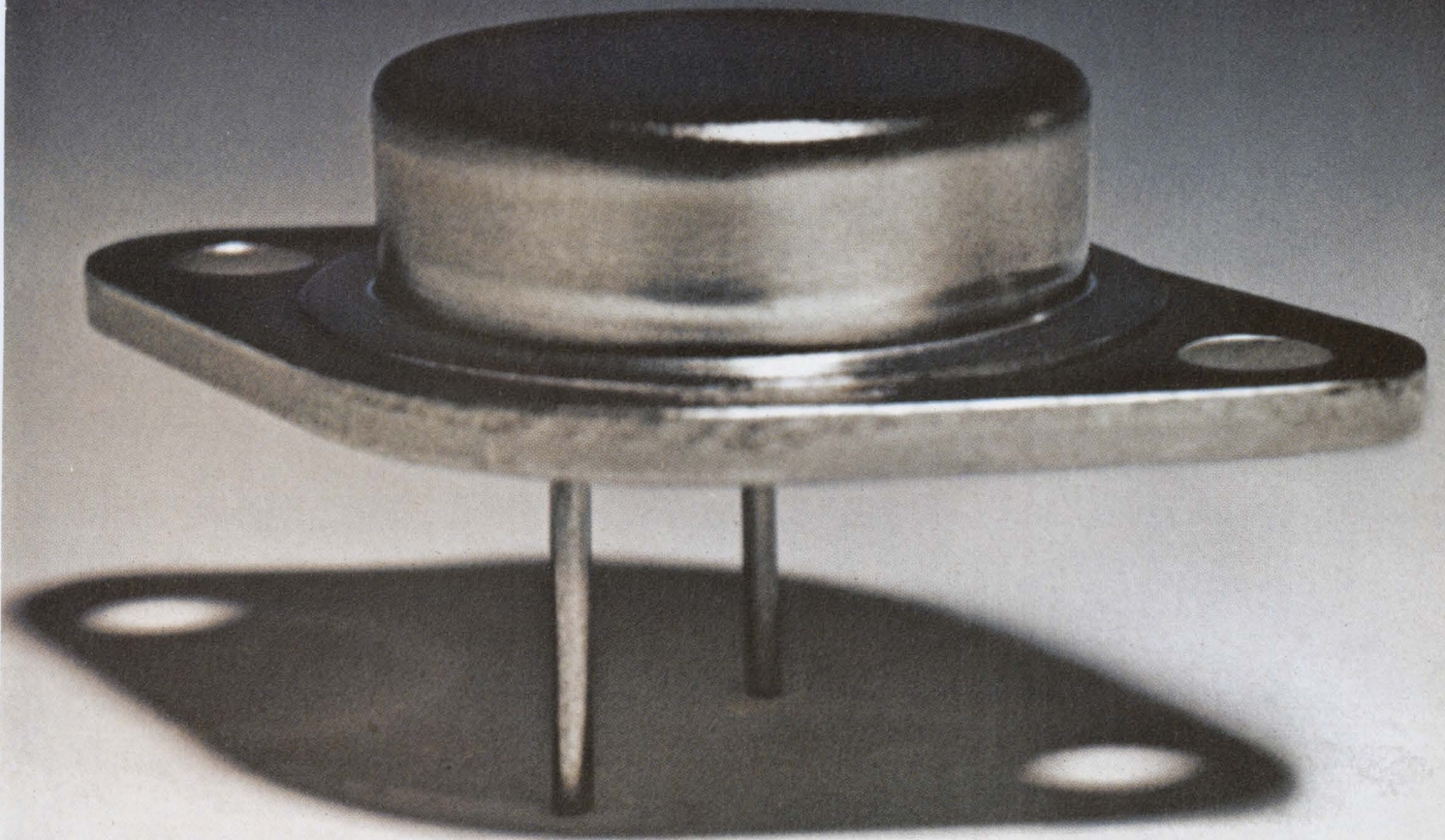

## We're available

**Get up to 1000 units of  
2N3773 and 2N3054 transistors  
in less than two weeks.  
Now from Westinghouse.**

What's more, we'll also give you fast service on larger orders. However many it takes to fill your total requirements.

Our 2N3773, 2, 1 (TO3) is a family of 30-amp diffused transistors for high power switching and amplifying applications. They offer a wide selection of voltage and gain.

Our 2N3054 (TO66) is a 4-amp device used to drive our

2N3773, or as the output stage in low-to-medium power applications.

For complete data—and a large ready supply—of any and all of these transistors, contact your local Westinghouse Sales Office or Westinghouse Semiconductor Division, Youngwood, Pa. 15697.

You can be sure... if it's

**Westinghouse** 



# $\pm 50 \text{ ppm}/^\circ\text{C}$ in all Helipot Cermet Trimmers

This significant advance in Helipot's cermet technology is now available at only a dime/unit more . . . 100 ohms thru 2 megohms. In addition, you get essentially infinite resolution, environmental stability, reliability, no catastrophic failures — all superior to wirewound trimmers. We'll also deliver off-the-shelf, locally stocked trimmers with a standard tempco of  $\pm 100 \text{ ppm}/^\circ\text{C}$  in the 100 ohm thru 2 megohm range.

**Beckman**

INSTRUMENTS, INC.

HELIPOT DIVISION

FULLERTON, CALIFORNIA • 92634

INTERNATIONAL SUBSIDIARIES: AMSTERDAM; CAPE TOWN; GENEVA; GLENROTHES, SCOTLAND; LONDON; MEXICO CITY; MUNICH; PARIS; STOCKHOLM; TOKYO; VIENNA



# Technical Articles

---

**Cat's eyes  
for the  
military  
page 64**



Electro-optic systems in general and low-light-level television in particular have yet to provide an all-purpose solution to the military's night-vision problems. As a result, the Pentagon, which has long been high on such equipment, is taking a long, hard look at the difficulties involved in coming up with practicable apparatus. Among the hang-ups: a lack of uniform standards and sensor-tube shortcomings. The sec tube, for example, though considered a workhorse, still lags at low light levels and overloads in strong light. Silicon vidicon units, just now getting into production, look promising. The fabulous feline on the cover is named Ruffles; she belongs to art director Jerry Ferguson's little girl, Emily.

**Sorting IC's  
economically  
page 74**

Integrated-circuit users will soon be faced with the problem of testing assemblies at a reasonable cost. What's needed is a system that can check devices for pennies apiece. The Digital Equipment Corp. has come up with a computer-based set-up that does just this. All an operator must do is type the IC's number on the Teletype and insert the device in the test fixture; the machine measures every parameter specified by the manufacturer and burst-tests flip-flops.

**Magnetic bubbles—  
a technology  
in the making  
page 83**

Bell Telephone Laboratories has developed a new technology using magnetic bubbles—cylindrical magnetic domains. Bell has generated, propagated, and detected these bubbles, which can be as small as .00004 inches in diameter, and performed both memory and logic operations. Though there are no magnetic-bubble devices commercially available at the moment, companies with mask-making, thin-film, and chip-handling facilities shouldn't find it too difficult to market simple systems within the next year or so. If they choose to do so, however, they'll find magnetic bubbles competing with their digital semiconductor product lines.

**Memory testing:  
four approaches  
page 102**

When you cut into a three-layer cake, you get something from each section. This is analogous to what's involved in memory testing, where elements, arrays, and systems must be checked separately, as well as, to an extent, in common. The techniques and technology required are discussed in four articles by engineers at the Computer Test Corp.; this is the eleventh installment in *Electronics* memory series.

**Integrated circuits  
in West Germany**

## Coming

The articles in this special report on the state of the IC art in West Germany will cover such subjects as partitioning for color tv applications, circuits for automatic camera controls, noise-immunity designs, and the like. An overview article will survey the efforts of top producers.



# Cat's eyes for the military



**Low-light-level tv systems hold out great promise, but development has been painstakingly slow—and costly**



By Alfred Rosenblatt

Associate editor

● Hailed by the military as critical for night combat operations, electro-optical systems—particularly low-light-level television—haven't turned out to be the panacea hoped for by their advocates. True, there has been progress (both color and black-and-white low-light-level tv have been deployed in Vietnam on a limited scale in recent years). But the progress has been painstakingly slow and the cost for research and development has already run into the millions of dollars. So slow has been the development that the military is now wondering whether it is getting a sufficient return on its investment.

This has led the Pentagon to take another, closer look at its entire night vision effort. Or, to use the phrase popular during the Eisenhower Administration, the time has come for an agonizing reappraisal. And considering the political climate in Washington and the cost-conscious mood of the American public—the furor over the costly, ill-fated Cheyenne helicopter is ample testimony of what the military is up against—this reappraisal is none too soon. The Army has already moved to strengthen the management and evaluation of its night operation programs [see “Army seeks more light on low-light-level tv,” p. 68].

Unquestionably, electro-optical systems hold out a great potential for the military. But fulfilling this potential is apparently far more difficult than what had been anticipated. To be sure, electro-optics is an emerging technology. And like all new technologies, electro-optics is plagued by a host of problems. Perhaps the most outstanding problem of all is the lack of standards. This, to some degree, has led to unrealistic specifications—specifications that are fine on paper, but, as they often turned out, had little to do with the actual en-



**Promising contender.** Arrays of silicon photodiodes, used in a tv tube like Texas Instruments' Tivicon, can take pictures in very low light levels and will probably be used in most light-sensing tubes of the future.



vironment in which the systems had to operate.

In hopes of specifying systems so that they work in the field as well as in the laboratory, the Air Force embarked on a study aimed at setting standards for the technology [*Electronics*, Aug. 4, p. 33]. The study is primarily an effort by the Image Evaluation Criteria Working Group at the Avionics Laboratory, Wright-Patterson Air Force Base, Ohio. With the help of industry, through seminars for exchanging ideas, the Air Force, hopefully, will standardize not only terminology, but its approach to defining and measuring the performance of electro-optical systems as well. The study also covers infrared sensor systems. What prompted the almost sudden decision to start this study? Problems that have cropped up in Vietnam, says the Air Force.

"Presently there are no criteria, no procedures, and no facilities in any one laboratory for really evaluating any one sensor, or any facilities that are accepted by all laboratories for evaluating one sensor," wrote Lucien M. Biberman, in a report earlier this year for the Institute for Defense Analyses. "As yet, there is no way that one can compare the performance of different types of sensors for some given task."

Not even the same units of measurement are used to specify the performance of an electro-optical sensor. Two techniques are generally used—the photometric technique, which is geared to the characteristic spectral

response of the eye and uses such units as foot-candles, lamberts and luxes, and the radiant technique, which is geared to energy concepts. This difference can make performance comparisons almost impossible.

J.E. Hamby, manager of low-light-level tv systems at Westinghouse Aerospace opts for the radiant technique. "We'd like to see everybody using radiant units because you can specify watts at any wavelength," he says. "You can't do that with photometric units."

If the difference in measurement techniques make comparisons difficult at best, it makes pinning down specifications equally difficult. And this had led to a great many misunderstandings, which are always costly.

But the lack of standards hasn't stopped the military from pouring R&D funds into electro-optics. And as things now stand—with or without standards—even more funding is in the offing. Airborne systems, particularly those using secondary electron conduction (sec) vidicon tubes, are expected to get a good chunk of the money. Also due for a sizeable share are complex systems that will employ different types of electro-optical sensors. These systems will handle multiple tasks that might include surveillance, target detection, and acquisition. "Any one sensor is not going to do the complete job," says Loren H. Ford, manager of electro-optics systems engineering at the General Electric Co.'s aerospace electronics department in Utica, N.Y. "We'll probably

## IDA's Biberman sees sec tube as a workhorse

*What's the best tv tube for low-light-level systems? There is no simple answer; much depends on the application. But if one type were to be singled out, it would probably be the sec. According to Lucien M. Biberman, one of the nation's leading experts on low-light-level tv systems, sec's hold out the greatest promise and will, in all probability, become the workhorse of future systems. Here, Biberman addresses himself to the place of these tubes in low-light-level systems.*

By Lucien M. Biberman

Institute for Defense Analyses, Arlington, Va.

• Simple image-intensifier tubes, together with good optical collectors and eyepieces, are more than sufficient for direct-view systems in which video processing or transmission isn't required. But when it comes to remote viewing, a television tube and display replace the eyepiece. The result: a low-light-level tv system.

With a good light amplifier, the amount of information that can be transmitted is proportional to the area of its photocathode. Basic experiments have shown that the performance of a good photoemissive sensor depends, in addition to its size, upon the irradiance of the scene imaged on the photocathode, the contrast within the scene, and the spectral quantum efficiency of the cathode. Thus, for a particular low-light-level scene and collecting optics of equal F-number and field of view, an 80-millimeter cathode will provide more than three times the number of resolved lines at a given contrast, or about ten times the information, than will a 25-mm cathode.

In a well-designed system, the emitted photoelectrons

should be amplified sufficiently to produce a readily discernible image on the output or display. But, the gain shouldn't be so high so that the random fluctuations or photon noise start to obscure the image.

Useful gains in the system, taken from where the photons strike the photocathode, may well run from 50 to 50,000, but this depends on the application. For the higher gains, two or more intensification stages are used in series. Since each stage not only has gain, but distortion and contrast losses as well, multiple stages result in higher brightness but lower image quality and contrast.

**When a tv tube replaces** the eyepiece of the direct-view system, an additional set of noise problems is introduced. Picture quality from tv tubes is degraded by noise and loss of contrast. The noise arises in the input scene, in the tv-tube storage target, in the reading beam, and in the video amplifier. If the tube's output is small, the noise in the video amplifier might well dominate.

The quality of readout depends largely upon the quality of the readout beam and the capacity of the target. High-capacity targets store large numbers of photoelectrons and result in large beam-signal currents in the target-discharge process. Thus, high signal-to-noise outputs and good picture quality are achieved.

However, a great number of photoelectrons are needed to charge these high-capacity targets. This, in turn, requires many photons. Simply, a great deal of light is needed to provide the high resolution potentially available in high-capacity tubes.

Preferable would be a small number of photons to charge a high-capacity target to a significant level. Internal gain in the target can help make this possible. The image orthicon





**Dark eyes.** Low-light-level tv and direct-view systems of Infant "see" through round light sensors mounted on front of this UH-1C helicopter. Targets can also be illuminated by searchlights mounted at sides of cabin. Hughes Aircraft developed this system for the Army's Night Vision Laboratory.

tube was developed to achieve this function. The sec (secondary electron conduction) vidicon is similar to the image orthicon in this respect, but it has approximately ten times the gain in the target, less capacity, and, thus, an inherent capability to provide moderate resolution at moderately low light level, or starlight, conditions.

**The isocon version** of the image orthicon can outperform the sec vidicon at low light levels on stationary scenes. But the return-beam version of the sec is a strong contender. However, because of its image persistence, the isocon is less desirable for moving targets. It is best, however, for low-velocity moving scenes where smear isn't a problem and where the values of the irradiance incident on the photocathode are quite low.

Some selected types of vidicons, such as the Plumbicon and Oxycon, provide much higher resolution than the orthicon or isocon. But because they have low gain and high target capacity, they require a great deal of light. In a low-light level system, this light can be obtained, from a series of cascaded intensifiers, each of which degrades the image quality at the same time that it amplifies the brightness.

A low-light level system using a "starlight sniperscope" made up of image intensifiers coupled to an oxide vidicon will work if the requirements of resolution at low contrast aren't demanding. It is a cheap system that provides an amplified image of a low-light level scene, but with added distortion and a loss in contrast. It may be adequate, however, for law enforcement applications, such as looking into a darkened alley in which the targets are relatively close and are moving at relatively slow speed.

For high-performance airborne systems operating in a low-light-level environment, a family of sec vidicons and intensifier sec vidicons has been developed. The larger and costlier sec devices meet the more demanding needs, while the smaller and less expensive ones fill less demanding needs.

The cost of the sec tube is expensive, at present, since production runs on the tubes have been short.

**The major advantages** of the sec vidicon are its high gain and its target's low capacitance. These characteristics make possible moderate resolution of low contrast scenes at moderately low light levels. Price of the sec is higher because comparatively few tubes are being produced and used.

Current developments of tubes similar to the sec, but with both much higher target gain and target capacitance, have led to a new family of tubes based upon silicon microcircuit technology. These tubes have good sensitivity. And, because of their high target gain, coupled with high target capacity, they have—with a well-designed beam readout—good contrast transfer.

These silicon-target tubes make possible potentially simpler fabrication and higher yields, and thus could have appreciably lower prices than current sec devices. It would appear that direct interchange of the new for the present sec tube may be in the offing.

Future oxide versions of the vidicon, with surfaces of the same high quantum efficiency but appreciably larger diameters, could become of considerable interest. But they would require multiple, large and costly intensifiers. The silicon target tubes, which should be in general use within two to three years, however, are expected to provide better performance at lower cost with but a single intensifier. Until then, the sec vidicon appears to be the workhorse for most applications of low-light-level tv. ●

## References

- J. W. Coltman, *Journal of the Optical Society of America*, Vol. 44, p. 234 (1954).
- J.W. Coltman and A.E. Anderson, *Proceedings of the IRE*, pp. 858-865 (May 1960)
- Albert Rose, *Journal of the Optical Society of America*, Vol. 38, p. 196 (1948)



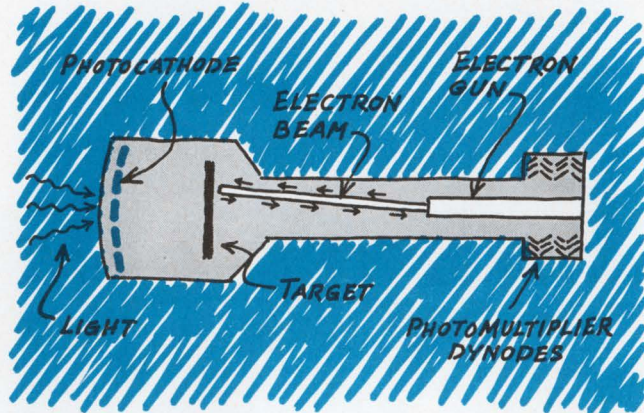
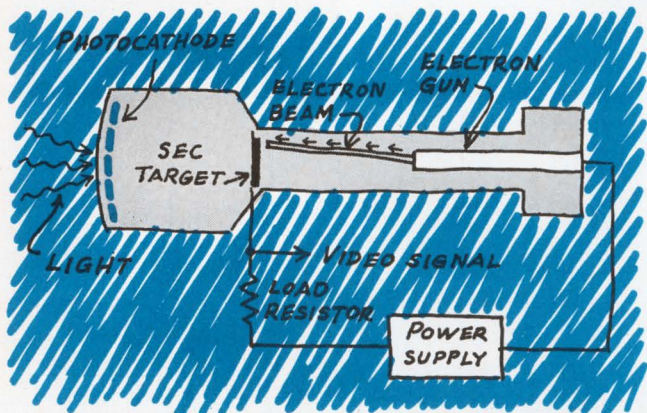

• Apparently dissatisfied with the slowness in getting night-vision programs in high gear, the Army is counting heavily on two newly formed organizations—Task Force Riposte and Stano—to get things moving. Among the high-priority systems that have fallen behind schedule is low-light-level tv.

Riposte, which is under the jurisdiction of the Combat Development Command, is officially charged with developing, testing, and fielding and “integrated night operations capability” in Vietnam by June of next year. But even if Riposte adheres to its schedule—unlikely, considering the Army’s limited success in recent years—operational systems couldn’t be ready for combat zones for at least another year; systems developed by June 1970 will be funded in fiscal 1971.

By seeking, via Riposte, new planning, management, and quality-assurance programs to define the equipment and operating procedures for its night-operations capability, the Combat Development Command has admitted, in effect, that its present programs have failed. Critics of the night-operations programs have charged that the Army is guilty of unsatisfactory planning and bad management when it comes to night-operations programs. And, they add, the result has been poor performance in existing systems.

Stano, which stands for surveillance, target acquisition, and night operations, goes beyond any one Army command. Headed by Brig. Gen. William Fulton, who reports directly to Gen. William C. Westmoreland, Army chief of staff, Stano is charged with overseeing night operations within any command of the Army. Its primary mission: correct and improve all systems whose performance is considered unsatisfactory.

But before the Army can get started on new systems, it will first have to obtain a lot more performance data than is now on hand. According to sources at the Army’s Night Vision Laboratory at Ft. Belvoir, Va., systems that have been operational in Vietnam have provided precious little data on performance. A great deal more data will be needed before existing systems can serve as a guide for the development of future systems. •

## Army seeks more light on low-low-level television



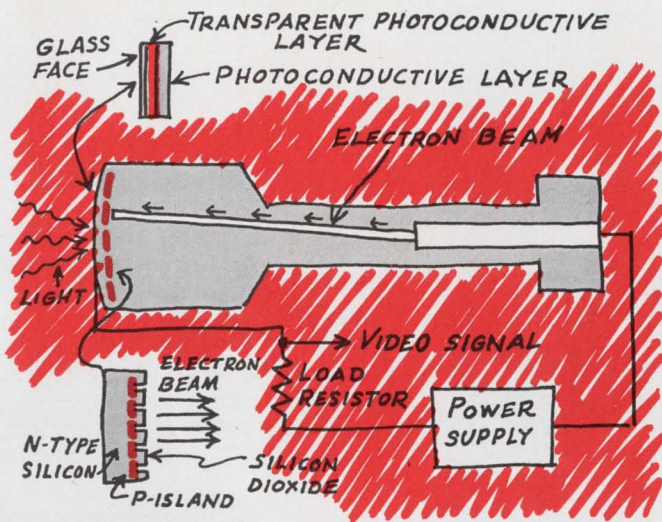

For openers. Sketches show basic image reading techniques for a sec tube, top left, which reads image from secondary target; for image orthicon, bottom left, which relies on information in the return beam; and for direct-reading vidicon, shown with both silicon array and photocathode faceplates, top.

see combinations of i-r and tv, for example," says Ford. The i-r sensor would detect targets at long range, he points out, and the tv, with its better resolution, would identify them.

How these sensors will be combined into systems is shrouded by a cloak of secrecy. Although a great deal of work has been, and is still being, done on low-light-level tv systems, almost all of it was and is for the military. Therefore, most of it is under security classification. But even the military will admit that there is no commonality among the services—Air Force, Army, and Navy—because of differing mission requirements. The Army, for example, has only light aircraft and helicopters, therefore, specifies smaller and lighter systems than either the Air Force or the Navy. And, the Army stresses that its systems, must operate under "any conditions" and must be simple enough so that it can be operated by what the Army calls the average GI, a difficult task even with mature technology.

One of the Army's newest systems, but one that doesn't quite fit the "average GI" classification is called Infant (for Iroquois night fighter and night tracker). Developed by the Hughes Aircraft Co. under the direction of the Army's Night Vision Laboratory at Ft. Belvoir, Va., Infant could be considered a follow-on to the outfitting of several UH-1B helicopters with low-light-level tv systems three years ago.

**See-through tube.** Intensified image of target scene produced by direct-view portion of the Army's Infant night vision system is viewed by helicopter crewman through a fiber-optic cable. The cockpit also contains two displays of the target taken with low-light-level television camera.

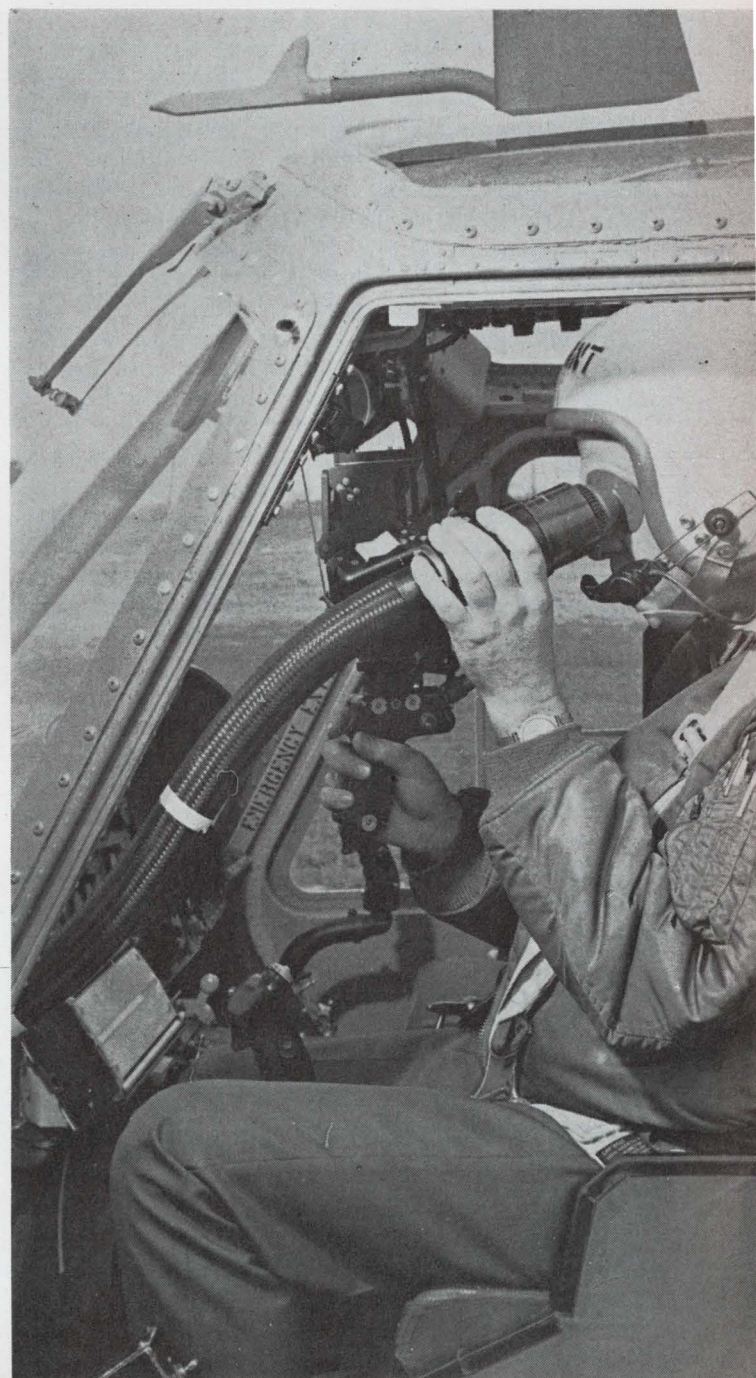



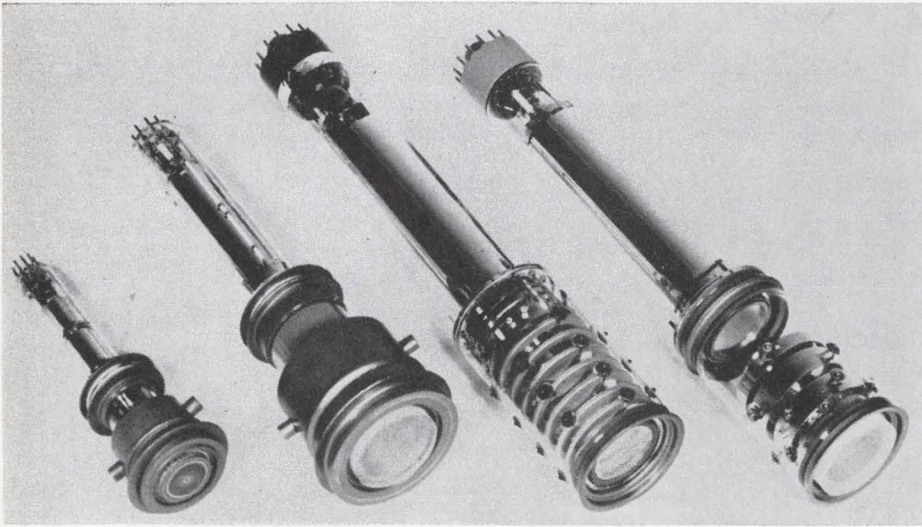

**Commercial family.** Four types of sec tubes are in standard production at Westinghouse's Electronic Tube division. Tube at left has 25 mm photocathode; the others have 40 mm photocathodes.

Infant is essentially two night-viewing systems in one—a direct-view system and a tv system. In the direct-view system, image intensifiers are mounted in the nose of the helicopter and coupled to an eyepiece in the cockpit via a fiber-optic cable. In the tv system, a low-light-level tube—probably a sec tube made by Westinghouse—is mounted, along with intensifiers, in the aircraft's nose and coupled to three displays in the cockpit. Infrared searchlights, mounted outside of the aircraft, can be used to illuminate targets. Although the system is under tight security wraps, it is believed to incorporate automatic video tracking that aims the helicopter's machine guns. In effect, the system provides the pilot with cat's eyes to wage combat at night.

Equally active, if not more so, as the Army in the pursuit of such tv systems is the Navy, which is in the process of purchasing 80 systems for antisubmarine warfare. Earmarked for the P-3C aircraft is the AN/AXR-13, a tv system that uses an image orthicon tube with an image-intensifier stage in front. The system, developed by GE, is mounted in a wing pod and will be used to detect and identify vessels running on the sea's surface at night.

GE is also employing a focus projection-scanning vidicon and starlight scope-type image intensifiers in a system being readied for the Navy's Tartar Mark 74 missile director. The tv system, which was originally intended

for reconnaissance and surveillance missions is bore-sighted with the missile radar and will classify and identify targets picked up by the radar.

Yet another type of low-light-level tv system has been ordered by the Navy for its A-6 Intruder, probably the country's most heavily instrumented tactical aircraft. The system is designed for all-weather weapons-delivery missions. RCA is supplying 17 cameras and six ground-test consoles at a cost of \$4 million. This system, like the other military programs, is under security wraps. But from all indications, the system will operate in conjunction with an infrared-detection system and uses a sec tube.

Combining low-light-level tv and infrared systems is also close to the Air Force's heart. Several such programs are on board and still others are in the works.

Thus, on the surface at least, there appear to be a great number of developments in low-light-level tv. But the truth of the matter is that the developments have been slow in becoming operational. At the very heart of these systems is the tv tube used. Some 95% of all military contracts call for sec tubes, says Robert Collins, electro-optics project manager at Textron Inc.'s Dalmo Victor division. Dalmo Victor is working several systems for the military. But despite its widespread use, the sec has been greeted with mixed emotions. Whatever unhappiness there is about the sec—and there is a great

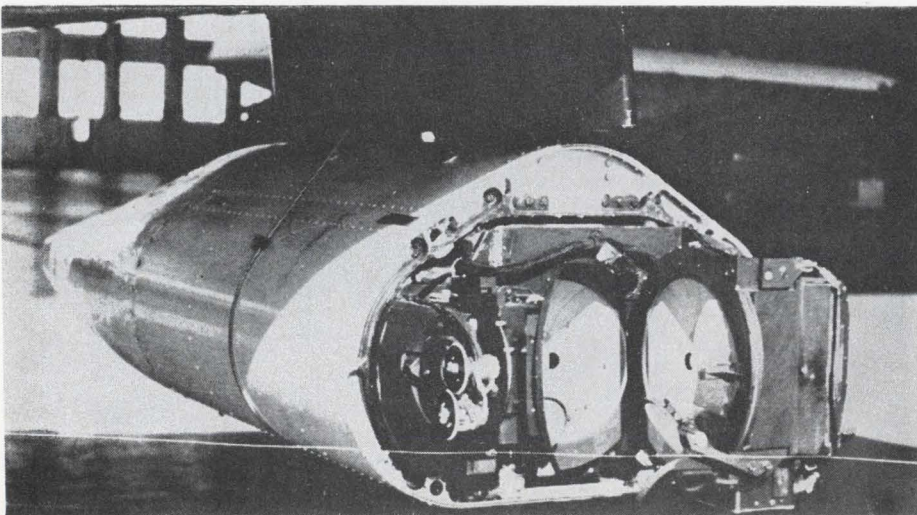

**Multifunction pod.** Weapons delivery system has low-light-level tv camera (with optics folded open), combined with a laser ranging unit, mounted in an under-slung wing pod. The system, built by Westinghouse Aerospace as an outgrowth of the Air Force's Tropic Moon #2 program, also contains an automatic video tracker, electronic zoom intensifier, and weapons computer.



deal—it's the best tube available for low-light-level tv. "And because it's the best," says George Smith, a vice president at Hughes Aircraft and director of its research laboratories in Malibu, Calif., "they (the military and system makers) have to use them." Robert Lee, electro-optics manager at Westinghouse Aerospace, agrees. Says Lee about the sec: "It's best for imaging in motion at low-contrast targets." And as another industry source puts it, "It's a low-contrast world out there (referring to the environment of most military targets).

One of the sec tube's most troublesome areas is the lag time that occurs in erasing an image to accommodate a new picture: as light levels fall, this lag effect worsens. This leads, in airborne systems, to streaking or blurring in the picture. The solution to this problem lies in removing the image from a sec tube quickly enough to accommodate the 30 image-per-second speed generated by the system. Another problem is the "blooming effect"—sometimes called the "blossoming"—which occurs when light levels change rapidly from one extreme to another. A tracer bullet or a shell burst has the same effect on the system as a flash bulb has on the human eye. There's a momentary blindness.

Then, of course, there's overloading of a target, causing a light runaway effect. This has been solved by simply turning off the camera, erasing the image and starting over again. The Army, for one, wants its sys-

**Motion problem.** Aimed at a static scene, the image orthicon, top, has a higher resolution than that of a sec tube, bottom. However, in a dynamic situation, the resolution of both tubes decreases.

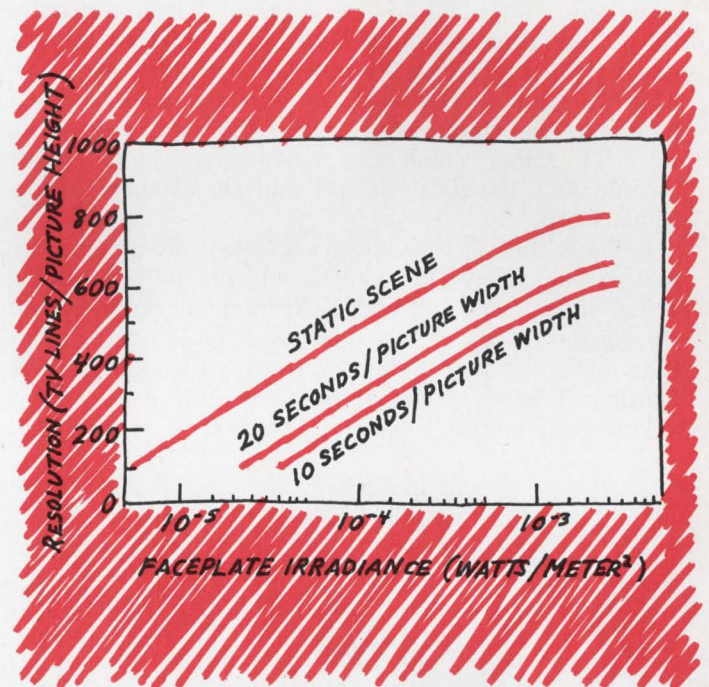
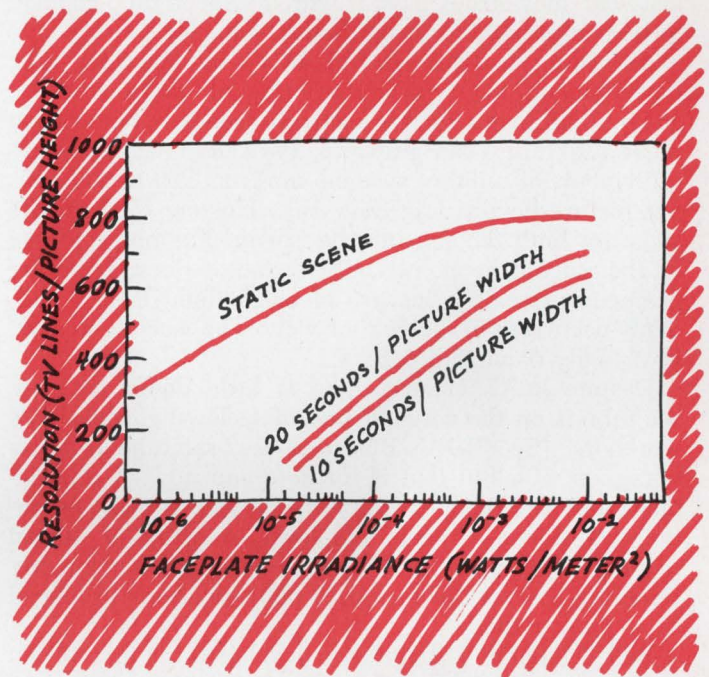



tems to have dynamic ranges greater than what is presently available.

Along with the development of sec's have come other tube types, as well. An ardent advocate of isocon tubes is RCA. More than three years ago, the company abandoned its sec development and started to redesign its isocon tube for low-light-level applications. And only last year, they struck paydirt with an isocon tube claimed to be comparable to, if not better than, sec's.

According to Paul Huston, RCA's manager for tube development, the typical resolution of an isocon tube at low light levels for low-contrast scenes is better than what sec tubes can provide. Typically, resolution requirements of military systems run from 200 to 400 lines per picture height. Lag time, says Huston, is about the same for both the sec and the isocon. The biggest edge of the isocon, he points out, is that it doesn't require protection circuitry because of bright light flashes suddenly occurring in the field of view. The isocon, he says, is virtually damage-proof.

Despite RCA's claims, there is little doubt that the sec tube is on the verge of becoming low-light-level tv's workhorse [See "IDA's Biberman sees sec tube as workhorse," p. 66]. But that is for here and now. A replacement tube is already on the horizon. One version, essentially a silicon vidicon, employs an array of silicon diodes to sense photons directly. Another version, resembling a sec vidicon, senses photoelectrons produced by a photocathode.

Bell Telephone Laboratories developed the first silicon vidicon for its Picturephone. And Texas Instruments, using guns supplied by the General Electrodynamics Corp., has already supplied a rugged mil-spec tube to the Air Force. TI calls its tube a Tivicon, plans to use it in tv studios. High-contrast pictures could be obtained in the studio with 1/16th the light now used, says TI. Other companies developing similar tubes include RCA, Hughes Aircraft and the Amperex Electronic Corp.

Perhaps the silicon vidicon's greatest advantages are that it can follow fast-moving objects with little lag at low light levels and high light intensity doesn't harm the silicon. Moreover, the silicon vidicon is less complex than both the isocon and the sec vidicon, says E.I. Gordon, director of electro-optic research at Bell Labs.

However, silicon is most responsive to visible light

**Solid sensing.** Vidicon from Philips Laboratories senses light with an array of silicon photodiodes on its face. Developmental models like this 6-1 inch-long, 25-mm-diameter tube will be put into production.

in the near-infrared region—out to 1 micron—rather than in the visible, which means conventional fiber optics cannot be used to couple them to image intensifiers, points out Ralph Levitt, product manager, Amperex Electronic Corp. Fiber optics can only transmit light in the visible region.

Rather than coat the faceplate of a silicon vidicon with an antimony trisulfide photoconductor, a silicon diode mosaic a few thousandths of an inch thick is put on the side of the tube facing the vidicon-like electron gun. The mosaic is formed by photoetching holes through a silicon dioxide layer on n-type bulk silicon. P-type silicon is then diffused through to form the diodes. When an image is focused on the bulk silicon side, a charge pattern, related to light intensity in the image, is stored in the mosaic. This image is periodically scanned and erased by the electron beam, with each erasure generating a video signal.

In another version of the silicon vidicon, electrons from a photocathode on the faceplate bombard the diode array. This version is sometimes called an EBIC, for electron bombardment induced conductivity.

Unlike the silicon vidicon in which there is no gain, the EBIC has gain. An electron from the photocathode generates an electron-hole pair for every 3.5 volts between the cathode and target, says Edward Stupp, technical program director at Philips Laboratories, an



**Space twins.** Westinghouse's Apollo color camera, left, and the camera that took the pictures on the surface of the moon during the Apollo 11 mission use sec tubes developed for low-light-level tv applications.



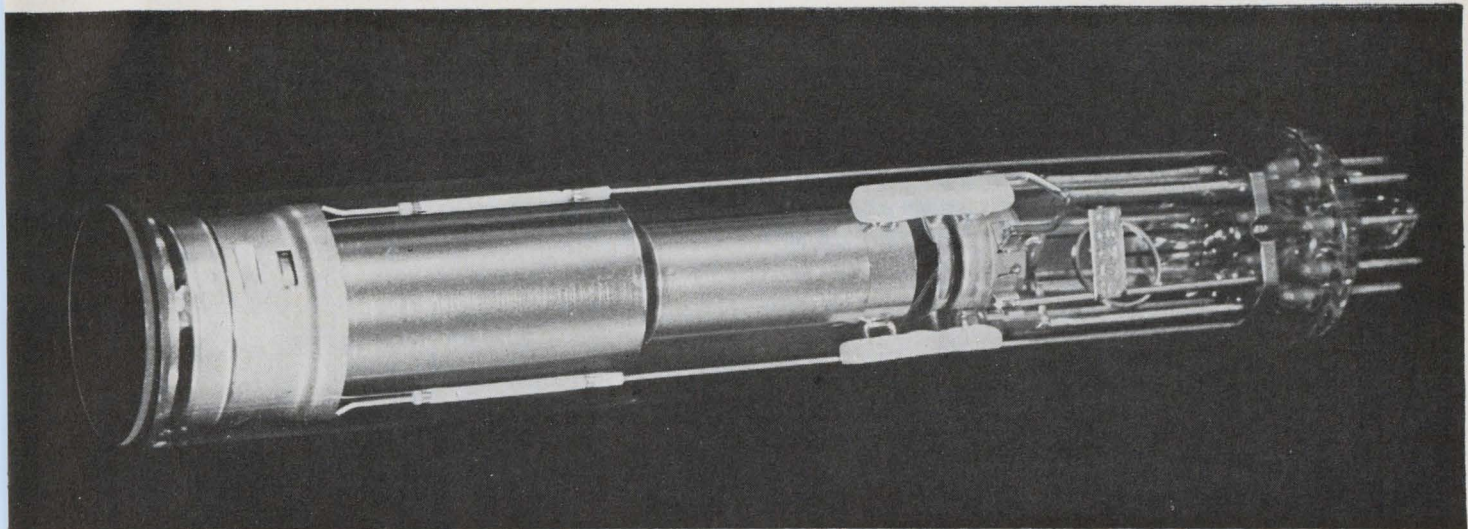

EBIC developer, Briarcliff, N.Y. For a 10,000-volt accelerating potential, some 3,000 electron-hole pairs are generated, for a gain of 3,000. Unfortunately, the photocathode isn't nearly as efficient, so over-all tube gain would only be about 300.

Sensitivity of the tube is comparable to that of a sec with an image intensifier, primarily because the target gain is about tenfold greater. Resolution is limited only by the number of diodes that can be etched into an array, but RCA says it can make arrays with 2,000 diodes per linear inch. If the photocathode is illuminated by  $5 \times 10^{-7}$  foot-candles of light the limiting resolution could be 200 lines, according to RCA; illumination by  $2 \times 10^{-5}$  foot-candles of light would boost resolution to 600 lines. (These figures are for 100% contrast, or black-and-white scenes.)

By early next year, RCA hopes to have sample quantities of a 23.5-inch-long tube with a 40-millimeter photocathode, and a 16-mm target.

But progress in silicon vidicon and EBIC notwithstanding, practical application of these tubes in low-light-level tv systems is still far down the road. Both the military and industry are concerned with the here and now. And since the military can no longer afford a "cost-be-damned" attitude, it must now reckon with costs just as private industry does. Heard often these days is criticism of sec prices. Tube yields are low,

largely because the tube's potassium chloride target is difficult to manufacture. At the moment, military-quality sec's cost \$10,000 and up. "But," says IDA's Biberman, "the price could be a lot lower if designers would standardize on tubes and bottle sizes. The military specifies performance, but the contractor picks the tube."

The tube's manufacturer is quick to point out that the high prices stem, in large part, from low-quantity production. "If we had the chance to manufacture the military-type tubes in quantity, prices would come down to the level that commercial tubes have reached," says Gerhardt W. Goetz, an operations manager for Westinghouse's Electronic tube division. An image orthicon for broadcast studios, for example, costs about \$1,000, Goetz points out. But special image orthicons for military tv systems, which usually include fiber-optic faceplates and special photocathodes, will cost from five to 10 times more.

And as recently as early last year, sec prices ranged from about \$12,000 to \$18,000. But thanks to the growth of commercial applications, prices started a downhill turn. Commercial applications, of course, tend to lend themselves to large—if not mass—production techniques simply because they usually involve standardized specifications and large orders. Westinghouse, for example, has standardized four basic tube types.

"With the efficiencies possible in production-line manufacturing, a WL30691 sec tube now sells for \$2,500, even lower if the tube is ordered in large quantities," says Goetz. And, according to Westinghouse, there are now more than 100 commercial customers for sec tubes. Applications include use in electron microscopes, in closed-circuit field-sequential color cameras, and in black-and-white closed circuit camera systems.

But if the price of sec's is coming down, then the same could be said for isocons. An isocon—with an intensifier, yoke, and focus coils—now sells for about \$9,000 in small quantities. But RCA sees the price coming down to \$6,000. A military isocon tube itself could, in product lots, sell for roughly \$3,000 to \$3,500, according to RCA. That is, of course, if RCA landed such an order.

If nothing else, the furor over the Cheyenne helicopter cancellation as well as that of cost overruns in general, have alerted the military that it will have to get what it wants—but at a reasonable cost. And both the military and industry have only to gain from this. ●



Integrated electronics

## Sorting IC's economically

Incoming inspection system executes static, dynamic, and burst tests on 2,500 IC's/hour with self-adjusting programmable signal source

By Robert A. Hughes and W. Blaine Belecki

Digital Equipment Corp., Maynard, Mass.

**Automatic.** One test station on the system has a mechanical handler that loads untested IC's and sorts tested ones at the rate of 2,500 per hour. At the other station, a girl loads and unloads at the rate of 1,000 IC's per hour.





**The day is fast** approaching when there will be 100 integrated circuits or more on a single digital circuit-board module. At the typical reject rate of 1% on incoming IC's, as received from the manufacturer, this means that every IC must be tested by the user, because sampling just won't do—with one out of a hundred IC's defective, chances are that every module would be defective too.

So the real question for a big user of IC's is not whether to test 100%, but how to test cheaply. At the Digital Equipment Corp. the answer was found to be a completely computerized system that can test IC's at a cost of only 2.7 cents apiece.

Essentially, the system is a standard PDP-7 computer with standard peripheral equipment, connected to a custom-designed subsystem that accepts test-program commands from the computer and provides digitized test data. Key elements of this special subsystem are programable power supplies, a pulse-burst generator, an analog-to-digital converter, a reed-relay switching matrix, and an IC adapter.

The system is automatically programable; the operator types the IC number on the teletype and inserts the IC's in the test fixture; the machine does the rest. The system is thorough, too. For example, it performs 116 tests, both static and dynamic, on the series 74 TTL two-bit adder. And it's versatile; it tests resistor-transistor logic circuits as well as transistor-transistor logic circuits, with their widely different input and output levels.

The key technical innovation that made all this possible was self-adjusting programable signal sources. These control upper and lower voltage swings for dynamic tests and control worst-case d-c signals for static tests. They generate signals that are accurate ( $\pm 1$  millivolt) and fast (rise and fall times of 5 nanoseconds, fast enough to test high-speed TTL circuits).

The tester measures every parameter that the IC manufacturer specifies, and, in addition, does burst testing on flip-flops, which determines the sensitivity of the IC to pulse-repetition frequency.

Besides accepting or rejecting IC's, the tester can print out measurements. This is useful in debugging a new test program and in analyzing rejects when a large number of failures crop up in a lot.

The design challenge posed by the programable signal sources was to assure that precisely the desired voltages and currents are applied to the IC during the test. These levels may be changed a hundred times or more during the 1-second test sequence, and are critically influenced by the saturation voltage of the signal-source output transistors—which varies with time, temperature, and different transistors.

It's not enough to program by switching in appropriate resistor networks; some form of feedback and adjustment is needed. The solution was an analog-to-digital converter to monitor the signal-source output so that it can be compared to the required value that's stored in the core memory of the system.

Essentially, the signal source for dynamic tests consists of a pnp-npn transistor combination with upper-level and lower-level supplies, page 77 top right; these supplies set the range of the voltage swing in a dynamic test. The collector of the npn is connected to the upper-level power supply and the emitter of the pnp is connected to the lower-level supply. The npn emitter and pnp collector combine to form the signal-source output. The base drive for both transistors is a current-mode switch. The a-d converter is connected to the output terminal.

In operation, the npn transistor is turned on and the upper-level supply adjusted until the programable output is at the required level, as determined by a comparator using the inputs from the a-d converter and from the core memory. Then the procedure is repeated for the pnp transistor to adjust the low-level supply.

The adjustment is accomplished by means of relays which, under the control of a computer subroutine, shunt out resistors in the feedback loop of the power supply (page 77 top left). The correct voltage can usually be set within three passes of the subroutine. If the power supply can't be set in 35 passes, the line printer types out "Cannot set signal source." This is a rare occurrence, but the printout is helpful in troubleshooting.

The dynamic test signals—essentially a train of very fast square waves—can now be applied to the IC under test.

For static tests, the programable power supply operation is similar, except that only one voltage level is set for each test. Under the control of a flip-flop register, relays switch the resistors in or out so that the output gives a first approximation to the required level. The a-d converter provides a final precise adjustment.

### Standard but modified power

There are 12 programable power supplies in all. Eight are used to control the upper and lower voltage swings of the four signal sources used for dynamic tests, and the other four are for d-c conditioning tests. The supplies themselves are standard commercially available types, but the company has modified them with zener diodes and matched resistors to give the stability and the highly linear characteristic that's needed (1,000 ohms of programing resistance per volt of output). They can be programed in increments of 5 millivolts.

The complete IC test system includes the PDP-7 computer with high speed paper tape reader, a high speed tape punch, a teletype, and three magnetic tape units. In addition to the 12 programable power supplies, the A/D converter, the reed-relay matrix, and the programable pulse-burst generator, the tester portion of the system contains a programable sampling scope, a digital readout device, a programable event counter, and a line printer control.

An IC to be tested is inserted in an adapter on the tester. The purpose of the adapter is to reduce



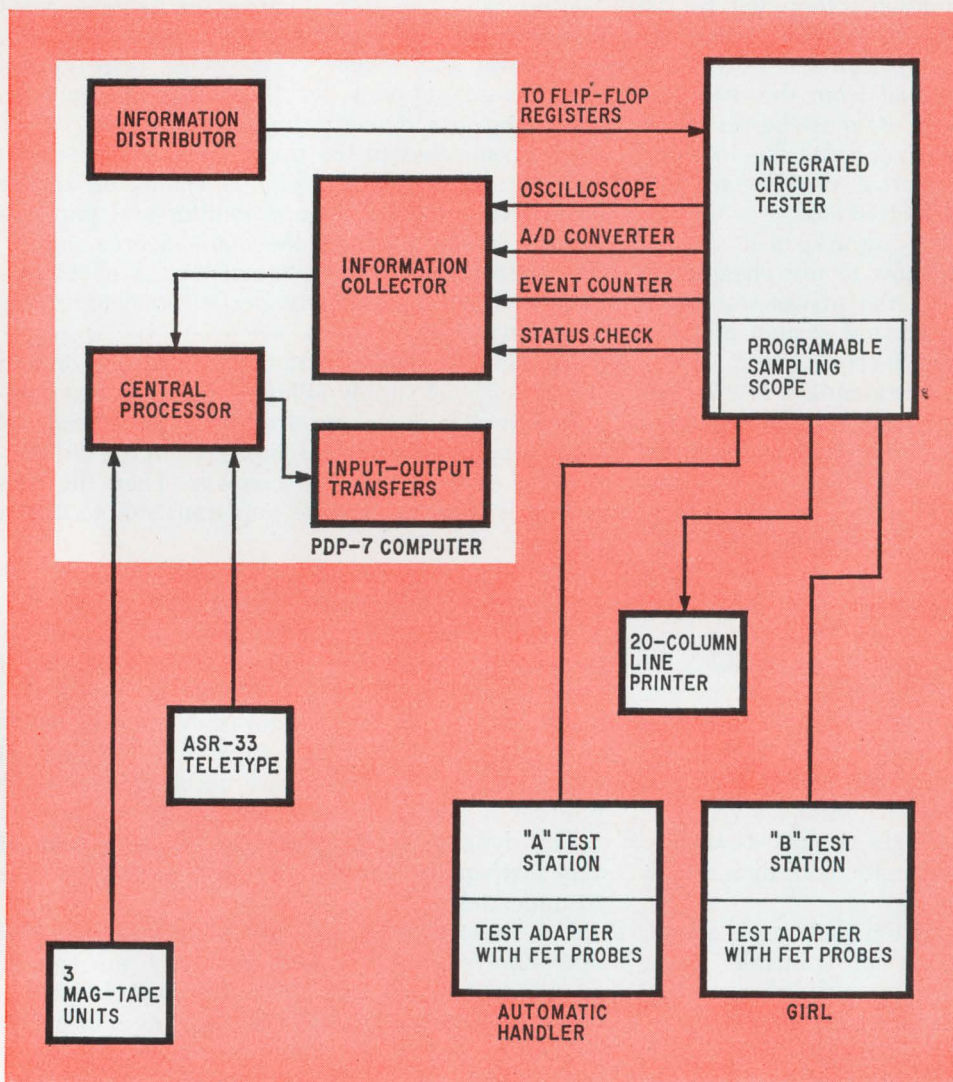

**Central Processing.**  
Test system is built around a computer and other standard equipment.

the lead capacitance to a minimal known value so that dynamic testing can be done accurately. The adapter reed relays switch out unused portions of the switching matrix that connects the IC terminals to the appropriate parts of the system. In effect, the adapter maintains minimum lead length.

Reed relays are used both in the adapter and the switching matrix—about 300 in all. Reed relays were selected instead of transistors because an “ideal” switch—one with essentially zero resistance—was needed for measurement accuracy. And, for dynamic test accuracy, the relays must have very low capacitance—2 picofarads or less, contact to coil. In this application, the advantages of reed relays outweigh their disadvantage of low switching speed which in effect limits overall speed of the system.

For dynamic testing, the adapter connects to the system via a test probe. This is a commercially available item—it’s the same type used on some oscilloscopes—that employs a field-effect transistor to give high impedance and low capacitance to the system. Unlike the more conventional cathode-

follower probe, the FET probe does not suffer from drift and inaccurate gain. The adapter can accommodate IC’s with as many as 24 pins.

### Burst testing

For flip-flop IC’s Digital Equipment feels that a burst test is needed. This is over and above tests for the parameters that a manufacturer would specify for his product. It subjects the IC to a sudden burst of high-frequency pulses to detect its sensitivity to pulse-repetition frequency.

The test system’s pulse-burst generator sets the input frequency for the burst pulses.

The programed prf supplied by the burst generator depends on the IC type. For example, the IC might be required to operate with 30-nsec pulses at a 10 megahertz rate. The tester would apply a burst of 630 pulses to the IC. The abrupt high-frequency nature of the burst changes the charges on the internal capacitances of the IC, which were previously at quiescent values.

With J-K flip-flops particularly, prf sensitivity is a problem. Suppose, for example, that 630 pulses in



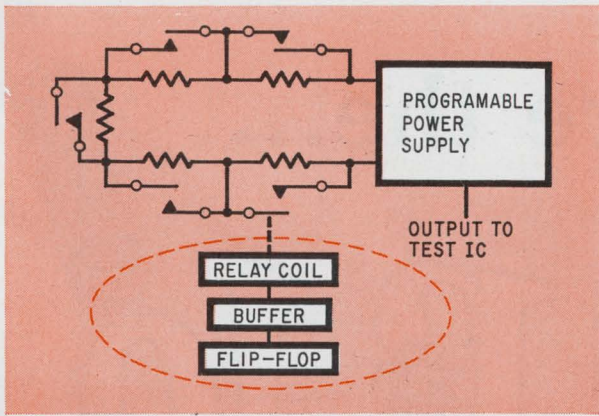

**Switching.** Both static and dynamic power supplies employ relays to make an initial adjustment of the output

all were applied to an IC. The tester would count the number of output transitions from the flip-flop under test. If the IC is to function properly in a system, there should be 315 transitions for the 630 burst pulses. But sometimes there are only two transitions, sometimes 630. This prf sensitivity is a condition that would be hard to track once the IC was installed on a circuit board, and entire lots of IC's have been known to be afflicted.

The burst generator can be programmed to generate positive or negative pulses with respect to ground. The two different polarities are used in noise testing of flip-flops. To determine the noise immunity of a flip-flop in the 1 state, for example, negative pulses—negative with respect to the bias  $V_{CC}$ —can be applied to the input terminal. Suppose that the IC is guaranteed not to switch when a voltage of +2.4 volts or higher is on the input terminal. Then a burst of negative pulses—going from the bias of +5 volts to 2.4 volts—is applied to the input terminal. If the flip-flop switches, it is not noise immune as guaranteed.

In addition to checking for prf sensitivity and noise immunity, burst testing is helpful in obtaining a more realistic measurement of propagation delay. For example, in an ordinary dynamic test propagation delay may appear to be 10 nanoseconds, whereas under burst conditions it may really be 15 nsec for the first pulse and 10 nsec for the remaining pulses. This effect, too, is related to the difference in charge under quiescent and high-frequency conditions.

### Writing the program

Once a program has been established for one member of a logic family, it's an easy matter to program the system for testing other members of the same family. Digital Equipment has found, for instance, that only minor changes in the test program for the 7400 TTL circuit were needed to test the 7410. The tests are the same; the difference is

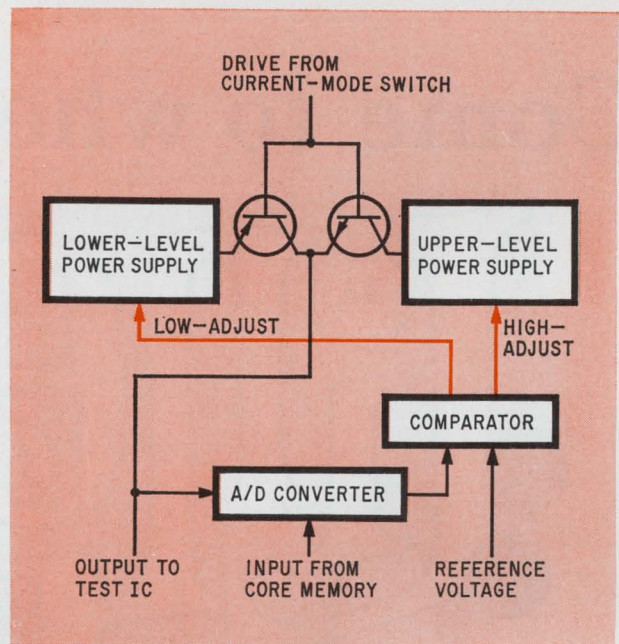

**Dynamic.** For a-c tests, lower and upper levels of pulses are adjusted independently.

in the connections to the pins of the IC.

Actually, the software program used in the IC tester is an outgrowth of a master program developed some five years ago for the company's first automatic tester—a machine for general-purpose digital modules. Because of this previous work, a technician can program an IC test merely by calling out pin connections and various existing sub-routines—stored in the core memory—on a punched paper tape. After debugging, the new test program is transferred to magnetic tape. It can then be put into operation simply by typing in the device number on the teletype.

Equipment and costs for the test system amounted to \$100,000. Care and feeding of the machine requires an engineer and two technicians. Amortizing the system cost over two years, and including the salary and overhead for the maintenance people and two operators, Digital Equipment figures that the cost of testing each IC is 2.7 cents.

Actual test time is about 1 second, but time has to be allowed for loading and unloading the test socket. One of the system's two test stations is still operated manually; the girl can move 1,000 IC's per hour. The other station is equipped with an automatic handler that can move 1,500 per hour. Both are multiplexed to the computer.

All IC's come in Barnes carriers. At the automatic station, they are dumped in batches into a vibrating bowl, which feeds a positioning machine that places the IC's under a test head one by one. After testing, each is automatically delivered to an appropriate bin. Although only three bins are used now—accept, d-c reject, a-c reject—eight are available if further sorting is required. ■



# Come to where the...

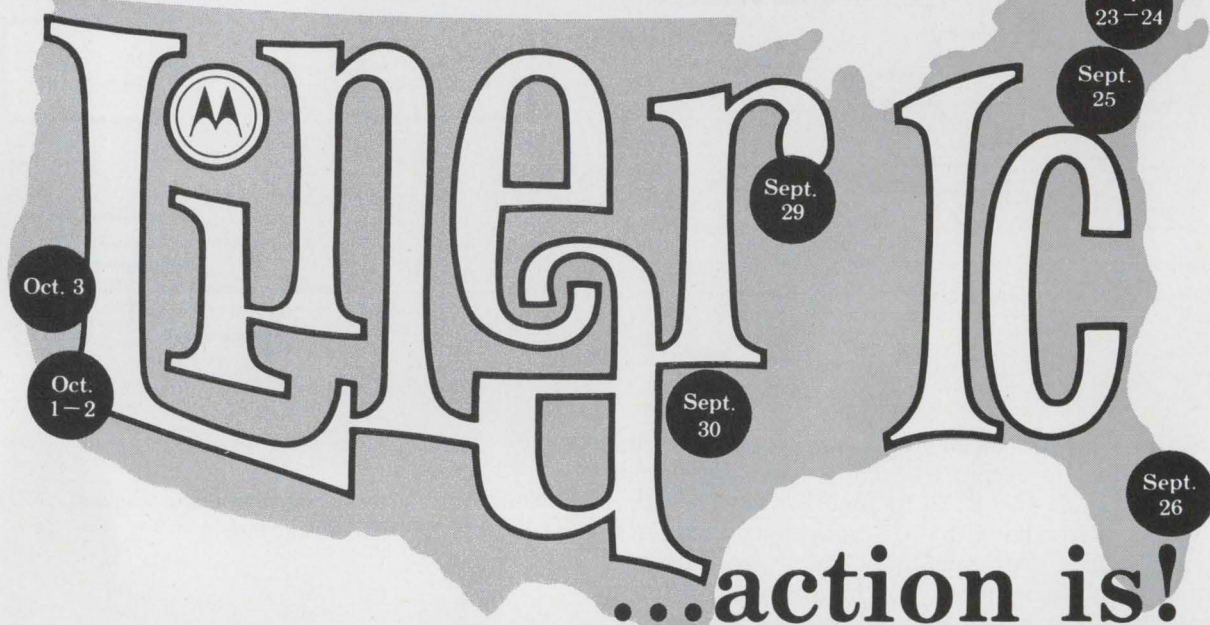

## Here's Where & When

- Sept. 22 — Boston  
Boston Marriott Motor  
Hotel, Newton
- Sept. 23 — New York  
Garden City Hotel,  
Garden City, L.I.
- Sept. 24 — New York  
Friar Tuck Inn,  
Cedar Grove, New Jersey
- Sept. 25 — Washington/Baltimore  
Sheraton-Silver Spring,  
Silver Springs, Maryland
- Sept. 26 — Ft. Lauderdale  
Pier 66
- Sept. 29 — Chicago  
Marriott Motor Hotel,  
Chicago
- Sept. 30 — Dallas  
Royal Coach Inn
- Oct. 1 — Los Angeles  
Airport Marina,  
Los Angeles
- Oct. 2 — Los Angeles  
Grand Hotel,  
Anaheim
- Oct. 3 — San Francisco  
Cabana Hyatt House  
Palo Alto

To find out what's really happening with state-of-the-art linear integrated circuits, plan now to attend one of Motorola's in-depth seminars. You'll find that there's more to linear circuits than Op Amps! We'll have sessions on Linear Multipliers, Balanced Modulator/Demodulators, Voltage Regulators, and Sense Amplifiers . . . in addition to new Operational Amplifiers that are setting the performance standard for the industry.

It's a full day . . .

But, don't bring your lunch. That's part of the program, too; and, is included in the nominal \$25 registration fee.

## Talk To The Experts

There'll be plenty of time for Q & A with our "first team," including the designer of our premier line of IC Voltage Regulators plus our most knowledgeable Applications Engineers, to provide valuable "how to use" information about our complete line.

Seating will be limited to the first 250 reservations in each area; so, make arrangements now. Contact your nearby Motorola Semiconductor sales Office or distributor. Or, send your check or money order for \$25.00 to P. O. Box 20912, Phoenix, Arizona 85036.

*- where the priceless ingredient is care!*



## MOTOROLA

### Linear Integrated Circuits







## Asynchronous pulse gives tape's data signal

By J.E. Wohler

Goodyear Aerospace Corp., Akron, Ohio

To control data input to tape transports, the digital computer's asynchronous record signal must be converted to a synchronous pulse train. To produce pulses of the same width and insure that no partial

pulses appear, two dual-input quad gates are used.

Gates A and B are cross-coupled to form a reset-set flip-flop. If the output of the flip-flop is in the 1 state, gate C will conduct and a signal will appear at the output. If the flip-flop is in the 0 state, gate C will not conduct, and no output is observed. Setting the flip-flop requires the absence of a clock pulse and the presence of a record signal. Under these conditions input 1 will be in the 0 state and input 2 will be in the 1 state. No pulse will appear at the output until the next clock pulse occurs, since the flip-flop can be set only between clock pulses. Once the flip-flop is set or reset, the state of the flip-flop may only be changed by removing the record signal.

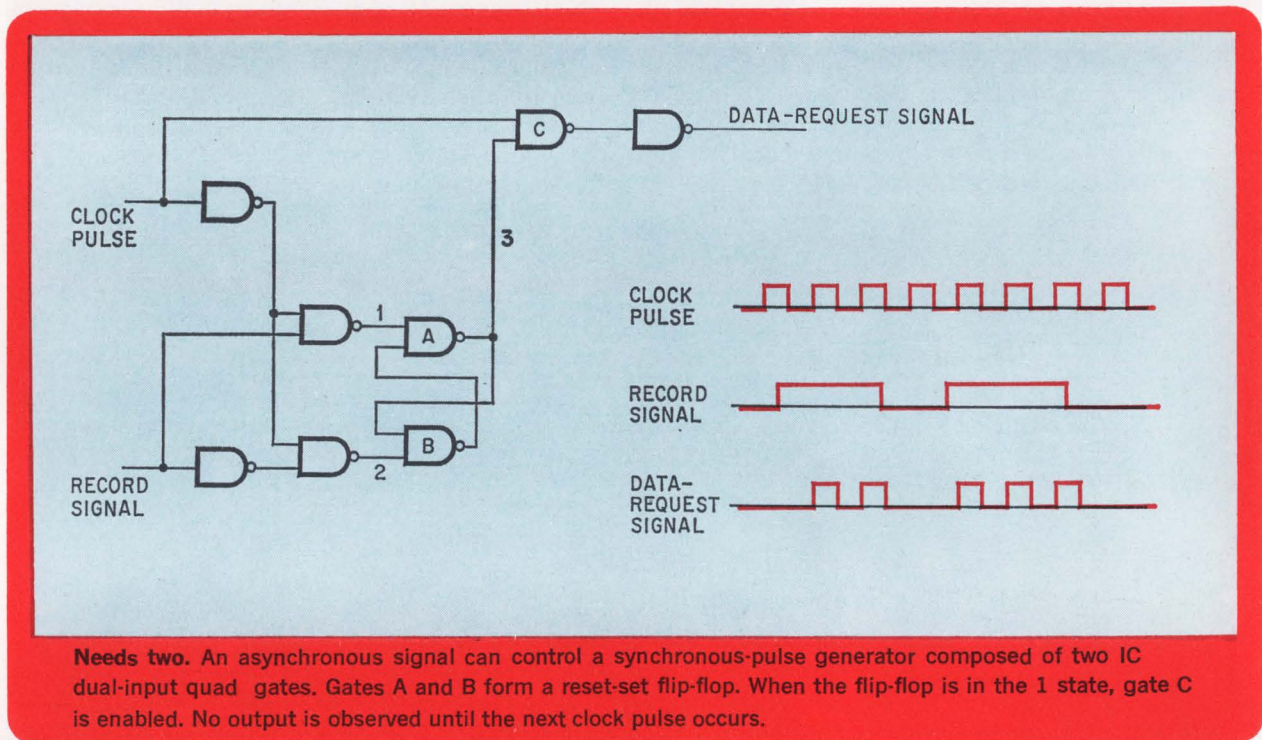

## Pulse modulator regulates pneumatic valve closure

By Walter A. Cooke

Lockheed Missiles & Space Co., Sunnyvale, Calif.

Thrust and flow control are functions in missile and space vehicles that require a control system that offers reliability and low power dissipation. A

pulse-width/pulse-frequency valve modulator that opens and closes solenoid pneumatic valves has advantages that the ordinary bang-bang systems do not have. In conventional systems, the limit-cycle rate is proportional to the thrust, and the engineer is forced to design the control jets to the largest thrust requirements of the mission. This often results in excessive limit-cycle gas consumption. But with a pulse-width/pulse-frequency modulator, both coarse and fine control can be performed on the same valves, and large savings in gas and energy consumption can be realized.

For large signals, the control system operates in



a bang-bang mode, while for small signals the valves are modulated with the minimum pulse width set to just barely open the valve. There are three parts to the circuit: an integrator ( $A_1$ ) a positive level detector with hysteresis ( $A_2$ ), and a negative level detector with hysteresis ( $A_3$ ).

When the input voltage is zero the integrator's output is zero.  $A_2$ 's output voltage is negative, back biasing the feedback diode  $D_1$ ; and  $A_3$ 's output is positive, back biasing the feedback diode  $D_2$ .  $A_3$  saturates transistor  $Q_1$ . Both  $E_1$  and  $E_2$  are at the zero output condition.

When a negative voltage is delivered to the input, the integrator output increases in the positive direction until the level detector  $A_2$  triggers, producing a positive output voltage. This voltage is fed back to the input. If the feedback current is greater than the input current, the integrator is

driven back toward zero. When the hysteresis point is reached,  $A_2$ 's output reverses, and the integrator output again begins to increase.

The integrator cycles between the hysteresis-trigger voltage and the output voltage of the first valve,  $E_1$ , thus causing a series of positive output pulses. If the input current is greater than the feedback current, then the output voltage  $E_1$  stays on.

For positive inputs, the integrator generates a negative output, triggering the negative level detector. The negative output of the level detector turns  $Q_1$  off, delivering a positive output. If the input current is less than the feedback current, the output at  $E_2$  will be a series of positive pulses resulting from charging and discharging the integrator output across the negative level detector's switching points. For positive input currents greater than the feedback current,  $E_2$  stays on.

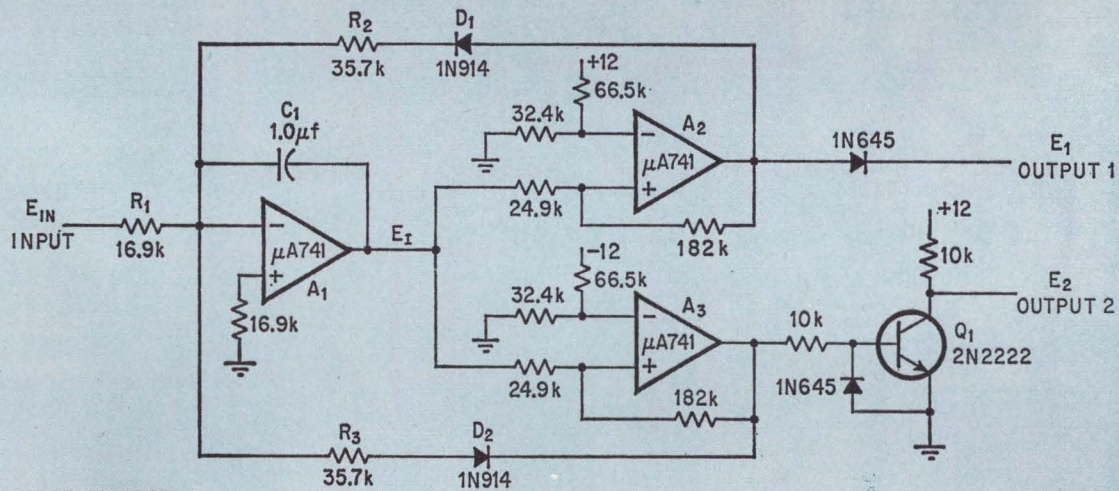

INPUT VOLTAGE  
FOR 100% DUTY  
CYCLE =  $10 R_1/R_2$   
MINIMUM PULSE WIDTH =  
 $3 R_2 C_1/10$   
MAXIMUM FREQUENCY =  
 $10/R_2 C_1$

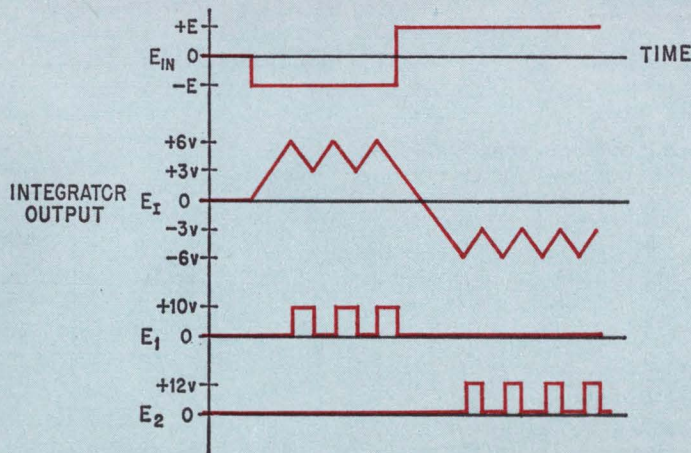

**Open and shut.** The pulse width/pulse frequency modulator controls pneumatic valves. A positive input level charges the integrator until the negative detector triggers, generating the output pulse's leading edge. Negative feedback discharges the integrator, shuts the detector off, and terminates the pulse.



Behind the new versatility and lower costs of digital displays...

# RCA's New 7-Segment Decoder-Drivers

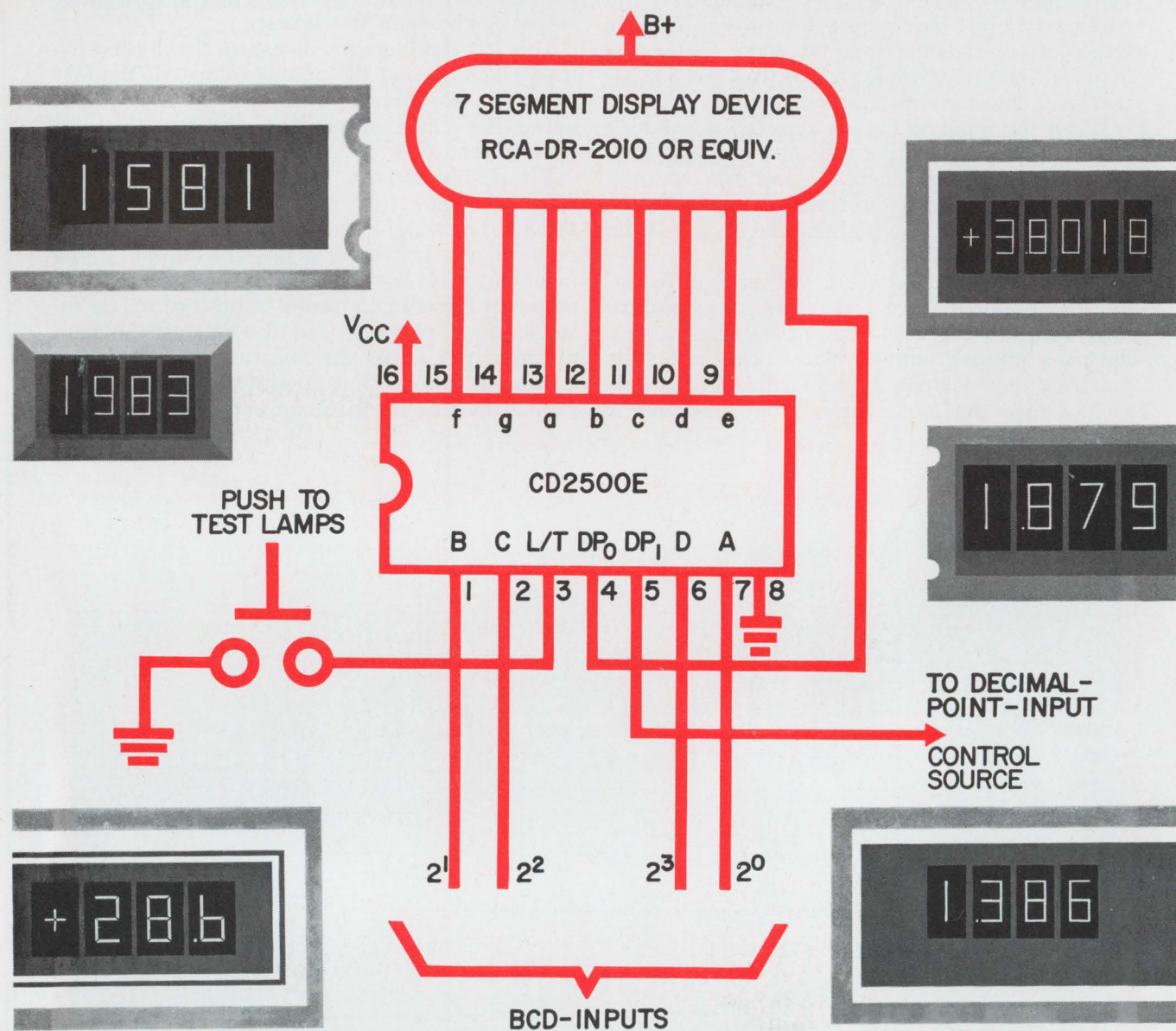

Whether you drive your digital displays with low current or high current, your drive circuits can now be more versatile—simpler—lower in cost. RCA's new CD2500E series of 16-lead DIP 7-segment Decoder Driver MSI integrated circuits includes both 30 mA devices for driving RCA's new NUMITRON 7-segment Digital Display Units and 80 mA devices to drive miniature low-voltage lamps or relays.

Look at the tabulation of the new CD2500E devices. Compare their prices and their advantages with present decoder-drivers and decoder and driver combinations. Then contact your local RCA Representative for details. For technical data, write to RCA Electronic Components, Commercial Engineering, Section ICN 9-1, Harrison, N. J. 07029.

**RCA** Integrated Circuits

RCA's 7-segment Decoder-Drivers		
Operating Current per Segment	Type Number	Price (1,000 units)
30 mA 80 mA	CD2500E CD2502E	\$6.75 \$8.00 with decimal point
30 mA 80 mA	CD2501E CD2503E	\$6.75 \$8.00 with ripple blanking
<b>ADVANTAGES</b>		
<ul style="list-style-type: none"> <li>* Power supply and input voltages compatible with DTL and TTL devices</li> <li>* Lamp test provision</li> <li>* High current sinking capability for direct display driving</li> </ul>		<ul style="list-style-type: none"> <li>* Clamp diodes on all inputs</li> <li>* Intensity control capability</li> <li>* Over-range detection</li> <li>* 0° to 75°C temperature range</li> <li>* Lamp supply voltage up to 8 V</li> </ul>

See the back cover of this publication for advertisement on RCA's new NUMITRON Digital Display Devices.



**Red dots.** Cylindrical magnetic domains, bright red dots at right, represent binary data in shift register, whose mask is shown below.

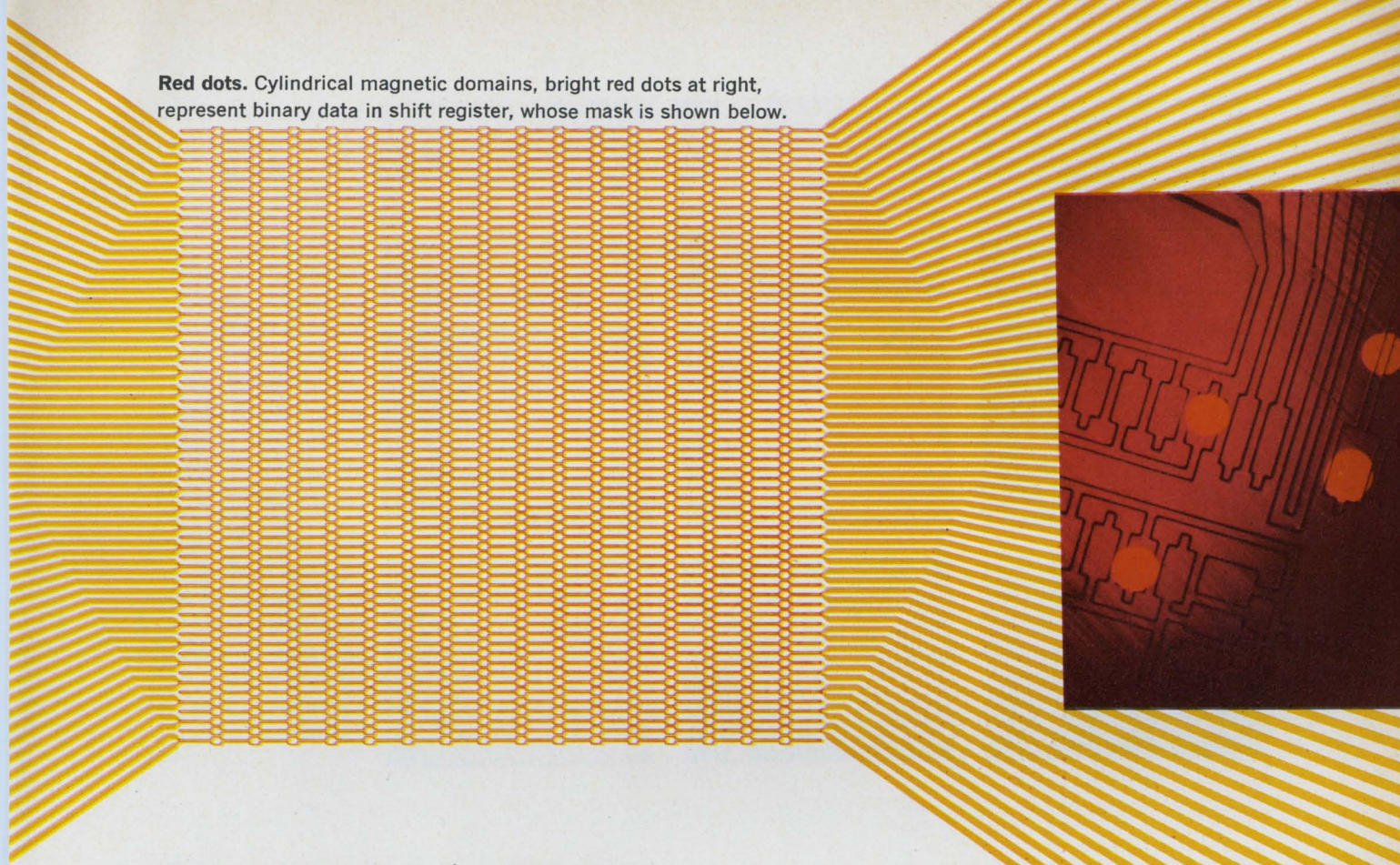

# Magnetic bubbles— a technology in the making

Developed by Bell Labs, new technique  
for storing and manipulating digital data appears  
set for exploitation by makers of computers and memories

By Harry R. Karp

Senior associate editor

**Magnetic-bubble devices**, even simple shift registers and counters, are still a long way off. What makes this new technology exciting is its potential to provide low-cost, high capacity memory and logic functions not feasible today.

For example, it would be possible to have a solid state disk file measuring 1 cubic inch that could have a capacity of several megabits. The cost per bit would be but a few thousandths of a cent. This could lead to large and inexpensive memories for information-retrieval systems. The bubbles themselves, cylindrical magnetic domains, can be as small as 0.00004 inch in diameter. Each one represents a data bit.

An important part of the technology, which was

developed by Bell Telephone Laboratories, is the manner in which bubbles are generated, propagated, and detected so that they perform memory operations, and the manner in which bubbles interact so that they perform logic operations.

Already memory and computer companies have approached Bell to discuss licensing. Any semiconductor maker, with its mask-making, thin-film, and chip-handling capabilities, should experience little difficulty in producing simple magnetic-bubble devices in relatively short order—within six months to a year if they wanted to. Ironically, though, magnetic-bubble devices will probably become digital semiconductor devices' greatest competition.

Take energy, or power, for example. To move a



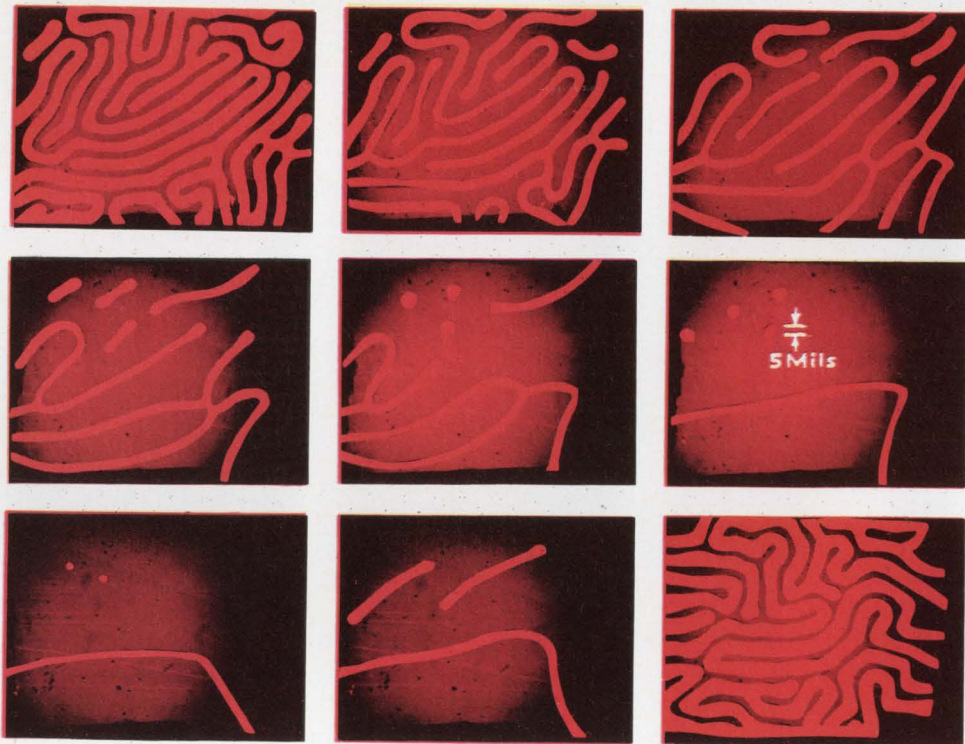

**Less for more.** Raising applied magnetic bias field, normal to platelet's surface, shrinks bound domains (isolated strips) to cylindrical magnetic domains—magnetic bubbles. The platelet, cut and polished from terbium ferrite, is 2.5 mils thick. Starting at upper left, the bias field in oersteds for the nine conditions are: 0, 16.0, 21.8, 24.5, 26.5, 28.0, 37.0, 27.0, and 0. Note that as field exceeds a certain value, some bubbles are destroyed. Dropping the field restores a serpentine pattern. (Photos retouched.)

magnetic bubble from a 0 to a 1 state in 1 microsecond requires  $4 \times 10^{-14}$  joules. Thus, the power to perform  $10^{12}$  binary operations a second in magnetic bubble devices is only 0.04 watt, compared with semiconductor switches' 10 watts.

### Creating bubbles

Before bubbles can be created, a crystal that serves as source and host for the bubbles must first be grown. A rare earth such as thulium or terbium is placed in a crucible and a ferrite is added. This combination is then heated to well above the molten state and then cooled slowly to room temperature. The result: a single crystal magnetic oxide called an orthoferrite. The crystal is then sliced and

polished to make a platelet several mils thick.

Orthoferrites have an easy magnetization axis normal to its surface and hard axes in its plane, below, at left. Conventional serpentine-like domains form in the platelet, with the domain walls separating areas of opposite magnetic polarity. Fortunately, orthoferrites are transparent enough in the red portion of the visible spectrum to permit visual observation of the domains, provided polarized light and an analyzer are used.

The sequence of photographs, top of the page, indicates what happens when the serpentine patterns are subjected to a magnetic bias field perpendicular to the platelet's surface. The photo at top left shows a platelet without an external field. In the five

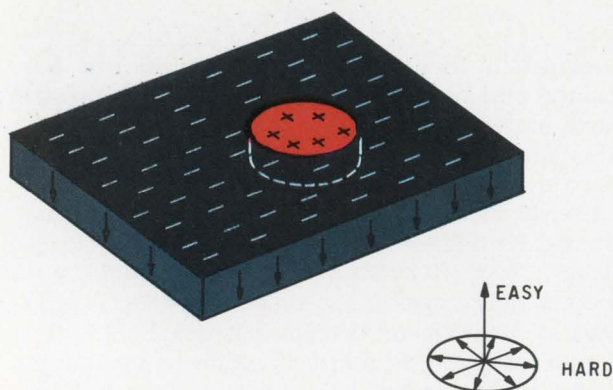

**Hard and easy.** Orthoferrites can be magnetized easily in the axis normal to the plane, but they're hard to magnetize in the plane.

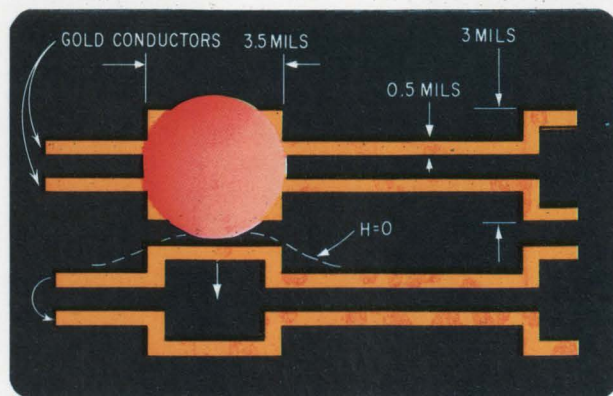

**Conductor drive.** Current through lower square loop reduces bias relative to loop above, so magnetic bubble (red disk) moves readily into new location.



photos that follow, bias field is introduced and raised to higher values until the serpentine patterns gradually disappear.

However, any strip domain, one bounded by a wall that closes on itself, decreases in length as the field increases. And when a field is at a high enough value, the strip shrinks to a cylindrical domain, or magnetic bubble. In the fifth photo of the sequence, for example, three bubbles have appeared. In the following photo, five bubbles can be noted.

But when the field is increased even more, as in the seventh photo, three of the bubbles explode and disappear. Now, when the field decreases—the eighth photo—the two remaining bubbles revert to strips and, as the last photo clearly indicates, a serpentine pattern reappears when the field value is 0.

According to Andrew H. Bobeck, supervisor of solid state memory devices at Bell Labs' Murray Hill, N. J., facility, these experiments verify that under appropriate magnetic and dimensional conditions, cylindrical domains—magnetic bubbles—can be formed and that they remain stable (cylindrical) over a range of bias-field values.

Ample theory exists that relate stable cylindrical domains and their collapse with orthoferrite material parameters, domain wall energy, and saturation magnetization. Bobeck credits Alfred A. Thiele, also of Bell Labs, for extending the general magnetic domain theory to orthoferrites.

Magnetic domains respond to two opposing forces. One force, the magnetostatic energy, tries to increase the domain's surface area, while the other force, the sum of the bias field energy and the domain wall energy, tries to reduce the domain's volume and wall area.

The domain wall takes a shape that minimizes the net energy, which at substantially 0 is cylindrical. Moreover, the bubble essentially retains this shape over a range of bias values equal to about 10% of the orthoferrite's magnetic saturation value. The uniform applied bias field is about 30% of saturation value. In effect, the bubble is stable.

When the bias increases beyond that which would define a minimum diameter, the bubble is destroyed. As the bias is lowered, the cylinder's diameter increases. At about three times its minimum diameter, the cylinder takes on an elliptical shape.

### Determining the binary state

Making the bubbles smaller and larger through modulation of the bias field is a key mechanism in propagating a magnetic bubble across the plane of the platelet. And it's the presence or absence of a bubble in a particular location in the plane that's the equivalent of either a 1 or 0 state. Actually, this movement takes very little energy because the domain wall coercivity of orthoferrites is small. For example, while the applied bias through an orthoferrite might be about 40 oersteds, a change of about 0.1 oersted is all that's needed to overcome domain wall coercivity and let the bubble move to a new location.

However, usable locations must be separated by

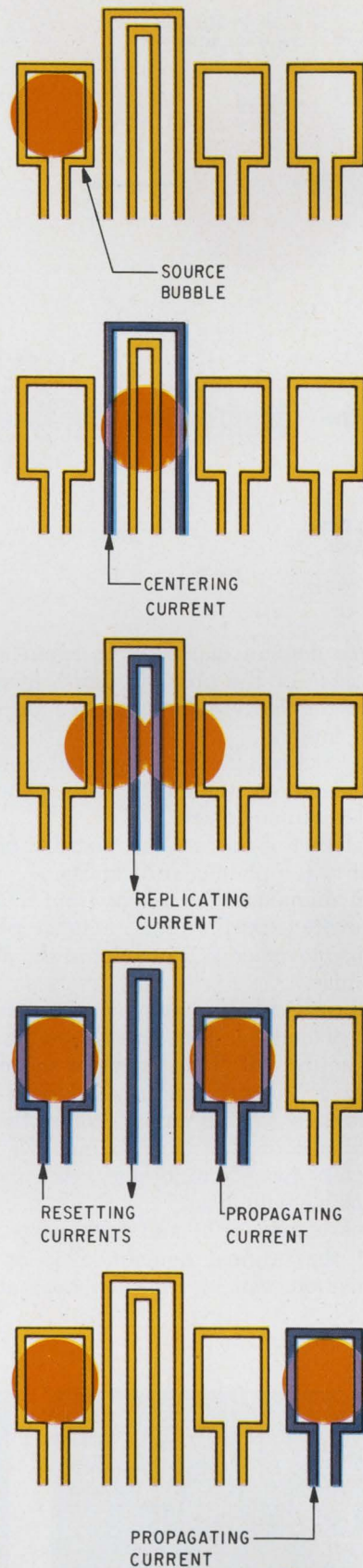

**Bubble generator.** Magnetic domain at top moves to right when centering current of about 15-20 ma, in outer hairpin loop, decreases local field. About 500 ma in inner hairpin splits disk. Next, resetting and propagating currents restore bubble to its source and moves its offspring into propagating channel.



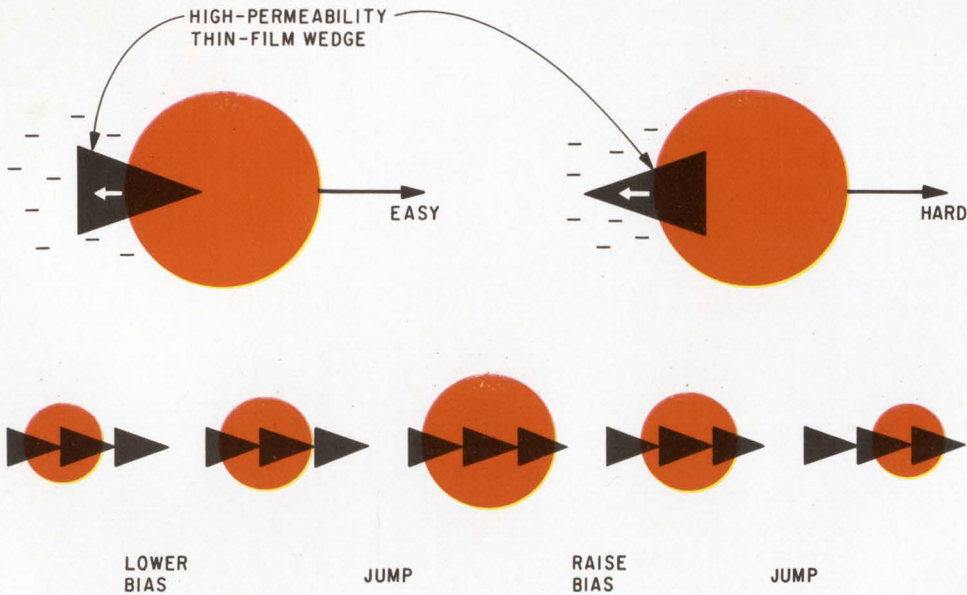

**Follow the arrows.** Magnetic bubble slides off point of permalloy wedge easily, but sliding off blunt end is hard. In modulated field bubbles jump in direction of angel fish wedge points.

at least three domain diameters to avoid any ambiguity because of the possible 3-to-1 increase in diameter as the local field decreases during the propagation interval.

Before the technology can be applied, one should consider some other significant facts about magnetic bubbles. Among them:

- The diameter of the smallest possible bubble is about equal to the platelet's thickness.
- Domain diameters can range from 2 mils for a terbium ferrite to 0.04 mil for a magnetoplumbite.
- Domains move across a platelet in the direction of reduced bias.
- A cylindrical domain can move the distance of one domain diameter in less than 100 nanoseconds, so that the equivalent 10-megabit-per-second clock rate permits a 3-megabit-per-second data rate in practical devices (taking into account the 3-to-1 division because of the need to move a domain three diameters away from its previous location).
- Domains have no mass.
- Domains can be split and both parts assume the size of the original domain. This operation, called replication, can be repeated over and over

again, a practical application being a bubble (bit) source for shift registers.

Bell Labs' scientists have developed three ways to drive bubbles in appropriate time and spatial intervals—conductor, angel fish, and T-bar methods. In a three-phase conductor method, a gold pattern of semiclosed loops and connecting conductors is deposited by thin-film techniques on the orthoferrite. Suppose a magnetic bubble exists under a loop, as shown in this figure on page 84. Next, a propagating current, perhaps 200 milliamps, is sent through the lower loop, creating a field gradient large enough to overcome domain wall coercivity. The bubble moves down into the energized loop.

Because usable locations must be separated by three domain diameters, three adjacent loops are energized in quick sequence. Reversing this three-phase sequence moves the bubble in the opposite direction. Thus, the conductor method lends itself readily to the construction of bidirectional shift registers and counters.

The complete pattern for 16 shift registers, each with 20 positions (hence the need for 60 loops per register), is at the top of page 83. The pattern's

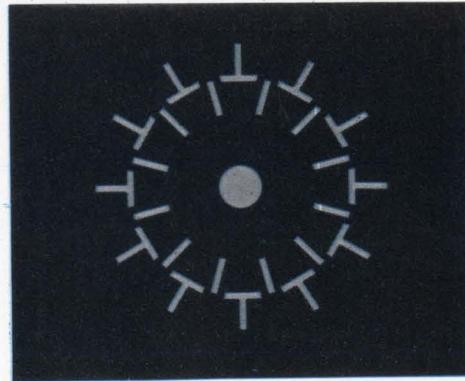
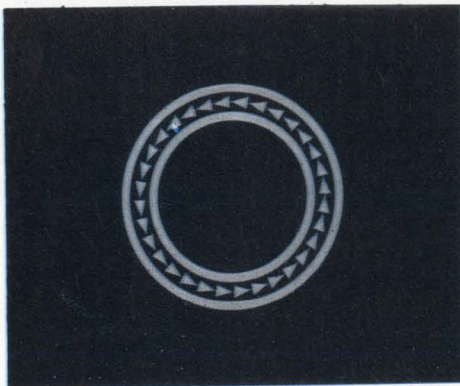

**Angel fish and T-bar.** Magnetic modulation inchworms bubbles along the permalloy wedges, left. This is called angel fish. The T-bar method, right, magnetically polarizes permalloy bars using a rotating field in plane. Masks shown are for 12-position shift registers.



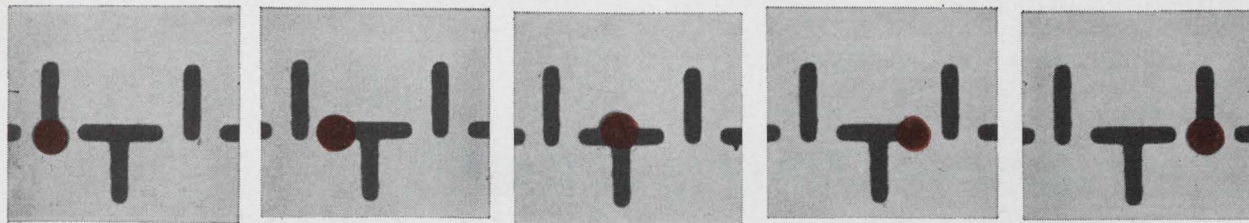

**Jumpers.** Magnetic bubbles favor positive-polarity magnets. Rotation of the in-plane field changes the polarity of each vertical and horizontal bar every 90° of field rotation, and bubbles moves to right.

actual dimension is about 200 mils on a side. To the right of the pattern is a small section of an operating shift register photographed through a microscope. Note the magnetic bubbles (shown in red) in several of the loops. The loop at the lower right is a bubble generator. Its operation is explained in the sequence on page 85.

When a similar pattern of loops is placed over the orthoferrite platelet at right angles to the first, a bubble can be driven in x and y directions.

### Massive memories

The shift register is, of course, a memory that can store digital data. Make the magnetic bubble shift register large enough and it becomes a solid state version of a disk file. Data words can be inserted by generating and shifting a bubble for a binary 1, and not generating but shifting for a bubble train, then raising the local field by run-bubble string, then raising the local field by running a high current through the proper loop to collapse a bubble and obtain a 0. Because a bubble can be replicated yet retained in its original location, this permits design of a read-only memory.

Storage density of more than 100,000 bits per square inch has been obtained with orthoferrites. Other materials offer the prospect of over a 100 million bits per square inch. Consider also that several quite thin platelets can be stacked to raise the storage capacity significantly without appreciably taking up volume.

Finally, the applied perpendicular bias field of around 30 to 40 oersteds is obtained from permanent magnets, meaning that the memory is non-destructive and retention of stored data doesn't depend on the vagaries of an external power source.

The angel fish method employs a thin-film high permeability (permalloy) wedge. The bubble takes a position on the wedge that minimizes magneto-static energy. As shown on page 86, it's easy for the domain to move off the point of the wedge, but difficult to move off the blunt edge. As the bias decreases, the domain's diameter increases until the domain jumps and covers three wedges. When the bias increases, the diameter decreases and the domain slides to the right along the wedge until it jumps again. Thus, in one bias-modulation period, the domain moves from the first wedge across to the third wedge.

A permalloy pattern, at the left, is for a uni-

directional 12-position angel-fish shift register in which the domains travel in a counterclockwise direction. Note that 12 positions require 36 wedges. The concentric permalloy tracks confine lateral movement of domains. Permalloy thickness is about 4,000 angstroms.

Structured permalloy circuits, called T-bar as shown on page 86, is another way to propagate bubbles. In this method, an inplane rotating field creates positive and negative magnetic poles at the ends of bars in the T. As the field rotates, the ends change polarity and the poles selectively attract and repel bubbles. Thus, bubbles move toward the positive pole, as required to execute the prescribed memory or logic function.

The sequence of photos, top of the page, depict the operation of a T-bar shift register. Every 90° of field rotation polarizes either vertical bars on horizontal bars. At first, the rotating field points downward so that the bottoms of all vertical bars assume a positive polarity. The bubble rests on this pole. When the field points left, the left end of the horizontal bars take on a positive polarity and the bubble jumps to the right. When the field points upward, the top of the vertical bars become positive and the domain again moves to the right, and so on around the full 360° rotation.

The T-bar method is extremely versatile. Domains can be generated by a local disk that spins bubbles into a propagate channel. Through appropriate geometric placement of bars and T's, logic functions can be implemented. For example, a flip-flop would contain sequencing pole positions (an idler) that could trap and circulate a cylindrical domain. Thus, each new bubble entering the flip-flop's input channel would change the state of the device by becoming trapped in the idler if it is empty or by forcing the trapped domain from the idler if it is full.

Induced voltage, optical, and Hall-effect techniques can detect the absence or presence of a magnetic bubble—a bit—in the platelet. The induced-voltage method employs the sense line and sense amplifier common in other types of memories. In this application, the signal magnitude depends on the rate of change of current with respect to time created by purposeful collapse of the bubble. Under controlled conditions for read out (expanding the bubble to 40 times its area) an output of 1 millivolt per microsecond has been obtained. ■





# Memory testing is a task that comes in layers

By Leonard Kedson and Alan M. Stoughton

Computer Test Corp., Cherry Hill, N.J.

**Like memories themselves**, memory testing technology forms a hierarchy. Yet, despite an ascending scale of complexity, each level in the hierarchy shares some attributes common to the levels above and below. These common factors superimposed on the hierarchy lend a degree of complexity to memory testing that isn't always readily apparent to engineers not directly involved in the technology.

At the first level is the testing of individual storage elements—be they ferrite cores, lengths of plated wire, or some other type. Elements that pass the individual tests are assembled into arrays, which then undergo a higher level of testing. Finally the arrays are combined with drive and sense electronics and other circuitry and are tested again, this time at a system level.

Obviously, the nature of the tests performed on the elements depends on the type of element. And, to a certain extent, this specificity carries through to array testing. But at the system level the memory is a black box in which data can be stored and from which it should be retrieved without change; system testing is therefore largely independent of the kind of element itself.

Test methods for the different types of memories are similar in concept if not in detail. But because ferrite-core memories are the most widely used and most understood, they are used here merely to explain the underlying principles of the testing techniques.

## From the bottom up

If element, array, and systems tests are considered as successively higher horizontal layers of tests, then tests that are common to all layers correspond to vertical cuts through them. These vertical cuts represent characterization tests, production tests, and quality-control tests.

Characterization tests are usually made on new core types or new array designs to establish product specifications. Their results may be plotted as curves similar to those on p. 89, which show how

a core's performance differs as a function of drive current variations. Similar curves may be plotted to show the effect of temperature and other operating parameters.

Production tests are usually run on a 100% basis to detect and isolate deficiencies in components or in workmanship. They are generally the same in all manufacturing plants, but often differ in detail. Their result is very simple: acceptance or rejection of the unit being tested.

Quality-control tests are performed on random samples selected after the production tests to assure full compliance with product specifications. Rather than simply accept or reject, these tests measure and record actual core parameters; the results are often processed statistically.

At the array level, not only must each individual element be tested again for proper operation, but the way it is affected by its neighbors in the array must also be evaluated. Interactions may occur among neighboring storage elements because of half-select noise or because of parasitic effects among address and sense wires that thread the elements. Array tests usually require several passes through the array, using different storage patterns and drive currents to measure these effects fully.

Characterization tests for memory arrays define operating margins within which error-free operation can be expected. These margins, presented graphically, are called shmoo plots. Theoretically, they should be polygons in two dimensions or prisms in three dimensions, depending on the number of independent variables. But because inherent electrical noise tends to round off the corners, the plots become irregular closed curves, whose shapes explain their name—the shmoo was originally a curvy little comic-strip character. Shmoo plots are

This is the eleventh installment in *Electronics'* continuing series on memory technology, which began in the Oct. 28, 1968, issue.



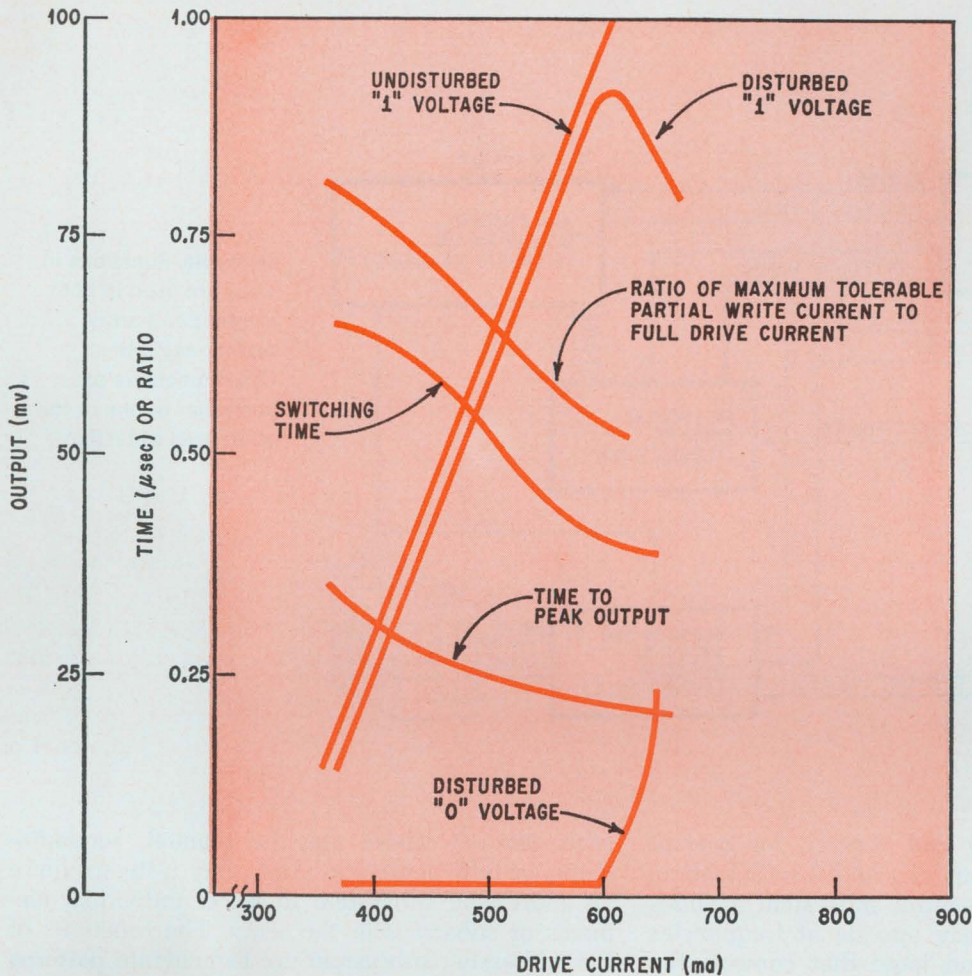

**Characterization.** These curves characterize the response of a typical memory element to different drive currents. From such curves, specifications for new elements are drawn up.

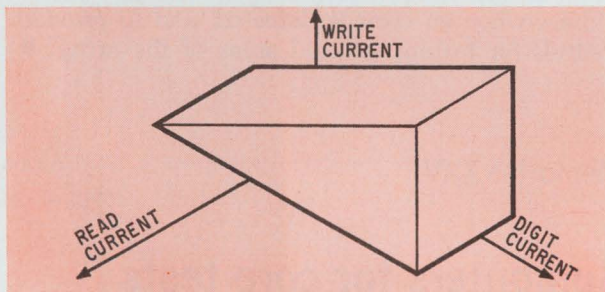

**Theoretical.** Satisfactory operation of a memory element depends on all currents going through it having optimum values. Above is the relationship between the theoretical maximum variations for these currents.

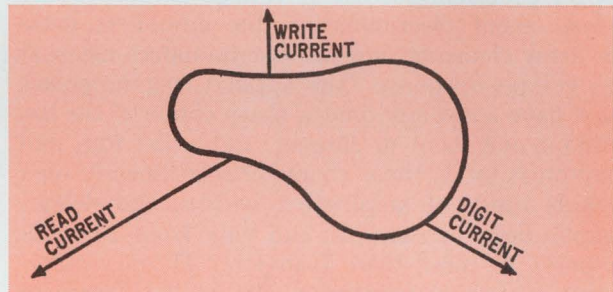

**Actual.** Noise and other parasitics round off the sharp corners so that the region of satisfactory operation is pear-shaped rather than prismatic. The curve is called a shmoo plot.

one method of defining the acceptance limits for subsequently manufactured arrays. They are also used for defining the operating range over which system electronics must operate.

Production tests of arrays assure compliance with design specifications and also detect such manufacturing defects as broken or chipped cores, missing cores, or wiring errors. These tests, like production tests of cores, usually call for acceptance or rejection of the array without recording specific

core response values. Although a single fault in an array is sufficient cause for rejection, the entire array must be tested and all defective locations identified. In most cases rejected arrays can be repaired and do not need to be thrown away.

Quality-control tests run by manufacturers on arrays are primarily to assure good workmanship and uniform performance. They are often duplicated by users as part of an incoming inspection.

Both element and array test systems use sub-



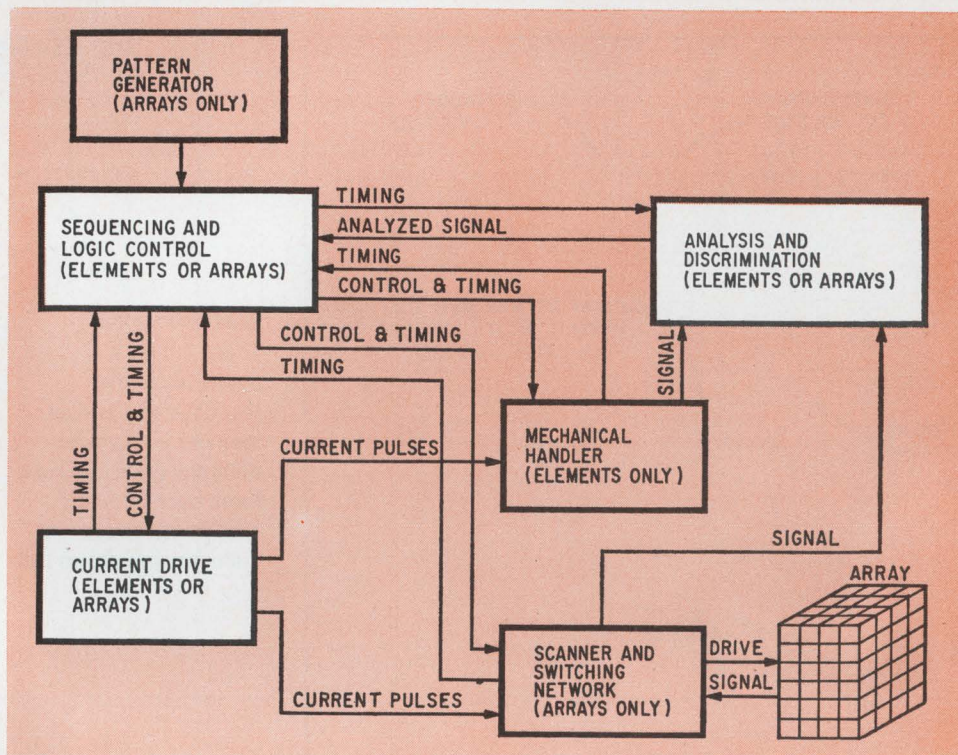

Dual role. Functions in color are used in both element and array testing equipment. Other functions are particular to one or the other level of testing.

systems for sequencing and control, for current pulse driving, and for analysis and discrimination.

The sequencing and control subsystem includes pulse generators that may operate at frequencies up to 25 megahertz, and logic that controls the pulse train distribution and timing. These pulse trains are usually low-power voltage signals that trigger precision current or voltage amplifiers and measurement discriminators; the amplifiers drive the array elements, and the discriminators measure the voltage response. The applied current pulses must have a fast rise time, a sharp corner at the top without overshoot or ringing, and a flat top; and they must retain these characteristics linearly over a wide range of amplitudes, widths, and delays. Amplitudes, for example, can vary from 10 milliamperes to more than 1 ampere. These requirements impose severe constraints on the design of the current-drive subsystem.

In a typical analysis and discrimination subsystem, a 100-megahertz differential amplifier and several types of discriminator circuits may be used to measure the single transient output signal. Different types of discriminator circuits determine whether the signal amplitude exceeds a threshold at its peak or at some prescribed time; compare the peak amplitudes of two simultaneous signals with one another; determine the elapsed time from the beginning of the drive signal's rise to the output signal's peak; and temporarily store the results of these measurements. These discriminators must be capable of resolving voltage and time measurements with millivolt and nanosecond accuracy.

In addition to these basic subsystems, element testers require mechanical handlers to position

each element. These may be manual, semiautomatic, or fully automatic. And array testers require an addressing subsystem to select individual elements or subarrays in the array. The functions of the addressing subsystem are to generate patterns of data for evaluating worst-case noise conditions and signal-to-noise ratios, to cycle through the entire array, to stop temporarily or recycle at an address when an error is detected, and to provide controls for testing selected areas of the array. ■

## Memories XXVI



## Computers for core tests

By William R. Blatchley

Computer Test Corp., Cherry Hill, N.J.

Computer-controlled testers for ferrite cores and core arrays are poised to replace traditional semi-automatic test systems. In many applications, computer control not only does the job faster and cheaper, but is more accurate as well.

Time and dollar savings on the production line arise directly from the computer-controlled tester's ability to establish or change test parameters rapidly and concisely. In addition, the flexibility of computer programming provides the user a hedge against obsolescence of his test equipment.



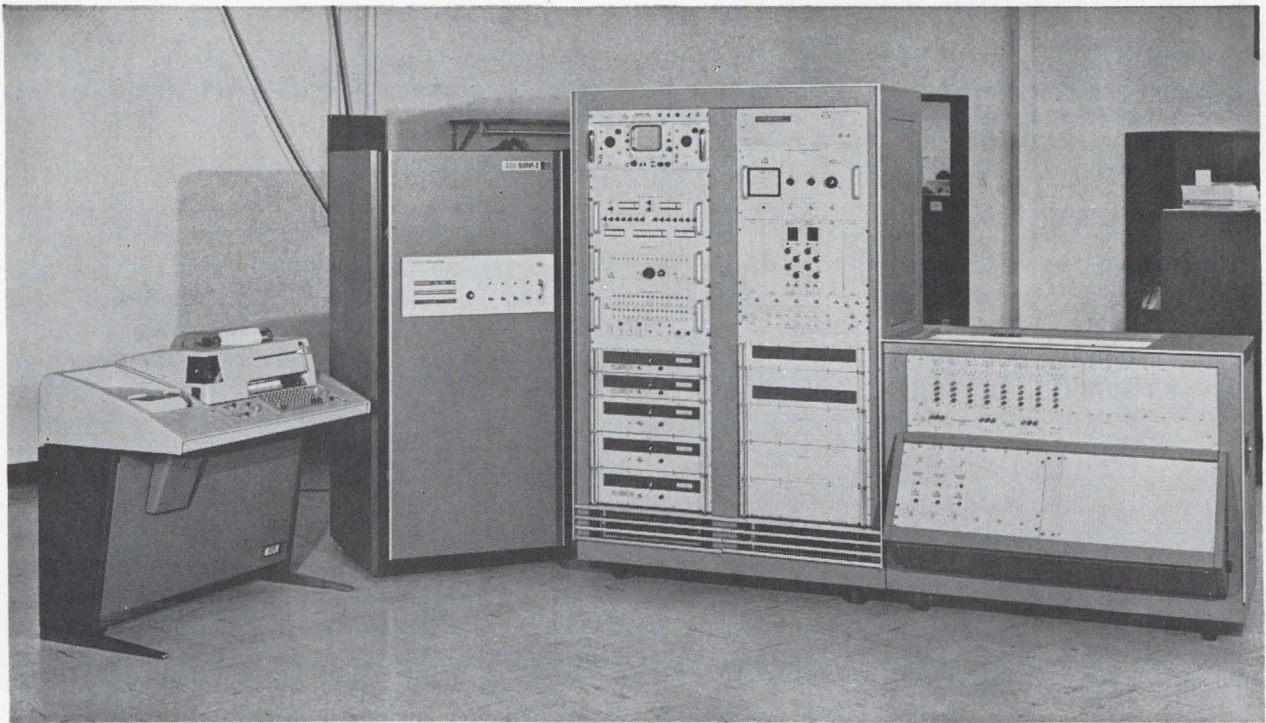

**Computer control.** Computer Test Corp.'s Delta 400 is an example of a computer-controlled array tester. It saves hours of the operator's time because the stored program sets up the test parameters. The computer, a Scientific Data Systems Sigma 2, is to the right of the teletypewriter.

Although manual testing is still in wide use and probably will remain so for quite some time, it is subject to some rather pronounced disadvantages that render it quite unsatisfactory.

For example, the operator must set a large number of controls both to define various operational characteristics of the memory being tested and to establish precise values of the test equipment's outputs to the memory. Some of the characteristics are the ranges of the parameters used in the test, the drive pulse sequences, and the data patterns that generate the worst noise levels. Then, when the test is under way, the operator must adjust these controls to obtain the proper waveforms, as he observes them on an oscilloscope, over wide ranges to close tolerances.

#### **Time and money**

Not only is this procedure tedious and repetitious but it also causes equipment to remain unused because it's easier to duplicate pieces of test equipment for different memory products than it is to readjust the setting on a single test rig when the product run changes.

Furthermore, no two operators will get the same results on identical products, because of subjective differences. And finally, because setting the controls consumes too much time, marginal testing such as plotting shmoo curves is held to a minimum, or omitted entirely—particularly since such tests are to be run on the completed system.

Special-purpose automatic test equipment that isn't computer-controlled doesn't necessarily solve the problem. Such equipment is very expensive and can be used for only the lifetime of a particular array design. Few manufacturers of core arrays can afford to underwrite the cost of a different custom-designed tester for each of his products; no manufacturer of test equipment can afford to underwrite these costs for the industry.

#### **Control, not monitor**

Computer-controlled testers offer a way out. They are much easier to set up than the manual systems and are far more versatile—yet they are as simple to operate as a special-purpose tester.

Every computer-controlled test system—as distinguished from a manual tester with a computer monitoring its outputs—has three important characteristics:

- Its current drivers, discriminators, and other key circuits are programable to work with different amplitudes, rise times, and other parameters.
- It has a display and recording arrangement to show exactly what inputs it provides to the memory being tested.
- It can automatically enter new information at predetermined points in the test sequence, such as new current rise times, new pulse widths, or new thresholds.

In a typical test system that has these characteristics, shown above, the controls can be set in less



than five minutes, because all the pertinent information is available on paper tape. Out of these five minutes, 33 seconds is spent on the current drivers, which require from 15 minutes to two hours on manual systems. A few more seconds go for printing instructions that tell the operator how to set the console switches for specific results. Following the basic test, the system can always read new instructions from paper tape that direct it to execute variations on the test without operator intervention.

These testers have many applications today and hold out the promise of almost unlimited applications in the future. For example, they are already effective for multiplexed testing, mixed-lot testing, marginal testing, shmoo plots, and, in general, all testing that goes beyond accept/reject.

In multiplexed testing, the system and the operator can work independently on one or more arrays simultaneously. This requires the system to have two or more sets of current drivers and switches, but the production volume can be doubled, or perhaps more than doubled.

For example, during the five minutes an array is being tested, the operator can be connecting another array to the second set of drivers. Then, while the second test is going on, he removes the first array and connects a third.

In mixed-lot testing, the quick setting of the controls in a computer-controlled test system permits much more thorough testing of the arrays in a given time than would be feasible, or even possible, with manual testing.

### Seven times as fast

For example, suppose seven arrays of seven different designs are to be tested in a given eight-hour shift. If the controls on a manual tester can be set for any of the types in an hour, most of the day's work would consist of resetting them, and a total of only one hour's testing would be accumulated—an average of only about 8½ minutes per array. That's barely enough time to verify that the assembly works the way it should—which leaves more than enough time for a thorough workout.

But setting the controls on the computer-controlled tester—five minutes for each array—adds up to only 35 minutes for all the arrays, leaving 445 minutes for testing, or more than an hour for each array, let alone enough time for a thorough test of the array.

Marginal testing on a single product provides assurance that the array works equally well at both ends of the published current specifications. This requires different control settings for the two ends of the range for each array tested. In a manual test, a typical approach would be to set the controls only once for each end of the range and connect each plane twice, because connecting planes is quicker than setting controls.

But with the computer control, setting involves only running a paper tape through a reader; this can be done twice for each array, so that the array

need be connected only once. Depending on the exact time required for setting up and connecting, this can more than double the production in a given period of time.

### Shmoo made easy

Shmoo plots usually aren't made on planes when manual methods are used; they are put off until the memory system is assembled because on planes they take too much time. In their simplest form, they require every word in the memory to be cycled and checked for an error for every combination of two drive currents. These currents are varied in small increments over a range wider than the range the memory will encounter in normal use.

Obviously, making all those small changes in the x and y drives can take a lot of time. For this reason, even simple shmoo plots made manually can take days to complete—whereas a computer-controlled tester can do the job in an hour. Furthermore, once the job is started, it runs by itself—an attendant is no longer needed.

Although simple computer-controlled testers use discriminators capable of making an accept/reject decision, it's easy to add complex circuitry that can measure the American Society for Testing Materials' standard test parameters—the time taken for an output signal to reach a peak, the amplitude of that peak, and the time for the core or other memory element to switch completely. These complex circuits also permit histograms, or distribution curves, to be made; and they need not be removed for a return to the simple accept/reject level, as in production testing.

### What's to come

Computer-controlled testers are capable of almost unlimited applications. As memory technology advances, new test methods will be necessary. These methods, which will be easy to implement with computer-controlled testers, will make special-purpose testers obsolete.

For example, 2½-D memories only recently became very popular, but many suppliers and users of test equipment found themselves with rooms full of special-purpose equipment that became obsolete almost overnight.

Read-only memories of various kinds are becoming more common every day, and large-scale integrated-circuit memories appear to be just around the corner. Only the developers of these memories know now what kind of test equipment is likely to be needed, and they're not talking about their thus-far proprietary designs.

When these designs hit the market, users with computer-controlled testers will be able to adapt rather quickly, laying out cash only for new programs and maybe a little for new connectors, jigs, and other accessories.

But the howl that went up when 2½-D came out will be heard again from those who are sticking to manual and special-purpose equipment. ■





## Exercising memory systems with worst-case bit patterns

By Charles R. Elles

Computer Test Corp., Cherry Hill, N.J.

and Elwood A. Dance\*

Scientific Measurement Systems, Inc.,  
Moorestown, N.J.

**It's not enough** to test only memory elements and assembled arrays. After these tests, connecting the array to its drive, sense and control circuitry completes the memory system; and only after this complete system passes its own level of testing can there be any reasonable assurance of high reliability, for the unit as a whole.

In a system test, the drive and sense electronics and memory address, data, and timing logic have been installed; the memory is operated during the test under normal conditions, at normal environment, as specified for its ultimate environment.

Generally the best test of a memory system—as opposed to memory elements or arrays—is a functional test: Can information be stored and retrieved without error at full memory speed? In other words, can complex patterns of digital data stored at each address location be completely retrieved without error?

Worst-case patterns, which depend on the wiring configuration of the memory, determine to what degree inherent noise affects the memory's stored data. This noise is either generated in the half-selected cores or capacitively coupled from drive to sense lines. When the noise is too great, the discriminator may detect it and erroneously indicate the presence of a 1 in place of a 0, or a 0 in place of a 1.

Besides the obvious all 1's and all 0's, a variety of other data patterns are useful. Among the simpler patterns are checkerboards, double checkerboards, checkerboards shifted by one bit, interlaced rows of 1's and 0's, and their complements. Large memories may require more complex patterns to generate the worst-case noise conditions that they may encounter in use.

### Memory exercisers

A memory exerciser contains address, data and timing logic that generates these patterns, stores them in the memory being tested, and recovers them at memory speeds. It is made up of an address counter—which coordinates all memory op-

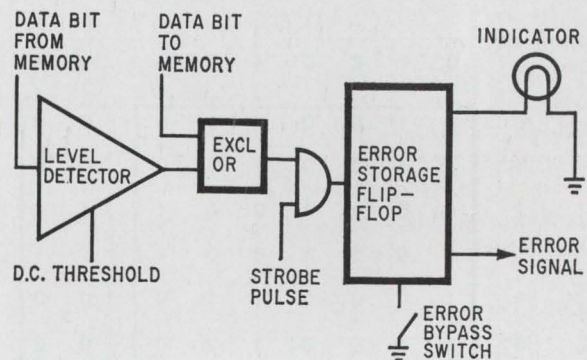

**Detector.** Any pulse from the memory, identified as a 1 or a 0 by the level detector, is compared in the exclusive-OR gate with the binary value that it should have. When the values are different at the time of the strobe pulse, the flip-flop records an error, and the indicator warns the test operator. One circuit exists for each word bit.

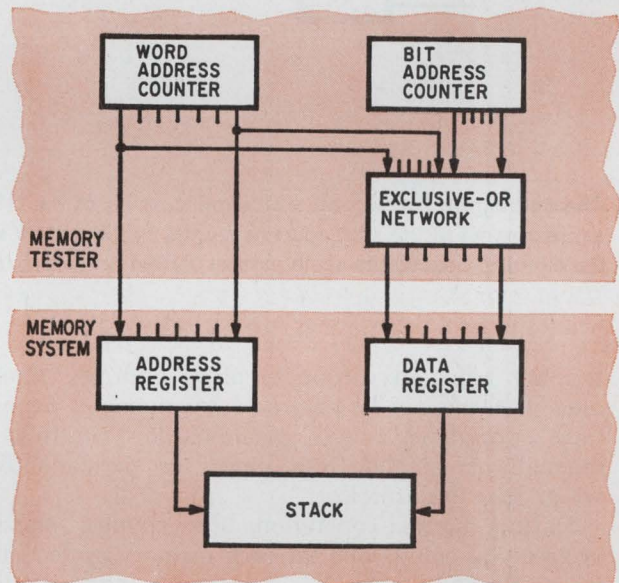

**Pattern generator.** Exclusive-OR network combines bits in exerciser's two address counters and transmits them to memory's data register, to load pattern into array.

erations—a pattern generator, mode controls, and timing circuitry.

The address counter is usually organized in straight binary form. If the memory being tested contains  $2^n$  words of  $k$  bits each, the address counter is  $n$  bits long. This counter specifies the memory location being tested at any instant; at this location all  $k$  bits are checked in parallel. To generate any of the checkerboard or other specialized patterns, a second address counter of  $k$  bits specifies the individual bits, as shown directly above. For example, a memory containing  $2^{12} = 4,096$  words of  $2^4 = 16$  bits each would require an address counter of 12 bits to specify every word, and 4 more bits to specify individual bits in each word for the data patterns.

In this example, individual bits in the data pat-

\* Formerly with Computer Test Corp.



		k BITS									
		0	1	2	3	4	5	6	...	k-1	k
2 <sup>n</sup> WORDS	0	1	1	0	0	1	1	0	0	0	
	1	1	1	0	0	1	1	0	0	0	
	2	0	0	1	1	0	0	1	1	1	
	3	0	0	1	1	0	0	1	1	1	
	4	1	1	0	0	1	1	0	0	0	
	5	1	1	0	0	1	1	0	0	0	
	6	1	0	0	1	1	0	0	0	1	
	...										
	2 <sup>n</sup> -1	0	0	1	1	0	0	1	1	1	
	2 <sup>n</sup>	0	0	1	1	0	0	1	1	1	

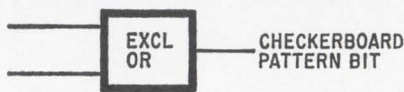

		k BITS									
		0	1	2	3	4	5	6	...	k-1	k
2 <sup>n</sup> WORDS	0	0	1	1	0	0	1	1	1	0	
	1	0	1	1	0	0	1	1	1	0	
	2	1	0	0	1	1	0	0	0	1	
	3	1	0	0	1	1	0	0	0	1	
	4	0	1	1	0	0	1	1	1	0	
	5	0	1	1	0	0	1	1	1	0	
	6	1	0	0	1	1	0	0	0	1	
	...										
	2 <sup>n</sup> -1	1	0	0	1	1	0	0	0	1	
	2 <sup>n</sup>	1	0	0	1	1	0	0	0	1	

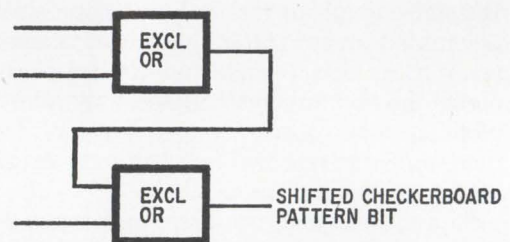

**Checkerboards.** The second least significant bit of the n-bit address counter is combined with the second least significant bit of the k-bit address counter to generate a worst-case checkerboard pattern, left. A slight variation in the circuit produces the same pattern shifted one bit to the right. Both circuits use exclusive-OR gates.

tern are defined as a function of the address. Other data patterns can be entered from punched paper tape, programed with patchboards, controlled manually from the front panel, or permanently wired into the exerciser.

During normal operation, the counter starts at zero and counts one for each memory cycle that is performed until the maximum address is reached. All memory locations are thus sequentially tested. This process can be repeated—that is, the test may be recycled as many times as desired in a search for transient errors.

Using manual control switches on the panel, the operator selects upper and lower address limits or selects only one location. Lamps indicate the memory location under test.

A bank of exclusive-OR circuits compares each output data word, bit for bit, with the pattern originally stored. When there's an error, a comparator output lights an indicator on the front panel that pinpoints the data bit in error. This may also cause the machine to enter a preprogrammed error mode that helps to isolate the error.

### Different courses of action

Once an error is detected, different options are open to the operator. Much depends on the test being performed. In acceptance testing, the best course is to count the error and continue the test; the number of accumulated errors is then displayed

after the test has been run to completion.

In troubleshooting, however, the defective address and the error bit must be ascertained. Stop-on-error and error-recycle modes are important aids in this task. To locate the source of error, the exerciser can stop and display the contents of the address counter and data error flip-flops. If the error is transient, the machine can continuously recycle the memory at a single address, while the operator investigates the cause of the error.

### One-shot timing

Mode control and exerciser timing are derived from internal read and write timing pulses, or from an external source. In one system, one-shot multivibrators provide this external timing—two are used for each read-write pulse. One multivibrator defines the pulse position, and the other, triggered from the trailing edge of the first, controls pulse width. These multivibrators must be stable to within 0.5% and must have a duty-cycle capability that approaches 100%.

Logic levels in general-purpose exerciser systems rarely match those of the memories under test. Interface circuits therefore are placed between the exerciser logic and the memory. With these circuits, which are designed to drive terminated transmission lines, the operator can select and set the logic levels required to match the memory system being tested. ■





## Boosting plated-wire yield: which knob to adjust?

By Gary Chernow

Computer Test Corp., Cherry Hill, N.J.

**Fast switching**, low power dissipation, and nondestructive readout make plated wire an attractive memory element. But these features may be accompanied by a serious production disadvantage—the medium's unpredictable yield, sometimes as low as 30%, which severely restricts the length of usable pieces of wire. Several solutions to this problem are being investigated.

A closed-loop process could be solution to the yield problem. In this process, test results obtained on-line would be fed back automatically to the manufacturing process, varying critical parameters and allowing plating, testing, and cutting of the wire at speeds of up to 100 inches per minute.

Wire is now plated and tested continuously at speeds ranging from 10 to 30 inches per minute. But there is no feedback from the testing to the plating operation, except when an operator decides that the rejection rate is too high and makes a manual adjustment. For example, he may adjust the temperature of the electrolyte, vary the concentration of the plating solution, or change the plating current density; but between the times when he makes these decisions and adjustments, many flaws may be detected in the wire produced.

For these tests, a closed-loop system is perhaps easier to envision than to implement, because of the adjustments that test results dictate. They include such factors as film thickness, alloy composition, surface roughness of the substrate, the anisotropy field, the film's magnetic history, and so on. All these parameters affect the stability of the film's domain and wall structure, which in turn affect the output signal's behavior. But there's no clear correlation between the results of a test and the parameter to be adjusted; such correlation is a prerequisite of automatic closed-loop control.

Data is recorded in plated wire by magnetizing the thin film of plating material in either direction around the wire; the magnetizing force is the resultant of currents in a perpendicular word strap and in the wire itself. To read out the stored data, a word current acting alone tilts the magnetization vector of the wire away from its circumferential direction; the resulting flux change induces an emf between the ends of the wire. When the word current is removed, the vector is returned to its rest

position by its anisotropic energy, thus permitting nondestructive readout.

The testing operations measure four quantities: the intrinsic amplitude of a readout pulse from the wire, the effect of disturb currents in both the word and bit directions, and the effect on a particular bit cell of repeated reading and writing operations in adjacent cells. These measurements are usually made immediately after the last step in the plating process. In one instrument for making the measurements, the wire passes through a frictionless electrical contact such as a cup of mercury, then through three word straps—each of which generally makes one turn around the wire—and finally through another mercury cup. The word straps carry the word current, just as in the complete plated-wire array. During the test, the bit cell being tested is under the middle word strap, while the other two straps are used for reading and writing in adjacent cells. The mercury cups establish contacts for bit current through the wire itself. Because there is current in the wire during the plating process as well as during testing, the upstream mercury cup is grounded and a current source is connected to the downstream cup. This prevents the bit current and the plating current from interfering with one another.

### Step-by-step procedure

One common test uses a sequence of four steps: First, 0's are written 1,000 times into each of the three cells under the three word straps, one cell at a time, after which a 1 is written once into the middle cell. This 1 is then read out and the amplitude of its readout pulse recorded. This first step thus requires about 3,000 separate operations.

In the second step, the same 1,000 0's in three cells and the single 1 in the middle cell are written as before, but then a word current passes through the middle cell's word strap 1,000 times in the absence of a bit current in the wire. This is tantamount to 1,000 read operations, but the peak is stored only at the 1,000th time. Because of the disturbing effect of repeated reading in one position, the peak will be slightly lower than previously.

The following step is essentially the same as the second, except that 1,000 bit-disturb current pulses pass through the plated wire, while no current passes through any word strap. This further reduces the peak of the middle cell's output, which is stored again.

Finally, the 1,000 0's and the single 1 are written again, followed by an additional 1,000 0's in each of the two adjacent cells. Again the middle cell's 1 is read out and stored.

After all four steps have been completed, the ratio is taken of the peak output pulse in the second, third and fourth phases to that in the first. These ratios should be uniform along the full length of a segment of plated wire, and are more important than the absolute amplitude of the pulses; for if disturbances from adjacent cells cause too great a



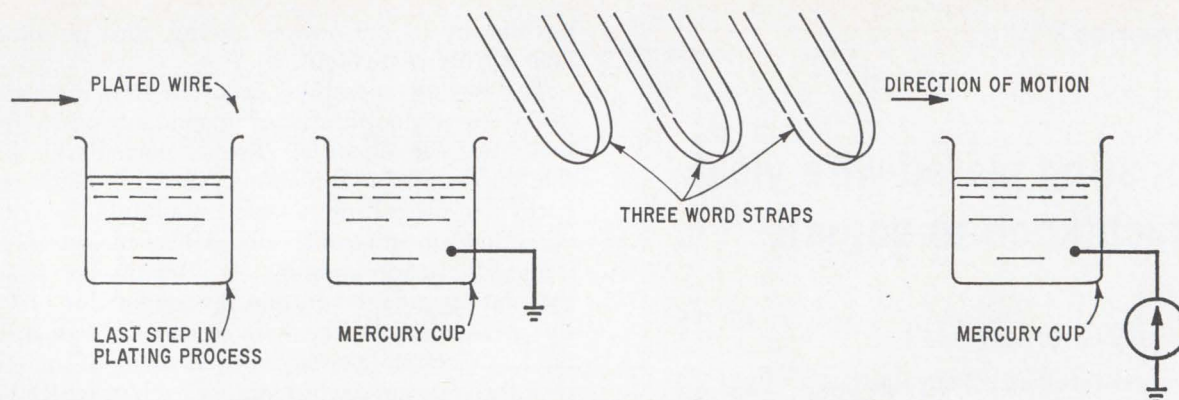

**Nimble.** Plated wire coming out of the manufacturing process is tested as it passes through the middle one of the three word straps. The other two help to simulate an actual memory environment. Mercury cups are electrical contacts for bit current in the wire during testing. 32,000 cycles are executed while the wire moves only a few mils.

shrinkage of the output pulse, the data cannot be interpreted. On the other hand, because a single sense amplifier serves the whole wire, it can be adjusted to work with the absolute amplitude of that wire's output over a wider range than the allowable shrinkage caused by the disturbances that arise from adjacent cells.

These four sequences add up to about 16,000 operations. The entire procedure is then repeated with complementary data—1's replacing the 0's, and the 0's substituting for the 1's, for a total of 32,000 operations. Repeating the process with complementary data establishes the skew factor of the plated wire, or the degree to which the film's easy axis differs from a perfectly circumferential direction. Although 0's and 1's produce output pulses that are nominally equal in amplitude and opposite in polarity, skew tends to make one pulse lower than the other.

### Handle with care

In making these tests, the 32,000 read and write cycles are performed while the wire moves no more than 4 mils, or 1/10 of a bit cell length; if the wire moves at 30 inches per minute, these 32,000 operations must be completed in 8 milliseconds, allowing about 250 nanoseconds per cycle. Repeating the test every 4 mils insures that the wire's characteristics are uniform along its length.

Not all tests are now performed on-line. One important off-line test is for zero magnetostriction. Plated wire's magnetic characteristics must not be changed when the wire is physically stressed. To this end, the characteristics of the plating material are carefully controlled and great pains are taken to mount each segment of wire in an array so as to protect it from stress. Nevertheless, selected wire segments that pass the on-line test are subjected to pulling or twisting while their B-H characteristics are being measured. If the magnetostriction isn't zero, the physical stress will change the shape of the B-H loop; if the change is excessive, the plating process must be adjusted. This test is difficult, but



**Tester.** This device contains the apparatus diagramed.

not impossible, to implement on-line.

Another off-line test is a plot of sense output versus write current and bit current, called a window test. This test is the plated-wire analog of the shmoo tests carried out on ferrite core arrays, except that there is only one independent variable for each plot instead of two. These tests require a considerable length of time to make, even with automatic equipment, so it's impractical to carry them out on a moving wire. This being the case, the window test probably won't be on-line at any time in the foreseeable future. Instead, the plots are made at intervals of 10 or 15 minutes on samples taken from the on-line test; a comparison of successive tests is one indication of the plated film's uniformity. ■

### Bibliography

- Tentative Methods of Test for Nonmetallic Magnetic Cores . . . , American Society for Testing Materials, Standard C-526-63T.
- Sampling Procedures and Tables for Inspection by Attributes, MIL-STD-105D, April 1963.
- C.P. Womack, "Schmoo Plot Analysis of Coincident Current Memory Systems," IEEE Transactions on Electronic Computers, February 1965.
- Frank S. Greene Jr., "An Automatic Ferrite-Core Tester," Computer Design, April 1966.
- J. Hubbs, "What's Wrong With Pulse Instrumentation," IEEE, Nov. 11, 1967.
- C.J. Walter, A.B. Walter, M.J. Bohl, "Setting Characteristics for Fourth Generation Computer Systems," Computer Design, August 1968.
- Alan M. Stoughton, "Computer-Controlled Memory Testing," Modern Data Systems, August 1968.
- George A. Fedde, "Plated wire: a long shot that's paying off," Electronics, Nov. 11, 1968, p. 124.



# Four ways to improve your memory:

**1. Improve your computer's memory with Linear Circuit 525.** It's the one, the only high-speed core memory sense amplifier of its type that lets you set the threshold internally. (Or externally; take your pick.) More unforgettable features: 1) uncertainty range,  $\pm 4\text{mV}$ ; 2) propagation delay, 30 ns; 3) low power consumption: 110mW; 4) high common mode range:  $+4.5\text{V} - 3.5\text{V}$ .

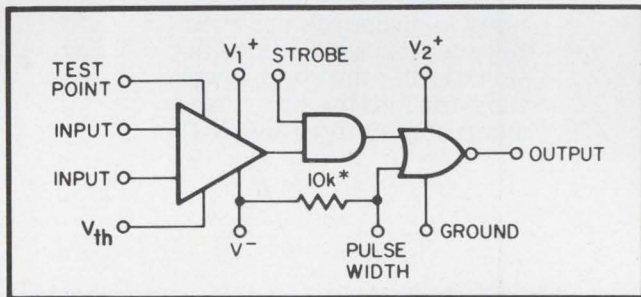

**3. Improve your computer's memory with Linear Circuit 526** — the high-speed comparator that's beyond compare! (Do you know of another comparator with a propagation delay of 30 ns?) Other features to remember: 1) operates from  $\pm 5\text{V}$  supplies; 2) overdrive recovery, 20 ns; 3) fanout of 10; 4) high gain operation; 5) output compatible with DCL, DTL and TTL.

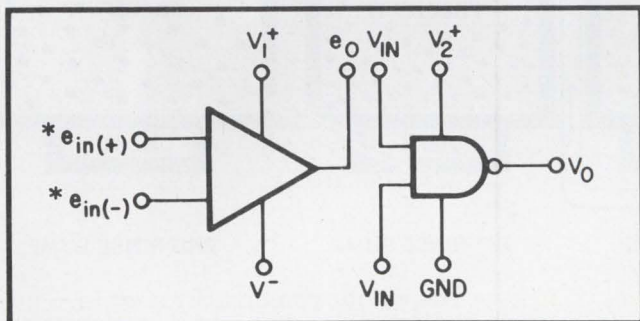

**2. Improve your computer's memory with Linear Circuit 511.** This one's a versatile transistor array. It's also a pre-amp — with DC characteristics that are 50 to 100% better than competing devices! Other memorable points: 1) low offset voltage  $\pm 2\text{mV}$ ; 2) low offset current; 3) single power supply; 4) AGC capability.

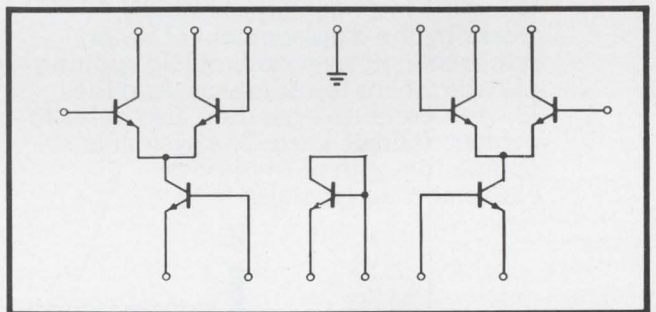

**4. Improve your computer's memory with Linear Circuit 5733.** It's the video amplifier that operates over — are you ready? — 120 MHz band width! Differential in/differential out with minimal phase distortion, too. And as a pre-amp in computer applications, don't forget: 1) 10 ns rise time; 2) fixed gains of 10, 100, 400 available (variable between 10 and 400 with a single, external resistor); 3) internally compensated (no external frequency compensation components required.)

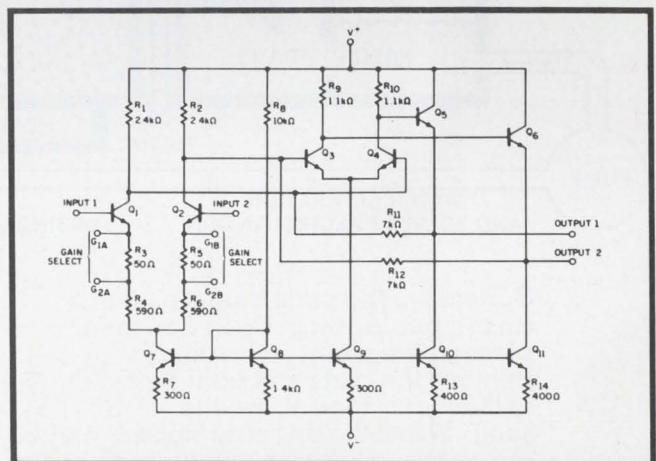

**P.S.** We almost forgot: all four of these monolithic linear circuits are available right now — in production quantities. So are all the specs, facts, figures. Send for them today — before you forget!

# Signetics

Signetics Corporation / 811 E. Arques Ave., Sunnyvale, California 94086 / A subsidiary of Corning Glass Works



# Announcing the "Freon" Solvent Drying System.

## Dries water-wet parts spot-free at 118°F...in 3 easy steps.

1. Lower the parts into the drying sump containing FREON® T-DA 35 solvent boiling at 118°F. Low-temperature boiling eliminates water spotting caused by the evaporation of water. (This system, using the high density of FREON, works by the displacement of water, rather than its evaporation.) No spotting of parts means fewer rejects. And the low-temperature operation also helps to protect delicate parts. The system is compatible with most plastics, elastomers and metals.

2. Remove the parts and allow the excess solvent to drain back into the drying sump. (The solvent is re-usable—no need to discard the solvent because it is saturated with water.) After draining, lower the parts into the first rinse sump containing FREON TF.

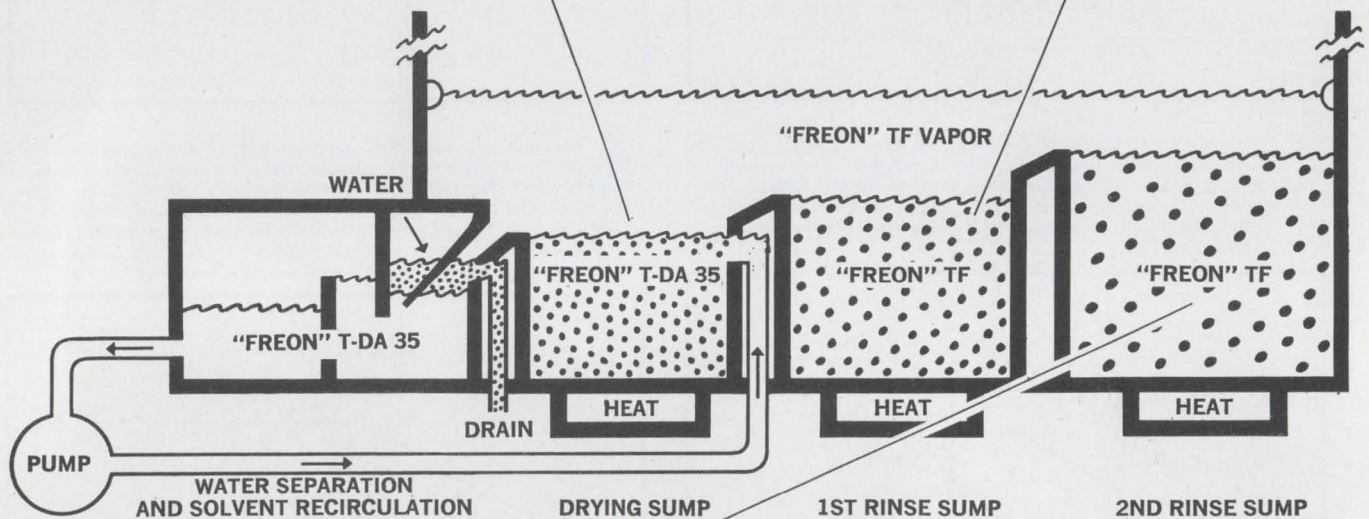

3. Remove the parts from the first rinse sump. Allow to drain and then place in the second rinse sump. Remove the parts and hold them in the vapor zone above the sump. When the dripping stops, remove the parts from the drying system. Parts will be completely dry, spot-free and immediately ready for further processing.

The whole, remarkably simple operation takes only a few short minutes. Furthermore, it is completely safe. FREON solvents are nonflammable, nonexplosive, nonirritating and low in toxicity. **For further information on the efficient, economical FREON Solvent Drying System, write: Du Pont Company, Room 7304-H Wilmington, Delaware 19898.**





# MSI

## **MSI/LSI Circuit Seminar For Equipment And Systems Designers**

Presented by Electronics/Management Center. An Information Service of McGraw-Hill  
New York — September 29-October 1, 1969, Statler Hilton Hotel  
7th Avenue & 33rd St., New York, N.Y.  
California — December 1-3, 1969, Airport Marina Hotel  
8601 Lincoln Blvd., Los Angeles, Calif.



## Program

### 1. Evolution of Large Scale Integration (LSI)

#### 1.1 Unique Properties of MOS

- self-isolation
- no voltage offset
- bilateral switching
- clocked load resistors
- temporary memory via gate storage
- design through mask topology
- second layer interconnect through diffused crossunders

#### 1.2 Limitations of MOS

- lower speed than bipolar
- surface sensitivity – charge control, traps, radiation susceptibility
- gate oxide vulnerability
- low output current drive
- interface problems
- parasitic capacitive coupling

### 2. MOS Device Structure and Characterization

#### 2.1 Basic Geometry of MOS Device

#### 2.2 Device Design Parameters

- $V_{GST}$ ,  $K$ , body effect,  $BV_{DSS}$ ,  $BV_{OX}$ ,  $I_{DSS}$ ,  $C_{GS}$ ,  $C_{PN}$ , etc.
- parameter temperature sensitivity

#### 2.3 Basic Device Model

- drain current in SAT and NONSAT regions
- $R_{ON}$  and  $g_m$
- body effect
- voltage dependent capacitive loading

### 3. Basic MOS Circuit Techniques

#### 3.1 Circuit Solution Using the Basic Device Model

- DC solution with active load resistors
- clock power relationships
- transient solution – speed, power, speed-power product

### 4. Topological Design and Layout

#### 4.1 Examples of Logic Gate Mask Layout

- $2\phi$  ratio shift register layout
- logic gate layout
- design rule considerations and limitations

### 5. Advanced Circuit Techniques

#### 5.1 Circuit Evolution

- early  $4\phi$ , modern  $4\phi$ , ratioless  $2\phi$ , precharged  $2\phi$ , capacitive pullup

- interrelationships between circuit forms
- circuit models and their solutions for each circuit form – charge, discharge, power dissipation, speed-power product, charge sharing and parasitics
- clock requirements – timing relationships, amplitudes, drive requirements

#### 5.2 Suitability of Circuit Forms to Given Applications

- shift registers
- general logic
- memories

#### 5.3 Use of Circuit Forms in Combination

### 6. LSI Artwork Generation

#### 6.1 Design Approaches

- handcrafted layout
- standard array
- discretionary wiring
- building block (library of functions)

#### 6.2 Comparison of Design Approaches

- development cost
- turnaround time
- error susceptibility
- chip size and yield
- performance tradeoffs

### 7. Logic Implementation with LSI

#### 7.1 Advantages of Multiphase Logic

- master-slave avoidance
- ease of delay implementation
- area, power and speed advantages

#### 7.2 Conversion of System Logic into Form Suitable for LSI Implementation

- availability of multiple AND-OR capability at a single logic node
- minimization of logic levels
- power and propagation delay minimization

#### 7.3 Comparison of $2\phi$ and $4\phi$ Logic Systems (Ratio vs. Ratioless)

- timing problems and their solutions
- logic level limitations
- speed, power, area and speed-power product comparison

### 8. Design Examples

#### 8.1 System Partitioning Techniques

- multiphase logic implementation

## Purpose

This seminar is designed to give the systems designer the knowledge he needs to deal effectively with MSI and LSI circuits as basic subsystems.

Through lecture, panel discussion, and hands-on sessions, the systems designer will be exposed to all phases of the newest and most popular circuit techniques, their design, manufacture, and application.

He will achieve a broad, realistic, and authoritative approach to: realizing the systems parameters made possible by MSI/LSI; achieving maximum cost-performance ratio; maintaining a competitive edge; getting the most out of off-the-shelf units; improving communications with vendors; using multiple sources; developing in-house capabilities; establishing realistic schedules, and meeting production deadlines.

## Faculty

Presentations, discussions, and work sessions are under the direction of the staff of Integrated Systems Technology, Inc. of Santa Clara, California. Each member of the staff has wide experience in the areas of circuit design, systems application and semiconductor research and development.

**Donald E. Farina** – President, Integrated Systems Technology, Inc. One of the contributors to the design of the first micrologic integrated circuit families. Served as head of the R&D department in digital circuits for Fairchild Semiconductor, responsible for both digital circuit and bipolar device structure development.

For the microelectronics division of Philco-Ford Corporation Mr. Farina served as Director of R&D and was responsible for device and research devoted to MOS large scale integration. He received his BSEE at New York University in 1953.



## 8.2 Artwork Generation

- composite plan — logic cell placement, minimization of interconnect length and crossunder
- chip area estimating
- computation of cell loading in order to determine device geometry
- array performance calculations

## 9. MOS/Bipolar Interface Techniques

### 9.1 Requirements for Interface Circuits

- voltage level translator bipolar $\leftrightarrow$ MOS
- low impedance output driver MOS $\rightarrow$ MOS
- power supply compatibility
- low power dissipation on chip
- small area on chip
- minimum number of discrete components off chip

### 9.2 MOS Output Buffers on Chip

- scaled ratio type inverter
- push-pull driver
- push-pull with bootstrap driver
- dual load buffer
- series-sampled buffer
- diffused NPN emitter follower
- lateral PNP
- discrete load resistor

### 9.3 MOS Output Buffers off Chip

- NPN inverter — clamped and nonclamped
- NPN emitter follower
- PNP inverter
- complementary inverter

### 9.4 Input Buffer Techniques

- lateral PNP
- biased substrate
- lateral coupling device
- PNP inverter

## 10. Low Threshold Technology

### 10.1 Low Voltage Circuit Design

- speed, power, area and speed-power product of ratio circuits
- speed, power, area and speed-power product of ratioless circuits
- direct output compatibility with bipolar IC's
- direct input compatibility with bipolar IC's
- system and array power tradeoffs

## 11. Cost Considerations for LSI

### 11.1 Chip Size and Complexity vs. Cost per Function

### 11.2 Distribution of Fabrication Costs

- materials cost
- labor cost — process labor, sorting, dicing, packaging, testing, etc.

### 11.3 Array Development Costs

- handcrafted array
- standard matrix
- building block
- discretionary wiring

### 11.4 System Cost Factors

- system overhead — clock generation, interface circuitry, assembly cost, power supplies, etc.
- systems cost examples — discrete IC vs. LSI

## 12. Computer Aided Design

### 12.1 Logic Verification

### 12.2 Array Topological Design

- minimization of area, interconnect, crossunders and loading

### 12.3 Array Performance Prediction

- calculation of propagation delay, power dissipation, operating speed, etc.

### 12.4 Computer Artwork Generation

- library of standard functions
- computer controlled coordinatograph, photo exposure head, CRT

### 12.5 Test Sequence Generation

- test requirements
- algorithms
- test hardware

## 13. MOS Structures and Fabrication Techniques

### 13.1 Substrates and Preparation

### 13.2 Mask Sequences and Variations

- oxidation and diffusion
- field oxide and crossunders

### 13.3 Gate Structures

- surface preparation
- dielectric: homogeneous and composite
- metallization and delineation
- annealing and alloy

## 14. Process Constants and Minimum Design Rules

**Ronald Pasqualini** — Vice President, Engineering. Widely experienced in R&D on MOS memory systems for Philco-Ford Corporation. Performed initial logic design, circuit analysis, and composite layout of a monolithic read-only memory. Was responsible for the interface between R&D processing and R&D design.

Systems design experience in integrated circuits includes shared responsibility on an Air Force large scale array navigation computer, and Ranger spacecraft. Also designed a monolithic 2-MHz binary/BCD converter employing 4-phase circuit techniques.

Mr. Pasqualini holds a BS in Aeronautics from M.I.T., 1962, and an MSEE from U.S.C., 1966.

**Richard Craig** — Vice President, Technologies. Mr. Craig has devoted the major portion of his career to the semiconductor. With three major semiconductor manufacturers his experience includes such early developments as planar and epitaxial processes and structures. More recent experience includes responsibility for the development of advanced MOS LSI techniques, including multilayer and minimum size structures, oxide and interface charge control, and MOS circuit innovation and evaluation.

Mr. Craig received his BA in Physics from Fresno State College in 1958.

**Richard Aladine Carberry** — Senior Design Engineer. Presently involved in the logic and circuit design of complex MOS devices, and the design of digital equipment utilizing bipolar and MOS IC's. As a project engineer for Philco-Ford Corporation he was involved in the design of MOS memory and arithmetic chips for a guidance computer, as well as a sequencer and other control circuitry utilizing bipolar IC's.

For Lockheed Missiles and Space Company he designed analog circuits for a guidance system, switches, modulators and demodulators, active and passive filters, and various operational amplifier circuits.

Mr. Carberry holds BSEE and MSEE degrees from the University of California at Berkeley.



**14.1 MOS Gate Capacitance**

- dielectric constant and thickness
- gate dimensions and overlap capacitance

**14.2 MOS Field Capacitance and Crossover Capacitance**

**14.3 Junction Depth, Capacitance and Resistivity**

**14.4 K values** —  $t_{ox}$ ,  $\mu_p$ ,  $\epsilon_0$ ,  $W/L$

**14.5 Metallization Width, Spacing and Thickness**

**14.6 Area/Performance Optimization**

- minimum length/width structures

**14.7 Discussion of a Complete Set of Topological Design Rules**

**15. Yield Factors and Process Control**

**15.1 Processing Variables and Design Tolerances**

- alignment uncertainties
- photoresist limitations
- working plate constraints

**15.2 Threshold Control**

- oxide thickness
- fixed charge (Deal's triangle) — crystal orientation and cooling ambient
- mobile charge — gettering, contamination sources

**15.3 Test Devices and Patterns**

- MOS capacitor (C-V evaluation)
- gate threshold device  $V_{TH} = f(I_D)$
- field threshold device
- alignment marks, sizing marks and critical dimensions
- process development test vehicles

**15.4 Gate Oxide Vulnerability — Protection Techniques**

- MOSSAB and zener diodes

**15.5 Wafer and Device Attrition**

- in-process testing and rejection criteria
- probing, assembly, packaging and final testing

**16. Facilities and Equipment Requirements for LSI**

**16.1 Requirements for a Prototype Facility**

- personnel
- mask making equipment
- process equipment
- assembly, packaging and test equipment

**16.2 Available Products and Services**

**17. Applications and Product Types Most Suited to LSI**

**17.1 The following examples will be discussed:**

- desk calculator
- input/output peripheral equipment
- scratchpad memory
- read-only memory
- airborne computer — GP and DDA
- associate memory
- correlator applications
- multiplexers
- A/D and D/A converters
- industrial controls
- medical electronics

**18. Currently Available MSI/LSI Products**

**18.1 Bipolar MSI**

**18.2 MOS MSI/LSI**

**19. Advanced Technology Trends**

**19.1 Contributors to Improved LSI Technology**

- smaller geometries
- multilayer interconnect
- MOS-bipolar in same array — internal clock generation, high speed decoders
- array passivation
- multichip assembly

**19.2 Contribution of Advanced Technology to Cost, Performance and Density**

- memories
- delay lines
- general logic
- reliability

**20. Technological Controversies**

**20.1 Semiconductor Developments**

- complementary N and P MOS
- other MOS structures — SOS, TFT, self-aligning gate, MNS and MNOS and epitaxial
- isolation techniques — dielectric isolation, etch and back-fill

**20.2 Custom vs. Standard Products**

- memories
- logic
- production volume considerations

**Fee**

The registration fee for all sessions, a complete set of notes, and luncheons — \$385.

**Registration**

Register now for either the New York or Los Angeles program. Use the registration form below. Make checks payable to Electronics/Management Center. You must register in advance. We will be happy to bill you or your company, but only fully paid-up registrants will be permitted to attend the seminar.

Hotel reservations should be made directly with the hotel. A number of rooms is being held for seminar attendees. When you make your reservations, identify yourself as an attendee of the MSI/LSI seminar.

Samuel Weber, Mgr.  
Electronics/Management Center  
330 West 42nd Street, N.Y., N.Y. 10036

**MSI/LSI Circuit Seminar for Equipment and Systems Designers**

\_\_\_\_ Please register me in your three day seminar at \$385

\_\_\_\_ New York session    \_\_\_\_ Los Angeles session.

\_\_\_\_ Check enclosed

\_\_\_\_ Bill me

\_\_\_\_ Bill company    PO# \_\_\_\_\_

Name \_\_\_\_\_ Title \_\_\_\_\_

Address \_\_\_\_\_

Company \_\_\_\_\_

City \_\_\_\_\_ State \_\_\_\_\_ Zip \_\_\_\_\_



# Computer makers look East

The market for electronic data processing equipment in Comecon nations is growing at a fast pace as a result of requirements for next five-year plans

**Aggressive sales tactics**, along with government support at the business level, have enabled British computer makers—notably International Computers Ltd.—to build a big lead over their American rivals in Eastern Europe—one of the world's fastest growing outlets for electronic data processing wares. Strategic trade restrictions imposed by the U.S. government partially explain the comparatively laggard pace set by such domestic giants as IBM, Univac, Honeywell, National Cash Register, and the Control Data Corp. Nonetheless, all of these concerns have closed important deals within the past 12 months and are eagerly scrambling for further orders.

Their particular interest in the satellite elements of the Comecon (Council for Mutual Economic Assistance) market, which embraces Russia, Poland, Czechoslovakia, Rumania, Bulgaria, Hungary, and East Germany, is not difficult to understand. Eastern Bloc countries have assigned top priority to large hard-currency investments in Western-made computers and peripheral gear for the next five-year plan, running from 1970 through 1974.

Those perennial late starters in international markets for advanced technology—the West Germans and Japanese—have not overlooked potentially lucrative Eastern European outlets. Both are now actively competing for computer orders that a few years ago were pretty much in British or American bags. Siemens has completed a recent series of sales successes with its big System 4004 commercial machine, and it is giving England's Ferranti a brisk battle for the flood of orders now being let by gigantic Comecon industrial combines for process-control equipment. The Japanese, meanwhile, are quietly sew-

ing up the burgeoning market for desk-top computers and selling licenses for other electronic systems.

**Cockpit trouble.** The Russians, oddly enough, though long accustomed to considering Eastern Europe their own backyard, seem to have given up trying to meet the area's growing demand for advanced EDP equipment. The Soviet Union's well-publicized failure to supply its own planning and statistical offices and factories with enough machines effectively prevents it from exporting more than a trickle of largely outmoded second-generation Minsk and Ural machines.

Then there is a very big question as to whether the neighbors are really anxious to have the high-priced, low-quality Soviet machines—the memories have extremely small capacities and peripherals are notoriously slow. The Poles and Czechoslovaks are openly shopping for Western peripherals and software to modernize the Soviet machines they're saddled with. They are even considering the purchase of Western memories if they can be adapted to their Soviet models.

Western peripheral manufacturers like Sweden's Addo Business Machines have been quick to exploit the new markets for faster and more reliable peripheral equipment as the slower Bloc-made systems get bogged down under a steadily growing flood of paperwork. The firm's export sales have jumped from \$800,000 in 1966 to a current annual rate of \$4 million in Eastern Europe outlets.

NCR is now selling its Mohave encoder throughout Comecon; negotiations are reported in progress with the Soviet Union, Poland, Czechoslovakia, and Rumania. Honeywell was asked by the Poles at last June's Poznan Trade Fair

whether its peripherals could be adapted to the Russian Minsk 22. Poland is also in the market for memories to increase the Minsk's capacity. Last summer, Britain's ICL sold Metronex—Poland's large electronics enterprise—a license to produce and sell fast computer-driven printers throughout Comecon. In addition to supplying special components the Poles are still unable to make, the company will train Polish engineers in England. ICL probably counts on the license producing more computer business since peripherals are still a comparatively small piece of the action. Eastern European computer volume is now reportedly running at an annual rate of \$50 million for third-generation gear alone.

## A run for the money

The long-suffering acquiescence of the Russians to the Western invasion of neighborhood EDP

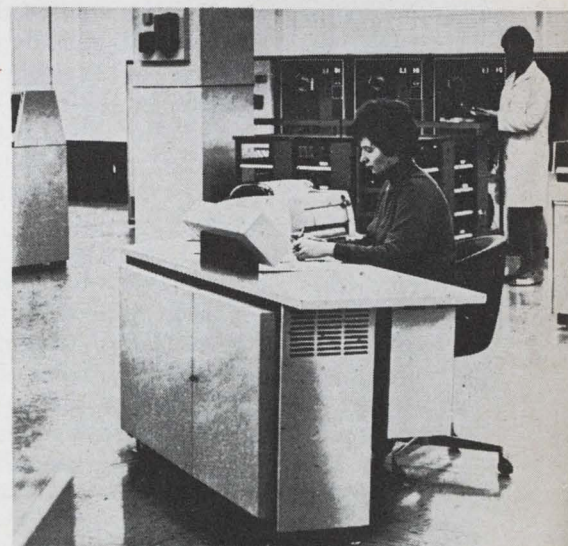

**Czech mate.** Million-dollar ICL computer installation at Ostrava steelworks is being used initially for stock control and accounting.



markets will not last for more than two years, at most, say Vienna-based observers of Comecon computer developments. The Soviets continue to buy large Western-made machines—but only those that are compatible with IBM's 360 programming language over the long term, however, the country doesn't have enough hard currency available; moreover, it doesn't want to become dependent upon Western EDP suppliers to meet its rapidly growing needs.

Thus, it came as no surprise last spring when the Soviet Union announced plans for the development and manufacturer of a complete family of third-generation computers in cooperation with Comecon partners. The new system is supposed to be compatible with the IBM's 360 series. The project has been designated RJAD (The Russian abbreviation for Unified Data Processing Program), and the first equipment deliveries are scheduled for late in 1971. The largest machine will reportedly be about the same capacity as the 360/65; the smallest model will be on a par with the 360/20.

According to current plans, the Soviet Union will supply all central processing units, Czechoslovakia and East Germany the peripheral units, and Hungary the software. Poland will furnish memories, while Bulgaria and Rumania will provide components—largely from lines built with Soviet assistance.

**Hedging.** Despite the Soviet-led project, satellites are still including substantial imports of Western-made EDP systems in their five-year plans. Even the Russians have reportedly earmarked nearly \$300 million for computer imports over the next few years.

While Russia's EDP purchasing plans are difficult to assess because of the veil of secrecy that surrounds all decisions there, Western firms have an easier time when it comes to keeping tabs on the import plans of other Comecon countries. When it comes to an overall assessment of these markets, West Germany's Siemens has probably the best picture, thanks to a survey it commissioned last year. One of the company's Russian-speaking engineers who is responsible for Comecon outlets says that the big-

gest current market is to be found among the state-operated tourist agencies, railways, and airlines. Not only do they have to improve their efficiency if they are to continue attracting Western clientele, but they are also in a privileged position to spend hard currency since they bring in so much.

#### Where it's at

Siemens is now negotiating with the Rumanian State Railway for the sale of a System 4004/35, which will be used mainly for seat bookings and related commercial operations. Several other deals are now pending with other Comecon transport and tourist enterprises, the company reports. Honeywell recently sold a complete computer-based booking system to Yugoslavia's State-owned airline. This type of equipment will have to come from the West for a long-time to come, Comecon planners admit, because of the concentration on industrial applications.

Apart from specialty outlets, which are admittedly limited and highly competitive for Western companies, today's big Eastern European commercial EDP market encompasses state banks, planning offices, and statistical agencies, and industrial plants. But as an NCR executive at the Poznan Fair last June commented: "It is a very irregular market, depending heavily on the currency position of the potential buyer."

In other words, as long as Comecon economies continue to be short of hard currency, they'll have to restrain their managers, who are to a man enthusiastic about Western-made computers. According to the NCR official: "There is no real competition from Eastern Europe." State planners, however, control hard-currency outlays, and ultimately they decide who is going to supply the equipment.

Since the potential earnings power of Western-made capital goods is the big consideration in purchase decisions, computers for universities and research institutes usually come from the Soviet Union. Machines are imported under barter-type bilateral trade agreements. Expensive Western models are reserved for factories which can improve their efficiency and hence export potential, or state

bureaucracies with close ties to planning offices.

**Secondary outlets.** In countries where Western computer purchases are limited by hard-currency shortages, there's still a market for Western peripheral equipment, often a low-cost solution to the problem of speeding up Soviet-, Polish-, or East German-made machines. Last year, the Czechoslovak State Bank in Prague, for example, brought what is probably Europe's most modern data acquisition system. It was wholly installed by Sweden's Addo, even though the bank relies heavily on Soviet-made computers. Last Spring the Bank began to expand the system as the first step of its five-year plan to supply data transmission services from its branches to computers in Prague and Bratislava. It awarded a \$70,000 contract to Britain's Plessey Co. for its 200-baud and the higher speed 600/1200-baud data transmission systems. Transmitters and receivers will be interconnected through the public telephone network.

In recent months the Poles blandly announced that although they only have 165 computers in operation, they will need three times as many for the 1970-74 plan; and most of the larger units will have to come from the West. The Czechoslovaks estimate that they'll need around 500 computers during the next five years, as against the 135 installed so far. They emphasize that while the Soviets supplied 40 of this total (three or four years ago), Univac and ICL together account for more than 50 (installed mainly within the past three years). Hungary, even though a small country, is rapidly industrializing and has a strong Western orientation when doing business. The 75 computers it now has in operation are about evenly divided between Western sources (mainly Univac) and Comecon suppliers. But the current trend is clearly toward more Western-made systems.

#### Self help

A quick check of Comecon's EDP capacities reveals why Eastern Europe will have to rely on Western-made computers for a long time to come. The Soviet Union generally



offers second-generation medium-size Minsk 22 and Ural 14 computers to its neighbors. These machines are notable for relatively small memories—in the 8,000-word range. More powerful models introduced during the past year or two include the Minsk 23, the BESM 6, and the Razdan 3. But few of these are shipped into Eastern Europe since Russia's internal demands for large-capacity machines are far from being satisfied.

After the Soviets, the leading Comecon EDP exporter is Poland's Elwro plant in Wroclaw, which will have turned out nearly 200 of its second-generation Odra 1204 (comparable to Elliott Automation's 803 or IBM's 1130) by the end of the year. A company official reports that 75% of the plant's output is shipped to other Comecon nations—largely East Germany, Russia, and Czechoslovakia. He says: "We can sell as many to the Soviet Union as we have available." Elwro buys its peripherals from East Germany's Optima office machinery plant, which supplies typewriters, tape punches, and tape readers. Although the Hungarians have exhibited some of their peripherals in Poland, the Poles consider them too slow. They would buy Western peripherals for the Odra, if they were compatible and "if the price were right." Elwro is now getting ready to launch its second-generation 1300, but it still has no plans to get into third-generation technology partly because Poland does not yet produce integrated circuits on a commercial scale.

Czechoslovakia may soon be one of Comecon's leading computer exporters thanks to a license its Tesla electronics group bought last year from France's Bull-GE on the Gamma 140. This is a medium-size, second-generation machine never produced in commercial quantities, even though it was widely exhibited at Eastern European trade fairs beginning in 1965.

**Second choice.** Originally the Czechs wanted a license for the ICL 1901, a more powerful medium-size machine. But a diplomatic assist from French Foreign Minister Couve de Murville during a visit to Prague helped to push through the Bull-GE sale. Since the Czechs bought the license, French



**Exception,** NATO trade restrictions have held down computer shipments to Soviet Russia; ICL, however, has delivered this 4-50 gear to Gosnab.

suppliers of peripheral equipment and accessories used with the Gamma line have also sold licenses to Tesla and other Czech enterprises.

The Hungarians, Bulgarians, and Rumanians—with some Russian help—also manufacture computers. But such operations are mostly prestige projects conceived as a sop to nationalistic planners and engineers who continually agitate for the establishment of independent EDP capacity. Although these smaller second-generation machines usually get out of the prototype stage, they cannot measure up to Western-made or even Soviet and Polish machines.

The East Germans have concentrated on desk-top and small business computers. These are exported throughout Comecon but enough cannot be produced to meet growing demands. Consequently, the Japanese are now finding a ready market for their low-priced units.

#### Ratings game

Poland and Czechoslovakia offer Western commercial EDP suppliers the best potential, with Hungary and Rumania a strong third and a weak fourth, respectively. Soviet intentions at this moment are too hazy to justify an accurate forecast of future trends. East Germany is still strongly tied to Soviet and Polish sources as is Bulgaria. But the former recently bought a \$3 million ICL 1900 system for its optical industry.

Although the potential Soviet market is by far the largest in Comecon, deals take a long time to negotiate, are usually one-shot affairs, and are often encumbered by political overtones. Relatively few Western computers have been sold there. Moreover, Soviet policies are difficult to assess because of their inconsistency, a situation, which doubtless reflects internal power struggles in the current rush to computerize the economy.

ICL, with 95% of Poland's Western EDP installations, is now opening up a sales and service office in Warsaw to better cover the market. Until recently, the country was covered directly from England. Honeywell is now making a bid for a share of the Polish market. It just made its first sale: a 200 Series commercial computer and various process control machines for a nitrogen plant being put up by a French company.

Univac is the leading Western computer brand in Czechoslovakia, with ICL a close second and IBM a poor third. More than 35 Univac machines are either installed or on order, half of which are the small and medium models, like the third-generation 9300 model. Univac's volume during the past three years in Czechoslovakia has averaged \$2.5 million; this level should be exceeded during 1969 despite the country's economic troubles following the Soviet invasion.

**Barter.** Honeywell is reported negotiating a 10-machine deal in



return for machinery of various types to be shipped to a Scandinavian plant, which in turn will pay Honeywell in hard currency. If this triangle trade goes through, it will be the largest deal of its kind yet undertaken by any Western computer company in Eastern Europe. Like IBM and other Western EDP equipment suppliers to Comecon, Honeywell has always insisted on straight cash deals. With the heavy competition in the Czech market today, however, the company has to make a concession. Besides, the Czechs are very short of hard currency since the Soviet invasion.

Univac leads in the number of Hungarian installations but ICL has the larger dollar volume. Honeywell is making a strong bid for a share of the market after having recently sold Series 200 machines worth \$2.5 million to the Ministry for Home Trade, the Post Office, the National Bank, and the State Railway. IBM, NCR, Siemens, and Bull-GE have also sold one or more machines, which are usually in the medium-size category. Hungary would buy more Western EDP equipment if suppliers were willing to take Hungarian products in part payment, say trade officials in Budapest.

**Room to grow.** Rumania is wide-open market by Western standards with plenty of competition developing. Although ICL with six has the most installations, Univac is pushing the hardest since its exhibit in Bucharest last autumn. IBM has scored a notable sales coup; Siemens and Bull-GE are actively seeking orders. Even Japan's Nippon Electric Co. has sold equipment. Last year ICL thought it had an order for its 1904 model from the U.N.-financed management development center all but sewed up when the fickle Rumanians suddenly opted for an IBM 360/40 machine. A three-man consultant committee set up by the U.N.'s Development Program had already recommended the ICL machine. But hard selling by IBM in Bucharest changed the Rumanians' mind.

Although Eastern Europe's smallest EDP market, Bulgaria has been getting its full share of attention from Western EDP firms, probably mindful of its long-term po-

tential. ICL's handful of installations lead all Western companies. Japan's Fujitsu has also sold some Facom computers; at last report it was negotiating the sale of a license for the same model.

**Process progress.** The Eastern European market for process control computers has been slower in developing. So far most Comecon business in this type of equipment has been shared by Siemens, Elliott Automation (now a part of ICL), and Ferranti, though Honeywell has just made its first sale to Poland. Siemens foresees more sales in the process control area over the long run than in the commercial EDP area, mainly because Eastern Europe is so far behind the West in such computer applications. Furthermore, as quality requirements become more stringent in most industries and plant managers can be called to account for excessive raw materials inputs under current economic reforms, the acceptance of process control spreads.

Partially responsible for the hesitancy to computerize processes is the realization that qualified technicians to operate and maintain such systems are not around. Nonetheless a few industries in Eastern Europe are swinging over. At the head of the list are the newly built and expanded steel and chemical complexes in Rumania, Czechoslovakia, and the Soviet Union. For example, the Galatz Steel Works in Rumania now uses Siemens Systems 300 to control blast furnace operations, while Czechoslovakia's new Kosice Steel Works uses the same system for converter operations. Power stations in both countries use Siemens systems, for the control of 1,000-megawatt blocks of generation equipment. The Poles are now negotiating with Siemens for similar gear.

#### Hang-ups

U.S. EDP sales to Eastern Europe would certainly be larger than the \$15 million level they have reached if producers did not have to contend with strategic trade controls, clearly more stringent than those applied by any other NATO country. For the past 20 years, the Paris-based Coordinating Committee (Cocom) of 15 NATO countries, plus Japan, has maintained a list

of 1,300 strategic goods that cannot be exported to Communist nations. Although this list has grown shorter over the years, it still includes large third-generation machines with a capacity above that of the IBM 300/40, many types of semiconductors, certain IC technology, and other advanced electronics.

Most NATO countries maintain strict observance of the list, with the exception of France. Thus the British Government in recent years has refused permission to ICL to sell the larger 1900 Series to East Germany and the Soviet Union. English Electric has had difficulty in securing export permits for certain System 4 machines to the Soviet Union.

U.S. EDP manufacturers support their Government's position on the embargo issue to varying degrees. At IBM's annual meeting last year, company chairman Thomas J. Watson Jr. stated that IBM only sells models to Communist countries that are equivalent to what Western European competitors are permitted to sell by their governments. Control Data Corp. is typical of those U.S. companies which claim that U.S. embargo policy has closed off Comecon markets to American EDP makers, while permitting their European competitors to gain a foothold.

**Bitter experience.** CDC was asked by Czechoslovaks to supply its 3400 machine for Bratislava's Computing Research Center; it agreed to do so until Washington refused to grant the export license. The company had to persuade the Czechoslovaks to take the 300 model instead; they could have bought nearly the same thing from ICL at a lower cost. CDC officials have testified before Congressional committees investigating east-west trade policies that U.S. Dept. of Commerce officials have openly declared that U.S. policy is to withhold advanced technology—including certain types of third-generation computers—from Communist markets in order to protect the American technological lead in such equipment. Apparently military strategic considerations are only of secondary concern when it comes to the embargo provisions affecting computers.

Last May's decision by the



National Security Council to keep the Export Control Act of 1949 in force beyond its June 30, 1969 expiration date means that the U.S. embargo list of recent years should remain unchanged for the foreseeable future. The application of this embargo policy results in some 2% of all demands for export licenses for sale to Communist nations being turned down. The vast majority of U.S.-made EDP equipment, however, including nearly all peripheral gear, is unaffected by the embargo. Some U.S. companies that do find their equipment on the embargo list have found it expedient to sell equivalent models made by their Western European subsidiaries to Eastern European buyers.

### Strategy and tactics

The easiest way to sell anything in Eastern Europe is to offer to take goods in return either to the full value of the sale (rare in the EDP area) or to a minimum fixed percentage—usually 20%. NCR says that a few years ago, when it was getting a foothold in Eastern Europe, it had to take 100% of the value of its equipment in machinery, which it then had to sell elsewhere to get hard currency. To close many current deals it says that it still must take 20% to 30% of its equipment's value in Eastern European goods. Although Siemens flatly refuses any such barter for its EDP equipment, it does accept goods in exchange for conventional medical electronics, instrumentation and measurement equipment, where the competition from the West is keener.

Whether or not a Western company interested in selling to Eastern Europe is prepared to take Comecon-made goods, it can only close the deal once the particular piece of equipment has been written into the industry's annual plan. As a Siemens executive comments, "Once the computer has been specified in the plan, there is no problem in financing the deal." But getting the computer written into the plan is no easy matter. It means frequent visits to the end user, the foreign trade enterprise that will handle the deal if the end user does not have the right to engage in foreign trade (most do not), planning commission officials, the State

## WHY GAMBLE!

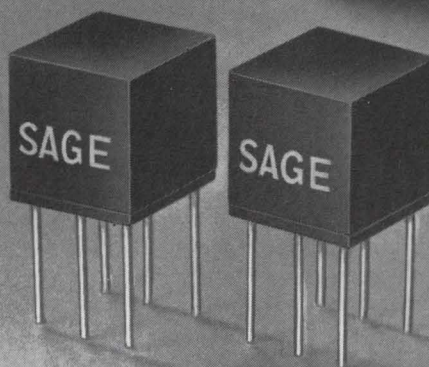

When your design calls for high reliability miniature transformers look to

## THE NEW SAGE MICROCUBE LINE

When Sage makes it, you can count on advanced design, highest quality and complete dependability. These new Microcube Miniature Transformers, featuring highly efficient laminated cores and sealed construction, are no exception. Specify Sage when you require . . .

- A MINIATURE BROADBAND AUDIO TRANSFORMER that utilizes minimum space and standard grid spacing. Sage can supply them with power ratings of up to 50 milliwatts at 1KHz; frequency response of  $\pm 2$  DB from 400 Hz to 250 KHz; 5% maximum distortion; primary impedance "Standard" to 25K ohms, "Special" to 100K ohms.
- A PLUG-IN PULSE TRANSFORMER with very fast rise times. Sage manufactures a microcube transformer with rise times to 50 nanoseconds; ET constants to 5000 volt microseconds; high pulse impedance with low droop.
- ONE SIZE PACKAGE STANDARDIZATION. Sage can provide miniature inductors in the microcube configuration featuring inductances to 50 henries, highest Q and excellent stability.

Give us the opportunity to discuss your requirements. SAGE ELECTRONICS CORP., Box 3926, Rochester, N.Y. 14610; Tel: (716) 586-8010

A Leader in Micromagnetics

# SAGE

## ELECTRONICS

SUBSIDIARY OF GULTON INDUSTRIES, INC.



# Dependable Hermetic Seals For Highly Critical Specs...

MAXIMUM RESISTANCE TO THERMAL CYCLING

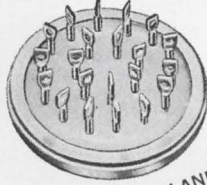

MAXIMUM RIGIDITY AND DURABILITY

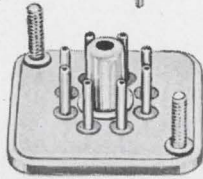
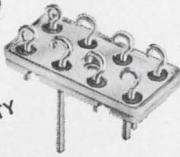

(E-I produces for aero-space!)

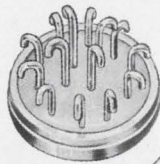

EXTREMELY HIGH DIELECTRIC STRENGTH

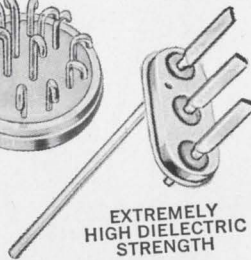

HIGH MECHANICAL SHOCK AND VIBRATION RESISTANCE



## -Must Have Continuous Quality Control Procedures Like This...

(E-I has the strictest!)

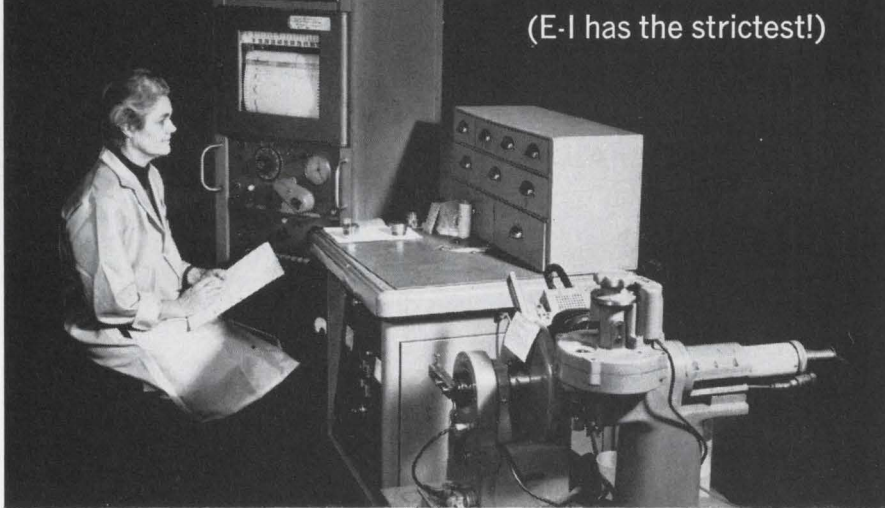

### Specify E-I Glass-to-Metal Seals for Sophisticated Applications:

Quality Control at E-I begins with the raw material and follows through to the finished product. The picture above depicts one phase of this program — X-Ray Spectrographic Analysis. The Spectrograph provides a quantitative chemical analysis of the metals, alloys and glasses which are utilized in the manufacture of Electrical Industries' glass-to-metal seals. Continued surveillance of the chemical constituents of materials is just the beginning of the E-I quality control program that assures our customers of the highest quality hermetic seals each and every time.

If you require standard or custom seals or sealing of your own components, check with E-I. Our engineers will gladly make recommendations. Illustrated technical literature is available — call or write today.

- Sealed Terminals and Multiple Headers • Transistor and Diode Bases • Compression-type Threaded End Seals
- Plug-in Connectors • Vibrator Plug-in Connectors • High Voltage Glass-bonded Ceramic Seals
- Hermetically-sealed Relay Headers • Special Application Custom Seals • Custom Sealing to Specifications



## Electrical Industries

A Division of Philips Electronics and Pharmaceutical Industries Corp.  
Murray Hill, N.J. 07974 — Tel. (201) 464-3200

Patented in U.S.A., No. 3,035,372; in Canada, No. 523,390; in United Kingdom, 734,583; other patents pending.

bank, and a long list of other bureaucracies, all of which must be somehow convinced that the seller's particular model is the best suited for the country's needs and payment capabilities.

The criteria for measuring these needs varies from one organization to another. On the top rung of the decision-making hierarchy, officials are most concerned with the increase in hard-currency earning potential afforded by the equipment. In other words, will the plant using the computer be in a position to increase the volume and/or quality of its sales to Western buyers? If so, by how much? Before the machine purchase is approved for inclusion in the plan, which automatically means that hard currency will be set aside for its purchase, the end user will have to prove to the responsible ministry that the increased exports afforded by the machine will be worth so many times the hard-currency cost of the machine over a specified number of years.

**Bedfellows.** For these and related reasons, the Western seller has to become intimately concerned with the operational problems of the end user, going so far as to assist him work up the brief that must be presented to the ministry before the purchase will be considered. At the same time, the seller will have to demonstrate that the computer is successfully solving the same kind of production problems in another country, preferably Eastern European. To instill confidence in the officials of the end-using plant and the competent ministry, the seller is advised to invite a delegation to his home office, show them his production facilities, and take them to inspect several installations similar to the one the end user wishes to buy.

Sending a delegation of Government trade officials to the Eastern European capital on a good-will mission at a strategic point during the negotiation of a large contract can produce remarkable results, as the British and French have discovered to their profit on many occasions. Top officials from Britain's Board of Trade routinely represent ICL interests on their frequent trips to Comecon-area capitals. The diplomatic pressure



brought to bear on Czechoslovak, Rumanian and Soviet trade officials by top-level French Government delegations—often headed by the Foreign Minister himself—has helped Bull-GE to clinch more than one sale, not to mention their impact on the spread of Secam color tv technology and equipment.

Sellers might also be obliged to exhibit their computer wares or peripheral equipment at the country's annual trade fair. Usually when the seller has been invited, he is fairly certain of a sale. Although his participation will cost him \$10,000 to \$15,000 for the average 10-day fair, he is fairly sure of getting the attention of visitors from neighboring Comecon countries, who carefully observe what their neighbors are interested in buying. The West must assume that some Comecon countries compare notes on the offers they receive and mutually inform one another of the state of negotiations with the same Western seller, in hopes of driving down prices.

#### Time lag

Most Western data processing companies report that they seldom make a major sale within a year after initiating negotiations. The average time can drag out to 18 months or two years, depending upon the country, the type of equipment, and the amount of barter involved.

The Japanese have probably set the example that Western companies should follow when trying to sell in Eastern Europe. Platoons of salesmen are camped at all times in the luxury hotels of most Comecon capitals; they tenaciously make their way from one office to another with their wares. The same men will stay in the same capital for years on end, interspersed by short visits home for briefing, while delegations of top-level executives from Japan periodically visit the Eastern European trade fairs and specialized exclusively Japanese exhibits staged for several weeks at a time in various Comecon capitals.

ICL's considerable early success throughout Eastern Europe can be largely attributed to this mode of operation, which the Japanese are now emulating, as are the West Germans.

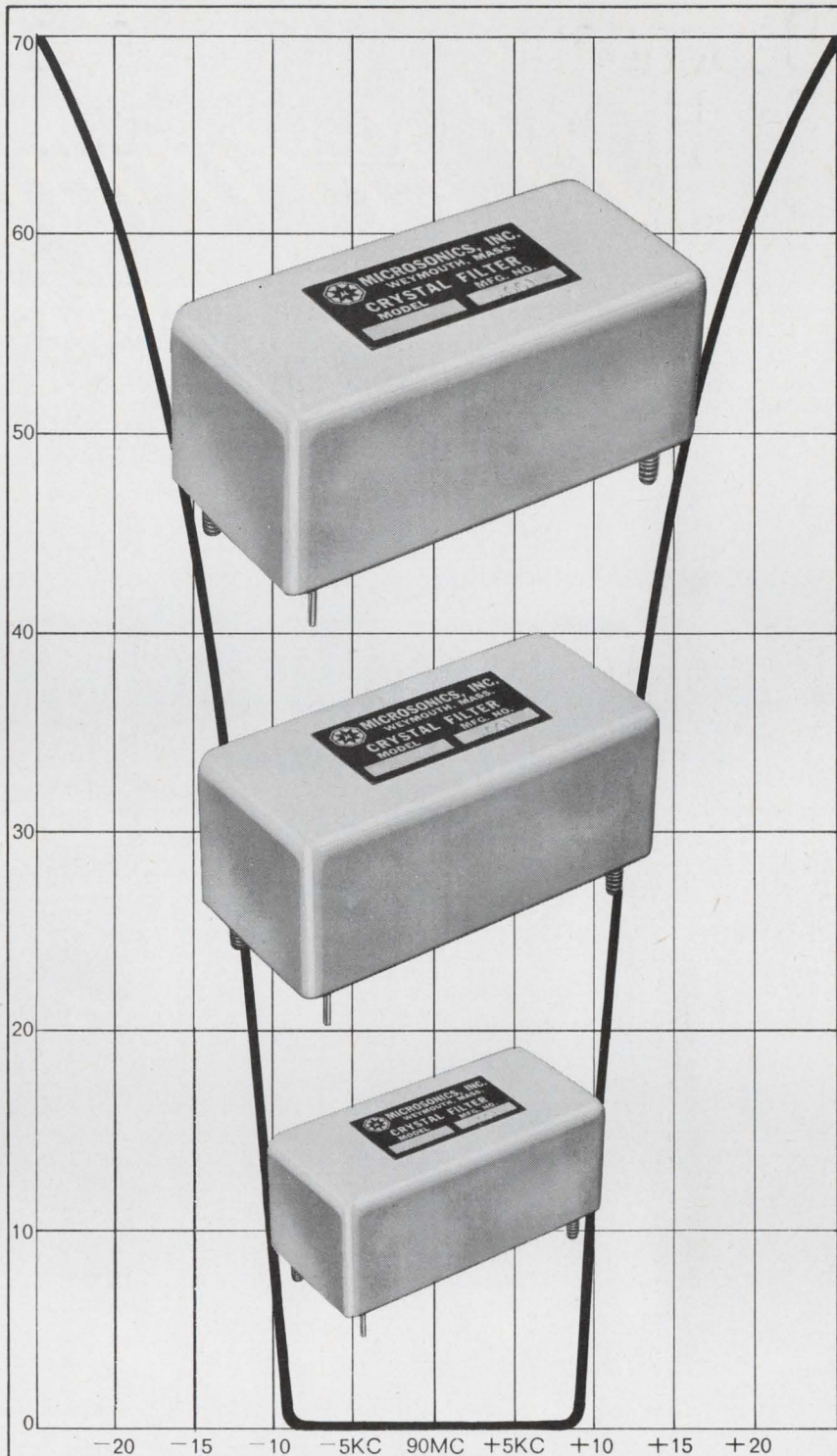

## MICROSONICS

for proven design, reliability & performance in

# CRYSTAL FILTERS



Write for Bulletins today

## MICROSONICS

60 Winter Street, Weymouth, Mass. 02188

Tel: 617 337-4200

A division of the Sangamo Electric Company



# Wirewound

## Because...



... **Because** the noise in wirewound potentiometers is low—typically 10 ohms ENR in *all* resistance ranges!

... **Because** with temperature coefficient of 50 ppm/°C or less you get exceptional stability!

... **Because** if it's power you need, wirewounds score again and surpass other elements!

... **Because** there's over 20 years of field experience with wirewounds so their reliability can be statistically verified!

... **Because** there's off-the-shelf delivery. We at Bourns stock 500,000 units at the factory while our 63 distributors stock 1,500,000 pieces. Remember . . . whether from factory or distributor stocks *you get* the potentiometers *you need* . . . *when* you need them by specifying Bourns wirewound potentiometers—the best in the industry!





# Acronyms—antic abbreviations

Specialists and laymen alike are finding it's an increasingly tricky proposition to keep track of short forms generated by the boom in science and technology

By W. Eric Aiken

Assistant managing editor

and Paul A. Dickson

Associate Editor

**This summer**, a Republican congressman took to the floor of the House, and, in all seriousness, recommended renaming the possibly apocryphal military-industrial complex. His proposal: military, university-union, science, industrial complex, which telescopes conveniently—and disarmingly—into the acronym, MUSIC. Though perhaps offbeat in the national context of student disorders, a tense racial situation, the war, and related matters, the representative's suggestion does illustrate the extent to which acronyms have entered the language.

Given the rapid expansion of science and technology, these concise and often colorful bits of verbal shorthand have proved generally useful as ready references for complex projects, products, and processes. They've probably saved miles of newsprint and months of news broadcasting time. But things have gotten out of hand. Odd-ball word assemblages, obviously selected with an eye to coming up with memorable acronyms, are being generated faster than specialists—much less laymen—can keep tabs on them. As a result, an increasing number of terms, supposedly devised as communications shortcuts, are becoming comprehension detours. Aerospace and electronics outfits, the military, and agencies at all levels of government are among the worst offenders.

Acronyms (from the Greek *akros*, meaning tip, plus *onym*, name) are formed by combining the initial letters or syllables of a string of words. Radar (Radio Detection and



**Medium rare.** It takes a special sort of pundit to guess that SWAMI is an acronym for Standing Wave Area Motion Indicator.

Ranging) and Sonar (Sound Navigation and Ranging) are familiar examples from the electronics field. A sort of instant acronym, SALT (Strategic Arms Limitation Talks), is currently making the headlines.

Acronyms have two significant offshoots—initialisms and “portmanteau words.” The former are straightforward combinations of the first letters from a series of words; NASA (National Aeronautics and Space Administration) and NTDS (Naval Tactical Data System) provide cases in point. Lewis Carroll is responsible for portmanteau words. Humpty Dumpty came up with the term to explain “slithy” (lithe and slimy) in the poem about the Jabberwocky. Portmanteaus are blends of two or more words in which the roots are generally rec-

ognizable. The Navy is particularly fond of them as grotesqueries like BuWeaps (Bureau of Naval Weapons) and NAVFORKOR (Naval Forces, Korea) attest. Transceiver (Transmitter/Receiver) and Fortran (Formula Translation) are examples from the workaday world of electronics.

**Points of origin.** “Probably the most interesting development in our changing language has been the vast current popularity of acronyms,” says the distinguished lexicographer William Morris, editor in chief of the American Heritage Dictionary of the American Language, which will be published this month. He reports scholars claim to have located examples of acronyms in ancient Hebrew scriptures. But their appearance in pro-





**Bum steer.** The second-generation acronym, BEEF (Business and Engineering Enriched Fortran), is a laughing stock outside the data processing field.

fusion dates from World War I, when such terms as ANZAC (Australian-New Zealand Army Corps) and WAAC (Women's Army Auxiliary Corps) were coined.

During the 1920's, the Russians produced short forms like GOSPLAN (Gosudarstvenny Plan), a state commission responsible for drafting economic programs, and AMTORG (Amerikanskaya Torgovlya), a Soviet trading concern founded to traffic in commodities between the U.S. and USSR.

"Acronyms didn't really catch on in America until Roosevelt's New Deal and World War II," says Morris. "I'd guess the custom of referring to the alphabet agencies such as WPA (Works Progress Administration) and NLRB (National Labor Relations Board) accelerated the trend toward naming organizations and offices with pronounceable combinations of letters."

**Language barrier.** For all their popularity, acronyms are little more than gibberish to many people. A recent study indicates that the average reader fails to understand one-third of the acronyms used in newspaper headlines. Another survey, made by the University of Florida's Journalism Department, concludes most people forget acronyms almost as soon as they encounter them.

The acronym explosion has, however, proved a business boon to some. Among the beneficiaries is the Gale Research Co. of Detroit, which compiles and publishes the

Acronyms and Initialisms Dictionary (AID). The first edition came out in 1961 with 12,000 entries. The second in 1965 had 45,000. Ellen Crowley, assistant editor, reports that a 13,500-word supplement was issued last September. She and her staff are now working on a second supplement with 13,500 new acronyms and initialisms.

On a smaller scale, public relations department at aerospace and electronics concerns have put out handy glossaries of space-age abbreviations. The Raytheon Co., for instance, published a booklet called ABRACADABRA (Abbreviations and Related Acronyms Associated with Defense, Astronautics, Business, and Radio-electronics) with 400 entries during the early 1960's. In 1963, a second edition with 900 of what the firm describes as ABRACADDENDA appeared. General Dynamics in 1966 distributed an 80-page Dictionary of Acronyms and Project Names.

Of late, however, there's been a notable lack of corporate activity in this area, probably because simply keeping track is a full-time job for professionals. Acronyms, it seems, are into a second and even third generation. A working definition of the former might be an acronym within an acronym. BEEF (Business and Engineering Enriched Fortran) is an example, as is SATIN, for SAGE (Semiautomatic Ground Environment) Air Traffic Integration.

Third-generation acronyms have

two or more internal acronyms. Among the qualifiers: ALTAIR, for ARPA (Advanced Research Projects Agency) Long-Range Tracking and Instrumentation Radar. Another somewhat grisly case in point is a perfectly peaceful Army project with the unfortunate designation of NAPALM, for National ADP (Automatic Data Processing) Program for AMC (Army Materiel Command) Logistics Management.

### Good for laughs

The time and effort expended in dreaming up snappy acronyms is incalculable; the wonder is that the results are so often ludicrous. An IBM source confides his company will invest literally hours in naming a single project. Having stung itself more than once, the colossus of the computer world is apparently inclined to be supercautious these days. The first cut on what is now the DACOR (Data Correction) System was FECEC (Forward Error-Control Electronics System).

This sort of SNAFU (Situation Normal, All Fouled Up) is also common at the Federal level. A preliminary name proposal for the National Data Center was Federal Information Bank (FIB). The words "Housing and" were hastily added to the Department of Urban Development to save it from the ignominious title of DUD. And a West Coast outfit, which shall be

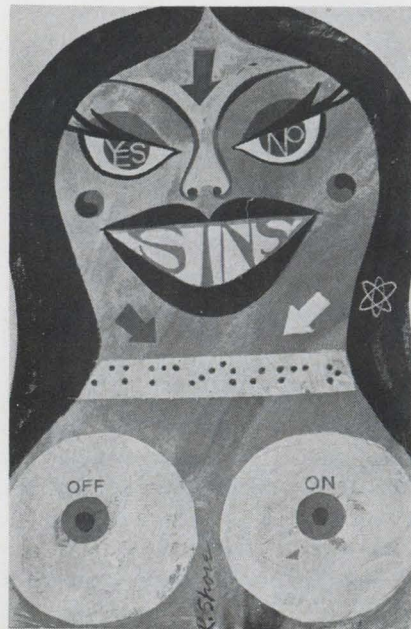

**Culpable.** The Navy's SINS are only Ships Inertial Navigation Systems.



nameless, belatedly rechristened its Light Sensing Devices division to avoid running an LSD operation.

A number of technologists and bureaucrats are content to let the verbal chips fall where they may. The project manager for a new Navy computer system is under some pressure from his superiors to come up with something catchier than AADC (for Advanced Avionics Digital Computer). He's standing pat, however, on the grounds that close congressional scrutiny has made flashy acronyms a liability.

**In a fog.** He's perhaps mindful as well of the plight of an industry colleague, which a source in the Navy Electronics Command recalls. It seems the man was shepherding a radar project into the funding stage. He was persuaded that he needed an acronym to put a final touch on his work. The poor soul wound up gratefully accepting a string of words that worked out to MIASMA—a designation sufficiently offensive to higher-ups for his proposal to be returned.

NASA also has an apparent genius for this sort of thing. But for good or ill, the agency generally brazens things out. The Goddard Space Flight Center, for example, has a Manpower Utilization Department that straight-faced staffers refer to as MUD. Goddard did back away from GIRLS (Global Interrogation, Recording, and Location System), dropping the first word. "Since the system works with oceanographic buoys, we were afraid editors would take all sorts of liberties with the combination," explains a spokesman. The switch to IRLS, however, didn't come in time to avoid having to scratch the name plates that had been ordered.

**Hindmost.** Francis J. Sullivan, director of electronics and control at NASA, is increasingly bemused by the proliferation of acronyms and initialisms in his own field. During a recent interview on the aeronautical services satellite—a project still in search of an acronym—he confessed he couldn't recall the designation of a group that had made a key decision concerning this program at a recent meeting. He made several calls during the course of which such terms as ICAO (International Civil Air Organization) and IATA (International Air Transport Association) were ban-

**NEW**

## BUY YOUR EMI FILTERS DIRECT FROM THIS FILTER GUIDE!

✓ SPECTRUM OFFERS 30 dB WHERE FORMERLY YOU COULD BUY ONLY 5 dB

✓ ALL QUALITY FILTERS... REALISTICALLY PRICED

✓ SPECTRUM FILTERS ARE AVAILABLE FOR IMMEDIATE DELIVERY

CURRENT RATING (AMPS)	VOLTAGE RATING @ 125°C	INSERTION LOSS			PARTS SHOWN ACTUAL SIZE	SPECTRUM PART NO. (USE WHEN ORDERING)	PRICE* 1-49 (EACH)
		30kHz	1MHz	10MHz			
NEW 10	100	-	-	5	42	51-712-001	2.90
						51-712-003	5.60
						51-714-004	1.60
						51-714-007	4.90
NEW 10	200	-	-	5	45	51-719-001	2.40
NEW 10	100	-	12	30	50	51-717-001	7.25
						51-343-003	8.65
NEW 10	500	-	-	5	45	51-301-030	12.80
						51-702-003	1.32
25	50	20	60	70	70	51-715-001	2.50
25	500	-	-	10	55		
25	750	-	-	10	50		

DOUBLE VOLTAGE RATING @ 85°C.

SEND ORDER DIRECT TO OUR FAIRVIEW PLANT...

OR CALL JOHN LANE

814/474-5593

QUANTITY PRICE BREAKS QUOTED ON REQUEST

\*PRICES INCLUDE ALL HARDWARE

**SPECTRUM CONTROL INC.**

152 EAST MAIN ST. • FAIRVIEW, PENNSYLVANIA 16415



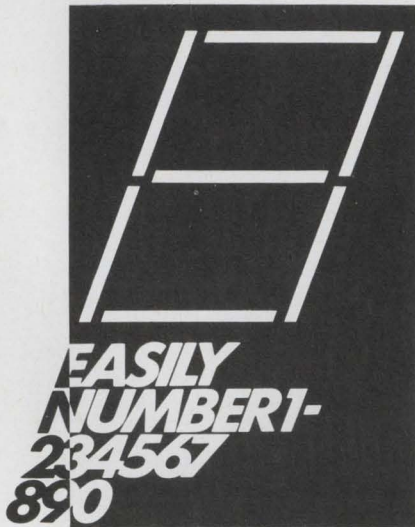

The EDP Modular Numeric Readout, Series 100: Easy to see. Easy in price! Competitive with neon glow readouts. Modularized, high quality construction. A long life of 150,000 hours. Viewing angle? Up to 170°. You choose the options, including color lens variations.

The Series 100 seven segments character forms numerals 0 thru 9. All modules available with decoder / driver. The size (1.3" deep) is as small as the price! We did mention that, didn't we? Easy to see why you should be interested. Easy to tell you more. Or show you!

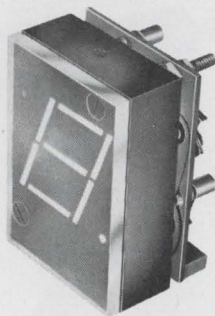

**edp** EDP CORPORATION  
1900 NORTH MILLS AVENUE  
ORLANDO, FLORIDA 32803

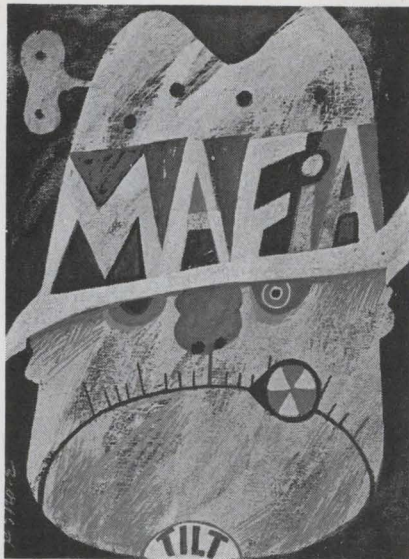

**Mob scene.** MAFIA, a sort of fractured acronym is Navy shorthand for Microaerofluometer.

died about as possibilities.

At length, an aide arrived to tell him the group in question was ASTRA (Application of Space Techniques Relating to Aviation), an ICAO arm. "There are so many acronyms around, I hit at least one a day that I don't know or can't remember," said Sullivan.

#### Circumlocutions

Sullivan may be comparatively well off in this respect. At the annual briefing for industry, held by the Federal Aviation Administration (FAA) this June, one speaker, discussing a computer scheme, kept referring to DICE. This produced a lot of back-and-forth whispering among the thoroughly confused audience. The speaker finally sensed the problem, and explained the term stood for Direct Course Error, conceding it was a neologism of his own devising.

Another would-be explicator, Gen. James Ferguson, who heads the Air Force Systems Command, took communications techniques as his subject for a speech to the Armed Forces Management Association (AFMA) this spring. "... I personally have had to sit through too many briefings that went overtime and befogged me with acronyms and technical jargon to an extent that nearly obliterated both the problem and the solution," he said. The general's points were well taken. Later on, he served up the following mouthful: "Incidentally,

ARDC became AFSC, adding AMC's procurement responsibilities to the R&D phase of development." (Probable translation: The Air Research and Development Command became the Air Force Systems Command, adding Air Materiel Command procurement responsibilities to the research and development phase of development.)

**Insider's newsletter.** Expository writing likewise offers good opportunities for trotting out acronyms—obscure and otherwise. The following is from an issue of Skywriter, North American Rockwell Corp.'s house organ: "Examples of the functional planning and control systems in COMPASS are the BEACON system used by Research and Engineering, the SCAN system used by Manufacturing, Quality, and Reliability, the POISE system used by Material, and several product-control systems used by Logistics and Support." Nowhere in the story is there any explanation of these four acronyms.

Other confusion factors abound. The Massachusetts Institute of Technology's Project MAC, for example. MAC is a double-barrelled acronym, standing for Machine-Aided Cognition and Multiple-Access Computer. The six-year-old program—an experimental investigation of new ways to apply on-line machines—has generated a fair number of acronyms during its existence, including: ADEPT; SIR; SET; SARGE; SIMPLE; LOTUS; DISH-

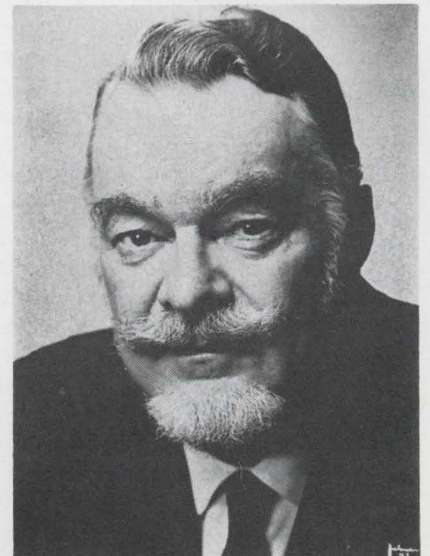

**Bearded sage.** William Morris, editor of the American Heritage Dictionary, notes acronyms didn't become really popular until the Second World War.



PAN; CARPS; MAD; and SCAD.

But MAC is a comparative piker when it comes to multimeanings. Knowledge of one particular translation of an acronym is no guarantee against befuddlement. Most informed readers would, for example, judge AID to be the State Department's Agency for International Development. It ain't necessarily so. In a medical context, this versatile term can be Artificial Insemination by Donor; in all, it has at least 10 meanings. Likewise the familiar EIA doesn't have to stand for Electronics Industries Association; it can also mean Envelope Institute of America and Equipment Interchange Commission. AMC has 25 or more equivalents, and AMA over 20. Gale Research's first supplement, which repeats nothing from the second edition of AID, has six entries for ACE, nine for FAST, seven for CAP, nine for SOS, three for CORAL, and so on.

Exemplars in the look-alike category are NOA and NOAA, the National Oceanic Association and National Oceanic and Atmospheric Agency, respectively. In the newsletter, Oceanology, these two terms can lead to headlines like this: "NOA Adopts Resolution Endorsing NOAA Plan."

**Golden Greeks.** Acronym fanciers can, if they so choose, categorize their favorites. There are enough of what might be called classic cases to populate a fair-sized history. The cast of characters could include such luminaries as: SOCRATES (System for Organizing Content to Review and Teach Educational Subjects); ARISTOTLE (Annual Review and Information Symposium on the Technology of Training); PLATO (Programed Logic for Automated Learning Operation); AESOP (Artificial Earth Satellite Observation Program); CASSANDRA (Chromatogram Automatic Soaking, Scanning, and Digital Recording Apparatus); ADONIS (Automatic Digital On-Line Instrument System); and MIDAS (Missile Defense Alarm System).

Animal lovers have plenty of PETS (Pacific Electronics Trade Show) in the acronym kingdom. The space agency's menagerie alone includes: MOOSE (Man out of Space Easiest); MOUSE (Minimum Orbital Unmanned Satellite of Earth); POSSUM (Polar Orbiting

# Add hard copy printout to your Wang electronic calculator



Column Printer

## Now you can have both instantaneous display and a permanent record.

The new Model 301 Column Printer plugs into any Wang 200/300 series electronic calculator to give you a convenient and low cost means of validating input and permanently recording output.

The 301 utilizes a highly reliable computer line-printer concept to produce clear and accurate numerical records at 3 lines/second on conventional roll paper.

The unit retains the floating decimal feature of the Wang Calculator, but positions it in the center of the printout with a possible total of 9 digits to the left and 10 digits to the right. An automatic or manual mode switch gives you a choice of printout for all or only specific calculations and input values.

The Model 301 printer is a fitting companion for your Wang calculator. If you're interested in bringing them together, call your nearest Wang office.



Dept. 9H, 836 North St., Tewksbury, Massachusetts 01876 • Tel. 617 851-7311

Call today!	(216) 333-6611	(314) 727-0256	(504) 729-6858	(614) 488-9753	(716) 381-5440
(201) 272-7160	(301) 588-3711	(315) 463-9770	(505) 255-5775	(615) 523-8648	(717) 236-4782
(203) 288-8481	(301) 821-8212	(317) 631-0909	(512) 454-4324	(615) 889-1408	(801) 487-2551
(205) 881-5360	(303) 364-7361	(404) 633-6327	(513) 531-2729	(615) 266-5055	(805) 962-6112
(206) 525-2000	(304) 344-9431	(405) 524-4489	(515) 288-5991	(616) 454-4212	(808) 536-5359
(212) 682-5921	(305) 563-8458	(412) 366-1906	(516) 437-2500	(617) 542-7160	(813) 872-7347
(213) 776-2985	(305) 841-3691	(414) 442-0160	(517) 835-7300	(702) 322-4692	(816) 444-8388
(214) 361-7156	(309) 674-8931	(415) 692-0584	(518) 463-8877	(703) 595-6777	(915) 565-9927
(214) 759-5950	(312) 297-4323		(601) 875-5588	(703) 359-6320	(915) 683-3304
(215) 642-4321	(313) 352-2144	(502) 426-1116	(608) 255-4411	(713) 666-2451	(918) 747-0018
			(612) 881-5324	(714) 276-8464	(919) 272-5683



# IRRAVIN<sup>TM</sup>

INSULATED WIRE

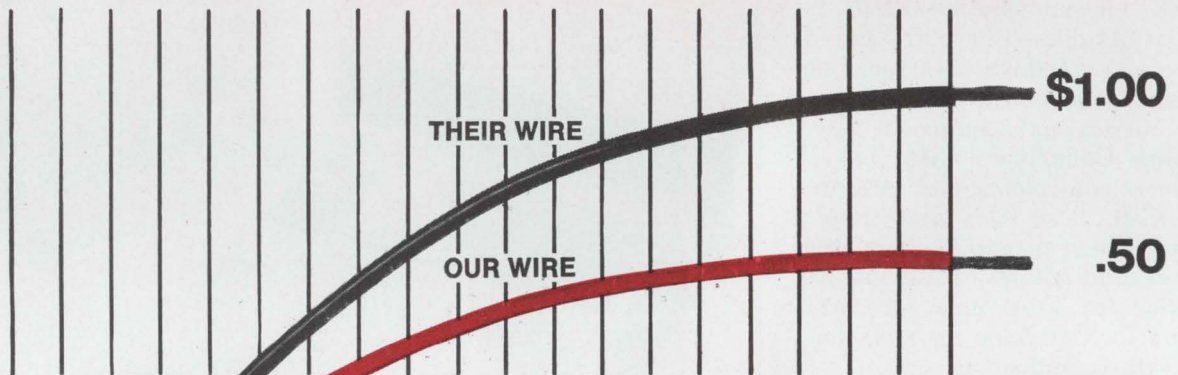

## Cuts cost of solder-iron resistant wire by 50%.

IRRAVIN insulated hook-up wire resists hot solder iron damage and high ambient heat. Yet, it sells for less than half of the other leading high temperature wires. You cut costs without cutting corners.

And that's only part of the savings possible. You also get longer lengths for faster production with less scrap (up to 50,000 ft. of continuous lengths available), lower inventory costs (IRRAVIN hook-up wire is a universal wire—easily replaces a host of other "specials").

So, you see using IRRAVIN wire is like getting half your order free!

IRRAVIN wire is not a cheap wire—just costs you less. What's more, IRRAVIN wire is great on crush, cut through and abrasion resistance, no need of outer jacketing. It is U.L. Listed and conforms to MIL-W-16878.

Want a sample for comparison? Write: ITT Wire and Cable Division, Surprenant Products, International Telephone and Telegraph Corporation, Pawtucket, Rhode Island 02862. In Europe: ITT Europe-Components Group, Lister Road, Basingstoke Hants, England, United Kingdom.

**IRRAVIN**—the wire that stops the grumbles.



Have a good application?  
Enter our Pot-O-Gold Contest.

Write for your  
entry form today.

WIRE AND CABLE **ITT**



Satellite System); and the beloved cartoon character POGO (Polar Orbit Geophysical Observatory). Elsewhere, there are: ZEBRA (Zero Energy Breeder Reactor Assembly); BAMBI (Ballistic Antiballistic Missile Boost Intercept); FLEA (Flux Logic Element Array); RATS (Radio Altimeter Target Simulator); and CATS (Centralized Automatic Test System).

Girl-watching is also a possible pastime for acromaniacs; they can ogle such DOLLS (Delayed Opening Leaflet System) and MAIDS (Multi-purpose Automatic Inspection and Diagnostic System) as: ROSE (Rising Observational Sounding Equipment); ROSIE (Reconnaissance by Orbiting Ship Identification Equipment); SADIE (Scanning Analog-to-Digital Input Equipment or Secure Automatic Data Information Exchange); and DIANE (Digital Integrated Attack and Navigation Equipment).

The lay civilian sector has caught on, but probably not up, in the name game. A number of CIVACS (Civilian Acronyms) have even superseded their origins, entering the language as full-fledged words or trade names. It's doubtful, for example, that many people remember CARE stands for Cooperative for American Remittances to Everywhere. Motel (Motor Hotel), Nabisco (National Biscuit Co.), Alcoa (Aluminum Co. of America), Scuba (Self-Contained Underwater Breathing Apparatus), Smog (Smoke and Fog), Core (Congress of Racial Equality, and Socony (Standard Oil Co. of New York) are among the other success stories.

Along similar lines, civic action groups and other organizations have demonstrated a knack for conscious or unconscious puns. How else is one to view MUDPIE (Museum and University Data Processing Information Exchange)? And an aroused group in Santa Barbara, Calif., has christened itself GOO, for Get Oil Out. Another movement, gathering steam these days, is PAUSE (People Against Unconstitutional Sex Education); perhaps they'll work something out with the MOMS (Mothers for Moral Stability). Then again, tomorrow may just belong to a recently formed group calling itself A Contrived Reduction of Nomenclature Yielding Mnemonics—ACRONYM.

# IT'S LOGICAL!

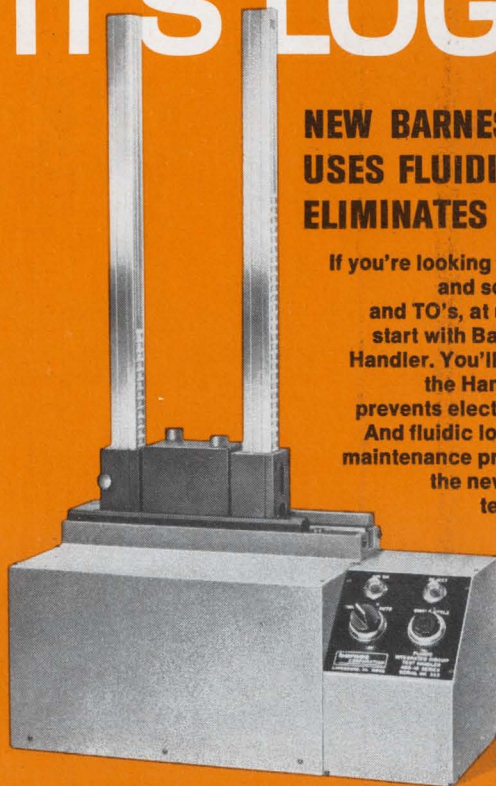

## NEW BARNES IC TEST HANDLER USES FLUIDIC LOGIC CONTROL... ELIMINATES ELECTRICAL NOISE!

If you're looking for fast, interchangeable testing and sorting of flat-packs, dual-in-lines and TO's, at up to 4800 cycles an hour, better start with Barnes new Fluidic Automatic Test Handler. You'll get error-free test results, since the Handler's fully pneumatic operation prevents electrical noise and spurious signals. And fluidic logic virtually eliminates wear and maintenance problems. Used with any IC tester, the new Handler is ideal for production testing or QC inspection. Two and four-sort categories are available, with manual, magazine or vibratory bowl loading. Write for data.

**barnes**  
CORPORATION

Lansdowne, Pa. 19050 • 215/MA2-1525

**barnes** / THE WORLD'S MOST COMPLETE LINE OF SOCKETS, CARRIERS AND CONTACTORS FOR I.C.'S

Circle 167 on reader service card

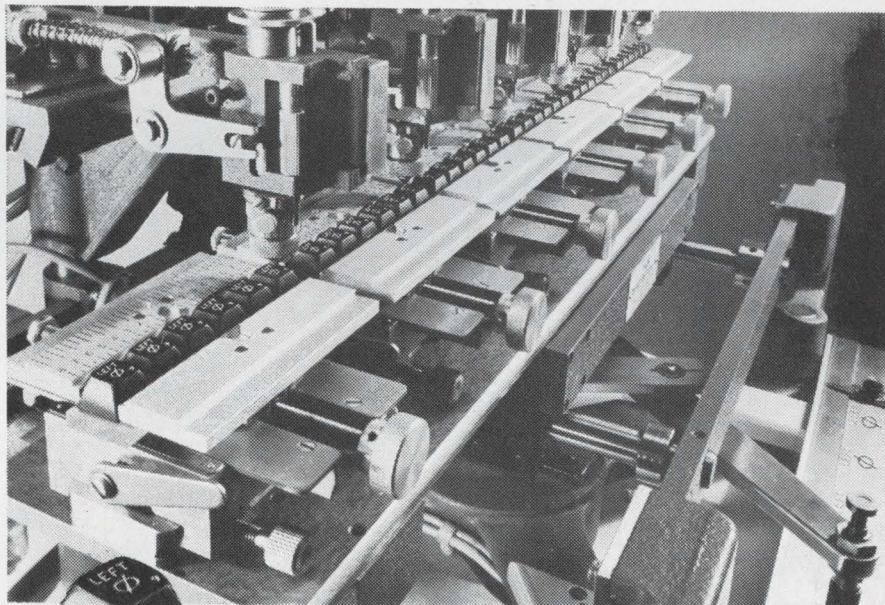

## 6 will get you 36

Now, new 6-spindle New Hermes engraves up to 36 machine keys with one set-up.

Any unskilled worker simply guides the pantographic tracer on this pneumatically-operated engraving

machine. Each spindle has an automatic depth-regulator, guaranteeing uniform depth and width of engraving over the complete contour of the key.

Write for detailed brochure No. 197.

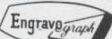
*new hermes engraving machine corp.* 

20 Cooper Square, New York, N. Y. 10003  
Chicago, Atlanta, Los Angeles, Dallas, Montreal, Toronto, Mexico City

Circle 117 on reader service card

117



# Low Cost AC Calibrator

Don't let the low cost of \$975 fool you. The AC Calibrator HP Model 6921A provides you with a constant voltage or a constant current output. Select from .1 to 280 V rms in 4 ranges or .1 mA to 5A in 5 ranges, all with an accuracy of .25% under load conditions. Power is another plus feature; you get up to 28 watts output. Standard output frequencies of 60Hz, 400Hz or 1kHz are provided, with 50Hz available as an option. Proven applications for the Model 6921A AC Calibrator include calibration of ac meters and ac devices. The relatively high output power of 28 watts and the ability of the calibrator to operate into reactive loads, makes it particularly suitable for calibrating large, moving-vane meters and for multi-unit calibration of meters on the production line.

For complete specifications on the 6921A and other HP meter calibrators, write for our new file folder, or contact your local HP Sales Office. Hewlett Packard, New Jersey Division, Green Pond Road, Rockaway, New Jersey 07866. In Europe: 1217 Meyrin-Geneva.

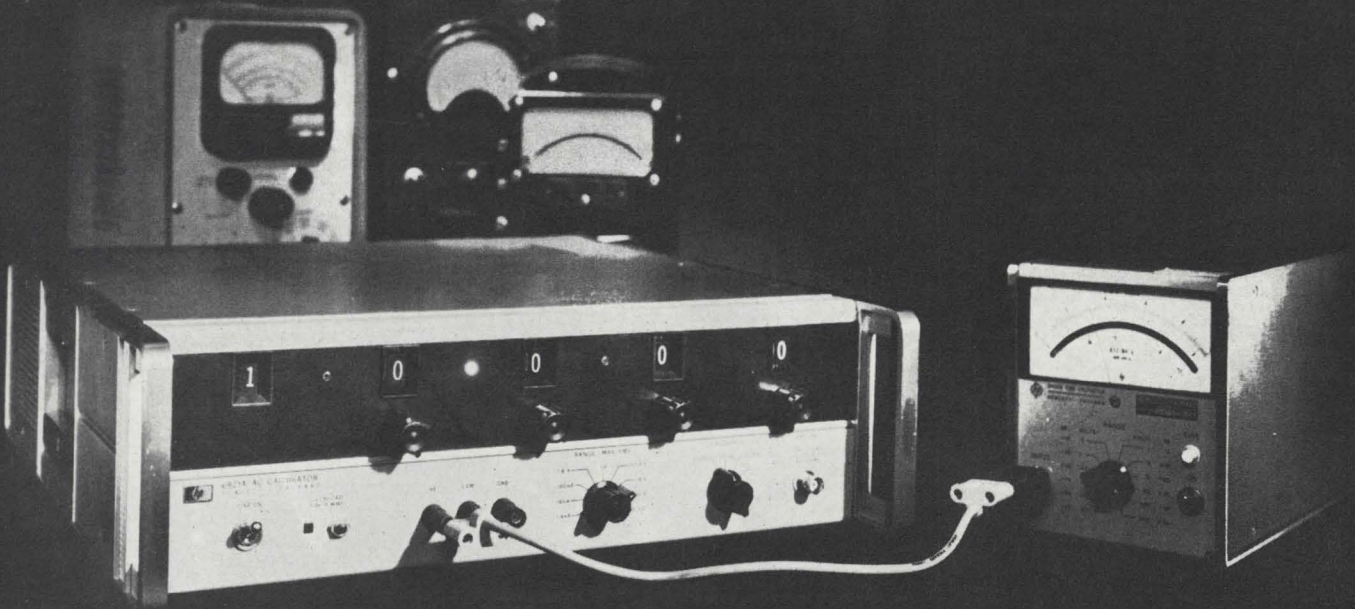

HEWLETT  PACKARD  
WORKING STANDARDS

*Literature Available Upon Request*



AC CALIBRATOR  
MODEL 745A  
Programmable  
Signal Generator

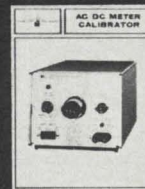

AC/DC METER  
CALIBRATOR  
Model 6920B  
Four Calibrators  
In One Case



# Supernova is order of magnitude faster than its parent; fits in same size box

Invention is the mother of necessity; the Nova, first third-generation small computer, begets the Supernova, by extending basic design concepts

**Two-score** and seven weeks ago the Data General Corp. brought forth upon this continent a new notion, conceived in architecture and dedicated to the proposition that small computers can be third-generation—especially when medium-scale integrated circuits are available in large quantities.

Now the same design approach, using improved MSI circuits that have become available, has produced a new small computer capable of five to 15 times the speed of its parent, selling for only about 50% more, and fitting in the same size box—either desk-top or rack-mounted versions.

The new machine, called the Supernova, is aimed at that segment of the market where the Nova or any minicomputer is used now at or near 100% of its capacity. For example, if a Nova is capable of regulating the roll spacing in a steel rolling mill, the Supernova can do it more accurately and carry on some additional computations besides. Or in a data-communication application, pre-processing messages arriving on a telephone line, where the Nova can handle perhaps 10 lines one at a time and must occasionally pass on some of its work to a larger central computer, the Supernova can easily keep up with as many as 30 incoming lines simultaneously. Data General figures that perhaps a third of the minicomputer market could use a machine with this capability.

Like the earlier machine, which remains on the market, the Supernova is designed around an architectural plan which uses multiple accumulators and a read-only mem-

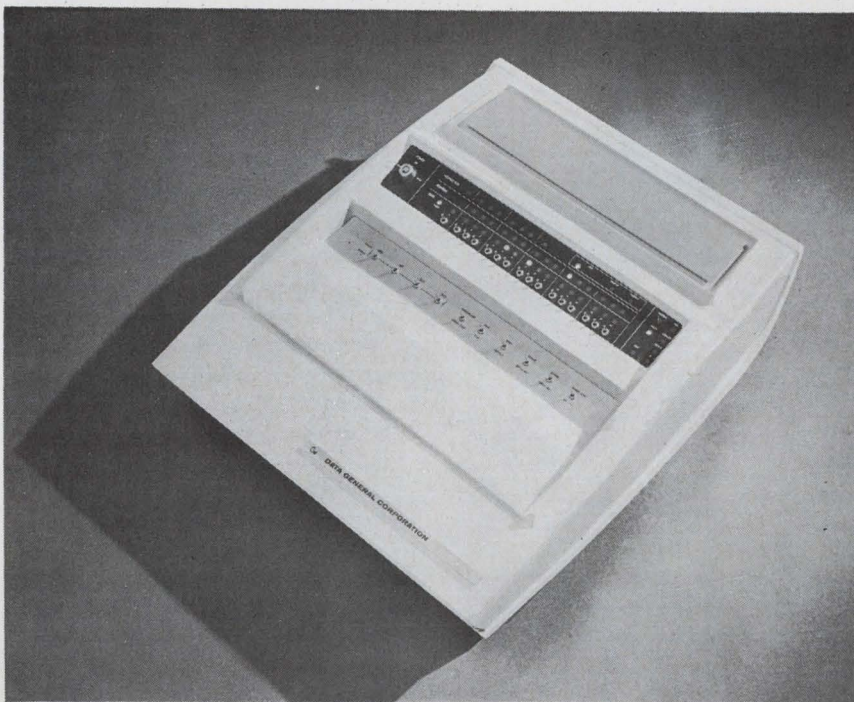

**Expanding star.** Although the Supernova uses the same outside design and layout as the year-old Nova, it can operate at 5 to 15 times the speed.

ory that's homogeneous with the main memory. The homogeneity means that a program used over and over without reloading—in the classic minicomputer application—can be thoroughly debugged in main read-write memory, then committed to a read-only memory module that replaces a module of main memory; once wired into read-only form, it's immune to any new bugs that don't involve physical damage. A customer sends a roll of paper tape containing debugged programs to Data General, which builds a custom ROM containing that program.

**New target.** The Nova [*Electronics*, Sept. 30, 1968, p. 147; Dec.

9, 1968, p. 76] was designed to be as small as possible and to sell for the lowest possible price, and speed was sacrificed to attain these objectives. In the Supernova, speed was a prime objective, together with upward compatibility with the Nova.

To attain the speed, the Supernova operates in fully parallel fashion on its 16-bit words—all 16 bits at once in a single 300-nanosecond machine cycle. In the Nova the word is divided into four 4-bit "nibbles" that require four 400-nsec cycles to process.

Furthermore, the Supernova can fetch a new instruction from the memory and decode it while the



# New Concept AC Regulator Outperforms them all!

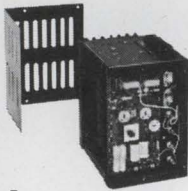

## Compare!

	ERA SOLID STATE MODELS	CONVENTIONAL MAGNETIC TYPES
Small Size	Yes	No
Light Weight	Yes	No
Wide Freq. Range	Yes	No
Tight Regulation	Yes	No
Fast Transient Response	Yes	No
Silent Operation	Yes	No
Fully Repairable	Yes	No
Stable with Temperature	Yes	No
High Efficiency	Yes	No
Wide Temp. Range	Yes	No
High Surge Rating	Yes	No
Minimum RFI	Yes	No
Series Operation	Yes	No
Remote Sensing	Yes	No
Sinusoidal Output	Yes	Special Order

## SPECIFICATIONS

Input: 105-130 VAC, 47-440cps  
 Output: 115 VAC nom (See table for power rating)  
 Line Regulation: Within  $\pm 0.1\%$  for full input change.  
 Load Regulation: Within 0.2% for full load change  
 Frequency Regulation: Less than 0.002% per cycle  
 Wave Form Distortion: Less than 5%  
 Load Power Factor Range:  $+0.7$  PF through  $-0.7$  PF  
 Response Time: Less than 16 millisecc  
 Operating Temperature:  $-20^{\circ}\text{C}$  to  $+71^{\circ}$  free air

## STANDARD MODELS

Power Rating	Size (Inches)	Weight	Model	Price*
250 VA	$6\frac{1}{8} \times 7\frac{1}{4} \times 4\frac{7}{8}$	13 lbs.	RT250	\$130
500 VA	$6\frac{7}{8} \times 8\frac{7}{8} \times 7\frac{1}{2}$	16 lbs.	RT500	\$175
1000 VA	$7\frac{1}{16} \times 9\frac{1}{16} \times 7\frac{5}{8}$	22 lbs.	RT1000	\$235

\*Liberal Discounts for Larger Quantities



Send for full technical data.

**ELECTRONIC RESEARCH  
ASSOCIATES, INC.**

67 Sand Park Road, Cedar Grove, N. J. 07009

previous instruction is still being executed. This takes advantage of the read-only memory's intrinsically nondestructive readout; the computer can begin fetching a new instruction immediately after delivering the previous one to the execution hardware, without waiting to regenerate the previous one.

The degree of speed improvement is illustrated by comparing the execution times of typical instructions in the two machines. One of the most common instructions is ADD, which takes 5.9 microseconds in the Nova and only  $0.8 \mu\text{sec}$  in the Supernova— $0.3$  in the Supernova when the instruction comes from the read-only memory. A less common instruction that doesn't benefit as much from the Supernova's speed because of its built-in complexity is the JUMP TO SUBROUTINE instruction. In the Nova this took  $3.5 \mu\text{sec}$ ; in the Supernova it's down to  $1.4 \mu\text{sec}$ , and with a read-only memory it is  $1.2 \mu\text{sec}$ .

**By the rule.** To achieve these speed improvements, the Supernova operates under a basic rule: to execute every basic arithmetic instruction in exactly one machine cycle. This rule doesn't apply to more complex operations, such as multiplication, which by their nature require repeated operations on a given number. But it's a rule that up to now has usually been implemented only in much larger computers.

To make it possible, the Supernova doesn't scrimp on hardware. For example, where the Nova processed four bits at a time, the Supernova processes 16; where the Nova had to fetch and decode an instruction and then execute it, the Supernova can do both at once.

In both the Nova and the Supernova the number of control steps and the amount of control logic is minimized by making each instruction quite powerful. For example, a single instruction can contain add, shift and skip conditions, so that the machine can add two numbers, shift the result left or right one bit position, and skip to a new instruction other than the normal one next to it in the program—all in a single cycle. But the Supernova contains a substantially larger instruction set than the Nova, and therefore requires more control

logic. To keep this logic from slowing down the Supernova, most control steps are executed through no more than two logic stages, an approach which requires a substantial amount of redundant logic be built into the computer.

A design feature that is very important in attaining the high speed is the clock-pulse distribution scheme, which uses a single source for pulses that control the entire machine. There are no gates in any of the clock lines to slow down the clock pulses, and the lines themselves are built like microwave transmission lines: ground and signal lines alternate on both sides of a printed-circuit board in such a way that a signal line on one side is opposite a ground line on the other side. Thus each signal line is surrounded by three ground lines, effectively shielding the signal line from outside interference and providing a waveguide-like path from the source to the load.

All the extra hardware is packaged onto three 15-inch square printed-circuit boards, as compared with two in the Nova; much of the circuitry is in large 24-pin dual-in-line packages. The memory's cycle time is  $800 \text{ nsec}$ , compared with the Nova's  $2.6 \mu\text{sec}$ ; but as in the Nova, the 4,096-word memory is completely packaged on another 15-inch board and the ROM on still another. Other boards contain control logic for peripheral devices; these are wired in such a way that any of them and either of the memory boards can be plugged into any of the remaining slots in the back panel. There are a total of seven slots; three of these are for the processor and two for the memories, leaving two for peripheral equipment.

In this respect the Supernova must defer to the Nova, because the Nova has three slots available for peripherals. But that's not really a disadvantage for the Supernova; Data General figures most installations of the new machine will have more peripheral equipment that requires socket space outside the basic machine than the typical Nova installation has.

The Supernova's price, not yet firmly established, will be less than \$12,000.

Data General Corp., Southboro, Mass. 01772 [338]



New instruments

## Signal generator for all

Instrument with range of 7.75 to 512 Mhz has a-m, f-m and pulse-modulation capabilities



Inside or outside. The generator's built-in counter shows either the output's frequency or the frequency of some external signal.

Antique shops haven't started displaying signal generators out in the front windows alongside the Tiffany lamps and the buggy whips, but they might as well, say some engineers at the Singer Company's Instrumentation division. According to these men, most signal generators around today belong in another era. "Until the SG-1000 came along, there hadn't been a significant advance in this field in years," says Julian Hirsch, the division's senior applications engineer.

The SG-1000 is, of course, Singer's new signal generator. Its main virtues, says Hirsch, are excellent specifications, extensive modulation capabilities, and a \$3,800 price.

Hirsch and Robert Bickley, the engineer who designed the 1000, like to point out a number of things they feel are wrong with competitive signal generators. First, they say, most generators use switched LC circuits for frequency control, and are therefore limited in their frequency range. The 1000 devel-

ops its basic frequency band, which is 248 to 512 megahertz, with a cavity-tuned solid state oscillator; a five-stage binary divider develops the submultiples from the basic band. Therefore, the 1000 has a range of 7.75 to 512 Mhz, split into six octave bands. An optional plug-in takes the range down to 61 kilohertz and another option, a doubler which plugs into the 1000's output boosts the range to 1.024 Ghz.

Another problem with most signal generators, says Bickley, is that their output frequency rarely can be set with any accuracy better than 1% because that's about as close as their tuning dials can be set. If the user wants to set the frequency more precisely, he has to hook up a counter. However, the 1000 has its own counter to display the instrument's output frequency, and therefore the frequency can be set to within 0.001% to 0.008% of a desired value.

The counter can also measure the frequency of an external signal over

# Reliability

EXCEEDS 100 MILLION CYCLES

# Simplicity

EASY TO USE

# Performance

VALUE ENGINEERED

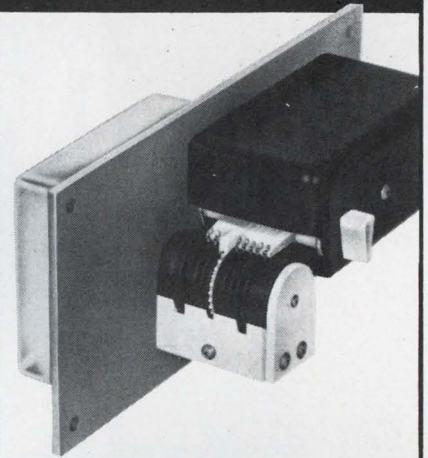

## CMC MODEL 18 Tape Reader

This simple unit reads tape uni-directionally... at 30 characters per second. **Starwheels sense holes;** output is in the form of contact closures.

Model 18 Tape Reader provides control equivalent to that of far more costly units **without complex circuitry or timing.** As easy to use as a relay.

Other models also available for special applications (call or write for more information).

**CMC** COMPUTER MECHANISMS CORPORATION

493 WASHINGTON AVENUE  
CARLSTADT, N.J. 07072 U.S.A.  
(201) 438-1770



*The Standard of Excellence*

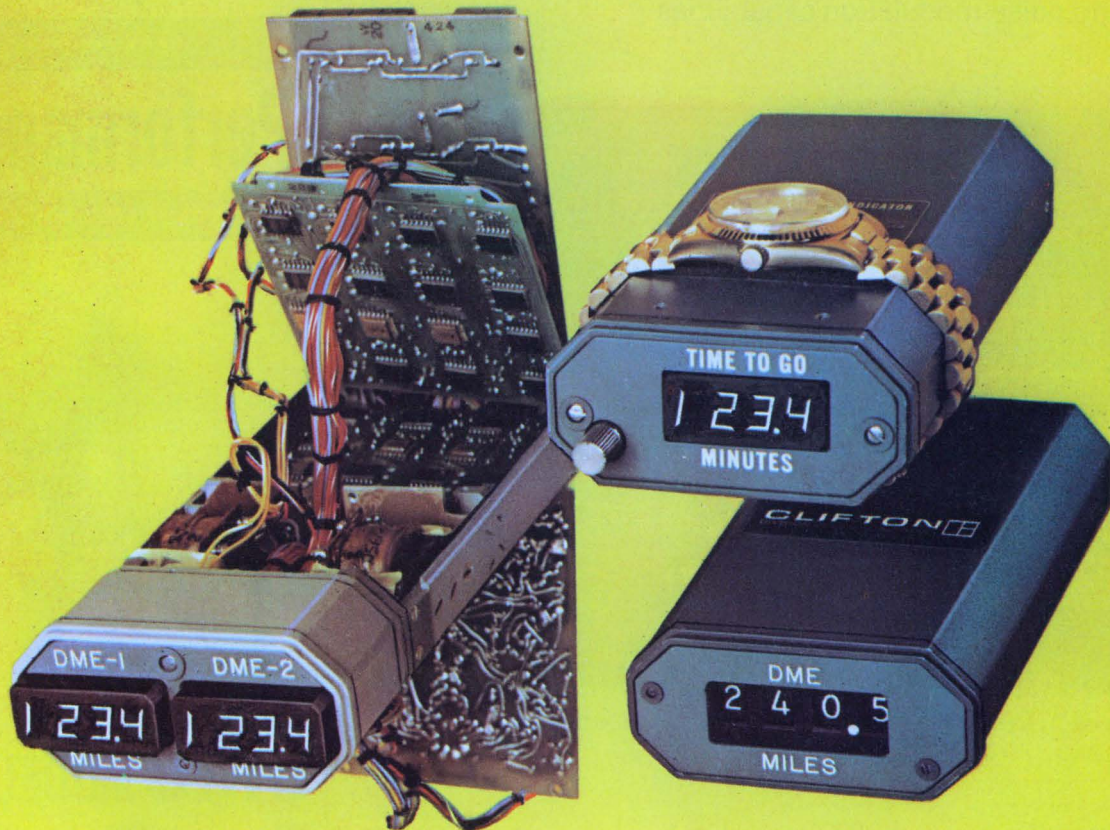

## Digital Indicators by Clifton

In the Clifton family of ARINC type, solid state, Time-To-Go, INS and DME indicators, we are proud to have anticipated and produced advanced cockpit hardware for the new generation of commercial transports.

Important design advances in the areas of fault monitoring and detect circuitry plus central dimming capabilities are incorporated into the basic design.

In operation, each indicator recognizes the address of a specific function pa-

rameter, decodes the serial BCD data, and provides a digital display of the information. Each basic indicator in the family has the capability of being converted to any other indicator format by simply changing a lightplate and programmable connector. Seven segment lamp or magnetic wheel readouts are available for most designs.

Two basic display families, a 4 Digit and Dual 4 Digit configuration, are included in the INS and DME indicator product line. Sim-

ilar indicators are available for AIR DATA applications. A variety of indicator readout configurations meet all INS, DME or AIR DATA indicator requirements.

You can obtain full information on this advanced line of indicators which is available and now flying by calling your Local Clifton Sales Office or area 215 622-1000; TWX 510 669-8217.

**CLIFTON**   
DIVISION OF LITTON INDUSTRIES

Chronometer and Band from J. E. Caldwell Co., Philadelphia—\$1200.



a range of 100 hertz to 2 Mhz and count pulses whose widths are as small as 100 nanoseconds.

**On display.** The counter's display has four digits, one of which is for overranging. Pushing a button on the generator's front panel adds two more digits of resolution. So the 1000's counter is actually a 5½-digit meter.

Setting the output frequency is a three-step procedure. First the RANGE switch selects the right octave; then the FREQUENCY switch mechanically tunes the cavity over the selected octave to the desired frequency; and finally the VERNIER electrically tunes the oscillator. The VERNIER has a range of 1%.

Narrow ranges and poor tuning accuracies aren't the only things wrong with many of today's signal generators, says Bickley. In many units, he says, the unmodulated output contains residual f-m, caused by power-line hum or by microphonics, or the a-m output contains some incidental f-m. In the 1000, the residual f-m is 0.25 parts-per-million, and the incidental f-m in the presence of 30% a-m is 0.5 ppm.

Singer engineers also feel that competitive generators don't offer a broad enough range of outputs. They point out that typical high-frequency generators have a range of -127 decibels above 1 milliwatt (0.1 microvolt into a 50-ohm load) to 20 dbm. In vhf and uhf generators, the maximum output is typically 7 dbm. "And every time you change the frequency range, you have to play around with the attenuator to get the same output back," says Hirsch.

The 1000's output range is -146 dbm to +20 dbm, and the output is flat to within 0.25 decibel out to 25 Mhz, and to within 0.5 db out to 512 Mhz.

The output's magnitude is the sum of the setting of the attenuation dial and the reading of the r-f level meter. Both the dial and the meter are scaled to read both in dbm and in volts into 50 ohms.

**Mod.** The most important virtue of the 1000 is its modulation capabilities. The instrument's output can be amplitude, pulse or frequency modulated. And the output can also be subjected to simultaneous modulation, such as a-m and

f-m, or a-m and pulse modulation.

On one side of the meter are a row of connectors; over each connector is a pushbutton, and over each pushbutton are two smaller pushbuttons.

The first large button is labeled 1 KHZ. When it's pushed, a 1-khz signal, generated by an internal oscillator, is available at the connector below the button. This signal's distortion is less than 1%.

The next large button says AM and the buttons above it are labeled AC and DC. When the AM button and one of the smaller buttons are pushed, an input to the connector under the AM button amplitude modulates the generator's output.

The next large button says PULSE and the buttons over it are labeled PULSE and VID. When both the large and the small PULSE buttons are pushed, any input whose magnitude is higher than +1 volt and whose frequency is between 20 hertz and 0.5 Mhz will pulse modulate the 1000's output. The pulse amplitude depends on the attenuation setting, and the pulse width depends on how long the magnitude of the modulating signal is above the 1-volt threshold.

If the VID button is pushed, the 1000 is capable of wideband linear amplitude modulation. If the input to the PULSE connector is 0 volt, the 1000's output is 0 volt. As the input's magnitude increases, up to ±3 volts, the output's amplitude increases linearly. Increasing the input past ±3 volts has no effect on the output.

With the VID button pushed, the 1000 can, for example, modulate a 400-Mhz carrier with a signal whose bandwidth is 50 Mhz.

The next large button says FM. When it's pushed, the input to the FM connector frequency modulates the output. At the maximum setting of the sensitivity control, a 2.7-volt input shifts the frequency 0.5% about the unmodulated frequency. The modulation linearity is within 1% for deviations up to 0.1%.

Besides being versatile, the 1000 is on the small side. It's 5 by 17 by 22 inches, and weighs 45 pounds.

Deliveries start in November.

Singer Company, Instrumentation Division, 915 Pembroke St., Bridgeport, Conn. 06608 [339]

## TAKE 12 SMALL LAMPS

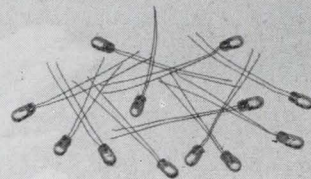

## MOUNT ON A CIRCUIT BOARD

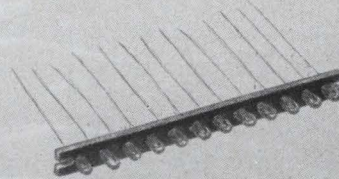

## MOLD A NUMBERED BEZEL



## RESULT A LIGHT MODULE TO MONITOR TWELVE COMPUTER CIRCUITS\*

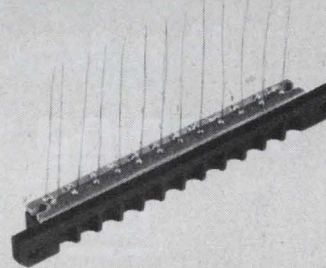

\*Can be made for a lesser number down to one

We can help you refine your small lamp application. Write, describing the requirement. Tung-Sol Division, Wagner Electric Corporation, 630 W. Mt. Pleasant Avenue, Livingston, N.J. 07039. TWX: 710-994-4865. Phone: (201) 992-1100; (212) 732-5426.

## TUNG-SOL®

WHERE BIG THINGS ARE  
DONE WITH SMALL LAMPS

© Reg. T.M. Wagner Electric Corporation



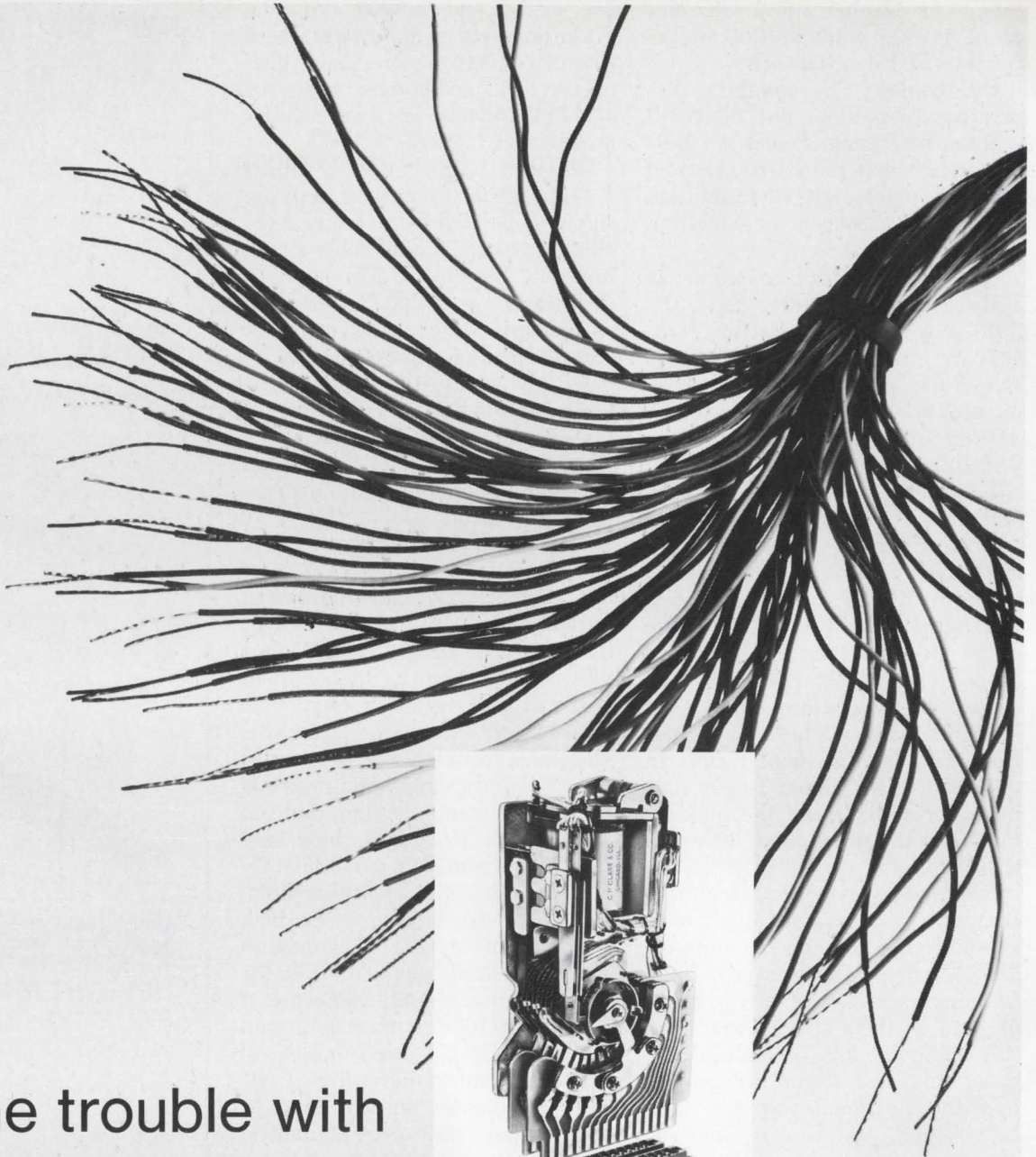

## the trouble with stepping switches isn't anymore

You no longer have to fight a fist-full of spaghetti when you service a stepping switch. Exclusive Clare Quick-Mount lets you pull out the old switch and plug in the replacement—in less downtime than it takes to install the simplest device.

Clare Quick-Mount is available on all spring-driven stepping switches, using 15, 22 or 28-pair connectors. You can get up to 416 switching points in less space than most other hard-contact devices.

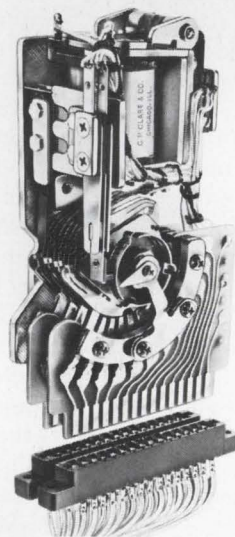
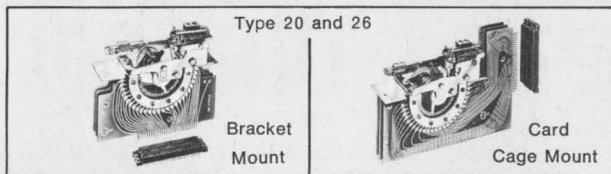

Type 210 and 211

Clare offers a complete line of standard and special-purpose stepping switches to meet every application requirement—spring-driven and direct drive—operating voltages from 6 to 110vdc, speeds to 60 steps/second.

For complete information, circle Reader Service Number, or write for Manuals 601, 602, and Data Sheet Series 651. C. P. Clare & Co., Chicago, Illinois 60645... and worldwide.

LOOK  
TO



**CLARE** FOR  
STEPPING SWITCHES

a GENERAL INSTRUMENT company



# Line of uncased resistors and inductors offered

Unpackaged components, aimed at microwave field, have inductances from 28 to 230 nanohenries and resistances from 5 to 10,000 ohms

Until monolithic technology becomes commonplace in the microwave world, engineers faced with increased demand for high-frequency circuits will continue to put them together by using discrete components. And they will find themselves resorting more and more to unpackaged active and passive discrete chips—from inductors to transistors and uncased in-

tegrated circuit dice. Recognizing a growing market, planners of Motorola's Semiconductor Products division are introducing a line of thin-film unencapsulated passive components, including inductors and beam-lead resistors. The division already has a modest line of uncased discrete transistor chips available, and will be expanding it soon.

The inductors and resistors aren't limited to microwave operation, however. They're useful in the ultra-high-frequency region also, for tuning and biasing applications. There are six spiral thin-film inductors in the line, with self-resonating frequencies ranging from 740 megahertz at a test frequency of 100 Mhz to 1,800 Mhz at a test frequency of 200 Mhz. Craig Mar-

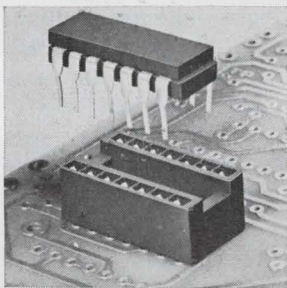

IC sockets have solder tails that fit into holes in a p-c board for hand or wave soldering. Available in sizes for standard 14 or 16 lead IC package, adjacent sockets can be mounted on centers as close as 0.400 offering greater packaging density or rows of IC's. Price in 1,000 lots ranges from 41 to 96 cents. Advanced Packaging Inc., 1357 E. Edinger Ave., Santa Ana, Calif. [341]

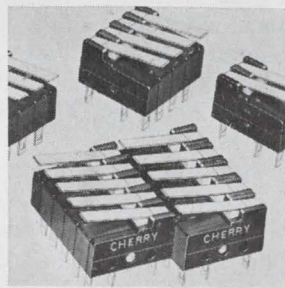

Subminiature switch modules provide multicircuit switching control, high electrical capacity and space economy. The series features 2, 3, 4 or 5-gang modules that are thinner than standard subminiatures. They are double-throw circuitry with ratings of 10.1 amps, ¼ h-p, 125 v a-c. Cherry Electrical Products Corp., Old Deerfield Rd., Highland Park, Ill. [342]

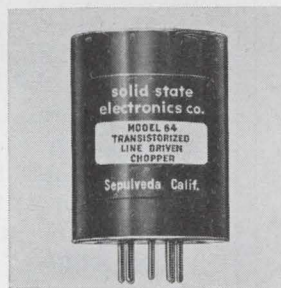

Plug-in line driven chopper model 64 incorporates a transformer-coupled isolating drive network and clipping diodes so that it can, for example, be driven from a 400 hz sine wave power line or from a drive source that is common to the d-c voltage being chopped. Unit utilizes a standard 7-pin header. Solid State Electronics Corp., 15321 Rayen St., Sepulveda, Calif. 91343 [343]



Servo mount precision potentiometer model 3451 is a 10-turn 2-in. diameter device featuring an Infrinon conductive plastic element. It has rugged element terminations, essentially infinite resolution, and a 50 million shaft revolution rotational life. Resistance range is 1,000 ohms to 500 kilohms. Power rating is 5 w at 70° C. Bourns Inc., 1200 Columbia Ave., Riverside, Calif. [344]



Magnetic reed switch MRR-5 is a single pole, normally open, Form A, and measures 0.130 in. max. glass diameter, 0.800 in. max. glass length, and 2.230 in. nominal over-all length, including leads. Initial contact resistance is 100 milliohms at 20 amperes turns overdrive. Maximum switching voltage is 500 v d-c; breakdown voltage, 1,000 v d-c. Hamlin Inc., Lake Mills, Wis. [345]

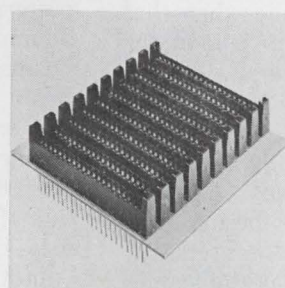

Card edge plate connectors are for solderless wrapped electrical connections. Series E1200/E1201 receptacles feature 20/40- and 30/60-pin connectors for 0.062-in. p-c boards. Contacts are bifurcated and preloaded for uniform deflection and excellent mating characteristics. Wrap posts are 0.025-in. square. Teradyne Components, 900 Lawrence St., Lowell, Mass. 01852 [346]

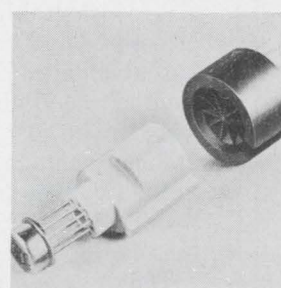

Series TS sockets are for test and burn-in applications of 8 and 10 lead TO-5 can IC's. Funnel entries guide leads into double-leaf, gold over nickel plated beryllium-copper contacts. One-piece bodies are molded from glass-filled diallyl phthalate good to 200° C. Contacts withstand many thousands of lead insertions and withdrawals. Robinson-Nugent Inc., New Albany, Ind. [347]

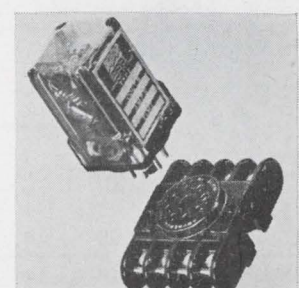

Plug-in dpdt control relay series ERB is comprised of an integral power supply, amplifier, transformer, output relay and circuit board, all in a case 2½ x 1⅜ x 1⅜ in. It plugs into a standard 11-pin socket. The control instantly detects resistance changes in its input circuit from short circuit to 50 million ohms. Frost Electronics Corp., 1 Goddard Dr., Rockaway, N.J. [348]





more Colors from  
**BENTRON**

less problems with  
**COOLING  
MOUNTING  
SERVICING**

in your transistorized circuitry

with a single **SPRING**  
and five different  
**COLORS**

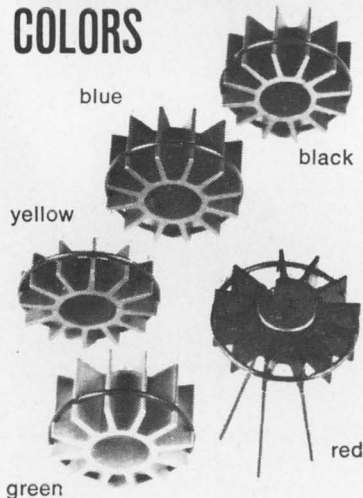

**BENTRON  
COOLERS**

for TO-5 and TO-18 Cans  
Cooler Halves  
with Spring

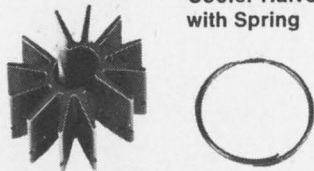

Prices	1-49	50up	500up	1000up
TO-5N	\$ .25	.19	.14	.11
TO-5H	\$ .27	.20	.15	.12
TO-18N	\$ .25	.19	.14	.11
TO-18H	\$ .27	.20	.15	.12

High 10mm • Normal 5,5mm  
Large quantities available  
from stock

**ANCRONA CORP.**

65 E. 55th St., NEW YORK, N.Y. 10022  
Tel. (212) 688-6285  
TWX (710581/4513)

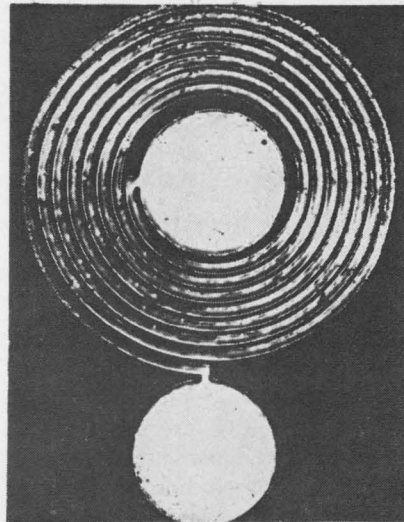

In the chips. Spiral inductors and beam-lead resistors are being marketed by Motorola in unpackaged form for use in high-frequency circuits.

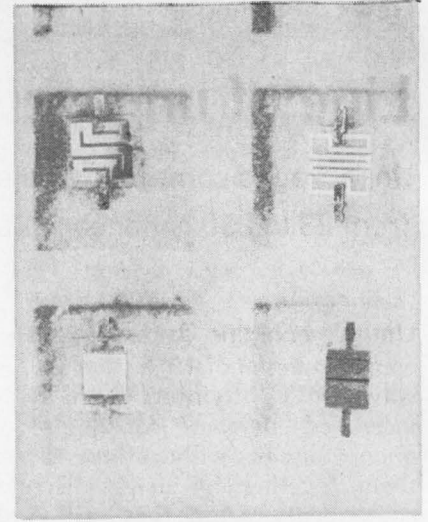

shall, product planner for consumer and microwave IC's, says that the small size and low cost of the inductors will be one of their biggest advantages. Clay Tatom, manager of linear IC product planning, who is handling the line, adds that because the chips are fully tested and specified, users need not be as concerned about their interconnect metalization pattern as they must be when using stripline techniques.

**Competition.** The largest of the chips is only one-quarter-inch square and 10 mils thick. Tatom expects the inductors to compete with the smallest prewound toroidal "chokes" often used in hybrid circuitry. Marshall points out that users of these chokes can eliminate tooling costs by buying chips instead. He adds that the highest self-resonating frequency (1,800 Mhz) for any of the inductors is also considerably higher than that of wire-wound chokes. "One of our big advantages," he notes, "is that we don't need girls to sit and wind toroids; you just have to pop these inductors into a circuit and bond to the two bonding pads." Conventional ultrasonic or thermo-compression bonding can be used.

Tatom says a typical application might be in a tuning circuit such as a tank coil; another might be in biasing, for which the inductors could be combined with tuning diodes and varactors in a series-resonant circuit.

**On the beam.** Motorola isn't alone in providing beam-lead resistors, but the initial seven de-

vices in this line, which eventually will include resistors with 28 different values, are logical companion parts for customers buying the inductors. The values to be offered first are 5 ohms (MCH5862), 50 ohms (MCH5867), 250 ohms (MCH5871), 500 ohms (MCH5872), 1,500 ohms (MCH5875), 5,000 ohms (MCH5880), and 10,000 ohms (MCH5883). Each has a temperature coefficient of 50 parts per million per °C, and each is made of Nichrome deposited on a 400-angstrom-thick glass substrate that is typically 50 by 50 by 1.75 mils.

Marshall says the small size and low inductance of the resistors are their chief advantages. The beam leads, which are essentially gold-plated Kovar, contribute greatly to the low inductance, which is so low that Marshall says it can't be measured. Tatom adds that the resistor pattern itself contributes to reducing inductance, also. The beams measure 5 by 20 by 0.3 mils. Beam leads also help in handling the small chips with a vacuum needle. Marshall also observes that the resistors' power dissipation of about 125 milliwatts is good for a chip so small.

Inductor prices range from \$3.95 to \$4.30 for 10-99 units. Resistor prices are \$1.60 to \$1.90 for 100 units or more. The division is providing the resistors in holders containing either 10 or 400 chips; 10 pieces of any one value is the minimum order.

Motorola Semiconductor Products, Inc.,  
Box 20912, Phoenix, Ariz. 85036



# Who's First... with 5,000,000 SILICON POWER transistors per month

- Over 300 standard types/over 500 custom types
- P-N-P and N-P-N
- From 50 mA to 100 A, 1 W to 300 W, 50 V to 500 V
- Using all the SILICON POWER technologies
  - Hometaxial Base
  - "Overlay"
  - Epitaxial
  - Plastic Power
  - Multiple Epitaxial
  - Triple Diffused
  - Diffused Planar
- Multiple packaging, including hermetic and plastic "VERSAWATT"
- Commercial, industrial, military high reliability specs
- Providing specific, versatile, economic answers to all your circuit needs

## Who? The Leader in SILICON POWER

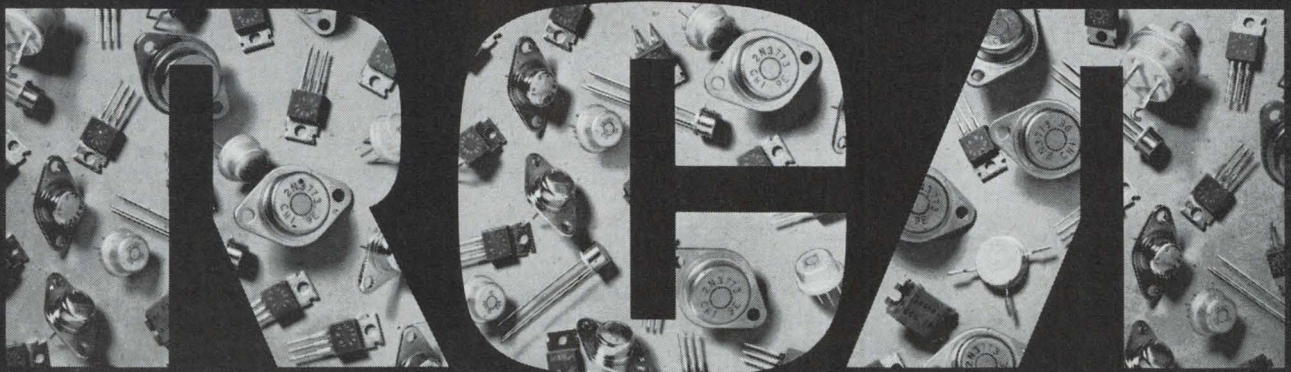

For more information, see your local RCA Representative or your RCA Distributor. For technical data, write:  
RCA Electronic Components,  
Commercial Engineering, Section IN9-1, Harrison, N. J. 07029



After 5,000,000 bits of bipolar memory . . .

# 64 BITS and 16 low-power BITS

## 64-Bit Bipolar Memory has full TTL compatibility

Introducing the 64-bit bipolar memory cell . . . another industry "first" from Transitron, which has already produced and shipped over 5 million bits of bipolar memory. Transitron's TMC6464 is compatible with all major TTL series, and provides substantial savings in space and power requirements.

The new cell is arranged in a 16 x 4 matrix, with internal address coding and address-enable, four data inputs, four sense amplifiers, and write-enable. It operates from a nominal supply voltage of 5V, with addressing, writing and sensing voltage levels compatible with TTL logic circuitry.

The TMC6464 is available in a 16-pin dual in-line ceramic package. For many applications it provides significant advantages over the 16-bit cell:

1. Since the 64-bit cell provides its own address decoding, one package replaces six (four 16-bit cells plus two input gates)
2. System speed can be increased by as much as 50%
3. Power-per-bit is reduced over 50%

## New 16-Bit Bipolar Memory Cell features low power drain

A low-power version of the 16-bit bipolar memory first introduced to the industry several years ago by Transitron is now available for immediate shipment.

The new cell reduces drive current requirements by half . . . has a power dissipation of only 175mW vs. 250mW for the standard device. This makes the unit ideal for aerospace systems and other applications using battery power.

Aside from its low power requirements, the cell is identical to the standard unit in all other characteristics, including full compatibility with all TTL devices.

Two types are presently available. The TMC3262 operates over the full military temperature range,  $-55^{\circ}$  to  $+125^{\circ}\text{C}$ ; the TMC3264 is rated for  $0^{\circ}$  to  $+70^{\circ}\text{C}$ . Both units provide 20mA fanout current, and are available in flat pack or dual-in-line package. Price is only about 10% above the standard cell.

Send for complete technical data on these  
exciting new Transitron developments.

**Transitron**  
electronic corporation

168 Albion Street, Wakefield, Mass. 01880



# FET's help to spot the spikes

Meter measures amplitude of transient signals wider than 1  $\mu$ sec; 200-volt and 2,000-volt models are available; price is \$48

Two different reactions can follow when a relay burns out or switches when it's not supposed to. The man who made the relay blames unstable line voltage, and the man who bought it blames the relay.

John Howard Industrial Electronics Ltd., a British maker of solid state switching networks, was having such debates with some of its customers. Howard, a

small company, didn't want to buy a lot of expensive gear to prove its point, so company engineers developed a small, easy-to-use meter to measure spike amplitude. To Howard's surprise, other companies wanted to buy the spike detector.

The initial interest came from fellow relay makers wanting to check the cause of burned contact

points, but the company has since had inquiries from designers of semiconductor circuitry. A big buyer could be telephone companies, thinks John Howard, the company's president, because the telephone system uses so many relays. The British Post Office, which runs that country's telephones, is testing some preproduction units.

One thing that's attracting in-

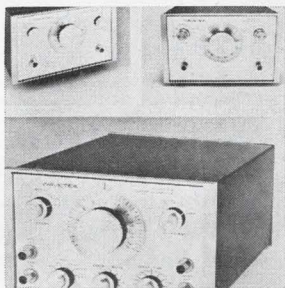

Precision signal generators for general lab use produce sine, square, triangle, and ramp waveforms over the range of 0.2 Hz to 2 MHz with an adjustable output of 10 V peak-to-peak into a 50-ohm load. Model 130 is a function generator; model 131, a voltage-controlled generator; model 134, a sweep/trigger voltage-controlled generator. Wavetek, Box 651, San Diego, Calif. [361]

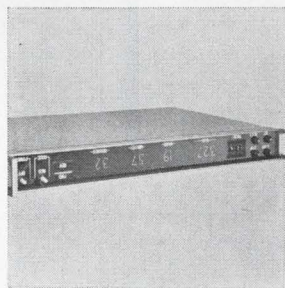

Time code reader-generator DST-840 features 100% silicon integrated circuits, 1 3/4 in. panel x 10 in. depth, internal noise immunity of 1 V, and automatic forward/reverse sensing. Uses include data recording and retrieval, communications data indexing, and data acquisition and reduction. Gulston Industries Inc., 15000 Central Ave. East Albuquerque, N.M. 87112 [362]

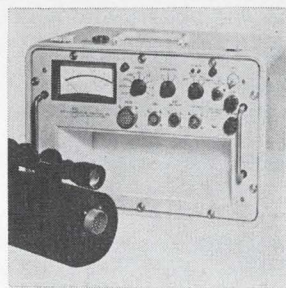

Precision radiometer 464 employs focusable reflective optics and reflex viewing for maximum convenience in field. It can be operated from a separate rechargeable battery pack (supplied) or power line or battery sources. Focus range is 10 ft to infinity; field of view, 1.5 milliradians; accuracy,  $\pm 2\%$ . Electro Optical Industries Inc., Box 3770, Santa Barbara, Calif. [363]

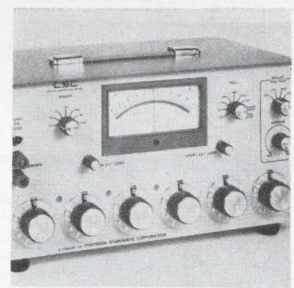

Wheatstone bridge WB-200B can also be used as a resistance comparator. It provides accuracy to  $\pm 0.005\%$  of reading and measurements of 0 to 110 megohms in 7 ranges. It combines in a compact and portable unit an all transistorized chopper, stabilized readout amplifier and an adjustable bridge voltage power supply. Precision Standards Corp., 1701 Reynolds, Santa Ana, Calif. [364]

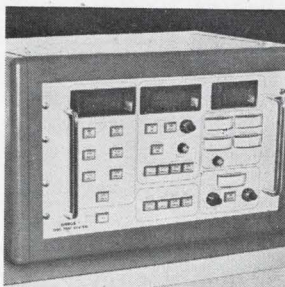

Disk test system designated Diskos I is for testing plated magnetic memory disks and drums. It displays all test parameters eliminating the need for oscilloscope viewing and operator calculations. Automatic head positioning and 3 test modes are offered: dropout, bulk properties and saturation. Diskos Electronics Corp., 201 Lonetree Ct., Milpitas, Calif. 95035 [365]



Random noise generator model 421 is designed to meet the need for an accurately calibrated noise source flat from 10 kHz to 12.5 MHz. To provide truly Gaussian amplitude distribution to better than 4 sigma and constant spectral density with frequency, the thermal noise of a resistor is used as the noise source. Quantech Laboratories Inc., S. Jefferson Rd., Whippany, N.J. [366]

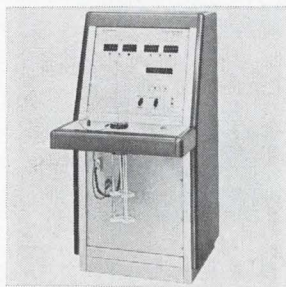

Automatic coil turns analyzer model 2000 checks both turns and resistance. Accuracy for counting from 1 through 99,999 turns in an air core is guaranteed at better than 1 turn in 1,000 or  $\pm 0.1\%$ , whichever is greater. Resistance checks from 0.5 to 9,999.9 ohms are accurate to 0.5 ohm or 0.5%, whichever is greater. New Product Engineering Inc., Wabash, Ind. [367]

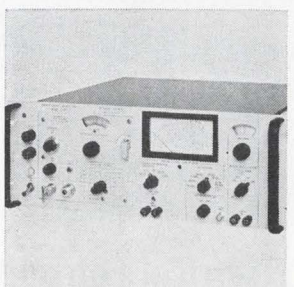

A-m/f-m vhf/uhf signal generator model 6301 originally designed for ground check-out of military aircraft communication and data links is available as a general purpose unit. It features a-m modulation to 80%, and f-m to  $\pm 100$  kHz, or phase modulation, together with 2 V (+19 dbm) of r-f output. Price is \$4,450. Wiltron Co., 930 East Meadow Dr., Palo Alto, Calif. 94303 [368]





**NEW**

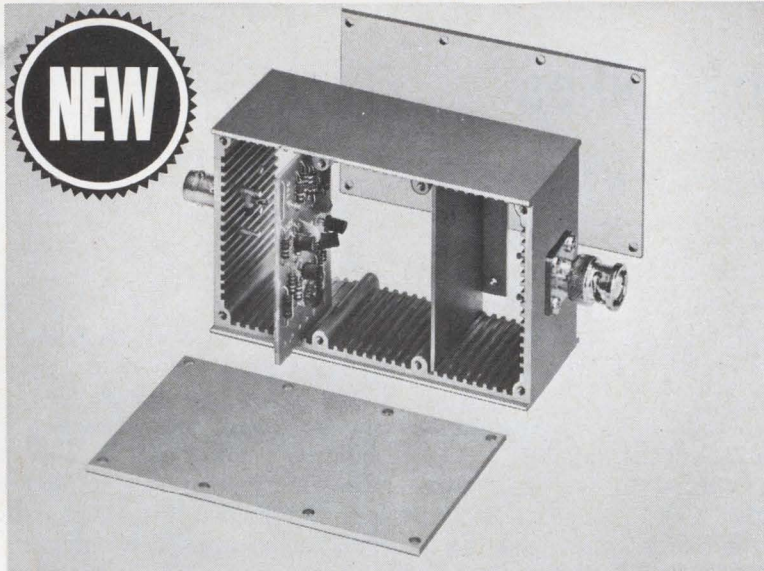

## SHIELDED BOXES with CARD GUIDES

Rugged die-cast aluminum boxes, slotted to accept  $\frac{1}{8}$ " circuit boards and shielding dividers. Excellent for packaging electronic circuitry. Boxes have removable top and bottom covers. Useable inside space: 4"x2"x1 $\frac{1}{2}$ ". Several models with various connectors.

Write for 1969 Catalog



**POMONA ELECTRONICS CO., INC.**  
1500 E. Ninth Street, Pomona, California 91766

Circle 168 on reader service card

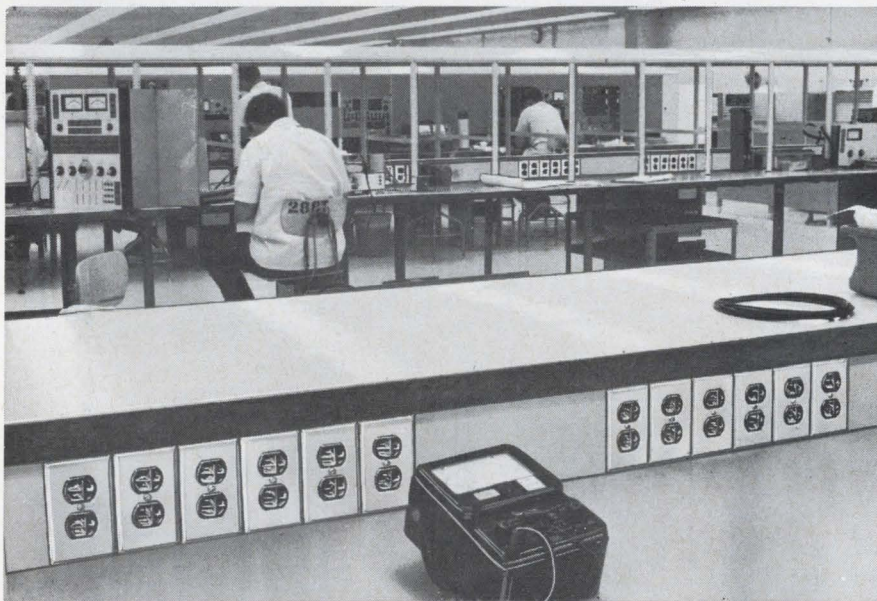

## Electrical convenience for electronic equipment

Whether you make, use or test electronic equipment, the power you need can be delivered neatly in a Wiremold® surface wiring system. All necessary electrical

services and devices are housed in a *single raceway*, properly sized for present and future needs. Send for literature on the entire line of Wiremold systems.



THE WIREMOLD COMPANY / HARTFORD, CONNECTICUT 06110

130

Circle 130 on reader service card

terest is the meter's price. In Britain, the instrument sells for \$48. The U.S. price will be set by yet-to-be chosen reps, but Howard expects it to be about \$50.

The reason Howard gives for the low price is that the meter's key components are inexpensive field effect transistors. At the meter's input is a circuit which converts a spike of any shape into a square wave. This wave turns on a FET, which charges a capacitor. A FET network connected across the capacitor calculates the spike's amplitude.

Another attraction is the meter's portability. It's 5 by 5 by 5 inches, weighs 22 ounces and is powered by standard 1.5-volt batteries.

Two leads connect the meter to the line being tested. If a spike lasting 1 microsecond or longer appears, the spike's amplitude is immediately displayed in d-c volts on the meter. The needle stays at the peak for 3 or 4 seconds, and falls slowly back to zero through a period lasting thirty seconds to two minutes. This slow return allows the user to do something else while he's checking for spikes. He has to glance only occasionally at the meter to see if it's registering. If he notices the needle on its way back to zero, he knows that he must then pay careful attention to the meter just before the same point in the next cycle. If the user doesn't want the slow return, he can cancel it by pushing a fast-reset button.

The reading is in d-c volts because that's the way the maximum capacities of many components are rated. A minimum surge time of 1 microsecond was chosen as the best compromise between cost and useful sensitivity. "To detect surges of less than 1  $\mu$ sec would have meant tighter time constants throughout the circuitry, and therefore greater expense," says Howard, "and we found most potential users were more than satisfied with 1  $\mu$ sec." In fact, surges as fast as 200 nanoseconds will deflect the needle, but the needle won't reach peak amplitude.

Two instruments are available now—a 200-volt and a 2,000-volt model.

John Howard Industrial Electronics Ltd.,  
32 Oaks Road, Great Glen, Leicester,  
England [369]

Electronics | September 1, 1969



**For infrared input**

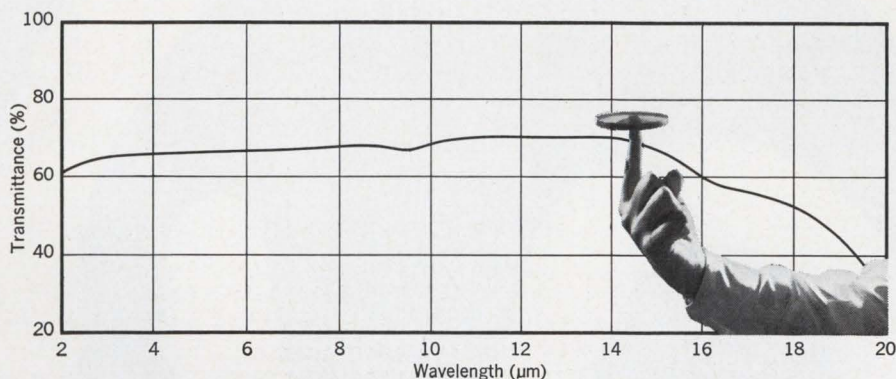

This is KODAK IRTRAN 4 Infrared Optical Material at room temperature. We ship it from stock in finished forms bigger than shown here. We can fabricate it to almost any configuration for you. It's not glass. It is polycrystalline ZnSe. It doesn't crack like glass. That 70% transmittance jumps into the nineties with an anti-reflection coating.

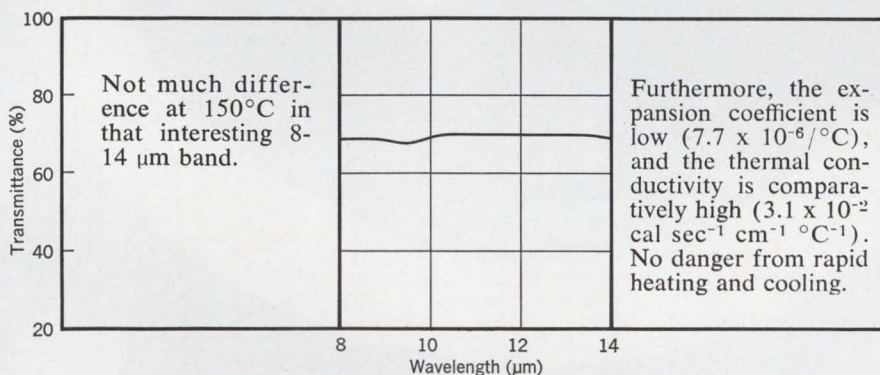

Not much difference at 150°C in that interesting 8-14 μm band.

Furthermore, the expansion coefficient is low ( $7.7 \times 10^{-6}/^{\circ}\text{C}$ ), and the thermal conductivity is comparatively high ( $3.1 \times 10^{-2} \text{ cal sec}^{-1} \text{ cm}^{-1} \text{ }^{\circ}\text{C}^{-1}$ ). No danger from rapid heating and cooling.

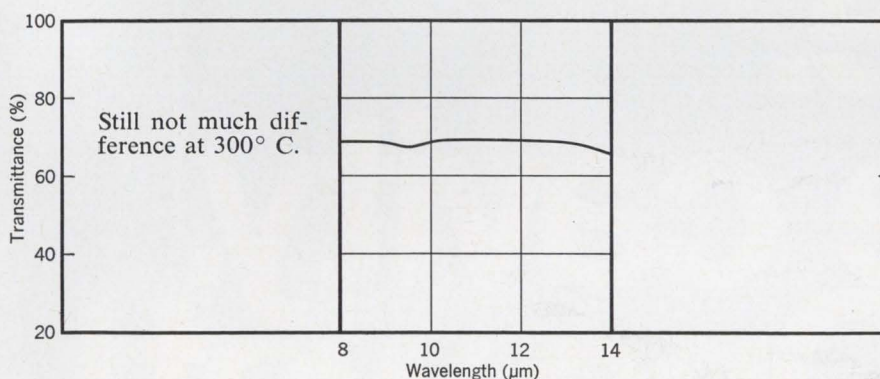

Still not much difference at 300°C.

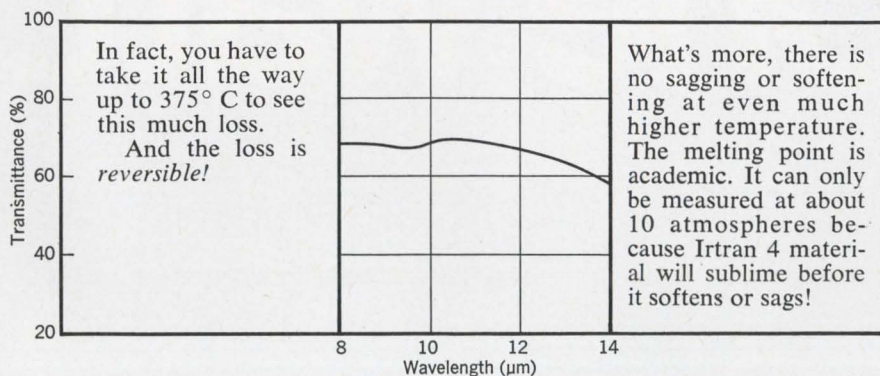

In fact, you have to take it all the way up to 375°C to see this much loss. And the loss is reversible!

What's more, there is no sagging or softening at even much higher temperature. The melting point is academic. It can only be measured at about 10 atmospheres because Irtran 4 material will sublime before it softens or sags!

**For darkroom output**

Though photography serves as a principal production step for today's electronics, not everything leaving the darkroom is product.

Whether business is good or bad, the physical environment we all share is remarkably finite. To expect a little stream behind the plant or even an ocean tide lapping the factory wall to dilute untreated industrial wastes is becoming too much of a burden to bear with self-respect.

Agreeing, you may nonetheless wonder just what the treatment is, your own technical education having concentrated elsewhere. Insofar as Kodalith, Kodagraph, and Kodak HRP processing chemicals are concerned, the treatment after they have done their jobs consists of working off the Biochemical Oxygen Demand of your effluent. This so-called "secondary waste treatment" is really performed by microorganisms. We watch them at work by TV-microscopy. Here are some we found working in an experimental treatment plant of our own:

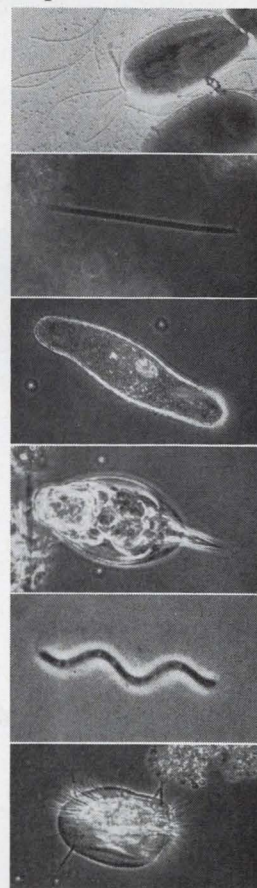

The practical aspects of this important story, with tables of BOD contributions by our products, can be read in Kodak Publication J-28, "Disposal of Photographic-Processing Wastes," available for \$1 from Dept. 454, Eastman Kodak Company, Rochester, N.Y. 14650.

Price subject to change without notice.

Call (716)-325-2000, ext. 12170 or write Eastman Kodak Company, Kodak Apparatus Division, Rochester, N.Y. 14650.





# One diode. One cavity. One watt.

Now Varian delivers the highest power single-diode oscillators on the market. These Impatt-mode devices put out 1 watt CW in C or X band, operate at 6% typical efficiencies and require only 160 mA at 95 Vdc for X band or 110 mA at 150 Vdc nominal for C band.

Operating frequency range is from 6 to 10 GHz. Two versions are offered: a  $\pm 250$  MHz tunable model and a fixed-frequency model. Delivery is 60 days or less.

These Varian oscillators are available with optional current regulators and power supplies, operating from 115 Vac, 60-400 Hz, or 28 Vdc. Or you can order the high power Impatt diode alone.

Only from Varian. What you need in Microwave Solid State. Contact our more than 30 Electron Tube and Device Group Sales Offices around the world, or call our Solid State Microwave Operation, Salem Road, Beverly, Massachusetts.





# Broadband power amps can be combined

Internal feedback loops minimize interaction and increase compatibility so amps can work together for higher outputs

**Combining** power amplifiers, even those with the same model number, to increase power output is not a simple process of connecting a few leads together. For one thing, interaction between the devices' transistors is difficult to control. For another it's difficult to get the amplifiers' gain flatness and phase linearity to match. But a newly-formed Rochester, N.Y. firm has

developed a broadband power amplifier that is designed to be combined with others of the same line.

The firm, Electronic Navigation Industries Inc., says its Model 300L has internal feedback loops that minimize troublesome amplifier interaction. Furthermore, phase and gain are well matched from one device to the next. The 3-watt amplifier covers a frequency

range of from 0.25 megahertz to 110 Mhz; and its dimensions are 5 by 8 by 6 inches.

Another feature of the 300L is that it's untuned, making it relatively easy to use. Also, the unit is unconditionally stable and can thus work into any load mismatch including open or short circuit conditions without damage. "Effectively, this amplifier looks like

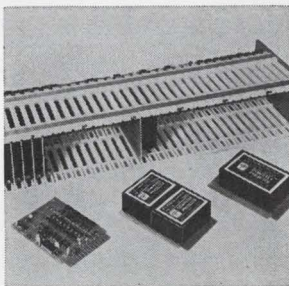

D-a conversion package series DAP600 provides a convenient and inexpensive solution to implementing analog output requirements in digital systems. Any number of channels up to 16 can be specified initially. There can be 8, 10 or 12-bit resolution per channel. Price for a 4-channel, 10-bit unit is \$1,015. Computer Products Inc., 2709 N. Dixie Highway, Ft. Lauderdale, Fla. [381]

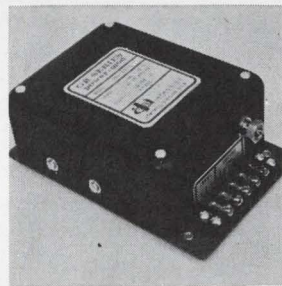

Power supply 3D5-2.5 for use with DTL, TTL and RTL logic uses 70% MIL parts. The calculated reliability per MIL-HDBK-217A is in excess of 150,000 hours. Input is 115 v a-c  $\pm 10\%$ , 60 to 400 hz. Output is 5 v at 2.5 amps; line and load regulation,  $\pm 0.3\%$ . Price (1-99) is \$49 each. Powertec Div. of Airtronics Inc., 9168 DeSoto Ave., Chatsworth, Calif. [382]

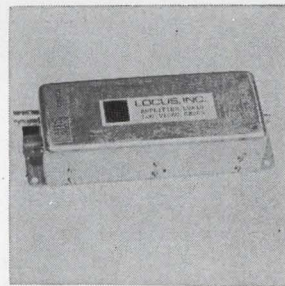

Logarithmic video amplifiers series LVA have a dynamic range in excess of 60 db for pulsewidths greater than 0.3  $\mu$ sec and are available as unipolar or bipolar amplifiers. The design is based using feedback pair transistor amplifier stages whose feedback elements have exponential voltage-current characteristics. Locus Inc., 908 W. College Ave., State College, Pa. 16801. [383]

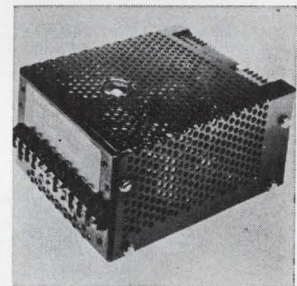

D-c power supply 1301 is a low profile package with a 0 to 6 v d-c output at 0 to 2 amps. It features an unregulated isolation transformer-rectifier followed by a highly stable high-gain regulator. Load regulation is 2 mv maximum no-load to full-load. Line regulation is 2 mv maximum. Dressen-Barnes Electronics Corp., 250 N. Vinedo Ave., Pasadena, Calif. [384]

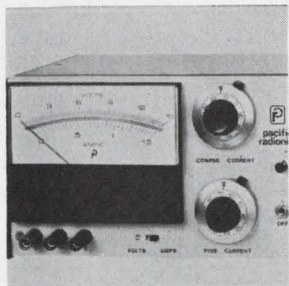

Constant current power supply model PP-21-6 was designed for YIG tuning applications. It provides up to 1 amp output current with compliance voltage up to 12 volts. Current adjustment is by two 10-turn digital dial controls providing 10  $\mu$ a resolution. Unit features ripple and noise below 0.05 ma rms. Price is \$225. Pacific Radionics Inc. 581 Division St., Campbell, Calif. [385]



D-c reference source model 980 features output voltages adjustable for decimal or binary systems; remote sensing of the load voltage; shunt rather than series regulation circuitry for fast, transient-free operation and minimum interaction with the module's own d-c supply. Dual polarity is 10 v output at  $\pm 10$  ma. Analog Devices Inc., 221 Fifth St., Cambridge, Mass. [386]



Programmable waveform generator model F280A is for use in automatic test system. Covering a frequency range of 0.01 hz to 1.1 Mhz, each unit can deliver up to 11 v peak-to-peak into 50 ohms in the manual mode or be programmed to generate up to 16 v p-p into a similar load (32 v p-p into open circuit). Data Royal Corp., 8014 Armour St., San Diego, Calif. 92111 [387]

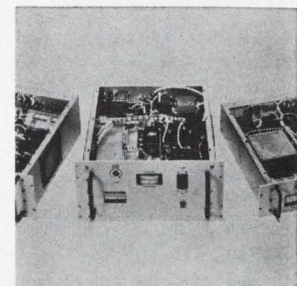

Power supplies series CR27.5 are suitable for demanding communications and process control. They come in ranges from 25 to 150 amps output at 28 v d-c. Voltage regulation is  $\pm 1\%$  with maximum allowable input voltage, frequency, load, and ambient conditions;  $\pm 0.36\%$  with constant input voltage and ambient conditions. Tung-Sol Div., Wagner Electric Corp., Livingston, N. J. [388]



## Parelco R10 Relay

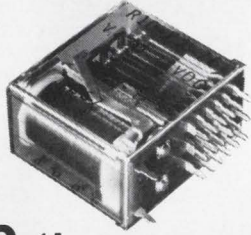

## 2 times more pull force

**Here's Why:** The optimum distribution between magnetic core and pole piece cross sections and coil volume, and a low reluctance armature bearing, produces a force-displacement product of 140 gm/mm at .050" actuator displacement. The end result is higher contact pressure and greater overtravel. Sensitivities to 20 mw/pole.

**Contacts**—From 2 to 8 Form C. 6 types: From heavy duty 10A silver cadmium oxide to bifurcated cross bar gold-platinum—silver for dry circuits.

**Coils**—From 3 to 115 vdc.  
UL listed.

## New Parelco R40 Slimline®

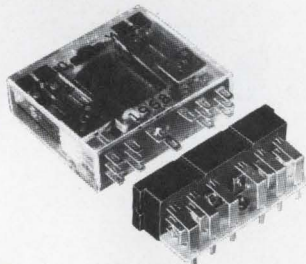

## .43" max. thickness

Lowest profile industrial relay available. Higher switching density: .18 cubic inches/Form C. Easy pc board layout. Lower cost, wider switching range (dry circuit to 10A) than dry reed packages. 5 mounting options.

**Contacts**—2 and 4 Form C. 5 types: From heavy duty 10A silver cadmium oxide to bifurcated cross bar gold—platinum—silver alloy for dry circuits

**Coils**—From 3 to 115 vdc.

### Other Standard Models

R11, a guarded, low capacitance type for instrumentation use; R30, magnetic latching relays; R10-T octal base relays.

**Specials**—Custom coils and contacts. Various mounting configurations. Special engineering.

**Fast delivery**—110 standard models stocked. Prototypes in 3 days; production quantities in 3 weeks! FREE: Parelco's know-how and sample relay to your specs. Phone, TWX or write now. Complete data in EEM, Section 4500.

**AMF PARELCO OPERATIONS POTTER & BRUMFIELD**

26181 Avenida Aeropuerto  
San Juan Capistrano, California 92675  
Phone (714) 493-4507  
TWX (910) 596-1412

a 50-ohm signal generator, but produces much higher output voltage," says the company's engineering vice president, M. H. Sonkin.

The amplifier has a gain of 40 decibels, and both its input and its output impedance are 50 ohms. The device's standing wave ratio is 1.5

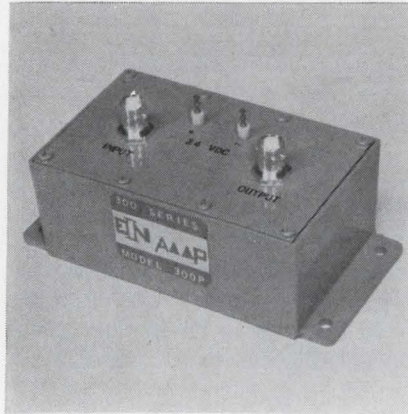

**Booster.** Over its range of 0.25 to 110 Mhz the 300 L has a gain of 40 db and a peak output of 3 watts.

and, according to Sonkin, even at maximum output the harmonic distortion is "fairly low".

ENI's Sonkin points out that the 300L is just the first in a series of solid state power amplifiers that the company intends to build and sell. ENI, which was formed late last spring by a group of former General Dynamics personnel, also expects to use its line of amplifiers as a stepping stone to get into the more general area of aviation and marine electronic products.

The Model 300L is priced at \$485 and includes a calibrated r-f voltage and power-output meter which is accurate to within 5%. It also comes with an a-c power supply. The 300L can be used as a laboratory or field tool for extending the capability of such instruments as signal and sweep generators.

However, for use as a plug-in module in larger systems, the amplifier comes in a different configuration which does not include the power supply and output meter. In this configuration, designated Model 300P, the amplifier's price is \$390.

Electronic Navigation Industries Inc.,  
1337 Main St. East, Rochester, N.Y.  
14609. [389]

## Security system gets your number

Holobeam's device uses shift register instead of magnetic memory

**Plagued by** unauthorized "visits," more and more companies, banks, credit card concerns, and hospitals are turning to personnel access control systems that electronically verify a person's identification.

The latest, from Holobeam Inc., offers an identification system consisting of a card reader and a remote console, at just under \$3,000, which the company claims under-sells all similar products.

The user inserts a plastic card containing a binary coded number into the card reader and then keys in his number on the keyboard. The card reader then issues a go/no-go command to the remote console depending upon whether the numbers match. If the numbers fail to match, the remote console denies entrance. The cardbearer is given another opportunity to gain access by pushing a reset button and keying in his number again. If the numbers match, entry is permitted. If the numbers don't match an audio alarm is automatically activated. The remote console can be used to control door locks to individually secured areas or to many areas at once.

The card reader uses an optical system that detects the black and white coded areas on the card and converts them to a digital output that could as an option be stored in a computer memory. The digital information is delivered to a shift register in the reader and then compared to the number keyed in. In this way, the need for a magnetic memory is avoided.

Each digit of the coded alphanumeric information is a four-bit binary code whose weights can be altered by changing one printed-circuit card in the reader. If a six-digit number is used, there's only one chance in  $10^{12}$  of guessing the right combination of bits.

Holobeam Inc., 560 Winters Avenue,  
Paramus, N.J. [390]



# Save Time, Save Money with BUSS QUICK-CONNECT Fuseholders and Fuseblocks

An important thing to remember when ordering fuseholders and fuseblocks is that BUSS has the most complete line available with quick-connect terminals.

BUSS fuseholders and fuseblocks with quick-connect terminals can save you money by greatly

reducing assembly time for wire attachment. Harnesses can be pre-assembled, then simply "plugged in" to the BUSS fuseholders or blocks. You can forget about soldering guns and screwdrivers.

To learn more about the many applications in which you might cut costs with BUSS Quick-Connect Fuseholders and Fuseblocks, get in touch with your local BUSS Representative or write for BUSS Bulletin SFB.

BUSSMANN MFG. DIVISION, McGraw-Edison Co.  
University at Jefferson, St. Louis, Mo. 63107

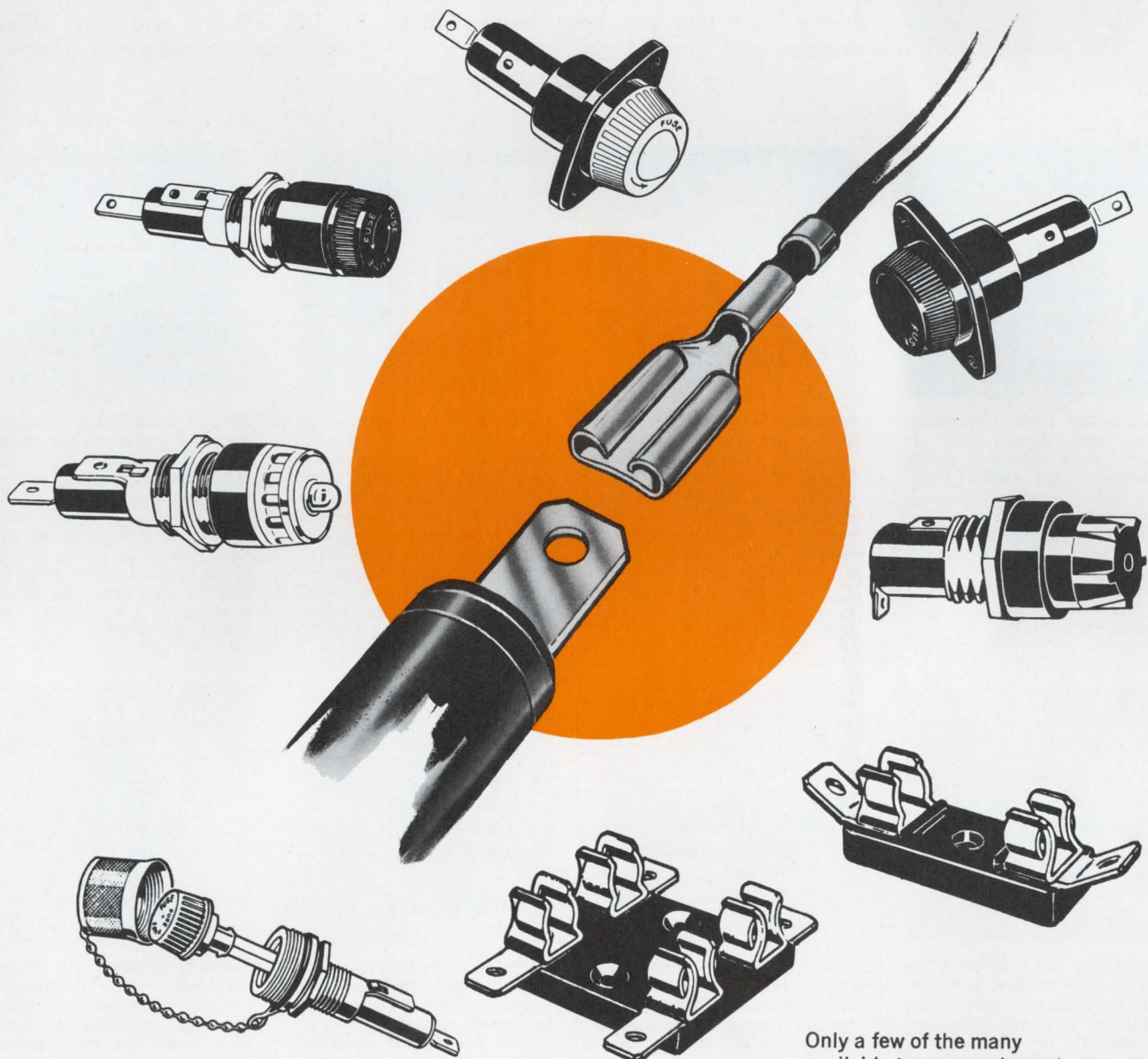
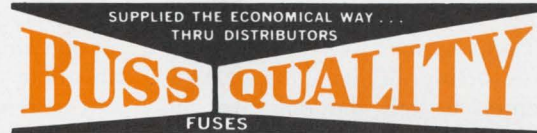

Only a few of the many available types are shown here.



# Sorter checks 5,600 epoxy transistors an hour

Vibrating bowl in Daymarc model 1635 uses flanges to correctly orient TO-105 and TO-106 round devices and feed them to multi-station checker

**Alike as peas in a pod**, epoxy transistor packages are without a doubt economical. But because of their shape the TO-105 and TO-106 packages so far have resisted automatic sorting. It's hard for a simple machine to tell the outward difference between a collector, emitter, and base, so getting the right leads in the test sockets is chancy.

"The packages look like aspirin

tablets with three leads," says A.H. MacQuarrie, applications engineer at the Daymarc Corp., Waltham, Mass. "Other packages have a tab on one side that permits lead identification, making automatic testing and sorting possible. The round TO-105 and 106 packages may be the least expensive ones available, but they are about the most difficult to orient."

Therefore, these round packages are usually tested and sorted by hand. Automatic handling has been attempted, but only low sorting rates—about 500 transistors per hour—have been attained.

Now this has changed. The Daymarc Corp. has developed its model 1635, which can handle the TO-105, TO-106, and most other short lead transistor packages.

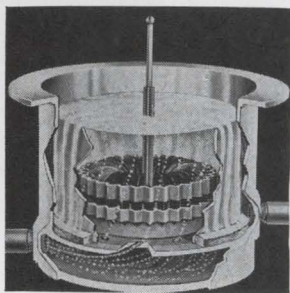

Single-stage rinser uses moving water and nitrogen burst to achieve rapid cleaning of wafers, substrates, and optical lenses. The rinser is a tank-within-a-tank, with water and nitrogen introduced through angle-drilled holes in the bottom of the inner vessel. Outer tank is 9¾ in. o-d by 8¾ in. high. Inner tank is 7 in. i-d by 5 in. deep. Fluoroware Inc., Chaska, Minn. [421]

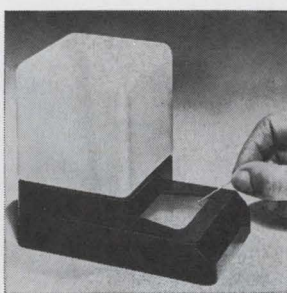

Constant level flux dispenser model FD-1 is for dipping leads and components prior to soldering or tinning. It utilizes a hydrostatic principle to minimize surface skinning. Its constant level is exposed to a well base that is resistant to hot soldering irons. Price (1-24) is \$5.50 each; (100 up), \$4.50 each. E.P.E. Corp., 6 Kane Industrial Dr., Hudson, Mass. 01749 [422]

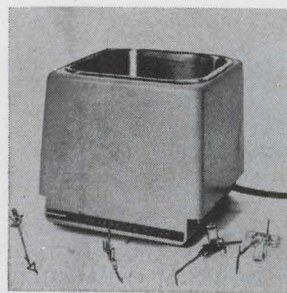

Ultrasonic cleaner model EA 12 has a tank size of 5 x 5 x 3 in., suiting it for cleaning inking components of recorders. Unit uses high intensity sound waves to accomplish cleaning. Cleaning power is 50 watts, and line voltage is 115 v, 50 to 60 hz. It can be operated with common household detergents or solvent cleaners. Price is \$60. Esterline Angus, Box 24000, Indianapolis [423]

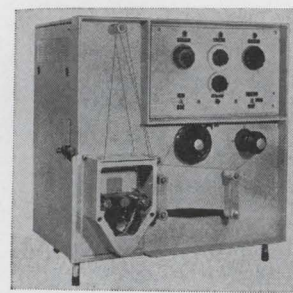

Sea-Saw model 700 is for wafering and dicing silicon and similar hard, fireable materials. It enables dicing of crystals up to 3 in. in diameter. Cutting is done by thin, oscillating tungsten wires which pass through an abrasive slurry. Wafers as thin as 0.0055 in. can be sliced with an 0.004 in. diameter wire. Geoscience Instruments Corp., E. Third St., Mt. Vernon, N.Y. [424]

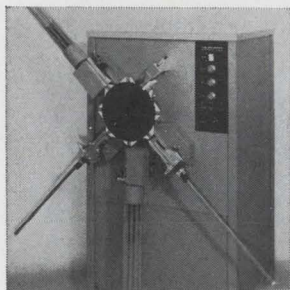

Sorter type 852 with high volume turrets, and operating with suitable test equipment, automatically tests and sorts over 7,000 dual in-line IC's per hour, stick to stick, with 250 msec test time. Following tests, the sorter classifies tested IC's into three categories. Input/output turrets each hold up to 10 sticks. Daymarc Corp., 40 Bear Hill Rd., Waltham, Mass. 02154 [425]

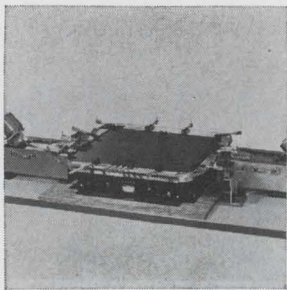

Automated rotary dipping apparatus (ARDA) is designed for solder coating axial and non-axial component leads. It features a conveyor system to carry components around its circumference and to permit automatic lowering and raising of components in a vertical plane, while rotating them simultaneously in 90° increments. Electrovert Inc., Hartford Ave., Mt. Vernon, N.Y. [426]

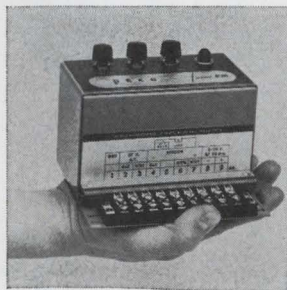

In less space than a desk phone occupies, a solid state extrasensory perception system can be installed to completely automate control of product flow in any production operation. The RM variable rate control module and a sensor work together to detect product flow and send signals to the scr motor controlling production line speed. PECO Corp., Ortega Ave., Mtn. View, Calif. [427]

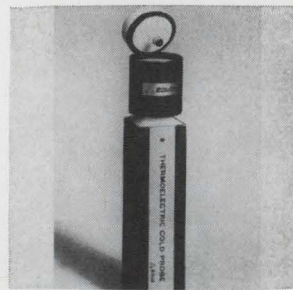

Standard adapters and micro-chambers simplify component evaluation at temperatures within the -60° to +180° C range. Used with the self-contained ThermoSpot environmental probe system, the adapters provide chamber free stable temperatures for TO-5, TO-18, flatpack and DIP IC's, diode and scr configurations. EG&G Inc., 160 Brookline Ave., Boston. [428]



## What is the life of a good aluminum capacitor?

Sample #7, shown below, survived 100,000 hours. It is one of a group of computer grade aluminum electrolytic capacitors that we put under test back in 1957.

All capacitors were operated at rated DC working voltage, surge voltage, ripple current and temperature range found in typical computer type power supply circuits.

Sample #7 works almost as well today as it did eleven years ago.

Mallory capacitors enjoy long, reliable life because they are built to exacting standards and tested for surge voltage, vibration resistance, container seal tightness, shelf life, and capacitance, ESR, DC leakage current

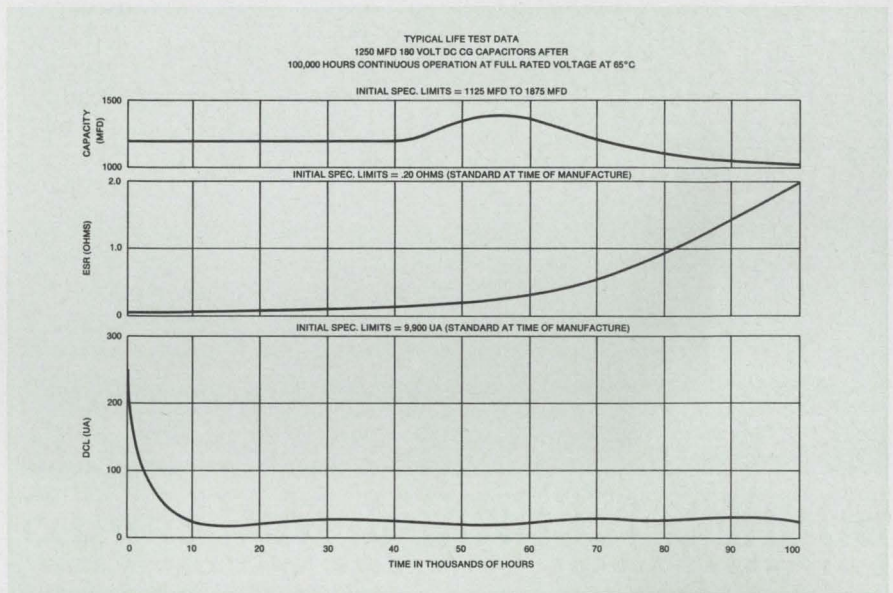

and electrolyte leakage.

All Mallory CG capacitors should have a useful life of about ten years, when operated at specified conditions. They will last even longer if derated in one or more operating conditions.

### Temperature Range

CG capacitors are designed to operate within a range of  $-40^{\circ}\text{C}$  to  $+85^{\circ}\text{C}$ . They have been tested at  $105^{\circ}\text{C}$  at less than rated voltage without immediate catastrophic failure. Extended operation under these conditions, however, will shorten their life.

### Capacitance

Capacity is measured at 120 cps and at  $25^{\circ}\text{C}$ . Tolerance of capacitors rated at 3 to 150 volts is  $-10, +75\%$ . For capacitors rated at 151 to 450 volts, the tolerance is  $-10, +50\%$ .

### Low Temperature Capacitance

Capacitance of Mallory CG capacitors at reduced temperatures and 120 cps does not fall below

the following percentage of nominal rated room temperature ( $+25^{\circ}\text{C}$ ) capacity.

Rated DC Voltage	Percent of Nominal Rated Capacitance		
	$-20^{\circ}\text{C}$	$-30^{\circ}\text{C}$	$-40^{\circ}\text{C}$
0-15	65	50	30
16-100	80	65	40
101 and up	85	75	50

### Equivalent Series Resistance

ESR measurements are made at 120 cps and  $25^{\circ}\text{C}$ . ESR for Mallory computer grade capacitors is very low.

Mallory wants the highest possible rating for its CG capacitors—but not at the expense of long life and reliable operation. The object of all our research and care in manufacturing and testing is to provide our customers with the “best” capacitor. For data, write or call Mallory Capacitor Company, a division of P. R. Mallory & Co. Inc., Indianapolis, Indiana 46206.



**BOURNS INTRODUCES  
NEW CONCEPT  
CERMET RESISTIVE  
AND CONDUCTIVE INKS**

New Concept permits Calibration/Targeting of Inks to your equipment and facilities, assuring desired resistance values, temperature coefficient of resistance and repeatability. Evaluation kits are available containing four resistive inks, one conductive ink and an instruction manual at \$200 per kit.

**WRITE FOR COMPLETE TECHNICAL DATA TODAY!**

**BOURNS TECHNICAL MATERIALS**  
3231 KANSAS AVENUE • RIVERSIDE, CALIFORNIA 92507  
Circle 169 on reader service card

HIGH GAIN, HIGH FREQUENCY  
**2500 Watt Peak Power**  
INDUSTRIAL DC SERVO AMP

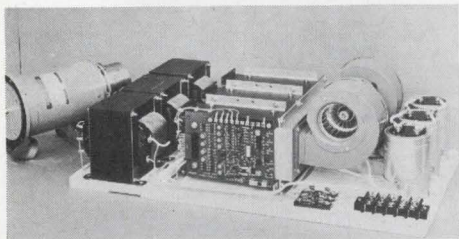

*For Low-Inertia Fast-Response*  
**TORQUE MOTORS**

Model A5231 is a complete high performance servo control designed for use in all kinds of closed loop position, velocity and torque-systems. This high power servo amplifier operates from a conventional three phase, 50/60Hz power supply, or with slightly reduced rating from single phase. High gain multiple inputs, plus peak power, plus dual mode current limit, and 1 KC response, make unit adaptable to all kinds of fast response or continuous torque DC motors.

HIGH POWER SERVO AMPLIFIERS

**WESTAMP**  
1542 FIFTEENTH STREET  
SANTA MONICA, CALIF. 90404  
PHONE: (213) 393-0401

**SAN-E**  
*MSP-4 full four track stereo  
R/P head for auto-reverse  
cassette system*



MSP-4 ¼ track full 4 heads R/P  
head for philips cassette tape

Other product

erasing head for MSP-4  
8 truck (MS-8) stereo head  
for home & car stereo

**\* write immediately  
for further details**

**SAN-E DENKI COMPANY, LIMITED.**

110-1 Minami-Kawahori-cho, Tennoji-ku,  
Osaka, Japan  
phones: 779-1591  
cable: SANMAGNETICS

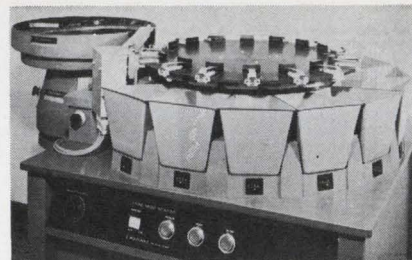

**Shook up.** Vibratory bowl at left aligns around transistor for sorting.

Used with a Teradyne tester such as the model T217, the machine sorts 5,600 devices an hour, assuming a test time of 230 milliseconds.

The problem of handling the TO-105 and TO-106 was solved by modifying the vibratory bowl used by Daymarc in other systems. The bowl's vibrations move transistors outward and along a ramp which spirals around the bowl's side to the probe station. By adding flanges along the ramp, Daymarc was able to ensure that only transistors with properly oriented leads would reach the station. Improperly aligned devices are knocked back into the bowl.

**On the table.** Once safely past the flange, the transistor is placed in one of several holders on a circular table and swung to a station where two nonshorting terminals probe each lead. Probes have Kelvin connections, collector-base capacitance is 0.1 power factor maximum, contact resistance is below 0.05 ohms, and leakage resistance is more than  $10^{14}$  ohms. The tester categorizes each transistor and sets a magnetic trip beneath its holder. When the table rotates, the arm trips a mechanism, dropping the transistor into the proper bin.

The sorter comes equipped with two probes and eight bins. As many as four probes or 11 bins may be used, but the total can't exceed 13. Many types of transistors may be sorted by simply plugging different testers into the probe socket, and both d-c and dynamic tests can be run. The rate of the 1635 sorter can be changed if different test times are required.

A prototype has been in operation since the beginning of July, and already several are on order. The price of the unit is not yet set; but delivery is 12 to 14 weeks.

Daymarc Corp., 40 Bear Hill Rd., Waltham, Mass. 02154



# In 10 days we can teach you how to design your own MOS/LSI arrays.

## **Engineering Design Workshop uses standardized equations and procedures to assist systems engineers in the evaluation and design of their own MOS/LSI circuitry.**

The systems designer who understands the advantages, limitations, costs, and performance of LSI will be able to translate existing designs or meet new systems objectives with greater speed, efficiency, and profit to his company and to himself.

This is the purpose of the course of study and work sessions developed by Integrated Systems Technology Inc., a company which has made a specialty of assisting others to acquire design and/or fabrication capabilities.

The MOS/LSI Engineering Design Workshop is presented by the Integrated Systems Technology staff and has achieved international recognition as a highly effective, practical way for equipment designers to become familiar with the LSI technology in a relatively short period of time.

Combining lectured material with IST's "topological" rules and private engineering consultation,

each attendee will design an LSI array or library of standard functions. The IST design approach permits multiple sourcing. Design experience will include system partitioning, calculation of array performance, and generation of an array plan diagram. A number of computer programs has been prepared to facilitate calculation of array performance, and a computer terminal will be provided as a design aid.

Each attendee will also receive a complete, 220-page set of notes detailing IST's design equations, circuit forms and analyses, and topological design rules.

The MOS/LSI Engineering Design Workshop will be in session from September 15-26, 1969 under the sponsorship of Electronics/Management Center. It will be held

at IST facilities in Santa Clara, California. Fee for individual registrant is \$3000. Special rates for multiple company registrations. To register, or for additional information, call Mr. Samuel Weber, at 212-971-3485 or write to Electronics/Management Center, 330 West 42nd Street, New York, N.Y. 10036.

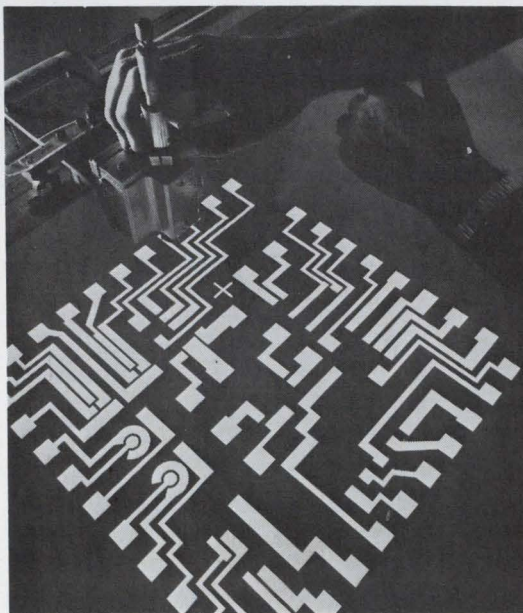

## **The MOS/LSI Engineering Design Workshop September 15-26, 1969**

Presented by Electronics/Management Center  
in cooperation with Integrated Systems Technology, Inc.



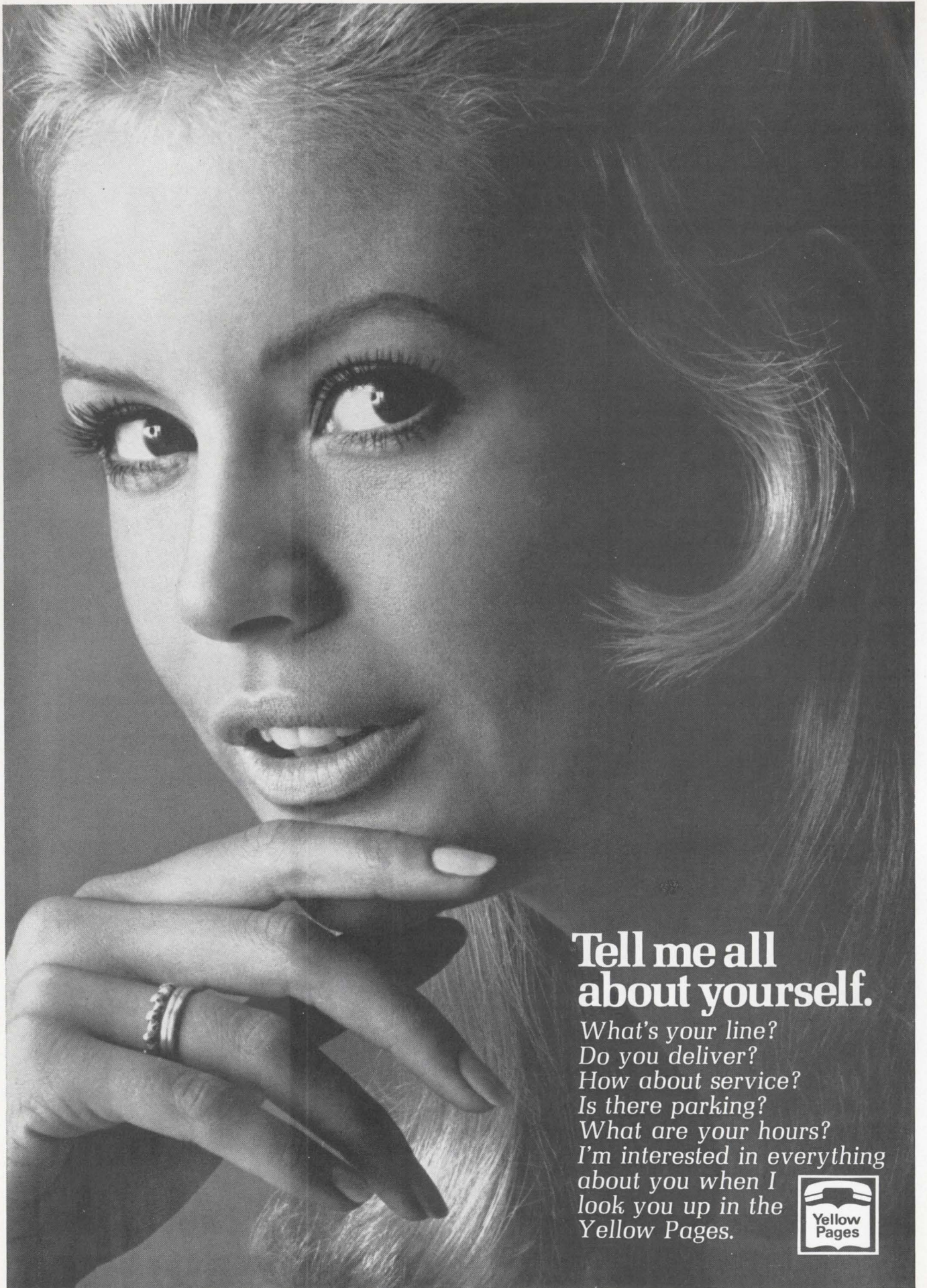

**Tell me all  
about yourself.**

*What's your line?  
Do you deliver?  
How about service?  
Is there parking?  
What are your hours?  
I'm interested in everything  
about you when I  
look you up in the  
Yellow Pages.*





# Hybrid-IC transistors served in ceramic cup

150-mil-diameter package has lands instead of leads; smaller than a TO-5 can, it costs up to 40% less

Increasingly, hybrid-circuit makers are mounting semiconductor chips directly on a substrate, but many of them would prefer to give the chip more protection—if the right package could be found.

Conventional metal packages like the TO-5 can aren't the answer because their size tends to cancel the advantage of the hybrid technique. However, a ceramic cup manufac-

tured by Circa Tran Inc. may provide a solution. The package is not much larger than the chip itself, and with lands for leads, it can be easily and firmly attached to the hybrid substrate as a "leadless inverted device." It's equally at home with thick films or thin films, and the manufacturer says it won't change electrical properties during circuit assembly.

So far, Circa Tran has introduced only one version, the CT-1, a three-land package for transistors. It's 150 mils in diameter and 75 mils thick, and can accommodate a semiconductor up to 40 mils square. By comparison, the TO-5 can is roughly 2½ times wider and thicker.

The company is now developing cups for other devices, including

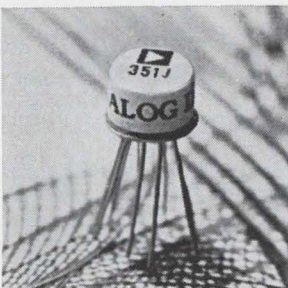

Differential d-c comparator model 351 is a monolithic IC device in a T-100 case, and designed for accurate sensing and measuring applications. It is capable of resolution in the fractional millivolt and sub-microamp regions and will handle 10<sup>5</sup> ohm signal sources. Unit lists singly for \$11.70; \$7.80 in lots of 100. Analog Devices Inc., 221 Fifth St., Cambridge, Mass. [436]

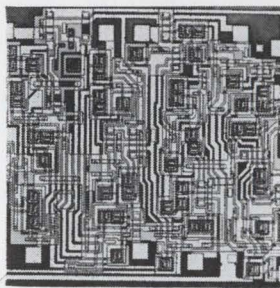

Integrated decade up-counter MC880P features plastic encapsulation. It implements the counting function through the interconnection of four flip-flops, with individual direct set inputs provided for setting the counters to any number. The device counts at a typical 4 Mhz rate. It costs \$3.40 in lots of 1,000 up. Motorola Semiconductor Products Inc., Box 20924, Phoenix [437]

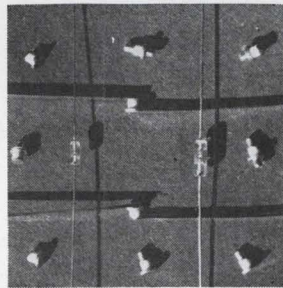

Microwave tuning varactors GC-1700 offer octave tuning through S-band. Featuring low series resistance, they are oxide passivated providing maximum diode stability at high temperatures. Standard capacitance tolerance is ±10% and operating temperature range is -60° to +125°C. Capacitances range from 1.2 to 22 pf. GHZ Devices Inc., Kennedy Dr., N. Chelmsford, Mass. [438]

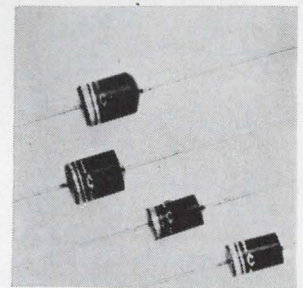

Wide area Varactron silicon voltage-variable capacitance diodes series VA521-824 feature all-epitaxial construction, Q as high as 200, and d-c ratings as high as 100 v. The devices are suited for such applications as vhf-uhf frequency multiplication, harmonic generation, oscillator tuning, and parametric amplification. Crystalonics Inc., 147 Sherman St., Cambridge, Mass. [439]

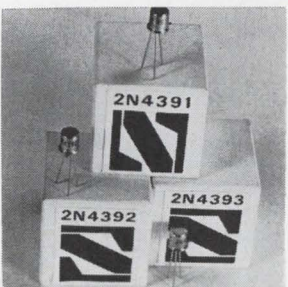

FET choppers 2N4391, -2 and -3 feature a switching time of 15 nsec (typical) and low leakage of 100 pa maximum. Units offer optimum performance in micro-volt amplifiers and meters, multiplexers, commutators, tv equipment, oscilloscopes, a-m and c-b receivers. Price is from \$2.50 to \$3.50 for 100 up. National Semiconductor Corp., San Ysidro Way, Santa Clara, Calif. [440]



Planar p-i-n switching diode VSD-211 offers a typical switching speed of 10 nsec, and will operate over a wide dynamic range of r-f series resistance from 1.4 to 15,000 ohms. It will perform efficiently over a frequency range from 1 to 18 Ghz, depending upon r-f power and package parasitics. Operating temperature range is -65° to +175°C. Varian, Beverly, Mass. [441]

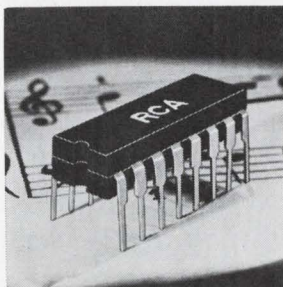

A-c amplifier array CA3052, on a single monolithic substrate, can be connected as a pre-amp to provide a high performance stereo tape head or full-function stereo amplifier. Each of four independent amps' typical operating features include an equivalent input noise voltage of 4µv and a high voltage gain of 58 db. RCA/Electronic Components, Harrison, N.J. 07029 [442]

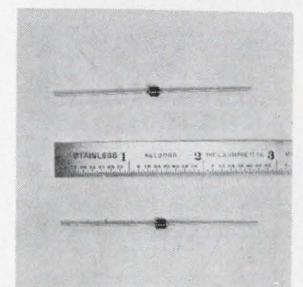

Glass, 5-watt, axial lead JAN and JAN TX zener diodes 1N4954 through 1N4969 meet MIL-S-19500E/356A and MIL-STD-701 specifications. Voltage ranges of from 6.8 v through 30 v are available. Size is 0.140 in. maximum diameter by 0.230 in. maximum length with 0.040 in. diameter silver leads. MicroSemiconductor Corp., 11250 Playa Court, Culver City, Calif. 90230 [443]



# Ordinary engineers have their place. Elsewhere.

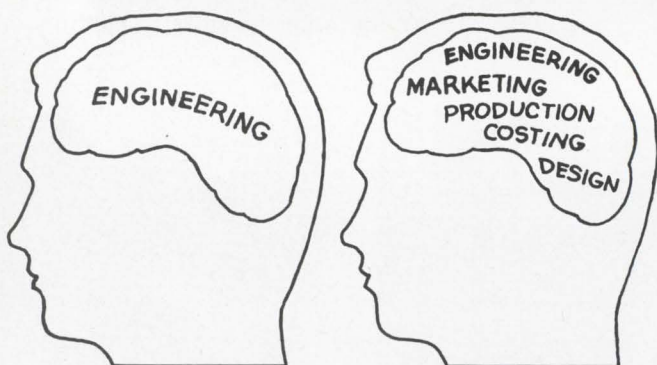

ORDINARY ENGINEERS

OUR ENGINEERS

Ordinary engineers are the guys who sit in somebody's bullpen and slave away on a tiny part of some immense project. Doing the same kind of thing. Over and over, without ever really knowing what their contribution amounts to.

We go about things a little differently. And we think that's the reason we've become a leader in computer memories.

Our technique is to let engineers get involved in as many different activities as they can handle. Technical proposals, design, development, costing, production, marketing, planning—you name it, our engineers get involved in it. And the involvement leads to commitment. It's worked out beautifully.

As a result we have a busy and extremely interested engineering staff. And

the finest line of memory systems and stacks and interconnect circuitry on the market.

It should surprise no one to learn that

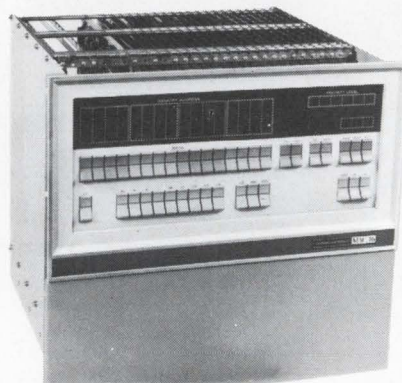

we're growing at a healthy clip. Just recently, we introduced our new digital Multi-Application Computer — M A C 16 —and that's

going to accelerate our growth.

So, we need more engineers. Good minds. Good technical backgrounds. And the desire to get involved.

We pay well. And, because of our continuing growth, we offer rapid advancement.

If you're interested in us and you've got an M.E. or E.E. and E.D.P. hardware or software experience, let's get together.

Write to me—E. N. Gage—at 6201 E. Randolph Street, Los Angeles, California 90022. Better still, call collect. (213) 722-6810. Naturally, we're an equal opportunity employer.

## LOCKHEED ELECTRONICS COMPANY

**LEC** Data Products Division • A Division of Lockheed Aircraft Corporation



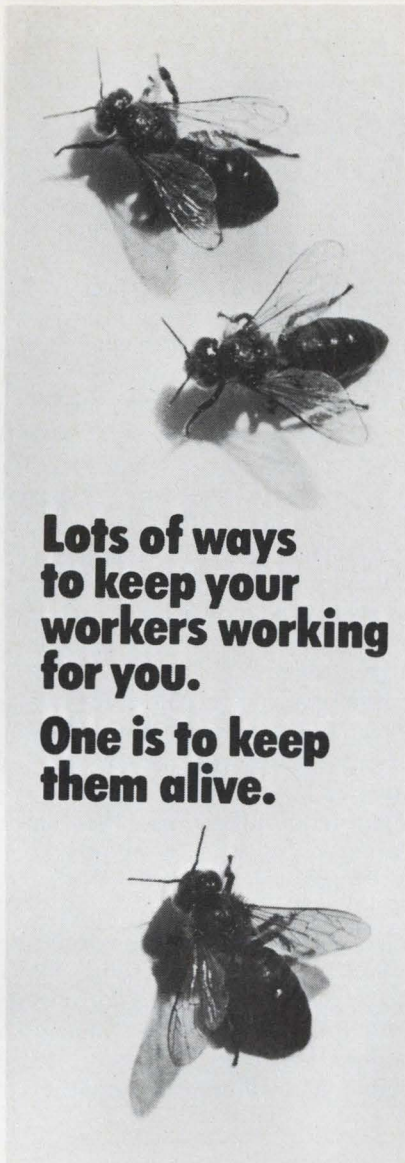

**Lots of ways  
to keep your  
workers working  
for you.  
One is to keep  
them alive.**

And we want to help. With a comprehensive employee education program. That tells your people life-saving facts about cancer. And how their doctors can spot it early—when most cancer is beatable.

We have free films, exhibits, speakers, booklets, articles for your house organ. Tell your local American Cancer Society Unit your plans, and they'll work with you.

Because we want you to keep your workers. By keeping them alive.

**american  
cancer  
society**

*This Space Contributed by the Publisher*

one with 16 lands for integrated circuits.

The company packages transistors in the cup with highly mechanized techniques, which permit a savings of up to 40% compared with the cost of putting the same device in a TO-5 can. First, the chip is eutectically bonded to the flat bottom of the cup. Second, an ultrasonic nail-head bonder connects wires between the interior treads (which connect to the external lands) and the chip. Third, an encapsulating material of the customer's choice is injected into the cup. Finally, the d-c parameters of each assembled transistor are measured on a high-speed au-

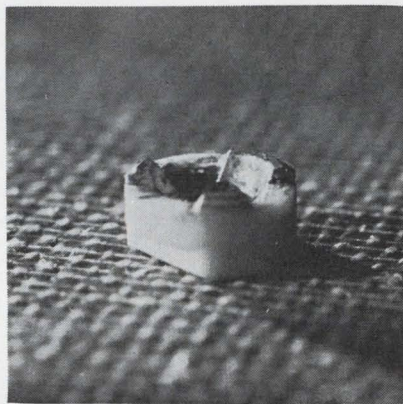

**Cupped.** Three lands replace the traditional leads in new ceramic package. Notch in side aids orientation.

tomatic tester. Circa Tran says its yield is higher than 95%.

When the filled cup is inverted and mounted on the hybrid substrate, there is enough room to allow 15-mil-wide interconnections to run underneath.

After it's mounted on a substrate, the cup has an adhesive force of 7,000 psi, according to the manufacturer. It provides good heat dissipation, keeping the junction temperature rise as low as 70°C per watt, relative to the ambient temperature. The cup is well suited to experimental bread-boarding because it can be installed and removed several times without affecting the device parameters.

Price depends on the semiconductor device. With a 2N918, for example, the unit price would be roughly 50 cents.

Circa Tran Inc., P.O. Box 832, Wheaton, Ill. 60187 [444]

ELFIN  
2.99 \*

# think digital

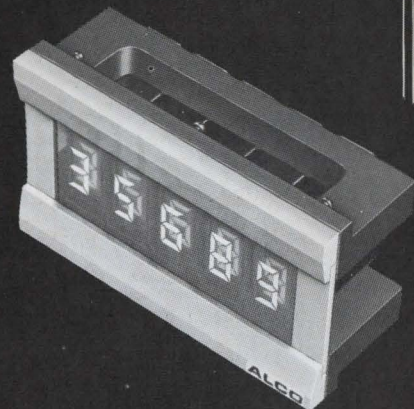

Think ELFIN—the new single plane, segmented neon readout indicator that provides brighter displays and wider viewing. Only 0.41" dia. ELFIN display 0-9, + and —, some alpha symbols and decimal.

The MS-4000 Series has new readouts added to include numeric and symbol indications. Each model is a miniature encased readout with the flat single-plane viewing, and uses 100,000 hr. #683 T-1 subminiature lamps. Plug-in feature expedites replacement. Photograph above shows five MS-4000 readouts used with a module mounting and bezel kit.

ALCO's RK numeric and symbol readouts have a unique in-line design to provide clear displays without focusing problems. The precision machined 1-piece aluminum case also serves as a heat sink.

The MS Mosaic numeric segmented indicators are available in 2 sizes and use either 6, 14 or 24V lamps for flexibility in design.

SEND FOR  
ALCO - NUMERIC  
CATALOG

\* 1000 Lot Prices

MS-3

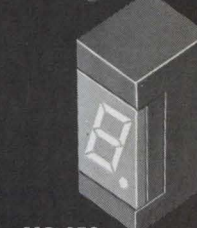

MS-250  
4.97 \*



MS  
4.97 \*

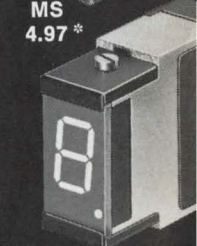

MSM-5A  
4.97 \*

# ALCO

ELECTRONIC PRODUCTS, INC.

Lawrence, Massachusetts 01843



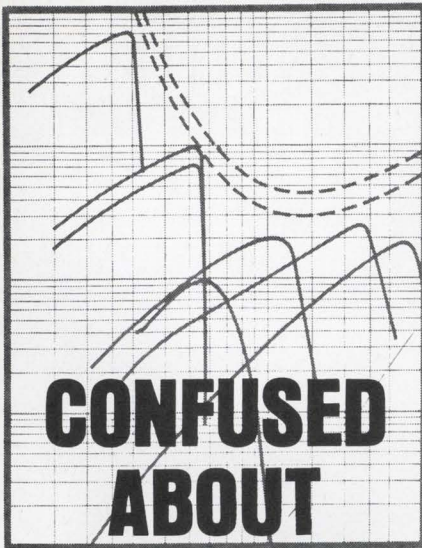

# CONFUSED ABOUT INFRARED DETECTOR SPECS?

Get the answers from  
the experts at Barnes!

Head in a spin with noise-value figures? Time constants? Detectivity? Flake sizes?

Do you need a simple thermal detector? Cooled or uncooled photon detector? A sophisticated mosaic array? Why not ask the experts?

Our credentials speak for themselves. For the past 15 years our infrared specialists have been helping customers select the best detector for their requirements. We've built complex detectors to meet the most demanding specs for advanced military, space, and research programs. And we've made them simple for off-the-shelf delivery to industry.

For personal service, competitive prices and fast delivery, just call or write:



**BARNES  
ENGINEERING  
COMPANY**

30 Commerce Rd/Stamford, Conn. 06902  
Phone (203) 348-5831 / TWX 710-474-3367

## New Books

### One step beyond

Basic Circuit Theory  
Charles A. Desoer and Ernest S. Kuh  
McGraw-Hill Book Co., 876 pp., \$15.50

The use of computers has freed circuit designers from the complicated, time consuming, and, to a certain degree, specialized task of solving complex circuit equations. But, this liberation adds a further burden: today's engineers must develop a more systematic formulation of problems. Thus, circuit designers should be able to write reasonably complicated equations and at the same time have an understanding of system theory, stability, and device modeling as well as circuit theory. This book's unusually unified approach should help; its formulation of lumped circuit theory treats linear and nonlinear, time invariant and time varying, and passive and active circuits.

The aim is to get engineers to the point where they can decide which aspects of theory they want to apply to a particular problem in circuit design. Many of the concepts and techniques described were developed by people doing research in circuit and systems theory.

The organization breaks down into three parts covering simple circuits, complex networks, and the main results of circuit theory. At the outset, the authors classify two-terminal networks into linear or nonlinear and time invariant or time variant categories. One interesting chapter discusses the phasor method used for sinusoidal steady state analysis.

On more complex networks, the book first deals with standard coupled elements—transformers, coupled inductors, and controlled sources. It illustrates the usefulness of general methods by explaining graph theory and showing how general properties of impedance functions can be derived from Telegen's theorem. This is followed by a systematic presentation of general network analysis, consisting of discussions of node, mesh, and cut-set methods. Part two then concludes with a descrip-

tion of the state-variable method, shown by the authors to be an important aid in formulating equations for nonlinear and time-varying networks.

After a brief discussion of Laplace transforms in part three, the authors first consider the fundamental properties of linear and time-invariant networks and then launch into discussions of natural frequencies, network functions, the four standard network theorems, and two-ports. Whenever possible they relate these discussions to the fundamental properties. Also, a chapter on resistive networks shows that general properties of nonlinear resistive networks can be formulated when closed-form solutions aren't known. And, the final chapter considers the energy balance in time-varying elements, parametric amplifiers, and the characterization of passive one-ports.

Figures are ample and informative. And the summary and problems at the end of each topic are welcome. Also very useful are the three appendixes, devoted to mathematics, that cover the concept of a function, matrices and determinants, and differential equations.

### Recently Published

**Working With Semiconductors, Albert Saunders, Tab Books, 221 pp. \$7.95**

A lucid discussion of semiconductor circuit operation and application with the theoretical mathematics. Beginning with background data on semiconductor technology, Saunders progresses into basic circuit configurations, power supplies, SCR's, and field-effect transistors. An excellent beginning text for those who work with solid state equipment.

**Estimation Theory and Applications, N. E. Nahi, John Wiley & Sons, 280 pp. \$14.95**

This introduction to the theory of estimation should be easily understood by first-year graduate students in engineering and physics. Necessary mathematical notations and techniques, as well as a conceptual background, are presented before the treatment of principle estimation methods. Numerous examples aid in the clarification of theory and application.



## Technical Abstracts

### High dielectric for uhf

Integrated microcircuits for the uhf range  
Robert M. Knox  
IIT Research Institute  
Chicago

A high dielectric constant ceramic IC holds out promises of low cost, small size, and high reliability for applications in the ultra high-frequency range, 0.3-3.0 gigahertz. The circuit is almost  $\frac{1}{10}$ th the size of hybrid alumina IC's and can incorporate either the pill package or the conventional beam-lead configuration.

The microcircuit substrate is of low-loss, high relative-dielectric constant ceramic material on which thin-film stripline conductors are deposited to form microwave transmission lines and passive components. The high dielectric-constant substrate reduces the size of the microwave components. Thus, several microwave circuit functions can be combined in one module.

Although a triplate configuration of stripline transmission lines—balanced double-ground plane construction—can be used, a microstrip configuration is preferable. Not only is the microstrip simpler—a single ground plane—but it also has a higher characteristic impedance for equal strip width and dielectric thickness. Also, the propagation loss per unit length is lower in microstrip.

Among the factors that determine a microwave circuit's size at a given frequency are characteristic impedance, substrate thickness, and dielectric constant. The amount of transmission loss that can be tolerated must be considered, too.

No theory describes the transmission line properties of microstrip accurately. However, experimental measurements have provided some useful information. High dielectric constant transmission lines with different strip widths have been fabricated to determine the characteristic impedance as a function of strip width, and substrate thickness. For a given strip width, the high dielectric constant substrate more nearly lends itself to the idealized trans-

verse electromagnetic wave solutions than the lower-dielectric constant silicon or aluminum oxide substrate material.

Propagation losses result from finite conductivity and power dissipation in the medium of the line. Smaller transmission lines lead to higher conductor losses. When a very low loss substrate is used, conductor losses predominate. And, in high dielectric-constant—20 or above—ceramic transmission lines, conductor losses also predominate.

Presented at Wescon, San Francisco, Aug. 19-22.

### Hail to the chip

Microwave transistor amplifier design and specification  
James R. Reid  
Avantek Inc.  
Santa Clara, Calif.

The frequency domain previously held by traveling-wave tube amplifiers is fast falling to transistor amplifiers as microwave systems designers improve both performance and reliability. Moreover, the replacement of these thermionic devices with transistors has brought about a large reduction in maintenance costs.

Low noise and medium power microwave transistors are finding increased application in both narrowband amplifiers and broadband amplifiers. Broadband amplifiers are used for electronic countermeasures and reconnaissance systems; narrowband amplifiers are used for telemetry, spacecraft to ground communications, troposcatter, radio astronomy, radio relay and phased array radar systems.

Commercially available low-noise transistor amplifiers are now capable of replacing traveling-wave tubes, tunnel-diode amplifiers, and parametric amplifiers for many applications in the L and S bands and will soon compete for applications through the C band.

Microwave amplifiers commonly fall into two categories: ultra wide-band types that cover at least an octave; and comparatively narrow-band, with bandwidths of less than 100 megahertz. Each of these amplifiers offers different performance

# variety with ALCOSWITCH

The greater the variety, the more flexibility you have when designing a miniature ALCOSWITCH into your quality equipment. The broad ALCOSWITCH line offers over a hundred different models.

Miniature Toggle Switches are available in five series including high performance waterproof types, locking handles, and switches with 15/32" bushings.

Miniature Push Button Switches include the new illuminated series, top-grade SPDT-DPDT-4PDT types, 15/32" bushings, and economy priced miniatures.

$\frac{1}{2}$ " Dia. Miniature Adjustable-Stop Rotary Switches are built to meet the highest reliability standards and are available with or without their own specially mated knobs.

Whether you need one or one thousand switches you have a greater variety to choose from when you specify an ALCOSWITCH.

SEND FOR  
20-PAGE  
ALCOSWITCH  
CATALOG



# ALCO

ELECTRONIC PRODUCTS, INC.

Lawrence, Massachusetts 01843



# What happened when doctors and engineers got together.

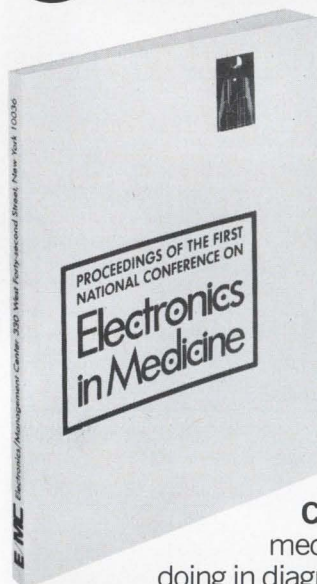

Doctors told engineers how they were using electronics and revealed their most urgent needs. Engineers described and demonstrated their newest equipment for diagnosis, treatment, and prevention. And hinted at things to come.

Their complete dialogue, with illustrations, makes pretty informative reading on a vital and growing market.

Here are some of the things it contains:

**Computers:** How they're joining the medical team. What computers are doing in diagnosis. In communications. The small computer as a paramedical aid.

**Instrumentation:** What's needed. What's available. Patient management. Protection. Standards and safety.

**Electronics in the Hospital:** The surgeon, the hospital, the instruments. What the administrator wants. Prescription for large-scale health care. The surgery department.

Electronics/Management Center  
330 West 42nd Street, New York, N.Y. 10036

Enclosed is \$12 for a copy of the Proceedings of the First National Conference on Electronics in Medicine.

Send the Proceedings and bill me later. P.O. # \_\_\_\_\_

Name \_\_\_\_\_

Company \_\_\_\_\_

Address \_\_\_\_\_

City \_\_\_\_\_ State \_\_\_\_\_ Zip \_\_\_\_\_

## Technical Abstracts

capabilities that arise from the different parameter tradeoffs required for each application. And they need transistors that are optimized for each case.

Microwave transistors that offer state-of-the-art performance are now available. These medium power, low noise S-band transistors are optimized for input, interstage, and output stages, and can be supplied with complete S-parameter characterizations in addition to the more conventional parameter such as  $h_{FE}$ ,  $f_t$ ,  $r_b$ ,  $C_c$ , maximum available gain, and noise figure. In addition, the designer can choose to use either discrete components or hybrid microwave integrated circuit types using chip transistors. Also, specifications must be considered, since different applications require different performance.

Telemetry, ecm, and communication receivers require very high sensitivity or low noise inputs and wide bandwidths, whereas in troposcatter, high sensitivity is a must. Other systems require extremely close matching of gain and phase characteristics of many amplifiers. To adequately specify the best transistor amplifiers requires careful consideration of many diverse parameters: flatness over the bandwidth, noise figure, frequency range, r-f power handling capability, the amplifier's limiting characteristics, intermodulation products, the spurious-free dynamic range, reverse isolation of the amplifier, input-output vswr, and stability.

In addition care must be taken to meet any special requirements such as phase linearity which needs special tracking adjustments to produce a fairly large bandwidth coverage. In addition, both the phase and gain tracking accuracy must be taken into account, particularly before ordering many amplifiers for a system that requires better than 2:1 matching. And finally, the operating environment will affect the amplifier, since transistor parameters vary with temperatures. Thus, the amplifier must be fully compensated for changes in its surrounding.

Presented at Wescon, San Francisco, Aug. 19-22.



## New Literature

**Oscillators.** Accutronics Inc., 628 North St., Geneva, Ill. 60134. A 16-page catalog defines a complete line of oscillators from less than 1 hz to 250 Mhz.

Circle 446 on reader service card

**Resistor networks.** Kelvin, 5919 Noble Ave., Van Nuys, Calif. 91401, offers a 12-page catalog on precision wire-wound resistor networks. [447]

**Automation systems.** Electroglas Inc., 150 Constitution Dr., Menlo Park, Calif. 94025, has published a six-page full-color folder covering its new line of digital automation systems. [448]

**Automation dictionary.** Honeywell Inc., 2701 Fourth Ave, S., Minneapolis 55408. A 47-page automation dictionary defines more than 200 terms, ranging from "algorithm" to "zener diode." [449]

**Tantalum capacitors.** NCI Inc., 5900 Voss Rd., West Palm Beach, Fla. 33407. Bulletin 613B contains ready reference information on Mil type solid and wet tantalum capacitors.. [450]

**Command communications system.** Theta Instrument Corp., Fairfield, N.J. 07006. Digital command communications system model DM-3 is covered in engineering bulletin 67-14A. [451]

**Conductive coatings.** Electro-Science Laboratories Inc., 1133 Arch St., Philadelphia, Pa. 19107, has released a product bulletin on silver based cermet conductive coatings numbers 590 and 5964. [452]

**Log periodic antenna.** RF Systems Inc., 154 King St., Cohasset, Mass. 02025. A single-page data summary describes heavy duty model LP-213 log periodic antenna. [453]

**Voltage-to-frequency converters.** Solid State Electronics Corp., 15321 Rayen St., Sepulveda, Calif. 91343, has available a data sheet on the series 300VF solid state voltage-to-frequency converters. [454]

**Relay tachometers.** Dynalco Corp., 4107 N.E. 6th Ave., Fort Lauderdale, Fla. 33308, has issued Dynaform RT 2000 describing a line of precision electronic tachometers with adjustable limit switches. [455]

**IC operational amplifiers.** Union Carbide Semiconductor, 8888 Balboa Ave., San Diego, Calif. 92123, has available a data sheet on the UC4101A and IC operational amplifiers. [456]

**Indicator lights.** Eldema, Division of Genisco Technology Corp., 18435 Susana Rd., Compton, Calif. 90221. A seven-page brochure provides a compre-

hensive cross-reference between the company's MIL-Lites and revised MIL-L specifications. [457]

**Industrial relay.** Teledyne Relays, A Teledyne Co., 3155 W. El Segundo Blvd., Hawthorne, Calif. 90250. A technical bulletin describes the 712T general purpose TO-5 industrial relay. [458]

**Rotary switches.** RCL Electronics Inc., 700 S. 21st St., Irvington, N.J. 07845. An expanded engineering handbook gives complete technical specifications on six new series of miniature rotary switches. [459]

**Low-cost timer.** Sealectro Corp., 225 Hoyt St., Mamaroneck, N.Y. 10543. A two-page data sheet describes a multiple function, low-cost timer. [460]

**Conductive silicone adhesive.** Chomerics Inc., 77 Dragon Court, Woburn, Mass. 01801. A comprehensive data sheet lists typical properties and directions for preparation and application of a new, improved conductive silicone adhesive. [461]

**Arc suppressors.** Genisco Technology Corp., 18435 Susana Rd., Compton, Calif. 90221. Specifications of a new series of rfi miniature arc suppressors—each smaller than an ordinary thimble—are provided in a data sheet. [462]

**Sealing trimmer capacitors.** Voltronics Corp., Hanover, N.J. The subject of sealing precision piston trimmer capacitors is discussed in detail in a recent issue of Trimmer Topics. [463]

**Relay catalog.** James Electronics Inc., 4050 N. Rockwell St., Chicago 60618, offers an eight-page catalog containing specifications on high speed Micro-Scan relays with a full range of models and illustrative package drawings. [464]

**Photocoupled pair.** Monsanto Electronic Special Products, 10131 Budd Road, Cupertino, Calif. 95014, has published a data sheet on the MCT1 phototransistor coupled pair. [465]

**Encoders guide.** Collectron Corp., 304 E. 45th St., New York 10017. A 12-page guide details encoder technology and provides extensive data on encoder applications. [466]

**Data modem.** Quindar Electronics Inc., 60 Fadem Rd., Springfield, N.J. 07081. Product data sheet PDS-2-14 covers the QDM-103 data modem. [467]

**Magnetic switches.** Kessler-Ellis Products Co., 120 First Ave., Atlantic Highlands, N.J. 07716. A six-page bulletin

# designer's keyboard

SB-033 — INTERLOCK  
SB-034 — MOMENTARY

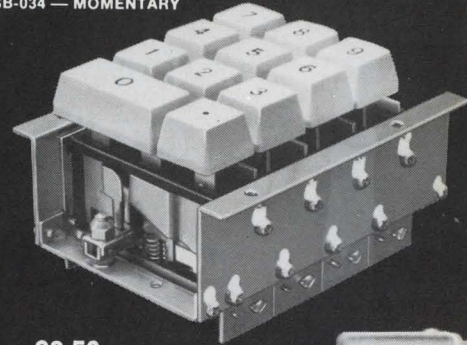

28.50 User Net

The ALCO modular idea is a simple concept for the design engineer to create his own custom push button layouts from "stock" switch modules and assemblies.

The basic modules allow use of up to twelve (shown at right) switches per section. A designer may stack any number of these switch sections in a group by themselves or in conjunction with the ALCO mating 12-segment keyboard assemblies (shown above).

Highly efficient, single pole "normally open" reed switches are used throughout, thus assuring reliability and extremely long life expectancy.

For design-service assistance and price quotations, call (Area 617) 686-3887.

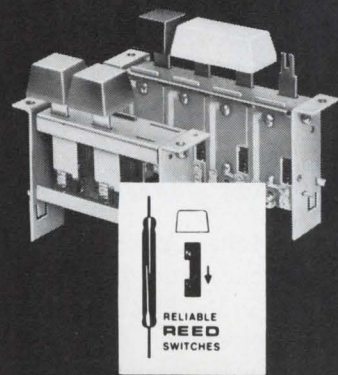

RELIABLE  
REED  
SWITCHES



Available as  
Momentary  
and Interlock

# ALCO

ELECTRONIC PRODUCTS, INC.

Lawrence, Massachusetts 01843

Circle 147 on reader service card



# We're not interested in next year's callawumpus.

*Our display terminals are priced and programmed for today. No blue sky over-engineering. No payments for loafing parts.*

*We offer a complete line, starting under \$1500. And every unit is ready for immediate employment.*

*For further details, call (617) 272-6660 collect. Or see us at the following:*

**NEREM '69**, November 5-7,  
Booth 1A73,  
War Memorial Auditorium.

**FALL JOINT COMPUTER CONFERENCE**,  
November 18-20,  
Booth 21010,  
Sahara Hotel.



## Infoton

INFOTON INCORPORATED  
SECOND AVENUE, BURLINGTON, MASSACHUSETTS 01803  
*Incorporating Information Research Associates, Inc.*



Circle 148 on reader service card

## Make your own break.

You can take a lot of the chance out of your future by including yourself in the Electronics Manpower Register.

When you do, your experience and talents become part of a nationwide computerized placement service.

Our computer is programmed to give every registrant the same

look for every opening. With your prior approval, you'll be considered for every opportunity that matches your resume.

All you have to do is send one to:

Electronics Manpower Register  
**Electronics**  
330 West 42nd Street  
New York, N.Y. 10036

## New Literature

describes a new line of magnetically operated reed switches specially housed for industrial applications. [468]

**Insert molding techniques.** Capsonic Group Inc., 1000 Bluff City Blvd., Elgin, Ill. 60120, has issued a six-page brochure on thermoplastic and thermoset insert molding for the electronic and aerospace industry. [469]

**Reliability program.** National Semiconductor Corp., 2950 San Ysidro Way, Santa Clara, Calif. 95051. "National/883" is the title of a brochure describing the company's Mil-Std-883 reliability program. [470]

**Ferrite beads.** Ferronics Inc., 68 N. Main St., Fairport, N.Y. 14450. Bulletin 201 covers a line of ferrite beads available for use as broad band chokes or suppressors. [471]

**Etched circuit materials.** Kepro Circuit Systems Inc., 3630 Scarlet Oak Blvd., St. Louis, Mo. 63122, has available its 1970 catalog listing that describes a comprehensive selection of circuit board materials, supplies, and equipment. [472]

**Thermocouples.** Nanmac Corp., Framingham Centre, Mass. 01701. Bulletin TB-165 covers inert-gas filled thermocouples for 4,000°F environments. [473]

**Pressure measuring systems.** MB Electronics, a Textron Co., Box 1825, New Haven, Conn. 06508, has released bulletin 500S describing its complete line of systems and components for measuring pressure electronically with high accuracy transducers. [474]

**Environmental testing.** Ogden Technology Labs Inc., 573 Monterey Pass Road, Monterey Park, Calif. 91754. An eight-page brochure describes the environmental testing facilities and capabilities of the company's seven test lab locations. [475]

**Measuring microwave pulses.** Varian Solid State Microwave Project. Salem Road, Beverly, Mass. 01915. A four-page application engineering bulletin entitled "Precise Measurement of Spike Leakage in Gas Switching Tubes" may be obtained by request on company letterhead.

**Miniature relay.** Price Electric Corp., Frederick, Md. 21701. Bulletin CPH01 describes the style PHP miniature general purpose relay. [477]

**Stand-off terminals.** Sealectro Corp., 225 Hoyt St., Mamaroneck, N.Y. 10543. A six-page folder describes a new series of Riv-Loc Teflon-insulated terminals that feature a stand-off with a twin-turreted solder area. [478]



OVER  
**1,000,000 SIZES**

**MILITARY CASES**

COMBINATION • TRANSIT • INSTRUMENT

MIL-T-945A, T-4734, T-21200, STD-108, C-4150



Choose from over 1,000,000 variations in dimensions, proportions, metals, finishes, and custom accessories. Whatever your need, the MM (multi-measure) method gives you high production savings even on custom runs as low as 25 units. Send your print or requirements. Manufacturers representatives in all major cities.

SEND FOR FREE CATALOG & DIMENSION SPECIFICATION SHEETS.

**MM ELECTRONIC ENCLOSURES, Inc.**

111 Bloomingdale Rd., Hicksville, N.Y. 11801 • 516-935-9400

Circle 170 on reader service card

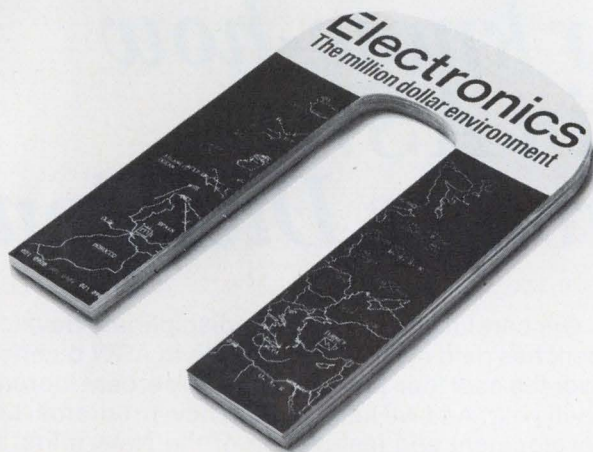

Every year, **ELECTRONICS** attracts requests for over 125,000 editorial reprints.

They're like interest payments on our million-dollars-a-year editorial principles.

That's how much we spend annually to produce timely, authentic, and useful articles like those listed on the reader service card as reprints currently available.

Investment and interest make both **ELECTRONICS** and its readers more meaningful to its advertisers.

**New!**  
**An economical way to get high performance filters.**

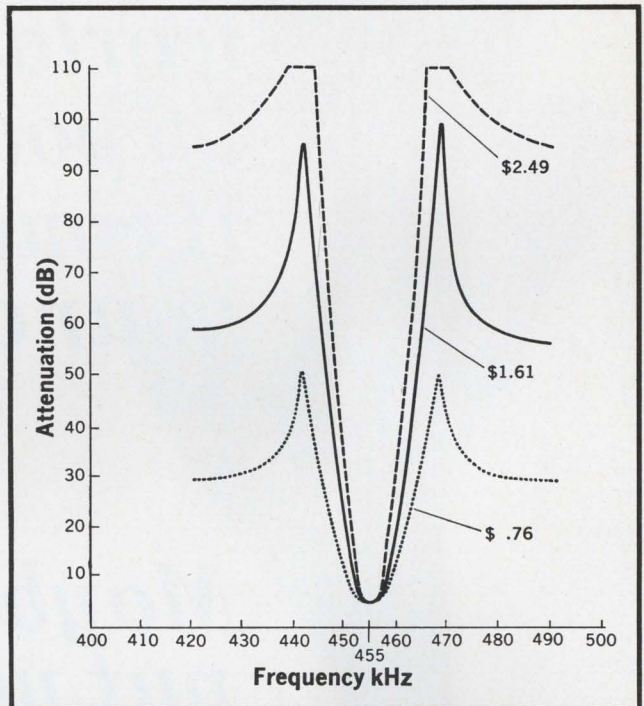
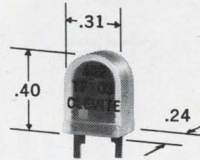

Typical response curves and component costs for three IR Filters—based on quantities of 500 resonators.

Now you can easily make your own ceramic filters—at low cost—with any of these performance factors:

Center Frequency	455 kHz
Stop Band Rejection	to 105 dB
Bandwidth @ 6dB	2-23 kHz
Shape Factor	better than 2:1

Here's a totally new concept from Clevite: high performance ceramic IF bandpass filters you build yourself. You do it by taking two or more standard Identical Resonators (IR's) and interconnecting them to known capacitors in a prescribed network configuration. Just check Clevite's tables for required capacitance values for given filter responses. And the tables are free for the asking.

Compared with conventional LC filters or IF cans, Clevite's IR approach offers extreme design simplicity and flexibility, plus economy. Here's an ideal way to get a special filter without paying a special price. In fact, the IR's cost just 35¢ in lots of 500.

Interested? A letterhead inquiry brings design tables and full information. Clevite Corporation, Piezoelectric Division, 232 Forbes Rd., Bedford, Ohio 44146, U.S.A. Or: Brush Clevite Company Ltd., Southampton, England.

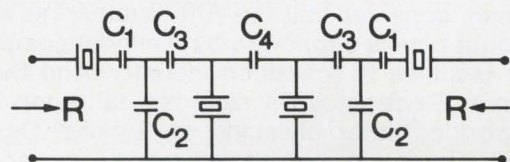

Example of IR filter with  $n=4$  Identical Resonators. By changing capacitors  $C_1$  to  $C_4$ , a continuous range of different filter responses becomes possible.

**CLEVITE**



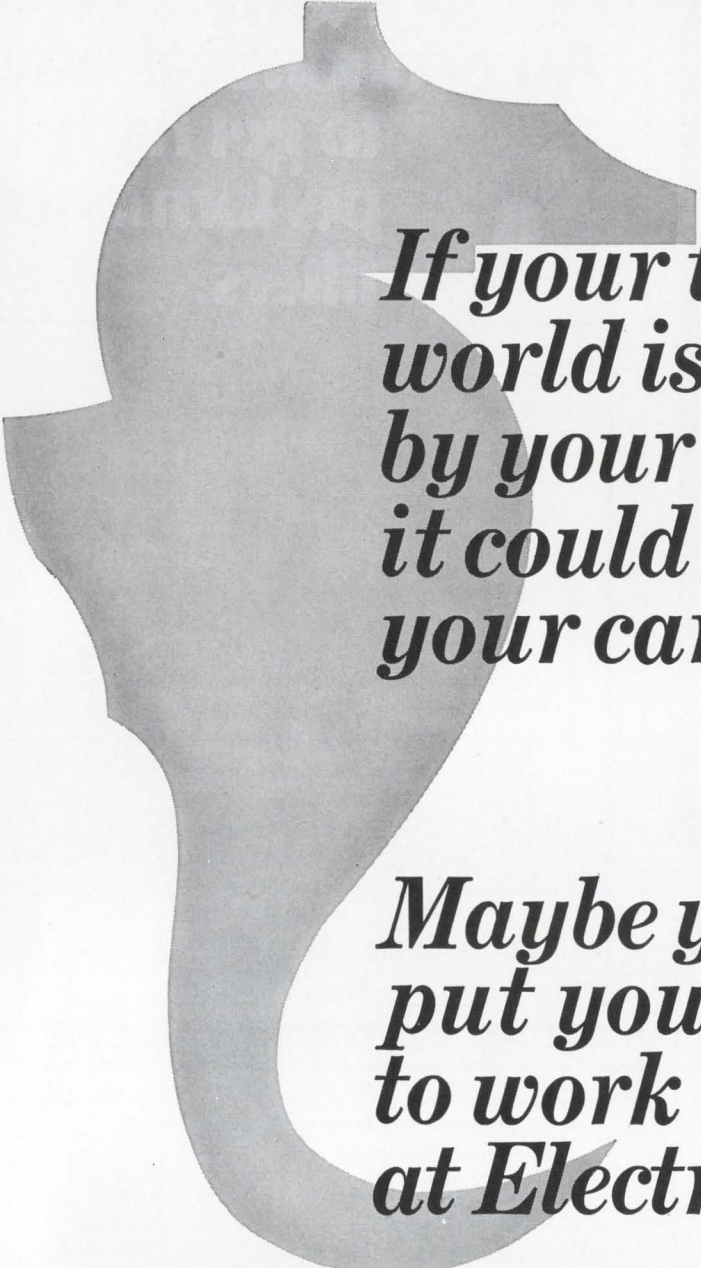

*If your technological world is bounded by your own field, it could be limiting your career.*

*Maybe you should put your know-how to work in ASW at Electronics Division.*

Here, tired careers get the stimulation of thinking in many advanced technologies—electroacoustics, hydroacoustics, avionics, optical tracking, acoustic navigation, high data rate underwater data transmission, high data rate recording, high speed computerized data analysis, all supported by in-house capabilities such as microelectronics and math modeling. Spectrum coverage spans from sub audio to UHF frequencies. All this, mind you, housed under one roof. So, interdisciplinary communication is quite convenient. Comfortably so.

Then, consider that the Anti-Submarine Warfare Product Line is supported by the most comprehensive facilities in American industry. And the ASW team at Electronics Division can call upon the full support of other divisions of General Dynamics which engage in aircraft, submarine, surface ship, space vehicle and industrial natural resources fields. The kind of in-house support no other company can provide.

Our careful attention to interdisciplinary development has paid off. The growth rate in ASW business over the past four years shows a 40 percent increase each year. And we keep getting new programs. Like development and installation of the Navy's first *in-situ* sonar calibration system and sonar range for the Atlantic Underwater Test and Evaluation Center to be located in the Bahamas.

We're also wide awake to the fact that current and planned business requirements necessitate expansion of the engineering staff in all areas; from theoretical scientific analysis to hardware development and manufacturing support. Why not see how your specialty might take on new meaning in this environment? Send a resume, in confidence, to W. H. Vickery, Dept. 139.

**GENERAL DYNAMICS**

***Electronics Division***

1400 N. Goodman St., Rochester, New York 14601

An Equal Opportunity Employer (M&F)

CIRCLE 951 ON READER SERVICE CARD

Electronics | September 1, 1969







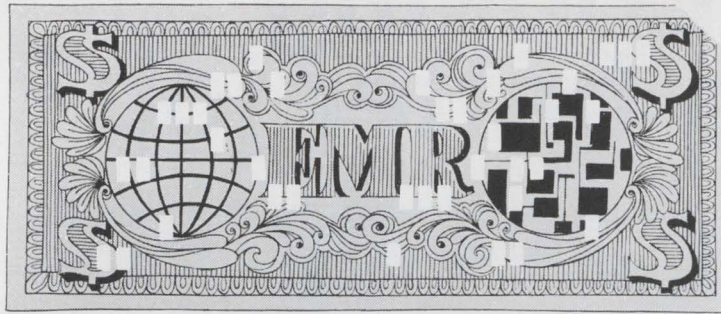

The cost of all this to you? Absolutely nothing. No fees or charges at any time.

Other advantages of EMR:

- Your resume is sent only to those companies that have a genuine requirement for your particular skills.
- There is no general "broadcasting" in the hope "someone will be interested."
- Your identity is protected because your name is released only according to your prior instructions. Your name can be deleted on request.
- EMR's service is nationwide. You may be considered for job opportunities anywhere in the U.S.

The Electronics Manpower Register is a powerful tool and should be considered when you are seriously seek-

ing a new position. And, although you may be reasonably happy in your present position, chances are that you might have that ideal job in mind.

This is why EMR makes good sense for you. If that job does turn up, you'll be there.

To get your name in the EMR file, just fill out the resume form and return to:

Electronics Manpower Register  
330 West 42nd Street  
New York, N. Y. 10036

Please enclose a copy of your resume if you have one. A detailed brochure further describing EMR will be sent to you.

## **Electronics Manpower Register** A computerized employment opportunity service

CONTINUED FROM OTHER SIDE				
Previous Position	Employer	City/State	From	To
Duties and accomplishments				
Previous Position	Employer	City/State	From	To
Duties and accomplishments				
<b>GENERAL INFORMATION</b> (Summarize your over-all qualifications and experience in your field. List any pertinent information not included above.)				
Current annual base salary	Total years of experience	Date available (within four months)	U.S. Citizen <input type="checkbox"/>	Non U.S. Citizen <input type="checkbox"/>
My identity may be released to: employer <input type="checkbox"/>	All but my present employer <input type="checkbox"/>	Have you security clearance? Yes <input type="checkbox"/> No <input type="checkbox"/>	If yes, What level	
Mail (with a copy of your resume, if you have one) to:				
<b>Electronics Manpower Register</b> <b>ELECTRONICS</b> <b>330 West 42nd St.</b> <b>New York, N. Y. 10036</b>			<b>NO FEES</b> <b>OR</b> <b>CHARGES</b>	
			<b>EMR-19</b>	





## EMPLOYMENT OPPORTUNITIES

### POSITION WANTED

Young Dynamic Swiss chemical engineer (SEIT) likes to expand his knowledges in U.S.A. in a progressive American firm for printed circuits, chemical milling and multi-layers. Experience in manufacturing of PC-boards with plated-thru-holes, electroplating, chemical analysis, repro-photography. Fluent in English, French and German. Please contact: R. Erismann, Puntstrasse 20, 8132 Egg, Switzerland.

### SPECIAL SERVICE

Capital Contacts—Before you try Public or Private Placements to Underwriters, Investment Banking Houses, write for free helpful information to Confidential Consultant 817 51st St., Brooklyn N. Y.

Don't forget

### THE BOX NUMBER

when answering the classified advertisements in this magazine. It's our only means of identifying the advertisement you are answering.

# Make your own break.

You can take a lot of the chance out of your future by including yourself in the Electronics Manpower Register.

When you do, your experience and talents become part of a nationwide computerized placement service.

Our computer is programmed to give every registrant the same

look for every opening. With your prior approval, you'll be considered for every opportunity that matches your resume.

All you have to do is send one to:

Electronics Manpower Register  
**Electronics**  
330 West 42nd Street  
New York, N.Y. 10036

## SEARCHLIGHT SECTION

### ELECTRON TUBES

KLYSTRONS • ATR & TR • MAGNETRONS  
SUBMINIATURES • C.R.T. • T.W.T. • 5000-  
6000 SERIES  
• SEND FOR NEW CATALOG A2 •  
A & A ELECTRONICS CORP.  
1063 PERRY ANNEX  
WHITTIER, CALIF.  
696-7544

CIRCLE 954 ON READER SERVICE CARD

**New**  
for picking up miniature parts

**VACUUM PENCIL**

\$7.50 ea.

Selected Distributorships available.

**PHILIP FISMAN COMPANY**  
7 CAMERON ST., WELLESLEY, MASSACHUSETTS

CIRCLE 955 ON READER SERVICE CARD

### WELDING HAND TOOL

TW 17 A  
\$48.00



Replaceable Tips—Adjustable Pressure  
AC and Stored Energy Power Supplies

**EWALD Instruments Corporation**

Kent, Conn. 06757

CIRCLE 956 ON READER SERVICE CARD

Remember . . .

MAIL MOVES

THE COUNTRY

but . . .

ZIP CODE MOVES

THE MAIL

### AUTOTRACK MOUNT

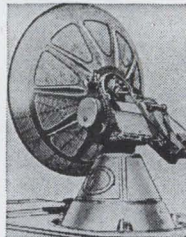

360 degree azimuth, 210 degree elevation sweep with better than 1 mil. accuracy. Missile velocity acceleration and slewing rates. Ampidyne and servo control. Will handle up to 20 ft. dish. Supplied complete with control chassis. In stock—immediate delivery. Used world over by NASA, USAF, MP-61-B. Type SCR-584. Nike Ajax mounts also in stock.

### PULSE MODULATORS

**MIT MODEL 9 PULSER 1 MW—HARD TUBE**  
Output 25kv 40 amp., 30kv 40 amp. max. Duty cy .002. .25 to 2 microsec. Also 5 to 5 microsec. and .1 to .5 microsec. Uses 6C21. Input 115v 60 cycle AC. Mfr. GE. Complete with driver and high voltage power supply. Ref: MIT Rad. Lab. Series, Vol. 5, p. 152.

### 2 MEGAWATT PULSER

Output 30 kv at 70 amp. Duty cycle .001. Rep rates. 1 microsec 600 pps. 1 or 2 msec 300 pps. Uses 5948 hydrogen thyratron. Input 120/208 VAC 60 cycle. Mfr. GE. Complete with high voltage power supply.

### 250 KW HARD TUBE PULSER

Output 16 kv 16 amp. Duty cycle .002. Pulses can be coded. Uses 5D21, 715C or 4PR60A. Input 115 v 60 cy. AC \$1200 ea.

### 18 MEGAWATT PULSER

Output 150KV at 120 amps. Rep rate: 50-500 PPS. Pulse length: 5 msec. 15KV 120 amp. into pulse transformer. Rise time 1.5 msec. Filament supply 5V 80 amp. incl. 17.5KV 1.5 amp DC power supply. Input: 220V 60 cy AC.

### INDICATOR CONSOLES

AN/SPA-4A. PPI 10", range to 300 ml.  
VJ-1 PPI 12", Range to 200 ml.  
VL-1 RHI 12" to 200 ml. 60K ft.

### SCR 584 AUTOTRACK RADARS

Our 584s in like new condition ready to go, and in stock for immediate delivery. Ideal for telemetry research and development, missile tracking, satellite tracking. Fully Desc. MIT Rad. Lab. Series, Vol. 1, pps. 207-210, 228, 284-286. Comp. Inst. Bk available \$25.00 each.



## Radio-Research Instrument Co.

45 W. 45th St., New York, N.Y. 10036 ■ 212-586-4691

CIRCLE 953 ON READER SERVICE CARD

### ANTI-AIRCRAFT GUN MOUNT

Will handle 6,000 lbs. rapid slew through 360° azimuth, 180° elevation. Mobile.

### MICROWAVE SYSTEMS

### 200-2400 mc. RF PKG

Continuous coverage, 30 Watts Cw nominal output. Uses 2C39A. Price \$575.

### I BAND RF PKG.

20 KW peak 990 to 1040 MC. Pulse width .7 to 1.2 micro sec. Rep. rate 180 to 420 pps. Input 115 vac incl. Receiver \$1200.

### 200-225 mc RADAR SYSTEM

1 Megawatt output. 200 nautical mile range for long range detection of medium and high altitude jet aircraft as well as general search. AN/TFS-28.

### SURVEILLANCE DRONE RADAR SYSTEM

X-Band tracking system with plotting boards. Type AN/MPQ-29. Drone also in stock.

### 5 MEGAWATT C-BAND

Klystron RF package delivering nominal 5 megawatt pulse RF. Complete with pulser and power supply.

### 500 KW I BAND RADAR

500 kw 1220-1359 msc. 160 nautical mile search range P.R.I. and A scopes. MTI. thyratron mod 5J26 magnetron. Complete system.

### AN/GPG-1 SKY-SWEEP TRACKER

3 cm. automatic tracking radar system. Complete package with indicator system. Full target acquisition and automatic tracking. Input 115 volts 60 cycle New. In stock for immediate delivery. Entire System 6' long, 3' wide, 10' high. Ideal for Infrared Tracker, Drone Tracker, Missile Tracker, R. & D.

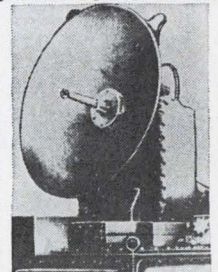

### C Band Autotrack

1 Megawatt 10 ft. Parabola. Sperry.

### 40 KW TRANSMITTER

4 to 21 MHz. 40 kw Telegraphy, 30 kw Voice, can be SSB. New condition. Two systems in stock. Excellent rf source, broadcast or point-to-point.



# Only one man in a thousand needs the tracking speed of this synchro-to-digital conversion system...

(the other 999 sleep nights knowing it's there)

Continuously tracks 10 channels of resolver and synchro data to 20,000°/sec.

Ratiometric conversion and solid-state AC switching minimize harmonic and quadrature errors, yield 0.1° accuracy.

Control multiplexer selects one of 30 channels for real-time viewing. Formatting and timing logic adaptable to digital tape recorder or computer.

Modular building-block approach provides 60 Hz and 400 Hz conversion at 11.8V, 26V, and 90V line-line voltages.

High-speed tracking coupled with velocity constant of 20,000 seconds<sup>-1</sup> minimizes velocity errors.

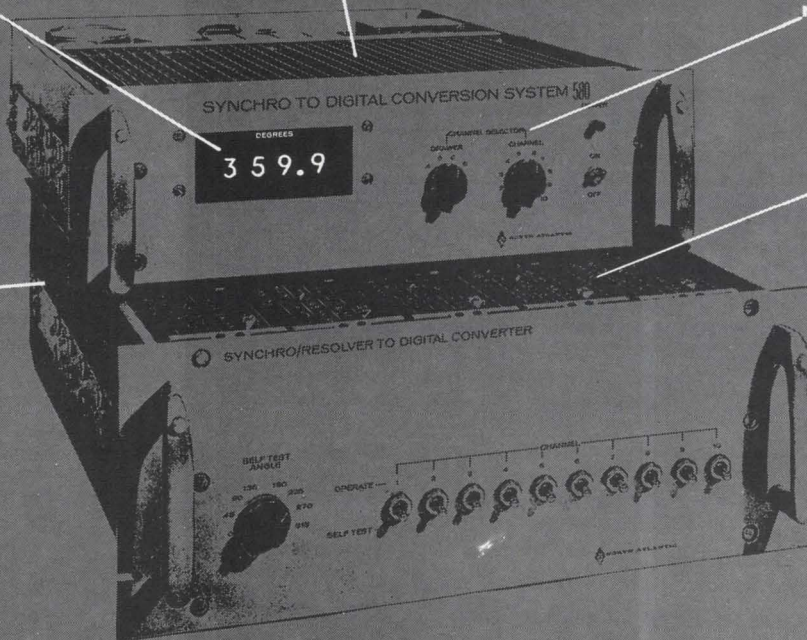

North Atlantic System 580 is available in a standard panel-mounting rack. Optional models offer higher accuracy and increased resolution or tracking speed. Each drawer accommodates up to 10 modules.

This low-cost data-acquisition system is another elegant example of North Atlantic's creativity in automatic test equipment, resolver/synchro instrumentation, and computer interface equipment.

For additional, rewarding details call our field-engineering representative (see EEM), use the reply card, or call or write North Atlantic Industries, Inc., Terminal Drive, Plainview, Long Island, N.Y. 11803. (516) 681-8600.



**NORTH ATLANTIC**  
industries, inc.



---

# International Newsletter

---

September 1, 1969

## Parts pinch shades Danish show . . .

Danish component suppliers expect the current parts penury in Europe will last another 18 to 24 months. So burdened with backlogs are the country's few parts producers, that there was a dearth of new product debuts last month at Electronica 69—even though it was the industry's first shown in eight years.

Most likely to achieve international interest among Danish-made components introduced at the show were latching reed relays, a Yugoslavian development, that Kirk Electric A/S has latched onto and Milspec quartz crystals—microminature ones that come in cans 7.8 by 7 by 2 millimeters—the work of Dantronik, an affiliate of Sweden's AGA.

Nearly all Danish instrument makers, by contrast, had something new on their stands. And although set makers, whose sound and color television spectacles dominated the Copenhagen show, had plenty of new model numbers on their stands, there was little significant change in the basic electronics. One exception: Bang & Olufsen's new stereo phono cartridge, whose flat response from 15 hertz to 20 kilohertz comes mainly from a cross-shaped needle carrier and a shanked diamond that combine to give an effective tip mass of 1 milligram.

## . . . and electronic fair in Stuttgart

And at this week's West German broadcast fair, which houses all segments of the entertainment electronics industry, officials say production in that sector would have been higher this year if it had not been for the lack of parts to build more. Even so, they expect a 20% boost in production and sales, for a record \$750 million for the year. Color tv production is expected to top 500,000 sets.

## Color for Japanese tv data displays

The big hit at this month's Japan Computer Show was a group of computer data terminals with color television picture tubes as display screens. Both Mitsubishi and Toshiba showed color terminals, which can display about 100 different characters in seven distinct colors. Besides the primary tv colors (red, green and blue), the units can mix any two for three more colors (yellow, purple, and cyan) and can mix all three for white.

The companies say the color display does not add much to the price of the units in black-and-white, because the additional cost for the color tube and color controls is only a small percentage of the total system price. But the big addition is in readability. The colored characters seem to have more clarity and the color can be used to differentiate headings or columns to impose a visual order on a crowded display. The Mitsubishi device can show a total of 640 characters in 16 rows of 40 characters. The Toshiba unit can display 12 rows of 32 characters, for a total of 384.

## West Germany injects more funds for technological growth

The Bonn government, more convinced than ever that the economically strong nations of tomorrow will be those who have built a solid technological base today, is stepping up its research and development spending. The industry that's likely to benefit most is the electronics industry.

The Ministry for Scientific Research plans to double its spending for various scientific programs. This year is spent about \$292 million; by 1973 the total is expected to be more than \$600 million. Space research and electronic data processing will get the biggest boost. Space spending, will



---

# International Newsletter

---

rise from \$90 million this year to \$140 million in 1973. Expenditures for data processing R&D will increase five times—from \$20 million to \$100 million annually—during the five-year period.

**What's more the electronics industry will get the hefty share of a new Science Ministry program called "new technologies," for which spending will rise from a scant \$5 million this year to \$75 million in 1973. Under this program new means of intercity rail transportation, and methods of combatting air and water pollution will be investigated.**

## British move ahead in solid state lamps

British government-sponsored research into solid state display lamps is bearing fruit. By the end of the year, all three companies with gallium-based semiconductor lamp development contracts, [*Electronics*, March 3, p. 249], will have red lamps ready for market.

**Ferranti is in the lead;** customers supplied with samples of its epitaxial gallium phosphide lamps are happy, and regular production is planned. **Its lamps measure 20 mils square, peak at 6,900 angstroms, and will cost \$5 apiece.** Alphanumeric arrays, says the company, are still a long-term development, waiting refinements in monolithic gallium phosphide technology. Plessey, using the same basic approach, plans to have samples with customers later this year.

**Although back in the pack now, Standard Telecommunications Laboratories may be the front runner soon.** That's because its planar diffused gallium arsenide phosphide lamps can be easily made either as arrays or as individual lamps. **So, when STL starts production it may go right to arrays, leaving the competition behind.** Meanwhile its single lamps, which may be offered as samples first, show an improved level of external quantum efficiency—up to 0.13% from 0.07%, although still behind the 0.5% reported for gallium arsenide. STL's lamps, 15 mils in diameter, have a spherical transparent covering to magnify the image.

## Japanese boost SCR power

Japan has come up with yet another first. This time it's the world's largest power semiconductors. Hitachi has announced an SCR with a blocking voltage rating of 10,000 volts and a maximum forward current rating of 400 amps, another SCR with ratings of 2,500 volts and 1,600 amps, and a diode with ratings of 10,000 volts and 600 amps.

Hitachi developed the 1,600 amp semiconductor device for use on a-c electric railroad trains, which have 750 volt d-c motors. The 2,500 volt rating allows the use of only one SCR in each arm of the rectifier, and the high current rating minimizes the number that must be connected in parallel arms.

## ESRO eyes a planetary mission

Western Europe may be the first to reach Mercury. A feasibility study just completed for the European Space Research Organization says a television-equipped probe could be launched by the Western European group in 1975.

West Germany's Messerschmidt-Boelkow-Blohm group carried out the study, which calls for the development of a 900-pound satellite with an 80-pound payload. **Its television system would be designed to spot details with dimensions greater than 1,000 feet, from a planned orbiting altitude of about 3,000 miles.** Information transmission, over a distance of about 90 million miles, would be at the rate of 2,000 bits per second.



# Centralization cuts costs in tv data display character generation

London Stock Exchange members and Japanese telephone subscribers to get wide range of information services, with computer doing all the work.

**For television data displays**, one of the costly subsystems is the character generation circuitry. With standard telephone lines connecting a central computer with remote displays, each display unit needs its own character generators to translate the digital input of the computer into video signals.

Obviously, when the number of remote displays reaches a certain point, it starts becoming economically feasible to let the central computer generate the video signals and send them over high-grade lines to simple, relatively inexpensive receivers.

That's just what is being done in England for a new stock market information system and in Japan for an experimental telephone company data service. In both cases, the number of remote units tapping the central information source will be large. And in Japan, the number

of characters that have to be stored will be large. Thus, it will save money—and make user rental charges more attractive—to put the character generators at the computer.

**In Britain.** At the end of September the London Stock Exchange will start providing brokers with a continuously updated tv display of 700 stock prices. So far, about 1,000 displays have been ordered for installation in more than 200 stock-brokerage offices in London. The 700 prices, plus information on mergers, dividends and other financial developments will be on 22 channels, selected by a switch on the display. Updating of the correct price on the correct channel is controlled by a computer, into which the operators on the floor of the exchange will key stock price changes as they occur. The computer output is fed through control

and selection logic to a character generator and transferred as characters to the correct points on the tracks of a drum store. The drum holds information for all 22 channels, which are read continuously in parallel. The video information from the drum is used to modulate ordinary tv radio-frequency carriers which are transmitted over coaxial cable to subscribers' offices. The displays are ordinary domestic tv receivers modified to take 22 channels. As a result the total system cost is much less than with closed-circuit tv data transmission and display facilities, says Ferranti Ltd., suppliers of the system's central electronic gear.

The computer used is a Ferranti Argus 400, and the hardware excluding the r-f stage and the modified commercial receivers is supplied by Ferranti. The r-f modulation and transmission gear is supplied by the British Post Office, and the receivers will come from the British ITT subsidiary, Standard Telephones and Cables Ltd. Ferranti has named its part of the system Digi-tv and plans to sell it for other applications—with the option of keyboards so that the displays become computer terminals.

The stock exchange installation has six keyboard-display terminals on the floor for feeding price changes into the system. When the operator receives notice of a price change, he keys a four-character code, and the line in question is then displayed on his monitor. He keys in the new price, and the computer generates the new line on the monitor. If it's correct, he presses an accept button, and the new line passes through the system to the

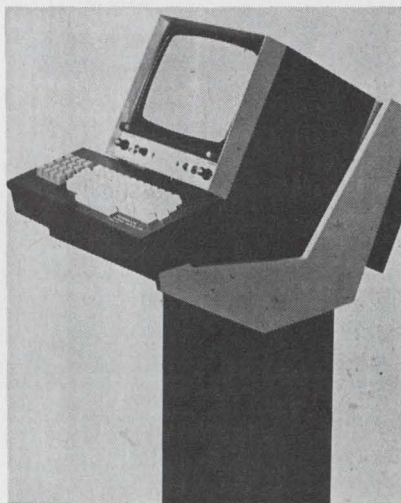
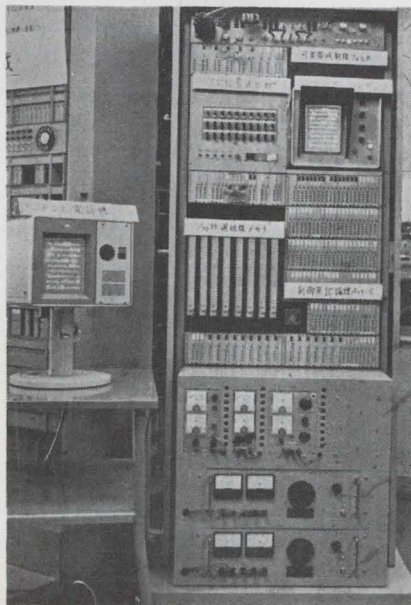

**Outposts.** Remote tv display units, such as in Japanese (left) and British systems, rely on central computer.



proper channel location on the drum store.

The digital output from the computer goes first through control electronics which recognize the instructions for the channel and row of the upcoming new row, for the configuration of the characters in that row and for the address on the drum. This is followed by data for all the characters in the row which is presented scan line by scan line, and which is stored and scanned by the character generator to produce a two-level video waveform. The drum stores the waveform digitally by using three tracks in parallel to store a 312-line field, with 40,000 bits per track. A complete field contains 120,000 bits. One rotation of the drum writes one field every 20 milliseconds, or 50 fields per second.

Synchronization of video and character generation is controlled by a clock track on the drum so that a slight variation in drum speed will not distort timing. The video output has a 6-megahertz bandwidth, but this is filtered down to 3 Mhz before transmission to match the characteristics of the commercial receivers.

Ferranti says a single character generator can be time-shared over as many as 40 channels because it can, on the average, write a complete character every 6 microseconds and completes a frame in 20 to 40 milliseconds—far faster than any possible typed input.

**In Japan.** Tv telephones, which will allow a caller to see the person he is talking to, may have an even bigger potential as data transmission devices. Although initial installation of tv telephones on the lines of the Nippon Telegraph and Telephone Public Corp. is still several years away, company researchers have already put together an experimental data supply service. The company points out that such a service is a natural extension of the processing capability of its projected electronic telephone exchange.

In NTT's data display system, it is only necessary to generate for each customer the equivalent of a single tv frame at a time. Then the computer can attend to the tasks

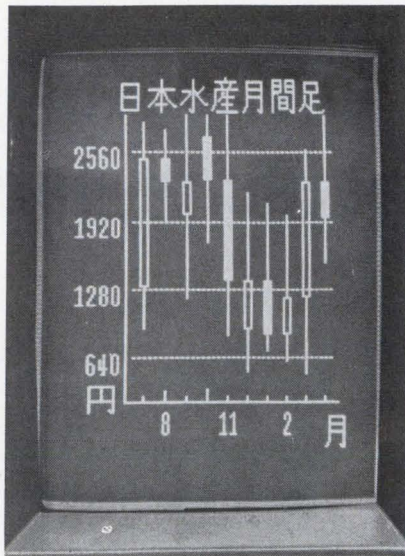

Screen test. Japanese system, still experimental, will offer such data as stock price movement charts.

of other subscribers until the customer makes another request. To keep the required information displayed continuously on the subscribers set, the information is stored and circulated in a one-thirtieth second magnetrostrictive delay line. This information is processed in a video signal generator, which adds synchronizing pulses and blanking signals. Thus each time the information is circulated in the memory, the frame is repeated on the picture tube of the subscribers set. A commercial exchange of this type would need only one expensive central processor, and could keep information on subscribers sets by providing a number of relatively inexpensive delay line memories.

When push button telephones are used as input units, the data service functions in a question and answer mode. NTT figures that while some tv telephone installations will have additional keyboard input and printer equipment, all the installations will have at the very least a pushbutton telephone. In the experimental system, a subscriber is given a choice of services, such as computing service, telephone number information, stock market price information, and weather forecasts.

If, for example, the subscriber asked for the weather forecast, he

might be asked if he wanted a long-range forecast, short-range forecast, or weather map. If he said he wanted a short-range forecast he then would be asked for a specific district of the country. After he had selected the district he would get his forecast.

At the central processor, patterns for 2,000 Chinese kanji characters are stored in a drum memory, those for the Roman alphabet, Japanese katakana syllabary, Arabic numbers, and symbols are stored in the core memory for more rapid access. Information for charts, including stock prices and weather maps, is stored in drum memory of the computer.

Characters are the equivalent of 20 tv lines high, although the full height is used only for the kanji characters. The kanji characters are 18 units wide, so that they are formed as dots on a 20 by 18 wide matrix. Other characters are six or 12 units wide. This allows grouping the information for patterns to be put into groups of six bits.

## Great Britain

### Frame up

For high-speed photography, mechanical shuttering can achieve speeds of up to about 10 million frames per second. Above that, designers have to turn to electronic techniques. Even so, the limit has been about 20 million frames per second for production-line high-speed cameras.

Now a British firm, John Hadland Ltd., has come up with an electronic image converter camera that just gets warmed up at 20 million frames per second. One version of the camera delivered recently to the Lawrence Radiation Laboratories in California, operates at 60 million frames per second. In Hadland's development labs another model, still basically a production-line unit and not custom built, has run at 100 million frames per second. What's more, the camera, called the Imacon, delivers bursts of ten frames or more without loss of speed, over three



times as many as other image converter cameras.

**Sine wave.** The Imacon was developed by Alex Huston, Hadland's chief engineer, using techniques on which he worked while with the United Kingdom Atomic Energy Authority which holds the main patents. Houston has abandoned pulsing, which limited shuttering to 20 million frames per second, and substituted a continuously generating photocathode.

Shuttering is accomplished by deflecting the photocathode's electron beam up and down, using a sinusoidal voltage applied to deflector plates, so that the beam crosses a tiny hole in an aperture plate. The beam crosses the hole twice per cycle, taking one-tenth of total cycle time or less to do so. The time it takes for the beam to cross the aperture is 10 nanoseconds at 20 million frames a second. The crossover period is centered on the deflection voltage zero crossing points.

However, because the beam is moving across the hole, the screen image is blurred. This blurring is rectified by using a second pair of deflector plates on the screen side of the aperture plate. These plates apply the same sinusoidal waveform as the first, but in opposite phase, so that the motion is cancelled. Actually, the second waveform is not exactly opposite in phase to the first, but is brought forward five nanoseconds, so that its zero crossing occurs when the beam first reaches the edge of the aperture hole.

**Bonus.** Huston says that with a little bit of amplitude adjustment this offset makes no significant difference to compensations of the blurring, yet adds a very useful bonus effect: double the number of frames.

This increase occurs because the offset waveform voltage is either completely positive or completely negative during the time the shutter is open. Therefore, the second pair of plates deflects the beam alternately to each side of the center line of the converter's phosphor screen, providing two separate consecutive frames, one above the other. By adding a stepped voltage

to a set of horizontal shift plates, the pairs of consecutive frames can be moved across the screen. Huston's dimensions and timing allows two rows of five frames measuring five-eighths of an inch square. By increasing the number of stepped voltage stages and adding masks in the optical system to reduce frame width, the two rows can have more frames of the same height but reduced width.

The frame rate is increased basically by increasing the frequency of the sinusoidal waveforms. So far, it seems the limit is set by the ratio of necessary exposure time to total wave cycle time. If exposure time is more than 10% of wave cycle time the wave curves too much during exposure, degrading resolution. Thus, at very high frequencies not enough electrons can pass through the aperture hole in the maximum permissible exposure period.

**Hair trigger.** Huston has included in the camera a further feature which is a Hadland patent. Instead of letting the light from the subject to be recorded trigger all camera functions, which is the usual method of synchronizing the camera and the event, Huston allows the shutter to run prior to the event and the first light triggers

the stepped voltage action only. Though this may mean that the first one or two frames are wasted, it eliminates the danger of losing the first instants of an event because the camera has not started to work.

Because the Imacon doesn't use pulses it doesn't need a grid, avoiding space-charge troubles with stray electrons. What's more, continuous operation simplifies power supply requirements. The sustained high voltages are generated in a passive network on circuit boards mounted in the camera.

The Imacon has modular controls that plug into the camera body. One series of plug-ins, for event-triggered framing, allows fast dialing of the number of frames. Another series does the same for triggering of stepped voltage by the event.

A third series of plug-ins allows the recording of events as streaks across the screen rather than as frames. This streaking is accomplished by using an even ramp voltage on the third set of plates and keeping the first two sets of plates at zero voltage.

The standard Imacon is priced in England at about \$17,000. It will be sold in the U.S. by Red Lake Laboratories Inc. of Santa Clara, Calif., which will set the price for the U.S.



**Greased lightning.** Imacon high-speed camera uses controlled deflection of electron beam to capture 10 or more frames at 20 million frames a second.

France

### Scooped on scope

The prospect was sweet for awhile. A small French firm figured it had an advanced new product and a year of breathing space before anybody else started competing. But along came a big United States instruments firm with a similar product and—poof—the time advantage became a mere two months.

But what's disappointing to the French company is good news to research laboratories. The price of a new 250-megahertz oscilloscope will be as much as one-third lower.

**Hopes.** For the past year, Constructions Radioelectriques et Electroniques du Centre (CRC) thought it was home safe with its 250-Mhz



scope, which it planned to launch this fall with a bang in both Europe and the U.S. CRC announced the new scope—perhaps to its regret—at last fall's Mesucora show in Dusseldorf and showed it at the Paris components show in March.

The French company knew Hewlett-Packard was working on a more sophisticated, integrated-circuit 250-Mhz scope, but figured the American unit wouldn't be out until sometime next year. The French scope thus would have been the fastest on the market, and "we would have done a nice business in the U.S. for at least several months," mourns Jacques Croizier, CRC's technical director. Hewlett-Packard's announcement of a 250-Mhz oscilloscope [*Electronics*, July 7, page 90], dashed that hope.

As it stands, the CRC scope still should beat the competition into the laboratory since first deliveries are scheduled for this month, versus Hewlett-Packard's November delivery target. And the French firm still has one commercial advantage: for the moment it is the only maker of a double-gun version of a 250-Mhz scope.

**Price cut.** A year ago, CRC figured to sell its new scope for around \$6,000. Following common European practice, it would lower the price a few months after introduction, when development costs would be largely amortized. That would have made a nice pocketful, as European clients have taken options on 100 of the new scopes.

But since Hewlett-Packard has announced a U.S. price of about \$3,000 plus probes, CRC will have to come down to at least \$4,000 to meet what it figures will be the American company's European price. CRC hasn't set a final price yet.

CRC has some high bills to amortize. It had to pay \$140,000 to Philips Gloeilampenfabrieken's French subsidiary, La Radiotechnique, to develop a helical transmission line cathode ray tube, that's similar to the Hewlett-Packard tube, and that gives the scope its high speed.

The main difference between the tubes is that the French one uses standard electro-static lenses after

the deflectors to increase tube sensitivity—to 2.5 volts per centimeter—whereas Hewlett-Packard relies entirely on its IC circuitry to up sensitivity. Overall sensitivity is 20 millivolts per centimeter for the French scope half the 10 mv per cm of the American unit. The main circuitry difference is that CRC uses discrete transistors in its linear amplifiers while Hewlett-Packard's unit has monolithic arrays.

The French company expects to do a reasonable business despite Hewlett-Packard's one-upmanship. It foresees a first-year European market for 300 of its single-gun scopes and 150 of its double-gun units.

And it still has some prospects to savor. CRC is now working on a 300-Mhz, IC scope that it hopes to introduce late next year.

### West Germany

#### Filtering up

A microwave filter using polycrystalline ferrite material, handling 1.5 watts at X-band and S-band, having quality factors as high as 12,000 at X-band, and promising to be cheaper than current single-crystal ferrite filters has been developed at the Philips Central Laboratories in Hamburg.

The new filter uses polycrystalline spheres suspended in a cavity, similar to the single-crystal types. However, instead of using ferromagnetic resonances to tune the filter, the Philips device harnesses electromagnetic volume resonances.

Although these volume resonances can be excited only if the diameter of the ferrite sphere is at least as large as the wavelength being handled, making for a larger filter, these filters are essentially free from the power-limiting magnetic losses of the ferromagnetic resonance type.

**Useful.** Tunable filters with such high power ratings and Q-factors—much higher than have been obtained so far with similar devices—are especially well suited for relatively high power measuring and

test setups, such as an electronically controlled frequency meter and a sweep generator-receiver combination where the filter, installed at the receiver input, would act as a frequency synchronizing device and as a highly selective filter.

Another application would be for radar frequency hopping. As the radar transmitter's frequency is varied, the frequency of the ferrite filter in the receiver would follow, making the radar receiver insensitive to all but that particular transmitter frequency. Without such a filter the receiver would have to search around for the transmitter frequency and this takes time—too long for some military applications. Also it is more difficult to jam this kind of radar.

Still another potential use for the high power capability of polycrystalline filters is in telephone microwave links, where it would be used also as a selective frequency device. But before such a filter finds its way into commercial products, a lot more development work is required, says its designer Hans-Dieter Ruepke, who is now with Valvo GmbH, another Philips subsidiary in West Germany.

**Single vs. poly.** Single crystal spheres for typical filter are made from highly polished yttrium-iron-garnet material. They have a diameter of from one-twentieth to one-thirtieth of the wavelength, or roughly 0.5 millimeters at X-band and use uniform precession modes for tuning. The cost of single-crystal yig spheres is about \$25.

Ruepke's polycrystalline-sphere filter is also made of yig material, but any other ferrite material will do as long as its dielectric loss is low. By comparison, its size is 7.5 millimeters for X-band.

Polycrystalline ferrite spheres are not being mass-produced yet; they're being made only for lab purposes. But Ruepke thinks once they're mass produced they should be a little less expensive than single-crystal spheres despite their larger size. That's because they don't need the high purity values required for single-crystal types and they don't have to have to be highly polished.



# Electronics advertisers

September 1, 1969

■ Acopian Corp. Mort Barish Associates	164	■ Hewlett Packard, International Div. Lennen & Newell, Inc.	2	□ Solartron Electronics Group Ltd. T.B. Browne Ltd.	13E
□ Alcatel Agence Rene Sicard	15E	■ Hewlett Packard, Loveland Div. Tallant/Yates Advertising	43	■ Sorensen AG, CH-8045 Zurich	5E
Alco Electronic Products, Inc. Marketronics Advertising	143, 145, 147	■ Hewlett Packard, New Jersey Div. McCarthy, Scelba and DiBiasi Adv. Agcy., Inc.	118	■ Sorensen Operation Raytheon Co. Spectrum Control, Inc. Altman-Hall Assoc.	51 113
Allen-Bradley Co. Fensholt Adv. Agcy.	25	■ Hewlett Packard, Palo Alto Div. Lennen & Newell, Inc. Hughes Aircraft Co. Foote, Cone & Belding	1 60	Sprague Electric Co., The The Harry P. Bridge Co. □ Ste Jules Richard PVP	17 14E
■ American Lava Corp., Sub. of Minnesota Mining & Mfg. Co. Designers, Inc.	15	■ Indiana General Corp., Ferrites Div. Griswold Eshleman Infoton, Inc.	12, 13 148	■ Systron-Donner Corp. Bonfield Assoc., Inc.	32
American Optical Corp. Fuller & Smith & Ross, Inc.	54	□ Ing. C. Olivetti & Co. Spa. Studio Giuliano Blei	6E	■ Tektronix, Inc. Dawson, Turner & Jenkins, Inc.	57
American Telephone & Telegraph Co.— Yellow Pages Cunningham & Walsh, Inc.	140	□ ITT Metrix Promotion Vente Publicite ITT Wire and Cable MacManus, John & Adams, Inc.	8E 116	Tempress Industries, Inc. Hal Lawrence, Inc.	30
■ Amperite Co. H.J. Gold Co.	22	Johnson Co., E.F. Martin Williams Adv.	26	Texas Instruments Incorporated, Components Group Albert Frank-Guenther Law, Inc.	28, 29, 58
Ancona Corp./Neumuller and Co. Wilhelm Bacher Werbung	126	Litton Industries, Inc., Electron Tube Div. MacManus, John & Adams, Inc.	56 142	■ Texscan Corp. Burton Browne Advertising Transitron Electronic Corp. Larcom Randall Adv., Inc.	16 128
Andrew Corp. Fensholt Adv., Inc.	48	Lockheed Electronics Co. McCann-Erickson, Inc.		TRW Semiconductors, Inc. Fuller & Smith & Ross, Inc.	55
■ Barnes Corp. Industrial Public Relations, Inc.	117	■ Mallory & Co., P.R., Mfg. Div. Aitkin-Kynett Co.	137	■ Tung-Sol Div., Wagner Electric Corp. Feeley & Wheeler, Inc.	123
Barnes Engineering Co. Albert A. Kohler Co., Inc.	144	□ Marconi & Co. Ltd., Radio Communication Div. Hampshire House Ltd.	18E	Varian Associates-Solid State Microwave Project Botsford, Constantine & McCarthy, Inc.	132
■ Beckman Instruments, Inc., Helipod Div. N.W. Ayer/Jorgensen/MacDonald, Inc.	62	■ Microsonics, Inc. S. Gunnar Myrbeck & Co. Mitre Corp.	109 36	Wang Laboratories Impact Adv., Inc.	115
Beta Instrument Corp. Hill, Holiday, Connors, Cosmopolos, Inc.	24	■ MM Electronic Enclosures, Inc. Berin/Pecor, Inc.	149	Watkins-Johnson Co. William C. Estler Advertising	47
Bourns, Inc., Trimpot Div. The Lester Co.	110, 138	Monsanto Co. Michel Cather, Inc.	23, 162 78	Westamp, Inc. Siegmeister-Grant	138
Bunker-Ramo Corp., The, Amphenol Div. Marsteller, Inc.	35	Motorola Semiconductor Products, Inc. Lane & Bird Adv., Inc.	78	Westinghouse Semiconductor Div. Ketchum, MacLeod and Grove, Inc.	61
■ Busmann Mfg. Div. of McGraw Edison Co. Henderson Adv. Co.	135	National Semiconductor Corp. Hall Butler Blatherwick, Inc. New Hermes Engraving Machine Corp. Lester Harrison Adv., Inc.	10, 11 117	Wiremold Co., The Charles Brunelle Co.	130
Clare & Co., C.P. Reincke, Meyer & Finn Adv., Inc.	124	■ North Atlantic Industries, Inc. Ross Roy of New York, Inc.	154		
■ Clivite Corp., Piezoelectric Div. Carr Liggett Adv., Inc.	149	Northern Natural Gas Co. Bozell & Jacobs, Inc.	163		
■ Clifton Precision Products Co., Litton Industries Div. Ivey Adv., Inc.	122	O. S. Walker Co., Inc., Scientific Div. Davis Adv., Inc.	5		
■ Computer Mechanisms Corp. Raymond Hammel Adv., Inc.	121	Parelco Operations, Potter & Brumfield Van Der Boom, McCarron, Inc.	134		
Computer Signal Processors, Inc. L.K. Frank Co., Inc.	59	■ Pomona Electronics Co. Buxton Adv. Agcy.	130		
□ Cosmocar	7E	Radio Corporation of America Al Paul Lefton Co.	4th Cover, 52, 53, 82, 127		
DuPont de Nemours & Co., Freon Div. N.W. Ayer & Son, Inc.	98	Raytheon Semiconductor Botsford, Constantine & McCarty, Inc.	41		
Eastman Kodak Co., Technical Corporate Adv. Rumrill Hoyt, Inc.	131	□ Rohde & Schwarz	10E		
□ Ebauches S.A. Claude Langel	9E	Sage Electronics Corp. Mathison Adv., Inc.	107		
EDP Corporation Lawrence Associates	114	San E Denki Co., Ltd. Sanko Sha Adv. Agcy. Co., Ltd.	138		
■ Electrical Industries Douglas Turner, Inc.	108	□ Schlumberger Ltd. EMD	2E		
Electronic Arrays, Inc. Hal Lawrence, Inc.	20, 21	□ Schlumberger SOMV T. B. Browne Ltd.	4E		
Electronics Buyers Guide Subscription Card	156A, 156B	□ Schlumberger SIS Sodipa	3E		
■ Electronic Research Assoc., Inc. Josephson Cuffari Co.	120	□ Schneider R. T. Noirclerc Publicite	17E		
E/MC Electronic/Management Center Ries Cappiello Colwell, Inc.	99, 100, 101, 102, 139, 146	Sierra Research Corp. B. P. Myer Assoc., Inc.	14		
Fairchild Semiconductor, Inc. Chiat/Day, Inc.	18, 19	Signetics Corp., Sub. of Corning Glass Works Cunningham & Walsh, Inc.	97		
Farinon Electric Jack Herrick Adv., Inc.	7				
Garrett Corp., Airesearch Mfg. Div. J. Walter Thompson Co.	3rd Cover				
■ General Instrument Corp., Semiconductor Products Div. Norman Allen Associates	6				
General Magnetics, Inc. Carpenter, Matthews & Stewart, Inc.	9				
General Radio Co. Horton Church & Goff, Inc.	2nd Cover				
■ Heath Co., Sub. of Schlumberger Ltd. Advance Advertising Service	45				
Heinemann Electric Co. Thomas R. Sundheim, Inc.	27				

## Classified & Employment Advertising

F.J. Eberle, Manager  
212-971-2557

EMPLOYMENT OPPORTUNITIES . . . . . 150-153

Corcoran, J.P. . . . . 153

General Dynamics . . . . . 150

EQUIPMENT  
(Used or Surplus New)  
For Sale

A&A Electronics Corp. . . . . 153

Ewald Instrument . . . . . 153

Fishman, Philip Co. . . . . 153

Radio Research Instrument Co. . . . . 153

■ For more information on complete product  
line see advertisement in the latest Elec-  
tronics Buyer's Guide

□ Advertisers in Electronics International

## Electronics Buyers' Guide

George F. Werner, Associate Publisher  
[212] 971-2310

Robert M. Denmead,  
Midwest Regional Manager  
[312] MO 4-5800

William A. Capuzzi,  
New York, New England District Manager  
[212] 971-3793

Regina Hera, Directory Manager  
[212] 971-2544

Thomas M. Egan, Production Manager  
[212] 971-3140

Carol Gallagher,  
Assistant Production Manager [212] 971-2045

## Circulation Department

Isaaca Siegel, Manager [212] 971-6057

## Research Department

David Strassler, Manager [212] 971-6058



# light-quick

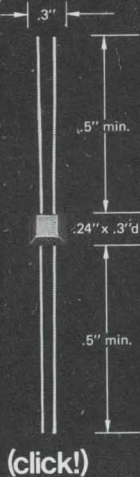

If you're looking for a swift (and noiseless!) electronic switch that offers high voltage isolation of  $10^{11}\Omega$  I/O, consider our MCT 1 coupled GaAs/LED phototransistor pair.

- 2500 volts isolation
- current transfer ratio of 35%
- isolating capacitance: 3pf
- input/output IC-compatible
- light, rugged, reliable
- analog or digital applications

Call your orders to Semiconductor Specialists, K-Tronics, Kieruff or Schweber. Want more details? Write us at 10131 Bubb Road, Cupertino, California 95014 Phone (408) 257-2140

## Monsanto

### Advertising Sales Staff

Wallis Clarke [212] 971-2187

#### Advertising Sales Service Manager

Warren H. Gardner [215] LO 8-6161  
Eastern Advertising Sales Manager

Atlanta, Ga. 30309: Michael H. Miller, 1375 Peachtree St., N.E. [404] 892-2868

Boston, Mass. 02116: William S. Hodgkinson McGraw-Hill Building, Copley Square [617] CO 2-1160

Cleveland, Ohio 44113: William J. Boyle, 55 Public Square, [216] SU 1-7000

New York, N.Y. 10036  
500 Fifth Avenue

James R. Pierce [212] 971-3615

John A. Garland [212] 971-3617

Michael J. Stoller [212] 971-3616

Philadelphia, Pa. 19103:

Jeffrey M. Preston  
Warren H. Gardner,  
6 Penn Center Plaza,  
[215] LO 8-6161

Pittsburgh, Pa. 15222: Jeffrey M. Preston,  
4 Gateway Center, [412] 391-1314

Rochester, N.Y. 14534: William J. Boyle,  
9 Greylock Ridge, Pittsford, N.Y.  
[716] 586-5040

Donald R. Furth [312] MO 4-5800  
Midwest Advertising Sales Manager

Chicago, Ill. 60611: Kenneth E. Nicklas  
Ralph Hanning 645 North Michigan Avenue,  
[312] MO 4-5800

Dallas, Texas 75201: Richard P. Poole, 1800 Republic National Bank Tower,  
[214] RI 7-9721

Houston, Texas 77002: Robert Wallin,  
2270 Humble Bldg. [713] CA 4-8381

Detroit, Michigan 48226: Ralph Hanning,  
856 Penobscot Building  
[313] 962-1793

Minneapolis, Minn. 55402: 1104 Northstar Center [612] 332-7425

St. Louis, Mo. 63105: Kenneth E. Nicklas,  
The Clayton Tower, 7751 Carondelet Ave.  
[314] PA 5-7285

James T. Hauptli [415] DO 2-4600  
Western Advertising Sales Manager

Denver, Colo. 80202: David M. Watson,  
Tower Bldg., 1700 Broadway  
[303] 266-3863

Los Angeles, Calif. 90017: Ian C. Hill,  
Bradley K. Jones, 1125 W. 6th St.,  
[213] HU 2-5450

Portland, Ore. 97204: James T. Hauptli,  
Don Farris, 218 Mohawk Building,  
222 S.W. Morrison Street,  
Phone [503] 223-5118

San Francisco, Calif. 94111: James T. Hauptli,  
Don Farris, 255 California Street,  
[415] DO 2-4600

Pierre Braude Tel: 225 85 88: Paris  
European Director

Paris: Denis Jacob  
88-90 Avenue Des Champs-Elysees, Paris 8  
United Kingdom and Scandinavia

London: Oliver Ball, Tel: Hyde Park 1451  
34 Dover Street, London W1

Milan: Robert Saidel, Roberto Laureri Jr.  
1 via Baracchini Phone 86-90-656

Brussels: Denis Jacob  
27 Rue Ducale Tel: 136503

Frankfurt/Main: Hans Haller  
Elsa-Brandstroem Str. 2  
Phone 72 01 81

Geneva: Denis Jacob  
1 rue du Temple Phone: 31 95 60

Tokyo: McGraw-Hill  
Publications Overseas Corporation,  
Kasumigaseki Building 2-5, 3-chome,  
Kasumigaseki, Chiyoda-Ku, Tokyo, Japan  
[581] 9811

Osaka: Akihiko Kamesaka, McGraw-Hill  
Publications Overseas Corporation, Kondo  
Bldg., 163, Umegae-cho Kita-ku [362] 8771

Australasia: Warren E. Ball, IPO Box 5106,  
Tokyo, Japan

#### Business Department

Stephen R. Weiss, Manager  
[212] 971-2044

Thomas M. Egan,  
Production Manager [212] 971-3140

Maury D'Gongora,  
Assistant Production Manager [212] 971-2045

Dorothy Carmesin, Contracts and Billings  
[212] 971-2908

Frances Vallone, Reader Service Manager  
[212] 971-2865

# IR LED'S

Great little performers: 1.5 mW min. @ 100 mA. And all the power they need is .15 W.

Fast, too. Switching time is light-quick — typically 1 nanosecond.

Long life and reliability are assured by our with-it planar solid-state technology.

Put those features together with their instant availability and you've got a good reason to call Schweber, Kieruff, K-Tronics or Semiconductor Specialists.

Get all the details about our four varieties of IR LED's by writing to us at 10131 Bubb Road, Cupertino, California 95014.

## Monsanto



**Charley Melton said he'd quit if anybody ever designed him another one-of-a-kind.**

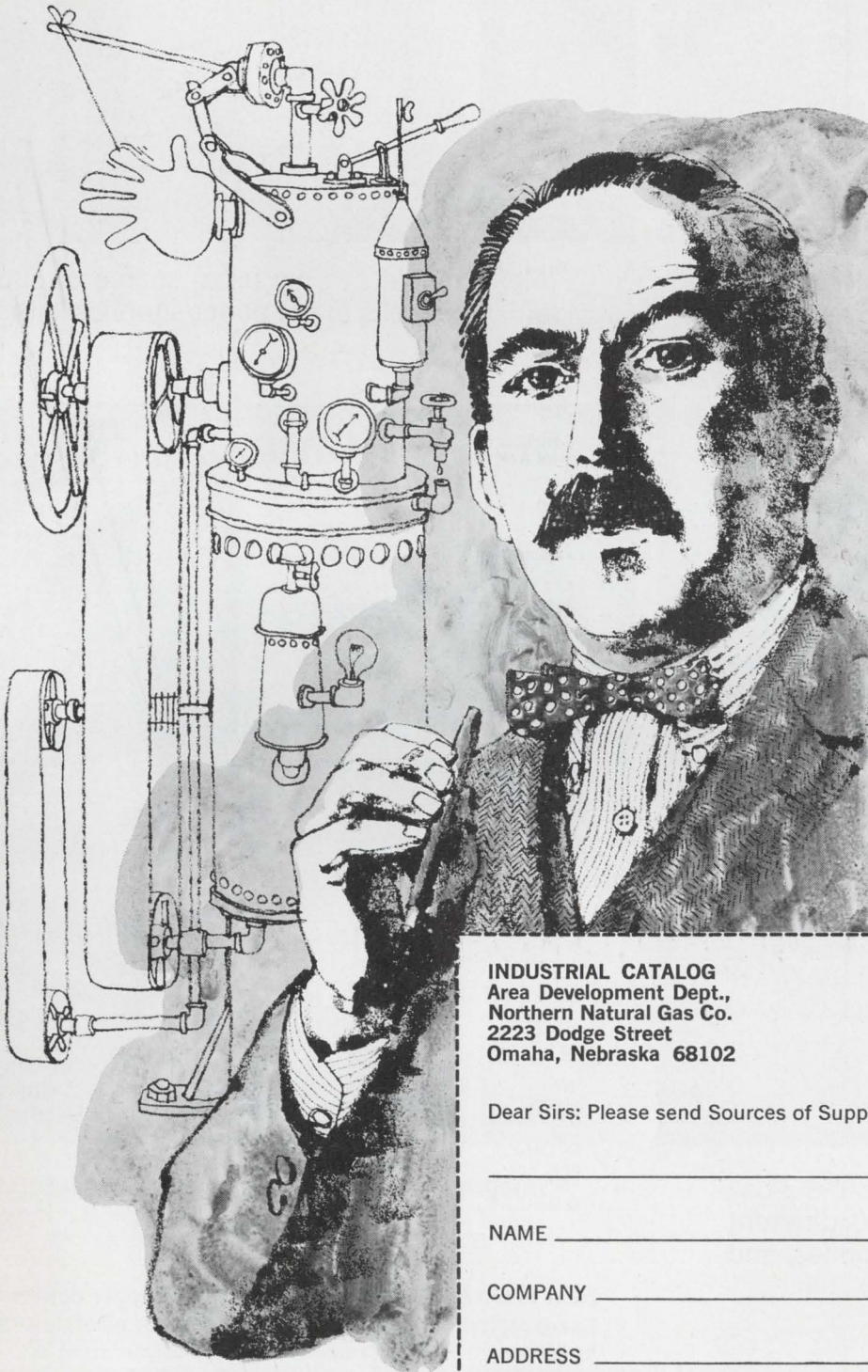

**Guess what, Charley?**

Charley's an engineer. He comes up with new ideas for new products. Then somebody else designs the parts that make up the new products. That's the problem. Because Charley inevitably ends up having to track down some creation the likes of which may never be equalled. Who makes 'em?

Keep your job, Chuck. Help's on the way in the form of the **NORTHERN PLAINS INDUSTRIAL CATALOG**. It's a complete, indexed, cross-referenced, multi-everything compilation of valuable information on creations like the one you're faced with. Tells you who makes them, where, how much, how to order. More, too. The Industrial Catalog's probably got a line on your — whatever it is, right now. So find out. Clip the coupon and return. It won't cost a penny. And it's better than quitting.

**INDUSTRIAL CATALOG**  
 Area Development Dept.,  
 Northern Natural Gas Co.  
 2223 Dodge Street  
 Omaha, Nebraska 68102



Home Office: Omaha, Nebraska

Dear Sirs: Please send Sources of Supply information on:

\_\_\_\_\_  drawing enclosed.

NAME \_\_\_\_\_ TITLE \_\_\_\_\_

COMPANY \_\_\_\_\_

ADDRESS \_\_\_\_\_

CITY \_\_\_\_\_ STATE \_\_\_\_\_ ZIP \_\_\_\_\_





"I was in terrible trouble. The additional circuitry changed my power supply requirements."

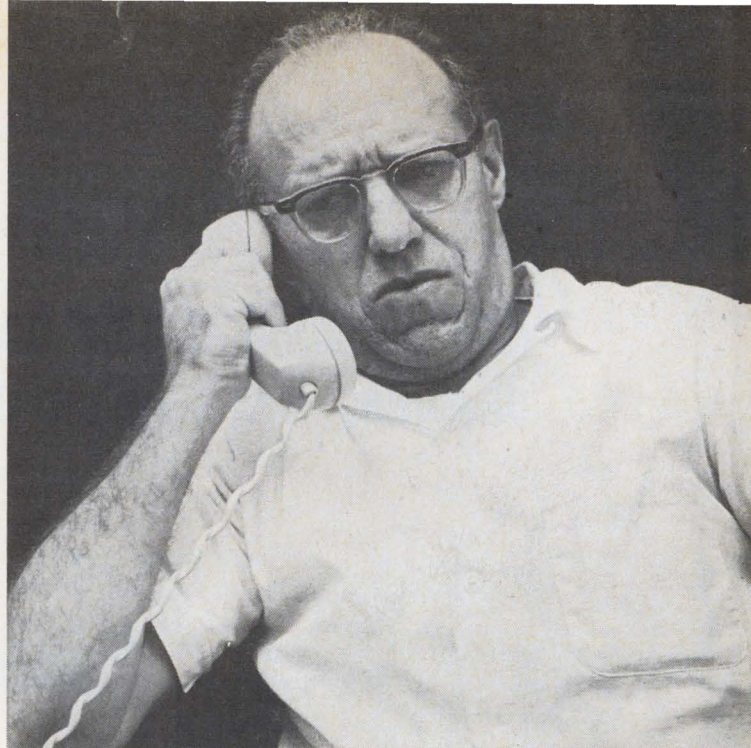

"More trouble . . . my usual source of supply said, 'Six weeks to get power supplies with the new ratings.'"



"I had heard about Acopian's incredible 3-day shipment guarantee on their 62,000 different types of AC to DC plug-in power supplies, and decided to give them a try."

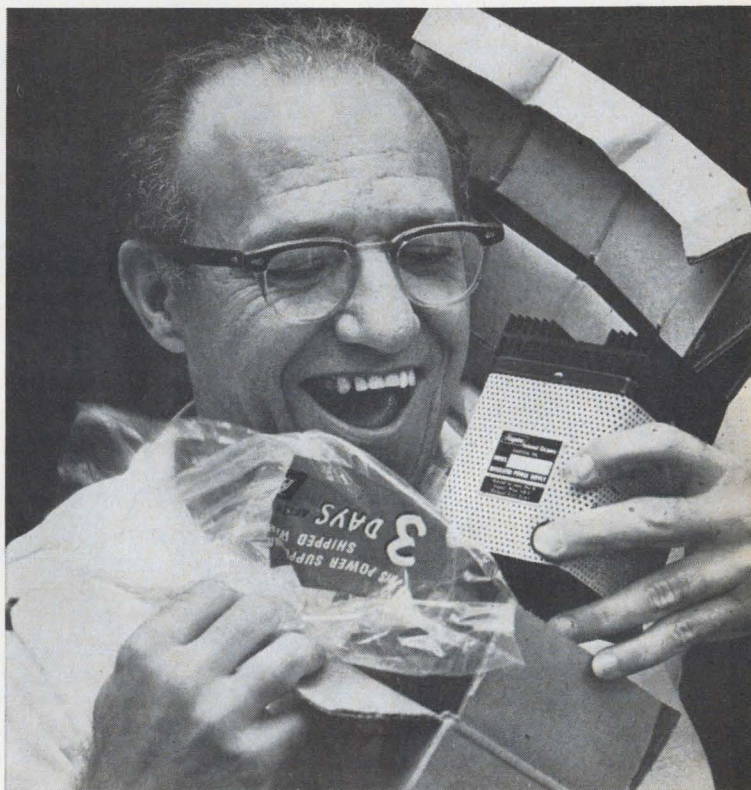

"Imagine my glee . . . when a few days later . . ."

Next time you're in trouble with power supply delivery, contact Acopian. If you do not have a copy of our latest catalog, by all means, request one. It lists 62,000 different AC to DC plug-in power supplies, any of which will be shipped to you in just three days! For particulars, contact your local Acopian rep., call us at (215) 258-5441, or write to Acopian Corp., Easton, Penna. 18042.





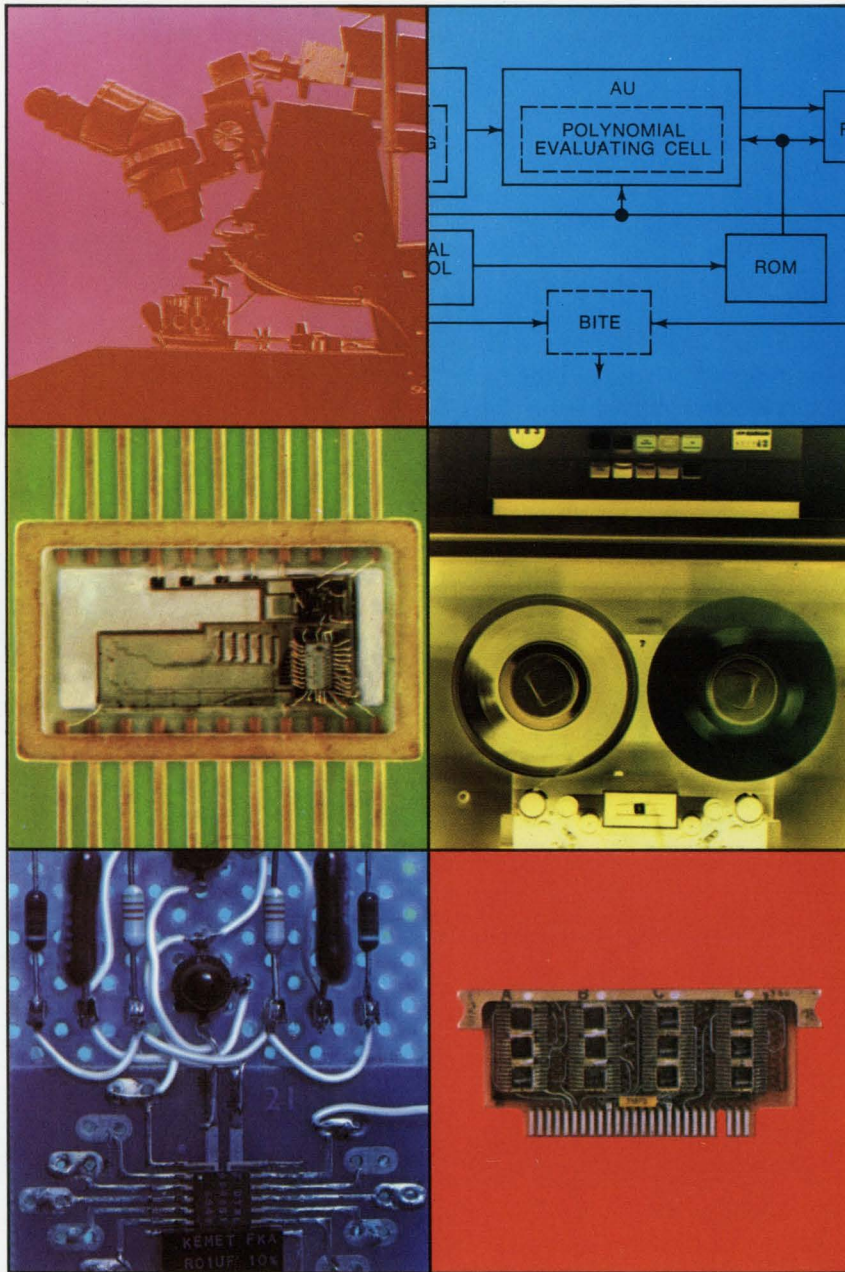

## AiResearch has a unique capability in making airborne electronic systems.

A big reason is 360° vision.

At AiResearch we can see all facets of the electronics picture from a total system point of view. The reason is simple. We analyze the need. We design the system. We build our own circuits. Then we produce the total system.

We don't merely answer specifications. We start with your basic problem. Our knowledge of airborne systems lets us make the right tradeoffs at the right time.

And we have the total system concept throughout the complete range of electronics development: analysis, computer simulation, design, breadboard, manufacture, testing, and final hardware.

We'd like the opportunity to show you how we can apply our electronics capability to engine fuel controls, engine speed controls, cabin pressure controls, airborne integrated data systems,

air data systems, propulsion monitoring systems, displays, multiplexing systems, and others.

AiResearch Electronics Systems, 2525 West 190th Street, Torrance, Calif. 90509.

**AiResearch electronics capability starts at home.**



**AiResearch**  
Electronic Systems

one of The Signal Companies



# It's time for a change in your digital displays! Increase versatility, decrease costs — with RCA's new NUMITRON Digital Display Devices

Compare these RCA product advantages:

- Sharper, cleaner displays
- Controllable high brightness
- Up-front planar numerals for wider viewing angle
- Unlimited filter-color selection
- Low voltage operation—designed for 4½ V
- Fully compatible with RCA's new Integrated Circuit Decoder/Drivers

- Rugged construction
- Long life—high reliability
- Designed for low-cost 9-pin miniature sockets

Interested? For more information on the new RCA NUMITRON Digital Display Devices, contact your local RCA Representative or write to RCA Electronic Components, Commercial Engineering, Section 119DE-1 Harrison, N.J. 07029. Also ask for

data on the new RCA Integrated Circuit Decoder/Drivers, especially designed for use with RCA's Digital Display Devices. Type Numbers of NUMITRON Digital Display Devices:

RCA-DR-2000—Numerals 0 through 9  
RCA-DR-2010—Numerals 0 through 9, with decimal  
RCA-DR-2020—Plus-Minus and Numeral 1  
RCA-DR-2030—Plus-Minus

Unretouched photograph of operating NUMITRON devices mounted on plastic tubing.

**RCA**  
Digital Display Devices



See page 82 of this publication for advertisement on RCA's new 7-segment Integrated Circuit Decoder Drivers.