

Detecting thermocouple failures 96

\$1.00 A McGraw-Hill Publication

Memories: raising speed limits 105

October 13, 1969

Reducing microwave radiation hazards 123

# Electronics®



**How large a role  
for computers  
in MOS design?**



# They're on our shelf



The "special" audio transformers you need  
are "standard" at UTC.

When you're ready to specify transformers and inductors, before you turn to costly specials, check UTC. Chances are there's a standard unit that fits your special electrical and mechanical requirements exactly.

UTC has over 500 audio types in stock, ready for immediate delivery. And UTC engineers are constantly adding to the line. Microwatts to kilowatts. Less than  $\frac{1}{4}$  Hz to greater than 1 MHz. MIL-T-27 or industrial. Metal-encased or open frame. Input, output, mixing, matching, modulating, phase shifting, hybrid,

baluns, ring modulator. All in continuous production for sample or high-volume requirements.

If the specific unit you need isn't on our shelf, we'll tailor a standard unit to your special requirements—saving the time and costs of starting from scratch. Check your local distributor for immediate off-the-shelf delivery. For catalog, write: United Transformer Company, Division of TRW INC., 150 Varick Street, New York, N.Y. 10013.

**TRW**<sup>®</sup>  
UNITED TRANSFORMER COMPANY



## Digitally Controlled Power Sources Include Added Systems-Oriented Functions

Digitally Controlled Power Sources (DCPS's) are complete digital-to-analog links between a computer (or other digital source) and any application requiring a fast, accurately settable source of dc or low frequency ac power. Such applications generally require more than a programmable power supply or D/A converter with a power amplifier — the DCPS's include these added functions in a single compact trouble-free package:

**INTERFACE** Customized plug-in interface cards match the Digitally Controlled Power Source to the computer (8421 BCD or Binary).

**ISOLATION** All digital inputs are floating and isolated from the floating analog output, thus avoiding troublesome loops between the output ground and computer ground.

**STORAGE** Inputs from all digital data lines are stored upon receipt of a gate signal from the computer. Output levels are maintained until a new gate signal is received — thus, the computer is free to perform other tasks in the interval between voltage level changes.

**FUNCTION SELECTION** Selects the output voltage range, and isolates the three input bits to the current limit D/A converter.

**OUTPUT VOLTAGE D/A CONVERTER** Converts one polarity bit plus 16 BCD voltage bits or 15 binary voltage bits to an analog voltage for input to the power amplifier. Thus, resolution is 0.5mV for straight binary and 1mV for BCD operation.

**REFERENCES** Provide voltage for the Output Voltage and Current D/A Converters.

**CURRENT LIMIT D/A CONVERTER** Sets current limit of power amplifier to one of eight values.

**CIRCUIT POWER SUPPLIES** Provide all the necessary dc power — no external power supplies are required.

**FEEDBACK** Informs the computer when each programming operation is completed and when the output current is overloaded.

**BIPOLAR POWER AMPLIFIER** Programs either side of zero or through zero without output polarity switches or "notch" effects, with an accuracy of 1mV, 5mV, or 10mV depending on range and model. Outputs from -100V to +100V with currents up to 5A are available.

# all this

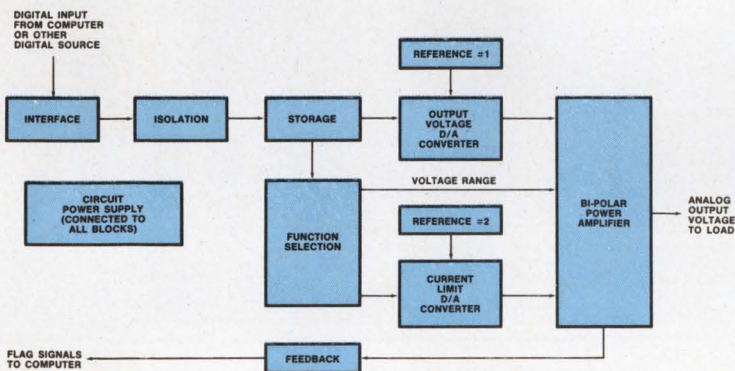

# in one compact package

Write for Digitally Controlled Power Brochure.

Circle 1 on reader service card

HEWLETT  PACKARD

COMPUTER INSTRUMENTATION

100 Locust Avenue, Berkeley Heights  
New Jersey 07922 • (201) 464-1234

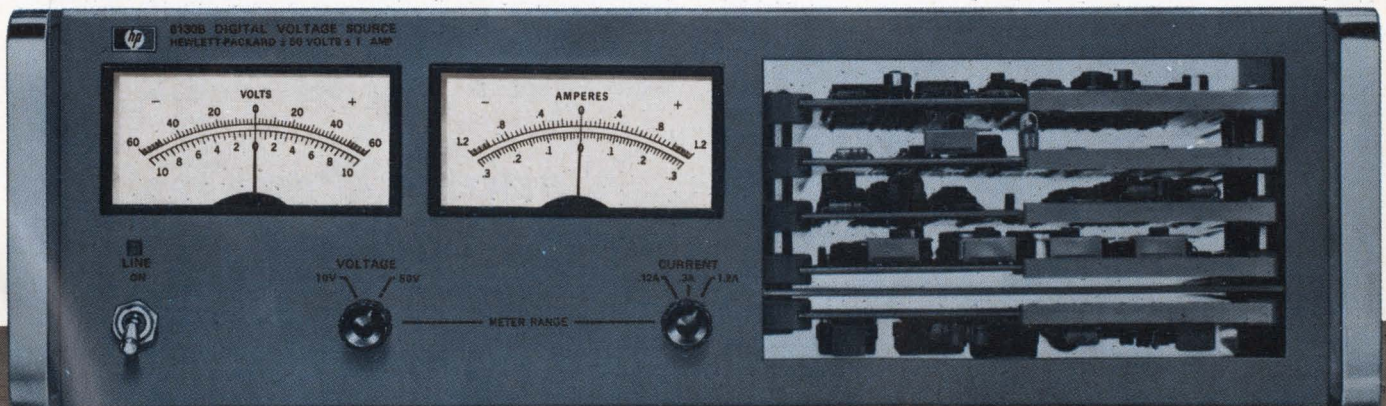



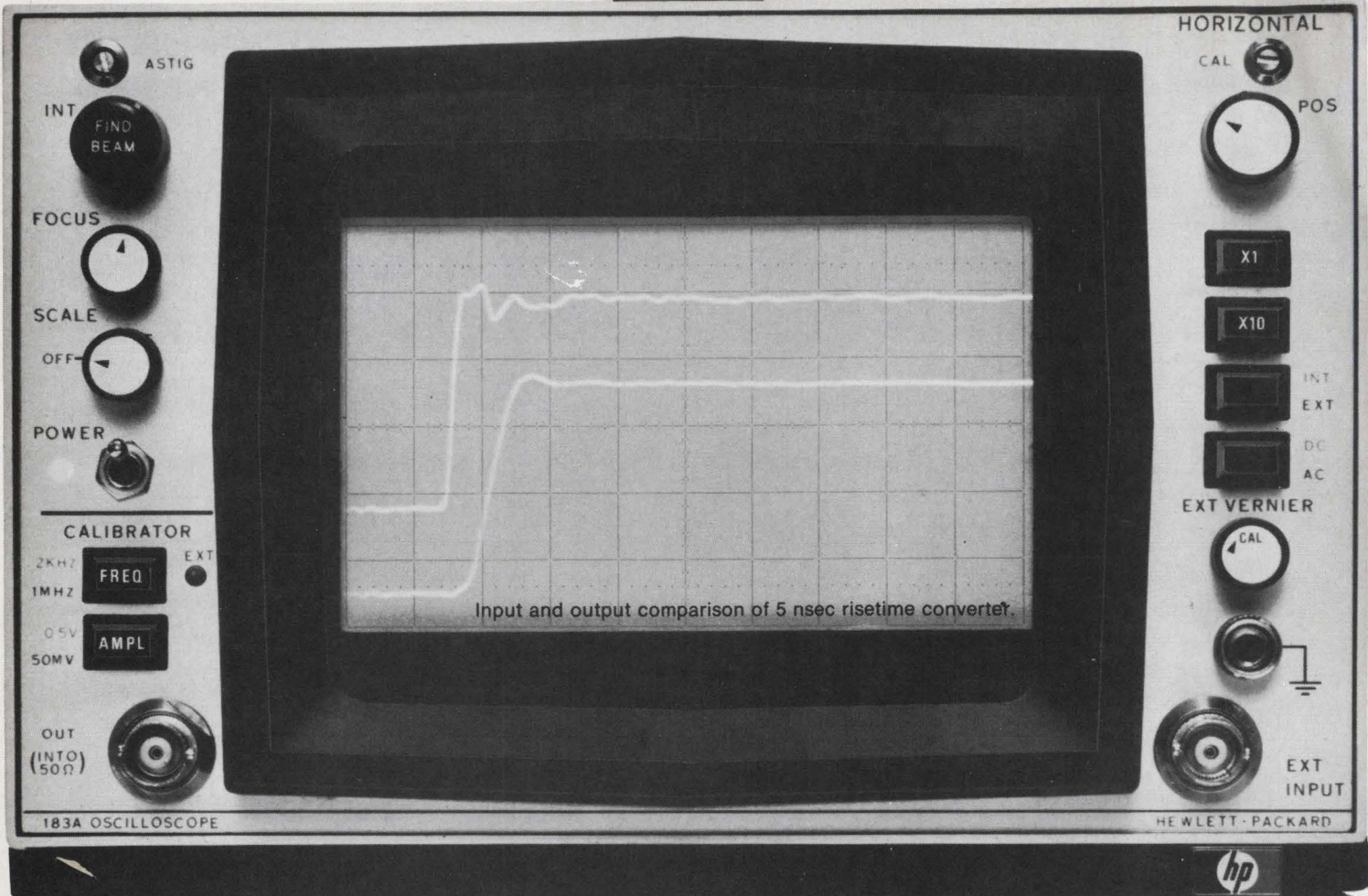

## The Performance Champ – world's fastest general-purpose real-time scope!

The HP 183A Oscilloscope system adds one more way that you **see more—do more** with the field-proven 180 scope system.

Now you can measure from dc to 250 MHz—real time! Now you have a vhf scope that also gives you a bright dual-trace with a fast-writing speed of 4 cm/nsec on a big 6 x 10 cm screen. Plus, a sensitivity of 10 mV/div for low-level signal measurements—sweep speeds of up to 1 nsec/div for easier viewing of high frequency signals—and complete compatibility with the entire 180 series of plug-ins.

Sound expensive? Well, the 183A mainframe with a 250 MHz dual-channel vertical amplifier and a >250 MHz time base costs only \$3150. That's less than some systems that don't even approach this kind of high frequency performance.

The basic 183A mainframe uses the all-new step-ahead technique of a CRT transmission line deflection system to provide real-time bandwidth beyond 500 MHz. And since it contains only the CRT and power supplies,

future, improved plug-ins will give you full performance in the mainframe you buy now. You won't have to worry about built-in mainframe limitations—now or in the future.

If you're interested in maximum scope performance per dollar invested, then the HP 180 system is the answer. From 50 MHz, to 100 MHz, to sampling, to variable persistence and storage scopes, the 180 system has the right combination to meet your requirements. You get more for your dollar today. You get more for your dollar in the future. You get the best performing, most versatile high-frequency scope system available today!

For more information, call your local HP field engineer. Or, write to Hewlett-Packard, Palo Alto, California 94304. Europe: 1217 Meyrin-Geneva, Switzerland.

089/14A

HEWLETT  PACKARD

OSCILLOSCOPE SYSTEMS

ACTUAL SIZE

Circle 2 on reader service card



## News Features

### Probing the News

- 123 **Microwave:** U.S. lights fire under microwave ovens  
129 **Companies:** Charting a course to high profits

## U.S. Reports

- 43 **Consumer electronics:** Laser plus vidicon equals home entertainment  
44 **Manufacturing:** New discretionary wiring technique; depositing ferrite films  
46 **Components:** Hybrid IC power-switching amp cools it  
48 **Industrial electronics:** I-r used in bill changer  
52 **Integrated electronics:** Hughes goes with I (for ion implantation) MOS  
54 **Companies:** Autonetics makes its move  
56 **Computers:** LSI for the military  
58 **Avionics:** Boeing cranks up for SST

## Electronics International

- 207 **Japan:** Self-aligning double-diffusion process for MOS FET's  
208 **Japan:** Alumina for MOS-bipolar compatibility  
209 **West Germany:** Airborne probe breaks a log jam  
210 **Sweden:** AGA to build in U.S.

## New Products

- 149 **In the spotlight**  
149 Disk memory runs on air bearings and fluidic logic control  
153 A miniprinter for minicomputers  
159 **Components review**  
159 Light diodes aimed at mass market  
162 Hybrid op amps offer low drift  
165 **Data handling review**  
165 IC memories with 5-year warranty  
168 Wire memory cycles in 200 nsec  
172 Controller has a stored program  
175 **Production equipment review**  
175 Artwork generator for p-c boards  
179 **Semiconductor review**  
179 Light switch is integrated  
183 IC sense amp reads wire memory

## Technical Articles

- Solid state** 82 **Computers make a big difference in MOS designs**  
Computers now do about everything from laying out customized IC's to providing fabrication instructions  
Lawrence Curran, associate editor
- Circuit design** 93 **Designer's casebook**  
▪ Load current monitor doesn't break circuit  
▪ Transistors improve high-frequency limiter  
▪ Diode generator yields complex functions
- Instrumentation** 96 **Taking the heat off thermocouple failures**  
An electronic thermocouple open-circuit detector slated for use in digital data-acquisition and computer control systems tests 250 thermocouple circuits a second  
Ronald S. Harmon, Leeds & Northrup Co.
- Design theory** 102 **Core-memory driver runs cooler**  
Dual-mode device reduces heat dissipation by automatically switching power supplies depending on circuit demand  
Charles J. Ulrick, Collins Radio Co.
- Memories** 105 **'Cache' turns up a treasure**  
Donald H. Gibson, Systems Development Division, IBM  
W. Lee Shevel, Component Division, IBM  
108 **Speeding up ferrite core memories**  
Robert M. Whalen, IBM

## Departments

- |    |                          |     |                          |
|----|--------------------------|-----|--------------------------|
| 4  | Readers Comment          | 45  | Index of Activity        |
| 8  | Who's Who in this issue  | 65  | Washington Newsletter    |
| 14 | Who's Who in electronics | 184 | New Books                |
| 22 | Meetings                 | 187 | Technical Abstracts      |
| 31 | Editorial Comment        | 195 | New Literature           |
| 33 | Electronics Newsletter   | 205 | International Newsletter |



# Electronics

Editor-in-Chief: Donald Christiansen

## Senior Staff Editors

Technical: Stephen E. Scrupski

News: Robert Henkel

International: Arthur Erikson

Art director: Gerald Ferguson

Senior associate editors: Joseph Mittleman, Harry R. Karp

Assistant managing editors: H. Thomas Maguire, Howard Wolff, William Bucci, Richard Gundlach, Frederick Corey

Special projects editor: Roger Kenneth Field; Senior staff writer: John Johnsrud

## Department editors

Advanced technology: Laurence Altman

Communications: Leon M. Magill

Computers: Wallace B. Riley, George Weiss

Design theory: Joseph Mittleman

Industrial electronics: Harry R. Karp

Instrumentation: Owen Doyle

Military/Aerospace: Alfred Rosenblatt

New products: William P. O'Brien

Solid state: George Watson, Stephen Wm. Fields

## Field bureaus

Boston: James Brinton, manager; Gail Farrell

Los Angeles: Lawrence Curran, manager; Ralph Selph

New York: Peter Schuyten

San Francisco: Stephen Wm. Fields

Washington: Ray Connolly, manager; Robert Westgate, Lois Vermillion

Bonn: John Gosch

London: Michael Payne

Paris: Arthur Erikson

Tokyo: Charles Cohen

Copy editors: Edward Flinn, William S. Weiss

Assistant art director: Charles Ciatto

Production editors: Susan Hurlburt, Arthur C. Miller

Editorial research: Virginia Mundt

Editorial secretaries: Lorraine Longo, Claire Goodlin, Barbara Razulis, Vickie Green, Bernice Pawlak, Patricia Bispham

## McGraw-Hill News Service

Director: Arthur L. Moore; Atlanta: Fran Ridgway; Chicago: Robert E. Lee

Cleveland: Arthur Zimmerman; Dallas: Marvin Reid

Detroit: James Wargo; Houston: Barbara LaRoux

Los Angeles: Michael Murphy; San Francisco: Margaret Drossel, Tyler Marshall

Seattle: Ray Bloomberg; Washington: Charles Gardner, James Canan, Herbert W. Cheshire, Seth Payne, Warren Burkett, William D. Hickman

## McGraw-Hill World News Service

Bonn: Robert Dorang; Brussels: James Smith; Hong Kong: Kate Mattock

London: John Shinn; Mexico City: Gerald Parkinson; Milan: Jack Star

Moscow: Jack Winkler; Paris: Robert E. Farrell, Stewart Toy

Tokyo: Marvin Petal

Reprints: Gail Niles

Circulation: Isaaca Siegel

Reader communications manager: John Drummond

Publisher: Gordon Jones

Associate Publisher: Dan McMillan

Assistant to the publisher: Wallace C. Carmichael

Electronics: October 13, 1969, Vol. 42, No. 21

Published every other Monday by McGraw-Hill, Inc. Founder: James H. McGraw 1860-1948. Publication office 99 North Broadway, Albany, N. Y. 12202; second class postage paid at Albany, N. Y. and additional mailing offices.

Executive, editorial, circulation and advertising addresses: Electronics, McGraw-Hill Building, 330 W. 42nd Street, New York, N. Y. 10036. Telephone (212) 971-3333. Teletype TWX, N.Y., 710-581-4235. Cable address: MCGRAW-HILL N.Y.

Subscriptions solicited only from those professionally engaged in electronics technology. Subscription rates: qualified subscribers in the United States and possessions and Canada, \$8.00 one year, \$12.00 two years, \$16.00 three years; all other countries \$25.00 one year. Non-qualified subscribers in the U.S. and possessions and Canada, \$25.00 one year; all other countries \$50.00. Air freight service to Japan \$50.00 one year. Single copies: United States and possessions and Canada, \$1.00; all other countries, \$1.75.

Officers of McGraw-Hill Publications Company: Joseph Allen, President; John R. Emery, J. Elton Tuohig, Senior Vice Presidents; Gordon L. Jones, Jr., Group Vice President; Vice Presidents: John R. Callahan, Editorial; Paul F. Cowie, Circulation; John M. Holden, Marketing; David G. Jensen, Manufacturing; Jerome D. Luntz, Planning & Development; Robert F. Marshall, Administration; Robert M. Wilhelm, Finance.

Officers of the Corporation: Shelton Fisher, President and Chief Executive Officer; John L. McGraw, Chairman; Robert E. Slaughter, Executive Vice President; Daniel F. Crowley, Donald C. McGraw, Jr., Bayard E. Sawyer, Senior Vice Presidents; John J. Cooke, Vice President & Secretary; Gordon W. McKinley, Vice President & Treasurer.

Title © registered in U.S. Patent Office; © Copyright 1969 by McGraw-Hill, Inc. All rights reserved. The contents of this publication may not be reproduced either in whole or in part without the consent of copyright owner.

Subscribers: The publisher, upon written request to our New York office from any subscriber, agrees to refund that part of the subscription price applying to copies not yet mailed. Please send change of address notices or complaints to Fulfillment Manager; subscription orders to Circulation Manager, Electronics at address below. Change of address notices should provide old as well as new address, including postal zip code number. If possible, attach address label from recent issue. Allow one month for change to become effective.

Postmaster: Please send form 3579 to Fulfillment Manager, Electronics, P.O. Box 430, Hightstown, New Jersey 08520

## Readers Comment

### Radiation and tv . . .

To the Editor:

In regard to your editorial [Sept. 1, p. 31] you may be interested to know that to date, over 6,000 color-tv sets have been inspected in Suffolk County, N.Y. Approximately 17% of those tv sets checked emitted X rays at or above the recommended levels established by the National Council for Radiation Protection.

Seymour Becker

Department of Health,  
Suffolk County  
Riverhead, N.Y.

### . . . and solid state

To the Editor:

Your editorial [Sept. 1, p. 31] calling for replacement of radiation-emitting vacuum tubes in television receivers with solid state devices seems to presuppose that this hasn't occurred yet. As manufacturers of high-voltage silicon rectifiers and packaged configurations, we can report that:

▪ Nearly every major color tv producer is redesigning one or more models to incorporate solid state power circuitry to replace the high-voltage shunt regulator tube and/or the high-voltage regulator tube.

▪ They are evaluating single stacks, doublers, triplers, and quadruplers developed by semiconductor manufacturers.

▪ We expect that by 1972, the changeover to solid state power supply circuitry will be more than 75% complete, rendering academic the furor over emission of harmful X-radiation.

While the color-tv industry is concerned about the radiation controversy, evidence of the emission of harmful X-radiation is still far from conclusive. The main reason the industry is undertaking the expense of redesigning and testing to accommodate solid state high-voltage circuitry is the very recent development of silicon rectifiers at competitive prices for the applications required. The industry has been moving steadily to replace



# Don't blow a fuse because your semiconductors aren't properly protected.

The new Airpax CEL-GARD® semiconductor fuses make fault-current protection easy for you! Now you can be sure that your rectifiers, thyristors, silicon-controlled rectifiers, and power transistors are properly protected . . . even in the face of short circuit disaster . . .

by using the easy steps outlined in our new catalog.

CEL-GARD® fuses are designed specifically for the semiconductor. The fastest arc-quenching techniques available are used to insure the **shortest possible** total fault-clearing time. In addition, CEL-GARD® fuses offer more mechanical durability when subjected to frequent switching of maximum rated currents. This means **longer CEL-GARD® life and increased circuit reliability.**

Protect your semiconductors properly. Send today for your catalog. Then you can be sure you're safe!

**AIRPAX ELECTRONICS**  
 Phone: (301) 228-4600  
 Telex: 8-7715  
 TWX: (710) 865-9655  
**Cambridge Division**  
 Cambridge, Maryland 21613

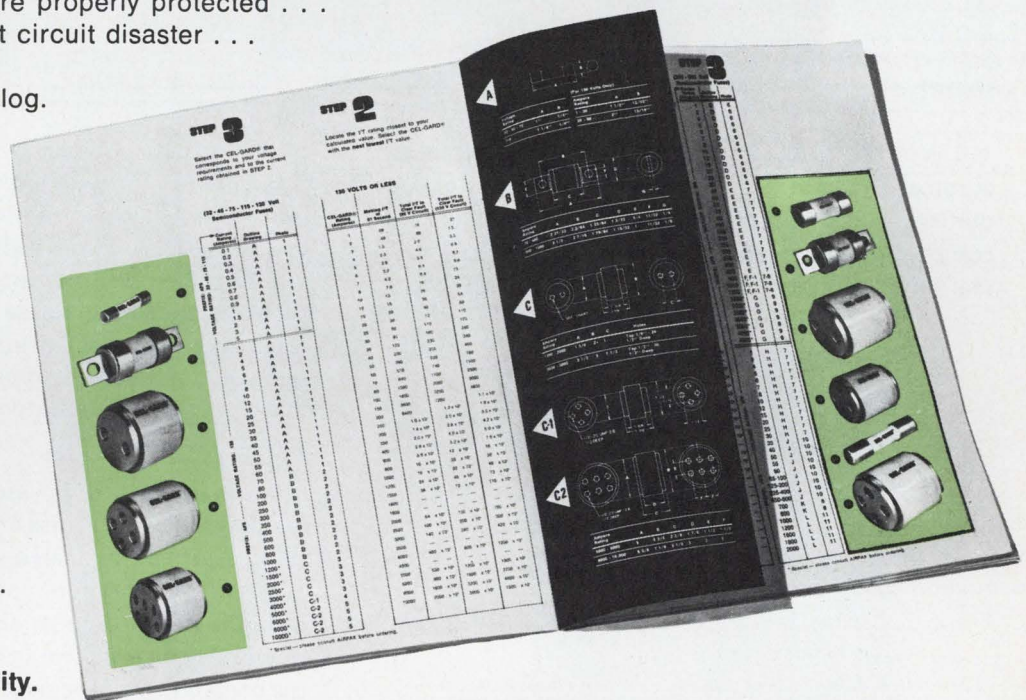

**Send for your AIRPAX CEL-GARD® fuse catalog today!**

NAME \_\_\_\_\_  
 TITLE \_\_\_\_\_  
 COMPANY \_\_\_\_\_  
 ADDRESS \_\_\_\_\_  
 CITY \_\_\_\_\_ STATE \_\_\_\_\_ ZIP \_\_\_\_\_  
 PHONE \_\_\_\_\_

Mail to: AIRPAX ELECTRONICS, Cambridge Division, Cambridge Md. 21613



g of the heart;  
 . India; about  
 .ian. See CON-  
 .A pl.] 1 An  
 mature sori or  
 the stigma in  
 so, any similar  
 ., tunic] — IN-  
 ed in industry.  
 manufacture.  
 lock or security  
 .LY adv.  
 participation in  
 that industry.  
 an industry, as  
 amounts, usu-  
 being paid in  
 industrial system,  
 ufacturing in  
 A condition of  
 in peaceful in-  
 T adj. & noun.  
 render indus-

injustice; also, an unfair act.  
**IN·ER·RAN·CY** (-ēr'un-sī) *noun* The state of being free from error; as applied to Scripture, plenary inspiration.  
**IN·ER·RANT** (-ēr'unt) *adj.* Exempt from error; unerring.  
**IN·ERT** (-ürt') *adj.* 1 Destitute of inherent power to move; possessing inertia; inactive. 2 Sluggish. 3 Devoid of active chemical properties; as, the *inert* gases; neutral. See synonyms under HEAVY, IDLE, LIFELESS, PASSIVE, SLOW. [*L. iners* <*in-*, not, + *ars*, art] — **IN·ERT·LY** *adv.* — **IN·ERT·NESS** *noun* — **IN·ERT·ION** *noun*.  
**INERT GASES** Helium, neon, argon, krypton, xenon, and radon.  
 [REDACTED]  
 in-er-tia? — The word just doesn't exist at General Radio!  
 [REDACTED]  
 Compare **IN POSSE**.  
**IN·ES·SEN·TI·AL** (-shū) *adj.* 1 Unessential; not essential. 2 Immaterial. — **IN·ES·SEN·TI·AL·I·TY** *noun*.  
**IN·ES·TI·MA·BLE** *adj.* Above price; very valuable. — **IN·ES·TI·MA·BLY** *adv.*  
**IN·EV·I·TA·BLE** *adj.* 1 That cannot be prevented; unavoidable. 2 Hence, jocularly; customary; usual. See synonyms under NECESSARY. [*L. inevitabilis* <*in-*, not, + *e*, out, + *vito*, shun] — **IN·EV·I·TA·BLE·NESS**, **IN·EV·I·TA·BLI·I·TY** *noun* — **IN·EV·I·TA·BLY** *adv.*  
**INEVITABLE ACCIDENT** See FORCE MAJEURE.  
**IN·EV·I·TA·BLI·I·TY** (*in-ēv'it-ē-blee-ē-tee-ē-tee-ē-tee*) *adj.* 1 Not exact accounts of time

cal  
 IN·F  
 cor  
 ph  
 IN·F  
 2  
 cor  
 gro  
 IN·F  
 IN·F  
 em  
 not  
 IN·F  
 wa  
 IN·F  
 I  
 y  
 of  
 FA  
 IN·F  
 IN·F  
 sati  
 not  
 teri  
 bid  
 tair  
 mo  
 in  
 vov  
 <in

GR is on the move, quoting and building custom automatic measuring systems. We're busy putting our established impedance bridges into automatic component and network testing systems — our real-time analyzers into acoustical-analysis systems.

Even with access to our own excellent instruments, we wanted the added efficiency and savings of automatic systems for our own programs. So we took those same instruments, applied our know-how to the problems of interface and automation, and came up with in-house test systems. The result: new and sophisticated GR instruments that could not have been produced and competitively priced without automatic measurements.



"Automatic Capacitance-Comparison System".

**NAME YOUR SYSTEM!**  
 If you want quantity measurements of capacitance, loss, dc bias effects on ac impedance, leakage current, or analyses of logic circuits or of sound and vibration, you, too, can profit from the time and dollar economies of a General Radio system — and we mean *system!* We'll supply the complete measurement capability, from power supply to peripheral devices to packaging (and if you need a special device made elsewhere, we'll get that, too!).

So triumph over inertia in your production and inspection areas — write or phone your system requirements to General Radio Company, West Concord, Mass., 01781; telephone (617) 369-4400. In Europe, write Postfach 124, CH 8034 Zurich 34, Switzerland.

**GENERAL RADIO** 



## Readers Comment

vacuum tubes and, in my opinion, the changeover would have taken place anyway as soon as economic and performance criteria had been adequately fulfilled.

Edmond H. Borneman  
President  
Scientific Components Inc.  
Linden, N.J.

### End product

To the Editor:

Your newsletter item [Sept. 15, p. 221] incorrectly states that the Sanyo Electric Co., under a license from the General Instrument Corp., will be allowed to sell large-scale integration circuits separately. Sanyo is licensed for the use of General Instrument LSI circuits for internal consumption only. It is allowed to sell the end product, such as calculators or computers, anywhere in the world, but not the individual circuits.

Lewis Solomon

Vice president,  
marketing and sales  
General Instrument Corp.  
Hicksville, N.Y.

### Not new to him

To the Editor:

The concept of multistable logic [Aug. 18, p. 105] is not new to me. Approximately 20 years ago—in the vacuum-tube era and inspired by loran-type stair-step counters—I built a two-counter “phase-shift register,” using the grid of a vac-

uum-tube one-shot as reference and discharge for the capacitor rather than the then traditional blocking oscillator. However, I did not put the circuit to any practical use at the time.

Some eight to 10 years ago, I designed a phase-shift (or multistable) register using three conventional transistor flip-flop counters as two storage counters and one reference counter. This type of circuit (identical in principle to that described in the article) easily produces an analog or a digital read-out. The output was to a computer, and the customer was Wright Field in Dayton, Ohio.

Since then, I have built up a file of breadboard and paper designs including logic concepts for a small calculator. My work has not been as extensive as that of the Russians, but I would hate to think that I would have to obtain a license to use a technique I have now used for about 20 years. My approach has been to use transistor one-shot staircase counters, and this Russian circuit is the simplest for the purpose that I have ever encountered in my experience.

W.A. Spoor

Gulf Aerospace Corp.  
Houston, Texas

Readers' letters should be addressed:  
Electronics  
To the Editor  
330 West 42nd Street, New York,  
N.Y. 10036

## Applications Power \*

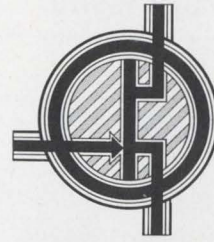

# FET QUADS AS VCRs

**Problem:** Find technique for solid state control of quad attenuator or phase shift networks.

**Solution:** Siliconix VCR13N Quad FET; 5% tracking from 200–2K ohms.

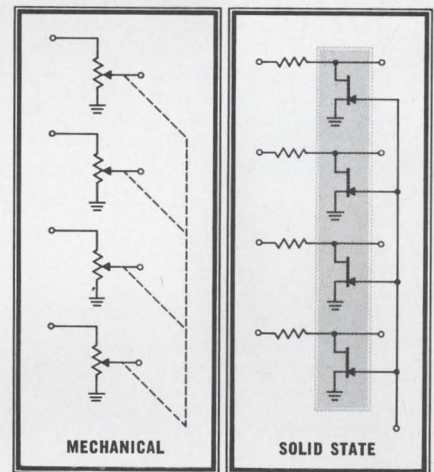

These quad VCRs are specially matched to give close tracking over the specified resistance range. Others: Single and dual voltage controlled resistors (VCR10N, VCR11N) for many applications such as multipliers, phase shift circuits, attenuators, feedback resistors in variable gain amplifiers or . . . what have you?

*For immediate applications assistance call the number below.*

**Siliconix**  
incorporated

2201 Laurelwood Rd. • Santa Clara, Calif. 95054  
(408) 246-8000 Ext. 201 • TWX: 910-338-0227

**\*Applications Power: A broad product line and a service-oriented applications team waiting to serve you!**

### SUBSCRIPTION SERVICE

Please include an Electronics Magazine address label to insure prompt service whenever you write us about your subscription.

Mail to: Fulfillment Manager  
Electronics  
P.O. Box 430  
Hightstown, N.J. 08520

To subscribe mail this form with your payment and check  new subscription  renew my present subscription

Subscription rates: qualified subscribers in the U.S.: 1 year \$8; two years, \$12; three years, \$16. Non-qualified: 1 year \$25. Subscription rates for foreign countries available on request.

### CHANGE OF ADDRESS

ATTACH  
LABEL  
HERE

If you are moving, please let us know five weeks before changing your address. Place magazine address label here, print your new address below.

name

address

city

state

zip code



## Who's Who in this issue

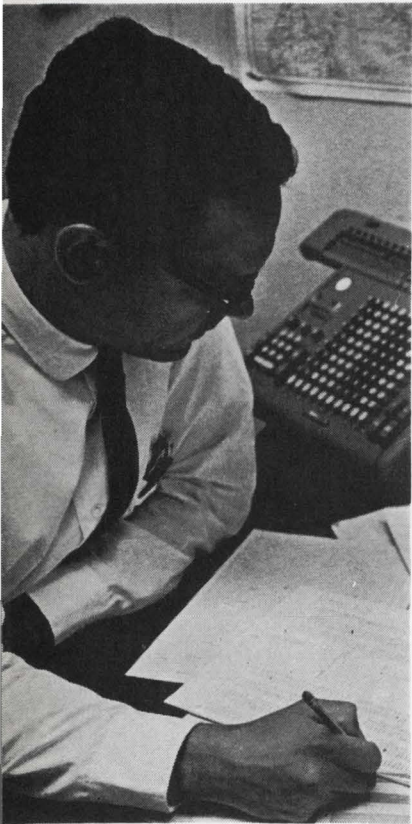

Gibson



Shevel

**Teamwork** is as important in developing an engineering concept as it is in scoring a touchdown on the football field. Proof of this is the article starting on page 105, authored by IBM's Donald H. Gibson and W. Lee Shevel. Gibson's work on the buffer design for the 360/85 earned for him the company's outstanding contribution award. He is with the Systems Development division, while Shevel is with the Components division.

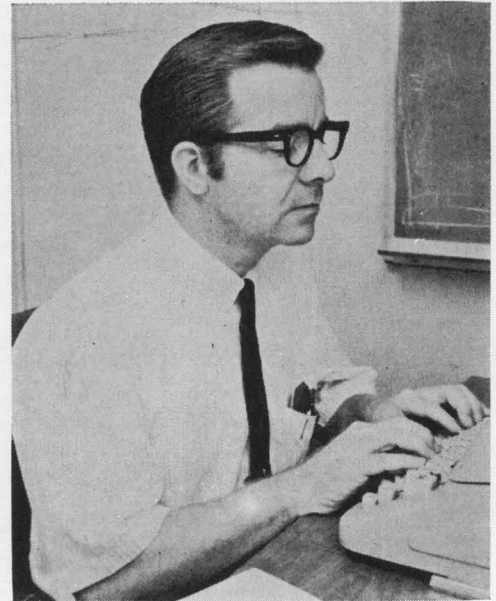

Curran

**No stranger** to *Electronics*' readers, associate editor Lawrence Curran's byline has appeared frequently since 1967, when he took over the magazine's Los Angeles bureau. Curran has been keeping tabs on the impact of computers in designing custom MOS circuitry and has filed several reports on the subject. His latest is the article starting on page 82.

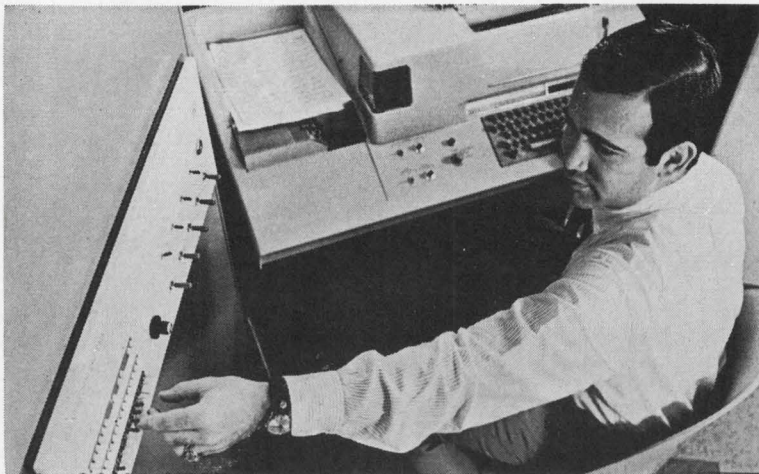

Harmon

**Necessity** may be the mother of invention, but there must always be a father—the role played by the Leeds & Northrup Co.'s Ronald S. Harmon, author of the article starting on page 96. A 1965 graduate of the University of Pennsylvania, Harmon is the man behind a thermocouple open-circuit detection system that can be used in multiplexed, digital data-acquisition systems. He is a development engineer at the company's Digital Equipment division, where he has designed, among other things, logic and peripheral equipment for interfacing with computers. In the company's LN-5000 digital computer control system, Harmon was primarily responsible for the analog input subsystem.

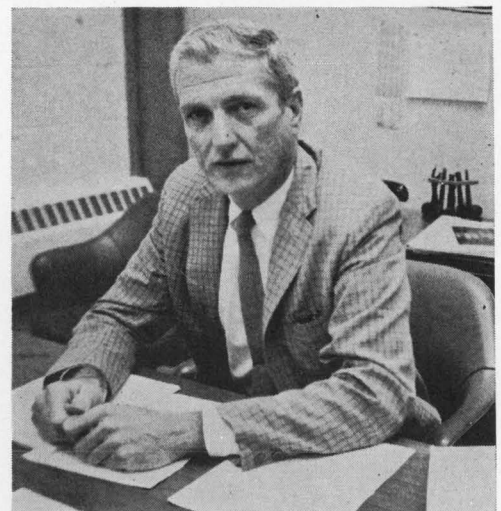

Whalen

**Robert M. Whalen**, author of the article starting on page 108, is an 18-year IBM veteran. A graduate of Cornell University, he helped develop the memories for the company's 7000 series and System/360 series of computers. Whalen designed central-processing hardware before he began his present specialization.



# OP AMP FAMILY

## FASTEST SLEW RATE

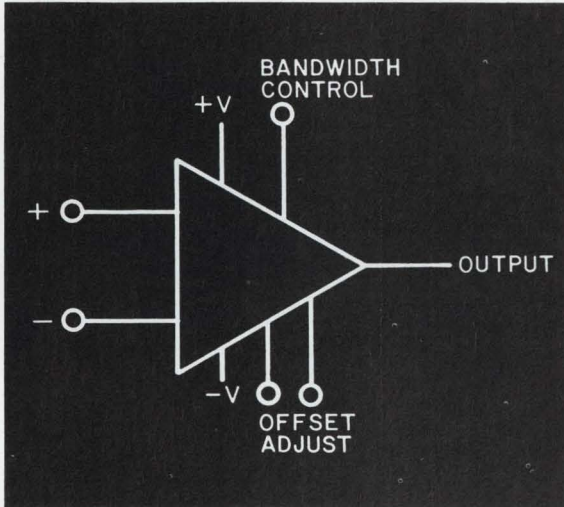

	RA 2520	RA 2510	RA 2500
● Slew Rate	$\pm 120\text{v}/\mu\text{s}, \text{Av}=2$	$\pm 60\text{v}/\mu\text{s}, \text{Av}=1$	$\pm 30\text{v}/\mu\text{s}, \text{Av}=1$
● Voltage Gain	15000	15000	30000
● Large Signal Bandwidth	2000kHz	1000kHz	500kHz
● Gain Bandwidth	24mHz	12mHz	12mHz
● Offset Current	10 nA	10 nA	10 nA
● Offset Voltage	4 mV	4 mV	2 mV
● Output Current	$\pm 20\text{ mA}$	$\pm 20\text{ mA}$	$\pm 20\text{ mA}$
● Input Impedance	100 megohms	100 megohms	50 megohms
	Non-Compensated	Fully Compensated	Stable at Unity Gain

## HIGHEST IMPEDANCE

RA 2600	
● Input Current = 2 nA	● Gain = 200,000
● Input Impedance = 200 megohms	● Gain Bandwidth = 12 mHz
● Slew Rate (at unity gain) = $\pm 7\text{v}/\mu\text{s}$	● Short Circuit Protected
	● Fully compensated (stable at unity gain)

## LOWEST NOISE

RA 909A	
● Equivalent Noise Input = $1.0\mu\text{s RMS}$	● Slew Rate (at unity gain) = $+5, -2.5\text{v}/\mu\text{s}$
● Gain Bandwidth = 7 mHz	● Gain = 45000
	● Power Dissipation = 52 mW

You can be assured of: Monolithic op amps that exceed hybrid performance Off-the-shelf delivery, full military temperature range and compliance with MIL-STD-883 . . . when you pick the BEST IC for the job from Radiation's fast expanding linear line.

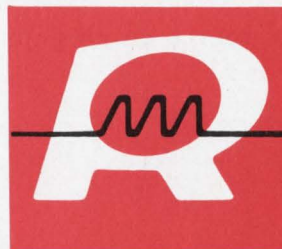

**RADIATION**  
INCORPORATED

SUBSIDIARY OF HARRIS INTERTYPE CORPORATION  
MICROELECTRONICS DIVISION

Lexington, Massachusetts (617) 862-1055  
Norwalk, Connecticut (203) 853-3641  
Washington, D.C. (202) 337-4914  
Dallas, Texas (214) 231-9031  
Long Beach, California (213) 426-7687  
Palo Alto, California (415) 321-2280  
Albuquerque, New Mexico (505) 268-3549  
P.O. Box 37, Melbourne, Florida 32901 (305) 727-5430



# Equal

## Gates

DM8000N (SN7400N)	Quad 2-Input NAND gate
DM8001N (SN7401N)	Quad 2-Input NAND gate (Open Collector)
DM8002N (SN7402N)	Quad 2-Input NOR gate
DM8003N (SN7403N)	Quad 2-Input NAND gate (Open Collector)
DM8004N (SN7404N)	Hex inverter
DM8010N (SN7410N)	Triple 3-Input NAND gate
DM8020N (SN7420N)	Dual 4-Input NAND gate
DM8030N (SN7430N)	Eight-Input NAND gate
DM8040N (SN7440N)	Dual 4-Input buffer
DM8050N (SN7450N)	Expandable Dual 2-Wide, 2-Input AND-OR-INVERT gate
DM8051N (SN7451N)	Dual 2-Wide, 2-Input AND-OR-INVERT gate
DM8053N (SN7453N)	Expandable 4-Wide, 2-Input AND-OR-INVERT gate
DM8054N (SN7454N)	Four-Wide, 2-Input AND-OR-INVERT gate
DM8060N (SN7460N)	Dual 4-Input expander
DM8086N (SN7486N)	Quad Exclusive-OR-gate

## Flip Flops

DM8540N (SN7472N)	MASTER-SLAVE J-K flip flop
DM8501N (SN7473N)	Dual J-K MASTER-SLAVE flip flop
DM8500N (SN7476N)	Dual J-K MASTER-SLAVE flip flop
DM8510N (SN7474N)	Dual D flip flop

## Counters

DM8530N (SN7490N)	Decade counter
DM8532N (SN7492N)	Divide-by-twelve counter
DM8533N (SN7493N)	Four-bit binary counter
DM8560N (SN74192N)	Up-down decade counter
DM8563N (SN74193N)	Up-down binary counter

## Decoders

DM8840N (SN7441AN)	BCD to decimal nixie driver
DM8842N (SN7442N)	BCD to decimal decoder

## Miscellaneous

DM8550N (SN7475N)	Quad latch
-------------------	------------

Spec-for-spec. Pin-for-pin. Second source on all popular 74N.



# Opportunity

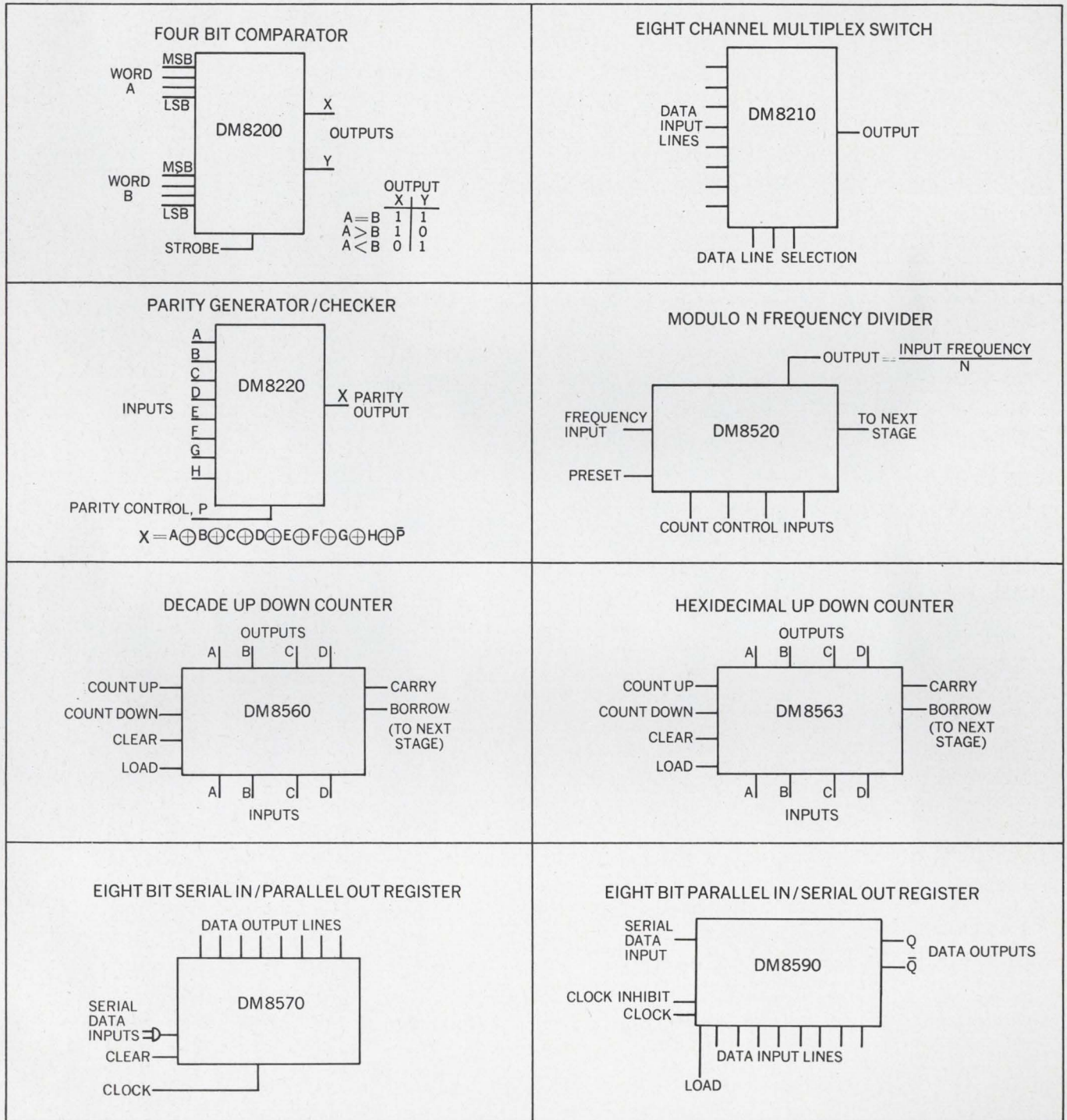

These exclusive National TTL MSI circuits offer designers increased opportunities for circuit savings in design time, board space and costs. Write or call for your free TTL Spec Guide, TTL Cross Reference Guide, and TTL Performance Tables. National Semiconductor, 2975 San Ysidro Way, Santa Clara, California 95051 (408) 245-4320 TWX: 910-339-9240 Cables: NATSEMICON

## National/TTL



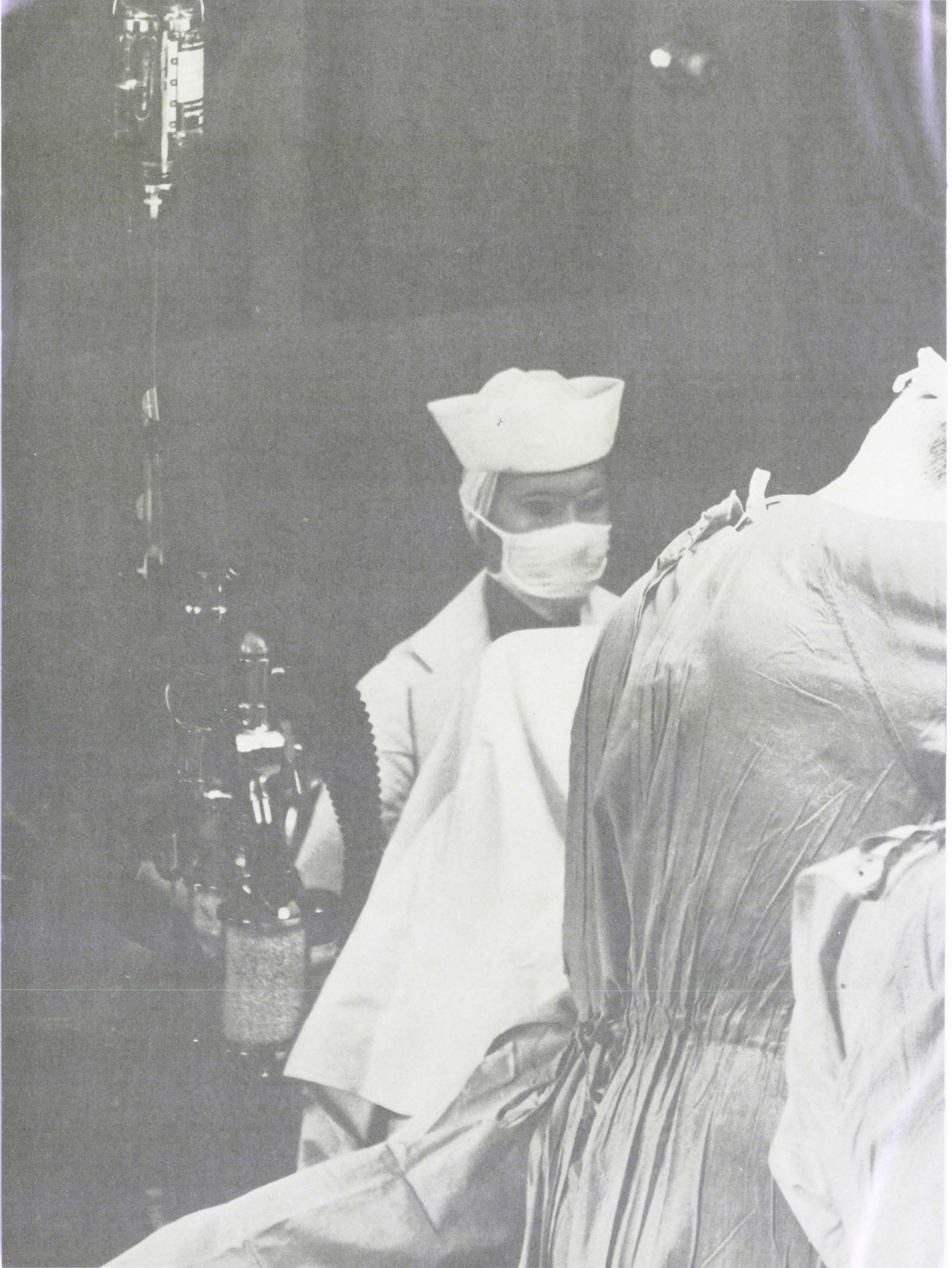





## How did TRW get into the operating room?

You may never see the TRW name in your doctor's office or community hospital. But doctors rely on TRW from diagnostics through surgery.

Miniature precision TRW motors are used in X-ray machines. They drive surgical tools and heart by-pass pumps. TRW subminiature transformers and precision potentiometers are widely used in medical electronics. And TRW communications components summon the life-saving ambulance.

TRW is a highly diversified manufacturer of quality components for the broad spectrum of the electronics industry. TRW components are found in almost every conceivable electronic circuit, operating in nearly every environment known to man. **TRW**<sup>®</sup>

THE ELECTRONICS GROUP OF TRW INC.—World-wide manufacturer of components for the Government, Commercial and Industrial Markets.



# The Connector- Protector- Detector- Inspector



Here's a connector accessory that serves as a dust cap, inspection fixture, assembly fixture, pin protector, and pin straightener. Now you can guard against the fates of connector mishandling from assembly to installation . . . and at a price comparable to an ordinary dust cap!

Over 25 different insert arrangements in 9 shell sizes are available for



MIL-C-26482 and NAS 1599 Bayonet Coupling Connectors, and in various clocking positions. Shell and insert identification is molded into the face of each unit, and it is color coded for easy reference . . . plugs are yellow, receptacles are blue. Veritectors are nonmagnetic, impervious to salt spray and seal connectors against hostile environment.

They can be used over and over, meeting or exceeding 500 cycles of durability.

For the complete story and specifications on the Veritector family, ask for our brochure. Write, or call us at (213) 341-0115.

**CONTROL DATA**  
CORPORATION

Control Data Corporation  
Connector Operation  
8758 Remmet Avenue  
Canoga Park, California 91304

## Who's Who in electronics



API's Reekie

**Can a vice president** for technology in a giant scientifically oriented company grossing \$280 million a year quit and find happiness in a similar job with a \$10 million instrument firm?

For James Reekie, who just joined API Instruments of Chesterland, Ohio, as vice president for technology after seven years with Bell & Howell, the answer is yes. There were two major reasons for his move: a reorganization, plus the opportunity to share in the excitement of a fast-growing firm. Reekie, who was vice president and director of technical operations at Bell & Howell's photo products group in Chicago, puts it this way:

"A policy change at Bell & Howell had decreed that the central research staff of 300 people be divided among the five divisions in the group. After company divisions grow to a certain point, they can exert quite a bit of leverage in getting autonomous R&D. That shift, in effect, eliminated my job in Chicago. Also, I have always liked to be associated with ventures which have steep growth curves in developing new technology, or in increasing sales, or whatever. It seems to me API is facing that kind of growth."

**Taking both forks.** Reekie reasons that API has had steady but relatively modest growth up to now because it had confined itself to instruments. But by expanding its reach both ways, toward the sensing end and toward the information display, API is poised to become a systems supplier rather than simply a component manufacturer, and to turn its projected growth curve sharply upward.

While long-term growth potential is about equal on both ends of this systems spectrum, Reekie says the first effort will be in displays.

"The information explosion is going on in many directions, including industrial processes where a human being must observe, quickly assimilate, analyze, and act upon an increasing amount of data," Reekie points out. "There is tremendous potential for improving the compactness and ease of comprehension of such information, and it doesn't require any new technology, either."

"The instruments and controls in a modern aircraft are a good example of what I mean," Reekie continues. "The display gives the pilot a picture of the plane and what it's doing without his having to think much about it or to interpret it. That's the kind of aspect I believe can be designed into industrial control information."

"Two benefits derive from this approach. One is that great gains can be obtained from technology that already exists. What is required is to think in terms of the human being and his wants and requirements first, instead of emphasizing the machine as in the past. This also avoids the pitfall of going into too much basic research; that can be unwise for a small firm."

**Here they come.** API will introduce a new product in information display within the next six months or so and, according to Reekie, there are four more new product candidates which will take a little longer to evaluate, select, and develop.

Reekie is reluctant to reveal the precise nature of these new prod-



# SCIENCE/SCOPE

Nearly all major U.S. space flight missions have relied on Hughes traveling-wave tubes to beam voice and picture signals back to earth -- most recently Apollo 11 and Mariners 6 and 7. The powerful but compact Hughes TWT, amplifier, and power supply are also aboard the Early Bird, Intelsat II, ATS-1, ATS-3, and Tacsat-1 satellites, which were part of the network that gave worldwide distribution to Apollo 11 TV coverage. Early Bird had been retired recently after nearly four years of service, but was reactivated for the Apollo 11 mission.

The nuclear-powered USS Long Beach, already the world's most advanced missile cruiser, will soon be given a battle-control capability unmatched in naval history. Her Hughes-built Scanfar radars and radar computers, which can detect and automatically track hundreds of targets simultaneously, are scheduled for an electronic face-lifting that will improve her surveillance of a battle zone covering thousands of square miles of land and sea.

The infrared radiometers aboard Mariners 6 and 7 provided high-accuracy surface temperature measurements which were correlated to the TV pictures of the Martian surface. The Mariner 7 radiometer also measured polar cap temperatures consistent with the presence of dry ice. The 7½-pound instruments were made by Hughes' Santa Barbara Research Center, which is now at work on two radiometers for the Mars Mariner 1971 orbiter mission.

In a recent Project BOMEX weather experiment, a Hughes-built 30-foot antenna and portable terminal were installed on Barbados Island to receive the 35 color pictures transmitted daily by the ATS-3 satellite over the Atlantic (it was the same equipment Hughes set up in San Jose, Calif. last year to relay live TV of the Olympic games from Mexico to Japan). BOMEX is directed by ESSA, which is coordinating the efforts of 10 government agencies, 19 educational institutions, and seven contributing corporations including Hughes.

Hughes needs experienced engineers: Microcircuit, digital communication system analysis, computer systems, digital systems test, signal processing, circuit design, missile guidance & fuze, radar systems, SAF ordnance specialists, real-time and weapon system programmers. B.S. degree, two years related experience, U.S. citizenship required. Please write: Mr. J.C. Cox, Hughes Aircraft Company, P.O. Box 90515, Los Angeles 90009. Hughes is an equal opportunity employer.

A night-vision system for helicopters, developed for the U.S. Army by Hughes, presents a cockpit image almost as bright as day -- even when the target is illuminated only by starlight. New system combines the latest developments in fiber optics, low-light-level TV, image-intensifier tubes, and covert illuminators. Called INFANT (for Iroquois Night Fighter and Night Tracker), it has been installed in a UH-1M Iroquois helicopter and successfully demonstrated during night operations in the California desert.

*Creating a new world with electronics*

**HUGHES**

HUGHES AIRCRAFT COMPANY

Circle 15 on reader service card



Forgive us our little deception. What you read here is in no sense a guide to the rare earths.

Our few words are rather a guide to the guide. They are meant to direct you to the proper source(s) that will reveal the potential of that remarkable class of chemical elements, the rare earths.

Which are those elements from lanthanum (atomic number 57) to lutetium (atomic number 71), with the addition of yttrium and thorium.

Hardly sound like they would be interesting to the intelligent electronic engineer, do they? Well, for some excellent reasons, the rare earths are not only interesting, but exciting, promising, and downright stimulating.

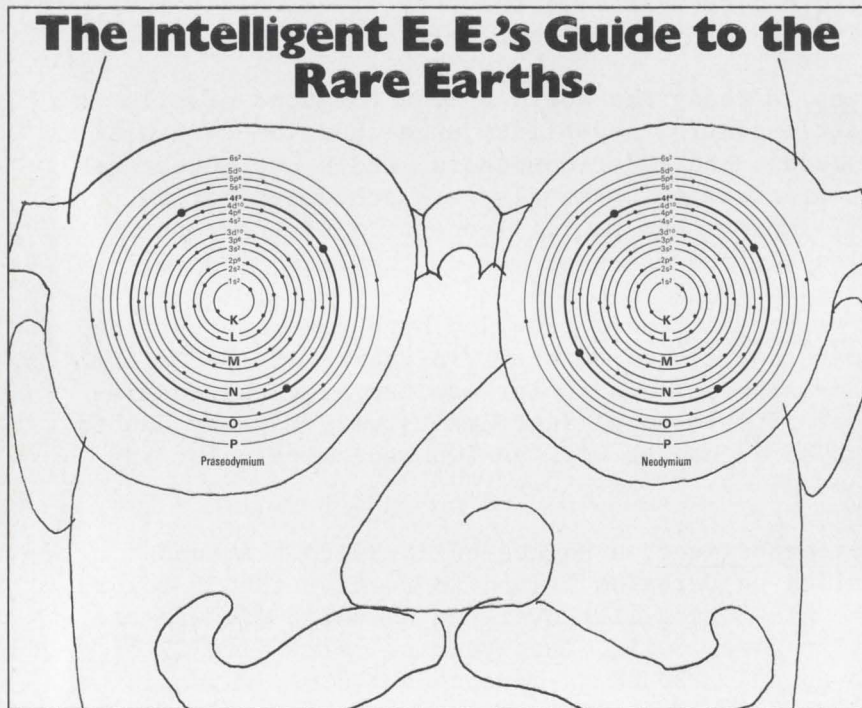

The interest in rare earths comes from their unique electrochemical properties. That leads to excitement over their use as capacitors, thermoelectrics, lighting and CRT phosphors, and more. The promise is partially illustrated by the rare earth's semi- and superconductive properties.

The stimulation, the motivation to do more with the rare earths comes from the fact that what is known about them is far greater than what has been done with them.

And if someone *is* to do great things with them—why not you? All you'll need is time, conviction, and a *guide*. Who could, quite happily, be one of your own colleagues. A chemist, in your own company.

Ask the willing and able chemist to equip you for an excursion into rare-earth territory. Ask us too. With our company and your chemist as guides, you may find an electronic Eldorado in the rare earths.

9-213

## RARE EARTH DIVISION

AMERICAN  
POTASH & CHEMICAL  
CORPORATION

A SUBSIDIARY OF KERR-MCGEE CORPORATION

258 Ann Street; West Chicago, Illinois 60185; Telephone: (312) 231-0760

## Who's Who in electronics

ucts. But he does point out that a digital display doesn't give any rate-of-change information, and "from the human viewpoint, rate of change is often critical in determining proper functioning of a system. So, we need to add rate-of-change data to the display."

He envisions a central monitoring and alarm system for the home which would tell the householder through a central panel that all of his pilot lights were on and systems functioning properly.

"I can see such systems being built fairly economically," Reekie says, "and that is what I call large-volume business."

Another possible market? "Automotive," suggests Reekie, "though we may be too late for that one already. But I can see a system which monitors various critical functions and displays the data on the dashboard."

**Cleaning up.** Still another? "Pollution, and by that I don't mean necessarily air or water," says Reekie. "I'm thinking of noise pollution. Here is an area where no one is quite certain yet what ought to be measured in order to ascertain the levels of pollution. I am recommending that API investigate the measurement of noise in a novel fashion and display the information in novel fashion."

To assist Reekie in his new product efforts, present manning charts call for a development group of about six people. Reekie already has hired two new men for this group, who, he says, have demonstrated their innovative capabilities. One came from General Instrument and the other from General Electric.

What happens when these men and other creative types like them feel constricted by an enlarged API and begin to want to move on?

"I'm not so sure we will want to try to keep them from leaving," Reekie says. "They may already have made their most creative contribution to this company and ought to use their particular expertise elsewhere; and I believe a company needs a more or less constant flow of new people and new ideas to regenerate itself."



# THE GOOD OLD DAYS



## are here again-with the new Beckman 6155 Counter and Timer.

In the good old days there were vacuum tubes, and the instruments made with them were big, slow, hot and not too reliable... but they were easy and inexpensive to repair. Then there were printed circuits that were smaller, faster, more reliable (still hot, though), easy to repair...but expensive. And then there were integrated circuits that were still smaller, much faster, much more reliable (cool)...but very difficult and expensive to repair.

Now, we have the Beckman Model 6155 that really takes us back to the good old days with small, fast, reliable, (cool) and easy-to-repair integrated circuits. How? It's easy. We have field-replaceable integrated circuits that can be handled just like the old vacuum tubes...a new dimension in instrumentation which provides the lowest total cost of ownership: costs less to buy, less to own.

Before you buy your next counter/timer, consider all the costs: basic instrument,

plug-ins, test equipment, spare parts, and servicing. Then compare to the new Beckman Model 6155, which adds up to the lowest total cost-of-ownership expandable IC counter and timer on the market today. Note such features as: field-replaceable IC chips; a complete set of spare parts for less than \$100; MTBF of over 35,000 hours (about 4 years of continuous 24-hour service); plug-in expandability to 12.4 GHz and 1 nanosecond time interval; TIM-1 PULSE MEASUREMENTS: front-panel slope select switches provide pulse width measurement capability; a general purpose, low cost IC tester is the only test equipment needed for rapid servicing. (Ask about our Model 999 IC Tester.) Total the dollar value benefit of all these and you'll know why we say, THE GOOD OLD DAYS ARE HERE AGAIN!

For complete information, contact your local Beckman office, sales representative or the factory direct.

### Model 6155 Specifications

*Measurement Modes:* Frequency: 100 MHz (to 12.4 GHz with optional plug-in). Period: To 100 ns (to 1 ns or 10 ns with optional plug-in). Multiple Period Averages: 1 to 10<sup>5</sup> in decade steps. Ratio: X/Y with X = 0 to 100 MHz and Y = 0 to greater than 1 MHz. Pulse Width & Separation: (To 1 ns or 10 ns with optional plug-in). Voltage & Current: (Optional plug-in). Scaling: By decades up to 10<sup>9</sup>. *Crystal Frequency:* 1 MHz. *Stability:* Better than 3 parts in 10<sup>9</sup> per 24 hours. (5 parts in 10<sup>10</sup> per 24 hours optional). *Output Frequencies:* 0.1 Hz to 10 MHz in decade steps selected by front-panel TIME BASE selector. *External Frequency:* 1 MHz, 1V rms into 1000 ohms required at rear-panel BNC connector. *Display:* 8 inline digits of glow-tube display, 9th digit optional. *Signal (X input) Sensitivity:* 100 mV rms. *Digital Output:* Four-line, 1-2-4-8 BCD output at rear panel. Output compatible with Beckman 1453 Digital Printer. *Power:* 115/230 Vac, 50 to 400 Hz, 80 W. *Size:* 5¼ in. high, 16¾ in. wide, 19 in. deep. *Weight:* 30 lbs. *Price:* \$2,450.

**Beckman®**

INSTRUMENTS, INC.

ELECTRONIC INSTRUMENTS DIVISION

RICHMOND, CALIFORNIA • 94804

INTERNATIONAL SUBSIDIARIES: AMSTERDAM; CAPETOWN; GENEVA; GLENROTHES, SCOTLAND; LONDON; MEXICO CITY; MUNICH; PARIS; STOCKHOLM; TOKYO; VIENNA

Circle 17 on reader service card









# Several hundred thousand unfair advantages.

There you are, busting your back trying to beat another company to market with a new, improved electronic Thing.

Everything looks good — up to the point where sub-assembly X has to be connected to board B. And you've never seen a connection like that before.

What do you do now? Take an R&D break? Give a connector-maker a panic call, and half your budget, to develop a special?

Sweat not. We're sitting over here with several hundred thousand different connectors. Most of them were specials, once. Many of them are patented. And all of them are ready. Now.

Card edge connectors. Two-piece PC connectors. Board-to-board connectors. Miniatures. Sub-miniatures. Dual-in-Line receptacles. Back panel metal plates. Rack and panel connectors. Mil spec cylindrical connectors. Tube and transistor sockets. Even new Mojo™ modular card edge connectors which you sort of invent as you go along. All available with the respected Varicon™ metal-to-metal connection that fully meets Mil-E-5400.

Because they're ready, you get a jump on your competitor while he re-invents one. Because they're standard, you put your Thing together for less money than he can. It may be unfair. But it's fun. And profitable.

But what if we *don't* have a standard for you? Still no problem. Because, with hundreds of thousands of different connectors already behind us, your special will just be a not-quite-standard. So we'll be able to save a lot of time and R&D, too.

We have several pounds of catalog, containing more information about connectors than you probably care to have. So don't just send back a reader information card. Call, write, wire, or TWX us, and tell us either your specific problem or your general field of interest. We'll send you the pertinent few ounces.

Elco Corporation, Willow Grove, Pa. 19090. (215) 659-7000 TWX 510-665-5573.

## ELCO Connectors



# 12

**Ways to Solve**

*Cermet*

POTENTIOMETER

**PROBLEMS**

*...All with TC of 100 PPM/°C Standard*



## Model 3009



3009Y(RJ11)



3009P

- Low Cost Industrial (RJ11 Pin Configuration)
- Power 0.75 watt at 25°C
- Resistance: 10Ω to 1 Meg.

## Model 3069



3069P

- Low Cost Industrial
- Mil-Spec Immersion
- Power 0.75 watt at 25°C
- Resistance: 10Ω to 1 Meg.

## Model 3282



3282L

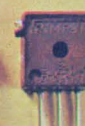

3282H



3282P

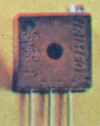

3282W

- Meets requirements of MIL-R-22097
- Power 0.5 watt at 85°C
- Resistance: 10Ω to 1 Meg.

## Model 3012



3012L

3012P

- Meets or exceeds MIL-R-22097, Style RJ11
- Power 1.0 watt at 70°C
- Resistance: 10Ω to 1 Meg.

## Model 3052



3052L

3052P

3052S

- Meets or exceeds MIL-R-22097, Style RJ12
- Power 1.0 watt at 70°C
- Resistance: 10Ω to 1 Meg.

## Model 3262



3262W

3262P

3262X

- Meets or exceeds MIL-R-22097
- Power 0.25 watt at 85°C
- Resistance: 10Ω to 1 Meg.

## Model 3252



3252L

3252P

3252W

3252X

- Meets or exceeds MIL-R-22097, Style RJ22
- CRV 1.6% over entire resistance range
- Power 1.0 watt 70°C
- Resistance: 10Ω to 2 Megs.

## Model 3099



3099

- First Dual In Line Cermet Available
- Std DIP size (TO-116)
- Sealed to meet MIL-R-22097 Immersion
- Power 0.75 watt at 25°C
- Resistance: 10Ω to 1 Meg.

## Model 3059

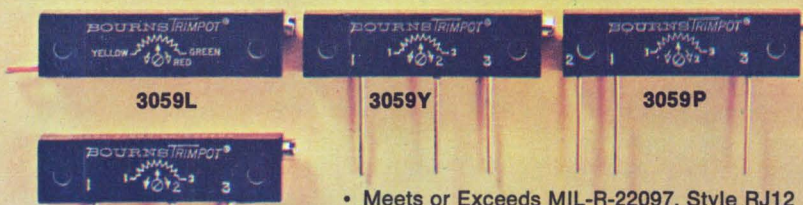

3059L

3059Y

3059P



3059J

- Meets or Exceeds MIL-R-22097, Style RJ12
- Power 1.0 watt at 70°C
- Resistance: 10Ω to 1 Meg.

## Model 3292

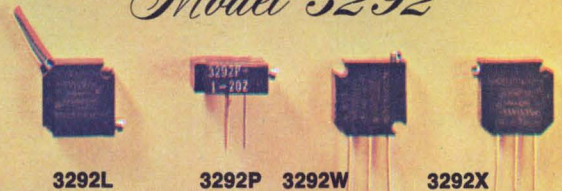

3292L

3292P

3292W

3292X

- Meets or exceeds MIL-R-22097, Style RJ24
- Power 0.5 watt at 85°C
- Resistance: 10Ω to 1 Meg.

## Model 3082

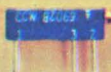

3082P

- Only .10" x .15" x .50"
- Power 0.3 watt at 85°C
- Resistance: 10Ω to 1 Meg.

## Model 3329



3329P

3329H

3329W

- First Commercial single turn to meet or exceed MIL-R-22097
- Only 0.25" dia. x 0.18" high
- Power 0.5 watt at 70°C
- Resistance: 10Ω to 1 Meg.

For a detailed package of technical data on the entire line of TRIMPOT® cermet potentiometers write or call the factory, your local field office or representative!





## PROBLEM:

# A low-cost site to serve the West

## SOLUTION:

# UTAH!

All costs considered, Utah is the most profitable plant site in the West. No other state offers such a combination of prime location in the center of the West . . . plus:

- Low-cost land
- Productive, trainable workers
- Fair taxes
- Friendly government
- Distribution savings
- Quality education
- Fast transportation to markets

Write:

Calvin L. Rampton, Governor  
State Capitol, Dept. 119  
Salt Lake City, Utah 84114



**UTAH!**  
The problem  
solver.

## Meetings

### Nerem: bring your track shoes

**Don't categorize Nerem**—it's one of the rare conferences at which it's hard to select one session over another, so attendees should plan to review the proceedings and prepare to rush from one session to another.

To be held Nov. 5 through 7 at the Sheraton-Boston Hotel and War Memorial Auditorium, Nerem—the Northeast Electronics Research and Engineering Meeting—comprises 24 technical sessions, five tutorial seminars, industry exhibits, and a special how-to-do-it presentation on new enterprise for the budding entrepreneur.

The meeting's \$4 registration fee looks like a bargain; the Nerem program committee appears to have succeeded in second-guessing this autumn's hot topics and to have obtained good papers to cover them. Air traffic control, electronic navigation, automated test systems, monolithic memory systems, automated IC and LSI artwork generation, electronics in medicine, and other topics are represented.

**The hot ones.** Lead zirconate and lead titanate may become the 1970's substitute for cathode-ray tubes in some data display applications. C. E. Land of the Sandia Corp., Albuquerque, N.M., summarizes his work, which already has included construction of light gates and modulators, in Session 1, Optoelectronics.

Computer analysis of heartbeat is closer with development of a so-called ectopic beat detector by the American Optical Corp. of Framingham, Mass. The machine, discussed by G. J. Harris in Session 2, Bioelectronics, already has proven its effectiveness at spotting heartbeat irregularities.

Circal-2, a new program for network computer-aided analysis, bows in Session 3, CAD, in a paper by G. P. Jessel and J. R. Stinger of MIT. Circal-2 is modular in form, and offers easy interchange of analysis routines, dynamic core memory allocation, and multimode operation.

The realization that testing soon could become a limiting factor in sale and production of large-scale integrated circuits is demonstrated in Session 4, Computer Instrument Systems. E-H Research Labs' R. S. Broughton discusses a test system for LSI which uses an IBM 1130 computer. Matthew L. Fichthenbaum of General Radio talks about his firm's new model 1970 complex logic tester, a system capable of checking entire instruments.

**Artful.** Although some companies continue to cut rubylith artwork for LSI designs, it seems that the razor-blade days are numbered. Commercial artwork generators have been around for almost two years, and in Session 7, Artwork Generation, spokesmen from Lincoln Lab, IBM, Bell Telephone Labs, and Systematic Design Inc. present the details of their in-house-developed systems.

Session 21—Monolithic Memories—covers developments in both magnetic and pure electronic devices. The two key papers appear to be R. J. Spain's study of cost and performance of sequential magnetic memories under examination at Sylvania Semiconductor, and a paper by W. R. McKinley and others on development of a read-only memory with a user-programmable decoder at Fairchild.

Session 20, Air Traffic Control, reviews the control problem today and from the perspective of the 1980's. General conclusions of the four speakers seem to indicate that more on-board avionics will be needed, as will use of radio-navigation systems like Omega, and perhaps digital data links.

Session 24, Electronic Navigation Systems, complements Session 20 and again looks ahead at doppler navigation as it will evolve, at NASA's work on satellite location systems, the present and future status of Omega, and at a proposed system for civil aircraft based on the Apollo midcourse navigation system.

Session 25, Computerized Test





The solid state numeric  
is ready at Monsanto.

So are 19 other LED's.

## Send a P.O.

MAN 1 shown 6x actual size.

You know we've been working on the MAN 1 visible diode numeric for several years. Well, now we're ready to take orders.

It offers all the good things you expect from microcircuits. Low power drain. Shock resistance. Happy interface with your solid-state circuitry. Plus it gives you design flexibility you've never had before. And the multi-segmented construction avoids the danger of a number being altered by a small circuit failure.

Send a P.O. and be the first designer on your block to give your

digital readout the look of the 70's.

The 19 other low-cost, long-lived LED's? Four are bright red light-emitting semiconductors that have ns switching time, diode reliability and million-hour\* life.

One of our LED's emits amber light, one green light. Five put out frequencies in the infrared. One is a coupled pair, with detector and emitter in the same package to give you a light-quick switch (5 ns rise and fall) with 3 kV isolation.

Six are room temperature lasers in a variety of miniaturized configurations. Number 19 is a bunch of new

CO<sub>2</sub> laser modulator components.

So there's the whole line. They're all currently available from Schweber, Kierulff, K-Tronics, or Semiconductor Specialists. Or from us: Monsanto Electronic Special Products, 10131 Bubb Road, Cupertino, California 95014. Phone (408) 257-2140.

Want more information on our new numeric, the MAN 1? Circle reader service #317.

For specs on the other 19 LED's, circle #318.

\* T<sub>A</sub> = 25°C, I<sub>F</sub> = 50ma. Result of step-stress testing with end of life projections.

# Monsanto



# WE'VE JUST MADE THE INDUSTRY'S BROADEST LINE OF TEFLON\* TAPES A LITTLE BROADER

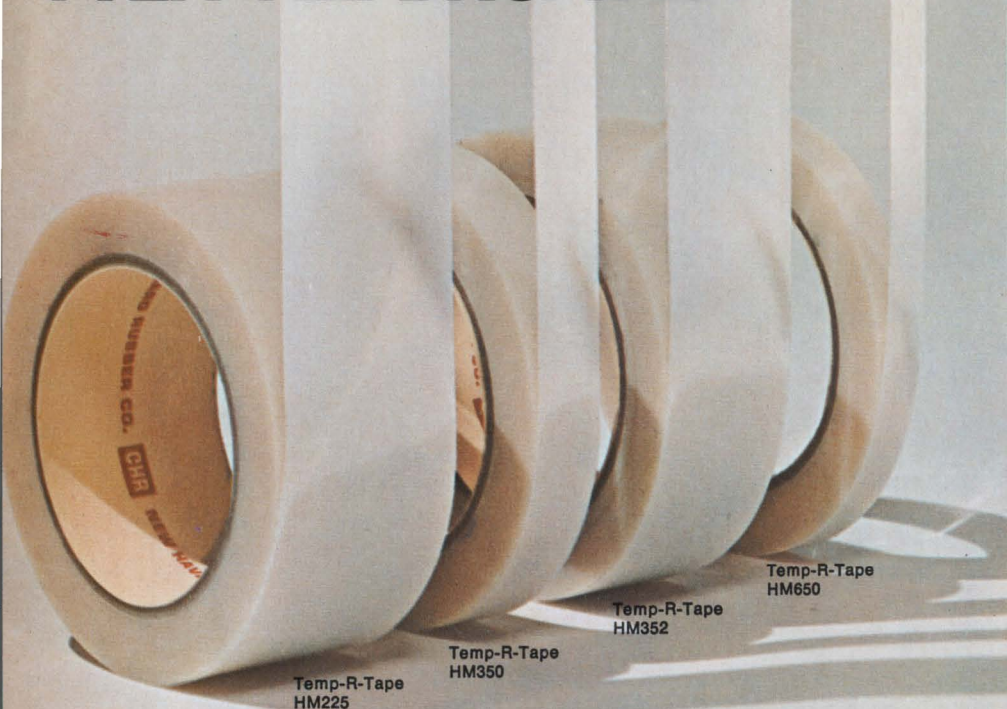

## By about a thousandth of an inch.

That's the thickness of the Teflon film used in our new HM225 Temp-R-Tape®. With its silicone polymer pressure sensitive adhesive it mikes out to only .00225".

Along with the super-slipperiness of Teflon, HM225 has low elongation, high strength, easy no-curl handling, outstanding electrical properties and a -100 to +500 F operating range.

You can't buy a thinner Teflon tape that offers this combination of unique qualities.

CHR has a tape of Teflon to match just about any design requirement you may come up with. And with the other new high modulus tapes (see box) CHR has the broadest line in the industry.

\* TM of DuPont

### NEW CHR TEMP-R-TAPE OF TEFLON

Four HM series tapes are available with silicone polymer pressure sensitive adhesive: HM225—2¼ mils, HM350—3½ mils, HM650—6½ mils and HM352—3½ mils with the Teflon surface treated to promote adhesion of varnishes.

For the widest selection of tapes of Teflon in the industry see your nearest CHR distributor for technical assistance and prompt delivery. Look in the Yellow Pages under "Tapes Industrial" or in major industrial directories and microfilm catalogs under CHR. Or write for details and sample. The Connecticut Hard Rubber Company, New Haven, Connecticut 06509.



Subsidiary of U.S. Polymeric, Inc.

Circle 24 on reader service card

## Meetings

(Continued from p. 22)

Techniques, again explores LSI testing, but also touches on program language requirements and finishes with a discussion of a proposed on-board checkout system for the NASA Air Force space shuttle. J. F. Hughes and L. H. Browning of the Manned Spacecraft Center, Houston, discuss the system aimed at speeding pre-launch turnaround time.

For further information contact Boston Section, IEEE, 81 Channing St., Newton, Mass. 02158

## Calendar

**Thermionic Energy Conversion Specialist Conference**, IEEE; Carmel, Calif.; Oct. 21-23.

**Joint Materials Handling Engineering Conference**, IEEE, American Society of Mechanical Engineers; Sheraton Motor Inn, Portland, Ore.; Oct. 27-29.

**Joint Conference on Mathematical and Computer Aids to Design**, Society for Industrial and Applied Mathematics, Association for Computing Machinery, IEEE; Disneyland Hotel, Anaheim, Calif.; Oct. 27-30.

**Nuclear Science Symposium**, IEEE; Sheraton Palace Hotel, San Francisco; Oct. 29-31.

**International Electron Devices Meeting**, IEEE; Sheraton Park Hotel, Washington; Oct. 29-31.

**Northeast Electronics Research & Engineering Meeting (NEREM)**, IEEE; Sheraton Boston Hotel, War Memorial Auditorium, Boston; Nov. 5-7.

**University Conference on Ceramic Science**, Dept. of Metallurgical and Materials Engineering, University of Florida; Nov. 10-14.

**Symposium on Adaptive Processes**, IEEE; Pennsylvania State University, State College; Nov. 17-19.

**Conference on Applications of Simulation**, Association for Computing Machinery, IEEE; International Hotel, Los Angeles, Dec. 8-10.

**International IEEE G-AP Symposium**, The University of Texas at Austin, Dec. 9-11.

**Asilomar Conference on Circuits and**

(Continued on p. 26)





**Allen-Bradley Type G  
variable resistors  
help seal Sylvania's  
rescue transceivers against**

# ocean dunkings

Built primarily for aiding in the location and recovery of downed airmen, Sylvania's emergency rescue transceiver must be reliable under extremely adverse conditions. It is lightweight and compact enough to be carried in the pocket of a flight jacket. It must withstand impact and immersion in salt water without damage.

Essential to meeting these requirements is Allen-Bradley's Type G variable resistor. It's rugged. It's compact. And it provides the necessary seal against water. This particular Type G has two "O" rings—one between the bushing and shaft, and one between the bushing and mounting panel. This dual seal prevents water entering the enclosure, as well as the control.

The Type G variable resistor features the Allen-Bradley solid, hot-molded resistance track. It gives long life—less than 10% resistance change after 50,000 complete cycles. The noise level is extremely low, and the smooth adjustment provides virtually infinite resolution. Low inductance permits operation across a broad frequency spectrum.

For complete details and immediate delivery on this 1/2-inch-diameter Type G 1/2-watt variable resistor, call your authorized A-B industrial electronics distributor. Or write: Marketing Dept., Electronics Div., Allen-Bradley Co., 1201 South Second Street, Milwaukee, Wis. 53204. Export Office: 1293 Broad St., Bloomfield, N. J., U.S.A. 07003. In Canada: Allen-Bradley Canada Limited.



Type G  
variable resistor  
shown  
actual size



Sylvania AN/PRC-90 dual channel rescue transceiver permits two-way voice communication, the transmission of Morse code or the sending of a homing beacon.



**ALLEN-BRADLEY**  
QUALITY ELECTRONIC COMPONENTS

Circle 25 on reader service card



# HYBRID CIRCUITS

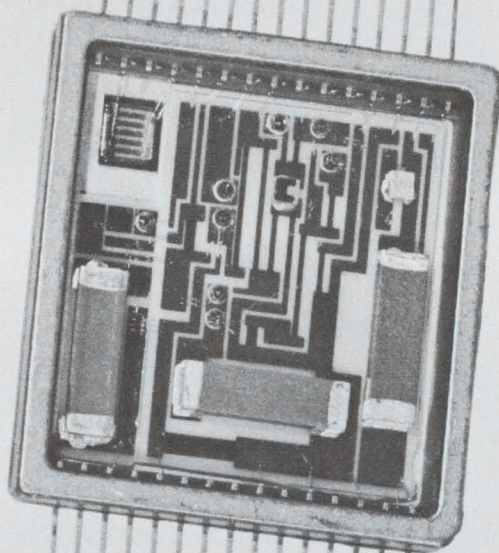

## we make them!

DESIGNED AND BUILT TO YOUR SPECIFICATIONS  
WRITE OR CALL FOR FURTHER INFORMATION



**WEMS, INC.** 4650 WEST ROSECRANS AVENUE  
HAWTHORNE, CALIF. 90250 ■ TELEPHONE (213) 679-9181

An equal opportunity employer.

## Meetings

(Continued from p. 24)

**Systems**, Naval Postgraduate School, The University of Santa Clara, Stanford University, and IEEE; Asilomar Hotel and Conference Grounds, Pacific Grove, Calif., Dec. 10-12.

**Winter Power Meeting**, IEEE; Statler Hilton Hotel, New York; Jan. 25-30, 1970.

**Annual Symposium on Reliability**, Group on Reliability of the IEEE, American Society for Quality Control, American Society for Nondestructive Testing, and the Institute of Environmental Sciences; Ambassador Hotel, Los Angeles; Jan. 27-29, 1970.

**International Solid State Circuit Conference**, IEEE, University of Pennsylvania; Sheraton Hotel and University of Pennsylvania, Philadelphia, Feb. 18-20, 1970.

## Short courses

**Reliability Engineering and Management Institute**, General Electric Co., University of Arizona, Tucson, Nov. 3-12. \$275 fee.

**Hybrid Computing Techniques, Programming, and Applications**, Purdue University, Lafayette, Ind., Nov. 10-21. \$300 fee.

**MSI/LSI Circuit Seminar**, Airport Marina Hotel, Los Angeles, Dec. 1-3. \$385 fee.

## Call for papers

**Electronic Components Conference**, Electronic Industries Association and IEEE; Statler-Hilton Hotel, Washington, May 13-15, 1970. **Nov. 15** is deadline for submission of abstracts to Darnell P. Burks Sprague Electric Co., Marshall St., North Adams, Mass. 01247.

**National Aerospace Electronics Conference (NAECON)** IEEE and American Institute of Aeronautics and Astronautics; Sheraton-Dayton Hotel, Dayton, Ohio, May 18-20, 1970. **Dec. 1** is deadline for submission of abstracts to Mrs. Rita Gustin, 5455 Flotron Ave., Dayton, Ohio 45424.

**Southwestern IEEE Conference**, Memorial Auditorium, Dallas, April 22-24, 1970. **Dec. 1** is deadline for submission of abstracts and summaries to Prof. Andrew P. Sage, Information and Control Sciences Center, SMU Institute of Technology, Dallas, Texas 75222.



Allen-Bradley's experience in resistor production reaches...

to the moon and back!

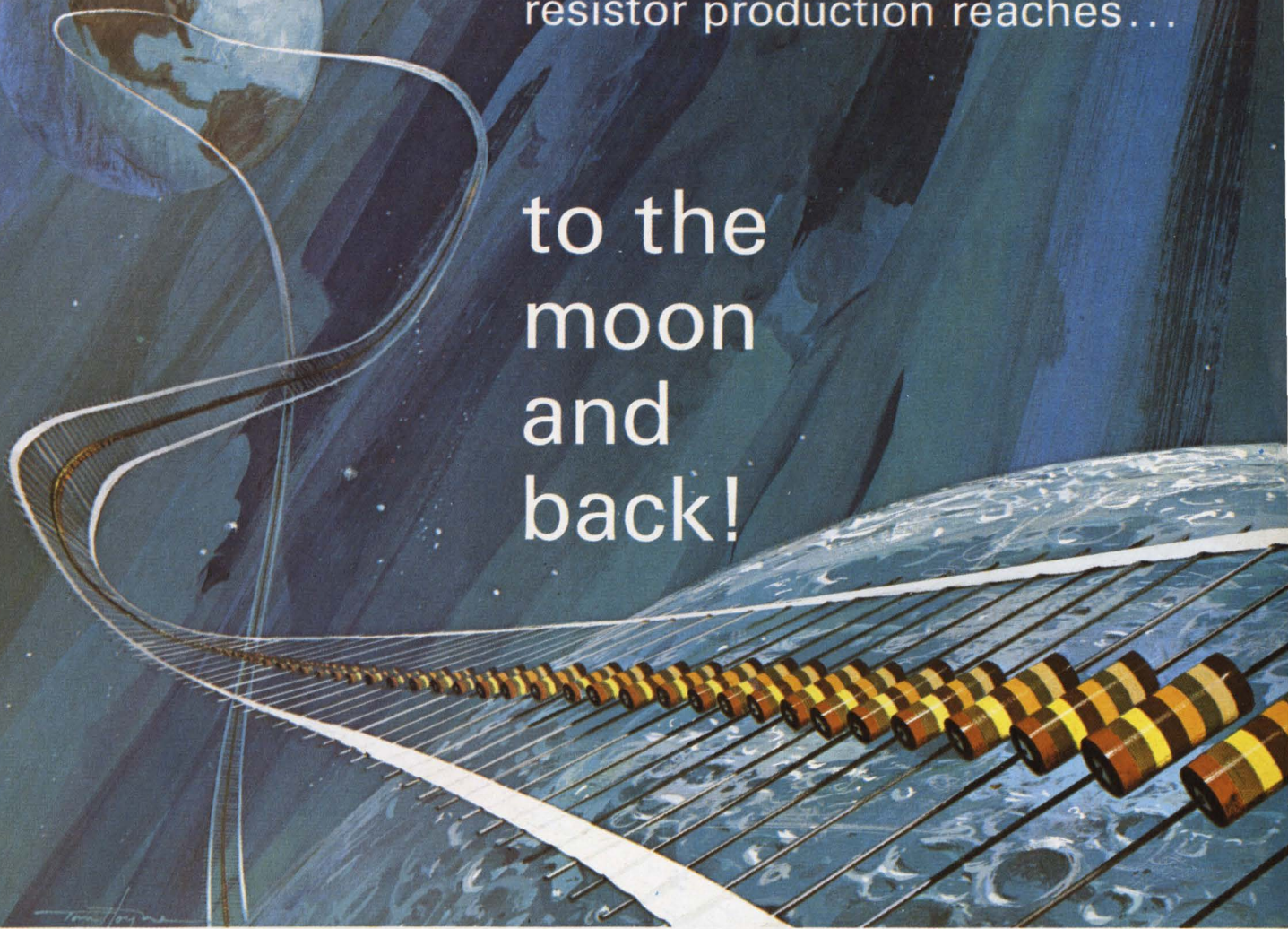

TYPE BB 1/8 WATT

TYPE EB 1/2 WATT

TYPE HB 2 WATTS

TYPE CB 1/4 WATT

TYPE GB 1 WATT

A-B industrial grade hot-molded fixed resistors are available in all standard resistance values and tolerances, plus values above and below standard limits. A-B hot-molded resistors meet or exceed all applicable military specifications including the new Established Reliability Specifications at the S level. Shown actual size.

After more than three decades and untold billions of hot-molded resistors, Allen-Bradley has accumulated manufacturing "know-how" which cannot be approached by anyone else. The fact that the resistors made by A-B over the years—if placed side by side—would more than reach to the moon and back, may be impressive. But "how" they are made is the key.

Allen-Bradley resistors are produced by an exclusive hot-molding technique—developed by A-B. They're made by completely automatic machines—also developed, built, and used only by Allen-Bradley. The human element of error is removed. Uniformity is so precise from one resistor to the next—year in and year out—that

long-term resistor performance can be closely predicted.

The reputation for quality and performance established by Allen-Bradley hot-molded resistors is reflected in the fact that they have been an integral part of virtually every U.S. space probe. And they are "on" the moon. No other resistor applications demand a higher measure of reliability.

For immediate delivery at factory prices, call your authorized A-B industrial electronics distributor. Or write: Marketing Department, Electronics Division, Allen-Bradley Co., 1201 South Second St., Milwaukee, Wis. 53204. In Canada: Allen-Bradley Canada Limited. Export Office: 1293 Broad Street, Bloomfield, N.J., U.S.A. 07003.

EC69-60A

QUALITY ELECTRONIC COMPONENTS



ALLEN-BRADLEY

© Allen-Bradley Company, 1969

Circle 27 on reader service card



# Worldwide capability

## internal connectors

## input/output connectors

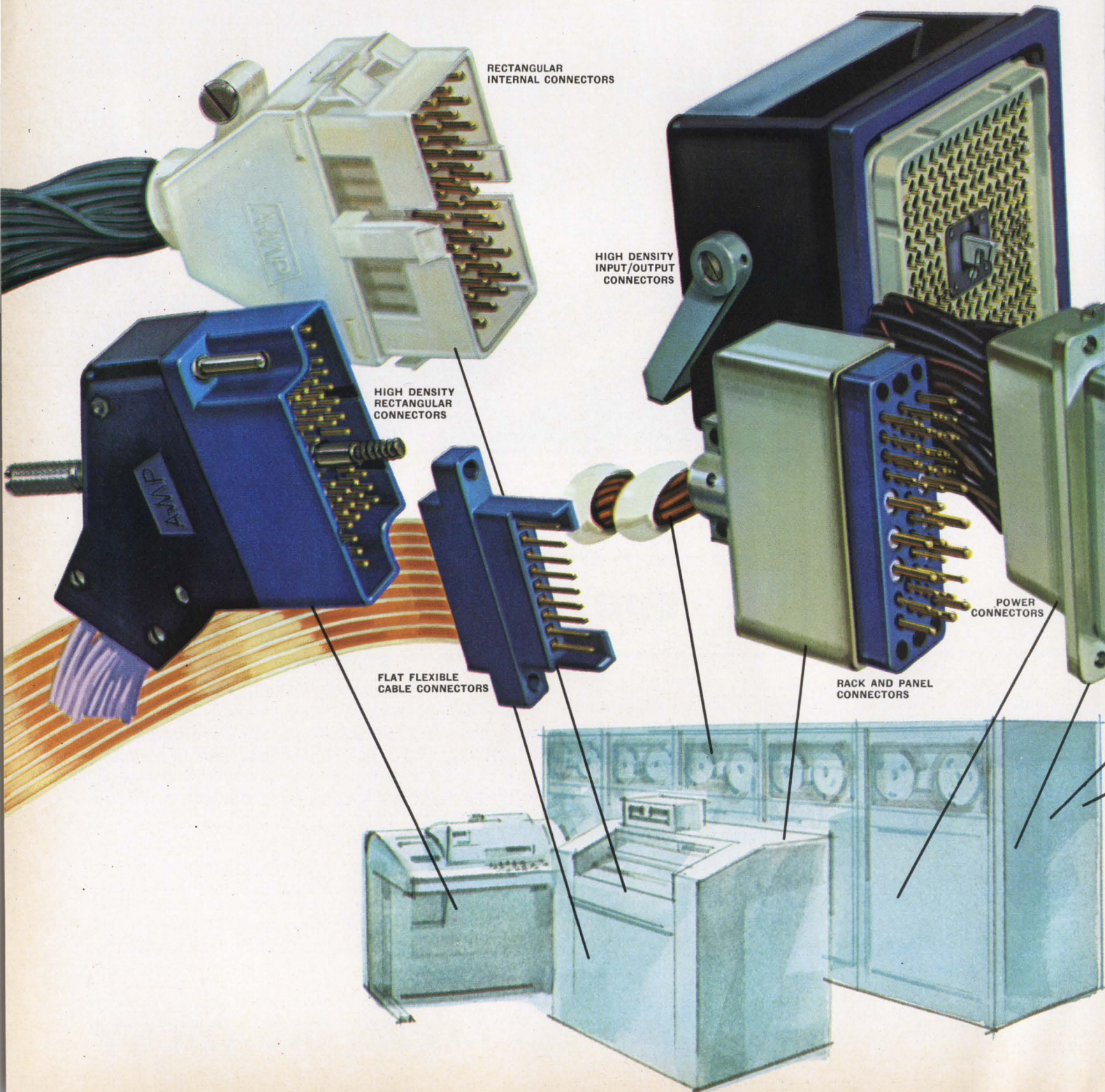



# for computers in:

## interconnection systems

## wired panels

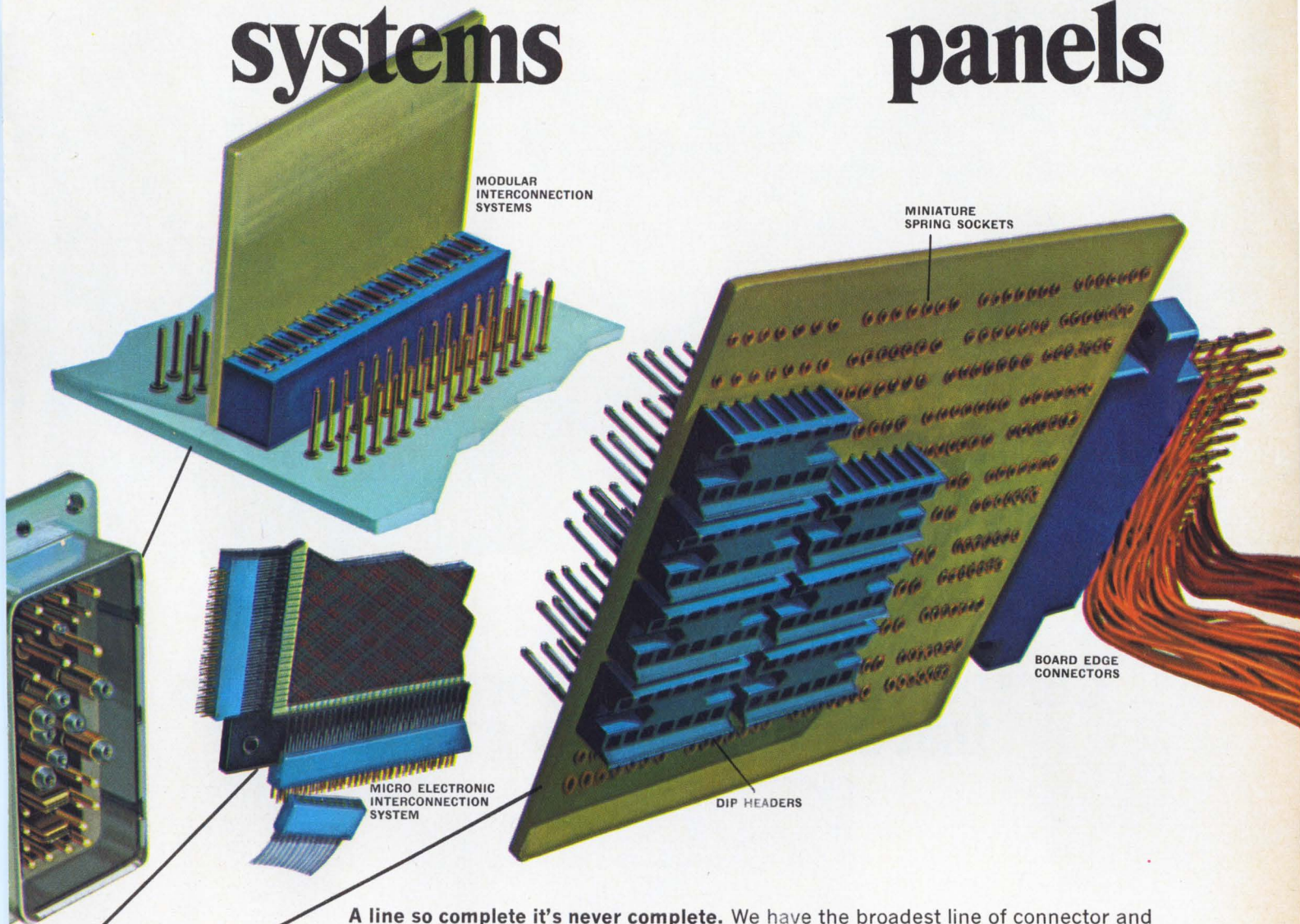

**A line so complete it's never complete.** We have the broadest line of connector and interconnection techniques for computers and peripheral equipment in the world. And we can design new ones to fit your ever changing needs.

**No matter where you are.** We're worldwide. In manufacturing, engineering and direct sales representation. And the quality of our products and services never varies.

**Some say we're experts.** And we think our connectors live up to it. Board-to-board, point-to-point, racked, stacked, panelled or hanging free our connectors are among the most reliable in the world.

**How can we do all this and save you money, too?** A-MP\* automatic application tooling for use right in your own plant . . . engineered specifically for the A-MP product. This application tooling enables you to realize the lowest total installed cost.

**Want more?** Write today for complete catalog data on our connector and interconnection products for computers.

**INDUSTRIAL PRODUCTS DIVISION, AMP INCORPORATED, HARRISBURG, PA. 17105.**

\*Trademark of AMP Incorporated

European companies or affiliates refer to International Section

Circle 29 on reader service card

# AMP

INCORPORATED





## Our solid state keyboards are for locations that are expensive to go back to.



Service calls, especially to remote locations, can cost half again as much as the original cost of the keyboard.

Our inexpensive solution to this expensive problem is our new keyboard. It's all solid state.

In fact, it's the world's first use of an integrated circuit as a keyboard switching element.

Codes are transmitted electronically, not mechanically. So there's no need for mechanical linkages, electromechanical parts, contacts, buffer circuitry or any of the moving stuff that normally

wears out and causes malfunctions.

The reliability of solid state becomes an important part of the

offer you're able to make to your customers. And it helps you beat the economics of servicing remote equipment.

MICRO SWITCH can supply all standard and custom key arrays. Each with the same touch and spacing as a regular keyboard.

Our "Condensed Keyboard Guide" explains it all. We'd like to send you a copy. Just write.

### **MICRO SWITCH**

FRÉEPOR, ILLINOIS 61032  
A DIVISION OF HONEYWELL



---

## Editorial Comment

---

### A matter of poor communications . . .

**More sleepless nights** seem the lot of technical executives at the country's telephone companies. Angry subscribers in metropolitan centers are demanding a cure for inadequate and unreliable service. The phrase, "out of order," has become almost synonymous with the public telephone. Furthermore, lines are overloaded and new installations are far behind schedule. But of all the complaints, the loudest and most persuasive are those from businessmen who report loss of revenue. Customers can't get through to them because of overloaded circuits. Data-communications firms, for example, want assurances that their increasing business can be handled by the telephone companies. And now the Federal Communications Commission has asked the telephone companies to account for their increasing troubles.

Ironically, the Bell System, long considered a leading practitioner of systems engineering and management skills, is being questioned on its ability to manage and maintain the U.S. communications network in satisfactory working order. Beyond that, the inquiry delves into Bell's slowness in improving the system—as in the case of its conversion from electromechanical to electronic switching.

Thus far, hearings and criticisms have revealed that

the telephone companies' troubles stem from a combination of inadequate forecasting of user requirements, unpredictable overloads, and shortages of trained installers and maintenance personnel. In one Denver area, for example, telephone users attempted to make 40,000 calls at once in an exchange designed to handle 30,000. In their own defense the phone companies say it's difficult to accurately forecast the amount of traffic. The soaring demands of Wall Street and of Florida's east coast are examples. Phone installations in Florida were backlogged for up to five months. Furthermore, the needs of businesses that supply data-communications service are particularly hard to predict. Such firms can emerge virtually overnight and are loath to reveal needs far in advance in an effort to protect potential business.

However, one must be sympathetic to the pressures being brought to bear upon the telephone utilities. Their sheer size and complexity provide a tremendous inertia. Their management systems are unwieldy and improvements in such systems can be traumatic. Even the smallest technological improvement of telephone systems requires weighty deliberation. Nevertheless, predicting future needs is at the heart of the matter, and better forecasting methods are clearly needed.

### . . . that could get better

**Data communications**, while not yet a serious contributor to the present phone system logjam, will pose an additional burden in the near future (computer utilities and time-sharing service companies are doubling in volume of business annually). In anticipation of the "data jam," independent firms are seeking Federal permission to establish microwave links that could handle not only data, facsimile, and teletypewriter, but radio and voice transmissions as well. FCC permission to go ahead with one such line in direct competition with AT&T has already been granted [*Electronics*, Sept. 29, p. 133].

In many ways the move to open the private-line market to competition makes a great deal of sense. The telephone companies themselves are the first to admit that the existing system is best suited for voice communications. The flexibility promised by the new independents is indeed appealing. In one case, 72 basic microwave channels will be offered in 10,000 combinations in bandwidths ranging from 200 hertz up to a high of 1 megahertz.

In that system, subscribers can have part-time or one-way use, and as many as five subscribers may share one channel. A communications system designed specifically for data transmission can offer accuracies in the order of one error in  $10^7$  bits. Also, separate microwave channels avoid potential errors in data transmission caused by noise from telephone-switching circuits. Conversely, the avoidance of heavy data-transmission loads on the telephone utilities eliminates a potential source of noise injection into that system.

Not incidentally, new microwave systems will need terminal equipment designed to transmit a variety of data. Undoubtedly, electronics entrepreneurs are standing in the wings waiting for just such an equipment market to open up, and engineers are already at work analyzing the technical problems such gear will have to solve. Finally, permitting independents to tackle the private-line, data-transmission market could buy time for the telephone utilities, enabling them to catch up with backlogs and iron out management difficulties. ■



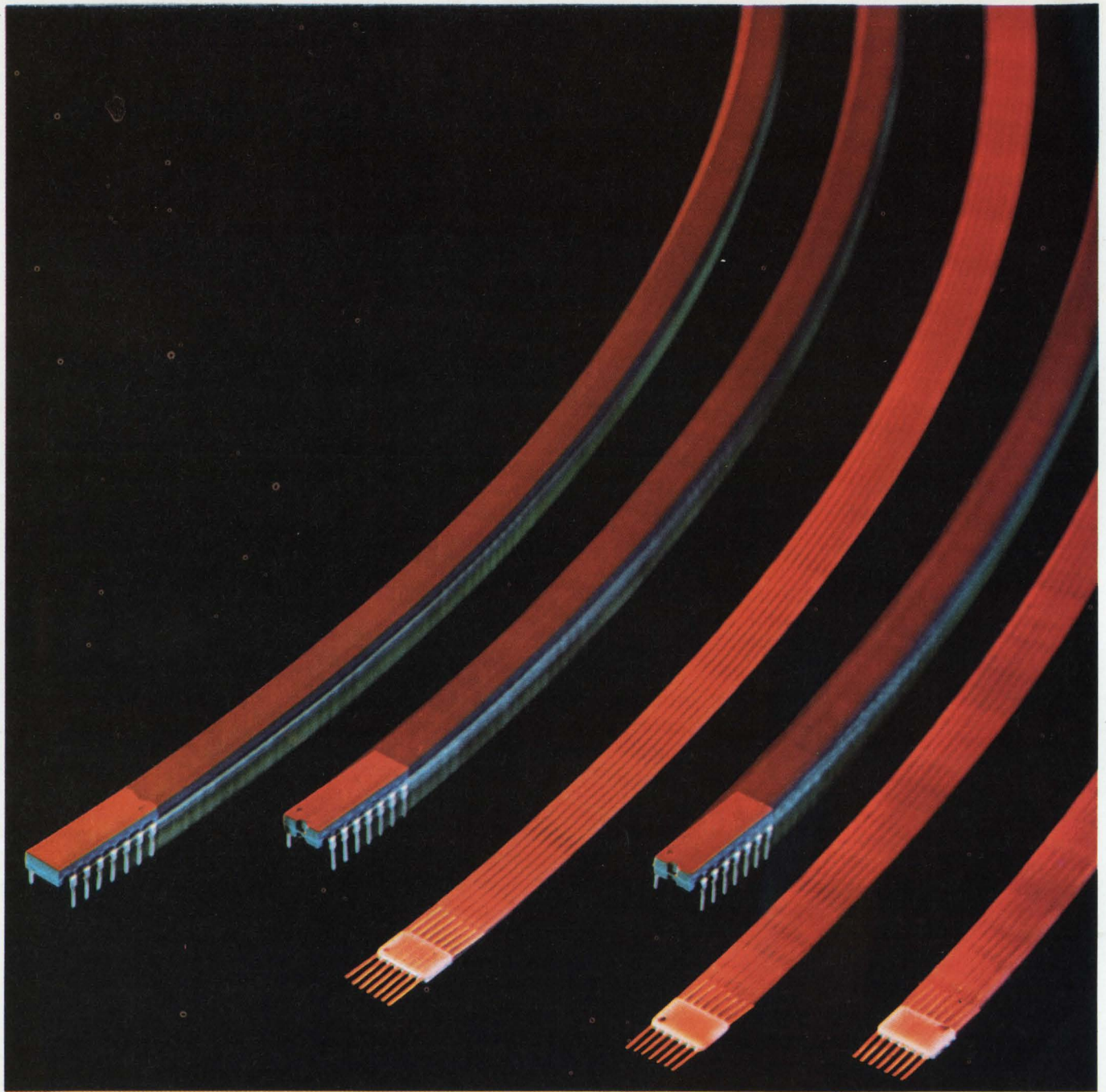

Sprague Digital ICs. Illustration: Series 54H/74H in flatpack and DIP

## Just arrived. Series 54H/74H. The fast ones.

Just about the fastest saturated logic circuits around. Series 54H/74H from Sprague. The whole family. Flip-flops and all.

Use them in arithmetic and processing sections, where speed really counts. Mix and match them with Sprague's standard Series 54/74.

**Get off to a fast start with Sprague Series 54H/74H.**

Call Sprague Info-Central (617) 853-5000 extension 5474.

TYPICAL CHARACTERISTICS	GATES	FLIP-FLOPS
Propagation Delay	6 nsec	17 nsec
Power Dissipation	22 mW	80 mW
Noise Immunity	1 V	1 V
Temperature Range	-55 to +125° C	
Series 54H	0 to +70° C	
Series 74H	DIP or Flatpack	
Packages		

455-9127R1

For complete specifications, circle the reader service number below.





---

# Electronics Newsletter

---

October 13, 1969

## Search under way for laser scribers . . .

Semiconductor makers, hunting for yield-increasing wafer scribing methods, are taking a hard look at lasers. While such firms as Fairchild and Signetics—both of which say they lose 8% of dice with present diamond scribers—admit only that they're after something better, other companies have taken concrete steps.

Autonetics, for example, says it's interested in lasers; **Motorola has given a study contract to a laser manufacturer.** And the Integrated Circuit Engineering Corp., working for "a major semiconductor manufacturer," is developing a prototype laser scriber. **A major part of ICE's effort will be to find out which type of laser can cut silicon without splattering it on the wafer.**

An ICE source points out that not only could a laser boost yield in the scribe-and-break step, but the resulting clean edges also facilitate automatic handling. **However, he's "not sure it would be economically feasible for normal production,"** indicating the firm's work may involve special requirements, possibly for large chips.

## . . . as firms seek better dicers

But there are those who are sticking with, and improving on, diamond scribers. Tempress is known to be working to modify its diamond dicers, but isn't talking about what changes are being made. **Tempress president Fred Christensen points to the silicon redeposition problem as a fault in laser scribing,** and adds that even without that drawback, lasers don't solve the problem of how to break the wafer cleanly into dice.

At NASA's Electronics Research Center, which has a contract from Spacerays Inc. to investigate laser scribing, senior scientist Samuel Polcari doesn't like silicon redeposition either, **and has developed advanced diamond-cutting methods said to produce exceptionally clean edges, leading to nearly 100% separation yields.**

Another firm sticking with diamond tools is National Semiconductor, which has modified some Tempress scribers itself to yield dice edges so smooth they look like they've been lapped, one observer reports. National isn't saying what's involved in the modification.

## New firm plans 2-inch-thick, 18-bit computer

Would you believe an 18-bit computer less than 2 inches thick? Computer Logic Systems Inc. hopes to build the rack-mounted machine as one of its long-term goals—though it might not arrive until late 1970, **it still could be among the first to use monolithic MSI circuits interconnected on hybrid substrates to cut size and manufacturing costs.**

For the present, the Billerica, Mass., firm is content to prepare an 18-bit machine as small as an 8-bit computer, and with a price tag well below that of some 16-bit processors. **This one should be ready in January.**

## NASA mixing best of antenna worlds

While studies show phased-array antennas will be best for most future communication satellite uses, NASA's Electronics Research Center is trying to develop an interim system combining part of the beam control of an array with some of the simplicity and low cost of reflector antennas. **The goal is a single parabolic antenna, about 15 feet in diameter, with perhaps three 3° controllable beams.** Multiple feeds would steer the beam



---

# Electronics Newsletter

---

with individual power amplifiers, and diode-switching would key the proper feeds. Gain would be about 34 db.

NASA spokesmen say there's room in the fiscal 1970 budget request for pertinent study contracts and add that while the system would be an inexpensive phased-array simulator for future communications satellite programs, **the three-feed dish could be cost-effective in commercial applications.**

## Response heavy to ATC satellite study request

Plenty of industry interest is being stirred up in air traffic control satellites. The latest evidence: NASA's Electronics Research Center got more than 40 letters of interest in response to word of a "very modestly funded" study on satellite techniques for air traffic control. And 38 requests for proposals have been sent out, with responses due Oct. 25. Contracts are to be awarded late next month.

The single six-month study is slated to investigate the concept and implementation of satellite-controlled traffic. "There's still a question about satellite ATC in domestic environments, and we want this study to provide a rationale for either pushing or dropping the effort," says a NASA spokesman. Another spokesman says **industry may envision a significant commitment to satellite ATC in the 1975-1985 period** and wants an early position in the planning stage. Unfortunately, he adds, there's no such commitment yet.

## Hall keyboards having problems

Honeywell-Micro Switch's Hall-effect keyboards [*Electronics*, Sept. 16, 1968, p. 169] are disappointing some users. "We got our first six, and all failed," says one customer. The failures seem to center on the temperature sensitivity of Hall-effect devices, he says, and other circuits like the IC strobe control—sometimes strobing stops without warning. **Also, simple workmanship errors and intermittent open or short circuits appear, only to defy troubleshooting.**

Some trouble seems associated with flexible flat cables connecting the keyboards circuit boards; other users say the circuit boards themselves don't hold up—an allegation Honeywell denies, saying the p-c boards are of mil-spec quality fiberglass. **Honeywell lays other errors, such as improper coding, to improper customer specification—but customers say the keyboards encode properly on delivery and fail soon afterward.**

Meanwhile, perhaps to solve some of these problems, **Honeywell is changing to redesigned MOS IC's**, and also expects to save users an estimated \$20-per-keyboard worth of coding electronics by packing more circuit functions on the MOS Hall-effect chip.

## Comsat gripe cuts off cable talks

The Communications Satellite Corp. has won a battle from AT&T in the satellite vs. cable war. **The victory: an FCC order to AT&T to stop negotiating for new undersea cables.**

A strong, though diplomatic, letter from Comsat chairman James McCormack triggered the order. **McCormack pointed out that the FCC's cable-satellite inquiry was being prejudiced by AT&T talks with French and Hawaiian phone companies for 720-circuit cables, and with the British for an 1,800-circuit link.** Furthermore, wrote the Comsat chairman, new international cable negotiations are a form of leverage for AT&T, and they could embarrass the U.S. if terminated.





# ERIE

When you want radar as pure and coherent as a laser beam...

Symbolic electronic signal undistorted by EMI —  
photographed by Howard Sochurek

## bring ERIE in early.

31,000 feet...heavy traffic...ugly weather over the Plains. This isn't the time for "noise" in the radar. But, no sweat! RCA's exciting new AVQ-30X Weather Radar is up front, sweeping the sky...protected from EMI by 39 special ERIE filters. No other airborne radar has ever approached the single or dual system reliability of the AVQ-30. From the start, RCA has called on the outstanding research and component capability of ERIE TECHNOLOGICAL to help in the development of this great new unit. Proof, once again, that it pays to bring ERIE in early.

**ERIE TECHNOLOGICAL PRODUCTS, INC.**

644 West 12th Street, Erie, Pa. 16512  
(814) 456-8592



# Plotting the dielectric constant of a TEFLON resin against frequency, or temperature, or what-not makes a pretty dull-looking graph.

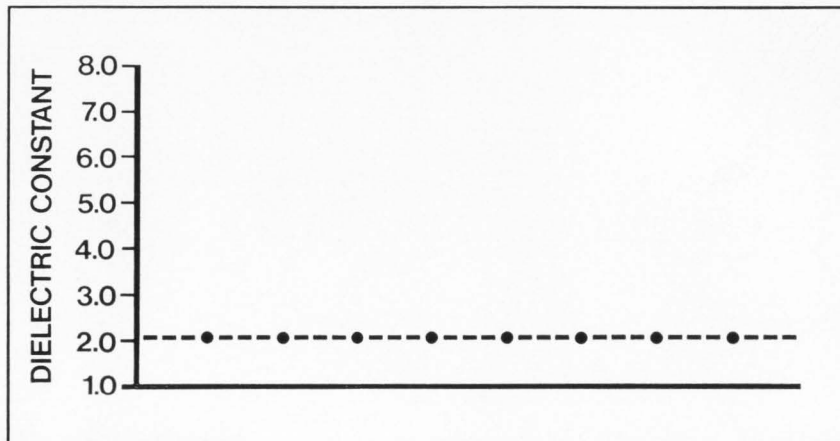

## But useful to an electronic designer.

A straight line parallel to the X axis is about all you get when you plot the dielectric constant of a Du Pont TEFLON fluorocarbon resin — over a wide frequency range — and over a wide temperature range. The same stubborn constancy applies also to the other excellent electrical characteristics of TEFLON: a dissipation factor of only 0.0002 and a high dielectric strength (500 volts/mil).

The dielectric constant is in the lowest range of any solid material: between 2.0 and 2.1, depending on the exact TEFLON resin used and its processing.

But once established, it remains a fixed design constant. This is particularly important to designers of RF cable who require the highest propagation velocity and a constant impedance — and to designers of microwave transmission lines.

Some of the typical hazards that may affect the use of conventional insulations but leave TEFLON virtually unaffected include: moisture, fungus, deicing fluids, UV radiation, salt spray, chemical fumes, cleaning agents, fuels and lubricants.

These are some of the reasons why insulations of

TEFLON have established their reliability in use for more than 20 years. When you specify TEFLON, you specify electrical characteristics that can be depended on consistently.

We'd like to send you more detailed information on the electrical properties of TEFLON. Write: Du Pont Company, Room 7314G, Wilmington, Del. 19898.



**TEFLON**<sup>®</sup>  
fluorocarbon resins





## We can guide you to the easiest wire and cable buy for peripheral equipment.

Brand-Rex has been the leading supplier of wire and cable for major computer systems for 20 years. And if you manufacture computer peripheral equipment, this leadership can work for you a number of ways. You save shopping around, because Brand-Rex has designed and makes available the broadest selection. You can get what other people call "custom" designs at little or no extra cost from us. We're already making it, or can come up with it easily by modifying an existing design. (Brand-Rex engineers turn out as many as 3,000 new versions of wire and cable in a year.)

U.L., MIL-Spec. and other approvals? No strain. Brand-Rex has more U.L. approvals on computer wire and cable than anybody else. Plus the lab and Q.C. facilities to get new ones . . . fast.

Our people catch on to your needs the first time around, because they've been around.

Write for our catalog on "Business Machine Wire and Cable" Brand-Rex Division, American Enka Corp., Willimantic, Conn. 06226. Phone 203 423-7771.

**Connect for tomorrow. BRAND-REX**

Circle 37 on reader service card



**Reliability is 756 little dents  
and one big one.**

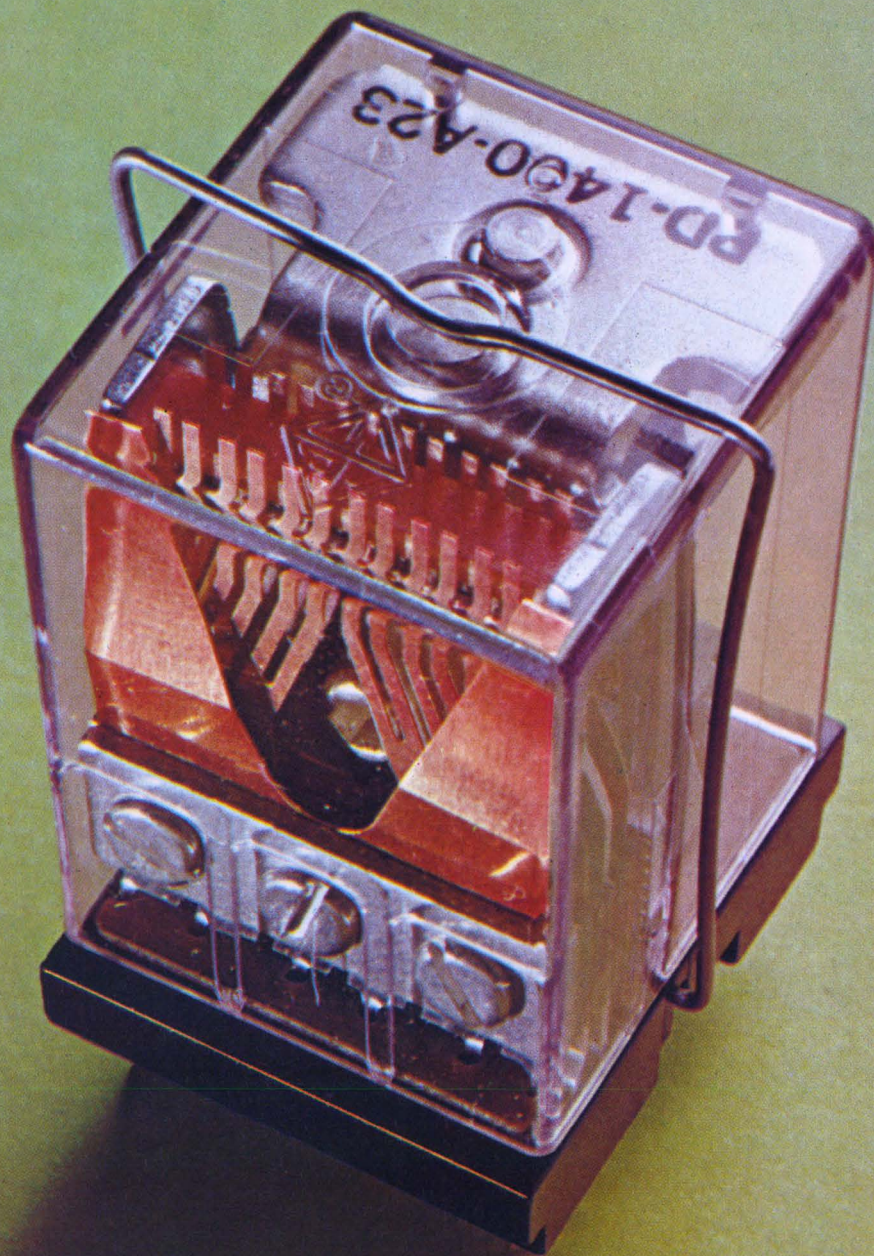





### The big squeeze.

The heelpiece and frame are the backbone of our Class H relay. The slightest squiggle or shimmy out of either and the whole relay is out of whack.

756 tiny dents on the heelpiece, plus one big one on the frame, make sure this'll never happen.

They're the result of planishing, a big squeeze. Planishing is an extra step we go through in forming the pieces to add strength and stability by relieving surface strain. It also makes the parts extra flat.

This takes the biggest press in the industry and the biggest squeeze. Both exclusively ours.

### A different kind of coil.

The heart of a relay is the coil. If ours looks different, it's because we build it around a glass-filled nylon bobbin. It costs us more, but you know how most plastic tends to chip and crack.

Also, moisture and humidity have no effect on glass-filled nylon. No effect means no malfunctions for you to worry about. No current leakage, either.

The coil is wound on the bobbin automatically. No chance of human error here.

### We didn't forget the solder.

We use a solderless splice. That's because solderless splice connections are sure-fire protection against the coil going open under temperature changes, stress, or electrolysis.

A solderless splice is more expensive to produce, so it's usually found only on the most reliable relays. AE is the only manufacturer to use this method on all of its relays.

Finally, we wrap the whole assembly with extra-tough, mylar-laminated material. A cover is not really necessary here; but why take chances?

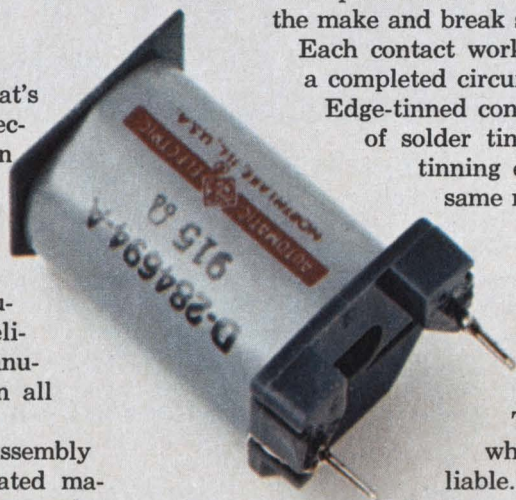

### Springs and other things.

We don't take any chances with our contact assembly, either. Even things like the pileup insulators (those little black rectangles) get special attention. We precision mold them. Other manufacturers just punch them out.

It makes a lot of difference. They're stronger, for one thing; and because they're molded, there's no chance of the insulators absorbing even a droplet of harmful moisture. Finally, they'll withstand the high temperatures that knock out punched insulators.

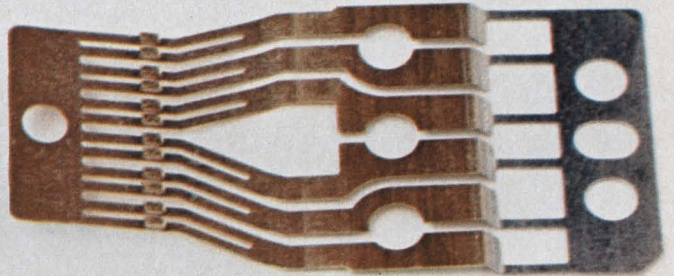

Then there are the contact springs.

Ours are phosphor-bronze. Others use nickel-silver. Our lab gave this stuff a thorough check, but found nickel-silver too prone to stress-corrosion. Atmospheric conditions which cause tarnish and ultimately stress corrosion have almost no effect on phosphor-bronze.



### Two are better than one.

Our next step was to make sure our contacts give a completed circuit every time. So we bifurcate both the make and break springs.

Each contact works independently to give you a completed circuit every time.

Edge-tinned contact springs save you the job of solder tinning them later. Also, edge-tinning enables you to safely use the same relay with sockets or mounted directly to a printed circuit board. A simple thing, but it takes a big chunk out of the inventory you have to stock.

### Etc. Etc. Etc.

There's a lot more to tell about what makes our Class H relay reliable. Now we're waiting to hear from you. Automatic Electric Company, Northlake, Ill. 60164.

# AUTOMATIC ELECTRIC

SUBSIDIARY OF GENERAL TELEPHONE & ELECTRONICS

Circle 39 on reader service card





we goofed.



This Howard Cyclohm Fan was engineered to run 10 years. So far it's been running 12 years, 6 months, 21 days.

Our modest 5-year guarantee on Cyclohm Fans and Blowers is based on an engineered lifespan of 10 years. So, what do we tell our customers when they report the fans are still blowing strong 12 or even 14 years after installation? We tell them we goofed—and they benefit.

There's more to the Howard Cyclohm Fans and

Blowers success story than just long life. There's the high reliability of Howard's unit bearing motor that never needs maintenance or re-lubrication. And all metal construction. Indestructible nylon blades. Standard mounting on 4-1/8" centers. UL yellow card listing. All units are off-the-shelf... available for immediate delivery from Standard Motor Product Sales. All the facts are in the newly-published, 14-page Cyclohm Fans and Blowers Catalog EL109 From Howard.



**HOWARD**

HOWARD INDUSTRIES  
MSL INDUSTRIES, INC./MOTOR GROUP  
2420 18th STREET, RACINE, WISCONSIN 53403  
414-632-2731 TWX 910-271-2387



## FAIRCHILD'S AIRBORNE QUALIFIED SIGNAL SOURCES (MIL-E-5400)

*Meets MIL-E-5400, class II:*

SHOCK ————— 15 G's  
VIBRATION ————— 10 G's  
TEMPERATURE ——— -54°C to +71°C  
HUMIDITY ————— 100%  
ALTITUDE ————— 70,000 ft.

*Cover entire frequency spectrum from .685 MHz to 14.23 GHz*

*Standard package for  
phase-locked sources.  
Packages for free-running  
and waveguide sources  
have same form factor.*

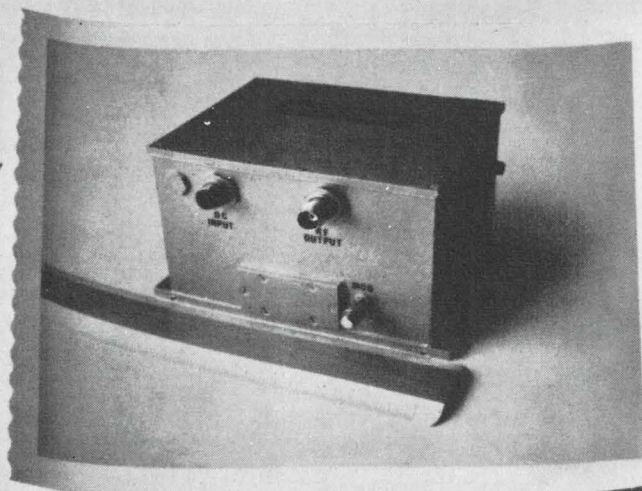

**NOTE:**

*Optional crystal and internal oven for  $\pm 0.0005\%$  stability (phase-locked).*

Now all of Fairchild's signal sources, from L-band through K-band, are available qualified to MIL-E-5400, Class II. They're ready now to make your systems perform better, longer and for less money.

To give you the performance you need in your communication, radar or other microwave systems, we manufacture our sources with our own microwave transistors. And, for critical systems, with our own unique phase-lock technique. To give you performance you just can't get with multiplier chains or klystrons. Like stabilities of  $\pm 0.005\%$ ,  $\pm 0.002\%$  or  $\pm 0.0005\%$ . Like spurious signals 75dB down in band. Like extremely low

residual FM noise. And they're all smaller, lighter and less expensive than other designs.

To meet MIL-E-5400, we use three different packages, one each for our free running, phase-locked and waveguide sources. No more expensive "specials," no more "delayed" deliveries. Now just add "-30" to the part number of the Fairchild source you need and call your Fairchild sales representative. We've made it that easy.

Fairchild Microwave and Optoelectronics / A Division of Fairchild  
Camera and Instrument Corporation / 2513  
**FAIRCHILD** Charleston Road, Mountain View, California  
94040, Tel. (415) 961-1391. TWX: 910-379-6940  
MICROWAVE AND OPTOELECTRONICS



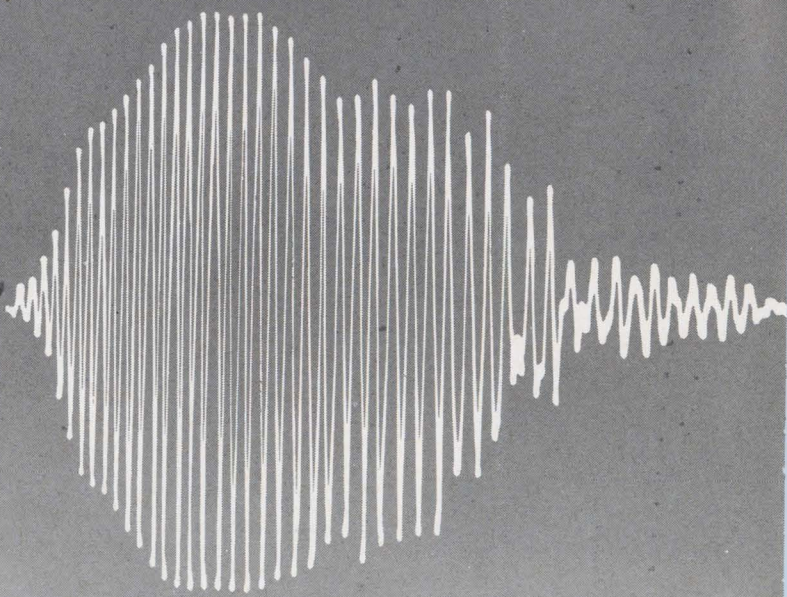

## ANALYZE EVEN THE MOST COMPLEX SIGNALS ...

Recent research into the cry of the bat provides us with an unusual opportunity to demonstrate the ability of our Correlation Function Computer and Fourier Analyzer to analyze and sometimes derive unsuspected information from a complex signal.

The experimenter's objective was to characterize the bat's acoustic transmission to shed light on its sonic signal processing mechanisms. Through the use of the Correlation Function Computer, he derived the autocorrelation function of the cry and found that the bat's range discrimination success curve mirrored the envelope of the autocorrelation of its cry. This supports the hypothesis that the bat ranges by crosscorrelating its transmission with the returned echo.

The experimenter next processed the autocorrelation function through a PAR™ Fourier Analyzer to obtain the power spectrum of the cry. This spectrum is being studied to gain additional insight into the acoustic physics of the bat's vocal apparatus.

Whether you are working with bat cries or other phenomenon such as velocities in flowing turbulent fluids, potentials in an active plasma, pressure density in a boiling fluid or current flow across a reverse biased p-n junction, let us familiarize you with this powerful signal processing system. Write Princeton Applied Research Corporation, P.O. Box 565, Princeton, New Jersey 08540, or call (609) 924-6835.

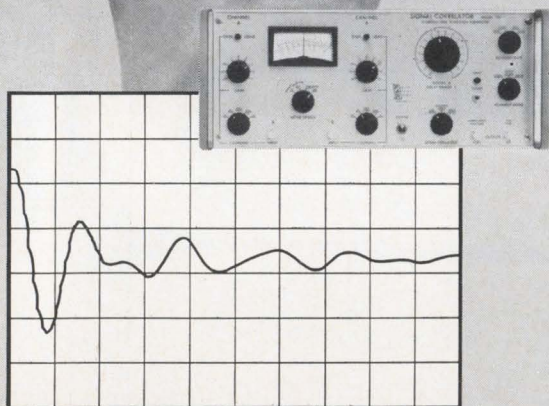

Autocorrelation of bat cry defined by Model 100 Correlation Function Computer (Price: \$8,500.)

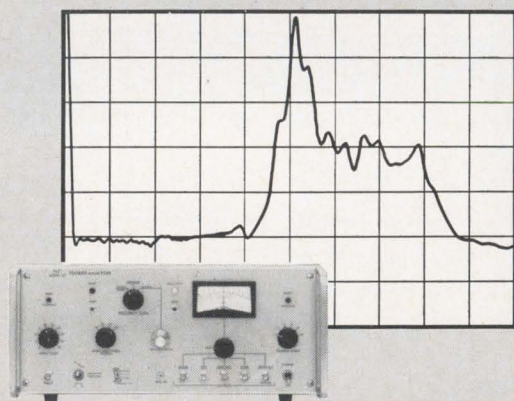

Power spectral density of bat cry transformed from autocorrelation function by Model 102 Fourier Analyzer (Price: \$2,950.)



PRINCETON APPLIED RESEARCH CORPORATION



## SelectaVision: willing, able, not yet ready

It was like introducing a new prototype sports car with no high gear. RCA, with as much fanfare as ever has been drummed up for a development—that won't be ready until 1972 at the earliest—was showing off its SelectaVision. The home television entertainment system will employ holographs on vinyl film reconstructed by a laser to play prerecorded programs through a color receiver. Exciting because of its design innovations for consumer electronics, SelectaVision's demonstration picture was far from broadcast quality and didn't have a sound track.

But there's a good reason for what some viewed as a premature announcement: RCA simply didn't want any similar system, such as CBS Laboratories' Electronic Video Recording (EVR), to be the only one to be considered now. An old hand at such marketing maneuvers, RCA knows it can't do it alone—that an industry effort will be needed to get SelectaVision going. The company has already put aside a multimillion-dollar kitty for programing—the real key to big sales of the system. So, realizing that it wouldn't get enough of the right kind of programing available from other major suppliers if it kept its system a secret, RCA made the announcement.

While other companies chose between magnetic tape or photographic film for home tv playback systems, RCA picked clear vinyl—the kind commonly used to wrap meat. While the others experimented with photographic images or magnetic recording (neither of which lends itself to high-speed copying), RCA turned to mechanical printing of holographic images, a technique limited only by the speed at which the vinyl rips. And while others tried to keep the playback unit uncluttered, RCA

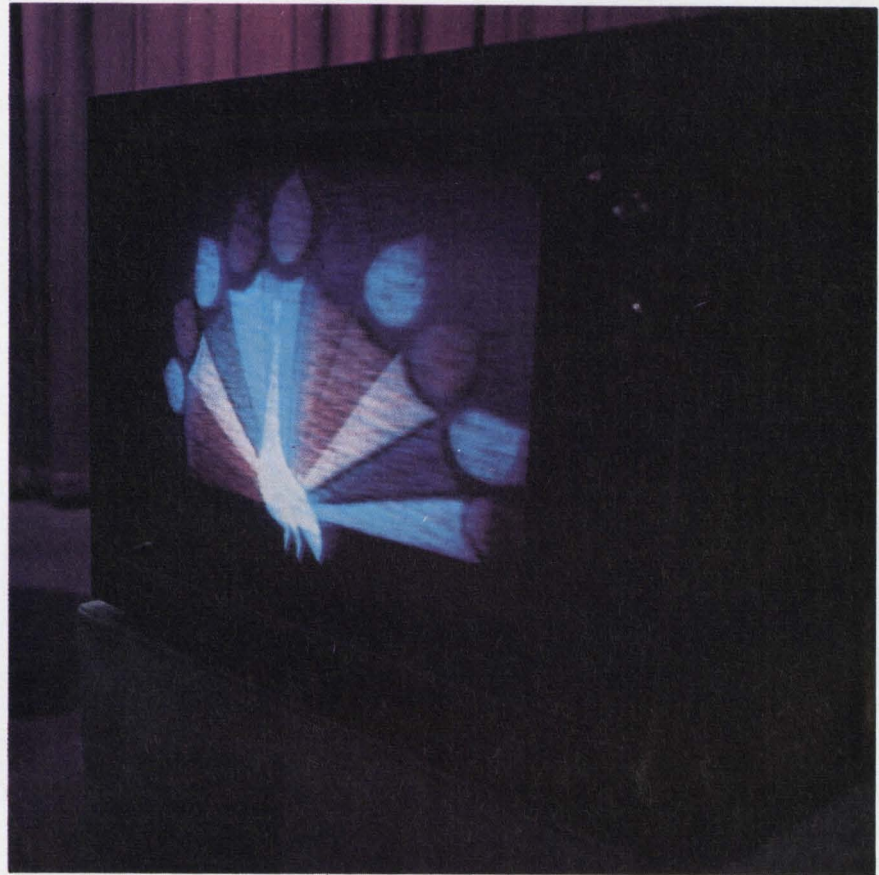

**Purple pinfeathers.** RCA's demonstration of its SelectaVision home tv entertainment system featured the NBC peacock in living lavender—among other shades and tints of purple.

crammed a vidicon and a laser into the SelectaVision unit, hoping the system would tolerate non-critical assembly and less-than-ideal tape handling—yet produce clear images.

The master is made from a photographic film or magnetic videotape. The program is lasered frame by frame on a plastic tape coated with clear photoresist in the form of a phase hologram. After development, the exposed photoresist is washed away, leaving hills and valleys on the tape, which then is nickel plated. The tape, with its 1-micron irregularities, is sandwiched between two rollers with the clear vinyl film that is to be the copy. Roller pressure embosses the bump pattern into the vinyl. Color is electronically encoded on bands in the hologram's upper-frequency spectrum.

Although RCA has not yet added a sound track, company scientists say it could be effected with sim-

ilar encoding techniques, or the film could be shot with an optical soundtrack whose image would be recreated along with those of the video frames.

To play back, the clear tape, packed in a cartridge for easy handling, is run smoothly through the light from a 2-milliwatt helium-neon laser. The images produced are recovered by an inexpensive vidicon camera. The adapter includes laser, vidicon, and circuitry to decode color bands and soundtrack. The adapter feeds the signal directly to the tv set.

Plainly much work is required. While the black-and-white image at the demonstration was good considering that the recording technique is new and the film itself requires less processing than ordinary clear plastic adhesive tape, there was slight speckling and a moire effect. The color, which is coded in two upper bands (centering on 3 megahertz and 5 Mhz)



## U.S. Reports

in the hologram, flickered a bit, faded out every few seconds, and did not look very natural.

But RCA executive vice president Chase Morsey Jr. promised that "video quality will be equal to the best of broadcast television—no ghosts or interference, and bright, sharp colors."

**Opposites.** Comparison of SelectaVision and CBS's EVR is inevitable. Actually, though, the two systems have only one thing in common: they play prerecorded programs through a conventional tv set. The CBS version uses film, has not yet demonstrated color, doesn't use holographic images—and now is aimed at a different market.

RCA's Morsey, comparing the two on a cost basis, said SelectaVision's adapter would sell for under \$400 while EVR's will cost about \$800. He contrasted SelectaVision's intended custom-copying price—\$2 to \$3 for a half-hour color cartridge—to EVR's \$14.40 for a half-hour of monochrome as published in a CBS price list for the educational market. In addition, he said that the RCA system is aimed at the consumer market, while the CBS unit, "as we understand it, is aimed at the higher-priced industrial, educational, and commercial markets."

**Equal time.** Robert Brockway, head of CBS's Electronic Video Recording division, insists that the RCA comparison with EVR is unfair. "They took figures from our present price list," he says, "and compared it with what they plan to offer in over two years. Our units will be out on the market in less than nine months."

Brockway adds that CBS is readying an announcement about the fate of EVR in the consumer market, "and we haven't said we would necessarily be using a silver emulsion on the film we plan to use in the consumer market."

He also maintains that comparisons between the two systems should be drawn on the basis of image quality and state of development, rather than on cost of unit or tapes. "We have a higher resolution," says Brockway, "and our color is much better than RCA's."

## Manufacturing

### Good, bad, and pad

Until manufacturers of multilayer metallization MSI or LSI circuits achieve consistent 100% good circuits through wafer probing they will be stuck with interconnection methods for good units that ignore bad ones. Since no one is likely to wager that Nirvana is coming, two principal methods of performing multilayer MSI/LSI interconnects probably will continue to be used:

- Employment of a standard interconnect mask assuming 100% good circuits, which limits array complexity because defective circuits inevitably crop up, especially as complex functions dictate large chips.

- For larger arrays, use of some form of discretionary wiring to hook up good dice on the wafer, dictating unique signal interconnect masks for each wafer based on its probe yield.

**Yet a third.** But engineers in the advanced technology department of Hughes Aircraft's Data Systems division have an alternative for using the good portions of uncut wafers. It's called "pad relocation." Navy and Air Force officials are being converted to the technique, and are backing further study. Hughes has one Air Force contract to further its effort, and is about to get at least two from the Navy and one from the Air Force. The latter will expedite development of a digital data transmission and multiplexing system with pad-relocation.

In pad relocation, say the wafer has only one "cell" or circuit type on it—a quad two-input nand gate, for example. (Don Calhoun, project engineer for LSI designs in the advanced technology department, says the firm has worked with much more complex circuit types. Calhoun conceived the technique and will detail it in a paper at the Fall Joint Computer Conference.)

Before Hughes has any idea what the probe yield of this kind of wafer is, engineers prepare a standard master pattern for the array function, based on typical probe yield distributions. Calhoun says the master pattern assumes more good

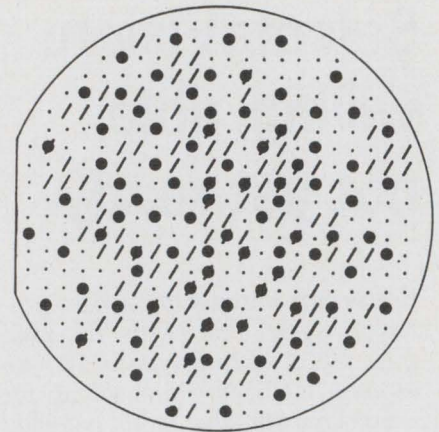

The pad and how to move it. Dots show interconnect pattern . . .

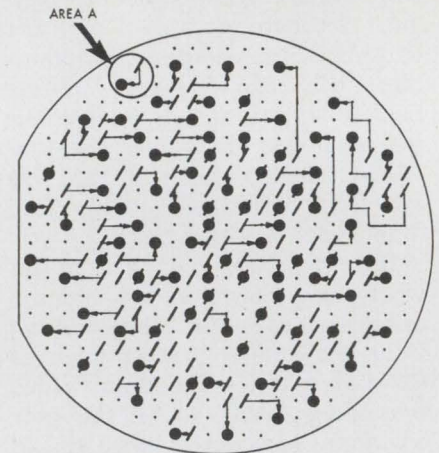

. . . slashes, the good circuits. Area A, when blown up . . .

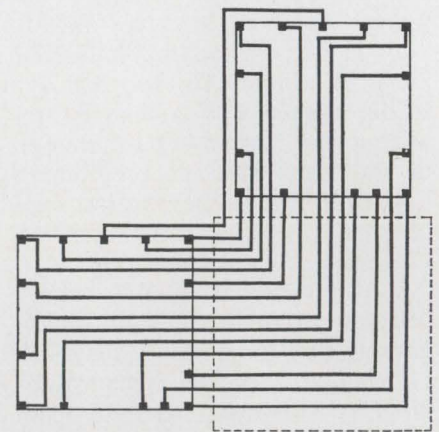

. . . shows pad relocation pattern needed to replace quad two-input gate.

circuits toward the wafer center than on the periphery. Also, the master pattern of good circuits never places two adjacent to each other, allowing flexibility to relocate in any direction from the assumed



good point—up, down, left, or right—to the nearest known good circuit once probed wafers are in hand.

**All for one.** All wafers of a given circuit function will be matched to this master pattern by pad relocation. The master pattern is superimposed on the d-c probed wafers (top drawing) allowing an engineer to see how far he has to go to relocate the pads of a circuit function from the master pattern to the nearest good circuit on the wafer. Where the dots on the master pattern match underlying slashes indicating a good circuit on the actual wafer, no relocation is needed. The pad positions above a bad or an unused circuit are isolated from that circuit by a dielectric layer.

Calhoun says only two man-minutes were required to manually specify the pad relocations for a wafer with five circuit types: 642 nand gates of four different types, and 128 j-k flip flops. To do the pad relocation from the master location

to the nearest good circuit in Area A of the center illustration, the interconnect pattern shown in the third sketch is used. It's one of eight stored in a disk file that can accomplish any pad relocation required for the single-gate function on this wafer.

After manually rerouting the interconnects in the third drawing (automation of this step is being developed), the engineer prepares a coding sheet on a standard form describing the relocation pattern for each point using a four-digit mnemonic. His instructions are key-punched and are entered into a PDP-9 computer, which assembles instructions to withdraw the probe pad-relocation interconnect patterns from disk storage, draws the second-layer metal pad-relocation mask, and then drives a Gerber plotter to cut rubies for that mask.

Thus the only unique mask for a given wafer is the pad-relocation mask. If the wafer incorporates three-layer metallization, the first

layer interconnect is standard, linking individual devices to form an integrated circuit. The second layer incorporates the unique pad relocations plus cross-under areas from the third or top layer of metal—the signal interconnect layer. The cross-under areas are so specified that they don't interfere with pad-relocation interconnect lines.

**Yield doesn't count.** The third-level metal for signal interconnection is standard for every wafer of a given type because it's made to agree with the master pattern Hughes prepared before seeing any actual wafers. It is not dependent on wafer yield, as other approaches to full-wafer LSI discretionary wiring are. In traditional discretionary wiring, two unique masks per wafer are required because signal interconnection is done on both of the two upper levels, with one level used for horizontal signal interconnect lines and the other for vertical signal interconnections.

Compared with conventional dis-

## Electronics Index of Activity

October 13, 1969

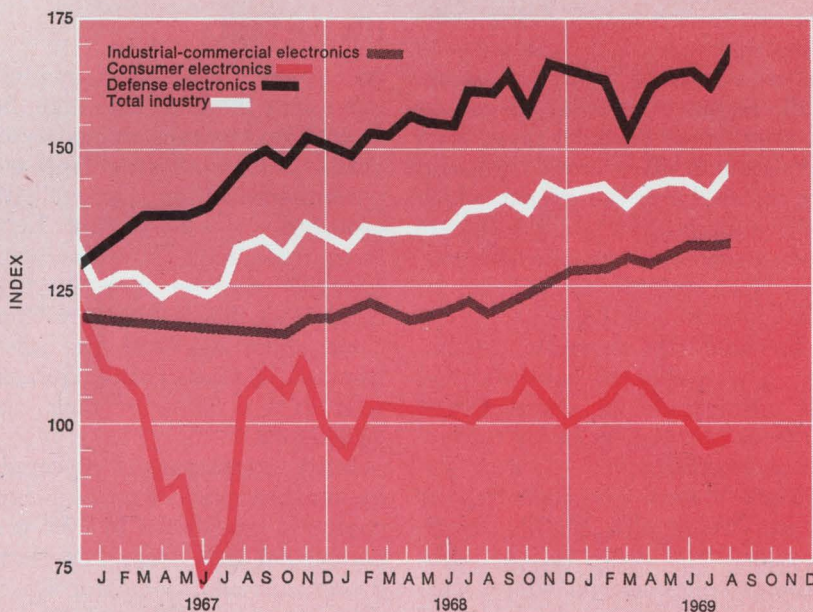

Segment of industry	August 1969	July 1969*	August 1968
Consumer electronics	97.7	96.4	103.8
Defense electronics	170.0	162.3	172.7
Industrial-commercial electronics	134.2	133.9	122.9
Total industry	147.1	142.7	146.4

Total electronics production in August hit 147.1, a 4.4-point advance over the revised July figure, and the second consecutive record month-to-month gain. But the advance was a mere 0.7 point over the August 1968 index.

The defense sector led the August spurt with a 7.7-point jump, which was still 2.7 points behind the 1968 month's total. Consumer electronics production rose 1.3 points, but, like defense, was still off its 1968 pace—by 6.1 points. But the industrial-commercial electronics area, which moved up only 0.5 point from July to August 1969, showed a whopping 11.3-increase over the same month a year ago.

Indexes chart pace of production volume for total industry and each segment. The base period, equal to 100, is the average of 1965 monthly output for each of the three parts of the industry. Index numbers are expressed as a percentage of the base period. Data is seasonally adjusted. \*Revised.



## U.S. Reports

cretionary wiring, Hughes says pad relocation involves lower nonrecurring engineering costs, making it economical for both high-volume and prototype quantities. And because the signal interconnection layer is standard for each wafer of a given type, Hughes officials assert testing is simpler than it is for conventional discretionary wiring of full-wafer LSI. They know they can handle wafer complexities of at least 780 gates with pad relocation, and most of the digital military systems they're designing have been partitioned into 250-to-500-gate "chunks," they report.

Pad relocation is the "advanced wafer technology" Hughes has suggested to the Naval Air Systems Command for the Advanced Avionic Digital Computer [*Electronics*, Sept. 29, p. 72] for which proposal requests are expected soon. To date, the technique has been applied only to bipolar MSI and LSI, but when multilayer MOS comes along, Hughes will be ready for it.

### Making a deposit

As microwave technology gallops on, the need for better methods to deposit ferrite films on microwave integrated circuit substrates becomes more pressing. The most common techniques—such as chemical vapor deposition, r-f sputtering, and vacuum evaporation—are costly while being tedious and time-consuming. What's more, they leave something to be desired in terms of stoichiometry (proper chemical composition to attain particular characteristics), consistency, density, and adaptability to batch processing.

The Monsanto Research Corp. of Dayton, Ohio, a division of the Monsanto Co., thinks it has the answer. Under the direction of D.H. Harris, it has evolved a simple technique that it calls arc-plasma spray that is unique in the control it affords over the stoichiometry of the deposited film.

**Spritz.** Monsanto has modified a spray gun used to coat turbine blades and rocket linings. It can lay down magnesium-manganese ferrites and other C- and X-band

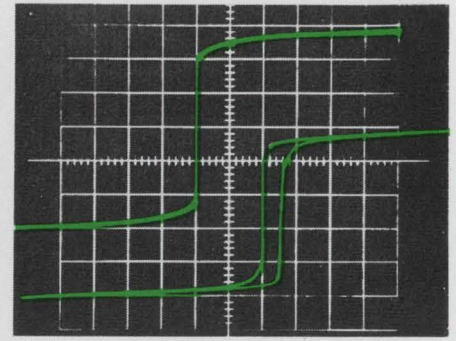
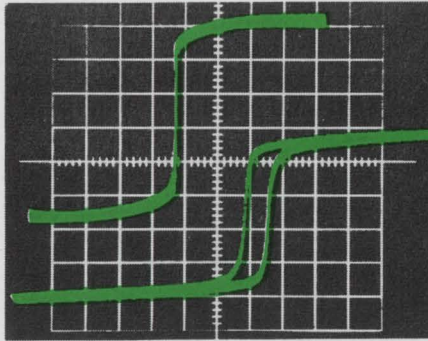

**Intrinsic agreement.** Weiss hysteresisgraph traces of the Monsanto film at left, and bulk material of the same thickness at right, show close agreement at 400 oersteds. Differences in remanence ratio results from reduced grain size (5 microns) of deposited materials.

materials on a wide variety of substrates at a rate of 4 microns to 2 mils per minute per square inch. This, says the company, is a rate other methods can't match. The result is a thick, dense film that is chemically and electromagnetically almost identical to the bulk starting material. Additionally, the nonvacuum process is ideal for batch or continuous-run manufacturing because it does away with the confining containers required in vacuum techniques.

The sprayer is a series of gas arc-plasma torches with stabilized vortices. Inert gases, such as argon or helium, generate a plasma stream. Bulk ferrite is pulverized into a powder whose particles range from 1 micron to 40 microns thick and are injected into the stream, which carries the powder to the substrate surface via any noncombustible carrier. Here, multiple feeders may be used for alternate filming.

Mechanically, deposition is simple. The preheated substrate and the sprayer are fix mounted, and either is rastered by an x-y traversing mechanism.

**Good grades.** Monsanto reports impressive results. Mg-Mn ferrite powder was deposited on substrates of platinum, palladium, various magnesium titanates, alumina, and beryllia at temperatures of 100°C to 1,300°C, depending on the degree of adherence required. With one ferrite powder used, for instance, film thicknesses from 1 micron up to 130 mils were achieved, indicating the process can be used for thick-film devices.

Electron microprobes indicate a better than 10% tolerance over the entire surface; densities, measured on free-standing films, average 99% of theoretical. Also, key electromagnetic properties—hysteresis, remanence ratio, dielectric constant, and dielectric loss tangent—all show close agreement with bulk starting material.

### Components

#### It's the heat

As power-switching amplifiers move into the kilowatt range, heat dissipation becomes an increasingly vexing problem. Several large computer manufacturers are evaluating prototypes of a 1.5-kilowatt hybrid integrated-circuit power-switching (class D) amplifier from TRW Semiconductors that is 90% to 95% efficient, about one-tenth the size of comparable Class B amplifiers, and sells at a fraction of their usual \$3,000 cost.

Initial application is expected to be in capstan drives for high-speed computer tape decks. In a 200-inch-per-second tape deck, a one-horsepower capstan drive motor must be accelerated to 2,000 revolutions per minute in 10° of shaft rotation, or in about 1.8 milliseconds. Heat dissipation in a Class B linear amplifier reduces efficiency to about 65% because as many as 32 transistors in parallel are being used essentially as variable resistors. Furthermore, high-speed fans are required



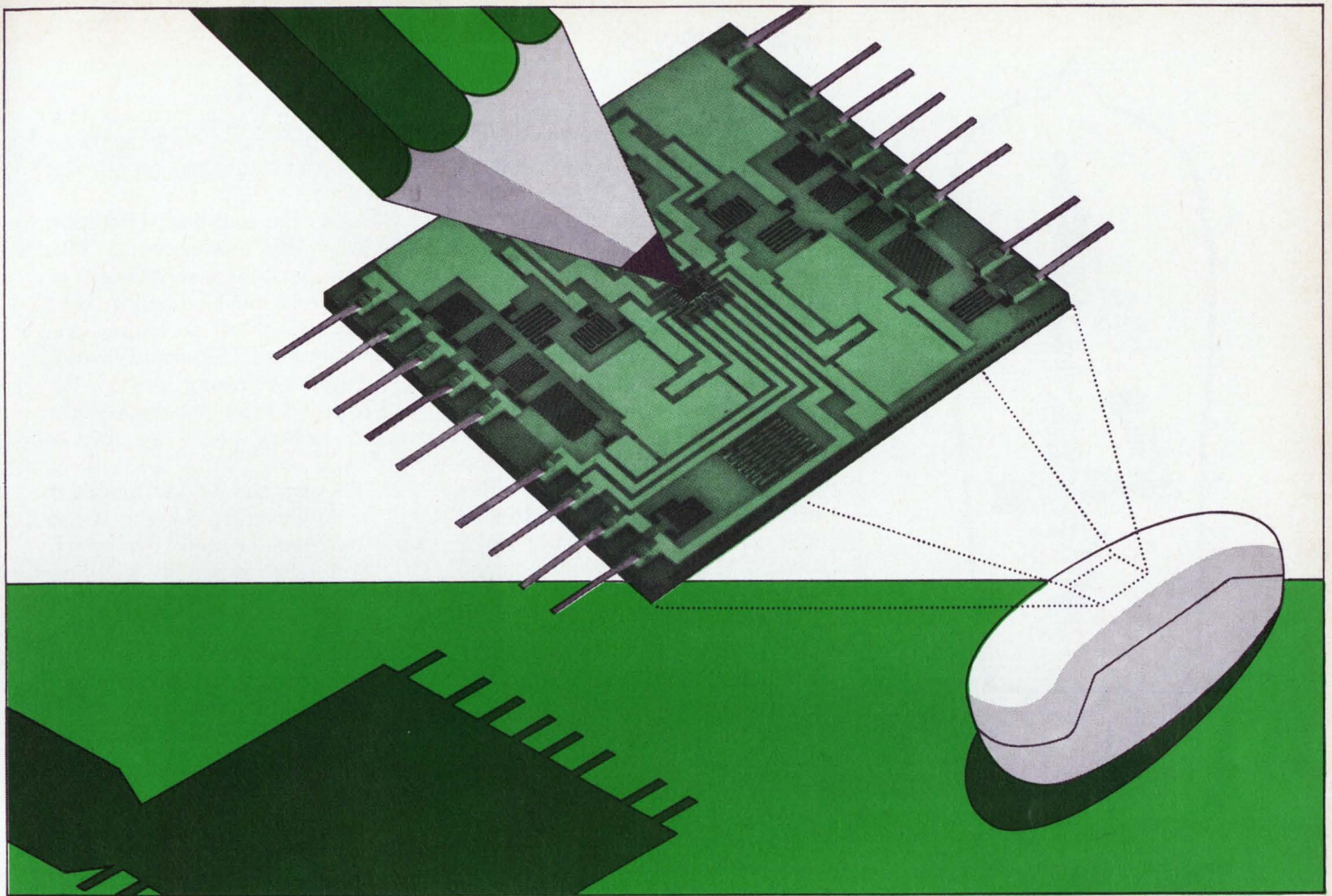

### Big future for little circuits

Bell Laboratories engineers have developed a special TOUCH-TONE Trimline® handset that suggests great possibilities for designers of future telephones. In this one, the musical tones you hear when you push the buttons are generated by two oscillators in a "hybrid" integrated circuit (one combining tantalum and silicon technology).

Such tiny, inexpensive circuits free designers from limits imposed by bulky, costly to assemble, discrete components—which restricted the type and complexity of circuit functions that could be designed into a telephone handset. Now, designers can think of people first—of what is easy to use—knowing that the electronics can be made to fit. The postage-stamp size, rugged integrated circuit above, for instance, contains 14 transistors, a diode, and

16 resistors in the silicon chip (under the pencil point), and 19 resistors and 8 capacitors made with tantalum film on the substrate.

Much of Bell Laboratories' integrated circuit work combines tantalum thin-film circuits (for precision passive components) and silicon integrated circuits (for active devices). To unite the two, we invented beam leads—small gold conductors which are formed as an integral part of the silicon circuit. They allow us to bond the silicon to the tantalum circuit in a simple one-shot operation. We've also developed a chemical-metallurgical system which fully seals off and protects the vulnerable parts of the circuit from environmental damage. So, we don't need costly vacuum-tight enclosures.

The extreme operational and environmental conditions of tele-

phone use gave us some problems: Tailoring the resistance of thin-film resistors so that the resistance-capacitance product remains constant despite changes in temperature. Designing oscillator circuits whose output frequencies are not affected by varied loadings due to differing cable lengths between telephone and central office. Finding an encapsulant to adequately insulate closely spaced conductors in high humidity.

To customers who use them, handsets with this new circuit will seem like other TOUCH-TONE Trimline sets—though a trifle lighter. But this new telephone technology opens the way to greater freedom for designers and even better telephones for Bell System customers.

**From the Research and Development Unit of the Bell System—**



**Bell Labs**





## 3 ways to prevent numerals from "spotting" at 55°C.

Fill with freon...  
keep in shade...  
or specify Datavue\*  
Indicator Tubes.

All Datavue tubes are rigorously tested to meet commercial and military specifications, produced for 200,000 hours of reliable operation. U.S.-made, they can cost less than \$3.95 each.

Datavue tubes feature: straight, stiff leads for fast insertion; fully formed, high-brightness characters; rated for strobing operation; wide range of alphanumeric, decimals, special characters. More than 40 different sockets, including right-angle types, are available.

Call your Raytheon distributor or sales office. *Raytheon Company, Industrial Components Operation, Quincy, Mass. 02169.*

\*Trademark of Raytheon Company



## U.S. Reports

to get rid of the heat.

In contrast, the TRW Class D amplifier dissipates only 100 watts at 1.5 kw, and is packed in a 4-by-7-by-3-inch heat sink.

**Three cans.** Dick E. Noble, power controls project manager for the microelectronics unit, says the size of the amplifier package is dictated by the need for 50 square inches of heat-sink surface at 1.5 kw. In production models, the transistors probably will come in two TO-3 equivalent packages with a monolithic Schmitt trigger in a third, although an alternate configuration with the entire circuit on a single 1-by-1.5-inch substrate also is under consideration.

Hybrid thick-film resistors and interconnects are used on a beryllium-oxide substrate, with two high-speed, 30-amp silicon planar switching transistors. Voltage is placed across the indicator, and the transistors are pulsed to maintain a uniform voltage level. Pulse width modulation is employed: the time constant of the load controls the pulse width, and variations in the pulse width control the motor speed. An external current-sensing resistor in series with the load supplies feedback to the amplifier input. At the maximum switching frequency of 75 kilohertz, 30 amps of current are switched in 500 nanoseconds. The two switching transistors alternately act as a drive to bring the motor to full speed, and as a brake.

The amplifier operates from a dual unregulated  $\pm 50$ -volt maximum power supply, and delivers 30 amps continuous d-c output current into an inductive load. Peak output current is 50 amps with a 25% duty cycle. For a-c operation, the switching frequency is set at 10 times the a-c carrier frequency, and the amplifier is driven with an a-c error signal. In voltage-drive applications, voltage feedback is from a resistor-capacitor network in parallel with the load.

**No shorts.** A monolithic high-speed differential comparator circuit is used as a Schmitt trigger at the input stage. Input hysteresis is 200 millivolts typical, and input offset voltage 100 mv. Short-circuits between the power supplies are

prevented by a filter network that keeps both of the switching transformers from turning on at the same time.

Because the amplifier operation is pulse-width modulated, a 150-milliamp peak-to-peak holding or ripple current must be delivered to the load even when no output current is required. The ripple current is equal to the current through the load required to switch the Schmitt trigger, which has a 150-mv window.

Noble says the 1.5-kw amplifier will be followed by 5-kw-to-10-kw versions over the next five years. "I don't see anything standing between us and the ability to handle 10 kw," he asserts. Power switching applications are expected to include programing machine tool operations, disk files, tape transports, and computer peripherals, he adds.

## Industrial electronics

### The buck stops here

One of life's little frustrations fades away next year if a new, small integrated circuit currency-note acceptor is built into vending machines. Right now, a consumer needs coins to do business with the machine, and too bad if he only has a bill. While there may be an automatic bill changer on the premises, the odds are against it: only about 40,000 such changers are in operation around the world, usually in attended locations for security reasons.



The new Mark 7 note acceptor, developed by Ardac/USA of Chesterland, Ohio, measures only 3.5 by 6.5 by 4.5 inches and weighs 3 pounds. It's small enough to fit the tight space requirements of most automatic merchandisers. And Ardac president Jack Bayha says its electronic scanning and logic—that analyze details of the engraving—make it foolproof against counterfeit money. It also bars retraction of a bill once the acceptor acknowledges the bill's validity.

Bayha expects his note acceptor will greatly increase the versatility



# IF YOU'VE GOT THE TIME...

WE CAN DELAY IT 

REPEAT IT  VARY IT 

RESET IT  ADJUST IT

 RE-CYCLE IT 

CALIBRATE IT 

SWITCH IT  PROGRAM

IT  AND STOP IT.

And if that's not enough, we'll custom build almost any combination of the above capabilities to do exactly what you need. We're timing experts. Call us when you have time.

**MIDTEX**   
INCORPORATED  
AEMCO DIVISION  
10 STATE STREET  
MANKATO, MINNESOTA  
56001

PROGRAMMERS/TIME DELAY RELAYS/MINIATURE COAXIAL RELAYS/INDUSTRIAL RELAYS/MERCURY-WETTED CONTACT RELAYS



# More Watts per \$ per lb. per cu.in.

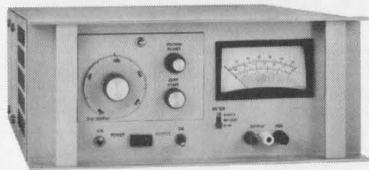

## Behlman AC Power

The originators of the famed Inverton have put 17 years of AC Power Supply know-how into this brand-new, completely superior line of solid-state supplies.

A major feature of this new line is a wide selection of basic power amplifiers with frequency response only as wide as your application requires. There is no longer any need to pay cost, size and weight penalties for capability outside your requirements.

### Some typical prices:

	350 VA	500 VA	750 VA
Fixed freq.			
150/2 kHz	\$ 995	\$1095	\$1595
Variable			
350/450 Hz	\$1130	\$1230	\$1730
Variable			
45/10 kHz	\$1385	\$1485	\$1985

### Typical features:

- Tight regulation independent of power factor
- Very low distortion sine wave output
- Choice of plug-in oscillators
- Instantaneous overload protection
- Expanded scale 3-range meter
- Two & three phase outputs available

Write for further details

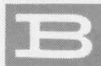

# Behlman

**ENGINEERING CORPORATION**

P. O. Box 4518, 427 N. Nopal St.  
Phone (805) 963-9019  
Santa Barbara, California 93103  
Not affiliated with any other company

## U.S. Reports

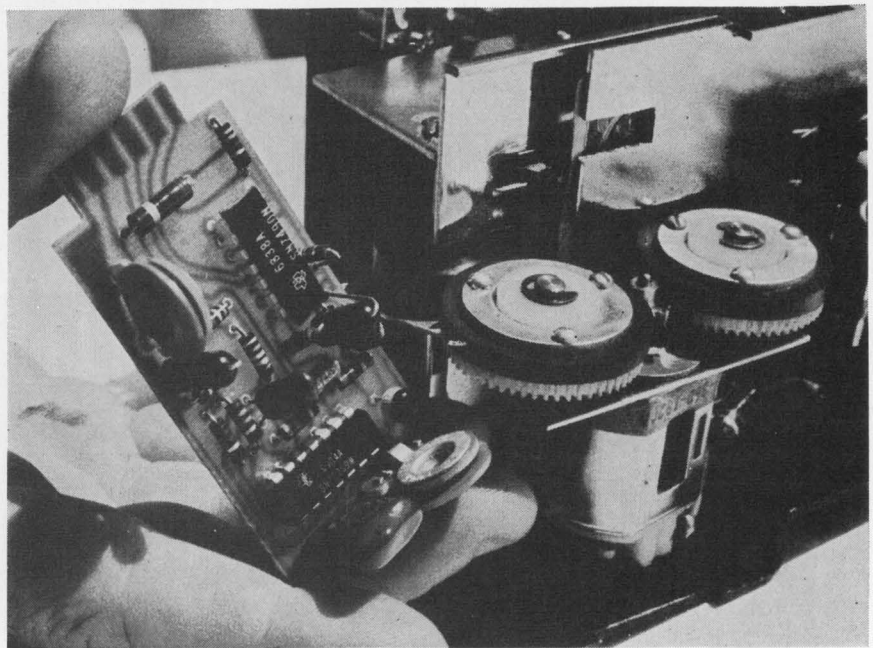

**For the money.** The Mark 7 bill changer uses TI's new gallium arsenide infrared source. The rubber wheels, driven by a d-c motor, pull the bill into the path of the i-r light.

of unattended automatic merchandisers. For example, even if a gas station is closed for the night, a driver can buy gasoline by inserting one or more dollar bills into an acceptor connected to the gas pump. Each device will cost \$200 to \$300.

**Up to date.** The Mark 7 incorporates some of the latest electronics technology. In 0.1 second, it scrutinizes and scoops in the bill. Bayha says, for example, that his device represents the first industrial application of Texas Instruments' gallium arsenide infrared source and will use the companion gallium arsenide infrared detector that Texas Instruments has under development.

Infrared energy is absorbed by the bill's engraving pattern and ink thickness in a more specific and efficient manner than the broad-spectrum light from an incandescent lamp used in previous note acceptors. In the Mark 7, the i-r beam shines upward through the bill onto the detector. In front of the detector is a grid, or mask, that is the reverse, or negative, of the pattern surrounding the portrait of the bill.

When a bill is inserted, rubber wheels driven by a d-c motor re-

tract the bill until the portrait background is in the i-r light path. After a delay, a scanning operation moves the bill's pattern past the mask pattern. In effect, the mask interrupts the i-r beam every time there's a match between the two patterns. The detector thus delivers a sequence of pulses; a genuine dollar bill will produce eight.

A 709 operational amplifier increases the pulse signals to drive a TI SN490N IC decade counter. Only when the unit reaches a count of eight will it deliver a signal that pulls in the bill and then, for example, latch a relay in the automatic merchandiser to drop the product and return the appropriate change.

**Hold it.** If the user tries to prevent the bill from completely entering the acceptor, the motor stops and the latching won't occur even though the bill has been validated. Conduction of the SCR that drives the motor depends on a unique turn-on signal at the SCR's gate. This is derived from the electrical noise generated by the motor's brushes; if the user tries to withdraw the bill, the tight grasp of the rubber wheels will stall the motor. Without the brush-noise



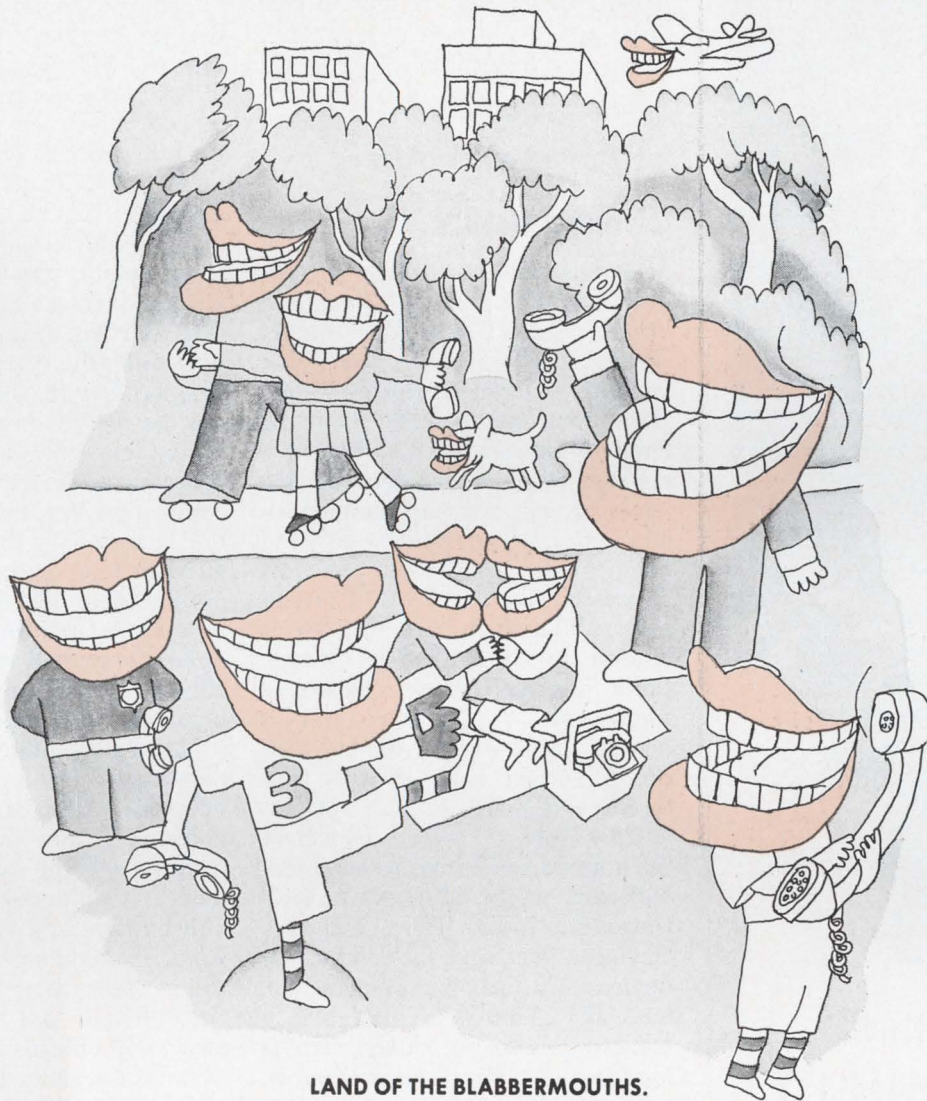

### LAND OF THE BLABBERMOUTHS.

Blab blab blab. The communications flow in the U.S. is turning into a gusher. Can technology keep up? Martin Marietta communications people are studying unusual new digital techniques to expand the volume of conventional circuits. We're also conducting transmission experiments in the millimeter wave region. It could give some much-needed tongue room in the crowded electromagnetic blab spectrum. Martin Marietta Aerospace Group. Headquarters: Friendship International Airport, Maryland.

**MARTIN MARIETTA**



# STATIONKEEPING

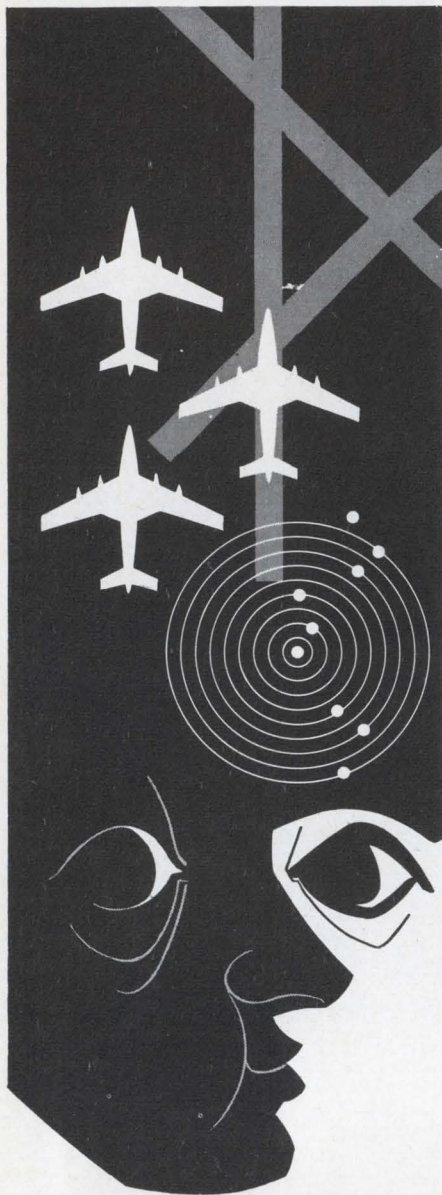

TOTAL ELECTRONIC  
SYSTEMS CAPABILITY.  
SPECIALISTS IN  
TIME/FREQUENCY,  
RADAR AND  
DATA SYSTEMS  
OFFERING RAPID  
GROWTH.

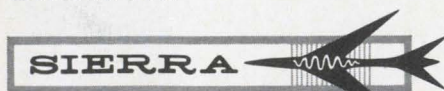

RESEARCH CORPORATION  
an equal opportunity employer

P.O. BOX 222, BUFFALO, N.Y. 14225

## U.S. Reports

signal, the SCR stops conducting and the motor stops.

Threshold levels in the Mark 7 are set to the specific characteristics of the bill's pattern, ink, and paper. Thus, a unit can be set up at the Ardac factory to accept any denomination bill or any foreign note.

## Integrated electronics

### Getting the MOST

Although silicon gates have become the latest hot item in MOS [*Electronics*, Sept. 29, p. 88], another skeptic has joined the ranks that include General Instrument and Texas Instruments. Officials at the Hughes Aircraft Co. feel they have a better idea—ion implantation—to lower capacitance and thereby obtain better MOS device speeds. And Hughes also is shooting for low thresholds with its "IMOS" treatment, although the first test device offered by the Newport Beach, Calif., division doesn't feature low threshold.

This single 64-bit dynamic shift register is the fruit of more than three years' work in ion implantation by Robert Bower, manager of the applied solid-state research department in the Hughes research laboratories, and Hans Dill, the labs' section head for field effect devices. The unit is designated the LISR 0064, and it's available in small quantities at \$200 each. The idea is to get samples out to prove that it really works at more than 20 megahertz, against about 10 Mhz for the fastest shift registers available today.

**Masks.** Fundamental to the Hughes project is the fact that both the gate metal and thick oxide are used as implantation masks, automatically aligning the gate region between the source and drain, and insuring virtually no lateral spread of the boron ions that form the p-n junction about 0.4 micron deep into the channel region [*Electronics*, Nov. 11, 1968, p. 55]. Because the gate doesn't overlap the source and drain, parasitic overlap capacitance is greatly reduced, thus boosting

speed. Bower points out that besides yielding automatic gate registration, as does silicon-gate technology, ion implantation is completely compatible with p-channel MOS processing; the silicon-gate method isn't.

"The p-channel technique is the best process for MOS so far," Bower asserts. "Silicon gates or refractory metal gates (molybdenum, for instance) used for auto-registration dictate process changes to make them manufacturable." Dill also maintains that the additional processing required with other methods of automatic gate alignment actually can increase threshold voltages and introduce noise, "in effect, worsening the surface state density compared with that of normal p-channel processing."

Hughes employs normal diffusion procedures: the gate oxide is grown conventionally. Ion implantation is the last step in the process, done at room temperature after the aluminum gate metal has been deposited. Actual bombardment requires only one or two minutes, although loading and unloading can boost the total time to 20 minutes.

**Narrowing price gap.** The implantation machine accommodates only one wafer at a time, but an indexing fixture that will hold 20 wafers will be added within a month. A production version of the unit has been designed and capital has been committed for its purchase. This increased production capability is one reason Hughes marketing officials predict the price of IMOS devices will approach that of conventional p-channel parts during the next year.

Dill describes the LISR 0064 as a two-phase device using a ratioless cell design and housed in an eight-lead, solid-base TO-5 package. It operates from 100 kilohertz to more than 20 Mhz (Hughes has specs on it at 30 Mhz). Clock levels are -12 volts at 10 Mhz and -15 volts at 20 Mhz; the drain level is -12 volts at both those frequencies and the input drives are -7 volts for both.

Hughes officials are painfully aware that its semiconductor division has a reputation for not effectively transferring technological strengths into production power,



# Semtech Silicon Rectifiers & Assemblies



**"Cool Power"**

Semtech Corporation manufactures a complete line of silicon rectifiers and devices. Offering unique packages — designed to solve old and new circuit problems efficiently, reliably and at low cost.

Semtech has a continuing research and development program, utilizing interrelated technologies, to guarantee state-of-the-art rectifiers and assemblies. The new "Metoxilite" rectifier is just such a device — the result of years of intensive materials research and testing. Fashioned from metal-oxides, this new device offers impermeable monolithic construction and advanced electrical characteristics.

Unique devices introduced by Semtech include:

- SEMPAC® (100 to 1000V) ■ MINISTAC (1 to 7kV) ■ COMPAC (50 to 3000V) ■ MINISTIC (10 to 40kV) ■ SLIMPAC® (2.5 to 45kV) ■ ALPAC® (50 to 600V) ■ STACPAC (500V to 25kV)
- "METOXILITE" (100 to 1000V) ■ A complete line of Multipliers (up to 50kV).

For complete information, contact your nearest representative and get your Free copy of Semtech's 1969 Silicon Rectifier Catalog. All products listed in our catalog are available for immediate delivery.

**San Francisco**—941 E. Charleston, Suite 10, Palo Alto, California 94303 / (415) 328-8025  
**Chicago**—140 N. La Grange Road, La Grange, Illinois 60525 / (312) 352-3227 / TWX: 910-683-1896  
**Dallas**—402 Irving Bank Tower, Irving, Texas 75060 (214) 253-7644  
**New York**—116-55 Queens Blvd., Forest Hills, New York 11375/(212) 263-3115/TWX: 710-582-2959  
**European Sales**—Bourns A. G. Alpenstrasse 1, Zug, Switzerland / (042) 4 82 72/73

 **SEMTECH**  
CORPORATION

652 Mitchell Road, Newbury Park, California 91320  
(805) 498-2111, (213) 628-5392 / TWX: 910-336-1264

®SEMPAC, SLIMPAC and ALPAC are registered trademarks of the Semtech Corporation.



## U.S. Reports

so they're hesitant to talk in detail about other IMOS devices. They do, however, have a dual 64-bit dynamic shift register that's been clocked at 30 Mhz, and a 10-channel multiplexer that's about five times faster than today's best. Both parts will be available in sample quantities "in the very near future," they claim.

## Companies

### Autonetics, Act 2

Undoubtedly jolted when they fell behind schedule in delivering MOS large-scale integrated circuits to Hayakawa Electric Co. for the Japanese firm's desk calculator [*Electronics*, Sept. 15, p. 47], officials at the Autonetics division of North American Rockwell maintain they're back on the track with Hayakawa, and have moved in other ways to strengthen their commitment as a supplier of commercial MOS LSI devices.

Most significant is their preparation of the Microelectronics Products division (MPD) to be spun off as a separate company when the parent firm decides the time is right. North American Rockwell management recently broke out the Autonetics Information Systems division as Narisco (North American Rockwell Information Systems Co.) and indications are that MPD could become a separate entity by Jan. 1.

**Making books.** The division is realigning its accounting procedures in anticipation of becoming a separate NR company, but MPD general manager Robert Carlson says it isn't clear exactly what organizational reporting lines will be established if the go-ahead is granted. "We'd like to have our cake and eat it, too," says Carlson, an Autonetics vice president. "We want to be able to work in the commercial market but we also want to maintain a relationship that will give Autonetics the benefit of an MOS LSI supplier for its military applications." Carlson has hired Harold Edge as MPD's controller to handle financial and administrative opera-

tions. The position is new, and is part of the buildup for a separate company. Edge was controller at Philco-Ford's Houston operations.

In addition, these other developments have strengthened MPD's capacity or added to its backlog:

■ A 20,000-square-foot assembly site has been leased in Mexicali, Mexico; it will begin delivering assembled devices back to Anaheim for testing this month. This augments a similar facility in Princeton, W. Va., that has been working on parts since June.

■ The division has been delivering small quantities of nine circuit types to Viatron for the memory subsystem of its System 21. These comprise two keyboard circuits, four tape-control circuits, two memory control logic circuits, and a shift register.

■ Work already is under way on a follow-on to the contract with Instrument Systems Corp. to supply four circuit types for the multiplexed passenger services and communications systems ISC is building for the Boeing 747. This job, worth about \$4 million, brings the total business with ISC to about \$5 million.

■ The division has added 12 diffusion furnaces at the 40,000-square-foot Anaheim site, giving it a total of 24.

**Eye on Viatron.** Says Carlson, "We're in a position now to take on more business without further facilities or equipment expansion, but we're readying plans for expansion." This would involve equipment purchases, not new facilities, to the tune of about \$2 million in assembly and test gear. The outlay could be triggered if Viatron comes through with a big order. The current contract with Viatron is about \$450,000; Carlson says follow-on potential "runs to levels of a million circuits a year or more, but they have backup suppliers and we don't know which circuits we might put into quantity production."

The division has delivered 1,000 of a slightly redesigned version of its 1,024-bit shift register to California Computer Products. Calcomp has an option to buy 9,000 more, but Autonetics isn't disclos-



## COMPAR Facilities to serve you!

<b>Alabama</b> Compar Southern 904 Bob Wallace Ave. Huntsville—35801 205-539-8476	<b>New Jersey—Southern</b> see Pennsylvania—Eastern
<b>Arizona</b> Compar Rocky Mountain 84 West First St. Scottsdale—85252 602-947-4336	<b>New Mexico</b> Compar Rocky Mountain 2129 San Mateo Blvd. NE Albuquerque—87110 505-265-1020
<b>California—Northern</b> Compar San Francisco 820 Airport Blvd. Burlingame—94010 415-347-5411	<b>New York—Metropolitan and Long Island</b> Compar New York 335 Crossways Pk. Dr. Woodbury, L.I.—11797 516-921-9393
<b>California—Southern</b> Compar Los Angeles P.O. Box 7018 Burbank 213-843-5550	<b>New York—Upstate</b> Compar Albany 6 Highland Avenue Albany—12205 518-489-7408
<b>Colorado</b> Compar Rocky Mountain 300 E. Hampden Ave. Englewood—80110 303-781-0912	Compar Albany 319 Wells Ave. West North Syracuse 13212 315-471-3356
<b>Connecticut</b> Compar New England 2357 Whitney Avenue Hamden—06500 203-288-9276	Compar Albany P.O. Box 135 Endwell—13760 607-723-8743
<b>Delaware &amp; Dist. of Col.</b> see Maryland	<b>North Carolina</b> Compar Southern 1106 Burke Street Winston-Salem—27101 919-724-0750
<b>Georgia</b> see Alabama	<b>Ohio</b> Compar Ohio P.O. Box 338 Fairborn—45324 513-878-2631
<b>Illinois—Northern</b> Compar Midwest 315 Laura Drive Addison—60101 312-543-8833	Compar Ohio 19500 Center Ridge Rd. Rocky River—44116 216-333-4120
<b>Illinois—Southern</b> see Missouri	<b>Oklahoma</b> see Texas
<b>Indiana—Northern</b> Compar Midwest 5027 No. Kemore Rd. Indianapolis 317-545-6081	<b>Oregon</b> see Washington
<b>Indiana—Southern</b> see Ohio	<b>Pennsylvania—Eastern</b> Daniel & Company 231 So. Eastern Rd. Glenside—19038 215-887-0550
<b>Iowa</b> see Illinois—Northern	<b>Pennsylvania—Western</b> see Ohio
<b>Kansas</b> Compar Midwest 6045 Mortway Suite 102, Shawnee Mission—66202 913-432-6333	<b>Rhode Island</b> see Massachusetts
<b>Kentucky</b> see Ohio	<b>South Carolina</b> see North Carolina
<b>Louisiana</b> see Texas	<b>Tennessee</b> see North Carolina
<b>Maine</b> see Massachusetts	<b>Texas</b> Compar Southwest 8609 Northwest Plaza Dr. Dallas—75225 214-363-1526
<b>Maryland</b> Daniel & Company P.O. Box 124 Lutherville—21204 301-825-3330	Compar Southwest 5757 Bellaire Blvd. Houston—77036 713-667-3420
<b>Massachusetts</b> Compar New England 88 Needham St. Newton Highlands—02161 617-969-7140	<b>Utah</b> see Arizona
<b>Michigan</b> Compar Midwest 21250 Civic Center Dr. Southfield—48075 313-357-5369	<b>Vermont</b> see Massachusetts
<b>Minnesota</b> Compar Twin Cities P.O. Box 16095 Minneapolis—55416 612-922-7011	<b>Virginia</b> see Maryland
<b>Missouri</b> Compar Midwest 11734 Lackland Ind. Dr. St. Louis—63141 314-542-3399	<b>Washington</b> Compar Northwest 12610 N.E. 104th St. Kirkland—98033 206-822-4191
<b>New Hampshire</b> see Massachusetts	<b>Wisconsin</b> see Illinois—Northern
<b>New Jersey—Northern</b> See New York—Metropolitan	<b>Canada</b> Kaytronics Engineering 5800 Monkland Ave. Montreal 28, Quebec 514-487-3434
	1001 Finch Ave. W. Downsview, Ont. 416-638-5511

COMPAR CORPORATION • 828 AIRPORT BLVD.  
BURLINGAME, CALIF. 94010 • (415) 347-9501



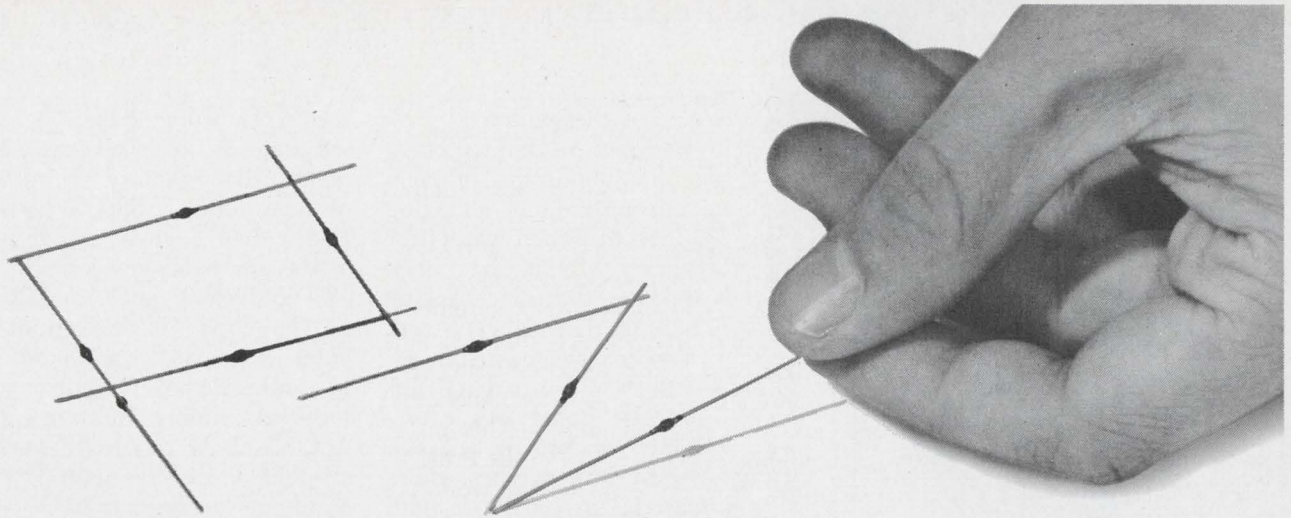

## Introducing the PZ Zener

The new fused-in-glass  
1 watt zener . . .

Typical Unitrode fused-in-glass  
stability and high-performance at  
the price of an ordinary device

Order your free samples today

- Fills the bill from 400 mw thru 1 watt
- Voltages from 6.8 to 200 V
- 8 millisecond surges to 30 watts
- Low reverse current — to 500 nA
- A quarter the size of a conventional 1 watt
- Weighs less than 1/4 gram
- No plastics, epoxies, silicones, oxides, gases, or solders are used

580 Pleasant St., Watertown, Mass. 02172 • (617) 926-0404

# UNITRODE

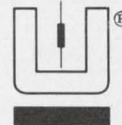

TOUGH AS ALL GET-OUT FROM THE INSIDE OUT

With the silicon die metallurgically bonded between terminal pins of the same thermal coefficient, the hard glass sleeve is fused to the entire outer silicon surface. Result — a voidless, monolithic structure.



#### 4 EASY WAYS TO GET FREE SAMPLES AND SPECS

1. Call your Compar office, listed on the facing page.
2. Call your nearest Daniel & Co. office.
3. Call Bud Anderson COLLECT, at (617) 926-0404.
4. Check off the magazine Reply Card number.



# FAMOUS SINGLES



**\$45.90\***  
per pair

## THAT WORK TOGETHER!

**Regulated DC Power Supplies that team up as duals—for LE\$\$**

Computer Products' big family of DC power supplies, from 3.6V 250 MA to 180V 10 MA, PC and Octal, are small, tough and high-performance—and TWO FAMOUS SINGLES COST LESS THAN A DUAL.

Prices are significantly lower than competitors near-equivalents, too. Check this:

Output Voltage	15VDC
Input Voltage	115 ± 10VAC
Output Current	100 MA
Line-load reg. ea	± 0.02%
Temp. Co./°C	0.02%
Ripple/Noise	0.5mV RMS
Output Z@10KHz	0.2 ohms
Case size	1.75x2.25x1
Model No.	PM576

### PRICE PER UNIT:

1-9, \$25.95; 10-29, \$22.95; 30-99, \$21.95

\*5 pair quantity price, \$45.90 per pair.

*We also have unregulated PC mount power supplies, 5 to 45 VDC . . . and more powerful regulated 5, 15 and 180 VDC supplies.*

Call or write for complete information . . . or for **3-DAY SHIPMENT**

Computer Products, Inc.  
P. O. Box 23849

Fort Lauderdale, Fla. 33307  
Phone: 305/565-9565



**COMPUTER PRODUCTS™**

FORT LAUDERDALE

## U.S. Reports

ing the size of the contract.

Alvin Phillips, MPD director of operations, maintains the diffusion problem encountered in changing from 1½-inch to 2-inch wafers for the Hayakawa circuits has been solved and the diffusion backlog is down to normal levels. "We were getting erratic sheet-resistance," Phillips reports. "We had the diffusion process going beautifully with 1½-inch wafers, but 2-inch wafers meant larger tubes, more silicon material in the tubes, and bigger boats to hold the wafers; this resulted in a difference in gas flows. It was a balancing and tweaking process that took some time." Phillips expects the output for Hayakawa to grow from a reported level of about 88,000 arrays per month to the peak of 160,000 a month by the second quarter of next year.

## Computers

### Off we go—into LSI

Raytheon's RAC-251 computer may represent the military's first sizable commitment to large-scale integration. But the possibilities for keeping down the machine's size and price are such that it could show promise for commercial applications.

The RAC-251, to be built for radar data processing in the Air Force's TPN-19 program, would use eight large-scale bipolar circuits to form the core (about 3,100 gates) of a 32-bit arithmetic unit and control section.

Private-sector users would be attracted by the combination of a 32-bit processor no larger than most 8-bit machines at a price possibly as low as that of today's 18-bit computers.

Walter F. Dawson, manager of the system design section at Raytheon's Equipment division, Sudbury, Mass., says the 251 makes more use of bipolar LSI than any other computer he's aware of—the only technical competition being an experimental processor built by Texas Instruments for the Air Force's avionics lab at Wright Pat-

erson Air Force Base.

Raytheon uses Texas Instruments' discretionary wired arrays of TTL logic. Eight arrays—each larger than a silver dollar and in a 100-pin package—contain about 385 equivalent gates, including 28 j-k flip flops, 70 three-input nand gates, 22 seven-input nand gates, 21 and-or-invert circuits, several registers, adders, bussing circuits. A total of 35 read-only memories are included in the eight Texas Instruments arrays.

**Economy.** Dawson feels that the RAC-251 may have been one of the first computers designed with the economics of bipolar MOS strongly in mind. "With LSI development costing \$10,000 to \$20,000 per circuit, we tried to develop as few circuits as necessary," he says. "We worked out a design that required only a single LSI format, which we'll be able to procure for \$500 to \$800 per unit."

One goal was to keep non-repeating logic functions to a minimum; otherwise it would have made for costly LSI's with poor gate-to-pin ratios and more basic circuits. One result was a microprogrammed controller. "To have built a control unit out of combinatorial logic," says Dawson, "would have required about 500 circuits in flat-pack formats. By substituting read-only memories and LSI, we've cut that number by 40% and parceled the remaining logic among the eight LSI's."

Smaller IC's still are necessary, he adds, because some functions just don't repeat often enough to make LSI economical. Thus there are 17 printed-circuit cards, each measuring five by seven inches, containing ordinary integrated circuits.

Much of the development of the RAC-251 came from the RAC-250, an in-house development program, during 1968 and 1969. The TI arrays used in the 250 had only about 300 equivalent gates, "but TI's yields kept going up, and their process began to look much more repeatable as time passed," says Dawson. "So we changed the metallization to add bussing and some other features to the LSI's



# EAGLE...where the state of the art is the standard of the industry

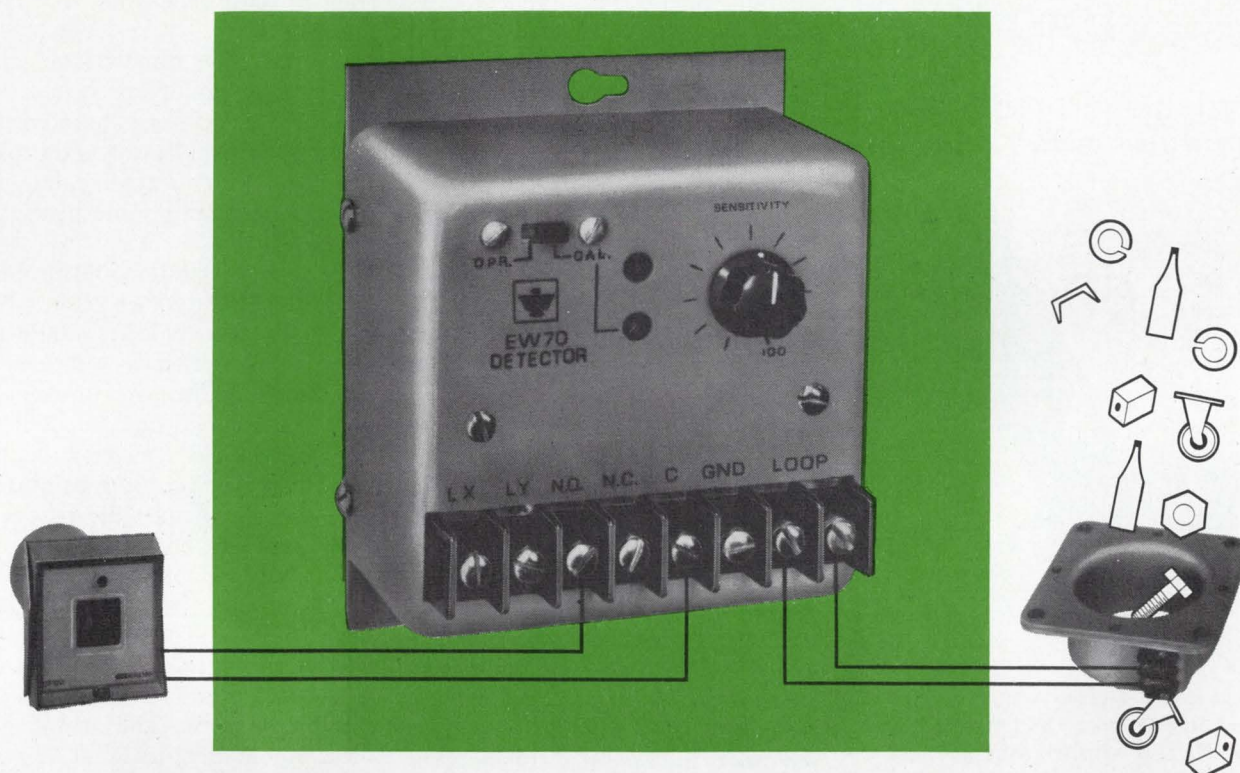

## Solid-State Area Metal Detection for Accurate Count or Control

Eagle works with the state of the art to bring you the best automation controls that can be made commercially, using proven components, materials and methods. For example, the new Eagle EW70 carries the art of metal detection beyond mere proximity sensing into clearly defined *area* detection. That is, any *ferrous or non-ferrous* metal object, regardless of size, weight, shape or mo-

tion, passing singly through the sensor area is detected as a discrete object. Smoke, oil, dust, water...even vibration... have little or no effect on sensitivity.

USE IT TO COUNT up to 400 parts/minute...for accurate, reliable control of product counts and process cycles.

USE IT TO DETECT tramp metal in process lines and equipment...assure product quality

and prevent costly damage to machines.

The EW70 *works*, even where others fail. No wonder it's rapidly complementing Eagle time/count instruments that are standards of the industry.

GET THE SPECS and full details... more than \$1 million in Eagle time/count controls, control relays, precision potentiometers...waiting to serve you in 35 major areas throughout the world...including U.S.A., S.A., Europe, U.K., Canada and Australia.

**GW** Eagle Signal Division  
A GULF + WESTERN COMPANY

Davenport, Iowa 52803



# High Voltage Silicon Rectifier. For large screen color television.

Available in production quantities now!



This silicon rectifier was designed to provide high voltage DC for the picture tube in hybrid color television receivers. A lower cost version is available for use in all-solid-state receivers.

Varo also makes a complete line of high voltage rectifiers for black and white receivers.

A complete line of voltage multiplier devices are also available in production quantities.

When you think of Varo semiconductor products, remember this—we're the company that not only made the first silicon high voltage rectifier ever used in consumer TV sets, but we received the first order for multipliers to be used in consumer TV production, too.



SEMICONDUCTOR DIVISION 1000 N. SHILOH ROAD, GARLAND, TEXAS 75040 (214) 272-4551

## U.S. Reports

and improve our economics." TI, he says, has never had LSI delivery problems.

Two preproduction models of the RAC-251 are assembled now. They should go into checkout very soon, and should be operating by year's end. By the final quarter of 1970, Raytheon should begin producing the 251 in enough quantity to soak up 1,000 arrays or more by 1972.

Dawson already has done some thinking about the 251's commercial possibilities. "The 251 could cost only about \$20,000 if produced at 100 to 200 units a year," he says.

## Avionics

### Now for a U.S. SST

While the British-French jet transport, the Concorde, was breaking the sound barrier for the first time during a nine-minute flight, the Boeing Co. was acting on President Nixon's SST go-ahead and setting avionics specifications for the U.S. supersonic plane.

The latest word from sources at the Seattle-based firm say that the specs are completed for three major items—the air-data computer system, the inertial navigation system, and flight instrumentation. Boeing will soon release them to industry for proposal preparation. Requirements for the rest of the avionics, including cockpit displays, the airborne integrated data system, weather radar, and attitude direction indicators, are now in various stages of undress, but should be ready by the end of this year.

A multiplexing system for transmission of a variety of signals from the rear of the airplane to the front over common wiring—at one time thought to be a definite SST weight- and space-saving requirement—is now questionable. Boeing sources say multiplexing will definitely not fly on prototype versions of the craft, due in 1972, and may not make it aboard the production models either, which are scheduled to fly in 1978. The reason: multiplexing seemed essential when the SST was still a swing-wing design, but with fixed wings cable runs are

much shorter because electronic racks have been relocated nearer the pilot.

Communications and inertial navigation systems on the supersonic craft are not expected to be radically different from those on the Boeing 747 jumbo jet. However, according to one source, Boeing is thinking about moving the inertial navigation system computer off the inertial platform and adding tasks such as data generation for, say, a map display.

The displays themselves, along with a map-projection system, will include a computer generated multifunctional unit that would provide the pilot with weather radar, fuel management, and sonic boom profile data.

The weather radar will probably be a multifrequency system working in the Ka and Ku bands that locates the top of a weather disturbance, not just its presence as with existing equipment; when a pilot knows where a storm tops out, he can determine the feasibility of slicing through part of it to reach clear weather above.

Currently Boeing is evaluating two attitude-direction indicators developed by Norden. Boeing will also be looking at other systems from both Sperry Gyroscope and General Electric. The attitude and direction indicators will have to work under category III-A landing conditions—runway visibility range of about 700 feet—and will include a landing monitor that will provide the pilot with a picture of the runway from high-resolution Ku-band radar.

## For the record

**STV on the air.** Subscription television (STV) may finally become a reality in December, one year after the Federal Communications Commission adopted rules to set up a nationwide, over-the-air STV service. A U.S. Court of Appeals decision against the National Association of Theater Owners and Joint Committee Against Toll Tv upholds FCC authority to set technical standards and regulations for operation of STV stations.



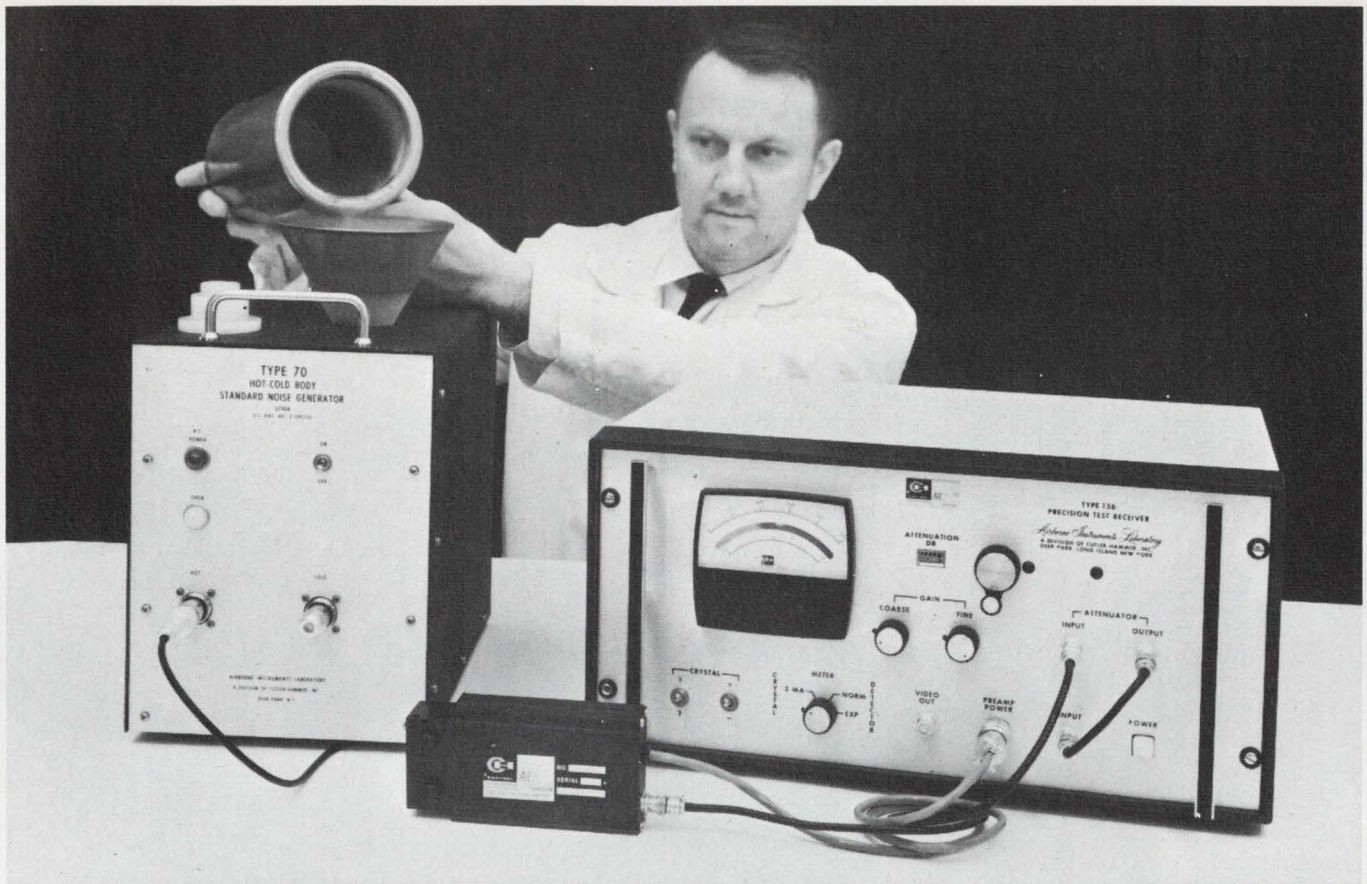

This AIL Receiver and Hot/Cold Standard Noise Generator give you the world's most precise noise figure measurements.



AIL's precision pair: Type 136 Precision Test Receiver (left) is priced at \$1350; Type 07009 DC to 9 GHz Hot/Cold Standard Noise Generator at \$1950.

Meet the precision pair. AIL's Type 136 Precision Test Receiver and Type 07009 Hot/Cold Noise Generator provide manual measurement of noise figure in the 0 to 5 dB range. Accuracy is to 0.1 dB with a resolution of 1° K.

Here's how: The unique Hot/Cold Noise Generator provides the extreme accuracy because the temperatures of its resistive elements are very accurately controlled. One element is immersed in liquid nitrogen and is always 77.3° K. The other is in a temperature-controlled oven at 373.1° K.

And our Type 136 Precision Receiver with its unique scale-expansion feature provides Y-factor readouts with comparable accuracy and great resolution.

Alone you can use the versatile Type 136 as an IF and RF receiver for everything from attenuation measurement to

spectrum analysis. Unique plug-in mixers and converters extend the range of the basic 30 MHz instrument from 10 MHz to 40 GHz.

So whether you need the world's most precise noise figure measurement set-up, or just the most versatile and economical precision test receiver you can buy, we'd like to arrange a demonstration. Just phone our "hot line" (516-595-3216) during East Coast business hours.



Or write for AIL's full-line catalog of Microwave Instruments including the Type 136 Precision Receiver and Type 07009 Hot/Cold Noise Generator.

**AIL** a division of  
**CUTLER-HAMMER**



DEER PARK, LONG ISLAND, NEW YORK 11729



# THIS AGE CAN TEST THE AVIONICS OF ALL NEW AIRCRAFT OF THE 1970'S.

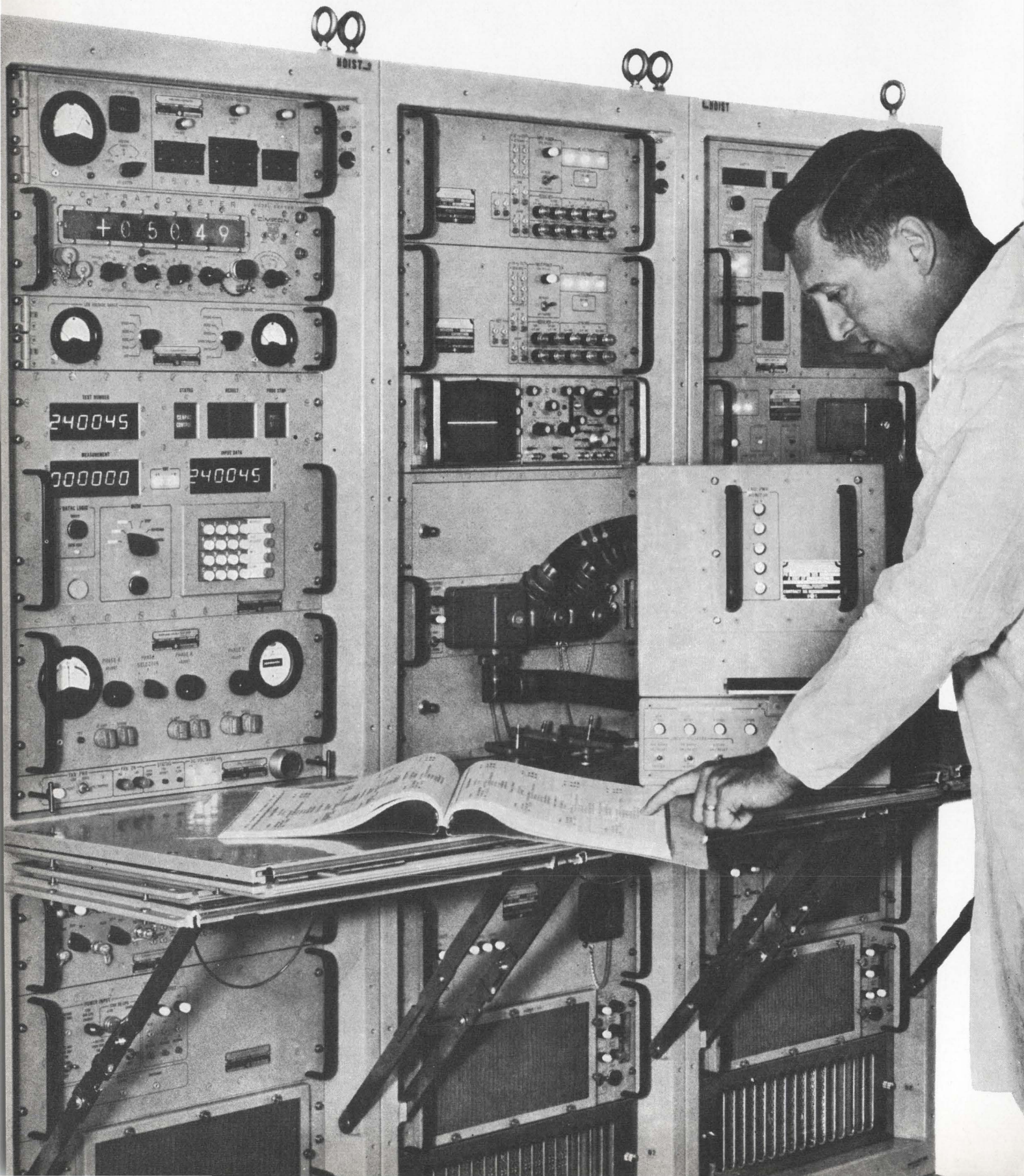



Historically, a new aerospace ground equipment system has been designed for each new aircraft. This has led to recurrent problems. Less than optimum standardization, repetitive research and development costs, variable quality and reliability, and often a lag between delivery of aircraft and the system to support them.

What's needed is AGE that will support not just one aircraft but a whole generation. A system that will be on line when the aircraft goes operational. General Dynamics has designed and developed an AGE concept that meets these requirements.

#### **First completely integrated system.**

Our Electronics division, in support of the Fort Worth division, developed and delivered concurrently with the F-111, the first totally coordinated AGE system. It was available when the avionics were delivered.

The system is made up of integrated test stations. They use a highly flexible building block configuration that can readily be adapted for use with all advanced operational aircraft planned through the late 70's.

This AGE system, on line with the F-111, could be adapted to the new F-15, meeting 70% of its avionics AGE requirements with little or no change; another 15% with minor modification; and only 15% with new de-

velopment. The system is also applicable to the AWACS and B-1A as well as other Air Force programs; and the Navy's F-14 and S-3A programs.

#### **Automatic and manual testing.**

The test stations are a combination of automatic and manual units offering the advantage of selective automation.

The multiple input design of this system virtually eliminates the possibility of an AGE shutdown when trouble is encountered at an input position, and allows simultaneous testing of several avionics equipments.

#### **One AGE for all avionics systems.**

The capability of General Dynamics' integrated AGE system ranges over the full spectrum of analog and digital avionics found in multi-mission aircraft, including flight control systems, mission and traffic control subsystems and penetration aids.

The AGE subsystems are configured to serve the full range of flight line, field and depot level requirements.

The adaptability and flexibility of this AGE concept also makes it feasible for application as an integrated shipboard test center for the Navy, or as an advanced electronics depot testing center in support of ground forces.

The universal AGE concept is just one example of how General Dynamics puts technology to work solving problems from the bottom of the sea to outer space... and a good bit in between.

## **GENERAL DYNAMICS**

1 Rockefeller Plaza, New York, New York 10020



**The deepest source  
for answers to ceramic  
magnet questions.**



# INDIANA GENERAL

*We make it easy for the design engineer.*



Try drawing on Indiana General. After all, we introduced ceramic magnets commercially in the U. S. And since our engineers work for the pioneer in the field, they've a knowledge of ceramic magnet materials and technology that your engineers just can't be expected to match.

Besides materials, where can we help you? In design assistance.

Production capacity. New applications. Costs. Plus the broadest materials range anywhere. We can often ship the type, size and shape you want right off the shelf.

Or, maybe we can send you something a little more animated. Like our engineers, who conduct magnet seminars frequently all over the country. If you'd rather stay home and curl up with a good book, try "Ceramic Permanent Magnet Motors," by our James Ireland. It's the definitive work on design. Just what you'd expect from a vice president of the corporation that gave ceramic PM motor design its start.

For some lighter reading on what we can do for you with ceramic magnets, write for our Indox manual, or bulletins.

Mr. C. H. Repenn, Sales Manager  
Indiana General Corporation  
Magnet Division  
Valparaiso, Indiana 46383

Let's see if your ceramic magnet knowhow can make it easier for me. Please send me the following magnet literature:

- Indox Ceramic Magnets manual
- Catalog (stock) Indox Magnets
- Designing DC Motors with Indox Permanent Magnets
- Ceramic Magnet Axial Gap Synchronous Drives.

NAME \_\_\_\_\_ TITLE \_\_\_\_\_  
COMPANY \_\_\_\_\_  
ADDRESS \_\_\_\_\_  
CITY \_\_\_\_\_ STATE \_\_\_\_\_ ZIP \_\_\_\_\_



## MICROWAVE IC PROGRESS REPORT #7: COMMUNICATION MODULES

Sperry's PACT (Progress in Advanced Component Technology) Program is developing a fully-integrated transmitter/receiver/duplexer module for an airborne communications array at X-band. The program has contractual support from the Air Force Avionics Laboratory, USAF, Dayton, Ohio.

The function of the phased array system is to establish communications between aircraft and synchronous satellite repeater stations, which in turn are linked to a ground station network and to other aircraft. This makes it possible for the crew of an airplane to be in constant contact with anybody, worldwide. Handy for all sorts of missions and indispensable in the event of conflict.

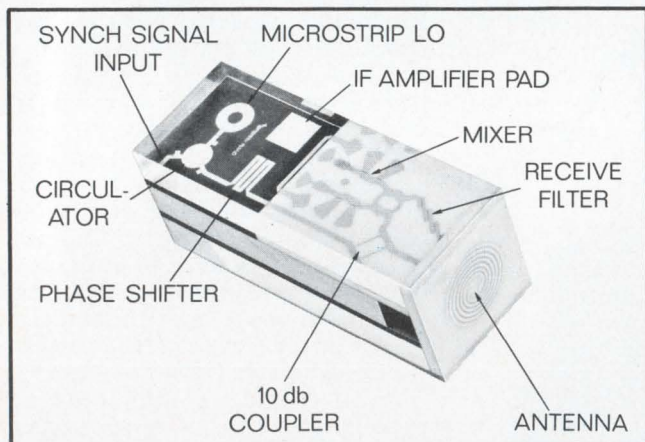

RECEIVER CIRCUIT FOR COMMUNICATIONS MODULE

Within the confines of each phased array element, which is less than an inch square and three inches long, is a complete transmitter/receiver/duplexer. Essentially composed of a signal source, a receiver, a mixer and an antenna, the module utilizes Sperry's advanced thinking throughout.

The rf circuitry is photo etched on metallized ceramic substrates 0.055 inches thick. Conductors are vacuum deposited gold on top of chromium. Follow-up plating produces half-mil thick strips. Transmission efficiency can be gauged by measuring rf energy loss, which, in this case, is no more than 0.15 db per inch.

Transmitter signals are generated by a Sperry Avalanche Transit Time Oscillator (ATTO), discussed in Progress Report #1. Energized by a DC voltage, the ATTO yields a 1-watt CW, X-band signal at an efficiency of 5%.

Sperry's gallium-arsenide Schottky-barrier diodes do the active conversion work in the receiver and the "rat-race" hybrid handles the signal with a single sideband noise figure of better than 6.5 db over a 12% bandwidth. (Sperry hybrid work was discussed in Progress Report #5.) Signal processing and control circuitry design has been materially aided by a Sperry-developed computer program.

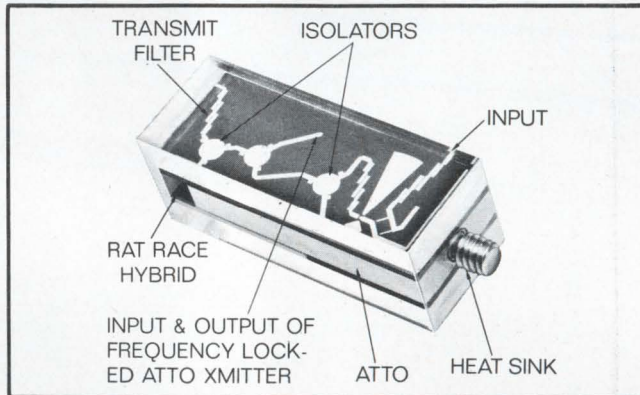

TRANSMITTER CIRCUIT FOR COMMUNICATIONS MODULE

What we have accomplished for the Air Force, we can accomplish for your microwave system, regardless of frequency or operational mode. At Sperry, PACT is more than a clever acronym. Our business is **microwaves**, and our goal is to provide customers with ways of accomplishing microwave functions.

May we hear from you about your system requirement?

*For faster microwave progress,  
make a PACT with people  
who know microwaves.*

# SPERRY

MICROWAVE ELECTRONICS DIVISION  
CLEARWATER, FLORIDA



---

# Washington Newsletter

---

October 13, 1969

## House vs. Senate on defense bill . . .

Some maneuvering by hawkish Congressmen like L. Mendel Rivers (D., S.C.) is likely to result in much of the \$1.29 billion cut by the Senate being restored to the authorization bill for Defense procurement, and research and development. Rivers, chairman of the House Armed Services Committee, "threw in a lot of money at the last minute that the Pentagon never asked for, and that smells like fat for bargaining," says one Senate staffer.

Nearly all of the money cut earlier by the Senate was restored by the House in its \$21.35-billion authorization bill. The bill now goes to the Senate-House conference committee, which will hammer out a compromise. The House seems certain to get at least half of the money it restored—perhaps even more—when the conferees meet.

This larger spending level is now expected to hold up for fiscal 1970. The appropriation bill follows the final authorization, but it must originate in the House, and any efforts by opponents of rising defense costs to trim appropriations are given little chance for success. "They've already shot their bolt on the authorization, and they lost," summarized one House official.

## . . . with Senate yielding on cuts

Although Senate members of the conference committee meeting to thrash out the compromise Defense authorization bill will be fighting to wipe out some of the funding gambits added by the House, most of the House restorations are likely to stand, according to dispirited Senate sources.

These include just about all of the \$75-million House-restored R&D money for Raytheon's Sam-D ground-to-air missile successor to the Hawk; \$66.1 million for the A- and the C-versions of Grumman's E-2 aircraft; and \$165.4 million for the Lockheed ASW carried-based S-3A. Apparently safe is \$40 million for the long-delayed airborne warning and control system (Awacs), which gives the Air Force two-thirds of what it wanted.

Other restored money that is expected to remain in the compromise bill includes: \$18.5 million for the F-106X Awacs interceptor R&D, \$15 million for the RF-111 reconnaissance fighter, and \$1 million for the light intratheater transport.

Aircraft money also expected to resist any major cutting is the \$104 million for the LTV A-7E, and \$38.5 million for the Air Force's A-37B.

One likely subject of negotiation in the conference is Rep. Rivers' controversial insertion of \$100 million to acquire long lead-time items for a fourth nuclear attack carrier. A hawkishly-oriented conference, however, is expected to leave in at least some money for the carrier, which was not sought by the Pentagon.

## Navy resolicits Tacan proposals

ITT's Federal Labs won its protest over the award of the AN/ARN-84 Tacan navigation contract. Proposals are now being resolicited by the Naval Air Systems Command. Originally, Hoffman Electronics was believed to have been selected to build the 526 microminiaturized digital units [*Electronics*, July 21, p. 34]. But ITT, one of three bidders, protested in June that specs were too ambiguous and the open-ended contract would not be "in the best interest" of the Government. The contract



---

# Washington Newsletter

---

is expected to be worth between \$12.5 million and \$15 million.

ITT received \$6.27 million through fiscal 1967 for production of the older AN/ARN-52 analog sets, which the AN/ARN-84 will replace.

## Undersea 'R&D' covers up for Caesar's ghost

A \$17.8-million cost-plus Navy award to Western Electric for "oceanographic R&D" proves to be one more cover-up for underwater intelligence-gathering systems. Naval Electronic Systems Command won't reveal a thing, but non-government sources say the one-year effort, to be performed for Western Electric at Bell Telephone Labs, Whippany, N.J., is aimed at developing a Pacific Ocean counterpart to the Atlantic's "Caesar" program—the submarine detection and tracking network.

But the Pacific system will require hardware capable of operating at much greater depths—the Pacific continental shelf is but 20 miles wide, against the 75-mile width of the Atlantic shelf on which Caesar operates.

## Navy confirms Northrop winner of Jifdats award . . .

Hughes and Motorola aren't expected to protest the award of the Jifdats program to Northrop's Electronics division. Northrop's digital proposal to develop the triservice, joint in-flight data acquisition and transmission system won out over partially-analog systems proposed by Hughes and Motorola [*Electronics*, Aug. 18, p. 71]. Indications had been that the losers might protest because the oft-delayed and reoriented program had changed even after the last proposals had been received.

Northrop, which has received its first \$25-million increment from the Naval Air Systems Command, has been working with Cubic Corp. for the basic transmission link, with Bourns (Canada) for the airborne film processor, with Philco-Ford for the digital modems, and with Magnavox for beacon transmitters. The system could be worth \$300 million over the next four to five years.

## . . . as Cubic's work on data link seen playing key role

Navy officials who selected Northrop no doubt had one eye on the Air Force's successful flight tests with a near real-time data link built by Cubic to meet a Southeast Asia operational requirement (Seaor 45). With the joint Cubic-Air Force tests now completed, the service will conduct further tests on its own before final acceptance and deployment of the data link in the field.

It's believed that Cubic's data link, developed initially to handle infrared-sensor inputs only, can be expanded readily to handle other types of sensors. The firm's original \$5.1-million Air Force contract has been expanded, and one source says the new money is not to buy additional systems, but to add additional sensor capability. Cubic competed against Hughes and Motorola's Government Electronics division, among others, to win the Air Force data link award.

## Addendum

Just because President Nixon gave his blessing to the supersonic transport doesn't mean the program is out of the woods yet. SST avionics competitors still see political problems before final approval of fiscal 1970 Federal funding for the Boeing program. So does Sen. Henry Jackson (D., Wash.), who anticipates that the Congressional floor fight will rival that of the Safeguard ABM earlier this year. White House approval of the program still needs a fiscal 1970 appropriation of \$96 million over the \$90 million the Department of Transportation will carry over.



# Performance / Efficiency / Size

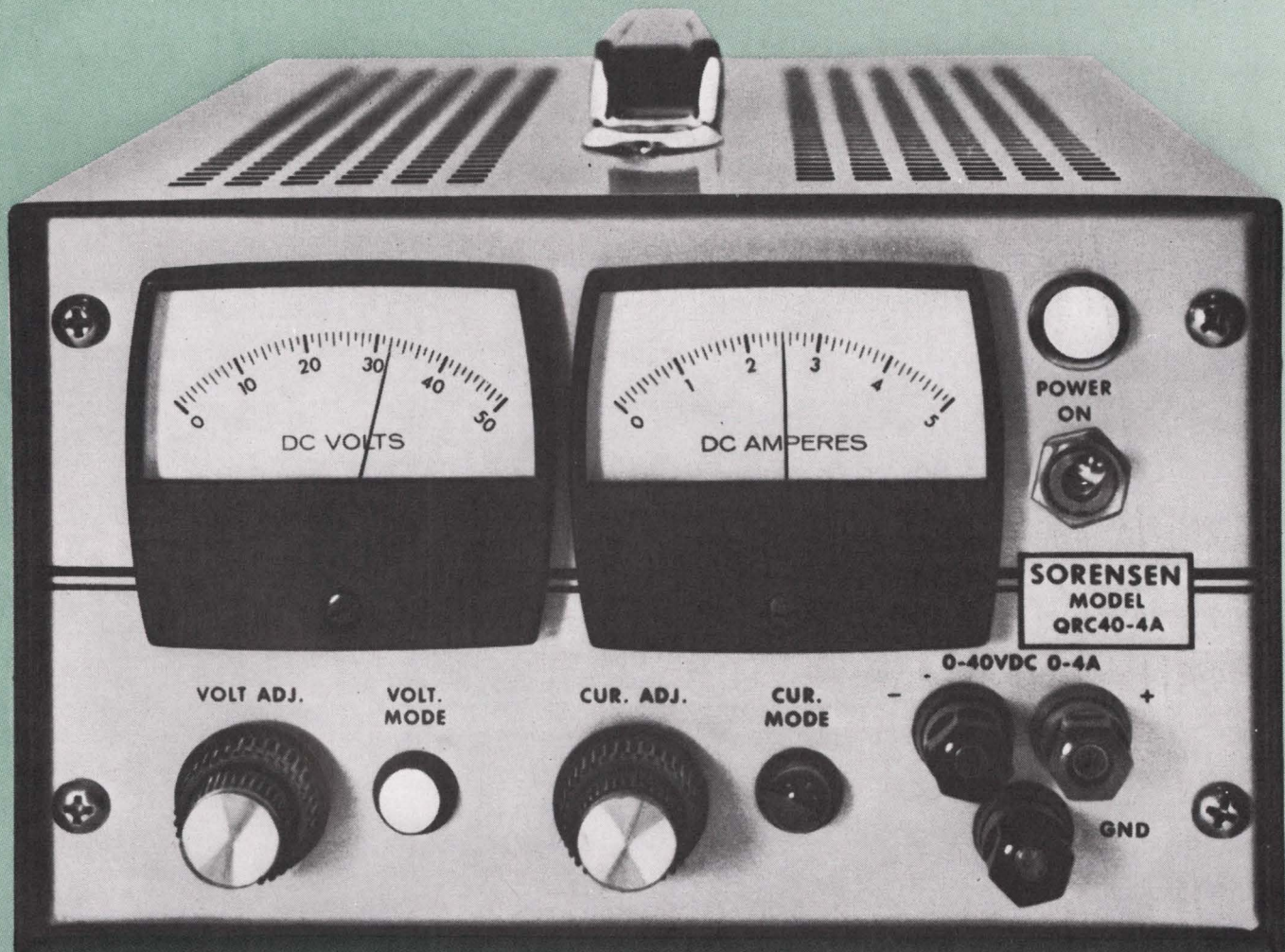

The QRC Series solves the specification/power/volume problem by utilizing all silicon, series regulator techniques with modern high speed transistor switching circuitry.

7 models, all available from stock, cover the voltage ranges of 0-20 and 0-40 Vdc at currents up to 30 amperes with prices starting at \$350 for model QRC 40-4A.

Features include: ■  $\pm 0.005\%$  voltage regulation for line and load changes combined ■  $< 1\text{mV}$  r.m.s. ripple (10Hz-7MHz)

■ 0.01% resolution ■ 25 $\mu$  sec. response time ■ optional overvoltage protection ■ voltage and current regulation with automatic crossover ■ remote programming and remote sensing ■  $-20$  to  $+71^\circ\text{C}$  operating temperature.

For more information contact your local Sorensen representative or; Raytheon Company, Sorensen Operation, Richards Avenue, Norwalk, Connecticut 06856.

Tel.: 203-838-6571;

TWX: 710-468-2940;

TELEX: 96-5953.

**RAYTHEON**



Circle 200 on Inquiry Card



**BELDEN...new ideas for moving electrical energy**

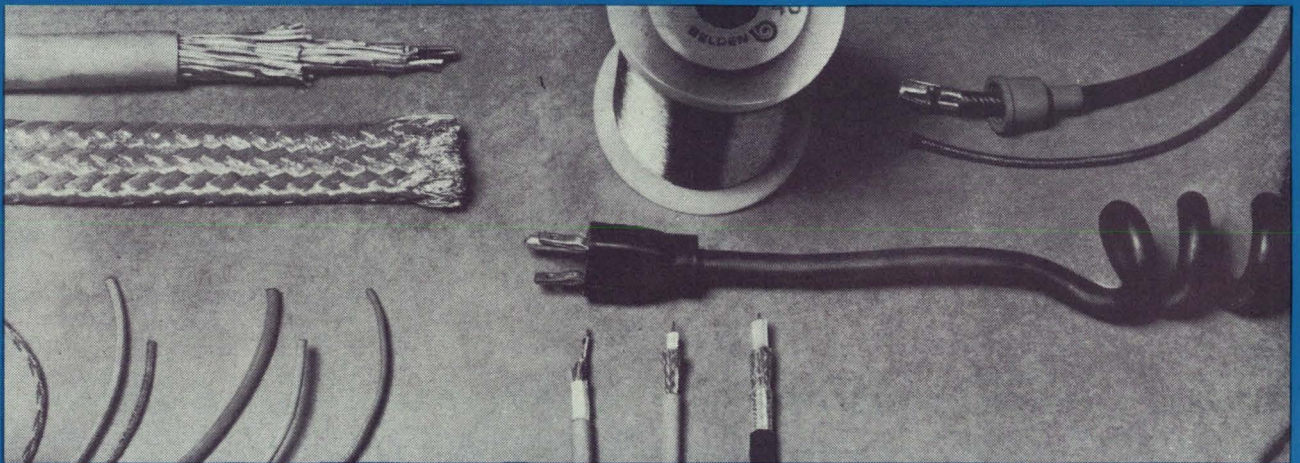
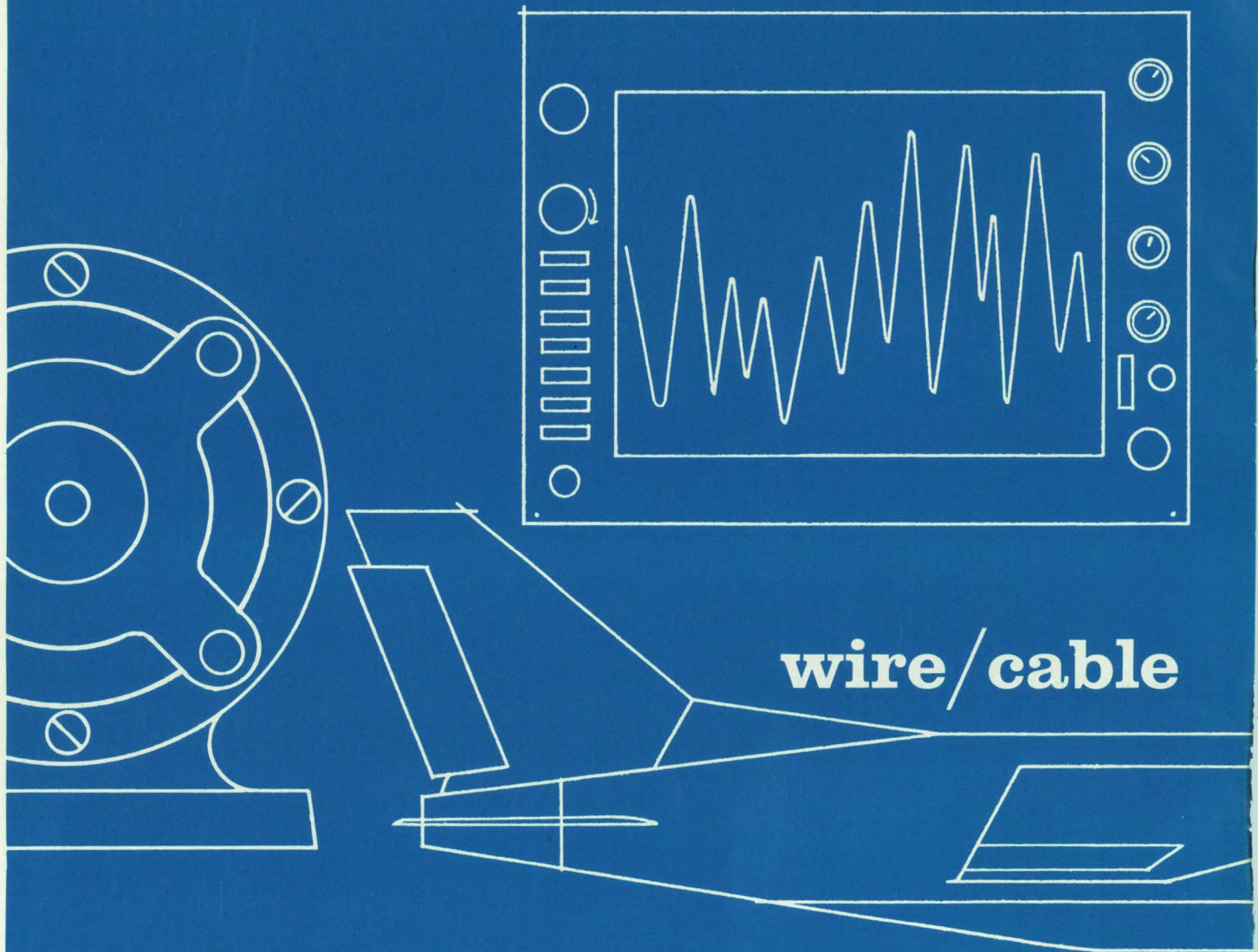



# BELDEN

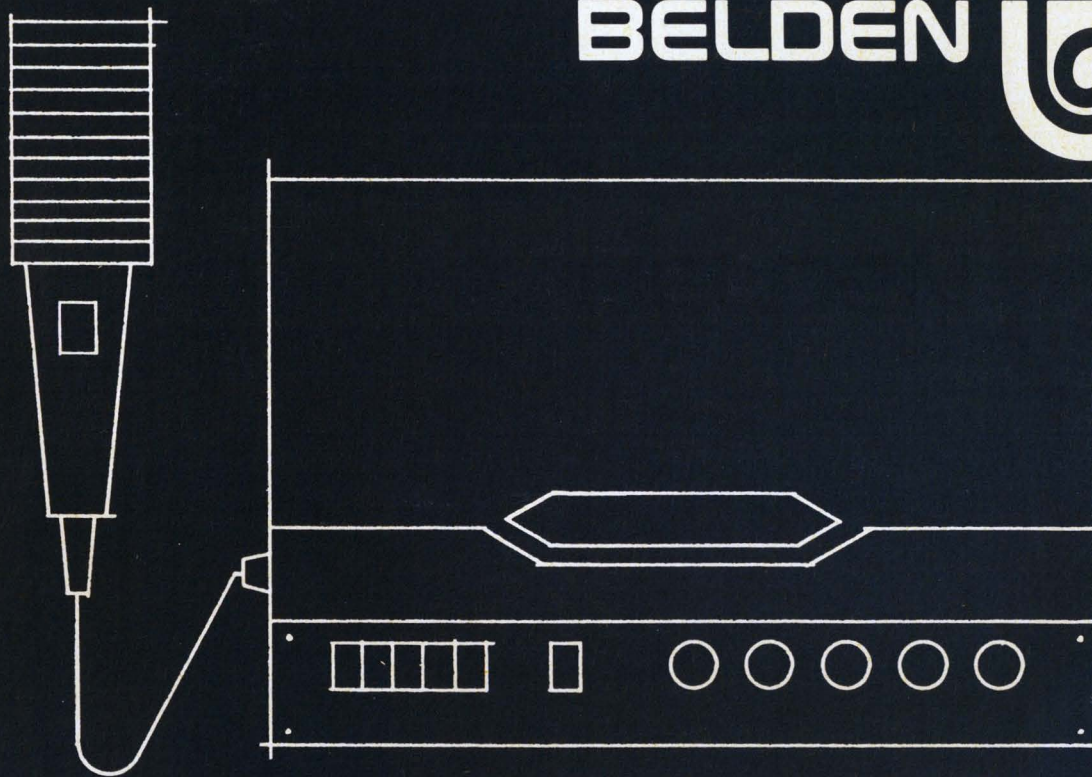

## systems turn us on

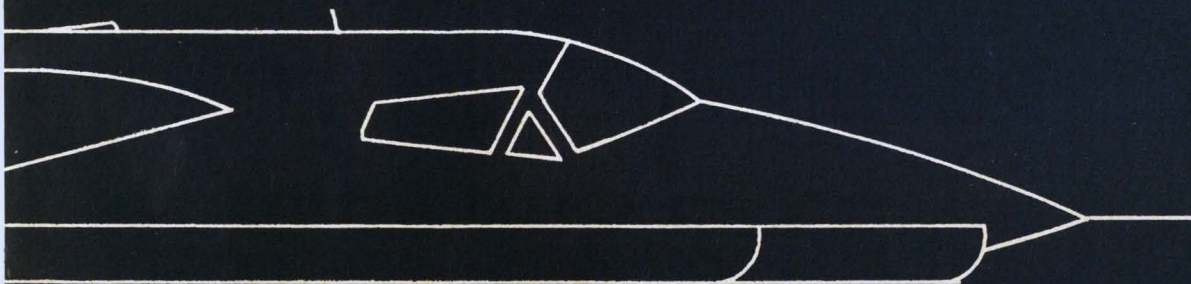

We have an active imagination when it comes to wiring. Because it's sparked by a lot of savvy about wire and cable and its capabilities. With applied imagination we can create fresh ideas that help a customer get a better value for his dollar. Our Wire Systems Specialists are trained to explore every wire-related aspect of a product—compatibility, production, packaging, operating environment . . . the entire system. And then put their imaginations to work. To eliminate a shielding or stripping problem\*. Or save money. Or enhance the product's reliability. And whatever type of wire or cable it takes to turn an

idea into reality . . . well, we make all kinds of wire for all kinds of systems. Why not see what we can imagine for your product? Call or write: Belden Corporation, P.O. Box 5070-A, Chicago, Illinois 60680. And ask for our catalog, and the reprint article, "Key Questions and Answers on Specifying Electronic Cable."

\*For example: We've insulated some of our lead wire with silicone. So no glass braid protection is needed. This means that stripper blades will last much, much longer. And a potential health hazard to stripper operators is eliminated.

G-1-B



**The April update: 95,100 pages of product data**  
**The June update: 90,400 pages of product data**  
**The August update: 129,600 pages of product data.**

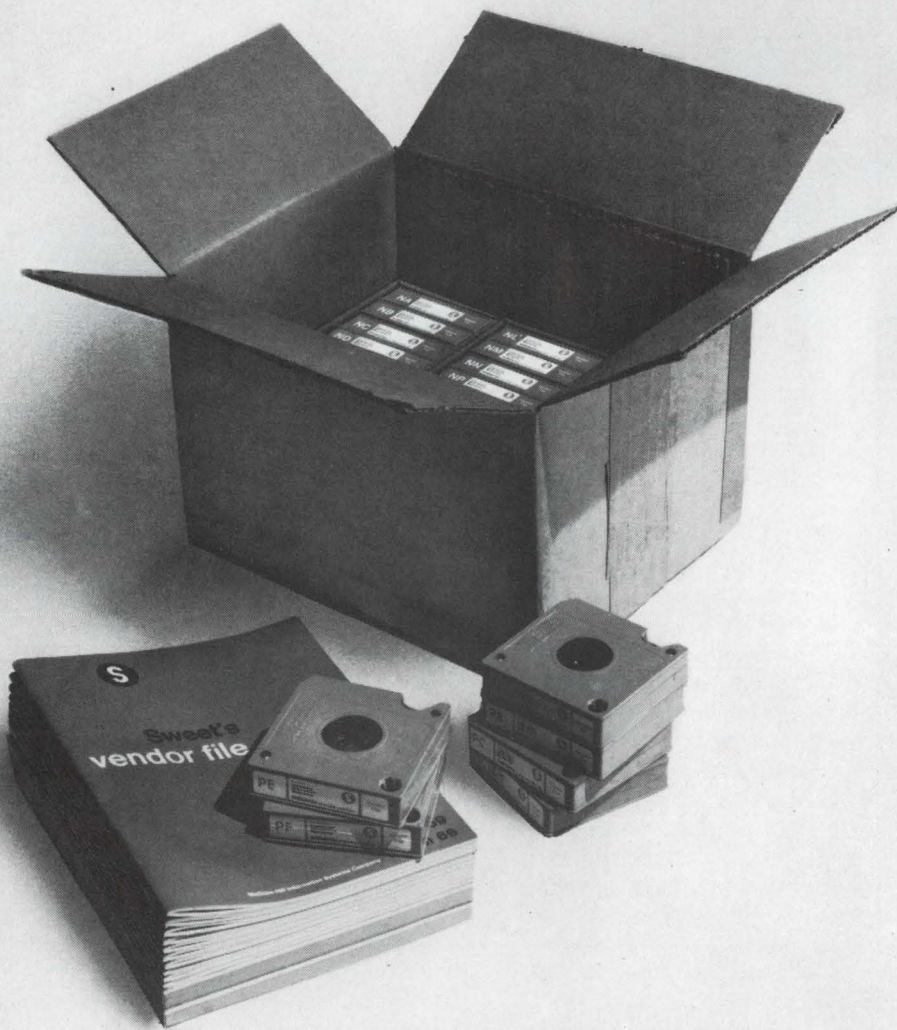





## Every other month, Sweet's Microfilm System packages the data explosion

In 5 minutes, you can collect, index and file the data explosion. That's the amount of time you'll spend every other month putting the latest Sweet's Microfilm System update into the cartridge carousel. Essentially zero-maintenance; Sweet's has done all the work.

We mail about 30 cartridges in each bimonthly update of our product/vendor file. The *total* of current information is already more than three-quarters of a million pages. *More current information than contained in any other system... updated more often, more thoroughly, than any other system.*

A typical update will contain new and revised data from about 800 important industrial suppliers... 75% of them new to the file. For example we've recently added a 3500-page apparatus handbook... and lots of smaller but equally important firms too. And we keep them all up to date.

How could you possibly keep up with all this new data? Obviously, you can't. Sweet's can, with a simple plan and

a computer. The plan is simply that we don't charge anyone to get their data into our File. *So we get all their data, and new information as soon as it issues.*

Then a computer takes over, after we've thoroughly indexed the new data. A complete new index is printed out by computer for every update. Over 6,000 product entries, plus vendor index, speed you to the right information in minutes. (You'd have a terrible time finding data if we just issued supplemental indexes with the updates.) If you want a copy of the data you've found, our reader/printer delivers one in 6 seconds... *and the File remains wholly intact.* No data gets borrowed, and the cartridges easily go back into the carousel without filing confusion.

Sweet's Microfilm also has several other important data packages. Our MIL Specs file has all of them, complete, updated with a new index every month. Another package contains five important sets of MIL Standards. And, we've just added the ASTM Standards to the system, *exclusively.*

These standards are conveniently offered in four sections, with automatic updating every two months.

Now, Sweet's introduces a new data system: Characteristic Search. The capability is fast survey and comparison of product areas. The first segment, the six-volume Electronic Instruments Edition, will issue shortly. More than 35,000 electronic instruments have been described with up to 15 important parameters; manufacturer's data is in the Microfilm System for final reference if needed. Use the coupon to get information on this new system.

You may already be sold on microfilm for data storage and retrieval... because of the amount of data there is now... and the amount that's coming next month. Sweet's is not the only system available. But Sweet's Microfilm System has more data than anyone. And we update more often, to make sure things stay that way... and to make sure your engineers find what they want, fast.

***We make engineers out of engineers.***

**SWEET'S INDUSTRIAL DIVISION**  
McGraw-Hill Information Systems Company

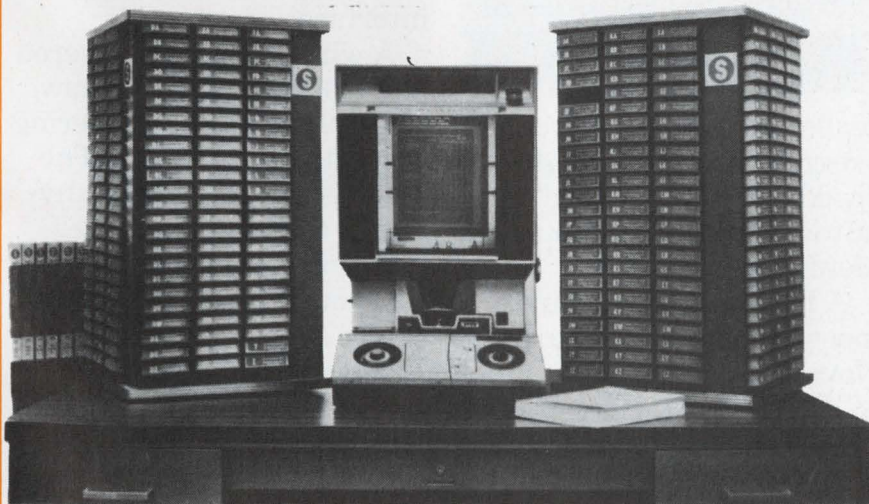

Please send a complete information package on:

- Sweet's Microfilm System.
- Sweet's Characteristic Search: Electronic Instruments
- ASTM

Name \_\_\_\_\_

Title \_\_\_\_\_

Company \_\_\_\_\_

Address \_\_\_\_\_

City \_\_\_\_\_

State \_\_\_\_\_ Zip \_\_\_\_\_

Send to Sweet's Microfilm System, Dept. EL57C, 330 West 42nd Street, New York, N.Y. 10036 or call G. O. Stevens collect at (212) 971-3586.



# LAST YEAR DATA GENERAL OPENED ITS BIG MOUTH AND INTRODUCED "THE BEST SMALL COMPUTER IN THE WORLD!"

We were cocky when we brought out our Nova a year ago.

We knew we had the best small computer in the world, and we weren't embarrassed to say so.

So maybe we came on a little strong.

And maybe some people said, "Put up or shut up."

But look at what we put up:

The first mini computer built around medium-scale integration.

The first mini computer with a multi-accumulator organization, an expandable



read-only memory you can program like core, a high-speed data channel and automatic interrupt source identification.

A big plant, so we could mass produce the remarkable Nova.

A technical service group

big enough to really service our customers.

And a price of \$7950 (rack-mountable version) with a basic 4096 16-bit word memory and Teletype interface.

A while back, we delivered our 100th Nova. We're now well on our way to delivering several hundred more. The Nova is a smash hit by anybody's calculations.

Of course, if this computer had bombed, we'd have felt pretty silly.

But we'd have felt even more surprised.

**NOVA**  
**\$7950**



# THE MOUTH STRIKES AGAIN.

Introducing the best small computer in the world.

The Supernova. With all the features that made the Nova a great mini computer. And a price of \$11,700.

Maybe you wonder why it costs \$3750 more than the Nova.

For one thing, the Supernova is the fastest small computer in the world. Add time is 300 nanoseconds in read-only memory, 800 nanoseconds in core.

And by overlapping fetch and execute cycles in read-only memory, the Supernova



has an effective operating speed that's 3-10 times faster than its competition's.

Core memory is expandable to 32,000 words and interchangeable with read-only. The same programs run in both memories.

As options, Supernova has

a hardware multiply/divide and memory- and I/O-protect hardware. Automatic program load is standard.

Supernova's hardware and software are compatible with Nova's.

Does all this mean we've obsoleted the Nova?

No, it doesn't. It just means Data General now has the *two* best small computers in the world.

So if you thought we had a big mouth before, we'd better warn you:

We have not yet begun to bellow.

**SUPERNOVA**  
**300-NANOSEC. ADD**



# IRRAVIN<sup>TM</sup>

INSULATED WIRE

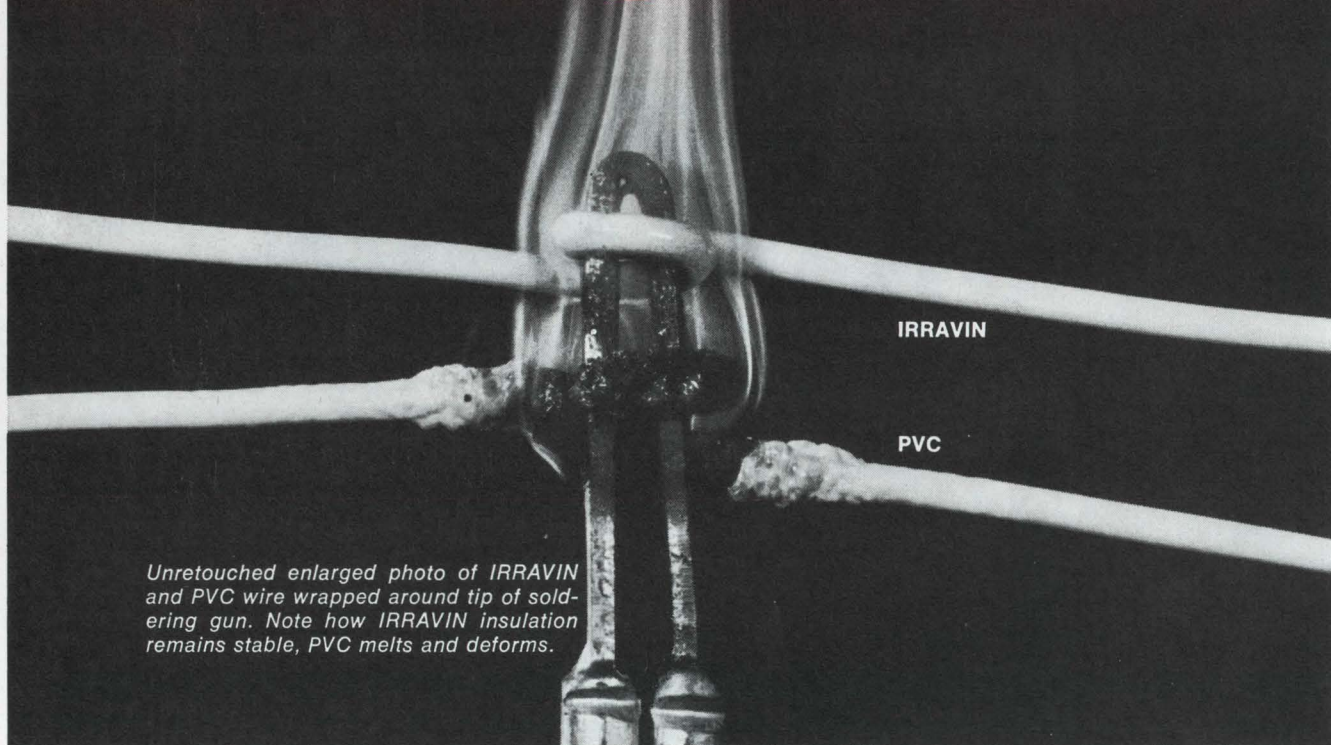

*Unretouched enlarged photo of IRRAVIN and PVC wire wrapped around tip of soldering gun. Note how IRRAVIN insulation remains stable, PVC melts and deforms.*

## Hot problem...cool solution.

IRRAVIN insulation won't melt, flow or shrink back.

This photo was made to demonstrate the solder iron resistance of IRRAVIN insulated hook-up wire, compared with ordinary PVC insulated hook-up wire. It's proof that low-cost IRRAVIN wire suits applications where heat, even direct hot solder iron contact, is encountered. IRRAVIN insulation won't shrink back, or deform. It stays in place to maintain insulation integrity.

IRRAVIN wire can be soldered in snug spaces, even when terminals are

closely set. This, in addition to a small O.D., means space-savings, reduced rework and production time, less scrap.

To get the same product advantages of IRRAVIN wire you would have to specify wire that costs a lot more, two to three times more in fact! With IRRAVIN wire you not only save on time, space and waste. . . . you save on the initial cost too!

Don't just take our word for it. See for yourself with a sample.

Don't just take our word for it. See for yourself with a sample.

It's yours FREE! Write ITT Surprenant, a division of International Telephone and Telegraph Corporation, Clinton, Massachusetts. In Europe: ITT Europe-Components Group, Lister Road, Basingstoke, Hants, England.

**IRRAVIN**—the wire that stops the grumbles.

SURPRENANT **ITT**



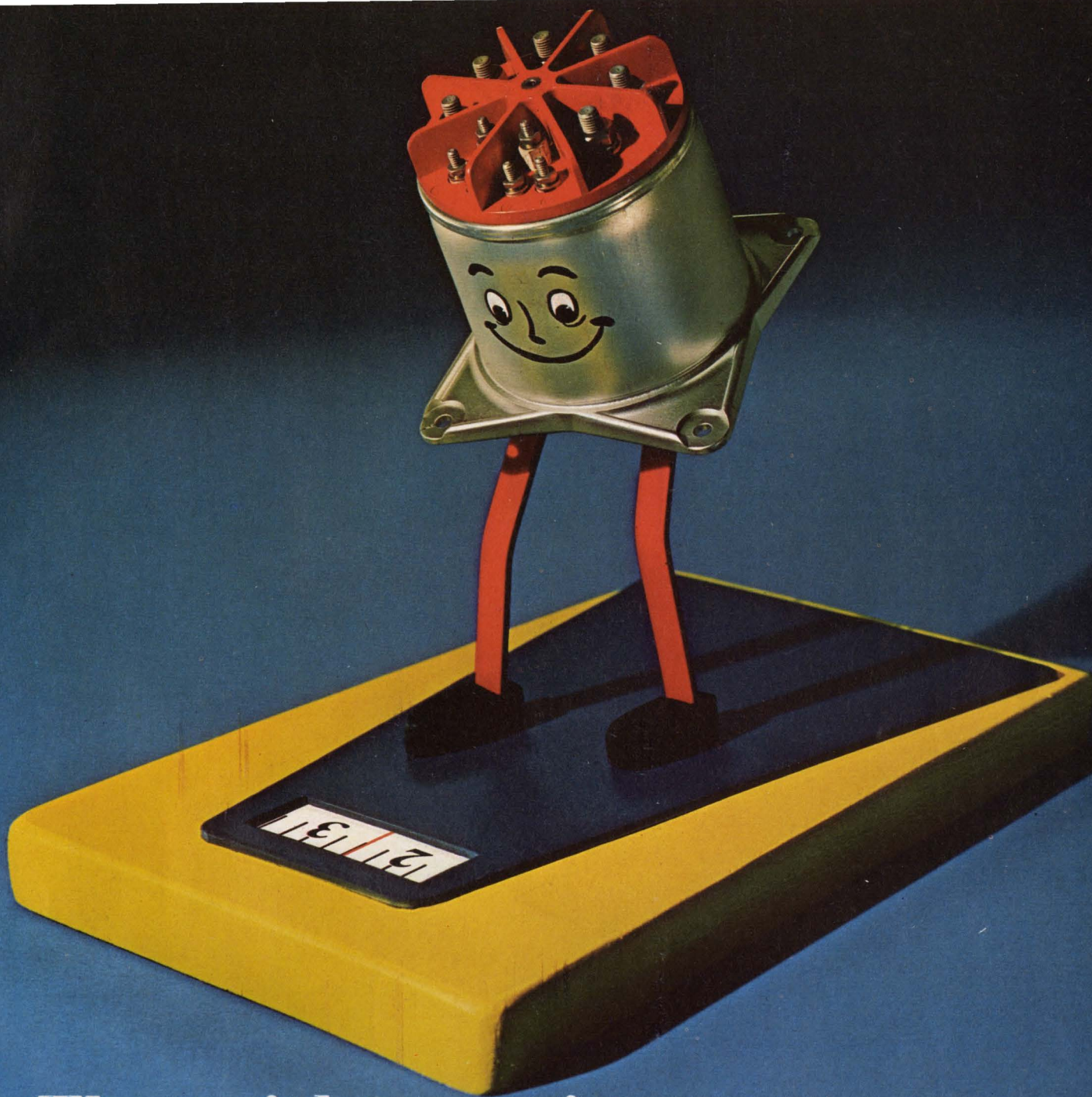

## The weight-conscious contactor...

### (for heavy-amp applications)

Twenty-two percent lighter for 150 amp applications than any existing 100 amp contactor: 3 lb. max. to be exact. That's right, the new Guardian 150 amp Series 4400 Contactor is 22% lighter and 16% smaller in volume than any existing 100 amp contactor.

Unique? You bet. And there's more. The 4400's design features internal as well as external phase isolation. It's unique—again—in offering a hermetically-sealed coil to prevent contact contamination, plus a hermetically-sealed unit outer cover.

Available 3 PSTNO normally open with 10 amp (*not* 5 amp) auxiliary contacts, the 4400 is designed for 240/416 VAC, 400 Hz systems of the future as well as 115/200 VAC, 400 Hz and 28/30 VDC systems of today.

A new 75 amp contactor, the Series 4500, offers the same basic design advances. For complete specifications and test reports on these two new weight-conscious contactors that let you do more with less, write for Bulletin D3.



**GUARDIAN<sup>®</sup>  
ELECTRIC**

MANUFACTURING COMPANY 1550 W. Carroll Ave., Chicago, Illinois 60607

Circle 75 on reader service card







# automate

## Unique Gardner-Denver Wire-Wrap<sup>®</sup> machines

wire back panels at the rate of  
**1,600 connections an hour...**  
**without error**

What happens when you try to wire panels where the pin matrices have 0.100-inch centers? You create a rat's nest, that's what, unless—

Unless you use a Gardner-Denver Wire-Wrap machine. Wire-Wrap machines, assisted by computers and instructed by punched cards, automatically position the back panels, cut the wire, strip the insulation from it, and wrap the wire around the desired terminals—at a speed 25 times faster than hand-soldering. Complete computer back panels may be wired in 2 hours.

Cost-savings, needless to say, are spectacular, can range as high as 50 to 1 over hand-soldering.

And the connections are reliable, remain airtight even when exposed to extreme changes of temperature and humidity. Not a single reported electrical failure in billions of connections. There's minimum crosstalk between wires. The wirepath consistency is nearly equal to that of printed circuits.

So sensitive to error is the Wire-Wrap machine that it will stop if it detects an error in card sequence or card punching. Wiring defects stop the machine immediately so the operator can correct them.

Wire-Wrap machines today are widely used in fabricating telephone exchanges, computers, communications equipment, guidance systems.

Call today for complete information—or write for Bulletin 14-121.



## GARDNER-DENVER

Gardner-Denver Company, Quincy, Illinois 62301



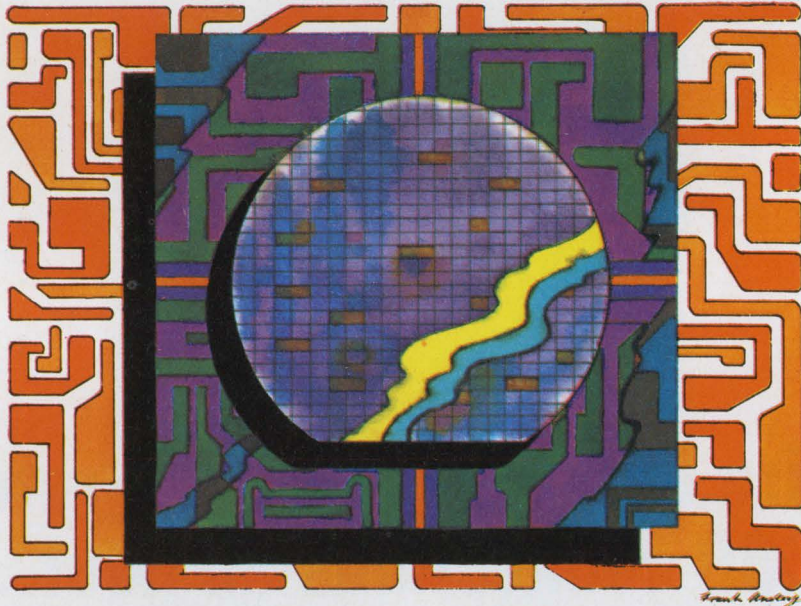

# MOS/LSI WAFERS

Here's your opportunity to take advantage of MOS/LSI in new equipment designs without getting involved in lengthy negotiations, high costs, design compromises and next year deliveries!

If you're doing microelectronics design, MOS/LSI implementation can be easier than you think... without building a semiconductor facility within your plant you perform the tasks that best enable you to add value to your final product.

Cartesian's MOS/LSI lets you re-assume design responsibility and perform those manufacturing operations which you can easily handle. We take care of mask-making and wafer fabrication.

From your layout, we prepare masks and produce prototype wafers in quantities of ten for about \$100 each plus cost of mask-making... production-run quantities for less. We guarantee integrity. Turn-around time is normally five weeks, less if you provide masks. No design compromises unless you make them.

No subordination to the demands of semiconductor companies, no loss of proprietary design rights, and no staggering costs. Sound interesting? Write for a free copy of our MOS/LSI Implementation Guide and see how easily you can take advantage of the opportunities in MOS/LSI!

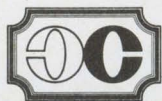

## CARTESIAN, INC.

10432 NORTH TANTAU □ CUPERTINO, CALIF. 95014 □ PHONE (408) 257-0481





## Win a free jar of CHERRY jam

*Just guess who is  
the fastest growing  
manufacturer of  
snap-action switches*

Consider these clues, then test your Buying Awareness by completing the coupon below. Prizes will be shipped promptly . . .

**CLUE #1** They shipped their 100,000,000th switch last year.

**CLUE #2** They invented the new "Leverwheel" switch.

**CLUE #3** They applied Gold "Crosspoint" contacts to snap-action switches for low energy circuits.

**Please complete and  
send coupon to:**

**ANONYMOUS  
ADVERTISER**

1650 Old Deerfield Road  
Highland Park, Illinois 60035

I think your name is \_\_\_\_\_  
Send my prize now.

I give up . . . send my prize anyway!

NAME/TITLE \_\_\_\_\_

COMPANY \_\_\_\_\_

ADDRESS \_\_\_\_\_

CITY/STATE/ZIP \_\_\_\_\_



# BURROUGHS DEVELOPS... SELF-SCAN PANEL DISPLAY

## the most significant development in electronic display

Burroughs, the originator of NIXIE® tubes, now revolutionizes display technology with the first commercially practical dot matrix display system. It took SELF-SCAN panel display, the remarkable Burroughs invention that takes the electronics out of the present electronic display ... reducing costly drive circuitry up to 90%.

With a minimum number of leads and drivers, Burroughs' system automatically scans data input into in-plane readout characters formed by glowing dots ... making possible a totally new combination of readability, minimal packaging and cost advantages.

The new flat-panel display is basically a matrix of small gas discharge cells hermetically sealed between heavy glass plates in a sandwich configuration. The matrix itself, formed of insulating material, has small grooves on its top surface to allow positioning of information anode wires which intersect each hole. Cathode conductors behind the center sheet intersect at each cavity with a second set of anode wires.



By utilizing the phenomena of preferential glow transfer and glow shifting, the initial glow caused by cathode ionization in the dot matrix may be moved through selected holes to a visible position on the top surface. A sequential flow of light is thus achieved without separate drivers for individual columns and rows.

Burroughs' alphanumeric SELF-SCAN panel displays are available with or without memory for any application requiring 16 or 18 digit readout.

Write today for descriptive brochure, Burroughs Corporation, Electronic Components Division, P. O. Box 1226, Plainfield, New Jersey 07061. Tel.: (201) 757-5000.

Burroughs 

Electronics | October 13, 1966

Circle 80 on reader service card



# Technical Articles

---

**Computers make  
big difference  
in MOS designs  
page 82**

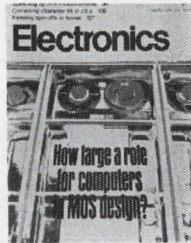

How large a role does the computer have in designing MOS circuits? Apparently, when it comes to custom circuits, the machine has a dominant role. Not only does it lay out and partition the circuit, but it builds the circuit with standard cells where it can and designs new cells where it can't. After both device maker and customers' check the layout, the computer prepares the instructions for fabrication, controls the cutting of the masks, and even produces the testing procedures. The result: vendors can deliver custom MOS circuits within a few months after a user sends in his first logic diagram.

**Taking the heat off  
thermocouple  
failures  
page 96**

In industrial applications, where thermocouples are used to control processes and to safeguard the plant, there's too much at stake to let open thermocouples go undetected. Testing just a few of these sensors is one thing, but testing hundreds of thermocouples is something else altogether. And in high-speed scanning systems, conventional methods of testing these sensors are anything but satisfactory. Engineers at the Leeds & Northrup Co., however, have come up with a solution—an open-circuit detector capable of testing 250 thermocouple circuits a second. Designed specifically for digital data-acquisition and computer-control systems, the detector signals the outcome of each test to the system's computer.

**Memories: Boosting  
performance  
and speed  
page 105**

Either you make a memory operate faster or you make it appear that way, with the latter route becoming increasingly popular. Used successfully in IBM 360/85's and 360/195's—not to mention other machines for which it is being investigated by other manufacturers—this approach is based on a secondary memory, a smaller but faster unit that serves as a cache and stores data needed by the computer. The main memory transfers the data to the cache at relatively slow speeds. Of course, you can always make a faster memory. With ferrite cores, this means making the cores smaller—the smaller the core, the faster it switches.

---

## Coming

**Air traffic control:  
Girding for the 1980's**

The FAA, criticized for its failure to come up with an adequate air traffic control systems plan as well as its inability to incorporate the latest technology, has developed a blueprint for a system capable of handling the heavy air traffic anticipated for 1980 to 1995. The technology required for this new generation system will be spelled out in a staff-written report.



# Computers make a big difference in MOS designs

From just a minimum of design input, machines not only lay out customized circuits, but they provide fabrication instructions as well; in fact, says associate editor *Lawrence Curran*, computers do just about everything.

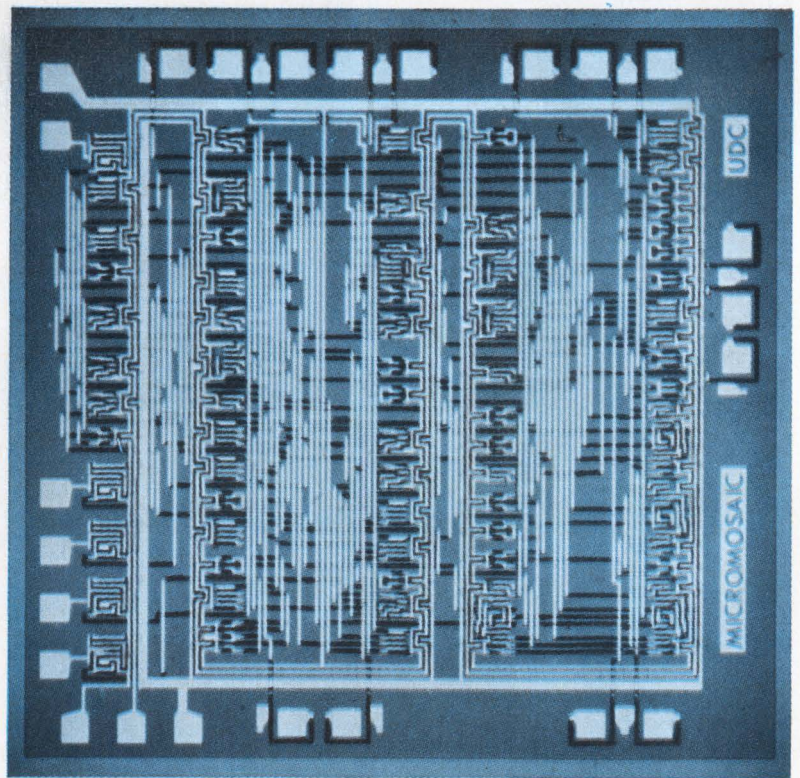
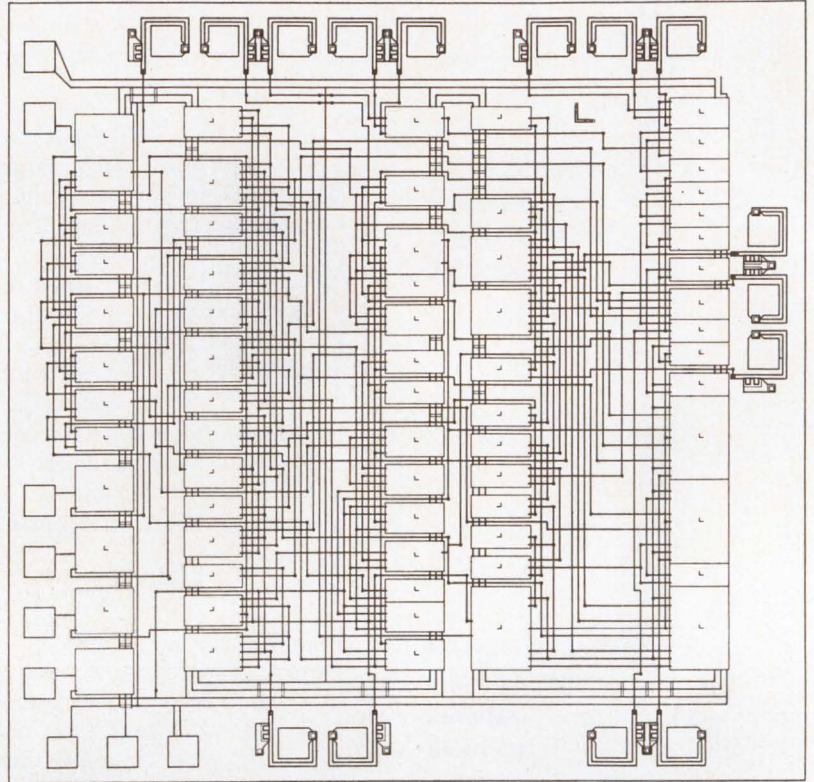

**Before and after.** In block-composite form from a computer is a circuit developed at Fairchild Semiconductor. The circuit is a four-bit up-down counter.



● Largely as a result of a growing demand for custom-designed MOS IC's, circuit makers are beginning to rely more and more heavily on automation. Computers can do everything from turning a set of logic equations into a circuit to printing out instructions for fabricating the integrated circuits. They're storing cells (the standard subcircuits put together to make the IC's), partitioning logic, and controlling the generation of artwork.

Speed is the computer's main contribution to the metal oxide semiconductor industry. Starting with just logic equations, the Collins Radio Co. can turn out circuits within 60 days. And the industry average is around 14 weeks. When done by hand, custom designing an MOS IC is sometimes a six-month task.

However, to ensure that this fast turnaround time doesn't become excessively expensive, the buyer should understand the design and manufacturing process. For example, the buyer who hands the circuit maker a set of equations and says "build it" is going to pay a lot more for his circuits than the man who gives the maker already-partitioned logic diagrams.

The buyer can learn quite a bit about the various custom MOS houses before selecting one. Probably the best single document source of information that the vendor can provide in the early discussions is his complete cell library. Cells vary in complexity from maker to maker, which partially explains why some have a few hundred

cells in their libraries while other makers have as few as 50 cells in theirs. After perusing the library, the buyer can quickly see if the subcircuits he needs—be they output buffers, binary adders, flip-flops or gating arrays—either are in library themselves or can be made from already-designed cells. If they aren't or if they can't, he'll have to pay time and money for the design of new cells. His alternative is to redesign his logic, making sure that his functions can be synthesized with standard cells.

At the Collins Newport Beach, Calif. facility the library has about 175 cells. Collins also offers the potential buyer a set of computer programs with which the customer can design his own logic. Thus, Collins engineers are less involved in the actual designing and partitioning than they would be if the programs weren't around. Collins officials, noting that they usually charge from \$8,000 to \$12,000 per circuit for design, estimate that the buyer's design participation saves him \$3,000.

The first buyer that Collins signed for its custom-MOS service was the Viatron Computer Systems Corp., the Burlington, Mass., firm that's offering a computer with peripherals that rents for \$39 a month [*Electronics*, Oct. 14, 1968, p. 193]. Viatron agreed with Collins to develop nine chips just a few days after Collins announced the beginning of its customer-controlled MOS design automation system at Wescon this year. George Grondin, assistant director of Collins' Equipment division and the man most familiar with the software aspects of the system, reports that of the 1,000 cells included in those first nine Viatron chips, only eight cells were not in the Collins library and had to be designed.

**At American Micro-Systems Inc.**, in Cupertino, Calif., the library has some 70 to 80 cells. One difference between Collins and AMI is that if an AMI customer has to have cells designed and then returns a year or two later wanting the same cells, he may have to pay development costs all over again. Andy Prophet, AMI's supervisor of digital products, says that if there has been a process change, the standard-cell library will be updated while the customer's special cells won't be. Collins' Grondin stresses, on the other hand, that the customer's special cells can be stored.

James Downey, Fairchild Semiconductor's section head for MOS array engineering, says that his division's cell library has about 55 cells. A good many of them are listed in the 24-page "primer" Fairchild gives to potential customers. Called "Micromosaic arrays . . . an MOS approach to customer LSI," the pamphlet contains Fairchild's process specifications; an explanation of the symbols used in logic diagrams (per Mil-Std-806B); and information on packaging and testing options. It also shows the organization of a representative custom array, with cell dimensions, standard cell interconnection alleys, customized interconnection patterns, and bussed voltage and distribution lines. In addition, it has an introduction to the division's Fairsim, the format with which customers can encode array designs on punched cards.

The document's last page is a custom-array technical specification sheet, which the customer can submit to get a quote on his job. The sheet has space for detailed electrical specs and package preference in addition to a place where the customer indicates how much help he wants.

The customer may choose the performance specification as the initial interface point. This choice means more work for Fairchild engineers than would be required if



the customer were to supply a cell logic diagram and functional test specifications. If the logic diagram, technical and test specs are firm, Downey says, it takes Fairchild engineers at Mountain View, Calif. just 30 minutes to come up with a firm price quote and delivery data.

Besides the Micromosaic array primer, Fairchild also has a 35-page Fairsim user's manual that acquaints customers with control language and computer simulation of digital systems. However, Fairchild engineers are quick to emphasize that a customer doesn't have to know computer programming before he can use the Fairsim approach. But, Downey says, "The more detailed information the customer gives, generally, the lower the price he'll get." This is not to say that Fairchild won't take on the whole systems design job for the customer who doesn't want to tackle it. They will as will AMI. But Collins' emphasis is on having the customer do the lion's share of the design.

**Collins has a four-volume** MOS design automation manual which outlines design rules, lists the standard cells, and gives general instructions for specifying circuits. But the firm has decided to boil the huge set down into one volume that will take the customer up to the point of automatic generation of artwork and just short of mask making, where the customer drops out of the loop. The new manual will be available this month.

Collins also relies on face-to-face exchanges with potential customers and an eight-page spec sheet that calls out performance characteristics for its four different manufacturing processes to acquaint customers with its custom-design automation facility.

Although systems engineers are available for consultation on logic partitioning, Grondin expects that once the one-volume user's manual is distributed, little "hand-holding" with the customer will be required once the logic equations reach Newport Beach. Collins assumes that potential customers are aware of the advantages and limitations of MOS when they prepare their logic design. "For example," observes Grondin, "a customer should know that he can't get speeds of 20 megahertz with MOS logic today."

AMI counts heavily on its cell list to impress its customers, but beyond that, the firm has a team of systems designers available to design and partition the logic. These specialists also are available for any other assistance the customer may need. AMI's Prophet says that

his firm has 12 engineers in applications engineering, the first group the customer deals with. "These people represent a merger of two disciplines—systems engineering and MOS design—and they are critical people to find."

AMI offers a virtually fully automated design process when the majority of the cells called for are in the library. Another opinion entails manually drawn cell and circuit-block composites and automatically generated artwork; a third option involves a complete manual design from laying out the cells through drawing the circuit block composite to making the artwork.

At Fairchild, Downey's Micromosaic design group is backed by five men in array systems engineering whose initial job is to draw the logic circuit if a customer doesn't choose to submit one.

Texas Instruments begins working with its customers at any point in the MOS design sequence, depending on the customer's wishes and experience. As a starting point, TI accepts any input from design concept, logic equations, or logic diagram, through logic circuit designs or partitioned designs, up to numerical-control tapes for making artworks, finished artwork or glass masks. The company draws the line only at processing partly finished silicon wafers. These present too many difficulties because of differences in processing techniques, says Dave Roop, TI's MOS marketing manager.

From logic equations up, TI's design procedure is

**Who does what.** A great deal of information flows between Collins and the customer in an automated procedure for designing custom MOS circuits.



# Automated MOS Design Procedures

## Customer

## Collins

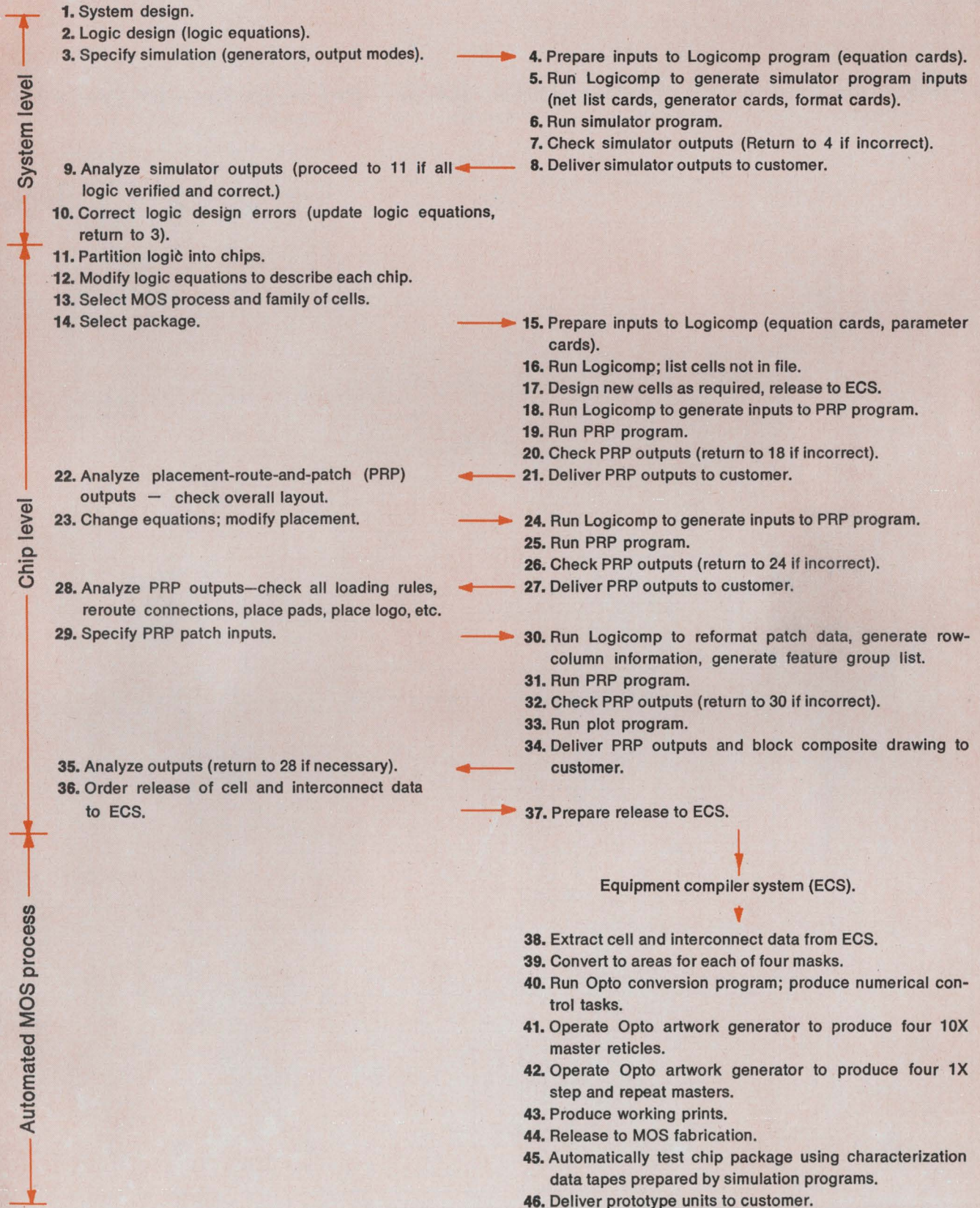



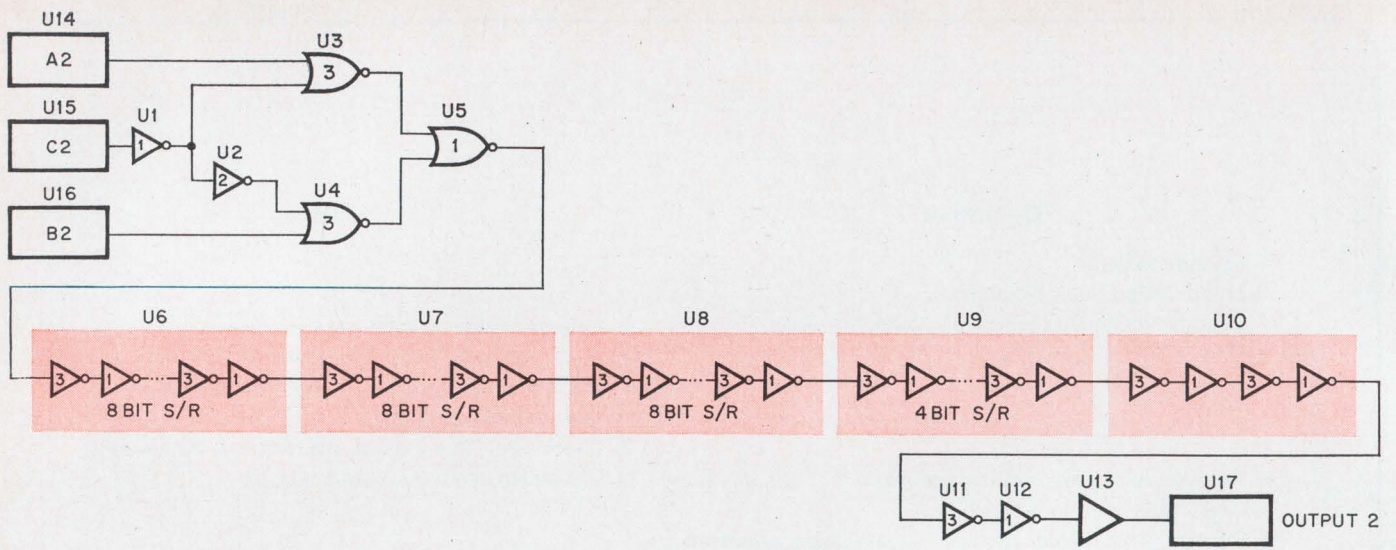

DUAL 32-BIT SERIAL ACCUMULATOR

FINAL BLOCK COMPOSITE

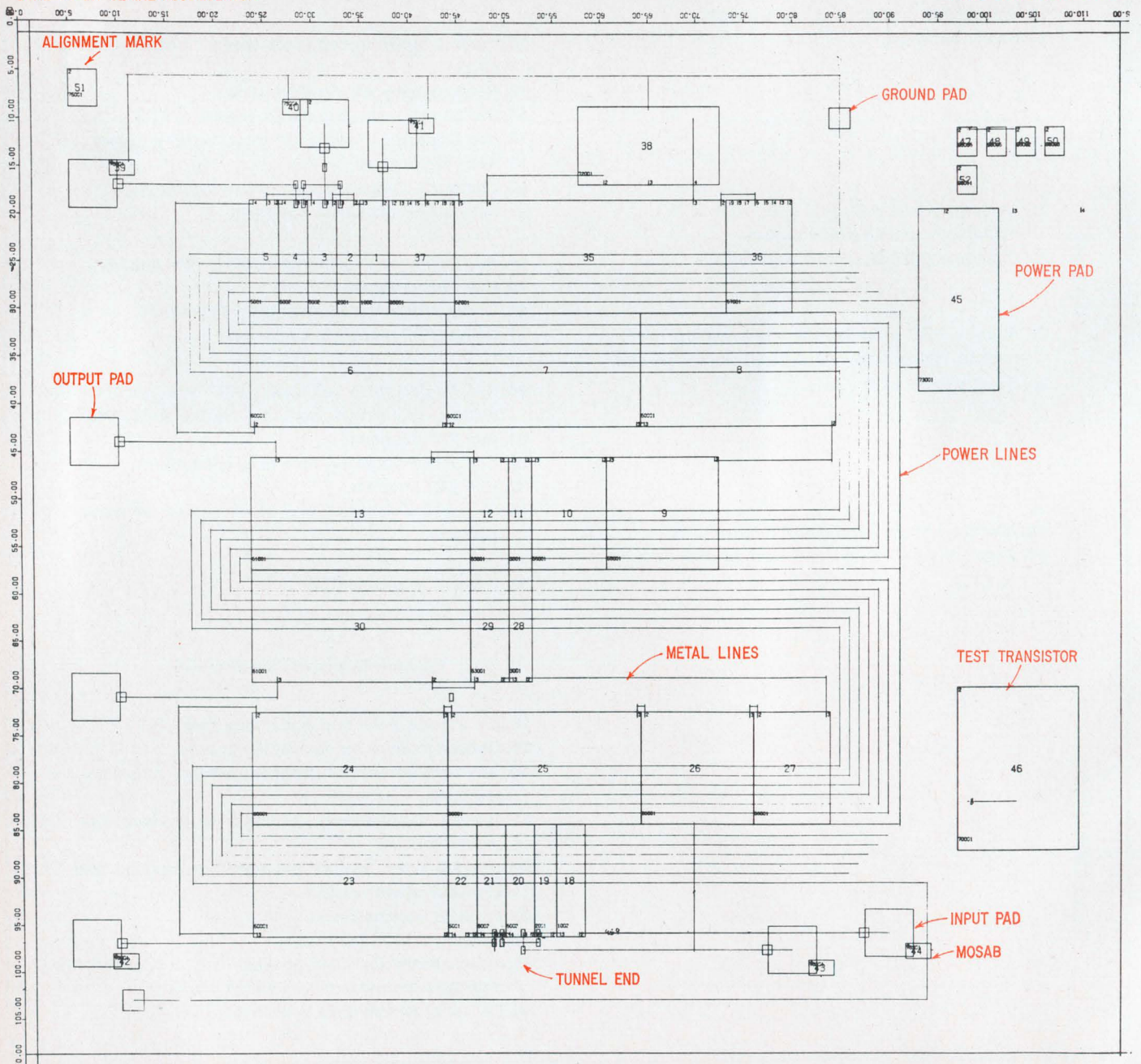



**Half-chip.** The dual 32-bit serial accumulator chip developed at Collins has two circuits of the type shown at left. The numbers coded "U" refer to cell numbers, called out in the final block-composite plot, below.

"automated all the way," Roop says. No masks are cut by hand, and even the test patterns and logic checks are computer-generated. "We just can't do these things by hand," Roop says, "there aren't enough draftsmen." He cites as an example of the large-volume turnover the fact that a present customer is calling for the design processing of 30 separate circuits, all of which have to be done simultaneously so that all the circuits will be completed at the same time. Thanks to TI's automated facilities, this program is being handled by only six engineers.

TI is "probably less formal than other manufacturers" in the information it supplies customers, Roop says. For example, the company doesn't furnish a brochure with design rules to prospective customers. However, TI does supply a design manual "once a customer is engaged," Roop says. There are two main reasons for this informal relationship: TI regards many of its design rules as confidential, and also it's constantly updating them.

Once engaged TI's customer gets one of two kinds of information, depending on what he needs and how much he's willing to invest in the designs: a basic cell library of standard sub-circuits or a set of basic design rules without the cell library.

TI also has "a cadre of experienced personnel" to train the customer's engineers, Roop says. "We can educate them in a week or two (in the bare essentials) and then send them home to work. Or we can provide closer liai-

**Final Block.** The accumulator, in final block-composite form, shows the computer-designed chip layout with the test transistor added to the chip.

son and have them work with our engineers."

If the customer does the entire design work and supplies error-free masks, turnaround time is six weeks, Roop says. He points out that the IC's can be made in a shorter time, but six weeks is a "realistic" figure that takes into account the intricacies of production scheduling. The lead time grows when the customer calls on TI to take on more of the design and layout work. TI engineers need one to two months to design subcircuits from a logic diagram, two to four weeks to partition, one week to prepare numerical-control tapes, one week to prepare artwork, and two to three weeks to make masks.

Roop reports that most customers want to design tests and supply test patterns to TI. However, "testing is probably one of the most hazy areas in MOS," he says. TI has found it's best to use its own computer systems to check out the customer's testing requirements.

**The process flow** from receipt of the logic design to delivery of parts differs from company to company mainly in the degree of automation at each step. At some stages in all the automatic processes a design engineer looks at the chip layouts developed by the computer, and makes any needed improvements.

At Collins the customer first sends in his logic equations, along with an indication of the kind of simulation he wants performed.

Grondin says: "We don't force the customer to specify the simulation, but we have SIMOS, TESSI, plus simpler ones that allow him to define the driving inputs and tell how long he wants the simulation to run." Regarding simulator outputs, Grondin explains that the customer can call out every node in his system to find out what its logic state is under any drive condition for whatever number of clock pulses.

Collins engineers then translate the equations and the simulation into punched-card inputs for the Collins' Logicomp program, which converts the equations into the format required for the simulation program. Then Logicomp is run again to generate the simulator program input, such as net list cards and generator cards.

After the generated program checks the simulator outputs, the simulator's printout is sent to the customer, who analyzes the logic simulation and corrects any design errors by altering the appropriate equations. The new equations go back to Collins where a second simulation is generated. This exchange of simulations and



equations continues until the customer is satisfied.

Once satisfied, the customer partitions his logic onto individual chips and then does some redesigning to accommodate the logic requirements of each chip, such as providing higher drives at a chip's input. Then he picks an MOS process (static or dynamic, two- or four-phase, high- or low-threshold) and along with it the proper cell family, and selects a package. All of this information goes to Newport Beach where Collins engineers prepare the equation and device-parameter punch cards that serve as inputs for the Logicomp program. The program is then run, calling out cells from the library to be used, and listing those cells not in the Collins file. After the new cells are designed, they're released to the equipment compiler system (ECS). The ECS program puts the new cells into the library, digitizing all the information needed to make masks.

**Next the Logicomp program** runs again, this time to generate information for a placement, route, and patch (PRP) program. Patching is the technique the customer uses to change the computer-generated designs. The PRP program is then run, and Collins engineers check its outputs, which include the identity of the cell library used; the assignment of gates to patterns; a net list and net capacitance; and the coordinates of each cell, interconnect line, and unwired test device on the chip. The important program outputs go to the customer, giving him a complete digital description of his layout. Collins puts any further modifications from the customer into the Logicomp program which generates new inputs for the PRP program. After the PRP program runs again, its outputs are sent back to the customer for further scrutiny.

Using the PRP outputs, the customer next checks all node loading rules, reroutes connection if necessary, positions the contact pads, and puts his logo on the part. All this is done by making manual patches to the line printer plot. When the customer specifies these new patch inputs—eliminating an interconnect, for example, by calling out its coordinates on the line printer plot—Collins again runs the Logicomp program to reformat patch data, to generate row-column information and any mask alignment marks, and to test transistors and bonding-pad data peculiar to the chip. The results are new inputs for the PRP program. Collins runs the PRP program again, checks the outputs, and delivers a revised line printer plot to the customer, along with a block composite drawing.

The customer is now in the final design stages, and will probably be checking the PRP outputs and block composite for such details as good ground connections to the substrate, pad locations far enough from the chip perimeter, and correct bussing. If he's satisfied, the customer orders his cell and interconnect data released to the equipment compiler system, which generates artwork and instructions for wafer fabrication.

The fast turnaround once the job reaches the ECS is what Collins believes makes its system unique. Three principal programs are called into play. The first extracts all the digital information for each of a circuit's four masks and stores it. The second handles what Collins calls "smashing"—breaking the composite's outline polygons into a group of rectangles compatible with the variable-aperture camera that makes 10X masks in the first of two steps that leads to a 1:1 step-and-repeat master for the fabrication masks.

The third translates the "smashed" information into paper-tape commands that control the aperture, the table on which the master reticle is mounted, and the camera's flash mechanism.

Commands on a second paper tape convert the camera into a step-and-repeat camera, after a second lens reduces the master reticle by a factor of 10.

With this optical system, Collins needn't make ruby-lith masters and turns out a mask an hour. The company wants to cut that time to 20 minutes by next year.

**After the circuits** are made, Collins uses one of two methods to test them. The firm's digital pseudorandom inspection machine runs both of them. In the first approach, inputs for a chip simulator are derived from the customer's logic equations, but the initial logic state must be specified by Collins. The tester's logic is also simulated to produce a routine that sets the simulated chip to a known reference state. The tape containing the routine is loaded into the tester, and production devices are checked against the simulated reference chip. The clock may be run for, say, 512 pulses, at which time the logic levels of all the output leads are stored in a register. While the test continues, a comparison of the stored logic levels against the simulated reference is made. Another "snapshot" may be made 512 clock pulses later, and the same kind of comparison made. This test is run at from 1 to 2 megahertz, and is run longer than more







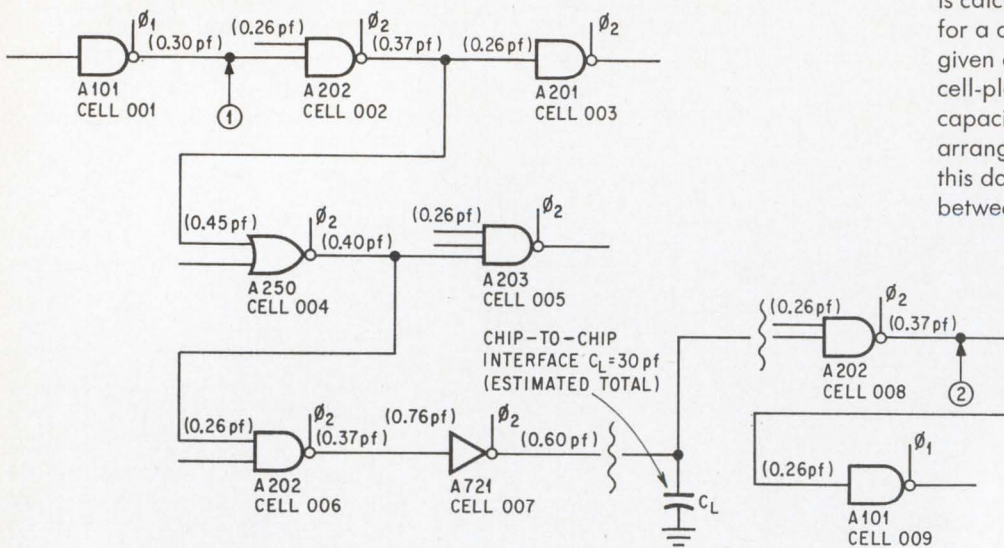

**Computation.** A typical design problem is calculation of propagation delay for a chain of logic gates driven by a given clock. American Micro-Systems' cell-placement program provides capacitance values after the cells are arranged in an optimum layout. From this data, the worst-case propagation between point 1 and 2 is then calculated.

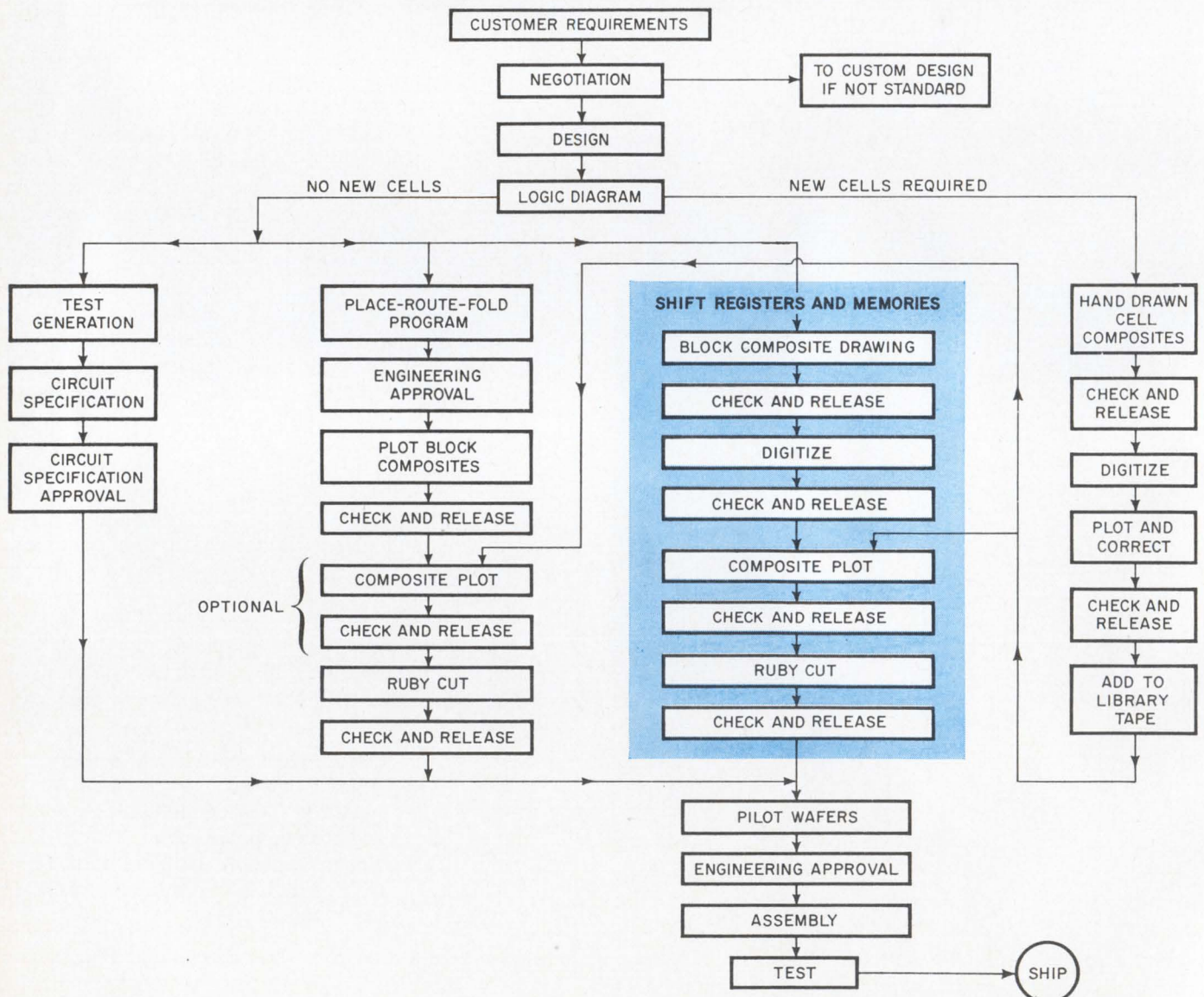

**Simpler path.** The design and reduction process at American Micro-Systems shows that shift registers and memories follow a simpler path than less repetitive circuits. In either case, test generation is performed in parallel with design process.



rigid test sequences because of its pseudorandom nature.

In the second test technique, Collins assumes that a device is a good one after getting the customer's routine that sets all clocks to a known initial state. Collins runs a program to generate the reference tape for that good device; then the snapshot procedure is followed to check the outputs of the device under test against the known good device.

Although Collins' 60-day turnaround is the fastest in the MOS industry, Grondin isn't satisfied. "Within one year," he says, "I feel we'll be able to go from logic equations to the finished article in 14 days."

**AMI's Prophet** feels that supplying a logic diagram is the ideal way for a customer to ensure the fastest turnaround. The AMI manual asks the customer to prepare the logic diagram and calculate propagation delays on the nodes. Says Prophet: "We can handle 300 to 400 devices on a chip, and the optimum chip size is about 120 mils square."

If the logic diagram satisfies AMI's systems engineer, it's coded onto punched cards that identify cells by function. Interconnect paths are coded at the same time. AMI uses a Control Data Corp. 6600 computer in its system and a CDC line printer to make the wire list. Prophet says the 6600 was chosen because AMI wanted a fast computer with a large core memory. Chip-size limitations are tied not only to yield, but also to memory

size, he says and adds that the 6600 "is the best we've found" for speed and memory capacity.

Once the punched cards are prepared, any new cells required are hand drawn, their parameters being digitized by a Calma Co. digitizer; then a Calcomp 718 plotter checks the circuit for continuity and design errors. The new design is added to the tape library. Once all the cells are in hand, a special program positions the cells and draws the interconnect pattern dictating the chip layout while minimizing interconnections and optimizing cell density. The Calcomp plot of the chip layout is then checked by a circuit engineer for excessive fanout, capacitance, and chip size. The engineer may have cells and wiring rearranged if his experience suggests a better layout. Once he's satisfied with the design, a magnetic tape is generated that contains the layout.

AMI calls this layout a block composite; on it are the cell outlines (but not precise geometries), interconnect lines and tunnel ends (tunnels are interconnections below the surface of a chip), and rectangles that represent the contact pads. The composite, which has different names at different firms, is becoming important as the document on which the logic designer can sign off, confident that the computer will accurately place the right cells in the right positions.

AMI and Fairchild still make fully plotted composites of all masks needed for cutting the rubylith artwork, which is also checked for continuity and adherence to design rules. And some customers insist on seeing these fully plotted composites. Normally, however, says Prophet, the last thing the customer sees is his logic diagram. Because of growing confidence in computer programs, both AMI and Fairchild are planning to dispense with the fully plotted multilayer composites of the chip.

After the composite tape is generated, AMI technicians replace the pens in the plotter with knives; now when the tape drives it, the plotter cuts the mask pattern in the rubylith. Cutting this way takes 12 hours; by hand it's a three-week job. After cutting, the rubyliths are manually stripped and checked. Then come the conventional steps—photoreduction, the step-and-repeat process, wafer fabrication, and finally testing of the completed chip.

Prophet says that the customer who has his own logic diagram is also likely to have his own test pattern. Using these patterns, AMI engineers work out an internal specification. The logic is thus coded for use in a simulation-verifier program, and test patterns that detect and verify failures are generated. The punched cards used as inputs to the simulation-verifier program are then converted to paper tape to program an AMI-built semiautomatic functional tester. Prophet says, "Pilot wafers are probed by the tester, with approval required from both the systems engineer and the circuit engineer at the wafer probe stage. The systems engineer is the last one to sign off before assembly and final testing."

Five engineers work for Prophet in the digital products group, and, each oversees a custom-design program involving up to 16 chips. He says that AMI can handle about 12 new designs a month in its custom design automation program, and is gearing up to handle more by the end of the year. Daniel Yoder, manager of central marketing, says that circuit development costs for chips done with the design automation program can range



from as little as \$1,000 to \$1,500 for a read-only memory metal mask to a maximum of \$15,000 to \$20,000 for logic circuits.

Regarding turnaround time, AMI marketing director Glenn Dumas stresses that the firm quotes "realworld times because we're committed to on-time delivery. If everything went exactly right," he adds, "the turnaround time might be 12 weeks, but this isn't the way it happens in 90% of the cases. We'll contract for 14 weeks."

Besides the design automation program, AMI has a second approach which involves a half and half mixture of hand tooling and design automation; the block composite is laid out by hand, but is digitized so that artwork generation can be done automatically. Yoder points out that circuit development costs using this approach range from \$7,000 to \$25,000. AMI also will manually draw block composites and manually cut the rubylith if the circuits are highly complex. This approach costs between \$15,000 to \$30,000 per circuit design, and possibly as much as \$45,000 for circuits that either push the state of the art in speed, power dissipation, and chip size, or require a large number of new cells to be designed. But this approach leads to better packing density on the chip, and often lower costs to the customer in volume production.

Prophet says that the automation program can handle logic speeds of 1 Mhz using standard cells.

AMI started its design automation program last November, and has designed more than 40 circuits for various customers since then.

Fairchild got going with its Micromosaic program a month after AMI started its program, and has custom designed about 45 circuits since then. And Fairchild is working with customers on 200 new designs, Downey reports.

The process flow at Fairchild is quite similar to that at AMI. Once the logic diagram is in hand, Downey's Micromosaic group codes the network of cells onto punched cards and stores them in an IBM 360/44 computer. A simulation control language is also generated, and it yields the timing diagram to be associated with the logic.

The simulation printout is used to convey to the customer Fairchild's understanding of his requirements. If the customer approves the printout, the network description is translated into a logic diagram. Next the layout program places the cells and routes the interconnect paths.

"At this point," Downey notes, "the designer enters the loop to manually optimize real estate usage, to place cells to special pin-rotation requirements, to make sure that critical high-speed nodes are topologically small, and to shorten the interconnect paths between these nodes. There could be as many as 20 interactions at this point, ranging in complexity from moving one cell over one grid point to moving entire rows of cells." Downey points out that a circuit laid out automatically is usually about 20% larger than it would be if it were laid out manually.

After the manual manipulation is finished, two layout documents are produced. One shows the cells and interconnect paths in printout form, and is done by a high-speed IBM 360/44 printer; the other, called a stick drawing by Fairchild, shows cell locations and interconnect lines, and is similar to AMI's block composite.

Contact pad descriptions are coded in a computer program, but they have to be located manually. Downey says this manual effort represents about 20% of the work involved in manually optimizing the cell layout. Next the Calcomp plotter is used for automatic cutting of the mask artwork. A design review involving the project engineer, project designer, and supervising engineer follows manual rubylith peeling, in preparation for final mask making.

Parallel with laying out the cells, an engineer is working out a test sequence for the circuit. He first proposes a test sequence, and then a test verification program, and then checks it for such errors as stuck inputs or outputs on the cells. Says Downey: "This is usually enough to catch lesser errors, such as shorts or gate inputs taken three or four at a time stuck at various states." He says that the goal of the test-verification program is to identify any test defects that could occur but which the test designer hasn't proposed. These show up on a statistical summary of detected and undetected defects. If the design engineer is satisfied with the statistical summary, a test tape for Fairchild's 8000A array test system is generated. The designer may want to synthesize new test patterns to pin down the undetected errors before the array test tape is made.

Total turnaround time at Fairchild is 10 to 14 weeks. It takes three to four weeks after the receipt of the customer's final logic description before the artwork is finished, and usually six to eight weeks for fabrication, assembly, and testing. Jack Balletto, Micromosaic marketing engineer, is aiming for a total turnaround time of eight weeks by next spring, and says he'll do it by cutting manual cell layout optimization time. Fairchild's development charge for a custom MOS design runs from \$12,000 to \$25,000.

Most of the static random-control logic chips Fairchild has designed using the program have between 140 and 180 gates, which means the chips are between 105 and 125 mils on a side. "We like to keep the designs under 200 gates," Downey says. "We're able to go larger, but the price per unit starts to go up above 200 gates because the chips have to be larger."

Fairchild doesn't have shift registers in its cell list. But says Downey: "We've seen enough shift register requirements to add this to the family. They're not yet characterized, but they should be in our stable soon." ●



# Designer's casebook

*Designer's casebook is a regular feature in Electronics. Readers are invited to submit novel circuit ideas and unusual solutions to design problems. Descriptions should be short. We'll pay \$50 for each item published.*

## Load current monitor doesn't break circuit

By Fred H. Horan

HO-CO-LO Laboratory, Waltham, Mass.

The common method of locating overloads in complex electronic equipment—measuring current in the load—can create transients as circuits are opened and closed. To eliminate such transients, a pair of diodes, connected in a parallel front-to-back configuration, is inserted in series with each load. This allows the load current of either a positive or negative power supply to be read directly by a d-c ammeter placed across the diode pair.

The ammeter used must have a very low internal resistance and, for this reason, a Weston Model 911, which has a voltage drop of only 100 millivolts at a full scale reading of 10 amperes, was chosen. When the meter is connected across the diodes, the voltage is low enough so that the diodes have a high forward resistance allowing only a negligible amount of the current to flow through them. Thus, almost all of the current in the circuit flows through the ammeter. In this manner, the meter can be switched across any of the diode pairs to measure the current in the load without opening the circuits and causing transients.

To warn against faulty diodes, a lamp lights if any diode is open. If the lamp is off, indicating the diodes are operative, the momentary contact switch, S<sub>1</sub>, is then depressed and the load current measured in any of the circuits.

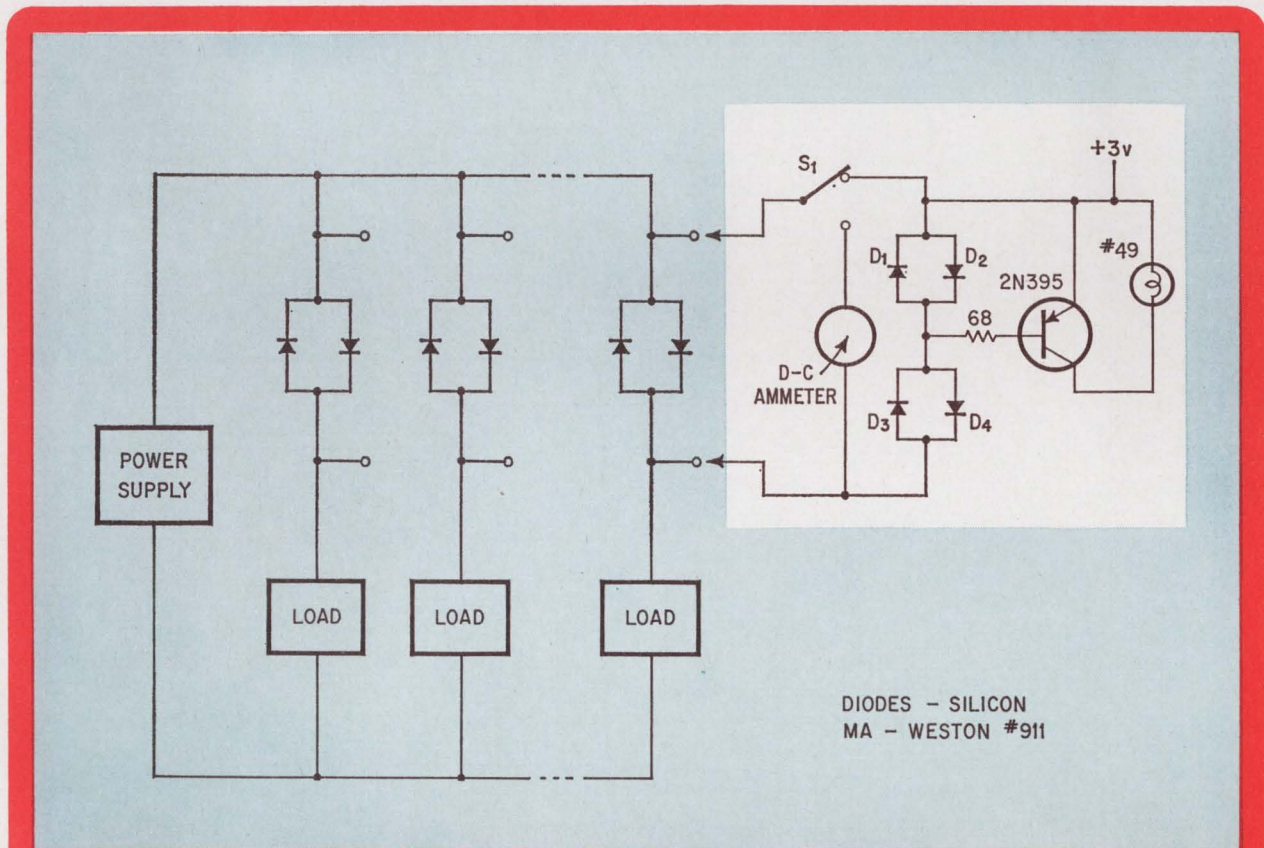

DIODES - SILICON  
MA - WESTON #911

**Fault finding.** Parallel diodes connected in a front-to-back arrangement along with the current measuring circuit at the right, provide a means of reading load current without breaking the circuit. In addition, if the conducting diodes in series with the load circuit are faulty, a warning lamp lights.



# Transistors improve high-frequency limiter

By Roland J. Turner

General Atronics Corp., Philadelphia, Pa.

Limiters must provide an output that is essentially independent of input-amplitude changes—and do so without introducing a phase shift between the input and output signals. These conditions are difficult to meet with conventional diode limiters much above 10 megahertz. The reasons: phase shifts that depend on the limiting level are produced, and effective limiting is achieved only at high input signal levels (6 volts peak-to-peak). But, when high-frequency transistors are driven into cutoff to achieve limiting, the circuit's phase response is then insensitive to the limiting level. And several transistor stages can be used to achieve harder limiting

over a greater range of input signal levels.

The circuit shown, starts to limit at an input level of 9 millivolts, and maintains the output level constant to within 0.06 db even though the input level is increased by 50 db. Each stage consists of two transistors and functions in the same manner. One transistor is driven into cutoff by positive input voltage swings whereas the following transistor is cut off for negative swings.

The maximum voltage swing at each transistor's collector depends only on the amount of current flowing through the transistor's collector load. The maximum input signal swing before limiting can be found by dividing the transistor's collector voltage swing by its gain. For the values shown, the circuit limits input signals greater than 9mv root mean square.

An output driver stage, which consists of  $Q_6$  and a resonant circuit tuned to 80 megahertz, drives a 50- or 100-ohm cable.

Although the upper cutoff frequency is about 100 Mhz, the upper frequency of operation depends only on the transistor's cutoff frequency,  $f_T$ .

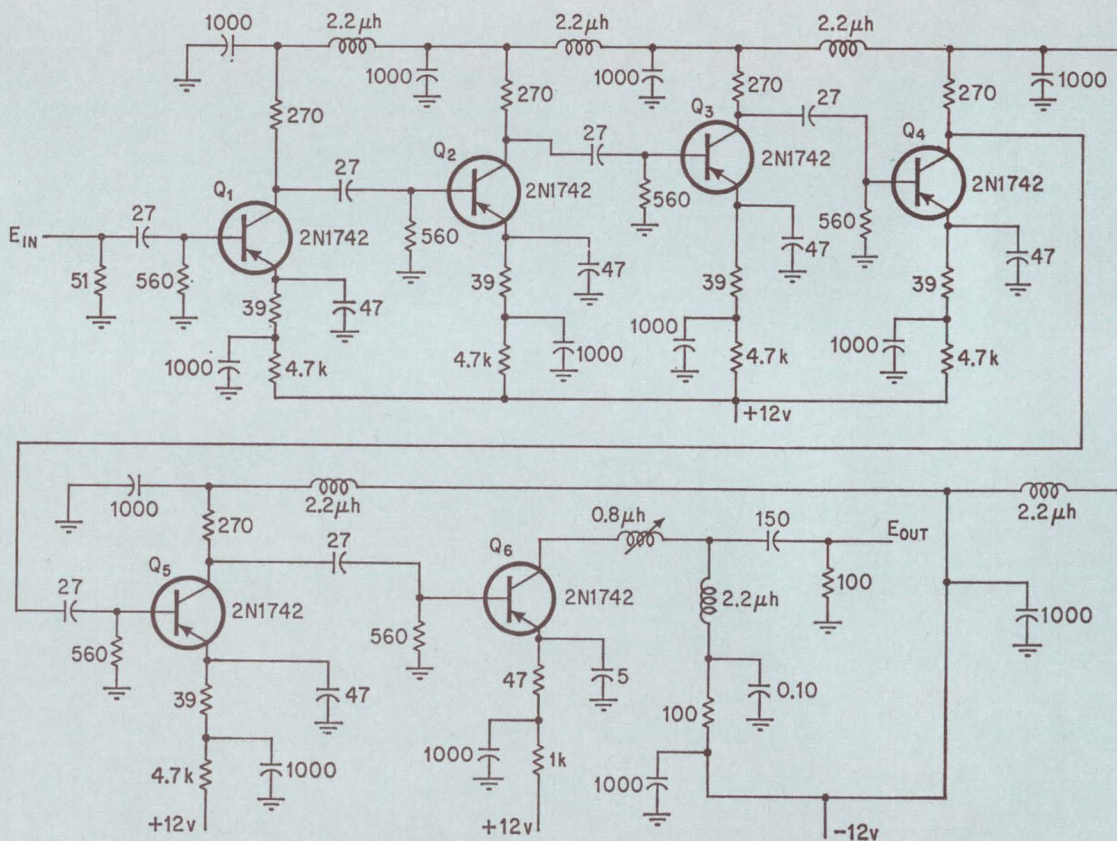

\* ALL CAPACITORS IN PICOFARADS

**Better than diodes.** With high frequency transistors, limiting occurs at signal levels greater than 9 millivolts for frequencies up to 100 megahertz. And for a 50-db increase in the input signal level, the output remains constant to within 0.06 db.



# Diode generator yields complex functions

By William E. Peterson

ITL Research Corp., Northridge, Calif.

Commonly used function generators fail to perform adequately when required to generate complex voltage waveforms, such as tangent functions or similar functions that become unbounded in magnitude at key points. These function generators, using diode shunts, are suitable for producing an output waveform with a slope that is less than the input, but inadequate for producing functions whose output slopes must be greater than the input slopes. However, these functions can be produced by combining a diode generator with a differential amplifier in such a manner as to sequentially raise the amplifier

gain as the input signal increases.

Transistors  $Q_1$  and  $Q_2$  form the differential amplifier. For low input signals none of the diodes conduct, and the gain of the amplifier, determined by collector resistors  $R_5$  and  $R_6$  and emitter resistors  $R_3$  and  $R_4$ , is unity. However, when the input signal level is high enough to cause the diodes in the emitter of the amplifier to conduct, the total emitter resistance decreases. This, in turn, increases the gain of the amplifier, which can be controlled by the potentiometer.

Three break points are used to shape the positive section of the wave and another three for the negative section. Each diode-potentiometer path represents a different break point. The exact shape of the output can be selected by making the appropriate adjustments with the potentiometers.

$Q_3$  is an emitter-follower that's used to isolate the output collector from loading effects.

The input signal used was a constant amplitude, symmetrical triangle.

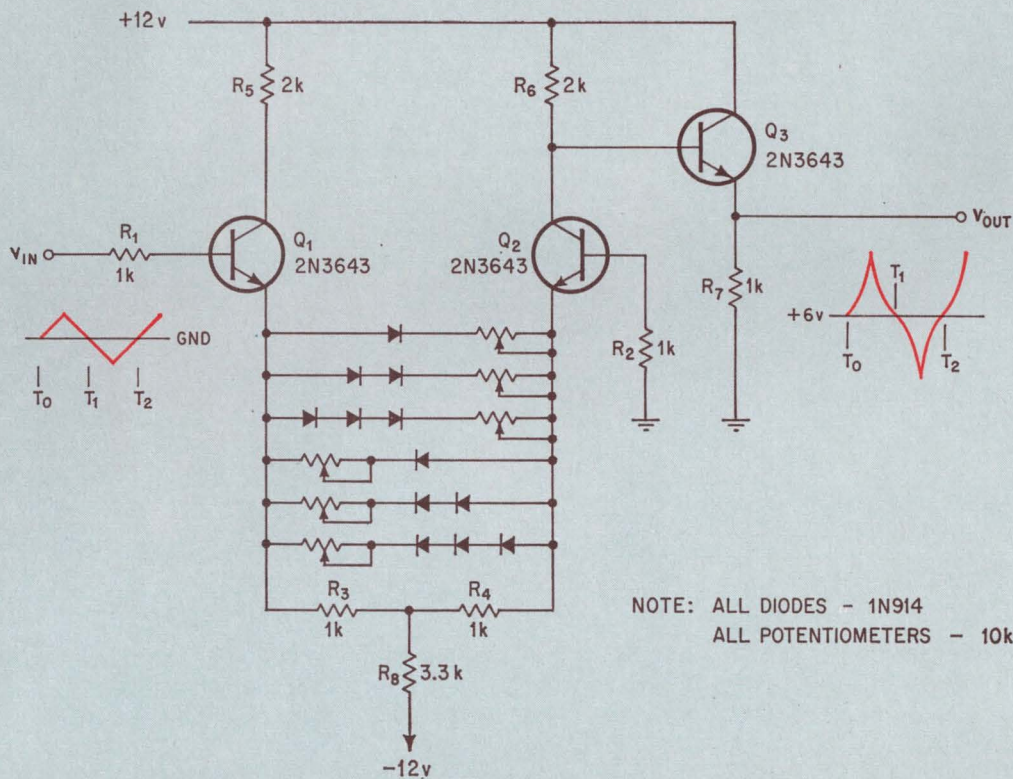

**Function generator.** The diode-potentiometer branches in the emitter section of the differential amplifier lower the emitter resistance as the voltage increases thus increasing the amplifier gain.  $Q_3$ , an emitter follower, matches the high impedance circuit to a low impedance load.





Industrial electronics

# Taking the heat off thermocouple failures

By Ronald S. Harmon

Leeds & Northrup Co., North Wales, Pa.



**Bitter experience teaches** that the thermocouple, on which industry depends so much to control its processes and safeguard its plants, can open circuit and invalidate the very reason for which it was installed. Thus for critical processes, it's mandatory that each thermocouple be tested every time it's read to see whether it's operating properly or has failed.

When a plant has hundreds of temperatures that must be sensed by thermocouples, perhaps 200 to 800 of them, a digital data-acquisition system is used because it reduces instrumentation costs, centralizes information for the operator, and helps run the plant better. In a few seconds, the data system must test, read, and convert to digital format all TC outputs.

Unfortunately, the seeming simplicity in checking for an open thermocouple circuit is complicated by the intricacies of a multiplexed digital data acquisition system. A new electronic method for thermocouple open-circuit detection—tailored specifically for digital data-acquisition and computer-control systems and developed by the Leeds & Northrup Co., of North Wales, Pa.—tests 250 thermocouples a second and signals the outcome of each test to the system's computer for appropriate action. If the test indicates an open thermocouple circuit, the action might be to sound an alarm for the plant operator's attention and disregard the measurement. However, if the test indicates a valid measurement, the data system continues normally.

It's not unusual for thermocouple circuits to open because of the harsh industrial environment in which TC's operate. Vibration leads to fatigue, and exposure to extremely high temperatures leads to melting. Then, of course, there are open connections, broken transmission lines, and mechanical damage.

How dangerous is an open thermocouple circuit? Consider a simple case. A thermocouple is inserted in a bearing of a 100 horsepower motor, and should lubrication fail, it will set off an alarm before the expanding bearing suddenly locks the motor's shaft. However, if the thermocouple open circuits, the system wouldn't know it—without an open circuit check. The reason: after the TC opens, a signal still may remain stored on the capacitors in the input filter, and this can be mistakenly interpreted as a valid signal by a data acquisition system's data amplifier.

Because the new method of thermocouple open-circuit detection (TCOCD) was designed for multiplexed systems, such a system is reviewed first—at the right. This is followed by a discussion of why the shunt-battery (page 98) and bridge (page 99) methods have practical shortcomings. The main focus is on the TCOCD, which is described on pages 99 and 100. A significant factor is that one TCOCD is shared by all thermocouple channels. Further, TCOCD requires neither periodic recalibration nor battery replacement.

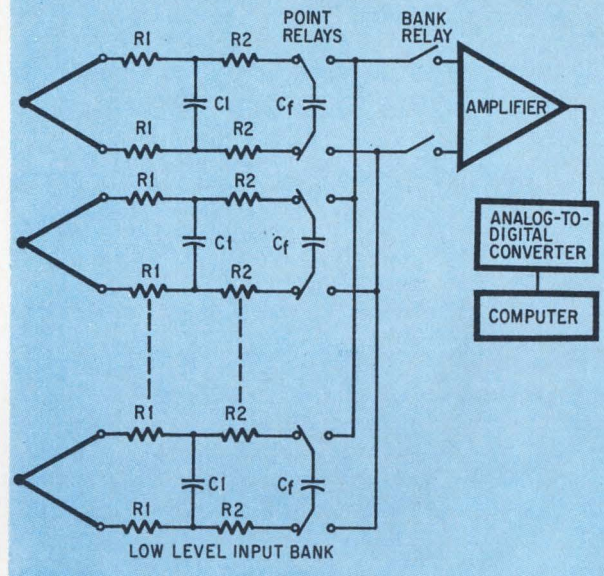

**In digital data acquisition** and computer-control systems, such analog inputs as thermocouples are multiplexed—switched in and read one at a time—into a single data amplifier and a single analog-to-digital converter.

The actual measurement site may be thousands of feet away from the system, and the long signal-transmission lines more than likely pick up electrical noise from nearby equipment and power lines. Thus, for high-accuracy, high-speed data systems, each input channel includes a low-pass RC filter. Further, all of the many hundreds of thermocouple channels must be thoroughly isolated from the data amplifier because the TC's are usually ungrounded, so while each line in the pair may float at the same voltage, these common mode voltages can be quite large and quite different from each other.

A typical low-level analog-input multiplexing scheme is shown above. The input differential filter, comprised of  $R_1$ ,  $C_1$ ,  $R_2$ , and  $C_f$ , usually gives about 60 decibels of rejection at 60 hertz.

Capacitor  $C_f$ , called the flying capacitor, charges to the thermocouple-signal voltage. When a channel, or point, is addressed by the computer for read out, the associated point relay transfers  $C_f$  to the amplifier's input. After a few milliseconds' delay for amplifier and relay settling, an analog-to-digital conversion occurs, and then the computer instructs that the digital information be read into the computer as the measured value of the addressed point.

*But the flying capacitor isn't ideal . . .*



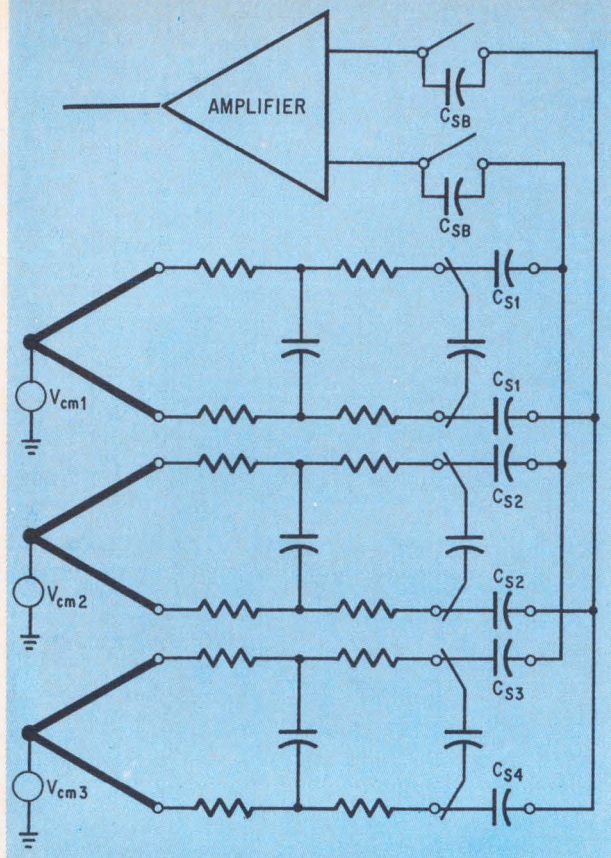

Ideally, the flying capacitor should isolate the data amplifier from the input lines. In fact, however, each unaddressed point relay contributes a contact capacitance,  $C_s$ , between the point inputs and the amplifier input, as shown above. The large number of point-relay-contact capacitances in parallel reduces isolation and increases the amount of common mode voltage converted to normal (or signal) voltage.

However, isolation can be improved by connecting a group, or bank, of point relays to the data amplifier through the contacts of a bank relay. Now, bank contact capacitance,  $C_{sB}$ , is in series with the parallel capacitances of the point relay contacts. The net capacitance is reduced between input-signal-lines and the amplifier and thus creates a much higher impedance, hence greater isolation, between all the inputs not being addressed and the amplifier.

What complicates the detection of an open thermocouple circuit by any simple method, such as the shunt-battery technique that works well for single thermocouples, is that the many hundreds of thermocouple circuits will probably have different TC internal resistances and use different lengths of transmission lines. The single amplifier can't compensate for so many variations. The next panel, on the shunt-battery method, explains the problem in more detail.

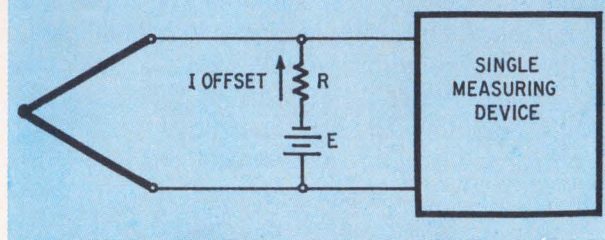

In the shunt-battery method of thermocouple open-circuit detection, above, a single thermocouple feeds into a single measuring device such as a d-c moving-coil meter. Then a high-value current-limiting resistor in series with a battery,  $E$ , is shunted across the thermocouple.

Because of different line lengths, the resistance of the thermocouple and its lead wires ranges from 25 to 500 ohms; this is much less than the current-limiting resistance,  $R$ , which is about 100 kilohms. The current through the resistor develops a millivoltage that offsets the thermocouple's true reading. This offset voltage can be zeroed or calibrated out easily over the temperature range of interest.

If the thermocouple opens, though, the full value of  $E$  would then drive the meter's pointer off scale.

This method of open-circuit detection is more than satisfactory for single-channel temperature measurement in which the compensation for that one TC can be made permanently in the meter. But when it comes to complex digital data-acquisition and computer control systems, in which such highly accurate equipment as a data amplifier and an analog-to-digital converter are shared in succeeding time intervals by many hundreds of input measurements, the shunt-battery method is anything but satisfactory.

For a geographically widespread industrial plant, with varying lengths of transmission lines, each thermocouple channel would be likely to have an offset different from all the others. The single data amplifier could not, within the scope of engineering reasonability, be designed to change to a different zero to compensate for the unique offset of each thermocouple.



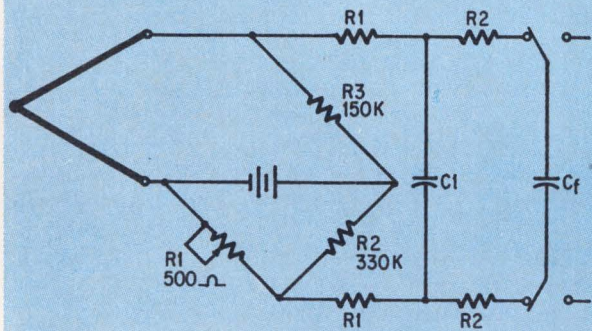

To avoid the offset problem, a common approach to TC open-circuit detection is to have the thermocouple serve as one of four arms of a bridge circuit, shown above. Since a variable resistor,  $R_1$ , balances the bridge in each of the channels, there is no offset in any channel and thus hundreds of channels can be multiplexed to the single amplifier.

Should a thermocouple open, its bridge becomes severely unbalanced, and the amplifier input signal—approximately equal to the battery voltage—can be easily interpreted by the computer as an open-thermocouple situation.

While the TC bridge circuit eliminates the offset situation, it creates design and installation problems when used in multiplexed systems.

- Each ungrounded thermocouple may be operating at a different common mode voltage.

- To avoid circulating currents, hence erroneous voltage drops, each bridge must have its own isolated excitation—usually a battery.

- Each of perhaps 200 to 800 bridges must be balanced when the system is installed and rebalanced periodically thereafter.

Using the bridge to detect TC open circuits poses a serious tradeoff problem. On the one hand, to reduce battery drain,  $R_3$  in the bridge must be made relatively large. (Even so, batteries must be replaced about once a year.) On the other hand, this same resistance forms part of the channel's noise filter. Thus, a large  $R_3$  increases the filter's time constant if the TC opens and slows the channel's response.

Thus in multiplexed systems, neither the shunt-battery nor bridge methods are entirely adequate for detecting open thermocouple circuits.

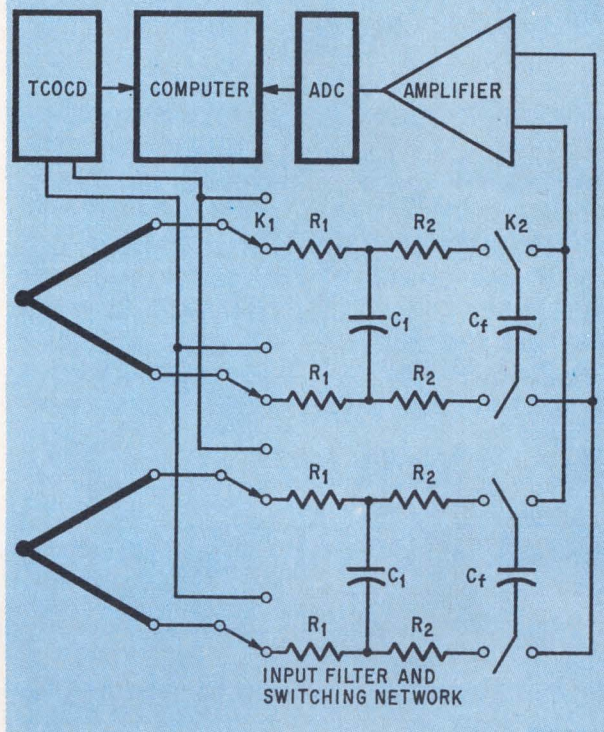

Specially designed to operate in multiplexed systems and to avoid shortcomings of both the shunt-battery and bridge methods of TC open-circuit detection, a newer scheme (patent applied for) employs a pulse of current to sense whether the circuit is complete or open. Since the thermocouple open-circuit detector, shown above, tests 250 points a second, it can determine whether an open circuit exists in less than four milliseconds. In doing so, it must differentiate between a true open circuit and a high-resistance circuit that can be caused by 1,000 or more feet of thermocouple connecting wire; and it must distinguish between a complete circuit and an open circuit that—because of the large capacitance of long connecting wires—may appear as a complete circuit to the pulse.

One TCOCD is shared by all thermocouple inputs. Each input point requires a relay,  $K_1$ , that connects the thermocouple to the TCOCD. The TCOCD relay,  $K_1$ , operates at the same time that the point relay,  $K_2$ , is addressed by the computer, and transfers  $C_f$  to the amplifier input. Thus, both the open-circuit check and the data conversion take place in the same four-millisecond time interval allotted to a channel.

*Pulse occurs only when circuit is complete . . .*



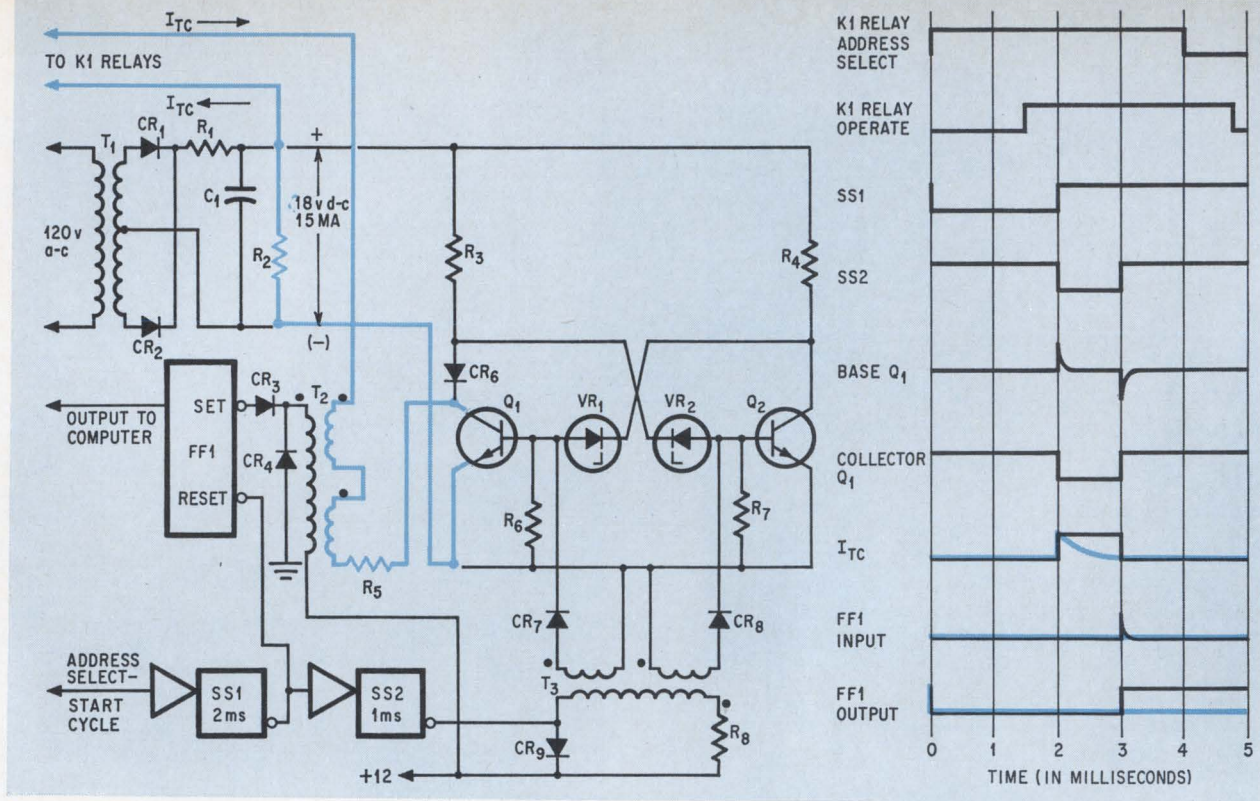

In the thermocouple open-circuit detector circuit, shown above left, transistors  $Q_1$  and  $Q_2$  form the main flip-flop which permits a detectable pulse to develop only when the TC circuit is closed. In the timing diagram shown above, right, black pulse shapes denote conditions for a complete TC circuit, and the colored pulses denote an open TC.

At the instant of point selection the address-select start-cycle signal fires the one-shot multivibrator SS1, which resets a flip-flop, FF1, and also provides a two millisecond delay for the K1 relay to operate and settle. At the end of this delay, SS2 initiates a one-millisecond pulse whose leading edge turns on  $Q_1$  and sets the main flip-flop.

As the heavy lines in the schematic show, with  $Q_1$  conducting (low resistance) and if the thermocouple circuit is closed, a current,  $I_{TC}$ , flows from the positive side of the 18-volt supply, through the thermocouple via the K1 contacts, through the primary of pulse transformer  $T_2$ , through  $R_5$ , through  $Q_1$  and back to the negative of the supply.

At the end of the one millisecond interval the trailing edge of the SS2 pulse turns off  $Q_1$  thus resetting the main flip-flop. If the thermocouple circuit is complete when  $Q_1$  turns off, the current in the primary of pulse transformer,  $T_2$ , collapses and generates a pulse in the transformer's secondary. The secondary's pulse sets FF1, and this state tells the computer that the thermocouple circuit is complete. If the TC is open, then there's no current in the primary, hence no pulse is created in the secondary—and FF1 remains in its reset state.

The one-millisecond interval provided by one-shot SS2 allows the stray capacitance of the line to charge to a steady state so that current flow due to line charging is not confused with current flowing due to a complete circuit. In a typical case, the TC circuit might be 500 ohms and the stray capacitance

0.5 microfarads. There's an additional 1,000 ohms in the path due to  $R_5$ . Thus, the charging time constant would be the product of 1,500 ohms and 0.5 microfarads, or 0.75 milliseconds.

Note that the test circuit is completely isolated from ground by pulse transformers and a floating power supply. Thus the TCOCD can handle thermocouples which, while they develop millivolt-level signals, may actually operate in an environment that produces much higher and different common mode voltages.

The TCOCD is compatible with computer requirements. In a computer system using a 16-bit word, the analog-to-digital converter produces a 15-bit word, 14 bits of which are for the digitally converted analog measurement and 1 bit is for the word's sign. The 16th bit comes from the TCOCD's FF1 output. This flip-flop's state (SET for open, and RESET for closed thermocouple) is checked by the computer program at the same time the 15-bit digitized measured value is read into the computer. Thus it takes only one READ instruction for the computer to store a measurement and ascertain that the thermocouple hasn't failed and the reading is valid. ■



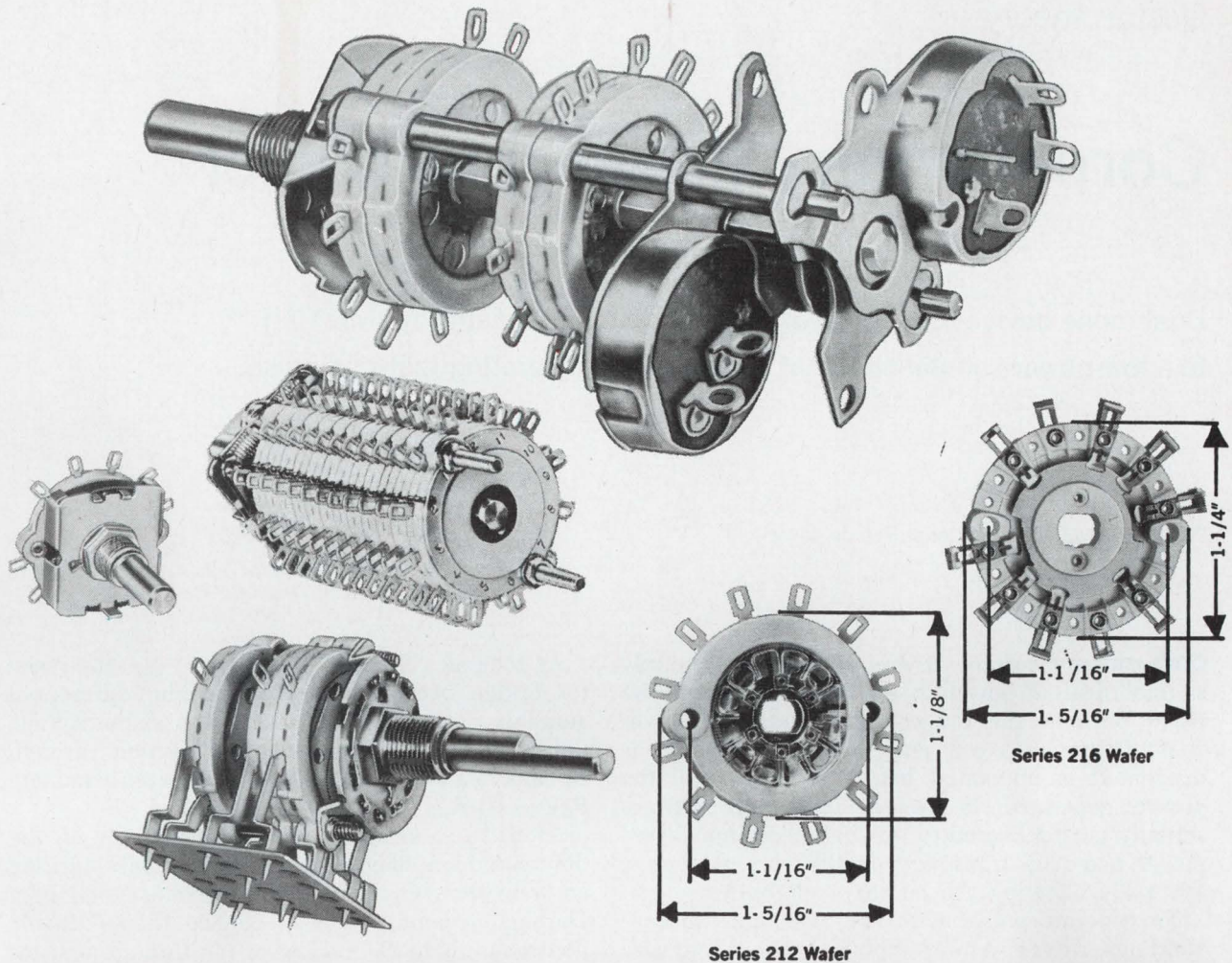

## These are the facts that make CTS Switches the engineer's choice

**NO BREAKAGE**—They don't break on production lines or on finished equipment if dropped or jarred...CTS glass alkyd wafers are not brittle like phenolic... easy to handle.

**NO SHIFTING**—Precision molded construction eliminates mechanical shifting of stator circuitry and terminals.

**MORE COMPACT**—No spacers needed when stacking wafers... Maximum switching capability with minimum depth... Smaller diameter—only 1 1/8" (Series 212 wafers)

**VERSATILITY OF CIRCUITS**—Many circuit variations available due to varied rotor contact configurations.

External jumpers eliminated by CTS internal connectors between adjacent positions.

**AVAILABILITY OF POWER SWITCHES**—Available with 4 types of power switches and/or numerous potentiometers.

**SUPERIOR INSULATION**—Glass alkyd is superior to phenolic insulation.

- Soldering heat can't loosen terminals.
- Meet MIL-S-3786 A&B, Style SR03 (Series 211, 212 and 215)
- Balanced contact spring.
- Natural solder barrier provided by glass alkyd insulation.

Which Detent best fits your requirement?			
Detent	Application	Cycle Life	Switching Torque
Type 211—Star Wheel Detent	Highest quality applications	250,000	10-50" oz.
Type 215—Double Ball Detent	Quality instrument applications	100,000	6-35" oz.
Type 212—Hill and Valley Detent	Home entertainment and low cost instrument applications	25,000	20-48" oz.
Type 212 ND—Die Cast Detent	Lowest cost applications	20,000	18-40" oz.



4-6 WEEKS DELIVERY

# CTS CORPORATION

ELKHART, INDIANA 46514

® Phone: 219, 523-0210. TWX: 810-294-2256

**Western Source**  
 CTS Electronics, Inc.  
 (formerly Chicago Telephone of California, Inc.)  
 1010 Sycamore Avenue  
 S. Pasadena, California 91031  
 Phone: 213, 254-9141  
 TWX: 910-321-4060

**Canadian Source**  
 CTS of Canada, Ltd.  
 Streetsville, Ontario  
 Phone: 416, TA 6-1141



# Core-memory driver runs cooler

Dual-mode device reduces heat dissipation by automatically switching to a low-power constant current source after generating fast-rise pulse

By Charles J. Ulrick

Collins Radio Company, Cedar Rapids, Iowa

**Core-memory** current drivers initially must supply a great deal of power to generate fast pulse rise times. But once this is accomplished, all that power is no longer required, and the excess amount is dissipated in unwanted heat. Less than half the power generated in conventional core drivers actually gets delivered to the load. And the wasted power heats up transistors in the current source, adversely affecting the circuit's reliability.

To generate pulses with fast rise times in core windings, drivers require voltage sources four and five times larger than those used to power ordinary integrated circuits. But once the pulse's rise time has been effected, the energy requirement to maintain a constant current through the winding drops sharply. A current-monitoring circuit operating as a voltage generator and as a current generator dissipates much less power than ordinary drivers, has a cooler ambient temperature, and can be packaged in integrated circuit form.

When the circuit is triggered, a large voltage is delivered to the selected core, generating a fast-rising pulse across its inductive load. Current through the core winding increases and is sensed by a comparator which, at a selected current amplitude, switches off the large voltage supply and automatically substitutes a constant current source with a low supply voltage.

The circuit consists of a differential amplifier,  $Q_3$ - $Q_4$ , that activates either of two voltage supplies, +5 volts and +12 volts. A resistor bridge,  $R_1$ ,  $R_2$ ,  $R_3$ ,  $R_4$ , and  $R_8$ , feeds the input terminals of the differential amplifier.

A push-pull circuit,  $Q_1$  and  $Q_2$ , supplies a reference voltage,  $V_{REF}$ , of -5 volts or +12 volts to the differential amplifier's input depending on the input logic swing.

The core driver is inactive when the reference voltage is at -5v and triggers when the push-pull circuit applies +12v to the amplifier's input.

As soon as +12 volts appears at  $V_{REF}$ , the resistor bridge becomes unbalanced. The differential amplifier, acting as a comparator, senses the voltage difference across  $R_8$ . The output current through  $R_8$  rises to a steady state value,  $I_o$ , of approximately  $R_2 V_{REF} / R_1 R_8$ .

After  $V_{REF}$  switches to +12 volts,  $Q_3$  of the differential amplifier conducts very heavily, turning on transistors  $Q_5$  and  $Q_7$ . These transistors, in a Darlington configuration, connect the +12-volt power supply to the inductive load through resistor  $R_8$ . The pulse's leading edge continues as long as the +12-volt supply is applied.

While the +12-volt supply generates the pulse's leading edge, the +5-volt source remains cut off because  $Q_6$ 's base-emitter junction is reverse-biased.

As the current through the inductor approaches the steady state value  $I_o$ ,  $Q_3$  of the differential amplifier conducts less and less. Current through the Darlington pair decreases and the voltage delivered to the load begins to drop.  $Q_5$  and  $Q_7$  cut off when the load voltage of +5 volts is reached.

But the voltage never drops below 5 volts, because at this level transistors  $Q_6$  and  $Q_8$  are conducting, applying the current source to the load. Little or no current flows through the Darlington pair as long as  $R_5$ ,  $R_6$ , and  $R_7$  are selected properly.

**Quick switch.** This core driver operates in two modes to reduce power losses. When activated by the input control logic, the 12-volt supply kicks in to deliver the power necessary to generate a 50-nanosecond rise time. Once the desired current level is reached, the 5-volt supply takes over and delivers a constant current with much lower power dissipation. The reduced power requirement makes this circuit suitable to be packaged as a thin-film IC.



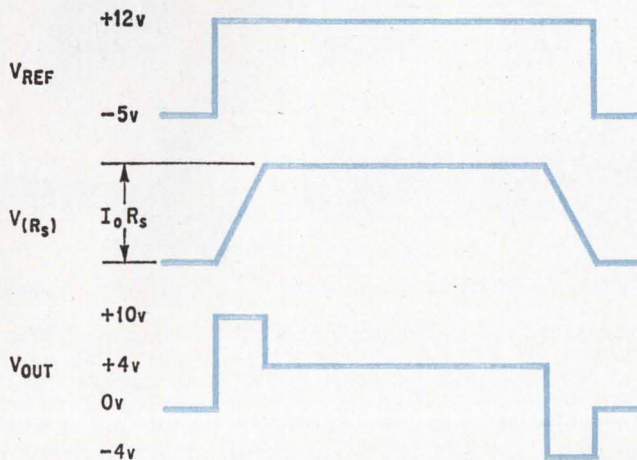
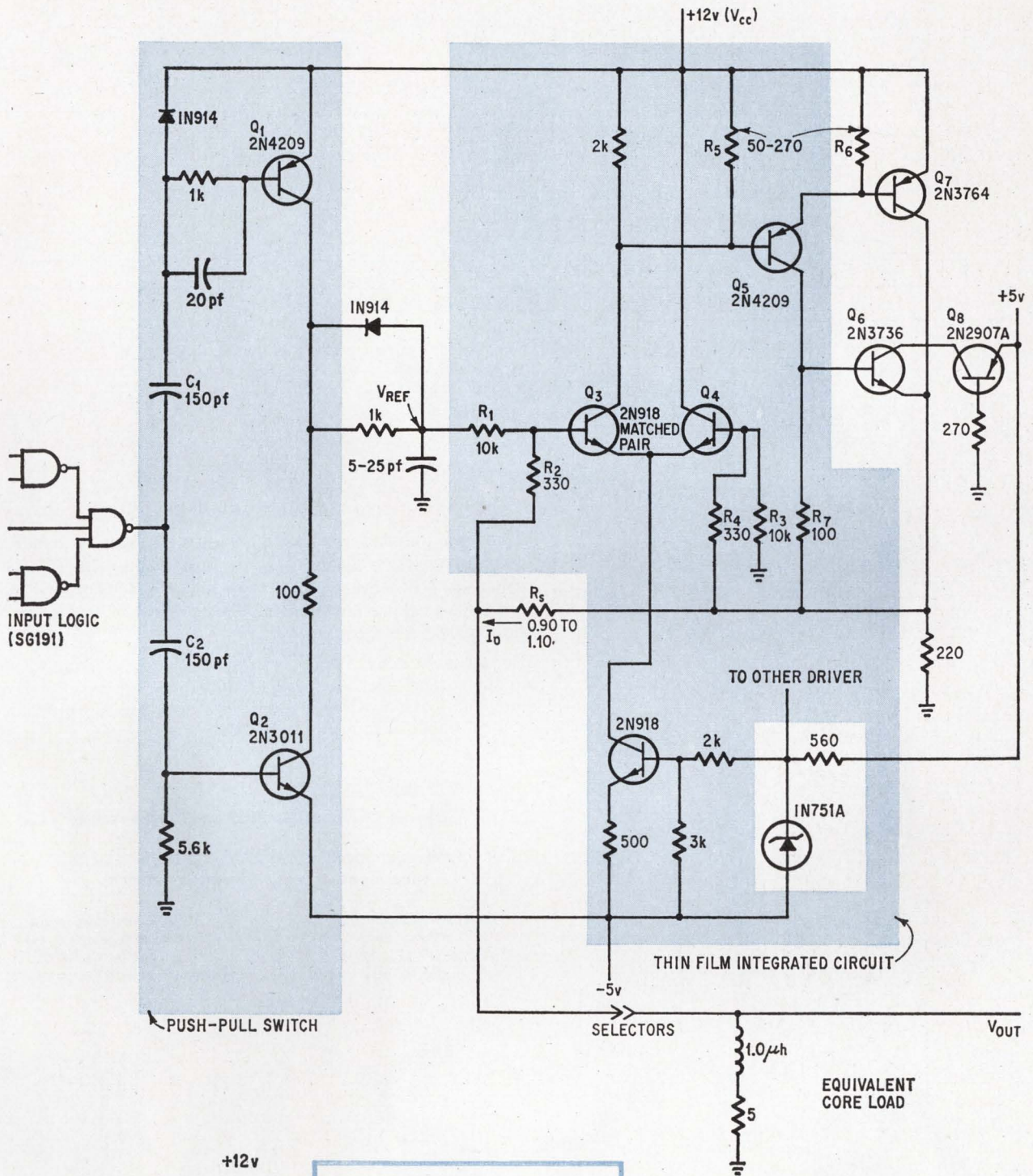



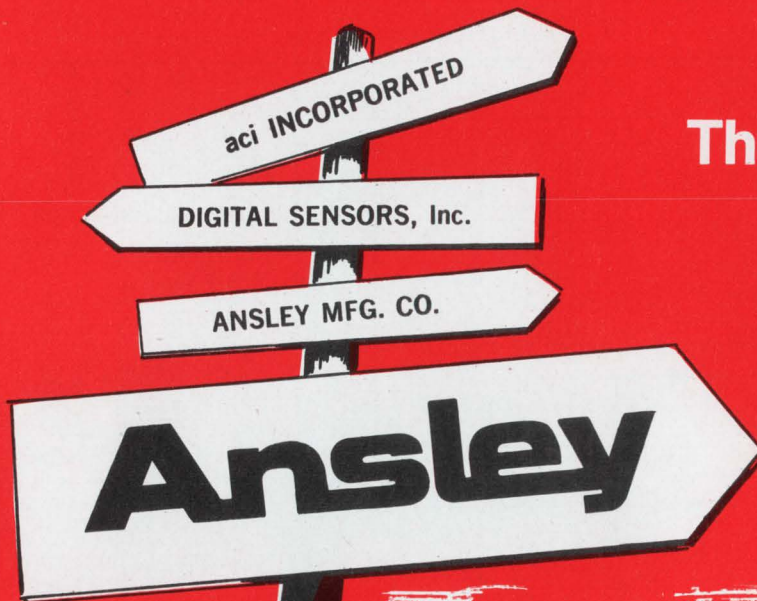

The big,  
new way!

Three strong product lines are made even stronger by combining a significant spread of wiring concepts, technologies and experienced production know-how . . . under our new name, ANSLEY. The old company names (aci Incorporated, Digital Sensors, Inc., and Ansley Mfg. Co.) will disappear.

You will benefit by ANSLEY's expanded product capabilities for interconnection and packaging to meet the needs of the entire electronic industry. There's more right now. Much more to come later . . . from one source . . . ANSLEY!

**Ansley**

Division of Thomas & Betts Corporation 

*Production facilities are located with geographic advantages to best serve our customers.*

ANSLEY east Corporation  
Old Easton Road  
Doylestown, Pa. 18901  
Telephone 345-1800 area code 215

ANSLEY west Corporation  
4100 North Figueroa Street  
Los Angeles, Ca. 90065  
Telephone 223-2331 area code 213

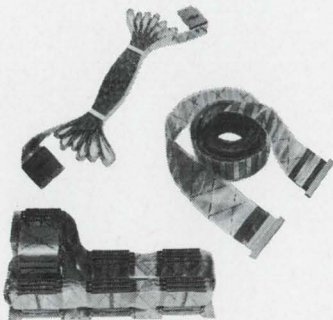

ANSLEY Signaflo™ Wiring Systems

Reduce cost, yet improve your wiring! If you want to see one industry that's gone to flat cable . . . eliminated twisted pairs, coaxial cable and other conventional wiring methods . . . take a look at today's EDP equipment . . . then see ANSLEY.

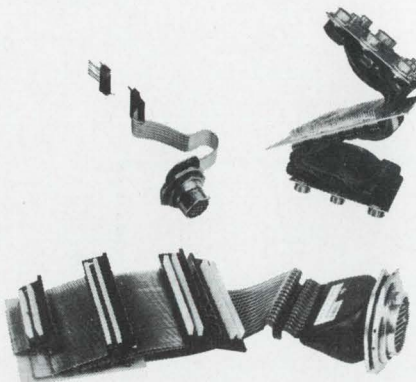

ANSLEY Flex-Weld® Cable Assemblies

Here is packaged wiring using ANSLEY's patented welded pin process for sophisticated aerospace electronic equipment. Pin terminations are welded directly through the insulation . . . giving adaptability to any connector. If you're looking for flat cable assemblies offering repairability, maintainability and circuit change possibilities . . . then see ANSLEY!

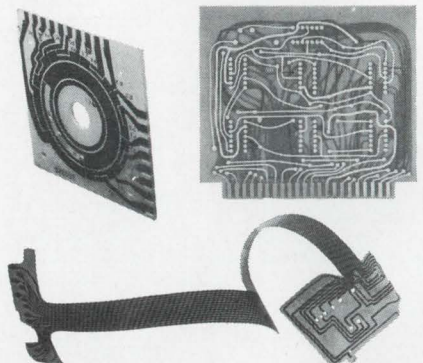

ANSLEY Chemically Created Circuitry

If you need Free-Flex® circuitry . . . one or two sided or multilayer hard board circuitry . . . or combinations using conventional or exotic materials . . . or fine line etching . . . or low-cost switch decks that stay flush permanently . . . then see ANSLEY!



# 'Cache' turns up a treasure

By Donald H. Gibson

Systems Development Division, International Business Machines Corp., Poughkeepsie, N.Y.

and W. Lee Shevel

Component Division, International Business Machines Corp., East Fishkill, N.Y.

**Caught between the devil** and the deep blue sea is the designer who wants to build a computer that incorporates both high speed and large main-memory capacity—say 10 million bits or more. His quandary: such a memory is large physically, and the rate at which data can move is limited by the speed of light.

In practice, the data may take more than 100 nanoseconds to traverse the distance between a storage location in the memory and a register or other location in the processor, while the processor's cycle is likely to be less than 100 nsec. Speeding up the memory wouldn't minimize this mismatch, and it might even boost the memory's cost to an unacceptable level.

The trick is to use two memories. Such a hierarchy, properly organized, can resolve the clash between design objectives and the laws of the physical universe.

One is a buffer, small and fast to match the

speed of the processor, and close in for quick accessibility; the other is large and relatively slow, but able to transfer large batches of data into the small memory in a single cycle.<sup>1</sup> Thus the two memories have approximately equal bandwidths, but their cycle times differ by a factor of, say, 10 to 16.

For example, the IBM System 360 model 95 had a multiunit processor whose basic machine cycle was 60 nsec and had a main memory of approximately 10 million bits. When the main memory, standing alone, was exercised under the control of its own circuits, a pulse could travel from the main panel into the memory array itself in 60 nsec, to begin the actual reading out of data. Yet the functionally identical signal, originating at the adder in the processor when the memory operated as part of the system, took 180 nsec—three times as long—to travel into the array and initiate the same process. A larger memory would have required an even greater time spread.

But in the 360/85, the buffer memory, or "cache," is used for the first time in a production-line computer. The cache is a monolithic semiconductor memory packaged inside the processor and it is 12 times as fast as the main memory, or "backing store." The latter is in a separate frame several feet away along a direct line and further away along the connecting cables. The cache contains instructions and data immediately required for processing, and exchanges these directly with the processor, as shown at left, which thus needs only occasional reference to the backing store.

## Big one

The backing store in the 360/85 is available in several capacities; the largest contains ap-

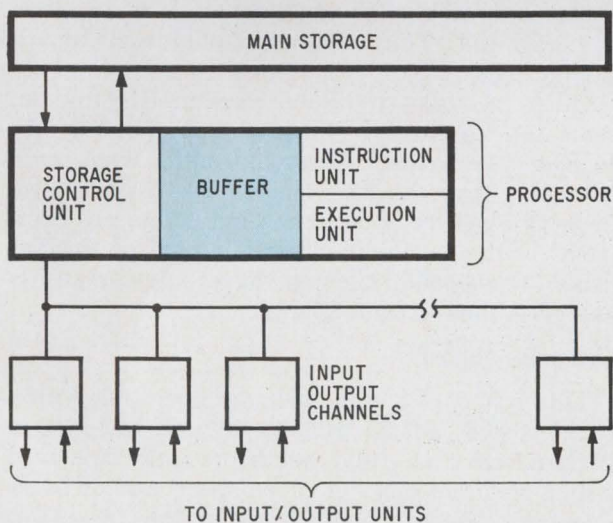

**Cache.** Like a squirrel's store for the winter, the processor keeps a supply of instructions and data readily available in the high-speed buffer.

This is the 13th installment in *Electronics'* continuing series on memory technology, which began in the Oct. 28, 1968, issue.



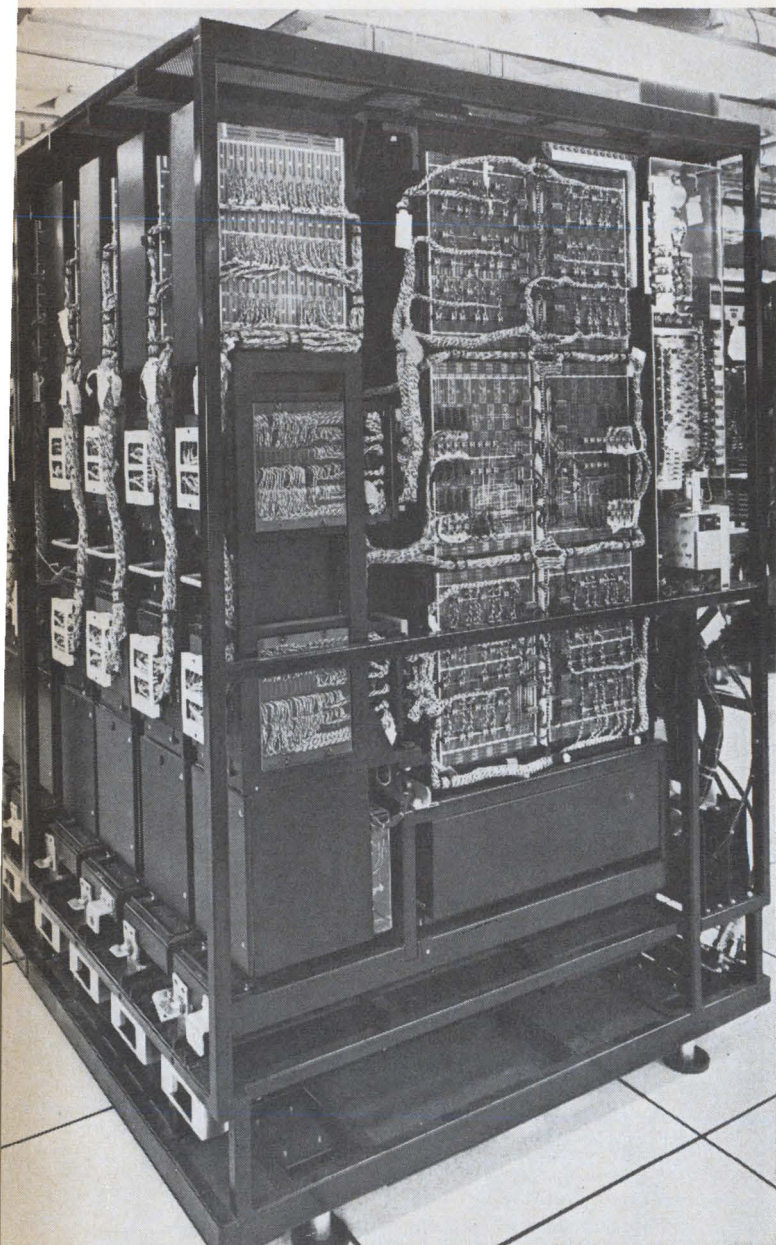

**Mouthful.** This frame stores one million bytes of data or instructions; any group of 16 bytes is accessible in 960 nanoseconds. It's part of the main memory for the IBM 360/85.

proximately 4 million eight-bit bytes. This biggest configuration comprises two 2-million-byte frames, each with its own controls and error-correction circuits; within each frame are two 1-million-byte modules, one of which is shown above, each made of eight subunits containing 16,384 words of 72 bits per word. These eight subunits are electrically organized as four 16K-by-144-bit memories, reading out two 72-bit words in parallel in each cycle. The 72 bits include eight 8-bit bytes and eight redundant bits that work with error detection and correction circuits. The backing store is made with conventional toroidal ferrite cores 21 mils in diameter,

which switch in less than 200 nsec. They are wired into a stack of 36 planes, each plane a square array 128 cores on a side.

The cycle time of the modules in the larger-capacity backing store is 960 nsec. Access time of each 16K-by-144-bit element is 415 nsec. When placed in the physical configuration of the 360/85, the memory's access time as seen from the processor is 960 nanoseconds—the same as the module's cycle time. The difference between 415 nsec at the memory frame and 960 at the processor is accounted for by transmission delays in the cable and propagation lags in the priority and error-correction circuits.

In the 4-megabyte backing store, the four 1-megabyte modules are interleaved four ways, permitting new cycles to be initiated in each module at 80-nsec intervals. Thus, with interleaving, the main memory's time slot temporarily matches that of the buffer—a request for data from the main memory produces two 72-bit words or 16 eight-bit bytes from the first module, 960 nsec after the request is issued; but it also automatically triggers interleaved requests for data in the other modules, and this other data arrives in 16-byte groups at 80-nsec intervals. But no single module can be accessed a second time before the end of its 960-nsec cycle.

#### Little one

The second key element of the hierarchy is the buffer memory. This unit, or cache, on the IBM 360/85 is available in sizes of 16K, 24K, and 32K bytes ( $K = 1,024$ ). The 16K-byte unit contains 16 cards, identical in function and in components, each with a 1K byte capacity.

The storage cells on each card are contained in an 8-by-9 array of modules in the center section of the card; these are surrounded by circuits for addressing, writing, and sensing. The modules are based on IBM's half-inch-square solid logic technology (SLT) substrates. Each holds two silicon chips, and each chip contains an 8-by-8 matrix of storage cells. Thus each module holds 128 binary storage cells.

Other memories could be structured using the same set—for example the cache in the 360/195. In fact, this system utilizes the buffer even more efficiently than the 85.<sup>2</sup> The 85 also has smaller memory registers of 64 to 256 bytes that are composed of these same modules mounted on smaller cards. The smaller registers have a faster access and cycle time of 25 to 30 nsec.

#### Ultimate—almost

This system of a cache memory operating with a backing store attains 64% to 96% of the system performance that could be theoretically achieved with a single memory of cache speed and of backing-store capacity, housed within the processor. If the actual cache always contained the data required by the processor, the performance would be 100%; and even when the program was care-



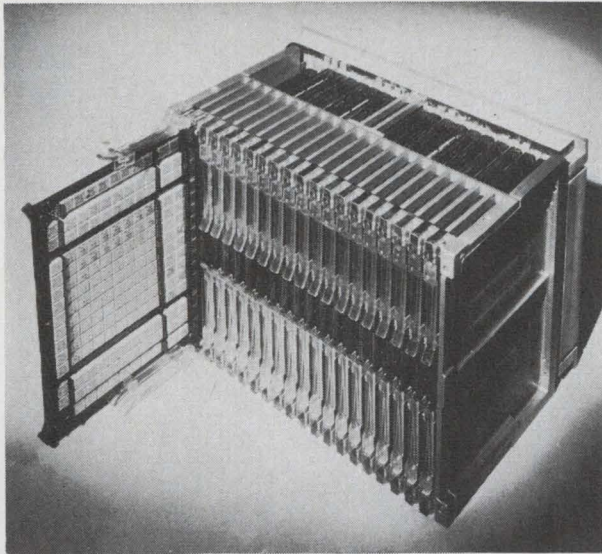

**Buffer.** These 16 cards can hold 16,000 bytes for quick access by the 360/85 processor. The data arrives in groups of 64 bytes from the memory.

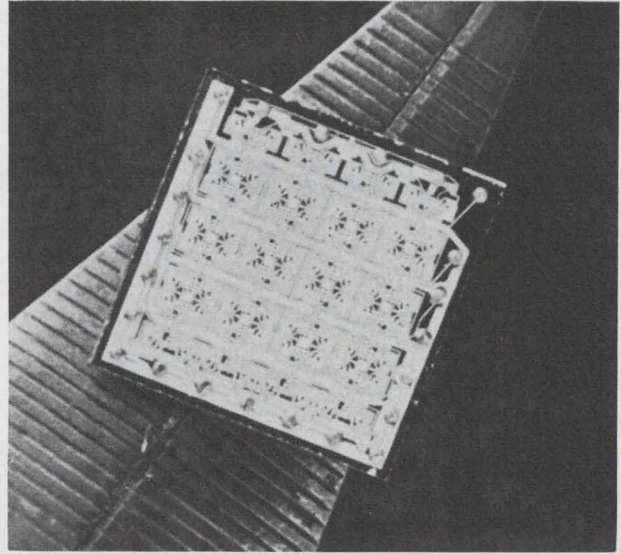

**Small but fast.** This silicon chip, shown on the nib of a pen, contains 64 memory cells that deliver data in as little as 54 nsec, in the 360/195.

fully constructed to have the required data in the cache as seldom as possible, performance was 64% of the theoretical maximum. To date, no actual customer's program has been worse than the most severe worst-case programs. If these percentages hold for a 16K cache, they would be somewhat higher for larger caches, because, obviously, the proportion of data found in the larger cache is higher.

These results were obtained by a simulation process, and verified in an exhaustive study that employed cycle-by-cycle timing modules for a number of cache system designs, and actual programs of IBM 360/65 and IBM 360/75 users.<sup>3</sup> From the results of simulation runs on these designs and programs, detailed timing charts were prepared of program performance on a machine with a cache.

### Questions and answers

These charts provided answers for the major questions that arise in evaluating the cache concept: How large should the cache be? What optimum block size should be transferred between backing store and cache? How does performance vary with backing-store access time?

The study produced highly favorable results. It disclosed that cache capacity of 16K to 32K bytes is sufficient for holding, on the average, 95% of all storage requests made by the central processing unit. When extended to the model 195, the study showed that the proportion of storage requests satisfied in the cache averages 99%. A block of 64 bytes represents the proper amount of information to bring into the cache when a backing store access is required. System performance varied no more than 10%-15% as backing store access time ranged from zero to two microseconds,

corresponding to a wide range of cycle times for the main memory, and of cable lengths between it and the processor.

These results correspond reasonably well to the findings for an IBM 7000 series machine.<sup>4</sup>

The cache concept has proven feasible largely because the set of programs to be run on a cache system have addressing patterns readily adaptable to the concepts. This is true because programs usually comprise lists of instructions in successive locations to be executed in sequence, and because blocks of data also are usually in successive locations. They don't have to be, but it would be more effort for programmers to scatter them around and it wouldn't have any advantage.

The cache concept, as implemented in the System 360/85, has proven to be as good as expected. But one interesting point has been established by the hardware that was not established by the simulation, because the hardware includes a switch on the console to disable the cache. With this switch set in the disable mode, all programs require three to four times as long to complete as when the cache is working. It's one of several controls that disable certain parts of the machine; they keep the system running at reduced speed in the presence of a component failure that otherwise would stop the machine completely. ■

### References

1. M.V. Wilkes, "Slave Memories and Dynamic Storage Allocation," IEEE Trans. on Electronic Computers, April, 1965, p. 270.
2. C.J. Conti, "Concepts for Buffer Storage," IEEE Computer Group News, March 1969, p. 9.
3. J.S. Liptay, "Structural Aspects of the System 360/Model 85: the Cache," IBM Systems Journal, Vol. 7, No. 1, 1968, p. 15.
4. D.H. Gibson, "Consideration in Block-Oriented Systems Design," AFIPS Conference Proceedings, Vol. 30 (Spring Joint Computer Conference), 1967, p. 75.





# Speeding up ferrite-core memories

By Robert M. Whalen

International Business Machines Corp., Poughkeepsie, N.Y.

For nearly 20 years, the introduction of new fast computers has been confronted by the discovery of a class of problems that require even faster processors—and faster memories. However, the drive for faster ferrite-core memories has temporarily slowed, due to developments in computer architecture that make them seem to run faster than they actually do [see “Prodding memories,” p. 109]. But these architectural developments themselves require fast memories that presage the even higher speeds required of future main memories.

Conceptually, the method of making today's memories faster is to make the cores smaller. Smaller cores can be made to switch faster without increasing drive current, because they have shorter magnetic path lengths which result in higher switching fields. They also have smaller cross-sectional areas, which reduces inductance, and can be placed closer together, which reduces drive line length. The result is lower transmission delay, back voltage, and power dissipation. The latter two make the storage array, as a load, easier to drive with high-density integrated circuits. The shorter line lengths even compensate for the higher resistance per unit length of the smaller wires that are required.

Signal-to-noise ratios do not deteriorate when

core size is reduced, as shown on page 110, because delta noise, which is produced by half-selected cores, can be cut in proportion to signal output, and lower drive voltages and line delays reduce spurious couplings, thus generating less noise. The surface-to-volume ratio also increases as cores get smaller, increasing their efficiency in dissipating heat generated during switching.

## Mechanical problems

The principal problems in smaller cores are more mechanical than electrical.<sup>5</sup> Making, testing, and wiring cores becomes more difficult as core size is reduced. The problems in making cores range from obtaining finer ferrite powder, to building presses with close tolerances, to controlling time and temperature in sintering. In testing, the cores must move continuously along controlled paths despite air currents and magnetized mechanism parts. And in wiring, the cores usually are vibrated into positions in a type of jig that is quite difficult to make for the smallest core sizes.

Wiring the cores—a task that up to now has been largely manual—inevitably will become completely automated. Limitations of human dexterity and, coordinately, the inability of manual threading to stay abreast of an ever-increasing bit market, will

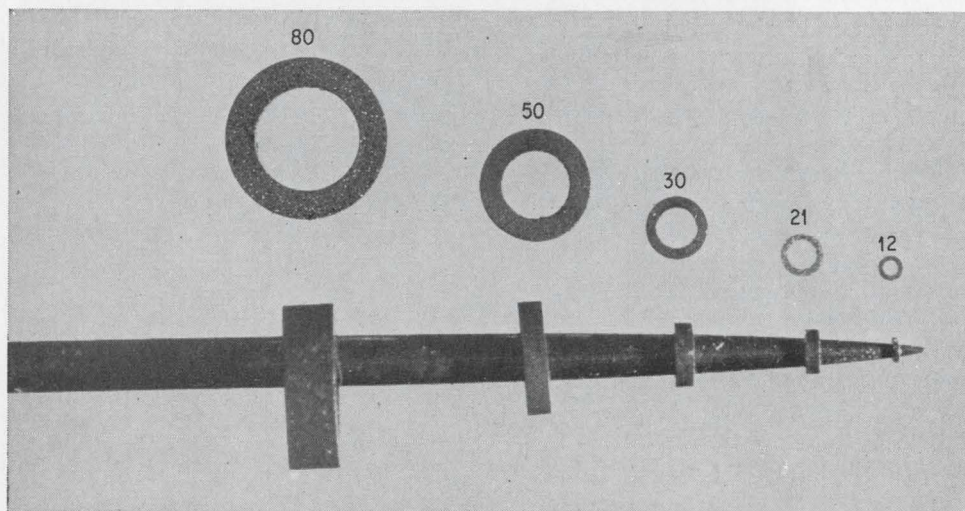

**Sized for speed.** Five common ferrite core sizes have been in use in computers. Each was smaller than the one before, and made it obsolete, because the new size could switch faster. Numbers show the outside diameter of the cores are in mils; the lower line-up shows them mounted on the tip of a sewing needle.



## Prodding memories

Ferrite-core memories with cycle times faster than 500 nanoseconds are not generally available commercially, even though designers long have been tinkering with the idea of building them,<sup>1,3</sup> and even though a relatively large memory with a 100-nsec cycle was demonstrated as long ago as 1966.<sup>2</sup>

But faster memories have not appeared for three primary reasons: the development of architectural techniques that match relatively slow memories to faster processing units;<sup>7</sup> difficulties in handling and wiring the small cores that would be required, and the expense of achieving speed by switching only part of the ferrite core's toroidal volume instead of all of it.

There are two basic types of architectural techniques. The simpler of these divides the large memory into relatively small modules that can operate at the necessary speed, and are connected via a single common bus to the central processor. But even this approach is limited by transmission and switching delays, which erect a performance barrier between the processor and its large and remote memory frame.

To compensate, the architectural alternative is to add a relatively small, high-speed buffer directly in the processor to exchange data with the remote memory [see p. 105]. The processor could randomly access individual words in the internal buffer without delay while the buffer obtains new data from the

external main memory in larger blocks. Although this requires more control hardware in the processor, the cost/performance tradeoffs have made it worthwhile.<sup>4</sup>

A high-speed buffer still requires the external main memory to transfer data at a rate commensurate with the internal buffer's cycle time, and there are techniques to accomplish this that do not impose severe requirements on the latter. For example, the accesses to separate modules can be interleaved—new cycles can be started in one or more modules before a previous cycle in a different module is complete—or long words can be transferred by accessing several modules in parallel. Thus the main memory cycle can be considerably longer than the buffer cycle.

Module capacities for these systems usually are limited to a half-million bits or less, which is desirable because, by distributing successive memory addresses, it permits an apparently very fast cycle but doesn't require individual modules to be unusually speedy. In an interleaved operational mode it reduces the statistical probability of a double access to a single module during its cycle time—this would interrupt the data flow.

But there's a tradeoff for permitting the modules to be slow: they also must be inexpensive. For this reason 3-D and 2½-D organizations are most frequently used.

make automation an economic must. But it will be necessary to further extend the capability of the wire insertion tools presently available, or to develop an entirely different approach to plane design—for example, a way of fabricating ferrite arrays in batches.

These mechanical problems have been solved, at least on an experimental basis, with cores that have an inside diameter of 7½ mils, an outside diameter of 12 mils, and a thickness of 2½ mils—compared with today's standard size of 20 mils o.d. A 12-mil core can switch in about 70 nsec when excited by a full-select current of 900 milliamperes. In a 3-D memory the core must switch both ways, first to read out the data and then to store it again for reuse later. This two-way switching time typically represents about 50% of the cycle of a 3-D memory in the quarter- to half-million-bit range; the other 50% permits transients to die away. These figures thus project a 280 nsec cycle. A slightly faster cycle time of about 230 nsec can be projected for a three-wire 2½-D organization, primarily because of the elimination of one of the dimensional controls.

But these projected times don't really indicate how much swifter main memories will actually become. There are too many factors that will influence future demand—for example, how much a customer is willing to pay for speed, or how

quickly competing technologies develop and how rapidly they're adopted.

## Buffer memories

Fast operation becomes the key requirement—if necessary, at the expense of bit capacity—when cores are used in buffer memories. Their clock cycles must match those of modern high-performance processors—usually faster than 200 nsec, and in some cases even 100 nsec. Buffer memories also must be compact enough to house the required bit capacity within or very near the processing unit. These two requirements—speed and compactness—when coupled with cost and limitations of today's memory technologies, have restricted buffer capacity to a quarter of a million bits or less.

Ferrite cores can meet the speed and compactness requirements for most buffer applications, but they lose much of the cost advantage in main memories. Although the necessary compactness can be achieved in 3-D or 2½-D organization with still smaller cores, a significant improvement in performance is possible, with present standard core sizes through partial switching. Because it switches less flux—in effect, less of the core's toroidal volume—switch time is cut.

Switching duration could be made almost arbitrarily small, except for some practical limitations such as the 1-to-0 signal ratio; it becomes pro-



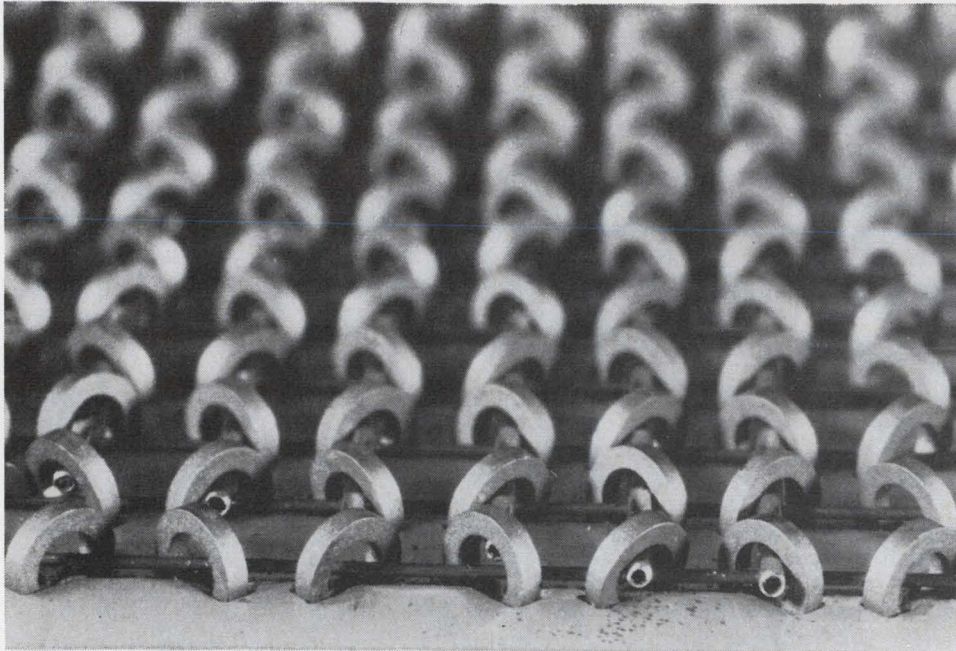

**Wired up.** These cores are being wired in an automatic machine. One coordinate already has been threaded and the second is being inserted through hollow needles. Use of the needles indicates that the cores are 30 mils or more in diameter; in smaller cores, a similar machine simply pushes the wires through a row of cores without the use of needles.

gressively smaller as less flux is switched. To maintain the ratio at a practical level, a second core is introduced at each bit position. The second core is used to store a reference flux; a differential flux-sensing system detects the presence of a 1 by measuring the difference between the flux stored in the data core and the flux stored in the second core.

### 2-D is a necessity

But the chief disadvantage of partial switching is that it requires a 2-D or word-organized system. A 3-D or  $2\frac{1}{2}$ -D organization cannot be used because both depend on half-select current pulses that affect many cores besides the full-select core; a partially-switched core produces large spurious signals when exposed to these half-select pulses, and these can even change its flux state. In a 2-D organization a single word line is selected; it carries the full drive current, but it requires more drive and sense circuitry, which, together with the use of two cores per bit, makes an inherently more expensive system than one using full switching.

On the other hand, partially switched cores dissipate less power and use lower drive currents, which are more easily obtained with state-of-the-art semiconductor circuits. Furthermore, because even in the fastest systems only two wires thread each core, the array is easier to assemble, and therefore less expensive.

Whether 2-D ferrite core systems continue to be cost-competitive with other technologies remains to be seen, though the availability of low-cost monolithic drive and sense circuits will enhance their chances. From a performance standpoint, quarter-million-bit memories with 100 nsec cycle times can be produced with the 7-by-12 core. To attain even higher speeds, a number of design choices are available, but the most chal-

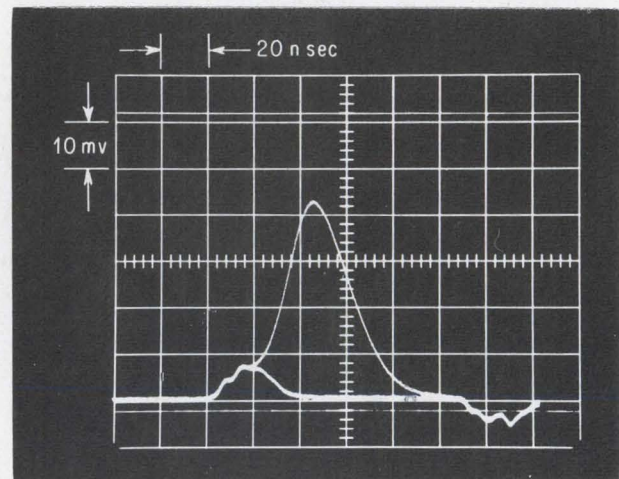

**Silence, please.** These 1 and 0 signals from a 12-mil core under worst-case coincident-current test conditions still show an excellent signal-to-noise ratio.

lenging and most promising in many respects is to continue to make cores smaller. This will increase core fabrication and winding problems, but will considerably ease the semiconductor and cooling requirements and permit a denser package. ■

### References

1. J.A. Rajchman, "Computer Memories—Possible Future Developments," RCA Review, June, 1962.
2. G.E. Werner and R.M. Whalen, "A 110-Nanosecond Ferrite Core Memory," IEEE Transactions on Magnetics, September 1966.
3. T.J. Gilligan, " $2\frac{1}{2}$ -D High-Speed Memory Systems—Past, Present and Future," IEEE Transactions on Electronic Computers, August 1966, p. 475.
4. C.J. Conti, D.H. Gibson, and S.H. Pitkowsky, "Structural Aspects of the System 260 Model 85," IBM Systems Journal, Vol. 7, No. 1, 1968, p. 2.
5. John L. Turnbull and John J. Kureck, "Smaller cores, bigger challenge," Electronics, Oct. 28, 1968, p. 112.



# Signetics was on the ball.



**We've also been to Mars.**

**And Venus.**

**And, all in all, we've taken part in 76 major space probes. So far.**

**Which really means nothing to our earthbound friends. Except for this: Here at home, you need reliability too. The highest you can get.**

**So, wherever you're heading, shouldn't Signetics integrated circuits go along for the ride?**

# Signetics

Signetics Integrated Circuits, 811 E. Arques Ave., Sunnyvale, Calif. 94086 / A subsidiary of Corning Glass Works



# It took us years to develop the best stereo microscope.

## Now give us a few minutes to prove it.

Let us compare our StereoStar/ZOOM to any stereoscopic microscope in your lab.

Our microscope offers high resolution, larger fields of view, greater working distance. We have as wide a magnification range as you're likely to need: a full 6 to 1 zoom range with magnifications from 3.5 X through 210 X. The zoom control knob is coupled—so that it's conveniently located on both sides, for either left or right-hand operation. And the entire head is easily rotatable through 360°.

135 years of optical excellence went into the AO StereoStar/ZOOM. Let us compare it to any stereo microscope in your lab. After all, if it's worth your money, it's worth your time.

Call your AO Representative. Or write for our convincing 24-page brochure.



**AMERICAN OPTICAL  
CORPORATION**

SCIENTIFIC INSTRUMENT DIVISION • BUFFALO, N.Y. 14215

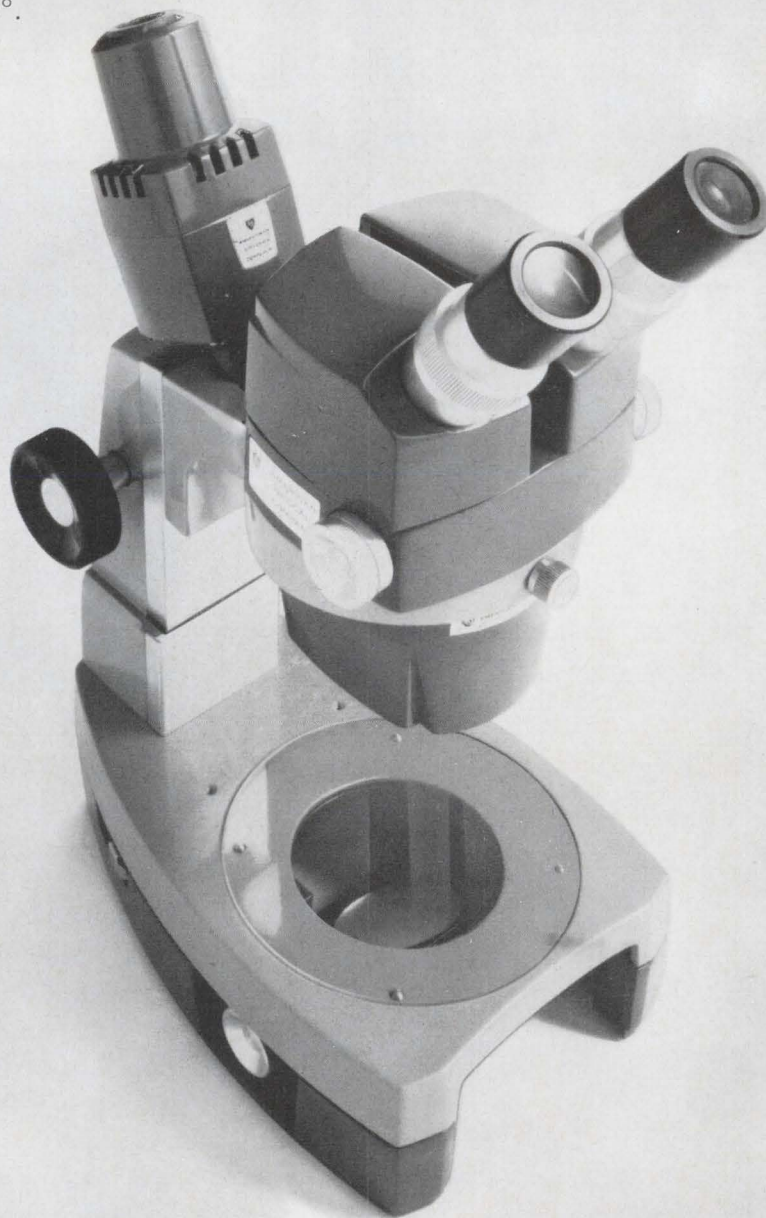



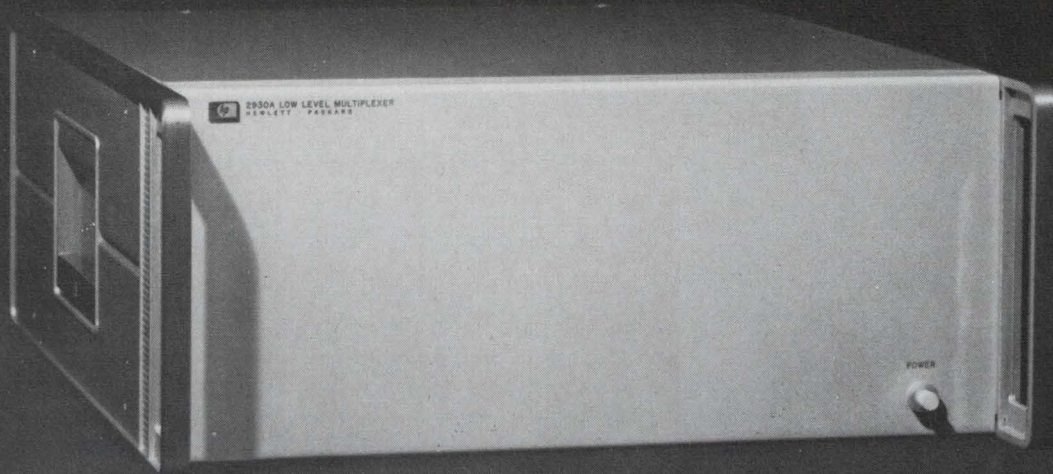

## The Much-Better Multiplexer

There's only one multiplexer that can boost millivolt-level signals to 10-volt levels at switching rates to 20-kHz—with 120 dB common mode rejection and cross-talk below 100 dB.

It's the Hewlett-Packard 2930A Low-Level Multiplexer, featuring MOS FET switches and a fast-recovery amplifier that settles in 40 microseconds. Channel gain can be programmed in 11 binary steps from 10 mV to 10 V. For noise rejection or bandwidth limiting, there's a choice of nine plug-in second and third order presampling filters.

And interfacing with any A-to-D converter and 16-bit or 12-bit computer is straightforward through one of five plug-in interface cards.

Channel capacity is plug-in expandable from 8 to 64 channels in the mainframe; several multiplexers can be controlled through one computer I/O channel. Ask your HP field engineer about other advantages of the HP 2930A Low-Level Multiplexer. Or write Hewlett-Packard, Palo Alto, California 94304; Europe: 1217 Meyrin-Geneva, Switzerland.

HEWLETT  PACKARD

DATA ACQUISITION SYSTEMS



For high speed harnessing  
with continuous lacing...

HERE IS THE WORK SPEEDING - MONEY SAVING -

## GUDEBROD SYSTEM "C"

**GUDEBROD FLAT TAPE BOBBINS**—This special packaging of Gudebrod Flat Braided Lacing Tape is highly popular in the harness shop. Whether used in all hand tying or with the Cable-Lacer (for which it was designed) the bobbin makes conveniently available, high quality Gudebrod Tape in most of its many types—all engineered to lie flat, tie tight.

**GUDEBROD CABLE-LACER**®—This unique harnessing hand tool has proved a production speeder and harness improver. Makes up to 30 knots per minute. While making firmer harnesses with tighter, more uniform knots, it eliminates wear and tear on operator's hands because special brake takes strain of knot setting. Holds bobbin of Gudebrod Tape in handle.

**LONGER WIRE HOLDING PINS**—They make wire threading much easier, quicker (no repeated wire redressing between pins). In harness tying they preserve the layout while using the Gudebrod Cable-Lacer. Special case hardened pins, nail better, stay straight, no nailheads.

**GUDEBROD SWIVEL-TILT HARNESS BOARD MOUNT**—Two dimensional balanced mobility puts every section of the cabling within easy, natural reach of the operator. Work done in this unstrained manner goes faster, is better, all day through.

There it is, the Gudebrod System "C" solving the cable making problems in a speedy, economical, profit improving way. Ask about System "C" (If you use intermittent tying, ask about Gudebrod System "S").



Gudebrod's  
Special, Longer  
Case Hardened Pins

©T.M.—UNION SPECIAL  
MACHINE CO.

**G**UDEBROD  
*Electronics Division*

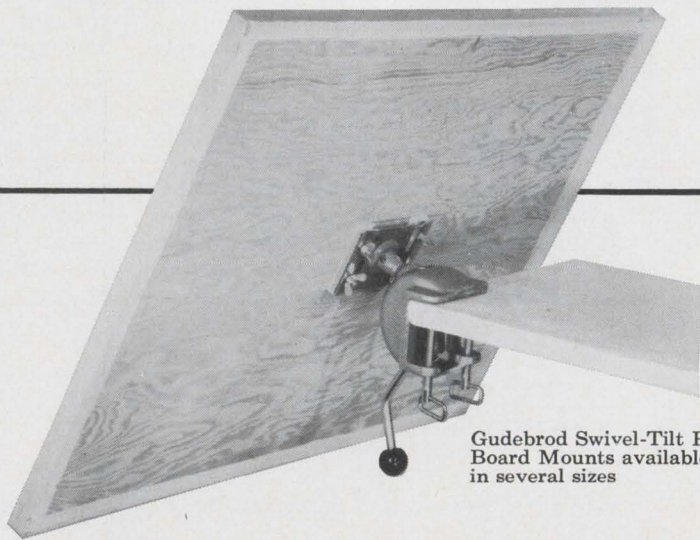

Gudebrod Swivel-Tilt Harness  
Board Mounts available  
in several sizes

GUDEBROD BROS. SILK CO., INC. Founded 1870, 12 South 12th Street, Philadelphia, Pa. 19107



# The little black box that makes you a whiz at signal processing

The CSS-3\* is incredibly easy to operate. The unique software package lets everyone do real time Fast Fourier Transforms, digital filtering, correlations, convolutions, cepstra, amplitude histograms, signal averaging, and other special application-oriented digital signal processing routines. And after only a few minutes of training, too!

Make us prove it! For more information write:  
Computer Signal Processors, Inc., 209 Middlesex Turnpike,  
Burlington, Massachusetts 01803. Tel. (617) 272-6020.

**cspi** COMPUTER  
SIGNAL  
PROCESSORS, INC.

\*CompuSignal System-3 Digital Signal Processor

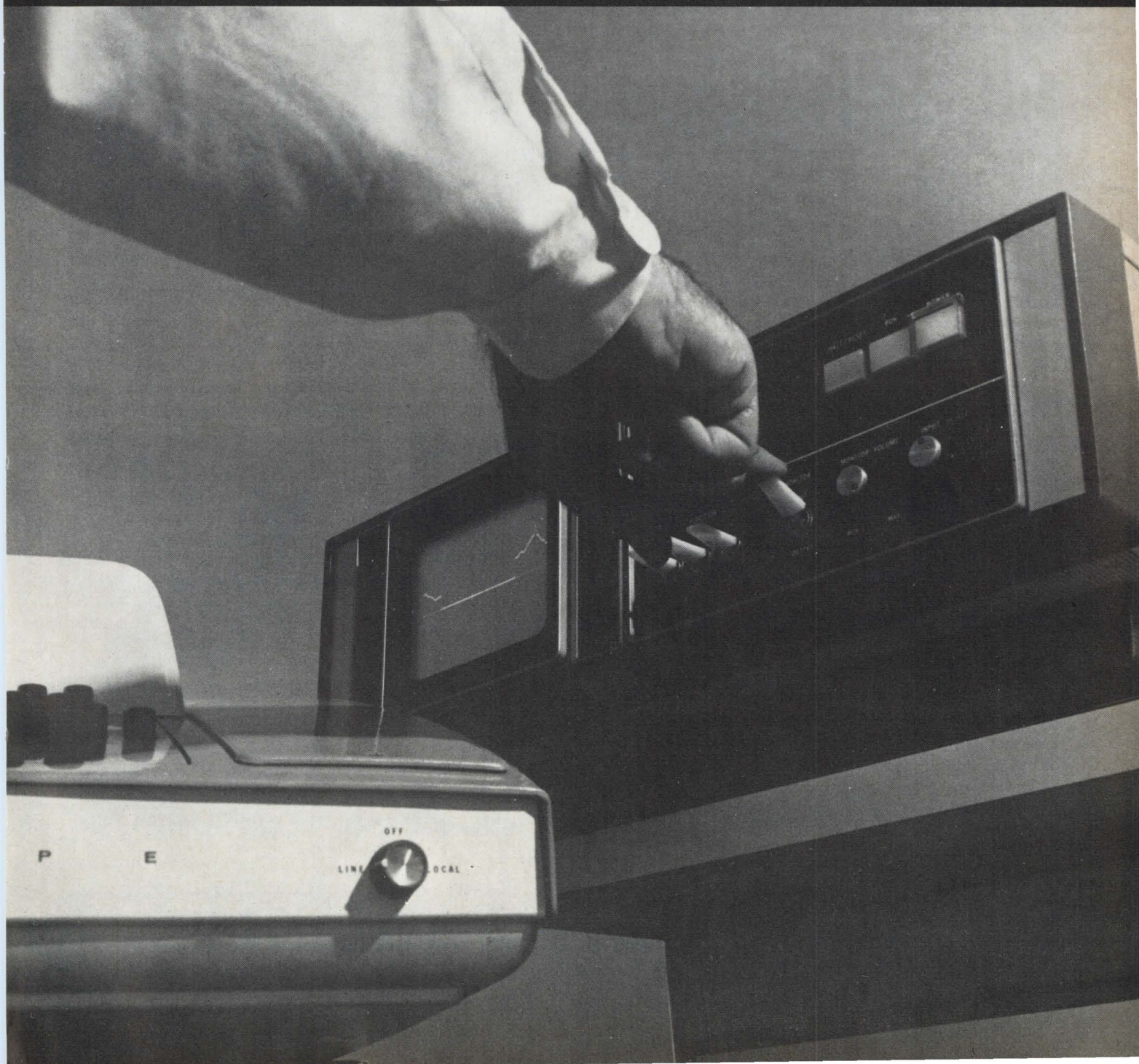



# Tips on cooling off hot semiconductors

As power levels go up and up and package size shrinks, circuit designers are keeping semiconductors cool with IERC Heat Sinks/Dissipators. Reducing junction temperature gives many benefits: faster rise and fall times, faster switching speed and beta, fewer circuit loading effects and longer transistor life and circuit reliability.

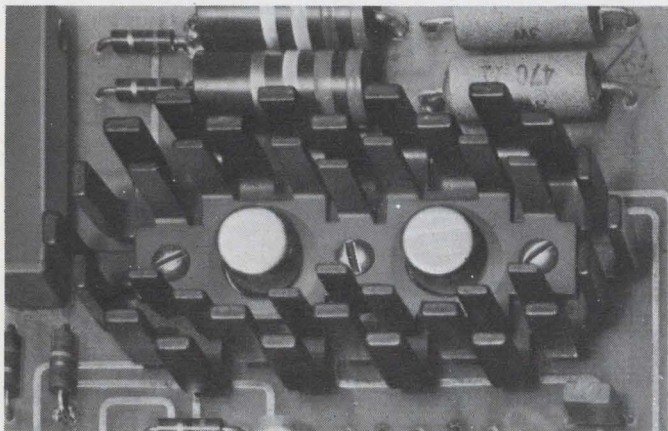

Thermal mating of matched transistors, such as these TO5's shown on a dual LP, maintains matched operating characteristics. The LP's unique multiple staggered-finger design (both single and dual models) maximizes radiation and convection cooling, results in a high efficiency-to-weight and -volume ratio.

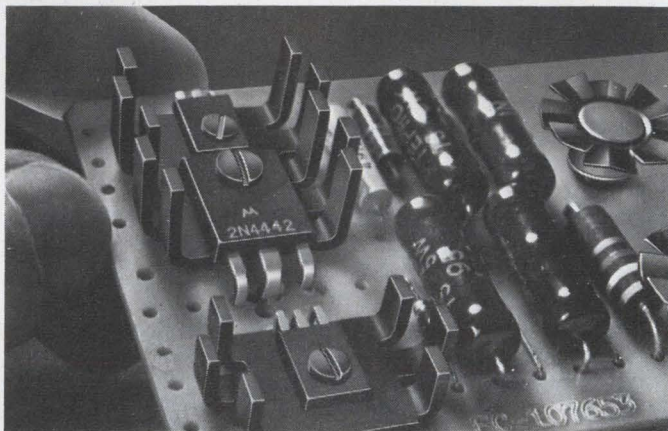

Power levels of plastic power devices such as X58's, MS9's, and M386's can be increased up to 80% in natural convection and 500% in forced air when used with PA and PB Dissipators. PA's need only .65 sq. in. to mount; PB's 1.17 sq. in. Staggered finger design gives these light-weight dissipators their high efficiency.

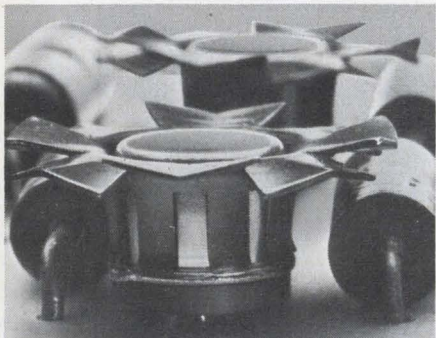

TO5's and TO18's in high density packages can be cooled off with efficient push-on Fan Tops that cost only pennies. T-shaped, need no board room, let other components snugle close. Spring fingers accommodate wide case diameter variations. Models for RO97's, RO97A and D-style plastic devices also.

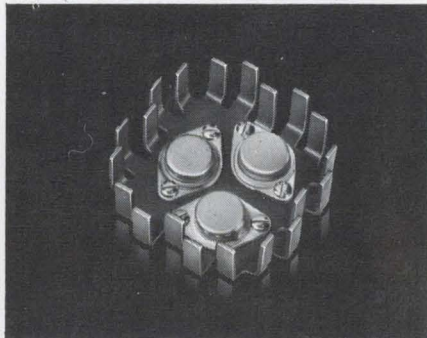

High power TO3's, TO66's, TO6's, TO15's, etc. can be operated with much more power when used with HP's. These compact, light-weight staggered finger devices accommodate from one to four TO3's. Provide the same heat dissipation as an extrusion that's three times heavier and one-third larger.

Heat problems? IERC engineers welcome the opportunity to help solve your heat dissipation problems. As the world's largest manufacturer of heat sinks/dissipators for lead and case mounted semiconductors, they can come up with a practical, low cost solution.

Free four-page Short Form Catalog. Send for your copy today.



Heat Sinks/Dissipators

**IERC**





# FOR A WIDE RANGE

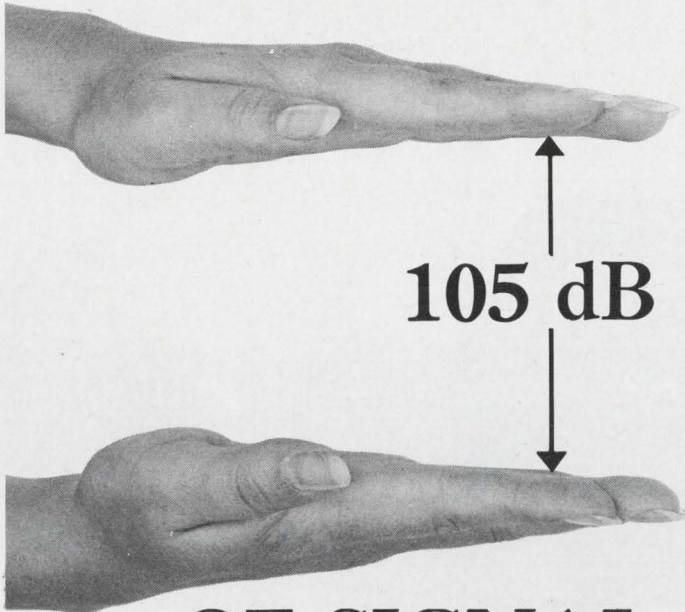

# OF SIGNAL LEVELS

Telonic's new Log Amp Detector operates over a dynamic range of 105 dB *without switching scales*. That's a 178,000 to 1 voltage swing which can be displayed on a scope or XY plotter in sweep operation, or read on the instrument's meter for fixed frequency measurements.

And if that doesn't make it the most versatile detector ever built, consider a few more

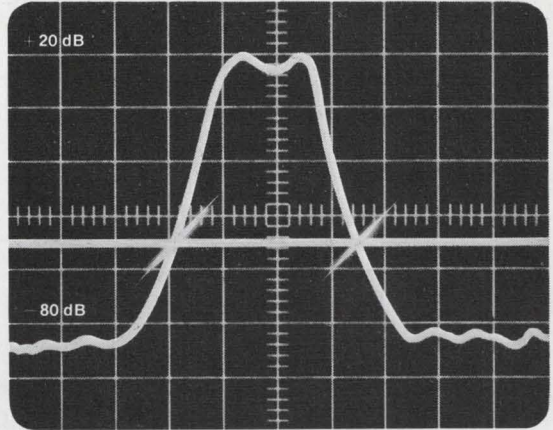

features: a tangential sensitivity of  $-85$  dBm, frequency range of 400 kHz to 130 MHz, direct readout in dBm, and a calibrated reference line for swept operation.

Capable of accepting any RF input within its frequency range and as low as  $-85$  dBm, the 6001 Log Amp Detector converts the signal to a log DC output for display or readout. Its *calibrated* dynamic range is  $-70$  dBm to  $+20$  dBm and convenient Expansion and Offset controls permit even closer looks at low level signals.

(Note: For users of Telonic's 2003 Sweep/Signal Generator, the Log Amp Detector is available as a plug-in unit, Model 3353).

*Write our Marketing Dept. for complete specifications.*



**TELONIC INSTRUMENTS**

A Division of Telonic Industries, Inc.

60 N. First Avenue

Beech Grove, Indiana 46107

Tel: 317 787-3231 • TWX: 810 341-3202

Circle 117 on reader service card



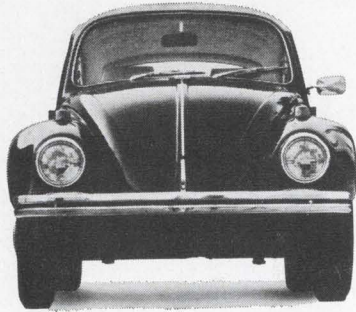

# Win a bug for Christmas.

No big thing. Just whip out the stub of a pencil and jot down one little idea. An application for the Minilever<sup>®</sup>. Either a brand-new application, or as a replacement in an existing system.

The Minilever<sup>®</sup> is a lot like the bug: Beautifully built, efficient, compact, and economical over the long haul. It's designed to increase operator efficiency where frequent, rapid switch-settings are required. Its lever clicks over a

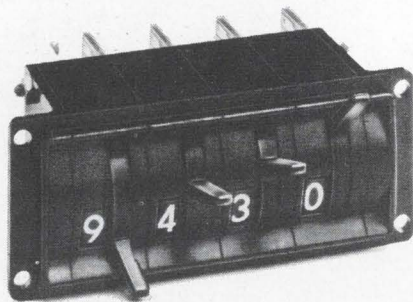

90-degree arc as the wheel rotates displaying 0.200 inch high characters. And a sweep of the hand re-sets everything—up to 12 positions—back to zero.

Now, if you circle the reader card number below, we'll send you the two things you'll need to win: Our Official Entry Blank, and a Spec Sheet that details why and how the Minilever<sup>®</sup> works.

Okay?

## **THE DIGITRAN COMPANY**

A Division of Becton, Dickinson and Co. **B-D**

855 So. Arroyo Pkwy., Pasadena, Calif. 91105  
Phone (213) 449-3110 TWX 910-588-3794





# NEW

# 7000 SERIES

## Plug-In Oscilloscopes

## 150 MHz Bandwidth . . .

USABLE performance to 150 MHz or 90 MHz. Combined mainframe and plug-in bandwidths are specified at minimum deflection factors with or without probes. With . . .

## MORE Sensitivity . . .

Higher sensitivities are achieved at greater bandwidths than ever before. 5 mV/div at 150 MHz, 1 mV/div at 100 MHz and 10  $\mu$ V/div at 1 MHz. With . . .

## MORE Flexibility . . .

Each mainframe accepts up to four plug-in units. Thirteen plug-ins are currently available to cover virtually all multi-trace, differential, sampling, and X-Y applications. Plus . . .

## NEW Convenience . . .

Greater convenience in all areas of instrument operation. Features such as Auto Scale Factor Readout, lighted push-button switching, and true automatic triggering assure faster, more accurate, less complicated measurements.

Please turn for additional information.

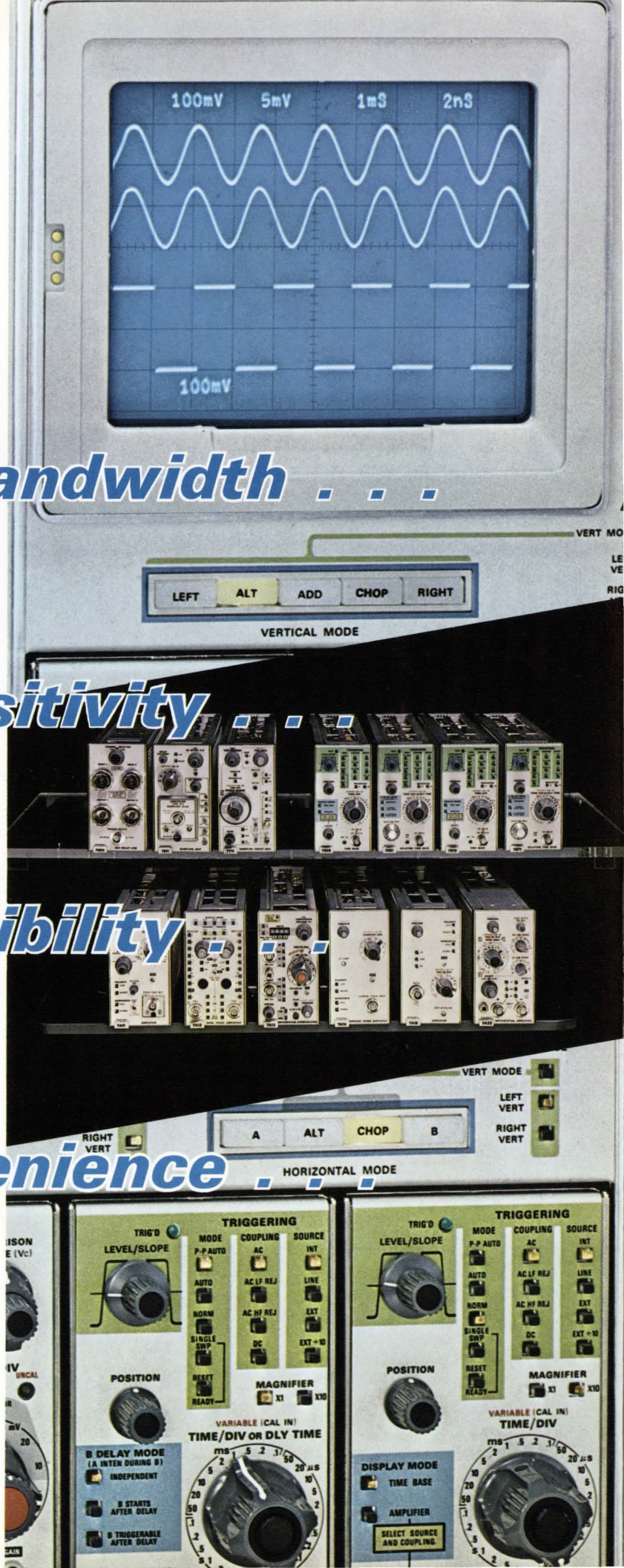



# 7504

## CONTROLS

Most "A" sweep, "B" sweep, independently. A single- or astigmatism adjustment, under complete the control

## CALIBRATOR

A multi-function generator usable as a "standard" for calibration of voltage and current GAIN, time/div, and probe compensation. The output is DC or AC (1 kHz or variable) voltage or current (fixed at 40 mA). The amplitude accuracy is within 1% and the time accuracy is within 0.5% at 1 kHz.

## TRIGGERING

The signals from both vertical plug-ins are coupled through a main-frame logic circuit and made available to each horizontal plug-in, selectable from LEFT channel, RIGHT channel, or slaved to VERTICAL MODE. The latter frees the operator from manual source changes during single-trace operation and, in conjunction with the P-P AUTO TRIGGER MODE in the time-base units, provides true hands-off triggering during routine measurements.

## FOUR PLUG-IN CHANNELS

The modular approach is the answer to instrument flexibility. With dual-trace switching in the mainframe amplifiers, each plug-in can be "specialized" in function and operate in combination with other units. Thirteen plug-ins are currently available for the 7000-Series. Together, they represent the widest range of performance options for multi-trace, differential and sampling applications available today.

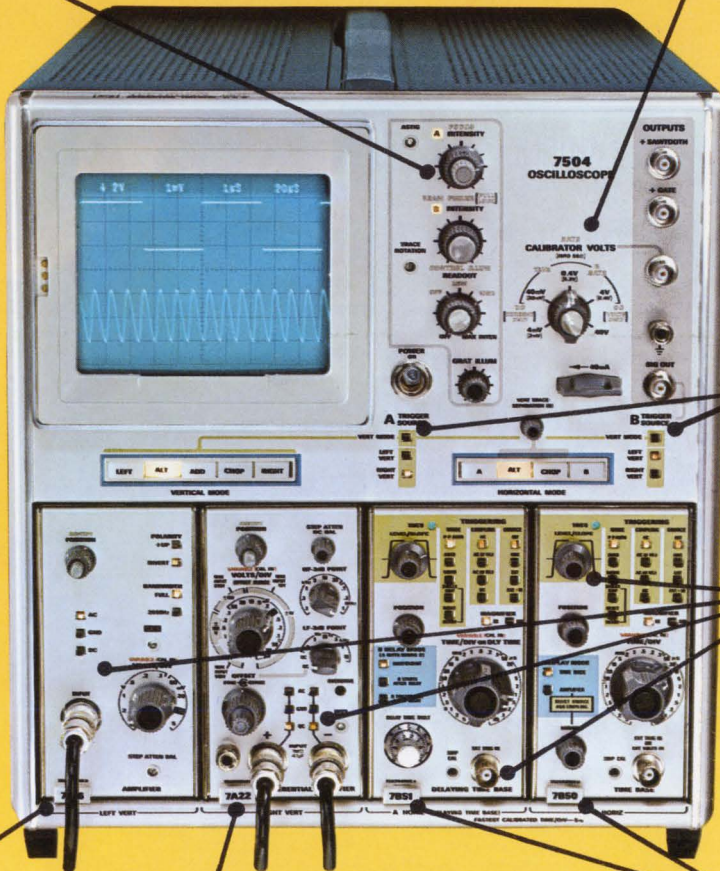

## Vertical Amplifier

10 MHz (2.4 ns tr) in the 7504. 10 ns tr in the 7504. 10 mV/div at full band-

## 7A22 High-Gain Differential Amplifier

Bandwidth—DC to 1 MHz with selectable upper and lower —3 dB points. Min deflection factor—10  $\mu$ V/div at full bandwidth.

## 7B51/7B50

### Time-Base Units for the 7504

5 ns/div maximum sweep speed. Operable singly or in combination for delaying sweep capability.



## 7M11 Delay Line Unit

Two 75 ns, 50- $\Omega$  delay lines. Trigger selection from either line.



## 7S11 Sampling Amplifier

Accepts the plug-in sampling heads for bandwidths to 14 GHz (25 ps tr).

## 7T11 Random Sampling Time Base

10 ps/div to 5 ms/div sweep range, accomplished with equivalent-time and real-time techniques.

Triggering to 12 GHz.





# 7704

## AUTO SCALE FACTOR READOUT

A character generator senses the position of volts/div, amps/div, time/div, polarity, and uncalibrated variable controls, then accounts for probe attenuation and displays the correct scale factors for all channels directly on the CRT.

## DISPLAY

Three intensity controls adj and READOUT brightness focus control, a screwdriver and a two-position beam group.

## BRIGHT TRACE

The acceleration potentials are 24 kV for the 7704 and 18 kV for the 7504 for improved trace visibility. Single-shot photographic writing speed is 3300 cm/ $\mu$ s (7704) measured with the standard P31 phosphor, the new C-51 camera and 10,000 ASA film. The display area is 8 cm x 10 cm with a parallax-free illuminated graticule.

## DUAL-TRACE SWITCHING

Both the vertical and horizontal mainframe amplifiers are "dual trace" providing a unique level of flexibility with plug-in combinations. A relatively small number of plug-ins can then meet a wide range of application requirements. The CHOP and ALT modes permit simultaneous displays of delaying and delayed sweep, and, through switching logic, may be "slaved" to provide a functional dual-beam type of display.

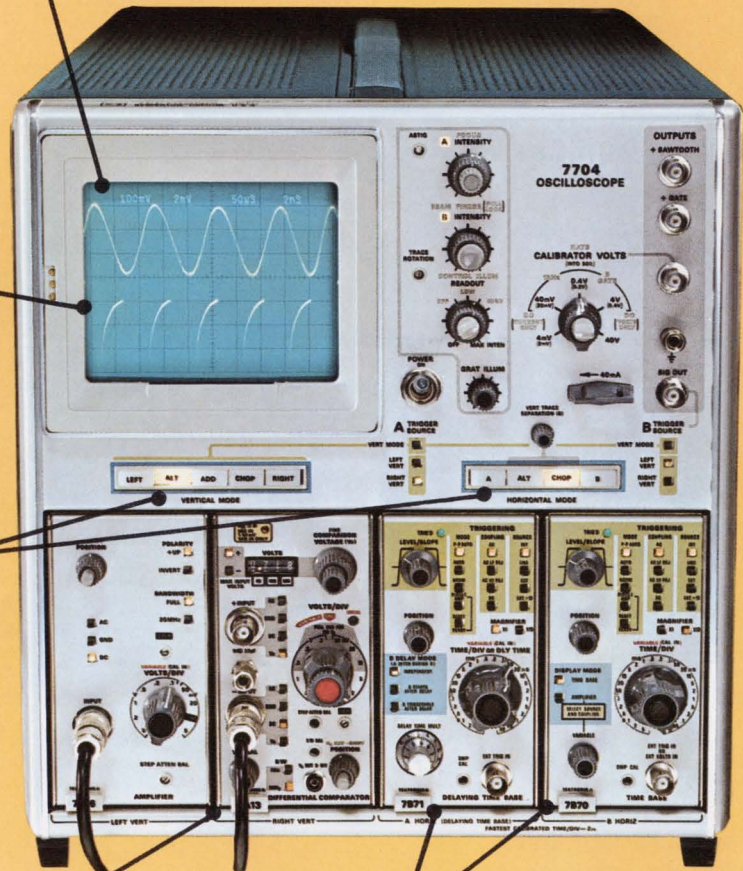

## 7A13 Differential Comparator Amplifier

Bandwidth—DC to 100 MHz (3.5 ns tr) in the 7704; DC to 75 MHz (4.7 ns tr) in the 7504. Min deflection factor—1 mV/div at full bandwidth.

## 7B71/7B70

### Time-Base Units for the 7704

2 ns/div maximum sweep speed. Operable singly or in combination for delaying-sweep capability.

## 7A16 Wide-B

Bandwidth—DC to 150 MHz (3.5 ns tr) in the 7704; DC to 90 MHz (3.9 ns tr) in the 7504. Min deflection factor—1 mV/div at full bandwidth.

## 7A11 Captive FET Probe Amplifier

Bandwidth—DC to 150 MHz (2.4 ns tr) in the 7704; DC to 90 MHz (3.9 ns tr) in the 7504. Min deflection factor—5 mV/div at full bandwidth.

## 7A12 Dual-Channel Amplifier

Bandwidth—DC to 105 MHz (3.4 ns tr) in the 7704; DC to 75 MHz (4.7 ns tr) in the 7504. Min deflection factor—5 mV/div at full bandwidth.

## 7A14 AC Current Probe Amplifier

Bandwidth—25 Hz to 105 MHz depending on mainframe and current probe; two probes available. Min deflection factor—1 mA/div at full bandwidth.





# C-51/C-50 Trace-Recording Cameras

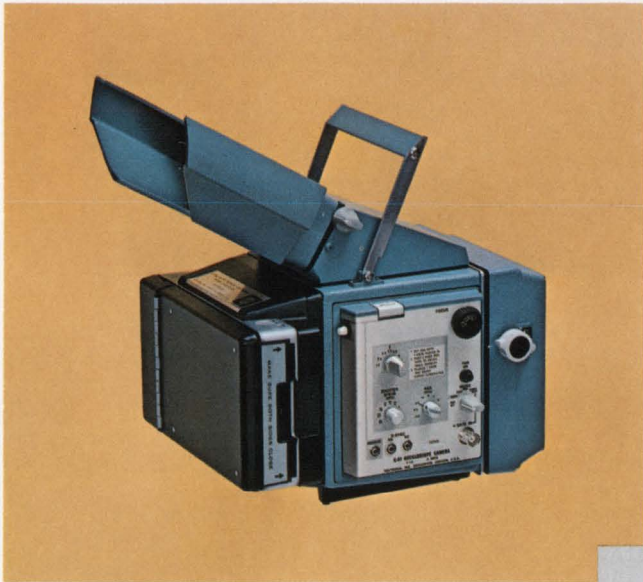

Two new compact trace-recording cameras have been designed for direct compatibility with the 7000-Series Oscilloscopes. The C-51 and C-50 cameras are basically identical units, differing only in the lens system. The C-51 has an f/1.2, 1:0.5 lens; the C-50 uses an f/1.9, 1:0.7 lens. The C-51 is recommended for single-shot photography at the fastest sweep rates, the C-50 for more general purpose applications. Photographic writing speed of the two 7000-Series mainframes with the C-51 and 10,000 ASA film (without prefogging) is 3300 cm/ $\mu$ s (7704) and 2500 cm/ $\mu$ s (7504).

The cameras offer a new level of operational convenience for mistake-proof trace photography. The guess work normally associated with selection of f stop and shutter speed to match the ASA index and trace brightness is eliminated. After setting the ASA index, the built-in photometer allows a visual correlation of trace intensity to the correct f stop setting and shutter speed. After initial adjustment, a change of f stop or shutter speed will still maintain the same exposure. Focusing is accomplished by two beams of light projected on the CRT which, when superimposed, indicates optimum focus. The insert shows the photometer spot and the range-finder focusing images.

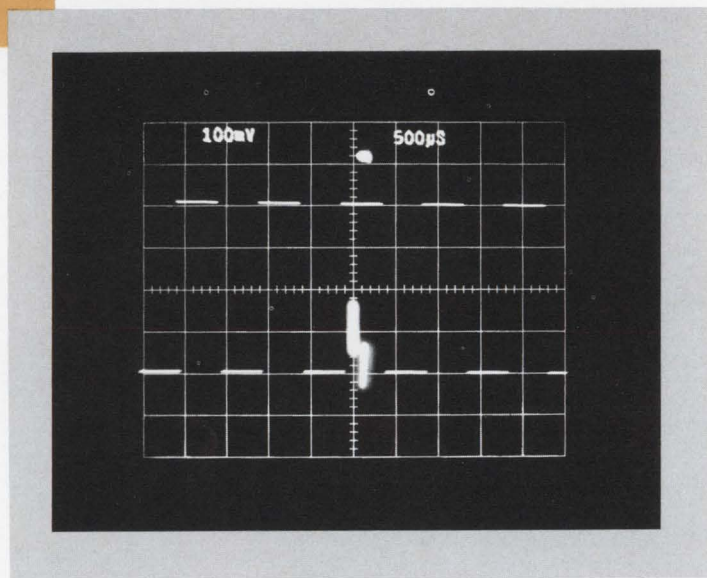

TEKTRONIX PRODUCT REPORT — 7000-SERIES OSCILLOSCOPES

## SCOPE-MOBILE® CARTS

The 204-2 Scope-Mobile® Cart is specifically designed for the 7000-Series instruments. It provides a securing mechanism for the oscilloscope, nine positions of selectable tray tilt, a large storage drawer, storage for five 7000-Series plug-ins, and large locking-type wheels.

## PROBES

The P6053 is a miniature fast-rise 10X probe designed for full compatibility with the 7000-Series instruments. Input R and C is 10 M $\Omega$ , 10.3 pF. Probe risetime is 1.2 ns or less.

The P6052 is a passive dual-attenuation probe designed for measurements below 30 MHz. A sliding collar selects 1X or 10X attenuation. Input R and C is 1 M $\Omega$  or 10 M $\Omega$ , 100 pF or 13 pF. Risetimes are 60 ns (1X) and 7 ns (10X).



7704 Oscilloscope .....	\$2500
7504 Oscilloscope .....	\$2000
7A11 Amplifier Plug-In .....	\$850
7A12 Amplifier Plug-In .....	\$700
7A13 Amplifier Plug-In .....	\$1100
7A14 Amplifier Plug-In .....	\$575
7A16 Amplifier Plug-In .....	\$600
7A22 Amplifier Plug-In .....	\$500
7B71 Time-Base Plug-In .....	\$685
7B70 Time-Base Plug-In .....	\$600
7B51 Time-Base Plug-In .....	\$510
7B50 Tme-Base Plug-In .....	\$450
7S11 Sampling Plug-In .....	\$450
7T11 Sampling Time-Base Plug-In .....	\$1100
7M11 Dual Delay Line Unit .....	\$250
204-2 Scope-Mobile® Cart .....	\$155
C-51 Trace-Recording Camera .....	\$900
C-50 Trace-Recording Camera .....	\$700
P6052 or P6053 Probes .....	ea \$50

U.S. Sales Prices FOB Beaverton, Oregon

## Tektronix, Inc.

For a demonstration, call your local Tektronix field engineer or write: Tektronix, Inc., P.O. Box 500, Beaverton, Oregon 97005.



# U.S. lights fire under microwave ovens

HEW seeks to reduce the allowable level of emitted radiation to 1 mw/cm<sup>2</sup>, but industry sees no clear evidence of health hazards under its own standard

By Robert Westgate

Associate editor

**Too much radiation** from high-power microwave sources isn't good for you—that's a fact. But just where to draw the line between what poses a health hazard and what doesn't isn't quite that clear cut—at least not to the Government or, for that matter, to the manufacturers of microwave ovens.

At issue is a decision pending before the U.S. Bureau of Radiological Health on setting the maximum safe emission level from the ovens to one-tenth the value previously considered safe by both the military and industry. One milliwatt per square centimeter, measured 5 centimeters from any of the oven's outer surfaces, is the new level proposed by the bureau, an agency of the Department of Health, Education and Welfare. As the manufacturers see it, the proposal could spell disaster.

"The proposed standard would restrict and inhibit the development of the . . . American market and restrict technological progress in microwave ovens and in other fields," says Gunther Baumgart, president of the Association of Home Appliance Manufacturers. "It would also increase oven design and manufacturer's costs," he adds.

The problem is an old one in industry-Government relations. The oven manufacturers, like the automobile and color-television makers before them, fear Government standards will raise cost and purchase price, eliminating potential customers. But, buttressing the association's position that the present industry-regulated standard of 10 mw/cm<sup>2</sup> is "wholly adequate" is the absence of any general scientific agreement as to levels at which

microwave radiation becomes a health hazard. The 10 mw/cm<sup>2</sup> standard also is considered adequate by the Electronics Industries Association, whose members supply the magnetrons for the ovens, and the American National Standards Institute, which sets standards for a wide range of industries.

## Having their day

They will have the chance to air their views on Oct. 31, when the 14-member Technical Electronics Products Radiation Safety Standards Committee meets in Washington to hear arguments from the

microwave-oven manufacturers. Established by the Radiation Control for Safety and Health Act of 1968, the committee advises HEW on radiation standards for all products. It reportedly favors the lower minimum level.

The committee has asked the manufacturers of the ovens, which operate at either 915 or 2,450 megahertz, to supply answers to several key questions:

- How does the age of an oven affect microwave radiation leakage?
- What is the industry's record in product improvement?
- What design changes would be necessary, and how long would

## For consumer protection

One of the biggest problems facing the microwave oven industry is how it will be able to assure HEW—and the general public—that its products will remain safe as they grow older. What happens, for instance, if it is dropped, or dirt accumulates around the dirt seal, and the door leaks excessive radiation? And how can anyone detect it?

The industry feels dealer installation and periodic checks of the ovens might scare the public and would be too expensive. Federal Trade Commission regulations might be violated if the installation and checks were restricted to the dealer's factory-trained repairmen, they contend.

However, at least one company is trying to develop a reasonably priced (less than \$10) sensing device which would indicate excessive leakage. A company spokesman says the device might flash a light for several seconds and then turn off the oven.

But making measurements is even a problem in a laboratory. Researchers do not use standard instruments or methods to determine radiation levels. And up to now, a safe, accurate instrument that would not disturb the measured field does not exist.

However, Ronald R. Bowman of the National Bureau of Standards, Boulder, Colo., has drawn up a list of characteristics for an electromagnetic probe which the bureau feels would be ideal for testing radiation levels. And Paul W. Crapuchettes, a vice president and technical director of Litton Industries' Electron Tube division, has completed an instrument study as a consultant to the Association of Home Appliance Manufacturers. The study describes several new instruments that he rates as effective for measuring the radiation.



# FASTER THAN A HOLE A SECOND!

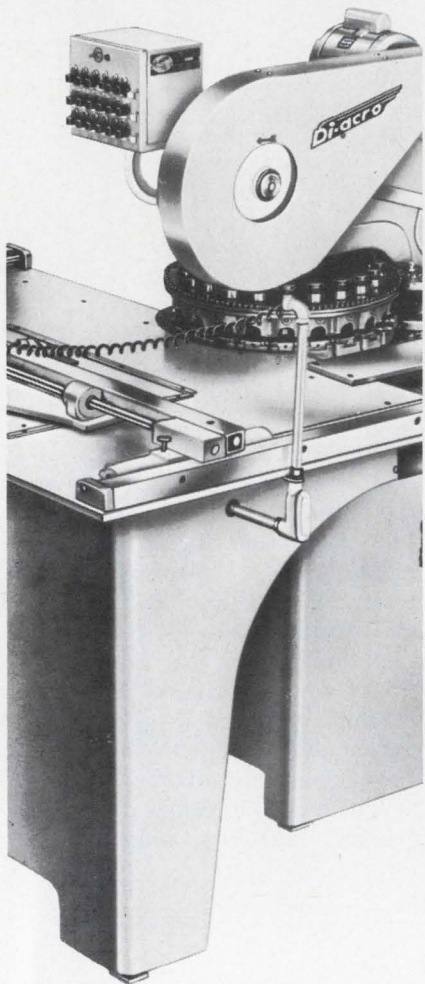

This is an 18 station turret punch press. Electrically linked to a floating stylus. Trace the template, touch the button—punch your holes.

The feather-touch stylus floats on recirculating ball bearings. Accurate within .005" of the template. Eighteen punch and die sets always ready, always perfectly aligned. Change setups fast as you can drop in a new template.

Capacity: up to 2" dia. hole in 14 ga. steel blank up to 19" x 24". Over 500 standard and "special" punches and dies from stock. Custom shapes to your order.

Call your Di-Acro distributor for the big 44-page Punching Catalog.



they take to implement if the 1 milliwatt standard should become law?

▪ What "normal service adjustments" performed by a repairman would not cause an oven to leak excessive radiation?

▪ How could companies assure that the standard would remain in force for the life of the oven?

HEW's proposed standards also would require that ovens be equipped with two independent interlocks—one mechanical, the other electrical—in addition to the on-off switch. The interlocks would shut off primary power between the power source and the magnetron when the oven door is opened. They could be located on either side of the power transformer, but one would have to be hidden and "defeatable" only if the oven were dismantled to the point where it can no longer operate. The interlocks would not cut off power to the oven light, blower, or tube filament.

## Underscoring the needs

HEW says it is trying to push the industry to the limits of its technical ability. Many of the engineering problem areas already are known. Better-fitting doors are needed, as are higher quality and more effective r-f seals; a good repair schedule; a corps of trained servicemen; an efficient way to measure microwave radiation leakage from the ovens, and possibly a latch that would cut off the radiated power before the door is opened, HEW says. HEW claims tests have shown that leakage may balloon to as high as 100 mw/cm<sup>2</sup> after the door is opened and before present interlocks switch off the power.

It's also been found that the metal-to-metal seals deteriorate with age. Newer ovens that use a choke seal with energy-absorbing material may leak more than the metal-sealed ovens at first, and may be harder to clean, but thus far they appear to maintain their leakage level better with age. The latter seal also may be troublesome when used in a self-cleaning oven which subjects even the seal to temperatures above 800° F.

**More pollution.** Why are microwave radiation standards necessary? According to one expert, William T. Ham, chairman of the Biophysics department at Virginia

Commonwealth University, microwaves are a definite air pollutant. "The atmosphere is permeated from one area to another with microwave radiation," he says. "The pollution problems aren't that great now, but we must be ready for the future."

HEW points out that "microwave systems have become a part of our way of life." Exposure is not just limited, for instance, to military personnel operating radar equipment or to those involved in a radar manufacture and installation. Microwaves are used in laboratories, in commercial drying and heating processes involving such diverse products as photographic film, potato chips, and glue binders, and in communications and navigation. Use of microwave ovens is increasing rapidly in restaurants, hospitals, and self-service vending and fast-food operations, and—most important in terms of potential hazards—in homes. Therein lies the urgency of immediate, adequate safety standards, HEW asserts.

The market for microwave ovens already is substantial—roughly \$15 million annually. Predictions are that by 1976 a quarter of the ovens sold in the U.S. will be microwave. And HEW fears most of the oven owners will be unaware of the potential hazards to their health.

U.S. appliance manufacturers now making microwave ovens, which range in price from about \$500 to \$1,200, include the General Electric Co., Louisville, Ky.; Microwave Oven division, the Tappan Co., Mansfield, Ohio; Microwave and Power Tube division, the Raytheon Co., Waltham, Mass., and a Raytheon subsidiary, the Amana Refrigeration Co. in Amana, Iowa; Microwave Oven division, the Roper Co., Kankakee, Ill.; and Atherton division, Litton Industries, Minneapolis.

Imported, and perhaps lower-priced, units from Japan, Britain, Holland, Sweden, and Germany haven't hit the U.S. market yet, chiefly because models haven't been submitted to the Federal Communications Commission for frequency checks or to HEW for safety examinations. Foreign ovens will be subject to the same emission regulations, but the law will be even tougher on them than on domestic products: if foreign ovens



## Coordinating research

Look for at least two groups to coordinate future research on the effects of microwave radiation: HEW's Consumer Protection and Environmental Health Service and an ad hoc committee headed by Dr. John M. Heller of the New England Institute for Medical Research, Ridgefield, Conn.

Assistant Surgeon General John J. Hanlon says HEW hopes to coordinate all Government research in this area. Dr. Heller says his committee will act as a clearing house for research papers, so that scientists can share the results of their experiments and avoid duplication.

A number of veteran researchers in the field were dissatisfied with the quality of research papers presented at last month's symposium on the health implications of microwave radiation held in Richmond, Va. They suggested that some of the less experienced scientists didn't understand good research practices, that time and money were being wasted on performing experiments on organisms or animals when the conclusions could not be applied to humans, and by duplicating experiments which had first been done in the 1940's and 1950's.

are found defective, they can be destroyed; U.S.-made ovens either must be repaired or replaced, or their cost refunded. One British company complained to HEW that this provision amounts to "another Boston Tea Party."

### How safe is safe?

Until now, 10 mw/cm<sup>2</sup> has been considered a safe emission level by military and industrial organizations, and oven manufacturers say they've accepted this standard for their designs. But HEW doesn't think this level is safe enough for commercial and household installations.

Military personnel, scientists and industrial users have plenty of microwave experience, are aware of the hazards, and know how to handle problems should they arise, HEW points out. The ordinary user, HEW feels, must have extra protection.

"The 10 milliwatt level is close enough to levels that have created injuries in animals and we just can't take the chance that it won't have a bad effect on humans," says an HEW spokesman.

Most ovens right off the production line could readily meet the 1 mw/cm<sup>2</sup> standard, HEW believes. Far more serious is the problem of maintaining this level for the life of the oven. It will be hard to do even if checks and adjustments are made by dealer- or factory-approved repairmen. And according to recent Federal Trade Commission rulings, appliance guarantees must hold regardless of who makes the repairs.

Unlike gas or electric ovens, microwave units operating at 915 Mhz do not produce a heat sensation to warn a user he is being burned. Microwave ovens heat up too quickly—in seconds. Usually, the burn occurs in a subsurface skin layer where the effect is not immediately evident [*Electronics*, Sept. 30, 1968, p. 43]. And although the higher oven frequency—2,450 Mhz—does produce a heat sensation, it poses another danger. It can cause cataracts in the eyes. Most microwave ovens now on the market are designed for the higher frequency.

**Affects sex life.** Even more bizarre human health and biological effects of low-level microwave radiation have been claimed by Russian observers. These effects include everything from headaches and irritability to lessened sexual activity, fear, asthma, hypochondria, and fatigue.

The full clinical significance of Russian and other East European studies into the cumulative effects of low-level radiation is not fully understood by Western scientists, perhaps because they are skeptical about the validity of the findings. Westerners claim the Russians do not supply enough data to support their findings, and do not—or are ordered not to—answer questions.

However, U.S. scientists not only disagree with the Russians—they disagree among themselves. At last month's Symposium on the Biological Effects and Health Implications of Microwave Radiation in Richmond, Va., the lack of agreement was highlighted by Assistant

# THEY'VE GOT OUR NUMBER!

## Computer Access Systems

## Hewlett-Packard

## International Computer Products

## Omnitec

## Sycor

## Viatron

## Wang

## Laboratories

## Westinghouse



## FOR MINI-DIGITAL READ / WRITE HEADS

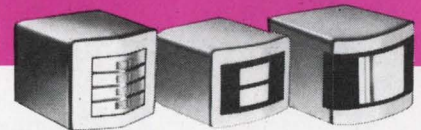

YOU TOO CAN GET THE HEADS  
YOU NEED FOR DESK-TOP,  
INPUT/OUTPUT, TERMINAL, AND  
PERIPHERAL EQUIPMENT,  
BY CALLING THIS NUMBER:

(612) **545-0401**

**Northronics**  
COMPANY, INC.

World's Largest Tape Head Manufacturer

8101 Tenth Avenue North  
Minneapolis, Minnesota 55427  
Phone—(612) 545-0401



## The Testex 410 IC Analyzer not only isolates your problem; it pins it on a specific pin.

This is an *in-circuit* analyzer. You do not remove the integrated circuit from the PC board (this alone saves many an IC from the scrap barrel); and you do not have to shift the multi-pin probe to get level error, logic error, low Vcc — or visual display of signal presence at each pin.

The procedure is quicker than pin-by-pin checking and is simple enough to have non-technical people relieve skilled personnel of the testing chore. This does not make them circuit designers or service-men, but it does save valuable time.

Dual-in-line and flat-pack types — digital DTL, RTL, and TTL's are checked on Testex 410. Other specifics — function, applications and economics — are found in our literature. Testex Incorporated, 154 San Lazaro Avenue, Sunnyvale, California 94086. Telephone (408) 732-0461.

# TESTEX

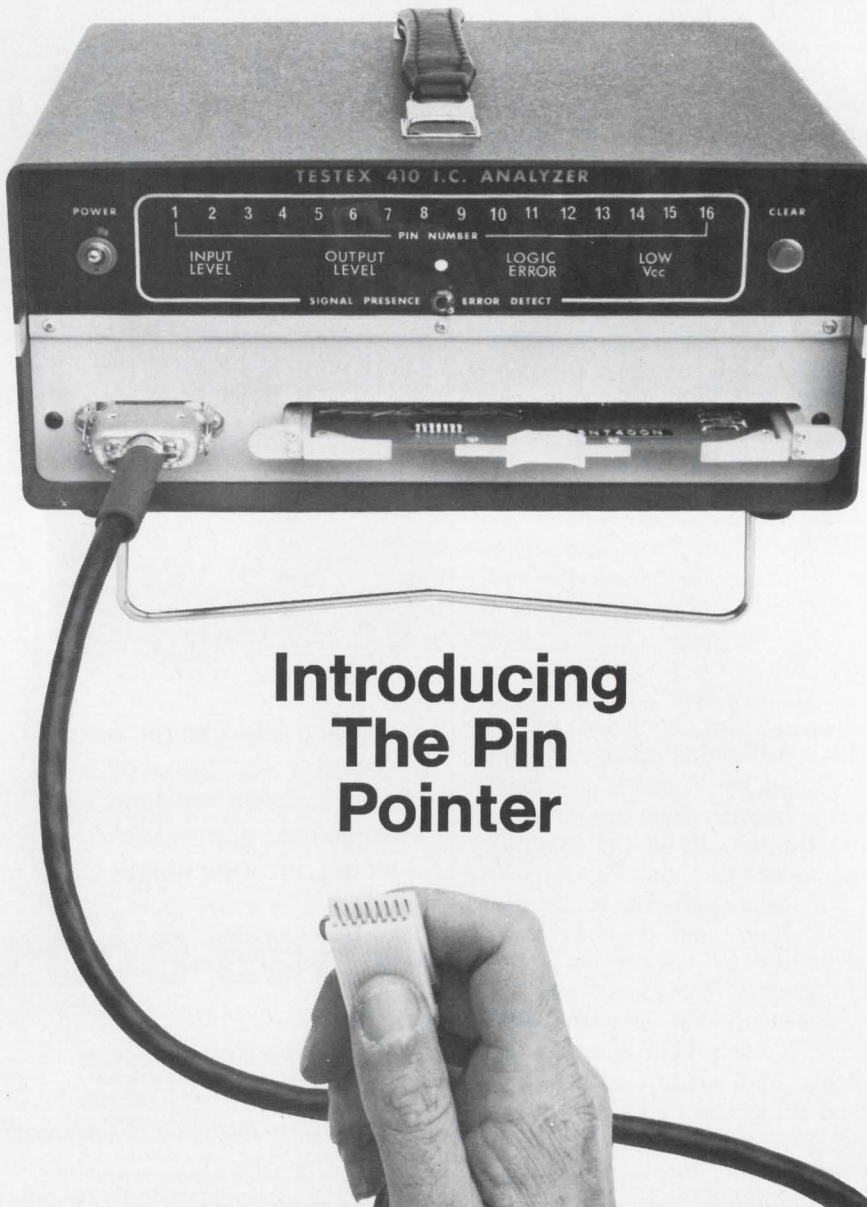

## Introducing The Pin Pointer

Surgeon General John J. Hanlon, deputy administrator of HEW's Consumer Protection and Environmental Health Service. Reading from testimony about microwave radiation during Congressional hearings, Hanlon said he was impressed by the "frequent use of such phrases as 'no systematic work has been done' . . . 'no one knows if' . . . 'we do not know if there are other harmful effects' . . . 'our present knowledge is limited'." There is a great need for additional, well-controlled microwave research to provide a sound basis for regulating microwave-radiation-producing devices, he said.

But after three days, the nearly 400 delegates were still divided on the conclusions to be drawn from the research papers presented. Some said there wasn't enough valid information on incapacitating injuries resulting from the radiation, and at what field strengths, frequencies, and exposure times they occur. Others felt that even the sketchy existing data was enough to warrant the low standard. The split perhaps was epitomized by a seven-man, blue-ribbon panel convened to discuss future research needs. To the question of whether it was premature to toughen the existing standard, three panel members replied it was not premature, three said it was, and one had no firm opinion.

**Nebulous.** One of those opting for the stricter standard, Allen Frey of Randomline Inc., asserted that "it is not a matter of inadequate information. We must make the best decision on standards with the information we have. And we can't wait to see if the same effects that have appeared at low-level microwave radiation in animals — such as a change in brain activity — also will appear in humans."

On the other side of the issue were Dr. John H. Heller of the New England Institute for Medical Research, and Sol Michaelson of the University of Rochester. Heller wanted still more research. "Until we have explored different frequency ranges and different human systems," he said, "we must be careful before setting standards people consider safe." And Michaelson, who helped write the 1965 Air Force report recommending a 10 mw/cm<sup>2</sup> level, said he had



learned nothing new from the symposium. It was premature, added Russell Carpenter of Tufts University, "to take a stab in the dark. Let's stay with the 10-mw standard and experiment to see if it should be lowered."

To complete the fragmentation of opinion, others at the symposium said it would be better to ease a tight standard, rather than tighten an easy one. With 1 mw/cm<sup>2</sup> established as a level of acceptable risk, said symposium chairman Stephen V. Cleary of Virginia Commonwealth's biophysics department, research should then begin to determine how high radiation levels could rise and still be safe for humans.

Because of all this uncertainty the appliance manufacturers' association charges that 1 mw/cm<sup>2</sup> maximum leakage level may become law on the basis of unsupported health hazard claims. The design of microwave ovens was based on the opinion of leading microwave scientists that the safe radiation exposure level was 10 mw/cm<sup>2</sup>, the association points out; changing the design is unwarranted without conclusive evidence.

Only one microwave oven manufacturer, the Commercial division of Magic Chef, Cleveland, Tenn., says it has accepted the tougher standard. The company is making its initial entry into the restaurant and vending market.

Almost all the other companies in the field, though reticent to discuss the hazard factor, were seriously concerned about the "bad press" the industry was receiving. They referred to "scare headlines" and "inaccurate" stories about alleged effects on animals—effects which they felt could not apply to humans.

One company official concluded that "the growth of an industry depends on the industry itself. If stricter standards are set, I am sure we have the technical competence to meet them . . . if we are given time to do so." HEW has proposed an 18-to-24-month delay in adopting the 1 mw/cm<sup>2</sup> standard to give the manufacturers time to meet the requirements. The new standard, which will be set initially at 10 mw/cm<sup>2</sup>, could go into effect as early as next summer, according to one HEW estimate.

## a complete digital system



- circuit breadboarding
- for: • customized digital instruments
- learning digital techniques

## HEATH 801 Digital System...

buy the complete system or discrete components

Now . . . A Complete System to Enable You to Get the Most Out of Digital Electronics. Here is a system that is revolutionizing instrumentation in labs and classrooms throughout the world. The basic design concepts of Professors H. V. Malmstadt and C. G. Enke combined with the engineering of Heath's scientific instrument group have resulted in the unique 801 Analog Digital Designer (ADD) and the EU-51A breadboard and parts group. This versatile system can perform equally well in constructing high performance research-quality instruments, in performing hundreds of experiments in the teaching laboratory, in rapid testing of new digital ideas, or in interfacing to computers.

Start . . . By Learning the New Digital Electronics. Drs. Malmstadt and Enke have written a pioneering new text "Digital Electronics for Scientists" (published by W. A. Benjamin, Inc.) that provides a systematic introduction to the digital circuits, concepts and systems that are basic to the new instrumentation — computation revolution. The book is written for engineering and science students and for practicing engineers, scientists, and technicians so that all may effectively utilize the startling recent advances in digital electronics.

Never before have the latest "state-of-the-art" methods been made so rapidly and conveniently accessible through an integrated combination of new text and versa-

tile equipment. The experimental section of the text is written specifically for utilizing the Heath 801A and 51A to provide experience and working knowledge with hundreds of digital and analog-digital circuits, instruments and systems.

Write . . . for Complete Information on Cards, Modules and Parts in the Heath Digital System. The basic Analog-Digital Designer (EU-801A) contains 3 modules (power supply, binary information, and digital timing) and 13 circuit cards including TTL gates, flip-flops, monostable MVs, relays, op amps, and V-F converter. The EU-51A Experimental Parts Group is a highly flexible breadboard system for circuit design and teaching. The group includes a desk chassis, 493 components, a patch card accepting these components, and a power patch card.

The system is open-ended. New cards and modules are continuously being introduced so you can construct your own special frequency meters, counters, timers, DVMS, rate meters, and many dozens of other instruments.

Take . . . advantage of the digital revolution — order your Heath Digital System now.

**EU-801A**, Analog-Digital Designer . . . . \$435.00\*  
**EU-51A**, Experimental Parts Group . . . . \$135.00\*  
**EUP-19**, text "Digital Electronics For Scientists" by H. V. Malmstadt and C. G. Enke (published by W. A. Benjamin, Inc.) . . . . . \$9.50\*

### FREE Heath Scientific Instrumentation Catalog



Describes these and other precision instruments for laboratory, engineering, education and R & D applications. Send for your FREE copy now . . . just write on your school or company letterhead.

HEATH COMPANY, Dept. 586-04  
 Benton Harbor, Michigan 49022



a Schlumberger company

Please send FREE Heath Scientific Instrumentation Catalog

Name \_\_\_\_\_

Address \_\_\_\_\_

City \_\_\_\_\_ State \_\_\_\_\_ Zip \_\_\_\_\_

Prices and specifications subject to change without notice.  
 \*Mail Order Prices; F.O.B. Factory

EK-278



# BIG ADVANCES Come in Small Packages

Now... Reeves has developed the highly accurate sub-miniature heaterless Mini-RIG Integrating Gyro... and the full capability for packaging it as a self-contained sub-system.

The Mini-RIG development represents a major advance in reliability, cost reduction and performance, in the field of subminiature high-volume inertial sensors.

Only one inch by two inches in size, the Mini-RIG can stabilize short-mission-time inertial platforms or serve as an inertial sensor in strap-down applications. Automated gyro assembly techniques have reduced final assembly time from the normal one month to **one work-day!** This, in turn, has minimized the possibility of contamination and maximizes reliability. Reeves has full

packaging capability, too. For example, the illustration shows a typical compact three axis rate package especially designed for aircraft missile and satellite system applications. It is system-engineered to provide the necessary accuracy and to meet the most stringent environmental requirements of outer space. Within its 30 cubic inch volume are three Mini-RIG Rate integrating gyros **plus** all necessary electronic modules to operate the entire package.

What are your special needs for subminiature gyro packages and sub-systems? Reeves can meet them! Our engineers working within the Total Systems Concept, will isolate the problem areas and provide the most practical solutions for them.

For complete data and application information call (516) 746-8100 ext. 540, or write Component Division, Reeves Instrument, Garden City, N.Y. 11530.

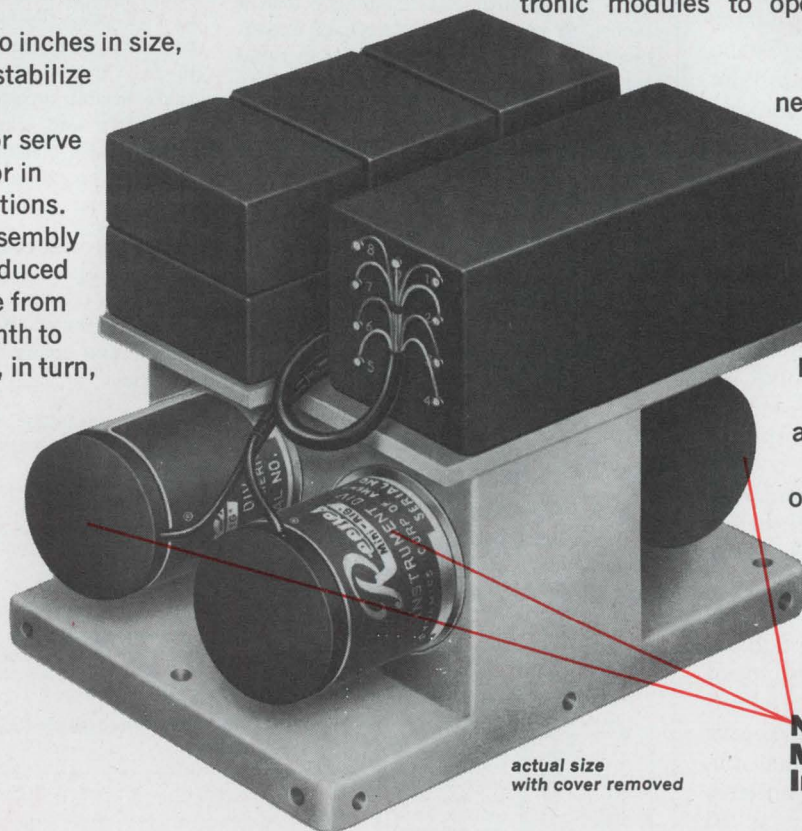

actual size  
with cover removed

**NEW! REEVES  
Mini-RIG®  
Integrating Gyro.**

**Reeves®**

INSTRUMENT DIVISION



DYNAMICS CORPORATION OF AMERICA / GARDEN CITY, NEW YORK 11530



# Charting a course to high profits

With Sporck at the helm, National Semiconductor moves from red ink to black by narrowing the scope of its research and focusing on high-volume devices

By Stephen Wm. Fields Associate editor

**Turning** a money-losing company into a highly profitable one isn't as easy as ABC, particularly in the hotly competitive semiconductor industry. But, from Charles Sporck's point of view, the ABC's—or basics—point the way to black, rather than red, ink. For that's exactly what has happened at the National Semiconductor Corp. since Sporck took over as president in 1967, a year in which the company reported an operating loss of \$724,000 on sales of \$7.2 million. (In the same fiscal year, ending on May 31, National Semiconductor also reported an extraordinary loss of almost \$1.5 million as a result of inventory writeoffs.)

What were Sporck's ABC's for success? In straightforward terms, they were (and still are):

- Concentrate on products that fill special needs so as not to spread resources too thin while, at the same time, enhancing the company's reputation.

- Accept no orders for small runs of custom products, but produce in large volume only.

- Keep a reasonable emphasis on research and be reasonably sure marketable products are in sight.

Financial statements for 1968 and 1969 provide ample testimony as to how well Sporck's approach works. In 1968, National Semiconductor earned \$900,000 on sales of \$11 million; a year later the figures were \$1.5 million and \$23 million, respectively. But what about the current fiscal year, which will end next May 31? The company is publicly projecting sales in the neighborhood of \$48 million—and is privately expecting \$75 million, according to insiders. And that's a long, long way from sales totaling \$28,530 in 1959—the year the com-

pany was founded.

At the outset, Sporck had to cope with the purchasing-agent psyche. "We couldn't be a 'me too' type of company," says Sporck, "because then we would have nothing special to offer. And why should a guy start buying semiconductors from an unknown company when he could just as easily get them from one of the big boys?" National decided to market a special product to fill a specific need.

The philosophy behind this, according to Sporck, was "to get a foot in the door and get the name National known." Thus LM 100 and LM 101 were born. The LM 100 was the first monolithic voltage regulator. The LM 101 is an operational amplifier that's essentially a better version of the Fairchild 709, and that, by comparison, offers reduced input offset current and voltage, eliminates latch-up, is short-circuit proof, and requires fewer external components for compensation. The 101 was designed by Bob Widlar, National's director of advanced circuit development, who had designed the 709 while at Fairchild Semiconductor. What's more, both linear circuits—the 100 and the 101—fell in with Sporck's strategy.

National became known as the "linear house." Sporck saw this as only a stepping stone to "maximum sales, maximum profit, and minimum dilution of corporate funds." Sporck's three points could be any company's goals but for one thing. "At National, we live by, and for them," says Sporck. "Other companies might think that they do but they don't." For example, some try to be innovators, which, says Sporck, is all right as a name builder but can be disastrous as a way of life. Free-wheeling research

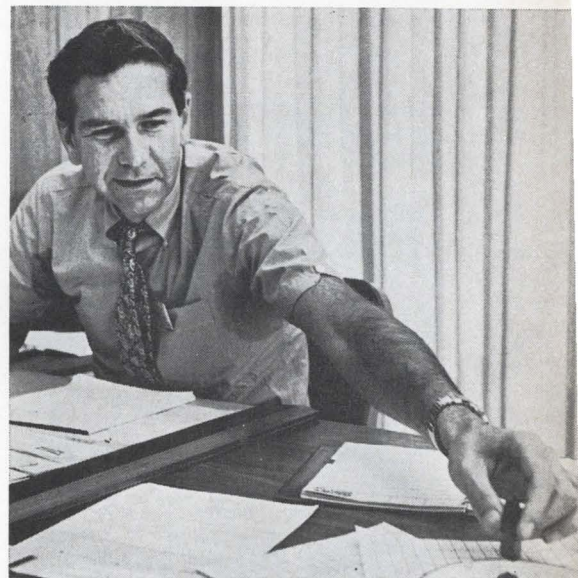

**Strategist.** Charles Sporck is the chief architect of National Semiconductor's growth. His strategy consists of product selectivity, applied research, and large volume production.

and development carries a stiff price tag and produces only a few items with a large market. And a large market is necessary for high profits.

National keeps up with the latest technical developments by drawing on the same people who work on production-line items, rather than by going to a group hidden away in some corner. "This way," says Sporck, "we can get something from the lab into production with less effort. We haven't got the left hand developing prototype 50-lead large-scale integration packages when the right hand can't produce the LSI chips." Pursuing directed research exclusively isn't unusual for a small company, but it is for a company with such large sales.

Second source houses also espouse the three points. They spend



# TAKE

12 SMALL LAMPS

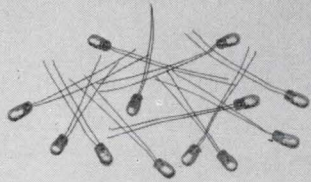

# MOUNT

ON A CIRCUIT BOARD

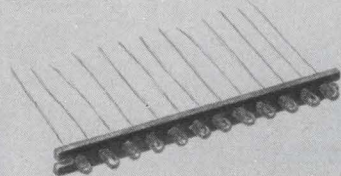

# MOLD

A NUMBERED BEZEL

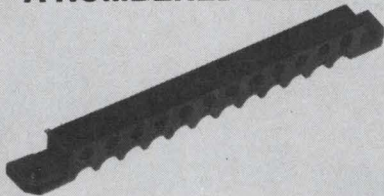

# RESULT

A LIGHT MODULE TO  
MONITOR TWELVE  
COMPUTER CIRCUITS\*

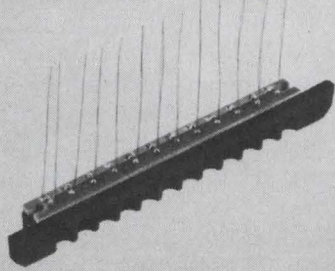

\*Can be made for a lesser number down to one

We can help you refine your small lamp application. Write, describing the requirement. Tung-Sol Division, Wagner Electric Corporation, 630 W. Mt. Pleasant Avenue, Livingston, N.J. 07039. TWX: 710-994-4865. Phone: (201) 992-1100; (212) 732-5426.

# TUNG-SOL®

WHERE BIG THINGS ARE  
DONE WITH SMALL LAMPS

© Reg. T.M. Wagner Electric Corporation

almost nothing on R&D. Instead, after signing licensing agreements, a company will produce a complete line of someone else's products. According to Sporck, this is a wasteful tactic; rarely are all the products in a given line profitable.

The third type is the custom house where everything is made to order. Profit can be made here, according to Sporck, only when very high volume orders are involved, and this is not the case with the majority of custom orders. "And besides," adds Sporck, "with the custom business, you spread your designers too thin. Too much time and money is spent in designing circuits while the profit is in producing them."

**Stepping out.** Having made a name for itself with monolithic linear integrated circuits, National went looking for a high-volume line of digital circuits. And it didn't have to look too far. Texas Instruments was having trouble with its complex transistor-transistor logic devices, and in stepped National with two of its "people."

Jeff Kalb and Tom Thorkelson had been with TI during the design stages of the 54/74 series of TTL devices. Kalb, who is 28 years old, had been working for TI in its co-op plan since he was 17 and was the chief architect of National's TTL line. Kalb designed a complete line of medium-scale integration TTL devices for National, while Thorkelson, who is digital product marketing manager at National, provided the software backup.

And once National's MSI TTL devices started moving off the line in high volume, it was only natural for Kalb to design a series of TTL gates for National. Exercising discretion, National only second-sourced those TI devices that it thought could be sold in high volume. According to Sporck, this is not the typical "me too" approach. Although National's TTL devices are pin-for-pin replacements for TI's, the design has been improved and the manufacturing process is different.

National's next step was to avoid the computer main-frame market, which Sporck says is too specialized to the point of being custom, and concentrate on the small business machine, the computer peripheral, and the industrial markets

which have settled on certain types of TTL circuits, and are considered standard markets.

As to why National's TTL line would be bought over TI's, Floyd Kvamme, National's microcircuit product manager, says, "National can deliver in quantity and at a lower price. We showed our customers that we could deliver complex TTL when they needed it, and we could do the same thing with TTL gates."

At the same time the TTL line was introduced, National also brought out a line of metal oxide semiconductor shift registers and analog gates. Again, this was to be high-volume only and no custom orders would be taken. National's MOS technology was brought over from the Hewlett-Packard Co. in the person of Ken Moyle, leader of an IC development group at H-P working on 1-0-0 silicon. From the outset, National built its MOS devices with 1-0-0 silicon—a factor, which, while not greatly emphasized at the time, made these devices low-level and thus TTL compatible. Later, when the other MOS manufacturers started touting their low-level circuits, National already had them in production.

National has organized engineers into workteams according to device technology. For example, Ken Moyle is the MOS process engineer, and he works with Dan Izumi who is an MOS circuit designer. Together, they are responsible for a product from its initial design stages through final production and for any problems that may crop up as long as the product is being made.

According to Floyd Kvamme: "When Sporck and the rest of us came to National in 1967, we knew what didn't work from what happened at Fairchild, so we tried something else. In effect, we have a design engineering group that reports to the plant management and the process people, and they are backed up by a systems group that provides applications support." Moyle was working on MOS processing techniques at Hewlett-Packard before he came to National, and Izumi was with Philco-Ford (formerly General Micro-Electronics) as an MOS designer.

Jeff Kalb, Bob Schwartz and Tom Thorkelson make up Na-





# DESIGNERS: AVOID SHOTGUN MARRIAGES

For design freedom, 12 sizes, all 550 Mu



## Use Magnetics Inc. 550 Mu Powder Cores

Magnetics Inc. first filled the void between 300 Mu powder cores and nickel laminations with the 550 Mu moly-permalloy powder core. We introduced it in three sizes.

And this perm is still exclusive with us. However, now you can get it in 9 new sizes—an O.D. range of .250" to 1.602". These fixed-gap toroids keep you from being forced into undesirable component marriages, let you tighten design to meet packaging requirements, cut total assembly costs in filters, chokes, transformers, inductors. They also provide: 1. A high inductance-to-size ratio. 2. Reduced d.c. copper resistance. 3. Less distributed capacity. 4.

Greater temperature stability than laminations. Avoid shotgun designing and get more freedom in using magnetic cores for circuit components. Try 550 Mu—we can ship from stock all 12 sizes. For additional information on 550 Mu powder core advantages, write Dept. EL-105 for Bul. FLC-02. Magnetics Inc., Butler, Pa. 16001.



Tape, bobbin, ferrite, powder cores • Laminations • Photo-etched parts • Specialty metals • Engineered control systems



# A 2 KVA 400 CYCLE, SOLID STATE BIPPY?

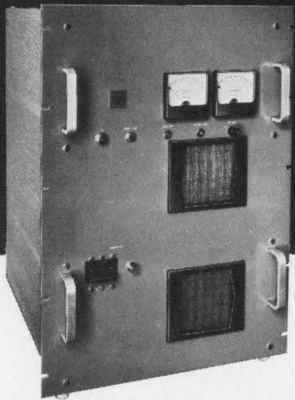

Around here, it's affectionately called just that. But you can simply refer to our newest creation as the CML Model CRS-2000A Frequency Converter until you get used to the idea of a Bippy hanging around. It features low distortion sine wave output and excellent regulation... less than 1% voltage regulation, less than 0.5% frequency regulation. Full power is available into leading and lagging power factor loads. The Bippy is solidly built (as all Bippys are), air cooled, and extremely quiet (as all Bippys are not)... measures 19" x 26 1/4" x 20". Ideal for marine and ground support installation, portable shelters, communications vans, radar systems, aircraft maintenance depots. This truly is the Bippy you can bet on. It socks the power to you!

**CML, Inc.**  
a subsidiary of  
Tenney Engineering, Inc.  
350 Leland Avenue  
Plainfield, N.J. 07062  
(201) 754-5502 • TWX 710-997-9529



## Rally 'round the flag

Founded by Bernard Rothlein in 1959, National Semiconductor was building momentum when in 1965 it was hit with a patent-infringement lawsuit by Sperry Rand—Rothlein's former employer. The reaction on Wall Street was a plunge of National Semiconductor stock. No sooner did this happen than Peter Sprague, nephew of the Sprague Electric Co.'s Robert Sprague, entered the picture.

First on a speculative basis and then later with the intent of gaining control of the company, Sprague bought up shares of the then-sagging National Semiconductor stock. Within a year, Peter Sprague was in a position to oust Rothlein as board chairman, and take his place. He then proceeded to woo Bob Widlar and Dave Talbert from Fairchild Semiconductor. But Sprague's crowning achievement was getting Charles E. Sporck to join him as president in February 1967. This ushered in a new era at National Semiconductor.

For with Sporck came Pierre Lamond as general manager, Roger Smullen, as production manager for standard linear circuits, Floyd Kvamme as microcircuits product manager, Fred Bialek as international operations manager, and Bill Routh as director of engineering—all from Fairchild. That June, Don Valentine left Fairchild to become National's director of marketing. Other acquisitions included from Hewlett-Packard—Ken Moyle as MOS process manager; from Texas Instruments—Jeff Kalb for digital design, and Bob Schwartz for digital process; and from Philco—Dan Izumi for MOS design; Dave Campbell, another Fairchild alumnus, took over National's linear design. Bob Christiansen, who is responsible for FET process, is from Union Carbide, while Don Wollesen charged with FET design stems from Philco-Ford. John Finch, plant manager for transistors in Danbury, Conn., came from Motorola.

tional's digital team. Schwartz is also an ex-TI man. As a team they have designed, developed, and produced National's complete TTL line as well as its new diode-transistor logic line.

The advanced linear design team is Bob Widlar and Dave Talbert. All of National's operational amplifiers and voltage regulators were developed under their guidance. They worked as a team at Fairchild before coming to National and are responsible for the LM 100 and LM 101, the two linears that got National on its feet. Their latest design is the LM 109 voltage regulator [*Electronics*, Sept. 29, p. 141]. Talbert is the process man who, in effect, makes Widlar's circuits work.

**Passed along.** Once the Widlar-Talbert circuits are past the development stage, they are passed along to Roger Smullen and Dave Campbell—both ex-Fairchild people—who are in charge of linear circuit production. Campbell is also the designer of what National calls standard linear circuits which include communications devices such as the LM 371 integrated r-f or i-f amplifier.

National also has an extensive line of field effect transistors pro-

duced by the Don Wollesen-Bob Christiansen team. Christiansen came from Union Carbide where he was a FET designer, and Wollesen came from Philco-Ford where he was in FET design applications.

Bill Routh, National's director of engineering, says that National's staff is about one-third of "what you would normally expect from an operation as large as ours. We don't waste people because they're our most important asset. Ken Moyle, for example, may be solving some production problem, but at the same time, he's the one who keeps abreast of new techniques such as the silicon gate process.

"Other companies have a solid division between design and manufacturing," says Routh. "But we have chosen to tear down these artificial barriers." And this goes for the hardware as well. Pilot production is done on the regular manufacturing line.

**Farms out.** To keep the engineering staff small and creative, the company emphasizes the design and production of silicon wafers. Sporck says, "When we came to National, our initial strength had to be people and not equipment. We knew who the technically competent people were, and we knew



# ADVANCED TESTING

# 1...2...3...

THE WORLD'S MOST ADVANCED  
ALL-SOLID-STATE VOM

# "601"

It's the first of its kind. Triplet's creative engineering has gone and done it. It has designed and engineered an entirely new concept in All-Solid-State VOM's for fast in-circuit testing of electronic and electrical applications. It has built the new portable Model 601 with Field Effect Transistorized circuitry, push-button and battery operation and with 11 Megohm Input Resistance on all AC-DC voltage ranges. It's ideal for testing IC's, making audio measurements, and usable with Frequencies to 50 KHz.

- 1 14 Ohmmeter ranges with 7 Low-Power ranges at 75 mV DC for transistorized and Integrated Circuits.
- 2 Voltage ranges from 10 mV AC and 100 mV DC full scale; plus AC and DC Current ranges from 10 uA full scale.
- 3 Modern, easy-to-use push-button selection of DC Polarity, AC and Low-Power Ohms functions.

See this new, All-Solid-State (F-E-T) VOM at your local Triplet distributor and you'll be Testing 1 . . . 2 . . . 3

Model 601 (F-E-T) VOM

# \$150

Suggested U. S. A. User Net

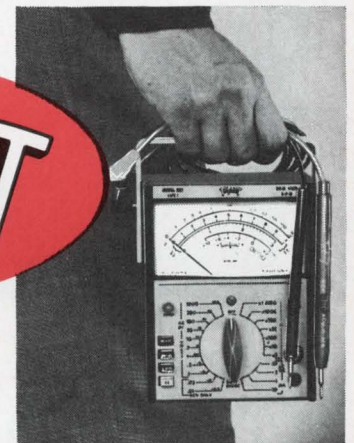
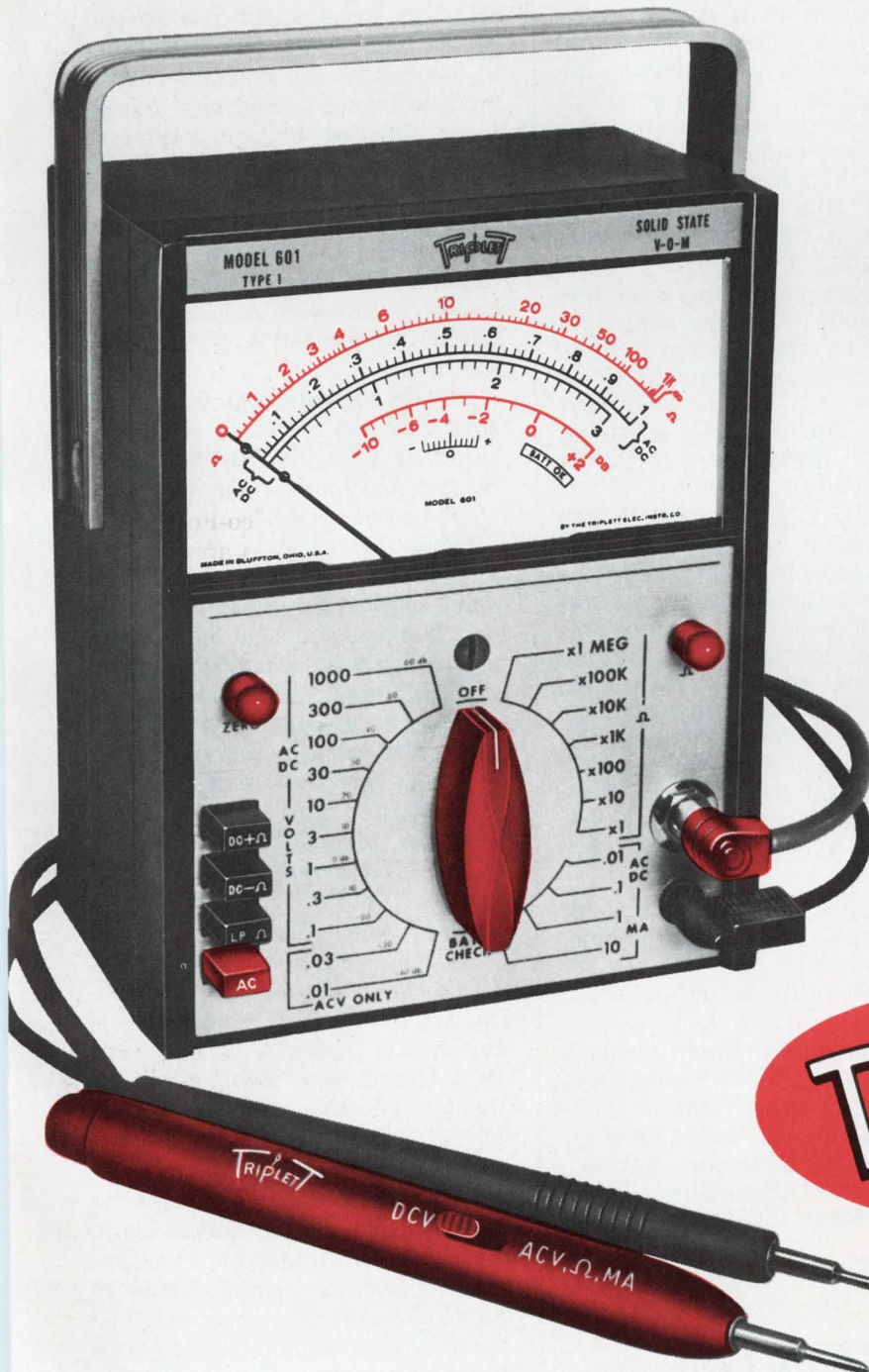

THE TRIPLET ELECTRICAL INSTRUMENT COMPANY

BLUFFTON, OHIO 45817

Circle 133 on reader service card



# How fast is GE's new helium leak detector?



## Let your fastest operator show you

Manufacturers of electronic components asked us to help cut down leak test time.

So General Electric engineers designed a new leak detector to do the job.

It's the LC-40 Mass Spectrometer Helium Leak Detector, which offers unmatched testing speed in a general purpose leak detector. The LC-40 achieves this by combining the highest net pumping speed of any leak detector on the market (for equivalent sensitivities), with fast recovery from leaks. This combination pays off in a time-to-test of only seconds.

Complementing this test-time capability is a new simplified control system, which permits the operator to complete a test merely by loading the test piece and flipping a single switch. Results are instantly displayed on a meter.

But the LC-40 detector isn't just fast. It includes such performance-proven features as all-solid-state circuitry for dependable service; burnout-resistant thoria-coated iridium filament, exclusive with GE; all-welded stainless steel high vacuum system; high sensitivity ( $5 \times 10^{-11}$  atmo. cc/sec He), a new source design to eliminate background signals, and many other significant advances.

Although ideally suited for high-speed production testing, the unit also can be used for general purpose applications. If you would like to learn more about General Electric's new LC-40 Mass Spectrometer Leak Detector, write General Electric Company, Analytical Measurement Business Section, 4MX, 25 Federal Street, West Lynn, Mass., 01905

268-41

GENERAL  ELECTRIC

how to apply this competence. The problem was to obtain and hold them. We did this by letting them work in the field of their choice, by promising that they would not be doing something unrelated to the tasks of making semiconductor devices, and by offering them an extensive stock-option plan."

Sporck's list of unrelated tasks includes such things as the construction of mechanical fixtures, transistor and integrated circuit assembly, and the printing of applications notes. These jobs were done under a subcontract basis. One of National's competitors says that this arrangement may be one of the reasons for National's success—initially, the company didn't have to invest in assembly equipment. Instead the subcontractor would have to update and maintain the equipment. Problems with any particular assembly operation were solved by changing subcontractors. However, National now has a considerable amount of assembly equipment in its overseas locations.

**Not the surroundings.** But Sporck says the main reason he went outside was to avoid bogging down his people. Sporck's theories must work because it certainly isn't the surroundings that keep the employees content. Although a new main building is under construction, National's present Santa Clara headquarters is spread out over five small buildings, and the surrounding streets are congested with engineers in smocks carrying semiconductor chips from building to building. The offices are just about adequate, and the halls are cluttered with test equipment and office machines. But this doesn't seem to bother anyone—the place is just as busy at 7 a.m. or 7 p.m. as it is at 10 a.m. and the quality of the product apparently hasn't suffered any. In fact, a price-cut on Mil-Spec MOS circuits was announced last month indicating that National is having no trouble at all in producing high reliability products.

All wafer fabrication, except for transistors, is done in Santa Clara. Assembled in Singapore, the completed devices are shipped back to Santa Clara where they are packed for delivery. Plants in Germany and Scotland are planned and these also will handle assembly and final test-





10 KHz — 115 MHz Sweep Plug-In



50 KHz — 110 MHz Sweep Synthesizer

# KAY



50 KHz — 110 MHz Sweep & Marker Generator

# 3 accurate 110 MHz sweepers!

## Require no markers!

For those with uncalibrated vision:

- VARIABLE PULSE MARKERS
- VARIABLE BIRDIE MARKERS
- CRYSTAL PULSE MARKERS
- CRYSTAL BIRDIE MARKERS
- HARMONIC MARKERS
- VERTICAL MARKERS
- HORIZONTAL MARKERS
- RF TURN-OFF MARKERS

### 10 KHz — 115 MHz SWEEP PLUG-IN

- Log Sweep To Below 10 KHz
- Two Band Sweep Function
- Residual FM 100 Hz

### 50 KHz — 110 MHz SWEEP GENERATOR

- Plug-In Markers
- Companion to 159C  
300 MHz Wide Sweep

All three  
all solid-state  
100 MHz wide  
sweeps

Full-time controls

### 50 KHz — 110 MHz SWEEP SYNTHESIZER

- Phase Locked Sweep & CW
- Drift < 5PPM/min.  
< 20PPM/hr.
- Residual < 10 Hz @ 10 MHz  
< 40 Hz @ 70 MHz

**KAY** ELECTRIC  
COMPANY  
Maple Avenue, Pine Brook, N.J. 07058 • (201) 227-2000

Circle 135 on reader service card



**this  
man  
is  
headed  
for  
trouble**

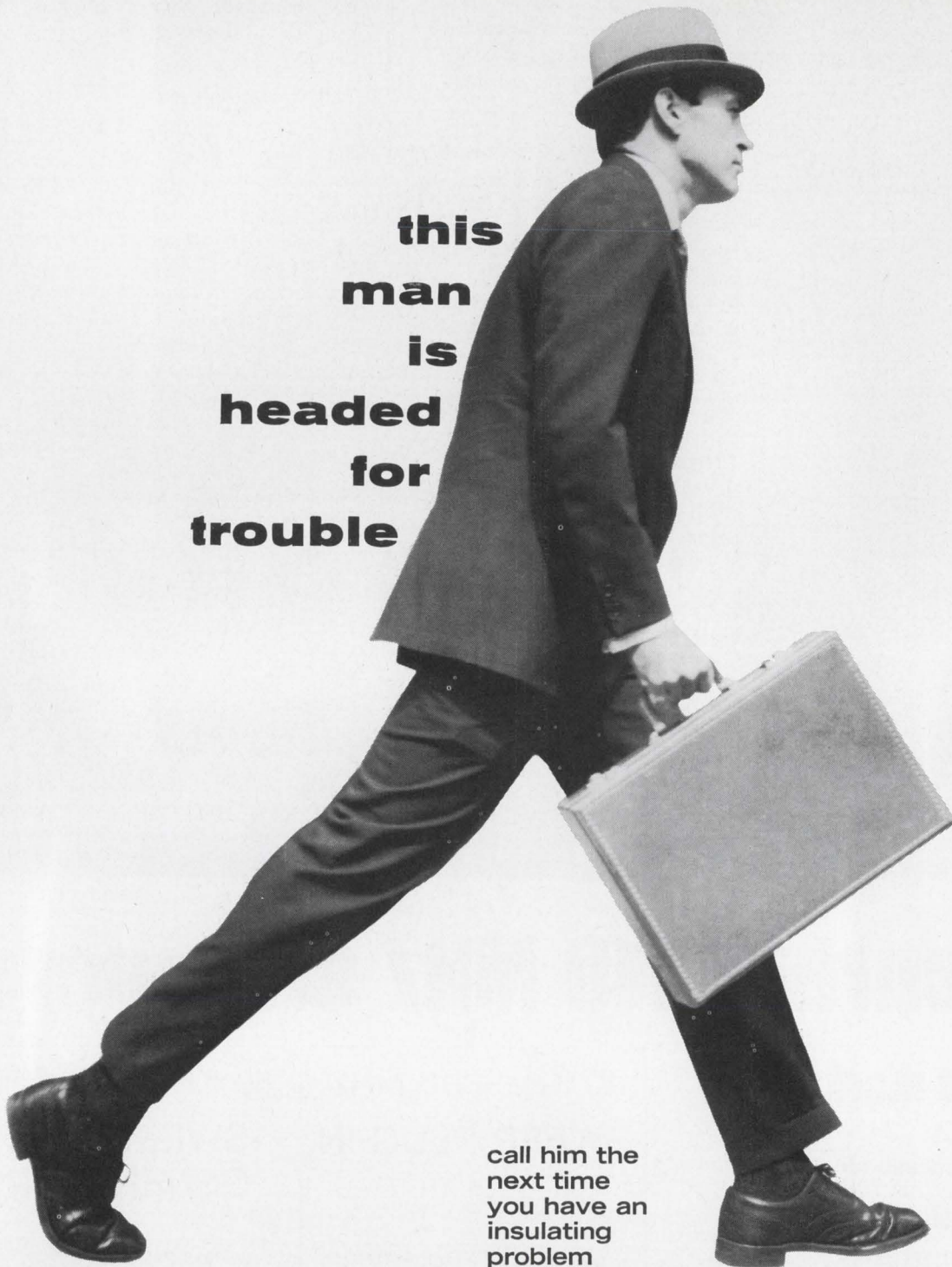

**call him the  
next time  
you have an  
insulating  
problem**

ONE SOURCE for EXCELLENCE  
in Insulating Tubings and Sleeveings  
High Temperature Wire and Cable



**L. FRANK MARKEL & SONS, INC.**  
NORRISTOWN, PA. 19404 • 215-272-8960

When it comes to electrical insulating problems, there's a man near you who makes a business of solving them. He's the Markel sales representative in your area. He not only knows the answers . . . he can deliver them! He handles what is probably the world's broadest line of insulating tubings and sleeveings . . . more than 3500 different types and sizes in all. But if one of these doesn't meet your needs exactly, we'll make one for you that does. The next time you have an insulating problem, call your nearest Markel "trouble-shooter." You'll find his name and phone number on the opposite page.



# There's a Market trouble-shooter near you!

## NORTHEAST REGION

### NEW ENGLAND

R. P. Mahan Co., Inc., Wellesley, Mass.  
—617-237-1040  
Watertown, Conn.—203-274-2363  
†Green Shaw Co., Newton, Mass.—617-969-8900

### EASTERN NEW YORK STATE

Barco Sales, Schenectady, N.Y.—518-393-2729

### WESTERN NEW YORK STATE

Gislason Sales, Inc., Rochester, N.Y.—716-454-4741

### NEW YORK CITY, LONG ISLAND, WESTCHESTER COUNTY, NO. NEW JERSEY

Harold B. Heft, Lynbrook, L.I., N.Y.—516-599-3351  
Cedar Grove, N.J.—201-239-5623

### EASTERN PENNSYLVANIA, SO. NEW JERSEY, MARYLAND, DISTRICT OF COLUMBIA

C. H. Newson & Associates, Phila., Pa.  
—215-CH 8-3377  
†Smith of Philadelphia, Phila., Pa.—215-GA 5-6869  
†Electronic Wholesalers, Inc., Washington, D.C.  
—202-483-5200  
Baltimore, Md.—301-646-3600  
†Commercial Plastics & Supply Corp., Phila., Pa.  
—215-223-8600  
Hyattsville, Md.—301-864-6226

### WESTERN PENNSYLVANIA

P.E.I. Sales Corp., Munhall, Pa.—412-462-6300

## NORTHCENTRAL REGION

### OHIO

Electrolock, Inc., Chagrin Falls, Ohio—216-247-4245  
Dayton, Ohio—513-277-3221  
†Electric Parts & Service Co., Cleveland, Ohio  
—216-881-6044

### MICHIGAN

Lloyd George Agency, Northville, Mich.  
—313-474-1505  
Benton Harbor, Mich.—616-925-3244  
Gross Point Farms, Mich.—313-TU 6-2647  
†McNaughton-McKay Electric Co., Detroit, Mich.  
—313-834-7600

### INDIANA, ILLINOIS, SOUTHERN WISCONSIN

J. J. Glenn & Co., Chicago, Ill.—312-847-6400  
Elm Grove, Wis.—414-352-7262

### MINNESOTA, NORTHERN WISCONSIN

Fred Peterson Co., Minneapolis, Minn.—612-927-4453  
†D. A. Schultz Co., Minneapolis, Minn.—612-339-7701

### MISSOURI

Hippler Sales Co., Webster Groves, Mo.  
—314-961-8499  
†D. A. James Co., St. Louis, Mo.—314-MI 4-0411

### KANSAS, MISSOURI

Ray Deane, Kansas City, Mo.—816-942-0130

## SOUTH REGION

### VIRGINIA, NORTH & SOUTH CAROLINA

Harry T. Altman Co., Charlotte, N.C.—704-399-8926  
†Electronic Wholesalers, Inc., Winston-Salem, N.C.  
—919-725-8711  
†Cramer Electronics, Raleigh, N.C.—919-832-6441  
†Commercial Plastics & Supply Corp., Raleigh, N.C.  
—919-834-2511

### GEORGIA

Estes Associates, Inc., Decatur, Ga.—404-373-8266  
†Cramer of Atlanta, Chamblee, Ga.—404-451-5421  
†Commercial Plastics & Supply Corp., Atlanta, Ga.  
—404-577-2600

### FLORIDA

J. F. Griffin & Co., N. Palm Beach—305-848-4617  
Altamonte Springs, Fla.—305-831-1080  
†Cramer of Florida, Fort Lauderdale—305-566-7511  
†Hughes Supply, Orlando, Fla.—305-841-4710  
†National Wire & Cable Co., Orlando—305-423-2491

### ALABAMA, TENNESSEE, MISSISSIPPI

Jackson & Assoc., Chattanooga, Tenn.—615-267-4260  
†Electronic Wholesalers, Inc., Huntsville, Ala.  
—205-539-5722

### LOUISIANA, SOUTH MISSISSIPPI

Mitchell White Engineering Co., Inc., Metairie, La.  
—504-833-3731  
Industrial Distributors, Inc., Metairie, La.  
—504-833-3731

### TEXAS, ARKANSAS

Cline and Son, Inc., Arlington, Texas—817-261-2255

### OKLAHOMA

John H. Cole Co., Oklahoma City, Okla.—405-235-2447

## WEST REGION

### COLORADO

Ward Electric Supply Co., Denver—303-222-3541  
Plasticrafts, Inc., Denver, Colo.—303-433-8801

### ARIZONA, NEW MEXICO

AR/TEC, Inc., Scottsdale, Ariz.—602-947-6304

### UTAH

Electric Parts & Insulation Co., Salt Lake City, Utah  
—801-486-0773

### CALIFORNIA

Insulation Supply Co., Los Angeles, Calif.  
—213-747-5416  
Redwood City, Calif.—415-369-7357  
National Wire & Cable Co., Los Angeles, Calif.  
—213-225-5611  
San Mateo, Calif.—415-344-3066  
Vanderveer Industrial Plastics, Inc., Los Angeles,  
Calif.—213-269-0625  
Western States Wire & Cable Co., Los Angeles,  
Calif.—213-264-1291  
Burlingame, Calif.—415-342-7201

### WASHINGTON, OREGON

C. E. Riggs, Inc., Portland, Ore.—503-266-3286  
Seattle, Wash.—206-623-5707  
Spokane, Wash.—509-624-7554

### CANADA

H. P. Ruggles Co., Burlington, Ontario—416-632-1403  
West Montreal, P.Q.—514-486-5640

†Jobber

For areas not covered by the above  
representatives, call or write:



L. FRANK MARKEL & SONS, INC.  
NORRISTOWN, PA. 19404 • 215-272-8960

ing. However, Sporck intends to keep the wafer fabrication close at hand.

## Tailored equipment

The job of keeping the production lines rolling and profitable rests with Pierre Lamond and Fred Bialek. Lamond is the general manager of the Santa Clara facility and is responsible for wafer fabrication. It's Bialek's job to see that the devices are assembled and tested—he's National's international operations manager. Bialek has a team of specialists that modify production and test equipment "to make them more efficient and turn out more good devices." In fact, National tailors most of its equipment for a specific need.

The success of these modifications combined with National's overall marketing approach is confirmed by the company's sales projection for 1970 of \$48 million. However, even this figure may be modest as last month, the company had memo pads (for internal use only) printed with the number 75 at the top. This, together with the opening of the plants in Germany and Scotland, and production figures that are projected for 1970, could indicate that National expects to triple sales in 1970 to \$75 million.

Present production is about 1.6 million IC's and 700,000 transistors. By June 1970 it will be 7.5 million IC's and 3 million transistors. The IC increase is expected to come largely from digital circuits.

**Move to DTL.** National will add a line of DTL circuits. Accounting for this move, Kvamme says: "We have a tremendous amount of assembly equipment, especially for dual-in-line plastic packages. We wanted to find an area where we could take up excess production capabilities." There are about 7 million plastic DTL devices made a year. According to Kvamme, they now sell for about the same as ceramic devices, "and we can sell them for less." Putting it another way, he says, "We make complex TTL circuits which are used with DTL circuits, so why not make the DTL circuits."

But most important, it's a volume market, and that's National's overall target. ■





# Flight Companion

## 417—the lightweight recorder you carry on the plane

It's the one data recorder you don't have to waste time crating and shipping, or possibly having damaged by baggage-style handling. The compact 417 flies with you, safely under the seat, ready to work when you step off the plane.

Only 6"x14"x15", the rugged 417 weighs just 28 pounds—50 pounds less than any comparable recorder. Works in any position, under roughest vibration conditions, for dependable data gathering in plants, labs, on and under the seas, or out in the wilds.

Maintenance-free mechanism has exclusive low-mass differential capstan drive for precision opera-



**LOCKHEED ELECTRONICS COMPANY**  
A Division of Lockheed Aircraft Corporation.

tion. Phaselock servo for precise speed control, with accuracy matching large rack machines. Records on 7 channels, IRIG compatible. Runs on 110/220v AC/DC or internal battery. Power consumption as low as 10w. Frequency response: 100 kc direct, 10 kc FM.

Priced as low as \$7,000.

Send for our catalog containing full details on the 417, one of a family of precision data recorders for land, ocean, air and space applications. Write: Boyd McKnight, Dept. E-10F, Lockheed Electronics Company, Plainfield, New Jersey.

Have questions on data recording? Call us at (201) 757-1600.

Circle 138 on reader service card



# Special introductory offer to new members of the ELECTRONICS AND CONTROL ENGINEERS' BOOK CLUB

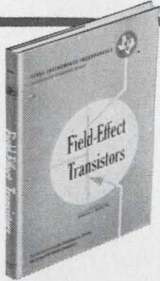

**Pub. Price**  
\$10.00  
**Club Price**  
\$8.50

Field-Effect Transistors by L. J. Sevin.  
Code #355

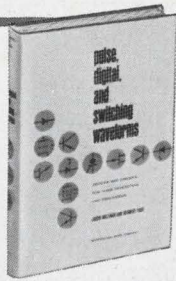

**Pub. Price**  
\$18.00  
**Club Price**  
\$15.30

Pulse, Digital, and Switching Waveforms by J. Millman and H. Taub.  
Code #381

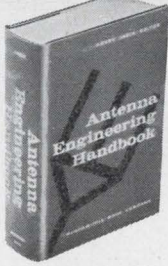

**Pub. Price**  
\$27.75  
**Club Price**  
\$23.60

Antenna Engineering Handbook by Henry Jasik.  
Code #290

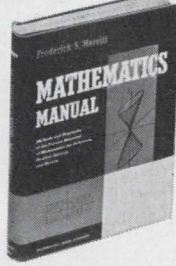

**Pub. Price**  
\$11.95  
**Club Price**  
\$10.15

Mathematics Manual by F. S. Merritt.  
Code #1509



**Pub. Price**  
\$19.50  
**Club Price**  
\$16.55

Electronic and Radio Engineering by F. E. Terman.  
Code #509

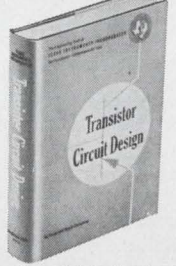

**Pub. Price**  
\$16.50  
**Club Price**  
\$14.05

Transistor Circuit Design by the Engineering Staff of Texas Instruments, Inc.  
Code #737

# ANY ONE

for only

# \$1.00

Special \$1.00 bonus book comes to you with your first club selection

VALUES FROM \$10.00 TO \$29.50

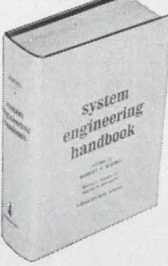

**Pub. Price**  
\$29.50  
**Club Price**  
\$25.00

System Engineering Handbook edited by R. E. Machol.  
Code #371

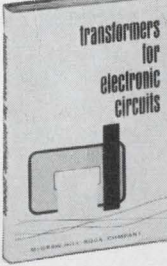

**Pub. Price**  
\$14.00  
**Club Price**  
\$11.90

Transformers for Electronic Circuits by N. R. Grossner.  
Code #978

SAVE TIME AND MONEY BY JOINING TODAY

MAIL THE ATTACHED POSTPAID CARD

IF CARD IS REMOVED SEND COUPON BELOW

Here is a professional club designed specifically to meet your day-to-day engineering needs by providing practical books in your field on a regular basis at below publisher prices.

HOW THE CLUB OPERATES. Basic to the Club's service is its publication, the *Electronics and Control Engineers' Book Club Bulletin*, which brings you news of books in your field. Sent to members without cost, it announces and describes in detail the Club's featured book of the month as well as alternate selections which are available at special members' prices.

When you want to examine the Club's feature of the month, you do nothing. The book will be mailed to you as a regular part of your Club service. If you prefer one of the alternate selections—or if you want no book at all for that month—you notify the Club by returning the convenient card enclosed with each *Bulletin*.

As a Club member, you agree only to the purchase of four books over a two-year period. Considering the many books published annually in your field, there will surely be at least four that you would want to own anyway. By joining the Club, you save both money and the trouble of searching for the best books.

**Electronics and Control Engineers' Book Club**  
330 WEST 42 ST., 18TH FL., NEW YORK, N.Y. 10036

Please enroll me as a member of the Electronics and Control Engineers' Book Club and send me the two books indicated below. I am to receive the higher priced of the two for just \$1, and my first selection at the special Club price. These books are to be shipped on approval, and I may return them both without cost or further obligation. If I decide to keep the books, I agree to purchase as few as four additional books during the next two years at special Club prices (approximately 15% below list).

Write Code # of higher priced selection here

Write Code # of lower priced selection here



NAME \_\_\_\_\_

ADDRESS \_\_\_\_\_

CITY \_\_\_\_\_

STATE \_\_\_\_\_ ZIP \_\_\_\_\_

(Offer good in U.S. and Canada only)

E 33118



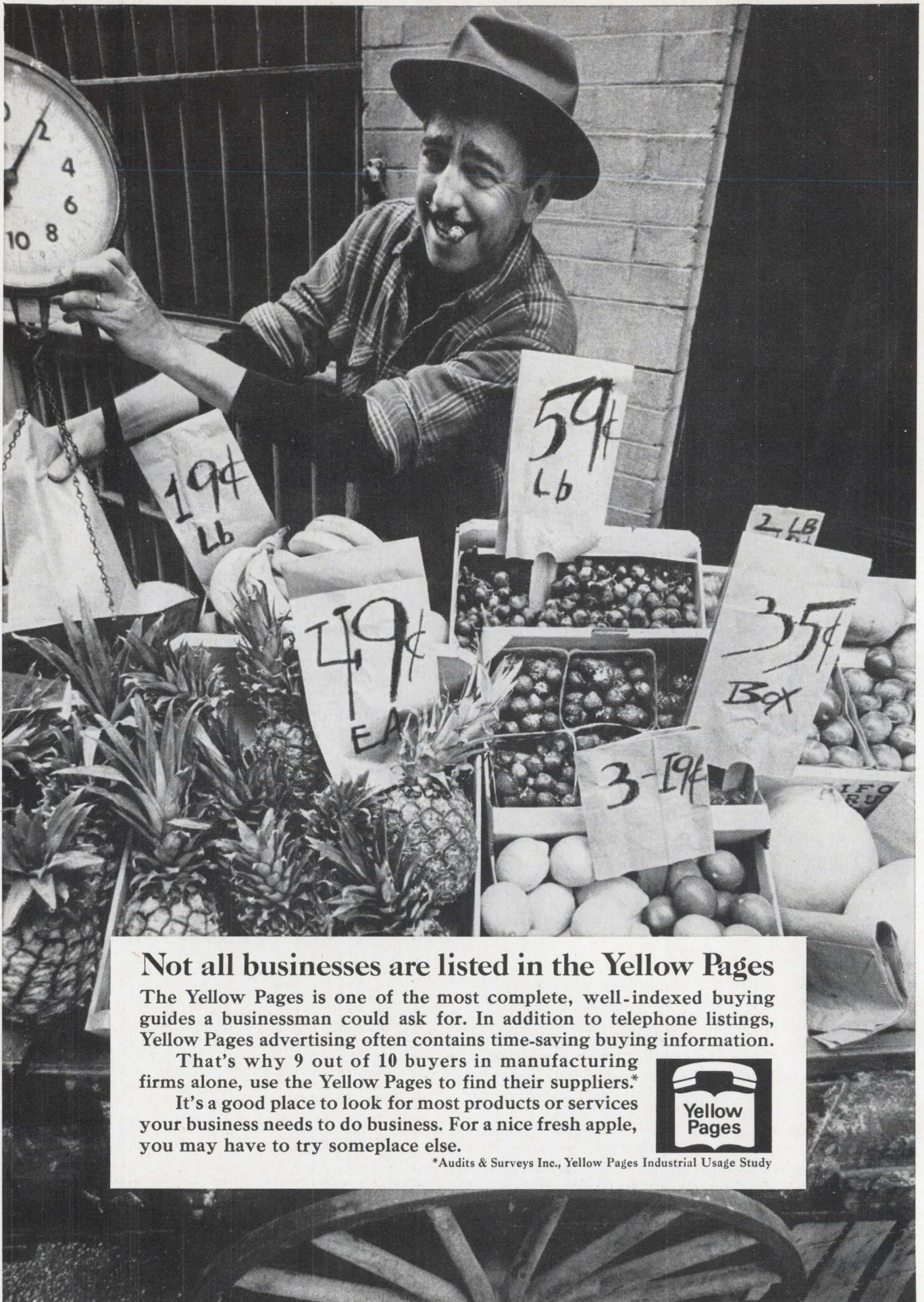

## Not all businesses are listed in the Yellow Pages

The Yellow Pages is one of the most complete, well-indexed buying guides a businessman could ask for. In addition to telephone listings, Yellow Pages advertising often contains time-saving buying information.

That's why 9 out of 10 buyers in manufacturing firms alone, use the Yellow Pages to find their suppliers.\*

It's a good place to look for most products or services your business needs to do business. For a nice fresh apple, you may have to try someplace else.



\*Audits & Surveys Inc., Yellow Pages Industrial Usage Study



**No tetrodes  
with higher  
linearity.**

In the power tetrode field we're defining the state of the art by demonstrating intermodulation distortion better than any other known tubes. In 1966 we introduced the 4CX1500B, a 1.5 kW tetrode with the highest linearity then known: better than  $-40$  dB 3rd order IM distortion. Since then we produced the 4CX600J, a 600 watt tube with  $-45$  dB 3rd order IM products—without feedback—and later a 5 kW tetrode with the same figure. Now the latest tetrode in our program, a 15 kW tube, exhibits  $-40$  dB 3rd order IM products. We can show IM distortion improvements from 10 to 20 dB in a practical quiescent plate current range.

Other tetrodes now under development will deliver up to 40 kW with linearity as high as  $-45$  dB IMD, according to preliminary data. Such performance advances are part of a long range program employing computer-assisted design studies to optimize internal tube geometry—all part of our plan to insure you get state of the art products every time you buy from Eimac.

Contact your nearest Varian/Eimac distributor or ask Information Operator for Varian Electron Tube and Device Group.





# The Trend is TTL... the Choice is TI.

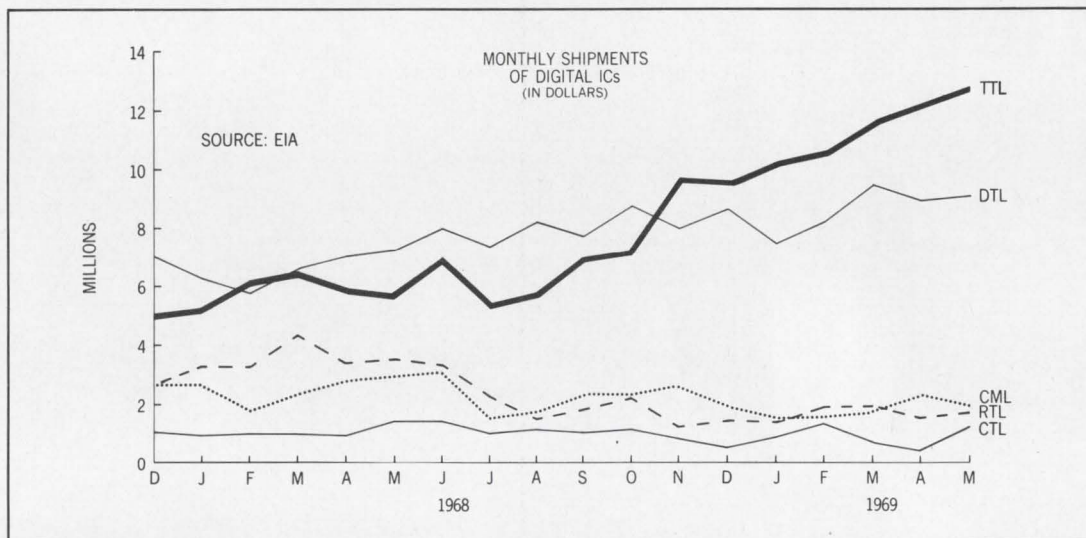

(And the broadest choice is getting broader.)

- Now, more than 90 distinct Series 54/74 circuits to choose from...including 35 MSI circuits.
- Three compatible performance ranges – standard, high speed, low power.
- Three packages – flat pack, ceramic or plastic dual-in-line.
- Two temperature ranges.
- All from the first TTL source – TI.

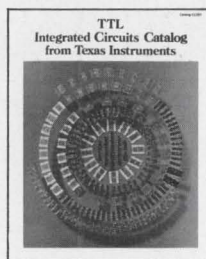

Could you ask for anything more? Yes. TI's new 424-page TTL catalog which contains data sheets on all Series 54/74 circuits. Circle 171 on the Reader Service Card or write Texas Instruments Incorporated, P.O. Box 5012, M.S. 308, Dallas, Texas 75222. Or see your nearest authorized TI Distributor.



**TEXAS INSTRUMENTS**  
INCORPORATED



# Announcing a small breakthrough in 4-track instrumentation recorders.

At 50 pounds, our new HP 3960 is a true instrumentation tape recorder that can go just about anywhere. And starting at \$3800, it's about half the price you'd expect to pay for this performance in a 3-speed, 1/4" tape machine.

For instance, our instrument provides an FM signal-to-noise ratio of better than 46 dB at 15/16 ips. With it, you can record signals that would be buried in noise on the average 40 dB rated machine. This exceptional performance is achieved *without* the use of flutter compensation or external filtering. Offering direct response to 60 kHz and FM to 5 kHz, performance is equal to or better than the most expensive instrumentation recorders now available. This high performance is achieved through the use of a single casting capstan assembly, phaselock servo drive system, and HP quality electronics.

This combination of large-scale performance and small-scale portability makes our recorder the ideal instrument for work in a number of fields: vibration and stress analysis; research and clinical areas of medicine; acoustical work; oceanography, and many others. And its basic simplicity and ruggedness help it to meet stringent environmental specifications.

•• For a close-up of our small breakthrough in the 4-track instrumentation recorder field, just call your local HP field engineer. Or write Hewlett-Packard, Palo Alto, California 94304; Europe: 1217 Meyrin-Geneva, Switzerland.

HEWLETT  PACKARD  
MAGNETIC RECORDERS

42904





# SOME ENGINEERS DON'T KNOW WHEN TO QUIT

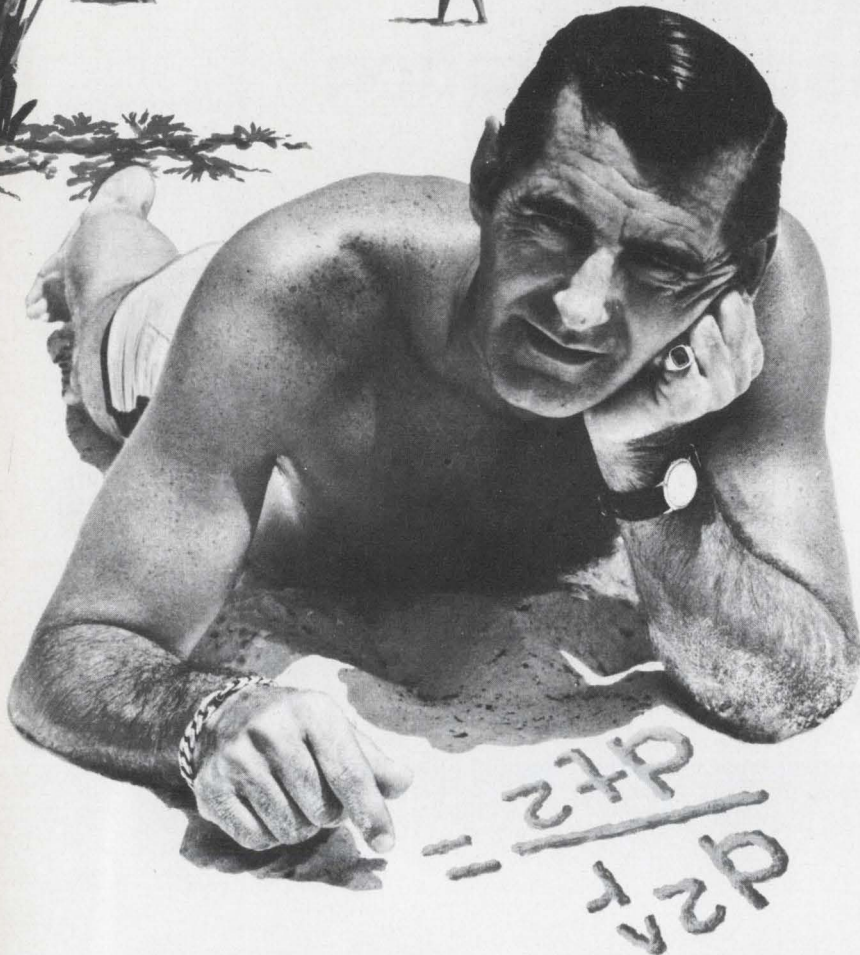

Give a guy a mile of sandy beach as a blackboard and you might find him doing equations from here to the moon . . . thinking about navigation and guidance systems.

At Honeywell-Florida we've got a lot of people who think engineering is an adventure. They create some of the world's most sophisticated equipment . . . computers . . . monolithic subsystems . . . plated wire memories . . . precision components. We give 'em room to think . . .

provide a stimulating environment and then recognize their creative individuality.

We can't promise you can do all your engineering on the beach but we can promise an atmosphere where you'll always have the engineering freedom you need to do something significant. Of course while you're relaxing on the white sand beaches of the Gulf of Mexico you may get some of your best ideas.

If you and your family fit into the Florida picture tell us about your qualifications today. We have great opportunities for engineers with experience in logic, components, integrated circuits, computer memories, circuit or programming analysis, advanced packaging, manufacturing or industrial engineering, materials or quality assurance.

Write now to Mr. Owen S. Spring, Honeywell Inc.  
13350 Highway 19, St., Petersburg, Florida 33733.

## Honeywell-Florida

An equal opportunity employer

To investigate professional openings in other Honeywell facilities,  
send resume to F. F. Laing, Honeywell, Minneapolis, Minnesota 55408.



# can't get away for evening classes?



## here's a practical way to avoid technical obsolescence

Are irregular hours, travel and family obligations keeping you from attending classes—even though you worry about becoming technically obsolescent? Check into the Special Programs in Electronics for Engineers developed by CREI, the Home Study Division of the McGraw-Hill Book Company.

These are not simply courses, but comprehensive programs in advanced electronics offering major electives in such fields as:

Communications Engineering, Aeronautical and Navigational, Television Engineering, Automatic Control Engineering, Missile and Spacecraft Guidance, Radar and Sonar Engineering, Nuclear Instrumentation and Control, Computers.

Industry-recognized CREI Programs make it possible for you to catch up on new developments in electronics through study in your own home, at your own pace,

your own schedule. Free book gives complete information and details of technical material covered. For your copy, mail coupon below or write: CREI, Home Study Division, McGraw-Hill Book Company, Dept. WTC-08, 3224 Sixteenth St., N.W., Washington, D.C. 20010.

Founded 1927



Accredited Member of the National Home Study Council



**CREI, Home Study Division, McGraw-Hill Book Company**  
Dept. WTC-08, 3224 Sixteenth St., N.W.  
Washington, D.C. 20010

Send me free brochure describing CREI Programs in Electronics for Engineers.

NAME \_\_\_\_\_ AGE \_\_\_\_\_

ADDRESS \_\_\_\_\_

CITY \_\_\_\_\_ STATE \_\_\_\_\_ ZIP CODE \_\_\_\_\_

COMPANY \_\_\_\_\_

TITLE \_\_\_\_\_



# SDS just made a name for itself in the business world:

**Xerox Data Systems.**

When scientific data systems were all we made, Scientific Data Systems was an excellent name.

But for the past few years distinctions between scientific and business computing have been disappearing. And we've been

expanding into applications for general business and industry.

So we're adopting our parent company's name. It's as respected in the business world as the one SDS has in the technical world.

**XDS**  
Xerox Data Systems  
El Segundo, California



# Disk memory runs on air

New mechanical design includes air bearings and fluidic control; 'clean room' protects replaceable disk; fixed heads shorten access time



Team member. Disk memory, center, has an input-output section that makes it compatible with most computers.

**Brilliant electronics engineers** don't necessarily design good disk memory systems. And, according to officers of the Digital Information Storage Corp., the usual design team is composed of five logic designers to each mechanical engineer. As a result, says DISC president Roland Boisvert, the less costly disk memories now available have flying heads that crash or that sink onto the disk when rotation stops and abrade it, they have electrical interference that causes errors, and they are generally troublesome units.

Boisvert and his partner, Steven A. Lambert, vice president, are veterans of design work at the Digital Equipment Corp., and have specific ideas about the right way to make memories. As defined by their new DDR-1 disk memory, the right way includes interchangeable disks and fixed heads, air bearings, fluidic control of disk position, a "clean room" compartment to minimize contamination of the disk during operation, skew-free timing, and what they call anticipation logic to ease computer software problems. The DDR-1 will be

shown for the first time at the Fall Joint Computer Conference in Las Vegas, Nov. 18-20.

One of the first areas attacked by the company was the problem of supporting the memory disk. The decision to use 16 fixed head pads for short access times had already been made, as had the commitment to removable and replaceable disks for convenience. Ball bearings had been a thorn in the side of both of Boisvert and Lambert while at DEC; according to Boisvert, "It's just about impossible to buy ball bearings which not only have good runout and vibration specs at first, but retain them. Also, the same model ball bearing is going to show unit-to-unit performance variations that are troublesome."

So Lambert suggested the air bearing, whose characteristics read like the reverse of those for ball bearings. Friction (and thus wear), is very small because there's no metal-to-metal contact. At high temperatures, an air bearing's load-carrying ability increases, making a room-temperature design a worst-case design. Low friction translates into high speed, and it's attained

without lubrication (removing a possible contaminant from the area of the disk). Finally, the air bearing is self-centering and mechanically stiff, free from vibration and mechanical noise.

**Shiftless.** Having removed one cause of unreliability and timing skew by moving to a vibration-free air bearing, DISC's designers then added a special timing system. Rather than using a separate timing track, DISC's approach inserts a separate timing mark between each recorded word, thus timing is resynchronized at each word. And with timing and data signals read



**Air tight.** Sealed cartridge containing disk is received or ejected at push of button on front panel.



TUBULAR,  
BULKHEAD  
MOUNTING TYPE

# RFI/EMI FILTERS

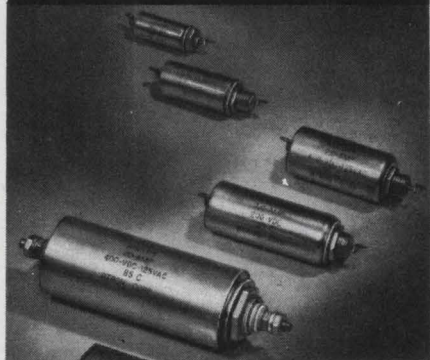

**Rtron**  
○○○○○○○○○○○○○○○○○○○○

## Cylindrical Style Interference Filters

that reduce or eliminate unwanted noise or signals. Small size, light weight, maximum attenuation. Voltage current or insertion loss characteristics required, determine physical size. Maximum isolation of terminals and high frequency performance are assured by threaded neck design for bulkhead mounting. Feed-thru capacitor circuitry conservatively rated for both military and commercial applications.

**Rtron** corporation

P.O. Box 743 Skokie, Illinois 60076

- Send catalog and prices.
- Have Representative call for appointment.
- Specifications enclosed on Multi-circuit or custom design filters. Send estimate.

Name \_\_\_\_\_

Firm \_\_\_\_\_

Address \_\_\_\_\_

City \_\_\_\_\_

State \_\_\_\_\_ Zip \_\_\_\_\_

from the same head, timing offset is impossible.

As added insurance, DISC has designed its own magnetic recording disk an eighth of an inch thick—more than two times the 0.050-inch thickness of usual disks. This offsets the umbrella effect in which a disk sags around its edge. Also, rather than a number of small holes near its center, the new disk has a single large-diameter hole which fits on the spindle. Boisvert hints at ultra-high-speed disk recording in the future, perhaps with modified DDR-1's, when he notes that the several smaller holes used in most disks can cause stress patterns, then microscopic cracks, and perhaps shattering of disks driven at very high rates.

To keep the disks free from abrading dust, they are packaged in an air-sealed case, called a DISClosure. To load a disk onto the drive, the case is pushed into a slot on the front of the DDR-1, opening a seal on the case and a second seal in the machine itself. A fork-like handler driven by a pneumatic cylinder pulls the disk out of the case, into the DDR-1, and places it on the spindle. Filtered air discharges into the "clean-room" compartment now enclosing the disk and maintains positive pressure to keep out dust. Thus the recording disks are never handled or exposed directly to the air, and so it is hoped their surfaces will hold up longer than those of more easily contaminated disk-packs.

**Breadth of air.** "With pressurized air already in the machine, we began thinking about fluidic logic control. It seemed natural," says Lambert. They soon realized that fluidics could eliminate electrical noise of relay-controlled systems which can distort readouts and cause error. Such electromagnetic noise also could trigger optoelectronic sensing schemes. Thus, the job of sensing disk position and assuring the proper 100-microinch distance below the heads also is done with fluidics. "Interference and false alarms are cut, and there are no electromechanical failure mechanisms to fret about," says Lambert.

The fluidic logic system, supplied by Pitney-Bowes, comprises 80 NOR gates in a laminated block about the size of a small brick.

An antipollution pump from a Ford car supplies pressurized air which feeds both the air bearing system and fluidic logic; a 1-micro-inch fine air filter strains out dust and contaminants.

Thus fluidic sensors, switches, and logic help position the disk on its spindle, control the position of the spindle itself, and operate the electric motor drive. Furthermore, through diaphragm or strain gage transistor switches, the fluidic system controls the status displays on the front panel. The system also monitors the spinning disk's position relative to the heads, preventing scraping, and warns of electronic and mechanical malfunctions.

**Heads up.** Each of the 16 head pads contains eight heads, making a total of 128 read-write heads. The system records five megabits on one surface of a disk. If more on-line storage is needed, up to three slave disk drives can be controlled from the basic DDR-1, to bring total accessible data up to 20 megabits.

Data transfer rate is 16 microseconds per 16-bit word plus parity and timing; average access time is 16.67 milliseconds with the maximum reaching 33.3 msec.

For reliability, each of the 16 head pads has its own read-write circuitry. Thus, if one read-write block fails, 15/16ths of the data is still available.

DISC's anticipation logic is aimed at easing the load of time sharing or multiprogramming operations. Large machines usually have hand-wired interrupt features that allow programs, data, and interim results to be stored quickly and easily. By contrast, smaller slower machines generally do fewer tasks in parallel, and an interrupt may force them to dump work already done.

With the DDR-1, when a computer requests data in a given position, the DDR-1 notes this. At a certain number of microseconds before readout, it warns the computer that the data will soon arrive. Thus the computer's software can be written to allow the processor enough time to efficiently prepare for the data.

The DDR-1 is priced at about \$14,500 minus OEM discounts. Delivery time is 90 days.

Digital Information Storage Corp., 100 Carter St., Berlin, Mass. 01503 [338]



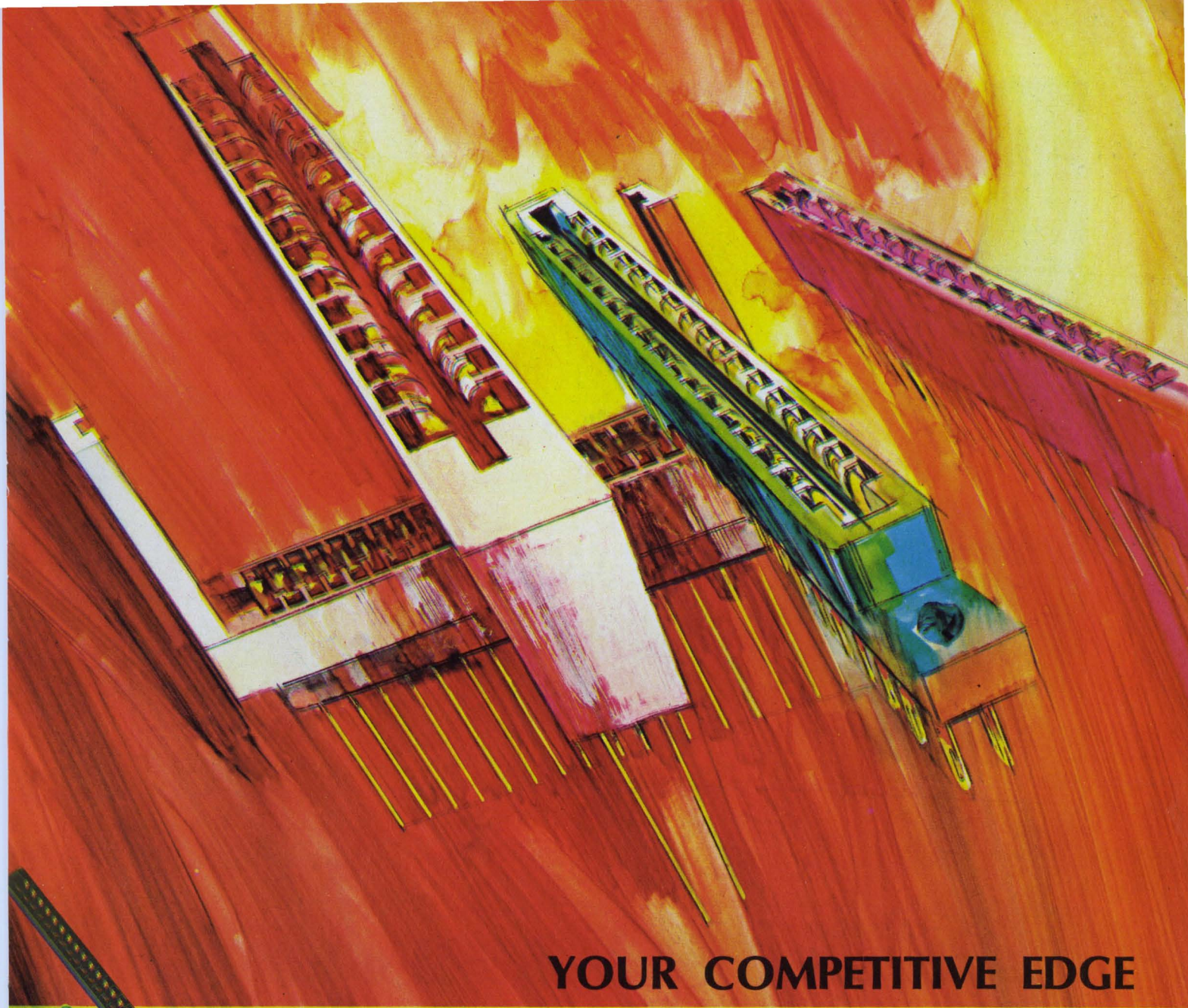

**YOUR COMPETITIVE EDGE**

## **CINCH PRINTED CIRCUIT CONNECTORS**

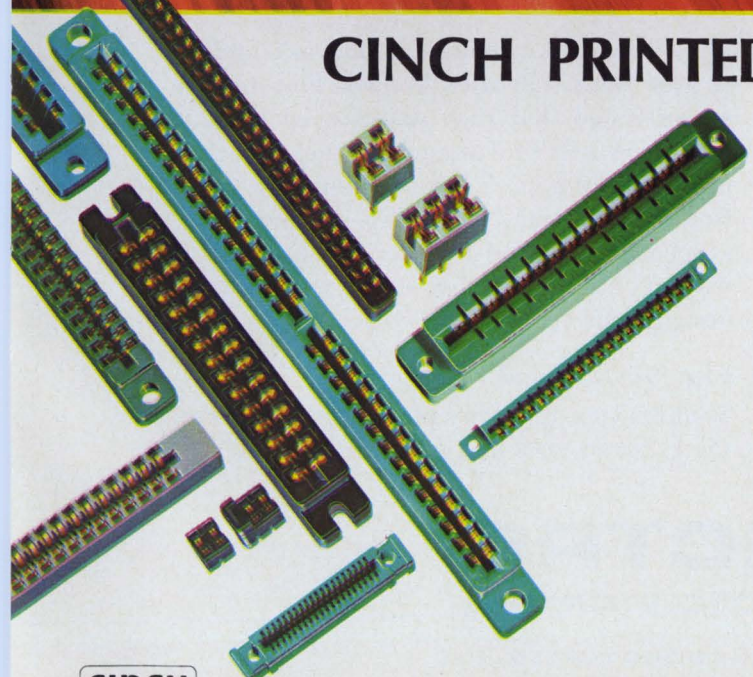

Improved performance and lower cost are the best competition beaters . . . and you get either or both with Cinch PC connectors.

There are 22 basic designs described in the new Cinch PC Connector catalog. If the one you need isn't there, Cinch can develop a special connector for your application.

It can incorporate any of six methods of gold deposition (including two selective plating techniques), eight types of contacts, eight types of terminations and six insulator materials . . . whatever best gives you your competitive edge. The resulting product can be produced in quantity in a surprisingly short time.

Write for the Cinch Printed Circuit Connector catalog to Cinch Manufacturing Company, 1501 Morse Avenue, Elk Grove Village, Illinois 60007.

**IMMEDIATE DELIVERY** of many Cinch printed circuit connectors—from stock—can be obtained through Cinch Electronic distributors.

C-6910



CINCH MANUFACTURING, CINCH-GRAFIK, CINCH-MONADNOCK, CINCH-NULINE AND PLAXIAL DIVISIONS OF UNITED-CARR INC., A SUBSIDIARY OF TRW INC.

Circle 151 on reader service card





We're geared  
to solve your  
**CONTROL**  
problems

## Twenty-five years of solid background and research have put **ELECTRO** way out front

We have solved so many sensing and control problems for industry that we probably already have developed a magnetic pickup to fit your specific needs.

In our large selection of standard and special models you will find some smaller than a dime for tight packaging, you will find pick-

ups with inductance limits as low as 6 and up to over 540 millihenries. You will find some so sophisticated that they are covered by patents. You will find magnetic pickups that bring a new approach to tachometry, positioning, counting, triggering, telemetering, synchronization and other actuations. And, if we don't have exactly what you need, we can design it for you.

*Free Handbook and Nomograph*

Send for your free copy plus specifications on the **ELECTRO LINE** and application data.



# **ELECTRO**

**MAGNETIC PICKUPS**

**ELECTRO PRODUCTS LABORATORIES, INC.**

6125 WEST HOWARD STREET, CHICAGO, ILLINOIS 60648  
312-647-8744/FAX: JMQ/CABLE ELECTROLAB



# A miniprinter for minicomputers

200-lines-per-minute unit will sell to equipment manufacturers for \$6,000; IC controls made possible by lightweight, spring-loaded hammer mechanism

By James Brinton

Associate editor

**Small, low-cost** computers generate a demand for inexpensive peripheral equipment; users don't like to spend more for an accessory than for their processor. This explains some of the drive for inexpensive crt terminals, memories, modems, and other peripherals. But line printers have lagged behind, with many "lower"-priced printers costing as much as \$10,000 more than OEM price for a minicomputer, and with those in the \$7,000 to \$10,000 bracket offering restricted specs.

A printer with 200-line-per-minute speed, and with most of the features found on larger machines, at a price of about \$6,000 in OEM lots and \$10,000 in unit orders, is the first product of Nortec Computer Devices Inc., Ashland, Mass. Nortec vice president Richard Holtzman hopes the model 200 is the "Volkswagen-type printer" that makers and users of minicomputers may have been waiting for. It will be introduced at the Fall Joint Computer Conference in Las Vegas, Nov. 18-20.

Nortec cut costs by using more electronics and less electrical and mechanical gear. It came up with a printer little larger than an electric typewriter. "Instead of being as big as a desk, the model 200 fits on top of one," says Holtzman. "and its other parameters are in proportion." The machine weighs less than 100 pounds, and needs only about 300 watts of power.

"It's necessary to know what the model 200 isn't to understand what it is," says Holtzman. It isn't a drum- or chain-type printer. In those devices, a heavy metal cylinder with raised letters spins in front of an array of solenoid-con-

trolled hammers, and as the proper letter appears along the line being printed, banks of relays fire the appropriate hammers, which squeeze the paper and ink ribbon between themselves and the drum. Chain printers are similar, but substitute a sidewise moving link belt for the horizontally spinning drum. Both systems require high current for banks of hammer solenoids. This usually means heavy equipment for relay switching and bulky power supplies. Holtzman says that some of the power supplies now in use weigh more than the whole Nortec 200. By contrast, the 200's supply fits on a single circuit board.

The chain and drum in printers also are heavy, and expensive to manufacture. For them Nortec substitutes a thin alloy belt, said to be lighter and both easier and less costly to produce. For solenoid hammers, Nortec has substituted smaller, lighter spring-loaded hammers, cocked by the paper advance system, and fired by energizing a small coil to neutralize the holding force of a magnet latch.

These coils in turn are controlled by an integrated-circuit hammer selection and switching matrix.

The hammer design is basic to many of Nortec's economies. Since the designers of the 200 didn't have



**Small and light.** Desktop-size printer swings open in front for loading convenience. Font belt, shown above with one of the print hammers, takes the place of chains and drums used in many printers.



# For industrial use...here's a \$400 bonded strain gage priced under \$200.



For pressure measurement, a price/performance advantage like you get from the new 4-402 didn't just happen.

It took a lot of blood, sweat and tears to perfect a bonded, bolted, pressure transducer that... offers standard ranges from 0-10 psi through 0-5000 psi, in absolute or gage configurations, provides connection for external shunt calibration, available with NPT or AND threading, and is utterly reliable, virtually indestructible and immediately available.

For all the facts Engineering is so proud of, call our nearest office.

Or write Bell & Howell, Pasadena, California 91109. Ask for Bulletin Kit 3327-X3.

CEC/TRANSDUCER DIVISION



**BELL & HOWELL**

to worry about the rise time of solenoid hammer actuators—the lag time between application of a pulse and the point at which the hammer begins to move—they didn't have to begin one set of pulses before terminating others. Thus the current needed at any given time is lessened. Also, the mechanical energy needed to thrust the hammer against the paper and font belt is supplied by springs, not by a solenoid, and so current requirements are cut further.

These two factors reduce current enough so that the control of the hammers can be performed using a small power supply and integrated circuits rather than relays, or even discrete transistors. Also, says Holtzman, print quality, even down to the sixth carbon copy, is

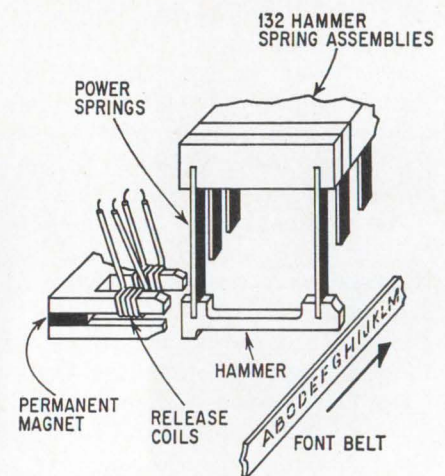

**Spring-loaded.** Pulse to proper coil releases hammer against font belt.

clearer than is possible with some IBM high-speed printers, because spring control is more repeatable than electric hammer control.

**Nine from Texas.** IC's appear elsewhere in the model 200. Nine dual 50-bit MOS/LSI static shift registers from Texas Instruments form the heart of the model 200's buffer system. The buffer accepts parallel 6-bit character identification data from most small computers without modification. Input data rate is as high as 500 kilohertz, and the buffer holds a full-line width of 132 characters.

Most printers use a system of gears, chains, or encoders to synchronize arrival of a hammer blow with the appearance of a letter on a chain or drum. Nortec instead



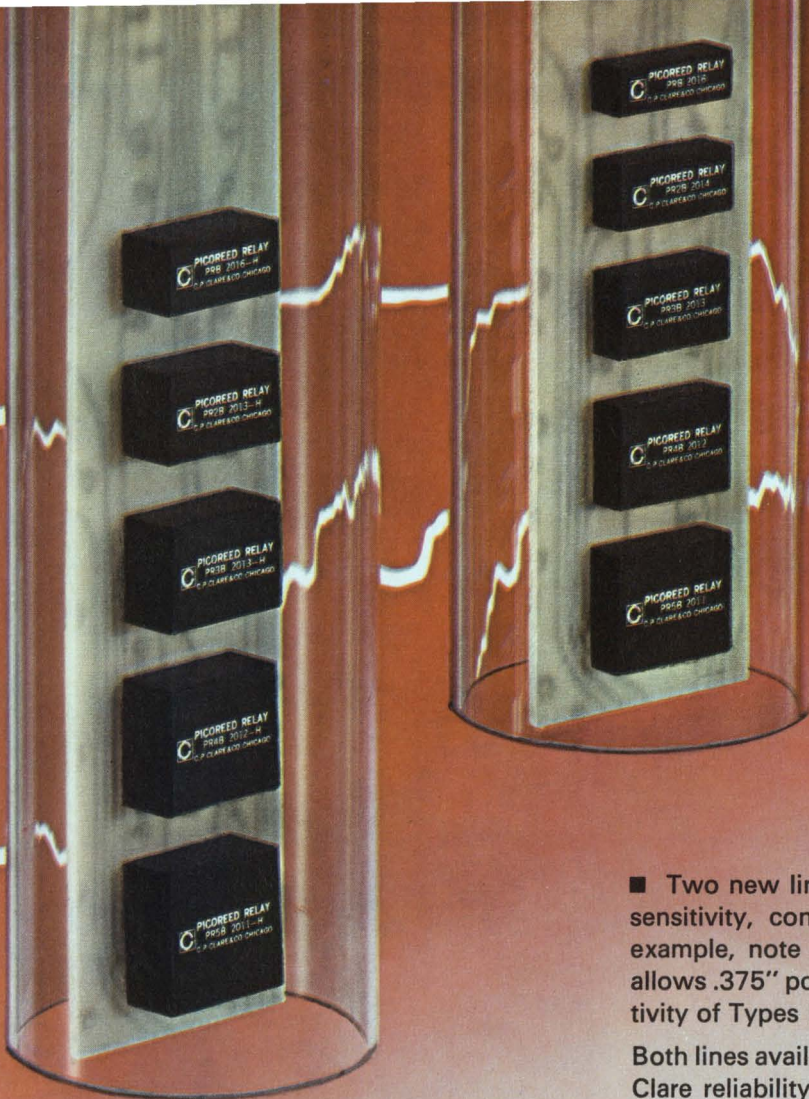

**NEW**  
 ...from CLARESEARCH  
 ...Ultraminiature  
 reed relays

■ Two new lines of Picoreed® relays give you a wider choice in sensitivity, contact configurations and space-saving size. For example, note the new low profile of Types PRA and PRB—allows .375" pcb mounting centers. And note the new high sensitivity of Types PRAH and PRBH.

Both lines available in one to five Form A contacts with traditional Clare reliability. 100,000,000 operations at signal levels. 5 volt (must-operate 3.75v), compatible with standard 5 v DTL and TTL logic families. 6, 12 and 24 volt standard relays also available.

For information, circle Reader Service number, or write for Data Sheet 971A. C. P. Clare & Co., Chicago, Illinois 60645...and worldwide.

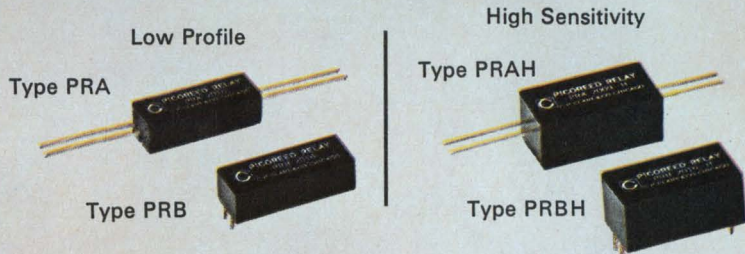

<i>Electrical and Dimensional Characteristics</i>	Types PRA/PRB—Low Profile		Types PRAH/PRBH—High Sensitivity	
	Form 1A	Form 5A	Form 1A	Form 5A
Operate time, including bounce	500 μs	600 μs	600 μs	900 μs
Average nominal power for 5 volt units	65 mw	250 mw	46 mw	140 mw
Pcb mounting centers	.375"	.375"	.500"	.500"
Length	.781	.800	.800	.800
Width*	.250	.675	.400	.800
Height	.187	.225	.350	.350

\*Widths vary according to number of switches. One through 5 available.



a GENERAL INSTRUMENT company

Circle 155 on reader service card



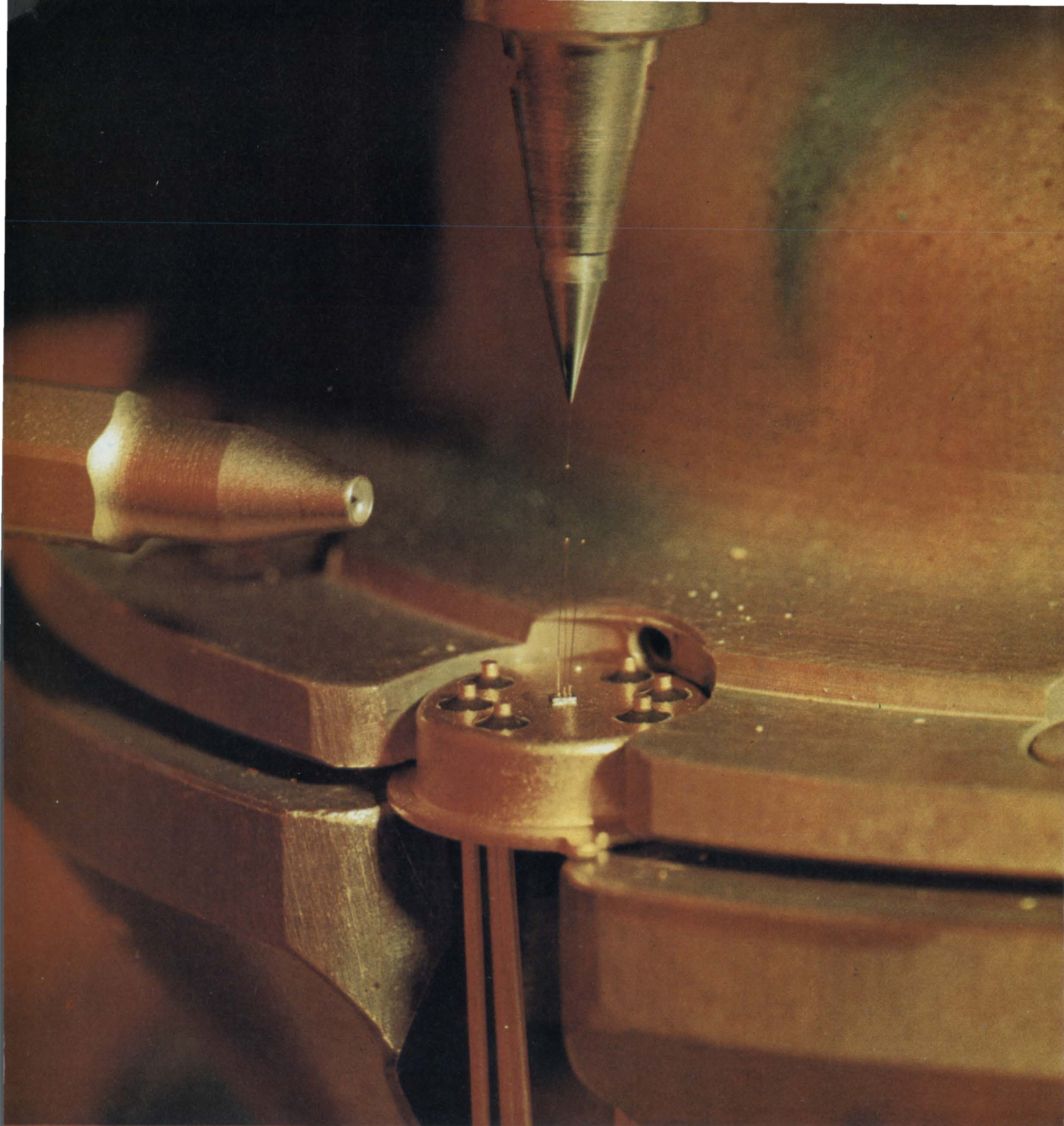

## Ball .002" dia., Iteration $\pm 5\%$

TEMPRESS HYDROGEN FLAME-OFF TORCHES FOR LEAD-BONDING MACHINES ARE STAINLESS STEEL, WITH SAPPHIRE ORIFICE INSERTS that maintain size and shape accuracy of the 2166°C hydrogen flame. The highly polished inner surface of the sapphire insert assures this by eliminating gas turbulence and a resultant distortion of the flame. The end result is essentially identical gold balls on every lead, from start to finish of a production run. 14X magnification of operation shows flame-off torch at left, with orifice partially visible. Gold wire, with perfectly formed ball, protrudes from Tempress tungsten

Circle 156 on reader service card

carbide capillary tube, ready for next bonding cycle. This extreme precision symbolizes the Tempress approach to every project... explains why it requires 11 months to train an operator for many Tempress production operations. Other Tempress products include automatic scribing machines, diamond scribes, diamond lapping points, and tungsten carbide probe contact needles.

*Lead-bonding, Model DTN-1, at Union Carbide Electronics.*



# TEMPRESS

Tempress Industries, Inc., 980 University Ave., Los Gatos, Calif. 95030



## ... electronic timing prevents errors ...

places a magnetic code on the font belt beneath each letter, and adds an additional code location to tell when the belt has made a full revolution. The code is read with a reluctance-sensitive pickup and the results sent in turn to a code character generator and a digital comparator. The former tells the comparator what letters are where at any given time, and the comparator checks this information against data in the MOS buffer. And if the information matches, the comparator circuit triggers the hammer-release electronics to print the desired character.

Nortec's electronic timing is said to eliminate print position errors that otherwise would creep in, caused by gear backlash, slipping pulleys, or other mechanical factors.

The character generator, comparator, and hammer control electronics are all IC, with the hammer release circuits being custom-made, multistage pulse power amplifiers capable of 2-amp, 0.5-millisecond pulses.

Each pulse is shared among five hammers, with only one of the five printing when a transistor switch closes the circuit.

Because IC's are smaller and less costly than gears, relays and the like, Nortec has been able to design into its machine several control and mechanical features much like those found on printers selling for \$15,000 or more, according to Holtzman.

Among them are tape-controlled vertical formatting, variable width (any width up to 132 columns), lateral positioning (with a vernier for adjustments as small as  $\pm 0.05$  inch), and adjustable hammer impact.

The company plans delivery of the first printers within three months after introduction of the machine at the FJCC.

### Specifications

Character set	64 alphanumeric characters (cols 2 through 5 on ASCII chart)
Paper advance	10 inches per second slew, one line in 25 milliseconds
Size	22.5 x 9.5 x 20 inches

Nortec Computer Devices Inc., 95 Nickerson St., Ashland, Mass. 01721 [339]

# Atec's new 12.5 MHz universal counter/timer measures Frequency, Time Interval, Ratio, Period, Multiple Period, and Totalizes.

**That's  
quite  
a bit  
for  
\$850!**

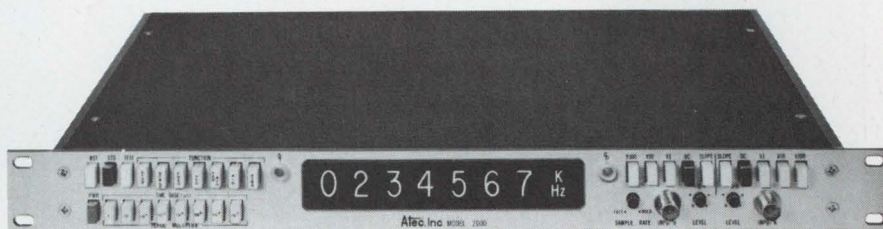

Atec's new Model 2000 offers more performance for less money than any competitive instrument. Standard features include a 1 MHz crystal-controlled time base stable to one part in  $10^8$ /day, remote programming, and 1-2-4-8 BCD output. Options include display storage, oven-stabilized crystal, and additional digits (to seven). Modular plug-in design makes it simple to add options at any time.

Input sensitivity is 10 mV (DC to 5 MHz) and 30 mV to 12.5 MHz. Front panel height is only  $1\frac{3}{4}$  inches.

For complete specifications or a free demonstration, call your local Atec engineering-sales representative, or write Atec today.

## Atec, Inc.

1125 LUMPKIN STREET, HOUSTON, TEXAS • PHONE (713) 468-7971  
MAILING ADDRESS: P.O. BOX 19426 • HOUSTON, TEXAS 77024



**TRW Announces  
40 Watts at 50 MHz  
40 Watts at 175 MHz  
20 Watts at 470 MHz**

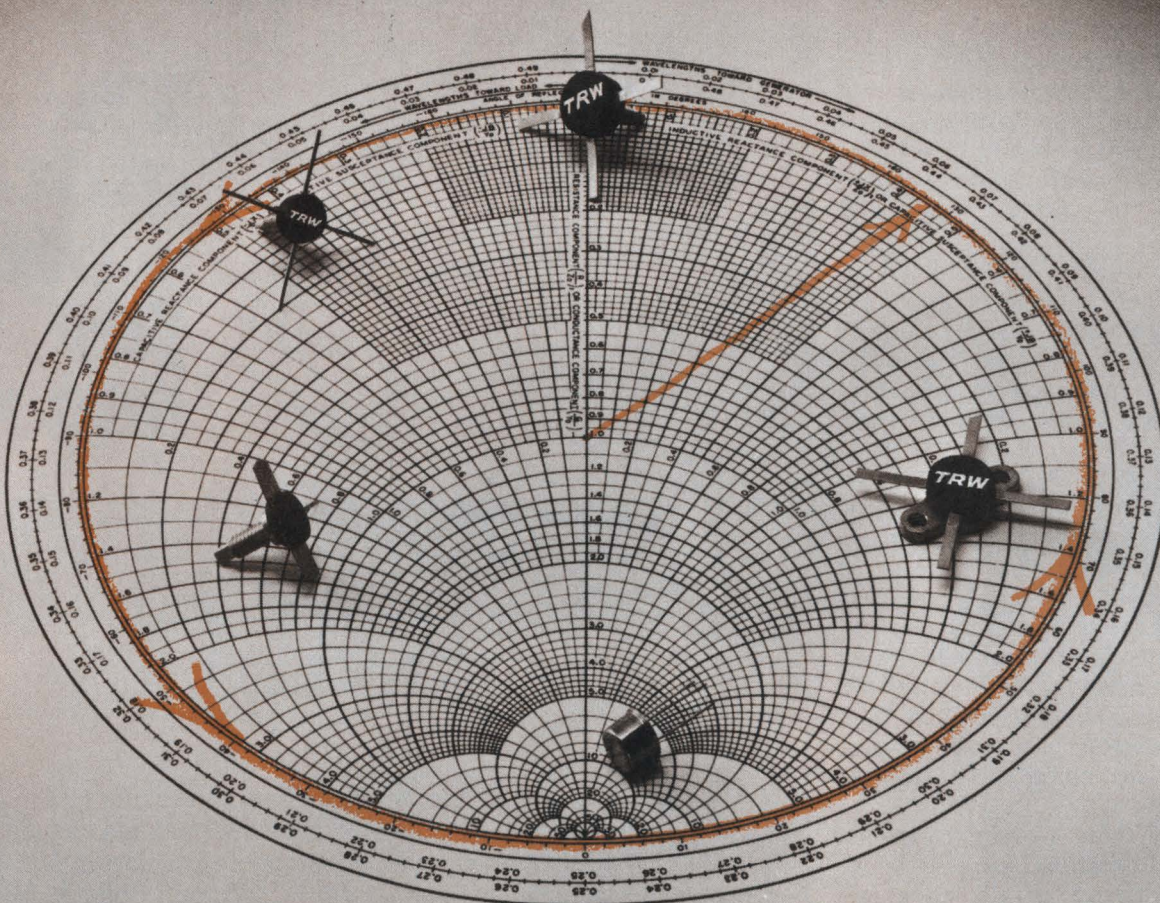

**12.5 Volts...withstands infinite VSWR**

TRW offers three new families of 12.5 volt RF transistors in a wide range of power levels. These rugged transistors will withstand severe mismatch—any load, any phase. Broken or shorted antennas are no longer a problem.

Complicated push-pull or parallel output stages are a thing of the past.

Using single output devices, you can design transmitters with up to 20 watts output at 470 MHz (2N5701), 40 watts at 175 MHz (2N5706) and 40 watts at 50 MHz (2N5691). Fifteen new devices provide complete RF line-ups.

Contact any TRW Distributor or Dept. MR-1, TRW Semiconductors,

14520 Aviation Blvd., Lawndale, Calif. 90260. TRW Semiconductors Inc., is a subsidiary of TRW INC.

**TRW**<sup>®</sup>



# Light-emitting diode seeks mass market

Long-lived unit challenges subminiature incandescent lamps for use in printed-circuit boards, panels, optical logic cards

**Though available** for about five years, light-emitting diodes have been largely confined to high-price, low-volume applications. Now Monsanto is marketing its gallium arsenide phosphide units for high-volume jobs at a reduced price of \$1.50 each in quantities of 1,000. One of the principal reasons for lower manufacturing costs, Monsanto says, is batch fabrication

using the lead-frame technique, a production-line method first developed for transistors.

Monsanto claims the visible solid state light source, designated the MV 50, already has proven its superior reliability—the device has a calculated lifetime of nearly 1 million hours, against the 5,000-hour lifespan of incandescent lamps.

The biggest disadvantage of filament lamps is their large inrush or initial current, which can be 12 times as great as normal operating current. And their weak filaments reduce reliability under rugged conditions.

The MV 50 however, has no problem with either the filament or the inrush current. The light source is a diffused, planar, gallium arsenide

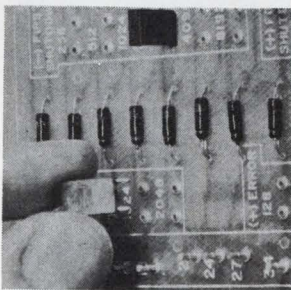

Sized-to-order Cirkut Socket allows direct plug-in to circuit boards of component and connector leads of varying diameter. Sockets are installed in circuit boards by a simple swaging operation with a die set and standard arbor-press. Installed profile of the socket projects 0.040 in. above the p-c board surface. SAE Advanced Packaging, E. Edinger Ave., Santa Ana, Calif. [341]



Wirewound power resistors in the WP line have a standard total resistance tolerance of only 1%. They are stocked in a variety of 9 sizes and styles ranging from 0.078 x 0.250 in. to 0.375 x 1.780 in. in ratings from 0.4 to 11 watts. Maximum resistance ratings are available from 3.5 kilohms to 200 kilohms. Nytronics Inc., 550 Springfield Ave., Berkeley Heights, N.J. 07922 [342]

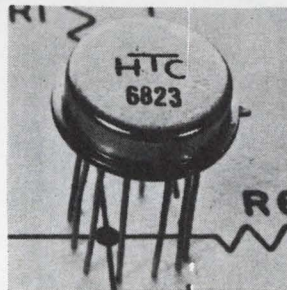

Timing module in a T0-8 case measures 0.5 in. in diameter by 0.170 in. in height. It provides time delays of from 1/10 to 100 sec with an accuracy of  $\pm 3\%$  and a repeatability of  $\pm 2\%$ . Type 333-35001 features an scr output rated at 1/2 amp at 28 to 32 v d-c. It is suited for airborne and industrial use. Price is \$25. Hi-Tek Corp., 2220 So. Anne St., Santa Ana, Calif. [343]

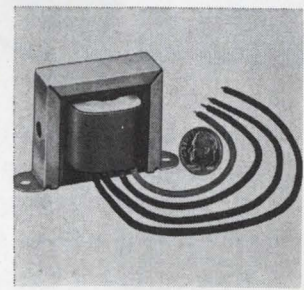

Silicon and selenium rectifier power transformers series RT feature multiple primary taps to provide a large range of secondary a-c output voltages under load. Voltages vary from 11 to 29 volts or 25 to 53 volts, depending upon which transformer is in use. Prices (1-9) range from \$7 to \$77 each; availability, from stock. Essex International Inc., 3501 W. Addison St., Chicago [344]

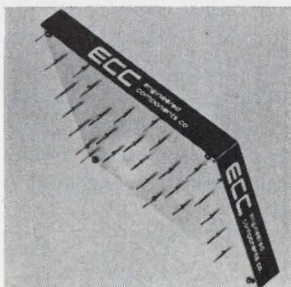

Delay line series 25 is a lumped-constant unit that can be tapped at any or all single nsec increments between 1 and 25. Attenuation is less than 0.06 db and rise time is 4 nsec in both the 50 and 90 ohm versions. Unit is encapsulated with epoxy in a diallyl phthalate case 1.40 x 2 x 0.225 in. Engineered Components Co., 2134 West Rosecrans Ave., Gardena, Calif. [345]



Relay series 600 (4pdt) is for aircraft, missile and ground support equipment power switching. It is rated at 10 amps for 100,000 cycles minimum at 28 v d-c. Its contact mechanism delivers a positive wedge-wiping action which cuts through surface films to create a continual self-cleaning of the contacts during make and break movements. Electro-Tec Corp., Ormond Beach, Fla. [346]

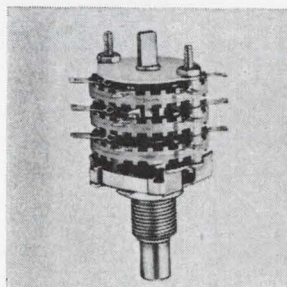

Selector switch series 223 for instrumentation and industrial controls is 1 in. in diameter and provides 0.812-in. strut screw spacing. It has a double-ball detent with 30° indexing from 2 to 12 positions. Detent rotational life is rated at 100,000 cycles through 12 positions and return at 10 cycles per minute. CTS Electronics Inc., 1010 Sycamore Ave., S. Pasadena, Calif. [347]

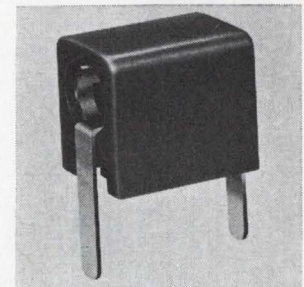

Horizontal p-c jack measures 0.203 in. high (mounted), 0.208 in. long and 0.150 in. wide. It accepts an 0.080 in. diameter tip plug at either end. It has maximum current capacity of 5 amps and an operating voltage of 1,500 v rms at sea level. Contact resistance is less than 2 milliohms. Unit is available in 10 colors. E.F. Johnson Co., Waseca, Minn. 56093 [348]



# Convert any X-Y scope into a curve tracer: \$655\*

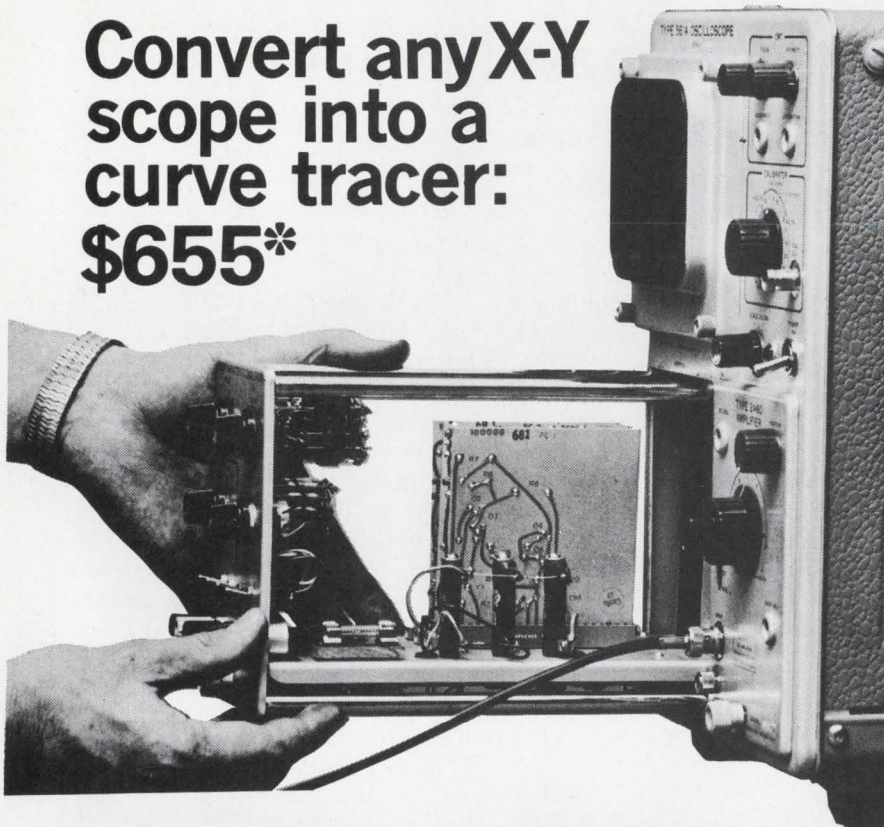

Now U-Tech's plug in and console units are all your oscilloscope needs to become a curve tracer. Save 1/2 to 1/3 the cost!

For the price of one curve tracer, you can now buy two to three of these U-Tech units that use the facilities of your present scope to display the dynamic characteristics of both NPN and PNP transistors, N Channel and P Channel junctions, FETs, MOS-FETs, bipolars, uni-junctions, diodes, tunnel diodes and SCRs.

Ask your distributor about these U-Tech curve tracer units or order direct from:

\*Prices apply to purchase and shipments within U.S.A. fob Salt Lake City, Utah  
 †Registered Trademark Tektronix Inc.

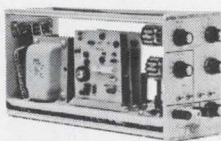

U-Tech plug-in Model 681: \$655.00\*. For use with Tektronix† 560 series Oscilloscopes.

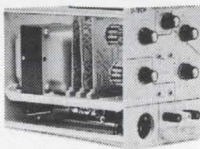

U-Tech plug-in Model 682: \$675.00\*. For use with Tektronix† 530, 540, 550, 580 series Oscilloscopes.

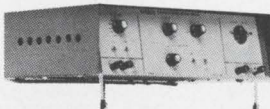

U-Tech Console Model 683: \$685.00\* For use with any X-Y Oscilloscope.

phosphide diode that needs only 0.03 watt driving power to generate 750 foot-lamberts of brightness. And because of its low power requirements, the device is compatible with integrated circuits, where it is expected to find its widest applications. It requires 1.6 to 2.0 volts input, and can be switched at speeds as fast as 1 nanosecond, according to Monsanto engineers.

Its 0.08-inch-diameter lens makes the MV 50 suitable as an indicator for use in computer systems and electronic data processing equipment, as an on-off indicator for instruments, or as an element in large visual arrays and optical logic systems. And Monsanto is aiming at such high-volume applications as

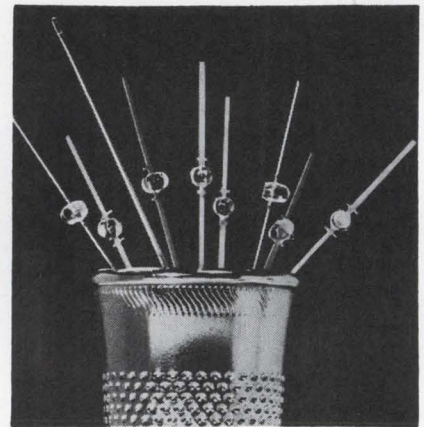

Point sources. Light diodes with leads are batch-processed.

diagnostic lights on printed-circuit boards and panels.

The MV 50 can be used to replace miniature and subminiature lamps as small as the T3/4 size.

Simultaneously, Monsanto will market another light-emitting diode that the company calls the highest-power unit of its type on the market. Designated the MV4, it emits 5,000 foot/lamberts and requires a 2-watt, 1-amp input.

## Specifications (maximum)

Power dissipation at 25°C ambient	70 mw
Derate linearly from 25°C	1.6 mw/°C
Storage temperature	-55°C to 100°C
Operating temperature	70°C
Continuous forward current	40 ma
Reverse voltage	3 v

Monsanto Electronic Special Products, 10131 Bubb Road, Cupertino, Calif. 95014 [350]

## U-TECH

A Division of Industrial Physics and Electronics Company

4190 South State Street, Salt Lake City, Utah 84107 Tel. (801) 262-2663

Yes, send me curve tracer model.....

Enclosed is:  Check  P.O.  Bill me  Send literature

NAME \_\_\_\_\_ TITLE \_\_\_\_\_

COMPANY NAME \_\_\_\_\_

COMPANY ADDRESS \_\_\_\_\_ PHONE \_\_\_\_\_

CITY \_\_\_\_\_ STATE \_\_\_\_\_



# TODAY YOUR CLOCK IS 32 HOURS SLOW!

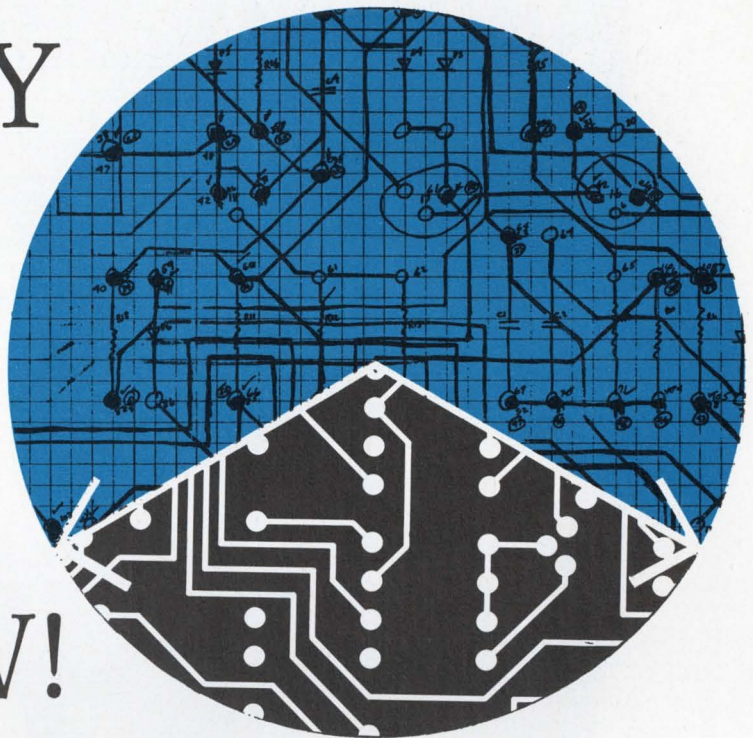

And, you can lose a valuable 32 hours on every circuit board film master you produce . . . unless, of course, you have a SLO-SYN® N/C Photo Artwork Generator to shave those 32 hours from the time it normally takes from printed circuit board sketch to finished size film master.

Then, it's *sketch to etch* in 8 short hours or less!

N/C tapes can be made directly from engineer's rough sketch and the basic program

can then be used to control drilling, eyelet and component insertion.

Time saving is your number one benefit . . . but improved accuracy, a complete manufacturing blueprint on tape and the positive production control that results are great big profit plusses.

If your clock is losing 32 hours or more on every circuit board . . .

call, write or wire:

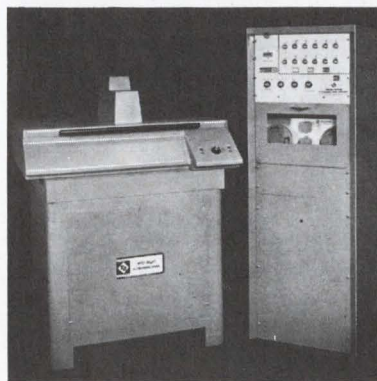

Other systems include conventional and cantilever style positioning tables and complete machines for PC board drilling, wire terminating and eyelet insertion. Request complete literature file.



**THE  
SUPERIOR ELECTRIC  
COMPANY**

506 Middle Street, Bristol, Connecticut 06010  
203/582-9561

SALES ENGINEERING OFFICES IN PRINCIPAL CITIES



SMALL COMPANY

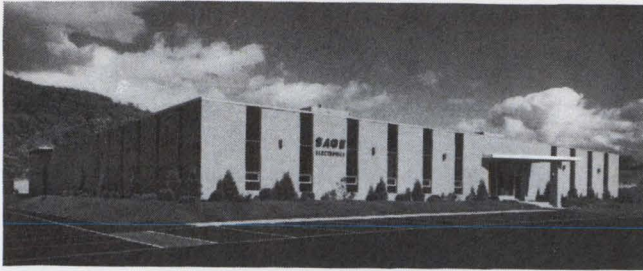

BIG PERFORMANCE



Why knock yourself out when your customer keeps scoring your performance at zero? It makes sense at Sage Electronics, especially when that score is another Zero Defects citation, as evidenced by the examples above.

We are specialists in MINIATURE POWER RESISTOR products. Accordingly SAGE pursues active programs second to none in respect to:

1. Zero Defects
2. High Reliability
3. MIL spec production and test
4. High volume commercial production

Look us over, first by exploring SAGE Catalog R-66. Phone or write for a copy. SAGE ELECTRONICS CORP., Box 3926, Rochester, N. Y. 14610. Tel.: (716) 586-8010.



Precision Power Resistors

**SAGE**  
**ELECTRONICS**

SUBSIDIARY OF GULTON INDUSTRIES, INC.

New components

## Hybrid op amps offer low drift

Converter units are temperature-compensated and miniaturized

**Low amplifier drift** under wide ambient temperature changes is essential to stable analog-digital and digital-analog converter performance. To meet this requirement, the Quantum Devices Corp. has developed four hybrid, temperature-compensated miniature operational amplifiers featuring offset voltage drift as low as  $\pm 0.5$  microvolt per  $^{\circ}\text{C}$ , while maximum internal temperature change can be held to  $10^{\circ}\text{C}/100^{\circ}\text{C}$  ambient temperature swing.

The amplifiers, designated as models 08304, 08305, 08301A, and 08302, offer maximum drifts of  $\pm 0.5$ ,  $\pm 1$ ,  $\pm 1.5$ , and  $\pm 3$   $\mu\text{V}/^{\circ}\text{C}$ , respectively. The dual in-line devices measure 0.78-inch long, 0.28-inch wide, and 0.15-inch high, and can be mounted on a printed-circuit card or inserted into a standard 14-pin dual in-line connector. The operating ambient temperature range of the amplifiers is from  $-25^{\circ}\text{C}$  to  $+75^{\circ}\text{C}$ . The model 08304, the most sensitive unit, has only a  $\pm 5^{\circ}\text{C}$  change in the temperature of the hybrid substrate and is priced at \$85 singly or \$72 in quantities of 100.

Each of the units is capable of accepting both inverted and noninverted inputs. Open-loop gain is 150,000. Unity gain is achieved by adding an external resistor; voltage offset can be trimmed to zero through a potentiometer. The amplifiers are internally frequency-compensated and have circuit protection on both the input and output stages. The temperature-compensation circuit requires external bias voltages of  $+15$  volts and  $-15$  volts; each bias supply provides 20 milliamperes.

Delivery is from stock.

Quantum Devices Corp., 15 West Main St., Bergenfield, N.J. 07621 [350]



When accuracy is important — and noise, harmonic distortion, or non-sinusoidal wave shapes are a problem—a true rms responding voltmeter is the only answer.

With the HP 3450A digital multi-function meter you get **true rms** readings! The AC Voltage and AC Ratio (Option 001) makes the 3450A the only five-digit DVM available today with this capability. And you not only get **true rms** readings, but you get them from 45 Hz to 1 MHz on any of four ranges (1 V to 1000 V). When you add the midband accuracy of  $\pm 0.05\%$  you know that what you are reading or recording is the true value of the ac voltage you are measuring.

The same ac converter (Option 001) also provides true four-terminal ac ratio capability. Gives you the com-

plete isolation you need between X and Y inputs to make accurate ratio measurements between two ac voltages. Four ranges (1:1 to 1000:1) of true four-terminal ac ratio are provided. Option 001 gives the 3450A the capability to make fast, accurate ac readings for **all** the ac information you need.

And, true rms ac voltage measurement is only one face of the incredible dodecameter! The 3450A can also be used for dc and ohms—with ratio, limit tests and ratio limit tests. You get autoranging on all functions and there are options to provide remote control and rear input terminals.

The basic dc unit is integrating and fully guarded for excellent noise immunity. You can make 15 readings

per second with a sensitivity of  $1 \mu V$ . You start with this basic meter and add the capability that best fits your requirements. If your requirements change, any of the options (except the rear input terminals) can be easily installed in the field.

To get more information on how rms readings will improve the quality of your ac measurements or on any of the other options for the 3450—just call your local HP Field Engineer. Or, write Hewlett-Packard, Palo Alto, California 94304. Europe: 1217 Meyrin-Geneva, Switzerland.

Price: Basic 3450A, \$3150; AC Option 001, \$1250; Ohms Option 002, \$400; Limit Test Option 003, \$350; Digital Output Option 004, \$175; Remote Control Option 005, \$225; Rear Input Terminal Option 006, \$50.

# True rms readings! Just one face of the Incredible Dodecameter—

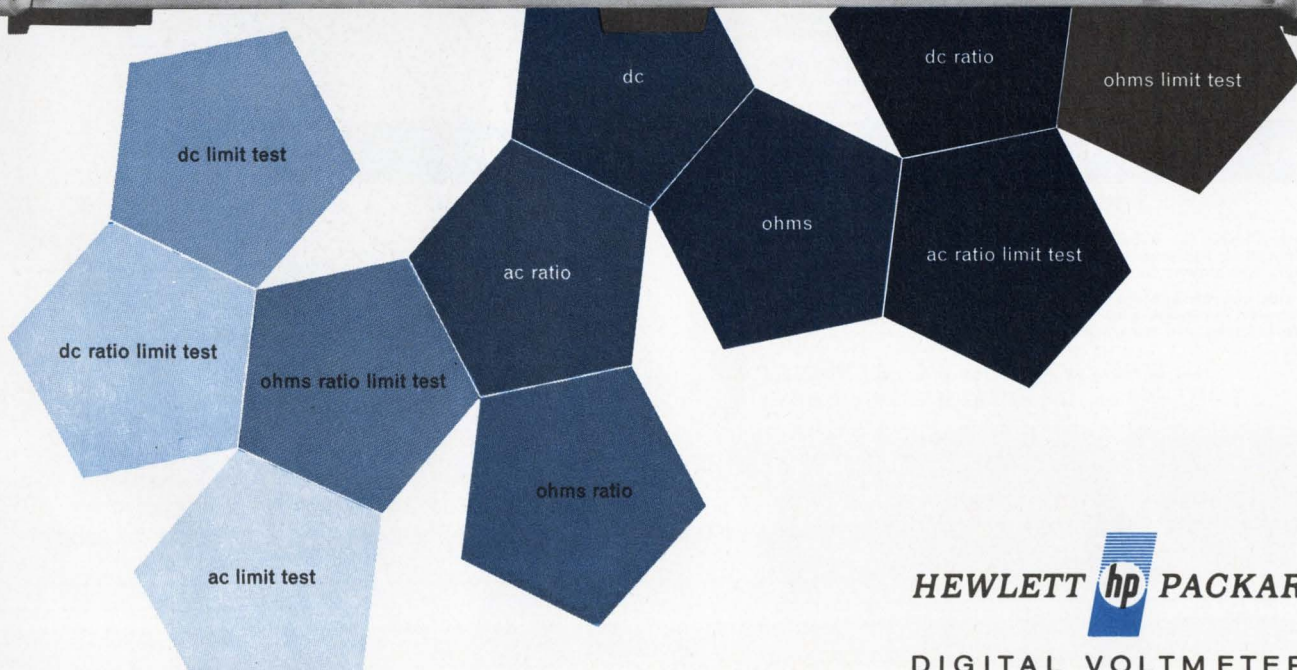
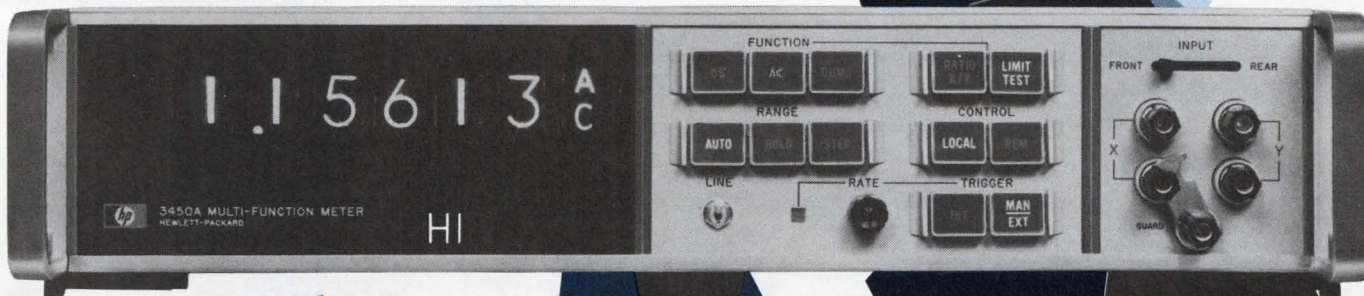

HEWLETT **hp** PACKARD

DIGITAL VOLTMETERS



For Capacitors with **GREATER RELIABILITY . . .**

*Choose*



*The Capacitors You Find Wherever There's Electronics!*

**EL-MENCO DUR-MICA CAPACITORS**

**Only 1 Failure Per 43,000,000 Unit-Hours!**

- It has been computed that "debugged" DM30, 10,000 MMF units, when subjected to 257,000 hours of life at 85°C with 100% of the rated DC voltage applied, will yield only 1 FAILURE PER 43,000,000 UNIT-HOURS!
- DM15, DM16, DM19, DM20 . . . perfect for miniaturization and for new designs using printed wiring circuits. Also available in DM30, DM42 and DM43.
- New "hairpin" parallel leads insure easy application.
- Exceed all electrical requirements of military specification MIL-C-5A.

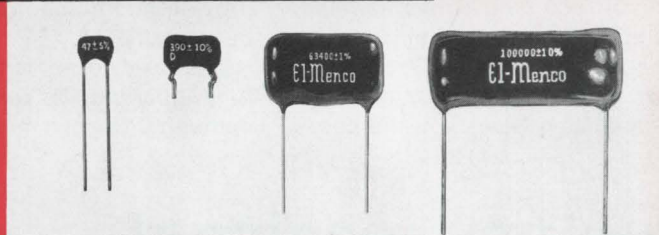

**EL-MENCO TRIMMERS & PADDERS**

**Design Versatility!**

- Available in 350 VDC and 500 VDC as well as other test voltages.
- All bases are of low-loss steatite.
- Special lugs are obtainable for printed circuitry.
- Miniature units are available.
- Solder Lugs can be bent in any position without affecting the capacity setting due to the rigid construction.
- Various types of mounting brackets are available for all trimmers.
- Units can be constructed for special applications.

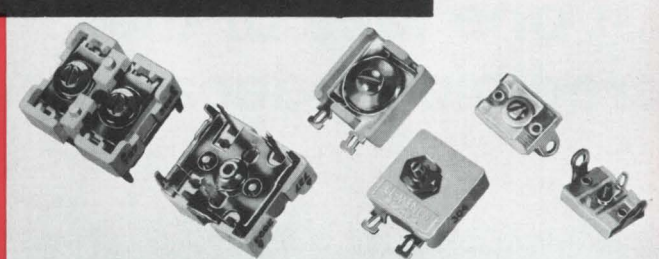

**EL-MENCO \*MYLAR-PAPER DIPPED CAPACITORS**

**Only 1 Failure in 7,168,000 Unit-Hours!**

- Life tests at 100°C with rated voltage applied have yielding only 1 FAILURE PER 7,168,000 UNIT-HOURS for 1 MFD. Since the number of unit-hours of these capacitors is inversely proportional to the capacitance, 0.1 MFD Mylar-Paper Dipped capacitors will yield only 1 FAILURE PER 7,168,000 UNIT-HOURS!
- Working volts DC: 200, 400, 600, 1000 and 1600.
- Durez phenolic resin impregnated.
- Tolerances:  $\pm 10\%$  and  $\pm 20\%$  (closer tolerances available).
- Dielectric strength: 2 or  $2\frac{1}{2}$  times rated voltage, depending upon working voltage.
- Exceed all electrical requirements of E.I.A. specification RS-164 and military specifications MIL-C-91A and MIL-C-25A.

\*Registered Trademark of DuPont Co.

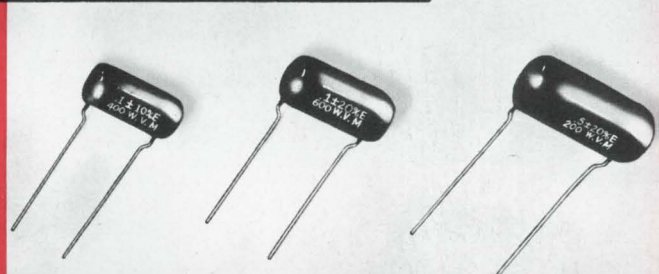

**EL-MENCO MOLDED MICA CAPACITORS**

**Superior Performance!**

- Unmatched for excellent stability, dielectric strength, high insulation resistance, extremely high "Q" and correspondingly low power factor.
- Units can be subjected to a short "debugging" life test at elevated voltage and temperature for removal of early life failures and for improved reliability.

*Write for Free Samples and Booklets on Any of The Above Capacitors*

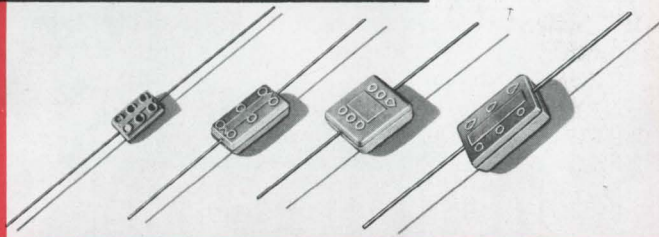

**THE ELECTRO MOTIVE MFG. CO., INC.**

WILLIMANTIC, CONNECTICUT 06226

Dipped Mica • Molded Mica • Silvered Mica Films • Mica Trimmers & Padders  
Mylar-Paper Dipped • Paper Dipped • Mylar Dipped • Tubular Paper

West Coast Manufacturers contact: COLLINS & HYDE CO., 900 N. San Antonio Rd., Los Altos, California 94022  
5380 Whittier Blvd., Los Angeles, California 90022

ALSO SOLD NATIONALLY THROUGH ELECTRONIC PARTS DISTRIBUTORS



# Monolithic memories carry five-year warranty

Quartz-sealing of chips and solder-reflow bonding are used in manufacture; complete system including logic is contained on a single card

Although the technology is less than five years old, monolithic semiconductor memories have advanced to the stage where high-reliability claims will be backed by a five-year warranty.

The warranty is offered by the Cogar Corp., a company formed in 1968 by a group of former employees of the Mohawk Data Sciences Corp. and IBM. The memory sys-

tems, to be available early next year, will be guaranteed for five years against all defects and failures, a precedent-making move by Cogar. Most manufacturers guarantee their memories for 90 days.

Cogar's first series of products will provide in the semiconductor memory market what Sanders Associates' Memcards offer in the ferrite-core segment of the busi-

ness—a complete storage and logic system on a single card [*Electronics*, Dec. 9, 1968, p. 144]. The Cogar systems will be offered in bit capacities of from 10,000 to 5 million and in cycle times of from 80 to 300 nanoseconds.

The company's initial product line includes three general classes of memory: high-performance, where maximum speed is manda-

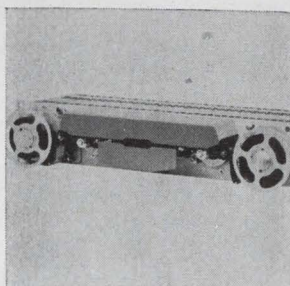

Photoelectric punched tape readers series 5000 are capable of two years of continuous operation with simple operator maintenance. Readers and handlers operate to 625 characters per sec synchronous and 300 cps asynchronous. Tape capacity may be specified from 100 ft of fan-fold to 1,000 ft of tape on the TH500 handler. Chalco Engineering Corp., S. Broadway, Gardena, Calif. [401]

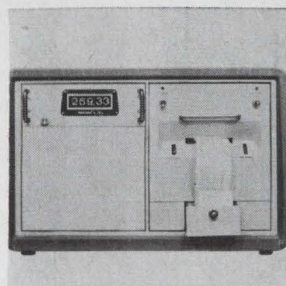

Data monitor DM-1 provides continuous digital readout as well as a printed record of remotely-located analog variables. The parameter being monitored may be an angular rotation, a synchro or resolver output, or the voltage output from a pot or load cell. Range is 0 to 9999; accuracy, 1 part in 10,000; printing rate, 3 lines per sec. Theta Instrument Corp., Fairfield, N.J. [402]

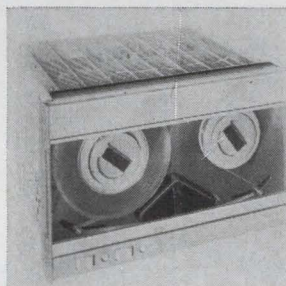

Magnetic tape handler model 3600 is for the small digital computer data acquisition, and data communication fields. It is IBM 360-compatible, sells at under \$3,000, operates at 24 ips, handles 8½-in. reels and includes all read/write, servo and motion control electronics. It handles 800, 556, or 200 bpi, ½-in. wide tape. Digitronics Corp., Albertson, N.Y. [403]

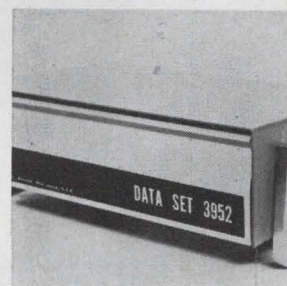

High speed modem model 3952 is for digital data communications. It transmits and receives serial binary data over a voice bandwidth at a synchronous rate of 2,400 bits per second. It is designed for use with all present-day transmission equipment including conventional and dedicated telephone lines, power lines, microwave and radio. RFL Industries Inc., Boonton, N.J. 07005 [404]

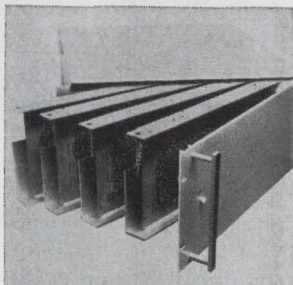

Controller series 1200 models are available for interfacing the 7200 series disk memories with most small computer systems. The 1200 operates up to four 7200 series memories. Each memory has a capacity of 6.4 million bits, and an average access time of 17 msec. Typical controller cost is less than \$8,000. Data Disc Inc., 1275 California Ave., Palo Alto, Calif. 94304 [405]

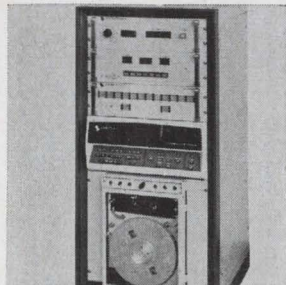

Computerized data logger model 100C makes it possible to monitor up to 100 analog points, translate into binary data and instantaneously produce finished computations in engineering units. The computer has a 4,096 word core memory, expandable up to 16,381 words. All software is provided from the factory. A. D. Data Systems Inc., Linden Ave., Rochester, N.Y. [406]



Eleven-high disk storage drive designated ISS714 has an access time ranging from 10 to 60 msec. It maintains complete disk pack and data compatibility with the IBM2314. The unit provides storage of 29 million bytes at a data transfer rate of 312,000 bytes per sec, and utilizes the 20 recording surface. Information Storage Systems Inc., N. Tantau Ave., Cupertino, Calif. [407]

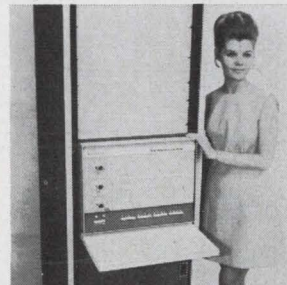

High speed communications computer model 15 will interface directly with the IBM360, Burroughs 5500 and Univac 1108 computers. Two or more semi-autonomous processors operate in a foreground/background relationship to balance the teleprocessing load on the system. Price is between \$40,000 and \$70,000, depending upon options. Interdata, Oceanport, N.J. 07757 [408]





## Look what \$325 buys in a 1 $\mu$ V Full Scale DC Null Detector/Microvoltmeter

It buys you a portable performer with 0.15 microvolt resolution. It's handy and convenient to use. It's rugged, too—works more than 1000 continuous hours on four carbon-zinc batteries. It's the Keithley Model 155—the lowest-priced electronic null detector on the market today.

The 0.03  $\mu$ V rms input noise is quieter than any other in its price class. Coupled with better than  $\frac{1}{2}$   $\mu$ V per day stability and 1 megohm input resistance at 1  $\mu$ V full scale, the 155 is ideal as a null detector for potentiometers, bridges, ratio devices and comparator circuits.

When the Model 155 isn't working as

a null detector, it doubles as a 1  $\mu$ V to 1000 volt microvoltmeter with 19 zero center ranges. Use it for measuring thermocouple and thermopile potentials, contact resistance, making Hall Effect studies, or whatever.

See this little giant perform. Call your Keithley Sales Engineer for your demonstration. Or contact Keithley Instruments, Inc. for complete details—28775 Aurora Road, Cleveland, Ohio 44139. In Europe: 14, Ave. Villardin, 1009 Pully, Suisse. Prices slightly higher outside the U.S.A. and Canada.



KEITHLEY

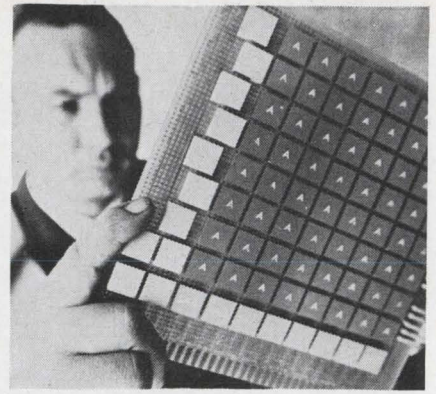

Complete. Array modules, drivers, other functions are on single card.

tory; medium-performance, where speed is still important but less so; and cost-performance, where capacity is more important than speed. All three classes are available as either read-write or read-only memories, and all three kinds of cards can be paralleled to create large-capacity memories.

Circuits in the high-performance line are compatible with emitter-coupled logic, although they are not themselves ECL circuits. They are a modified multiemitter circuit similar in appearance to transistor-transistor logic, but capable of higher speeds. The medium-performance units are made of TTL and diode-transistor circuits, while metal oxide semiconductors are used in the cost-performance models of the memory.

The guarantee is made possible by advanced manufacturing techniques such as sealing the silicon chips onto the substrate with a thin film of quartz, applied by sputtering. This is the same process IBM uses in its solid-logic-technology hybrid microcircuits; Cogar has obtained a license from IBM to use the process. But unlike IBM, Cogar encloses the circuits in a metal container that is just clipped on; anybody can, with a little effort, pry the container off and look at the circuit underneath without damaging it. IBM's circuits are encapsulated in plastic.

Also expected to add to reliability are the use of computer-generated masks, a solder-reflow bonding process, and extensive quality control and computer-controlled testing procedures.

Cogar Corp., All Angels Road, Wappinger, N.Y. [409]



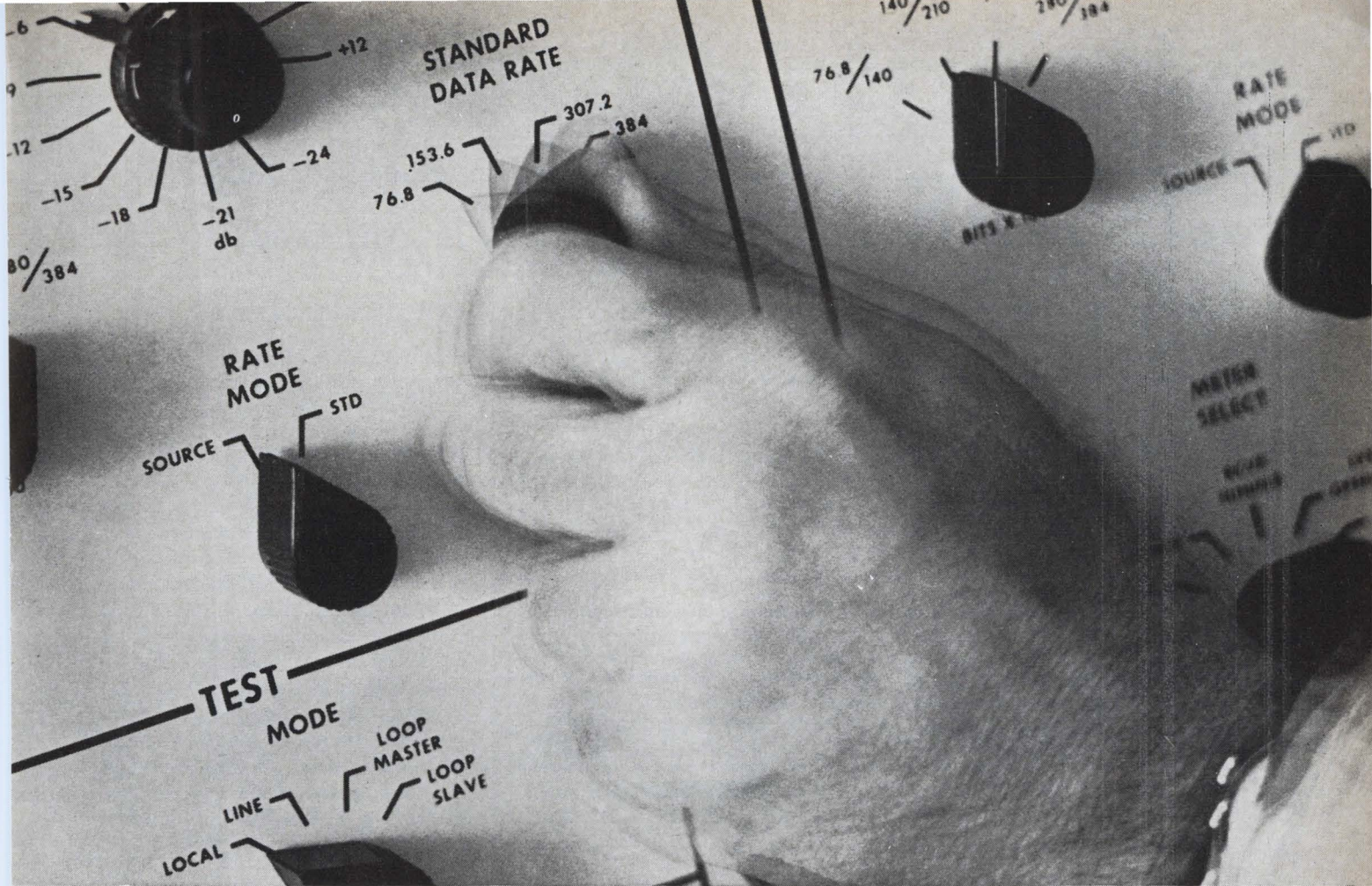

# Our new modem just set a speed record: 384,000 bits per second.

Finally somebody has developed high speed modems that can grow as your communications system grows.

With two new IBM modems, all you do to upgrade is flip a selector switch. Custom-built for government applications, the speed can be varied from 9600 all the way to 384,000 bits per second.

One mil spec modem (AN/USC-25) operates on a wideband 240 khz channel without expensive automatic equalization. It can be equalized quickly with built-in fixed and manual controls.

Another model, AN/USC-24, operates from 9600 to 76.8 bits per second on 48 khz channels.

It has an average error rate of only one in a million bits. Other features: independent full duplex capability, and built-in self test.

Ask us about our communications capabilities. Not only with modems, but with error-control devices, multiplexers and automatic routing equipment.

We want to help you set speed records of your own.

IBM, Federal Systems Division,  
Gaithersburg, Maryland 20760.

# IBM®

IBM Marketing Information  
18100 Frederick Pike  
Gaithersburg, Maryland 20760

Please rush me more facts about IBM high-speed modems.

Name \_\_\_\_\_  
(please print)

Title \_\_\_\_\_

Company \_\_\_\_\_

Address \_\_\_\_\_

City \_\_\_\_\_ State \_\_\_\_\_ Zip \_\_\_\_\_

H080105

Circle 167 on reader service card



# COHU'S DESIGN 6000

## hi resolution camera

Cohu's 6100 Series high-resolution camera—one of the new look 6000 design series—is designed for continuous unattended duty. Camera functions are remotely controlled from a Cohu solid-state 6900 Series Camera Control that connects with a single multiconductor cable. Add a TV monitor for a complete CCTV system.

The 6100 is housed in a high-strength cast aluminum-alloy housing with a scuff-resistant epoxy finish, brushed chrome rear panel and lens mount. The control unit is a rack mount in 5¼" vertical space. It is available with horizontal scan rates from 525 to 1225 lines and bandwidths to 32 MHz. Performance of the camera is characterized by superior corner resolution and flatness of field.

The circuit design of the 6100 series high resolution camera features the latest integrated circuits for maximum reliability. Maintainability is simplified by modular construction and plug-in etched circuit boards.

For complete details and specifications, contact your nearest Cohu representative or call Bob Boulio direct at 714-277-6700, Bx 623, San Diego, California 92112, TWX 910-335-1244.

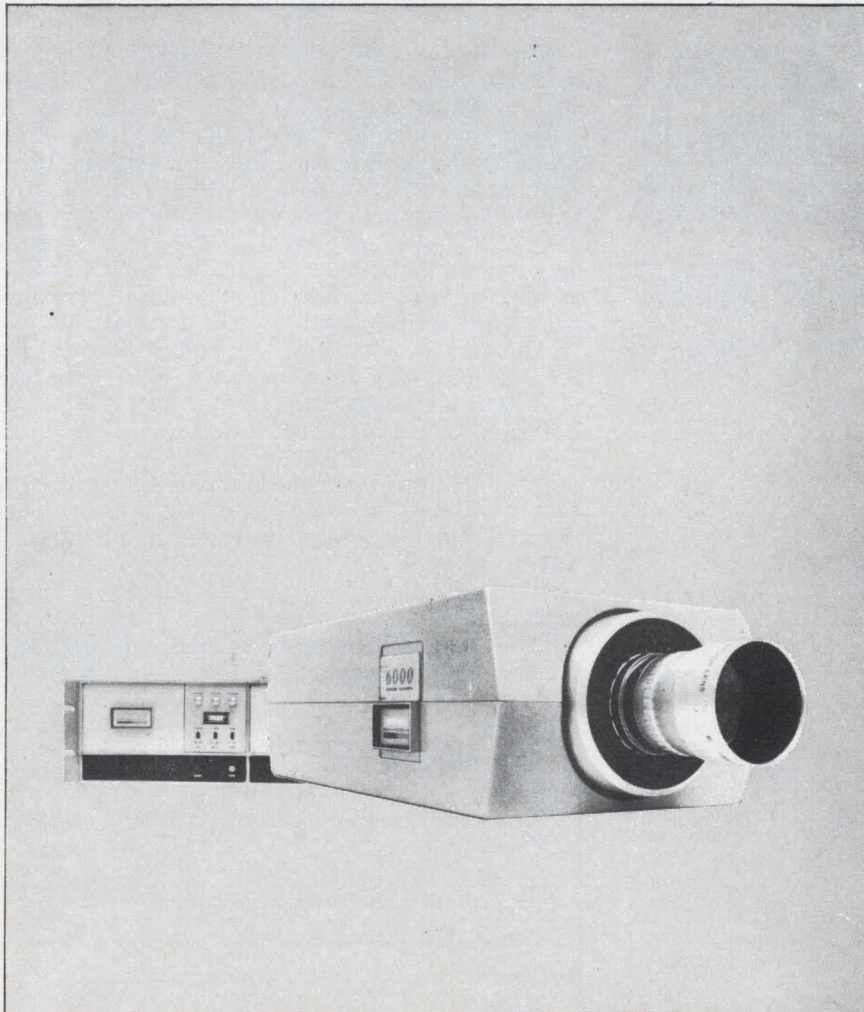

## Data handling

### Memory cycles in 200 nsec

Plated-wire system  
designed for control,  
buffering, special jobs

**Nature abhors** a vacuum—and so do creative computer systems developers. Bruce Kaufman, president of Memory Systems Inc., found that the direction of wire-plated memories, aimed largely at military applications, main-frame computer memories, and in-house corporate needs, was leaving an important gap—the special-purpose memory sector. So his new company stepped in to fill the vacuum with its System/200, a 36,000-bit memory system with a 200-nano-second cycle time and nondestructive readout. The plated wires are horseshoe-shaped, so that the word wire crosses each bit twice.

The system's capacity is 1,024 36-bit words, with options of 4,096 9-bit words or 2,048 18-bit words. Read access time is 120 nsec maximum, with a random access mode in which the selected address is generated by a 10-bit binary number. Word current is 700 milliamps, read or write, with one-turn word strap. In addition to permitting NDRO, the equal read-write word-drive currents simplify circuitry because the word-drivers need drive only one current level, Kaufman says. Bit currents are  $\pm 45$  ma; the Texas Instruments 74-H family of high-speed transistor-transistor-logic gates are used as digit drivers.

The system package is mounted in a standard 19-inch rack, and uses a 115-volt power supply. Environmental operating limits are  $+15^{\circ}\text{C}$  to  $+45^{\circ}\text{C}$ .

The word-select matrix uses an ITT 2N3725 transistor per word line instead of a diode per line because diodes tend to develop capacitance at speeds faster than one-half microsecond, says Kaufman. The transistors are used in a floating switch configuration so that the current flows in a loop and



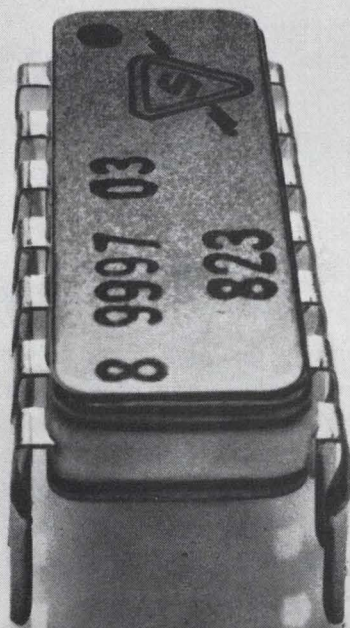
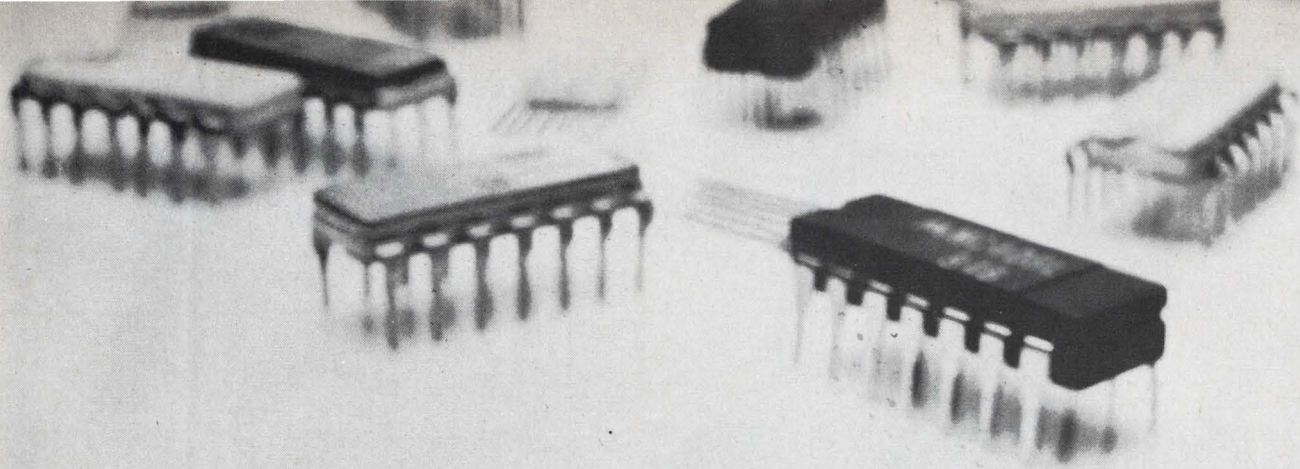

# Our arrays aren't proud. They'll talk to any TTL family.

To most DTL families, too.  
Because Sylvania functional arrays are designed to be compatible.

They use the same 5-volt power supply common to TTL circuitry. Their input-output levels are the same as SUHL I, SUHL II, 5400 and 7400N.

In short, you can use Sylvania functional arrays without interface problems.

And you get other advantages by using our arrays.

You get input/output buffering and the high noise immunity common to TTL circuitry.

You get the highest functional density at the lowest possible cost.

And you also get your choice from one of the largest lines of arrays available in the industry.

Sylvania functional arrays are avail-

able in military and commercial temperature ranges.

If you want to talk to TTL systems, talk to Sylvania first.

*Sylvania Electronic Components,  
Semiconductor Division, Woburn,  
Massachusetts 01801.*

**SYLVANIA**  
GENERAL TELEPHONE & ELECTRONICS



Now With  
Solid State Circuitry &  
Rechargeable Batteries



# ICM FM-2400C frequency meter...

- Completely Portable
- Tests Predetermined Frequencies  
25 MHz - 500 MHz

The FM-2400C provides an accurate standard frequency signal for testing and adjustment of mobile transmitters and receivers at predetermined frequencies between 25 and 500 MHz. Up to 24 crystals may be inserted into the meter. The frequencies can be those of the radio frequency channels of operation, and/or of the intermediate frequencies of the receivers between 5 MHz and 40 MHz. Frequency stability (standard)  $\pm .001\%$  from  $\pm 32^\circ$  to  $\pm 122^\circ\text{F}$ . Frequency stability with built-in thermometer, calibrated crystals and tempera-

ture corrected charts, .00025% from  $\pm 25^\circ\text{F}$  to  $\pm 125^\circ\text{F}$ . (.000125% special 450 MHz crystals available)

FM 2400C  
(Meter Only).....\$445.00  
RF Crystals  
Hi Band.....\$24.00 ea.  
Lo Band..... 15.00 ea.  
IF Crystals..... 8.00 ea.

Write for free catalog.



CRYSTAL MFG. CO., INC.  
10 NO. LEE • OKLA. CITY, OKLA. 73102

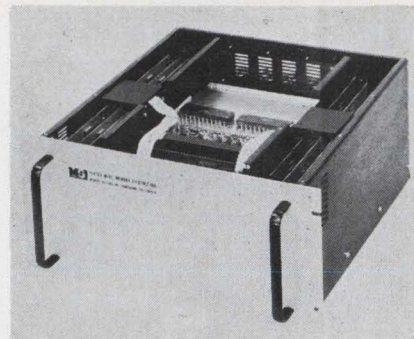

Storage module. Memory is designed for special tasks in systems.

doesn't leak into the circuit. To assure a clean wave form, all the word lines are shunt-terminated with 0.25-watt shunt resistors, and transmission line problems are minimized through impedance matching.

The system organization is 2-D multiplex, utilizing a large memory word in which either the upper or lower half are selected from 72 readout signals for a 36-bit output. Each of 36 RCA 3000 series integrated-circuit sense amplifiers is switched between two channels; the sense amplifiers are driven and selected by 72 gated preamplifiers. High-speed TTL is used in the system both internally and at the interface port. Interconnection within the system is through a printed-circuit mother board. Several interface options are available, including a sequential access buffer with a counter, and a 100-nsec read cycle achieved at the expense of slower write time.

Kaufman says the System/200's cycle time compares favorably with other plated-wire memories, including Univac's 600-nsec memory built for the 9000 computer, and Toko's 500-nsec memory without non-destructive readout.

He predicts the system will find wide use as a cache store in systems with memory hierarchies, as a control memory, and as a main-frame storage memory for small, fast central processing units. It also may be used in high-speed pattern generators for LSI testing, and fast Fourier transform processors, according to Kaufman. The price is about 10 cents per bit in quantities of 50 memories or more. Delivery time is 60 days.

Memory Systems Inc., Hawthorne, Calif. [410]



# Announcing the mail-order skilled worker.

Available on request: A skilled-labor force for your electronics plant. Quality: guaranteed. The cost: A 6¢ stamp.

How can we make such an offer? Tennessee has a unique technical and vocational school training program. At the school in Nashville, we can set up a class in the skills your plant demands. Even train workers on your own machines. And have them ready to start when you are.

Fill in the order blank below to start the ball rolling.

Only one hitch. We don't ship workers outside the Nashville area. You'll have to build your plant down here. And why should you? Key access to growing consumer markets, for one thing. A good female labor supply at payroll savings, for another. University engineering facilities — and graduates. Low-cost electric rates.

And more you'll find out about if you let us take orders from you.

The Plus City  
**NASHVILLE**   
Nashville Plus Steering Committee/  
Metropolitan Industrial Development Board



Nashville Area Chamber of Commerce  
Nashville, Tennessee 37201  
Phone 615—256-5171

I'm interested. Tell me more about how you'll train my work force free.

NAME \_\_\_\_\_

ADDRESS \_\_\_\_\_

CITY \_\_\_\_\_

STATE \_\_\_\_\_ ZIP \_\_\_\_\_



only from  
**BELL & HOWELL**



**model 248 A<sub>2</sub>**  
**5pA input bias current**  
**10  $\mu$ V/ $^{\circ}$ C thermal offset rate**  
**full Mil temp. range**  
**hybrid fet op amp**

**\$63.00\***

*...and these other high performance  
hybrid op amps*

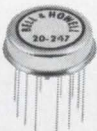

**model 247 A<sub>1</sub>**  
**Bipolar**  
**1  $\mu$ V/ $^{\circ}$ C**  
**Mil Temp. Range**  
**\$34.00\***

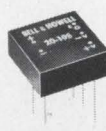

**model 108 FET**  
**5 pA Bias Current**  
**5  $\mu$ V/ $^{\circ}$ C to 100  $\mu$ V/ $^{\circ}$ C**  
**Thermal Rates**  
**\$54.00 to \$18.00\***



**model 008 B<sub>1</sub> FET**  
**5pA Bias Current**  
**25  $\mu$ V/ $^{\circ}$ C Thermal Rate**  
**\$31.00\***

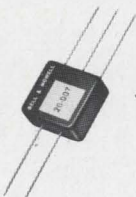

**model 007 Bipolar**  
**1  $\mu$ V/ $^{\circ}$ C to 20  $\mu$ V/ $^{\circ}$ C**  
**Thermal Rates**  
**\$26.00 to \$11.00\***

\*Price for 25-99 Quantities — Stock Delivery

**CONTROL PRODUCTS DIVISION**

706 Bostwick Ave., Bridgeport, Conn. 06605 (203) 368-6751

 **BELL & HOWELL**

Data handling

## Controller features a stored program

Modular unit is adaptable  
for monitoring data, tests,  
lighting, and communications

**When is a computer** not a computer? When it's a low-cost digital controller such as the H-112, developed by Honeywell's Computer Control division. The \$5,000 unit, which has almost everything that a computer has except an extensive arithmetic unit, can be used either independently or as part of a computer system to control or monitor data flow.

The H-112, latest entry into the control segment of the data-processing industry, is a stored-program machine. Honeywell says this flexibility makes it suitable for use in data acquisition, where it may act as a remote terminal, a buffer unit, or as an electronic data assembler and message switcher. It also may be employed to control test equipment, conveyor systems, numerical-control machines, graphic displays, lighting systems, or communications networks.

Modular in design, the H-112 contains a plug-in control panel, a 4,096-word, 12-bit memory, a logic section, and power supply. The unit can be tailored to a variety of control applications by the use of standard digital and analog modules and subsystems.

Honeywell integrated-circuit logic modules are used throughout; they are similar to the modules in the company's series of 16-bit computers for control applications.

Memory is organized into 128-word sectors, 32 in the basic controller, and 64 with the optional 8-kilobit expanded memory. Cycle time is 1.69 microseconds.

The rack-mountable H-112 measures 19 inches wide, 7 inches high, and 26 inches deep. Power consumption is 200 watts.

Honeywell Computer Control Division,  
Old Connecticut Path, Framingham,  
Mass. 01701 [411]



# Signal Generators...

here's the one  
that replaces  
them all.....\*

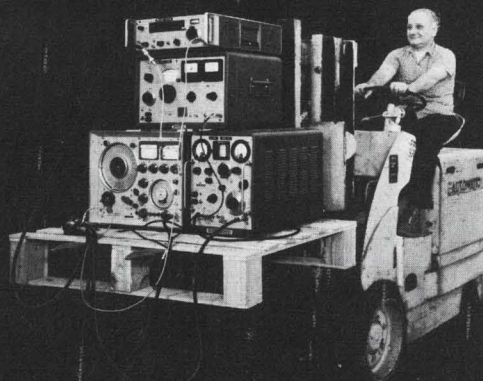

## The New SG-1000 outperforms all other signal generators from LF to UHF (singly or in combination)

The new Model SG-1000 Signal Generator has obsoleted all others within its frequency range . . . singly or in combination. The specifications of this 5<sup>1</sup>/<sub>4</sub>" high instrument are unequalled . . . and are rarely approached.

- LF to UHF coverage . . . 61 kHz, to 512 MHz, extendable to 1024 MHz with simple passive doubler
- Output frequency is read directly on three digit display with two digit extension
- Unsurpassed frequency accuracy and resolution . . . typically 0.005% . . . without the commonplace problems of human error in readout.
- Unparalleled modulation capability, AM, FM, pulse, video (100 MHz bandwidth!) . . .

simultaneous combinations such as AM/FM, FM/pulse, etc. with negligible interaction

- Automatic leveling . . . within  $\pm 0.25$  dB over *entire* frequency range from +20 dBm to -146 dBm
- Doubles as a frequency counter for measuring external signals between 100 Hz and 2 MHz

And if you are still not convinced that the Model SG-1000 has obsoleted most of your present signal generating equipment, consider the fact that its spectral purity approaches that of a crystal oscillator . . . that it has negligible warm-up drift . . . *no* "settling time" after band switching . . . and many other performance features not found in ordinary generators.

For additional technical information, or for Singer's new Application/Data Bulletin SG-10, contact your nearest Singer Field Representative or write directly to The Singer Company, Instrumentation Division, 915 Pembroke Street, Bridgeport, Conn. 06608. (203) 366-3201. *In Europe contact:* The Singer Company, Instrumentation Division, P.O. Box 301, 8034 Zurich, Switzerland, Telephone: (051) 47 25 10

**SINGER**  
INSTRUMENTATION

\*Hewlett-Packard Models 608F, 606A and 5245L/5253B./ Marconi Model 1066B/6, Pin Diode Modulator, Coaxial Switch



# Maintainability<sup>3</sup>

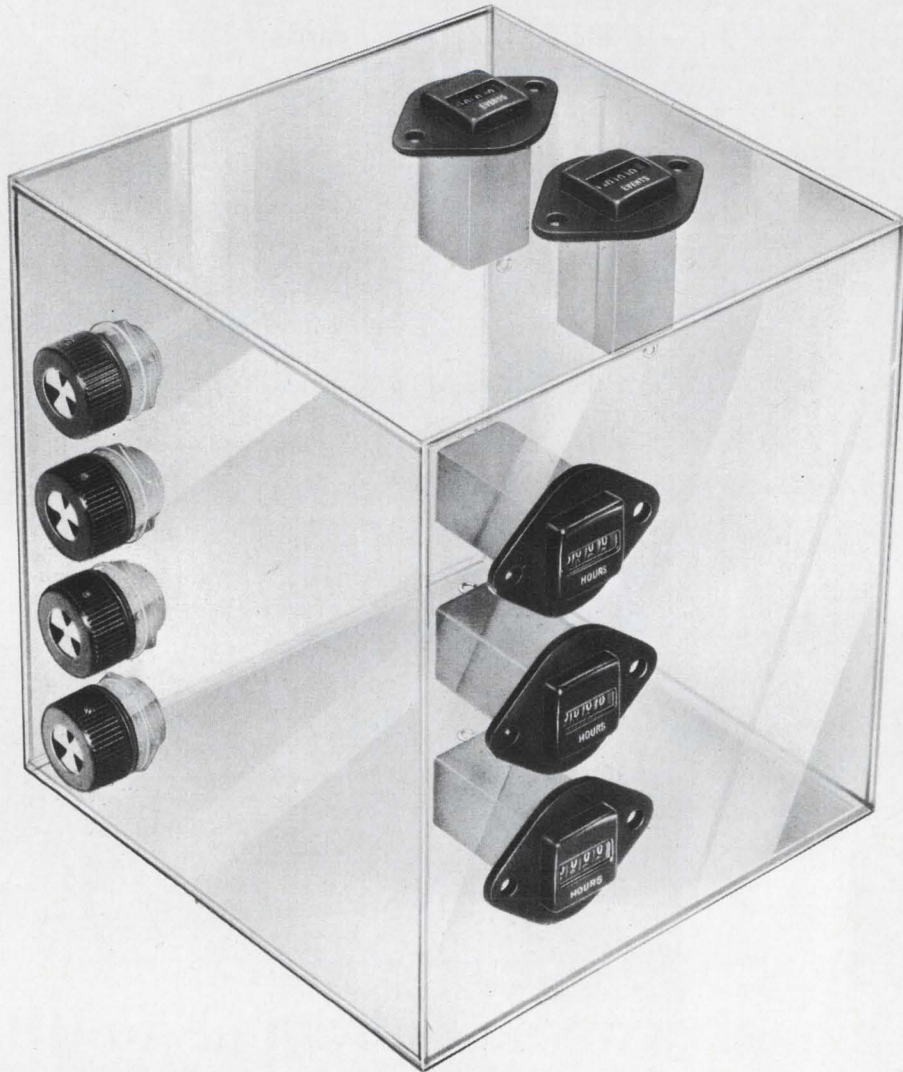

Systems maintainability is assured by Minelco's power of 3: BITE (Built in test equipment) indicators that pinpoint circuit faults, say GO or NO GO. Elapsed Time indicators that tell you how long things have been going on. Events Counters that tell you how often they've happened. And Minelco is the exponent of the maintainability component. Miniature and subminiature—in a size, configuration, and type for every requirement—for *your* requirement. Minimize downtime... get up with the Big Time.



## MINELCO<sup>®</sup>

SPACE AND SYSTEMS DIVISION



GENERAL TIME

High Ridge Park, Stamford, Connecticut 06904

For information and specifications, contact our local representative:

Huntsville, Ala. (205) 883-0244 / Phoenix, Ariz. (602) 267-3916 / Palo Alto, Calif. (415) 326-4186 / San Diego, Calif. (714) 298-1121 / Orlando, Fla. (305) 851-1210 / Marietta, Ga. (404) 422-8242 / Berkeley, Ill. (312) 544-7400 / Indianapolis, Ind. (317) 925-3528 / Santa Monica, Calif. (213) 451-5711 / Wichita, Kans. (316) 683-7518 / Waltham, Mass. (617) 894-9165 / Bridgeton, Mo. (314) 731-3011 / Plainview, N.Y. (516) 681-8710 / Utica, N.Y. (315) 735-8341 / Columbus, Ohio (614) 231-4571 / Dayton, Ohio (531) 224-0728 / Devon, Pa. (215) 688-5157 / Fort Worth, Tex. (817) 335-4541 / Arlington, Va. (703) 525-1191 / Bellevue, Wash. (206) 454-7922.

**BITE INDICATORS • ELAPSED TIME INDICATORS • EVENTS COUNTERS • ROTARY SWITCHES • TRIMMER POTENTIOMETERS**



# P-c artwork generated automatically

Price—and precision—of system geared to circuit board needs; special software package converts sketch data for input cards

**Generating masks** for printed-circuit board fabrication can be an involved procedure, requiring drawing, cutting, and peeling a rubylith master, and then photographing and reducing it. However, a "turnkey" system manufactured by the Gerber Scientific Instrument Co. can considerably lighten the burden by automatically preparing p-c artwork from design sketches

or engineering drawings.

Other automatic artwork generators are geared largely to integrated-circuit mask-making. With the very high accuracy required in this application, prices shoot up into the several-hundred-thousand-dollar range. The Gerber unit, called the System 40, is designed expressly for printed circuits, and extremely high accuracy isn't

needed. The price is \$55,000.

Dimensional data from the sketch is fed into the System 40 by punched cards prepared on an IBM 024 or 026 keypunch, or optionally, on an ASR-33 teletypewriter. A program, called Gerber Graphics Generator, or 3G, was developed by Applied Programming Technology, a Gerber subsidiary, to convert sketch data for the system's

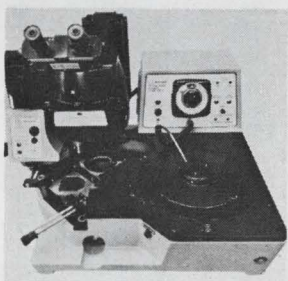

Optical mask alignment and exposure system model 500D offers operational flexibility and initial exposure rates as high as 430 wafers per hour. Wafer-to-mask alignment is accomplished by an X-Y joystick control. The system's vacuum chuck will accommodate wafers from 0.750 to 2.125 inches in diameter. Electroglas Inc., 150 Constitution Drive, Menlo Park, Calif. 94025 [421]

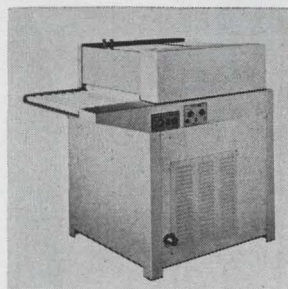

P-c board drier D-4 24-HPVC is a high pressure water rinse unit that cleans the boards after sanding or removes any other foreign matter that fills and clogs the holes. The high production unit takes up less than 12 sq ft of floor space, dries boards up to 24 inches wide and any length, and has a built-in sink and drain. Marco Engineering Co., Box 5247, Buena Park, Calif. [422]

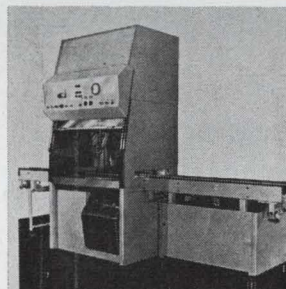

ConveyORIZED automatic precision coating system series 11000 provides uniform coatings as low as 5,000 angstroms at feed rates up to 10 ft per minute. Applications include photoresist on p-c boards and thin-film substrates, adhesives on frets for magnetic heads and laminates, and silicone for packaging and circuit protection. Zicon Corp., E. First St., Mt. Vernon, N.Y. [423]



Automated wafer finishing machine simultaneously flat finishes both sides of silicon wafers, ceramic substrates and many other materials with surface finishes to one micron precision. One worker operating several machines can easily achieve production rates exceeding 1,000 high-precision 1-in. wafers or substrates an hour. P.R. Hoffman Co., 359 Cherry St., Carlisle, Pa. [424]

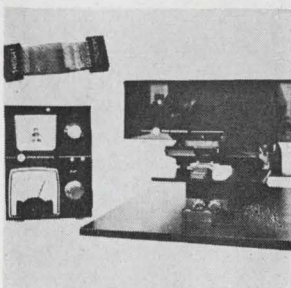

Flat flexible cable soldering systems series FS joins soldered connections rapidly and reliably using focused infrared heating techniques. Entire rows or groups of joints are soldered simultaneously and the heater never touches the workpiece. A complete row of terminations, as many as 200 joints, require less than 5 sec to complete. Argus Engineering Co., Hopewell, N.J. [425]

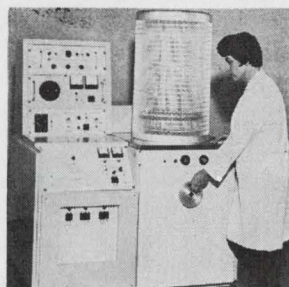

High-vacuum console model 625 features a design oriented toward continuous operation for high-level production of semiconductor devices or other high-vacuum processed products. Units are available manually controlled, with presettable sequencing timers, and with interlocking pushbutton controls. Davis & Wilder Inc., 1115 E. Arques Ave., Sunnyvale, Calif. 94086 [426]

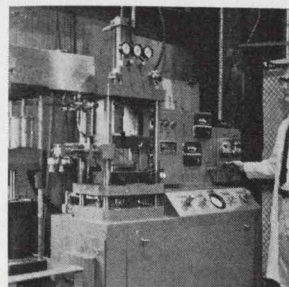

Liquid transfer molding system can be used for encapsulation of a new range of electronic components as well as components presently encapsulated by transfer molding. A wide range of two-component-resin systems can be used, some with properties unobtainable by transfer molding. Extremely fragile devices can be encapsulated. Hull Corp., 9030-N Davisville Rd., Hatboro, Pa. [427]

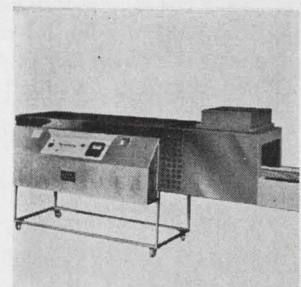

Infrared oven F037-A is for fast drying and curing of silk screening, epoxies, and inks on p-c boards and other small parts. Parts are carried through the oven on a flat, continuous mesh conveyor belt. Conveyor speed can be varied from zero to 8 ft per minute. The oven has a built-in cooling section. Glo-Quartz Electric Heater Co., 188 N. Berkeley Ave., Pasadena, Calif. [428]



# JFD COMPACTUNER

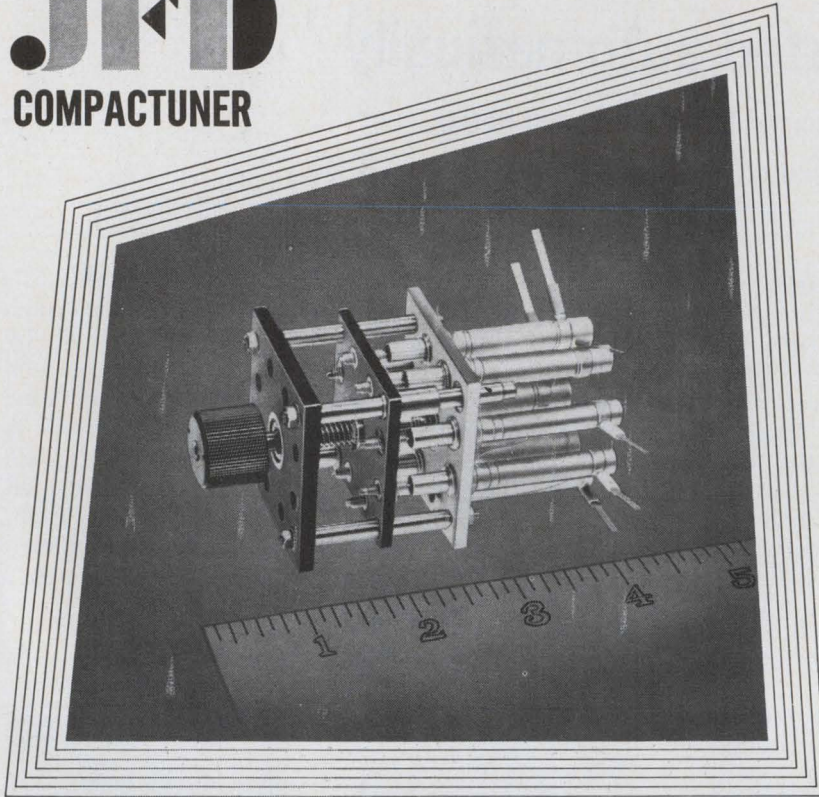

## NOW! VERSATILITY IN A MINIATURE TUNER

Compactuner is its name. A standardized · Miniaturized · Multigang · Modular tuner with all the versatility of custom built units, yet without costly tooling.

The use of solid dielectrics with their inherent stability and high voltage ratings, allow these unique tuners to be built-in smaller sizes than have ever been possible before. Wide capacitance ranges or frequency ratios can be achieved in packages that will withstand the severe environmental conditions that today's equipment require.

The built-in versatility is made possible by two new mechanical packages that allow up to eight independent capacitor elements to be tuned simultaneously.

Two basic models are available both featuring ten full turns of adjustment for precise tuning and excellent resolution. One model will accommodate up to four cylinders; the other from five to eight cylinders. These cylinders are available in a wide choice of dielectric materials and metalized patterns allowing unlimited design freedom.

The Compactuner can accommodate straight line capacitance, straight line frequency, special function, split stator, differentials, etc. or any combination can be specified on a single unit.

In addition, JFD features a line of specially designed and built tuners to meet custom applications.

Write for catalog.



"TODAY'S COMPONENTS BUILT FOR TOMORROW'S CHALLENGES"

**JFD ELECTRONICS CORP. / COMPONENTS DIVISION**

15th Avenue at 62nd Street / Brooklyn, New York 11219 / Phone 212-331-1000

SUBSIDIARY OF RIKER-MAXSON CORPORATION

input cards.

**Lights on.** System 40 reads the cards and automatically plots the p-c-board interconnection pattern by exposing photographic film or glass plates. Because the plotting table has its own light-proof cabinet, the system can operate in a normally lighted room, which must be darkened only when the film is loaded and unloaded.

Plotting is both sufficiently accurate and fast for p-c work. Maximum error is  $\pm 0.0015$  inch, and repeatability is  $\pm 0.0005$  inch. Plotting can proceed at a maximum speed of 100 inches per minute over the 14-by-20-inch plotting area. The photohead, mounted on a beam over the plotting table, has 24 apertures which can be selected by the computer for flashing images



**Artwork station.** Photohead is mounted over plotting table. Light-proof cabinet forms a darkroom.

or tracing lines from 0.0005-inch to 0.250-inch wide. Because of its smallness, the System 40's table, instead of the photohead, is movable, whereas in other plotting modes the table is stationary.

After the whole pattern has been exposed on the film, it's removed from the cabinet and developed. There's no need for photographic reduction—a major source of error—since the film is plotted on a 1:1 relationship with the final p-c board.

The System 40's price includes plotting table, plotting control, photohead, and keypunch, as well as a complete software package.

The Gerber Scientific Instrument Co., 83 Gerber Road, South Windsor, Conn. 06087 [429]



# Test drive the new Honeywell 2206 Visicorder

That's right. Go ahead and test drive it . . . mounted, for example, in an automobile. Or a tractor. Or on a piece of heavy machinery. Or even in a pleasure boat. This is the oscillograph that's built so rugged and so light-tight (with integral take-up), it goes where other recorders fear to tread. And that consumes only 150 watts . . . from a standard vehicle electrical system or from separate batteries . . . for complete portability.

What's more, when you choose our new 2206 Visicorder, you don't sacrifice performance for portability. In fact, this oscillograph does everything you'd expect a Honeywell Visicorder to do, recording up to 12 channels of data simultaneously, plus two event channels, at frequencies ranging from 0 to 13kHz.

Because this Visicorder uses a mercury lamp with true ultraviolet recording, it also gives you some other interesting bonuses, like high writing speeds (over 40,000 in/sec.). Plus

more stable records. Plus better trace density. And even offers you, as an option, an amplifier package that groups all signal conditioning into a single unit, and that fastens right to the Visicorder itself.

To arrange a test drive of our new Honeywell 2206 Visicorder or to just get more information, call your nearest regional sales manager (listed below), or write: Honeywell Test Instruments Division, P.O. Box 5227, Denver, Colo. 80217.

**Regional sales offices:** Albuquerque, NM (505) 345-1656, Dave Dimick; Chicago, IL (312) 674-9770, Frank Doherty; Long Island City, NY (212) 392-4300, John Paull; Los Angeles, CA (213) 724-3500, Durke Johnson; McLean, VA (703) 893-4660, Milt Womack.

## Honeywell

Honeywell engineers sell solutions

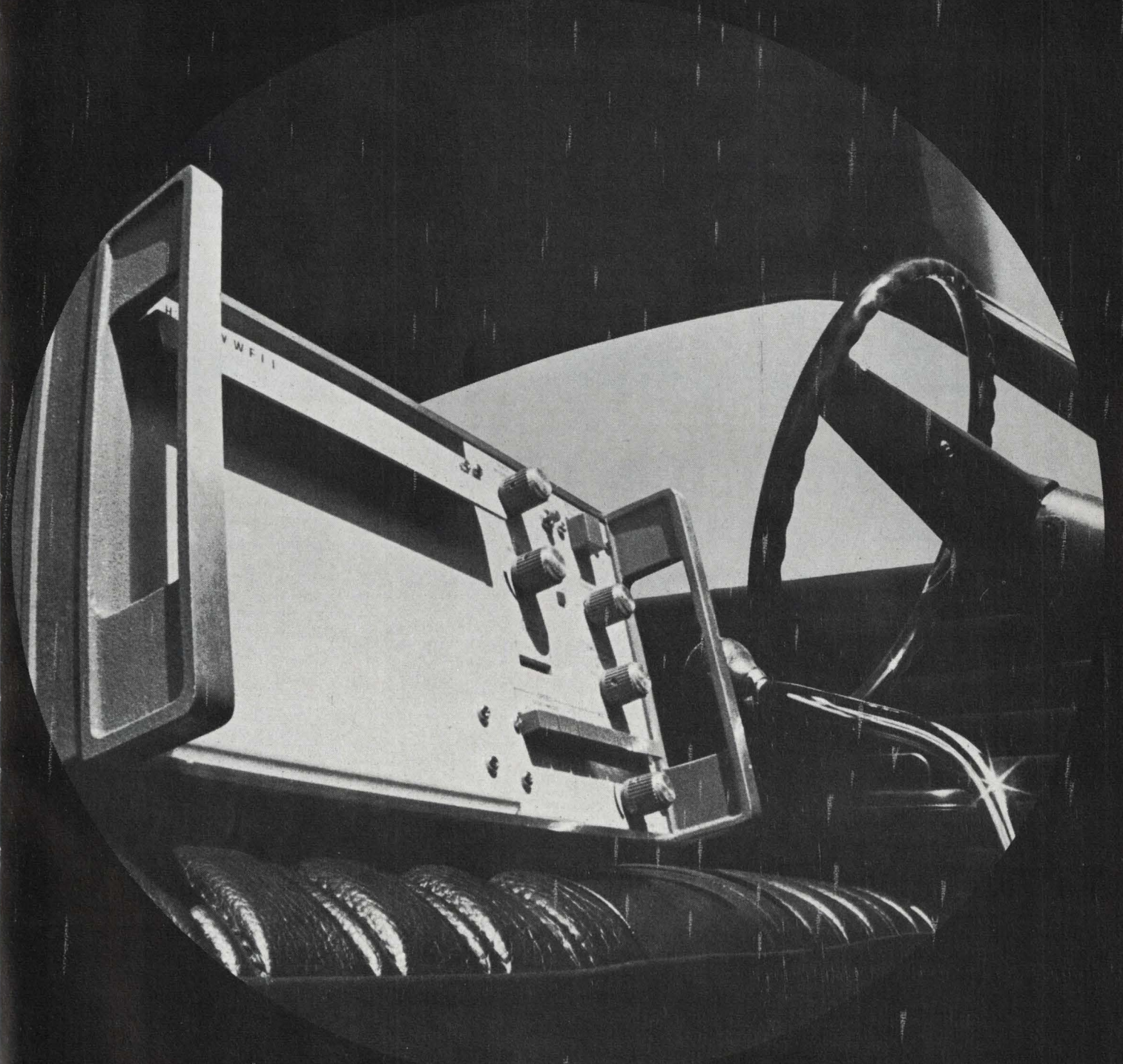



# MORE V LESS ¢ plastic SCRs from Transitron

## New, silicon planar SCRs in plastic, rated to 300V, at industry's lowest prices\*

Transitron's low-cost RTJ Series plastic SCRs offer new scope to designers of commercial and consumer electronic equipment. Now, for the first time, inexpensive plastic SCRs with documented reliability are available with 200V ratings (for 115V applications) and even 300V ratings for special requirements. Plastic-encapsulated in a TO-92 package, the new units are designed especially for applications requiring long life and high performance.

### RTJ02 & RTJ05 SERIES

- Ratings to 300V @ .8A RMS
  - Triggering sensitivities to 20 $\mu$ A
- Now also available: 2N5060 Series

\* RTJ0201 (15V rating): \$.44 in 100-quantities, with immediate availability at your local Transitron Distributor. Production quantities, 2-4 weeks ARO.

**Transitron**  
electronic corporation  
168 Albion Street, Wakefield, Mass. 01880

- Supported by the industry's first reliability and performance report on plastic SCRs . . . 24 pages of valuable information for design engineers — available free.
- Also available . . . up-to-the-minute application data on full plastic SCR line.

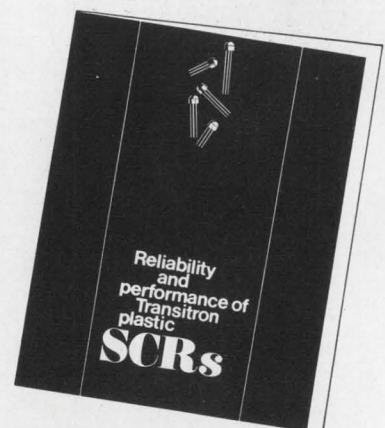



# IC light-sensitive switch can handle 5 ma

British company developing integrated optoelectronic devices also markets strip-array detector for linear measurements

After a heavy investment of its own and British government money to develop integrated optoelectronic devices, the Plessey Co. found demand was not great enough to merit production. But one of the British company's chief research engineers decided that there was enough for a small company to handle. So Peter Noble founded Integrated Photomatrix

Ltd. to design and manufacture light-activated semiconductor devices and systems, using integrated-circuit techniques.

Among his firm's first products are an IC light-sensitive switch and a strip-array detector of 50 chips, each containing a silicon planar photodiode, MOS output amplifiers, and associated circuitry. They will be available off-the-shelf this

month, and will be marketed in the U.S. through Teknis Inc.

Noble says different design and processing criteria must be emphasized in integrated optoelectronics technology, vis-a-vis conventional digital or linear IC's. The spectral response of the material is important, and so are structural and geometric uniformity—to insure that the response from all diodes on the

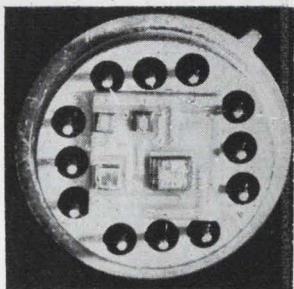

Operational amplifier model 2741 is for military and industrial use in sample and hold applications, as integrators, and as high impedance filters. It provides low input bias current of 40 pa, low input offset current of 15 pa, and low power dissipation. It is available in flatpack or TO-8. Amelco Semiconductor, 1300 Terra Bella Ave., Mountain View, Calif. 94042 [436]

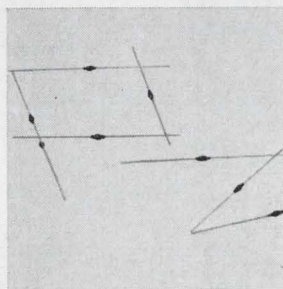

Fused-in-glass, zener diodes designated PZ Zener are subminiature devices. The series is rated at 1 watt continuous and 30 watts surge with reverse leakage as low as 500 na. They are designed to replace conventional zeners from 400 mw to 1 w. Price (in lots of 1,000 pieces) is from 69 cents each. Unirode Corp., 580 Pleasant St., Watertown, Mass. 02172 [437]

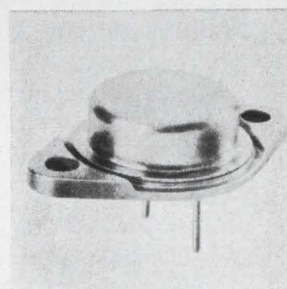

High-voltage epitaxial transistor type 1843 has a typical speed of 30 Mhz at voltages up to 375 v and a peak current of 30 amps. It is for use in power supplies, voltage regulators, d-c to d-c inverters, linear amplifiers, d-c to a-c converters, and control circuitry. Price in 100 lots rated at 300 v is \$45.75 each. Westinghouse Electric Corp., Box 868, Pittsburgh, Pa. [438]

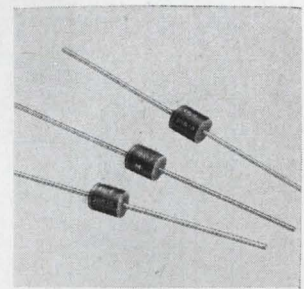

Silicon rectifier series 30R is a 3-amp unit featuring prv ratings from 50 v to 1,200 v, and designed for industrial and commercial service. Use of high density molding compounds and silicon polymer junction coatings insure long life stability in adverse environments. Prices are from 40 cents to \$1 in small lots. Erie Technological Products Inc., 644 W. 12th St., Erie, Pa. [439]

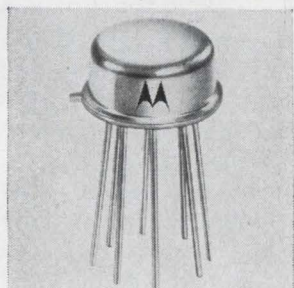

Monolithic r-f/i-f amplifier type MC1590 is for the commercial and military communications equipment markets. It features an agc range over 60 db, power gain of 40 db minimum at 60 Mhz, and can operate as a general-purpose amplifier at frequencies as high as 200 Mhz. Price (100-up) is \$3.75 each. Motorola Semiconductor Products Inc., Box 20924, Phoenix [440]

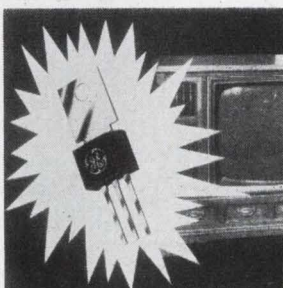

Power transistor for application in tv circuits is a 300-v video output device. The D40N is packaged in silicone and features an excellent free-air rating of 1.33 w at 50° C ambient, and a 6.25 w rating at 25° C tab temperature, a 3 pf maximum collector capacitance at 20 v, and an fr of 75 Mhz minimum at 20 v. General Electric Co., 1 River Road, Schenectady, N.Y. 13025 [441]

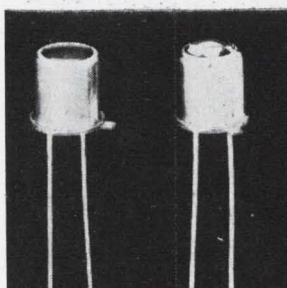

Photodiode detectors MD1 and MD2 are designed to complement the company's light-emitting semiconductors. Responses range from 0.4 to 1.1 microns. At 0.9 micron the MD1, which has built-in optics, has a minimum sensitivity of 1.5  $\mu\text{a}/\text{mw}/\text{cm}^2$ ; and the MD2, with its flat lens, a minimum sensitivity of 3  $\mu\text{a}/\text{mw}/\text{cm}^2$ . Monsanto Co., 10131 Bubb Rd., Cupertino, Calif. [442]

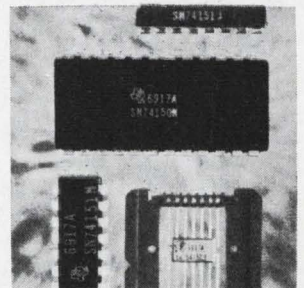

Three series 54/74 MSI data selectors are announced. The SN54150/SN74150 are 16-bit units in 24-pin plastic packages (with 600 mil row spacing). SN54151/SN74151 are 8-bit devices in either the 16-pin plastic or ceramic dual-inline package. SN54152 is an 8-bit circuit in a 14-pin  $\frac{1}{4} \times \frac{1}{8}$  in. flatpack. Texas Instrument Inc., N. Central Expressway, Dallas [443]



# What happened when doctors and engineers got together:

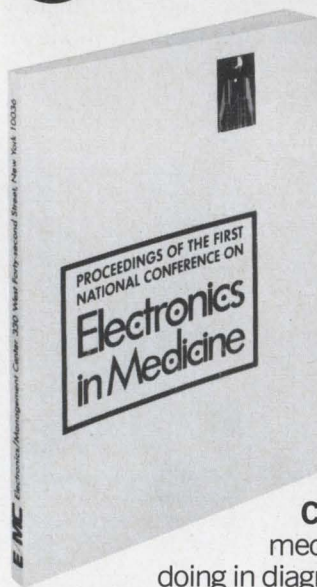

Doctors told engineers how they were using electronics and revealed their most urgent needs. Engineers described and demonstrated their newest equipment for diagnosis, treatment, and prevention. And hinted at things to come.

Their complete dialogue, with illustrations, makes pretty informative reading on a vital and growing market.

Here are some of the things it contains:

**Computers:** How they're joining the medical team. What computers are doing in diagnosis. In communications. The small computer as a paramedical aid.

**Instrumentation:** What's needed. What's available. Patient management. Protection. Standards and safety.

**Electronics in the Hospital:** The surgeon, the hospital, the instruments. What the administrator wants. Prescription for large-scale health care. The surgery department.

Electronics/Management Center  
330 West 42nd Street, New York, N.Y. 10036

Enclosed is \$12 for a copy of the Proceedings of the First National Conference on Electronics in Medicine.

Send the Proceedings and bill me later. P.O. # \_\_\_\_\_

Name \_\_\_\_\_

Company \_\_\_\_\_

Address \_\_\_\_\_

City \_\_\_\_\_ State \_\_\_\_\_ Zip \_\_\_\_\_

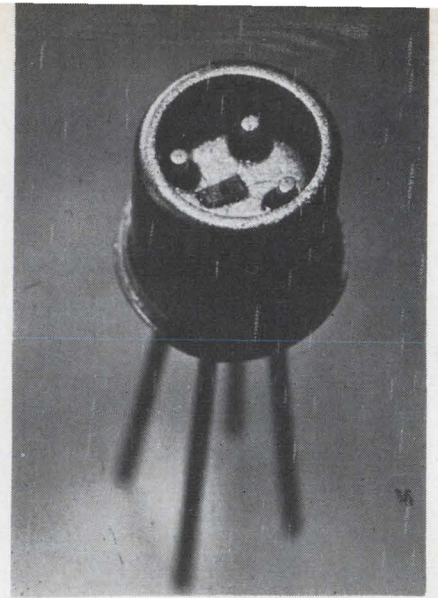

**Light switch.** TO-18 can with transparent top houses device.

same array is identical. On the other hand, says Noble, ultraminia-turization is not important. "We're not concerned to get the ultimate in minute definition," he asserts, "and that will help us keep our costs down. But we do have to bother about high uniformity on more than normally complex chips." He uses MOS transistors because of their low leakage current and high input impedance.

In addition to current applications, Noble sees jobs for light-sensitive semiconductor triggers in biomedical research—particularly cellular studies—in crystallography, position-sensing in industrial processes, and fingerprint recognition.

The first of the company's products, the light-sensitive switch designated the IPL 11, is described as the first fully integrated light switch on the market. It will switch a current of up to five milliamps when incident light falls above and below a preset level. Light reaches the diode through the glass top of the can. The switching level is adjustable over a range of 1,000 times the minimum sensitivity level, and two alternative minimum sensitivities are offered: light levels corresponding to  $10^{-7}$  and  $10^{-5}$  watts per square centimeter. Switching speed varies from about 100 microseconds at maximum light levels to 100 milliseconds at the minimum. Nominal operating voltage is -27 volts, which Noble says is sufficient to interface directly with small relays, but it would



# Maybe we should have called it The Polar-Sex.

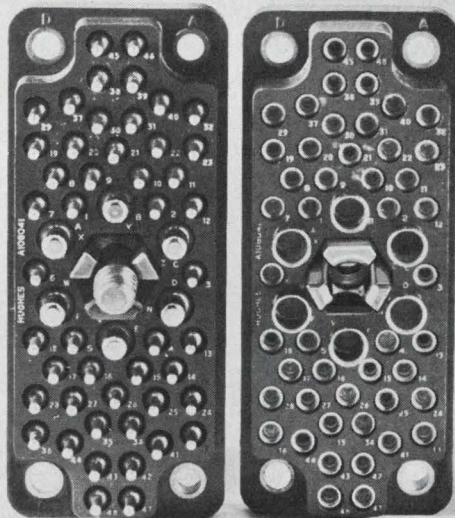

For a foolproof interlocking device, it's a more descriptive name than PolarHex.

We would have gotten more publicity too.

But even with a handle like PolarHex, Hughes got plenty of notice. There has never been a coupling method like it for connectors.

Instead of conventional coupling nuts, we use a center jack-screw and boss. There's only one way they can fit together.

So they polarize every time.

The contacts are perfectly aligned every time.

By designing the PolarHex we were also able to design a circular subminiature with the highest contact density ever.

You'll find the PolarHex on all Hughes MS rectangulars and high-density subminiatures. Including our new BULLS-EYE line of circular subminiatures.

That's PolarHex. The name may not fit. But the contacts do.

Write Hughes Aircraft Co., Connecting Devices, 500 Superior Avenue, Newport Beach, Calif. 92663. Phone (714) 548-0671. TWX 714-642-1353.

 Connecting Devices, part of Hughes Circuit Technologies. Including: Contour™ Cable; Semiconductors; Flip Chips/Equipment; Frequency Control Devices; Microelectronic Circuits; MOSFETs.

**HUGHES**

HUGHES AIRCRAFT COMPANY

If it's happening in connectors,  
it probably started at Hughes.



# The optimum garble disposal.

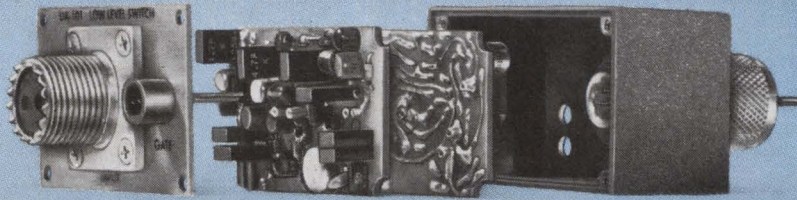

**CTC's new low level differential switch.**  
**Super-speed time spectrum isolation and high CMR**  
**... eliminates garble from desired signals!**

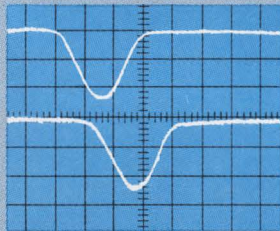

Fast pulse input and output signals:  
Hor: 10ns/div Vert: 5mv/cm

**From CTC ... where advanced state-of-the-art technology meets tomorrow's memory test requirements!**

We call this esoteric device our Model UA-101 d-c coupled, wideband, linear, gated differential amplifier. Quite a mouthful. And quite a switch, too! CTC designed and built it to help test plated wire elements and memory arrays. Think of it: all these features *together*, in one switch no bigger than a match box.

- Super-speed gating—typically less than 50ns full turn-on time, for isolating a precise time spectrum to be analyzed.
- Differential input—providing a 40db CMR (Common Mode Rejection).
- Wide, flat frequency response (greater than 100 MHz).
- D-c coupling—for plated wire element testing, and for testing any memory array which utilizes common- or direct-coupled Sense and Digit lines.
- Extremely wide bandpass; flat frequency response characteristics, devoid of resonances.
- Extremely linear gain characteristics over the 2 to 150 MV range.

These features add up to a practical, precise measurement tool for a variety of switching applications. Tell us about your particular requirement. Or send for Bulletin No. 68—MZ-1.



**COMPUTER TEST CORPORATION**

THREE COMPUTER DRIVE • CHERRY HILL, NEW JERSEY 08034  
PHONE: 609/424-2400 • TWX: 845120 • CABLE: COMPUTER

Circle 182 on reader service card

## Want to be unique in our memory?

It's easy. Enter the Electronics Manpower Register.

We'll feed your professional background into the talent memory of our nationwide computerized recruitment service.

Our computer will match your unique profile against every opening being programmed into it by a long list of electronics

companies. You'll automatically be qualified for every logical career opportunity. But we'll only release your availability to those companies you approve.

To enter, send us your resume.

Electronics Manpower Register  
**Electronics**  
330 West 42nd Street  
New York, N.Y. 10036

more often drive a medium-power transistor to switch larger loads.

The chip, which measures 20 mils by 40 mils, combines a boron-diffused silicon planar photodiode with MOS control circuitry. The adjustable switching level is set by an external resistor-capacitor circuit, the only external components required.

**Refil.** Noble calls the circuit Refil, for recharge from inversion layer, and it essentially consists of measuring the photodiode current by comparing its leakage rate with a fixed current input to the diode, instead of the conventional method of measuring the charge level of the diode after a fixed time period. The chip thus requires neither sample-and-hold circuitry, nor timing and threshold networks.

The IPL 11, housed in a TO-18 can will sell in the U.S. for \$5.50 each in quantities of 1,000.

The second item offered off-the-shelf is a 50-by-1 strip array of silicon planar photodiodes and MOS output amplifiers integrated on a single chip with scanning circuitry, consisting of a 51-bit MOS shift register and 100 MOS gates. This device is controlled by an external clock and gives an output with amplitude proportional to the scanning rate and the light intensity at the sampled diode. It is intended to be used with optical input systems for character recognition, position-sensing, density-profiling and other linear measurements.

The chip measures 228 mils by 40 mils and is packaged as a half-inch-diameter, glass-fronted, circular flat-pack with 40 circumferential leads, of which 15 are used. The U.S. price will be between \$200 and \$300.

The device works by repetitively recharging the photodiodes in sequence and measuring the charge decay of each diode after a fixed time interval set by the clock. The 51-bit shift register is in parallel with the diode array, and as the data pulse traverses the register, it operates two gates connected to each diode. The first gate allows the charge level remaining in the diode to be sampled; the second gate recharges the diode to the fixed datum level.

Teknis Inc., Plainville P.O., No. Attleboro, Mass. 02762 [444]



The Material  
of Unlimited Uses...

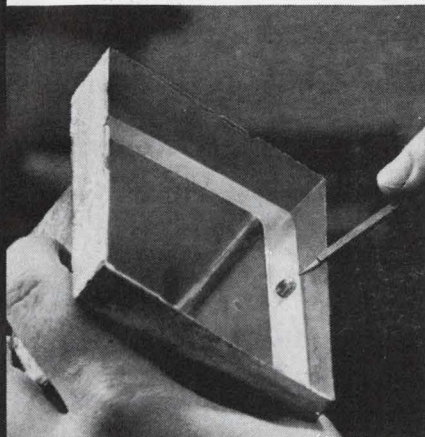

## INSTANT DIP-A-MOLD

In seconds, you can make perfect molds, like this one, for potting any encapsulation, and make them economically, with low-melting CERRO® Alloys. Just dip the master in molten alloy. A thin coating of alloy clings to the pattern. Withdraw the pattern, and you have a perfect high fidelity mold. When the encapsulating plastic cures, simply remove the CERRO Alloy. Use it over and over again, almost without limit.

This particular alloy—CERROTRU®—does not shrink, slips easily from the pattern without parting or contaminating compounds or coatings. Because of its low melting point, it is safe and easy to handle.

You can reproduce such unusual details as positioning lugs for transformer cases, as shown above, without the use of cores, inserts or secondary operations.

Instant molding is just one of the many uses for CERRO Alloys. To find out more, contact Cerro Copper & Brass Co., Alloy Dept., Bellefonte, Pa. 16823.

Telephone (814) 355-4712. In Europe, contact Mining & Chemical Products Ltd., Alperton, Wembley, Middlesex, England.

# CERRO®

Circle 218 on reader service card

New semiconductors

## IC device reads wire memories

4-channel sense amplifier  
converts 3-mv signals  
to TTL logic levels

**Performance requirements** until now have held back use of integrated circuits for reading signals from plated-wire memories. The major problem is that signal levels in a plated-wire memory are so low—typically  $\pm 3$  to  $\pm 10$  millivolts, uncomfortably close to the offset voltage of most IC's. For reliable detection of a 1 or a 0 from a plated-wire memory, the sensing IC should have an offset at least an order of magnitude lower. The low signal level also means that the IC must provide uncommonly high gain.

Now Motorola Semiconductor Products Inc. is challenging the primacy of discrete devices with a monolithic four-channel sense amplifier that meets the needs of plated-wire memories. The input offset voltage for any channel of the device is 0.5 mv and typical voltage gain is 600. The unit, designated the MC1546L, overcomes the substantial common-mode noise usually present at the sense amplifier's input terminals during the write cycle. It has a  $\pm 5$ -volt tolerance of those signals and a common-mode recovery time of 60 nanoseconds, which is vital to preserve the less than 400 nsec cycle time of the plated-wire memory.

A binary code with two bits is used to select one of the four channels, and the common-output stage has strobe capabilities. The output is compatible with TTL/DTL signal levels, and operating temperature is  $-55^{\circ}\text{C}$  to  $+125^{\circ}\text{C}$ .

The unit is packaged in a 16-pin, dual in-line ceramic case, and is priced at \$38 in 100-unit quantities. A modified version, the MC1446L, with  $0^{\circ}$  to  $75^{\circ}\text{C}$  operating range, costs \$28. Both devices are available off the shelf.

Motorola Semiconductor Products Inc.,  
Phoenix, Ariz. [445]

Circle 183 on reader service card →

# your best buy in D.C. . . .



## from any angle

For the mini-price of \$90, you can choose from three compact, well regulated, constant voltage/current limiting laboratory power supplies. And, for only \$25 more, 3 additional models are available with constant voltage/constant current. We call them BENCH supplies.

These stable battery substitutes are packaged in molded, high-impact plastic cases with an interlocking feature for stacking. They can be rack mounted with an accessory kit.

Check the following specs for proof of quality at no sacrifice in performance.

**Outputs** ..... 0-10V @ 0-1A, 0-25V  
@ 0-4A, 0-50V @ 0-2A  
**Regulation** ..... 4 mV, Load or Line  
**Ripple** ..... 200  $\mu\text{V}$  rms/1mV p-p  
(DC to 20 MHz)  
**Stability** ..... 0.1% +5 mV for 8 Hours  
**Size** ..... 3 1/4" H x 5 1/4" W x 7" D

HEWLETT  PACKARD

POWER SUPPLIES

112 Locust Avenue  
Berkeley Heights, New Jersey 07922 21901



# NEW! *smallest axial shielded inductor available* the "NANO-RED"

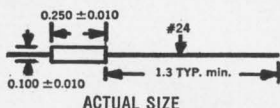

Range: 0.10 $\mu$ h to 1,000 $\mu$ h in 49 stock values  
Size: 1/10 dia. by 1/4 lg.  
Inductance Tolerance:  $\pm 10\%$

This new "NANO-RED" offers the highest inductance to size ratio available in an axial shielded inductor. Exceptional "Q" and self-resonance characteristics. Max. coupling 2% units side by side. Non-flammable envelope. Designed to MIL-C-15305C. Operating temperature  $-55^{\circ}\text{C}$  to  $125^{\circ}\text{C}$ .

## Other Lenox-Fugle Subminiature Shielded Inductors:

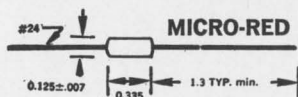

The "Micro-Red" is a shielded inductor that offers the largest inductance range in its size: 0.10 $\mu$ h to 10,000 $\mu$ h. "Q" to "L" ratio unsurpassed, with excellent distributed capacity. Inductance tolerance  $\pm 10\%$ . Designed to MIL-C-15305C. Stocked in 61 pre-designed values.

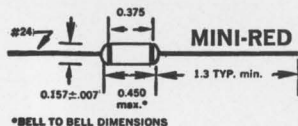

The "Mini-Red" offers the highest "Q" to "L" ratio available over inductance range 0.10 $\mu$ h to 100,000 $\mu$ h in its size. Inductance tolerance  $\pm 10\%$  measured per MIL-C-15305C. Stocked in 73 pre-designed values.

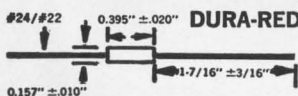

The "Dura-Red" is designed to MS-90537 with inductance range 0.10 $\mu$ h to 100,000 $\mu$ h with tolerance  $\pm 10\%$ . Stocked in 73 pre-designed values.



Data Sheets: write or phone

## LENOX-FUGLE ELECTRONICS, INC.

100 Sylvania Place, South Plainfield, N. J. 07080

Telephone: Code 201, 756-1164

Circle 219 on reader service card

## FAMOUS MAGNELINE® QUALITY

**NEW  
COMPACT  
SIZE!**

**NEW  
LOW PRICE!**



Patwin's Series 18000 indicators operate from pulsed DC voltages in decimal form to display digits or symbols. They have the same reliability, readability and memory as other MAGNELINE models but are more compact and lower in price. The new indicators are only .29" wide and .92" high yet digit size is a full 1/4 inch. Unit price is \$33.80 in quantities of 100.

The Series 18000 has many applications in aviation and general instrumentation, especially where extreme reliability and low maintenance cost are important. Open construction of the unit gives instrument designers a wide choice of mounting methods. Full information available from Patwin, 41 Brown Street, Waterbury, Connecticut 06720. Telephone (203) 756-3631.

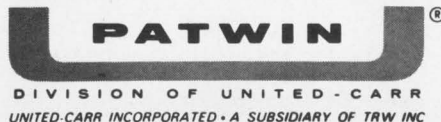

**WATERBURY,  
CONNECTICUT 06720**

## New Books

### Complete and unabridged

Circuit Design of Digital Computers  
Joseph K. Hawkins  
John Wiley & Sons, 515 pp., \$17.50

It is the author's thesis that up to now no comprehensive treatment of digital circuit behavior has been available—that all studies of the circuits have been fragmented or limited to specific types of behavior, such as static stability equations or approximate switching time calculations.

To correct this omission he has put together a comprehensive and well-written description of just what a digital circuit is and what is expected of it—including magnetic as well as semiconductor elements. He describes both combinational and sequential functions—which he terms "decision" and "memory" functions—in the most basic terms, and he includes some forms that couldn't possibly be of any use, such as circuits that are always 0, always 1, or always one or the other unalterably.

The book's high level of sophistication and low level of basic fundamentals is perhaps best illustrated by its inclusion of an entire chapter on mapping functions (it had never occurred to this reviewer that enough could be said about mapping to fill a whole chapter, but there it is). Mapping is the first of two operations in a decision function—it transforms the input variables into a single intermediate variable, on which is based the decision functions' output. In a diode-transistor logic circuit, for example, the diodes do the mapping and the transistor makes the decision. This chapter, of course, is mated with one on transistor decision elements—the longest in the book.

Equally informative are the chapters on equivalent circuits for transistors and for magnetic elements. The author derives a universal equivalent circuit for a transistor, showing how to simplify it for specific purposes. This is chapter 2—out of sequence in this review, but not in the book. The magnetic-core equivalent circuits are in chapter 3.



NPN-Silicon-Planar-Transistor



**ANCRONA**

**2N4044**  
**2N4045**  
**2N4100**

Dielectrically  
Isolated  
Matched Pairs  
for Differential  
Amplifiers

**DUAL**

Monolithic



TO - 18

- **HIGH GAIN AT LOW CURRENT**  $h_{FE} \geq 200$   $10 \mu A$
- **LOW OUTPUT CAPACITANCE**  $C_{obo} \leq 0.8 pF$
- **$h_{FE}$  MATCH**  
 $h_{FE1}/h_{FE2} \leq 10\%$
- **TIGHT  $V_{BE}$  TRACKING**  
 $(V_{BE1} - V_{BE2}) \leq 3 \mu V/^\circ C$   
 $-55^\circ C$  to  $+125^\circ C$

<b>PRICES</b>	1-24	25 up	100 up
2N4044	\$ 16.50	14.-	11.-
2N4045	\$ 7.30	6.50	4.90
2N4100	\$ 9.20	8.-	6.15

**ANCRONA CORP.**

65 East 55th Street • New York, N. Y. 10022  
(212) 688-6285 • Telex 223 117 • TWX (710581 / 4513)

## New Books

There also is a chapter on transistor memory elements—not quite as long as the one on transistor decision elements, but equally exhaustive. Its treatment is limited to the four basic kinds of flip-flops: the set-reset, the trigger, the J-K, and the combination set-reset-trigger.

The book concludes with chapters on magnetic decisions and memory elements, magnetic-core storage, and magnetic surface recording, all as basic, thorough, and sophisticated as their predecessors.

### Bits of conversation

Telecommunications and the Computer  
James Martin  
Prentice-Hall Inc., 470 pp., \$14

Most promotional phrases on book jackets seem to come from a standard bag: “most exciting development,” “explains in very clear language,” “contains a detailed survey,” and “discusses new developments.” This book is no different; all these phrases are found on its jacket. Here, though, these hard-sell lines are true, at least for the moment. The terminal equipment field evolves so rapidly that any discussion of it has a limited shelf life.

The marriage of the telecommunications and computer technologies is an exciting development. This book clearly explains to data processing personnel what they need to know about telecommunications. A detailed survey charts the sorts of errors that can be expected to crop up when communications lines are used for data. And it does discuss new developments, such as satellites, lasers, waveguides, pulse-code modulation and broadband switching.

Estimates for the 1970's list machine to machine communications as a greater source of communications revenue than man to machine or man to man, says the author. His discussions of the telecommunications networks centers, for the most part, on the Bell System, but coverage is also given to Western Union, General Tele-

## WORKHORSE!

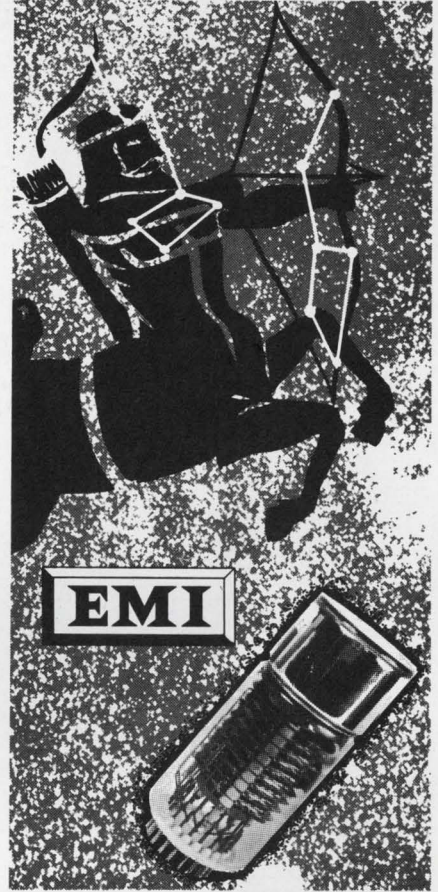

### TYPE 9750

Nothing fancy, and not expensive. Just a good old 10 stage photo-multiplier but: It has a superb bi-alkali cathode with excellent collection efficiency (which is fundamental for good S/N ratio), highly stable CsSb dynodes which provide a gain of  $10^6$  at just over 1,000 volts, and a dark current of  $10^{-10}$  A. at that voltage (50 A/L).

As usual EMI has provided a number of variations: 9750QB with a spectroil window for UV and low level counting applications, (liquid scintillation) 9750B with Pyrex window for visible applications, and finally 9750KB for those who prefer the B-14A overcapped base. In the “K” configuration, it is directly interchangeable with our 9656KB or a number of competitive types.

The 9750 with its high quantum efficiency and low dark current gives excellent resolution for low energy gamma rays. When used with a thin two inch sodium iodide crystal with a beryllium window, the resolution for  $Fe^{55}$  is of the order of 40%.

Flying spot scanners, photometers, thermoluminescent dosimeters, low level scintillation counting are all applications for which the 9750 is highly suitable. Detailed specifications on request from:

**GENCOM DIVISION**  
varian/EMI

80 EXPRESS STREET, PLAINVIEW, N. Y. 11803  
TELEPHONE: (516) 433-5900



# DESK-TOP CIRCUIT DESIGNER



The **elite 1** is ideal for designing, laying out, and testing all IC and discrete component circuitry!

**\$650** complete

- Built-in pulse generator and power supply
- NO SOLDERING REQUIRED
- NO special tools, plugs or patch cords needed
- Write or phone for complete specifications and catalog



**EL Instruments Incorporated**

61 First Street, Derby, Conn. 06418 • Phone 203/735-8774

Circle 221 on reader service card

## X-Y-Y' Quick-draw artist

The first recorder to be designed with analog computers in mind, the 901-2P X-Y-Y' PLOTAMATIC charts one or two signals as a function of a third signal, or as a function of time. And it does it at a slewing speed that no other unit can match: minimum of 40 inches/second on all axis... more than twice as fast as the next X-Y-Y' recorder.

Moreover, the 901-2P performs with a time-base accuracy 500% greater than existing equipment. Through the use of a unique digital clock, the time base is switchable to either the X or Y axis, and 12 sweep rates or any arbitrary range may be selected.

Other 901-2P PLOTAMATIC features include: Choice of dotted, dashed, and solid lines • Calibrated zero offset control • Greater than 150 db common mode rejection • Sensitivity to 40 microvolts/inch • Fast frequency response—flat to 7 Hz/inch peak-to-peak deflection.

Write today for complete literature and a personal evaluation test.



**BOLT BERANEK AND NEWMAN INC.**  
Data Equipment Division  
1762 McGaw Avenue  
Santa Ana, California 92705  
(714) 546-5300



## New Books

phone & Electronics, and the major international satellite communication systems, such as Comsat and Intelsat.

After starting from basics—telegraph circuits and baseband signaling—the author soon moves to such topics as transmission media, attenuation and repeaters, channel capacities, noise and distortion, modulation and demodulation, and multiplexing. In each discussion, however, the author keeps his eye on the requirements of data handling.

The chapter on data errors, summarizes the results of error-rate studies for transmissions over telegraph and telex circuits, 200-band circuits, and voice grade lines. Primary sources are the Bell System studies and a study made by the International Telecommunication Union on the German telephone network in 1964. While both sources report similar results, the author says he has encountered errors greater than the numbers he reports. However, such errors as these only serve to point up the need for correct adjustment of terminal equipment.

### Recently Published

**Stimulation with GASP II; A Fortran-Based Simulation Language, A. Alan, B. Pritsker, and Philip J. Kiviat, Prentice Hall, 332 pp., \$10.50**

Thoroughly explains GASP II, a new Fortran-based simulation language, and its use as a basic for understanding the concepts of simulation. Contains numerous examples and solved illustrative problems, along with 11 complete simulation studies involving queueing situations, network analysis, design, and inventory systems. Includes flow charts and final output reports.

**Computerized Approximation and Synthesis of Linear Networks, Jiri Vlach, John Wiley & Sons, 477 pp., \$14.95**

A practical guide for designers of linear networks, this book covers the two basic areas of approximation and synthesis. Emphasis is placed on computer approximation, and computer programs are included, in addition to explanations of techniques. Intended for readers with a background in engineering and some knowledge of Fortran.





# the newest shape in receiving antennae

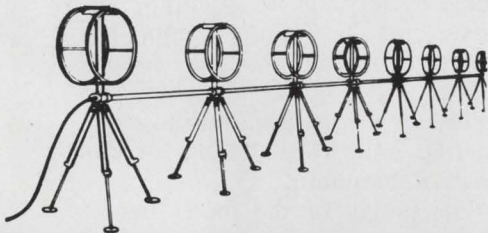

Aperiodic Loop Antennae . . . in an array composed of eight one-metre diameter untuned balanced loops spaced 13 feet apart . . . is the newest concept in "active" h.f. receiving arrays developed by E.M.I.

Each loop is fitted with a transistor pre-amplifier in its base, making possible a broad band (2 to 32 MHz) directional array much like a log-periodic or rhombic antenna. The system is only 30 metres long and a few feet wide. As it occupies but fraction of the space required for conventional passive fixed arrays, it is ideal for applications in areas of restricted space or when quick and simple set-up is important.

The new model 8E13 Aperiodic Loop Antenna Array has us rather excited. We would welcome the opportunity to tell you all about it in detail.

## E.M.I. ELECTRONICS CANADA, LIMITED

Dartmouth, Nova Scotia, Canada  
 Mail: P.O. Box 1005  
 Phone (902) 466-7491  
 Cables: EMI CAN

Circle 222 on reader service card

## Technical Abstracts

### Show off

Displaying engineering data on a color crt  
 Walter H. Tew Jr.  
 General Electric Co.  
 Daytona Beach, Fla.

Consolidating computer-processed information—that is, displaying large quantities of monitored data of different characteristics—is a logical application for the color cathode ray tube. Not only is there a human-engineering advantage in making it easier for the user to select specific data from a myriad of similar data, but it's often cheaper to use the color crt.

In a large operating system, such as at a rocket launch site, it's been customary to display thousands of measurements on meters, strip chart recorders, event lamps, and hard copy printers. Together, such equipment yields analog values, events and event sequences, time histories, and alphanumeric messages. One installation takes over 700 square feet of panel to mount all the devices.

Each of these devices permits information to be rapidly absorbed and understood by the user and gives him a physical feel for the meaning of the measurement. An event lamp is a good case in point. When an event lamp changes from green to red, there's no doubt that the meaning is "trouble".

To demonstrate a standard color crt's effective use as a replacement for individual devices and its capacity to edit information for the user, a project was set up with the following goals:

- To display 30 analog measurands (quantities to be measured) on a "page" complete with their values in engineering units and in color to indicate each measurand's status within predetermined limits.
- To produce 90 discrete measurands on a page to indicate go, no-go, or caution.
- To generate one or more history plots of analog measurands.
- To handle alphanumeric.
- To incorporate combinations of these four formats.

A raster-scan crt with a 525-line raster pattern is the display. The

# TEC expands it's product line... for you!

New modular products by TEC meet more of the stringent requirements demanded by design engineers. Proven reliability of System Power Supplies is complemented by equally reliable thick film hybrid Voltage Regulators. Check our specifications . . . if your requirements are unique, try our custom design capability!

	<p>TEC VRH Series Hybrid Regulators High Performance-cold weld Hermetic Seal, metal, Dual-in-Line package. Fixed output voltages. Plug-in connectors available for testing and breadboarding.</p>
<p>TEC VR Series Hybrid Regulators Economy Price-2X DIP package. Built-in fold back current limiting. Adjustable and fixed output voltages. Plug-in connectors available.</p>	
	<p>TEC RM Series Power Supplies 115 VAC Input. "Point of Load" dual supply. +5, ±12, ±15 volts DC output . . . plus others. Totally encapsulated.</p>

See our ad in EBG . . . inside front cover  
 We're also in EEM . . . pages 2120-2125



P.O. Box 910  
 Boulder Industrial Park  
 Boulder, Colorado  
 (303) 442-3837

Circle 187 on reader service card

187



# OPTICAL SCANNING ?

Convert Your TV Camera (or ours) into a highly Versatile computer input device with the CVI model 321 Video Analyser!

Sampling bandwidth compression allows convenient low rate digitization of wide band video signals with line or raster scanning, X-Y-Z point analysis, noise reduction, and other significant operations.



## cv<sup>i</sup> COLORADO VIDEO, INCORPORATED

P O BOX 928 • BOULDER, COLO. 80302 • PHONE (303) 444-3972

Video Data Acquisition—Processing—Display—Transmission

Circle 223 on reader service card

### Precision X-Y CRT Displays

Beta builds better. It's as simple as that. Our CRT displays have proven themselves in situations ranging from applesauce processing to creating the recently televised Apollo moon pictures. Take our new PD1400. It resolves over 4000 elements/diameter. It can be used for film recorders and readers, flying spot scanners, bubble chamber experiments, video recorders, scan converters, even hard copy printers.

	PD900	PD1100	PD1200	PD1400
Resolvable Elements/Diameter	1700	2100	3400	4200
CRT Diameter	5 inches	5 inches	5 inches	7 inches
Maximum Spot Size	0.0025	0.002	0.00125	0.0015
Small Signal Bandwidth	1 MHz	1 MHz	1 MHz	1 MHz
Settling Time	10 $\mu$ sec	12 $\mu$ sec	20 $\mu$ sec	50 $\mu$ sec

**Beta Instrument**

377 Elliot St., Newton Upper Falls, Massachusetts 02164 / Tel. 617 969-6510 / TWX 710-335-6973

## Technical Abstracts

crt face can be considered as having  $455 \times 525$  unique cells determined by the horizontal sweep frequency and the vertical frame rate. However, the vertical retrace time between sweeps—540 microseconds during which data is fetched from the computer—reduces the usable matrix to  $384 \times 496$ . Cells can be addressed in an ordered sequence. Synchronization and logic circuits decode a cell's x-y address, decide whether the data word energizes a cell, and—if so—in which color.

The display subsystem ties in with the computer, so display operation intimately depends on computer software. All desired information formats—metering, events, histories, and the like—can be obtained through programing.

In analog meter representation, for example, counts (cell locations) 128 to 255 along the raster line are allocated to the meter display itself, counts 0 to 127 for alphanumeric legends to identify the meter reading (CBN Temp, for cabin temperature), and counts 256 to 383 for the alphanumeric value of the measurand in engineering units (68.0 DEGF, for degrees Fahrenheit).

The height of the meter bar is 10 raster lines, allowing a total of 30 meters to be displayed vertically and leaving room at the top for meter-group titling (for example, Life Support). A separate processor converts the measurand's data value to a proportional length across the meter bar, and the bar's color depends on the measurand's state—that is, green for in-tolerance, red for out-of-tolerance, and yellow for marginal.

To plot trends, previously stored data is called from the memory, ordered in time sequence, and returned to memory. Through decoding, a dot is written at its appropriate x-y cell location on the crt to display the value and time of each data point. Because of fast dot-writing speed, screen persistence yields a time record of the measurand. Color selection information, to indicate tolerance value or to distinguish two or more measurands plotted relative to each other, can be carried along with



# Relay Race!

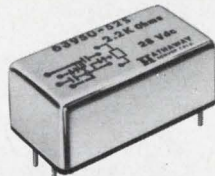

1 amp. switching.

## HATHAWAY HIGH ENVIRONMENTAL SERIES DRIEED RELAY

Who's the toughest contender in the rugged drieed relay race? Back up to the two operative words—toughest and rugged. That's the way we build Hathaway's "R" Series relay team of up to 12 Form A's and 4 Form C's in a variety of configurations. Try them in a starting line up and watch their track record.

Send for our full line mini-catalog.

Address: 5250 East Evans Avenue, Denver, Colorado 80222, (303) 756-8301—TWX 910-931-0569.

# HATHAWAY

components

A DIVISION OF HATHAWAY INSTRUMENTS, INC.

*To buy less  
would cost you more*

Circle 269 on reader service card

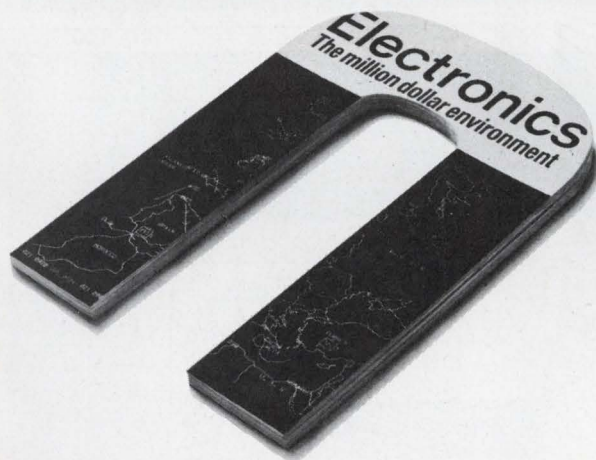

Every year, ELECTRONICS attracts requests for over 125,000 editorial reprints.

They're like interest payments on our million-dollars-a-year editorial principles.

That's how much we spend annually to produce timely, authentic, and useful articles like those listed on the reader service card as reprints currently available.

Investment and interest make both ELECTRONICS and its readers more meaningful to its advertisers.

# The new non-contactive encoder,

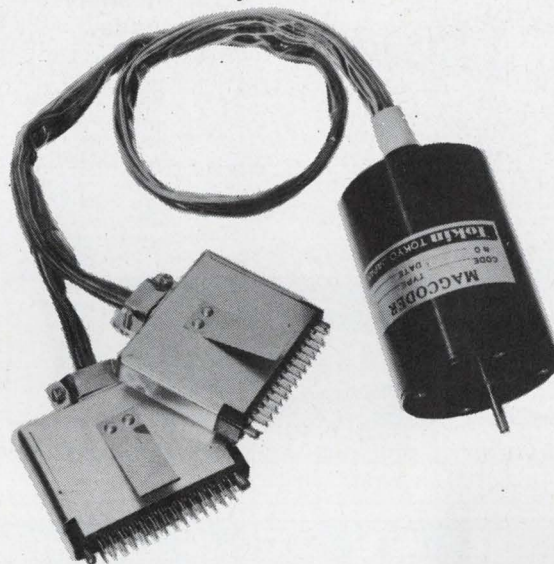

**Magcoder** from Tokin. A non-contactive analog-digital converter. With longer life, higher speed (10,000 rpm). Used in telemetering, industrial robots, automatic control NC devices.

**Works better,  
costs less  
because...**

1. **Magcoder is friction-free.** Magnetic saturation principle has no read-out abrasion, eliminates faulty contact during high-speed operation.
2. **Magcoder has double head.** This does away with wrong readings.
3. **Magcoder is dust-proof.** Which means stable operation, any conditions.
4. **Magcoder has less drive-torque.** Which means no mechanical effect on controlled object.
5. **Magcoder doesn't use precious metals or photocell elements:** so less cost.
6. **Magcoder has unique Tokin design**—which cuts price lower even than other non-contactive encoders.

## Tokin

**Tohoku Metal Industries, Ltd.**

Koei Bldg., 13-10, 7-chome, Ginza, Chuo-ku, Tokyo, Japan  
Telephone: Tokyo 542-6171 Cable Address: TOHOKUMETAL TOKYO

Main Products: Ferrite Cores, Memory Cores, Memory Matrices, Ferrite Magnetostrictive Vibrators, Pulse Transformers, Permanent Magnets (Cast, Ferrite), Tape Wound Cores, Bobbin Cores, Magnetic Laminations, Fe-Co Alloys, Sendust Cores



## The Complete Line of Signal-Indicating Alarm-Activating Fuses

For use on computers, microwave units, communication equipment, all electronic circuitry.



BUSS GLD- $\frac{1}{4}$  x  $1\frac{1}{4}$  in. Visual-Indicating, Alarm-Activating.

BUSS GBA- $\frac{1}{4}$  x  $1\frac{1}{4}$  in. Visual-Indicating.



BUSS MIC- $\frac{13}{32}$  x  $1\frac{1}{2}$  in. Visual-Indicating, Alarm-Activating.

BUSS MIN- $\frac{13}{32}$  x  $1\frac{1}{2}$  in. Visual-Indicating.



FNA FUSETRON Fuse  $\frac{13}{32}$  x  $1\frac{1}{2}$  in. slow-blowing, Visual-Indicating, Alarm-Activating. (Also useful for small motors, solenoids, transformers in machine tool industry.)



BUSS Grasshopper Fuse, Visual-Indicating, Alarm-Activating.



BUSS ACH Aircraft Limiter, Visual-Indicating.

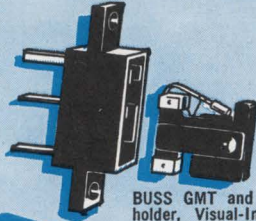

BUSS GMT and HLT holder, Visual-Indicating, Alarm-Activating.

Write for BUSS Form SFB

INSIST ON

# BUSS QUALITY

FUSES

BUSSMANN MFG. DIVISION, McGraw-Edison Co. St. Louis, Mo. 63107  
Circle 190 on reader service card

## The Complete Line of Fuses For The Protection of Semi-Conductor Rectifiers

### TRON Rectifier Fuses

Provide extremely fast opening on overload and fault currents, with a high degree of restriction of let-thru current. Many types and sizes available. Ampere ratings from  $\frac{1}{2}$  to 1000 in voltage ratings up to 1500.

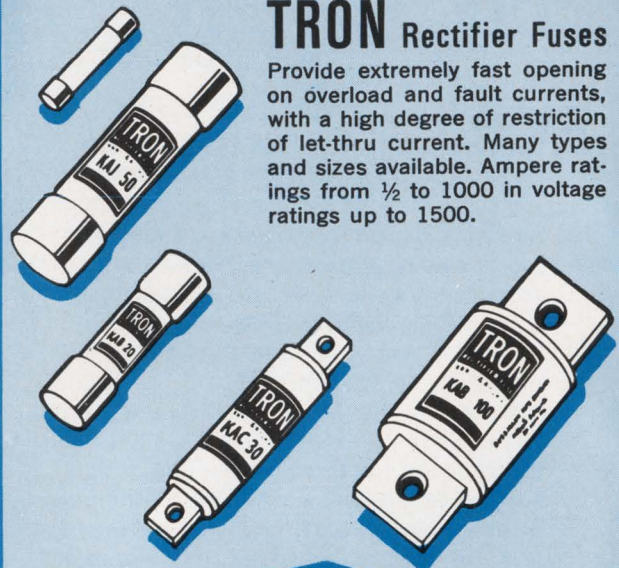

Write for BUSS Form SFB

INSIST ON

# BUSS QUALITY

FUSES

BUSSMANN MFG. DIVISION, McGraw-Edison Co. St. Louis, Mo. 63107  
Circle 190 on reader service card

## BUSS: The Complete Line of Fuses and . . .



**\$195<sup>00</sup>**

### a new concept in laboratory load simulation featuring

- Instant dial-a-load control
- Static and dynamic load simulation up to 100 watts
- Front panel voltage and current read-out
- Light weight, compact, and portable
- Available in rack mount or bench configuration
- Immediate Delivery

Use the inquiry card in this magazine for additional technical data or call direct:

**SPECIAL PRODUCTS**  
**DATA SYSTEMS DIVISION • LITTON INDUSTRIES**  
8000 WOODLEY AVENUE, VAN NUYS CALIFORNIA 91406

Circle 270 on reader service card



## Technical Abstracts

the other information about a dot. Or, color bands denoting tolerance regions can be drawn across the crt's face.

Presented at Wescon, San Francisco, Aug. 19-22.

### Use a library

Computer-aided LSI design  
Robert W. Ulrickson  
Fairchild Semiconductor  
Mountainview, Calif.

Future economic feasibility for large scale integration requires a drastic cut in design costs and turnaround time. In general, the high cost of LSI devices derives from their complex custom design and low manufacturing volume.

Only computer-aided design and the concept of the cellular array can bring about the necessary cost reduction. For the cellular array technique, standard cells—com-

posed of a variety of logic circuit building blocks—are designed, characterized, and their descriptions stored in a computer library. Once specified, these cells can be used again and again as components in larger, more complex circuits. Previous tests and use in other circuits guarantee a completely debugged cell and fewer design errors. Ordinarily, only the actual production reveals an error in design.

Computer programs for circuit analysis, logic simulation, and test generation along with programs for cell placement, wire routing, and artwork generation are used to reduce to a few weeks the time required to go from the logic diagram to masks. This, in turn, permits technicians and draftsmen to do work that once required engineers.

In a typical LSI design system,

the process starts by partitioning the logic to fit on a particular size chip. The predesigned cells—logic blocks—are then chosen from the computer library and placed in an array. The computer then simulates the logic function to verify that the design is correct and performs as the customer intended. To aid in checking, the simulation includes a list of input and output signals as a function of time, and additional information such as the fan-in and fan-out of each signal. At this point, the customer is asked to approve the design.

Once the design is approved, a mask is made. Topological data on all cells used in the array is taken from the computer's memory and used with a placement algorithm. The algorithm arranges the cells in a pattern of rows to minimize length and difficulty of interconnections. The designer

## Fuseholders of Unquestioned High Quality

### THE COMPLETE LINE OF *Small Dimension* FUSES

*For The Protection of All Types of Electronic and Electrical Circuits and Devices . . .*

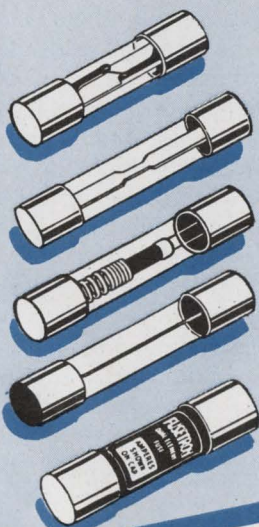

. . . includes dual-element "slow-blowing", single-element "quick-acting" and signal or visual indicating types . . . in sizes from 1/500 amp. up.

For special fuses, clips, blocks or holders, our staff of fuse engineers is at your service to help in selecting or designing the fuse or fuse mounting best suited to your requirements.

Write for BUSS Form SFB

INSIST ON

# BUSS QUALITY

FUSES

BUSSMANN MFG. DIVISION, McGraw-Edison Co. St. Louis, Mo. 63107

Circle 191 on reader service card

### SUB-MINIATURE FUSES

Ideal for space tight applications, light weight, vibration and shock resistant. For use as part of miniaturized integrated circuit, large multi-circuit electronic systems, computers, printed circuit boards, all electronic circuitry.

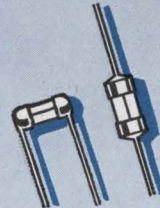

### TRON Sub-miniature Pigtail

Fuses — Body size only .145 × .300 inches. Glass tube construction permits visual inspection of element. Hermetically sealed. Twenty-three ampere sizes from 1/100 thru 15.



### BUSS Sub-miniature GMW Fuse and HWA Fuseholder

Fuse size only .270 × .250 inches. Fuse has window for visual inspection of element. Fuse may be used with or without holder. 1/200 to 5 amp. Fuses and holders meet Military Specifications.

Write for BUSS Form SFB

INSIST ON

# BUSS QUALITY

FUSES

BUSSMANN MFG. DIVISION, McGraw-Edison Co. St. Louis, Mo. 63107

Circle 191 on reader service card



# New free facts on "films."

Get the latest data on Mallory film resistors. A complete line. Made by the company with total capability in film resistors. Write, today.

Mallory Controls Company, a division of P. R. Mallory & Co. Inc., Box 327, Frankfort, Ind. 46401.

## GENERAL SPECIFICATIONS

MALLORY TYPE	MILITARY TYPE	TEMPERATURE RATING	POWER RATING (WATTS)	RESISTANCE RANGE (OHMS)
<b>Precision Resistors</b>				
MAC 55	RN55	70°C & 125°C	1/4 & 1/10	10Ω-100K
MAC 60	RN60	70°C & 125°C	1/4 & 1/10	10Ω-499K
MAC 65	RN65	70°C & 125°C	1/2 & 1/4	10Ω-1 meg
MAF 55	RN55	70°C & 125°C	1/4 & 1/10	10Ω-100K
MAF 60	RN60	70°C & 125°C	1/4 & 1/10	10Ω-499K
MAF 65	RN65	70°C & 125°C	1/2 & 1/4	10Ω-1 meg
<b>Semiprecision Resistors</b>				
MAL 07	RL-07	70°C	1/4	10Ω-100K
MAL 20	RL-20	70°C	1/2	10Ω-470K
MAL 32	RL-32	70°C	1	10Ω-1 meg
<b>Power Resistors</b>				
2MOL		70°C	2	30Ω-125K
3MOL		70°C	3	40Ω-125K
4MOL		70°C	4	85Ω-125K
5MOL		70°C	5	95Ω-125K
7MOL		70°C	7	125Ω-125K

# MALLORY

Circle 224 on reader service card

## One of these modular memories should fit your prototype because we planned it that way

Tetra planned its line of standard, small capacity memories to meet standard needs. By optimizing designs for mass production to inventory, we are able to give you a performance/cost ratio that you may find quite favorable.

ALPHA 10.2 MEMORY SYSTEM	ALPHA 12.2 MEMORY SYSTEM
1024 x 10	4096 x 10
1024 x 9	4096 x 9
1024 x 8	4096 x 8
512 x 10	2048 x 10
512 x 9	2048 x 9
512 x 8	2048 x 8

ALPHA 10.2 operates with a full cycle time of 1.5 usec. ALPHA 12.2 operates with a full cycle time of 1.75 usec. Both are compatible with DTL and TTL. We supply mating connectors with prototypes, free.



7309 WASHINGTON AVE. SO.  
MINNEAPOLIS, MINN. 55435  
PHONE (612) 941-5450

Cordially,  
TETRA CORPORATION

*William J. Neumann*

William J. Neumann  
Vice President

## Technical Abstracts

then reviews the design, makes any modifications that may be necessary, and calls for the artwork generation programs that draw the mask on the plotter. With the artwork completed, a prototype can now be produced. At the same time, the designer goes back to the computer where he gets a list of all possible faults and a sequence of tests. The units are then tested, assembled in a package and tested again.

Presented at Wescon, San Francisco, Aug. 19-22.

### Powder's Pluses

Powder interconnections  
L.F. Miller  
IBM Components division  
Hopewell Junction, N.Y.

Reliable interconnections between layers in multilevel ceramic modules can be effected by using a conductive powder. This method results in much higher yields than the paste method, requires no registration and no change in tooling, except for land pattern masks and new holes as circuit formats are changed. Moreover, it requires but one operation.

In the powder process, interconnections are formed by filling holes with a flowable metallic powder which electrically connects internal conductive layers to other parts. The assembly then is fired to sinter the powder and metallurgically bonded to the other parts. If the powder does not enter a particular hole, that part can be reprocessed without any detrimental effects. Even in the case of an electrical open, the powder can be pressed into that hole and reprocessed to salvage the part.

Although the conductive powder method features many pluses, there are a few noteworthy minuses. Holes must be open at the top surface—no blind holes should be made; for adequate filling, the holes are limited to a minimum diameter of about 0.010 inch and should be closed at the bottom to prevent the powder from falling out. And connections could be more susceptible to thermal shock.

Presented at Wescon, San Francisco, Aug. 19-22



# TRANSTECTOR

CIRCUIT PROTECTOR



prevents transients from causing "unexplainable" circuit failures.

Don't blame circuit failures on bad luck. Voltage transients can cause circuits to fail or suffer undetected and progressive damage. Transtector\* circuit protector, a new solid state device, senses transients within nanoseconds, absorbs the surge and resets itself. Gives continuous protection for tubes, transistors, diodes and integrated circuits.

Find out about Transtector Systems from M&T Chemicals Inc., 1161 Monterey Pass Road, Monterey Park, Calif. 91754. Tel. (213) 264-0800.

**M&T Chemicals Inc.**   
SUBSIDIARY OF AMERICAN CAN COMPANY

\*Trademark of M&T Chemicals Inc.

Circle 159 on reader service card

# FREE!

## CLAMP Design Manual



**72 pages of engineering data!**

The most complete work of its kind, this manual features 72 pages of prints, illustrations, tables, specifications and installation tips for any clamp situation. Whether of aluminum, titanium or stainless steel, from 1/8" to 6" diameter, for hot or cold temperature insulation... for any situation, you'll find the best way to "clamp down" clearly shown in this booklet. ■ Over 41,000 clamp designs at your fingertips, ready for shipments now, at big off-the-shelf savings. Also shows blocks, brackets, line supports and related items. BEFORE YOU DESIGN OR BUY, CHECK WITH TA FIRST! Write or phone today for a quotation. ■ Send for your free clamp manual today!

**TA MFG CORP**  A DAYCO COMPANY

4607 Alger Street, Los Angeles, California 90039 ■ Phone 213-245-3748/  
TWX 910-497-2065 L. A./WUX CAT L. A., Calif.

Circle 226 on reader service card

# FULLY TRANSISTORIZED



**ACCURACY  
RELIABILITY  
LITTLE POWER CONSUMPTION  
EASY OPERATION  
EASY MAINTENANCE  
DESIGNED FOR  
INTEGRATED AUTOMATION  
ELECTRONIC CONTROL SYSTEMS  
DATA LOGGERS  
(MANUFACTURED UNDER  
HOKUSHIN LICENSE — JAPAN)**

### GENERAL SPECIFICATIONS

- Unified signal (Input-Output) 2... 10, 4... 20, 0... 5, 0... 20 mA etc.
- Load resistance 0... 3 Kohms
- Ambient temperature -10°... +60°C (for field instruments)  
-10°C... +45°C (for panel instruments)
- Power supply 200 or 220 V (+10... -15%) A.C. or 60 c/s)

### ELECTRONIC CONTROL SYSTEMS INCLUDE:

- Temperature transmitters with
  - thermoresistance (-200... +500°C)
  - thermocouples (0... +1600°C)
  - radiation pyrometer (+600... +2000°C)
- Pressure transmitters with
  - Bourdon tube (0... 350 kgf/cm<sup>2</sup>)
  - capsule (0... 1 kgf/cm<sup>2</sup>)
  - bellows (0... 1000 mm Hg)
- Differential pressure transmitters with
  - bell (0... 100 mm H<sub>2</sub>O)
  - bellows (0... 400 mm<sup>2</sup>H<sub>2</sub>O)
  - bellows (0... 35000 mm H<sub>2</sub>O)
- Area type flow transmitters: 0, 24... 54, 94 m<sup>3</sup>/h
- Electromagnetic flow transmitters: 0, 41... 1770 m<sup>3</sup>/h
- Displacement type liquid level transmitters: 0... 2000 mm.
- pH transmitters: 0... 12 pH
- Water quality, psychrometer, mol ratio, concentration transmitters
- Miniature indicators
- 120 and 250 mm scale one and two point recorders
- Multipoint (2, 3, 6, 12) recorders
- Calculators and accessories: square root extractors, multipliers, dividers, adders-subtractors setters, program setter, integrators, signal limiters, manual control stations etc.
- Controllers
  - continuous (PI-PID) with and without indicators
  - Multipoint on-off controllers
  - Relay amplifiers
- Electro-pneumatic converters
- Computers:
  - multi-point scanner
  - data logger

# MASINEXPORT

Bucuresti — România Str. Matei Millo 7  
Cables: MASEXPORT — Bucuresti  
Telex: 216

Circle 193 on reader service card 193



# EPSYLON

## Incremental Data Loggers for Meteorological Measurement



Two types available—EDL.10, and EDL.12 illustrated here. (EDL.10 is of similar appearance)

### FEATURES

BATTERY OPERATED WITH LOW POWER CONSUMPTION  
CASSETTE LOADED  
PORTABLE (SIZE 12" x 9" x 9" WEIGHT 14 LBS APPROX)

The Event Recorder Type EDL.10 is designed for recording the occurrence of events, on one of its tracks, against an extremely accurate time marker on the second track.

The Incremental Data-Logger Type EDL.12 is designed to sample sequentially up to 12 channels of analogue information, digitising these analogue values and recording them in 8 bit parallel words on ½ inch wide magnetic tape.

These equipments are the basis for the following complete systems of HYDROMETRIC MEASUREMENT:

### RAINFALL INTENSITY MEASUREMENT

by using EDL.10 combined with a tipping bucket type of rainfall gauge.

### CLIMATOLOGICAL SYSTEMS

incorporating sensors for measurement of parameters such as run of wind, solar radiation, etc. The data is recorded on EDL.12 for subsequent calculation of evaporation.

### WATER QUALITY MONITORING STATIONS

Translation systems for all the above are available.

For further information write to



# EPSYLON

## INDUSTRIES LIMITED

Faggs Road, Feltham, Middlesex, England  
Telephone: 01-890 5091 Telex: 25318

*Speed-up*  
Wire  
Marking  
with a  
**KINGSLEY**  
Wire & Tube  
Marking Machine  
*right in your plant!*



Write  
for  
Details

Now you can permanently mark wire or tubing directly on the insulation... quickly... economically... right in your own plant!

Cut costs and speed production with the same machine that has consistently proven so successful in the aircraft/missile field.

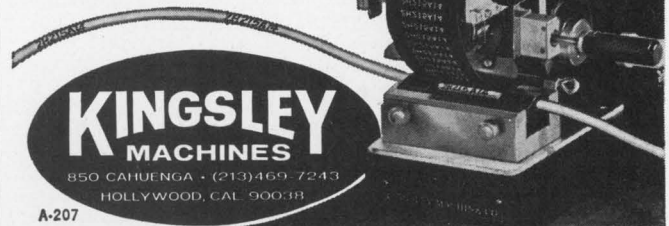

A-207

Circle 227 on reader service card

## Here's A Switch

### Fast Response... No Bounce

The MERCURON SWITCH effectively combines the mechanical advantages of a snap-action switch with the electrical properties of a mercury switch. It is a miniature switch of unique and simple design relying on mercury movement in a flexible sealed tube for fast response with no bounce, perfect for direct switching of solid state circuits. Actuating a plunger simultaneously releases a pinch in the tube and "pumps" the divided mercury together to close the normally open circuit. A simple cricket spring in direct contact with the tube provides the snap-action.

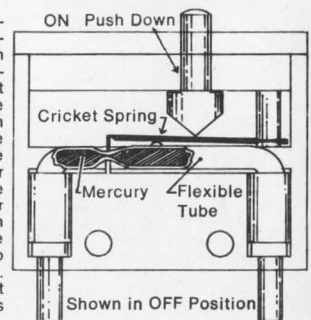

Switching Capacity .....	60 ma @ 24 VDC
Contact Rise Time .....	< 1 x 10 <sup>-9</sup> seconds
AC Contact Noise .....	10 Microvolts
Bounce Time .....	Zero
Maximum Cycling Rate .....	200 Hz
Life at Rated Load .....	250,000 cycles
Operating Temperature Limits .....	-30°C to 60°C
Shock Resistance .....	30 G's min.

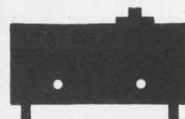

Actual size



For further information write or call  
**MECHANICAL ENTERPRISES**  
3127 Colvin Street, Alexandria, Virginia 22314, (703) 549-3434



## New Literature

**Computerized induction motor.** McLean Engineering Laboratories, Princeton N.J. 08550. A high-speed digital computer in conjunction with internal program analysis was used to achieve optimum predictable performance in PSC induction motors described in a new catalog.

Circle 446 on reader service card.

**Test sockets/carriers.** Textool Products Inc., 1410 Pioneer Drive, Irving, Tex. 75060. A six-page short-form catalog describes a line of versatile test sockets and carriers for integrated and hybrid circuits, MSI and LSI, rectifiers, and other semiconductors. [447]

**Charge amplifiers.** Kistler Instrument Corp., 8989 Sheridan Drive, Clarence, N.Y. 14031, has released bulletins on two new charge amplifier models. [448]

**Drivers and pulse-shapers.** Adar Associates Inc., 85 Bolton St., Cambridge, Mass. 02140. Bulletin 350-1 describes the D-50 series of drivers and pulse-shapers designed to handle the high voltage and capacitive load requirements of MOS drivers. [449]

**Variable electronic filters.** Rockland Laboratories Inc., 13 Erie St., East, Blauvelt, N.Y. 10913, offers a four-page catalog describing an extensive line of precision variable electronic filters, including the new programmable series. [450]

**High-purity nickel.** Magnetics Inc., Metals Division, Butler, Pa. 16001, has issued a data sheet describing Blendalloy 22-1000 high-purity nickel rod, wire, and strip products. [451]

**Automated test systems.** American Computer Technology Inc., 8740 Shirley Ave., Northridge, Calif. 91324, has published a facilities brochure detailing its capabilities in the design and production of complex computer, digital test and control systems; subsystems and components, and the use of counter-programmed design for electronic manufacturers. [452]

**Test instrumentation.** Siemens America Inc., 350 Fifth Ave., New York 10001, has available a four-page bulletin describing the R127 capacitance bridge and K946 generator and detector. [453]

**Binary ladder network.** Beckman Instruments Inc., 2500 Harbor Blvd., Fullerton, Calif. 92634. A two-page catalog sheet describes the model 815 binary ladder network. [454]

**Trimming potentiometers.** Techno-Components, 7803 Lemona Ave., Van Nuys, Calif. 91405, has released a catalog covering its line of miniature wire-

# HEW... more power to you!

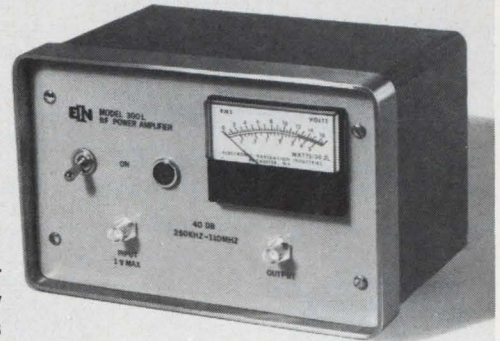

Thank you Hewlett Packard for building so many top quality sweep and signal generators and frequency synthesizers.

You've created a market for our power amplifiers because many engineers need our product to extend the power output of your instruments. We've made sure that our broadband, untuned, 3 watt amplifier mates easily with most sweep generators, signal generators, and frequency synthesizers (no matter what brand). Our power amplifier also features an output meter plus low harmonic and intermodulation distortion. So thanks again Hew . . . and we're glad we could help you.

- 250 KHz-110 MHz frequency coverage
- 40 dB  $\pm$  1 dB Gain
- 50 ohms input/output impedance
- Failsafe for any load mismatch and unconditionally stable.

MODEL 300L  
**\$485**

The ENI Model 310L will provide 10 watts of power when identical specifications with higher output are required.

For additional specification and application information contact:

**ENI ELECTRONIC NAVIGATION INDUSTRIES**  
1337 Main Street East Rochester, New York 14609 716/288-2420

Circle 229 on reader service card

FASTENERS FROM

**GRC**

DIE CAST  
ZINC ALLOY



Wing Nuts



Cap Nuts



Thumb Nuts



Thumb & Wing Screws

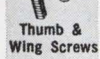

Screws



Hex Nuts

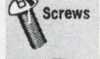

Washers



Screw Insulators



Screw Insulators



Screw Insulators

Big help for your  
tiny assemblies!

MINIATURE molded  
NYLON SCREWS

Now as  
small  
as  
#00

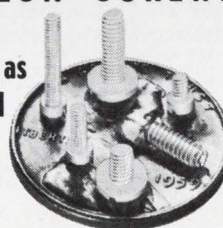

GRC Small & miniature screws  
simplify designs—at lower cost.

- Sizes #00, #0, #1, #2, #3 and #4.
- Many head types, lengths. Set screws, too.
- Flash-free, precise and uniform.
- Corrosion-resistant, vibration-proof, electrical insulating with high strength to weight.

Ask for sample kit prices . . . data  
about other GRC Plastic Fasteners—  
screws, nuts, washers, etc.

**GRIES**

GRIES REPRODUCER CO.

Division of Coats & Clark Inc.  
151 Beechwood Ave.,  
New Rochelle, N.Y. 10802  
(914) 633-8600

World's Foremost  
Producers of Small  
Die Castings and  
Plastic Moldings

**CAN YOUR PRODUCTION  
AND PROFITS BE  
BOOSTED BY TRAINING  
INNOVATION?**

**RCA INVITES YOU TO  
FIND OUT.**

If you're in a field where technology is  
advancing, there's a good chance some  
of your employees have not "kept up".

That's where we can help.

We're ready to train your personnel at  
your place or ours, or even at home.  
Courses can be developed in sales,  
engineering, management, programming,  
data processing, electronics, and many  
other areas.

Mail coupon today for full information...

**RCA** Technical  
Institute

A Service of RCA Institutes, Inc.  
Bldg. 204-1, Dept. X-64  
Camden, N. J. 08101  
Phone: (609) 963-8000, ext. PY-5084

Please furnish information about customized  
training programs. We're particularly interested in  
 Programmed Instruction  Industrial Training

Name \_\_\_\_\_ Title \_\_\_\_\_  
Company \_\_\_\_\_  
Address \_\_\_\_\_  
City \_\_\_\_\_ State \_\_\_\_\_ Zip \_\_\_\_\_



# EG&G SILICON DIFFUSED PHOTODIODE

- HIGH QUANTUM EFFICIENCY
- WIDE SPECTRAL RANGE • FAST RESPONSE TIME • LOW NOISE

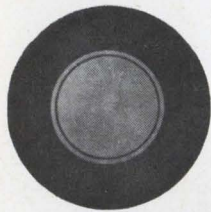

SINGLE CELL

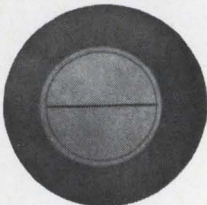

BI-CELL

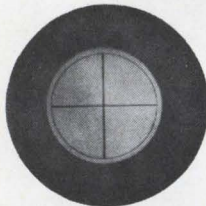

QUAD-CELL

## SGD-444 SERIES

The SGD-444 Series complements the versatile EG&G SGD-100A Photodiode. Improved diffused guard ring construction permits higher sensitivity, lower noise and faster response factors than ever before available in large (1 cm<sup>2</sup> active) area diodes.

Bi-cell and quadrature cell configurations with isolations of greater than 20 to 1 are standard. The photodiodes are oxide-passivated and hermetically sealed in a TO-36 package.

Sensitivity . . . . . 0.5μA/μW @ 0.9μ (70% Quantum Efficiency)  
Spectral Range . . . . . 0.35 to 1.13μ  
Leakage . . . . . 0.5μA @ 100 volts  
Rise Time . . . . . 10 nanoseconds  
NEP . . . . . 1.0 x 10<sup>-12</sup> watts  
Linearity of Response . . Over 7 decades

Applications include CW, pulsed light and laser detection and measurement, star tracking, optical navigation and guidance, and range-finding systems. The SGD-444 series is in quantity production for fast delivery at low price.

For information, write EG&G Inc., 166 Brookline Avenue, Boston, Massachusetts 02215. Or phone 617-267-9700. TWX: 617-262-9317. On West Coast, telephone 213-464-2800.



ELECTRONIC PRODUCTS DIVISION

## New Literature

wound trimming potentiometers. [455]

**Crystal can relays.** Welch Relay Co., 11161 W. Pico Blvd., Los Angeles 90064. A 12-page brochure describes a complete microminiature, crystal can relay line. [456]

**Analog multiplier/dividers.** Intronics Inc., 57 Chapel St., Newton, Mass. 02158, announces a six-page catalog featuring four new analog multiplier/dividers. [457]

**R-f crystal oscillator.** Reeves-Hoffman division, Dynamics Corp. of America, 300 W. North St., Carlisle, Pa. 17013. A two-color specification sheet gives technical data for a fast-warmup r-f crystal oscillator. [458]

**Mounting sockets.** Barnes Corp., 24 N. Lansdowne, Pa. 19050. Product bulletin PB-1005 describes 041-007 and 041-008 sockets for high density mounting of TO can-style transistors in production applications that require a provision for easy replacement of individual transistors. [459]

**Temperature controller.** Gulton Industries Inc., 3860 North River Rd., Schiller Park, Ill. 60176. Bulletin 300 describes a series of solid state temperature controllers designed to use a minimum amount of panel space. [460]

**Life test/burn-in systems.** Wakefield Engineering Inc., Wakefield, Mass. 01880. Catalog 61 covers several new additions to the company's line of temperature-controlled semiconductor life test/burn-in systems. [461]

**Automated artwork.** Optical Gaging Products, a division of Ex-Cell-O Corp., 26 Forbes St., Rochester, N.Y. 14611, has published a four-page color brochure on its Optimat system for automated artwork generation. [462]

**Ground plane tape.** Tapecon Inc., 475 River St., Rochester, N.Y. 14612, has available a data sheet discussing the use of pressure sensitive ground plane tape as an aid to production of delay lines. [463]

**Data modems.** RFL Industries Inc., Boonton, N.J. 07005. An informative booklet discusses transmitting and receiving data for computer, data terminal, time sharing, and other digital devices over standard telephone lines. [464]

**Ultrasonic level monitor.** Industrial Nuclear Corp., 650 Ackerman Rd., Columbus, Ohio 43202. The AccuRay ultrasonic level monitor, for continuous level measurement to 60 feet, is described in a four-page folder. [465]

**P-i-n diodes.** Hewlett-Packard Co., 1501

THE -100°F. TO +400°F.  
CHAMBER  
WE WON'T  
SELL TO  
JUST ANYONE



(IT'S TOO MUCH UNIT  
FOR ORDINARY WORK)

It's a fact: Blue M Versa-Range Test Chambers are too much unit for run-of-the-mill needs. There are many, cheap, mass-produced chambers that can meet average requirements adequately. *But*, if you have really tough requirements, then consider these Versa-Range facts: They meet your needs because they meet the specifications we quote. When we say -100°F., for example, we mean -100°F. Not -95°F. or -88°F.

Our chart recordings are correct. Our pull down rate of 60 minutes or less to -100°F. is exact at nine points, not just one.

Versa-Range Chambers feature the patented POWER-O-MATIC 60® Proportioning Control for straight-line performance . . . not low-cost, on-off controls.

Blue M's mechanical refrigeration features long lasting continuously operating compressors — not the slam-on, cut-off, cycling type you find in cheaper chambers.

Versa-Range Chambers come with two different ranges in five sizes to 64 cu. ft. Accessories include programming.

If you want fine, reliable performance without a lot of parts failure, costly maintenance, and service calls, a Versa-Range Chamber is your best buy. Send for complete details: Blue M Engineering Company, A Division of Blue M Electric Company, Corporate Headquarters, Blue Island, Illinois 60406.







Free copy  
on request

**NEW!**

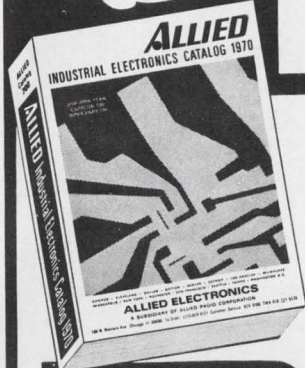

**ALLIED 1970  
600-PAGE  
INDUSTRIAL  
ELECTRONICS  
CATALOG**

- World's largest selection
- Factory OEM prices
- Reliable service

600 pages, over 60,000 items—by far the largest, most comprehensive electronics catalog in the world. Circle reader service card for your free copy, or send postcard to:

**ALLIED ELECTRONICS**  
Dept. 689, 100 N. Western Ave.  
Chicago, Ill. 60680

FEATURING



**DEARBORN  
WIRE & CABLE CORP.**

Allied's in-depth stocks of Dearborn wire and cable are available to service the needs of the industrial, military, and electronics market. Allied can supply any Dearborn wire and cable to satisfy your requirements.

Circle 233 on reader service card

**Should you  
be using a  
reed switch?**

Are you switching with a costly solid-state device or lumbering mechanical device, instead of with a reed switch that could do the job better at less cost? Unless you know about the types of reed switches available and how to select the best switch for your application, you may be guilty. Find out if you are by sending for your **FREE** 22-page booklet *Reed Switch Application Notes*. In addition to such selection criteria as reed size, gap location, power factors, operate and release points and contact materials; information is given on lead cutting and bending, encapsulation, bounce, dynamic noise, temperature effects, and insulation resistance.

Free.

**Gordos**



REED SWITCH  
APPLICATION NOTES

Everyone interested in reed switches should own this booklet. Send for your free copy NOW.

Nationwide Distributor:  
**Permag Corporation**

**GORDOS**  
CORPORATION 201-743-6800  
250 Glenwood Ave. Bloomfield, N.J. 07003

Circle 232 on reader service card

**Just right for  
two-way radio!**

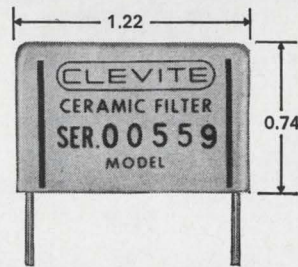

**Clevite's  
computer-designed  
TCF ceramic filter.**

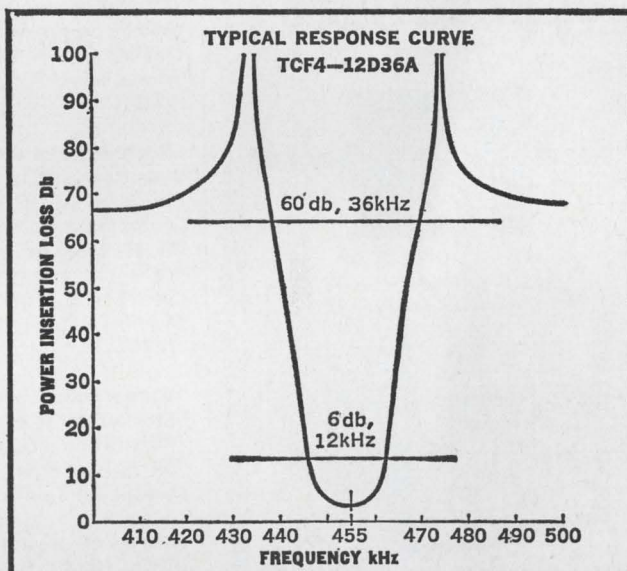

**TCF — a hybrid combination of a tuned transformer and ceramic resonators . . . in less than 0.6 cu. in.!**

Designed specifically for use in two-way communication sets including mobile two-way, aircraft communication, aircraft navigation SSB receiver applications and CB. The TCF combines the input advantages of a tuned transformer with the stability and high performance of a ceramic filter. Result: manufacturers of quality FM receiving equipment (and AM as well) get greater selectivity at a lower cost. TCF filters are free of unwanted responses, and input impedances are suitable for both transistor and vacuum tube circuits.

Model Number	Bandwidth	
	6 db (Min.)	60 db (Max.)
TCF4-4D10A	4kHz	10kHz
TCF4-8D20A	8kHz	20kHz
TCF4-12D36A	12kHz	36kHz
TCF4-18G38A	18kHz	38kHz
TCF6-30D55A	30kHz	55kHz
TCF6-35D60A	35kHz	60kHz
TCF6-12F36A	12kHz	36kHz (90 db)

**PRICES:** TCF-4 models: 1—\$15 ea; 25—\$10 ea; 100—\$8.50 ea; 500—\$6.75 ea; 1000—\$6.00 ea; 2500—\$5.45 ea. TCF-6 models slightly higher.

(Prices subject to change without notice)

Send order or request for Bulletin 94026 to: Clevite Corporation, Piezoelectric Division, 232 Forbes Rd., Bedford, Ohio 44146, U.S.A. Or: Brush Clevite Company, Ltd., Southampton, England.

**CLEVITE**

Circle 197 on reader service card



# NEW SOLID STATE POWER PACKS

for  
regulated  
low voltage  
applications  
from

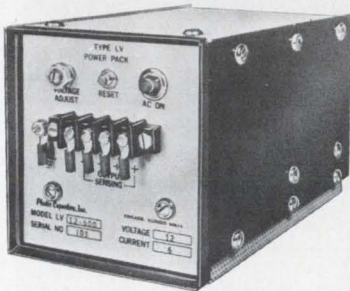

Plastic Capacitors' new LV Series Power Packs, ranging from 12 to 100 volts DC, offer an improved solution to today's system requirements. Models available with DC output voltages of 12, 24, 28, 36, 48, and 100 volts with power ratings of approximately 25, 50, 100 & 150 watts.

#### FEATURES INCLUDE:

- 0.01% LINE REGULATION
- 0.05% LOAD REGULATION
- 3MV PEAK TO PEAK RIPPLE AND NOISE
- NEGATIVE 0.015%/°C TEMPERATURE COEFFICIENT
- LESS THAN 0.2 OHMS OUTPUT IMPEDANCE
- TEMPERATURE OPERATING RANGE OF 0°C TO 55°C

For positive proof that good things come in small packages . . . check your power pack needs with Plastic Capacitors. Write for full engineering data today.

## Plastic Capacitors INC.

2620 N. Clybourn Chicago, Ill. 60614  
Tel: (312) 348 3735

## New Literature

Page Mill Rd., Palo Alto, Calif. 94304, has published 20-page application note 922 covering the uses of p-i-n diodes. [466]

**Timing cells.** Sprague Electric Co., 35 Marshall St., North Adams, Mass. 01247. Complete technical information on miniature, current-integrating timing cells is given in engineering bulletin 11001. [467]

**Alternate action switch.** Grayhill Inc., 523 Hillgrove Ave., La Grange, Ill. 60525. A four-page, illustrated technical bulletin describes a line of alternate action push-button switches designed for on-off switching, or maintained circuit condition. [468]

**Capacitors and resistors.** Corning Glass Works, Corning, N.Y. 14830, has released short form catalog EPD DSF-1 on a line of capacitors and resistors. [469]

**Recorder/reproducer.** Magnasync/Moviola Corp., 5539 Riverton Ave., N. Hollywood, Calif. 91601. A 16-page catalog contains a general description, applications, features, specifications and typical systems installation diagrams of the series TR-1700 10- and 20-channel audio logging recorder/reproducer. [470]

**Tunnel diodes.** Aertech Industries, 825 Stewart Dr., Sunnyvale, Calif. 94086. Publication 105 is a four-page bulletin on an extremely reliable line of alloy junction tunnel diodes. [471]

**Silicon chips and wafers.** Union Carbide Corp., 8888 Balboa Ave., San Diego, Calif. 92123, has released a semiconductor and IC chip catalog describing silicon chips and wafers, and listing 13 separate categories of transistors and IC's with their type numbers and important parameters. [472]

**Arc suppressors.** Genisco Technology Corp., 18435 Susana Rd., Compton, Calif. 90221. Specifications of a new series of rfi miniature arc suppressors—each smaller than an ordinary thimble—are provided in a data sheet. [473]

**H-v power supplies.** Spellman High Voltage Electronics Corp., 1930 Adee Ave., Bronx, N.Y. 10469. Six-page condensed catalog 6900 describes a line of high-voltage power supplies. [474]

**Resonant reeds.** Motorola Communications and Electronics Inc., 4501 W. Augusta Blvd., Chicago 60651, has released brochure TIC3521 describing its Vibrasponder contactless resonant reeds. [475]

**Snap switches.** Sigma Instruments Inc., 170 Pearl St., Braintree, Mass. 02185,

# SAN-E

*MSP-4 full four track stereo  
R/P head for auto-reverse  
cassette system*



MSP-4 ¼ track full 4 heads R/P head for philips cassette tape

Other product  
erasing head for MSP-4  
8 truck (MS-8) stereo head  
for home & car stereo

\* write immediately  
for further details

### SAN-E DENKI COMPANY, LIMITED.

110-1 Minami-Kawahori-cho, Tennoji-ku,  
Osaka, Japan  
phones: 779-1591  
cable: SANMAGNETICS

Circle 234 on reader service card

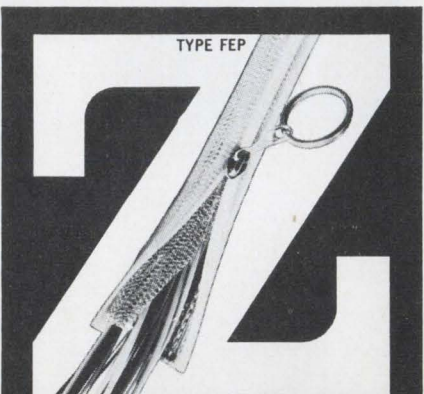

## ZIPPERTUBING® TEFLON\* JACKETING

for extreme temperature variations —  
minus 425° to plus 400° F!

FEP TEFLON provides low installation cost, and abrasive-resistant jacketing for extreme temperature environments.

In 3 types: Shrinkable, regular and shielded for R.F.I. protection with grounding braid. Sizes ½" to 4" (or larger) in ⅛" increments. \*Reg. T.M. of Dupont

For full information on specialized,  
high-performance jacketing, contact

### THE ZIPPERTUBING® CO.

CORPORATE HEADQUARTERS  
13000 S. BROADWAY  
LOS ANGELES, CALIF. 90061  
Phone (213) 321-3901  
TWX 910-346-6713



BALTIMORE • BOSTON • CHICAGO • CLEVELAND • DALLAS  
NEW YORK • ORLANDO • PHOENIX • SAN FRANCISCO • WEST GERMANY



# engineers with good connections keep up their contacts



They use MS-230 Contact Re-Nu to maintain full electrical continuity on relays, connectors... all types of contacts where dirt, erosion dust and greasy films can lead to erratic operation. MS-230 is formulated especially

for cleaning contacts. Make it a part of your regular preventive maintenance program.

Write on your company letterhead for a free 16-oz. sample. For literature only, use bingo card.



**miller-stephenson chemical co., inc.**

Route 7, Danbury, Conn. 06813

Circle 236 on reader service card

## WANTED: ELECTRONICS MANUFACTURER

who desires to fill a dependable supply of government contracts

Excellent opportunity for growth-minded electronics manufacturer to locate in Texas and help meet the needs of the government and the third fastest-growing state. Stable, productive labor. Incomparable tax advantages. Lowest living costs. For Texas Fact Book, write or call:

James H. Harwell, Executive Director  
**TEXAS INDUSTRIAL COMMISSION**  
Capitol Station Box JJ-E  
Austin, Texas 78711  
Telephone 512/475-4331

Circle 237 on reader service card

## Laminar Clean Air

### with Tenney Lami-Flow Benches

The most advanced "second generation" design for work bench contamination control. These are self contained units with air circulator, filters, lighting and work space all combined into one integral package. Just plug it in. Tenney benches feature a new patented air-directing, permuting membrane to direct and focus the air while giving it true laminar flow. This enables new design location flexibility for greater filter efficiency, giving you air cleanliness exceeding the requirements of Class 100, Federal Standard 209A.

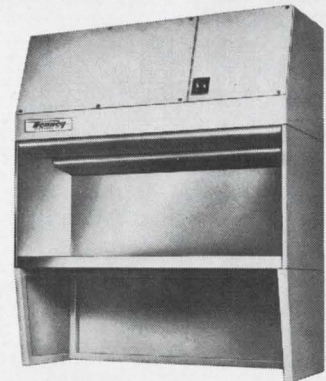

Write or call for further information.



**Tenney**  
ENGINEERING, INC.

1090 Springfield Rd., Union, New Jersey 07083 • (201) 686-7870

Western Division: 15721 Texaco St., Paramount, Calif. 90723

556

Circle 199 on reader service card

199



It's the  
era of the  
mini-skirt . . .  
and electronic  
miniaturization!



Now  
the newest and smallest  
multi-pin connector  
puts *meaning* into  
miniaturization!



**Meet Navajo:** The miniature multi-pin that complements your miniaturization program. This is

the industry's first miniature, circular multi-pin connector series offering 3, 5, 7 and 9 pin-contact versions *all in one 1/2" maximum diameter shell size.* (Also available are combinations of coaxial and power contacts.) Five key polarization. Shell and contacts gold over nickel plating. Threaded 7/16"-28 THD coupling. Contacts fused into glass or molded into thermo-setting compound per MIL-M-24325. Contacts are closed entry design with one amp rating. Seven and nine pin versions' contact solder pots accept 22 gauge wire. Three and five pin versions accept 18 gauge wire. Receptacles available in various mounting configurations. Typical mated parts weigh less than 1/2 oz. These connectors are moisture-proof and extremely resistant to shock, vibration and corrosion.

Navajo was designed for *you*. So before you finalize your next design, learn more about the miniature multi-pin connectors that really *are* miniature. Ask about our complete line of coaxial connectors, too. They're not ordinary, either. Contact:



**MANUFACTURING CORPORATION**  
11415 Johnson Drive  
Shawnee Mission, Kansas 66203

## New Literature

offers a catalog providing technical data on an expanded line of Omron precision snap switches. [476]

**Straight cable plug.** Sealectro Corp., 225 Hoyt St., Mamaroneck, N.Y. 10543. Product bulletin CX-99A deals with a clamp-type straight cable plug developed for the SRM series of miniature r-f connectors. [477]

**Shielding foil.** Magnetics Inc., Butler, Pa. 16001, has issued a data sheet on an 80% nickel-iron shielding foil, called MuGuard 80, designed to provide optimum initial and maximum permeabilities for electromagnetic shielding applications. [478]

**Spectrum analysis.** Federal Scientific Corp., 615 W. 131st St., New York 10027. A technical paper describes a method for using the Ubiquitous real-time spectrum analyzer to test and service high-quality tape recorders. [479]

**Data generator.** Adar Associates Inc., 85 Bolton St., Cambridge, Mass. 02140. Bulletin 200-1 describes the Sq 260/280 generator, which offers versatile and high-speed data generation for stimulating digital devices and packages with preprogrammed forcing functions. [480]

**Readout indicators.** Alco Electronic Products Inc., P.O. Box 1348, Lawrence, Mass. 01842. An eight-page catalog lists and illustrates the company's line of miniature readout indicators and the decoder-drivers required for particular models. [481]

**Electronic kits.** Heath Co., Benton Harbor, Mich. 49022. The 1970 edition of the Heathkit catalog illustrates over 300 electronic kits for every budget and interest. [482]

**Programmable data amplifier.** Dana Laboratories Inc., 2401 Campus Dr., Irvine, Calif. 92664. Two-page data sheet 972 describes the capabilities of the model 2865 programmable data amplifier. [483]

**Coils and chokes.** J.W. Miller Co., 19070 Reyes Ave., Compton, Calif. 90221. An 80-page catalog describes the standard line of industrial r-f coils, r-f chokes and related components. [484]

**Power equipment.** Lambda Electronics Corp., 515 Broad Hollow Road, Melville, N.Y. 11746, has available four new lines of power components, power instruments and power systems. [485]

**Electronic switches.** Lorich Electronics Corp., 105 Cedar Lane, Englewood, N.J. 07631. Catalog ES-697 illustrates and describes the company's line of electronic switches and represents a useful tool for the design engineer. [486]

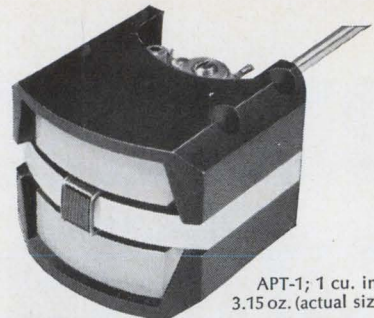

APT-1; 1 cu. in.,  
3.15 oz. (actual size)

## More torque, Less weight in moving coil mechanism

Highly stable, linear and accurate mechanism for indicating, control or recording systems. 18-0-18° linearity is 1%. Coil design with over 75% of winding "working" in high energy, uniform field air gap assures greater accuracy. Coil system weighs 0.85 gm, develops 26.4 mmg of torque; 31:1 T/W. Mechanism offers negligible vibration pivots and jewels — custom damping — wide range of sensitivities.

# AMMON

AMMON INSTRUMENTS, INC.  
345 Kelley St., Manchester, N.H. 03105

Circle 239 on reader service card

## Want to be unique in our memory?

It's easy. Enter the Electronics Manpower Register.

We'll feed your professional background into the talent memory of our nationwide computerized recruitment service.

Our computer will match your unique profile against every opening being programmed into it by a long list of electronics companies. You'll automatically be qualified for every logical career opportunity. But we'll only release your availability to those companies you approve.

To enter, send us your resume.

Electronics Manpower Register  
**Electronics**  
330 West 42nd Street  
New York, N.Y. 10036











# Make your own break.

You can take a lot of the chance out of your future by including yourself in the Electronics Manpower Register.

When you do, your experience and talents become part of a nationwide computerized placement service.

Our computer is programmed to give every registrant the same

look for every opening. With your prior approval, you'll be considered for every opportunity that matches your resume.

All you have to do is send one to:

Electronics Manpower Register  
**Electronics**  
 330 West 42nd Street  
 New York, N.Y. 10036



## EMPLOYMENT OPPORTUNITIES



We have been placing B.S., M.S. and Ph.D.

### ELECTRONIC ENGINEERS

in fee paid positions throughout the U.S. since 1959. Send resume today or request confidential application. We are graduate engineers, working full time . . . for you.

### ATOMIC PERSONNEL, INC.

Suite L. 1518 Walnut St., Phila., Pa. 19102  
 AN EMPLOYMENT AGENCY FOR ALL TECHNICAL FIELDS

CIRCLE 966 ON READER SERVICE CARD

### EMPLOYMENT SERVICE

Southeast/Nationwide EEs. Send resume Tech Div. Brodeur Personnel Services Inc. 3947 Blvd Center Dr. Jax., Fla. 32207.

### — RATES —

**DISPLAYED:** The advertising rate is \$79.00 per inch for all advertising appearing on other than a contract basis. Contract rates quoted on request.

An advertising inch is measured 7/8" vertically on a column—3 columns—30 inches to a page.

**UNDISPLAYED:** \$3.60 per line, minimum 3 lines. To figure advance payment count 5 average words as a line. Box numbers—count as 1 line.

Discount of 10% if full payment is made in advance for 4 consecutive insertions.

Not subject to Agency Commission.

Send new ads to:

### ELECTRONICS

Class. Adv. Div., P.O. Box 12, N.Y., N.Y. 10036

## SEARCHLIGHT SECTION

### ELECTRON TUBES

KLYSTRONS • ATR & TR • MAGNETRONS  
 SUBMINIATURES • C.B.T. • T.W.T. • 5000-  
 6000 SERIES  
 • SEND FOR NEW CATALOG A2 •  
**A & A ELECTRONICS CORP.**  
 1063 PERRY ANNEX  
 WHITTIER, CALIF.  
 696-7544

CIRCLE 968 ON READER SERVICE CARD

### WELDING HAND TOOL

TW 17 A  
 \$48.00

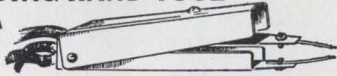

Replaceable Tips—Adjustable Pressure  
 AC and Stored Energy Power Supplies

### EWALD Instruments Corporation

Kent, Conn. 06757

CIRCLE 969 ON READER SERVICE CARD

### Minifluid DISPENSER

for miniature potting  
 and encapsulating

Available in 3 sizes  
 6cc - 12cc - 30cc



\$34.00

**PHILIP FISHMAN COMPANY**  
 7 CAMERON ST., WELLESLEY, MASSACHUSETTS 02181

CIRCLE 970 ON READER SERVICE CARD

### 2-AXIS POSITIONING TABLE

Manual precision indexing for testing gyros, accelerometers, etc. 14" dia. platen, capacity 100 lbs. Table drive, 1° per rev., 15 sec. readout. Tilt drive, 4° per rev., 15 sec. readout

Also available: rate drive model with torque motor, slip rings and brushes (including electronics).

**R. D. MAXWELL CO.**  
 Winchester, Mass. 01890  
 617-729-5490

CIRCLE 974 ON READER SERVICE CARD

### AUTOTRACK MOUNT

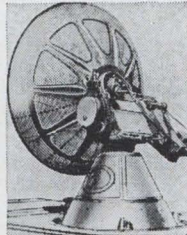

360 degree azimuth, 210 degree elevation sweep with better than 1 mil. accuracy. Missile velocity acceleration and slewing rates. Amplidyne and servo control. Will handle up to 20 ft. dish. Supplied complete with control chassis. In stock—immediate delivery. Used world over by NASA. USAF. MP-61-B. Type SCR-584. Nike Ajax mounts also in stock.

### PULSE MODULATORS

#### MIT MODEL 9 PULSER 1 MW—HARD TUBE

Output 25kv 40 amp., 30kv 40 amp. max. Duty cy. .002. .25 to 2 microsec. Also 5 to 5 microsec. and .1 to .5 microsec. Uses 6C21. Input 115v 60 cycle AC. Mfg. GE. Complete with driver and high voltage power supply. Ref: MIT Rad Lab. Series, Vol. 5, p. 152.

#### 2 MEGAWATT PULSER

Output 30 kv at 70 amp. Duty cycle .001. Rep rates. 1 microsec 600 pps. 1 or 2 msec 300 pps. Uses 5948 hydrogen thyratron. Input 120/208 VAC 60 cycle. Mfr. GE. Complete with high voltage power supply.

#### 250 KW HARD TUBE PULSER

Output 16 kv 16 amp. Duty cycle .002. Pulses can be coded. Uses 5D21, 715C or 4PR60A. Input 115 v 60 cy. AC \$1200 ea.

#### 18 MEGAWATT PULSER

Output 150KV at 120 amps. Rep rate: 50-500 PPS. Pulse length: 5 msec. 15KV 120 amp. into pulse transformer. Rise time 1.5 msec. Filament supply 5V 80 amp. incl. 17.5KV 1.5 amp DC power supply. Input 220V 60 cy AC.

#### INDICATOR CONSOLES

AN/SFA-4A. PPI 10", range to 300 ml.  
 VJ-1 PPI 12", Range to 200 ml.  
 VL-1 RHI 12" to 200 ml. 60K ft.

#### SCR 584 AUTOTRACK RADARS

Our 584s in like new condition ready to go, and in stock for immediate delivery. Ideal for telemetry research and development, missile tracking, satellite tracking. Fully Desc. MIT Rad. Lab. Series, Vol. 1, pps. 207-210, 228, 284-286. Comp. Inst. Bk available \$25.00 each.



## Radio-Research Instrument Co.

45 W. 45th St., New York, N.Y. 10036 • 212-586-4691

CIRCLE 967 ON READER SERVICE CARD

### ANTI-AIRCRAFT GUN MOUNT

Will handle 6,000 lbs. rapid slew through 360° azimuth, 180° elevation. Mobile.

### MICROWAVE SYSTEMS

#### 200-2400 mc. RF PKG

Continuous coverage, 30 Watts Cw nominal output. Uses 2C39A. Price \$575.

#### L BAND RF PKG.

20 KW peak 990 to 1040 MC. Pulse width .7 to 1.2 micro sec. Rep. rate 180 to 420 pps. Input 115 vac incl. Receiver \$1200.

#### 200-225 mc RADAR SYSTEM

1 Megawatt output 200 nautical mile range for long range detection of medium and high altitude jet aircraft as well as general search. AN/TPS 28.

#### SURVEILLANCE DRONE RADAR SYSTEM

X-Band tracking system with plotting boards. Type AN/MPQ-29. Drone also in stock.

#### 5 MEGAWATT C-BAND

Klystron RF package delivering nominal 5 megawatt pulse RF. Complete with pulser and power supply.

#### 500 KW L BAND RADAR

500 kw 1220-1359 msc. 160 nautical mile search range P.R.I. and A scopes. MTTI. thyratron mod 5J26 magnetron. Complete system.

#### AN/GPG-1 SKY-SWEEP TRACKER

3 cm. automatic tracking radar system. Complete package with indicator system. Full target acquisition and automatic tracking. Input 115 volts 60 cycle. New. In stock for immediate delivery. Entire System 6' long, 3' wide, 10' high. Ideal for Infrared Tracker, Drone Tracker, Missile Tracker, R. & D.

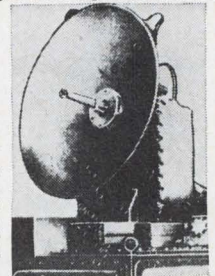

#### C Band Autotrack

1 Megawatt 10 ft. Parabola. Sperry.

#### 40 KW TRANSMITTER

4 to 21 MHz. 40 kw Telegraphy, 30 kw Voice, can be SSB. New condition. Two systems in stock. Excellent rf source, broadcast or point-to-point.



Meet Datapoint.  
It's 20 times faster  
than other multipoint recorders.  
And infinitely more versatile.

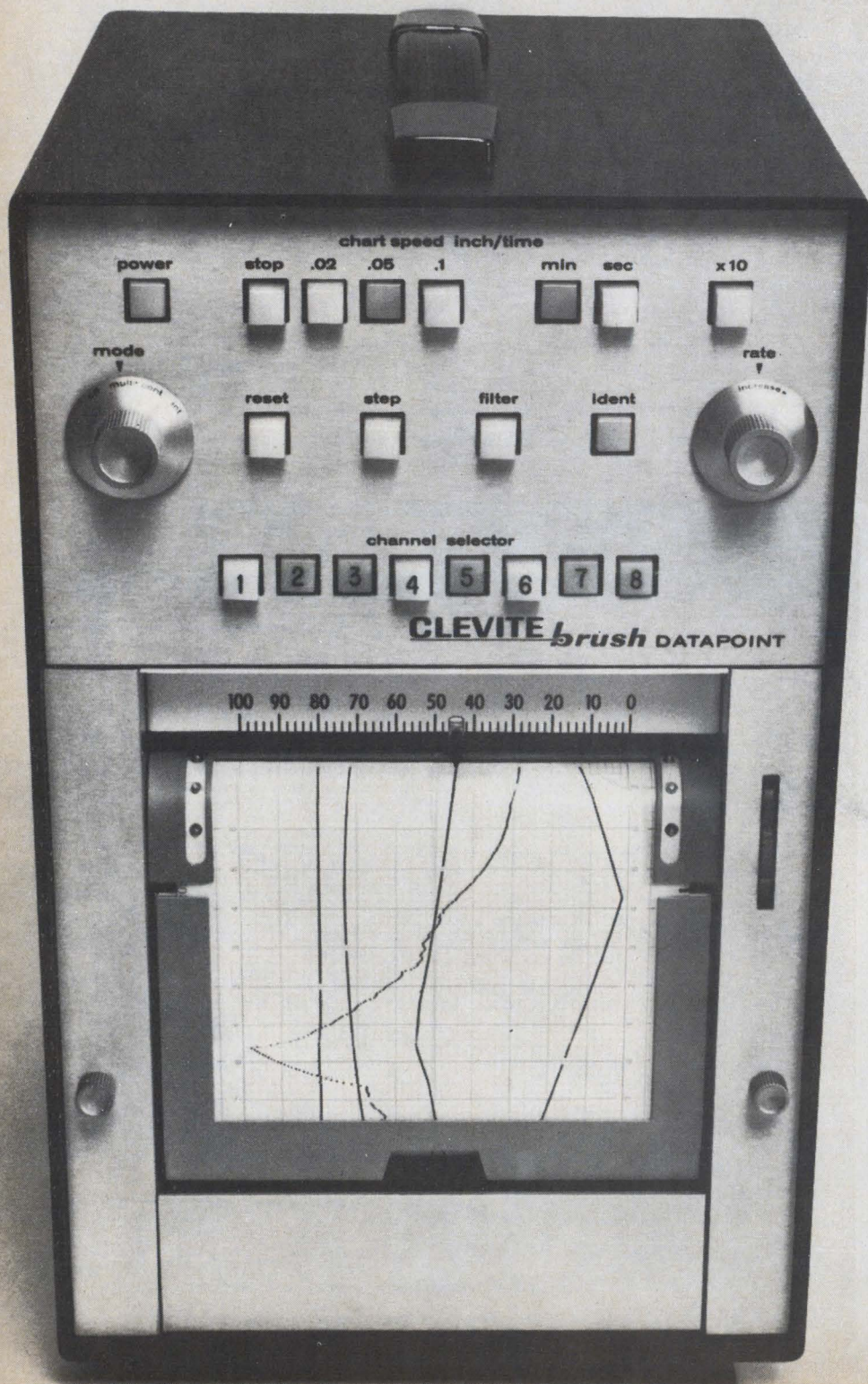

This new high-speed multipoint recorder by Brush runs off as many as 20 samples per second on 2 to 8 channels. So it's great for monitoring fast-changing variables in temperature, flow, pressure, strain, chemical processes, displacement dynamics and the like.



Datapoint handles mixed inputs from high and low level inputs. All on one chart. Recordings come out clear, crisp, uncluttered. And Z-folded. You've got a choice of 12 chart speeds, pushbutton controlled.

About that versatility. Datapoint works in three modes: multipoint sampling, intensified sampling, for channels of high dynamic content, or continuous single channel recording. So you get much more than just a fast multipoint recorder. Without paying more to get it.

And Datapoint is accurate, too. A full 99.5%, enforced by a non-contact position-feedback system. It's a first in this type of recorder. (But a proven success in countless Brush direct writing oscillographs.)

Speed. Versatility. Accuracy. These make Datapoint a new concept in recording. There's never been anything like it. You'll find more proof in the Datapoint brochure. Send for your copy today. Clevite Corporation, Brush Instruments Division, 37th and Perkins, Cleveland, Ohio 44114.

**CLEVITE BRUSH**



# International Newsletter

October 13, 1969

## British mini-computer makers gear up . . .

U.S.-owned companies that dominate the under-\$12,000 computer market in Britain—Honeywell, Hewlett-Packard and Digital Equipment Corp.—will face some unexpected competition from the natives next year. Although the big British computer manufacturers have shown no interest in this sector of the market, at least three new, small British companies plan to deliver during the first half of 1970 the initial models of machines costing less than \$12,000.

One firm, Arcturus Electronics Ltd., has government financial backing for a machine with four or eight accumulator processors and an 18-bit word store. It will sell in a four accumulator, 4-K store configuration for less than \$10,000; smaller versions will cost less than \$5,000.

Essex University engineers are producing an eight-bit machine selling for \$12,000 with 100-K disk store, and \$5,000 with 1-K of internal store. It uses single-byte instructions operating on multi-byte data, and incorporates microprogramming from a read-only store. The first production model will go to the Department of Health in January for on-line patient monitoring.

The third company, Micro-Consultants Ltd., analog-to-digital conversion specialists, will sell, for about \$7,000, a 16-bit 1-K machine aimed at process control.

## . . . to reach market ahead of Viatron

The market for small British machines as well as the reigning U.S. units may well be upset if Viatron Computer Systems Corp. succeeds in getting its planned 16-bit 4-K machine off the ground in the U.S. and then onto British market as projected in the fall of 1970 at \$5,800—half the price of the Honeywell 316 in Britain. Viatron is drawing crowds at the London Business Efficiency Exhibition with its prototype microprocessor with crt display which is priced at \$2,100 in 1,000-word memory form—less than one-third the price of the only directly comparable unit, the Italian Olivetti 521.

## Sescosem gets leg up in French IC market —with U.S. help

The secret's out: the French government's attempt to break the U.S. stranglehold on semiconductor sales may owe its success to American know-how. The only French-owned semiconductor maker, Sescosem—recipient of \$18 million in government aid—has quietly teamed up with America's National Semiconductor Corp. Under an agreement signed 18 months ago but never made public, Sescosem is importing complex integrated circuit chips diffused by National, and is assembling them in France. These American chips account for about 10% of Sescosem's IC production, due to reach 200,000 circuits a month by year-end, according to Sescosem president Olivier Garreta.

National also is helping the French firm project IC sales patterns in Europe one to two years from now, based on National's U.S. experience. In return, Sescosem expects to help National break into Europe, although details are still to be worked out. And Sescosem ultimately hopes to sell its components through National in the U.S.

Sescosem, a Thomson-Brandt subsidiary, began making IC's in January 1968; they already account for 40% of the firm's expected 1969 sales of \$35 million. One study gives Sescosem 18% of the French IC market, compared to 24% for the leader, Texas Instruments.



---

# International Newsletter

---

## **New postal service in West Germany: time sharing**

Postal officials have begun plumping for a massive program to make time-share computer services available to West Germany's small- and medium-sized companies. The plan calls for about half-a-dozen central computer installations to which firms would be linked by regular Post Office teleprinter or phone lines. Officials are confident that trials will start during the second half of 1970.

As a first step the Post Office, together with Siemens AG and AEG-Telefunken, has set up a new company to help push this scheme. Called Deutsche Datel GmbH (DDG), the firm will sell computer time on a rental basis. DDG also will offer firms programming and software packages for specific computer operations, advise them on terminal equipment and help support development of new terminal devices.

## **Philips bid for Sema-Metra threat to Plan Software**

Philips Gloeilampenfabrieken is negotiating for a 35% interest in France's largest software and management consulting firm, the Sema-Metra group. Leasco Data Processing Equipment Corp. tried to buy 20% of Sema last spring, but was blocked by the French government [*Electronics*, April 28, p. 155]. This time Sema officials say the government is giving the green light, so long as the partner is European.

Government support comes as a surprise, since this goes counter to talk of a French Plan Software to include Sema [*Electronics*, July 7, p. 182]. But, Sema, needs capital and is anxious to become more international. The firm is studying the feasibility of a European computer time-sharing system and now is negotiating with hardware makers. The network could be set up early next year, Sema officials say, and would compete directly with the General Electric Co.'s time-sharing operation in Europe.

## **British-made IC's bound for Japan**

The Plessey Co., which has found a regular market in the U.S. for its specialized communications linear integrated circuits, is probing the Japanese market. Plessey will appoint the Nichimen Co. of Osaka provisional agent for its IC's on a mutual trial basis until end of the year; a permanent arrangement is possible.

According to Plessey, Nichimen will push hardest on consumer IC's particularly color-tv devices. However, prices may not be competitive; hence the best sellers may turn out to be, as in the U.S., its logarithmic i-f amplifier and high-frequency communications amplifiers, for which Plessey claims a world lead in performance.

## **AGFA-Gevaert enters IC photoresist field**

Semiconductor producers soon will have a second major source for photoresist materials they need to turn out integrated circuits.

AGFA-Gevaert, the German-Belgian photochemicals combine, is field testing a negative-working resist for microcircuits: its resolution is unusually high and its pinhole density is very low. Unless the tests uncover a flaw, AGFA-Gevaert will start marketing the resist early next year. So far, Kodak has had this market—between \$2 million and \$4 million yearly—practically to itself.

AGFA already has on the European market similar, but lower resolution, resists for printed circuit production. And last spring, the company started selling in Europe and the U.S. photographic plates for IC fabrication. The plates have a resolution of better than 50,000 lines per inch, currently the upper limit for commercially available photo plates.



# Japanese take two steps forward in MOS-bipolar compatibility

One team at the government's Electrotechnical Laboratory use double-diffusion to make MOS FET's. The other, at Hitachi, uses alumina

**Using double-diffused** bipolar-transistor fabrication techniques, researchers at Japan's Electrotechnical Laboratory have succeeded in making microwave MOS FET's. What's more the technique is inherently self-aligning.

The team of Yasuo Tarui, Yutaka Hayashi, and Toshihiro Sekigawa are responsible for the advance. They previously collaborated on such significant developments as Schottky diodes in IC's [*Electronics*, Feb. 5, 1968, p. 209].

Two factors combine to limit the frequency capabilities of MOS transistors fabricated by present photolithographic techniques. First, the margin of accuracy inherent in the process makes it impossible to achieve channel lengths—distance between source and drain—of less than about 1 micron. Second, the depletion layer extends almost completely through the channel, shorting the source and drain for channel lengths below about 0.7 microns.

Tarui has long felt that MOS transistors have the potential for better high-frequency operation than bipolar units, because theory predicts that for same base width or channel length the cut off frequency of the MOS transistor is proportional to minority carrier diffusion velocity. This velocity is one or two orders of magnitude higher for an MOS transistor because of the drift-field provided by the source-to-drain voltage across the channel.

The process for making the new device, called DSA for diffusion self-aligning, yields MOS transistors with channel lengths equivalent to those of conventional high-frequency bipolar transistors. The

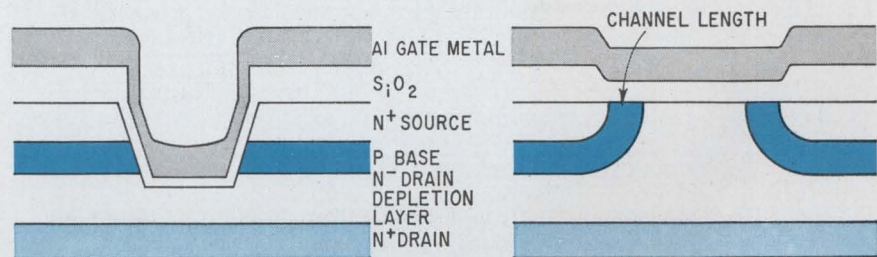

**One mask, two structures.** Japanese team have made both planar and nonplanar MOS transistors using double-diffusion fabrication techniques, instead of photolithography. Same masking system can be used as pattern for etching moats in nonplanar structure (left) or for under-mask diffusion in planar version of the device (right).

usual photolithographic procedure is replaced by a double diffusion process. The channel length is determined by the difference in depth of two diffusions, just as is base width in bipolar transistors. The difference can be controlled very precisely to obtain short channel lengths. If the wafer is an n<sup>+</sup> substrate with a thin n<sup>-</sup> epitaxial layer, the depletion layer will extend into the n<sup>-</sup> drain rather than into the channel, and a decrease in output resistance or punch-through will not occur even for submicron channel lengths.

**Planar or nonplanar.** Two types of geometry are possible. In the nonplanar version the device's geometry is oriented perpendicularly to the chip surface. The starting wafer is n<sup>+</sup> with an n<sup>-</sup> epitaxial layer about 2 microns thick. Lattice orientation is 1-0-0 to allow clearly defined moats to be etched.

Diffusion steps are similar to the base and emitter diffusions of a bipolar transistor, with separate masks for each. In experimental units, n<sup>+</sup> diffusion extends about 0.5 micron below the surface, while

the diffusion extends about 0.6 micron further into the chip. Separate leads can be brought out from the two regions. The n<sup>+</sup> lead is the source lead. The region lead, while functionally equivalent to the substrate lead in a standard MOS transistor, is similar geometrically to the base lead of a bipolar transistor.

Gate fabrication is started by etching a number of moats about 5 microns wide and 15 microns long into the region where it overlies the region. The moat's depth is sufficient to extend through the region but not through the n<sup>-</sup> region. Silicon dioxide of appropriate thickness is regrown over the sides and bottom of the moat, and metal is applied to form the gate electrode.

Since the n<sup>-</sup> drain is a depletion region the capacitance of the gate to the drain is small. And since the silicon dioxide coating over the source from previous diffusions is thick the capacitance of the gate to the source is small. Also, the short distance through the n<sup>-</sup> layer from the channel edge of the low-resistivity substrate source connec-



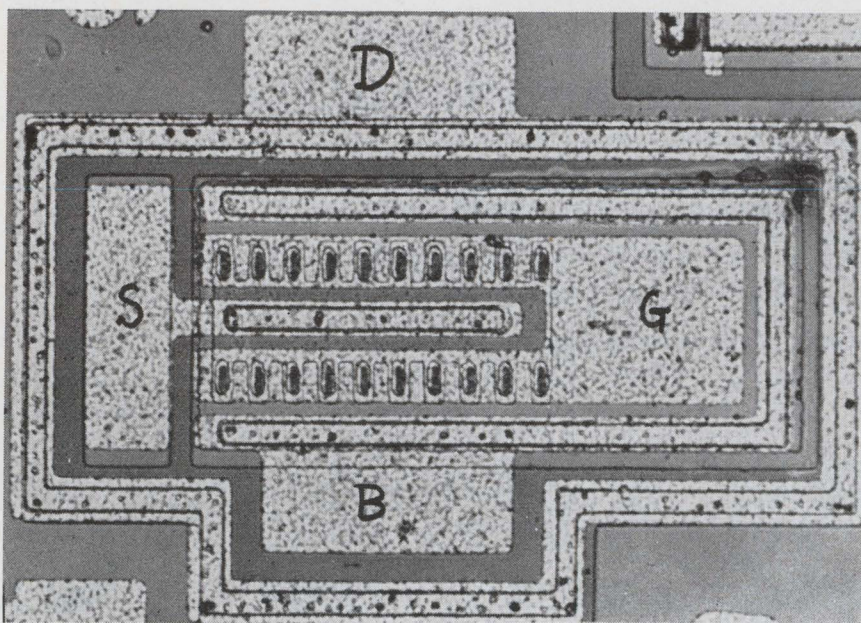

**Diffused MOS.** Non-planar geometry of microwave-frequency FET is one of two used by Japanese team to make transistor by bipolar-type diffusion. The rows of vertical slots are gate moats etched through the source, base and drain depletion layers, then covered with oxide and metal.

tion keeps the added parasitic resistance low. This structure is somewhat more difficult to fabricate than the planar structure also developed, but it promises to give the best characteristics when optimum performance is required.

**Planar.** The other geometry is planar, and is fabricated on an epitaxial substrate with a single mask. With the mask, which is a single rectangle of silicon dioxide at the center of the chip, impurities diffused vertically also diffuse laterally the same distance under the silicon dioxide. The transistor is completed by stripping off the oxide mask, regrowing a thin oxide layer over the surface, and then applying gate metalization.

The silicon dioxide naturally grows thicker over the high-impurity-density source region, cutting down on gate-to-source capacitance. Gate-to-drain capacitance is low because the region is a depletion region with all carriers swept out. The big disadvantage of this structure however, is that carriers must travel further through the  $n^-$  layer to reach the  $n^+$  substrate, which somewhat degrades high-frequency performance.

The group has not yet operated the DSA devices at gigahertz fre-

quencies, because they have not yet been able to obtain appropriate headers. Indeed, the first units were only fabricated within the past month. But, a cutoff frequency of about 6.8 Ghz is predicted from measurements of d-c forward transfer admittance and high-frequency measurements of capacitances.

### ... Alumina enhancement

Many's the time circuit designers would like to couple MOS and bipolar transistors in the same circuit, but trying to match threshold voltage and circuit polarity often makes this marriage incompatible. Bringing alumina to the rescue, researchers at Hitachi's Central Research Laboratory have come up with an IC fabrication technique that promises greater MOS-bipolar compatibility.

Shigeru Nishimatsu and Takashi Tokuyama use the alumina to fabricate n-channel transistors that operate in the enhancement mode. These devices differ from conventional MOS transistors in having a thinner layer of silicon dioxide over the channel, and in adding a layer of alumina between the silicon

dioxide over the gate and the aluminum gate metal.

Enhancement transistors have n-type source and drain, and the channel region under the gate normally is p-type with low impurity concentration. Enhancement-biasing the gate causes inversion of the channel to n-type silicon, which greatly reduces channel resistance and causes an increase in source-to-drain current of the field effect transistor.

In theory, n-channel transistors are preferable to the p-channel units commonly used because the carrier mobility in n-type silicon is about three times better—as are transistor frequency response, transconductance, and current. Thus, if a given requirement calls for p-channel units with channel lengths so short that yield is too small, more than sufficient speed and good yield could be obtained with n-channel units and slightly larger channel length. Or channel width could be decreased to obtain smaller units with the same current rating but higher frequency operation than p-channel units.

But in actual practice, the charge contained in the silicon-dioxide insulating layer between the gate and the channel causes inversion of the channel with no bias applied. Depletion bias on the gate will cause the inverted layer to become p-type, and thus n-channel transistors usually can be operated only in the depletion mode. This same inversion does not occur in p-channel transistors, and so, normally,

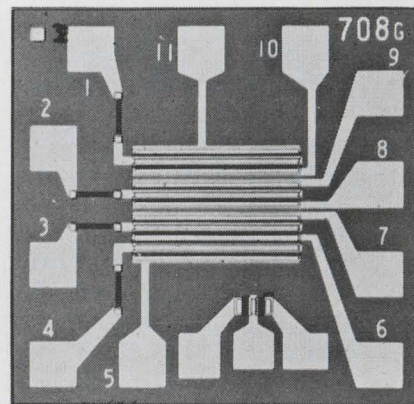

**Two oxides.** MOS approach uses alumina as well as silicon dioxide. Numbers ease microscope work.



enhancement transistors are p-channel type.

But when alumina is added over the silicon dioxide layer in the gate insulation, negative charges at the interface between the alumina and silicon dioxide cancel the effects that tend to invert p-silicon, opening the door to n-channel enhancement devices.

**Convenience.** Enhancement transistors are convenient to use in digital circuits. The zero input condition provides stable operation with no power supply drain, and the threshold voltage offers a noise margin against unwanted inputs. And in linear circuits biasing is easier for enhancement-type units.

Hitachi calls its new structure MAOS for metal/alumina oxide/silicon. Fabrication of the integrated circuit transistors using this process starts off in the same manner as for conventional MOS devices. Dopants are diffused through windows etched into the silicon dioxide layer to form source and drain regions in a 5 ohm-centimeter substrate. Then in regions overlying the channels the silicon dioxide is etched until the thickness is only about 800 angstroms, thinner than in conventional devices.

Next come two cycles of alumina deposition and etching. Deposition is done by pyrolytic decomposition of organo-oxaluminum compounds on wafers heated to about 450°C. The first deposition forms a 0.6-micron layer of alumina. Alumina is etched away over gate regions and where windows for making contact to sources and drains are required. This thick insulating layer greatly reduces capacitance of interconnection metal to substrate and also decreases parasitic effects where metal overlies other portions of the substrate.

The second alumina layer, 1500 angstroms thick, is deposited and etched away where contacts are required. This layer and the oxide form the gate insulation. Finally aluminum is deposited on the wafer and etched to the pattern required.

**Gateway.** Since the dielectric constant of the alumina is about six, the equivalent thickness of the insulating layer in terms of silicon dioxide is about 1800 angstrom

units. Experimental transistors have gate lengths of 10 microns, and gate widths of 450 microns. Threshold voltage is on the order of 1 volt.

Further improvements and life testing are under study. There are organic contaminants in the deposited alumina layer, but they evaporate during annealing. The alumina does provide protection from contamination by sodium ions.

## West Germany

### Breaking a log jam

Wind-tunnel tests help predict aircraft and missile performance, but nothing beats in-flight test to show how they actually do perform. But the instrumentation required often is too bulky to be carried aloft in anything but the larger test vehicles, making multiple flights necessary. And there are some cases—sounding rockets, for example—where it is impossible to get all the flight data needed because the vehicle is small and the exact flight pattern cannot be repeated.

What's more, to get data on air speed at specific air densities, acceleration, angle of attack, sideslip, spin rate and other variables, a number of individual sensors are used—pitot tubes, temperature probes, and other transducers—boosting test costs.

Faced with just those obstacles, engineers at Dornier GmbH, a large West German aircraft-maker with

substantial avionics interests, have developed a small airborne device that can monitor the physical quantities aerodynamicists need for determining flight behavior. Dornier's all-purpose instrument, called the Airlog, packs potentiometers, a photodiode and other electronic components into a missile-shaped assembly only 20 inches long and weighing less than 2 pounds.

An even smaller version, which Dornier calls its miniature Airlog, was developed specifically for testing small sounding rockets and military missiles. It is about 5 inches long and weighs only 50 grams. Since the device is aerodynamically styled and symmetrically mounted on the nose of the aircraft or missile, it has a negligible effect on the airflow around the vehicle. Although developed mainly for in-flight testing of aircraft and missiles, Airlogs can be used in wind-tunnel tests and for meteorological investigations for determining the magnitude and direction of airstreams. They are designed for speed ranges between 7 miles per hour and Mach 2.5.

**Jointed.** The Airlog, a cone-shaped body with a two-axis swivel joint at its center of gravity, aligns itself with the airstream for sensing true air vectors. A stabilizer ring at the tail end of the device keeps it aimed into the airstream. Attached to the airlog's nose is a small impeller, or airscrew, of known pitch, driven like a propeller as it passes through the air.

Mounted out in front of an airplane, the Airlog can measure with

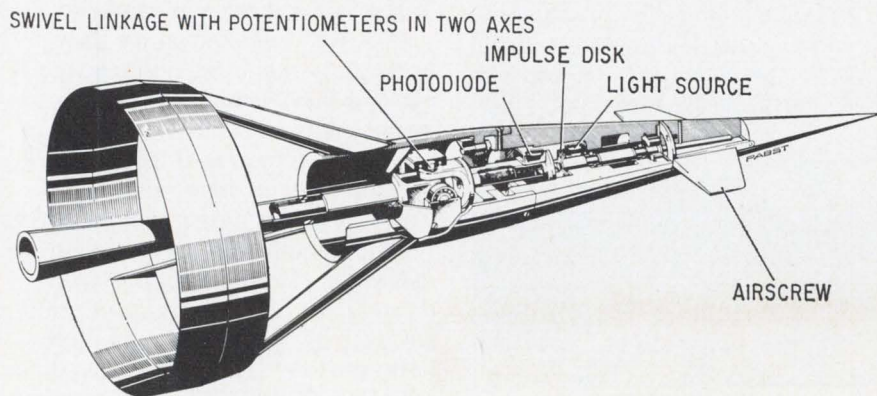

**Out in front.** Mounted on a boom extended ahead of an airplane, the Airlog is free to swivel. Potentiometers and airscrews deliver in-flight data.



accuracies that are far better than those obtained by ordinary means. The airspeed measurement, for example, is accurate to better than 0.4%. Conventional methods of determining airspeed use dynamic pressure sensors, which can be thrown off by changes in temperature and atmospheric pressure, and so results can be accurate only to roughly plus or minus 3%.

The Dornier Airlog has no such troubles—it derives airspeed from the number of revolutions of the impeller. A counting unit inside the aircraft simultaneously records both the number of revolutions and time, permitting digital or analog indication of true airspeed. The number of impeller revolutions is sensed by a torqueless pulse generator—a light source, a slotted disk and a photodiode. The slotted disk, spun by the impeller, rotates between the lamp and the photodiode, producing a train of up to 1,000 rectangular pulses per impeller revolution. Each pulse has an amplitude of 4 volts peak-to-peak. True airspeed is then determined inside the flight vehicle by counting these pulses against a fixed time interval. Acceleration in the direction of flight is obtained by time differen-

tial analysis of the number of pulses.

**Pitch and yaw.** The flight vehicle's angle of attack and amount of sideslip are detected by the Airlog's precision potentiometers which sense the direction the Airlog is pointing, compared with its longitudinal axis. Pitch and yaw data are similarly sensed. The potentiometers are wound at five turns per degree, yielding angular information to accuracies of 0.2°. The number of spin rotations and the rate of spin are also obtained from these potentiometers. They sense the relative movement between the Airlog and the vehicle itself.

An independent d-c power supply unit with a pulse amplifier, which can be mounted in the beam extending from the aircraft's nose, stabilizes outputs, despite fluctuations of the plane's regular airborne d-c supply system. During test operations the data from the Airlog generally is stored on magnetic tape, but it can be registered on plotters or cockpit displays inside the vehicle. Magnetic storage takes up the least bulk and allows the data to be digitally evaluated later.

### Sweden

#### Vikings, modern style

The old-time Vikings came to the Western Hemisphere and all they found were grapes. Now some Swedish descendents of the Vikings are coming back looking for a more substantial harvest—a slice of the U.S. electronics market.

AGA AB, well-known in Europe but not in the U.S., plans to grab more of the business by starting to manufacture in the U.S. rather than just selling imported gear. It already makes, in many parts of the world, a broad range of electronic products, including medical instrumentation, laser ranging systems, thermal imaging equipment, and navigational and radio communications devices. Until last year, AGA maintained only sales and service operations in the U.S.

Under the leadership of Alvar

Ohlsson, president of AGA, USA, the company has chosen to go the acquisition route instead of building facilities for manufacturing and research - and - development work from the ground up. Already it has bought a controlling interest in two U.S. firms, with others soon to follow, according to Ohlsson.

Its first acquisition—Boxtton-Beel Inc., a Brooklyn, N.Y. maker of precision optics—could well be the model for AGA's overall approach to the tricky business of building itself up in the U.S.

**Grubstake.** Until it was purchased last fall, Boxtton-Beel had been a small—about 100 employees—manufacturer of prisms and beam splitters. Almost all of its work was with glass. Under a five-year development plan AGA is increasing Boxtton-Beel's staff to around 600 and taking over an adjacent building for more room, as well as pushing the company into the electro-optics area. Now under development, for example, is a low-light-level television system, a logical step from the kind of work the company had done with gun sights and scopes, comments Ohlsson.

Boxtton-Beel is no stranger to military work. In fact, during the last three months it has won contracts to supply periscopes and daylight scopes for Army tanks.

Further, according to Ohlsson, besides looking forward to manufacturing AGA's existing product line in the U.S., Boxtton-Beel also will become a center for extensive R&D. "Not only does the U.S. represent half of the total market for so-called sophisticated electronic products, but it also has the most access to technological knowhow as well as a much larger work force," he says.

Last month AGA took another step toward establishing itself in the U.S. by acquiring control of Consolidated Airborne Systems Inc., an avionics firm in Carle Place, N.Y. Although Ohlsson hesitates to comment on Consolidated Airborne's eventual role in AGA's American plans, he indicates that the company's products are a natural tie-in with AGA's own line of radio communications and navigation products.

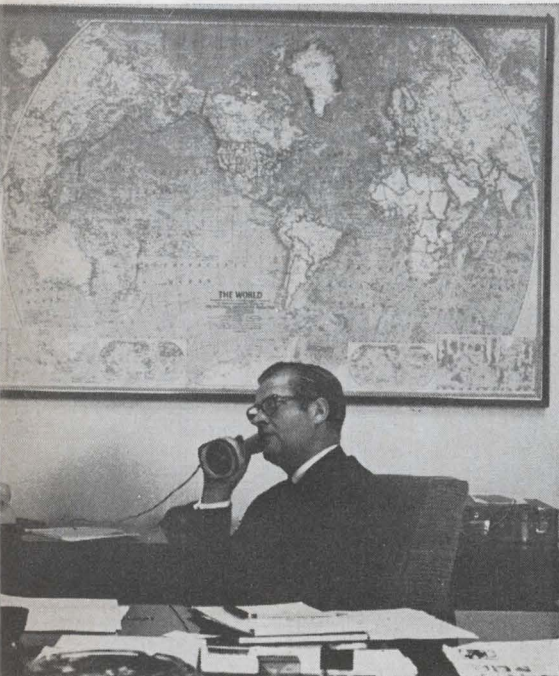

Far-flung. Alvar Ohlsson leads push to put U.S. on AGA's manufacturing map.



Airborne Instruments Laboratory Campbell-Mithun, Inc.	59	■ Dale Electronics, Inc. Sub. of Lionel Corp.	3rd Cover	□ Kennedy Co.	23E
Airpax Electronics, Inc. Tech Communicators, Inc.	5	Swanson, Sinkey, Ellis, Inc.		Kingsley Machine Co., Aero Space Div. Brown, Clark & Elkus, Inc.	194
Allen-Bradley Co. Fensholt Adv. Agcy.	25, 27	Data General Corp. Pearson Guy Weiss, Inc.	72, 73	Lenox-Fugle Electronics, Inc. Keyes, Martin & Co.	184
Allied Radio Corp. Marvin H. Frank Co.	197	Di-Acro Corp., Div. of Houdaille Industries, Inc.	124	Litton Industries, Data Systems Div. Lockheed Electronics Co.	190 138
American Optical Corp. Fuller & Smith & Ross, Inc.	112	■ Digitran Company, The Jansson Advertising, Inc.	118	□ LTT Promotion Vente Publicite	8E-9E
American Potash and Chemical Corp., Rare Earth Div. Sidney Clayton Assoc., Inc.	16	DuPont de Nemours Co., Teflon Div. Batten, Barton, Durstine & Osborn, Inc.	36	■ Magnetics Incorporated Lando Advertising Agency Inc.	131
American Telephone & Telegraph Co. Cunningham & Walsh, Inc.	142	■ Eagle Signal Division of Gulf & Western Co. Feeley & Wheeler, Inc.	57	■ Mallory & Co., P.R. Mfg. Division Aitkin-Kynett Company	192
■ Ammon Instruments, Inc. Culver Adv., Inc.	200	E G & G, Incorporated Culver Adv., Inc.	196	□ Marconi Instruments Ltd. Taylor Advertising Ltd.	18E
□ AMP Europe Allardyce Palmer Ltd.	3E, 4E	El Instruments, Inc. Froehlich Advertising Services	186	Markel & Sons, L. Frank George Moll Adv. Inc.	136-137
■ AMP, Inc. Garceau, Hallahan & McCullough, Inc.	28, 29	Elco Corp. Schaefer Advertising, Inc.	18, 19	Martin Marietta Corporation Redmond Marcus & Shure Inc.	51
Ancrona Corp./Neumuller and Co. Wilhelm Bacher Werbung	185	■ Electro Motive Mfg. Co., Inc. Culver Adv., Inc.	164	Masinexport Publicom Romanian International Publicity Agency	193
■ Ansley, Division of Thomas & Betts Corp. Richard L. Renner Industrial Adv.	104	Electro Products Laboratories, Inc., Transducer Div. Grant, Wright & Baker, Inc.	152	Mechanical Enterprises White Advertising Inc.	194
□ AOP Dumesnil Publicite	13E	Electronics and Control Engineers Book Club	139, 140, 141	■ Micro Switch Division of Honeywell N.W. Ayer & Son Inc.	30
Atec Incorporated Helm Associates, Inc.	157	Electronic Navigation Industries Hart-Conway Co., Inc.	195	Midtex/Aemco Chuck Ruhr Associates Advertising	49
Automatic Electric Co., Sub. of General Telephone & Electronics Corp. Marsteller, Inc.	38, 39	E/MC Electronics Management Center Ries Cappiello Colwell, Inc.	180	Miller-Stephenson Chemical Co. Inc. Michel-Cather Inc.	199
■ Babcock Relays Div. of Babcock Electronics Corp. Jansen Assoc., Inc.	213	E.M.I. Electronics Canada, Ltd. Greiner Harries Maclean, Ltd.	187	Minelco, a Subsidiary of General Time Alden Advertising Agency Inc.	174
Beckman Instruments, Inc., Electronic Instrument Div. Hixson & Jorgensen, Inc.	17	Epsilon Industries, Ltd. Rede Ward Assoc., Ltd.	194	Monsanto Company Michel-Cather Inc.	23
Behlman Engineering Corp. Alden Advertising of California, Inc.	50	Erie Technological Products Co., Inc. Walcker, Schmidt, & Mackall, Inc.	35	M & T Chemicals Inc. Marsteller Inc.	193
Belden Corporation Fensholt Advertising, Inc.	68, 69	□ ESC Electronics Corp. AC Incorporated	14E, 15E	□ Morgan Group, The Scientific Advertising & Marketing	11 E
Bell & Howell, Electronic Instrumentation Group-CEC/ Transducer Div. N.W. Ayer/Jorgensen/MacDonald, Inc.	154	Fairchild Semiconductor, Inc. Chiat/Day, Inc.	41, 214	Nashville Area Chamber of Commerce Noble-Dury & Associates Inc.	171
Bell Telephone Laboratories N.W. Ayer & Son, Inc.	47	□ Ferisol Agence Domenach	28E	National Semiconductor Corp. Hall Butler Blatherwick Inc.	10-11
Beta Instrument Corp. Hill, Holliday, Connors, Cosmopolos, Inc.	188	Gardner-Denver Co. Buchen Adv., Inc.	76, 77	■ Nortronics Company Inc., OEM Division Stral Advertising Company Inc.	125
■ Blue M. Electric Co. South Suburban Advertising	196	Gencom Division—Varian/EMI A. D. Adams Adv., Inc.	185	Patwin Electronics Graceman Advertising Inc.	184
Bolt Beranek and Newman Cochrane Chase & Co., Inc.	186	General Dynamics Corp. Young and Rubicam, Inc.	60, 61	□ Philco Ford Corporation Hal Lawrence Incorporated	24 E
Bourns, Inc., Trimpot Div. The Lester Co.	20, 21	General Electric Co., Analytical Measurement Business Section Robert S. Cragin, Inc.	134	□ Philips NV., Pit/TMI Division Marsteller International S. A.	2 E
Brand-Rex Creamer, Trowbridge, Case & Basford, Inc.	37	General Radio Co. Horton Church & Goff, Inc.	6	■ Plastic Capacitors Inc. Sander Rodkin Adv. Agency Ltd.	198
■ Brush Instruments, Div. of Clevite Co.p. Carr Liggett Adv., Inc.	204	Gordos Corporation Halloff & Caine Associates	197	Princeton Applied Research Corporation Mort Barish Associates Inc.	42
□ Burr-Brown Research Corp. N.A. Winter Adv. Agcy.	5E	Gries Reproducer Co. Harold Marshall Adv.	194	Radiation Inc. W.M. Zemp & Associates Inc.	9
■ Burroughs Corp., Electronic Components Div. Conti Adv. Agcy., Inc.	80	■ Guardian Electric Mfg. Co. K & A Advertising	75	Radio Corporation of America Al Paul Lefton Company	195
■ Bussmann Mfg. Div. of McGraw Edison Co. Henderson Adv. Co.	190, 191	■ Gudebrod Brothers Silk Co., Electronics Div. Ramsdell-Bickley & Co.	114	Raytheon Company, Components Division Fuller & Smith & Ross Inc.	48
Cartesian, Inc. Miller/Stoll Adv.	78	Hansen Manufacturing Co. Keller-Crescent Co.	212	■ Reeves Instrument Division Duncan Brooks Inc.	128
■ Cerro Copper & Brass, Co. Sykes Adv., Inc.	183	Hathaway Instruments, Inc. Waldie and Briggs, Inc.	189	Sage Electronics Corporation Mathison Adv., Inc.	162
■ Cherry Electrical Products Corp. K & A, Inc.	79	■ Heath Co., Sub of Schlumberger Ltd. Advance Advertising Service	127	San E Denki Company Ltd. Sanko Sha Adv. Agency Co. Ltd.	198
■ Cinch Manufacturing Co. Stral Adv. Co., Inc.	151	■ Hewlett Packard, Colorado Springs Div. Tallant/Yates Advertising, Inc.	2	Scientific Data Systems Doyle Dane Bernbach Inc.	148
Clare & Co., C.P. Reincke, Meyer & Finn Adv., Inc.	155	■ Hewlett Packard, Loveland Div. Tallant/Yates Advertising, Inc.	163	■ Semtech Corporation Buresch Advertising	53
■ Clevite Corp., Piezoelectric Div. Carr Liggett Adv., Inc.	197	■ Hewlett Packard, Mount View Div. Lennen & Newell, Inc.	145	□ Sercel Termont Technique	10 E
■ CML Division of Tenny Engineering Co. Keyes, Martin & Co.	132	■ Hewlett Packard, New Jersey Div. McCarthy, Scelba and DiBiasi Adv. Agcy., Inc.	1, 183	□ Sescosem □ Sfernice Publicitor	17 E 16 E
Cohu Electronics, Inc. Colorado Video, Inc. Wolff & Weir	168 188	■ Hewlett Packard, Palo Alto Div. Lennen & Newell, Inc.	113	□ SGS Lansdale Italia S. P. A.	7-E
■ Computer Products, Inc. Grenman Assoc., Inc.	56	■ Honeywell, Test Instruments Div. Cambell Mithun, Inc.	117	Sierra Research Corporation B.P. Myer Associates Inc.	52
Computer Signal Processors, Inc. L.K. Frank Co., Inc.	115	Honeywell-Florida Bradley Yeager & Associates, Inc.	146	Signetics Corporation Sub. of Corning Glass Works Cunningham & Walsh Inc.	111
Computer Test Corp. Industrial Public Relations, Inc.	182	Howard Industries, Inc. K & A, Inc. Advertising	40	□ Silec Electronique Publicite Y Ch. Lambert	27 E
Connecticut Hard Rubber Co. Chirurg & Cairns, Inc.	24	Hughes Aircraft Co. Foote, Cone & Belding	15, 181	Siliconix Inc. Robertson West Inc.	7
Control Data Corp. Connector Operation Barnes-Champ/Advertising	14	■ IBM-Federal Systems Div. Marsteller, Inc.	167	Singer Company, Instrumentation Division Technical Industrial & Scientific Marketing Inc.	173
Control Products Division Consolidated Electrodynamics Corp., a Bell & Howell Co. Porter & Mills Advertising	172	■ Indiana General Corp. Griswold-shleman	62, 63	■ Sorensen Operation Raytheon Company S.P. Electronica	67 20E-21E
□ C.R.C. IRP	22E	□ Ina. C. Olivetti & C. Spa. Studio Giuliano Blei	6E	Studio Sergio Rosata Sperry Rand Corporation, Sperry Microwave Electronics Division Neals & Hickok Inc.	64
CREI, Home Study Division of the McGraw-Hill Book Co. Henry J. Kaufman & Associates	147	■ International Crystal Mfg. Co. Robert V. Freeland & Associates	170	Sprague Electric Company, The Harry P. Bridge Company	32
■ CTS Corporation Reincke, Meyer & Finn, Inc.	101	International Electronic Research Corp. Van Der Boom, McCarron, Inc. Adv.	116	■ Standard Condenser Corporation R.N. Johnson Advertising	150
		ITT Wire and Cable MacManus, John & Adams, Inc.	74	■ Superior Electric Co. K.C. Shenton Company	161
		■ J F D Electronics Co., Components Div. Delphi Advertising, Inc.	176	Sweet's Industrial Information Systems J.J. Lane Inc.	70-71
		Kay Electric Co. Josephson, Cuffari & Co.	135		
		Keithley Instruments, Inc. Bayless-Kerr Co.	166		



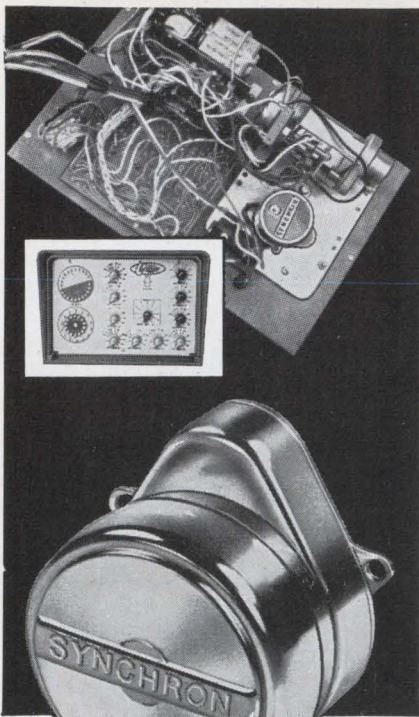

## HOW SYNCHRON® MOTORS control this specialized TIME-DELAY RELAY

In this special design timer a Hansen SYNCHRON Motor drives the cam-type sequence timer for an electronic time-delay relay. When power is applied, SYNCHRON runs through the first three sequences; starts the time-delay relay, then stops. Relay performs a panel-adjustable delay period of 180-240 seconds, then returns power to the motor to complete the sequence. Special applications are easy to design, using SYNCHRON Motors. How about yours? Call or write Hansen, or your SYNCHRON representative, for brochure and all the facts.

**SYNCHRON timing and control motors; 168 different speeds. Right, left or reversible rotations. 8, 20 or 30 oz.-in. torques; 220, 110 or 24 volts; 60, 50 or 25 cycles.**

## HANSEN

Manufacturing Co., Inc., Princeton, Ind. 47570

**HANSEN REPRESENTATIVES:** CAREY & ASSOCIATES, Houston and Dallas, Texas; R. S. HOPKINS CO., Sherman Oaks, Calif.; MELCHIOR ASSOCIATES, INC., San Carlos, Calif.; THE FROMM CO., Elmwood Park, Ill.; JOHN ORR ASSOCIATES, Grand Rapids, Mich.; H. C. JOHNSON AGENCY, INC., Rochester, N.Y.; WINSLOW ELECTRIC CO., Essex, Conn.; Villanova, Pa., and New York, N.Y.

**EXPORT DEPARTMENT:** 2200 Shames Drive, Westbury, N.Y. 11590

Sylvania Electric Products Inc. Electronic Components Group Doyle Dane Bernbach Inc.	169
TA Manufacturing Corporation Bear Advertising Inc.	193
Ted Manufacturing Corp. Lane/Tavis/Pollard Inc.	200
■ Tektronix Inc.	119 to 122
Dawson, Turner & Jenkins Inc.	
Telonic Instruments Jansen Associates Inc.	117
Tempress Industries Inc. Hal Lawrence Inc.	156
Tenney Engineering Inc. Keyes Martin & Company	199
Testex Inc. Jerry Steimle & Co.	126
Tetra Corporation White, Herzog and Nee Inc.	192
Texas Industrial Commission The Pitluk Group	199
■ Texas Instruments Incorporated, Components Group	144
Albert Frank Guenther Law Inc.	
■ Tohoku Metal Industries Ltd. Hakuhodo Inc.	189
■ Transformer Electronics Company Wolff & Weir	187
Transitron Electronic Corporation Larcom Randall Advertising Inc.	178
Triplett Electrical Instrument Company Byer & Bowman Advertising	133
TRW Electronics	12-13
Fuller & Smith & Ross Inc.	
■ Tung-Sol Division, Wagner Electric Corporation Feeley & Wheeler Inc.	130
■ United Transformer Company, Division of TRW Inc.	2nd Cover
Fuller & Smith & Ross Inc.	
■ Unitrode Corporation Silton Brothers Inc.	54-55
□ U.S. Trade Ruder & Finn France S. A.	12 E
Utah Industrial Promotion Commission David W. Evans Associates	22
U-Tech, A Division of Industrial Physics and Electronics Co. Ross Clay Advertising	160
Varian Associates, Eimac Division Botsford, Constantine & McCarty Inc.	143
■ Varo Inc. Tracy-Locke Inc.	58
□ Watkins Johnson Company Williams C. Estler Advertising	25 E
Wems Inc. Nova Advertising	26
Zippertubing Company Edward S. Kellogg Company	198

### Classified & Employment Advertising

F.J. Eberle, Manager  
212-971-2557

**EMPLOYMENT OPPORTUNITIES** ... 201-203  
Atomic Personnel Inc. .... 203

**EQUIPMENT**  
(Used or Surplus New)  
For Sale

A&A Electronics Corp. .... 203  
Ewald Instrument ..... 203  
Fishman, Phillip Co. .... 203  
Radio Research Instrument Co. .... 203

■ For more information on complete product line see advertisement in the latest Electronics Buyer's Guide

□ Advertisers in Electronics International

### Electronics Buyers' Guide

George F. Werner, Associate Publisher  
[212] 971-2310

Robert M. Denmead,  
Midwest Regional Manager  
[312] MO 4-5800

William A. Capuzzi,  
New York, New England District Manager  
[212] 971-3793

Regina Hera, Directory Manager  
[212] 971-2544

Thomas M. Egan, Production Manager  
[212] 971-3140

Carol Gallagher,  
Assistant Production Manager [212] 971-2045

### Circulation Department

Isaaca Siegel, Manager [212] 971-6057

### Research Department

David Strassler, Manager [212] 971-6058

## Advertising Sales Staff

Dan McMillan III [212] 971-3468  
Associate Publisher

Wallis Clarke [212] 971-2187  
Advertising Sales Service Manager

Warren H. Gardner [215] LO 8-6161  
Eastern Advertising Sales Manager

Atlanta, Ga. 30309: Michael H. Miller, 1375  
Peachtree St., N.E.  
[404] 892-2868

Boston, Mass. 02116: William S. Hodgkinson  
McGraw-Hill Building, Copley Square  
[617] CO 2-1160

Cleveland, Ohio 44113: William J. Boyle, 55  
Public Square, [216] SU 1-7000

New York, N.Y. 10036  
500 Fifth Avenue

James R. Pierce [212] 971-3615  
John A. Garland [212] 971-3617

Michael J. Stoller [212] 971-3616

Philadelphia, Pa. 19103:

Jeffrey M. Preston  
Warren H. Gardner,  
6 Penn Center Plaza,  
[215] LO 8-6161

Pittsburgh, Pa. 15222: Jeffrey M. Preston,  
4 Gateway Center, [412] 391-1314

Rochester, N.Y. 14534: William J. Boyle,  
9 Greylock Ridge, Pittsford, N.Y.  
[716] 586-5040

Donald R. Furth [312] MO 4-5800  
Midwest Advertising Sales Manager

Chicago, Ill. 60611: Kenneth E. Nicklas  
Ralph Hanning 645 North Michigan Avenue,  
[312] MO 4-5800

Dallas, Texas 75201: Richard P. Poole, 1800  
Republic National Bank Tower,  
[214] RI 7-9721

Houston, Texas 77002: Robert Wallin,  
2270 Humble Bldg. [713] CA 4-8381

Detroit, Michigan 48226: Ralph Hanning,  
856 Penobscot Building  
[313] 962-1793

Minneapolis, Minn. 55402: 1104 Northstar  
Center [612] 332-7425

St. Louis, Mo. 63105: Kenneth E. Nicklas,  
The Clayton Tower, 7751 Carondelet Ave.  
[314] PA 5-7285

James T. Hauptli [415] DO 2-4600  
Western Advertising Sales Manager

Denver, Colo. 80202: David M. Watson,  
Tower Bldg., 1700 Broadway  
[303] 266-3863

Los Angeles, Calif. 90017: Ian C. Hill,  
Bradley K. Jones, 1125 W. 6th St.,  
[213] HU 2-5450

Portland, Ore. 97204: James T. Hauptli,  
Don Farris, 218 Mohawk Building,  
222 S.W. Morrison Street,  
Phone [503] 223-5118

San Francisco, Calif. 94111: James T. Hauptli,  
Don Farris, 255 California Street,  
[415] DO 2-4600

Pierre Braude Tel: 225 85 88: Paris

European Director

Paris: Denis Jacob  
88-90 Avenue Des Champs-Elysees, Paris 8

United Kingdom and Scandinavia

London: Oliver Ball, Tel: Hyde Park 1451  
34 Dover Street, London W1

Milan: Robert Saidel, Roberto Laureri Jr.  
1 via Baracchini Phone 86-90-656

Brussels: Denis Jacob  
27 Rue Ducale Tel: 136503

Frankfurt/Main: Hans Haller  
Elsa-Brandstroem Str. 2  
Phone 72 01 81

Geneva: Denis Jacob  
1 rue du Temple Phone: 31 95 60

Tokyo: McGraw-Hill  
Publications Overseas Corporation,  
Kasumigaseki Building 2-5, 3-chome,  
Kasumigaseki, Chiyoda-Ku, Tokyo, Japan  
[581] 9811

Osaka: Akihiko Kamesaka, McGraw-Hill  
Publications Overseas Corporation, Kondo  
Bldg., 163, Umegae-cho Kita-ku [362] 8771

Austrialias: Warren E. Ball, IPO Box 5106,  
Tokyo, Japan

### Business Department

Stephen R. Weiss, Manager  
[212] 971-2044

Thomas M. Egan,  
Production Manager [212] 971-3140

Maury D'Gongora,  
Assistant Production Manager [212] 971-2045

Dorothy Carmesin, Contracts and Billings  
[212] 971-2908

Frances Vallone, Reader Service Manager  
[212] 971-2865





ACTUAL SIZE

# RELAYS

## 1/6-Size Relay Model BR10

- Dry Circuit to 1 Amp.  DPDT
- Welded or Soldered  Universal Contacts  To MIL-R-5757

Babcock's Model BR10 1/6-size crystal can relay packs a lot of performance in a small package. Its unique universal contacts give you "non-stop" operation from dry circuit to 1 amp...one subminiature relay to meet all your requirements for high-density circuit-board applications—at no cost premium.

You'll find that this small, versatile, DPDT unit has everything. Designed to specification MIL-R-5757, it features rugged unitized construction for increased shock and vibration resistance. Both soldered or welded versions are offered. Regular and gold-plated plug-in, solder-hook, and long-lead terminal styles are available, in standard circuit-board grid pattern, with a range of mounting types.

The Model BR10 has a record of dependability, attested by its proven conformance to MIL-R-5757 and specified use in programs requiring operation under the most severe environmental extremes. Built-in reliability, outstanding performance, application flexibility...all assurances that your relay is *better because it's Babcock.*

**The Babcock Model BR10 relay has proven its reliability in a variety of aerospace and commercial avionics applications.** Its subminiature size makes it ideal for single and multi-relay circuit-board installations. In fact, a brace of four BR10's has been found to take less board space than a similar group TO-5 units. You get efficient high-density packaging, *plus* full 1-amp. capability.



**Need 2-amp. performance?** The Model BR10 will operate dependably at 2 amps. (28 VDC), through 100,000 operations, in the temperature range  $-65^{\circ}\text{C}$  to  $+125^{\circ}\text{C}$ . Contact our Applications Engineering Group for further details.

### SPECIFICATIONS

Contact Rating	.....1 amp. @ 28 VDC
Operate/Release Time	....3.5 ms., max.
Pull-In Power	.....100 mw
Bounce Time	.....2 ms., max.
Shock	.....50 g's (11 ms.)
Vibration	.....30 g's, 38-2000 Hz
Operating Temp.	.... $-65^{\circ}\text{C}$ to $+125^{\circ}\text{C}$
Life	.....100,000 operations, min.

Get complete information on the versatile, subminiature Model BR10 today...contact Babcock Electronics Corp., Relays Division, Subsidiary of Esterline Corp., 3501 Harbor Blvd., Costa Mesa, Calif. 92626. CALL COLLECT (714) 540-1234 or TWX 910-595-1517.

**Available off-The-Shelf from  
AVNET, POWELL or PDQ.**

Challenging opportunities now exist at Babcock for experienced relay-switch engineers.





# FAIRCHILD'S MICROWAVE TRANSISTORS (OSCILLATOR & AMPLIFIER TYPES)

## NOISE PERFORMANCE

Noise Figure (dB)	Frequency - MHz					
	450	1000	1500	2000	2500	3000
7						MT 2500
6					MT 2500	
5				MT 2500		
4			MT 2500			
3	MT 1061A	MT 2500				
2	MT 2115					
1.5	MT 2116					

## OSCILLATOR PERFORMANCE

Frequency (GHz)	Output Power					
	1W	.5W	250mW	100mW	50mW	25mW
.5	MT 1039	MT 1039	MT 1060A			
1.0	MT 1038A	MT 1039	MT 1060A			
1.5		MT 1038A	MT 1039	MT 1060A		
2.0			MT 1050	MT 3833	MT 3834	MT 3834
2.5				MT 1050	MT 1070	MT 1070
3.0				MT 1116	MT 1115	MT 1070
3.5				MT 4014	MT 1116	MT 1115
4.0				MT 4015	MT 4014	MT 1116
5.0						MT 4015

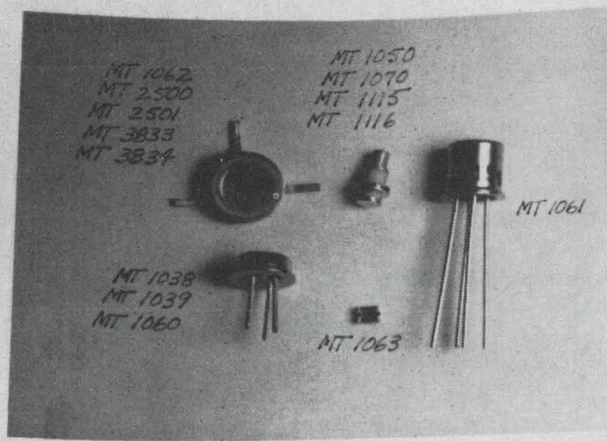
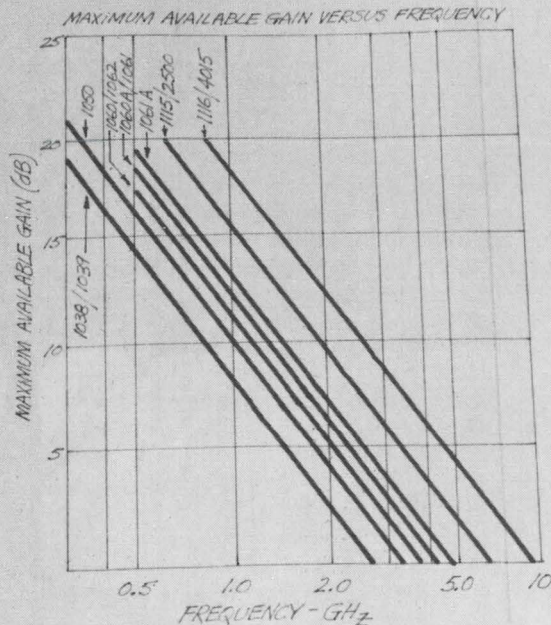

**NOTE:**  
 Cover range from 200 MHz - 5 GHz with over-laps. Often 3 choices. Check cost/performance trade-offs for specific applications.  
 - And use Fairchild's s-parameters (brochure attached)

If you've been taking notes, you know why the Fairchild family of microwave transistors can do more for your systems. You know that you can upgrade your ECM, telemetry or communication systems with the only microwave transistor in the industry that provides low noise and high gain at the same bias level. And that you can cut system costs and weight by using Fairchild transistors to build fundamental oscillators all the way up to 5GHz, eliminating bulky, expensive multipliers and filters. And that for any given application, the breadth of the Fairchild line often gives you three choices so you can make your own cost/performance trade-offs.

You also know that Fairchild devices are easier to use because they all come completely characterized by s-parameters across their full useful frequency range. So there's a

lot less tweaking of prototypes. And a lot fewer surprises in production.

If you don't happen to have your notes handy, we'll be glad to send you a new, up-dated set. You'll get detailed specs on all our amplifier transistors (400MHz to 2GHz) and our oscillator devices (500MHz to 5GHz). And we'll include our latest brochure, "Fairchild Microwave Transistors/S-Parameters."

If you've got the notes and now need hardware, just contact your local Fairchild distributor. He stocks the whole line.

Fairchild Microwave and Optoelectronics / A Division of Fairchild Camera and Instrument Corporation / 2513 Charleston Road, Mountain View, California 94040, Tel. (415) 961-1391 TWX: 910-379-6940





# Dale connector line grows with new SHP-40 modular style

Make sure you have Dale on your list of connector sources. Describe Dale's connector line as: "Small, but growing...able to supply volume quantities of all items in line...capable of meeting special design requirements."

Among the new models now being produced by Dale is the SHP-40. This NAFI design conforms to BUWEPS 63A49F100 and gives us a strong entry into the modular field. For a quick look at some of the popular models we can

supply, see below. Then make sure you have our new connector catalog. It lists complete details on these styles:

- PRINTED CIRCUIT • Direct card edgeboards as well as two-piece right angle and straight-thru types.
- TEST POINTS • Printed Circuit Jacks or Points
- RACK & PANEL (Rectangular)
  - Miniature, Subminiature and Microminiature
  - Shelled versions of Rack & Panel
- UMBILICAL • Missile & Avionics Models • Shorting Plugs
- NAFI • 40 pin

*Write today for your catalog. Phone 402-564-3131 for price & delivery information.*



**DALE ELECTRONICS, INC.** 1300 28th Ave., Columbus, Nebr. 68601  
 In Canada: Dale Electronics Canada, Ltd. • A subsidiary of The Lionel Corporation

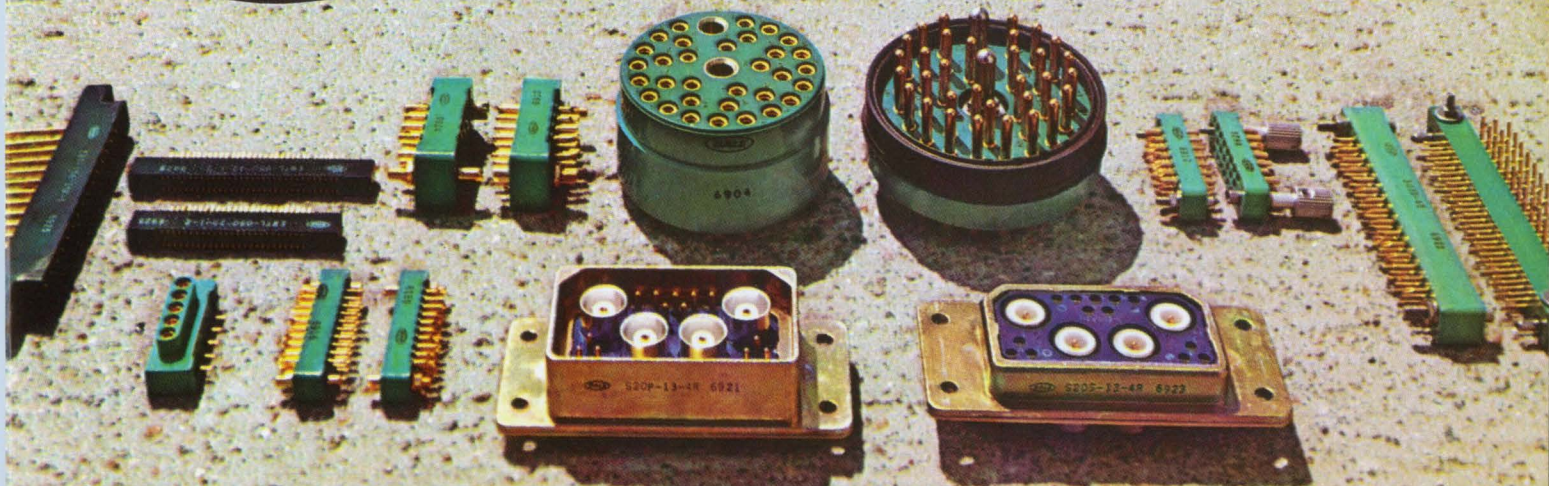



It's here NOW...from RCA

# The 98¢ Op Amp



**RCA**  
Integrated Circuits

Watch for it! Industry's First Monolithic Triple Integrated Operational Transconductance Amplifier

- 2 decades of operating current from 10  $\mu$ A to 1 mA
- Adjustable transconductance (100 mmho per mA of total amplifier current)

Now — more than ever — you can look to RCA for Op Amp economy. New levels of production now bring you RCA Op Amp performance at new low prices — across the entire line, starting with the CA3029 at 98¢ (1,000 units). Check your requirements against RCA's new Op Amp prices (1,000 units) shown at right . . . then see your local RCA Representative or your RCA Distributor. For specific circuit data, write RCA Electronic Components, Commercial Engineering, Section ICN-10-2 Harrison, N.J. 07029

Match these RCA Op Amps to your design needs						
	Low-noise Types and Economy Types			High-Gain, High-Power Types		
	$\pm 6$ -V types		$\pm 12$ -V types	$\pm 12$ -V types		$\pm 18$ -V types
Flat Pack (14-lead)	CA3008 \$3.90	CA3008A \$5.90	CA3016 \$5.40	CA3016A \$6.90		
TO-5 (12-lead)	CA3010 \$1.58	CA3010A \$2.90	CA3015 \$2.40	CA3015A \$3.90		
DIC (14-lead)	CA3037 \$1.90	CA3037A \$2.90	CA3038 \$2.90	CA3038A \$3.90	CA3033 \$2.90	CA3033A \$4.90
DIP (14-lead)	CA3029 \$ .98	CA3029A \$1.90	CA3030 \$1.58	CA3030A \$2.90	CA3047 \$1.58	CA3047A \$2.90
Open Loop Voltage Gain	60 dB typ.	60 dB typ.	70 dB typ.	70 dB typ.	90 dB (Diff) typ.	96 dB (Diff) typ.
CMR	94 dB typ.	94 dB typ.	103 dB typ.	103 dB typ.	100 dB typ.	108 dB typ.
Input Bias Current	12 $\mu$ A max.	4 $\mu$ A max.	24 $\mu$ A max.	6 $\mu$ A max.	350 nA max.	200 nA max.
Input Impedance	10 k $\Omega$ min.	15 k $\Omega$ min.	5 k $\Omega$ min.	7.5 k $\Omega$ min.	1.5 M $\Omega$ typ.	1 M $\Omega$ typ.
Noise Figure @ 1kHz	-----	12 dB max.	-----	16 dB max.	-----	-----
(all prices shown at 1000-unit level)						