

A McGraw-Hill Publication

**How RCA puts lasers  
and holograms to work  
for low-cost tv playback**

page 108

November 10, 1969

# Electronics<sup>®</sup>

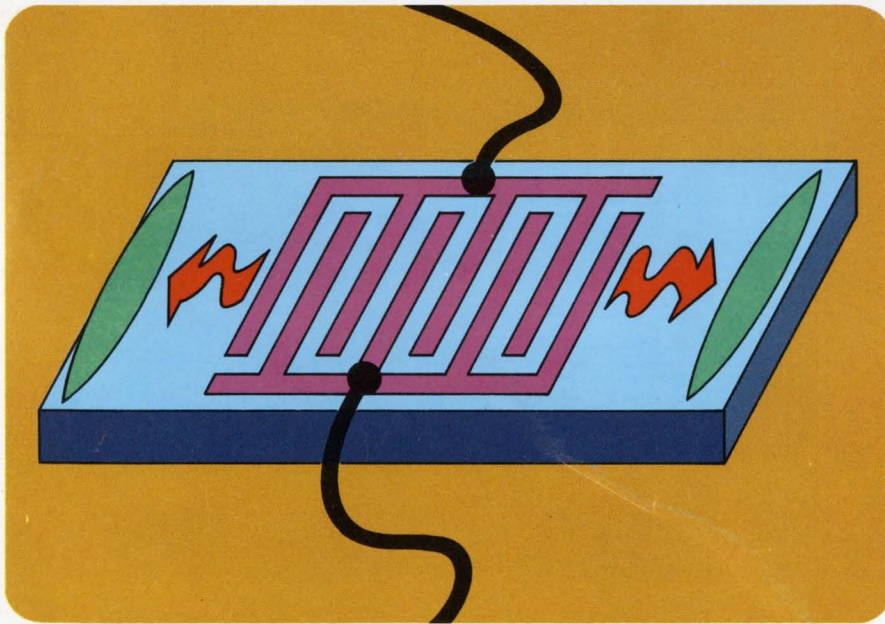

***What makes  
microwave  
acoustics  
attractive  
for signal  
processing***

page 94



**Why  
Supernova  
is  
faster**

page 114



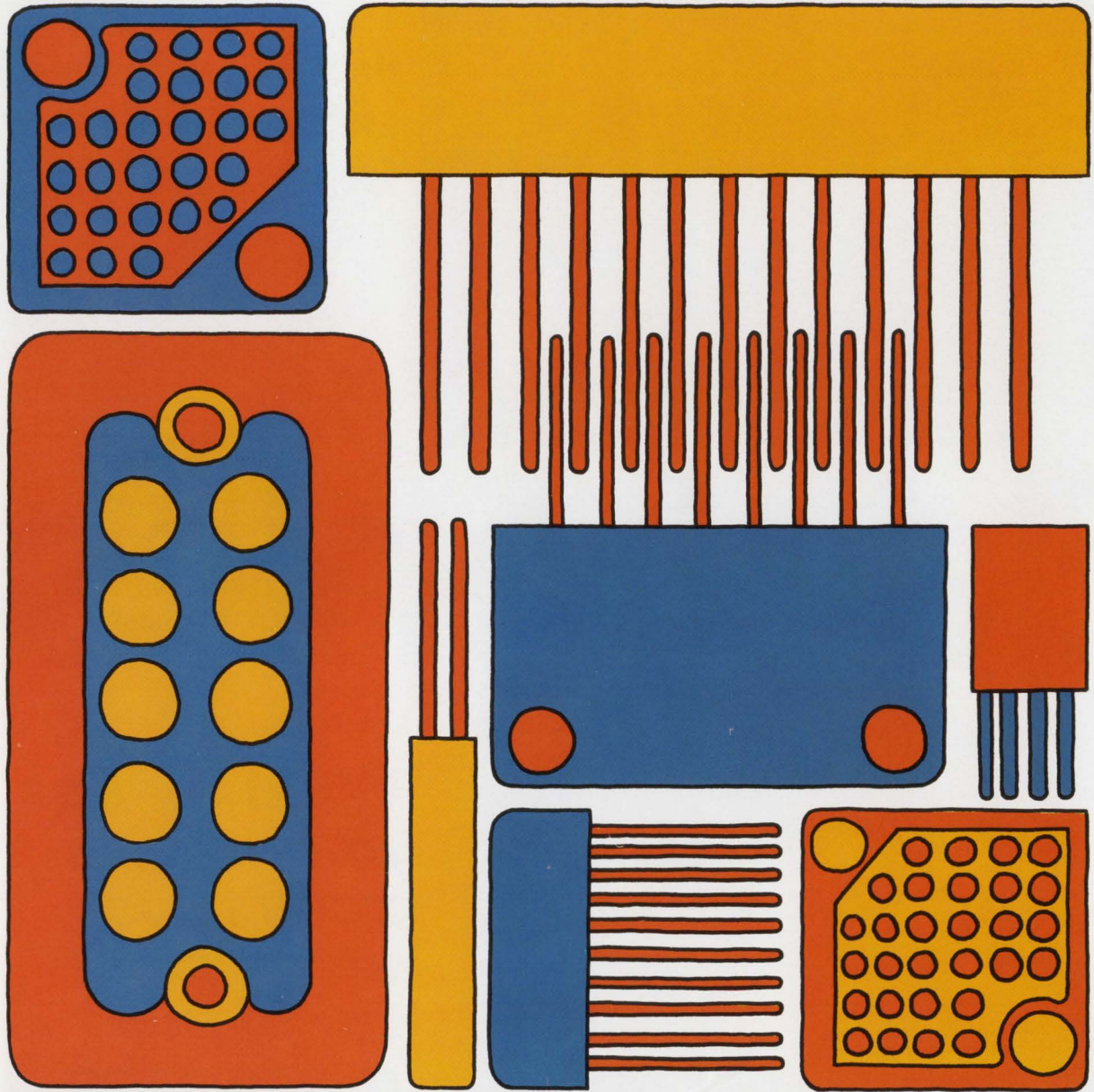

# Winchester Electronics

the long line that makes  
short work of today's problems

If you have any idea that Winchester Electronics specializes in just a special few connectors, forget it.

We make more than 31,000 different types of connectors—miniature, sub-miniature, hi-density, printed circuit. In the unlikely event you can't find just the one you need among these, say the word and we'll

make the odd ball you want. Faster than you ever thought possible—and in any quantity required, from ten to the hundreds of thousands!

Want to hear more about our capabilities in the connector field? Just write Winchester Electronics, Main Street and Hillside Ave., Oakville, Conn. 06779.



**WINCHESTER  
ELECTRONICS**

DIVISION OF LITTON INDUSTRIES

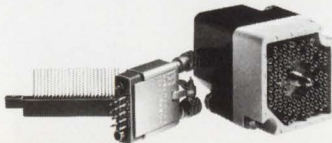

Circle 900 on Reader Service Card



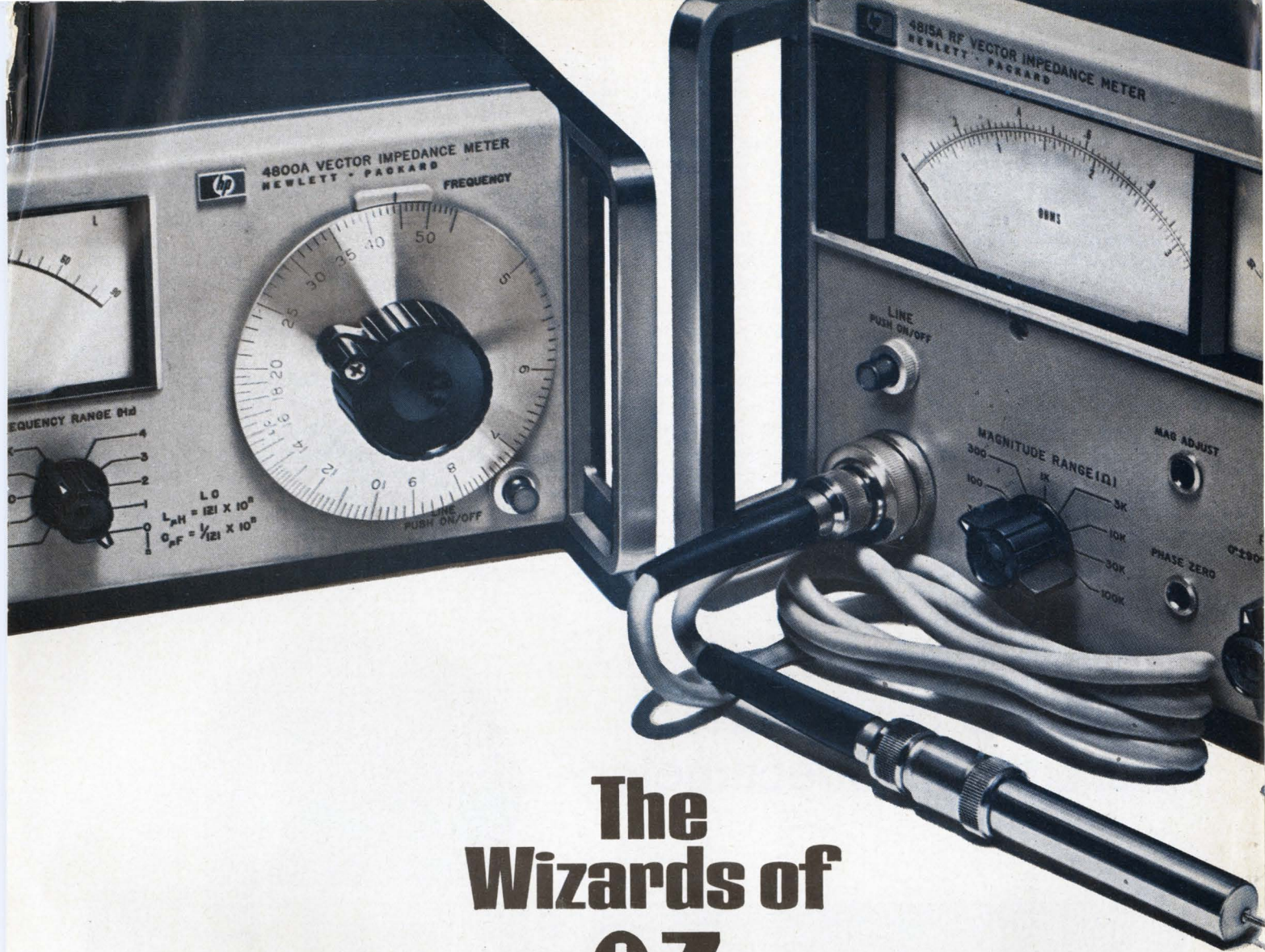

# The Wizards of $\theta Z$

**Like magic . . . vector impedance instruments read out complex impedance in an instant.**

With the HP impedance meters, measurements involving impedance magnitude,  $Z$ , and phase angle,  $\theta$ , no longer require tedious test procedures. These measurements are now as easy to make as voltage readings. No nulling . . . no balancing . . . no calculations to make. The wizardry of these HP instruments provides direct readout of  $Z$  (in ohms) and  $\theta$  (in degrees) over a continuous frequency range.

**HP 4800A Vector Impedance Meter** covers the 5 Hz to 500 kHz range. You set the frequency, select

the impedance range and read:  $Z$  from 1 ohm to 10 Megohms, and  $\theta$  from  $-90^\circ$  to  $+90^\circ$ . \$1650.

**HP 4815A RF Vector Impedance Meter** covers 500 kHz to 108 MHz. Measures, via a probe, active or passive circuits directly in their normal operating environment.  $Z$  from 1 ohm to 100 K ohms;  $\theta$  from  $0^\circ$  to  $360^\circ$ . \$2650.

Application Note 86 describes many applications of the 4800A and the 4815A Vector Impedance Meters including the measurement of  $Z$ ,  $R$ ,  $L$ , and  $C$ . For your copy and complete specifications, contact your local Hewlett-Packard field engineer or write: Hewlett-Packard, Green Pond Road, Rockaway, New Jersey 07866. In Europe: 1217 Meyrin-Geneva, Switzerland.

HEWLETT  PACKARD  
IMPEDANCE INSTRUMENTS

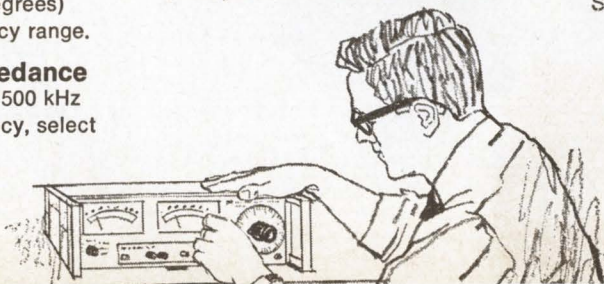



When accuracy is important — and noise, harmonic distortion, or non-sinusoidal wave shapes are a problem—a true rms responding voltmeter is the only answer.

With the HP 3450A digital multi-function meter you get **true rms** readings! The AC Voltage and AC Ratio (Option 001) makes the 3450A the only five-digit DVM available today with this capability. And you not only get **true rms** readings, but you get them from 45 Hz to 1 MHz on any of four ranges (1 V to 1000 V). When you add the midband accuracy of  $\pm 0.05\%$  you know that what you are reading or recording is the true value of the ac voltage you are measuring.

The same ac converter (Option 001) also provides true four-terminal ac ratio capability. Gives you the com-

plete isolation you need between X and Y inputs to make accurate ratio measurements between two ac voltages. Four ranges (1:1 to 1000:1) of true four-terminal ac ratio are provided. Option 001 gives the 3450A the capability to make fast, accurate ac readings for **all** the ac information you need.

And, true rms ac voltage measurement is only one face of the incredible dodecameter! The 3450A can also be used for dc and ohms—with ratio, limit tests and ratio limit tests. You get autoranging on all functions and there are options to provide remote control and rear input terminals.

The basic dc unit is integrating and fully guarded for excellent noise immunity. You can make 15 readings

per second with a sensitivity of  $1 \mu\text{V}$ . You start with this basic meter and add the capability that best fits your requirements. If your requirements change, any of the options (except the rear input terminals) can be easily installed in the field.

To get more information on how rms readings will improve the quality of your ac measurements or on any of the other options for the 3450—just call your local HP Field Engineer. Or, write Hewlett-Packard, Palo Alto, California 94304. Europe: 1217 Meyrin-Geneva, Switzerland.

Price: Basic 3450A, \$3150; AC Option 001, \$1250; Ohms Option 002, \$400; Limit Test Option 003, \$350; Digital Output Option 004, \$175; Remote Control Option 005, \$225; Rear Input Terminal Option 006, \$50.

## True rms readings! Just one face of the Incredible Dodecameter—

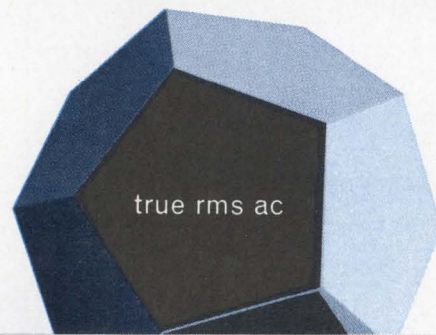

099/21

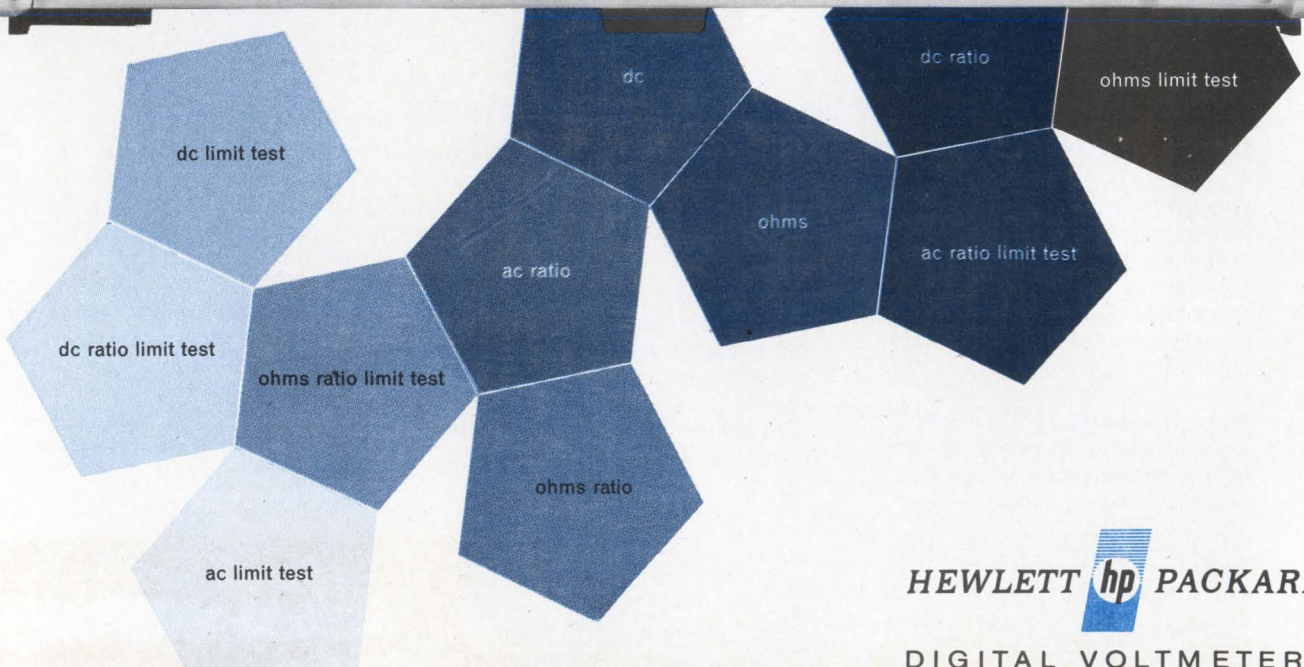
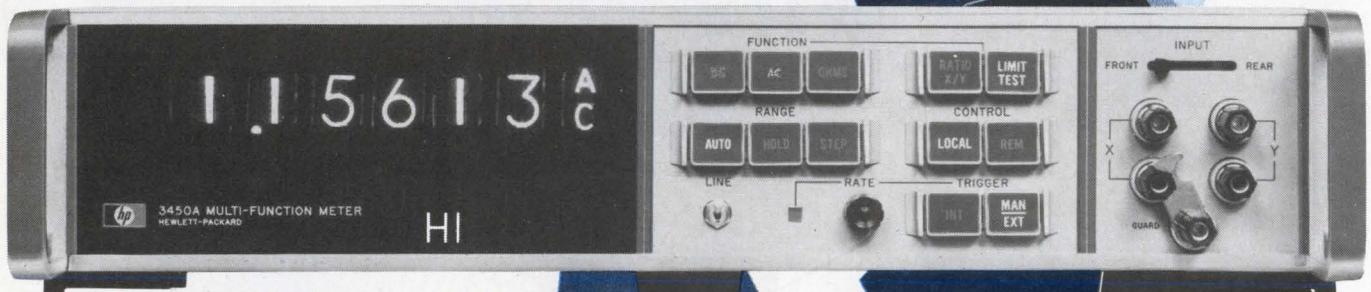

**HEWLETT  PACKARD**  
DIGITAL VOLTMETERS

Circle 2 on reader service card



## News Features

### Probing the News

- 145 **Subassemblies:** Users' choice is name of keyboard game  
153 **Navigation:** Omega, a global system or backup?

### U.S. Reports

- 51 **Communications:** Laird vs. Stans vs. frequency management; Tacsat 1 really works; the EIA talks broadband  
56 **Integrated electronics:** Schottky diode without a guard ring  
58 **Space electronics:** color tv for the sun; ERTS to fly with some electronics missing  
63 **Military electronics:** Raytheon awaits word on SAM-D funds  
66 **For the record**

### Electronics International

- 235 **West Germany:** Silicon is the target in new tv pickup tube  
236 **Japan:** Towards compatible video colorcoders—Matsushita magazine vs. Sony cassette  
237 **Japan:** An inexpensive route to direct digital control  
238 **France:** Solar power from CdT

### New Products

- 161 **Computer conference preview**  
161 Processor-display is self-cycling  
165 Modem on a card  
169 Rugged Nova dons uniform  
170 Kit provides acoustic terminal  
172 Data station adds and records  
177 **Components review**  
177 Two-gap head verifies data  
180 IC filter goes broadband  
184 2-pound battery delivers 100 amps  
186 **Microwave review**  
186 Modules put out 250-watt pulses  
190 Micrometer tunes coax attenuator  
193 **Data handling review**  
193 Small computer is expandable  
194 Computer prints directly on film  
198 Calculator is interruptible  
201 **Production equipment review**  
201 Optical IC printer loads manually  
205 **Industrial electronics review**  
205 Warehouse control system uses ICs

## Technical Articles

### Advanced technology 94

#### Tapping microwave acoustics for better signal processing

Surface waves traveling along miniature substrates can meet the signal processing needs of radar, navigation and communication systems  
J.H. Collins and P.J. Hagon, Autonetics

### Circuit design 104

#### Designer's casebook

- Optical isolation speeds digital data transmission
- Two-stage peak-holding circuit stores sub-microsecond pulses
- A simplified design approach for hysteresis circuits

### Consumer 108

#### 'Pressing' pictures on holographic tape is fast, inexpensive

Holograms, lasers and vinyl strips lend themselves to a mechanical process for copying visual material  
Owen Doyle, Electronics staff

### Computers 116

#### Making a minicomputer superfast

Supernova's 300-nsec cycle time stems from two big-machine features—instructions overlapping with execution and a read-only memory  
Lawrence Seligman, Data General Corp.

### Design aids 121

#### Universal graphs map direct route to mismatched pi and tee filters

Charts and nomographs provide practical insight to low-pass filter design.  
Robert B. Cowdell, General Steam Corp.

### Instrumentation 129

#### Know your d-a converter's capability

Differential amp with offset provides added gain and sensitivity to accurately measure d-a unit's settling time on an oscilloscope  
James J. Pastoriza, Pastoriza Electronics Inc., and David R. Weller, Bell Telephone Laboratories

## Departments

- |    |                          |     |                          |
|----|--------------------------|-----|--------------------------|
| 4  | Readers Comment          | 53  | Index to Activity        |
| 8  | Who's Who in this issue  | 75  | Washington Newsletter    |
| 14 | Who's Who in electronics | 208 | New Books                |
| 22 | Meetings                 | 212 | Technical Abstracts      |
| 31 | Editorial Comment        | 222 | New Literature           |
| 33 | Electronics Newsletter   | 233 | International Newsletter |



# Electronics

Editor-in-Chief: Donald Christiansen

## Senior staff editors

Technical: Stephen E. Scrupski

News: Robert Henkel

International: Arthur Erikson

Art director: Gerald Ferguson

Senior associate editors: Joseph Mittleman, Harry R. Karp

Assistant managing editors: H. Thomas Maguire, Howard Wolff,

William Bucci, Richard Gundlach, Frederick Corey

Special projects editor: Roger Kenneth Field; Senior staff writer: John Johnsrud

## Department editors

Advanced technology: Laurence Altman

Communications: Leon M. Magill

Computers: Wallace B. Riley, George Weiss

Design theory: Joseph Mittleman

Industrial electronics: Harry R. Karp

Instrumentation: Owen Doyle

Military/Aerospace: Alfred Rosenblatt

New products: William P. O'Brien

Solid state: George Watson, Stephen Wm. Fields

## Field bureaus

Boston: James Brinton, manager; Gail Farrell

Los Angeles: Lawrence Curran, manager; Ralph Selph

New York: Peter Schuyten

San Francisco: Stephen Wm. Fields

Washington: Ray Connolly, manager; Robert Westgate, Lois Vermillion

Bonn: John Gosch

London: Michael Payne

Paris: Arthur Erikson

Tokyo: Charles Cohen

Copy editors: Edward Flinn, William S. Weiss

Assistant art director: Charles Ciatto

Production editors: Susan Hurlburt, Arthur C. Miller

Editorial research: Virginia Mundt

Editorial secretaries: Lorraine Longo, Claire Goodlin, Barbara Razulis, Vickie Green, Bernice Pawlak

## McGraw-Hill News Service

Director: Arthur L. Moore; Atlanta: Fran Ridgway; Chicago: Robert E. Lee

Cleveland: Arthur Zimmerman; Dallas: Marvin Reid

Detroit: James Wargo; Houston: Barbara LaRoux

Los Angeles: Michael Murphy; San Francisco: Margaret Drossel, Tyler Marshall

Seattle: Ray Bloomberg; Washington: Charles Gardner, James Canan,

Herbert W. Cheshire, Seth Payne, Warren Burkett, William D. Hickman

## McGraw-Hill World News Service

Bonn: Robert Dorang; Brussels: James Smith; Hong Kong: Kate Mattock

London: John Shinn; Mexico City: Gerald Parkinson; Milan: Jack Star

Moscow: Jack Winkler; Paris: Robert E. Farrell, Stewart Toy

Tokyo: Marvin Petal

Reprints: Virginia Mundt

Circulation: Isaaca Siegel

Reader communications manager: John Drummond

Publisher: Gordon Jones

Associate Publisher: Dan McMillan

Assistant to the publisher: Wallace C. Carmichael

Electronics: November 10, 1969, Vol. 42, No. 23

Published every other Monday by McGraw-Hill, Inc. Founder: James H. McGraw 1860-1948. Publication office 99 North Broadway, Albany, N. Y. 12202; second class postage paid at Albany, N. Y. and additional mailing offices.

Executive, editorial, circulation and advertising addresses: Electronics, McGraw-Hill Building, 330 W. 42nd Street, New York, N. Y. 10036. Telephone (212) 971-3333. Teletype TWX, N.Y., 710-581-4235. Cable address: MCGRAW-HILL N.Y.

Subscriptions solicited only from those professionally engaged in electronics technology. Subscription rates: qualified subscribers in the United States and possessions and Canada, \$8.00 one year, \$12.00 two years, \$16.00 three years; all other countries \$25.00 one year. Non-qualified subscribers in the U.S. and possessions and Canada, \$25.00 one year; all other countries \$50.00. Air freight service to Japan \$50.00 one year. Single copies: United States and possessions and Canada, \$1.00; all other countries, \$1.75.

Officers of McGraw-Hill Publications Company: Joseph Allen, President; John R. Emery, J. Elton Tuohig, Senior Vice Presidents; Gordon L. Jones, Jr., Group Vice President; Vice Presidents: John R. Callahan, Editorial; Paul F. Cowie, Circulation; John M. Holden, Marketing; David G. Jensen, Manufacturing; Jerome D. Luntz, Planning & Development; Robert F. Marshall, Administration; Robert M. Wilhelmy, Finance.

Officers of the Corporation: Shelton Fisher, President and Chief Executive Officer; John L. McGraw, Chairman; Robert E. Slaughter, Executive Vice President; Daniel F. Crowley, Donald C. McGraw, Jr., Bayard E. Sawyer, Senior Vice Presidents; John J. Cooke, Vice President & Secretary; Gordon W. McKinley, Vice President & Treasurer.

Title registered in U.S. Patent Office: © Copyright 1969 by McGraw-Hill, Inc. All rights reserved. The contents of this publication may not be reproduced either in whole or in part without the consent of copyright owner.

Subscribers: The publisher, upon written request to our New York office from any subscriber, agrees to refund that part of the subscription price applying to copies not yet mailed. Please send change of address notices or complaints to Fulfillment Manager; subscription orders to Circulation Manager, Electronics at address below. Change of address notices should provide old as well as new address, including postal zip code number. If possible, attach address label from recent issue. Allow one month for change to become effective.

Postmaster: Please send form 3579 to Fulfillment Manager, Electronics, P.O. Box 430, Hightstown, New Jersey 08520

## Readers Comment

### Participation

To the Editor:

Concerning your article about Mil Std 883 [Aug. 18, p. 131], I would like to point out that participation in EIA engineering committees is open to all technically qualified members of the industry irrespective of membership in the association. It has always been EIA's policy to provide opportunity for the broadest representation of those companies having a significant interest in the activities of these committees.

J.A. Caffiaux

Engineering department manager  
Electronic Industries Association  
Washington

■ Edward Keonjian of Grumman says that the question hinges on the word "participation." Any organization—including NASA and the Defense Department—may send representatives to participate in EIA committee work. Nonmembers may also vote if they pay a \$50 fee per meeting. However, he says that the majority of nonmembers elect to act as observers and participate in discussions without voting.

### Historical perspective

To the Editor:

The article by Paul V. Wanek [Sept. 15, p. 119] omits some information that can put the technical material in better perspective. The general ideas expressed in the article—namely, the use of a notch filter in a feedback circuit to provide a selective circuit and, going one step further, to make this circuit into an oscillator—were described by Hermon H. Scott in 1937. And they are the subject of two patents assigned to the General Radio Co. The same material was also covered in a paper published that year in the Proceedings of the Institute of Radio Engineers.

The patents and the IRE paper were also the basis for numerous commercial instruments that included not only oscillators and sound analyzers manufactured by General Radio, but similar prod-



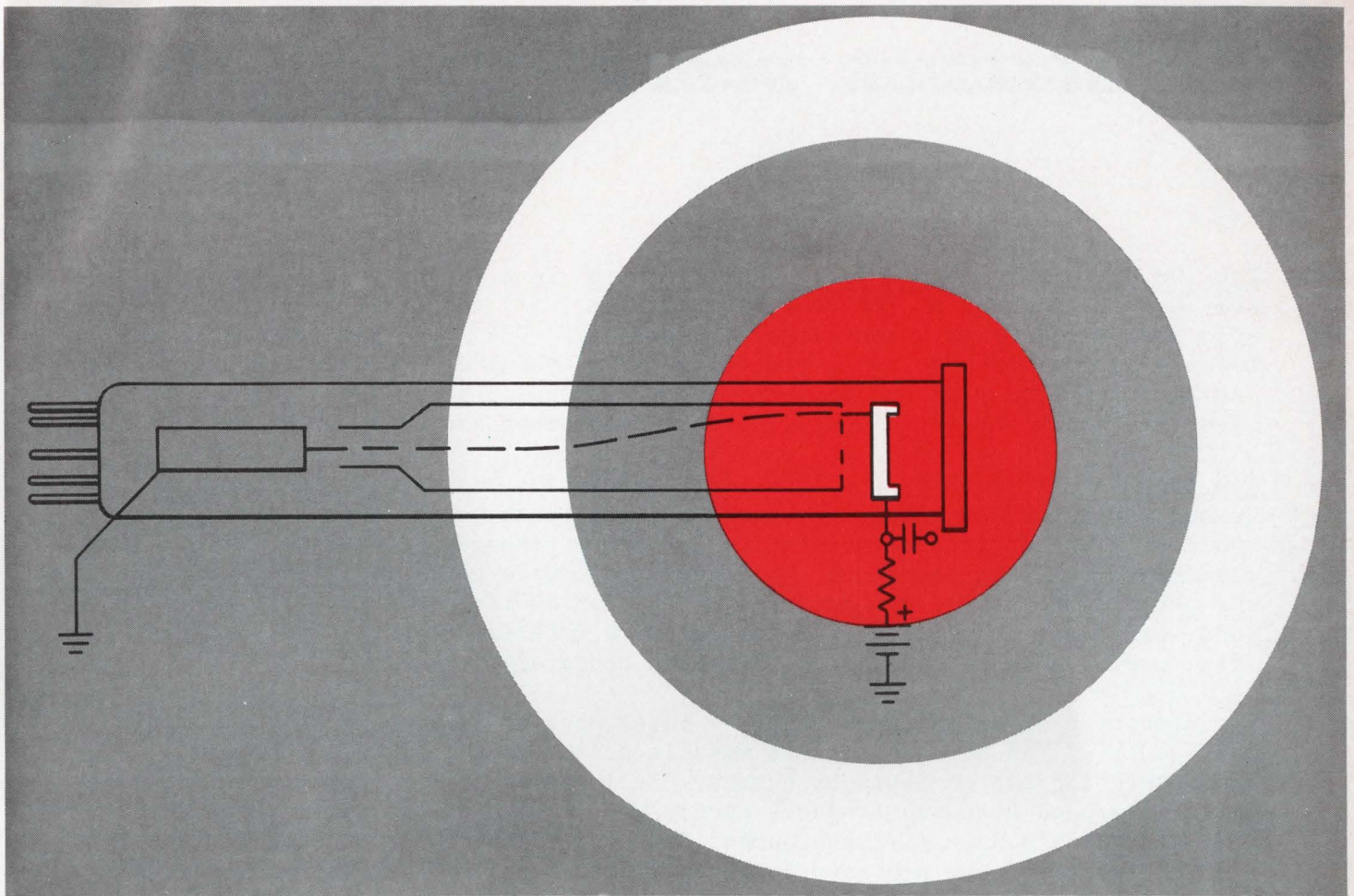

### A solid state target in a camera tube

Bell System PICTUREPHONE® service will need small, reliable TV camera tubes for use in offices and homes, where lighting ranges from dim to very bright. Conventional vidicon tubes are unsuitable, so Bell Labs developed a new kind.

The heart of the new tube is a light-sensitive target containing nearly 700,000 silicon photodiodes in an area less than a half inch square. They are made by diffusing boron, a p-type impurity, through a silicon-dioxide mask into n-type silicon.

A scanning electron beam charges the p material negatively, reverse-biasing the diodes. Holes, created by incident light, are collected by the electric field at the p-n junctions, and individual diodes discharge by an amount proportional to the local light intensity. Recharging of the diodes by the scanning electron beam produces a varying current ... the output signal.

Among the tube's advantages: Its target tolerates high-temperature baking ... a processing step to improve reliability. Conventional vidicon targets cannot stand this.

Silicon's high thermal conductivity and chemical stability help make the new tube immune to "burn-in" (degradation of performance from continuous exposure to a fixed image, very bright light, or

a strong scanning electron beam).

The time between a change in target illumination and a like change in output is much shorter with the new target. This improves response to fast-changing scenes.

The light-sensitive face of the new target is optically flat. So, a multi-layer antireflection coating can be applied for better sensitivity and minimum received-picture "halo"

Silicon targets have relatively uniform response through the visible and near-infrared—from 4,000 to 9,000 Å. Quantum efficiency (electrons per photon) exceeds 0.5. So, these targets have at least 10 times the sensitivity of a standard vidicon camera tube in incandescent light.

This new camera tube is in the latest model PICTUREPHONE set, now undergoing field trials.

**From the Research and Development Unit of the Bell System—**

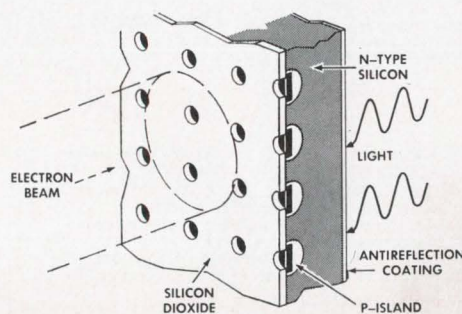

Bell Labs



# SCIENCE/SCOPE

The TOW anti-tank missile scored "ten for ten" in a recent test by the U.S. Army Missile Command at Redstone Arsenal, Ala. All ten missiles struck targets more than a mile away "with pinpoint accuracy." They were part of the first TOW production hardware delivered to the Army by Hughes. Wire-guided TOW, which can be fired from a ground emplacement or from helicopters and a variety of vehicles, can knock out field fortifications or destroy any known enemy armor.

Ion beam "sputtering" -- the life-limiting erosion that plagues designers of vacuum tubes and ion-propulsion engines -- has been turned into a precision tool for microelectronic fabrication by Hughes research scientists. Their ion-beam micromachining technique can remove and create patterns in any substance and permits the use of new materials. The ion beam's directionality makes it superior to wet chemical etches for removing material in very fine patterns (line widths down to 1/2-micron have been achieved).

The prototype of an advanced radar -- forerunner of what could be the world's most powerful for defense against missile attack in the 1970s and beyond -- is now undergoing system tests at Hughes. It is being built under a multi-million-dollar Advanced Research Projects Agency/U.S. Army contract administered by the U.S. Air Force's Rome Air Development Center. Though the prototype will be only 1/50 the power of the proposed long-range system called ADAR (for Advanced Design Array Radar), it will be the most powerful radar yet built by Hughes.

The first Phoenix missile system trainer, delivered recently to the U.S. Navy at the Pt. Mugu, Calif., Naval Missile Center, will be used to train missile control officers for the Navy's new F-14A fighter. The Hughes-built simulator eliminates costly, time-consuming in-flight training. Using computers, tapes, and displays, it simulates a complete mission profile, from target acquisition to lock-on and missile launch.

Hughes needs experienced engineers: Microcircuit, digital communication system analysis, computer systems, digital systems test, signal processing, circuit design, microwave solid state, radar systems. Also: real-time and weapon system programmers. A B.S. degree, two years of related experience, and U.S. citizenship are required. Please write: Mr. J. C. Cox, Hughes Aircraft Company, P.O. Box 90515, Los Angeles 90009. Hughes is an equal opportunity employer.

The U.S. Air Force's new Maverick missile passed its first air-launched test at Edwards AFB, Calif., recently -- just over a year after it went into development at Hughes. It was launched from an F-4, but is also designed for use on the A-7D and other aircraft. Mission of the air-to-ground Maverick is to attack small, hard, tactical targets, such as tanks and field fortifications. Automatic TV guidance will enable it to track its target after launch without further help from the launching aircraft.

*Creating a new world with electronics*

**HUGHES**

HUGHES AIRCRAFT COMPANY



## Readers Comment

ucts built by Hewlett-Packard and other licensees.

Victor H. Pomper

President,  
H.H. Scott Inc.  
Maynard, Mass.

### Added inputs

To the Editor:

Regarding your article on the IBM 360/195 [Sept. 1, p. 39], may I point out two additional significant operating features. The central processing unit of the 195, which operates at a 54-nanosecond cycle time, almost always will get data directly from the 54-nsec buffer memory, rather than from the 756-nsec main memory. Also, the central processing elements that operate in parallel have a high degree of overlapping, or concurrency: for example, the floating-point processing element alone can perform two additions and a multiplication concurrently.

R.W. DeSio

Director,  
High-performance systems  
International Business Machines  
Corp.  
White Plains, N.Y.

### From the start

To the Editor:

As a footnote to your article about the Army's Tactical Operations System [Sept. 1, p. 49], I would like to add that the TOS

effort was initiated in Stuttgart, Germany, in the latter part of 1964 as a joint Army/Bunker-Ramo Corp. project. Bunker-Ramo has been the prime system contractor—as opposed to the Control Data Corp.'s role as prime development contractor—since its inception (estimated \$15 million contracts to date) and has been responsible for problem definition, system design, implementation of all TOS software, total system integration, and system testing. Exercise Cardinal, held in Germany, represented the most recent in a long series of developmental steps which had led to the successful implementation of TOS by Bunker-Ramo.

R.J. Brousseau

Director,  
TOS operating system  
Bunker-Ramo Corp.  
Canoga Park, Calif.

### In the works

To the Editor:

In regard to your article [Oct. 13, p. 165], although the Cogar Corp. has applied to the IBM Corp. for patent licenses, they have not yet been issued. As a minor point, it should be also noted that the IBM solid-logic technology uses a metal can with a non-hermetic organic backseal whereas the Cogar packaging technique will employ plastic caps.

Robert M. Meade

Planning manager,  
Cogar Corp.  
Poughkeepsie, N.Y.

## Applications Power \*



# FET QUADS AS VCRs

**Problem:** Find technique for solid state control of quad attenuator or phase shift networks.

**Solution:** Siliconix VCR13N Quad FET; 5% tracking from 200–2K ohms.

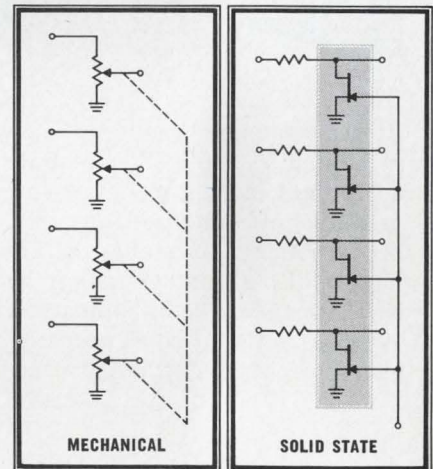

These quad VCRs are specially matched to give close tracking over the specified resistance range. Others: Single and dual voltage controlled resistors (VCR10N, VCR11N) for many applications such as multipliers, phase shift circuits, attenuators, feedback resistors in variable gain amplifiers or . . . what have you?

*For immediate applications assistance call the number below.*

**Siliconix**  
incorporated

2201 Laurelwood Rd. • Santa Clara, Calif. 95054  
(408) 246-8000 Ext. 201 • TWX: 910-338-0227

**\*Applications Power: A broad product line and a service-oriented applications team waiting to serve you!**

### SUBSCRIPTION SERVICE

Please include an Electronics Magazine address label to insure prompt service whenever you write us about your subscription.

Mail to: Fulfillment Manager  
Electronics  
P.O. Box 430  
Hightstown, N.J. 08520

To subscribe mail this form with your payment and check  new subscription  renew my present subscription

Subscription rates: qualified subscribers in the U.S.: 1 year \$8; two years, \$12; three years, \$16. Non-qualified: 1 year \$25. Subscription rates for foreign countries available on request.

### CHANGE OF ADDRESS

ATTACH LABEL HERE

If you are moving, please let us know five weeks before changing your address. Place magazine address label here, print your new address below.

name

address

city

state

zip code



## Who's Who in this issue

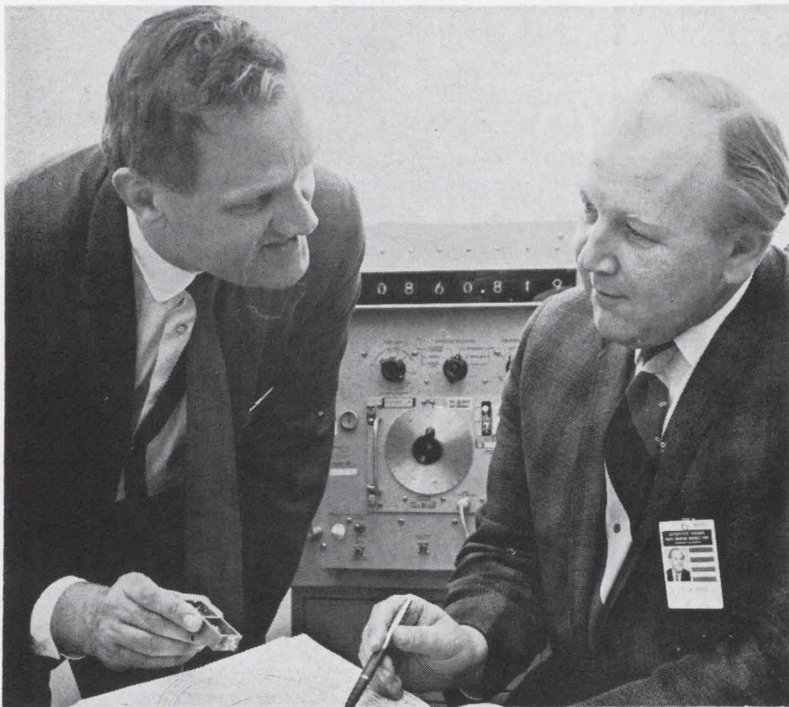

Collins

Hagon

**At home among** acoustic surface waves, J.H. Collins and P.J. Hagon of Autonetics explore key features of this new field and particularly delay lines in the first of a two part article starting on page 94. A graduate of London University, Collins researched at Stanford before joining Autonetics as director of physical sciences in 1968. Hagon, also a London grad, joined the firm in 1962 after nine years in the semiconductor industry. Currently, they're working on the interface between novel acoustic surface wave elements and micro-electronic integrated circuits.

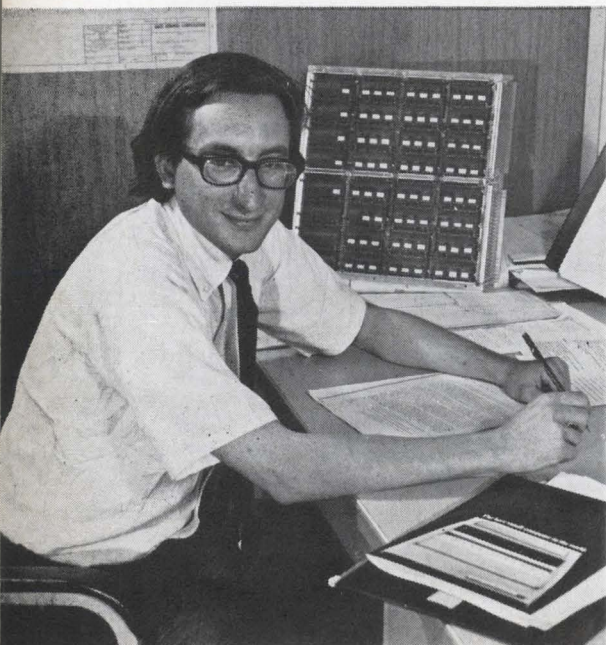

Seligman

**Ever since 1964** when he received both his bachelor's and master's degrees from the Massachusetts Institute of Technology, Lawrence Seligman has been working on the design of digital processors. After he joined Data General last February, he optimized the design of the Supernova computer. Starting on page 116, he describes this new machine, which is the third system to reach production under his guiding hand, no mean feat. And besides these, he has several "paper" computer designs to his credit as well.

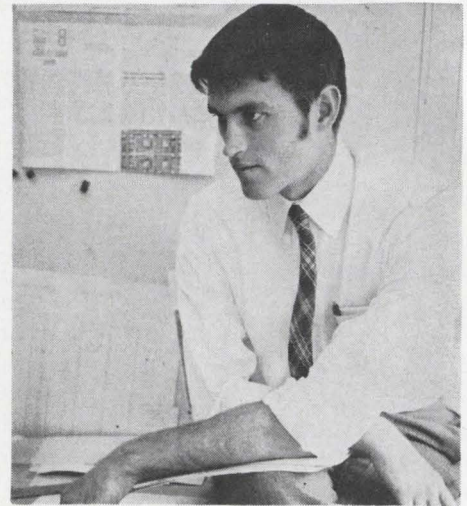

Doyle

**When RCA introduced** SelectaVision, *Electronics* instrumentation editor, Owen Doyle saw something else besides a video playback system. He tells about it starting on page 108. Holding an EE degree from Notre Dame, Doyle, who spent a year designing airplane guidance systems for the Navy, came to *Electronics* in 1967 after serving in the Army.

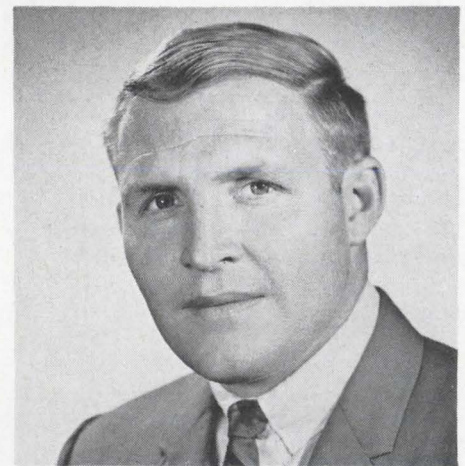

Cowdell

**While technical director** of Genisco Technology's components division, Robert B. Cowdell wrote the article on mismatched low-pass pi and tee filters, starting on page 121. His graphs, generated by computer, offer a direct route to filter design. Now at General Steam, Cowdell received BSEE and MSEE degrees from the University of Southern California.



# Look at the screen, not the knobs.

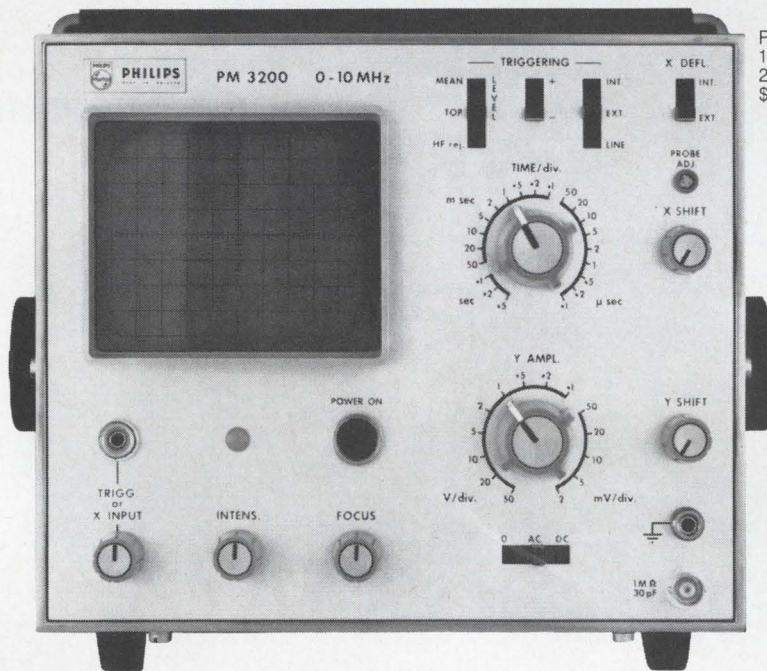

PM 3200  
10MHz  
2mV/div  
\$480

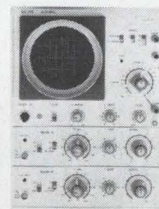

More of the Unbeatable  
Philips Scopes

PM 3231  
15 MHz: 10mV  
Dual Beam Delay Lines  
\$975

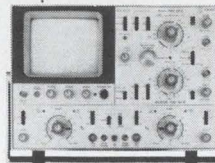

PM 3250  
50 MHz: 1mV  
Dual Trace  
\$1995

**Three fewer controls mean you spend more time measuring, less twiddling.** Dc balance, trigger stability and manual level are out. So triggering is fully automatic.



Explanation. When waveforms start looking like this: all other automatic trigger circuits stop triggering. So you have to switch to manual and start knob twiddling. With the PM 3200 you switch from "mean" to "top" and stay with signal-derived, fully automatic triggering.

In either position automatic means automatic over the whole of the 10MHz range. And then on to at least twice this nominal bandwidth figure.

This unique Philips circuit has yet another feature. Whatever the signal, even no signal and whatever the sweep speed, the trace is always clearly visible.

There's no dc balance control because none is needed. Drift is feedback and virtually eliminated. (At max. sensitivity (1/4div/24hours).

The PM 3200 is highly portable (11.7 lbs.). Battery pack optional.

Available in U. S. from Philips Electronic Instruments, 750 S. Fulton Ave., Mt. Vernon, N.Y. 10550



## PHILIPS™



# The Emancipator Becomes a Show-off!



The HP 9100A Calculator gave you

**Freedom from waiting** to get on the BIG computer;

**Freedom from translating** your problems into foreign computer languages;

**Freedom from starvation-level computing** with under-developed calculators;

**Freedom from the drudgery of manual computation** — All for the one-time price of \$4400.

## **NOW — EVEN GREATER COMPUTING FREEDOM IS YOURS. GRAPHIC DISPLAY**

Add the new HP 9125A X-Y Recorder. Make your HP 9100A desk-top computing calculator a show-off. You will be liberated from the tediousness of hand-plotting, from the

omnipresent human errors and from inundating reams of data that go with point-to-point hand plotting.

Think back! Would a picture be worth a thousand figures, to you? ... to your company? Be an innovator ... be a producer ... a picture producer.

The 9125A recorder automatically draws the answers as the calculator solves your problems—such as network response (photo shows Tchebysheff filter response expanded around  $f_c$ ), differential equations, roots of polynomials and curve-fitting. It shows you the results of your calculations faster, easier, and more accurately than you can get with hand plots! It ends the gnawing frustration of interpreting the limbo between data points. And ... it gives you a calibrated plot so you can read your units directly!



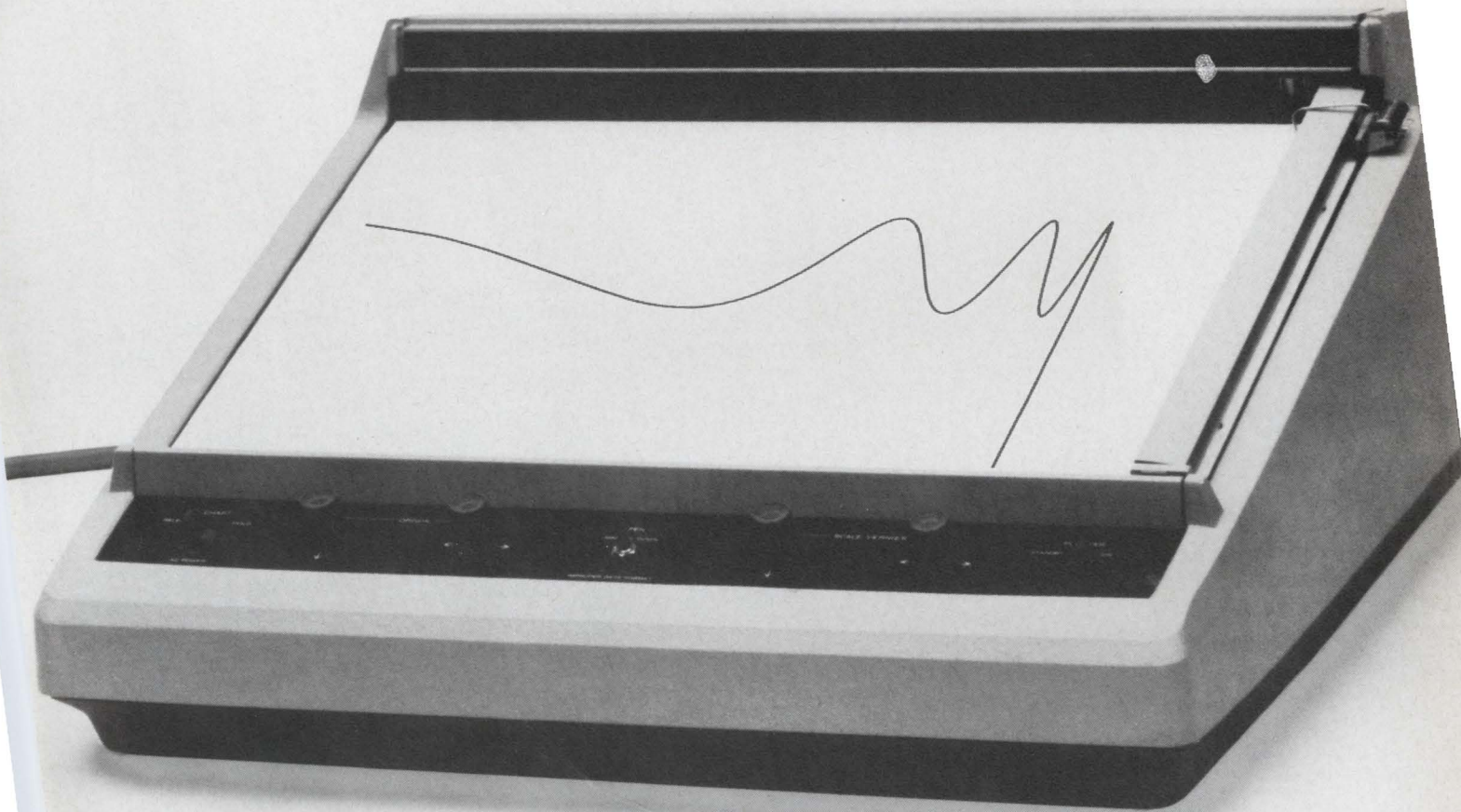

What's more, once the 9125A has given you a permanent graphic presentation, you can modify the input data, plot again, and immediately see the changes you have made. Nuances in areas of critical importance can be readily identified because of the pin-point resolution of the calculator/recorder combination — a resolution made possible by the four-digit calculator output that locates coordinate points with hair-splitting accuracy.

Completely documented programs for use with the HP 9100A Calculator and the HP 9125A X-Y Recorder are supplied with your instrument.

Show off with the 9125A for only \$2475. Add \$4400 if you don't already have the 9100A. Both are ready for immediate delivery.

Start your new liberation today. Call for a demonstration or send your purchase order to any Hewlett-Packard Sales and Service office (located in principal cities throughout the world). For a 22-page brochure, write Hewlett-Packard, P.O. Box 301, Loveland, Colorado 80537. Europe: 1217 Meyrin-Geneva, Switzerland.

*9100A/9125A puts answers just a glance away!*

HEWLETT  PACKARD

099/20A

Circle 11 on reader service card



That's right—the 216 Computer price has been reduced by nearly \$5,000—from \$12,890 to \$7,990.

Nothing else has been removed, it still has a 42 $\mu$ s software multiply, 122 instructions, three levels of hardware priority interrupts, automatic I/O multiplexing, 500,000 bytes/sec I/O block transfers, automatic memory scan, immediate instructions, big (512 words) floating pages, direct, relative, indirect and indexed addressing, byte manipulation, two accumulators, an index register, and 4096 X16 core memory. Software has been operational (and delivered) for 10 months. It's a Programmer's dream.

Service is available world-wide through our relationship with Control Data. Eighty-four Service Centers, 34 of which are overseas. We train CDC service engineers, they maintain our computers. With our emphasis on reliability, you may never meet your CDC serviceman.



Computer Automation also has three other mini-computers, one of them is only \$4,990 complete. We have price, performance, history, service, reliability and a solution to your problem.

Who says the computer business isn't exciting?

*Now our MAXI for \$7,990 from*





MODEL 216 — ~~\$12,890.00~~  
MAXI.

**\$7,990.00**

MULTI.

MIDI.

MINI.

# COMPUTER AUTOMATION, INC.

895 West 16th Street, Newport Beach, California 92660  
TWX: 910-596-1377

SALES AND SERVICE OFFICES: WESTERN REGION: COMPUTER AUTOMATION, Newport Beach, Tel: (714) 642-9630 • SHOWALTER-JUDD INC., Seattle, Wash- ington, Tel: (206) 324-7911 • Hillsboro, Oregon, Tel: (503) 648-6372 • COMPUTER AUTOMATION, Arlington, Texas, Tel: (817) 261-2411 • BARNHILL ASSOCI- ATES, Denver, Colorado, Tel: (303) 934-5505 • Phoenix, Arizona, Tel: (602) 959-2115 • Albuquerque, New Mexico, Tel: (505) 265-7766 • Houston, Texas, Tel: (713) 621-0040 • Richardson, Texas, Tel: (214) 231-2573 • EASTERN REGION: COMPUTER AUTOMATION, Southfield, Michigan, Tel: (313) 356-5776 • COZZENS AND CUDAHY, INC., Rosemont, Illinois, Tel: (312) 825-1144 • Medina, Ohio, Tel: (216) 725-5660 • Royal Oak, Michigan, Tel: (313) 585-5159 • Indianapolis, Indi- ana, Tel: (317) 244-2456 • Minneapolis, Minnesota, Tel: (612) 920-1022 • Edmundson, Missouri, Tel: (314) 423-1234

INTERNATIONAL HEADQUARTERS: JOHN R. AMOS, COMPUTER AUTOMATION, 326 Freeport Building, Schiphol Center, Amsterdam, Holland

BOOTH 6201 FJCC



# FET FACT

**3N178  
3N179  
3N180**

**the only  
MOS-FET  
family featuring  
high voltage  
breakdown**

- Each with Zener diode protection.
- High BV<sub>DSS</sub> and high BV<sub>SOS</sub> characteristics.

#### DRAIN BREAKDOWN VOLTAGE

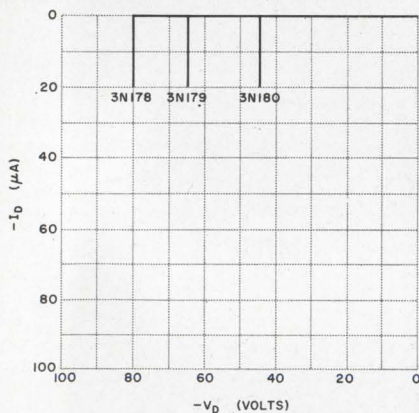

**100 pc. price**

**3N178—\$7.35 ea.**

**3N179—\$3.75 ea.**

**3N180—\$1.40 ea.**

The P-channel 3N178, 3N179, 3N180 are now available from your authorized General Instrument Distributor. For full information write, General Instrument Corp., Dept. F-8., 600 W. John St., Hicksville, L.I., N.Y. 11802.



GENERAL INSTRUMENT CORPORATION  
600 WEST JOHN STREET,  
HICKSVILLE, L. I., NEW YORK

## Who's Who in electronics

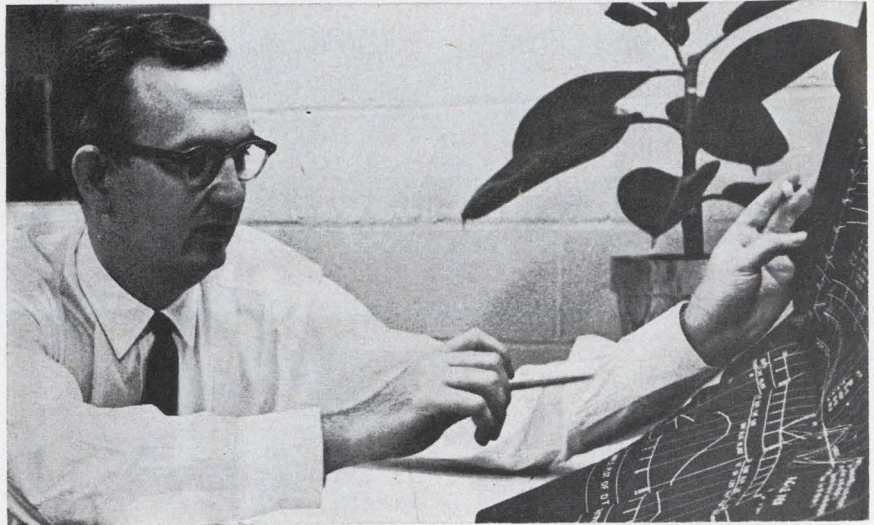

Charles L. Miller

**When the guard changes** at MIT's Instrumentation Laboratory on Jan. 1, so will the famed lab's direction. That's when C. Stark Draper will retire, to be succeeded by Charles L. Miller—chairman of MIT's civil engineering department, founder of the Civil Engineering Systems Laboratory, and head of the Urban Systems Laboratory.

Miller's appointment will mean an emphasis on applying the I-Lab's systems approach to social and urban problems—both of the other labs with which Miller has been associated apply technology to such areas. Up to now, most of the I-Lab's work, mainly in guidance and control, has been funded by NASA and the Defense Department. But the final report of an MIT panel appointed to "review . . . the procedures of the lab with respect to public service obligations" has recommended that the lab "not assume responsibility for developing operational weapons systems" such as Poseidon, but shift a balance of the work toward solving domestic problems. Other classified defense work still will be accepted, however.

**Merger.** Miller plans to effect this change in emphasis by incorporating the urban and civil engineering labs into the I-Lab. "The urban lab and the I-Lab are cooperating now in the design and development of a public transit system," he says. "The I-Lab's technology and sys-

tems approach is needed. I would expect to see more of this sort of thing." However, Miller does not expect to cut back on the amount of defense work done. Rather, he says, "I would hope to build up what we have started in urban problems rather than make any reductions in space and defense programs. I would like to see a parity among civilian, space, and defense, each doing about a third of the work, although this may take five years."

Looking to the future, Miller hopes the mergers eventually will "generate new technology for urban problems, but first we will turn to new applications and open up additional ways to use the computer. The main thrust of our work is apt to be in urban transportation at first."

**A knowledgeable outsider** describes Varadyne Inc. as "one of the most significant semiconductor operations to hit the Los Angeles area for some time." But to Charles Tobias, president, chairman of the board, and yacht racer par excellence, such a description is merely a cue for his pitch about vertical integration and the warning that he doesn't intend to be in the "jelly bean business" of making semiconductors only.

Tobias will admit, however, that integrated circuits are the keystone



# IN THE GOOD OLD DAYS

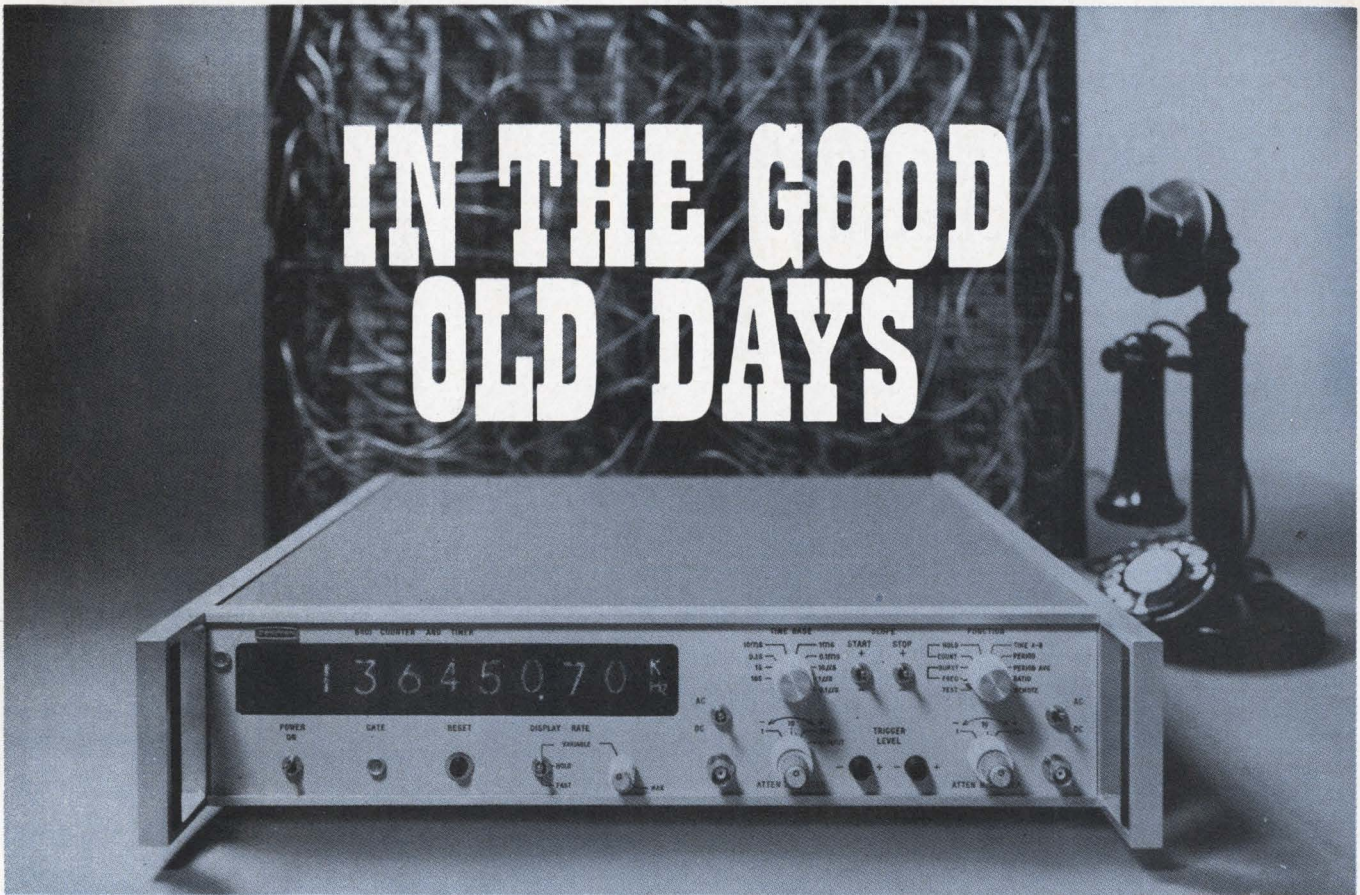

## Programming was pretty slow... Now, the Beckman 6401 is programmable to 136 MHz

In the Model 6401 Programmable Counter and Timer, Beckman offers a general purpose laboratory and production instrument that does what you want it to, at a price you can't resist...\$1375.

The 6401 provides direct frequency measurements to 136 MHz and complete programmability from contact closures. And the 6401 makes new measurements that were "unheard" of in the Good Old Days—like pulsed RF frequency or burst frequency measurements and period measurements from both channels for calibrated phase timing.

Timing measurements are a breeze with the exclusive trigger point monitor lamps in the 6401 for optimum attenuator and trigger adjustments. And maximum utilization of field replaceable IC's assures highest reliability and the lowest cost of ownership.

The 6401 is provided in a compact 3½" rackable package to conserve systems panel space, with 1-2-4-8 BCD outputs and scope markers as standard features. Options for serial input and output data, for nine digit display, and oscillator options with stabilities to 5 parts in 10<sup>10</sup> per 24 hours are available.

Regardless of what "programmable" meant in the good old days, take advantage of what Beckman has

to offer today. For complete information, contact your local Beckman office, sales representative or the factory direct.

### Specifications

*Measurement Modes:* Frequency: Input A, 0-136 MHz; Input B, 0-10 MHz. Burst Frequency: 0-136 MHz. Time Interval: A to B, 0.1  $\mu$ sec to 10<sup>8</sup> sec. Period: Input A, 0-10 MHz. Period Average: Input A, 1 to 10<sup>8</sup> in decade steps. Ratio:  $(F_x \div F_y) \times M$  with  $F_x = 0$  to 136 MHz,  $F_y = 0$  to 10 MHz,  $M = 1$  to 10<sup>8</sup>. Totalize and Scale: Input A, 0-10 MHz scale; 136 MHz count, 1 to 10<sup>8</sup> in decade steps. *Sensitivity:* Inputs A & B, 100 mV rms. *Crystal Frequency:* 10 MHz. *Stability Aging Rate:* Temperature:  $2.5 \times 10^{-6}$  from 0°C to 50°C; Line Voltage:  $1 \times 10^{-7}$  for  $\pm 10\%$  line voltage change. *Oscillator Output:* 10 MHz. *External Oscillator Input:* 10 MHz. *Time Base Output:* 3 V p-p. *Display:* 8 digits with overflow indication. Storage ON-OFF. Sample Rate: fast recycle and .1 sec to 10 sec display. Gate Lamp. *Remote Programming:* by switch closure to ground; BCD data at rear panel. *Temperature:* 0-55°C. *Power:* 115/230 V  $\pm 10\%$ ; 50-400 Hz. *Price:* \$1375. *Options:* ACL: Laboratory Stability Oscillator, 3 parts in 10<sup>9</sup> per 24 hrs; \$400. ACN: Ultra-high Stability Oscillator, fast warm up, 5 parts in 10<sup>10</sup> per 24 hrs; \$800. 9 digits: \$100. Rear Inputs (A and B): \$50.

**Beckman**

INSTRUMENTS, INC.

ELECTRONIC INSTRUMENTS DIVISION

RICHMOND, CALIFORNIA • 94804



# If you'd rather not have to choose between price and reliability—

At a surprisingly low price, you get the more consistent performance and reliability of:

- Hydraulic-magnetic operation
- Continuous-duty coil
- Hermetically-sealed actuating element
- Gold-diffused fine silver contacts
- Fast reset times (25% of delay, independent of cycling)
- And the Heinemann five-year warranty.

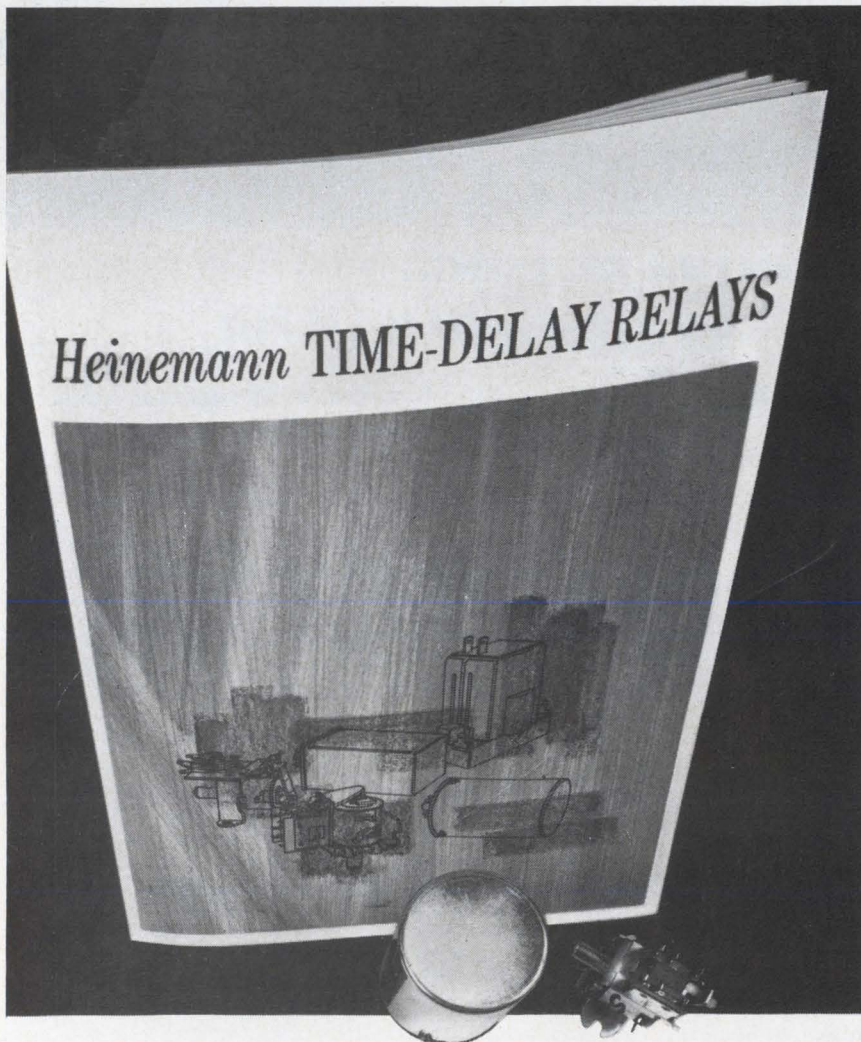

Five models to choose from, with delays from  $\frac{1}{4}$  to 120 seconds.  
For complete details, write for Bulletin 5006. 4441

**HEINEMANN**



Heinemann Electric Company, 2600 Brunswick Pike, Trenton, N.J. 08602.

## Who's Who in electronics

to his vertical integration—from components up through subsystems and systems—so he lured Chaz Haba, 34, a human dynamo like himself, from Fairchild Semiconductor to head the semiconductor division. "Within a year or two," says Tobias, Haba will become president of the Santa Monica-based firm.

**Second source.** Varadyne recently produced its first set of IC wafers—the VA 741 operational amplifier. It's the company's version of the popular Fairchild op amp, and sets the pattern for the initial thrust in linears—second-sourcing of industry standards, with some proprietary circuits to come. The amazing thing is that the first wafers came out of the ovens of the \$1.2-million, 16,000-square-foot facility only 4½ months after the building was gutted, rebuilt, and equipped. Even more amazing is Tobias's goal for Varadyne, which did \$4.5 million in sales for the year ended last June 30, and earned 30 cents a share. The goal: \$100 million in sales through internal growth and acquisition, a goal that Tobias says could be reached "within 40 months."

That goal must send shivers down Haba's spine, though he doesn't outwardly quarrel with it. Besides being vice president and general manager of the semiconductor division, he's corporate marketing manager, handling products including chip capacitors (which have been paying the bills), chip resistors, thick-film substrates, inks, packages and hybrid circuits, and now IC's. Combinations of these go into "subsystems" such as a line of active filters.

**Success—or else.** Haba maintains he'll sell IC's outside only when there's an established market. That's why he's picked up popular linears to start. The 741 will be followed by a Varadyne version of the Fairchild 723 op amp. Haba is considered an achiever by those who know him. One says, "He's always busted his gut to do what he sets out to do, but I wouldn't want to be in his position now because he's a success-oriented person."



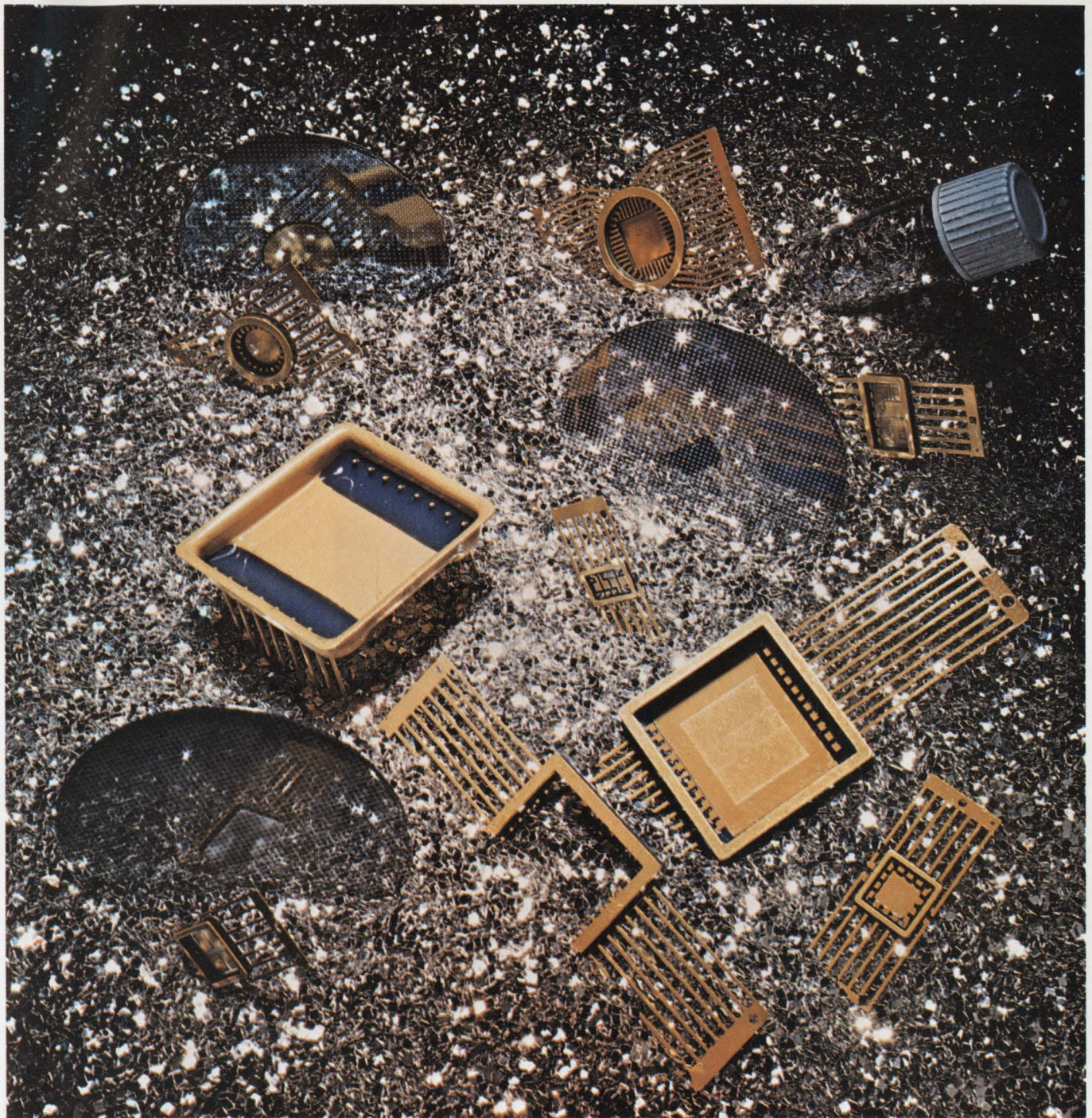

Sprague Semiconductor Chips and Packages. Illustration: 3 wafers, 8 packages, many chips

## Semiconductor chips. Packages. One source. Sprague.

Every device in the Sprague Semiconductor line is available in chip form. Transistors. Integrated circuits. Even precision nickel-chromium resistor networks. Just about everything you need to build your own hybrids.

And from the Hermetic Seal Department, flatpacks to put them in. From 1/4" x 1/4" to 1 inch square. From

6 leads to 40. Standard and ready for off-the-shelf delivery. Your custom package design can be made to order, too.

Make Sprague your one source when you're making your own hybrids. If you're going to put down our chips, put them in our packages.

Call Sprague Info-Central (603) 224-1961 extension 255

Get data on Sprague's chips and packages. Write to: Semiconductor Division, Sprague Electric Co., Pembroke Road, Concord, N.H. 03301. Or circle the reader service number below.



455-9130R1







# Let TI's special HI-REL Task Force take you through the turbulent sometimes uncharted universe of MIL-STD-883.

*We'll keep you on course.*

## Scout's honor.

Others have called 883 a lot of confusion, a mixed bag, and even "unprintable words."

But we have tried to keep our mouth shut, our shoulder to the centrifuge, and our nose to the stress levels.

While our best minds solved the problems.

Quietly, TI has committed itself to 883. Money, manpower and facilities.

And we're ready to deliver "in accordance to MIL-STD-883."

In fact, we've been delivering 100% tested ICs for years. Millions of them for Minuteman, Sprint, Poseidon, F-111 and other programs.

And some of these had even tighter requirements than 883!

From this experience, TI has organized special HI-REL Task Forces to help you meet 883. A special Task Force has been created for DTL, another for linear, and the one pictured here for TTL ICs.

Its members are some of TI's top

managers in the areas of reliability engineering, process engineering, product sales, military marketing, product planning, product engineering, quality control engineering, manufacturing and HI-REL assembly.

They're specialists in Series 54 and 54H TTL ICs, now available from TI in both flat pack and ceramic dual-in-line packages... standardized for 883 Classes A, B and C.

The Task Force's assignment starts with your problem: determining the specific test procedures and levels you'll need to satisfy 883 requirements.

Once the most practicable test plan has been devised, the Task Force sees it through. Thousands of TI personnel in many departments may be involved in your program, but the Task Force is responsible for its success.

Task Force members can cross departmental boundaries, step on toes and crack bottle necks, if need be, to keep your program on target.

In addition, you have the industry's best test facilities going for you at TI...from more than 50,000 burn-in sockets to environmental shake, rattle and roll labs, to IR scanners, microprobes, Radiflo and variable data loggers.

One thing more.



TI has prepared a comprehensive 40-page procurement specification incorporating MIL-STD-883 - sup-

plemented by 100 pages of detailed product specifications. From your first source for TTL ICs.

Use it to plot your course, and TI's HI-REL Task Force will keep you on it. Scout's honor.

Write for "MACH IV High Reliability Procurement Specification MIL-STD-883." Texas Instruments Incorporated, PO Box 5012, MS 308, Dallas, Texas 75222. Or just circle reader service number 256.



**TEXAS INSTRUMENTS**  
INCORPORATED



**UNIVERSAL SYSTEM:** Where shielding is not required, AMP's Universal Systems are excellent. Designed and tested to critical military specifications, they are ideal for applications such as ground support equipment, telemetry switching, and test instrumentation. Available in Panel Mount Systems (seven sizes from 240 to 4,896 hole arrangements), Rack Mount Systems (four sizes from 680 to 1,632 hole arrangements).

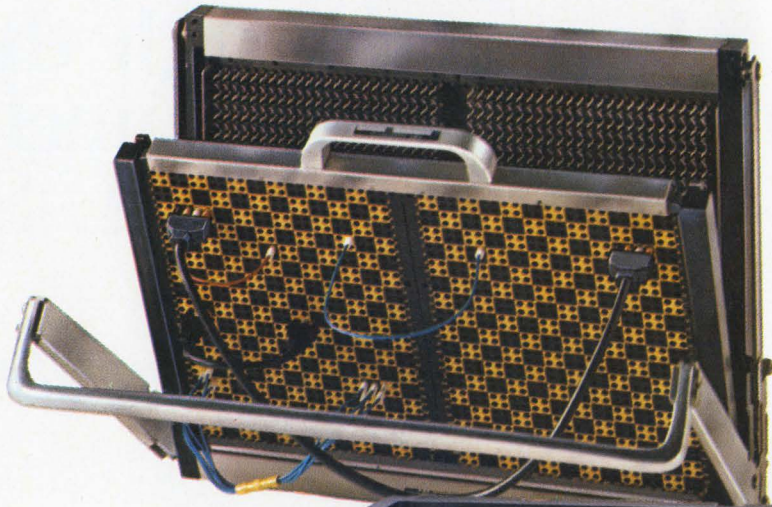

**LOW CAPACITANCE SHIELDED SYSTEMS:** Designed for use in critical low-level circuit applications. Specifically, where crosstalk and interference are objectionable such as analog computers and test instrumentation. Our low capacitance shielded systems are available in 960, 1,920 and 3,840 hole arrangements.

**STANDARD SYSTEMS:** This is the latest addition to our line. It's ideal for commercial applications where non-shielded systems are suitable. For example, test equipment, teaching systems, and simulators. Standard Systems are available in sizes from 816 to 4,896 hole arrangements

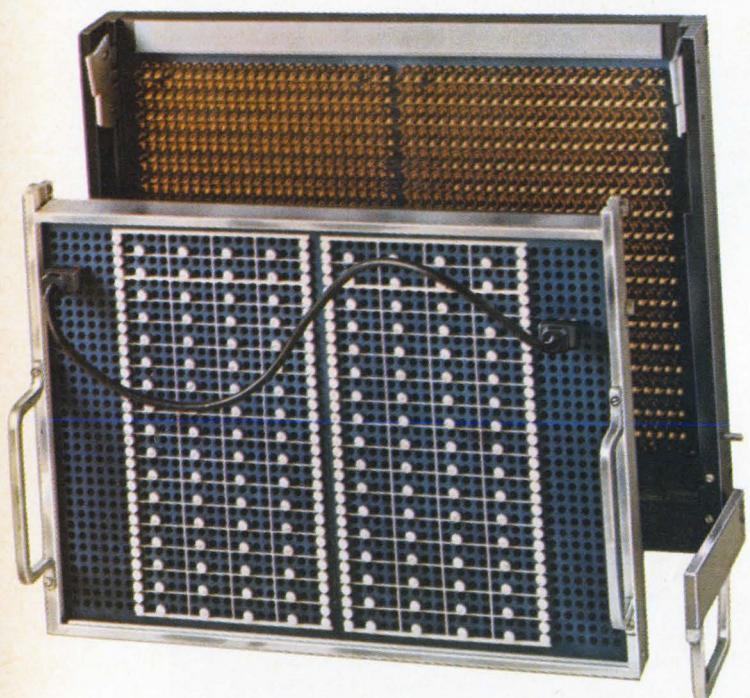

# Now





**COAXIAL SYSTEM:** Designed for the most sophisticated requirements where signal selection, impedance matching, or R.F.I. and EMI are critical. For example, RF switching and computer testing. Our Coaxial Systems are available in 506, 1,012 and 2,024 hole arrangements.

This is the world's most complete line of patchcord programming systems. And each is the best of its kind. Anywhere. AMP's patchcord programming systems run the gamut of application requirements. And all of them feature our unique, patented double-wiping action to assure a clean, reliable connection every time.

In addition to our breadth of systems, we also feature a wide choice of components and accessories.

**FRONT BOARD ACCESSORIES:** These include patch cords, multiple cords, squids, shunts, and component adapters.

**REAR BAY WIRING:** Each of our patchcord programming systems accepts some or all of the back plane wiring techniques shown. They are: 1. LANCELOK\* Terminals—for shock and vibration, 2. A-MP\* Taper Pins—noise-free terminations, 3. TERMI-POINT\* Clips—automated point-to-point wiring, 4. AMPMODU\* Interconnection System—to wire reduced conductor-lengths between components.

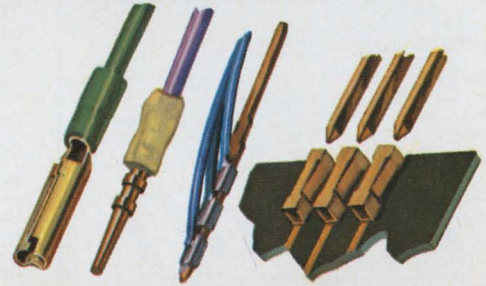

If this seems like a lot to choose from, it is. We can fill all your patchcord programming needs. Specify your requirements and write for more information to **Industrial Division, AMP Incorporated, Harrisburg, Pa. 17105.**

**AMP**  
INCORPORATED

\*Trademark of AMP INCORPORATED

European companies or affiliates refer to International Section

**you've seen everything.**



TUBULAR,  
BULKHEAD  
MOUNTING TYPE

# RFI/EMI FILTERS

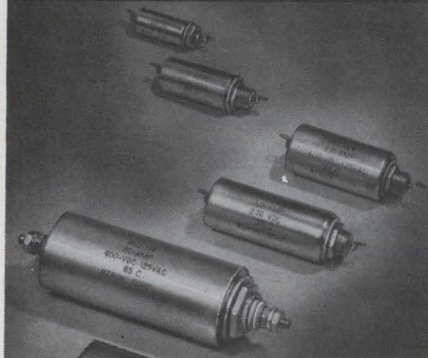

## Rtron

### Cylindrical Style Interference Filters

that reduce or eliminate unwanted noise or signals. Small size, light weight, maximum attenuation. Voltage current or insertion loss characteristics required, determine physical size. Maximum isolation of terminals and high frequency performance are assured by threaded neck design for bulkhead mounting. Feed-thru capacitor circuitry conservatively rated for both military and commercial applications.

**Rtron** corporation

P.O. Box 743 Skokie, Illinois 60076

- Send catalog and prices.
- Have Representative call for appointment.
- Specifications enclosed on Multi-circuit or custom design filters. Send estimate.

Name \_\_\_\_\_

Firm \_\_\_\_\_

Address \_\_\_\_\_

City \_\_\_\_\_

State \_\_\_\_\_ Zip \_\_\_\_\_

## Meetings

### NEC: 42 sessions for silver year

**It's Silver Anniversary** time for the National Electronics Conference in Chicago, and this year's 25th renewal, to be held at the Conrad Hilton Dec. 8-10, will be celebrated with 42 technical sessions. There will be 197 papers; three intensive refresher seminars covering mini-computers, MOS-LSI, and monolithic IC's will be available to those wishing to keep abreast of the latest advances.

The IEEE Communication Technology Group has invited papers for 16 sessions, while the IEEE Consumer Electronics Symposium has four sessions consisting only of invited papers.

**Color tv.** Session 1, consumer electronics, features a comparison of solid state subcarrier oscillators for color tv receivers presented by N. Doyle of Fairchild Semiconductor. An analysis of X-ray attenuation by glasses and resins in color tv picture tubes will be offered by G. Anderson, R. Tell, and H. Youmans Jr. of the U.S. Public Health Service.

Session 3 deals with the traffic service position system No. 1 and features a paper by J. Jacoby and B. Yokelson of Bell Labs on the

system's objectives, organization, and operation.

Recent advances in satellite communications are covered by session 31; it leads off with a discussion of satellite communication systems and follows with papers on antennas and amplifiers.

Developments in the Picture-phone encompassing service, design, planning, and transmission are taken up in session 29. Also dealing with the telephone system are sessions 36, new concepts in switching and customer equipment, and 17, switching systems and their control.

**Life.** Session 5 deals with engineering in medicine and biology and features a paper evaluating biomedical instrumentation and one outlining the use of the small computer in intensive-care units.

For the microwave engineer, session 18, microwave switching devices, presents papers covering such topics as microwave acoustics and microwave IC's. IC design also is discussed in sessions 33 and 41, while general circuit design is explored in session 27.

For further information, contact R.J. Napolitan, NEC, 1211 W. 22nd St., Oak Brook, Ill.

## Calendar

**Symposium on Adaptive Processes**, IEEE; Pennsylvania State University, State College; **Nov. 17-19.**

**Fall Joint Computer Conference**, IEEE; Convention Hall, Las Vegas; **Nov. 18-20.**

**Commerce Laser Colloquium**, Electronic Industries Association and the U.S. Commerce Department; Paris, France; **Nov. 18-20.**

**Conference on Magnetism and Magnetic Materials**, IEEE, American Institute of Physics; Benjamin Franklin Hotel, Philadelphia; **Nov. 18-21.**

**Conference on Image Storage and Transmission for Libraries**, U.S. Dept. of Commerce; National Bureau of Standards, Gaithersburg, Md.; **Dec. 1-3.**

**Annual Conference**, IEEE Group on

Vehicular Technology; Columbus, Ohio, **Dec. 4-5.**

**Conference on Applications of Simulation**, Association for Computing Machinery, IEEE; International Hotel, Los Angeles, **Dec. 8-10.**

**Fall USNC/URSI Meeting**, IEEE; The University of Texas at Austin, **Dec. 8-10.**

**Symposium on Circuit Theory**, IEEE; San Francisco, **Dec. 8-10.**

**National Electronics Conference**, Conrad Hilton Hotel, Chicago, **Dec. 8-10.**

**International IEEE G-AP Symposium**, The University of Texas at Austin, **Dec. 9-11.**

(Continued on p. 24)



TWO  
IN  
ONE

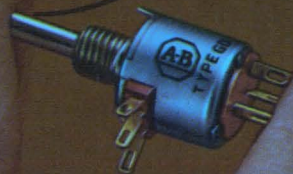

*New Allen-Bradley  
hot-molded Type GD  
dual variable resistor  
shown actual size*

## Allen-Bradley hot-molded dual variable resistor

Here's the most compact two section variable resistor currently available—the new Allen-Bradley dual Type GD. It's one-half inch in diameter and only a fraction of an inch longer than the popular single section type G control. The case is dust-tight as well as watertight. ■ Both resistance tracks in the dual Type GD are solid, hot-molded elements, which provide long operating life. As with the single Type G, the noise level is low initially and actually decreases with normal use. Adjustment is smooth at all times with virtually infinite resolution. And low inductance permits operation at frequencies far beyond the usable range of wirewound controls. ■ In addition to standard application, these new dual Type GD controls are ideally suited for use in compact attenuators. ■ Dual Type GD controls are available with nominal resistance values from 100 ohms to 5.0 megohms. You can get immediate delivery at factory prices from your authorized A-B industrial electronics distributor. Or write: Marketing Dept., Electronics Div., Allen-Bradley Co., 1201 S. Second St., Milwaukee, Wis. 53204. Export Office: 1293 Broad St., Bloomfield, N.J., U.S.A. 07003. In Canada: Allen-Bradley Canada Limited.



**ALLEN-BRADLEY**  
QUALITY ELECTRONIC COMPONENTS



Make a friend for life. With the guy down the hall. Or in the next building over. Someone your company hired because he is a chemist.

Take him to lunch.

Your motive: To learn about the lanthanides. The *what?*

The lanthanides. The *rare earths*, if you will. Those elements numbering from 57 to 71, from lanthanum to lutetium, in the periodic table. Plus their cousins, yttrium and thorium.

What's to learn? A lot, especially about the unique *electrochemical* properties of these elements and their compounds. Facts which can stimulate both old and new thoughts concerning the shape of IC's, TTL's, CRT's, etc. yet to come.



How's to learn? From your new-found friend—the chemist. Ask. Probe. Cajole. In any of a variety of ways:

Bluntly: "Say, tell me all you know about these rare earths."

Tactfully: "I knew you'd be the one person around here to ask. Isn't there something about the rare earths that we can use?"

Humbly: "I've heard about yttrium and gadolinium in color-TV phosphors. And about lanthanum capacitors. But there's more to rare earths than that—isn't there?"

Maybe what you don't know *can* hurt you.

Maybe what your associates (like chemists) *do* know (about rare earths) can help you.

And so can we. Write. Or call.

We'll send you—or the chemist you name—some helpful information on the rare earths.

9-211

**RARE EARTH DIVISION**  
AMERICAN  
POTASH & CHEMICAL  
CORPORATION

KERR A SUBSIDIARY OF KERR-MCGEE CORPORATION

258 Ann Street; West Chicago, Illinois 60185; Telephone: (312) 231-0760

## Meetings

(Continued from p. 22)

**Symposium on Application of Magnetism in Bioengineering**, IEEE, Israel Society for Biomedical Engineering; Rehovot, Israel, **Dec. 9-11.**

**Asilomar Conference on Circuits and Systems**, Naval Postgraduate School, The University of Santa Clara, Stanford University, and IEEE; Asilomar Hotel and Conference Grounds, Pacific Grove, Calif., **Dec. 10-12.**

**Winter Power Meeting**, IEEE; Statler Hilton Hotel, New York; **Jan. 25-30, 1970.**

**Annual Symposium on Reliability**, Group on Reliability of the IEEE, American Society for Quality Control, American Society for Nondestructive Testing, and the Institute of Environmental Sciences; Ambassador Hotel, Los Angeles; **Jan. 27-29, 1970.**

**International Solid State Circuits Conference**, IEEE, University of Pennsylvania; Sheraton Hotel and University of Pennsylvania, Philadelphia, **Feb. 18-20, 1970.**

**Symposium on Management and Economics in the Electronics Industry**, IEE; University of Edinburgh, Scotland, **March 17-20, 1970.**

**International Convention**, IEEE; New York Hilton Hotel and the New York Coliseum, **March 23-26, 1970.**

## Short courses

**System Effectiveness—From the Support Point of View**, University of California at Los Angeles, **Dec. 1-5.** \$275 fee.

**Characterizations and Models of SCR Circuits**, University of Wisconsin, Madison, **Dec. 9-10.** \$70 fee.

**Computer Control**, University of Wisconsin, Madison, **Dec. 11-12.** \$70 fee.

**Electronic Components**, University of Wisconsin, Madison, **Feb. 19-20.** \$70 fee.

**PL/1-Techniques and Perspective**, Association for Computing Machinery; **Nov. 10**, Sheraton Ritz Hotel, Minneapolis; **Nov. 12**, Sheraton Motor Inn, New York; **Nov. 14**, Sheraton Park Hotel, Washington. \$90 fee.

**Managing Systems Analysis and Design**, Association for Computing Machinery;

(Continued on p. 26)





less  
than  
\$1.00\*

for new high performance  
A-B solid hot-molded  
variable resistor...

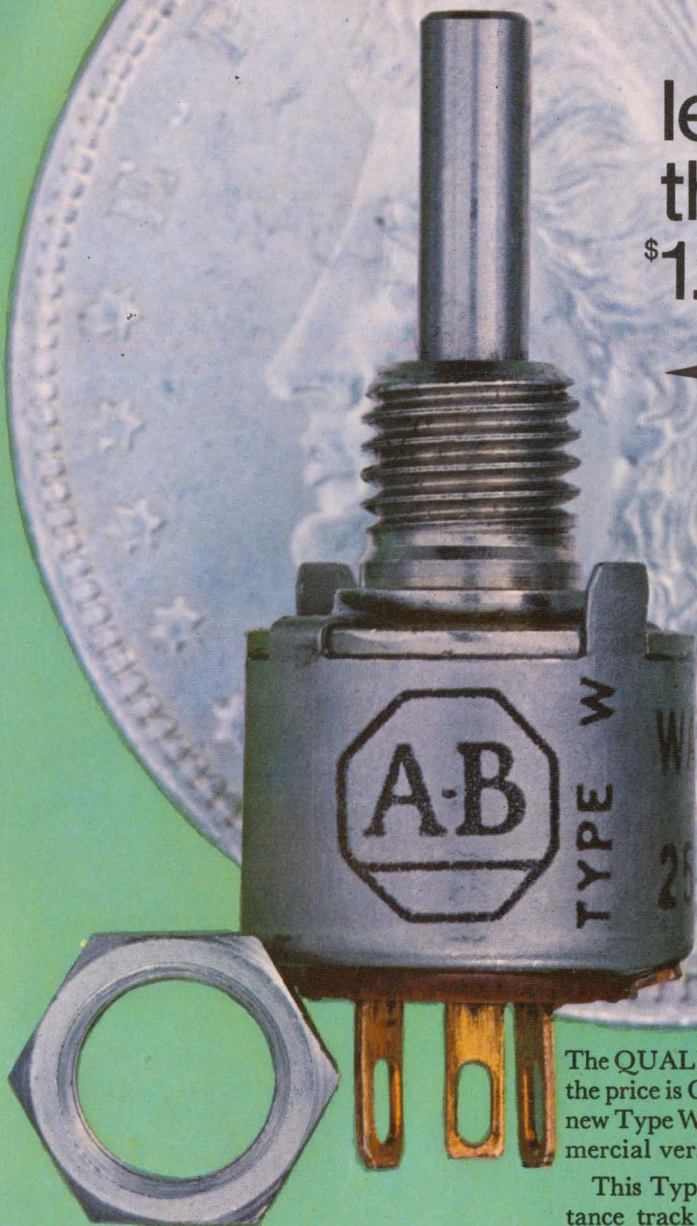

A-B Type W  
variable resistor  
shown about 5 times  
actual size

The **QUALITY** is Allen-Bradley—the price is **COMPETITIVE**! This new Type W variable resistor is a commercial version of the Type G control.

This Type W variable resistor features a solid, hot-molded resistance track for long operating life. Life tests show less than 10% resistance change after 50,000 complete cycles. Noise level is low initially and actually becomes less after normal use. Furthermore, the resolution is essentially infinite, and the low inductance permits operation at high frequencies where wirewound controls are useless.

The Type W control, while only  $\frac{1}{2}$  inch in diameter, is immersion-proof. The shaft is sealed with an "O" ring, making it watertight at that point.

Rated  $\frac{1}{2}$  watt at 70°C, the Type W can be operated at 120°C ambient with zero load. Nominal resistance values are from 100 ohms to 5.0 megohms.

You can get immediate delivery at factory prices from your authorized A-B industrial electronics distributor. Or write: Marketing Dept., Electronics Div., Allen-Bradley Co., 1201 S. Second St., Milwaukee, Wis. 53204. Export Office: 1293 Broad St., Bloomfield, N. J., U.S.A. 07003. In Canada: Allen-Bradley Canada Limited.

\*Standard unit with plain bushing and hardware, 20% tolerance in 1,000 piece quantities. Price subject to change without notice.

EC69-1A



**ALLEN-BRADLEY**  
QUALITY ELECTRONIC COMPONENTS

© Allen-Bradley Company 1969

Circle 25 on reader service card



## Have circuits to switch ?

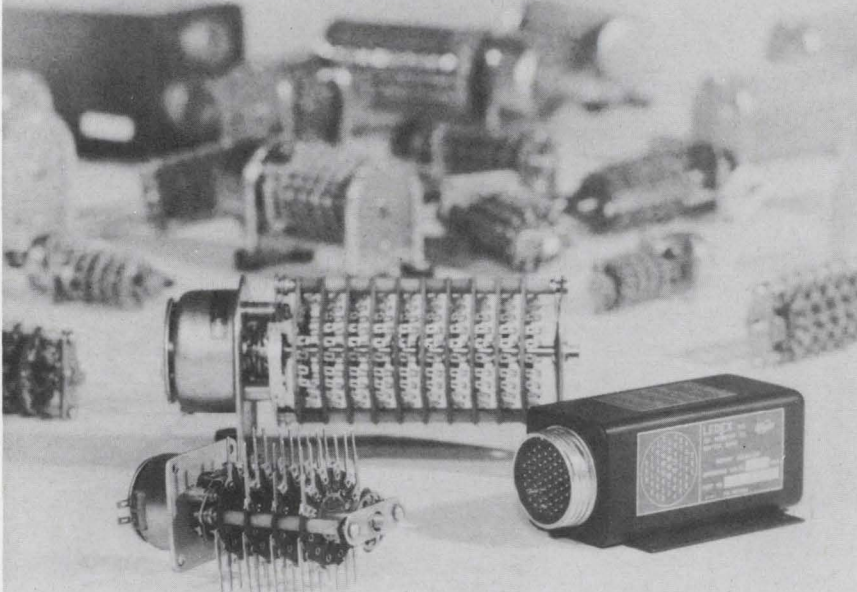

**... one of these 47 Ledex stock stepping switches can help you get a quick start on your prototype.**

**Ledex switches do a lot of work in a small space.** They are used as programmers, circuit selectors, sequencers, scanners, intervalometers, memory pulse decoders, converters . . . features like a rugged solenoid drive and corrosion resistant, self cleaning double grip contacts assure dependable switching.

**Exceptional variety, too**—open switches, hermetically sealed packaged switches and special designs. New PC leg terminals (optional) eliminate hand wiring and permit quick installation.

**Ledex also manufactures solid state switches** functionally interchangeable with other Ledex stepping switches. Check them when long life and speed are more important than price.

If one of these stock models doesn't meet your exact requirements, we'll custom design for you . . . whether it's an open circuit selector, a packaged switching network, a solid state selector or some combination of these. We've the people, facilities and capability to get the job done—fast and right.

Write or call today for our new stepping switch/circuit selector catalog or the new packaged switch catalog.

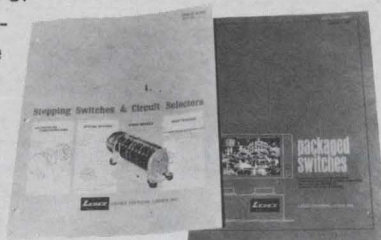

**Specialists in remote switching**



**LEDEX DIVISION, LEDEX INC.**

123 Webster Street, Dayton, Ohio 45402 • phone (513) 224-9891

## Meetings

(Continued from p. 24)

**Nov. 13-14**, Sheraton Motor Inn, New York; **Dec. 4-5**, Sheraton Cadillac Hotel, Detroit. \$165 fee.

## Call for papers

**National Aerospace Electronics Conference (NAECON)** IEEE and American Institute of Aeronautics and Astronautics; Sheraton-Dayton Hotel, Dayton, Ohio, May 18-20, 1970. **Dec. 1** is deadline for submission of abstracts to Mrs. Rita Gustin, 5455 Flotron Ave., Dayton, Ohio 45424.

**Southwestern IEEE Conference**, Memorial Auditorium, Dallas, April 22-24, 1970. **Dec. 1** is deadline for submission of abstracts and summaries to Prof. Andrew P. Sage, Information and Control Sciences Center, SMU Institute of Technology, Dallas, Texas 75222.

**Symposium on Management and Economics in the Electronic Industry**, IEE; University of Edinburg, Scotland, March 17-20, 1970. Synopses should be sent immediately to Conference Department, IEE, Savoy Place, London WC2.

**Conference on Gas Discharges**, IEE; London, England, Sept. 15-18, 1970. **Dec. 1** is deadline for submission of synopses to Conference Department, IEE, Savoy Place, London, L.C. 2.

**International Geoscience Electronics Symposium**, IEEE; Washington, April 14-17, 1970. **Dec. 1** is deadline for submission abstracts to Ralph Bernstein, IBM Corp., 18100 Frederick Pike, Gaithersburg, Md. 20760.

**National Telemetry Conference**, IEEE; Statler Hilton Hotel, Los Angeles, April 27-30, 1970. **Dec. 12** is deadline for submission of papers to A.V. Balakrishnan, 3531 Boelter Hall, University of California, Los Angeles, Calif. 90024.

**Frequency Control Symposium, U.S.** Army Electronics Command; Shelburne Hotel, Atlantic City, N.J., April 27-29, 1970. **Dec. 15** is deadline for submission of summaries to Director, Electronics Components Laboratory, Army Electronics Command, Fort Monmouth, N.J. 07703.

**ASTM-NBS Symposium on Silicon Device Processing**, American Society for Testing and Materials, National Bureau of Standards, Gaithersburg, Md., June 2-3, 1970. Papers should be sent immediately to C.P. Marsden, Electronic Technology Division, National Bureau of Standards, Washington, D.C. 20234.



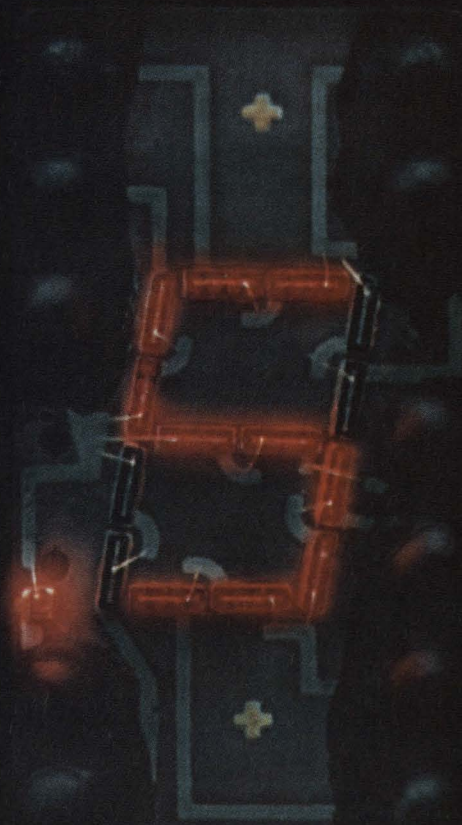

The solid state numeric  
is ready at Monsanto.

So are 19 other LED's.

## Send a P.O.

MAN 1 shown 6x actual size.

You know we've been working on the MAN 1 visible diode numeric for several years. Well, now we're ready to take orders.

It offers all the good things you expect from microcircuits. Low power drain. Shock resistance. Happy interface with your solid-state circuitry. Plus it gives you design flexibility you've never had before. And the multi-segmented construction avoids the danger of a number being altered by a small circuit failure.

Send a P.O. and be the first designer on your block to give your

digital readout the look of the 70's.

The 19 other low-cost, long-lived LED's? Four are bright red light-emitting semiconductors that have ns switching time, diode reliability and million-hour\* life.

One of our LED's emits amber light, one green light. Five put out frequencies in the infrared. One is a coupled pair, with detector and emitter in the same package to give you a light-quick switch (5 ns rise and fall) with 3 kV isolation.

Six are room temperature lasers in a variety of miniaturized configurations. Number 19 is a bunch of new

CO<sub>2</sub> laser modulator components.

So there's the whole line. They're all currently available from Schwebel, Kierulff, K-Tronics, or Semiconductor Specialists. Or from us: Monsanto Electronic Special Products, 10131 Bubb Road, Cupertino, California 95014. Phone (408) 257-2140.

Want more information on our new numeric, the MAN 1? Circle reader service #317.

For specs on the other 19 LED's, circle #318.

\* T<sub>A</sub> = 25°C, I<sub>F</sub> = 50ma. Result of step-stress testing with end of life projections.

# Monsanto



# Reliability is staggered steps and a hunk of DAP.

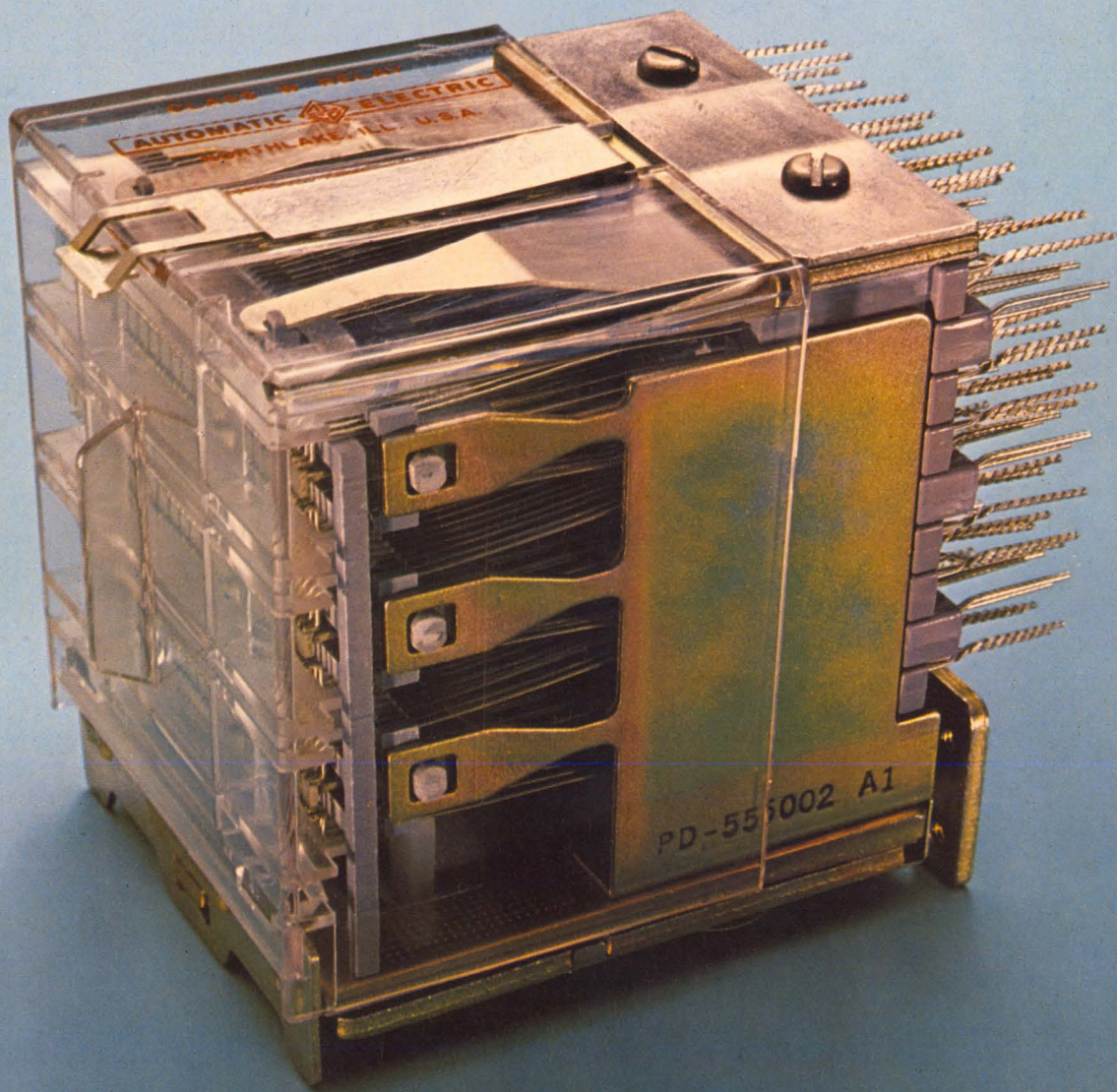



### Expect over a billion operations.

Our Class W wire-spring relay is different. In fact, there's nothing like it in the entire industry. Where else can you find a relay with lots of contacts and a mechanical life of more than a billion operations! That's about two and a half times the life of the best conventional relay around.

Another nice thing about our Class W is that it takes up a lot less space and costs less than using a bunch of other relays. That's because we build our Class W relay with one, two or three levels of contact assemblies, with 17 form C combinations per level. By the way, they're available with gold contacts for low-level switching.

### Making it tough on creepage.

All those staggered steps you see on the side were put in to raise the breakdown voltage between terminals. These molded steps add extra creepage distance between the terminals. This really counts for high voltage testing, or when using our Class W in unfavorable ambient conditions.

These steps, and all the molding compound used for insulating the contact springs, are made from

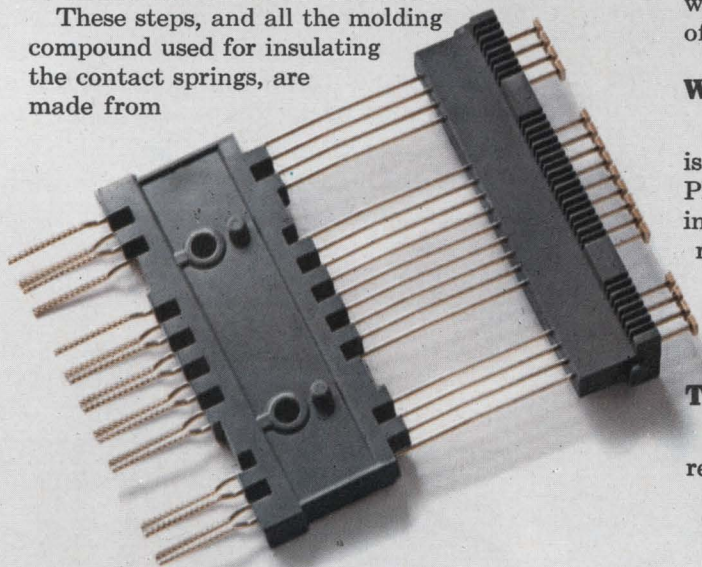

diallyl phthalate. (They call it DAP for short.) It has great insulating properties and it wears like iron. Even if the humidity is high, you have excellent protection.

### Redundancy—two springs are better than one.

Each of our long wire-spring contacts has an independent twin with the same function. One tiny particle of dust could prevent contact on other relays. Not with our Class W. You can be sure one of the twins will function. That's back-up reliability.

The twin contacts are twisted together at the terminal end. Then we give them a spanking (you might call it swedging) to provide solderless wrap.

### We're for independence.

Our springs are longer, because the longer the spring, the more independent they get. And the better contact they make. Don't forget, the wire-spring relay is the most reliable way to get a permissive make or break contact. You can rely on it.

The middle contact springs have to be stationary. To make sure they stay that way forever, we actually mold them between two thick pieces of DAP on both ends. Just try to move one.

### When we say flat, it's flat.

Each frame, banged out by a gigantic machine is extra thick and extra flat. Then they're planished. Planishing is another step we go through in forming the frame to add strength and stability by relieving surface strain.

We've made our spring-loaded pile-up clamp extra thick, too. Once it's tightened down, the whole pile-up is nice and tight, and stays tight.

### There's more.

We could tell you a lot more about our Class W relays. Like how the tough high-temp molded

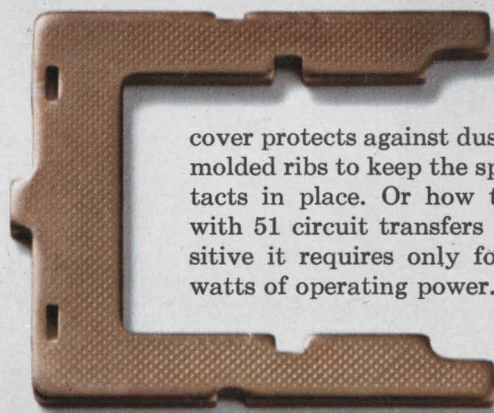

cover protects against dust and has molded ribs to keep the spring contacts in place. Or how this relay with 51 circuit transfers is so sensitive it requires only four to six watts of operating power.

But why don't you let us prove how much reliability we put into our Class W? We'll be waiting to hear from you. Industrial Sales Division, Automatic Electric Company, Northlake, Ill. 60164.

**AUTOMATIC ELECTRIC**  
GENERAL TELEPHONE & ELECTRONICS



# Announcing a new panel savings plan.

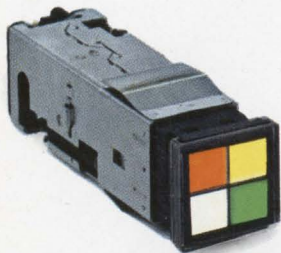

## Big dividends from small pushbuttons.

It doesn't take much to reduce the size of your control panels and cabinet fronts.

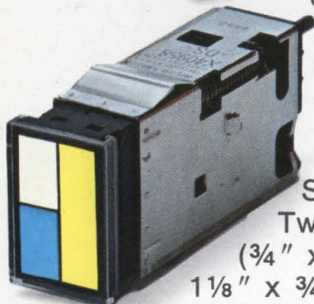

All it takes is compact miniature pushbuttons. Like the new MICRO SWITCH illuminated DS.

Two sizes are available ( $\frac{3}{4}$ " x  $\frac{3}{4}$ " for our 1-unit and  $1\frac{1}{8}$ " x  $\frac{3}{4}$ " for our  $1\frac{1}{2}$ -unit). And both can be matrix mounted on  $\frac{3}{4}$ " or  $1\frac{1}{8}$ " centers. So there's no need for spacers or barriers.

## A long-term investment.

A rugged metal housing encloses each switch and protects against the bumps and bangs of military and commercial use.

The housing also helps provide our DS pushbuttons with exceptional RFI attenuation capability. Incorporated into the housing are welded skirts that assure positive metal-to-metal grounding between the switch and adjacent units. And also between the switch and our rigid, box-girder matrix frame.

## Your choice of options.

Pick the mounting that best fits your application. Either individually mounted switches (meet the requirements of MIL-S-22885) or custom matrix configurations featuring plug-in switches that are best for remote stations or indicating functions.

You can have up to four lamps in every switch. And either one, two, three or four-way split section screens. (The  $1\frac{1}{2}$ -unit provides more than one-third additional legend area.) Full guards are available for single-unit switches.

Then save even more space by combining both 1-unit and  $1\frac{1}{2}$ -unit switches in the same matrix. A single frame will handle up to sixteen 1-unit switches or up to ten  $1\frac{1}{2}$ -units.

## Who can participate in the plan.

MICRO SWITCH DS pushbuttons meet both commercial and military requirements. So they can be used in almost any panel from power plant control to tactical ground support equipment.

For more information, call your MICRO SWITCH Branch Office or Distributor (in the Yellow Pages under "Switches, Electric"). He'll show you how little it takes to participate in our savings plan.

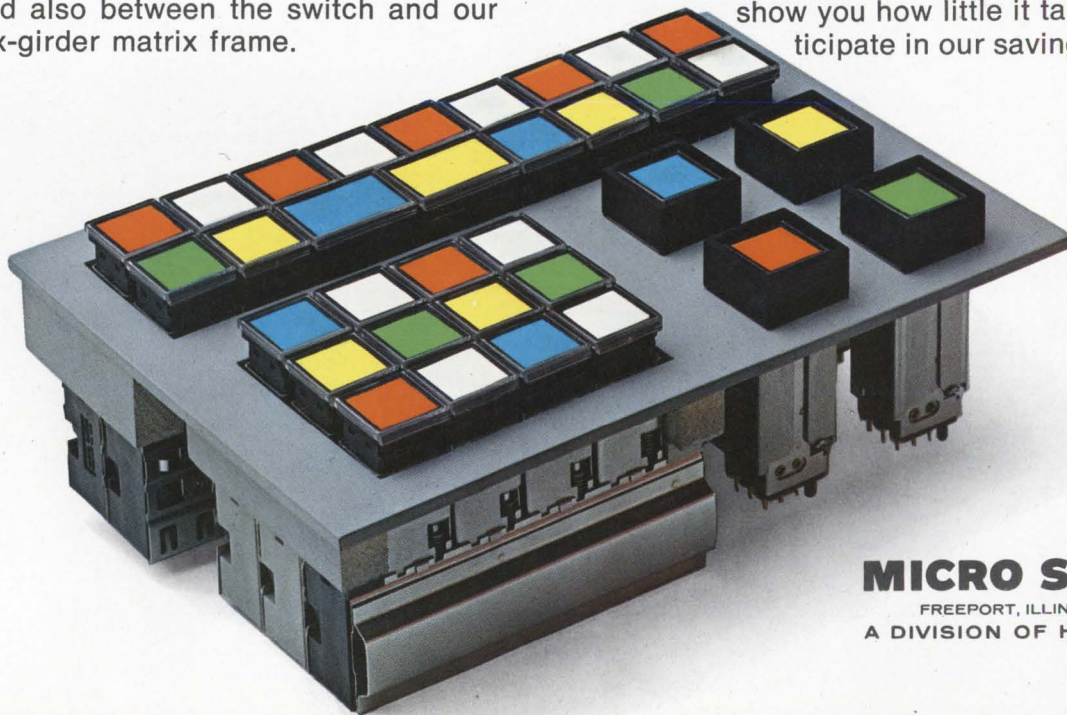

**MICRO SWITCH**

FREEPORT, ILLINOIS 61032

A DIVISION OF HONEYWELL



---

## Editorial Comment

---

### Doing what comes naturally . . .

**Important decisions** in the industry often are reached when engineers and managers put their heads together. Traditionally, engineers on the one hand and managers on the other assume specific roles in the decision-making process. Engineers basically tend to be thing-and-fact oriented, while managers take the people-and-profit tack. Thus, while engineers bring to bear technical objectivity and expertise, managers traditionally play the role of devil's advocate, demanding proof that a new technology can save time or money. As a result, wise decisions are reached.

The system usually works because both sides observe the ground rules; through their respective roles they function in check-and-balance fashion.

Occasionally, however, the system gets out of whack. It can happen when the engineer turns supersalesman, touting an idea or development out of all proportion to its technical worth. And sometimes the manager's sales resistance may be inade-

quate; he buys the concept based on the engineer's enthusiasm, not on the substance of his technical proposal. Too often, this unfortunate combination of role rejections happens when the stakes are especially high—as in the installation of capital equipment for production, or in the purchase of a new computer. In the latter case, engineers may feel professionally obliged to believe that a sophisticated computer ought to be able to alleviate their design problems or easily be plugged into the loop of a process control system. Managers may okay the investment merely to keep up with the Joneses. The result is overoptimism, oversell, and "overbuy."

All this may sound like a plea for unimaginative and intuition-free decision making, but it is not. It is a suggestion that when engineers and managers get together to make high-risk decisions they must operate from a base of their own expertise, and recognize emotional and intuitive factors for what they are.

### . . . in this case, too

**One of the reasons** automatic control systems have not made the giant strides they were supposed to may lie in the failure of hardware suppliers and users (processors) to stick to their own knitting. Honeywell's chairman, James Binger, upheld this viewpoint before a meeting of the ISA in Houston last month. Binger said if there is any confusion about the roles and responsibilities of either the processor or the hardware house, it can lead to "motion lost and money lost in earnest, but misguided, rain dances." Neither processor nor hardware maker should assume too much responsibility in the wrong places. Hardware manufacturers, Binger asserted, are in no position to guarantee operating results, yet they have sometimes accepted this responsibility, invariably with bad results. The processor, he noted, is the only party who ultimately can be liable for operating results. If he delegates his liability to the hardware maker, the project's success is threatened. Any hardware manufacturer who takes responsibility for operating results makes

a promise on which he cannot deliver. Both he and his processor-customer are headed for disillusionment and disappointment, Binger concluded. Conversely, the hardware manufacturer must stick to developing computers and control devices that meet system requirements and advance the state of the art.

It is our opinion that designing computers and control systems that work—in both performance and in cost savings—may be enhanced through temporary role reversal. That is, if the hardware or software designer looks at the task from the viewpoint of the customer his perspective may be augmented. Likewise, the user may profit from "playing vendor." But the knowledge gained through role reversal may backfire—it could tempt one or both parties to assume part of the other's job. Thus it is important that both manufacturer and customer return to, and jealously embrace, their original roles. It is a matter of each holding the responsibility for what he does best. ■





DOWCLENÉ WR Solvent, The Dow Chemical Company, Inorganic Chemicals Department, Midland, Michigan 48640.

## How would you clean his scanning devices?

With great care and a super-clean solvent. That's DOWCLENÉ® WR chlorinated solvent. Pure enough to meet NASA spec MSFC 471. Less than one part per million residue. And one of the safest chlorinated solvents you can use. Cost? About half of other white room solvents. We're proud of DOWCLENÉ WR. That's why you'll find a certified analysis for particulate matter on every drum. For more information and a free sample, why don't you send out a feeler? Today.

Circle 32 on reader service card





---

# Electronics Newsletter

---

November 10, 1969

## Multilayer MOS knocks on door

Watch for MOS circuits with more than one metalization layer to reach market next year. A number of firms are studying multilayer metal in MOS—the idea is to improve yields by reducing chip size. At Texas Instruments, where such wafers are being made in the semiconductor R&D laboratories, one spokesman forecasts products will be introduced in 1970. Although multilayer metalization necessitates additional process steps, TI looks for the extra cost to be more than compensated for by increased yields with the smaller dice, some of which can be reduced in area by as much as a factor of 2.

The TI spokesman stresses, however, that the company can meet present MOS requirements with single-layer metal. Fairchild Semiconductor and Hughes Aircraft also are examining multilayer MOS metalization, but a spokesman for the Newport Beach, Calif., division says Hughes “won’t have to worry” about producing such circuits until 1971, unless that custom job moves faster than expected. And while Fairchild Semiconductor also is doing research work, there are no plans to bring out a product line now.

## Librascope drops woven wire line

The Librascope Group of Singer-General Precision has abandoned the woven plated-wire memory business. Although the group still maintains its license to use the process developed by Toko Inc. of Japan, the production equipment is crated and the people who staffed the operation have left.

Librascope had problems with the weaving process [*Electronics*, Nov. 11, 1968, p. 132], but the principal reason for dropping the business appears to be that librascope management didn’t see the aerospace and commercially oriented products planned by the woven wire group meshing well with its primary emphasis—antisubmarine warfare. Librascope spokesmen will say only that it was a “management decision to drop the line.”

## TRW’s 2-watt, 3-Ghz power transistor finally makes it

Despite designer concern over the exclusive emphasis by most r-f power transistor producers on higher frequency and higher power [*Electronics*, May 26, p. 84], the power-frequency horse race continues. To gain the lead, TRW Semiconductor last spring promised a 2-watt, 3-gigahertz device off-the-shelf in time for Wescon, but stumbled and wasn’t ready for the August announcement date.

Now TRW has finally done it, and because of improved yields the top-of-the-line model—the PT6635—has gone up to 2.5 watts with a 4-decibel gain. It’s priced at \$170 in lots of 100. As part of the same 3-Ghz family, TRW is offering a 300-milliwatt unit with a 6-db gain, and a 1-watt model with a 5-db gain.

What wasn’t announced was TRW’s planned blockbuster—a 5-watt version with 3-db gain at 3 Ghz. This unit probably won’t be introduced until early next year, because TRW is having problems with yield and reliability.

The 3-Ghz family is aimed at replacing traveling wave tubes in electronic countermeasures, surveillance, weather radar, and telemetry applications.



---

# Electronics Newsletter

---

## Bell displays 5-psec optical gate

One little-noticed development presented at the International Electron Devices meeting in Washington was Bell Labs' 5-picosecond optical gate. The device could have major significance as a laser shutter in high-speed photography.

Bell builds its gate in much the same fashion as traditional Kerr liquid cells, using optical rather than electrical pulses to power the gate, and says it obtains 200 times faster gate time. Bell says that the present electro-optical liquid, carbon disulfide, prevents speeds faster than 2 psec. However, say the developers, gate times as low as 0.1 psec should be attainable with other liquids.

An attention-getter at the meeting was the ultrastable (1 part in  $10^9$ ) CO<sub>2</sub> laser system developed by Sylvania. The company says it can achieve continuous-wave beams of 20 to 30 watts with the same high stability as the source—a medium-level oscillator operating in the infrared—in conjunction with Sylvania's new 1,000-watt laser, which is the amplifier. What's more, Sylvania expects to obtain the full output capability of 1,000 watts by passing the source beam through the amplifier many times.

## Collins introduces solid state VOR

Collins Radio is showing customers a prototype of the first all-solid state vhf omnirange (VOR) receiver for commercial craft. The navigation receiver—the VOR-70—uses digital integrated circuitry to perform analog computations. The development illustrates the trend in avionics away from electromechanical components and toward very reliable and potentially low-cost digital IC's.

However, the cost of the IC's, even though they're available off-the-shelf, is still too high to make the receiver price competitive. Next step for Collins is to redesign some of the circuitry to dissipate less power. Test flights could begin in the first half of next year.

## U.S. safety report spurs crash program for color tv makers

With threats of Government action ringing in their ears, 17 color tv set manufacturers this week are in a crash program to develop safety standards and uniform methods of recording safety data. Deadline is Nov. 14. Estimating 10,000 tv set fires causing 10 deaths a year, the National Commission for Product Safety told the companies "we would have a national scandal" if the present rate continued.

This is in sharp contrast to the initial response of the EIA, which had dismissed the investigation by saying the ratio of sets catching fire was "infinitesimal" [*Electronics*, Oct. 27, p. 78].

The commission worries most about the aging characteristics of tv components. Manufacturers probably will be looking closest at horizontal output (flyback) transformers, which according to manufacturer-supplied data caused 29.2% of the fires. Another likely area would be inadequate or broken-down insulation of wires carrying high voltages which can result in arcing. This causes the wax insulating the transformer to become brittle and change its dielectric properties. The commission identified other hazard areas: uninsulated wires between high-voltage components; reduced space between the transformer and components such as ceramic transistors, cardboard-covered capacitors, a-c switches, the deflection yoke surrounding the crt; and automatic tuning devices. One of the color tv set components most susceptible to burning because of high temperature is XXXP, paper-based phenolic circuit boards, which are being replaced by polyester fiberglass-reinforced boards.



# fresh new Omnigraphic Recorder<sup>tm</sup>

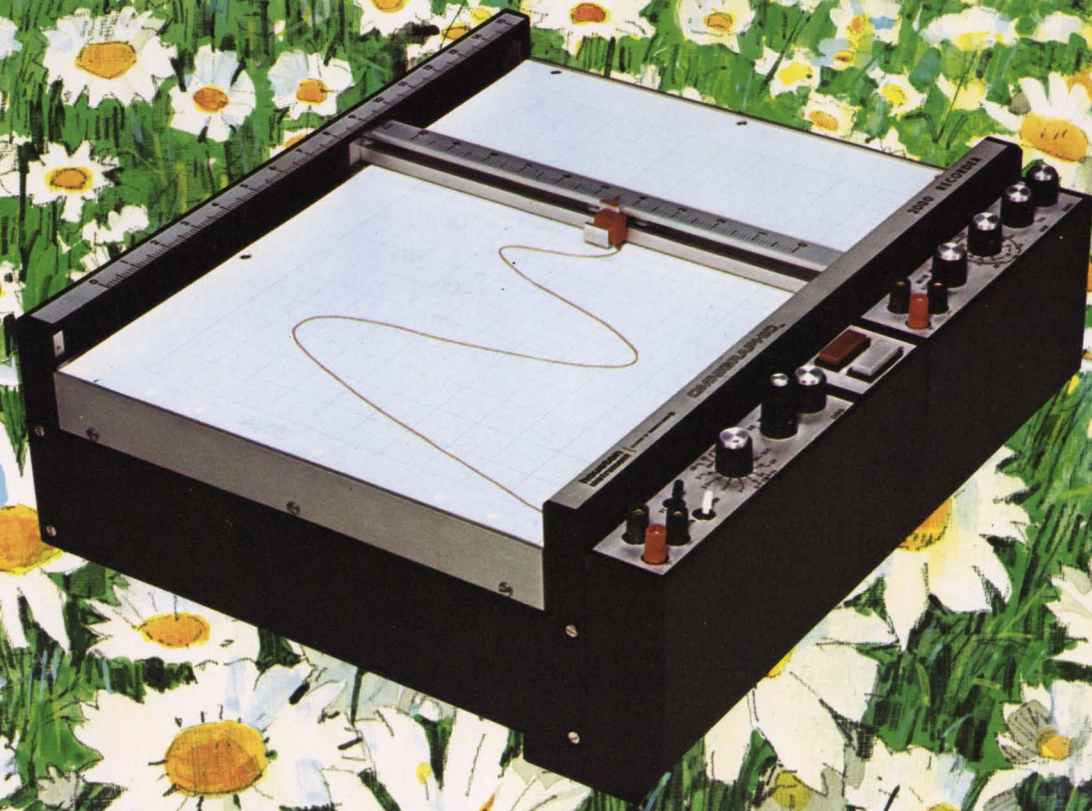

**BETTER, FASTER, LOWER PRICED, EXPANDABLE**



**COMPARE  
FEATURES...**

**COMPARE  
PRICE...**

Here they are... model for model

### HOUSTON INSTRUMENT X-Y RECORDERS

Both 8½" x 11" and 11" x 17" charts with English/Metric scaling switch and interchangeable plug-in ability

Houston Instrument Model No.	Houston Instrument Price	Houston Instrument Advantages
2200-3-3	\$ 975	Input resistance, Zero check
2200-3-4	\$1105	Input resistance, Zero check, Time base accuracy, no mercury cells
2200-5-6	\$1265	Input resistance, time base accuracy
2200-5-6	\$1265	Input resistance, X or Y time base accuracy
2200-7-8	\$1675	Time base accuracy
2211	\$995 + modules	

### HOUSTON INSTRUMENT 10" STRIP CHART RECORDERS

3300-50	\$835 + module	Differential inputs, electric pen lift, built-in chart and event marker
3200-50	\$835 + module	Differential inputs, electric pen lift, built-in chart and event marker

## For OEM:

**The Main Frame:** Dedicate its use, or command it from your control panel, for it's a complete X-Y recorder having 1 mv/inch sensitivity with remote control. Unhesitating  $\pm 0.2\%$  accuracy coupled with ultra-reliability, 1 megohm input resistance and electric pen lift. And plug-ins can expand its use later without modification via the remote connectors. \$770 in single quantities.

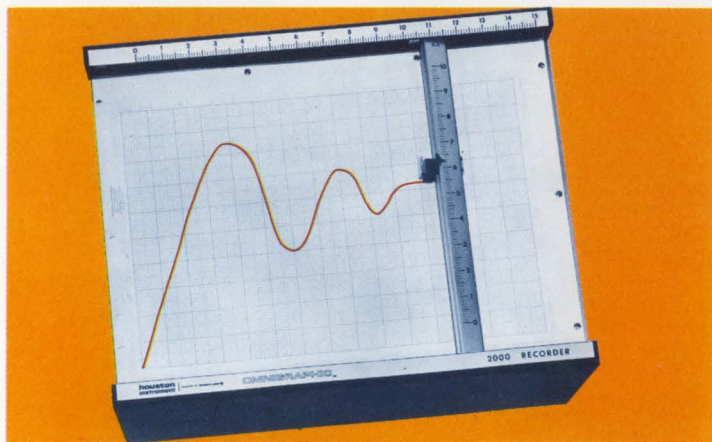

Circle No. 280 on Readers' Service Card

## For X-Y Plotter Users:

A flexible delight for the operator. Choice of twelve modules, interchangeable between axes, plus English/Metric switch selectable scaling gives total control. True differential inputs,  $>20$  in/sec. slewing speed and paper sizes to 11. x 17 inch are standard, yet at prices less than smaller and slower units. \$795 + modules.

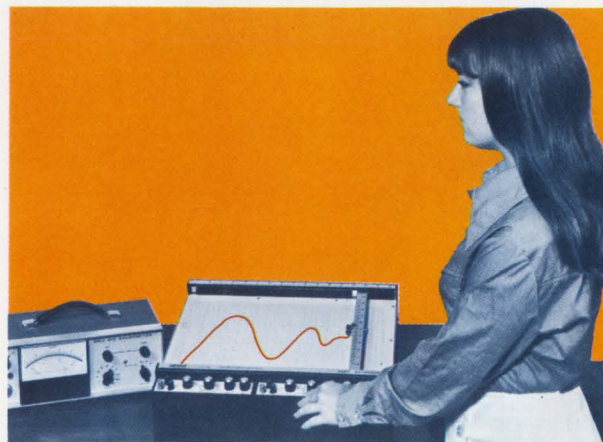

Circle No. 280 on Readers' Service Card



# COMPARE SPECIFICATIONS...

... Is there any choice?

## HEWLETT PACKARD X-Y RECORDERS

8½" x 11" charts only		11" x 17" charts	
Hewlett Packard Model No.	Hewlett Packard Price	Hewlett Packard Model No.	Hewlett Packard Price
7035 B	\$ 985	7005 B	\$1195
7035 B with 7108 A time base	\$1160	7005 B with 17108 A time base	\$1370
135	\$1650		
135 A	\$1650		
7030 A	\$1895	7001 A (with DC offset)	\$2175
7034 A	\$1195 + modules	7004 A	\$1295 + modules

## HEWLETT PACKARD 10" STRIP CHART RECORDERS

7101 B	\$1000 + module
7127 B	\$ 850 + module

## For Strip Chart Users:

Instant solution to previous inadequacies. Multi speeds and the multiple choice of input functions from the wide range of modules. Inherent are electric pen lift and event marker. Positive paper feed or roll take up in rack, panel or bench mounting without modification. \$710 + modules.

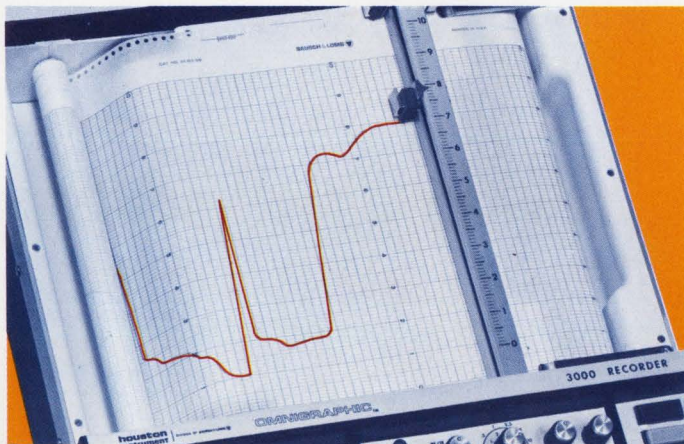

Circle No. 280 on Readers' Service Card

## Let the features speak:

- A choice of twelve interchangeable and inexpensive modules
- Truly differential inputs
- >20 in/sec. speed
- ±0.2% accuracy
- Local or remote control
- Electric pen lift
- Disposable non drying pens
- High input resistance
- Interchangeable amplifiers
- Wear compensating drives
- Rack, bench or panel mounting in vertical or horizontal positions
- English/Metric scaling at flick of a switch
- State of the art electronics with IC's and all solid state
- Accepts any paper size up to 11 x 17 inch in X-Y's; 10" strips
- X-Y vacuum hold-down independent of humidity, dust or line voltage
- Sealed re-balance potentiometer
- Sensitivities to 100 microvolt/inch (50 microvolt/cm)
- Over-range protection
- Electronic dead band detection eliminates servo wear
- Totally accessible in minutes by modular assembly
- Independent of ambient environment
- Unexcelled acceleration with critical damping.

**Truly—the finest, least expensive, most reliable line with total recording capability.**

# OMNIGRAPHIC,

graphic recorders

houston  
instrument

DIVISION OF BAUSCH & LOMB



# doubly fresh — doubly interchangeable

## Plug in Modules For X-Y, Strip, T-Y and Specials

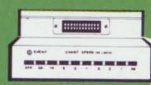

**50. Time Drive**  
\$100  
Nine ranges for strips or T-Y's with digital based accuracies.

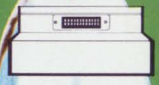

**0. Customizing**  
\$25  
A box of air for the customizer or do-it-yourselfer.

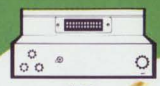

**1. DC Coupler**  
\$60  
Fixed sensitivity of 1 mv/in. (and 0.5 mv/cm) for single purpose or customizing.



**12. Precision Attenuator/Offset**  
\$320  
Take Module 5 and add 0-1 volt calibrated offset for suppressed signals.



**11. DC-1 mv Full Scale**  
\$340  
1 mv full scale for dedicated low level application.



**9. DC Precision Ranging**  
\$210  
Continuously calibrated attenuator from 1 mv/in. (0.5 mv/cm) with calibrated zero allows precise ranging at all times.



**8. DC Pre-Amp Attenuator/Time Base**  
\$490  
Take module 7 and add time/volt switch and reset/sweep switch.



**7. DC Pre-Amp Attenuator**  
\$390  
100 $\mu$ /in. (50 $\mu$ /cm) with eighteen ranges eliminates pre-amp.

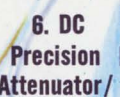

**6. DC Precision Attenuator/Time Base**  
\$290  
Take Module 5 and add eleven time sweeps from 0.1 to 200 sec/in.

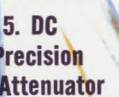

**5. DC Precision Attenuator**  
\$180  
Fourteen calibrated ranges from 1 mv/in. (and 0.5 mv/cm) in 1-2-5 steps.



**3. DC Switching**  
\$90  
5 calibrated ranges from 1 mv/in. (and 0.5 mv/cm) at modest expense.



**4. DC Switching/Time Base**  
\$220  
Take Module 3 and a selectable Time Base; again at modest investment.

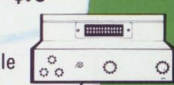

**2. DC Ranging**  
\$75  
Inexpensive and versatile for continuous calibration from 1 mv/in. (and 0.5 mv/cm).

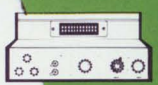

\$90

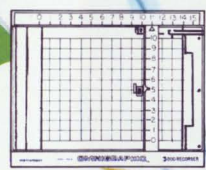

Strip-multispeed  
\$710

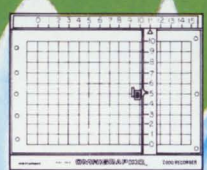

X-Y dedicated  
\$770 complete

X-Y user flexible  
\$795

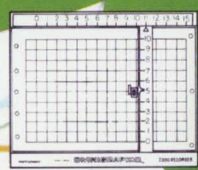

### 80% Interchangeable Module, Assembly, and Parts

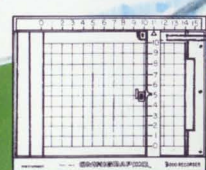

Strip-fixed speed  
\$660



T-Y fixed speed  
\$660

T-Y multispeed  
\$710

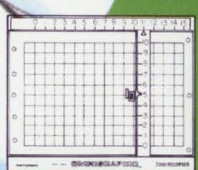

## UNIQUE MODULE WARRANTY

Should your application requirements change or if for any other reason you desire to exchange your Houston Instrument plug-in modules on this recorder for any other Houston Instrument modules, the following trade-in discount schedule has been set up to assure your satisfaction:

- Within 30 days—90% credit towards purchase of a new module
- Within 3 months—85% credit towards purchase of a new module
- Within 6 months—65% credit towards purchase of a new module
- Within 1 year—25% credit towards purchase of a new module

*L.C. Bower*

L. C. Bower, General Sales Manager

**houston instrument**

DIVISION OF BAUSCH & LOMB

4950 TERMINAL AVENUE, BELLAIRE, TEXAS 77401  
(713) 667 7403 CABLE HOINCO

Circle No. 280 on Readers' Service Card



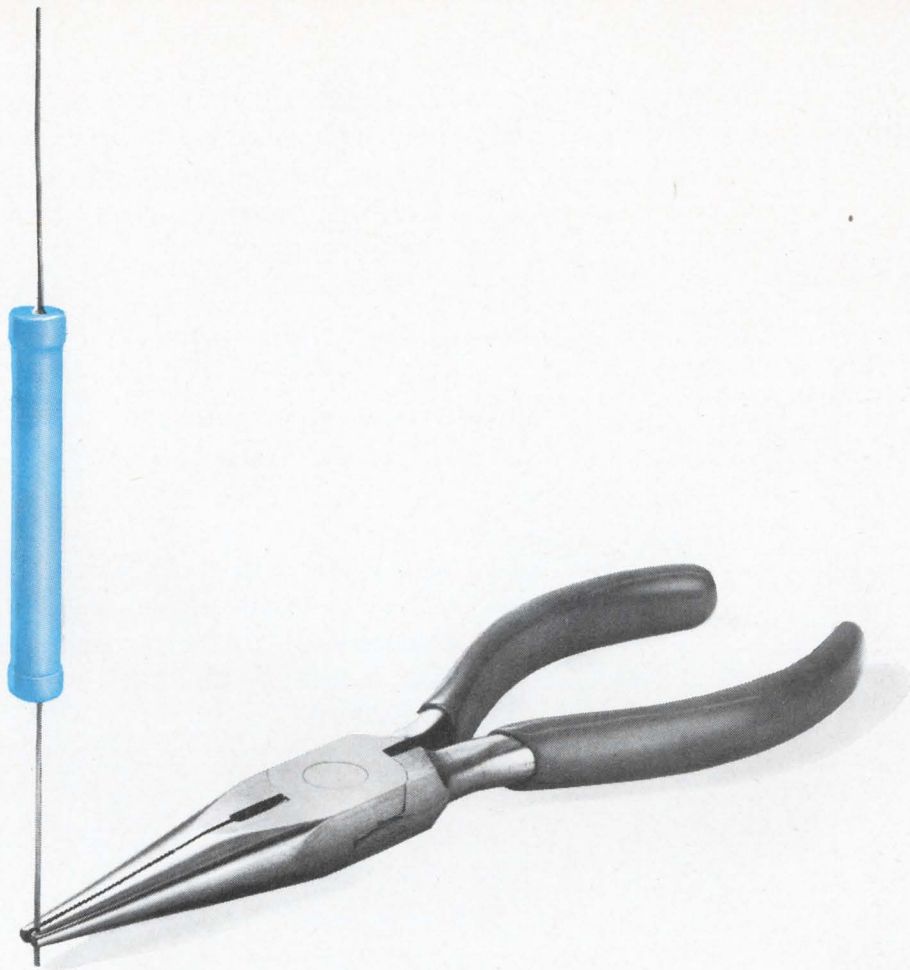

## The older it gets the more you'll appreciate it.

Victoreen now makes resistors which can work . . . and work . . . and never tire under the load. Or, they can sit . . . and sit . . . and never tire waiting around. We call them Mastermox — metal oxide glaze resistors.

When called upon to work, the stability of a Mastermox allows as little as 1% drift under full load in 2000 hours — with more than 40 watts power dissipation per cubic inch. On the shelf, Mastermox resistors' metal oxide glaze structure permits less than 0.1% drift per year.

Try Mastermox resistors. No permanent effect from voltage and temperature cycling. High resistance range accuracy — 10K ohms to 10,000 Megohms. Precision as good as  $\pm 0.5\%$ .

Mastermox. Even the old ones are new ones.

Model	Resistance Range	Power Rating @ 70°C	*Max. Oper. Volts	Length Inches	Diameter Inches
MOX-400	1 - 2500 megs	.25W	1,000V	.420 ± .050	.130 ± .010
MOX-750	1 - 5000 megs	.50W	2,000V	.790 ± .050	.130 ± .010
MOX-1125	1 - 10000 megs	1.00W	5,000V	1.175 ± .060	.130 ± .010
MOX-1	10K - 500 megs	2.50W	7,500V	1.062 ± .060	.284 ± .010
MOX-2	20K - 1000 megs	5.00W	15,000V	2.062 ± .060	.284 ± .010
MOX-3	30K - 1500 megs	7.50W	22,500V	3.062 ± .060	.284 ± .010
MOX-4	40K - 2000 megs	10.00W	30,000V	4.062 ± .060	.284 ± .010
MOX-5	50K - 2500 megs	12.50W	37,500V	5.062 ± .060	.284 ± .010

\*Applicable above critical resistance. Maximum operating temperature, 220°C. Encapsulation: Si Conformal. Additional technical data in folder form available upon request. Or telephone: (216) 795-8200.



**VICTOREEN INSTRUMENT DIVISION**  
**10101 WOODLAND AVENUE • CLEVELAND, OHIO 44104**  
 EUROPE: ARNDAL HOUSE, THE PRECINCT, EGHAM, SURREY, ENGLAND • TEL: EGHAM 4887







**SO** ON THE THIRD GO-AROUND WE HAD A CIRCUIT OUR SUPPLIER SAID HE COULD MAKE BECAUSE THEY WERE GETTING THIS NEW EQUIPMENT...

ONLY IT DIDN'T TEST TOO WELL BUT THEY COULD FIX THAT WITH SOME NEW STUFF THEY WERE GETTING...



AND WITH THEIR EXPANSION PROGRAM THEY'D SOON HAVE CAPACITY TO MAKE ENOUGH CIRCUITS IN TIME FOR OUR REVISED REVISED REVISED SCHEDULE...

AT REVISED REVISED REVISED COST—



THAT'S WHAT THEY SAID...



SO, I'M CELEBRATING THAT ALONG WITH MY THIRTY-THIRD BIRTHDAY.



## Aerojet microcircuits solve problems. First time around.

We've already done our homework on our own in-house program. Seven years of it. And we've already invested our own money in the most advanced, automated equipment. Millions of dollars worth. So when we say we're ready to tackle your problems in thin-film microcircuits... we're *really* ready.

The benefits to you start immediately because you don't need to compromise your design. Aerojet thin-film circuits can be built to meet an incredible range of specifications. We know components and can offer you many that are unobtainable elsewhere because we developed them ourselves. You get exactly what you need. Fast.

It's in actual production that Aerojet's investment in ahead-of-the-field equipment pays off. We're automated to the highest possible degree. This gives us big advantages in precision, speed and constant traceability. Defects get caught early. And costs come down. And schedules are met! For example, the largest of our six vacuum

deposition chambers can produce 10,000 circuits in a single production cycle. Automated machines and computers can test 100 circuits in less than a minute... measuring and storing component values. A computer "knows" each individual circuit and can trace it through the entire process.

But there's much more. You almost need to see it to believe it (by all means come and take a look or ask to see our movie).

Aerojet's aerospace projects demand the utmost in reliable, sophisticated microcircuit technology. We can apply our experience to your problems... in depth, in quantity and at highly competitive prices.

So get us involved early and get results the first time around. Contact the Aerojet field office in your area, or: Aerojet Microelectronics, Electronics Division, 1100 West Hollyvale Street, Azusa, California 91702. Phone (213) 334-6211, Extension 6561.







## The ultimate in complete wire wrapped panels...from one source

**Augat** and **Raytheon** Now Combine their Capabilities  
To Provide New Economies and Faster Turn Around Time.

An alliance of leaders.

Augat, long recognized for its innovations in  
IC packaging panels and the quality of its products.

Raytheon, offering the largest, most versatile of wire wrapping service facilities.

Together, we're now producing packaged panels unmatched  
in reliability, flexibility and fast turn around time.

Let us wrap up your IC and interconnection requirements efficiently and economically.

Contact: Augat Inc., 33 Perry Ave., Attleboro, Mass. 02703, (617) 222-2202.

**AUGAT**  
INC.





## Philco has something new in Series 74 T<sup>2</sup>L... glassivated chips in cerdip packages.

Why consider another source for Series 74 T<sup>2</sup>L? Here are three good reasons from Philco-Ford.

- **RELIABILITY**—as a final production step, we put an added layer of glass over the completed chip. This glassivation process protects the circuit against damage, and gives an extra measure of reliability.
- **HERMETIC DUAL IN-LINE PACKAGES**—All Philco-Ford Series 74 circuits are manufactured in hermetically sealed ceramic dual in-line packages . . . AND at prices comparable to plastic. Your assurance of quality is the experience we have gained in manufacturing many millions of cerdip DTL and T<sup>2</sup>L circuits.
- **CLAMP DIODES** — All Philco-Ford Series 74 circuits have been designed with clamp diodes input to reduce ringing and improve system noise immunity.

All popular Series 74 circuits are now available from our Lansdale facility, one of the country's largest IC manufacturing plants.

For complete data and prices, contact your nearest sales office. Or write Philco-Ford Corporation, Microelectronics Division, Blue Bell, Pa. 19422.

Contact the nearest Philco-Ford Sales office:

Suite 714, 9841 Airport Blvd.  
Los Angeles, Calif. 90045  
(213) 641-8105

3939 Fabian Way  
Palo Alto, Calif. 94303  
(415) 321-8740

2225 West North Ave.  
Melrose Park, Ill. 60160  
(312) 345-1000

Northwest Industrial Park  
Second Avenue  
Burlington, Mass. 01803  
(617) 272-1600

Blue Bell, Pa. 19422  
(214) 646-9100

20000 Rotunda Drive  
Eng. Bldg. 3, Room 2060  
Dearborn, Mich. 48121  
(313) 323-3797

609 Saw Mill River Road  
Ardsley, N.Y. 10502  
(914) 693-3700

900 Don Mills Road  
Don Mills, Ontario, Canada  
(416) 444-2541

Room 428, State Tower Bldg.  
Syracuse, N.Y. 13202  
(315) 422-3154 or 3155

*the better idea people in bipolar IC's*

**PHILCO**







FOR CONNECTOR CONFIDENCE

# CINCH ROYAL D MARK III SUBMINIATURES

There is an added feeling of confidence that comes with knowing that your D-subminiature connectors will be delivered on time and meet all your specifications at competitive prices.

Cinch Royal D MARK III\* rack and panel connectors are confidently used in a wide range of military and industrial applications. They are precision, high density connectors with 0.109" contact centers, meet MIL-C-24308 specifications, and are available in 9, 15, 25, 37 and 50 contact configurations.

The Royal D MARK III incorporates a rear release crimp-on, snap-in contact assembly. A diallyl phthalate insulator provides a hard, closed entry socket for positive contact alignment and high bend resistance. A simple plastic tool permits quick contact removal and replacement without damage to the contact or insulator.

Be confident! Let Cinch supply your Royal D MARK III on fast, dependable delivery schedules. Call your local Cinch Electronics Group Sales Office or write to Cinch Manufacturing Company, 1501 Morse Avenue, Elk Grove Village, Illinois 60007.

**IMMEDIATE DELIVERY** from stock—can be made through Cinch Electronic distributors.

C-6912

\*Manufactured under license agreement with ITT Cannon Electric, Inc.

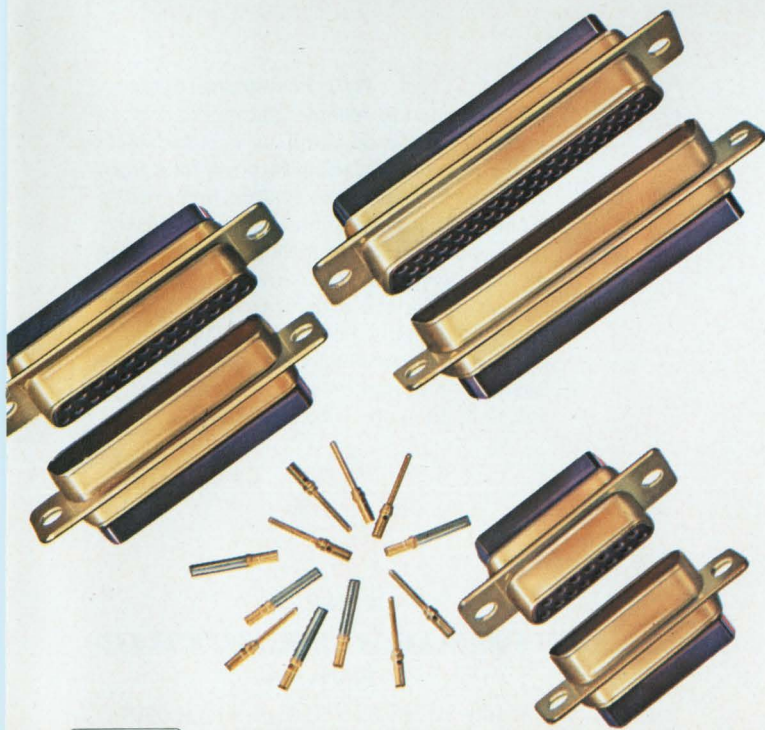



# Speed from design data to finished circuit board

using information  
from ONE basic  
N/C tape!

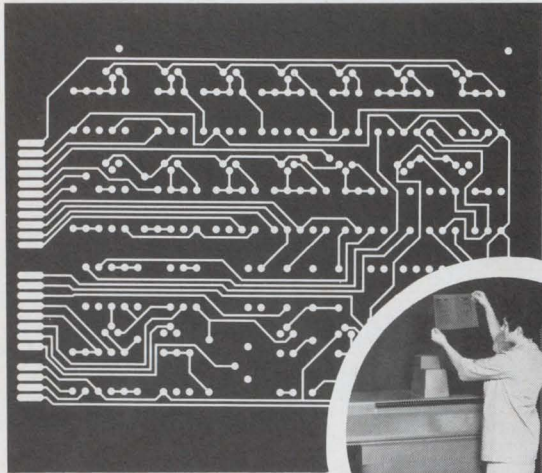

produce artwork

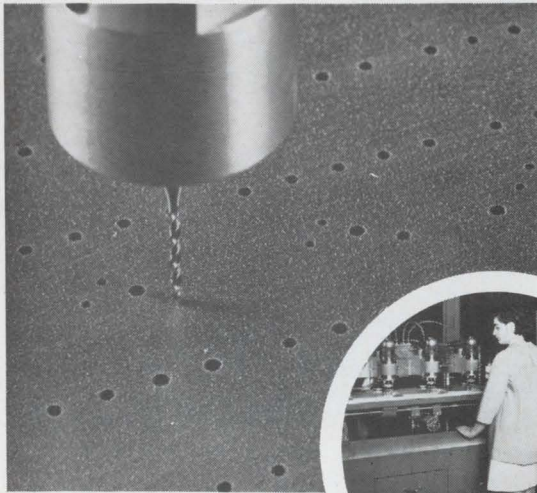
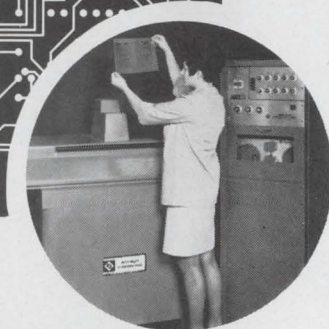

drill

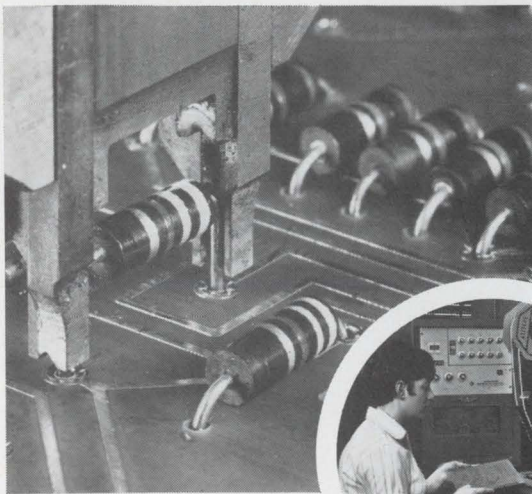
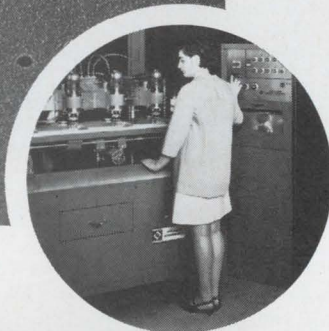

insert components



**SLO-SYN<sup>®</sup>** N/C Positioning Systems let you switch to reliable, automatic printed circuit board production at a surprisingly low investment. Starting with raw data from the rough, grid-paper sketch, every step from artwork generation to finished assembly is numerically controlled. Buy or lease as many systems as you need to make your operations more efficient. A 15-minute, full-color film, "POSITION COUNTS" is available free on loan to let you see these systems in action. Ask for it. For complete information, write, wire or phone:



**THE  
SUPERIOR ELECTRIC  
COMPANY**

506 Middle Street, Bristol, Connecticut 06010  
Telephone 203/582-9561



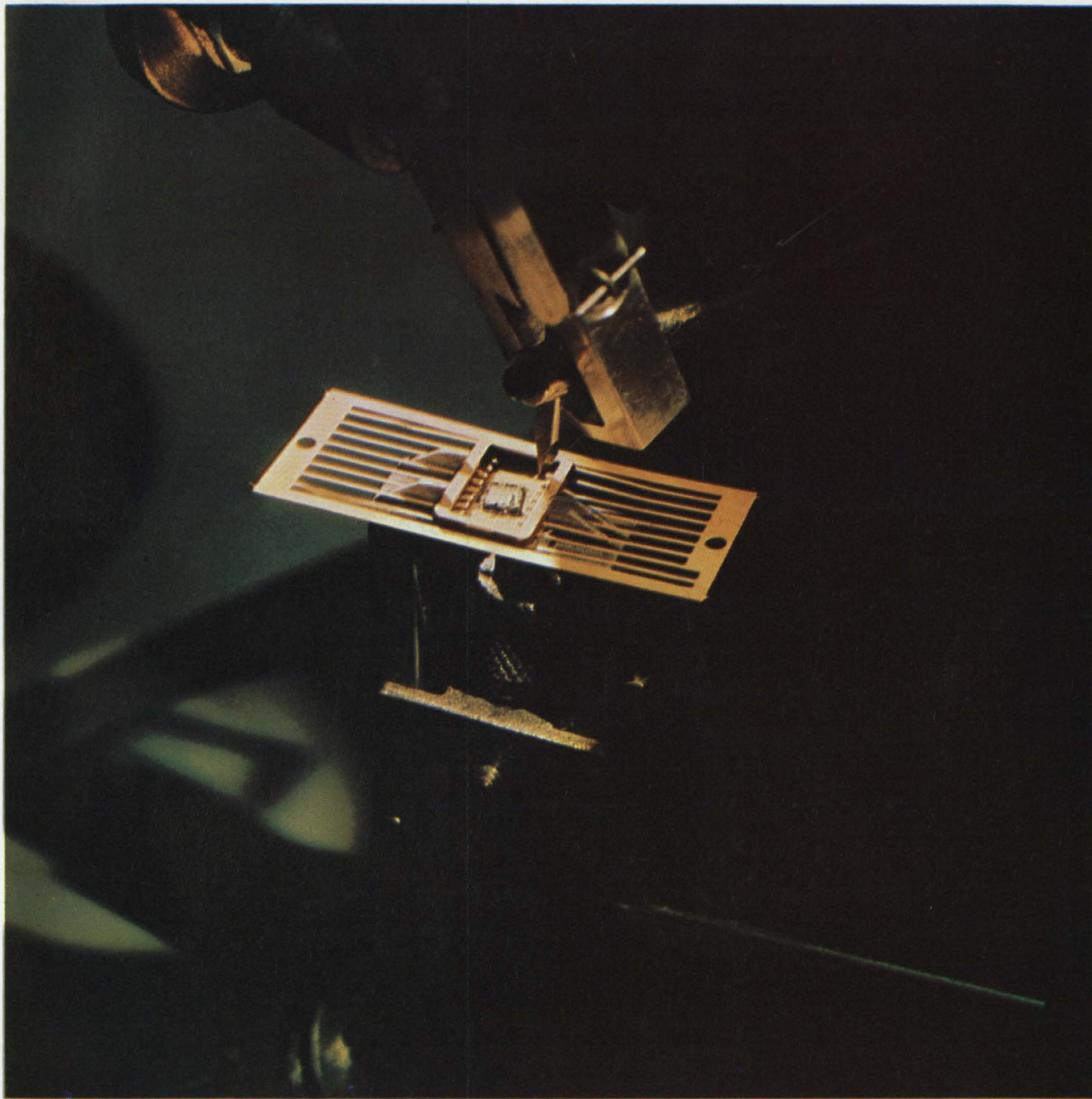

AMI is proud to announce the new AMI/MOS N-Length Shift Register, organized in singles, duals, triples and quads on single monolithic chips. Automated equipment is utilized to produce dynamic or static MOS shift registers to your exact specified bit length—the equipment has the design and production details; all it wants to know is how many bits. Send for details; better yet, hop a jet and visit the newly expanded AMI/MOS production facility—America's largest.

## **NEW N-LENGTH MOS SHIFT REGISTER CAN BE "ANY" LENGTH**



**AMERICAN MICRO-SYSTEMS, INC.**

3800 Homestead Road, Santa Clara, California 95051  
Telephone 408-246-0330, TWX 910-338-0018  
CUSTOM & STANDARD MOS ARRAYS/MEMORIES/REGISTERS/LOGIC



# Flame retardancy!

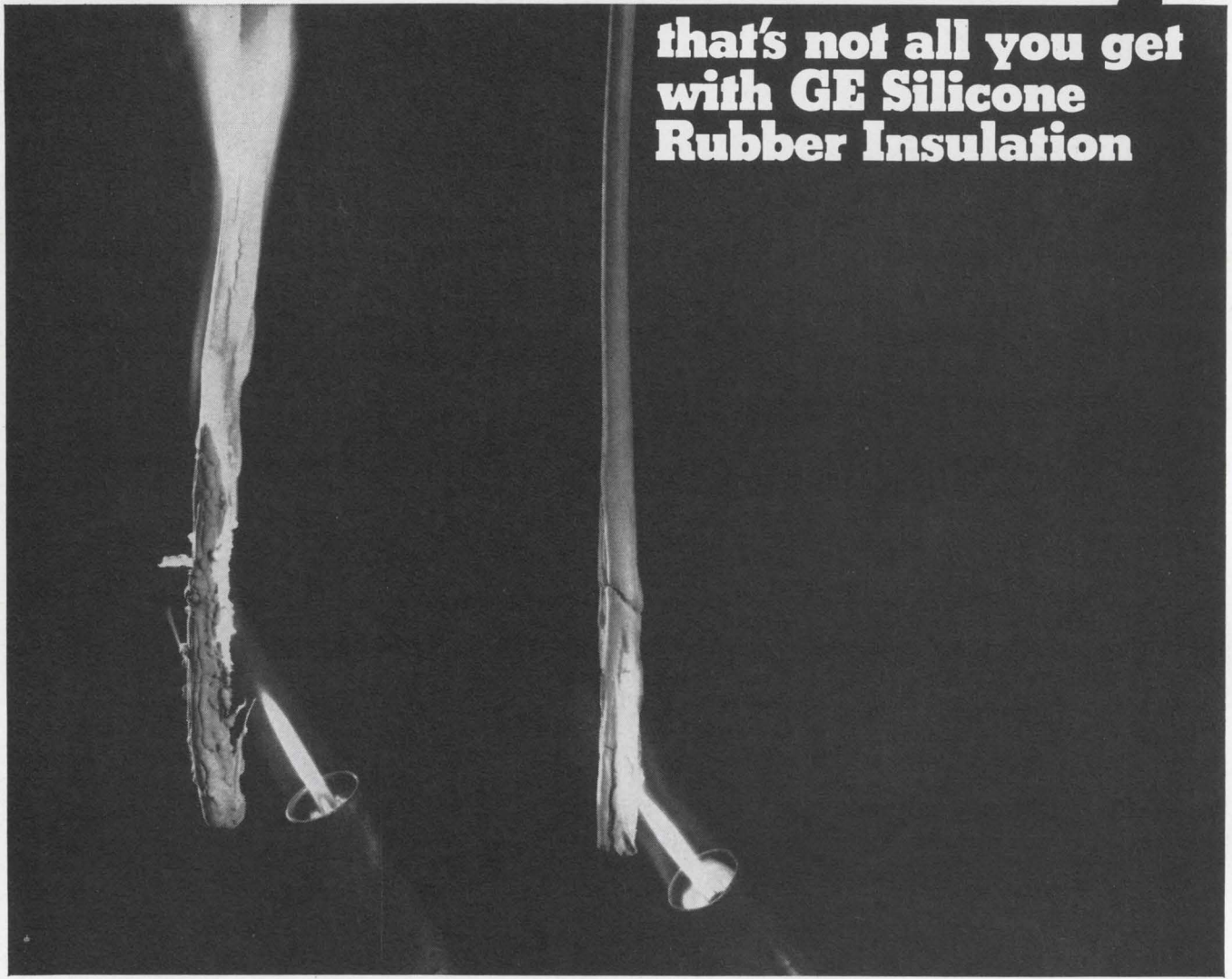

that's not all you get  
with **GE Silicone  
Rubber Insulation**

*New ultra-tough SE-9090 braidless wire and cable insulation (right) doesn't support combustion like conventional insulation. It's shown here passing the UL vertical flame test. SE-9090 has both outstanding insulation resistance and dielectric strength.*

The big news in silicone rubber this year is flame retardancy *plus* high physical strength.

But don't overlook the other design advantages of GE silicones: radiation, ozone, corona, and fungus resistance ... reliable performance from  $-150^{\circ}\text{F}$  to  $600^{\circ}\text{F}$  ... and the proved dependability of silicones for the most demanding dielectric requirements. Weigh them all and you'll find that GE silicones offer the best combination of desirable values in insulation.

Versatile silicones take many shapes and forms to adapt to your specific problems. For a new booklet illustrating electronic applications for GE silicones, write Section N11294, General Electric Company, Waterford, N.Y. 12188.

**GENERAL  ELECTRIC**

Use GE flame-retardant silicones for...

Potting applications

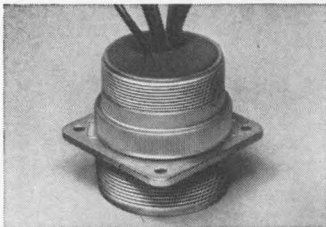

Conformal coatings

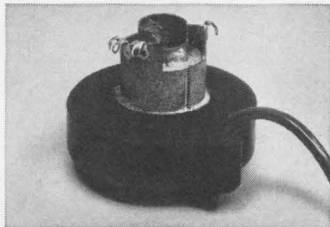

Wire & cable insulation

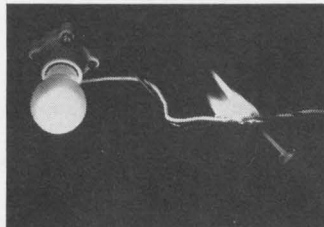

Fabricated parts

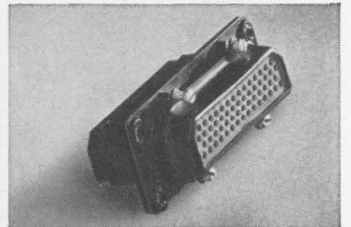





# ERIE

When you want radar as pure and coherent as a laser beam...

Symbolic electronic signal undistorted by EMI —  
photographed by Howard Sochurek

## bring ERIE in early.

31,000 feet... heavy traffic... ugly weather over the Plains. This isn't the time for "noise" in the radar. But, no sweat! RCA's exciting new AVQ-30X Weather Radar is up front, sweeping the sky... protected from EMI by 39 special ERIE filters. No other airborne radar has ever approached the single or dual system reliability of the AVQ-30. From the start, RCA has called on the outstanding research and component capability of ERIE TECHNOLOGICAL to help in the development of this great new unit. Proof, once again, that it pays to bring ERIE in early.

**ERIE TECHNOLOGICAL PRODUCTS, INC.**

644 West 12th Street, Erie, Pa. 16512  
(814) 456-8592



For over 20 years, wire insulations of Du Pont TEFLON fluorocarbon resins have provided maximum performance and reliability under extremes of temperature and adverse environments. But did you know there are composite constructions of TEFLON and polyimides

**TEFLON: all by itself  
the most  
thoroughly proven,  
high-reliability  
insulation**

**Now consider  
the additional  
advantages  
of TEFLON plus  
polyimides**

which offer you extra performance benefits for all wiring applications? TEFLON plus polyimide constructions guard against installation damage because of their toughness and abrasion resistance. They are made in two forms: a polyimide enamel over a primary insulation of TEFLON or a polyimide tape wrapped around the TEFLON.

Both these "TEFLON plus..." constructions are rated for use over a wide temperature range—up to 260°C. They are easily printed and potted, nonflammable, chemical-resistant, lightweight and have a small diameter. They provide the optimum dielectric quality which you expect from insulations made with TEFLON.

If you'd like additional information on composites of TEFLON plus polyimides (or composites using mineral fillers or polyvinylidene fluorides with TEFLON), write us and let us know about the specific application you have in mind.

Write: Du Pont Company, Room 7297J, Wilmington, Del. 19898.

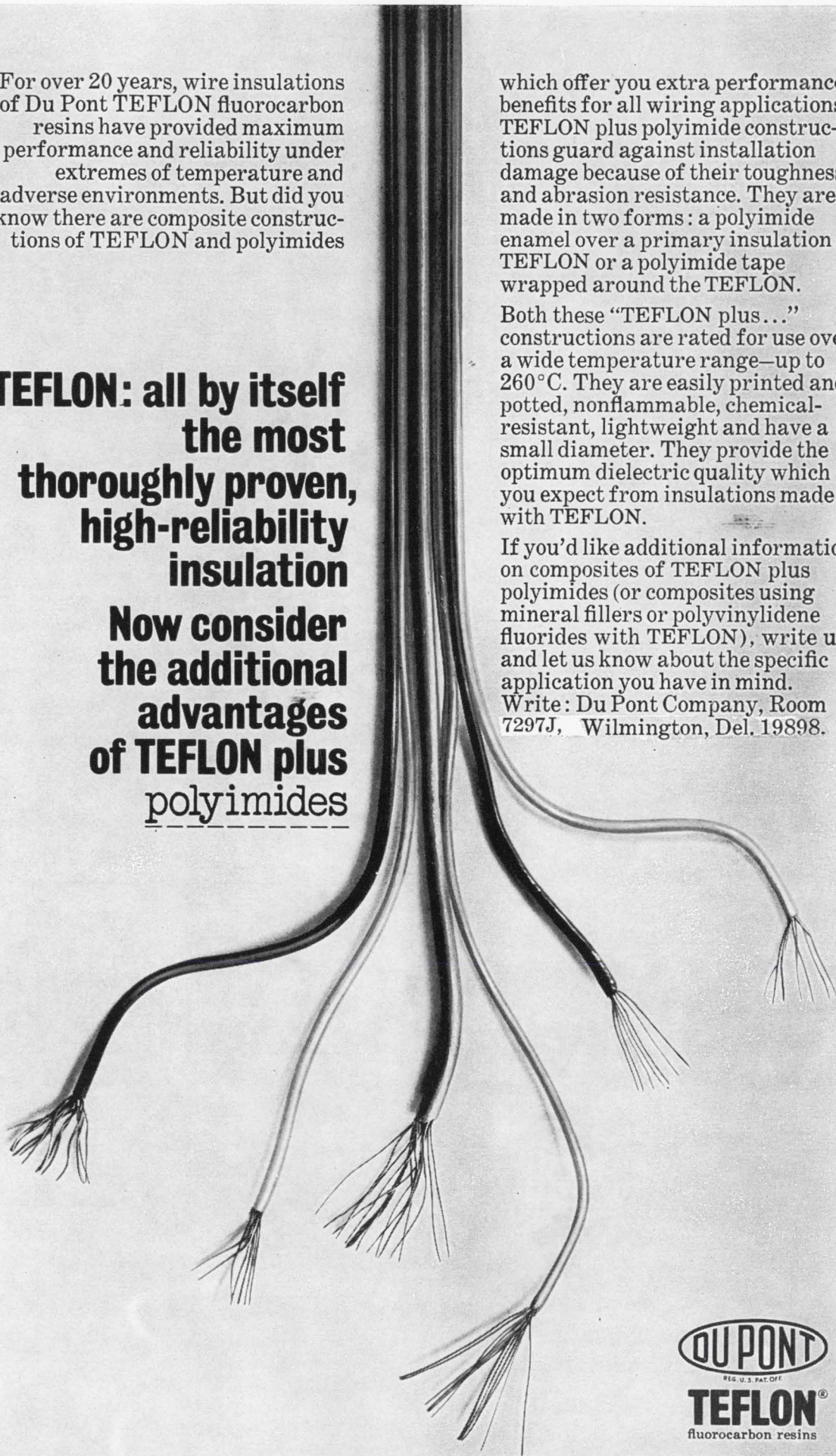

**DU PONT**  
REG. U.S. PAT. OFF.  
**TEFLON**<sup>®</sup>  
fluorocarbon resins



See us at FJCC—Booth #2000

## Digitally Controlled Power Sources Include Added Systems-Oriented Functions

Digitally Controlled Power Sources (DCPS's) are complete digital-to-analog links between a computer (or other digital source) and any application requiring a fast, accurately settable source of dc or low frequency ac power. Such applications generally require more than a programmable power supply or D/A converter with a power amplifier — the DCPS's include these added functions in a single compact trouble-free package:

**INTERFACE** Customized plug-in interface cards match the Digitally Controlled Power Source to the computer (8421 BCD or Binary).

**ISOLATION** All digital inputs are floating and isolated from the floating analog output, thus avoiding troublesome loops between the output ground and computer ground.

**STORAGE** Inputs from all digital data lines are stored upon receipt of a gate signal from the computer. Output levels are maintained until a new gate signal is received — thus, the computer is free to perform other tasks in the interval between voltage level changes.

**FUNCTION SELECTION** Selects the output voltage range, and isolates the three input bits to the current limit D/A converter.

**OUTPUT VOLTAGE D/A CONVERTER** Converts one polarity bit plus 16 BCD voltage bits or 15 binary voltage bits to an analog voltage for input to the power amplifier. Thus, resolution is 0.5mV for straight binary and 1mV for BCD operation.

**REFERENCES** Provide voltage for the Output Voltage and Current D/A Converters.

**CURRENT LIMIT D/A CONVERTER** Sets current limit of power amplifier to one of eight values.

**CIRCUIT POWER SUPPLIES** Provide all the necessary dc power — no external power supplies are required.

**FEEDBACK** Informs the computer when each programming operation is completed and when the output current is overloaded.

**BIPOLAR POWER AMPLIFIER** Programs either side of zero or through zero without output polarity switches or "notch" effects, with an accuracy of 1mV, 5mV, or 10mV depending on range and model. Outputs from -100V to +100V with currents up to 1A are available.

21904A

# all this

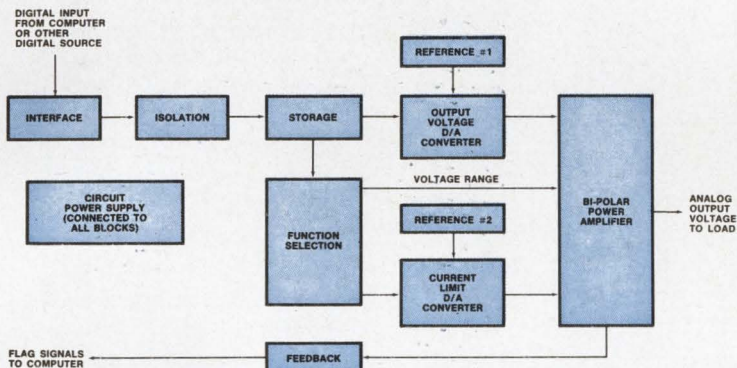

# in one

# compact package

Write for Digitally Controlled Power Brochure.

HEWLETT  PACKARD

COMPUTER INSTRUMENTATION

100 Locust Avenue, Berkeley Heights  
New Jersey 07922 • (201) 464-1234

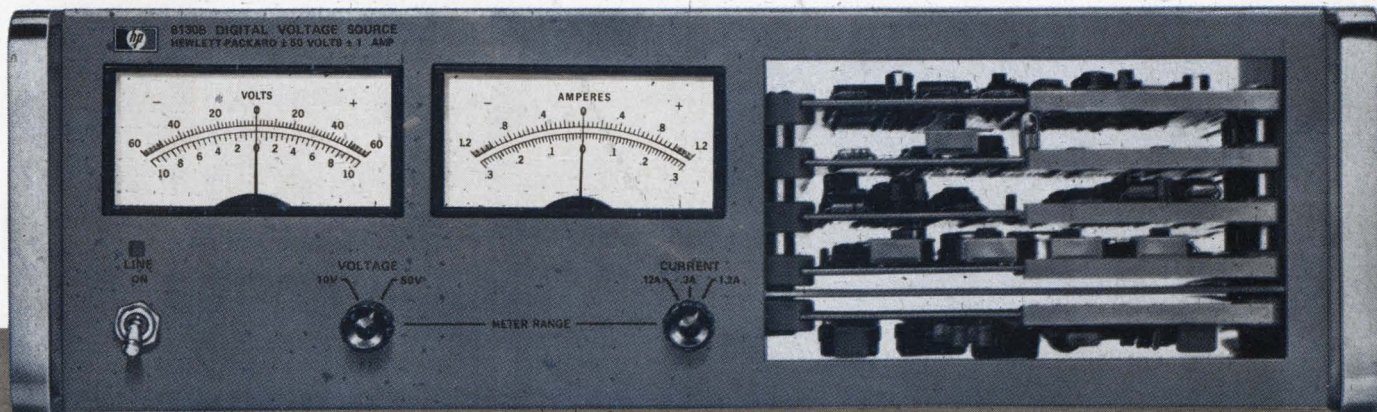





It's our Model 110. For **wave analysis** it permits adjustment of Q from 1-100 (bandwidth to 1.0%) over a frequency range of 1 Hz - 110 kHz. For **distortion analysis**, you can measure levels of distortion as low as 0.1%. Or combine two Model 110's in tandem for measurements down to 0.001%.

Why the "PLUS"? Because the Model 110 can also serve you in so many other ways. Use it as a: **Stable low-distortion oscillator** providing up to 5 volts rms into 600 ohms and capable of synchronization by an external signal. **Flat or selective ac voltmeter** with sensitivity ranging from 10 microvolts to 5 volts rms full scale. **Low noise amplifier** with a voltage gain from 1 to 10,000 and a typical noise figure of 1 dB. **Notch filter** with set frequency rejection in excess of 100 dB. **Allpass delay phase shifter** with an amplitude response flat with frequency, and a phase lag which increases monotonically with frequency.

Price of the Model 110, complete with all its PLUSES, is \$1,350. For additional information or a demonstration, write Princeton Applied Research Corporation, Box 565, Princeton, New Jersey 08540, or call (609) 924-6835.



PRINCETON APPLIED RESEARCH CORPORATION

## Meet our "Wave/Distortion Analyzer PLUS"

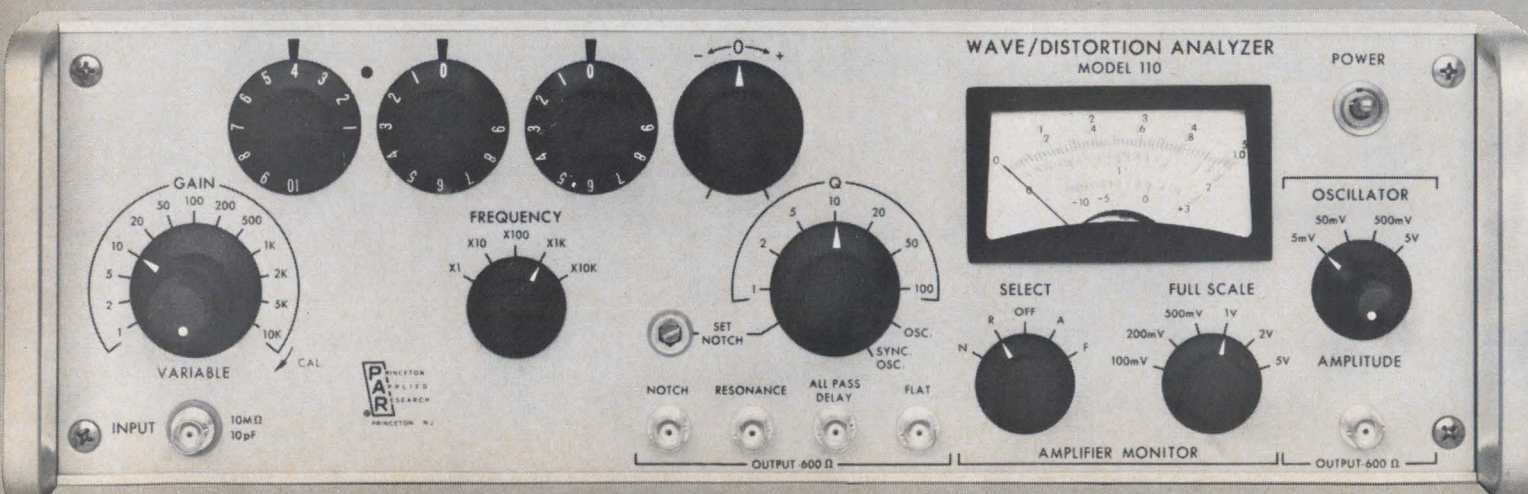



# Administration infighting delays improved frequency management

In a private exchange of letters, Defense Secretary rejects plan to allow Commerce to take over telecommunications policy

By Ray Connolly

Electronics staff

Every new Administration that arrives in Washington has its share of empire builders whose infighting frequently subordinates the public interest. The Nixon Administration is no exception. Nevertheless, specialists in communications anxious to implement at least some of President Johnson's task force recommendations for a modern communications policy are becoming increasingly frustrated by the existing Administration's lack of action.

What's the reason? Some lay the problem at the doorstep of that old Nixon campaign manager, Commerce Secretary Maurice Stans, and his current effort to acquire responsibility for national telecommunications affairs. Support for this criticism comes from two pieces of hitherto private correspondence between Stans and Defense Secretary Melvin Laird, an exchange that left Stans—clearly out of his political depth when he tangled with the former Congressman—the loser.

To the letter. On October 1, Defense Secretary Melvin Laird wrote a "Dear Maury" letter to Stans. It was a reply to Stans's September 2 "Dear Mel" letter outlining how, in Laird's words, "Commerce would effect leadership in the telecommunications management area." Laird's salutation is the only bit of cordiality in the private four-page rebuttal of the Stans proposal, a proposal put forth earlier in an interview by his assistant secretary for science and

technology, Myron Tribus [*Electronics*, Sept. 1, p. 14].

The Secretary of Defense, citing his role as executive agent for the National Communications System (NCS) and the fact that "my Defense Communications System (DCS) constitutes 80% of that system," does not take kindly to the idea of concentrating telecommunications responsibility within Commerce or any other department. What would happen, for example, if NCS chief Laird were unable to resolve a communications policy conflict involving, say, Commerce's weather bureau networks and another agency? "Under your proposed arrangement," Laird points out, "I would go to an

assistant secretary of commerce for a policy decision, rather than to the President as I do now."

Overlooked in the praise of communications specialists familiar with Laird's surgical destruction of Commerce Department's empire builders is the Defense chief's inadvertent exposure of a principal weakness of the whole Federal structure of telecommunications management. By pointing out to Secretary Stans that "instances where your networks were a party to the dispute," the role of Commerce "as disputant and adjudicator would be a most difficult one," Laird leaves his letter readers to recall that DOD's own dual role as NCS executive agent and

## How Commerce was going to do it

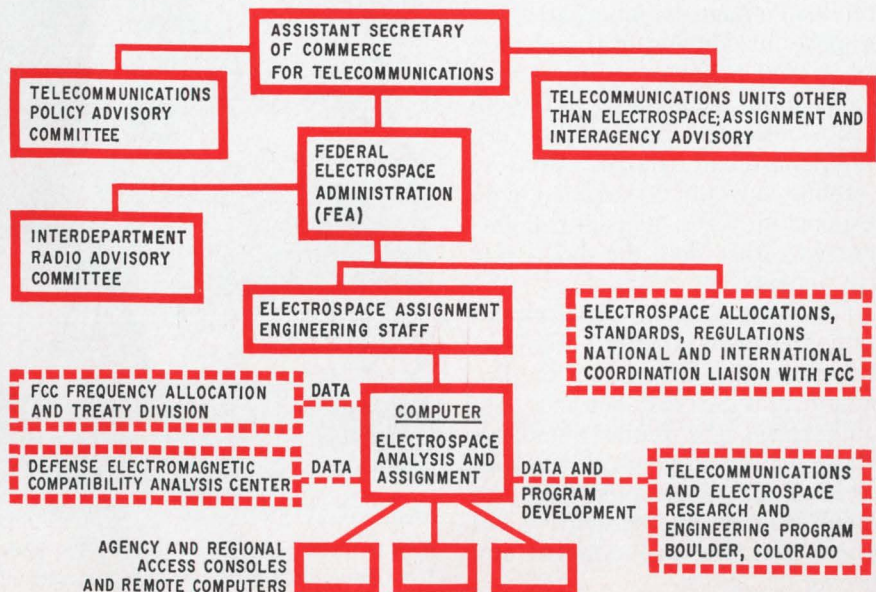



## U.S. Reports

Defense Communications Agency operator came in for exactly the same criticism in a General Accounting Office report to Congress this summer.

**Change in plan.** An apparent uncertainty within Commerce as to just what would comprise "a new Federal Electrospace Administration," as Stans calls it, gave Laird just the opening he needed: "Comparing the September proposal with the correspondence and study previously provided on July 3," Laird remarks, "I find it significant that your department no longer proposes transfer of certain statutory responsibilities of the FCC to the Executive branch. I am gratified by this change since I did not consider it appropriate for the Executive branch to propose that Congress transfer responsibility to regulate interstate and foreign commerce, insofar as telecommunications is concerned, from the FCC to the Executive branch."

Under the Commerce Department plan, drafted by assistant secretary Tribus, it would take over virtually every telecommunications policy function within the Government as well as "allocation, assignment, and regulation of Federal use of the electrospace"—a favorite Tribus expression—plus "guidance and coordination of Government systems development, standards and procurement criteria; interagency and Federal-state telecommunications coordination."

As the Commerce secretary put it to his Pentagon counterpart: "We propose introducing to the electrospace assignment process a central engineering assignment staff with a substantial computer facility. The Interdepartment Radio Advisory Committee would be retained, with responsibility for oversight of this process rather than the day-to-day assignments."

The Stans concept also includes "activities of the Institute for Telecommunication Sciences of the Environmental Science Services Administration, the Radio Standards Divisions, the Technical Analysis Division, and other units of the National Bureau of Standards, and other appropriate government and private resources."

**Unimpressed.** But as Mel told Maury, "The fact that the Department of Commerce has certain radio research and analytical resources is not, to my mind, a compelling argument for the relocation of telecommunications management to Commerce."

The bitter choice to a proposal that offers no "significant advantages but does present many disadvantages," according to Laird, is to provide the FCC and the Director of Telecommunications Management "with more resources" and "elevating the DTM to separate office status within the Executive Office of the President, as has been recommended by the Comptroller General."

With those closing words, the Secretary of Defense finally comes down on the side of the GAO report which this summer spoke critically of DOD's own conflict of communications interest with its Defense Communications Agency overseeing operation of the larger National Communications System.

## Communications

### It works

Can you picture a portable satellite ground station in New Zealand transmitting, noisily but readably,

with its parabolic antenna pointed at the satellite at a  $0.4^\circ$  down angle? Or another small terminal at Scott Air Force Base in Illinois, turning down its amplifier power to 2.5 watts and still getting through loud and clear via satellite relay to a man-carried terminal in front of a Washington hotel?

You can, because results like those are bringing smiles to military communications people as testing with the tactical communications satellite picks up speed.

**They came.** Whether it was to check out reports that Tacsat I wasn't working as planned, or the likelihood of massive future terminal purchases, an overflow crowd jammed the Tacsat session at the Electronic and Aerospace Systems Convention (Eascon) in Washington late in October. It was the most detailed unclassified briefing yet on the R&D program.

To find out if the tests were working, all the engineers had to do was step outside the convention hall. There, they could listen to a TRC-156 teampack terminal, operating with 11 other ground terminals and at least one EC-135 jet transport flying off Bermuda.

The satellite, built by Hughes Aircraft and launched in February, is now performing all its scheduled tests. Earlier problems with super-high frequency (shf) tests were



**Mighty mite.** Three GI's can carry the 120-pound uhf satellite terminal. The Collins-built TRC-156 puts 20 watts into its 5-foot dish.



November 10, 1969

# Electronics Index of Activity

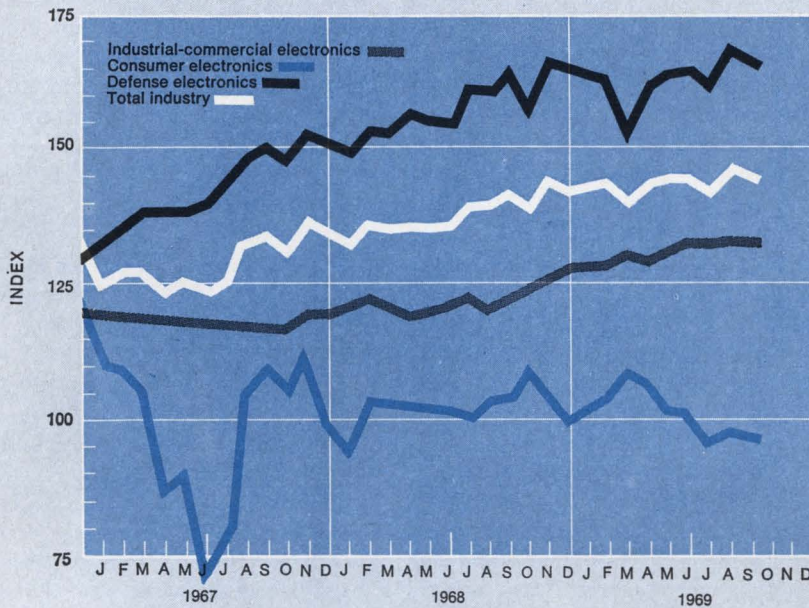

Segment of industry	Sept. 1969	August 1969*	Sept. 1968
Consumer electronics	97.0	97.7	105.3
Defense electronics	166.1	170.0	166.1
Industrial-commercial electronics	134.1	134.2	122.9
Total industry	144.9	147.1	143.1

After back-to-back record month-to-month gains, total electronics production in September dipped 2.2 points from August's 147.1. But the index still maintained a 1.8-point lead over the September 1968 level.

The defense sector, which led the August spurt, also was the September leader—in the opposite direction—with a 3.9-point loss. Consumer electronics fell 0.7 point, while industrial-commercial production was fairly steady with a mere 0.1-point decrease.

Indexes chart pace of production volume for total industry and each segment. The base period, equal to 100, is the average of 1965 monthly output for each of the three parts of the industry. Index numbers are expressed as a percentage of the base period. Data is seasonally adjusted. \*Revised.

traced to ground stations; they have since been resolved. The only problem remaining in the spacecraft was a degradation of the uhf effective radiated power, down 3 to 5 decibels. This was described as "not too serious" by Peter T. Maresca, deputy director of engineering development at the Army Satellite Communication Agency, Fort Monmouth, N.J. No tests have been affected, he maintains.

Hughes engineers believe the dropoff in signal is due to a damaged antenna, possibly one of the helices in the five-element uhf array. At first they were afraid to turn on all 16 uhf amplifiers, but they did, and everything on the bird is working. At any rate, no one seems to be particularly worried about the uhf degradation. One reason: Hughes says that overall, it's getting 3 db of effective radiated power over design specifications—or 40 db over 1 watt rather than the 37 dbw called out in the specs. This just about makes

up for the loss, which averages around 3 dbw, Hughes engineers say.

**Punch.** That's a lot of power for a communication satellite. For example, Tacsat, with its high effective radiated power, would be capable of supporting more than 20,000 high-quality telephone channels if it were working with a standard commercial ground station with an 85-foot antenna, low-noise receivers, and high-power transmitters. This compares with only 1,200 channels relayed by the Communication Satellite Corp.'s currently operational Intelsat 3, and the 10,000-channel Intelsat 4 now being designed and built for Comsat by Hughes.

The 1,600-pound Tacsat puts out 980 watts of solar power into a uhf and an shf frequency-translating repeater, each capable of operating on selectable bandwidths from 50 kilohertz to 10 megahertz. The final uhf output level with all 16 amplifiers on its 23.6 dbw, while

the shf transmitter, by combining the output of any two of its three 20-watt traveling-wave-tubes, puts out a carrier power of 14.6 dbw.

Until now, Tacsat has been used primarily for checkout and initial compatibility testing between ground terminals and spacecraft, but Hughes engineers claim that feasibility has already been proved. Very little multiple-access testing has been done yet, though as many as 11 terminals have operated at the same time, all on 2,400 bits-per-second vocoder voice. But even this takes careful power balancing, done manually to within about 1 db.

Several prototypes of a modem designed for multiple access in tactical satellite communications have been designed and built by Massachusetts Institute of Technology's Lincoln Laboratory. The TATS (for tactical transmission system) modems have already been operated successfully through Tacsat as well as Lincoln experimental satellites (LES 5 and LES 6). Sylvania is



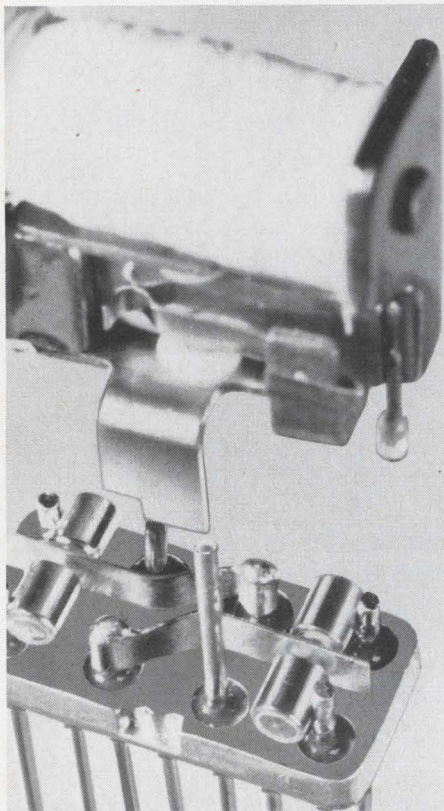

## mite-size relays with macro-size contacts

Couch 2X relays are true 1/2-size, yet the contacts are as large or larger than many full and half-size crystal can units.

Couch 2X relays meet MIL-R-5757D/19 and /30 specs in 1/25th of a cu. in. Design simplicity and oversize contacts assure the ultimate in performance. Each relay is fully tested. Ideal for missile and aerospace switching applications or wherever reliability in small space is of prime importance. Available in many terminal styles and a wide choice of mountings.

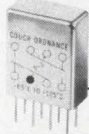

Write for Data Sheets No. 9 and No. 10 today.

	2X (DPDT)	1X (SPDT)
Size	0.2" x 0.4" x 0.5"	same
Weight	0.1 oz. max.	same
Coil		
Operating Power	100 mw or 150 mw	70 mw or 100 mw
Coil		
Resistance	60 to 4000 ohms	125 to 4000 ohms
Temperature	-65°C to 125°C	same
Vibration	20G	same
Shock	75G	same

RUGGED ROTARY RELAYS  Dynamically and Statically Balanced



## S. H. COUCH DIVISION

ESB INCORPORATED

3 Arlington St., North Quincy, Mass. 02171

## U.S. Reports

building R&D versions (MD-801), in a pilot production run, that have been reduced to one rack-mounted drawer including the power supply.

**Hippity.** The modem employs coded multiple frequency-shift keying message modulation and bandspreading by frequency-hopping the signal over the total transmitted bandwidth. The hopping pattern of the carrier is made up of a repetitive sequence of seven frequencies (a carrier frame). The modem can handle inputs at both 75 and 2,400 bits per second for teletypewriter and vocoder inputs.

In flight tests using the LES 6 satellite as the relay, Lincoln Lab was able to squeeze 17 carefully balanced power users at the high data rate (2,400 bps), which is "quite close to the theoretical capacity of the modem," says Steven L. Bernstein of the lab. With all 17 channels, the transmissions started breaking up; it's essential to get near power balance among users, he points out. About 544 low data rate (75 bps) users could be handled in the multiple access mode with the TATS modem.

Already demonstrated as feasible, Bernstein says, is that allocations can be shared by conventional equipment and satellite users, and uhf satellite communications can be handled from aircraft with simple blade antenna structures. Coding and frequency diversity of the TATS modem can minimize multipath propagation, while they can combine with the matched filter output limiting to provide protection against sporadic r-f interference usually found in a tactical environment.

**Sales.** As to the potential modem and terminal market, consider the numbers in a Tacsat computer model employed by Stanford Research Institute to come up with a control system that could handle the mixing of tactical satellite terminals. While it was emphasized that the model was not representative of any planned number, the SRI force was a large force in Europe with 4,208 satellite terminals. This included 22 ship units, 265 aircraft units, 128 in helicopters, 252 teampacks, and 1,200 truck-mounted terminals.

## Brave new network

Imagine, if you can, communities of homes and offices interconnected in modules of 6,000 units by a 300-megahertz broadband cable able to fulfill man's every communications need and you will see the electronics industry view of the future. It's a vision conceived by the Electronic Industries Association's Industrial Electronics division and delivered to the FCC. It's also a picture drawn many times by industry's best-known expert on spectrum management, Richard P. Gifford [*Electronics*, Sept. 29, p. 14]. Gifford also heads GE's Communications Systems division.

The EIA concept of a broadband net is its 41-page response to the FCC docket seeking guidance on the "broad question of how best to obtain . . . the full benefits of developing communications technology for the public, with particular immediate reference to CATV technology and potential services. . . ."

**Space.** On the premise that America's life style in the next two decades will continue to be marked by affluence and an increasing demand for services, Gifford poses an almost poetic question: "Why then, oh why, must we jam into stacked cells, follow rivers of steel and flesh, and force ourselves into social orders that regulate crowded living and destroy the individualized human thrust to be found in more open family and home-based living?" The answer, of course, is we don't—if the nation can be wired with a broadband, nonswitched network to accommodate that 80% of the population living on less than 10% of the land mass and, most likely, accommodating the remainder via point-to-point and broadcast satellites.

What will it cost? Conceding that cable technology for commercial use has a long way to go to achieve a 300 Mhz capacity, the ability to carry multichannel video more than 15 miles without repeaters significantly degrading the signal, and the necessary development of digital systems to insure privacy in two-way services, the EIA does project costs of wiring households.

Drawing on a Rand Corp. model



## TRW METALLIZED POLYCARBONATE CAPACITORS



... small enough to fit!

TRW 50-volt Metallized Polycarbonate Capacitors are made to squeeze into tight places. Imagine 10 microfarads measuring .547" x 1¼" long... the smallest wound capacitor on the market!

Short on size and long on reliability, the X463UW series meets all requirements of MIL-C-27287.  
**VOLTAGE**—50V, 100V, 200V, 400V  
**CAPACITANCE**—.001 through 10 mfd  
**TOLERANCE**—available to  $\pm 1\%$ .

For data, write TRW Capacitor Div., Ogallala, Neb. Phone (308) 284-3611. TWX 910-620-0321.

# TRW®



# Time Sharing Makes Sense

**FOR EXPENSIVE  
ELECTRONIC  
INSTRUMENTS, TOO!**

RENTRONIX gives you ready access to sophisticated electronic instruments and small computers on a short-term rental basis. Choose from one of the largest, most modern name-brand pools of electronic equipment on the market. With Rentronix you pay only for the time you use the equipment.



**FREE**

48-page catalog covering hundreds of electronic instruments and small computers available for short-term rental.

## Rentronix

A Division of Inmark, Inc.  
11501 Huff Court  
Kensington, Maryland 20795

## U.S. Reports

for 12-channel distribution with no converters, cost per home would be \$240 for the first 50% of the nation, or an investment of \$4 billion for the densest area, or \$11 billion on the basis of random selection. From there the estimate soars to \$66 billion—or \$11,000 for the last home to achieve 100% coverage—suggesting the less costly alternative of broadband signal distribution by satellite.

Though the industry position is that a broadband communications network—as opposed to the services offered—would have public monopoly characteristics comparable to the switched telephone net, it urges local regulation rather than strong Federal control. It is a position compatible with the “modular wiring” concept of Gifford, but not one that all industry sources buy—particularly in view of the generally ineffective nature of local regulatory agencies. And, while urging competitive systems development be left to industry, the EIA also notes that growth is more likely to come from “good reliable service” rather than “overeager cost-cutting.”

**Terminals.** Significant growth potential for terminals to be used in homes, education, and industry tied to a broadband net is forecast, including 0.3 kilohertz band teleprinters, 3 khz voice carriers, 4 khz to 10 Mhz facsimile systems, as well as video phones requiring 1 Mhz plus voice, color tv at 4.2 Mhz plus sound, and data channels ranging upward from 40 khz. There will also be a major requirement for “comparatively simple digital circuits” for coding and decoding transmissions addressed to specified recipients, as in the case of first-class mail.

### Integrated electronics

### No depletion allowance

One of the unresolved questions in Schottky-diode integrated circuits [*Electronics*, July 21, p. 74] has been what's the best method for eliminating high-field edge effects. Even when the Intel Corp. intro-

duced the first commercial Schottky IC's in August, the company wasn't favoring one of the two available methods at the expense of the other. But at least one company is now taking a stand; Fairchild Semiconductor views the extended-metal technique as clearly superior to the guard ring. Albert Y.C. Yu, of Fairchild's Research and Development Laboratory, reports that after 1½ years of work the technique is advanced enough to be adapted to factory production in large numbers.

Schottky diodes, of course, can greatly increase the speed at which IC's operate and decrease the power that they consume. The diodes couldn't be used in IC's until recently, however, largely because of an edge effect. Essentially, the diode is nothing more than an aluminum electrode on a silicon substrate, and the trouble is that there is a very high concentration of electric field around the periphery of the aluminum electrode that can generate noise and spurious currents which completely mask the diode current.

**Both ways.** The two contending techniques for eliminating this edge effect have helped make Schottky IC's possible. In the guard-ring technique, a p+ ring is diffused into the silicon substrate under the periphery of the electrode. This ring prevents the depletion region, with its high electric field, from getting near the edge of the electrode. In the extended-metal technique, the aluminum overlaps the silicon dioxide passivation layer with the same effect: the depletion layer is prevented from contacting the edge of the substrate's electrode.

A major advantage of the extended metal structure, in Fairchild's view, is that it makes the fabrication process simpler and more economical, since there's no need for diffusion of the p+ guard ring. But even more important, Yu says, is the fact that the guard ring adds significant capacitance to the circuit, since it forms a parasitic junction with the n-substrate. Its elimination therefore enhances the speed of the IC.

One of the difficulties of the ex-





Progress Report  
**CERAMICS**  
That Conduct Heat!

## BERYLLIA CERAMICS

.....

In recent months there have been significant technical advances in ASiMag® BERYLLIA Ceramics. ASiMag 794, an extremely dense and fine grained 99.5% BERYLLIA composition, has demonstrated its superior mechanical properties. Its modulus of rupture is typically 33,000 psi. It can be processed to close tolerances as fired. Where necessary for ultra precision, it can be ground and lapped.

### HIGH THERMAL CONDUCTIVITY

The high thermal conductivity of beryllia ceramics gives superior resistance to thermal shock and permits the ceramic to serve as a heat sink as well as an electrical insulator.

### EXCELLENT ELECTRICAL CHARACTERISTICS

The dielectric strength of ASiMag 794 is typically 230 volts/mil on a sample 250 mils thick. Electrical losses are very low, the loss factor at room temperature and 1 MHz is .0011.

### METALLIZED BERYLLIA

ASiMag® BERYLLIA Ceramics can be supplied metallized using the refractory metal process. Single source responsibility and integrated facilities, including ceramics, precision pattern generation plus plating (including gold) offer savings in time and cost.

### NEW PRODUCTION CAPABILITIES

ASiMag® BERYLLIA Ceramics can now be processed, in general, in the same wide range of designs and to the same close tolerances as the well known ASiMag® alumina ceramics.

### PROTOTYPES

Prototypes to your sketch or prints can usually be supplied at reasonable cost for your evaluation. Give us your operating requirements and our technical people will be happy to work with you.

**BULLETIN NO. 693 sent on request.**

CODE IDENT. NO. 70371

PHONE 615 265-3411 • CHATTANOOGA, TENNESSEE 37405, U.S.A.

For service, contact American Lava representatives in Offices of Minnesota Mining and Manufacturing Company in these cities (see your local telephone directory): Boston: Needham Heights, Mass. • Chagrin Falls, Ohio • Chicago: Elmhurst, Ill. • Dallas, Tex. Indianapolis, Ind. • Laurens, S. C. • Los Angeles, Calif. • Metropolitan New York: Ridgefield, N. J. • Up-State New York and Canada: Phoenix, New York • Orange, Conn. • Philadelphia, Penna. • Roanoke, Virginia • St. Louis: Lee's Summit, Mo.

**American Lava Corporation** **3M**  
A SUBSIDIARY OF COMPANY

68th  
YEAR  
OF  
CERAMIC  
LEADERSHIP



# TV Multipliers for color or black and white television.

Available in production quantities now!

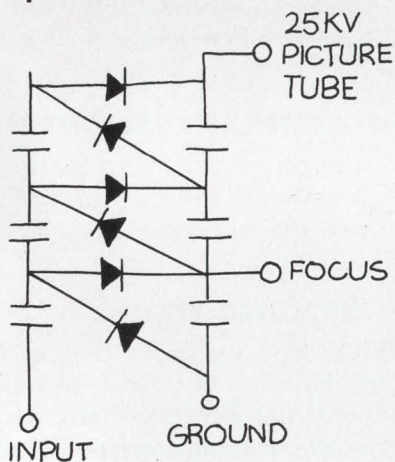

Doublers.  
Triplers.  
Quadruplers.

These specially designed TV multipliers incorporate the latest in silicon high-speed rectifiers.

They offer significant improvement in the performance, reliability, and economy of all TV high-voltage systems.

When you think of Varo Semiconductor products, remember this—we're the company that not only received the first order for multipliers to be used in consumer TV production, but we made the first silicon high voltage rectifier ever used in consumer TV sets, too.



SEMICONDUCTOR DIVISION, 1000 N. SHILOH ROAD, GARLAND, TEXAS 75040, (214) 272-4551

## U.S. Reports

**Away from the edge.** For good performance, high-field depletion region must be kept away from the edge of the aluminum Schottky-diode electrode. Two approaches are the guard ring (center) and extended metal (bottom). Both methods interpose material—either p-type silicon or silicon dioxide—between the depletion region and the electrode.

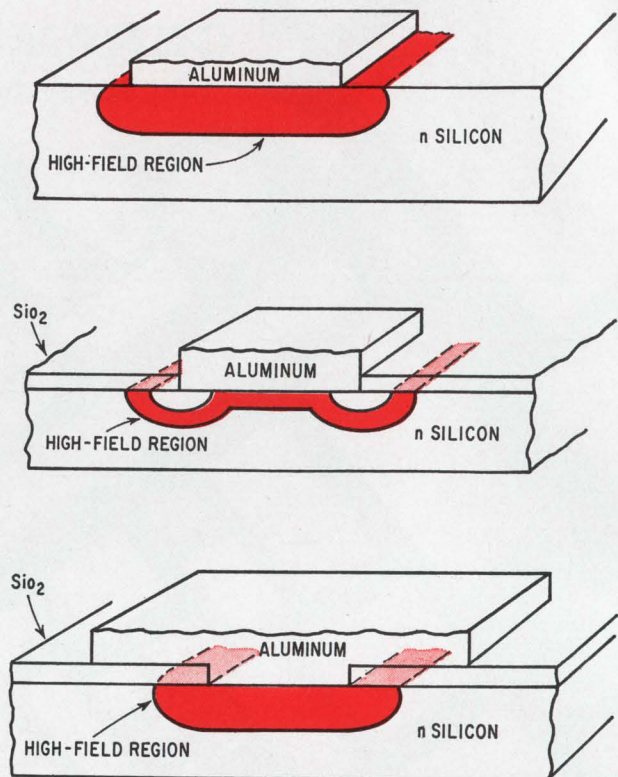

tended-metal structure was its poor noise performance. Typically, noise would increase with frequency up to the megahertz range. The cure, Yu says, was good oxides; oxide defects such as pinholes allowed the depletion region to contact the electrode. By concentrating on producing a near-perfect oxide under the electrode, Yu is making Schottky diodes in which the noise-frequency curve turns flat at 1 kilohertz at 10 microamperes forward bias. This, he says, is comparable to the best p-n junction and guard-ring Schottky diode devices made.

Yu's work is now cut out for him: he's advising Fairchild engineers during the transition of extended-metal Schottky-diode IC's from R&D to the factory.

### Space electronics

#### Solar color

Harvard's astronomers can turn in their crayons when NASA's Goddard Space Flight Center finishes debugging its first color cathode-ray display for real-time observa-

tion of solar activity transmitted from orbiting solar observatory (OSO) spacecraft.

The display was produced under a \$50,000 contract with NASA by Systems Technology Associates of Falls Church, Va. George Anikis, coordinator of the OSO experiment at Goddard, calls the piece of equipment a "giant step in solar observation."

"Now we can make intelligent use of OSO and tell it what to do soon enough so as to see the development of flares and sun spots," he said.

Experiments aboard the OSO examine the sun with a scanning spectroheliograph. The device scans a raster of 96 by 64 elements, which are first stored on tape recorders and transmitted from the OSO in the form of 16-bit binary words when the spacecraft is over a land station. They are received, along with other data, by Xerox Data System 930 computer at Goddard and fed into the color sun display in real time.

**Show and tell.** Previously, this data printout was retransmitted to the Harvard College Observatory. Dr. Leo Goldberg's graduate students would color intensity blocks





now . . . the fast-recovery  
**MAGNUM™**

The first 20 amp,  
500 nanosecond  
rectifier assemblies  
with full-power operation  
up to 40kHz.



Here's what we mean when we say  
"They're reliability designed from the inside out."

All four of the diodes in this aluminum heat-sink case are Unitrode's individually fused-in-glass controlled avalanche, fast-recovery high-surge diodes. So you start with monolithic parts that have typical failure rates of less than 0.0006%, and you have the added bonus of the convenience of the Magnum package.

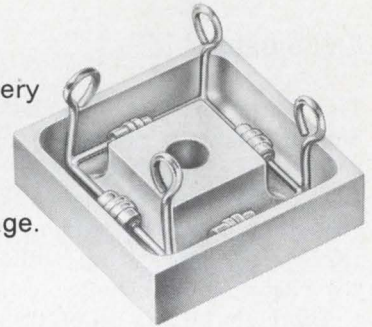

This is what's in the heart of our diodes

- #682 Series Three Phase 20 amp Bridges
- #683 Series Single Phase 20 amp Bridges
- #684 Series Single Phase 10 amp Bridges

PIV'S to 600V.  
Standard Recovery 25 amp  
Magnums also available

With the silicon die metallurgically bonded between terminal pins of the same thermal coefficient, the hard glass sleeve is fused to the entire outer silicon surface. Result — a voidless, monolithic structure.

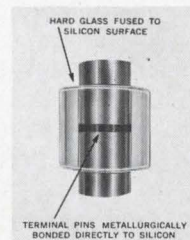

For fast action, call Fred Swymer COLLECT

**UNITRODE**

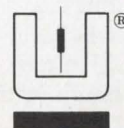

580 Pleasant Street, Watertown, Massachusetts 02172 • (617) 926-0404



## U.S. Reports

with color pencils, pretty much the same way would-be artists fill in the blocks of a color-by-number painting set. Once they had discovered what activity they wanted to take a closer look at on OSO's next orbit—96 minutes later—they would contact Goddard and OSO would get a command.

But with the use of the sun display, the observers will be able to see the intensity in real time and be able to tell OSO where to point within a few minutes.

The display converts the binary data into colors that represent the specific energy ranges on the surface of the sun, explains Joseph S. Harrison, its designer. The color transformation is selected from among five function curves stored in a small SPC-12 computer that serves as a data processor and refresher memory for the color crt, which gives the display a flexibility "... not to be found in handwired displays," the company claims. The data, in the form of 3-bit color words, is displayed in a tv raster form on the color monitor. The sun can be shown in four raster sizes from 96 by 64 to 1 by 1.

## ERTS gaps

The Earth Resources Technology Satellite, long a political football [*Electronics*, March 17, p. 58; May 12, p. 98], may just get off the ground on its latest schedule—early 1972—but it may go up without a key part of its electronics.

Although NASA is "in pretty good shape with regard to instrumentation for the first spacecraft," according to Leonard Jaffe, director of the agency's space applications programs, there's a chance that the wideband 10 megahertz tape recorder, which was to store video data on the satellite before it's transmitted to ground stations, may not be ready in time. However, the satellite would fly without it. "It just means we'll need direct readout," Jaffe says. "And because initially we'll mostly be interested in the United States, we'll have the ground stations to enable us to do this."

**Rerun.** What's more, you'll be

right if you think you've seen the ERTS before. Rather than build a completely new spacecraft, NASA has decided to adapt an old one. Hence, the two design studies awarded for ERTS have gone to old hands in the satellite business who'll rework tried and tested designs: TRW of Redondo Beach, Calif., will make over its Orbiting Geophysical Observatory (OGO) and General Electric's Space Systems organization, Valley Forge, Pa., will modify its Nimbus meteorological craft.

The studies, to proceed in parallel, will aim at the spacecraft system—with a minimum of modification to the basic satellite, specifications NASA—and the ground system that will process the data relayed by the ERTS. Each of the \$500,000 studies, which combine Phases B and C of the NASA procurement cycle, should last five months. When they're completed, NASA will award a contract for the final ERTS hardware.

Stabilized about three axes, the ERTS will circle 500 miles above the earth in a high-inclination orbit. Even though the first craft will be experimental, NASA hopes to obtain useful information. Data from sensors will be used for such tasks as developing land-use and agricultural maps of the U.S., classifying geological and soil features, and collecting data from remote stations that measure such things as river flow and water depth.

**Bit picture.** The sensor payload on the first ERTS will include three return-beam vidicon cameras for taking television pictures of the earth through three different spectral bands, and a multispectral point scanner which will operate into the near infrared band. RCA is building the vidicons and NASA has selected Hughes Aircraft to build the scanner. The award to Hughes, made early last month, could reach \$1.8 million.

NASA recognizes the vast problem faced in translating the ERTS data into useful form. Accordingly, a major part of the study awards are given over to establishing the data processing requirements on the ground. TRW, for one, has teamed with IBM's Federal Sys-

COMES WITH EVERY  
GE CAPACITOR

## Dependable Distributor Service

General Electric Distributors help you solve the tough ones with capacitors from local stock:

### EAST AND NORTHEAST

Cramer/Washington, Inc.  
692 Loftstrand Lane  
Rockville, Maryland 20850  
Tel: 301-424-2700

Gerber Electronics, Inc.  
852 Providence Highway  
Dedham, Mass. 02026  
Tel: 617-329-2400

Rome Electronics, Inc.  
108 Spring St.  
Rome, N. Y. 13440  
Tel: 315-337-5400

Schweber Electronics, Inc.  
Jericho Highway  
Westbury, N. Y. 11591  
Tel: 516-334-7474

5640 Fisher Lane  
Rockville, Maryland 20852  
Tel: 301-427-4977

213 Third Ave.  
Waltham, Mass. 02154  
Tel: 617-891-8484

Semiconductor Specialists, Inc.  
2011 Waverly St.  
Pittsburgh, Pa. 15218  
Tel: 412-351-3611

Standard Electronics, Inc.  
1501 Main St.  
Buffalo, N. Y. 14209  
Tel: 315-883-5006

### SOUTHEAST

Cramer/Florida Electronics  
4141 N.E. 6th Ave.  
Ft. Lauderdale, Fla. 33308  
Tel: 305-947-6517

Jackson Electronics Co.  
P.O. Box 19837  
Atlanta, Ga. 30318  
Tel: 404-355-2223

Schweber Electronics, Inc.  
2830 N. 28th Terrace  
Hollywood, Fla. 33020  
Tel: 305-927-0511

Southeastern Radio Supply Company  
414 Hillsboro St.  
Raleigh, N. C. 27603  
Tel: 919-828-2311

### MIDWEST

Electronics Marketing Corp.  
814 W. 3rd Ave.  
Columbus, Ohio 43212  
Tel: 614-299-4161

Hamilton Electro Sales  
920 S. Westwood  
Addison, Ill. 60101  
Tel: 312-543-8500  
1400 W. 46th Ave.  
Denver, Colorado 80216  
Tel: 303-433-8551

### Lew Bonn

7275 Bush Lake Road  
Edina, Minn. 55435  
Semiconductor Specialists, Inc.  
P.O. Box 66125  
Chicago, Ill. 60666  
Tel: 313-255-0300  
25127 W. Six Mile Road  
Redford, Mich. 48240  
Tel: 313-279-1000

### SOUTHWEST

Arco Electronics, Inc.  
P.O. Box 34772  
Dallas, Texas 75234  
Tel: 214-239-9123

Hamilton Electro Sales  
P.O. Box 10227  
Dallas, Texas 75207  
Tel: 214-638-0900

1216 W. Clay St.  
Houston, Texas 77019  
Tel: 713-526-4661

1741 N. 28th St.  
Phoenix, Arizona 85009  
Tel: 602-272-2601

### WEST & NORTHWEST

Elmar Electronics, Inc.  
2288 Charleston Rd.  
Mt. View, Calif. 94041  
Tel: 415-961-3611

Hamilton Electro Sales  
10912 W. Washington Blvd.  
Culver City, Calif. 90230  
Tel: 213-870-7171

2320 6th Ave.  
Seattle, Wash. 98121  
Tel: 206-442-2011

5567 Kearny Villa Rd.  
San Diego, Calif. 92123  
Tel: 714-279-2421

340 Middlefield Rd.  
Mt. View, Calif. 94041  
Tel: 415-961-7000

Kimball Electronics, Inc.  
350 Pierpont Ave.  
Salt Lake City, Utah 84101  
Tel: 801-328-2075

G. S. Marshall Co.  
9674 Telstar Ave.  
El Monte, Calif. 91731  
Tel: 213-686-1500

Electronic Capacitor & Battery Dept., Irmo, S. C.

**GENERAL  ELECTRIC**

430-44



COMES WITH EVERY GE  
COMPUTER GRADE CAPACITOR

# Extensive research and development

Research at General Electric is directed toward one basic philosophy: to give every customer the most reliable product at a reasonable price. Toward this end, our capacitor research staff in Irmo, S.C., working with their colleagues in the GE Research and Development Center and the Material Supply Operation in upstate New York, have contributed unique innovations in electronic capacitor development.

An outstanding example is the GE 86F computer grade capacitor. Advanced foil technology produces an exceptionally reliable product with useful service life in excess of 10 years when operated within rated conditions. GE 86F 500 computer grade capacitors offer the highest capacitance available per case size — up to 540,000 microfarads at 5 volts. This can mean up to a 30 percent reduction in the number of units required, or a significant reduction in assembly size, when you specify GE computer-grade capacitors. In addition, you gain a unit with high ripple current capability, low ESR, and a long shelf life.

High-capacitance units are available in nine case sizes — diameters  $1\frac{3}{8}$ " to 3" with lengths up to  $8\frac{5}{8}$ " — for operation up to 100VDC.

Choose from other standard ratings of computer grade capacitors for operation up to 450VDC (370,000uf maximum at 5VDC) . . . or let General Electric special-design a computer grade capacitor to fit your application.

Call your GE Electronics Distributor or GE ECSO District Sales Manager or write Section 43038, General Electric Company, 1 River Road, Schenectady, N. Y. 12305.  
Electronic Capacitor & Battery Dept., Irmo, S. C.

**GENERAL ELECTRIC**

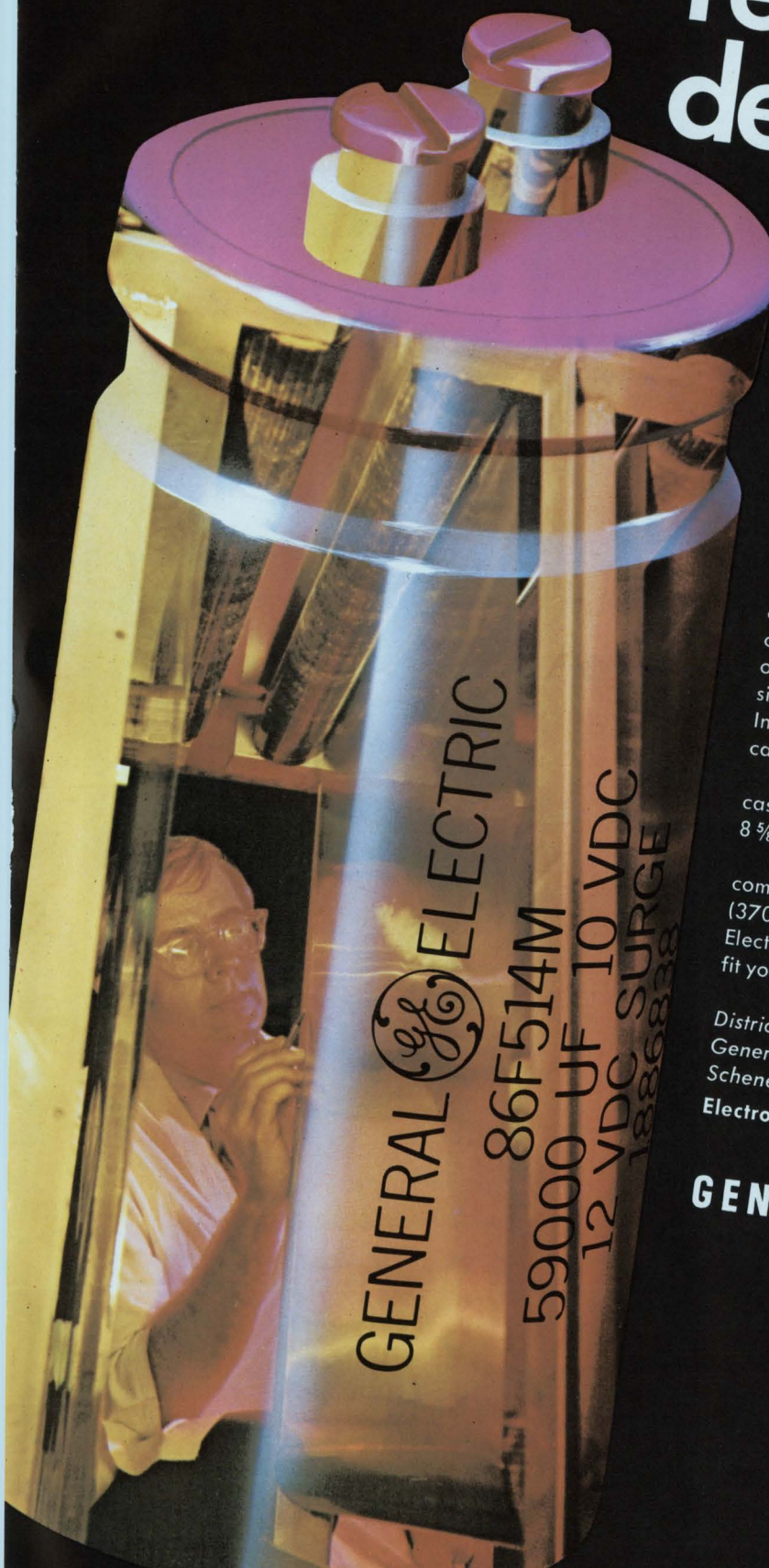



**“A Yellow Pages customer brought me  
a turntable I couldn’t fix.”**

“The turntable belonged to a merry-go-round. He found us in the Yellow Pages, but in that situation we weren’t much help,” laughs Whitey Hoffman, President (right) and Tom Ruback, Secretary Treasurer of Whitey’s Electronics, in Santa Ana, California. “Yellow Pages is a necessity though. It attracts customers. I can’t afford not to advertise in the Yellow pages. If people don’t pass by your shop,



how else are they going to find out about you? Through the Yellow Pages, right? I’ve got a pretty good idea Yellow Pages really works!”

Let the Yellow Pages do your talking. People will listen.



***An effective way to build business.***



## U.S. Reports

tems Division in Washington and the Optical Systems Division of the Itek Corp. in Lexington, Mass., to help solve the data problem. IBM will develop concepts for the data processing center that will process, store, and retrieve information; Itek will concentrate on the system for processing and reconstructing the digital images. GE's teammates are Bendix and EG&G's Wolf R&D.

## Military electronics

### SAM faces life

Pentagon rumblings hint that the Raytheon Co. is having technical problems with the SAM-D air defense missile system. But Raytheon disagrees, noting that while there has been some slippage, it's only a couple of months—not much by military contract standards.

Nor are there said to be any unexpected development problems. "The system's technical merits aren't being challenged," according to an insider. "All of SAM-D's key concepts have been demonstrated individually, and all worked."

The slippage may be due partly to some unintentional psychological warfare waged by the House of Representatives when it sliced the entire \$75 million SAM-D appropriation out of the fiscal 1970 defense budget—not the first time SAM-D money has been cut—holding Raytheon to about \$80 million through fiscal 1969. While the Senate restored the money, funding still is to be decided in a Congressional conference committee.

Also, there's talk that the sort of threat SAM-D was to have dealt with in the mid-1970's won't materialize until as late as 1980. Because of this threat reevaluation, SAM-D may be in for a stretch-out five years beyond its planned 1974-1975 operational date. Ironically, Raytheon's own improved Hawk missile is supposed to bear some of the Tactical Air Defense burden formerly slated for SAM-D.

**Bills.** The effect this is having at Raytheon is hard to measure. One spokesman at the firm's Bedford

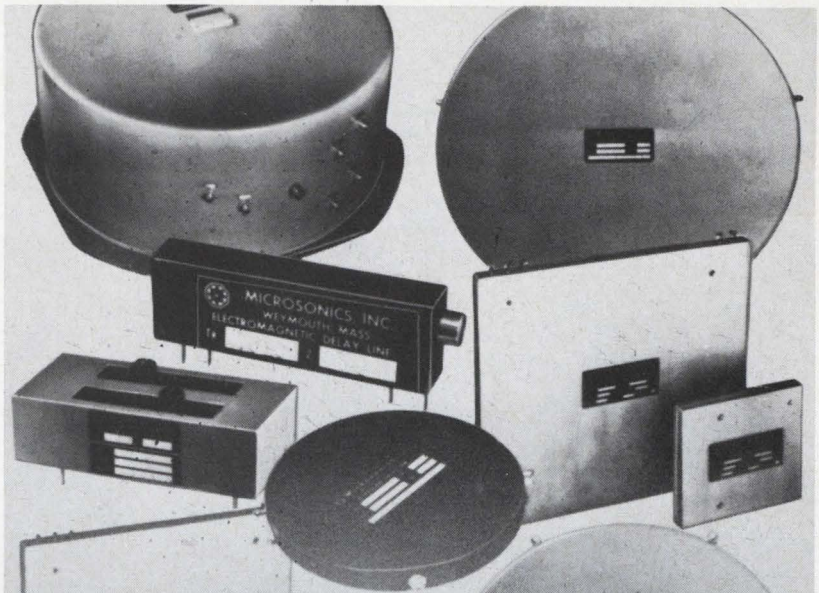

**LC & DC • DISPERSIVE • DIGITAL  
MAGNETOSTRICTIVE • QUARTZ  
GLASS • VARIABLE • TAPPED  
LC & DC • DISPERSIVE • DIGITAL  
MAGNETOSTRICTIVE • QUARTZ  
GLASS • VARIABLE • TAPPED  
LC & DC • DISPERSIVE • DIGITAL  
MAGNETOSTRICTIVE • QUARTZ  
GLASS • VARIABLE • TAPPED  
LC & DC • DISPERSIVE • DIGITAL  
MAGNETOSTRICTIVE • QUARTZ  
GLASS • VARIABLE • TAPPED  
LC & DC • DISPERSIVE • DIGITAL  
MAGNETOSTRICTIVE • QUARTZ  
GLASS • VARIABLE • TAPPED  
LC & DC • DISPERSIVE • DIGITAL**

## **MICROSONICS**

*for proven design, reliability &  
performance in*

## **DELAY LINES**

*Serial Memories*



Write for Bulletins today

**MICROSONICS**

60 Winter Street, Weymouth, Mass. 02188

Tel: 617 337-4200

A division of the Sangamo Electric Company











**Save**

# BUY YOUR FEED-THRU CAPACITORS DIRECT FROM THIS GUIDE!

Spectrum Control has engineered a complete line of reasonably priced Feed Thru Capacitors for bypass and filtering applications. Ideal where quality and economy are design factors. Feature ceramic dielectrics with sintered silver electrodes and the "Spectra Seal" resin coating. Eliminates dripping wax problems.

SPECTRA CAPACITOR VALUES SHOWN  
ARE SHIPPED FROM STOCK

SIZE AND PART NUMBER	dc Current	Working Voltage +85°C	Capacitance pF - GMV	Price Each 1-49 Pcs.
 3/16" HEX BUSH: #8-32 THD. 54 713 001	10A	200V	5000	77.5
			22,000	4.80
 1/4" HEX BUSH: #12-28 THD. 54 743 001	10A	500V	7000	.54
		200V	39,000	4.90
 5/16" HEX BUSH: #1/4-28 THD. 54 721 003	15A	500V	4000	49.5
 5/16" HEX BUSH: #12-28 THD. 54 747 001	25A	500V	6000	.39
 5/16" HEX BUSH: #1/4-28 THD. STAND OFF 54 751 001	10A	500V	10,000	.42
 5/16" HEX BUSH: #1/4-28 THD. 54 752 001	10A	500V	5000	.47
 5/16" HEX BUSH: #12-28 THD. 54 758 001	10A	500V	10,000	.39
 3/8" HEX BUSH: #5/16-24 THD. 54 763 001	25A	1500V	1000	.66

DERATE WVdc AT +125°C BY 50%  
OTHER CAPACITANCE VALUES AVAILABLE FROM 10 pF —  
ASK FOR BULLETIN 64000

SEND ORDER DIRECT  
TO OUR FAIRVIEW PLANT . . .

OR CALL JOHN LANE  
814/474-5593  
FOR QUANTITY PRICES



**SPECTRUM CONTROL INC.**  
152 EAST MAIN ST. • FAIRVIEW, PENNSYLVANIA 16415

laboratories wonders who is going to pay the bill for equipment already ordered in anticipation of fiscal 1970 development money.

Another notes that engineers today can't get dumped from one company and quickly plug into another—with the defense budget tightening there aren't many places to turn if your program gets axed." Thus, he wonders if slippage in SAM-D might not be traced to a case of the fidgets by the men involved. He adds that he's hearing more talk about engineering unionization and job security than ever before.

If SAM-D goes down the drain, it will take a well organized development scheme along with it. Learning from experiences with the Hawk and improved-Hawk missiles, Raytheon invested time and talent in several computer-based design aids for SAM-D. Both its radar-data-processing and guidance computer, and the missile-control system itself, are to be tested with thorough computer simulation. The first model of the SAM-D computer already may have been delivered and hitched to a DDP-124 to be tested in an electronic interchange.

"The environment this computer will deal with—radar, countermeasures, multitarget tracking, multi-missile guidance aid, target priority assignment, and so on—is so complex that the only way to check it out is to let it talk with another computer. There's nothing else big enough to exercise it except the real world," says an insider.

**Computer.** Meanwhile, the missile would be put through its paces by what may be the world's largest and fastest hybrid computer.

A phased array of horn antennas would face a missile nose cone in an anechoic simulation chamber, emitting the sort of countermeasure-filled, misleading, scintillating signals expected as returns from mid-70's targets. "The seeker and guidance head is going to be presented with multiple targets in its field of view, and some of the ground-based SAM-D computer gear will help the seeker ignore decoys and pick the proper target," says a spokesman.

Also on the simulation list are



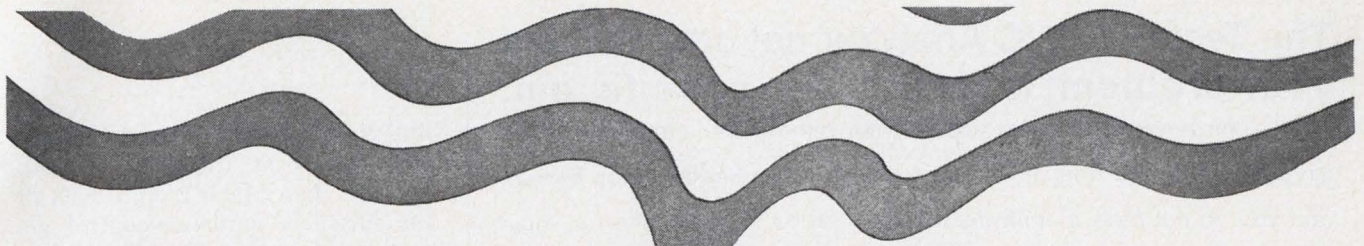

RCA-CA 3055

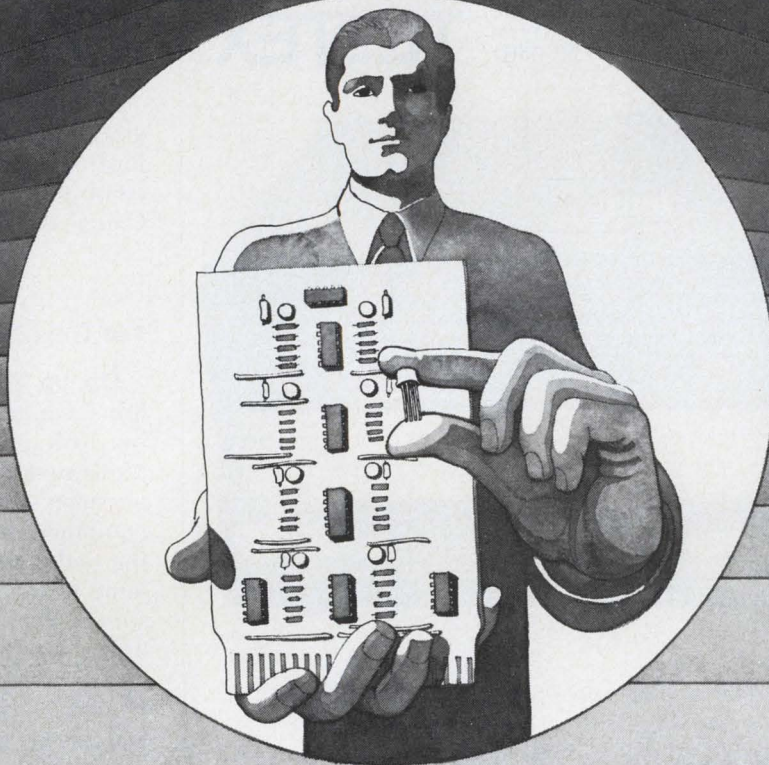

**THE REGULATOR THAT GIVES MORE PERFORMANCE FOR THE MONEY**

**We wouldn't make it any other way.**

Just \$2.95 (1,000 units) for sophisticated voltage regulation in its simplest and most economical form — RCA's CA3055 monolithic VR in the TO-5 style 8-lead package.

It offers high current capability. The CA3055 handles up to 100 mA, four times the current capability of similar solid-state VR's. It improves system performance too, because it permits engineers to put regulators where they're needed — right on the circuit board, thereby reducing power supply requirements.

Look at the CA3055's performance characteristics: 7.5 to 40 V input voltage range; 1.8 to 34 V output voltage range (adjustable); 0.025% line and load regulation; 0.075 ohm (typ.) output resistance; 0.0025% per °C ref-

erence and output voltage temperature coefficient, and -55°C to +125°C operation.

Wherever size, performance, and economy are requirements, use the CA3055. Its price is right. For details, see your local RCA Representative or your RCA Distributor. For technical data bulletin, File No. 395, write RCA Electronic Components, Commercial Engineering, Section N11-1/CA19, Harrison, New Jersey. In Europe: RCA International Marketing S. A., 2-4 rue du Lièvre, 1227 Geneva, Switzerland.

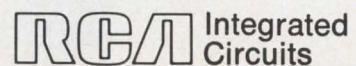
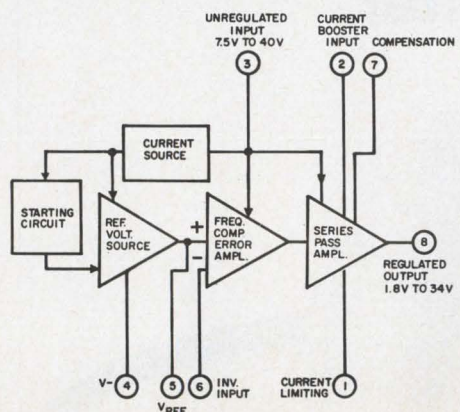



## The Testex 410 IC Analyzer not only isolates your problem; it pins it on a specific pin.

This is an *in-circuit* analyzer. You do not remove the integrated circuit from the PC board (this alone saves many an IC from the scrap barrel); and you do not have to shift the multi-pin probe to get level error, logic error, low Vcc — or visual display of signal presence at each pin.

The procedure is quicker than pin-by-pin checking and is simple enough to have non-technical people relieve skilled personnel of the testing chore. This does not make them circuit designers or service-men, but it does save valuable time.

Dual-in-line and flat-pack types — digital DTL, RTL, and TTL's are checked on Testex 410. Other specifics — function, applications and economics — are found in our literature. Testex Incorporated, 154 San Lazaro Avenue, Sunnyvale, California 94086. Telephone (408) 732-0461.

# TESTEX

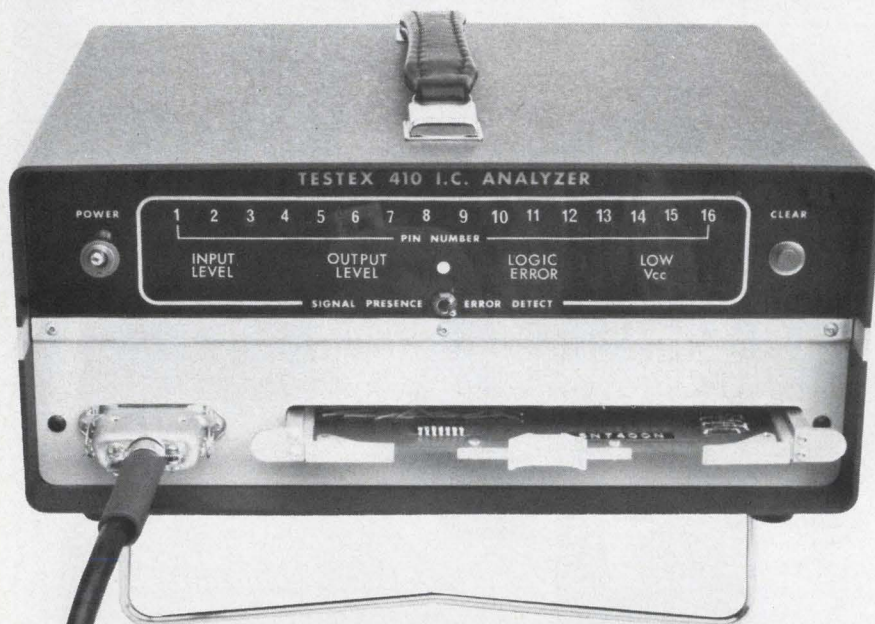

## Introducing The Pin Pointer

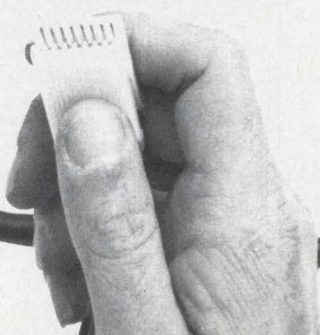

## U.S. Reports

lift, drag, and control surface pressure effects at speeds from zero to more than Mach 2, and tests of the missile's guidance-control actuators. More than 25 control loops will be tested this way, eventually simultaneously, using a combination of a Control Data Corp. 6600 digital computer and a Comcor 5000 analog system. These computers, plus their interfacing electronics, are the basis of Raytheon's "largest, fastest hybrid computer" claim.

As the tests progress, the hybrid installation, the SAM-D computer, and the missile will be linked. It's claimed that this will come about as close to a field test as possible without moving outdoors.

But for now, despite these preparations, morale at Raytheon-Bedford is getting low, and it won't climb until an answer comes from Congress on SAM-D funding.

## For the record

**Up, up—and leveling.** Electronics firms' capital expenditures will rise by 16% next year, according to McGraw-Hill's fall survey of businessmen's plans for plant and equipment investment. In addition, the industry is expecting an 8% jump in sales volume for 1970. The survey also finds that electronics firms currently project a 5% increase in expenditures during 1971. However, this figure will be affected, in part, by the expected elimination of the 7% tax investment credit as well as by other anti-inflationary measures.

**Go-ahead.** The Air Force has awarded a \$5.2-million Phase 2 cost-plus-award-fee contract to Honeywell for Geans—gimbaleled electrostatic aircraft navigation system. Geans incorporates an improved electrostatic gyro in an inertial nav system. Flight tests in the 28-month advanced prototype development project are scheduled for 1970. The heart of the system, the inertial platform, houses two gyroscope packages, an accelerometer group, and IC electronics. The computer is a digital Honeywell 601P.



# Wirewound

## Because...

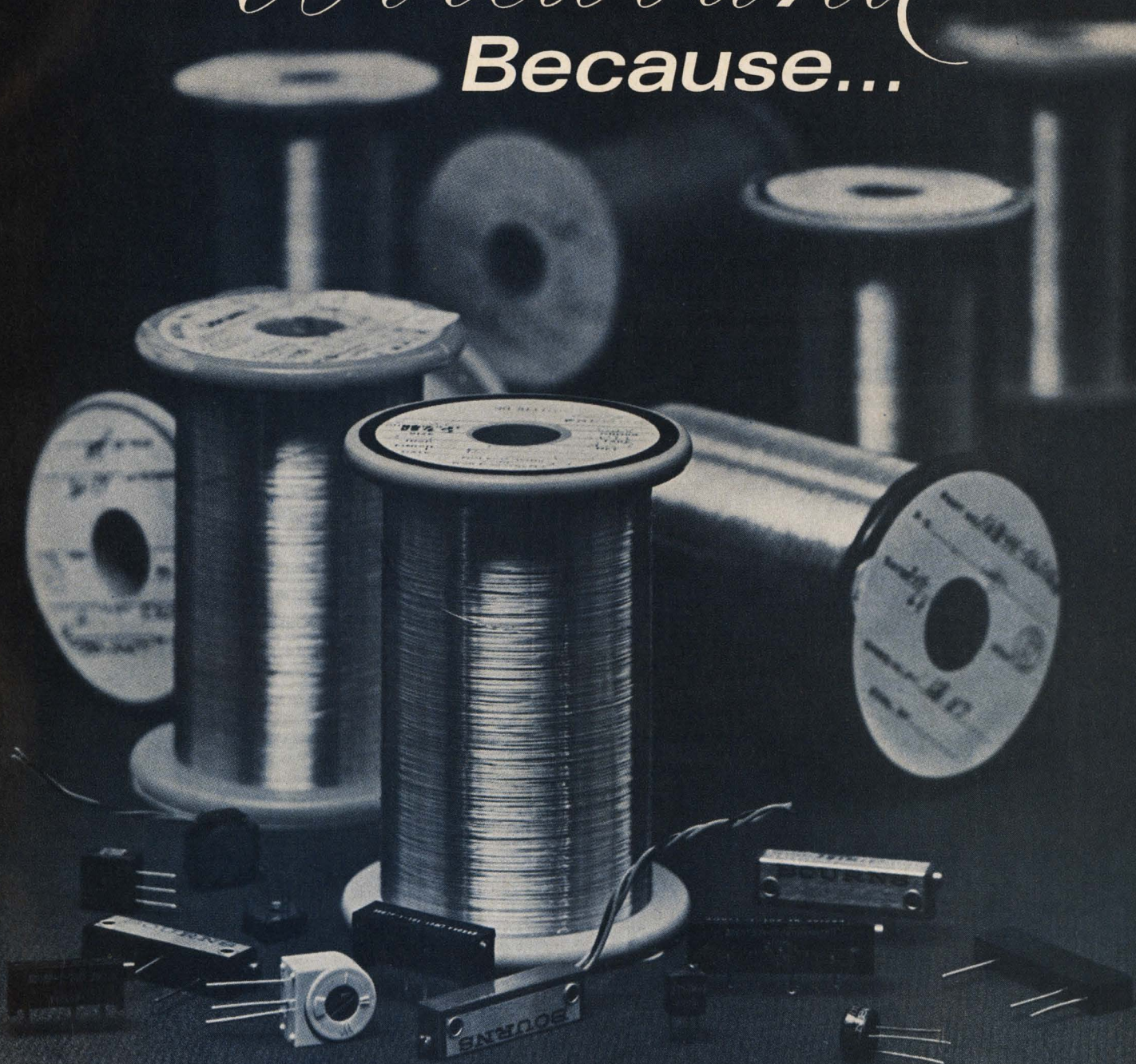

... **Because** the noise in wirewound potentiometers is low—typically 10 ohms ENR in *all* resistance ranges!

... **Because** with temperature coefficient of 50 ppm/°C or less you get exceptional stability!

... **Because** if it's power you need, wirewounds score again and surpass other elements!

... **Because** there's over 20 years of field experience with wirewounds so their reliability can be statistically verified!

... **Because** there's off-the-shelf delivery. We at Bourns stock 500,000 units at the factory while our 63 distributors stock 1,500,000 pieces. Remember . . . whether from factory or distributor stocks *you get* the potentiometers *you need* . . . *when* you need them by specifying Bourns wirewound potentiometers—the best in the industry!







# With a little

The new Bit 483 mini computer is not lucky. It's a machine with about as much daring as a hammer.

We designed quiet, dull reliability into the soul of our new 483.

And then we started stamping out that soul like cookies. If anything was a gamble, that was. But then, a guy named Ford kind of took the initial risks on mass-production.

He showed that mass-producing something like the 483 would allow us to deliver the 483 yesterday. And that producing in volume would allow us to discount the price.

Putting your money on the 483 means putting your money on a general purpose





# Bit of luck.

digital computer with proven design performance and unparalleled problem solving capability. BYTE orientation. Variable word length. Cycle stealing data channel. 350 nanosecond memory access time. Binary and decimal arithmetic. Priority interrupt. And a complete line of I/O options.

That makes the 483 the cost/performance leader in the mini computer field. And we're making it the best serviced computer in any field.

Frankly, the kind of people who take a chance on the 483 are the kind of devil-may-care people who take a chance on t.v. sets, the horseless carriage and peanut butter in the jar.



BIT, INCORPORATED  
5 Strathmore Road  
Natick, Mass. 01760

Circle 69 on reader service card



**the**  
**GIANT**™

GENERAL INSTRUMENT ADVANCED NITRIDE TECHNOLOGY

**MUX**



# the first and only nitride passivated 10 channel multiplexer is also the lowest priced per channel (\$2.12)\*

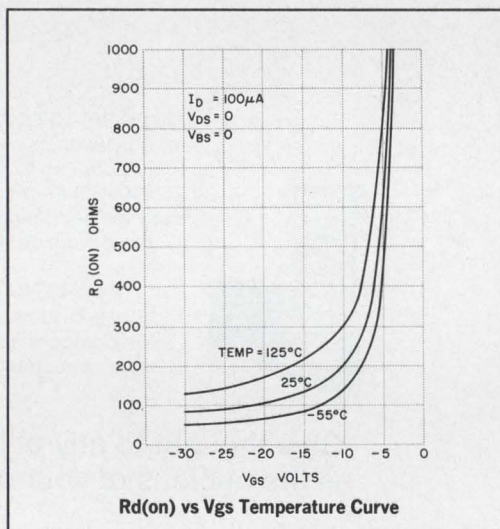
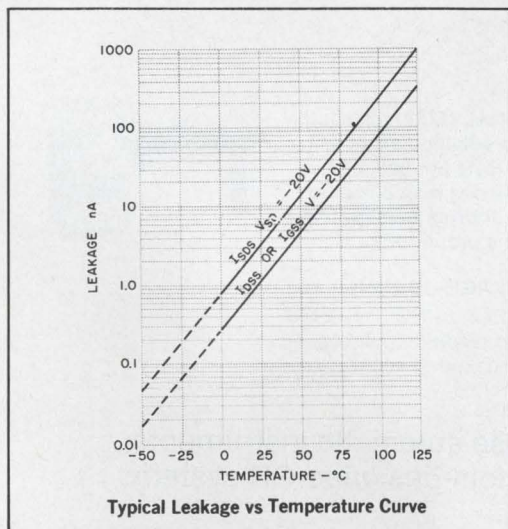
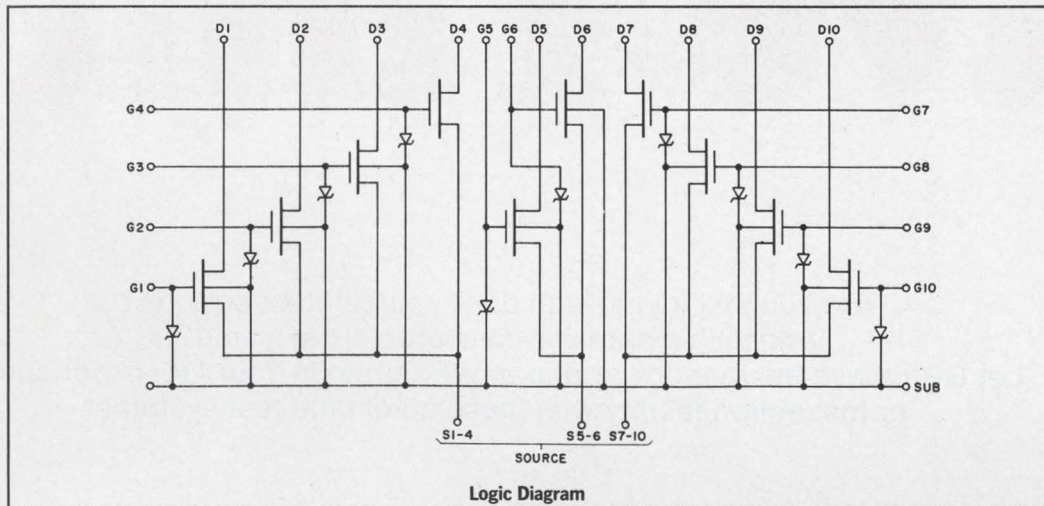

The newest GIANT is General Instrument's 10 channel multiplexer containing 10 P-channel nitride passivated insulated gate field effect transistors. It is the first MUX to use General Instrument's exclusive MTNS (Metal-Thick Oxide-Nitride-Silicon) process with its well-known performance and reliability advantages.

Significant parameters of the GIANT MUX are: low threshold capability, low "ON" resistance (150 Ω max), and wide operating temperature range (-65° to +125°C).

The high dielectric resulting from the use of silicon nitride in the gate structure is the feature which makes possible the low threshold voltage capability and the lower "ON" resistance. And it is silicon nitride's virtual imperviousness to contaminants which assures the reliable +125°C operation.

With the unique arrangement of its source connections, the

\*\$21.20 per 10 channel GIANT MUX in quantities of 100 pcs.

MUX gives the user maximum flexibility for switching applications. And, by proper biasing, it can be employed as a multiple switch, rotary switch, "AND" gate or "NOR" gate.

The design flexibility of the MUX, along with the benefits inherently derived from its MTNS construction, combine to make it the giant in its field.

The 10 channel GIANT MUX (part #MU-6-2281) is available now from your authorized General Instrument Distributor.

For full information write, General Instrument Corporation, Dept. M, 600 West John Street, Hicksville, L.I., N.Y. 11802. (In Europe, write to General Instrument Europe S.P.A., Piazza Amendola 9, 20149 Milano, Italy; in the U.K., to General Instrument U.K., Ltd., Stonefield Way, Victoria Road, South Ruislip, Middlesex, England.)





# Save Time

Are you still toying with do-it-yourself test set-ups?  
And taking data one measurement at a time?  
Let GR relieve the manpower and money strain in your lab, production,  
or inspection facility with these automatic test systems:

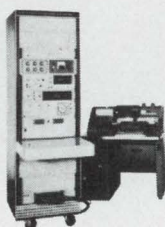

1790 LOGIC-CIRCUIT ANALYZER • tests logic circuits with as many as 96 inputs and 144 outputs • up to 4000 tests per second • GO/NO-GO or complete diagnostic testing • easy test language • autoprogramming lets the device determine proper outputs

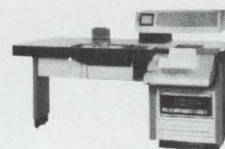

AUTOMATIC LEAKAGE-CURRENT  
and CAPACITANCE-MEASURING SYSTEMS  
• picoampere current resolution • 0.1%  
basic capacitance-measuring accuracy

Give thought to any of these automatic instruments  
as the nucleus of your custom-designed GR system:



1682 AUTOMATIC 1-MHz CAPACITANCE BRIDGE • 20,000 pF to 20.00 nF full scale • 0.1% accuracy • 20 measurements per second • five-wire connections

1683 AUTOMATIC RLC BRIDGE • Resistance: 20.000 m $\Omega$  to 2000.0 k $\Omega$  full scale • Inductance: 2000.0 nH to 200.0 H • Capacitance: 100.00 pF to 10.00 mF • 0.1% basic accuracy • up to 20 measurements per second • five-wire connections



1654 IMPEDANCE COMPARATOR • 0.003% impedance-difference resolution • 100 Hz to 100kHz – 4 fixed frequencies • wide impedance ranges: 2  $\Omega$  to 20 M $\Omega$ , 0.1 pF to 1000  $\mu$ F, 20  $\mu$ H to 1000 H • stable solid-state circuits • Fast sorting (greater than 4000/h) with accessory limit comparator

General Radio Company • West Concord, Mass. 01781 • (617) 369-4400



# Save Money

Every purchase requires a thorough comparison of specifications – and for over half a century customers who wanted the *best* in performance and quality have looked to General Radio.

It was worth paying a few extra dollars to get a top-performing GR product!

TAKE ANOTHER LOOK! We still offer the finest instruments available, but now, with new design techniques and automated test methods, you can't beat the price, either!

Quantity discounts, too, for two or more!

Look at these examples of technical and fiscal ingenuity from GR:



1192 COUNTER • dc to 32 MHz (to 500 MHz with scaler) • 10-mV sensitivity • crystal time base • 5, 6, or 7 digits and data output – \$575 and up.

1808 AC MILLIVOLTMETER • 1.5 mV to 150 V full scale in six ranges • 20-dB dynamic meter range • up to 12.5-M $\Omega$  input impedance • accuracy  $\pm 1\%$  at full scale – \$295.

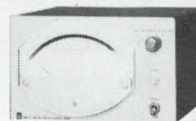

1340 PULSE GENERATOR • 0.2 Hz to 20 MHz • 2.5 s to 25 ns duration • 5-ns rise time • 10-V output with  $\pm 1$ -V offset • amplitude, period, duration modulation – \$395.

1310-B OSCILLATOR • 2 Hz to 2 MHz • 20 V  $\pm 2\%$  constant output • 0.25% maximum distortion • all solid state – \$275.

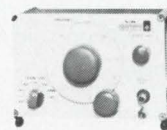

Now get a closer look!

Write or phone General Radio Company,  
West Concord, Massachusetts 01781, telephone (617) 369-4400.  
In Europe, write Postfach 124, CH 8034 Zurich 34, Switzerland.

**“NATIONAL ELECTRONICS CONFERENCE”**

**DECEMBER 8, 9, 10, 1969**

**CHICAGO  
BOOTH #310 GENERAL RADIO**







## MICROWAVE IC MODULES PROGRESS REPORT #8: PRODUCTION

Sperry Rand's PACT (Progress in Advanced Circuit Technology) program has moved microwave integrated circuits and modules out of the laboratory and onto the production line. As far as we know, Sperry Rand is the first company in the industry to take this revolutionary step.

Our functional assignment was to design the world's first radar performance analyzer for end-to-end testing of doppler radars. For a Navy program, our customer wanted a portable tester that could exercise navigation radar without radiating energy and without making any interconnection with the aircraft. Since size, weight and power consumption are critical, all the microwave functions were integrated. The result: three microwave integrated modules replacing 32 conventional microwave components.

At one time or another, Sperry Rand had produced fully integrated versions of every microwave component in the test set. Why not reduce the whole circuit to integrated modules? First, integrated modules have fewer interconnections, and are therefore more reliable. Second, integrated modules cost less to produce than present day collections of discrete components. Third, by making all of the circuit elements ourselves, we sidestepped a lot of procurement problems.

Development of the microwave integrated circuit modules for the doppler test set proved to be well within Sperry Rand's capability.

The unit works well. In the old days (last month) the microwave section would have occupied 90 cubic inches. Today it takes up 3 cubic inches. Our ferrite-

substrate modules have a low-pass filter, 6 circulators, 11 attenuators, 5 diodes, 2 mixers, 2 converters and 4 thermistors. The old way would have required 25 more flange connections than the integrated modules use. The microwave circuit functions within the same tight tolerances that it would have under the older technology.

Now that we're delivering integrated modules, you can't afford to pass up our experience. In fact, if we're not helping design your microwave system, it's probably obsolete.

A letter will start us working on your next system improvement. Write: Sperry Microwave Electronics Division, Sperry Rand Corporation, P. O. Box 4648, Clearwater, Fla. 33518 or call us at (813) 784-1461.

**ABOVE RULER: The old way. Thirty-two conventional microwave components.**

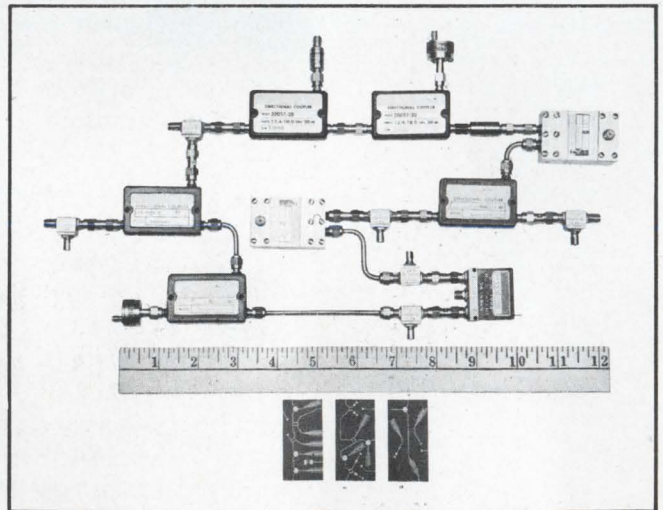

**BELOW RULER: Sperry's new way. Three integrated modules. Lighter, less expensive, more reliable.**

*For faster microwave progress,  
make a PACT with people  
who know microwaves.*

**SPERRY**  
MICROWAVE ELECTRONICS DIVISION  
CLEARWATER, FLORIDA



---

# Washington Newsletter

---

November 10, 1969

## Micom to file for giant step: a national hookup

Microwave Communications Inc. will cap its Nov. 3 petition to the FCC for a West Coast network with a much grander effort the week of Nov. 17. It plans another filing and a Washington press conference outlining a national microwave net of more than 100 U. S. cities. Micom president John D. Goeken says MCI Pacific Coast Inc. will employ 56 microwave dropoff sites to serve 15 California cities from San Diego north to Stanford; three in Oregon—Eugene, Salem, and Portland, and five in Washington—Longview, Olympia, Tacoma, Seattle, and Everett [*Electronics*, Sept. 29, p. 133]. United Artists Theater Circuit will be the largest shareholder in the \$6.5 million West Coast system, with 21% of the stock and options that could raise its holdings to 30%. Micom will retain about 20%, with the remainder distributed among other investors.

## Trouble forecast for computer utility plan going to FCC

University Computing Co.'s plan to file with the FCC a proposal to build and operate a nationwide digital data transmission net—in effect, a computer utility—is expected to run into trouble in the capital. Though FCC won't talk until it gets the filing, sources are quick to point out that a favorable ruling permitting the Dallas-based computer service company's new subsidiary, Data Transmission Co., to compete with common carriers like AT&T and Western Union for EDP transmission would run counter to an earlier FCC recommendation that carriers be barred from entering the computer service business.

Other sources note that UCC may have blown its case by revealing that its Falls Church, Va., subsidiary, Microwave Transmission Co., has been developing its computer utility plan for more than 15 months. This disclosure, some feel, runs contrary to UCC's claim before the FCC last year that it contemplated no expansion of services such as data processing transmission.

## Can cablecasters find success using new signal booster?

A solution to the problem of video signal degradation caused by repeaters in cable transmission (see p. 54), could come from the Zenith Radio Co. technique for upgrading low-quality, low-resolution signals by passing them through an acoustic lens scanner in sync with the tv beam. Using this approach—one of two key concepts presented at the IEEE International Electron Devices meeting in the capital—Zenith claims it can get a hitherto unattainable 17-to-1 increase in signal resolution. The technique uses an acoustic beam traveling in a water medium arranged in such a way that optical beam focusing is obtained.

RCA's Princeton operation says it has come up with a low-power—one milliwatt-per-centimeter—filter it can make at an unspecified low cost to electrically pulse liquid crystals and produce color changes. Called flat, rugged, and lightweight, the filters have 1-to-5-millisecond response times with 30-to-200-msec relaxation, which could make them useful in commercial display applications where high speed is not a requirement.

## Military halts retreat from Proxmire guns

Military leaders are no longer running from Sen. William Proxmire (D., Wis.) now that virtually all his efforts to achieve major budget cutbacks have failed in Congress [*Electronics*, Oct. 13, p. 65]. Some



---

# Washington Newsletter

---

resent Proxmire's latest assertion that Defense Secretary Melvin Laird's panel to examine DOD operations is "at best a sham"—based on the fact that panel members' companies hold a total of over \$1 billion in DOD contracts or in securities of DOD-contractor companies. Says a senior Air Force officer, "Who would the Senator suggest be on the panel? Should they be totally ignorant of defense programs and their management?"

Members of the "in-house Pentagon pet" group singled out by Proxmire include Robert C. Jackson, chairman, Ryan Aeronautical Co., 23rd largest DOD contractor with \$293 million; Ruben F. Mettler, TRW director, 52nd, \$127.5 million; Wilfred J. McNeil, director and adviser, Fairchild Hiller, 56th with \$121 million in DOD contracts; and Gilbert Fitzhugh, panel chairman, who resigned the chairmanship of the Metropolitan Life Insurance Co.

## Think-tank outlook —2 opposing views

Plans at technology-oriented universities such as MIT to sever their ties to the Pentagon are producing a surge of optimism within some of the 16 Federal contract research centers. **Planners at these think tanks see more defense R&D money coming their way** (they got \$263 million last year) as military researchers seek new brainpower sources. However, some Congressional sources consider the optimism premature, citing continuing Congressional criticism of some apparently thoughtless performances. **Latest target is the Hudson Institute**, which, Sen. Thomas F. Eagleton (D., Mo.) observes, "contributed the suggestion that we dig a moat around Saigon."

## \$78.6 million sought for storm radar ...

Criticized for letting Hurricane Camille catch its victims unprepared, the Environmental Science Services Administration (ESSA) is responding to President Nixon's call for a study of meteorological services with a **\$78.6 million plan to upgrade airborne weather radars and other instrumentation**. Some who have seen the proposal say it's inadequate, since the figure includes aircraft replacements for six weather-beaten Navy RC-121's and is spread over two fiscal years. Guts of the plan include \$68 million in fiscal 1972 for instrumentation for the replacement planes; another \$9.2 million for new weather sensors and on-board data processors for refitting the Air Force's WC-130's; plus \$1.35 million for ESSA in fiscal 1971 to update two DC-6's with surveillance and doppler radars, digital data recording units, and Omega navigational systems.

## ... and Air Force has its own battle plan

The Air Force, making its own technical study to find the most effective weather radar for its aircraft, warns that **availability of hardware before the next hurricane season is unlikely since its effort is only a development program in its present form**.

Capabilities ESSA wants for hurricane reconnaissance craft include: an in-flight visual recorder, from which maximum gradients of critical elements (wind, temperature and humidity) can be reported in flight, plus a doppler radar wind-finding system with minimum attenuation from rain beneath the aircraft. Also needed, says the ESSA, are an S-band weather radar, PPI mode, with a beamwidth less than 3° and a range of at least 200 miles; a radar, X or K band, for measuring cloud tops; and an i-r sensor for measuring sea-surface temperature gradients.



# New precision dc power supplies with 0.1% + 1mV accuracy \$345<sup>00</sup>



The QHS Series is composed of three instruments, each having: ■ direct voltage programming to 6 digits ■ 11 $\mu$ V resolution ■ 0.1% + 1mV calibration accuracy ■ constant voltage regulation of 1ppm + 30 $\mu$ V for 20% line voltage fluctuations ■ constant voltage regulation of 5ppm + 50 $\mu$ V for 100% load changes ■ 100 $\mu$ V p-p ripple (10Hz—500kHz) ■ 10ppm + 100 $\mu$ V stability for 8 hours ■ resetability of 30ppm or 200 $\mu$ V ■ optional overvoltage protection ■ 250 hour factory pre-aging.

The QHS 20-1 (0-20 Vdc @ 1A), QHS 40-.5 (0-40 Vdc @ .5A) and QHS 100-.2 (0-100Vdc @ .2A) are available for immediate delivery in a 3½" x 8¼" x 12¾" modular package suitable for rack mounting.

For more information contact your local Sorensen representative or; Raytheon Company, Sorensen Operation, Richards Avenue, Norwalk, Connecticut 06856.

Tel: 203-838-6571;  
TWX: 710-468-2940;  
TELEX: 96-5953

**RAYTHEON**





**We polish off  
miniature ferrite devices  
no one else can make.**



**INDIANA GENERAL** *We make it easy for the design engineer.*



For a single qualified source for special, difficult to make ferrite assemblies, you'll probably take quite a shine to Indiana General.

We're not competing with the volume suppliers of wound components. Instead, we've got a unique capability that *combines* skills in ferrite materials, design, assembly, and testing.

We've successfully explored cross-field modulators for missile guidance systems; ferrite cross cores in variable inductors for a motor control circuit; and a new, low-pass RFI filter. In one case, we re-designed an existing broadband inter-stage transformer from TO-5 down to TO-18 size. That's a 5-to-1 size reduction.

And all these projects involved precision-regulated, critical applications. All involved a problem requiring a unique solution. Any time those criteria crop up, chances are you should talk to Indiana General.

Start the conversation with our coupon. And let us consult, or quote, on your next special project assignment. The one no one else will tackle. Even the one that seems impossible.

Mr. K. S. Talbot, Manager of Sales  
Indiana General - Electronic Products  
Div. of Electronic Memories & Magnetics  
Keasbey, New Jersey

- Please send me an application form for a miniature ferrite device design evaluation.
- Please calculate design possibilities, based on the attached requirements and data: Application description, performance specifications, drawings.

NAME \_\_\_\_\_  
TITLE \_\_\_\_\_  
COMPANY \_\_\_\_\_  
ADDRESS \_\_\_\_\_  
CITY \_\_\_\_\_ STATE \_\_\_\_\_ ZIP \_\_\_\_\_



**DTL**  
**goes**  
**National.**



930 DTL is a price and delivery business. We're in that business. Digital IC's are volume products and that's also our business.

With the addition of DTL to our digital line of MOS and TTL, we now cover 85% of the most popular digital sockets in the world.

Price, volume, delivery. That's us.

Write for our spec sheet, if you need one, as well as our cross reference guide. Completely covers our new brand 930 dual in-line, silicone, 0° to 75° C. DTL line. We'll also send you our silicone molded rel report as a bonus. National Semiconductor, 2975 San Ysidro Way, Santa Clara, California 95091. (408) 245-4320. TWX: 910-339-9240 CABLES: NATSEMICON

**National/Digital**



On the left you see the HP 5323A Automatic Counter at work in a system. On the right is our HP 5325B Universal Counter, making a hard test easy.

The counters could easily be reversed. Because both are programmable and with either of them you can count up to 20 MHz in a system or on your bench. The one you choose depends on what you need.

**The Automatic Counter** has automatic range selection from 0.125 Hz to 20 MHz. And it needs no switching from frequency measuring mode for high frequency measurements to period measuring mode for accurate low frequency measurements. That's because all measurements are made in the period mode, and internal

computing circuits invert the period measurements to frequency. Thus you get the speed and accuracy benefits of period measurements at low frequencies coupled with the convenience of direct readout in frequency at all frequencies. There's no accuracy penalty at any frequency. The 5323A has a score of other advantages built in. For instance, it can automatically measure the carrier frequency of pulsed signals. Some people buy the 5323A for bench and production line use because its simple, automatic operation and direct readout in frequency reduce errors, even with untrained users. It even keeps tabs on the user by refusing to display more digits than it should for a given measurement speed. For easy use in systems, it's programmable, of course.

## These two counters make systems run smoother.

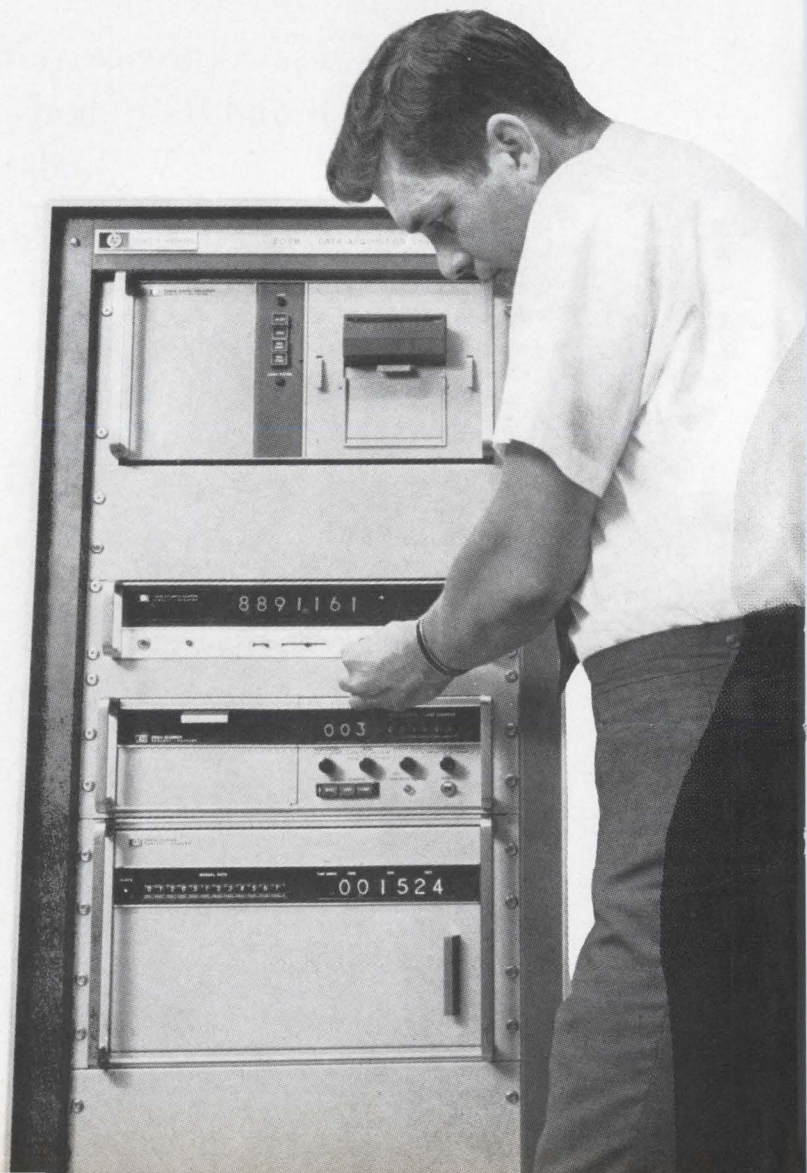



The Universal Counter is even more versatile but is less automatic. It will measure frequency to 20 MHz, time intervals from 100 ns to 10<sup>8</sup>s, and period, multiple period, ratio and multiple ratio. It will totalize input events or scale an input frequency. Time interval stop and start signals can be from common or separate inputs, with separate trigger-level, slope and polarity controls for each. And its very narrow trigger-level threshold band, less than 1.0 mV, prevents false counts when the trigger level setting is marginal. In addition, the Universal Counter generates two types of oscilloscope markers. These not only mark the start and stop points of a measured interval, but can also intensify the entire measured segment. For easy use in systems, it's

programmable, of course. The cost of this versatility for either system or bench use is \$2150 for the 5323A and \$1300 for the 5325B. Your local HP field engineer has all the details. So give him a call. Or write to Hewlett-Packard, Palo Alto, California 94304; Europe: 1217 Meyrin-Geneva, Switzerland.

HEWLETT  PACKARD  
ELECTRONIC COUNTERS

Circle 83 on reader service card

# And tests run faster.

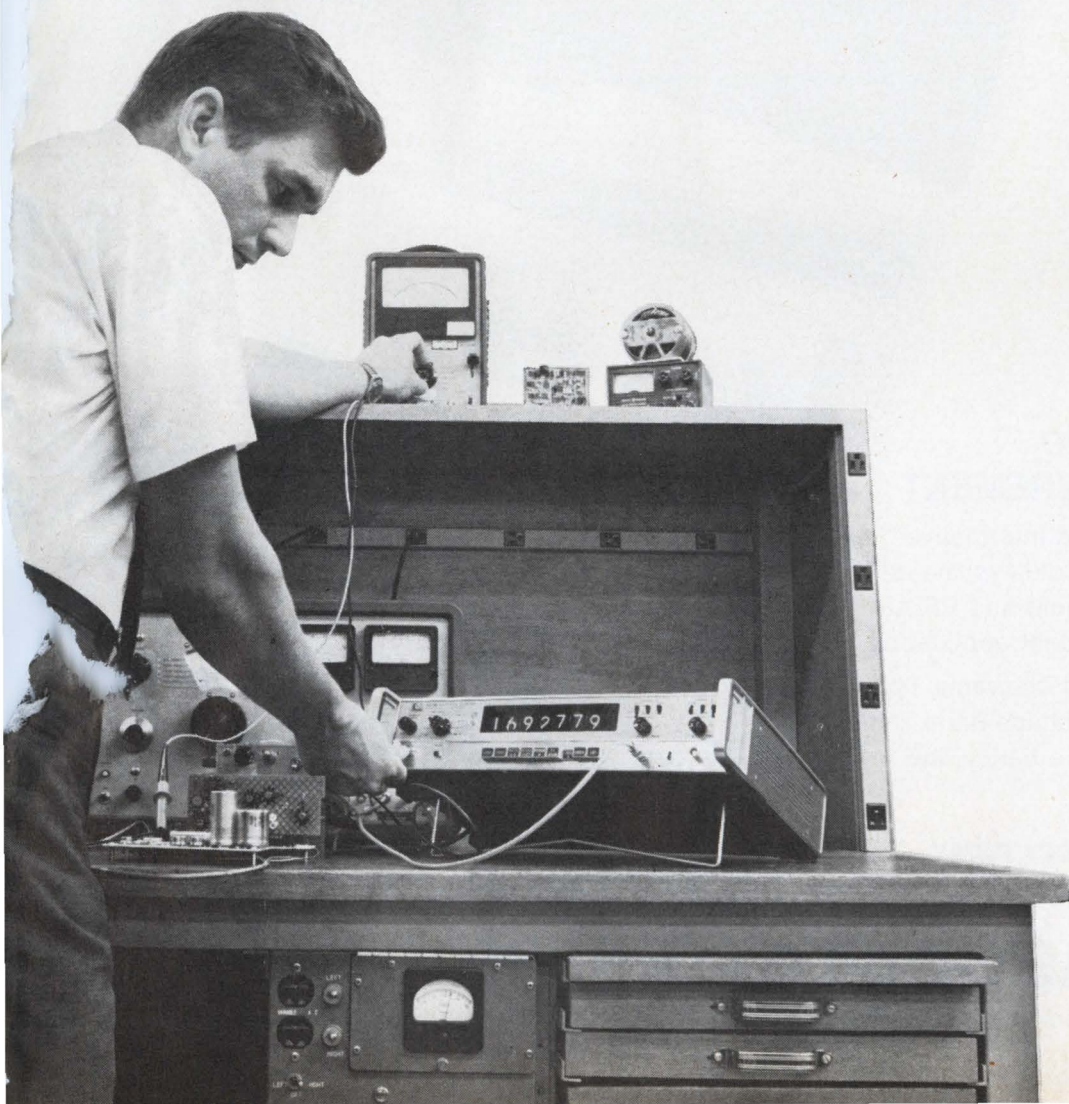



# if you need attenuators you need this catalog!

## AUDIO AND RF ATTENUATORS TO MEET ANY REQUIREMENT

Here in one compact and informative 28 page booklet is all the data you need to select a Precision Audio and RF Attenuator for your individual application.

Reference Charts, Circuit Diagrams, Types and Uses, Current and Voltage Ratio Tables, Ratings, Etc., make this a handy and invaluable reference.

**SEND FOR YOUR FREE COPY TODAY.**



## TECH LABORATORIES, INC.

Palisades Park, New Jersey • Tel.: (201) 944-2221 • TWX: (201) 947-0825



## Specify molded aluminum electrolytics for long life, quality, economy.

The best bargain in performance and value available. That's what you get when you use Mallory molded-case, aluminum-electrolytic capacitors in your circuit applications.

The remarkably good electrical characteristics of these capacitors result from a unique combination of quality materials and construction skills. Outstanding economy is made possible by Mallory's exclusive automated molding processes.

These molding techniques produce a moisture-proof, leak-proof, neat-appearing case of uniform size. The lead wires are uniformly positioned and spaced. And for the printed-circuit type (MTV), stand-off mounts are integrally molded to the case to assure mounting rigidity.

Mallory offers three types of tubular, molded-plastic, aluminum-electrolytic capacitors. Each type consists of a high-purity, aluminum-foil cartridge impregnated with a high-performance electrolytic system. The aluminum-foil

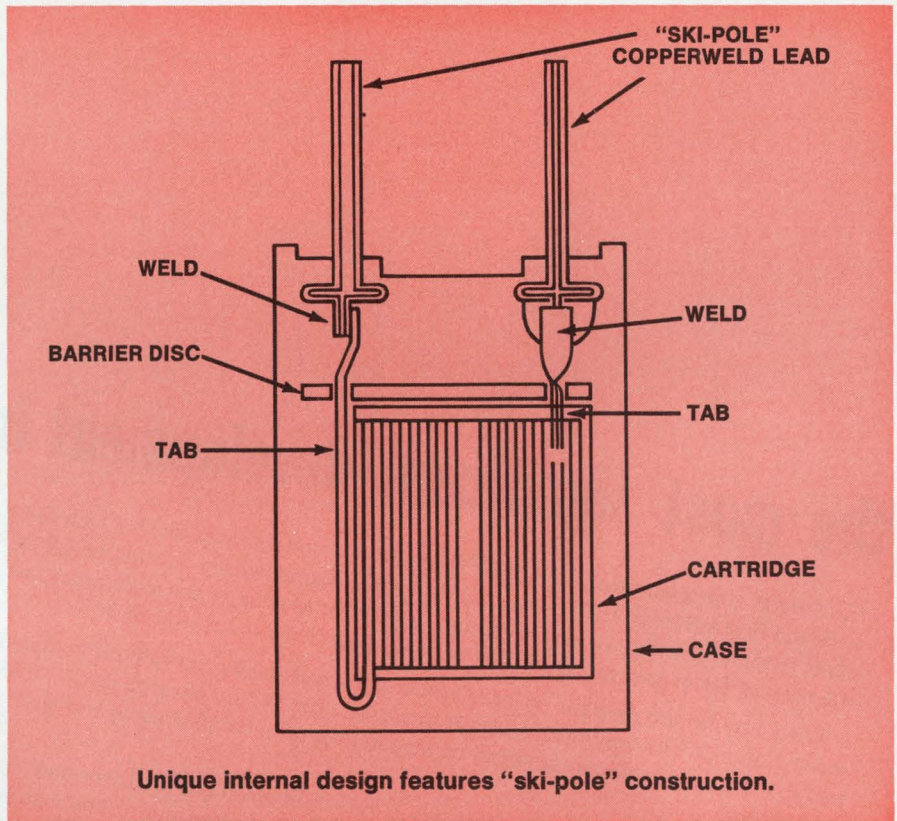

Unique internal design features "ski-pole" construction.

tabs are welded to the external lead wires. The cartridge is mounted and molded integral with the plastic case material.

**Type MTA** is an axial-lead, tubular-electrolytic available in several case sizes. The diameter range is  $\frac{5}{16}$ ",  $\frac{3}{8}$ ",  $\frac{1}{2}$ " and  $\frac{3}{4}$ ". Case lengths are  $\frac{7}{8}$ ",  $1\frac{1}{8}$ ",  $1\frac{1}{2}$ " and  $1\frac{7}{8}$ ". Voltage range is 3 to 100 volts in polar or nonpolar construction. Capacitance range is 1 to 3700 mfd.

**Type MTV** is a single-ended, plug-in type for printed-circuit board insertion. The lead wires are uniformly spaced .200" between leads. The cathode lead wire is #18 AWG; the anode lead wire is #20 AWG. The positive lead is identified by a row of (+) signs stamped on the cartridge. MTV capacitors are available in  $\frac{3}{8}$ " and  $\frac{1}{2}$ " diameters. Case lengths are  $\frac{13}{16}$ ",  $\frac{15}{16}$ ", 1",

$1\frac{1}{16}$ ",  $1\frac{1}{4}$ " and  $1\frac{1}{2}$ ". Voltage range is 3 to 100 volts; capacitance range to 1000 mfd. The MTV design features a "ski-pole" lead wire which provides rigid anchoring in the plastic case material and eliminates intermittent "opens" (see cutaway view).

**Type MCT** is a single-ended, tubular-electrolytic capacitor with insulated, flexible wire leads. Case diameter is  $\frac{7}{8}$ ". Case lengths are  $1\frac{1}{2}$ ",  $1\frac{3}{4}$ ", 2" and  $2\frac{1}{2}$ ". Voltage range is 3 to 100 volts, polar or nonpolar. Capacitance ranges to 7000 mfd.

All three types are suitable for +65°C and +85°C operation.

For data, write or call Mallory Capacitor Company, a division of P. R. Mallory & Co. Inc., Indianapolis, Indiana 46206.

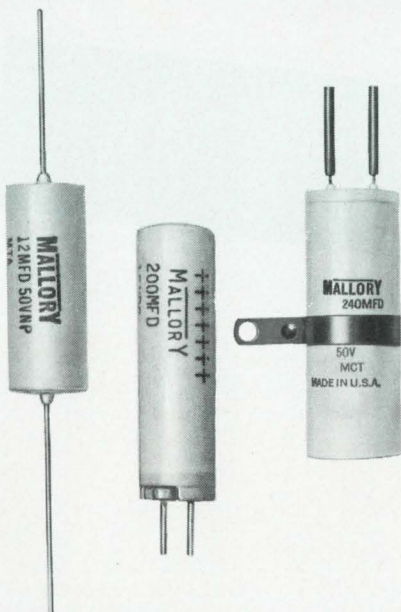

Mallory Type MTA, MTV and MCT molded-case capacitors.



# BURROUGHS DEVELOPS... SELF-SCAN PANEL DISPLAY

## the most significant development in electronic display

Burroughs, the originator of NIXIE® tubes, now revolutionizes display technology with the first commercially practical dot matrix display system. It took SELF-SCAN panel display, the remarkable Burroughs invention that takes the electronics out of the present electronic display ... reducing costly drive circuitry up to 90%.

With a minimum number of leads and drivers, Burroughs' system automatically scans data input into in-plane readout characters formed by glowing dots ... making possible a totally new combination of readability, minimal packaging and cost advantages.

The new flat-panel display is basically a matrix of small gas discharge cells hermetically sealed between heavy glass plates in a sandwich configuration. The matrix itself, formed of insulating material, has small grooves on its top surface to allow positioning of information anode wires which intersect each hole. Cathode conductors behind the center sheet intersect at each cavity with a second set of anode wires.

A black rectangular panel displaying a red dot-matrix alphanumeric readout: ".0123456789+-= E."

By utilizing the phenomena of preferential glow transfer and glow shifting, the initial glow caused by cathode ionization in the dot matrix may be moved through selected holes to a visible position on the top surface. A sequential flow of light is thus achieved without separate drivers for individual columns and rows.

Burroughs' alphanumeric SELF-SCAN panel displays are available with or without memory for any application requiring 16 or 18 digit readout.

Write today for descriptive brochure, Burroughs Corporation, Electronic Components Division, P. O. Box 1226, Plainfield, New Jersey 07061. Tel.: (201) 757-5000.



# Technical Articles

---

**Microwave acoustics: key to signal processing**  
page 94

Long-range wideband signals and complex coded waveforms for missile guidance and detection, and aircraft flight control must be handled with great speed and accuracy. Signal processing systems that handle this information require many wideband delay lines not only for storage, but to perform pulse compression and spectral analysis. Microwave acoustics, a rapidly developing technology that uses readily tappable surface waves, can provide low-loss delay lines—the heart of any processing system. The principles, current status, and potential of this technology are explored in the first of a two-part series.

**'Pressing' pictures on holographic tape**  
page 108

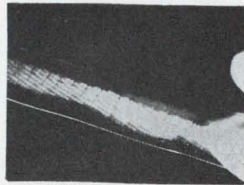

The most innovative feature of RCA's new video playback system is the way prerecorded films are made. The televised images are converted into a roll of embossed holograms, coated with nickel. When stripped away the nickel still retains the impressions of the

holograms, and when pressed onto vinyl film can produce copies, yielding a mechanical, inexpensive means of quickly turning out copies of motion pictures. In the playback system a prerecorded vinyl film cartridge is reconverted to signals and fed to the tv set.

**Making a minicomputer superfast**  
page 116

To be superfast, a computer no longer must be supersized. Hardware built with medium-scale integrated circuitry makes it possible to offer high-speed capability in a small package, exemplified in the Supernova computer developed by Data General Corp. System architecture was developed for a computer introduced a year ago. By using off-the-shelf MSI liberally, the Supernova has a 300-nanosecond cycle time and boasts instruction overlapping and a fast read-only memory.

**Universal graphs for mismatched pi, tee filters**  
page 121

Simple in design concept, low-pass pi and tee filters can behave strangely in a circuit unless actual source and load impedances are considered. If impedances are unequal and the filter is designed for matched conditions, its characteristic transfer function may not yield the desired response. To provide some insight into a filter's performance, a set of 12 design curves and two nomographs provide a graphical portrait of a filter's insertion loss characteristics. These curves, applicable over a wide range of source-to-load-impedance ratios, allow an engineer to design a filter for mismatched yet specify performance for matched conditions.

---

## Coming

**Communications industry's bright future**

Economists predict \$1 trillion of the 1980 GNP going to the communications industry. A special report will discuss the impact of electronics on face-to-face communications and the new equipment and transmission networks needed to meet this unprecedented growth.



# Tapping microwave acoustics for better signal processing

Unlike electromagnetic waves which need bulky cables and waveguides, surface waves travel along miniature substrates; *Laurence Altman* of *Electronics'* staff puts this emerging technology into perspective, and then *J. H. Collins* and *P. J. Hagon* of Autonetics explain how acoustic signals can meet the signal processing needs of today's radar, navigation and communication systems

**Radar and communication systems** demand rapid acquisition and processing of vast quantities of data. Long-range, wideband signals and complex coded waveforms for missile guidance and aircraft flight control must be handled with high resolution. Delay lines are essential which can store these signals, and compress, expand and decode their waveforms. But these functions still are being handled largely by electromagnetic devices that require unwieldy lengths of stripline or coaxial cable which, in addition to consuming valuable space, generally are lossy and often are inefficient.

Clearly, what's needed is compact, lossless, undistorted delays of up to many microseconds, with easy access to the signal for processing anywhere on its path. Microwave acoustics, still in its early stages of growth, promises to provide these vital functions.

Consider the requirements of one of the key components of a signal processing system, the tapped delay line used for the important system function of matched filtering. First there must be a storage facility—a delay capability—during which time the signal must proceed undistorted. At the same time the signal must be available at many points along the line, so that many waveform samplings can be made simultaneously. Furthermore, in-out losses must be kept small enough to enable further signal-processing at other points in the system. Moreover, for long delays, the signal will require amplification at one or more points along its path. Finally, and probably most far-reaching, the new technology must be compatible with developments in inte-

grated and microelectronic circuitry.

Bulk acoustic waves were the initial means of achieving long delays without the inherent shortcomings of electromagnetic cables. These waves move in any medium slower than electromagnetic waves—by a factor of  $3 \times 10^5$  to  $4 \times 10^6$  slower—depending on the material. In its simplest form, the bulk system uses a frequency-matched pair of piezoelectric transducers that are placed on opposing ends of a crystalline block. The input transducer, excited by an r-f signal, beams acoustic energy through the block, where it is received and reconverted back to a usable electrical signal at the exit transducer. The delay is simply the time the wave remains in the block. Delays normally less than 20 microseconds have been achieved this way.

But all bulk devices have a built-in deficiency; they are inflexible. It is almost impossible to tap, switch, or vary the delay, and quite difficult to amplify the signal or otherwise manipulate the acoustic energy during its time in the block. In fact, bulk systems are confined largely to fixed delays that are restricted to passive devices, and additional circuits must be employed to further process the signal.

On the other hand, surface waves have all the desirable properties of bulk waves—and are also very accessible. Like bulk waves, they travel in solids about five orders of magnitude slower than electromagnetic waves, so that storage crystals can be 100,000 times shorter than the old coaxial cable—at 100 megahertz a 10 microsecond delay can be achieved in a 1¼-inch slab of quartz.



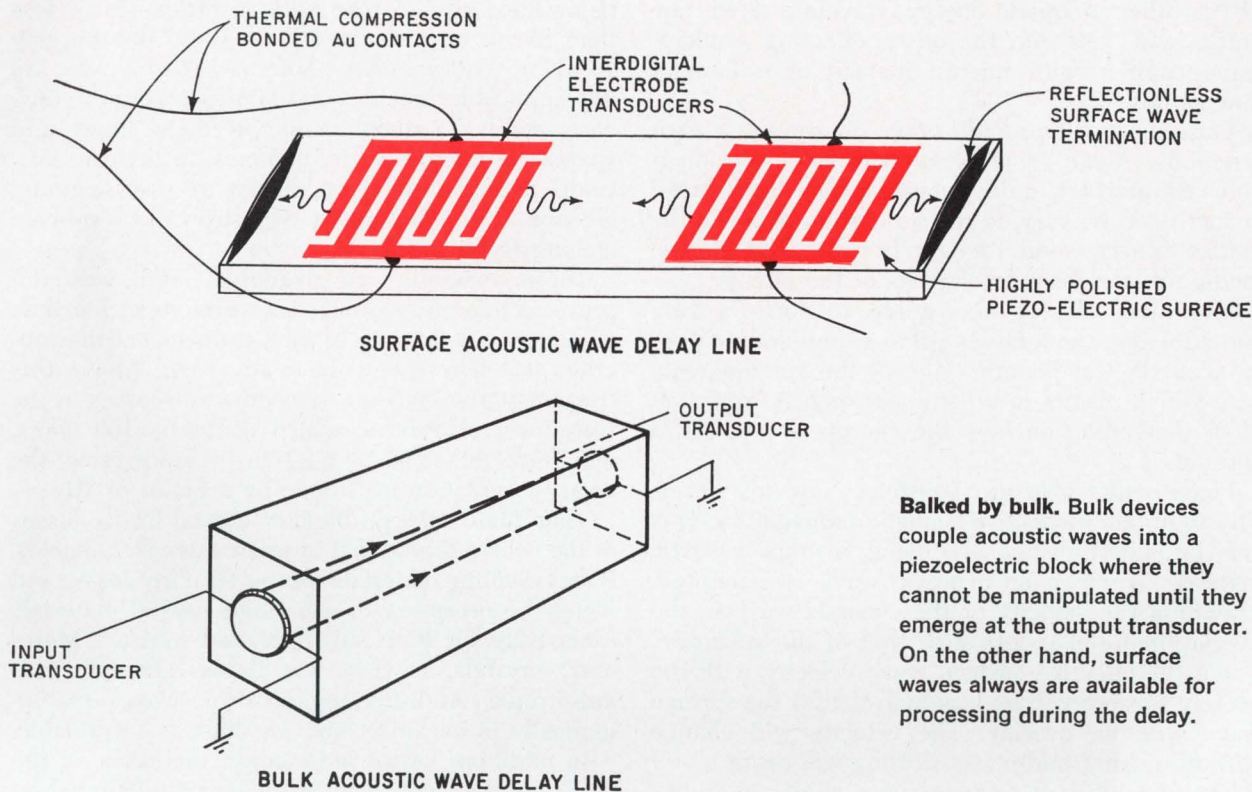

**Balked by bulk.** Bulk devices couple acoustic waves into a piezoelectric block where they cannot be manipulated until they emerge at the output transducer. On the other hand, surface waves always are available for processing during the delay.

But technologies don't live by velocity alone; like bulk waves, surface waves are also nondispersive—signals maintain their phase relationships at all frequencies during the delay. And since constant-phase signals are at the heart of a matched filter network, acoustic wave technology can be an important tool. Sampled anywhere along its train, after any duration, the delayed waveform will be identical with the input waveform. This decoding possibility opens up an entire area of applications.

One such decoding application is the multiple tapped delay line, in which the taps are correlated to the information contained in a coded signal passing through the line. At a particular instant in time, depending on the signal code, all the tap outputs will add in phase to produce a single high level output corresponding to information points. At other instants, the tap outputs are out of phase and cancel each other, giving no signal output.

### Standing Alone

An important property of surface waves is their uniqueness in providing multiple direct access to the signal. Sensing conductors may be deposited directly onto the surface of the acoustical material, at many points along the delay path, to yield any waveform resolution that is desired. Only at high frequency is the resolution limited, at which point the acoustic wavelength is in the order of microns, and multiple taps at wavelength separations become extremely difficult to fabricate.

There's yet another aspect of sensing. Like bulk waves, when acoustic energy passes through a piezoelectric or ferromagnetic media, it generates

an associated r-f electric or magnetic field. This r-f energy allows direct communications with the outside world via controlled electromagnetic interaction anywhere along the acoustic path. Thus multi-tapped circuits performing a variety of microwave system functions all on a single substrate package are entirely feasible.

But at high frequencies, amplification usually is required, since above 1 gigahertz transducer and acoustic propagation losses increase. Yet surface acoustic waves can be amplified with remarkable ease, a property difficult to obtain with bulk waves. In fact, terminal gains of 30 db are achieved with a d-c electric field applied to a semiconductor material held adjacent to the acoustic material.

Finally, the small wavelength of acoustic surface waves at uhf and vhf allows a designer to combine the integrated lumped circuit technology used at low frequencies with the distributed circuit techniques used at microwave frequencies, producing a new micro-distributed IC technology. Thus, as the microwave acoustic technology develops further, it will be incorporated into existing circuitry.

### Microdistributed circuits

One of the main attractions of microwave acoustics is its ability to perform many signal-processing functions. This may be done with a simple delay line and waveguide set-up consisting of an input transducer, a narrow length of acoustic material and an output transducer. If two such guides are placed on a single substrate, and the distance between guides is a wavelength or two, then one guide is well within the energy field



of the other. Acoustic energy, traveling down one guide, will pass into the other, effecting a microwave coupler with micron instead of millimeter dimensions.

Variations will provide other microwave circuit functions. Again by analogy with its electromagnetic counterpart, guide coupling may be reduced or increased by varying the separation between the guides. Energy will transfer between the guides, feeding or isolating other parts of the circuit.

Moreover, closing the guide to form a ring and adjusting the total length to an integral number of acoustic wavelengths, allows the ring to resonate which results in a bandpass or band-rejection filter, depending on how the energy is coupled in and out.

Phase shifts also are possible. Now it's necessary to obtain dispersive acoustic propagation. This can be accomplished by using overlay acoustic material in which an acoustic wave is generated, providing the velocity of the acoustic wave in the overlay material is less than that of the substrate. Then, the effective surface wave velocity with the overlay present will be less than that of the surface wave with no overlay. The velocity will change with frequency, and phase-shifting will result.

This flexibility of acoustic wave guides is an important asset. In fact, just by using a combination of the simplest delay line waveguide configurations, it's possible to build the surface-wave analogue to most distributed-parameter, microwave electronic functions—and in a very small package, since the acoustic wave lengths are 100,000 times smaller than their electromagnetic analogues.

The engineering problems do exist, especially at microwave frequencies, where small size becomes both a blessing and a difficulty. The trend is toward miniaturization, but at Ghz frequencies and above, some device component dimensions are in microns and less, which require less than micron line definition. Recently fabricated transducers, for example, use metallic electrode arrays deposited on a piezoelectric substrate which have operated in

delay lines at 1.75 Ghz with insertion losses less than 25 db and bandwidth of 10%. But roughly speaking, conventional photomask techniques are not applicable much above 800 megahertz, which corresponds to about 1-micron metal lines and spaces. At microwave frequencies, to deposit electrode patterns, it is necessary to use scanning electron-beam photoresist exposure and ion-beam etching techniques.

These methods are available, and will improve as microwave acoustics technology demands greater line definition. In fact, transducers that operate at 4 Ghz should be ready soon. Above this frequency, the inherent r-f conduction losses in the transducer electrodes, which could be 100 ohms, will form the major limitation, overpowering the acoustic radiation resistance by a factor of 10.

Then there's the problem of crystal lattice losses of the substrate material at microwave frequencies. Polycrystalline materials are particularly lossy, and it may be necessary to use single-crystal materials exclusively for both substrate and overlay. Moreover, crystals as they are found generally are anisotropic. And treating acoustic waves mathematically in an anisotropic medium is formidable.

In addition, lattice attenuation increases as the square of the frequency. But where miniaturization is a prime consideration for delay line applications, if one does not think in terms of loss per centimeter, or microsecond, but rather in terms of loss per wavelength, which only increases linearly with frequency, the difficulty is considerably eased. And coaxial cable, with a loss of about 50 db per microsecond at 5 Ghz, nevertheless is widely used to carry such signals.

Problems remain, and work still is in the research stage, the most significant being done at the Microwave Laboratory, Stanford University. But processing system requirements are beginning to be met by devices that exist, such as 50 tap delay line conductors and pulse compression filters with 100:1 compression ratios. And largely responsible for this progress is the work done at Autonetics.

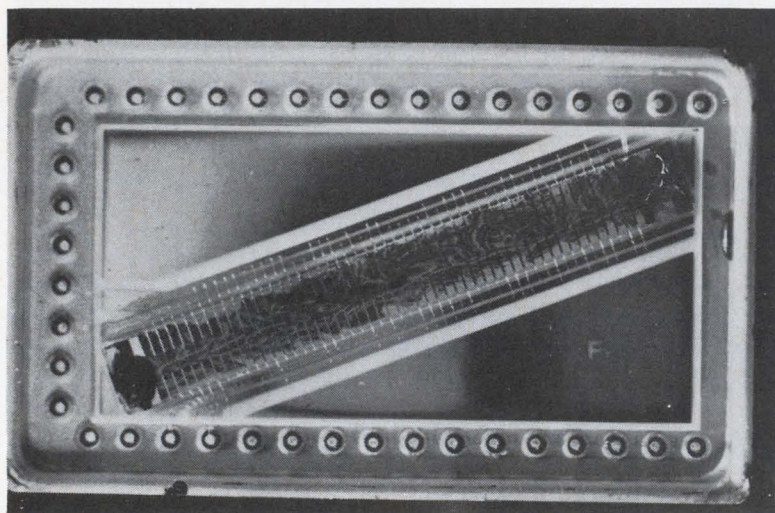

**Accessible.** This 50-tap delay line is fabricated on YX quartz. It operates at 120 megahertz, with a 50-Mhz bandwidth determined by the 25-finger pair input interdigital transducer. The tap spacing is 25 mils (200 nanoseconds) or 24 wavelengths of the operating frequency; this corresponds to a 5-Mhz bit rate.



# Applying surface wave acoustics

By J.H. Collins and P.J. Hagon

Autonetics Division, North American Rockwell Corp., Anaheim, Calif.

In just two short years, microwave acoustic technology has progressed from novel electronic concepts to the practical hardware stage. At the heart of this technology is the surface acoustic wave delay line—building-block of all applications. And vital to the operation of the delay line are its two principle components: the interdigital transducer and the piezoelectric substrate on which it is bonded.

One point should be made clear: the interdigital transducer is simply a series of metal electrodes that form a pattern which is deposited on a substrate surface to provide acoustic energy to the substrate. The transducer is not the mechanism for converting electric signals to acoustic energy; rather it is the means of converting an incoming electrical signal into a time-dependent, spacially-varying electric field pattern which in turn generates an

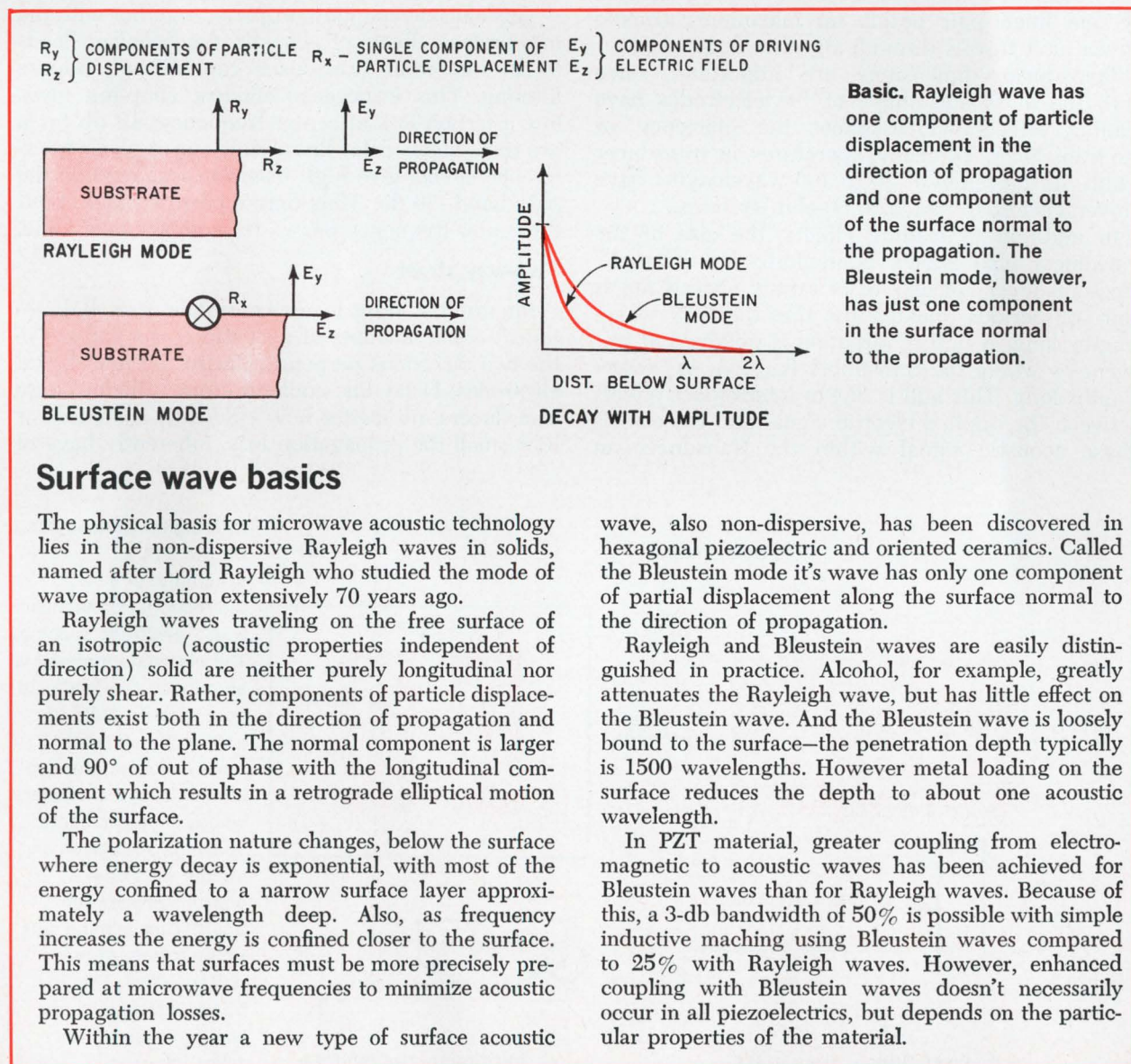

## Surface wave basics

The physical basis for microwave acoustic technology lies in the non-dispersive Rayleigh waves in solids, named after Lord Rayleigh who studied the mode of wave propagation extensively 70 years ago.

Rayleigh waves traveling on the free surface of an isotropic (acoustic properties independent of direction) solid are neither purely longitudinal nor purely shear. Rather, components of particle displacements exist both in the direction of propagation and normal to the plane. The normal component is larger and 90° out of phase with the longitudinal component which results in a retrograde elliptical motion of the surface.

The polarization nature changes, below the surface where energy decay is exponential, with most of the energy confined to a narrow surface layer approximately a wavelength deep. Also, as frequency increases the energy is confined closer to the surface. This means that surfaces must be more precisely prepared at microwave frequencies to minimize acoustic propagation losses.

Within the year a new type of surface acoustic

wave, also non-dispersive, has been discovered in hexagonal piezoelectric and oriented ceramics. Called the Bleustein mode it's wave has only one component of partial displacement along the surface normal to the direction of propagation.

Rayleigh and Bleustein waves are easily distinguished in practice. Alcohol, for example, greatly attenuates the Rayleigh wave, but has little effect on the Bleustein wave. And the Bleustein wave is loosely bound to the surface—the penetration depth typically is 1500 wavelengths. However metal loading on the surface reduces the depth to about one acoustic wavelength.

In PZT material, greater coupling from electromagnetic to acoustic waves has been achieved for Bleustein waves than for Rayleigh waves. Because of this, a 3-db bandwidth of 50% is possible with simple inductive matching using Bleustein waves compared to 25% with Rayleigh waves. However, enhanced coupling with Bleustein waves doesn't necessarily occur in all piezoelectrics, but depends on the particular properties of the material.



acoustic surface wave directly on the substrate through the electroelastic action of piezoelectric crystals.

The substrate has two functions. It provides the electro-acoustic energy conversion, while furnishing the acoustic signal delay path. Quartz and lithium niobate are two of the most commonly used substrate materials.

But regardless of the substrate used, the design of the interdigital transducer is fairly standard: it's a two-terminal electrical device that consists of two separate arrays of metal strips, or electrodes, which resemble interleaved fingers. These electrodes generate maximum acoustic power as follows:

The r-f signal voltage impressed on the electrodes interacts with the piezoelectric substrate and produces two acoustic traveling waves on the substrate surface, in opposite directions and perpendicular to the metal strips. This bidirectional array is designed so that alternating electrodes are spaced an integral number of half-wavelengths apart. Because it receives an in-phase energy boost at each finger-pair location, a traveling acoustic wave generated by one finger-pair builds up maximum acoustic power as it travels through all other finger-pairs.

Transducer dimensions are important, since both the mass and shape of the electrodes have loading effects which affect the efficiency of the transducer. Typically, apertures, or transducer width, in the range of 30 to 100 wavelengths have proven easiest to match to 50-ohm systems.

In addition to loading effects, the size of the transducer also affects bandwidth. For example, the transducer consists of  $N$  evenly spaced finger pairs or periods, making the transducer  $N$  wavelengths long. A null in radiation is obtained at frequencies where the transducer is  $(N + \frac{1}{2})$  wavelengths long. This null is due to interference effects between the applied electric signal and the out-of-phase acoustic signal within the transducer—an

effect also present in antenna array radiation patterns. In fact, the interdigital transducer is an acoustic analogue of the electromagnetic antenna array. But the fractional bandwidth between nulls is equal to  $1/N$ , so the greater the number  $N$  of electrode pairs, the smaller the operational bandwidth. On the other hand, the number of electrodes also determines the amount of coupling and therefore available power, so that a compromise must be made between efficiency and bandwidth.

Moreover, since electrodes are spaced an acoustic wavelength apart, the periodicity in the direction of the required soundwave propagation is equal to the wavelength of the sound wave. This condition, called acoustic synchronism, serves to spatially force the electric field applied to the transducer into the same periodicity as the electric field associated with the piezoelectric Rayleigh wave. Thus, by operating the transducer at acoustic synchronism, it's possible to get extremely efficient coupling in the desired direction. In fact, conversion loss can be made less than 3.2 db in one direction.

This efficient coupling property, together with the interference effects of acoustic synchronism, leads to an important transducer capability—bandpass filtering. This is because efficient coupling gives low insertion loss at center frequency—10 db for a two transducers delay line—while out-of-phase interference effects give high insertion loss outside the pass band—36 db. Thus only a narrow band about the center frequency passes through the delay line.

### Two-way street

Interdigital transducers normally are bidirectional—equal amounts of acoustic power radiate in the two directions perpendicular to the interdigital electrodes. Delay line configurations utilizing these transducers, no matter how efficiently matched, or how small the propagation loss, inherently have at

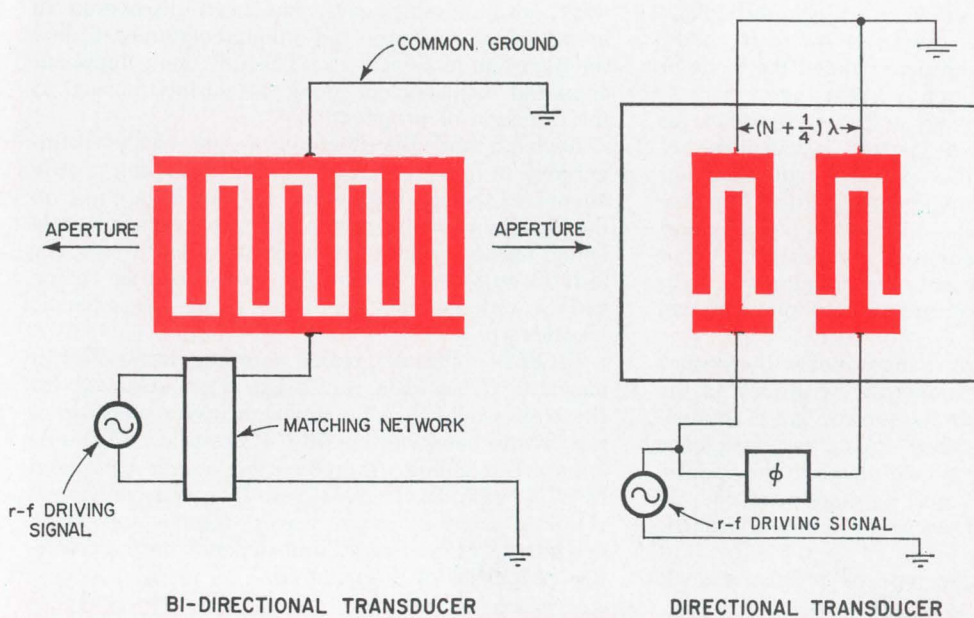

### Interdigital transducers.

On the left, a schematic of a bidirectional transducer with  $\lambda$  electrode spacing. The electrode material is aluminum, the leads are gold wire. To build the unidirectional transducer, shown right, two bidirectional transducers whose center to center spacings are placed an integer plus one-quarter wavelength apart. This spacing sets up an interference pattern which kills the transducer reflections leading to unwanted delay line echos.



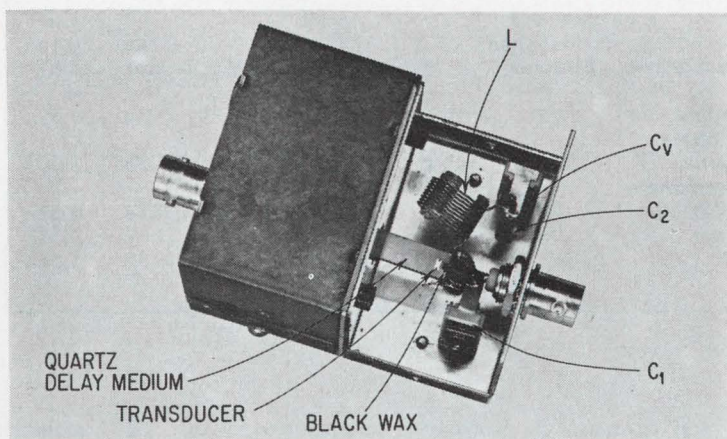

## Delay line performance and characteristics

The right-hand metal cover of the 30-finger-pair quartz delay line, built for the 100 megahertz region, has been removed to show the internal structure. The quartz bar provides a substrate for the interdigital transducer, and a delay path for the signal. The black wax depositions at the substrate edge give acoustic termination. An identical transducer on the other end of the quartz bar, together with the one shown, form an input-output pair. The spacing between the transducers is 1.2 inches, which corresponds to a delay time of 10 microseconds.

The transducers are matched to 50 ohms through a series turning inductor and a shunt capacitor, which form a  $\pi$  network with the transducer. The circuit elements have the values  $L = 1\mu\text{H}$ ,  $C_1 = 21\text{pF}$ ,  $C_2 = 15\text{pF}$ , and  $C_3$  is fixed within 1-10pF. The metal baffle provides electromagnetic isolation between the input and output transducers.

The delay line has mid-band insertion loss of 10 db. Isolation between input and output exceeds 90 db, and spurious echo rejection exceeds 20 db. The bandwidth is quite narrow,  $3\frac{1}{2}\%$ , because each transducer uses 30 electrode pairs, which are necessary to compensate for the low effective electromagnetic coupling of quartz. The transmission characteristics of the delay line in the bandpass region centering at 96.5 Mhz are shown in the graph. The input impedance of the delay line is displayed in the Smith chart. The tightly wound loops are due to the acoustic reflections of the interdigital transducers.

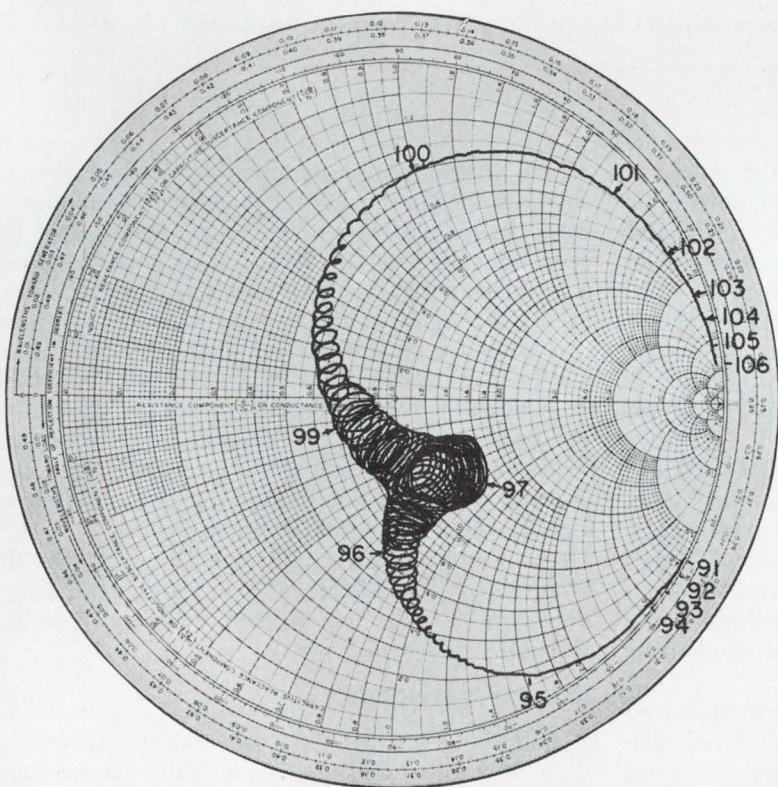
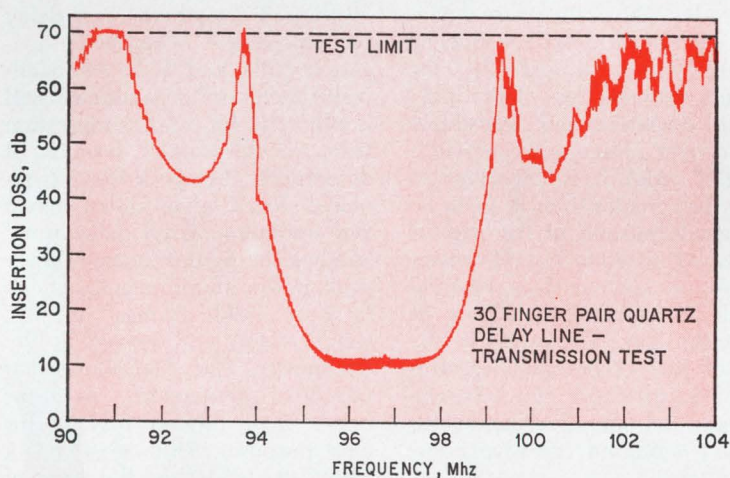



## Bidirectional transducers

To design an interdigital transducer for a 3db maximum fractional operating bandwidth, B, compatible with minimum insertion loss, B is optimized for series inductive tuning:

$$B_{opt} = \frac{1}{N_{opt}} = \sqrt{\frac{4}{\pi} K^2}$$

Where  $N_{opt}$  is the optimum number of transducer electrodes for maximum bandwidth, and K is the effective electromechanical coupling constant for the particular cut and orientation of the piezoelectric material.

The effective electromechanical coupling constant, K, is determined empirically by fabricating an interdigital transducer, of N electrodes, on a piezoelectric substrate that's ringed with black wax to absorb undesired reflections. Then measuring the input impedance at acoustic synchronism,  $f_0$ , yields the series radiation resistance,  $R_a$ , and the transducer capacitance,  $C_T$ .  $K^2$  is calculated from these values.

$$K^2 = \frac{\pi^2}{2N} (f_0 C_T R_a)$$

The equation of  $B_{opt}$  implies that any value of N other than

Piezoelectric	Cut and Propagation Direction	$k^2$ (%)	$N_{opt}$	B	$M_{opt}$	T ( $\mu\text{sec/cm}$ )	TxB ( $\mu\text{sec/cm}$ )
Lithium Niobate	YZ	4.92	4	0.24	108	2.88	0.69
Bismuth Germanate	110, 110	2.30	6	0.17	183	6.33	1.08
Zinc Oxide	XZ	0.52	12	0.08	46	3.74	0.31
Quartz	YX	0.22	19	0.053	53	3.06	0.16
PZT	Poled	4.30	4	0.23	—	4.55	1.04
	Normal						

$N_{opt}$  will decrease B. However, for  $N > N_{opt}$ , the bandpass characteristic is made more rectangular. When  $N = N_{opt}$ , the phase deviation from linearity with frequency is minimized. Specifically, for lithium niobate, less than  $\pm 5^\circ$  phase deviation per transducer occurs over a fractional bandwidth of 0.17. Also it is important to note that greater than  $B_{opt}$  can be achieved, but only at the price of increased insertion loss. However, techniques such as stagger-tuning to obtain variable periodicity of the interdigital electrodes, or the use of low Q bandpass electromagnetic matching networks, can increase the operating bandwidth without suffering excessive insertion losses.

Optimum design parameters are shown for various piezoelectric substrates.  $M_{opt}$  is the active

transducer width, in acoustic wavelengths, that's required for an acoustic radiation resistance of 50 ohms. T denotes the time delay per unit length along the propagation path, and B is the bandwidth factor. The parameter TxB is important for pulse compression filters in chirp radar systems. It determines the peak power required for a given radar range and resolution. High delay time-bandwidth figures mean lower peak power requirements, which in turn yield savings in size, weight, cost, and power in the transmitter. The chart shows that bismuth germanate performs better than lithium niobate for most purposes. Although PZT is a strong contender in the area of piezoelectric coupling and TxB, it has high lattice attenuation, even at frequencies of 100 Mhz.

least a 6-db insertion loss, since half the power is radiated in the wrong direction. Also, if not terminated correctly this backwave can be reflected at the substrate edge and can get into the delay line, causing a spurious signal in the output.

To avoid this echo, black wax often is deposited on the substrate edge to absorb the backwave, or the substrate surface behind the transducer is etched so that the backwave is scattered, or both can be done.

But there are other problems in bidirectional transducers. Most serious are multiple reflections between the transducers themselves, caused when a transducer reflects, as well as absorbs, a fraction of the energy incident on it. These multiple reflections are a basic property of lossless three-port junctions, which applies to a bidirectional transducer that launches two surface waves.

In this case there is one electrical port, and two acoustic ports. Scattering matrix analysis of this three-port junction shows that under ideal matching conditions, when the acoustic radiation resistance

of the transducer is matched to the r-f driving source impedance, and the electrical reactance is zero, the transducer will reflect one-quarter of the power incident on it. Thus, in any bidirectional transducer delay line configuration, a sizable fraction of the signal incident on the output transducer is reflected back to the input transducer, where it's again reflected, each reflection causing a 6-db drop in the power level. Unfortunately, this inherent spurious echo, called the triple-transit signal, will be seen again at the delay line output, at a level only 12 db below that of the original delayed signal, which made the trip only once.

One way to get rid of this echo is to convert the bidirectional transducer to a unidirectional transducer which suppresses acoustic energy traveling through it the wrong way.

### One way transducers

A unidirectional transducer is made with two bidirectional transducers which utilize a common ground and which are arranged in a collinear array.



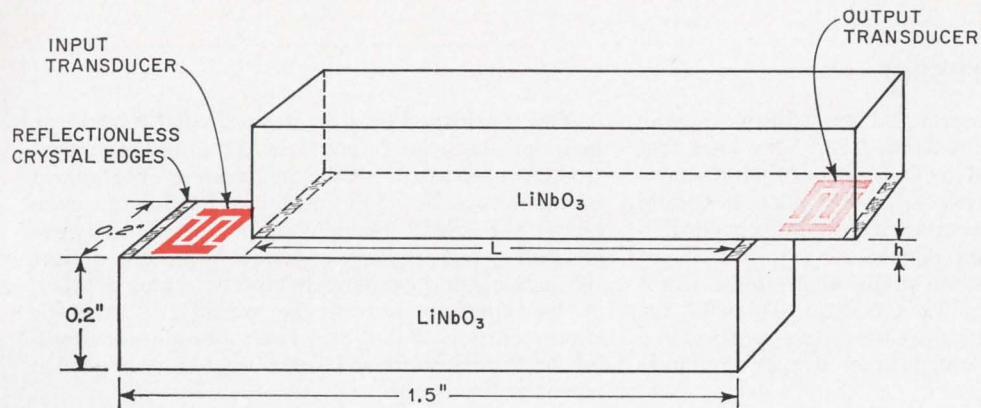

**Bridging the gap.** The effective length of the delay line is increased when two piezoelectric bars are cascaded. When the overlap distance  $L$  is adjusted to an odd integer of quarter beat wavelengths all the power is transferred from the input to the output bar.

	Bulk Plane Waves	Surface Acoustic Waves
<b>Non-dispersive</b>	Yes	Yes
<b>Available frequencies</b>	dc—60 MHz and 200 MHz—12 GHz	50 MHz to 1.75 GHz
<b>Effective <math>k^2</math> (%)</b>	11.6 (Zinc oxide, longitudinal)	4.92 (Lithium niobate)
<b>Maximum input power (W)</b>	50 (UHF)	1 (VHF)
<b>Delay (<math>\mu</math>sec/cm)</b>	0.9 (Longitudinal waves in sapphire)	2.88 (lithium niobate)
<b>TTS (dB)</b>	$\sim 20$ (difficult to control)	$> 20$ (highly predictable)
<b>Frequency filtering</b>	Technology difficult	Technology easy, design well understood
<b>Tappability</b>	Inefficient	Efficient

**Performance.** A comparison of key delay line parameters show surface wave flexibility, especially in accessibility, filtering capability, and triple transit suppression (TTS).

The most important design consideration is the center-to-center separation between transducers—an integer plus one-quarter acoustic wavelength. To achieve one-way directivity, each transducer must be fed by the same electromagnetic signal amplitude, but the phase of these signals must differ by  $\pi/2$  at each transducer. This can be accomplished by using a familiar microwave component, the 3-db quadrature hybrid. Now stress contributions from the two transducers will add in phase for propagation in the forward direction and will cancel for propagation in the reverse direction—just the condition of a matched four-port network, consisting of two acoustic ports and two electrical ports simultaneously matched at all four ports.

To test the theory, a 15-electrode pair of bidirectional transducers, forming a unidirectional transducer, was deposited on a lithium niobate substrate. Insertion losses, compared to the bidirectional type, were halved, while spurious echo level suppression increased to 52 db. However, the operating bandwidth was reduced by two-thirds.

In either case—bidirectional or unidirectional—

one attractive property of all interdigital transducers is their wide dynamic range. At 100 Mhz in air, for example, 1 watt of peak power can readily be pumped into a delay line system before breakdown occurs. Assuming an operating bandwidth of 25 Mhz, a receiver noise figure of 10 db and a delay line insertion loss of 10 db, results in a dynamic range exceeding 100 db.

One source of delay line loss, r-f conduction losses arising in the interdigital electrodes and inductors used for transducer matching, is small at vhf, since impedances in the lines at these frequencies typically are less than 10 ohms. At microwave frequencies, however, conduction losses are quite large, because impedances generally are greater than 100 ohms, compared with a radiation resistance of approximately 10 ohms.

Propagation losses, however, can be significant, even at 100 Mhz. This loss does not arise primarily from aperture diffraction. Because apertures of interdigital transducers are in the order of many wavelengths, diffraction is negligible. Moreover, substrate lattice structure becomes a significant



## Sidelobe suppressor

Pairs of standard interdigital transducers having constant periodicity and width form delay lines that yield sidelobe levels 26 decibels greater than the minimum insertion loss. This can be a problem in certain bandpass filter applications which require good definition of closely spaced signals.

The sidelobe amplitude produced by these transducers falls off in a  $\sin x/x$  fashion. To make the decrease more rapid, it is necessary to approximate a Gaussian function, which has much steeper amplitude decay.

This is achieved by a Gaussian-shaped transducer, in which the overlap length of the interdigital electrodes are varied in a Gaussian manner. This allows maximum overlap at the center and minimum overlap at the edges. Periodicity, or spacing between electrodes, must remain constant. With this design, the piezoelectric coupling is tapered, being weakest at the aperture end of the transducer. Acoustic energy outside of the main beam is reduced, resulting in greatly suppressed sidelobes but a somewhat narrower bandwidth.

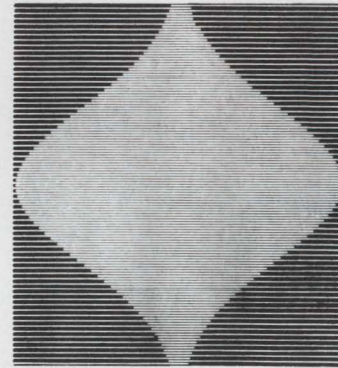
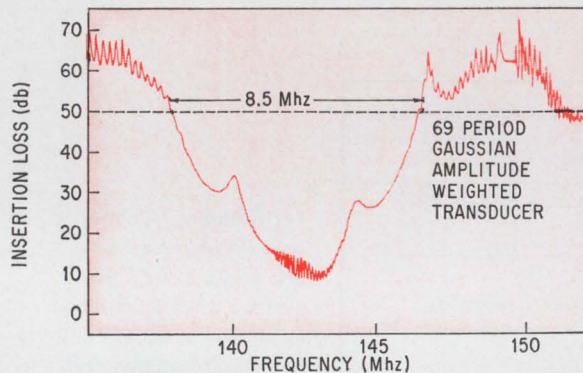

contributing factor only at high frequencies. An exception are the piezoceramics, such as lead zirconate titanate (PZT), where the lattice attenuation can reach several  $\text{db}/\mu\text{sec}$  even at 50 Mhz.

Beam steering, caused by misalignment of the transducers, is the major propagation loss. This effect results from a misorientation between the axis of the transducer and a major crystallographic axis, with the beam being pulled along the crystallographic axis at an angle to the transducer center line or beam launching direction. Investigation of the electrical field distribution associated with the acoustic wave in front of the receiving transducer indicates that only a few tenths of  $1^\circ$  of transducer misorientation can throw the energy beam out of alignment by the same amount.

These alignment losses amount to about 3 db for present generation transducers. As deposition and orientation techniques improve, this major propagation loss should be reduced to less than 1 db. But despite all transducer and propagation losses, delay lines can be designed now with insertion losses of less than 4 db at vhf.

At higher frequencies insertion losses are dominated by lattice attenuation in the piezoelectric crystal, which increases as the square of the frequency. Lithium niobate, which appears to be a good substrate, shows a typical attenuation of 1  $\text{db}/\mu\text{sec}$  at 1 Ghz. But here surface finish is important, and improved lapping and polishing methods should reduce losses. Typically, surface scratches will have to be smaller than one-tenth

acoustic wavelength to keep scattering negligible.

Because propagation losses can be considerable, it is important to achieve maximum acoustical coupling to the crystal. But coupling isn't a simple matter, and is highly dependent on the crystal material used, its cut, and orientation.

### Coupling

What's needed are materials that yield the largest value of electromechanical constants—the measure of how well a crystal transforms electrical to acoustical energy. Quartz, although commonly used, is inferior to lithium niobate. Use of Y-cut, Z-propagating lithium niobate in place of quartz for the delay line material, allows the bandwidth to be increased from 5% to 24% with simple inductive matching, without increasing insertion loss.

On the other hand, lithium niobate has certain inherent disadvantages. For one, it's expensive—almost six times the cost of quartz. And it's quite brittle and prone to crack in processing, especially if thin substrates are required. Worse yet, to achieve low propagation loss it must be poled at some process stage to orient all ferroelectric domains in one direction. Looking ahead, it seems that bismuth germanium oxide will prove more cost-effective.

Regardless of the material used, it's important to determine the maximum time delay available. Clearly, delay line length should have maximum range, but since crystal ends can't be butted without producing prohibitive reflections at the seams,



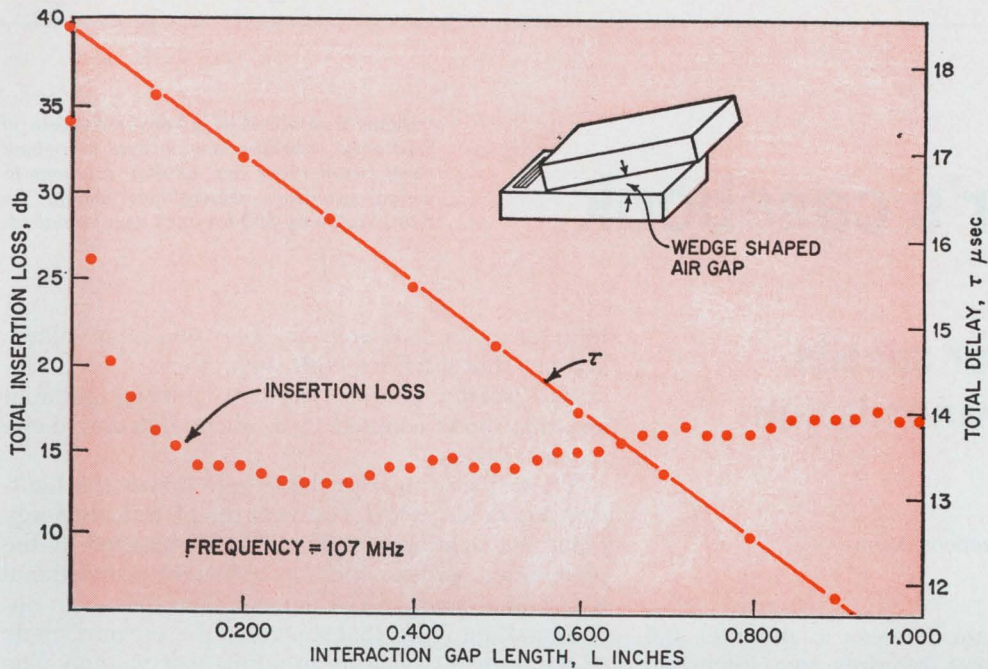

**Variable.** Mechanically moving one crystal with respect to the other provides variable delays. The wedge gap allows a fairly constant insertion loss of approximately 17 db over the total delay time.

the length of single crystals is a limiting factor in producing long delays. Six inches seems to be about the maximum length for most crystals. This corresponds to a delay of 45  $\mu\text{sec}$  in lithium niobate and 90  $\mu\text{sec}$  in bismuth germanium oxide.

The single crystal problem can be circumvented by cascading short crystal lengths, which serves to effectively increase the delay line path. Two piezoelectric bars which are optically flat and spacially parallel are placed one over the other in step fashion, the two crystals separated by a small air gap. The input transducer is placed on one end of the lower bar and the output transducer on the opposite end of the upper bar. With this arrangement, coupled-mode analysis similar to traveling-wave tube helix-coupling theory, shows that for particular values of the overlap distance,  $L$ , an acoustic signal fed into one bar will transfer completely to the second bar and be picked up at the output transducer.

This coupling through the gap results when the Rayleigh wave launched on one substrate generates even and odd modes on reaching the overlay region, which has a symmetry plane midway between the gap. Because these two modes have slightly different wavelengths, after one-quarter-beat wavelength all energy has been transferred to the second bar.

#### Variable delays and the wedge gap

An extension of the cascading delay line principle allows delays of any desired duration—simply add more cascaded crystals. Moreover, by moving the bars in relation to one another, thereby changing the effective delay path, variable non-dispersive delays are produced, thus providing a capability for system synchronization. With variable delays, it's best to offset the upper bar to form a slightly wedge-shaped air gap. This configuration keeps the

insertion loss fairly constant when the bars are moved to obtain different delays.

Operating at 107 Mhz, a lab-fabricated delay line using wedge-shaped gaps yielded variable delays of up to 7  $\mu\text{sec}$ , while the insertion loss was kept below 17 db. This means surface wave delay lines with variable time delays can be built with insertion losses at vhf frequencies less than bulk delay lines with fixed time delays. Furthermore, the spurious triple transit suppression was greater than 26 db because backwave coupling through the wedge gap is not very efficient. Although quite promising, fabricating air gaps in the order of 0.6 microns at 100 Mhz, and much smaller at Ghz frequencies, is at best difficult. ■

#### Coming up

How near are microwave acoustic applications? How will they affect the engineers who are designing radar and processing systems?

At present, surface acoustic wave amplifiers give 30 db terminal gains, and new materials yielding greater acoustic power are being developed. Acoustic wave transmission lines are becoming a reality, and acoustic microwave circuits are in the works. Directional and hybrid couplers, magnetoacoustic isolators and phase shifters, double-pole, double-throw switches, resonators, and cavities are all possible acoustic contenders to replace their electromagnetic counterparts. Tapped delay lines, Barker decoding systems, analog matched filters, pulse and expansion systems all are under development.

In an upcoming second article, J.H. Collins and P.J. Hagon further explore the current technology and look to future applications.



# Designer's casebook

*Designer's casebook is a regular feature in Electronics. Readers are invited to submit novel circuit ideas and unusual solutions to design problems. Descriptions should be short. We'll pay \$50 for each item published.*

## Optical isolator speeds digital data transmission

By Gary L. Burkart

Control Data Corp., Minneapolis, Minn.

Transmitting digital data between a computer and its peripheral equipment requires two important considerations: speed of the transmission, and the isolation of each piece of equipment from high-voltage effects and electromagnetic interference. One way of achieving both—speed and isolation—is with a photodiode-coupled isolator. It transmits data with typical propagation delays of 70 nanoseconds, which is equivalent to about a 7-megahertz transfer rate, and insures a breakdown capa-

bility of up to 2500 volts d-c between high-voltage systems that interface with each other.

The isolator contains a light-emitting gallium-arsenide diode coupled to a silicon-detector diode by clear epoxy.

A transistor-transistor-logic gate drives the light-emitting diode, which converts the electrical energy input into light energy. The light is detected by the photodiode, which generates a current proportional to the light energy. The current then drives an operational amplifier that converts the current mode of the optical device to an equivalent voltage. The output of the op amp feeds a comparator, which delivers voltage levels that are compatible with TTL or diode-transistor logic.

Lead-lag compensation for the operational amplifier provides a large bandwidth and fast response times during pulse transmissions. The output swing of the op amp ( $\pm 60$  millivolts) is kept small to minimize RC time constant delays.

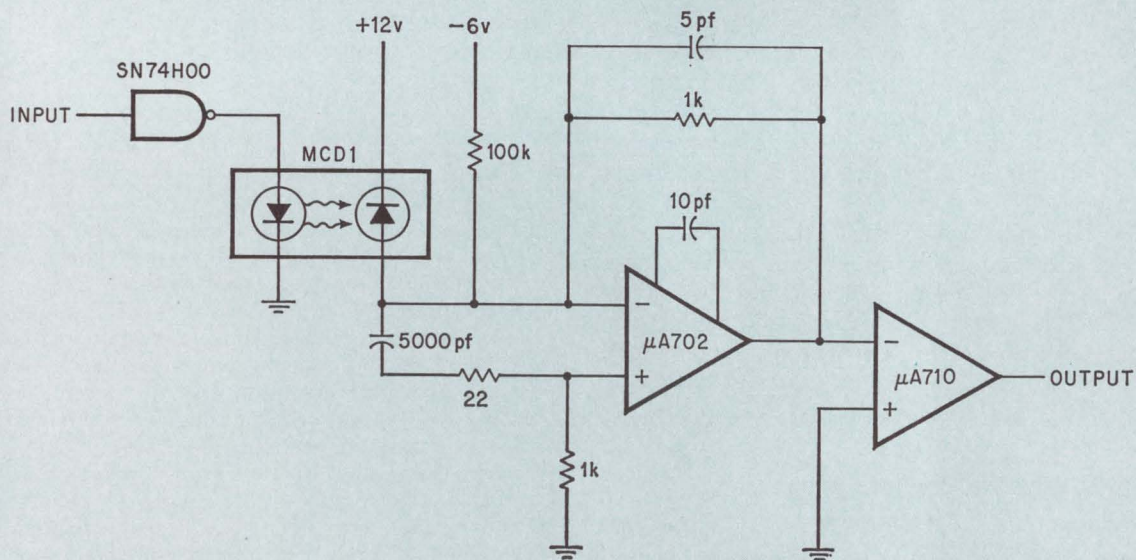

**Light emitting.** With an optical-coupling device, digital signals can be transmitted between peripheral gear with small propagation delays and good isolation. A digital input signal activates the light-emitting GaAs diode whose light energy is detected by a silicon photodiode, which converts the light to electrical energy.



## 2-stage peak-holding circuit stores submicrosecond pulses

By Joseph McDonald and Arthur Pinkerton

Sloan-Kettering Institute for Cancer Research, New York

Peak amplitude measurements of fast rise-time pulses can be made with a digital voltmeter only if the pulse is first stretched by a holding circuit before being fed to the voltmeter. Unfortunately, most commercial units which are peak detectors, are unable to follow rise times faster than 0.5 microsecond—too slow for some applications. And, such peak detectors are expensive to boot. A circuit with two unity-gain stages, however, will enable a digital voltmeter to read pulses with rise times of less than 100 nanoseconds. And, this circuit is less expensive than the other units because of the cheaper components.

Each stage, containing a pair of operational amplifiers and a diode-capacitor peak detector, has positive feedback to maintain unity gain that compensates for the forward drop in the diode. By using two stages, each driver needn't supply exces-

sive charging current to the capacitors. In the first stage, op amp A is capable of passing negative pulses with rise times less than 50 nsec at currents up to 100 milliamperes. The amplifier's slewing rate is 160 volts per  $\mu\text{sec}$ .

Capacitor  $C_1$  charges to the input pulse's peak amplitude and holds the voltage for a time determined by the discharge time constant—which depends on the capacitor's value, and the parallel combination of the diode's back resistance and the input impedance of the op amp follower. The time constant for this stage is 1 second.

The second stage works in the same way as the first except that it uses a different type follower with a smaller bandwidth and slewing rate. The electrical requirements are less severe in this stage because the pulse had already been stretched in the first stage.

In this second stage, the slope, or droop, in the pulse's amplitude is 25 microvolts per second—superior to existing units in which the droop is as high as 0.1 volt/sec. Here, the droop depends largely on the diode-leakage current and capacitor  $C_2$ . For an input amplitude of 2 v, the output amplitude slopes less than 1 mv per 40 seconds.

Because of the unity gain of the two stages, input and output amplitudes never vary more than  $\pm 1.5\%$  of each other.

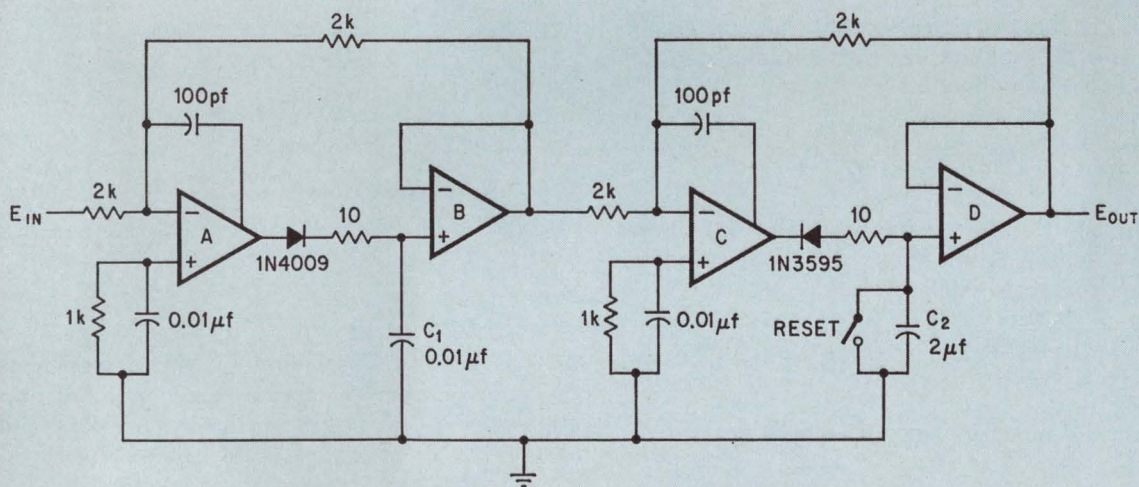

### OPERATIONAL AMPLIFIERS

- A, C NIM MA-30 (NUCLEAR EQUIPMENT)
- B 148-C (ANALOG DEVICES)
- D KM 47-C (K and M ELECTRONICS)

**Stretcher.** Most peak detectors have difficulty storing amplitudes of high speed microsecond pulses. This circuit, however, uses two op-amp stages each with a diode-capacitor peak detector that stretches pulses into seconds and allows the amplitude to be read by a digital voltmeter.



# A simplified design approach for hysteresis circuits

By Walter A. Cooke

Lockheed Missiles & Space Co., Sunnyvale, Calif.

Quick, simple, and accurate designs of hysteresis circuits are afforded by a mathematical procedure in which only four resistor values need be calculated. With the proper choice of the resistors, any upper and lower threshold point on the hysteresis curve can be obtained; and, depending on whether the feedback is to the positive or negative terminal of the operational amplifier, the curve can span any quadrant.

The key to this design approach is the assumption of these conditions: the operational amplifier's input impedance is much larger than the source impedance; its output impedance is much smaller than the load impedance; and the amplifier switches state when the differential input voltage is 0 volts. Based on these assumptions, equations can be derived to determine the values of the four resistors needed to define a particular hysteresis curve.

For the condition in which the differential voltage at the op amp's input terminals is 0,

$$E_1 = E_2 = \frac{R_2}{R_1 + R_2} E_r$$

where  $E_r$  is the reference supply voltage, and  $E_1$  and  $E_2$  are the voltages at the amplifier's inputs.

$E_2$  can also be defined as

$$E_2 = \frac{R_4}{R_3 + R_4} E_i + \frac{R_3}{R_3 + R_4} E_o$$

where  $E_i$  is the input voltage and  $E_o$  the output voltage. Equating these two expressions and rearranging the terms, yield

$$E_i = \frac{R_2 (R_3 + R_4)}{R_4 (R_1 + R_2)} E_r - \frac{R_3}{R_4} E_o \quad (1)$$

When a d-c offset close to 0 volts is desired, let

$$\frac{R_1 R_2}{R_1 + R_2} = \frac{R_3 R_4}{R_3 + R_4} \quad (2)$$

In a typical hysteresis curve, there are two switching thresholds that trigger the amplifier to a high or a low voltage state.

Let  $E_U$  be the input voltage required to switch the op amp from its high voltage state,  $\bar{E}_o$ , to its low output state,  $E_o$ . And let  $E_L$  be the input voltage required to switch the amplifier from the low volt-

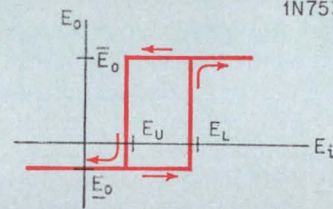
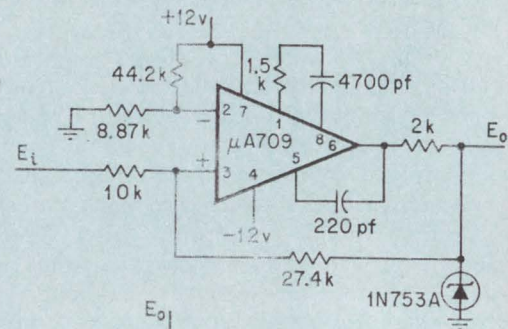
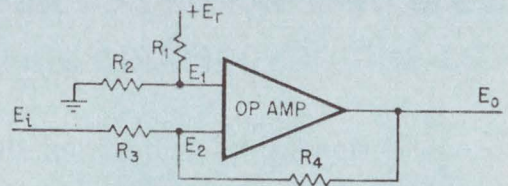

**Selecting thresholds.** A set of algebraic equations can be derived for any op amp hysteresis circuit defining any two threshold points.

age state to the high state. These conditions then define the last two equations:

$$E_U = \frac{R_2 (R_3 + R_4)}{R_4 (R_1 + R_2)} E_r - \frac{R_3}{R_4} \bar{E}_o \quad (3)$$

$$E_L = \frac{R_2 (R_3 + R_4)}{R_4 (R_1 + R_2)} E_r - \frac{R_3}{R_4} E_o \quad (4)$$

By combining equations 3 and 4, the value of  $R_4$  can be calculated in terms of  $R_3$  as

$$R_4 = \frac{R_3 (\bar{E}_o - E_o)}{E_L - E_U} \quad (5)$$

$R_3$  is arbitrarily selected by the designer, and this allows him to control the minimum input impedance of the circuit. The other parameters in equation 5, which are also selected by the designer, define the shape of the hysteresis curve.

Now that resistors  $R_3$  and  $R_4$  are known, it is a simple matter of solving equations 3 and 4 to determine  $R_1$  and  $R_2$ .

If, for example, the following parameters are chosen for the design:  $\bar{E}_o = 6.2$  volts,  $E_o = -0.7$  volt,  $E_L = 3$  volts,  $E_U = 0.5$  volt,  $E_r = +12$  volts, and  $R_3 = 10$  kilohms, then the other resistors can be determined from the procedure just described as:  $R_1 = 43.8$  k,  $R_2 = 8.82$  k, and  $R_4 = 27.6$  k.



# New from Philco-Ford: Custom Systems from Standard Products



Philco-Ford Wiring Verifier virtually eliminates wiring errors. Design prevents wire wrap gun from operating if wrong pin is selected.

#### Ask about new Services . . .

Find out about our complete design engineering service. Experienced engineers fully qualified in all aspects of logic equipment design are at your command to perform circuit and hardware design, specification writing, acceptance test writing, maintainability analyses, reliability calculations, many other functions. We'll figure out what modules you need, generate the logic diagram, wiring and maintenance lists — or, if you wish, we do just the tedious clerical work. And if you need a special module, we'll design it for you. Either way, you receive the product "fail-safe" wired, ready to use.

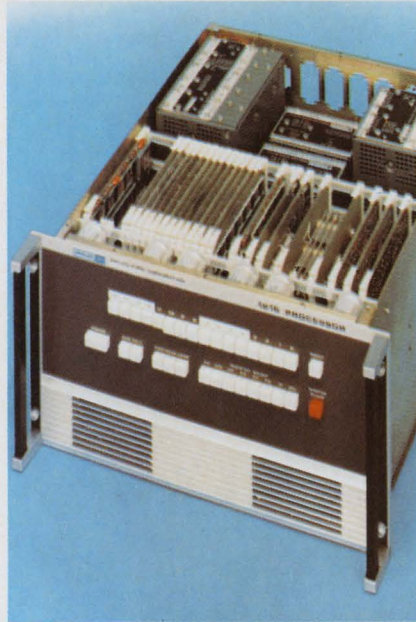

New family of 6 control processors are designed specifically for on line, real time, monitoring and control systems.

#### Ask about new Processors . . .

New this year: a family of sparkling new control processors designed for on-line, real time, monitoring and control systems. Choose from 6 models in our new 1200 Series. Offered are word sizes of 12, 16 and 20 bits, in conjunction with memory cycle times of 1.9 or 3.5 microseconds. A full line of compatible peripheral equipment is available, including a disc memory, magnetic tape station, CRT operator station, modem controllers, card reader, line printer, normal and high speed paper tape equipment and teletypes. A complete family of software, including ASA Basic Fortran is available.

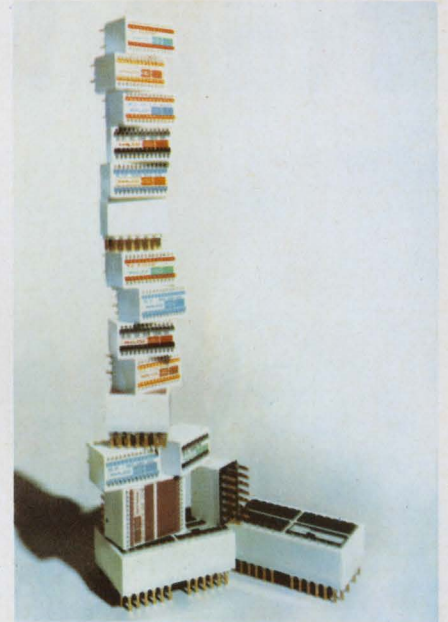

Substantial savings on popular proven Philco Logic modules — including NAND Gate, Flip Flop, op amps, Schmitt trigger circuits.

#### Ask about new Philco Logic prices . . .

Save on Philco Logic analog and digital circuit micromodules. Choose from a wide line of DTL, TTL, and MOS elements in compatible 5 MHz to 40 MHz logic. These are the most popular, widely used Philco-Ford modules. Outstanding electrical performance is assured thanks to quality design and long experience. Package is rugged, durable. All test points are available from the front.

For big news in logic economy, processors and service — stop in to see us.

Philco-Ford, Booth 123-124, Convention Center,  
Fall Joint Computer Conference, Nov. 18-20, Las Vegas

**PHILCO**



PHILCO-FORD CORPORATION  
Industrial Systems & Products Operation  
3939 Fabian Way  
Palo Alto, California 94303  
Phone: (415) 326-4350 (Ext. 6017)

**The Better Idea People in Industrial Systems**



# 'Pressing' pictures on holographic tape is fast, inexpensive

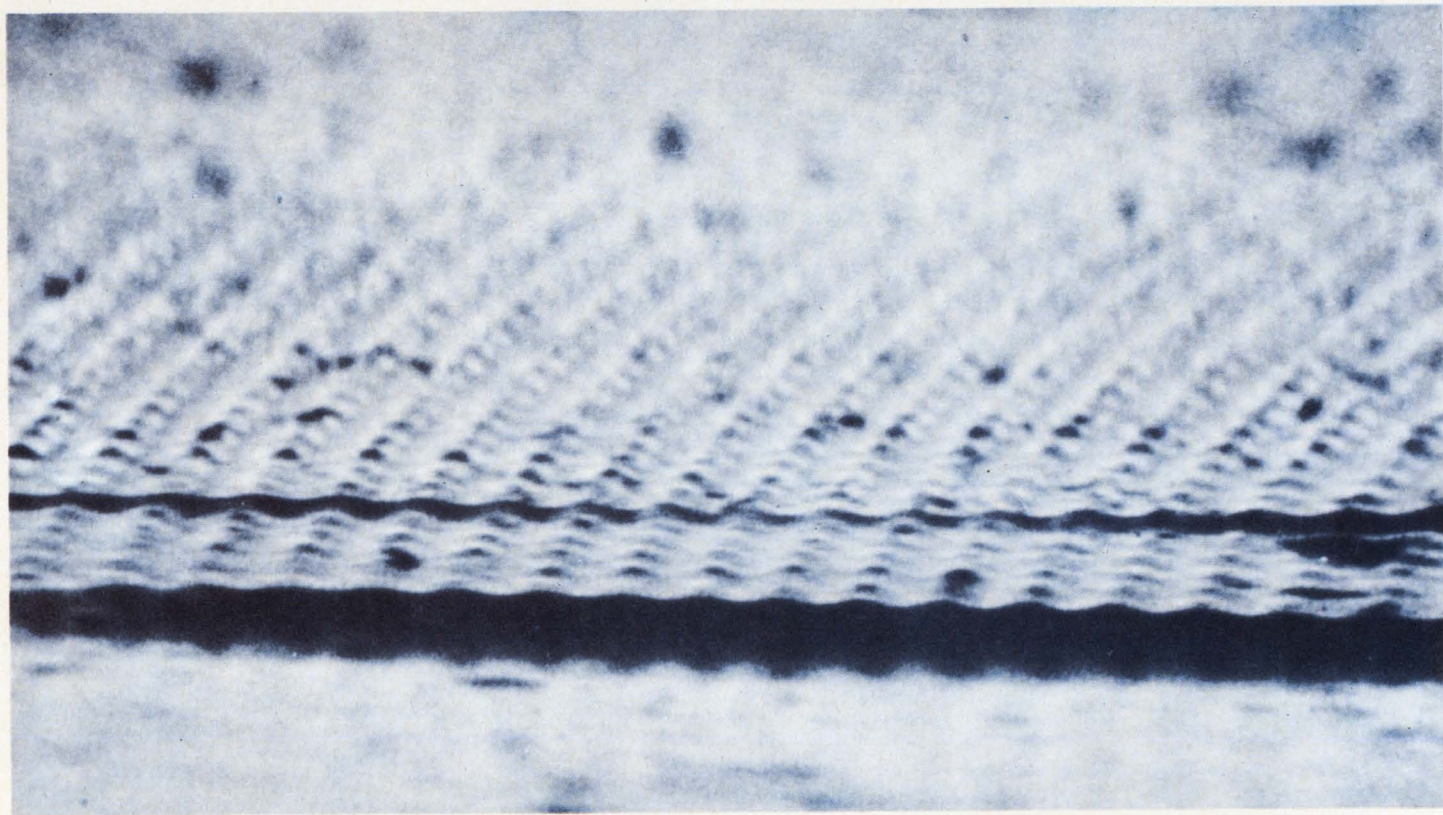

**Holographic relief.** Observed through a microscope an embossed hologram shows a hill-and-valley pattern. The hologram is fabricated by focusing a laser's object and reference beams onto a photoresist-coated surface. Where the light is most intense, the photoresist softens; when the soft areas are washed away, the embossed hologram remains.



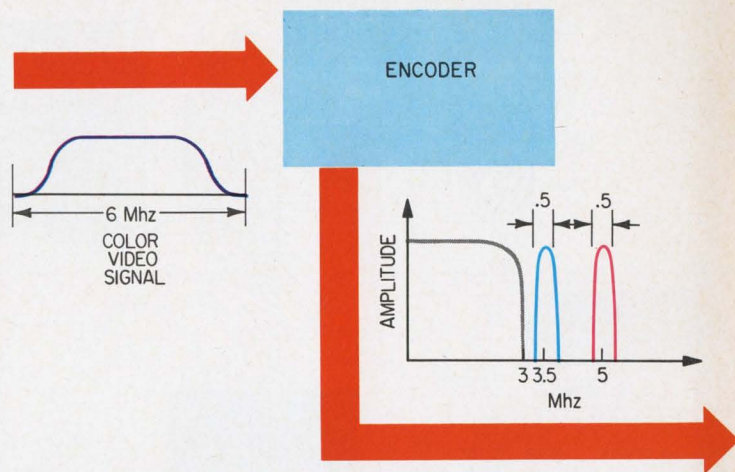
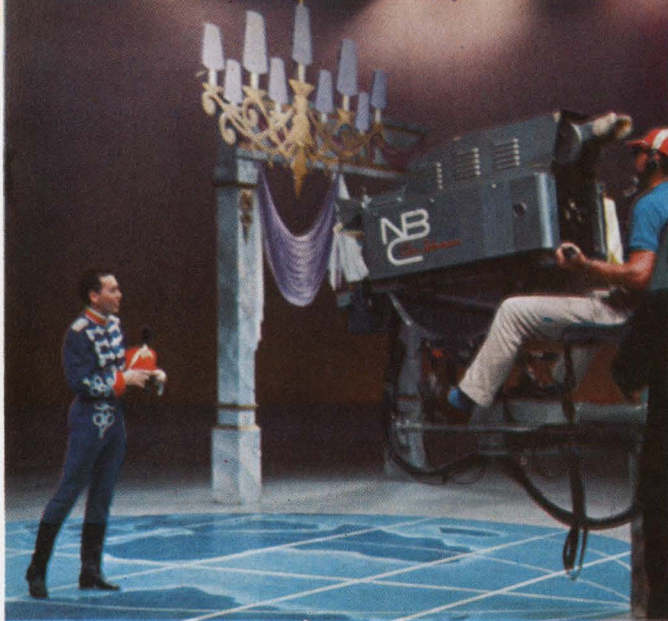

● Bringing the virtues of the printing press to bear against the slow, chemical or electronic processing involved in producing motion pictures sounds like a tall order. Innovating is called for—and RCA is doing it by using embossed holograms in a fast, inexpensive mechanical method for duplicating visual images.

In holograms, half a loaf is almost as good as the whole. That's because if you cut a hologram in half and throw away one half, you could reconstruct the complete image simply by shining a laser through the other half, with only a slight loss of resolution. Therefore holograms aren't affected much by scratches or pin holes, and will stand up to the rough handling involved in mass production and home use.

RCA plans to make the initial use of its technique in SelectaVision, the recently demonstrated video playback system [Electronics, Oct. 13, p. 43]. In the RCA application, holography is the key: the original images, in color, are converted into embossed holograms from which a master can be made that presses the copies on vinyl, a material about as cheap as paper. SelectaVision is built around a suitcase-size attachment for a tv set; cartridges of prerecorded vinyl tape are plugged into the attachment and the tape is played on the receiver's screen. Inside the attachment a laser reconstructs the vinyl tape's holograms, and a vidicon (a low-light-level

tv tube) converts the reconstructed images into electrical signals for display.

SelectaVision won't be ready commercially, RCA says, until 1972. The company still has problems to solve. The quality of the system's color reproduction is poor and RCA engineers have yet to put audio signals onto the holographic film.

The first step in making a SelectaVision tape, naturally, is televising a program. RCA engineers use a standard technique for preserving the color information; they separate the color signals from the luminance signal and encode color information before making holograms.

The output of a tv camera (or a video tape recorder) goes to an encoding network whose output consists of a luminance signal, with a frequency band extending out to 3 megahertz; a blue signal modulating a 3.5-Mhz subcarrier whose bandwidth is 0.5 Mhz; and a red signal modulating a 5-Mhz subcarrier whose bandwidth also is 0.5 Mhz. (The green signal can be obtained by subtracting the blue and red signals from the luminance.)

The encoder's output modulates the beam intensity of an electron beam recorder. Mounted in the recorder is a reel of 16-mm electron-sensitive film, which reacts to beam intensity the same way photographic film reacts to light. As a takeup reel intermittently pulls the film through the beam, the film is scanned in a raster pattern.

**Holograms, lasers and vinyl strips lend themselves to a mechanical process for copying visual material; Owen Doyle of Electronics' staff takes a close look at this innovative approach and explains how RCA is applying it to a home color-television system**



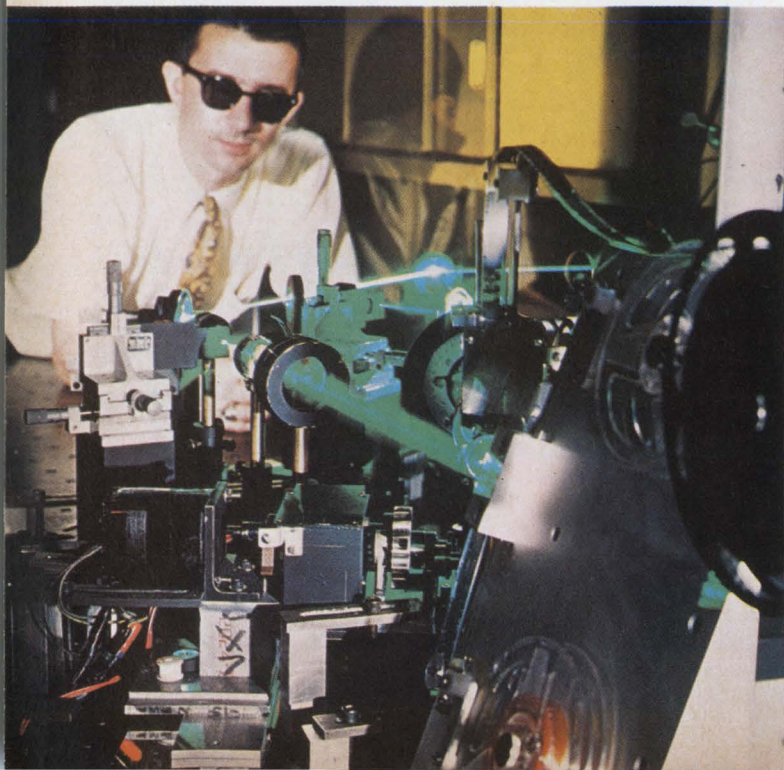
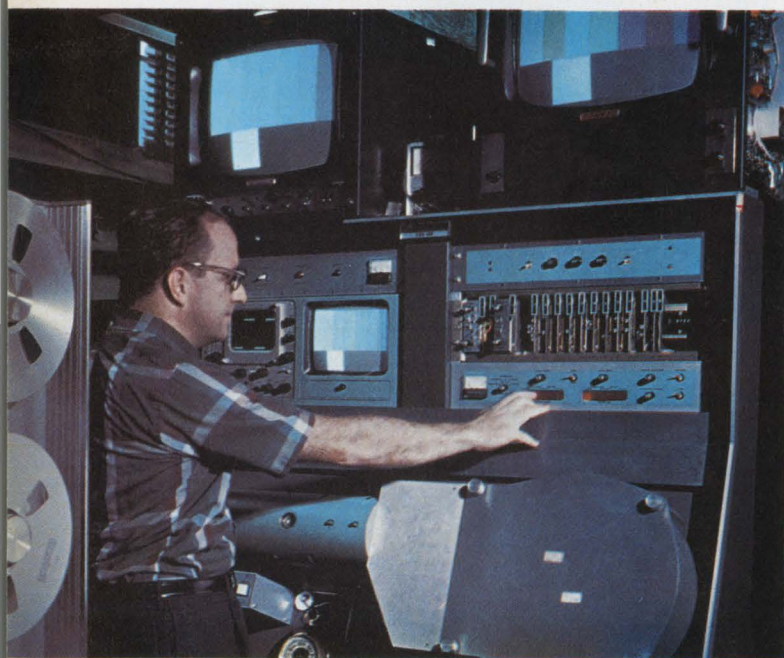
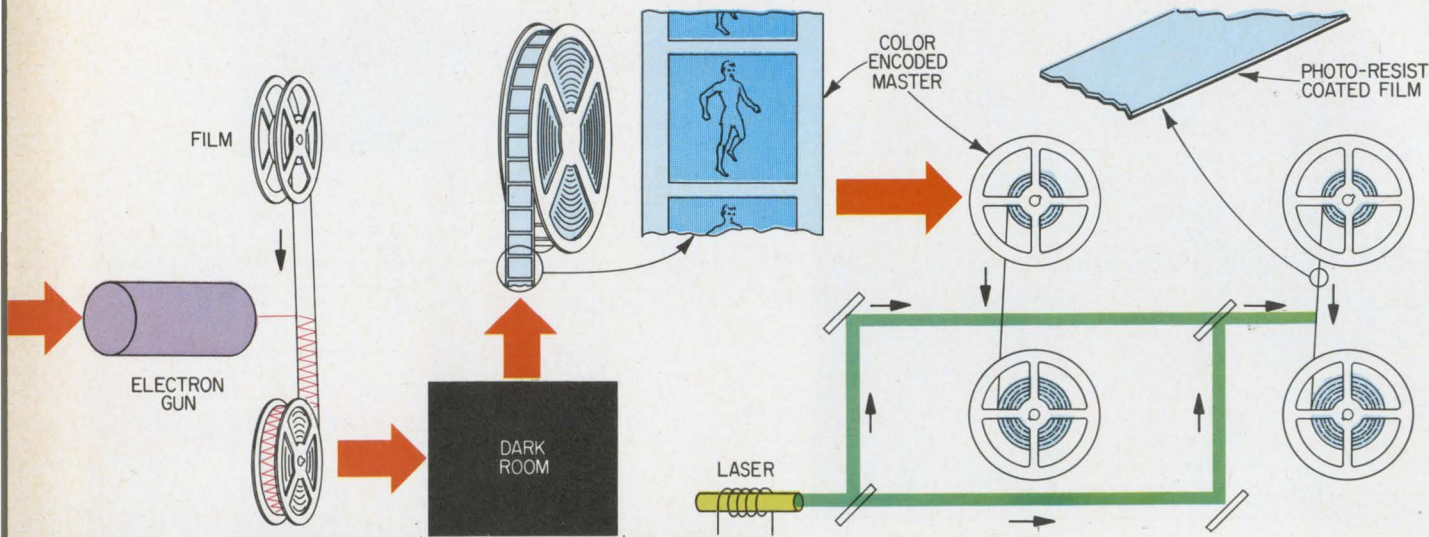

When developed, the film is called the color encoded master. On each of its frames is a black-and-white image and on top of the image are vertical stripes, each 25 microns wide. Encoded in these stripes is the color information. Actually there are two sets of stripes, one for the blue signal and the other for the red. The stripes containing the blue information are 90 microns apart, and the ones containing the red are 60 microns apart.

**Next, RCA engineers** make a strip of holograms from the color encoded master. They coat a role of ½-inch-wide Cronar (a plastic similar to Mylar) with a few microns of photoresist. Then the Cronar film is mounted on a set of reels so that it moves parallel to the master, which also is mounted on reels. The holograms are made conventionally: a laser beam is split; one part, the object beam, goes through the master to the photoresist-coated film, and the other part, the reference beam, goes to the coated film without passing through the master. The laser, the splitter, and various reflecting mirrors are arranged so that the two portions of the beam strike the coated film at the same spot and travel the same distance. The result: an interference pattern uniquely associated with the image through which the one beam passed is formed on the coated film. This pattern is a hologram.

The master and the coated film move intermittently. Each frame on the master is in the beam for a fraction

**Recorder to laser.** Working with the output of a tv camera the electron beam recorder (top, under the operator's arm) makes a color encoded master. Then the images on the master are converted (bottom) into embossed holograms. The master is on the large reel, and the photoresist-coated film is on the two small reels.



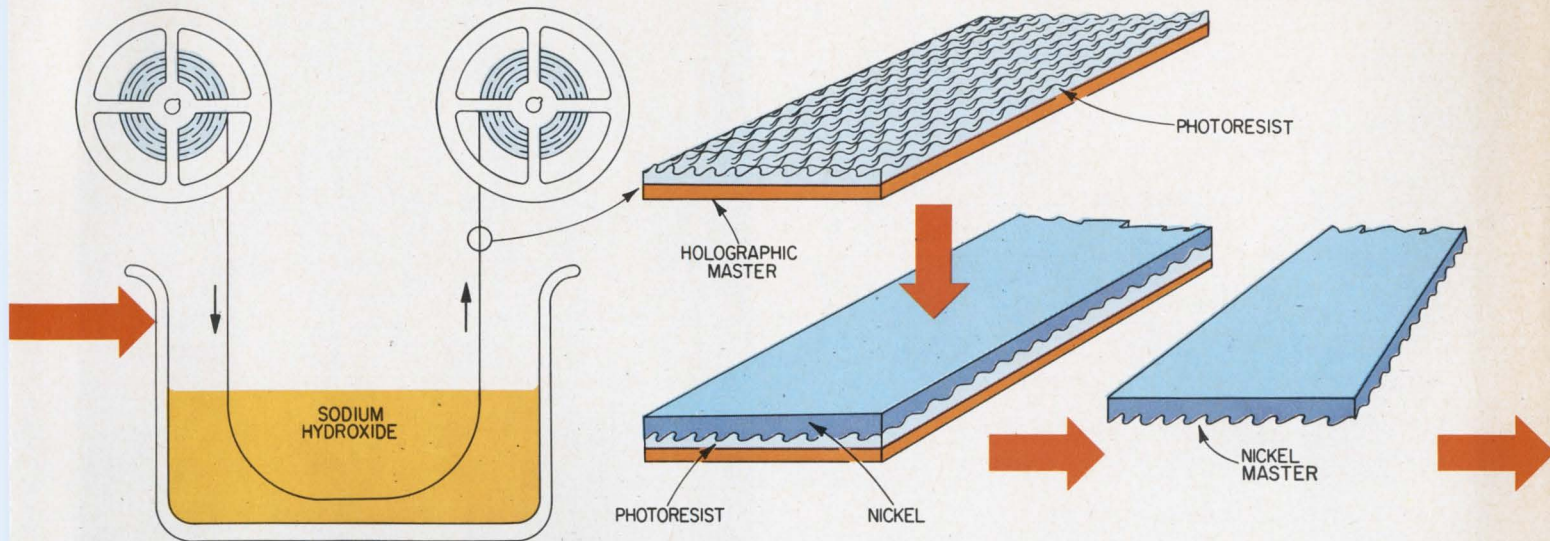

of a second. Two holograms are made of the first frame through; three are made for the next frame; two for the next one and so on. This 2-3-2-3 pattern, says RCA, makes SelectaVision tapes compatible with both motion picture and television frame speeds.

The light from the laser softens the photoresist: the more intense the light at a given point, the softer the photoresist becomes, selectively preparing it for easy removal later in the process.

The making of the holograms isn't quite this simple. As was pointed out, holograms are inherently redundant; scratch them and you can still reconstruct images. However, RCA engineers claim that their vinyl tapes have "added redundancy" which markedly reduces noise on the holograms. But no one is saying how this redundancy is added.

**Developing** the holograms is next. The coated film is treated with sodium hydroxide, which removes the softer portions and leaves on each frame a hill-and-valley pattern of photoresist. Viewed from above with a microscope the film looks like a relief map. The valleys' average depth is 0.05 micron, and the average distance between peaks is 1 micron.

The developed roll of holograms, called the holographic master, is electrolytically plated with about 150 microns of nickel. When stripped away from the holographic master, the nickel contains the impression of the

**Next step.** A takeup reel (right) pulls the photoresist-coated film through a tank of sodium hydroxide.

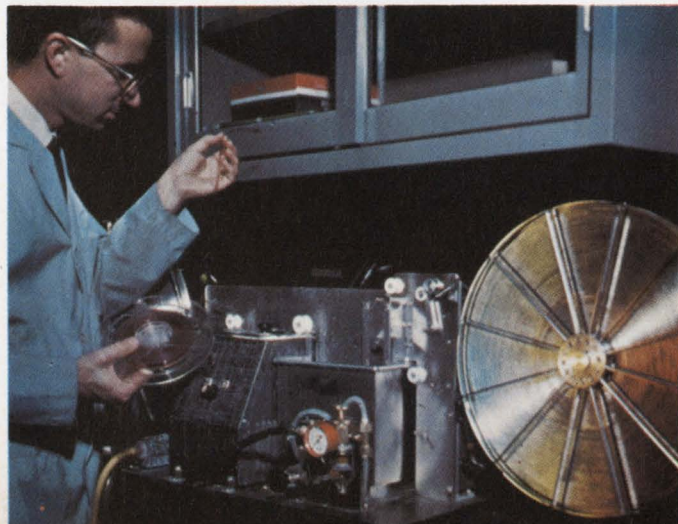

master's hill-and-valley pattern.

At this point, RCA engineers prepare to make copies. They put a spool of vinyl onto a machine that pulls the vinyl off and puts it in contact with the nickel master. The nickel and the vinyl pass between a pair of rollers; the top roller presses down on the film and the master, while the bottom one applies heat. This combination embosses the holographic pattern onto the vinyl. As the master and the vinyl move away from the rollers an air blower separates them; the master cycles back and the vinyl copy goes to a takeup reel. Finally the tape goes into a cartridge.

The holograms running down the length of a vinyl tape, a nickel master or a holographic master show up as a rainbow-colored strip. The holograms appear colored not because the images they contain are colored but because their irregular surface diffracts the wavelengths present in the incident light.

Inside the playback unit the vinyl film moves through a laser beam, which reconstructs the visible images that are then picked up by the vidicon.

If the vidicon were placed along the axis of the beam, the tube would see not only the reconstructed image but also the hologram itself. Therefore the vidicon is positioned so that the angle in radians between its long axis and the laser beam is equal to the laser's frequency divided by the vinyl's diffraction gradient. In this way,

**Nickel bath.** Wrapped around a cylinder, the holographic master is electrolytically plated with nickel.

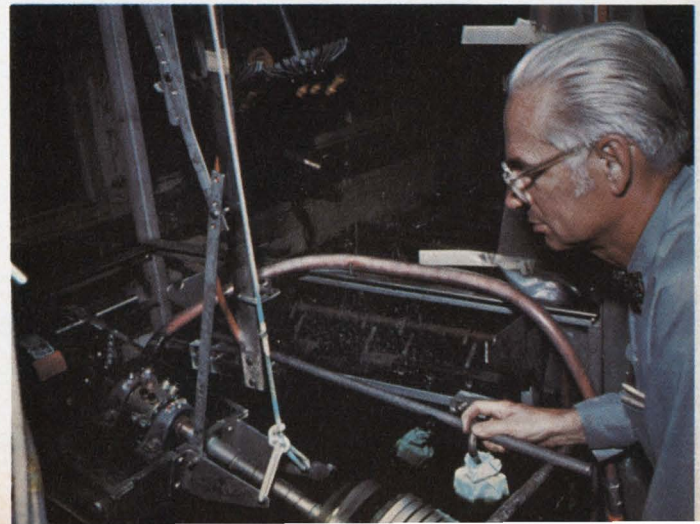



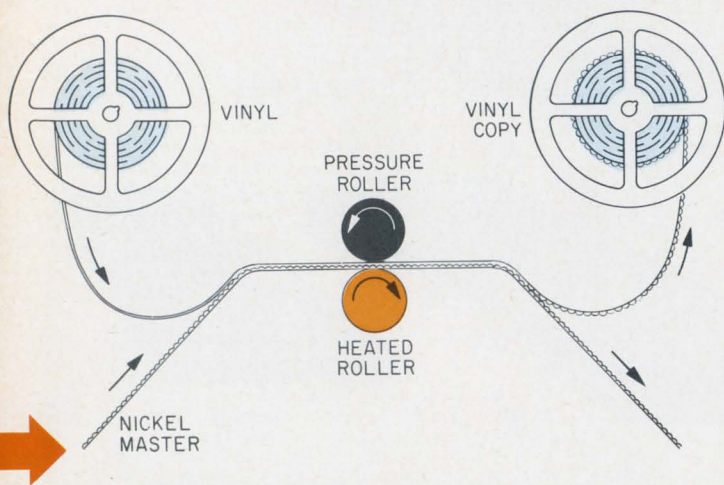

the vidicon sees only the reconstructed image.

The vidicon's output—identical to the coded outputs of the encoder used in making the holograms—goes to a decoder, which converts the signal into standard luminance and color signals, which go to the tv set.

**The playback unit's laser** has an output of 2 milliwatts and a beam diameter of  $\frac{3}{8}$  inch. Donald McCoy, director of RCA's Consumer Electronics Research Laboratory, where SelectaVision was developed, says that in large quantities RCA will build these lasers for \$30 each. The vidicon used in the playback unit is a commercial tube, made by RCA's Industrial Tube division. McCoy expects the vidicon price to also be about \$30. And life expectancy for both the vidicon and the laser working in the playback unit, he says, will be "thousands of hours".

McCoy doesn't feel the laser will present a safety problem. "You have to recognize that the power of that laser is quite small and the beam is quite large," he says, "so the energy concentration is quite small"—about 30 milliwatts per square centimeter.

What would happen if someone took the laser out of the playback unit and stared directly at the beam? McCoy answers: "You notice that the light from the laser is visible, and any time your eye is subjected to a bright light, whether it's from the sun or a laser or anything else, you will blink to protect the eye. And I think that you could damage your eye by looking at the sun for a

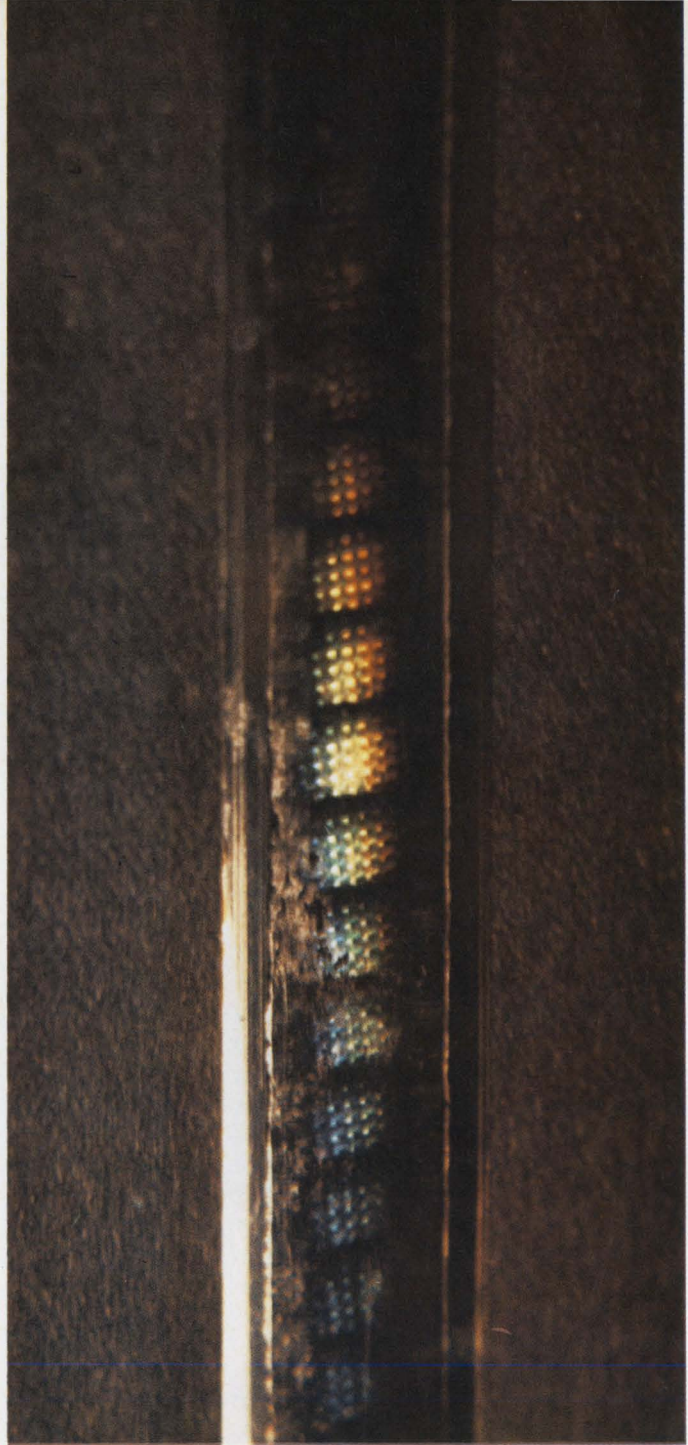

**Impressions.** When stripped away from the holographic master, the nickel master retains the embossed holograms.

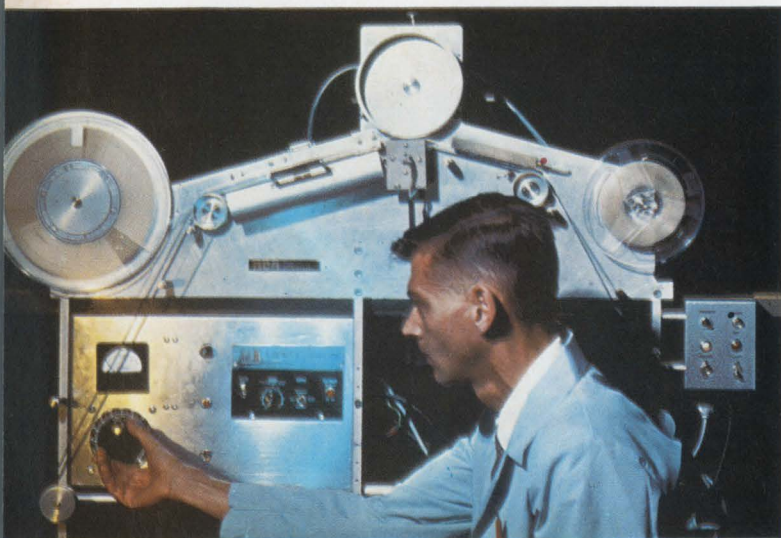

**Master to copy.** This machine presses the nickel master (stored on the small reel near the operator's right hand) against the vinyl (stored on the large reel). The reel on the right takes up the embossed vinyl.



## The other guys: Black-and-white EVR coming out in 1970



RCA is playing catch-up. While its engineers labor to solve SelectaVision's color and sound problems, salesmen from CBS and Motorola Inc. are rounding up orders for EVR (electronic video recording) systems which the two companies will start delivering next summer.

EVR is the video playback system developed at CBS Laboratories. Like SelectaVision, EVR comprises a tv attachment and film cartridges. But EVR film is photographic, not holographic, and playback is effected through electron scanning. Motorola got into the EVR act by signing an exclusive contract with CBS.

The black-and-white EVR systems coming out next year sell for \$800, regardless of which company you buy from. CBS's fee for making cartridges varies according to the program time and the number of cartridges ordered. For example, 2,000 half-hour cartridges would go for \$14.40 each, while 150 of them would cost \$19 apiece.

CBS will introduce a color system in December or January, and at that time start taking orders for delivery in the summer of 1971. Motorola will start delivering color units at the same time. Neither company has set prices for the color unit, but Lloyd Singer, Motorola's marketing manager for EVR, says, "We hope to come in at under \$1,000."

On the other hand, the announced prices for SelectaVision are \$400 for the color playback unit and \$10 for a half-hour cartridge. RCA says that the system will be ready sometime in 1972.

CBS says that comparing these prices is unfair. Company

spokesmen point out that announced EVR units are intended for industrial and educational markets, not the consumer sector that RCA is after. They also note that, manufacturing costs aside, industrial and educational films are more expensive to make than entertainment tapes because of the difference in volume. In other words, on a per-cartridge basis, it costs a lot less to make 100,000 copies of a Smothers Brothers show than it does to make 1,000 copies of a physics lecture.

Spokesmen at CBS also question RCA's ability to meet either its announced timetable or price schedule. The guess at CBS is that SelectaVision is three to five years away. In that time CBS hopes to get EVR entrenched and its price down.

But EVR may have an Achilles' heel. The film used in EVR cartridges is quite expensive because of its high sensitivity. SelectaVision tape, on the other hand, is inexpensive vinyl. If SelectaVision lives up to RCA's claims, RCA's manufacturing costs will be considerably less than those of CBS.

EVR and SelectaVision aren't the only new things in video playback. Sylvania, working with Eastman Kodak Co., has developed a motion-picture version of its already commercial system that shows color slides on a tv screen. According to a Sylvania spokesman, it's strictly a marketing decision when if ever the system will be sold. One advantage the Sylvania system would enjoy is that the user could make his own films, something he can't do with either SelectaVision or EVR.

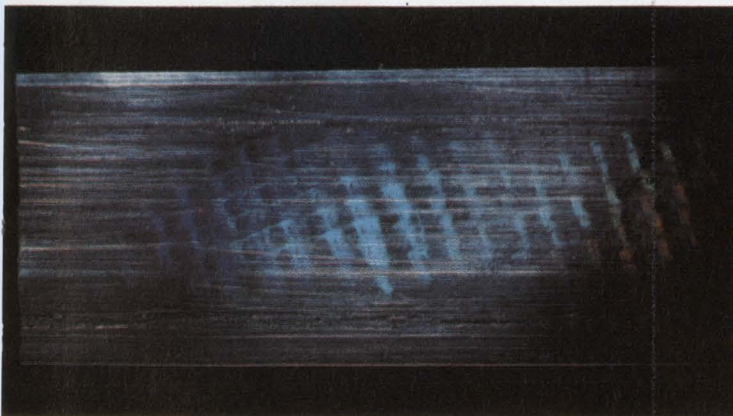

**Wear resistant.** Even when the vinyl tape is scratched as badly as the one on the left, the holograms on it can be reconstructed.



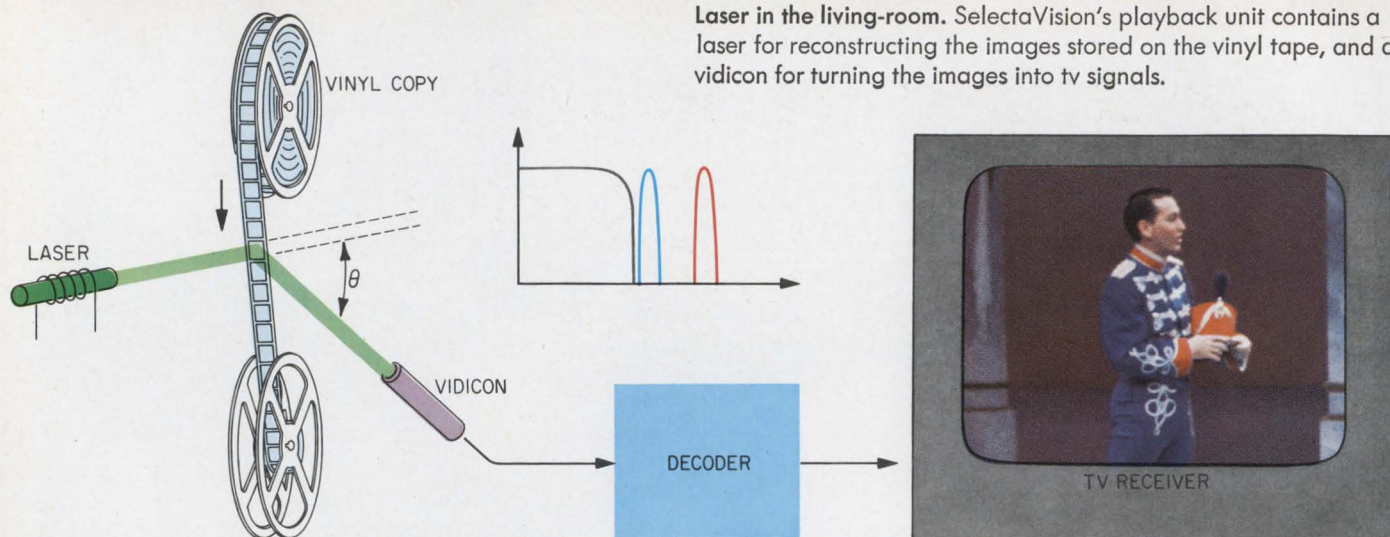

**Laser in the living-room.** SelectaVision's playback unit contains a laser for reconstructing the images stored on the vinyl tape, and a vidicon for turning the images into tv signals.

length of time about equivalent to the length of time it would take to damage your eye from the laser."

A consumer application for lasers is an exciting idea. But, even so, SelectaVision's most significant feature is making the vinyl tapes.

There are two reasons why RCA's embossing technique lends itself to mass production, according to McCoy. First, he points out, none of the manufacturing steps demand critical control of any parameter.

The other reason centers around the speed of the embossing. The machine RCA engineers now use to emboss the vinyl moves the tape at slightly more than the real-time rate of 7½ inches per second. "We'll do everything we can to speed that process up," says McCoy, "but you must realize that it isn't necessary for us to go fast to mass-produce because we can put many replication stations on a single line so that the same master is replicated many times on a single pass."

As for performance, SelectaVision still has far to go. The color reproduction demonstrated so far has been poor, and McCoy admits that even under laboratory conditions RCA engineers have yet to produce broadcast-quality color. "But we will," he adds. "You have to remember that we're still in a research state, and we haven't begun to optimize the processing steps." McCoy feels that most of the color-reproduction problems will be solved by improving the uniformity of the holographic

master. He says that until now no attempt has been made to make or buy vinyl of uniform thickness, or to ensure that the photoresist thickness is constant across the tape.

The main flaw of SelectaVision's color reproduction is that colors fade in and out; for example, an object will go from dark blue, to lighter blue, to light green, back to light blue, and so on. This could very well be due to lack of uniform vinyl and photoresist thickness.

SelectaVision's color problems may not be all that severe. The only time RCA has shown SelectaVision was at a September press conference; there the color quality was poor. However, more than one RCA engineer has since said that the nickel master used to make vinyl tapes for the conference was bad. Given a little extra time, say these engineers, they could have made a better master, and the result would have been better color.

Another problem to be solved is the sound track. Again McCoy is confident that there will be little difficulty here. He says that RCA has several methods for adding sound, noting that one technique has just about been selected. He won't identify it, but he does say that the sound will be added at the time the holographic master is made. This implies that RCA will use some type of acoustic hologram. The video holograms take up only half the width of the vinyl tape, leaving RCA engineers plenty of room to maneuver. ●

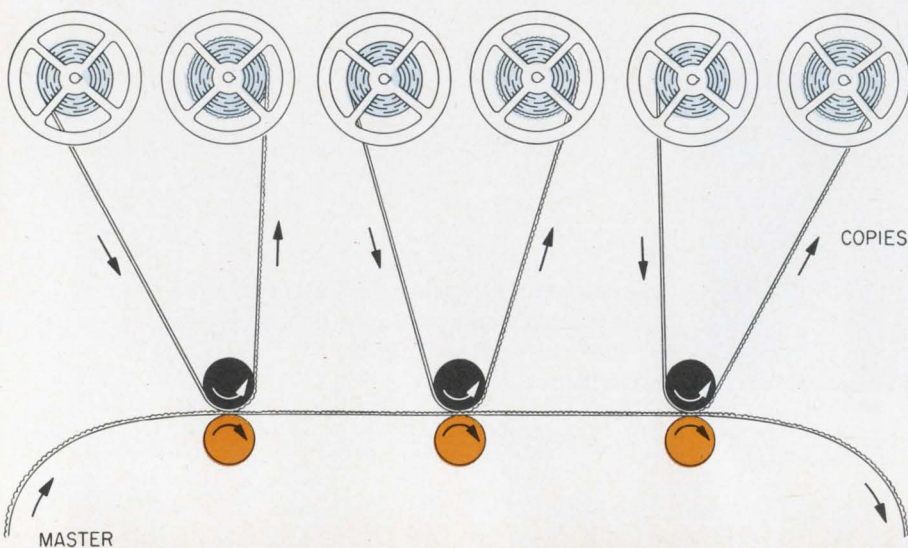

**Production speedup.** One way RCA hopes to mass-produce SelectaVision tapes is to make more than one vinyl copy at a time from a single nickel master. On the left is a four-copy machine.



# Run it hot, run it cold, run it wet, run it dry... **ZERO-TC diodes** always run it constant voltage...

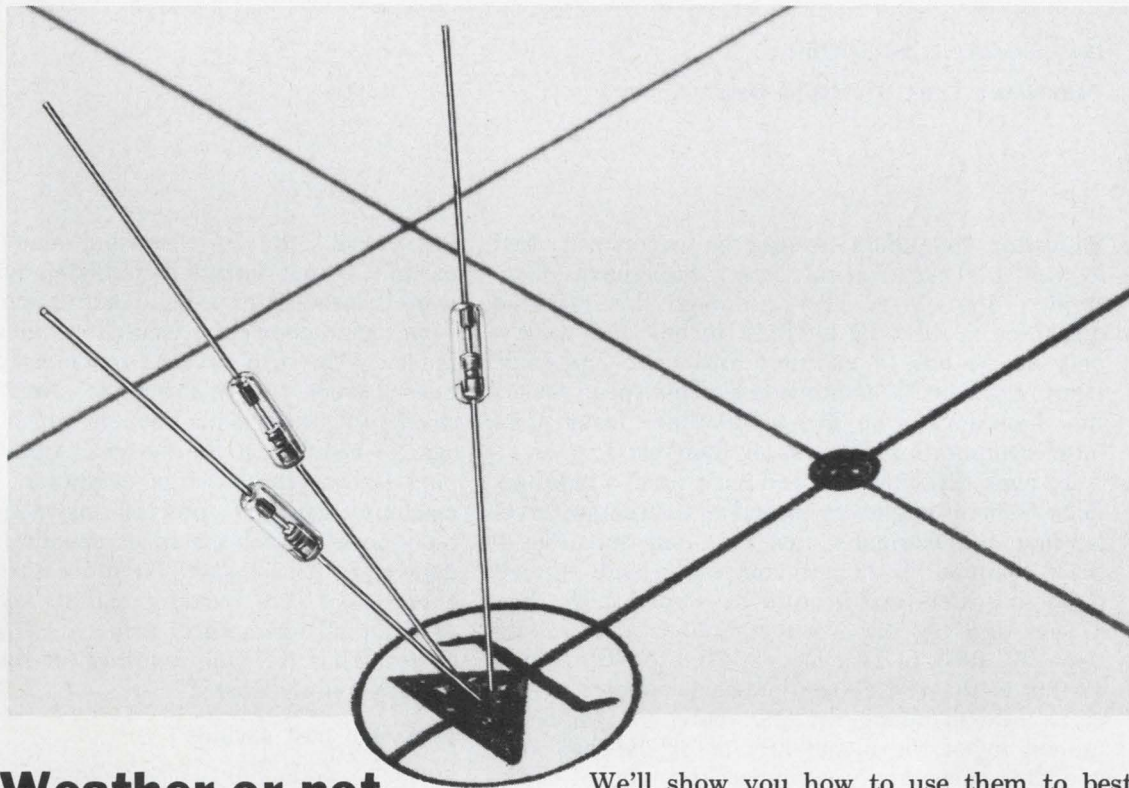

## Weather or not.

When all you can stand in your new circuit design is a few millivolts output voltage change over many degrees centigrade variation, a ZERO-TC<sup>®</sup> diode is the ideal equalizer.

Providing voltage-time stability limits as low as 5 ppm/1,000 hours of operation, ZERO-TC's provide environment-tight, hermetic glass seals, "no-failure" RamRod<sup>®</sup> construction and oxide-passivation for long-term, low-leakage stability and integrity of characteristics under most any external climate conditions.

\*Trademark Motorola Inc.

*- where the priceless ingredient is care!*



**MOTOROLA**  
Zener and Reference Diodes

We'll show you how to use them to best advantage, too.

Send for AN-437, an application note explaining all the design criteria and characteristics you'll need to know about how to lock in voltage stability and circuit equilibrium under most any ambient temperature/humidity environments.

You'll also receive a Selector Guide — for choosing the exact reference device you'll need from 141 standard ZERO-TC types — and the key to hundreds of specials, too.

So you can do just the right thing about the weather.

Motorola Semiconductor Products Inc. • P. O. Box 20912 • Phoenix, Arizona 85036



# Making a minicomputer superfast

Supernova's 300-nsec cycle time stems from two big-machine features  
—instruction fetch overlapped with execution and a read-only memory

By Lawrence Seligman

Data General Corp., Southboro, Mass.

**Superfast computers** needn't be supersized. Just look at the Data General Corp.'s Supernova [*Electronics*, Sept. 1, p. 119]. Although this machine measures 5¼ by 19 by 21¼ inches and weighs only 45 pounds, it executes arithmetic and logic instructions in 300 nanoseconds. This speed makes the Supernova from five to 10 times faster than most computers regardless of their class.

To pack this kind of speed in so small a package, Data General engineers turned to instruction overlapping and extremely fast read-only memories—both common to bigger computers—and applied them to system architecture developed more than a year ago for the Nova computer [*Electronics*, Sept. 30, 1968, p. 147; Dec. 9, 1968, p. 76]. Added to this is the use of medium-scale integrated circuits. And in taking the MSI route, the engineers cashed in on the availability of off-the-shelf IC's and thus successfully minimized component costs.

The Supernova, like the Nova, employs four accumulators and a read-only braid memory. But unlike the Nova—a minicomputer in its own right—in which data is manipulated in the accumulators in four-bit “nibbles,” the Supernova manipulates the 16-bit data words in full parallel. And the read-only memory in the super version, although physically interchangeable with the read-write core memory, as is the case with the Nova, is speeded considerably (300 nsec compared with 2.4 microseconds for the Nova). Thus, in addition to providing the user with fixed, unalterable data, secure against errors and an electrically noisy environment, the read-only memory is also a source of frequently used software routines that can be executed at great speed.

The new computer also uses fast 18-mil ferrite cores in its 800-nsec main memory (the Nova uses 30-mil cores); the cores are small enough so that an entire 4,096-word memory panel, together with its driving circuitry, fit on a single memory board.

But perhaps the most unusual innovation in the machine is that despite its minisize, sufficient hardware is included to provide instruction overlapping—one instruction is executed while the next is fetched. This can save as much as 300 nsec between every two instructions. And this saving effectively doubles the rate at which instructions can be handled in the system. Although overlapping is common in large computers, the smaller machines generally process instructions sequentially because such machines usually have but one data path. As a result, the processor is slaved to a particular core memory and its main adder is used for all operations, even trivial housekeeping chores. Thus the time required for the fetch operation is simply wasted.

## Time and cost savings

The Supernova differs from other small machines in that it has three separate data paths to handle instruction fetch and execution. And, these paths are logically independent. One path is used by the main adder and logic sections for instruction execution and certain address calculations; another path is used by independent circuitry to increment the program counter between instructions; and the other path is used to transmit address information from the program counter to memory address registers in both the processor and the memory.

However, to help minimize component costs, the designers of the Supernova decided that some of the other data paths should be shared. Data and address information, for example, are multiplexed from the processor to the core memory onto a common set of wires. This route was taken because the operations always occur at different times.

Both arithmetic and nonarithmetic operations can benefit from instruction overlapping. Typical of the arithmetic operations is the inner loop that is part of the subroutine for determining the square



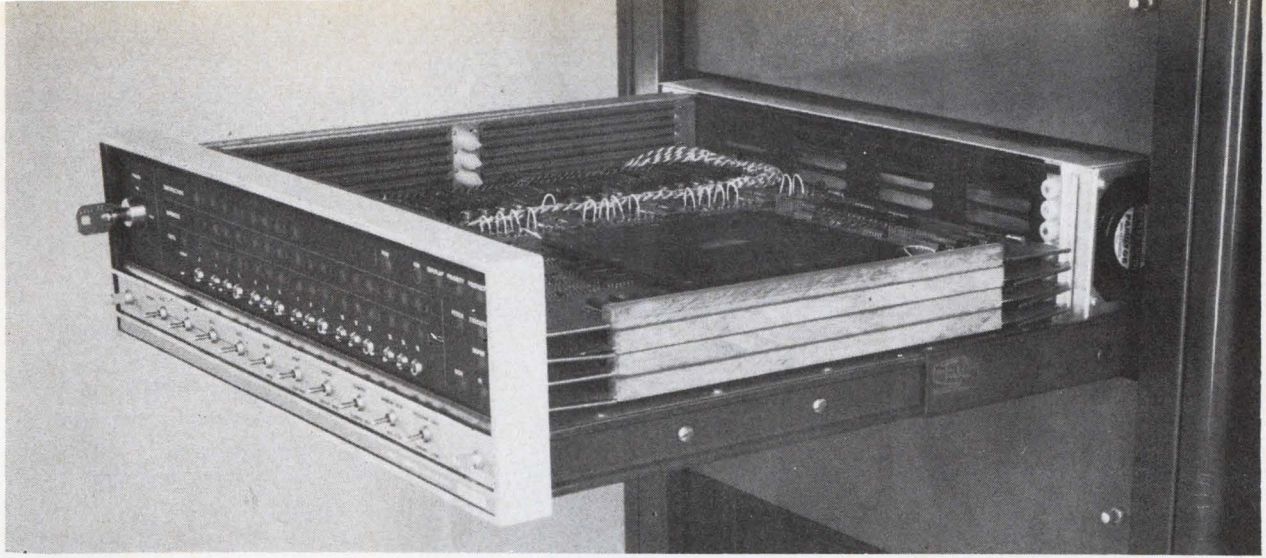

**Fast contender.** MSI circuitry, used liberally in the Supernova, enables hardware for such features as instruction overlapping and a fast 300-nsec cycle to be packed into a small machine. Version mounted in standard 19-inch-wide rack weighs only 45 pounds. A desk-top model (cover) is slightly larger.

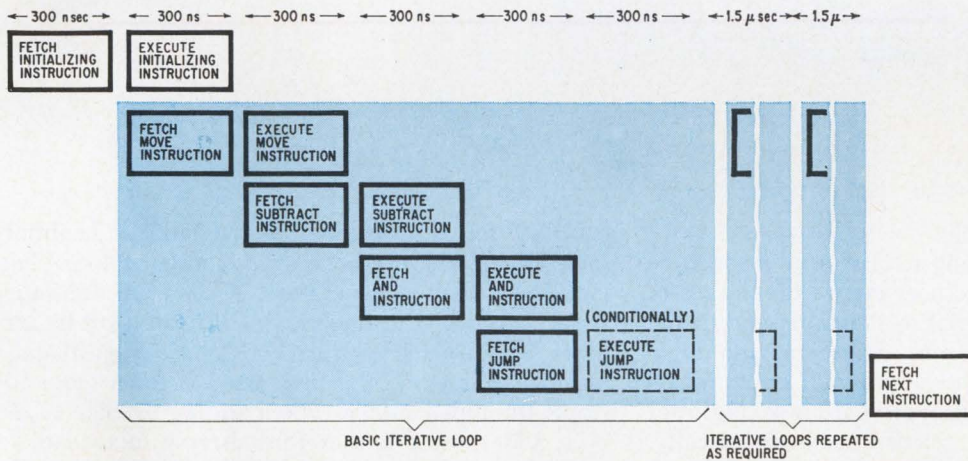

**Double time.** Processor in Supernova computer simultaneously executes one instruction while it fetches another as shown here for a parity-determining program. Such overlapping saves an extra 300 nsec in each machine cycle that would be required to execute or fetch an instruction in separate steps.

root of a number. The loop must be iterated until a particular condition is met. Overlapping the steps within the loops halves the time needed to reach the condition so that the computation can be completed.

How instructions are overlapped is shown above in a timing diagram for a simple five-instruction program used to determine the parity of a word (whether a binary word has an even or odd number of bits). This program for a nonarithmetic operation involves an iterated loop in which each of the bits in a word must be checked to determine whether it is a 1 or 0.

It isn't possible to overlap the first instruction following the end of the iterated subroutine because the subroutine's last step is a conditional jump in which the address for the next instruction is dependent upon the result of the preceding instruction. Simply, the next address is either that of the instruction immediately following the jump, which means the parity determination is completed, or that of the instruction at the top of the loop.

Typically, the program segment for parity determination, when stored in the read-only memory, runs 6.3  $\mu\text{sec}$  for the seven-bit character in the

American Standard Code for Information Interchange (ASCII).

Generally, only the most frequently executed instructions—arithmetic and logic—are overlapped; overlapping is controlled in hardware. However, because the instruction must be rewritten in the memory, the execution of the instructions stored in core memory cannot be overlapped with subsequent fetches. As a result, the execute step is overlapped with the rewrite step.

In the Supernova, as in the Nova, a single arithmetic or logic instruction combines several operations, such as add two numbers, test the sum, and branch. And since the instructions are complex, this capability, in effect, provides a user with a built-in microprogramming capability. There is no need for the user to learn a special microprogramming language. The user has direct control of the cycle-by-cycle operations of the processor while writing in the computer's assembly language into which the programmer's ordinary symbolic language is translated. And when fed into the read-only memory, instead of the slower core memory, each assembly-language arithmetic or logic instruction can be executed by the processor during the 300-



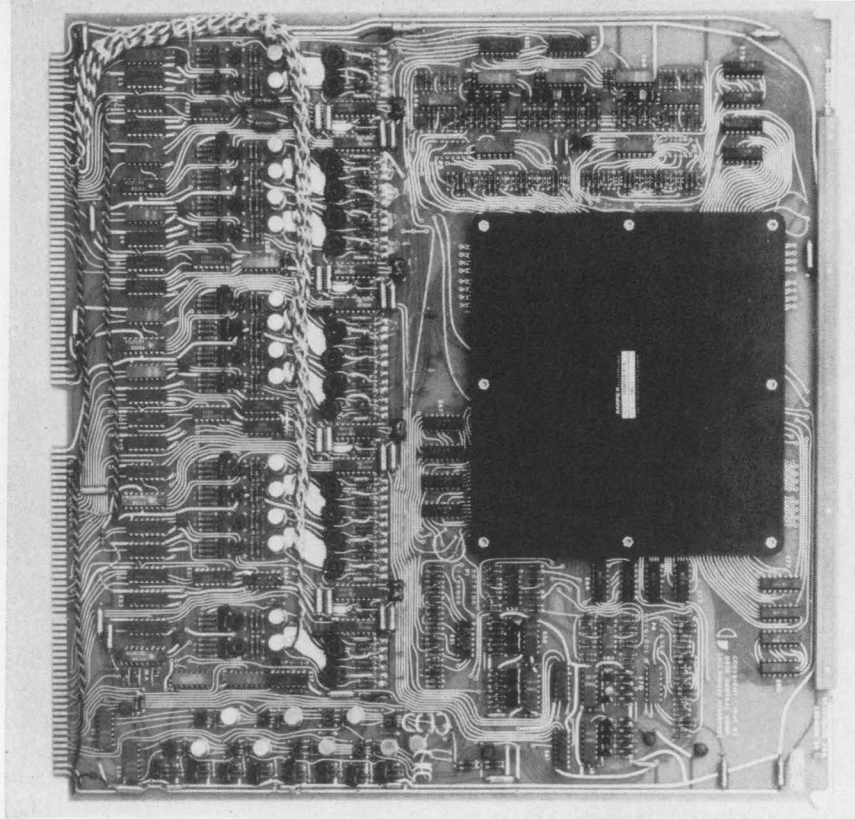

**All in one.** Tiny 18-mil cores of the main memory are small enough so that 4,096-word memory module, together with its sense and drive circuitry, fit on a single 15-inch-square p-c board.

nanosecond machine cycle.

This results in efficient use of processor time regardless of whether the user knows the details of the gating paths and timing restrictions within the machine. The user can mix arithmetic and logic instructions with those for a series of operations—such as subroutine call and hardware indexing. And all of the instructions are carried out automatically. This requires less storage than written microprogramming instructions.

#### **MSI—size and reliability**

This capability is indeed a big plus. But what gives the Supernova its power and speed in so small a package is MSI. Close to 60% of the computer's gates and more than 80% of its flip-flops are in MSI packages that use transistor-transistor logic. Not only do these circuits reduce the number of individual components required in the computer, they also lead to better reliability because they cut down on interconnections. Lacking the relatively long and expensive cabling between memory and processor, which is the case with bigger high-speed machines, helps avoid delay problems. Moreover, ringing and noise problems on signal wires are also avoided. The entire processor for the computer fits onto three 15-inch-square printed-circuit boards and a complete core-memory module fits, together with its sense and drive circuitry, on a single board.

Also contributing to Supernova's small size is the use of IC's in 24-pin, dual in-line packages, as well as in the smaller 14- and 16-pin units. It's the first small computer to use the 24-pin package.

Two types of circuits—a four-bit adder with logic

circuitry for a look-ahead carry, and a 12-input multiplexer—are in the 24-pin configuration. The look-ahead feature generates a carry from the logic state of four bits at once instead of on a bit-by-bit basis. This reduces the number of carry-propagating logic gates and the time needed for a carry to ripple through a sum, as when adding 99999. . . . 9 + 1; adder speed is therefore sharply increased.

The multiplexer circuit, which replaces seven separate chips, switches four-bit inputs from three separate sources onto a four-bit output bus. Placed in front of four-bit adder circuits, for example, this circuit complements a number for subtraction.

Interestingly, the accumulators do not use the densest package that's available in MSI circuitry. An entire 16-bit word could have been implemented on a single chip, but the designers chose, instead, a four-bit package. In this manner, any two of the four hardware accumulators can be referenced at one time. The larger package would have allowed only a single 16-bit accumulator to be referenced at a time, slowing some of the instructions by as much as 100 nsec.

Some of Supernova's speed also can be attributed to the core memory itself, which is more than three times faster than that used in the Nova (a 800-nsec cycle compared with a 2.6- $\mu$ sec cycle). Although 22-mil-diameter cores could have easily yielded the required cycle time, 18-mil-diameter cores were chosen instead because they're small enough to permit the 4,096-word, 16-bit-per-word memory, together with drive and sensing circuitry, to fit on a single memory board. The larger cores would have required more interconnections and would have required two or more boards. This,



certainly, would have been more costly. Equally important, the smaller and faster cores also reduce the drive power for the memory. And this, indeed, is an important factor.

Because of the Supernova's speed, two design aspects had to be considered that are generally ignored in slower machines. Firstly, the logic that controls the register section had to be designed for minimum delay, rather than for the less expensive minimum component count; delay in the control logic could, in a fast computer, equal the delay in the register section itself. Secondly, delays arising from the uncertainty of the relative positions of the clock signals that gate data into registers and control flip-flops had to be eliminated. This delay is introduced in conventional designs to assure, for example, that a register is turned on in time to receive a data stream.

The most important element of this delay is eliminated by simply distributing 10-megahertz system-clock signals without any intervening gate structures. Instead, the registers and control flip-flops receive a clock signal continuously. A particular device is turned on to accept this signal by an enabling d-c level generated by ultrafast combinational logic. This logic is included in the device's MSI circuitry. The d-c level is set during the 100-nsec interval preceding the clock signal. This scheme, too, helps give the Supernova its speed.

### Controlling input and output

High-speed computers are limited by the speed of light, particularly when communicating with input-output devices. A delay of 3 nsec must be allowed for every foot of cable running between such a device and the processor. Thus, when the device operates 50 feet from the processor, the delay is 150 nsec—half the Supernova's cycle.

What the designers of Supernova do is control the input-output signals with separate timing generators that provide the proper timing signals even at the end of a long cable. The processor's central timer, driven by the system's constant-frequency clock, is not used because it is simply too fast.

Each timing generator consists of a shift register driven by the central system clock and connected in such a way that a bit shifted out of one end is inverted and fed back to the input. Thus, a wide variety of timing waveforms, which depend on the logic combinations of the bits in the register, can be generated. This is similar to the way timing waveforms are generated in the memory-timing scheme used in the Nova computer.

The input-output timing generators take over from the processor's central timing generator when an input-output instruction is executed or when a device requests a data-channel transfer. Processor, memory, and input-output speeds can be chosen independently so that the speed at an input-output device can be optimized. Separate timing generators are also used in other functional subsystems of the Supernova. For example, the generators control such things as the automatic loading of pro-

grams into the core memory, and the hardware multiply-divide unit.

By quantizing the timing waveforms into multiples of the basic 10-Mhz clock signal distributed through the machine, all the timing generators are synchronized. Thus, the same clock signal gates data within the machine and controls the shift registers generating the timing waveforms. A quantization interval of 100 nsec preserves an independent "asynchronous" character of the functional units, while permitting the greater economy of synchronous design. The data channel add-to-memory operation is a good example of how this works. This operation is used often in very-high-speed signal analysis where the input-output device is a fast analog-to-digital converter. Processor hardware reads a word from both the memory and the requesting device, adds the two together, replaces the sum in memory, and then transmits this sum to the device where it is checked to see whether it is out of bounds.

Upon recognizing an add-to-memory interrupt request from a device, the processor first generates the control signals to read the device's address. This identifies the word in memory to which the device's input is to be added. While the address is being transmitted from the device, the processor timing generator is halted, and the input-output generator takes over. When the address is received, the central processor timing generator restarts and the core-memory generator begins reading at the selected address. Simultaneously, the input-output timing generator is restarted to read data from the device. The timing generator in the processor then stops until both data words have been received, one from the memory and the other from the device. When both operations are completed, the processor starts again. The actual addition occurs next. Then, the input-output and memory generators restart and rewrite the data as the processor stands by for this to be completed.

### Hardware vs. programs

When it comes to arithmetic computations, users of the Supernova have two routes from which to choose for multiply and divide instructions—separate, but additional, hardware or including the necessary subroutines in the programs stored in the read-only memory. Taking the hardware approach is faster, all that's necessary is a single instruction. Subroutines require several steps, with at least two separate instructions for each. Moreover, multiplication and division use or generate double precision operands. In the software approach, each of the double operands would have to be manipulated with separate instructions.

When hardware is used, the Supernova's register section move the two data quantities simultaneously. And it cuts the multiplication cycle to 100 nsec per step when an addition isn't required. Typical multiplication time is less than 4 nsec, including instruction fetch; maximum execution time for division is less than 7 nsec. ■



# ALL POWER TRANSISTORS LOOK ALIKE... BUT THEY'RE NOT EQUAL

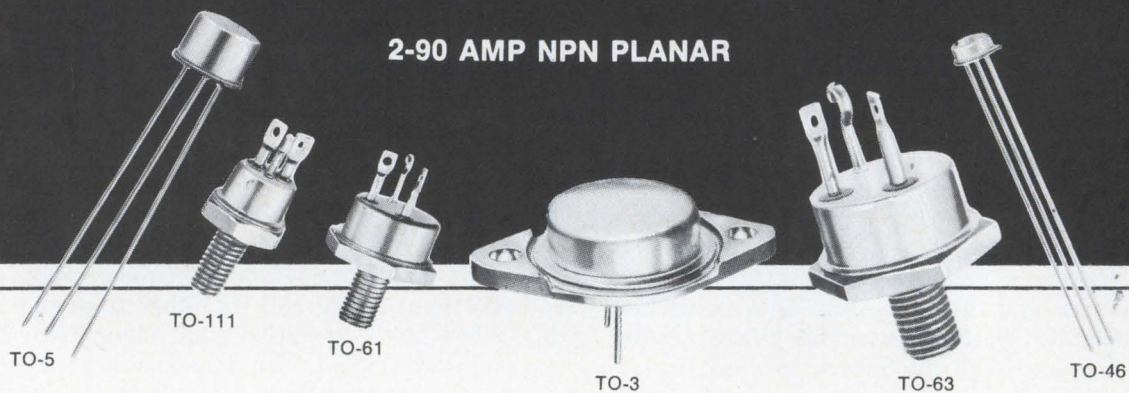

To the eye, the only difference between Pirgo power transistors and other makes is the name behind them. But that's quite a difference.

Pirgo is a new company—not committed to old ways of doing things. We have the most modern equipment and quality control facilities for the production of NPN and PNP planar silicon transistors rated from 2 thru 90 amps.

Pirgo's management group grew up with the semiconductor industry. We are staffed with skilled management and engineers of the highest technical capability.

Pirgo is an affiliate of the Sprague Electric Company, and draws upon the full resources and sales staff of Sprague.

All of this translates to high reliability, outstanding service, and on-time delivery. Even our low price policy is unusual.

Don't take our word for it. Ask for a copy of our new catalog, then send us your toughest spec. Or contact your local Sprague Electric sales engineer. We'll show you what a difference a name makes.

Pirgo products are available from authorized Sprague semiconductor distributors.

**PIRGO**  **ELECTRONICS INC.**  
A Sprague Electric Company Affiliate

130 CENTRAL AVENUE  
FARMINGDALE, NEW YORK 11735  
Tel.: 516-694-9880



# Universal graphs map direct route to mismatched pi and tee filters

Charts and nomographs can offer ready-made solutions to practical problems of determining insertion losses of low-pass filters with mismatched terminations

By Robert B. Cowdell

General Steam Corp., Costa Mesa, Calif.

**Technically tedious** trial-and-error methods may be rendered obsolete by a simple, graphical technique for designing low-pass filters for mismatched source and load impedances. Significantly, the new method also yields an insight into how the insertion loss and attenuation characteristics of the filter change with different values of mismatching.

Design charts and nomographs, which were generated as the result of a computer study, take into account many of the practical aspects of filter design that aren't apparent in the strictly classical treatment. Moreover, since most insertion loss and attenuation specifications assume a 50-ohm matched system regardless of the actual filter performance conditions, the graphical approach provides for a mismatched-case filter design while specifying characteristics that would be measured in a 50-ohm matched system.

Classical filter designs consider only matched cases. But, in practice, filters generally operate under mismatched load and source impedances. Mismatching always alters the insertion loss characteristics of a filter and can affect performance.

For a matched system, pi and tee filters can be designed as duals to provide identical insertion loss. The same circuits, though, will not have the same insertion loss under mismatched conditions. One type usually will provide better performance and result in a smaller and less expensive filter.

Under operating conditions, at some band of frequencies the filter response may exhibit a sharp change in attenuation characteristic. The insertion loss may decrease to zero or even may develop a voltage gain of 20 to 30 decibels. These conditions can be avoided during the design stage through use of the 12 design charts on the foldout.

A mismatched system might have a source impedance of several ohms and a load impedance of several hundred ohms. The design engineer finds it difficult to measure the insertion loss of the filter under the mismatched conditions.

Further, the insertion-loss characteristics of a filter most often are specified for operation in a matched system; in fact, MIL-STD-220A established a matched 50-ohm system as a standard for all testing. Hence, the engineer must be able to design filters to operate in mismatched systems, but specify insertion loss requirements which would be measured in a 50-ohm system.

Matched impedance filter designs frequently require components that are either too expensive, impractically large, or unusable because of line inductance or capacitance-to-ground system limitations. The designer then must devise a circuit which avoids unacceptable element values and yet provides the required filtering.

The illustration on page 122 contains circuits and insertion-loss equations for mismatched pi and tee filters, and defines two of the key variables involved in filter design. In addition, the following parameters were used to solve the insertion loss equations and to prepare the design charts.

$$\text{Mismatch ratio (A)} = \frac{\text{Load resistance (R}_L\text{)}}{\text{Source resistance (R}_s\text{)}}$$

$$\text{Normalized frequency (F)} = \frac{\text{Frequency of interest (f)}}{\text{Cutoff frequency (f}_o\text{)}}$$

$$\text{Cutoff frequency} = \omega_o = 2\pi f_o$$

$$\text{Response curve factor} = d$$



## PI FILTER

$$IL \text{ (db)} = 10 \log \left[ 1 + F^2 \left( \frac{4d^2 - 4(A^2 + 1)d - 4A^2}{(A + 1)^2 d^{2/3}} \right) + F^4 \left( \frac{4(A^2 + 1)d - 8A^2}{(A + 1)^2 d^{1/3}} \right) + F^6 \left( \frac{4A^2}{(A + 1)^2} \right) \right]$$

$$\omega_0 = (2/R_s LC^2)^{1/3} \text{ radians per second}$$

$$d = (L/2CR_s^2)$$

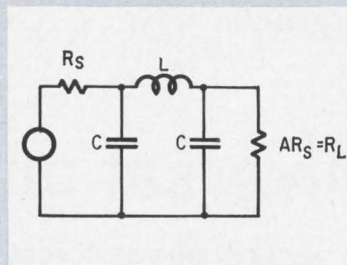

## TEE FILTER

$$IL \text{ (db)} = 10 \log \left[ 1 + F^2 \left( \frac{4A^2 d^2 - 4(A^2 + 1)d + 4}{(A + 1)^2 d^{2/3}} \right) + F^4 \left( \frac{4(A^2 + 1)d - 8}{(A + 1)^2 d^{1/3}} \right) + F^6 \left( \frac{4}{(A + 1)^2} \right) \right]$$

$$\omega_0 = (2R_s/L^2C)^{1/3} \text{ radians per second}$$

$$d = (R_s^2 C/2L)$$

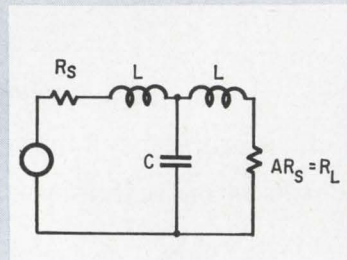

**Special arrangement.** Equations for mismatched filters take unusual form to simplify computer study. Here, insertion loss is stated in terms of normalized frequency,  $F$ , and parameters based on element values.

The cutoff frequency,  $f_0$ , is the frequency at which the filter's insertion loss is 3 db for matched impedance conditions and an ideal response curve.

The response curve factor  $d$  is defined as follows: In the matched case, element values can be selected to produce a smooth response curve with any desired cutoff frequency. Any departure from the original values generally causes an undesirable shift from the smooth insertion loss characteristics. The response curve represents the amount of departure from the smooth response. The ideal response curve is  $d = 10^0$ . Positive response curve factors are defined as  $d$  values with positive powers of 10 ( $10^0 < d < 10^6$ ). Negative response curve factors have negative powers of 10 ( $10^{-6} < d < 10^0$ ). For simplicity on the nomographs and charts, the values of  $d$  are denoted by their power of 10, including sign. That is,  $10^{-4}$  is called out as  $-4$ .

The insertion loss equations for pi and tee filters, stated in terms of the defined parameters, are shown in the illustration. These equations were solved over a wide range of parameter values on an IBM 7094 digital computer. Some 65,000 data points were generated and then were used to prepare the two nomographs, one for pi and one for tee filters, on page 126 and the 12 charts that can be used for pi filters on pages 123, 124, and 125.

These equations and graphs were based on the assumption that the source and load were purely resistive. All reactive elements were considered to be lossless, and the effect of stray parameters were not taken into account.

The 12 charts for pi filters also can be used to design tee filters, provided that the reciprocal of the  $A$ -value is used to determine the applicable chart; that is, if  $A = R_L/R_s = 10^3$  for a pi filter,

then  $A = 10^{-3}$  would apply when selecting the chart to design a tee filter.

### Straight to the point

Nomograph I is for pi filters and Nomograph II for tee filters. They solve the response curve factor and frequency equations shown in the illustration above. Each nomograph involves five variables— $R_s$ ,  $L$ ,  $C$ ,  $f_0$ , and  $d$ ; any two can be determined when three are known. For example, in Nomograph I,  $L$  can be found by connecting a straightedge between  $R_s^2 C$  and  $(f_0/R_s)$ .

The response curve factor,  $d$ , is equal to the value of that line that best parallels the slope formed by the straight line connecting  $L$  and  $R_s^2 C$ . This slope can be determined from the family of slopes located in the center of each nomograph. Linear interpolation can be used between slope values shown with sufficient accuracy.

The insertion loss characteristic of the filter in a system with a known amount of mismatch can be determined once the cutoff frequency,  $f_0$ , and the response curve factor,  $d$ , have been found. First locate the family of curves for a known mismatch ratio,  $A$ , and select the desired response curve,  $d$ . For each value of normalized frequency,  $F$ , determined from the selected curve, find the corresponding insertion loss in decibels. Multiply  $F$  by the known cutoff frequency,  $f_0$ , to obtain actual frequency,  $f$ . Now, using this information, the insertion loss versus actual frequency can be plotted to obtain the frequency response of the filter.

The design charts can be used to check, calculate, and select both pi and tee low-pass filters. Several detailed examples are shown on pages 126, 127, and 128.



# Designing mi

## NEGATIVE RESPONSE CURVE FACTORS ( $d=10^X$ , where $X$ is adjacent)

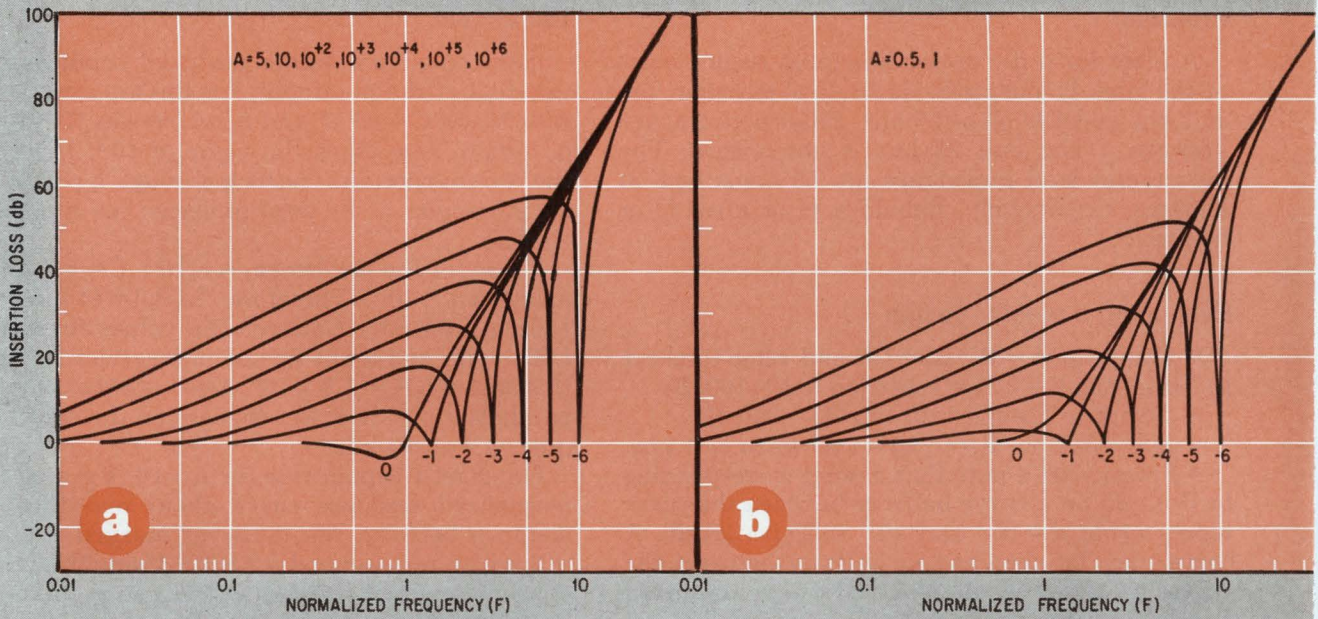

## POSITIVE RESPONSE CURVE FACTORS ( $d=10^X$ , where $X$ is adjacent)

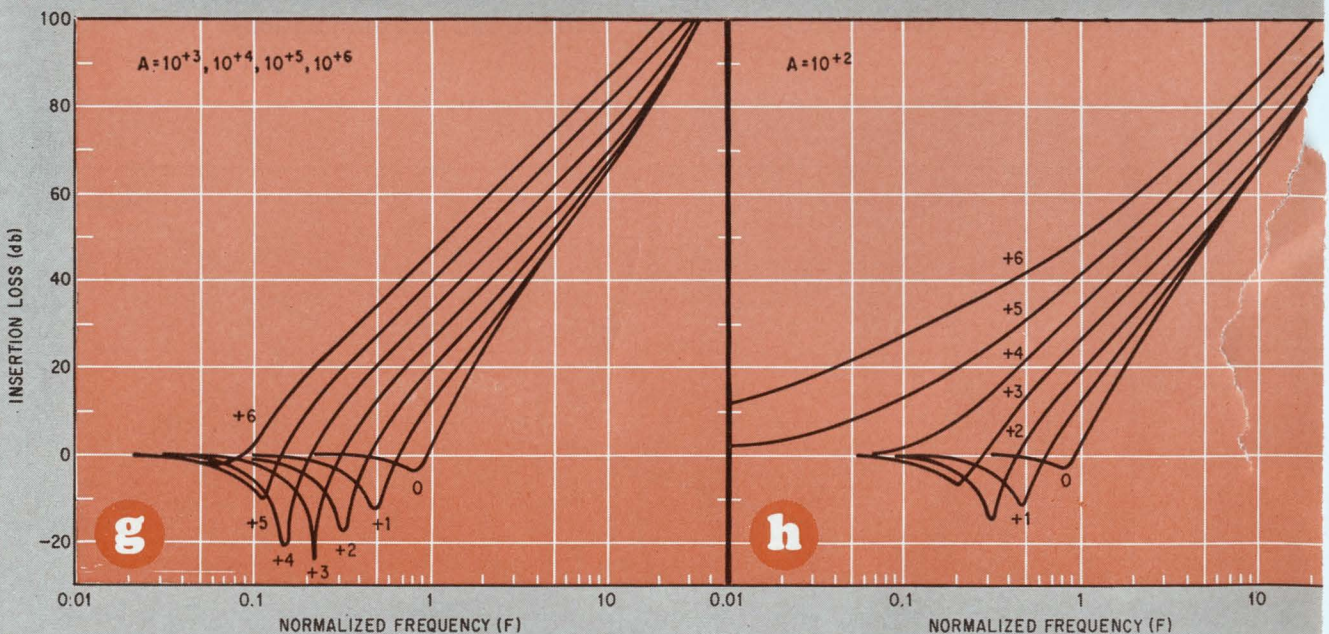



### Filter response for a matched system

The component values,  $C = 0.01 \mu\text{f}$ ,  $L = 10 \text{ mh}$  remain unchanged, but now  $R_s = R_L = 50 \text{ ohms}$ , so that  $A = 1$ .

- Compute  $R_s^2 C = 2.5 \times 10^{-5}$ .
- Using nomograph I, find  $(f_o/R_s) = 1.2 \times 10^3$  and  $d = 4 \times 10^2$ . Therefore,  $f_o = 1.2 \times 10^3 \times 50 = 60 \text{ khz}$ .
- Because a curve for  $d = 4 \times 10^2$  is not included

in the chart, draw one about halfway between the  $d = 10^2$  and  $d = 10^3$  curves.

■ Using this curve, replot the insertion loss versus actual frequencies by multiplying  $F$  values by  $60 \text{ khz}$ . The resulting performance is shown by the brown curve.

Note that the mismatched design provides a sharper low-pass cutoff characteristic than does the  $50\text{-ohm}$  matched design.

## Design example 3: Selecting the right filter—pi or tee?

### Problem:

A filter for a d-c power line must reduce noise at the load. It must provide  $20 \text{ db}$  of insertion loss at  $1 \text{ khz}$  and  $100 \text{ db}$  at  $20 \text{ khz}$ . Filter performance between  $1 \text{ khz}$  and  $20 \text{ khz}$  is not critical. The source and load impedance are  $50 \text{ ohms}$  and  $50 \text{ kilohms}$ , respectively. Should a pi or a tee filter be used?

### Evaluating a pi-filter design

- Compute  $A = R_L/R_s = 10^3$  and refer to chart a. Note that  $F = 37$  for insertion loss =  $100 \text{ db}$ .
- Compute  $f_o = f/F = 20 \text{ khz}/37 = 540 \text{ Hz}$ .
- If  $f_o = 540 \text{ hz}$ ,  $F = (f/f_o) = 1.85$  when  $f = 1 \text{ khz}$ .
- From chart a note that a point corresponding to  $F = 1.85$  on a curve halfway between the curve representing  $d = 10^{-3}$  and  $10^{-2}$  will give  $20 \text{ db}$ . A curve may be sketched in halfway between the curves for these two  $d$ -values. The dip in insertion loss that occurs at  $F = 2.7$  is not critical. The actual-frequency response for this pi filter is plotted here, in red.
- Next, compute  $f_o/R_s = 540/50 = 10.8$ .
- Using nomograph I, place a straightedge at  $(f_o/R_s) = 10.8$ , sloping parallel to a line halfway between  $d = 10^{-2}$  and  $d = 10^{-3}$ . Find  $R_s^2 C = 8.5 \times 10^{-2}$ . Therefore  $C = 34 \mu\text{f}$  and  $L = 8 \times 10^{-4} = 800 \mu\text{h}$ .

### Tee circuit

The tee circuit, under matched conditions, is the dual of the pi circuit. For the tee circuit  $L = 400 \mu\text{h}$  and  $C = 68 \mu\text{f}$ , and  $A$ , which was  $10^3$  for the pi design, now takes the value of  $10^{-3}$ . Inverting the  $A$ -value permits charts a through I, computed for pi circuits, to be used to design tee-type filter circuits.

Thus, for the tee design,  $A = 10^{-3}$ ,  $C = 6.8 \times 10^{-5}$ , and  $L = 4 \times 10^{-4}$ . Therefore,  $L/R_s^2 = (4 \times 10^{-4}) / (50)^2 = 1.6 \times 10^{-7}$ . Connect the values for  $C$  and  $L/R_s^2$  with a straight line on nomograph II. From this obtain  $f_o R_s = 1.7 \times 10^5$ . Also note that this line parallels  $d = 3 \times 10^2$ . For this design the cutoff frequency,  $f_o$ , is  $3.4 \text{ khz}$ .

On chart I (applicable for  $A = 10^{-3}$ ) sketch in a normalized response curve about one-third the distance between the  $d$  curves marked  $+2$  and  $+3$ , which represents  $d = 3 \times 10^2$ . Using this curve, obtain the actual-frequency response by multiplying the normalized frequency by  $f_o = 3.4 \text{ khz}$ . The actual response curve is shown in brown.

Note that while the tee filter has the same insertion loss as the pi filter at  $1 \text{ khz}$ , it doesn't produce  $100\text{-db}$  attenuation required at  $20 \text{ khz}$  till  $310 \text{ khz}$ . Thus the pi filter yields the better performance for the same values of  $L$  and  $C$ , and source and load terminations.

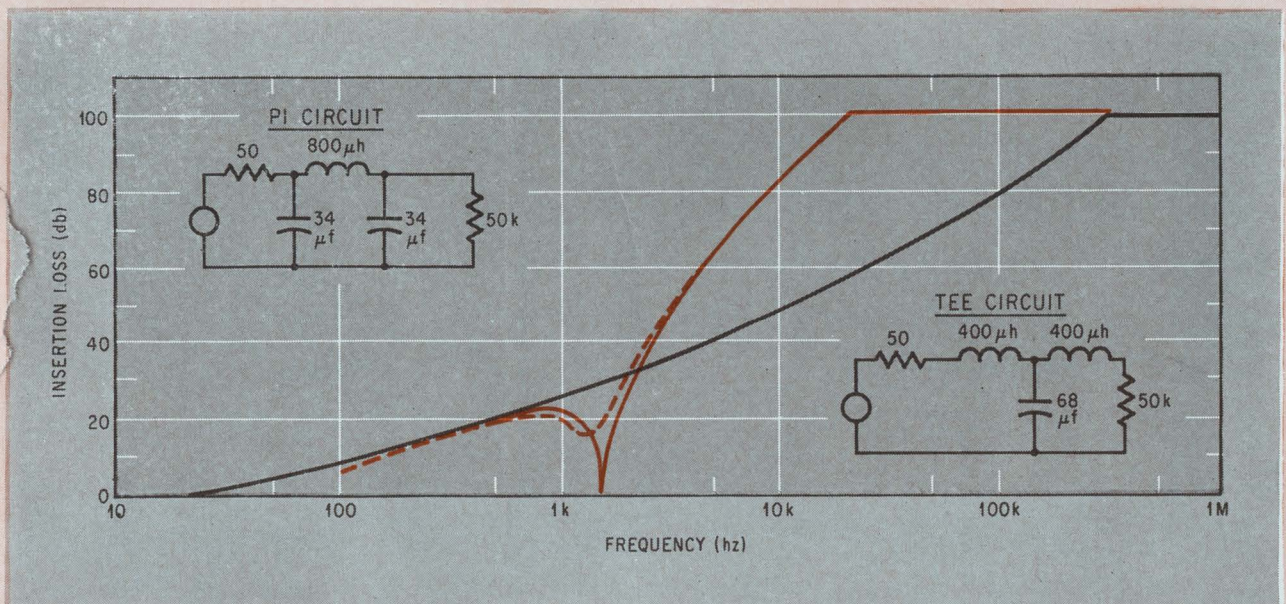



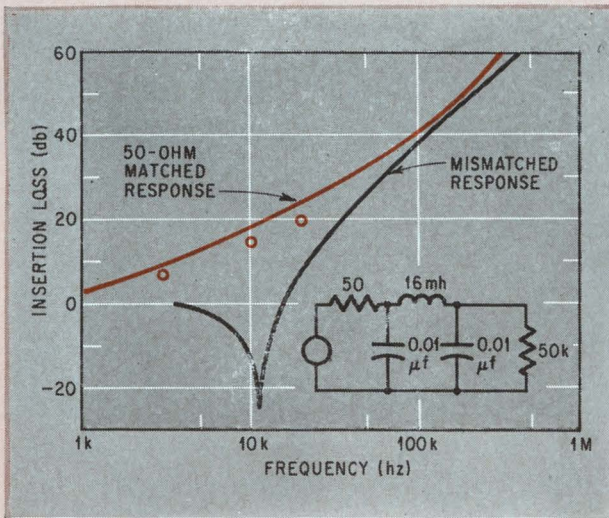

F	f (kHz)	Insertion loss (db)
0.01	0.5	7
0.1	5	13
0.4	20	25
1.0	50	33
2	100	40
4	200	48
6	300	54
8	400	59

This data confirms the manufacturer's claims for his filter with 50-ohm matched terminations.

To generate a similar table for the filter under mismatched conditions ( $R_s = 50$  ohms and  $R_L = 50$  kilohms) proceed as follows:

- Determine  $A = \frac{50 \text{ kilohms}}{50 \text{ ohms}} = 10^3$ .
- Refer to chart g, since  $A = 10^3$  and the power of d is positive.
- Use values from the  $d = 10^3$  curve since it is close enough to the  $5 \times 10^2$  curve, and then compile the following table:

F	f (kHz)	Insertion loss (db)
0.15	7.5	- 5.5
0.2	10	-14
0.225	11.3	-25
0.25	12.5	-12
0.5	25	12
1.0	50	25
8	400	64

These values were used to plot the brown curve. Note the dip in the response at around 11 kHz. From this curve it is possible to compare the required performance (circles) with the "mismatched" response. This is shown below:

Frequency, (kHz)	Insertion loss, db	
	Desired	Mismatched
3	8	0
10	15	-14
30	20	15

Thus, although the manufacturer's insertion loss data, based on a 50-ohm matched system, initially appeared to be adequate, the filter proves unsatisfactory when used in the actual circuit.

## Design example 2: calculating the response of a mismatched filter

### Problem:

Design a pi filter that has an insertion loss of 20 db at 50 kHz in a mismatched system, where  $R_s$  is 600 ohms and  $R_L$  is 600 kilohms. Then compute the response curve that would be measured in a matched 50-ohm system.

### Designing for the mismatched case

- Compute mismatch ratio  $A = R_L/R_s = 10^3$ .
- Locate on chart a, which shows the insertion loss for  $A = 10^3$  mismatch, the normalized-frequency insertion loss curve for  $d = 10^0$ —the ideal response.
- Then translate this normalized curve to the actual frequency. For insertion loss = 20 db, find  $F = 1.8$ . Since an insertion loss of 20 db at  $f_0 = 50$  kHz is desired, then  $f = f_0/F = 50 \text{ kHz}/1.8 = 27.8 \text{ kHz}$ . This curve is shown in red.
- Compute  $(f_0/R_s) = 27,800/600 = 46.3$ .
- Find, from nomograph I,  $L = 7.5 \text{ mh}$  and  $R_s^2 C = 3.5 \times 10^{-3}$ .

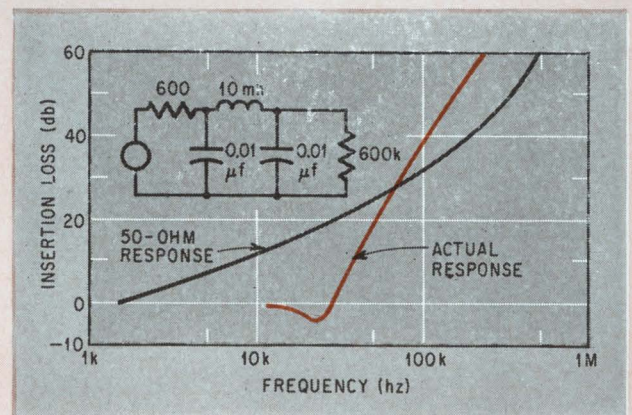

- Then  $C = (3.5 \times 10^{-3}) / (600)^2 = 0.0097 \mu\text{f}$ .
- These values of L and C can be altered slightly to take advantage of the more readily available standard values ( $L = 10 \text{ mh}$  and  $C = 0.01 \mu\text{f}$ ) with only slight departure from the ideal response curve.



# Mismatched low-pass f

ent to each curve.)

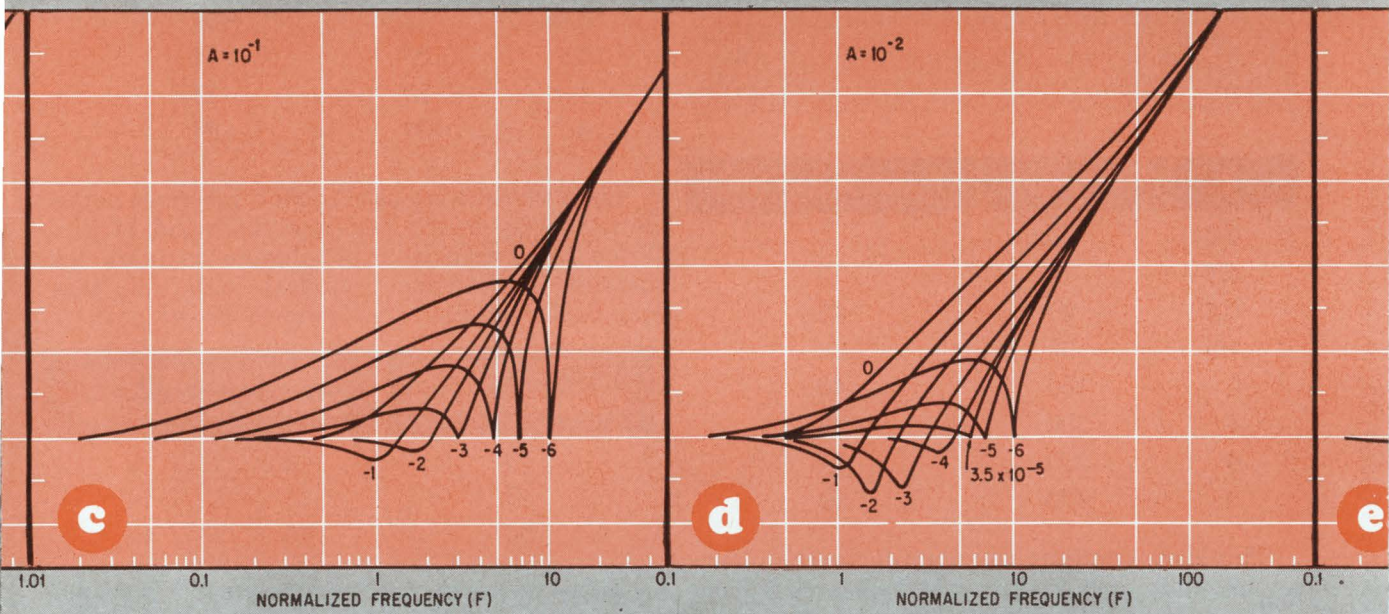

ent to each curve.)

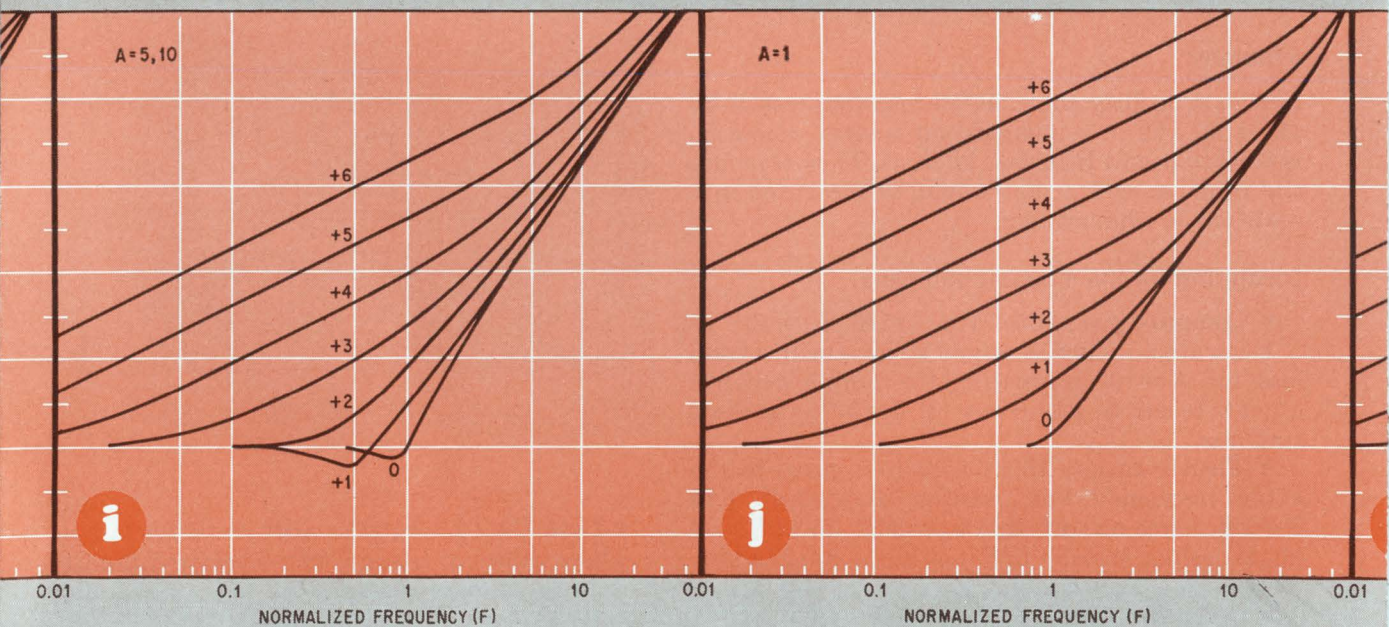

Note: The curves shown here apply as is to pi filters. To design tee filters, the same curves apply except use the reciprocal of A, where A is defined as  $(R_L/R_S)$ .



## Nomograph I: Pi filters

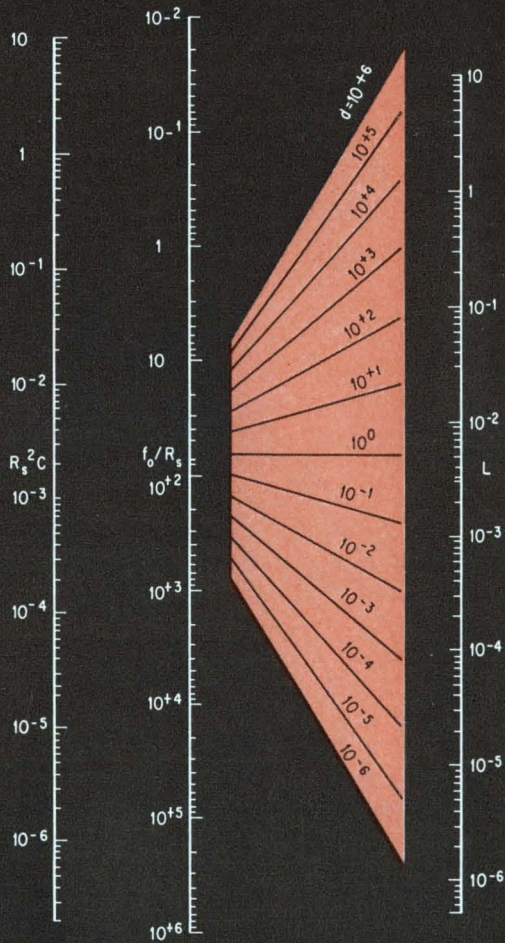

## Nomograph II: Tee filters

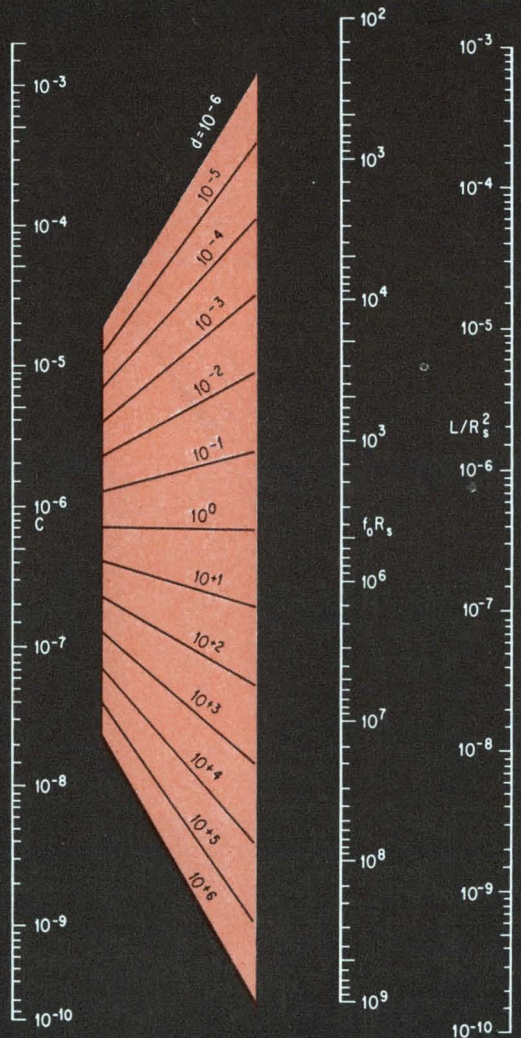

## Design example 1: checking a commercial filter

### Problem:

Will an off-the-shelf pi filter, which uses a 16-millihenry inductor and two 0.01 microfarad capacitors, give 8 db of insertion loss at 3 kilohertz, 15 db at 10 khz, and 20 db at 30 khz? These points are circled on the graph. The filter appears to be ideal since the system line-to-ground capacitance is limited to 0.05  $\mu$ f. First check the advertised IL (shown in red) when driven from and terminated in 50 ohms. Even if the filter does produce the desired response under matched conditions, will it perform adequately under the actual terminations of  $R_s = 50$  ohms and  $R_L = 50$  kilohms? The design curves on pages 123 through 125 will aid in predicting performance.

### For the matched case

■ Compute  $R_s^2 C = (50)^2 \times 10^{-8} = 2.5 \times 10^{-5}$ .  
 $L = 1.6 \times 10^{-2}$ .

■ Place a straightedge from the L value to the  $R_s^2 C$  value on nomograph I and note that  $f_0/R_s = 10^3$ . And since the slope of the straightedge is parallel to a slope halfway between the  $d = 10^2$  and  $d = 10^3$  lines on the response curve scale,  $d = 5 \times 10^2$ .

■ Compute  $f_0 = 10^3 \times R_s = 50$  khz, and  $A = R_L/R_s = 1$ .

■ Sketch a curve that is halfway between the  $d = 10^2$  and  $10^3$  curves on chart j and compile the following table. All normalized frequencies, F, from the chart are multiplied by  $f_0$  (50 khz) to obtain actual frequencies, f.



# filters graphically

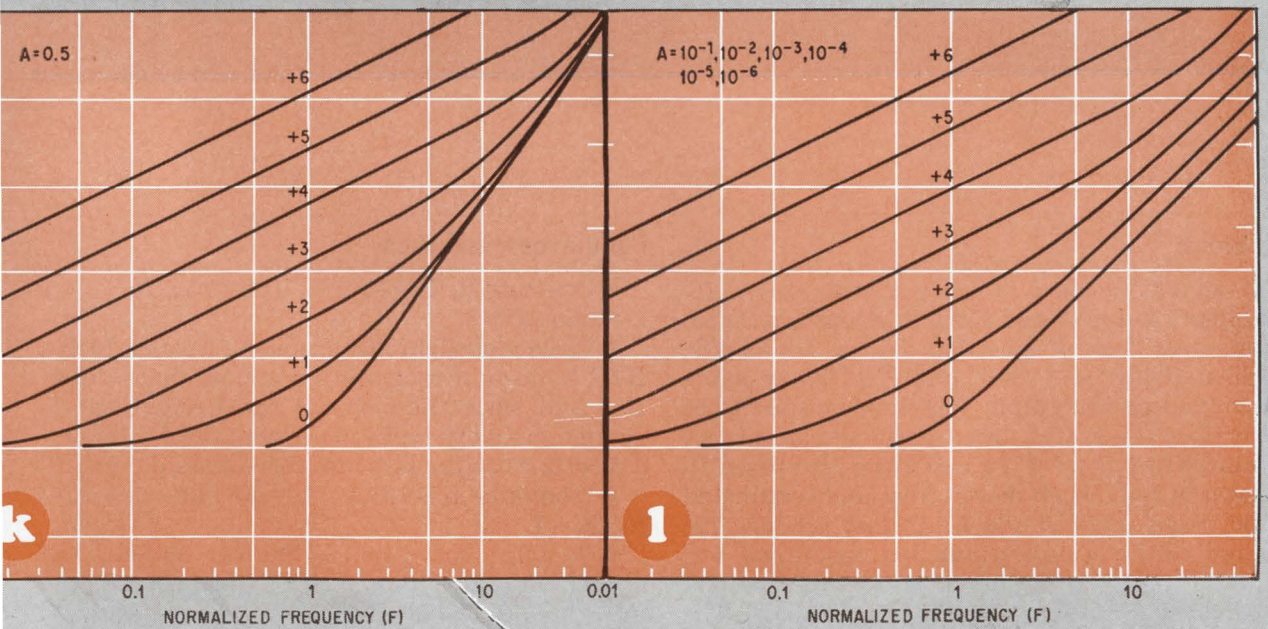
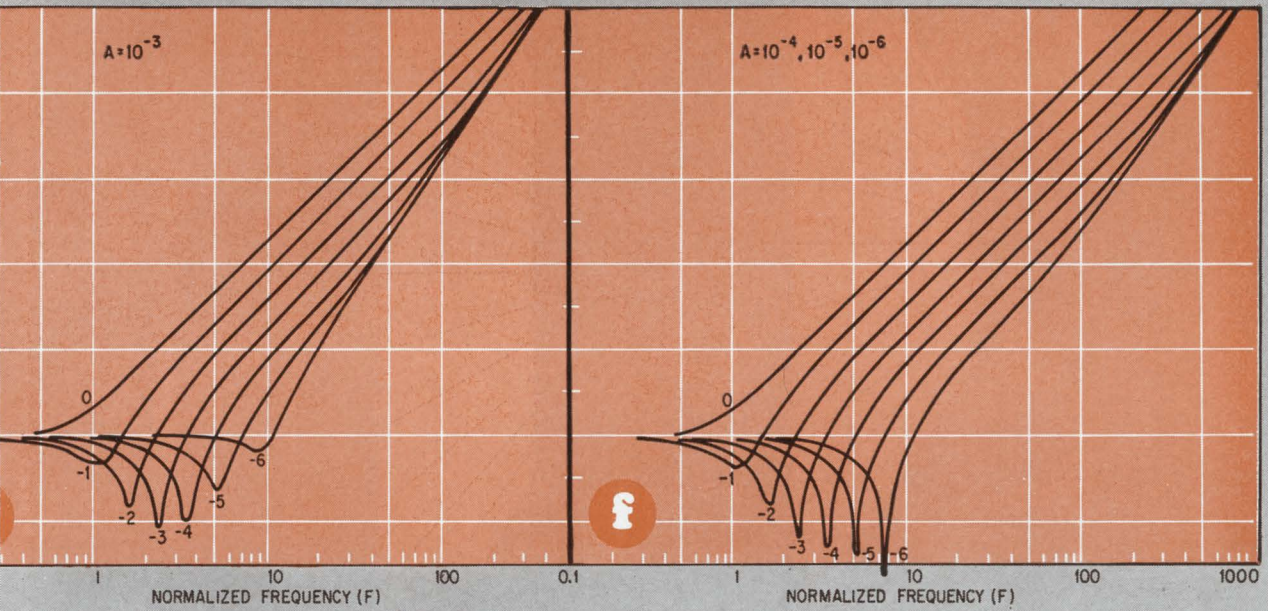



# Know your d-a converter's capability

Differential amp with offset provides added gain and sensitivity to accurately measure d-a unit's settling time on an oscilloscope

By James J. Pastoriza

Pastoriza Electronics Inc., Newton Upper Falls, Mass.

and David R. Weller

Bell Telephone Laboratories, Murray Hill, N.J.

**Speed in itself** isn't inherently a virtue if it's accompanied by harmful side-effects, as, for example, in a high-speed digital-to-analog converter. The task is either to overcome the bad effects or simply avoid them while, at the same time, taking advantage of the speed.

In a typical digital-to-analog converter, particularly high speed units, troublesome transients are generated. These transients, if fed to subsequent slower circuits, would be integrated over many microseconds, thus increasing the effective settling time, and perhaps slowing the effective conversion speed by an order of magnitude or more. This would be intolerable for applications such as non-flickering cathode ray tube displays of high-speed computer readouts.

Usually neither the transients nor their effects are included in device specifications and engineers must check the output responses of the d-a converters themselves. To do this they rely on the oscilloscope. However, regardless of how good their oscilloscopes are, the engineers find it somewhat difficult to obtain the necessary gain and sensitivity to measure pulse settling times—particularly to within a few millivolts resolution over a full scale voltage range that may be 10 volts or more.

But by using a simple preamplifier ahead of the scope with a special offset input to suppress the large d-c component in the converter's output, the rise and settling times of the pulses can be measured accurately and the transient behavior can be observed. This preamplifier consists of a high-

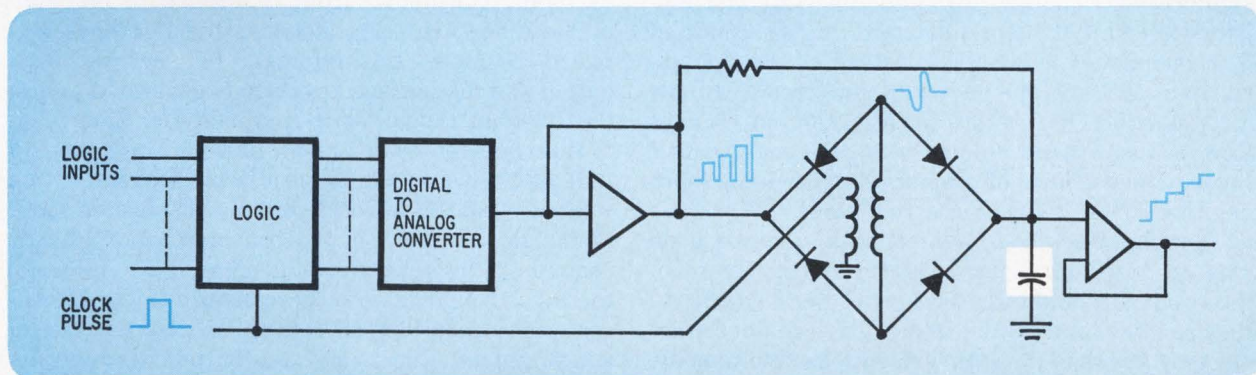

**Track-and-hold.** This circuit transmits only the voltage increments and bypasses the transients. The clock pulse is differentiated by the pulse transformer into a bipolar signal; this contains a negative backswing and positive frontswing which alternately opens and closes the diode bridge. When the diodes are forward-biased, the d-a's output charges the capacitor which also holds the charge when the bridge opens during the clock pulse's negative swing. Transients occurring during this negative swing never get through to discharge the capacitor.



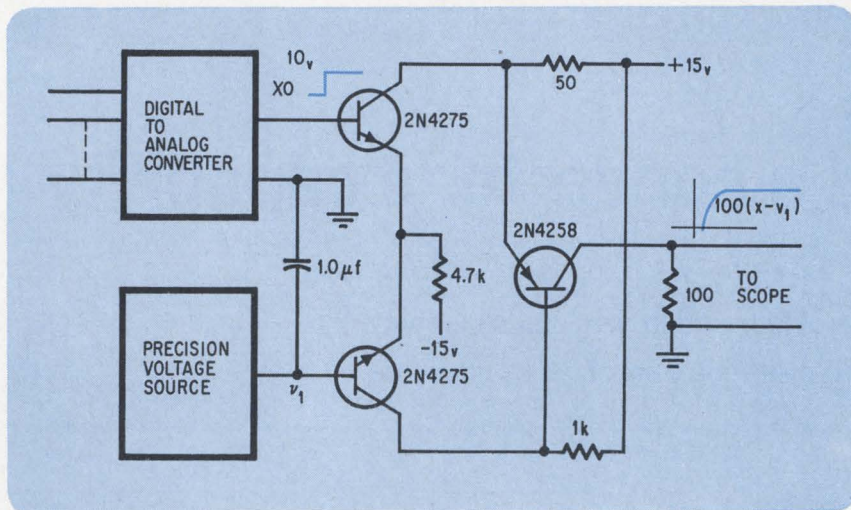

**Booster.** Most scopes have neither the gain nor sensitivity to accurately measure the d-a's rise and settling times. With the differential preamplifier circuit, enough offset is provided by the voltage source to look at just the top of the converter's waveform while the circuit's gain of 100 gives the needed amplification. The difference between the step function at the converter's output and the voltage offset is delivered by the output transistor to the 100-ohm resistor connected to the scope's input terminals.

frequency, high-gain differential amplifier with a reference source at one amplifier input that provides the right voltage offset.

If transient behavior of the converter proves unacceptable, an additional circuit operating on the track-and-hold principle can be used to store the output amplitude while ignoring the switching transients. The primary cause of the transients is the unsymmetrical logic switching gates in the d-a converter. Since they open slightly faster than they close, it takes longer to complete a transition from the binary 0 state to the binary 1 state where the switches must close than to complete the reverse transition 1 to 0 where the switches must open.

To illustrate the effect of these transients on the output waveshape, suppose a four-bit flip-flop register that drives the d-a converter has a binary count of 7. Its most significant bit is a 0 and the other bits are 1's. If the next logic state adds a binary 1 to the count, three switches in the d-a converter would have to toggle from 1's to 0's while the switch driven by the most significant bit would have to toggle from a 0 to a 1.

However, since it's faster to switch from a 0 to a 1 state, the three 1's shift to 0's before the most significant bit changes to 1; thus the converter registers a count 0 before the next higher count of 8 is completed. Therefore, instead of moving directly from 7 to 8, the converter goes from 7, briefly to 0, and then to 8. Consequently, the output goes from the equivalent voltage level that represents a binary 7 to the level of a binary 8, but with a sharp negative spike between the two steps.

Though a track-and-hold technique seems a good way to sidestep the transient problem, most of the track-and-hold circuits haven't been effective—they're slow, inaccurate, and often introduce transients worse than those they're supposed to remedy.

The track-and-hold circuit on page 129, however, effectively eliminates transients in the d-a converter's output by only transmitting the meaningful part of the waveform. It does this by sensing a clock pulse delivered simultaneously to the converter's input logic and the diode bridge of the

track-and-hold circuit via the pulse transformer.

The transformer differentiates the timing pulse into a positive frontswing and a negative backswing. The pulse, inductively coupled to the bridge, opens and closes the diode paths transmitting the signal when the diode paths are closed, and blocks the signal when the paths are open.

During the backswing, the diodes are forward biased and the capacitor charges to the d-a's output. The capacitor stays charged during the frontswing while the diodes are back-biased. Since transients occur during the frontswing they are blocked from discharging the capacitor, preventing them from being transmitted to subsequent circuits.

The transient-free signal at the output of the track-and-hold circuit now must be amplified and the voltage level offset so that its settling time can be accurately measured on an oscilloscope. To do this, the differential amplifier circuit shown above with a gain of 100 and an offset range of 10 volts (for a converter with a full-scale range of 10 volts) increases the scope's sensitivity for accurate settling-time measurements.

To see how long it takes a d-a converter to reach its final value, a 10-volt step function is applied to its input. The d-a's output is applied to one side of the differential amplifier and the reference signal to the other. The difference between the d-a's output and the reference voltage is generated across the 100-ohm resistor—but amplified 100 times.

With the reference set at 10 volts, just the top part of the waveform is visible on the scope; the reference can be lowered slightly to observe more of the slope or slew in the converter's output. For example, if the reference is decreased 20 millivolts, the top 20 millivolts of the converter's output become visible. In fact, by setting the reference to an appropriate voltage, any d-a output through its 10-volt range can be closely observed and its settling time measured.

The differential amplifier's gain and linearity can be checked by varying the reference voltage in 10-mv steps and observing the corresponding variations in the output signal on the scope. ■



# Is your TTL source complete?

We regret to announce that it's not.

Unless your source is Signetics. And DCL, which stands for our Designer's Choice Logic series.

Because DCL performs more functions than any other TTL line. And gives you better specs to boot.

Signetics DCL also has the reliability you want. The prices you want. The choice you want: in MSI arrays; in gates and flip flops; in commercial and military temperature ranges; in flat packs, silicone DIP's, ceramic DIP's.

To prove it, send us the coupon below. Until you do, you'll never know what you're missing.

To: Signetics Corporation  
811 E. Arques Avenue, Sunnyvale, California 94086

Okay, Signetics, send me specifications and applications memos on your DCL series – and *prove* it performs more functions than any other line of TTL. As soon as I complete this coupon:

Name \_\_\_\_\_ Company \_\_\_\_\_

Address \_\_\_\_\_

City \_\_\_\_\_ State \_\_\_\_\_ Zip \_\_\_\_\_

**Signetics** 

Signetics Corporation A subsidiary of Corning Glass Works



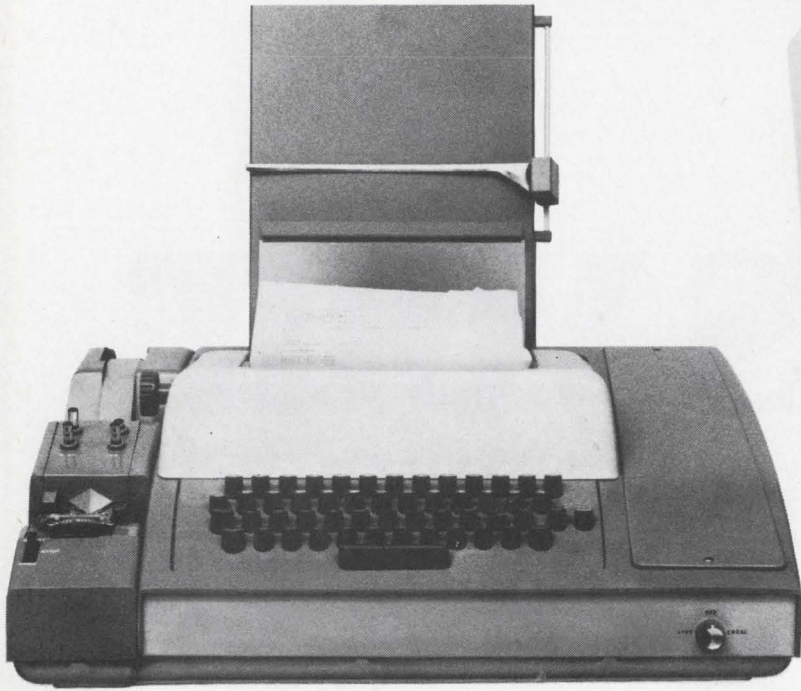

Printers—low cost, limited flexibility.

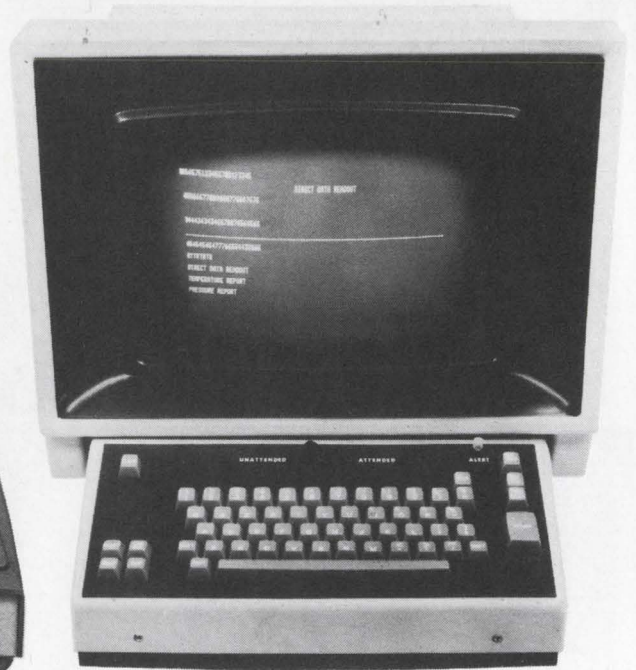

CRT Terminals—high-cost, high flexibility.

# Print out In/out



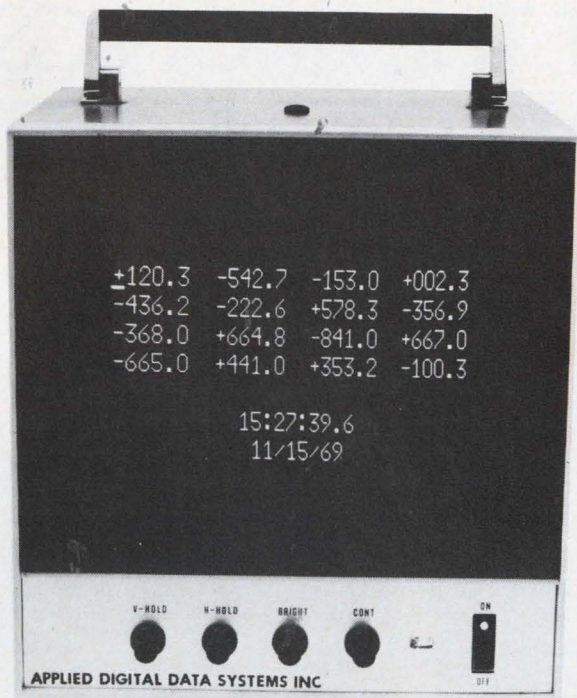

New CRT readout—low cost, high flexibility.

# Just out

## Announcing the MRD-100—a new, low-cost way to display sequential numeric data on TV monitors.

Now it's practical to use TV monitors to read out data from keyboards, magnetic tape or any other sequential source.

The MRD-100 accepts character serial and bit parallel data, stores it in its own refresh memory, converts it to a composite video signal and displays it on a TV monitor. In 2, 4 or 8 lines with 32 characters per line; 4 or 8 lines with 16 characters per line.

Data may be displayed on any standard 525-line TV monitor at any number of remote locations—with just a single coaxial cable. Interfacing is simpler than that for full-scale terminals.

Basic cost, not including monitors, is under \$1500.

Control features let you advance to any line or character position, blink on and off any character or combination of characters, use a cursor symbol for tracking the location of the next character and erase all or part of the screen.

So if you have a design problem in sequential numeric readout, you no longer have to worry about the reliability of printers, the cost of a full-scale terminal or the trouble of building your own memory for indicator tubes.

Now you have a tailor-made solution.

From the company that specializes in innovative data communications systems.

**ADDS**  
Applied Digital Data Systems, Inc.

Mr. Richard Kaufman, Dept. 15  
Applied Digital Data Systems, Inc.  
89 Marcus Boulevard  
Hauppauge, New York 11787

Please send more information about the MRD-100.

Name \_\_\_\_\_

Title \_\_\_\_\_

Company \_\_\_\_\_

Address \_\_\_\_\_

City \_\_\_\_\_

State \_\_\_\_\_ Zip \_\_\_\_\_



# THIS AGE CAN TEST THE AVIONICS OF ALL NEW AIRCRAFT OF THE 1970'S.

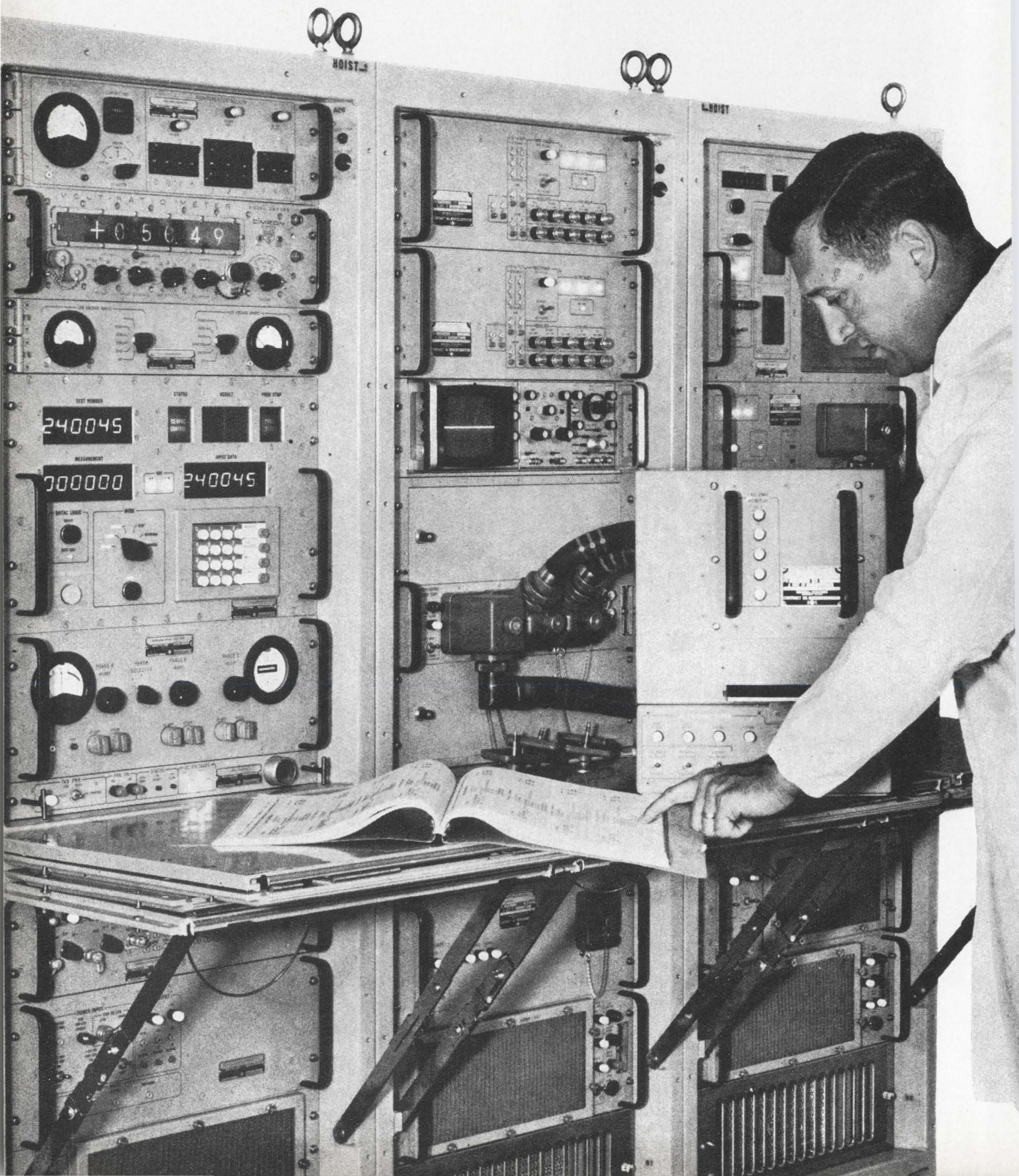



Historically, a new aerospace ground equipment system has been designed for each new aircraft. This has led to recurrent problems. Less than optimum standardization, repetitive research and development costs, variable quality and reliability, and often a lag between delivery of aircraft and the system to support them.

What's needed is AGE that will support not just one aircraft but a whole generation. A system that will be on line when the aircraft goes operational. General Dynamics has designed and developed an AGE concept that meets these requirements.

### **First completely integrated system.**

Our Electronics division, in support of the Fort Worth division, developed and delivered concurrently with the F-111, the first totally coordinated AGE system. It was available when the avionics were delivered.

The system is made up of integrated test stations. They use a highly flexible building block configuration that can readily be adapted for use with all advanced operational aircraft planned through the late 70's.

This AGE system, on line with the F-111, could be adapted to the new F-15, meeting 70% of its avionics AGE requirements with little or no change; another 15% with minor modification; and only 15% with new de-

velopment. The system is also applicable to the AWACS and B-1A as well as other Air Force programs; and the Navy's F-14 and S-3A programs.

### **Automatic and manual testing.**

The test stations are a combination of automatic and manual units offering the advantage of selective automation.

The multiple input design of this system virtually eliminates the possibility of an AGE shutdown when trouble is encountered at an input position, and allows simultaneous testing of several avionics equipments.

### **One AGE for all avionics systems.**

The capability of General Dynamics' integrated AGE system ranges over the full spectrum of analog and digital avionics found in multi-mission aircraft, including flight control systems, mission and traffic control subsystems and penetration aids.

The AGE subsystems are configured to serve the full range of flight line, field and depot level requirements.

The adaptability and flexibility of this AGE concept also makes it feasible for application as an integrated shipboard test center for the Navy, or as an advanced electronics depot testing center in support of ground forces.

The universal AGE concept is just one example of how General Dynamics puts technology to work solving problems from the bottom of the sea to outer space... and a good bit in between.

## **GENERAL DYNAMICS**

1 Rockefeller Plaza, New York, New York 10020



# MSI/LSI

MSI/LSI circuit seminar  
for equipment  
and systems designers.

California-Dec. 1-3, 1969  
Airport Marina Hotel  
8601 Lincoln Blvd.  
Los Angeles, Calif.

## Program

1. Evolution of large scale integration (LSI)
2. MOS device structure and characterization
3. Basic MOS circuit techniques
4. Topological design and layout
5. Advanced circuit techniques
6. LSI artwork generation
7. Logic implementation with LSI
8. Design examples
9. MOS/Bipolar interface techniques
10. Low threshold technology
11. Cost consideration for LSI
12. Computer aided design
13. MOS structures and fabrication techniques
14. Process constants and minimum design rules
15. Yield factors and process control
16. Facilities and equipment requirements for LSI
17. Applications and product types most suited to LSI
18. Currently available MSI/LSI products
19. Advanced technology trends
20. Technological controversies

## Purpose

The MSI/LSI seminar is designed to acquaint systems designers with the capabilities and limitations of the LSI technology. It will provide for more effective product planning through knowledgeable appraisal and proper use of LSI for specific applications. Attendees will receive instruction in MOS device models and characterization, and in MOS circuit forms and their performance comparisons. They will also learn topological rules that permit multiple sourcing of LSI arrays, procedures for the design of a standard cell library, how to make an LSI composite plan drawing, and how to determine transient response and propagation delay. LSI cost factors will be discussed, and systems designers will be instructed in the preparation of specifications for LSI.

## Faculty

Presentations, discussions, and work sessions are under the direction of the staff of Integrated Systems Technology, Inc. of Santa Clara, California. Each member of the staff has wide experience in the areas of circuit design, systems application and semiconductor research and development. *Donald E. Farina*—President, Integrated Systems Technology, Inc. One of the contributors to the design of the first micrologic integrated circuit families. Served as head of the R&D department in digital circuits for Fairchild Semiconductor, responsible for both digital circuit and bipolar device structure development. For the microelectronics division of Philco-Ford Corporation Mr. Farina served as Director of R&D and was responsible for device and research devoted to MOS large scale integration. He received his BSEE at New York University in 1953. *Ronald Pasqualini*—Vice President, Engineering. Widely experienced in

R&D on MOS memory systems for Philco-Ford Corporation. Performed initial logic design, circuit analysis, and composite layout of a monolithic read-only memory. Was responsible for the interface between R&D processing and R&D design.

Systems design experience in integrated circuits includes shared responsibility on an Air Force large scale array navigation computer, and Ranger spacecraft. Also designed a monolithic 2-MHz binary/BCD converter employing 4-phase circuit techniques.

Mr. Pasqualini holds a BS in Aeronautics from M.I.T., 1962, and an MSEE from U.S.C., 1966.

*Richard Craig*—Vice President, Technologies. Mr. Craig has devoted the major portion of his career to the semiconductor. With three major semiconductor manufacturers his experience includes developments in planar and epitaxial processes and structures. He received his BA in Physics from Fresno State College in 1958.

## Fee

The registration fee for all sessions, a complete set of notes, and luncheons —\$385.

## Registration

Register now for the Los Angeles program. Use the registration form below. Make checks payable to Electronics/Management Center. You must register in advance. We will be happy to bill you or your company, but only paid-up registrants will be permitted to attend the seminar. Hotel reservations should be made directly with the hotel. A number of rooms is being held for seminar attendees. When you make your reservations, identify yourself as an attendee of the MSI/LSI seminar.

## MSI/LSI circuit seminar for equipment and systems designers.

Samuel Weber, Mgr.  
Electronics/Management Center  
330 West 42nd Street, N.Y., N.Y. 10036

MSI/LSI

Please register me in your  
three day seminar at \$385  
 Check enclosed  
 Bill me  
 Bill company  
PO # \_\_\_\_\_

Name \_\_\_\_\_ Title \_\_\_\_\_  
Address \_\_\_\_\_  
Company \_\_\_\_\_  
City \_\_\_\_\_ State \_\_\_\_\_ Zip \_\_\_\_\_





## How Rexolite<sup>®</sup> helps King Radio put a life-saving "squawk" in Airborne Transponders.

Reliability is the first requirement of a device used to help sort out air traffic. When the pilot of Aircraft X pushes the "ident" button of his transponder he wants to be mighty sure that a "blip" marking his position will show up on the radar screen in the control tower.

Of course light weight and low power drain are also important. And reasonable cost doesn't hurt, either. King Radio Corporation, Olathe, Kansas chose Rexolite 2200 clad laminate for the stripline assembly in their new KXP 750 Transponder because it measures up on all counts.

1. The **dielectric constant** of this

Brand-Rex material, 2.62 from 100 MHz to 10 GHz, was in the right range for what they had in mind.

2. King's engineers liked the **rigidity** of 2200, calling it "a nice, solid sort of substrate with no cold flow problems". They found this glass-reinforced, styrene copolymer as rigid as heavier, more expensive materials. No back plate required.

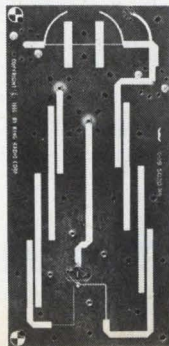
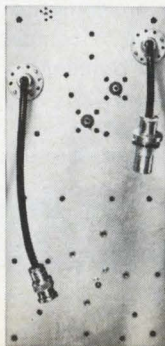

3. This manufacturer was also impressed with Rexolite 2200's **stability**, especially where temperature variations are concerned. (The transponder has to meet FAA requirements involving a range of  $-50^{\circ}$  to  $+71^{\circ}$  C.) They say it offered the lowest amount of parameter shift of all medium-priced materials considered.

*Are you looking for a microwave laminate that can take on stiff challenges without stiff price? Write for the complete story on our REXOLITE 2200.*

American Enka Corporation, Brand-Rex Division, Willimantic, Connecticut 06226. Phone: 203-423-7771.

**BRAND-REX**



## THE MARRIAGE MADE IN MINCOM

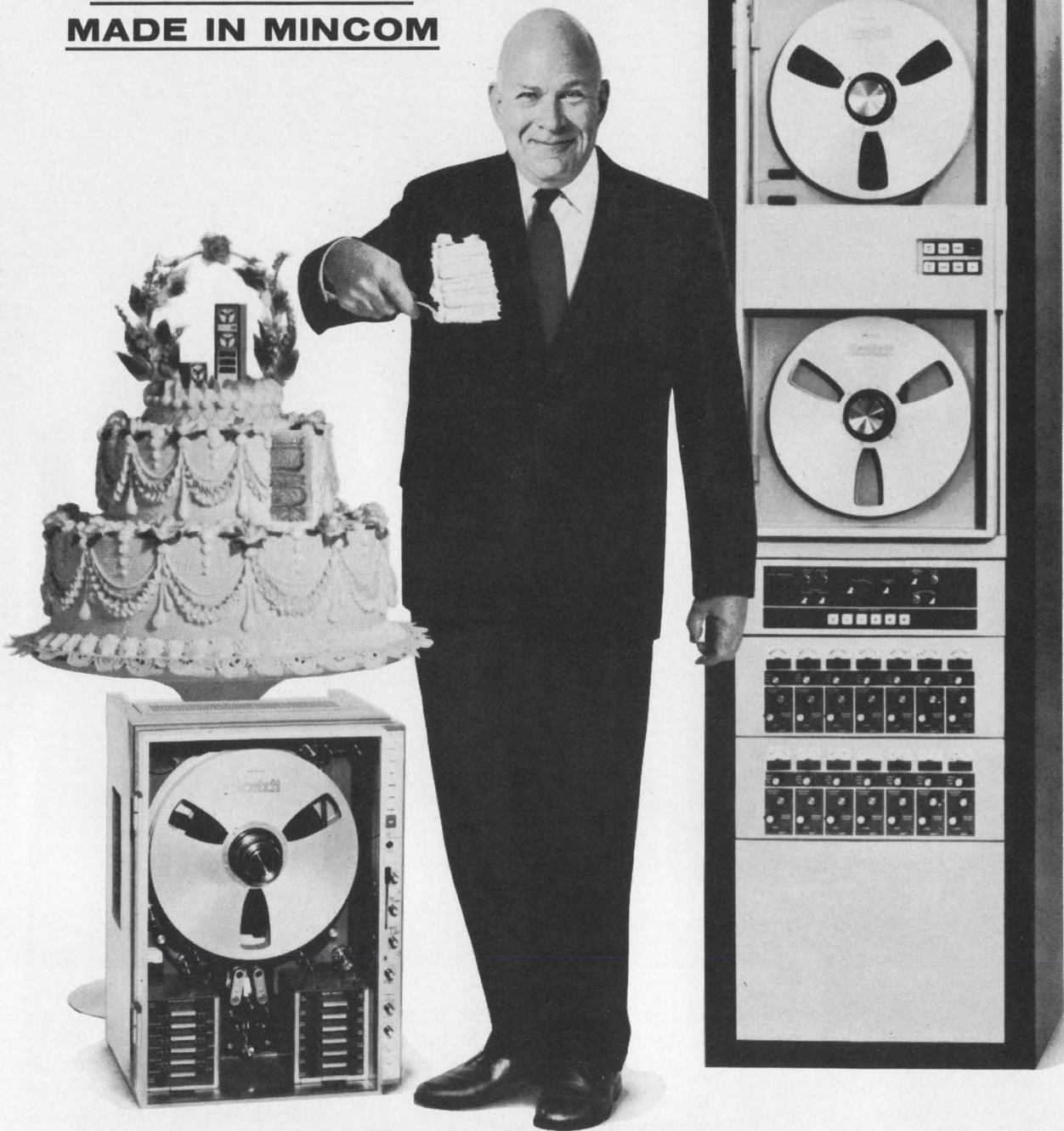

**PC-500 IN THE FIELD**

**TICOR III IN THE LAB**

This matched pair of Mincom Instrumentation Recorder/Reproducers are truly wedded to their art and to each other. Call them childhood sweethearts, because every Mincom PC-500 and every TICOR III grow up together—literally—and that's why they do the best possible job in data acquisition and reduction. They share telemetry's ultimate compatibility while providing up to 2 MHz on fourteen channels. The rugged PC-500 was designed from the blackboard up to complement TICOR III's flutter suppression performance. In both systems the basic servo design thinking is identical. At the sub-assembly level, electronics and circuits design are the same. Add to this TICOR III's unmatched servo bandwidth, its low  $\pm 0.4 \mu$  sec time base error, its highly successful two years of field-test as Mincom's Model 32—and look no further for your complete (and compatible) data team. Write us for more details and specifications.

**Mincom Division** **3M**  
COMPANY  
300 SOUTH LEWIS ROAD • CAMARILLO, CALIFORNIA 93010



# Meet our power twins

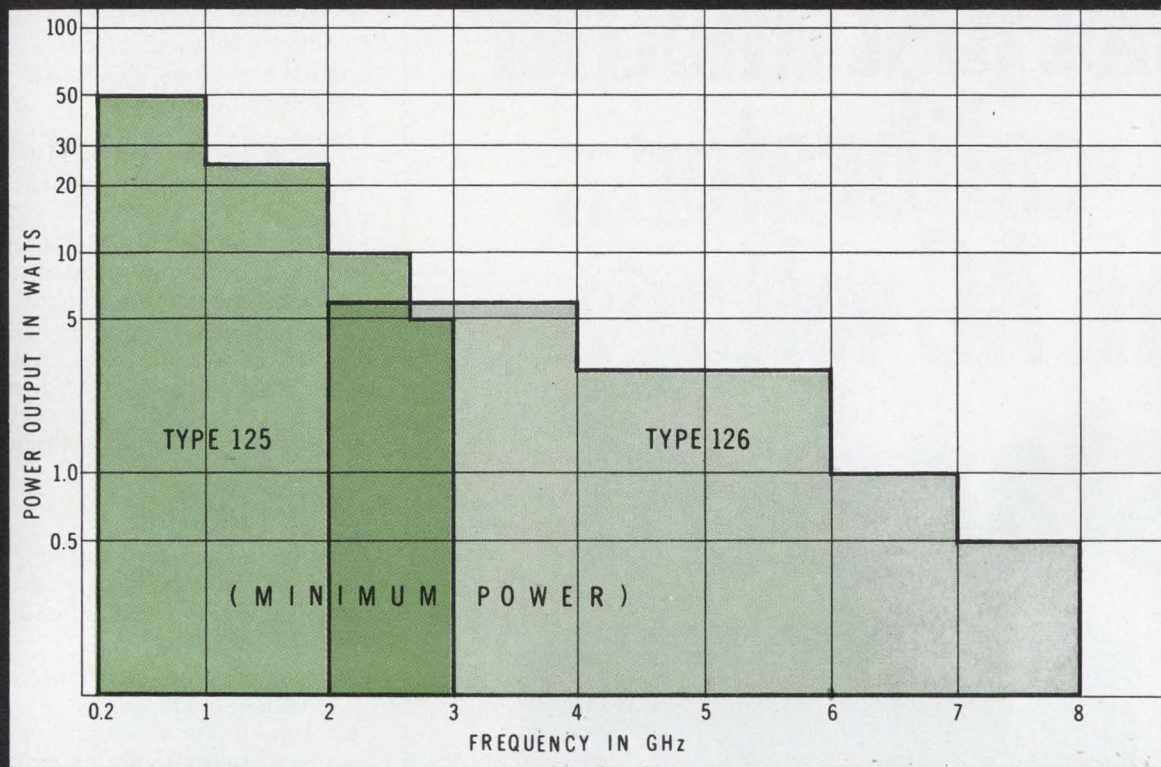

All's two **Power Signal Sources** cover the entire range from 200 to 8000 MHz. Powerfully.



Meet ALL's Power Signal Source twins: Type 125 covers the range from 200 to 3000 MHz, is priced at \$3950. New Type 126 operates from 2000 to 8000 MHz, at a price of \$4950.

Only ALL can do the job with just two units. Our Type 125 and Type 126 span the range of up to eight competitive instruments.

The chart shows the really abundant power you get at each frequency. The values shown are guaranteed minimum specs—higher CW values and peak-pulse powers of several hundred watts are attainable. But that's just the beginning.

Each source has internal 100% square wave modulation, external pulse and amplitude modulation capability, 0.004% frequency stability, and 1% power stability.

Want to use them for your low level signal source needs, too? Both units provide over 60 dB power adjustment range to cover all of your requirements.

So why consider six or more signal sources when ALL's power twins do the job—and at much lower cost! For convincing proof, call our "hot line" to arrange a demonstration. Just dial 516-595-3216 during East Coast business hours.



Or write for our new catalog describing ALL's full line of Microwave Instruments, including complete specifications for the Types 125 and 126 Power Signal Sources.

**AIL** a division of  
**CUTLER-HAMMER**



DEER PARK, LONG ISLAND, NEW YORK 11729



# not just another calibrator... an AC voltage standard

(the first to 110 kHz)



The **WESTON-LEXINGTON ACS-176 AC Voltage Standard** is the most accurate, most stable AC Voltage Standard produced.

Here, at last, is a laboratory instrument that combines the accuracy and stability of a primary standard with versatility and operating simplicity needed for the rapid, precision calibration of AC test instruments without external monitoring equipment. Wide voltage (0.1  $\mu$ V to 121 volts) and frequency (10 Hz to 110 kHz) ranges with in-line digital display provide broad test flexibility for use in production and incoming inspection. Direct indication of voltage, frequency, and % error simplify and speed operation while eliminating human error. Remote programming is available, including voltage and error measurement ranges, together with an error measurement output for data recording.

- 10 Hz to 110 kHz
- 0.02% + 2  $\mu$ V absolute accuracy of setting from 0.1 mV to 121 V (no need to worry about or look for additional adders or uncertainties; there are none)
- Direct indication of % error
- 0.01%/year amplitude stability
- Remotely Programmable
- Many other advanced features

Send for complete data and specifications on this extraordinary new instrument.

Weston Instruments Division,  
Weston Instruments, Inc.  
17 Hartwell Avenue, Lexington, Mass. 02173  
Tel: (617) 861-9000; TWX (710) 326-0596

a Schlumberger company

**WESTON**®

## COMPARE!

Check the features below against any other 100kHz AC voltage standard.

### Unparalleled performance

The ACS-176 offers the best overall accuracy available (0.02% + 2 $\mu$ V to 20kHz over its full voltage range) and the best frequency temperature-coefficient characteristic in its field. An important plus is its capability for calibrating phase-angle voltmeters with 0.1° accuracy to 10kHz. And it is available with a data acquisition system (Series 710).

### Unique features:

From its human-engineered panel design to its exclusive convenience and safety features, the ACS-176 offers:

- Transient-free, rapid-settling voltage selection.
- Large in-line numerical read-out for repeatable, accurate, frequency selection.
- In-phase and quadrature phase reference outputs for calibrating phase meters.
- Overload-memory circuit for safety.
- Totally fail-safe operation.
- Remote programming of ranges.

### For the first time:

Now you can rely on a meaningful and useful *total* accuracy specification. Absolute Amplitude Accuracy, including: 90 day stability; all calibration uncertainties in traceability to NBS; all effects of noise, cycle-to-cycle instability, and distortion in calibrating average or rms-responding instruments; 0.1mV to 121V, all effects of line-voltage variation within the stated temperature limits.

### 1000 volt amplifier

Also available to expand these outstanding calibration capabilities to high voltage levels is the KVA-121 kilovolt amplifier. This all-solid-state add-on unit simply and conveniently extends the versatility of the basic instrument, providing full-range calibration voltages to 1000 volts from the *same* output connector.



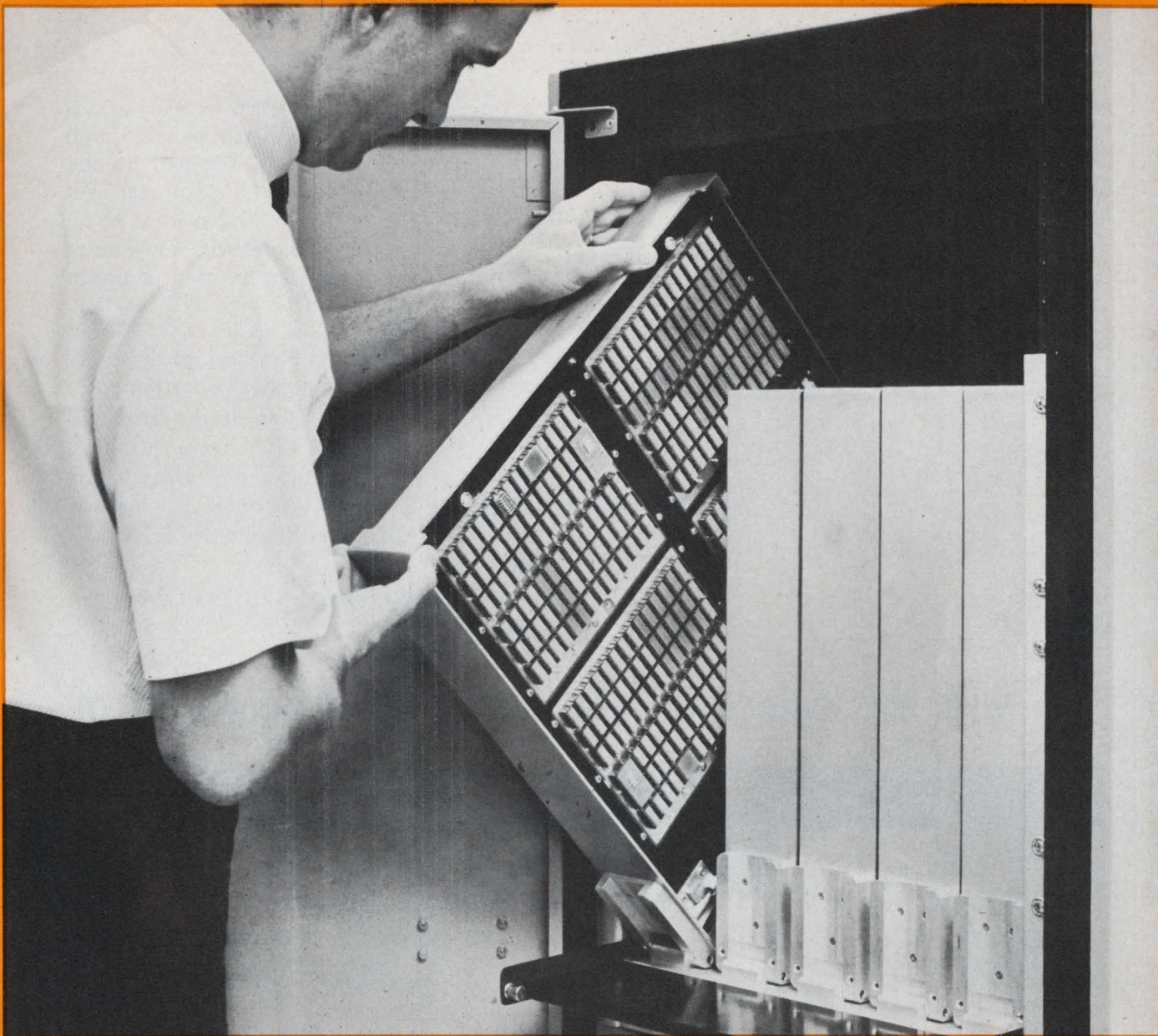

# Real FFT

*(not imaginary)*

You've heard about Fast Fourier Transform "paper tigers" and "black boxes" priced out of this world. The new TIME/DATA 90 System is real — ready now with interface to your computer for: Fast Fourier Transforms and Auto Spectra, with a choice of Spectral Averaging, Linear Windowing, and Quadratic Smoothing. Or, use the System as a free-standing unit if you prefer.

TIME/DATA's 90 cuts computer processing costs from 100 to 1,000 times . . . processes a 1,024-word data frame in 28 milliseconds . . . offers 20 KHz real-time bandwidth . . . and its options will suit your needs.

**The price is right — not out of this world!**

*See the real FFT at FJCC Booth 8423-8424 or phone today for a copy of our real brochure.*

**TIME/DATA Corporation** 490 San Antonio Road, Palo Alto, California 94306 • (415) 327-8322  
Washington, D. C. (703) 280-1700 • Los Angeles (714) 675-6840 • Boston (617) 443-2140 • Dallas (214) 255-0441

Circle 141 on reader service card



# You're never at a loss for words...

That's because you have total format access via the keyboard . . . without patch panels, jump cords, thumbwheels or pegs. We feel it's the simplest, fastest word selection you can get anywhere.

Because DCS software operates with any kind of PCM format, our system can be used wherever PCM decommutation is necessary. Not only that, the key component — our Series 4000 decomm — stands alone during off-line use of the processor, lets you run data without interruption.

Why not field all your PCM decomm problems with this new system?

Just let one of our engineering types come around for a short talk. We think you'll enjoy having a few selected words together.



**DATA-CONTROL SYSTEMS INC.**

Commerce Drive, Danbury, Conn. 06810  
Telephone: 203-743-9241

## ...with this computer interfaced PCM decomm system.

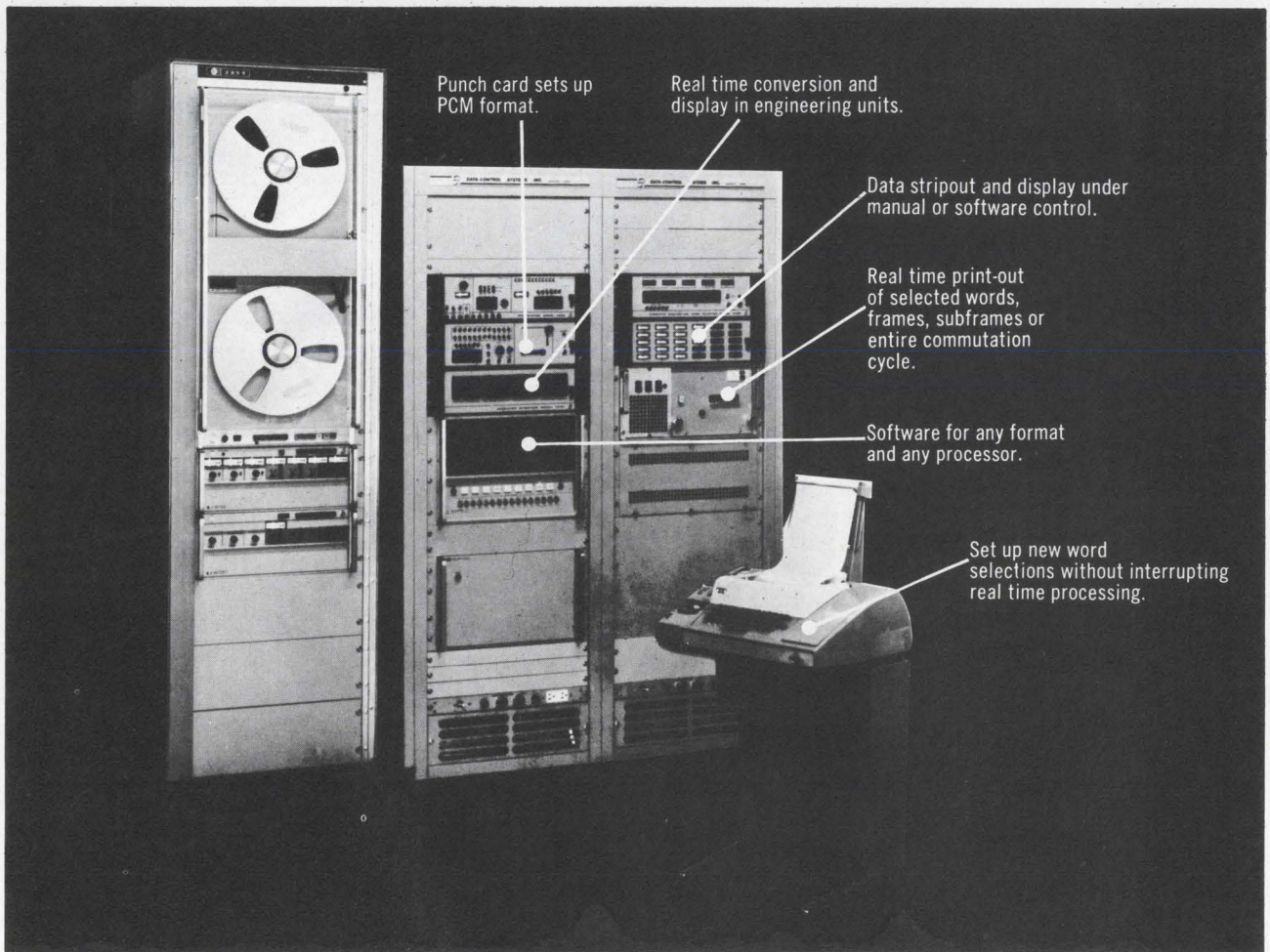





Is minimum space  
your goal...  
or limited space  
your problem?

**HERE'S THE  
PANEL-MOUNTED  
FUSEHOLDER  
YOU NEED**

for 1/4 x 1-1/4 inch fuses

The BUSS HTA fuseholder measures only 1-25/32 inches in overall length and extends behind the face of the panel only one inch.

The holder features the popular bayonet type knob. A strong coil spring inside the knob assures good contact when the fuse is inserted into the holder. If a test hole in the knob is needed, a breakaway hole can be punched out to allow use of a test probe.

Rugged in construction to withstand vibration and shock, the HTA fuseholder can also be furnished with a special washer to make it drip-proof from the front of the panel. And the best feature of the HTA fuseholder is that it has *famous built-in BUSS quality*. You can't get it anywhere else.

*For more information on the HTA fuseholder, or anything else in the*

*complete line of BUSS small dimension fuses, fuseblocks, and fuseholders, write for BUSS Bulletin SFB.*

**Bussmann Mfg. Division  
McGraw-Edison Co.  
University at Jefferson  
St. Louis, Mo. 63107**

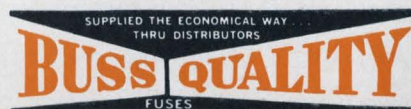



# Making instrumentation measurements? Let HP put them on tape for you. Right now.

Hewlett-Packards' new HP 3960 Instrumentation Recorder is so portable and versatile that our field engineer can carry it into your facility, connect it to whatever you've got going and have it working for you immediately. You can run it yourself without any specialized operating knowledge. And buy it without beating your budget into the ground.

For example, just \$4070 buys a complete four channel 1/4" system with three electrically switchable speeds, direct recording to 60 kHz, and FM to 5 kHz.

FM signal to noise ratio at 15/16 ips is 46 dB, a figure you'll find difficult to match with even the most expensive laboratory machine. And your signals come through loud and clear without external filtering. A phaselock servo drive system assures minimum flutter and exact tape speeds.

Design features for reliability and low maintenance include rugged single casting capstan assembly, permanently adjusted brakes, and built-in FM calibration facilities. Put the HP 3960 in the lab or out in the field. Use it for vibration and

stress analysis, medical research, acoustical evaluation or any other application you can find. Our lightweight portable gives you maximum information for minimum dollars. Instantly. Call your local HP field engineer for a demonstration or write Hewlett-Packard, Palo Alto, California 94304; Europe: 1217 Meyrin-Geneva, Switzerland.

**HEWLETT  PACKARD**

**MAGNETIC RECORDERS**

42905

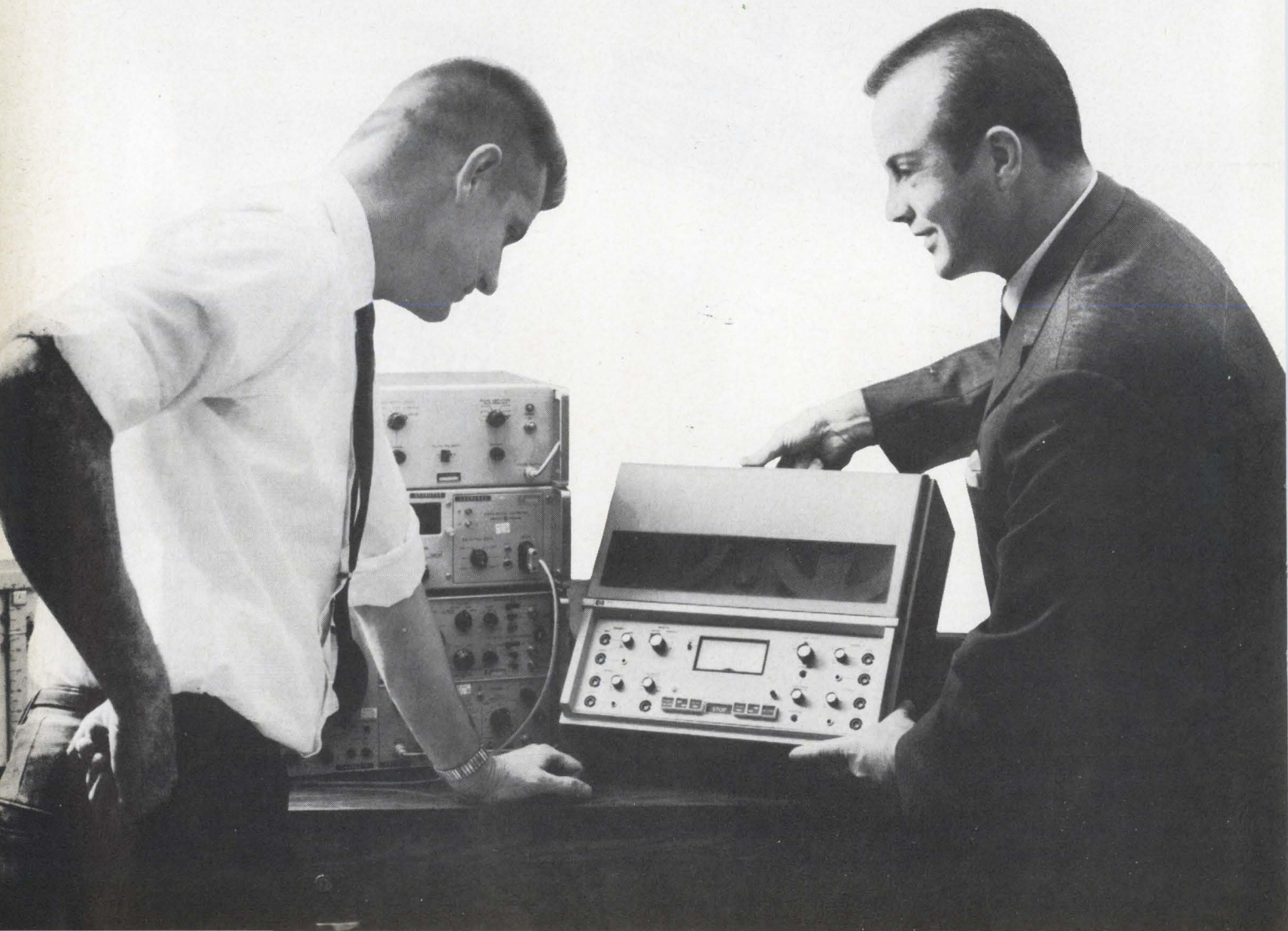



# Users' choice is name of keyboard game

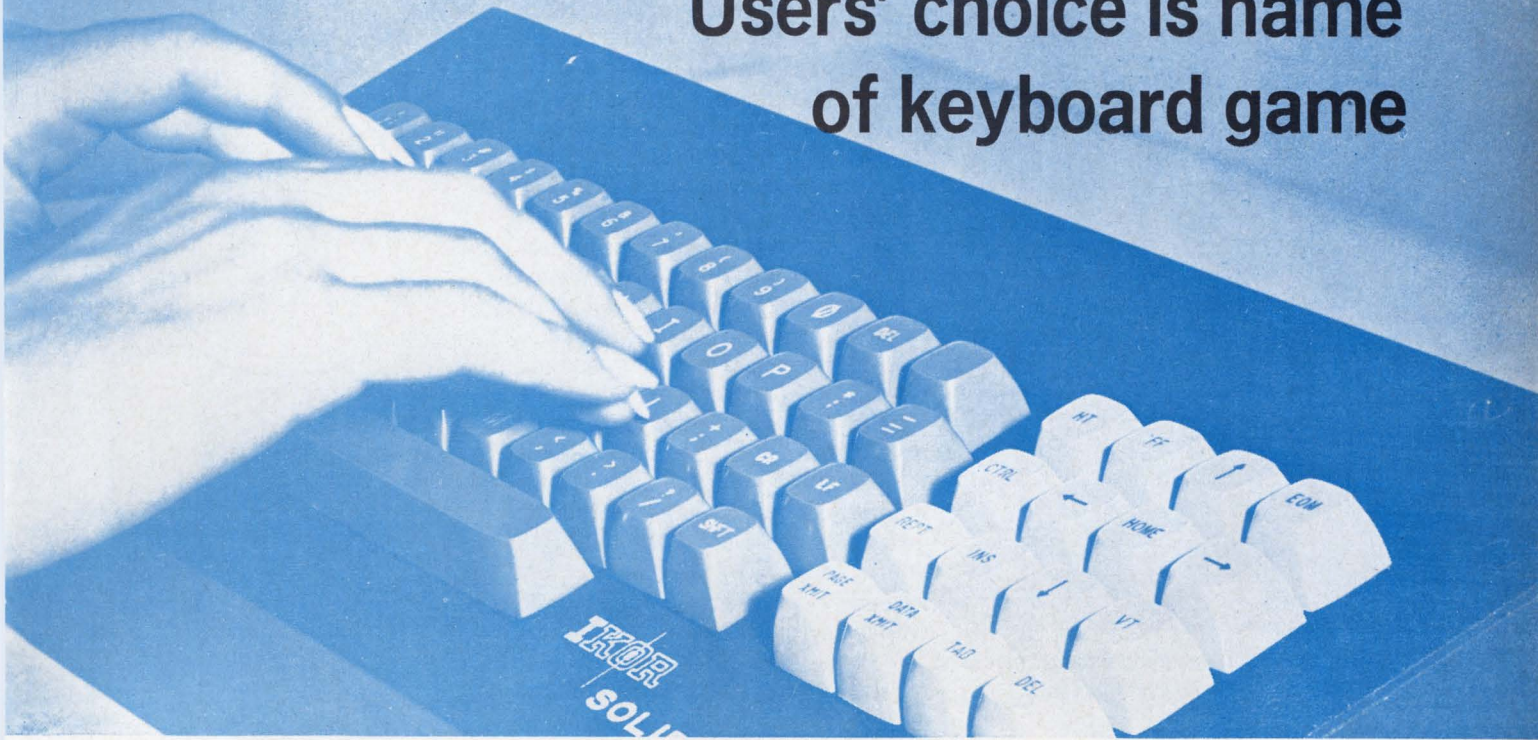

Variety of electromechanical and solid state devices with multiplicity of logic circuits offer buyer different performance, reliability claims

By Leon Magill

*Electronics staff*

**Spurred by the growth** in time-sharing terminals, the keyboard industry's expansion presents engineers with an increasingly wide choice of units for computer terminals. But although companies are claiming high reliability, they use different yardsticks to measure lifetime and vary strongly in their approaches to achieving it.

Reliability primarily depends on the type of device used to obtain key closure and on the encoding circuit. Most companies are pushing electromechanical reed switches, although some strongly maintain that contactless types, such as capacitive-coupled or Hall-effect units, offer the highest reliability. But few agree on the optimum encoding circuitry; some favor diode logic while others criticize this approach for its excessive use of components and complicated

wiring interconnections.

However, the engineer at least can specify any code to the keyboard manufacturer and get the unit he wants—provided he's willing to pay the price. All keyboards now handle the American Standard Code for Information Interchange (ASCII) and many can handle the extended binary coded decimal interchange code (EBCDIC).

But even if special codes aren't designated, keyboard price remains high because of the custom nature of the business—most manufacturers don't have product lines but fill each special order as it's received.

Prices could drop in the near future if the industry booms as expected. Estimates of the present keyboard market range from \$5 million to \$10 million. William Polley, marketing manager of Ikor, Inc., sees sales reaching \$75 million

by 1975, and George L. Rice, vice president of Synergistics Inc., anticipates a growth rate of 50% a year with no end in sight.

**Old standby.** Most keyboards today use electromechanical reed switches whose contacts are in the open state. One of the big drawbacks is that reed tips may bounce away from each other as they are brought together, rebounding several times before they make contact. Wetting contacts with mercury eliminates bounce, but also boosts price, increases susceptibility to damage from shock and vibration, confines the switch to a fixed position, and slows operating speed.

Other approaches to reducing bounce include use of buffer circuitry or of strobes indicating that encoded outputs are ready to be read. KDI-Navcor Inc. installs an optional r-c network to completely





**All in one.** MOS encoding circuit replaces multitude of discrete components.

eliminate bounce. All three techniques are costly.

But in spite of the bounce problem manufacturers like George Risk Industries of Columbus, Neb., KDI-Navcor Inc. of Norristown, Pa., and Killian Engineering of Braintree, Mass., stick with reed switches. The newer, more exotic keyboards just don't make it, asserts Killian's marketing manager, William Bixby. "Keyboards incorporating oscillators such as proximity pickups, transducers, capacitive-coupled and magneto-resistive boards, are subject to frequency drift, while the more esoteric types such as the Hall-effect keyboard, require expensive tooling

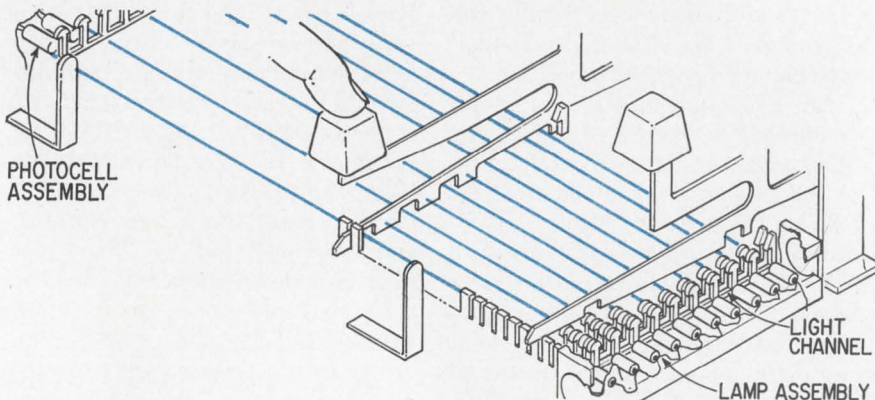

**Beaming in.** Depressing the key allows only light beams predetermined by the "shuttered" keylever to pass, thereby forming the correct code.

and IC manufacture leading to the development of new technologies at the user's expense," he says.

Another approach to the electro-mechanical switch is taken by Synergistics Inc. of East Natick, Mass. The basic element of its modular keyboard is a three-part keyswitch consisting of a key, key strip, and terminal strip. The key assembly, the guts of the Synergistics keyboard, is capable of producing a 9-bit code using preset pins and a mechanical switch. A code mask is provided in the form of a plastic material to allow contact with only selected pins. The code contact comprises a stamped spring metal plate with 10 contact arms to join with the unmasked pins when the key is depressed. The key strip is a flat plastic wire with 10 conductors into which the key assembly pins are embedded to contact with the wire conductors. The pins form the contact point for the code contacts of the key assembly. The plastic terminal strip contains 10 conducting wires; the wires contact each key strip to form a given keyboard configuration.

The Synergistics keyboard is the least expensive unit on the market. The company says it keeps the price down because no printed-circuit boards are needed; there are no switch placement changes, only pin layout alterations, and there's no tooling necessary for any number of rows. Yet the reliability claimed—over 10 million keystrokes—compares with similar claims made by other manufacturers.

Another keying approach—taken by Mechanical Enterprises of Alexandria, Va., in its Mercutronic Coding Keyboard makes use of a

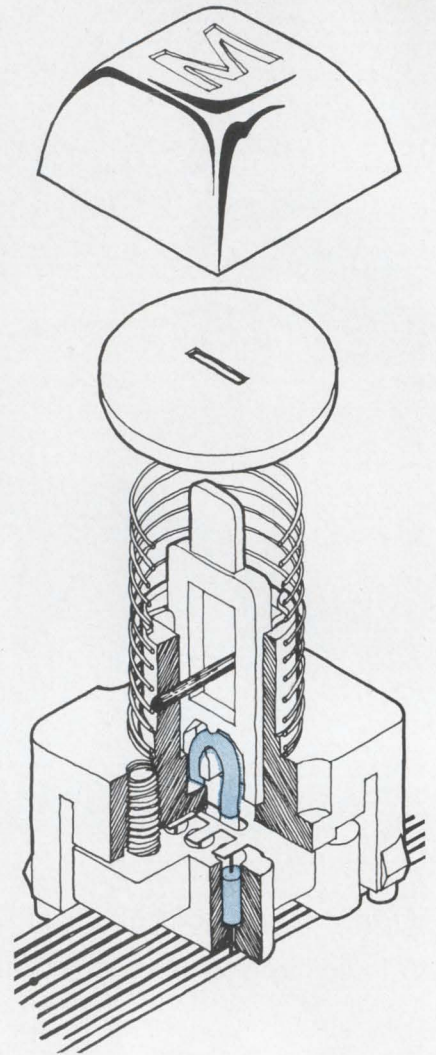

**Squeeze play.** When pinch is removed, mercury flows in tube (inverted u) and circuit is formed with diode (cylinder).

mercury movement in a sealed, flexible tube that is pinched in a normally closed position. When the key is depressed, the pinching action on the tube is relieved and an electrical circuit is formed. The key module itself is snapped into an aluminum extrusion containing a flat 11-wire cable. Diode encoding circuits are located in the key module and make permanent contact with the wires; the number of diodes in the key module determine the code for that particular key.

"This mechanical approach to the solution of an electronic problem has yielded a reliability of better than 3 million keystrokes", says Ted Watts, marketing manager of ME, adding that "There have been no life measurements on the ability of the natural rubber tube to withstand the corrosive properties of the mercury. A new silicate compound



## Who's offering what and at how much

Company	Keying Mech.	Logic	Max. Bits Per Key	Quantity Price	In Lots Of	Unit Price	Keys Per Board
George Risk	reed switch	diode matrix	9	\$190	1000	\$500	73
KDI-Navcor	reed switch	diode matrix	14	\$125	1000	\$350	67
Killian	reed switch	diode matrix	8	\$150	1000	\$500*	50
Synergistics	mechanical spring loaded	diodes in key	9	\$ 50	1000	\$125	50
Mechanical Enterprises	sealed mercury movement	diodes in key	10	\$ 75	1000	\$235	50
Datanetics	diaphragm switch	diode matrix	8	\$150	500	\$350	60
Micro Switch-Honeywell	Hall effect device	DTL	8	\$100	2500	\$250	50
Ikor	capacitive coupling	TTL	12	\$140	1000	\$375	67
Transducer Systems	proximity transducer	TTL	8	\$150	5000	\$500*	67
Digitronics	photo cell	photocell & op amp	14	\$325	1000	\$650	64

\*Plus non-recurring charge

is being tested for use as the mercury holding element," he says.

**Multilayers.** A keyboard making use of multilayer diaphragm mechanical switches as the keying element is produced by Datanetics of Redondo Beach, Calif. The switch is placed above three layers of plastic: the top layer has conductors in the X-direction and the bottom layer in the Y-direction, while the middle layer has holes over the conductor intersections. When the key is depressed the conductors touch, making the circuit. The epoxy-sealed p-c board switching module has two gold contacts per key to insure circuit continuity.

"The Datanetics keyboards have been tested to 14 million keystrokes without a failure" says marketing manager Jerry Satuloff, "and can stand temperatures from -40°F to 140°F in high relative humidities.

**Hall-effect.** When keyboard manufacturers talk about the competition, the name that usually pops up first is the Micro Switch division of Honeywell Inc. of Freeport, Ill. In place of its old switch, the company employs a Hall generator on an IC chip located in the key [*Electronics*, Sept. 16, 1968, p. 169].

When the key is depressed, a magnetic field surrounds a metallic epitaxial layer on a chip of p-type silicon, whose current is perpendicular to the field. The Hall voltage, developed perpendicular to both the current and field, is in the order of microvolts. An amplifier increases this voltage to a usable level and then flips the trigger which switches the amplifier's output to the proper lines to represent the binary codes for the depressed key. E.C. Leibig, product manager at Micro Switch, says, "Since the output voltage of the Hall generator as a function of magnetic flux is linear, it is not a switch," and engineers at Micro Switch claim there's really no yardstick for life in number of keystrokes; however they have been cycled more than 100 million times without failures.

**Jury-rigging.** Micro Switch has been receiving some bad publicity recently as a result of keyboard failures [*Electronics*, Oct. 13, p. 35] due to temperature instability of the Hall-effect device and poor workmanship. But Leibig blames improper supply voltage and jury-rigged circuit boards by one customer. However, the consensus

## or...you can use platinum

and avoid the headaches

Specify products made of platinum for those tough jobs other materials can't do. Platinum products—sheet, tape, foil, wire, tubing, gauze, discs, cathodes, electrodes, crucibles, others—offer properties unobtainable elsewhere. They withstand temperatures to 3200° F, will not erode or corrode, are catalytically active, and chemically inert. And, platinum can be recovered and reused, time and again. For details, contact . . .

# MBI

**MATTHEY BISHOP, INC.**

MECHANICAL DIVISION  
Platinum Mechanical Department  
MALVERN, PENNSYLVANIA 19355  
A Johnson Matthey Affiliate



throughout the industry is that the Hall-effect keyboards do not live up to all the hoopla that preceded them. In fact, several large computer console manufacturers, including Honeywell's computer division, are sticking with the older Micro Switch reed keyboard.

Ikor Inc. of Burlington, Mass., is pinning its hopes on a solid state keyboard using capacitive coupling to perform the keying operation. "We aren't going to exotic techniques, but are using proven ones that offer simplicity and reliability; after all, the capacitor has been known since Ben Franklin flew his kite," says Polley. Each key is made of two metal plates, each with a specific hole pattern of from one to seven holes, producing a key with a 12-bit code capability. When the key is depressed, the plates lower into a space between a transmit bar (tied to a 50-kilohertz oscillator) and a receive bar (feeding into an operational amplifier), allowing the 50-khz signal to be capacitively coupled. The amplified a-c signal is sent to logic circuitry when the signal strength is at maximum.

"Since the keyboards don't use switches, reliability is measured as mean-time-between-failures (MTBF) and is in excess of 30,000 hours," Polley says. Manufacturers differ on standards for reliability in quoting either key cycles or MTBF, but both methods have flaws. The key cycle standard overlooks the fact that the keyboard is only as good as the most frequently used key; on the other hand, MTBF includes terminal-on time but not in-use time. The user is largely on his own determining which method is best.

**A-c excitable.** An a-c excited electromagnetic proximity transducer is the keying mechanism nucleus in a new electronic keyboard manufactured by Transducer Systems Inc. of Willow Grove, Pa. The proximity transducer, excited with a specific voltage at a particular carrier frequency, produces an output signal which is a function only of the item or material being detected and is independent of the movement speed of that item. The output response of the transducer can be improved by decreasing the air gap between transducer and detecting element. Since the keying transducers are a-c excited, a 5-khz oscillator is an integral part of the

# We have the instruments for your next recording session.



VR 3360



VR 5000



CEC 5-126



CEC 5-124



VR 3700



VR 3400

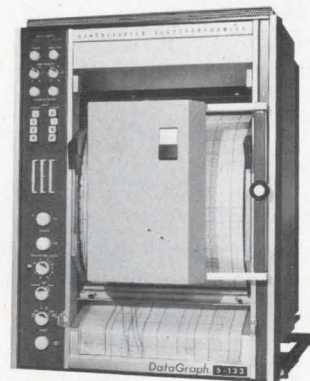

CEC 5-133



### **Magnetic tape instrumentation recorders that . . .**

cover the scale of all industrial, aerospace and military requirements.

There's the *VR 3360* — the most flexible and rugged of all portable recorders.

The *VR 3400* — performance leader of the mid-band group.

The *VR 3700* — first 2.0 MHz laboratory recorder to combine versatility and reliability at a budget price.

And the *VR 5000* — first 2.0 MHz recorder with  $\pm 400$  nanoseconds TBE and flutter correction beyond 300 Hz.

Other tangible advantages include Bell & Howell's longer lasting, high performance heads. A complete range of accessories. Sixty full-time service engineers for on-the-spot assistance anywhere in the nation. And the fact that all instruments are immediately available from a single source.

### **When it comes to light beam oscillographs . . .**

here are the three so many are coming to.

The *CEC 5-124* — for big graph capability in a portable, low-cost package.

The *CEC 5-126* — the only graph that delivers all the basic advantages of a light beam oscillograph at a cost competitive to direct writing recorders.

And the *CEC 5-133* — the first graph to combine the versatility of two instruments in one. Two data setups can be made at one time and recorded simultaneously, or be made alternately and recorded sequentially utilizing full chart width for each.

If you require more convincing, consider that Bell & Howell has the *only* oscillographs with high impedance galvos. Thus eliminating the need for preamps and driver amps. And significantly reducing panel space, weight, component cost, galvo repairs and setup time.

Accessories, papers and chemicals? Just name it.

For the full story, call our nearest office. Or write Bell & Howell, Pasadena, California 91109. Bulletin Kit 3324-X3. You might also be interested in a copy of our brochure of current training courses for engineers and technicians.

**CEC/DATA INSTRUMENTS DIVISION**

 **BELL & HOWELL**

keyboard. Even though it employs a contactless switch, TSI chooses to quote reliability in terms of key depressions—more than 200 million without a failure, it claims.

**'Shuttered.'** The interruption of a collimated beam of light is the keying mechanism method used by Digitronics of Albertson, N.Y., in its photocell keyboards. The board, available in either a 10- or 14-bit version, consists of a row of miniature light bulbs on one side of the keyboard and a corresponding row of photocells on the other. Each keylever is notched, or "shuttered," on the underside in a pattern to determine the number of light beams to be passed by that key. Depression of a particular key will interrupt specific light beams, thereby yielding its binary code. Electrical characteristics of the photocells change from 3,000 ohms in the "light" condition to 200,000 ohms in the "dark" state; the photocell output goes directly to an operational amplifier to produce a logic output at the required voltage level.

The lamps used to produce the light beams are connected in series, so a failure of one lamp will produce an easily sensed condition—all lights out. "The MTBF for the lamps is greater than 20,000 hours," says Kenneth Whitehouse, special projects manager at Digitronics. "However we are investigating the use of single, operator-removable light sources in conjunction with fiber optics. This will allow the operator to replace a light failure without waiting for the service man," adds Whitehouse.

On the other side of the coin the Digitronics keyboard requires more power than others—2.2 volts d-c at 350 milliamps for each lamp and 60 volts d-c with power dissipation up to 50 milliwatts at 25°C, derating to zero at 75°C for the photocells. The 14-bit keyboard with data strobe and mechanical interlock requires 30.8 volts d-c at 350 ma to power the logic circuitry.

Keyboard logic ranges from diode matrices to the new metal oxide semiconductor encoding packages. Included in present keyboard logic packs are diode-transistor logic (DTL), transistor-transistor logic (TTL), photocells, and diodes mounted directly in the key module.

Several reed switch keyboard manufacturers consider diode





# this is Simpson's 2700 digital system...

*New - Fast warm-up\**

- **4½ digits**
- **0.05% accuracy**
- **5 plug-in function modules**

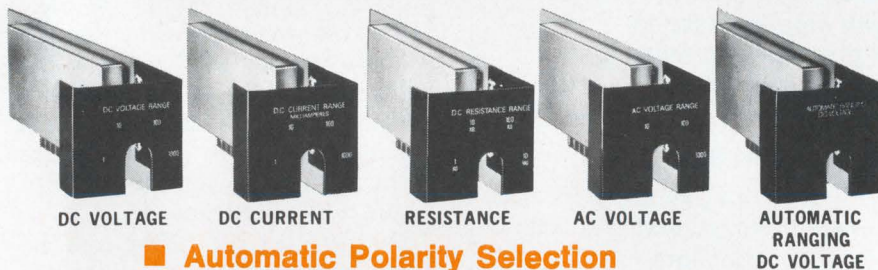

- **Automatic Polarity Selection**
- **Built-in Self Calibration**
- **100 Microvolt Resolution**
- **Optional BCD output**
- **IC Modular Design for reliability**

\*Just 1 minute for 0.1% accuracy. 5 minutes for 0.05%.

**2700 DIGITAL SYSTEM \$615<sup>00</sup>**  
complete with DC voltage range module, test leads, and operator's manual

AVAILABLE "OFF-THE-SHELF" AT ELECTRONIC DISTRIBUTORS STOCKING SIMPSON INSTRUMENTATION PRODUCTS.

**Simpson** ELECTRIC COMPANY



5200 W. Kinzie Street, Chicago, Illinois 60644 • Phone (312) 379-1121  
Export Dept: 400 W. Madison Street, Chicago, Illinois 60606. Cable Simelco  
IN CANADA: Bach-Simpson Ltd., London, Ontario • IN INDIA: Ruttonsha-Simpson Private Ltd., International House, Bombay-Agra Road, Vikhroli, Bombay

matrices the best approach to low cost and high reliability. Micro Switch does not share this point of view: its older reed switch keyboard and its Hall-effect unit utilize DTL encoding to provide the required speed at reasonable cost. However, to provide higher reliability at lower cost, they are introducing a new keyboard featuring an MOS encoding circuit enabling the operator to generate up to four levels of code from the same key. The keying mechanism still will make use of the Hall-effect device used previously. MOS will reduce the number of discrete components in the DTL pack significantly—the actual number of components replaced by MOS package exceeds 100. And fewer components means fewer solder joints, and increased logic reliability. Micro Switch is counting on Texas Instruments, producers of the MOS circuit, for the dual in-line encoding pack to be used in their new keyboards.

The new MOS encoded keyboard will go into production in 1970 and is expected to be available in volume quantities by 1971. The new keyboard, in a 50-key array, will be demonstrated for the first time this month at the Fall Joint Computer Conference in Las Vegas.

**Faster logic.** The TTL pack offers speed at an increase in cost. But the cost/volume ratio decreases as the size of the order increases, offering the big-volume user a faster logic circuit at a decreasing premium. Ikor and TSI use TTL packs to perform the encoding function in their solid state keyboards.

Finally, the photocell encoding is done without the use of diodes or special encoding packs such as DTL and TTL. Photocell output is raised to the desired level by an operational amplifier, with the binary code formed by selection of the desired photocell outputs. The photocell offers simplicity at a sacrifice in speed.

Although the keyboard manufacturers note that savings increase with large orders, the newness of most of the manufacturing companies limits high-volume production capabilities, which vary from 200 to 1,000 units per month. However, most firms, seeing which way the wind is blowing, are beginning to tool up for the anticipated large orders of the early 1970's.



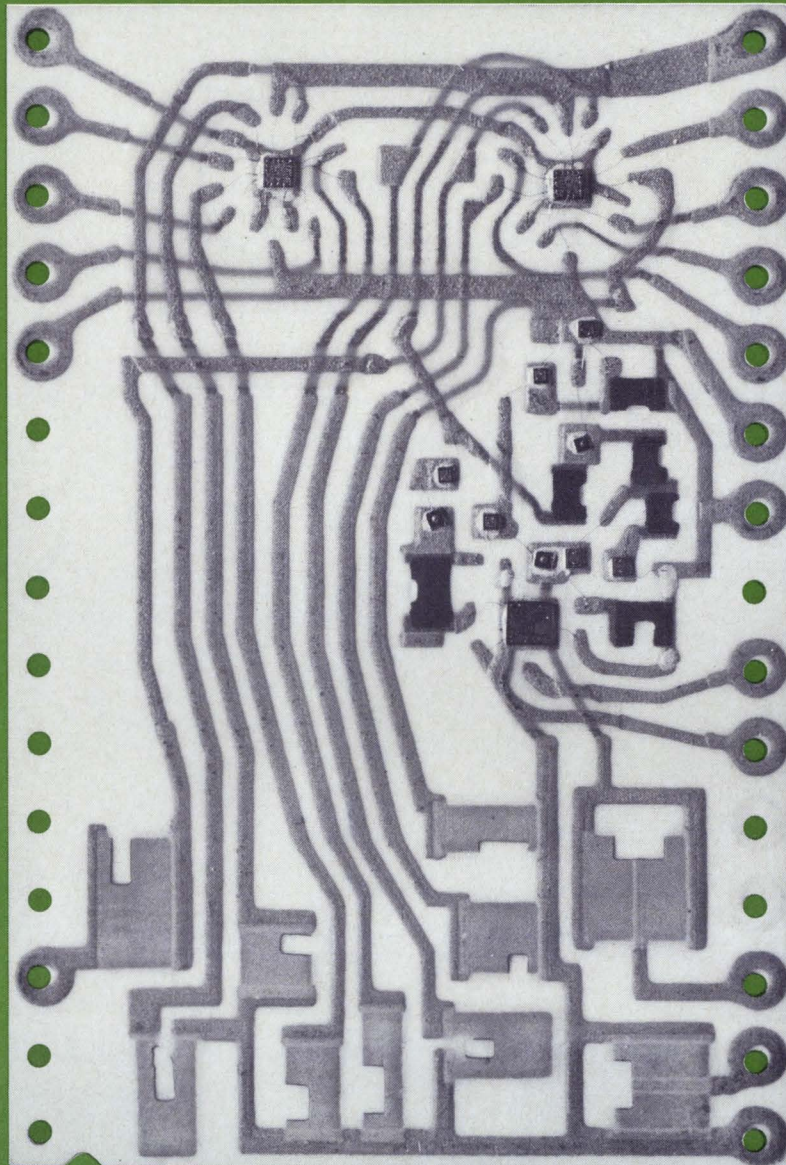

X Actual Size.

## A complete 8-bit Digital-to-Analog Converter for \$75!

The new Helipot Model 845 is a thick-film, miniaturized hybrid digital-to-analog converter (DAC) that converts an 8-bit binary word into an analog output. The input gates, switches, resistor network, reference voltage, and output amplifier are all in the hybrid module.

Because of its operating temperature range ( $-20^{\circ}\text{C}$  to  $+85^{\circ}\text{C}$ ), Model 845 can be used for any industrial digital-to-analog conversion, process control being a typical application. Price is \$75/unit in 1-9

quantities (less in greater numbers). The package size is 1.0 inch x 1.5 inches x 0.170 inch. The unit accepts an 8-bit, parallel, binary word that is TTL- and DTL-compatible, and an enable gate is provided. Four different output-voltage ranges are available as standard models: two unipolar (0 to +5 v, 0 to +10 v) and two bipolar ( $-5$  to +5 v,  $-10$  to +10 v). Power-supply requirements are +15 v at 60 ma and  $-15$  v at 10 ma. The output accuracy is  $\pm 1/2$  least-significant bit at  $25^{\circ}\text{C} \pm 1$  mv

per percent of supply-voltage variation. The output-current range is 0 to  $\pm 2.5$  ma, and the output slew rate is  $0.3$  v/ $\mu\text{sec}$ .

And, it's available from stock.

**Beckman**<sup>®</sup>

INSTRUMENTS, INC.

HELIPOT DIVISION

2500 HARBOR BOULEVARD

FULLERTON, CALIFORNIA 92634

INTERNATIONAL SUBSIDIARIES: AMSTERDAM; CAPE TOWN; GENEVA; GLENROTHES, SCOTLAND; LONDON; MEXICO CITY; MUNICH; PARIS; STOCKHOLM; TOKYO; VIENNA

Circle 151 on reader service card



# Solid State Relays

Another big breakthrough from the "little relay" people

Little Relay



TO-5 Relay

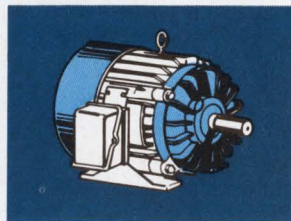
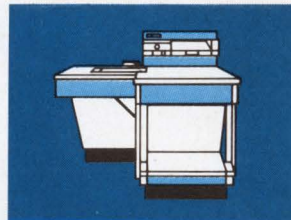
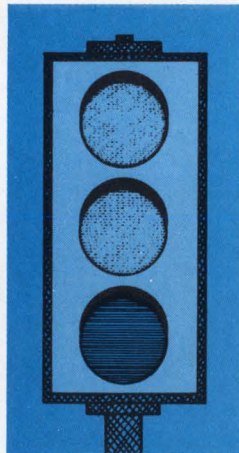

Big Breakthrough

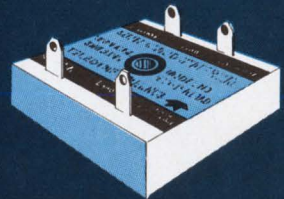

Solid State Relay

We got our nickname "little relay" people because we usually put our *big* breakthroughs in *small* packages. (Our success started when we introduced the TO-5 relay.) Now, we've made another breakthrough . . . a completely solid state, four terminal relay with enormous power gain. Only 1 milliwatt switches up to 5 KVA, and it can be resistive, inductive, capacitive, tungsten or quartz lamp loads.

Our new relay operates on inputs up to 280 VAC or from

3.5 to 300 VDC (either polarity) permitting direct interface with TTL logic. Input-output isolation is  $10^{11}$  ohms "coil" to "contact" and "coil" to mounting plate. Dielectric is 2000 VRMS. Output characteristics include contact ratings up to 21 amperes, 280 VAC, 60 Hz. Surge current ratings of 200 amperes, and "contact" resistance as low as 50 milliohms. And, . . . these are real *breakthroughs* for a relay which doesn't have "coil" or "contacts."

Available options include zero

voltage switching for RFI suppression and lamp life extension.

Prices start as low as \$18.30 in quantities of 100. For complete technical data on our Series 6 Solid State Relay . . . contact us . . . the "little relay" people.



**TELEDYNE RELAYS**  
A TELEDYNE COMPANY

3155 West El Segundo Boulevard Hawthorne, California  
90250 Telephone: (213) 679-2205



# Worldwide system or backup —which role will Omega play?

Some advocates feel the low-frequency concept will fill most navigation needs for the next two decades; others see it augmenting present-day techniques

By Ralph Selph

*Electronics staff*

**Nurtured by more** than \$30 million in Navy research and development funds since the mid-1950's, the Omega navigation system is coming to fruition at a time when the significance of its role is under close scrutiny by military planners and electronics firms alike. Some proponents of the system regard it primarily as a means of augmenting doppler and inertial units; other backers of the very-low frequency Omega concept see it as a relatively inexpensive interim worldwide system that can meet most navigation needs over the next 10 to 20 years until a truly global satellite system is a reality.

The military users of the system—both shipboard and airborne—want to know they're buying advantages over other navigation techniques—Loran, for example, or at least that they're getting a system that can augment the accuracy of airborne doppler and inertial navigation systems. Some potential commercial users of the system, such as Continental Airlines, want to find out if an airborne Omega receiver/computer can refine the accuracy of their inertial navigation systems [*Electronics*, July 21, p. 33], and allow them to cut costs by installing fewer inertial units.

In Omega, position is fixed by measuring the phase difference of signals from three stations. Since the signals always intersect at a relative phase angle of 0° at eight-mile intervals, it can be determined how far a ship has traveled from the last wave intersection.

Michael Turney, who is the

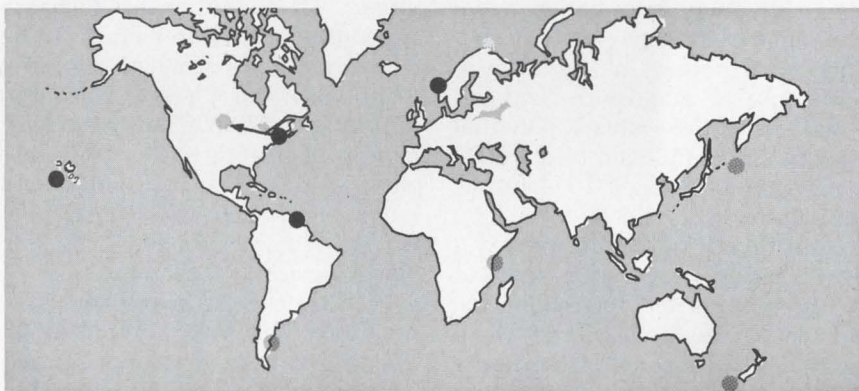

**Global coverage.** Worldwide navigation will be provided using only eight Omega stations. Presently, there are four operating stations located in Norway, Trinidad, Hawaii, and New York. Ultimately the N.Y. station will be moved to Minnesota, and four additional stations located in southern South America, the South Pacific, the Far East, and in the Indian Ocean. These locations insure that a ship or aircraft will always be within the range of at least three stations.

Omega project manager at Northrop Corp.'s electronic division, has strong views on Omega's future. But then his firm is prime contractor to the Navy for 140 shipboard Omega receivers and is also developing the first four airborne units for the Naval Air Systems Command under a \$1.6-million contract. Says Turney, "Today you'd have to consider Omega a backup system. But when all of the eight transmitters become operational in 1972, I think it will be the prime navigator, with inertial as a backup." Turney believes the only system likely to supplant Omega is a navigation satellite system with 100% global coverage, such as the tri-service 621B Navsat program, which has

run into many uncertainties.

"That kind of coverage involves a lot of money, and I just don't see it on the horizon," Turney asserts. A Navy study estimates the total Omega shipboard market at 20,000 units over the next 20 years; Northrop feels the airborne market will be 15,000 units between 1971 and 1980.

A number of U.S. firms either are producing Omega receivers or doing research and development on the system. ITT's Defense/Space Group Avionics division was early into the field, producing its first receiver for the Navy nine years ago. The company has a contract for 24 AN/SRN-14 shipboard and AN/BRN-4 submarine receivers. Lear Siegler's instrument di-



vision also has done development work for the Navy and Coast Guard, and is working on a low-cost airborne/receiver/computer that would sell for \$15,000 to \$20,000. Tracor Inc., a Texas firm, has delivered 50 shipboard sets to the Navy under a \$500,000 contract, and also is competing in the low-cost commercial shipboard receiver market.

The Navy is expected to invite proposals for 800 additional shipboard receivers soon, and also will ask for bids on 500 airborne receivers, both under three-year buys. Navy officials look for refitting of their aircraft for Omega to begin in fiscal 1971; shipboard installations are already underway.

Although several hundred shipboard receivers have been obtaining navigation information from four makeshift, low-power transmitters operating in the 10.2-to-13.6-kilohertz range since last year, a real test of the system's potential must await completion of a worldwide network of eight 150-kilowatt stations in 1972.

**Looking up.** With shipboard systems already in operation, most of the attention is now focused on the airborne system. The first of a year-long series of crucial airborne Omega flight tests in military and commercial aircraft began recently when a Navy P3A Orion lifted off from Los Angeles International Airport. Aboard was the first of four AN/ARN-99 airborne navigation units produced for the Navy by Northrop. The second unit is being prepared for six months' environmental acceptance testing at Northrop's Hawthorne, Calif. plant. The other two units, to be completed in March, will be flown in a P3C Orion and other subsonic Navy aircraft. These two units will include only receivers and buffers, using the Orion's onboard Sperry Univac computer.

Flight tests are being conducted over the next several months by Continental Airlines over its Pacific routes, using a Boeing 707. Beginning in mid-March, the Federal Aviation Administration will test the system for 2½ months in a Convair 880.

One airborne unit will be installed in a submarine, the USS Lapon, for testing with a Mark 3 ship's inertial navigation system.

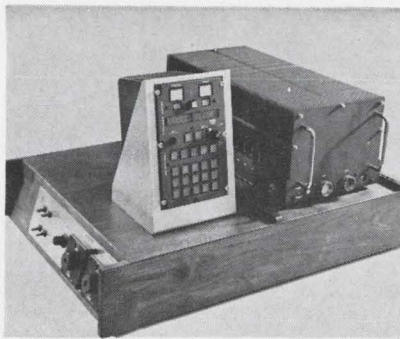

**Airborne omega.** The AN/ARN-99, designed and developed for aircraft navigation, includes a receiver/computer, control/indicator, and an antenna (not shown).

Northrop will use its own F-5 and T-38 aircraft and a corporate Gulfstream 2 for additional flight testing during the first half of 1970. The Air Force's strategic air command also will place a Northrop unit in a C-135 in January for four months of testing. SAC is also evaluating a Lear-Siegler airborne computer programed with a Mark 3 Omega receiver developed by the Naval Research Laboratory.

Finding the right antenna configuration has been a problem in airborne Omega development, according to Turney. To avoid introducing noise into the Omega system, it has been necessary to measure the skin currents on each aircraft to determine the best antenna position. Antenna design is also critical in airborne Omega because the signal strength may be as low as 1 microvolt per meter, with a ½ millimeter antenna effective height. This results in a ½ nanovolt receiver input that usually must be separated from 10 nanovolts of white, or noncoherent, noise.

**Key component.** An antenna furnished by the Navy has proven less than satisfactory, Turney indicates. "The antenna is oriented toward Loran and isn't optimized for Omega. It became apparent to me over a year ago that the key to the whole thing was the antenna," he adds. "We are still using the original antenna, but we're also building our own now and expect to test it before the year is out. The effective height is vastly better than that for the old antenna," says Turney.

Line noise from 400- and 60-cycle power used in aircraft poses a difficulty because it tends to creep into the Omega signals. The 400- and 60-cycle noise are subharmonics of 10.2 khz and 13 khz, two of the Omega frequencies. Although airborne Omega is supposed to be able to navigate for any aircraft flying at speeds up to 1,000 knots, Turney says ionized air from the skin of a high-speed aircraft may cause a signal interference problem.

**Answers by July.** "We expect to get answers to some of these questions by July of 1970, after flight tests in high-speed aircraft. We're attempting to obtain a French Mirage for some of the tests," Turney says. The French Navy has indicated an interest in Omega, and a licensing agreement with a French company might be in the cards, he says. Northrop already has a marketing agreement with a British firm, Marconi International Marine Ltd., for its low-cost Omega 1 commercial shipboard navigation receiver, is now operating aboard the Cunard Line's Queen Elizabeth 2, and the Challenge, a container cargo ship.

Whether production models of airborne Omega will end up as a stand-alone system or will be used primarily with inertial or doppler systems, still is not certain. One such hybrid being considered by Northrop for submission to the Air Force would mate a small 5 miles-per-hour accuracy inertial platform with Omega to achieve a 1-to-2 mph position accuracy. The cost for such a hybrid would be less than \$100,000, compared to \$150,000 or more for a pure inertial system of comparable accuracy, says Turney.

Commercial versions of airborne Omega will sell for much less than the \$50,000 price tag on military models, because less accuracy is required. According to Turney, most airlines will settle for an error of less than 5%, 92% of the time—enough to bring the aircraft within range of Vortac stations.

**Cause errors.** Because the vlf waves essentially use the ionosphere and the earth's surface as a waveguide, changes in the height of the ionosphere from day to night, together with variations in ground conductivity, the earth's



magnetic field, solar activity, and other factors can change the apparent speed of the signal and cause serious navigation errors.

In airborne Omega, propagation corrections are computed in Northrop's unit using the firm's NDC-1070 general-purpose, 16- or 32-bit computer, which has an 8,000-word memory. The propagation phenomena are mathematically modeled and contained in a 600-word real-time computer program. Besides the propagation model, which contains six more or less predictable parameters, the program includes a scatter model that uses redundant information obtained from the transmitted signals to optimize correction of the propagation prediction model. Omega researchers predict that within five years, better data on solar anomalies and weather conditions will permit position accuracy to within  $\frac{3}{4}$  mile during the day and  $1\frac{1}{2}$  miles at night; the best present accuracies are about one mile during daylight and two at night.

The Navy appears to be more enthusiastic about Omega than the U.S. Coast Guard. The Navy has begun replacing its Loran A shipboard receivers with Omega, and, depending on budgets, expects to have Loran A phased out by the mid-70's. Loran C equipment, however, aboard the large capital ships, will not be replaced, at least not by Omega. The Coast Guard, which has a different set of customers than the Navy, has no plans to dump either its Loran A or C equipment. The Coast Guard users, according to one source, range "from a Maine fisherman trying to find a net he snagged at the bottom to the navigator of a DC-8 in transoceanic flight."

The Coast Guard has been evaluating Omega receivers aboard five ships, but has not asked for funds to purchase any of the units. Navy sources say Omega's accuracy is equal to or better than that of Loran A, but not as good as Loran C (there is no Loran B). Coast Guard officials claim Loran A is accurate to within  $\frac{1}{4}$  mile; Navy sources say Loran A accuracy is more like 1 to 5 miles. Omega's accuracy has been pegged to less than 2 miles on the surface and to within 300 yards for the airborne version.

Other differences between Loran and Omega include base line lengths (maximum distance between stations), ground-sky wavelengths (distance signals can be used accurately), frequencies and number of transmitting stations. Loran A has a 500-mile baseline, 700-mile ground wave and a 1,500-mile sky wave. The figures for Loran C are 1,000-mile base line, 1,500-mile ground wave and a 3,500-mile sky wave. Omega, on the other hand, has a 5,000-mile baseline, ground and sky wave. The 123 present Loran stations operated by the Coast Guard, by foreign governments and by private organizations cover only about 17% of the earth's surface; Omega will be world-wide once all eight stations are on the air by 1972.

**Building costs.** Individual Omega station construction costs are higher than they are for Loran, but because fewer of them are needed, the total expenditure for the stations is less. Also, the Omega site location isn't as critical as it is for a Loran station, which means that the site can be chosen to minimize its cost, the cost of access roads, and a remote airstrip.

Between now and 1972, the U.S. share of the tab for fully implementing Omega—stations and equipment—is expected to be \$50 million. But many nations are eager to help with their share of the costs, because as a Navy spokesman puts it, "Omega is not peculiarly a military system, or even a U.S. system. It will undoubtedly be used by all seafaring and airline operating nations."

Overall accuracy will be improved when all eight stations are in use, because to get the greatest accuracy, the three best signals of five that can be heard anywhere in the world should be used to get position triangulation. Stations are now located on Oahu; at Forestport, N.Y.; Bratland, Norway; and Port of Spain, Trinidad. Four more are needed in the Pacific Ocean. Japan is the strongest contender, having done site studies and because it is already operating a monitoring station. Other locations being considered are New Zealand and Australia, Madagascar or La Reunion in the Indian Ocean, and Chile or Argentina in South America.

To control this power supply

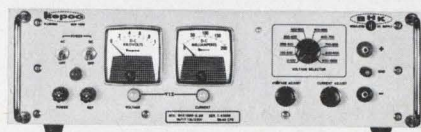

Model BHK 1000-0.2M

WITH THIS KEYBOARD

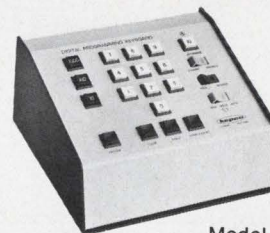

Model DPK-1

## All you need is Kepco's new DIGITAL PROGRAMMING SYSTEM

A direct digital-to-analog converter with provision for parallel or serial inputs in BCD or straight decimal form, the Kepco DP System programs any Kepco operationally programmable DC power supply from 0.000 to 1000.0 volts. The system is offered in three parts: a parallel input D/A converter, the Model DPD-1; a 4-channel serial-parallel storage register, Model DPR-1, and a manual entry keyboard, Model DPK-1. Together they are an inexpensive interface between the digital world of numerical control and the analog world of voltage control.



Model DPR-1

If you'd like our brochure  
describing the Digital Programmer,  
write Dept. BM-14



131-38 SANFORD AVE. • FLUSHING, N.Y. 11352  
(212) 461-7000 • TWX #710-582-2631







# 21 months ago, this was American Data Systems. Today, it's 200 strong.

## TI Supply supplied the supplies.

Here, behind company president Arthur Wilkes, is where American Data Systems got its start.

Not too impressive, perhaps, but the products that came out were. Demand for the company's data transmission terminals has been so great that the staff has grown from 6 to 200 employees in less than two years. And American Data Systems is moving into a modern 100,000 sq. ft. plant.

TI Supply—a new breed of industrial distributor—played a key role in this meteoric growth

...with engineering assistance in matching electronic components to a product that's pushing the state of the art.

...with balanced inventories and scheduled deliveries to keep production lines running without ADS tying up a large amount of money.

...with overnight delivery of special TTL integrated circuit orders from far-away stocks.

We've supplied American Data Sys-

tems with connectors, resistors, capacitors, integrated circuits, wire, and cable.

Plus lots of personalized service.

But these aren't the only ways we serve our customers.

You might want to use our assembly and custom-marking services, tailoring products to your specific requirements.

Or our testing service to screen devices to specific electrical parameters.

Many of our customers needing high-reliability semiconductors couldn't do without our "burn-in" services.

But above all, we are dedicated to helping your business grow. We have thirty-nine world-wide locations, any one of which is ready to serve you now.

Maybe your problems are not the same as those of American Data Systems, but if they involve electronic components, industrial supplies or services, there's a good chance we can come up with right solutions.

Give us a call.

### Join the trend to TTL

American Data Systems specified Series 54/74 TTL integrated circuits for their system. It's the overwhelming logic choice for new equipment designs. And TI's Series 54/74 family offers you more than 90 distinct functions—including 35 MSI circuits—with 3 compatible speeds and 3 package choices.

For service on Series 54/74 integrated circuits, your best choice is TI Supply. We have in-depth stocks on all devices at our 39 world-wide locations, a wide selection of technical literature, cross-reference information and experienced applications assistance. Call your local TI Supply branch office now and watch us go to work on your IC problems or simply write TI Supply Co., P.O. Box 35486, Dallas, Texas. 75235



## TI SUPPLY... the problem solvers.

#### EAST COAST

Boston (Canton), Mass. (617) 828-5020  
Clark, New Jersey (201) 382-6400  
Lake Success, L.I., New York (516) 488-3300  
New York, New York (212) 895-0803

#### MIDWEST

Tulsa, Oklahoma (918) 437-4555  
Kansas City, Missouri (816) 753-4750  
St. Louis, Mo. (314) 867-5700  
Minneapolis (Edina), Minn. (612) 941-5020  
Chicago (Rosemont), Ill. (312) 296-7187  
Wichita (Derby), Kansas (316) 788-1714

#### SOUTHWEST

Austin, Texas (512) 454-2531  
Dallas, Texas (214) 357-6121  
Fort Worth, Texas (817) 332-9361  
Houston, Texas (713) 785-4800

#### WEST

Santa Monica, California (213) 393-6731  
Los Angeles, California (213) 870-0261  
Denver, Colorado (303) 757-7671  
San Francisco (Sunnyvale), Calif. (408) 732-5555

#### CANADA

Montreal (St. Laurent), P.Q. (514) 332-3550  
Toronto (Richmond Hill), P.O. (416) 889-0844



# Unplug the computer

MONTHLY INVENTORY											
TAG	AC	COST	ACQ. DATE	COST	CODE	MANUFACTURER	INV. CATEGORY	DESCRIPTION	WDDL	SFRAL	AP NO
C7312	29	201	03-64	83.17	2	COLUMBIA	TEST CHAMBER	CABINET	00154L		10503
C7313	24	134	05-54	2,445.30	2	TEHNEY	LUMINITE	TIME	100350		90502
C7314	24	139	05-54	25.65	2		CHAIR	ELECTRONIC	L-212		90509
C7315	29	101	11-61	58.20	2	BALLANTINE	VOLTMETER	IMPEDANCE TEST JIG	00300H	00001121	90501
C7316	24	139	03-64	290.00	2	GEN RADIO	GEN RADIA	BRIDGE	016504		90501
C7317	24	139	03-64	495.00	2	FLUXE	BERKELEY	OSCILLATOR	01311A		90501
C7318	24	139	03-64	190.00	2	CONTINENTAL	UNIVERSAL	CABINET	00003P	0000126A	90501
C7319	29	010	09-53	50.99	2	KEANEY	ODALL	FILE GRAY	05230R	00000947	90501
C7321	26	140	03-64	701.05	2	SELLER		DIFFERENTIAL			90501
C7322	26	140	04-64	1,637.50	1			MODIFICATION	000100	00021137	10501
C7323	29	181	03-64	1,207.48	1			SEE C5500 YEAR 1954	000151	00005103	10006
C7324	24	141	03-64	1,491.00	1			SEE C5900 YEAR 1953	00721A	00014X10	30403
C7325	26	143	05-64	738.79	2			CANTOUR MATT			90501
C7326	24	141	03-64	10,016.98	1						90501
C7327	26	175	12-63	123.20	1						90501
C7328	26	140	01-64	1,047.00	1						90501
C7329	29	230	01-64	1,810.00	1						90501
C7330	29	230	01-64	890.00	1						90501
C7331	29	230	01-64	181.00	1						90501
C7332	29	230	04-64	595.00	1						90501
C7333	29	207	03-64	415.01	2						90501
C7334	29	207	03-64	143.90	2						90501
C7335	29	207	03-64	143.90	2						90501
C7336	24	179	04-64	143.90	2						90501
C7337	29	302	04-64	143.90	2						90501
C7338	29	302	04-64	143.90	2						90501
C7339	29	302	04-64	143.90	2						90501
C7340	29	302	04-64	143.90	2						90501
C7341	24	301	04-64	143.90	2						90501
C7342	24	301	04-64	143.90	2						90501
C7343	24	301	04-64	143.90	2						90501
C7344	24	301	04-64	143.90	2						90501
C7345	24	301	04-64	143.90	2						90501
C7346	29	101	01-64	205.53	2						90501
C7347	29	101	01-64	402.23	2						90501
C7348	29	101	01-64	48.29	2						90501
C7349	24	139	12-63	930.00	2						90501
C7350	29	200	12-63	447.63	2						90501
C7351	29	201	12-63	.00	2						90501
C7352	29	201	12-63	77.07	2						90501
C7353	29	067	01-61	77.66	2						90501

03/13/60-PRINTFL-PRINTA

In the time it takes a line printer to pound out one oversize page of printout...







# Want a reliable, inexpensive solution to your DC amplifier problems?

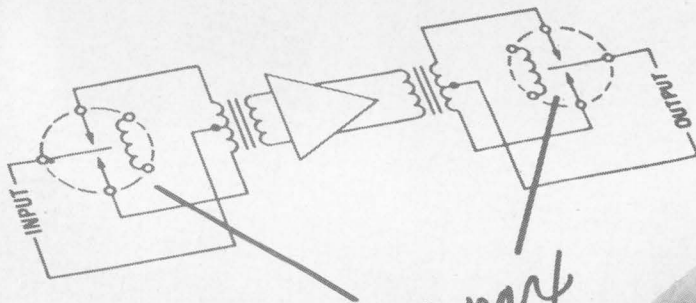

*Airpax*

## Design in an Airpax Chopper.

There is an Airpax chopper for every DC amplifier application. We make electromechanical choppers, photo-electric choppers, transistor choppers. In fact, we've just introduced an all-new MOS FET chopper with performance that's hard to believe!

- Airpax choppers are available in many configurations. You can have plug-in, solder-in, bolt-in or clamp-in models, ranging from nine-pin miniatures to TO-99 transistor packages. We can deliver SPDT or DPDT break-before-make or make-before-break. You specify it, we have it!
- Just call an Airpax representative and tell him your problem. He'll help you select the very best Airpax chopper for your needs . . . quickly.

**AIRPAX ELECTRONICS** Cambridge Division  
Phone: (301) 228-4600, Telex: 8-7715  
TWX: (710) 865-9665, Cambridge, Maryland 21613



# Self-cycling display is processor too

Versatile system aimed at builders of time-sharing equipment  
has basic price of \$6,545; will bow at Fall Joint Computer Conference

**Some users** of time-sharing terminals still gripe about having to employ the main computer's core memory to refresh their cathode-ray tube display, using memory space and mainframe time as well as transmission channels. For several years, firms have used devices ranging from delay lines to storage tubes at the terminals to get around this problem.

But the Imlac Corporation has another idea. Rather than using mainframe core for display refreshment, Imlac's new PDS-1 display system—to be shown at the Fall Joint Computer Conference, Nov. 18-20, in Las Vegas—uses a built-in 16-bit processor and refreshes its 14-inch alphanumeric and/or graphic display out of its own core memory. And since the basic PDS-1 includes a 4,096-word stack, and needs only 2,048 words for vector storage, there's still half the memory left for such routines as editing, formatting, verification, and standard processing.

The \$6,545 price quoted to original equipment manufacturers is well below that of many crt consoles that display only alphanumerics and have no built-in processor. Besides price, says Imlac's vice president, John M. Colburn Jr., the firm's sales pitch will be keyed to versatility. "One of our first units went to Columbia University," he says, "and the user is happy to find that he isn't a slave to the English alphabet. Through simple reprogramming, he now gets a Hebrew display." And if he wanted it, he could program for Greek, Cyrillic, or cuneiform—the PDS-1's characters all are generated through software routines.

Not only is it compatible with the alphabet of choice, but the PDS-1 interfaces with any transmission line and has a data transfer capability of up to 9,600 bauds.

The PDS-1 "just hangs on the

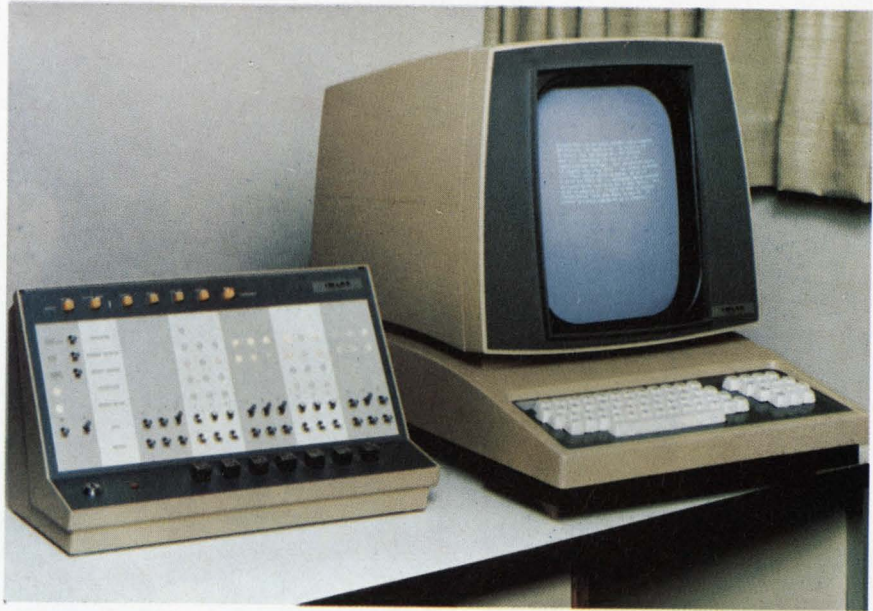

**Companion.** To use the computer capabilities of the PDS-1 to best advantage, a separate control console, shown at left, is required.

end of any voice grade (or better) phone line," he says; "no re-engineering of an existing system is needed to add or substitute a PDS-1, neither is added core, nor increased transmission cost."

He calls the PDS-1 the "great impostor" because it can replace "any and all on-line communications terminals—even teletypewriter installations using five-level ASCII code." He adds that the PDS-1 may be the only crt display to take the five-level ASCII character code: "While the trend is to eight-level ASCII transmission, the vast majority of teletypewriter terminals still use five-level coding."

"Interstate costs for eight-level quality conditioned lines can run to twice the price of a line good enough for five-level transmission," he says.

At \$6,545 in lots of 50 or more, the PDS-1 seems like a lot of hardware per dollar. James E. Cunningham, chief systems engineer and chairman of Imlac's board, is per-

haps most responsible for this. "We had to design a processor which could work without a display bias, and yet control a display as well. So we used a central processor unit—and a peripheral display processor which accesses memory through the CPU on a cycle-stealing basis. Also, we wanted the machine to be easily programmed, but couldn't see spending large amounts on hardware registers—but we do have eight autoindex registers realized in core and a general-purpose register in hardware at a significant saving in logic costs."

**Saving a bit.** Imlac also pays less for memory by buying only core stacks and diodes, then assembling the circuits it needs around the stack. Cunningham feels the modular memories now available often use logic inefficiently—to help the maker easily test the module rather than to aid the end user.

"We also avoided hardware multiply-and-divide features," says



# The Standard of Excellence

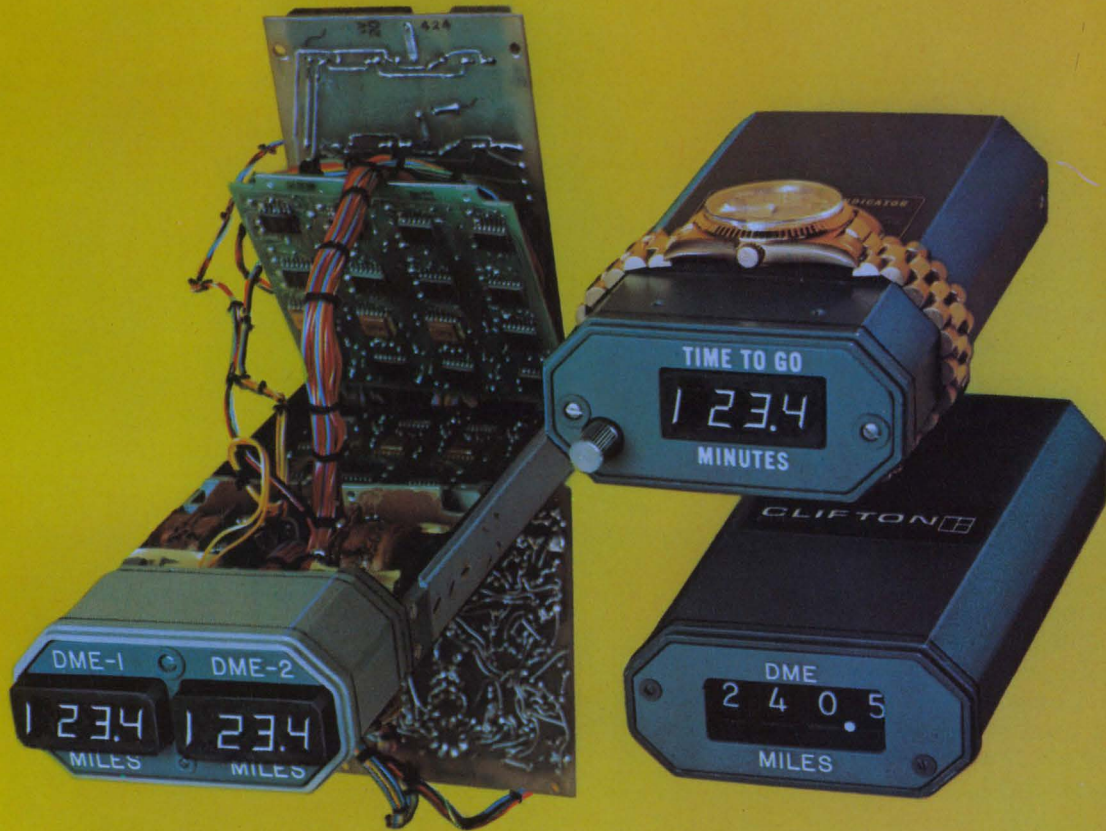

## Digital Indicators by Clifton

In the Clifton family of ARINC type, solid state, Time-To-Go, INS and DME indicators, we are proud to have anticipated and produced advanced cockpit hardware for the new generation of commercial transports.

Important design advances in the areas of fault monitoring and detect circuitry plus central dimming capabilities are incorporated into the basic design.

In operation, each indicator recognizes the address of a specific function pa-

rameter, decodes the serial BCD data, and provides a digital display of the information. Each basic indicator in the family has the capability of being converted to any other indicator format by simply changing a lightplate and programmable connector. Seven segment lamp or magnetic wheel readouts are available for most designs.

Two basic display families, a 4 Digit and Dual 4 Digit configuration, are included in the INS and DME indicator product line. Sim-

ilar indicators are available for AIR DATA applications. A variety of indicator readout configurations meet all INS, DME or AIR DATA indicator requirements.

You can obtain full information on this advanced line of indicators which is available and now flying by calling your Local Clifton Sales Office or area 215 622-1000; TWX 510 669-8217.

**CLIFTON**   
DIVISION OF LITTON INDUSTRIES

Chronometer and Band from J. E. Caldwell Co., Philadelphia—\$1200.



Cunningham. "The PDS-1 is largely aimed at applications where arithmetic speed isn't a priority. It does math in software instead.

"Finally, a 16-bit word gave a good combination of instruction set length, handy page size, and the economy of widely available 8- and 16-bit oriented hardware," he notes.

Specifications for the PDS-1's built-in processor include: a 2-microsecond cycle time; optional memory protection; input-output word rate of 500 kilohertz; optional direct memory access; single level priority interrupt; optional real time clock, and optional restart.

Medium-scale integration is used wherever practical, and more will be added as it becomes deliverable. Metal oxide semiconductor devices also are on Cunningham's purchase list, and PDS-1's architecture is designed to absorb such differing and developing logic without major production-line changes. Meanwhile, Cunningham conducts a continuing re-evaluation of available logic, seeking the next lower price level for a given amount of performance.

**Words and pictures.** Cunningham felt that a graphic capability would be necessary in Imlac's market area—and more so in time—but didn't like the combined cost of character and graphic generators.

So he uses the machine's graphic capability to draw alphanumerics too. "It's not as inexpensive as alphanumerics alone," he says, "but it beats the price of separate generators."

Also, this approach gives the PDS-1 its variable fonts—Greek, Hebrew, and other alphabets. Instructions for writing any symbol are pulled out of core—and even the alphanumeric dot matrix size can be changed through software from its standard 7-by-9-dot format to a faster working 5-by-7 matrix, though the display loses some definition.

Cunningham adds that instead of drawing discrete dots in its alphanumeric matrix, the PDS-1's graphic character generator connects dot positions, for improved definition.

Instead of using a hardwired unit to create vector instructions, Imlac uses push-down and pull-up

**JFD**

**TINY....  
BUT—MVMs  
CAN TAKE IT!**

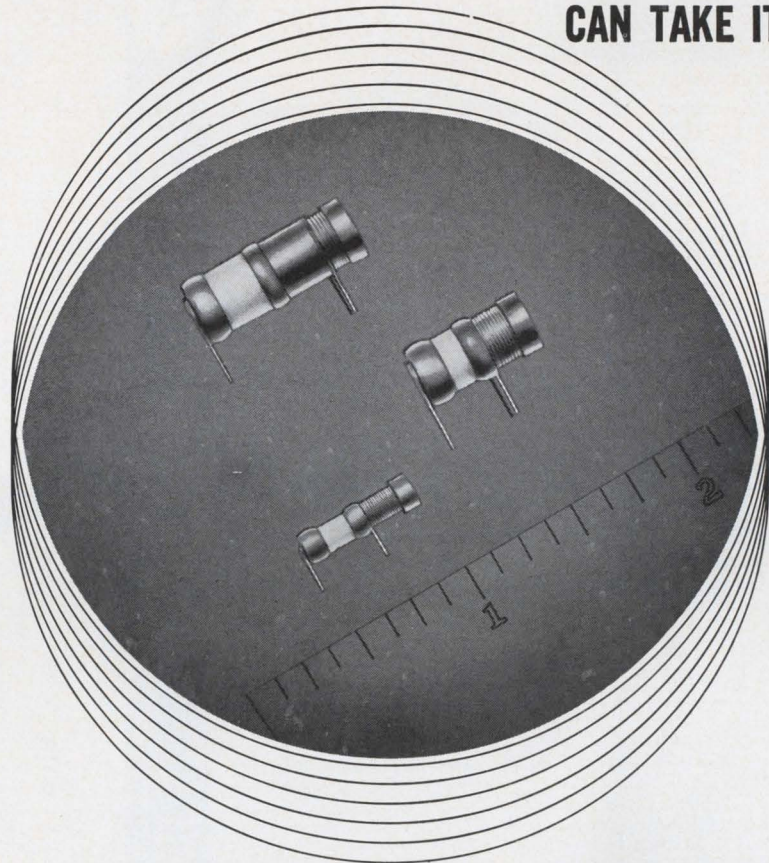

## THESE NEW HIGH Q AIR VARIABLES ARE RUGGED

JFD has developed three sizes of unusually rugged air variable capacitors. All three feature a unique internal guiding mechanism with a positive stop. The result: concentricity is constant and these capacitors can withstand conditions of extreme shock and vibration.

Further, newly developed metal biasing elements provide smoother, more constant torque during and beyond life cycling.

Other unique features of the series are:

- Engineered to withstand heat — during soldering.
- Internal air meshing shells are silver plated to provide best surface conductivity and long life.

All MVM's are completely interchangeable with competitive models.

Write for MVM catalogs.

**MVM-003** — Microminiature in size. Capacitance range is 0.35 pf to 3.5 pf. The Q factor measured at 3.5 pf and 100 MHz is 5,000. Available in 2 models.



**MVM-010** — Adjustable from 0.8 pf to 10 pf. Q greater than 3,000 measured at 10 pf and 100 MHz. Available in 4 models.

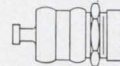

**MVM-020** — Adjustable from 1 to 20 pf. Q ranging from 3,000 at minimum capacitance, to 1200 at maximum capacitance. Available in 4 models.

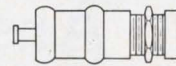

Illustrations actual size.

**JFD**

"TODAY'S COMPONENTS BUILT FOR TOMORROW'S CHALLENGES"

**JFD ELECTRONICS CORP. / COMPONENTS DIVISION**

15th Avenue at 62nd Street / Brooklyn, New York 11219 / Phone 212-331-1000

SUBSIDIARY OF RIKER-MAXSON CORPORATION



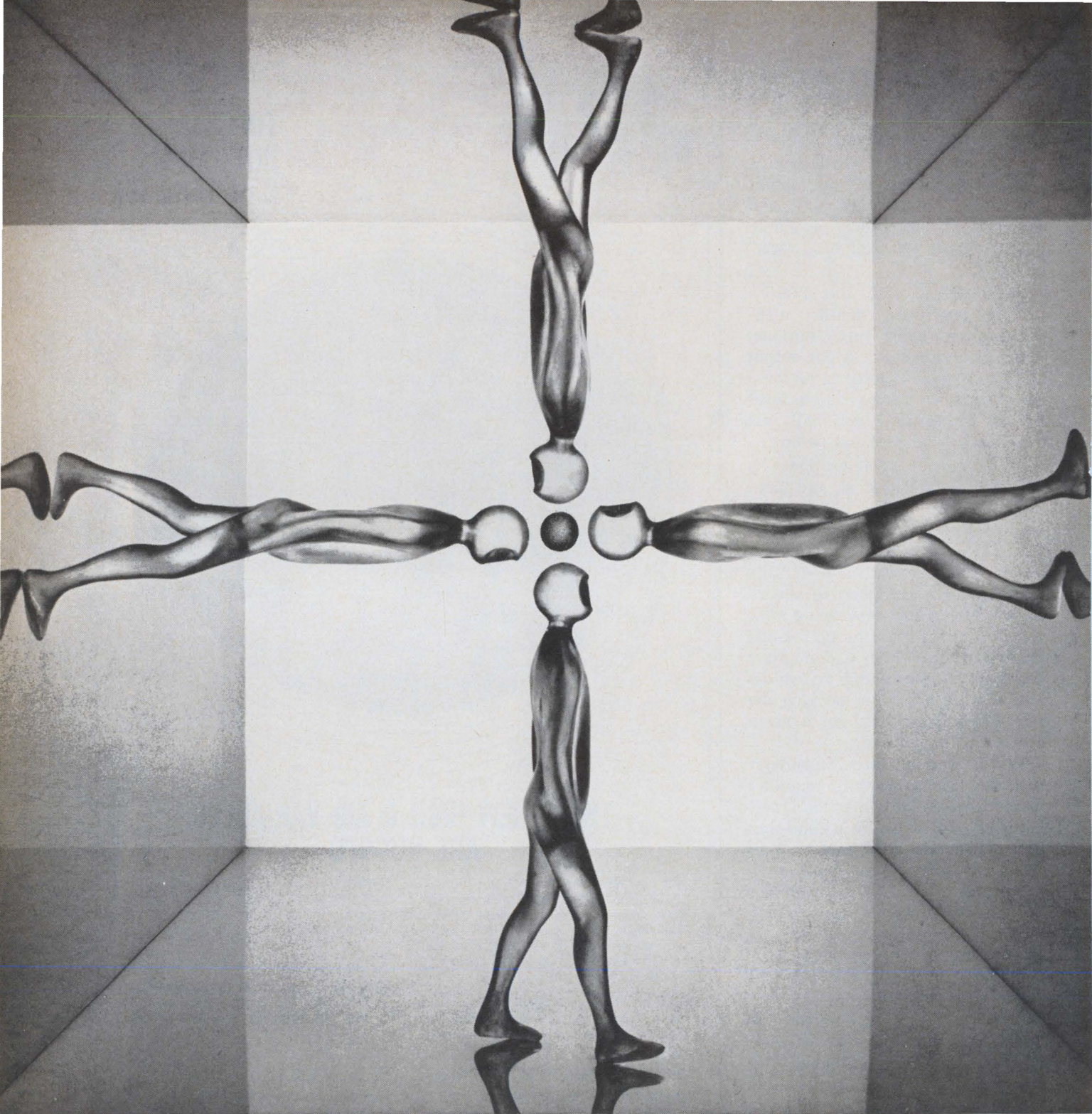

## A new frame of reference.

A microscopic glass ball that floats in a balanced electric field could lead to a new concept in guidance and space navigation. When the device with the floating ball is moved, forces acting on the ball itself can be measured with great accuracy. This is particle reference. Several years ago, Martin Marietta people began studying ways to make particle reference more than a laboratory phenomenon. They've solved a lot of physics and electronics problems along the way. Now they're testing actual devices. It could be the start of a whole new ball game. *Martin Marietta Aerospace Group. Headquarters: Friendship International Airport, Maryland.*

**MARTIN MARIETTA**



lists that store vector instructions originating in software. Thus to fill a 1,040-character display frame, the display processor just moves down a list; and if on the way, it encounters a pure graphic vector instruction among alphanumeric instructions, it can treat it like any other list member.

After readout to the display computer, the lists are restored to core where they await the next cycle for either refreshment of the display or change.

The processor memory can be expanded to 32,768 words, thus the PDS-1 can store routines for a large number of jobs at a console location. And the more work done off-line, the less port time is re-

quired at the main computer, and time-sharing charges should fall off accordingly. But to use the computer capability of the PDS-1 to best advantage, a separate control console is required. This rents for \$40 monthly, or sells for \$950, or about 10% of the total cost of a single installation.

From one such control console, several PDS-1's can be controlled, creating in effect a manually operated multiprocessor. It is even conceivable that PDS-1 computers might be linked in some future system configuration into a true multiprocessor. Though Cunningham doesn't foresee this replacing large central computer systems ("some central mass memory controller

still would be needed," he feels, "and perhaps a high-speed arithmetic unit"), a PDS-1 multiprocessor system could be configured as a low-cost solution to slow-speed processor needs.

Single-unit cost of the PDS-1 is \$9,450 and includes a 4,096-word memory, keyboard, display, and computer control console. PDS-1's can be leased for \$250 to \$285 per month. Prices fall to \$6,545 each for 50 or more units similarly equipped, but without control consoles. First deliveries already have been made, and Colburn estimates an output of about 35-40 units per month by January.

The Imlac Corp., 296 Newton St., Waltham, Mass. 02154 [338]

## Modem on a card

### User's choice.

Modem card, center, is shown at right in one type of packaging for an EDP system. At left is a modem pack that includes power supply.

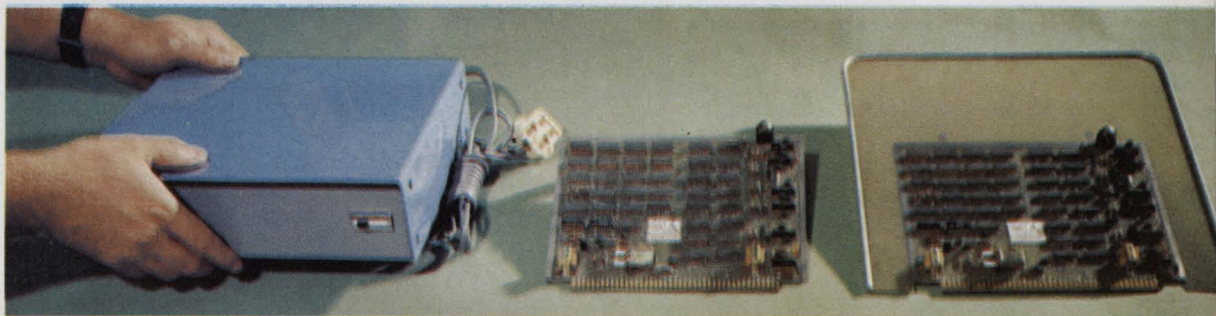

**The company** that went mod with memory systems [*Electronics*, May 12, p. 180] now has a new line of modules, called Modem Cards.

First of the new series from Sanders Associates is the Model 18A. It's said to be the only digital, asynchronous, full-duplex modem available in the 0-to-1,800-bits-per-second range, and it sells for about \$550 in its simplest form, a 7-by-9-inch plug-in card.

A 12-by-12-inch card also is available at about \$550; both modules are compatible with transistor-transistor logic, and plug into computers or peripheral equipment on 0.75-inch centers, taking power from these mainframes. Back-to-back (two-way transmission) error rates are said to be 1 in  $10^5$  bits at 1,800 bps over a phone line with a 16-decibel signal-to-noise ratio, Sanders says.

**Inboard.** With a Modem Card

module, a computer maker could replace an outboarded data set or an EIA standard RS 232B interface. And since the modules operate throughout the 0-to-1,800 bps range, they might replace two or more modems aimed at narrower speed ranges. For existing installations, Sanders will sell a modem pack—a box holding a Modem Card and the requisite power supply—for about \$750. The company will show the new line at the Fall Joint Computer Conference.

The Modem Card grew less out of a management plan than out of dissatisfaction with other firms' modems. Sanders data processing and transmission engineers needed equipment that could overcome noisy phone lines, accommodate varying transmission rates, and—naturally—be bought or built at relatively low cost.

The engineers were working in

the full-duplex mode (simultaneous transmission and reception) with frequency-shift-keyed teletypewriter signals. The modems available were analog devices, and, according to Jack R. Glover of the technical staff, each had its problems.

Error rates were higher than Sanders desired, some modems needed frequent adjustments, and false alarm rates were said to be high on others. To get around these problems, Sanders built its own in a crystal-controlled, all-digital format.

"High-speed FSK operation can be tough to achieve with low error at low cost," says Glover. He notes that at 1,800 bps, the shift from the lower to the higher of the two tones making up the frequency-shift-keyed signal is quick—a modem often has less than one cycle of a given tone in which to identify



# FET FACT

## 3N175

## 3N176

## 3N177

### the most universal N-channel MOS-FET family available

Each is useable as an amplifier or switch.

- As an amplifier, desirable characteristics are: low  $V_{GS}$  (TH), high  $Y_{fs}$  and low  $I_{GSS}$ .
- As a switch, desirable characteristics are: low  $R_{DS}$  "ON" and high  $I_D$  "ON".

#### DRAIN TO SOURCE RESISTANCE vs GATE VOLTAGE

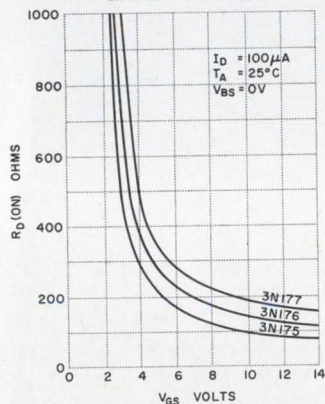

#### 100 pc. price

3N175—\$5.85 ea.

3N176—\$2.95 ea.

3N177—\$1.10 ea.

3N175, 3N176, 3N177 are available now from your authorized General Instrument Distributor. For full information write, General Instrument Corp., Dept. F-5, 600 West John St., Hicksville, L.I., N.Y. 11802.



GENERAL INSTRUMENT CORPORATION  
600 WEST JOHN STREET,  
HICKSVILLE, L. I., NEW YORK

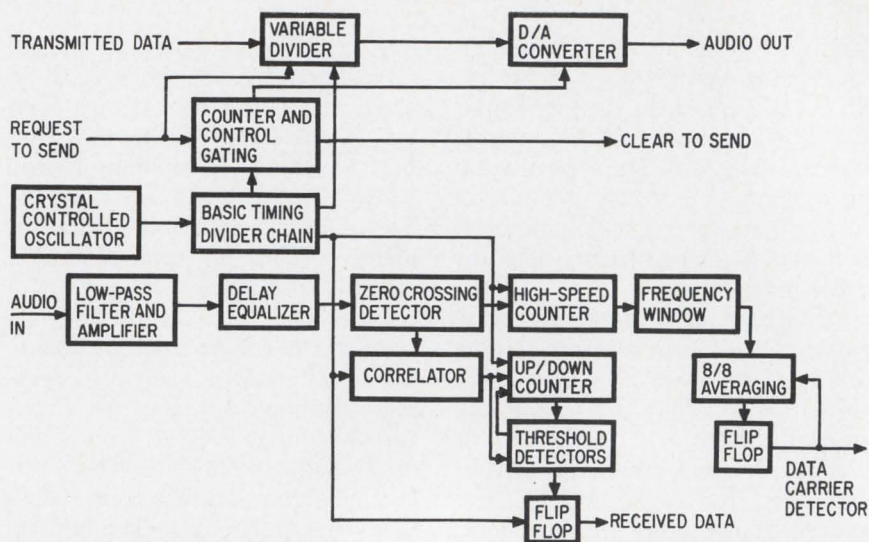

In the beginning, a crystal-controlled oscillator, highly accurate and stable, initiates the frequency-shift-keyed tones for transmission.

it. This explains why lower bit rates generally give lower error rates with analog modems—there are more cycles with which to make an identification.

But Sanders needed 1,800 bps; at that rate, its modem would have to spot the 1,200-hertz component in about 0.6 cycle, and would have only about 1½ of a cycle's worth of the 2,200-hertz component with which to make a decision.

**Stable.** To generate their FSK tones for transmission, Sanders engineers began with a crystal-controlled 1.056-megahertz oscillator accurate to 1 in  $10^4$  hertz and stable over  $0^\circ\text{C}$  to  $50^\circ\text{C}$ . Glover claims: "Our oscillator scheme is easily 100 times more stable than that of competitors. We specify our 1,200- and 2,200-hertz signals to within  $\pm 0.01\%$  versus  $\pm 1\%$  for other units, High accuracy and low drift make it easier for us to detect the two tones at fast switching rates [high bit rates]."

TTL flip-flops clocking at 105.6 kilohertz divide the oscillator signal by 6 and 8 or by 11 and 8 to get the two frequency-shift-keyed output signals in response to TTL control signals from the mainframe. And these are sent to the transmission line.

On the receive or demodulation side, the incoming signal first encounters an impedance matching transformer, then an active low-pass filter—an operational amplifier that has a parallel resistance-capacitance network in its feedback loop.

It lops off undesired high frequencies, mostly noise and transients.

Then the signal passes to an active delay equalizer. This is the only adjustable part of the Modem Card, and it's only adjusted once, to match its characteristics with that of the transmission line the modem is working with. Telephone lines can have varying amounts of delay at frequencies near the edges of the audio bands they transmit, and the equalizer's job is to make delay constant over the full band.

**Clean.** From there, the sanitized signal passes to a limiter-cum-zero-crossing detector. Noise doesn't perturb the locations of zero crossings and so the limiter-detector discriminates against it.

Afterward, it's necessary only to count zero crossings to determine if the incoming signal is data. If so, the modem forwards a "data coming" signal to the mainframe. Meanwhile a correlator, an up-down counter, a threshold detector, and a flip-flop convert zero crossings into a serial binary bit stream (at TTL levels) for mainframe consumption.

Sanders also claims a 36-month mean-time-between-failure and points to the built-in loop testing features of Modem Card, among others. But the features that probably will matter most are modular convenience, 1-to-1,800-bps all-digital operation, and low error with noisy phone lines.

Sanders Associates Inc., Spit Brook Road, Nashua, N.H. 03060. [339]





Model 58364  
Shown  
actual size.

# No other magnetic pickup can match the performance of Electro's new *DI-MAG*\*

The digital pulse output of the new Di-Mag\* pickup is a dramatic breakthrough development in non-contact sensing. Another example of ELECTRO leadership in metal detection that started more than 25 years ago.

**PROVIDES DIGITAL PULSE OUTPUT:  
CONSTANT AMPLITUDE PULSES  
FROM BUILT-IN CIRCUITRY**

**ELIMINATES INTERFACE CIRCUITRY:  
SIGNAL IS ALREADY PROCESSED  
FOR DIRECT USE IN DIGITAL  
COMPUTATION EQUIPMENT**

**CHOOSE FROM 3 MODELS:  
FOR OUTPUT VOLTAGES OF  
+5, +12 OR -12 VOLTS NOMINAL**

**LOWER SENSING SPEEDS:  
FULL OUTPUT AT 15" PER SEC.**

**GREATER SENSING DISTANCES:  
FROM 0.010" TO 0.100"**

**LESS SUSCEPTIBLE TO NOISE:  
COMPLETELY SHIELDED CIRCUITRY**

**COMPACT:  
SMALL SIZE FOR DENSE PACKAGING**

**WRITE FOR BULLETIN DM-769**



## **ELECTRO**

**ELECTRO PRODUCTS LABORATORIES, INC.  
6125 West Howard St., Chicago, Ill. 60648 • 312/647-8744**

\*Patent Pending



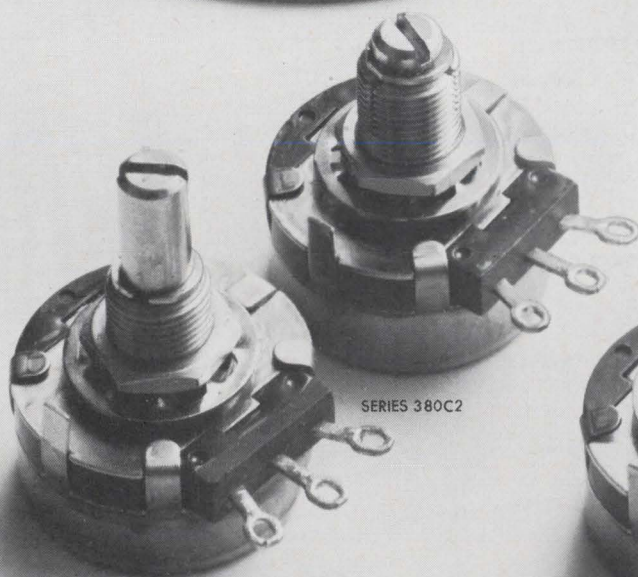

SERIES 380C2

SERIES 380C3

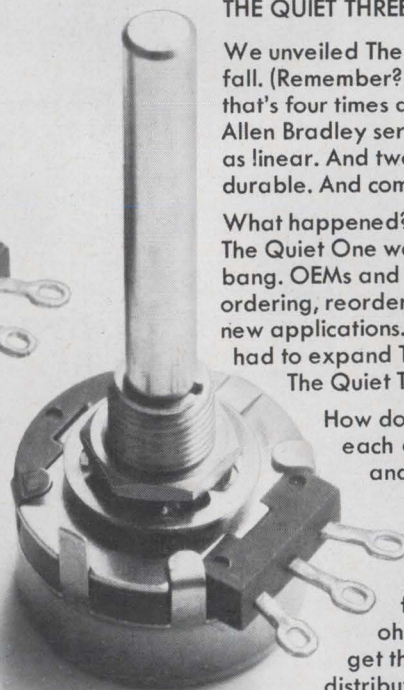

SERIES 380C1

### THE QUIET ONE IS NOW THE QUIET THREE

We unveiled The Quiet One last fall. (Remember? The potentiometer that's four times as noise-free as the Allen Bradley series J. And twice as linear. And twenty times as durable. And competitively priced.)

What happened? You might say The Quiet One went over with a bang. OEMs and engineers kept ordering, reordering, suggesting new applications. And soon we had to expand The Quiet One to The Quiet Three.

How do they differ from each other? Only in shaft and bushing. They can meet MIL-R-94 specs. They're available in resistance categories from 100 to 1-meg ohms. And you can get them at any of the distributors listed in the column to the right. So speak up. Ask for The Quiet One (or Two or Three). Loud and clear.

# CLAROSTAT



HERE'S WHERE TO SPEAK UP  
FOR THE QUIET ONE  
SERIES 380C1  
SERIES 380C2  
SERIES 380C3

#### STOCKING DISTRIBUTORS

**ALABAMA** ACK RADIO SUPPLY Birmingham JAMES W. CLARY CO. Birmingham **ARIZONA** INLAND ELECTRONICS Tucson STERLING ELECTRONICS Phoenix **CALIFORNIA** DUNLAP ELECTRONICS Sacramento Oakland and Mountain View ELECTRONIC SUPPLY Riverside ELMAR ELECTRONICS Mountain View TERMINAL HUDSON Mountain View HOLLYWOOD RADIO & ELECTRONICS, INC. Hollywood MILO OF CALIFORNIA San Diego RICHEY ELECTRONICS North Hollywood SANTA MONICA ELECTRONICS Gardena R.V. WEATHERFORD CO. Glendale WESCO ELECTRONICS Los Angeles WESCO ELECTRONICS Palo Alto **CANADA** TRITEL ASSOCIATES Downsview, Ontario **COLORADO** NEWARK-DENVER ELECTRONICS Denver ELECTRONIC PARTS CO. Denver **CONNECTICUT** BOND RADIO Waterbury CRAMER ELECTRONICS N. Haven J.V. ELECTRONICS East Haven WESTCONN ELECTRONICS Bridgeport **FLORIDA** CRAMER ELECTRONICS Ft. Lauderdale ELECTRONIC EQUIPMENT CO. Miami ELECTRONIC WHOLESALERS, INC. Miami ELECTRONIC WHOLESALERS, INC. Orlando GRICE ELECTRONICS Pensacola HAMMOND ELECTRONICS Orlando **GEORGIA** ACK RADIO SUPPLY Atlanta JACKSON ELECTRONICS Atlanta **ILLINOIS** ALLIED RADIO CORP. Chicago J&M ELECTRONICS Rockford NEWARK ELECTRONICS CORP. Chicago PACE/AVNET ELECTRONICS Schiller Park OHMTRONICS Palatine **IOWA** DEECO, INC. Cedar Rapids **INDIANA** GRAHAM ELECTRONICS Indianapolis FORT WAYNE ELECTRONICS Fort Wayne **KANSAS** RADIO SUPPLY CO. Wichita **KENTUCKY** P.I. BURKS Louisville **LOUISIANA** STERLING/CRESCENT RADIO & SUPPLY New Orleans EPCOR New Orleans RALPH'S RADIO & ELECTRONICS Lafayette **MAINE** HOLMES ELECTRONIC SUPPLY Portland MARYLAND EMPIRE ELECTRONICS Bethesda KANN-ELLERT ELECTRONICS Baltimore PYTRONICS Baltimore RADIO ELECTRIC SERVICE Baltimore **MASSACHUSETTS** CRAMER ELECTRONICS Newton DEMAMBRO ELECTRONICS Boston GERBER RADIO Dedham GREENE-SHAW CO., INC. Newton INDUSTRIAL COMP. Wilbraham A.W. MAYER CO. Boston MILO OF NEW ENGLAND INC. Lawrence STERLING ELECTRONICS Watertown **MICHIGAN** ELECTRONIC SUPPLY Kalamazoo NEWARK-DETROIT ELECTRONICS Detroit NEWARK INDUSTRIAL ELECTRONICS Grand Rapids **MINNESOTA** HARRY STARK ELECTRONICS SUPPLY Minneapolis **MISSISSIPPI** MAY ELECTRONIC SUPPLY Pascagoula **MISSOURI** ECI SEMICONDUCTORS Kansas City OLIVE INDUSTRIAL ELECTRONICS St. Louis VAN SICKLE St. Louis **NEBRASKA** SCOTT ELECTRONIC SUPPLY Lincoln **NEW JERSEY** GENERAL RADIO Camden FEDERATED PURCHASER Springfield STATE ELECTRONICS Hanover **NEW HAMPSHIRE** EVANS RADIO Concord **NEW MEXICO** ELECTRONIC PARTS Albuquerque **NEW YORK** ARROW ELECTRONICS Farmingdale CRAMER Eastern Syracuse H.L. DALIS, INC. Long Island City HARRISON RADIO E. Farmingdale MILO ELECTRONICS New York NEWARK ELECTRONIC CENTER New York PEERLESS RADIO CORP. Lynbrook ROME ELECTRONICS Rome SIMCONA ELECTRONICS Rochester STANDARD ELECTRONICS Buffalo E.E. TAYLOR Albany TAYLOR ELECTRONICS Baldwin TERMINAL HUDSON New York **NORTH CAROLINA** KIRKMAN ELECTRONICS Winston-Salem CAROLINA RADIO SUPPLY CO., INC. Greensboro **OHIO** AKRON ELECTRONICS Akron JOHN BECKER Dayton THOMPSON RADIO SUPPLIES Columbus HUGHES-PETERS, INC. Cincinnati and Columbus NEWARK-HERRLINGER Cincinnati W.M. PATTISON SUPPLY Cleveland RADIO ELECTRONIC PARTS Cleveland UNITED RADIO Cincinnati **OKLAHOMA** RADIO INC. Tulsa TRICE WHOLESALE ELECTRONICS Oklahoma City **OREGON** ALMAC/STROM ELECTRONICS Portland LOU JOHNSON Portland **PENNSYLVANIA** ALMO INDUSTRIAL ELECTRONICS Philadelphia GEORGE D. BARBEY CO. Reading CAMERADIO Pittsburgh DIAL SALES Edgely HERBACH & RADEMAN Philadelphia A.A. PETERS, INC. Allentown PHILADELPHIA ELECTRONICS Philadelphia FRED PURSELL CO. Scranton PYTRONIC INDUSTRIES Harrisburg R.P.C. ELECTRONICS Pittsburgh ROSEN ELECTRONIC CO. York SIMCO ELECTRONICS Philadelphia **RHODE ISLAND** W.H. EDWARDS CO. Providence **SOUTH CAROLINA** CAROLINA RADIO SUPPLY Greenville DIXIE RADIO SUPPLY Columbia **TENNESSEE** ELECTRA DISTRIBUTING Nashville MC CLUNG APPLIANCES Knoxville **TEXAS** ALL STATE ELECTRONICS Dallas STERLING ELECTRONICS Austin LENERT CO. Houston MC NICOL, INC. El Paso STERLING ELECTRONICS San Antonio STERLING ELECTRONICS Houston SWIECO, INC. Fort Worth WICKS RADIO Corpus Christi **UTAH** KIMBALL ELECTRONICS Salt Lake City **VERMONT** RUTLAND ELECTRONIC SUPPLY Rutland **VIRGINIA** DISTRIBUTORS, INC. Portsmouth MERIDIAN ELECTRONICS Richmond VIRGINIA RADIO SUPPLY Charlottesville **WASHINGTON** ALMAC/STROM ELECTRONICS Seattle **WASHINGTON** ELECTRONICS Seattle **WASHINGTON, D.C.** CAPITOL RADIO WHOLESALERS ELECTRONIC WHOLESALERS **WISCONSIN** See Illinois.

## Data handling

# Rugged Nova in uniform

Traditionally a commercial version of a device has been evolved from a military-spec design. But the Rolm Corp. took the opposite route, making a ruggedized computer for military jobs out of Data General's Nova [*Electronics*, Sept. 30, 1969, p. 147].

Rolm says its model 1601 is more than just a rugged version of an existing computer—it is a completely redesigned machine. The 1601 is a small, general-purpose, 16-bit computer whose instructions, software, and electrical input/output circuits are identical to those of the Nova—the difference is in the options.

The 1601 employs metal oxide semiconductor read-only memories containing three kinds of programs, available as options. One of these is a binary loader that loads programs written in the Basic language into the computer's main memory. Another is a floating-point interpolator program, and the third is a system diagnostic program.

Says Ken Oshman, president of Rolm: "We can have up to 8,000 words with MOS ROM's. The Basic binary loader requires only 133 words." Oshman says the MOS diagnostics can track down 85% of any errors that can occur. "They pinpoint the bad card and in a minute or so, the system is running again."

Another difference between the Nova and the 1601 is a multiply/divide option. In Rolm's unit, a hardware multiply/divide function can be supplied. With it, multiplication of two 16-bit words takes only 10 microseconds.

Basic core memory is 4,000 words. But the 1601's power supply can drive seven more memory blocks for a total of 32,000 words. An additional 12,000 words of memory can bolt on to the back of the 1601 package in 4,000-word blocks, and the other 16,000 words in a separate case. The core memory may be intermixed with MOS ROM's which are available in 256-word increments.

Five printed-circuit boards make up the central processing unit and there are five slots available for input/output interface cards. These include digital-to-analog and analog-to-digital converters, channel controllers for direct memory access, buffer registers, and line drivers. Part of the problem in converting the Nova to a rugged computer was that the Nova used 15-inch-square boards. Aside from being too large to fit into a standard military box, they were not ridged and their thermal properties did not meet mil specs. But a unique packaging arrangement solved both problems.

For the central processing unit, five 6½-by-9½-inch boards are used. The integrated circuits are arranged in six rows, seven in each row. Before the IC's are attached, a copper heat-sink, shaped like a comb, is bolted to the board. The teeth of the comb are about ¼-inch wide, ⅛-inch high, and are spaced about one inch apart. The IC's straddle the teeth, so heat is directed out toward the edges of the boards. And because the comb is closed all around and is made from one piece of copper, it adds strength to the boards. The final assembly step is to attach a cover—an aluminum "cookie sheet"—which also adds stiffness and acts as a radiator to draw heat away from the boards.

The operating temperature range of the 1601 is -55 to +95°C. Since the 1601 and the Nova are software-compatible, Oshman points out, "You can write and de-bug programs on the Nova back at the home office and be sure that these programs will work in the field on the 1601."

Delivery for the 1601 is slated to begin by the end of February; it will sell for about \$20,000 with 4,000 words of memory and a teletypewriter interface. The system will be demonstrated at the FJCC.

Rolm Corp., 10925 North Wolfe Road, Cupertino, Calif. 95014 [340]

CLAROSTAT Dept. 101  
Dover, N.H.. 03820



**Do you think you have to sacrifice performance because no single capacitor possesses all your critical requirements?**

**Don't think negative... think DEARBORN**

**METALIZED POLYCARBONATE FILM CAPACITORS**

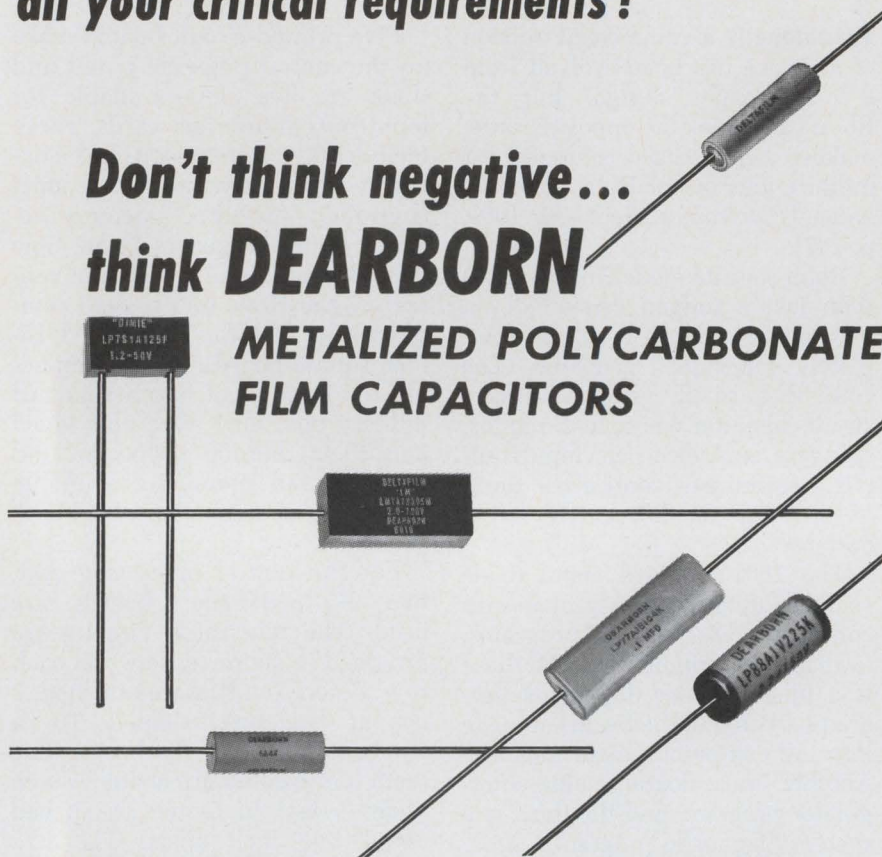

- Extremely low leakage current
- Low dissipation factor
- Non-polar construction
- 125 C operation without derating
- Light weight
- Mini-size
- Suitable for ac/rf applications
- Low temperature coefficient
- Long term stability
- Close capacitance tolerance
- Low dielectric absorption
- Consistent retrace
- Capacitance values to 100  $\mu$ F
- Voltage ratings, 50 V to 400 V

**There's a style for every circuit need...**

Style No.	Description
LP8	Hermetically-sealed metal-case tubular
LP9	Hermetically-sealed metal-case tubular, insulating sleeve
LP7A	Epoxy-case rectangular, axial leads
LP7S	Epoxy-case rectangular, radial leads
LP66	Wrap-and-fill round tubular
LP77	Wrap-and-fill oval tubular
LP88	Fuz-ion® sealed tubular

For engineering bulletins on the capacitor styles in which you are interested, write to Dearborn Electronics, Inc., Box 530, Orlando, Fla. 32802.

**Dearborn Electronics, Inc.**  
(a subsidiary of the Sprague Electric Company)  
**FOREMOST IN FILM CAPACITORS**

1D-9101

Data handling

**Kit provides acoustic terminal**

Hardware package converts teletypewriter into time-sharing station

In less than an hour, a teletypewriter can become an advanced acoustic data terminal, says the Omnitec Corp., a subsidiary of Nytronics Inc., of its model 701C, a fully asynchronous coupler kit that converts the audio tone from a standard voice-quality telephone line into error-free digital signals. All operational hardware in the compact kit fits within the standard Teletype housing, eliminating the need for external boxes and cords.

The kit allows any model 33 Teletype to operate with a standard office-type phone. After plugging the Teletype power cord into a standard outlet, the phone receiver

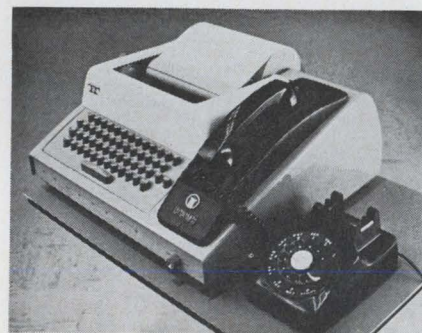

**Conversion.** Coupler on right side of Teletype transforms it into terminal.

is placed into the coupler's cushions, power turned on, and the desired destination dialed. As soon as the carrier tone is received, the unit is ready for two-way communication. The unit will be shown publicly for the first time at the Fall Joint Computer Conference, Nov. 18-20, in Las Vegas.

The full duplex operation of the coupler divorces the transmitter from the receiving circuit, and the teletypewriter can be used simultaneously for receiving one message and transmitting another. In the



# Don't buy another chart recorder... until you learn about VIDAR 5400 Digital Data Acquisition Systems

The VIDAR 5400 D-DAS™ can economically upgrade data recording where you have used strip-chart or graphic recorders. Although useful in many situations, chart recorders suffer from many shortcomings which are overcome by VIDAR systems which offer new benefits you'll want to consider:

**Relative cost per channel** — of VIDAR D-DAS is comparable to chart recorders for a few channels and much more economical above 10 channels. Chart recorders require an amplifier for every channel, but VIDAR Systems use a single amplifier with a built-in 0.003% 1-volt standard for calibration.

**Data interpretation** All chart-recorded data must be visually interpreted and translated into numerical values by people. VIDAR D-DAS gives "instant results" in numerical (digital) form that eliminates human errors in interpretation and allows computer data processing.

VIDAR D-DAS records absolute digital readings which are not subject to visual/manual setting or reading/interpretation errors. Chart recorder accuracy and human reading uncertainty produce errors ranging from 2% to 5% under the best conditions. Superimposed noise can further degrade chart trace uncertainty. VIDAR digital systems offer 15 times better linearity and produce absolute reading accuracies in the range of 0.025% to 0.2%. Data averaging (integration) eliminates superimposed noise effects.

When an event occurred or a value was reached may be very significant. Interpretation of time based on measured chart distance is subject to cumulative chart-speed errors, marking errors and interpretation errors because the chart speed is not auto-

matically recorded. The VIDAR 5400 systems eliminate these errors by recording the time with the data, or recording the data at precise time intervals.

**Dynamic range capability** — ratio of the highest to the lowest discernible value — is a measure of precision. Single-channel pen recorders may achieve 46dB (200:1), but multi-channel ones seldom achieve better than 26dB (20:1) ... a reading uncertainty of 5%. VIDAR Digital Data Acquisition Systems provide over 80dB (10,000:1) regardless of the number of channels.

**Amplitude-ranging problems** — pen recorders require known signal amplitudes so that amplifier settings will keep each channel's readings "in scale." Not all phenomena "cooperate," and regardless of care, operators frequently find pen recorders pinned against full scale. You just can't turn your back on a pen recorder. VIDAR Systems automatically change ranges within 4 milliseconds to stay "in scale," maintaining the best accuracy range for all data channels. Range is identified in the recorded data, so there is no ambiguity or error in interpretation.

**Partnership with pen recorders** — VIDAR 5400 inputs can be connected to chart recorders to provide digital data logging on punched tape or magnetic tape to allow your computer to analyze the process or test measurements — without need for intermediate interpretation by people.

**Have the best of both worlds** — with the monitor and display options of the VIDAR data systems, you can have all of the advantages of automatic digital data logging and still observe selected data in numeric form — or on a monitor pen recorder.

For all the facts on VIDAR D-DAS  
versus Chart Recorders,  
write or call

## VIDAR®

77 Ortega Ave., Mountain View, California 94040  
Phone (415) 961-1000

### VIDAR D-DAS

**DATA INPUTS**  
Up to 1,000 channels.  
Data amplifiers not usually required.  
Systems expandable in 10-channel increments



Output is digital data ready for use when the test is completed.

Punched or magnetic tape recorded data is ready for entry into a computer. Printed tape or typed page data format provides numerical data for manual computation. Accuracy is 0.025% to 0.2%. Time can be a permanent part of the record.

### CHART RECORDERS

**DATA INPUTS**  
Data amplifiers commonly required. System expands by buying more chart recorders.

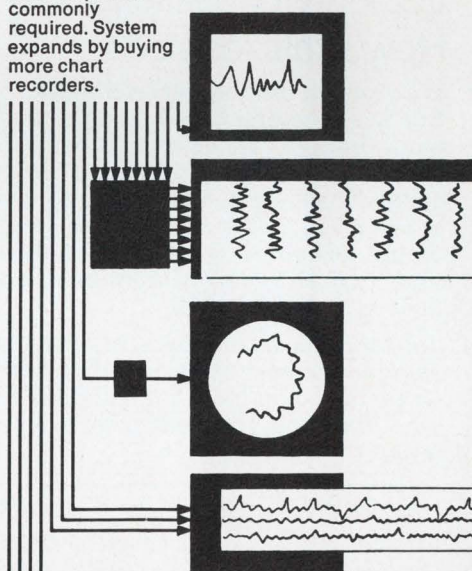

Data is not ready for use after the test run. Data traces or "pictures" must be manually sorted out, measured, and converted to numbers before any computation can be accomplished manually or with a computer.



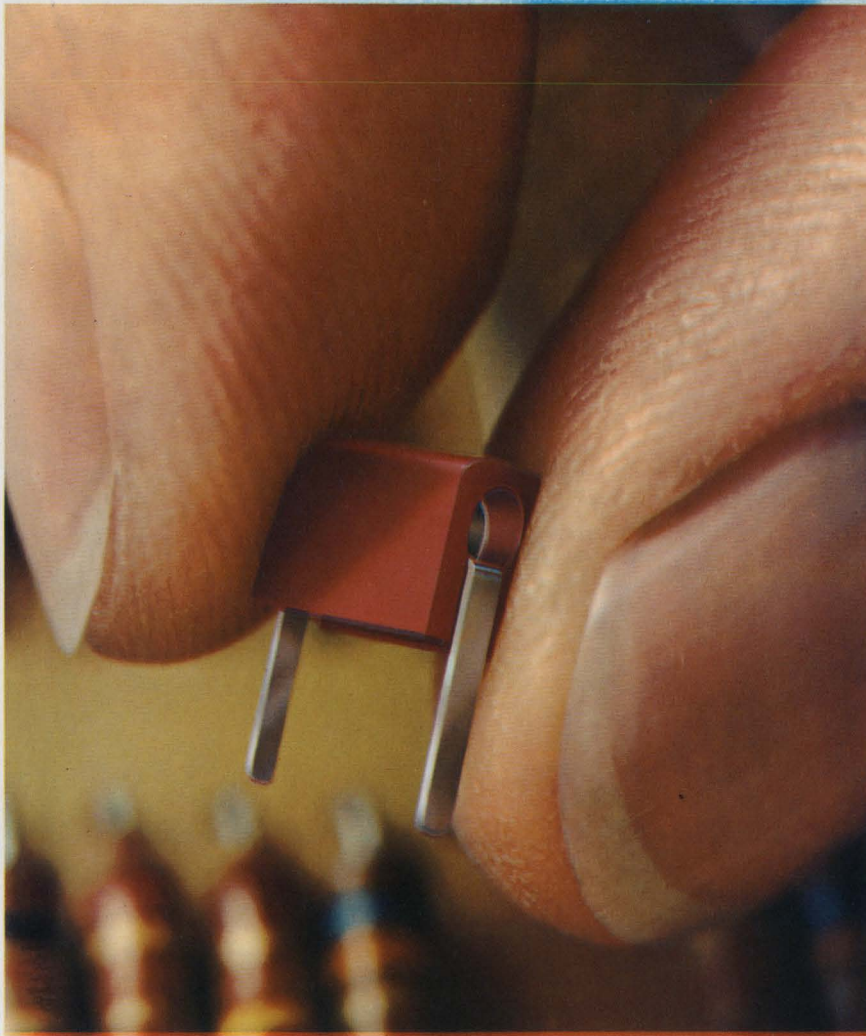

Looking for a little jack?  How's this for size?   
 (Actual Size)

We've been making miniature jacks for over 10 years. But this new one is half again as small as any horizontal mounting type we've offered before. It accepts a 0.080" diameter tip plug on either end and has a maximum current capacity of 5 amperes. Operating voltage is 1500 volts RMS at sea level, 350 at 50,000 feet. Contact resistance is less than 2 milliohms. Capacitance between adjacent jacks is less than 1 pF at 1 MHz. Comes in 10 colors meeting Federal Standard #595.

Johnson makes hundreds of different jacks and plugs . . . and carries most of them in stock for immediate delivery. Or perhaps you have a unique need. Our engineers will work it out for you. Just give us a call. Meanwhile, return the coupon.

E. F. JOHNSON COMPANY/3010 Tenth Ave. S.W./Waseca, Minnesota 56093

- Send me a sample of your new miniature jack and complete design details.
- Send me information on your complete connector line and other Johnson components.

NAME \_\_\_\_\_ TITLE \_\_\_\_\_

FIRM \_\_\_\_\_ ADDRESS \_\_\_\_\_

CITY \_\_\_\_\_ STATE \_\_\_\_\_ ZIP \_\_\_\_\_



**E. F. JOHNSON COMPANY**

half-duplex mode, transmission is identical with the terminal readout. A slide switch selects the operating mode.

The 701C kits will be sold to companies supplying terminal equipment to time-sharing network users. The price will be \$345 each in quantities of 50, with off-the-shelf delivery.

Omnitec Corp., 903 North Second St., Phoenix, Ariz. 85004 [500]

Data handling

## Acoustic terminal adds and records

Conventional tape cassette and MOS shift register keep price down on numeric unit

**Tie together** an adding machine, a cassette tape recorder, and an acoustic coupler—and what have you got? Applied Peripheral Systems, Inc., calls it the DC-4 adding machine terminal, and general manager Leslie Jasper says it's aimed at applications in which the user needs to enter numeric data at a remote site into a central collection system—say, for accounting and inventory.

Applied Peripheral's unit contains the acoustic coupler and modem, which makes the information compatible with 103-type data sets; the firm buys the standard Philips-type cassette recorder and the 10-key adding machine. The latter is equipped with a cable connection that carries data to the cassette recorder after it's dumped from a metal-oxide-semiconductor shift register, which stores the numbers until one of the adding machine function keys (plus, minus, subtotal, total, non-add), is actuated.

After being recorded on the cassette unit, the data is transmitted over the telephone coupler to a computer or central collection center for storage on computer-compatible magnetic tape.

The ASCII-coded characters are transmitted in standard teletype-writer format and speeds, using a



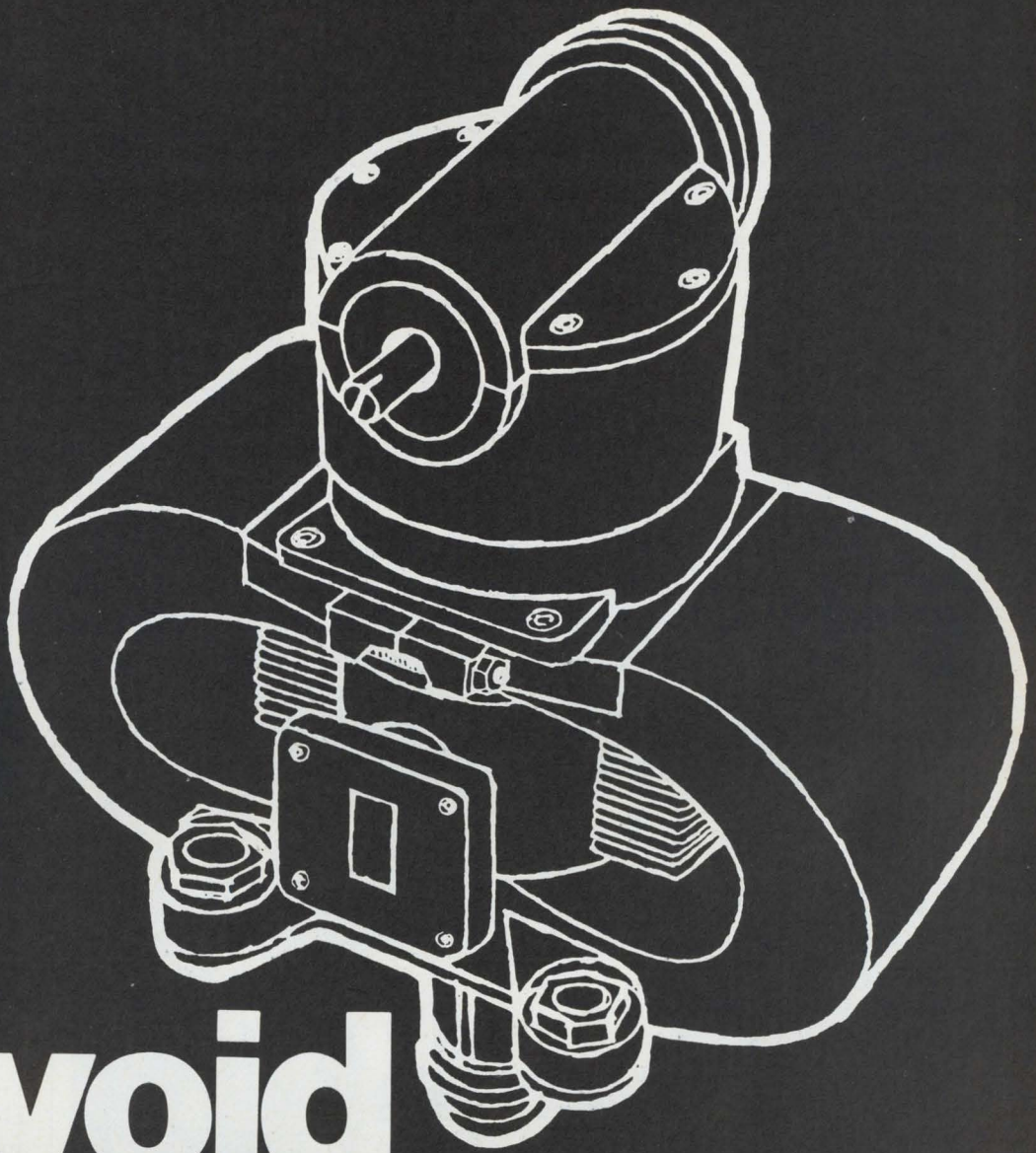

# Avoid the Ku band jitters.

Varian's pulse magnetrons, operating in the 15 to 18 GHz frequency range, boast a pulse stability that provides your radar with superior overall jitter performance resulting in improved MTI cancellation ratios.

The line includes coaxial and conventional magnetrons providing power levels from 1 to 100 kW. Models vary in weight from 22 ounces, including magnet, to about 10 pounds, and exhibit typical efficiencies up to 35%.

Tubes are warranted from 500 to 2,000 hours, depending on system use. But tests recently conducted demonstrated average operating lifetimes as high as 5,000 hours at 0.001 duty cycles for many models.

So endow your Ku band radar with long life and a steady pulse by installing a quality output tube from Varian, the company that delivers what you really need. Talk to any of our more than 30 Varian Electron Tube and Device Group Sales Offices around the world, or contact our Bomac Facility, Salem Rd., Beverly, Massachusetts, or our S·F·D Facility, 800 Rahway Ave., Union, N.J.





In Servo Pot performance

# MystR<sup>®</sup>

conductive plastic

is

# tomorrow, here today

MIL-R-39023

For servo requirements you get "Second Generation" Pot Performance with Waters' exclusive new MYSTR conductive plastic resistance material. This is tomorrow — here today!



- Infinite resolution
- Resistance ranges from 10 ohms to 5 megohms
- Excellent linearities
- Output smoothness, less than 0.1%
- Rotational life — upwards from 10 million cycles
- Dither life in excess of 400 million cycles
- Operational temperature to 150°C
- Hysteresis <math>< 0.25^\circ</math>



From Waters now — a complete line of MIL Spec rated precision potentiometers, standard or custom, wirewound, linear or non-linear or with MYSTR Conductive Plastic. Also Trimmers and Torque Measuring Devices.

**WATERS MANUFACTURING, INC. WAYLAND, MASS. 01778**

## ... printout records system input ...

standard telephone set.

Jasper believes his company has the jump on others, which he says are just beginning to come out with equipment to perform numeric data-entry functions. For one thing, he says the use of conventional tape cassettes (instead of incremental tape) in combination with the MOS shift register, which can store 11 characters, keeps the DG-4's price down—\$1,850 vs. up to \$2,500 for similar units, one of which, he says, does not include the acoustic coupler. The DG-4 will lease for \$50 a month.

Jasper notes that the adding ma-

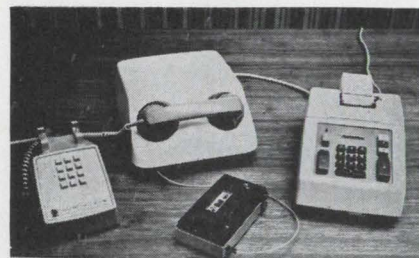

**Tieup.** Terminal for computer input consists of adding machine, cassette recorder, and acoustic coupler.

chine printout—although not unique for numeric data-entry devices—provides a record of what has been entered into the central system—a feature not always included in such devices.

The cassette tape accommodates 33,000 characters per side—66,000 total characters for a 30-minute tape and twice that for a double-sided, one-hour tape, which is also available. Errors may be cleared, or a correction entry may be recorded.

Since the terminal is designed for accumulating and transmitting data for applications where numbers are the primary input, the company will aim at accounting tasks, the taking of inventory by merchandising outlets, and for other jobs where an adding machine is the basic tool. The terminal will be introduced at the Fall Joint Computer Conference.

Applied Peripheral Systems Inc., P.O. Box 36221, 7121 Harwin, Houston, Tex., 77036 [501]



# OP AMP FAMILY

## FASTEST SLEW RATE

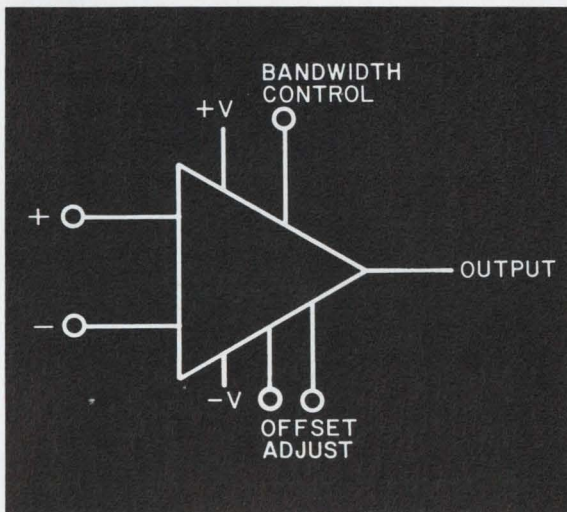

	RA 2520	RA 2510	RA 2500
● Slew Rate	$\pm 120\text{v}/\mu\text{s}, \text{Av}=2$	$\pm 60\text{v}/\mu\text{s}, \text{Av}=1$	$\pm 30\text{v}/\mu\text{s}, \text{Av}=1$
● Voltage Gain	15000	15000	30000
● Large Signal Bandwidth	2000kHz	1000kHz	500kHz
● Gain Bandwidth	24mHz	12mHz	12mHz
● Offset Current	10 nA	10 nA	10 nA
● Offset Voltage	4 mV	4 mV	2 mV
● Output Current	$\pm 20\text{ mA}$	$\pm 20\text{ mA}$	$\pm 20\text{ mA}$
● Input Impedance	100 megohms	100 megohms	50 megohms
	Non-Compensated	Fully Compensated	Stable at Unity Gain

## HIGHEST IMPEDANCE

RA 2600	
● Input Current = 2 nA	● Gain = 200,000
● Input Impedance = 200 megohms	● Gain Bandwidth = 12 mHz
● Slew Rate (at unity gain) = $\pm 7\text{v}/\mu\text{s}$	● Short Circuit Protected
	● Fully compensated (stable at unity gain)

## LOWEST NOISE

RA 909A	
● Equivalent Noise Input = $1.0\mu\text{V RMS}$	● Slew Rate (at unity gain) = $+5, -2.5\text{v}/\mu\text{s}$
● Gain Bandwidth = 7 mHz	● Gain = 45000
	● Power Dissipation = 52 mW

You can be assured of: Monolithic op amps that exceed hybrid performance  
Off-the-shelf delivery, full military temperature range and compliance  
with MIL-STD-883 . . . when you pick the BEST IC for the job  
from Radiation's fast expanding linear line.

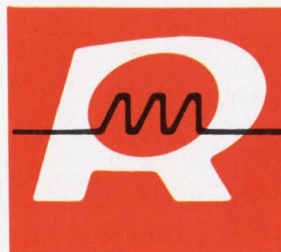

**RADIATION**  
INCORPORATED  
SUBSIDIARY OF HARRIS-INTERTYPE CORPORATION  
MICROELECTRONICS DIVISION

Lexington, Massachusetts (617) 862-1055  
Norwalk, Connecticut (203) 853-3641  
Washington, D.C. (202) 337-4914  
Dallas, Texas (214) 231-9031  
Long Beach, California (213) 426-7687  
Palo Alto, California (415) 321-2280  
Albuquerque, New Mexico (505) 268-3549  
P.O. Box 37, Melbourne, Florida 32901 (305) 727-5430



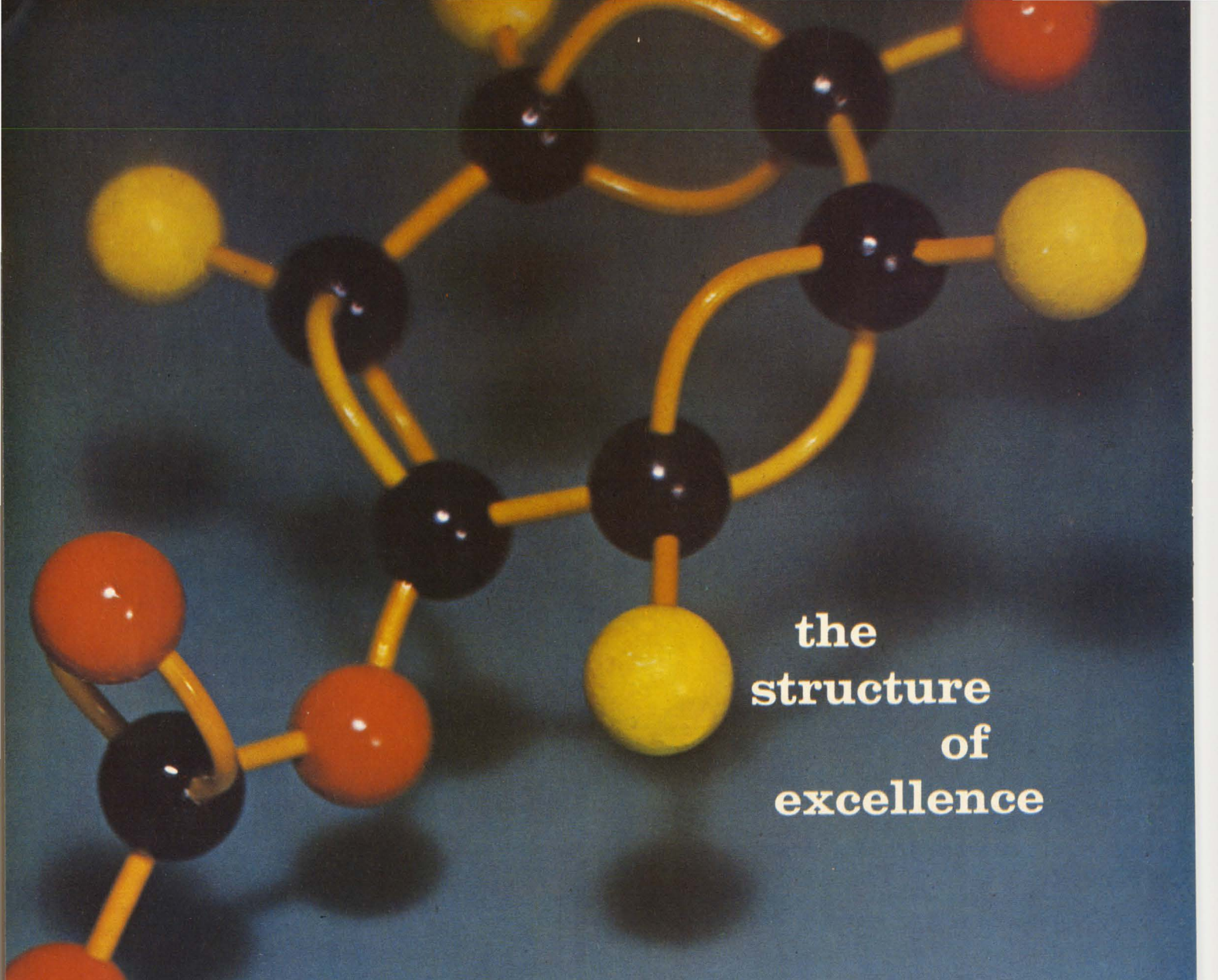

the  
structure  
of  
excellence

The excellence of Markel electrical insulating products is composed of many elements.

● First, there is Markel's experience . . . almost fifty years of it . . . providing a thorough understanding of the electrical insulating problems of industry and the know-how to solve them. ● Then, there is the massive line of Markel products, developed one at a time to meet every conceivable requirement. More than 3,500 different types and sizes in all. ● To produce all these different insulations in large volume at competitive prices requires extensive, modern manufacturing facilities . . . probably the finest in the business. ● But all this experience, knowledge and capacity would be of little value to you without Markel's nation-wide network of sales engineers who bring Markel products and problem-solving capabilities as close to you as your telephone.



ONE SOURCE FOR EXCELLENCE  
*in Insulating Tubings and Sleeveings  
High Temperature Wire and Cable*



L. FRANK MARKEL & SONS, INC., NORRISTOWN, PA. 19404 • PHONE: 215/272-8960

Circle 176 on reader service card



# Two-gap head verifies recorded data

Unit designed for cassette-type EDP equipment checks data immediately to prevent error input to system

**Check as you go**—that's the idea behind a two-gap head developed by Michigan Magnetics for computer equipment using cassette tape recorders. The two gaps make it possible to enter data on a tape and check the entry immediately after it's written. Thus, flaws—such as dust particles or missing oxide—will not transmit erroneous data.

The head, called KRW-3, has

dual-shielding construction. This permits all four gaps to ride comfortably on the tiny pressure pad of the cassette. The shielding holds crosstalk and crossfeed levels to a point where usable verification is not swamped out by succeeding write current signals.

The dual-channel head has write-track widths of 0.041 inch on 0.070-inch centers, and read-track

widths of 0.029 inch on 0.070-inch centers. These track widths have been selected to maximize signal levels while allowing sufficient coil spacing within the head to keep channel 1 to channel 2 crosstalk to a —45-decibel level.

**Two levels.** Shielding is provided on two distinct planes—one is between the channels, and the other is a perpendicular one parallel to

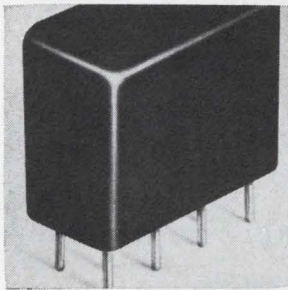

Half-size microminiature, crystal-can relays require only 100 mw pull-in. The 2pdt series is rated at 2 amps and meets MIL-R-5757E electrical requirements, while surpassing the environmental requirements. Units withstand vibration of 20 g to 2,000 hz, acceleration of 100 g minimum, and 50 g shock. Welch Relay Co., 11161 W. Pico Blvd., Los Angeles [341]

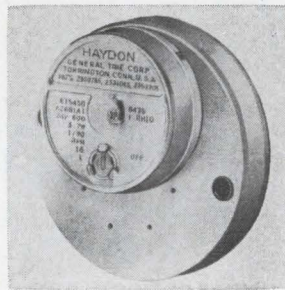

Synchronous hysteresis, heavy-duty gear head motor MA20 provides an output torque of 15 pound inches for speeds of 1/60 rpm to 14 days per revolution. It is available with optional size output shaft, anti-backlash gear train, and voltage range of 24, 120 and 240. Motor is custom built to meet exact OEM needs. General Time Corp., Route 8, Torrington, Conn. 06790 [342]

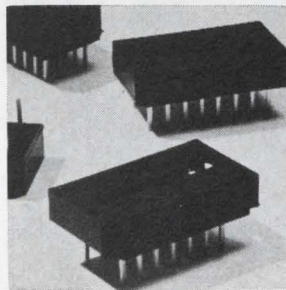

Low-profile IC-compatible connectors can terminate round conductors of up to 30 Awg into p-c boards, motherboards, backplanes and other IC elements. They can also serve as jumper blocks to switch or interconnect pins in a given IC socket by use of internal wiring. The 0.2-in.-high units are 14 or 16-pin type. Spectra-Strip Corp., Box 415, Garden Grove, Calif. 92642 [343]

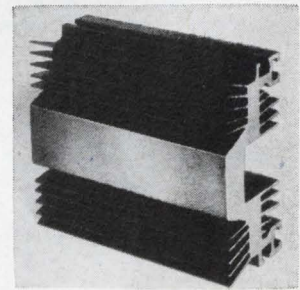

JEDEC-approved, high-power heat sink model 2570 is designed for use with "hockey-puck" or flat-pack type rectifiers. The broad base provides an efficient heat transfer surface and permits secure mounting of the scr's when two such heat sinks are mounted back-to-back under pressures typically 700 lbs or greater. Astrodyne Inc., 207 Cambridge St., Burlington, Mass. 01803. [344]

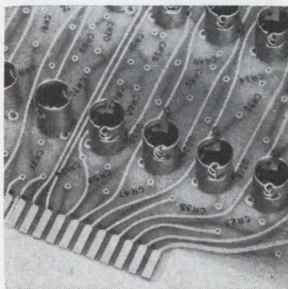

Bayonet base T-3¼ lamp socket is for pcb mounting in back-lighted panel uses. The socket rests firmly and flat on single-sided 0.062 in. boards, with minimum protrusion on the back side. The units, either cadmium or gold plated, are available as component items for customer installation using conventional mounting tools. Display Devices Inc., 2nd & E Sts., Encinitas, Calif. [345]

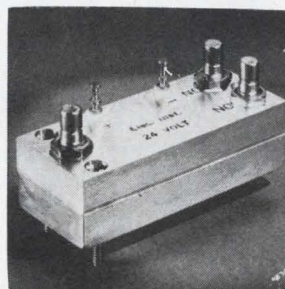

R-f coaxial switches have spdt contacts. They switch in 1 msec, have coil resistance of 2,700 ohms for 24 v operation, and are 0.50 x 0.75 x 1.80 in. R-f characteristics are 50 ohms impedance, and insertion loss is under 0.003 db at 500 Mhz. Vswr is 1.10 up to 400 Mhz, and useful performance is to 1 Ghz. Electronic Instrument & Specialty Co., Winchester, Mass. [346]

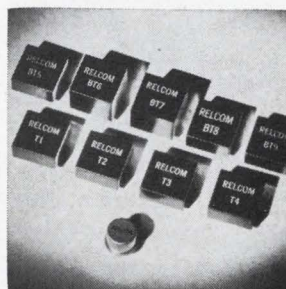

Miniature transformers feature a frequency range of 0.1 to 700 Mhz and have insertion loss of less than 0.5 db. Impedance transformations include 50 ohms to 12.5, 25, 50, 100, 200, and 800 ohms. Six transformers are balanced with both amplitude and phase balance specified. Four units are single ended Relcom, Charleston Rd., Mtn. View, Calif. [347]



Solid state relay designated Mini-tactor model 751 is activated by a-c signals as low as 10 mv. It is suited for industrial, aerospace and military applications where environmental conditions, miniaturization or power conservation are required. It will switch up to 2 amps at 200 v rms. Price is \$25 in small lots. E.D.C. Data Components Corp., Massapequa, N.Y. [348]



# Clare announces a new treat in General Purpose Relays

## *It's called the GP1.*

If you haven't heard the name before, it's because we haven't made it before.

You see, we didn't want to make just another general purpose relay. We wanted to make the best. Now we have it.

The new GP1 gives you everything standard 4 PDT, 3 amp relays do. Plus a lot more. Contacts rated at 1/10 horsepower, 240 volts AC. Opposite polarity capability. Largest selection of contact types.

And you can buy it at a price competitive enough to make you the company hero.

With every order of Clare General Purpose Relays, you get something no other company can offer. The Clare guarantee of outstanding service. The new GP1. Only from Clare.

The first of a complete line of Clare General Purpose Relays—all fully interchangeable with existing types.

For full information, circle Reader Service number, call your Clare Sales Engineer or local Clare Distributor. Or write C. P. Clare & Co., Chicago, Illinois 60645... and worldwide.

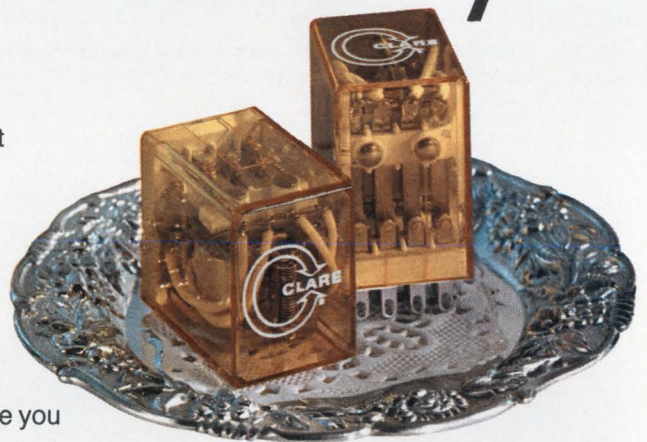

- Competitively Priced
- Interchangeable with Existing Types
- 4 PDT
- 3 amps—1/10 HP Contact Rating
- Opposite Polarity Capability
- Designed for U/L Recognition
- Six Contact Types
- All Standard AC & DC Coil Voltages

LOOK FOR



ON GENERAL PURPOSE RELAYS

a GENERAL INSTRUMENT company



the dual gaps. The base of the housing is ground perpendicular to the gap planes to eliminate azimuth adjustments and to insure interchangeability of cassettes from machine to machine.

Typical specifications are 16 millivolts peak-to-peak playback voltages, when recorded with a write current of 4 milliamperes peak-to-peak amplitude at 3 kilohertz (using two flux reversals per bit with a 5 kilohm load).

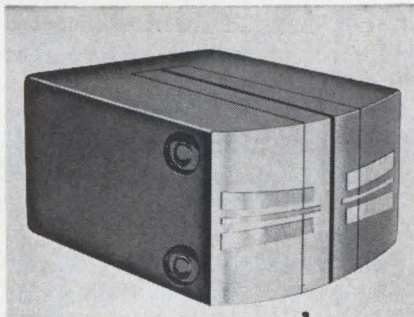

**Verifier.** Two-gap design permits real-time check on recorded data.

Several companies including Sycor, International Computer, and Viatron have announced low-cost computer hardware designed to use the Philips cassette tape cartridges, and have been very optimistic regarding the potential sales of such equipment. It is believed by most that the equipment will be priced low enough for high-volume use of computers by small businessmen, for example. One of the major pitfalls, verification of data, will be avoided by the two-gap head, according to the designers.

Now that such a device is available there are several applications that will be possible. For example, a gas station attendant can enter the amount of oil and gas used in a day's time into a computer terminal and the data can be checked at a remote location. In addition, department stores and other small businesses may want to do their billing directly into a computer terminal and have it verified at another location down the line.

The device will sell for \$70 to \$80 in quantities of 500 or more and will be available on three-week delivery.

Michigan Magnetics, Vermontville, Mich. 49096 [349]

# HEW... more power to you!



Thank you Hewlett Packard for building so many top quality sweep and signal generators and frequency synthesizers.

You've created a market for our power amplifiers because many engineers need our product to extend the power output of your instruments. We've made sure that our broadband, untuned, 3 watt amplifier mates easily with most sweep generators, signal generators, and frequency synthesizers (no matter what brand). Our power amplifier also features an output meter plus low harmonic and intermodulation distortion. So thanks again Hew . . . and we're glad we could help you.

- 250 KHz-110 MHz frequency coverage
- 40 dB  $\pm$  1 dB Gain
- 50 ohms input/output impedance
- Failsafe for any load mismatch and unconditionally stable.

MODEL 300L  
**\$485**

The ENI Model 310L will provide 10 watts of power when identical specifications with higher output are required.

For additional specification and application information contact:

**ENI ELECTRONIC NAVIGATION INDUSTRIES**  
1337 Main Street East Rochester, New York 14609 716/288-2420

Circle 179 on reader service card

## IS YOUR PRODUCT WORTH TESTING? ... THEN IT'S WORTH Impact-o-graphing!

If the equipment you make is an assembly of parts and components that are held together by screws, bolts, nuts, rivets, brazing or soldering; includes electrical circuits and controls, adjustable by twisting, turning, raising or lowering, — THEN INSIST THAT THE FINAL TEST BE MADE WITH AN IMPACT-O-GRAPH.

Impact-O-Graph is the instrument that measures shocks and impacts during handling and shipping and which could cause malfunction of the equipment shipped. It also proves whether the shipment had a safe journey between your final factory test and the customer's installation.

The Impact-O-Graph measures shock by direction of impact, by magnitude and if desired, by time.

The few dollars it costs to check a shipment, while it is in transit, with an Impact-O-Graph can pay off a thousand times.

You can also LEASE an Impact-O-Graph only when you need it.

### Impact-o-Graph

DIVISION OF TORQ ENGINEERED PRODUCTS INC.  
1760 EAST 18TH ST. • CLEVELAND, OHIO 44114  
PHONE (216) 241-5838



Write for  
Catalog 67  
and full  
details about  
Leasing Costs.

SAA 4061-2



## Need sophisticated components such as these?

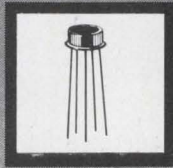

### This?

Most circuit designers do.

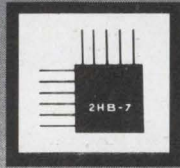

### Or this?

Integrated circuit packages are critical in use by just about any standard.

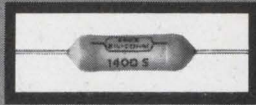

### And how about this two terminal device—

a small but critically important Resistor?

After perusing the following details, more circuit designers and component-reliability engineers than ever before will realize that SAGE SILICOHM® miniature power resistors stand out above all others in providing:

- ① smallest size vs wattage rating
- ② fully welded construction using precision wire elements
- ③ Sage IMPERVOHM® silicone encapsulation, designed for 1000 volt body insulation and operating temperature extremes  $-65^{\circ}\text{C}$  to  $350^{\circ}\text{C}$
- ④ close tolerance, 1%, .5%, .25%, .1%, .05%
- ⑤ close TC,  $\pm 10$  PPM/ $^{\circ}\text{C}$  standard
- ⑥ copper leads standard; weldable nickel or Dumet when specified



- ⑦ premium high conductivity core materials available
- ⑧ non-inductive windings when specified
- ⑨ low values to  $.05\Omega$ , specials even lower
- ⑩ millions of unit-hours reliability documentation under Polaris and Improved Minuteman programs

We welcome the opportunity to discuss your requirements.  
Sage Electronics Corp., Box 3926, Rochester, N. Y. 14610  
Tel: (716) 586-8010

Precision Power Resistors

# SAGE

## ELECTRONICS

SUBSIDIARY OF GULTON INDUSTRIES, INC.



## New components

### IC filter goes broadband

Monolithic crystal unit provides high selectivity in 0.3-cubic-inch package

Originally designed for military use in the VRC-12 mobile transceiver, a monolithic crystal filter now is available for commercial and industrial applications where a broadband, highly selective filter is required at the commonly used intermediate frequency of 11.5 megahertz.

The unit, model 6508 MA, was developed by Damon Engineering. Because of its wideband characteristics, it is not included in Damon's standard monolithic crystal filter line.

The 6508 MA is a product of computer-aided design and of advances in vacuum deposition techniques. The required geometric parameters, such as electrode size, spacing, and thickness, are determined by feeding the desired bandwidth, center frequency, and number of poles into a computer program.

Once the geometry is determined, the electrodes are vacuum-deposited on a quartz substrate in the form of circular disk resonators, with the first pair becoming the filter input and the last pair becoming the output.

The intermediate resonators are used to acoustically couple the signal. Because of the elasticity of the quartz substrate, the coupling is performed there.

"The uniqueness of the device", says Robert Kent, general manager of the division, "lies in its large fractional bandwidth of 0.3% and its high rejection of spurious signals. Small size is also a definite asset." The filter is a 7-pole design at a center frequency of 11.5 Mhz  $\pm 2.0$  kilohertz with a 3-decibel bandwidth of 35 khz minimum. The 60-db bandwidth is 75 khz maximum and the shape factor (ratio of the 60-db BW to



# THE SUPER SWEEPER



Alfred introduces the pushbutton, programmable sweeper with up to ten different heads for complete coverage from 250 MHz to 40 GHz. (And if you already have a sweeper, we'll show you how to make your own "super sweeper").

If you are working in a wide range of microwave frequencies, you know how much time it takes to change heads and how cumbersome it is to set up automatic programmed testing. Now you can relax.

Alfred's new multi-band sweep oscillator solves both problems and at the same time offers you all the performance proven features of the Alfred 650 Sweep Oscillator.

**Front Panel Plug-in.** For convenient head changes, the "super sweeper" offers Alfred's exclusive front plug-in design. Alfred multi-band sweep oscillators provide sweep coverage of the complete range from 250 MHz to 40 GHz or any portion thereof. Systems consist of the Alfred 650 Sweep Oscillator, any combination of up to ten 650 series plug-in oscillator units, Model 9510 Pushbutton Control Unit, and the Model 9511 Plug-in Container Unit. A rear panel connector can be used for remote programming.

**Calibrated Frequency Dial for All Ranges.** Read frequency directly as soon as you switch to a new range. A preset sweep range can be set independent of the 650 sweep control for each plug-in oscillator.

**So I already own an Alfred 650 and a set of oscillator plug-ins, what about me?**

**You're in luck.** You simply buy the Model 9510 Push Button Control unit and the Model 9511 Plug-in Container Unit and make your own "Super Sweeper" just like the one shown above. Add more container units to bring the system up to its 10 head capacity.

**For more information.** To arrange a demonstration and secure complete technical information, please call your Alfred sales engineer (listed in EEM and EBG) or write us directly. Please address Alfred Electronics, 3176 Porter Drive, Palo Alto, California 94304. Phone: 415-326-6496. TWX: 910-373-1765.

# ALFRED ELECTRONICS



# test drive our quiet wavemakers.

**CTC's Unidriver Current Drivers. 250  $\mu$ v  
sense line noise level at 15ns rise time . . .  
delivers clean, precise drive waveforms  
and noise-free sense outputs!**

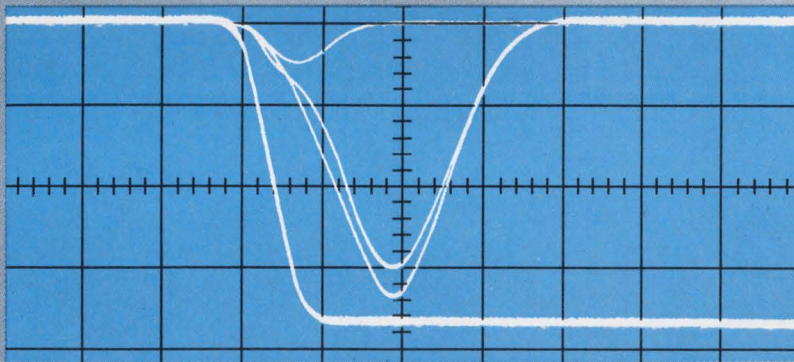

700 ma pulse amplitude (uncalibrated): Vert: 10mv/cm (core) Hor: 20ns/cm (both)

It's logical: a memory core or plated wire test output waveform can be only as good as the input. That's why we designed the Unidriver as an integral part of a test fixture. Our Unidriver is faster than the fastest memory elements, and quieter because of unique noise cancellation circuitry. So you get precise, undistorted waveforms at both input and output ends, for accurate test results. Send for literature and tell us your memory test requirements. We'll put you in the Unidriver seat.



From CTC . . . where advanced state-of-the-art technology meets tomorrow's memory test requirements!

**COMPUTER TEST CORPORATION**

SUBSIDIARY OF COMPUTEST CORPORATION  
THREE COMPUTER DRIVE ■ CHERRY HILL, NEW JERSEY 08034  
PHONE: 609/424-2400 ■ TWX: 845120 ■ CABLE: COMPUTER

Circle 182 on reader service card

## ***Want to be unique in our memory?***

It's easy. Enter the Electronics Manpower Register.

We'll feed your professional background into the talent memory of our nationwide computerized recruitment service.

Our computer will match your unique profile against every opening being programmed into it by a long list of electronics

companies. You'll automatically be qualified for every logical career opportunity. But we'll only release your availability to those companies you approve.

To enter, send us your resume.

Electronics Manpower Register  
**Electronics**  
330 West 42nd Street  
New York, N.Y. 10036

## **. . . military model covers wide temperature range . . .**

the 3-db BW), which is a figure of merit of the filter, is 2.14:1. The insertion loss of the filter is less than 3 db, and the ripple is less than 1 db. The stopband rejection is greater than 70 db, and the spurious return level is specified at 55 db. The terminating impedance of the device is 15 kilohms, resistive.

The Damon monolithic crystal filter provides the circuit designer with a smaller broadband intermediate-frequency filter than was previously available in the company's discrete filter line. The new IC design, a result of thick-film technology, is also said to be less costly than comparable discrete crystal filters.

The unit occupies 0.3 cubic inch and operates over a temperature

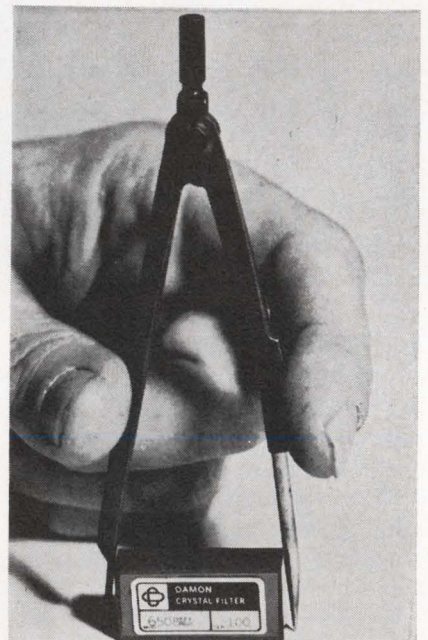

**Spacesaver.** Wideband IC filter measures 1.25-x-0.625-x-0.35 inch.

range of 0°C to +60°C. It is priced at \$52 in quantities of 100, and \$295 singly. Delivery is scheduled at 3 to 4 weeks, with delivery from stock anticipated by February. A military version can be ordered, to cover a much larger temperature range.

Electronics Division, Damon Engineering Inc., 115 Fourth Ave., Needham Heights, Mass. 02194 [350]



# FREE TEST...

(How can you solve  
your filtering problem  
if you don't know  
you have a problem?)



# FREE PROOF

that Cox can solve a contamination problem  
you may not know you have,  
boost your filtrate throughput up to ten times,  
and guarantee filtrate purity within absolute limits!

Do you insist on "absolute" filtration, without knowing if your filtering system delivers it, day in, day out?

More importantly, do you *know* the proper degree of filtration your process actually needs, or is it based on an educated guess?

At no obligation, Cox will be glad to analyze both the efficiency and the effectiveness of your present filtering system. We'll be glad to evaluate the true degree of filtering which your process requires. We'll show how you can achieve the ideal balance between particle retention and filtrate throughput, while increasing throughput volume many times. If your present system turns out to be correct for your process requirements, we'll tell you so and go away.

But chances are we can show you ways to improve your present process, ranging from suggesting

minor improvements up to proposing a totally new set of specifications and the mechanical changes necessary to maintain those specs on a continuing basis.

**DO IT NOW:** send us a representative sample of your process filtrate, together with a note telling us your filtering specifications and the nature of your process and product. We'll return to you an analysis report within 24 hours after receiving your test sample. There's no obligation.



**COX INSTRUMENT**  
DIVISION OF LYNCH CORPORATION

15300 Fullerton Avenue • Detroit, Michigan 48227

Circle 183 on reader service card



# Diversified Glass-to-Metal Hermetic Seals like these...

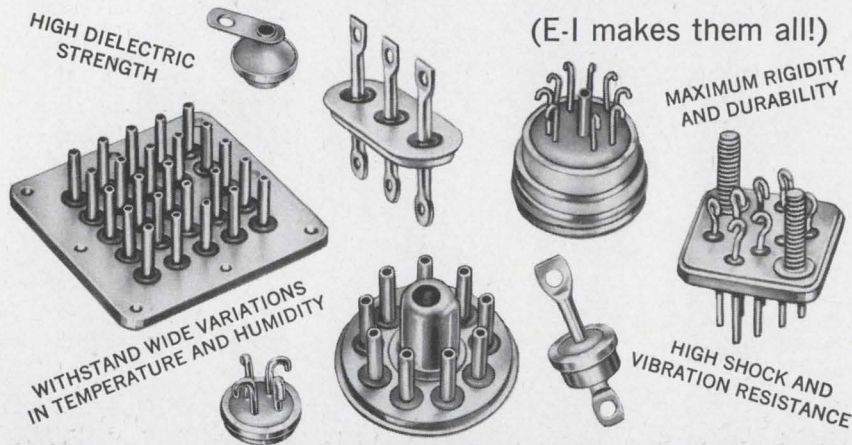

## Require Highly Specialized Engineering Capabilities...

(E-I has the know-how!)



### Specify E-I Sealed Terminations for Unusual Service Applications!

How does E. I. produce a quality line of hermetic seals? The answer is simple. A stringent program of testing and control! Above is shown an optical comparator being utilized to measure wire terminals for use in a hermetic seal. Testing in this manner assures that the finished hermetic seal will comply with all your requirements.

Available in thousands of standard types, E-I seals can be produced in 'specials' to meet particular component or equipment requirements.

Technical literature edited for the engineer/designer/specifier, and containing complete data and information, is available on request.

- Sealed Terminations
- Multiple Headers
- Transistor and Diode Bases
- Semiconductor Bases
- Compression-type Threaded End Seals
- Plug-in Connectors
- Vibrator Plug-in Connectors
- High Voltage Glass-bonded Ceramic Seals
- Hermetically-sealed Relay Headers
- Special Application Custom Seals
- Custom Sealing to Specifications



## Electrical Industries

A Division of Philips Electronics and Pharmaceutical Industries Corp.  
Murray Hill, N. J. 07971 — Tel. (201) 464-3200

Patented in U.S.A., No. 3,035,372; in Canada, No. 523,390; in United Kingdom, 734,583; other patents pending.

184 Circle 184 on reader service card

New components

## 2-pound battery delivers 100 amps

Lead-acid power source has built-in charger, protected by zener diode

A lead-acid battery that weighs only two pounds but can deliver bursts of 90 to 100 amperes has been developed by General Motors' Delco-Remy division. And the battery, a spinoff of a silver-zinc unit developed for missile applications, is fully rechargeable. A simple built-in charging unit protected by a zener diode, can keep the battery on the line for an indefinite period without being damaged.

The battery, called Energette, has a spill-proof design that permits mounting in any position for greater flexibility. It's 1/20 the size

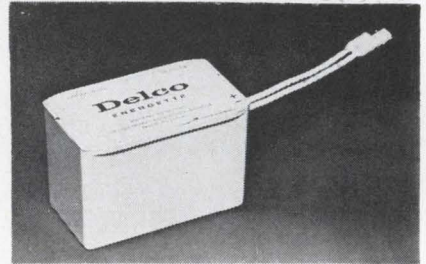

and weight of a typical automotive battery, yet it produces more than twice the number of watts per pound. The first unit, soon to be demonstrated, has a power rating of 540 watts at 14 volts. But a GM spokesman says the battery will be tailor-made to practically any standard voltage.

Applications include emergency communications facilities, military backpack equipment, television sets, and emergency lighting.

### Specification

Voltage range	6-14 typical
Current	100 a max surge
Watts per pound	257
Watts per cu. in.	9
Volume	29.4 cu. in.
Net weight	2.1 pounds
Power	540 w at 75° F

Delco-Remy Division, General Motors Corp., Anderson, Ind. [351]

Electronics | November 10, 1969



# Room for improvement

General Electric's TO-5<sup>2</sup> transistor-size sealed relays give you more room for increased power, improved performance

We didn't cut any corners on this high-reliability, transistor-size sealed relay. We left them on so there'd be more room for a more powerful magnet—2½ times more powerful.

This added power means this type 3SBS, 2PDT, 1 amp relay gives you higher contact forces, larger contact gaps, and greater overtravel to minimize mechanical shifts. Shifts which usually increase early-in-life failures.

Though there's more room inside to give you all these advantages, the outside dimensions—top-to-bottom (.275") and side-to-side (.370")—are the same as any transistor-size relay.

So don't cut corners on your next transistor-size relay application. Specify GE's square Type 3SBS. For full details, write General Electric, Section 792-45, Schenectady, New York 12305.



ACTUAL SIZE

**GENERAL**  **ELECTRIC**



# Amplifier modules deliver 250-watt pulses

Units can be combined to provide 1-kilowatt output; realignment, testing unnecessary in field repair

**Ease of replacement** was a prime design consideration for a series of ultrahigh-frequency amplifier modules now being marketed by Microwave Power Devices Inc. Each module can produce at least 250 watts peak pulse power, and 120 watts continuous-wave. The center frequency is 300 megahertz with a bandwidth of 25 Mhz. They can be combined to provide powers

in the range of 500 to 1,000 watts, and defective modules can be replaced by semiskilled personnel with a minimum of downtime.

Each module's gain and phase characteristics are marked on it, permitting installation without realignment or testing. Simple companion circuitry controls the output over a minimum 10-decibel range while maintaining a leveled output

over temperature extremes.

A module measures approximately 0.75 inch by 1.75 inches and can be replaced by removing four screws and unsoldering three connections. A defective unit can be replaced in 15 to 30 minutes, allowing operation 99.9% of the time, according to Samuel Bayer, president of the company.

The power module of the over-all

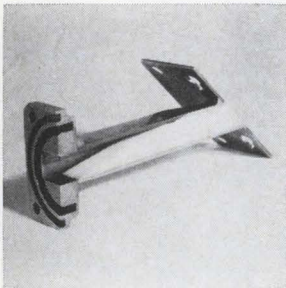

Loaded waveguides eliminate the potential for flashover from internal condensation or ice formation, without relying on pressurization and air-dryer equipment. They are designed with X-band and higher-frequency capabilities for airborne radar applications. Fabrication of copper plated directly to Teflon saves weight and space. Polyflon Corp., 35 River St., New Rochelle, N.Y. [401]

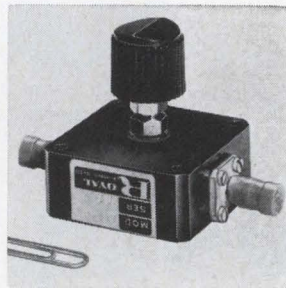

Continuously variable coaxial attenuators come in tiny packages. In both narrow and broad bandwidths, the units are available for frequencies from 2 to 12.4 Ghz. Typical maximum vswr's range from 1.5 for narrowband (20% bandwidth) units to about 2 for octave bandwidths. Power rating for all units is 6 watts, average. Solitron/Microwave, 37-11 47th Ave., L.I.C., N.Y. [402]

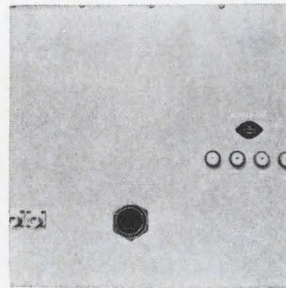

Militarized microwave synthesizer 710M provides a remotely tunable output from 1 to 2 Ghz. It is designed for system applications in a rugged environment where reliability and maintainability are important. The circuitry is packaged in functional modules with output test points for simplified maintenance. Frequency Engineering Laboratories, Farmingdale, N.J. 07727 [403]

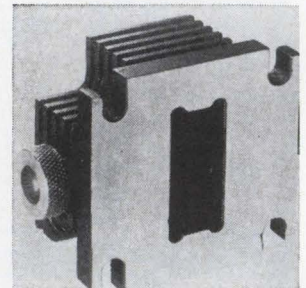

Gunn-effect oscillators VX2020 have minimum c-w output power of 100 mw. They are mechanically tunable over a 20% bandwidth from 8.2 to 12.4 Ghz. Output power varies less than 2 db over the entire tuning range. F-m noise is less than 0.7 hz rms in a 1-khz bandwidth 1 Mhz from the carrier. Monsanto Co., 11636 Administration Dr., St. Louis, Mo. [404]

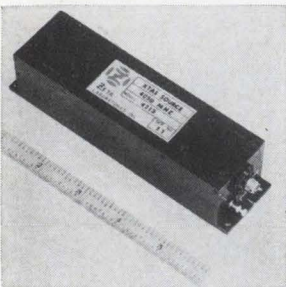

Crystal-controlled source model 4213 provides 10 mw minimum power output in the frequency range of 1 to 5.5 Ghz. Frequency stability is  $\pm 0.003\%$  over the temperature range of  $-20^\circ$  to  $+65^\circ$  C and into any phase of a 3:1 load vswr. Spurious and harmonic outputs are rejected by 60 db minimum. Zeta Laboratories Inc., 616 National Ave., Mountain View, Calif. 94040 [405]

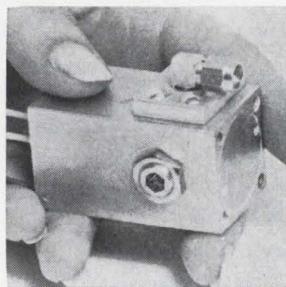

Microwave oscillator module C-2014 is designed for grid pulsed service at S-band. Typical applications are high data rate transponders, fusing, altimetry, and lightweight radar. Specifications include: peak power output of 1,500 w; peak plate current, 3.5 amps; heater voltage, 6.3 v a-c; heater current, 1.2 amps; pulse duration, 500 nsec. General Electric Co., Owensboro, Ky. [406]



Broadband tunnel diode detectors series D cover the 1-12.4 Ghz range. They come with either type N or miniature inputs and are available with maximized sensitivity over octave or multioctave bands. Prices for the type N range from \$75 for octave band coverage without a d-c return to \$95 with integral d-c return. Electro/Data Inc., 1621 Jupiter Rd., Garland, Texas [407]

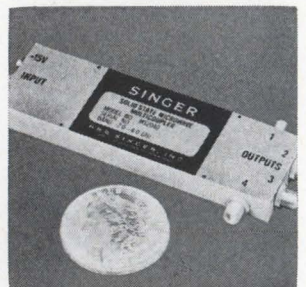

Miniature, microstrip, transistorized multicouplers model MS2040 covers the frequency range of 2 to 4 Ghz. The octave band units provide 4 outputs from a single input with no reduction in signal level, and a minimum isolation between outputs of 20 db. Package size is  $1\frac{1}{4}$  in. wide x  $\frac{3}{8}$  in. thick x  $4\frac{1}{8}$  in. long. HRB-Singer Inc., Microwave Laboratory, State College, Pa. [408]



### MOLY-PERMALLOY POWDER CORES

16 standard sizes with ID's from .110" to 1.40", and OD's from .250" to 2.25". Guaranteed  $\pm 8\%$  inductance limits on toroids with permeabilities of 14, 26, 60, 125, 160, 200, 300 and 550. Available either stabilized or unstabilized with temperature.

### TAPE WOUND CORES

Made from nickel, silicon, or cobalt irons. We supply all AIEE standards plus special sizes in thicknesses from  $\frac{1}{2}$  through 14 mils. All sizes boxed in phenolic or plastic, aluminum or GVB-coated aluminum boxes.

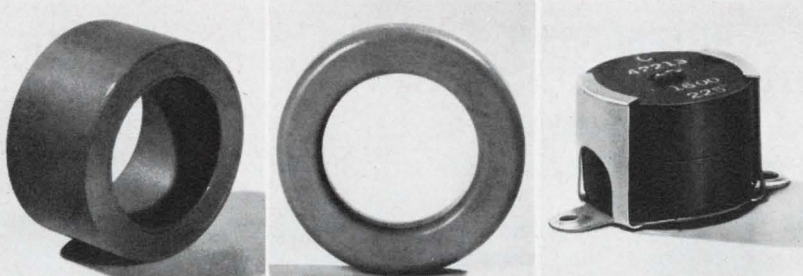

### FERRITES

Guaranteed linear temperature coefficients on 750, 1400 and 2000 perm materials. Flat temperature coefficient on 2300 perm material also guaranteed. A total of 175 part numbers to choose from.

### BOBBIN CORES

Made from Permalloy 80 and Orthonol<sup>®</sup> strip .000125" to .001" thick and .023" to .250" wide.

Diameters range to less than .050", with flux capacities as low as several maxwells.

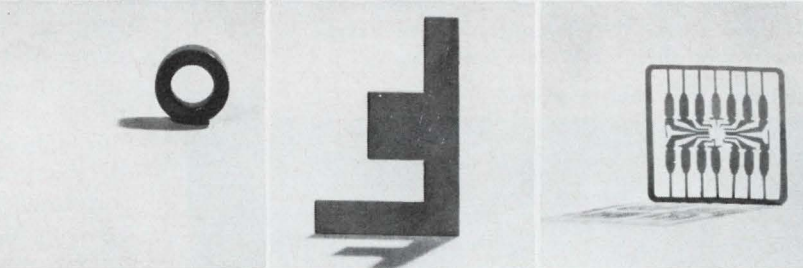

### PHOTOFAB<sup>®</sup> PARTS

Precision flat components chemically milled from almost any magnetic or specialty alloy. Thickness tolerances range from  $\pm 5\%$  to  $\pm 10\%$ , depending on thickness and type of material.

### MAGNETIC LAMINATIONS

Nickel-iron materials in thicknesses of .004", .006" and .014". 38 standard shapes in sizes from DU-87 and EI-12 down to EI-093, EE-30-31 and F-094.

## Magnetics Inc. gives you total quality control and single-source responsibility on every component

At Magnetics Inc., we're particular about what the finished component does for you. So particular that we maintain up-tight control right from the start. On ferrites and powder cores, we begin with the exact blending of powders. Our metal strip products also evolve from closely controlled custom blending and composition. This emphasis on precision, from start to finish, results in product uniformity—you get optimum characteristics and full-measure performance *every* time. That's what we mean by single-source responsibility. For additional information on any of our products, mail coupon today.

Magnetics Inc.  
Dept. EL-103, Butler, Pa. 16001

Please send me additional information on:

Tape Wound Cores  Bobbin Cores  Moly-Permalloy Powder Cores  Ferrite Cores  Magnetic Laminations  Photofab Parts  Specialty Metals

Name \_\_\_\_\_

Title \_\_\_\_\_

Company \_\_\_\_\_

Street \_\_\_\_\_

City \_\_\_\_\_ State \_\_\_\_\_ Zip \_\_\_\_\_



Tape, Powder, Bobbin, Ferrite Cores • Laminations • Photo-etched Parts • Specialty Metals • Engineered Control Systems



# WHERE ACCURACY COUNTS!

## INTERNATIONAL MODEL 6000 FREQUENCY METER

measures frequencies

10 khz to 600 mhz with accuracy as close as .000125%

The Model 6000 Modular Frequency Meter will measure frequencies 10 KHz to 600 MHz with .000125% accuracy. The wide variety of plug-in oscillator accessories and range modules makes the

Model 6000 adaptable to a number of jobs in the field and in the laboratory. Designed for portable and bench use. Self-contained, rechargeable, nickel, cadmium batteries.

Model 6000 with 601A charger, less plug-in modules .....\$195<sup>00</sup>



CHARGER



RANGE MODULES (Mixers)  
\$25.00 to \$45.00 each

OSCILLATOR MODULES  
(Crystal Controlled For  
Frequency Measurement)  
\$30.00 to \$90.00 each

... For complete information  
write International today.



CRYSTAL MFG. CO., INC.  
10 NO. LEE • OKLA. CITY, OKLA. 73102

amplifier consists of four transistors, each capable of a 40-watt output. These are operated at approximately a 1.5/2.0:1 safety factor. Each transistor is capable of dissipating 70 watts, with a minimum derating of 2:1, resulting in long life-expectation.

The submodules, each consisting of one transistor and associated circuitry, are driven by a four-way combiner. After each submodule is gain- and phase-tracked, its power is recombined in the four-way combiner to provide the total power output.

In tests, modules were made inoperative to test the effect on the over all operation. Failure of one of four submodules causes a power drop of no more than 3 db, depending on the failure modes; failure of two of four submodules causes a maximum power drop of 6 to 9 db, and failure of three of four submodules drops power 12 db maximum. During the tests, performed under operating conditions, no degrading due to the resultant mismatch conditions was detected. Replacing one submodule with another of similar characteristics returned the amplifier to normal performance.

The amplifiers are intended for use in highly reliable communications circuits, covering the range from transmitter outputs through electronic countermeasures and Sonobuoy applications.

### Specifications (model 300-25-120-0.1)

Center frequency	300 Mhz
Bandwidth	25 Mhz@ 1 db points
Power Output (50 ohms)	120 watts c-w 250 watts pulse
Power gain	6-45 db, as required
Overall efficiency	45-60%
Voltage	+28 v d-c
Impedance	50 ohms
Harmonics	-20 db min
Connectors	Type N standard

Microwave Power Devices Inc., 556 Peninsula Blvd., Hempstead, N.Y., 11550 [409]

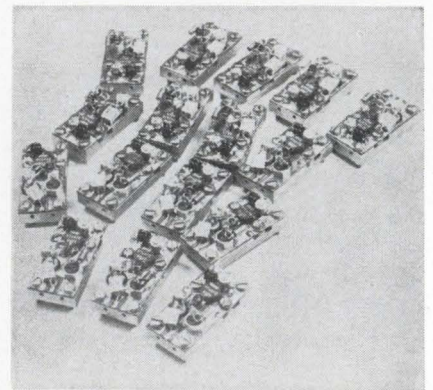





For half a century, ultrasound was regarded as a curiosity—an obscure principle employed by moths in flight. Then Branson happened. A generation of research and discovery was under way.

Today Branson Ultrasonic Cleaning incorporates every discovery we've made since the early days. Our cleaners are more efficient for the lead zirconate transducer we

pioneered. More useful because our new solid-state Powerpack generator can power an entire series of tanks, automatically adjusting frequency to a different load in each. More versatile thanks to the wide range of models, from small standard and custom units to large systems.

But perhaps you're still just a little bit up in the air about what ultrasonics

can, or cannot do for you. If that's the case, see Branson. We've had time to get our feet on the ground.

Branson Instruments Co., a subsidiary of Smith Kline & French Laboratories, Progress Drive, Stamford, Connecticut 06904

**BRANSON**

For sound ideas in cleaning, testing and measuring

**The silent world of working sound.**



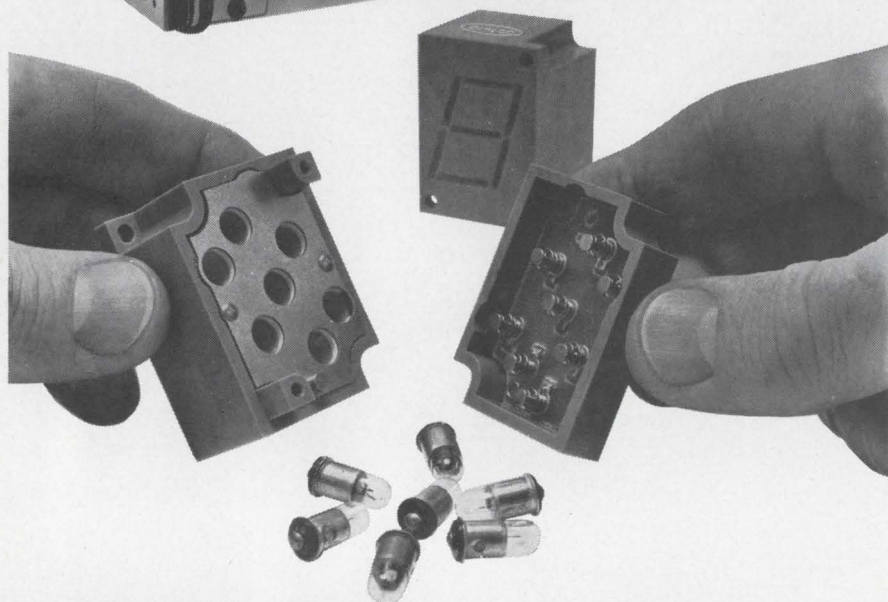

## *What makes low-cost Dialight readouts so reliable and easy-to-read?*

Reliable because of simple module construction and long life lamps. Designed for use with neon or incandescent lamps to meet circuit voltage requirements. Easy-to-read from any viewing angle. 1" high characters are formed by unique patented light-gathering cells, and may be read from distances of 30 feet. Sharp contrast makes for easy viewing under high ambient lighting conditions.

### **Dialight Readout Features**

1. Operate at low power.
  2. 6V AC-DC, 10V AC-DC, 14-16V AC-DC, 24-28V AC-DC, 150-160V DC or 110-125V AC.
3. Non-glare viewing windows in a choice of colors.
  4. Available with RFI-EMI suppression screen.
5. Available with universal BCD to 7 line translator driver.
  6. Can be used with integrated circuit decoder devices now universally available.
7. Caption modules available; each can display 6 messages.

## *Send for catalog*

Catalog-folder contains complete specifying and ordering data on numeric and caption modules, translator drivers, mounting accessories. Dialight Corporation, 60 Stewart Avenue, Brooklyn, New York 11237. Phone: (212) 497-7600.



# **DIALIGHT**

DT-126

New microwave

## **Micrometer tunes coax attenuator**

3 models initially designed  
for military applications  
cover 0.8 to 11 Ghz range

**Engineers** who require coaxial attenuators in the standard 0- to 30-decibel range for laboratory and production test applications can choose from among three new units made by the Royal Microwave Devices division of Solitron Microwave. The devices, designated models 5444, 5445, and 5446, had been aimed primarily at military customers.

Each of the three new attenuators is continuously variable, and each can handle 10 watts average power and a peak of five kilowatts. The model 5444 covers a range from 0.8 to 2.5 gigahertz, the 5445 accommodates 2 to 6 Ghz, and the 5446 is for use from 7 to 11 Ghz. Insertion loss is 0.2 db maximum. The voltage standing wave ratio for the 5444 and 5446 is 1.5; the 5445 has a maximum VSWR of 1.3.

The attenuators include micrometer drives to vary the attenuation element loading angle, and the low insertion losses and VSWR ratings are achieved by using hand-selected, film-deposited attenuation elements. These also contribute to longer life, the company says.

Standard connections are female type N, and impedance is 50 ohms, but custom units with other impedances and frequency ranges also are available. The units are 5 inches in diameter and 1 inch high, excluding the connectors and micrometer drive. They're suitable for testing and attenuating signals from transmitters, oscillators and other frequency sources, as well as for buffering signals. Price is \$225 each or \$650 for a set of three. A company official says the price is "slightly less" than that of competitive devices.

Royal Microwave Devices division, Solitron/Microwave, 37-11 47th Ave., Long Island City, N.Y. 11101 [410]



# We Androids absolutely demand Guardian Steppers



If there's one thing a robot hates it's that embarrassing maintenance check! That's why we want long-life components built for dependable operation. Like Guardian stepping relays (some humans call them rotary stepping switches). They average over five million operations on the life-test rack.

Then, too, Guardian steppers are compact . . . replace relays in series or banks of multiple circuitry . . . so we keep slim.

If you don't want a fat, broken-down android on your hands, specify Guardian steppers. Lots of types available . . . sequence selecting, automatic resetting, pulse multiplying, slave and master, etc., etc. Up to 52 contacts per deck . . . up to 8 undivided circuits. Write for Bulletin F32.

## **GUARDIAN<sup>®</sup>**

GUARDIAN ELECTRIC MANUFACTURING COMPANY

1550 W. Carroll Ave. • Chicago, Ill. 60607



Circle 191 on reader service card



# No EA customer has ever had to wait for delivery.

Electronic Arrays is now manufacturing and shipping state-of-the-art MOS circuits *in volume*. More than 10,000 units a month.

Since our first product announcement last February, we've batted 1.000. All orders for our standard products have been, and are, shipped immediately from either distributor or factory inventory.

If you think all this is just the usual MOS talk, there's one sure-fire way to put us to the test.

Just send us a purchase order for any of the following off-the-shelf items:

- EA 1200/1201 Quad 32 bit register
- EA 1202/1203 Variable 64 bit register
- EA 1204/1205 256 bit register

- EA 1400 64 word, 2 bits/word RAM
- EA 3001 256 word, 9 bits/word multi-function ROM
- EA 1808 Fixed logic array
- EA 1806 Variable hex gate array
- EA 3501 dot code matrix ASCII character generator ROM
- EA 1003 dual 32 bit static shift register

Order from any of our 18 distributor locations or directly from **Electronic Arrays, Inc.**, 501 Ellis Street, Mountain View, California 94040. (415) 964-4321.



**electronic  
arrays, inc.**

**Proven MOS products delivered in volume.**

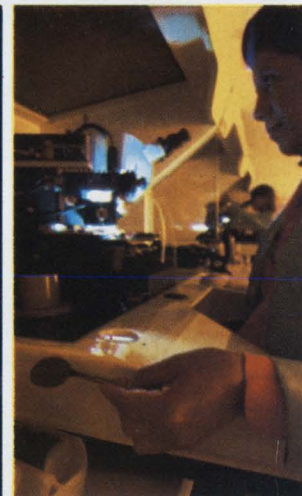



# Small computer is expandable

Low-priced modular unit is software-compatible with larger machines of same maker; can be satellite, remote terminal, or stand-alone

**As Control Data sees it**, there are plenty of customers who need small-scale computers for business and scientific purposes, but don't want to buy a minicomputer because they might want to expand their system later on. The solution: the SC 1700. Because of its modular construction it can be expanded to any degree while still offering the basic package at small-computer

prices. And since it is software-compatible with Control Data's larger computers, the 6000 and 7000 series, the SC 1700 can be used as a satellite of the bigger systems.

The SC 1700 doesn't markedly differ in capability or size from the 1700 model that came out in 1967—the big difference is in price. And Control Data is keeping that a secret until the Fall Joint Computer

Conference, where the SC 1700 and several pieces of peripheral gear will be unveiled. But the company says the price will be substantially lower than the \$30,000 tag on the 1700.

"The price difference results from the new logic circuits in the computer. We're using our own standard logic circuits instead of going to outside sources," says a

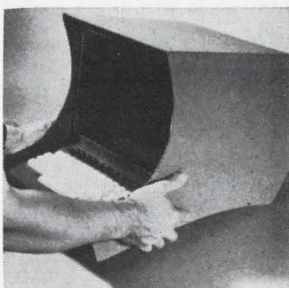

Crt computer display terminal Alpha 101 is an 800 character, Teletype compatible unit. It measures 12 in. wide, 14 in. high and 20 in. deep. It has an adjustable internal clock, making it possible to transmit data at any synchronous rate up to 2400 baud. Unit has both MOS memory and MOS character generation. Beehive Electrotech Inc., Salt Lake City, Utah. [381]

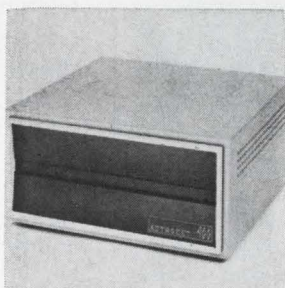

High speed modems designated the Astrosat 400 series can interface with Bell Telephone's 301/303 data sets. Data transmission rates are available from 10 kilobits per sec for the series 410 to 96 kilobits per sec for the series 496. Units come equipped with built-in repeaters to increase the distance of transmission. Astrocom Corp., 293 Commercial St., St. Paul, Minn. [382]

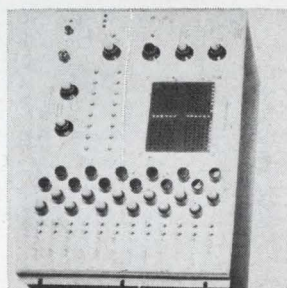

Data generator model SQ260/280 is for versatile and high speed data generation in dynamic testing of digital devices, packages and subsystems. A 12 bit by 16 word plugboard programs the input pattern for the device under test. The SQ260 has a 10 Mhz word rate and the SQ280 has a 15 Mhz word rate. Adar Associates Inc., 85 Bolton St., Cambridge, Mass. 02140 [383]



Magnetic tape transport C-200, designed around the stability of the Norelco cassette, is for digital applications. It is for remote terminal and keyboard entry, intermediate storage, as well as computer input/output and medical data acquisition. It replaces punched paper tape with faster, quieter data storage. Cipher Data Products Inc., 7545 Convooy Court, San Diego, Calif. [384]

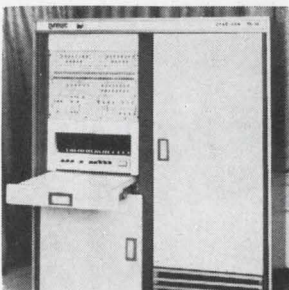

Simultaneous data communications between 120 remote terminals and a central computer over a single voice grade line is possible with the Dyne-Com 70 multiplexer. With a synchronous line efficiency of over 80%, it can handle 6 or 7 times as many terminals as conventional time division multiplexers. Prices start at \$60,000. Dynelec Systems Corp., Glen Rock, N.J. [385]



Data collection terminal DG-3 may also be used at the computer center to collect data off line. Data is received over the telephone from a remote DG-3 and is written off line on a computer compatible magnetic tape (7 track, 556 bpi or 9 track, 800 bpi). Data tape is then mounted on computer tape drive for processing. Applied Peripheral Systems Inc., Houston [386]

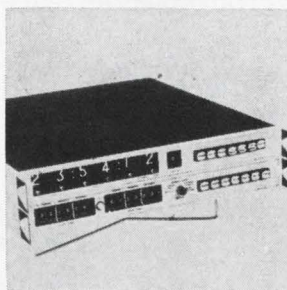

Tape search and control system, occupying 3 1/2 in. of panel space, is comprised of a model 9300 time code generator-reader and a model 9240 tape search and control unit. During periods of data acquisition the system supplies serial hours, minutes and seconds in the IRIG B format on a 1 khz sinewave carrier. Datum Inc., Liberty Ave., Anaheim, Calif. [387]

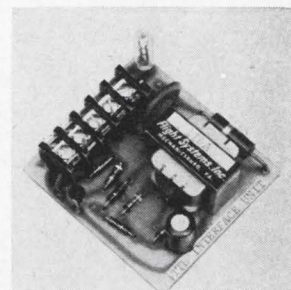

Interface unit 114A converts line voltage command signals to TTL or DTL logic levels. It performs the direct interface between IC logic and machine tool control circuit. Immunity to false actuation in either the "1" or "0" state is incorporated. Unit will not actuate on any noise signal up to 3 msec duration. Price (1-10) is \$19.50. Flight Systems Inc., Mechanicsburg, Pa. [388]



# NEW VACTEC

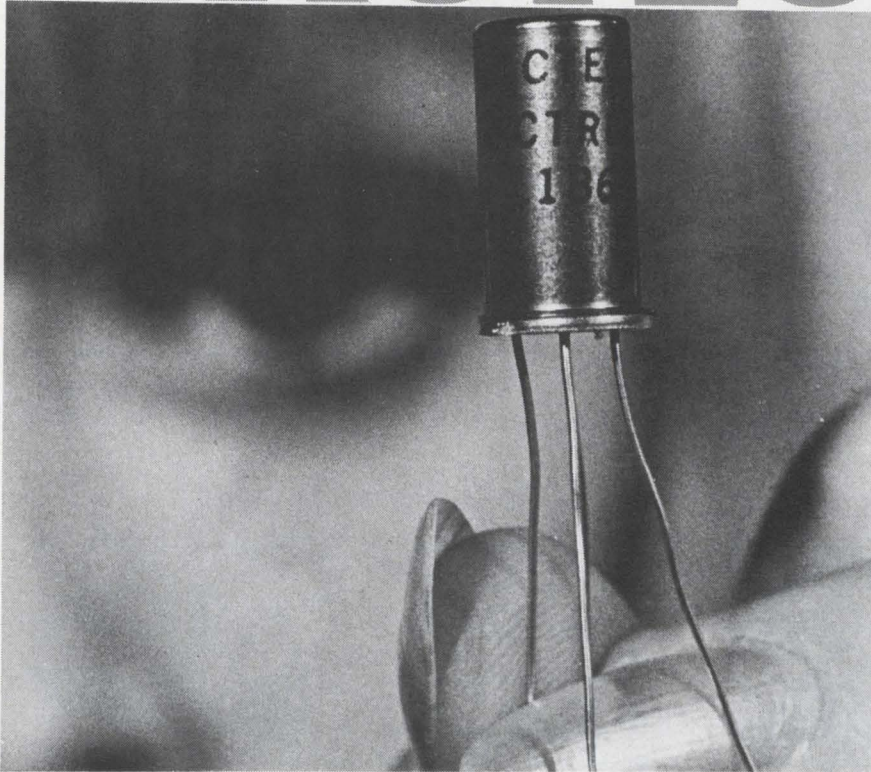

## Hermetic TO-5 Vactrol Photon Isolators

Vactec's new photocell-lamp control module is filled with clear flexible resin to provide high vibration immunity. It is hermetically sealed in a TO-5 enclosure, and available in low voltage (incandescent) and high voltage (neon) types.

These devices are widely used for signal isolation, audio level controls, SCR and triac turn on, and noiseless switches. They are priced less than \$1.25 in 1,000 quantities for some models. Write today for Bulletin PCD 4C3.

### Specifications at 25° C

Minimum off resistance	10 <sup>7</sup> ohms
Cell voltage max.	150 V.
Cell dissipation	100 MW.

Part Number	LAMP		PHOTOCELL		
	Voltage max.	Current (ma)	Max. ON (ohms)	Ascent Time ms	Decay to 100K ms
VTL1A1	1.5	50	400	80	350
VTL1A2	6.0	40	200	75	400
VTL1A3	10.0	14	800	60	150
VTL1A4	12.0	25	250	120	500
VTL1B5	*150	1.2	1000	80	65
VTL1B6	*90	.3	5000	6	50

## VACTEC, INC.

2423 Northline Ind. Blvd.  
Maryland Heights, Missouri 63042  
Phone: (314) 432-4200

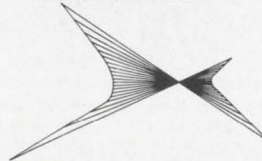

Specializing in standard Cds, Cdse, and Se cells; custom engineering for every photocell need.

Listed in EBG under "Semi-Conductors" and in EEM Sec. 3700.

company official. "This provides us with a considerable savings and is advantageous to our customer because he goes right back to Control Data for repairs and extra parts whenever he needs them."

The chief difference between the new model and its predecessor is the memory cycle time—the SC 1700 is a little bit slower at 1.5 microseconds, compared to 1.1  $\mu$ sec for the 1700. However, memory capacity is the same. Core memory contains 4,096 18-bit words which can be expanded to 32,768 words in increments of 8k, 16k, and 32k.

Slanted toward applications encompassing scientific computing, industrial control processing, high-speed data acquisition, and hybrid applications (analog-to-digital conversion), the system can include various pieces of peripheral equipment. Among some of the attachments that Control Data offers are drums, disk packs, magnetic tapes, teletypewriters, printers, card readers and punches, optical character recognition equipment, and cathode-ray tube displays for alphanumeric readout and graphics.

The customer will have the option of using the computer as a small satellite scientific or business data processor for the larger Control Data 6000 and 7000 series computer systems; a data collection concentrator; a remotely programed terminal for large computing systems; or as a stand-alone system for process control, graphics, and automatic testing.

Control Data Corp., 8100 34th Ave., So., Minneapolis, Minn. [389]

### Data handling

## Microfilm printer takes direct route

Dense alphanumeric storage provided at low cost; conversion is eliminated

Microfilm and computers have been teamed up before, but to put computer output on film, expensive digital-to-analog converters and



# RUB-OUT PROOF

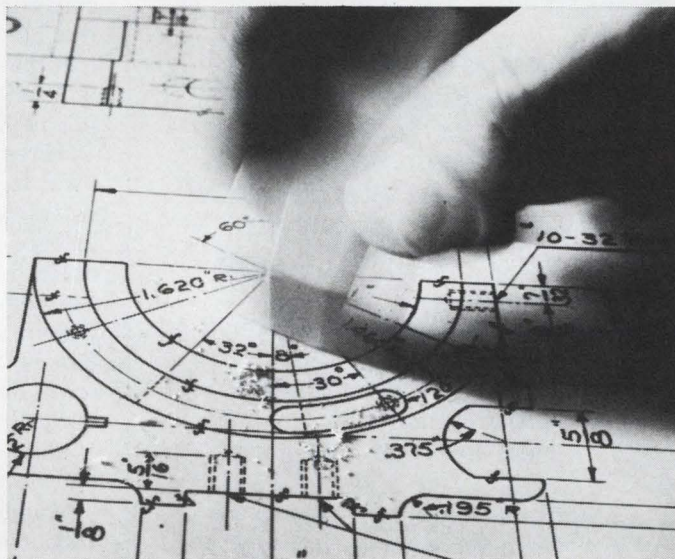

**After as many as 10 changes,  
KODAGRAPH ESTAR Base Films  
still won't tell on you.**

That's right. KODAGRAPH ESTAR Base Films have surface toughness that stays ahead of your eraser. This rugged matte drafting surface retains its "tooth" under repeated same-area changes, and always maintains its smooth acceptance of your ink and pencil lines.

You'll really like working with ESTAR Base Films.

They're easier to handle and correct. For example, KODAGRAPH Wash-Off Film wet-erases in seconds with a drop of water and a few swipes of your eraser. And it's so easy to process; you can count on getting your prints back faster than ever before.

KODAGRAPH ESTAR Base Films are designed by Kodak to make you and your work look good. Next time, order them from your reproduction department or blueprinter. Your local Kodak Technical Sales Representative can show you the full line this week. Or write: Eastman Kodak Company, Business Systems Markets Division, Rochester, New York 14650.

**Kodak**

**DRAWING REPRODUCTION SYSTEMS BY KODAK**



# What happened when doctors and engineers got together:

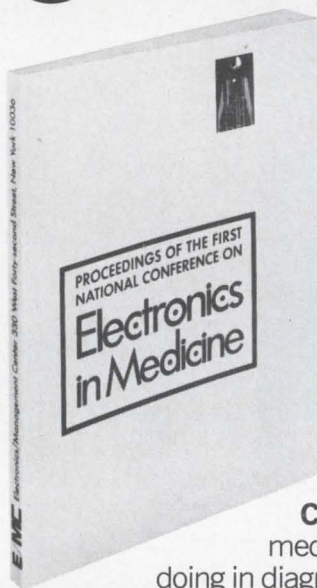

Doctors told engineers how they were using electronics and revealed their most urgent needs. Engineers described and demonstrated their newest equipment for diagnosis, treatment, and prevention. And hinted at things to come.

Their complete dialogue, with illustrations, makes pretty informative reading on a vital and growing market.

Here are some of the things it contains:

**Computers:** How they're joining the medical team. What computers are doing in diagnosis. In communications. The small computer as a paramedical aid.

**Instrumentation:** What's needed. What's available. Patient management. Protection. Standards and safety.

**Electronics in the Hospital:** The surgeon, the hospital, the instruments. What the administrator wants. Prescription for large-scale health care. The surgery department.

Electronics/Management Center  
330 West 42nd Street, New York, N.Y. 10036

Enclosed is \$12 for a copy of the Proceedings of the First National Conference on Electronics in Medicine.

Send the Proceedings and bill me later. P.O. # \_\_\_\_\_

Name \_\_\_\_\_

Company \_\_\_\_\_

Address \_\_\_\_\_

City \_\_\_\_\_ State \_\_\_\_\_ Zip \_\_\_\_\_

cathode-ray tubes were required. The Memorex Corp. has eliminated the need for these devices in a new computer-output microfilm device that employs a light-emitting diode matrix.

Designated the 1603 microfilm printer, the device is hardware- and software-compatible with IBM 1403 and 1443 line printers, and operates as a standard peripheral with the IBM 360 model 25 and above. The 1603 prints out 10,000 132-character lines per minute—10 times faster than line printers.

According to Laurence Spitters, president of Memorex, "The 1603 will cost about half as much as other microfilm printers because it has a control unit that allows it to interface directly with IBM data channels. Other printers require converters." As an example, Spitters cites a Stromberg-Carlson system that sells for \$100,000; the 1603 will sell for \$44,250 or rent for \$895 per month.

Three major components are used to generate the output characters: a translation matrix, a bank of light-emitting diodes, and a fiber optics bundle. Digital signals from the computer are decoded by the matrix and directed to the proper diodes, where light then is piped to a lens assembly by the fiber optics bundle. The entire assembly is aligned and sealed at the factory and never needs adjustment.

Maintenance also is easy on the 1603 compared with other microfilm units or even standard line printers. The 1603 doesn't have the mechanical complexity of a line printer or the electronic adjustments of a crt or electron-beam recorder system. The only moving parts are the shutter and the film transport, and since the film moves at only six inches per second, the mechanical system is kept simple.

The 1603 uses 16-millimeter microfilm, supplied in cartridges that hold 500 feet of film—enough for 80 minutes of continuous output, or about 12,000 pages of fan-fold paper printout. Spitters says that paper-printout costs about 0.5 cent per page for single-copy paper, or about 0.8 cent per page for carbon paper, but the microfilm costs only 0.04 cent per page.

Delivery will begin in early 1970.

Memorex Corp., 1180 Shulman Ave., Santa Clara, Calif. 95050 [390]



# The non-catalog connector.

If you can't buy it. We'll make it. Any kind of printed circuit connector.

Tell us how many positions, how many contacts. And what kind of shape it ought to be in.

We'll take it from there, and turn out a connector for you, at a price that's probably the lowest in the business.

The biggest reason is our contacts—because they're the biggest single factor in the price of connectors.

We put more gold at the contact area than any plater does. But we weld it there instead of plating it. So we use less gold overall.

As a result, our contacts are the best you can buy. (Maybe that's why many of our competi-

tors use them.)

We also do our own wire drawing, coining, forming, bending, and solder plating. We design our own tooling and mold our own plastic bodies. And we assemble and test the whole connector ourselves.

If you're looking for ordinary connectors look in ordinary catalogs.

But if you want something a little special, now you know where you can go.

Sylvania Metals & Chemicals, Parts Division, Warren, Pennsylvania 16365.

**SYLVANIA**  
GENERAL TELEPHONE & ELECTRONICS

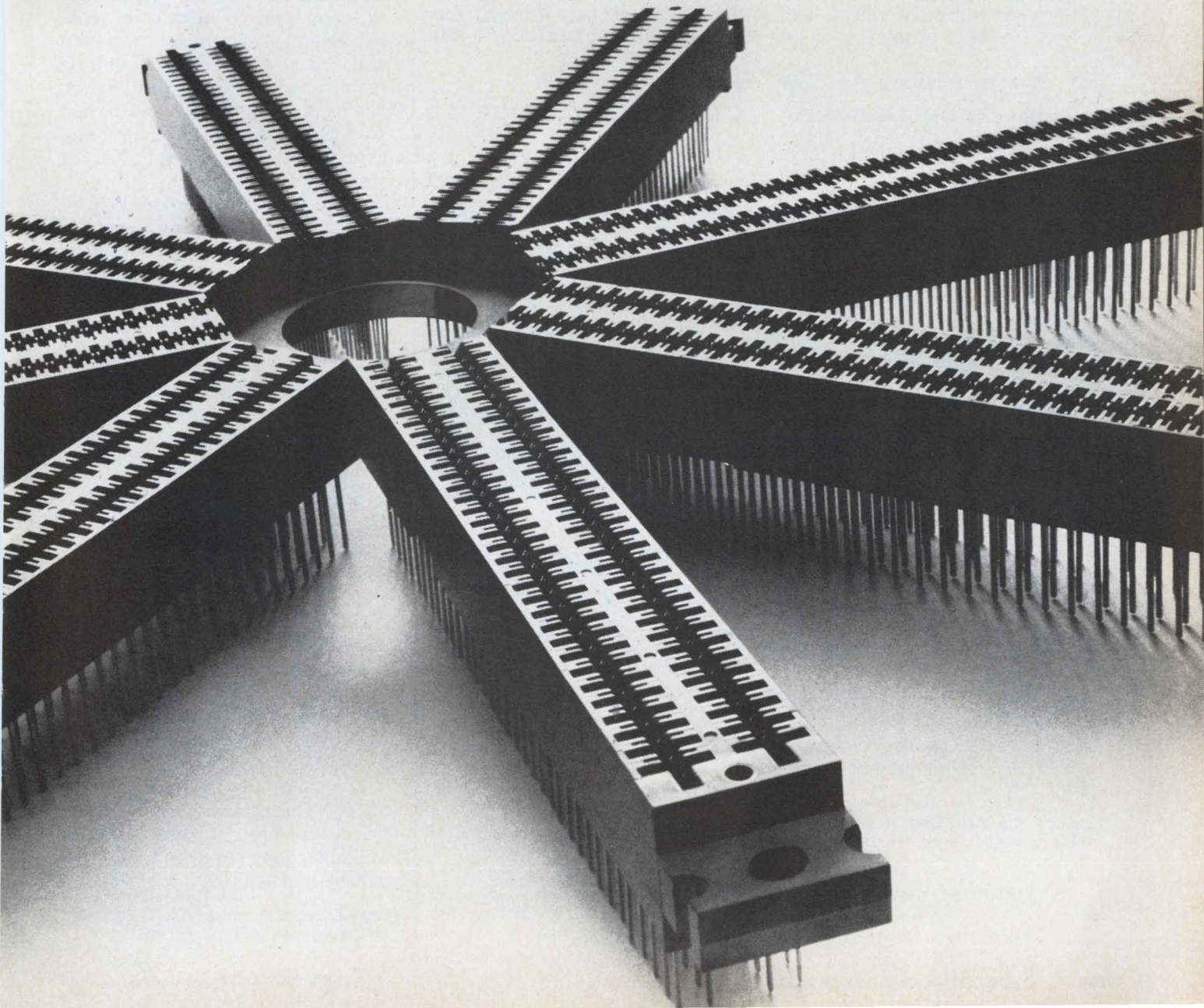



**FAMOUS MAGNELINE® QUALITY**

**NEW  
COMPACT  
SIZE!**

**NEW  
LOW PRICE!**



Patwin's Series 18000 indicators operate from pulsed DC voltages in decimal form to display digits or symbols. They have the same reliability, readability and memory as other MAGNELINE models but are more compact and lower in price. The new indicators are only .29" wide and .92" high yet digit size is a full ¼ inch. Unit price is \$33.80 in quantities of 100.

The Series 18000 has many applications in aviation and general instrumentation, especially where extreme reliability and low maintenance cost are important. Open construction of the unit gives instrument designers a wide choice of mounting methods. Full information available from Patwin, 41 Brown Street, Waterbury, Connecticut 06720. Telephone (203) 756-3631.

**PATWIN**®  
DIVISION OF UNITED-CARR  
UNITED-CARR INCORPORATED • A SUBSIDIARY OF TRW INC

**WATERBURY,  
CONNECTICUT 06720**

Circle 198 on reader service card

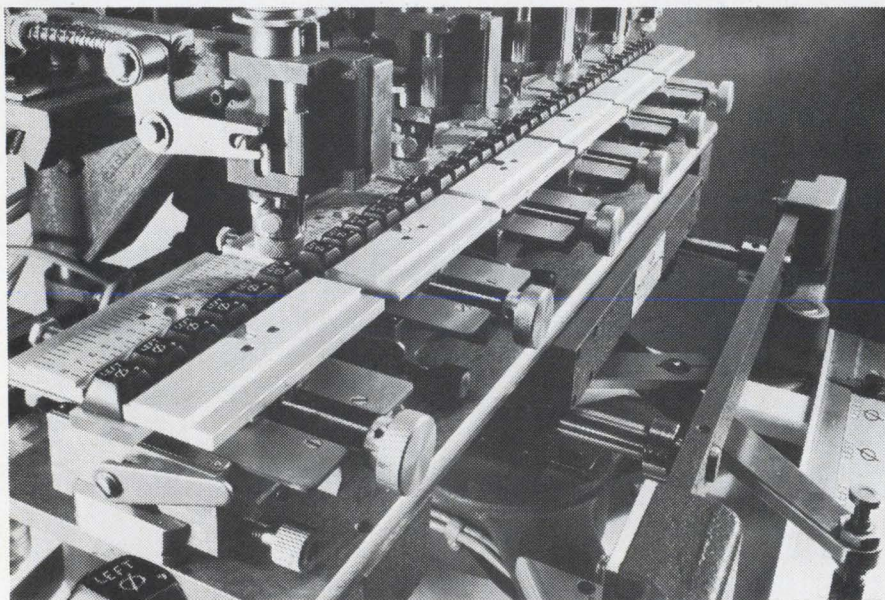

### 6 will get you 36

Now, new 6-spindle New Hermes engraves up to 36 machine keys with one set-up.

Any unskilled worker simply guides the pantographic tracer on this pneumatically-operated engraving

machine. Each spindle has an automatic depth-regulator, guaranteeing uniform depth and width of engraving over the complete contour of the key.

Write for detailed brochure No. 197.

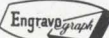
*new hermes engraving machine corp.* 

20 Cooper Square, New York, N. Y. 10003  
Chicago, Atlanta, Los Angeles, Dallas, Montreal, Toronto, Mexico City

Data handling

## Calculator is interruptible

Easily programable unit resumes automatic mode after manual operation

**Branching out** from its well-established niche in consumer electronics, the Sony Corp. is seeking to tap the office-machines market with its new programable electronic calculator, designated the ICC-2500W.

The unusual feature about this calculator, the company points out, is ease in programing. There are no complicated routines such as jumps and transfers which an operator has to learn from an instruction manual. Equation steps can be keyed in almost as exactly as when writing them on paper. Once the program has been entered, the operator just keys in the variables and can forget about pressing add, subtract, or square-root buttons.

In addition, the operator can interrupt a program at any point to run some calculations manually, and then return to the original program without having to re-enter the program or re-start calculations. Furthermore, should a wrong program instruction be entered, that instruction can be erased immediately without wiping out any of the previous instructions.

The calculator is equipped to handle 111 instructions, and has a display capability of 15 digits with automatic decimal placement.

The main memory consists of a 360-bit magnetostrictive delay line and 15 registers.

One of the options is an electrostatic printer.

Sony also will be offering in the first half of 1970 an external cassette storage unit for quick programing input to the calculator and for storing programs in library use.

The price for the calculator is \$1,695. The printer goes for \$550. When cassette storage becomes available, Sony says, the total price will be under \$2,000.

Sony Corp. of America, 47-47 Van Dam St., Long Island City, N.Y. [391]



# It's not easy to forget a name like Honeywell. But try.

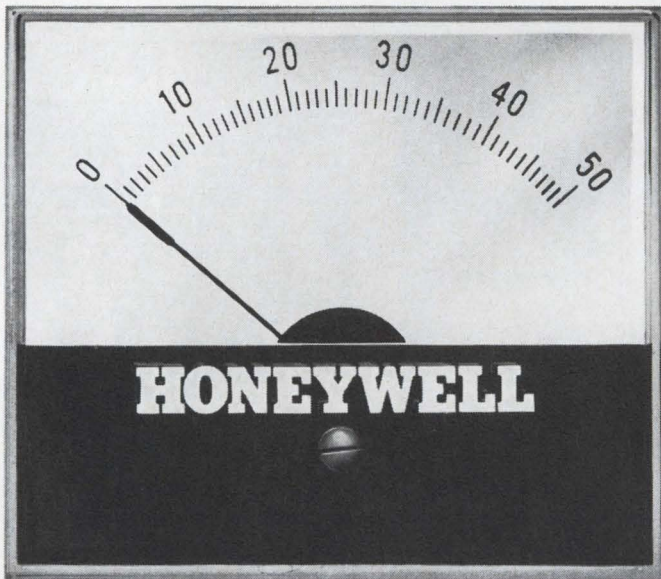

This used to be a Honeywell meter. Now it's a Jewell.

The quality is the same. The performance is the same. Even the face is the same. Only the name is changed.

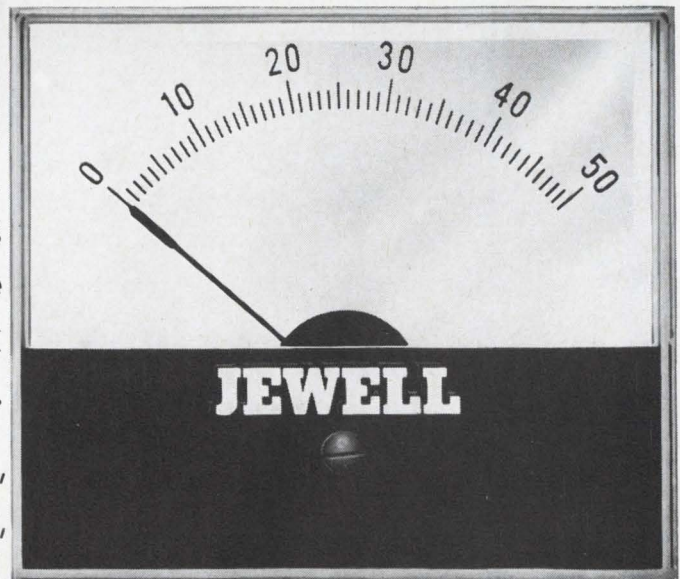

So please remember. Jewell Electrical Instruments now has the process, the people, and the plant to make the meters that Honeywell made famous.

Jewell Electrical Instruments, Inc.,  
Grenier Field, Manchester,  
N.H. 03105 — 603/669-6400.

# HONEYWELL JEWELL



This portable will record more facts in less time, at less cost than any other 2-channel recorder on the market.

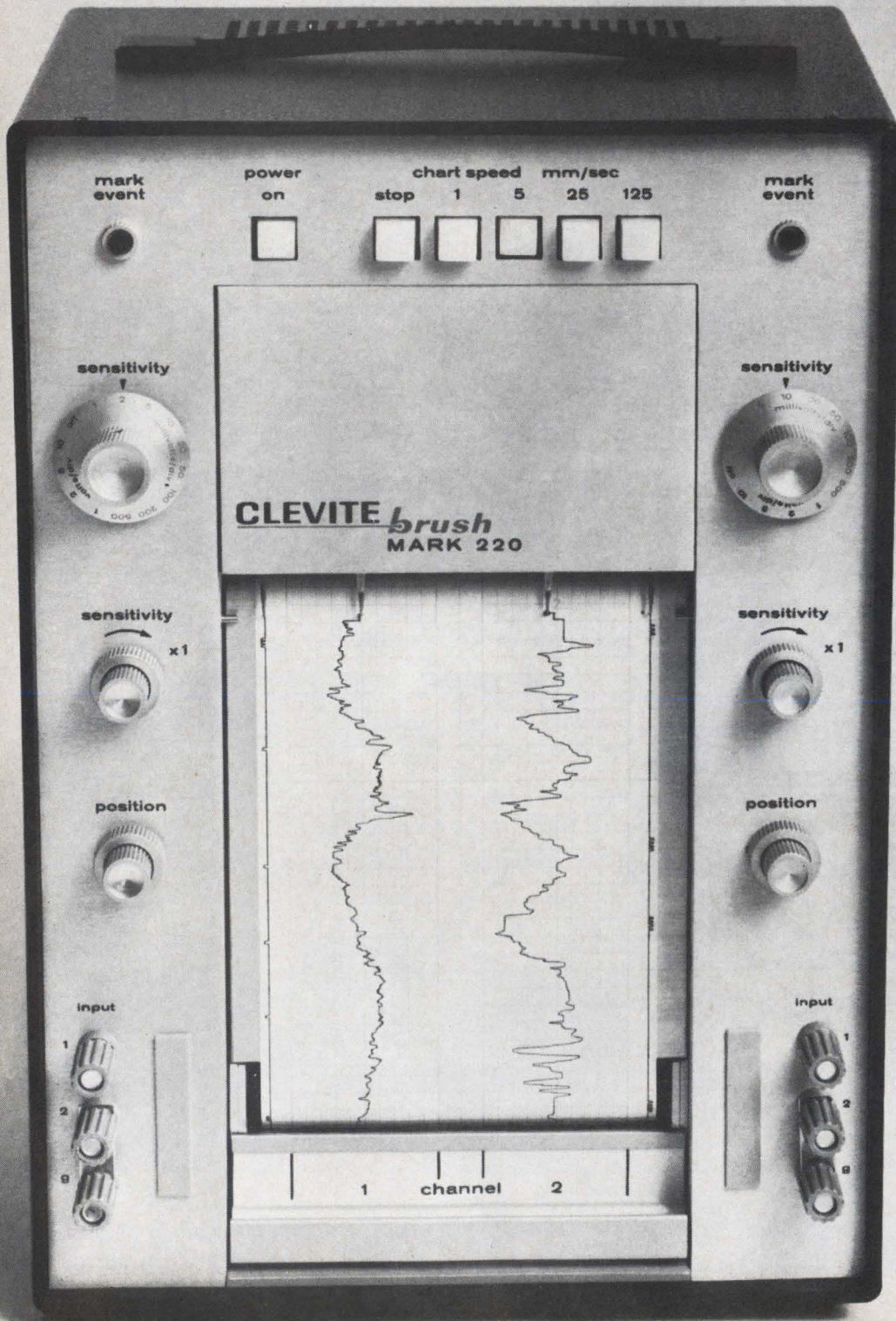

We call it the Mark 220.

And once we put it through its paces for you, you'll call it the most amazing piece of recording gear around.

To begin with, we *guarantee* the Mark 220 to be 99½% accurate. Which is a good deal better than almost anything else on the market . . . regardless of size or price. The pressurized ink-writing system is the same one you'll find in our six and eight channel systems. Instead of laying the trace on the

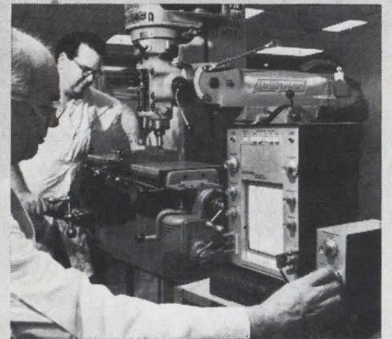

paper, it forces it *in*. Run your finger over it. There's no smear, no smudge. And trace crispness and uniformity is in a class by itself.

Built-in preamplifiers give you measurement range from 1 mV per division to 500 V full scale — and you never have to re-calibrate. Pushbutton controlled chart speeds. Two handy event markers. Ink supply is a disposable cartridge, good for a year.

Yes, for a 25 pound portable that's no bigger than a breadbox, the Mark 220 is quite a recorder. Ask your Brush representative for a demonstration. Or, write for complete details. Brush Instruments Division, Gould Inc., 3631 Perkins Avenue, Cleveland, Ohio 44114. We'll include our informative booklet "Elimination of Noise in Low-Level Circuits".

**GOULD BRUSH**



# Noncontact IC printer loads manually

Japanese machine trades cycle time to avoid alignment woes; second-generation equipment, in two models, aimed at U.S. market

**Optical masking**, or noncontact printing, of integrated circuits looked like a natural to revolutionize the industry a few years ago. The technique—projecting circuit patterns through the mask directly onto the photoresist covering the wafer—promised pattern accuracy equal to that of conventional direct-contact printing, and with higher device yields. Further, because the

mask never touches the wafer, there is less chance of scratching and having to replace the costly masks frequently.

Yet IC makers generally remained cool toward the process, citing image distortion in the optics, and problems with the automatic feeding mechanisms which load and align the wafer in the printer.

Now, however, Ushio Electric Inc. hopes to eliminate these woes with its Unimask 101 noncontact IC printer, which will be marketed in the U.S. It will be available in two models, one for 1.5-inch wafers and the other for 2-inch wafers.

The Japanese firm's improved optics design includes Nikon lenses and a 500-watt mercury lamp that projects powerful 400,000-lux light

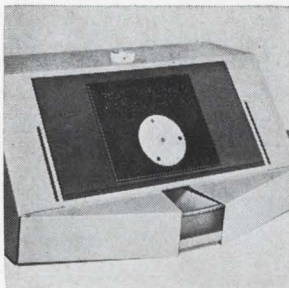

Optoline assembly director uses fiber optics to provide visual instruction to the operator in the positioning of printed-circuit board components. Components are selected from a rotating tray, and a central member indexes the power source current through a program module to the visual fiber optic readout panel. Hollis Engineering Inc., Nashua, N. H. 03060 [421]

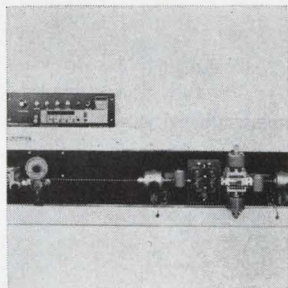

Automatic wire stripper 2600 has electronic measuring devices which speed set-up and enhance operating speeds. Wire cutting lengths are set up by pushbuttons in 0.1 in. increments, providing for lengths ranging from 0.1 in. to 999.9 in. Unit measures, cuts and strips wire for leads and cable harness in sizes from 32 to 10 Awg. Eubanks Engineering Co., Monrovia, Calif. [422]

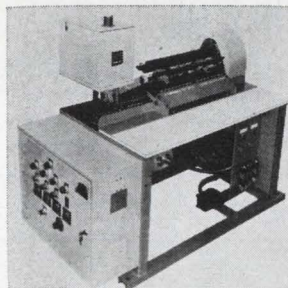

Coating machine CC3 uses the fluidized bed principle. Intended for epoxy-resin coating of radial lead components such as small printed circuits, capacitors and resistors, it provides a truly conformal coating with re-cycling possibilities. An unskilled operator can turn out 15,000 units max. per hour, depending on component size. English Electric Corp., 1 Park Ave., N.Y. [423]

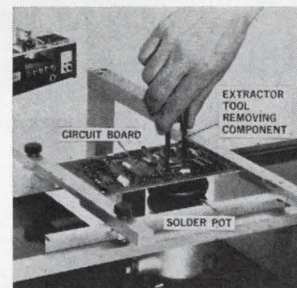

Automatic de-soldering machine for multilead components causes molten solder to flow beneath the p-c board, covering only the total area of the component leads. This allows all lead joints on the component to become molten simultaneously. The component is then removed by hand with an extractor tool. Model DSM-2A costs \$1,500. Air-Vac Engineering, Milford, Conn. [424]

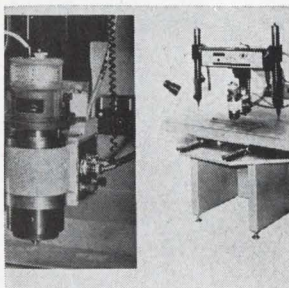

Accessory called Auto Drill 65 allows two models of wire terminating systems to be used as numerically controlled p-c board drilling machines. Unit can be installed singly or ganged in groups of up to 5 drill heads. Each head has a speed control allowing rates from 10,000 to 45,000 rpm. Prices \$1,600 to \$2,850. Synergistic Products Inc., Santa Clara, Calif. [425]

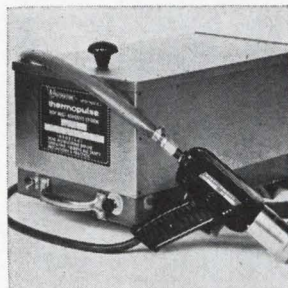

Portable hot melt adhesive system Thermopulse 1500 series is designed to provide efficient, high-production, thermoplastic application in assembly, packaging and various manufacturing operations. Other features include temperature control throughout, variable voltage adjustment, minimum operator controls, and no clean-up. Spraymation Inc., 52 Sindle Ave., Little Falls, N.J. [426]



Universal laser system 202 is for production of semiconductor devices including IC design and fabrication. The solid state system has been successfully applied in effecting various changes in silicon wafers through precise irradiation. It permits a component to be made at a specific point on a wafer without disturbing surrounding material. General Laser Corp., Natick, Mass. [427]

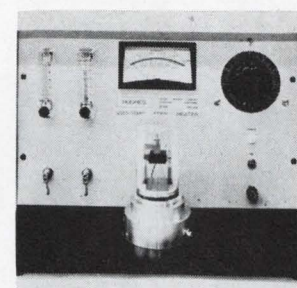

Strip heater HVT-600, for sealing hybrid circuit packages, provides rapid temperature acceleration up to 600°C for a variety of uses. Unit can also be used to seal crystal and relay cans, and for die attaching, wafer alloying, metal sintering and annealing, and low-temperature glass-to-metal seals. Price is \$1,600. Hughes Equipment, 2020 Ocean-side Blvd., Oceanside, Calif. [428]





# Every Engineer or Draftsman should have the **NEW BY-BUK** **CROSS REFERENCE GUIDE P-45**

(supersedes By-Buk Catalog No. P-42)

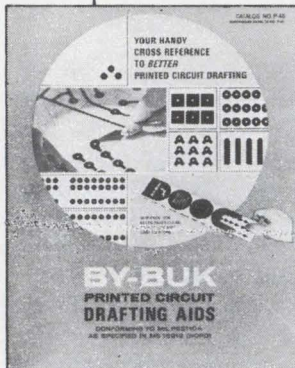

to better printed circuit  
drafting.

This **FREE** 24 page booklet contains color-coded standard MIL-SPEC SIZES and design standards . . . plus a newly added numerical index for easy reference to over 2000 pre-cut tapes, pads, shapes, transistor tri-pads, spaced IC

terminal pad sets and other drafting aids for faster, more accurate, distortion-free printed circuit master drawings.

Send for your **FREE** guide today!

## BY-BUK COMPANY

4326 West Pico Blvd. • Los Angeles, Calif. 90019 • (213) 937-3511



Circle 202 on reader service card

## The geniuses who perfected the Dalic selective plating process certainly had electronic manufacturers in mind.

If Sifco's Dalic process of electroplating had just one reason for existence, one might say it was to make life pleasanter for electronic manufacturers, their operations more profitable. ■ Pleasanter, because the Dalic process is designed to be an integral part of the electronic manufacturer's setup, ready for plating jobs anytime. ■ Profitable, too, because—being portable—it saves masking, dismantling and processing time . . . saves sending parts out and waiting for them to come back. ■ With Sifco's exclusive Dalic process, makers of electronic equipment can spot-plate gold, silver, rhodium or other metals directly onto conductive surfaces . . . without disturbing the assembled components. ■ The Dalic electroplating process consists of power pack, tools and electrolyte solutions. Applying metal coatings with this "package" is easily mastered with a minimum of training and no previous experience. ■ The thickness of deposited metals can be accurately controlled to as fine as 0.000010 inches. ■ Additional information on the Sifco Dalic process for electronic equipment sent on request.



**Sifco Metachemical**  
935 East 63rd St. • Cleveland, Ohio 44103  
Phone 216/881-8600 and 216/431-0306  
TWX 810-421-8464

DIVISION OF  
**SIFCO**  
INDUSTRIES, INC.

rays onto the photomask.

The Unimask 101 is a 1:1 reproduction system. In terms of resolution, it can print approximately 300 lines per millimeter at the edge of a wafer and 400 lines at the center. Effective line-width resolution is about 4 microns, the company says.

Both models have a manual feed. To some, this might seem like a step backward, particularly because it means longer cycle times—between 1 and 2 minutes depending upon the operator. But Ushio engineers say that automatic feed mechanisms present alignment and other problems that no amount of cycle-time advantage can compensate for.

Because the Unimask is manually operated, the machine has a

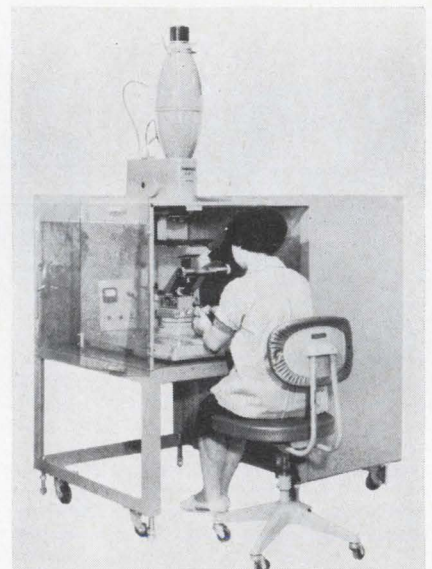

**Untouched.** IC pattern is projected through mask onto wafer. Assembly atop enclosure holds lenses.

binocular, or split-field, alignment system that provides the operator with 2-micron resolution as well as a focal depth of 30 microns. Exposure time is approximately 8 seconds.

The 1.5-inch version, which is being tested by several large semiconductor houses, sells for about \$23,000, and the 2-inch machine, which will be brought to the U.S. later this month, will sell for about \$34,000.

Kurt Orban Co., Orban Way, Wayne, N.J. 07470 [429]



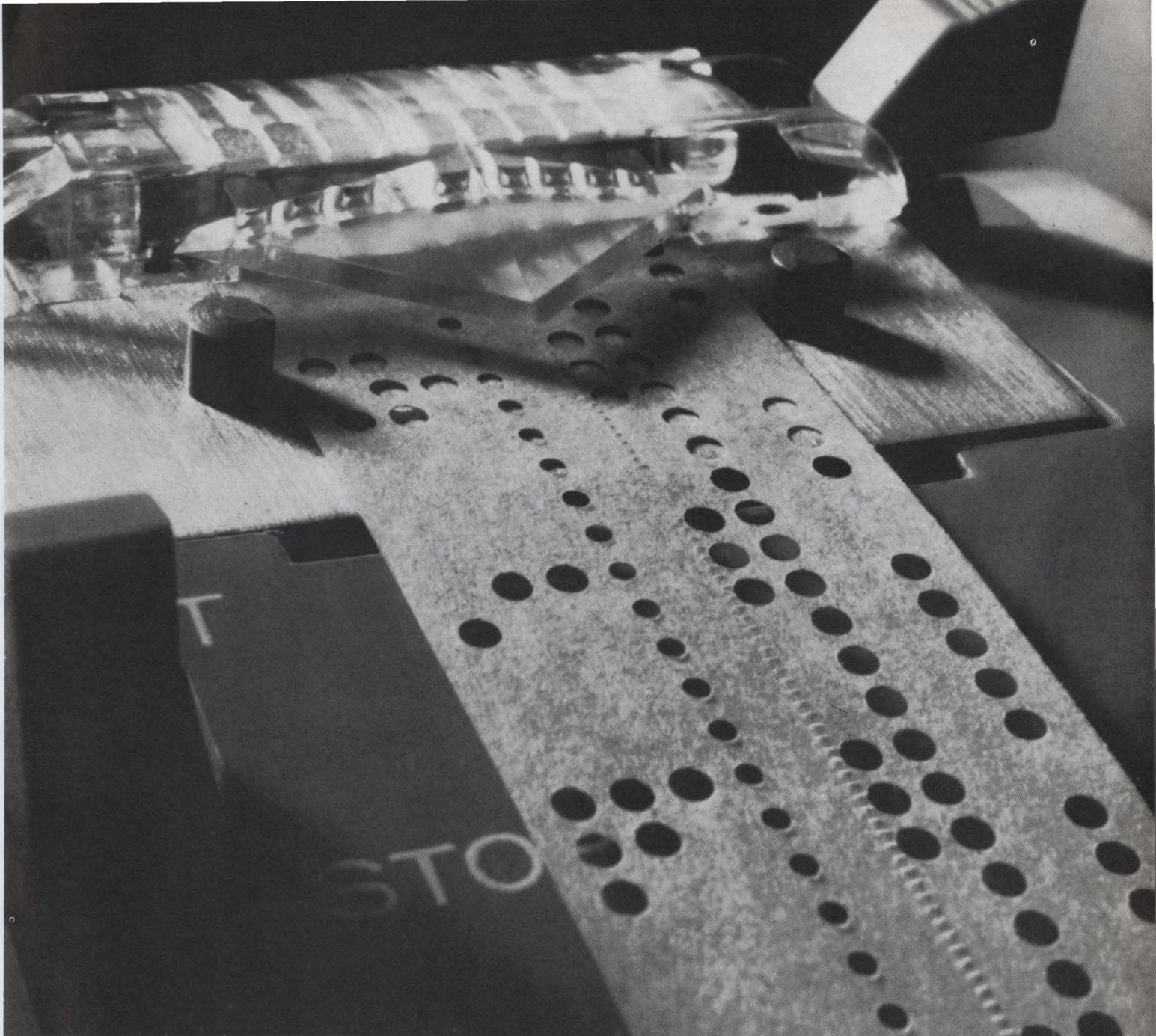

## Couple your measurements to a time-sharing terminal. On-line or off.

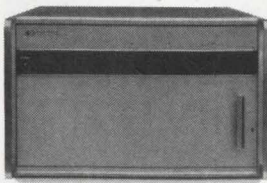

With HP's 2547A Coupler, raw BCD data from up to six instruments at a time can be processed in seconds. On-line, through your commercial or in-house time-sharing system. No special programming is required, and any language can be used.

Where data is generated too slowly to process economically on-line, you can

record through the 2547A on your terminal punch, for later reduction. For rapid data acquisition, an optional high-speed punch enables you to record at 120 char/sec. Off-line recording also lets you take measurements when the time-sharing system isn't available.

The 2547A Coupler works with more than 40 different HP measuring instruments—and most other instruments with BCD output.

Cost for the complete package, including coupler, 10-digit data input

interface, and EIA compatible output, is only \$3550. For complete information on the 2547A Coupler and time-sharing applications, contact your local HP field engineer. Or write to Hewlett-Packard, Palo Alto, California 94304; Europe: 1217 Meyrin-Geneva, Switzerland.

**HEWLETT**  **PACKARD**

**DATA ACQUISITION SYSTEMS**

06913 EN



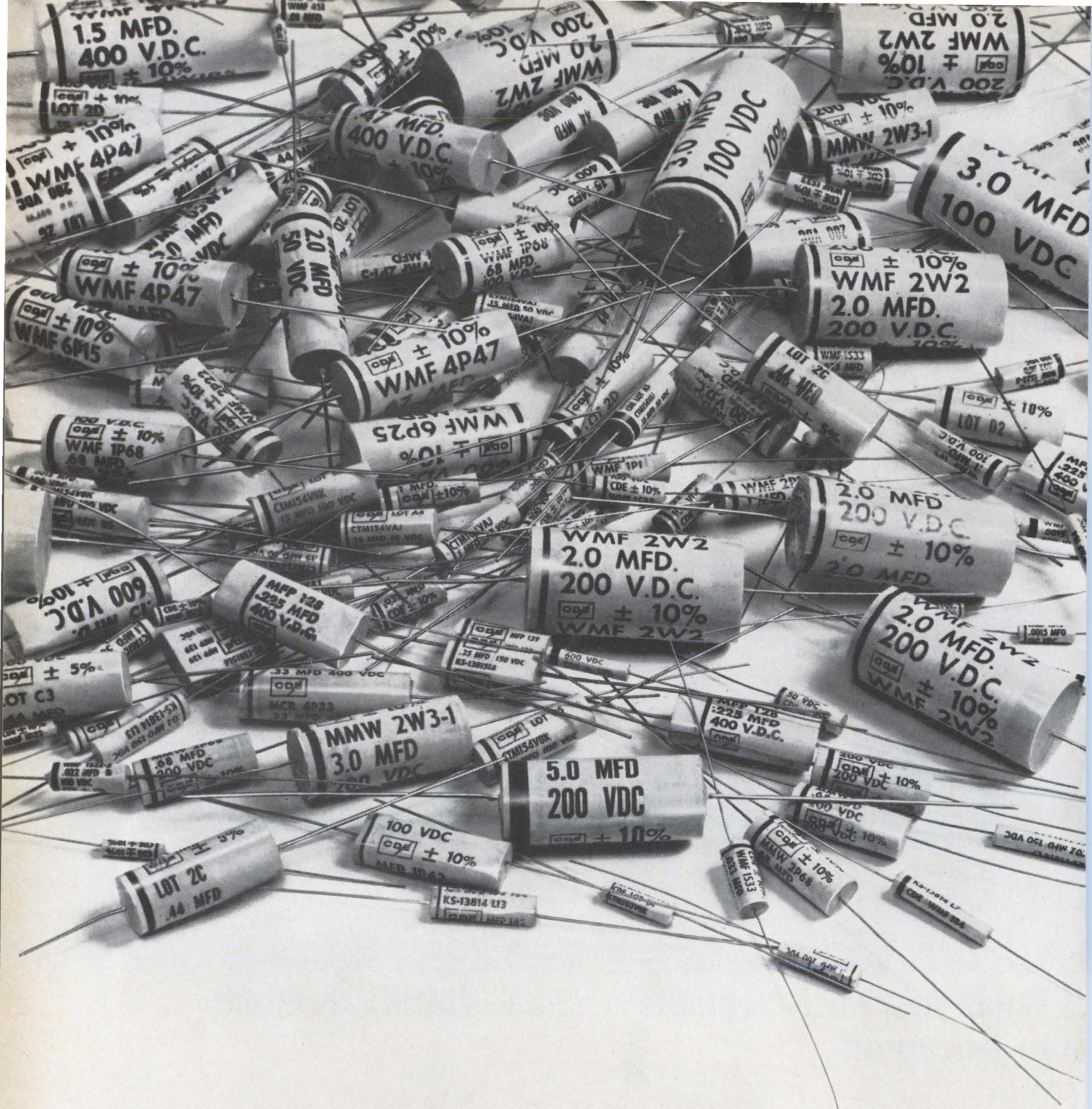

## You'll never get a bum wrap.

Not with a CDE wrapped tubular. For Cornell Dubilier has set the industry standard in wrap-and-fill capacitors. And we offer the most comprehensive stock in depth. Over 500 items, round and oval, covering capacities from .001 to 5 mfd, voltages from 50 to 600V DCW, and tolerances from 1% through 20%.

In polyester, polycarbonate, or polystyrene, in foil/film or metalized dielectrics—to meet every industrial or military need. And all are Sprint stock standards. SPRINT is the CDE program that assures you quick delivery of standardized components covering 98% of industry requirements.

**CDE** **CORNELL-DUBILIER**  
50 Paris Street, Newark, New Jersey 07101



# Putting products in their place

Materials-handling control system, using manual, card, tape, or computer inputs, directs stacker to store and retrieve items

**Riding along** on a stacker crane, an integrated-circuit warehouse control system designed by Cutler-Hammer's Industrial Systems division assures maximum utilization of expensive building space, and rapid storage and retrieval of products and materials. Each storage bin, in racks that can be as high as 80 feet, is assigned a unique binary address in both hori-

zontal and vertical directions. These addresses, sensed on-the-fly by an unattended moving stacker crane, are one set of inputs of the stacker control that performs two basic cycles. The other set of inputs are specific commands for the desired operation.

In one cycle, material is picked up at an entry point, moved to a selected bin location, and stored.

In the other, the crane moves to a bin, retrieves the bin's contents, and delivers it to the exit point of the storage area.

**Done with magnets.** Small permanent magnets imbedded about 2 inches apart in the floor and oriented magnetically to provide a binary 1 or 0, establish the horizontal-address code. The vertical address is coded on the stacker. A

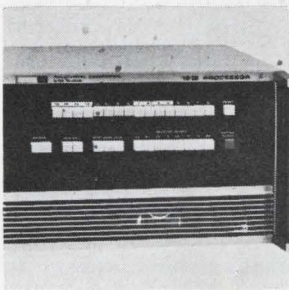

Control processors series 1200 are for on line, real time, monitoring and control systems. Six units offer word sizes of 12, 16 and 20 bits, with memory cycle times of 1.9 or 3.5  $\mu$ sec. A feature is the capability to test or modify individual bits of information within a word, by means of a set of bit manipulation instructions. Philco-Ford Corp., Palo Alto, Calif. [361]

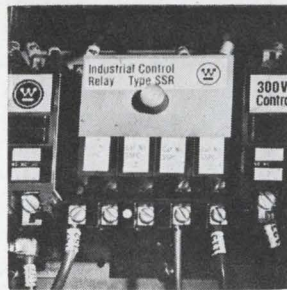

Solid state relay type SSR can be used interchangeably with conventional electromechanical relays in electrical control systems. It is equipped with suppression circuits in both its input and output sections to counteract the kinds of electrical noise commonly found in industrial installations. Surge capacity is up to 20 amps. Westinghouse Electric Corp., Beaver, Pa. [362]

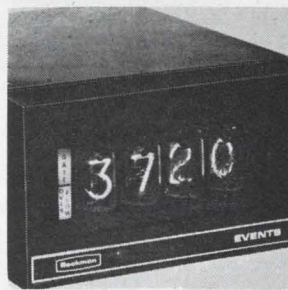

Accumulator model 4038, which can count events at rates up to 1 million per sec, is for systems use. Events counted may be repetitive, intermittent, or random. Typical sources in the system would be the opening or closing of a relay, changes in the voltage output of a photocell, or individual cycles of a sine wave. Beckman Instruments Inc., Harbor Blvd., Fullerton, Calif. [363]

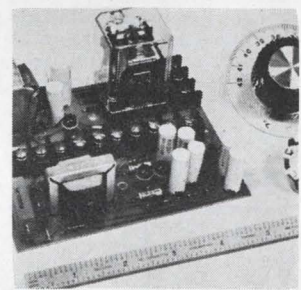

Remote mounting on-off temperature controller series 931 is sensitive to 0.005°F. It can control temperature in discrete ranges from -300°F to +1700°F. Unit features all solid state components and a dpdt covered plug-in relay mounted on a p-c board measuring 5 x 4½ x 2¼ in. Price in lots of 1,000 is \$32.95. Pak-Tronics Inc., 4044 North Rockwell St., Chicago [364]

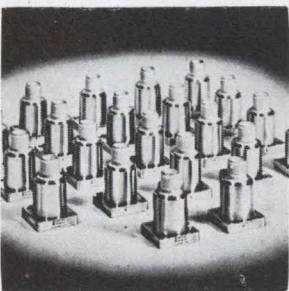

Aerospace type sensors series IV-400 detect and measure vibration as low as 0.01 g or explosive blasts as high as 100,000 g either dynamically in microseconds or over indefinite periods of time. They are for interfacing production control and alarm in commercial and industrial plants. Price (10 to 10,000) is as low as \$25. Columbia Research Laboratories Inc., Woodlyn, Pa. [365]

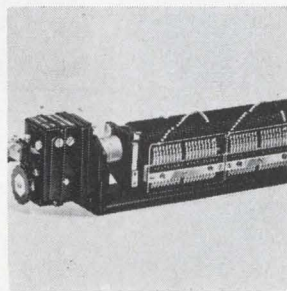

Replaceable 15-amp contact is a feature of a stepping motor now available for Sealectroswitch programming switches. The motor has a capacity of 180 steps-per-minute and is equipped with a replaceable position sensor and a replaceable relay control. It operates on 117 v a-c, 60 hz power supply and has a one-way friction clutch. Sealectro Corp., 225 Hoyt St., Mamaroneck, N.Y. [366]



Stepper motor 2.75-100-1-8 uses a nutating disk principle. The disk has a bevel gear and is attracted by 8 solenoids. By varying gear ratios and switching sequences, from 200 to 1,600 steps per revolution may be obtained. Standard unit offers 800 or 1,600 steps/rev, 30 in. lbs of torque at stall, 5 in. lbs at 4,800 steps/sec. Mesur-Matic Electronics Corp., Warner, N.H. [367]

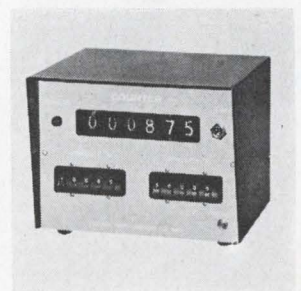

Standard models of solid state preset counters have from 2 to 6 digit capacities and have either dual, single or no built-in preset comparators. Others have up to 6 set point controls. Units are designed so input counting circuitry will operate either directly from contact closure or from voltage level signals. Digital Instruments Inc., Merriam Lane, Shawnee Mission, Kan. [368]



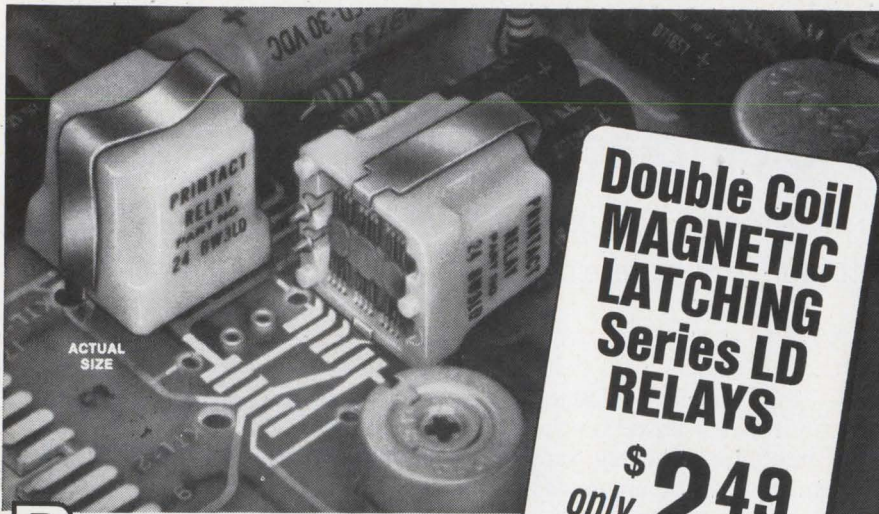

# Printact®

**Plugs into your PC board... mates with plated conductors**

Where **memory without power** is a requirement in the design of control circuitry, the use of the "LD" relay results in a **compact-low cost module**. Reliability is assured by the unique design which includes, as standard, many features not generally available in commercial relays.

Encapsulated coil, bifurcated gold or palladium contacts, low thermal EMF, plug-in without sockets or soldering, low bounce and chatter, series-break switching eliminates pig-

tails, permanent magnet avoids return spring and mechanical linkage—all of which assures continuous performance for many millions of cycles.

Available with 6, 12 or 24 VDC 1 watt coil (AC operation with series diode) in 2, 3 and 4 pole configuration. Series break swingers permit each pair of fixed contacts to be etched with common (Form C) or isolated (Form A plus Form B) switching between make and break circuits.

For data write or call 212-EX 2-4800.

Printact Relay Division, Executone, Inc., Box 1430, Long Island City, N.Y. 11101

Circle 206 on reader service card

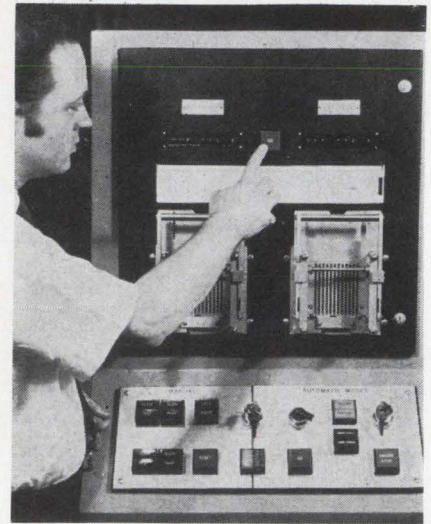

... and go. System modes range from operator-run to fully automatic.

magnetic head on the stacker reads the binary address serially.

The present-location address is gated into a quadruple bistable latch which stores the four-bit bin address. The selected-location address (chosen for example by a digital switch) and the read address (obtained from the bistable latch) are compared (subtracted) in a four-bit binary full adder. A zero-valued comparison orders the crane to stop. A positive-value moves the crane forward and a negative value moves the crane in reverse. The adder's outputs, decoded through NAND logic groupings associated with the desired coordinate of crane motion. These logic groupings define motion direction and, if wanted, crane-slowdown zones ranging from one to six positions away. The basic four-bit modules handle 16 addresses.

Using manually positioned digital switches, cards, tape, or computer signals as commands, the stacker control can be programmed for four material movements: store only, retrieve only, store-and-retrieve, and transfer.

For computer input, a special version of the address selection and compare board containing IC shift registers receives commands for insertion into the system.

Cutler-Hammer officials say price depends on the application.

Cutler-Hammer Industrial Systems Div., 4201 N. 27th St., Milwaukee, Wis. 53216 [444]



Got masks, need parts?  
Send masks. Get parts. Two weeks.

**NORTEC**   
ELECTRONICS CORPORATION

3697 TAHOE WAY, SANTA CLARA  
CALIFORNIA 95051 (408) 732-2204

INSTANT  
LSI

High or low  $V_{gst}$  same low price, same  
instant turnaround



**NEW**

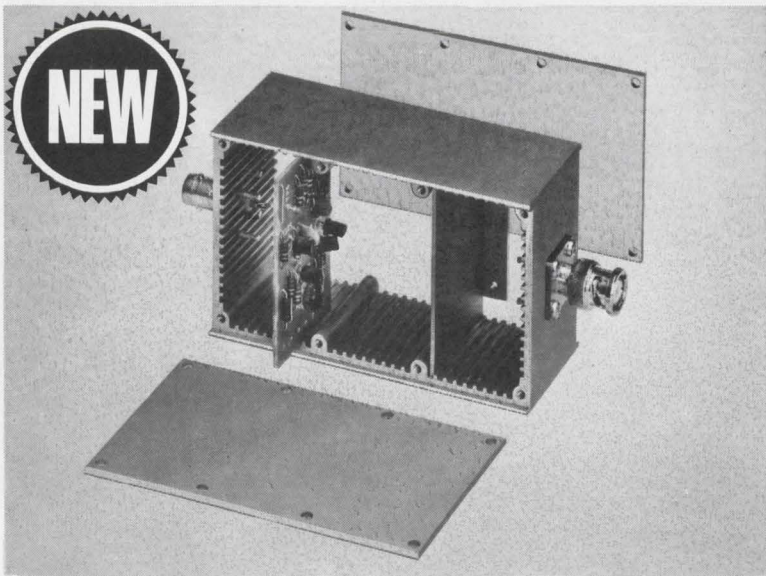

## SHIELDED BOXES with CARD GUIDES

Rugged die-cast aluminum boxes, slotted to accept 1/8" circuit boards and shielding dividers. Excellent for packaging electronic circuitry. Boxes have removable top and bottom covers. Useable inside space: 4"x2"x1 1/2". Several models with various connectors.



Write for 1969 Catalog  
**POMONA ELECTRONICS CO., INC.**  
 1500 E. Ninth Street, Pomona, California 91766

Circle 208 on reader service card

## Build this pipelike Schober Recital Organ for only \$1850!\*

You couldn't touch an organ like this in a store for less than \$4,000—and there never has been an electronic instrument with this vast variety of **genuine** pipe-organ voices that you can add to and change any time you like! All four families of formal pipe tones are present in variety to delight players of classic and religious music. Yet you can change the entire organ for popular and theatrical sounds, or plug in special voices for baroque, romantic, or modern repertoires. If you've dreamed of the sound of a large pipe organ in your own home, if you're looking for an organ for your church, you'll be more thrilled and happy with a Schober Recital Organ than you could possibly imagine—kit or no kit.

You can learn to play it—and a full-size, full-facility instrument is easier to learn on than any cut-down "home" model. And you can build it, from Schober Kits, world famous for ease of assembly without the slightest knowledge of electronics or music, for design and parts quality from the ground up, and—above all—for the highest praise from musicians everywhere.

Send right now for the full-color Schober catalog, containing specifications of all five Schober Organ models, beginning at \$499.50. No charge, no obligation. If you like music, you owe yourself a Schober Organ!



\* Includes finished walnut console. (Only \$1446 if you build your own console.) Amplifier, speaker system, optional accessories extra.

The *Schober* Organ Corp., Dept. EL-13  
 43 West 61st Street, New York, N.Y. 10023

- Please send me Schober Organ Catalog and free 7-inch "sample" record.
- Enclosed please find \$1.00 for 12-inch L.P. record of Schober Organ music.

NAME \_\_\_\_\_

ADDRESS \_\_\_\_\_

CITY \_\_\_\_\_ STATE \_\_\_\_\_ ZIP \_\_\_\_\_

## New Books

### Body engineering

A Systems Approach to Biomedicine  
 William B. Blesser  
 McGraw-Hill, 615 pp., \$19.50

When applying engineering principles to the study of biological systems, no single discipline can do it alone. For example, the electrical engineer may be right at home tracing the interconnections of the central nervous system, but when he tries to study the nature of the hormones that affect the nervous system, he'll find he needs the skills of a chemical engineer; or when he looks into the interaction of the nervous system with the motion of a limb, he'll find he needs the knowledge of a mechanical engineer to understand muscular dynamics.

The fact is that the human body contains complicated machinery: a digital computer (the brain); a complex logic network (the central nervous system); and, among other things, a two-pump plumbing network (the heart and the circulatory system); a sewage treatment system (digestive tract) and a pair of gas exchangers (lungs).

Therefore, as electronics engineers become more and more involved in biomedicine, they'll find themselves needing to learn not only the disciplines of the life scientists but also the studies of other types of engineers. And in learning the latter, they may find this book useful.

The author says that the book is for life scientists out to learn engineering, but it can also be used by electronics engineers who want to know how other engineering specialties fit into biomedicine.

Blesser's drawings and explanations of physiological measurement setups are good, as are his discussions of the physiological bases for these measurements. Some of the topics he describes are the response of the eye, dye dilution studies, and muscular activity.

The treatment of the respiratory system is particularly good. The author develops a model of the system, explains the compliance of the lungs, and then studies the effects of a step input to the system. Another valuable feature is the appen-



# THE OUTCLASSERS!

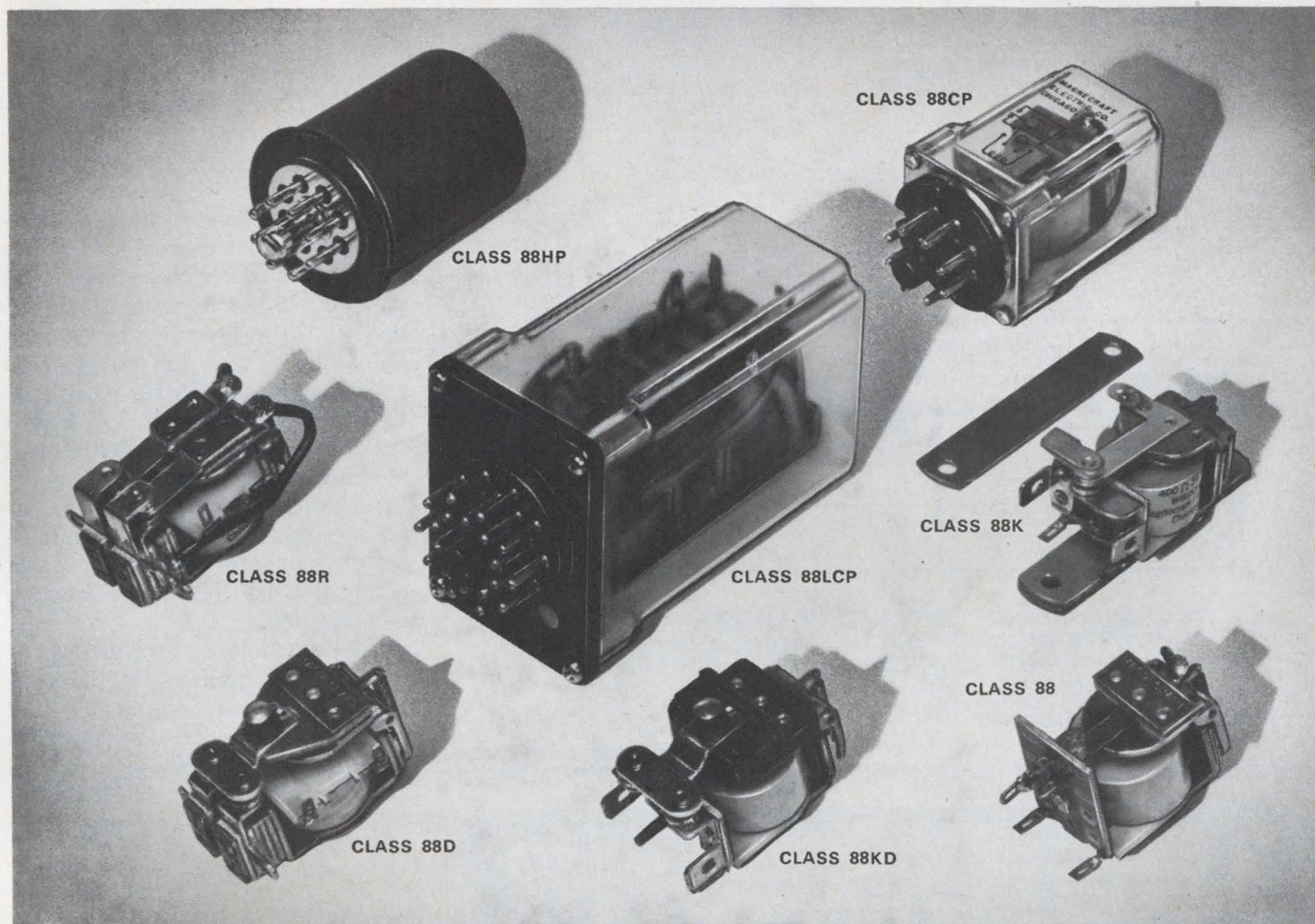

## MAGNECRAFT GENERAL PURPOSE RELAYS

Our general purpose relays aren't known as the least expensive. But they have earned the reputation for reliability with the most consistent performance record of any general purpose relay on the market.

In addition, Magnecraft has more general purpose relays in stock than anyone else. This means nearly all your requirements can be filled in days—if not hours. As for variety, we have it over the others with relays such as our improved Class 88KD 50 ampere relay that's ideal for industrial switching applications. And the new Class 88LCP Latching Relay that's composed of two Class 88 Relays with interlocking latching levers mounted on a common base and a crack-proof polycarbonate cover.

If all this doesn't overcome price alone, better forget us. But if you want large silver cadmium oxide contacts, precision hinge-pin armature bearings, molded nylon bobbins and overall custom made quality, then keep us in mind for all general purpose relays. Ours outclass the others at any price.



**FREE! Product File** — Yours for the asking. Contains full details on all our stock relays.

**Magnecraft<sup>®</sup> ELECTRIC CO.**

5575 NORTH LYNCH AVENUE • CHICAGO, ILLINOIS 60630 • 312 282-5500



# Multiplex' power-packed, high-speed, space-saver

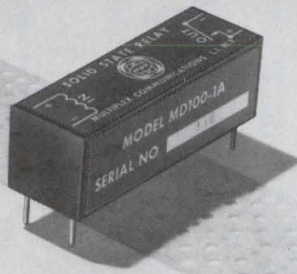

At last a truly small and practical Solid State Relay. Mini in size, it's big in performance, big in practicality, big in reliability. Check these important advantages of the Multiplex Solid State Relay.

FEATURES	ELIMINATES
All Solid State	Mechanical Moving Parts
Non-Reactive Input	Inductive Kickback or Noise Spikes
Exceptional Reliability	Mechanical Fatiguing
Wide Speed Range	Contact Bounce or Arching
Wide Dynamic Range & Use	Motion, Shock, or Position Problems

We can supply packages of 96 Relays or Telegraph Repeaters in the standard 19" x 1 1/4" rack space. Relay size: 1 1/2" long, 1/2" wide, 1/2" high.



## MULTIPLEX COMMUNICATIONS INC.

70-C Bell Street, West Babylon, N. Y. 11704  
Phone (516) 694-5225  
Sales and Maintenance Office  
Pennsylvania Bldg., Washington, D. C.

Circle 210 on reader service card

# 3.999 REASONS WHY

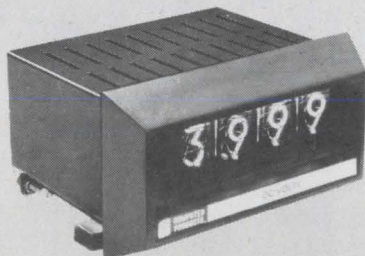

## 4000 COUNT DIGITAL PANEL METER \$196<sup>00</sup>\*

Computer Products' new DP400 series digital panel meter measures DC voltage with extreme accuracy: .05%  $\pm$  1/2 count... and with 4000 count resolution. It's priced with the DPMs and performs with the DVMs. Using revolutionary encoding techniques, it offers 8 voltage ranges (200mV to 400V) and 6 current ranges (2mA to 400mA) with internally selectable decimal point position.

The DP400 series' styling will enhance the appearance of your system. All this, and behind-panel space required is only 2.5" x 3.0" x 4.2".

As if that weren't enough, DP400s have remote display capabilities.

The temperature coefficient of the DP400 series is .005%/°F and the operating temperature range is 30° to 140°F.

In quantity orders, the DP400 series is available for measuring AC voltage and resistance.

SHIPMENT 15 TO 30 DAYS ARO		
Prices	1-3	4-9
	\$222	\$206
		*10-29
		\$196

We also make: OP-AMP and logic power supplies, pulse generators, D/A and A/D converters and decimal display modules (with counter).

Call or write for complete information on our entire line

Computer Products, Inc. • P.O. Box 23849 Ft. Lauderdale, Florida 33307 • 305-565-9565



**COMPUTER PRODUCTS**<sup>TM</sup>  
FORT LAUDERDALE

## New Books

dix that deals with nodal analysis.

There are a few things that may put an engineer off, however. First, much in the book is basic. An engineer may be reluctant to lay out nearly \$20 for a text that spends 70 pages explaining LaPlace transforms and 56 pages discussing "The Impedance Concept."

Another problem: the author assumes that his readers are pretty well versed in physiology and anatomy. For the uninformed, he does put in a glossary, but it isn't much help. If you don't know what a bronchiole is, Blesser's explanation that it's "the last and tiniest subdivision of the bronchial tree opening into the alveoli" isn't going to clear things up much. On the other hand, some of the definitions are obvious; it's not big news that respiration is "the act or function of breathing".

To help the reader learn about the systems approach to biomedicine, Blesser does put in a lot of problems at the end of each chapter; and many of these problems are quite challenging. On the other hand, however, he neglects to put in any answers.

### Recently Published

**Sources of High-Intensity Ultrasound, Vol. 1, edited by L.D. Rozenberg, Plenum Press, 309 pp., \$25**

First of a two-volume work, this text covers work done by the Russians in applied acoustics. It describes theory, analysis, and engineering design of devices and techniques for generating powerful ultrasonic fields used in laboratory and industrial requirements. Topics include gas-jet sound generators, magneto-strictive ferrites, ultra-high-intensity focusing systems, and ultrasonic focusing transducers.

**A Systems Approach to Biomedicine, William B. Blesser, McGraw-Hill, 599 pp., \$19.50**

This book introduces biomedical workers to engineering and mathematical concepts relevant to the study of living systems. Included are discussions of linear-resistance analysis, distributed and lumped systems, the electrical analogs of compliance and springiness, pulse response of a dye-dilution system, transfer functions, the impedance concept, transient oscillations, and resonance and feedback.



Using spot ties for  
wire harnessing?

HERE IS THE  
**GUDEBROD  
SYSTEM "S"**

**—SPEEDS THE WORK—SAVES MONEY, TOO!**

**GUDE-TIES CUT LENGTHS**—Specifically produced for spot knotting these handy cut lengths of Gudebrod Flat Braided Lacing Tape are dispenser packaged for one hand, speedy withdrawal. Available in 6", 8", 10", 12", 15", 18", 20" and 22" lengths (other lengths on order). Meet or exceed MIL-T Specs, no-slip knots hold firmly without cutting insulation.

**GUDE-SNIPS**—These palm-of-the-hand snips cut cleanly, easily. For right or left hand use, spring action, DuPont Teflon bearing. Allow operator to have free use of fingers without constant reaching for knife or shears. Save motion, save time.

**GUDEBROD SWIVEL-TILT HARNESS BOARD MOUNT**—Balanced, two dimensional action brings every section of the harness within easy reach. No stretching, no straining. Knots are tied in an easy, natural position. Cuts fatigue—speeds work.

Here you have the Gudebrod System "S" for spot tie lacing, based on the high quality, high speed Gudebrod Lacing Tape—if you're interested in saving money while speeding the harness work, get in touch with us. (For continuous tying, ask about System "C".)

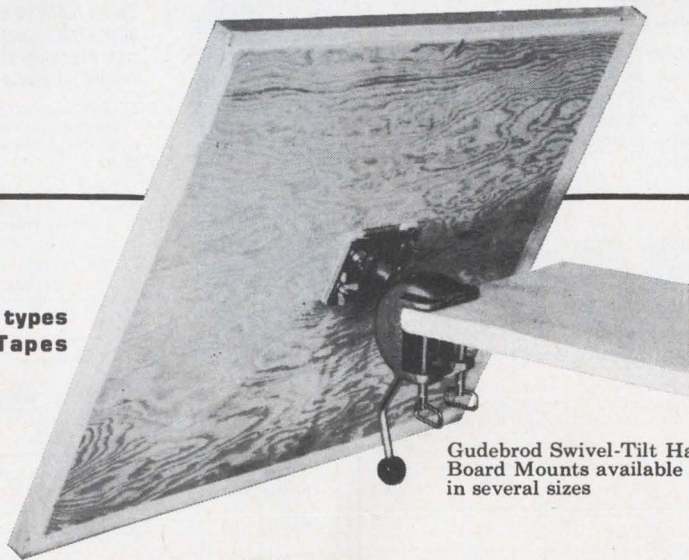

Gudebrod Swivel-Tilt Harness Board Mounts available in several sizes



Available also in other types  
of Gudebrod Lacing Tapes

**G**UDEBROD  
*Electronics Division*

GUDEBROD BROS. SILK CO., INC. Founded 1870, 12 South 12th Street, Philadelphia, Pa. 19107



# New free facts on "films."

Get the latest data on Mallory film resistors. A complete line. Made by the company with total capability in film resistors. Write, today.

Mallory Controls Company, a division of P. R. Mallory & Co. Inc., Box 327, Frankfort, Ind. 46401.

## GENERAL SPECIFICATIONS

MALLORY TYPE	MILITARY TYPE	TEMPERATURE RATING	POWER RATING (WATTS)	RESISTANCE RANGE (OHMS)
<b>Precision Resistors</b>				
MAC 55	RN55	70°C & 125°C	1/8 & 1/10	10Ω-100K
MAC 60	RN60	70°C & 125°C	1/4 & 1/8	10Ω-499K
MAC 65	RN65	70°C & 125°C	1/2 & 1/4	10Ω-1 meg
<b>Semiprecision Resistors</b>				
MAL 07	RL-07	70°C	1/4	10Ω-100K
MAL 20	RL-20	70°C	1/2	10Ω-470K
MAL 32	RL-32	70°C	1	10Ω-1 meg
<b>Power Resistors</b>				
2MOL		70°C	2	30Ω-125K
3MOL		70°C	3	40Ω-125K
4MOL		70°C	4	85Ω-125K
5MOL		70°C	5	95Ω-125K
7MOL		70°C	7	125Ω-125K

# MALLORY

Circle 212 on reader service card

**CAN YOUR PRODUCTION AND PROFITS BE BOOSTED BY TRAINING INNOVATION?**

**RCA INVITES YOU TO FIND OUT.**

If you're in a field where technology is advancing, there's a good chance some of your employees have not "kept up".

That's where we can help.

We're ready to train your personnel at your place or ours, or even at home. Courses can be developed in sales, engineering, management, programming, data processing, electronics, and many other areas.

Mail coupon today for full information...

**RCA Technical Institute**

A Service of RCA Institutes, Inc.  
Bldg. 204-1, Dept. Y-64  
Camden, N. J. 08101  
Phone: (609) 963-8000, ext. PY-5084

Please furnish information about customized training programs. We're particularly interested in  
 Programmed Instruction  Industrial Training

Name \_\_\_\_\_ Title \_\_\_\_\_  
Company \_\_\_\_\_  
Address \_\_\_\_\_  
City \_\_\_\_\_ State \_\_\_\_\_ Zip \_\_\_\_\_

**NOW! APPLY KODAK PHOTO RESISTS this new AEROSOL way**



**QUICK CONVENIENT ECONOMICAL**

Three types to suit all your etching needs now available at local industrial photo dealers

**TYPE-P** containing Kodak KPR\*—for copper, copper-clad laminates, other metals. 16 oz. \$5.95

**TYPE-M** containing Kodak KMER\*—for aluminum, stainless steel, titanium, other metals. 16 oz. \$5.95

**TYPE-T** containing Kodak KTRF\*—for high resolution etching of thin films. 16 oz. \$6.95

\*KPR, KMER, KTRF are products of Eastman Kodak Co.

**INDUSTRIAL CHEMICAL SPECIALTIES CORPORATION**  
75 Hillside Rd., Fairfield, Conn. 06430

Please rush me more information on Spray Resist products and, also, name of nearest dealer:

NAME \_\_\_\_\_  
COMPANY \_\_\_\_\_  
CITY \_\_\_\_\_ STATE \_\_\_\_\_

## Technical Abstracts

### Speed up

Large linear system transient analysis via frequency domain, mathematical models, Fourier integral, and computer Joseph J. Ellis and Edward A. Dobberstein  
IBM Corp., Kingston, N.Y.

Although programs are available for transient analysis of both linear and nonlinear electrical systems, these depend on conventional numerical techniques that bog down when the system is described over a long time period. When this happens, the designer is forced to break the defining transfer function into many increments and integrate each of them over the range of zero to infinity. This takes a long time to reach a numerical solution, and taking larger time steps does not produce accurate results.

A new approach, called Tabfit, for transient analysis by Fourier integral theorem, links the time domain and frequency domain rapidly. No physical model is needed to perform the desired integration. Instead, the function is subdivided into many segments and represented by a series of equations, each of which—one for each segment—is similar in form but differs only by coefficients. Each of these coefficients are solved. The coefficients are not a function of the requested solution time. Therefore, if a transient solution for 100 different time points were desired the designer would need only one set of coefficients. Using this technique, it takes about 1 to 4 seconds to reach a solution for each requested point, based on using an IBM 360 system.

The program accepts system input information as transfer functions of frequency in magnitude and phase for a set of discrete frequency points over the significant portion of the spectrum. A complicated function may require 70 such points; a simple one may require only two. This type of data is easily obtained for large electrical networks via an a-c analysis program. Excitation functions of almost any description are easily inputted as a function of time. The output is the time domain response of the given transfer function to the given



# Hi yo silver, awwa-a-a-y.

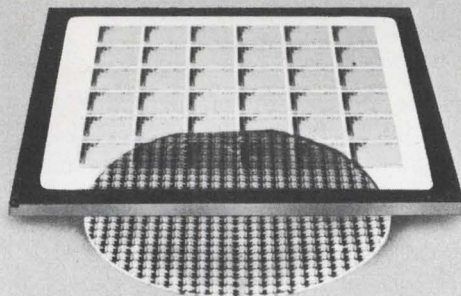

Enter... the Chromium Photomask. That's Bell & Howell's new advanced High Contrast Photomask System for more reliable, highly improved Integrated and MOS Circuits. Unlike the conventional emulsion masks used today, chromium images now provide the highest resolution and edge acuity ever before obtained, practically eliminating IC waste on the production line.

How? Chromium atoms in masks are smaller than the silver

particles in emulsion. Size reproduction is more accurate, images sharper.

And since chrome is so much more reliable than emulsion, wafer yield is greatly increased.

That's why replacing emulsion masks with Bell & Howell's High Contrast Photomask System means not only sharper masks, but more reliable and economical ICs. Ask your Bell & Howell photomaskman about it. Pronto.

For further information write:

**ELECTRONIC MATERIALS DIVISION**

360 No. Sierra Madre Villa Ave., Pasadena, Calif. 91109



**BELL & HOWELL**



# AGAIN VISHAY LOWERS THE COST OF HIGHER RESISTANCE VALUES

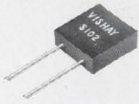

NOW TO  
75K ~~50K~~

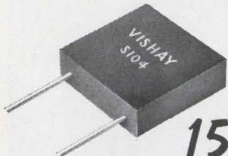

NOW TO  
150K ~~100K~~

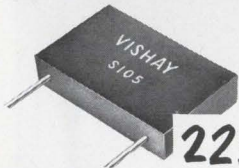

NOW TO  
225K ~~150K~~

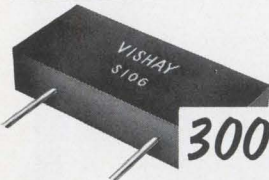

NOW TO  
300K ~~200K~~

Vishay again extends standard resistance values . . . this time by another 50%! You get a precision resistor that's smaller and costs less than the larger size you needed before!

You get these savings without a single compromise of Vishay's unique spec package . . . the "no-trade-off" performance specs only Vishay can offer.

- Tolerance (Abs.): to 0.005% ■ TC (any value):  $0 \pm 1 \text{ ppm}/^\circ\text{C}$ . ( $0^\circ$  to  $+60^\circ\text{C}$ ) ■ Stability: Shelf 25ppm/yr. (50/3 yrs.), Load  $< 0.02\%$  max. (0.15w. @  $125^\circ\text{C}$ ., 2000 hrs.) ■ Speed: 1ns., no ringing (non-inductive) ■ Noise: Non-measurable.

This complete Data Catalog tells how Vishay does it, where you can use them and gives complete spec data on Vishay Precision Resistors. Send for your free copy today.

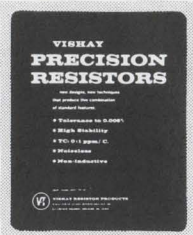

## VISHAY RESISTOR PRODUCTS

a division of Vishay Intertechnology, Inc.



63 LINCOLN HIGHWAY  
MALVERN, PA. 19355

## Technical Abstracts

excitation. Another feature of the program is the availability of the Fourier integral transform of the excitation function.

The program, written in PL/1 programming language for IBM system 360, fits the input data to mathematical models for the description of the drive and transfer functions. The Fourier integral theorem then is involved to effect the desired time domain solution from the frequency domain. Numerical integration, in the conventional sense, is avoided because each equation is similar in form and not represented as a set of complicated definite integrals. Since each solution point is evaluated in the same amount of time the designer can predict in advance just how long the solution will take. In the conventional technique each solution varies. In addition, this method allows for the study of a large group of transfer functions in a laboratory for which no physical system exists or at least has not yet been fabricated.

Presented at Joint Conference on Mathematical and Computer Aids to Design, Anaheim, Calif., Oct. 26-30.

### Antenna polarization

S-band antenna systems for missiles  
John E. Hill  
Granger Associates  
Chatsworth, Calif.

Since the transfer of telemetry activities to S-band four years ago, engineers have sought an antenna system that would provide an omnidirectional, or null-free, radiation pattern at reasonable cost. Although such an antenna is not yet a reality, a considerable amount of information has been gathered from the design and test of S-band telemetry antennas used on missiles. Perhaps the most significant realization is the importance of polarization, and the earlier concern that full-pattern coverage could not be achieved by the newer shorter wavelength S-band antennas, flush-mounted on a missile whose diameter was several wavelengths, may be allayed through employment of polarization diversity receiving systems.

Armed with the knowledge of

# HELL TO HEAVEN & between

## SAICOR REAL TIME SPECTRUM ANALYZERS MAKE SENSE!

Devour and analyze data fast — subsurface or space; natural or man-made; esoteric or explosive — with no sacrifice of resolution. Engineered for instant action, simple operation, continuous and transient analysis in real time with almost any output format—digital or analog. Solid-state, MOS FET shift register memory for non-spurious data. Options to fit any application: 1/3 octave, frequency tracking, translator, etc.



Don't buy more resolution than you can use.

5 standard models, each designed for the resolution required. SAI-21 (above) was developed for applications requiring 200 point resolution. Only SAICOR makes such a unit; priced at the lowest cost anywhere for the finest real time spectrum analyzer. Lighter weight, smaller size, portability, make it ideal for field and laboratory.

Just developed! A brand new scientific instrument —  
**SAICOR DIGITAL CORRELATION AND PROBABILITY ANALYZER**  
Contact us for full details

For literature, write or call Dept. E,  
Signal Analysis Industries Corp.  
595 Old Willets Path, Hauppauge, NY 11787  
Phone: 516/234-5700



Circle 255 on reader service card



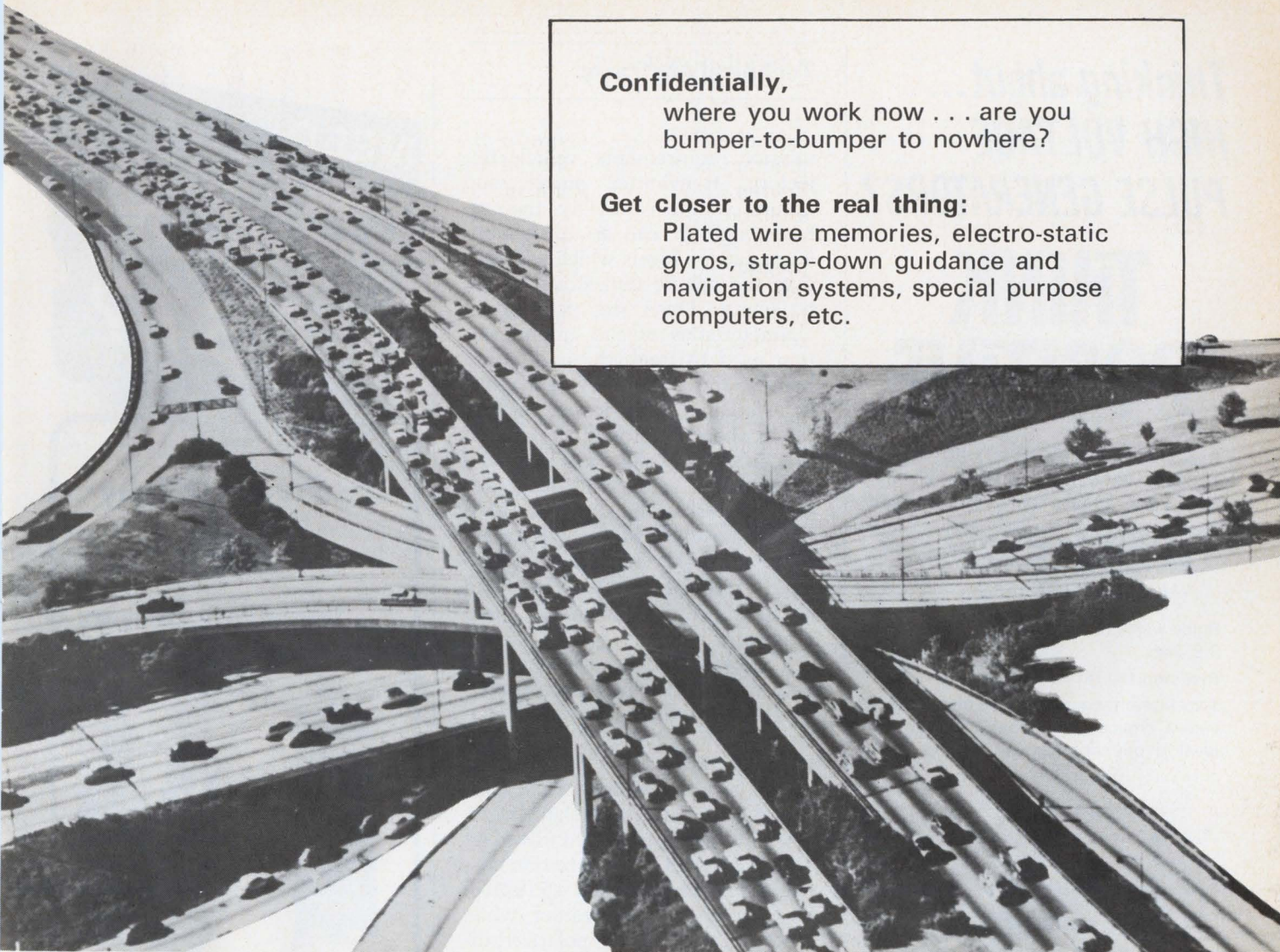

**Confidentially,**

where you work now . . . are you bumper-to-bumper to nowhere?

**Get closer to the real thing:**

Plated wire memories, electro-static gyros, strap-down guidance and navigation systems, special purpose computers, etc.

## Try Honeywell-Florida for a change.

Driving bumper-to-bumper to work is bad enough without being bumper-to-bumper to nowhere once you get there. Once you're on your way to Honeywell-Florida — you'll forget there ever was such a thing as a traffic jam . . . And the traffic at work — well, it makes way for the guy with someplace to go . . . the guy who likes to start with the odds way against him — and then make things happen . . . the swimmer upstream . . . the maverick . . . the man who kicks procedural traces and turns things around. And then there are the fringe benefits: swimming in the warm water of the Gulf of Mexico year 'round; some of the cleanest air in North Amer-

ica; miles of unspoiled white sand beaches; things like plated wire memories, electro-static gyros and strap-down guidance-and-navigation systems to keep you busy.

Want to get closer to the real thing? Try Honeywell-Florida for a change. Are you experienced in: advanced packaging, circuit analysis, components design, computer memory design, integrated circuit design, logic design, programming/analysis, systems design, or test engineering? Honeywell-Florida wants your resume now and — could be — you soon.

Write now to S. Owen Spring, Dept. 120-1, Honeywell Inc., 13350 Highway 19, St. Petersburg, Florida 33733 — or call collect (813) 531-8977, 7-10 P.M. (E.S.T.) Mondays.

# Honeywell-Florida

an equal opportunity employer.

To investigate professional openings at other Honeywell locations, send resume to F. F. Laing, Honeywell Inc., Minneapolis, Minnesota 55408.



# Thinking about... HIGH VOLTAGE PULSE GENERATORS?

# THINK POSITIVE

Besides POSITIVE OUTPUT PULSES OF 1000V or 500V, the new TRW Model 89A High Voltage Pulse Generator gives you

**LOW INTERNAL DELAY  
VARIABLE PULSE WIDTH  
VARIABLE DELAY**

Pulse width is variable from 100 nsec to 9.9  $\mu$ sec.

Rise and fall times are fast: 40 nsec.

Two interchangeable input plug-ins provide a choice of external, internal, low-level or optical trigger.

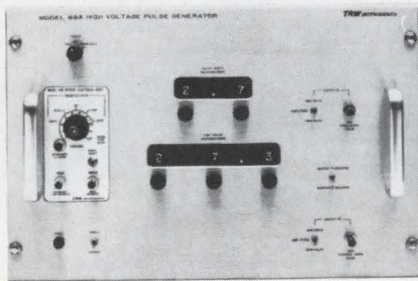

The Model 89A has been tested for these applications, among others:

- laser diode pulsing
- shockwave studies
- testing semiconductors and components
- input triggering
- measuring delay lines
- pulse transformer, dielectric, induced voltage testing of magnetic devices
- determining transient response of photodiodes
- driving photochemical devices

For complete specifications on the Model 89A High Voltage Pulse Generator, WRITE OR CALL OUR FACTORY OR NEAREST SALES OFFICE.

**TRW INSTRUMENTS**  
DEPT. E-119

Factory: 139 Illinois Street, El Segundo,  
California 90245 • (213) 535-0854  
Sales Offices: New York (516) 333-1414,  
Los Angeles, California (213) 887-9374

**TRW**

## Technical Abstracts

mission requirements, vehicle trajectory, transmitter power, and ground station capability, the systems engineer can establish minimum pattern levels which will vary over the sphere depending on the trajectory. Once the polarization characteristics of the ground station used to track the missile are known, the airborne antenna can be evaluated. The losses encountered when the ground station and the airborne system are polarized differently have been labeled polarization mismatch loss and have been determined for many polarizations: vertical, horizontal, right-hand circular (RHC), left-hand circular (LHC), slant linear, and elliptical.

The polarization mismatch loss was tabulated when encountered at ground stations of various polarizations, including circular and linear diversity, and when the missile polarization was vertical, horizontal, RHC, LHC, and slant linear. The circularly polarized diversity system showed no polarization mismatch loss greater than 0.5 decibel for any missile polarization, while the loss for a linearly polarized diversity system was no greater than 1.6 db. Polarization diversity assumes a 2.5 db enhancement of signal level when two equal signals are received, and no enhancement of the stronger signal when the two signals received by the antenna are unequal.

A radiation distribution printer, modified to type out particular levels of antenna radiation as they were selected, was used to scan the entire sphere and record the antenna pattern in angle increments of 2° and amplitude increments of 1 db. The tape was rerun and only values less than -10 db isotropic were typed out; a counter counted the number of typewriter strikes per row, and through a normalization process the percentage of the total area in which the signal level was below the selected level was determined. Areas of the radiation pattern that fell below the selected level were termed nulls and were categorized as either polarization or power nulls. Polarization nulls are a result of a polarization mis-

**NEED  
HIGH VOLTAGE  
CAPACITORS  
FAST?**

... Prompt Delivery -

**NO!**

... Immediate Delivery

**YES!**



GLASS  
CONTAINERS

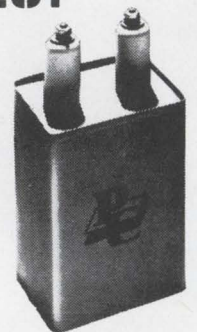

METAL CAN  
CONTAINERS

Our list of satisfied "blue chip" customers is growing and growing which necessitated a large expansion of our manufacturing and engineering facilities. Now, we can supply a complete range of voltages from 2,000 to 50,000 volt capacitors from our expanded "stock on hand". Don't take excuses, we'll supply you faster than at any time in our many years in the field—**BETTER PRODUCTION FROM US—  
BETTER DELIVERY FOR YOU!**

Write for complete list of Standard High Voltage Capacitors in stock—or, send specifications for custom quotations.



**Plastic Capacitors, INC.**  
2620 N. Clybourn • Chicago 14, Ill.  
DI 8-3735



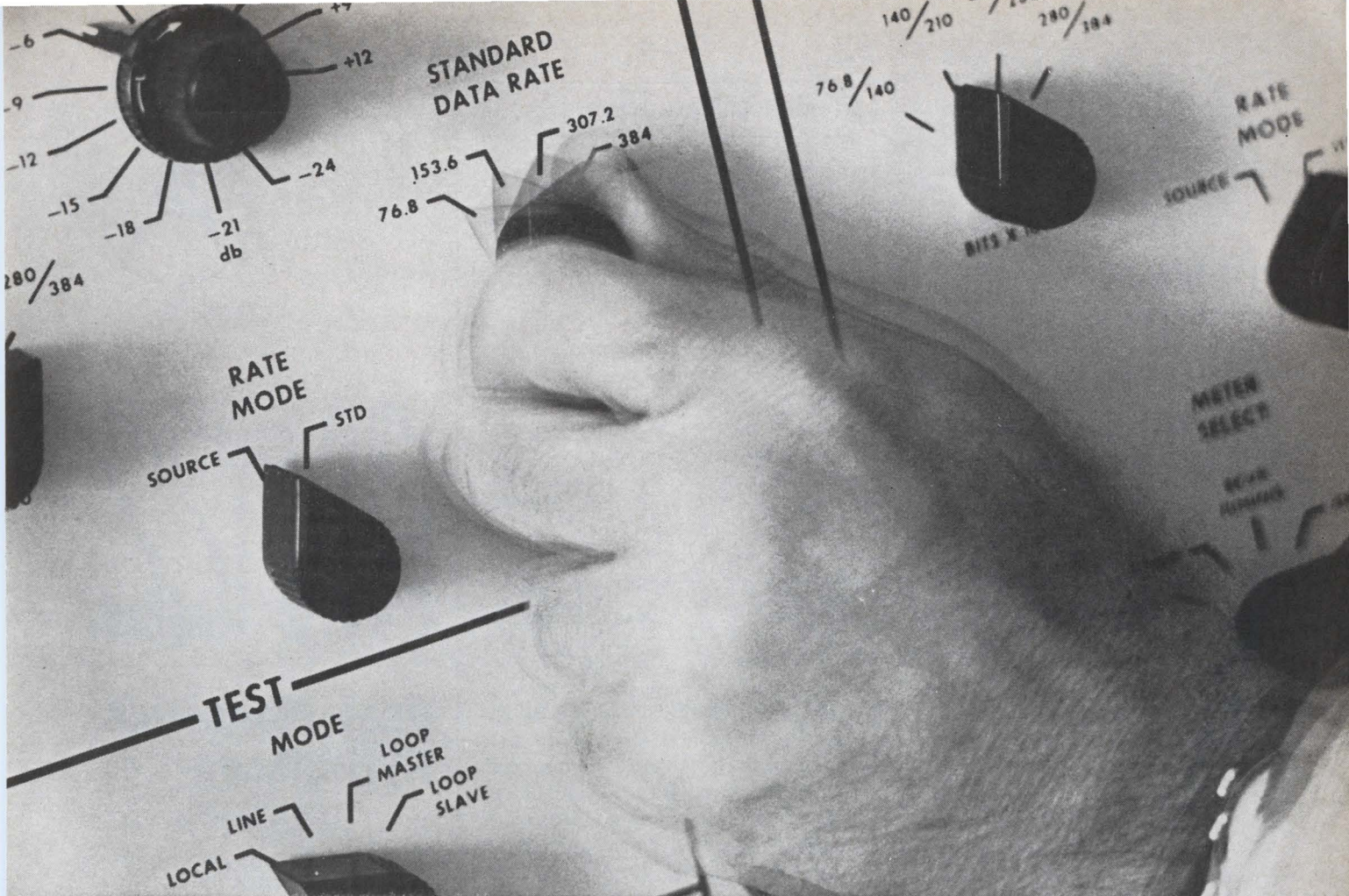

# Our new modem just set a speed record: 384,000 bits per second.

Finally somebody has developed high speed modems that can grow as your communications system grows.

With two new IBM modems, all you do to upgrade is flip a selector switch. Custom-built for government applications, the speed can be varied from 9600 all the way to 384,000 bits per second.

One mil spec modem (AN/USC-25) operates on a wideband 240 khz channel without expensive automatic equalization. It can be equalized quickly with built-in fixed and manual controls.

Another model, AN/USC-24, operates from 9600 to 76.8 bits per second on 48 khz channels.

It has an average error rate of only one in a million bits. Other features: independent full duplex capability, and built-in self test.

Ask us about our communications capabilities. Not only with modems, but with error-control devices, multiplexers and automatic routing equipment.

We want to help you set speed records of your own.

IBM, Federal Systems Division,  
Gaithersburg, Maryland 20760.

**IBM**<sup>®</sup>

IBM Marketing Information  
18100 Frederick Pike  
Gaithersburg, Maryland 20760

Please rush me more facts about IBM high-speed modems.

Name \_\_\_\_\_

(please print)

Title \_\_\_\_\_

Company \_\_\_\_\_

Address \_\_\_\_\_

City \_\_\_\_\_ State \_\_\_\_\_ Zip \_\_\_\_\_



## REMOTE CONTROL SWITCHING WITH AUDIO SIGNALS

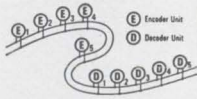

A single pair of wires, or a leased telephone line, can carry the audio signals for a complete control system.



For inaccessible areas or mobile installations, a radio transmitter and receiver system can carry the signals.

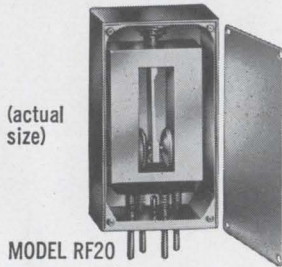

(actual size)

MODEL RF20  
contactless resonant reed encoder/decoder  
.395 x .620 x 1.100

An audio tone can be generated by an electronic oscillator or resonant reed encoder circuit, then transmitted by wire or radio. The tone activates a resonant reed relay to perform a control function.

Bramco reeds permit over 100 selective control frequencies within the 67 to 3000 Hz. spectrum. This is assured by: (1) the narrow response band-width of about 1% for decoders and (2) the high accuracy of Bramco reed encoders (1/10 of 1% of design frequency).

A big advantage of reeds in control switching is that they are ideally suited for simultaneous and sequential coded tone systems. The actual number of control functions possible in such a system is virtually unlimited. For example, over 3300 individual control functions are possible with only 16 frequencies coded sequentially in groups of three.

Compared to other types of tone filters, resonant reeds are small and inexpensive. They give more control functions per spectrum, per size, per dollar.

If you work with controls that select, command, regulate, or indicate, you should know how it can be done with audio signals. We custom design and stock a broad line of encoder/decoder components and modules. Bramco also custom designs LC filters from 0 to 200 KHz.

For literature write Bramco Controls Division, Ledex Inc., College and South Streets, Piqua, Ohio, or call 513-773-8271.



BRAMCO CONTROLS DIVISION  
LEDEX INC.

College and South Streets, Piqua, Ohio 45356

## Technical Abstracts

match between the transmitting and receiving antennas while power nulls are a result of signal cancellation and are independent of the type of receiving antenna used in the system.

Experiments performed on the Athena H antenna system showed that when the number of antennas on a missile were considered, the best pattern was not necessarily produced by a large number of antennas. A set of six monopole elements was arrayed circumferentially around the missile and fed to produce phase rotation resulting in RHC polarization in the direction of vehicle travel and LHC in the opposite direction. The result was a multilobed pattern whose null depth could not be reduced. A three-element array was tried and produced a better null structure than the six element array. Two three-element arrays were used to provide the required redundant S-band telemetry system using two transmitters without a diplexer; the three antennas and associated cables and power divider resulted in a lower cost and weight system than one that uses a diplexer instead.

Presented at the International Telemetry Conference, Washington, Sept. 15-17.

### Light link

Wideband fiberoptic analog information link

R.A. Churchill and K. Avicola  
Autonetics division of North American Rockwell  
Anaheim, Calif.

Many electronic systems are tested in high electromagnetic fields. Test data must be transmitted to processors and recorders without affecting or being affected by the field. A data link that meets these requirements utilizes a gallium arsenide (GaAs) infrared light emitting diode, a glass fiber optic light guide cable, and a photo-multiplier tube. This link has a high channel capacity and does not require a line-of-sight path transmitter and receiver.

The diode is energized by a modulated signal from a current probe. At the same time, this signal is

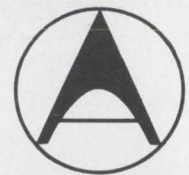

ANCRONA

# AN122

## Dual Monolithic NPN-Silicon-Planar-Transistors

### MATCHED PAIRS FOR DIFFERENTIAL AMPLIFIERS

Low Profile six lead TO-5 six lead epoxy



- HIGH  $h_{FE}$  AT LOW CURRENT  $>200$
- LOW OUTPUT CAPACITANCE  $<2.0$  pf
- $h_{FE}$  MATCH  $<10\%$
- TIGHT  $V_{BE}$  TRACKING  $<5.0$   $\mu V/^{\circ}C$   
 $-55^{\circ}C$  to  $+125^{\circ}C$

#### PRICES

	1-24	25 up	100 up
\$	3.80	3.20	2.55

## ANCRONA CORP.

65 East 55th Street • New York, N. Y. 10022  
(212) 688-6285 • Telex 223117 • TWX (710581/4513)

Circle 257 on reader service card

218 Circle 218 on reader service card



# Special introductory offer to new members of the ELECTRONICS AND CONTROL ENGINEERS' BOOK CLUB

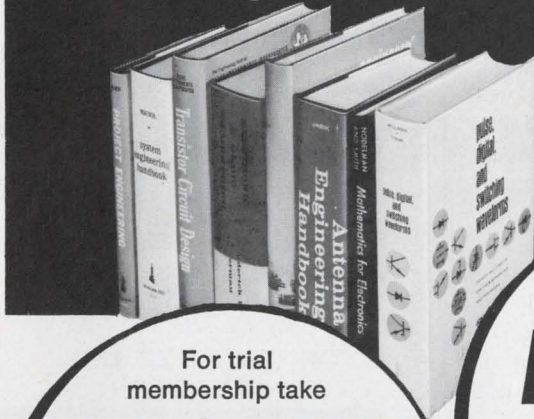

For trial membership take

**ANY ONE**  
for only \$ **1.00**  
Values up to \$12.50

Choose bonus from Library Group A

For trial membership take

**ANY ONE**  
for only \$ **2.00**  
Values up to \$16.50

Choose bonus from Library Group B

For trial membership take

**ANY ONE**  
for only \$ **3.00**  
Values up to \$37.50

Choose bonus from Library Group C

#A850 **MATHEMATICS FOR ELECTRONICS WITH APPLICATIONS** by H. M. Nodelman and F. W. Smith. Pub. price, \$8.00. Club price, \$6.80

#A896 **BASIC PULSE CIRCUITS** by R. Blitzer. Pub. price, \$8.50. Club price, \$7.25

#A530 **PROJECT ENGINEERING** by V. Hajek. Pub. price, \$9.75. Club price, \$8.30

#A355 **FIELD-EFFECT TRANSISTORS** by L. J. Sevin. Pub. price, \$10.00. Club price, \$8.50

#A475 **MOSFET IN CIRCUIT DESIGN** by R. H. Crawford. Pub. price, \$10.00. Club price, \$8.50

#A142 **TUNNEL-DIODE AND SEMI-CONDUCTOR CIRCUITS** by J. M. Carroll. Pub. price, \$11.00. Club price, \$9.35

#A509 **MATHEMATICS MANUAL** by F. S. Merritt. Pub. price, \$11.95. Club price, \$10.15

#A955 **ELECTRONIC TESTING** by L. L. Farkas. Pub. price, \$12.00. Club price, \$10.25

#A144 **DESIGN MANUAL FOR TRANSISTOR CIRCUITS** by J. M. Carroll. Pub. price, \$12.50. Club price, \$10.65

#B978 **TRANSFORMERS FOR ELECTRONIC CIRCUITS** by N. R. Grossner. Pub. price, \$14.00. Club price, \$11.90

#B905 **INTRODUCTION TO RADAR SYSTEMS** by M. I. Skolnik. Pub. price, \$14.50. Club price \$12.35

#B677 **DATA TRANSMISSION** by W. R. Bennett. Pub. price, \$14.50. Club price \$12.35

#B270 **MICROWAVE MEASUREMENTS** by E. L. Ginzton. Pub. price, \$16.50. Club price \$14.05

#B310 **AUTOMATIC FEEDBACK CONTROL SYSTEMS** by J. G. Truxal. Pub. price, \$16.50. Club price, \$14.05

#B690 **MODERN OPTICAL ENGINEERING** by W. J. Smith. Pub. price, \$16.00. Club price, \$13.60

#737 **TRANSISTOR CIRCUIT DESIGN** by Texas Instruments, Inc. Staff. Pub. price, \$16.50. Club price, \$14.05

#B981 **DIGITAL COMPUTER AND CONTROL ENGINEERING** by R. S. Ledley. Pub. price, \$16.50. Club price, \$14.05

#C509 **ELECTRONIC AND RADIO ENGINEERING** by F. E. Terman. Publisher's price, \$19.50. Club price, \$16.55

#C861 **FLUID AMPLIFIERS** by J. M. Kirshner. Pub. price, \$17.75. Club price \$15.10

#C381 **PULSE, DIGITAL, AND SWITCHING WAVEFORMS** by J. Millman and H. Taub. Pub. price, \$18.00. Club price, \$15.30

#C360 **ELECTRONIC ANALOG AND HYBRID COMPUTERS** by G. A. Korn and T. M. Korn. Pub. price, \$18.75. Club price, \$15.95

#C085 **DIGITAL AND SAMPLED-DATA CONTROL SYSTEMS** by J. T. Tou. Pub. price, \$19.75. Club price, \$16.75

#C304 **HANDBOOK OF SEMICONDUCTOR ELECTRONICS 2/e** by L. P. Hunter. Pub. price, \$22.50. Club price, \$19.10

#C290 **ANTENNA ENGINEERING HANDBOOK** by H. Jasik. Pub. price, \$27.75. Club price, \$23.60

#C371 **SYSTEM ENGINEERING HANDBOOK** edited by R. E. Machol. Pub. price, \$29.50. Club price, \$25.00

#C503 **AMPLIFIER HANDBOOK** by R. F. Shea. Pub. price, \$37.50. Club price, \$29.50

You can save time and money by using this coupon to join today

**YOUR BONUS BOOK** comes with your first selection

**YOUR FIRST CLUB SELECTION** available from any Library Group above

**H**ERE is a professional book club designed to meet day-to-day engineering needs by providing practical books in your field on a regular basis at below publisher prices.

**How the club operates:** Basic to the Club's service is its publication, the *Electronics and Control Engineers' Book Club Bulletin*, which brings you news of books in your field. Sent to members without cost, it presents in detail the featured book of the month as well as many alternate selections also available at special members' prices.

When you want to examine the Club's featured book, you do nothing. It will be mailed as a regular part of your Club service. If you prefer one of the alternate selections—or if you want no book at all for that month—you let us know by returning the convenient card enclosed with each Bulletin.

As a member, you agree only to take four books in two years. Considering the many essential books published in your field, there will surely be at least four that you would want to own anyway. By joining the Club, you save both money and the trouble of searching for the best books.

**NEVER A MEMBERSHIP FEE**  
ELECTRONICS AND CONTROL ENGINEERS' BOOK CLUB  
330 W. 42 St. 18th floor, N.Y., N.Y. 10036

Please enroll me as a member of the Electronics and Control Engineers' Book Club and send me the two books indicated below. I am to receive the bonus book at the special Library Group price and my first selection at the special Club price. These books are to be shipped on approval, and I may return them both without cost or further obligation. If I decide to keep the books, I agree to purchase as few as four additional books during the next two years at special Club prices guaranteed to be about 15% under publisher prices.

Write Code No. of  
bonus book  
here

Write Code No. of  
first selection  
here

Name \_\_\_\_\_

Address \_\_\_\_\_

City \_\_\_\_\_

State \_\_\_\_\_ Zip \_\_\_\_\_

(Offer good in U.S. and Canada only.)

E33120



# The first plug-in curve tracer costs 1/3 less!

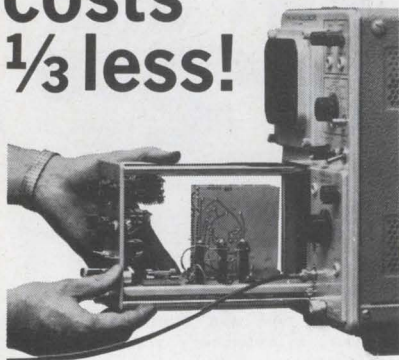

With U-Tech's plug-in and console units, any X-Y oscilloscope becomes a curve tracer displaying the dynamic characteristics of both NPN and PNP transistors, N Channel and P Channel junctions, FET's, MOS-FET's, bipolars, unijunctions, diodes, tunnel diodes and SCR's. You have curve tracer capabilities, without buying a complete curve tracer unit. In so doing you pay up to:

## 1/3 less!

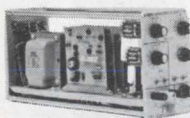

U-Tech plug-in **MODEL 681**: \$655.00\*. For use with Tektronix† 560 Series Oscilloscopes.

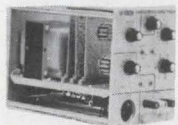

U-Tech plug-in **MODEL 682**: \$675.00\*. For use with Tektronix† 530, 540, 550, 580 Series Oscilloscopes.

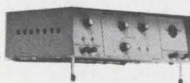

U-Tech console **MODEL 683**: \$685.00\* For use with any X-Y Oscilloscope.

Ask your distributor about these U-Tech curve tracer units or order direct from:

## U-TECH

A DIVISION OF INDUSTRIAL PHYSICS AND ELECTRONICS COMPANY  
4190 SOUTH STATE STREET,  
SALT LAKE CITY, UTAH 84107  
(801) 262-2663

†Registered trademark Tektronix Inc.  
\*Prices apply to purchase and shipments within U.S.A. fob Salt Lake City, Utah

## Technical Abstracts

sensed by a detector antenna, which feeds a 10-microsecond bias pulse to the diode. The energizing signal from the probe is delayed 50 nanoseconds so the diode can become fully forward-biased before receiving the energizing signal. Since GaAs radiates only when forward-biased, it must be biased "on" previous to the appearance of the data so that the negative-going portions of the waveform are not clipped.

A 10- $\mu$ sec bias step was selected to accommodate long-duration data pulses. But the output of GaAs diode is a function of temperature, and if the diode is warmed excessively during the bias step, a non-linear effect is introduced. Bias steps up to 100  $\mu$ sec can be used without excessive heating of the GaAs diode.

The system transmits data over a 40-foot flexible fiber optic light guide. This guide conducts light, including infrared, by the phenomenon of total internal reflection. If the glass fiber light guide is surrounded by material with a lower index of refraction than the glass fiber in the guide, light will be completely reflected at the interface of light guide and the surrounding material, and the transmitted signal will suffer little or no reflection attenuation.

The receiver chosen was a photomultiplier tube which has a response time of 2.4 nsec, compared with an entire-system rise time of 4.5 nsec. The receiver converts the a-m infrared radiation signal to an electrical signal for display on a recording oscilloscope. The oscilloscope has a bandwidth of 150 megahertz when used with minimum sensitivity of 20 millivolts division.

Overall system performance was measured from probe input to oscilloscope display. Input sensitivity is 240 microvolts; output noise level, 2 mv peak to peak; maximum output signal, 120 mv peak; maximum signal-to-noise ratio: 40.1; dynamic range: 32 db; linearity:  $\pm 5\%$  over the entire dynamic range.

Presented at the International Telemetering Conference, Washington, Sept. 15-17.

# START

WITH A LENS-END LAMP

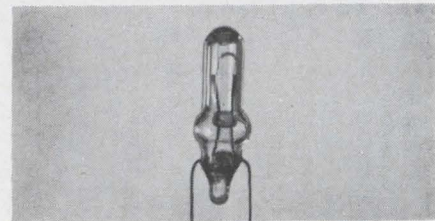

# TEST

FOR SPOT SIZE AND  
CANDLEPOWER

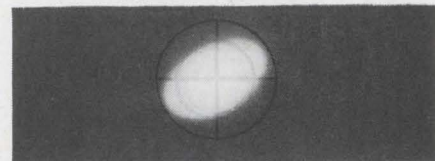

# WELD

PINS TO END OF LEAD  
WIRES

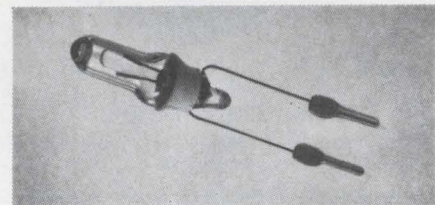

# MOLD

TO MAKE A PLUG-IN LIGHT  
MODULE THAT WILL ACTIVATE  
PHOTO ELECTRIC SENSOR IN  
A HIGH SPEED CHECK SORTER

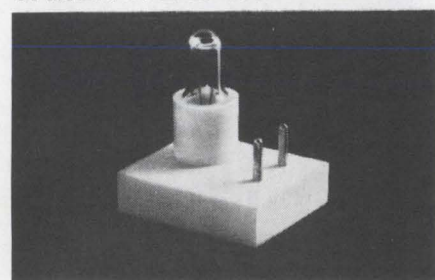

We specialize in finding practical solutions to small applications where cataloged items won't do. Write, describing your requirement. Tung-Sol Division, Wagner Electric Corporation, 630 W. Mt. Pleasant Avenue, Livingston, N.J. 07039. TWX: 710-994-4865. Phone: (201) 992-1100.

## TUNG-SOL®

WHERE BIG THINGS ARE  
DONE WITH SMALL LAMPS

© Reg. T.M. Wagner Electric Corporation



# WANTED: ELECTRONICS MANUFACTURER

who desires to fill a  
dependable supply of  
government contracts

Excellent opportunity for growth-minded electronics manufacturer to locate in Texas and help meet the needs of the government and the third fastest-growing state. Stable, productive labor. Incomparable tax advantages. Lowest living costs. For Texas Fact Book, write or call:

James H. Harwell, Executive Director  
**TEXAS INDUSTRIAL COMMISSION**  
Capitol Station Box JJ-E  
Austin, Texas 78711  
Telephone 512/475-4331

Circle 221 on reader service card

# You really turn me on!



## HATHAWAY OPEN FRAME 2 AMP DRIREED RELAY

And off! And vice-versa, back and forth. The reliability is part of the package. Inside of that open frame is a brace of Hathaway Drireed switches to make sure things always work. Rated at 2 amps, 25 Watts. For choosy specifiers the 2 amp relay is also available with a snap-on magnetic shielding case. Click! **Send for our full line mini-catalog.** Address: 5250 East Evans Avenue, Denver, Colorado 80222, (303) 756-8301 —TWX 910 931-0569.

# HATHAWAY

components

A DIVISION OF HATHAWAY INSTRUMENTS, INC.

Circle 259 on reader service card

Be prepared for

# THE CHANGING INTERFACE



Medium and large scale integration are slated to have major impact on the electronics industry. The effects are already being felt — not only on systems and component design — but on fundamental, traditional relationships between equipment builders and component suppliers.

Important trends that will affect your profession, your job, your company, are explored in THE CHANGING INTERFACE, a 150-page illustrated volume to be published shortly by McGraw-Hill's Electronics/Management Center.

In THE CHANGING INTERFACE, leading design engineers and managers, the men responsible for guiding their companies through the next generation of electronics, discuss the problems that LSI/MSI are stirring up — and offer their solutions.

Here are some of the vital topics covered.

- Implications of LSI on the Electronics Market
- The Rationale for an In-House IC Capability
- The Component Maker's Responsibility vs. the System Builder's Responsibility
- Masks and Computer-Aided Design at the Interface
- The Testing Interface
- How IBM and Bell Laboratories Deal with the Interface Problem
- Controversies and Future Trends in LSI

You can reserve a copy of THE CHANGING INTERFACE now at the special pre-publication price of \$6.50 by returning the coupon below. If you send a check now, we'll pay the cost of postage and handling.

Electronics/Management Center  
330 West 42nd St.  
New York, N.Y. 10036  
Attn. Mr. Wayne Cowart

Please reserve my copy of THE CHANGING INTERFACE at the prepublication price of \$6.50.

Name \_\_\_\_\_ Title \_\_\_\_\_

Company \_\_\_\_\_

Company Address \_\_\_\_\_

City \_\_\_\_\_ State \_\_\_\_\_

Check enclosed for \$6.50  Bill me  
 Bill Company P.O. Number \_\_\_\_\_







221



# We'll stack these components up against anybody's!

TEC's reliable ones, ideally suited for "point-of-load" regulation, for power distribution for TTL, DTL, op-amps, etc.

When your system requires excellent source to circuit and circuit to circuit isolation and protection, nothing beats the SPACE PROVEN RELIABILITY of these TEC components.

	 <p>REGULATOR VR 1240 1132-8913</p> <p>VR Series Low Cost Hybrid Regulator 2X DIP Size</p>
 <p>Dual Converter 9646-101 Single inputs Dual outputs</p>	
	 <p>Low Cost Unregulated power sources</p>

Write for TEC notes on "point-of-load" regulation including specs and prices



P.O. Box 910  
Boulder Industrial Park  
Boulder, Colorado  
(303) 442-3837

## New Literature

**Instrumentation.** North Atlantic Industries Inc., Terminal Dr., Plainview, N.Y. 11803. An eight-page condensed catalog gives application and a summary of key specifications for some 40 items—eight of them introduced during 1969—in the firm's instrumentation product line.

Circle 446 on reader service card.

**Design assistance.** Texas Instruments Inc., P.O. Box 5012, Dallas 75222, has published a directory that describes all literature and personal consultation services offered by the company to designers using semiconductor devices and integrated circuits. [447]

**P-c connectors.** Elco Corp., Willow Grove, Pa. 19090, has available the revised, 52-page 1969 edition of its p-c connector guide. [448]

**Electrical insulation.** Johns-Manville Dutch Brand division, 22 E. 40th St., New York 10016. An electrical insulation selection chart contains actual samples and data on 20 different thermosetting electrical insulating tapes for OEM use. [449]

**Crystal can timing modules.** The A.W. Haydon Co., 232 N. Elm St., Waterbury, Conn. 06720. Two-page brochure MD407 describes a line of crystal can timing modules designed to provide selectable or fixed time delays. [450]

**Coaxial cables.** Andrew Corp., 10500 W 153rd St., Orland Park, Ill. 60462, has released a mailing piece on Helix coaxial cables for a-m broadcast arrays. [451]

**High-voltage capacitors.** AMP Inc., Capatron Division, Elizabethtown, Pa. 17022. Over 300 high-voltage capacitors and nearly 70 capacitor stacks are described in the 28-page Amplifilm capacitor catalog 710-8. [452]

**Silicon power transistors.** Power Physics Corp., P.O. Box 626, Eatontown, N.J. 07724, has available a four-page catalog listing a complete line of diffused mesa and radiation-hardened silicon npn power transistors. [453]

**Solderable conductive coatings.** Aremco Products Inc., P.O. Box 145, Briarcliff Manor, N.Y. 10510. Product bulletin 536 describes a single component pure silver filled polymer alloy used to produce conductive coatings. [454]

**Electronic signal selector.** Fischer & Porter Co., 641 Jacksonville Rd., Warminster, Pa. 18974. Specification 55ES3000 describes a solid state electronic signal selector. [455]

**Semiconductors.** Centralab Electronics division of Globe-Union Inc., 5757 N. Green Bay Ave., Milwaukee 53201,

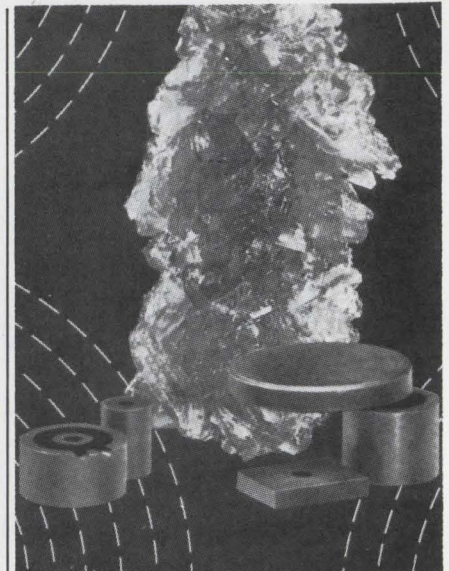

Typical ferrites with synthetic melanterite crystals from which their iron oxides were made.

# A New Challenge and Opportunity for Ferrites!

Pfizer research has made possible an advanced line of iron oxides for both soft and hard ferrites that reflects new achievements in purity, reactivity, shape perfection, and uniformity from lot to lot.

Manufacturers of ferrites are thereby enabled to make these "magnetic marvels" with greater ease, better results, and for ever-widening applications. Pfizer technical literature on our advanced ferrite oxides is available on request.



## MINERALS PIGMENTS & METALS DIVISION

Dept., 9E2 235 East 42nd Street  
New York, New York 10017



low  
light  
level  
television

integrating orth  
10<sup>-7</sup>fc.

image orthicon  
10<sup>-6</sup>fc.

image isocon  
10<sup>-5</sup>fc.

infra-red vidicon

by

**mti**

DIVISION OF KMS INDUSTRIES, INC.

Circle 223 on reader service card

If your Research, Instrumentation, Astronomical, or Surveillance project is stymied because of low light level imagery or data problems — you haven't conferred with MTI.

10534 YORK ROAD COCKEYSVILLE, MARYLAND 21030

# Help stamp out dropouts

## Clean tape heads with MS-200\*

Oxide dust on tape heads and helical scan recorders is a frequent source of dropouts. Some engineers still clean them the hard way, with swabs, but many have found a better way: MS-200 Magnetic Tape Head Cleaner. MS-200 sprays away dust and dirt in seconds. You can even apply it safely while the tape is on the air. Finally, users report more than twice as many passes of tape between cleanings with MS-200 as with swabs. Recommended by leading tape manufacturers. Write on letterhead for literature and prices.



**miller-stephenson  
chemical co., inc.**

ROUTE 7, DANBURY, CONNECTICUT  
\*U.S. and foreign patents pending





# The Connector-Protector-Detector-Inspector

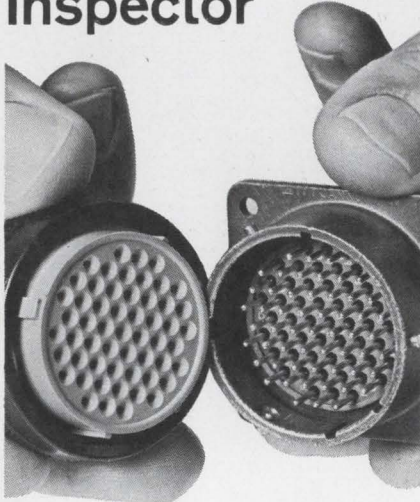

Here's a connector accessory that serves as a dust cap, inspection fixture, assembly fixture, pin protector, and pin straightener. Now you can guard against the fates of connector mishandling from assembly to installation . . . and at a price comparable to an ordinary dust cap!

Over 25 different insert arrangements in 9 shell sizes are available for



MIL-C-26482 and NAS 1599 Bayonet Coupling Connectors, and in various clocking positions. Shell and insert identification is molded into the face of each unit, and it is color coded for easy reference . . . plugs are yellow, receptacles are blue. Veritector are nonmagnetic, impervious to salt spray and seal connectors against hostile environment.

They can be used over and over, meeting or exceeding 500 cycles of durability.

For the complete story and specifications on the Veritector family, ask for our brochure. Write, or call us at (213) 341-0115.

## CONTROL DATA CORPORATION

Control Data Corporation  
Connector Operation  
8758 Remmet Avenue  
Canoga Park, California 91304

## New Literature

offers a catalog covering silicon semi-conductors including chip devices, zener regulators, reference diodes, solar cells, and photovoltaic assemblies. [456]

**Remote-controlled attenuators.** Texscan Corp., 2446 N. Shadeland Ave., Indianapolis 46219. Catalog sheet RC gives complete description and technical parameters of a newly developed remote controlled attenuator line which has a life expectancy of 100,000 revolutions minimum. [457]

**Silicon power rectifiers.** Edal Industries, 4 Short Beach Rd., East Haven, Conn. 06512. The F4 series of silicon power rectifiers is fully described in bulletin 124. [458]

**Precision switches.** Chicago Dynamic Industries Inc., 1725 Diversey Blvd., Chicago, Ill. 60614. Ten series of precision switches for industrial and military applications are described and shown in a four-page, two-color condensed catalog. [459]

**Capacitor additives.** Aerovox Corp., New Bedford, Mass. 02741. A four-page technical bulletin provides detailed information on additives "A" and "AH" for a-c capacitors. [460]

**Servo recorder.** Esterline Angus division of Esterline Corp., P.O. Box 24000, Indianapolis 46224. A revised catalog sheet provides details about a truly portable recorder that operates on rechargeable nickel-cadmium batteries for 12 hours, on conventional 1½ "D" cell batteries for eight hours or on a-c indefinitely. [461]

**MOS FET's.** Union Carbide Corp., P.O. Box 23017, 8888 Balboa Ave., San Diego, Calif. 92123, has released a brochure on the 3N172, 3N173 P-channel enhancement mode MOS field effect transistors. [462]

**Circuit card guides.** Calabro Plastics Inc., 8738 West Chester Pike Upper Darby, Pa. 19082, has issued an eight-page brochure describing Unitrack circuit card guides. [463]

**Miniature electric counter.** Durant Digital Instruments, A Cutler-Hammer Co., 622 N. Case St., Milwaukee 53201, has published technical literature describing a miniature electric counter series for the OEM. [464]

**Attenuators.** Greenpar Engineering Ltd., Station Works, Harlow, Essex, England, has published a catalog sheet on its new range of precision coaxial attenuators and attenuator kits. [465]

**Hybrid computing system.** Electronic Associates Inc., West Long Branch, N.J. 07764. The versatile and economical

# Quan-Tech makes Wave Analyzers (LOTS OF THEM)



## MODEL 304-TD LOW FREQUENCY TRACKING WAVE AND SPECTRUM ANALYZER

**Frequency Range:** 1 to 5000 Hz, 5 place electronic digital readout. **Bandpasses:** 1, 10, and 100 Hz. **Sensitivity:** 30µV to 300V FS. **Tuning:** electronic; modes: manual, AFC, sweep, tracking (over full frequency range or part), search and track, master-slave capability. **Outputs:** BFO, restored signal, analogs of amplitude, frequency, and phase. **Price:** \$3575.

**MODEL 304-T** Same specs as Model 304-TD except 5000 division linear dial instead of digital readout. **Price:** \$3025.

**MODEL 304** Same specs as Model 304-T except no AFC, tracking, or master-slave capability. **Price:** \$2700.

**MODEL 305-D** Same specs as Model 304-TD except: **Frequency Range:** 10 Hz to 50 KHz. **Bandpasses:** 10, 100, and 1000 Hz. **Price:** \$3350.

**MODEL 305** Same specs as Model 305D except 5000 division linear dial instead of digital readout. **Price:** \$2800.

**MODELS 1304 and 1305** Slave units for multi-channel, phase-locked systems when used with 304-T, 305 series. No tuning controls, but a phasemeter is included. **Price:** \$2050.

**MODEL 303** **Frequency Range:** 30 Hz to 100 KHz, semi-log tuning dial. **Bandpasses:** 10, 30, 100, and 1000 Hz. **Sensitivity:** 100µV to 300V FS. **Price:** \$1700.

**MODEL 2156** Same specs as Model 303 except: **Frequency Range:** 10 Hz to 30 KHz. **Bandpasses:** 3, 10, 100, and 300 Hz. **Price:** \$2375.

**MODEL 2223** Same specs as Model 303 except: **Frequency Range:** 10 Hz to 200 KHz. **Bandpasses:** 10, 100, 750, and 1000 Hz. **Price:** \$3525.

SEND FOR COMPLETE DETAILS ON THE ABOVE OR OTHER INSTRUMENTS

# Quan-Tech

DIVISION OF KMS INDUSTRIES, INC.  
Quan-Tech®

43 So. Jefferson Rd., Whippany, N. J. 07981  
Phone: (201) 887-5508 TWX: 710-986-8251



# 10 times more void-free!

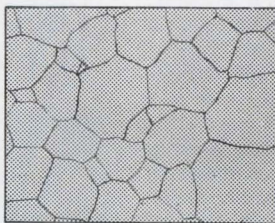
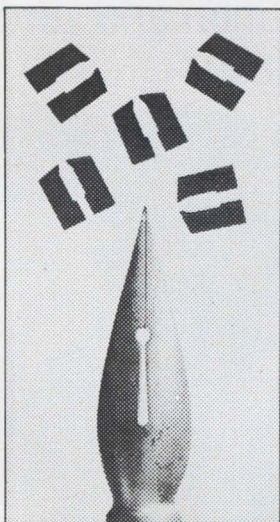

NEW HIGH-DENSITY FERRITE  
(Ni-Zn) 1,000power

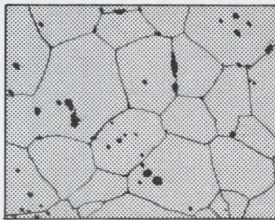

CONVENTIONAL FERRITE  
(Ni-Zn) 1,000power

## TDK's NEW HIGH-DENSITY FERRITE

Made available by TDK's new manufacturing technique are a series of Mn-Zn and Ni-Zn high-density ferrites with no more than 1% total void, intracrystalline and boundary. Hard (Vickers 600) and adapted to precision machining, the new ferrites are superior even to single-crystal ferrite where cost and magnetic properties (particularly radio-frequency characteristics) are major concerns. For single and multi-track magnetic heads used in computers and the like, and also for many other ferrite devices involving close-tolerance machining, High Density TDK Ferrites are the logical choice of every engineering designer.



Write to MH&W for full technical data and information on applications  
Representative in U.S.A. & Canada for Ferrite Core for Communications

### MH&W INTERNATIONAL CORPORATION

280 Midland Avenue, Saddle Brook, N.J. 07662  
Phone: (201) 791-6277 (212) 244-0695



# TDK

TDK ELECTRONICS CO., LTD.  
2-14-6 Uchikanda, Chiyoda-ku, Tokyo Japan.

## Going to IC's? Or Higher IF's?

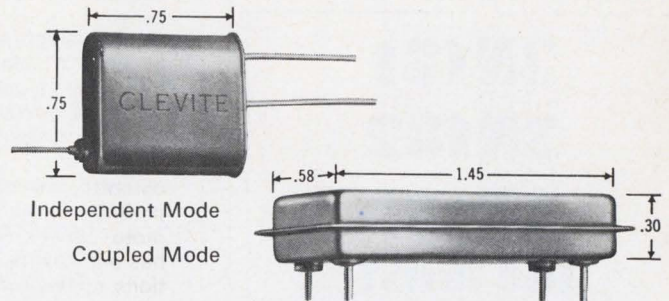

## Go two ways with Monolithic Quartz Uni-Wafer<sup>®</sup> Filters

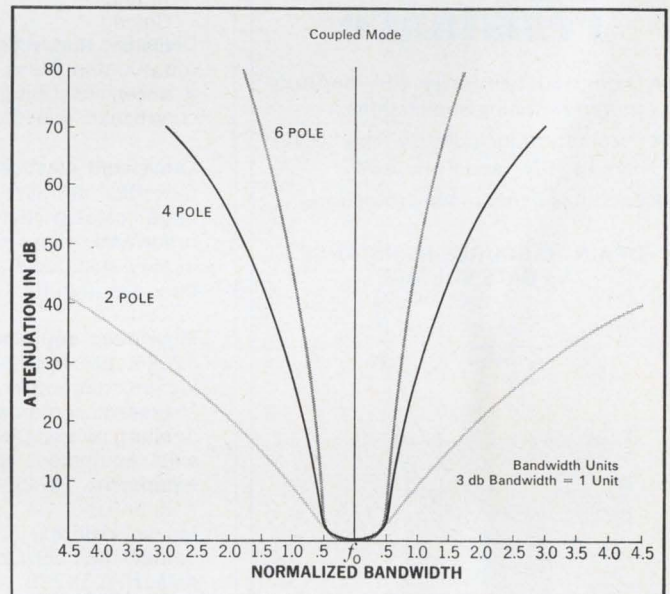

Go independent mode. Go coupled mode. You can go either mode with monolithic Clevite Uni-Wafer<sup>®</sup> filters. They're smaller and more reliable (fewer interconnections) than conventional filters.

Clevite Uni-Wafer filters are ideal for matching IC circuitry in communications receivers operating in the VHF and UHF frequency ranges as well as in telemetry, radar and aerospace systems.

They are 2, 4 and 6 pole crystal filters with a choice of center frequencies ranging from 8 MHz to 75 MHz. They've been developed using Clevite's advanced engineering techniques and Clevite's original thin film approach to quartz filters. In this concept, arrays of resonators are achieved on a single quartz wafer with resonator isolation and spurious suppression controlled by the trapped energy principle.

So if you're going to IC's or higher IF's, go Clevite Uni-Wafer filters. They're available in both independent and coupled mode.

For more information and complete specification data, write: Piezoelectric Division, Gould Inc., 232 Forbes Road, Bedford, Ohio 44146.

## GOULD CLEVITE



# FET FACT

## 3N181 3N182 3N183 the most complete family of ATOS-FETs featuring low "ON" resistance

- Designed primarily for medium power switching applications.
- Parameters include low  $R_{DS}$  "ON", high  $I_D$  "ON" and  $P_{wr}=2.0W$ .
- Each has Zener diode protection.

**DRAIN TO SOURCE RESISTANCE  
vs GATE VOLTAGE**

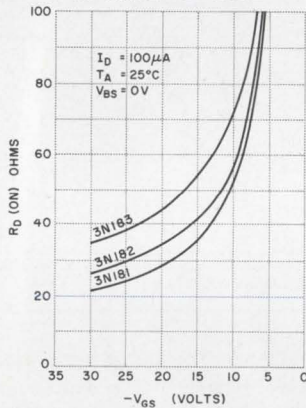

100 pc. price

3N181—\$11.50 ea.

3N182—\$ 5.90 ea.

3N183—\$ 2.05 ea.

The P-channel 3N181, 3N182, 3N183 are immediately available from your authorized General Instrument Distributor. For complete information, write, General Instrument Corp., Dept. F-1, 600 W. John St., Hicksville, L.I., N.Y. 11802.



GENERAL INSTRUMENT CORPORATION  
600 WEST JOHN STREET,  
HICKSVILLE, L. I., NEW YORK

## New Literature

590 hybrid computing system is the subject of a 16-page brochure. [466]

**Data acquisition system.** Systems Data Inc., 1951 W. Market St., Akron, Ohio 44313, offers a data sheet on the model 1001 short burst, high-frequency data acquisition system. [467]

**Plated-wire element testers.** Computer Test Corp., Three Computer Dr., Cherry Hill, N.J. 08034. A bulletin features two new instruments, models E-310 and E-310A, designed for production or laboratory testing of magnetic plated-wire elements. [468]

**IC logic manual.** General Dynamics, Dynatronics Operation, P.O. Box 2566, Orlando, Fla. 32802, has available a 122-page manual with descriptions, specifications and construction details for over 60 TTL IC logic cards. [469]

**Dielectric materials.** Emerson & Cuming Inc., Canton, Mass. 02021, has released a folder describing its line of thermally conductive dielectric materials. [470]

**Laminated plastics.** UOP Norplex, Norplex Dr., LaCrosse, Wis., 54601. A 20-page catalog details the company's broad line of laminated plastics and the quality assurance program under which they are manufactured. [471]

**Microwave equipment.** Sivers Lab, Box 42018, Stockholm 42, Sweden. A catalog on microwave components and instruments contains 75 pages giving full details on switches, rotary joints, coaxial equipment, yig devices and test equipment. [472]

**Linear devices.** Linear Motion Technology Inc., 39 Central Ave., Farmingdale, N.Y. 11735. A design guide issued as a boon to designers and engineers gives the total picture on X-Y tables, positioning systems and other linear devices. [473]

**Induction motors.** Eaton Yale & Towne Inc., 3122 14th Ave., Kenosha, Wis. 53140, has published a bulletin containing cutaway drawings of open drip-proof and totally enclosed fan-cooled electric motors available in standard and special designs. [474]

**Ultrasonic die bonder.** Mech-EI Industries Inc., 73 Pine St., Woburn, Mass. 01801, offers a technical data sheet introducing the model UW-700 ultrasonic die bonder. [475]

**Insulated terminals.** Electronic Molding Corp., 40 Church St., Pawtucket, R.I. 02860, has released a 72-page catalog packed with photos, drawings, specifications and details on a complete line of molded insulated terminals. [476]

**Encoder electronics.** Dynamics Re-

New Raytheon self-locking devices hold instrument settings against...

**VIBRATION & SHOCK SHOCK**

with infinite resolution and zero backlash.

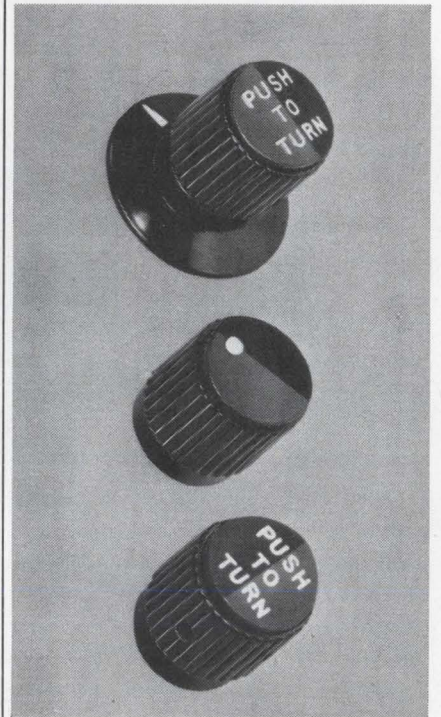

Pushed in, these Raytheon self-locking mechanisms can rotate control shafts in either direction to precise settings. Released, they automatically lock the shaft against vibration, shock, accidental turning. Their simplified, rugged packaging complies with MS91528C and MIL-K-3926B.

Available from your Raytheon distributor, or write for data and prices. *Raytheon Company, Industrial Components Operation, 465 Centre Street, Quincy, Massachusetts 02169.*





## IT'S A DATA TRANSFER SYSTEM! Not A Data Coupler

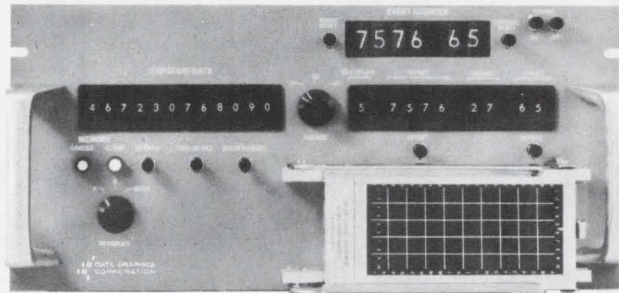

*The difference is VERSATILITY*

### ACCEPTS DATA FROM:

- DIGITAL VOLTMETERS
- A TO D CONVERTERS
- TIME CODE GENERATORS
- COUNTERS
- DIGITAL CLOCKS
- DATA GRAPHICS READOUT SYSTEMS
- DATA GRAPHICS VARIABLE SCALER SELECTOR

### INTERFACES DIRECTLY TO:

- KEY PUNCHES
- TYPEWRITERS
- TAPE RECORDERS
- PRINTERS
- PAPER TAPE PUNCHES
- ON LINE WITH A COMPUTER
- THE MULTIPLEXING OF MORE THAN ONE SYSTEM

PRICES FROM \$3,400 TO \$10,000 (INCLUDING RECORDING DEVICE)

**DATA GRAPHICS  
CORPORATION**

P. O. Box 18324  
San Antonio, Texas 78218  
(512) 342-9486

Circle 227 on reader service card

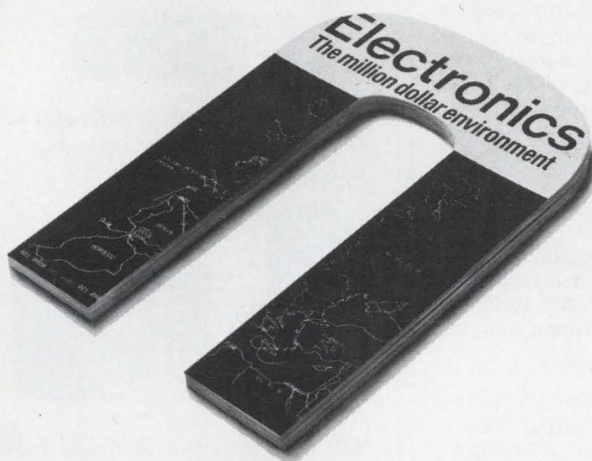

Every year, **ELECTRONICS** attracts requests for over 125,000 editorial reprints.

They're like interest payments on our million-dollars-a-year editorial principles.

That's how much we spend annually to produce timely, authentic, and useful articles like those listed on the reader service card as reprints currently available.

Investment and interest make both **ELECTRONICS** and its readers more meaningful to its advertisers.

## FOR EXCELLENCE IN TERMINATION HARDWARE SPECIFY GRAYHILL



Test Clips

### Test Clips

Adjustable tension, threaded studs or plug in bases, various sizes.

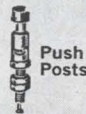

Push Posts

### Push Posts

Plunger action lets you connect and disconnect quickly and easily, assures positive contact.



Stand-Off Insulators

### Binding Posts

Screw type or spring loaded, banana plug or stud mounting, single or multiple units, with various colors for circuit identification.



Binding Posts

### Stand-Off Insulators

High dielectric strength, low loss insulation, low moisture absorption, various mounting styles.

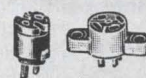

Sockets

### Sockets

Lamp or transistor, various colors, various mountings including printed circuit.



Plastic Molded Parts

### Custom Molded Parts

Tight tolerances provide you with "assembly ready" units. Thermosetting plastics to meet most specifications.

**Grayhill**  
INC.

For your Grayhill Engineering Catalog offering complete technical data—contact

523 Hillgrove Avenue  
LaGrange, Illinois 60525  
Area Code 312, Phone 354-1040



... the Difference Between Excellent and Adequate



## Best Buys in Lab & Shop Instruments Come From Heath

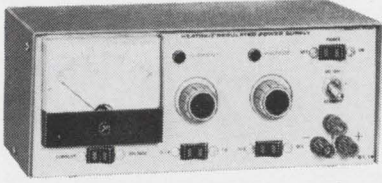

### IP-28 1-30 VDC Power Supply

A Versatile Low Voltage Source For All Solid-State Work. Variable output ... 1-10 & 1-30 VDC ranges. Adjustable current limiting in 2 ranges ... 10-100 mA & 10 mA-1A. Floating output ... AC & DC Programming ... external Voltage Sensing. Switch-selected metering of both voltage & current. Excellent load & line regulation. 9 lbs. Kit, \$47.50 \*

### Low Cost IP-18 1-15 VDC Power Supply



Your Best Buy In A Low Voltage Source. Continuously adjustable output 1-15 VDC. Adjustable current limiting 10-500 mA. AC & DC Programming ... Darlington Pair voltage regulation for excellent stability ... floating output for positive or negative ground. Simple, fast circuit board construction. 5 lbs. Kit, \$21.95 \*

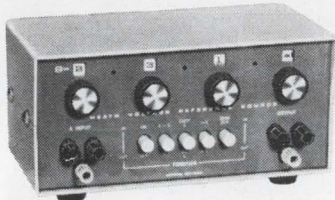

### EU-80A Voltage Reference Source

Lab Standard Accuracy At Low Cost. An extremely accurate, stable reference for recorder calibration & linearity checks, meter calibration, op amp circuits, recorder offsetting and many other uses. 0-10 VDC output ... 15 ppm/hr stability ... push-button polarity reversal, chopped DC, sum-difference & calibrator modes. Voltage-to-current accessory included. 6 lbs. Factory Assembled, \$100.00 \*

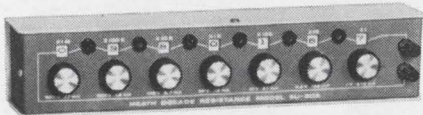

### EU-30A Decade Resistance Box

Provides Excellent Resistance Arm For AC & DC Bridges. Selects values from 1-999,999 ohms in 1 ohm steps. 0.1% & 1% precision resistors. Connections between decades allow precise voltage divider applications. Mechanical digital readout. 3 lbs. Factory Assembled, \$50.00 \*



**HEATH COMPANY, Dept. 526-28**  
Benton Harbor, Michigan 49022

Please send FREE Heathkit catalog.

Enclosed is \$ \_\_\_\_\_, plus shipping.

Please send model (s) \_\_\_\_\_

Name \_\_\_\_\_

Address \_\_\_\_\_

City \_\_\_\_\_ State \_\_\_\_\_ Zip \_\_\_\_\_

Prices & Specifications subject to change without notice.

\*Mail Order Prices; FOB Factory. TE-213

## New Literature

search Corp., 38 Montvale Ave., Stoneham, Mass. 02180, has issued a technical bulletin describing its series EI incremental encoder electronics modules. [477]

**Breadboard data.** AP Inc., 72 Corwin Dr., Painesville, Ohio 44077. A data sheet describes in detail a highly versatile solderless breadboard providing over 2,000 instant plug-in tie points for use with all dual-in-line packages, TO-5's and discrete components. [478]

**Variable transformers.** The Superior Electric Co., Bristol, Conn. 06010. Sixty-four page Powerstat variable transformer catalog P869 gives ratings, dimensions, performance curves and schematic connection diagrams in easy-to-read, efficient format. [479]

**Trimming potentiometers.** Vishay Resistor Products, 63 Lincoln Highway, Malvern, Pa. 19355, has released a catalog sheet illustrating and describing a line of precision trimming potentiometers with temperature coefficient of  $\pm 10$  ppm/ $^{\circ}$ C from  $-55^{\circ}$  to  $+125^{\circ}$ C. [480]

**R-f toroidal inductors.** Vanguard Electronics, Division of Wyle Laboratories, 930 West Hyde Park, Inglewood, Calif. 90302. Miniature and subminiature r-f toroidal inductors are the subject of a six-page brochure bulletin 100. [481]

**Elapsed time indicators.** The A.W. Haydon Co., 232 N. Elm St., Waterbury, Conn. 06720. Seventeen different subminiature, hermetically sealed elapsed time indicators are described in bulletin MI 606-R2. [482]

**Tantalum capacitors.** P.R. Mallory & Co., 3029 E. Washington St., Indianapolis 46206, has available a technical bulletin describing its division's line of TDC solid electrolyte tantalum capacitors. [483]

**Radiation monitoring systems.** Victoreen Instrument Division, 10101 Woodland Ave., Cleveland 44104. A comprehensive 25-page literature package provides a wealth of information on engineered systems for radiation monitoring. [484]

**Automated accounting system.** Clary Datacomp Systems, 408 Junipero Serra Dr., San Gabriel, Calif. 91776, has published a six-page three-color brochure on an automated accounting system for the building materials supply field. [485]

**Transistor chips.** Sprague Electric Co., North Adams, Mass. 01247. Comprehensive short-form catalog CN-164 describes 26 different silicon planar epitaxial transistor chips for use in hybrid circuits. [486]

# NEW 1970 COMPREHENSIVE DRIMICA<sup>®</sup> HIGH VOLTAGE CAPACITOR CATALOG

- High Energy Densities
- High Corona Resistance
- Excellent Capacitor Stability
- High Radiation Resistance
- Dry Solid State Package
- No High Voltage Bushings
- Compatible for use in Dielectric Fluids
- Wide Temperature Capability



Write for Catalog No. MP101

*Axel*

**AXEL ELECTRONICS, INC.**

134-20 Jamaica Ave. • Dept. A • Jamaica, N.Y. 11418

Circle 267 on reader service card

## SAN-E

*MSP-4 full four track stereo R/P head for auto-reverse cassette system*

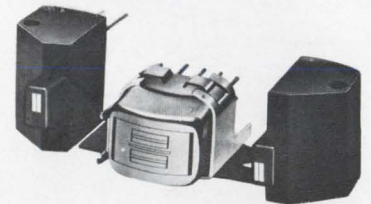

MSP-4 ¼ track full 4 heads R/P head for phillips cassette tape  
PE-M AC bias eraser for MSP-4 head

Other product  
8 track (MS-8) stereo head for home & car stereo  
\* write immediately for further details

### SAN-E DENKI COMPANY, LIMITED.

110-1 Minami-Kawahori-cho, Tennoji-ku, Osaka, Japan  
phones: 779-1591  
cable: SANMAGNETICS

Circle 268 on reader service card



## New Literature

**Hybrid IC capabilities.** Dickson Electronics Corp., P.O. Box 1390, Scottsdale, Ariz. 85252, has released a brochure dealing with its hybrid integrated circuit capabilities. [487]

**Rfi filters.** Components Corp., 2857 N. Halsted St., Chicago 60657, has issued a catalog describing an expanded line of miniature rfi filters covering 50 wvdc, 100 wvdc, 150 wvdc, 115 wvdc, and 400 wvdc types. [488]

**Subminiature lamps.** Chicago Miniature Lamp Works, 4433 N. Ravenswood Ave., Chicago 60640. A 21-page catalog contains valuable basic design information, technical discussions of the various parameters involved in lamping, and a usable cross reference guide to lamp substitution. [489]

**Test and measurement.** Julie Research Laboratories Inc., 211 W. 61st St., New York 10023, offers a catalog covering the latest d-c techniques for precision test and measurement in general production and engineering areas, as well as in standards and calibration laboratories. [490]

**Component contactor.** Daymarc Corp., 40 Bear Hill Rd., Waltham, Mass. 02154. A revised condensed bulletin describes a triple head contactor for inspecting taped diodes in an automatic system. [491]

**Microwave connectors.** Phelps Dodge Communications Co., 60 Dodge Ave., North Haven, Conn. 06473. A six-page catalog bulletin MMC-1 describes a line of miniature microwave connectors. [492]

**MOS/LSI implementation.** Cartesian Inc., 10432 N. Tantau, Cupertino, Calif. 95014. A 12-page brochure is available to original equipment manufacturers interested in designing their own MOS/LSI circuits and having masks and wafers fabricated by an outside source. [493]

**High-gain antennas.** Andrew Corp., 10500 W. 153rd St., Orland Park, Ill. 60462. Bulletin 8577 covers new high-gain antennas suited for wide area coverage in the 450-470-Mhz band. [494]

**N/C machine systems.** CompuDyne Controls Inc., Hatboro, Pa. 19040. Model "C" N/C machine systems for point-to-point and contour milling are described in the eight-page Bulletin 0569. [495]

**Analog and digital building blocks.** Anadex Instruments Inc., 7833 Haskell Ave., Van Nuys, Calif. 91406, has completed an eight-page catalog on its line of electronic solid state digital counters and frequency instruments. [496]

Billy Helms is just one of the 42,146 highly skilled workers trained in state-sponsored technical schools last year.

Trained absolutely free for South Carolina industry.

Trained for the very machines they'll be using.

Trained and ready to go on opening day.

Before you decide where and when that opening day will be, you'll want to know more about plant sites, construction, transportation, electric service, tax rates and Billy Helms.

Find out more.

Mail the coupon today.

Mr. R. H. Kennedy, Vice President,  
Area Development  
South Carolina Electric & Gas Co.  
Box 764 Dept. E  
Columbia, South Carolina 29202

He's got the facts.

Name \_\_\_\_\_

Address \_\_\_\_\_

City \_\_\_\_\_

State \_\_\_\_\_

Zip \_\_\_\_\_

**SOUTH CAROLINA  
OFFERS YOU IDEAL PLANT  
SITES, LOW CONSTRUCTION COSTS, GOOD  
TRANSPORTATION FACILITIES, ECONOMICAL  
ELECTRIC SERVICE, LOW TAX RATES,  
AND BILLY HELMS.**

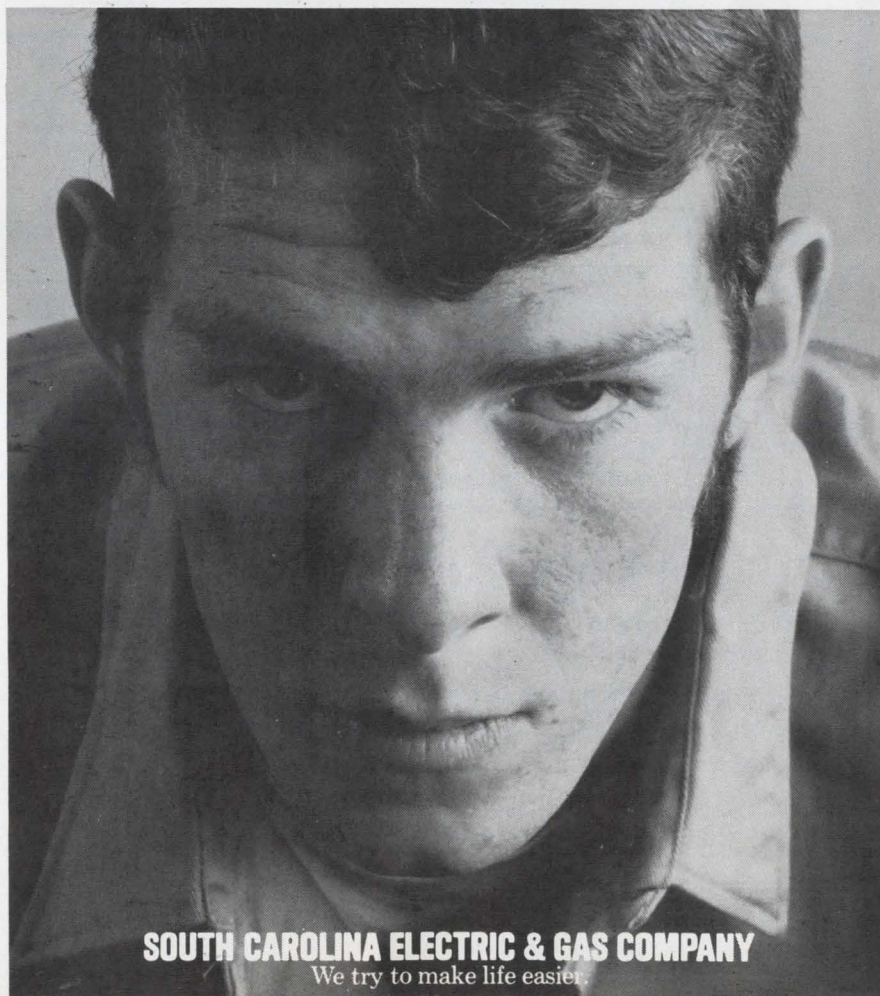

**SOUTH CAROLINA ELECTRIC & GAS COMPANY**  
We try to make life easier.



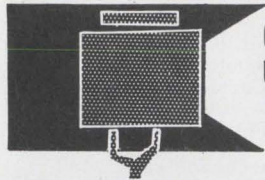

# SEARCHLIGHT SECTION

- CLASSIFIED ADVERTISING • BUSINESS OPPORTUNITIES
- USED OR SURPLUS EQUIPMENT

## AUTOTRACK MOUNT

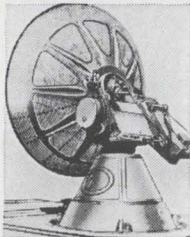

300 degree azimuth, 210 degree elevation sweep with better than 1 mil. accuracy. Missile velocity acceleration and slewing rates. Amplidyne and servo control. Will handle up to 20 ft. dish. Supplied complete with control chassis. In stock—immediate delivery. Used world over by NASA, USAF, MP-61-B. Type SCR-584. Nike Ajax mounts also in stock.

## PULSE MODULATORS

### MIT MODEL 9 PULSER 1 MW—HARD TUBE

Output 25kv 40 amp., 30kv 40 amp. max. Duty cy. .002. .25 to 2 microsec. Also 5 to 5 microsec. and .1 to .5 microsec. Uses 6C21. Input 115v 60 cycle AC. Mfg. GE. Complete with driver and high voltage power supply. Ref: MIT Rad. Lab. Series, Vol. 5, p. 152.

### 1.2 MEGAWATT HARD TUBE

0-40 KV at 0-30 amp. 20-5,000 pps. .5-5 microsec. Input 208V. AC, 60 cycle, Levinthal mod. 333M. Price \$4400.

### 2 MEGAWATT PULSER

Output 30 kv at 70 amp. Duty cycle .001. Rep. rates 1 microsec. 600 pps. 1 or 2 msec. 300 pps. Uses 5348 hydrogen thyratron. Input 120/208 VAC 60 cycle. Mfr. GE. Complete with high voltage power supply.

### 250 KW HARD TUBE PULSER

Output 16 kv 16 amp. Duty cycle .002. Pulses can be coded. Uses 5D21, 715C or 4PR60A. Input 115 v 60 cy. AC \$1200 ea.

### 18 MEGAWATT PULSER

Output 150KV at 120 amps. Rep. rate: 50-500 PPS. Pulse length: 5 msec. 15 KV 120 amp. into pulse transformer. Rise time 1.5 msec. Filament supply 5V 80 amp. incl. 17.5KV 1.5 amp. DC power supply. Input: 220V 60 cy AC.

### SCR 584 AUTOTRACK RADARS

Our 584s in like new condition ready to go, and in stock for immediate delivery. Ideal for telemetry research and development, missile tracking, satellite tracking. Fully Desc. MIT Rad. Lab. Series, Vol. 1, pps. 207-210, 228, 284-286. Comp. Inst. Bk available \$25.00 each.

## ANTI-AIRCRAFT GUN MOUNT

Will handle 6,000 lbs. rapid slew through 360° azimuth, 180° elevation. Mobile.

## MICROWAVE SYSTEMS

### 200-2400 mc. RF PKG

Continuous coverage, 30 Watts Cw nominal output. Uses 2C39A. Price \$575.

### L BAND RF PKG

20 KW peak 990 to 1040 MC. Pulse width .7 to 1.2 micro sec. Rep. rate 180 to 420 pps. Input 115 vac incl. Receiver \$1200.

### 200-225 mc RADAR SYSTEM

1 Megawatt output, 200 nautical mile range for long range detection of medium and high altitude jet aircraft as well as general search. AN/TPS-28.

### SURVEILLANCE DRONE RADAR SYSTEM

X-Band tracking system with plotting boards. Type AN/MPQ-29. Drone also in stock.

### 5 MEGAWATT C-BAND

Klystron RF package delivering nominal 5 megawatt pulse RF. Complete with pulser and power supply.

### 500 KW L BAND RADAR

500 kw 1220-1359 msc. 160 nautical mile search range P.R.I. and A scopes. MTI, thyratron mod 5J26 magnetron. Complete system.

### C BAND AUTOTRACK

1 Megawatt 10 ft. Parabola. Sperry.

### AN/GPG-1 SKYSWEEP TRACKER

3 cm. automatic tracking radar system. Complete package with indicator system. Full target acquisition and automatic tracking. Input 115 volts 60 cycle New. In stock for immediate delivery. Entire System 6' long, 3' wide, 10' high. Ideal for Infrared Tracker, Drone Tracker, Missile Tracker, R. & D.

## INDICATOR CONSOLES

AN/SPA-4A, PPI 10", range to 300 ml.  
VJ-1 PPI 12", Range to 200 ml.  
VL-1 RH1 12" to 200 ml. 60K ft.

Hundreds more in stock. Largest radar inventory in the world. Send for catalog on your company letterhead.

## 40 KW TRANSMITTER

4 to 21 MHz, 40 kw Telegraphy, 30 kw Voice, can be SSB. New condition. Two systems in stock. Excellent rf source, broadcast or point-to-point.

# Radio-Research Instrument Co.

45 W. 45th St., New York, N.Y. 10036 ■ 212-586-4691

CIRCLE 966 ON READER SERVICE CARD

**Minifluid DISPENSER**  
AIR OPERATED

for miniature potting and encapsulating

Available in 3 sizes  
6cc - 12cc - 30cc

**\$34.00 UP**

**PHILIP FISHMAN COMPANY**  
7 CAMERON ST., WELLESLEY, MASSACHUSETTS 02181

CIRCLE 967 ON READER SERVICE CARD

## FUNCTION GENERATORS

We are overstocked. Tremendous savings on latest solid state function generators. Sine, square, triangle, ramp, complex. Laboratory quality. Every item 60% to 90% off. Absolutely will not last. Send for free brochure.

### LABORATORY EQUIPMENT SALES

15603 12th So., Seattle, Wn. 98148

CIRCLE 968 ON READER SERVICE CARD

## Mr. Used Equipment Dealer:

When you advertise in the Searchlight Section . . . You have hired your most persuasive salesman:

He's efficient . . . He thrives on long hours . . . His territory is the entire nation . . . and overseas . . . He doesn't see buyers of used and new surplus equipment: They see him—regularly. They depend on him.

He is Searchlight—The section of this publication where wise dealers advertise and list their stocks for sale.

## SEARCHLIGHT SECTION

Classified Advertising Dept.

Post Office Box 12 • New York, N. Y. 10036

## EMPLOYMENT OPPORTUNITIES

This ad is not for men who love their jobs.

It's for the man who's found his job has become a chore.

If that man is you, then you're the man we want to talk to.

We're Management Recruiters — the matchmakers. We've got 80 offices across the country and in Canada.

Call us. And the next time you see this ad, you'll be able to pass it by.

*Management Recruiters*  
The matchmakers

CIRCLE 969 ON READER SERVICE CARD

We have been placing B.S., M.S. and Ph.D. **ELECTRONIC ENGINEERS** in fee paid positions throughout the U.S. since 1959. Send resume today or request confidential application. We are graduate engineers, working full time . . . for you.

**ATOMIC PERSONNEL, INC.**  
Suite L, 1518 Walnut St., Phila., Pa. 19102  
AN EMPLOYMENT AGENCY FOR ALL TECHNICAL FIELDS

CIRCLE 970 ON READER SERVICE CARD

Don't Forget the Box Number

When answering the classified advertisements in this magazine don't forget to put the box number on your envelope. It's our only means of identifying the advertisement you are answering.



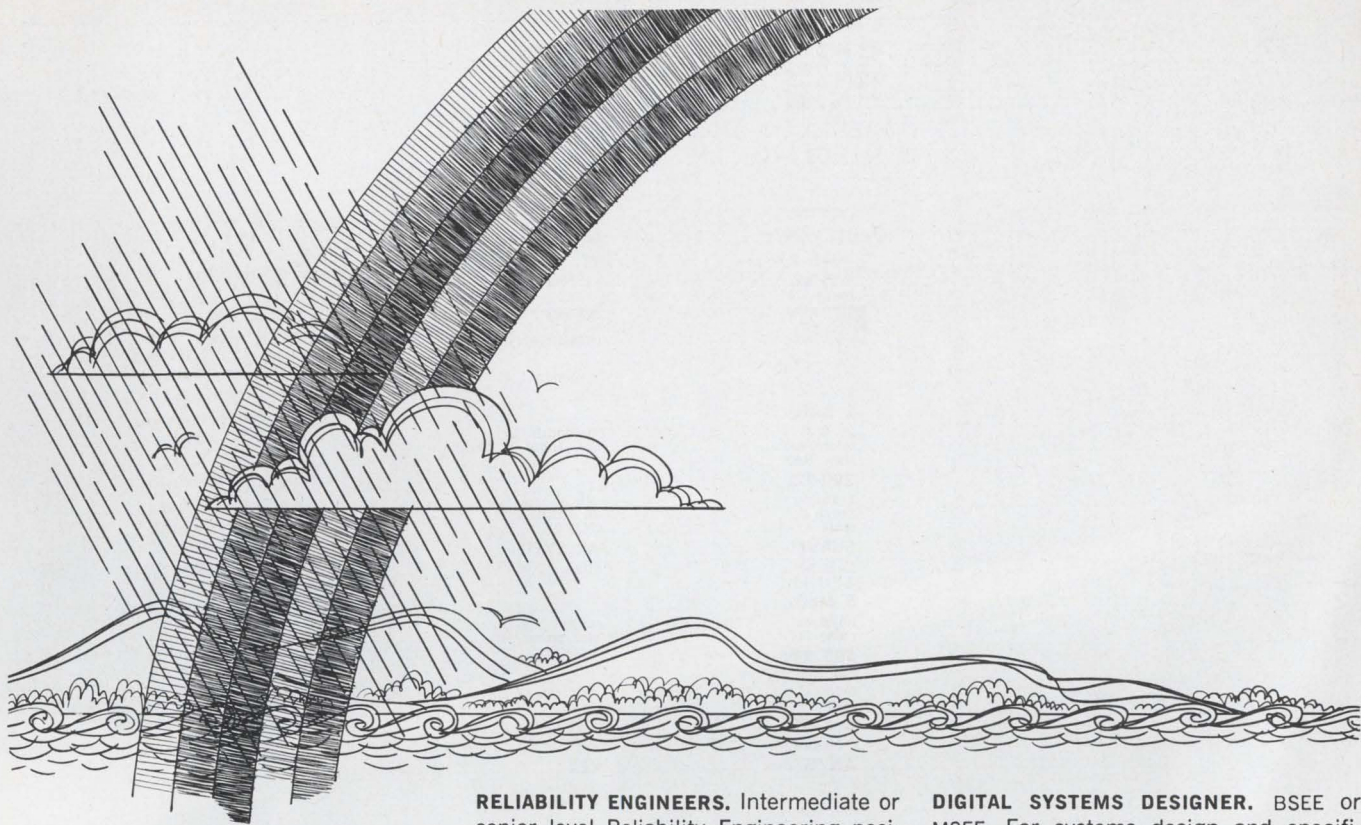

## How much opportunity can you find under one roof?

At Electronics Division, probably all you're looking for. Everything from aircraft ground equipment to ASW to Communications and Avionics to Operations Research to Product Assurance Engineering, all comfortably housed in one plant in Rochester. (The living is great here, too.)

If you like the idea of being comfortably close to opportunities in your specialty—and others—check the openings listed, and send us a resume. Address J. P. O'Reilly, Dept. 147

**QUALITY CONTROL ENGINEERS.** BS in EE, ME or equivalent, with 2 to 10 years quality assurance experience. Background in military electronics desirable. Experience required in inspection planning, documentation review, configuration control, material review or project quality engineering with wired assemblies, micro-electronic devices or systems.

**RELIABILITY ENGINEERS.** Intermediate or senior level Reliability Engineering positions. BS in EE or Science plus two or more years experience in any of the following: circuit design, circuit analysis, reliability predictions (manual or computerized), failure reporting, analysis and corrective action, reliability test planning, reliability program planning, demonstration testing, reliability proposal preparation and design review. Assignments will involve the performance of all functions associated with a MIL-STD-785 reliability program. Senior level positions require a working familiarity with the above items. Emphasis is required in the planning stages of Hi-Rel programs to ensure demonstration of contract specified requirements.

**MAINTAINABILITY ENGINEERS.** BSEE plus 2 or more years experience in maintainability engineering—establishment of qualitative and quantitative maintainability requirements (maintenance concepts, throwaway vs. repair, maximum repair time, maintenance down time per operating hour, maintenance man-minutes per operating hour, etc.). Positions involve design analysis, design review, maintenance engineering analyses, and demonstration testing. Task flexibility is enhanced by participation in cost effectiveness/integrated logistics support studies, proposals, and other research activities.

**DIGITAL SYSTEMS DESIGNER.** BSEE or MSEE. For systems design and specification of digital data acquisition, data processing and data reduction systems. Experience in special purpose computer design, general purpose computer interface and peripheral equipment specification, digital data transmission systems and digitally driven display systems.

**SHIPBOARD SYSTEMS DESIGNER.** BSEE or MSEE. For systems design and specification for shipboard instrumentation systems with experience in shipboard sonar, stabilization and fire control, communication, navigation and data acquisition systems. Emphasis is on analog signal acquisition storage, processing and display.

**TRANSDUCER DESIGN/DEVELOPMENT ENGINEERS.** BS in EE, ME or Physics. Minimum 2 years experience in underwater transducer development, vibration technology, or airborne acoustics.

**AEROSPACE GROUND EQUIPMENT ENGINEERS.** BSEE or MSEE with 2 or more years experience in electronics support of airborne weapons systems. Two types of assignments requiring: (a) System engineering with specific experience in one or more of the following: RF, video, pulse techniques, computer and digital techniques, operations analysis, attack radar, penetration aids, flight control systems; (b) Design experience in AGE radar (indicator, synchronizers), IF, video, RF and ECM (threat simulation).

### GENERAL DYNAMICS

#### Electronics Division

1400 N. Goodman St., Rochester, New York 14601

An Equal Opportunity Employer (M&F)



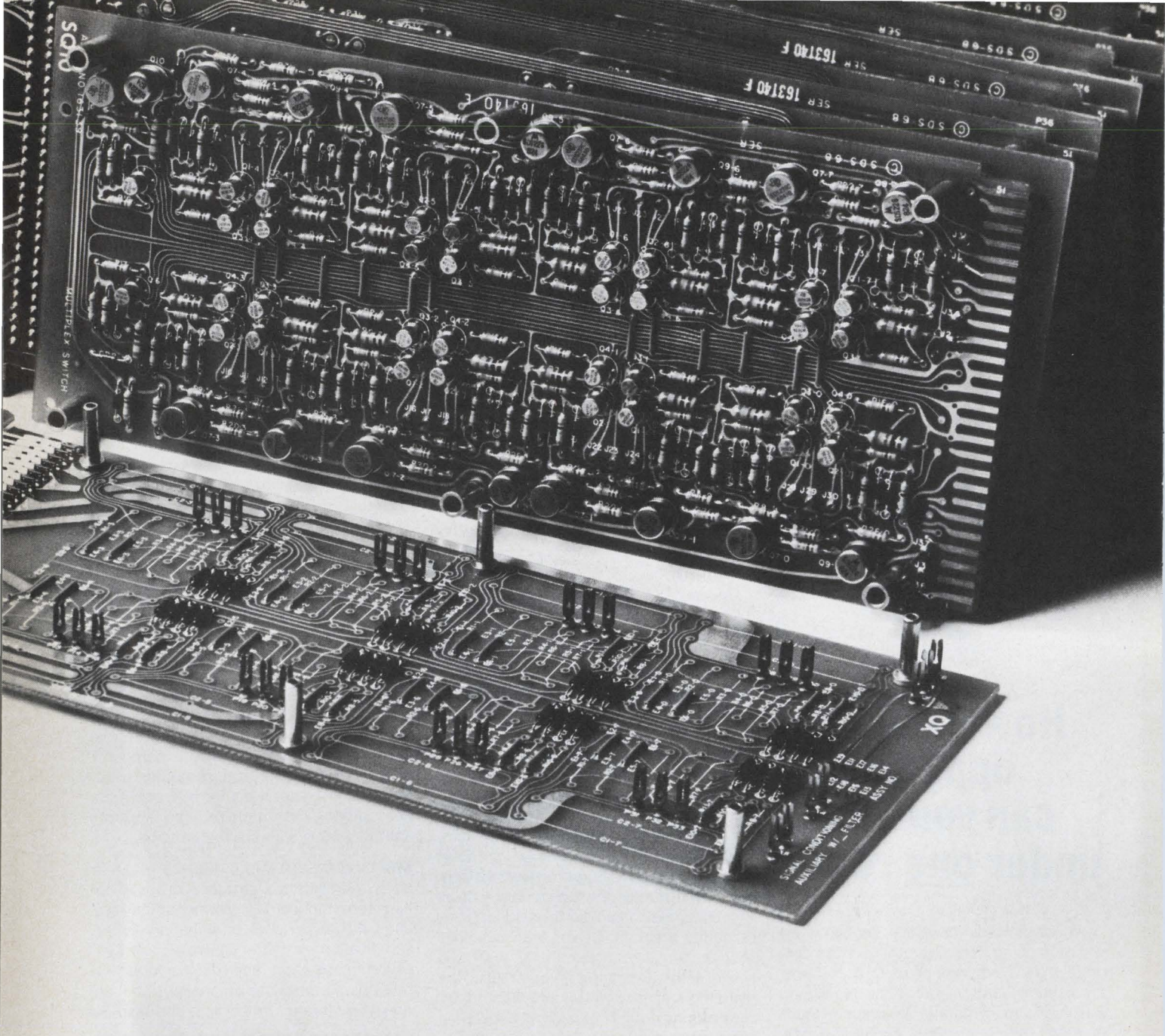

## Look into our new low level multiplexer. It's good for your system.

Our DM40 solid-state differential multiplexer makes a great front-end, with amplifier per channel performance. It accepts analog signals from thermocouples, strain-gauges, resistance bridges, transducers, amplifiers and the like. It has very low noise and you don't have to worry about acquisition errors due to previous channel overload. The DM40 takes 128 input lines and you can hook eight units together for a total of 1024 inputs. It multiplexes and amplifies each signal and transmits it to your digitizer at a rate up to 10KHz. When you use it with one of our controller-digitizers you can get 13 different gain ranges.

In fact, the DM40 is even better when you get all your system components from us. This way you can be sure they'll work as a system. No interface problems to solve, no missing hardware to engineer. Our components are made to get along together.

After all, they come from a good family.

### DM40 Minispecs:

Input signals:	From 2.5 millivolts full scale to 10 Volts full scale.
Gain Accuracy:	0.02% between steps.
Linearity:	0.005%
Zero Stability:	1 microvolt rti +20 microvolts rto/°C.
Crosstalk:	120db
Common Mode Rejection:	120db, DC; 100db, 60Hz.
Noise:	10 microvolts peak rti +100 microvolts peak rto.

Write for complete specifications.

# XDS

Xerox Data Systems  
El Segundo, California



---

# International Newsletter

---

November 10, 1969

## Mitsubishi expands its computer line with XDS machines

Mitsubishi Electric Corp. has confirmed that it applied for a government go-ahead to manufacture Xerox Data System's Sigma 5 and 7 computers for control applications. Approval is expected in November. Mitsubishi's computer position is the weakest of Japan's six domestic computer manufacturers. At the top of its line are a small, general purpose computer and a process control machine whose capability is near the bottom of the medium-size range.

Competitors are watching with interest. Apart from conceding a good market for the computers in control applications, rival makers wonder whether Mitsubishi will use these computers to attempt a comeback in the general-purpose field. One competitor points out that the Sigma 7 is a rather advanced time-sharing device and with appropriate input-output equipment and programs would be a very respectable general-purpose machine.

## Plessey may gain British NC monopoly

Numerical control of machine tools in Great Britain may get a shot in the arm if the Plessey Co. manages to pull off negotiations for the acquisition of Ferranti's NC division. That step, following its purchase in September of Airmec-AEI Ltd. from Racal Electronics, would give Plessey control of well over 90% of British NC output. It would also lay a foundation for profitable NC activity, which has so far eluded most British efforts. No anti-monopoly action is expected, because U.S. and German companies hold about half the British market, concentrating on the more sophisticated ware. A revitalization of interest in NC should benefit them all, since only about 1% of the nation's machine tool population is NC-equipped now.

## Europe gets another US IC competitor

Another U.S. semiconductor firm is joining the scramble for a piece of the European integrated circuit action. Transitron Electronic Corp. in a few weeks will start assembling dual in-line TTL packages at its two-year-old French semiconductor plant in Normandy. Assembly of U.S.-diffused linear IC's may start by next spring, and the company will push to diffuse IC chips in France "as soon as possible," says French general manager E. Louis Huguenin.

Some sources say Transitron plans to build a new IC plant in the south of France, where Motorola and Texas Instruments already have plants; the company "can't confirm or deny" the report. The French government offers attractive credit incentives and other inducements to firms willing to settle in underdeveloped areas, a factor that could tempt Transitron to go south rather than expand its Normandy facility. The company already diffuses IC's in a plant near London.

## Japan government uneasy over computer export agreement

Long a promoter of exports and a restrictor of imports, the Japanese government is—surprisingly—far from overjoyed by the latest computer export deal. Fujitsu Ltd. has agreed to send two of its Facom 230 model 25 batch-processing computers to Automation Sciences, one of its U.S. representatives. Automation Sciences, based in Jersey City, will supply software and provide maintenance. What troubles Japan's Ministry of International Trade and Industry is that successful export and operation



---

# International Newsletter

---

of the computers raises the danger that U.S. industry and Government agencies will increase pressure on Japan to liberalize its restrictions against the import of computers.

## Politics, price lead AEG-Telefunken to Asia again

West Germany's chronic labor shortage has become so bad that, instead of importing more workers from the Mediterranean countries, electronics firms are stepping up the export of work to Asia. AEG-Telefunken, the country's No. 2 electronics-electrical company, is combing Asia for its third semiconductor assembly plant there. The company has reportedly narrowed the search to three cities—Manila, Seoul, and Singapore. It already assembles discrete devices at plants in India and Hong Kong. While an inexpensive labor force is one inducement to farm out more work to Asia, the remembrance of a recession two years ago is as important. As one company official points out, it is politically far more palatable to curtail production abroad than it is to lay off workers at home.

## Philips puts fingers in three more pies

Philips Gloeilampenfabrieken, already Europe's top electronics producer, stands to grow even larger—by tapping other company's know-how. In one week it revealed it was entering into a technology-exchange agreement with Fairchild Semiconductor, will promote a video tape recorder cassette system with West Germany's Grundig and Japan's Sony (see p. 236), and will go fifty-fifty with Japan's Matsushita on a dry battery plant. In all three deals, Philips will contribute its marketing or management expertise in return for technological information.

In the potentially most significant agreement, that with Fairchild, Philips will also trade know-how. All the companies will say now is that the agreement covers cooperation between the semiconductor and microwave optoelectronic groups of Fairchild and Philips' Elcoma Division. Fairchild, says one company man, also expects to lean heavily on Philips' marketing organization to gain a larger share of the European market.

## Spain opts for PAL over Secam; Italy, Portugal may follow

Now that Spain has decided to broadcast color television using the PAL system developed by West Germany, other nations are expected to choose PAL over France's Secam plan. Officials of AEG-Telefunken, owners of PAL rights, are understandably happy, since the Spanish move greatly improves the chances for neighboring Portugal to land in the PAL camp. Furthermore, they expect it to strongly influence Italy's decision, as well as that of Spain's overseas territories—Spanish Morocco, for example. Having a foot in North Africa may help PAL beat back Secam there; up to now the split between the two has been more political than technical, with the East Bloc nations going for Secam and Western Europe for PAL.

## Austria may get new Bull-GE plant

General Electric is looking in both Spain and Austria for a site to build a new computer manufacturing plant. And Austria may have the edge. Josef Krainer, governor of Styria province, visited GE's computer headquarters in Phoenix, Ariz., went home to his capital, Graz, where it's understood that GE would be more interested if the city decided to install a Bull-GE time-sharing computer. What's more, Austria would be a good base for more Eastern European business; Bull-GE has already granted a manufacturing license to Czechoslovakia's Tesla plant.



# Silicon-target video tube moves toward commercial market

West German firm's Telecon is unaffected by high light intensities, yet performs at lower light intensities than vidicon and plumbicons and has a longer lifetime; serial production will start sometime next year.

**Silicon**, a basic material for the solid state devices that have replaced vacuum tubes, may even find a place in television pick-up tubes. In West Germany, AEG-Telefunken has just released details of a promising commercial video tube built around a silicon light-sensitive target. Called the Telecon, the tube is superior to the widely used vidicon and plumbicon tubes in almost every respect. Its operation is unaffected by high light intensities, yet it exhibits a much greater light and spectral sensitivity, and it can last longer in harsh environments.

To be sure, tv camera tubes with silicon targets, have already been built in the U.S. and are now also being developed elsewhere in the world. But those of U.S. origin are intended primarily for military purposes and are therefore too expensive for commercial applications. AEG-Telefunken, however, could well be the first—at least in Europe—to market a silicon-target pick-up tube for commercial and industrial uses. Serial production will start sometime next year and first units should hit the market early in 1971.

The Telecon's basic construction and operation are roughly the same as those of ordinary video pick-up tubes. A highly concentrated electron beam scans one surface of the target. The image to be transmitted is focussed on the other surface. The target converts and stores the optical image as a charge pattern until the electron beam starts its scanning operation.

In conventional tv camera tubes this conversion and storage proc-

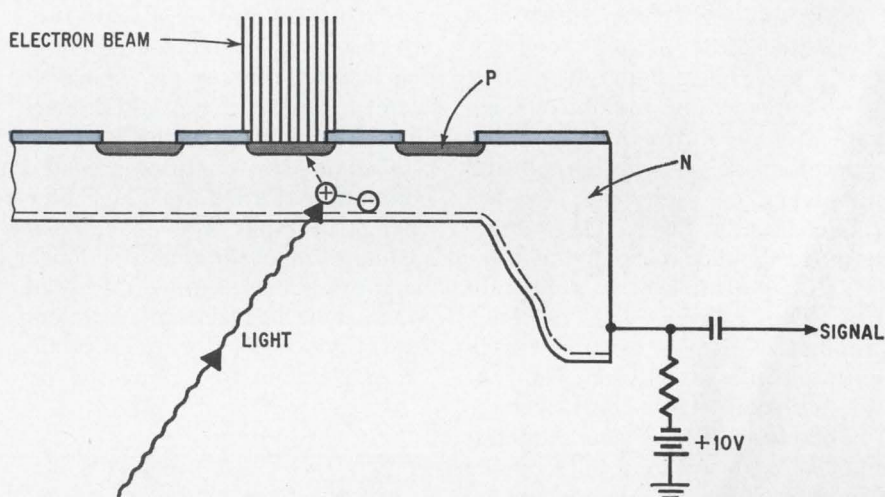

**On target.** One million diodes on the surface of the silicon target serve to store then convert light image into signal during electron beam scan.

ess takes place in thin amorphous semiconductor layers—in an anti-monide tri-sulphite layer in the vidicon and in a lead oxide and lead sulfide layer in the plumbicon. These layers, however, are sensitive to mechanical forces, to high temperatures and especially to high light intensities—and are limited both in application and operating life.

**Diode.** The Telecon's target is a multidiode disk about the size of a quarter-dollar coin and from 10 to 25 microns thick. There are about 1 million planar diodes on an area of 1.28 by 0.96 centimeters in size. The diode diameter is from 5 to 8 microns and the distance between the centers of adjacent diodes is from 10 to 15 microns.

The scanning electron beam charges each diode to a reverse voltage whose magnitude is from 5 to 10 volts. Light hitting the

other side of the target produces electron-hole pairs which cause the diodes to discharge. The charging current required is proportional to the light intensity, giving video signals that vary as a function of light intensity.

At a signal current of, say, 200 nanoamperes, the Telecon's sensitivity to light is around 20 times greater than that of the vidicon or plumbicon. AEG-Telefunken gives credit for this to the considerably higher quantum yield possible with single-crystalline silicon compared with that of the amorphous semiconductor layers, which have many recombination centers.

The silicon target's spectral sensitivity range, too, is higher than the vidicon's or the plumbicon's. In fact, its sensitivity extends well into the near infrared region, thanks to the characteristic distance between energy bands in the



silicon. And the maximum sensitivity is shifted further towards the longer wavelengths in the spectrum—an important plus in color-tv applications.

The Telecon also shows excellent resistance to residual signals, or afterglow, an effect which shows up as blurs that follow a moving object across the screen. In the Telecon, residual signal effects are caused only by the energy distribution of the scanning electron beam and are relatively low, 4% compared with the vidicon's 20%.

Still another Telecon feature is the insensitivity to high temperatures and high light intensities. With vidicons and plumbicons elevated temperatures or light intensities tend to set off thermal and photochemical reactions in the semiconductor layer. These reactions form bad spots in the layer which, in turn, lead to tube failure. The Telecon has no such troubles. Not even a camera flash unit set off directly in front of the tube will harm the target.

Therefore, the Telecon's operating life is determined only by the life-time of its cathode and not by the semiconductor material. If long life cathodes are used, the Telecon can, under optimum conditions, last twice as long as the other types—up to 20,000 hours. Under non-optimum conditions, such as prevail in steel plants and in traffic control, the Telecon's life can be 100 to 1,000 times longer than that of the other two tubes.

**Bugs.** AEG-Telefunken says for perfect picture reproduction, 99.999% of the diodes would have to be absolutely perfect—no more than 10 diodes out of 1 million could be defective. So far, the company has obtained a yield of 99.99%. For many closed-circuit tv applications—in traffic control, for instance—such yield can be tolerated. But the firm is striving to obtain a better diode yield.

AEG-Telefunken says that initially at least the Telecon will cost more than either a plumbicon or a vidicon. However, the company expects the Telecon's long life, together with its other performance

characteristics, to more than offset its initial higher costs.

### Japan

#### Toward compatible vtr's

With video tape recorder magazines and cartridges beginning to proliferate (see below), one Japanese maker has decided to hold back until 1972—even though it has a complete working system ready for production right now.

Matsushita Industrial Co. Ltd., which is more widely known by its Panasonic brand name, wants to avoid a repeat of the initial fiasco in reel-to-reel video tape recorders—when no two companies used a compatible format, making interchange of tapes from machine to machine impossible, and seriously hampering market growth. Instead, Matsushita has scheduled a long lead period—not for product development, but for selling the vir-

tues of its system to other companies and for making any changes necessary to secure industry cooperation.

Matsushita's vtr can record and playback a half hour of color or black-and-white program material. Developed jointly by the company's production development laboratory and video tape recorder department, Matsushita considers the system satisfactory in its present form. Prototype units directly record and play back NTSC color signals—and color reproduction is clear and faithful. Sound is on the tape, and everything needed in a commercial product is included. Only thing missing is agreement from other Japanese companies that the new system is the most suitable—so that production can be standardized. The prototype measures a compact 13.9 inches wide by 14 inches wide by 5.1 inches high. It can be played while being carried as well as stationary.

The company says that with development of a magazine-type vtr

### And another vtr from Sony

Even in electronics six months may seem like a short lifetime, yet the color video tape recorder with magazine load announced by Sony just last spring [*Electronics*, May 12, p. 239] is already dead. In its place the company is promoting a machine with a far smaller tape cassette. And, the company says it has reached tentative agreement with Philips and Grundig on the tape format and cassette design—and is aiming at establishing the system as the worldwide standard.

Sony's video cassette measures 8 by 5 by 1¼ inches and weighs one pound. Inside is enough ¾-inch tape operating at 8 centimeters per second for 1½ hours playing time. The cassette contains a counter so that borrowed tape can be charged for by the number of plays. There are two sound channels for stereo or for two languages.

Sony says it started work on this unit because the magazine introduced earlier was too large. It says it expects to start sales in Japan toward the end of next year, and



in its largest market—the U.S.—at some later date. Sony feels that with mass production the price in the U.S. will be about \$350, and the 90-minute cassette about \$20.

The Sony cassette is designed so that the magnetic coated side is in, and the tape is pulled out of the cassette and over the recording drum. Tape wind on the drum is equivalent to the omega wind, but because of geometry it is a U wind, because it doesn't double back. Reels are omitted as in Philip's audio cassette for compactness. The recorded signal is processed NTSC signal, rather than pure NTSC signal as recorded by Matsushita.



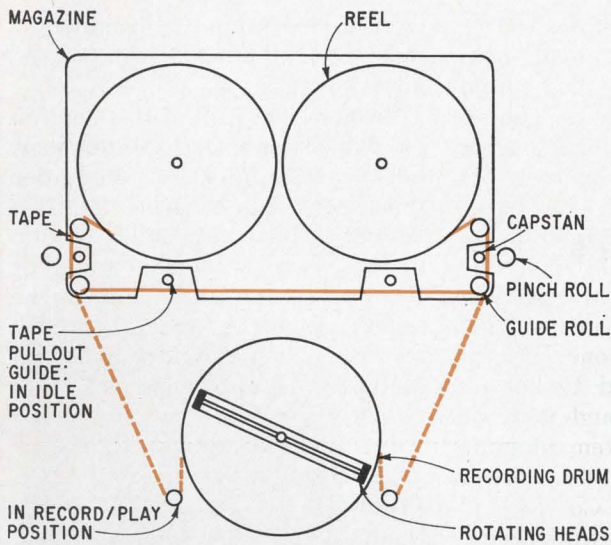

**Inside.** Matsushita's magazine holds tape, coated side in, on two reels, but rollers turn it around for correct wrapping at recording drum.

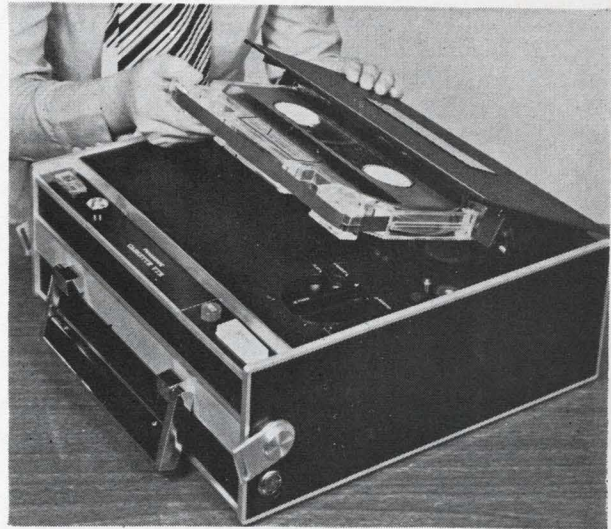

**Outside.** The magazine, the size of a large book, drops into recorder. The reels can be removed for operation on reel-to-reel machines.

it has solved the three basic problems associated with these units. First, earlier this year it solved the problem of high speed tape duplicating [*Electronics*, March 31, p. 181]. Second, the automatic loading feature of the new recorder makes for easy handling. Unlike the earlier-announced Victor recorder [*Electronics*, June 23, p. 213], it can record a full hour and the magazine can be removed from the recorder at any point on the tape. Third, the new recorder provides inexpensive NTSC-compatible color.

**Package.** The new Matsushita magazine looks like an oversize version of the Philips cassette used in audio recorders, but it is relatively longer because it includes two reels. Matsushita opted for the reels for two reasons. They provide smoother tape feed and takeup, which is very important in video recorders where jitter causes serious picture degradation. And reels allow the tape to be removed from the magazine and played on a standard reel-to-reel video tape recorder conforming to the new standard format [*Electronics*, September 29, p. 197].

Even with reels, the magazine is no larger than a book and can be stored on a bookshelf. It measures 10.6 by 6.4 by 0.9 inches.

For compatibility with reel-to-reel operation the tape is wound

coated side in, rather than out as in the Philips cassette. Then the magazine has four slots, which fit over two capstans and two movable tape guides. Two capstans are used to insulate motion of the tape at the recording drum from vibration at the reels. They also make it possible to play the recorder while it is being transported. Two-capstan drive has been limited to use on professional video tape recorders and on computer tape handlers. The two guides are moved outward during recording and playback to force the tape against the drum.

**Advances.** Two developments, have enabled Matsushita to allow direct recording of NTSC color—without any preprocessing or use of a pilot signal. Improved hot-press ferrite magnetic recording heads designed for improved magnetic circuit efficiency and better gap geometry make it possible to record frequencies up to 10 megahertz on 0.5-inch magnetic tape operating at 7.5 inches per second.

Also, Matsushita has developed an improved double heterodyne automatic phase control system that removes jitter from the playback signal. Double heterodyne APC systems have been used on costly studio recorders for this purpose, but Matsushita engineers had a more difficult job than the studio designers. Inexpensive recorders

have more jitter, so the new system had to be able to pull in a signal over a wider range of phase difference—and be inexpensive.

## Cutting cost of DDC . . .

High cost of backup controls has kept Japanese users from rushing to adopt direct digital control, despite its many promised advantages. To ensure that a plant will remain in operation even during digital computer failure they feel they must provide conventional analog-type controls as a backup for the digital computer. Thus the system costs almost as much as conventional controls and computer hardware combined.

Now, Toshiba has come up with a far less expensive answer. It has designed an input-output station that handles both the hold function needed for computer output interface and the analog-type control needed for backup. A single operational amplifier is used for both functions, and it can be switched from one mode of operation to the other without change in output for bumpless changeover.

Although the new Toshiba controller performs the same functions as standard analog controllers, it has been simplified because it is used as an analog controller only when the computer is down. For



example, meters replace servo indicators. Thus, the controllers are suitable for some users who want an economy line of instruments—only operating convenience is sacrificed to obtain low cost, not accuracy or reliability.

**In parallel.** Process variable signals are fed in parallel to the central processor and the input-output station. During normal DDC operation, however, only the input to the central processor is effective. Output from the computer is fed through the station—which operates as holder—to process the unit being controlled. In this mode the operational amplifier feedback and input resistors are not required.

If the computer fails, the input end of the hold capacitor is switched to ground so that the output value remains the same, and passive components needed for analog control are switched into the circuit. Process variable signals now feed directly into the station, through a subtracting point where the set point value is compared to give error voltage.

If the set point of the controller is the same as that of the computer the switchover will be bumpless. For most DDC controls the computer set point doesn't change, so that once the controller set point is adjusted to match the computer set point no adjustment is needed. If the station's process is operating normally the error voltage meter on the panel should be in zero center position, the controller set point can be adjusted to equal the computer set point by adjusting the set point control until the meter reads zero.

### ... and an end to hunting

Toshiba has already modified its DDC analog controllers for processes that have dead times as long or longer than system's time constant. Dew point controls and conveyor belts are examples.

Ordinary analog controls tend to hunt or respond sluggishly when used to control processes of this type. Toshiba engineers say that two general methods of handling this problem are to use rather

expensive digital controls, or to simply give up on automatic control. Digital controllers can be used because they can make control action proportional not only to error at a given time but also to errors at previous times.

Toshiba engineers analyzed the problem mathematically and discovered that they could perform automatic control with a modified conventional analog controller. It is essentially the controller developed for DDC applications with the addition of motor-driven sampling switch and with a few circuit modifications.

Toshiba's new control is designed so the change in output is proportional not merely to error signal at the instant of sampling but also to the previous error signal—which is stored in the input capacitor. If the present error signal is smaller than the previous error signal, the amplifier input signal is the difference between the present and previous signals, with polarity opposite to that of the previous signal. This mode of operation prevents the control from greatly overshooting the target value.

For proper operation of this control it is necessary to match the operational amplifier gain, integration time constant, sampling period, or time from one sample to the next, and length of time that the process is sampled to the process being controlled. Matching of controller parameters to process can usually be performed empirically.

When error voltage is sampled, controller output voltage changes abruptly by an amount dependent on controller gain and error voltage. Output then continues to change during the remainder of sampling time because of integration. A hold capacitor between output and ground is charged up to amplifier output voltage at the end of the sampling time. After the sampling period this capacitor is reconnected between input and output terminals of amplifier to hold output voltage steady until the next sample is taken. At the same time, another switch disconnects one end of the input capacitor so that it stores voltage across its terminals until the next sampling period. Actually,

voltage across input capacitor is a function of all previously impressed error voltages.

Proportional gain of this controller can be adjusted continuously between 2% and 500%. Integration time constant can be adjusted between 0.01 minute and 3 minutes in 11 steps. Typically sampling time is 3 seconds, with a maximum of 30 seconds. Maximum hold time between samples varies with the model from 3 to 60 minutes.

## France

### Solar power from CdT

A major thrust in bringing sun-power to the consumer is being prepared these days in, of all countries, France—whose third place in the space race has generated scientific prestige though little industrial fallout up to now. But at a photography show now being held in Paris, a French firm is showing the world's first amateur movie camera powered by solar cells. A French sun-powered wristwatch is also being developed, and an inexpensive, 8-watt array of solar cells capable of running a tv set is ready for a buyer.

All these developments are the result of research work in cadmium telluride solar cells done for the French space program by a Paris subsidiary of Philips Gloeilampenfabrieken, La Radiotechnique-Compelec (RTC). Virtually the only company with an important CdT effort—most of the world's other solar cell makers concentrate on silicon or cadmium sulfide—RTC has refined its CdT production techniques to the point where it can turn out a continuous thin-film sheet of the pliable material and literally slice it with a paper-cutter into low-cost squares that convert light into electricity. RTC's production process involves evaporating evenly-sized grains of cadmium telluride onto a molybdenum backing. Copper telluride is then vacuum-diffused over the CdT, forming the p side of a semiconductor junction of which the CdT is the n side.



# Electronics advertisers

November 10, 1969

<b>Aerojet General Corp.</b> D'Arcy Adv. Co.	40	<b>Data Graphics Corp.</b> R & W Enterprises	227	<b>IBM—Federal Systems Div.</b> Marsteller, Inc.	217
<b>Airborne Instruments Laboratory</b> Campbell-Mithun, Inc.	139	<b>Dearborn Electronics Inc.,</b> Sprague Electric Co. Div.	170	<b>Impact-O-Graph, Div. of</b> Torq Engineered Products, Inc.	179
<b>Airpax Electronics, Inc.</b> Tech Communicators, Inc.	160	Harry P. Bridge Co.	190	Scheel Adv. Agcy., Inc.	78, 79
<b>Alfred Electronics</b> Bonfield Associates	181	<b>Dialight Corp.</b> Michel Cather, Inc.	32	<b>Indiana General Corp.</b> Griswold Eshleman	212
<b>Allen-Bradley Co.</b> Fensholt Adv. Agcy.	23, 25	<b>Dow Chemical Co., The</b> MacManus, John & Adams, Inc.	12E, 13E	<b>International Chemical Specialties Corp.</b> Robert A. Paul Advertising	188
<b>American Lava Corp., Sub of</b> Minnesota Mining & Mfg. Co.	57	<b>DuPont de Nemours Co., Teflon Div.</b> Batten, Barton, Durstine & Osborn Inc.	48	<b>ITT Components Group</b> Brockie Haslam Chinery & Allon Ltd.	16E, 17E
<b>American Microsystems</b> Jordan Advertising	45	<b>Eastman Kodak Co.,</b> Business Systems Markets Div.	195	<b>Jewell Electrical Instruments, Inc.</b> Batten, Barton, Durstine & Osborn, Inc.	199
<b>American Potash and Chemical Corp.,</b> Rare Earth Div.	24	J. Walter Thompson Co.	242	<b>J F D Electronics Co., Components Div.</b> Delphi Adv., Inc.	163
<b>American Telephone &amp; Telegraph Co.</b> —Yellow Pages	62	<b>Elco Corp.</b> Schaefer Advertising, Inc.	184	<b>Johnson Co., E.F.</b> Martin Williams Adv.	172
<b>AMP Europe</b> Allardyce Palmer Ltd.	3E, 4E	<b>Electrical Industries</b> Douglas Turner, Inc.	192	<b>Kepeco Incorporated</b> Weiss Advertising	155
<b>AMP, Inc.</b> Garceau, Hallahan & McCullough Inc.	20, 21	<b>Electronic Arrays, Inc.</b> Hal Lawrence, Inc.	219	<b>Ledex Inc.</b> Yeck & Yeck, Inc.	26
<b>Ancrona Corp./Neumuller and Co.</b> Wilhelm Bacher Werbung	11E	<b>Electronics and Control</b> Engineers Book Club	179	<b>Ledex, Inc., Bramco Controls Div.</b> Yeck & Yeck, Inc.	218
<b>AOIP</b> Dumesnil Publicite	132, 133	<b>Electronic Navigation Industries</b> Hart-Conway Co., Inc.	167	<b>LTT</b> Promotion-Vente-Publicite	8E, 9E
<b>Applied Digital Data Systems, Inc.</b> Shaw Elliott, Inc.	41	<b>E/MC Electronics/</b> Management Center	136, 196, 221	<b>Magnecraft Electric Co.</b> Mills, Fife & MacDonald, Inc.	209
<b>Augat Inc.</b> Horton, Church & Goff, Inc.	28, 29	<b>Ries Cappiello Colwell, Inc.</b>	167	<b>Magnetics, Inc.</b> Lando Adv. Agcy., Inc.	187
<b>Automatic Electric Co., Sub. of General</b> Telephone & Electronics Corp.	228	<b>Electro Products Laboratories, Inc.,</b> Transducer Div.	206	<b>Mallory &amp; Co., P.R. Mfg. Div.</b> Aitkin-Kynnett Co.	91, 212
<b>Axel Electronics</b> Packer Advertising Corp.	15	<b>Grant, Wright &amp; Baker, Inc.</b>	206	<b>Markel &amp; Sons, L. Frank</b> George Moll Adv., Inc.	176
<b>Beckman Instruments, Inc.,</b> Electronic Instrument Div.	151	<b>Engineered Components Co.</b> Rob's House of Marketing	47	<b>Maryland Telecommunications, Inc.</b> Tel-Ad Agency	223
Hixson & Jorgensen, Inc.	148, 149, 213	<b>Erie Technological Products Co., Inc.</b> Walcker, Schmidt & Mackall, Inc.	206	<b>Martin Marietta Corp.</b> Redmond Marcus & Shure, Inc.	164
<b>Beckman Instruments, Inc.,</b> Hellipot Div.	5	<b>Executone Incorporated,</b> Printact Relay Div.	206	<b>Matthey Bishop, Inc.</b> Richardson, Thomas & Bushman, Inc.	147
N.W. Ayer/Jorgensen/MacDonald, Inc.	68, 69	<b>General Dynamics Corp.</b> Young and Rubicam, Inc.	134, 135	<b>Microsonics, Inc.</b> S. Gunnar Myrbeck & Co.	63
<b>Bell &amp; Howell, Electronic</b> Instrumentation Group-CEC/ Transducer Div.	67	<b>General Electric Co., Electronic</b> Components Sales Operation	60, 61	<b>Micro Switch, Div. of Honeywell</b> N.W. Ayer & Son, Inc.	30
N.W. Ayer/Jorgensen/MacDonald, Inc.	137	<b>General Electric Co.,</b> Capacitor Div.	85 to 90	<b>Miller-Stephenson Chemical Co., Inc.</b> Michel-Cather, Inc.	223
<b>Bell Telephone Laboratories</b> N.W. Ayer & Son, Inc.	137	<b>General Electric Co.,</b> Silicone Products Div.	46	<b>Minnesota Mining &amp; Mfg. Co.,</b> Mincom Div.	138
<b>BIT, Inc.</b> Hill, Holliday, Connors, Cosmopolus, Inc.	67	<b>General Instrument Corp., Semiconductor</b> Products Div.	14, 70, 71, 166, 226	<b>Monsanto Co.</b> Michel Cather, Inc.	27
<b>Bourns, Inc., Trimpot Div.</b> The Lester Co.	189	<b>Norman Allen Associates</b>	72, 73	<b>Motorola Semiconductor Products, Inc.</b> Lane & Wampler Adv., Inc.	115
<b>Brand-Rex</b> Creamer, Trowbridge, Case & Basford, Inc.	189	<b>General Radio Co.</b> Horton Church & Goff, Inc.	200	<b>Multiplex Communications, Inc.</b> John Mac Gown Adv., Inc.	210
<b>Branson Instruments, Inc.</b> Industrial Div.	5E	<b>Gould Inc., Brush Instruments</b> Carr Liggett Adv., Inc.	158, 159	<b>National Semiconductor Corp.</b> Hall Butler Blatherwick, Inc.	80, 81
<b>Burr-Brown Research Corp.</b> N. A. Winter Adv. Agcy.	92	<b>Gould, Inc., Graphics</b> Carr Liggett Advertising	225	<b>New Hermes Engraving Machine Corp.</b> Lester Harrison Adv., Inc.	198
<b>Burroughs Corp.,</b> Electronic Components Div.	143	<b>Gould, Inc., Piezoelectric Div.</b> Carr Liggett Adv., Inc.	227	<b>Nortec Electronics Corp.</b> Paul Pease Advertising	207
<b>Conti Adv. Agcy., Inc.</b>	143	<b>Grayhill, Inc.</b> Carr Liggett Adv., Inc.	191	<b>Olivetti &amp; C. Spa, Ing. C.</b> Studio Giuiano Blei	6E
<b>Bussmann Mfg. Div. of</b> McGraw Edison Co.	202	<b>Guardian Electric Mfg. Co.</b> K & A Advertising	211	<b>Patwin Electronics</b> Graceman Adv., Inc.	198
<b>By-Buk Co.</b> Albert Frank Guenther Law Adv., Inc.	43	<b>Gudebrod Brothers Silk Co.,</b> Electronics Div.	221	<b>Pfizer &amp; Company Chas. MPD Division</b> Newmark, Posner & Mitchell, Inc.	222
<b>Cinch Manufacturing Co.</b> Stral Adv. Co., Inc.	178	<b>Hathaway Instruments, Inc.</b> Waldie and Briggs, Inc.	228	<b>Philco Ford Co., Microelectronics Div.</b> The Aitkin-Kynnett Co., Inc.	42
<b>C. P. Clare &amp; Co.</b> Reincke, Meyer & Finn Adv., Inc.	168, 169	<b>Heath Co., Sub of Schlumberger Ltd.</b> Advance Advertising Service	16	<b>Philco Ford WDL Division</b> Hal Lawrence, Inc.	107
<b>Clarostat Manufacturing Co.</b> Horton, Church & Goff, Inc.	162	<b>Heinemann Electric Co.</b> Thomas R. Sundheim, Inc.	82, 83	<b>Philips Electronic Instruments</b> Marsteller, Inc.	9
<b>Clifton Precision Products Co.,</b> Div. of Litton Industries	12, 13	<b>Hewlett Packard,</b> Frequency & Time Div.	2, 10, 11	<b>Philips N.V. PIT/TMI Div.</b> Marsteller International S.A.	2E
Ivey Adv., Inc.	210	<b>Hewlett Packard, Loveland Div.</b> Tallant/Yates Advertising	144	<b>Pirgo Electronics, Inc.</b> Herbert Lindauer Associates	120
<b>Computer Automation</b> Busterlman Burkhart, Inc.	182	<b>Hewlett Packard, Mt. View Div.</b> Lennen & Newell, Inc.	49	<b>Plastic Capacitors, Inc.</b> Sander Rodkin Adv. Agcy., Ltd.	216
<b>Computer Products, Inc.</b> Grenman Assoc., Inc.	10E	<b>Hewlett Packard, New Jersey Div.</b> McCarthy, Scelba and DiBiasi Adv. Agcy., Inc.	203	<b>Pomona Electronics Co.</b> Buxton Adv. Agcy.	208
<b>Computer Test Corp.</b> Industrial Public Relations, Inc.	224	<b>Hewlett Packard, Palo Alto Div.</b> Lennen & Newell, Inc.	1	<b>Princeton Applied Research Corp.</b> Mort Barish Assoc., Inc.	50
<b>Contelec</b> Mario Willi	204	<b>Hewlett Packard, Rockaway Div.</b> Culver Adv., Inc.	215	<b>Quan Tech Laboratories</b> Knip Associates	224
<b>Control Data Corporation,</b> Connector Operation	18E	<b>Honeywell—Florida</b> Bradley Yeager & Assoc., Inc.	35 to 38		
<b>Control Data Corporation,</b> Barnes-Champ/Advertising	183	<b>Houston Instrument,</b> Div. of Bausch & Lomb	6		
<b>Cornell-Dubilier Electronics</b> Daniel & Charles, Inc.	19E	<b>Hughes Aircraft Co.</b> Foote, Cone & Belding			
<b>Cosmicar</b> Cox Instrument Div. of Lynch Corp.					
<b>CRC</b> Gray & Kilgore, Inc.					
<b>Dale Electronics, Inc.,</b> Sub. of Lionel Corp.	3rd Cover				
Swanson, Sinkey, Ellis, Inc.	142				
<b>Data Control Systems</b> Technical, Industrial & Scientific Marketing, Inc.					



<b>Radiation, Inc.</b>	175	■ <b>Tech Laboratories, Inc.</b>	84
W.M. Zemp & Assoc., Inc.		Lewis Adv. Agcy.	
<b>Radio Corporation of America</b>	4th Cover, 65, 212	<b>Techné (Cambridge) Limited</b>	240
Al Paul Lefton Co.		Harrison Wright Assoc., Ltd.	
<b>Raytheon Co., Components Div.</b>	226	<b>Teledyne Relays Co.</b>	152
Fuller & Smith & Ross, Inc.		S. Michelson Advertising	
<b>Rentronix, Inc.</b>	56	<b>Testex, Inc.</b>	66
E.G. White Adv., Inc.		Jerry Steimle & Co.	
□ <b>Rohde &amp; Schwarz</b>	22E	<b>Texas Industrial Commission</b>	221
		The Pitluk Group	
<b>Sage Electronics Corp.</b>	180	<b>Texas Instruments Incorporated, Components Group</b>	18, 19
Mathison Adv., Inc.		Albert Frank-Guenther Law, Inc.	
<b>San E Denki Company, Ltd.</b>	228	<b>Time/Data Corp.</b>	141
Sanko Sha Adv. Agcy. Co., Ltd.		Bill Fisher Advertising	
<b>Schober Organ Corp.</b>	208	<b>TI Supply Company</b>	156, 157
Harry C. Waterston, Inc.		Albert Frank-Guenther Law, Inc.	
□ <b>Sercel</b>	7E	■ <b>Transformer Electronics Co.</b>	222
Termost Technique		Wolff & Weir	
<b>S.H. Couch Division, ESB Incorporated</b>	54	<b>TRW Electronics, Capacitors Div.</b>	55
Culver Advertising, Inc.		Fuller & Smith & Ross, Inc.	
<b>Sifco Metachemical</b>	202	<b>TRW Instruments</b>	216
The W.N. Gates Co.		Fuller & Smith & Ross, Inc.	
<b>Signal Analysis Industries Corp.</b>	214	<b>TRW Semiconductors, Inc.</b>	241
Robin Advertising Service, Inc.		Fuller & Smith & Ross, Inc.	
<b>Signetics Corp., Sub. Corning Glass Works</b>	131	■ <b>Tung-Sol Division, Wagner Electric Corp.</b>	220
Cunningham & Walsh, Inc.		Feeley & Wheeler,	
□ <b>Silec Electronic</b>	21E	Div. of Geyer, Oswald, Inc. Adv.	
Publicite Y Ch. Lambert		<b>Unitrode Corp.</b>	59
<b>Silliconix, Inc.</b>	7	Siltron Brothers, Inc.	
Robertson West, Inc.		<b>U-Tech, A Div. of Industrial Physics and Electronics Co.</b>	220
<b>Simpson Electric Co.</b>	150	Ross Clay Advertising	
Amerad Advertising Service, Inc.		■ <b>Vactec Incorporated</b>	194
<b>Sorensen Operation Raytheon Co.</b>	77	Coleman & Assoc. Adv.	
<b>South Carolina Electric &amp; Gas Co.</b>	229	<b>Varian Associates, Bomac S.F.D. Div.</b>	173
Cargill, Wilson & Acree, Inc. Adv.		Botsford, Constantine & McCarty, Inc.	
<b>Spectrum Control, Inc.</b>	64	<b>Varo, Inc.</b>	58
Altman-Hall Associates		Tracy-Locke, Inc.	
<b>Sperry Rand Corp., Sperry Microwave Electronics Div.</b>	74	<b>Victoreen Instrument Division</b>	39
Neals & Hickok, Inc.		Dix and Eaton, Inc.	
<b>Sprague Electric Co., The</b>	17	<b>Vidar Corp., Instrumentation Div.</b>	171
Harry P. Bridge Co.		Bill Fisher Advertising	
■ <b>Standard Condenser Corp.</b>	22	<b>Vishay Resistor Products</b>	214
R.N. Johnson Advertising		Alpern Communications	
□ <b>Ste Jules Richard</b>	14E	<b>Waters Manufacturing Co.</b>	174
PVP		Goldman, Daniels, Inc.	
<b>Superior Electric Co.</b>	44	<b>Weston Instruments Inc., Lexington Div.</b>	140
K.C. Shenton Co.		Larcom Randall Adv., Inc.	
<b>Sylvania Electric Products, Inc., Parts Div.</b>	197	<b>Winchester Electronics, Div. of Litton Industries</b>	2nd Cover
Doyle Dane Bernbach Inc.		Wilson, Haight & Welch, Inc.	
<b>TDK Electronics Co., Ltd.</b>	225	<b>Xerox Data Systems</b>	232
ChuoSenko Co., Ltd.		Doyle, Dane, Bernbach, Inc.	

## Advertising Sales Staff

**Dan McMillan III [212] 971-3468**  
Associate Publisher

**Wallis Clarke [212] 971-2187**  
Advertising Sales Service Manager

**Warren H. Gardner [215] LO 8-6161**  
Eastern Advertising Sales Manager

**Atlanta, Ga. 30309: Michael H. Miller, 1375 Peachtree St., N.E.**  
[404] 892-2868

**Boston, Mass. 02116: William S. Hodgkinson**  
McGraw-Hill Building, Copley Square  
[617] CO 2-1160

**Cleveland, Ohio 44113: William J. Boyle, 55 Public Square, [216] SU 1-7000**

**New York, N.Y. 10036**  
500 Fifth Avenue  
James R. Pierce [212] 971-3615  
John A. Garland [212] 971-3617  
Michael J. Stoller [212] 971-3616

**Philadelphia, Pa. 19103:**  
Jeffrey M. Preston  
Warren H. Gardner,  
6 Penn Center Plaza,  
[215] LO 8-6161

**Pittsburgh, Pa. 15222: Jeffrey M. Preston,**  
4 Gateway Center, [412] 391-1314

**Rochester, N.Y. 14534: William J. Boyle,**  
9 Greylock Ridge, Pittsford, N.Y.  
[716] 586-5040

**Donald R. Furth [312] MO 4-5800**  
Midwest Advertising Sales Manager

**Chicago, Ill. 60611: Kenneth E. Nicklas**  
Ralph Hanning 645 North Michigan Avenue,  
[312] MO 4-5800

**Dallas, Texas 75201: Richard P. Poole, 1800**  
Republic National Bank Tower,  
[214] RI 7-9721

**Houston, Texas 77002: Robert Wallin,**  
2270 Humble Bldg. [713] CA 4-8381

**Detroit, Michigan 48226: Ralph Hanning,**  
856 Penobscot Building  
[313] 962-1793

**Minneapolis, Minn. 55402: 1104 Northstar**  
Center [612] 332-7425

**St. Louis, Mo. 63105: Kenneth E. Nicklas,**  
The Clayton Tower, 7751 Carondelet Ave.  
[314] PA 5-7285

**James T. Hauptli [415] DO 2-4600**  
Western Advertising Sales Manager

**Denver, Colo. 80202: David M. Watson,**  
Richard W. Carpenter  
Tower Bldg., 1700 Broadway  
[303] 266-3863

**Los Angeles, Calif. 90017: Ian C. Hill,**  
Bradley K. Jones, 1125 W. 6th St.,  
[213] HU 2-5450

**Portland, Ore. 97204: James T. Hauptli,**  
Don Farris, 218 Mohawk Building,  
222 S.W. Morrison Street,  
Phone [503] 223-5118

**San Francisco, Calif. 94111: James T. Hauptli,**  
Don Farris, 255 California Street,  
[415] DO 2-4600

**Pierre Braude Tel: 225 85 88: Paris**  
European Director

Paris: Denis Jacob  
88-90 Avenue Des Champs-Elysees, Paris 8

**United Kingdom and Scandinavia**  
London: Oliver Ball, Tel: Hyde Park 1451  
34 Dover Street, London W1

Milan: Robert Saidel, Roberto Laureri Jr.  
1 via Baracchini Phone 86-90-656

Brussels: Denis Jacob  
27 Rue Ducale Tel: 136503

Frankfurt/Main: Hans Haller  
Elsa-Brandstroem Str. 2  
Phone 72 01 81

Geneva: Denis Jacob  
1 rue du Temple Phone: 31 95 60

Tokyo: McGraw-Hill  
Publications Overseas Corporation,  
Kasumigaseki Building 2-5, 3-chome,  
Kasumigaseki, Chiyoda-Ku, Tokyo, Japan  
[581] 9811

Osaka: Akihiko Kamesaka, McGraw-Hill  
Publications Overseas Corporation, Kondo  
Bldg., 163, Umegae-cho Kita-ku [362] 8771

**Australasia: Warren E. Ball, IPO Box 5106,**  
Tokyo, Japan

**Business Department**  
Stephen R. Welss, Manager  
[212] 971-2044

Thomas M. Egan,  
Production Manager [212] 971-3140

**Maury D'Gongora,**  
Assistant Production Manager [212] 971-2045

**Dorothy Carmesin, Contracts and Billings**  
[212] 971-2908

**Frances Vallone, Reader Service Manager**  
[212] 971-2865



the quick way to printed circuits  
for full details write to

Techne Incorporated 661 Brunswick Pike  
Princeton New Jersey 08540 USA  
Telephone (609) 452-9275

### Classified & Employment Advertising

F.J. Eberle, Manager  
212-971-2557

<b>EMPLOYMENT OPPORTUNITIES</b>	230
Atomic Personnel Inc.	230
General Dynamics, Electronics Div.	231
Management Recruiters	230
<b>EQUIPMENT</b> (Used or Surplus New) For Sale	
Fishman, Philip Co.	231
Laboratory Equipment Sales	231
Radio Research Instrument Co.	231

■ For more information on complete product line see advertisement in the latest Electronics Buyer's Guide

□ Advertisers in Electronics International

### Electronics Buyers' Guide

**George F. Werner, Associate Publisher**  
[212] 971-2310

**Robert M. Denmead,**  
Midwest Regional Manager  
[312] MO 4-5800

**Cliff Montgomery,**  
New York District Manager  
[212] 971-3793

**Regina Hera, Directory Manager**  
[212] 971-2544

**Thomas M. Egan, Production Manager**  
[212] 971-3140

**Carol Gallagher,**  
Assistant Production Manager [212] 971-2045

**Circulation Department**  
**Isaaca Siegel, Manager [212] 971-6057**

**Research Department**  
**David Strassler, Manager [212] 971-6058**



# TRW Announces Ultra-Linear RF Power Transistors... 2 to 150 MHz

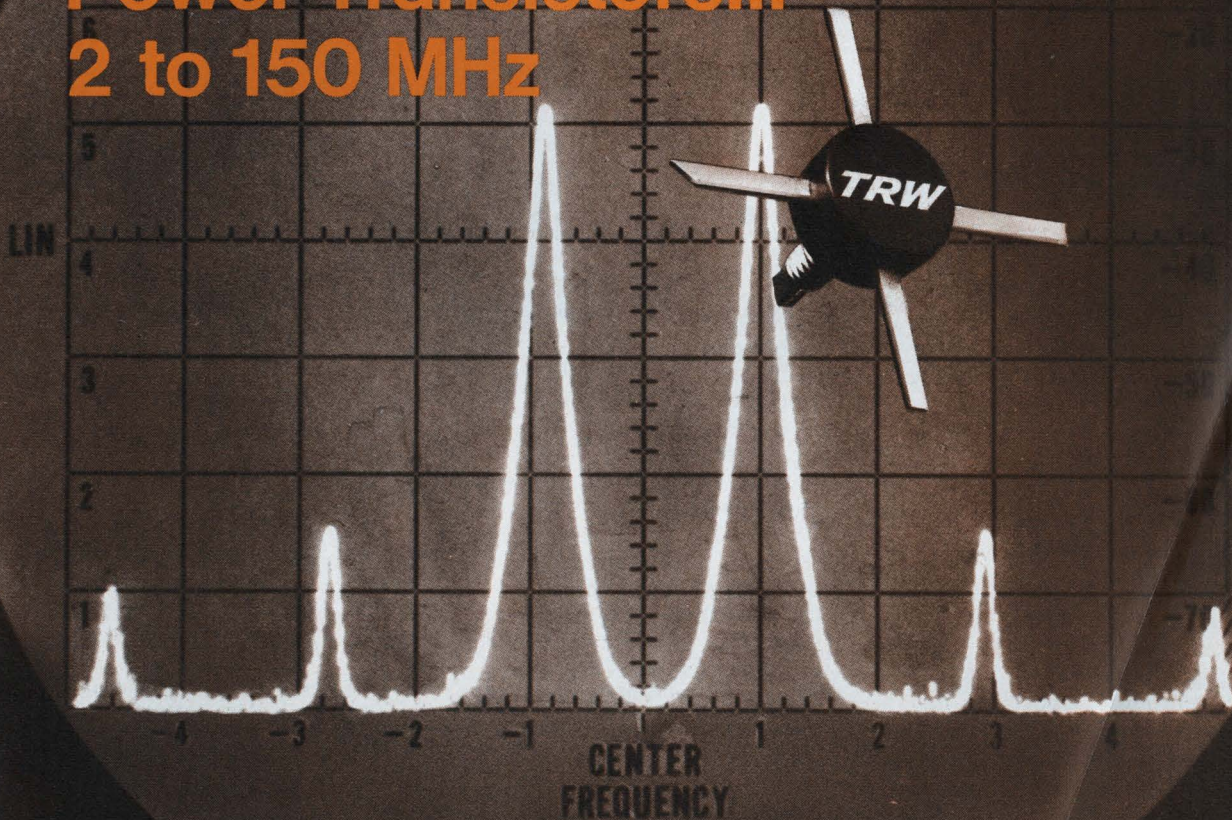

## 20 to 100 watts...- 32 dB intermodulation guaranteed

TRW offers three new 28-volt RF transistors to meet a range of output power needs in either SSB or CW. All are designed for Class A, Class AB, or Class C operation. All will withstand severe output mismatch. All are available in low profile, strip-line packages.

The 2N5707 provides 20 Watts

P.E.P. in SSB use from 2 to 30 MHz, and 30 Watts CW output to 150 MHz. The 2N5708 provides 40 to 50 Watts respectively over the same frequencies, and the 2N5709 furnishes 80 and 100 Watts in the same operating modes. All three have excellent broadband capabilities.

Contact any TRW Distributor or

TRW Semiconductors, 14520 Aviation Boulevard, Lawndale, California 90260. Phone: (213) 679-4561. TWX 910-325-6206. TRW Semiconductors Inc. is a subsidiary of TRW Inc.

# TRW®



# How our Variplate<sup>TM</sup> connecting system keeps your fifty-cent IC's from becoming four-dollar headaches.

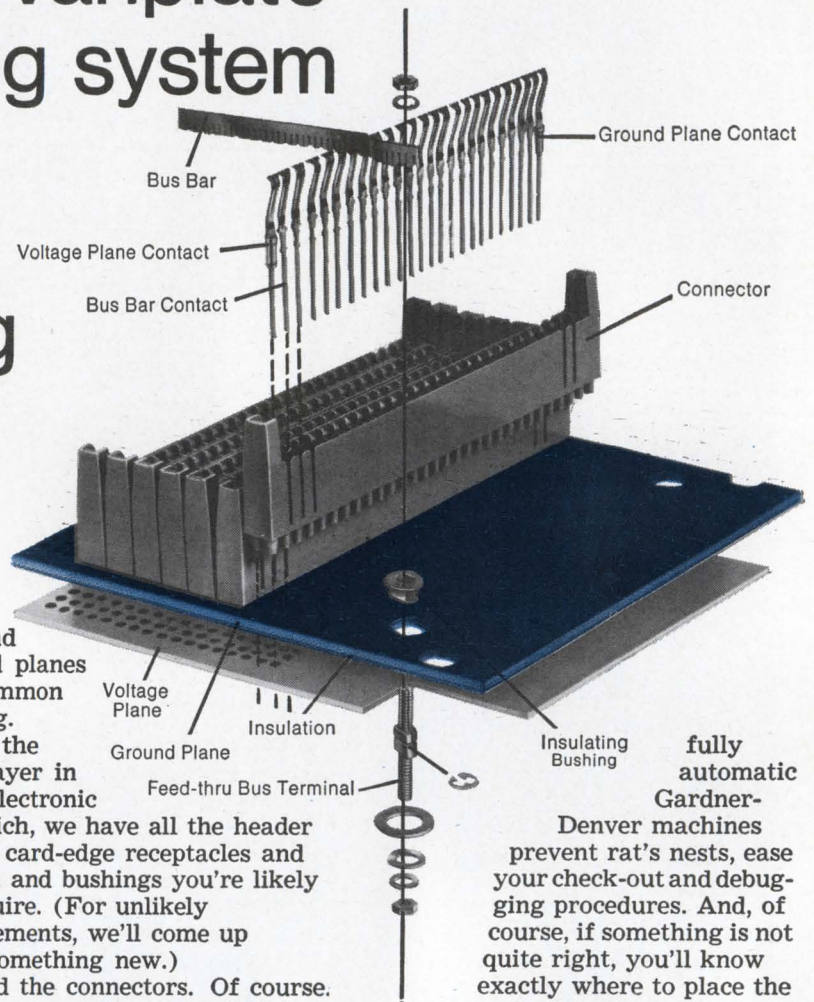

IC's don't cost much. Until you use them. You can buy, say 20,000 IC's for the innards of a compact computer, packed in the transistor cans, flat packs, or Dual-in-Line (DIP) packages, for a unit cost of less than fifty cents.

Great.

But then you have to connect them.

Not so great.

Because those 20,000 IC's have anywhere from 200,000 to 280,000 leads waiting to be connected. Fine leads. Closely spaced. And, of course, you want to pack the IC's as densely as possible. So it's really no surprise that your *in-place* cost of an IC can climb to \$4.00.

Fortunately, we have a system that can keep your in-place cost down: the Variplate interconnection system.

With the Variplate system, you can pack those IC's—and all the pc boards and other components you have—as densely as the application demands. You can do it on automated equipment—and we'll even do the wiring for you.

## All the components you need.

The system begins with the base plate, a self-supporting structural member. It carries the insulated contact modules, accommodates secondary components and hardware, and provides for mounting to support framework.

The plate can be a single metal sheet that provides a ground plane, or it can be a sandwich that provides both volt-

age and ground planes for common bussing.

For the next layer in your electronic sandwich, we have all the header plates, card-edge receptacles and guides, and bushings you're likely to require. (For unlikely requirements, we'll come up with something new.)

And the connectors. Of course. Our own respected Varimate<sup>TM</sup>, Varicon<sup>TM</sup>, and Varilok<sup>TM</sup> connectors, or standard fork-and-blade, terminal stud, card-edge, or bus strip contacts. Your choice.

## No holes barred.

We put all these components together in any size, any shape, and almost any density of package you require. Plates can be any size. Contacts can be spaced on .100", .125", .150", or .200" centers, in square or offset grids—on non-standard configurations where you need them.

What you get is a solid electrical and mechanical foundation for your electronic network, so precisely made that any automated assembly equipment can take over from there.

However.

You'll save time and money if you let us go one step further and wire your network for you. Our

fully automatic Gardner-Denver machines prevent rat's nests, ease your check-out and debugging procedures. And, of course, if something is not quite right, you'll know exactly where to place the responsibility.

Altogether, it's quite a system. And worth all the work we've put into it. Because if we can save you just a nickel on the cost of installing each of your 20,000 IC's you can add a thousand dollars to

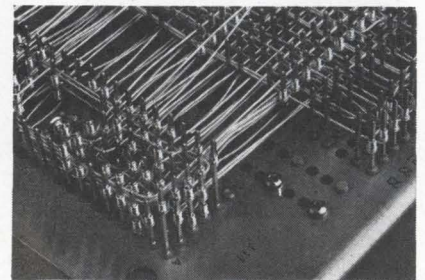

your company's profits.

We're sure we can save you that nickel, and more. For more information, write, wire, call, or TWX us for our Variplate interconnecting systems catalog. Elco Corporation, Willow Grove, Pa. 19090. 215-659-7000; TWX 510-665-5573.



**ELCO** Variplate Connectors



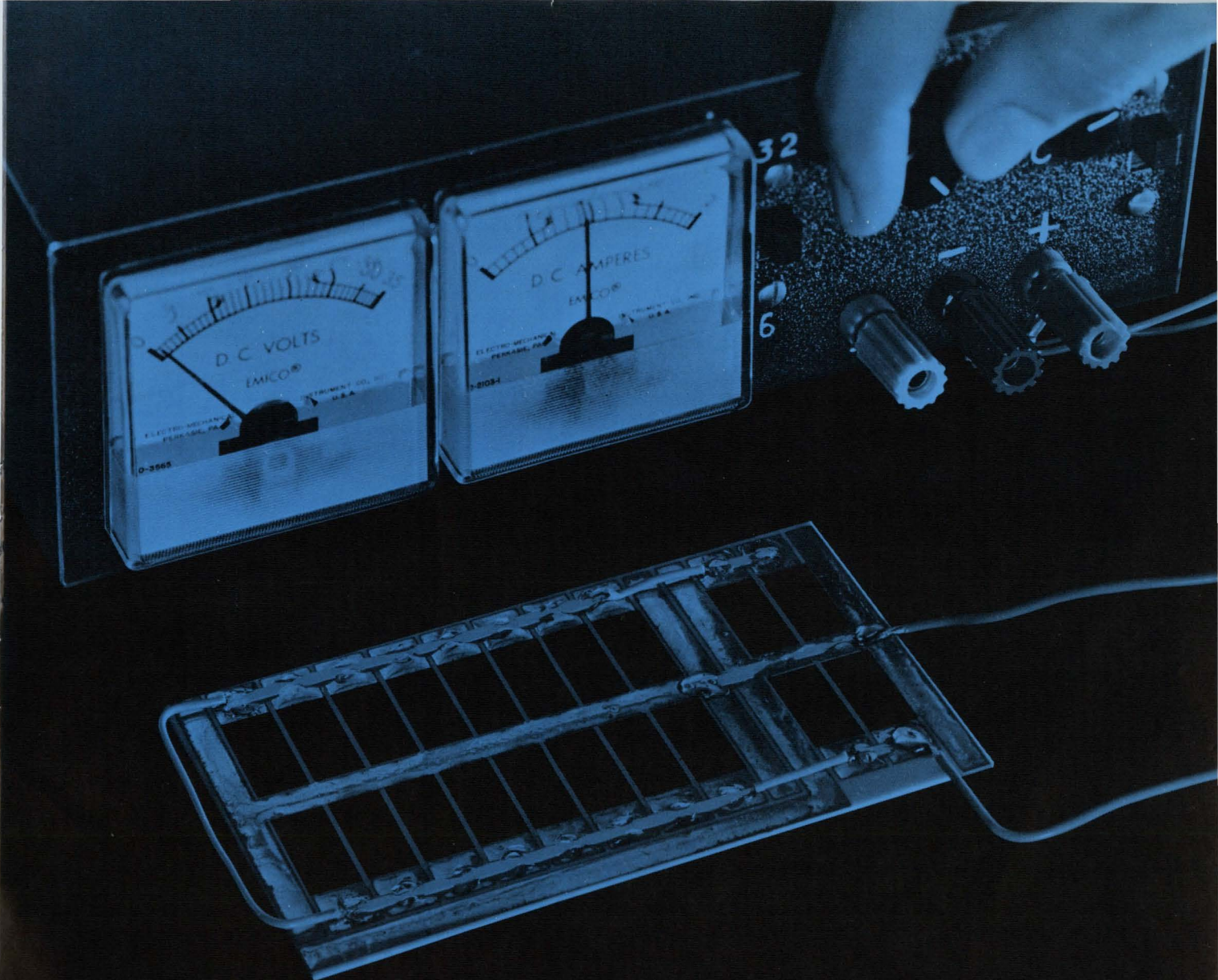

## Dale puts the power in thick film networks

Dale makes thick film R-C networks as standard as this dual in-line package and as small as this 1/4-inch square model.



Within this broad capability we've become known as power specialists.

Our ability to work with substrate, heat sink, package density and all the other network variables lets us deliver the power you need—in the size you need. "Big" jobs like the one shown above (5" x 2-1/2", 20 resistors, 60 watts) don't scare us a bit. Whether your next network is tremendous or tiny, give us a shot at it.

PROTOTYPES ON MOST DESIGNS IN LESS THAN THREE WEEKS... Call 402-564-3131 for complete details or write for Catalog A.

### GENERAL NETWORK SPECIFICATIONS

**Temperature Coefficient:**  $\pm 250$  PPM max. from  $-55^{\circ}\text{C}$  to  $+150^{\circ}\text{C}$ . T.C. as low as  $\pm 50$  PPM in limited resistance ranges.

**Tolerance:** Standard  $\pm 10\%$ . As low as 1% when required.

**Power Loading:** 16 watts/in.<sup>2</sup> standard with aluminum oxide substrate .015" - .040" thick. Substantially higher with heat sinking and beryllia substrates.

**Terminations, Conductors and Land Areas:** Platinum gold, palladium gold, gold and silver, depending upon application. Crossovers can be made. Lands for attaching active or passive components can be provided.

**Moisture Changes:** Meet Method 103, MIL-STD-202.

**Resistor Patterns:** Thick film resistive materials with resistivities from 1 ohm/sq. to 1 megohm/sq. can be used. Patterns can be made from 1/10 square to 10 squares.

**Capacitors:** Screened =  $.01 \mu\text{fd}/\text{in.}^2$ ; Chip = up to  $5 \mu\text{fd} \pm 10\%$  to  $\pm 20\%$  or GMV. Dissipation Factor = Less than 1.5%. Working Voltage = 50.

**Packaging:** Dual-in-line packaging can be used with plated Kovar or other types of leads. Also conformal coatings can be applied to modules with wire or ribbon leads. Screened and cured silicone coatings can be used to protect specific areas of the circuit.

**DALE ELECTRONICS, INC.**  
1372 28th Ave., Columbus, Nebr. 68601  
In Canada: Dale Electronics Canada, Ltd.  
A Subsidiary of The Lionel Corporation





# This 40 Amp TRIAC really controls power

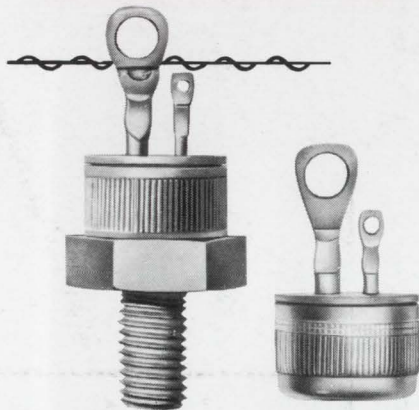

2N5441 and 2N5442 press-fit types give you:

- 300 amp full cycle surge capability
- power handling capability of 5,000 watts for 120-volt operation
- power handling capability of 10,000 watts for 240-volt operation

Because a Triac can do the job of two SCR's back-to-back, the 2N5441 or the 2N5442 can virtually replace any two types in the 2N690-series or the 2N3873-series in circuits having comparable voltage and current ratings — and with fewer components.

2N5444 and 2N5445 stud types also available.

Please give your RCA Field Representative a call if you need application assistance in applying Thyristors to your control problems. Ask him, too, for pricing information — or contact your RCA Distributor. For technical data, write RCA Electronic Components, Commercial Engineering, Section RN11-1, Harrison, N. J. 07029.

# RCA

