

- 89 Interactive image processing with a minicomputer
- 113 Charts simplify active filter design
- 119 Nonvolatile encoder makes remote meter reading reliable

LIBRARY  
STATE TECHNICAL INSTITUTE  
AT MEMPHIS

# Electronics®

**PANEL METERS**  
Does going digital  
MAKE SENSE?



1420 TCH598 MCSA1 JUN73  
ST TECHNICAL INST  
LIBRY  
5983 MACON COVE  
MEMPHIS TN  
38128

**System Diagram**

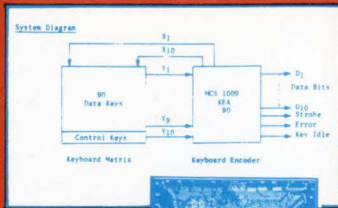

**MCS 1007**  
**64 KEY**  
**ENCODER**  
**ARRAY**

**MCS 1009**

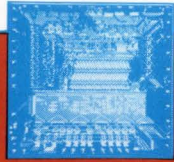

**MCS 1009** **90 KEY**  
**KEYBOARD ENCODER**  
**ARRAY**

**featuring**

- Four level, 10 bits per level, encoding for 90 keys.
- Dual operation of two KEA 90 arrays for expansion to 180 keys.
- True N-key rollover operation.
- Error detection and data lock-out for simultaneous key depression.
- Manual or automatic repeat operation.
- Parity bit (odd or even externally selected).
- Automatic key inhibit action for selected keys (defined by user).
- Complete switch bounce immunity.
- Latched data outputs and control signal outputs.
- TTL compatibility for all control signals and data outputs.

**MCS 1008**  
**(MTS 1008)**

**28 KEY**  
**KEYBOARD**  
**ENCODER**  
**EXPANDER**  
**ARRAY**

**KEY'd up!**

**MOS KEYBOARD ENCODER ARRAYS!**  
**LSI SUBSYSTEM THAT GENERATES**  
**ENCODED DATA FROM KEYBOARD**  
**SWITCH ENCLOSURES**

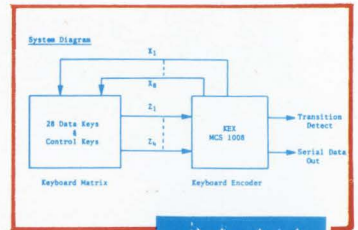

**System Diagram**

**MCS 1008**  
**(MTS 1008)**

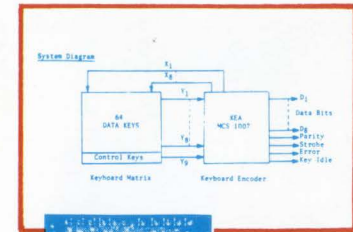

**System Diagram**

**MCS 1007**

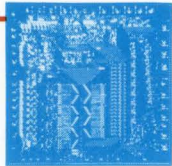

**featuring**

- Four level encoding of 64 keys.
- Expansion to 92 or 128 keys (using add'l. units).
- True N-key rollover operation.
- Error detection and data lock-out for simultaneous key depression.
- Repeat operation.
- Internal parity generation (odd or even).
- Complete switch bounce immunity.
- Latched data outputs, control signal outputs.
- TTL compatibility for all control signals, data outputs.

**CLOCK GENERATOR FEATURES**

- 5 KHz to 100 KHz variable frequency, externally selected.
- 25% to 49% variable duty cycle, externally selected.
- Low Output Impedance—up to 500 pf loads are practical.
- Low Power Consumption—220 mw typical.
- May be synchronized with external oscillator.

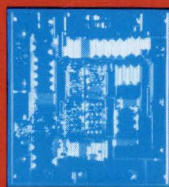

**MTS 2517**

**MTS 2517**  
**CLOCK GENERATOR AND REPEAT OSCILLATOR**

*Supplies two phase clock signals and a gated repeat oscillator signal required by Keyboard Encoder products currently available from MOS TECHNOLOGY, INC.*

**REPEAT OSCILLATOR FEATURES**

- 5Hz to 45Hz—variable frequency, externally selected.
- Oscillator Gating—separate on/off controls with variable delay for "on" control.

**FEATURING**

- Two-level 8 bit encoding of 28 keys.
- True N-key rollover operation.
- Complete switch bounce immunity.
- Serial TTL compatible data output.
- Electrical Shift/Lock.

**WE TURNED A TECHNOLOGY INTO A COMPANY**

**CONTACT US DIRECT**

**EASTERN REGIONAL SALES DIRECTOR**

Mr. William Whitehead  
MOS TECHNOLOGY, INC.  
88 Sunnyside Blvd.  
Suite 307  
Plainview, N.Y. 11803  
Phone: (516) 822-4240

**CENTRAL REGIONAL SALES DIRECTOR**

Mr. Alan Mattal  
MOS TECHNOLOGY, INC.  
10400 W. Higgins Rd.  
Suite 631  
Rosemont, Ill. 60018  
Phone: (312) 298-2035

**WESTERN REGIONAL SALES DIRECTOR**

Mr. Jack Buckamier  
MOS TECHNOLOGY, INC.  
2172 Dupont Drive  
Suite 221, Patio Bldg.  
Newport Beach, Calif.  
92660  
Phone: (714) 833-1600

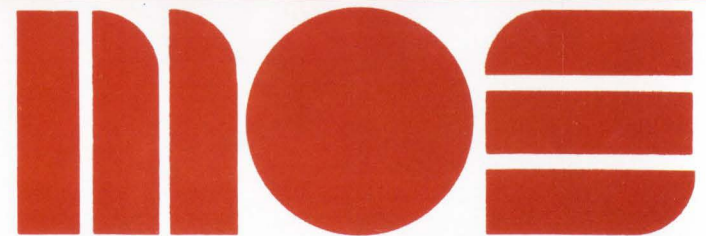

**MOS TECHNOLOGY, INC.**

VALLEY FORGE INDUSTRIAL PARK, VALLEY FORGE, PA. 19481 • (215) 666-7950

*an affiliate of ALLEN-BRADLEY*





**Behind this counter are 40 million hours of reliability data.**

**That's only one reason it's the world's best seller.**

Only the 5245's have over 40 million hours of operating data behind them — data which is computerized so HP can keep track of the performance of the 20,000 5245's now in use around the world. In addition, they all get torture-tested up to 160° F to make sure they'll operate under the most severe conditions.

The 5245's adapt easily to your needs. 14 plug-ins go from dc to 18 GHz and perform a great variety of functions. You can even order a long-term time-base stability of  $<5 \times 10^{-10}$  — good enough to use as a precision frequency standard.

That's why, in the long run, buying the best all-around counter on the market

— the 5245 — will save you money. Downtime and servicing are minimal. But you can get parts and service around the world. No wonder these counters are the only choice for many leasing companies.

Prove it to yourself. Call your local HP field engineer and find out why these are the most accurate, flexible and economical counters you can get. Anywhere.

Or write Hewlett-Packard, Palo Alto, California 94304; Europe: 1217 Meyrin-Geneva, Switzerland.

HEWLETT  PACKARD

ELECTRONIC COUNTERS

Circle 1 on reader service card

# HP's new six pack.

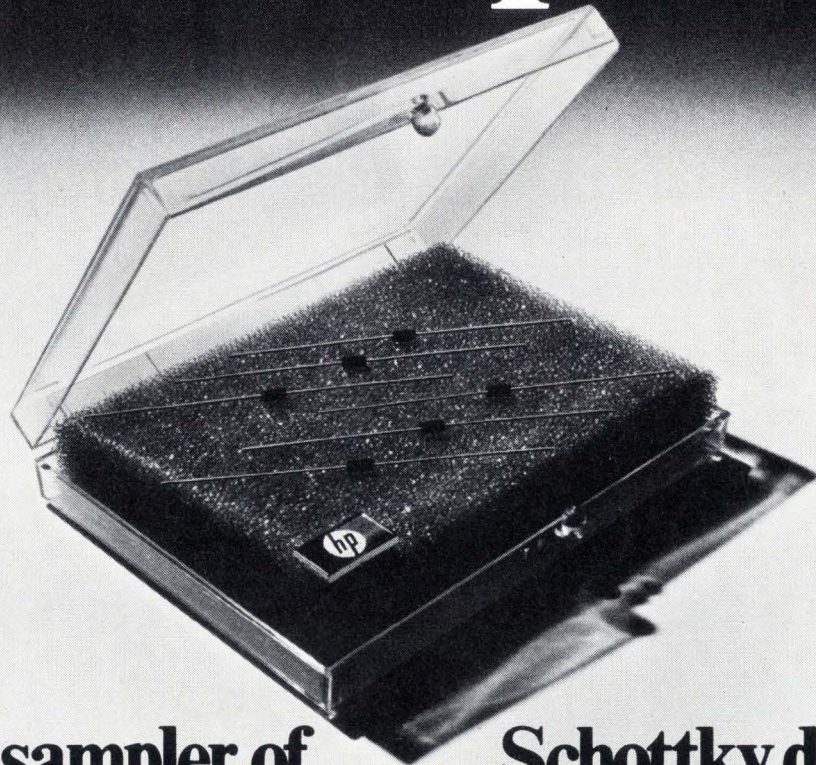

## A free sampler of Schottky diodes for those who don't know they need them.

We're so sure our Schottky diodes can make your design life easier, we've put together a kit containing six samples. And we'll send it to you for nothing but the coupon and a hint as to your possible application.

You'll find Schottky diodes easier to design with than conventional PN diodes. They give better noise performance, eliminate switching transients and RFI and provide exceptional device uniformity. In addition, HP Schottky diodes are economically priced for industrial and consumer applications. HP's Schottkys are passivated silicon diodes that come in hermetically sealed subminiature glass packages.

Your free six pack will contain two high breakdown voltage, high speed Schottkys — ideal for high level detecting, clipping, clamping and sampling. Also included are four low threshold, high conductance, high speed Schottkys — for mixing, detecting and clamping where minimum offset is required.

Fill out the coupon and send it along for immediate delivery.

Please send me HP's new six-pack along with complete specifications.

Name \_\_\_\_\_ Title \_\_\_\_\_

(Company) \_\_\_\_\_ (Street) \_\_\_\_\_

(City) \_\_\_\_\_ (State) \_\_\_\_\_ (Zip) \_\_\_\_\_

It's remotely possible I could use these Schottky diodes for:

- RF Mixing     Low Level Clipping     RF Detecting     Gating  
 Balanced Modulating     Clamping     Frequency Doubling  
 High Frequency Rectifying     Sampling     Power Detecting  
 Analog Switching     Limiting     Log-Linear Element

Your free kit contains

TYPE	QUANTITY	$V_F$ (mv) @ 1mA	$V_{RR}$ (v)	$C_j$ (pF)	$\tau$ (psec)
5082-2800	2	410	70	2.0	100
5082-2835	4	340	5	1.0	100

Offer expires Dec. 31, 1972

Mail to:  
Hewlett-Packard,  
620 Page Mill Road,  
Palo Alto, California 94304;  
Europe: P.O. Box 85,  
CH-1217 Meyrin 2,  
Geneva, Switzerland.

HEWLETT  PACKARD

COMPONENTS

01204

## 29 Electronics Review

COMMERCIAL ELECTRONICS: Companies vie in traffic control, 29  
COMPUTERS: DEC's Bell sees minis following LSI routes, 30  
COMPUTERS: IBM takes wraps off 370/125, 30  
COMPUTERS: Lab system seeks third of market, 31  
OPTOELECTRONICS: Laser writes liquid-crystal display, 32  
OPTOELECTRONICS: Fm video system shines through rain, 32  
COMMUNICATIONS: 'Gerty' controls long-distance calls, 34  
MILITARY ELECTRONICS: Aircraft spending up as ABM is cut, 36  
MEETINGS: ISA attendance hits 10-year low, 36  
INTERNATIONAL: Mission sees U.S. bar to big East Bloc market, 38  
FOR THE RECORD: 38

## 53 Electronics International

JAPAN: Liquid-crystal display shows black letters on white, 53  
ITALY: Color TV shelved again, 53

## 65 Probing the News

SEMICONDUCTORS: MNOS devices head out of labs, 65  
COMPANIES: Intermetall sets fast IC pace, 68  
INSTRUMENTS: Noise-monitoring laws create orders, 72  
SEMICONDUCTORS: IC users seek outside testing help, 75

## 89 Technical articles

COMPUTERS: Image processor speeds pattern recognition, 89  
DESIGNER'S CASEBOOK: Feedback linearizes resistance bridge, 102  
Soldering iron converts to constant-temperature probe, 103  
Exclusive-OR gate makes bidirectional one-shot, 104  
INSTRUMENTS: Digital panel meter matches analog capability, 108  
CIRCUIT DESIGN: Tables aid design of active filters, 113  
INDUSTRIAL: MNOS IC retains data for meter reader, 119  
ENGINEER'S NOTEBOOK: V-f module serves diverse uses, 127  
Optical trigger for scope reduces rf interference, 128

## 139 New Products

IN THE SPOTLIGHT: 25 cable pairs terminated in a stroke, 139;  
Recorder packs 33,000 bits per inch, 141  
SUBASSEMBLIES: Translator modules save computer power, 143  
SEMICONDUCTORS: Op amp preamp minimizes drift, 149  
INDUSTRIAL: GE moves into computer numerical control, 153  
DATA HANDLING: Tape system offers high data rate, 157  
MATERIALS: 164

## Departments

Publisher's letter, 4  
Readers comment, 6  
40 years ago, 8  
People, 14  
Meetings, 20  
Electronics newsletter, 25  
Washington newsletter, 49  
Washington commentary, 50  
International newsletter, 55  
Engineer's newsletter, 130  
New literature, 167  
Personal Business, 173

## Highlights

### MNOS memories may almost be here, 65

Although electrical alterability is their outstanding asset, the devices will probably function mainly as ROMs in data terminals and minicomputers. But their commercial viability is still the subject of some doubt.

### Pattern recognition by computer—fast, 89

General-purpose machines can't do it quickly enough to be useful. The job takes a special-purpose unit plugged into a standard minicomputer, plus a human operator to teach the unit how to analyze images.

### Digital panel meter does as well as analog, 108

A precision, voltage-controlled oscillator, built around a charge-switching circuit, is the key element in a digital panel meter that rivals analog performance. Standard, high-density TTL circuits keep manufacturing costs low and the meter's price competitive.

### The passing of the meter reader, 119

A computer-based system for reading meters automatically at a distance promises to lower costs for public utilities, provided the system's reliability level can be made good enough and its power demand small enough.

### And in the next issue . . .

A new look at optical measurements . . .  
FET input op amps . . . an atoms-thick film for mass memory.

### The cover

Interior of Analogic Corp.'s digital panel meter appears beneath the three-digit display.

EDITOR-IN-CHIEF: Kemp Anderson

EXECUTIVE EDITOR: Samuel Weber

MANAGING EDITORS: Lawrence Curran, *News*;  
Arthur Erikson, *International*

SENIOR EDITORS: John Johnsrud,  
H. Thomas Maguire, Lawrence Altman

ART DIRECTOR: Fred Sklenar

ASSOCIATE EDITORS: Richard Gundlach,  
John N. Kessler, Howard Wolff

DEPARTMENT EDITORS

*Aerospace*: William F. Arnold  
*Circuit Design*: Lucinda Mattera  
*Communications & Microwave*:

Lyman J. Hardeman  
*Computers*: Wallace B. Riley  
*Consumer*: Gerald M. Walker  
*Industrial*: Alfred Rosenblatt  
*Instrumentation*: Michael J. Riezenman  
*Military*: Ray Connolly  
*New Products*: H. Thomas Maguire  
*Solid State*: Laurence Altman  
*Special Issues*: Harry R. Karp

COPY EDITORS: Margaret Eastman,  
Everett C. Terry

ASSISTANT EDITOR: Marilyn Offenheiser

ART: Charles D. Ciatto, *Associate Director*

PRODUCTION EDITORS:  
Patricia Cybulski, Arthur C. Miller

EDITORIAL SECRETARIES: Janet Annunziata,  
Julie Gorgoglione

FIELD EDITORS

*Boston*: James Brinton (Mgr.), Gail Farrell  
*Dallas*: Larry Armstrong (Mgr.)  
*Los Angeles*: Paul Franson (Mgr.)  
*New York*: Alfred Rosenblatt (Mgr.)  
*San Francisco*: Stephen Wm. Fields (Mgr.),  
Judith Curtis  
*Washington*: Ray Connolly (Mgr.),  
William F. Arnold  
*Frankfurt*: John Gosch  
*London*: Michael Payne  
*Paris*: Arthur Erikson  
*Tokyo*: Charles Cohen

McGRAW-HILL WORLD NEWS

*Director*: Walter A. Stanbury; *Atlanta*: Stan Fisher; *Chicago*: Mike Sheldrick; *Cleveland*: Arthur Zimmerman; *Detroit*: James Wargo; *Houston*: Robert E. Lee; *Los Angeles*: Michael Murphy; *Gerald Parkinson*; *San Francisco*: Margaret Drossel; *Seattle*: Ray Bloomberg; *Washington*: James Canan, Herbert W. Cheshire, Seth Payne, Warren Burkett, William D. Hickman; *Bonn*: Robert Ingersoll; *Brussels*: James Smith; *London*: Marvin Petal; *Milan*: Peter Hoffmann, Andrew Heath; *Moscow*: Axel Krause; *Paris*: Stewart Toy, Michael Johnson; *Stockholm*: Robert Skole; *Tokyo*: Mike Mealey

PUBLISHER: Dan McMillan

ADVERTISING SALES MANAGER: Pierre J. Braudé

ADVERTISING SALES SERVICE MANAGER:  
Wallis Clarke

BUSINESS MANAGER: Stephen R. Weiss

CIRCULATION MANAGER: George F. Werner

MARKETING SERVICES MANAGER:  
Tomlinson Howland

**A**s we continue to expand our coverage of the electronics world, we're opening a Midwest news bureau in Chicago. Our bureau manager will be Larry Armstrong, who is no stranger to the Midwest. He graduated from Northwestern University with a BA in chemistry in 1969 and earned a master's degree in journalism there in 1970.

Armstrong, after a year's seasoning in our Washington bureau, was picked to take over the Dallas bureau last December. And he will remain our man in the Southwest, shuttling down that way to keep tabs on doings there.

Because of the track record he has established in two widely varying assignments, we know that he will add a new dimension to our Midwest coverage.

**T**he health field is one of the biggest beneficiaries today of the transfer of electronic expertise from military and commercial markets. In this issue, we feature (see p. 89) an innovative use of computer hardware and software that, interacting with and extending the interpretive ability of the human mind, is vastly speeding the analysis of chromosomes for spotting abnormalities.

And, since the method has applications in a wide range of image-processing tasks—from white-cell scanning to discerning missile sites in satellite photos—we think you will be quite interested in this pioneering work by Kendall Preston Jr. and Philip Norgren.

The long journey to interactive image analysis—the hardware was done in 1967, but it took another four years to work out the interactive software—finally reached the point when the men could sit down at a computer keyboard and begin to teach the computer what to look

for in chromosome images. The session at the keyboard took only six hours, including all the steps discussed in the article plus producing codes to do such things as measuring chromosome arm lengths. And, says Preston, "we were pleased to find that the entire chromosome analysis could be typed as one procedure containing only 35 lines of commands."

Mike Riezenman, our Instrumentation Editor who edited the article, says that's one gauge of the power of interactive processing. Here's another. Earlier this month, a program to scan X-rays of the lungs of coal miners, part of a black-lung analysis program, was developed in just one hour at the keyboard.

Preston—who holds 25 patents and invented synthetic aperture acoustic holography and a flexible light modular that performs the fastest fast-Fourier transforms to date—and Norgren are involved in other transfers of technology. Not the least of them is a new method, on which they hold patents, of preparing blood smears.

According to Preston, the time-honored blood-smear technique is to squeeze out a drop of blood into a thin film between two glass plates, which produces a nonuniform film and can badly damage cells. Since they were deep in microelectronic work, they saw a better way—the way photoresist is applied during IC processing. When the substrate is set to spinning, a drop of resist spreads out neatly into a thin film. Now two companies are marketing blood-smear spinning machines.



October 23, 1972 Volume 45, Number 22  
89,753 copies of this issue printed

Published every other Monday by McGraw-Hill, Inc. Founder: James H. McGraw, 1860-1948. Publication office 1221 Avenue of the Americas, N.Y., N.Y. 10020; second class postage paid at New York, N.Y., and additional mailing offices.

Executive, editorial, circulation and advertising addresses: Electronics, McGraw-Hill Building, 1221 Avenue of the Americas, New York, N.Y. 10020. Telephone (212) 997-1221. Teletype TWX N.Y. 710-581-5234. Cable address: MCGRAW HILL N.Y.

Subscriptions limited to persons with active, professional, functional responsibility in electronics technology. Publisher reserves the right to reject non-qualified requests. No subscriptions accepted without complete identification of subscriber name, title, or job function, company or organization, including product manufactured or services performed. Subscription rates: qualified subscribers in the United States and possessions, Canada, and Mexico \$8.00 one year, \$12.00 two years, \$16.00 three years; all other countries \$25.00 one year except Japan \$50.00 per year including air freight. Limited quota of subscriptions available at higher-than-basic rate for persons outside of field served, as follows: U.S. and possessions and Canada, \$25.00 one year; all other countries \$50.00. Single copies: United States and possessions and Canada, \$1.00; all other countries, \$1.75.

Officers of the McGraw-Hill Publications Company: John R. Emery, President; J. Elton Tuchig, Senior Vice President—Services; Donald B. Gridley, Group Vice President; Vice Presidents: Ralph Blackburn, Circulation; John R. Callahan, Editorial; John B. Hoglund, Controller; David G. Jensen, Manufacturing; Jerome D. Luntz, Planning & Development; Joseph C. Page, Marketing.

Officers of the Corporation: Shelton Fisher, President; Wallace F. Traendly, Group President, McGraw-Hill Publications Company; John J. Cooke, Senior Vice President and Secretary; Ralph J. Webb, Treasurer.

Title registered in U.S. Patent Office; Copyright 1972 by McGraw-Hill, Inc. All rights reserved. The contents of this publication may not be reproduced either in whole or in part without the consent of copyright owner.

Subscribers: The publisher, upon written request to our New York office from any subscriber, agrees to refund that part of the subscription price applying to copies not yet mailed. Please send change of address notices or complaints to Fulfillment Manager; subscription orders to Circulation Manager, Electronics, at address below. Change of address notices should provide old as well as new address, including postal zip code number. If possible, attach address label from recent issue. Allow one month for change to become effective.

Postmaster: Please send form 3579 to Fulfillment Manager, Electronics, P.O. Box 430, Hightstown, N.J. 08520.

# SIMPLE VOLTAGE STABILIZATION

## your key to low cost reliability

The ferroresonant voltage stabilizing principal depends on the saturation of a portion of the transformer's iron by the use of a resonating capacitor. The squarish waveform in the tank winding is amplitude isolated from the primary winding (and, therefore, the line's noise) and will collapse if overloaded to protect itself and your load.

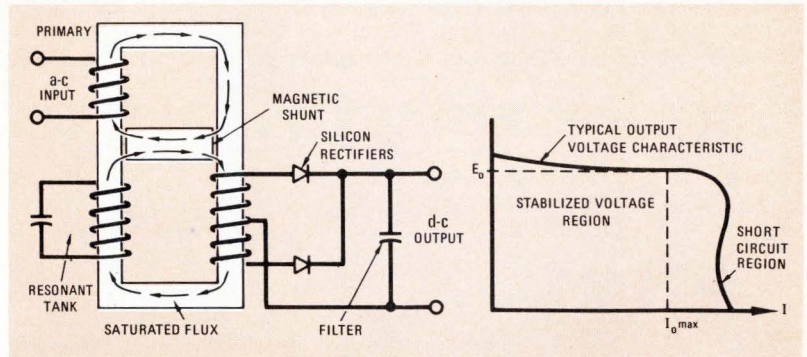

Why do things the hard way? There's a nice, easy way to provide stable, transient-free, d-c voltages in your system . . . the Kepco PRM modules. Low cost power supplies which, by their elegant simplicity, yield rich dividends in reliability and longevity.

There's no clamped-down high voltage to break out of its regulator and mess up your circuits; no noise-generating switches or oscillators to confuse your logic; no delicate transistors requiring elaborate protection. Kepco's PRM power supplies use a self-stabilizing resonant transformer, oil-filled a-c capacitor, some silicon rectifiers and husky aluminum electrolytic filters. That, plus some copper wire is it!

Voltage is controlled by the saturation flux of the transformer's iron lamination. You can't get more rugged than that. There's no need for auxiliary overvoltage crowbars, trigger circuits, current limiters or even fuses! PRM's are inherently protected for every sort of abuse.

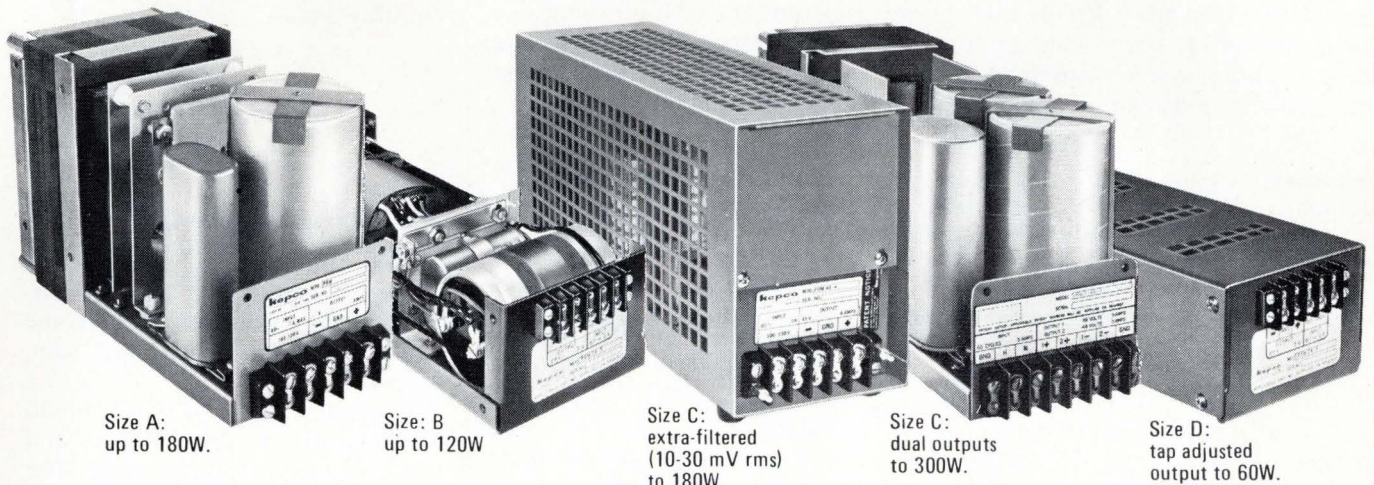

Size A:  
up to 180W.

Size B:  
up to 120W

Size C:  
extra-filtered  
(10-30 mV rms)  
to 180W.

Size C:  
dual outputs  
to 300W.

Size D:  
tap adjusted  
output to 60W.

- $\pm 1\%$  source effect (the "line regulation" for a 100-130V a-c unstable source).
- 100-300 mV rms ripple, spike free! Rejects line noise by more than 120 dB.
- Outputs from 4.5V d-c to 240V d-c.
- Built to exceed 200,000-hour service life.

For complete specifications and applications notes, write Department O-14

# KEPCO®

KEPCO, INC. • 131-38 SANFORD AVENUE • FLUSHING, N.Y. 11352 • (212) 461-7000  
TWX # 710-582-2631 • Telex: 12-6055 • Cable: KEPCOPOWER NEWYORK

**IN STOCK**

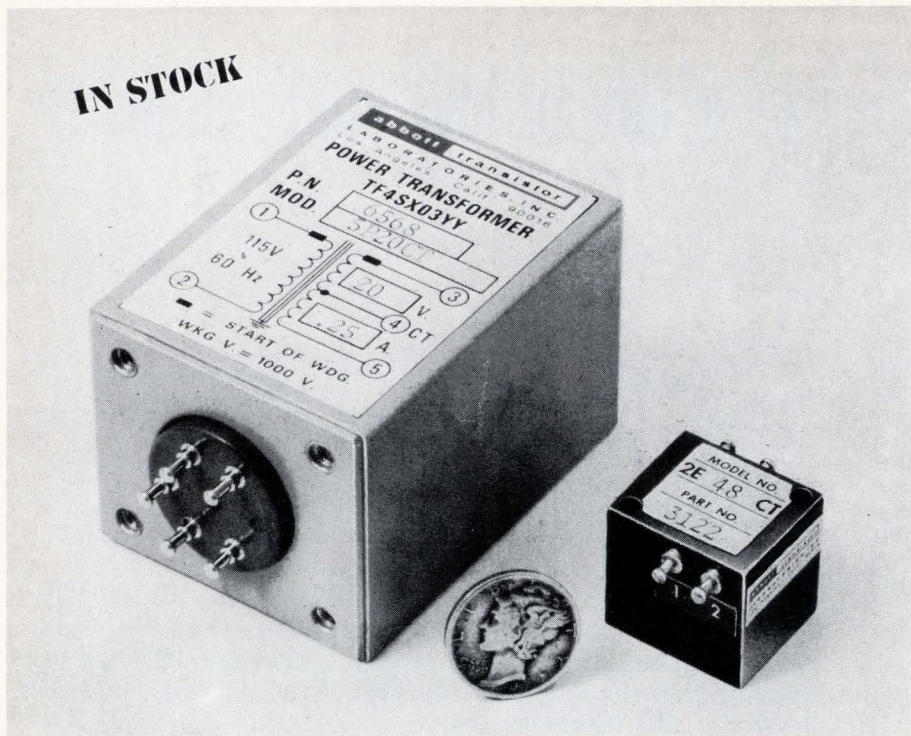

## If You Need A Power Transformer Tomorrow - Call Abbott Today

Now Abbott Stocks 60 Hz and 400 Hz Transformers  
With Output Voltages from 5 to 5000 Volts

Both the 60 Hz and the 400 Hertz transformers are built to meet the specifications of MIL-T-27C. Long life and reliability are inherent in these hermetically sealed, ruggedly built power transformers. The 60 Hertz line comes in eleven power ratings from 5 to 300 watts. The 400 Hz line comes in six power ratings from 2 to 175 watts. Most all of your power transformer needs can be found in this line of Abbott transformers.

	60 Hertz	400 Hertz
<b>Input Primary</b>	115 VAC, 60 Hz $\pm$ 5 Hz, 1 phase	115 V, 400 Hz $\pm$ 20 Hz, 1 phase
<b>Insulation</b>	1750 VAC or 150% of secondary voltage (whichever is higher)	2500 VDC or 150% of secondary voltage (whichever is higher)
<b>Construction</b>	To MIL-T-27C, grade: 4, class: "S", life: "X" (10,000 hrs.), case: steel	To MIL-T-27C, grade: 5, class: "S", life: "X" (10,000 hrs.), case: smaller
<b>Environment</b>	To operate in 105°C maximum ambient temperature. Encapsulated to meet MIL-E-5272C and MIL-E-5400H for vibration, shock, acceleration, sand, dust, humidity, saltspray, fungus, sunshine, rain, explosion, and altitude (to a vacuum)	Encapsulated to meet MIL-E-5272C, including vibration to Proc. XII, temperature to 105°C, shock, sand, dust, humidity, saltspray, fungus, sunshine, rain, explosion, and altitude (to a vacuum)
<b>Secondary</b>	From 5 volts to 5000 volts at 32 milliamperes to 20 amperes	From 5 volts to 5000 volts at 14 milliamperes to 35 amperes

A complete description of all of these power transformers together with their prices is contained in Abbott's 10 page transformer brochure, available FREE on request.

Please see pages 618 to 632 of your 1971-72 **EEM** (ELECTRONIC ENGINEERS MASTER Catalog) for complete information on Abbott modules. Send for our new 56 page FREE catalog.

**abbott transistor**

**LABORATORIES, INCORPORATED**  
5200 W. Jefferson Blvd./Los Angeles 90016 (213) 936-8185 Cable ABTLABS  
1224 Anderson Ave./Fort Lee, N.J. 07024 (201) 224-6900

## Readers comment

### Phone speeds EKGs

**To the Editor:** In reference to an article, "Phone system cuts EKG time, cost" [*Electronics* Aug. 14, p.42], I must point out that Marquette Electronics Inc. has been manufacturing a special electrocardiograph for the purpose of transmitting electrocardiograms by telephone for the past three years.

The Marquette system, which is completely automatic, transmits the entire EKG in precisely 22 seconds, including 20 digits of patient identification.

It is interesting that many manufacturers claim immunity to patient electrical hazards because of battery operation.

In actual practice, none of these battery-operated machines meets the new proposed safety specification of AAMI, UL, and NFPA, which is a maximum of 10 microamperes, even if the patient is exposed through other sources to the 115-volt power line.

The Marquette equipment meets these specifications by isolating the patient from the rest of the unit by optical coupling through light-emitting diodes.

Michael J. Cudahy  
President  
Marquette Electronics Inc.  
Milwaukee, Wis.

### SOS substrate statistic strays

**To the Editor:** A serious error was made in the printing of our "Silicon-sapphire substrates overcome MOS limitations," [*Electronics*, Sept. 25, p.113].

The Y axis values of Fig. 2 should be 50 centimeters per volt-second higher for each rating shown. The size and color treatment draws the reader's attention to Fig. 2 more than any other portion of the article.

The mislabelled axis leaves the reader with the lingering impression that our SOS transistors have characteristics inferior to those of bulk MOS devices.

A. Karl Rapp  
Inselek Inc.  
Princeton, N.J.



Fluke problem solvers

# Introducing the Fluke 8100B. At \$595, you'll wonder how we did so much in a 4½ Digit Multimeter.



The new version of Fluke's most successful DMM, Model 8100B, gives you the most value for your money ever offered in a quality digital voltmeter.

With a basic dc accuracy of 0.02%, the Fluke 8100B measures ac and dc volts in four ranges from 100 microvolts to 1200 volts and resistance from 100 milliohms to 12 megohms. With an optional ac/dc current shunt accessory, it measures from 10 nanoamperes to 12 amps in six switched ranges.

Features include an active 2-pole switchable filter and automatic polarity indicator. All functions are push-button selectable.

For \$100 extra, a rechargeable battery pack can be

added to give the user complete portability with up to eight hours continuous operation. Other options include RF and high voltage probes, switched ac/dc current shunts, data output and a ruggedized case.

Demonstrated MTBF is over 10,000 hours, to make the instrument the most reliable available. The 8100B has tough environmental specs to ease your workload. Fully backed by Fluke's no-nonsense 12-month guarantee and service policy, here's an instrument that will meet your greatest expectations.

Call your local Fluke sales engineer for a demo and details. In the contiguous U.S., get his location by dialing our toll free number, 800-426-0361. Otherwise, address one of the locations listed below.

Fluke, P.O. Box 7428, Seattle, Washington 98133. Phone (206) 774-2211. TWX: 910-449-2850.  
In Europe, address Fluke Nederland (N.V.), P.O. Box 5053, Tilburg, Holland. Phone 13-670130.  
Telex: 884-55237. In the U.K., address Fluke International Corp., Garnett Close, Watford,  
WD2, 4TT. Phone, Watford, 33066. Telex: 934583.



Circle 7 on reader service card

# When your machine has more to say...



**IEE Readouts provide the vocabulary.**

When your machine has more to say, IEE rear projection readouts let it speak out with an eloquence that make other display systems seem taciturn.

For instance, just one IEE rear projection readout will improve the vocabulary of your machine with up to 64 new phrases expressed in any combination of alphanumeric, in any language, accompanied by the symbols of any discipline, all displayed in a variety of colors and in the type styles that go best with your panel decor.

No gas discharge tube, or LED or what have you, can make that statement.

**IEE units communicate — loud and clear!**

Our big Series 80 rear projection readout lets your machine shout in huge 3 3/8-inch characters. Or we can say things discretely

with our fit-anywhere 1/2 x 3/4-inch Series 345 model.

All with single-plane viewing, variable brilliance, and the capability to change vocabularies right in the field. To assist, we have a powerful new low-cost hybrid driver/decoder for any of the readouts. Plus a host of other driver/decoders... all, competitively priced... purchased separately or customer mounted.

Rear projection readouts give you an order of display versatility a world apart from other techniques, and IEE builds more of them than anybody. Send today for our Short-Form Catalog on units that are long on talk. Industrial Electronic Engineers, Inc., 7740 Lemona Ave., Van Nuys, California 91405. Telephone: (213) 787-0311 • TWX 910-495-1707



Industrial Electronic Engineers, Inc.



## 40 years ago

From the pages of Electronics, October 1932

Forces of the Government and of industry are now mobilized on the campaign to stimulate business recovery through industrial re-equipment. Important committees have been appointed, and leading industrialists are at work organizing the campaigns.

Electronic apparatus engineers can take advantage of this more favorable view toward factory re-equipment, using this opportunity to show how electronic methods can speed up production and make for superior products.

The Peters Cartridge Company has constructed a piezoelectric gage for making time-pressure records in small arms. Although the importance of time-pressure records in ballistics has long been recognized, work along this line until recently has been rather slow due to the complications of recording such curves, imposed by the inertia factors of various apparatus. Among various methods which have been used for recording pressures in small arms the only entirely successful method at the present time is said to be the piezoelectric method. It has the advantage that the direct plotting of the time-pressure curve is possible. This is accomplished by connecting the gage to an especially designed resistance-coupled amplifier.

"Electronics has been rather frank in pointing out the deficiencies in existing apparatus and suggesting its improvements," writes a reader, who continues: "I would like to suggest a line of development badly needed by modern business and which could be accomplished by the use of electronic devices.

"In any business where technical terms are used it is essential that dictation be very plain in order that the typist be able to transcribe correctly. The existing dictating machines are so very poor as to necessitate much guess work. The range of frequencies reproduced (350 to 2000 cycles) is little better than that of the average telephone (300 to 1800 cycles)."

# with Cinch edge connectors you've got it made.

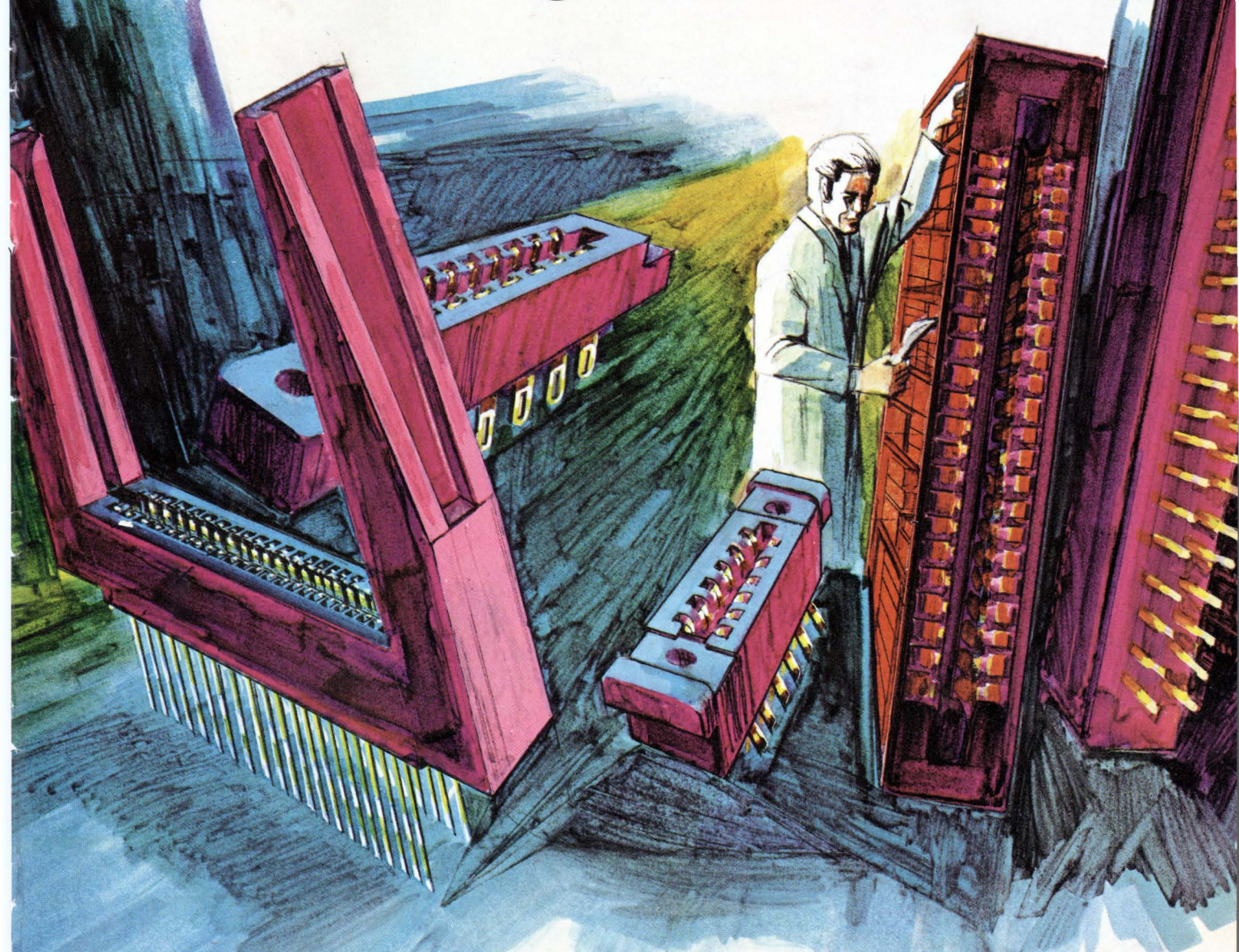

... because we've already made it for you.

Your best combination of cost and reliability lies in a connector that already exists—that has been tooled, tested and has proven itself in use. Next best is a custom combination of available insulators and contacts that provide the functions you require. Either way you've got it made with Cinch because Cinch makes the industry's broadest range of contact spacings, insulator sizes, termination types and contact styles.

Whether you'll need large quantities for long range production scheduling—or smaller quantities for immediate delivery (through our nationwide network of stocking distributors), you'll save yourself a lot of trouble if you think of Cinch first.

Get a copy of the latest Cinch edge connector catalog from your local Cinch sales office, or write to Cinch Manufacturing, an Operation of TRW Electronic Components, 1501 Morse Avenue, Elk Grove Village, Illinois 60007; phone (312) 438-8800.

CM-7207



... cataloged in eem

**TRW**  
CINCH CONNECTORS

Circle 9 on reader service card

**Two new P&B series  
dry reed relays  
give designers  
9,627 options.**



## Now, your design work is simplified, your choice of dry reeds is broadened, with our new JRC and JRD series. And P&B Quality comes as a bonus.

With 9,627 options, these two new series of dry reed relays present printed circuit board designers new opportunities for creative engineering.

Each is miniature in size with terminals spaced on 1.00" centers.

Each offers a choice of contact arrangements and coil terminals.

Each is available now from authorized P&B electronic parts distributors.

Importantly, you get P&B quality at competitive prices in all quantities.

**JRC reeds** have terminals arranged for .100" x 1.00" grid spacing and feature a low profile (.36") to permit close stacking of pc boards. In-line termination is in keeping with the industry trend, and the JRC coil leads terminate at any of four corners. The terminals are supported by the bobbin, and any forces encountered are transmitted to the stand-off flange to prevent stressing the glass seal of the capsule.

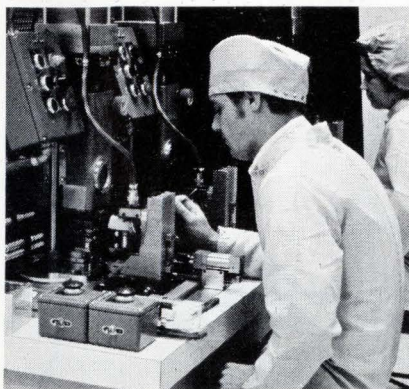

P&B precision assembly machines make it possible to control gap variance in reeds to within 2/10,000ths of an inch. (1/10th the thickness of a human hair.)

Contact configurations are available in Form A (SPST-NO), Form B (SPST-NC) and combinations of Forms A and B. For DC restive loads, the contacts have a maximum rating of 10 watts, .5 ampere, and 200 volts. Typical operate speeds at 25°C are 1 millisecond including bounce for pick-up and .05 millisecond drop-

out. Available coil voltages range from 3 to 48VDC.

The JRC series may be ordered with 1, 2, 3, 4, 5 or 6 cavity bobbins.

**New JRD dry reed relays** offer design engineers the option of .150" x 1.00" grid spacing. Slightly larger than the JRC package, the JRD's are similar except they offer, in addition to Forms A and B, a true Form C (SPDT) contact configuration. JRD's may be ordered in 1, 2, 4 or 6 cavity bobbins.

JRC and JRD open style, dry reed relays are produced to exacting tolerances and provide design engineers with a wide selection of contact configurations for logic circuitry, instrumentation and low voltage applications. Both series are available with or without magnetic shielding.

For complete information, or advice, and for your copy of the 226 page relay catalog, write Potter & Brumfield Division, AMF Incorporated, Princeton, Indiana 47670. Or, simply call 812 385-5251.

**Replacements for IBM Reed Relays.** While not identical in all aspects, JRD Reed Relays have the same terminal spacings and electrical characteristics as those manufactured by IBM.

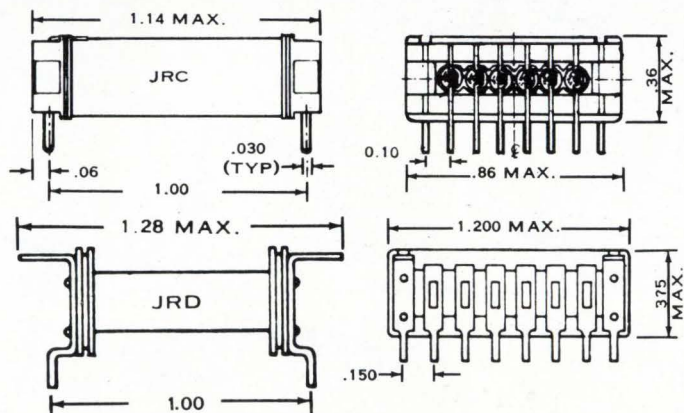

**P&B makes more of more kinds of relays  
than anybody in the business.**

**Anybody.**

## Get less for your money.

Less packages, less wiring, less cost, less space and weight, less power needed.

The Am 2502: An 8-bit successive approximation register for serial or parallel data output.

The Am 2503: An 8-bit SAR for expandable parallel data output with input enable.

The Am 2504: A 12-bit SAR for serial or parallel output.

**There's more.** 20MHz response. Synchronous start capability. Easy adaptation for truncation. MIL-STD-883.

If you're doing A-to-D conversion, recursive techniques, ring counters, serial to parallel conversion, you've got to let us introduce you to our SAR family.

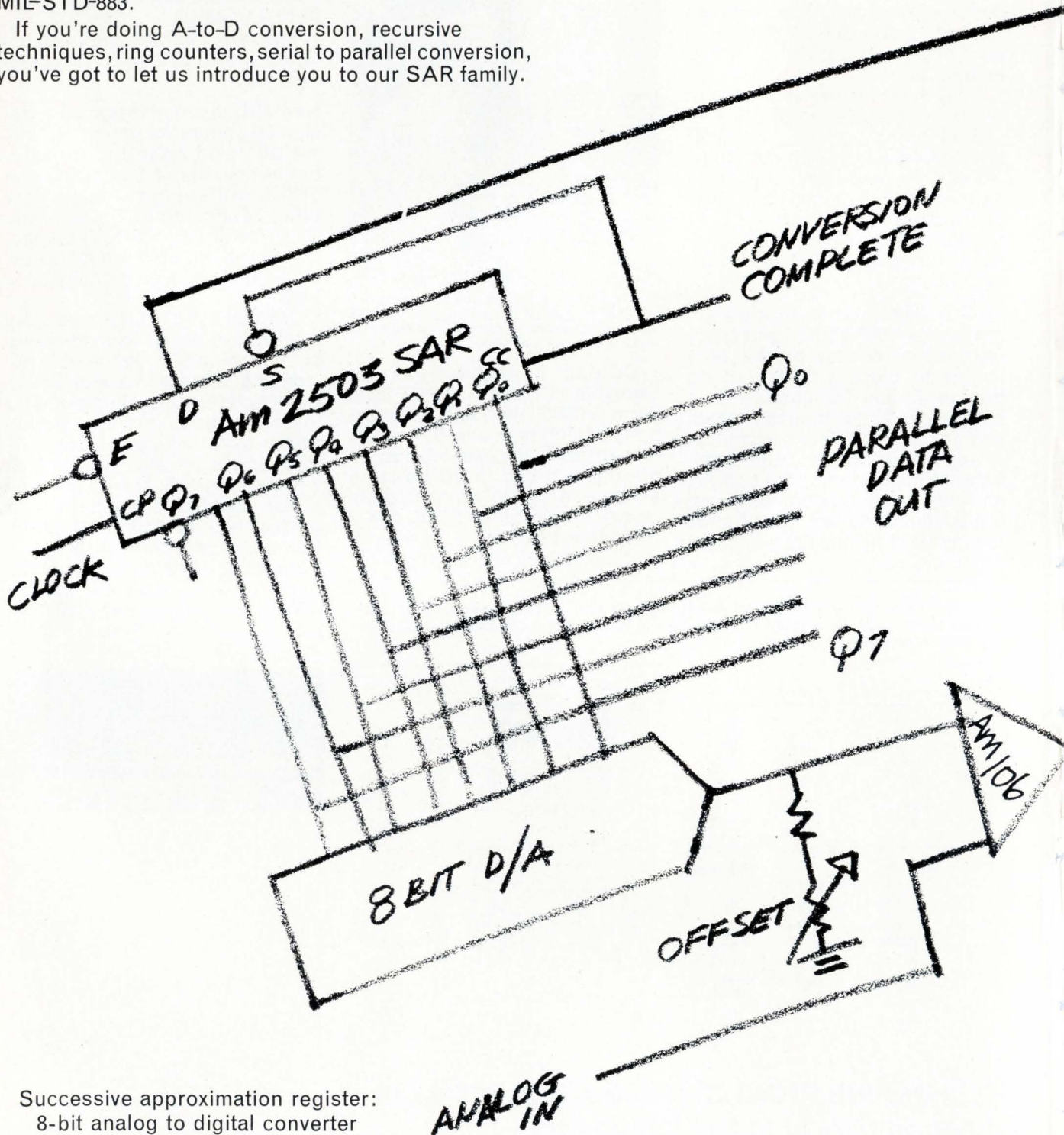

Successive approximation register:  
8-bit analog to digital converter

**All the logic for an  
A-to-D converter in one chip,  
one package.**

**(Eight or twelve bits.**

**Serial or parallel data**

**outputs.) More reasons**

**why we're going to be the**

**sixth largest integrated**

**circuit company in the**

**United States by 1975.**

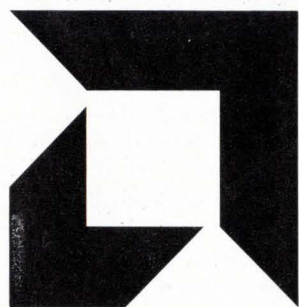

**Advanced Micro Devices, Inc.**

**(We're going to be #6)**

Distributed nationally by Hamilton/Avnet and Cramer Electronics. Telephone 800-538-7904 toll free, or in California 408-732-2400, and ask for Shel Schumaker. In Los Angeles, Steve Zelencik or Russ Almand at 213-360-2102. In Mid-America, Chuck Keough at 312-297-4115. In the eastern United States, Steve Marks or Bill Seifert at 516-676-4500, and Stu Cohen at 516-482-9320. 901 Thompson Place, Sunnyvale, California 94086/TWX 910-339-9280/TLX 346306.

Circle Bingo #202

# RCL

## SWITCH ENGINEERING HANDBOOK



AN EASY-TO-READ  
NEWLY EXPANDED  
TECHNICAL CATALOG OF  
INDUSTRY'S MOST  
COMPLETE SELECTION  
OF  
MINIATURE  
ROTARY  
SWITCHES

# RCL

General Sales Office  
RCL ELECTRONICS, INC.  
700 South 21st Street  
Irvington, New Jersey 07111

## People

### GSA's Trimmer aims for computer impact

Changing the name of a Washington agency from one acronym to another may not sound like much, but to Harold S. (Ted) Trimmer of the General Services Administration, it was important. Three days after he took over GSA's brand-new Automated Data Processing and Communications Service (Adpacs), the thoughtful Trimmer changed it to the Automated Data and Telecommunications Service (ADTS).

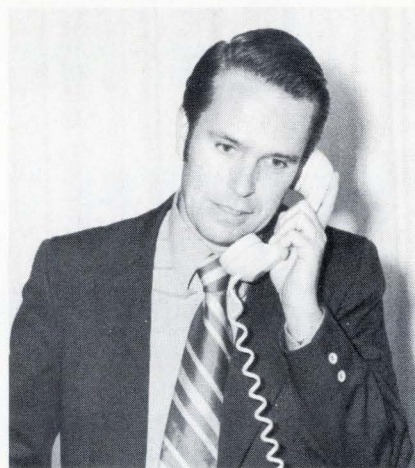

**Trimmer:** There is something in a name.

"Adpacs sounded like some sort of military operation in the Pacific," he says with a smile. "That name emphasized automated data processing, whereas the whole thrust is toward data management." Also, Trimmer adds, "it's telecommunications we're talking about, not just mail."

The 34-year-old lawyer explains that the new name reflects "the growing convergence of the two technologies" and the reason for the reorganization that created his agency, one that is designed to give GSA much greater control over the Government's computers [*Electronics*, July 31, p. 33]. Besides leading ADTS into new hardware and systems projects, Trimmer must oversee the start-up of the new data teleprocessing and retrieval system being installed.

But the management-minded Trimmer also is looking into ways to

help Government managers improve use of the hardware, as well. "We're putting together a number of explanatory documents giving alternatives to ADP managers," he says, so that they can find the best and cheapest ADP uses and equipment. Another is development of a management-information inventory.

The first rule of management is to get results. Trimmer says that one of the first things he did was to set up a list of priorities with three criteria for each project on the list: "It will have a fairly significant impact on the community (agencies and suppliers) we serve;" "the projects are capable of realization in a short time;" and "the benefits are high, in proportion to the resources we invest," which he quickly translates as "more bang for the buck." Organizing his agency, hiring people, and getting them motivated are other priorities he mentions.

**Key man.** The quiet-spoken but energetic Trimmer is no stranger to administration in his short GSA career. Since signing on as director of Congressional affairs in 1969, he had been successively executive assistant to the administrator and assistant administrator before taking his new post. A Phi Beta Kappa graduate of Wesleyan University and Harvard Law School, Trimmer practiced in San Francisco, New York, and Washington and taught law at UCLA.

### U.S. ocean technology impresses Mikhaltsev

When Igor E. Mikhaltsev journeyed last month to Washington from the Soviet Academy of Sciences in Moscow, where he is deputy director of the Institute of Oceanology, he liked what he found. At the Marine Technology Society's meeting where he was both a speaker and a guest, he was impressed by the extent of information exchanged and "by people coming and just saying what they think."

It was, he said, a forum that fits in neatly with his concept that "pure



# BUNDLE WITH **TY-RAP**<sup>®</sup> CABLE TIES



WT-193 Tool

## Cut Costs at Each Step of Harness Fabrication

**1. Tying a large variety of bundle diameters?** The new WT-193 tool gives you an improved level of control and convenience. The accurate preset tension control makes tying uniformity the responsibility of the tool rather than of the installer. The narrow nose and long slim body reaches in, cinches the TY-RAP<sup>®</sup> tie to a preset tension and trims it evenly . . . even in those tough high-density areas.

**2. Repetitious tying in large quantities?** The new TR-300 high-speed tool gives you several benefits. In 8/10th of a second, it installs a TY-RAP tie around a bundle up to 5/8" diameter, cinches and trims evenly.

**3. Here's the most important reduction benefit!** The ultimate key to savings is the locking device in the cable tie. Only TY-RAP ties give you a "grip of steel." A patented, non-magnetic, stainless steel locking wedge is embedded in the nylon cable tie. It's in every self-locking tie, from the miniature 3 inch for 1/16" dia. to the 30 inch tie

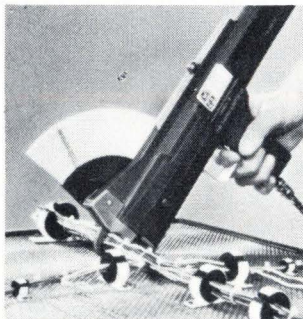

for 9 inch bundles. It is used in virtually every modern aircraft, communication, business machine and electrical equipment application . . . in general wherever wire is used.

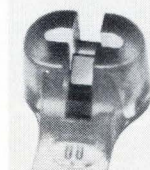

### 4. Tired of the recurring costs of harness boards?

Our new modular harness board is designed to substantially reduce costs while providing convenience. It is constructed of polyethylene foam sandwiched between two metal screens — the nails can be pushed in by hand. It's reusable. It's reversible. It's modular — boards interlock in seconds to produce any size board needed.

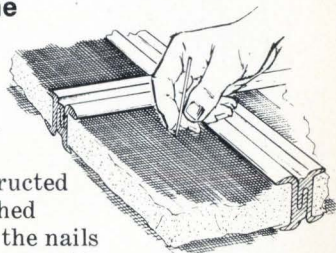

Write for new catalog, The Thomas & Betts Company, Elizabeth, New Jersey 07207 (201) 345-4321. In Canada, Thomas & Betts Ltd., P. Q.

509

Sold Only  
Through  
T & B Distributors



**THOMAS & BETTS**

Division of Thomas & Betts Corporation

Circle 15 on reader service card

# New types WIMA® capacitors for industrial electronics and for exacting requirements

- Metallized polyester capacitors
- Metallized polycarbonate capacitors
- Metallized polypropylene capacitors
- Plastic film capacitors in special capacitance tolerances
- Plastic film capacitors for A.C. and pulse duty
- Miniature capacitors
- Low voltage electrolytic capacitors



**WIMA capacitors are quality components for electronic equipment.**

*Please send for the latest technical catalogue.*



## WILHELM WESTERMANN

Spezialfabrik  
für Kondensatoren  
D-68 Mannheim 1  
Fed. Rep. of Germany

Augusta-Anlage 56  
P.O. Box 2345  
Tel.: (621) 40 8012  
Telex: 4-62 237  
Cables: Wimakondensator

## People

science has to be published" if it is to be useful.

Mikhaltsev looks like the archetypal oceanographer popularized by the likes of Jacques Cousteau. Lean almost to the point of being cadaverous, with graying hair uncombed, the Soviet oceanographer affects the casual attire of a middle-aged academic—unpressed white Oxford shirt, knit tie, slacks, saggy gray woolen socks, and unpolished loafers. It is a very Western image, enhanced by his grasp of English.

**Broad view.** Applications-oriented meetings like those of MTS are "a good idea," in Mikhaltsev's view. "We do not have them in Russia," where the emphasis is on a larger number of "narrow-beam symposia on many different topics." On the other hand, Mikhaltsev ranks West European ocean engineering meetings as too broad.

Though Mikhaltsev points out that the charter of his 600-man institute is to advance the state of the art, and therefore it "does not work on applied programs," his preferences among the papers presented at the MTS sessions were clearly for applications, notably military.

On the subject of oceanographic instrumentation, the Russian suggests a scientific disdain for the highly structured Soviet industrial bureaucracy that makes it difficult to obtain anything in small quantities. "We have no small industries in Russia," he observes with a smile, "so you must get instruments abroad if you want only one."

**Strategic.** But that is not the only problem Mikhaltsev faces in the administration of his widely scattered organization, with its Atlantic department at Kaliningrad on the Baltic Sea, a southern department on the coast of the Black Sea, and an expanding Pacific department at Vladivostok. Mikhaltsev finds himself occasionally stymied in his overseas procurement efforts by NATO constraints on the sale of potentially strategic items to Russia. It is a concept he finds philosophically puzzling: "What is strategic? You can call a pencil strategic if it is in the hands of a General Westmoreland or a General Zhukhov."

# A counter offer from Dana.

**Compare H-P's 5326A to our 8010B.  
If you don't buy ours,  
we'll help you buy theirs.**

Comparing the two won't take you very long. Dana's frequency is three times better. 150 MHz vs. 50 MHz.

Dana's sensitivity is two times better. 50 mV vs. 100 mV.

Dana gives you 8 digits. H-P gives you 7. Their eighth costs another \$75.

Dana's counter has a 100 second time base. H-P's has only 10 seconds. Dana's trigger levels are stable. You won't need to readjust triggers



during time interval measurement.

Dana uses standard TTL plug-in IC's. H-P doesn't. So we're easier to service.

Dana's base price is \$1,245. H-P's is \$1,250. Or, possibly, \$1,230.

Because if you will compare ours with theirs, and you still want theirs... we'll give you \$20.

In the U.S.A., call Tom Krueger collect at (714) 833-1234 before Dec. 31, 1972. Ask for his counter offer.

## DANA<sup>®</sup>

**Others measure by us.**



# AVX takes the bull by the horns



One year ago, Aerovox Corporation, the leading manufacturer of ceramic capacitors, recognized that the need for ceramic capacitors would expand rapidly over the next decade and decided to meet that demand horns-on.

In April 1972, Aerovox established AVX Ceramics as a separate incorporated entity with a charter to initiate and anticipate the steps necessary to meet the expanding markets.

As an autonomous subsidiary corporation, AVX Ceramics' management is committed to a policy of research, development and quality manufacturing, which will maintain and enhance the leadership position it now enjoys.

Within six months AVX Ceramics will add a new manufacturing facility — the first major ceramic capacitor plant built in recent years. This new facility, in addition to our Myrtle Beach, South Carolina, and Olean, New York manufacturing operations, will provide a continuing outstanding quality line of products plus adding a substantial increase in production capability to make AVX Ceramics your dependable, on-time source for ceramic capacitors.

Old habits are hard to break . . . we realize you may still think of us as Aerovox . . . and, that's fine . . . as long as you remember to call AVX Ceramics . . . for, in fact . . . we've got the Bull by the Horns.

*For complete information write or call*

AVX Ceramics Corporation, Myrtle Beach, South Carolina 29577.

Telephone: (803) 448-3191.

**AVX**  
CERAMICS CORPORATION

Braintree, Massachusetts

Circle 19 on reader service card

Dear Gabby

"My Boyfriend Says  
Three is a Crowd  
Unless It's A Datatron  
Time Search Unit..."



Datatron's Girl Gabby

DEAR GABBY. My boyfriend from the missile range says that 3 is a crowd on my front porch, unless it's a Datatron Time Search Unit. Is he trying to tell me something? TIME ON MY HANDS

DEAR TIME: No doubt he wants to get you alone for devious purposes. Gabby knows men! However, he's right about Datatron's new 3030 which combines a time code generator, a translator AND a tape search unit in a single compact 7" rack mount cabinet. It's certainly not a crowd, offering versatility, economy and a big saving in rack space.

who correlate time and events with computers. GABBY

★ ★ ★  
DEAR GABBY: My husband is all thumbs. He keeps setting up the wrong start and stop times on his tape search unit. Pleeze help us before he gets fired. FOND OF EATING

DEAR FOND: Again Datatron's new 3030 to the rescue! Instead of using conventional thumb-wheel switches, Model 3030 features a unique keyboard entry of start and stop times. Even a chimpanzee with gloves could enter data accurately. GABBY

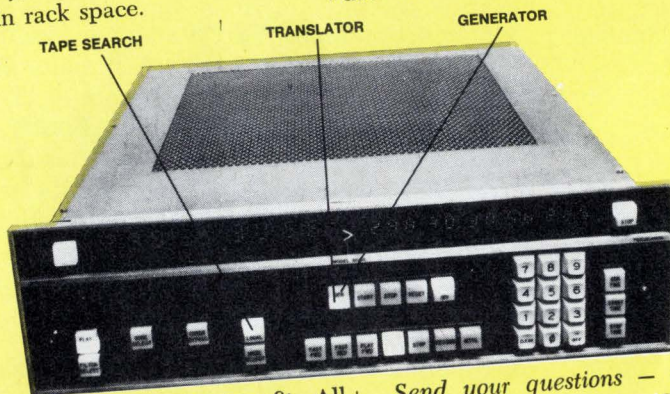

Another important benefit. All key functions such as tape motion control, filter and code selection, and error by-pass can be computer controlled. Which makes the 3030 ideal for data reduction centers

Send your questions — either straight or humorous — to Gabby. We'll mail a Flair pen for all received and pay \$100 if we use question in future ad.

**datatron inc.**

1562 Reynolds Ave / Santa Ana, Calif. 92711  
(714) 540-9330

moving up fast in...



Automatic Test Systems



Microelectronic Testing



Instrumentation Timing



Shelly Indicators and Readouts



Vidicue TV Editors

## Meetings

**International Microelectronics Symposium:** ISHM, Shoreham Hotel, Washington, D.C., Oct. 30-Nov. 1.

**Nerem:** IEEE, John B. Hynes Civic Auditorium, Boston, Nov. 1-3.

**Canadian Conference on Communications and EHV Power Transmission:** IEEE, Queen Elizabeth Hotel, Montreal, Nov. 9-10.

**Automatic Support Systems Symposium:** IEEE, Holiday Inn—Penn Center, Philadelphia, Nov. 13-15.

**Electronica 72:** Munich Fair Grounds, Munich, West Germany, Nov. 23-29.

**Int. Conference on Digital Satellite Communications:** Intelsat, Unesco Building, Paris, Nov. 28-30.

**International Conference on Magnetism and Magnetic Materials:** AIP, IEEE, et al., Hilton, Denver, Nov. 28-Dec. 1.

**National Telecommunications Conference:** IEEE, Astroworld, Houston, Dec. 4-6.

**International Electron Devices Meeting:** IEEE, Washington Hilton, Washington, D.C., Dec. 4-6.

**Annual Fall Conference:** IEEE, Sheraton-O'Hare, Chicago, Dec. 4-5.

**Fall Joint Computer Conference:** AFIPS, Convention Center, Anaheim, Calif., Dec. 5-7.

**Nuclear Science Symposium:** IEEE, Deauville Hotel, Miami Beach, Fla., Dec. 6-8.

**Aerospace Sciences Meeting:** AIAA, Sheraton-Park, Washington, Jan. 10-12, 1973.

**International Solid State Circuits Conference:** IEEE, Marriott, Philadelphia, Feb. 14-16, 1973.

**Aerospace and Electronic Systems (Wincon):** IEEE, Sheraton-U. of Pa., Philadelphia, Feb. 13-15, 1973.

# Bendix puts an end to the bends.

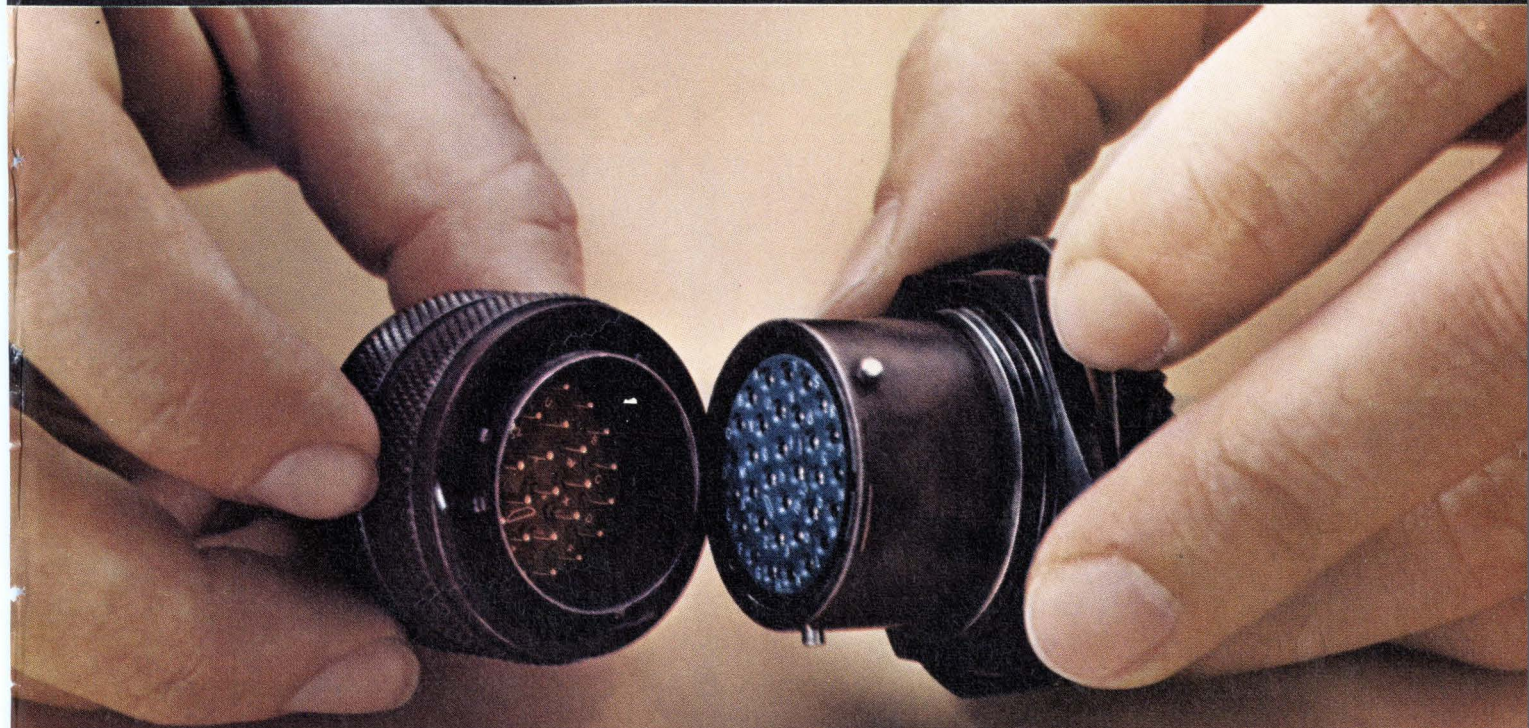

You know the bends. That's when connector pins are bent or damaged during mating by misaligned plug and receptacle.

The bends just can't happen with Bendix SJT connectors. Pins are recessed. Stronger, too. And that makes them 100% scoop proof. You get positive protection whether the pins are in receptacle or plug.

You get five-key polarization, too. And that makes mismatching a thing of the past.

Another key feature: Bendix 100% scoop-

proof SJT connectors conform to the mounting dimensions of low silhouette (JT) series II MIL-C-38999 connectors. They're available in lightweight shell sizes from 8 to 24 with from 3 to 128 crimp type contacts accommodating wire gauges from 12 to 28.

Now then. Like to put an end to the bends? Write for our new SJT catalog.

The Bendix Corporation, Electrical Components Division, Sidney, New York 13838.



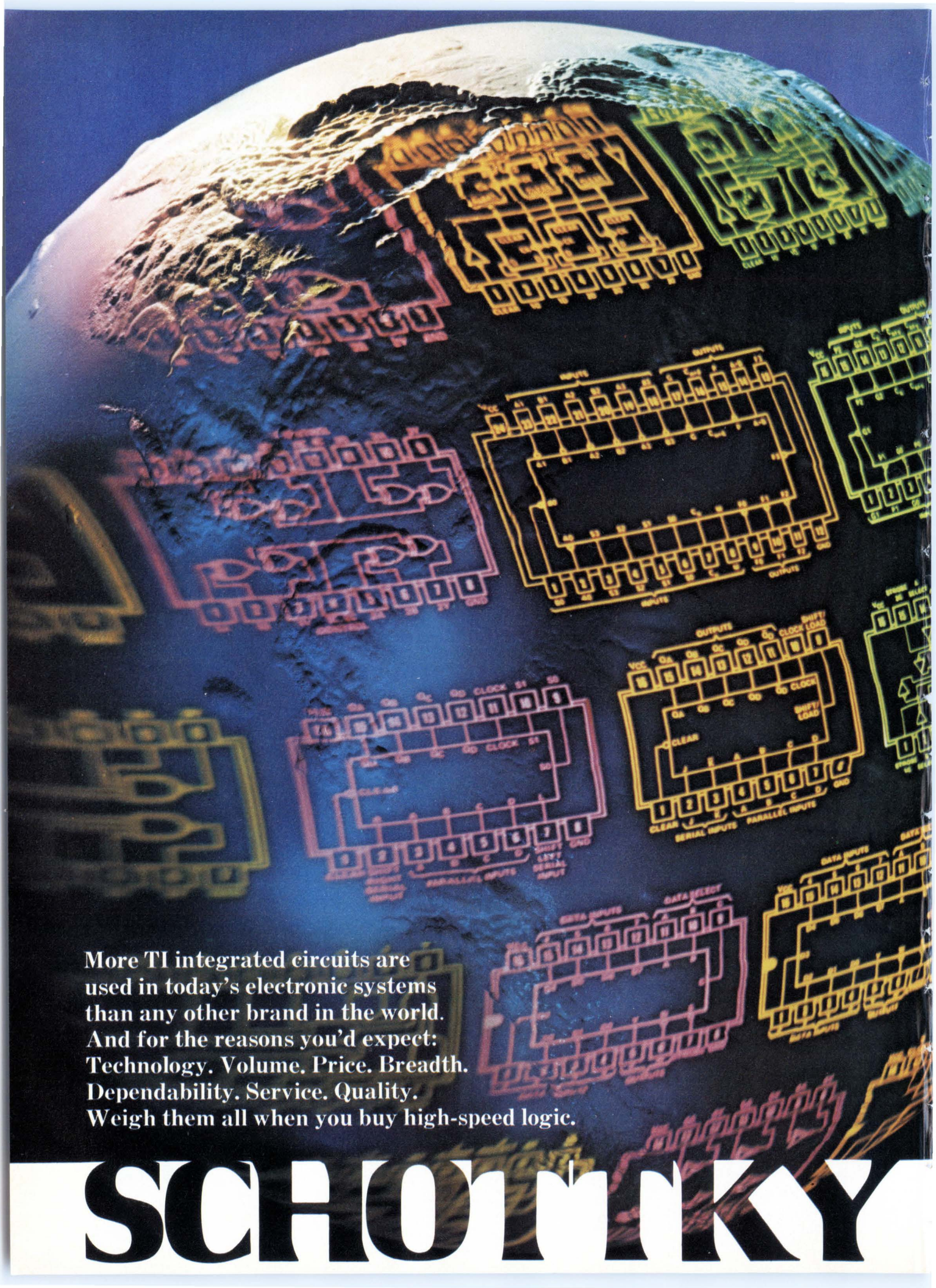

More TI integrated circuits are used in today's electronic systems than any other brand in the world. And for the reasons you'd expect: Technology. Volume. Price. Breadth. Dependability. Service. Quality. Weigh them all when you buy high-speed logic.

# SCHOLARKEY



# It's a 54/74 world.

## And TI's 3-ns Schottky TTL expands your design horizons.

36 functions now...12 soon to come. And more tomorrow.

More and more designers are finding, as their competition gets keener, that TI's Schottky TTL gives them a competitive edge. Not only in system performance, but also in the price, delivery and reliability of their equipment.

The reason is simple. Since TI introduced it in 1965, 54/74 TTL has become the most popular, most second-sourced logic form. It offers an unmatched combination of reliability, design simplicity, volume availability, low cost, versatility and MSI complexity. It has set the standards for the industry.

Schottky 54S/74S TTL, introduced by TI in 1970, still offers all these advantages—but adds greatly improved performance. And again, TI's Schottky TTL is setting the standards.

### Broadest choice of functions

TI has introduced and delivered more Schottky TTL circuits than any other manufacturer. We've announced 17 new ones this year—decoders, D-registers, shift registers, multiplexers, arithmetic elements—for a total of 36 MSI and SSI functions available now. Within six months, there will be 12 more (including some high-performance memories).

Some benefits of TI's Series 54S/74S are:

- **Volume availability**—TI has been building Schottky circuits for 2½ years. High-volume production experience keeps yields up, delivery lead-time short, and distributor stocks full.
- **Proven reliability**—the same built-in reliability found in all TI 54/74 circuits has been proven for TI Schottky TTL by extensive factory testing and field experience.
- **Full temperature operation, full package choice**—both industrial (0° to 70°C) and military (-55° to 125°C) ranges for all MSI and SSI functions, available in plastic and ceramic DIPs and ceramic flat packs.
- **Improved system performance**—average gate speeds are less than 3 ns at 19mW.
- **Full compatibility**—TI Series 54S/74S Schottky is

fully compatible with all 54/74 TTL—standard, high-speed, low-power and low-power Schottky.

### Series 54S/74S Schottky MSI circuits

#### 110-MHz Shift Registers/Storage Registers

SN54S/74S174	Hex D-type storage register
SN54S/74S175	Quad D-type flip-flop, complementary outputs/clear
SN54S/74S194	4-bit bi-directional shift register
SN54S/74S195	4-bit parallel-access shift register

#### Arithmetic Elements

SN54S/74S86	Quadruple Exclusive—OR
SN54S/74S135	Quadruple Exclusive—OR/NOR
SN54S/74S181	4-bit arithmetic logic unit and function generator
SN54S/74S182	Carry look-ahead generator for SN54S/74S181

#### Data Selectors/Multiplexers

SN54S/74S151	8 to 1-line
SN54S/74S251	8 to 1-line with tri-state outputs
SN54S/74S157	Quad 2 to 1-line, true output
SN54S/74S257	Quad 2 to 1-line with tri-state true outputs
SN54S/74S158	Quad 2 to 1-line, inverting output
SN54S/74S258	Quad 2 to 1-line with tri-state inverting outputs
SN54S/74S153	Dual 4 to 1-line

#### Decoders/Demultiplexers

SN54S/74S138	3 to 8-line
SN54S/74S139	Dual independent 2 to 4-line

### Series 54S/74S Schottky SSI circuits

SN54S/74S00	Quadruple 2-input positive-NAND gate
SN54S/74S03	Quadruple 2-input positive-NAND gate, o.c. output
SN54S/74S04	Hex inverter
SN54S/74S05	Hex inverter, o.c. output
SN54S/74S10	Triple 3-input positive NAND gate
SN54S/74S11	Triple 3-input positive AND gate
SN54S/74S15	Triple 3-input positive AND gate, o.c. output
SN54S/74S20	Dual 4-input positive NAND gate
SN54S/74S22	Dual 4-input positive NAND gate, o.c. output
SN54S/74S40	Dual 4-input positive NAND buffer
SN54S/74S64	4-2-3-2-input AND-OR-INVERT gate
SN54S/74S65	4-2-3-2-input AND-OR-INVERT gate, o.c. output
SN54S/74S74	Dual D-type edge-triggered flip-flop
SN54S/74S112	Dual J-K negative-edge-triggered flip-flop (125 MHz) with preset and clear
SN54S/74S113	Dual J-K negative-edge-triggered flip-flop (125 MHz) with preset
SN54S/74S114	Dual J-K negative-edge-triggered flip-flop (125 MHz), common clock and clear
SN54S/74S133	13-input NAND gate
SN54S/74S134	12-input NAND gate with tri-state output
SN54S/74S140	Dual 4-input positive-NAND line driver

For Bulletin CC-408 on TI's 3-ns Schottky TTL, circle 216 on Service Card. Or write Texas Instruments Incorporated, P. O. Box 5012, M/S 308, Dallas, Texas 75222.



TEXAS INSTRUMENTS  
INCORPORATED

# For fast, accurate settings,

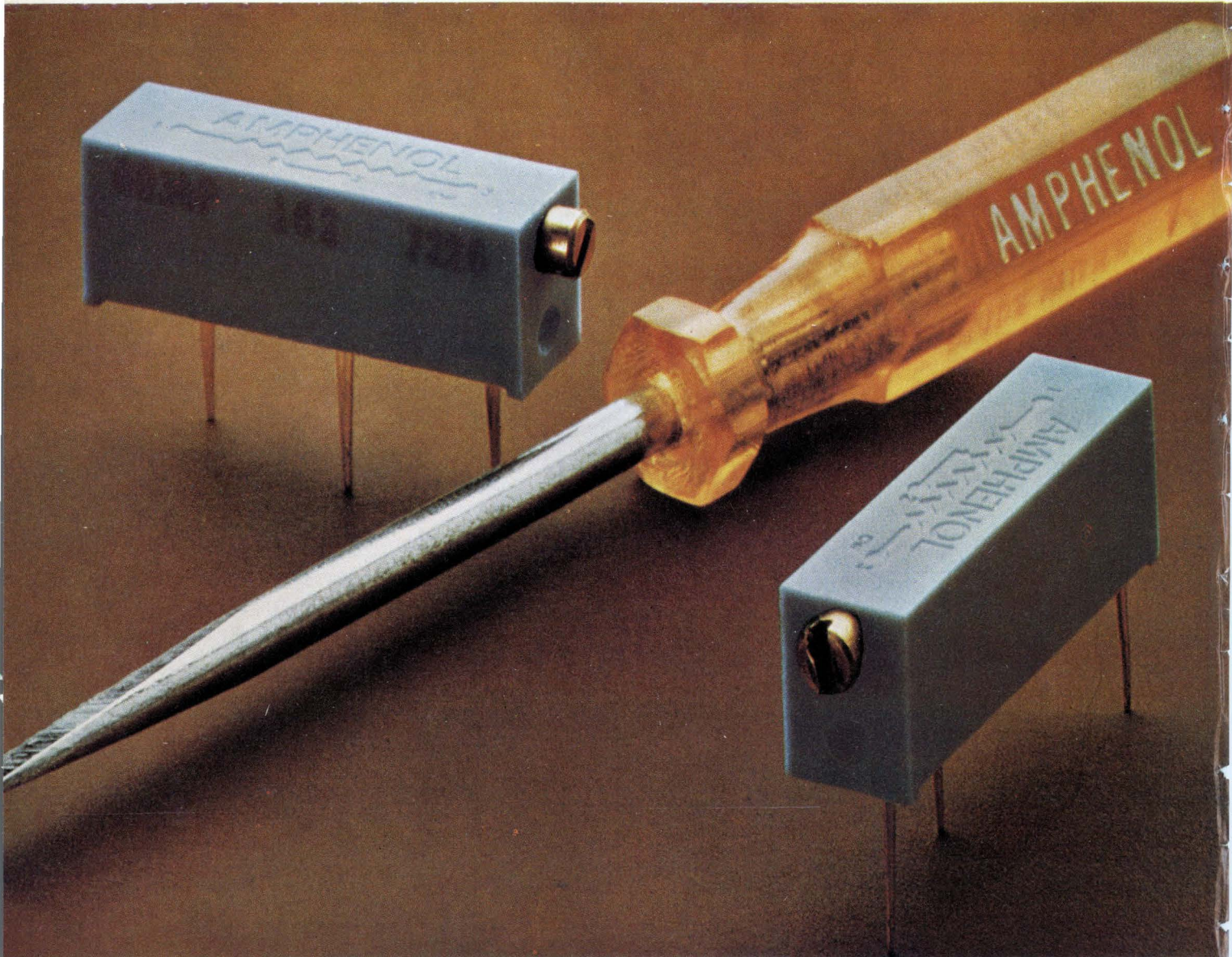

## test drive our 6034 trimmer.

Amphenol's 6034 Series trimmers have multi-finger contacts to give you better setability, lower CRV, and longer rotational life.

This  $\frac{3}{4}$ " cermet trimmer is designed with a low profile for maximum board stacking and has a solvent-resistant nylon case with epoxy seal for automated board cleaning processes. The Amphenol 6034 Series trimmer will operate at ambient temperatures up to 125°C and is completely humidity-proof. Three termination styles—P, K or Y terminals—are available.

The low-cost 6034 has a rotation life of 200 cy-

cles minimum with no discontinuity. All are 100% inspected for noise, total resistance, continuity and end resistance before shipping.

A barbed lead screw, with a 15-turn shaft adjustment, positively seals and eliminates end play. Without the typical O-ring there is no chance of pinching or breaking the seal.

Your local Amphenol distributor can arrange a "test drive" on your board. Let us set it up for you. Write Al Nemetz, Amphenol Connector Division, Controls Operations, Bunker Ramo Corporation, 2801 South 25th Avenue, Broadview, Illinois 60153.

Circle 24 on reader service card

**BUNKER  
RAMO**

# AMPHENOL

## TI breaks its CCD silence

TI's work in charge-coupled devices finally has surfaced with the development of two types of CCD analog matched filters used extensively in radar. One is a 5- to 10-megahertz unit, matched to a 13-chip Barker code; the other is a filter matched to a linear fm signal. **CCD technology is suited for analog filter applications because, unlike the conventional coaxial and glass filters, the filters are built by conventional semiconductor processing.** By simple clocking, they can produce constant, as well as tapped, variable delays—from a couple of microseconds to hundreds of milliseconds. TI's CCD structures, which are adaptable to imaging, as well, are three-phase single-level p-channel devices with threshold voltages of less than 4 volts.

## IBM eyes CCDs for high-density memory

Coming off its early modest CCD memory work [*Electronics*, Feb. 28, p. 31], IBM has developed a new CCD structure that has densities of 2 to 3 million bits per square inch—**5 to 10 times the density of today's semiconductor technologies.** IBM, at its Essex Junction, Vt., facility, has tested CCD series memories of eight, 128, and 256 bits that exhibit an average bit area of 0.32 mil<sup>2</sup> to 0.48 mil<sup>2</sup>, compared to 2.08 mil<sup>2</sup> for the old structures.

Even when refresh circuitry is included, IBM designers envision putting 32,000 bits of memory on a 150-by-150-mil chip, with clocking rates of about 20 megahertz. **The only problem IBM foresees for these high-density chips is power handling**—at 20 MHz, the average power requirement is approximately 50 microwatts per bit, or 1.6 watts for 32-kilobit chip, a power requirement that could strain conventional support circuitry.

## Western Digital microcomputer to be ready in spring

Continuing the trend among semiconductor houses to larger systems, **Western Digital Corp. has hired a vice president for MOS LSI research and development.** He is William H. Roberts, one of the founders of minicomputer-maker Microdata Corp., who has had extensive experience in digital computers, software, and data communications. He admits that Western is now developing a microcomputer for sale to OEMs, and plans its introduction in the spring.

Roberts thinks that present minicomputer companies will be big customers for the products, particularly for use in terminals and other peripherals. He says Western, therefore, will not go after end-user sales. **The company also will introduce a complex high-speed synchronous/asynchronous data-communications receiver and transmitter** in November, and a FIFO (first-in, first-out), or silo, register this winter.

## D.C. to count votes with OCR system

A strikingly simple electronic vote-counting technique, to be used in Washington, D.C., on Nov. 7, may make such technology look good again after the 1968 and '70 California punch-card snarls. **Not only that, it may bring back the paper ballot.**

Voters in the capital will mark ballots with ordinary No. 2 pencils. The ballots will be taken to a central station where a Control Data Corp. optical-character reader with a solid-state mark-read head will read them. A small CDC model 8092 computer will tabulate the vote

and cull incorrect or double markings for later examination by election officials.

Joseph Pisarra, national sales manager at Control Data's OCR division in Rockville, Md., says **the equipment will cost the district about \$2,200 a month—less than it would cost to store and set up voting machines.** And the system will be used year-round for other jobs.

### **Epitaxial reactor viewed as help for overbooking**

A new epitaxial reactor, expected soon from Hugel Industries, Sunnyvale, Calif., may relieve some of the pressure felt in the semiconductor industry by overbooking, even though some plants are operating two shifts a day, seven days a week. **Many semiconductor companies are looking toward the switch from 2-inch to 3-in. wafers as a way for them to get out from under, and the Hugel reactor may be the key.**

Present units have a capacity of 20 2-in. wafers per tube (most are two-tube units), but the new Hugel module will be able to handle up to 44 2-in. wafers, or 21 3-in. wafers per tube. Thus, manufacturers will be able to process the same number of wafers as they did before, but the number of dice will be doubled because 3-in. wafers carry twice as many dice as 2-inchers. Some of the new reactors are expected to roll out by the end of November, but the company is quoting delivery for early next year.

### **AMI, Austrian firm form joint liquid-crystal company**

A joint venture to develop, manufacture, and sell liquid-crystal displays and associated display products has been launched by American Microsystems Inc., of Santa Clara, and D. Swarovski & Co. of Wattens (near Innsbruck), Austria. The new jointly owned company, AMI-Swarovski AG, will headquarter in Switzerland and **will market its products in the U.S. and throughout Europe.** The agreement is the result of an 18-month cooperative effort to perfect liquid-crystal-display technology and capitalize on the rapidly growing market.

AMI's recent research efforts in the joint enterprise have been concentrated on liquid-crystal materials and sealing techniques, while Swarovski has been perfecting the necessary glass metalization and manufacturing technology. **Swarovski is a major producer of metalized and optically coated precision glass parts, optical products, abrasives and synthetic gems, and is one of the world's largest manufacturers of fine custom jewels and cut glass.** The 77-year old family-owned company, which has plants in several Austrian cities and 47 companies worldwide, employs more than 5,000 persons.

Both AMI and Swarovski are manufacturing and selling pilot-line quantities of liquid-crystal displays. Full-scale production facilities are expected to be operational by the end of 1973.

### **Addenda**

Look for even faster subnanosecond switching times in ICs, **thanks to a constant-impedance coaxial interconnect system now under development at AMP Inc.** in Harrisburg, Pa. In addition to speed, AMP claims its technique will reduce crosstalk and improve thermal dissipation. . . . GE's venture capital subsidiary, Business Development Services, and C-MOS manufacturer Solid State Scientific of Montgomeryville, Pa., are forming a new company to develop "integrated" display systems incorporating C-MOS circuitry and liquid-crystal displays.

# Q-LINE SCRs

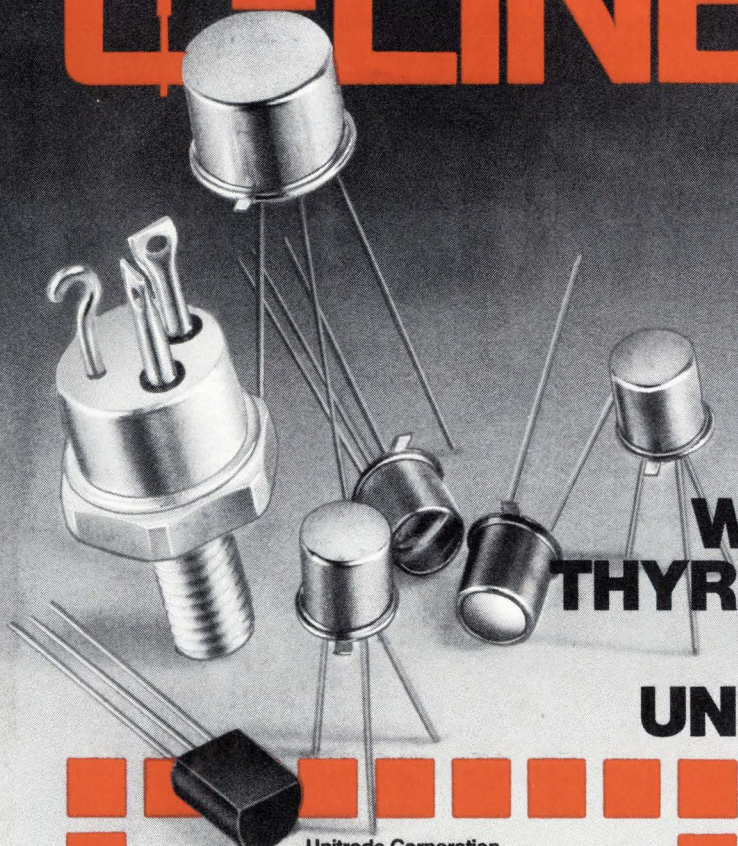

**WE PUT 14 YEARS OF  
THYRISTOR EXPERIENCE  
INTO EVERY  
UNITRODE SCR.**

**Unitrode Corporation**  
Dept. 10Y, 580 Pleasant St., Watertown, Mass. 02172

Please send SCR information kit containing detailed specs and application notes.

NAME \_\_\_\_\_

TITLE \_\_\_\_\_

CO. \_\_\_\_\_

ADDRESS \_\_\_\_\_

CITY \_\_\_\_\_ STATE \_\_\_\_\_ ZIP \_\_\_\_\_

And that means a better industrial product. Our performance record proves it. In industrial/commercial applications, the use of Unitrode SCRs doubled last year and has doubled again this year. For the military, Unitrode supplies more lead-mounted SCRs than everyone else combined. Unitrode is the only SCR supplier with Military Qualification Approval on all TO-5 and TO-18 mil. specs. Why this kind of acceptance? Our experience. It means a lot to people who've had experience with less.

Our broad line of SCRs including plastic and hermetically sealed metal types offers a wide range of choices for literally hundreds of applications. The Unitrode SCR product line ranges from our very popular, rugged 0.8 amp TO-92 plastic package and TO-18 hermetically sealed series to our 1.6 amp TO-5 and TO-39 series and 5 amp TO-59 stud series. Some series are available to 600 volts.

It's what you would expect from a company that makes thyristors a major part of its effort — not just a sideline.

For fast action, call Sales Engineering collect at (617) 926-0404. Unitrode Corporation, 580 Pleasant St., Watertown, Mass. 02172.

See EEM Section 4800 And EBG Semiconductors Section for more complete product listing.

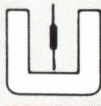

**UNITRODE** quality takes the worry out of paying less.

# DOOPS!

## The Heavy-Duty DMM Bounces Back.

Don't worry about missing with the rugged Hickok 3300A Digital Multimeter. Its tough ABS case and shock-mounted components will take plenty of hard bounces.

Besides being tough, this 3½-digit Multimeter is versatile. It measures:

- DC/AC voltage from 100  $\mu$ V to 1.5 kV;
- DC/AC current from 100 nA to 2 A;
- Resistance from 100 m $\Omega$  to 200 M $\Omega$ .

And accuracy is good for 12 months.

The \$435 price includes real portability. The 3300A operates continuously 20 hours off its internal rechargeable battery. You can make measurements while recharging the battery. And the battery's good for 1000 recharges.

Notice the handy form factor—unique among digitals. It's made to carry around or to hang from a convenient spot by its handle.

You'll also like the automatic polarity and decimal point position, the out-of-range indication, 1500 volts off ground operation, and the continuous automatic zeroing. But you expect these from the company which was first with LSI circuits in digital multimeters.

Test it yourself. Call Hickok for a demonstration or for complete specifications.

## HICKOK

the value innovator

Instrumentation & Controls Division

The Hickok Electrical Instrument Co.

10514 Dupont Ave. • Cleveland, Ohio 44108

(216) 541-8060

# HICKOK

## Big market forecast by firms making auto traffic control systems

Should be \$200 million—  
SDC has \$133,000 contract  
from Oklahoma City; Sperry  
doing job for Raleigh, N.C.;

**Companies making** computerized traffic-control systems foresee a growing market as cities turn toward automation as a way to handle their traffic problems. Automatic Signals division of Laboratory for Electronics, Computran, Eagle Signal division, Econolite, IBM, System Development Corp., and Sperry Rand are driving into the lucrative municipal marketplace to install systems. System Development Corp., for example, recently received a \$133,000 contract to automate 33 intersections in downtown Oklahoma City by the end of next year, and Sperry Rand has just won a contract in Raleigh, N.C.

"We see quite a large market for these systems," says Allen L. Weber, project manager for SDC's Transportation and Telecommunications Systems department. "There must be 20 cities right now in various stages of developing specifications." SDC, among others, is bidding on a system for Baltimore, Md., that would control 900 intersections, and which Weber estimates will cost between \$7 million and \$8 million.

Concurring is Harold Whalen, marketing manager, traffic and transportation systems, in Sperry Rand's Systems Management division. "It's a big market," he says. If one looks at the number of cities that should have a digital system over the next four to five years, it adds up to \$200 million worth of

business." Sperry Rand soon will unveil the \$5 million urban traffic-control system, a 113-intersection project it built in Washington, D.C., as a demonstration system for the Department of Transportation.

Most systems operate on the same principle. SDC's traffic-actuated computerized signals (Tracs) system, for example, uses electronic vehicle-detectors buried in the pavement at each intersection to feed real-time data on vehicle count and speed to a centrally located minicomputer. Calculating 250,000 times per second, the computer selects the best traffic-light schedule for jammed streets at 5 p.m., as well as

nearly deserted ones at 5 a.m., updating the strategy every 5 minutes.

Telephone lines link the intersection signal controller to the computer and control center. The solid-state intersection controller receives the sensor inputs, and through multiplex communications, forwards them to the computer. The controller also replays the computer commands to the individual signals and automatically reverts to backup mode, should either the communications or the computer fail.

**Options.** The control center includes a display board showing the status of traffic lights at each intersection, a display board and com-

**Keep 'em rolling.** System Development Corp.'s Tracs (traffic-actuated computerized signals) system uses detectors buried at each intersection to feed data to minicomputer.

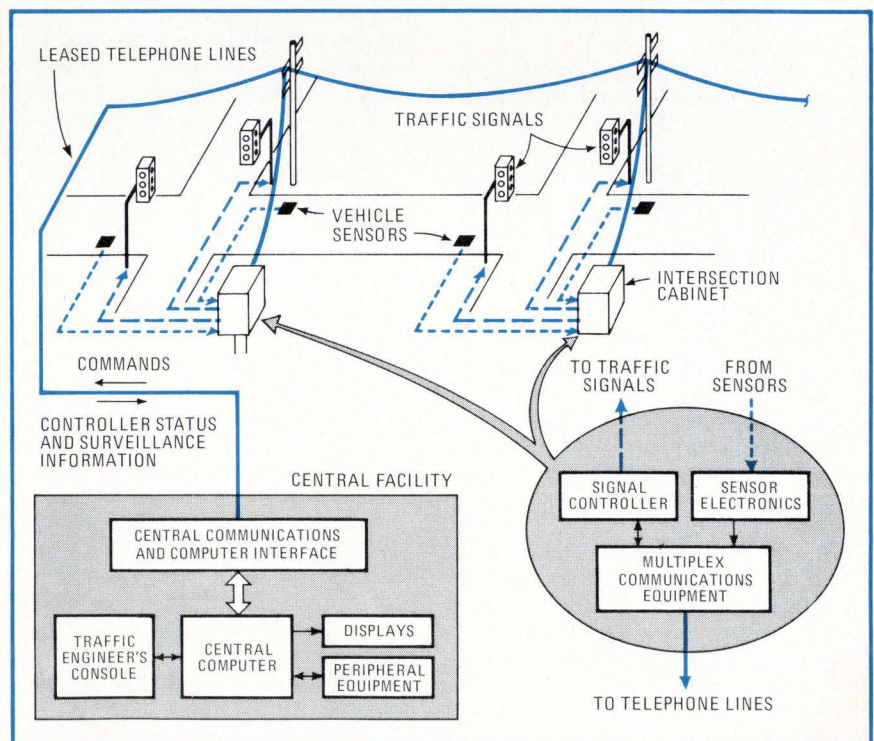

munications interface, and a traffic engineer's console. The system is designed so that a municipality can also operate its traffic lights from a preset pattern or otherwise override the computer to modify signal cycle lengths, splits, and offsets.

Weber says that, wherever possible, SDC prefers to retain the electromechanical signal controllers common to most cities. "We like to interface with existing controls," he says. "We prefer electromechanical controls over solid-state ones because they're generally more reliable." Part of SDC's background

comes from studies performed for the Transportation Department's Federal Highway Administration.

Among the cities that have installed or about to install systems, built by various companies, are: Wichita, Toronto, San Jose, New York City, Los Angeles, West Palm Beach and Tampa, Fla., Atlanta, Savannah, and Albany, Ga., Norfolk, Va., and Worcester, Mass.

There are larger projects in Miami-Miami-metropolitan Dade County, Fla., and New Orleans, La. Abroad, Glasgow, West London, and Berlin have similar systems. □

## DEC's Bell sees minicomputers following one of three routes determined by LSI

Which way are minicomputers headed? According to at least one executive, Gordon Bell, vice president of Digital Equipment Corp., and two of his colleagues, the industry can choose from three directions, all affected by LSI technology. They are:

- Hold technology constant and follow the LSI cost curves downward, giving a constant capability at an even lower price;
- Hold cost constant and incorporate more and more functions as LSI costs decline.
- Build increasingly powerful machines, impossible with older technology, and allow cost to float upward.

The views, contained in a paper by Bell, Loren Gale, chief of design for small computers, and Charles Kaman, research engineer, at the Maynard, Mass., firm, are to be presented at Nerem, Nov. 1-3.

Any of the routes has appeal, say the three authors, but there are pitfalls in each. In the case of constant technology, they point out that studies have shown that even if the CPU were free, the peripherals necessary for applications-oriented systems still would cost about \$10,000. The route of constant technology is being taken by the builders of "smart" terminal equipment, they say, and by those making increasing use of minis as centers of terminal networks.

In the long run the DEC spokes-

men figure that yesterday's so-called minis—priced for a market becoming ever more consumer-oriented—will be selling for calculator prices, while tomorrow's minis will be very similar to the large machines of today, but in smaller boxes.

**Promising.** Thus, the constant-price case appears more promising to Bell and his coauthors. For one thing, purchase price is not the only customer consideration. In addition, maintenance, programing, and usage all increase over-all costs significantly. Therefore, added memory, low-cost floating-point capability, memory mapping, multiprograming, and cache memory all appeal on a cost vs performance basis. Bell figures that this kind of capability lineup will be standard in minicomputers within about five years.

Bell goes not have much comment on the third scenario—that of all-out LSI utilization and escalating costs—perhaps preferring to let the nature of the market dictate events here. But the effects of LSI on existing minis serve to underlie his other conclusions. For example, the low-cost, high-performance LSI memory has already led to minis with large numbers of general registers and now is bringing about increasing and more efficient use of micro-programing. Within the central processor, though, the effect is less dramatic.

## Computers

### IBM unveils the 125, bottom of 370 line

IBM has extended the 370 downward with the seventh in the system—the model 125, at the low end of the line. Like the most recently announced 370 models, the 158 and 168 [*Electronics*, Aug. 14, p. 40], the new machine offers virtual storage, an MOS memory, and a reloadable control store.

An out-of-the-ordinary feature of the new machine is its use of satellite subprocessors, which independently handle program instructions, input-output functions, and diagnostics. IBM hasn't used this design approach before in commercial machines, and it's unusual in one of this size and capability. The basic machine contains four of these satellites; three more are optional. They are built into the computer's mainframe, and are used in lieu of external controllers for the various input/output devices. They are, essentially, integrated controllers for these devices.

Integrated controllers for disk storage units and for communications adapters had been announced previously by IBM, on the 370/145 and 370/135 respectively. Independent manufacturers of peripheral equipment viewed those earlier announcements with consternation, because they saw greater difficulty in attaching their equipment to IBM computers with integrated adapters. Now that integrated controllers, in the guise of satellite subprocessors, are also installed for printers, card equipment, and magnetic tape, the independents' howls are sure to be heard again.

The disk storage unit offered with the new system is IBM's 3330 series—its largest and fastest, although available only in smaller configurations than are used on larger machines. The unit is rapidly becoming the industry standard, because it permits more and faster on-line



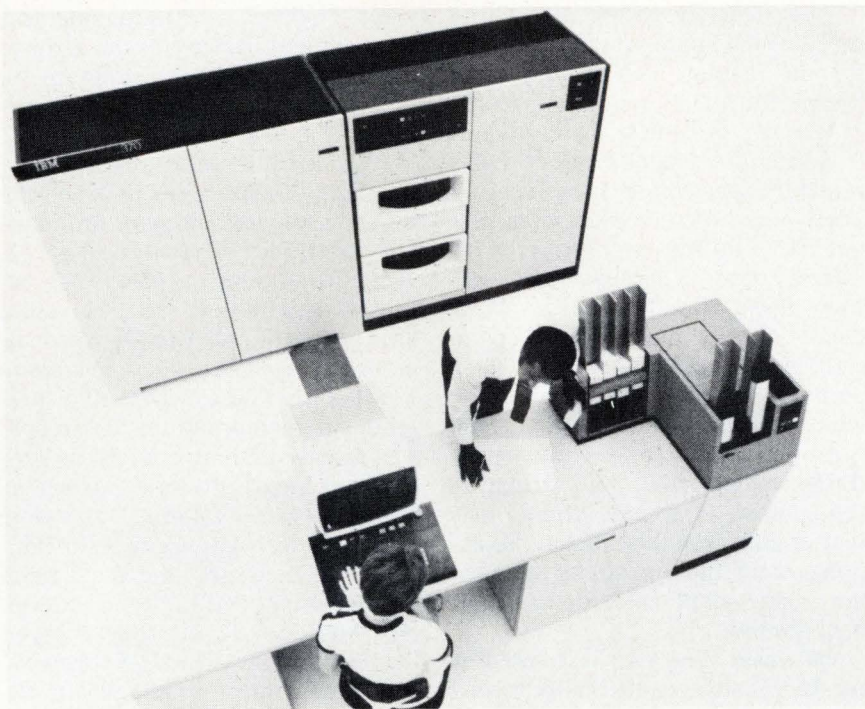

**New baby.** The addition to the low end of IBM's 370 line, the model 125, incorporates virtual memory and offers large on-line disk storage capacity. The total can be 400 million.

storage without changing the disk packs—the manually removable media that actually store the data. Several independent makers have brought out their own versions of the 3330, and in fact the previous standards—2314 and 2319—are no longer in new production at IBM.

**Slow drives.** Introduction of the integrated tape adapter is surprising. It means that the model 125 can't be used in a tape-switching configuration, where two or more computers have access to a single string of tape drives. But the really surprising thing is that only slow, low-cost tape drives—models 3410 and 3411—can be attached to the 125. Nobody is interested in tape switching with these units. But it seems the 125 could handle faster drives, in view of the availability of 3330 series disk units; if they were attached, the 125 would be useful in a tape-switching installation. Furthermore, the 3410/3411 subsystem always consists of one 3411 drive and one or more 3410 drives, and its controller is in the 3411. The so-called integrated tape adapter isn't a controller at all—it's functionally similar to the tape attachment fea-

ture, an optional collection of printed-circuit cards required when the subsystem is connected to another computer—the System 3, for example.

IBM's limiting the 125 to slow tapes would tend to boost the market for these tapes, which one industry observer termed "disappointing," and to identify the machine as the top end of the older 360/20 and System 3 markets rather than as the bottom of the 370 line.

IBM plans to begin shipping the 370/125 next April. Its rental ranges from \$8,207 to \$13,794, and it sells for \$377,815 to \$602,620. □

## Computers

### Lab system seeks third of market

What includes agronomy, medicine, physics, meteorology, and electronics, and is worth \$120 million to \$150 million a year? The answer is the highly competitive laboratory-automation market; it stands to rea-

son that any company that can devise a system appealing to a third of that market should be something to reckon with.

That's exactly the attitude of EMR Computer of Minneapolis, Minn., with its new DynaLab unified computer system. EMR, a Schlumberger company, says its highly versatile system is capable of data acquisition, data analysis, lab control, information management, and new-application development.

The system's modules are compatible, meaning that parts up to and including the central processor can be changed or upgraded according to the user's needs. And the program permits simultaneous independent applications.

Basically, the user can choose one of two EMR real-time central processors. The smaller one is the 6140, which starts with 16,384 words of core memory and a cycle time of 1 microsecond. The larger is the 6145, which may include up to 131,072 words of core at 650 nanoseconds. The 6145 also features two-way memory interleaving, bringing effective cycle time down to 400 ns. Available peripherals range from card readers through magnetic tape, drives, line printers, and digital plotters.

But the strong suit of DynaLab, since it's a lab system, must be measurement. At lower speeds, the analog input system can handle almost any signal, with six programmable controlled input ranges, from  $\pm 10$  millivolts to  $\pm 10$  volts. What's more, the computer features an integrating conversion process that makes sure it's reading data and not instrument noise. At higher speeds, analog input systems read as fast as 60,000 times per second and can handle high-level ( $\pm 5$  V) and low-level ( $\pm 10$  mV) signals.

James R. Egbert, EMR's manager of industrial marketing, says that minicomputer houses, such as Digital Equipment Corp., Xerox Data Systems, and Hewlett-Packard, are moving more and more strongly into the lab field that EMR has considered for years to be its private preserve. "But," adds Egbert, "we don't think any of them can offer

the multiapplication approach of our DynaLab because what they're doing is taking standard computers and calling them lab systems. What we've done is built a system from the ground up for the lab." □

---

**Optoelectronics**

---

## Laser writes liquid-crystal display

Surmounting technical problems is good engineering; turning those technical problems to an advantage is brilliant engineering. That's what Bell Laboratories technologists have done with their liquid-crystal display that's written with a laser. Capable of displaying both alphanumeric and graphics, the system appears to be a better way of displaying information that is transmitted over Data-Phone lines because it avoids the problems associated with CRTs.

**Picture method.** Bell Labs researchers have built laser-written liquid-crystal display.

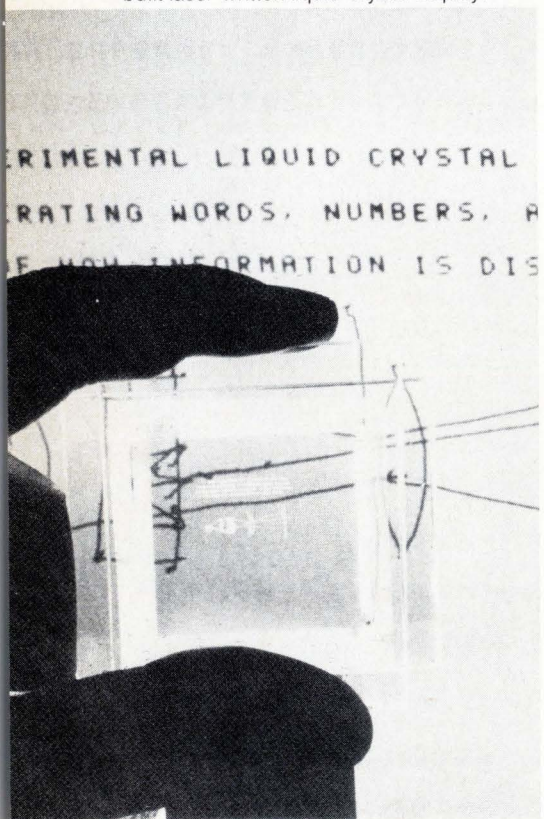

The heat-dependent switching mode of the liquid crystal is adapted for the display method—the same temperature dependency that's plaguing ordinary voltage-controlled liquid-crystal displays. Bell's researchers get the heat by focusing a low-power yttrium-aluminum-garnet laser, emitting strongly in the infrared, onto a liquid-crystal cell. The liquid-crystal material, when heated locally by the laser beam, changes from an isotropic transparent state to a disordered state, which, when cooled back to the isotropic condition, generates scattering centers that were frozen in the cooling. It is these centers that scatter light from a schlieren projection system and appears as the written image—dark areas on a bright background.

**YAG laser.** The YAG laser used in the Bell system to thermally record the data operates at less than 50 milliwatts, continuous-wave; the information is modulated by a tellurium-oxide acousto-optic modulator, which is controlled by a pattern generator. An Z-Y galvanometer-mirror deflects the modulated beam across the cell.

The utility of the system is illustrated by the fact that it can record both computer and/or graphic tablet information, generated at a rate of  $10^5$  resolvable elements per second. Resolution is 2,000 by 2,000 pictorial elements per frame. In addition, written images have a contrast ratio of better than 20 to 1, and can be stored in the cell for long periods—typically 500 hours—with minimal loss in resolution and contrast. A 50-volt audio signal erases the cell. □

---

**Companies**

---

## IBM competitors await next move

IBM's competitors last week were wearing their best poker faces in public as the Justice Department asked a Federal court to break up the giant computer maker. In pri-

vate, however, those competitors were smiling broadly at the sight of the biggest computer company in the world trying to fend off the Government's trust busters.

It's been almost four years since the filing of what is being called the biggest antitrust suit since Standard Oil in 1911 [*Electronics*, Feb. 3, 1969, p. 44]. But anyone who expected that by now the U.S. would have a specific plan ready for dealing with the giant is going to have to wait longer. The government's "preliminary memorandum on relief" was exactly that—five pages of generalities—with Federal attorneys saying they are "unable at this time to specify with any more significant degree of precision" the exact relief needed to end IBM's alleged monopoly. And an IBM attorney charged that, not only was the U.S. proposal the same general demand for divestiture filed in 1969, but it had both "changed the ballgame" and "enlarged the ballpark" by introducing new issues.

The next pretrial hearing is set for Oct. 30. Thomas D. Barr, IBM counsel, asked the judge to permit a trial within 30 days on the single key issue of defining the market. The Justice Department said it will oppose the trial motion as premature.

Among the competitors, the prevalent attitude is wait and see. At Control Data Corp., which is the plaintiff in one of the half-dozen or so suits still pending against IBM, president William C. Norris is "heartened." However, he warns, "the industry has been changing, and we must ensure that any relief obtained will be sufficient to prevent IBM's growing domination of the growing computer markets, such as the semiconductor business, time-sharing and data services, programming, terminals, and communications equipment. We fear that divestiture alone may not be sufficient."

Much the same warning is sounded by Paul W. Williams Jr., president of Boothe Computer Corp. in San Francisco. Mere divestiture, he points out, isn't the whole story. "The financial muscle of IBM is the damaging thing. Until they clear that up, nothing else can

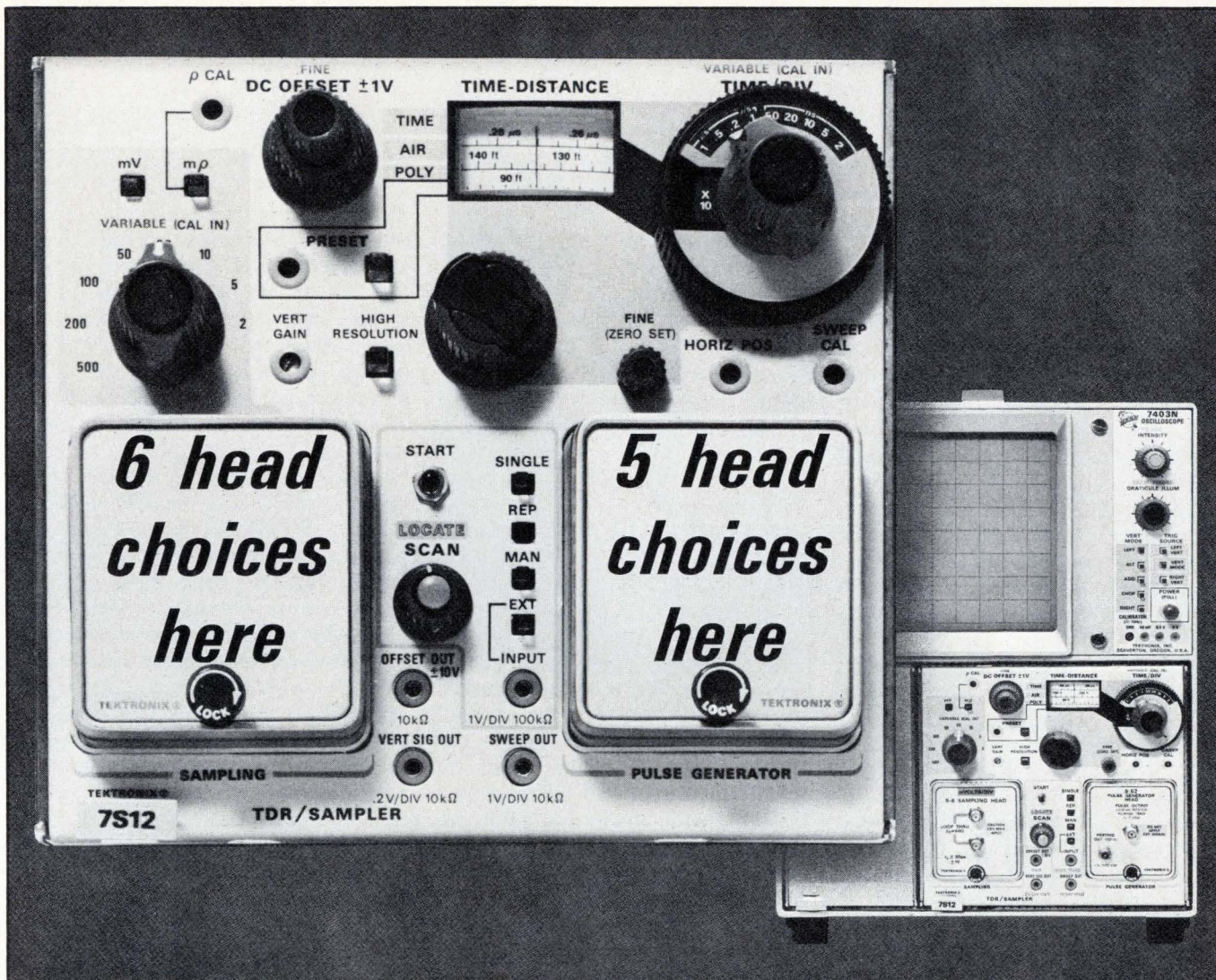

# *2 heads are better than 1 when you have 11 to choose from*

Time Domain Reflectometer or General Purpose Sampling . . . the choice is yours with the TEKTRONIX 7S12 TDR/Sampler, a scope plug-in that uses your choice of plug-in heads to do many sampling jobs well. When installed in a 7000-Series mainframe with your selection of two of the eleven plug-in heads, the 7S12 is ● a general-purpose single-trace Sampler ● or a high-resolution 45-pico-second Sampler/Time-Domain Reflectometer ● or a Sampler/Time-Domain Reflectometer for long lines ● or a Sampler with a Hi-Z probe ● or a Sampler with 30-pico-second response ● or a Sampler with one megohm BNC input ● or a Sampler with 50-ohm feedthrough ● or a Sampler with 11.6-GHz bandwidth ● or with a 7M11 in another scope mainframe compartment, the 7S12 is a Sampler with a delay line.

The 7S12 uses one of six sampling input heads in its left compartment to provide the input characteristics and response you desire. The right compartment uses a pulse generator head for TDR or a trigger recognizer head for general-purpose sam-

pling. There are three pulse generator and two recognizer heads to choose from.

Systems prices start at \$2950 for general purpose applications (7403N/7S12/S-1/S-53). TDR systems start at \$2850 (7403N/7S12/S-5/S-54). Your Field Engineer will be glad to discuss what TEKTRONIX Sampling can do for you. Give him a call.

U.S. Sales Prices FOB Beaverton, Oregon  
Tektronix, Inc., P.O. Box 500-A, Beaverton, Oregon 97005, U.S.A.

## *the 7S12 TDR/Sampler*



**TEKTRONIX®**

committed to  
technical excellence

be resolved. IBM has been able, because of financial muscle to employ short-term leases to such an extent that small manufacturers can't get equity."

What if IBM is split into three or more separate entities? Thomas S. Kavanagh, director of special programs at Storage Technology Corp. in Louisville, Colo., says it won't make any difference. "IBM split off the Service Bureau Corp. some time back under pressure," he says, and it hasn't made any difference; SBC is still thought of as part of IBM." And it wouldn't affect his firm or the other independent plug-compatible companies, says Kavanagh; "We still would attach to IBM gear, the same as always."

The prediction of Dick Brandon, president of Brandon Applied Systems in New York, is that there will be a consent decree like that of 1956. IBM will agree to cut its share of some part of the market, Brandon forecasts, adding: "IBM is a monopoly; nobody denies that. But where would the industry be without it?" □

## Communications

### 'Gerty' controls long-distance calls

Texas Instruments has an unusual new telephone operator. Her co-workers call her Gertrude or Gerty, and, like most operators, she's been accused of being a little impersonal. Although a recording, she still asks for the number you're calling and thanks you for it. Gertrude's a part of the new long-distance telephone-scheduling system that the firm's Digital Systems division developed and installed to improve operator efficiency and WATS line utilization. TI will also lease or sell similar equipment.

The system, officially dubbed LDC for long-distance control, relies on a TI 960A minicomputer, disk and tape storage units, a Cognitronics voice-response unit, and video displays at standard Bell System switchboards.



**Call manager.** TI's long-distance control system uses minicomputer to schedule calls.

LDC asks each calling employee for the phone number he wants and his employee badge number for validation and accounting purposes. Gerty then estimates the delay in placing the call, assigns the employee a call-ticket number, and places the call in an appropriate queue. Employees can also ask for revised delay estimates, or further delay or cancel the call through the voice-response unit. At the switchboard, LDC monitors queues and available WATS lines and displays to the operator the information needed to place each call.

The system also relieves operators of all the routine paperwork of logging calls, as well as most of the necessity of timing the calls and billing them to the correct TI cost center. Roy Reynolds, manager of telecommunications services, estimates that operators can typically handle 30% more calls per hour. The disk unit maintains queues and personnel files, which contain employees' names, cost centers, and telephone extensions keyed to TI badge numbers. Billing information is now automatically logged on magnetic tape, replacing keypunch operators that used to work from operators' hand-written tickets.

But perhaps the most significant saving results from the capability to

use shorter zoned and measured WATS lines. "We had tried using shorter WATS," Reynolds says, "but our operators just couldn't do it manually." He estimates this saves TI, which uses 18 WATS lines, about \$1,000 per month. And when the Austin and Houston activities are consolidated into the Dallas-based system later this year, the firm should save another \$2,500 a month, he says. Reynolds now estimates the system, originally scheduled for a three-year payout, will pay for itself in less than two years.

The Digital Systems division plans to offer versions of Gerty to organizations with high-volume long-distance telephone traffic. Each LDC will be configured to match user requirements, based on number of WATS lines and operators, says Robert A. Thomas, manager of systems development. Three models are available to handle from eight to 32 long-distance lines and have four to 16 operator stations. One of the first such systems available, LDC lease rates will start at about \$2,500 per month and will range up to \$4,800 on a five-year lease, or will sell from about \$100,000 to \$150,000, including installation.

Thomas says that TI is the first firm to reliably extract data from dial telephones, but he won't elaborate because TI has applied for a patent on that circuitry. "We use standard telephone company data-access arrangement," he admits, "but what we do with the Bell information is proprietary." □

## Military electronics

### Aircraft spending up as ABM cut is voted

A House-Senate compromise has led to final enactment of a \$74.4 billion defense budget for fiscal 1973—the largest since World War II and one that contains good news for military electronics contractors. The legislation, which cut President Nixon's request by \$5.2 billion, restored, for example, previously cut

# Our compact portable lab grade recorder in 1/2" or 1" models has 7-speeds, phase- lock servo and is IRIG compatible. You can save up to \$1,500 on accessories.

Find out how the Bell & Howell CPR-4010 compact instrumentation recorder/reproducer with its complete pre-wiring can really cut your accessory bill. Compare the CPR-4010's toughness and portability with its competition.

Look into its low maintenance, high performance and application versatility. Send us the coupon and we'll send you complete information including a handy Buyer's Check List for Compact Instrumentation Recorders that lets you compare our recorder's features, size, weight, performance,



and value with your current equipment, or theirs.

Yes, I'd like to know more about the CPR-4010 and receive a free Buyer's Check List. Write: Bell & Howell.

#### CEC/INSTRUMENTS DIVISION

360 Sierra Madre Villa, Pasadena, California 91109



## BELL & HOWELL

NAME \_\_\_\_\_

TITLE \_\_\_\_\_

COMPANY \_\_\_\_\_

ADDRESS \_\_\_\_\_

CITY \_\_\_\_\_ STATE \_\_\_\_\_ ZIP \_\_\_\_\_

TELEPHONE NO. ( ) \_\_\_\_\_

CPR-4010

funds for the Marines' AV-8 Harrier VTOL fighter, the Navy's S-3A Viking ASW aircraft, the Air Force's F-15 fighter, and in addition, approved some \$83.2 million for 24 A-7D fighters that the Air Force had not asked for. Procurement money for other key programs remained pretty much intact [*Electronics*, July 17, p. 23], including the Airborne Warning and Control System (Awacs) (see panel).

The election-year good news for industry was offset, however, by some anticipated bad news from the Pentagon. It notified Safeguard ABM system contractors of hardware cancellations required by the Strategic Arms Limitation agreement with the Soviet Union. Although the Defense Department contends that contract-termination costs still in negotiation, plus retention of some hardware parts as spares, makes precise dollar figures unavailable now, estimates are that some \$400 million in awards and as many as 9,000 jobs eventually will be lost.

Hardest hit will be Safeguard prime contractor Western Electric Co., which expects to be cut back by about \$170 million through 1973; missile-site radar builder Raytheon Co., which will lose about \$70 mil-

lion in the same period, as two of its three units were dropped; and General Electric Co., which developed the large-perimeter acquisition radar, one of which will not go forward.

Martin Marietta, maker of the Sprint I and developer of the Sprint II interceptor missiles, will be relatively unaffected, say Army Safeguard system officials, as will McDonnell Douglas, subcontractor for the longer-range Spartan missile system. Martin's remaining Sprint I missiles probably will be salvaged for spares, says the Army, while development and flight-testing of Sprint II will go on at Martin's Orlando, Fla., division under a \$168 million award made earlier this year.

While the SALT agreement limits ABM systems to a single 100-missile installation for defense of Minuteman III offensive missiles and another to defend the national capital, there is no limit on site upgrading through development of new replacement missiles, the Army explains. The agreement banned a Great Falls, Mont., site, leaving one at Grand Forks, N.D., for Minuteman defense. Congress has appropriated funds for that installation,

but has yet to act on a Washington-area defense site, tentatively proposed for Virginia, and there is some question in the legislature as to whether or not it is worth the proposed investment of several billion dollars.

**New hardware.** But if Congress seems cautious on ABM spending, it has been less stingy in other areas. Beyond including a total of \$5.2 billion for strategic nuclear systems upgrading in the defense appropriation, the legislators also approved \$53.2 million for the Advanced Airborne National Command Post (AANCP), or \$28.7 million more than requested, but then it reduced procurement of Boeing 747s for the system to three of the six the Air Force wanted. Restoration of \$7.1 million sought for Hawker-Siddeley Harrier VTOL, licensed for production by McDonnell Douglas, raised the buy to 114 planes from the 90 already provided for. The \$421 million voted for 30 McDonnell F-15s is \$101 million more than the House had okayed earlier for half as many planes. And the money for 35 of Lockheed's S-3A aircraft represents a compromise between the 23 in the House bill and 42 in the Senate version. The \$83.2 million windfall for 24 more of LTV's A-7Ds was inserted in the bill by House Appropriations Chairman George Mahon of Texas, where the contractor's production line is based. □

### ... back at Baltimore

There is joy in Baltimore over the selection of the Westinghouse Defense and Electronic Systems Center there to build the Airborne Warning and Control System's surveillance radar. Boeing is the prime contractor. The Westinghouse victory over Hughes Aircraft is expected to gradually add about 1,000 new jobs at the Baltimore area center, stabilizing employment around the present 10,600 level.

After peaking at 17,000 jobs in late 1968, the center experienced "seriously declining employment" over the past four years, says center president Nicholas V. Petrou. Failure to win earlier competitions such as the Navy's Mk. 48 torpedo and the Air Force's McDonnell Douglas F-15 radar contributed to the cutbacks, but the Awacs radar job buildup is expected to compensate for jobs lost on declining programs such as the AN/APQ-120 airborne fire-control radar for the McDonnell Douglas F-4E and Japanese-built F-4EJ.

In the fiscal 1973 defense appropriation just passed, Congress approved the recommended \$233 million for Awacs R&D [*Electronics*, July 17, p. 24], of which \$150 million is for the radar and avionics system integration and \$83 million for three preproduction model Boeing planes. The 707-320 model carrying the winning Westinghouse radar will be made ready for a three-month series of tracking demonstrations, scheduled to begin early in 1973. Defense Department approval is expected in December for the second-phase design, development, test, and engineering of Awacs—now that the radar technology has been proved.

### Meetings

## ISA attendance hits 10-year low

The economy may be picking up, but that isn't evident from the statistics at the 27th annual instrumentation-automation conference and exhibit, sponsored in New York earlier this month by the Instrument Society of America. Attendance of somewhat more than 9,000, of which roughly one-quarter were exhibitors' personnel, hit a 10-year low. And the number of exhibitors themselves—175—was down more

**Adar Associates, Inc.**

85 Bolton Street, Cambridge, MA 02140

Gentlemen:

Please send me details on  Dr. 12  Dr. 32-II  
 Dr. 64  Look, while you're at it, tell me  
about the whole series.

NAME \_\_\_\_\_

TITLE \_\_\_\_\_

COMPANY \_\_\_\_\_

STREET \_\_\_\_\_

CITY \_\_\_\_\_ STATE \_\_\_\_\_ ZIP \_\_\_\_\_

A5

# THE DOCTORS.

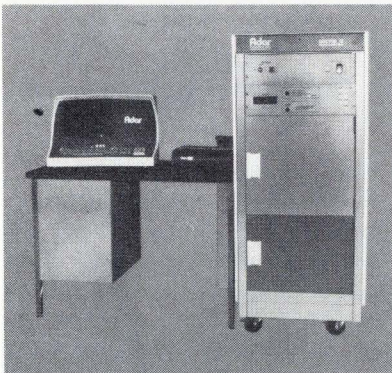

## Doctor 12.

The smallest and newest in the Doctor series provides the most complete functional testing available. Dr. 12 tests core memories for mini and maxi computers, semi-conductor add-on memories, memory cards, Shift Register memories, ROM's and RAM's. Up to 72 bits wide and down to 125 nanoseconds. Test programs are activated via a CRT-keyboard link. That means flexibility. But it means about half what you'd expect to pay. Send for more facts.



## Doctor 32-II

Doctor 32 was the first of our Doctor series. More of them have been sold than any other computer-controlled, high speed functional test system in existence. And the most important customer requested options have been incorporated into the new -II configuration. Doctor 32-II tests 95% of all digital IC's. And it does it functionally, parametrically, and dynamically. Dr. 32-II has a highly refined software package which includes data logging, automatic device characterization, and schmoo plotting. Send for more facts.

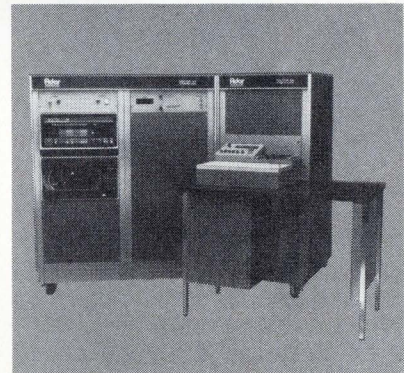

## Doctor 64.

This is the big one. It tests everything. SSI, MSI, LSI, MOS, Bipolar, Hybrid, ROM's, RAM's, Shift Registers, Logic Arrays. Dr. 64 tests functionally, parametrically and dynamically. It does all of today's testing, and most of tomorrow's as well. Dr. 64 is the most cost effective system available. It does production testing, device characterization, engineering evaluation, incoming inspection. Everything. Send for more facts. Or call.

## Adar Associates, Inc.

85 Bolton Street, Cambridge, MA 02140, Call Fran Bigda collect: (617) 492-7110

"See A Doctor at the NEREM Show in Boston."

High resolution,  
low cost  
**SCAN  
CONVERTERS**  
display any  
electronic  
information

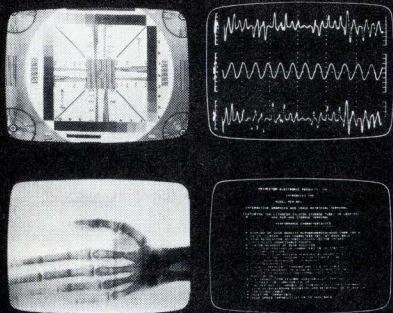

Any electronic information—from computers, lasers, TV cameras, scanners, X-ray, electron microscopes or whatever—can be displayed sharper, brighter, faster and at lower cost with PEP scan converters. Regardless of its format or speed. Even if it's only transient information. The reason: **only** PEP scan converters offer this combination of advantages:

- RESOLUTION to 3000 lines
- GRAY SCALE: 10 Logarithmic levels
- NON-DESTRUCTIVE readout
- WIDE RANGE of reading and writing speeds: video to DC
- WIDE system bandwidth: 30 MHz
- READ, write, selective erase, zoom, other functions
- LONG, trouble-free life

We're the people who developed high resolution, low cost scan conversion and image storage technology. Our Lithocon® silicon storage tube is the heart of all PEP scan converters, and makes them feasible for a whole new world of applications. Like microfilm/microfiche. Industrial process control. Facsimile. CATV systems. And X-ray, ECG and low light level detection systems. And hundreds more. We'll be happy to tell you about them. Write or call today for details. Princeton Electronic Products, Inc., P.O. Box 101, North Brunswick, New Jersey 08902; (201) 297-4448.



**PRINCETON  
ELECTRONIC  
PRODUCTS, INC.**

**Electronics review**

than 20% from last year's show in Chicago.

ISA's exhibit director Philip N. Meade primarily blamed the economy and secondarily the show's location in rough, tough New York ("50 or 60 companies won't exhibit here," Meade says). However, one exhibitor, from Beckman Instruments Inc., also blamed the ISA itself. "The technical program is so weak, it's attracting no one. Only 18 people showed up at one session in the chemical-petroleum area, and this used to be the backbone of the ISA show."

In the face of the poor attendance, many exhibitors contented themselves with the thought that at least the "quality" of visitors was

good. And one, sales manager Don Munger of Fisher Controls Co., Marshalltown, Iowa, was exceptionally pleased. "None of our competitors are here," he beamed. "We have a clean shot at everyone." Munger, responsible for Fisher's analog and digital control-instrumentation lines, referred to such process-control electronics stalwarts as Foxboro, Honeywell, Taylor Instrument, and Bailey Meter.

However, ISA's Meade says three of the four have already signed up for next year's show in Houston. And given the great number of chemical and petroleum plants in the Houston vicinity, Meade, like so many other exhibit managers, predicts next year will be better. □

**International**

Mission sees American policy barrier to a big market in the Eastern Bloc

Soviet and Polish communications technology "is impressive," but both countries appear to have difficulty converting prototype developments to production on a large scale, and therefore have a strong interest in acquiring American products. That's the judgement of a 13-company U.S. team following a two-week exploratory trade mission to Moscow and Warsaw concluded last month. The group was organized and headed by John Sodolski, a vice president of the Electronic Industries Association [*Electronics*, Sept. 25, p. 14].

"Both countries have gaps in their communications systems which need to be filled," says Sodolski, "largely as a result of production deficiencies." Nevertheless, the East European market potential, which could run to an estimated annual rate of several millions of dollars, will never be fully realized until the U.S. relaxes strategic export controls it exercises through the Paris-based multinational Coordinating Committee (Cocom) [*Electronics*, Oct. 9, p. 76].

"This obstacle probably is larger

than competition from foreign firms," Sodolski complains. "The subject of export control was touched on in Russia and discussed rather pointedly in Poland. If we are to sell equipment, services, and licenses in either country, we must sell them new equipment, not old things for which we no longer have any use. Otherwise they simply will not buy."

Officials in both countries "kept pointing out that there no longer are any technological secrets in this world," says the EIA executive, who adds that "equipment is available to them from other non-US. sources" if Americans are unable to obtain export approvals.

**Turnkeys.** Poland and Russia "seem to have a fondness for large turnkey-type operations," Sodolski says. In Warsaw, for example, it was learned that there is a potential for a large air-traffic control electronics and communications network for an international airport the Poles want to build at Gdansk. However, ATC hardware could be construed as potentially strategic under current export restrictions and could prevent



# NOTHING GETS BY LIONBARGER AND TETSCHLAG

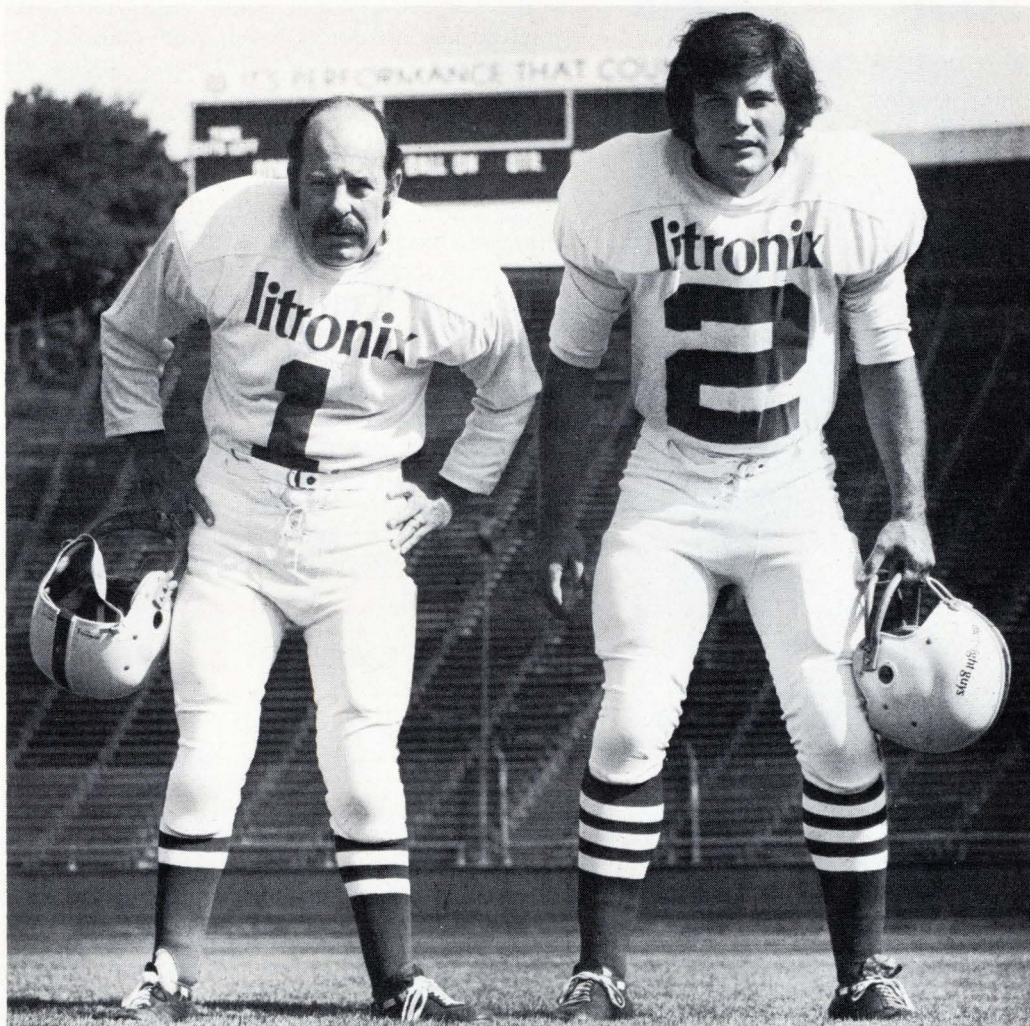

Lionbarger's tough. A veteran of 17 years in the pros, he heads-up Litronix' reliability and quality assurance. Tetschlag's tough too. He's an all-American youngster who moved up in the pro ranks to Litronix. He got 'Linebacker of the Year' award even before the season started.

Why do we have such tough guys? Well, as our volume commitments have grown, we have become tougher and tougher on ourselves. We always have, and will continue to 100% test all our LEDs before they go out the door. Lionbarger simply kills all end-runs and Tetschlag doubles as safety. In addition, QA independently selects samples from every lot and runs them through scrimmage. Only if the samples survive, do we ship.

If you're looking for high volume, high quality, solid state displays, indicator lights, infrared emitters or opto-isolators—join a tough winning team. Call the Bright Guys.

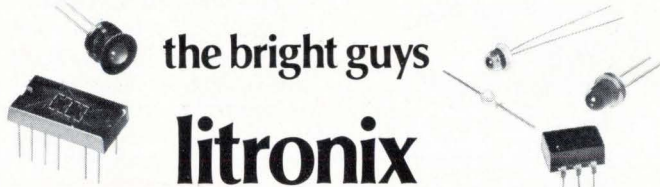

Litronix, Inc. • 19000 Homestead Road • Cupertino, California 95014 • (408) 257-7910 TWX: 910-338-0022

## Distributors

**Arizona:** Hamilton, Phoenix (602) 269-1391  
 Compar, Scottsdale (602) 947-4336  
**California:** Hamilton, Mountain View (415) 961-7000  
 Culver City (213) 870-7171  
 San Diego (714) 279-2421  
 Compar, Burlingame (415) 347-5411  
 Burbank (213) 843-1772  
**Colorado:** Hamilton, Denver (303) 433-8551  
 Intermark Electronics, Denver (303) 936-8284  
 Compar, Littleton (303) 798-5919  
**Florida:** Hamilton, Hollywood (305) 925-5401  
 Compar, St. Petersburg (813) 342-8741  
**Illinois:** Allied Electronics, Chicago (312) 421-2400  
 Hamilton, Schiller Park (Chicago) (312) 678-6310  
**Kansas:** Hamilton, Prairie Village (Kansas City) (913) 362-3250  
**Maryland:** Hamilton, Hanover (Baltimore) (301) 796-5000  
 Pioneer, Rockville (301) 427-3300  
 Compar, Baltimore (301) 484-5400  
**Massachusetts:** Electrical Supply, Cambridge (617) 491-3300  
 Hamilton, Burlington (617) 273-2120  
 Compar, Newton Highlands (617) 969-7140  
**Michigan:** Hamilton, Livonia (313) 522-4700  
 Compar, Utica (313) 781-3900  
**Minnesota:** Hamilton, Bloomington (612) 854-4800  
 Compar, Minneapolis (612) 922-7011  
**Missouri:** Hamilton, Hazelwood (St. Louis) (314) 731-1144  
**New Jersey:** Hamilton, Cherry Hill (609) 662-9337  
 Cedar Grove (201) 239-0800  
 Compar, Clifton (201) 546-3660  
 Haddonfield (609) 429-1526  
**New Mexico:** Compar, Albuquerque (505) 242-3633  
 Century Electronics, Albuquerque (505) 265-7837  
**New York:** Semiconductor Concepts, Inc., Hauppauge (516) 273-1234  
 Hamilton, Syracuse (315) 437-2642  
 Westbury, L.I. (516) 333-5812  
 Compar, Albany (518) 489-7408  
 Arrow, Farmingdale (516) 694-6800  
**North Carolina:** Compar, Winston-Salem (919) 723-1002  
 Pioneer, Greensboro (919) 273-4441  
**Ohio:** Arrow, Compar, Dayton (513) 253-9176  
 Fairview Park (216) 333-4120  
**Texas:** Compar, Dallas (214) 363-1526  
 Hamilton, Dallas (214) 638-2850  
 Houston (713) 526-4661  
**Washington:** Hamilton, Seattle (206) 624-5930  
 Compar, Kirkland (206) 822-4191  
**Canada:** Prelco Electronics, Montreal (514) 389-8051  
 Ottawa (613) 237-6150  
 Electro Sonic Ind. Sales, Toronto (416) 924-9301  
 Hamilton, Montreal (514) 381-9127  
 Toronto (416) 789-1838

## Representatives

**Alabama:** Twentieth Century Marketing, Huntsville (205) 772-9237  
**Arizona:** Q. T. Wiles & Assoc., Scottsdale (602) 947-5791  
**California:** Celtec, Inc., San Diego (714) 279-7961  
 Trident Assoc., Mountain View (415) 967-7031  
 Q. T. Wiles & Assoc., Los Angeles (213) 649-1232  
**Colorado:** R. G. Enterprises, Denver (303) 744-2464  
**Florida:** W. M. & M. Assoc., Altamonte Springs (305) 831-4645  
 Clearwater (813) 446-0075  
 Pompano Beach (305) 943-3091  
 North Palm Beach (305) 622-0932  
**Illinois:** Coombs Assoc., Des Plaines (312) 824-0104  
**Maryland:** Burgin-Kreh Assoc., Baltimore (301) 788-5200  
**Massachusetts:** Contact Sales, Inc., Lexington (617) 273-1520  
**Michigan:** Greiner Assoc., Grosse Pointe Park (313) 499-0188  
**Minnesota:** Comstrand, Inc. Minneapolis (612) 560-5300  
**Missouri:** Coombs Assoc., St. Louis (314) 567-3399  
**New Mexico:** Electronic Marketing, Albuquerque (505) 265-7837  
**New York:** Win-Cor Electronics, Manhasset (516) 627-9474  
 Tritech, DeWitt (315) 446-2881  
**North Carolina:** Burgin-Kreh Assoc., Winston-Salem (919) 768-4174  
**Ohio:** Em A. Inc., Centerville (Dayton) (513) 433-2800  
 Aurora (Cleveland) (216) 247-4488  
**Pennsylvania:** G. C. M., Ambler (215) 646-7535  
**Texas:** Semiconductor Sales, Richardson (214) 231-6181  
**Virginia:** Burgin-Kreh Assoc., Lynchburg (703) 845-5600  
**Washington:** Compar, Kirkland (206) 822-4191  
**Canada:** Cantronics, Montreal (514) 733-0749  
 Ontario (416) 636-8311

# The Elegant Custom Coils

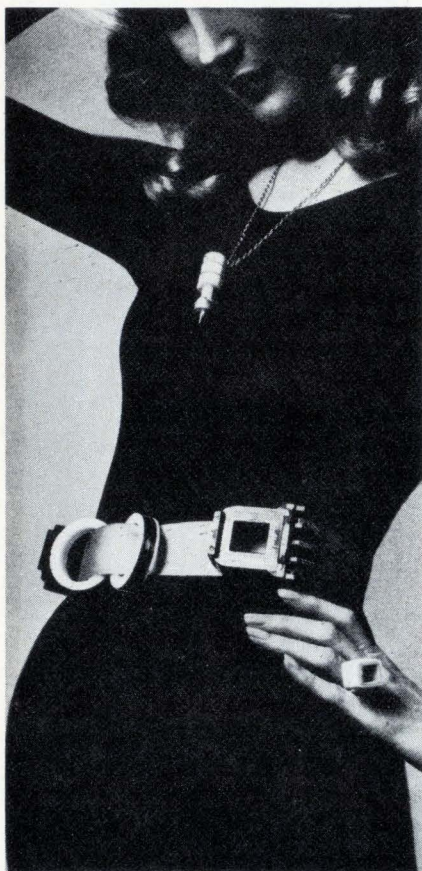

Inductor coils made with a jeweler's touch. At mass-production prices. Elegant answers to applications that demand exacting performance. Like solenoid control valves. And coils for computer disc drives. With custom bobbins, windings and transfer-mold encapsulation executed under a single roof. So turnaround is fast — even when you want sample or pilot quantities.

At U.S. Electronics, you'll find all the precision and finesse you expect from an EAI component company. Look to EAI also for transformer kits. For thick-film



audio and servo amps. For capacitors. Active filters. Analog/digital converters and other special-function modules. Plus a

growing list of other elegantly crafted etceteras.

## USEC

United States Electronics Corporation  
275 Warren Street  
Lyndhurst, New Jersey 07071  
Tel. (201) 438-2400

A Subsidiary of Electronic Associates, Inc.

## Electronics review

U.S. competition for the system.

Communications equipment sales to the Soviets, Sodolski points out, must be made through Mashpriborintorg, its trade agency for technology and sole purchasing agent for all other user ministries which pass only on technical specifications. Russia, which uses the French-developed Secam television system, is interested both in purchasing and licensing agreements, as is Poland.

The Soviet shopping list outlined to the Americans includes satellite earth stations, about which they "urgently want concrete talks with American manufacturers," microwave equipment, tropospheric-scatter communications, parametric amplifiers, videotape recorders, video cassettes, and mobile radio. The existing mobile-radio market in

Russia amounts to about 70,000 units a year, most of which are limited to 10 watts and have a range of about 50 kilometers. Many of these radios are used in agriculture and by oil and gas utilities, which operate at 57-58 megahertz and 140-160 megahertz, respectively, Sodolski says.

Poland—"where it is much easier to see the end-user of a product than in Russia, where often it is impossible"—plans to upgrade its color TV system to be "the best in Europe" by 1975. The mission was told the TV system needs new studio broadcast and transmission equipment. The Poles also are anxious to build up their telephone network and need "just about everything"—from cable transmission equipment to advanced handsets. □

## For the record

### DataGen goes west

Data General Corp., the minicomputer maker, plans to open a semiconductor research and testing facility in the Sunnyvale-Mountain View, Calif., area. The facility will include wafer processing and packaging equipment "to gain insight into the technical and economic aspects of semiconductor manufacturing," says Richard G. Sogge, vice president of engineering. The company will also do incoming testing and inspection of semiconductors there, a job formerly done by subcontractors.

### Philco in private

Philco-Ford Corp., Blue Bell, Pa., has reentered the private television labeling business after a hiatus of several years. However, company executives will not reveal what kinds of sets are being made, or for whom.

### Laser recorder shows head

Machining holes with lasers on metal for microfilm recording systems is a technique that has been actively pursued at several laboratories. And Bell Laboratories, one of the earliest to work with laser recording, has now surfaced with its system, using a helium neon laser writing on a bismuth-Mylar film. Essentially the same system that was under development for several years [*Electronics*, Nov. 8, 1971, p. 62], Bell sees it as an alternate to microfilming hard copies of transmitted data. Although still in a tricky, laboratory state, its development as a commercial recording system offers real-time high-resolution recording typical of any data now microfilmed. The system, whose laser burns holes in the bismuth film for data points, has a resolution of 1,900 lines, with approximately 1,300 spots in each line per frame. Thus, each frame consists of about 2.5 billion sites where holes may be machined.

### Crystal blamed for crash

The crackup of the Bay Area Rapid Transit train on Oct. 2 has been traced to a faulty crystal aboard the train [*Electronics*, Oct. 9, p. 36]. According to one source, the crystal shifted in its mounting, causing one of the leads to be shorted to ground. The crystal was in an oscillator circuit used in decoding speed commands transmitted by wayside equipment.



## It takes us less time to tell you what it's not.

### What it's not.

It's not an office copier. But it's as fast and easy to use as an office copier. The output is a digital bit stream. And that's the major difference: You can optically scan input documents. Or pictures. Or patterns. Or characters to your computer system. Or storage system. Or high-speed communications system. Or pattern recognition system. In short, it begins to relieve the input bottleneck of *your* system.

### What it isn't for.

It isn't for the guy without ideas. More applications exist than time to list them all. But you might consider these few: A photocomposition system for the typesetting trades. An optical character reader for computer input. A document storage and retrieval system for large filing requirements. A facsimile scanner for high speed communications (up to one megabit per second). A pattern recognition system for computer analysis of any type of graphics—such as line

drawings, symbols, half tone prints, handwriting and fine art. An automatic inspection system for most surfaces; natural or manufactured; animal, vegetable, or mineral. An input to any machine requiring the translation of artwork to digital form—computer controlled knitting machines, welding machines, graphics plotters, and artwork generators.

### Why you might not buy it.

You might not buy it if you like to tinker. It has one moving part and all solid-state electronics. You might not buy it if you're not in a hurry. It optically scans and digitizes a complete document in two to four seconds depending on the resolution desired. You might not buy it if you don't want photopic response. It recognizes every color—from light blue to dark red—and, like the human eye, differentiates the data from the background by degrees of contrast.

### What it won't do.

It won't scan at infinite speeds. And it won't deliver at infinite resolutions. But it *will* scan at up to one megabit per second—with resolutions of 240 points per inch. That translates to mean our product can scan an 8½ x 11 inch field and then reduce it to digital data in less than four seconds. And that's about five times faster than anything else we know of on the market. And that's pretty important if you need your data rapidly digitized. If you need more information rapidly, call John Brown direct at (408) 734-1225.



### DEST DATA CORPORATION

1285 Forgewood Avenue  
Sunnyvale, California 94086  
(408) 734-1234

# Harris

Here are the first eight of our new growing DI/CMOS family—the fastest low-power devices of their kind available today.

If you're joining the big move to CMOS, we've got your device. Or soon will have. Because we've committed ourselves to dielectrically isolated CMOS (DI/CMOS) development on a major scale. The first eight are available now. These devices offer speeds twice as fast any comparable ICs, typically 10ns with 10-volt power supplies. They also offer a wide power supply range (3VDC to 18VDC), while providing large noise immunity, typically 45% of supply voltage. In terms of chip reliability, our engineers currently report more than 230,000 device hours at +125°C without failure.

All of the new devices are available in 14-pin dual in-line packages except the HD-4009 and HD-4010, which come in 16-pin packages. Because of their compatible pin-out configurations these circuits will replace or interface with the CD 4000A series. For details see your Harris distributor or representative.

## 1

HD-4000 Dual 3 NOR Gate

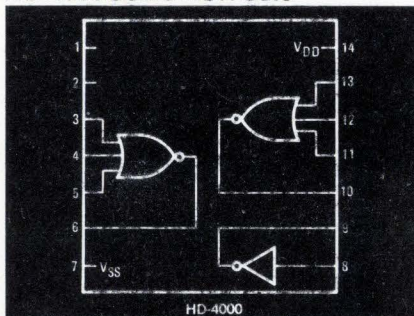

Pin for pin compatible with CD 4000A.

High speed 10ns  
Low power 1nW

−40°C to +85°C 100-999 units \$1.00  
−55°C to +125°C \$3.10

## 3

HD-4009 HEX Inverter

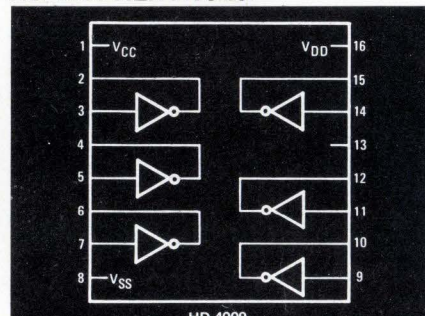

Pin for pin compatible with CD 4009A.

High speed 10ns  
Low power 50nW

−40°C to +85°C 100-999 units \$2.20  
−55°C to +125°C \$5.25

## 2

HD-4001 Quad 2 NOR Gate

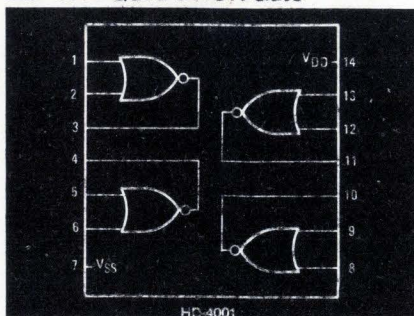

Pin for pin compatible with CD 4001A.

High speed 10ns  
Low power 1nW

−40°C to +85°C 100-999 units \$1.00  
−55°C to +125°C \$3.30

## 4

HD-4010 HEX Buffer

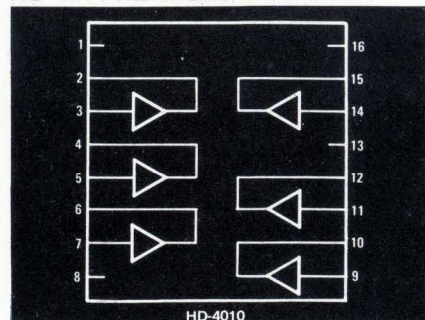

Pin for pin compatible with CD 4010A.

High speed 10ns  
Low power 50nW

−40°C to +85°C 100-999 units \$2.20  
−55°C to +125°C \$5.25

# CMOS.

## 5

**HD-4011 Quad 2 NAND Gate**

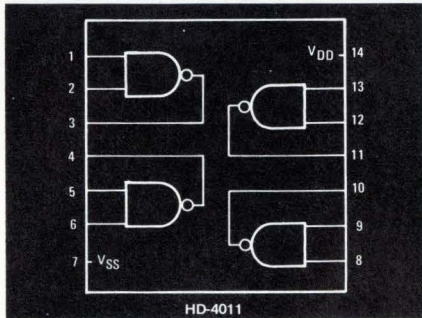

Pin for pin compatible with CD 4011A.

High speed 10ns  
Low power 1nW

-40°C to +85°C	100-999 units	\$1.00
-55°C to +125°C		\$3.30

## 7

**HD-4013 Dual "D" Flip Flop**

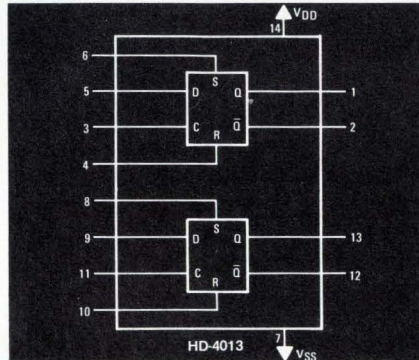

Pin for pin compatible with CD 4013A.

High speed 18MHz typical toggle rate  
Low power 50nW

-40°C to +85°C	100-999 units	\$2.10
-55°C to +125°C		\$4.75

## 6

**HD-4012 Dual 4 NAND Gate**

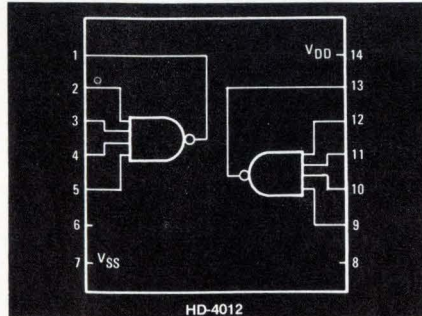

Pin for pin compatible with CD 4012A.

High speed 10ns  
Low power 1nW

-40°C to +85°C	100-999 units	\$1.00
-55°C to +125°C		\$3.45

## 8

**HD-4809 Triple/True Complement Buffer**

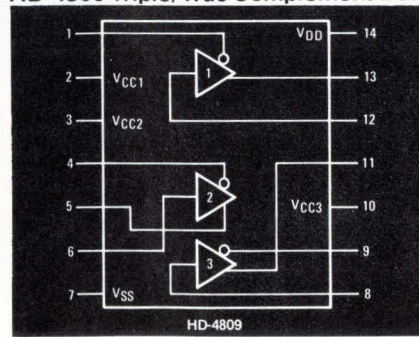

A Harris proprietary device.

High speed 10ns  
Low power 50nW

-40°C to +85°C	100-999 units	\$2.25
-55°C to +125°C		\$5.30



**HARRIS**  
**SEMICONDUCTOR**

A DIVISION OF HARRIS-INTERTYPE CORPORATION

P.O. Box 883, Melbourne, Fla. 32901  
(305) 727-5430

**WHERE TO BUY THEM:** ARIZONA: Phoenix—Liberty, Weatherford; Scottsdale—HAR (602) 946-3556  
CALIFORNIA: Anaheim—Weatherford; El Segundo—Liberty; Glendale—Weatherford; Long Beach—HAR (213) 426-7687; Mountain View—Elmar; Palo Alto—Weatherford, HAR (415) 321-2280; Pomona—Weatherford; San Diego—Weatherford, Western  
COLORADO: Denver—Elmar, Weatherford  
WASHINGTON, D.C.: HAR (202) 337-3170  
FLORIDA: Hollywood—Schweber; Melbourne—HAR (305) 727-5430  
ILLINOIS: Chicago—Semi-Specs, Schweber; Palos Heights—HAR (312) 597-7510  
INDIANA: Indianapolis—Semi-Specs  
MARYLAND: Rockville—Schweber  
MASSACHUSETTS: Lexington—R&D; Waltham—Schweber; Wellesley—HAR (617) 237-5430  
MICHIGAN: Detroit—Semi-Specs  
MINNESOTA: Minneapolis—Semi-Specs  
MISSOURI: Kansas City—Semi-Specs; St. Louis—Semi-Specs  
NEW MEXICO: Albuquerque—Weatherford  
NEW YORK: Melville—HAR (516) 249-4500; Syracuse—HAR (315) 463-3373; Rochester—Schweber; Westbury—Schweber  
OHIO: Beachwood—Schweber; Dayton—Semi-Specs  
PENNSYLVANIA: Pittsburgh—Semi-Specs; Wayne—HAR (215) 687-6680  
TEXAS: Dallas—Weatherford, Semi-Specs, HAR (214) 231-9031  
WASHINGTON: Seattle—Liberty, Weatherford.

**LEGEND FOR HARRIS SALES OFFICES & DISTRIBUTORS:** Harris Semiconductor (HAR); Elmar Electronics (Elmar); Harvey/R&D Electronics (R&D); Liberty Electronics (Liberty); Schweber Electronics (Schweber); Semiconductor Specialists, Inc. (Semi-Specs); R. V. Weatherford Co. (Weatherford); Western Radio (Western).



**TEKTRONIX®**

committed to  
technical excellence

# Oscilloscope + Digital Plug-ins

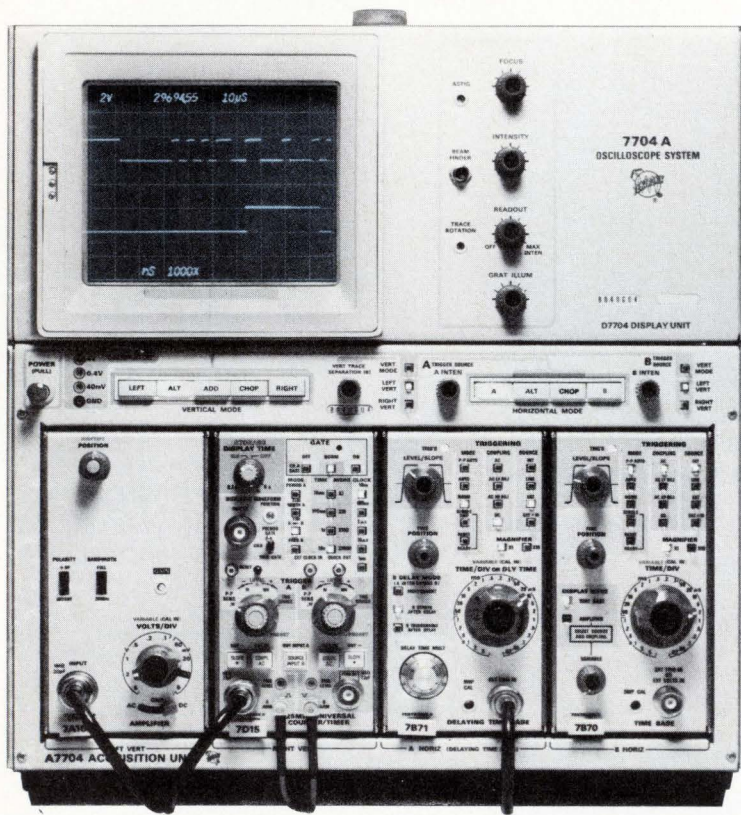

=

Unique  
Solutions  
to  
Difficult  
Problems

FEATURING  
7D15 Universal  
Counter/Timer

## PROBLEM:

Accurately measure the time between two nonadjacent pulses in a word train (displayed in upper trace).

## SOLUTION:

Use the scope's delayed sweep gate to selectively control the counter's measurement interval (displayed in lower trace). A time interval of 29694.55 ns is measured and displayed on the scope's CRT READOUT.

# 7000-Series DIGITAL FAMILY

TEK's Digital Family consists of two counters, a DMM and a delay unit that improve measurement accuracy through digital technology. Now, both digital and analog data can be viewed together when teaming these measurement capabilities with a 7000-Series Scope.

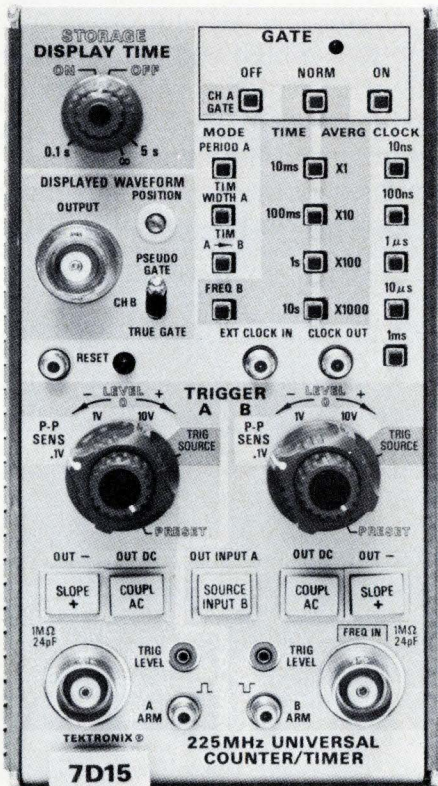

Applications unique with the new 7D15 Universal Counter/Timer include measuring: time intervals of selected portions of complex waveforms (such as telemetry and computers); time between nonadjacent pulses; time between desired events (such as radar)—while ignoring effects of noise; fre-

quency of burst—the arming feature permits measurement inside a burst so that burst turn on can't introduce possible error; and frequency of events—while ignoring signal ringing.

Teaming the 7D15 with a scope gives you more solving power for today's complex measurements. This unique combination allows you to: (1) *Display* on the CRT the measured signal together with the measurement interval, or the counter Schmitt trigger signal; (2) *Precondition* the signal via the scope's vertical amplifier to provide input possibilities such as, 10  $\mu$ V sensitivity, Differential input, and Current probe input; and (3) *Accurately Control* the start and stop points of measurement by selective arming.

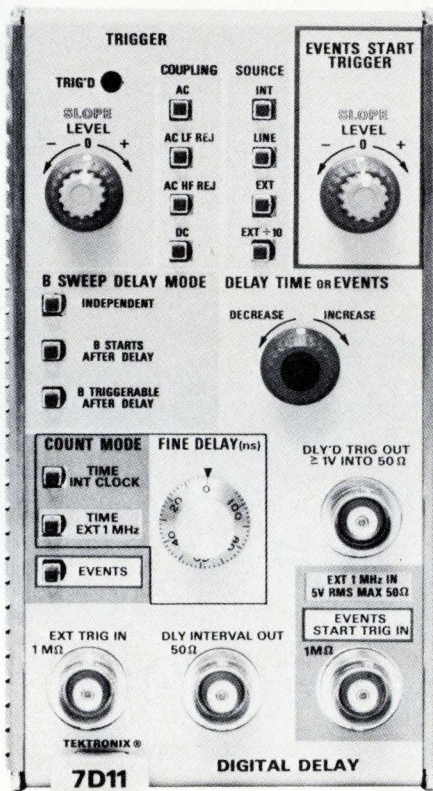

The new 7D11 Digital Delay Unit with its 100 ns-to-1 s delay range in Time-Delay mode and its 10,000,000 count range in the Events-Delay mode, fulfills many measurement requirements for accurate delays.

Applications in the Time-Delay mode include measuring: accurate low jitter sweep delays; propagation delays of delay lines or delay devices; delay path equalization in networks, logic systems, cable systems, or distribution amplifiers; oscillator stability; pulse width jitter, pulse-to-pulse jitter; and more.

Applications in the Events-Delay mode include: disc memory skewing adjustments; computer main storage or local storage timing adjustments; lost bit identification and location on disc memory or magnetic tapes; modulation analysis on time division multiplexing (TDM) or pulse modulation (PWM) in communication and data systems; and more.

The 7D13 Digital Multimeter with its unique temperature probe and 7D14 525-MHz Digital Frequency Counter are two more problem solvers in TEK's digital family.

TEK's concept of integrating these digital measurement capabilities with the scope brings you many advantages over separate test units:

- measuring convenience and confidence
- easier and faster solutions to complex problems
- fewer dollars invested
- more bench working space
- signal conditioning

Add to these, the new dimension of scope-controlled measurements and you realize the potential of the 7000-Series Integrated Test System concept. ...Watch for more to come.

For more information contact your local TEKTRONIX Field Engineer or write: Tektronix, Inc., P. O. Box 500, Beaverton, Oregon 97005.

**Tektronix, Inc.**

Offering sales, after-sales support and service...worldwide.

# NOW, 400V & 600V DARLINGTONS FROM



**Delco Electronics**

DIVISION OF GENERAL MOTORS CORPORATION, KOKOMO, INDIANA

Delco's new DTS-4000 series Darlington transistors with  $V_{CE0}$ 's of 400V and 600V are triple diffused mesa units built for rugged duty. They come to you with a practical 15 Ampere rating that you can depend on all the way up to the high voltage requirements of ac motor speed controls, for instance—or the 1.5 kW switching regulator in the illustration.

And they offer new possibilities

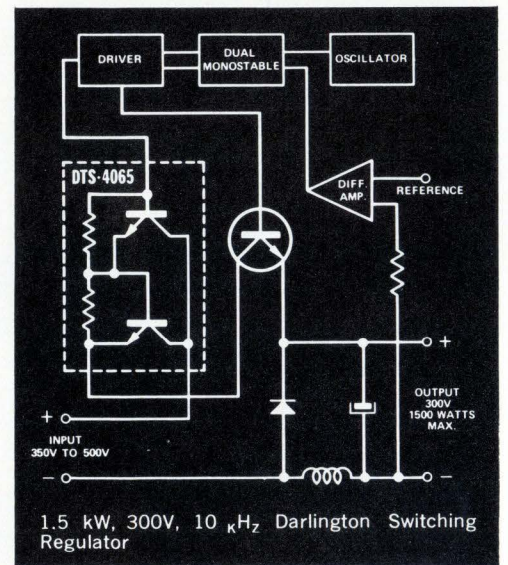

in circuit design where dc drive conditions may have created awkward problems when using SCR's.

Our new Darlington transistors can save you space and give you more design flexibility. The high energy capability of the DTS-4000 series is

## SAFE OPERATING CURVES

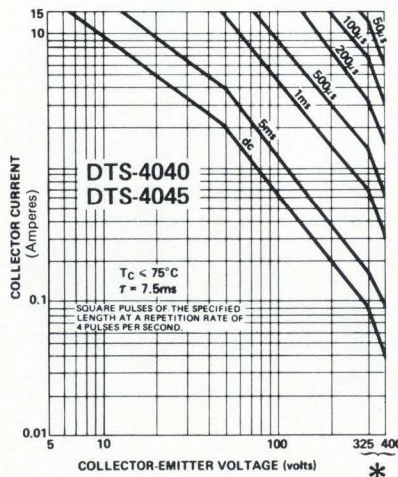
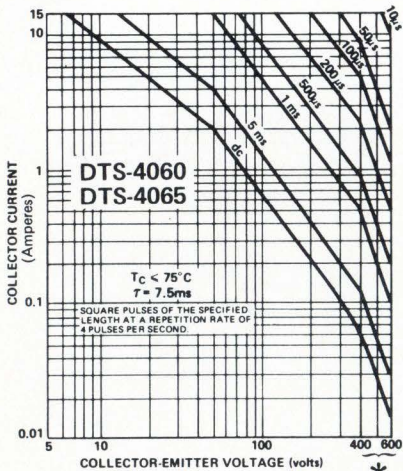

\*Reverse Bias Required

TYPE	$V_{CE0}$	$I_C$ (Cont.)	$V_{EBO}$ (Max.)	$V_{CE0}(sus)$	$h_{FE}$ @ $I_C$	$t_f$ (com. base)	$P_D(max.)$
DTS-4040	400V	15A	20V	325V	250/3A	$0.25 \mu s$	100W
DTS-4045	400V	15A	20V	325V	500/3A	$0.25 \mu s$	100W
DTS-4060	600V	15A	20V	400V	250/3A	$0.25 \mu s$	100W
DTS-4065	600V	15A	20V	400V	500/3A	$0.25 \mu s$	100W

NPN—Triple diffused Darlington transistors packaged in solid copper TO-204MA (TO-3) cases.



# HIGH ENERGY THE KOKOMOANS.

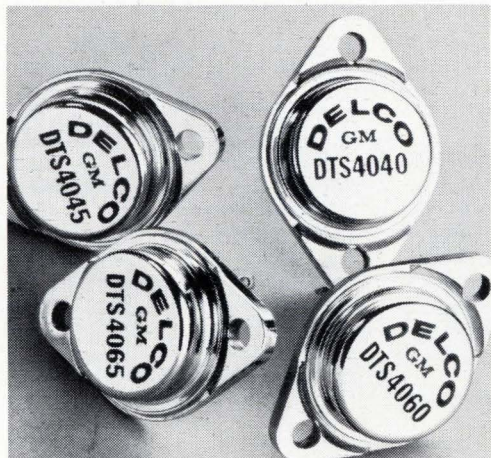

backed by safe operating curves up to 600 volts, as shown at left. And to further aid your circuit design  $h_{FE}$  is plotted continuously from 15mA to the maximum collector current rating of 15A.

As you expected, the new DTS-4000's are in stock and ready for delivery. Contact us or your nearest Delco distributor for complete details. Ask for Application Note 52 on the switching regulator.

## Now available from these distributors in production quantities:

ALA., BIRMINGHAM • Forbes Distributing Co., Inc. (205)-251-4104  
 ARIZ., PHOENIX • Sterling Electronics (602)-258-4531  
 CAL., LOS ANGELES • Kierulff Electronics, Inc. (213)-685-5511 • Radio Products Sales, Inc. (213)-748-1271  
 CAL., PALO ALTO • Kierulff Electronics, Inc. (415)-968-6292  
 CAL., REDWOOD CITY • Cramer/San Francisco, (415)-365-4000  
 CAL., SAN DIEGO • Radio Products Sales, Inc. (714)-292-5611  
 CAL., SAN DIEGO • Kierulff Electronics, Inc. (714)-278-2112  
 COLO., DENVER • Cramer/Denver (303)-758-2100 • Denver Walker Electronics (303)-935-2401  
 CONN., NORWALK • Harvey/Connecticut (203)-853-1515  
 FLA., MIAMI SPRINGS • Powell/Gulf Electronics (305)-885-8761  
 ILL., ROSEMONT (Chicago) • Kierulff Electronics (312)-678-8560

ILL., SKOKIE (Chicago) • Merquip Electronics (312)-282-5400  
 IND., INDIANAPOLIS • Graham Electronics Supply, Inc. (317)-634-8202  
 MD., BALTIMORE • Radio Electric Service Co. (301)-823-0070  
 MASS., NEEDHAM HEIGHTS • Kierulff Electronics, Inc. (617)-449-3600  
 MASS., NEWTON • The Greene-Shaw Co., Inc. (617)-969-8900  
 MICH., ROMULUS • Harvey-Michigan (313)-729-5500  
 MINN., MINNEAPOLIS • Stark Electronics Supply Co. (612)-332-1325  
 MO., KANSAS CITY • Walters Radio Supply, Inc. (816)-531-7015  
 MO., NO. KANSAS CITY • LCOMP-Kansas City, Inc. (816)-221-2400  
 MO., ST. LOUIS • LCOMP-St. Louis, Inc. (314)-647-5505  
 N.J., CLIFTON • Eastern Radio Corporation (201)-365-2600, (212)-244-8930  
 N.Y., BINGHAMTON • Harvey/Federal (607)-748-8211  
 N.Y., EAST SYRACUSE • Cramer/Eastern (315)-437-6671  
 N.Y., ROCHESTER • Cramer/Rochester (716)-275-0300  
 N.Y., WOODBURY • Harvey/New York (516)-921-8700, (212)-582-2590  
 OHIO, CINCINNATI • United Radio, Inc. (513)-761-4030  
 OHIO, CLEVELAND • Pattison Supply (216)-441-3000  
 OHIO, DAYTON • Kierulff Electronics (513)-278-9411  
 OKLA., TULSA • Radio, Inc. (918)-587-9123  
 PENN., PHILADELPHIA • Almo Electronics (215)-676-6000  
 PENN., PITTSBURGH • RPC Electronics (412)-782-3770  
 S.C., COLUMBIA • Dixie Radio Supply Co., Inc. (803)-253-5333  
 TEXAS, DALLAS • Adleta Electronics Co. (214)-741-3151  
 TEXAS, FORT WORTH • Adleta Electronics Co. (817)-336-7446  
 TEXAS, GARLAND • Kierulff Electronics, Inc. (214)-271-2471  
 TEXAS, HOUSTON • Harrison Equipment Co., Inc. (713)-224-9131  
 UTAH, SALT LAKE CITY • Cramer/Utah (801)-487-3681  
 VA., RICHMOND • Meridian Electronics, Inc., a Sterling Electronics Company (703)-353-6648  
 WASH., SEATTLE • Kierulff Electronics, Inc. (206)-763-1550  
 WASH., TACOMA • C & G Electronics Co. (206)-272-3181  
 CANADA, ONT., SCARBOROUGH • Lake Engineering Co., Ltd. (416)-751-5980  
 ALL OVERSEAS INQUIRIES:  
 General Motors Overseas Operations  
 Power and Industrial Products Dept.,  
 767 Fifth Avenue, New York, N.Y.  
 10022. Phone: (212)-486-3723.  
**Kokomoans' Regional Headquarters.**  
 Union, New Jersey 07083, Chestnut Station, (201) 687-3770.  
 El Segundo, Calif. 90245, 354 Coral Circle, (213) 640-0443.  
 Kokomo, Ind. 46901, 700 E. Firmin, (317) 459-2175 (Home Office)



# INTRODUCING 54C/74C. CMOS, SIMPLIFIED.

If you've been designing with 54/74 series TTL (standard or low-power) and would now like to design with CMOS, we've greatly eased the procedure.

Our new MM54C and MM74C devices are functionally equivalent to and pin-and-power-supply-compatible with standard and low-power 54/74. Noise immunity is typically *45% of supply voltage* (which can be anywhere from 3 to 15 volts). And power dissipation is typically *10 nanowatts per gate*. All this with the kind of functions you've come to know and love with 54/74 TTL.

In addition to our new full temperature range MM54C/74C series and our intermediate temperature range MM64C series, we are also second-sourcing many of the other popular CMOS devices on the market.

For full particulars on CMOS, National style, simply call us at (408) 732-5000.

Or drop us a line. National Semiconductor Corporation, 2900 Semiconductor Drive, Santa Clara, California 95051.

## CMOS, NATIONAL STYLE

Part Number	Function	Availability
MM74C00/MM64C00/MM54C00	Quad 2-input NAND Gate	Now
MM74C02/MM64C02/MM54C02	Quad 2-input NOR Gate	Now
MM74C04/MM64C04/MM54C04	Hex Inverter	November
MM74C10/MM64C10/MM54C10	Triple 3-input NAND Gate	Now
MM74C20/MM64C20/MM54C20	Dual 4-input NAND Gate	Now
MM74C74/MM64C74/MM54C74	Dual "D" Flip-Flop	Now
MM74C73/MM64C73/MM54C73	Dual J-K Master-Slave Flip-Flop	October
MM74C76/MM64C76/MM54C76	Dual J-K Master-Slave Flip-Flop	October
MM74C107/MM64C107/MM54C107	Dual J-K Master-Slave Flip-Flop	October
MM74C95/MM64C95/MM54C95	4-Bit Parallel-In/Parallel-Out Shift Register	December
MM74C160/MM64C160/MM54C160	Synchronous Decade Counter	November
MM74C161/MM64C161/MM54C161	Synchronous 4-Bit Binary Counter	November
MM74C162/MM64C162/MM54C162	Fully Synchronous Decade Counter	November
MM74C163/MM64C163/MM54C163	Fully Synchronous 4-Bit Binary Counter	November
MM74C195/MM64C195/MM54C195	4-Bit Parallel-Access Shift Registers	November
MM74C173/MM64C173/MM54C173	Quad Latch	December
MM74C151/MM64C151/MM54C151	8-Bit Data Selections/MUX with Strobe	December
MM74C157/MM64C157/MM54C157	Quad 2 Line to 1 Line MUX	February
MM74C42/MM64C42/MM54C42	BCD-to-Decimal Decoder	December
MM74C154/MM64C154/MM54C154	4 to 16 Line Decoder Demultiplexer	January
MM74C192/MM64C192/MM54C192	Synchronous Up/Down Decade Counter	February
MM74C193/MM64C193/MM54C193	Synchronous Up/Down 4-Bit Binary Counter	February
MM74C164/MM64C164/MM54C164	8-Bit Parallel-Out Shift Register	January
MM74C165/MM64C165/MM54C165	Parallel-Load 8-Bit Shift Register	February
MM74C123/MM64C123/MM54C123	Retriggerable Monostable Multivibrator	January
MM74C200/MM64C200/MM54C200	256 Bit RAM	2nd Qtr 1973
MM4601A/MM5601A	Quad 2-input NOR Gate	Now
MM4602A/MM5602A	Dual 4-input NOR Gate	Now
MM4609A/MM5609A	Hex Inverter Buffer	Now
MM4610A/MM5610A	Hex Non-inverter Buffer	Now
MM4611A/MM5611A	Quad 2-input NAND Gate	Now
MM4612A/MM5612A	Dual 4-input NAND Gate	Now
MM4613A/MM5613A	Dual "D" Flip-Flop	Now
MM4623A/MM5623A	Triple 3-input NAND Gate	Now

# NATIONAL

## **GSA plans to upgrade data center . . .**

Consolidating its computer and telecommunications functions is only one of the several new projects being formulated by the General Services Administration. The renamed Automated Data and Telecommunications Service plans to issue requests for proposals next year, possibly in the spring, **to upgrade 10 data processing centers to third-generation equipment**, replacing the General Electric and Honeywell computers at an estimated cost of \$2-4 million per site. Installation would be completed late 1974 with fiscal 1975 funds. **Unresolved so far is whether ADTS will lease or buy the new equipment.**

## **. . . and looks at inventory communications**

ADTS also is expected to issue **RFPs in March for a communications-equipment management-information system**, which would inventory Government telecommunications and prepare better plans for their use. "Frankly, at the moment, we have no handle at all on the amount, variety, and location of equipment throughout the field," says ADTS chief Harold S. (Ted) Trimmer. **Still a question is whether the system will be a new network or an extension** of the information network leased from Computer Science's Infonet division.

Other developments in GSA's growing control of Government computers [*Electronics*, July 31, p. 33] are: new regulations increasing ADTS power of sole-source purchasing; development of a standard RFP for use throughout Government agencies, and investigation into multi-year and third-party leasing arrangements, perhaps among several Government agencies.

## **FAA to buy new Alford antennas**

The Federal Aviation Administration plans to buy the new Alford design of localizer antenna arrays **to replace older instrument-landing system antennas at certain airports**. AIL division of Cutler Hammer, Texas Instruments, and Wilcox Electric Co. have already told the FAA they want to bid on the purchase, expected to be less than 100 units in the first instance.

Designed as a series of overlapping rings by Andrew Alford Consulting Engineers, Winchester, Mass., the new antennas improve on old V-ring antennas because they **have no rearward radiation, perform better at difficult sites, cost a quarter to half as much to erect**, and, being modular in design, can be easily adapted to various weather category landing approaches. **Individual Alford arrays cost about \$20,000**, but unit costs would decrease with quantity production. TI is presently slated to deliver up to 60 Alfords as part of an ILS package under a previous FAA-Air Force agreement.

## **More computers for ARTS program?**

A request for proposals could be issued as early as this coming winter for additional processing capability in the Automated Radar Terminal System program under plans being formulated by the Federal Aviation Administration. The new buy, estimated to run \$50 million, would provide backup redundancy to the main computers at the 64 ARTS-3 terminals now being installed. One question within the agency is **whether the multiyear contract should be awarded competitively or as a sole source to ARTS-3 contractor Univac.**

## Nixon, Tanaka, Chou and the Muncs

Japan's Premier Kakuei Tanaka may have followed President Richard Nixon in his visit to the People's Republic of China and Premier Chou, but he achieved much more than a mere imitation of the American initiative, in the private view of some Federal analysts of international trade in Washington. Yet those who believe so maintain an official silence on the subject—not necessarily, they say, out of fear that such a disclosure would tarnish the Nixon image on the eve of his apparent reelection but because they are anxious to see just how the new Tanaka-Chou rapprochement evolves. At the moment it appears to be evolving in a way that will give Japan first crack at a massive untapped market for its electronics technology—industrial, commercial and consumer—at the expense of America's multinationals, those corporate giants popularly known as “Muncs,” which are racing to expand their sales and manufacturing operations around the world.

### A fast recovery

In Peking, where the President proceeded with caution, exchanging musk oxen for giant pandas and laying the groundwork for a gradual restoration between China and the U.S., the Japanese moved swiftly. After Tanaka apologized publicly to the Chinese for his country's invasion of the mainland during the Second World War, he quickly arranged for negotiations on reparations and then concluded an agreement to reestablish normal diplomatic relations. The next step: trade.

For Japan it was a remarkable recovery from—as well as a reaction to—what it called “Nixon shock,” the initial angry Japanese response to the Nixon announcement of his plan to visit Peking. For that reversal of U.S. policy was made without prior consultation with or warning to Tokyo, America's most stable ally in Asia.

Reaction within the U.S. electronics community to the blossoming Sino-Japanese accord and its meaning for American business produces an interesting set of responses, nearly all different. Says one executive in Washington of Japan's apparent plan to develop the mainland market: “Fine. Let them have it. Maybe it will take some of the pressure off us.” Clearly that is probably true for the short term. But it is also short-sighted. Among other things, it reflects an attitude found in segments of the Electronic Industries Association, which is still supporting U.S. retaliation against Japan in the form of countervailing duties on imports of television

receivers and parts that Americans say are being dumped on the U.S. market by Japanese manufacturers whose export prices are alleged to be lower than those at home.

Opposing that view are Government and industry officials who believe the actions of the EIA and others are but one more example of Americans trying to lock the barn after the horse has gone, in this case the market for television receivers. General Electric is one of those opposed. In an unreleased and unpublicized letter this summer to the U.S. Commissioner of Customs, GE's attorneys in Washington detailed the company's opposition to countervailing duties. As it and other U.S. manufacturers began some years ago to move their consumer electronics operations offshore to places like Taiwan, Hong Kong, and South Korea, or sub-contracted production to Japan in an effort to counter the Japanese inflow most economically, America began losing its ability to produce consumer electronic products competitively. Now, says GE, it is convinced that “resuscitation of a manufacturing capability sufficient to supply the American market is economically unattractive and unfeasible now and into the projectible future,” countervailing duties notwithstanding.

Indeed, invocation of such penalties will, in GE's opinion, “merely shift advantage in the consumer electronics trade from Japan to those producers in other foreign countries in the Far East and elsewhere who can opportunistically exploit the American market.” Supporters of the tariffs, of course, include a number of American-owned companies, particularly those in Taiwan.

### New direction

While it is worth noting that GE owns 12.06% of the stock of Toshiba, one of Japan's leading electronics manufacturers, it does not appear that its attitude on U.S.-Japanese trade relations cited here is influenced by that long-standing investment. What GE is saying is no more than what a number of other Muncs have been saying as well. And that is to look forward instead of backward, and act on developments that will shape the future, rather than haggle over issues already past.

Thus it would seem more useful for EIA and its membership to devote more of their time to considering what future, if any, they may have in the markets of mainland China, rather than litigate to protect domestic markets already lost.

—Ray Connolly

Careful there . . .  
you're likely  
to start  
something.



Just a  
"flutter" of pressure  
. . . and SNAP!

Less than 2 grams of force actuates this Cherry snap-action miniature switch. Outside, the external aluminum actuator is purposely  $2\frac{3}{8}$ " long to provide this unusually low operating force. Inside, an extra internal actuator further reduces operating force while maintaining solid contact mating pressure for reliable performance.

The "flutter force" switch is only one of Cherry's E22 series of unique miniatures. All are rated 3 amps, 125 VAC. All are also available in gold "crosspoint" configuration for low energy solid state circuits.

**A switch in your hand is worth two in the tree, so . . . SNAP UP A FREE SNAP-ACTION SAMPLE.**

Just TWX 910-235-1572 . . . or PHONE 312/689-7704 and ask Frank to give you facts on miniature switches . . . or circle appropriate reader service number.

**E22-75HX**  
5 grams LIGHT  
FORCE actuation  
Circle No. 49 for  
Free Sample



**E22-55HX**  
3.5 grams LIGHTER  
FORCE actuation  
Circle No. 50 for  
Free Sample



**E22-85HX**  
Less than 2 grams  
"FLUTTER  
FORCE" actuation  
Circle No. 51 for Free Sample



**CHERRY** 

CHERRY ELECTRICAL PRODUCTS CORP.  
3608 Sunset Avenue, Waukegan, Illinois 60085

Makers of patented Leverwheel/Thumbwheel Switches, Matrix Selector Switches, Snap-Action Switches and Keyboards.

# Sorensen has a bargain for you: DCR power supplies selling for \$360-\$4200.



Sorensen's DCR power supplies offer you the lowest cost per watt in the industry. More power output for each dollar you invest.

And DCR's comprise the broadest lab/systems line available anywhere: 37 models in 10 voltage ranges, 7 power levels.

Features? All silicon solid-state electronics. Precision regulation. Remote voltage, current or resistance programming — and remote sensing at distances to 200 feet. Operation in either voltage or current modes.

For complete data and prices, write Sorensen, a unit of Raytheon Company, 676 Island Pond Road, Manchester, N.H. 03103. Telephone (603) 668-1600. Or TWX 710-220-1339.

**Sorensen**  
**POWER SUPPLIES**

## Key Data

- 37 models available.
- 10 voltage ranges from 20 to 30,000 Vdc.
- 7 power levels from 400 to 20,000 W.
- Low output ripple.
- Voltage and current regulation with automatic crossover.
- Typical efficiencies to over 80%.
- Fits standard 19" rack (except 20 kW models).
- Optional overvoltage protection for all models (except 20 kW).
- Series or parallel operation.
- MTBF greater than 25,000 hours.

## Liquid-crystal display shows black letters against white ground

**Resembling a line of type**, dark characters appear on a white background in a matrix liquid-crystal display being developed at the Wireless Research Laboratory of Matsushita Electric Industrial Co. This reversal of values from the usual display comes with the use of a new operating mechanism that may open the way to inexpensive multiline alphanumeric displays.

The new display makes use of recently discovered property of a mixture of a nematic liquid crystal that has positive anisotropy and a cholesteric liquid crystal. With no applied electrical field, the mixture behaves as a cholesteric material and scatters incident light, which gives it a white appearance. But with an applied electrical field, there is a phase transformation to ne-

matic, and the material becomes transparent.

The phase transformation has a threshold value for an applied electrical field that can be changed by varying parameters, including the liquid-crystal materials used and the amount of each in the mixture.

Another characteristic of these mixtures is that a bias voltage that maintains an electric field below the threshold level increases the speed at which the liquid crystal transforms from the scattering to transparent state, and decreases the speed at which it returns from transparent to scattering state. The existence of a threshold level and the ability to slow the transformation back to the scattering state by applying a field below the threshold level permit use of a convenient X-

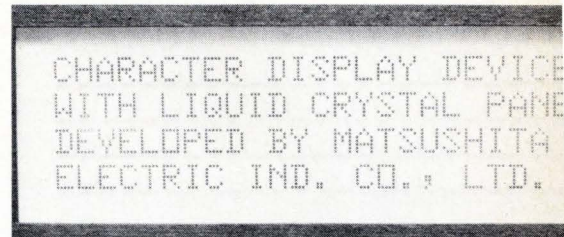

Y matrix arrangement to display multiple lines of characters or picture information.

**Displays.** Experimental displays using this mechanism are fabricated in a manner similar to other liquid-crystal displays. Two transparent tin-oxide electrodes sandwich an extremely thin layer of liquid crystal. To give a matrix configuration, the electrodes are arranged as a series of horizontal rows and vertical columns, with the liquid crystal material under each crosspoint.

One experimental unit displays 100 alphanumeric characters, with each character consisting of a five-by-seven-dot rectangle, in four lines of 25 characters each. To scan the entire display takes 2.1 seconds. But even at this relatively slow speed there is no flicker. Contrast for this reflection-type display is about 15:1.

Individual driving circuits with an output of 150 volts peak-to-peak are provided for each of the 28 horizontal electrodes, which are grounded when driving voltage is applied. Individual bias circuits with an output of 70 v peak-to-peak are provided for each of the 125 vertical electrodes, which have bias applied at all times. Both bias and driving voltages are at 40 hertz.

In operation, the driving voltage is applied to each horizontal electrode for exactly three cycles of the 40-Hz frequency, or 75 milliseconds, supplying 220 v to the selected crosspoint. Simultaneously, bias voltage phase is inverted, giving only 80 v at the crosspoints requiring dark cells. □

### Italy

## Color television decision: buyers will have to wait a little longer

"No color TV in Italy before 1974." With these words, Italian Premier Giulio Andreotti dashed the hopes of the Italian TV manufacturers, who were looking for a much-needed pick-up from the introduction of the color TV. Andreotti says that the poor economic situation "counsels no hurry."

The decision is a real let-down for the TV manufacturers. After the balmy of the last two months, when the French brought strong pressure to bear for the adoption of their Secam system and the Italian government tested the French system and the German PAL system for the duration of the Olympic Games, they felt that a decision was imminent [*Electronics*, Aug. 28, p. 47]. The government is still, after eight years,

undecided over the choice of the two broadcasting systems, although the feeling is that the German approach is currently ahead.

Commenting on the postponement, Lamberto Mazza, head of Zanussi, Italy's largest TV manufacturer, said that the recent color tests and the wide discussion of color TV has depressed even the sales of black-and-white sets. The public will now probably continue to put off the purchase of new black-and-white sets.

Silvano Ercolani, secretary of radio-TV sector of the industry association, ANIE, said "the situation is now somewhat dramatic. We cannot compensate with exports, since the only basis for competitive exporting is solid home sales." □

# Cincinnati Milacron now offers you the bare minimum

It's called the Strippable CIP. The new CIP/2002 is the minimum hardware framework from which you can build your own minicomputer.

You get only the basic components you need to build your own dedicated system. The CIP/2002 can save OEM users considerable cost because all but the most essential hardware has been stripped away. Only the control board, two data boards, and the frame remain. This allows the system builder to use the power of the minicomputer creatively. Incorporating and adapting the unit to your needs is vastly simplified. Best of all, the variety of options lets you pick just those you need. You don't pay for "frills" you don't need. And the price is very low as a result.

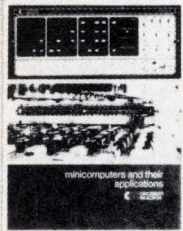

Send today for our free idea booklet entitled "Minicomputers And Their Applications" and get full details on how the Strippable CIP can save you money. Write or call (513) 494-5444, MINICOMPUTERS Cincinnati Milacron, Process Controls Division, Lebanon, Ohio 45036.

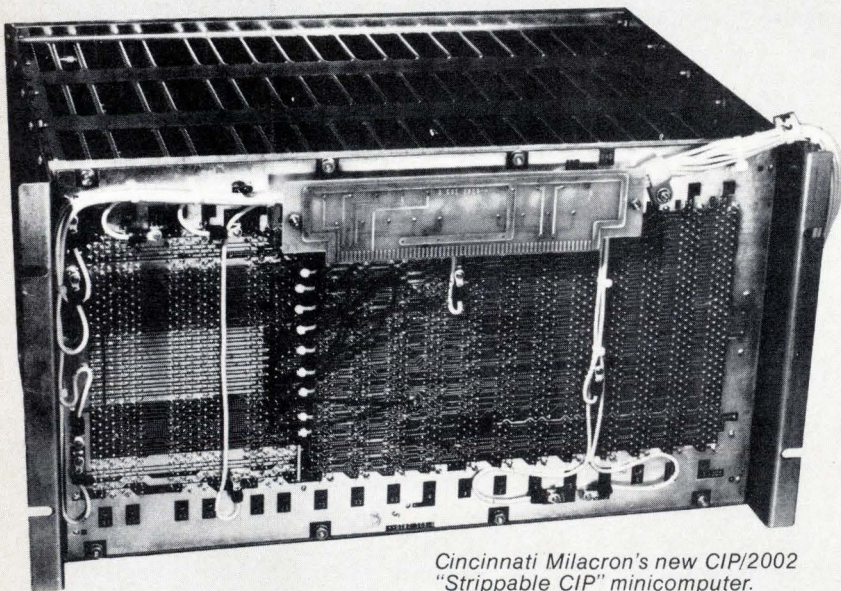

*Cincinnati Milacron's new CIP/2002 "Strippable CIP" minicomputer.*

**minicomputers**



**Machine Tools**  
**Process Controls**  
**Chemicals**  
**Plastics**  
**Plastics Processing Machinery**  
**Abrasives**



### **Fight on exports of computers to China delays new Cocom rules**

Most of the changes in the Cocom export embargo list have been approved by the 15 Cocom countries [*Electronics*, Oct. 9, p. 76], **but a stalemate over how far to liberalize computer exports has developed on political grounds.** Diplomats in Paris say the Japanese Cocom delegation wants to eliminate the special "China differential" that restricts most computer exports to China. The Japanese position is prompted by Prime Minister Tanaka's policy of rapprochement with mainland China, rather than any great Japanese hopes for computer sales to China. The United States is blocking the Japanese effort to put computer restrictions for China on an even footing with those for other Communist countries. **Sources say it may be the end of the year before the U.S. and Japan reach a compromise.** Meanwhile, Cocom is taking the unusual step of implementing the rest of its revised embargo list, holding off the eight-page computer section pending agreement. It is unclear how far computer parameters are being relaxed.

### **Pentagon move brings threat of French block to joint projects**

France could make things rough for American electronics ventures, if the Pentagon fails to lift its veto of General Electric's project to develop a new airliner engine jointly with France's state-owned engine builder, SNECMA. French government officials are warning privately that they may block "all technological cooperation" between France and the U.S., including strictly industrial ventures. **Government-backed projects like participation in the post-Apollo program or a joint transatlantic air traffic control system could similarly suffer.**

The Pentagon is blocking the engine project because it would be based on the highly advanced GE engine for the B-1 bomber, whose plans are classified. Says a high French government source: "The Americans have got to decide whether they are an integral part of the Atlantic community or not. If not, then we will simply have to start collaborating more on technology with the Germans and British—or even the Russians." However, **after next month's U.S. elections, France plans to pressure Washington into lifting the embargo.**

### **C-MOS, n-channel technologies mature in Europe**

Though behind U.S. companies, some European semiconductor manufacturers will soon offer MOS devices using n-channel and C-MOS technology. In Britain, **Plessey will offer samples of silicon gate n-channel 1,024- and 4,096-bit random-access memories early next year.** Speeds will be "typical, not exceptional." Plessey has no production C-MOS devices in view, but GEC Semiconductors Ltd. has built samples of C-MOS 64-bit and 128-bit memories for military use, where low power consumption is important, and may start manufacturing next year. **Like Plessey, GEC has a metal-nitride-oxide-semiconductor memory process and expects to offer samples of 128-bit, fully-decoded arrays by next March. Mullard Ltd., Philips' British subsidiary, will offer a 1,024-bit silicon gate n-channel RAM soon to be announced by Philips.** The Dutch company will also announce by year-end the first items in a range of C-MOS devices that will embrace TTL-compatible gates and flip-flops and MSI functions. LSI C-MOS custom design will follow.

### Russian computer imports are rising . . .

Last year, the Soviet Union imported 32 complete computer systems, worth roughly \$218 million, up from 26 systems imported in 1970. In the same period, Soviet exports in computers totalled roughly \$156 million. The fragmentary figures, contained in a brief report published by the authoritative Soviet economic weekly, *Ecotass*, give some indication of Soviet trading trends. And the trend towards increased computer imports is widely believed to be continuing.

The *Ecotass* report also discloses that:

- Czechoslovakia will buy nine Minsk 32 computers this year from Soviet export organizations.
- The Soviets have placed a "large" order with the Czech organization, Kovo, for delivery of "a batch of peripheral devices for electronic computers," valued at \$100 million.
- Last year, the Soviet Union imported five computer systems from France worth \$3.53 million, compared to one computer in 1970.
- Purchase of desk keyboard computers from Japan has expanded to 6,300 units last year, up from 1,930 in 1970.

### . . . as its computer program comes under fire at home

Openly complaining about the Soviet Union's computer development program, the authoritative Communist party newspaper, *Pravda*, claims the program is lagging in everything from availability of software to delivery of parts for third-generation computers. **Included in the criticism was the RJAD project—the joint computer program of several Eastern Bloc countries** [*Electronics*, Sept. 25, p. 72].

Manufacturers are supplying computers without proper programming and often without memory units. There is still a shortage of qualified personnel to install and operate computers at the plant or headquarters level, despite accelerating training programs within computer-related ministries, says *Pravda*. Moreover, when computers are delivered on schedule to end-users, often "they are not ready and their personnel are not qualified." **The result: many advanced computer systems stand idle, or are not used to maximum efficiency.**

Developers of the Soviet Union's third-generation computer, the EC 1020, which is now going into "mass production," **still haven't worked up necessary programs for end-users, reflecting similar problems that beset its predecessor, the Minsk 32.** "And nothing is known about when all necessary elements for the EC 1020, such as magnetic disks, will be put into production," adds the newspaper. **Indeed, *Pravda* questions the entire RJAD project**, which aims at developing a compatible line of data processing machines, ranging from minicomputers upwards to a machine comparable with IBM's 360/60. "When and in what quantity will our industry get improved computers of the RJAD-type?" asks *Pravda* rhetorically, **making it clear that high-ranking party officials are deeply concerned about the continuing lags.**

### British companies push small multimeters

Britain's Sinclair Radionics Ltd. is readying for market a small 23-range, 3½-digit digital multimeter that will **weigh not more than 22 ounces with batteries and probably be priced at less than \$150 in Britain.** It's driven by 9-volt transistor radio batteries, which give a usable life of 80 hours, the company claims. Read-out is cold-cathode tubes and the circuitry discrete. Another small multimeter, due shortly from Solatron Electronic Group Ltd., is built around a custom IC made by Plessey Co. It will be sold world-wide by the Schlumberger group.

# We made it because there wasn't a high performance digital panel meter at this price. Now there is.



## Our AD2003 3½-digit DPM. Only \$93 in 100's.

When we introduced our first 3½-digit panel meter it was the world's smallest and least expensive DPM.

We made it primarily for high accuracy display applications.

And it cost only \$89 in 100's.

Now for only \$4 more, our 5VDC powered AD2003 has the kind of performance you need for complex system interfacing and data processing.

That's because we designed it with a true differential instrumentation input amplifier and fully latched DTL/TTL compatible BCD outputs.

You can count on high common mode rejection of 80dB minimum at  $\pm 2.5V$ . Good normal mode rejection of 40dB. And you'll get a conversion

time of 60ms max.

A few other things that make our panel meter a lot better are green filtered RCA Numitron display tubes with optional color filters you can choose for color-coding.

Polarity and overload indicators.

A seven segment filament test.

And all this performance comes neatly and reliably packaged in a 1.8" H x 3" W x 2"D rugged aluminum case which easily snaps into your panel from the front.

Think of it as a component.

We burn-in each AD2003 for 7 days before shipping.

Something we do with all our panel meters.

Like our first 3½-digit meter — perfect for display.

Our second meter — an economical 2½-digit snap-in replacement for analog meters.

And now this new high performance 3½-digit DPM.

And a soon-to-be high performance 4½-digit model.

You can get evaluation samples of our AD2003 right now. As well as our Product Guide which shows all the other things we make to solve more of your problems better than anyone else.

Analog Devices, Inc., Norwood, Mass. 02062  
(617) 329-4700.



# Sooner or later you'll be considering a **MECL 10,000** design.

Since the introduction of MECL 10,000 in March, 1971 engineers have found that designing with MECL is no more difficult than designing high performance equipment with slower forms of logic. In fact, designers found that MECL features such as transmission line capability, complementary outputs and Wired-OR savings added as much to system performance as the short propagation delays and high toggle rates.

To appreciate these system advantages you have to evaluate. And here is a way that will make your job easier:

1. We are introducing four new MECL 10,000 devices bringing the family total to 38. Each new device is highly versatile and could be used for a variety of applications.
2. We have prepared a Design File which includes data sheets describing the new products, an application note covering interconnection techniques, and an application note illustrating varied uses of two of the four new devices.
3. This complete Design File will help you to evaluate the new additions and provide an insight into the application of MECL 10,000 for your future designs.

## And that's not all.

Just to make it interesting, we have included a "Design Idea" sheet in the file so you can explore new ways of using the new devices. Just jot down your circuit diagram showing possible applications using any one or more of the following:

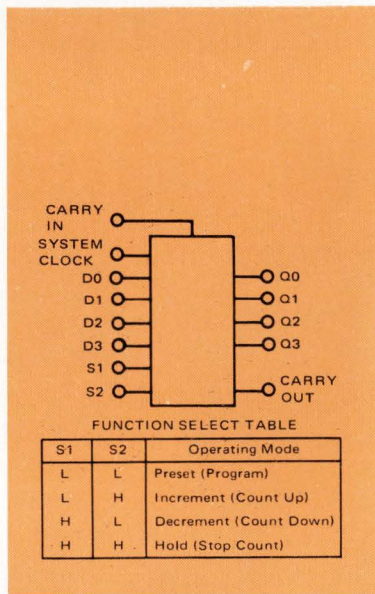

**MC10136 Universal Hexadecimal Counter, MC10137 Universal Decade Counter.** The MC10136 and MC10137 are both fully synchronous counters, MC10136 is a hexadecimal (0 thru 15 binary) counter, and MC10137 is a BCD decade counter. Logic configurations are similar for both counters.

The flexibility of these devices allows the designer to use one basic counter design for all applications. When used with appropriate MECL III prescalers, frequencies can be extended to over 500 MHz.

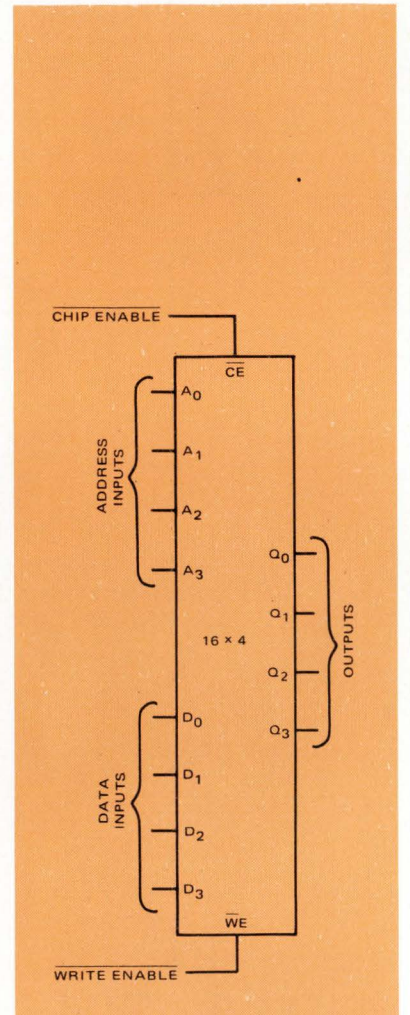

**MC10145 64-Bit RAM** Organized as a 16 x 4 array, the MC10145 is the first of a series of memories to be introduced in MECL 10,000. Fully decoded inputs, together with a chip enable, provide expansion of memory capacity. Access time is typically 10 ns, ideal for register file or small scratch pad applications.

# Here are four ways you can do it... sooner.

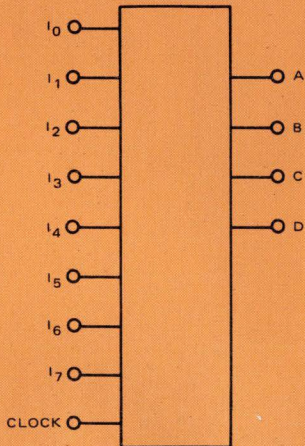

TRUTH TABLE

I <sub>0</sub>	I <sub>1</sub>	I <sub>2</sub>	I <sub>3</sub>	I <sub>4</sub>	I <sub>5</sub>	I <sub>6</sub>	I <sub>7</sub>	A	B	C	D
H	X	X	X	X	X	X	X	L	L	L	H
L	H	X	X	X	X	X	X	L	L	H	H
L	L	H	X	X	X	X	X	L	H	H	H
L	L	L	H	X	X	X	X	L	H	L	H
L	L	L	L	H	X	X	X	L	H	L	H
L	L	L	L	L	H	X	X	L	H	L	H
L	L	L	L	L	L	H	X	L	H	L	H
L	L	L	L	L	L	L	H	L	H	L	H
L	L	L	L	L	L	L	L	L	H	L	H
L	L	L	L	L	L	L	L	L	L	H	H
L	L	L	L	L	L	L	L	L	L	L	H
L	L	L	L	L	L	L	L	L	L	L	L

**MC10165 8-Input Priority Encoder** The MC10165 is designed to encode eight inputs to a binary coded output. The output code is that of the highest order input. Any input of lower priority is ignored. Applications include development of binary codes from random logic inputs, for addressing ROM, RAMs, or for multiplexing data.



**You're now on the way to becoming a high speed logic expert.**

After you have outlined your application, return the "Design Idea" sheet to Motorola Semiconductor Products Inc., Attention: MECL 10,000 Applications, P. O. Box 20912, Phoenix, Arizona 85036.

For each bona fide application submitted, we will send you, without charge, the comprehensive

MECL System Design Handbook and the newly printed, second-edition, MECL Data Book.

Together, these two books list the industry's broadest line of high-speed logic families and offer latest application techniques.

Act now. Send for your Design File today, and call your local Motorola distributor for evaluation devices. The sooner you evaluate — the sooner you'll be convinced.

**MECL 10,000 eliminates the alternatives. Evaluate and compare!**

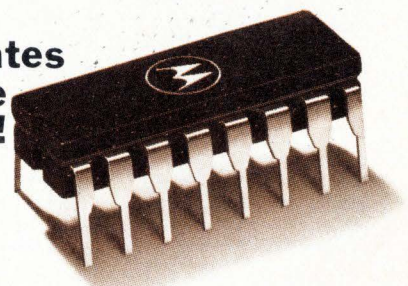

**MOTOROLA MECL**  
... for faster computers & systems

# Don't bug me with your nanoseconds.

Sometimes when I watch my golden boys drooling over the latest mini computer specs I think they are too young or I am too old. Is there anybody *using* computers who gives a damn about 100 nanoseconds one way or the other? What difference does it make if a computer's got one bus, two buses, or a trolley car.

When I buy a computer I buy maybe a hundred. I bury them in our own systems, and if they don't perform, my customers bury me.

Why the PRIME 200? It's really very simple. One, software. Two, reliability. Three, system price. I won't need a bunch of PhDs to develop systems software, because Prime has done it all. I won't have to sweat hardware failures because they provide byte parity, micro-diagnostics, and 24-hour replacement of a board—and there are exactly two boards in an 8K-word machine. As for price, it's competitive; what more could I ask?

Also, I have a feeling that the day I have to call Prime and tell them what I think, I'll be treated like a high priority interrupt, not a memory dump.



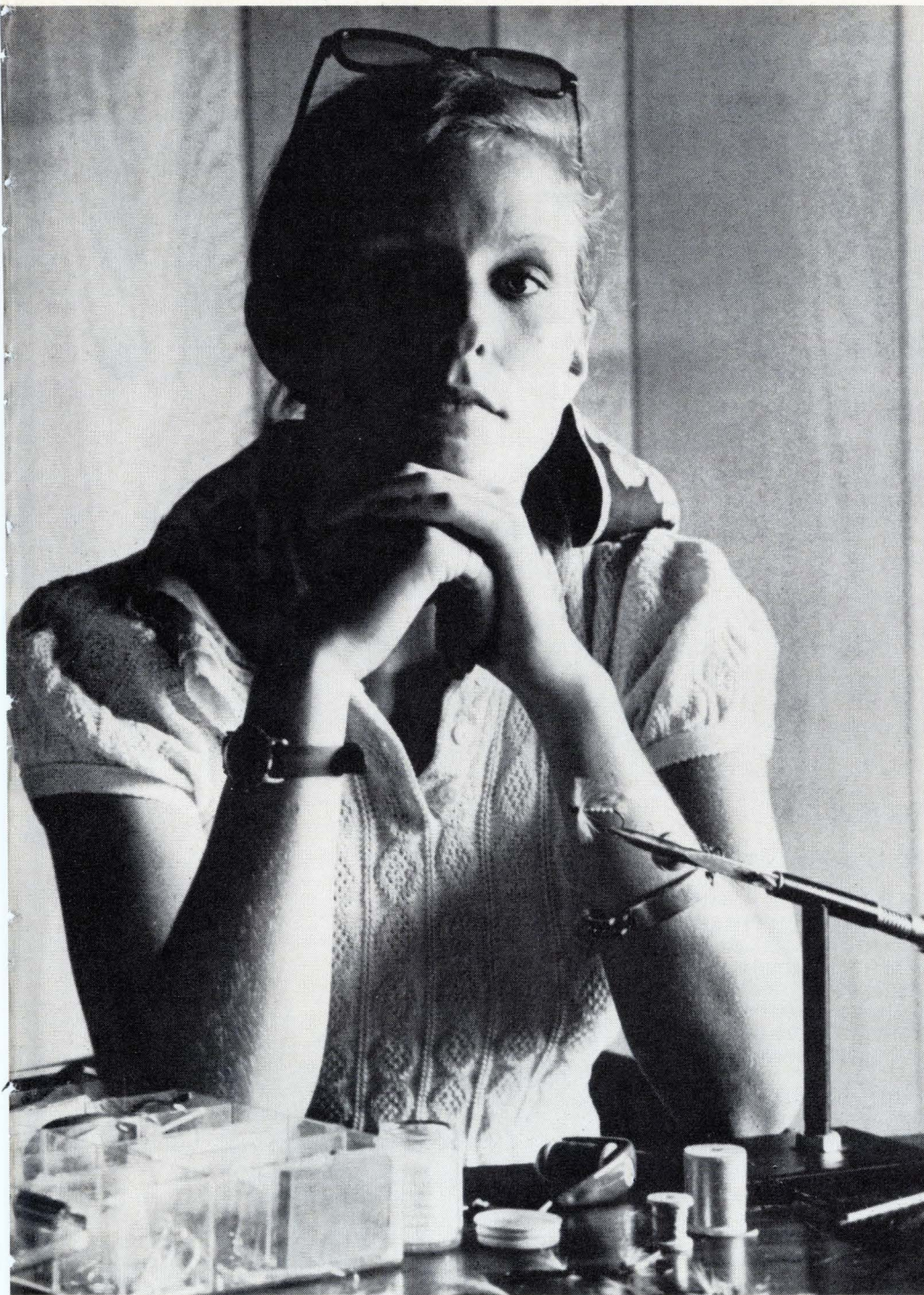

## I think these people have discovered software lib.

Why did it take so long for a computer maker to realize that software is every bit the equal of hardware, that it deserves a decent place to work and an equal opportunity to be great? Prime must have admitted this to themselves when they began the 200, because they defined the software completely before they built a home for it. The result is the most efficient small system I've ever seen.

DOS, RTOS, FORTRAN, macro assembler, editors, loaders — they're going out with first deliveries. The FORTRAN IV compiler is so efficient you can use FORTRAN as the systems programming language. Then you find that PRIME 200's logic is 100% microprogrammed with a 64-bit-wide microprogram word and you realize your programs are going to fly. It's refreshing to find a manufacturer who knows that memory cycle time doesn't mean much without software to make things happen.

One thing surprises me though — that they should use the phrase "small computer." That's nothing but chauvinistic hardware talk which deprecates the software and system performance. What they mean is, it doesn't weigh much.

The PRIME 200 16-bit computer raises a lot of interesting questions for which we have prepared detailed answers. Let us send them to you. Prime Computer, Inc., 17 Strathmore Road, Natick, Mass. 01760. (617) 655-6999.

## Prime 200 small computer

*Prime sales offices:* Boston (617) 237-4565, New York (212) 896-6262, Washington D.C. (703) 533-9343, Philadelphia (215) 688-0396, Jacksonville (904) 396-5253, Chicago (312) 887-1845, Dayton (513) 435-1343, Detroit (313) 356-4840, Tulsa (918) 663-0518, Palo Alto (415) 968-6003, Los Angeles (213) 881-8433.

*Authorized representatives:* Phoenix (602) 957-9110, Albuquerque (505) 255-2330, Denver (303) 771-0140, Seattle (206) 454-9332.

Circle 61 on reader service card

# ENOUGH! ENOUGH!

## ***Our cup runneth over!***

When we advertised our "coffee cup" survey a few months ago and gave you the opportunity to sound off about function generators, pulse generators, and test instruments in general, we anticipated a large response. But we didn't expect to be **deluged!** Your completed questionnaires poured in from IEEE and WESCON, and through the mail, and IEC responded with "Nobody Asked You" coffee cups by the thousands.

You had a lot to say, and true to our word, we read every single questionnaire. Your comments were frank and specific as you criticized, analyzed, accused... and complimented. Many of you told us you agreed with IEC's price-capabilities position, and you liked the performance ideas that were designed into our 3 MHz and 11 MHz function generator series. Thanks.

On the facing page is just a tiny sample from the tremendous number of replies we received — real statements from real engineering professionals — maybe even **you!** However, if you believe in forming your own opinion, we'll send you straight technical information, along with a free copy of our "Nobody Asked You" report. You can order it with the product information number given below. **Like our coffee cup, it's quite an eye-opener!**

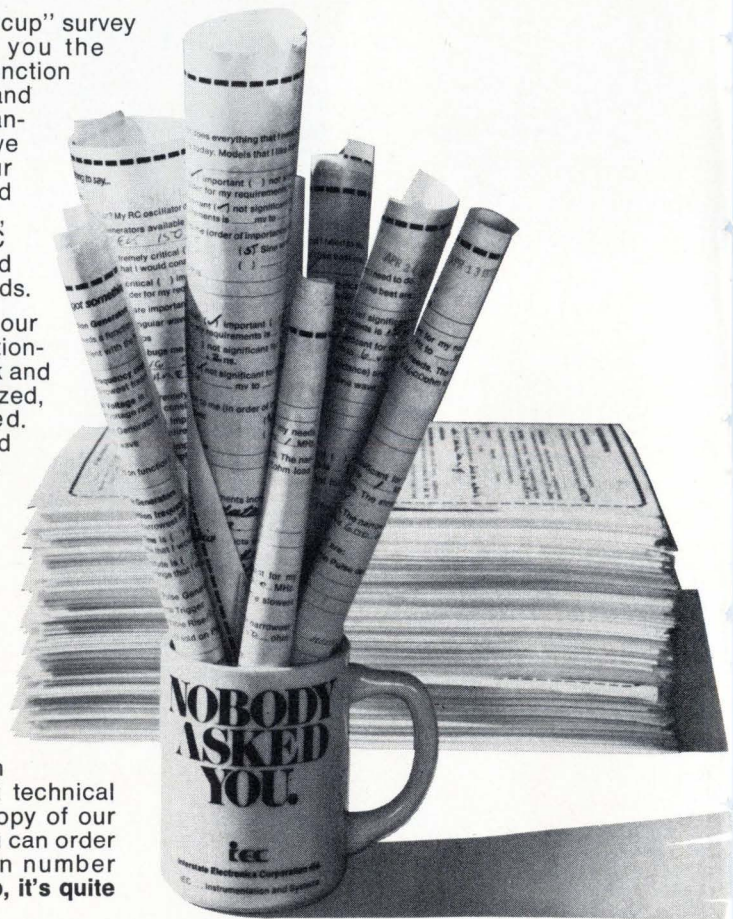



"Two engineers spent an entire afternoon looking over the specs of all the leading function generators. We came to the conclusion that several cheaper function generators can be a better deal than one super-deluxe job. Basically, they decided that your F34 looked good from a price/performance standpoint . . ."

*J.E., President — Gainesville, Fla.*

"Humbug." *J.F., Senior Project Engineer — Eatontown, N.J.*

"Your F55 is the best in the business. I just bought one."  
*D.L., Elect. Tech. — China Lake, Cal.*

"More suggestions for test applications should accompany the goods."  
*T.B., Test Engineer — Newport News, Va.*

"Unique applications that have developed in my use of test instruments include . . . detection of corona discharge by ultrasonics."  
*W.F., General Electronics Supv. — Cumberland, Md.*

" . . . Precision-shift position displays for astrological telescopes."  
*R.A.C., President — Claremont, Cal.*

" . . . Trouble-shooting my kids' electrical toys."  
*L.V., Chief Engineer — Wheaton, Md.*

"It would be helpful to get a composite function."  
*R.D.B., Sr. Logistics Engineer, Phoenix, Ariz.*

"Some models cannot be pulsed from an external source."  
*H.D., Field Engineer — Jolon, Cal.*

"They (function generators) must be capable of AM and FM modulation."  
*F.D.C., SMTS — Sunnyvale, Cal.*

"Like your function generators with AM/FM."  
*S.J.O., Senior Engineer — Baltimore, Md.*

"Glad a variable width pulse is included in your instruments."  
*W.K., Assoc. Prof. — Klamath Falls, Ore.*

"I like the F34. Versatility is important — otherwise one would stick to RC oscillators."  
*C.S., Tech. Specialist — Buffalo, N.Y.*

"OK, now send me my coffee cup so it doesn't break!"  
*J.K., Project Engineer — Oberlin, Ohio*

"My gripe about test instrument products is . . . \$, \$ and more \$."  
*D.T., Project Officer — Edgewood, Md.*

"Improve performance and lower prices for bottom-of-the-line equipment for people who don't need all the bells and whistles."  
*J.S., Engineer — Irvington, N.J.*

"Like the price and features of your Series 50."  
*H.A., Project Engineer — Indianapolis, Ind.*

"Many function generators lack output indicator or calibrated attenuator."  
*A.W., Senior Engineer — Philadelphia, Pa.*

"I appreciate IEC's function generators that have output attenuators and go to 11 MHz."  
*S.H.S., Physicist — Dahlgren, Va.*

"Forget about claims of 'fastest,' 'most,' 'best' . . . give us the numbers and we'll decide if it's 'best.'"  
*G.V., Senior Specialist — Dallas, Tex.*

"Your F31 — GREAT."  
*W.F., S.A.E. — San Jose, Cal.*

"My biggest gripe about test instrument manufacturers is . . . bidding on items that are out of range, spec-wise — and not delivering on time!"  
*M.R., Research Assoc. — Stillwater, Okla.*

" . . . New equipment that has to be sent back for repair when it comes in the door."  
*W.D., Assoc. Engineer — Niles, Ill.*

"I hate banana jacks."  
*R.L.G., Chief Engineer — Hayward, Cal.*

"Special parts are often available only after a long wait."  
*N.M., Electronic Engineer — Washington, D.C.*

"You try hard!" *R.H., Research Assistant — Little Rock, Ark.*

"Thanks for giving away coffee mugs to help steady our nerves."  
*F.W., Project Engineer — White Plains, N.Y.*

"If you send two cups, my partner will speak to me again."  
*T.R.L., Medical Electronic Tech. — Beaverton, Ore.*

"Don't like poor manuals, missing schematics, not enough calibration data."  
*N.M., Electronic Engineer — Washington, D.C.*

"Not sufficient data in catalogs or service manuals."  
*B.S., E.E. — Ft. Wayne, Ind.*

"The instruction book that came with our F53 . . . Wow!"  
*F.M., Research Engineer — Livingston, Mass.*

"Can't stand ultra-miniaturization on control knobs (my fingers are still the same size)."  
*J.G., Senior Staff Engineer — Los Angeles, Cal.*

" . . . In-human engineering."  
*R.K., Design Engineer — Athens, Ga.*

"Like IEC's ease of setting end points of the sweep function."  
*J.R.L., Senior Engineer — Goleta, Cal.*

" . . . Asking engineers in the field before designing equipment — Good show, IEC!"  
*H.S., E.E. Tech. — Danville, Ill.*

"Testing TTL with a standard pulser is like trying to tighten screws with a chisel . . . Both may have good characteristics, but not for the job at hand."  
*J.A.C., E.E. — Cambridge, Mass.*

"Why not put a 5 v d-c output on a pulse generator?"  
*B.A., Research Asst. — Middletown, Conn.*

"Too many Rolls-Royce pulse generator types — not enough VW's. We can build what we need at less cost than buying."  
*L.G., Ph.D., Director — Silver Springs, Md.*

"I would like a pulse generator with dependable frequency stability of 0.1%."  
*R.C., Chief Elect. Engineer — Reno, Nev.*

"Once in a while you guys do something right . . . like this feedback, for instance!"  
*L.C.McE., Chief of R&D — Ogden, Utah*



**IEC** INTERSTATE  
ELECTRONICS  
CORPORATION

Subsidiary of A-T-O Inc.

Dept. 7000, Box 3117, Anaheim, Calif. 92803  
Phone: (714) 772-2811 • TWX (714) 776-0280  
TELEX 655443 & 655419



# Crystalonics solid state relays in a TV studio?

## That's right.

## The best doesn't cost any more anymore.

Our TV studio customers formerly used reed relays to switch video signals from various cameras during recording sessions. The reed relays weren't fast enough to operate during the blanking times, so dead spots and image carry-over resulted. *Our* solid state relays switch video signals 1000 times faster than the reed relays, as well as adding solid state reliability at comparable cost.

Crystalonics solid state relays are also upping performance and holding the line on costs in process controls, telephone multiplexers, automatic testers, oceanographic research equipment, programmed lighting controls, input/output multiplexers for computers, medical electronic equipment, music synthesizers, and audio recording studios.

Let our applications engineers help you to apply today's solid state technology to *your* needs. Crystalonics' 13 years of technological leadership in solid state switches, fotofets, and varactors is available *now*, off the shelf, and the best doesn't cost any more anymore.

Send now for information on our solid state relays to  
Teledyne Crystalonics • 147 Sherman Street • Cambridge,  
Mass. 02140 • Telephone: 617-491-1670.

 **TELEDYNE**  
**CRYSTALONICS**

#### CRYSTALONICS SALES REPS AND AGENTS

U.S. & CANADA: (201) 835-0332 / (203) 932-5656 / (205) 883-0140 / (206) 454-7422  
(213) 466-6201 / (213) 469-5871 / (214) 231-6891 / (216) 221-0450 / (219) 485-0805  
(301) 823-3603 / (303) 771-4920 / (305) 622-1383 / (312) 359-9599 / (314) 542-3657  
(315) 458-4775 / (319) 363-6425 / (415) 964-5454 / (505) 268-0928 / (513) 299-4144  
(514) 684-7755 / (516) 593-2628 / (602) 273-7387 / (609) 983-6660 / (612) 488-0201  
(617) 731-0858 / (716) 342-1413

OVERSEAS: AUSTRALIA - 790-22846 / BELGIUM - 846-21169  
DENMARK - 855-5052 / ENGLAND - 851-23894 / FINLAND - 857-121676  
FRANCE - 842-62193 / GERMANY - 841-524506 / HOLLAND - 844-54512  
ITALY - 843-34424 / JAPAN - 781-4419 / NORWAY - 856-18625  
SWEDEN - 854-10338 / SWITZERLAND - 845-52042

Circle 64 on reader service card

# Probing the news

Analysis of technology and business developments

## MNOS devices head out of labs

Metal-nitride-oxide semiconductors, originally developed as RAMs, are showing promise as electrically alterable read-only memories

by Stephen Wm. Fields, San Francisco bureau manager

After years of experiments and discussion as to its potential use in deep-space probes and ultra-sophisticated airborne computer systems, the electrically alterable metal-nitride-oxide semiconductor memory has come down to earth and is ready for some practical applications.

Indeed, MNOS is already at work in an automated utilities meter-reading system developed by Westinghouse, and NCR is considering it for use in data terminals and similar equipment. At least three other firms have products available for customers to evaluate. But one observer believes MNOS must move into production quickly, or newer ways will be found to achieve the advantages MNOS now offers—small memory cells, high speed, low cost, and nonvolatility.

While most of the effort in MNOS has been toward the development of random-access memories, the focus has recently shifted to electrically alterable read-only memories (Earoms). This stems from work of a number of research organizations, including RCA's David Sarnoff Research Laboratories in Princeton, N.J., which have determined that the retention capability of MNOS devices degrades after from  $10^6$  to  $10^{11}$  cycles.

Joseph H. Scott Jr., head of RCA's IC technology and applications at the Princeton laboratory, says that MNOS devices "appear to have a fundamental instability so that after a number of read/write cycles, the device degrades, and loses its ability to tell a one from a zero."

The whole phenomenon isn't really understood, Scott continues. The degradation seems to depend on such factors as how fast the de-

vice is operating and the strength of the electrical field at the interface between the silicon and the oxide. Scott points out, however, that as a ROM, an MNOS device is not limited because it is not cycled that often. "Even  $10^6$  cycles is reasonable in a ROM," he says.

"We don't argue with Scott about the degradation problem," says K. R. McCune of NCR, Dayton, Ohio, "but there are other ways to maintain nonvolatility." McCune contends that circuit techniques can be developed so that an MNOS device operates in an MOS mode most of the time, but when the power goes down, the circuit will automatically switch on its MNOS data-holding capability.

However, Andrew Tickle, staff scientist at Nitron Corp., Cupertino, Calif., says that most recent development has gone back toward the simpler Earom, and "the value of the technology now depends on its applications." Nitron has a 64-by-2 memory that's partially decoded, ready for sample delivery to anyone

who wants it. "The 64-bit unit was intended for customer evaluation," says Tickle, adding, "the layout of a 1,024-by-2 has been completed, and we expect parts to be ready by the end of this year."

Such claims have been made in the past by people working on MNOS, but the difference now is that the other companies were trying to push for RAMs, while Nitron is working with ROMs. Litton Industries, for example, had developed a fully decoded 256-bit MNOS array and has a 1,024-bit MNOS RAM in development. But last month, the company decided not to put these products into production, but to evaluate the parts for use in-house.

Companies making Earoms, however, have had more success. NCR's McCune predicts, "We see a bright future for MNOS Earoms in data terminals and like equipment, where a nonvolatile, small-to-medium-size memory of from 1,000 to 100,000 bits is required." McCune, a member of NCR's Earom applications group, says that, while the Earoms

**MNOS in the air.** General Electric has developed a 256-ROM for Wright-Patterson AFB.

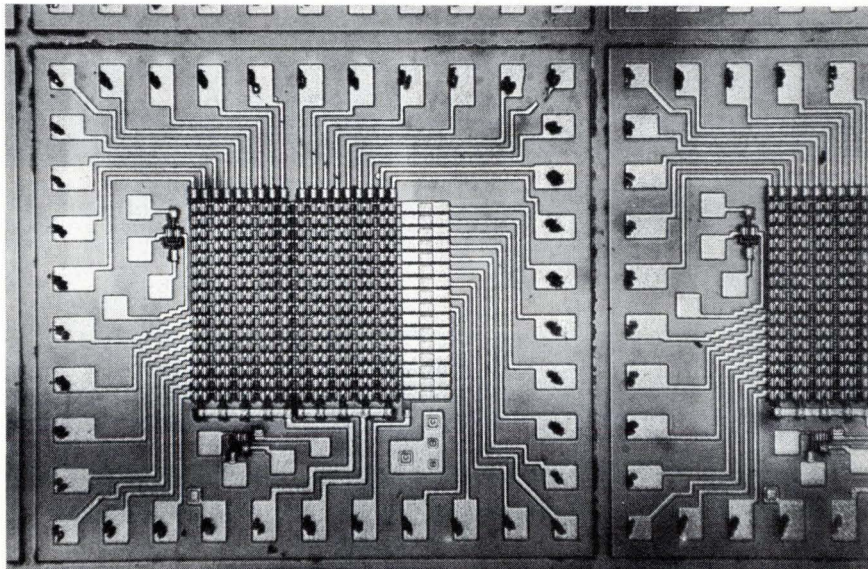

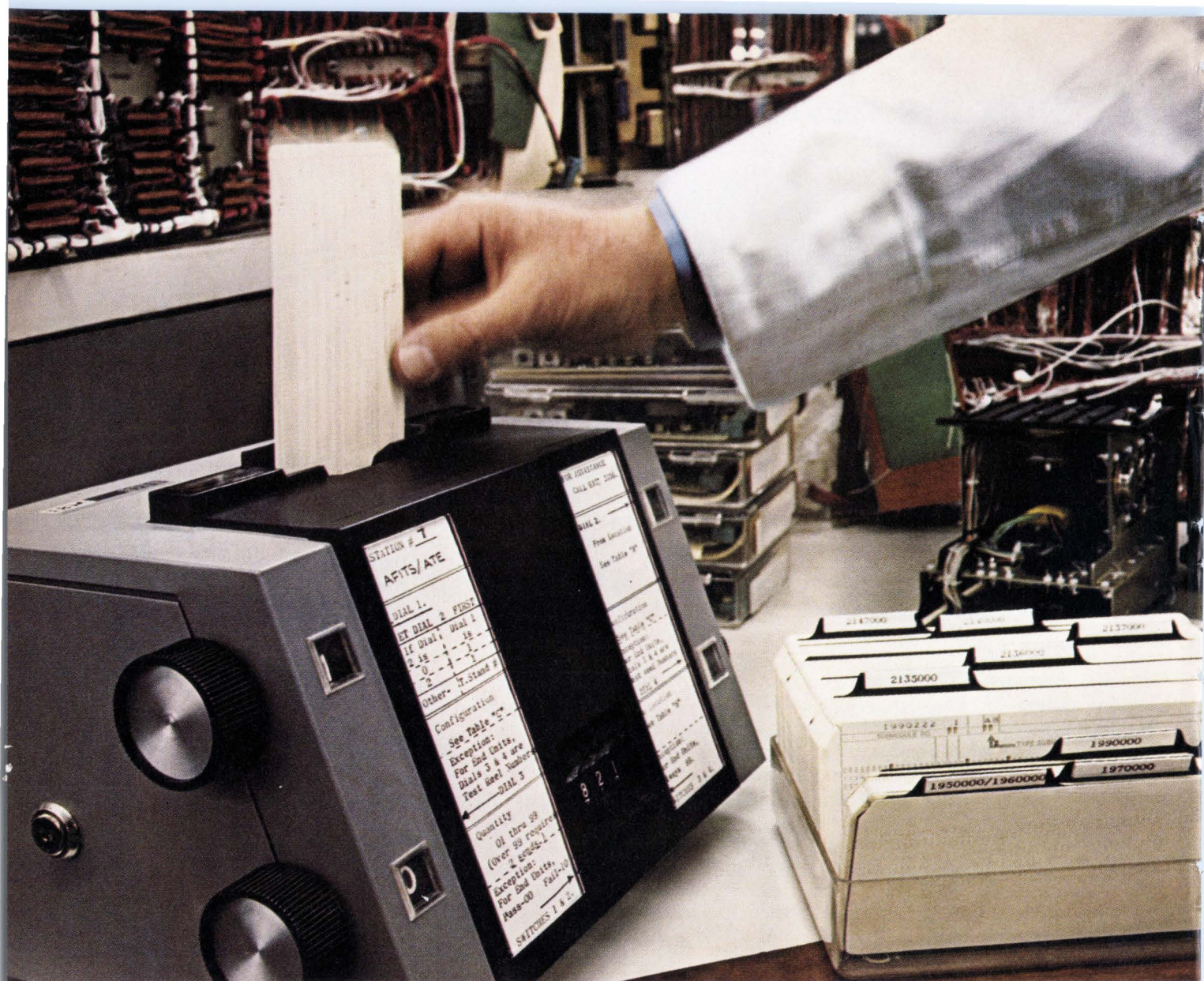

## IBM System/7 installed at Bendix to speed production reporting.

Until recently, production control reporting at a Bendix Corporation plant at Teterboro, N.J. was a 4-day process. It took that long to ascertain the status of some 10,000 electronic subassemblies moving through the shop.

Now, with the use of an IBM System/7 computer, a complete report on all of the previous day's activities is ready at the start of each working day. This simplifies and streamlines the flow of materials and the assignment of job priorities.

The plant, part of the Navigation and Control Division of Bendix, produces components used in the PB-100 Flight Guidance System which Bendix manufactures for the McDonnell Douglas DC-10 aircraft.

All changes in location and status of

the subassemblies are entered at fourteen IBM 2796 Data Entry Units on the shop floor. The units are controlled by the System/7, which edits the data input for accuracy. The data is then transmitted to an IBM System/370 Model 155 at a nearby Bendix plant, which updates production records and compares actual performance with planned schedules. Items not following schedules are singled out for immediate attention and corrective action.

Full information on the System/7 is available through your IBM representative or local office. Or write IBM Data Processing Division, Department 807-E, 1133 Westchester Ave., White Plains, N.Y. 10604.

**IBM**®



## Probing the news

are not now as cheap as mask-programable ROMs, they are only maybe one-and-a-half to two times as expensive, and this is not too much for electrical alterability.

NCR has been producing a 1,024-bit Earom for several months. The part, which is partially decoded, is organized as 256 words of 4 bits each and has write and erase times in the millisecond range; the reading rate is about 500,000 characters per second. G.C. Lockwood, a member of the applied research team working with Earoms at NCR, explains that the 1,024-bit device is intended for use in low-speed data terminals for program-control storage, replacing small core memories and mask-programable ROMs.

General Electric's Aircraft Equipment division, Utica, N. Y., has developed 256-bit read-only and read-mostly memories for the Air Force Avionics Laboratory, Wright-Patterson Air Force Base, Ohio. And, although this contract has been completed, GE is continuing to work with its own funds on a 2,048-bit array that is not fully decoded, according to Edward S. Joseph, manager, advanced electronics engineering. The matrix is set up with eight gates and 280 drain lines, and its operating organization is 560-by-4-bit words. Joseph says, "In about a year and a half we expect to go into pilot production."

**Meter reader.** The automated utilities meter-reading system, developed by Westinghouse Electric Corp., Pittsburgh, takes advantage of MNOS field reprogrammability and its very low power drain [see p. 119]. To determine the amount of power consumed, Westinghouse uses a 10-stage MNOS binary counter to count and store the pulses produced by a commercial watt-hour meter. The stored data is accessed periodically via phone lines, and the data is transmitted to a central data-collection point. MNOS was chosen for this application because it won't lose its contents in the event of a power failure, even for periods of up to several months, and it dissipates less than 125 milliwatts.

In the application, the lifetime of the device is no problem because

contents in the event of a power failure, even for periods of up to several months, and it dissipates less than 125 milliwatts.

In the application, the lifetime of the device is no problem because the pulses being read in are at a low rate—about 2 kHz—and Westinghouse says that the counter should be able to operate for about 50 years.

Another possible use for MNOS Earoms is in minicomputers. Instead of making many special-purpose machines, says Nitron's Tickle, the maker could have one type programmed by Earoms. The machines would be stocked blank, and then, when a buyer makes known a desired application, the minicomputer could easily be fed the proper tape for that application, and the Earoms would be programmed. Thus, if traffic controllers are particularly big one month and bakery mixing controllers are soft, the manufacturer is not stuck with a lot of slow-moving inventory—he just doesn't program that many mixing minicomputers.

Other applications include alterable logic arrays, which are being employed in some sophisticated electronic calculators, and self-heal-

ing circuits. All of these applications can be implemented with MNOS Earoms, now available.

RCA's Sarnoff Lab is developing 1,024-bit ROMs with MNOS on sapphire substrates. An insulator like sapphire is used because it allows the circuits to operate with but a single polarity pulse, instead of the dual-polarity pulse that is required for devices made on silicon substrates. This is possible because each transistor is isolated, and information is read in by simply interchanging the gate and ground, Scott points out.

**Days numbered?** Scott, however, believes the days of MNOS devices may be numbered. "If MNOS stays much longer in the laboratory," he says, "we'll find other ways to build electrically alterable ROMs, and RAMs will have gotten cheap enough so we won't need MNOS." Accordingly, Scott gives MNOS only two more years to get out of the laboratory and into the marketplace.

But as a ROM, the MNOS technology has merit, Scott continues. It leads to the only true electrically alterable semiconductor memory available today—a semiconductor analog of core. □

### What MNOS is

The most common metal-nitride-oxide semiconductor transistor structure looks like a p-channel MOS transistor, except that there is a thin layer of oxide from 20 to 60 angstroms thick between a silicon-nitride gate dielectric and the substrate. The dielectric constant of the silicon nitride is two or more times that of the thin oxide, causing the applied field to be doubled in the oxide when a signal is applied to the gate.

This field enhancement and the thin-oxide layer permit the charge to tunnel to the oxide conduction band when a high enough field has been reached. This charge, which is stored in traps at or near the oxide/nitride interface, will remain there for years.

In a p-channel device, the charge is stored by applying a large negative potential—about -30 volts—to the gate when the substrate is at ground potential. To remove the charge, the process is reversed and the gate is grounded with -30 volts applied to the substrate. Once programmed, the device acts as a read-only memory, but, unlike a ROM, it can be reprogrammed.

Most of the work in MNOS memories in the past few years has been aimed at nonvolatile, nondestructive-readout random-access memories. Andrew C. Tickle, staff scientist at Nitron Corp., Cupertino, Calif., says, however, that the things that make MNOS devices work are not amenable to random-access, high-speed operation. The erase mode, for example, requires that the gates of the transistors be isolated from each other and from the substrates to prevent the array gates from shorting to the substrates through the array drivers. And in this mode, there is no selective "clearing" of the storage transistors; all are reset at the same time (block erase). Thus, either each cell has to be placed in an isolation region, or each gate metal line has to be decoded off the chip—this is both costly and complicated.

Companies

# Intermetall sets fast IC pace

The ingenuity of the German company's consumer R&D profits both Intermetall and the five other members of ITT's semiconductor group

by John Gosch, Frankfurt bureau manager

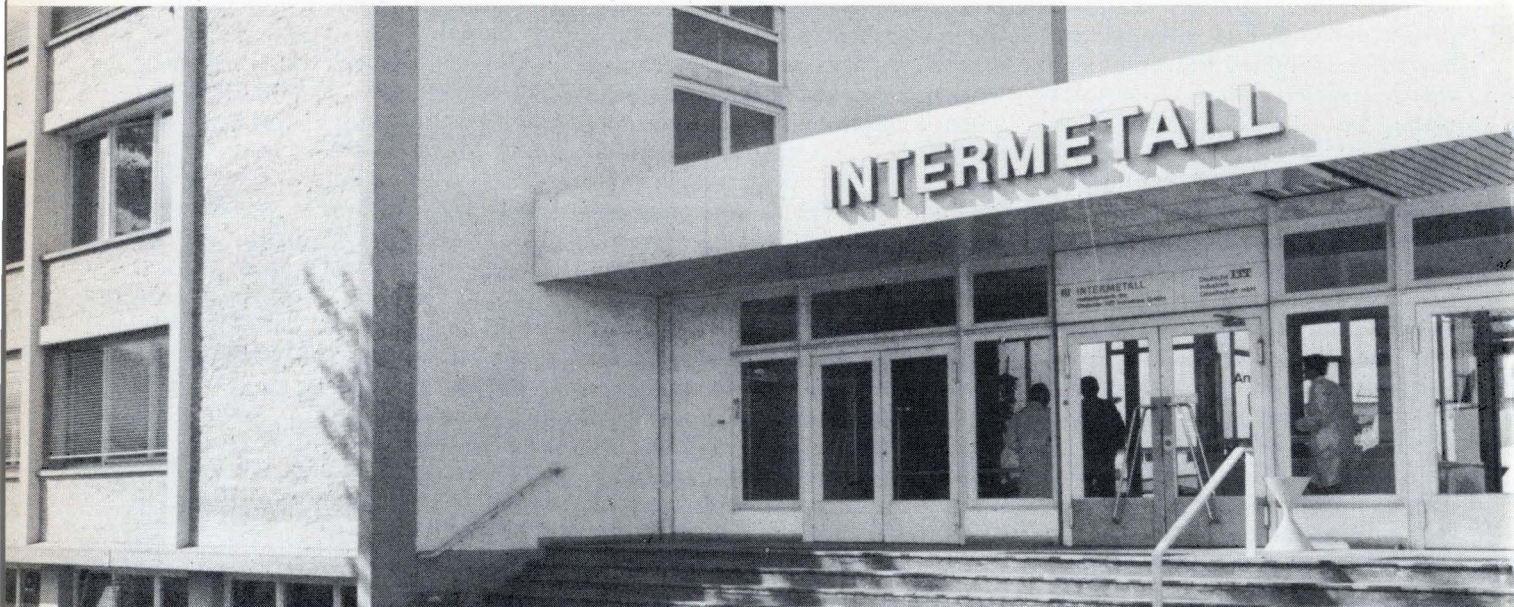

An American subsidiary in Europe is often regarded as a workbench across the Atlantic, with the foreign offshoot the recipient of U.S. know-how rather than a contributor to it. To at least one American affiliate in Europe, however, the workbench definition does not apply: Halbleiterwerk der Deutsche ITT Industries GmbH—better known as Intermetall, the German member of the International Telephone and Telegraph Corp.'s semiconductor group.

Not that the Freiburg firm and its New York-headquartered parent have exchanged the roles of technology supplier and receiver. But a good share of the group's knowhow in semiconductor design and application has originated in Intermetall's research and development labs.

Intermetall maintains it was the first to mass-produce IC devices at rates of tens of thousands per month. The company started delivering a tuner diode for TV sets in

late 1965, a monolithic IC for TV sets in early 1968, an IC for voltage-stabilized drives for time-pieces in late 1968, and an IC frequency divider for quartz clocks toward the end of 1970. In addition, even competitors credit Intermetall with being the world's biggest supplier of ICs for wristwatches and clocks.

Last year, Intermetall and the ITT-Semiconductor group as a whole had 10% of the European semiconductor market—ranking as the third largest semiconductor vendor in Europe, trailing only Philips Gloeilampenfabrieken and Texas Instruments. While Intermetall's sales were \$29 million in 1971, this year the firm expects them to rise to about \$35 million, an increase of 20%. And next year, Fritz G. Höhne, Intermetall's director of marketing, expects sales to increase another 15% to 20%.

While ITT-Semiconductor's industrial-device R&D efforts are concentrated at facilities in Great Britain

and in the U.S., the group's consumer R&D activities are the domain of Intermetall, the largest of the six companies in the group. Of the 1,600 people employed at the Freiburg facility and at a smaller German plant in Nürnberg, more than 200 are engaged in R&D, design and application.

The German firm is also active in industrial devices, which account for half of the company's production. It designs and fabricates many non-standard discrete components and digital ICs for industrial equipment apart from computers.

Still, Intermetall concentrates its development efforts on consumer devices. In addition to circuits for radios, TV sets, watches and clocks, Intermetall's consumer device lineup includes components for cameras, kitchen appliances, automobiles and electronic musical instruments.

One of the newest consumer electronic devices developed at Inter-

# Wrapped-wire solved a lot of printed circuit problems.

# Now Multiwire™ solves the wrapped-wire problem.

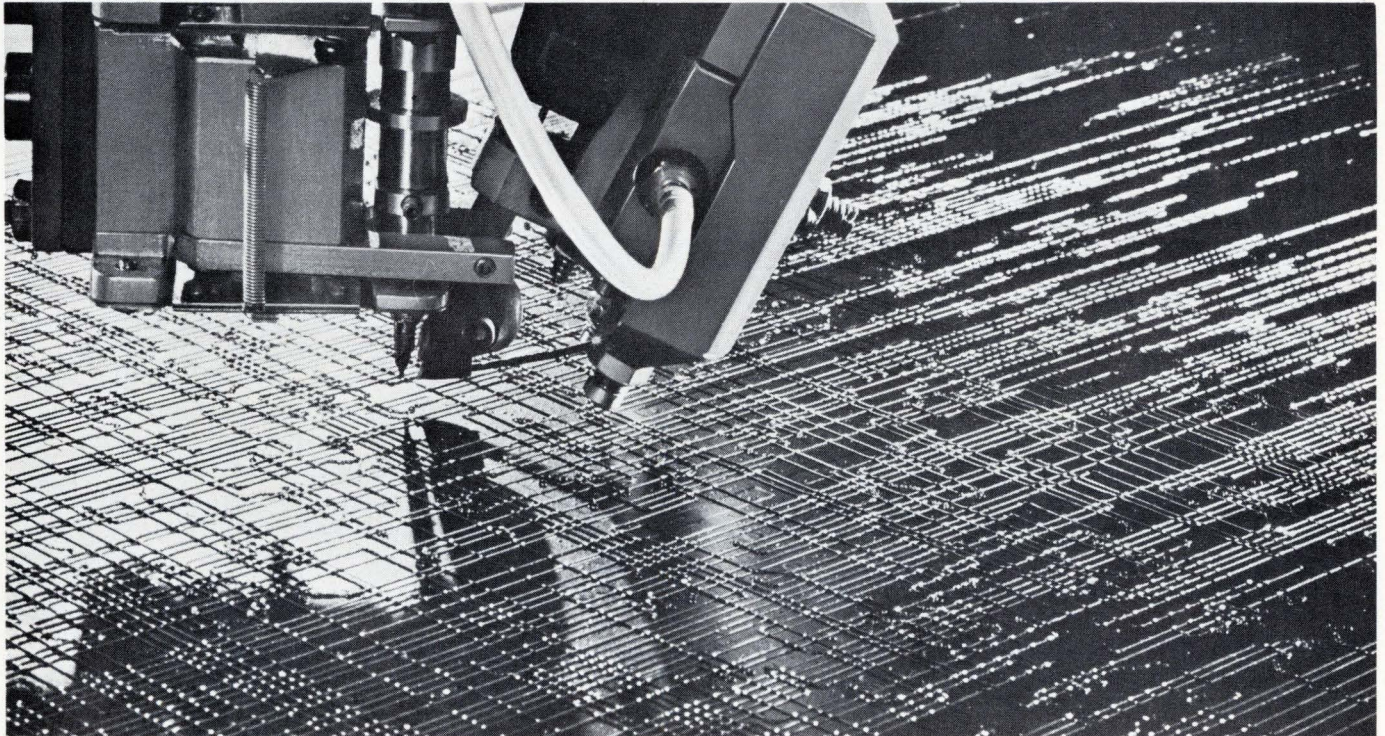

Let's face it. Wrapped-wire solved a lot of problems in its day.

But it introduced some of its own. Very high unit costs. Low 3-dimensional packaging density. Increased system weight. Erratic high-speed electrical characteristics.

Now that Photocircuits has invented Multiwire—the written circuit—many printed circuit and wrapped-wire panel problems are a thing of the past.

Multiwire provides a simplified approach to high-density interconnections. With an NC machine, polyimide insulated wire is "written" directly on adhesive coated substrates and terminated by plated holes. No artwork is necessary. Tooling can be computer-generated in 48 hours. Delivery of a finished part is usually 2-3 weeks.

This means you can have a new high-density, error-free board for two-sided or multilayer applications in less time than it used to take to tool up. Or revise a circuit several times in the same time it now takes you to get the first prototype. Or turn out small quantities or many different circuits for a new project without paying a fortune in design and artwork costs.

For more information or price estimate from a description of your requirements, phone our Multiwire Marketing Department at 516 676-8000. Or send the coupon. Save yourself half the cost—write it, don't wrap it.

## Multiwire

By Photocircuits

Marketing Dept. E-1  
31 Sea Cliff Avenue  
Glen Cove, New York 11542

- Please send me more detailed information on Multiwire.  
 Please have a sales engineer contact me.

Name \_\_\_\_\_ Job Function \_\_\_\_\_

Company \_\_\_\_\_

Address \_\_\_\_\_

City \_\_\_\_\_ State \_\_\_\_\_ Zip \_\_\_\_\_

Photocircuits is a division of Kollmorgen Corp.  

# What you don't know about custom CMOS can hurt you.

What we know about it could revolutionize your product.

At Micro Power, custom CMOS means proven production processes, a service approach that lets us perform as an extension of your own design and manufacturing departments, and a way to make your product smaller, less expensive and easier to build.

It also means advanced technology like High-Density CMOS (example below), a technique employing two-layer metallization for interconnecting circuit elements. HD/CMOS saves chip real estate, lowers power needs, and slashes costs.

Learn more about these very real possibilities. You can start by learning more about us—just circle reader service number 245.

**We can help.**

## **MICRO POWER SYSTEMS**

3100 Alfred Street, Santa Clara, California 95050 Telephone (408) 247-5350

Germany

Richard Bladowski  
8 München 23, Bismarckstraße 12  
Telefon: München (0811) 345600  
Telex: Mato 5-215969

Japan

Yas Kanazashi  
21 Mori Bldg., 2-2-5 Roppongi  
Minato-ku, Tokyo  
Phone: 586-0471

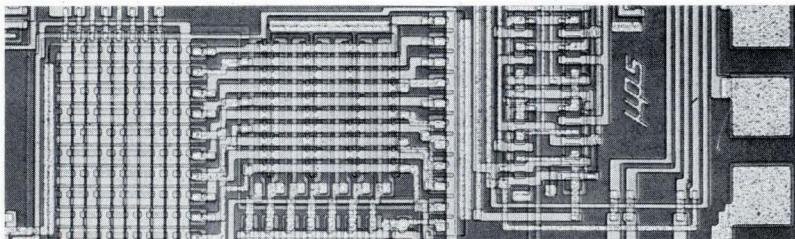

## **FIGHT THEM ALL...**

**Heart Attack  
Stroke  
High Blood Pressure  
Rheumatic Fever**

**GIVE ... SO MORE WILL LIVE HEART FUND**



## **Probing the news**

metal is an IC for automobile speedometers. To be shown at the Electronica exhibition, November 23 to 29, in Munich, the device eliminates the need for a flex shaft between the car's gear and the speedometer. It is controlled from the gear box by the output from a reed contact, or a proximity switch, or inductive sensors which pick up the revolution information. The circuit is the first speedometer IC on the market. It is offered in sample lots to automotive accessory makers.

The company recently went into production on two ICs for electronic organs. One is essentially a delay line, the first to faithfully reproduce violin sounds. The other circuit, in use since last year, is a development for Eminent, a Dutch company and one of Europe's largest concert- and home-organ makers. It is the first mass-produced custom MOS device for a consumer product.

These and similar MOS devices hint at another strong activity at Intermetall. The company handles all of the ITT-Semiconductor group's efforts in custom MOS ICs.

**Selling to the East.** For all its efforts on the West European semiconductor markets, Intermetall has not turned its back on the ones existing in Eastern Europe. Höhne cannot say precisely what share of the company's annual over-all exports of between 30% and 40% reaches the Eastern Bloc, but industry observers say it is substantial. In their view, Intermetall is the most active among Western semiconductor producers selling in the East.

As one would expect, the reason for Intermetall's relatively strong position in the Eastern Bloc is its wide range of consumer products. The embargo regulations for these products are not as stiff as for industrial devices. "We have the things that are allowed to be exported," comments Intermetall's general manager, Robert Stasek. "Besides, we are technologically interesting to people over there and are known for our expertise in the semiconductor field." Among the products Intermetall sells in the East are zener diodes, tuning diodes and other silicon semiconductors. □



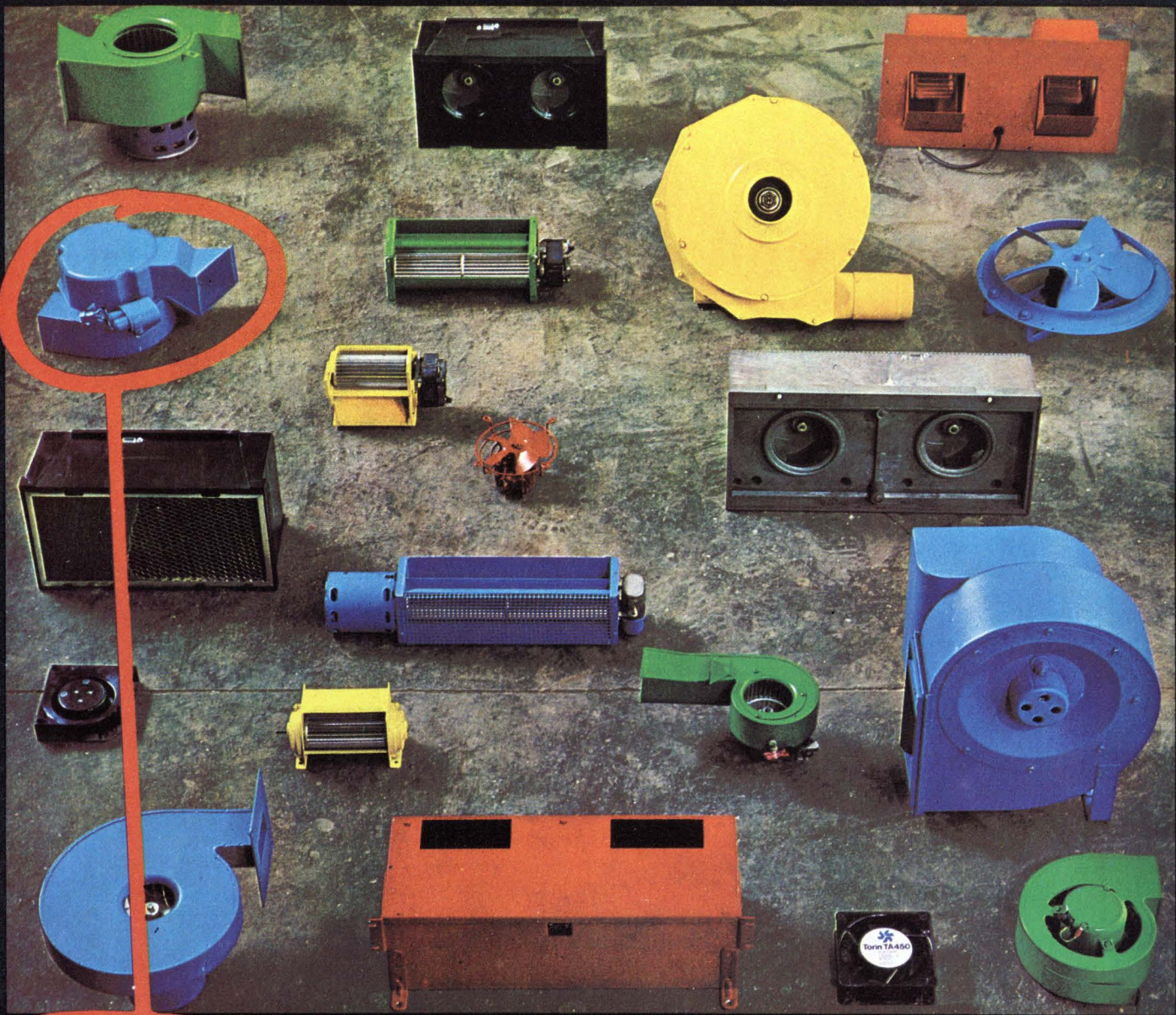

**This one**  
**does a job**  
**for your**  
**competitor.**  
**It might**  
**not be**  
**for you.**

 **Torin**

**Torin Flexibility**

**Problem:** Late in the development stage of a new product, one of our computer customers discovered an unforeseen contamination problem that could only be corrected by an air supply. No space allowance had been made for a blower unit. Air flow and pressure requirements that required a good sized centrifugal impeller presented further difficulty. Space tolerances were tight and rigid.

**Solution:** Our engineers used a specially-designed motor with an end bell that, in order to fit, had to meet a critical limitation within 20 thousandths of an inch. To save space the motor was set into the inlet end of the centrifugal wheel. The forward-curved inlet duct was given special configuration to get around hardware already existing within the computer. Although the wheel housing was originally conceived in sheet metal, experimentation revealed that plastic would not only reduce costs considerably, but would also allow better scroll development. Design to prototype was accomplished within three weeks. 90,000 units are now in actual use, only 50 have proved less than satisfactory.

Your competitor's air-moving problems are his. Yours are yours. And both are firmly dictated by optimum product performance. Often we can produce exactly what you require through modifications of existing units. But if custom design is called for we can turn that out too. More than 500,000 square feet of modern production space results in competitive pricing and realistic deliveries.

You see here just one example of our flexible problem-solving experience. There's so much more to the Torin story. Get it first hand from one of our twenty Technical Sales Representatives. Or, write or phone for our tells-it-all booklet.

**Torin Corporation**

**United States:** Torrington, Conn.  
 Van Nuys, Calif.  
 Rochester, Ind. / Elgin, Ill.

**Canada:** Oakville, Ont.

**England:** Swindon, Wilts.

**Belgium:** Nivelles

**Australia:** Sydney

Instrumentation

# Noise-monitoring laws create orders

Sales of electronic equipment for measuring noise have been boosted by growing anti-noise legislation; the market now approaches \$15 million

by William F. Arnold, Aerospace Editor

The growing din of modern life is creating a boom in electronic noise-monitoring systems. With mounting evidence from the U. S. Environmental Protection Agency that noise damages the hearing of millions annually, concerned legislatures are passing anti-noise laws, and Government agencies and industry alike are having to equip themselves to comply with the new regulations.

Robert A. Boole, marketing manager with General Radio Co., Concord, Mass., one of a dozen or so companies in the highly competitive field, puts the total market at an annual \$10 million to \$15 million. With his hand he gestures in imitation of an airplane in near vertical takeoff to describe next year's sales increase—about five times this year's. Others are more conservative. Although they won't divulge sales figures, companies such as Federal Scientific Corp., New York, B&K Instruments Inc., Cleveland, Ohio, and Spectral Dynamics Corp., San Diego, Calif., estimate their sales have been increasing about 15% a year, and the rate could reach 20% this year.

The market breaks down into four basic categories of equipment: sound-level meters, octave and third-octave analyzers, real-time spectrum analyzers, and computer-based signal-processing facilities. The entire market was less than \$1 million in 1967, according to Henry Bickel, president of Federal Scientific. In the last five years, says Bickel, the market has expanded and is now approaching \$15 million a year.

**Why buy?** Under the Occupational Safety and Health Act of 1970, the Labor Department's Oc-

cupational Safety and Health Administration OSHA enforces a set of Federal limits to the noise to which an employee of a company with interstate sales may be exposed in the course of a working day. These limits range from 115 decibels for 15 minutes to no more than 90 dB over an eight-hour shift, on a scale weighted to reflect the human's ear's greater sensitivity to higher frequencies. Since the decibel scale is logarithmic, adding two 60-dB sounds makes 63, not 120 dB.

Spurring the market are OSHA's corps of 500 inspectors who cross the country checking on violations. Further, while OSHA is concerned

**Noisy?** Sound level meters, like this B&K unit, can determine whether or not the noise level in factories exceeds Federal limits.

with in-plant noise, Congress is considering a noise pollution act that would eventually give the Environmental Protection Agency the authority to set up noise standards for equipment used outside the factory.

On the local front, New York City is the latest of scores of states, counties and cities to adopt noise level standards. And an example of general concern was this month's Inter-Noise '72, the International Noise Control Engineering Conference and Equipment Exposition, jointly held by two professional societies and six Government agencies, which met in Washington, D. C., to thrash out noise prevention problems.

**Who buys?** "When you have any kind of processing machinery, there's going to be noise associated with it," comments James G. Larson, supervisor for environmental control of Kraftco's Kraft Foods division, Chicago, Ill. He says his purchases of sound-monitoring equipment "depend on what problem we're trying to solve."

Thus, the market includes the automotive industry, construction, saw mills, metal shops, and foundries, says Richard D. Rainone, sales coordinator of Bendix Corp.'s National Environmental Instrument Inc., Warwick, R.I. Federal Scientific, for example, reports that Ford Motor Co. recently bought a \$25,000 computerized sound analyzer. Some companies also add that insurance companies buy sound monitors to check to see whether their customers are complying with the law.

The simplest and cheapest devices are portable sound-level meters that cost as little as \$250, depending on

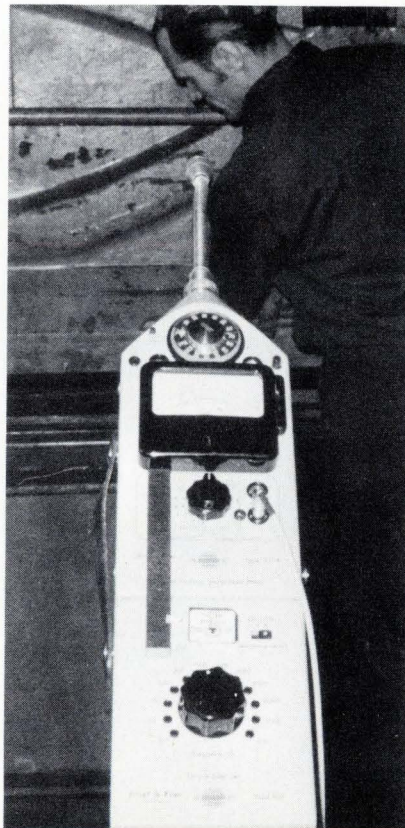

# Seven sure ways to pick the best pin and socket connector.

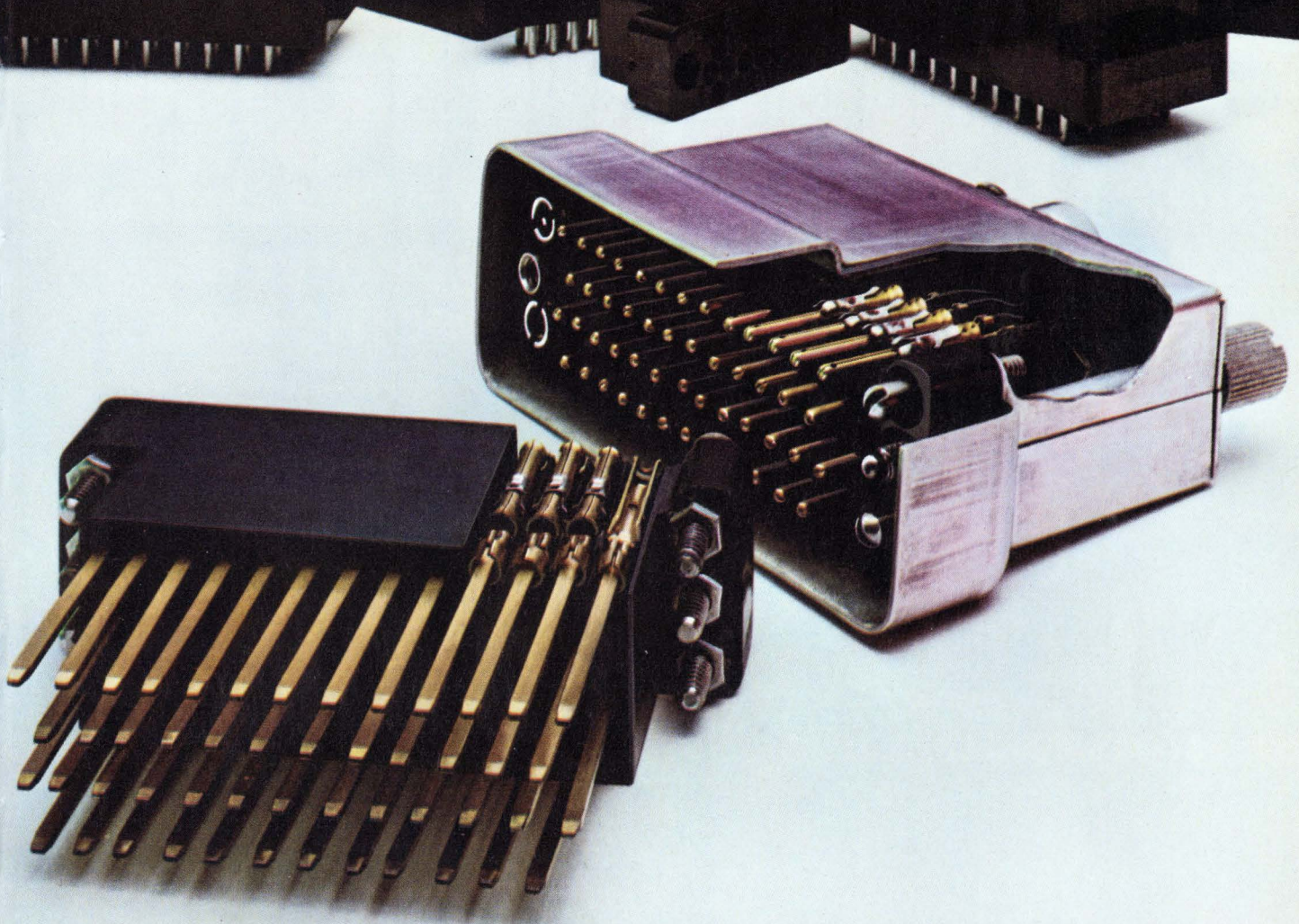

**1. Pick one that's reliable,** maintainable and rugged enough to withstand rough handling, hostile environments and hundreds of mating cycles.

Like our M Series.

**2. Choose from the most complete line** of posted or crimp-type contacts, so you get the flexibility of many manual and automated terminating techniques, plus the exact size and configuration you need.

Like our M Series.

**3. Be sure you get selective loading** so you don't wind up paying for contacts you don't need. And look for convenient extraction so damaged contacts can be replaced.

Like our M Series.

**4. Be sure stamped and formed contacts** are considered so you aren't forced to pay the unnecessary high cost of machined contacts.

Like our M Series.

**5. Look for a wide variety of housings** including .200-inch grid or denser, staggered grid-pattern housings so you'll be certain to find the one you need.

Like our M Series.

**6. Be sure contacts can be machine-terminated** by high-quality, high-speed stripping, crimping and point-to-point wiring machinery so you can take advantage of the lowest applied cost in the industry.

Like our M Series.

**7. Be certain it's made by AMP** so you'll get the finest quality at competitive applied cost.

Like our M Series.

For more information on M Series pin and socket connectors, write **AMP Incorporated, Industrial Division, Harrisburg, Pa. 17105.**

**AMP**  
INCORPORATED

Manufacturing and direct sales facilities worldwide: Barcelona, Brussels, Buenos Aires, Frankfurt, London, Mexico City, Paris, Puerto Rico, Sao Paulo, s'Hertogenbosch (Holland), Sydney, Stockholm, Tokyo, Toronto, Turin, Vienna.

Circle reader service number

Please send literature—possible future interest.

# THE HUGHES CONNECTION.

**It's a breakthrough, instead of a breakdown. With C-21 connectors, the greater the pressure change, the tighter the seal.**

Today's environmental connectors often begin to fail at pressures as low as 5 psi. The new C-21 keeps sealing even at 250 psi.

That's because we make atmospheric pressure changes work for you, not against you.

First, we got rid of the interfacial rubber seal commonly used today. It can take only low pressure changes before it starts leaking. Also, risk of leakage rises as the connector is coupled and uncoupled. And you can't change individual contacts without

endangering the whole seal.

Not good enough. So we developed a true environmental connector with individual pressure seals in front of and behind each contact.

They block out moisture, dust and other contaminants. As pressure rises, these small cup-shape seals, within their own special cavities in the connector body, only grip tighter.

Finger pressure is enough for connector mating. You can change contacts individually. And seals on

individual contacts.

The C-21 is designed for airborne, deep space, shipboard, and undersea applications in a wide range of sizes.

No other connectors with crimp-removable size 16 contacts approach the C-21 in sealing capabilities, versatility, or long life. Yet prices are competitive.

More information? Write: Hughes Connecting Devices, 500 Superior Ave., Newport Beach, CA 92663. Or call (714) 548-0671

**HUGHES**

HUGHES AIRCRAFT COMPANY  
CONNECTING DEVICES

**CONNECTORS, CABLES, CIRCUITS...ONLY HUGHES PUTS IT ALL TOGETHER.**

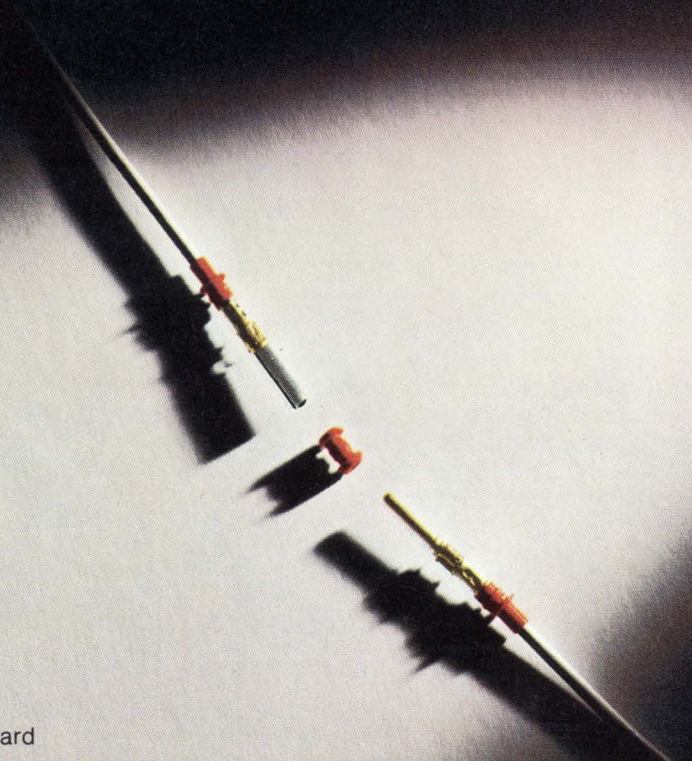

## Probing the news

their precision. Each of these solid-state, hand-held units contains a microphone to convert ambient sound into electrical energy, an amplifier to boost the signal to a level that can activate a meter, and the meter to indicate the sound level. To keep them accurate, the devices need calibrators, which can cost another \$300.

**What's offered?** Table-top sound-level meters with a wider sound-level range and a built-in calibration system cost several hundred dollars more. With such accessories as special-purpose microphones, analyzers, and recorders, they can run over \$1,000 each. Among the companies producing various types of sound-level meters are Bendix, B&K, General Radio, Quest Electronics, Milwaukee, Wis., and Dallas Instruments, Dallas, Texas.

Another class of monitors, dosimeters or noise-exposure meters, cost about \$1,000. These instruments tell if a worker has been exposed to an excessive noise at any time during his shift. Unlike the sound-level meters, these units "take the sound level and integrate it over time," explains Jerry C. Yohpe, design engineer with Quest. The key to these units is a voltage-controlled oscillator that drives a counter, he says. The faster the oscillator goes, the higher the count.

Quest's heavier dosimeter is a self-contained unit worn by the worker, while those of Bendix, General Radio, and the Education and Applied Technology division of E. I. duPont de Nemours & Co., Wilmington, Del., consists of two parts. The worker wears a pocket-size monitor, which is plugged into a desktop readout at the end of the shift. The readout console indicates exposure levels, clears the unit's memory, and calibrates its circuitry.

**Sophisticated.** A more sophisticated class of noise monitors lets a manufacturer find out where his bothersome noises are emanating from and at what frequencies. These are vibration, spectrum and Fourier analyzers, which help a company to correctly install its equipment and can be used to detect excessive wear on bearings or other delicate machinery before a serious breakdown occurs.

A rack of analyzer equipment, including chart or other graphic displays and a magnetic memory, can cost \$100 thousand and is available from companies like General Radio, Hewlett-Packard, or Spectral Dynamics.

"We'd like to sell five to 10 (Fourier analyzers) a month and I think we can," says Richard W. Procnier of Hewlett-Packard's Santa Clara (Calif.) division. He adds that "companies can use them in design, too, to look at the effect of a black box on noise levels." □

## From whoosh to whisper

There's probably no more audible example of the jet age than the sound of a four-engine transport taking off. Scores of communities around airports fight pitched battles against the nerve-racking noise. Joining the fray along with existing Federal Aviation Administration regulations and pending legislation are computerized aircraft noise-monitoring systems that help airports fight jet noise.

Under a California antinoise law, for example, San Francisco, San Diego and San Jose airports will need such systems, says Hewlett-Packard's Richard W. Procnier, whose Santa Clara division installed a \$200,000 system at Los Angeles and has systems operating in five other airports around the world. "On a statistical basis, there's a potential market of 100 airports or so around the country," he says. Two major acoustical manufacturers, General Radio and B&K, also are interested in the market.

H-P's model 80500A noise-monitoring system uses a 2100 series computer to process information received from field monitoring terminals for output to tape recorders, Teletypes, and visual displays. Depending on user requirements, the system can give airport and community noise levels for specific or cumulative time periods, alert for excessive noise, and even advise pilots on quieter takeoff patterns.

# Production Equipment? Call Hughes (714) 757-1200...

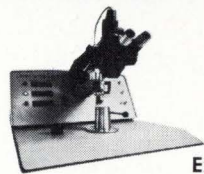

Ext. 258  
Microcircuit welders, bonders and soldering equipment (RS 232)

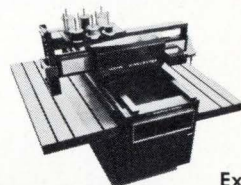

Ext. 393  
Wire terminating and harness laying systems (RS 234)



Ext. 393  
N/C positioning tables and systems (RS 235)



Ext. 393  
Numerical control systems (RS 233)

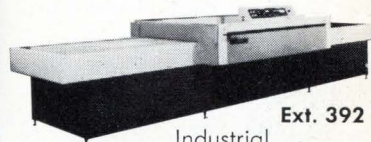

Ext. 392  
Industrial automation systems (RS 238)

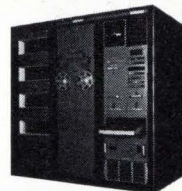

(213)  
670-9040,  
Ext. 6661  
Wiring analysis systems: FACT®  
Flexible Automatic Circuit  
Testers (RS 236)

Telephone the extension numbers shown for immediate information. For product literature, circle reader service (RS) numbers, or write Sales Mgr., 2020 Oceanside Blvd., Oceanside, CA 92054.

# HUGHES

HUGHES AIRCRAFT COMPANY

## Industrial Electronic Products

Semiconductors

# IC users seek outside testing help

Prosperous independent testing firms boast that they can eliminate 99% of all devices that would normally fail in the first year of operation

by Larry Armstrong, Dallas bureau manager

**While semiconductor** manufacturers boast of the increased reliability of their products, users are demanding still greater quality and reliability in commercial-grade integrated circuits. Into this reliability scramble have sprung a number of independent semiconductor testing services, and they report that business is better than ever.

"The IC is one of the most reliable active components ever manufactured," contends Everett Hanlon, president of the Houston-based Reliability Inc. But by expecting maintenance-free equipment in the field, at least through a one-year warranty period, consumer and industrial semiconductor users have been demanding better than 0.001%/1,000-hour failure rates without realizing it.

Independent testers claim they can achieve those failure rates for a few cents by testing devices before they are built into systems. "We can pull up to 99% of failures out of devices that would normally fail in the first year of usage," says Gary Pitts, operations manager at Micro-electronic Testing Laboratories, Santa Ana, Calif.

TTL device testing comprises the bulk of the business now, although the testers report increases in MOS, linear, LSI, ECL, high-speed bipolar, and Schottky devices. So the testers are expanding their repertoire: "We're doing about 5% dynamic testing now, to check switching speeds on high-speed lines," Hanlon reports. Pricing on MOS generally runs four to five times higher than TTL; some MOS electrical test programs run three minutes, compared to a couple of seconds for most TTL.

**Forecast.** Reliability Inc. says that its sales are five times larger than a

year ago. "In five more years, maybe the number of units will fall off by perhaps two-thirds," Hanlon says, "but the cost per device will increase as complexity does."

The cost of reliability screening is a tradeoff with the cost of servicing defective equipment. Electronic Test Center, Anaheim, Calif., has set up commercial programs based on those different levels of reliability for minicomputer and peripheral data manufacturers, says marketing vice-president Bill Coker.

"For systems using less than 100 IC's, an incoming electrical test is probably sufficient," Hanlon recommends. More extensive screening probably couldn't be cost-justified. "For 100- to 1,000-part systems, the user must look at his application pretty closely." Medical electronics, for example, demands the highest reliability, and heavy, fixed equip-

ment can't be easily returned to the factory for service. But for systems with more than 1,000 components, Hanlon contends that burn-in, temperature cycling, and stabilization bake are needed.

Typically, independent screening labs offer a combination of several tests:

- Electrical tests—the equivalent of an end-user's incoming inspection, but more thorough than manufacturer's check of critical parameters
- A stabilization bake—high temperature storage, usually at 150°C for 48 hours, to accelerate chemical degradation caused by surface contaminants
- Temperature cycling—10 cycles from -55°C to +125°C, to expose mechanical defects, principally poor bonds and package-seal problems
- Power burn-in—operating the semiconductor under maximum

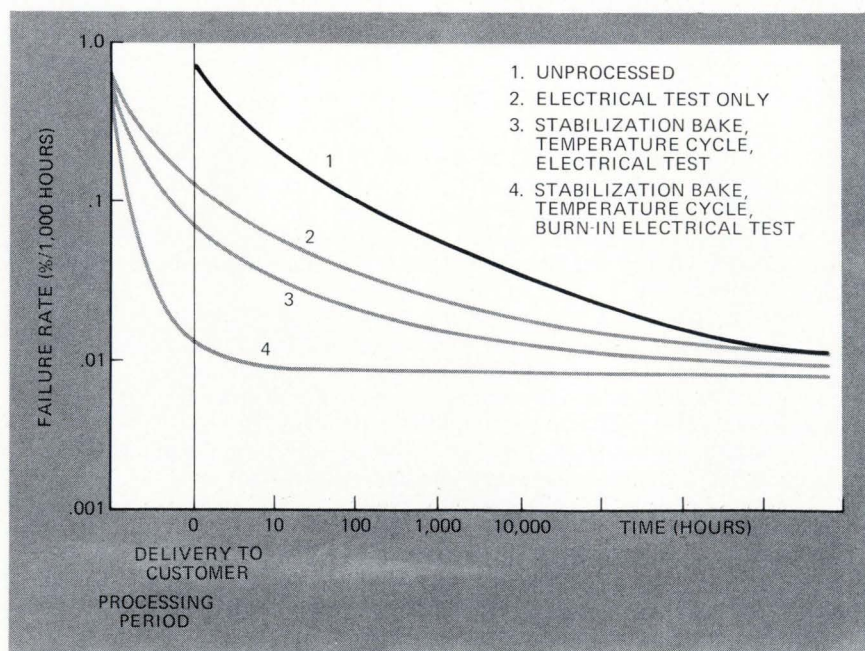

**Data Curve.** Reliability Inc. data is based on input from six customers on 1 million ics.

# Zenith is Determined to Keep Color TV Production in the U.S.

## Universal is Helping do it.

"Zenith has long been proud of its record of providing employees with job security and opportunity. But protecting the jobs of domestic employees is only one of Zenith's reasons for striving to maintain major portions of our television manufacturing operations in the United States.

Zenith's greatest single asset is the reputation for quality and reliability that its products have earned in the American consumer market. While a portion of Zenith's reputation is the result of engineering and management skills, the lion's share of the credit belongs to production employees, whose competence and pride are a major source of Zenith's strength in the market.

It has taken more than fifty years of hard work to build Zenith's current reputation for product quality and reliability. We place a high priority on maintaining the U.S. work force that has made it possible for Zenith to earn this unrivaled reputation."—Excerpt from Zenith Radio Corporation 1971 Annual Report.

A great help in this area has been the recent installation of computer-controlled systems from Universal Instruments Corporation. These systems are for high speed insertion of electronic components onto Zenith's Duramodule modular circuits. The high productivity and operational precision of these systems have helped reduce costs, with no compromise of traditional Zenith quality.

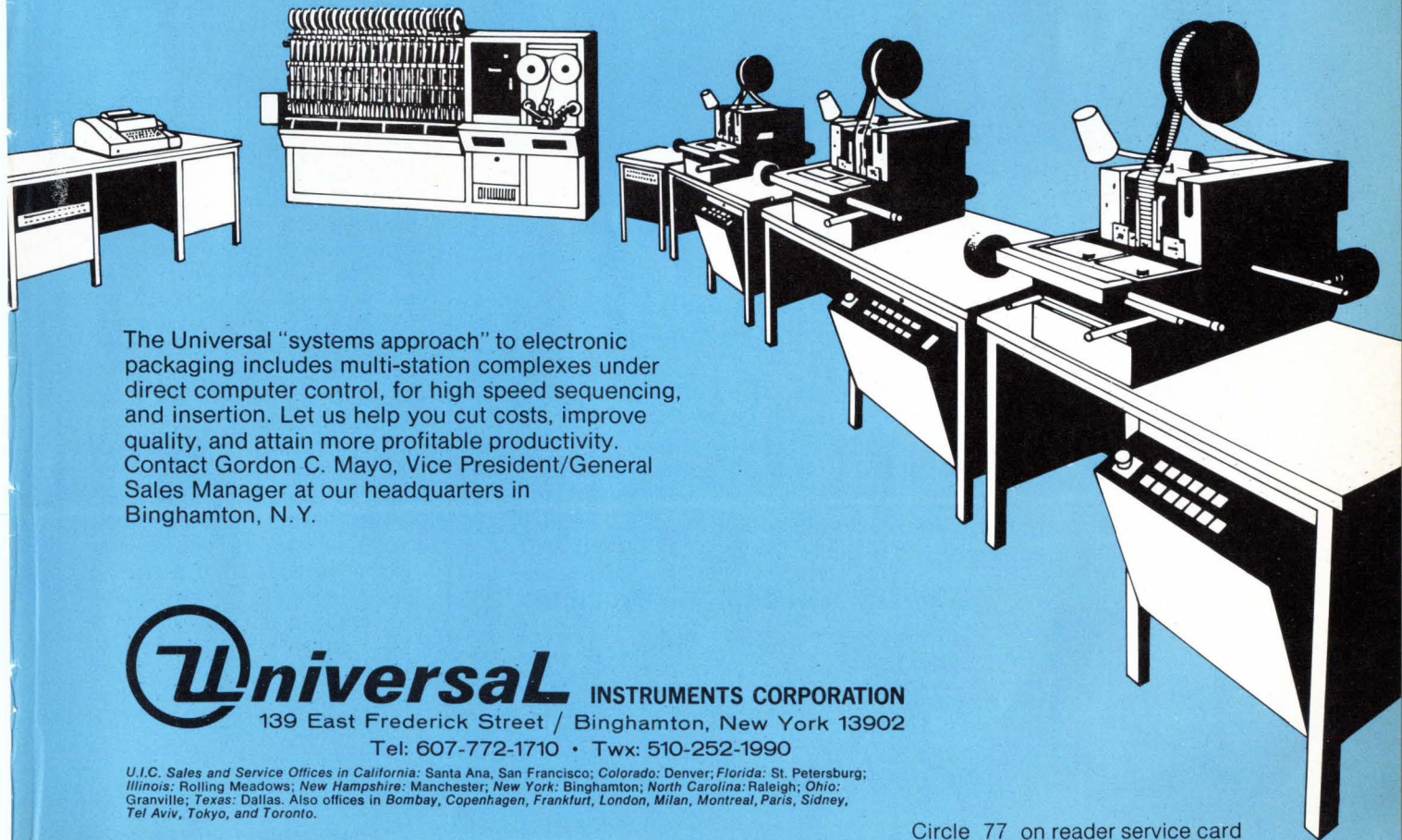

The Universal "systems approach" to electronic packaging includes multi-station complexes under direct computer control, for high speed sequencing, and insertion. Let us help you cut costs, improve quality, and attain more profitable productivity. Contact Gordon C. Mayo, Vice President/General Sales Manager at our headquarters in Binghamton, N.Y.

**Universal** INSTRUMENTS CORPORATION  
139 East Frederick Street / Binghamton, New York 13902  
Tel: 607-772-1710 • Twx: 510-252-1990

U.I.C. Sales and Service Offices in California: Santa Ana, San Francisco; Colorado: Denver; Florida: St. Petersburg; Illinois: Rolling Meadows; New Hampshire: Manchester; New York: Binghamton; North Carolina: Raleigh; Ohio: Granville; Texas: Dallas. Also offices in Bombay, Copenhagen, Frankfurt, London, Milan, Montreal, Paris, Sidney, Tel Aviv, Tokyo, and Toronto.

Circle 77 on reader service card

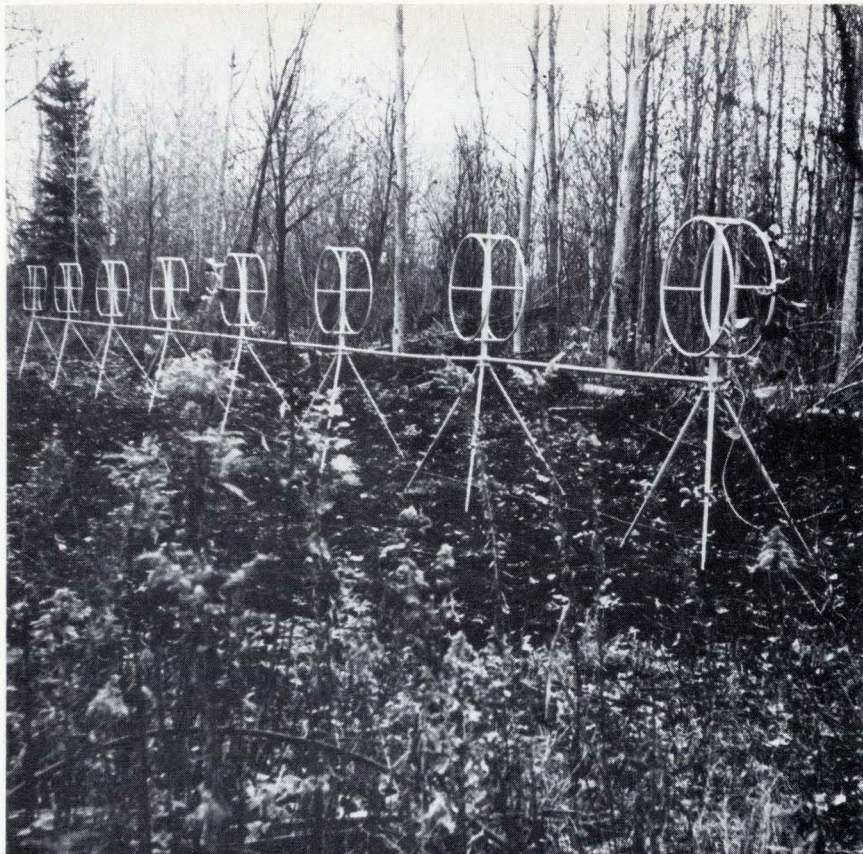

# Good Listeners maintain a low profile

Even in the solitude of the forest depths, from rooftops, arctic tundra, swamps to sweltering tropics, 'neath snow, sand or ice,

the Hermes Loop antenna keeps an ear to the sky.

The amazing aperiodic antenna does away with vast log periodic and rhombic arrays - those towering antenna farms.

In rosette configuration, the Hermes loop antenna provides an omnidirectional broadband receiving array in space merely 1/100th that of the traditional antenna farm.

More than 53 government agencies around the world have pressed the loop antenna into service.

A new, even more compact version is available.

Only Hermes Electronics makes it.

**2-32MHz  
BROADBAND**

**ASK US Send for our Brochure**

Hermes Electronics Limited  
Suite 315  
2020 F Street NW  
Washington, DC 20006 USA  
202-296 2978  
TWX 710 822 1106



## Probing the news

electrical and thermal conditions, usually for 168 hours at 125°C. Other tests that are sometimes requested are thermal shock, high-temperature continuity, X-ray, vibration, centrifuge, hermeticity, and dynamic electrical tests.

Contract testers are in a good position to quantify failures of manufacturers' devices, although they report that failure rates vary more lot-

### Distributors stock pretested ICs

Distributors have previously offered testing services, but as the market for higher-reliability semiconductors grows, they have decided to step up their reliability testing by starting comprehensive programs for products on the shelves. Besides supplying tested, burned-in parts in quantities so small the testing labs won't touch them, distributors claim that they can offer OEMs a unique service.

"End-users don't have to double-buy or double-handle the material, and they don't have to absorb the cost of the rejects," says Robert H. Linker, semiconductor product manager at Texas Instruments Supply Co.

Tisco launched a program called REL II last month to stock plastic integrated circuits at two different reliability levels. Level 1 parts have been through a stabilization bake and a second 100% electrical test. In addition, level 2 parts have been burned-in for 168 hours at 125°C. "What we're talking about is an improved quality level from an AQL (acceptable quality level) of 1% to 0.25%," Linker adds. All TI standard bipolar ICs are available under the program.

In addition, some of the testing services are beginning to play the distribution game. DCA Reliability Labs, Mountain View, Calif., for example, derives over half its revenue from procuring circuit devices for customers, testing them, and selling them to the customers. "In addition to selling reliability," says DCA's sales manager, James O'Rourke, "we sell the product."



# Press here to save on lighted pushbutton switches.



**buys all  
the switch  
you need.**

Oak's Series 300 gives you good looks and a small price-tag in lighted pushbutton switches. Plenty of switching performance for most jobs, without paying a premium. Even the Series 300 Split-Legend/4 Lamp Switch is less than \$1.60 (normal latch, 2P2T, glass alkyd insulation, no engraving, less lamps.)

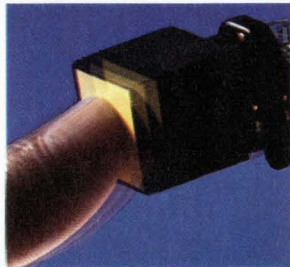

## Built to take it.

Series 300 is built for reliable performance and long life. Applications galore—bank terminals, calculators, and copy equipment.

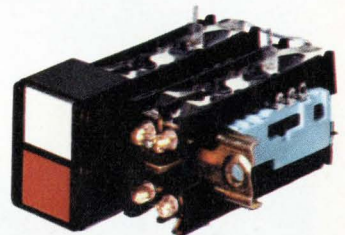

## Modular design.

Single-legend/single-lamp, split-legend/4-lamp, and single-legend/redundant lamp switches have snap-on lamp holders. Plus replaceable legend plates, lens caps, and button assemblies. Front-panel relamping, too, without special tools on all types.

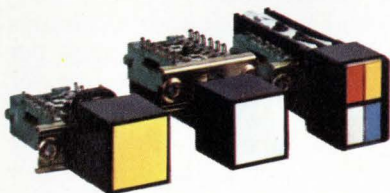

## Three versions with switching up to 4P2T.

Choose from single, dual, or four lamp display as well as non-lighted type. One to twelve station, momentary, interlock, alternate action, or any combination available on the same switch bank. Lockout feature available for all types. Power Module 3A125VAC. Lighted indicators are identical in size and appearance, but without switching.

## Gang them up by the dozen.

Order up to 12 switching stations on a single channel, any switching mix, with convenient panel-mounting studs. Color selection: white, lunar white, yellow, amber, orange, red, green, blue. Choose silk-screened, hot-stamped, or engraved-and-filled legends. Split-legend switches can be specified with any two, three, or four colors on insertable legend plates.

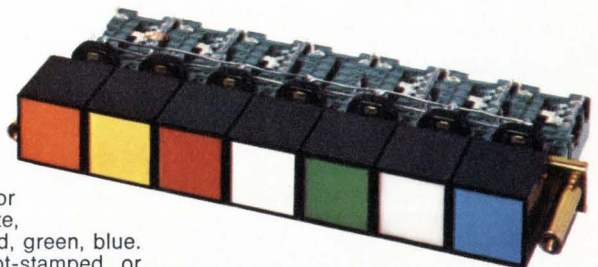

**Write for our Series 300 Brochure**

**OAK Industries Inc.**  
SWITCH DIVISION/CRYSTAL LAKE, ILLINOIS 60014  
TELEPHONE: 815 • 459 • 5000 ■ TWX: 910 • 634-3353 ■ TELEX: 72 • 2447

**BOURNS®**

# SPACE SAVER CERMET CONTROLS

## ARE—



**INTERCHANGEABLE WITH CTS 550 and 600**— Series 3852 is an exact CTS 550 replacement with less space required; Series 3859, ordered with a plastic bushing, also is interchangeable and costs even less. Series 3862 is interchangeable with the CTS 600 and is a better 1/2 inch diameter control.

**THIN**— Cut the bulk out of your new design . . . try the controls with the thinnest back-panel profiles in the industry— 1/4"!

**QUIET**— CRV is conservatively specified at 3% of total resistance. Actually it's substantially less on most units.

**CERMET**— This provides the designer with **BETTER STABILITY, HIGHER POWER-RATING, AND A  $\pm 150$  ppm/ $^{\circ}$ C TEMPCO.**

### COMPETITIVELY PRICED

SERIES	100 piece quantity	2000 piece quantity
3852	\$1.56	\$ .81
3859	1.27	.66
3862	2.20	1.18

**AVAILABLE**— All three Series, including their various shaft, bushing, and shaft-end styles, are stocked in-depth at each of 73 Bourns distributor locations. Delivery on standards is 24 hours.

### LOOK AT THE SIGNIFICANT SPECS —

	MODEL 3852/3859	MODEL 3862
Power Rating	2 watts at 70 $^{\circ}$ C	1 watt at 125 $^{\circ}$ C
Temperature Coefficient	$\pm 150$ ppm/ $^{\circ}$ C	$\pm 150$ ppm/ $^{\circ}$ C
Diameter	3/4"	1/2"
Depth Behind Panel	1/4"	1/2"
Resistance Range	50 $\Omega$ to 5 megohms	100 $\Omega$ to 5 megohms
Resistance Tolerance	$\pm 10\%$	$\pm 10\%$
Bushing	metal and plastic snap-in; locking and non-locking	metal; locking and non-locking

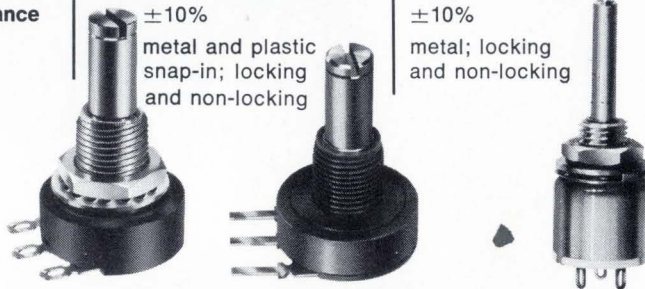

**FOR COMPLETE DETAILS, OR TO ENTER YOUR ORDER, CONTACT YOUR LOCAL BOURNS SALES OFFICE, DISTRIBUTOR, OR THE FACTORY-DIRECT.**



TRIMPOT PRODUCTS DIVISION • 1200 COLUMBIA AVE., RIVERSIDE, CALIF. 92507

### Probing the news

to-lot than manufacturer-to-manufacturer. Reliability Inc. sees 1% to 2% reject rates, compared with 4% to 5% four years ago. And Dennis Segreto, division manager at Micro-electronic Testing Labs, also sees more reliable devices coming from the vendors. "We see peaks and valleys," he says, "but the average failure rate is about 2%."

Most of the problems with ICs involve bonding, says Segreto. The bonds could be weak to begin with, and oxidation can form beneath the chip, generating a high resistivity. Burn-in is designed to put the equivalent of a year of life on the device before it goes into service.

**Prices drop.** With the trend toward reliability screening, the cost for testing is falling off dramatically. "We generally like to work on contracts for one year," says Coker, reflecting the sentiment of the industry. "The cost is based on an annual volume of parts, and the price range is very narrow." The highest price tag is on his ETC-3 program, comprised of thermal shock, burn-in, 100% dc and functional tests, and others. The price ranges from about 20 cents a part for low quantities down to about 10 cents a part in high quantities, he says.

"Price may vary quite drastically," MTL's Pitts says. "In three million quantity it may be 3 1/2 cents apiece, or for single quantity, it could be 30 cents—depending on what the device is."

Reliability's Hanlon estimates that, based on a million parts per year, the cost to the customer for stabilization bake, temperature cycling, burn-in, and electrical testing is about 20 cents per device. This compares with about \$4 per device for burn-in alone in 1969, he says.

And there is evidence that customers are becoming more sophisticated. "They're asking us to sample 2% to 3% for electrical test only before going through all the tests," says Hanlon. "They'll ask us to throw in a high-temperature continuity test to make sure all the bonds are intact at some fixed temperature, or for a continuity scan on a sample basis to throw out grossly defective lots." □

# Everything you need to know about power supplies is right here in this little box.

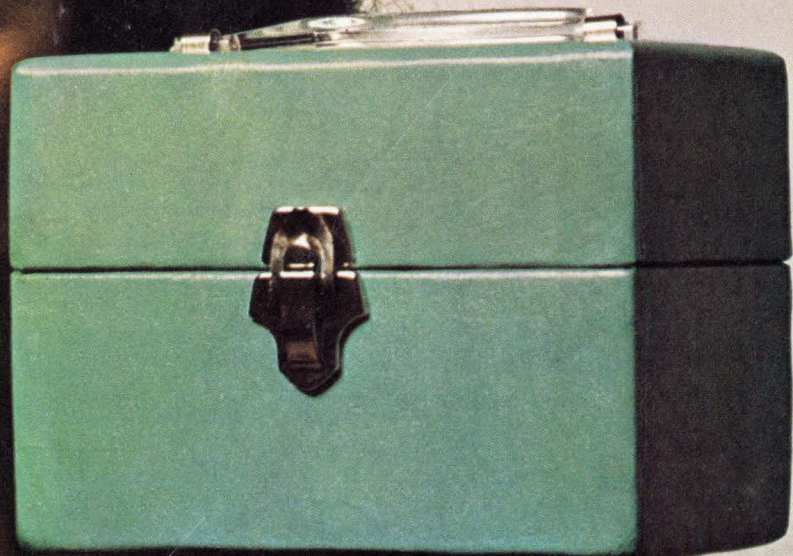

## Only \$94.00 complete

**The equivalent of 25 cubic feet of catalogs sits right on your desk in this little 4" x 6" box.**

The most complete Power Supply Catalog File available anywhere . . . 6667 current catalog pages have been collected and organized on microfiche cards — 98 pages per card. Every major source of power is listed, indexed and easy to find.

*This little box costs only \$94.00 and can save you hundreds of dollars in space, time and effort.*

**Never before available:** This is the first microfiche series from the Electronics Catalog Retrieval System. The microfiche cards fit any

standard reader and there is space in the box for up-dated information.

**Special introductory offer:** If you don't already have a standard microfiche reader, you can order the new Kodak Ektalite 120 *with your*

*purchase* of the Power Supply Catalog File at the special low introductory price of \$85.00 (delivery included).

The Ektalite 120 is a desktop reader weighing less than five pounds. It's compact, noiseless, easy-to-use. All you do is feed in the microfiche from left to right, and manipulate the control knob to locate the image you want.

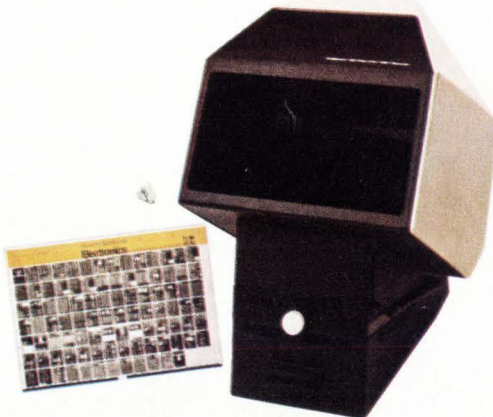

**McGraw-Hill** Electronics  
Catalog Retrieval  
System

1221 Ave. of the Americas/New York, N.Y. 10020

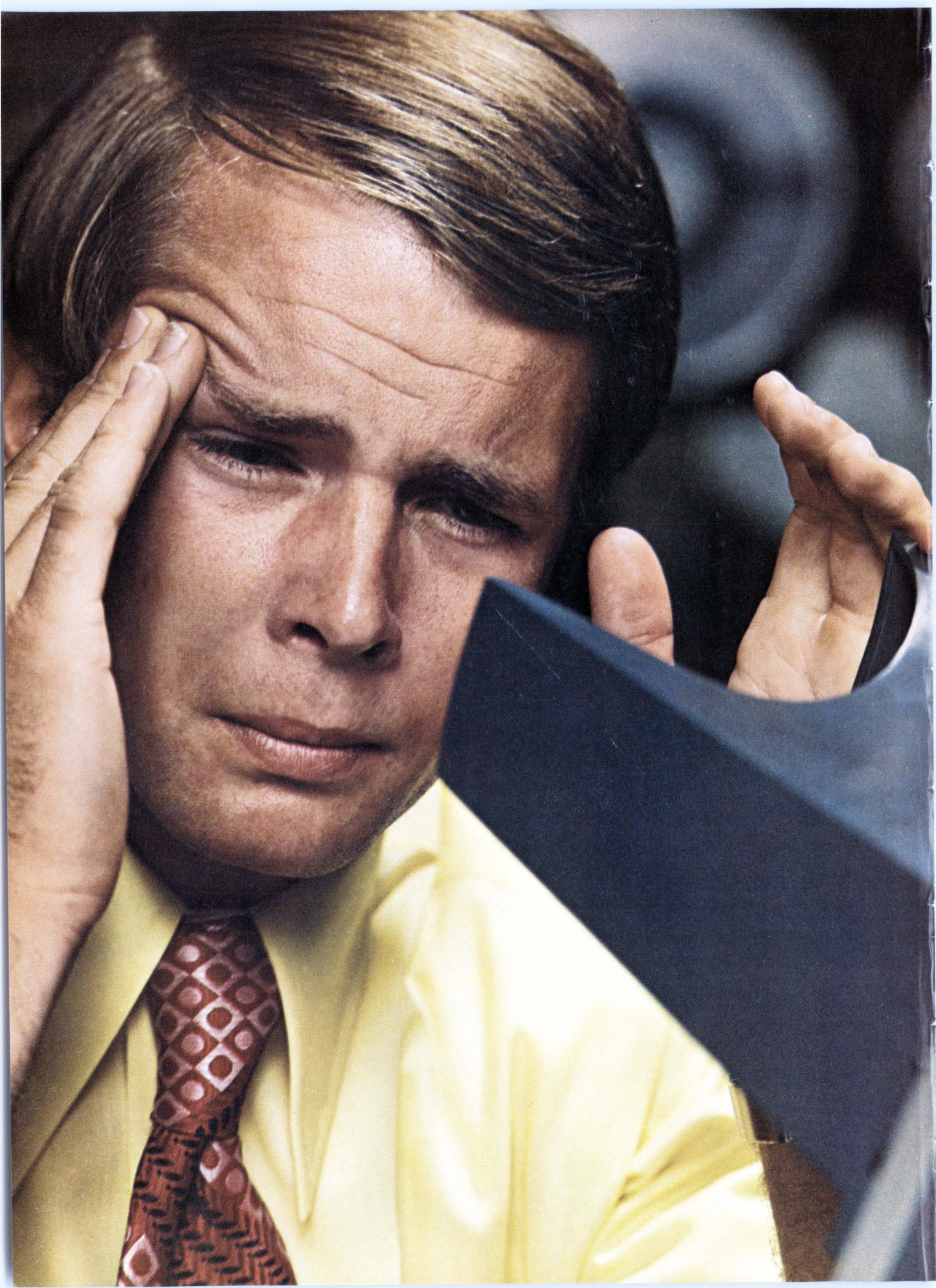

# Think Twice:

## What's one of the biggest measurement problems in the computer industry today?

### Low Duty-Cycle Measurements—

Making timing-pulse adjustments, and finding noise pulses in, or locating missing bits from low duty-cycle digital signals. Countless lost hours and eye-strain have resulted from this problem—trying to view low rep-rate signals like those found in disc, tape, or drum peripheral units. But with your refresh cycle occurring at such long intervals, coupled with short phosphor persistence, it's no wonder that you've spent an inordinate amount of time making such measurements. And it's no wonder that you often came out from under your scope hood rubbing your eyes. Well, no more!

### Storage CRT With Unmatched 400 cm/ $\mu$ s Writing Speed.

Hewlett-Packard just made it possible for you to throw away your scope hood by developing a new bright, burn-resistant, high-speed, variable-persistence CRT—available in either 100 cm/ $\mu$ s or 400 cm/ $\mu$ s writing speeds. Placing these new CRT's into an all new mainframe that's optimized for high-writing-speed storage measurements, HP now gives you a new dimension in storage scopes—the HP 184A. This unique combination offers the highest writing speed available, and a display with brightness as great as you can find anywhere. For the first time you can find those elusive transients that before were too fast for your storage scope to follow—like nanosecond noise pulses.

**Display True Replicas of Your Waveforms.** You'll appreciate being able to adjust persistence down to 0.2 seconds; that's 75 times lower than a major competitive unit. For those measurements that require faster sweep times, you'll know you are displaying true replicas of your waveforms when you're using an HP 184A. Capture low duty-cycle pulse trains, through repetitive sweeps, simply by adjusting the persistence to

"maximum," to build up the intensity of dim traces. This feature in the new 184A oscilloscope lets you do many jobs you previously allocated to expensive, single-shot scope/camera systems.

### Variable-Persistence Storage and Standard in One Scope.

Further, you'll find that your 184A is a true general purpose scope that offers you the capability to choose, by way of plug-ins, all the functional features of the HP 180 Series of oscilloscopes, including such items as selectable-input impedance, and sampling to 18 GHz. And for simplicity of operation, we think you're in for a pleasant surprise when you compare the 184A against the competitive unit.

**Superior Technology.** HP believes the most important part of a scope system is the CRT—the interface between you and your measurement. As the pioneer in practical applications of dome-mesh magnification, HP was first to expand the size of high-frequency CRT's to 6 x 10 cm; first to 8 x 10 cm; and first to 10.4 x 13 cm—all in high-frequency mainframes. HP was also the first to use dome-mesh technology to substantially lower power requirements for CRT deflection (making possible the only line of 35 and 75 MHz portable scopes with built-in battery packs—scopes that really are portable).

**From The Storage Leader.** HP was first with variable-persistence mesh storage for commercial applications—to give you a stored trace many times brighter than bi-stable tubes, and without annoying flicker. Variable-persistence, with its ability to build up waveform brightness, was the first CRT innovation that gave you a trace bright enough to let you tackle most single-shot or low rep-rate measurements problems. All you do is adjust persistence until the integrating storage effect brings your waveform up to a bright, clear display.

**Burn-Resistant CRT's.** HP placed variable-persistence in many of its scopes including the 181A, 1702A, and 1703A storage units. And now HP has developed, for its current line of storage instruments, carefree CRT's so highly burn resistant they require little more care than conventional CRT's. The new 184A high-writing-speed scope also has unprecedented inherent resistance to burns.

**Yes, Scopes Are Changing.** How many times have you wished for a scope that could display a low rep-rate digital signal brightly and clearly, and one that could also be used for a variety of general purpose measurements. That scope is here now in HP's 184A storage mainframe, \$2200 (for only \$500 more, you can boost your 184A's writing speed to 400 cm/ $\mu$ s), with plug-in capability to 100 MHz real time, or 18 GHz sampling. Think twice; put away your scope viewing hood and call your local HP field engineer for a demo today. Or write for our "No Nonsense Guide to Oscilloscope Selection." It covers the other members of HP's variable-persistence storage scopes. Hewlett-Packard, Palo Alto, California 94304. In Europe: P.O. Box 85, CH-1217 Meyrin 2, Geneva, Switzerland. In Japan: YHP, 1-59-1, Yoyogi, Shibuya-Ku, Tokyo, 151.

**Scopes Are Changing;  
Think Twice.**

HEWLETT  PACKARD

OSCILLOSCOPE SYSTEMS

# EVERYMAN'S GUIDE TO MOS

**“To MOS or not to MOS?” is a big question. Here are the answers. In a form everyone can understand. The OPTIMOS Book.**

The Optimos Book is over 300 pages of comprehensive information on MOS. It's for every level of MOS interest, from non-technical top management to the working engineer at the bench. From economic philosophy to product specifications.

The Optimos Book provides an overview of the state of the art in MOS. Most specifically, the state of our art, which we call OPTIMOS: the optimum use of MOS/LSI technology, of all available cost and design options for maximum return at minimum risk. The practical use of MOS.

This book is a vital tool for management in making the basic decision

whether to go MOS or not. Once that decision has been made and the task of implementation turned over to the working engineers, they, in turn, need the data, the detailed answers to their engineering questions, the tools to do *their* job efficiently.

At this point The Optimos Book is, if you will, a cookbook. A step-by-step guide on how to design with MOS. How to get the best out for what you put in, measured in terms of time, cost, effort and objectives.

**Everyman's Guide**

The chapter headings tell the story:

MOS/LSI today: The coming of age of low-power

high-density MOS technology. Where MOS/LSI makes sense. Some of the risks involved.

MOS economics: An overview. How volume and die size affect costs. Selecting the optimum die size.

The critical MOS decisions: Critical cost factors. Structuring the system for MOS. Standard vs. custom MOS. Optimum partitioning. Proven MOS processes that better your odds. How to evaluate MOS vendors.

Getting the most through OPTIMOS. Fairchild's OPTIMOS approach. Its history. Planning early with us for best balance between standard and custom devices. Customer/Fairchild interface options: design and performance responsibilities, co-engineering and communications.

Fine tuning the design. Testing. Our MOS production capabilities. OPTIMOS directions for the future.

Technical appendices: More than 180 pages of specifications and application data on our standard products. More than 60 pages of specifications and design rules for our Micromosaic MOS cell library and its application in computer-aided design.

Plus reliability data, packaging, ordering information. The technical guts of a very gutsy book.

**Free**

Anyone interested in MOS will be interested in The Optimos Book. If you request it on your company letterhead, we'll be glad to send you a copy.

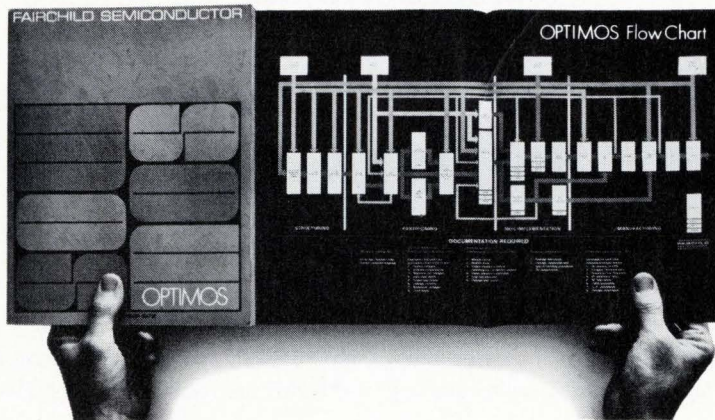

**MADE IN  
FAIRCHILD**

*This announcement is neither an offer to sell, nor a solicitation of an offer to buy, any of these securities. The offer is made only by the prospectus.*

September 28, 1972

620,000 Shares

# Advanced Micro Devices, Inc.

Common Stock

Price \$15 ½ Per Share

*Copies of the prospectus may be obtained in any State from only such of the undersigned as may legally offer these securities in compliance with the securities laws of such State.*

Donaldson, Lufkin & Jenrette, Inc.

E. F. Hutton & Company Inc.

Reynolds Securities Inc.

CBWL-Hayden, Stone Inc.

L. F. Rothschild & Co.

F. S. Smithers & Co., Inc.

Spencer Trask & Co.  
Incorporated

Bateman Eichler, Hill Richards  
Incorporated

Boettcher & Company

Crowell, Weedon & Co.

Dain, Kalman & Quail  
Incorporated

R. S. Dickson, Powell, Kistler & Crawford

Hambrecht & Quist

Mitchum, Jones & Templeton  
Incorporated

Putnam, Coffin, Doolittle, Newburger  
Division of Advest Co.

The Robinson-Humphrey Company, Inc.

G. A. Saxton & Co., Inc.

Shuman, Agnew & Co., Inc.

Singer, Deane & Scribner

Sutro & Co.  
Incorporated

Wheat, First Securities, Inc.

William D. Witter, Inc.

Birr, Wilson & Co., Inc.

Coleman & Company

G. S. Grumman & Associates, Inc.

Stern, Frank, Meyer & Fox  
Incorporated

Wagenseller & Durst, Inc.



**THE  
CONWAY  
MASTERANGER  
MODEL 639**



**This remarkable new  
Multitest set  
is unique  
in its versatility,  
in its sensitivity,  
and in its price.**

**100M $\Omega$  input resistance; accurate to 1.5%. 72 Ranges. Floating input for absolute user safety; fully overload protected. Completely portable; battery or AC operation. Attributes such as these make the Conway Masteranger the new STANDARD INSTRUMENT for all electronics. Its price \$150.\***

\*(Cdn. Dollars, export price—local taxes extra.)

The Conway Masteranger solid state Model 639 is the world's most comprehensively ranged F.E.T. Multimeter. It is the result of five years' intensive research and study to determine the most required measurement parameters and ranges for the rapid testing of AC/DC Voltages, Current, Decibel, Resistance and Voltage Levels.

**Its design concept employs 100% silicon solid state technology, making it applicable for the measurement of any anticipated electronic equipment development over the next 10 years. It can also carry out its functions on all contemporary equipment, and that of earlier technologies.**

Like many genuine technical advances, its principle is simple enough to make the Conway Masteranger relatively inexpensive. At \$150, it renders many other instruments (some much more expensive) either obsolete or unnecessary.

The Masteranger 639 is amazingly accurate—plus or minus 1.5% through most of its 72 ranges. Its input resistance is high—100M $\Omega$  on most voltage ranges. This, coupled with its outstanding sensitivity of 1.5mV AC or DC (full scale) and its current measuring capability from 0.15 $\mu$ A (150nA) up to 150A. AC/DC (with shunt box) puts the Masteranger Multitest set in a class of its own.

The instrument is supplied in a smart bridle leather carrying case with detachable shoulder and neck strap. At 2.5Kg (5.5 lbs) it is easily carried.

A wide range of quality matching accessories are available. RF probe extending frequency response to 1000 MHz, current range extension to 150 Amps AC and DC in 4 ranges, HV probe, Powerline cassette, Magic "T", etc.

Complete information, and specification sheets, on this unique professional Multitest set is available on request. Simply fill out the coupon below and mail to:



**CONWAY ELECTRONIC ENTERPRISES LIMITED**  
88-90 ARROW ROAD, WESTON, ONTARIO

Gentlemen: E 10/23

Please send me complete information on the Masteranger 639 solid state Multitest set.  I would like to test the Masteranger 639 for myself. Please contact me to arrange a demonstration at my office.

Name: \_\_\_\_\_

Address: \_\_\_\_\_

Company: \_\_\_\_\_ Telephone: \_\_\_\_\_

Title: \_\_\_\_\_

Type EJ, the pot  
with rotational life  
in excess of  
1 MILLION CYCLES.

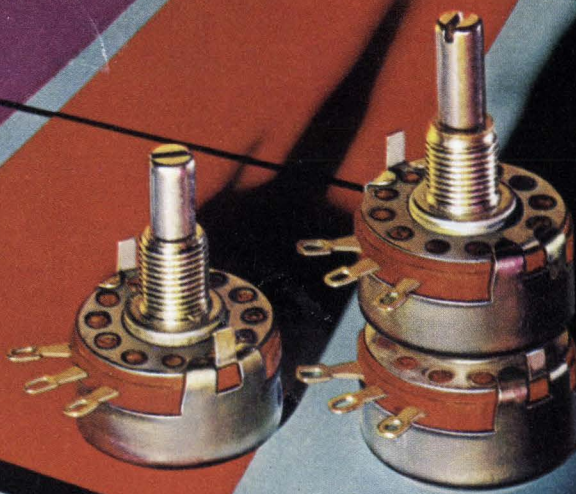

Actual Size

If you're really  
serious about cost,  
be serious about quality.

This is the EJ, an extended life version of our famous "J" pot. Same dependable performance. Same power handling capability. Same quality throughout, but with a tremendous difference in rotational life. One good turn after another for more than 1,000,000 cycles (under normal use

within ratings per Publication 5230). Specify the EJ for electronic organs, lift trucks, automotive and process control applications. Hot molded composition, 2.25 watts. Resistances from 50 ohms to 5.0 megs. Usable from  $-55^{\circ}\text{C}$  to  $+120^{\circ}\text{C}$ . Five standard tapers. Single or dual sections.

Request Publication 5230. Allen-Bradley Electronics Division, 1201 South Second Street, Milwaukee, Wisconsin 53204. Export: Bloomfield, New Jersey 07003. Canada: Allen-Bradley Canada Limited, Galt, Ontario. United Kingdom: Jarrow, County Durham NE32 3EN.



# Interactive image processor speeds pattern recognition by computer

Picking out features in a photograph is too tough a job to be left to a computer alone; this special-purpose processor, called GLOPR, is fast enough to allow human operators to help the machine in real time

by Kendall Preston, Jr. and Philip E. Norgren, *The Perkin-Elmer Corp., Norwalk, Conn.*

□ When general-purpose digital computers are used to process two-dimensional pictorial data, the job may be so complex that they get bogged down in it and become impractically slow. The interactive digital system described here, however, is designed for the purpose of generating and testing image-processing algorithms. Its key advantage is its ability to perform many test runs without wasting computer time. Thus a large sample of images can be processed in order to gather statistical data on the effectiveness of the algorithms.

The short-term aim of the system is to permit experimental research into the use and effects of binary-image transformations, since by and large there is no theoretical foundation for the analysis of this kind of picture processing. In the longer term, though, effective algorithms for pattern recognition will have many uses. Tasks for the system may originate in such diverse fields as biomedicine, aerial reconnaissance, and metallurgy.

The heart of the system, trademarked GLOPR for Golay Logic Processor, performs the actual binary-image transformations that extract features from pictorial data. Connected to GLOPR are a general-purpose minicomputer and a CRT display. The former contains the system software that interfaces GLOPR to the operator, who is integral to the interactive system's operation. The latter lets the operator observe the images as they are processed.

Of course, before the system can operate on an image, the image must somehow be fed into the system. This is done by an image scanner, as shown in the complete system block diagram of Fig. 1. The scanner performs the spatial sampling of the picture and produces a quantized digital representation of the gray-scale value of each sample point of the picture. The minicomputer takes these samples, and converts them into a binary image by a simple thresholding process.

### The Golay logic processor

Just as many general-purpose digital computers use special hardware to multiply numbers, GLOPR has hardware to perform transformations of images (see "The Golay transforms").

GLOPR appears to the computer as a black box (Fig. 2a) with three inputs and one output. The output is the transformed image, and the inputs are two images and control information.

The main function of the control input is to tell

GLOPR what transform to perform on the input image. It also takes care of such housekeeping commands as specifying image size, specifying the number of sub-fields to be used, and telling the processor which sub-field to process on any particular cycle. The GLOPR flow diagram is given in Fig. 2b.

Central to GLOPR is the subsystem made up of the surround-decode and rotation logic and the image-transformation logic.

The first part of this subsystem is shown in Fig. 3. The surround bits are read into a six-bit shift register connected as a ring counter. This device inspects all possible rotations of the surround bits, thus making the transforms independent of the orientation of the field. The outputs of the ring counter are decoded by 14 AND gates—one for each of the 14 Golay surrounds.

At the beginning of a major GLOPR cycle the ring counter is loaded and then shifted five times—during five minor cycles—so that each gate looks at all possible orientations of the surround data. If, for instance, the surround existing is Golay surround number 1 (see panel), then a single bit out of the six surrounding bits will be a logic 1 and all other bits will be 0s.

As the logic is shown, when the A position and only the A position in the ring counter is occupied by a 1, the output of the gate which decodes Golay surround number 1 will become a binary 1. At each point in an image, one (and only one) Golay surround exists. Thus, at some time during each major cycle one of the decode gates will have a logic 1 output.

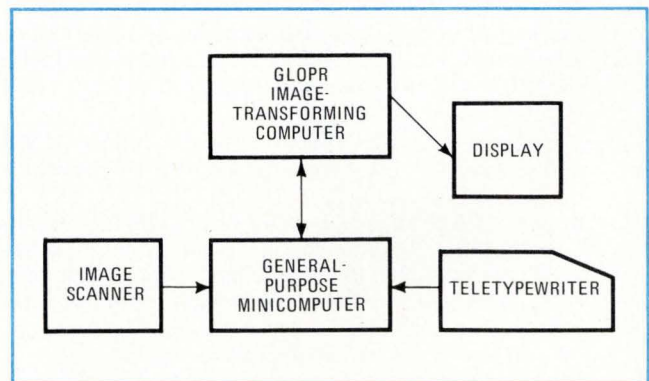

1. Interaction. Processing consists of transferring binary images into and out of GLOPR. Operator observes results of image transformations on CRT and acts on system through teletypewriter.

The outputs of these 14 gates feed into the image-transformation logic illustrated in Fig. 4. In addition, the image-transformation logic receives a center bit from the main image memory, a center bit from the second input image, and a 14-bit mask word from the control information of GLOPR. This word selects the desired combination of Golay surrounds to make up the transformation function. Other control information bits select the desired combination of the two center bits. One output bit is produced for each major cycle of GLOPR's operation.

Since users of the GLOPR system are interested in doing pattern-recognition research, and not in dealing with the details of the computer's hardware, a software

system is provided to interface operator and machine. Called GLOL (for GLOPR Operating Language), the software system was developed for the Varian 620i mini-computer.

### Operating the processor

Using the commands provided by GLOL, the operator can interactively design and test algorithms to process imagery and extract information from pictures. The GLOL system will also store groups of commands, called procedures, and execute these procedures later with a single command.

The GLOL system takes the form of an interpreter which is very similar to many time-sharing Basic com-

## The Golay transform

To obtain a binary image from a real-world image two operations must be performed. First, the image must be transformed into a two-dimensional discrete array of points. Second, the information at each point must be converted from a gray level value into a logic 1 or 0. A sample binary image is shown at the far left.

Note that a Golay transformation uses an image

0 0 0 0 0 0 0 0	0 0 0 0 0 0 0 0	
0 0 0 0 1 0 0 0	0 0 0 0 1 0 0 0	
0 0 0 0 1 1 0 0	0 0 0 0 1 1 0 0	1 2 3 1 2 3
0 0 1 1 1 1 0 0	0 0 1 1 0 1 0 0	3 1 2 3 1 2
0 0 1 1 1 1 1 0	0 0 1 0 0 1 1 0	1 2 3 1 2 3
0 0 1 1 1 0 0 0	0 0 1 1 1 0 0 0	3 1 2 3 1 2
0 0 0 0 1 0 0 0	0 0 0 0 1 0 0 0	1 2 3 1 2 3
0 0 0 0 0 0 0 0	0 0 0 0 0 0 0 0	
SAMPLE BINARY IMAGE	SAMPLE IMAGE TRANSFORMED TO SHOW EDGES	SUBFIELD MAP

which has been spatially sampled on a hexagonal grid rather than on the more familiar square-grid pattern. It produces as its output a second binary image. Each point on the output—or transformed—image is a function of the corresponding point on the input image grid and of the six nearest neighbors to that point. These six neighbors are called the surround while the point itself is referred to as the center bit.

The transforming function is a Boolean function. Its seven arguments—the center bit and the six surround bits—are Boolean values (0 or 1), and its output, the transformed center bit, is also a Boolean value.

Golay hexagonal binary image transformations are based on the fact that only 14 patterns of surrounds can occur on the hexagonal matrix. (The orientation of the surround pattern is ignored.) The 14 patterns are shown with the indexes assigned to them by Golay. (Note that the index refers to the surround pattern and is independent of the center bit.)

Patterns 0 through 6 are such that a change of the center bit from 1 to 0 does not affect the connectedness of the surrounding objects in the binary field. In patterns 7 through 13, a center-bit change from a 1 to a 0 will cause a connected pattern or patterns to become disconnected in the resultant image. Image features important in pattern recognition are associated with various surrounds or combinations of surrounds, as well as with the condition of the center bit.

As a simple example of a binary image transform which extracts a feature from an image, consider the image shown above. To obtain all the bits on the pe-

rimeter of the object in the given image, a transformed image is produced that has a 1 bit wherever the original image has any of the surrounds 2, 3, 4 or 5 with a center bit of 1. The resultant image (immediately to the right of the sample image) is said to be reduced to its edges.

Golay image transformations are parallel operations. That is, every point in an image is operated on at the same time, producing a new image with the same number of points. In certain cases, such parallel operations can disconnect a connected binary image. To prevent this when it is undesirable, Golay introduced the notion of subfields.

The hexagonal grid can be broken into three non-touching subfields, as shown in the subfield map on the far right. The bits in any surround are in subfields different from that of the center bit. When operating in subfields-of-three, parallel transformations are performed on only one of the three subfields at a time. The output of one such subfield transformation becomes the input to the next, until all three subfields have been transformed to complete one pass of the binary image transformation.

Many operations (such as the edge extraction shown above) do not involve any connectivity ambiguities and may be done completely in parallel on the entire field. This is sometimes referred to as operating in subfields-of-one.

*Editor's note: The transforms discussed in this article, and the hardware developed to perform them, are based on the pioneering work of M.J.E. Golay and Curt Stahl, respectively.*

### GOLAY'S 14 HEXAGONAL PATTERN CONFIGURATIONS

PATTERN	0 0 0 + 0 0 0	1 0 0 + 0 0 0	1 1 0 + 0 0 0	1 1 0 + 1 0 0	1 1 0 + 1 0 1
INDEX	ZERO	ONE	TWO	THREE	FOUR
PATTERN	1 1 0 + 1 1 1	1 1 1 + 1 1 1	1 0 0 + 1 1 0	1 1 0 + 0 0 1	1 1 0 + 0 1 0
INDEX	FIVE	SIX	SEVEN	EIGHT	NINE
PATTERN	1 1 0 + 1 1 0	1 0 0 + 1 0 0	0 0 1 + 1 0 0	1 1 0 + 0 1 1	
INDEX	TEN	ELEVEN	TWELVE	THIRTEEN	

puter systems; it runs in one of the five modes in the following list:

1. Interactive line-at-a-time operation
2. Procedure storage
3. Procedure execution
4. Run specification
5. Run execution

A procedure is defined as a group of commands, identified by name, and stored in a table within the system. Many procedures may be stored, each with its own name. A run is a group of commands stored in a special table. Only one run may be stored at a given time.

In modes 1, 2, and 4, input to the system is through the teletypewriter. All input is initially stored as a character string just as it is typed in. The system takes no action until the operator types a carriage return at the end of a command line. Thus, the operator has full freedom to edit the command line before it is interpreted.

In modes 3 and 5 the system runs under the control of previously stored procedures. It no longer takes input

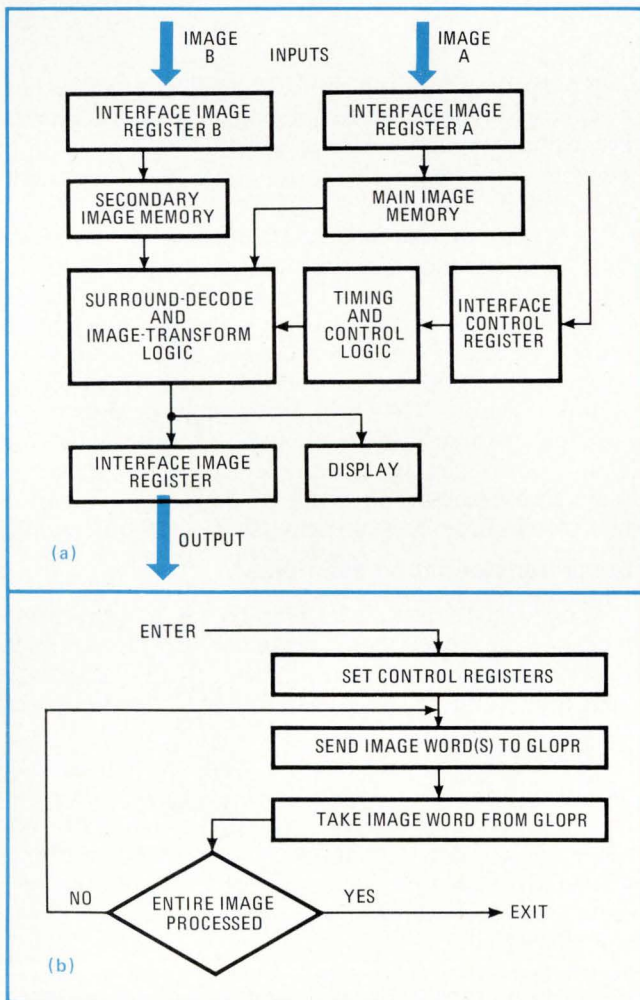

**2. Inside GLOPR.** Image data reaches the Surround Decode and Transform Logic where it is operated upon under the control of the Timing and Control Logic (a). This process takes place in a three-step sequence (b): the computer first sets the control registers to make GLOPR ready for processing, then, inputs an image word to GLOPR, and lastly takes an image word back from GLOPR. Because an image consists of many words, the second and third steps must be repeated until the entire image has been processed.

from the teletypewriter, but retrieves stored commands and executes them one after another.

The most important kind of operation on the GLOPR system is one which produces a new image from an old image. Binary images are stored in image buffers that are given names of one or two characters, such as A, B, C1, or B1. All but one of the commands that alter the contents of these buffers resemble the replacement statements in Fortran or Basic. (The exception is the PICK command, which is unique to GLOPR.)

A command such as  $A=B$  causes the contents of buffer A to be replaced by the contents of buffer B, without disturbing buffer B. Other replacement statements allowing Boolean operations between image buffers are also possible. For example,  $A=B*C$  puts the intersection of B and C into A. Similarly,  $A=B+C$  replaces A by the union of B and C. And  $A=B-C$  replaces A with the exclusive-OR combination of B and C; while  $A=0$  places the constant 0 in all of the words in image buffer A.

A more complicated image-replacement statement is used to control the operation of GLOPR itself. The general form of this Golay image-replacement statement is:

$$A = [G(B)C + G'(B)C]N1-N2/N3,N4,N5$$

The section within the square brackets is the actual replacement statement. It is a Boolean-valued function. Various constituents of this function may be left out to change the transform which is to be performed.

In the first numeric field, which extends from the right-hand square bracket to the first comma, the series of numbers indicates the Golay surrounds to be involved in constructing the function G. In this field a construction such as 1-3 means that surrounds 1, 2 and 3 are to be included, while a construction such as 3/7 means that 3 will be included and 7 will be included but none of the surrounds in between those numbers will be included. Therefore a field which contains 1-5/7-9 would cause a mask to be set up for the control register in GLOPR with bits 1, 2, 3, 4, 5, and 7, 8, and 9.

Field 2, between the first and second commas, specifies how many times the statement is to be performed. Field 3 specifies the subfield of the image plane which is to be processed, and can take on the values 1, 3 or 7. Fields 2 and 3 default to 1 if they are left blank.

Besides image-replacement statements, the PICK command, unique to the GLOL system, can also alter the contents of an image buffer. This command, written PICK A,B,N causes the destination buffer (A) to be cleared to all 0s and then have copied into it the Nth bit from the original buffer (B). The PICK command can be used to isolate binary image constituents, as an example later will show.

While image-replacement statements are the most important kind of command in GLOL, many other commands are necessary for full operation of the system. These fall into three functional categories: housekeeping, control, and measurement and arithmetic. The table lists these commands and describes their functions briefly.

### Other GLOL commands

Housekeeping commands allow the user to manage the available storage by assigning names to image buffers and procedures. They also include commands

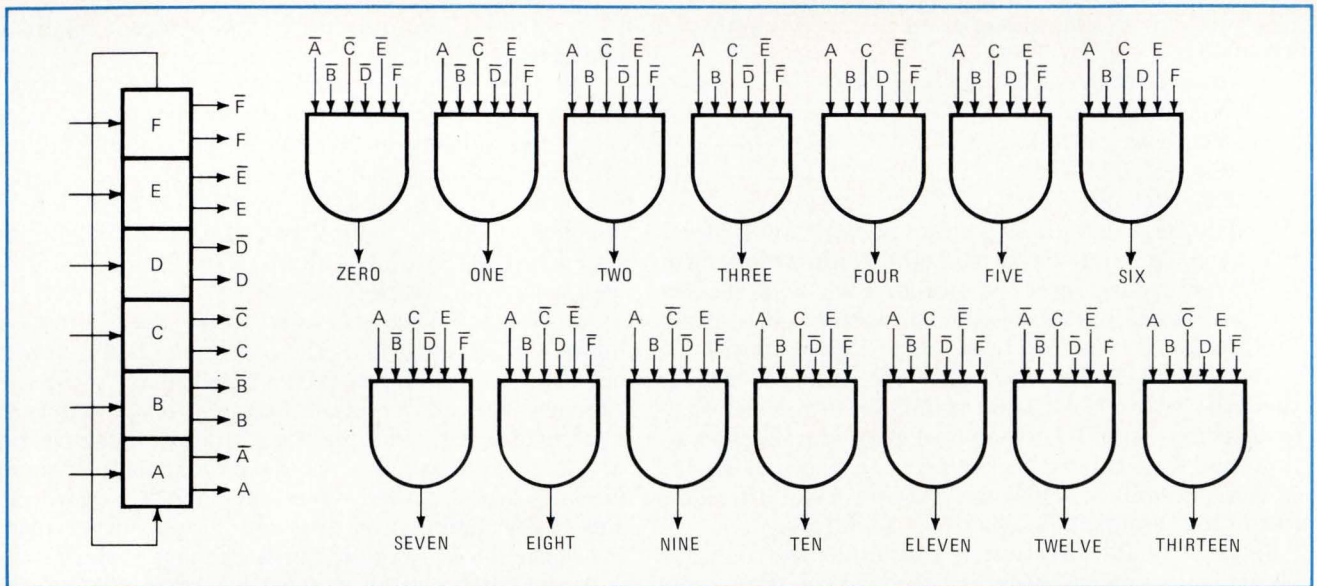

**3. Rotation.** After the six-bit ring counter is loaded, its contents are shifted five times so the decoding gates can determine if a given surround is present, regardless of its field orientation.

for operating peripheral equipment like the image scanner and the magnetic tape unit.

Control commands get the system into and out of its five modes of operation. Normally it runs in mode 1. The Define Procedure command causes it to enter mode 2, and assigns a name to the procedure which will be defined. The system remains in mode 2 until an End Procedure command is typed.

The Execute Procedure command places the system in mode 3 so that a previously defined procedure will be performed. The IF and DO loop commands allow the user to control the flow of operations within a procedure. These two commands may only be used within a stored procedure.

The Run command places the system in mode 4 so that a list of commands specifying the run can be stored. The specification mode is terminated by an End Run command, which places the system into mode 5.

The purpose of the Run mode is to allow procedures to be executed repeatedly. By placing one or more Execute Procedure commands within a Run the operator may perform a sequence of stored procedures repeatedly without further typing.

As for the measurement and arithmetic commands, the Count command is the primary means of making measurements on images. To measure a specific feature of an image, that feature is marked into an image buffer using a series of GLOL commands, and the resultant buffer is then counted to obtain a number associated with that feature. The Output command permits the inspection of these measurements. The Arithmetic command allows simple arithmetic to be performed on these measurements in order to derive new measurements or in order to test them using an IF statement.

### Some transformation examples

To appreciate the power of binary-image transformations, it is necessary to see what they can do. Unfortunately, space does not permit an exhaustive display of their capabilities, but Figs. 5 through 11 illustrate some of the more important features.

Figure 5, the starting point, is a sample binary image designed to contain all possible Golay surrounds. In the examples that follow, the assumption is made that this image is contained in buffer A, and the transformed images are made to appear in buffer B. A Golay replacement statement such as

$$B = [G(A)] 1,,$$

produces a transformed image as shown in Fig. 6a. This is called a marking transformation, as it marks the occurrence of the Golay surround 1 and may be written  $B = \text{MARK}(A) 1,,$ . The transformed image produced in B contains a 1 bit at each point where a Golay surround 1 occurred in the input image. All other bits in the transformed or output image are 0s. Figure 6b shows the transformed image of Fig. 6a superimposed on the original image, simply as a demonstration of the relationship of the transformed to the original image bits.

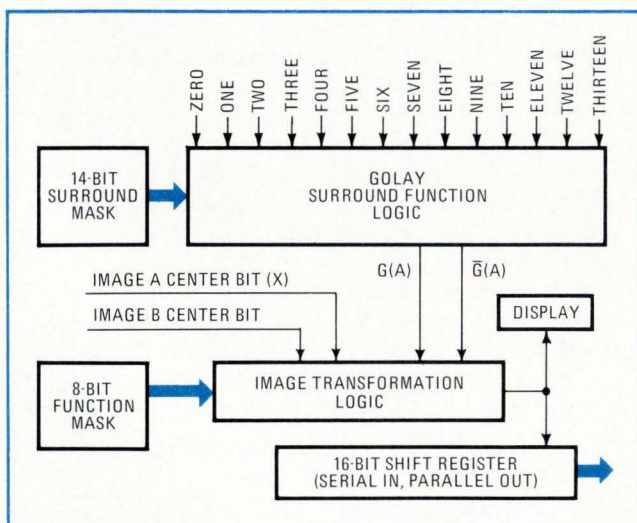

**4. Where it happens.** To execute the GLOL commands described in the text, the image-transformation logic needs not only the 14 surround-gate inputs but two center bits and control signals as well.

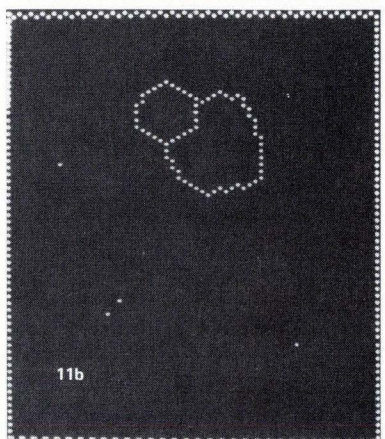
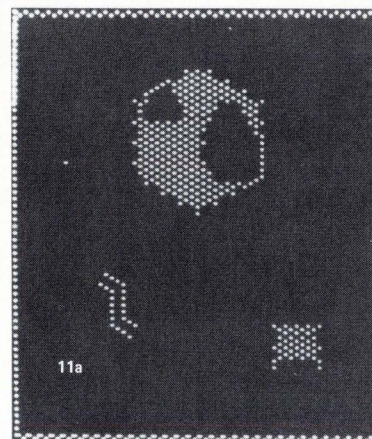
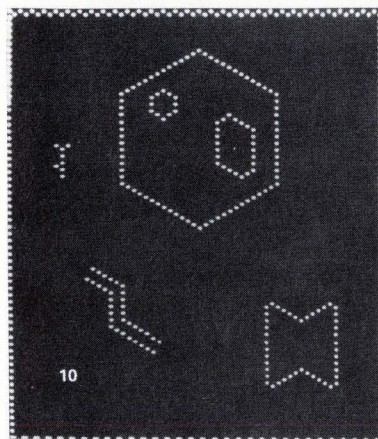
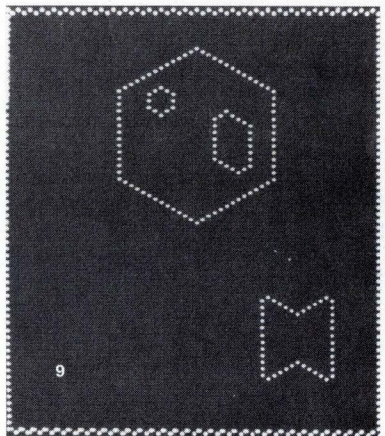
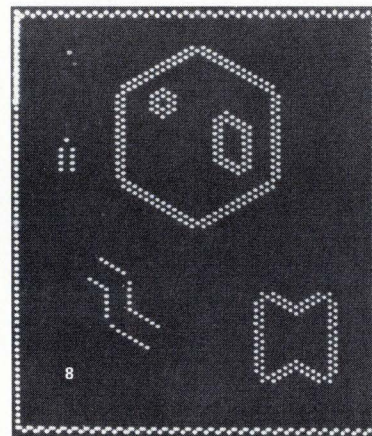
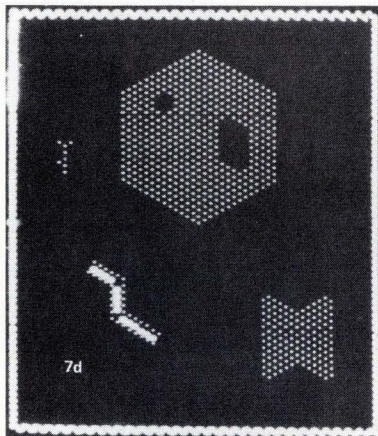
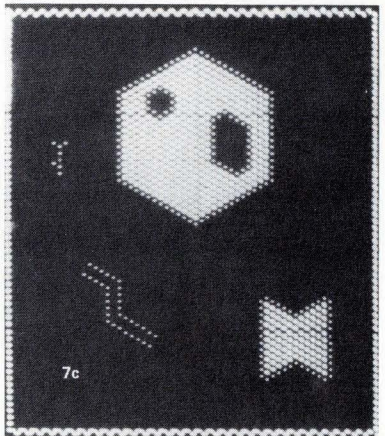
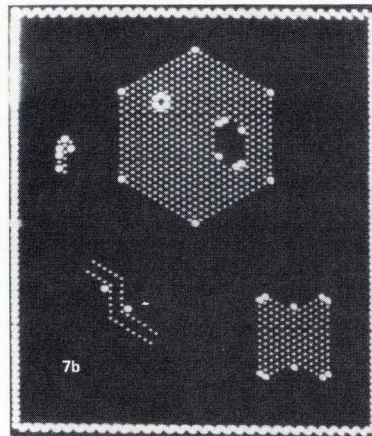
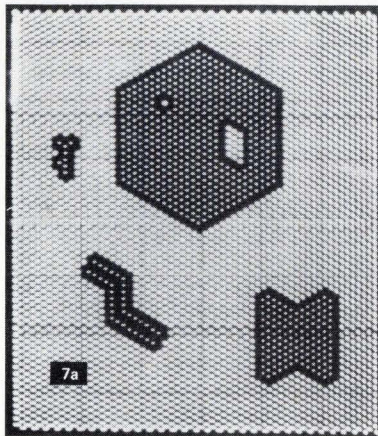
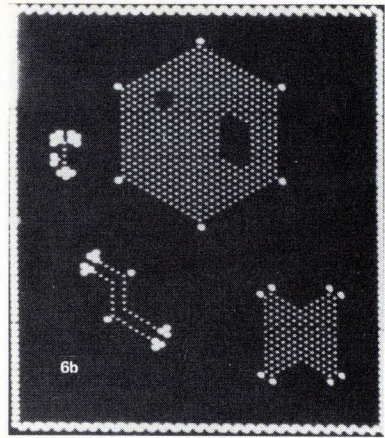
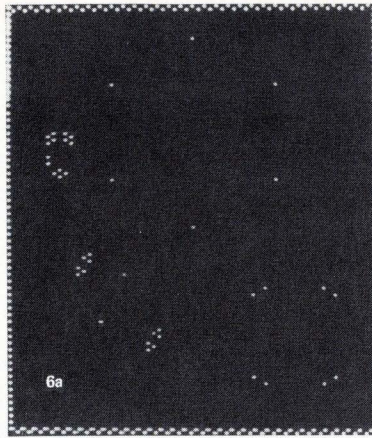
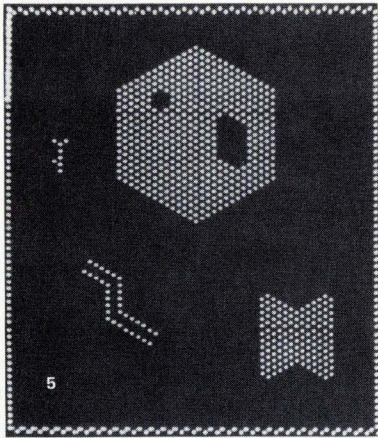

Figure 7 shows the results of marking four of the Golay surrounds in turn. Each of these four transformed shows the occurrence of a different Golay surround in the original test image.

While marking individual Golay surrounds is illustrative of the operation of binary-image transforms, image features are generally characterized by more than one surround type. As is noted in the panel on Golay transforms, edges might be looked for with the aid of surrounds 2, 3, 4 and 5. A Golay replacement statement for this would be

$$B = [G(A)]2-5,, \text{ or } B = \text{REDUCE } (B)2-5,,$$

The result of this transformation on the original test image is shown in Fig. 8. This marking operation produces more bits than would generally be wanted in a definition of the edges in the original picture, and therefore a somewhat modified transformation could be used to produce a reduced set of edge bits. Such a transformation would read

$$B = [G(B)]2-5,,$$

producing an image such as shown in Fig. 9. This edge transformation is accomplished by ANDing the Golay surround function with the condition that the original image also be a 1.

A different definition of an edge transformation may be obtained by changing the specification of the surrounds to be searched for in the transformation. Thus a Golay replacement statement such as

$$A = [G(B)]1-5/7-13,,$$

will produce a transformed image such as that in Fig. 10. Here all the edges shown in Fig. 9 are marked, but thin lines are also included in the transformation, giving a different edge picture.

All of the image transformations shown up till now have been examples of single-pass transformations. The input is taken from one image buffer and the transformed image placed in a second image buffer after one pass through GLOPR. Binary image transformations can be iterated by placing the resultant image back into the same buffer from which the original image is taken.

A typical example of such an iterative operation is shrinking the original image blobs down to points or thin lines (Fig. 11). The Golay replacement statement for performing this shrinkage is

$$A = [G'(A)]1-4, \text{INF}, 3$$

where the INF indicates that the transformation is to be performed to "infinity" or until no change occurs during a pass through GLOPR. Figure 11a shows one stage in the iteration of this shrinking process, and Fig. 11b shows the finally stabilized image. Note that four of the five objects in the original image have been reduced to single points while the large hexagon with holes in it has been reduced to a line object containing the same number of holes as were present originally.

Another type of replacement statement is written

$$C = [G(C)B + G'(C)]1-5, I$$

This statement is different from those in the previous examples in that two image-buffer names appear within its square brackets. This means that two input images are fed to GLOPR. An important use of this compound type of statement is in isolating individual objects from a complicated image, as we illustrate in the sample problem that follows.

## Chromosome analysis with GLOPR

Early in 1971 Samuel Cohen, a biologist at the U. S. Army Natick Laboratories, brought us some chromosome preparations made from tissue samples of the insect *Pycnoscelus Indicus*. Cohen wanted to form images of the chromosomes, feed these images into GLOPR, and analyze the chromosome structure automatically.

The X-shape of a typical chromosome is illustrated in Fig. 12. The tips of the X are called arm tips and the cross-over point is called the centromere. Of importance to biologists are the chromosome's arm lengths—that is, the distance from the centromere to each arm tip.

Making this measurement seems pretty simple until

GLOL COMMANDS	
COMMAND	DESCRIPTION
<b>IMAGE REPLACEMENT</b>	
C = [G(A)B+G' (A)B]N1-N2/N3, N4, N5	Golay replacement statement for performing image transformations using GLOPR.
A = B(op)C	Logical image replacement statement. (op) may be: +for "AND" +for "OR" -for "EXCLUSIVE OR"
A = B A = 0	Image replacement by another image or a constant such as zero.
<b>HOUSEKEEPING</b>	
*DEFine BUFFer NM	Reserve memory space for an image buffer, and assign a name (NM) to the space.
DEFine ARRArray ME (N)	Reserve (N) memory locations for measurements (numbers), and assign a name (ME) to the space.
DEFine PROCEDURE PNAME	Place all the commands between these two into a table for future execution, and assign the name (PNAME) to this table.
END PROCEDURE	
Display NM	Display the image buffer (NM) on the screen.
CLear	Stop displaying images.
ACquire Histogram Wavelength	Control the scanner to input binary images into memory.
WRite REad BACkspace BEGin END FILE	Control the magnetic tape drive to store images externally to the computer memory.
<b>CONTROL</b>	
Execute Procedure PNAME	Look up the table named PNAME and perform all commands stored there.
DO I/1, N . END LOOP	Perform the group of commands between these two N times. (This may be used only in a stored procedure.)
IF (LOGICAL TEST) . ELSE . STOP	If the logical test is True perform the first group of commands. If it is False, perform the second.
RUN N . END RUN	Perform the group of commands between these two N times. (The group may include Execute commands.)
<b>MEASUREMENT AND ARITHMETIC</b>	
COunt NM, ME (N)	Count the number of 1 bits in image buffer NM, and place this number in the nth location of array ME.
OUtput ME (N)	Type out the contents of the nth location in array ME.
ARithmetic X = Y (op) Z	Perform the arithmetic operation specified on the contents of locations Y and Z and place the result in location X. (op) may be: +, -, *, or /.
<b>MNEMONIC EQUIVALENTS FOR THREE COMMONLY USED GOLAY STATEMENTS</b>	
<b>MNEMONIC</b>	<b>FULL GOLAY STATEMENT</b>
A = MArk (B) N1, N2, N3	A = [G(B)] N1, N2, N3
A = REduce (B) N, N2, N3	A = [G(B)B] N1, N2, N3
A = AUgment (B) N1, N2, N3	A = [G(B)+G' (B)B] N1, N2, N3

\*Capital letters show those parts of a command which must be typed, lower-case letters show the optional parts.



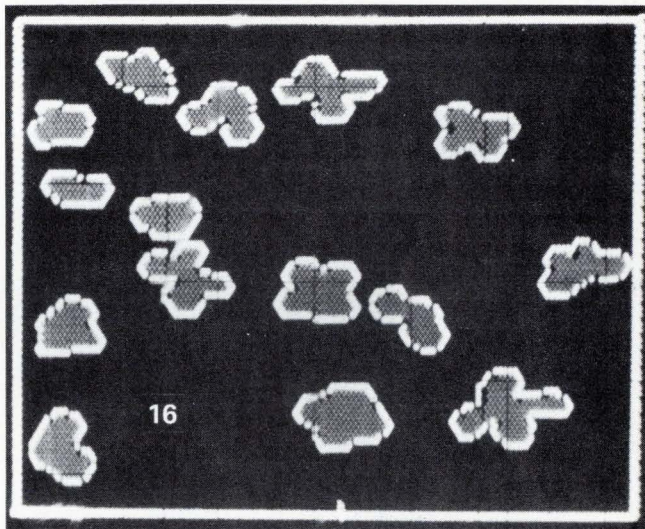
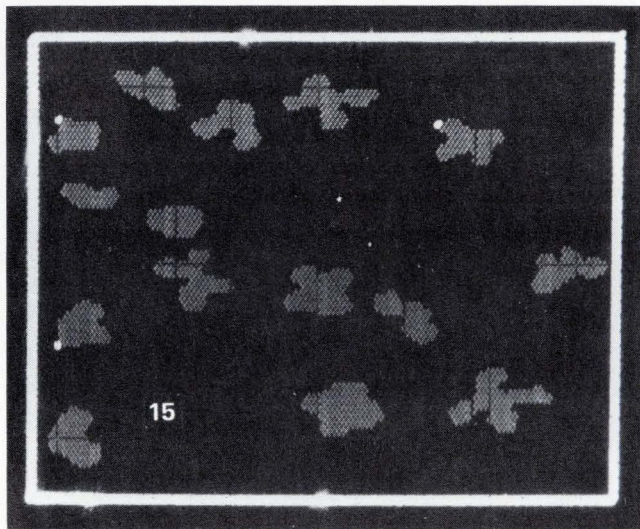
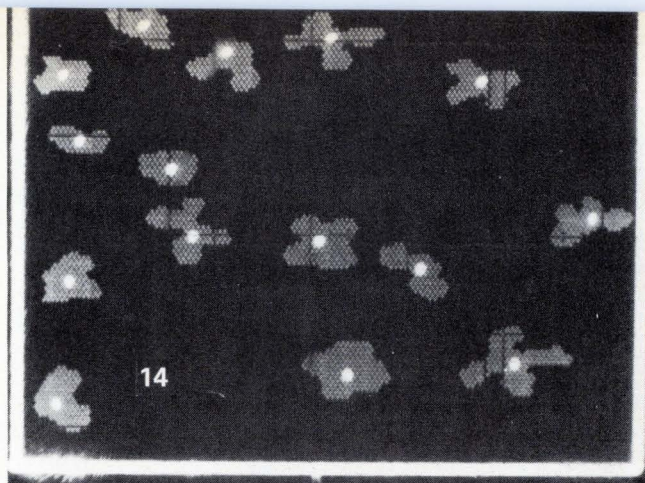
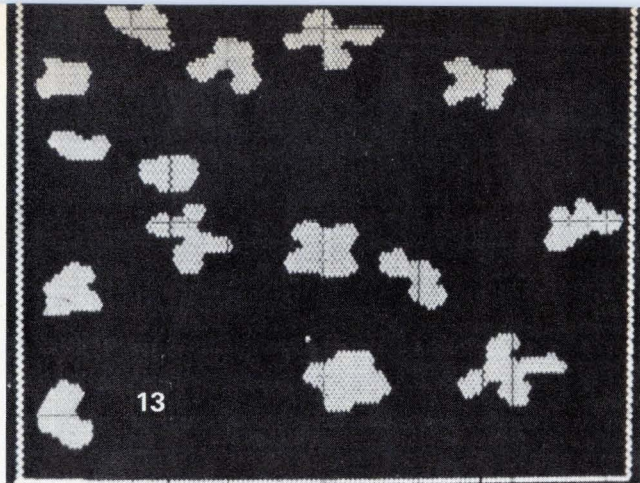

one realizes that a chromosome may have a length of only 100 millionths of an inch with arm widths of only 20 millionths of an inch. It is difficult to form clear images through an optically illuminated microscope when the wavelength of illumination is on the same order of magnitude as the chromosome arm width. To further compound our problems, most chromosomes do not have the clearly defined outline of Fig. 12.

Therefore, even after we have optimized the wavelength of our illumination source and the focussing of our scanner, we are not surprised to get the picture shown in Fig. 13. This is the image of a cluster of 15 chromosomes, stored in GLOPR, at a scale in which the separation between pairs of picture points represents 8 millionths of an inch. The name of the binary array containing this image is A.

### Beginning the analysis

We start the image analysis by typing `B=A`, which duplicates the image in the array named B. To locate the centromeres, we decide to try the shrinking transform as described earlier. Therefore, we next type `B=REDUCE(B),1-4,INF,3`. To display the results we decide to define a GLOL procedure called SHOW. We type

```

DEFINE PROCEDURE SHOW,Q,R
DO I/1,20
DISPLAY Q,4
DISPLAY R
END LOOP
END PROCEDURE SHOW

```

This procedure causes the images of two arrays, namely, Q and R, to be sequentially displayed, with Q's contents being held 80% of the time and R's the rest of the time. Thus Q will seem brighter than R. By embedding the display command in a DO LOOP, we made the entire operation continue for approximately 5 seconds so that we could take a photograph. Since the centromeres were contained in array B and the original chromosome image in A, we type `EXECUTE SHOW,B,A` and photograph the GLOPR screen. This result is shown in Fig. 14. So far so good.

Now, how should we go about locating arm tips and measuring arm lengths? Our first attempt is to use the fact that Golay surrounds numbers 1 and 2 are indica-

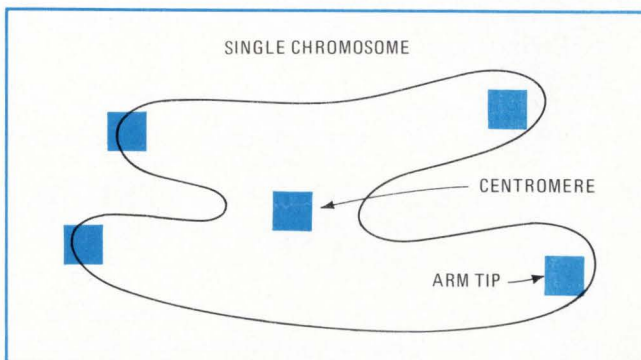

**12. Measuring chromosomes.** Pictured chromosome exhibits typical X shape. The tips are called arm tips and the cross-over point is the centromere. Most real chromosomes are not so clearly defined.

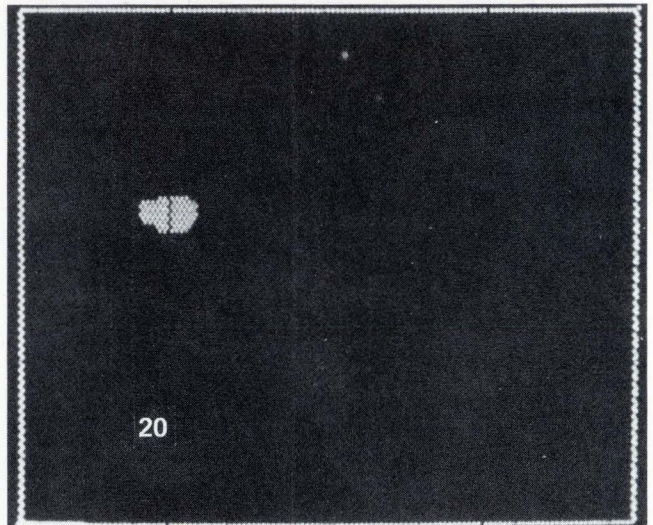
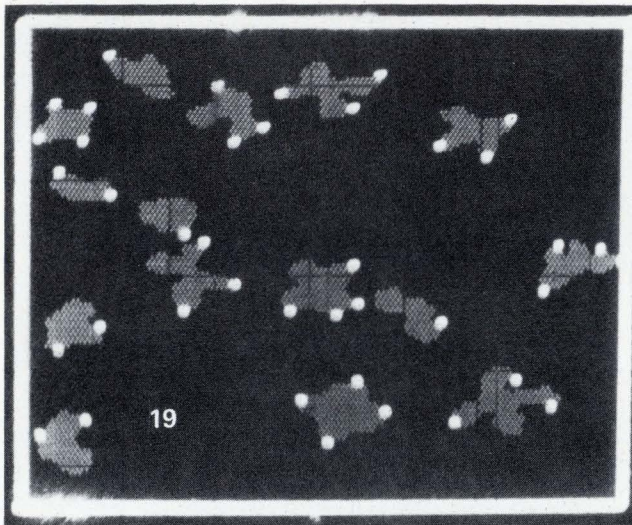
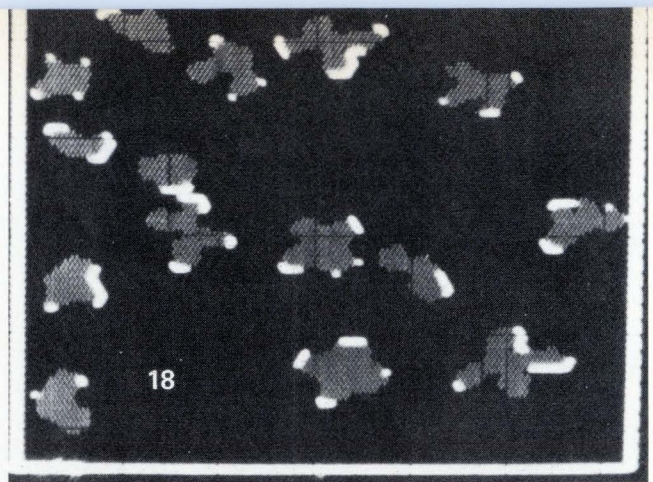
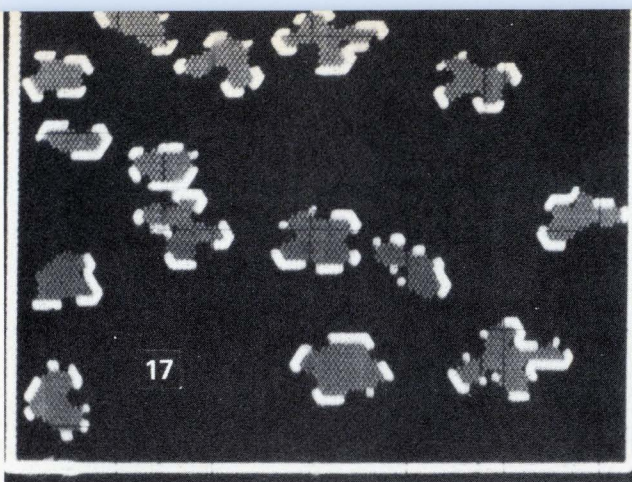

tive of tips or protrusions. We therefore type  $B = \text{REDUCE}(A), 3-13,,$ . This places in array B all points in A which do not exhibit surrounds 3-13. We then type  $\text{EXECUTE SHOW}, B, A$  and photograph the display (Fig. 15). Failure! We have located only three tips.

Still pursuing the idea of using Golay surrounds 1 and 2, we decide to use the Marking command as follows

```
B = MARK(A), 1-2,,
EXECUTE SHOW, B, A
```

The results (Fig. 16) are not encouraging. However, we notice that the marked regions are segmented and that the long segments appear to be related to true arm tips. We proceed to eliminate some of the short or "broken-up" segments and to shrink the longer connected segments as follows

```
B = REDUCE(B), 0-4,, 3
EXECUTE SHOW, B, A
```

and get the photograph shown in Fig. 17.

Progress! But too many tips have been marked on some chromosomes. So we repeat the reducing transform with the results shown in Fig. 18. Looks like we have gone too far, but we complete the job by typing

```
B = REDUCE(B), 1-4, INF, 3
EXECUTE SHOW, B, A
```

We now have arrived at the point shown in Fig. 19. Only two chromosomes seem to have all four arm tips properly located, and the others are still in bad shape.

We decide to examine one of the chromosomes that has given us particular trouble. To do this we code a

GLOL procedure which extracts or replicates the image of a single chromosome from array A into an array which we call C. We first put the centromeres in image array B and proceed as follows:

```
DEFINE PROCEDURE REPL, J
PICK C, B, J
C = [G(C)A + G'(C)C] 1-13, INF,
END PROCEDURE REPL
```

This procedure selects the  $j^{\text{th}}$  chromosome and copies it into array C.

We select chromosome 7 by typing  $\text{EXECUTE REPL}, 7$ . The resultant image is shown in Fig. 20. Look at Fig. 19 and you will see that we were able to mark only one arm tip on this particular chromosome. The difficulty is that this chromosome is so small and so poorly resolved that it is hard to perceive where the arm tips are. To enhance the image of this chromosome we form a regular figure or polygon from it by the simple means of typing  $C = \text{AUGMENT}(C), 3-5, \text{INF}, -$  with the result shown in Fig. 21. Now we decide to mark the arm tips by marking corners—that is, using the third Golay surround. We decide to place the results in a new array called D so that we may display them along with the polygon. We type

```
D = REDUCE(C) 0-2/4-13,,
EXECUTE SHOW, D, A
```

This operation places points in array D which correspond to points in C which do not have Golay surrounds 0-2 and 4-13—that is, only those points which have the 3 surround. The result is shown in Fig. 22.

We note that we have marked too many arm tips and

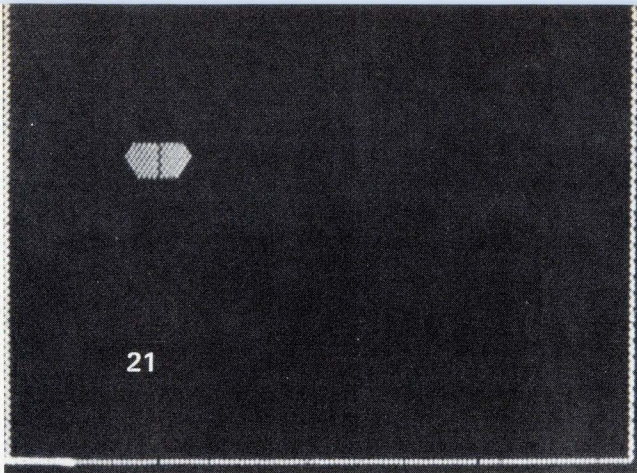

21

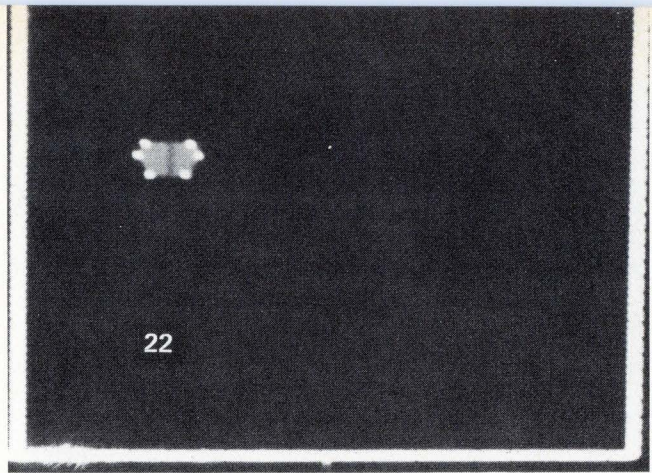

22

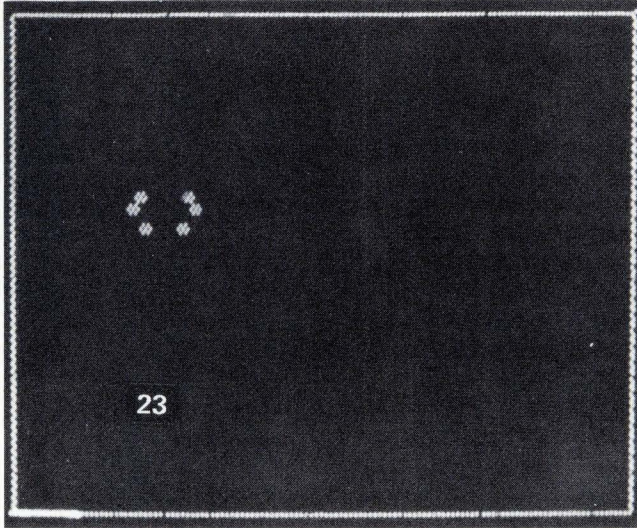

23

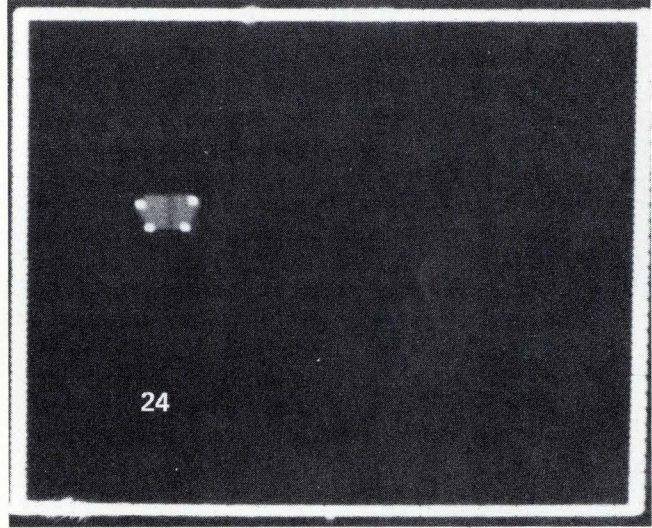

24

wonder what to do next. Seeing that there are two pairs of arm tips which are close together, we decide to merge these so that only four arm tips will remain. To do this we type `D=AUGMENT(B),1-13,,` and then type `DISPLAY D` and take a photograph. The result is Fig. 23. Progress!

We now must take these four clusters of bits, turn them into the marked arm tips desired, and display them superimposed on the contents of C. We do this as follows

```
D=REDUCE(D),1-4,INF,3
EXECUTE SHOW,D,C
and obtain Fig. 24.
```

This looks pretty good. We now decide to set things up and do it for the entire array of chromosomes. First we define a procedure called `polyon`, abbreviated `POLY`, as follows

```
DEFINE PROCEDURE POLY
C=AUGMENT(C),3-5,INF,
D=REDUCE(C),0-2/4-13,,
END PROCEDURE POLY
```

To write the procedure for merging extraneous arm tips according to their proximity, we decide to execute the operation in a `DO LOOP`. This permits us to perform the operation, sequentially checking as we go to see if we have reached the proper number of tips. The proper count should be four or less. Of course, if we have the proper count to begin with, we do not want to do any merging at all. We therefore code the following procedure to perform the desired operation.

```
DEFINE PROCEDURE THIN
```

```
D=C
DO I/1,8
COUNT C,K
IF K.GT.4
D=AUGMENT(D),1-13,,
C=D
C=REDUCE(C),1-4,INF,3
ELSE
STOP
END LOOP
END PROCEDURE THIN
```

We are now set to imbed the above procedure in what is called a `RUN`. A `RUN` is simply an outer `DO LOOP` within which we may call a series of procedures. To execute a `RUN` for the 15 chromosomes in image array A, we proceed as follows

```
RUN 15
EXECUTE REPL,RI
EXECUTE POLY
EXECUTE THIN
E=E+C
END RUN
EXECUTE SHOW,E,A
```

Note that we have used `RI`, the `RUN` index, as the argument for the procedure which replicates each chromosome. This allows each chromosome to be analyzed separately in the `RUN`, i.e., it is replicated, it is expanded to the nearest polygon, the corners of this polygon are marked, they are thinned, if necessary, by pairing until there are four or less remaining, and then

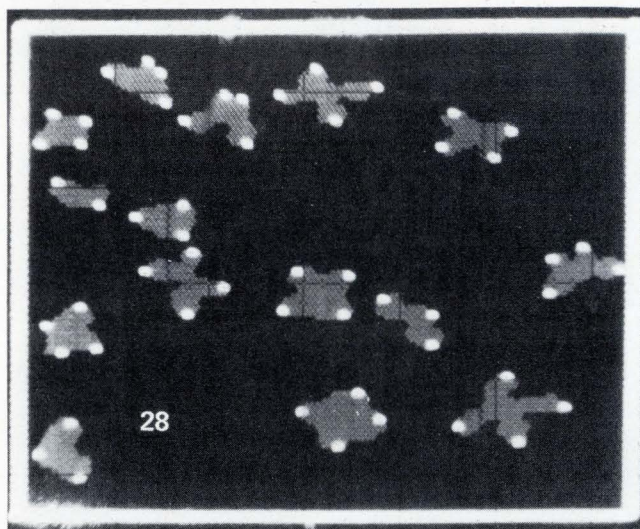
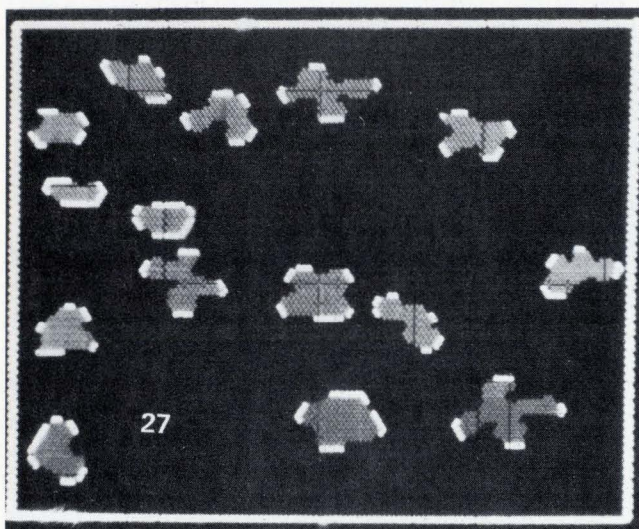
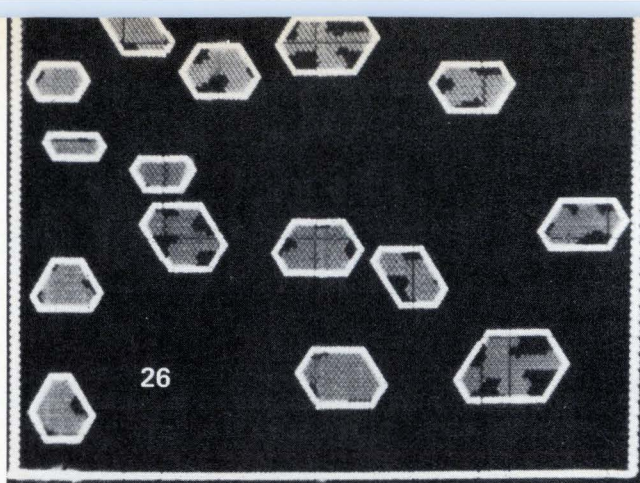
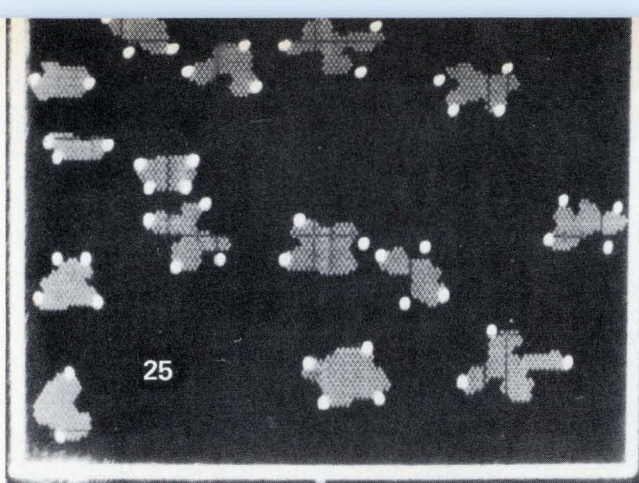

the results are accumulated in image array E.

The results of this run are shown in Fig. 25. We seem to be improving. We are doing better on all chromosomes. But our biologist, Sam Cohen, is far from satisfied. He points out that many tips are still unmarked and that in the case of chromosome 11 we have marked two points in space and called them arm tips though they do not even lie on the chromosome.

After some thought we decide to go to chromosome 11 and examine the polygon formed from it. We therefore type EXECUTE REPL,11 and follow this by C=AUGMENT(C),3-5,INF. We then mark the edges of the resultant polygon by shrinking away interior points and place the results in D. To do this we type D=REDUCE(C),6,. Using EXECUTE SHOW,D,A. we see the two polygon corners which led to the false arm tips.

Inspiration strikes! We note that the edge of the polygon appears to intersect the chromosome in regions where true arm tips exist. Is it possible that this is true for all chromosomes in array A?

We decide to find out. We type

```
C=A
C=AUGMENT(C),3-5,INF
C=REDUCE(C),6,,
EXECUTE SHOW,C,A
```

We get Fig. 26. We seem to be in luck.

We decide to form the intersection of arrays A and C and quickly type C=C\*A followed by EXECUTE SHOW,C,A. We get the result shown in Fig. 27. It looks good. Let's now define a procedure called TIPS. We start

abbreviating in our GLOL code so as to hasten our work. (We can use DEF PROC for Define Procedure, AU for Augment, RE for Reduce, etc.)

```
DEF PROC TIPS
C=AU(C),3-5,INF.
C=RE(C),6,,
C=C*A
END PROC TIPS
```

We also define the procedure ACCUMULATE (called ACCU) which simply accumulates results in image array E with a single line statement E=E+C. We then proceed with a run:

```
RUN 15
EX REPL,RI
EX TIPS
EX THIN
EX ACCU
END RUN
SHOW,E,A
```

Again abbreviations help (EX for Execute). We look at the display (Fig. 28) with a sense of accomplishment. The problem appears to be solved. □

#### BIBLIOGRAPHY

- N.F. Izzo and W. Coles, "Blood cell scanner identifies rare cells," *Electronics*, April 1962, pp. 52-57.
- B.H. McCormick, "The Illinois Pattern Recognition Computer ILLIAC III," *IEEE Trans. Computers*, Vol. EC-12, December 1963, pp. 791-813.
- M.J.E. Golay, "Hexagonal Parallel Pattern Transformations," *IEEE Trans. Computers*, Vol. C-18, August 1969, pp. 733-740.
- S.B. Gray, "Local Properties of Binary Images in Two Dimensions," *IEEE Trans. Computers*, Vol. C-20, May 1971, pp. 551-561.
- K. Preston, Jr., "Feature Extraction by Golay Hexagonal Pattern Transforms," *IEEE Trans. Computers*, Vol. C-20, September 1971, pp. 1,007-1,014.

Small  
in size  
**Big on  
power**

SOLITRON'S NEW  
10 AMP DARLINGTONS  
ARE SINGLE DIFFUSED, RUGGED  
AND ONLY \$2.60\*

Solitron's new 10 Amp NPN Silicon Power Darlington transistors are unique: They come in a small TO-66 package, but pack 30 watts power dissipation and  $V_{CE}$  ranges of 50, 80 and 100 Volts. Identified as the SDM 2501-6 Series, they exhibit excellent second break-down capability, but with low leakage characteristics similar to planar devices.

Typical  $I_{CEO}$ 's at an elevated temperature of 100°C are less than 1.0 mA, with typical gains of 5000 @ 5.0 Amps and  $V_{CE(sat)}$  @ 5.0 A typically 1.2 Volts. Ideal for power switching, inverters, converters and audio amplifier applications, all of these Darlingtons are low priced and are now available for immediate shipment, from the "House of Power."

\*Priced at \$2.60 each in 100 quantities

For complete information, prices and engineering application assistance, dial toll-free 1-800-327-3243. Or write:

**Solitron**  
DEVICES, INC.

1177 BLUE HERON BLVD. / RIVIERA BEACH, FLORIDA / (305) 848-4311  
TWX: (510) 952-7610

SAN DIEGO, CALIF.  
8808 Balboa Ave.  
CMOS, PMOS Circuits  
Diodes, Rectifiers, &  
Zeners  
FET & Dual FET  
Transistors  
High Voltage Assemblies  
Linear & Monolithic IC's

RIVIERA BEACH, FLA.  
1177 Blue Heron Blvd.  
Hi-Rel Power Transistors  
SI & Ge. Power  
Transistors  
Hi-Rel Power Hybrids  
PNP-NPN Industrial  
Transistors

PORT SALERNO, FLA.  
Cove Road  
Microwave Connectors  
Plaxial (R) Cable  
Precision RF Coaxial  
Connectors

JUPITER, FLA.  
1440 W. Indiantown Rd.  
Microwave Stripline  
Components  
Microwave Diodes  
RF and Microwave  
Transistors  
Hi-Rel Power  
Transistors

TAPPAN, N.Y.  
256 Oak Tree Road  
Diodes & Rectifiers  
Ferrite & Ferrite Devices  
High Voltage Assemblies  
Power Rectifiers  
Thick Film  
Hybrid Circuits

KENT, ENGLAND  
Tubbs Hill House  
London Road,  
Sevenoaks  
Solidev, Ltd.  
Full line of  
Solitron devices

BEN BARAQ, ISRAEL  
51 Hayarkon Street  
AEL Israel, Ltd.  
Full line of  
Solitron devices

TOKYO 105, JAPAN  
Rm. No. 21,  
Kyodo Bldg.  
No. 4-10, 2 Chome  
Higashi Shinbashi  
Minato-ku  
Full line of  
Solitron devices

# PDP-8's going after your

Last month we announced big price reductions on PDP-8 peripherals. Our 8K memory unit. And our 1.6 million word disk pack. Reductions as much as 61%. All because we've started making them ourselves.

Put them together with a

PDP-8, and the system price drops too. By an incredible 47% for a typical system. Before quantity discounts.

At the same time, we introduced a flock of new peripherals and software packages — all at amazingly low prices.

We could have stopped

there, but we didn't.

Now we've added 4 more new peripherals at unbelievably low prices. Not to mention 3 new software packages. Two of them supplied free when you get the new TA8-E dual DEC cassette system.

<p><b>PDP-8/E (8K)</b> WAS \$7,740 NOW \$5,650</p> 	<p><b>PDP-8/E (4K)</b> WAS \$4,990 NOW \$4,490</p> 	<p><b>PDP-8/F (8K)</b> WAS \$6,740 NOW \$5,150</p> 	<p><b>PDP-8/M (8K)</b> WAS \$5,990 NOW \$4,850</p> 	<p><b>LS8-E</b> (165-character/second line printer) <b>NEW \$5,000</b></p> 	
<p><b>TYPICAL PDP-8 SYSTEM</b> (PDP-8/E, 8K core, LA30 DECwriter, highspeed paper tape reader/punch, 1.6M word disk) WAS \$35,985 NOW \$19,900</p> 	<p><b>MM8-EJ</b> (8K core memory) <b>NEW \$3,900</b></p> 	<p><b>DISK PACK</b> (1.6M word disk pack) WAS \$20,400 NOW \$7,900</p> 	<p><b>KL8-M</b> (modem controller) <b>NEW \$250</b></p> 	<p><b>TECO</b> (text editor) <b>NEW \$55</b></p> 	<p><b>BITMAP</b> (core memory management program for absolute binary programs) <b>NEW \$30</b></p> 
<p><b>VR20</b> (two-color oscilloscope plotter display) <b>NEW \$4,000</b></p> 	<p><b>LA30A</b> (receive-only version of the LA30 DECwriter) <b>NEW \$2,500</b></p> 	<p><b>VT8-E</b> (low-cost alphanumeric display) <b>NEW \$1,900</b></p> 	<p><b>LA30-E</b> (DECwriter with EIA interface) <b>NEW \$3,195</b></p> 	<p><b>RT02</b> (data entry terminal with alphanumeric display) <b>NEW \$1,300</b></p> 	<p><b>KL8-F</b> (asynchronous data interfaces) <b>NEW \$425 each</b></p> 
			<p><b>OS/8 BASIC</b> (operating system program with file and string manipulation) <b>NEW \$150</b></p> 	<p><b>DEC/X8</b> (utility system exerciser package) <b>NEW \$300</b></p> 	<p><b>TD8-E COPY</b> (file management program for PDP-8 systems using magnetic DECtape storage) <b>NEW \$15</b></p> 

# business sale, Part 2.

For our next trick, we've reduced the price of our floating point processor by 30%.

All this makes the 15,000 PDP-8's now in use better than ever. It lowers the price on new ones even more. And we're still not done.

Surprised? Don't be. We're just doing what we always do. Make more computer cost less.

Write. Or call. Digital Equipment Corporation, Maynard, Mass. 01754. (617) 897-5111, extension

3306. European headquarters: 81 route de l'Aire, 1211 Geneva 26. Tel.: 42 79 50.

**digital**

**TA8-E**  
(dual DECcassette system for PDP-8)

**NEW**  
\$3,900

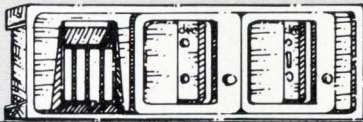

**TL8-E**  
(combination of DECcassette and DECwriter)

**NEW**  
\$5,700

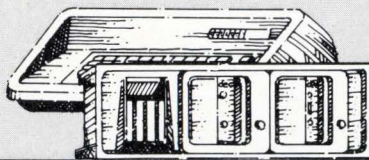

**CKM-8**  
(cassette keyboard monitor for PDP-8: loader, assembler, and editor on cassette tape)

**FREE WITH**  
TA8-E

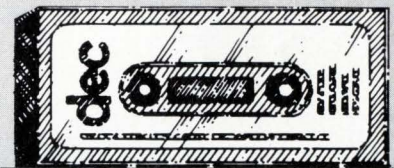

**FPP12-AP**  
(24-bit parallel floating point processor) for PDP-8.

**WAS**  
\$9,900  
**NOW**  
\$6,900

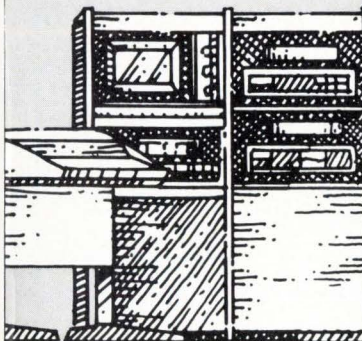

**DW8-E**  
(8 Family-to-Omnibus™ translator. Makes most PDP-8/E peripherals available on PDP-8/I and 8/L)

**NEW**  
\$1,500

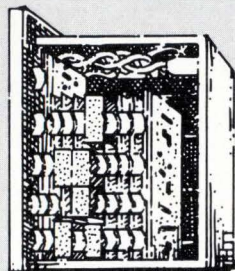

**CASSETTE BASIC™**  
(famous interactive language now on cassette-based PDP-8 systems)

**FREE WITH TA8-E**

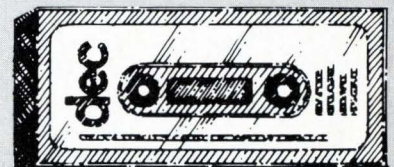

**M1709**  
(foundation interfacing module to Omnibus)

**NEW**  
\$125

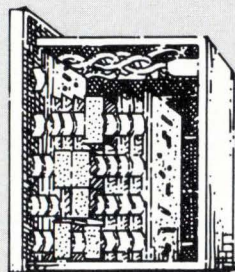

**OS/8 BATCH**  
(PDP-8 operating system now includes batch processing, FORTRAN, BASIC, 2 assemblers, 2 editors, etc. All at same original OS/8 price)

**NEW**  
\$300

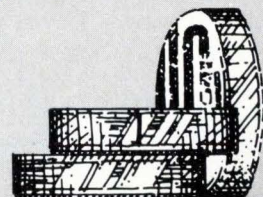

## Feedback linearizes resistance bridge

by Robert D. Guyton  
Mississippi State University, State College, Miss.

With the addition of a feedback circuit, the output voltage of a standard resistance bridge can be made to vary linearly for a change in bridge resistance. The feedback circuit provides good sensitivity for a wide range of bridge resistance variations, while maintaining the full-scale linearity of the bridge output voltage to within 0.1%. Furthermore, either an ac or a dc voltage may be used to excite the bridge.

The output voltage of the standard bridge remains zero as long as its four resistance arms are equal to each other, with a resistance value of  $R$  ohms. One arm of

the bridge is variable from this resistance null:

$$R_x = R + \Delta R$$

where  $\Delta R$  represents the change in bridge resistance.

For the standard bridge:

$$V_o' = V_1(\Delta R)/(2R + \Delta R)$$

This is not a linear relationship, since  $\Delta R$  appears in the denominator. The standard bridge, therefore, is usually limited to those applications that involve only small values of  $\Delta R$ .

The feedback circuit shown in the figure alters the bridge excitation voltage so that the relationship between the output voltage and  $\Delta R$  becomes linear:

$$V_o = (1 + 2R_f/R)V(\Delta R)/2R$$

Feedback resistor  $R_f$  determines the circuit's sensitivity to the change in bridge resistance. Bridge excitation voltage can be written as:

$$V_1 = V + RV_o/(R + 2R_f)$$

when:

$$R_1 = R_2(R + 2R_f)/R$$

Resistance  $R_x$  can vary from 0 to  $2R$ . □

**Linearized resistance bridge.** Adding feedback circuit to standard resistance bridge allows output voltage  $V_o$  to be linearly related to variations in bridge resistor  $R_x$ . Changes in bridge resistance produce output voltage that is linear to within 0.1%. Circuit sensitivity is set by value of feedback resistor  $R_f$ . Amplifiers control bridge excitation voltage  $V_1$ , which can be due to either ac or dc source.

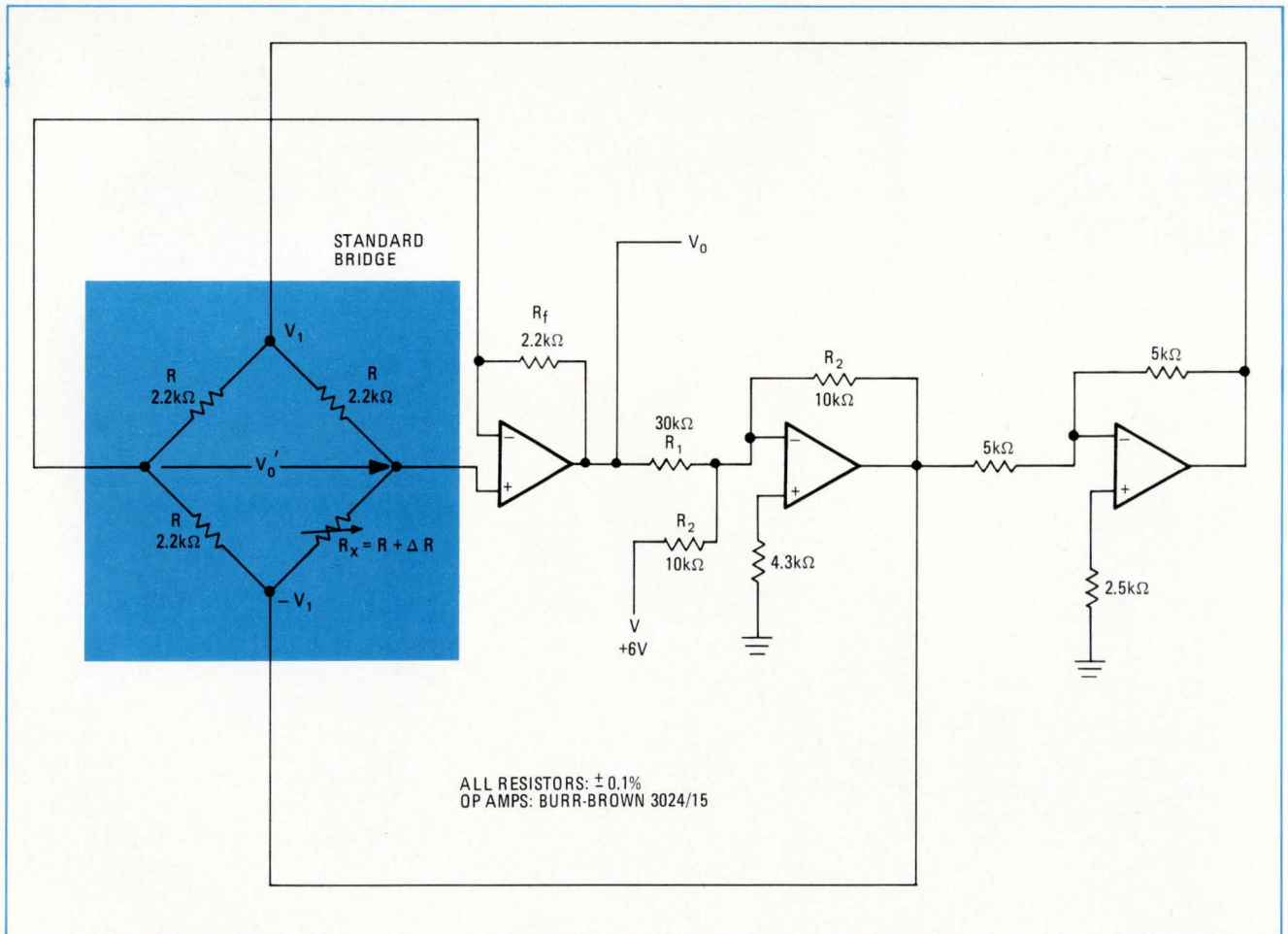



# Soldering iron converts to constant-temperature probe

by Mahendra J. Shah  
Univ. of Wisconsin, Space Science and Engineering Center, Madison, Wis.

Designing a circuit that has good temperature stability requires pinpointing those components that are the major drift contributors. These components can then be properly specified and compensated for temperature drift, if necessary. Unfortunately, the designer must frequently run temperature stability tests on the entire circuit because he cannot heat individual components selectively. And employing a soldering iron as a selective heat source does not produce precise temperature test results.

However, a conventional line-operated soldering iron can be easily converted into a constant-temperature probe. Since most low-power circuits operate very near ambient room temperature and most circuit components have a low thermal resistance for efficient heat transfer, the device being heated by the probe will be within a few degrees of the probe temperature. The drift contribution of the component can then be measured by noting the change in the circuit parameter of interest.

The temperature-control circuit in the diagram regulates the voltage applied to the tip of a 115-volt, 27-watt

soldering iron, allowing tip temperature to be set from near room ambient to 125°C. A potentiometer permits the temperature setting to be varied continuously. The tip-temperature-sensing element is a thermistor, which is installed by drilling a small hole in the tip and then epoxy-mounting the thermistor in place.

For best results, an isolation transformer should be placed between the source of line power to the tip and the triac at the output of the control circuit. The heat transfer of the probe can be improved by using silicone vacuum grease between the tip and the component under test.

Sometimes, testing component drift with a constant-temperature probe can reduce parts cost. For instance, suppose a regulated 600-v power supply that contains a high-stability zener reference costing about \$24 is tested. When the temperature of the whole supply is increased by approximately 50°C, the supply output drops around 5 v.

A transistor junction is found, with the probe, to be the principal cause of the drift. Substituting a general-purpose zener selling for about \$1 for the high-stability device will decrease over-all supply drift. The temperature-drift errors of the transistor junction and the low-cost zener almost cancel each other, since they have about the same magnitude but are of opposite polarity.

It is also possible to build a probe that lowers component temperature below room ambient by using a thermoelectric cooling element in a temperature-control loop. □

**Pinpointing component drift.** Constant-temperature probe can be built by controlling power to tip of soldering iron. Control circuit maintains tip temperature within a few degrees of desired setting, from room ambient to 125°C. Thermistor located inside probe tip acts as the temperature-sensing element. An isolation transformer (not shown) should be placed between the line input and circuit's output triac.

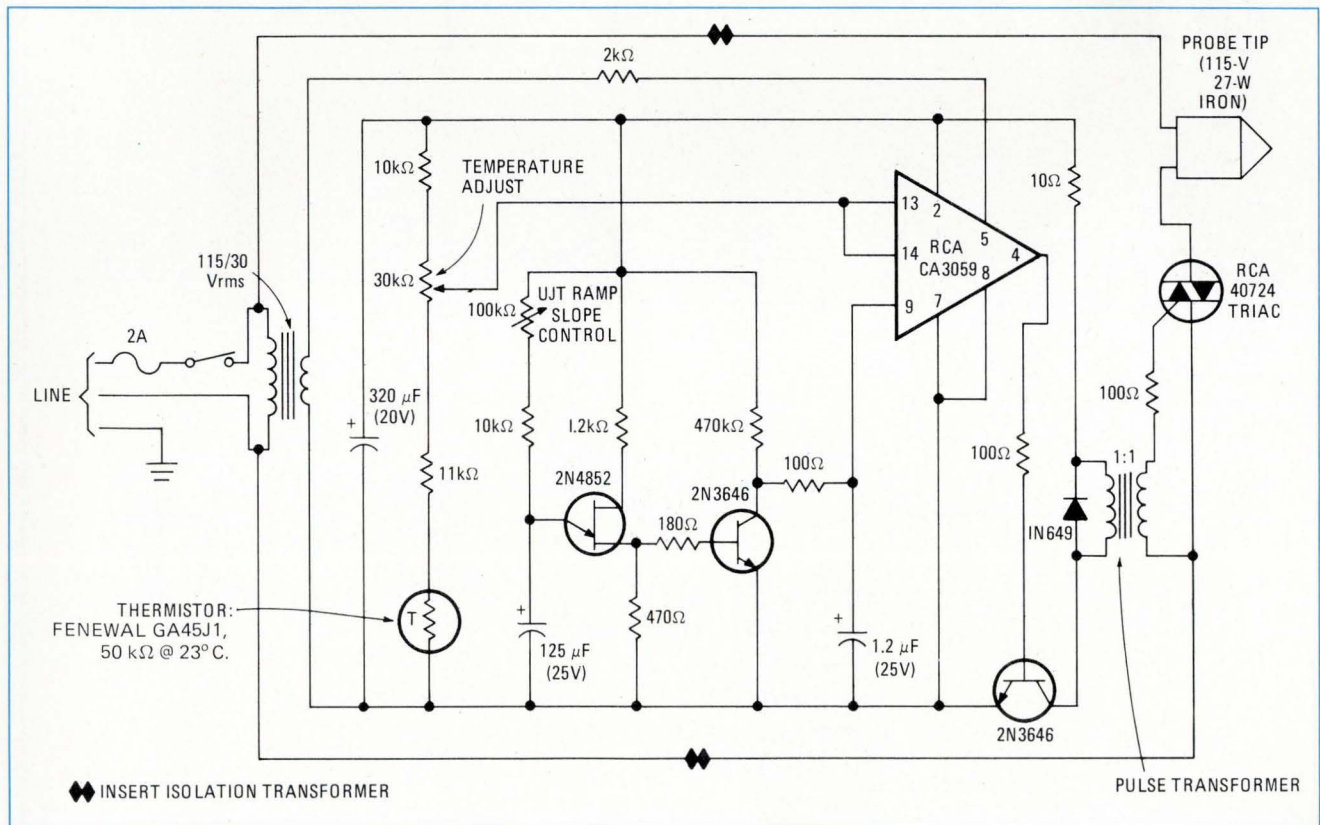

# Exclusive-OR gate makes bidirectional one-shot

by Tim O'Toole  
Tektronix Inc., Beaverton, Ore.

An exclusive-OR gate is an ideal device for building a bidirectional one-shot by running the same signal into both gate inputs, but putting a time delay on one of the inputs. The gate will then produce a pulse for every rising or falling edge of the input signal, and the width of the pulse is determined by the time delay.

In (a), the gate inputs are inverted with respect to each other so that the gate output is in the high state for either a high or low input signal. When the input signal switches from high to low, both gate inputs are low until the inverter has a chance to change states. During this time, the gate output goes low until the inverter switches and causes the gate output to return to the high state. This process repeats when the input signal switches from low to high. Therefore, for every transition of the input signal, the gate puts out a negative-going pulse having a width equal to the delay time of the inverter.

Two inverters can also be used as the delay element, as shown in (b). Now the gate inputs have the same polarity, causing the gate output to be low for either a high or low input signal. The output will be a train of positive pulses with a width equal to a single inverter's delay time. These output pulses may be easily extended or stretched by inserting an RC timing network between the two inverters.

Applying the operating principles of circuits (a) and (b) permits the realization of a bidirectional one-shot (c) that has an addressable output pulse polarity. Gates  $G_1$  and  $G_2$  simply duplicate the one-shot of (a) and feed one of the inputs of the exclusive-OR output gate,  $G_3$ . A flip-flop, comprised of gates  $G_4$  and  $G_5$ , drives  $G_3$ 's other input. The polarity of the output pulses is now selectable, since the state of the flip-flop controls output pulse polarity.

If longer or more accurate output pulse widths are required, the delay element in any of the three one-shots can be changed to a delay line, such as the ones now available in 14- and 16-pin dual-in-line packages. The delay device could even be a standard off-the-shelf one-shot, for example, Texas Instruments' SN74121 or Fairchild's 9601. □

Designer's casebook is a regular feature in Electronics. We invite readers to submit original and unpublished circuit ideas and solutions to design problems. Explain briefly but thoroughly the circuit's operating principle and purpose. We'll pay \$50 for each item published.

**Selectable one-shot polarity.** Either positive or negative output pulses can be generated by controlling high/low states of inputs to exclusive-OR gate. One-shot (a) uses time delay of single inverter to produce negative pulse train. One-shot (b) has additional inverter for positive output pulse train. Bidirectional one-shot (c) has addressable output polarity, which is determined by state of  $G_4$ - $G_5$  flip-flop.

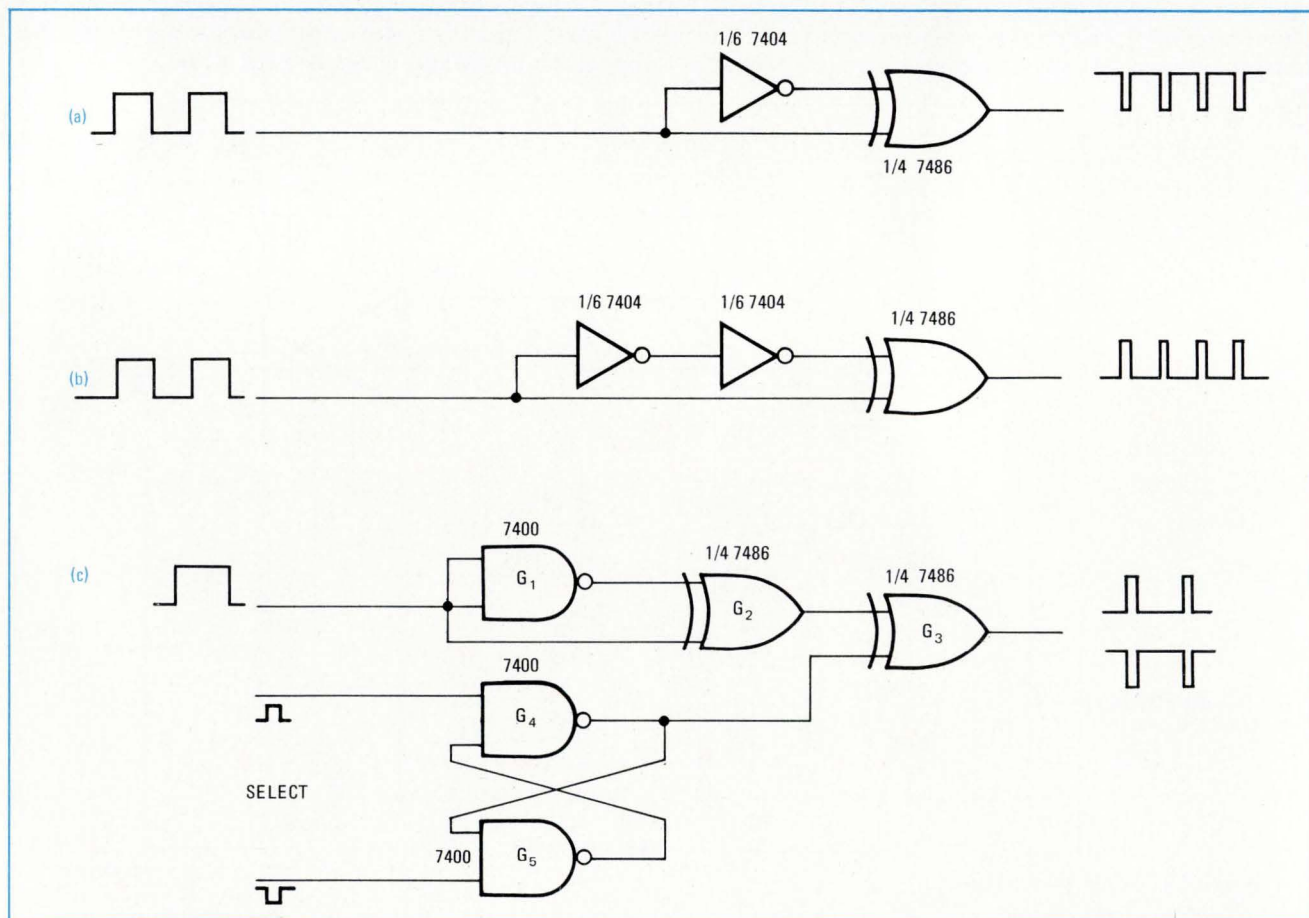

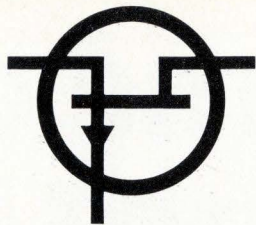

P-Channel  
JFET

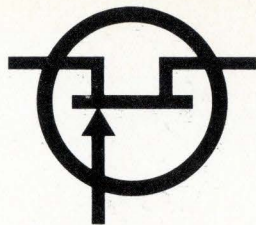

N-Channel  
JFET

Since 1962, Siliconix has evolved FET technology and applied it to a complete line of singles, duals, arrays, and ICs. So what's new?

# Economy Epoxy FETs

Siliconix, the world's leading supplier of FETs, now brings you a full line of plastic encapsulated field-effect transistors—at economy prices as low as 32c each in 1000-unit quantities. Why be concerned over alternate sources? Call on the FET leader for quality devices at rock-bottom cost.

The Siliconix line of epoxy products includes

- FETs for general purpose amplifiers
- FETs for VHF/UHF amplifiers and mixers
- FETs for switches, choppers, and commutators
- FET pairs for differential amplifiers
- FET diodes for current limiters and regulators

Use these new epoxy FETs with the same confidence you have placed in Siliconix products in the past—they are typed, manufactured, and tested specifically for the industrial and commercial markets.

A copy of our new epoxy FET cross-reference guide and full line catalog is yours for the asking. Just circle the bingo card number or call your nearest Siliconix distributor.

## Write for Data



**Siliconix S.A.R.L.**

9 Avenue d'Arromanches  
94 Saint-Maur  
France 283.57.90

**Siliconix Limited**

Saunders Way, Sketty  
Swansea, South Wales (U.K.)  
SWSEA (0792) 21221

**Siliconix GmbH**

7024 Bernhausen Postfach 1340  
Aicherstrasse 26  
Germany 0711-79.70.21

# Some of our don't know

Tell a fuel oil dealer that Lockheed Electronics makes a minicomputer-based business system, he just might question your source of information.

Tell a businessman we make a device for fuel oil dealers that rides on their trucks and produces on-the-spot, error-free invoices, he may think you've made an error.

Fuel oil dealers, businessmen, research scientists, control laboratories, service station chains, the United States Navy and Army

are all some of our best customers.

And the reason our customers come in all shapes and sizes is because our electronic products and services come in all shapes and sizes.

There's our 417 Data Recorder. It's rugged, portable (28 pounds), and fits under a plane seat.

And have you met SUE? A System User Engineered minicomputer with unequalled flexibility, which is available in a galaxy of

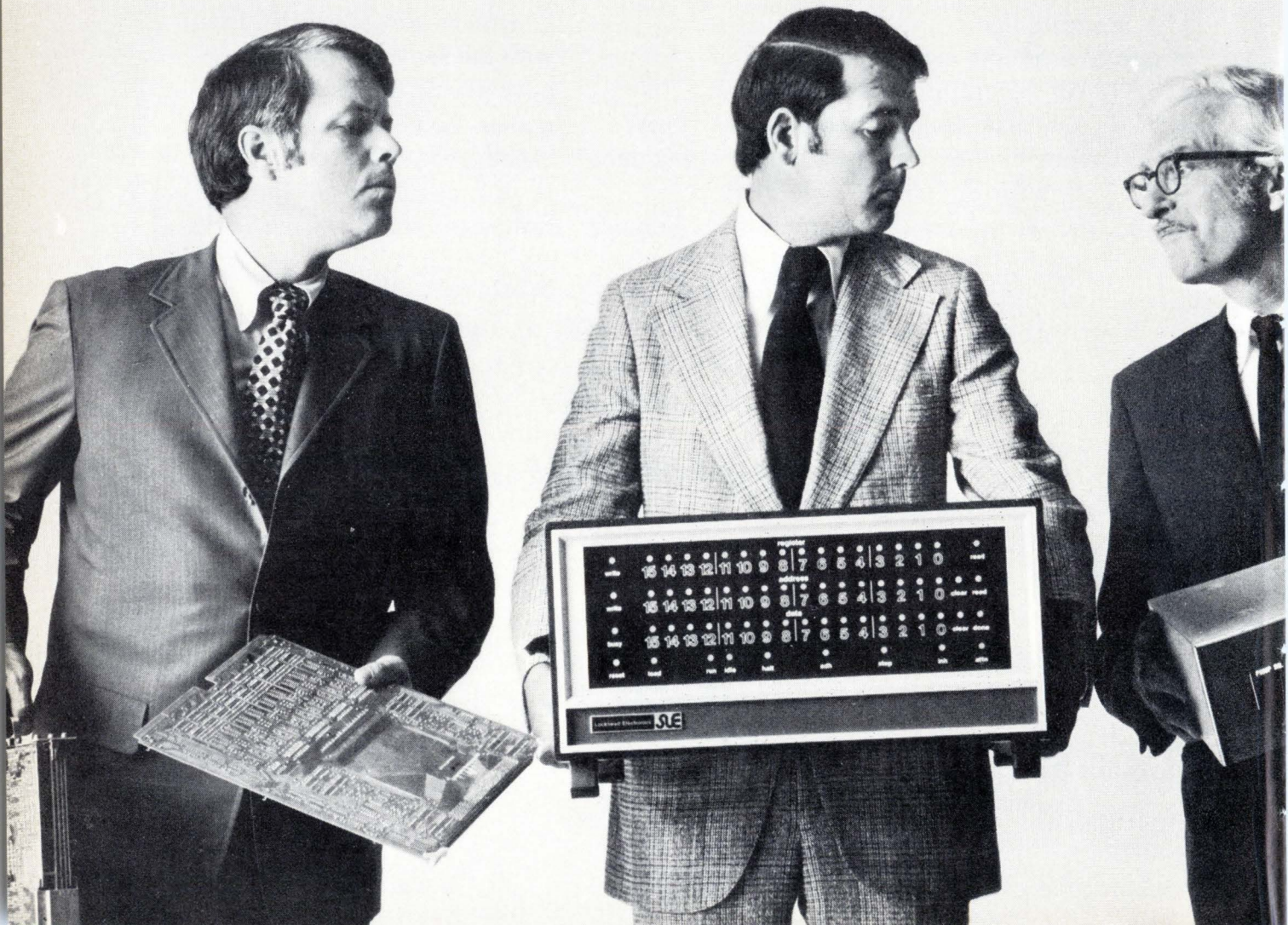

# best customers all we make.

configurations.

For self-service gas stations, our LTS transaction system is a great advance in reliability.

Our CC-150 and CB-65 memory systems combine high-speed with low-cost (650 nanosecond memory for the CB-65). Both provide off-shelf economy for a broad range of memory applications.

And for pinpoint accuracy against surface and air targets from shipboard, we're pro-

ducing the Mark 86 gunfire control system for the Navy. We also serve the Army at Fort Huachuca, Arizona, and NASA in Houston, with a wide range of technical services.

In fact, Lockheed Electronics isn't just an electronics company. It's diversity. Five profitable divisions accounting for some \$100,000,000 in sales.

It adds up to diversified strength.

## Lockheed Electronics

A Subsidiary of Lockheed Aircraft Corporation, Plainfield, N.J.

Circle 107 on reader service card

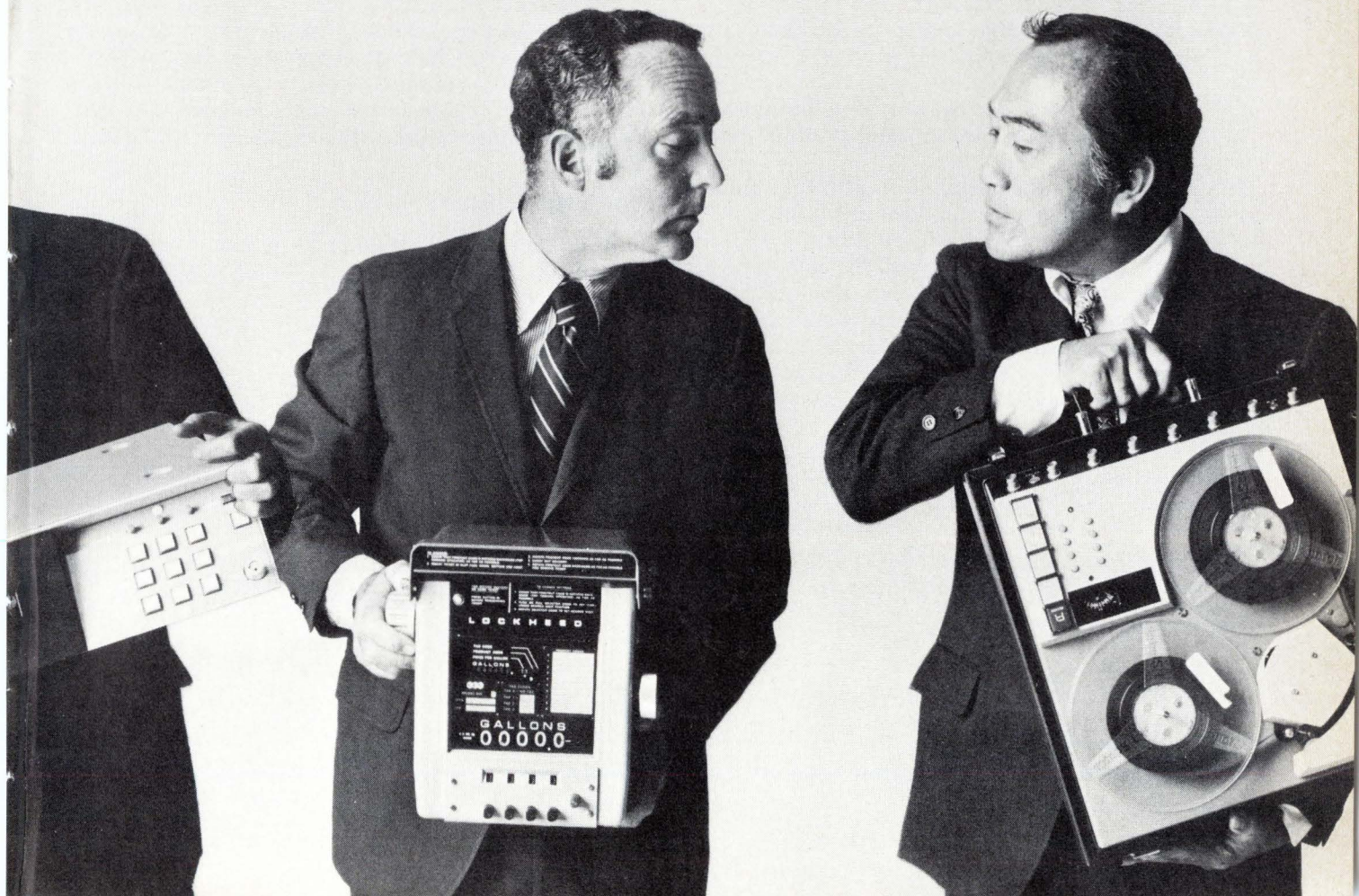

# Digital panel meter matches analog performance

High reliability is assured through a precision voltage-controlled self-synchronized oscillator built around a charge-switching circuit; manufacturing costs are minimized by standard high-density TTL chips

by Bernard M. Gordon, *Chairman, Analogic Corp., Wakefield, Mass.*

□ The design engineer now may choose between a digital panel meter and the highly reliable analog meter that has long been the industry standard. But the obstacles to development of a DPM that approaches the reliability and economy of its analog counterpart are formidable.

The instrument must offer—at a competitive price—as many of the desirable properties of the analog meter as possible, while adding the undeniable advantages of the digital approach—improved resolution, unambiguous digital readout, which makes a skilled operator unnecessary, and digital output for driving printers, computers, and other system components.

Several advantages of the analog meter that the new instrument must retain are:

- The free-floating capability of the analog device—that is, it must provide two terminals that can measure current or voltages at any arbitrary point in a circuit. For example, it should be able to monitor the plate current of a vacuum tube operating from a 300-volt power supply.
- The ability to measure without amplification low-level signals, such as the outputs of load cells or thermocouples.
- Easy scaling by the addition of external shunts or multipliers to read in arbitrary engineering units.

After all of these requirements are met, the DPM must match the notorious reliability of the analog instrument—with any luck, the analog meter will outlast the man who buys one. And all of this capability comes at a relatively modest price—typically \$50 to \$100.

But now, by virtue of a unique charge-switching analog-to-digital conversion technique, DPMs can compete in price and performance with the best analog meters. The first product that employs this approach is a three-digit unit with free-floating front end and a grounded parallel binary-coded-decimal output. And to keep manufacturing costs low and reliability high, standard high-density TTL devices minimize the number of components, and hence manufacturing costs.

## Techniques analyzed

In the beginning, the developers made an exhaustive analysis of the various possible method of converting analog input signals to digital forms. They considered dual-slope conversion, registered programed successive approximation techniques, cyclic successive-approxima-

tion techniques, ramp conversion, unidirectional counter-driven d-a converters, forward/backward driven d-a converters within digital servos, voltage-controlled oscillator techniques, and several hybrid schemes.

Although most existing meters have used some form of dual-slope conversion, the analysis shows that there is not too much cost difference between the various types of analog front-end circuitry, regardless of which technique was used, except for the requirement that the front end be completely isolated from the main power source, the digital outputs, and the display.

Further analysis indicated that a new circuit technique for a precision self-synchronized voltage-controlled oscillator built around a charge-switching circuit not only compared favorably in cost with any of the other techniques, but it also yielded the least-complex coupling scheme for free-floating operation. Also, for those industrial applications where it may be desirable to have a conversion section operating remotely from the display, this technique yielded the simplest means of coupling an analog-to-pulse-conversion unit. Accordingly, this voltage-controlled oscillator became the basis for the design.

## The basic scheme

In simplified block-diagram form (Fig. 1) the meter consists of an isolated analog section, a grounded multiplying counter, and a three-digit display section. The input voltage—which may, of course, be the drop across a current-measuring shunt—may be floated over a 600-v common-mode range ( $\pm 300$  v) with respect to the input power-supply return and the BCD outputs. Even for varying common-mode potentials over this voltage

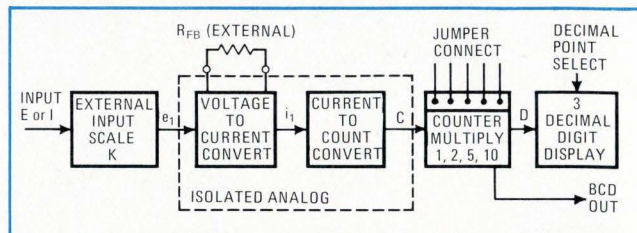

1. **Flexible scaling.** Arbitrary engineering units are easily accommodated by properly selecting external network (K), external range resistor ( $R_{FB}$ ), and counter multiplier (M). K and  $R_{FB}$  set the full-scale range, while M determines the size of the counting increments.

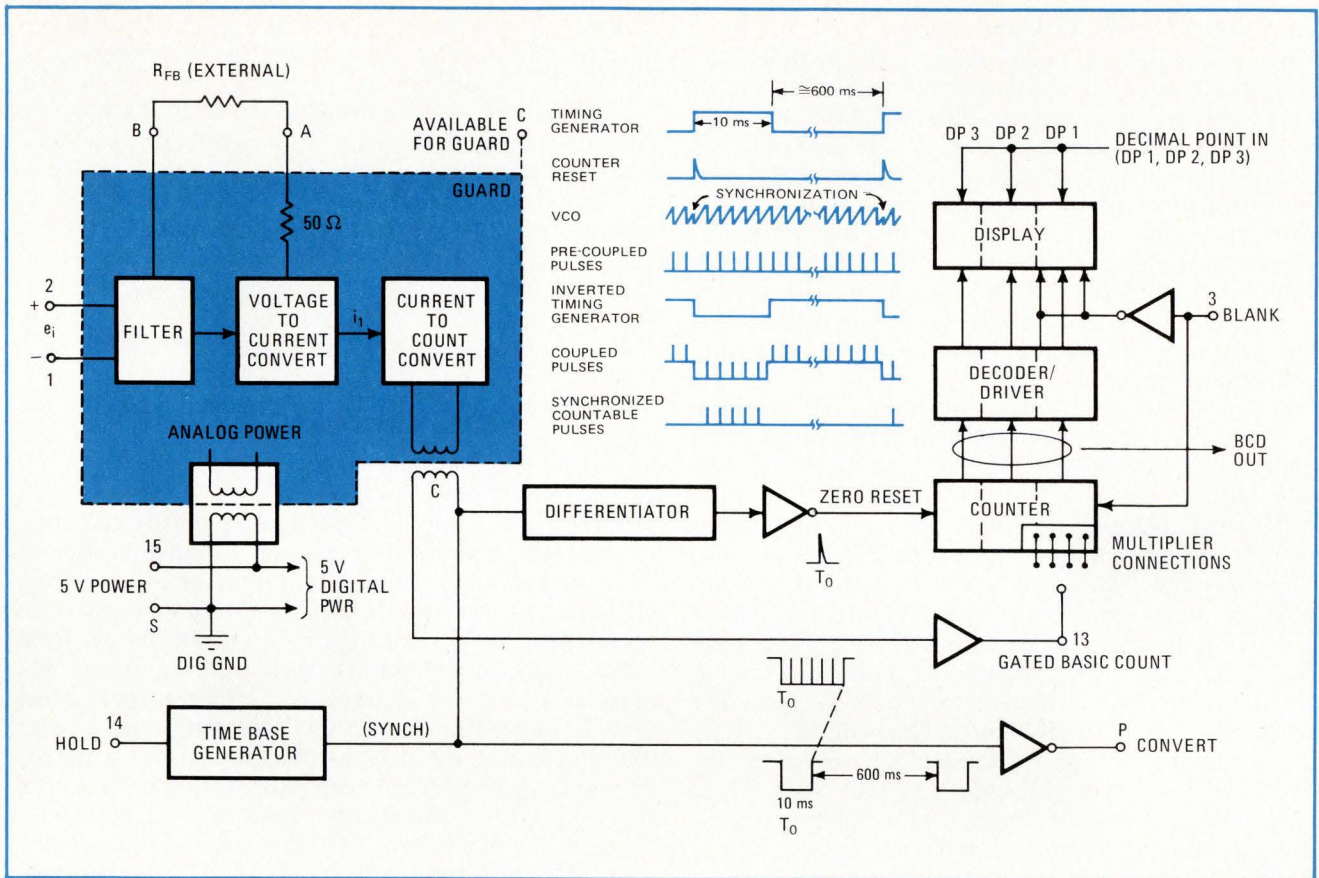

**2. Synchronized.** Time-base generator provides synchronizing pulse at start of each conversion cycle. As timing diagram shows, free-running VCO is forced to a well-defined starting position at beginning of each 10-ms measuring interval. Synchronizing signal is also available at terminal P for external control purposes. Decimal point is positioned independently through external connection.

range and with a considerable amount of input impedance imbalance, the common-mode rejection will be greater than 100 dB. The applied differential voltage  $e_1$  is first filtered (Fig. 2), and then converted to a proportional current  $i_1$ . The differential input voltage may have a full-scale value of anywhere from 20 mV to 2 V. This input voltage  $e_1$ , is scaled to the proportional current  $i_1$  by the simple relationship,  $i_1 = e_1/R_{FB}$ .

The current  $i_1$  is then applied to a current-to-count converter, which produces a number of pulses, C, proportional to  $i_1$  during the counting interval. For the meter under consideration, the proportionality constant is one count per microampere.

The output of the current-to-count converter is applied to a counter, which can be programmed to multiply the count by a factor M, which can have one of four values: 1, 2, 5, or 10. The final count, which is displayed, has a value  $D = MC$ .

The more-complete block diagram (Fig. 2) shows in greater detail exactly how the unit functions. A time-base generator produces a stable 10-ms pulse at intervals of approximately 600 ms. A hold-control on the time-base generator may stop and reinitiate conversion as desired.

A leading edge of the time-base generator is differentiated and utilized to reset the counter. The same leading edge is coupled through the coupling pulse transformer to synchronize the current-to-count converter. The time-base interval is also applied (not shown

on the diagram) to the decoder/driver to avoid a blinking display while the counter is counting and also provides a "convert" pulse to external system circuitry. The first (least-significant-digit) decade of the multiplying counter has its terminals arranged so that the counter can multiply by 1, 2, 5, or 10. It is this digital scaling capability, in conjunction with the ability to scale  $i_1$  with respect to  $e_1$  by  $R_{FB}$  that makes possible any arbitrary scaling into engineering units.

The 5-v input power is bypassed, filtered, and applied to the digital logic circuitry and to the primary circuitry of the isolated dc-dc converter. The secondary of the isolated converter supplies power to the analog front end.

### The completely isolated front end

The front end consists of an input filter, which doubles as an overload fault limiter, the voltage-to-current converter, which doubles as a high-impedance buffer; and a current-to-count converter with its own reference source and anti-lockup circuit. Also included is an internal 50-ohm resistor which provides a portion of  $R_{FB}$ . An electrical guard line, which passes around the floating circuitry and through the dc-dc converter transformer and the coupling transformer, is available for optimum external guard-line connection (Fig. 2). The only electrical coupling from the analog front end to the grounded digital section is through very-low-capacitance transformers. Therefore, the front end is com-

pletely isolated from the digital section.

The action of the voltage-controlled oscillator, as shown in the timing diagram, is synchronized at the beginning of each timing period. This eliminates any jitter which might otherwise occur. One "precoupled pulse" is generated for each negative-going transition of the voltage-controlled oscillator. Through the coupling transformer, these pulses are added to an inverted version of the precision timing signal. Only those pulses that ride on the lower level of the timing signal are counted by the counter. Thus, the counter counts only those isolated, synchronized, countable pulses that exist during the 10-ms timing period.

Fig. 3 is a detailed schematic of the analog front end. The upper portion of the circuit—consisting of elements  $R_1$ ,  $C_1$ ,  $R_2$ ,  $R_4$ ,  $Q_1$ , the op amp,  $R_{10}$ , and  $R_5$ —is the voltage-to-current converter. Resistor  $R_1$  serves the dual roles of current limiter and filter element. The combination of  $R_1$  and  $C_1$  yields a normal-mode rejection ratio of approximately 35 dB at 60 Hz. Voltage  $e_1$ , after being filtered, is applied to a low-bias-current, high-gain operational amplifier that has its output applied to the base of  $Q_1$ . Feedback to the operational amplifier is taken from the emitter of  $Q_1$ ; therefore, the voltage at the emitter of  $Q_1$  must closely equal input voltage  $e_1$ . The current passing through  $Q_1$  must closely equal  $e_1$ , divided by the feedback resistance ( $R_4$  plus  $R_{FB}$ ). Thus, this section performs the function of translating the input voltage into a proportional input current.

This input current is applied next to circuitry, which

## Newer isn't always better

It seems logical to expect the design of a brand new, high-performance, small-size digital panel meter to take maximum advantage of the latest developments in semiconductor technology. Nevertheless, the designers of Analogic's miniature new 3-digit DPM chose to build it around standard TTL circuits. The choice was based on two major factors:

First, and most obvious, it was decided to have available as a standard feature a parallel BCD output working at standard TTL voltage levels.

Second, the design team realized that it could design the meter with fewer parts if TTL were used than it could if it used even custom MOS chips. It does not yet appear to be technically feasible to build an MOS chip that can supply sufficient current to drive light-emitting diodes or incandescent displays, even if the displays are multiplexed (strobed).

Furthermore, if the display could be strobed, additional circuitry would be needed either for strobing the display, or to provide parallel BCD outputs. (In fact, a number of digital meters on the market today that do use MOS counter-latches have a considerable number of parts associated with them to drive the display.)

By contrast, all of the logic in the Analogic panel meter is contained in seven packages—three decoder-drivers, three counters, and one gate package. Not only is the cost of these TTL units lower than the sum of the costs of any available MOS circuit, plus the necessary drive circuitry, but this arrangement obviously also provides TTL-compatible parallel BCD outputs at no extra cost.

emits pulses at a rate proportional to  $i_1$ . Assume that  $C_2$  at some starting time is discharged by  $Q_2$ . When  $Q_2$  is turned off,  $C_2$  will rise at a rate determined by  $i_1$ . The voltage across  $C_2$  will continue to rise until it achieves a potential equal to the sum of the voltage developed across  $D_2$  plus the  $V_{BE}$  drop of  $Q_3$ . The voltage across  $D_2$  is nominally 5.6 V and the  $V_{BE}$  drop of  $Q_3$  is approximately 0.65 V. Thus, when the voltage across  $C_2$  rises to approximately 6.25 V,  $Q_3$  will begin to conduct. As soon as  $Q_3$  begins to conduct, its collector current turns on  $Q_4$ , whose collector current, in turn, pulls down the base of  $Q_3$ .  $Q_3$  and  $Q_4$  are very fast transistors, and a rapid regenerative action takes place.

Because the current through  $Q_4$  builds up quickly, the cathode voltage of  $D_1$  is rapidly pulled down by one diode drop. At the same time, the emitter current of  $Q_4$  drives into the base of  $Q_2$  and into the coupling transformer via  $R_9$ , building up a field in that transformer winding.  $Q_2$  now discharges  $C_2$  very rapidly. As soon as  $C_2$  is discharged by slightly more than one diode drop,  $Q_3$  begins to turn off, signaling the termination of the regenerative action. Since  $Q_4$  has removed charges from both  $C_2$  and  $C_4$ , it contains a certain stored charge. Because of this stored charge,  $Q_4$  continues, for a short time, to dump current into the base of  $Q_2$  and to continue increasing the field in the transformer winding; therefore,  $Q_2$  continues to discharge  $C_2$  until the stored charge in  $Q_4$  and the energy stored in the transformer winding are dissipated. At this time,  $C_2$  is fully discharged to the saturation voltage of  $Q_2$ . Since that transistor now has been turned off, the cycle commences again. The entire regenerative and discharge action takes place in about 40 nanoseconds.

## Transformer serves two functions

Notice, again, that the only connections between the grounded power and logic sections and the floating analog section are through the transformer of the dc-dc converter and the coupling transformer. The coupling transformer serves a dual function. Not only does it couple the pulses out from the floating analog section, but at the beginning of each timing interval, when the timing pedestal lowers the potential of the transformer (see timing diagram), a signal is introduced on the logic side of the coupling transformer, which introduces a pulse at the base of  $Q_2$  to turn on  $Q_2$  at the beginning of the timing cycle. Thus, regardless of the timing phase of the oscillator,  $C_2$  is always discharged at the start of the timing cycle. This assures synchronization between the data pulses and the timing interval.

The function of  $R_9$  is to provide anti-lockup protection. It should be clear that any time  $Q_4$  conducts, it tends to pull current from the power supply through  $D_1$  and  $R_7$  and  $R_8$ . The values of these resistors are such that if  $Q_4$  were to attempt to conduct on a steady-state basis, the voltage developed across  $R_9$  would be higher than the base-emitter turn-on voltage of  $Q_2$ , thus turning it on and discharging  $C_2$ . Since  $Q_3$  cannot conduct unless its emitter voltage is higher than its base voltage, this simple arrangement provides foolproof anti-lockup protection.

Since there are no sources of error in the digital section, a brief analysis of sources of error in the analog



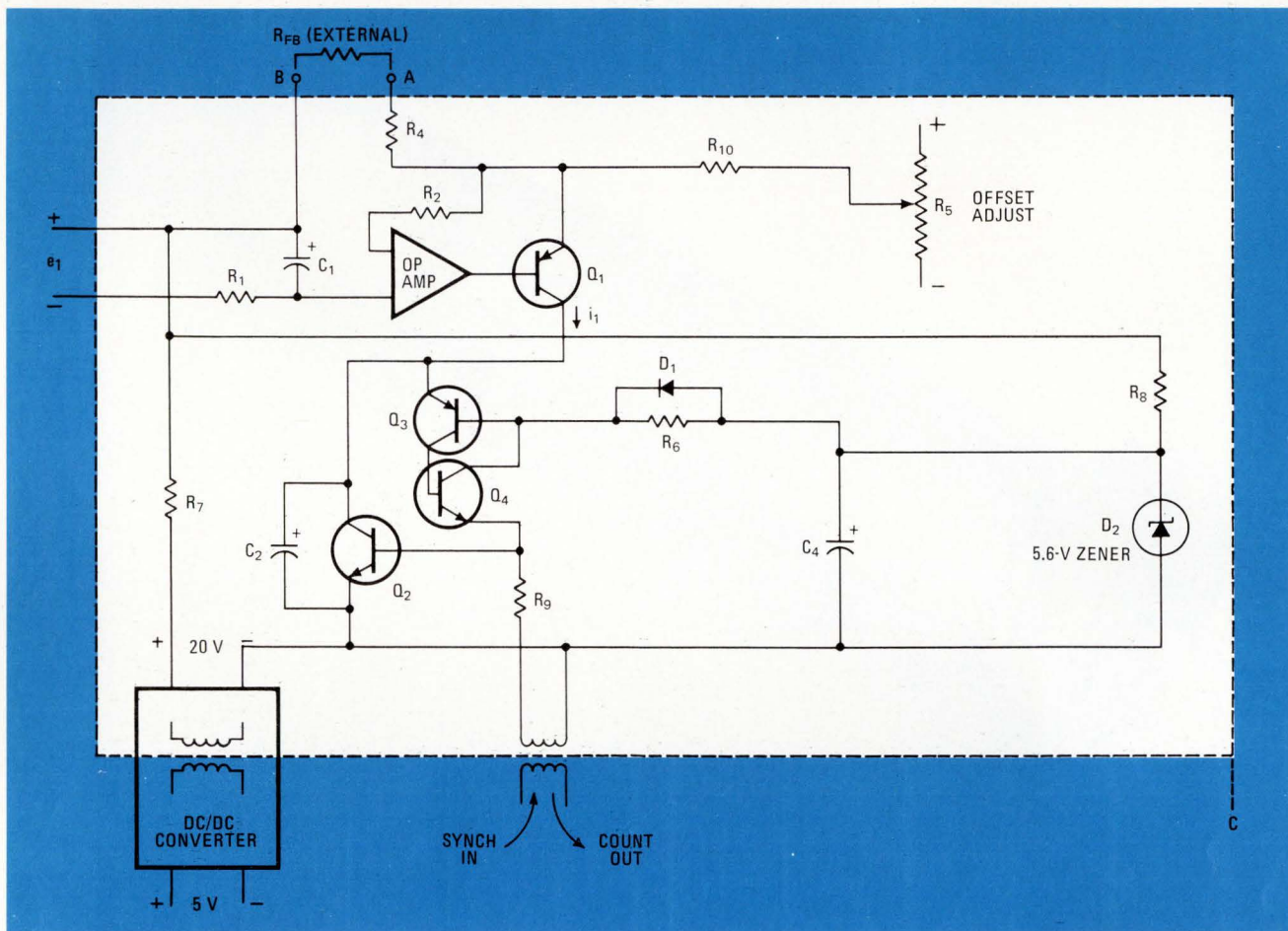

**3. Splendid isolation.** Entire analog front end is contained in a shielded, guarded, free-floating assembly. All electrical connections to the front end are through low-capacitance transformers; thus, analog circuitry is completely isolated from digital and power-supply sections.

section will suffice to define the accuracy performance of the meter. The unit is rated to have a maximum linearity error equal to its resolution—0.2%. Since the open-loop gain of the operational amplifier is extremely high—approximately 100,000—and since transistor  $Q_1$  has a very high value of beta, the linearity error between  $i_1$  and  $e_1$  is at least an order of magnitude less than the specification.

The biggest potential contributor to nonlinearity is the nonzero ratio of the discharge time of  $C_2$  to its minimum charging time. Since the discharge time is only a few tens of nanoseconds, and the minimum specified charge time is 20 microseconds, the linearity of the unit has a worst-case error value of approximately 0.1% of full scale. In actuality, however, it does even better. Circuit elements  $Q_4$ ,  $D_1$ ,  $R_6$ , and  $D_2$  serve to provide compensation for this nonlinearity by decreasing the firing potential at the base of  $Q_3$  as the frequency increases; thus the linearity error of the device is reliably expected to be less than 0.1% over its specified operating range.

The only significant source of offset, zero drift, in this design is the offset voltage of the operational amplifier. Even in the standard unit provided, the normal offset voltage is only approximately  $10 \mu\text{V}/^\circ\text{C}$ . Other possible sources of zero drift include leakages in  $Q_3$  and  $Q_1$ , but since these are normally on the order of  $1 \text{ nA}$  at room temperature, even at higher temperatures, their effect is negligible compared to the design factor of  $1 \mu\text{A}$  per

count. The scale-factor temperature-drift design has carefully taken into account changes in the saturation voltage of  $Q_2$ , the  $V_{BE}$  drop of  $Q_3$ , and the temperature dependence of the voltage drop across  $D_2$ . These parameters have been carefully chosen to yield a mean value approaching zero, a  $1\sigma$  value of approximately  $80 \text{ ppm}/^\circ\text{C}$  and a  $3\sigma$  value of less than  $250 \text{ ppm}/^\circ\text{C}$ .

#### High reliability means low component count

The total number of components—particularly the number of active components—was minimized. By making many of them perform more than one function, and by using standard TTL circuitry (see box “Newer isn’t always better”), the total component count was kept down to around 50.

Of these 50 components, 10 are power-supply filtering and bypass elements, 10—three displays, three counters, three decoder/drivers, and one gate package—perform all display, gating, control, multiplying, and counting functions. Five—of which only one is active—are in the time-base generator, and about 15 are in the analog front end. Of these last 15, only five are active, and four are single transistors.

All components are readily available, unselected, standard parts. Thus, in addition to enhancing the meter’s reliability, the design makes it both fast and easy to repair in the unlikely event of a failure caused by a faulty component. □



## We proudly present our new high resolution storage tube...

Over 4000 lines resolution, with the same long storage and fast erase features of our mini tubes.

Our TH 8803 storage tube is a single ended design in a two inch diameter Vidicon configuration that provides a limiting resolution performance of 4300 TV lines per diameter. It can store 16 millions of bits, in the digital form or the equivalent in the full TV gray-scale image form, for more than 20 minutes under continuous readout scanning operation.

A unique feature of the TH 8803 is its fast erasing capability by means of a special gun design\*. Two TV frames are sufficient to erase the whole surface down to the noise level of a good amplifier. Because the display function is separated from the storage system, the user can selectively edit the stored image or, if he is interested in blow-up, zoom-in on any portion of the image.

The two-inch diameter structured silicon target of the TH 8803 permits a resolution of 2700 TV lines at 50% modulation level. It also permits operation with standard Vidicon hardware, and low voltage levels.

The high performance level reached makes the TH 8803 ideal for a number of applications such as buffer memory, high density data storage and retrieval, bandwidth compression or expansion, scan conversion, etc.

For more information about this tube and our entire line of storage and display tubes, please circle the appropriate number on the Reader Service Card, or contact us directly.

\* Thomson-CSF patent.



**THOMSON-CSF**

THOMSON-CSF ELECTRON TUBES, INC. / 50 ROCKEFELLER PLAZA / NEW YORK, N.Y. 10020 TEL. (212) 489-0400

France - THOMSON-CSF Groupement Tubes Electroniques / 8, rue Chasseloup-Laubat / 75015 PARIS / Tel. 566.70.04

Germany - THOMSON-CSF Elektronenröhren GmbH / Am Leonhardsbrunn 10 / 6 FRANKFURT/MAIN / Tel. 70 20 99

Italy - THOMSON-CSF Tubi Elettronici SRL / Viale degli Ammiragli 71 / ROMA / Tel. 63 80 143

Japan - THOMSON-CSF JAPAN K.K. / Kyosho Building / 1-9-3 Hiraakawa-cho / Chiyoda-ku / TOKYO / T 102 / Tel. 03 264-6341

Sweden - THOMSON-CSF Elektronrör AB / Box 27080 / S 10251 STOCKHOLM 27 / Tel. 08/22 58 15

United Kingdom - THOMSON-CSF Electronic Tubes Ltd / Bilton House, Uxbridge Road, Ealing / LONDON W5 2TT / Tel. 01-579 1857 / Telex: 25 659

1652

# Tables shorten design time for active filters

Both low-pass and high-pass Butterworth-Thomson filters, which use either unity-gain or infinite-gain amplifiers, can be designed from tables of normalized component values; filter orders as high as 10 are covered

by Farouk Al-Nasser, Honeywell Test Instruments division, Denver, Colo.

□ As the IC operational amplifier grows steadily better and cheaper, active filters are becoming more popular than passive. Their performance is superior and more predictable, they have no need for impedance matching, nor are nonlinear inductor properties a problem, since the active filter uses an op amp and an associated RC network to simulate inductance.

But perhaps the greatest attraction that active filters hold for the designer is that they lend themselves to a building-block approach. Being inherently isolated, they can be cascaded to realize higher-order filter functions, and the passive-component values needed to implement each filter block or section can be computed in a normalized form and tabulated. This also means that active-filter design can be reduced to a matter of looking up tables, once the engineer has determined the type of filter required and chosen a filter circuit.

Selecting the right type of active filter depends on the signal being processed, as well as the time- and frequency-domain properties that the filtered signal must have. The Butterworth type of filter, for instance, exhibits flat passband amplitude characteristics up to the cutoff frequency, a rolloff of  $-6n$  decibels per octave beyond cutoff (where  $n$  is the order of the filter), and nonlinear phase characteristics that lead to a nonlinear group delay. On the other hand, the Thomson filter (also referred to as the normalized Bessel filter) has a linear phase response in the passband, and an amplitude response that is not as flat as that of the Butterworth filter in the passband and stopbands. Group delay for the Thomson filter is constant up to cutoff.

In some cases, a compromise characteristic that trades off the best properties of the Butterworth and the Thomson filter is needed. The result is the class of Butterworth-Thomson filter. Its characteristics vary smoothly between the maximally flat amplitude of the Butterworth filter and the maximally flat envelope delay of the Thomson filter.

## Butterworth-Thomson filter properties

In the complex frequency plane, the poles of the Butterworth-Thomson filter lie between those of the Butterworth and Thomson types, as shown in Fig. 1. The actual pole location is denoted by  $P$ , the length of the vector to the pole by  $R$ , and the angle of this pole vector by  $\theta$ . Letting subscript BT represent the Butterworth-Thomson filter, subscript B the Butterworth filter, and

subscript T the Thomson filter, the equation that defines the location of a Butterworth-Thomson pole can be written as:

$$P_{BT} = R_T^m \exp[-j(\theta_B - m(\theta_B - \theta_T))]$$

where  $m$  is a parameter that varies between 0 and 1. When  $m = 0$ , the Butterworth-Thomson poles are the same as those of the Butterworth filter:

$$P_{BT} = \exp(-j\theta_B) = P_B$$

When  $m = 1$ , the Butterworth-Thomson and the Thomson poles are the same:

$$P_{BT} = R_T \exp(-j\theta_T) = P_T$$

From these equations, the pole locations, the magnitude and angle of the pole vectors, and the filter Q factor can be computed for various values of parameter  $m$ . Tables 1 through 6 list this data for  $m = 0, 0.2, 0.4, 0.6, 0.8,$  and 1 for both even and odd filter orders from 2 to 10. Data for intermediate values of parameter  $m$  can be obtained by interpolation.

From the general transfer function of the Butterworth-Thomson filter, which can be found in reference literature, both the frequency- and time-domain characteristics can be obtained. Graphs 1 and 2 relate filter gain to normalized frequency for  $m = 0.4$  and  $m = 0.8$ , respectively. The group delay characteristics, again for  $m = 0.4$  and  $m = 0.8$ , are drawn in Graphs 3 and 4. For any order filter, in either the frequency or time domain, the Butterworth-Thomson filter changes smoothly from the Butterworth to the Thomson characteristics, as parameter  $m$  varies from 0 to 1.

Active-filter circuits synthesize a second-order transfer function with one or more op amps and an RC net-

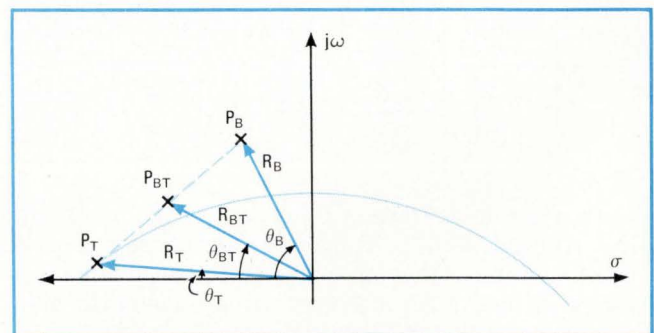

1. Pole locations. Butterworth-Thomson filter compromises the flat amplitude of the Butterworth filter with the flat envelope delay of the Thomson filter. Its poles ( $P_{BT}$ ) are located between those ( $P_B$ ) of the Butterworth filter and those ( $P_T$ ) of the Thomson filter.

TABLE 1					
POLE LOCATIONS FOR $m = 0$					
Order	Real	Imaginary	Magnitude	Angle from neg. real axis (deg.)	Q factor
2	-0.70711	0.70711	1.00000	45.00000	0.70711
3	-1.00000 -0.50000	0.00000 0.86603	1.00000 1.00000	0.00000 60.00000	1.00000
4	-0.92388 -0.38268	0.38268 0.92388	1.00000 1.00000	22.50000 67.50000	0.54120 1.30656
5	-1.00000 -0.80902 -0.30902	0.00000 0.58779 0.95106	1.00000 1.00000 1.00000	0.00000 36.00000 72.00000	0.61803 1.61803
6	-0.96593 -0.70711 -0.25882	0.25882 0.70711 0.96593	1.00000 1.00000 1.00000	15.00000 45.00000 75.00000	0.51764 0.70711 1.93185
7	-1.00000 -0.90097 -0.62271 -0.22252	0.00000 0.43388 0.78245 0.97493	1.00000 1.00000 1.00000 1.00000	0.00000 25.71430 51.48570 77.14290	0.55496 0.80294 2.24698
8	-0.98079 -0.83147 -0.55557 -0.19509	0.19509 0.55557 0.83147 0.98079	1.00000 1.00000 1.00000 1.00000	11.25000 33.75000 56.25000 78.75000	0.50980 0.60134 0.89998 2.56292
9	-1.00000 -0.93969 -0.76604 -0.50000 -0.17365	0.00000 0.34202 0.64279 0.86603 0.98481	1.00000 1.00000 1.00000 1.00000 1.00000	0.00000 20.00000 40.00000 60.00000 80.00000	0.53209 0.65270 1.00000 2.87939
10	-0.98769 -0.89101 -0.70711 -0.45399 -0.15643	0.15643 0.45399 0.70711 0.89101 0.98769	1.00000 1.00000 1.00000 1.00000 1.00000	9.00000 27.00000 45.00000 63.00000 81.00000	0.50623 0.56116 0.70711 1.10135 3.19623

TABLE 3					
POLE LOCATIONS FOR $m = 0.4$					
Order	Real	Imaginary	Magnitude	Angle from neg. real axis (deg.)	Q factor
2	-0.77715	0.62932	1.00000	39.00000	0.64338
3	-0.97622 -0.60258	0.00000 0.81318	0.97622 1.01211	0.00000 53.46100	0.83981
4	-0.91747 -0.49363	0.33698 0.89617	0.97740 1.02312	20.16790 61.15300	0.53266 1.03633
5	-0.96990 -0.82884 -0.42026	0.00000 0.52982 0.94279	0.96990 0.98371 1.03222	0.00000 32.58790 65.97430	0.59342 1.22806
6	-0.94334 -0.74738 -0.36750	0.22850 0.65067 0.97258	0.97062 0.99093 1.03970	13.61640 41.04320 69.30030	0.51446 0.66294 1.41455
7	-0.96698 -0.89375 -0.67773 -0.32766	0.00000 0.38787 0.73250 0.99328	0.96698 0.97429 0.99794 1.04593	0.00000 23.46010 47.22410 71.74330	0.54506 0.73623 1.59604
8	-0.95191 -0.83984 -0.62016 -0.29645	0.17265 0.50312 0.79008 1.00853	0.96744 0.97901 1.00440 1.05120	10.28030 30.92440 51.87040 73.61980	0.50816 0.58286 0.80979 1.77299
9	-0.96530 -0.92061 -0.78804 -0.57134 -0.27128	0.00000 0.30503 0.58929 0.83319 1.02026	0.96530 0.96982 0.98401 1.01026 1.05571	0.00000 18.33180 36.78860 55.56030 75.11010	0.52673 0.62434 0.88411 1.94581
10	-0.95561 -0.88324 -0.74041 -0.52990 -0.25052	0.13869 0.40843 0.65560 0.86636 1.02959	0.96562 0.97310 0.98895 1.01557 1.05963	8.25786 24.81720 41.52340 58.54810 76.32480	0.50524 0.55087 0.66784 0.95826 2.11490

TABLE 2					
POLE LOCATIONS FOR $m = 0.2$					
Order	Real	Imaginary	Magnitude	Angle from neg. real axis (deg.)	Q factor
2	-0.74314	0.66913	1.00000	42.00000	0.67282
3	-0.98804 -0.55189	0.00000 0.84115	0.98804 1.00604	0.00000 56.73050	0.91145
4	-0.92089 -0.43822	0.35967 0.91164	0.98863 1.01150	21.33390 64.32650	0.53678 1.15409
5	-0.98484 -0.81940 -0.36431	0.00000 0.55883 0.94842	0.98484 0.99182 1.01598	0.00000 34.29390 68.98710	0.60521 1.39440
6	-0.95464 -0.72778 -0.31255	0.24348 0.67917 0.97057	0.98520 0.99546 1.01966	14.30820 43.02160 72.15020	0.51601 0.68390 1.63120
7	-0.98335 -0.89756 -0.65070 -0.27429	0.00000 0.41069 0.75798 0.98524	0.98335 0.98706 0.99897 1.02271	0.00000 24.58720 49.35490 74.44310	0.54986 0.76761 1.86431
8	-0.96628 -0.83600 -0.58822 -0.24483	0.18372 0.52926 0.81141 0.99562	0.98359 0.98945 1.00220 1.02528	10.76510 32.33720 54.06020 76.18490	0.50896 0.59178 0.85188 2.09390
9	-0.98250 -0.93021 -0.77746 -0.53590 -0.22142	0.00000 0.32331 0.61608 0.85034 1.00334	0.98250 0.98480 0.99197 1.00512 1.02748	0.00000 19.16590 38.39430 57.78010 77.55510	0.52934 0.63795 0.93779 2.32017
10	-0.97154 -0.88731 -0.72420 -0.49204 -0.20237	0.14743 0.43102 0.68154 0.87947 1.00930	0.98266 0.98646 0.99446 1.00775 1.02938	8.62893 25.90860 43.26170 60.77410 78.66240	0.50572 0.55587 0.68660 1.02406 2.54337

TABLE 4					
POLE LOCATIONS FOR $m = 0.6$					
Order	Real	Imaginary	Magnitude	Angle from neg. real axis (deg.)	Q factor
2	-0.80902	0.58779	1.00000	36.00000	0.61803
3	-0.96454 -0.65189	0.00000 0.78218	0.96454 1.01822	0.00000 50.19150	0.78098
4	-0.91363 -0.54872	0.31462 0.87744	0.96629 1.03489	19.00180 57.97950	0.52882 0.94300
5	-0.95519 -0.83734 -0.47673	0.00000 0.50078 0.93409	0.95519 0.97566 1.04871	0.00000 30.88180 62.96140	0.58260 1.09989
6	-0.93203 -0.76590 -0.42357	0.21388 0.62165 0.97184	0.95625 0.98643 1.06013	12.92460 39.06480 66.45050	0.51300 0.64397 1.25144
7	-0.95088 -0.88954 -0.70377 -0.38258	0.00000 0.36543 0.70606 0.99892	0.95088 0.96168 0.99690 1.06968	0.00000 22.33300 45.09330 69.04350	0.54055 0.70826 1.39798
8	-0.93769 -0.84300 -0.65132 -0.34991	0.16189 0.47717 0.76748 1.01938	0.95156 0.96868 1.00660 1.07777	9.79540 29.51160 49.68070 71.05470	0.50740 0.57454 0.77274 1.54005
9	-0.94841 -0.91089 -0.79779 -0.60627 -0.32320	0.00000 0.28716 0.56242 0.81458 1.03545	0.94841 0.95508 0.97611 1.01543 1.08472	0.00000 17.49770 35.18290 53.34040 72.66520	0.52426 0.61176 0.83744 1.67811
10	-0.93990 -0.87879 -0.75575 -0.56752 -0.30089	0.13020 0.38623 0.62934 0.85167 1.04844	0.94887 0.95992 0.98348 1.02344 1.09076	7.88679 23.72580 39.78510 56.32220 73.98720	0.50477 0.54616 0.65066 0.90168 1.81256

work. First-order transfer functions, on the other hand, are realized with a simple passive resistor-capacitor combination, so that an active third-order filter is actually an active second-order circuit cascaded with a passive first-order RC network.

To realize high-order filters, second-order and/or third-order filter sections are cascaded. If the filter order is even, only second-order sections are used. For example, a sixth-order filter is obtained when three sec-

ond-order sections are cascaded. Odd-order filters are implemented by cascading a third-order section with one or more second-order sections. For a seventh-order filter, therefore, one third-order section is cascaded with two second-order sections.

Different circuits can be used to realize the basic second-order or third-order active filter section. Two popular configurations, which require only one op amp per section, are the positive-feedback and the multiple-

TABLE 5

POLE LOCATIONS FOR $m = 0.8$					
Order	Real	Imaginary	Magnitude	Angle from neg. real axis (deg.)	Q factor
2	-0.83867	0.54464	1.00000	33.00000	0.59618
3	-0.95300 -0.69963	0.00000 0.74822	0.95300 1.02436	0.00000 46.92200	0.73207
4	-0.90939 -0.60331	0.29260 0.85544	0.95531 1.04678	17.83570 54.80600	0.52524 0.86753
5	-0.94071 -0.84491 -0.53356	0.00000 0.47173 0.92225	0.94071 0.96768 1.06547	0.00000 29.17570 59.94860	0.57265 0.99845
6	-0.92071 -0.78333 -0.48063	0.19962 0.59213 0.96824	0.94210 0.98195 1.08097	12.23290 37.08630 63.60070	0.51162 0.62678 1.12454
7	-0.93505 -0.88496 -0.72878 -0.43895	0.00000 0.34336 0.67871 1.00204	0.93505 0.94923 0.99588 1.09397	0.00000 21.20590 42.96240 66.34370	0.53632 0.68325 1.24611
8	-0.92361 -0.84549 -0.68166 -0.40517	0.15142 0.45143 0.74367 1.02805	0.93595 0.95846 1.00881 1.10501	9.31054 28.09880 47.49090 68.48960	0.50668 0.56681 0.73997 1.36362
9	-0.93181 -0.90106 -0.80671 -0.64063 -0.37716	0.00000 0.26971 0.53551 0.79453 1.04877	0.93181 0.94056 0.96827 1.02063 1.11453	0.00000 16.66360 33.57720 51.12050 70.22020	0.52192 0.60014 0.79658 1.47752
10	-0.92441 -0.87399 -0.77020 -0.60482 -0.35349	0.12196 0.36442 0.60276 0.83542 1.06572	0.93242 0.94692 0.97803 1.03137 1.12281	7.51572 22.63440 38.04680 54.09630 71.64960	0.50433 0.54172 0.63491 0.85262 1.58817

feedback active filters. The first uses the op amp in its noninverting unity-gain mode, while the second uses it as an infinite-gain device.

The cutoff frequency and the Q factor of the positive-feedback filter are more sensitive to passive component tolerances and amplifier gain variations than the multiple-feedback filter. However, for the same cutoff frequency, the positive-feedback version does not demand as much bandwidth from the amplifier. Additionally, both the second- and third-order positive-feedback filters require one fewer resistor than the same-order multiple-feedback filters.

### Low-pass Butterworth-Thomson filters

A second-order low-pass filter section using a unity-gain amplifier and another using an infinite-gain amplifier are shown in Fig. 2a and 2b, respectively. The circuits in Fig. 2c and 2d are the comparable third-order low-pass filter sections.

The transfer function of the second-order low-pass positive-feedback filter of Fig. 2a can be written as:

$$G(s) = 1/[s^2 C_1 C_2 R_1 R_2 + s C_2 (R_1 + R_2) + 1]$$

where  $s$  is the Laplace transform variable. For the second-order low-pass multiple-feedback filter of Fig. 2b:

$$G(s) = (-R_3/R_1)/[s^2 R_2 R_3 C_1 C_2 + s C_2 (R_2 + R_3 + R_2 R_3/R_1) + 1]$$

For the third-order positive-feedback filter of Fig. 2c:

$$G(s) = 1/[s^3 C_1 C_2 C_3 R_1 R_2 R_3 + s^2 (C_2 C_3 R_3 (R_1 + R_2) + C_1 C_3 R_1 (R_2 + R_3)) + s (C_3 (R_1 + R_2 + R_3) + C_1 R_1) + 1]$$

For the third-order multiple-feedback filter of Fig. 2d:

$$G(s) = 1/[s^3 R_1 R_2 R_3 C_1 C_2 C_3 + s^2 ((R_2 R_3 + R_3 R_4 + R_2 R_4) (R_1 C_1 C_3/R_4) + (R_1 + R_2) R_3 C_1 C_3) + s ((R_3 R_4 + R_2 R_3 + R_2 R_4 + R_1 R_3 + R_1 R_4) (C_3/R_4) + (R_1 R_2 C_1/R_4)) + (R_1 R_2/R_4)]$$

TABLE 6

POLE LOCATIONS FOR $m = 1$					
Order	Real	Imaginary	Magnitude	Angle from neg. real axis (deg.)	Q factor
2	-0.86603	0.50000	1.00000	30.00000	0.57735
3	-0.94160 -0.74564	0.00000 0.71137	0.94160 1.03054	0.00000 43.65250	0.69105
4	-0.90476 -0.65721	0.27092 0.83016	0.94445 1.05882	16.66970 51.63250	0.52193 0.80554
5	-0.92644 -0.85155 -0.59059	0.00000 0.44272 0.90720	0.92644 0.95976 1.08250	0.00000 27.46960 56.93570	0.56354 0.91646
6	-0.90939 -0.79965 -0.53855	0.18570 0.56217 0.96169	0.92816 0.97749 1.10222	11.54110 35.10790 60.75080	0.51032 0.61119 1.02331
7	-0.91949 -0.88000 -0.75274 -0.49669	0.00000 0.32167 0.65047 1.00251	0.91949 0.93695 0.99485 1.11881	0.00000 20.07870 40.83160 63.64390	0.53236 0.66082 1.12626
8	-0.90968 -0.84733 -0.71114 -0.46217	0.14124 0.42590 0.71865 1.03439	0.92058 0.94834 1.01103 1.13294	8.82567 26.68610 45.30110 65.92450	0.50599 0.55961 0.71085 1.22567
9	-0.91550 -0.89113 -0.81480 -0.67436 -0.43314	0.00000 0.25266 0.50858 0.77305 1.06007	0.91550 0.92626 0.96050 1.02586 1.14515	0.00000 15.82950 31.97150 48.90070 67.77530	0.51971 0.58941 0.76061 1.32191
10	-0.90913 -0.86885 -0.78377 -0.64175 -0.40832	0.11396 0.34300 0.57591 0.81758 1.08127	0.91625 0.93410 0.97261 1.03937 1.15580	7.14465 21.54300 36.30850 51.87030 69.31190	0.50391 0.53755 0.62047 0.80979 1.41531

Tables 7 and 8 give the normalized capacitor values that satisfy these transfer functions when all the resistors have the same value. Table 7 lists the capacitances for the positive-feedback Butterworth-Thomson filter for  $m = 0.2, 0.4, 0.6,$  and  $0.8$  for both even and odd filter orders from 2 to 10. Table 8 duplicates this data, but for the multiple-feedback Butterworth-Thomson filter. Interpolation yields the normalized capacitor values for intermediate values of parameter  $m$ .

### How to use the tables and graphs

Now that all the data needed to put an active Butterworth-Thomson filter together is at hand, a general design procedure can be outlined. Of course, the filter characteristics that will satisfy the specifications must first be selected. This is done by choosing the best value of parameter  $m$ , as well as the necessary filter order, from Tables 1 through 6 and Graphs 1 through 4. (The desired filter operating frequency is set equal to the normalized frequency of 1 radian/second.)

If a low-pass filter is required, the first steps are to find the proper normalized capacitor values for each filter section from Table 7 or 8, depending on the circuit preferred, and then choose a convenient value of resistance. (A different resistance value may be assigned for each section.) Actual capacitor values ( $C_a$ ) are found by a simple division:

$$C_a = C_n/\omega_0 R$$

where  $C_n$  is the normalized capacitor value,  $\omega_0$  is the actual filter operating frequency, and  $R$  is the resistance value chosen for a given section.

High-pass filter functions synthesized with the positive-feedback circuit can also be designed from the normalized capacitor values given for low-pass filters in Table 7. Since the positions of resistors and capacitors cannot be interchanged for the multiple-feedback cir-

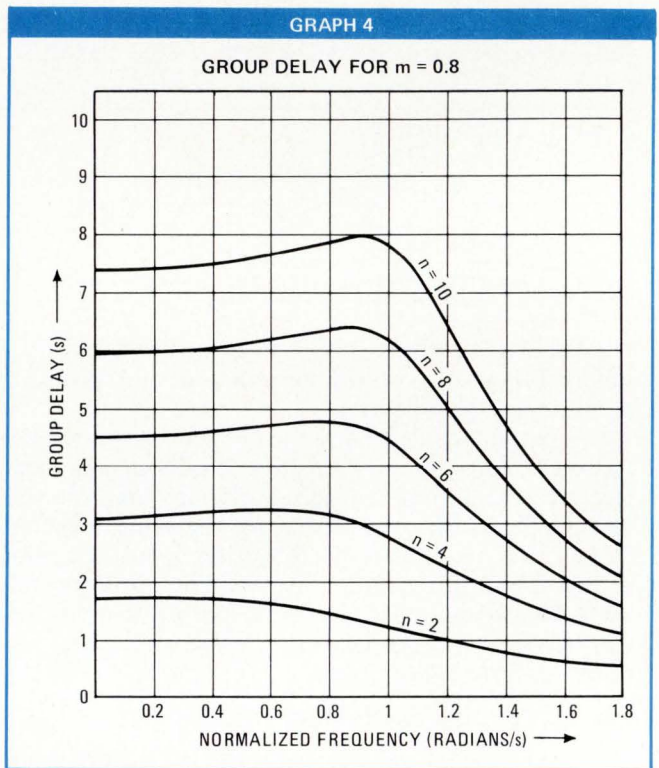
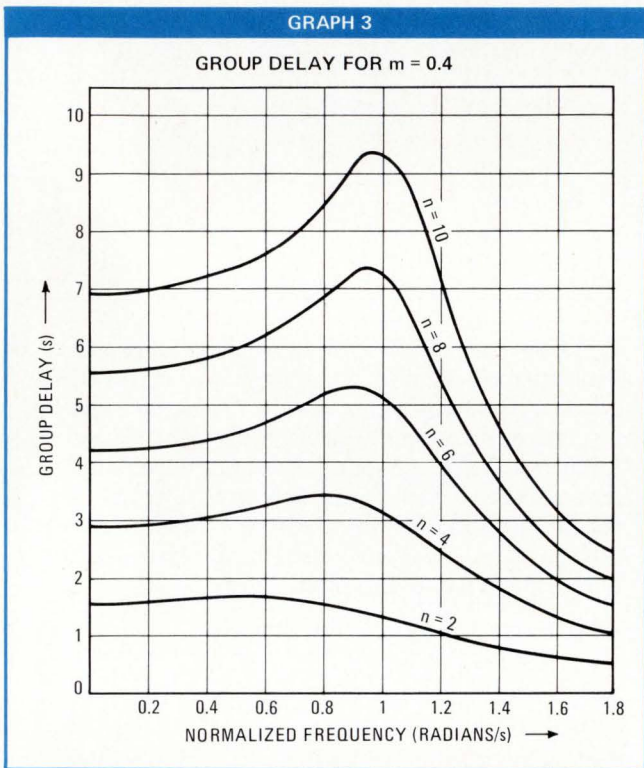
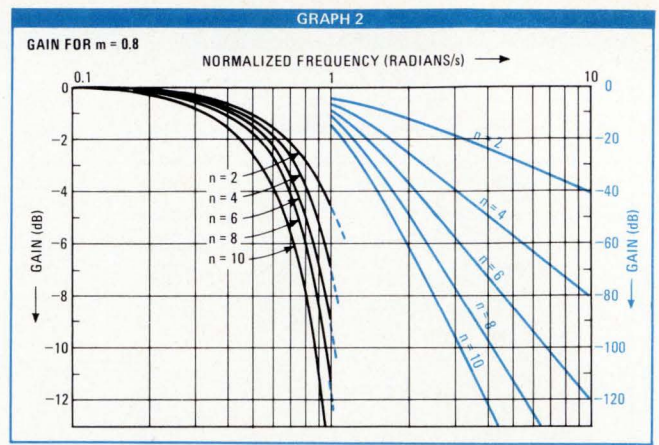
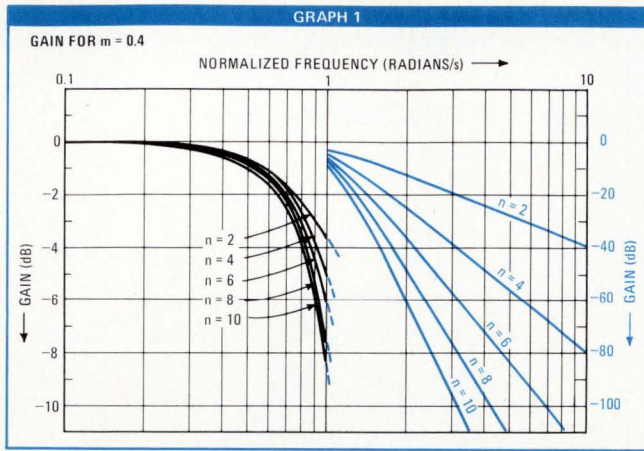

cuit, Table 8 cannot be used for this high-pass filter. Fig. 3 shows the two active filter circuits that correspond to the low-pass filters of Fig. 2a and 2c. The second-order high-pass positive-feedback filter is illustrated in Fig. 3a, and the third-order version of this filter is drawn in Fig. 3b.

### Designing the filter

The design procedure for an active high-pass Butterworth-Thomson filter is similar to the one for a low-pass filter. After the correct value for parameter  $m$  and the desired filter order have been selected, the normalized capacitor values are picked from Table 7. Normalized resistor values are then computed:

$$R_n = 1/C_n$$

A convenient value is next chosen for capacitor  $C$ ; a different value of  $C$  may be chosen for each filter section. The actual resistor values ( $R_a$ ) can then be found from the normalized resistor values:

$$R_a = R_n/\omega_o C$$

where  $\omega_o$  is the actual filter operating frequency.

A few specific examples will clarify the general procedures just outlined.

A fourth-order multiple-feedback low-pass Butterworth-Thomson filter is needed with  $m = 0.4$  and  $\omega_o = 10,000$  radians/second. From table 8, the normalized capacitor values can be obtained. For the first filter section:

$$C_{1n} = 2.8812 \text{ and } C_{2n} = 0.3633$$

For the second section:

$$C_{1n} = 1.4147 \text{ and } C_{2n} = 0.6753$$

Setting the resistors for both sections equal to 1,000 ohms, the denormalizing conversion factor becomes:

$$\omega_o R = 10^4(10^3) = 10^7$$

The actual capacitor values can then be computed. For the first section:

$$C_1 = 2.8812/10^7 = 0.28812 \text{ microfarad}$$

$$C_2 = 0.3633/10^7 = 0.3633 \mu\text{F}$$

And for the second section:

$$C_1 = 1.4147/10^7 = 0.14147 \mu\text{F}$$

$$C_2 = 0.6753/10^7 = 0.06753 \mu\text{F}$$

The component values needed to build the filter are now known.

A fifth-order positive-feedback high-pass Butterworth-Thomson filter must be designed for  $m = 0.2$  and  $\omega_0 = 1,000$  radians/second. The normalized capacitor values are found in Table 7. For section 1:

$$C_{1n} = 1.3369, C_{2n} = 1.7467, \text{ and } C_{3n} = 0.4276$$

For section 2:

$$C_{1n} = 2.7449 \text{ and } C_{2n} = 0.3529$$

The normalized resistor values for section 1 become:

$$R_{1n} = 1/1.3669 = 0.732$$

$$R_{2n} = 1/1.7467 = 0.573$$

$$R_{3n} = 1/0.4276 = 2.34$$

And for section 2:

$$R_{1n} = 1/2.7449 = 0.365$$

$$R_{2n} = 1/0.3529 = 2.84$$

Choosing a convenient value for capacitor  $C$ —let  $C = 0.1 \mu\text{F} = 10^{-7}$  farads—allows the denormalizing conversion factor for the resistances to be calculated:

$$\omega_0 C = 10^3(10^{-7}) = 10^{-4}$$

The actual resistor values for section 1 can then be readily determined:

$$R_1 = 0.732/10^{-4} = 7.32 \text{ kilohms}$$

$$R_2 = 0.573/10^{-4} = 5.73 \text{ kilohms}$$

$$R_3 = 2.34/10^{-4} = 23.4 \text{ kilohms}$$

And for section 2:

$$R_1 = 0.365/10^{-4} = 3.65 \text{ kilohms}$$

$$R_2 = 2.84/10^{-4} = 28.4 \text{ kilohms}$$

The filter can now be assembled from the computed component values.

### Practical considerations

For the most part, literature on active filter design supposes the op amp to be ideal—that is, it is assumed to have infinite gain, infinite input impedance, and zero output impedance. But when operating frequency be-

comes high and filter  $Q$  large, the finite gain-bandwidth product of an op amp, as well as its sensitivity parameters, can no longer be neglected.

A common assumption is to consider the actual op amp gain-bandwidth product,  $f_a$ , to be at least an order of magnitude larger than the desired filter cutoff frequency,  $f_0$ . However, for a second-order positive-feedback filter:

$$f_a/f_0 = Q/(1 - f_{0a}/f_0) \quad (1)$$

where  $Q$  is the desired filter  $Q$ , and  $f_{0a}$  is the actual filter cutoff frequency. This frequency ratio can also be expressed solely in terms of filter  $Q$ :

$$f_a/f_0 = Q/(Q_a/Q - 1) \quad (2)$$

where  $Q_a$  is the actual  $Q$ . The same relationships can be developed for the second-order multiple feedback filter, which uses an infinite-gain as opposed to a unity-gain amplifier:

$$f_a/f_0 = 1.5Q/(1 - f_{0a}/f_0) = 1.5Q/(Q_a/Q - 1)$$

Suppose that the actual cutoff frequency,  $f_{0a}$ , must deviate less than 5% from the desired cutoff frequency,  $f_0$ , and that actual filter  $Q$ ,  $Q_a$ , must be within 2% of the desired filter  $Q$ . Using Eq. 1 yields:

$$f_a/f_0 \text{ must be greater than } Q/0.05 = 20Q$$

or, from Eq. 2:

$$f_a/f_0 \text{ must be greater than } Q/0.02 = 50Q$$

Since the latter condition is the more stringent, it is the one that must be obeyed.

If a fourth-order filter, with  $m = 0.2$  and  $f_0 = 1,000$  hertz, is being designed, Table 2 indicates that  $Q = 0.53678$  for section 1 and  $Q = 1.15409$  for section 2. The gain-bandwidth product of the amplifier for the second section must satisfy the condition:

$$f_a \text{ must be greater than } 50Qf_0 = 5(1.15409)(10^3)$$

$f_a$  must be greater than 57.7045 kilohertz to achieve less than 2% accuracy in the  $Q$  of the filter. A multiple-feedback filter would require even more amplifier bandwidth, because:

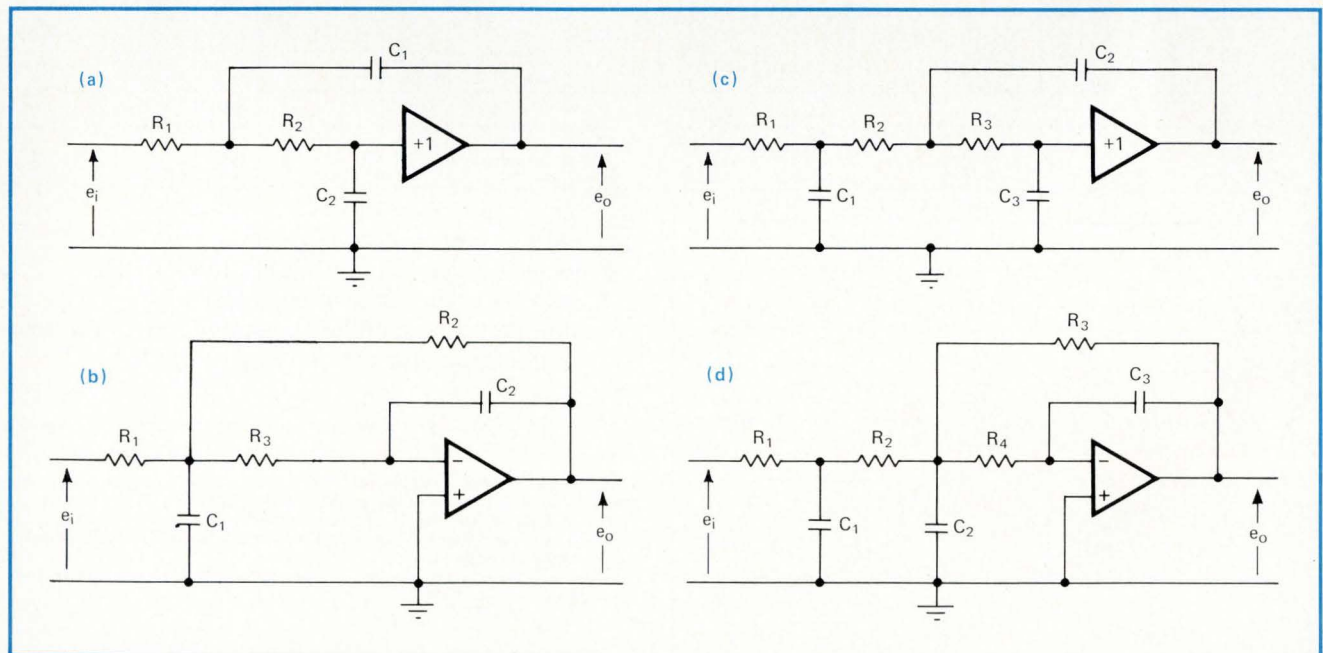

**2. Low-pass filters.** Second-order low-pass filter can be implemented with unity-gain amplifier in positive-feedback circuit (a), or with infinite-gain amplifier in multiple-feedback circuit (b). Third-order filters (c) and (d) are second-order filters that have been cascaded with first-order RC network at input end. Tables 7 and 8 give normalized capacitor values for these low-pass filters having orders up to 10.

TABLE 7

NORMALIZED CAPACITOR VALUES USING UNITY-GAIN AMPLIFIERS													
Order	Section	m = 0.2			m = 0.4			m = 0.6			m = 0.8		
		C(1)	C(2)	C(3)	C(1)	C(2)	C(3)	C(1)	C(2)	C(3)	C(1)	C(2)	C(3)
2	1	1.3456	0.7431		1.2868	0.7771		1.2361	0.8090		1.1924	0.8387	
3	1	1.3950	3.2775	0.2190	1.3963	3.2851	0.2185	1.3963	3.2853	0.2185	1.3951	3.2779	0.2189
4	1	1.0859	0.9422		1.0900	0.9604		1.0945	0.9785		1.0996	0.9965	
	2	2.2819	0.4283		2.0258	0.4716		1.8224	0.5123		1.6575	0.5506	
5	1	1.3669	1.7467	0.4276	1.3796	1.7651	0.4234	1.3922	1.7841	0.4192	1.4048	1.8036	0.4150
	2	2.7449	0.3529		2.3795	0.3944		2.0976	0.4335		1.8742	0.4700	
6	1	1.0475	0.9835		1.0601	1.0013		1.0729	1.0193		1.0861	1.0374	
	2	1.3741	0.7344		1.3380	0.7611		1.3057	0.7871		1.2766	0.8124	
	3	3.1995	0.3006		2.7211	0.3400		2.3609	0.3769		2.0806	0.4113	
7	1	1.3546	1.5423	0.4920	1.3726	1.5601	0.4860	1.3909	1.5791	0.4799	1.4094	1.5992	0.4738
	2	1.5368	0.6520		1.4755	0.6805		1.4209	0.7081		1.3722	0.7348	
	3	3.6458	0.2622		3.0519	0.2995		2.6138	0.3344		2.2782	0.3668	
8	1	1.0349	0.9988		1.0505	1.0171		1.0664	1.0356		1.0827	1.0544	
	2	1.1962	0.8539		1.1907	0.8762		1.1862	0.8984		1.1827	0.9204	
	3	1.7000	0.5856		1.6125	0.6147		1.5353	0.6428		1.4670	0.6698	
	4	4.0845	0.2329		3.3733	0.2683		2.8578	0.3012		2.4681	0.3318	
9	1	1.3487	1.4715	0.5197	1.3696	1.4889	0.5127	1.3908	1.5077	0.5056	1.4124	1.5279	0.4984
	2	1.2862	0.7901		1.2690	0.8139		1.2535	0.8373		1.2396	0.8604	
	3	1.8660	0.5305		1.7503	0.5598		1.6494	0.5880		1.5610	0.6150	
	4	4.5162	0.2097		3.6863	0.2434		3.0941	0.2747		2.6514	0.3036	
10	1	1.0293	1.0061		1.0465	1.0249		1.0639	1.0439		1.0818	1.0633	
	2	1.1270	0.9118		1.1322	0.9327		1.1379	0.9537		1.1442	0.9747	
	3	1.3808	0.7323		1.3506	0.7570		1.3232	0.7814		1.2984	0.8052	
	4	2.0324	0.4845		1.8871	0.5138		1.7621	0.5418		1.6534	0.5686	
	5	4.9415	0.1910		3.9918	0.2231		3.3235	0.2529		2.8289	0.2804	

TABLE 8

NORMALIZED CAPACITOR VALUES USING INFINITE-GAIN AMPLIFIERS													
Order	Section	m = 0.2			m = 0.4			m = 0.6			m = 0.8		
		C(1)	C(2)	C(3)	C(1)	C(2)	C(3)	C(1)	C(2)	C(3)	C(1)	C(2)	C(3)
2	1	2.2294	0.4485		2.3314	0.4289		2.4271	0.4120		2.5160	0.3975	
3	1	1.3495	5.2591	0.1405	1.3423	5.1960	0.1419	1.3337	5.1220	0.1436	1.3236	5.0383	0.1457
4	1	2.8266	0.3620		2.8812	0.3633		2.9355	0.3648		2.9894	0.3665	
	2	1.2850	0.7606		1.4147	0.6753		1.5370	0.6075		1.6518	0.5525	
5	1	1.2640	2.9081	0.2771	1.2713	2.9226	0.2757	1.2785	2.9372	0.2742	1.2857	2.9520	0.2728
	2	1.0588	0.9150		1.1833	0.7932		1.3004	0.6992		1.4100	0.6247	
6	1	2.9506	0.3492		3.0039	0.3534		3.0578	0.3576		3.1121	0.3620	
	2	2.2033	0.4580		2.2833	0.4460		2.3613	0.4352		2.4372	0.4255	
	3	0.9018	1.0665		1.0199	0.9070		1.1306	0.7870		1.2340	0.6935	
7	1	1.2297	2.7070	0.3202	1.2436	2.6252	0.3174	1.2578	2.6444	0.3146	1.2722	2.6647	0.3117
	2	1.9561	0.5123		2.0416	0.4918		2.1244	0.4736		2.2045	0.4574	
	3	0.7867	1.2153		0.8986	1.0173		1.0031	0.8713		1.1004	0.7594	
8	1	2.9964	0.3450		3.0512	0.3502		3.1067	0.3555		3.1631	0.3609	
	2	2.5618	0.3987		2.6287	0.3969		2.6952	0.3954		2.7611	0.3942	
	3	1.7569	0.5667		1.8442	0.5375		1.9284	0.5118		2.0094	0.4890	
	4	0.6987	1.3615		0.8048	1.1244		0.9037	0.9526		0.9955	0.8227	
9	1	1.2138	2.5053	0.3388	1.2311	2.5240	0.3353	1.2487	2.5440	0.3318	1.2667	2.5654	0.3282
	2	2.3703	0.4287		2.4416	0.4230		2.5120	0.4178		2.5813	0.4132	
	3	1.5914	0.6220		1.6794	0.5834		1.7640	0.5498		1.8450	0.5203	
	4	0.6292	1.5054		0.7302	1.2288		0.8241	1.0314		0.9109	0.8838	
10	1	3.0184	0.3431		3.0746	0.3488		3.1317	0.3546		3.1898	0.3606	
	2	2.7355	0.3757		2.7982	0.3774		2.8611	0.3793		2.9241	0.3814	
	3	2.1969	0.4603		2.2711	0.4502		2.3441	0.4411		2.4156	0.4328	
	4	1.4535	0.6775		1.5414	0.6290		1.6255	0.5874		1.7058	0.5511	
	5	0.5729	1.6472		0.6693	1.3306		0.7587	1.1078		0.8412	0.9430	

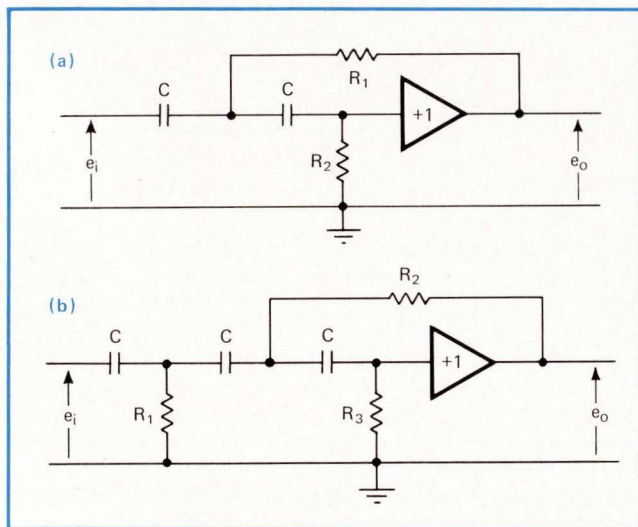

$f_a$  must be greater than  $1.5(50)Qf_0$   
 $f_a$  must be greater than  $1.5(50)(1.15409)(10^3)$   
 $f_a$  must be greater than 86.5568 kHz

The infinite-gain amplifier, however, has lower sensitivity parameters than the unity-gain amplifier. □

**BIBLIOGRAPHY**

Farouk Al-Nasser, "Tables Speed Design of Low-Pass Active Filters," EDN, March 15, 1971.  
 Aram Budak, "Active Network Synthesis," class notes, Colorado State University, 1971.  
 A. Budak and D. Petrela, "Frequency Limitations of Active Filters Using Operational Amplifiers," IEEE Transactions on Circuit Theory, Vol. CT-19, No. 4, July, 1972.  
 R. Golden and J. Kaiser, "Root and Delay Parameters for Normalized Bessel and Butterworth Low-Pass Transfer Functions," IEEE Transactions on Audio and Electroacoustics, Vol. AU-19, No. 1, March, 1971.  
 Analysis and Synthesis of Transitional Butterworth-Thomson Filters and Bandpass Amplifiers," RCA Review, Vol. 18, March, 1957, pp. 60-94.

**3. High-pass filters.** Circuits (a) and (b) correspond to low-pass configurations on Fig. 2a and 2c, but provide high-pass function. Reciprocals of normalized capacitor values in Table 7 are used to determine resistor values for these high-pass filters.



# Metal-nitride-oxide IC memory retains data for meter reader

Technology enables meter encoder to retain readings during power failures, thus bringing the computer-based experimental system near the standards of reliability demanded by public utilities—and at a cost reduction

by James Britton, J.R. Cricchi, and L.G. Ottobre, *Westinghouse Electric Corp., Raleigh, N.C.*

□ Periodic visits of public-utility meter readers at a high-rise apartment building in Raleigh, N.C., have just about ended. The utility has installed a new electronic system to read the meters remotely via a series of solid-state encoder-memories, linked by telephone line to a central computer.

This system involves a certain amount of risk because insertion of electronic counting, encoding/decoding, and communications into the operation presents the danger of introducing a degree of error unacceptable to utilities. The electronic approach must provide results equal to or better in reliability at a lower cost than the eye-ball method.

In addition, the electronic system must retain metered information during power outages and interruptions. And power companies with large-city installations want a meter-reading system that does not put an additional power drain on already overloaded systems. In New York City, for example, the electric company, hard-pressed to provide full service during peak loads,

would hesitate to accept a remote-reading setup that itself creates a constant power demand. For another thing, existing metering systems, anchored by the high reliability of the standard watt-hour meter, have proven to be extremely dependable over the years.

But cost advantages make the electronic approach attractive, despite the strict demands on performance. Westinghouse studies indicate that billings for operation of an automatic meter-reading system average about \$5 per metered point per year. Although this price range would apply for very large manual systems, present automatic systems are aimed at smaller installations, which are more costly because they must be read by employees. Combinations of such factors as high labor rates, remote locations, high customer turnover, and hard-to-read meters can increase the added cost by a factor of three or more.

Although the expected bugs were found in setting up a telephone data-transmission line, there has been no down time on the Raleigh electronic system hookup since

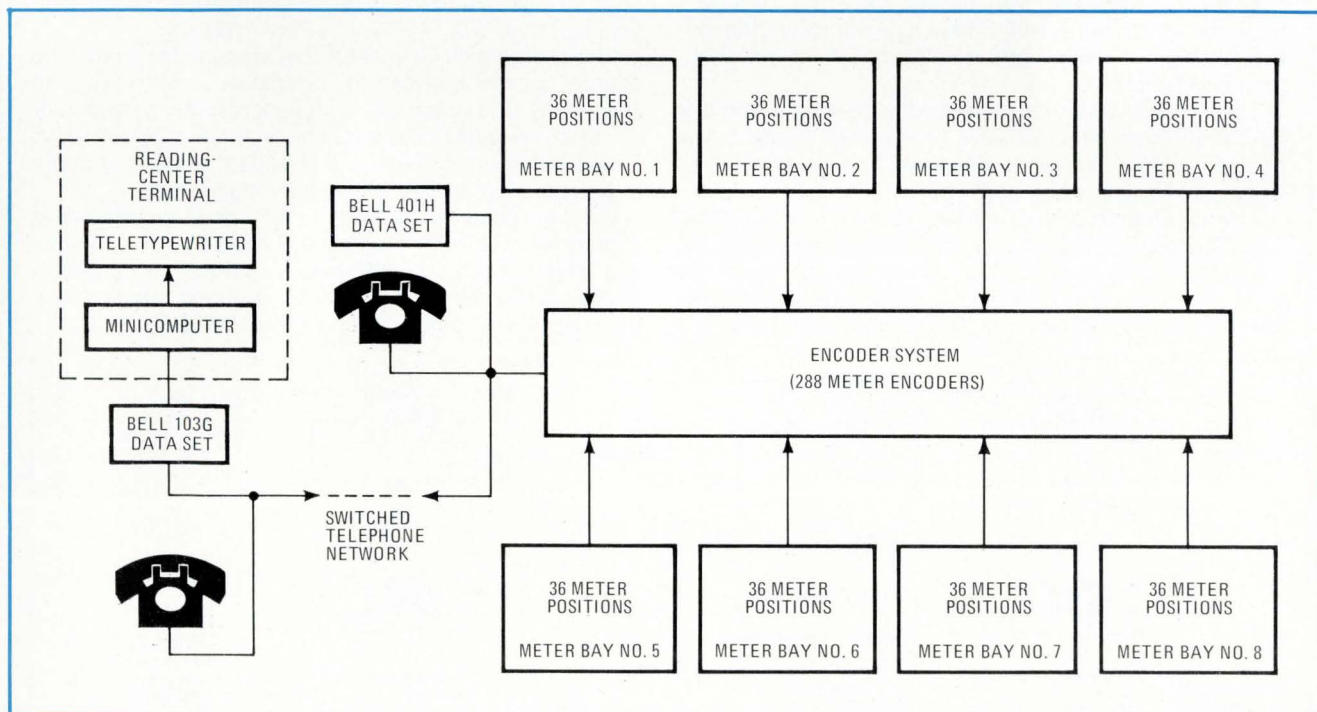

1. Remote readers. The electronic meter-reading system for utilities links meter bays to the encoder system, as shown in this block diagram of the Raleigh, N.C., installation, which in turn is linked to a central terminal minicomputer by telephone.

it went on line. In addition, the utility has found a method to retain meter readings without the use of backup batteries when power fails. Additional improvements may soon make automatic reading feasible.

### Equipment is on the roof

The system under trial in Raleigh (Fig. 1) consists of eight equally spaced watt-hour meter bays, each containing 36 metering points, that are located on the roof of the apartment building. Each watt-hour meter contains a small permanent-magnet assembly mounted on the first pointer shaft of the meter register, and a single-pole, single-throw reed switch mounts on the back side of the register-dial plate (Fig. 2). Each revolution of the first pointer shaft causes the reed switch to go through an open-close-open cycle. A twisted-wire pair connects each meter to the encoder bay, situated in a small room on the roof. The encoder bay contains the encoder system, heart of the remote installation, to a Bell 401H telephone dataset.

The total encoder section, which reads and stores individual meter readings, consists of 96 three-meter encoding boards, two communications boards, and a power transformer that drives a full-wave bridge circuit. The power transformer also supplies the 60-hertz clock frequency that controls the data transmission rate in the encoder system.

The reading-center terminal, about three miles from the apartment building, consists of a minicomputer and a teletypewriter. The minicomputer, which may be tied

into the utility's billing computer, if desired, can interface with a wide range of peripheral equipment, such as magnetic tape units, line printers, magnetic-disk storage units, and the like. A Bell 103G telephone dataset is connected to the minicomputer.

To initiate operation, the minicomputer places a call to the 401H dataset at the apartment building, which automatically answers the call with a tone. Once the integrity of the line is assured, the 401H presents a start signal to the encoder system. The start signal produces a serial-output data train containing the encoder meter information from each of the 288 meter points.

The dataset at the reading-center terminal converts the audio frequencies from the encoders into digital data, which is transmitted over the switched telephone network and stored in the computer memory. The computer terminates the data call when all of the output data has been stored in memory, and it instructs the teletypewriter to print out the number of meter readings received. The computer can issue all of the readings in sequence or any reading individually.

For the initial installation, a hand-held portable reading terminal (Fig. 3), which can display the reading stored in the encoder memories, is used to synchronize the encoder to the meter. To maximize flexibility and reliability while keeping costs down, a three-meter encoder printed-circuit board was chosen as the basic building block of the system. Selection of three meters was not completely random, for the typical encoder site will probably require electric, gas, and water meters.

## Recalling the MNOS memory

Non-volatile MNOS memory elements are similar to MOS transistors, except that the gate insulator is typically composed to 500-1,000 angstroms of silicon nitride ( $\text{Si}_3\text{N}_4$ ) and 20 Å of silicon dioxide ( $\text{SiO}_2$ ). Charge is transported via high-electric-field tunneling from the surface through the  $\text{SiO}_2$ , and it is trapped near the  $\text{Si}_3\text{N}_4$ - $\text{SiO}_2$  interface.

The process reverses if the field is reversed, and it is possible to trap either positive or negative charges. The trapped charge causes a threshold voltage shift of as much as  $\pm 15$  V for  $\pm 25$  V applied.

In the p-channel MNOS memory operation shown here, first the MNOS memory device is cleared (erased) to the low-threshold-voltage state by grounding the substrate and by applying a positive voltage  $V_M$ , called the memory-setting voltage, to the N-type substrate. The

voltage across the gate insulator is +25 v, typically.

Second, the high-threshold-voltage state is written by grounding the substrate and source while applying a negative voltage  $-V_M$  to the gate. The voltage across the gate insulator then is  $V_I = -V_M = -25$  V, typically.

In a third condition, called the write-inhibit mode, the source terminal charges to a negative voltage equal to  $(V_M + V_T)$ . The maximum voltage across the gate insulator, then, is equal to the threshold voltage, typically -1 V. This is not enough voltage to change the memory state, thus preserving the low-threshold-voltage state.

If during the read mode, the memory is operated as a source-follower, the voltage at the source  $V_S = -V_R - V_T$  is a direct measure of the memory state. The long-term temperature-independent charge retention results from the relatively deep-energy level of trapped charge.

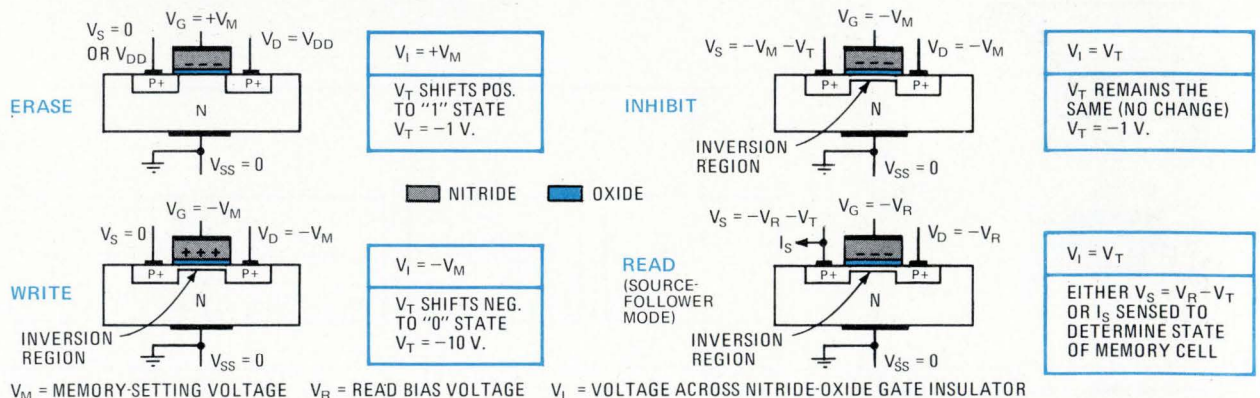

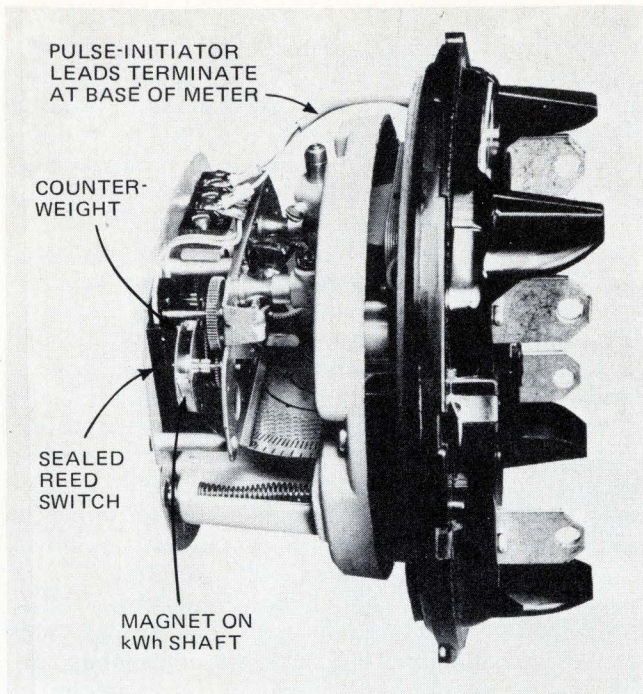

**2. Readable.** The MNOS intergrated-circuit encoder system does not require additional hardware in the single-phase watt-hour meter with pulse initiator. The meter contains a reed switch, which goes through an open-close-open cycle with each revolution of the first pointer shaft. It's connected to the encoder by a twisted-wire pair.

The three-meter encoder board (Fig. 4) is self-contained, except for the power-supply transformer. The printed-circuit board contains two Corning RC networks in dual in-line packages, three Westinghouse custom encoder chips, and numerous discrete components.

Because the electronic encoder must store the meter reading, even when power is removed or interrupted, most present systems solve the problem by placing the encoder inside the meter enclosure and providing coupling to the meter register mechanically, optically, or magnetically. Others provide a battery-powered backup system to an encoder located outside the meter enclosure.

Although both these approaches will retain the meter reading during outages, neither is reliable enough for the utility industry. First of all, use of hardware inside the meter would increase meter testing intervals, now typically every 10 years, which is unacceptable.

A second incentive to keep the encoder circuits out of the meter enclosure is that the glass cover traps heat, sometimes raising the temperature as high as 230°F. As for the battery backup, maintenance and replacement costs make this approach impractical in the long run for large-volume meter encoding.

### MNOS solves storage problem

How to retain the meter reading with the encoder outside the meter housing and without the use of backup batteries has been solved by using metal-nitride-oxide semiconductor (MNOS) integrated circuits and, in addition, the IC provides interfacing between the meter and the communications net.

Three major characteristics of MNOS permit integra-

tion of both encoder and memory circuitry on the IC. First, the fabrication procedures for the memory element are consistent with standard MOS technology—(p-MOS, n-MOS, or C-MOS); second, the threshold voltage of the MNOS transistor is electrically alterable with low voltages ( $\pm 25$  volts); and third, after the threshold voltage of the memory element has been altered, it remains near its new value for thousands of hours. The logic family chosen for the automatic meter reading encoder is p-MOS because it's cheap to fabricate, and a binary counter was used for the non-volatile storage circuitry.

As shown in Fig. 5, the idea behind the non-volatile counter is to shift the threshold of the memory transistors  $Q_{18}$  and  $Q_{19}$  so that if the supply voltage is removed and then reapplied, the binary counter will be initially imbalanced in a direction that will return it to the pre-power-loss state.

When the counter changes state, the voltage on the gate ( $V_M$  line) of the memory transistors, which is quiescently at  $-25$  v, is changed to  $+24$  v for approximately 25 microseconds. This produces a voltage across the gate insulator of each memory transistor, which shifts the threshold of both transistors to  $-2$  V.

The addition of a keeper-load transistor in parallel with depletion-load transistor  $Q_{20}$ , memory transistor  $Q_{18}$ , depletion-load transistor  $Q_{21}$ , and memory transistor  $Q_{19}$  prevents loss of operation due to the  $+25$ -v gate-to-source voltage, which turns the memory transistors off. When the  $V_M$  line is returned to  $-25$  v, the gate-to-source voltage of the memory transistors will be determined by the state of the binary counter. And, assuming the state of the counter to be  $Q = 0$  v ( $\bar{Q} = -20$  v) results in a gate-to-source voltage of  $-25$  v for  $Q_{18}$  and  $-5$  v for  $Q_{19}$ . While  $V_{GS} = -5$  v is not enough to af-

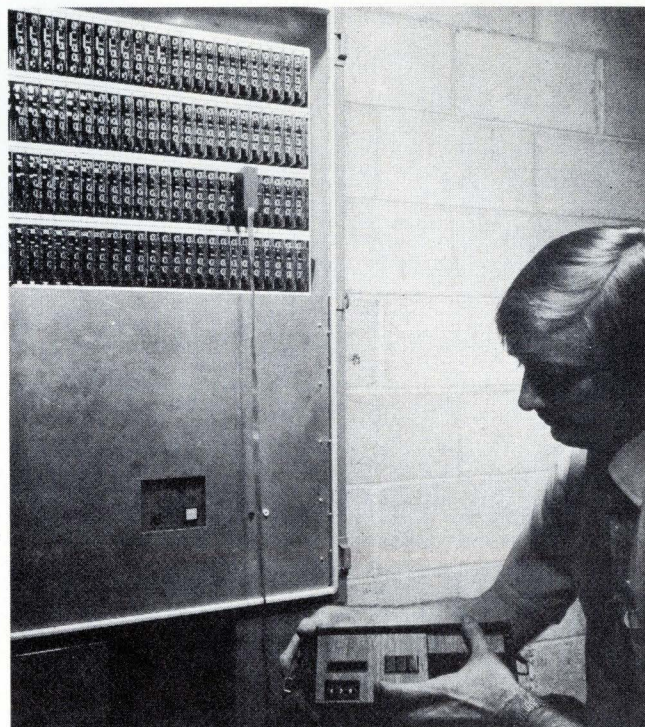

**3. Checking.** A hand-held reading terminal enables utility personnel to make sure that the meter and the encoder are in sync and to set the encoders initially.

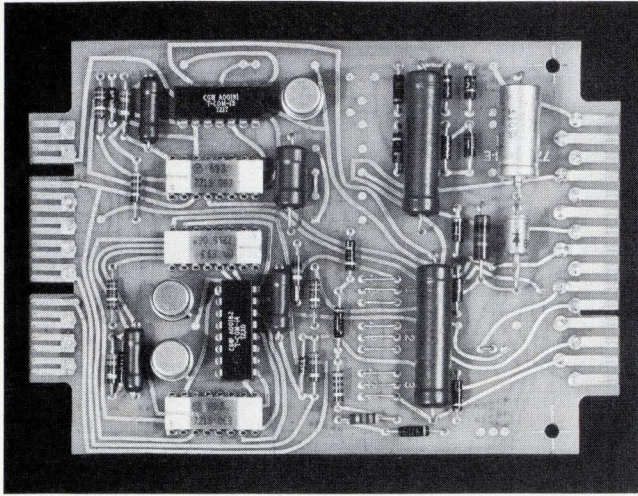

**4. Utilitarian.** The printed-circuit board handles circuits for a three-meter encoder. Modular unit is intended to read electric, gas, and water meters, or combinations of the three.

fect the threshold of  $Q_{19}$  ( $-2$  v),  $V_{GS} + -25$  v causes the threshold of  $Q_{18}$  to shift to  $-10$  v.

**No loss of memory**

Now assume that the supply voltage of the encoder has been removed for a long time. As the supply voltage ( $V_{DD}$ ) increases toward  $-30$  v,  $V_M$  will follow the supply voltage and also increase, except for the period when it is  $+25$  v. As  $V_M$  and  $V_{DD}$  increase, the memory transistor  $Q_{19}$  will turn on at a  $V_{DD}$  of  $-2$  v, and at a  $V_{DD}$  of  $-7$

v, the source of  $Q_{19}$  will begin to go negative. At a  $V_{DD}$  of  $-10$  v, the source of  $Q_{18}$  will begin to go negative, and the source of  $Q_{19}$  will be  $-3$  v. At a  $V_{DD}$  of  $-12$ v, the source of  $Q_{18}$  will be  $-2$  v, and the source of  $Q_{19}$  will be  $-5$  v. At this point, transistor  $Q_1$  will turn on, causing the source of  $Q_{18}$  to be  $0$  v, which keeps transistor  $Q_2$  off. As  $V_{DD}$  increases to  $-30$  v, the source of  $Q_{19}$  increases to  $-20$  v, and the source of  $Q_{18}$  remains at  $0$  v. Thus,  $Q = 0$  v, and  $Q = -20$  v, which is the same state that existed before the supply voltage was removed.

The automatic meter-reading encoder chip has negligible memory degradation for better than  $10^{12}$  memory cycles (more than 50 years in this application). This circuit will retain metered information for a minimum of one month without power, and when energized, it dissipates less than 125 milliwatts, worst case, at a supply voltage of  $-25$  v. Housed in a 16-pin, dual in-line ceramic package, the circuit counts meter pulses from 0 to 2 kilohertz, and may be read out at a 50-kHz rate. It will operate within a supply range of  $-20$  v to  $-30$  v.

The clock and meter-input level limits are: logic 1, maximum  $-13$  v; minimum  $V_{DD}$ . Logic 0 maximum  $V_{SS}$ ,  $+0.3$  v; minimum  $V_{SS}$ ,  $-6$  v. All other inputs, except  $V_M$ , require: logic 1, maximum  $-8$  v; minimum  $V_{DD}$ . Logic 0, maximum  $V_{SS}$ ,  $+0.3$  v; minimum  $V_{SS}$ ,  $-2$  v. The voltage at  $V_M$  must not exceed  $\pm 30$  v.

In operation (Fig. 6), the meter input-conditioning circuit ensures that the metered count is insensitive to noise and is not affected by power cycling. The 10-stage nonvolatile counter counts and stores the meter pulses. The delay circuit allows the binary counter to "settle"

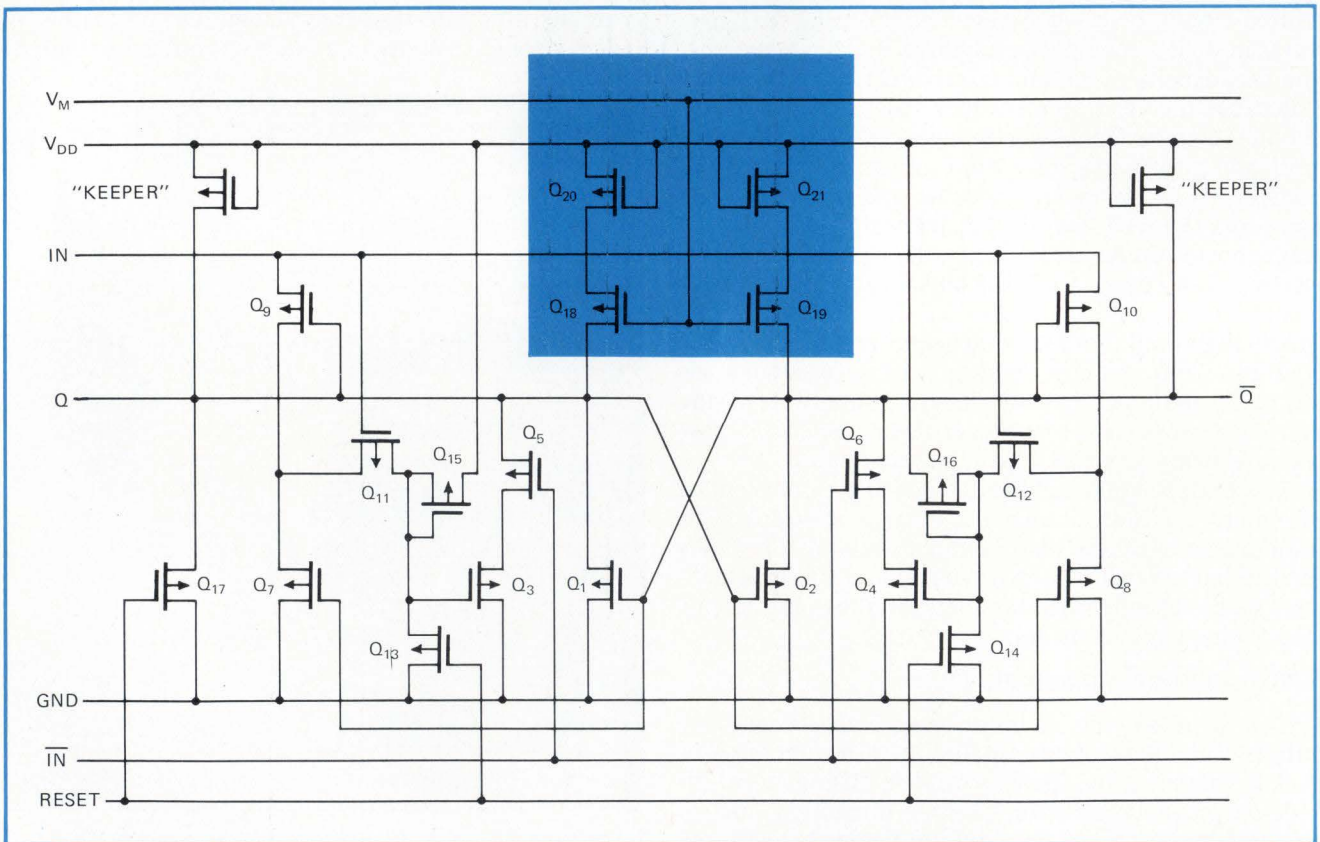

**5. Non-volatile counting.** The metal-nitride-oxide-semiconductor counter with memory is designed to ensure that the encoded data previously stored is retained even during loss of power or when turned off during peak loads to conserve power needed elsewhere.

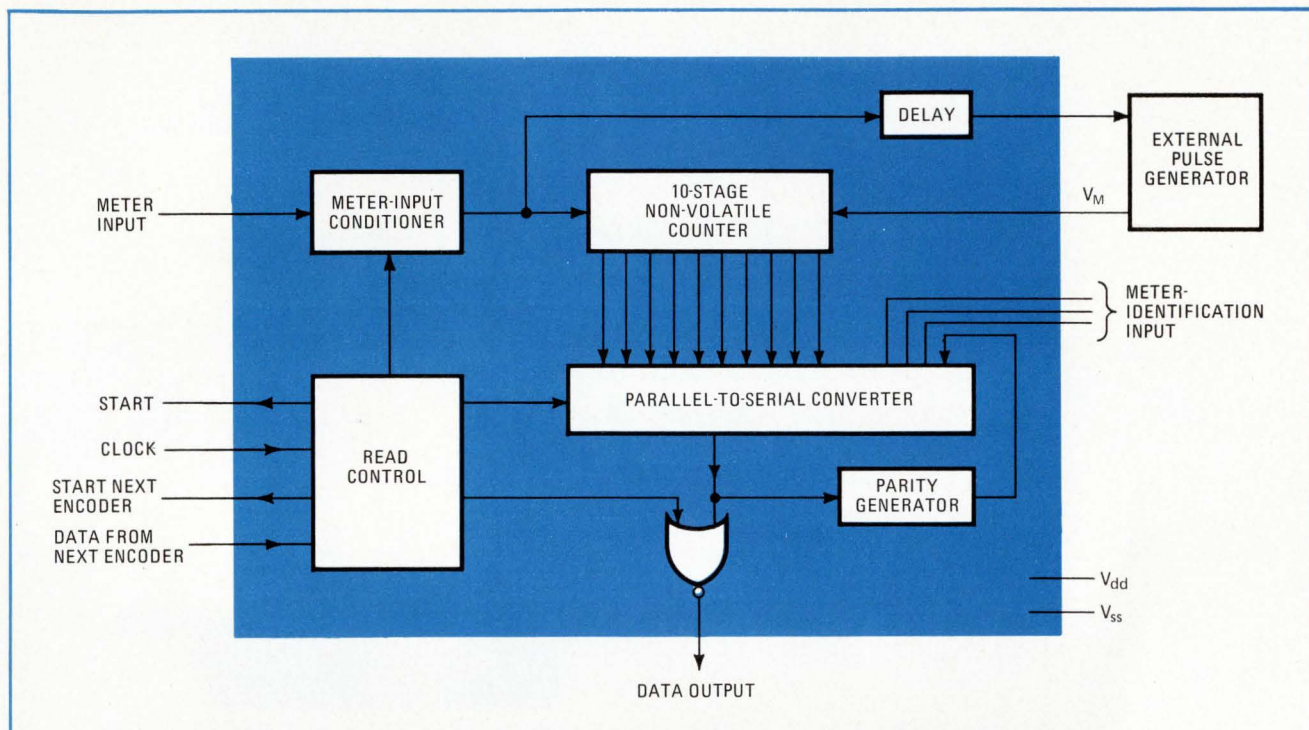

**6. Meter encoder.** After the 10-stage counter stores the meter pulses, a delay circuit allows the binary counter to "settle" before an external pulse generator provides a +25-V pulse to the  $V_M$  line of the counter that sets the memory transistors to a threshold of -2 V. Return of this line to its quiescent state of -25 V shifts the threshold of the proper memory transistor to -10 V, thus ensuring retention of metered count.

before a pulse being driven from the external pulse generator. The external pulse generator provides a +25 V pulse to the  $V_M$  line of the counter, which sets the memory transistors to a threshold of -2 v. To ensure nonvolatile retention of the metered count, the return of the  $V_M$  line to its quiescent state (-25 v) shifts the threshold of the proper memory transistor to -10 v.

The parallel-to-serial converter presents data to the output pin in a sequence of first bit for computer start; second-to-11th bits, for metered count; 12th to 14th, for meter identification; 15th, for parity; and 16th, for computer stop. The parity generator assures that an even number of logic 1s will appear in the output-pulse train.

The read-control circuitry drives the parallel-to-serial converter, inhibits the binary counter during readout, and allows the data-output information to be transmitted from encoder chip to chip in either serial or parallel format. It also provides a start signal (which may be used to start another encoder chip) at the start-next-chip output pin. Data-from-next-encoder input is used when serial data transmission from chip to chip is desired. The start-next-encoder and data-from-next-encoder pins allow any number of chips to be cascaded serially. Thus, the number of chips in an encoder system can be increased without the need for additional control circuitry as the number of meters at a location is increased.

Design of the nonvolatile encoder incorporates high-noise-immunity circuitry; however, no attempt was made to place the meter input RC noise filter or the communications interface circuitry on the chip. The meter-input noise filter, pulse generator, and power-supply circuitry are included on the encoder board. The communications-interface circuitry may be placed on the

basic encoder board for a few of the communications networks; however, because of large number of communications dataset options, most encoder systems will require an additional communications interface board. The three meter-encoder boards are designed so that the start signal described earlier will initiate a serial data output of all the meter-encoder chips on the board.

#### Further refinements possible

The requirement for a large number of meter encoders at a given location may be met simply by selecting the correct number of three-meter encoder boards to equal the number of meters to be encoded, placing them in a suitable enclosure, and interconnecting the boards electrically. The addition of a power transformer, and possibly a communications interface board, will complete the basic encoder system.

Because of the strong possibility of sharing the communications network and the variety of possible communications nets available (telephone switched network, hard-wired, distribution-line carrier, and bidirectional cable, to name a few), the automatic meter-reading system must be as flexible as possible.

In addition, a vigorous testing program for electronic system components, including the printed-circuit boards, had to be initiated to ensure that the automatic system can meet the same environmental conditions imposed on the wattmeter. And whereas meter manufacturers have years of experience in predicting meter life from accelerated tests, this experience has yet to be extended to the new electronic reading system. However, performance records from such test beds as the Raleigh installation will go a long way toward determining how soon utilities accept automatic meter reading. □

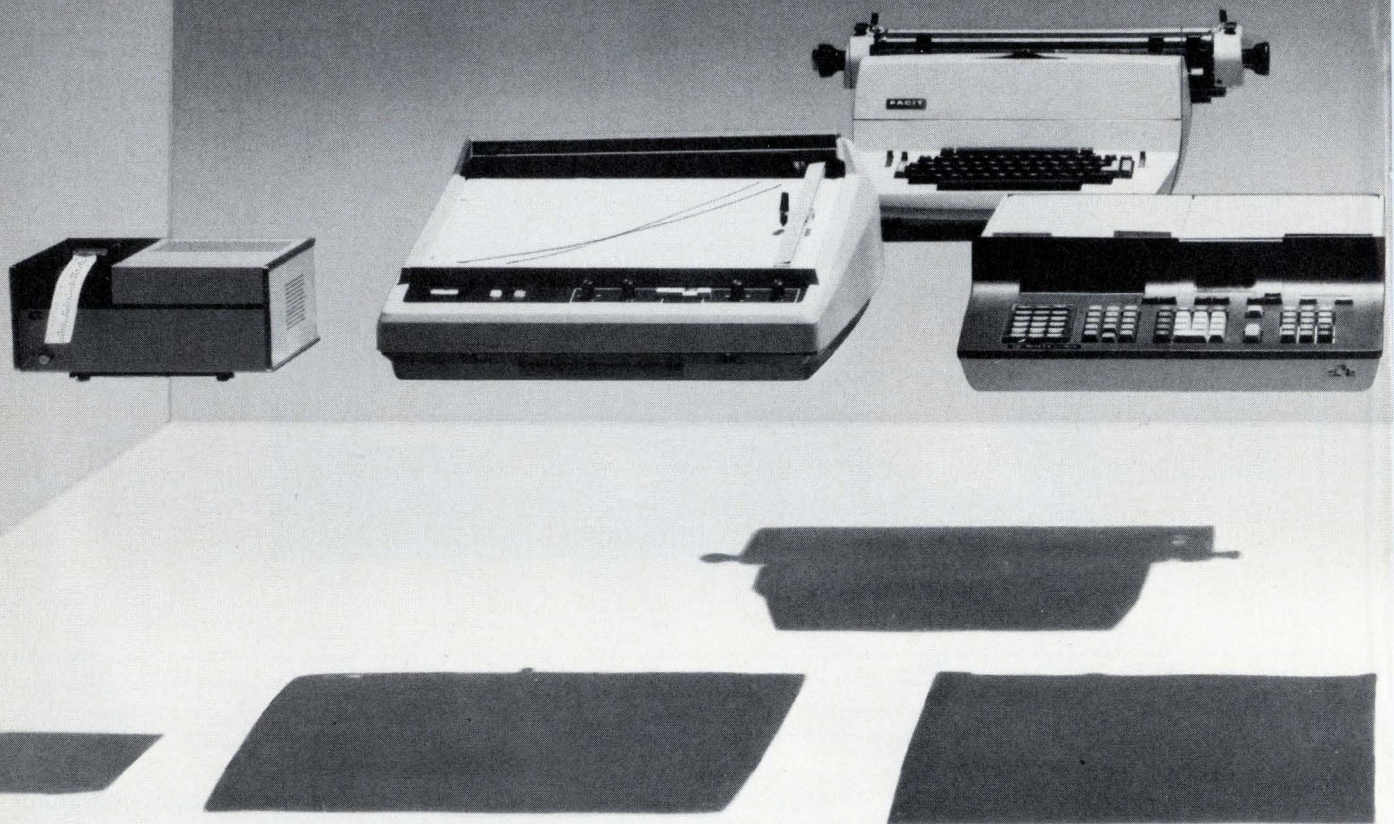

# Hewlett-Packard Series 9800. The Name And Number Mean More Than Calculators.

## Computing Power Is One Thing.

The most striking example of computing power, that we know about, is our HP-35 Calculator. At nine ounces, this *shirt-pocket powerhouse* marvelously challenges a computer in handling problems from simple arithmetic to complex mathematics. And costs \$395.



If we can package that much power in a shirt-pocket, imagine what our Series 9800 Model 10 and 20 can do:

Model 10. The one for doing repetitive problems (statistics, quality assurance, or surveying, to name a few). It comes with an LED Display, 50 registers *and* 500 program steps of memory. Coming in at under \$3,000, the Model 10 can both perform a complete regression analysis, and solve 10 simultaneous equations. You can add

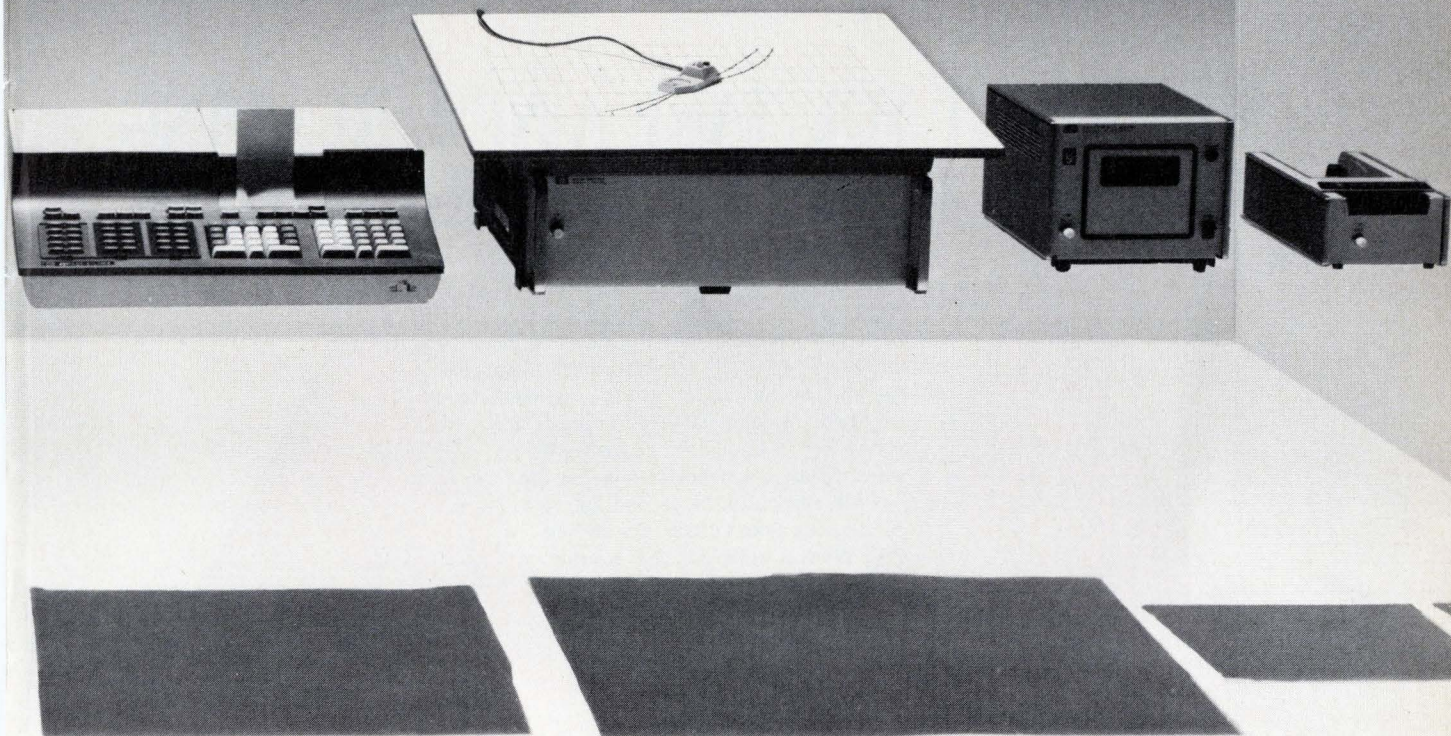

special functions, memory and printer with or without alphanumerics.

**Model 20.** The one for a lot of on-the-spot programming of complex problems. You get the best of both worlds: Very fast operation internally, with direct communication between you and the calculator. You key in your problem just as you'd write it—in Algebra and English. It gives you instructions and labeled solutions that you readily understand through its unique alphanumeric display and printer. Add to this Model 20's extensive error detecting and correcting features and its whopping memory—and you'll quickly find that it'll take you from concept to solution faster than any other system around.

What's more, with the Series 9800, you're not limited to the data formats of the Calculator. For input, you have your choice of Marked Card Reader, Paper Tape Reader, or Digitizer; for storage, the Tape Cassette; and for out-

**For more information, circle reader service no. 217**

put, a Typewriter, or our X-Y Plotter that both draws and writes.

**Support Is Another Thing.** We're in a unique position to help you. It's the aggregate of our experience in virtually every discipline of science and engineering that does it for us. Not just with products but with people. People like your HP Field Engineer. Chances are, he'll bring the solution to your problems with him. If not, he'll put you in touch with someone who will. The point is, he can talk your language. So you do get the most from your investment. Save time in the beginning. And money in the end.

**Service Is A Third.** With over 170 field service centers in 65 countries, service is available regardless of where you are. For most, it takes only a phone call.

**Product Line Is A Fourth.** You probably already know us as one of the world's leading designers and manu-

facturers of precision electronic measurement equipment. To that end we build over 2,000 products for scientists, engineers, doctors, and businessmen.

Today we're a leader in computing equipment as well. Our line runs from the Model 35 Calculator, right on up to the System 3000, a multi-lingual, multi-programming computer. Between those, and all that goes between, we can help you find the most cost-effective solution to your problems.

For more information or a demonstration of the HP Series 9800, write: Hewlett-Packard, P.O. Box 301, Loveland, Colorado 80537.

**HEWLETT  PACKARD**  
**CALCULATOR PRODUCTS**

HP sales, service and support in 172 cities in 65 countries.

For a demonstration, circle reader service no. 218

For information on the HP-35, circle reader service no. 219

092/5

# OUR ANGLE: angle position indicators that do more and cost less

## SHOULDN'T YOU TAKE A NEW READING ON THIS COST-PERFORMANCE ANGLE?

For better ways to measure synchro and resolver data, North Atlantic offers the best of both worlds: budget prices for the popular API-8025; superior performance and increased capability of the new 8525. • Both are interchangeable without any mechanical or wiring modifications. North Atlantic's solid-state 8525 offers an accuracy of  $0.05^\circ$  (3 minutes). Following a  $180^\circ$  step input, it synchronizes a five-digit NIXIE readout in  $\frac{1}{2}$  second flat. And it tracks at up to  $1000^\circ$  per second. Where cost can be traded against performance, the proven electromechanical API-8025 . . . a recognized indus-

MODEL 8525

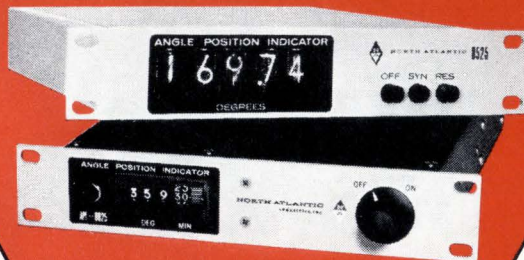

MODEL 8025

try workhorse . . . is available with its 6 minute accuracy,  $25^\circ$ /second slew speed, and many options. • Input of the 8525 is any 60 or 400Hz resolver/synchro data from control instrumentation. The patented servo design eliminates all inertia and improves dynamic performance many times over. Its digital outputs are especially suited to the computer-oriented requirements of today's automatic test systems. The 8525 . . . priced at \$1885 . . . and the API-8025 priced at \$995 actually cost less because they perform more functions per dollar. And with greater reliability. ®

For complete information on the cost-performance angle, please write or phone now.

**NORTH ATLANTIC**  
*industries, inc.*

200 TERMINAL DRIVE, PLAINVIEW, NEW YORK 11803  
cable: noatlantic / twx: 510-221-1879 / phone: (516) 681-8600



## Voltage-to-frequency module serves diverse applications

by Robert Allen Pease  
Teledyne Philbrick, Dedham, Mass.

With the addition of several external components, a versatile new voltage-to-frequency converter can be made to yield a broad range of communications and instrumentation functions at reasonable cost. The 1-cubic-

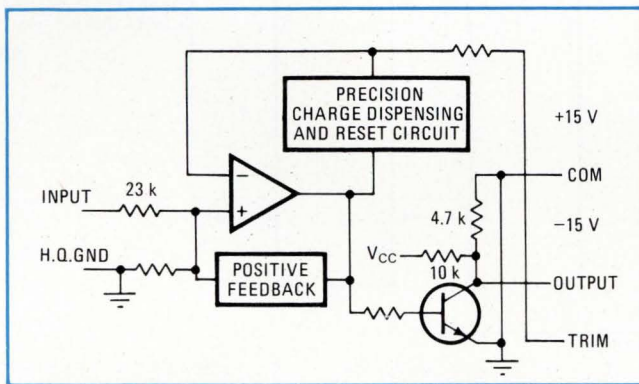

**1. Converter.** Frequency-to-voltage module follows charge-dispersing design approach. Output is buffered and TTL-compatible.

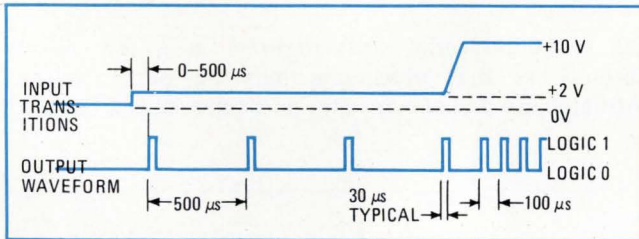

**2. Proper timing.** Typical waveforms show timing relationships between input and output for input levels of 2 and 10 volts.

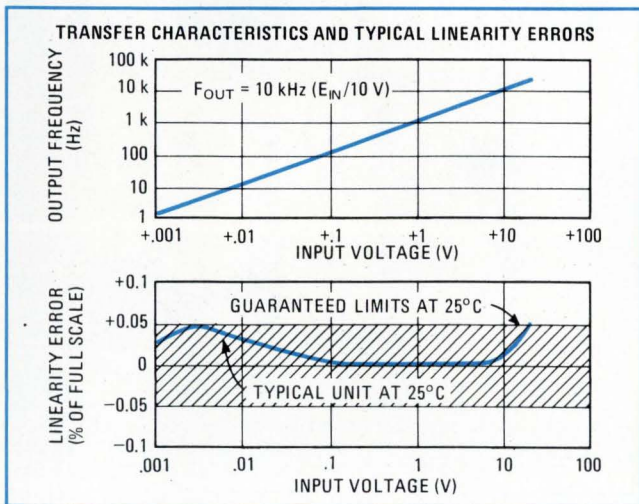

inch model 4701 adopts the charge-dispersing approach to v-f conversion, and has a unit price of \$59 in small quantities.

The module provides output pulses of about 30 microseconds width at a repetition rate that's directly proportional to the analog voltage level. As Fig. 1 shows, the amplifier functions as a zero crossing detector with a +13-volt quiescent output. When an input signal passes through the input resistor, the charge dispersing and reset circuit senses zero crossing and connects a large-value discharge capacitor. This capacitor quickly drives a precision timing capacitor below zero, cutting off the amplifier and thus resetting it rapidly to a +13-v output.

The negative-going pulse at the amplifier output is normally inverted in a TTL-compatible circuit. Typical input and output waveforms are shown in Fig. 2.

Three of the more interesting of circuit functions realizable with the v-f converter are: inexpensive digital voltmeters, ramp generators, and analog-to-digital converters. An inexpensive DVM can be constructed simply by adding a counter/display to the output of the v-f converter, taking advantage of the 4701's linearity, which is within 0.015%.

Programmable, very linear ramp generators based on v-f techniques (Fig. 3) overcome a major difficulty of conventional designs—they do not suffer from charge leakage of the timing capacitor under temperature extremes. By driving a ripple counter with an R-2R ladder connected to its output, the 4701 converter generates a highly linear 10-v ramp that operates at frequencies to 80 hertz. Output impedance is  $51 \text{ k}\Omega \pm 5\%$ .

An analog-to-digital converter is constructed from a 4701 and several inexpensive components. In Fig. 4, the converter output feeds a counter which is reset by a 1-

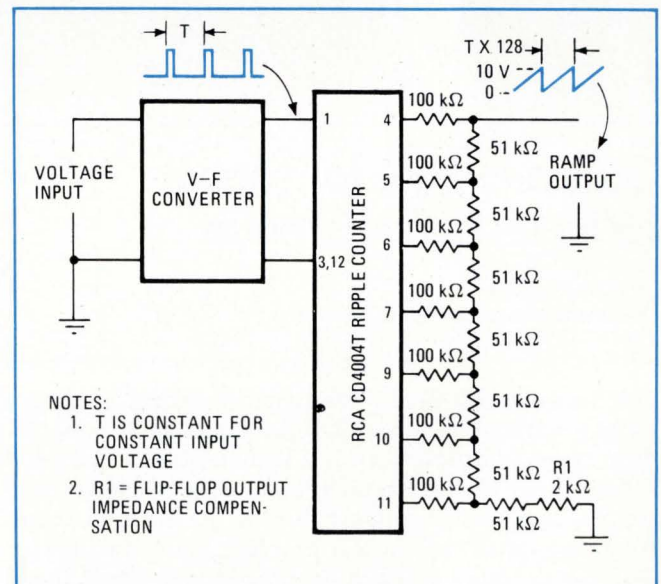

**3. Better ramp.** Voltage-controlled ramp generator doesn't share the charge-leakage problem of conventional generators.

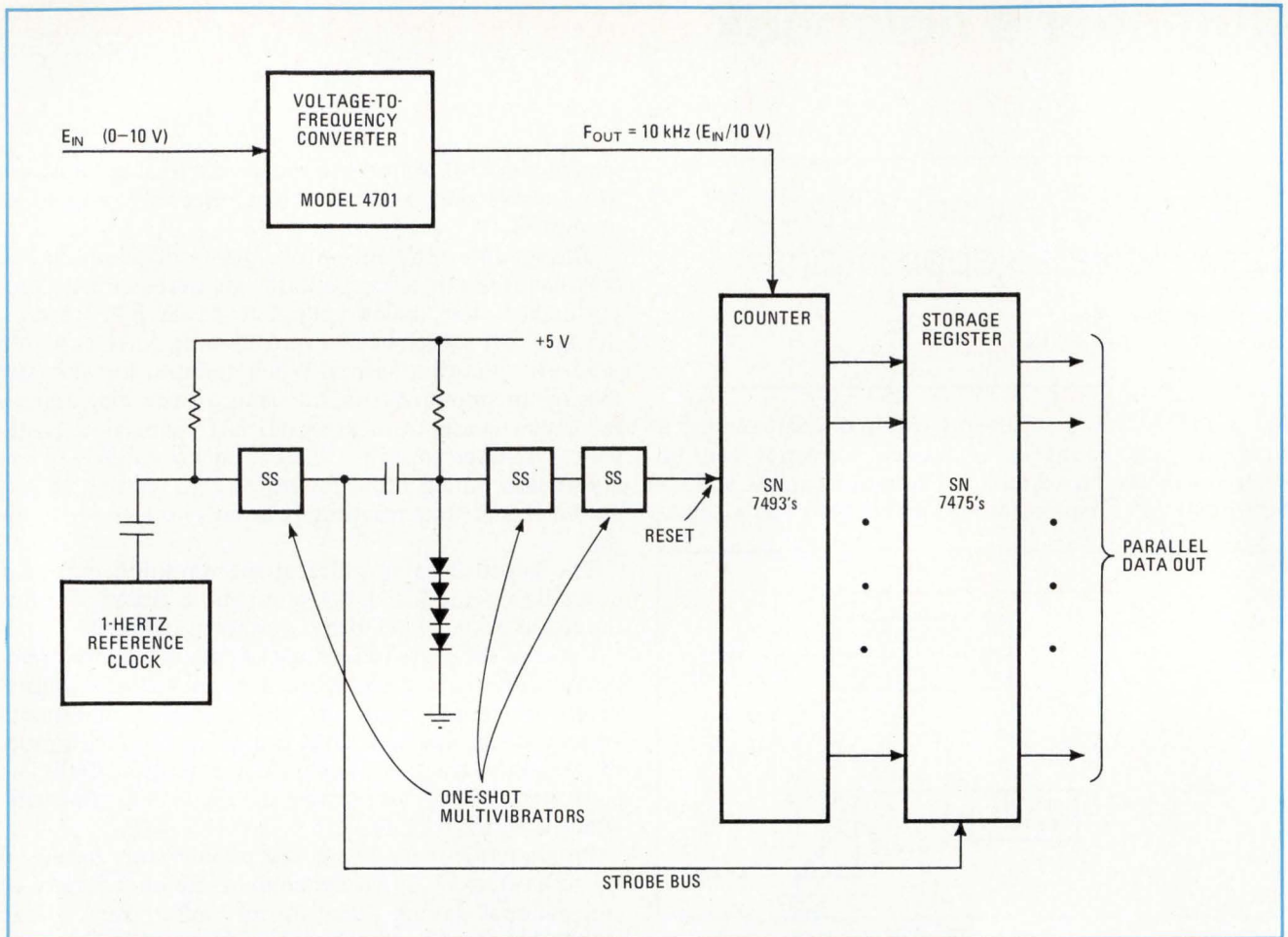

**4. Low-cost conversion.** Analog-to-digital conversion is inexpensive with the voltage-to-frequency converter and several other components. For fast computer processing, the output data is available in parallel from a single strobing.

Hz clock pulse. Just before reset, the peak counted value of the input frequency is strobed into the storage register. The data can be read out of the register (or a follow-

ing parallel-to-serial shift register) in a few microseconds, so that processing may be performed on virtually any digital computer on a time-shared basis. □

## Optical trigger for scope reduces rf interference

by R.J. Prochazka  
Harry Diamond Laboratories, Washington, D.C.

Oscilloscopes are usually designed to accept an externally generated trigger signal through coaxial cable. In most cases, this approach is adequate, but it does not suffice in an electromagnetic environment. However a simple, inexpensive modification of the external input triggering-circuit solves this problem, thus making the oscilloscope more useful for testing chores where there is electromagnetic interference. The modification doesn't interfere with any of the scope's other triggering abilities, and the instrument can be restored easily to



**1. Modified.** Optic trigger input in standard oscilloscope achieves high isolation in an electromagnetic environment.

the conventional external triggering when desired.

The modification consists mainly of substituting a fiber-optic cable for the conventional coaxial cable and terminating it at a photodiode inside the scope. This provides a light-activated, electrically isolated trigger. In addition to an easily constructed assembly to hold the photodiode and provide a receptacle for the fiber-

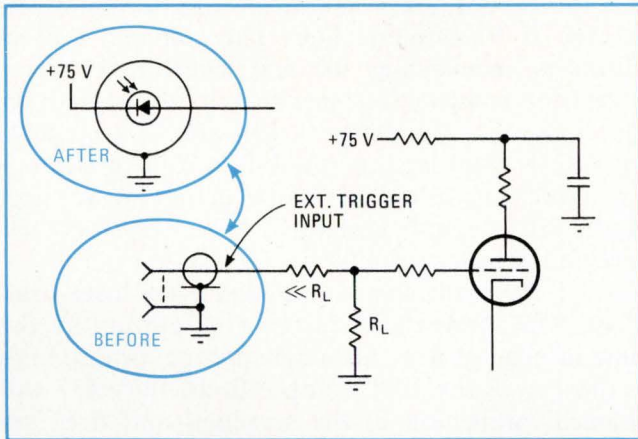

**2. Small change.** A single photodiode is the only electrical component to convert an external trigger input to an optical trigger.

optic cable, a couple of minor wiring changes are all the modifications that are necessary in the instrument. No external components or voltages are required, since both bias voltage and load resistor  $R_L$  for the photodiode are available inside the oscilloscope. Either p-i-n silicon or Schottky barrier-type photodetectors can be used, depending on the supply voltages available in the oscilloscope (this determines the junction capacitance,  $C_j$  of the diode) and the load resistance ( $R_L$ ) of the trigger input of the scope.

The  $R_L C_j$  combination determines the rise time of the trigger signal, however the full amplitude of this signal isn't needed for proper triggering.  $R_L$  is fixed by scope design; it can vary from as low as 50 ohms to about 1 megohm.  $C_j$  is a diode parameter that depends on bias voltage.

Optical external trigger conversion was tried and tested at Harry Diamond Laboratories, using a Motorola MRD-500 photodiode mounted in a Tektronix scope with a 1-megohm trigger input impedance. This combination produces a trigger response time of about 10 nanoseconds. The diode assembly and fiber-optic receptacle is fabricated from a bulkhead BNC connector, type UG-657/U (see drawing). Each end of the connector is cut off to remove the conventional bayonet cou-

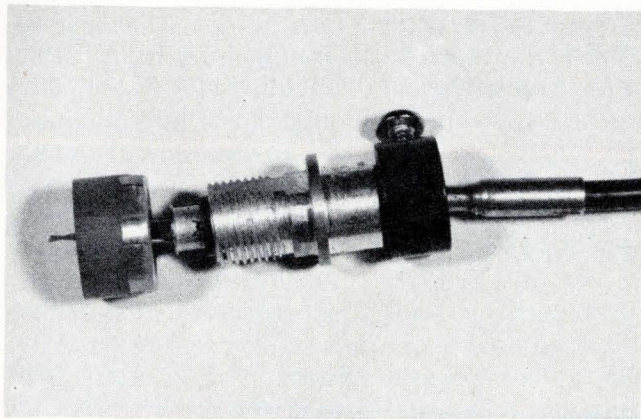
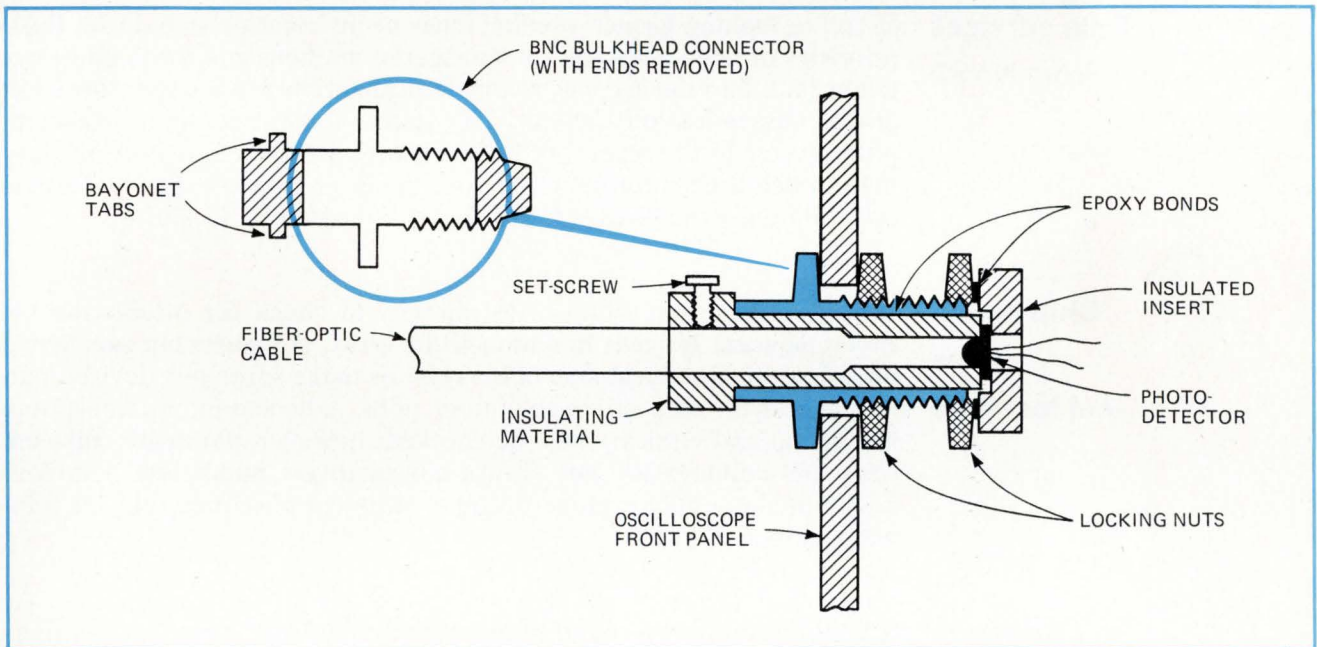

**3. New fixture.** A modified bulkhead-type BNC connector (UG-657/U) provides the foundation for an easily constructed assembly, which serves as a diode mount and optic cable receptacle.

pling mechanism and to allow removal of the coaxial inner conductor and dielectric.

A nonmetallic insert is then placed inside the connector shell and secured with epoxy. A hole is drilled and tapped in the insert and a set-screw clamps the fiber-optic cable in place. The photodiode is secured at the opposite end of the insert by a locknut, backed by insulating material.

Engineer's Notebook is a regular feature in Electronics. We invite readers to submit original design, applications, and measurement ideas. We'll pay \$50 for each item published.

## **Composition makes thick-film resistors that remain stable**

If your thick-film resistors are plagued by drifting after laser trimming, you may want to talk with duPont next week at the International Microelectronics Symposium in Washington, D.C. **The company's Electronic Products division is introducing its first controlled microstructured thick-film resistor composition specifically formulated for laser trimming.** DuPont is claiming a maximum drift of 0.5% or less after trimming for its new Birox 1400 series of thick-film resistor compositions, said to remain stable, regardless of resistor geometry or sheet resistivity. Noise from the fired resistors is claimed to be 6 to 8 decibels lower than duPont's previous resistor systems.

As a companion product, **duPont is also introducing a new laser-trimable glass encapsulant, 9137, formulated for ease of cutting by the popular YAG laser now in general use.** Although no encapsulation is necessary to stabilize the new Birox 1400 compositions, the 9137 will give additional mechanical protection to the screened and fired resistor.

## **Data services from NASA**

If you're looking for new-product ideas or information to help set R&D priorities or need a few tips on managerial methods and techniques, you might look into the services available through the **NASA-sponsored Regional Dissemination Centers.** The staffs of these centers have computer access to the several thousand NASA R&D documents, and can help match their information to your needs at low cost. For additional information, write NASA, Code KT, Washington, D.C., 20546.

## **Chip layout maps cut test time**

When you're establishing a test pattern to check for interaction between adjacent bit cells in a monolithic array, **get your chip supplier to furnish a topographical map of his chip,** or make sure your devised pattern checks for all possible cell interactions. Adjacent interactions, both horizontal and vertical, must be checked; however, **physically adjacent rows and columns are not always consecutively numbered.** Semiconductor makers may arrange decoder outputs nonsequentially to minimize chip size.

## **Addenda**

If you're involved in rf and microwave design work, you may be interested in a highly practical text that deals with capacitor influence on circuit design and includes other germane topics, as well. "The Capacitor Handbook," which sells for \$4.95, packs in much information that just won't be found in textbooks. The handbook discusses rf characteristics of capacitors, and includes actual test data, charts and equations for rapid circuit design, application notes, and an extensive rf circuit-design bibliography. Write American Technical Ceramics, 1 Norden Lane, Huntington Station, N.Y. 11746. . . . Motorola claims that its easy-to-read, informative booklet, "Everything You Always Wanted to Know About McMOS and MECL 10,000 (But Were Afraid to Ask)," gives startling frank answers to questions about subjects and situations too often distorted in backroom whispers, and more often buried in obscure texts. Write Motorola Technical Information Center, 5005 McDowell Rd., P.O. Box 20912, Phoenix, Ariz. 85036.

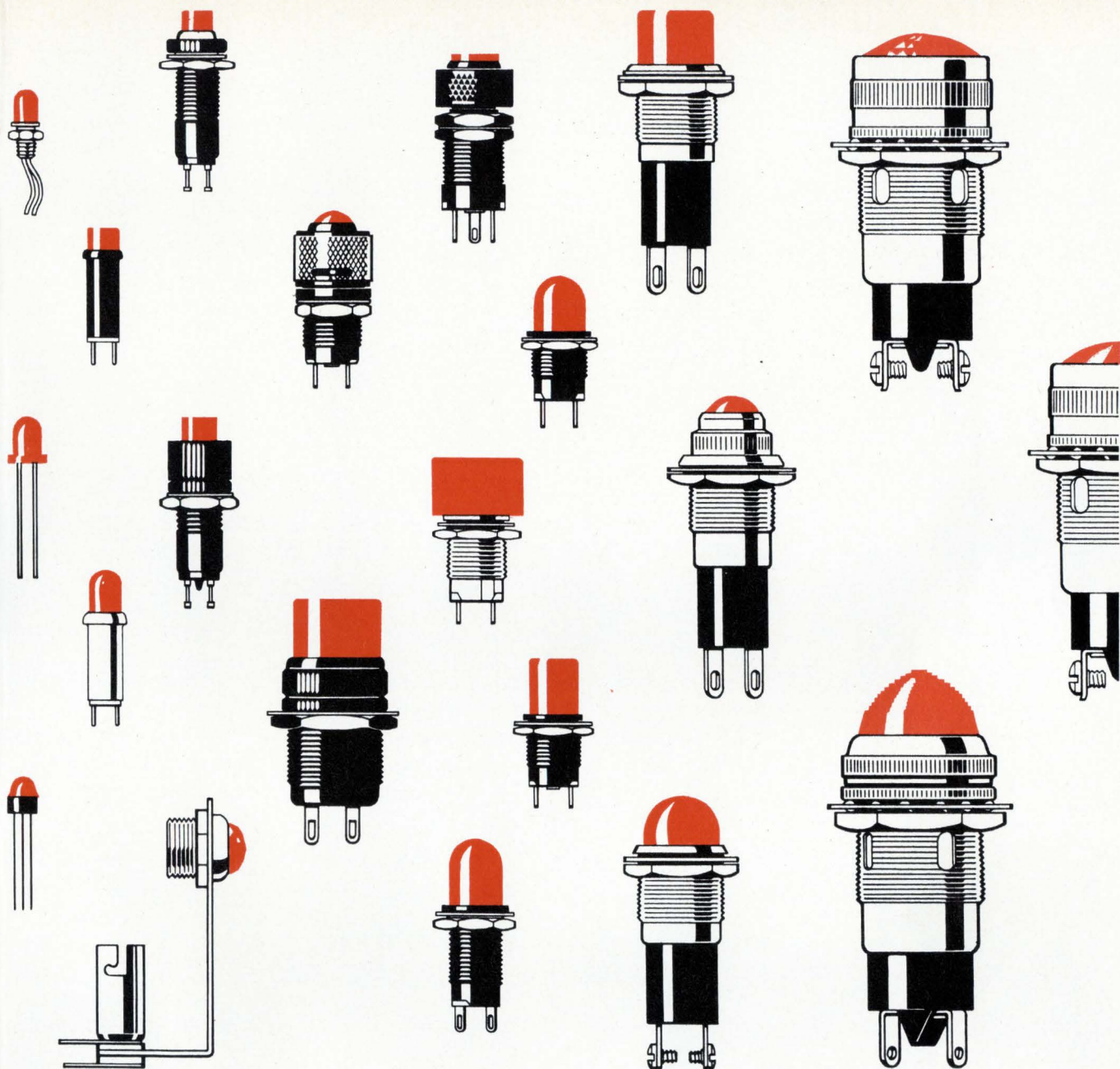

## 1,500,000 Indicator lights?

**Talk to the specialists at Dialight first.  
You won't have to talk to anyone else.**

Permutations on the indicator lights shown here (and others not shown) give you 1,500,000 different ones to choose from. This is no mere mathematical exercise. Thousands are available from stock; any other can be quickly made up for you. Just specify the size, shape, color and type of illumination (incandescent, LED, neon) you want. If you need a specialty—oil-tight,

flashing, MIL spec . . . whatever—order it. You'll get what you asked for. Promptly. Because we and our distributors stock more varieties of indicator lights than anyone else. Our Selector Guide shows you how to find your way quickly to the indicator light you need. Send for your free copy and see how easy it is to find the one best suited to your needs.

**DIALIGHT** DIALCO

DIALIGHT CORPORATION, A NORTH AMERICAN PHILIPS COMPANY • 60 STEWART AVENUE, BROOKLYN, N.Y. 11237 • (212) 497-7600

# GRAPHIC 15

## Find out if you're going

Press the button on your Graphic-15 and you'll have the answer. Fast. Without weeks of tedious work.

Actually, there's just as much work. The difference is that the computer does most of it. Your designer concentrates on designing.

And as soon as he's finished designing, Graphic-15 can help him lay

out the circuit. By putting each and every element where it'll work best.

And when that's finished and checked, Graphic-15 can put out tapes for artwork and numerical control.

All of which can't help but save you all sorts of time. Energy. And money. Whether you're designing IC chips,

PC boards or thick film devices.

Graphic-15 does it all.

But you won't have to become a computer expert. Graphic-15 puts you on line right away, thanks to a complete software application package.

It also offers a computer powerful enough to run a number of scopes simultaneously. A choice of 17" scopes or 21" scopes. Light pens. Writing tablets.

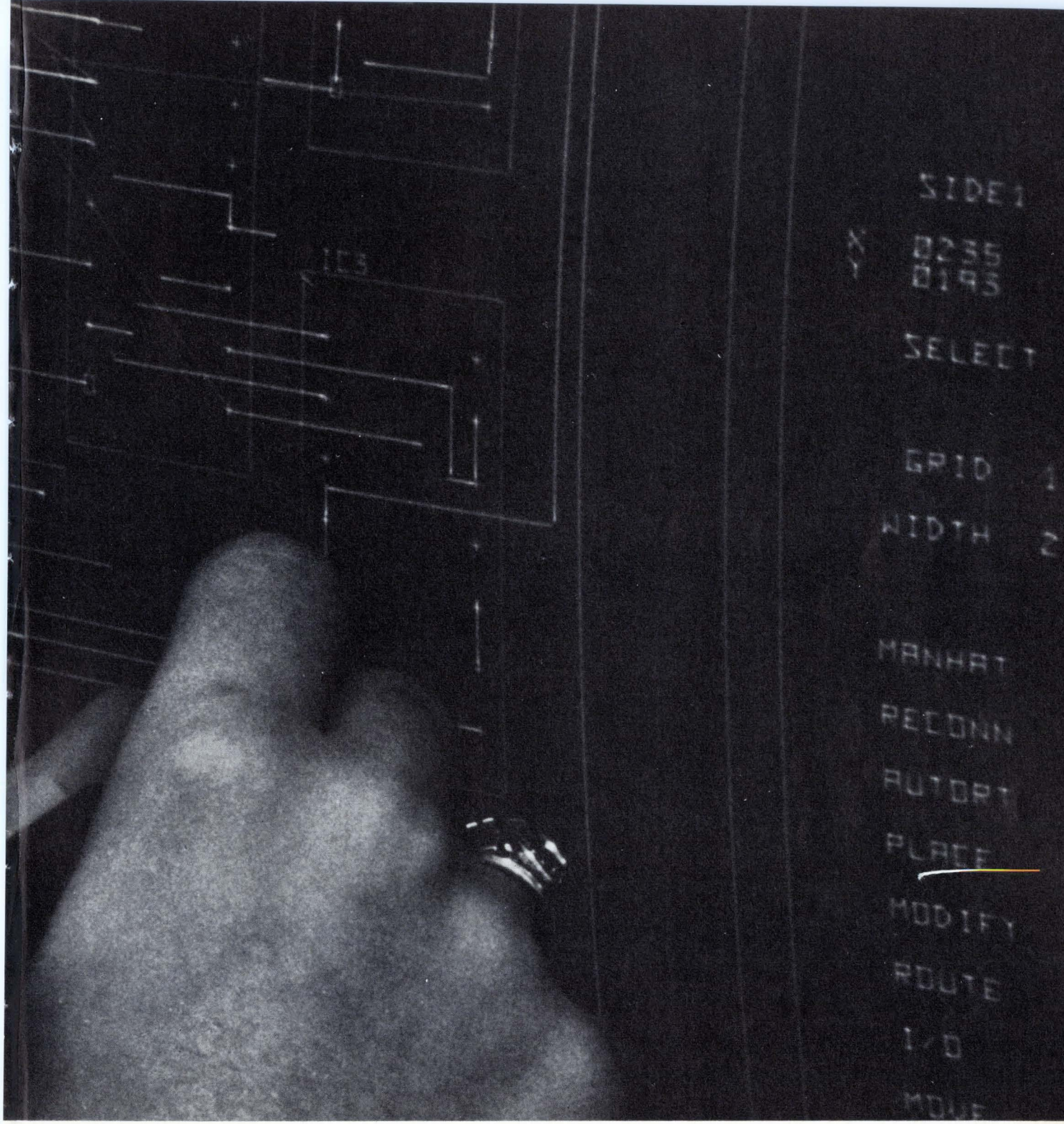

# to blow it in 5 seconds.

Operating system software. Graphic software. The works. Graphic-15 does it all there, too.

And when you're not designing circuits, Graphic-15 won't just sit there. You can use its PDP-15 computer for all kinds of computing jobs. If you want to do some programming, you can use

friendly, easy-to-learn FORTRAN IV.

Not long ago, computer-based graphic systems cost a couple hundred thousand. But that was before Graphic-15. Now prices start at under \$63,000.

Which may help to explain why we've quickly become the most experienced supplier of interactive graphic systems in the world.

Graphic-15 does it all.

Write for the information, Graphic-15 Group, Digital Equipment Corporation, 146 Main St., Maynard, Mass. 01754. (617) 897-5111. European headquarters: 81 route de l'Aire, 1211 Geneva 26. Tel.: 42 79 50.

**digital**

Circle 133 on reader service card

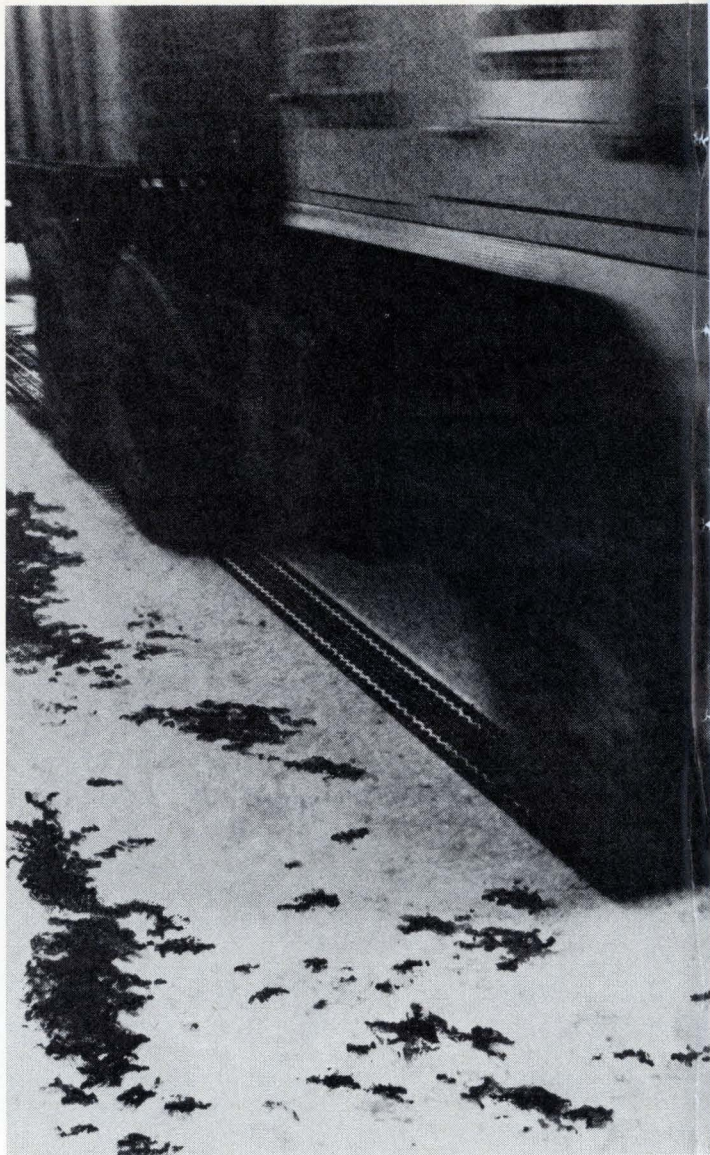
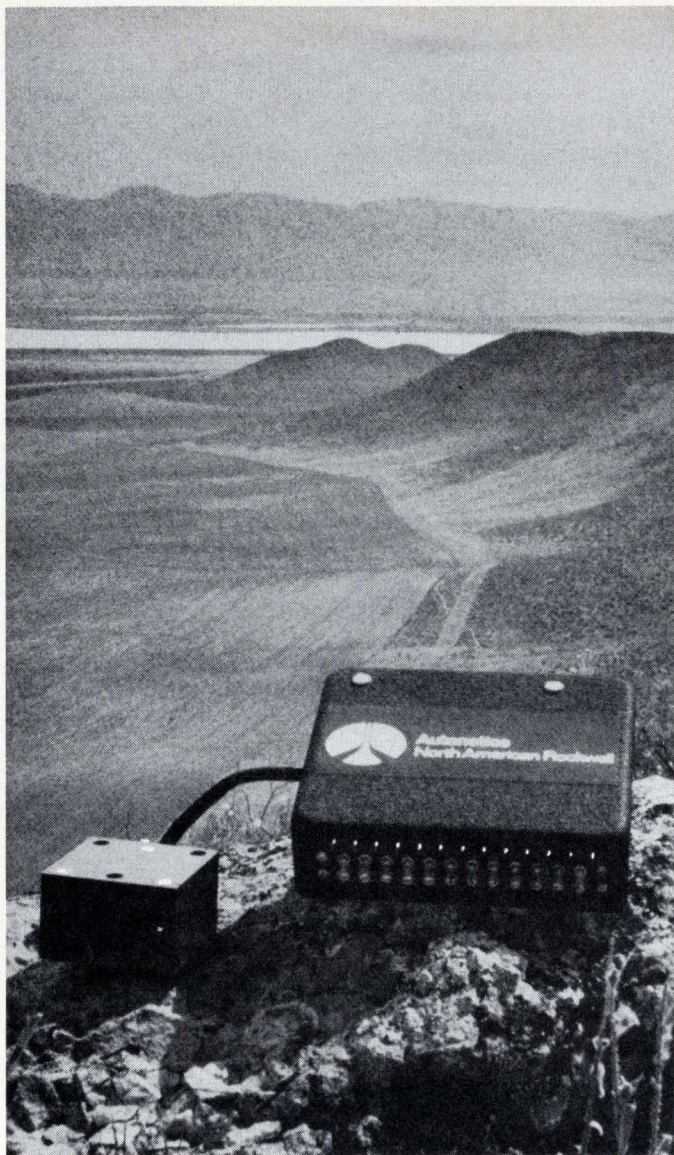

## Reads earthquakes.

Read on. Start with that little black box up there in the California coastal mountain range. It's our first environmental quality sensor—a tiltmeter. A unique electronic sensor installed by the California Division of Mines and Geology in a new state program aimed at earthquake prediction. Its major advantages, besides great

sensitivity, are small size and low cost.

A different kind of electronic measurement is employed in Skid-Trol®—our automatic braking system for trucks and trailers. It's a computerized control that reads and reacts to road conditions to help big rigs stop safely without jack-knifing. Even on wet and

## Reads road conditions.

icy pavements.

And shown at the right is the new home-use calculator that we're producing to customer specifications for the consumer market. Designed to sell in the \$100 price range, it figures the family budget and fits it, too. In addition to microelectronic circuitry, the calculator has big half-inch-high liquid



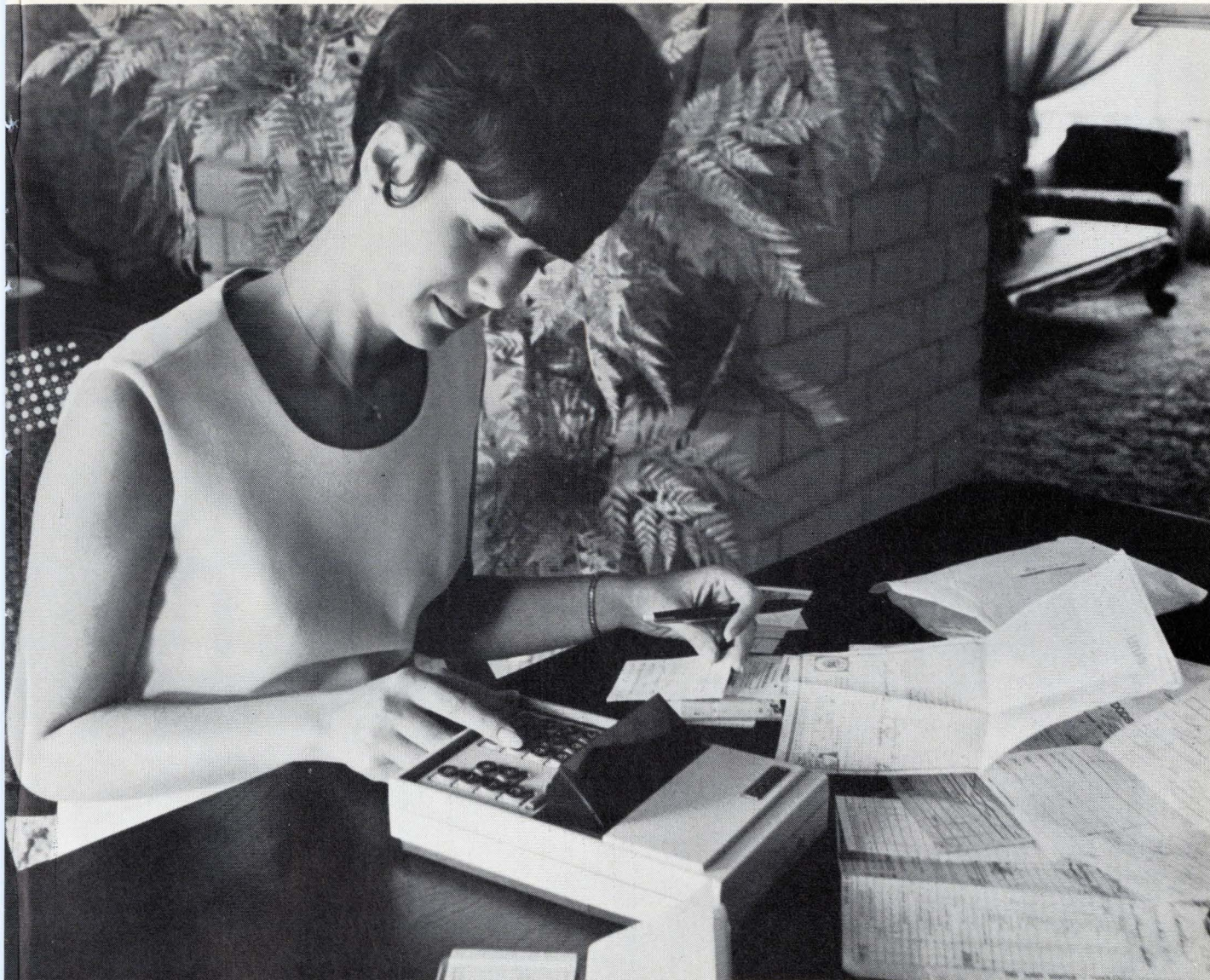

## Reads family finances.

crystal displays for showing entries and answers. It does everything a calculator should do—adds, subtracts, multiplies, divides. In any mixed sequence instantly.

There are many more examples of what we're doing in advanced electronics—enough to amount to a half-billion-dollar annual business in everything from home

calculators to Minuteman guidance systems and inertial navigation systems for the Polaris/Poseidon submarines. We'd like to tell you about them. And show you how we can apply electronics technology to your products.

When it comes to sensing, processing, storing, displaying or transmitting data, nobody knows electronics like North American Rockwell. We'd like to prove it. Write us in Anaheim, Cal. 92803. Or phone 714/632-4195.



**North American Rockwell  
Electronics Group**



We're the power  
semiconductor  
specialists.

# Good for us.

SCRs ■ SILICON RECTIFIERS ■ ZENER DIODES ■ SEMICONDUCTOR FUSES  
POWER CIRCUITS / ASSEMBLIES ■ OPTOELECTRONICS ■ HEAT EXCHANGERS

# Better for you.

That's right, better for you. And for more reasons than one.

When a company has specialized for 25 years in rectifiers and thyristors, it can come up with better new products to answer almost any design requirement.

**New products. Better design alternatives.** One good example is our Schottky Power Rectifier, which makes great increases in power conversion efficiency. Another is the PACE/pak™ molded assembled circuits, which reduce costs many ways.

Now, we are far along in the development of some exciting new products. Like new series of faster recovery rectifiers, low-cost, high performance SCRs, and high-frequency SCRs, including what we believe is the best 125 Amp device ever built.

But the present and future products are just one of the reasons you'll do better with IR.

**100% testing. Quality assurance programs.** Since rectifiers and thyristors are our only business, we've grown by solving problems for our customers. Our products have to be tops. Our service has to be exceptional. We can't afford anything less, because you can't.

That's why we maintain a highly effective QC program, and do extensive testing... still 100% on both high and low power devices. Some companies may have abandoned this practice in the face of today's high costs. But for us, abandonment is too high a price to pay.

**25 years of applications know-how.** We also know it takes more than a good data sheet to help equipment designers arrive at the best circuit design with the best device. That's why we've continued to expand our Applications Engineering group.

When you need an applications

engineer with a strong background in your product field, that's what we send.

**Leadership. International strength.** When you consider a source, it is always good to know its standing in the field. And in the field of power semiconductors, IR builds and sells more devices world-wide than any other company.

However, as good as specialization has been for us, it can be even better for you.

If our better design alternatives improve your product, you win new customers.

If we can help you lower costs, your profit grows.

And if we provide higher reliability, it helps you keep your customers.

We've done these things for other companies. We'd like to do the same for you. Write International Rectifier, 233 Kansas Street, El Segundo, CA, 90245.

# International Rectifier

...the innovative power people





## An accurate data recorder doesn't have to weigh you down.

The 417 is accurate enough to be used in the new advanced infrared systems. And light enough to go up in a small plane. (It weighs 28 pounds and measures 17" x 15" x 7".)

Consequently, the 417 is helping some concerned companies take a good long look at the earth.

From the air, infrared monitoring reveals such things as blighted crops, leaks in pipelines, volcanic activity and thermal water pollution.

Information from the infrared scanner is stored in our 417. Back on the ground, the infrared pictures are played through a color TV screen, which can be broken



down into as many as 36 color slices. A pipeline leak, for instance, would be indicated by the slightest color change. That's why the data recorder can't miss a single detail.

Whether it's infrared, shipboard noise reduction, seismic measurement, or plain torture testing of a

product in a rugged environment, the 417 brings accuracy and durable portability to the job.

Even the Japanese are impressed with our 417. They're importing it, because they haven't been able to match its accuracy and portability.

If you need a data recorder that makes every ounce count and operates on its own power, write Earl Nadeau, Dept. 413-103, Lockheed Electronics Company, Plainfield, New Jersey 07061. Or call him collect at (201) 757-1600.

Our European representatives: Aveley Electric, Essex; PTK, Cologne; Technitron, Rome.

**Lockheed Electronics**

A Subsidiary of Lockheed Aircraft Corporation

## New products

# 25 cable pairs terminated in a stroke

Solderless connector uses slotted-beam technique;  
hand tool permits wiring of device in the field in five minutes

by Stephen E. Grossman, Packaging & Production Editor

**Connector technology** has evolved from screw-type terminals through soldered, crimped, and wrapped versions—and now has arrived at a slotted-beam technique developed by AMP Inc.

Using the new connector, called the Champ, and a hand-operated tool, a field installer can terminate a 25-pair cable—the type that is commonly used in communications systems—in less than five minutes.

The Champ is interchangeable and mates with solder-type 50-pin connectors now widely used in the telephone industry. In addition to telephone work, the new connector is expected to be applied in telemetry, computer terminals, other data-processing peripherals, “and wherever multiple-pair connections are required,” says Jack Bowen, marketing manager for communications.

Wiring changes can be made in the field with a one-wire-at-a-time tool or with one that simultaneously terminates and cuts to length all 50 wires. A semiautomatic power tool is available for production use.

The wire-termination portion of each contact resembles an inverted U. A tapered slot with precisely controlled dimensions and sharp edges is cut into each leg (or beam) of the U. The termination tool forces the unstripped wire into the two legs of the U, and as the wire moves into the tapered slot, the insulation is pierced and the wire is extruded, thus removing any surface contaminants and at the same time estab-

lishing a stable electrical contact. The spring energy developed during the thrust of the wire into the slot ensures that this intimate contact is maintained. The contact's rear slot is wider than the front one and thus extrudes the conductor to a lesser degree. This rear slot also serves as a strain relief.

The all-plastic low-profile connector is molded from an SE-1 rated thermoplastic and can be furnished with or without an integral 90° cover and strain-relief made of the same material. Without the cover,

the connector is suited to panel mounting. Located on 0.085-inch centers, the replaceable, pre-loaded contacts are gold-over-nickel-plated, high-conductivity beryllium copper with the special dual-slot termination. An additional advantage is seen in the fact that the contacts provide an effective “scrubbing” action upon engagement.

AMP plans to market additional versions of the Champ connector—including 34-pin and 64-pin types—during the first quarter of 1973.

AMP Inc., Harrisburg, Pa. 17105 [338]

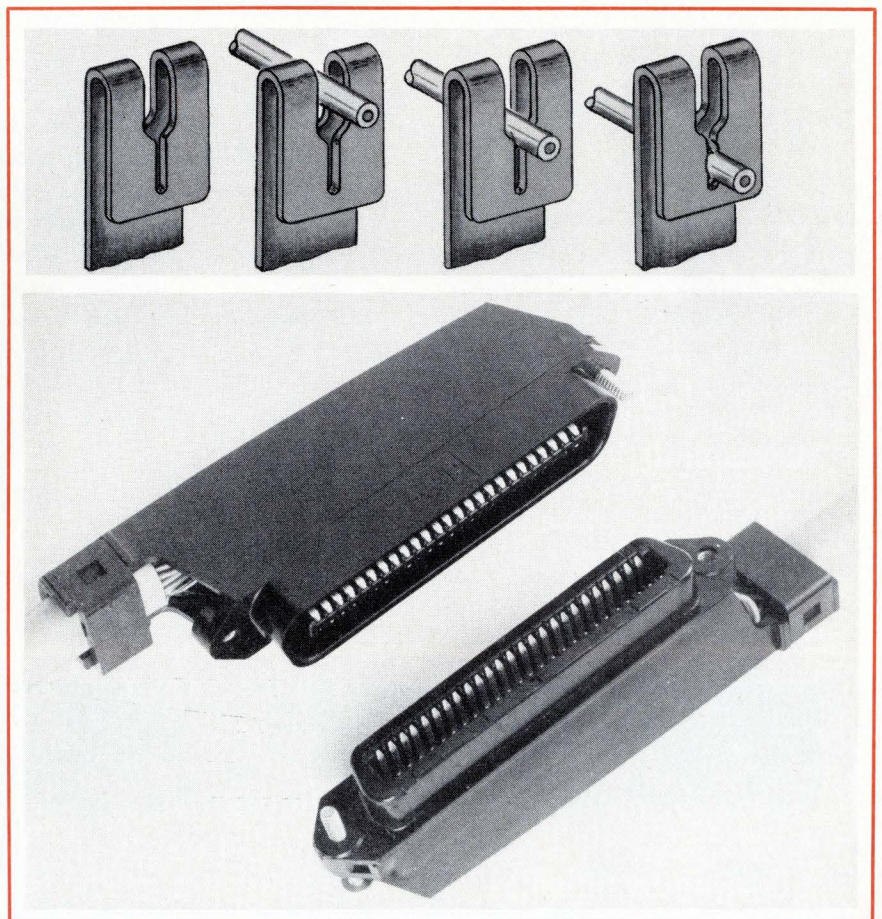

**Solderless.** Wire-receptacle portion of contact, top, has slotted-beam construction, permitting fast termination of wires in multiple-pair cable connectors.

# Another Exclusive From HP— Self Test!

Examine HP's new low-cost multimeter 3490A. It's a full 5-digit instrument that's priced \$300 less than two other major manufacturer's units—yet its low price includes Self Test.

Self Test is the built-in bonus you get because the circuits within the 3490A perform double-duty. Design scrutiny coupled with unique signal routing let us include Self Test without adding more circuits, and without raising the price.

**Always Ready**—Need to use your DMM? Simply flip the switch and Self Test tells you that 3490A is ready to perform. With a 3490A, you'll never be in doubt concerning your DMM's readiness.

**Programmable**—For systems work, 3490A's Self Test is remotely programmable, which lets your computer determine its operational capability *before* you start to measure data. You'll have assurance that your DMM is ready to tackle its assigned tasks.

**Cuts Equipment Costs**—Because calibration is aided by Self Test, the time needed to calibrate your 3490A is trimmed significantly, while the need for costly calibration equipment is reduced. And, if problems ever should occur in your 3490A, Self Test will assist your technician in isolating the fault.

Price for the 3490A is just \$1650 which includes AC, DC, Ohms, and Self Test functions. (Systems features—isolated BCD output and isolated remote control are low-cost options.) For further information on the 3490A, contact your local HP field engineer, or write Hewlett-Packard, Palo Alto, California 94304. In Europe: 1217 Meyrin-Geneva, Switzerland.

HEWLETT  PACKARD

AO92/3

DIGITAL MULTIMETERS



# Recorder packs 33,000 bits per inch

High-density instrument-type system uses pulse-code modulation; applications seen in satellite, geophysical, other high-volume links

by Paul Franson, Los Angeles bureau manager

**Use of digital techniques**, a significant trend away from the traditionally analog method of tape recording, has reached a dramatic milestone. Bell & Howell has developed an electronic system that provides 33,000 bits of data per inch on each track.

The high-density technique, provided for B&H VR-3700B recorders, means packing more data on tape than has ever been possible before, says Ed Hotchkin, Datatape product manager at the company's Instruments division. Pulse-code modulation provides the 33,000 bits per inch, with only one error in  $10^7$  bits. It is Bell & Howell's first PCM system for instrumentation recorders, which previously have used fm and direct recording. The density is applicable at any recorder speed up to the maximum of 120 inches per second.

The high-density system is expected to be used first in military systems, but project engineer Jon B. Wells foresees the likelihood of data processing applications as well: "One 15-inch reel of tape recorded at the highest density on 28 tracks, can replace 289 standard 10-in. reels of IBM-compatible tape at its standard density of 800 bits per inch." Wells says this is especially important for such applications as geophysical exploration, where storage and delivery of tapes is a problem because of the vast quantities of data that must be recorded at remote locations.

In this application, PCM has the advantage that it can provide the high-frequency response of direct recording (to 4 megabits per second or 2 megahertz), with the wide dynamic range of fm (50 to 60 decibels). In contrast, direct recording

provides only about 20 dB. The company has a number of PCM techniques, including any IRIG telemetry code format or delay modulation. Bell & Howell also offers a proprietary enhanced nonreturn-to-zero (NRZ) that includes error-checking capability.

Actual nonenhanced density can be as high as 40,000 b/in., but the technique adds a parity bit for every seven, reducing input-data density by one-eighth. Error checking, though common in digital applications, is not generally used in instrumentation recording, since it traditionally uses analog techniques. In addition to error checking, the B&H scheme assures that the recording will not maintain the same polarity for a long period, which would require the use of expensive dc recording amplifiers.

Since the clock data is synthesized by the electronics, all recorder tracks are available for data—14 or 28 are now offered, with 42 possible in the future. The bit synchronizer offers automatic switching for four tape speeds.

Bell & Howell now supplies the recorders, but expects to get into systems for such applications as compacting data and security. The recorders are not directly applicable to present digital uses, since they run at constant speeds rather than in the start and stop mode of computer peripherals.

For data rates above 4 megabits per second, Bell and Howell is developing a

data-stream splitting system so that no more than 4 Mb/s would be applied to any one track. One application would be in recording high-speed data from satellites. NASA is considering rates of 80 Mb/s, for example, which could be recorded in parallel on the 28 tracks. B&H is also considering possible use of double-bandwidth recording heads that permit 2-MHZ recording at 60 in. per second, instead of the usual 120 in./s.

For a basic 14-track recorder, prices will be in the \$20,000 range. The electronics alone are also available for retrofitting into existing VR-3700B recorders.

Bell & Howell, CEC Instruments Division, 360 Sierra Madre Villa, Pasadena, Calif. 91109 [339]

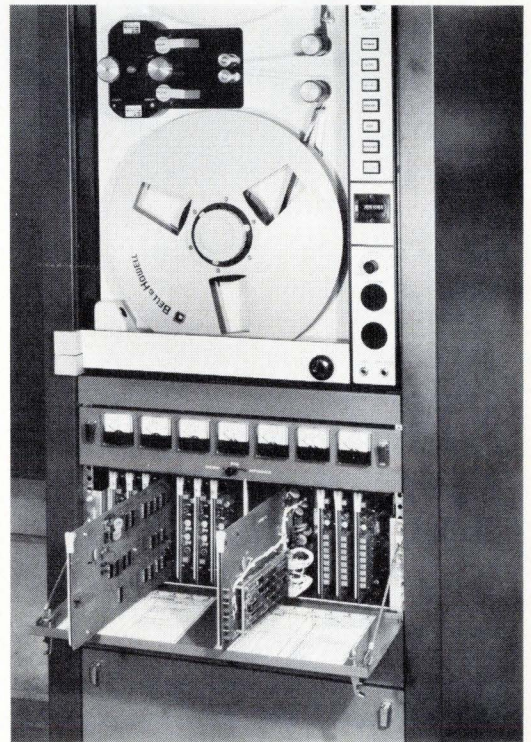

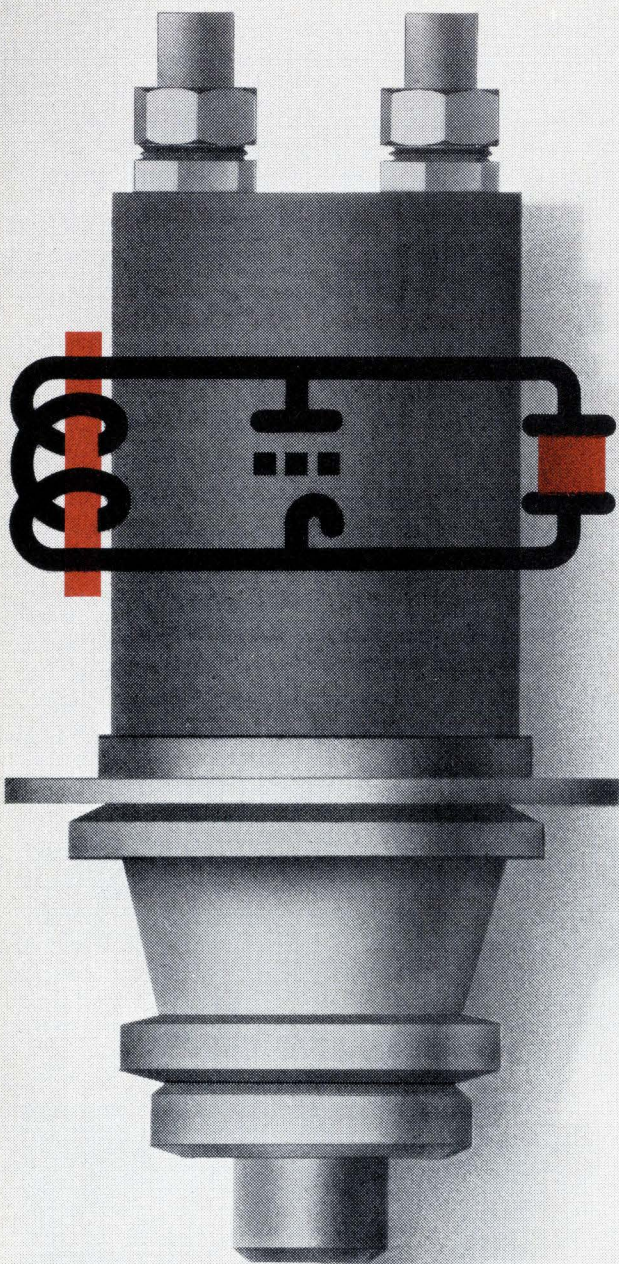

# A SHORT GUIDE TO R.F. HEATING TUBES

Tubes designed for broadcast transmitting don't work well when used for inductive or capacitive heating applications.

The environment is industrial, regulation is poor and loads are not matched, which means that grids get overheated.

Philips therefore developed a special range of tubes for this specialised market. The big difference is the Philips "K-material" grid that can withstand a continuous load of 25W/cm<sup>2</sup>. Moreover this is combined with a thermionic emission of about 1 $\mu$ A/cm<sup>2</sup> which remains stable over the total tube-life, even when complicated by the presence of thorium deposit evaporated from the cathode. Having developed a better tube, Philips then went on to develop a better range. It's comprehensive, going from 2.5 kW up to 480 kW. In addition the maximum frequency for most tubes is 100 MHz with full input power capability.

That's the short guide.

## THE LONG GUIDE

The long guide runs to 182 pages. It's the definitive handbook on the subject and combines all our 25 years of r.f. heating experience. It's full of quantitative and qualitative data and we'd like you to have it, provided you're seriously interested in the subject. To receive a copy please write on your company letterhead.

Philips Industries, Electronic Components and Materials Division, Eindhoven - The Netherlands

Distributed and sold in the U.S.A. by:  
Amperex Electronic Corporation  
230 Duffy Avenue, Hicksville N.Y. 11802

In Canada: Philips Electron Devices, a Division of Philips Electronics Industries Ltd., 116 Vanderhoof Avenue, Toronto - Ontario

Anode output power (kW)	Frequency (MHz)
2.5	160
4.0	160
7.5	150
15	120
30	100
45*	30
60	100
90*	30
120	100
240	100
480	30

\* High voltage types.



Electronic Components and Materials

# PHILIPS



## New products

### Subassemblies

# Modules save computer power

First two in series of translators convert binary to scaled BCD angle

It's a simple problem to convert a binary code representing an angle—of shaft rotation, for example—to binary-coded decimal for computer processing. But leaving the conversion up to the computer uses up processor and memory time, as well as memory space, and it increases the cost and size of the program. Furthermore, the computer must stop and do the conversion before it can get down to its real job. This isn't necessary with a new family of equipment, called digital translators, being marketed by Interface Engineering Inc., Stoughton, Mass. Most of the translators are industrial adaptations of military units.

First to be offered are the DD-107-4 and -5, which translate binary angle to scaled BCD angle. Among units planned for the near future are the DD-108-A and -B, which translate binary angle to binary sine; and the DD-109-A and -B, which convert binary angle to sine and cosine with 12- or 15-bit resolution.

"The idea behind this product family is not to replace computers," says Thomas J. Scanlon, sales manager. "Rather, the translators would permit use of less powerful, less costly processors requiring less memory and programming than heretofore possible in certain applications." The translators perform time-consuming repetitive operations, somewhat like microprogrammed outboard processors, and they are said to be faster than computers in many instances.

The firm's first commercial translator, the DD-107, is a 3- × 4-inch encapsulated module that permits direct communications between pure-binary output devices and devices with BCD inputs. Applications

include numeric industrial readouts, signal data-conversion systems, and test systems. For example, the DD-107 could adapt binary rotary-shaft-position encoders to BCD data-logging applications, as well as to control systems using BCD commands—the system can be made to translate in reverse by outboarding counter and comparator electronics.

The DD-107-5, a parallel ripple-through translator, accepts 15-bit binary words, permitting resolution of 0.01° in angle-translation applications and consequent full-scale readings of up to 359.99°. Its output is five-digit, 18-line BCD. Accuracy is to within ±0.015°. Performance of the DD-107-4 is similar, but resolution is 0.1°, accuracy is to within ±0.055°, and output is 14-line, four-digit BCD. The DD-107-5 is priced at \$190, the DD-107-4 at \$160.

Interface Engineering Inc., 386 Lindelof Ave., Stoughton, Mass. 02072 [381]

### Industrial logic module is photo-isolated

A power and signal isolator in the NJ series of logic modules for process control and monitoring applications is priced at \$150. The model NJ19 contains four digital power isolators to provide +4 or +5 volts that can be used as reference or regulated power. Additionally, four circuits on the module isolate digital inputs from outputs. The modules provide high noise rejection and up to 1,500 volts of ground isolation.

Xerox Corp., 701 S. Aviation Blvd., El Segundo, Calif. [384]

### Dc-to-dc converters have low profile

More than 100 types and configurations of dc-to-dc converters are available in a line that provides high isolation in powering signal-conditioning components, integrated-circuit logic, and medical preamplifiers. One type, the PS-2467, can simultaneously power nine operational amplifiers of the

741 type, fully loaded. Seated height of this and other models is 0.375 inch, permitting them to be mounted on racks where card spacing is only 0.5 in. Off-the-shelf models are available with input voltages of 5, 12, or 28 volts, dual output voltages of ±8, ±12, or ±15 v, and current ratings from ±30 to ±150 milliamperes. The 2467, which operates from a 5-v supply and puts out ±15 v at 30 mA, is priced at \$39 for one to nine.

Stevens-Arnold Inc., 7 Elkins St., South Boston, Mass. 02127 [383]

### Crystal oscillator ages at 5 parts in 10<sup>10</sup> per day

A miniature quartz oscillator warms up quickly; the crystal reaches stable frequency to within less than

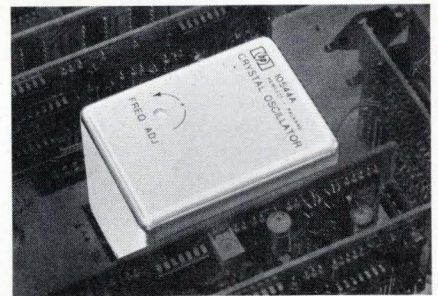

5 parts in 10<sup>9</sup> after 15 minutes. The unit ages at only 5 parts in 10<sup>10</sup> per day, which is less than 5/100 of a second in one year. Phase noise of one model is down 145 dB. The board-mounting units are 2.75 by 2 by 2.4 inches. Applications are in instruments, communications, and navigation equipment. The model 10543A is a 5-MHz oscillator, and the 10544A is a 10-MHz unit. Prices are \$850 and \$450 respectively.

Hewlett-Packard Co., 1501 Page Mill Rd., Palo Alto, Calif. 94304 [388]

### Voltage reference offers input range of 15–25 V

A voltage reference for use in conjunction with analog-to-digital converters and dc comparators offers an input voltage range of 15 to 25 vdc. It is preadjusted to an initial output voltage of 10 vdc ±0.01%. The

# Intronics' line is multiplying

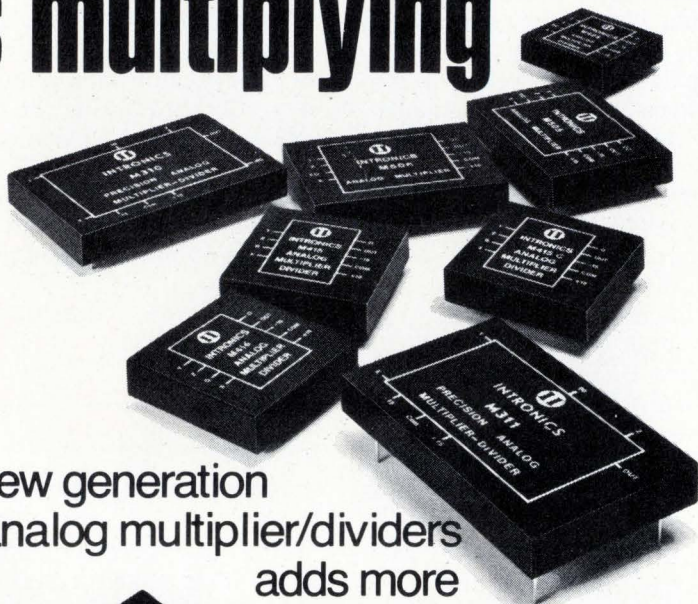

A new generation of analog multiplier/dividers adds more capabilities to meet your particular needs.



You can choose from a broad range of features. Outstanding accuracy, speed, temperature stability, bandwidth,

compact size, and economy. And all Intronics multiplier/dividers are four-quadrant devices capable of multiplication  $\frac{xy}{10}$ , division  $\frac{10z}{y}$ , squaring  $\frac{x^2}{10}$ , and square-rooting  $\sqrt{10z}$  by external pin connection only. All modules are internally trimmed to specified accuracy and have provision for optional external trimming for critical applications. There's one good reason to evaluate the capabilities of these second generation devices. Intronics has been the technological innovator from the introduction of the industry's first complete analog multiplier module to the latest line which offers accuracies to 0.05%, temperature coefficients as low as 0.005%/°C, and bandwidths to 5MHz. Obviously, it's not just another line. If you want to know more about us, contact:



## intronics

57 CHAPEL STREET, NEWTON, MASSACHUSETTS 02158 U.S.A.  
617-332-7350, TWX 710-335-6835

### New products

model A-803 is designed for applications where a precise voltage standard is required. The output stage of the module allows for current loads up to 2 milliamperes without degradation of accuracy or stability. Two versions of the reference are available: the model A-803

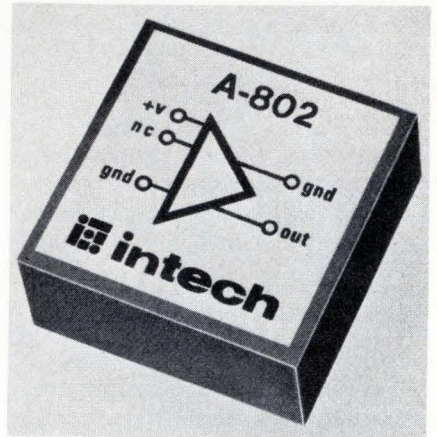

is specified to drift no more than 1.5 ppm/°C, and the A-802 no more than 3.5 ppm/°C over the entire temperature range. Price of the 803 is \$85, and of the 902, \$65.

Intech, 1220 Coleman Ave., Santa Clara, Calif. 95050 [385]

Transformer power supplies offer regulation to  $\pm 0.5\%$

The RT series of regulating transformer power supplies are designed for a range of applications, including process-control equipment, relay banks, computers, and assembly-line testing and communications equipment. The units are available in 250-, 500-, and 1,000-watt ranges, with output voltages from 5 to 48 vdc and currents up to 120 amperes. Also featured are regulation to  $\pm 0.5\%$  for combined line, load and

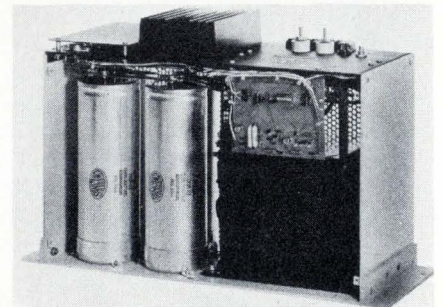

# YOUR IN-HOUSE POWER SUPPLY IS ON OUR SHELF

# 25 WAYS

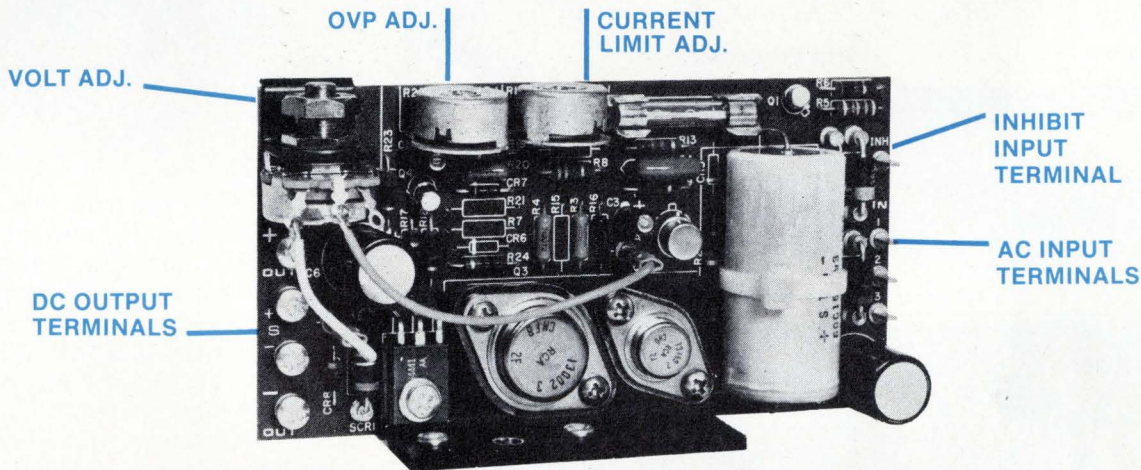

## NEW, UNIQUE LOW COST BUILDING BLOCKS WITH BUILT-IN RECTIFIER, FILTER, REGULATOR AND OVP.

25 models, 5 power packages, up to 30v, up to 18a. Direct electrical connection to a transformer and mounting to a heat sink completes a quality d.c. power supply that meets your specific needs at the lowest possible cost.

### OTHER EXCLUSIVE FEATURES:

- Regulation: Line/ Load  $\pm 0.075\%$
- Logic Inhibit Function
- Hermetic Transistors
- Remote Sensing
- Computer Grade Capacitors

No need to add external components.

**POWERTEC INC.** an Airtronics Subsidiary

9168 DeSoto Ave., Chatsworth, California 91311 • (213) 882-0004 • TWX (910) 494-2092

No bag of parts: Everything you need for In-House use is already built-in. **Write for new 8 page Sub-Modular Power Supply brochure with do-it-yourself specifier** for In-House applications.

## CUSTOM DESIGNS

Also these new standard sub-modules are ideally suited for custom designs at low costs and fast delivery.

Custom designs are standard practice at Powertec.

## SUB-MODULES OUTPUT RATING CHART AND PRICES.

MODEL	-100		-200		-300		-400		-500		PRICES*
	5V to 6V		8V to 10V		12V to 15V		18V to 20V		24V to 28V	100	
22A	1.0A	.875A	.725A	.625A	.575A	.500A	.475A	.450A	.425A	.400A	\$15.00
22B	3.0A	2.5A	2.2A	1.9A	1.7A	1.5A	1.4A	1.3A	1.2A	1.1A	18.00
22C	6.0A	5.2A	4.4A	3.8A	3.4A	3.0A	2.8A	2.6A	2.5A	2.3A	25.00
22D	12.0A	10.4A	8.8A	7.6A	6.8A	6.0A	5.6A	5.2A	5.0A	4.7A	35.00
22E	18.0A	15.6A	13.2A	11.4A	10.2A	9.0A	8.4A	7.8A	7.5A	7.1A	40.00

Typical ordering information for 5V, 1.0A, Model 22A-100; and 12V, 6.8A, Model 22D-300, etc.

\*Consult factory for prices at other quantities.

# POWERTEC

# Sleep With Us\*\*

\*\*When you place that order with us today you'll go to bed relaxed and confident your orders are in good hands. Quality and delivery when you need it most!

WE MAKE AND PLATE:  
**PINS—TERMINALS**  
**P.C. JACKS**  
**TEFLON\* INSULATED TERMINALS**  
**WIRE WRAPS**  
**SLOTTED—FEED THRU**  
**SOLDER TERMINALS**

Mil Specs Met.

Send For Catalog

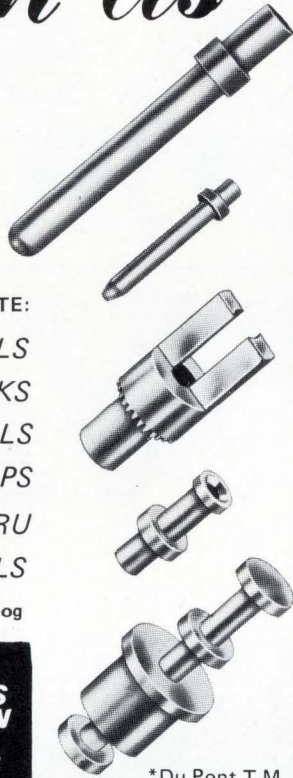

\*Du Pont T.M.

**CONCORD ELECTRONICS CORPORATION**

37 GREAT JONES STREET NEW YORK, N. Y. 10012  
 (212) 777-6571 TWX 710-581-4930

Circle 146 on reader service card

## Save Cost Enjoy Quality with TOKO INC.

Announcing a new cost saving plan on PCB assembly with transfermolded Dual-In-Line PULSE TRANSFORMERS and DELAY LINES by thick film approach.

Offering a wide range of custom-designed features which meet your requirements.

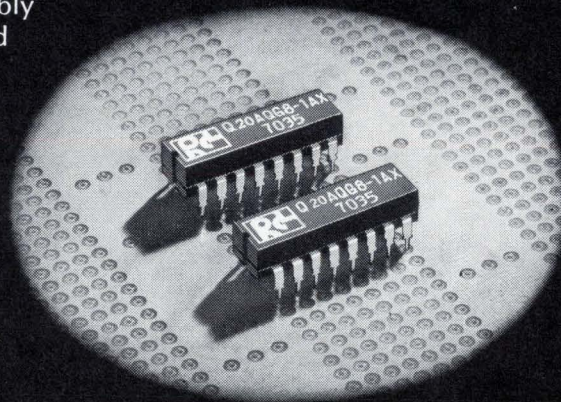

For further information, just call or write:



**TOKO, INC.**

Head Office: 1-17, 2-chome, Higashi Yukigaya, Ohta-ku, Tokyo, Japan  
 New York: ToKo New York, Inc.

350 Fifth Avenue, New York, N.Y. 10001 U.S.A. Tel: 565-3767

Los Angeles: ToKo, Inc. Los Angeles Liaison Office

1830 West Olympic Blvd., Los Angeles, 90006 Cal. U.S.A. Tel: 380-0417

Düsseldorf: ToKo Elektronik GmbH:

4 Düsseldorf, Lakronstrasse 77. W. Germany Tel: 0221-284211

## New products

frequency effects, and ripple at 1.0% or 150 mV rms. Price starts at \$150 in OEM quantities.

Technipower Inc., a Benrus Subsidiary, Benrus Center, Ridgefield, Conn. 06877 [389]

Sample-hold module settles to 0.01% in 1 microsecond

The model ZD452 sample-and-hold module settles to 0.01% in 1 microsecond. The FET-input buffer amplifier provides  $10^{11}$  ohms of input

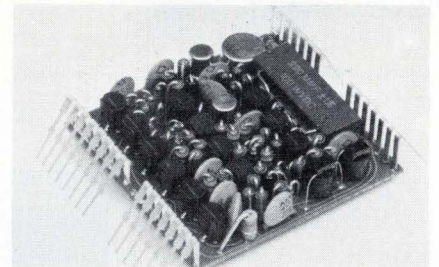

impedance and less than 50 picoamperes of input bias current. The analog inputs are fully differential, and gains may be selected by adding the appropriate input-feedback resistances. Also featured is a 40-V/ $\mu$ s slew rate and a 5-ns aperture time. The unit measures 1.96 by 1.76 by 0.4 inches. Price is \$149.

Zeltex Inc., a Subsidiary of Redcor Corp., 1000 Chalomar Rd., Concord, Calif. [387]

Instrumentation amplifiers have low input offset drifts

The models 4253 and 4253/01 are modular FET instrumentation amplifiers that feature guaranteed input offset drifts of  $2 \mu\text{V}/^\circ\text{C}$  and  $1 \mu\text{V}/^\circ\text{C}$  respectively. Typical applications include low-level instrumentation systems, high-resolution control loops, high-impedance differential voltmeters, and pressure transducers. The bootstrapped FET input circuit of the model 4253 provides a high input impedance to minimize source-loading errors, even from high source impedances. Price of the 4253 is \$67; and of the 4253/01, \$115.

Teledyne Philbrick, Allied Dr. at Rte. 128, Dedham, Mass. 02026 [390]

# GO AHEAD... DESIGN A 21ST CENTURY CALCULATOR SYSTEM

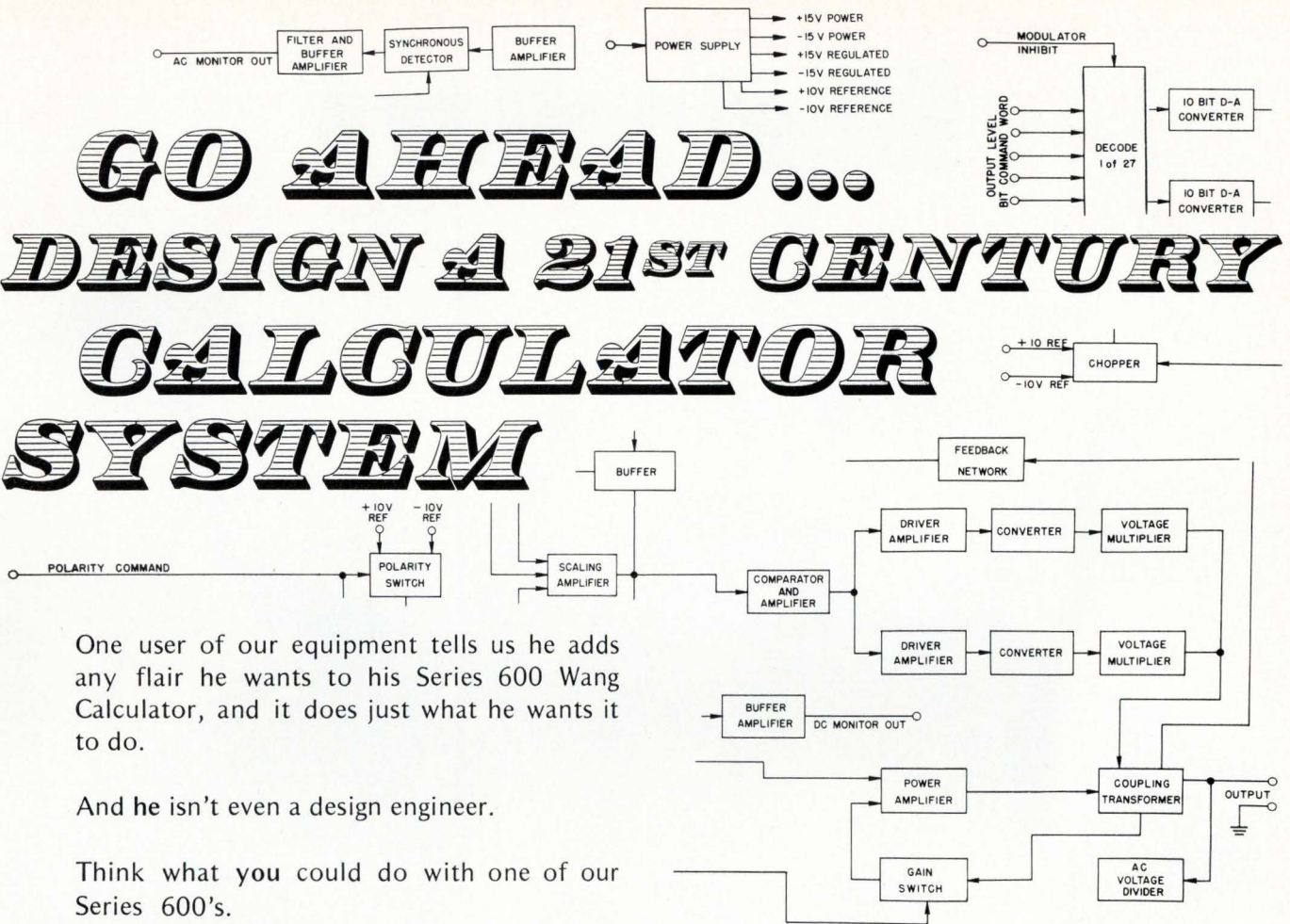

One user of our equipment tells us he adds any flair he wants to his Series 600 Wang Calculator, and it does just what he wants it to do.

And he isn't even a design engineer.

Think what you could do with one of our Series 600's.

If ever there was a do-it-yourself calculator system . . . this is it.

The Series 600 Wang Calculator.

Depending upon the capabilities you'd like to start with, you can choose the model to suit your needs . . . 55 storage registers or 312 program steps . . . 119 registers or 824 steps . . . 247 registers or 1,848 steps.

Add a Wang magnetic tape cassette, and you have up to 16,000 consecutive steps per side. Want more memory capacity? Add Wang Memory Extenders. Want formatted alphanumeric output in graph form? Add the Wang Plotter. Prefer an Analog Plotter which quietly and quickly provides a continuous line plot with alphabetic labeling? We have it. In fact, you can add an Output Writer, a Paper Tape Editor, a Card Reader or a Marked Sense Card Reader, or Microfacs to be hooked directly on-line to any piece of analytical equipment, or . . . you name it. With a Series

600 as your cornerstone, you can expand the system as requirements dictate.

You can program a 600's storage registers to perform special functions, without giving up storage capacity. You can perform every arithmetic function directly in each storage register. You can write or execute a program in algebra. You can add other hardwired functions in many fields. You can convert from radians to degrees and vice versa by pressing a single key. You can execute decisions, branching, looping, and subroutines. You get a standard 10-key keyboard, an electronic slide rule and trig table, plus not one but two calculators -- one for your main problem, the other for side calculations.

So go ahead. Show your boss what beautiful things you can do with a Series 600 Wang Calculator.

You could end up designing our first spaceship to Arcturus.



LABORATORIES, INC.

836 NORTH STREET, TEWKSBURY, MASSACHUSETTS 01876, TEL. (617) 851-7311, TWX 710 343-6769, TELEX 94-7421

# Bestsellers

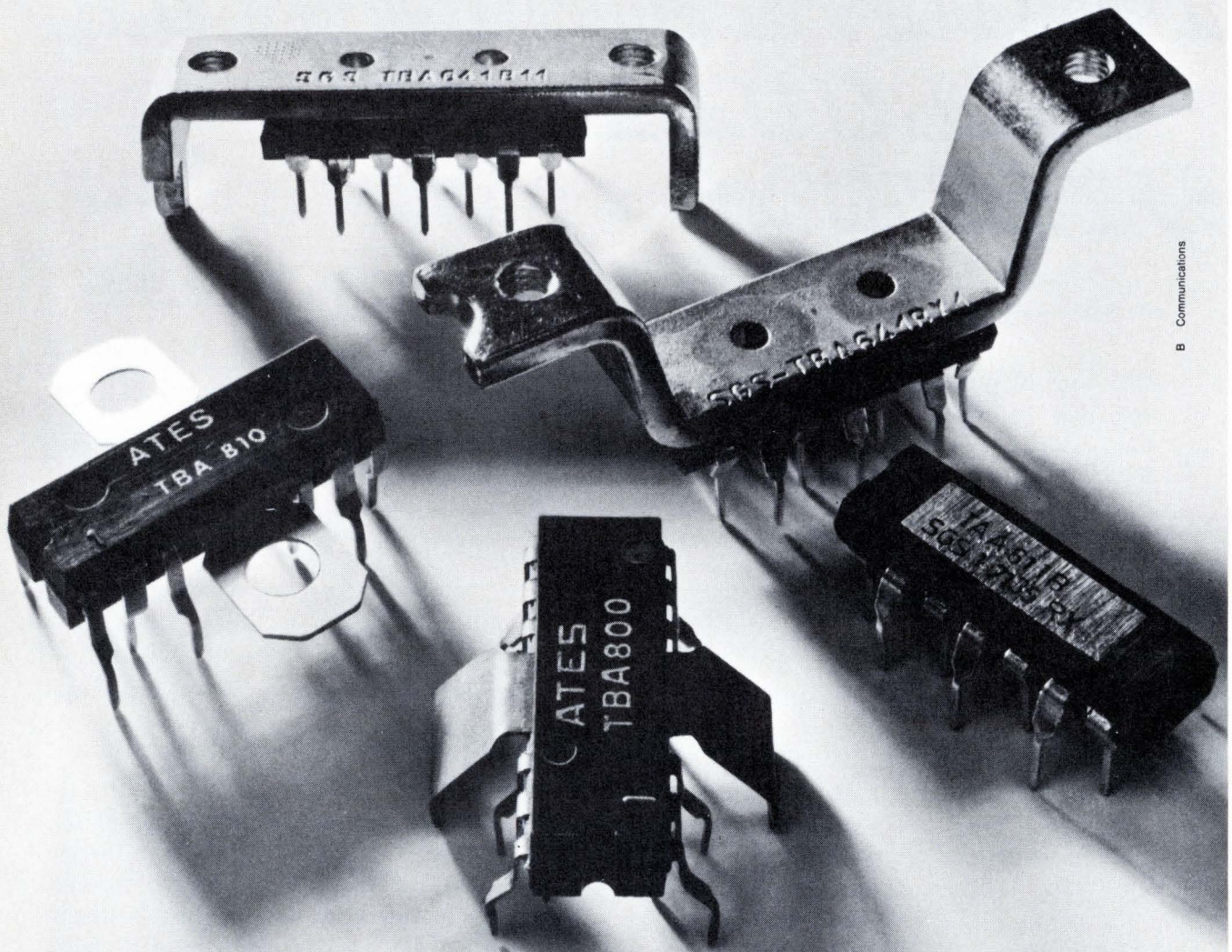

B Communications

## Audio power IC amplifiers from the world leaders.

The most comprehensive range in the market. Applications covering everything from portables (radios, TVs and cassette-players) to Hi-Fi, car-radios and colour television sets.

The longest production runs of any manufacturer.

Package configurations to suit your particular requirement.

What more need be said about the SGS/ATES range of integrated audio power amplifiers?

Try them and tell us.

A selection of SGS/ATES audio power ICs:

Type	P <sub>OUT</sub>	at	V <sub>CC</sub>	and	R <sub>L</sub>
TAA 611B	2.1 W		12 V		8 Ω
TAA 621	4 W		24 V		16 Ω
TBA 641B	4.5 W		14 V		4 Ω
TBA 800	5 W		24 V		16 Ω
TBA 810	5.5 W		14.4 V		4 Ω
TBA 820	1.6 W		9 V		4 Ω



Italy: Via C. Olivetti 1, 20041 Agrate Br., tel.: 039-65341  
 USA: 435 Newtonville Ave., Newtonville, Mass. 02160, tel.: 617-9691610  
 UK: Planar House, Walton Street, Aylesbury, Bucks, tel.: 0296-5977  
 France: 58, rue du Dessous des Berges, Paris 13e, tel.: 5895223  
 Germany: 809 Wasserburg/Inn, Post Box 1269, tel.: 08071-721  
 Sweden: Postbox, 19501 Märsta, tel. 0760-40120  
 Singapore: Lorong 4 and 6, Toa Payoh, Singapore 12, tel.: 531411



## New products

Semiconductors

### Op amp preamp minimizes drift

Monolithic first stage is guaranteed to contribute as little as  $0.2 \mu\text{V}/^\circ\text{C}$

What many users of operational amplifiers want is the performance found in chopper-stabilized modules, combined with the flexibility and low cost of the monolithic units. Now they may be able to get it.

National Semiconductor Corp., Santa Clara, Calif., has developed what it calls an op amp preamp, or as Robert Dobkin, manager of advanced development, prefers to call it, "the perfect preamp." Called the LM121 differential preamp, the device is designed to operate in front of such op amps as the LM301, LM308, or LM741, optimizing its performance for what Dobkin calls "ultra-low drift, along with either low-voltage noise or low bias current." The drift of the LM121A preamp is guaranteed to be no more than  $0.2 \mu\text{V}/^\circ\text{C}$  over the full  $-55$  to  $+125^\circ\text{C}$  range. Typically, the drift runs  $0.08 \mu\text{V}/^\circ\text{C}$ .

"In op amps, there are usually two or three stages in which drift can occur," Dobkin points out. "The user can generally null the input-stage offset, but he can't get to the second or third stage, since these are internal to the chip. But if he made the op amp the second stage and put a very-low-drift preamp up front, then he could null two stages." Besides, a typical operating point for the 121 is 10 microamperes of operating current, and at this level, the gain is 20, which reduces the effect of the op amp by this amount. Thus, if the op amp drift is  $10 \mu\text{V}/^\circ\text{C}$ , the effective drift of the amp-preamp combination is only  $0.7 \mu\text{V}$  for the A version of the 121, or  $1.5 \mu\text{V}$  for the standard version.

Dobkin says that the preamp can easily be operated at higher levels for low-noise operation, or lower

levels where bias currents of about 1 nA are required. For example, the 121 can be operated at  $2 \mu\text{A}$ , and, says Dobkin, "you get typically 1-nA bias current with 100 picoamperes of offset and a drift of  $1 \mu\text{V}/^\circ\text{C}$  guaranteed, and  $0.3 \mu\text{V}$  typical. Or you can operate the 121 with  $50 \mu\text{A}$  and a wideband noise of only about  $1.2 \mu\text{V}$  from 1 Hz to 10 kHz. Here the bias current is about 20 nA, but the drift is still  $1 \mu\text{V}$  guaranteed." In narrow-band use, say from 0.1 to 10 Hz, the noise voltage is typically  $0.3 \mu\text{V}$ , peak-to-peak.

The operating current is programmable over this range if an external potentiometer is used, and the net effect is that both drift and offset can be zeroed at the same time—something that couldn't be done before in monolithic op amps.

The full military temperature-range device, with maximum of  $1\text{-}\mu\text{V}$  drift, sells for \$15.95 in quantities of 100. The same part for the industrial temperature range sells for \$3.95, and the military version with a guaranteed maximum drift of  $0.2 \mu\text{V}$ , sells for \$39.95.

National Semiconductor Corp., 2900 Semiconductor Drive, Santa Clara, Calif. [411]

### Driver/receiver ICs aimed at high-speed data lines

Six driver/receiver integrated circuits are designed for use in transmitting data at high speeds over

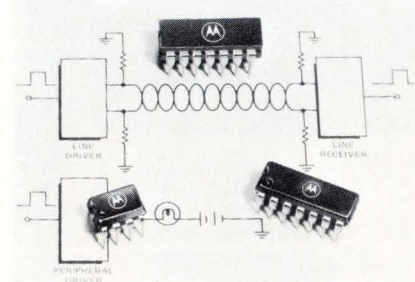

long lengths of twisted-pair lines. The units are pin-for-pin replacements for the 55107-110 and 75450-51. The new MC55107-110 devices meet the same requirements; the MC55107-108 is a dual line receiver; the MC55107 features an active pull-up; and the MC55108 uses

open-collector outputs. Both devices use diode-protected inputs. The MC55109-110s are dual line drivers, and the MC75450-51s are dual peripheral drivers. Price ranges from \$1.05 to \$3.35 in 100-lots.

Motorola Inc., Semiconductor Products Division, P.O. Box 20924, Phoenix, Ariz. 85036 [414]

### Dielectric-isolated C-MOS circuits offer speed gain

Eight digital integrated circuits made by the dielectric-isolation, complementary MOS process are the first in a series of 30 that Harris Semiconductor plans to introduce by next summer. According to the company, the circuits, called the HD-4000 series, show a 2:1 speed improvement over other C-MOS units. Seven of the devices are pin-for-pin replacements for RCA counterparts. The eighth, a triple true/complement buffer, designated the HD-4809, is an original Harris device. The commercial version of this circuit sells for \$2.25 each in quantities of 100-999; and the military version, for \$5.30. The pin replacements for RCA types include: HD-4000, dual 3 NOR gate, \$1 and \$3.10; HD-4001, quad 2 NOR gate, \$1 and \$3.30; HD-4009, hex inverter, \$2.20 and \$5.25; HD-4010, 16-pin hex buffer, \$2.20 and \$5.25; HD-4011, quad 2 NAND gate, \$1 and \$3.30.

Harris Semiconductor, Melbourne, Fla. 32901 [413]

### MOS LSI subsystem circuit converts data for processing

The conversion of data from serial communications links to a format suitable for processing equipment is the function of an MOS LSI subsystem circuit called the TMS6010. The circuit combines full transmit, receive, and format functions on a single chip that is fully DTL- and TTL-compatible. The IC is capable of simultaneous independent operations of the transmit and receive functions. The receiver section ac-

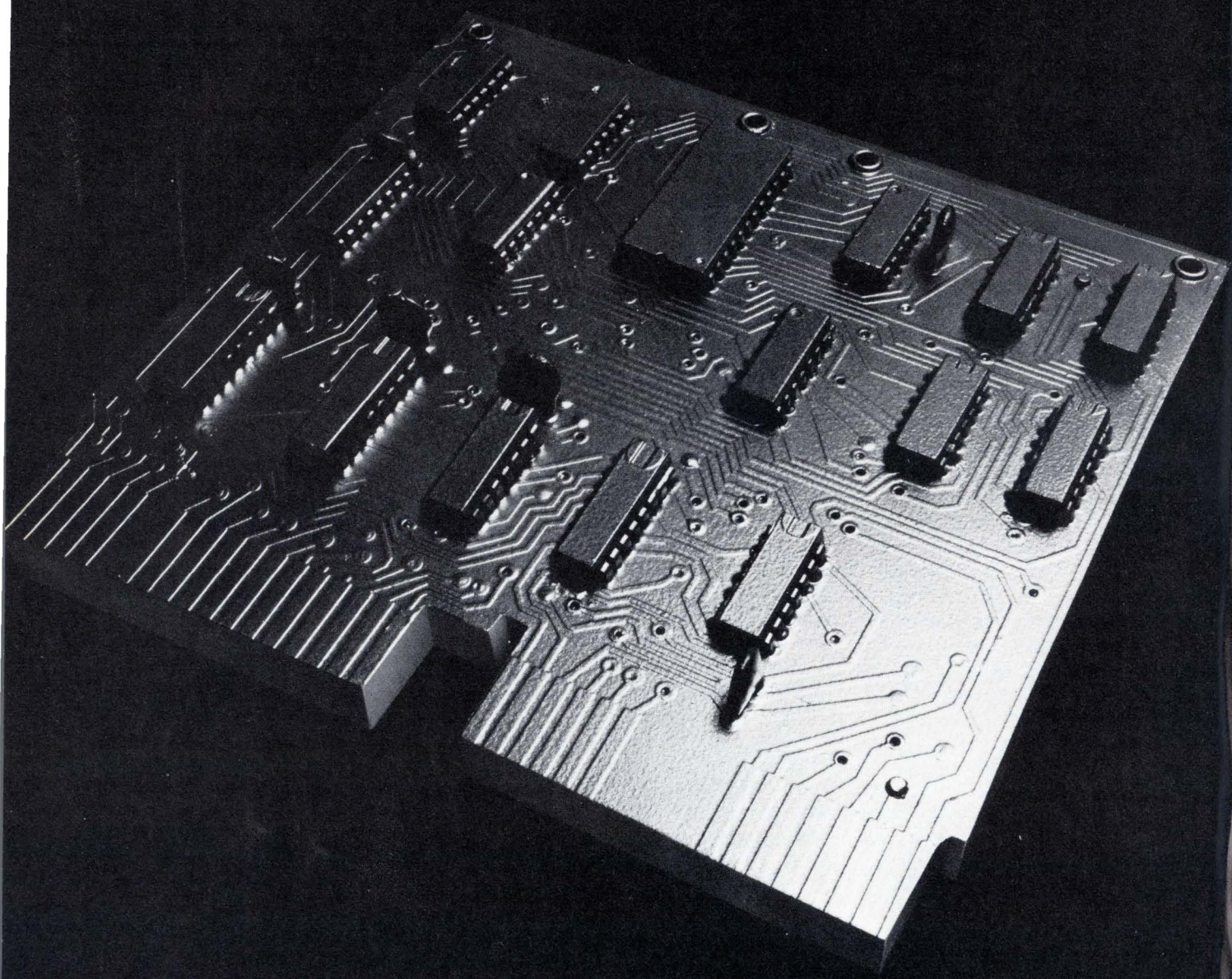

## Augat says: Take a hard look at circuits cast in iron.

Think about it. In the electronics industry – which thrives on change – something as difficult to change as the PC board is practically taken for granted.

Ironic. Especially since there's an alternative that gives you all the flexibility that PC boards lack. With Augat's dual-in-line plug-in panels you can make component and wiring changes in minutes. In bread-boarding, prototyping, production.

Augat saves you time and money. There's no waiting for artwork and fabrication, as with PC boards. No need for inventories of logic cards. What's more, the Augat panel gives you up to three times the packaging density of planar

printed circuit boards, with greater reliability.

All of which means that your product gains an important competitive edge simply by switching to Augat panels.



And now you probably understand why we're delivering thousands of these boards every week. We'll be happy to tell you more. Call us today at (617) 222-2202. Or write for our I.C. catalog showing our complete product line in panels and accessory equipment. Augat Inc., 33 Perry Avenue, Attleboro, Massachusetts 02703. Our representation and distribution is nationwide and international.

## Plug into Augat® instead.



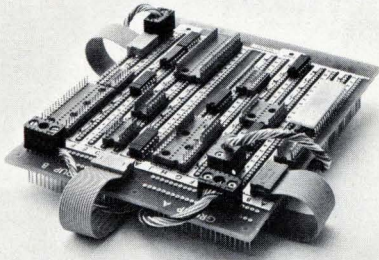

## Augat accessories give you more to plug in.

Wouldn't you know that Augat, the leader in wire-wrap panels, would come up with the most complete line of plug accessories around?

Like Augat interfacing plug assemblies for I-O connections. Or Augat adapter plugs to interpose discrete components or to let you build working modules on-the-spot. Or flat cable plugs with a unique "U" contact design for easy assembly without crimping, stripping or soldering. Plus header and jumper assemblies, too.

We'll also give you single-source supply for all panel interconnecting needs, including panels, sockets and enclosures. For quick information on price and delivery, call us at (617) 222-2202. Or write for our catalog. Augat Inc., 33 Perry Ave., Attleboro, Mass. 02703. Our representation and distribution is nationwide and international.

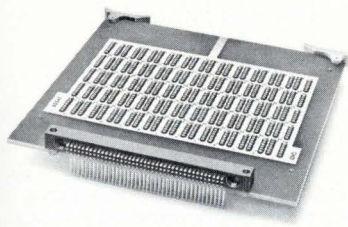

Plug into Augat®

## New products

cepts serial data from transmission lines, checks parity and start and stop bits, and converts data to parallel format. The transmitter section accepts parallel data and converts it to serial form. Price is \$15 in quantities of 250.

Texas Instruments Incorporated, P.O. Box 5012, Dallas, Texas 75222 [416]

Red LED provides 2 or 3 millicandelas at 10 mA

Two light-emitting diodes, designated the MV5054-1 and the MV5054-2, provide bright red light for back-lighting of panels. The 54-1 has a luminous intensity of 2 millicandelas at 10 mA; and the 54-2, 3 millicandelas at 10 mA. The gallium

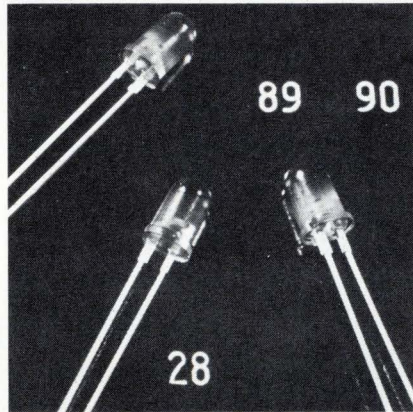

arsenide phosphide units, mounted in a red epoxy package, develop an output intensity comparable to present gallium phosphide LEDs but with added reliability, the company says. The units are able to illuminate a ¼-inch diameter circle and can be directly mounted on printed-circuit cards. Prices range from 65 cents to \$1.50, depending on quantity and type.

Monsanto Commercial Products Co., 10131 Bubb Rd., Cupertino, Calif. 95014 [417]

Character generator offers access time of 450 ns

A high-speed 5,184-bit static character generator is available in a 64-by-9-by-9 organization for use in vertical or raster-scan displays that use a

7 by 9 matrix, in printer character generators, panel displays and billboards, microprogramming applications, and panel-code conversion. The model 2526 has TTL-compatible

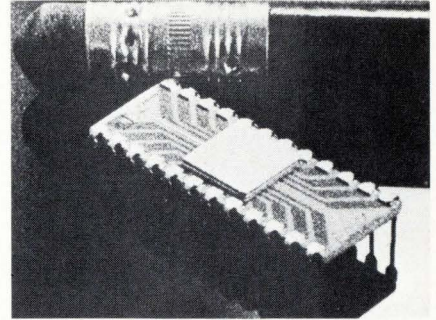

inputs and output and requires +5- and -12-volt power supplies. Typical access time is 450 nanoseconds. Price is \$16 each in quantities of 100.

Signetics, 811 East Arques Ave., Sunnyvale, Calif. 94086 [419]

Prototype board helps computer-on-chip design

A prototyping board facilitates the design of the Intel Corp. MCS-8 microcomputer that uses a computer on a chip, the type 8008 eight-bit central-processing unit. The board, called SIM 8-01, uses electrically-programmed PROMs in place of

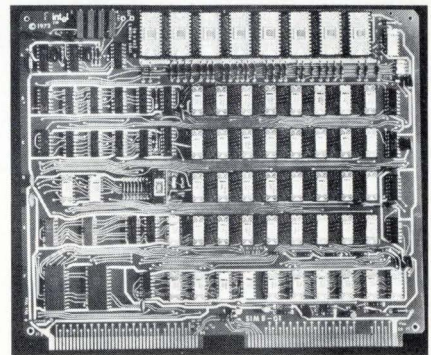

mask-programmed ROMs. The board contains one CPU, 32 256-bit RAMs, a two-phase clock generator, two input ports, four output ports, a teletype interface, and sockets for eight 2,048-bit PROMs. Price is \$900. A bootstrap loader is \$303, and the PROM programmer is \$400.

Intel Corp., 3065 Bowers Ave., Santa Clara, Calif. 95051 [420]

# The others were offering general-purpose LSI test systems that could not do it all... then along came Macrodata!

"Macrodata has done it again! Under these wraps sits the world's finest and most versatile LSI test system. At last you can have a system that is built the way you want it—with both hardware and software modularized for your selection. It is a true general-purpose system that allows you to put together the functions you need. We call it the MD-500, and we're unveiling it soon.

"The MD-500 tests both MOS and bipolar devices up to 64 channels at data rates as high as 10 MHz, and DC parametric tests are conducted independently or simultaneously with high speed functional tests at the user's option. It tests random logics, RAM's, ROM's, and shift registers—both synchronous and asynchronous devices, as well. And instead of a single pattern storage medium, it offers the user a choice of one or more of the following: a shift register buffer; a bipolar RAM buffer; and Macrodata's exclusive MD-104 micro-programmable multiprocessor for algorithmic pattern generation. All this provides you a testing capability well beyond that of other existing systems with limited hard-wire pattern generators.

"Also, in the tradition of being first with such innovations as random bit masking, channel masking, I/O in a single clock period, error delay counting, and galloping 1's and 0's, etc., Macrodata now adds another exclusive new feature in its MD-500—*Initial Vector Compare!*

"But that's not all. Instead of just a major and minor loop, the MD-500 offers up to 256 loops, nested in any fashion. And the MD-500 software compiler offers multi-station operation—up to four active stations plus a test compiler station. Programs may be compiled on line while other stations are testing, without test interruption. The test pattern data base and programs are independent of each other . . . you can program off the front panel . . . and, in addition, you can even talk to a single bit.

"Why wait for the me-too-ers to say—'Oh yes, we have that too?' Macrodata—the company the others are following—has it all now in the MD-500. For a look at this exciting new system, send for your free copy of the MD-500 brochure."



## Chapter Six. The Macrodata Story.



**Macrodata Company**, 6203 Variel Avenue, Woodland Hills, California 91364, Phone: (213) 887-5550, Telex: 65-1345

**Sales Offices:** Los Angeles Area Tel. (213) 245-9404 • San Diego Area Tel. (714) 232-2017 • Northern California Area Tel. (408) 244-1505 • (408) 268-7714 • West/Central Area — Denver Tel. (303) 934-5505 • Scottsdale Tel. (602) 947-7841 • Albuquerque Tel. (505) 299-7658 • Dallas Tel. (214) 231-2573 • Houston Tel. (713) 621-0040 • New England Tel. (617) 862-5700 • Southeast Area Tel. (205) 883-0140 • Foreign: West Germany — Dusseldorf Tel. (0211) 66 03 50 Telex: (841) 858-2189 • Munich Tel. (0811) 34 56 00 Telex: (841) 521-5969 • Milan, Italy Tel. 871-988/899-248 Telex: (843) 34314 • Sweden and Norway — Stockholm Tel. (08) 87 03 45 • Switzerland and Austria — Bern Tel. (031) 22 44 81 Telex: (845) 33172 • Tokyo, Japan Tel. (03) 985-5266 Telex: (781) 272-2171

## New products

Industrial electronics

### GE moves into computer N/C

'Soft-wired' system using mini can operate a machine cluster of up to eight axes

The largest manufacturer of numerical control systems in the world, General Electric Co., has joined the parade of companies going to market with "soft-wired" N/C systems that include minicomputers.

The newest in GE's Mark Century series, designated the 8500, retains the features of the company's 7500 series, while offering broader application flexibility because it incorporates a minicomputer, says Richard Barton, manager of GE's Numerical Control operation.

The computer numerical control (CNC) system can operate a single machine with up to four axes, or a machine cluster of up to eight axes. And with the minicomputer, a Gepak 30 CS, many functions can be implemented through software.

For example, the interface between controller and machine tool is programmable for the requirements of specific machine tools. In addition, the minicomputer can continuously monitor the controller's operation, identify malfunctions, and even isolate them to a specific printed-circuit board.

Other features include the ability to store pattern and part programs in the minicomputer's memory. This reduces use of the tape reader and therefore its maintenance requirements. An optional data communications link to a supervisory computer even allows elimination of the tape reader—programs can be sent to the minicomputer from a mass-storage location. In either case, the program can be edited for optimization at the control panel. Also offered as an option is a system capability of accepting a variety of tape-input formats.

Auxiliary code outputs and machine-interlock signals make the 8500 electrically and mechanically interchangeable with GE's Mark Century 7542. In price, however, the 8500 CNC system overlaps at the high end of the 7500 line and goes higher. Barton says the 8500 will sell for 20% to 60% more than the 7500, depending on whether it is used for one machine or a cluster.

Initially, GE is offering a configuration for control of turning machines. Called the 8500T, the system includes many of the features found in the 7500 series, including metric and inch-programming formats, plus-or-minus incremental, or absolute programming, linear and circular interpolation (in hardware), and speed of 500 inches per minute.

General Electric Co., Numerical Control Operation, Waynesboro, Va. 22980 [371]

### Four-digit counter is solenoid-controlled

A four-digit counter can be preset to a desired count by pushbutton, one for each number wheel, and it counts by solenoid through an escapement mechanism, one-half step on application of power and one-half on release. The remaining count is displayed on the register, and at zero, a SPDT output switch is thrown, giving the control signal. This switch remains off until reset, even if the count continues below 0000. Reset is by pushbutton, which restores the wheels to the original preset count and resets the control switch. Price in quantity is \$44.50.

Presin Co. Inc., Shelton, Conn. 06484 [373]

### Scanning system includes dual-detector camera

Component testing and industrial-process monitoring, are among the applications of the model 210 infrared scanning system that has the features of two systems in a single camera and a display unit. The camera head contains two separate detectors: indium antimonide for

the 2-to-5.6-micrometer waveband, and mercury cadmium telluride for the 8-to-14- $\mu$ m waveband. These detectors are switch-selectable from the front panel. The model 210 displays a thermal image of an object

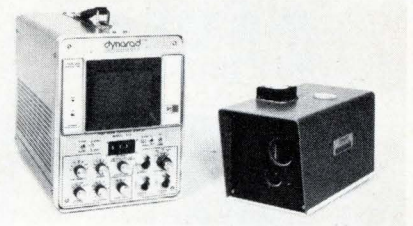

on the cathode-ray tube. The picture has 100 lines at a 60-frame-per-second rate.

Dynarad Inc., 1420 Providence Highway, Norwood, Mass. 02062 [374]

### Counter module presets to energize output on any count

A manually presettable counter module is a three-decade device that can be preset to energize an output on any accumulated count from 0 to 999. The output can be examined for the energized or de-

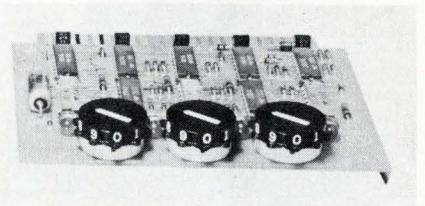

energized state in the control program as a condition to energize other outputs. Adjusting three thumbwheel switches edge-mounted on the module front presets the counter. The unit also has four indicator lights that provide a visual check of the counter operation.

Allen-Bradley Co., Systems Division, 747 Alpha Dr., Highland Hts., Ohio [376]

### Temperature indicator gives digital display to 1,800°C

A digital temperature-indicating system, model series 7000, is designed to display temperatures up to 1,800°C when used with platinum or

# NEW SHORTER CASE! SCHAUER 1-WATT ZENERS



**SAME LOW PRICES FOR  
1% TOLERANCE ZENERS  
ANY VOLTAGE  
FROM 2.0 TO 18.0**

Quantity	Price Each
1-99	\$1.07
100-499	.97
500-999	.91
1000-4999	.86
5000 up	.82

## IMMEDIATE SHIPMENT

Send for rating data and 20%, 10%, 5% and 2% tolerance prices.

Semiconductor Division

# SCHAUER

MANUFACTURING CORP.

4514 Alpine Ave., Cincinnati, Ohio 45242  
Telephone 513/791-3030

## New products

nickel resistance thermometers, or with various standard thermocouples. Display accuracy at 25°C ambient for resistance thermometers is to within  $\pm 1^\circ\text{C}$  and for the thermocouples it is  $\pm 2^\circ\text{C}$ . Cold-junction compensation is a feature, as well as a built-in signal conditioner to amplify and linearize low-level input signals.

Transducer Controls Corp., 737 N. Dodsworth Ave., Covina, Calif. 91724 [377]

Temperature controller  
is designed for OEMs

A nonindicating temperature control, designated the SSTC-1719 series, consists of a printed-circuit board, a heat-sink mounting bracket, fiberboard insulator, connection diagram, and heat sink. The

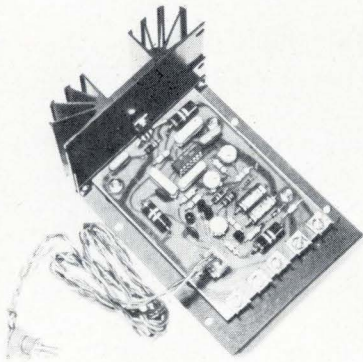

unit, designed for OEM applications, provides adjustable time-proportioned control of resistive loads. Switching at zero voltage crossing eliminates radio-frequency interference. Field-adjustable proportioning bandwidth and cycle-time controls allow tuning of the controller to the thermal system for straight-line temperature control.

ITT-Vulcan Electric, Kezar Falls, Maine 04047 [375]

Adapter modules convert  
relays to timers or flashers

A series of solid-state adapter modules converts plug-in relays to timers or flashers. The AT series modules are for timers and the FS

for flashers; both can be adjusted for rate via a screwdriver slot. The modules are available for ac or dc voltages up to 240 volts, and both will drive loads of up to 0.6 ampere.



The units are available as either self-contained devices or in plug-in or front-panel-mounted and wired configurations. Price is from \$8 to \$17, depending on options and quantity.

Ariel Corp., 24 Bland St., Emerson, N.J. 07630 [378]

Programmable controller  
offers CRT on-line display

Flexible relay-ladder-diagram programming and CRT on-line monitoring display are two features of the model IPC-4000 programmable controller. The 4,000-word read/write



core memory, with a 10-millisecond total scan rate, is programmed by a portable memory loader. Seven series and four parallel contacts, for a total of 28, may be used with an output. Unlimited timing and counting functions can be loaded into the central processor.

Industrial Solid State Controls Inc., 435 W. Philadelphia St., York, Pa. [380]

# Two GE men gave up a night's sleep. But they rebuilt our switch in time to meet a crash change in customer specs.

The change came at the last minute. A Cleveland OEM found he couldn't use the complex GE control switch he'd just received. A new one would take 10-12 weeks to get. But all he had was one week.

He called Jim Wink, GE's Cleveland District Sales Manager, and explained the problem. Jim and his Senior Sales Assistant, Ken Korbel, picked up the part at the customer's plant. That same afternoon. And then they called one of our design engineers.

The next morning Jim and Ken were back with the switch. They'd taken it back to the office and spent the night resequencing and regrinding the cams. It met the new specs exactly. And the customer got his rush order out in time. We can give you other examples where we wouldn't leave our customers alone. And we intend to. When a company has people like Jim Wink and Ken Korbel, you deserve to know about it. 690-11

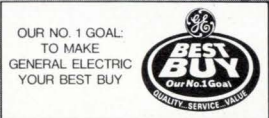
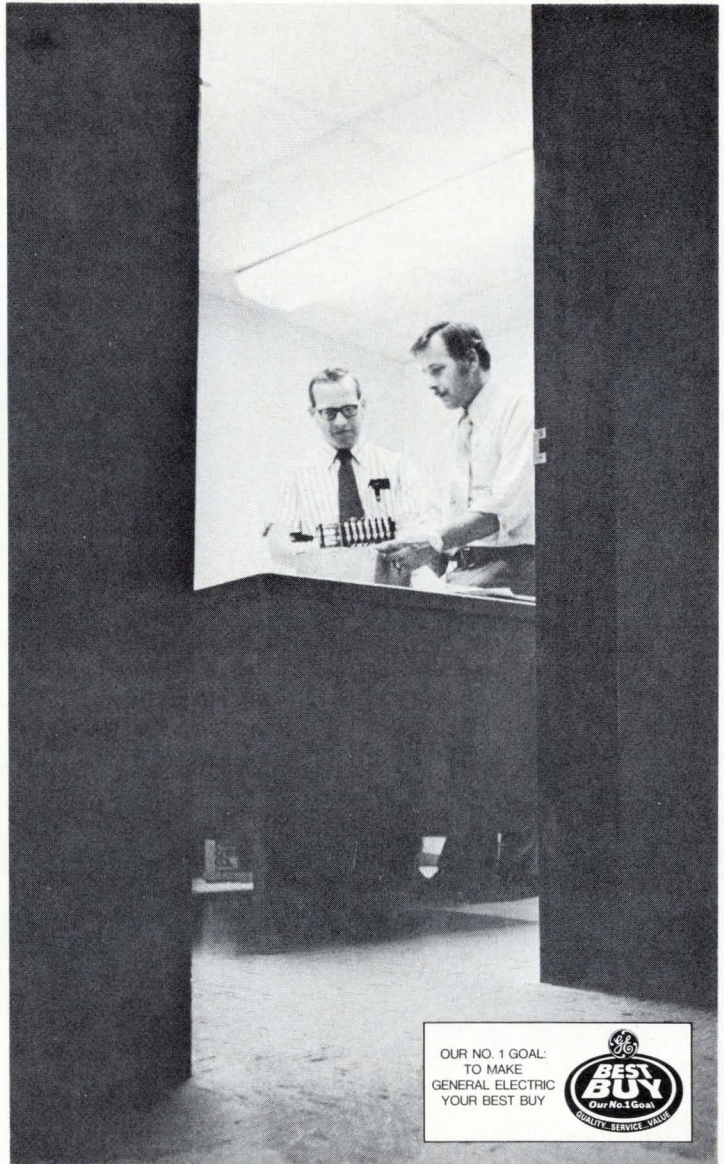

**GE won't leave you alone.**

**GENERAL  ELECTRIC**

NEW FROM HONEYWELL

# A complete graphic data acquisition system, with its own built-in signal conditioning, in a package just 8<sup>3</sup>/<sub>4</sub>" high!

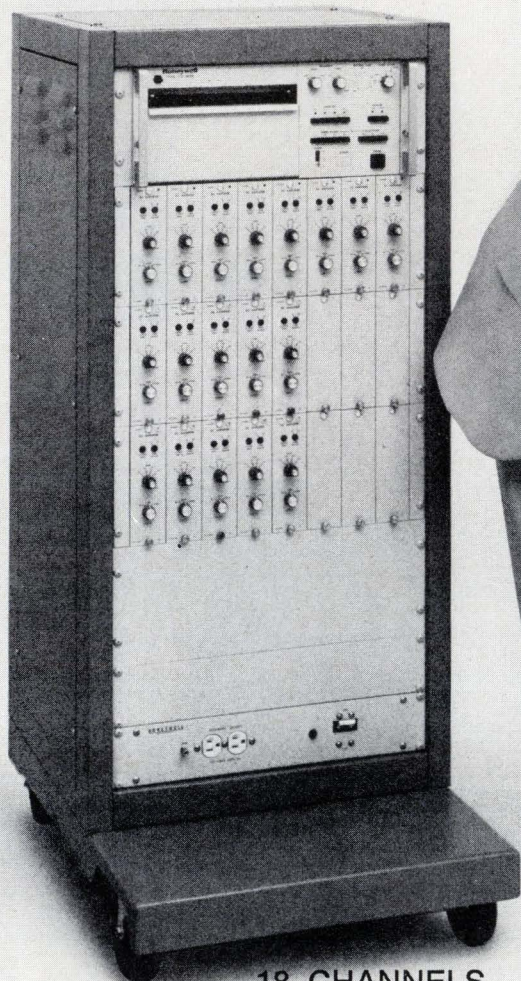

18 CHANNELS  
**THEN**

Our new one-piece data acquisition system offers benefits that other graphic systems can't, such as:

**Completely self-contained.** Signal conditioning circuitry is built right into the 1858! All you do is select and plug your choice of modules into the front panel.

**Most readable and accurate record available.** Our 1858 allows any trace to be positioned at any point on the record with full record width deflection, plus digital trace identification. In addition, it offers high-frequency response and a super-fast rise time—without trace overshoot—and without high-frequency trace wipe-out . . . for the easiest-reading record, the best resolution ever.

Circle 156 on reader service card



18 CHANNELS  
**NOW**

**As easy to use as an oscilloscope.** With the all-electronic, fiber-optic CRT 1858, there are no galvanometers or pens to fuss with. No mathematics or matching networks to fool with. There's simple front panel set-up for calibration, trace position and sensitivity. Just plug in your signal inputs and you're ready to record.

**18-channel recording capability.** This new system records up to 18 channels, each with DC to 5,000 Hz response. You also get a choice of 42 discrete paper speeds up to 120" per second!

**True portability.** Just because our 1858 gives you an 80% reduction in rack space and weight isn't the only reason it's called portable. It's also because *everything* you need is self-contained within that package, including signal conditioning and paper take-up! You

can stick it in a rack, set it on a table, or carry it away.

**A variety of signal conditioning modules.** Your choice includes a high-gain differential amplifier, a low-gain differential amplifier, a medium-gain differential amplifier, an impedance interface module, a strain gage control unit and a thermocouple control unit.

**And this is only part of the story.** For more information, call 303-771-4700. Write Lloyd Moyer, MS 218, Honeywell, Test Instruments Division, P. O. Box 5227, Denver, Colorado 80217.

**Honeywell**  
The Automation Company

---

## New products

---

Data handling

### Tape system has high data rate

Communications equipment can operate up to 50,000 bits a second

---

A magnetic tape unit in combination with a programable controller-communications formatter makes up the model DTS3210 data-communications system. It can transfer data on standard 7- or 9-level magnetic tape at rates as high as 50,000 bits per second, and can poll and receive data from other entry devices such as data-speed tape readers and teletypewriters. Control is entirely within the DTS3210 and no external computer-front-end communications control is required.

The incoming data is formatted in the manner required by the host processing computer so that it is not necessary to rerun a magnetic tape through formatting operation before data is entered in the computer. A monitoring system checks for read, write and transmission errors. Transmission error detection/recovery is compatible with binary synchronous communications procedures in the transparent text

mode. Tape read/write error detection is accomplished by buffer compare, or vertical and longitudinal parity checks. Correction is by re-read or rewrite to and from the buffer.

A DTS3210 is part of the General Electric Co. corporate data system, and another is used by the Environmental Science Services Administration to transfer weather satellite data.

Datran Corp., 319 Peck St., New Haven, Conn. 06513 [361]

---

### Data-entry system handles multi-input requirements

A mixed-media data-entry system is designed to handle a universal range of computer data input requirements. The system, the model 2250, combines an optical character-recognition reader with a cluster of up to 20 key-to-disk terminals. The 2250 system contains a feature called Multifont 10/12 that permits the OCR unit to read 13 commonly used pica and elite typewriter fonts, both 10 and 12 pitch, intermixed. Price of a basic 2250 is \$210,000, or lease is \$4,725 per month, with maintenance additional. Options such as terminals and controllers range from \$2,500 to \$12,000.

Scan-Data Corp., 800 E. Main St., Norristown, Pa. 19401 [341]

---

### C-MOS reduces power needs of data-distribution system

Designed to accept up to 256 single-ended or 128 differential analog signals, plus 32 simultaneous sample-and-hold channels in the basic package, a computer-compatible data-acquisition and distribution system, designated the System 256, uses C-MOS logic throughout for reduced size and power consumption [*Electronics*, Oct. 9, p. 127].

Datel Systems Inc., manufacturer of System 256, claims the power consumption is a fraction of that required for other systems, even though the 256 provides four times

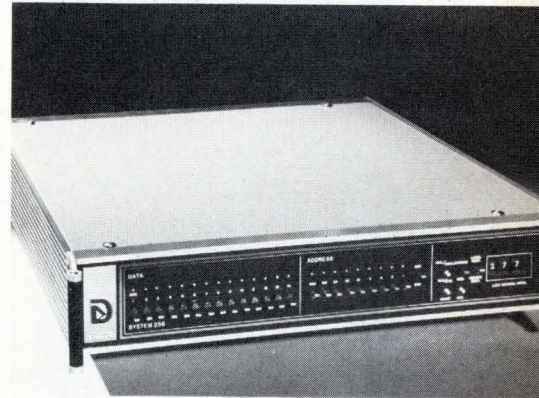

the channel capacity in a comparable package area. With a supply voltage of +15 volts, operating at 1 megahertz into 15 picofarads, the dynamic power consumption per logic function is approximately 1 milliwatt. Datel says this compares with about 10.5 mW per logic function for transistor-transistor logic.

The analog inputs to System 256 are multiplexed one at a time into a high-impedance buffer amplifier, then supplied to a sample-and-hold amplifier. The buffered analog signals are converted to digital data by a high-speed successive-approximation a-d converter of up to 14-bit resolution. The digital data is then fed to a least-significant-digit positioning circuit which assures that, regardless of the resolution of the converter, the least-significant digit will always be on the extreme right-hand position, as required by most minicomputer programming.

System accuracy is specified as  $\pm 0.025\%$ , with a temperature coefficient of  $\pm 40$  ppm/ $^{\circ}\text{C}$ . Price of the 256-channel model is \$4,469.

Datel Systems Inc., 1020 Turnpike St., Canton, Mass. 02021 [342]

---

### OCR tape reader handles up to eight type fonts

An optical-character-recognition journal-tape reader, called the System 4040 Mod II, reads up to eight different type fonts in lines up to 4½ inches wide on tapes from adding machines, cash registers, and accounting machines. It edits and formats data to 43 characters per line for output to magnetic tape. The

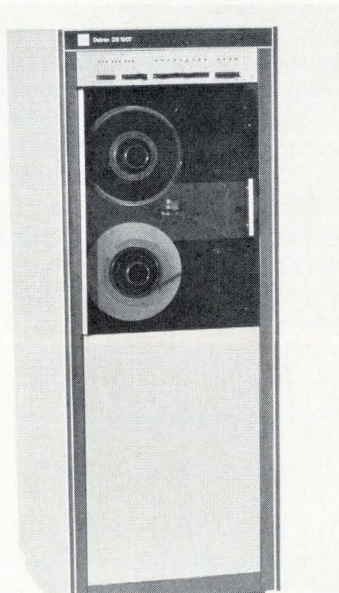



**Synchron®**  
When even one timing motor failure is too many.

When you can't afford to have a synchronous timing motor failure, specify Hansen. We build every motor like it'll be the most important single component in your product. (Usually, it is.)

As we build each motor, we inspect it fifty-one times. Run it in. Test it. 100%. To be sure you receive motors with an absolute minimum chance for failure. We even listen to each motor with an electronic stethoscope. It has to sound right, or you never see it.

Everything about a Synchron motor is custom. Except 100% inspection. That's standard. Write for specs. Or contact one of our representatives below.



**HANSEN MANUFACTURING COMPANY, INC.**  
PRINCETON, INDIANA 47670

Hansen Representatives: Carey & Associates, Houston and Dallas, Texas; R. S. Hopkins Co., Sherman Oaks, Calif.; Melchior Associates, Inc., San Carlos, Calif.; The Fromm Co., River Forest, Ill.; John Orr Associates, Grand Rapids, Mich.; H. C. Johnson Agency Inc., Rochester, N.Y.; Winslow Electric Co.; Essex, Conn.; Kiley Electric Co., Villanova, Pa., and Herbert Rude Associates, Inc., Teaneck, N.J.

Circle 158 on reader service card



## A free look at the best industrial buildings available in Georgia. Photos, specs and all.

Suppose you've read our free 1972 Industrial Survey and you've got a pretty good idea that Georgia could be the perfect location for your next facility.

The next step is easy.

Give us a call at 404-656-3599 or send us the coupon.

We'll send you an



up to the minute portfolio of the most desirable industrial buildings available in Georgia. Photos, dimensions, costs and all.

Georgia Department of Industry & Trade  
Industry Division, Dept. EL-13, P.O. Box 38097,  
Atlanta, Georgia 30334

Please send me your buildings portfolio.  
 Please also send me your 1972 Industrial Survey.

Name \_\_\_\_\_ Title \_\_\_\_\_

Company \_\_\_\_\_

Address \_\_\_\_\_

State \_\_\_\_\_ Zip \_\_\_\_\_

**Georgia.**

## New products

unit comprises a reader with companion keyboard, a logic cabinet containing both tape drive and minicomputer with memory ex-



pandable to 32,000 words, and a typewriter console for two-way communications with the system.

Lundy Farrington Division, Lundy Electronics and Systems Inc., Glen Head, N.Y. 11545 [363]

Minicomputer is designed for process-control applications

A 16-bit parallel-processing minicomputer is microprogramable and provides a 2-microsecond add time. The BDX-9000 unit is designed for process-control applications and is

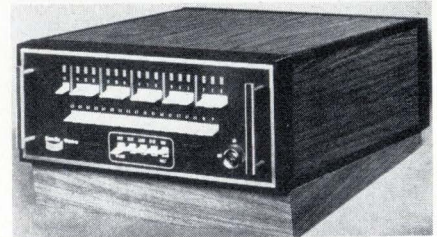

functionally interchangeable with a previously developed aerospace computer, the BDX-900. The entire central processor is contained on one printed-circuit card, and there is space in the basic chassis for up to 24,576 words of core memory contained on four cards, plus 12 peripheral-device controllers using three cards.

The Bendix Corp., Rte. 46, Teterboro, N.J. 07608 [365]

Printer operates at three lines per second

The model 55 printer is offered in a case with interface and power supply. The unit operates at a speed of



It's our new RT-02.  
Whereas our RT-01 has  
been a big hit because people  
know they can count on it.

It's numeric.  
Our new RT-02 is  
alphanumeric.

32 alphanumeric characters  
on a single-line gas-discharge  
type readout panel to be exact.

It has its own self-contained  
power supply and weighs so

little, it's really portable.

It's ASCII compatible so  
you can interface it, input and  
output, to any computer that's  
got a Teletype port.

And it doesn't cost much  
more, really, than our RT-01  
that's sold so well.

And it's simple as saying  
your A,B,C's to use.

We're the Logic Products  
Group, Digital Equipment

Corporation, Maynard, Massa-  
chusetts 01754/(617) 897-5111  
in the U.S.

81 route de l'Aire, 1211  
Geneva 26/(022) 42 79 50 in  
Europe.

And we'll be happy to show  
it to you, no matter how remote  
you are.

**digital**

## **Introducing a remote data entry terminal that you can read as easy as A,B,C. Anywhere you want to read it.**



**DURANGO,  
Colorado's  
Industrial  
Development  
Corporation  
HAS SOME SPACE  
FOR YOU.**

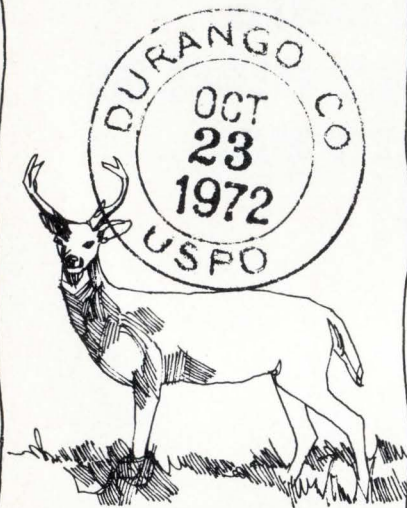

Choose your company's site in Durango's 400-acre industrial park or in any of numerous other low-cost locations. They have the transportation, the power and the kind of educated manpower you need.

But you're probably wondering what you'd do after office hours in Durango. Or in any other Colorado city with a population of 12,000 or less. How about skiing? Or hunting, fishing, golfing, boating, bowling . . . how about finding out more?

Send for our free 83-page Executive Portfolio. It describes 127 Colorado communities—including Durango—that have prime industrial sites to suit your business. Write William C. Hacker, Colorado Division of Commerce and Development, 1322 State Capitol Annex, Denver, Colorado 80203.

**COLORADO**  
where there's room to live and breathe

**New products**

up to three lines (36 characters) per second and accepts serial-by-character or full-parallel BCD data input. It is TTL-compatible, and has a 12-column capacity, using numerals or limited alpha characters. Twelve

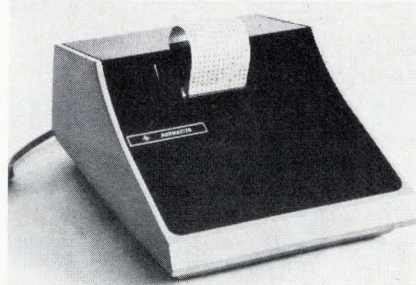

characters are available in each column. The printer operates with a 115-volt, 60-hertz ac motor.

Addmaster Corp., 416 Junipero Serra Dr., San Gabriel, Calif. [366]

MOS modem is designed for 4,800-bits/s transmission

A digital full-duplex MOS modem is designated the model ADS-448/IV. The unit operates over unconditioned voice-grade telephone lines and is designed for a transmission rate of 4,800-bits/s rate transmission. The modem can be switched to 2,400 bits/s when errors from deteriorating line conditions warrant the change. The unit is available as a compact stand-alone modem or, for OEM applications, as a printed-circuit card.

American Data Systems, 8851 Mason Ave., Canoga Park, Calif. 91306 [368]

CRT display can be tailored to user's special needs

Microprocessor-driven CRT displays have sufficient flexibility to enable the user to vary all the parameters of desired terminal programs to suit his individual needs. Among the programable options are: several configurations, including stand-alone, dual, quad, and cluster; 50/60-hertz supply; up to 1,920 characters per display; 12, 24, 48, or 96 rows; from 20 to 132 characters

**The pollution  
problem.**

**Maybe your  
engineers deserve  
a little help.**

The engineers' will be the ones to find the technical solutions to pollution problems. There's no doubt about it.

But pollution is a people problem, too. And the engineers' technological approach to pollution isn't going to solve people problems.

Maybe this booklet can help. It lists some of the things all people can do to fight pollution. And with all the people supporting your engineers we'll have a better chance of winning the fight.

For a free copy or a list of bulk rates write to Keep America Beautiful, Inc., Box 1771, Radio City Station, New York, New York 10020.

**Keep America Beautiful**

Advertising contributed for the public good

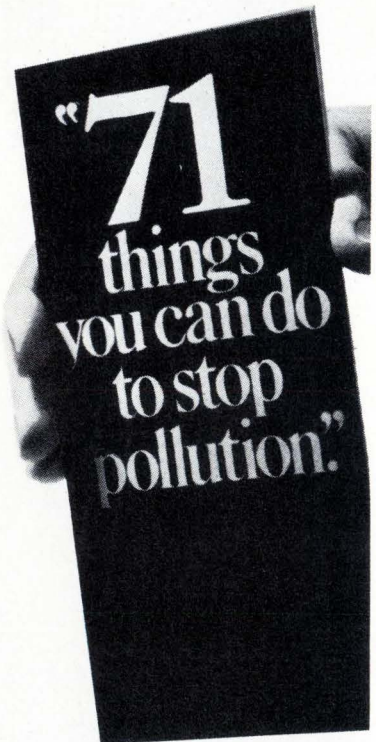

**People start pollution.  
People can stop it.**

# What do you get when you cross a signal source with a calculator?

Automatic testing with HP's new 3330B AUTOMATIC SYNTHESIZER. In this one outstanding instrument, you get a flexible synthesizer, a top-performing sweep generator, and a precision level generator—all under digital control. Its built-in controller adds computer flexibility—you can forget about tying up an external computer for your automatic testing on the production line, and for the first time make this level of testing economically feasible in your lab.

For man-machine interfacing, 3330B's convenient swing-out keyboard, coupled with 9-digits of frequency and 4-digits of amplitude readout, gives you complete flexibility for setting up your test routines.

As a frequency synthesizer spectral purity is exceptional. Spurious is down 70 dB, and harmonics at least 40 dB below the carrier. Through its easy-to-use keyboard, you can, with 0.1 Hz resolution, set in any frequency between 0.1 Hz and 13 MHz, then automatically or manually increment (tune) that frequency by any amount. Each point has the synthesizer stability of  $\pm 1$  part in  $10^8$ /day.

You can repeat the same automatic or manual sweep-operation with amplitude level. Its 100 dB range, 0.01 dB resolution and flatness of  $\pm 0.05$  dB make the 3330B a precision level generator.

Call on Model 3330B for your sweep generator needs, and you'll get performance levels of accuracy, linearity, and resolution never before available. That's because the internal serial microprocessor controls digital sweeping of synthesized frequencies or precise amplitudes. Through its keyboard and front-panel controls, you enter all sweep parameters—your 3330B takes it from there.

Systems Designers will find the standard 3330B fully programmable—ready for low-cost interfacing to other ASCII instruments and controllers, like marked card programmers, calculators, and computers.

Price? If you think about it, you would have bought a synthesizer, a sweeper, a marker generator, a counter, a programmable attenuator, and some computer time to come anywhere close to solving the same problems now done by the 3330B. At \$6000 for a complete frequency lab, we think you'll agree that the price-performance ratio of the 3330B is great. (Model 3330A, priced at \$5100, performs identically to the 3330B but has manual amplitude control and 13 dB range.)

For further information on the 3330A/B, contact your local HP field engineer. Or, write Hewlett-Packard, Palo Alto, California 94304. In Europe: 1217 Meyrin-Geneva, Switzerland.

A092/1

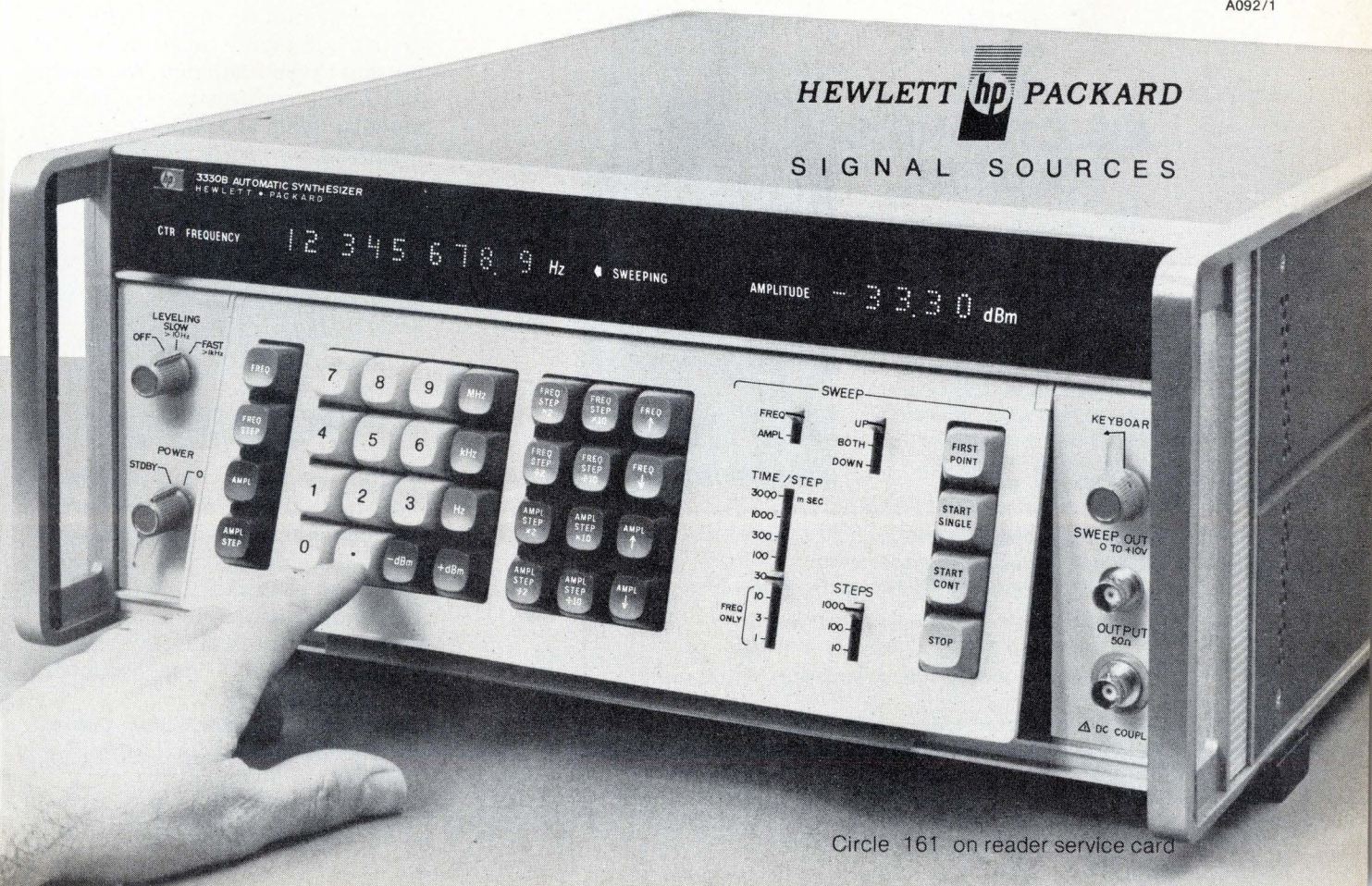

Circle 161 on reader service card

# Control displays—airborne, fast and error-free.



Whatever your airborne display needs, Bowmar's Logicator® units will provide fast, error free readouts that always reflect the last information update. Displays can present instructions, information, alarms, numbers, messages or symbols direct from your digital computer.

Bowmar's Logicator® displays are back-lighted magnetic wheel systems that are available complete with decoder and

drivers for direct interface with your digital computer.

For more information on how Bowmar's proven experience on a dozen major programs can solve your airborne control and display problems, call us at 219-747-3121.



Bowmar Instrument Corp., 8000 Bluffton Road, Fort Wayne, Indiana 46809

Circle 162 on reader service card

## Presenting in your corner: THE ELECTRONICS BOXER!

Why mess around when you can have the ELECTRONICS BOXER clean up your copies—keep them in top condition.

And, it's easy and inexpensive to keep the ELECTRONICS BOXER in your corner. Just complete the coupon and mail. Your order will be processed immediately, postpaid.

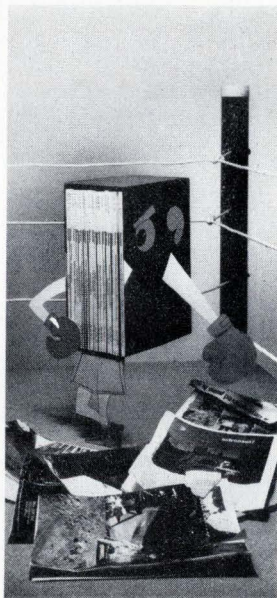

### ELECTRONICS BOXER

Jesse Jones Box Corporation

2250 E. Butler St., Philadelphia, Pa. 19137

Please send me:  boxes @ \$4.25 each;  
 3 boxes @ \$12.00;  6 boxes @ \$22.00

My check or money order is enclosed.

Name \_\_\_\_\_

Address \_\_\_\_\_

City \_\_\_\_\_ State \_\_\_\_\_ Zip \_\_\_\_\_

## New products

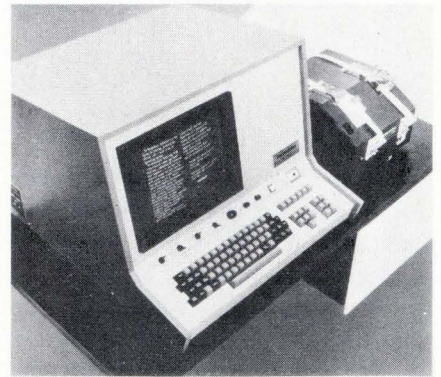

per row; any font up to 256 characters and symbols; limited graphics; and variable intercharacter spacing. All or any part of a program can be transferred from read-write to read-only memory in one day. Delivery time is 30 days.

SYS Computer Corp., 17-25 De Carolis Court, Hackensack, N.J. 07601 [367]

## CRT data terminal is message-oriented

A CRT data terminal is designed for use in message entry, order entry, and similar tasks. The unit can be linked with a computer by the terminal operator when a specially formatted message is ready for transmission to the computer. The model VST1296 is constructed on a plug-in modular basis and has the RS-232 asynchronous serial interface con-



necter that operates at 1,800 baud. This is used in remote telephone-line communication with the computer. Another feature is a parallel interface connector operating at 1,800 characters per second and used in near proximity to the computer in a demand/response mode. Price is \$3,995.

Video Systems Corp., 7300 North Crescent Blvd., Pennsauken, N.J. 08110 [370]

# Now there's a *on* generation gap

Here's the 50 MHz data generator you've needed all along—the one you've been stacking pulse generators to simulate. And it's a high speed pulse generator, too.

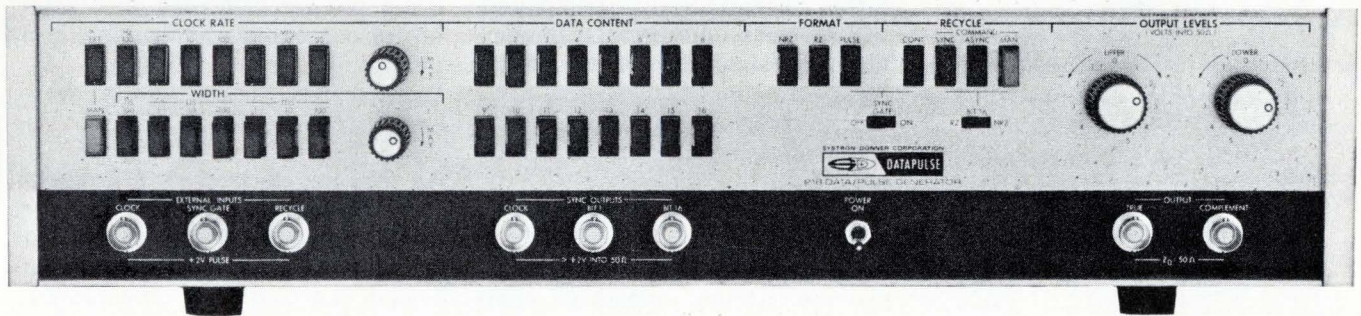

Check out the front panel. You have pushbutton control of the data content of 16-bit words in either NRZ or RZ format. You can recycle words continuously (synchronously or asynchronously), manually or by external command. You can vary pulse width continuously when using the 218 as a pulse or RZ data generator. Output is upper/lower level controlled.

Of course, there's a remote programming option. And two or more 218's in parallel provide multi-channel outputs, if you need them. In series, they permit longer word lengths.

You can't buy or build a more complete, more versatile data and pulse generator.

Get the full story on the low-cost (\$925) Model 218 Data/Pulse Generator from your nearest Scientific Devices Office, or contact Datapulse Division, 10150 West Jefferson Boulevard, Culver City, California 90230. Telephone (213) 836-6100; TWX 910/340-6766; Telex 67-3219. In Europe: Systron-Donner GmbH, Munich W-Germany; Systron-Donner Ltd., Leamington Spa U.K.

DATAPULSE  
DIVISION

SYSTRON  DONNER

The Systron-Donner Instruments Group:

Alpha Scientific  Computer Systems  Concord Instruments  Datapulse  Kruse Electronics  Microwave  Trygon Electronics

# free catalog

## POTTING APPLICATORS MANUAL AND DISPOSABLE

6cc 12cc 30cc

FOR POTTING, ENCAPSULATING, AND  
SEALING OF MINIATURE COMPONENTS

PHILIP FISHMAN COMPANY

7 CAMERON ST., WELLESLEY 81, MASSACHUSETTS

CIRCLE 952 ON READER SERVICE CARD

## FLASH STRIPPER For shielded wire braid



Weld groundlead and/or strip braid in one fast operation.

Submit sample wire. Ask for data sheets.

## EWALD Instruments Corporation

Rt. 7E Kent, Ct. 06757 - Tel (203) 927-3278

CIRCLE 953 ON READER SERVICE CARD

H.P. #624B uwave sig gen \$850  
H.P. #623 SHF Test Set \$open  
Gen Radio #667 A Indc. Bridge \$230  
Gen Radio #716-0 Cap Bridge \$240  
Leeds & Northrup #7 Deft Pot #250  
TS-418, TS-419, TS-403, TS-622  
UPM-42, UPM-44, UPM-70, etc.  
**B. F. WILLIAMS CO., P.O. Box 7057, Norfolk, Va. 23509**

CIRCLE 951 ON READER SERVICE CARD

### LEGAL NOTICE

#### U.S. POSTAL SERVICE STATEMENT OF OWNERSHIP, MANAGEMENT AND CIRCULATION

(Act of August 12, 1970: Section 3685, Title 39,  
United States Code)

- Title of publication: ELECTRONICS.
- Date of filing: October 1, 1972.
- Frequency of issue: Bi-weekly.
- Location of known office of publication: 1221 Avenue of the Americas, City, County and State of New York—10020.
- Location of the headquarters or general business offices of the publishers: 1221 Avenue of the Americas, City, County and State of New York—10020.
- Names and addresses of publisher, editor, and managing editor: Publisher, Daniel A. McMillan, III—1221 Avenue of the Americas, New York, N.Y.—10020; Editor, Kemp Anderson—1221 Avenue of the Americas, New York, N.Y.—10020; Managing Editor, Samuel Weber—1221 Avenue of the Americas, New York, N.Y.—10020.
- The owner is McGraw-Hill, Inc., 1221 Avenue of the Americas, New York, New York 10020; Stockholders holding 1% or more of stock are: Donald C. McGraw, Elizabeth McGraw Webster, Donald C. McGraw, Jr., and Harold W. McGraw, Jr., Trustees under Indenture of Trust m/b James H. McGraw, dated 1/14/21 as modified; Donald C. McGraw, Trustee under an Indenture of trust m/b James H. McGraw, dated 7/1/37 as amended; Donald C. McGraw, individually; Donald C. McGraw & Catharine McGraw Rock, as trustees of the Estate of Mildred W. McGraw, all of 1221 Avenue of the Americas, New York, New York 10020; FirJer & Co. c/o First National Bank of Jersey City, 1 Exchange Place, Jersey City, New Jersey 07302; Harwood & Co. c/o State Street Bank and Trust Company, P.O. Box 5006, Boston, Mass. 02101; Perc & Company c/o Northwestern National Bank of Minneapolis, Minneapolis, Minnesota 55480; Pratt & Co. c/o Boston Safe Deposit and Trust Company, 1 Boston Place, Boston, Mass. 02106; Way & Co. c/o The Bank of New York, 110 Washington Street, New York, New York.
- Known bondholders, mortgagees, and other security holders owning or holding 1 percent or more of total amount of bonds, mortgages or other securities: None.
- Permission requested.
- Not applicable.
- Extent and nature of circulation:

	Average No. Copies Each Issue During Preceding 12 Months	Actual No. Copies Of Single Issue Published Nearest To Filing Date
A. Total No. Copies Printed.	90,243	89,941
B. Paid Circulation		
1. Sales through dealers and carriers, street vendors and counter sales		
2. Mail subscriptions	86,094	86,500
Total Paid Circulation	86,094	86,500
D. Free distribution by mail, carrier or other means:		
1. Samples, complimentary, and other free copies	3,119	2,828
2. Copies distributed to news agents, but not sold		
E. Total Distribution	89,213	89,328
F. Office use, left-over, unaccounted, spoiled after printing	1,030	613
G. Total	90,243	89,941

I certify that the statements made by me above are correct and complete.

McGRAW-HILL, INC.

By JOHN J. COOKE,  
Senior Vice President & Secretary

## New products/materials

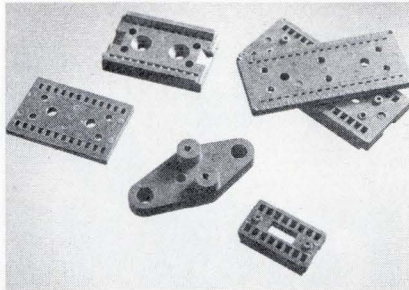

**A silicone molding compound** is designed for producing structural plastic parts by screw-injection and transfer-molding techniques. Applications are in sockets, connector inserts, edge connectors, integrated-circuit burn-in carriers, and coil forms. The M-91-121 compound, which is glass-reinforced, is in granular form suitable for direct hopper feed. Screw-injection molding cycle time is about 50 seconds, and transfer-molding cycles average 3 minutes.

Dow Corning Corp., Midland, Mich. [476]

**A styrene-based polymer, Dylark**, for use in electronic components, offers high heat resistance and rigidity. Six types of Dylark are available: glass-fiber blending grade, general-purpose crystal, medium and high impacts, self-extinguishing, and glass-fiber filled pellets. In heat tests, the material shows no distortion at 230°F.

Sinclair Koppers Co., Koppers Building, Pittsburgh, Pa. 15219 [477]

**Potting compound P-85** is a highly filled heat-curing epoxy designed for casting applications requiring long work life (45 minutes at 180°F) and short cure time (4 hours at 180°F). Suitable for applications involving high voltages, the material has a pot life of 90 minutes at 180°F, and water absorption over a 24-hour period at 77°F is 0.02%. Price is from 77 to 95 cents per pound, depending on quantity. An activator is priced at \$1 per pound in production quantities.

Bacon Industries Inc., 192 Pleasant St, Watertown, Mass. 02172 [478]

**A soft filled epoxy casting system** for use in transformers, coils, and other electronic components is designated

EE1029. It can be used in automatic dispensing machines and is an undiluted 100% solids system that can be used with a variety of hardeners to give a range of uncured and cured properties.

Hysol Division, Dexter Corp., Olean, N. Y. 14760 [479]

**A two-part silver epoxy** for die attach in hybrid circuit manufacture is a 100% solids system that has the consistency of a soft, smooth, free-flowing paste. It can be applied manually or with automatic dispensing equipment. The material cures in 15 minutes at 150°C or in 45 minutes at 100°C. Epo-Tek H11 has a pot life of eight hours. Trial kits of one ounce are available at a price of \$15.

Epoxy Technology Inc., 65 Grove St., Watertown, Mass. 02172 [480]

**An alkaline electroplating formula-** tion, which produces 99.99% pure gold coatings, is designated pyr-AU-bond 403. The material is resistant to corrosion and high temperatures, and it will not tarnish. The process is suitable for integrated circuits, transistors, flatpacks, and other semiconductor applications. The material has a fine-grained structure and is machinable. In addition, good distribution, solderability, and weldability are offered. Delivery is from stock.

Sel Rex Co., 75 River Rd, Nutley, N.J. 07110 [409]

**A urethane high-temperature varnish** air-dries in 15 minutes to a chemically resistant, tack-free resin film. Material IS41, resistant to water, acids, and alkalis, is a dielectric—2,000 volts per mil. The varnish is also abrasion-resistant and adheres to most surfaces. The material is a 42.5% solids system that is clear in color and can be thinned with Xylol. There is no corrosive effect on copper, and viscosity from a #1 Demmler cup at 86°F is 40 to 50 seconds. Price ranges from \$3.35 per gallon in 10 drums of 55 gallons each to \$6.60 per gallon in a one-gallon drum.

Isochem Resins Co., Cook St., Lincoln, R.I. 02865 [410]

# "THERE HAS TO BE AN EASIER WAY TO MAKE THESE REVISIONS."

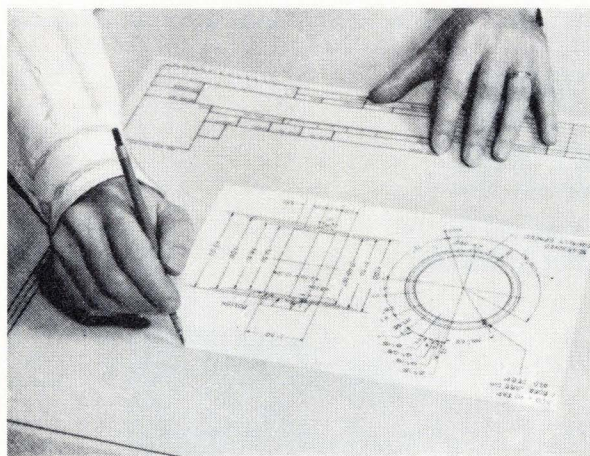

**Shorten your drafting time  
with KODAGRAPH materials.**

You've got a drawing that has to be revised, with new details to be added. You *could* redraw the whole thing, making the necessary changes in the process. But why not do it the easy way, with the help of a sharp, clear reproduction on Kodagraph film or paper?

From that reproduction, cut out the portions that are still useful, and tape them to a new drawing form. Then, make your revisions, redrafting only the portions that need changing. Finally, use Kodagraph film for a perfect print of the completed drawing.

For more ideas on saving design time with Kodagraph materials, fill out and mail the coupon.

Please send me complete details on the design shortcuts possible with Kodagraph materials.

Name \_\_\_\_\_

Position \_\_\_\_\_

Company \_\_\_\_\_

Address \_\_\_\_\_

City \_\_\_\_\_ State \_\_\_\_\_ Zip \_\_\_\_\_

Eastman Kodak Company  
Business Systems Markets Division  
Dept. DP879, Rochester, New York 14650

**PRODUCTS FOR  
ENGINEERING DATA SYSTEMS**



# EMI/RFI CONTROLLER

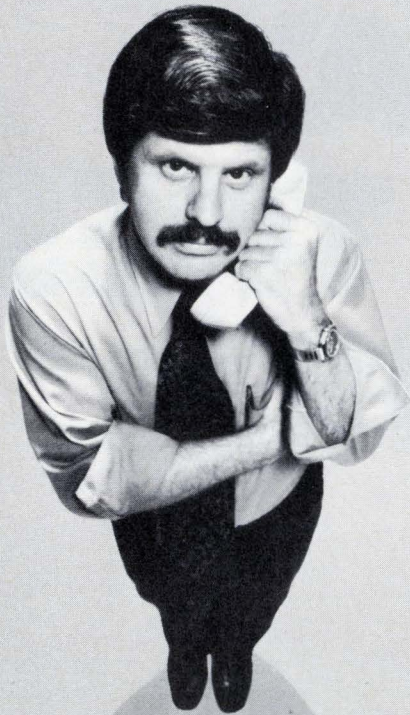

This USCC/Centralab expert can control your EMI/RFI problems. Call his hot line collect at (213) 843-3822.

He's a highly qualified applications engineer ready to suggest one of our broad lines of standard ceramic or layer-wound filters. He can design a custom unit for your specific application or even immediately ship an evaluation sample.

We feel solving EMI/RFI problems should be our worry, not yours. Call (213) 843-3822 now.

Is your requirement not that urgent? Send for USCC's EMI/RFI Filter catalog containing complete technical data on: Button, Miniature and Subminiature Ceramic types; the New UL recognized 8000 Series for Data Processing Units and Systems; and the 9000 Series Ceramic Feed-thru Filter/Capacitors.

**USCC** **USCC/Centralab**   
Electronics Division • Globe-Union, Inc.  
2151 North Lincoln Street • Burbank, California 91504

# FREE CATALOG

## OVER 26,500 POWER SUPPLIES



Over 26,500 models of DC Power Supplies — up to 1000VDC and 100A. Both wide and narrow range modules, plus Bench and Lab units for all applications. Quality power supplies based on industry-proven Power/Mate UniPower principles, featuring low ripple and excellent regulation. Low-cost, high reliability. 5-year warranty. Most models shipped same day.

SEND FOR YOUR FREE CATALOG

**P/MC** **POWER/MATE CORP.**

514 S. RIVER STREET, HACKENSACK, N. J. 07601  
Phone: (201) 343-6294 TWX: (710) 990-5023

Circle 191 on reader service card

## THE MITE<sup>T.M.</sup> NEW HEAT GUN FROM MASTER



Convenient  
Hanging Loop

Rugged, Anodized,  
Air Cooled Barrel

Safety Light — Easy to see ...  
indicates unit is "on."

One Hand Control —  
Three-way switch operated  
with simple finger movement.

Now bring a new dimension to heat shrinking as well as countless other industrial applications. Easier to handle ... only two pounds with nozzle ... perfectly balanced.

Three easily interchangeable color-coded nozzles to speed specific jobs. Silver (standard) ... used for most shrinkables (475°F.). Blue nozzle for Mylar\* (500°F.)...and Black for Teflon\* (800°F.) both optional equipment. Nozzles can be changed in seconds.

Draws only 5.4 amps. High impact housing withstands hard knocks of shop use. For information on the new MITE Heat Gun or the full line of Master Heat tools, contact your distributor or write:

\*Reg. Trade Name of DuPont

**MASTER**  
appliance corporation  
Racine, Wisconsin 53403  
Phone 414-633-7791



## New literature

**Transistors.** A four-page summary of four families of dual monolithic FET and bipolar transistors is available from Analog Devices, Rte. 1 Industrial Park, P.O. Box 280, Norwood, Mass. 02062. It includes general descriptions, specifications, and performance curves. Circle 421 on reader service card.

**Disk drive formatting.** Pertec Corp., Dept. 101N, 9600 Irondale Ave., Chatsworth, Calif. 91311. A 32-page application note on designing a sectored format for the company's disk drives provides an analysis of the parameters within a disk drive, along with algebraic expressions. [422]

**LED displays.** Monsanto Commercial Products Co., 10131 Bubbs Rd., Cupertino, Calif., is offering an eight-page catalog on its line of light-emitting-diode display modules. The brochure provides general and technical data. [423]

**Semiconductors.** Westinghouse Electric Corp., Semiconductor Division, Youngwood, Pa. 15697, is making available a condensed catalog of the company's line of power semiconductor devices, including rectifiers, thyristors, transistors, and prewired heat-sink assemblies. [424]

**Capacitors.** A catalog for miniature chip and leaded capacitors is a uhf-microwave design guide, offered by American Technical Ceramics, 1 Norden Lane, Huntington Station, N.Y. 11746. Graphs are given of Q, insertion loss, VSWR, reflected power loss, equivalent series resistance, and reactance versus capacitance value and versus frequency. [425]

**Oscilloscope.** Beckman Instruments Inc., Electronic Instruments Division, 3900 River Rd., Schiller Park, Ill. 60176. The type RS Dynograph recorder, a two-channel direct-writing oscilloscope, is described in a two-page bulletin. [426]

**Stepping switches.** A family of rotary stepping switches is described in a 56-page catalog from C.P. Clare & Co., 3101 Pratt Ave., Chicago, Ill.

60645. Catalog 601 includes design information, applications, and characteristics. [427]

**Resins.** Emerson & Cuming Inc., Dielectric Materials Division, Canton, Mass., has published a folder describing the company's line of Stycast resins, which include epoxies, polyurethanes and polystyrenes. [428]

**Diode.** A 6-ampere axial-lead diode in a plastic package is described in a brochure from International Rectifier Corp., Semiconductor Division, 233 Kansas St., El Segundo, Calif. 90245. [429]

**Keyprocessing system.** The CMC 18 Keyprocessing system, a means of computer-controlled data entry, is discussed in an eight-page brochure from Computer Machinery Corp., 2231 Barrington Ave., Los Angeles, Calif. 90064. [430]

**Dc power supplies.** Datel Systems Inc., 1020 Turnpike St., Canton, Mass. 02021. Ultraminiature dc power supplies are outlined in a two-page brochure that gives specifications and a selection guide. [431]

**Thumbwheel switches.** A 78-page thumbwheel switch catalog is being offered by Electronic Engineering Co. of California, Electronic Products Division, 1441 East Chestnut Ave., Santa Ana, Calif. 92701. [432]

**Resistors.** A resistor engineering handbook is being offered by RCL Electronics Inc., 700 South 21st St., Irvington, N.J. 07111. Specifications are provided for wirewound, precision, high-reliability, and chip resistors. [433]

**Diodes.** A condensed catalog detailing the specifications of the company's Micro State diodes has been published by Raytheon Co., Micro State Products, 130 Second Ave., Waltham, Mass. 02154. Included are tunnel microwave oscillator diodes, germanium video detector and back diodes, gallium arsenide varactor and avalanche types, and tunnel diodes. [434]

# \$125

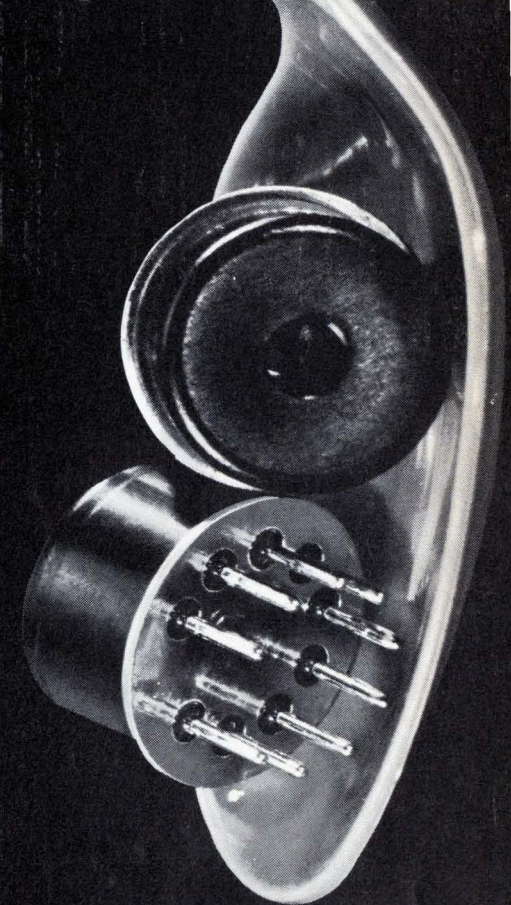

### it's so easy to take . . .

You can replace your thermopile with a SBN PYROELECTRIC DETECTOR.

- BROADBAND RESPONSE—UV to microwaves
- HIGH SENSITIVITY— $>$  to 125 V/W
- FAST RESPONSE—better than 5ns
- NO CRYOGENICS—operates from  $-40^{\circ}\text{C}$  to  $90^{\circ}\text{C}$
- RUGGED AND NONHYGROSCOPIC

This package includes a sensing element plus a integral FET and fits a standard 9 pin miniature tube socket. Available from stock for only \$125.00.

Call us at 216/248-7400 with your IR detection and measurement problems.



## HARSHAW

THE HARSHAW CHEMICAL COMPANY  
DIVISION OF KEWANEE OIL COMPANY

Crystal & Electronic Products Department  
6801 Cochran Road • Solon, Ohio 44139  
(216) 248-7400

# Some engineers are practically extinct at 35.

Birds and engineers both face occupational hazards.

The dodo, unfortunately, had tiny wings. He couldn't fly, so he perished three centuries ago.

Today many engineers face a real and growing hazard: professional obsolescence in the prime of their careers.

Because the proliferation of knowledge is so swift, because technological changes are so sweeping, R. & D. engineers often can't keep up. Their competence no longer fits the need.

Extinct at 35? It happens. In Alvin Toffler's best-seller, *Future Shock*, an electronics-industry spokesman is quoted as follows: "... the so-called 'half-life' of a graduate engineer is only ten years."

A tragic waste of one of the country's priceless assets. But at Hughes we do more

than deplore it. We've developed an extensive program to combat technical obsolescence.

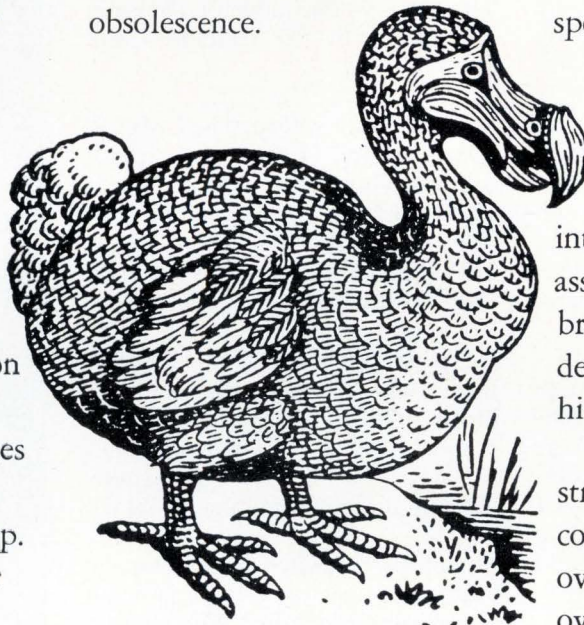

We award fellowships yearly to selected candidates for graduate study at Masters and Doctoral levels.

We pay 75% of the cost when Hughes engineers take appropriate college courses after hours.

Our Technical Education Center develops forecasts on future technology needs, and

establishes programs to meet these needs. Including courses, on-premises, by recognized specialists.

And the Engineering Rotation Program enables a new Hughes engineer to take on a series of interdisciplinary job assignments. He gains broader experience fast, determines what field interests him most.

We also keep building a stronger, more diversified company. Today Hughes is in over 80 major areas, including over 550 products and services. And that's good insurance against becoming extinct.

U.S. citizenship required.  
An equal opportunity M/F employer.



## If you're not, please send us your resume.

We'd like to hear from you if you're an electro-optical, infrared system, or radar system engineer, with an

accredited degree and about three to eight years of experience. If you qualify, we'll show our appreciation

by sending you a copy of *Future Shock*. Write: Mr. Robert A. Martin, Head of Employment, Dept. 31,

Equipment Engineering Divisions, Hughes Aircraft Co., 11940 W. Jefferson Blvd., Culver City, CA 90230.



# Help college help you.

Businesses like yours gave over \$340,000,000 to higher education last year.

It was good business to do so. Half of all college graduates who seek work go into business. The more graduates there are, and the better educated they are, the more college serves the business community.

Your money was vital to colleges. It relieved financial pressures, made planning more flexible, and contributed to the kind of basic and applied research that puts new knowledge and technology at the service of industry.

So that colleges can continue to help you, give to the college of your choice now. For information on ways to do it, please write on your letterhead to Council for Financial Aid to Education, Inc., 6 East 45th Street, New York, N.Y. 10017. Ask for the free booklet, "How Corporations Can Aid Colleges and Universities."

 Council for Financial Aid to Education, Inc.  
Advertising contributed for the public good. 

## Advertising Sales Staff

**Pierre J. Braudé** [212] 997-3485  
Advertising Sales Manager

**Atlanta, Ga. 30309:** Joseph Lane  
100 Colony Square, 1175 Peachtree St., N.E.  
[404] 892-2868

**Boston, Mass. 02116:** James R. Pierce  
607 Boylston St. [617] 262-1160

**Chicago, Ill. 60611:**  
645 North Michigan Avenue  
Robert W. Bartlett (312) 751-3739  
Paul L. Reiss (312) 751-3738

**Cleveland, Ohio 44113:** William J. Boyle  
[716] 586-5040

**Denver, Colo. 80202:** Harry B. Doyle, Jr.  
Tower Bldg., 1700 Broadway  
[303] 266-3863

**Detroit, Michigan 48226:** Robert W. Bartlett  
2600 Penobscot Building  
[313] 962-1793

**Houston, Texas 77002:** Charles G. Hubbard  
2270 Humble Bldg. [713] CA 4-8381

**Los Angeles, Calif. 90010:** Robert J. Rielly  
Bradley K. Jones, 3200 Wilshire Blvd., South Tower  
[213] 487-1160

**New York, N.Y. 10020**  
1221 Avenue of the Americas  
Warren H. Gardner [212] 997-3617  
Michael J. Stoller [212] 997-3616

**Philadelphia, Pa. 19103:** Warren H. Gardner  
6 Penn Center Plaza,  
[212] 971-3617

**Pittsburgh, Pa. 15222:** Warren H. Gardner  
4 Gateway Center, [212] 997-3617

**Rochester, N.Y. 14534:** William J. Boyle  
9 Greylock Ridge, Pittsford, N.Y.  
[716] 586-5040

**San Francisco, Calif. 94111:** Don Farris  
Robert J. Rielly, 425 Battery Street,  
[415] 362-4600

**Paris:** Alain Offergeld  
1 rue du Temple, Geneva, Switzerland  
Tel: 720-73-01

**Geneva:** Alain Offergeld  
1 rue du Temple, Geneva, Switzerland  
Tel: 32-35-63

**United Kingdom:** Keith Mantle  
Tel: 01-493-1451, 34 Dover Street, London W1

**Milan:** Robert Saidel  
1 via Baracchini Phone 86-90-656

**Brussels:** Alain Offergeld  
23 Chaussee de Wavre  
Brussels 1040, Belgium  
Tel: 13-65-03

**Stockholm:** Brian Bowes  
Office 17, Kontor-Center AB, Hagagarten 29,  
113 47 Stockholm. Tel: 24 72 00

**Frankfurt/Main:** Fritz Krusebecker  
Liebigstrasse 27c  
Phone 72 01 81

**Tokyo:** Masaru Wakeshima, McGraw-Hill  
Publications Overseas Corporation,  
Kasumigaseki Building 2-5, 3-chome,  
Kasumigaseki, Chiyoda-Ku, Tokyo, Japan  
[581] 9811

**Osaka:** Ryji Kobayashi, McGraw-Hill  
Publications Overseas Corporation, Kondo  
Bldg., 163, Umegae-cho Kita-ku [362] 8771

**Australasia:** Warren E. Ball, IPO Box 5106,  
Tokyo, Japan

## Business Department

**Stephen R. Weiss, Manager**  
[212] 997-2044

**Thomas M. Egan,**  
Production Manager [212] 997-3140

**Carol Gallagher**  
Assistant Production Manager [212] 997-2045

**Dorothy Carter,** Contracts and Billings  
[212] 997-2908

**Frances Vallone,** Reader Service Manager  
[212] 997-6057

## Electronics Buyers' Guide

**George F. Werner,** Associate Publisher  
[212] 997-3139

**Regina Hera,** Directory Manager  
[212] 997-2544

THIS SPACE CONTRIBUTED BY THE PUBLISHER

# LISTEN TO YOUR BODY.

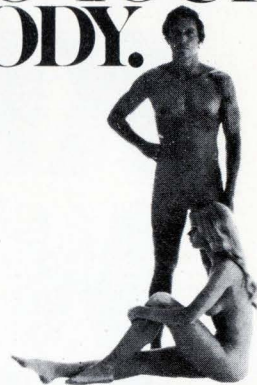

If something's going wrong, it'll tell you.

1. Change in bowel or bladder habits.
2. A sore that does not heal.
3. Unusual bleeding or discharge.
4. Thickening or lump in breast or elsewhere.
5. Indigestion or difficulty in swallowing.
6. Obvious change in wart or mole.
7. Nagging cough or hoarseness.

If you have a warning signal, see your doctor. If it's a false alarm, he'll tell you. If it isn't, you can give him time to help. Don't be afraid. It's what you don't know that can hurt you.

 American Cancer Society

# modern MAINE!

INDUSTRY is discovering there's more to Maine than lobsters and lighthouses! If a New England location is feasible in your industrial expansion/relocation plans, send for data on new international Air Park at Bangor and its plant location attractions.

RETURN  
COUPON  
NOW!

Name \_\_\_\_\_  
Address \_\_\_\_\_  
City \_\_\_\_\_  
State \_\_\_\_\_ Zip \_\_\_\_\_

ECONOMIC DEVELOPMENT DEPT.  
CITY HALL BANGOR, ME. 04401  
Edward G. McKeon tel. (207) 947-0341

## BANGOR, ME.

*New England Growth Center*

# 24,940 KEY PEOPLE WHO DON'T READ THESE,



# READ THIS.

That's a lot of people to be putting all their faith in just one magazine. Especially when there are so many others to choose from.

Yet all these important customers would rather go to The Source than read any of the next five electronics magazines.

That's a lot of readers. And that's a lot of trust.

We get so much unduplicated readership simply because we can't be duplicated.

So once they've read Electronics, they've read it all. And if you're advertising everywhere else, nearly 25,000 prospective buyers will never see it.

These readers are so loyal, they'd rather

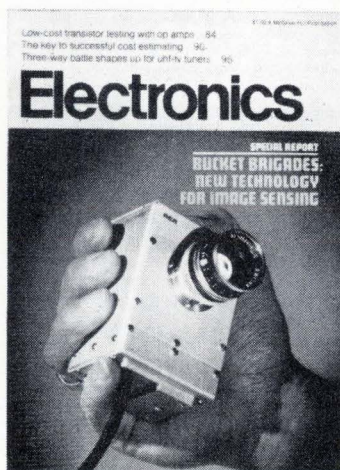

pay from \$8 to \$25 to read our magazine than get all the others free. And their loyalty is just part of our story.

58,000 (67%) Electronics subscribers are managers.  
70,000 (81%) have engineering job functions.  
74,000 (85%) decide who their companies will buy from. And a third of them decide on purchases of over \$100,000 a year.

These crucial buying influences believe in Electronics. And they'll believe in you when you advertise in Electronics.

With our kind of readership, you can't afford not to go to The Source.

**Electronics** **MS**  
**THE SOURCE.** **Grow**  
**Hill**

# Electronics advertisers

October 23, 1972

■ <b>Abbott Transistor Labs., Inc.</b> Technical Adv. Agency	6	<b>Georgia Department of Industry &amp; Trade</b> Cargill, Wilson & Acree, Inc. Adv.	158	<b>Princeton Electronic Products, Inc.</b> Mort Barish Associates, Inc.	38
<b>ADAR Associates, Inc.</b> Van Christo Associates, Inc.	37	* <b>Goerz Electro GmbH</b> Dr. Heinrich Fuchs	39E	* <b>Radiometer Copenhagen</b>	30E
<b>Advanced Micro Devices</b> Keye/Donna/Pearlstein	12-13	<b>Hansen Mfg. Company</b> Keller-Crescent Co.	158	* <b>RAFI</b> OSW - Werbeagentur	26E
* <b>Advanced Micro Devices</b> Keye/Donna/Pearlstein	20E	* <b>Harris Semiconductor</b> Tucker Wayne & Company	42-43,137	* <b>RCA Ltd.</b> Marsteller Ltd.	14E-15E
* <b>AEG Telefunken</b> Werbeagentur	37E	■ <b>Harshaw Chemical Company</b> Industry Advertising Company	167	■ <b>RCL Electronics, Inc.</b> Morvay Advertising Agency	14
<b>Allen-Bradley Company</b> Hoffman, York, Baker & Johnson, Inc.	88	* <b>Heinzinger</b> Technik Marketing	23E	* <b>Rheinisch-Westfälische</b> Verlag Werbewirtschaft	31E
* <b>Allen-Bradley</b> Hoffman York, Inc.	60-61	<b>Hermes Electronics Ltd.</b> Public & Industrial Relations Limited	78	* <b>Rohde &amp; Schwarz</b> <b>Schauer Manufacturing Corp.</b> Nolan, Keelor & Stites	1E 154
<b>AMF/Potter &amp; Brumfield Division</b> Fuller & Smith & Ross, Inc.	10-11	■ <b>Hewlett-Packard</b> Richardson, Seigle, Rolfs & McCoy, Inc.	2	* <b>Schlumberger Solartron</b> Scott MacTaggart Advertising	9E
<b>AMP, Incorporated</b> Aitkin-Kynett Co., Inc.	73	■ <b>Hewlett-Packard</b> Tallant Yates Adv. Inc.	82-83	* <b>Schneider R. T.</b> Intermedia	22E
■ <b>Amphenol Connector Division,</b> <b>Bunker Ramo Corporation</b> Marsteller, Inc.	24	■ <b>Hewlett-Packard</b> Tallant/Yates Advertising, Inc.	124-125	<b>SGS - ATES</b> STUDIO B Communications	148
<b>Analog Devices, Inc.</b> Schneider Parker Guy, Inc.	57	■ <b>Hewlett-Packard</b> Tallant Yates Advertising, Inc.	140,161	<b>Sheaffer World-wide</b> Sperry-Boom, Inc.	176
* <b>AOIP</b> DP Industries	33E,35E	■ <b>Hewlett-Packard</b> Richardson, Seigle, Rolfs & McCoy, Inc.	1	* <b>Siemens Aktiengesellschaft</b> Linder Presse Union GmbH	52
■ <b>Augat</b> Creamer, Trowbridge, Case & Basford, Inc.	150-151	<b>Hickok Electrical Instrument Company</b> Key Marketing Associates	28	* <b>Silec Electronique</b> France M-1	28E
■ <b>AVX Ceramics</b> Allied Advertising Agency, Inc.	18-19	■ <b>Honeywell Test Instrument Division</b> Campbell Mithum Inc.	156	<b>Siliconix Incorporated</b> Paul Pease Advertising	105
<b>Bell &amp; Howell - Electronics</b> <b>&amp; Instruments Group</b> Boylhart, Lovett & Dean	35	<b>Hughes Aircraft Company</b> Foote, Cone & Belding	74-75,168	* <b>Sodeco</b> Thomas Stocker	4E
■ <b>Bendix Corporation,</b> <b>Electrical Components Div.</b> D'Arcy-MacManus-Intermarco, Inc.	21	<b>IBM Data Processing Division</b> Geer, DuBois & Co., Inc.	66	<b>Solltron Devices, Inc.</b> <b>Transistor Division</b> Haselmire Pearson Advertising, Inc.	99
<b>Bourns, Inc.</b> Marlborough Assoc., Inc.	80	<b>Industrial Electronic Engineers Inc.</b> Van Der Boom, McCarron Advertising	8	<b>Sonoco Products Company</b> Cargill, Wilson & Acree, Inc.	179
<b>BOWMAR Inc.</b> Chirug & Cairns, Inc.	162	‡ <b>International Rectifier Corp.,</b> <b>Semiconductor Division</b> William E. Wilson Company	136-137	‡ <b>Sorensen Operation Raytheon Company</b> Provandie Eastwood & Lombardi, Inc.	52
* <b>Burndy Electra</b> Publicists	11E	■ <b>Interstate Electronics Corporation</b> Chris Art Studio Inc.	62-63	* <b>Souriau &amp; Cle</b> Ariane Publicite	29E
* <b>Cambridge Thermionic Corporation</b> Chirug and Cairns, Inc.	34E	<b>Intronics</b> Impact Advertising Incorporated	144	■ <b>Systron Donner Corp. -</b> <b>Datapulse Div.</b> Bonfield Associates	163
‡ <b>Cherry Electrical Products Corp.</b> Kolb/Tookey and Assoc., Inc.	51	■ <b>Kecco Incorporated</b> Weiss Advertising	5	■ <b>Tektronix, Inc.</b> Dawson, Inc.	33,44-45
<b>Chrysler Corporation-Chrysler Imperial</b> Young & Rubicam, Inc.	175	■ <b>Lambda Electronics Corporation</b> Michel Cather Inc.	3rd Cover	<b>Teledyne Crystalonics</b> Gerard J. Gormley Advertising, Inc.	64
‡ <b>Cinch Connectors, Operation</b> <b>of TRW Electronic Components</b> Stral Advertising Company, Inc.	9	<b>Litronix Inc.</b> Regis McKenna Inc.	39	<b>Teradyne Inc.</b> Quinn & Johnson, Inc.	172
‡ <b>Cincinnati Milacron,</b> <b>Process Controls Division</b> David K. Burnap Advertising	54	<b>Lockheed Electronics Company</b> McCann-Erickson, Inc.	106-107,138	■ <b>Texas Instruments Incorporated,</b> <b>Components Group</b> Albert Frank Guenther Law, Inc.	22-23
<b>City of Bangor, Maine</b> <b>Economic Development Dept.</b> Dick Bronson, Inc.	169	* <b>LTT</b> Publibel	32E	‡ <b>Thomas &amp; Betts Company</b> McCarthy, Scelba, DeBiasi Advertising Agency, Inc.	15
■ <b>Clalrex Corporation</b> Black-Russell-Morris	4th Cover	<b>Lyon Metal Products</b> Reincke, Meyer & Finn, Inc.	180	<b>Thomson CSF</b> Bazaine Publicite	112
<b>Colorado, State of Commerce</b> <b>and Development Division</b> Frye-Sills, Inc.	160	<b>Macrodata Company</b> JMR Advertising	152	<b>Toko, Inc.</b> Hakuhodo, Inc.	146
<b>Concord Electronics Corp.</b> Sound Advertising	146	<b>Master Appliance</b> Klau-Van Pietersom-Dunlap, Inc.	166	<b>Torin Corporation</b> Viscom International Inc.	71
<b>CONWAY ELECTRONIC ENTERPRISES</b> <b>LIMITED - Masteranger 639</b> Durish Advertising Limited	87	<b>Microfiche</b>	80A-B,81	<b>UniCom Systems, Inc.</b> Stanbro Drummon Advertising, Inc.	177
* <b>D. Olivetti &amp; C. Spa</b> Studio ECO	19E,21E	<b>Micro Power Systems</b> Associated Adventures	70	■ <b>Unitrode Corporation</b> Impact Advertising	27
<b>Dana Laboratories</b> Dailey & Associates	17	<b>MOS Technology, Inc.</b> Henry S. Goodsett Advertising, Inc.	2nd Cover	<b>Universal Instruments Corp</b> Conklin, Labs & Bebee, Inc.	77
<b>Datatron, Inc.</b> Larry Courtney Company	20	■ <b>Motorola Semiconductor Products, Inc.</b> E B Lane & Associates, Inc.	58-59	<b>U. S. Capacitor Corp.</b> S. Michelson Advertising	166
<b>Delco Electronics Division,</b> <b>General Motors Corp.</b> Campbell-Ewald Company	46-47	■ <b>National Semiconductor Corp.</b> Chiat/Day, Inc. Advertising	48	■ <b>Wang Laboratories, Inc.</b> WLI Associates Advertising	147
<b>Dest Data</b> Kassler Noble Advertising	69	* <b>Nippon Kogaku K.K.</b> K & L Advertising Agency	9	<b>Wima, Westermann</b>	16
<b>Diallight Corporation</b> Michel-Cather, Inc.	131	<b>North American Rockwell,</b> <b>Electronics Group</b> Campbell-Ewald Company	134-135	* <b>Yokogawa Electric Works Ltd.</b> General Advertising Agency, Inc.	15
■ <b>Digital Equipment Corporation</b> Creamer, Trowbridge, Case & Basford, Inc.	100-101,132-133	<b>North Atlantic Industries, Inc.</b> Diversified Corporate Services, Inc.	126	* <b>Zincoelere S. p. A.</b> Studio Dr. Giuliano Blei	25E
■ <b>Digital Equipment Corporation</b> Schneider Parker Guy, Inc.	159	■ <b>Oak Industries, Inc., Switch Division</b> Buchen Advertising, Inc.	79		
<b>Donaldson, Lufkin &amp; Jenrette, Inc.</b> Doremus & Company	86	* <b>Ohmic</b> Promoazur	7E		
<b>Eastman Kodak Company,</b> <b>Business Systems Markets Div.</b> J. Walter Thompson Co.	165	* <b>Oscilloquartz SA, Neuchatel</b> M R. Hofer Werbeagentur BSR/EAAA Bern	10E,12E,36E		
* <b>Electro Scientific Industries</b> Com/Mark Communications Group	51	<b>Pennsylvania Grade Crude Oil Asso.</b> Meldrum and Fewsmith, Inc.	176		
■ <b>Electronic Associates, Inc.</b> Gerald Clarke, Inc.	40	<b>Philips Elcoma</b> Tag-Intermarco delaMar	142		
<b>Fairchild Semiconductor, Inc.</b> Carson/Roberts, Inc. Adv., Division of Ogilvy & Mather, Inc.	84-85	* <b>Philips Elcoma</b> Tag-Intermarco delaMar	16E,18E,2E-3E		
■ <b>Fluke Manufacturing Co., John</b> Bonfield Associates	7	* <b>Philips N. V. Pit/T &amp; M Division</b> Marsteller International S. A.	54		
■ <b>General Electric Electronic Components</b> Robert S. Cragin Inc.	155	* <b>Philips Power Supplies</b> Marsteller International S. A.	13E		
* <b>General Instrument Europe S. p. A.</b> Studio Hedy	24E	<b>Photocircuits</b> Ries Cappiello Colwell, Inc.	41		
		* <b>Pignone Sud</b> Linea Spn	40E		
		■ <b>Power/Mate Corporation</b> Spectrum Marketing Associates	166		
		<b>Powertec, Inc.</b> Warren C. Wilson & Associates	145		
		‡ <b>Prime Computer, Inc.</b> Grover and Erickson, Inc.	60-61		

## Classified & Employment Advertising

F. J. Eberle, Manager 212-971-2557

EQUIPMENT (Used or Surplus New) For Sale	
Philip Fishman	160
Ewald Inst. Corp.	160
B. F. Williams	160

■ For more information on complete product line see advertisement in the latest Electronics Buyer's Guide  
\* Advertisers in Electronics International  
‡ Advertisers in Electronics domestic edition

# 22 trims, 44 cuts, 5 seconds.

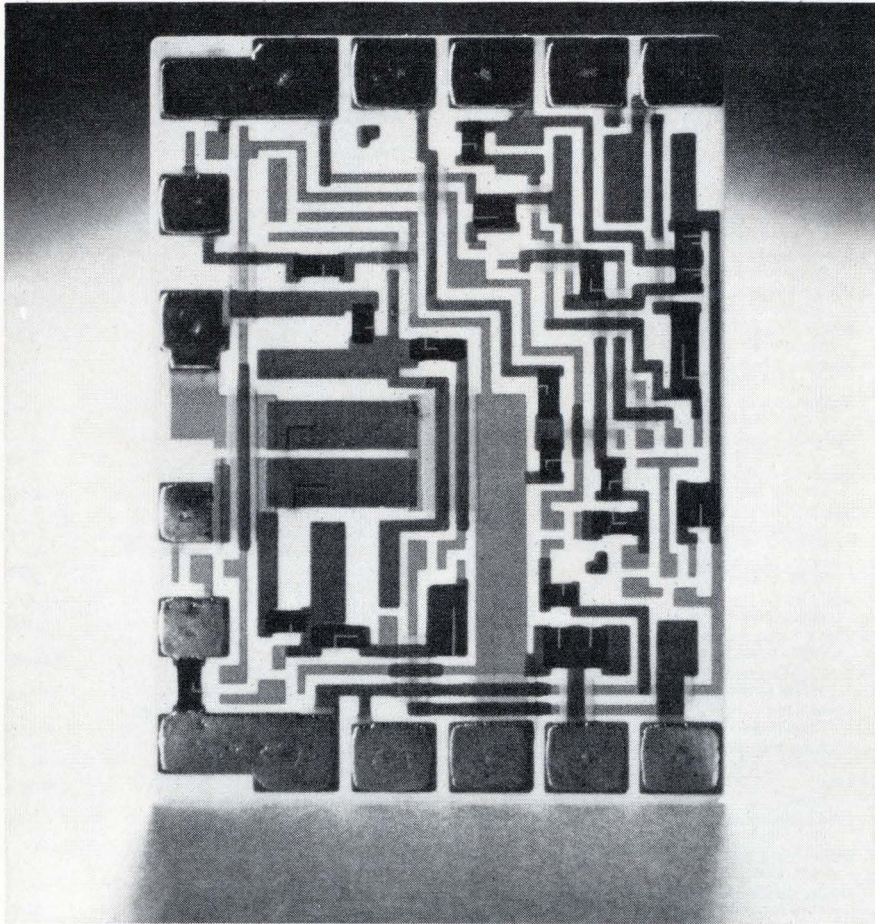

The circuit: a linear amplifier produced by RCA's Solid State Division, Mountaintop, Pa. 11 resistors are double-cut, 11 are L-cut. All trims are to 1% of nominal value or ratio. Throughput: better than 700 an hour. System datalogs before and after resistance values and deviations from nominal.

In laser trimming, you expect things to happen fast. But the Teradyne Laser Adjust System is *fast fast*.

Its unique beam deflector can move a laser beam from any location on a 2 x 2 substrate to any other in 30 milliseconds.

Its automatic handler indexes in less than 500 milliseconds.

Put it all together and you get the kind of productivity you need to stay cost-competitive in today's fast-moving hybrid business.

You also get the ability to make the kinds of cuts you need to produce high-quality resistors... double cuts, scanning cuts, serpentine cuts... in no more time than other systems take for compromise trims.

And that's not all. Industry's fastest laser trimmer is backed up by industry's most complete hardware and software for computer-controlled functional trimming. A trim station can be supplied, for example, as part of Teradyne's new J271 Analog Circuit Test System, for the active trimming of hybrid audio or rf circuits.

Learn more. Write Teradyne, 183 Essex St., Boston, Mass. 02111.

In Europe: Teradyne Europe S.A., 11 bis, rue Roquépine, 75 Paris 8<sup>e</sup>, France. Tel. 265 72 62.

IN THE U.S.: CHICAGO (312) 725-2011  
DALLAS (214) 231-5384  
NEW ENGLAND (617) 245-5340  
NEW YORK (201) 871-4052/PALO ALTO (415) 493-2340  
IN EUROPE: LONDON (093-28) 61111/PARIS 265 72 62  
ROME 59 47 62/MUNICH (0811) 33 50 61

## TERADYNE

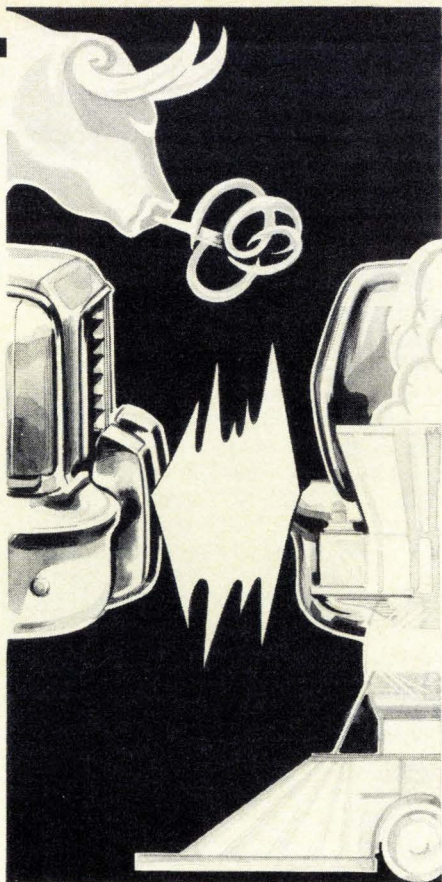

IN THIS SECTION:

AUTOS

This season's bumper crop

BOOKS

TAXES

HEALTHY, WEALTHY AND WISE

AUTOS

**Picking a '73 car:  
It's a matter of  
knowing bumpers**

Detroit's 1973 lineup of cars is a bumper crop—not because there are so many cars, but because their bumpers are so prominent. Under federal orders, the 1973s must be able to sustain a crash of 5 mph. in front and 2½ mph. at the rear without damage to safety items such as lights, locks, exhaust, fuel and cooling systems. Designing that much resistance into acceptable contours so monopolized the time of Detroit's engineers that they had little left to come up with more than a handful of new models.

For 1973, there are really only three: Chevrolet's Laguna (a top-of-the-line Chevelle); Oldsmobile's Omega (a well-appointed compact off of the same body as the Chevy Nova and Pontiac Ven-

tura), and American Motors' compact Hornet hatchback. The entire line of GM's intermediate cars, of course, have been restyled—but they were to have been changed for 1972. A 67-day strike, however, postponed the changes for a year. Buick's intermediate has also undergone a name change, from Skylark to the Century.

For 1973, no matter what the make, no one will have trouble recognizing the new cars. They all have that fat lower lip one Ford executive refers to as "the cow-catcher." The new bumpers stick out in front about three to four inches, reminiscent of the steel bumpers of the 1920s and 1930s, and, with the new rear bumpers, add between 40 and 140 pounds to a car's weight, depending on the system used. While most of the car makers are stuffing the space between the bumpers and the car bodies with plastic, they have taken some different

roads in complying with the new safety standards.

GM cars, for the most part, rely on a bumper system backed by shock absorbers made by GM's Delco Products Division. They yield under impact, then restore the bumper to its original position. Chevy's Laguna sports model has perhaps the best-styled system in the industry; it was designed as an integral part of the car, not as an after-thought. The urethane and steel-reinforced bumper (made by McCord Corp.) with Delco shocks encompasses the entire front end, collapsing and expanding upon impact like an accordion.

Ford Motor Co. cars employ rubber "pucks" which connect the bumper to the car, and soak up most of the bumper shock. The Ford Mustang does make use of a urethane, steel-reinforced system like the Chevy Laguna, but with some differences.

Chrysler decided to tackle the problem head-on, beefing up the entire car's structure, and using very rigid bumpers with two thick rubber guards in front. The system more resists impact than absorbs it, and the appearance is about as formidable as anything in the industry. AMC for the most part uses GM's Delco shocks, but its Javelin series employs a

This PERSONAL BUSINESS section is written by McGraw-Hill editors to give you helpful information on the better management of your leisure time and money. Personal Business covers everything from taxes and investments to education and travel. We feel that today, more than ever, personal-business planning is of prime concern to businessmen and professionals.

steel-reinforced front bumper with rubber strips, not unlike Chrysler's system.

Anyone expecting the new bumpers will free them from expensive trips to the body shop should consider this factor in the federal standard: The bumper only has to protect *safety-related items* in a fairly modest 5-mph. bump—the bumper itself can be bent, scratched and otherwise distorted to the point where *repairs to it alone could be costly*.

Further, while the new *front* bumpers are generally built to survive collisions

---

#### By J. PATRICK WRIGHT

with modest damage, many of the cars offer rear bumpers which can suffer severe damage while living up to the legal requirement of protecting the safety devices. To guard against scratching, the car makers do offer—as extra options—horizontal bumper strips. But, considering that vulnerability at the rear, it's a good idea to check with your dealer to see what he's offering in optional self-restoring rear bumpers, particularly if you do a lot of city driving.

The one financial advantage of the new bumpers may be what they do for insurance premiums. American Motors cars, for example, rate a collision premium reduction of between 10% and 20% from Allstate Insurance Co.

Next to bumpers, the biggest change in the 1973 cars is stricter emission control. Under the new federal standards, new cars can emit no more than 3 grams of nitrogen oxide per mile. The automakers are all meeting the requirement with a system that recirculates exhaust gases through the combustion process. This means, of course, that you can expect poorer fuel mileage, somewhat more sluggish engine performance—and you may have to take your 1973 model in quite frequently for a tune-up to keep it running smoothly.

The fine hand of the federal government will also be found *inside* your new car. Interiors for 1973 must be made of material which burns no faster than four inches per minute in tests.

While Detroit may have put styling on the back burner in meeting the new rules, the automakers haven't forgotten it entirely. Some of Chrysler's cars sport new front and rear ends. The "opera window"—born in the limousines of the 1920s and re-popularized by the Lincoln Mark IV last year—borders on a rage for 1973. You'll find it, or something like it, in the rear side roof panels of Pontiac's Grand Prix, Chevy's Monte Carlo, Olds' Cutlass Supreme, the Cadillac Eldorado, and Ford's Thunderbird. Generally, though, the new "opera windows" are bigger and not always of the oval shape of the old limousine version.

---

## BOOKS

KEN PURDY'S BOOK  
OF AUTOMOBILES  
BY KEN W. PURDY  
PLAYBOY PRESS, \$9.95



When bumpable bumpers and the defuming of exhaust take precedence over styling in Detroit—as they do this new-model season (see AUTOS)—the end of the automobile as we know it may not be far behind. Automotive engineers are already gearing for the day when cars will simply be utilitarian little buggies as standard as doughnuts in a bakery window. There are some, indeed, who figure the auto may have no place at all in our megalopolitan, rapid-transit future.

But here is a more reasoned view, from Ken W. Purdy, who, until his untimely death earlier this year, lived as intimately with the elite of motordom as any professional writer. In one of the more than two score articles included in this anthology, Purdy says this:

"In the present life-style of the horse, we can descry the future of the automobile. The horse population of the United States is booming. In 1959, when we supported 4,500,000 horses, who would have guessed that 1969's total would be 7,000,000?

"... We can't afford the automobile's pollution now (this was written in 1969), and if we are not appalled at using 300 horsepower and a gallon of gasoline to push one man and five empty seats ten miles, our children will be. So we'll see a day when great seven-passenger Rolls-Royce limousines are taken off their blocks only to run a few miles in nostalgic review. . . .

"On that day, race cars will be running everywhere, as thoroughbreds do now, and more sports cars will be at large than there are now, their function, with the saddle horse, pure enjoyment, and transportation over the ground quite incidental. . . ."

The *pure enjoyment* of motorcars—as things of beauty, expensive toys, and instruments of speed—is what fills these pages. The articles and stories, all previously printed in major magazines, roughly span two decades of Purdy's career. They begin with an in-depth profile of Stirling Moss, the British champion race driver, at the time (1962/63) when he was fighting manfully, but unsuccessfully, to return to racing after a near-fatal crash.

The succeeding pages teem with other names of motorcar greatness. We meet the Brothers Chevrolet, the inventive geniuses "who should have been multi-millionaires, but weren't." We are introduced to the fabulous Ferrari *gran turismo* cars that cost \$20,000 and repay their owners by hitting 85 mph. *in second gear*. We are led into the collector's rarefied world of classic cars, such as the 1930-ish Bugatti (Type 575 C) which brought \$59,000 at a Parke-Bernet auction last year. We are given a close-up of "the ultimate limousine," the Mercedes-Benz 600 (basic price: \$28,500), the built-to-order-only, seven-passenger vehicle currently favored by Middle Eastern oil-rich potentates.

Purdy also takes us into the pits, grandstands and drivers' minds at some of the world's most famous racing grounds, from "the Golden Brickyard" at Indianapolis to the world's oldest over-the-road circuit in Sicily where the Targa Florio, a gruelling long-distance race, has been run since 1906.

Perhaps because nearly everything in the book has been published as popular magazine fare, in individual pieces, there is a certain repetitiveness in reading the book straight through. But, for much the same reason, the material is served up with clarity and spice. Although loaded with motorcar and racing lore, it is not strictly for insiders.

Indeed, the book proves once again that Purdy, apart from being an authority on cars, could write. His prose bristles with the technical details to delight the aficionado, but the whole is polished with skill, broadened by insight, and touched with a certain amount of wit. Chasing a friend's Brescia Bugatti through a rainy dusk in the British countryside, Purdy recalls that the Brescia's taillights were "about the size and color of a pair of ripe raspberries and throwing all of three candlepower each."

"Most of the attitudes that make up sports car mystique," he notes at another point, "were imported from Britain. One of them has it that the owner of an open car shouldn't put the top up in anything short of a blizzard. I know a man who bought an XK-120 Jaguar off the showroom floor fifteen years ago and has *never* put the top up, and he never will."

Even for the reader who has never driven anything but the family sedan, *Ken Purdy's Book of Automobiles* is informative, entertaining reading, largely because its author clearly loved his subject. "I for one hope that the automobile, a little less lethal, a bit more civilized, will long be abroad in the land," he says in his preface, written last November. "I should hate to think that all the pleasure I've had of it, and anticipate having, would not be known to my children and my children's children."



# The Chrysler Imperial was built with the idea that a car should carry you from place to place in maximum comfort.

## That idea has never changed.

To begin with, there's the 1973 Imperial's comfortable ride, so quiet it's almost eerie. It's the result of a unique combination of its torsion-bar suspension (for good handling) and a sound isolation system that's designed to give you an extraordinary sense of remoteness and serenity.



We've added new sound deadeners to the '73 Imperial. Strategically placed foam seals, silencer pads and vibration absorbers, to name a few.



The interior of the new Imperial is enough to make you wish you didn't have to leave it. Depending on the model you pick, it indulges you with beautiful Cologne leather seats, individual folding center armrests, rear-seat reading lamps and built-in foam pillows.

To comfort your mind, our Electronic Ignition System starts up the car's insides no matter how wet the weather gets outside.



And you get an electronic digital clock that keeps time within a minute a month.



The Imperial is our finest, most comfortable car.

And the 1973 Imperial is our finest, most comfortable Imperial ever.

The car may change.

The idea never.



CHRYSLER

Plymouth

### Chrysler Imperial

Extra care in engineering...it makes a difference.



CHRYSLER  
MOTORS CORPORATION

## Tax scene: Pumping the oil deals dry

Last winter the promoters were touting oil as a smart money idea for the smaller, if not small, investor. A boom in syndication had made more modest investments possible. A man could put, say, \$10,000 into a deal, and pick up a tax shelter via the deduction of intangible drilling costs. Said one well-known California promoter: "A well gives you expense deductions months before there's even a drop of oil. And when you sell out, the beauty part is, you get capital gains."

Such deals still are workable, and profits can be realized by anybody who has the cash and can benefit from a tax deduction. But—and it's a big one—the chances of getting swamped have become increasingly apparent in recent months. The tax concept works. What oftentimes does *not* work is the *managerial* side of things.

"What's needed is a microscopic look at the promoter," says an oil consultant with a leading New York bank. "Is he, for example, taking his profit as though it was an *expense* of doing business? If he is, it's a warning that the whole operation may have too many pitfalls for the novice investor." . . . Meantime, Internal Revenue and the Tax Court have been taking a harder line on oil deals. Latest move: a clampdown on the practice of taking the sheltering tax deductions near year's end when activity in the operation would normally not justify them until the following year. "It limits oil-related year-end tax planning," says the consultant. "IRS will keep the pressure on oil."

*Dollar savers: Revolving credit accounts*—department store, credit card, and such—often cost as much as 18% in finance charges. IRS has now eased its old 6% maximum rule, and allows deduction of the full charge, even if it includes fees apart from actual interest. Refunds can be claimed by using an amended return (1040X). . . . Anyone with a *tax dispute with IRS* involving less than \$1,000 can go before the "small claims division" of the Tax Court and most likely come away with a tolerable result.



The extraordinary gift.  
Crowning jewel of the  
master craftsmen.

There are occasions when only the extraordinary will do. That is the time to give a solid sterling "Silver Imperial" or 14K gold-filled Sheaffer "Imperial Sovereign". Majestic masterpieces from the world's foremost penmaker. Luxuriantly crafted from clip to inlaid point. Single and gift sets from \$15.00 to \$67.50.

**SHEAFFER**  
the proud craftsmen

SHEAFFER, WORLD-WIDE, A **Textron** COMPANY

## In a class by itself



1920 Mercer Raceabout

Frederick C. Crawford Auto-Aviation Museum

### MOTOR OIL REFINED FROM 100% PURE PENNSYLVANIA GRADE CRUDE OIL — THE CLASSIC OIL FOR MORE THAN 63 YEARS

It's been true since the days of the classic 1920 Mercer: Motor oils refined from Pennsylvania Grade crude perform better naturally.

Just as Nature made it, Pennsylvania Grade crude is truly the oilier oil, the world's richest crude oil.

Motor oils refined from this remarkable crude offer surest resistance to build-up of varnish, sludge, and acid. They stay stable under severe high compression

and high temperature conditions.

Quality has made "Pennsylvania Grade" the most asked-for brands of motor oils.

Pennsylvania Grade crude oil. Just naturally richer. Definitely in a class by itself.

Free booklet gives helpful car care information. Write Dept. PB 21.



### PENNSYLVANIA GRADE CRUDE OIL ASSOCIATION

P.O. Box 250, Oil City, Pennsylvania 16301

# UNICOM ANNOUNCES THE END OF THE ADDING MACHINE...

WITH THE INTRODUCTION OF  
THE UNICOM 1000P — A REMARKABLE NEW  
ELECTRONIC PRINTING CALCULATOR  
AT ONLY \$295.

They said it couldn't be done. But those crazy guys from UniCom have done it. You'll never again have to buy an adding machine that only adds and subtracts. Now you can buy the amazing UniCom 1000P electronic printing calculator.

A significant breakthrough in calculator pricing, yes. Because it makes UniCom 1000P considerably less expensive than *electronic* printing calculators. Less expensive than most *electronic* display calculators. Less expensive than *mechanical* printing calculators. Even less expensive than office-type *adding machines!*

But price isn't the full story. At \$295, you'd expect a calculator with limited features. Not so. The 1000P adds, subtracts, multiplies, and divides. Has automatic credit balance. Highly legible, two-color printing. Automatic constants. Automatic chaining. Grand totals. Automatic decimals. And much more. If that's not enough, we have UniCom 1010P. It has some important additional features. Like a memory/equals key that completes a calculation and automatically adds to or subtracts from a memory. It sells for \$345. And that's a remarkable price, too.

These calculators are more than an engineer's pipe dream. You can see them today at UniCom branches and dealers throughout the country. Or just fill out the coupon. We'll see that you get information promptly. Or write us at 10670 N. Tantau Ave., Cupertino, California 95014.

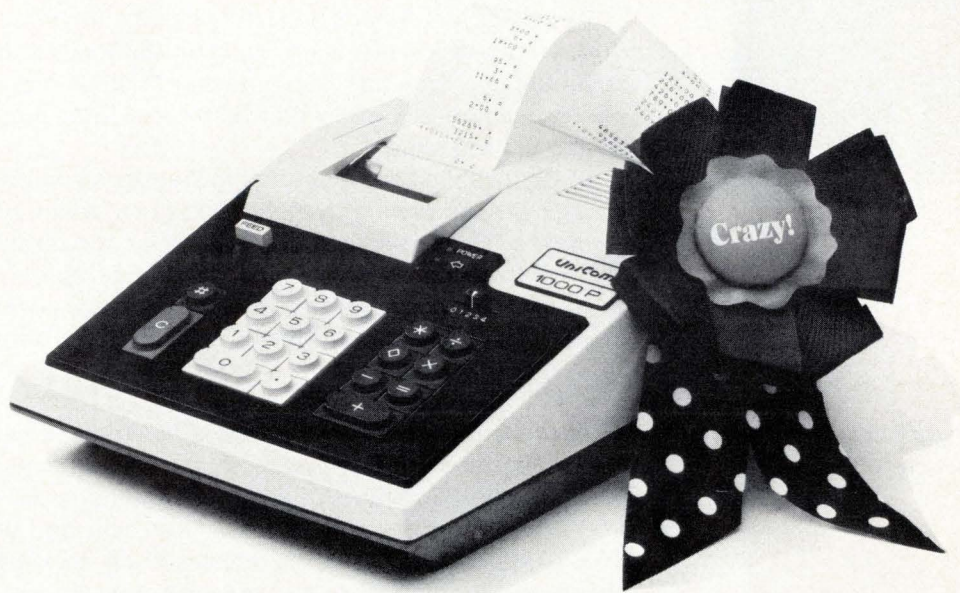

**THOSE CRAZY GUYS  
FROM UNICOM  
HAVE DONE IT AGAIN!**

Crazy! Send a salesman right away   
Send me complete information on UniCom  
1000P  1010P

Name \_\_\_\_\_

Address \_\_\_\_\_

City \_\_\_\_\_ State \_\_\_\_\_ Zip \_\_\_\_\_

Mail to: Unicom Systems, Inc.  
10670 N. Tantau Ave.  
Cupertino, California 95014

**UniCom**  
Systems, Inc.



**Wall Street radar:  
Coping with clear-air turbulence**



Gerald M. Loeb

The 1972 market has had some air pockets that have shaken investors, says Gerald M. Loeb, the Wall Street consultant and writer. He notes pockets of clear-air turbulence where an unusual number of solid stocks have had sudden drops in a reasonably stable market. Some losses from previous highs have been dire, and some stocks dropped 10% to as much as 40% in a day. Not high flyers, either, notes Loeb, *but all types of stocks*. How does one spot a possible air pocket? Follow these rules, he says:

(1) Buy the right stock at the right price. This means *smart* buying, even if it entails missing some possible long-shot profits. Air-pocket price drops are most apt to happen when a stock is selling at a sky-high price-earnings ratio, or "on concept rather than on actualities," or when the company is short of working capital or has an unusually high debt.

(2) Decide on *supervision*. Air pockets ahead are first revealed by chart action. Sudden downside drops are most apt to occur right after a sharp, unjustified price advance. But they can happen when a stock has already dragged down, and the charts must be followed with this in mind. They *must* be followed, indeed—or the investor is flying blind.

(3) Be aware of the institutional investors such as mutual funds. Watch out for a stock's excess popularity with institutions, which often react to news by selling out en masse. This big-selling can turn drops into tailspins.

All of this implies some farsighted investigation *and* follow-up by the investor, says Loeb. "But for most people, the cost of avoiding an air pocket, even with a risk of losing an occasional profit—is *well* worth the effort."

**Patching holes in umbrella coverage**

Umbrella insurance that protects against "all risks" isn't really *all-inclusive*, say the experts at John Liner Assocs., the Boston consulting firm. It often folds up over auto liability. For example: If you've a teenage son who gets his own car, he likely won't come under your umbrella—and you and your wife may not, either, when driving his car. . . . "Rec" vehicles such as snowmobiles and mini bikes cause coverage problems, too. A standard homeowner's policy doesn't cover such a vehicle when *away from home*, though the policy can be extended by added endorsement. Even some umbrellas have the same limitation, and need extension (at more premium cost). Note: *Rented* rec vehicles are covered by the standard homeowner's policy. . . . In some cases, it may make renting a better idea.

**The product line:  
gongs to goggles**

A new line of *home security alarms* by Magnavox features a radio-frequency (rf) receiver alarm, in combination with sensors, to detect the opening of a door or window, or the pressure of a person stepping on a mat. The system, working on a standard 9-volt battery, has a "panic button" attachment—a remote signalling device which can be kept at bedside and used to sound an alarm or turn on a light in an emergency (\$170). . . . An early warning fire and smoke detector works on an ionization principle, can detect smokeless fire; operates on a 10.7-volt battery (\$100). . . . General Tire's new *dual-steel radial tire* has a 40,000-mile guarantee (in test runs justifying the guarantee, tires were rotated every 4,500 miles). . . . Rockwell's new Model 95 *home workshop sander* weighs 3.5 lbs., is double-insulated, develops 10,000 rpm. pad speed (\$20). . . . "Ski Goggle II" by Bausch & Lomb is designed to fit over conventional prescription glasses, with changeable dark gray and yellow lenses (\$18).

For nippy days at the stadium try a warmer called *hot white* from the bar at Forum of the XII Caesars in New York: Put a bottle of Frascati wine (light white) and a stick of cinnamon into a pot; heat, then pour into your flask.

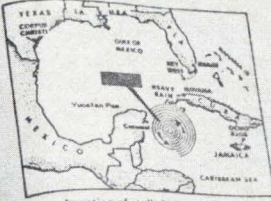

Location of stalled tropical storm

## Storm May Turn Into Hurricane

Tropical Storm Anne, with winds gusting to 90 miles per hour, slowly gathered strength Saturday and forecasters said she could become the first hurricane of the season.

At noon Saturday, Anne was packing winds 10 miles below hurricane force of 75 m.p.h., and was located at latitude 21.0 north, longitude 84.8 west, about 400 miles southwest of the coast.

National Hurricane Center forecasters said the storm could intensify as it continued to drift northward.

The brunt of the storm was being felt by western Cuba, forecasters said, where torrential rains had been reported on the Isle of Pines for several days.

"Anne is about 60 miles from Cuba," a hurricane center spokesman said.

"But she is not near any other land masses." The storm was causing gales and rough seas and small boats were warned to stay in protected waters.

"Seas are rough on the Atlantic side," said the forecaster. "But the storm is heading toward the Gulf and if a small boat ventures far out it could be blown far from port."

Anne was drifting at about 5 m.p.h., and that conditions favored "a slight increase in strength."

"She is already near hurricane strength and could reach the 75 miles an hour mark quite soon."

Forecasters said Anne was also causing rough seas and high winds in the Bahamas but was about 600 miles southwest of Grand Cay.

## Hike Expected In Food Costs

### Retailers Disclaim Blame

Major retail food chains and their trade organizations are quietly contacting consumer organizations to warn that a sharp rise in food prices is under way and to ask that retailers not be blamed.

The retailers are saying that the new round of food price increases is being generated by a rise in the carcass price of meat even steeper than those that caused consternation earlier this year.

As a result, they warn, prices will go to record levels at retail outlets and other food prices will rise as well.

### Commission Concerned

The chairman of the Price Commission, declared that the commission was concerned about the increase in food prices and is considering options for dealing with the problem.

It is not, however, ready to take action at this time.

"The actions we could take are so undesirable that they will only be a last resort."

It was



## Tax Crisis Reported Still Unresolved

The general fund tax collections were way up in May, but one Revenue Commissioner said the increase was not as large as it appeared.

The monthly report to the Governor said that the general fund took in \$123.5 million in May as compared with \$84.3 million in May of last year.

The 46.62 percent increase was deceptive, he explained, because there were fewer working days in April than in April of last year.

The discrepancy was also reflected in highway fund collections which totaled \$28.7 million in May for a \$7.6 million or 26.5 percent increase over May of last year.

It was reported that general fund collections for the first 11 months of the fiscal year totaled \$986.1 million as compared with \$867.6 million in the same period of last year, an increase of 13.66 percent.

Highway fund collections for the fiscal year totaled \$303.9 million for an increase of 7.6 percent over the \$282.2 million collected in the same period of last year.

## Market Battles To Stop Slide

The stock market made a day, and a dogged effort Monday to stop the downward slide.

# How we turn bad news into good news.

After the editors grind it out, Sonoco grinds it up.

More than 900,000,000 pounds of waste paper every year.

From that, we make more than 300 specialty grades of paper.

Which we use, in turn, to make inexpensive products that replace expensive ones.

Paper cones, for the textile industry, that replaced expensive and cumbersome wooden ones.

Fibre cores for paper and plastics that replace expensive metal cores.

Concrete forms and pitch-impregnated fibre pipe for the construction industry. And underground vaults for the utility industry.

And hundreds of other paper and plastic products that fill specific needs of industry. Products that cut costs, improve efficiency, make new ideas possible. Products that do practically everything

but run cars and trucks, which we leave to the Sunoco gas and oil people.

Learn what we do. Write Sonoco Products Company, Dept. PB, Hartsville, S.C. 29550 for our free booklet.

And remember, when you look at tomorrow's headlines. That every cloud has a silver lining.

Sonoco Products Company. Innovators in paper and plastics.



You have a lot more going for you when you make Lyon your single source for all your steel equipment needs. Because we must offer the best products and services to maintain our leadership. We must live up to our reputation for precision quality.

We must offer the broadest selection (more than 1600 stock items). Our products must be the easiest to order. Our packaging must be the finest. Our delivery must be the fastest. And our field service must be outstanding. So, we put more manpower in the

field, maintain the largest dealer network, and three strategically located plants. We see that you get personal help when you need it. Call your Lyon Dealer for *all* your steel equipment needs. There is a lot to be said for staying with the leading name.

## There's a lot to be said for staying with the leading name

LYON METAL PRODUCTS, Inc.  
75 Monroe Avenue, Aurora, Illinois 60507

Please send me a copy of catalog No. 100

Name \_\_\_\_\_

Firm \_\_\_\_\_

Address \_\_\_\_\_

City \_\_\_\_\_ State \_\_\_\_\_ Zip \_\_\_\_\_

Look for us in the Yellow Pages under LYON  
"STEEL SHELVING," "LOCKERS" or "SHOP EQUIPMENT"

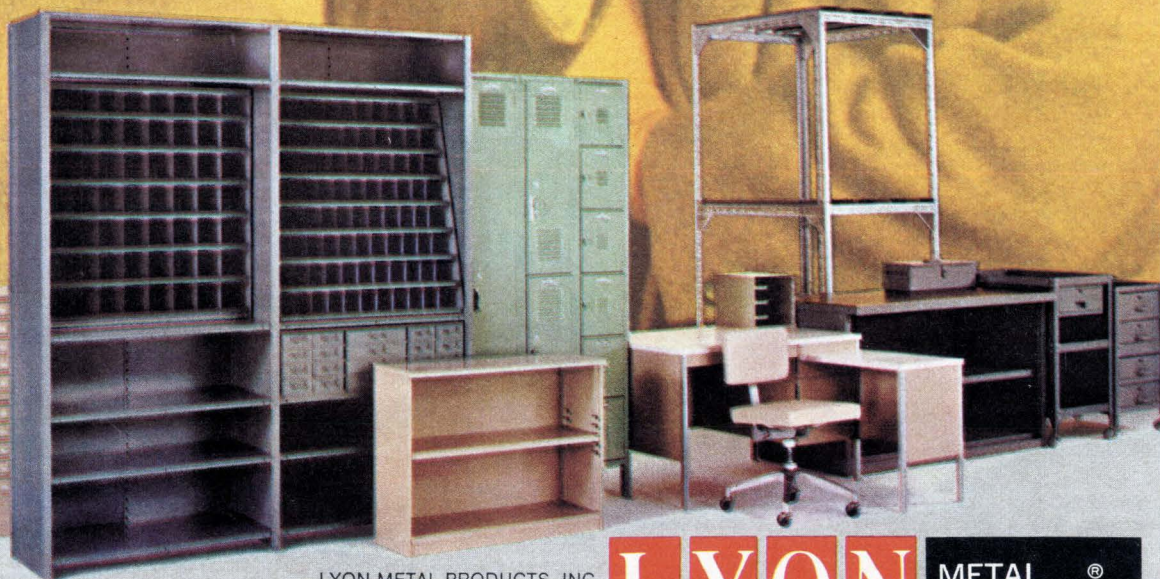

LYON METAL PRODUCTS, INC.  
General Offices: 75 Monroe Ave., Aurora, Ill. 60507  
Plants in Aurora, Ill., York, Pa., Los Angeles  
Dealers and Branches in All Principal Cities

**LYON** METAL PRODUCTS®