

- 95 Raster-scan techniques for low-cost graphic displays
- 107 Auto radar senses crash, triggers restraints
- 119 IC power transistor has built-in protection

LIBRARY  
STATE TECHNICAL INSTITUTE  
AT MEMPHIS

# Electronics®

**Product  
development  
profile**

**A PICOSECOND  
TIME-STOPPER**



STATE TECHNICAL INSTITUTE  
LIBRARY PERIODICALS 0-10992  
38134  
MEMPHIS TN

# BARGAINS GALORE on LEDs from DIALIGHT

## FEATURES:

High luminous intensity

Low cost

Low power consumption

IC compatible

Vibration/shock resistant

Solid state reliability

Life measured in years

Wide viewing angle



Dialight's high brightness 521-9200 LED is an intense large area light source that has this typical luminous intensity:

@  $I_F = 20 \text{ mA}$   $I_0 = 2.0 \text{ mcd}$ .

## APPLICATIONS:

Panel lighting • Circuit-status indicators • Back lighting of annunciators • Alpha-numeric displays • Automobile dashboards • Appliances • Desk-top calculators • Housewares



# 9¢

Quality LEDs are 9¢ each when purchased in million piece quantities



# 21¢

LEDs from 100 to 999 are only 21¢ each.

# 17¢



If you need LEDs from 1000 to 9999, Dialight has them for 17¢ each.

# 28¢



Even if you only need LEDs from 1 to 99, Dialight has them for 28¢ each.



# 16¢

Quantities from 10,000 are a low 16¢ each and Dialight can fill your order today

# FREE!

With this coupon you can get a free LED sample. Send this coupon to your nearest Dialight distributor or give him a call.

All prices are domestic and subject to change without notice.

## DIALIGHT

Dialight Corporation, A North American Philips Company  
60 Stewart Avenue, Brooklyn, N.Y. 11237 (212) 497-7600

## AVAILABLE NOW FROM THESE STOCKING DISTRIBUTORS

**ARIZONA**  
Moltronics of Arizona, Inc.  
602-272-7951

**CALIFORNIA**  
Western Electromotive  
213-870-7621  
Bell Electronics Corp.  
415-323-9431  
Fisher/Brownell  
408-244-6182  
Richey Electronics, Inc.  
213-875-2862  
Westates Electronics Corp.  
213-341-4411

**COLORADO**  
Meter Master Instrument Corp.  
303-722-5766

**FLORIDA**  
Hammond Electronics, Inc.  
305-241-6601

**ILLINOIS**  
Newark Electronics  
312-638-4411

**INDIANA**  
Graham Electronic Supply, Inc.  
317-634-8202  
Radio Distributing Co.  
219-287-2911

**MARYLAND**  
Pioneer Washington Elect. Co.  
301-424-3300  
Radio Electric Service Co.  
301-823-0070

**MASSACHUSETTS**  
Cramer Electronics, Inc.  
617-969-7700  
DeMambo Supply Co., Inc.  
617-787-1200  
Gerber Electronics, Inc.  
617-329-2400  
Sager Electrical Supply Co.  
617-542-2281

**MICHIGAN**  
RS Electronics  
313-491-1000

**MINNESOTA**  
Gopher Electronics Co.  
612-645-0241

**MISSOURI**  
Lcomp-St. Louis, Inc.  
314-647-5505

**NEBRASKA**  
Scott Electronic Supply  
402-434-8308

**NEW JERSEY**  
Federated Electronics  
201-376-8900  
Resco Electronics  
609-662-4000  
State Electronics  
201-887-2550

**NEW YORK METROPOLITAN AREA**  
Arrow Electronics, Inc.

516-694-6800  
Harrison Radio Corp.  
516-293-7990  
Harvey Radio Co., Inc.  
516-921-8700  
Melville Radio Corp.  
914-592-7100  
Peerless Radio Corp.  
516-593-2121

**NEW YORK STATE**  
Summit Distributors, Inc.  
716-884-3450

**NORTH CAROLINA**  
Hammond Electronics of Carolina, Inc.  
919-275-6391

**OHIO**  
Hughes-Peters, Inc.  
614-294-5351  
Pioneer-Cleveland Div.  
Pioneer-Standard Electronics  
216-587-3600  
Stotts-Friedman Co.  
513-224-1111  
Sun Radio Co., Inc.  
216-434-2171

**OKLAHOMA**  
Radio, Inc.  
918-587-9124

**PENNSYLVANIA**  
Almo Electronics Corp.  
215-676-6000  
George D. Barbey Co.  
215-376-7451  
Cameradio Co.  
412-288-2600

**TEXAS**  
Harrison Equipment Co., Inc.  
713-224-9131

**UTAH**  
Standard Supply Co.  
801-355-2971

**WASHINGTON**  
Almac/Stroum Electronics  
206-763-2300

**WISCONSIN**  
Parts Mart Corp.  
414-276-4160

**CANADA**  
Saynor Electronics Ltd.  
416-445-2347  
L. A. Varah Ltd.  
604-736-9252  
Wackid Radio TV Labs, Ltd.  
613-726-1821

# FREE!

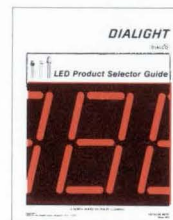

Ask for free LED Product Selector Guide. 60 pages of LEDs: discretes, indicators, displays, fault indicators, opto-isolators, etc.

**THE NEW WORD IN DATA COMMUNICATIONS**

# UAR/T,

a **GIANT**\* device. [part #AY-5-1013 & #AY-5-1013A]

1. the first one-package MOS **Universal Asynchronous Receiver/Transmitter**.
2. a General Instrument LSI subsystem which accepts binary characters from either a terminal device or a computer and receives/transmits this character with appended control and error detecting bits. All characters contain a start bit, 5 to 8 data bits, one or two stop bits, and either odd/even parity or no parity. In order to make UAR/T™ universal, the baud rate, bits per word, parity mode, and the number of stop bits are externally selectable. The device is constructed on a single monolithic chip utilizing MTNS P-channel enhancement mode transistors. All inputs and outputs are directly compatible with TTL/DTL/MOS logic without the need for interfacing components and with all strobed outputs having tri-state logic.
3. the UAR/T is now available in 30k baud (AY-5-1013) and 40k baud (AY-5-1013A) versions.
4. newest member of General Instrument's family of MOS LSI data communication subsystems which also includes the AY-5-1008 terminal receiver and the AY-5-1010 and AY-5-1011 terminal transmitters; all immediately available.

\*Registered Trademark for General Instrument Advanced Nitride Technology

**NEW & IMPROVED**

- 40 kilobaud capability (AY-5-1013A)
- Status word reset
- 46% distortion immunity (center sampling)
- New low price

**UAR/T— BLOCK DIAGRAM**

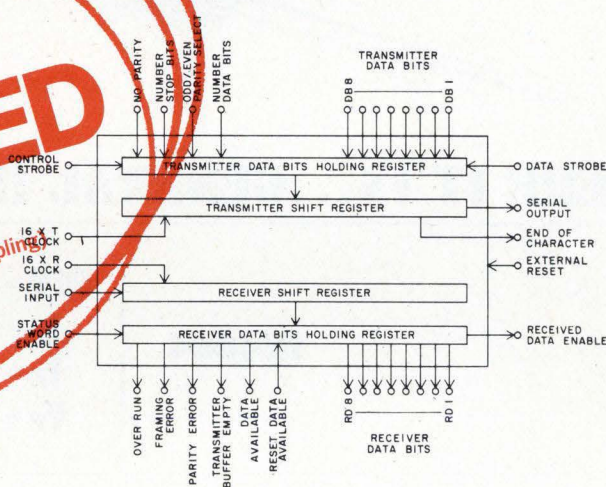

## GI'S GOT IT!

For further information call 800-645-9247 toll free (In New York State call 516-733-3107) or write, General Instrument Corporation, Microelectronics, 600 West John Street, Hicksville, N.Y. 11802.

**GENERAL INSTRUMENT CORPORATION  
MICROELECTRONICS**



# WHAT THIS COUNTRY NEEDS IS A GOOD

# 5¢ RECTIFIER\*

NOW SHIPPING  
OVER 50 MILLION  
RECTIFIERS  
PER MONTH

THIS AD FIRST APPEARED  
ON SEPT. 14, 1970

OUR PRICE IS STILL 5¢



## HERE IT IS...GENERAL INSTRUMENT'S 1N4004

**1N4004**

**PIV = 400V**

**I<sub>o</sub> = 1.0A @ 75°C**

**I<sub>R</sub> = 5.0 μA @ 25°C**

**V<sub>F</sub> = 1.1V @ 1.0A @ 25°C**

**\*Conditions of Sale**

Minimum Order Quantity : 25,000 units scheduled within 90 days

Minimum Delivery : Minimum Shipment 10,000 pcs.

Packing : Bulk Packing, 2000 unit/box

Marking : Cathode Band, 1N4004, GI, Date Code

AQL : 1%

Specifications : per EIA

For complete information write: General Instrument Corporation, Dept. F, 600 West John Street, Hicksville, N.Y. 11802, or call, in New York: 516-733-3333; in Chicago: 312-338-9200; in Los Angeles: 213-781-0489. In Canada, call or write: General Instrument Canada, Ltd., 61 Industry Street, Toronto 337, Ontario, Canada, Tel: 416-763-4133. In Europe, write: General Instrument Europe S.P.A., Piazza Amendola 9, 20149 Milano, Italy. In Germany, General Instrument Deutschland, Neumarkter Strasse 61, 8-Munich 80, West Germany. In France, 11/13 Rue Gandon, 75 Paris 13e France. In the U.K., write General Instrument (U.K.) Ltd., Cock Lane, High Wycombe, Buckinghamshire, England. In the Far East, write General Instrument of Taiwan Ltd., P.O. Box 22226, Taipei, Taiwan. In Japan, General Instrument International Co. Ltd., Fukide Building No. 17 Shiba Fukide-Cho, Minato-Ku, Tokyo 106, Japan.

**GENERAL INSTRUMENT CORPORATION  
SEMICONDUCTOR COMPONENTS**



## 39 Electronics Review

COMMUNICATIONS: Digital transmission helps hail taxis, 39  
Digitizing TV audio for improved sound, 40  
GOVERNMENT: Semiconductors win control exemptions, 40  
New budget limits electronics gains to DOD, 40  
CIRCUIT DESIGN: UGLI circuit may scare off large-scale ICs, 42  
AVIONICS: Grumman tidies up aircraft wiring, 42  
MEDICAL ELECTRONICS: Hearing-aid battery recharged by sun, 44  
Braille can be sent via telephone lines, 46  
SOLID STATE: Integrated injection logic stars at ISSCC, 46  
NEWS BRIEFS: 48  
LASERS: Airborne lasers to monitor pollution, 48  
Gallium-arsenide laser grown on a substrate, 50  
COMMERCIAL ELECTRONICS: Teleconferencing readied for use, 53

## 63 Electronics International

WEST GERMANY: Alarm alerts driver to 12 malfunctions, 63  
AROUND THE WORLD: 63

## 75 Probing the News

GOVERNMENT ELECTRONICS: Postal R&D adjusts to reality, 75  
ELECTRONICS ABROAD: Dutch build busy space computer  
PARAPSYCHOLOGY: ESP—cause for serious thought? 82  
AVIONICS: FAA points to foreign markets, 89

## 95 Technical Articles

DISPLAYS: Raster-scan tube improves graphic terminals, 95  
DESIGNER'S CASEBOOK: External gate doubles counter speed, 102  
Eliminating current spiking from dc-to-dc converters, 102  
SCR crowbar circuit fires quickly and surely, 104  
CONSUMER ELECTRONICS: Radar tightens seat belts before crash, 107  
PRODUCT DEVELOPMENT PROFILE: The HP 5345A counter, 114  
SOLID STATE: Load-protecting IC simulates power transistor, 119  
CIRCUIT DESIGN: IC Models, part 4, AND-OR-INVERT gate, 124  
ENGINEER'S NOTEBOOK: Low-cost microwave monitor is sensitive, 127  
Nonsequential counter design makes use of Karnaugh maps, 128

## 133 New Products

IN THE SPOTLIGHT: Low-voltage reference is ultra-stable, 133  
Testing integrated circuits at high temperatures, 136  
Instruments measure low-level signals, 138  
COMPONENTS: Proximity sensor is versatile, 144  
INSTRUMENTS: Amplifiers have low price tags, 152  
SEMICONDUCTORS: Memory reads while it writes, 159  
MICROWAVE: Gunn oscillator puts out 250 milliwatts, 165  
MATERIALS: 172

## Departments

Publisher's letter, 4  
Readers comment, 6  
40 years ago, 8  
People, 14  
Meetings, 30  
Electronics newsletter, 35  
Washington newsletter, 59  
Washington commentary, 60  
International newsletter, 65  
Engineer's newsletter, 130  
New literature, 176

## Highlights

### The cover: Designing a fast counter, 114

A direct-reading 500-MHz counter when no 500-MHz logic is available? How H-P engineers overcame this and other problems on their way to an instrument with 2 picosecond resolution is the subject of the latest article in *Electronics'* series of product development profiles.

### ESP—a new medium for messages? 82

At a one-bit-per-minute rate, communications received by extrasensory perception are unlikely to put the telephone company out of business just yet. But the potential of this novel form of energy is attracting increasing attention from scientists and from engineers.

### Raster-scan tube cuts graphic terminal cost, 95

Computer data can be reformatted in real time by a new scan-conversion algorithm for display on an inexpensive raster-scan monitor. Interaction with the computer is also easy.

### Auto radar tightens seat belts in collision, 107

Two Japanese companies have developed a pulsed-doppler radar for automobiles. Mounted on the car front, it senses when a crash is inevitable and activates restraint devices—air bags or seat belts—that ensure the passengers' safety.

### And in the next issue . . .

Special report: the renaissance in logic technology . . . a round-up of the International Solid State Circuits Conference . . . liquid cooling for high-power semiconductors.

EDITOR-IN-CHIEF: Kemp Anderson

EXECUTIVE EDITOR: Samuel Weber

MANAGING EDITORS: Lawrence Curran, *News*;  
Arthur Erikson, *International*

SENIOR EDITORS: John Johnsrud,  
H. Thomas Maguire, Laurence Altman  
Ray Connolly

ART DIRECTOR: Fred Sklenar

ASSOCIATE EDITORS: John N. Kessler,  
Howard Wolff, Gerald M. Walker

#### DEPARTMENT EDITORS

*Aerospace*: William F. Arnold  
*Circuit Design*: Lucinda Matterna  
*Communications & Microwave*:  
Lyman J. Hardeman

*Components*: Joel DuBow  
*Computers*: Wallace B. Riley  
*Consumer*: Gerald M. Walker

*Industrial*: Alfred Rosenblatt  
*Instrumentation*: Michael J. Riezenman  
*Military*: Ray Connolly

*New Products*: H. Thomas Maguire  
*Packaging & Production*: Stephen E. Grossman  
*Solid State*: Laurence Altman  
*Special Issues*: Harry R. Karp

COPY EDITORS: Margaret Eastman,  
Everett C. Terry

ASSISTANT EDITOR: Marilyn Offenheiser

ART: Charles D. Ciatto, *Associate Director*  
Patricia Cybulski, *Assistant Director*

PRODUCTION EDITOR: Arthur C. Miller

EDITORIAL SECRETARIES: Janet Annunziata,  
Julie Gorgoglione, Penny Roberts

#### FIELD EDITORS

*Boston*: Gail Farrell  
*Los Angeles*: Paul Franson (Mgr.)  
*Midwest*: Larry Armstrong (Mgr.)  
*New York*: Alfred Rosenblatt (Mgr.)  
*San Francisco*: Judith Curtis  
*Washington*: Ray Connolly (Mgr.),  
William F. Arnold  
*Frankfurt*: John Gosch  
*London*: Michael Payne  
*Paris*: Arthur Erikson  
*Tokyo*: Charles Cohen

#### MCGRAW-HILL WORLD NEWS

*Director*: Walter A. Stanbury  
*Bonn*: Robert Ingersoll;  
*Brussels*: James Smith;  
*London*: Marvin Petal;  
*Milan*: Peter Hoffmann, Andrew Heath;  
*Moscow*: Axel Krause;  
*Paris*: Michael Johnson, Richard Shepherd;  
*Stockholm*: Robert Skole;  
*Tokyo*: Mike Mealey

PUBLISHER: Dan McMillan

ADVERTISING SALES MANAGER: Pierre J. Braudé

ADVERTISING SALES SERVICE MANAGER:  
Wallis Clarke

BUSINESS MANAGER: Stephen R. Weiss

CIRCULATION MANAGER: George F. Werner

MARKETING SERVICES MANAGER:  
Tomlinson Howland

RESEARCH MANAGER: Margery Sholes

**O**ur series of Product Development Profiles continues in this issue with the story behind the design of Hewlett-Packard's new HP-5345A, successor to one of the most successful counting instruments ever built.

When we started the series, just a year ago, we covered products that had already achieved market success. Now, we have broadened our definition to include current development efforts, efforts where ultimate success can not yet be a criterion.

Instead, we are focusing on the design effort itself, stressing projects that show the unusual combination of market-need awareness, technical innovation to meet that need, and an effective organization both within the company and with other companies to produce the product.

We started the series because we feel that there are still a lot of lessons to be learned about applying state-of-the-art technology to build a successful product. And over the years, we will be picking more product-development efforts to highlight.

We already have a number in mind, but maybe you have a particular interest in reading about how a certain product came into being. If so, let us know, and we'll home in on those that are voted the most interesting by readers.

**E**lectronics industries representatives showed up last month for an FAA briefing on the expanding market for avionics and related electronic gear in the two thirds of the world that includes Asia, Africa, and the Pacific. Perhaps the Peoples' Republic of China stands out as the brightest potential market.

In the article on page 89, Bill Ar-

nold of our Washington bureau, one of the few newsmen at the briefing, rounds up the joint Government efforts to promote these international sales—and the factors that make it so tough for U.S. companies to compete.

The FAA's presentation, which included talks by officials from the Commerce Department, the State Department, and the Export-Import Bank, served to spotlight the continuing barriers to the penetration of U.S. products—soft loans from other countries, strong backing of foreign companies by their governments, and even the tendency for newer nations to buy from the former colonial powers.

**W**ill ESP ever be a practical means of communication? There is enough serious research going on now in extrasensory perception to raise that question—not the older “Is there such a thing as ESP? As you'll find in the thought-provoking Probing the News article on page 82, NASA has conducted ESP experiments with astronauts, and a scheduled session at the IEEE Intercon next month will detail some of the current work in parapsychology, which is quite wide-ranging. After reading our article, perhaps you'll agree that there's more to ESP than meets the eye.

**T**he index of articles published in *Electronics* in 1973 will be available shortly. For a copy, circle number 460 on the reader service card inside the back cover.

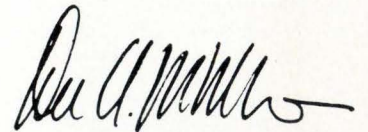

February 7, 1974 Volume 47, Number 3  
92,878 copies of this issue printed

Published every other Thursday by McGraw-Hill, Inc. Founder: James H. McGraw 1860-1948. Publication office 1221 Avenue of the Americas, N.Y., N.Y. 10020; second class postage paid at New York, N.Y. and additional mailing offices.  
Executive, editorial, circulation and advertising addresses: Electronics, McGraw-Hill Building, 1221 Avenue of the Americas, New York, N.Y. 10020. Telephone (212) 997-1221. Teletype TWX N.Y. 710-581-5234. Cable address: MCGRAW HILL N.Y.

Subscriptions limited to persons with active, professional, functional responsibility in electronics technology. Publisher reserves the right to reject non-qualified requests. No subscriptions accepted without complete identification of subscriber name, title, or job function, company or organization, including product manufactured or services performed. Subscription rates: qualified subscribers in the United States and possessions, Canada, and Mexico \$9.00 one year, \$18.00 three years; all other countries \$25.00 per year, except Japan \$50.00 per year and Brazil \$40.00 per year, including air freight. Limited quota of subscriptions available at higher-than-basic rate for persons outside of field served, as follows: U.S. and possessions and Canada, \$25.00 one year; all other countries \$50.00. Single copies: United States and possessions and Canada, 1.00; all other countries, \$1.75.

Officers of the McGraw-Hill Publications Company: John R. Emery, President; J. Elton Tuohig, Executive Vice President-Administration; Gene W. Simpson, Group Publisher-Vice President; Senior Vice Presidents: Ralph Blackburn, Circulation; Walter A. Stanbury, Editorial; John D. Hoglund, Controller; David G. Jensen, Manufacturing; Gordon L. Jones, Marketing; Jerome D. Luntz, Planning & Development.

Officers of the Corporation: Shelton Fisher, President; Wallace F. Trendley, Group President; McGraw-Hill Publications Company and McGraw-Hill Information Systems Company, Robert N. Landes, Senior Vice President and Secretary; Ralph J. Webb, Treasurer.

Title registered in U.S. Patent Office, Copyright © 1974 by McGraw-Hill, Inc. All rights reserved. The contents of this publication may not be reproduced either in whole or in part without the consent of copyright owner.

Subscribers: The publisher, upon written request to our New York office from any subscriber, agrees to refund that part of the subscription price applying to copies not yet mailed. Please send change of address notices or complaints to Fulfillment Manager; subscription orders to Circulation Manager, Electronics, at address below. Change of address notices should provide old as well as new address, including postal zip code number. If possible, attach address label from recent issue. Allow one month for change to become effective.

Postmaster: Please send form 3579 to Fulfillment Manager, Electronics, P.O. Box 430, Hightstown, N.J. 08520.

# The small economy size function generator,

**\$295.**

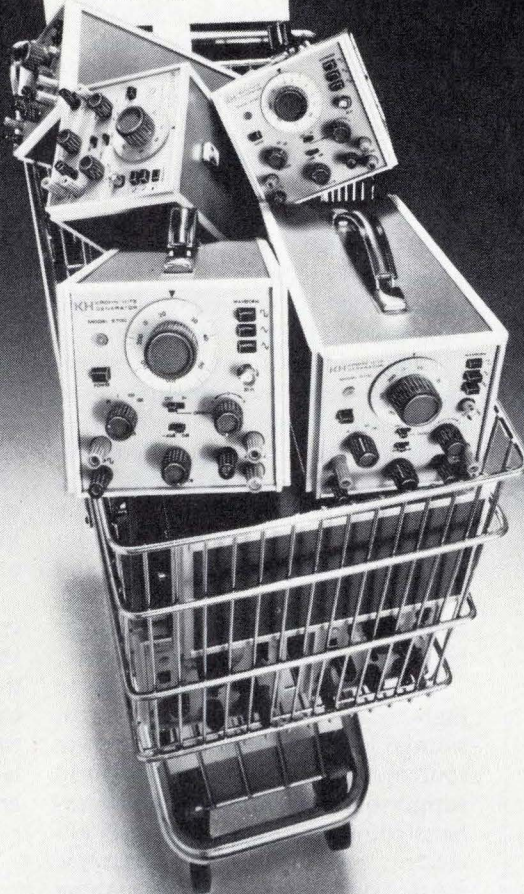

## Sine, square and triangle waveforms from 0.002Hz to 2MHz at a price you can handle.

If you're in the market for a low-cost, versatile function generator, we've got the unit for you. Model 5700 is the little big man of our 5000 series, with multifunctions, balanced output and a general versatility unmatched at the price. It features a 1000:1 tuning dial, covering the whole audio spectrum on one frequency range. The 50 ohm single ended output and 600 ohm balanced output are controlled by a common attenuator. An auxiliary

square wave output enables synchronization, gating and blanking. Model 5700 is the ideal choice for a broad range of electronic applications from research to calibration. With this performance at a bargain price why shop around?

For fast action, call (617) 491-3211, TWX 710 320 6583, or contact your local KH representative listed below.

**KH KROHN-HITE**  
CORPORATION  
580 Massachusetts Avenue, Cambridge, Massachusetts 02139

SALES OFFICES: ALA., Huntsville (205) 534-9771; ARIZ., Scottsdale (602) 947-7841; CAL., Santa Clara (408) 243-2891, Inglewood (213) 674-6850; COLO., Denver (303) 934-5505; CONN., Glastonbury (203) 633-0777; FLA., Orlando (305) 894-4401; HAWAII, Honolulu (808) 941-1574; ILL., Des Plaines (312) 298-3600; IND., Indianapolis (317) 244-2456; MASS., Lexington (617) 861-8620; MICH., Detroit (313) 526-8800; MINN., Minneapolis (612) 884-4336; MO., St. Louis (314) 423-1234; N.C., Burlington (919) 227-3639; N.J., Haddonfield (609) 795-1700; N.M., Albuquerque (505) 299-7658; N.Y., E. Syracuse (315) 437-6666, Rochester (716) 328-2230, Vestal (607) 785-9947, Elmont (516) 488-2100; OHIO, Cleveland (216) 261-5440, Dayton (513) 426-5551; PA., Pittsburgh (412) 371-9449; TEX., Houston (713) 621-0040, Richardson (214) 231-2573; VA., Alexandria (703) 354-1222; WASH., Seattle (206) 624-9020; CANADA, Montreal, Quebec (514) 636-0525, Toronto, Ontario (416) 444-9111, Stittsville, Ontario (613) 836-4411, Vancouver, British Columbia (604) 688-2619.

Circle 5 on reader service card

# More power to you...

at less cost,  
with Intronics'  
Modular  
Power Supplies.

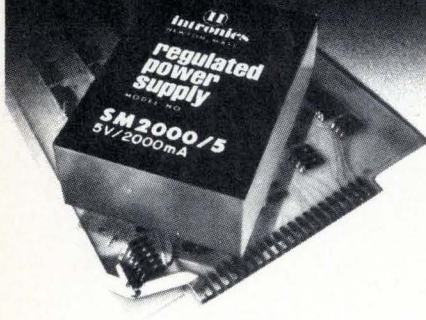

Intronics' SM2000/5 modular power supply offers you more power for your money . . . up to 10 watts of output power. Plus, a compact size that makes this unit the natural choice to power your IC logic circuitry.

All Intronics' modular power supplies are designed for easy use and trouble free operation. Outstanding characteristics include: preset voltages to  $\pm 0.5\%$ , output short circuit protection, low ripple, wide operating temperature range with no derating, 50 to 440 Hz operation and 50 meg ohm transformer isolation.

Exercise your buying power. Specify Intronics' Model SM2000/5 modular power supply for your IC logic circuit applications.



## intronics

57 Chapel Street, Newton, Massachusetts 02158 U.S.A.  
617-332-7350, TWX 710-335-6835

Overseas call:

Brussels, Belgium 13-73-84

Maidstone, England 54224

Helsinki, Finland 11-123

Paris, France 9077844

Munich, Germany 524181

The Hague, Holland 678380

Milan, Italy 9043983

Zurich, Switzerland 93-31-61

## Readers comment

### Arguing the energy crisis

**To the Editor:** Your editorial, "Apollo and the Arabs," [*Electronics*, Dec. 6, 1973, p.11] still avoids the central issue of the energy problem. Cosmetic measures, such as reducing speed limits, will actually use more fuel—not less. Over 60% of the driving is in urban areas at speeds already below 50 miles an hour. Reducing to 50 the 12% that travel 70 mph or more will save less than 1% of the annual national consumption, but at an annual cost of over \$6 billion in lost time and efficiency. This fuel saving will be more than offset by the stop-and-go freeway situations that develop from the "backward-wave-oscillator" effect at or below critical speeds, which are right around the new speed limits.

Our problem is not energy shortage; it is inept Government and too much of it. Remove all taxes of all kinds and all Government controls from new wells and refineries, from the profits there derived, from the products there produced, and from the employees producing them, and watch how fast we will get an overabundant supply of fuel at prices far below what we currently experience.

Apply that same philosophy to high-energy, low-weight, low-cost storage batteries and nuclear-power sources, and by the time our world supply of fossil fuels is indeed exhausted, we will be moving with all-electric propulsion and electronic control systems far beyond anything we know today. It is time we recognize the fact that more Government is the last thing we need.

R. W. Johnson  
Ben Lomond, Calif.

**To the Editor:** Your editorial on the energy crisis [Dec. 6, 1973, p. 11] and the delinquent manner in which the Administration is handling the situation certainly calls for a loud hurrah. Someone with a loud voice is saying what we all think.

This crisis presents a problem to the Government. Investments in money and materials in the fuel industry are of gargantuan proportions, so we are not talking about a throwaway item in proposing an alternative to the hydrocarbon-fuel economy, even if it is stretched over

a period of a few years.

The alternative to the hydrocarbon solid- and liquid-fuel economy is, of course, hydrogen. To convert to this, some very important problems need solving. The most important are storage and portability. Availability of hydrogen is, of course, no problem. If the portability problem, in particular, is solved, everything else falls into place.

The electronics industry can help by being scientific enough to realize that, in the long run, there is no other alternative and that immediate action is required. Put pressure where it is necessary because, in solving this problem, the electronics industry solves its own.

Frank Watlington  
Palisades Sofar Station  
St. Davids, Bermuda

**To the Editor:** My suggestion is to gradually deregulate the economy and then separate completely the Government from the economy in order to prevent intervention, and hence, interference; that is, complete *laissez-faire* capitalism.

Phases I through IV, the beef crisis, and now, the energy crisis, should have taught us that the best the boys in Washington can plan is chaos. A free market, with no controls and no favors, is self-regulating. There are no abrupt changes, and hence, no crises.

Edward W. Rummel  
Scott Graphics Inc.  
Holyoke, Mass.

### Rerouting amplifier input

**To the Editor:** There was an error in the wiring diagram for my Designer's casebook, "Transistor array cuts cost of algebraic inversion" [Jan. 10 p. 132]. The noninverting input of amplifier A<sub>1</sub> should go to a 40-kilohm resistor and then to the negative supply voltage (not to ground).

Pavel Ghelfan  
M.G. Electronics Ltd.  
Rehovot, Israel

### 1973 index is available

The index of articles published in *Electronics* in 1973 is now available. For a copy, circle 475 on the reader service card inside the back cover.



# A chicken in every pot. A JFET in every TO-92.

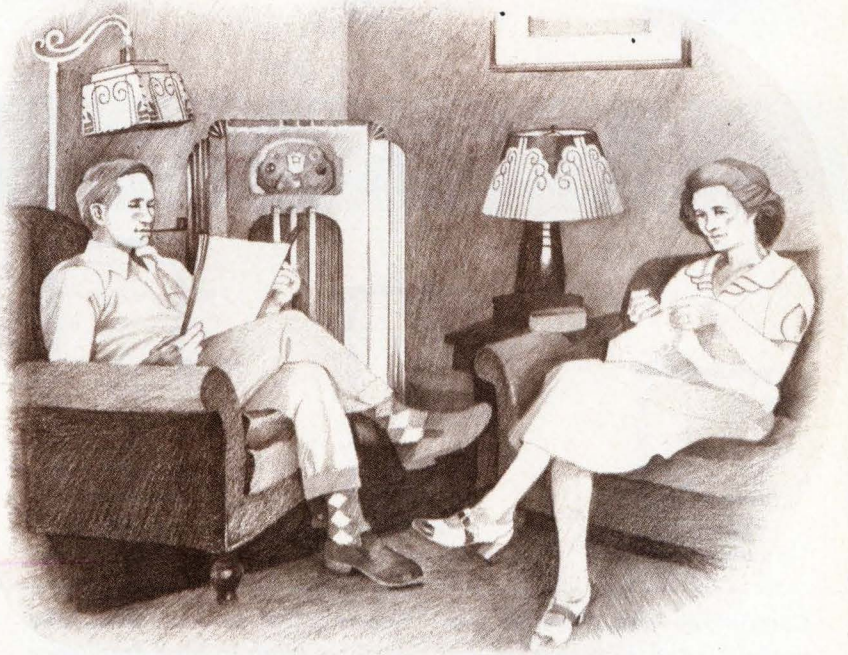

Things were tough when Hoover made his chicken speech. But now this country has more chickens in its pots than any other country in the world. And Teledyne has so many JFETs in its TO-92's, they're not only off-the-shelf, they're falling off the shelf.

You're in luck with Teledyne—because we're the ones with the tinned leads for easy soldering. But if you're more interested in delivery than tinned leads, how about 10 or 20K 2N5638's, 2N5639's or 2N5640's right now? Or 50K in four weeks?

Maybe you'd prefer some 2N5555's right now. Or any one of our 25 kinds of JFETs in TO-92's. Like the 2N5457, 2N5484, 2N5653 and 2N5668 families. Or the MPF100 series.

And, if you're in the market for TO-106's, we've got 117 kinds. And that's not chicken feed.

So if you're talking RF amplifiers, D/A converters, digital voltmeters, high-speed choppers, variable attenuators or any one of a hundred other applications, you're talking JFETs in TO-92's. And when you're talking JFETs in TO-92's, you're talking very little scratch. From reps and distributors. Or from Teledyne. Right now.

 **TELEDYNE**  
**SEMICONDUCTOR**

1300 Terra Bella Avenue Mountain View, California 94040  
(415) 968-9241 TWX: 910-379-6494 Telex: 34-8416

Higher component density...

Lower insertion costs...with

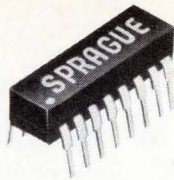

# MULTI-COMP<sup>®</sup> DIP MONOLITHIC<sup>®</sup> CERAMIC CAPACITORS

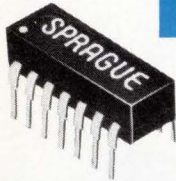

**STANDARDIZED DESIGN\* FOR BETTER AVAILABILITY, BETTER PRICES**

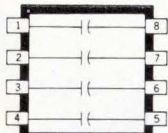

**TYPE 939C**  
(4 capacitor sections)

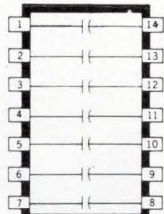

**TYPE 934C**  
(7 capacitor sections)

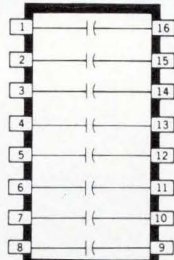

**TYPE 936C**  
(8 capacitor sections)

Compatible with ICs and other standard DIP devices. Especially useful for noise bypassing and signal coupling in high-frequency signal or data processing systems. Molded package provides mechanical protection and reliability under severe environmental conditions. Monolithic<sup>®</sup> construction . . . alternate layers of ceramic dielectric material and metallic electrodes are fired into an almost indestructible homogeneous block. Standard ratings, 18 pF to 0.1  $\mu$ F @ 100 WVDC. Temperature range, -55 C to +70C.

\*Other circuit configurations (including internally-paralleled capacitor sections, commoned capacitor leads, and various ratings within single package) are available on special order.

## Sprague puts more passive component families into dual in-line packages than any other manufacturer:

- TANTALUM CAPACITORS
- CERAMIC CAPACITORS
- TANTALUM-CERAMIC NETWORKS
- RESISTOR-CAPACITOR NETWORKS
- PULSE TRANSFORMERS
- TOROIDAL INDUCTORS
- HYBRID CIRCUITS
- TAPPED DELAY LINES
- SPECIAL COMPONENT COMBINATIONS
- THICK-FILM RESISTOR NETWORKS
- THIN-FILM RESISTOR NETWORKS
- ION-IMPLANTED RESISTOR NETWORKS

For more information on Sprague DIP components, write or call Ed Geissler, Manager, Specialty Components Marketing, Sprague Electric Co., 509 Marshall St., North Adams, Mass. 01247. Tel. 413/664-4411.

THE BROAD-LINE PRODUCER OF ELECTRONIC PARTS



## 40 years ago

From the pages of Electronics, February, 1934

### Amplifier units find new uses

In the loudspeaker, the amplifier, the microphone and the phonograph pickup, arranged in their several combinations, a variety of useful new tools are made available for the general public and for industry, although so far these have been used on a relatively limited scale. Plant superintendents, business men, engineers and others have not yet realized the possible uses of these amplifier circuits, and so have not yet found uses for them in the many ways in which they can save time, money, labor, and material.

With this versatile electronic tool, the boss can speak at a distance to his whole factory crew, or he can listen in on any department. Faint sounds can be amplified to override room noises, while unwanted sounds are filtered out. New sanitary possibilities are brought into food handling and food selling. Operating rooms are made germ-proof while student groups follow every movement of the surgeon's knife and lips.

In fact, into almost every field of activity, where the human voice, the human hearing, or the human sense of feeling needs amplification, these new amplifier combinations are now penetrating, and giving a good account of themselves.

For example, in an Ohio town, water supply records showed that a million gallons of water were leaking away daily at some point in the underground system. A microphone-amplifier survey of the surface was begun and carried throughout the town, listening for any trace of this leak. Finally, in the middle of Main Street, evidences of a leak were found. The water could be plainly heard gurgling there underground. But the water-supply maps showed no mains whatever at this point.

Excavations were begun, and as the digging proceeded, the sound of the leak became more distinct. At a depth of fifteen feet, the workmen came upon an old forgotten spur of the water-main system, through which the leak was taking place.

# CTC has less than 1% return rate.

# Which leaves the competition with many unhappy returns.

When you consider the average return rate for the industry, you suddenly realize CTC has something special going for us. And you, too. The most complete die attach, the most reliable wire bonding and cap sealing techniques, 100% RF, D.C., load pull tested—to boot.

When you consider further that no one else around is qualified to make this claim, you can believe what our customers tell us is true.

We've got the lowest field failure record in the industry. And that's a powerful help when you need it.

Communications Transistor Corporation  
301 Industrial Way, San Carlos, California 94070  
Phone (415) 591-8921 TWX 910-376-4893

## CTC: The power in RF power.

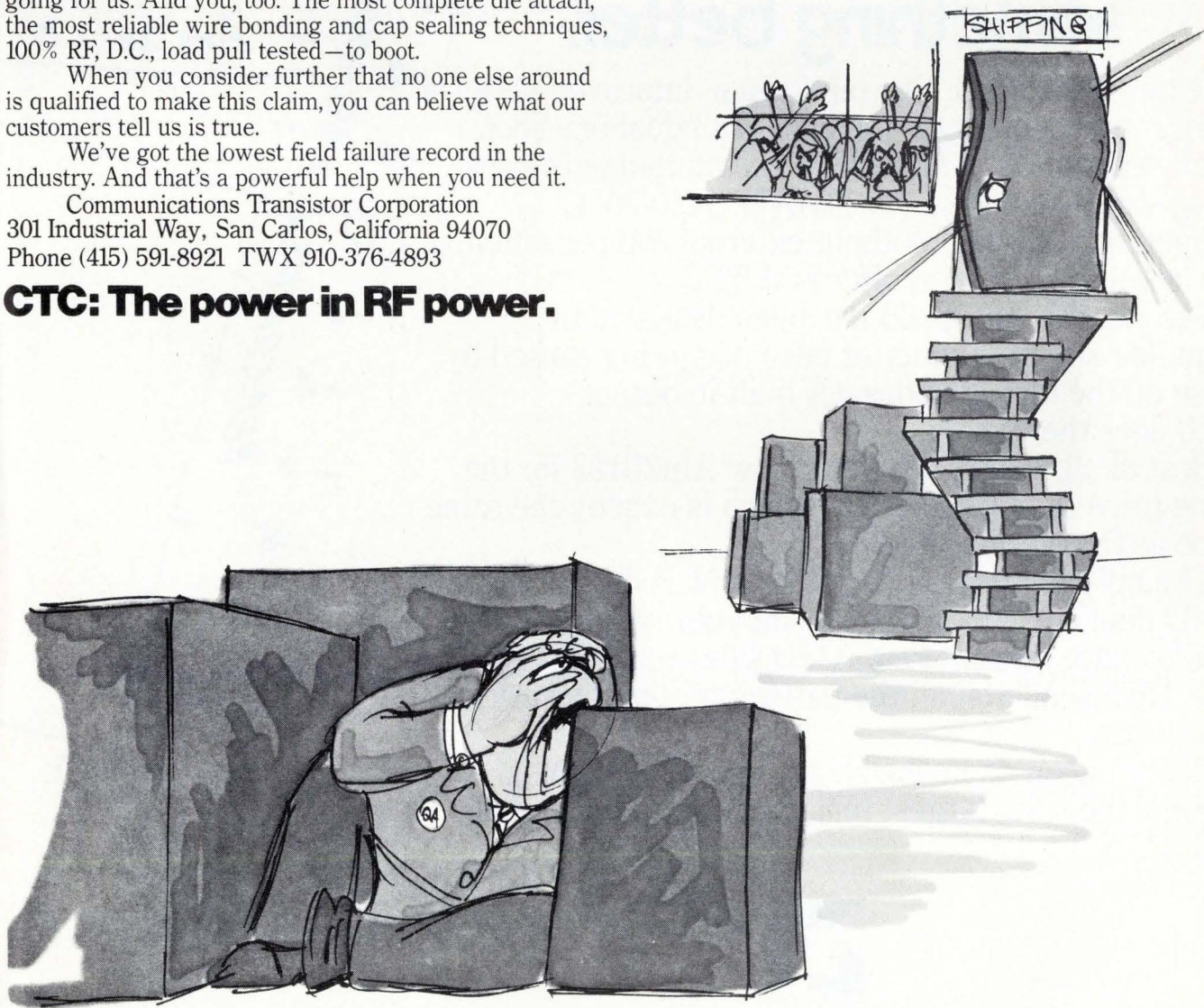

# You can buy a 54/74123 from AMD.

The Am54/74123 is a more-than-faithful reproduction of the dual one shot made popular by TI.

Not only is it guaranteed to meet all the original specs, but it's built to MIL-STD-883; and it's available for immediate delivery in both military and commercial temp versions. Just contact your nearest AMD sales rep or distributor.

## Or you can buy something better.

The new Am26123: Our pin-for-pin, improved performance replacement for the 54/74123 dual one shot.

First of all, the Am26123 has a guaranteed typical pulse width stability of  $\pm 1\%$  over the  $0-75^{\circ}\text{C}$  temperature range. (Without external compensation, the best the 74123 can offer is  $\pm 6\%$ .)

Second, the Am26123 has been designed to eliminate any possibility of false triggering caused by noise on the timing nodes. (A built-in output latch does the trick.)

Best of all, you can buy our new Am26123 for the same price as our Am74123, which is exactly the same price as the original 74123.

The only thing you need to do now is decide which AMD dual one shot will best suit your needs, then contact your nearest AMD sales rep or distributor. He'll send you all the parts or all the information you need.

Being big shots in one shots is going to help us become the sixth largest maker of integrated circuits in the U.S. by 1975.

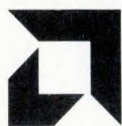
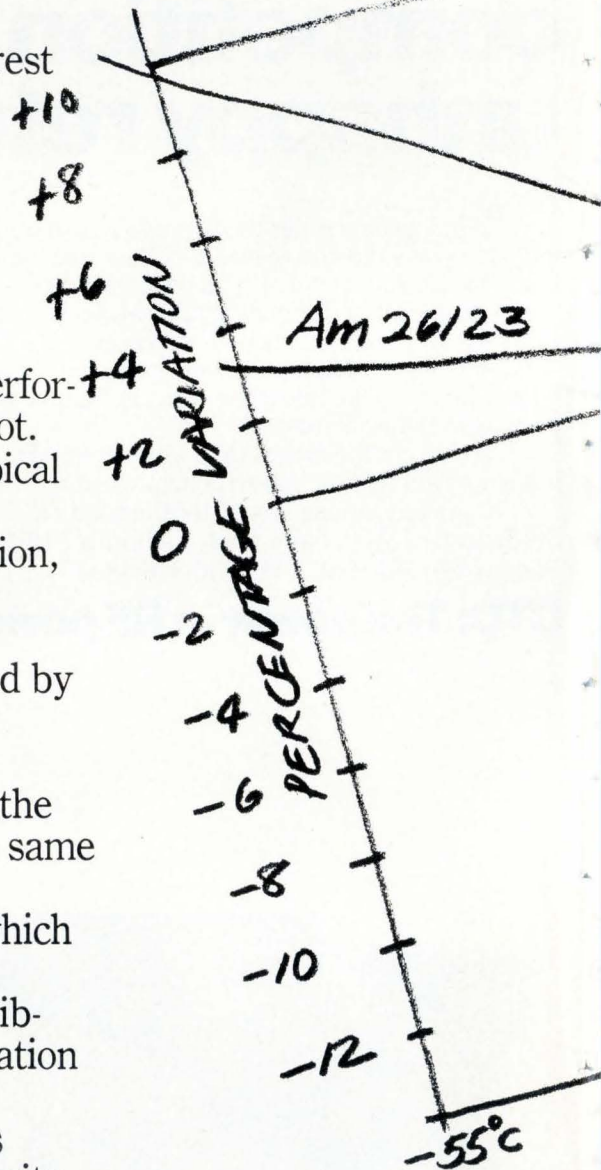

# Advanced Micro Devices, Inc.

(#15, going on #6.)

TYPICAL PULSE-WIDTH  
VARIATION  
NORMALIZED TO 25°C  
V<sub>CC</sub> = 5.0V

Am 54/74123

Am 26123

Am 54/74123

AMBIENT  
0°C

TEMPERATURE  
25°C

70°C

125°C

Advanced Micro Devices, Inc., 901 Thompson Place, Sunnyvale, California 94086 / TWX 910-339-9280 / TLX 346306

For Product or sales information, call the AMD sales representative nearest you. In the San Francisco Bay Area, Bill Siefert at (800) 538-7904 (toll-free from outside California) or (408) 732-2400, or Dave Haun (415) 967-7031. In the eastern United States, Steve Marks or Jack Maynard at (516) 484-4990; in Washington/Baltimore, Ken Smyth at (301) 744-8233; in Boston, Paul Macdonald at (617) 861-0606. In Mid-America, Chuck Keough at (312) 297-4115. In the Los Angeles area, Steve Zelencik or Russ Almand at (213) 278-9700. In the Northwest, Shel Schumaker at (408) 732-2400. In the United Kingdom, Des Candy at Herne Bay (Kent) 61611; and in Germany, Herman Lichotka at (0811) 594-680.

Advanced Micro Devices is distributed nationally by Cramer and Hamilton / Avnet Electronics.

Circle 252 on reader service card

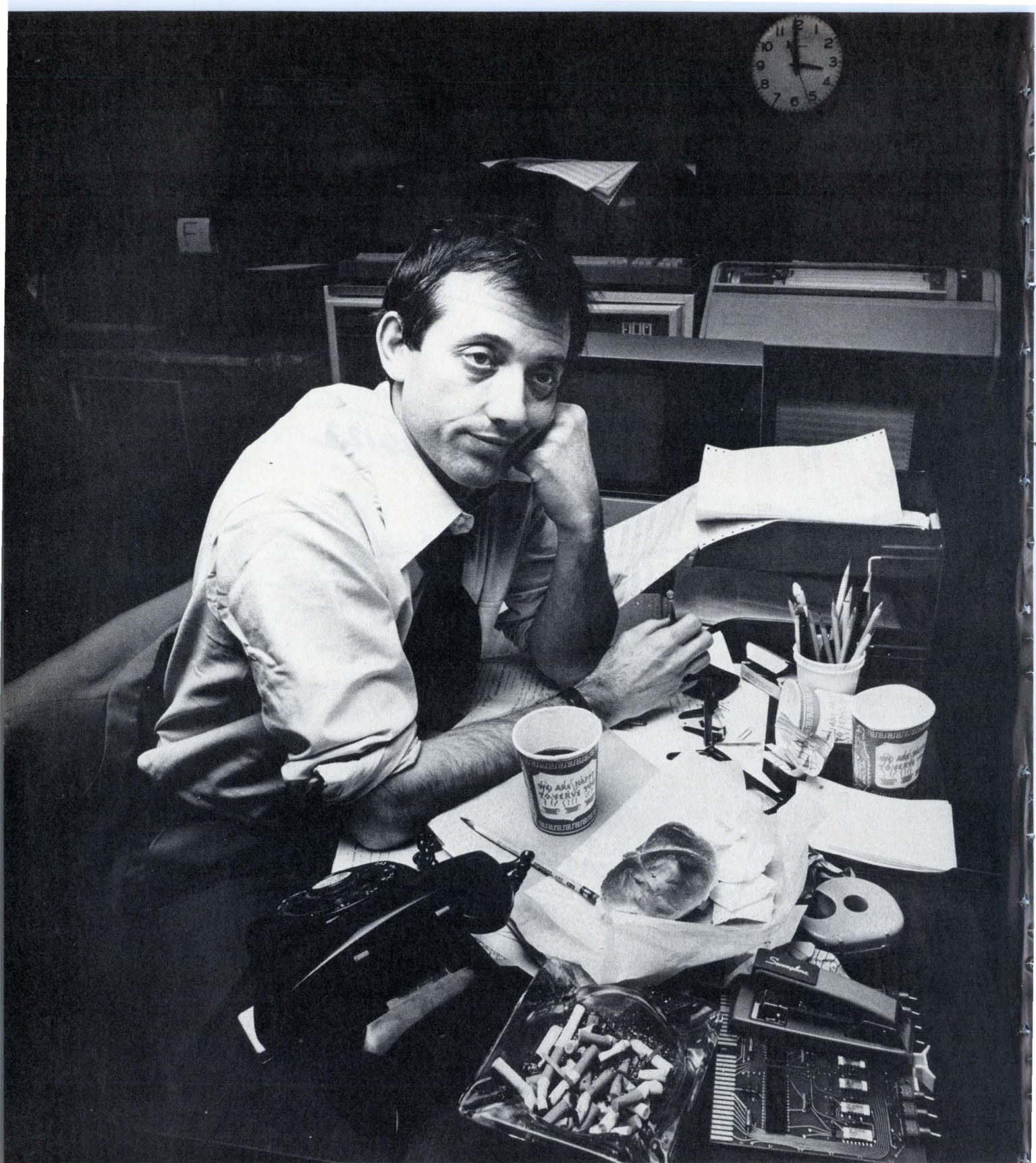

**It's hard to love the hardware  
when the software is keeping you  
up all night.**

There's a lot of great hardware around. But not much great systems software.

Which explains why a lot of programmers don't get much sleep. And why software development usually ends up costing more than the hardware.

When we make a computer, we put as much work into the software as the hardware.

So there's less work for you to do. And the work you have to do goes a lot faster.

Our Real-Time Disc Operating System (RDOS) lets you work the way you want. Interactively. Or Batch. It has a file management system that doesn't need any work at all. (It'll fit any application as is.) RDOS supports higher level languages. And utilities like MACRO Assembler, Text Editor and Symbolic Debugger make it easy to pull everything together.

And once you've finished your applications software, your job is done. Because RDOS helps run your programs as much as it helps write them.

It even lets you do two things at the same time. Like write new programs while you're running old ones. Or run Timesharing and Batch. Or Remote Job Entry and Timesharing.

Buy a Nova 840 from us and we'll give you RDOS. Free.

Then maybe you and your programmers can go home and get a good night's sleep.

# DataGeneral

The computer company you can understand.

• Data General Corporation, Southboro, Massachusetts 01772, (617) 485-9100.  
Datagen of Canada Ltd., Hull, Quebec (819) 770-2030/Data General Europe, Paris, France 504-23-44.

**Tubes?  
Forget them.**

# HERE'S 100 WATTS OF SOLID-STATE RF POWER!

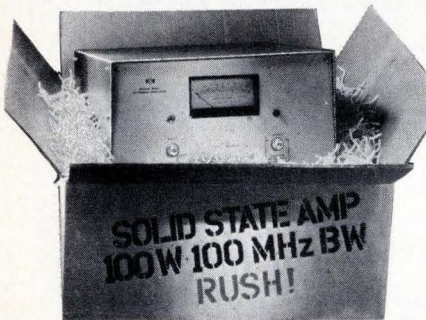

## **A state-of-the-art amplifier.**

ENI's new Model 3100L *all-solid-state* power amplifier provides more than 100 watts of linear power and up to 180 watts of pulse power from 250 kHz to 105 MHz. This state-of-the-art class A unit supplies over 50 watts at frequencies up to 120 MHz and down to 120 kHz. All this capability is packaged in a case as small as an oscilloscope, and it's just as portable.

## **Extraordinary performance.**

Featuring a flat 50 dB gain, the Model 3100L is driven to full power by any signal generator, synthesizer or sweeper. AM, FM, SSB, TV and pulse modulations are faithfully reproduced by the highly linear output circuitry. Immune to damage due to load mismatch or overdrive, the 3100L delivers constant forward power to loads ranging from an open to a short circuit.

Solid-state reliability is here.

The price? \$5,690.

Write for complete information: ENI, 3000 Winton Road South, Rochester, N. Y. 14623  
Call (716)-473-6900 or TELEX 97-8283  
Dept. E 524

**ELECTRONIC  
NAVIGATION  
INDUSTRIES**

**ENI . . . The world's leader  
in solid-state power amplifiers.**

## People

MIT's Davenport  
heads EE dept.

"As educators, we must ask ourselves 'Can we give our students a good start?'" This is now a major concern of Wilbur Davenport Jr., recently named head of the electrical engineering department of the

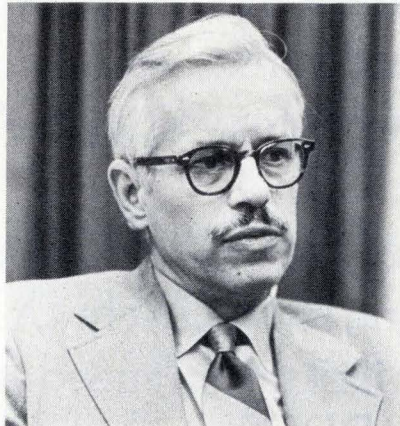

**Emphasis.** Wilbur Davenport sees more activity in energy and computers.

Massachusetts Institute of Technology.

But, speaking of an engineer's preparation for industry, Davenport says, "It is not really reasonable, however, to expect the university to bring the student up to the current state of the art." And he adds, "Schools should be sure that students are firmly grounded in the fundamentals of the sciences, but the industry should provide the device work."

Davenport is planning some changes for the electrical engineering department. "Electrical-energy work in the department has been quiescent for a long period," he says. "I expect it to be more active as time goes on, given today's problems." Davenport also intends to strengthen the interaction between electrical engineering and computer science.

A specialist in telecommunications, Davenport says that "the advancement of computer science has had a profound effect on communications and information processing. That interaction has become an important technology."

Davenport's last post was director of the MIT Center for Advanced Engineering Study, a group concerned with the post-collegiate education of working engineers, scientists and technologists.

But shifting his attention to study at the undergraduate and graduate level will not be difficult for the 53-year-old professor of education and engineering. Davenport believes "education is an ongoing process that does not stop with any formal degree and must extend one's own field of specialization."

He explains that working engineers and even graduate students are conscious of the social context in which they are using their technical skills—more so than undergraduates.

The electrical engineering department is the largest in MIT's School of Engineering. Enrollment was not affected by the recent recession, according to Davenport, who attributes the department's popularity to the positive attitude of the staff towards the students. "We've been told by outside observers that the department is a place to get a good education—and be treated as a human being."

## Norling manages quartz movement

The increasingly fuzzy line between semiconductor firms and their equipment-maker customers is nowhere more blurred than in the fast-growing watch business. And Motorola's announcement that it will begin making digital watch modules this year only highlights this sensi-

**Watch modules.** Motorola's Norling now heads timepiece electronics group.





# MOSTEK's 1024-bit static RAM, the MK 4102P, gives you 450 ns access time. Another big move forward in MOS RAMs!

MOSTEK's MK4102P-1 features two industry firsts: it's the fastest 1024-bit static RAM (450 ns access time) and the first to combine N-channel silicon-gate and ion-implantation technologies, industry's most advanced processing technique. Plus, it's a pin-for-pin replacement for the 2102-1.

All inputs are directly compatible with TTL circuitry. The high impedance "off state" coupled with "chip select" input

permits large memory array construction with a minimum of additional circuitry.

**Volume production capacity backs-up the 4102.** MOS RAM production at MOSTEK, bolstered through increasing use of 3-inch wafers, is currently exceeding 250 million bits per month with total deliveries to date of more than two billion bits. With this record, MOSTEK is now one of the world's largest producers of MOS RAMs. So you can be assured that your biggest orders will be handled promptly.

MOSTEK's memory heritage includes other popular RAM

circuits. The MK4006P dynamic RAM was the first TTL compatible 1024-bit RAM. The MK4007P 256-bit dynamic RAM was first to combine low power, high performance and wide voltage range. MOSTEK RAMs are available in volume now from distributor stocks.

Performance and volume production capacity — good reasons to call MOSTEK for random access memories. *And watch for the next big development in RAMs — coming soon from MOSTEK.*

For a data sheet on the MK4102P-1 contact: MOSTEK, 1215 West Crosby Road, Carrollton, Texas 75006, (214) 242-0444. Or call the MOSTEK representative nearest you.

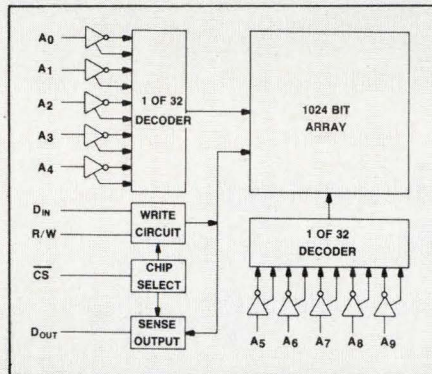

# MOSTEK®

**MOSTEK moves forward...in memories.**

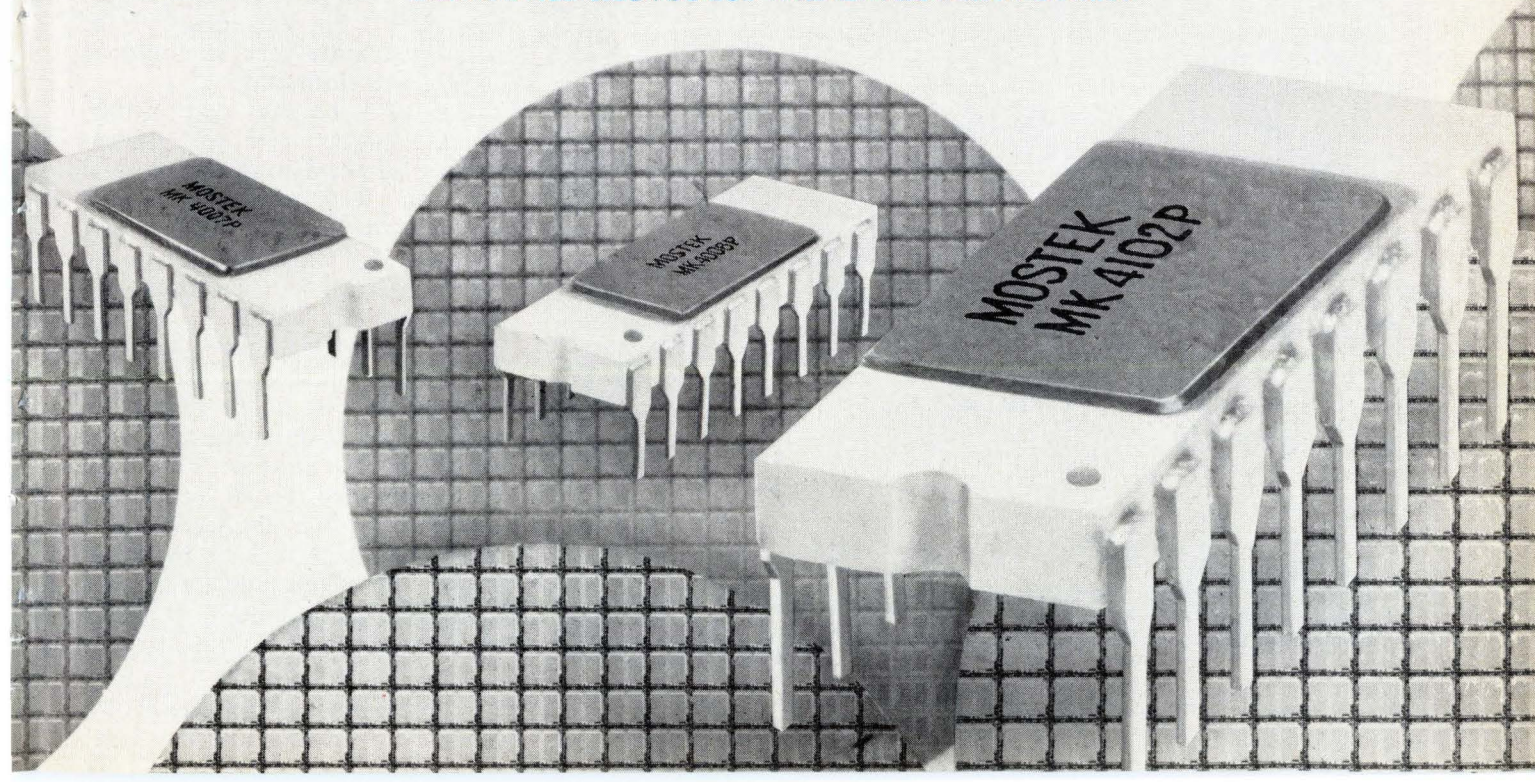

**SR-300 . . . the only complete unit for measuring shaft angle and displaying your actual engineering units.** The economical SR-300 synchro converter from DDC. With output already scaled to display the engineering units you need to measure—so you don't have to take the time to read angle, then scale. The SR-300 does it for you with custom scale factors—in psi, miles, degrees, temperature, pounds, velocity . . . any engineering unit you require.

Features include: bright .6-inch display in compact (2x4.5x7.5-inch) panel meter configuration; 3 or 4 decade resolution; all solid state reliability; accepts 11.8V or 90V L-L, 50-440Hz and synchro or resolver format; BCD output for computer interface and/or remote readout, and self-contained power supply. Input is transformer isolated and transient protected. Accuracy is  $\pm 30'$  or  $\pm 6'$  and is specified worse case over full environmental range.

So, whether your application is in industrial machine controls, batch weighing, processing systems, or data logging, such as utilized in maritime and industrial data recorders, why not select the indicator that speaks your language!

It's from DDC. The people who are shaping the future of data conversion and high speed signal conditioning equipment. *Send for free brochure.*



A subsidiary of ILC Industries, Inc.

**ILC DATA DEVICE CORPORATION**

100 TEC STREET, HICKSVILLE, N. Y. 11801 • PHONE: (516) 433-5330

Shaping the future of data conversion.

**APPLICATION CENTERS**

Long Beach, Calif.  
(213) 597-5744

Washington, D. C.  
(703) 536-2212

Bruxelles, Belgium  
Tel. 62.01.59

## At last! A low-cost synchro angle indicator that speaks your language.

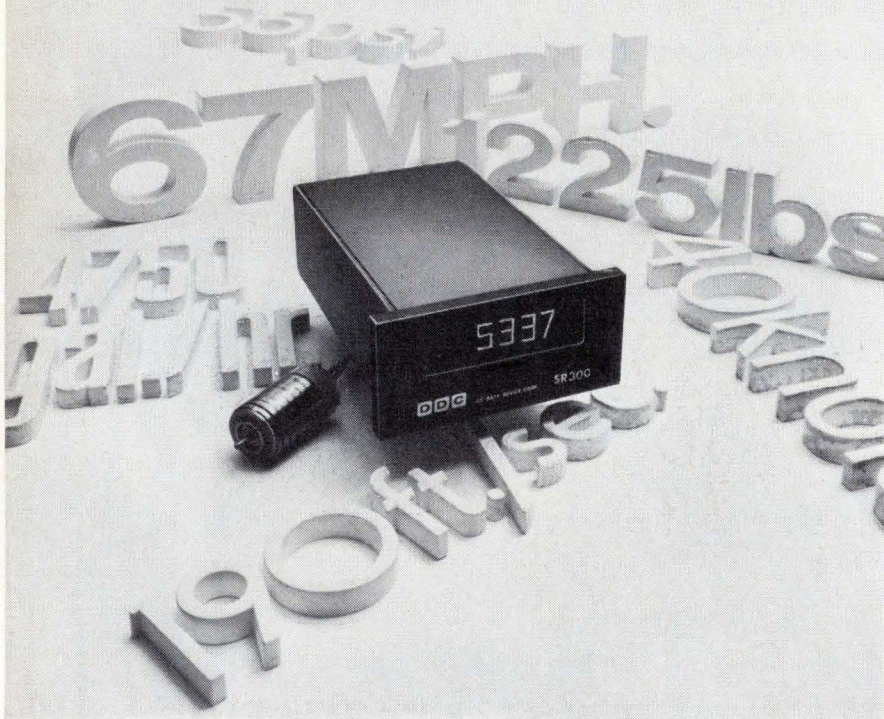

## People

tive situation. The man recently appointed to take over day-to-day management of the watch group from Dan Noble, who originated and spearheaded the watch effort, is James A. Norling. Sensitized to the delicate balance between supplier and customer, Norling carefully points out that Motorola is making only watch movements and is not going into the watch business—at least not this year.

Although the group manufacturing the quartz timepiece electronics is located in Phoenix, it is not part of the Motorola Semiconductor division. But the watch group is critically dependent on the semiconductor products made by its big sister. Norling, in fact, had been group operations manager for digital ICs at the Semiconductor division before joining the watch group.

Motorola started up its watch business with a commitment to analog-display quartz watches, taking sophisticated ion-implanted C-MOS from its Semiconductor division and quartz crystals from its Communications division.

The new modules Motorola is preparing to market to watchmakers, however, will have digital displays, not analog. The non-moving Motorola watch "movement" will use field-effect liquid-crystal displays. "Liquid-crystal displays will be bigger than LEDs this year and will be overwhelmingly bigger by 1980." He expects 25% of watches sold five years from now to have quartz electronics.

For 1973, he says that 750,000 quartz watches were sold. About 450,000 of them were analog, and fewer than 90,000 of the digital ones had LED displays. He predicts that sales for 1974 will balloon to almost 5 million quartz watches—about half analog and half digital.

Norling, a 1965 University of Illinois MSEE graduate, also thinks "the failure rate in the little companies that are springing up will be very high." But he adds: "I don't see the established watch companies disappearing from the scene, and I think that there will be moderate success for semiconductor houses getting into the business."



# MEASUREMENT COMPUTATION

innovations from Hewlett-Packard

# NEWS

FEBRUARY, 1974

## in this issue

Learn about logic

New solution to  
component test problems

Two new oscilloscopes

## New, large computer concept at a small system price

The HP 3000 multiprogramming, multilingual computer system gives you flexible, advanced computing capability at a price no other system can match.

Built around a unique operating system, the new HP 3000 multiprogramming system provides powerful computational capabilities to multiple users concurrently, whether they use interactive terminals or traditional batch devices for access. (This makes it easier for people and computers to work together.) You can program in high-level COBOL, FORTRAN, BASIC and SPL (System Programming Language) in any access mode. The HP 3000 combination of immediate access and powerful multiple capability is available at a cost no other computer system can match.

Convenient terminal access enables full-range program development, pro-

*(continued on page 3)*

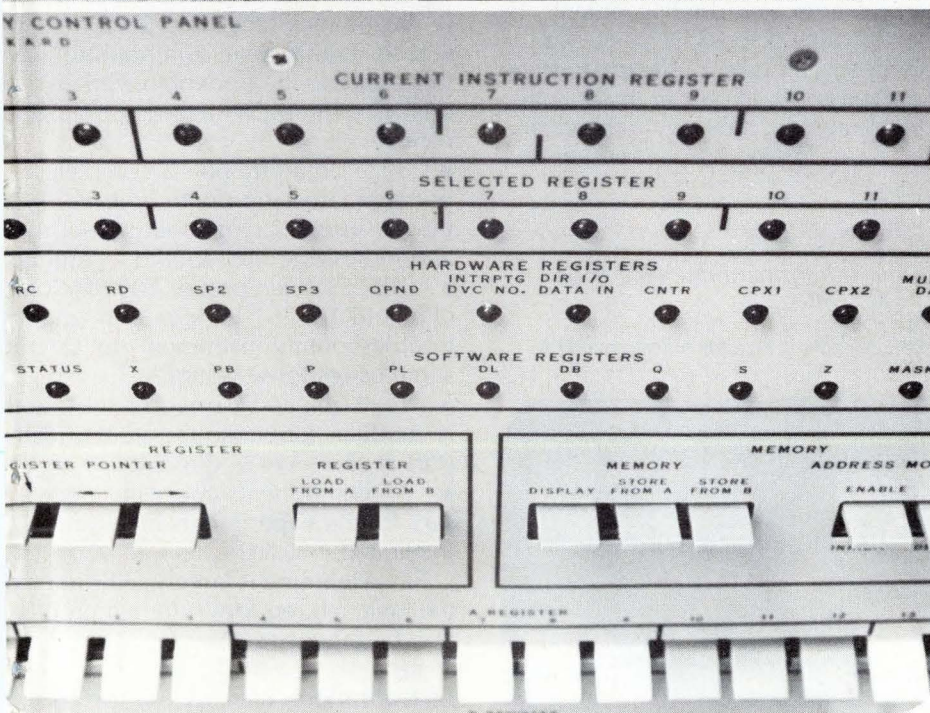
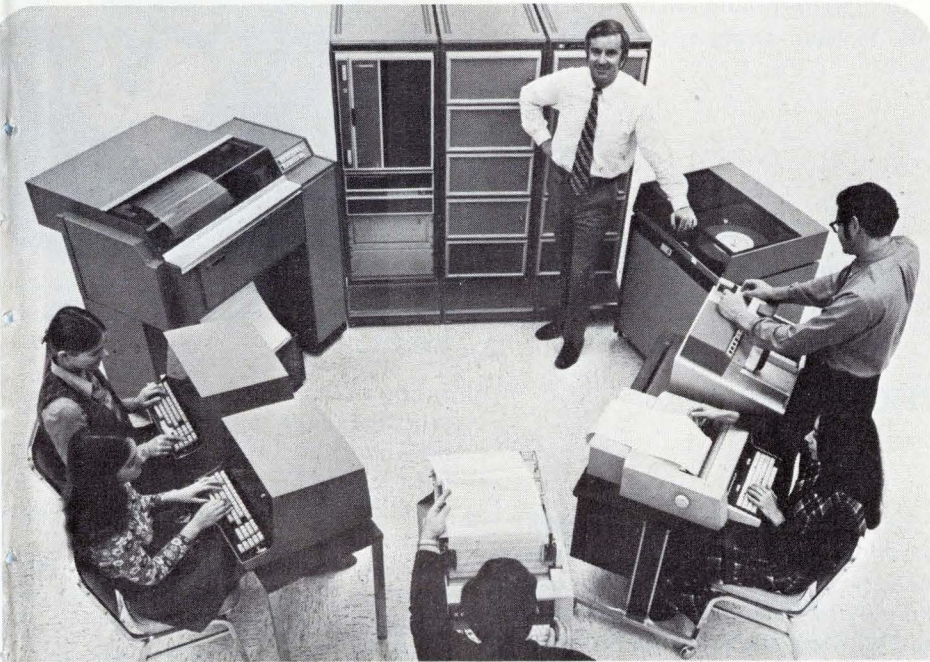

## Solid-state sweepers offer BWO-type power output

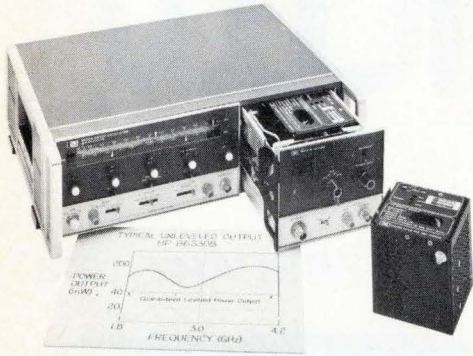

New solid-state RF power module for HP 8620 series sweepers delivers BWO-equivalent power, 1.8 to 4.2 GHz.

Swept frequency testing of high-loss S-band devices is now simpler and more practical. HP offers the first solid-state sweep oscillators whose power output above 2 GHz is comparable to that delivered by BWO-type sweepers.

The HP 86330B RF module for the HP 8620 series sweepers produces a guaranteed minimum of 40 mW leveled power from 1.8 to 4.2 GHz. Typically, power levels of 100 mW and above can be obtained. A wider band version, model 86331B, covers 1.7 to 4.3 GHz with some reduction in power at the band edges.

Altogether, solid-state RF units for the 8620 series sweepers span 3 MHz to 18 GHz to provide maximum flexibility for your swept measurement needs.

For full details, check N on the HP Reply Card.

## Low profile recorder with options for varied applications

HP's 7123A strip-chart recorder is an ideal choice for applications where space is limited. Fast response time, high reliability and wide range flexibility are combined in a package only 3.5 in. (8.9 cm) high. The recorder fits easily into OEM equipment and saves valuable rack space, yet still provides an easy-to-read 10 in. (25 cm) chart.

Over 50 options for span sensitivity, chart speed and other performance features guarantee flexibility to meet any need at minimum cost. Three special options satisfy analytical needs, such as gas chromatography applications.

Solid performance and low-silhouette design—the 7123A recorder is an ideal running mate for the HP 5700A gas chromatograph.

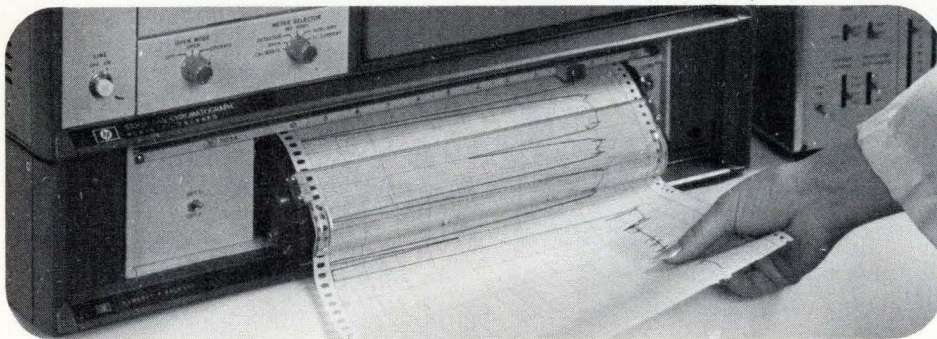

Reliability—the keynote of analytical recording—is achieved by a unique linear servo motor system with only one moving part: the slider/pen assembly. There are no ink spills or priming problems; you use convenient quick-change disposable pens, available in several colors. The chart drive is slanted so that you can make notes during operation. The entire magazine swings out for easy paper loading.

For more information, check K on the HP Reply Card.

## A new way to teach or learn digital logic

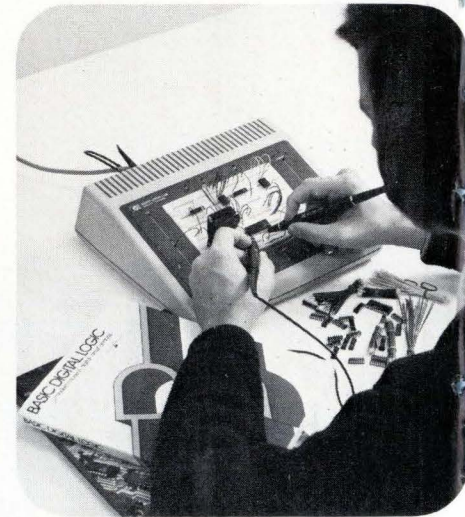

The logic lab's solderless, plug-in connection technique lets you breadboard circuits quickly and easily.

For a complete, concise course in practical digital electronics, try HP's new educational package. The 5035T logic lab contains all equipment and instructional material necessary to learn digital logic.

Designed for use in industrial training programs, high schools, technical institutes and universities, the 5035T is also handy for breadboarding logic circuits in engineering labs. This practical aid teaches digital logic in a realistic way that prepares the student to work in modern electronics. With the logic lab, you receive:

- 5035T mainframe—a complete, portable lab station with built-in 5V power supply, 2 clock sources, 4 LEDs, and removable breadboard assembly.
- 10525T logic probe, 10528A logic clip, and 10526T logic pulser—quality troubleshooting instruments for circuit stimulus-response testing.
- Textbook and lab workbook—both in modular format so the student can start at any level of difficulty.
- All components and wires necessary for the experiments including 30 integrated circuits.

Since learning is largely self-directed the logic lab requires minimal preparation by the instructor.

To learn more, check G on the HP Reply Card.

## New low-cost pulse generator for MOS circuits

HP's new 8011A pulse generator is an economical instrument ideal for testing newer MOS circuitry as well as linear circuits. It can drive all saturated logic families, low threshold MOS, CMOS and analog devices.

Amplitude ranges from 250 mV to 16V; rep rate, from 0.1 Hz to 20 MHz; and pulse width, from 25 ns to 100 ms with square wave selectable. Transition times are fixed at <10 ns. Source impedance on the lower ranges is 50Ω while in the 4V-16V range, impedance can be 50Ω or higher.

Choose positive, negative or symmetrical pulse polarity to change rapidly from positive to negative logic, or to enable duty cycles up to 100%.

To help overcome the problems of logic circuit design and troubleshooting, a counted pulse burst option is available. With this option, you simply preselect the number of pulses you need, from 1 to 9999. You can clock circuits at

their operational clock rate, then analyze them under static conditions.

The 8011A is probably the lowest priced pulse generator of its kind...only \$435. Add \$300 for the pulse burst option.

*For more information, check M on the HP Reply Card.*



The 8011A with HP's unique counted burst option offers a new concept in logic test and troubleshooting.

## New mainframe and plug-ins for HP 183 scopes

Two new plug-in modules and a new high speed scope mainframe enhance HP's proven 183 series oscilloscopes.

The new plug-ins add 200 MHz two-channel (model 1835A) or four-channel (1834A) general purpose measurements for both digital and analog applications. You can also couple these wide bandwidths with an HP time base module for accurate timing measurements in ECL and TTL logic circuits. Additional capability for high frequency timing applications is provided with the 4-channel chop rate of 500 kHz and the 2-channel chop rate of 1 MHz.

Both plug-ins have 10 mV/div deflection factors to 200 MHz. Selectable trigger source lets you reference any one channel while retaining time relationships with other channels. Composite triggering allows each channel to trigger independently with an alternate or added display.

Model 183B, option 005, is a new mainframe with high writing speed. The option 005 provides up to 24 cm/ns transient recording capability for the most demanding high-energy physics or laser detection applications. A direct-access plug-in allows real time, large signal transient analysis to greater than 600 MHz, as well as 10 mV/div capability to 250 MHz.

The 183B opt 005 costs \$2975. The 1835A dual channel amplifier, \$1400; the 1834A four-channel plug-in, \$1900.

*For specifications, check C on the HP Reply Card.*

Four-trace capability simplifies digital circuit testing.

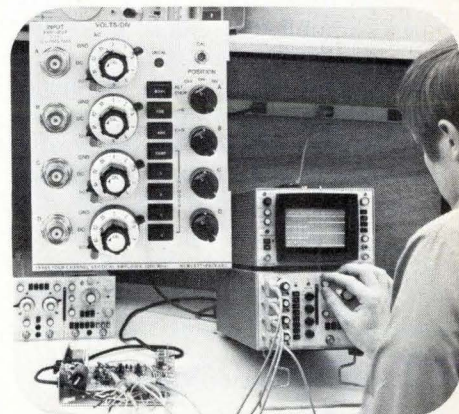

including separation of code and data, data stack, virtual memory through code separation, and a microprogrammed instruction set. Core memory options of 64, 96, and 128 kilobytes are available, along with a wide range of peripherals and terminals.

HP 3000 users are supported by comprehensive system training, documentation, regional and local service offices, and a flexible financial program ranging from lease arrangements to direct purchase.

The HP 3000 is currently in use in the U.S., Canada and Europe. For availability in other countries, contact your HP sales office. System prices start at \$175,000.

*For more information, check D on the HP Reply Card.*

*(continued from page 1)*

vides dedicated terminals for specific applications, and eliminates keypunching. Batch access to advanced computing power or batch execution gets batch production jobs done, while terminal users are also accessing the system. Full system capability is available to every user independent of access method, so people can use the method best suited for their problems.

A state-of-the-art multiprogrammed operating system (MPE/3000) assures maximum use of central processing resources through overlapping I/O and computation. MPE automatically schedules users for maximum operating efficiency.

The basis of the HP 3000 contribution is a unique architecture that provides advanced computer system concepts,

## Digitizer inputs graphic data for HP calculators

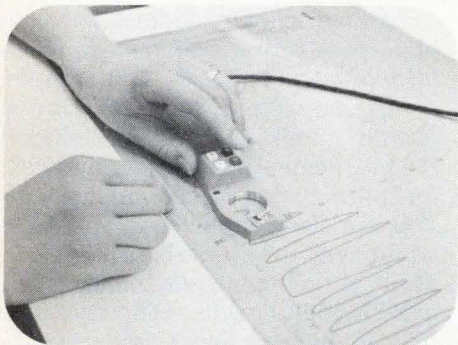

Here, the lab technician is digitizing a blood-analyzer strip-chart for medical data analysis and quality control.

The HP 9864A digitizer lets you enter analog data directly into an HP 9800 series programmable calculator for analysis without tedious manual measurements, conversion, and entry of

data. Simply move the cursor over the map, chart, or source material. The HP calculator then analyzes the digitized data according to your program. Resolution is .01 in. (.25 mm) and accuracy, 0.15 in. (.38 mm).

Applications for the digitizer are almost infinite. Use it to analyze contour maps, profile plots of terrain, mathematical curve fitting, nuclear data, cardiac plots, photographs, etc. Analog data can be in virtually any graphic form.

The standard platen will handle material up to 17 in. by 17 in. (43 cm by 43 cm). Options extend the platen maximum up to 42 in. by 60 in. (105 cm by 152 cm).

For more information, check P on the HP Reply Card.

## Universal card reader inputs 300 cards per minute

HP's 300 cards-per-minute optical mark reader is flexible as well as fast: model 7260A accepts all types of punched or marked cards, even specially-designed forms. With appropriate clock marks, single cards may be both punched and marked—in any number of columns from 1 to 80. This desktop reader is quiet enough for your office; fast enough to keep up with your computer.

The 7260A can be used with terminals, computers or remote data systems via a modem or direct connection. Data rates are switchable from 110 baud to 2400 baud. Data is stored in buffers so that you can optimize the card feed rate for high transmission efficiency. The 7260A transmits data in 7-level ASCII code; other decoding options are available.

OEM and quantity discounts are also available.

For more information, check L on the HP Reply Card.



Students can mark cards at their desks or at home, then handle other tasks while their programs are read and processed.

## New application notes on spectrum analysis

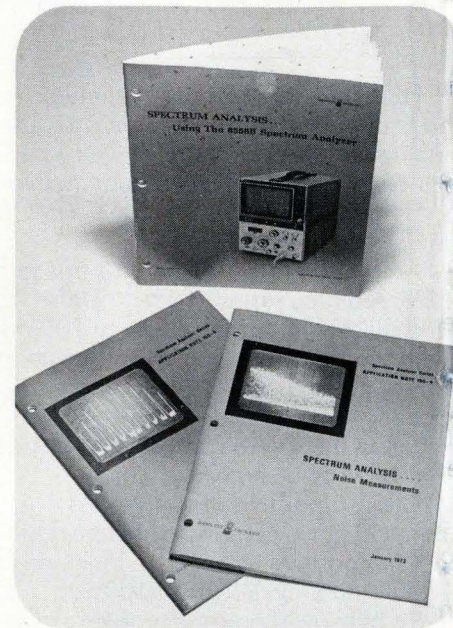

Three new spectrum analysis application notes are now available from HP. One is a general discussion of noise measurements; another treats CRT photography and x-y recording techniques; and the third is a "how-to-use" text about a versatile new HP analyzer.

AN 150A, *Using the 8558B Spectrum Analyzer*, introduces you to the operation, use and measurement capability of this 100 kHz to 1500 MHz instrument. A plug-in module that fits into any HP 180 series oscilloscope, the 8558B combines high performance with simple operation.

AN 150-4 shows how useful the spectrum analyzer can be for noise measurements. After distinguishing between random noise and impulse noise, the note deals with carrier-to-noise ratio, white noise loading, amplifier noise figure, and spectral purity characterization of several oscillator types.

Many spectrum analysis applications require photographs and plots for permanent records. AN 150-5 gives practical tips for making cathode ray tube photographs and x-y recordings of spectrum displays. Two types of CRTs and four types of recorders are covered.

Let us know which application note(s) you want; check T, U, or V on the HP Reply Card.

## New A/D converter for HP computer systems

Now there's a new low-cost analog measurement capability for research labs or production test stations that measure a few analog channels along with their digital work. The 91000A is a 16-channel, 12-bit analog-to-digital interface subsystem for HP 9600 series measurement and control systems or HP 100 series computers. It's easy to install—simply slip the A/D card into an I/O channel in the computer.

The 91000A card includes all necessary interface and control logic, 250-ns sample-and-hold amplifier, A/D converter, and an input multiplexer with capacity for 16 single-ended or 8 differential inputs. You can input, sample and digitize analog data at rates up to 100 kHz. The card accepts TTL-level external pacing signals.

Multiple A/D interface cards can be used together in a single 2100 series computer. And if your needs grow, your system can grow with them, to over 1000 analog channels, without changing your existing programs. Simply step up to the larger HP 2313B A/D interface system.

There's more. Just check O on the HP Reply Card.

The 91000A is a complete package with BCS or VME driver software (interfaced to FORTRAN, LOGOL or real-time BASIC programs) and an operation and service manual.

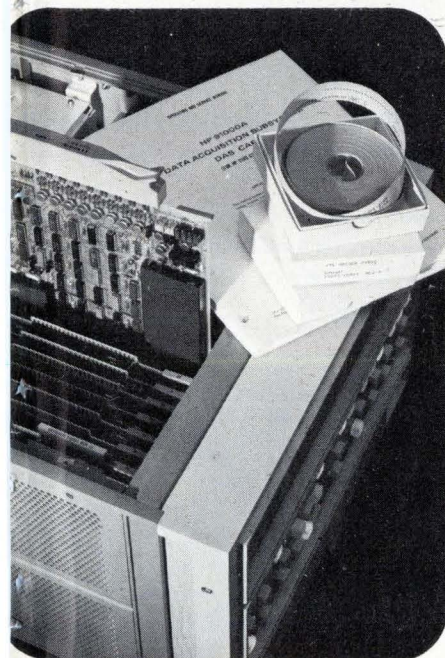

## New data link communications tester pinpoints system problems

With a new combination of measuring functions never before available, the 1645A lets you quickly troubleshoot modems, channels, or terminals.

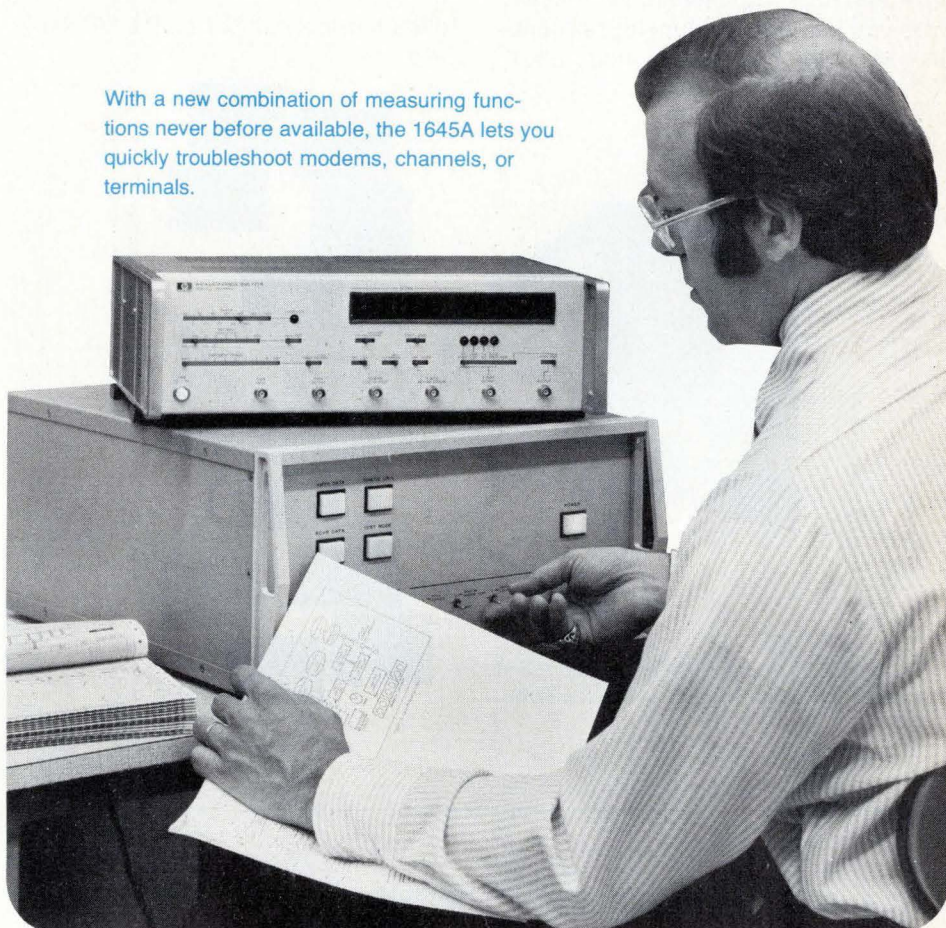

HP's new 1645A data error analyzer quickly isolates data communications link problems with six simultaneous measurements. You can use it to test modems, data channels, whole data communications systems, or low-speed memories. Yet it's easy enough to operate with little or no technical knowledge.

The 1645A measures bit error and block error rates directly—requiring no recalculation or interpretation—and maintains synchronization throughout a test, even in the presence of dropouts. Information appears on a digital LED display.

The analyzer also measures data error skew; counts the number of times carrier loss occurs; measures jitter or total peak distortion (the sum effect of jitter and bias); and counts the number of clock slips. With all these measurements taken simultaneously, you can locate the faulty system components in your communications link. And the storage feature leaves you free to work on other projects while the 1645A makes long unattended transmission analyses.

To learn about easier troubleshooting, check B on the HP Reply Card.

## Great way to make waves and save money

Sine waves, square waves, triangular waves—our low-cost function generator can produce them all, on 7 decades of range from 0.1 Hz to 1 MHz. The 3311A signal source also has dc offset and external sweep capabilities.

For convenience, there's pushbutton range and function selection. For versatility, you can put two function generators together and sweep the output. For

added value, the 3311A contains several features usually not found in this price range, such as 10:1 voltage control and separate pulse output for driving up to 20 TTL logic circuits. It also has a 15% duty cycle and 25 ns rise time.

All for an amazingly low price: just \$249.

To learn more, check E on the HP Reply Card.

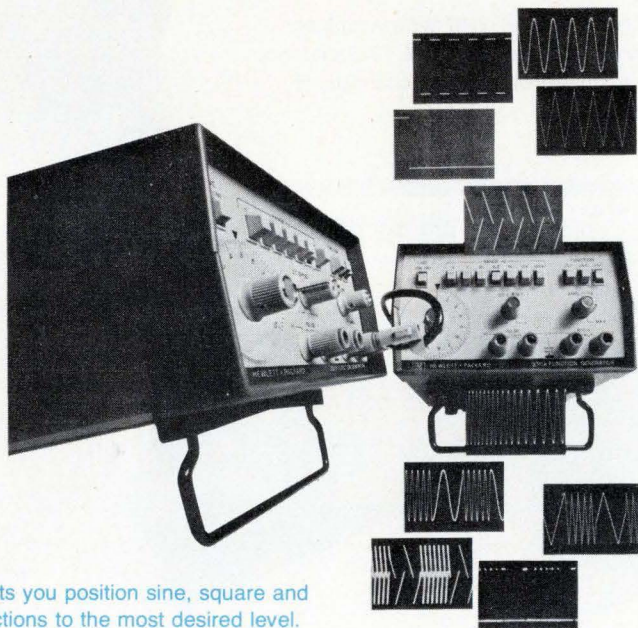

DC offset lets you position sine, square and triangle functions to the most desired level.

## New guide to HP electronic counters

Ever had to wade through mountains of specs to select a counter? Now, the HP counter brochure is here, making it easy to select from the most complete counter line available today. You'll find all types of counters here: simple low-cost units, battery-operated portables, universal counters/timers/DVMs, and models with versatile front-panel plug-ins. With HP counters, you buy just what you need, without paying for features you won't use.

Check R on the HP Reply Card and you can count on us to send your free copy.

## Design tips on microwave transistor bias

To help the microwave circuit designer, HP offers a new application note, *Microwave Transistor Bias Considerations* (AN 944-1).

In microwave transistor circuit design, the dc bias network significantly influences such RF parameters as gain and noise figure. Inattention to bias conditions can sacrifice RF performance. AN 944-1 is a practical guide that relates dc stability factors to RF performance.

For your free copy, check S on the HP Reply Card.

## New power supplies have dual output

Now, dual output capability has been added to HP's growing line of modular power supplies. Four models are offered:  $\pm 12V$  at 1.40A and 3.30A and  $\pm 15V$  at 1.25A and 3.00A. A single front panel control provides  $\pm 5\%$  adjustment of both outputs. These series-regulated supplies deliver full-rated output from 0 to 40°C with derated operation up to 71°C. All models are specified at 0.01% line or load regulation, 1 mV rms and 5 mV p-p ripple and noise, and  $\pm 1\%$  tracking accuracy.

Standard features include cut-back current limiting, overtemperature and reverse voltage protection, and remote sensing. Overvoltage protection is available as an option. These dual output power supplies are packaged in  $\frac{1}{2}$  and  $\frac{1}{4}$ -rack width cases.

For all the specifications, check I on the HP Reply Card.

These new power supplies are designed for powering operational amplifiers, core drivers, D/A and A/D converters, MOS devices, and voltage comparators.

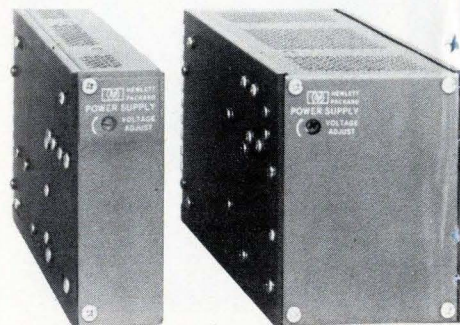



## New two and three digit low-power displays

Low power and MOS compatibility characterize HP's new series of solid-state numeric displays. They require only 300  $\mu$ A per segment, thereby eliminating the need for segment drivers when you interface them with MOS circuits.

These monolithic displays have a character height of 0.11 in. (.28 cm) and a standard lower right-hand decimal point. They are end stackable; digits

are on 200 mil centers. Built-in magnification increases luminous intensity.

The new indicators are available in two-digit clusters (5082-7432) and three-digit clusters (5082-7433).

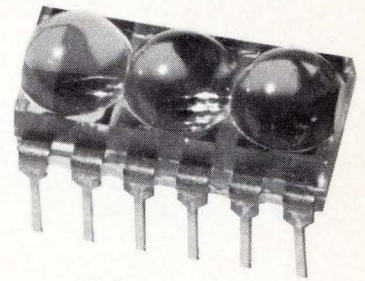

The new 5082-7430 series are ideally suited for use in handheld calculators and portable instruments.

For specifications, check H on the HP Reply Card.

## Send for a new diode and transistor catalog

Hewlett-Packard offers a wide range of diodes and transistors to meet your power, frequency, design and reliability requirements. The latest *HP Diode and Transistor Catalog* contains key specifications for the following products:

- Small signal microwave transistors.
- Schottky diodes—for mixing and detecting, microwave Schottky diode quads for double balanced mixers, beam lead and other Schottky and PIN diodes for hybrid ICs.
- RF, general purpose and switching Schottky diodes for high volume applications.
- PIN diodes for VHF, UHF and microwave applications.
- IMPATT diodes.
- Step recovery diodes.
- High reliability products.

The catalog includes packaging specs and drawings to aid the circuit designer.

For your copy, check Q on the HP Reply Card.

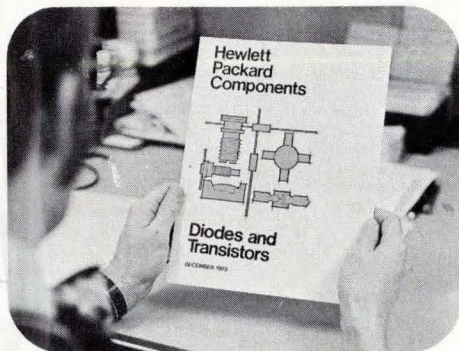

## Test components fast with new LCR meter



Typical uses for the 4271A LCR meter are: testing discrete components and varicap diodes, checking semiconductors, and L or C examinations of delay lines.

If you're testing diodes and capacitors or trimming IC capacitors and resistors, you need fast precise inductance, capacitance, resistance and loss measurements. Plug the new HP 4271A digital LCR meter into your system and you get 10,000 measurements or more per hour.

Using a four-pair measurement technique that reduces stray capacitance and residual inductance, this 1 MHz digital meter measures capacitance from 0.001 pF to 19,000 nF with an accuracy of 0.1%, and inductance from 0.1 nH to 1900.0  $\mu$ H. Capacitance loss components are measured as parallel conductance or as dissipation factor (as low as 0.0001). Inductance loss components are measured as series resistance (10  $\Omega$  to 10 K $\Omega$ ) or dissipation factor (as low as 0.0001). And you can vary dc bias from 0 V to 39.9V in 0.1 V increments.

The LCR meter has a four-digit LED display with 90% overrange, and it interfaces easily with HP computers, calculators, and digital recorders.

To learn how to improve component testing, check F on the HP Reply Card.

## New efficient dc supplies save watts and dollars

Low cost, high efficiency, compact size, outstanding reliability—you get them all with HP's 6427B-6483C family of high-power dc supplies. Using an advanced SCR-regulator design with up to 75% efficiency, these constant-voltage/current supplies are well suited to applications requiring high power with moderate regulation and ripple. You can use them for testing component aging, battery charging and discharging, station batteries, precision welding, and dc motor control.

Standard features include remote sensing, remote V and R programming, and auto-series, auto-parallel and auto-tracking operation. Nineteen different models provide outputs from 0-8 V to 0-600 V at currents up to 1000A.

To learn more, check J on the HP Reply Card.

High-efficiency dc supplies come in 300W, 1000W, 3500W and 11,000W power ratings.

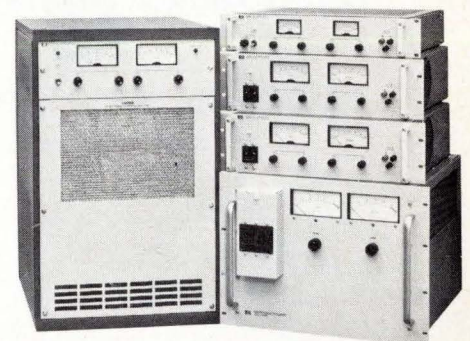

## New high value oscilloscopes for manufacturing, service and education

High reliability and low cost make the 1220A scope an ideal test tool.

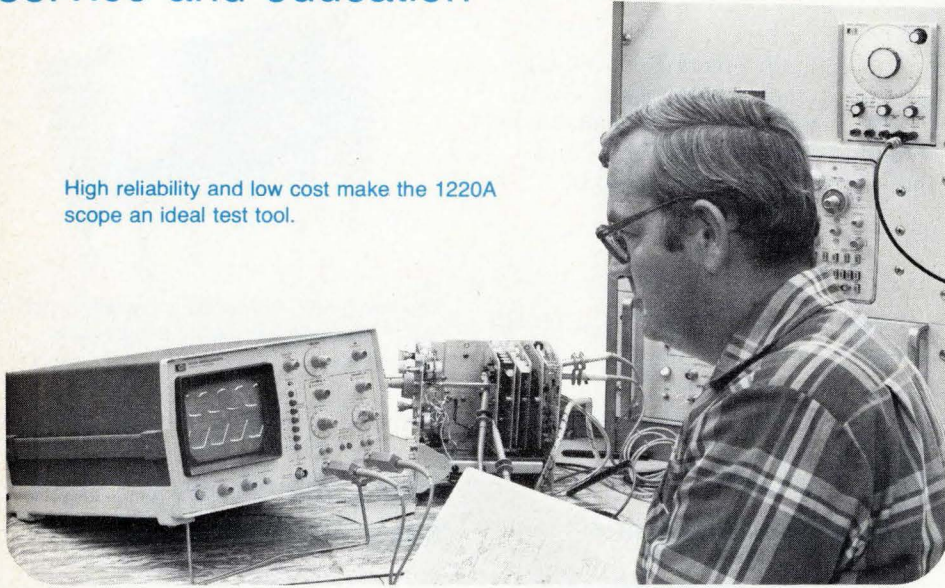

Two new 15 MHz oscilloscopes offer quality performance at minimum prices. Choose either the new 1220A dual channel scope, or the 1221A single channel model. Both have deflection factors from 2 mV/cm to 10 mV/cm for basic analysis of audio, video, logic circuits, FM, or direct output of mag pickups and heads. Built-in TV sync separation circuits make television servicing easy. And rugged construction makes these scopes useful in applications such as production and service of numerically-controlled machinery, process control equipment, automotive, aircraft, and marine electronics.

The large 8 by 10 cm graticule is internal, which eliminates parallax error.

Vertical accuracy of 3% and time base accuracy of 4% increase the validity of your measurements. Dc coupling is available for directly measuring absolute voltage levels, even on mixed ac and dc signals. A times-ten sweep expander makes it easy to examine signal details. The front panel controls are grouped functionally for easy understanding, and the pushbuttons are color-coded for easy use.

There's more: the automatic trigger sweep (just one control knob) assures stable displays. A bright base line is provided for fast setup in the absence of an input signal.

Built-in TV sync separation offers stable, automatic triggering on frame or

line for convenient TV troubleshooting. And, with the instrument's times-ten magnifier, vertical interval test signals can be "pulled out" for examination. The calibrated sweep helps identify timing problems in vertical or horizontal TV circuits.

An x-y mode makes reliable phase measurements with a phase shift of less than 3° at 100 kHz. The horizontal input also accepts horizontal drive signals from swept frequency oscillators for checking out tuners.

The 1220A displays two signals either in alternate for high sweep rates or, for lower rates, by chopping each sweep into short segments with blanking. The scope automatically selects the mode that will give you the best display. With dual channels, you can also compare input vs. output directly.

Solid-state design with its low power consumption and conservative component ratings makes for long, trouble-free life.

Check A on the HP Reply Card for more information.

**HEWLETT**  **PACKARD**

Sales, service and support in 172 centers in 65 countries.

**East**—W 120 Century Road, Paramus, N.J. 07652, Ph. (201) 265-5000.

**South**—P.O. Box 2834, Atlanta, Ga. 30328, Ph. (404) 436-6181.

**Midwest**—5500 Howard Street, Skokie, Ill. 60076 Ph. (312) 677-0400.

**West**—3939 Lankershim Boulevard, North Hollywood, Calif. 91604, Ph. (213) 877-1282.

**Europe**—Post Office Box 85, CH-1217 Meyrin 2, Geneva, Switzerland, Ph. (022) 41 54 00.

**Canada**—275 Hymus Boulevard, Pointe Claire, Quebec, Canada, Ph. (518) 561-6520.

**Japan**—Yokogawa-Hewlett-Packard, 1-59-1, Yoyogi, Shibuya-ku, Tokyo, 151.

# EMI FILTER CAPITAL OF THE WORLD

**FROM CERAMIC POWDER TO MIL-APPROVED TEST LAB...  
ERIE HAS IT ALL, UNDER ONE ROOF**

Only one company can deliver your total EMI Ceramic Filter needs . . . ERIE. We've been applying sophisticated ceramic and related technologies to developing superior filters for 35 years. Today ERIE has, by far, the broadest line of subminiature EMI Filters in the world. From tiny high frequency filters to broad band filters to custom filter assemblies, ERIE offers the ultimate in quality. And you get single-source responsibility too, for we build the complete filter in a plant devoted exclusively to the design and manufacture of EMI Filters. So come to ERIE for your filter needs. We'll put a team to work on your particular application. Aerospace. Communications. Avionics. Industrial Equipment. Whatever the market, we can help eliminate electromagnetic "noise" and emissions. In the meantime, write for our complete catalog . . . EMI Filters or call 613/392-2581.

**ERIE TECHNOLOGICAL PRODUCTS, INC.**  
Erie, Pennsylvania 16512

Circle 27 on reader service card

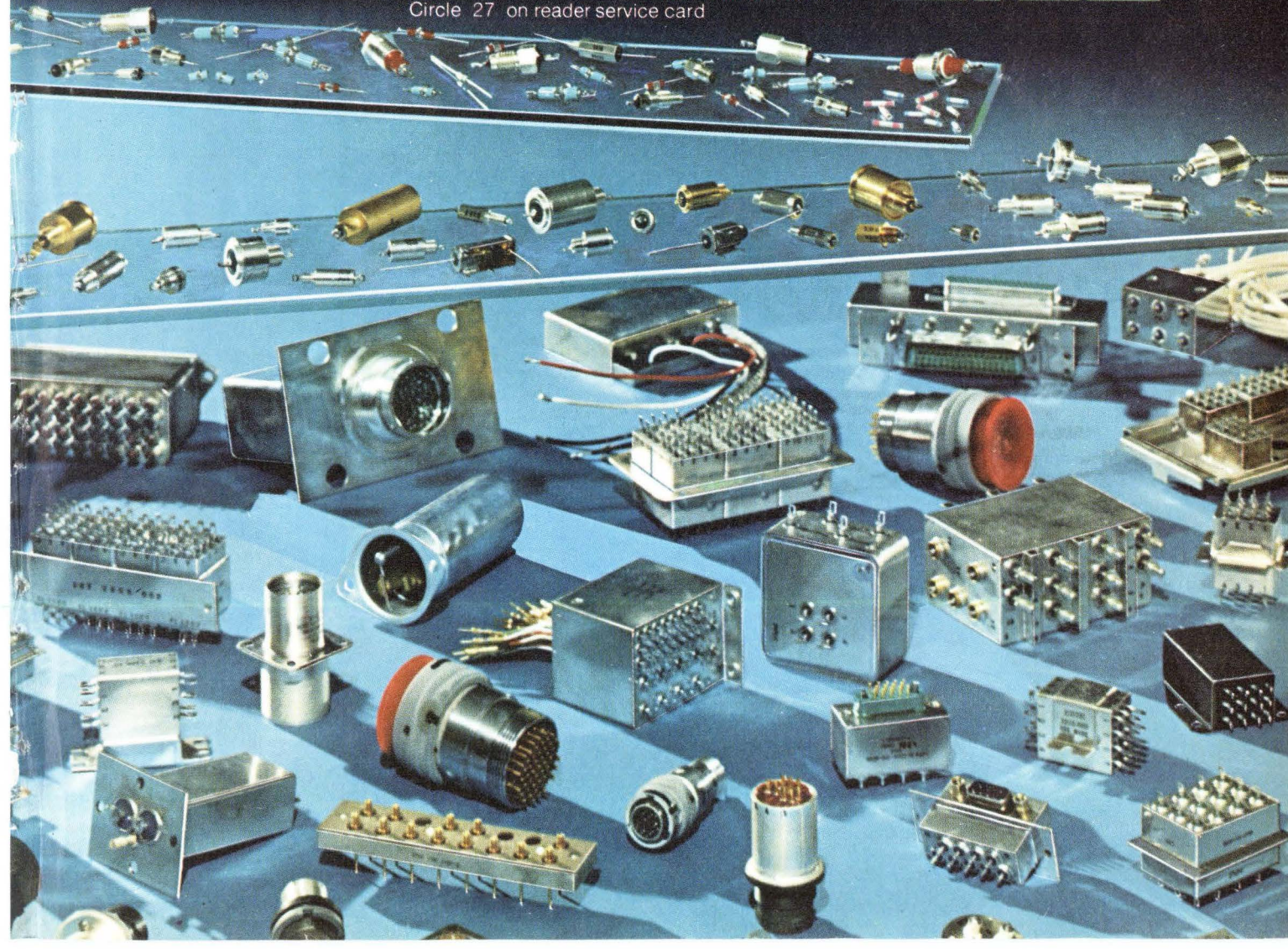
The logo for ERIE features the word "ERIE" in a bold, sans-serif font. The letter "I" is replaced by a stylized graphic of a sun or a signal, consisting of a central yellow circle with a black dot in the middle, surrounded by concentric black and white rings.

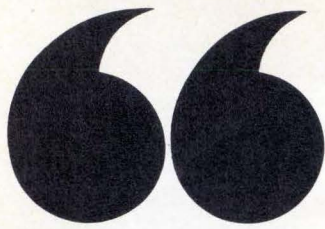

**No one else can**  
**The Products**  
A Subsidiary of OAK Industries Inc

Circle No.191 For immediate switch need

Circle No. 192 For immediate Indicator need



**make this statement.**

**of Marco-Oak**  
207 S Helena St, Anaheim, CA 92803

Circle No. 193 For switch information

Circle No. 194 For indicator information or call (714) 535-6037

AMERICAN

MADE

# Tolerance SCHAUER 1-Watt ZENERS

## Immediate Shipment Low Prices

ANY voltage from 2.0 to 16.0

Quantity	Price each
1-99	\$1.07
100-499	.97
500-999	.91
1000-4999	.86
5000 up	.82



Write for complete  
rating data and other  
tolerance prices.

## Buy the kit- Save a lot

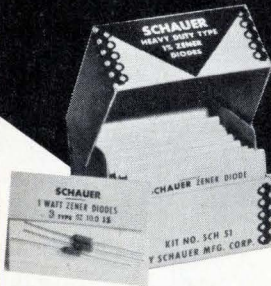

Kit contains a 51-piece assortment of SCHAUER 1% tolerance 1-watt zeners covering the voltage range of 2.7 to 16.0. Three diodes of each voltage packaged in reusable poly bags. Stored in a handy file box. Contact your distributor or order direct.

A \$54.57 value for

ONLY **\$24<sup>50</sup>**

Semiconductor Division

# SCHAUER

Manufacturing Corp.

4514 Alpine Ave. Cincinnati, Ohio 45242  
Telephone: 513/791-3030

## Meetings

**International Solid State Circuits Conference:** IEEE, University of Pennsylvania, Marriott Hotel, Philadelphia, Feb. 13-15.

**Computer Conference (Compon):** IEEE, Jack Tarr Hotel, San Francisco, Feb. 26-28.

**Nepcon '74 West:** Electronic Packaging and Production magazine, Anaheim Convention Center, Anaheim, Calif. Feb. 26-28.

**Aerospace and Electronics Systems Winter Convention (Wincon):** IEEE, Marriott Hotel, Los Angeles, March 12-14.

**Zurich Digital Communications International Seminar:** IEEE, Swiss Federal Institute of Technology, Zurich, Switzerland, March 12-15.

**International Convention (Intercon):** IEEE, Coliseum and Statler Hilton Hotel, New York, N. Y. March 26-29.

**Salon des Composants Electroniques:** SDSA, Porte de Versailles, Paris, France, April 1-6.

**International Reliability Physics Symposium:** IEEE, MGM Grand Hotel, Las Vegas, Nev., April 2-4.

**International Optical Computing Conference.** IEEE Computer Society, Zurich, Switzerland, April 9-11.

**Optical and Acoustical Micro-Electronics:** IEEE, Commodore Hotel, New York, N.Y., April 16-18.

**Carnahan Conference on Electronic Crime Countermeasures:** IEEE, Univ. of Kentucky, Lexington, April 17-19.

**International Circuits and Systems Symposium:** IEEE, Sir Francis Drake Hotel, San Francisco, April 21-24.

**Communications Satellite Systems Conference:** IEEE, International Hotel, Los Angeles, Calif., April 22-24.

**Pittsburgh Conference on Modeling and Simulation:** ISA, University of Pittsburgh, Pa., April 24-26.

## Your closest SIGNETICS distributor is...

### ARIZONA

Phoenix: Hamilton/Avnet Electronics (602) 275-7851  
Phoenix: Kieruff Electronics (602) 273-7331

### CALIFORNIA

Culver City: Hamilton Electro Sales (213) 870-7171  
El Monte: G. S. Marshall (213) 686-1500  
Los Angeles: KT/Wesco Electronics (213) 685-9525  
Mountain View: Hamilton/Avnet Electronics (415) 961-7000  
Palo Alto: Wesco Electronics (415) 968-3475  
San Diego: Hamilton/Avnet Electronics (714) 279-2421  
San Diego: Kieruff Electronics (714) 278-2112  
Sunnyvale: Cramer Electronics (408) 739-3011

### CANADA

Downsview: Cesco Electronics, Ltd. (416) 661-0220  
Downsview: Cramer Electronics (416) 661-9222  
Montreal: Cesco Electronics, Ltd. (514) 735-5511  
Montreal: Hamilton/Avnet (514) 735-6393  
Ottawa: Hamilton/Avnet Electronics (613) 725-3071  
Ottawa: Cesco Electronics, Ltd. (613) 729-5118  
Quebec: Cesco Electronics, Ltd. (418) 524-3518

### COLORADO

Denver: Hamilton/Avnet Electronics (303) 534-1212  
Denver: Cramer Electronics (303) 758-2100

### CONNECTICUT

Hamden: Arrow Electronics (203) 248-3801  
Georgetown: Hamilton/Avnet Electronics (203) 762-0361  
North Haven: Cramer Electronics (203) 239-5641

### FLORIDA

Hollywood: Hamilton/Avnet Electronics (305) 925-5401  
Hollywood: Schweber Electronics (305) 927-0511  
Orlando: Hammond Electronics (305) 241-6601

### GEORGIA

Atlanta: Schweber Electronics (404) 449-9170  
Norcross: Hamilton/Avnet Electronics (404) 448-0800

### ILLINOIS

Elk Grove: Schweber Electronics (312) 593-2740  
Einhurst: Semiconductor Specialists, Inc. (312) 279-1000  
Schiller Park: Hamilton/Avnet Electronics (312) 678-6310

### INDIANA

Indianapolis: Semiconductor Specialists (317) 243-8271

### KANSAS

Lenexa: Hamilton/Avnet Electronics (913) 888-8900

### MARYLAND

Hanover: Hamilton/Avnet Electronics (301) 796-5000  
Rockville: Pioneer Washington Electronics, Inc. (301) 424-3300  
Rockville: Schweber Electronics (301) 881-2970

### MASSACHUSETTS

Burlington: Hamilton/Avnet Electronics (617) 273-2120  
Needham Heights: Kieruff/Schley (617) 449-3600  
Newton: Cramer Electronics (617) 969-7700  
Waltham: Schweber Electronics (617) 890-8484

### MICHIGAN

Livonia: Hamilton/Avnet Electronics (313) 522-4700  
Detroit: Semiconductor Specialists, Inc. (313) 255-0300

### MINNESOTA

Minneapolis: Semiconductor Specialists, Inc. (612) 854-8844  
Edina: Hamilton/Avnet Electronics (612) 941-3801

### MISSOURI

Hazelwood: Hamilton/Avnet Electronics (314) 731-1144

### NEW YORK

Buffalo: Summit Distributors, Inc. (716) 884-3450  
Farmingdale, L. I.: Arrow Electronics (516) 694-6800  
Rochester: Schweber Electronics (716) 328-4180  
Syracuse: Hamilton/Avnet Electronics (315) 437-2642  
Westbury: Schweber Electronics (516) 334-7474  
Westbury: Hamilton/Avnet Electronics (516) 333-5800

### NEW MEXICO

Albuquerque: Cramer Electronics (505) 265-5767

### NORTH CAROLINA

Greensboro: Hammond Electronics (919) 275-6391

### NORTHERN NEW JERSEY

Cedar Grove: Hamilton/Avnet Electronics (201) 239-0800  
Saddlebrook: Arrow Electronics (201) 797-5800  
Moorestown: Arrow/Angus Electronics (609) 235-1900

### SOUTHERN NEW JERSEY AND PENNSYLVANIA

Mt. Laurel, N. J.: Hamilton/Avnet Electronics (609) 234-2133  
Cherry Hill, N. J.: Milgray-Delaware Valley  
New Jersey (609) 424-1300 Philadelphia: (215) 228-2000  
Somerset, N. J.: Schweber Electronics (201) 469-6008

### OHIO

Beechwood: Schweber Electronics (216) 464-2970  
Cleveland: Arrow Electronics (216) 464-2000  
Cleveland: Pioneer Standard Electronics (216) 587-3600  
Kettering: Arrow Electronics (513) 253-9176

### TEXAS

Dallas: Hamilton/Avnet Electronics (214) 661-8661  
Dallas: Cramer Electronics (214) 350-1355  
Houston: Component Specialties (713) 771-7237  
Houston: Hamilton/Avnet Electronics (713) 526-4661

### UTAH

Salt Lake City: Alta Electronics (801) 486-7227  
Salt Lake City: Hamilton/Avnet Electronics (801) 262-8451

### WASHINGTON

Bellevue: Hamilton/Avnet Electronics (206) 746-8750

# BCD arithmetic, all in a single IC.

Figure on whopping savings in parts, design time, systems costs.

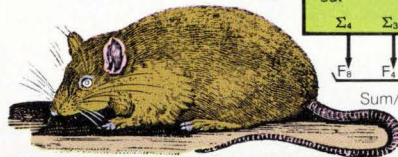
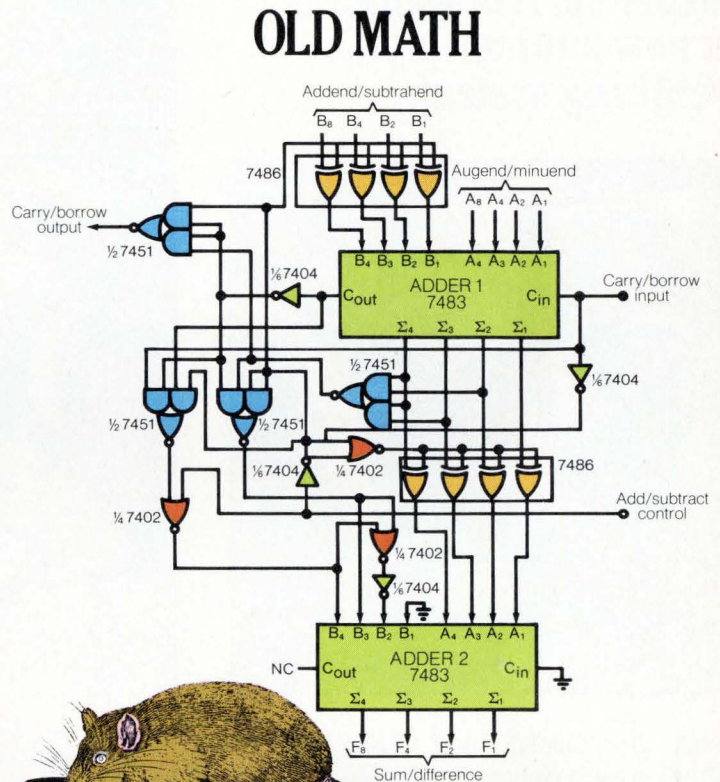
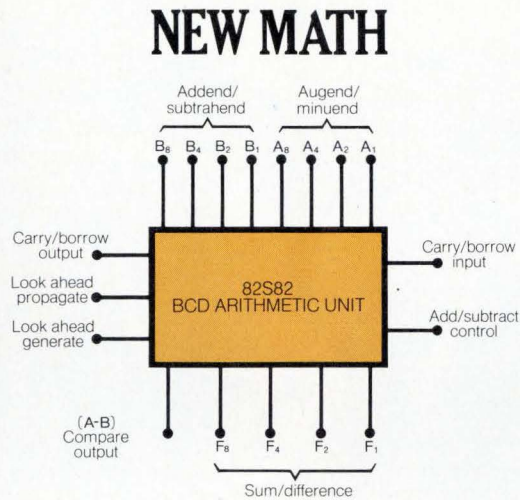

We've cut BCD arithmetic down to size. By applying Schottky MSI to those functions where it counts, we're delivering revolutionary tools in superfast processing — that are real power misers at a fraction (about half) of conventional circuitry costs. A lot more of exactly what you need. For less cost going in and coming out.

Available from Signetics, the under ten buck (100 up) 82S82 Adder-Subtractor slashes inventory requirements. Replaces four MSIs, and a rat's nest of gates and connections, now wasting valuable board space. With a staggering improvement in performance. Quadruples speed (22ns typical propagation delay). Cuts power 50%-67%. Wipes out a huge chunk of design, checkout and assembly time.

Versatile? Stand back. This unique Arithmetic Unit adds and subtracts in BCD directly, compares two BCD words, and can even be used for binary-to-BCD conversion. Cascades to operate on multiple decades. If you need ultra-high speed, get complete look-ahead carry with our 74182 fast-carry extender. What does the 82S82 do? Everything.

For a straight BCD add without all the bells and whistles, our companion 82S83 Adder gives you the same bonuses as the 82S82 Arithmetic Unit. Eliminates two MSI packages and a fistful of logic elements. Saves time, saves dollars — works better, faster, cheaper. Has to, for the same reasons as with the 82S82. It's less than seven bucks per 16-pin device, in 100-up quantity.

The way to get big, rich and famous: deliver faster, smaller, more powerful processors. Now you can. Get the facts quick. (And for immediate evaluation quantities, see your local Signetics Franchised Distributor. His name and telephone number are in the adjoining column.)

FOR SPEED ATTACH COUPON TO LETTERHEAD AND MAIL FAST

Signetics—BCD AU/Adder  
811 East Arques Avenue  
Sunnyvale, California 94086

You have what counts, can't miss it. Send me your new, comprehensive MSI 82S Data Booklet with full specs of the BCD AU/Adder, (containing also your complete family of 100MHz counters, 60MHz universal shift registers, parity checkers, decoders, multiplexers, and exclusive OR/NOR functions.)

Name

Title

Signetics Corporation—A subsidiary of Corning Glass Works.

## signetics

# Growing with the

**Amphenol connectors help assure correct weight in new automatic weighing system.**

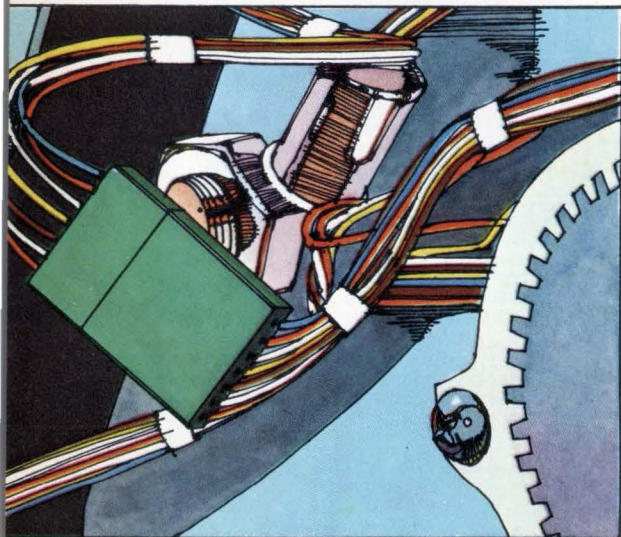

Meat merchandising has taken a big step forward with advanced solid state circuitry. The system includes a scale, mini-computer, and a printer in an integrated modular package that can weigh and price meat in seconds.

Amphenol 221 Series micro-miniature connectors share the responsibility for transmitting weight and price data to the mini-computer. Their low cost, sturdy design, and high-reliability contact configuration make them ideal for this application.

The 221 Series does the same kind of reliable work in a variety of equipment in the electronic data processing, telecommunications and home entertainment industries.





# new electronics

**Amphenol connectors help transmit computer data in new high speed printer.**

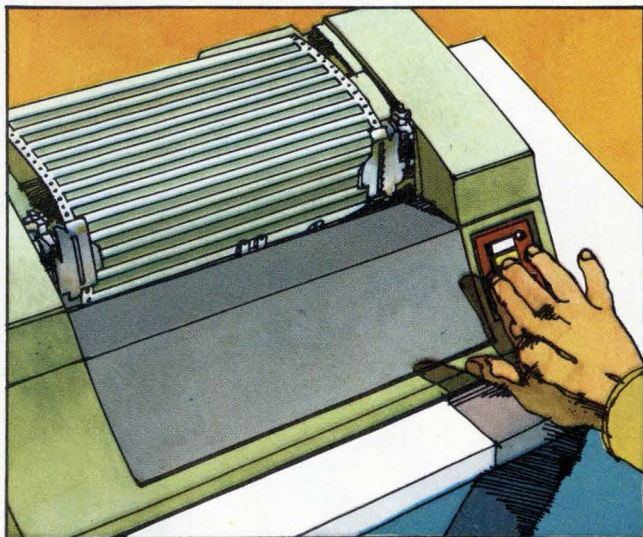

A unique modular matrix printer was recently developed to interface with mini-computers, medium-speed batch terminals, and other installations requiring high speed data output. Data is received at up to 75,000 characters per second. The data is then carried through PC cards to a printing head with an output of up to 165 characters per second.

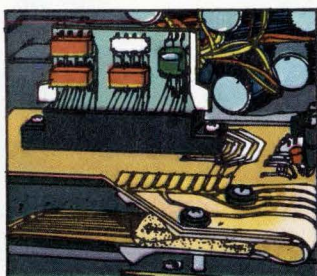

Precise signal input and data output depend on consistent and accurate information flow. That's why this peripheral systems manufacturer specifies Amphenol 225 Series PC connectors and 6034 Series trimmers. They also rely on Amphenol connectors as an important link to the power supply portion of the printer.

**Amphenol assembly services help produce new credit card verifier.**

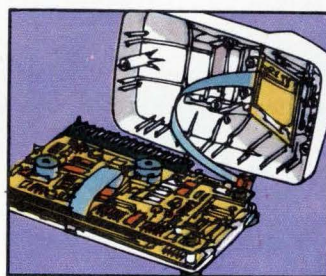

A major computer corporation recently developed a new computerized credit system. To eliminate a costly investment

in production equipment and inventories, they turned to the Amphenol Cadre Division.

All assembly and material supply is now handled by Amphenol people including component preparation, stuffing and wave soldering of printed circuit boards, hand wiring, and mechanical assembly. In addition, unique quality control tests are carried out.

Over 500 units have already been produced with excellent turnaround time and high product quality. They are now in use by a nationwide resort and restaurant chain for added customer convenience and man-hour savings.

**BUNKER RAMO AMPHENOL**

For more information, contact these manufacturing/sales facilities. **United States:** Amphenol Components Group, 1830 S. 54th Av., Cicero, IL 60650 **Canada:** Amphenol Canada Ltd., 44 Metropolitan Rd., Scarborough, Ont. **Great Britain:** Amphenol Ltd., Thanet Way, Fankerton, Whitstable, Kent, England **West Germany:** Amphenol-Tüchel Electronics GmbH, 8024 Deisenhofen bei München, West Germany **France:** Usine Metallurgique Doloise, 92a98 Avenue de Gray, 39100—Dole, France **Australia:** Amphenol Tyree Pty. Ltd., 10-16 Charles St., Redfern, N.S.W. 2016, Australia **India:** Amphetronix Ltd., 105 Bhosari Industrial Area, Box 1, Poona 26, India **Japan:** Daiichi Denshi Kogyo K.K., 20, 3-Chome, Yoyogi, Shibuya-ku, Tokyo, Japan 151



Stable Trimmers  
Small Duals  
Rugged Pots

If you're really  
serious about cost,  
be serious about quality.

Type FD trimmer. Type GD pot. Ideal variable resistors for CATV attenuators. Or any Bridged-T or L pad application requiring minimum size, stability and long life in severe environments. Exclusive hot-molded composition resistance elements permit peak set-ability. Diameter 1/2

inch (12.70 mm). Immersion-sealed (can be potted). Standard resistance values from 100 ohms to 5 megs and many popular impedance values. Single turn. For complete technical details request Publication 5231 (FD trimmer), Publication 5213 (GD potentiometer), Publication 5221 (FD/

GD attenuators). Allen-Bradley Electronics Division, 1201 South Second Street, Milwaukee, Wisconsin 53204. Export: Bloomfield, New Jersey 07003. Canada: Allen-Bradley Canada Limited, Cambridge, Ontario. United Kingdom: Jarrow, County Durham NE32 3EN.

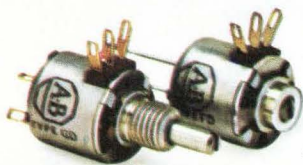

Actual Size



**Allen-Bradley**

Milwaukee, Wisconsin 53204

Circle 34 on reader service card

## 1,024-bit RAM gets 30 ns with regular bipolar processing

Signetics is about to introduce a 1,024-bit bipolar RAM that is super-fast—its typical access time is 30 nanoseconds. **The combination of high bipolar packing density and speed is attained through conventional Schottky processing.** The TTL part is even faster than ECL or TTL oxide-isolation products that already have been announced. In comparison, Fairchild's Isoplanar device has an access time of 60 ns.

**The development is part of a growing capability toward high-speed bipolar memories that can be built without highly sophisticated isolation techniques.** Another example is one developed by Intel (see p. 46). Two versions of Signetics' new RAM will be available—one with open collectors and the other a three-state memory. Pin configuration is the same as the standard 1,024-bit bipolar RAM, and the price is now \$63.20 each in quantities of 100.

## ITT maps U.S. semiconductor drive

ITT Semiconductors, coming out of 1973 with a 90% increase in sales, is making a major effort to increase its share of the U.S. market. Anxious to dispel its image as primarily a second source for bipolar products, **the firm plans to introduce several proprietary and custom-designed ICs in 1974, in addition to expanding its commodity line.**

One new product will be an i-f and audio-output combination, the 3701, in a 14-pin dual in-line package with integral heat sink. Designed to reduce the size and labor content of TV sound modules, the chip can deliver 2 watts of audio power directly to a loudspeaker, **eliminates many discrete components,** and features built-in remote volume control. The device also can be used for fm radio receivers.

The West Palm Beach, Fla., group is currently sampling a bipolar oxide-isolated 1,024-bit RAM chip, modeled after Fairchild's 93415, which it hopes to introduce in the second quarter. **And to increase its total thrust, the company plans to expand domestically into MOS, most likely by acquisition.** Gerard L. Seelig, vice president and group executive for semiconductors, predicts that there's a "90% chance we'll be in the MOS business by the end of 1974."

## TI using MiniMod for logic lines

The MiniMod process, submerged at Texas Instruments since TI acquired it from General Electric, has surfaced in bipolar logic products. TI acknowledges that it's using "modified outgrowths of the MiniMod concept and technology" among its automated assembly techniques for standard DTL and TTL products in plastic dual in-line packages. **Sources outside the company say that a large portion of TI's 7400 TTL is involved, and it's being built on TI's hush-hush automated Houston production line.** With MiniMod, chips are mounted on reels of plastic film in order to automate handling [*Electronics*, Feb. 1, 1971, p. 44].

## Signetics to offer no-coil i-f strip

Signetics is preparing to market for car and home radios a monolithic fm i-f strip **that requires no coils or variable tuning.** The NE 563 is a dual conversion circuit using a low-cost crystal filter and crystal local oscillator with phase-locked detection. Input is 10.7 megahertz from the tuner; output is a low-frequency stereo-composite signal and audio. The part is designed to compete with the RCA 3089, an i-f strip on a chip that requires a tuning coil.

## **EIA wants Nixon as its speaker**

The Electronic Industries Association, marking its 50th anniversary, is **pushing to get President Nixon to address its annual banquet in Washington** on March 13. EIA president V. J. Adduci says he is authorized to handle meeting arrangements and did not clear the invitation with the EIA Board of Governors. Have Nixon's political difficulties altered EIA's view since the first invitation? Adduci says, "No. Admittedly, he has some problems, but these are his own—not those of the office. We are inviting the President of the United States."

## **Boeing to install tracking system for St. Louis cops**

Boeing will begin equipping 25 St. Louis, Mo., police cars this summer with a computer-based, digital Fleet-Location And Information-Reporting (Flair) system **using technology derived from the Minuteman program. Almost a land-mobile version of an air-traffic control system**, the sophisticated prototype automatically updates each vehicle's location within 50 ft and the driver's status every two minutes. These changes are posted to a dispatcher's video map. Two-way coded responses also will be tested during the \$850,000 demonstration project.

## **ARTS rebidding causes concern**

Competitors for the FAA's rebidding of the ARTS-2 (Automated Radar Terminal System) program are nervous about the two-stage, low-bidder-take-all procurement. **They fear that selection from sealed bids might obscure technical fine points among the competitors.** First, the FAA has asked the eight it deems qualified to submit technical proposals by Feb. 27. Those surviving the technical evaluation will be asked to submit their prices by the end of March for a minimum of 53 systems, and **an award is scheduled in late April.** Qualifiers are: AIL division of Cutler Hammer; Burroughs; Lockheed Electronics teamed with ITT; Raytheon; Sperry-Univac; Tasker Systems division of Whittaker Corp.; Texas Instruments; Metis Corp. teamed with GTE; Sanders; Collins Radio; and Cardion Electronics. Lockheed had the ARTS-2 development contract but the FAA decided to rebid the production purchase.

## **Intel enters C-MOS watch picture**

The Intel Corp., a maker of p- and n-MOS memories, is **suddenly becoming a major factor in the C-MOS watch business.** Using its silicon-gate process, Intel is producing "tens of thousands" of circuits a month and expects to hit the 50,000 level by June. The parts, 5801, a low-voltage divider/timer, and 5202, a decoder/driver, are going to Intel's digital watch-making subsidiary, Microma Inc., and to Optel.

## **Will zip code get new zip?**

A new zip code that's alphanumeric instead of numeric, an automated telephone zip-code directory, and an automated change-of-address roster are being considered by the U.S. Postal Service (see p. 75). The alphanumeric zip code is only being discussed, **but the service plans to have a test model of a zip-code directory, created by a Data General Corp. Nova, ready by June.** A computer-generated voice would tell callers the zip codes for house addresses. The change-of-address directory would keep track of the 8 million pieces of mail daily that need new addresses. Because of sheer volume, both concepts, if proven, probably would be deployed on a regional basis.

# C-LINE INDUSTRIAL POWER SWITCHING TRANSISTORS

## 100 ways to get more switching performance for your money

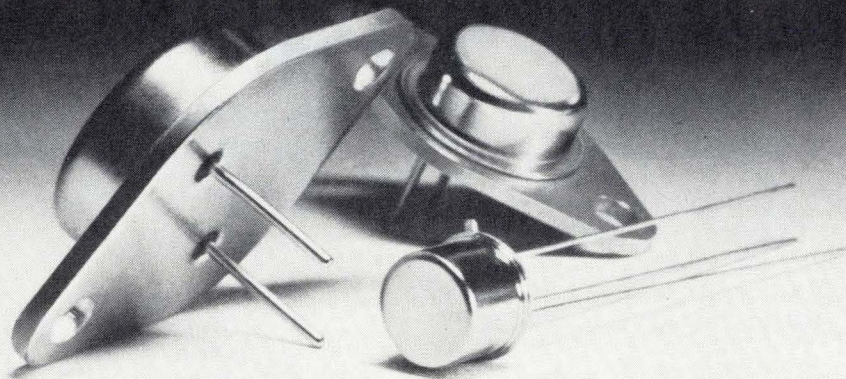

Unitrode's UPT Power Switching Transistor series offers the optimum combinations of price and performance from 0.5A to 20A, and up to 400V in 3 package types. Choose from 100 different transistor types for more efficient and simplified circuit design in power supplies, switching regulators, inverters, converters, solenoids, stepper motors and other inductive load driving applications. They're available off-the-shelf from your local Unitrode distributor or representative.

For the name of your nearest Unitrode representative dial (800) 645-9200 toll free, or in New York State (516) 294-0990 collect. For specific data sheets, containing full characteristics of devices, check the appropriate reader service numbers listed in this ad. Unitrode Corporation, Dept. 26Y, 580 Pleasant Street, Watertown, Mass. 02172. (617) 926-0404.

Reader Service No.	$I_C$	$V_{CEr}$	SERIES/ PACKAGE	$t_{on}$	$t_{off}$	100 Qty. prices each
18	0.5ADC	up to 400V	UPT011 -T05 UPT021 -T066	50ns	400ns	\$1.07 to 2.42
	1ADC	up to 150V	UPT111 -T05 UPT121 -T066	100ns	250ns	0.87 to 1.95
19	2ADC	up to 150V	UPT211 -T05 UPT221 -T066	130ns	300ns	1.13 to 2.54
		up to 400V	UPT311 -T05 UPT321 -T066	200ns	800ns	1.31 to 2.87
	3ADC	up to 400V	UPT521 -T066 UPT531 -T03	200ns	900ns	2.42 to 3.99
20	5ADC	up to 150V	UPT611 -T05 UPT621 -T066	250ns	550ns	1.31 to 2.86
		up to 400V	UPT721 -T066 UPT731 -T03	250ns	800ns	3.73 to 5.70
	10ADC	up to 150V	UPT821 -T066 UPT831 -T03	250ns	550ns	3.30 to 5.30
21	15ADC	up to 400V	UPT931 -T03	500ns	1200ns	8.05 to 14.62
		up to 150V	UPT1021 -T066 UPT1031 -T03	450ns	350ns	3.87 to 6.23
	20ADC	up to 150V	UPT1131 -T03	300ns	600ns	4.75 to 7.26

See EEM Section 4800 and EBG Semiconductors Section for more complete product listing.

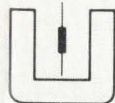

## UNITRODE quality takes the worry out of paying less.

Unitrode Franchised Distributors: **ARIZ.**, Phoenix, KIERULFF (602) 273-7331; **CAL.**, Los Angeles, KIERULFF (213) 685-5511, Palo Alto, KIERULFF (415) 968-6292, San Diego, KIERULFF (714) 278-2112; **CANADA**, Toronto, SCHWEBER (416) 925-2471; **COLO.**, Denver, KIERULFF (303) 343-7090; **FLA.**, Hollywood, SCHWEBER (305) 927-0511; **GA.**, Atlanta, SCHWEBER (404) 449-9170; **ILL.**, Elk Grove, SCHWEBER (312) 593-2740; **MD.**, Rockville, SCHWEBER (301) 881-2970, Baltimore, TECHNICO (301) 828-6416; **MASS.**, Waltham, SCHWEBER (617) 890-8484; **MICH.**, Troy, SCHWEBER (313) 583-9242; **N.J.**, Somerset, SCHWEBER (201) 469-6008; **N.M.**, Albuquerque, KIERULFF (505) 272-1055; **N.Y.**, Rochester, SCHWEBER (716) 328-4180, Westbury, SCHWEBER (516) 334-7474; **N.C.**, Raleigh, SCHWEBER (919) 832-8881; **OHIO**, Beachwood, SCHWEBER (216) 464-2790; **TEX.**, Garland, KIERULFF (214) 271-2471, Dallas, HAMILTON-AVNET (214) 638-2850, Houston, HAMILTON-AVNET (713) 526-4661, Houston, LENERT (713) 225-1465; **UTAH**, Salt Lake City, ALTA ELECTRONICS (801) 486-7227; **WASH.**, Seattle, KIERULFF (206) 763-1550.

# 3,500 VOLT ISOLATION 100% CURRENT TRANSFER OPTO COUPLER

## HOW GENERAL ELECTRIC DOES IT

General Electric's unique glass isolation produces precise alignment and controlled spacing between the LED and the silicon detector thus optimizing photon coupling...minimizing the effect of the inverse relationship of isolation voltage and current transfer ratio...and yielding optoelectronic couplers with BOTH high isolation voltage and high current transfer ratios.

3 new models 4N35, 36, 37 are characterized for high isolation voltage and high current transfer ratios. 4N35 offers 3,500 volts (peak) and 100% transfer ratio for \$1.85 each in 1,000 lot quantities.

Available now from any authorized GE Semiconductor distributor or GE Electronic Components Sales Office.

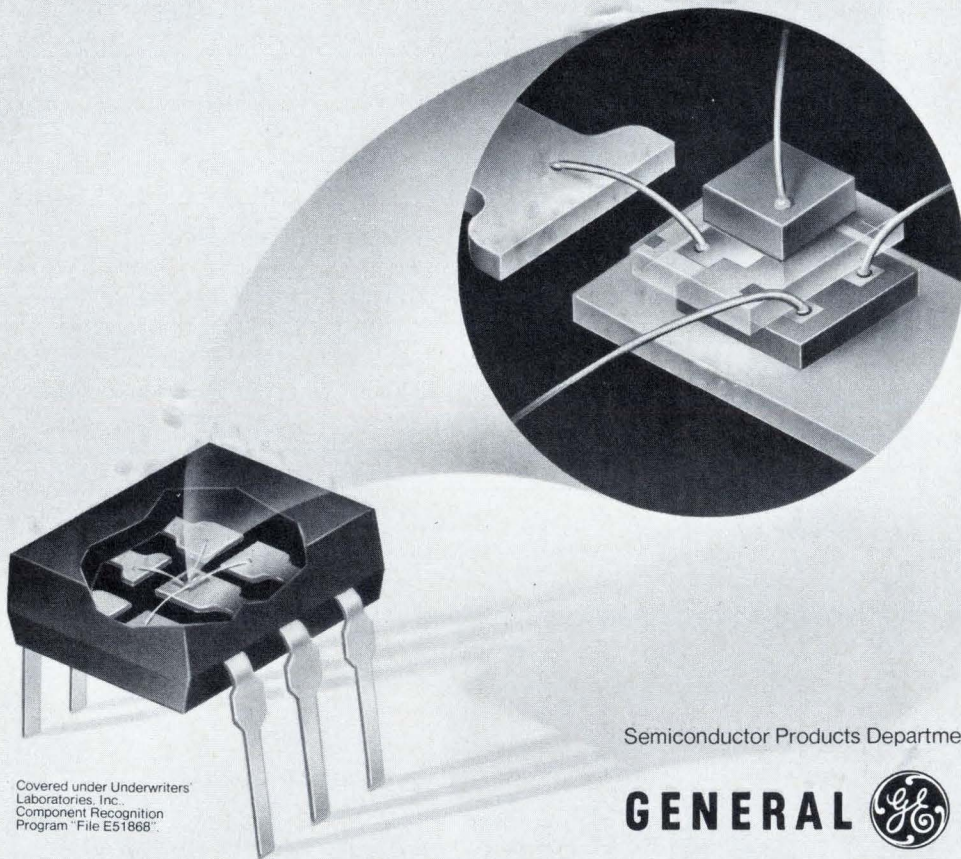

Covered under Underwriters' Laboratories, Inc. Component Recognition Program "File E51868".

Semiconductor Products Department, Syracuse, New York.

**GENERAL**  **ELECTRIC**

# Electronics review

Significant developments in technology and business

## Digital transmission over radio links helps hail taxis

About 250 cabs equipped now with two-way radios will add a display terminal under the meter

Probably the largest digital communications system yet to be installed for commercial mobile radio use is slated to hit the New York City streets by June. Developed by Sunrise Electro-Service Corp., Farmingdale, N.Y., the new system [*Electronics*, Jan. 24, p. 25], has been ordered at a cost of more than \$350,000 by New York-based Special Security Computerized Communications Inc., which was organized especially to provide a message-transmission service to users equipped with two-way mobile radio.

Initially, some 250 fleet-operated taxicabs will be outfitted with portable display terminals that mount under the taximeter, says Special Security president, Robert Chapey. The terminals will display messages to the drivers, telling them where to pick up fares who have telephoned to the central dispatch office for taxis. In addition, Chapey expects other types of users, such as trucking and armored-car firms, to rent the service and its terminals.

A digital means for transmitting messages is desirable because frequencies for mobile voice communications are now filled, and interference, static and signal fading are particularly troublesome. Because it is transmitted in a fraction of a second, a digital message lessens the likelihood of such problems. Also, digital coding and error-checking

techniques, calling for retransmission of faulty messages, will assure accurate reception.

The new system can be used with "any two-way radio of reasonable quality," says William Smith, president of Sunrise. For the taxi system, it will operate on a 420-megahertz uhf-band carrier by means of an encoding and modem scheme Smith considers highly proprietary. The system transmits at a 3,125-baud rate, almost three times faster than other available systems [*Electronics*, Dec. 6, 1971, p. 39]. The result is that a 50-word message can be transmitted in about half a second.

The mobile terminal, dubbed Moscan, weighs six pounds and displays messages on a 32-character Self-Scan neon-tube panel made by Burroughs Corp.'s Electronic Components division, Plainfield, N.J. A message of up to eight lines long can be displayed, one line at a time, from a 256-character metal-oxide-semiconductor random-access-memory buffer in the terminal.

Two types of base stations have also been designed by Sunrise. The simpler of the two includes an alphanumeric keyboard, a 32-character Self-Scan display, buffer and modem. Messages are typed in, formatted and sent on command. The station Special Security is buying is built around a CIP2200 mini-computer with 32,768 words of core memory from Cincinnati Milacron, and H-2000 CRT terminals from Hazeltine Corp. In addition, there is a high-speed line printer and a 5-megabyte disk memory for storing information on the operation of the taxi fleet.

The taxi-dispatching system divides New York City into 12 zones



Got the message? Digital transmission expedites taxi service in New York City.

and gives identification numbers to each cab. As a taxi enters an area, the driver uses a two-digit thumb-wheel switch on his portable terminal to identify the area. The base station continually polls its taxis and maintains queues of each one in each area; a call for a pickup goes to whichever empty cab was first to enter. In the cab, the driver can signal whether he accepts the pickup or not. He also signals for each of the eight possible message lines to be displayed.

The remote terminal also gathers other information, including whether the cab is occupied by a passenger (sensed automatically by seat sensors), and whether the meter

has been turned on. Also, if the cab has been stolen, the system can be used to turn off the engine entirely.

The more complex base station is priced in the \$100,000 range, while the simple unit costs about \$2,850, says Smith. In quantities greater than 100, the portable terminals are priced at \$975.

In addition to the cab system, Sunrise is also developing a portable terminal for police vehicles. □

---

## Digitizing TV audio for improved sound

Stereophonic or quadraphonic sound on TV may be possible with a new system that combines the video and audio TV signals after digitizing the audio portion. The Public Broadcast Service (PBS) and Digital Communications Corp. (DCC) have developed a system, Digital Audio for Television, that not only transmits better sound but costs less as well.

In digitizing the audio, the TV system can combine up to four high-quality network audio channels with the video baseband signal for concurrent transmission, explains Andrew M. Werth, DCC vice president. Since the system can send four channels with the video signal, he estimates that stations would save enough in telephone costs the first year to pay for the \$5,000 unit.

DCC will begin producing the units this spring to sell to the approximately 100 PBS-affiliated stations. If an evaluation by Bell Laboratories, Murray Hill, N.J., is favorable, a market of "literally hundreds of receivers" could open up with the other networks, he says.

The system can be used with either terrestrial or satellite transmission, which isn't surprising because "we used satellite modem technology to build it," Werth comments. In addition to stereophonic or quadraphonic sound, applications include multilingual program channels, piggyback fm radio transmission for simulcasting, and data or facsimile transmission. Tests

conducted over the PBS network show excellent sound with imperceptible interference with the TV signal. That performance is partially credited to the system's 15-kilohertz high-fidelity channels, compared to 8-kHz channels for most TV audio systems, he points out.

In transmitting, the system does two things. It converts the audio signals into a digital format and four-phase-modulates the 5.5-megahertz carrier by the multiplexed digital bit stream. Also, it limits the video band signal by a 4.5-MHz low-pass filter and combines it with the audio subcarrier. The composite baseband signal is then amplified and passed on for long-haul transmission.

At the receiver, the signal is passed through two filters: a 4.5-MHz low-pass filter, which isolates the video content, while a 4.5-MHz high-pass filter delivers the audio

subcarrier to the pulse-shift-keyed demodulator to recover the bit stream. The demodulated data is demultiplexed and converted to audio by an a-d converter.

To digitize the audio, each channel is filtered and then sampled at a nominal 35-kHz rate. Each sample is then converted to a 13-bit pulse-code-modulated word, which represents the numerical value of the sample. Each channel's bits are multiplexed to form a continuous 1.8-megabit-per-second stream. At the receiver, the data stream is separated into the four channels and reconverted to audio by a 13-bit d-a converter. The audio signals are then filtered and buffered for final output.

Werth says that the \$80,000 development began when AT&T's Long Lines department requested proposals 18 months ago. □

---

## Government

---

### Semiconductors win exemption from U. S. price controls

With hot competition and rapid technological change driving U.S. semiconductor price averages down every year, the industry shouldn't require exemption from Federal price and wage controls. Such exemption came, though, "to permit price flexibility on older product lines," says James J. Conway, Electronic Industries Association vice president for solid-state products. With those products, he says, production costs have stabilized, but materials prices continue to increase.

With that argument—plus "individual assurances" from leading semiconductor manufacturers that average prices in the first half of 1974 "will not increase and may decline, barring unforeseen major economic events"—the EIA and its member companies convinced the Cost of Living Council in late January to exempt semiconductors from Phase 4 price and wage controls.

Typical of the technologically ma-

ture devices where production costs have stabilized but materials costs have not are those using diode-transistor logic, resistor-transistor logic, and germanium transistors. These account for no more than 5% of the industry's estimated \$2 billion annual factory sales. As the council put it: "Any price increases which occur in these lines in the first half of 1974 will be offset by price reductions in the industry's remaining volume."

**Growth.** Capital spending plans of the expanding semiconductor industry also appeared to have their impact on the council. At a time when the national economy is distinctly wobbly, the council was impressed by the estimated \$245 million in capital outlays by semiconductor makers last year—much of which is still being spent. The figure comes close to doubling the \$130 million estimated for 1972. And of the 1973 level, nearly \$235 million is being spent by 23 com-



**ESTIMATED SEMICONDUCTOR-PROFIT TRENDS (a)**  
(MILLIONS)

	1966	1967	1968	1969	1970	1971	1972	1973E	1973E (d)	1974E (e)
U.S. factory sales (change) (b)	28%	(5%)	6%	19%	(9%)	(5%)	26%	26%	13%	7%
Manufacturers' world shipments (c)	\$1,180	\$1,230	\$1,270	\$1,670	\$1,510	\$1,465	\$1,850	\$2,300	\$2,640	\$2,460
Net operating profits (f)	\$65	\$26	\$25	\$58	\$(15)	b/e	\$77	\$161	\$185	\$123-135
Profits change	n/a	-60%	-4%	132%	-	-	-	109%	15%	-15%--25%
Net profit margin	5.5%	2.1%	2.0%	3.5%	-	-	4.2%	7.0%	7.0%	5%-5.5%

Source: Trade sources, William D. Witter Inc. estimates

Note: (a) Data represents approximations, rather than precise estimates, since the largest companies do not break out sales and earnings in semiconductors. (b) In the past, U.S. factory sales represented 80% to 90% of world sales of U.S.-based companies and are more indicative of profit trends, since data have higher reliability than our estimates of world billings of American manufacturers. Percentage changes from 1966 through 1972 were obtained from data published by the Electronics Industry Association. (c) World sales of U.S.-based companies. (d) Assuming favorable economic climate. (e) Assuming minirecession. (f) Losses are net of taxes. Profits are at fully taxed rates. (b/e) Breakeven.

panies. The EIA says, "it is expected that capital spending will rise again in 1974 as the companies make every effort to increase productive capacity."

The council also took note of a lower profit outlook in semiconductors for 1974 that was cited by the EIA in its argument. In keeping with its highly volatile nature, the semiconductor sector went from loss positions of 9% and 5% in 1970 and 1971, respectively, to estimated record profit margins of 26% in 1972 and 1973. According to the figures presented to the council by EIA, a favorable economic climate in 1974 should produce a 13% profit for the industry on a \$2.64 billion volume. In the event of a mild recession, the margin of profit is forecast at only 7% on a smaller volume of \$2.46 billion. □

## Government electronics

### Inflation fears offset Federal budget rises

Few surprises are contained in the fiscal 1975 Federal budget sent to Capitol Hill by President Nixon on Feb. 4. Budget director Roy Ash saw to that—preparing the 93rd Congress and other interested citizens for the record-setting request of nearly \$305 billion in budget authority—through a series of well-or-

chestrated background press briefings throughout January.

Any surprises yet to come will originate within Congress, should it elect to respond to the President's many domestic political problems and take a stronger hand in redirecting Federal expenditures through the appropriations process. At the moment, it is too soon to tell. Congressional leaders as well as the President and his advisers, are still trying to gauge the length and depth of the downturn beginning in the national economy.

**Hedges.** Beyond anticipated heavy increases in defense outlays [*Electronics*, Jan. 10, p.115], the electronics industries have limited opportunities, and even at the Pentagon—with its proposed increase of more than 8% in total obligational authority of a record \$92.5 billion—the Administration is hedging its bets by citing the drain of increased costs of oil, salary hikes, and other personnel costs already programed, as well as the uncertainties of inflation. Although the Defense Department proposes spending \$85.8 billion in the new fiscal year, some \$6.8 billion of that will come in a special package that contains some \$2.4 billion for resupply of Israeli and Cambodian forces.

Like every other agency, the Pentagon is chiefly disturbed by the uncertainties of inflation. Thus, the DOD leadership is complaining that its proposed increase in R&D funds to about \$9 billion still won't buy

them much more despite the fact that the rise is more than the 10% annual increment of recent years.

**Unknowns.** The fear of the unknown quantity of inflation is a major element in everyone's thinking in the Government, beginning with the Council of Economic Advisers, which estimates that seven of the eight percentage points of growth in the gross national product this year will be attributable to inflation.

Although Defense Department officials confirm that some of its new money—notably in R&D—can be used to quickly prime the national economic pump should a full-fledged recession develop, they point out that much of the procurement funds for aerospace and electronics are already committed to ongoing major programs such as the Air Force's B-1 bomber, the Navy's Trident missile-launching submarine, and the Army's modernization efforts in helicopters and tactical weapons.

Adding to the uncertainty of the military is the fact that Defense Secretary James Schlesinger is counting on a budget confrontation with Congress this year to gain its support in increasing peacetime budgets that stress hardware and, if possible, cutting DOD's manpower costs.

But at least the Pentagon is asking for significant dollar increases in areas affecting the electronics industries. That statement is more than can be said for most other agencies. A first look at budget documents

shows that the National Aeronautics and Space Administration does not fare as well. However, new—if limited—opportunities do appear for electronics in the Department of Transportation, with its mass transit and civil aviation programs, and to a lesser extent in the social programs of other agencies. □

Circuit design

UGLI may scare off large custom ICs

A universal logic gate, now in prototype as a small-scale integrated circuit, is expected to be less expensive than custom-designed LSI circuits, more powerful as a design tool than read-only memories and programmed logic arrays, and as fast as Motorola's MECL 10,000.

In a project called UGLI, which stands for Universal Gate for Logic Implementation, the Air Force Avionics Laboratory, Wright-Patterson Air Force Base, Ohio, in conjunction with Hughes Aircraft Co., Culver City, Calif., has made a circuit containing two independent cells, each with four inputs and one output, plus their complements. These four inputs can produce 222 equivalent classes of logic functions.

Two of these 222 are trivial, being merely a short circuit and an open circuit. Any one of the remaining

220 functions can be implemented by appropriately interconnecting portions of the universal gate—21 with a single cell, and 182 with two cells within one of the elementary two-cell gates. The remaining 17 functions require either three or four cells.

The two-cell gate is mounted in a 44-pin flatpack. The various logic functions are realized by externally connecting the parts of the cell; connections can be experimentally rearranged to change the functions. In a practical version, the cell functions would be established by a metalization pattern on the IC itself, much as the contents of a read-only memory or a programmed logic array are established during fabrication.

The cells are built with circuits equivalent to modern emitter-coupled logic, with a delay of no more than 3.5 nanoseconds per cell, including loading effects. The cells pay a penalty in power dissipation, but the logic capability and speed more than compensate for the loss.

**Fewer and faster.** For example, a conventional logic circuit for multiplying 4-bit complex numbers can be implemented with four 4-bit multipliers and two 8-bit adders, requiring 11 logic stages that operate at a maximum of 14 megahertz and dissipate 4.3 watts. But when built with universal gates, the multiplier requires fewer than half the logic stages and can go three to four times as fast.

Although the universal-gate de-

sign dissipates twice as much power, its power-delay product is only about half that of conventional logic, and further substantial reductions are expected. Furthermore, a complete arithmetic unit can be designed with the new gates, requiring only about one quarter as many components as would be necessary with conventional logic, and thus only about half the power. Likewise, the number of wire bonds in the arithmetic unit is reduced by a factor of nearly seven.

The Air Force lab's next step is to develop larger-scale universal gates. For example, a chip with four cells could implement any of the 220 classes of logic functions. But more useful would be a large chip with many cells—16, 20, or more—defined and interconnected by metalization to implement a major subdivision of a computer or other digital system. □

Avionics

Grumman tidies up aircraft wiring

The complex tangle of electrical wiring on board most aircraft often presents a serious problem when it comes to troubleshooting electrical defects. To streamline the wiring, Grumman Aerospace Corp. is developing a system in which avionics

**Simplification.** New universal logic gate (right) is faster than conventional logic; it also permits system power to be sharply reduced.

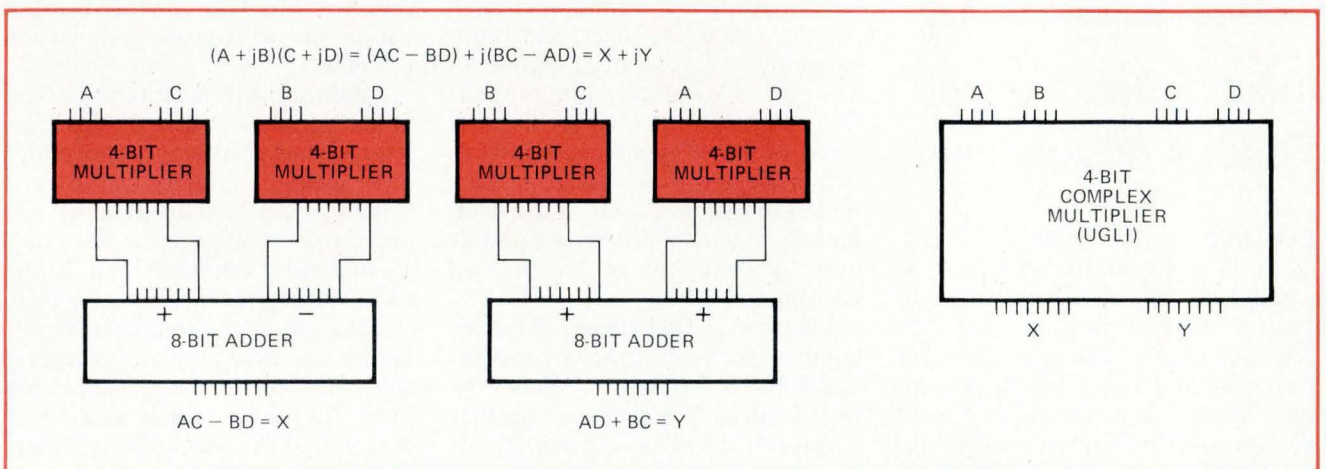

# a handful of measurement solutions...

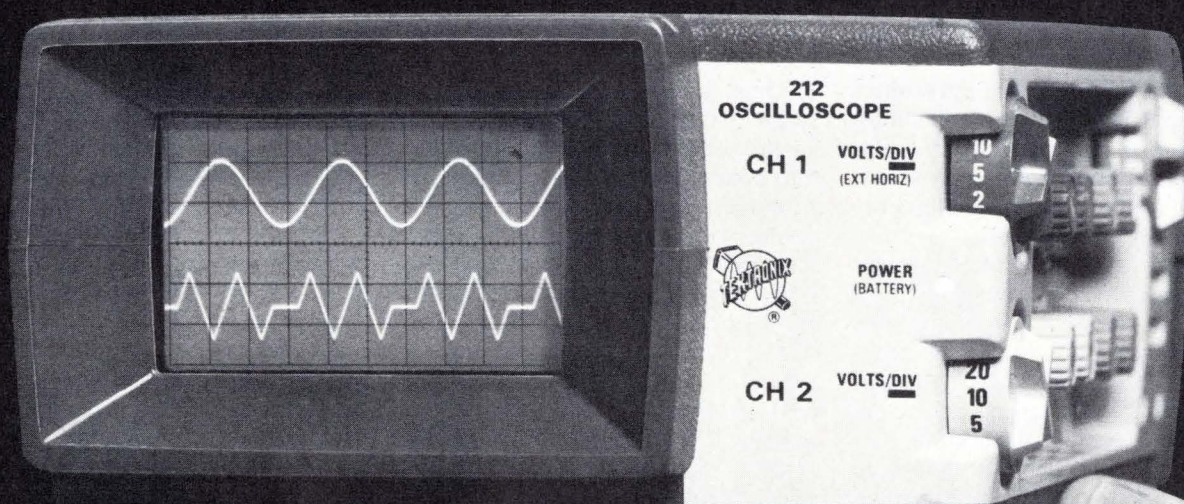

With the 212. A completely new DUAL-TRACE, 500-kHz, 3 x 5¼ x 9-inch scope that weighs only 3.4 pounds and costs just \$725. The high-impact plastic case withstands severe environments — double-insulated construction helps protect you while making high-voltage measurements.

Many other benefits are available in our first dual-trace mini: (1) 500 kHz and 1 mV/div; (2) Designed, developed and manufactured within the

For a demonstration circle 240 on reader service card

United States; (3) For clarity, probe bodies and vertical deflection controls are color-matched; (4) When not in use, the permanently connected probes and power cord store in an easy-to-use compartment; (5) There are only two trigger controls, one for level and slope, the other for source selection; (6) Controls are recessed to prevent accidental damage; (7) Up to 5 hours operation are provided from rechargeable internal batteries; (8) Vinyl carrying case . . .

For complete information or to arrange a demonstration, contact your local Tektronix, Inc. Field Office. Or, write Tektronix, Inc., P.O. Box 500, Beaverton, Oregon 97005. In Europe, write Tektronix, Ltd., P.O. Box 36, St. Peter Port, Guernsey, C.I., U.K.

212 Oscilloscope . . . . . \$725

U.S. Sales Price FOB Beaverton, Oregon



**TEKTRONIX®**

committed to  
technical excellence

## Electronics review

interconnections are centralized in a single box, and round wire harnesses are replaced by flat cable.

A system mockup for interconnecting the avionics on an Army OH-6A helicopter is being readied now, and flight tests are expected to begin in March, says Richard A. Bradshaw, Grumman project engineer in the Advanced Development department, Bethpage, N.Y. The program is being funded for somewhat over \$150,000 by the U.S. Army Electronics Command, Fort Monmouth, N.J.

Aboard the OH-6A, Grumman is interconnecting the power-distribution and signal lines of the Army's Standard Lightweight Avionics Equipment package. This includes three radios in the vhf and uhf bands, direction-finder and transponder systems, a gyromagnetic-compass set, and controls.

The key element in Grumman's new interconnection is a central interconnect box—called a Matrix Interconnect Device. All wiring from the black boxes goes to the MID, and all wiring between black boxes is eliminated. Interconnections between avionics boxes are made within the MID through holes drilled from one side of a printed-circuit board (incoming lines) to the other (outgoing lines). The pc-board setup resembles a matrix because the lines on one side of the board are vertical, and the lines on the other side are horizontal.

"Because everything comes back to a central point, you can readily troubleshoot and run preflight tests on the system," says Elmer Godwin, the project engineer at the Army's Electronic Technology and Devices Laboratory in Fort Monmouth.

For the helicopter program, Grumman's MID contains eight connectors, each with three rows of contacts and accommodating 816 input/output circuits in all. Within are the 12 pc boards that interconnect the black boxes. Each board is 8.6 inches long by 4.7 in. high and plugs into NAFI (Naval Aviation Facility, Indianapolis) connectors having a total of 98 pins in two rows on 150-mil centers. Connections between the boards and the connectors on the MID are made over flexible printed-circuit cables.

**Flat replaces round.** The other important feature of the system is the use of flat cable [*Electronics*, July 5, 1973, p. 84]—1-in.-wide Kapton-insulated strips with 17 conductors on 50-mil centers. In addition to weight and space savings over comparable round-wire interconnections, the flat cabling offers standard wiring modules that can quickly be replaced. And the relative inflexibility of flat cable because of its multiwire format can also be turned to advantage.

"With flat cable, the wiring of the avionics will have to be considered at the same time the system is being developed," explains Godwin. "This way, we'll be able to get an optimum packaging design."

Preliminary measurements indicate other advantages for flat cable. Inherent shielding in the cables reduces crosstalk, says Bradshaw, yielding superior immunity to electromagnetic radiation. In addition, the electromagnetic compatibility of interconnected systems will be repeatable from aircraft to aircraft, he says, because the relative position of each wire is fixed and doesn't vary as it would with con-

ventionally wired harnesses.

Another advantage would be the ability to use smaller, lighter-weight wire within the flat cable. This is possible because the cable is made stronger by the presence of many individual wires, while the current-carrying capacity for a given cross-sectional area is greater than round wire provides. □

## Medical electronics

### Hearing-aid battery recharged by sun

Few people regard hearing aids as a drain on precious natural resources or as a polluter of the environment. But that is what dependence on short-lived mercury and silver-oxide batteries makes them, maintains Endel Are, president of Ultima Audio Inc., of Key West, Fla.

An average hearing-aid battery lasts from five to seven days. Thus the approximately 2.5 million hearing-aid users in the United States consume about 160 million primary batteries and hundreds of thousands of pounds of silver and mercury per year at a cost of about \$100 million. In addition, battery disposal adds greatly to the problem of mercury pollution, Are says.

**Pollution solution.** To all of these problems, Ultima Audio has a partial solution: a tiny all-in-the-ear hearing aid with a built-in, rechargeable, nickel-cadmium battery. Selling for \$395 complete with its recharging unit, the Ultima V can run for from 24 to 36 hours on an overnight charge.

Earlier hearing aids incorporating rechargeable batteries have not been successful because they usually could not work a full day without recharging. Are's device, however, draws a total current of only 0.7 milliamperes, which gives it the required operating interval, even with the tiny 20-mA-hour battery that must be used with in-the-ear aids.

The low current drain is made possible by a low-power IC amplifier, made for Ultima by Philips of

**Focal point.** Connections among avionics boxes are made in a central interconnection box. In addition, flat cable is used for wiring, instead of round-wire harnesses.

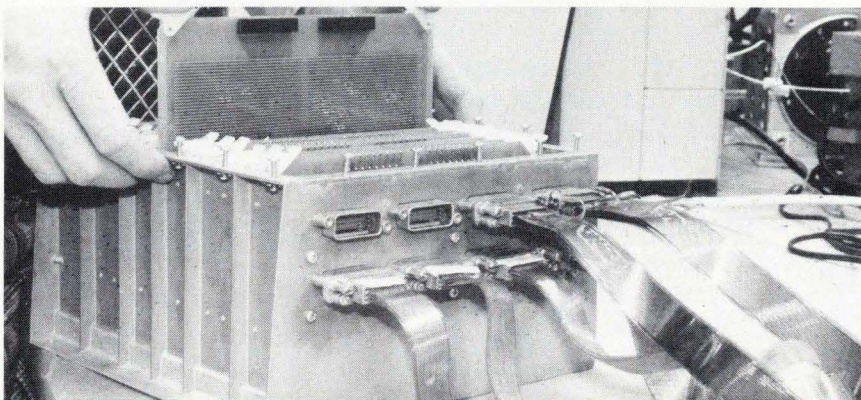

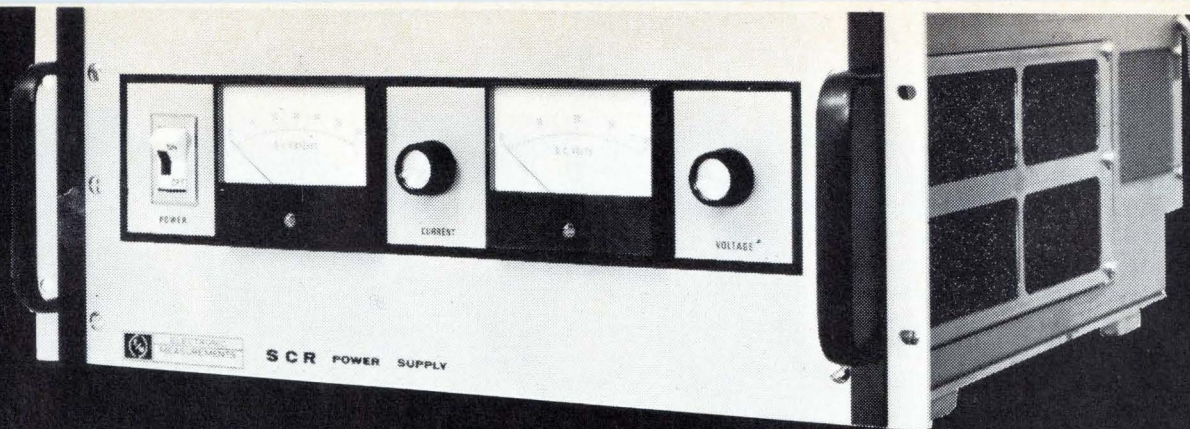

# POWER SUPPLIES

Electronic Measurements has designed and built many power supplies to solve a wide range of applications. Design reliability has been field proven since 1968. We have a wealth of application experience, and the flexibility to help solve your power supply problems. Call us.

The table shows the 0.1%-regulation SCR models and 1%-regulation EM models, but Electronic Measurements has a full line, bench-type and modular, with single and multiple outputs, from 5V to 500V and from 2.5A to 650A.

And there's more: remote sensing and programming, automatic E/I crossover, stability within 0.05%, full overload protection, rugged construction that's easy to service, and a five-year guarantee.

In Power Supplies, the best is Engineer Power, from Electronic Measurements. For a short-form catalog, use the Reader Service card, or contact Electronic Measurements.

Rating	Price	
	EM	SCR
6V-600A	\$1,600	\$2,000
7.5V-300A	1,200	1,400
10V-250A	1,200	1,400
10V-500A	1,600	2,000
20V-125A	1,050	1,200
20V-250A	1,275	1,500
20V-500A	2,050	2,650
30V-100A	1,050	1,200
30V-200A	1,450	1,800
40V-60A	950	1,100

Rating	Price	
	EM	SCR
40V-125A	\$1,300	\$1,600
40V-250A	1,975	2,500
50V-200A	1,975	2,500
80V-30A	950	1,110
80V-60A	1,200	1,500
100V-100A	1,975	2,500
120V-20A	975	1,300
120V-40A	1,200	1,500

Rating	Price	
	EM	SCR
160V-15A	\$ 950	\$1,100
160V-30A	1,300	1,600
160V-60A	1,975	2,500
250V-10A	950	1,100
250V-20A	1,300	1,600
250V-40A	1,975	2,500
500V-5A	1,300	1,500
500V-10A	1,600	2,000

19" Rack, 20" depth. Voltage and current adjustable over wide range.

See EEM Vol. 1, Pages 673, 674, 675 for additional product information.



## ELECTRONIC MEASUREMENTS INC.

405 Essex Road, Neptune, N. J. 07753

Phone: (New Jersey) 201 - 922-9300 • (Toll-Free) 800 - 631-4298

Specialists in Power Conversion Equipment

the Netherlands, and by the low source impedance of the Ni-Cad cell. According to Are, mercury and silver-oxide batteries are high-impedance devices that not only waste power internally, but also make it necessary to use power-wasting decoupling filters to prevent internal feedback. The Ni-Cad unit overcomes these problems and makes possible greater amplifier gain because it does not cause amplifier nonlinearities at high output levels.

In the portable charging unit for the new hearing aid is a high-capacity rechargeable alkaline battery with a 1.55-v output voltage that's enough to recharge the 1.25-v Ni-Cad cell in the Ultima V.

A line-powered charger is available, but, for users in sunny climates, Are also makes a solar-powered charging unit containing six silicon cells. Left in the sun for 10 hours, it will provide the aid with about a month's worth of energy. In normal use, the charger would be left on a window sill during the day and have the hearing aid plugged into it at night. □

## Braille can be sent via telephone lines

The everyday act of using the telephone may become possible for the nation's 10,000 deaf-blind by means of an electronic aid being developed at the National Center for Deaf Blind Youths and Adults, New Hyde Park, N.Y.

Built by the center's director of research, Frederick Kruger, the prototype unit—called Telebraille—is compact enough to fit into a briefcase. If produced commercially, a single unit might cost as much as several thousand dollars, but Kruger hopes an electronics firm will offer to make the devices as a tax-deductible contribution.

To send a message, the user presses any of six keys on a simple braille keyboard. Each key represents one dot in the six-dot matrix that is used to form braille characters. The keying is converted into



**Communications for deaf-blind.** Using the deaf hand language, Fred Kruger (right) teaches a deaf-blind man how to communicate by telephone through a Telebraille unit.

corresponding audio-frequency binary sequences, which are acoustically coupled to a telephone handset.

On the receiving end, the telephone handset is acoustically coupled to an identical unit, which converts the sequences to signals that push up pins forming a braille "cell." These pins, which form braille characters, are sensed by touch. The main component in the unit is a General Instrument MOS LSI universal asynchronous receiver-transmitter chip, which contains a converter, memory, and TTL signaling logic.

Future plans for the Telebraille, says Kruger, include the addition of more than one braille cell, so that the receiver can reread parts of the message. "Paper tape output would allow rereading," says Kruger, "but tape is awkward and expensive."

Kruger also plans the addition of a standard typewriter keyboard so that Telebraille could be hooked up to a computer. "This would allow computer-aided instruction for the deaf-blind. The computer output would be in braille."

**Future developments.** Such a keyboard would also allow Telebraille to be hooked into the deaf teletypewriter network—there are about 5,000 such units—through a conversion circuit, so that braille input could be sent as Baudot code. "The

problem here, though," Kruger points out, "is that the deaf acoustic coupler is not compatible with the standard acoustic coupler." □

## Solid state

## ISSCC spotlights bipolar LSI logic

Semiconductor laboratories are shifting their primary efforts from memory to logic. This shift will be clearly discernible at the annual International Solid State Circuits Conference coming up Feb. 13-15 in Philadelphia. With its spotlight on bipolar LSI logic, the ISSCC has changed the direction of the last few years, when new MOS memories have been featured.

These rejuvenated bipolar activities—including integrated injection or merged-transistor logic—together with a continued drive for practical charge-coupled imagers, memories, and signal processors, dominate this year's ISSCC and could foretell trends of the semiconductor industry in the near future.

Integrated injection logic (I<sup>2</sup>L), introduced at ISSCC two years ago, is going at a feverish pitch at major semiconductor laboratories [*Electronics*, Sept. 13, 1973, p. 35]. N.C.

# SCIENCE/SCOPE

The best pictures ever taken of Jupiter were made by the imaging photopolarimeter (IPP) aboard Pioneer 10 and sent a half-billion miles by radio to NASA's Ames Research Center at Mountain View, CA. They clearly show the Great Red Spot and -- because the immense gravity caused Pioneer 10's trajectory to curve around Jupiter as it sped to escape the solar system -- include views from angles that cannot be seen from earth. Pioneer 10's infrared radiometer returned data on Jupiter's net energy flux and the thermal structure and chemical composition of its atmosphere. Both instruments were built by Santa Barbara Research Center, a Hughes subsidiary.

A computerized pattern grading and marker making system for apparel manufacturing, developed by Autographics, Inc. of Baltimore, will be marketed by Hughes. The system is available in both semiautomatic and full automatic configurations; the latter can lay out a men's or ladies' suit marker in three minutes. It can also be used to provide computer tapes for the Hughes Lasercutter, an automated cloth-cutting system. While Autographics will continue to market its system directly, the arrangement with Hughes will provide additional system and service capability in the U.S. and abroad.

A new liquid crystal pictorial display system, developed by Hughes for the U.S. Air Force Avionics Laboratory, promises performance superior to that of the cathode-ray tube for displaying symbolic, graphic, and pictorial television images in real time. The liquid crystal display produces no light of its own, but is viewed by natural or artificial light. The brighter the ambient light the more brilliant the display -- a distinct advantage for airborne systems. It consists of 10,000 elemental liquid crystal cells per square inch of display. A cell appears black when no voltage is applied; increasing voltage produces tones ranging from black to white. The liquid crystal display offers high resolution, is compact and lightweight, requires little power, and needs only a simple electrical interface with sensors or video signals.

Circuit Design Engineers with project engineering experience are needed for our commercial and government programs. Responsibilities: design and development of complex high- and low-voltage power conditioners, including command signal conditioning, logic sequencing, and analog telemetry instrumentation. U.S. citizenship required. Please send your resume to: B.E. Shryack, Hughes Electron Dynamics Division, 3100 W. Lomita Blvd., Torrance, CA 90509. An equal opportunity M/F employer.

Two-way cable television has been tested for the past year in El Segundo, Calif., by Theta-Com of California, a Hughes subsidiary. The Theta-Com Subscriber Response System (SRS) includes a central computer and 30 prototype terminals in subscribers' homes. Among the various types of services available: purchase of first-run movies and blacked-out sporting events, theater and airline reservations, and merchandise. Computer confirms order on the terminal's paper-tape readout and automatically bills subscriber. Subscribers can also request information, participate in games and educational programs, respond to opinion polls, and be provided with emergency intrusion, fire, or medical alarm service. The El Segundo tests will be expanded in mid-1974 to include 1,000 terminals in a comprehensive market test.

Energy conservation is a potential future benefit of the SRS system, which could monitor and manage power loads from a central control and substitute two-way communication from home or office for physical transportation.

Creating a new world with electronics

**HUGHES**

HUGHES AIRCRAFT COMPANY

de Troye, technical manager of Philips Research Laboratories, Eindhoven, the Netherlands, tells why in an invited review paper at the first technical session. Philips, which with IBM, Boeblingen, West Germany, is credited with inventing the new integrated logic, has built I<sup>2</sup>L logic, memory, and analog circuits capable of packing densities of 400 gates per square millimeter, speed-power products of 0.13 picojoule, and logic speeds selectively adjust-

able by circuit geometries for maximum design flexibility. I<sup>2</sup>L technology achieves densities that are orders of magnitude better than other bipolar techniques, and, as de Troye will point out, better even than today's MOS logic circuits. Also, the speed-power product is almost 1,000 times higher than that of today's TTL circuits.

Horst Berger, device specialist at IBM, follows with an I<sup>2</sup>L-device model showing that, because the de-

vices are basically npn transistors having an additional source of base current, they are inherently smaller and less complex than TTL structures and therefore highly reproducible in extremely tight packing densities on high-yield chips.

In addition, workers at the Northrop Corp. Research and Technology Center, Hawthorne, Calif., show how they have combined oxide-isolation fabricating techniques with I<sup>2</sup>L-circuit techniques to extend still further the frontiers of the technology. Finally, in bipolar LSI, researchers at TRW Systems group share their work in using an ion-implanted version of conventional emitter-follower logic to implement large but highly reproducible multiplier chips, measuring 301 by 279 mils, for high-speed airborne-mini-computer systems.

A significant memory development to be aired at ISSCC is Intel's new 1,024-bit bipolar random-access memory. This RAM has a compact I<sup>2</sup>L-like inverted-transistor flip-flop memory cell that makes possible both high densities and high yields with conventional junction-isolated processing—a point not to be lost on those manufacturers still struggling with the various more demanding forms of passive isolation to reach bipolar integration densities of 1,024 bits and higher. (Intel is already supplying 256-bit versions of this design.)

In the CCD area, a three-level image structure by Bell Labs results in a completely sealed imager of high density and exceptionally good transfer efficiency. □

### News briefs

#### Boeing, TI receive digital avionics contracts

Competing teams headed by Boeing Co., Seattle, and Texas Instruments, Dallas, have each received \$420,000 Air Force contracts for six-month design studies of the Digital Avionics Information System. The Boeing team includes Honeywell Inc., Minneapolis, for the processor complex and digital flight controls, and Softech Inc., Waltham, Mass., for mission software architecture standards and DAIS software-requirements plans. On the TI team are Intermetrics Inc., Cambridge, Mass., and Harris Radiation.

#### Melpar receives intelligence-collection award

E-Systems Inc.'s Melpar division, Falls Church Va., will develop micro-miniaturized airborne receivers, direction-finding equipment, and techniques for remote control of the receivers under a \$3.5 million contract from the Air Force Aeronautical Systems division, Wright-Patterson AFB, Ohio. Melpar will perform research, development, test, and evaluation of the system proposed for use in remotely piloted vehicles. Also participating in the program as subcontractors to Melpar are the company's Garland division, Dallas; ESL Inc. Sunnyvale, Calif.; and Teledyne-Ryan, San Diego.

#### NASA plans earth-observatory satellite

For a proposed Earth Observatory Satellite to fly later in the decade, the National Aeronautics and Space Administration has issued requests for proposals covering design studies [*Electronics*, Dec. 18, 1972, p. 34]. Two or more contractors will receive awards of \$600,000 each to define the spacecraft, intended to be a modular 4,000-to-5,000-pound "bus" for earth observations or combinations of missions. If NASA later approves construction, the program could reach \$70 million.

#### USSR to exhibit at IEEE Intercon

The USSR will exhibit for the first time at this year's IEEE Intercon in New York, although Russian engineers have delivered technical papers, and observation teams have attended in past years. The Soviet Union's V/O Electronorgtehnika Agency will have a 600-square-foot exhibit devoted to export-import services and products for export, including control equipment, computers and data devices, semiconductors, and components.

#### Addenda

Fairchild Camera and Instrument Corp. is opening a semiconductor plant in Campinas, Brazil, pending approval by the Brazilian government. Operations will begin this spring in 13,000 square feet of leased space for assembling, testing, and warehousing various semiconductor components . . . Rockwell International Corp. is adopting the metric system of weights and measures, a project the company estimates will take 10 years to complete. Although U. S. conversion to the system is forthcoming, the company says a delay could hamper Rockwell's position in world industry.

### Lasers

## Airborne lasers to monitor pollution

Lasers have long been seen as ground-based pollution sensors because they are precise independent light sources that can quickly discriminate pollutants from other air constituents. Scientists at the National Aeronautics and Space Ad-



# 191 FLAVORS OF BECKMAN DIPS



All 191 flavors of RESNET™ DIPs offer system compatibility because we use the same packages you use for I.C.s; plus you get ceramic dependability at plastic prices.

Whether you're inserting resistors automatically or by hand — call your local Beckman/Helipot representative and ask how you can save money using RESNET DIPs. He stocks locally for immediate delivery.

If you need immediate technical literature or the telephone number of your local Beckman/Helipot representative, call H.E.L.P. (Helipot Express Literature Phone) toll-free (800) 437-4677.

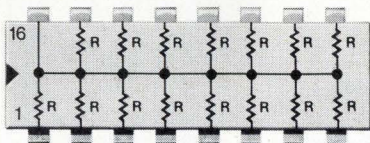

898-1 (15 resistors)  
Price (1,000-4,999) \$.85

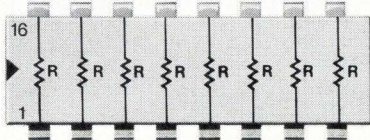

898-3 (8 resistors)  
Price (1,000-4,999) \$.76

**STANDARD RESISTANCE VALUES**  
(±2% or ±2Ω)

62*	110	330	1.0K	2.2K	6.0K	15.0K
68	150	470	1.5K	3.3K	6.8K	22.0K
100	220	680	2.0K†	4.7K	10.0K	

\*Standard in 898-3 only.  
†Standard in 898-1 only.

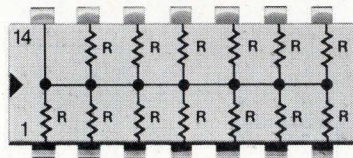

899-1 (13 resistors)  
Price (1,000-4,999) \$.81

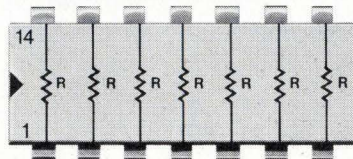

899-3 (7 resistors)  
Price (1,000-4,999) \$.72

**STANDARD RESISTANCE VALUES**  
(±2% or ±2Ω)

22	62	180	510	1.5K	4.3K	11K
24	68	200	560	1.6K	4.7K	12K
27	75	220	620	1.8K	5.1K	13K
30	82	240	680	2.0K	5.6K	15K
33	91	270	750	2.2K	6.0K	16K
36	100	300	820	2.4K	6.2K	18K
39	110	330	910	2.7K	6.8K	20K
43	120	360	1.0K	3.0K	7.5K	22K
47	130	390	1.1K	3.3K	8.2K	
51	150	430	1.2K	3.6K	9.1K	
56	160	470	1.3K	3.9K	10K	

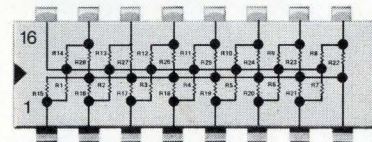

898-5-R220/330  
Pulse squaring TTL terminator.  
Price (1,000-4,999) \$1.45

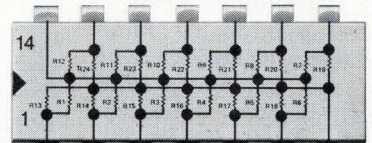

899-5-R220/330  
Pulse squaring TTL terminator.  
Price (1,000-4,999) \$1.35

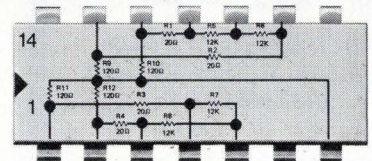

899-19  
DIP interface network providing resistors for μA711 core sense amplifier configuration.  
Price (1,000-4,999) \$1.18

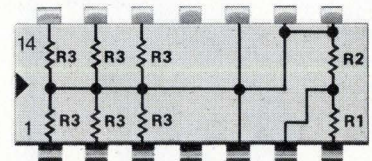

899-40  
DIP network provides six line terminators and the threshold setting divider for the Intel 3208A sense amplifier.  
Price (1,000-4,999) \$1.35



## SEMICONDUCTOR DEVICES

# We can mount 'em for under a penny\*

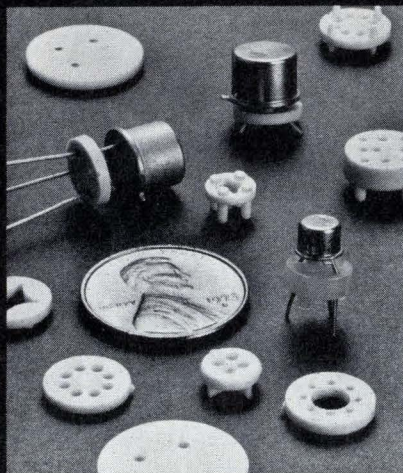

Over 120 different kinds of mounting pads for semiconductor devices including IC's and discretes. Pads simplify semiconductor mounting, protect them during flow soldering, provide free air space under device. Color coding available.

**ORDER DIRECTLY FROM  
YOUR LOCAL THERMALLOY  
DISTRIBUTOR**

\*Orders of 250,000  
or more nylon  
pads, typically  
99c per hundred.

Free complete  
catalog with  
samples.

Write for  
your copy.



**Thermalloy Inc.**  
P.O. BOX 34829  
2021 W. VALLEY VIEW LANE, DALLAS, TEXAS 75234  
PHONE 214-243-4321 / TWX 910-860-5542

## Electronics review

ministration's Langley Research Center, however, believe that lasers can do an even better job if they are airborne, and NASA has a program for building such systems.

In a few weeks, Langley will select a contractor to determine what is needed for an airborne analytical spectrometer using a tunable diode laser, and Langley intends to have the system built and flown once the study is finished. Moreover, the Environmental Protection Agency also is talking with NASA about using such devices, according to Frank Alario, head of the laser physics and applications section at Langley.

The first application of the system will be to find out whether high-flying supersonic aircraft damage the protective ozone layer. The environmentalists' "greenhouse effect" argument against the defunct supersonic transport project was that the build-up of nitric-oxide exhaust would degrade the ozone layer, allowing the sun's ultraviolet rays to penetrate the atmosphere. Since the Government and industry are quietly performing studies on a second-generation SST, an airborne lead-

sulfur-selenide diode laser system could measure nitric-oxide exhaust and perhaps settle the question.

Pointed toward the earth, a similar diode system could measure the density of pollution close to the ground over a broad area. That data would be essential for computer modeling of a region's pollution, Alario says. Less mobile, ground-based units point only from one site, he explains. Depending on the pollutant to be monitored, different laser diodes could be used, such as lead-selenide for sulphur dioxide or lead-sulfur-selenide for carbon monoxide. Current or magnetic tuning would focus the laser on the pollutant particles, and the low power poses no safety problems. □

## GaAs laser cavity grown on substrate

By growing vertical mesa structures directly on a gallium-arsenide substrate, researchers at Texas Instruments, Dallas, have moved a step

**Pollution monitor.** NASA has proposed an airborne diode-laser system for performing high-resolution spectroscopy. It could determine the effect of supersonic aircraft.

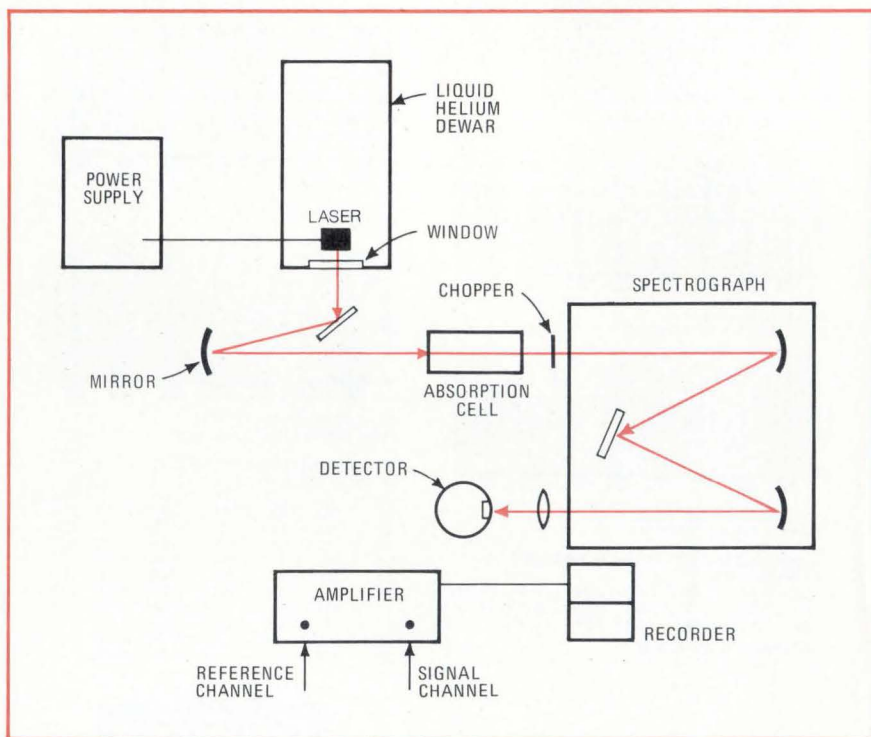

# You know what kind of Function Generator you need.

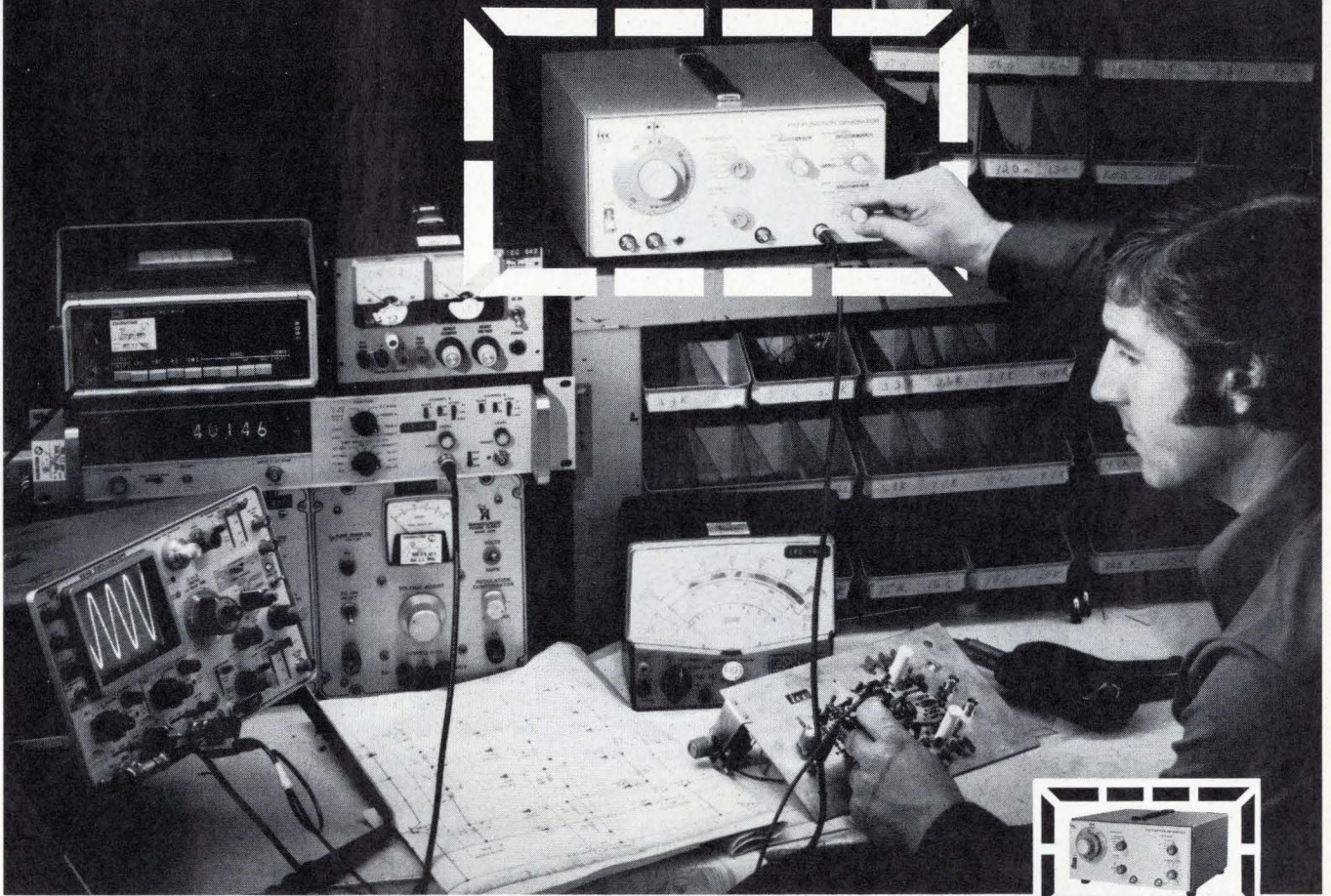

## So does INTERSTATE.

Our comprehensive Series 30 includes a function generator with your special requirements — PLUS more capability and time-saving features that we believe give you a better *price/performance value* than any competitive model. Capabilities like: 3MHz frequency range; clean sine, square, triangle, sweep, adjustable d-c, and variable width pulse waveforms; and trigger, gate, tone burst, and sweep operating modes. Time-saving features such as a well-organized front panel, our direct-reading Sweep Limit Control, and an unbeatable Instruction Manual.

**The "\$495 Comparison" lets YOU be the judge.**

You can find out exactly how INTERSTATE outperforms a competitor like Wavetek. Check the number below to receive the "\$495 Comparison: Interstate F34, Wavetek 134 Function Generators" and a new Specifier Guide that outlines cost and capability right down both model lines.



Purchase an INTERSTATE function generator and use it for 15 days. If you're not totally satisfied, return it to us for a full refund of the purchase price — *no explanations necessary.*

Take us up on our offer. Call John Norburg, collect, at 714/772-2811.



**IEC INTERSTATE ELECTRONICS CORPORATION** Subsidiary of A-T-O Inc.

Dept. 7000, Box 3117, Anaheim, CA. 92803: TWX 910-591-1197 TELEX 655443 & 655419



F31 \$295



F32 \$345



F33 \$395



F34 \$495



F35 \$595



F36 \$645

**Our function generator will perform better than you expect, or we'll take it back.**

# Super Cop

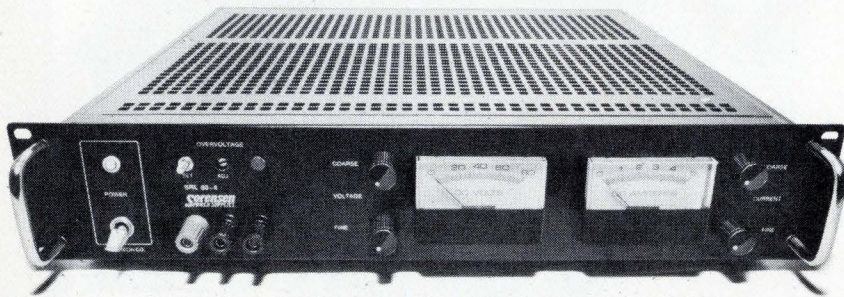

Super protection with the unique adjustable Crowbar Overvoltage Protector. Makes the Sorensen SRL a great supply for lab/system uses. Fast front panel adjustment of overvoltage level without removing the load . . . instant front panel monitoring of set point, plus these additional SRL features: resistance and signal programmability; fast response time—70 to 150  $\mu$ sec.—through full load range; low—3½" to 7"—rack panel height; high power-density . . . in 14 models with outputs from 250 to 2000 watts. SRL—the super choice for maximum reliability, stability and value in medium power, low voltage applications. For complete data, contact the Marketing Manager at Sorensen Company, a unit of Raytheon Company, Manchester, N.H. (603) 668-4500.

## Representative Specifications—SRL

- Voltage Mode
  - Regulation (combined line & load) .01%
  - Ripple (PARD) rms: 350  $\mu$ v.
  - p-p: 20 mv.
  - Temperature Coefficient  $\Delta/^\circ\text{C}$
  - .01% + 200  $\mu$ v.
- Current Mode
  - Regulation (combined line & load)
  - .02% + 4 ma.
  - Ripple (PARD) rms: 0.5 to 30 ma.
  - Temperature Coefficient  $\Delta/^\circ\text{C}$
  - .01% + 1 ma.
- Voltage Ranges
  - 0-10 volts to 0-60 volts (14 models)
- Price Range
  - \$500-1025

**Sorensen**  
POWER SUPPLIES

closer to the development of optical integrated circuits for high-speed, high-capacity communications. Using selective GaAs-vapor epitaxy, the TI team took advantage of the differences in growth rates of the various GaAs planes and equalized those growth rates to form an optical cavity for a laser from the mesa structures.

Previously, the optical cavities had to be cleaved from GaAs crystal, polished, and then bonded to a substrate. Now, says Kenneth L. Lawley, of TI's physical research laboratory, "by controlling the composition of the gallium-arsenic ratio in the gas phase, we can impede or increase the various growth rates to get a set of 1-1-1 planes perpendicular to the 1-1-0 substrate." TI has shown that the optical cavities, or mesas, will exhibit the mode pattern and threshold behavior of a laser when pumped with an argon laser.

**Diamond shapes.** TI grows the mesas through diamond-shaped holes in a silicon-dioxide film deposited on the GaAs substrate. "The diamond shape is critical for this type of faceted structure," Lawley notes. "It takes advantage of the symmetry of the substrate planes." From 80% to 90% of the mesas on a slice are well developed, and virtually all of those could be made to oscillate, he says.

The lowest threshold-power density that TI has seen is  $1 \times 10.5$  w/cm<sup>2</sup>. However, Lawley points out, TI has made no effort to optimize the electrical properties of the material. "In the future, we don't want an optically pumped surface laser. We want one that's electrically pumped. We've merely shown that you can get lasing action in a grown structure," he says. Electrically pumped surface lasers will require isolating a diffusion in the mesa, says Lawley.

Since variations in etch rates prohibit etching the mesa on the substrate, TI chose to grow the GaAs lasers instead of using a hybrid technique that involves mechanically cleaving or polishing the faces. The fabrication method is completely compatible with the growth of complex layered waveguides and

other electro-optical structures anticipated for future integrated optical circuits, Lawley says. What's more, it avoids the intermediate layers and refractive indexes inherent in hybridization and should lead to production efficiencies once optical communications take hold. □

### Commercial electronics

## Teleconferencing is readied for bank use

Reducing energy costs and saving on executive time are the goals of a two-way stereophonic communications system designed by Goldmark Communications Corp., Stamford, Conn. One installation of the company's Teleconferencing system already links the Stamford and New Haven executive offices of the Union Trust Company. The pilot project is being funded through Fairfield University by the U.S. Department of Housing and Urban Development.

Operating at 150 to 5,000 hertz on a dedicated four-line wideband cable, the system uses up to six speakers at each end. Cost estimates for the system, which operates on a leased line from the Southern New England Telephone Company, average about \$1,000 a month with about \$3,000 invested in equipment. But Union Trust executives say the system, used for regular business meetings, saves about \$1,700 in executive time and 200 gallons of gasoline a month—by eliminating commuting.

Peter C. Goldmark, the company's president, says costs may drop 65% in the next two months when a shift is made to a two-line cable, reducing monthly leased-line expenses to about \$360. The system also uses an automatic-answering facsimile system for transmitting graphic materials.

Teleconferencing is part of Goldmark's New Rural Society, a national program aimed to reverse the migration trend of people from rural to urban areas. □



## Solid State Image Sensing

Reticon offers the most complete line of solid state image sensors for OCR, facsimile, page/document reader, film scanning, real time spectroscopy, non contact measurement and inspection applications. High resolution of up to 1024 elements on 1 mil centers is available on a single monolithic chip with serial video readout. Charge storage mode operation provides high sensitivity with scan rates up to 10 MHz. Low power dissipation of less than 10 mwatts and the highest quality silicon gate process assures minimum dark currents and maximum dynamic range.

Circuit cards (RC series) containing complete drive and video amplifier circuits are also available from inventory for any Reticon image sensor.

Our RL256C through RL1024C devices are much improved pin compatible replacements for previous designs.

Write or call for detailed data sheets and external circuit information.

### RETICON®

450 E. Middlefield Road, Mountain View, CA 94043  
(415) 964-6800 TWX 910-379-6552  
HOTLINE (415) 964-3033

This SPECIAL OFFER is to introduce our "C" devices, which will be shipped complete with the RC series circuit cards providing all external drive and video amplifier circuits. Specify RL256C/RC, RL512C/RC, RL768C/RC and RL1024C/RC. Order must be received within 30 days from publication date and must be entered directly with the factory. Only one per customer. Offer is for U.S.A. domestic sale only.

**\$100/bit**  
plus \$250 (for inclusion of complete drive & video circuitry)  
as low as 25¢/bit in large OEM quantities

# Digitest 610. The digital multimeter that measures temperatures, too.

The Digitest 610 is a portable DMM that measures volts, amps, and ohms *plus* component surface temperature. When trouble shooting, this *plus* feature allows the user to quickly identify defective components by surface temperature measurement.

This light-weight, compact, 11,000 count unit goes where needed. When regular power sources are not available the built-in nickel cadmium power pack provides many hours of reliable portable measurement. Bold bright Sperry planar gas discharge displays provide easy viewing, even at angles up to 130° and in direct sunlight. Data can be clearly read at distances up to 40 feet.

Easy to operate push button switches enable rapid selection of all 16 ranges from zero to full scale without further adjustment. Non-skilled personnel can use the Digitest 610 with no training, yet the unit's precision design gives the trained technician and engineer the high degree of accuracy that he needs.

In addition to AC and DC volts, AC and DC currents, the Digitest 610 can measure resistances from 0.1 to 5 megohms, and temperatures from -50°C to +200°C. Accuracy is 0.1% and CMR is 100dB.

Sold and serviced throughout the United States and Canada. U.S. distributorships available.

For details or demonstration call:

Hartford	(203) 246-5643		
*Boston	(617) 879-5710		
New York	(201) 673-2500		
*Philadelphia	(215) 673-5600		
*Baltimore	(301) 796-5600		
Atlanta	(404) 436-5169		
Orlando	(305) 894-9863		
Huntsville	(205) 837-5778		
*Seattle	(206) 622-0177		
San Francisco	(415) 854-4870	*Denver	(303) 427-5299
Dayton	(513) 252-5627	*Salt Lake City	(801) 571-0129
*Chicago	(312) 358-6520	*Albuquerque	(505) 281-5602
Minneapolis	(612) 925-1883	*Phoenix	(602) 939-6757
Dallas	(214) 363-5291	*Los Angeles	(213) 789-0418

\*Stocking representative



**SCHNEIDER ELECTRONICS**

3 HAZEL STREET, PEABODY, MASSACHUSETTS 01960

(617) 535-5620

The Single Source For Reliable Protection For Every Type Of Electronic And Electrical Circuit And Device

# BUSS®

## SMALL DIMENSION FUSES AND FUSEHOLDERS

Include dual-element "slow-blowing" fuses, single-element "quick-acting" fuses and signal or visual indicating type fuses . . . in sizes from 1/500 amp. up . . . PLUS: a companion line of fuseholders.

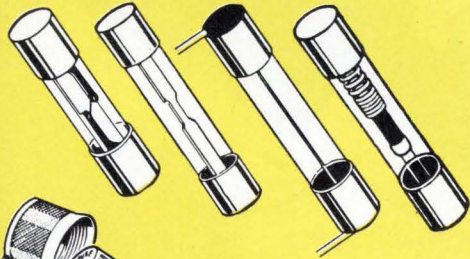

HMR — RF shielded fuseholder for 1/4 x 1 1/4 in. fuses.

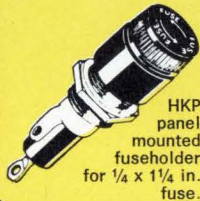

HKP panel mounted fuseholder for 1/4 x 1 1/4 in. fuse.

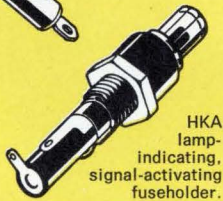

HKA lamp-indicating, signal-activating fuseholder.

### BLOCKS FOR BUSS FUSES

All types available for every application. Single pole, multiple pole, small base, full base, molded base, laminated base, porcelain base for fuses from 1/4 x 5/8 inches up. Also signal fuse blocks and special blocks of all types.

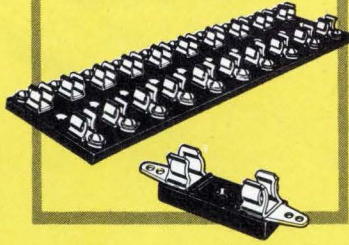
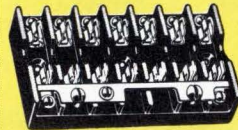

### TRON® Rectifier Fuses For the Safe Protection of Solid State Devices

Provide extremely fast opening on overload and fault currents, with a high degree of restriction of let-thru current. Many types and sizes available. Ampere ratings from 1/2 to 1000 in voltages up to 1500.

**BUSS SNAP-LOCK FUSE-HOLDER** — Rear panel-mounted fuseholder for 1/4 x 1 1/4" fuses. Snaps into place. Specify HTA-00 for space-saver type, HLD-00 for visual-indicating type, HKP-00 for standard fuseholder, or HJM-00 for 1/4 x 1" fuses.

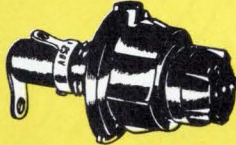

### THE COMPLETE LINE OF SIGNAL-INDICATING ALARM-ACTIVATING FUSES

For use on computers, microwave units, communication equipment, all electronic circuitry.



BUSS GLD 1/4 x 1 1/4 in. Visual-Indicating, Alarm-Activating.

BUSS GBA 1/4 x 1 1/4 in. Visual-Indicating



BUSS Grasshopper Fuse, Visual-Indicating, Alarm-Activating.



BUSS MIN 13/32 x 1 1/2 in. Visual-Indicating.

BUSS MIC 13/32 x 1 1/2 in. Visual-Indicating, Alarm-Activating.



BUSS ACH Aircraft Limiter, Visual-Indicating.



FNA FUSETRON® dual-element Fuse 13/32 x 1 1/2 in. slow-blowing, Visual-Indicating, Alarm-Activating. (Also useful for protection of small motors, solenoids, transformers in machine tool industry.)

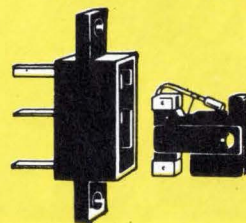

BUSS GMT and HLT holder, Visual-Indicating, Alarm-Activating.

**SUB-MINIATURE FUSE**—Ideal for space tight applications, light weight, vibration and shock resistant. For use as part of miniaturized integrated circuit, large multi-circuit electronic systems, computers, printed circuit boards, all electronic circuitry.

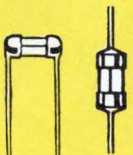

TRON Sub-Miniature Pigtail Fuses — Body size only .145 x .300 inches. Glass tube construction permits visual inspection of element. Hermetically sealed. Twenty-three ampere sizes from 1/100 thru 15.



BUSS Sub-Miniature GMW Fuse and HWA Fuseholder. Fuse size only .270 x .250 inches. Fuse has window for visual inspection of element. Fuse may be used with or without holder. 1/200 to 5 amp. Fuses and holders meet Military Specifications.

FOR MORE INFORMATION ON THE COMPLETE BUSS LINE, WRITE FOR BUSS FORM SFB.



BUSSMANN MANUFACTURING  
a McGraw-Edison Company Division  
St. Louis, Missouri 63107



# The First Scientific Calculator Arrays

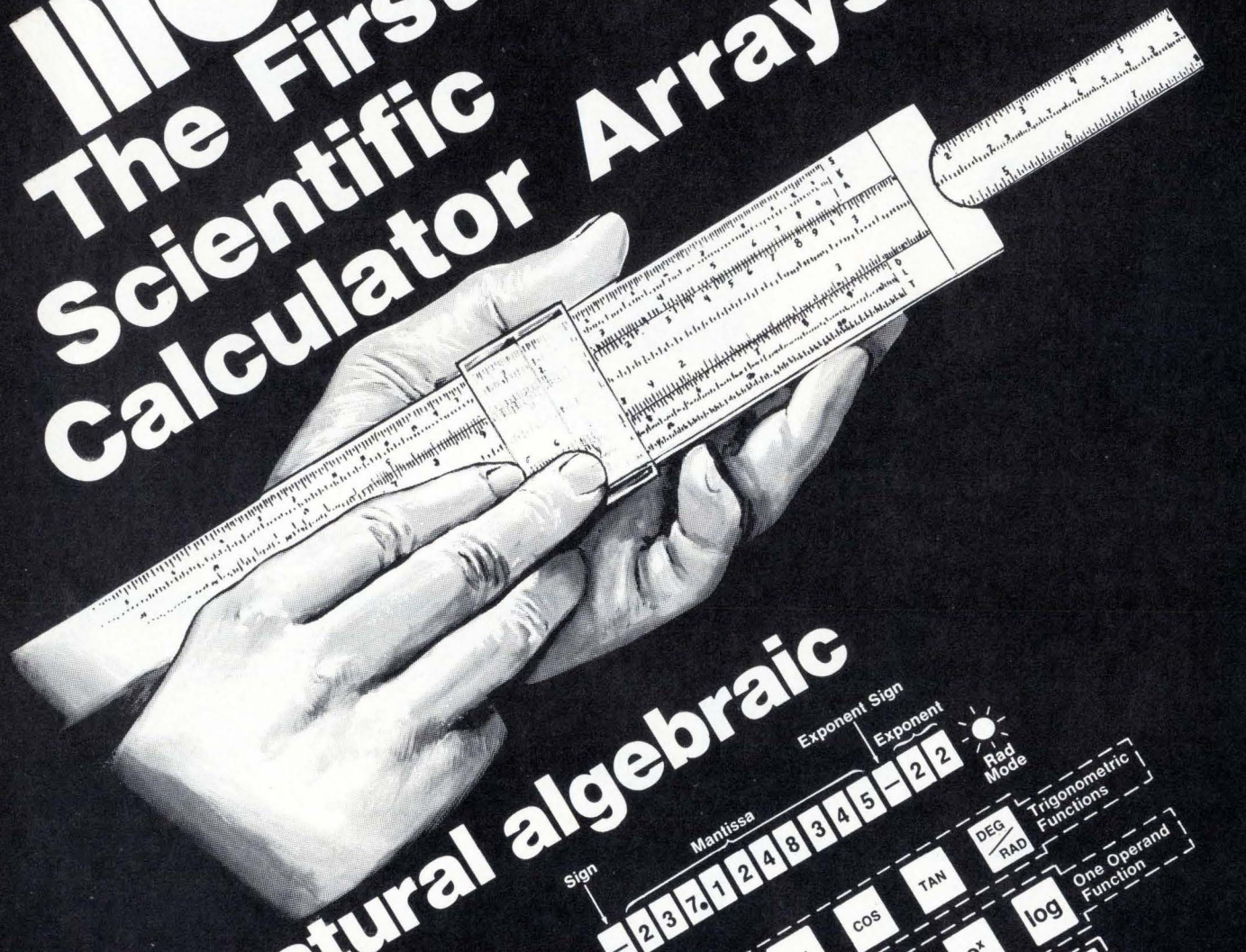

with natural algebraic  
 problem  
 entry

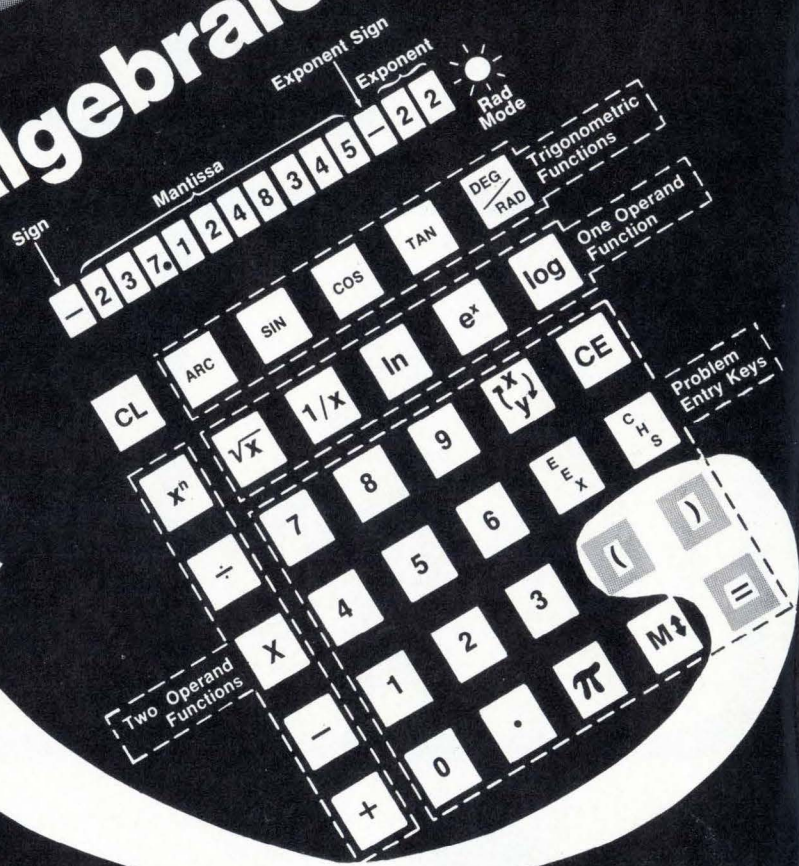



# ...and only arrays to provide!

with  
simplified  
electrical  
design

- Minimum system power consumption (< 200 MW average)
- Internal low battery and display cutoff circuits
- Direct display segment drive
- Internal clock generation
- All logic circuits provided in two 28 pin DIP's

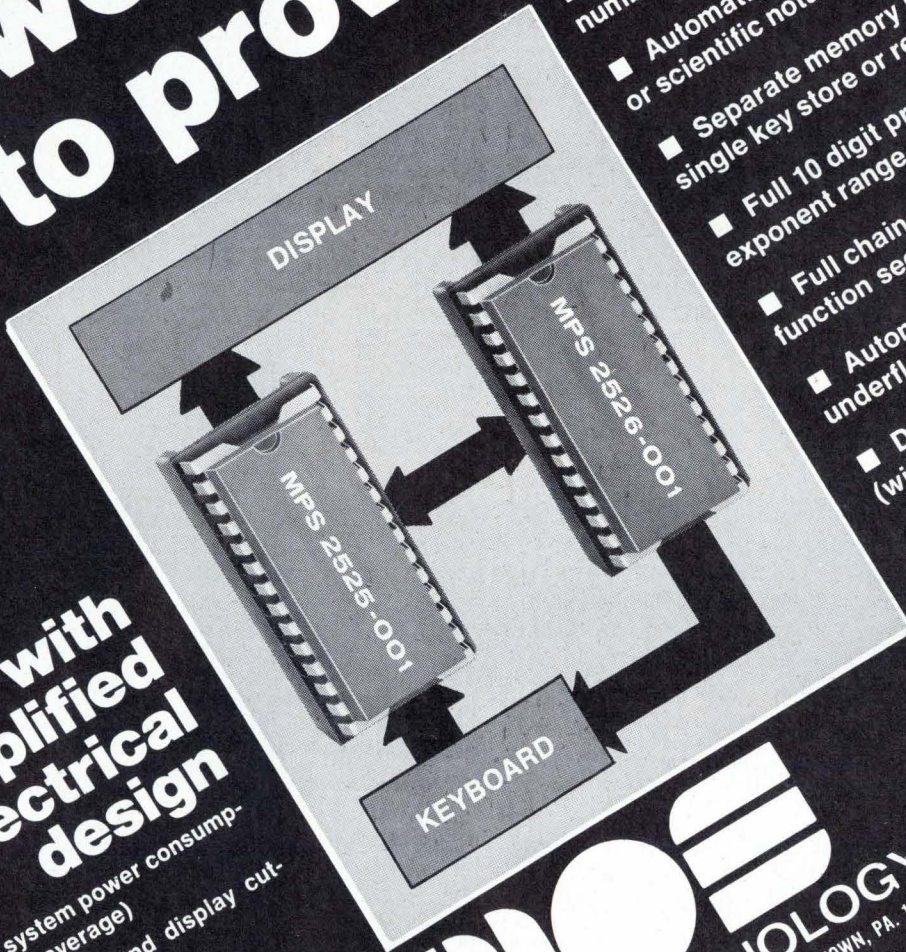

- Floating point or scientific notation number entry
- Automatic selection of floating point or scientific notation for result display
- Separate memory register; single key store or recall
- Full 10 digit precision;  $10^{-99}$  to  $10^{+99}$  exponent range
- Full chain calculation with any function sequence
- Automatic error detection (overflow, underflow, forbidden operations)
- Degree Radian mode selection (with mode display signal)

WE'VE TURNED  
A TECHNOLOGY  
INTO A  
COMPANY

**MOS TECHNOLOGY, INC.**  
VALLEY FORGE CORPORATE CENTER, NORRISTOWN, PA. 19401 (215) 666-7950  
an affiliate of  
**ALLEN-BRADLEY**



**HEADQUARTERS** — Applications Mgr.: Mr. Julius Hertsch;  
MOS Technology, Inc., Norristown, Pa. 19401  
**CENTRAL REGION** — MOS Technology, Inc., 838 S. Des Plaines  
St., Chicago, Illinois 60607 (312) 922-0288  
**EASTERN REGION** — Mr. William Whitehead, Suite 307 — 88  
Sunnyside Blvd., Plainview, N.Y. 11803 (516) 822-4240  
**WESTERN REGION** — MOS Technology, Inc., 2172 Dupont Dr.,  
Suite 221, Patio Bldg., Newport Beach, Calif. 92660  
(714) 833-1600

This new Guardian Relay Catalog...

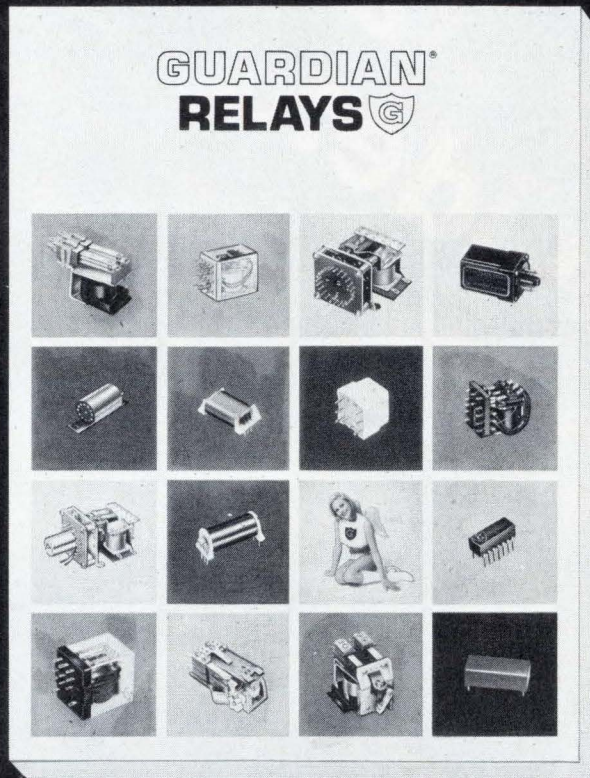

...is no small thing.

It's

## **THE BIG BOOK**

of relay facts, specs and ordering info.

(And it's yours free for the asking.)

**CIRCLE 58 ON THE READER SERVICE CARD**  
for your very own personal copy. Free from your Guardian Angel.



# **GUARDIAN<sup>®</sup>**

GUARDIAN ELECTRIC MANUFACTURING CO. 1566 West Carroll Ave., Chicago, Illinois 60607



# Washington newsletter

---

## Minicomputers wanted to update defense data net

The National Security Agency is moving to buy 150 to 200 minicomputers to interconnect with the Defense Communications Agency's automatic digital network. As suggested by the effort's title—Project Streamliner—the minicomputers would update the defense intelligence network. But Streamliner is not yet on the track. Disappointed with the responses to its first request for proposals, NSA has just issued a second RFP.

At least six companies have been identified as responding to the first RFP, among them Sperry Univac, Lockheed Electronics, and GTE Sylvania. **Digital Equipment Corp. hardware was proposed by DEC itself, as well as by Cybernetics Inc. and Planning Research Corp.**

## Police digital systems boosted; Cleveland buy near

Digital communications equipment for police has got a boost in a survey of developmental and operational systems completed for the Law Enforcement Assistance Administration by Urban Sciences Inc., Wellesley, Mass. The survey concludes that **digital techniques offer five times more capacity and more inherent security than analog voice networks**, and notes that "digital communications represents one of the most useful means that technology can offer" for improving law enforcement communications.

**The turn to digital police systems is supported by the city of Cleveland, O.,** which is soon expected to choose between hardware of IBM Corp. and Kustom Electronics Inc., **to equip 125 patrol cars following tests under an LEAA grant.** The city tested 10 IBM printers and 20 of Kustom's plasma displays.

## Raytheon SAM-D effort seen stable despite fund cuts

Raytheon Co.'s level of effort as prime contractor for the Army's SAM-D surface-to-air missile is expected to be virtually unchanged over fiscal 1974-75, say Federal budget sources, **despite a Pentagon cut-back in its fiscal 1975 budget request for the high-altitude air defense system.** Stung by the high congressional visibility given last year to the program's overruns by a critical General Accounting Office study, **the Defense Department ordered the Army to slow the project early this year,** pending completion of a new DOD cost-effectiveness study. Accordingly, the Army has cut its SAM-D budget request for fiscal 1975 by a third to about \$110 million. Nevertheless, **Raytheon is expected to get close to \$100 million of this in order to be able to meet flight test schedules later this year,** while the Army pushes for subcontractor cut-backs in Government-furnished subsystems in areas such as SAM-D communications.

## FAA's decision on airborne CAS delayed till 1975

The Federal Aviation Administration plans to decide on a national standard for airborne collision avoidance systems no sooner than mid-1975, **dashing the hopes of contenders Honeywell, McDonnell Douglas, and RCA.** The agency, which frankly favors ground-based techniques working through the air traffic control systems, has not yet tested general aviation CAS units and **won't complete its testing until March 1975,** says one authoritative source. He adds that **the FAA plans to tell the Senate it still believes ground-based approaches are better,** despite congressional pressure for airborne CAS units.

## A pitch for space applications

*Knowledgeable congressional advocates of a strong civilian space applications program are becoming increasingly rare birds, particularly since private enterprise now dominates one of those application areas, communications satellites. One such advocate is Rep. James W. Symington (D., Mo.), now Chairman of the Subcommittee on Space Science and Applications, who addressed the issue before the American Institute of Aeronautics and Astronautics' annual meeting in Washington at the end of January. Because Symington's provocative views deserve a wider audience, we have excerpted the substance of them here.*

—Ray Connolly

Despite overwhelming support by the public and the Congress, the Applications Program is one part of the space effort that seems to have been short-changed over the years. It is a curious history.

When the NASA budget was at its zenith in the mid-1960s, funding for Space Applications was languishing at less than \$100 million per year, a tiny fraction of the more than \$5 billion annual budget for space. In 1967, NASA commissioned a two-year summer study by the prestigious National Academy of Sciences. One of the main conclusions of that study was that the Space Applications budget was too small by a factor of two, or perhaps three.

### What OMB did

Well, funny things happened to the NASA budget on a visit to the Office of Management and Budget—not just once, but year after year. Although inflation has continued to take its toll every year since the academy's report, the Space Applications budget never quite reached \$200 million. Last spring, however, the budget for the Applications Program for fiscal 1974 dropped dramatically to \$153 million.

This reduction was associated chiefly with NASA's newly announced policy of phasing out communications satellite research and development. While NASA officials concede that there is plenty of R&D left to do on communications satellites, they say that private enterprise is expected to pick up where NASA leaves off. Is such faith or hope in the private sector justified?

Seemingly not. I have not found a single representative of American industry who believes private enterprise will take up the slack. No less an expert than Dr. Wernher von Braun has publicly stated his conviction that industry will not, indeed cannot do so.

Certainly, we should encourage private enterprise to do all that it can. But there are some

things that are beyond the capabilities of the free enterprise system. Risk capital is attracted to those activities which promise earnings in the relatively short term. Thus, it is reasonable to expect Comsat and others to improve and refine existing technology. But as a nation, we should have longer-range goals.

### Federal role unfinished

I am convinced that the role of the Government is not finished; there is plenty of research that looks far into the future which private enterprise cannot afford to undertake, and that therefore must be done with Government support if it is to be done at all.

The history of the Space Applications Program is even more curious when one considers the Earth Resources Technology Satellite project. In a year and a half of operation, the potential of such a system for the solution of a multitude of everyday problems here on earth has been amply demonstrated.

Although ERTS-1 has been successful beyond our fondest hopes, it has encountered some difficulties. While the multispectral scanner has performed superbly, the satellite has been limping along for many months without the use of the return beam videcon, the other major instrument board. Moreover, one tape recorder failed early in the mission, and the second failed partially several months ago.

Such anomalies are to be expected in experimental satellites, of course. That is the reason ERTS-B, an exact copy of ERTS-1, was originally scheduled for launch in November 1973. Last year, however, we were told that it would be delayed until early 1976 so that a fifth channel could be incorporated in the four-channel multispectral scanner.

To avoid a long hiatus in the acquisition of ERTS data, the House Science and Astronautics Committee increased the NASA authorization bill for fiscal 1974 by \$8 million and urged that ERTS-B be prepared for launch with the existing four-channel MSS as soon as practicable. After months of indecision, OMB finally relented, and ERTS-B, in its original configuration, is now scheduled for launch late this year or early in 1975, about a year and one half late.

At the present rate of spending, the Space Applications Program could be funded for six years for the cost of a single space science project—Viking. On the same basis, the cost of the Skylab program would support the entire Space Applications Program for about 17 years. These figures suggest that the space program is out of balance and has been for many years.

# Optimized 80A SCRs. But you'll have to pay less for them.



Lots of you are using 110 A SCRs in designs where 70 or 80 A would do. Or managing with 55 A SCRs where performance is marginal.

Stop.

The MCR80/81/82 *hermetic* SCR series is the optimized answer to both designs from now on.

In fact, there's no reason for continuing to plug in 55 A SCRs because this new 80 A 1/2" stud series gives you more than 1/3 greater current capability . . . at less price.

Right.

Less price.

At 100 volts, a 55 A unit costs about \$10, 10-99. The 80 A MCR81-10 costs \$7.50.

At 400 volts, a 55 A unit prices out at \$13.50. The 80 A MCR81-40 is just \$10.13.

At 600 volts, the comparison is \$27.50 for 55 A, \$20.63 for 80 A.

At 800 volts, it's \$32.50 and \$29.25.

You'll realize even more significant cost savings replacing 110 A types with the MCR series — at 200 volts, for example, the 110 A device costs \$16.75. The MCR81-20 is only \$7.87. About half the cost.

You get the idea.

Technologically speaking, this new SCR is quality all the way. Stud or unique, design-simplifying *isolated* stud packaging — pressfits whose prices are even more

economical — center-fired gate for excellent di/dt performance — reliable, double hermetic packaging with glassivated die inside a metal pressfit — outside epoxy-coated for long voltage creepage paths.

Electrically, the 50-800 volt series carries 1,000 A surge and 70 mA max. trigger characteristics.

New data sheets and "Guide to Thyristors" can be quickly had through Box 20912, Phoenix, Arizona, 85036.

Evaluation units through distributors.

Direct quotes through the coupon.

But only if you like the price.

Quote me an optimized price . . . on the optimized MCR80/81/82 series SCR in the voltage, quantity and package style I've indicated:

Pressfit     1/2" Stud     1/2" Isolated Stud

Voltage \_\_\_\_\_ Quantity \_\_\_\_\_

Name \_\_\_\_\_

Title \_\_\_\_\_

Company \_\_\_\_\_ Phone \_\_\_\_\_

Address \_\_\_\_\_

City \_\_\_\_\_ State \_\_\_\_\_ Zip \_\_\_\_\_

*Cost-conscious*

## From Motorola, the thyristor producer.

# REI has one question for people who buy electronic test equipment.

## Why?

**When you need it fast . . . rent it.** Purchasing equipment usually involves long delivery lead times. When you rent your electronic test equipment from REI it's a safe bet that you can get what you need within 36 hours of the time you call in your order, sometimes sooner. This fast service is possible because we maintain 9 Instant Inventory Centers throughout the U.S. and Canada, stocking millions of dollars worth of equipment.

**When you need it for only a short time . . . rent it.** Need equipment for a short-term project? Rent it from REI. When you don't need it any more, return it to us. It's the easy, low-cost way to use the equipment you need for just the time that you need it.

**When you care about what it costs . . . rent it.** Renting from REI can be less expensive than purchasing. There's no capital investment to adversely affect your company's cash flow. This means you'll get more mileage from your equipment budget. And your controller will tell you that your low monthly payments are tax deductible.

All REI rental equipment is tested to meet manufacturers' specifications prior to delivery, with free maintenance included. Certification and calibration are available upon request. Our flexible arrangements include rental, rental-purchase and leasing packages to give you the use of equipment from one week to three years or more.

Get your free copy of our 1974 catalog that lists virtually every item in our rental inventory. Just circle our reader service number on the postcard in the catalog directory section and drop it in the mail. For immediate information, call your local REI instant inventory center listed below. Once you rent from REI, you may never buy electronic test equipment again.

## Rental Electronics, Inc.

A PEPSICO LEASING COMPANY

Lexington, MA (617) 861-0667 • Gaithersburg, MD (301) 948-0620 • Oakland, NJ (201) 337-3757 • Ft. Lauderdale, FL (305) 771-3500  
Des Plaines, IL (312) 827-6670 • Dallas, TX (214) 661-8082 • Mountain View, CA (415) 968-8845 • Anaheim, CA (714) 879-0561  
Toronto, Canada (PLC Leasing Ltd.) (416) 677-7513



## When you think about renting, it's the only way to go.

## Dashboard indicator alerts driver to 12 car malfunctions

If an integrated automobile monitoring and warning system ever becomes a big electronics market, VDO Adolf Schindling AG, a big name in motor vehicle instrumentation in Europe, has a leg up on its competitors. It has developed prototype equipment that, by way of a single dashboard-mounted indicator, optically warns the driver when the critical value for any of 12 different car operating conditions is reached.

VDO's central information system monitors and gives warnings on engine rpm, temperature, and oil pressure. Other conditions it checks are brake pressure, lighting, and the level of cooling water, gasoline, oil, brake fluid and windshield cleaning water. Using inputs from variable-resistance sensors, the system also keeps tabs on brake lining, giving an alarm when it becomes too thin. Another alarm tells the driver that his seat belts aren't fastened.

**Lights.** As now laid out, the indicator has a central alarm field surrounded by 12 smaller fields, each specifying a particular parameter. A red warning is given either as flashing or steady lights that illuminate the fields from behind.

Various combinations of flashing and steady lights tell the driver whether or not an abnormal condition warrants immediate correction. An "acknowledge" button extinguishes some, but not all, alarms.

"What prompted this development," says Horst Römer, the VDO engineer responsible for the system's design, "was the desire to combine the scattered warning indicators scattered into a single unit."

The system has already interested several car makers. Talks are being held with one maker about a version with fewer than 12 warnings for some of the firm's top-of-the-line 1975 models.

VDO has assigned the conditions that the system checks into three categories of descending danger

level. In category I are engine rpm and oil pressure. If a parameter reaches its critical value, both the central alarm and individual alarm start blinking. The blinking can be extinguished only after the trouble is fixed.

Category II incorporates less serious parameters—like oil and brake fluid level, brake pressure and brake lining. If any of these become critical, both the central alarm and the individual alarm will shine steadily. The driver can turn off the central alarm, but the individual

alarm will go from steady to blinking operation. That tells the driver to be aware and adapt to the changed condition or to have the trouble fixed as soon as possible.

Alarm category III includes all conditions that do not call for immediate corrective action or are tolerable providing the driver adapts to them. In this class are water and fuel levels, engine temperature and the status of seat belts and lighting system. While the central alarm can be turned off, the one for the parameter can not be extinguished. □

## Around the world

### Machine relies on resistors for OCR

Two British university men have built a machine for optical character recognition that uses matrixes of resistors instead of digital logic to identify the characters. The resistors don't need close tolerance, the inventors claim—10% is satisfactory. What's more, the matrixes could be built easily and cheaply as film circuits in volume production. The originator and designer of the system is Wilfred Taylor, a teacher at University College of the University of London. A prototype, which was built by Taylor's colleague, Kahan Al-Kibasi, has been working two months. So far, it's used only the 15 characters in the OCR-B font commonly used by OCR document readers.

The prototype, which stores the characters on the rim of a phonograph turntable, passes them under a bundle of 100 optical fibers, each 10 mils in diameter. The fibers are arranged at random, rather than in a matrix configuration. The output of a photo-transistor at the top of each fiber is amplified and fed into a dual operational amplifier. When there's light in a fiber, the op-amp outputs have one polarity pattern, which is reversed when there's no light. Each op-amp output connects to one resistor in every 200-resistor matrix. The interconnect patterns in the matrixes are arranged so that the voltage in the matrix programed to respond to a specific character is at least twice as high after amplification as the voltage in any other matrix.

### Planning starts on post-Eole satellites

France's space agency has high hopes for a satellite system that will zero in from space on targets like sea-floor oil wells with an accuracy of 1 meter. So far, the best French performance has been 2 kilometers with its Eole balloon-tracking meteorological satellite. The French figure that the system—known as Geole—will find markets in oil and mineral exploration and even for such precise tasks as road or dam building in rough country.

The Centre National d'Etudes Spatiale is busy as its Toulouse facility with three stages in post-Eole development. First, it is tackling data-acquisition functions, which will see service soon in the U.S. Tiros-N program. Second, it has an experimental version of the Geole satellite at the laboratory stage; a version of this, called Dialogue, will be launched in 1977. And, it is pushing ahead on the design work for Geole itself. Data-acquisition experiments will get off to a flying start over the next few weeks after CNES signs an agreement with NASA for giving the French responsibility for a data-collecting system on board the Tiros-N meteorological satellite.

# THE NUMBERS GAME

(and how we can help you beat it)

Digital readouts. Ubiquitous in calculators and instrumentation. And the coming thing in all kinds of consumer gear. Appliances. Hi Fi. Cars. You name it.

You know it. We know it.

So what?

So, for starters, we can give you what nobody else can. All (that's right, all) of the standard character heights in the most commonly used digit combinations. With the best resolution in the business (because of our unique mask construction). And in easy to read, orange-red.

We call it DiaDigit™. A differently designed, single envelope package, multi-digit gas discharge display. You don't need other package combinations to get what you want. It's IC com-

patible. Mechanically you handle it like other components in your system: leads like an IC, mounts directly to your PC board, no fancy sockets to buy. It also has low power requirements. Super reliable. Sounds good, right? But by now you may be wondering just what our qualifications are. Good question. We're well known as the leader in innovative packaging to the semiconductor industry. (You guessed it. Logically, our package is based on DIP construction techniques. The processes used are our own patents.)

Bonuses: We're fast on specials. We can give you many combinations of letters, symbols and digits. Because

we're geared to handle the unusual, and the simplicity of our design lets us deliver what you need.

Now, if you're hooked on the possibilities, but worrying about the price. Don't. We're competitive.

After all, we think the name of the game is numbers. And we want everybody to play.

We can't spell out all the details here. And you probably have our competitor's specs. All we ask is you compare ours. (Along with price and delivery.)

Diacon, Inc., 4812 Kearny Mesa Road, San Diego, California 92111. Or phone 714/279-6992.

## DIACON

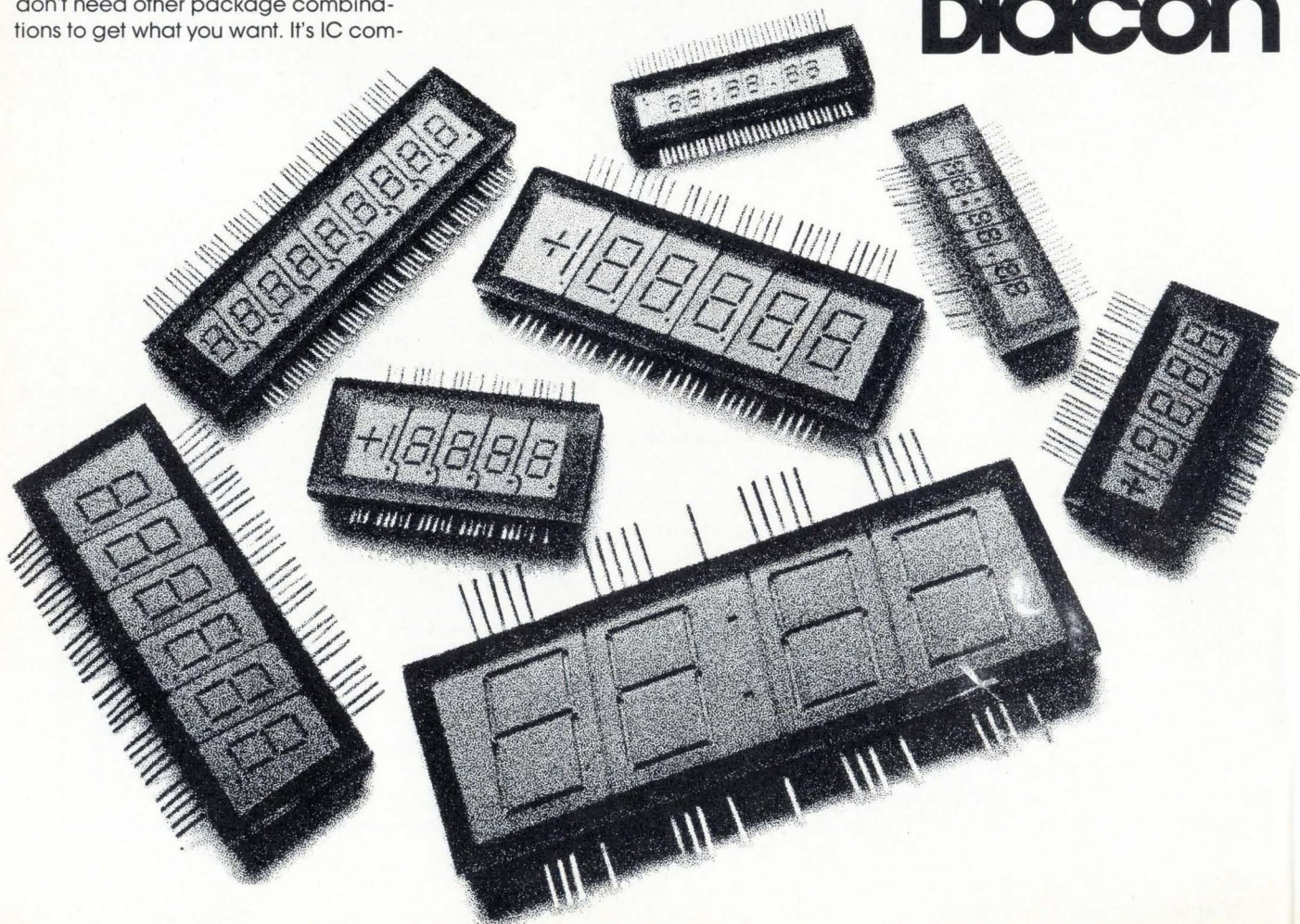



## **Consortium formed for satellite communications**

A consortium of German and French companies has embarked on a project aimed at developing a new time-division multiple-access (TDMA) system for satellite communications. Participating in the so-called TDMA-S2 project are West Germany's AEG-Telefunken, Siemens AG, and Standard Elektrik Lorenz AG as well as France's CIT-Alcatel, Société Anonyme de Télécommunications, and Thomson-CSF. SEL, an ITT subsidiary, is the consortium leader.

Time-division multiple-access principles, the development of which began in the mid-1960s in the U.S., Japan and West Germany, provide more effective and flexible use of satellite transponder capacity than the frequency-division multiple-access technique now employed. Germany's effort in this field resulted in the TDMA-S1 system which underwent trials with an Intelsat-3 satellite in 1971.

The new system will be based on Intelsat specifications derived from measurements obtained with the S1 version, with the U.S.-developed TDMA-1, and with Japan's TTT system. **The consortium's immediate goal is to develop, at SEL's Stuttgart facilities, a laboratory S2 model,** which is to be followed up with two prototype versions, one for Germany's Raisting and the other for France's Pleumeur-Bodou ground terminals. Plans call for testing these prototype systems with Symphonie and Intelsat-4 communications satellites early in 1976.

## **Failure of Britain's Skynet delays, but doesn't kill, project**

Failure of Britain's Skynet military communications satellite to get into orbit over the Indian Ocean on firing from Cape Kennedy on January 19 is not catastrophic for the British program—**provided a second spacecraft, originally scheduled to be an in-flight spare, can be successfully orbited sometime late this year.** Apparently, the second stage of the Delta rocket carrying the first spacecraft misfired, and it ended up in orbit just outside the atmosphere, though transmitting well. Firing its apogee motor didn't put it into a usable orbit, and it's now presumed to have burned up.

**The only consolation for spacecraft builders—Marconi Space and Defence Systems Ltd.—is that the telemetry system still worked properly** despite the second stage misfiring, which tumbled rockets and spacecraft and subjected Skynet to forces of 60 to 80 g. Since the Skynet program is costing Britain some \$50 million, including ground facilities, a lot hinges on the spare being launched successfully.

## **French companies look for sales in China, Japan**

**China expects to place a major order for data-switching equipment within the next several weeks,** following more than a year of dickering with ITT subsidiary, La Compagnie Générale des Constructions Téléphoniques in France and at least two unnamed U.S. firms. The order will be the biggest Chinese purchase of telecommunications equipment since RCA sold satellite ground receivers in 1972.

About a dozen Chinese technicians spent two weeks at CGCT in Paris last month inspecting the DS-4, the same system CGCT has sold in two versions to the Russians. CGCT feels well-placed in the bidding, partly because the Chinese want the system for an application the Russians already have operating—a domestic air-traffic-control network.

**The French also are stalking the Japanese for space contracts.** A top-level group from the Centre National d'Etudes Spatiales is flying off to

Tokyo this month to persuade the Japanese to use CNES hardware in the first cryogenic stage of a three-stage launcher designed to carry a 500-kilogram payload. The new launcher is scheduled to succeed the present N-series based on U.S. Thor-Delta rockets. The French also hope to sell electronic equipment for guidance systems.

## Unidata's French partner gets R&D fund infusion

Only six months after joining up with Siemens AG and Philips Gloeilampenfabrieken in the Unidata computer combine, **the French partner—Compagnie Internationale pour l'Informatique—finds itself badly short of research and development money.** While its main industrial shareholders—Thomson-Brandt and Compagnie Générale d'Electricité—continue to bicker between themselves over who should pay what, the Pompidou Government is trying to patch up the embarrassing row. For a start it will make sure that CII soon has the \$20 million or so it needs to get through this year's extra expenses towards building the new Unidata product range.

With the immediate financial pressure off, Jean Charbonnel, industrial and scientific development minister, will look around for a rich new shareholder or two to solve the medium- and long-term problems. **Meantime, to keep CII revenue flowing, the government is equipping more and more state companies and organizations with CII hardware,** at the expense of Honeywell-Bull in particular.

## Iran ups its buy of U.S. advanced jets

American avionics subcontractors on the price-plagued Air Force F-15 and Navy F-14 interceptors could wind up facing eastward to thank Iran for relieving congressional economic pressure on the two aircraft programs. Less than three weeks after deciding to spend an estimated \$900 million for 30 of the Grumman Aerospace F-14 Tomcat fighters for its air force, **Iran has also ordered 53 McDonnell Douglas F-15 Eagles and elated the U.S. Air Force.** The two buys—on which deliveries are scheduled to begin in 1976—will take the heat off the two services and their contractors' rising costs by sharing some of the risk and increasing production volume.

**Defense officials estimate that the Grumman F-14 order by Iran will cut the Navy's costs by \$600,000 per plane as the production rate is increased from four per month to six.** As with the F-14s, which Iran is buying fully equipped with the Hughes AIM-54A Phoenix missile, the McDonnell F-15 planes will come with a full complement of weapons, spares, replacement subsystems and ground support hardware, plus provisions for training Iranian pilots.

## France to trade electronics for oil

French electronics companies figure they will fare better in Mid-East markets because of Foreign Minister Michel Jobert's late-January whirl through the area in search of oil. The aftermath of Jobert's swing should keep electronics salesmen busy for months. **In partial exchange for some 800 million tons of oil from Saudi Arabia over the next 20 years, France will participate heavily in the Saudi effort to industrialize.** On the shopping list: telecommunications systems, Secam color television, and military hardware. **French electronics companies also will be bidding for contracts in a proposed deal that would see Kuwait swapping oil for military equipment.**

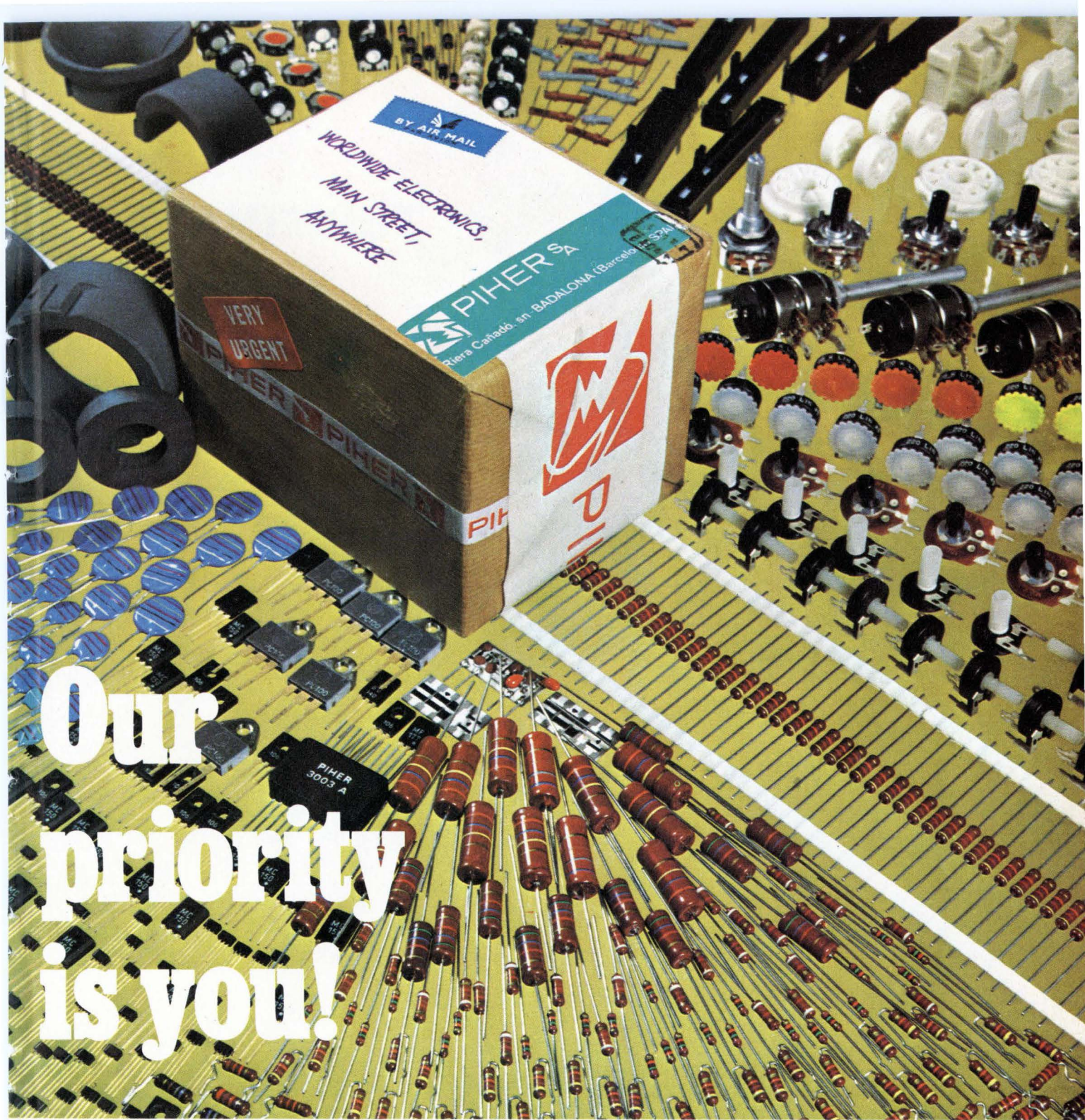

**Our  
priority  
is you!**

When you deal with Pihier you know you are dealing with one of Europe's foremost component manufacturers – and that's important to you, the customer. Because we only manufacture for you. No question of giving you long delivery dates because we divert components for our own product lines. We haven't any. Our component manufacture is for you – totally.

We have a wide range of high quality components – at really competitive prices. Demand for our carbon film resistors, for instance, is so high that our current production is committed months ahead. Our new manufacturing plant in the U.S.A. – operational early in 1974 – will help speed resistor deliveries. But we have other, shorter-term delivery components available. Trimmer,

spindle and rotary potentiometers, semi-conductors, ferrites, capacitors – all high quality items.

Send for our data sheets if you want to be kept in touch with the Pihier range. Find out more about us, it pays.



Head Office—Spain - Riera Cañadó, s/n. Apartado de Correos 53, Badalona (Barcelona) Spain. Tel: 389 03 00. Telex: 59521

PIHER International Corp. 1239 RAND ROAD, DES PLAINES, ILLINOIS 60016. Tel: 312-297 1560. Telex 282514

Circle 67 on reader service card

# TERMINATE WITH **STA-KON**<sup>®</sup> TERMINALS

WT-445A Tool

**From beginning to end and every place in between,  
our goal is to make your wiring more reliable.**

The STA-KON Terminal Method reduces the chance of human error...increases the level of reliability. Our exclusive Shure-Stake<sup>®</sup> principle makes the tool responsible (not the installer) for the compression connection. Once the tool's compression stroke has started, the tool will not release the terminal until the proper compression has been made.

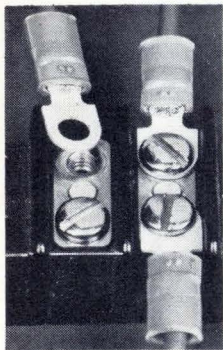

Another benefit of the STA-KON Method is the solderless terminal design. Take for example, the problems of high density wiring in terminal blocks. Our new mini-locking fork terminals and mini-ring types are considerably smaller than conventional terminals. They prevent overlapping of terminals at the block. They fit all kinds of restricted spaces... both in depth and width.



This configuration of the spring-like locking fork terminal itself, is another new idea from T&B. The terminal snaps on like a fork tongue and stays on like a ring tongue. No need to remove screws or nuts to install the terminal.

Our insulated ring, fork and locking fork terminals are now available tape mounted for use with high speed automatic installing tools... you can crimp over 3600 per hour with our new #11908 tool.

When you specify STA-KON, you get extras at no extra cost — long serrated barrels give positive contact and maximum pullout resistance — and precision tools are matched to the terminals. Write for catalog.

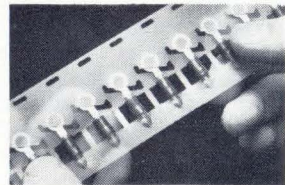

# BUNDLE WITH TY-RAP® CABLE TIES

WT-193 Tool

## Cut Costs at Each Step of Harness Fabrication

**1. Tying a large variety of bundle diameters?** The new WT-193 tool gives you an improved level of control and convenience. The accurate preset tension control makes tying uniformity the responsibility of the tool rather than of the installer. The narrow nose and long slim body reaches in, cinches the TY-RAP® tie to a preset tension and trims it evenly . . . even in those tough high-density areas.

**2. Repetitious tying in large quantities?** The new TR-300 high-speed tool gives you several benefits. In 8/10th of a second, it installs a TY-RAP tie around a bundle up to 5/8" diameter, cinches and trims evenly.

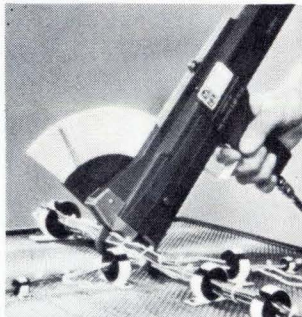

**3. Here's the most important reduction benefit!** The ultimate key to savings is the locking device in the cable tie. Only TY-RAP ties give you a "grip of steel." A patented, non-magnetic, stainless steel locking wedge is embedded in the nylon cable tie. It's in every self-locking tie, from the miniature 3 inch for 1/16" dia. to the 30 inch tie

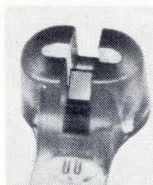

for 9 inch bundles. It is used in virtually every modern aircraft, communication, business machine and electrical equipment application . . . in general wherever wire is used.

**4. Tired of the recurring costs of harness boards?**

Our new modular harness board is designed to substantially reduce costs while providing convenience. It is constructed of polyethylene foam sandwiched between two metal screens — the nails can be pushed in by hand. It's reusable. It's reversible. It's modular — boards interlock in seconds to produce any size board needed.



Write for new catalog, The Thomas & Betts Company, Elizabeth, New Jersey 07207 (201) 354-4321. In Canada, Thomas & Betts Ltd., P. Q.

509

Sold Only  
Through  
T&B Distributors



**THOMAS & BETTS**

Division of Thomas & Betts Corporation

Circle 69 on reader service card

# From ele to blood analy



Smart system designers use Intel Microcomputers for almost everything.

Right now, Intel Microcomputers are being used to replace hardwired control logic, cut component and assembly costs, raise reliability and make systems easier to maintain. With control programs stored in read-only memories, Intel Microcomputers are replacing hundreds, in some instances even a thousand TTL packages.

Intel Microcomputers are making systems smarter, opening new markets and preventing product obsolescence. Our customers are adapting the Microcomputer to new applications and markets by programming ROMs instead of hardwiring logic. Products get to market faster since software takes months, perhaps man-years less time to develop than hardwired logic.

General purpose Microcomputers, invented two years ago by Intel, have already outmoded hardwired logic and expensive custom MOS/LSI in hundreds of applications:

computer terminals, traffic light controllers, medical instruments, business machines, mass-transit equipment, reservation systems, cash registers, inventory computers for fast-food restaurants, process controllers, electronic test instruments

and even pinball and slot machines.

You'll soon be seeing a new Toledo digital computing scale at the corner food store. Accurate to the penny, it converts weights to prices and operates a

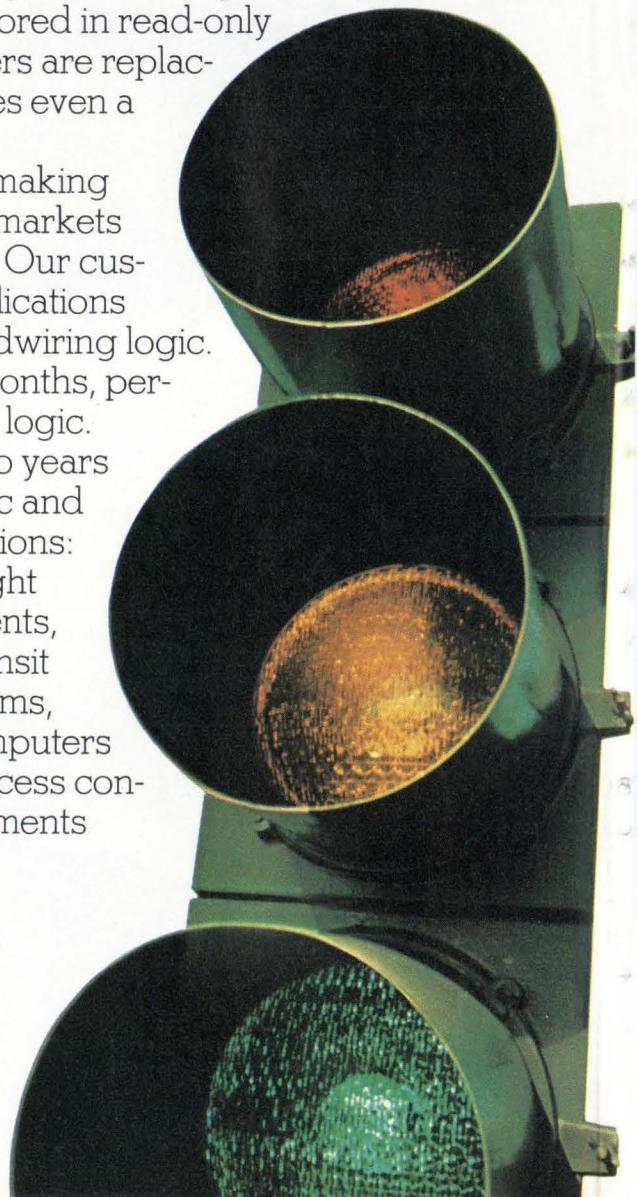

# Electronic games izers.

display, label printer, or both with an Intel Microcomputer. With equal ease, a similar Microcomputer handles graphics composition and editing in Automix Keyboard's Ultra Comp intelligent terminal for typesetting.

In a Helena Laboratory blood analyzer, an Intel Microcomputer translates the raw data from a sensing instrument into medically meaningful numbers and prints out separate quantitative readings of several different proteins. The Microcomputer reduced the electronics cost of the system about 30%. Another Microcomputer automated instrument is Coherent Radiation's Dioptron™.

While a patient reads an eye chart, the central processor analyzes the eyes' focus and prints out the results. Even kids too young to read the chart are tested rapidly and accurately.

Finally, just for fun, look at Atari's new video game, "Gotcha"™. Cat chases mouse (or boy chases girl) through a constantly changing maze. In this case, the Intel Microcomputer acts just dumb enough to let people win once in a while.

We started the Microcomputer revolution and we continue to lead the industry in the development, production, applications support and delivery.

To find out how you can enhance your product's capability, take advantage of our know-how, software library and programming aids, subscribe now to Microcomputer News. Just for asking, we'll also send you our new Microcomputer catalog.

Intel Corporation, 3065 Bowers Avenue, Santa Clara, California 95051 (408) 246-7501.

**intel**® Microcomputers. First from the beginning.

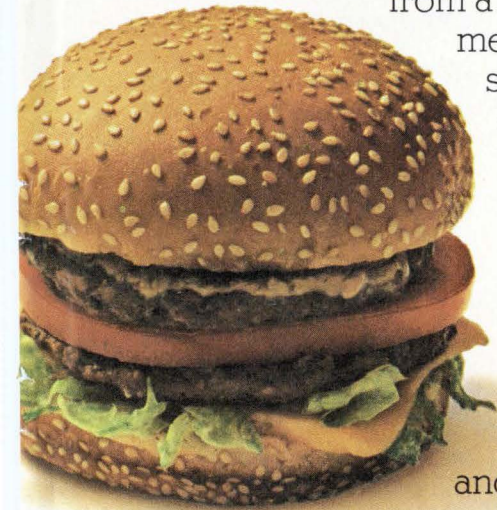
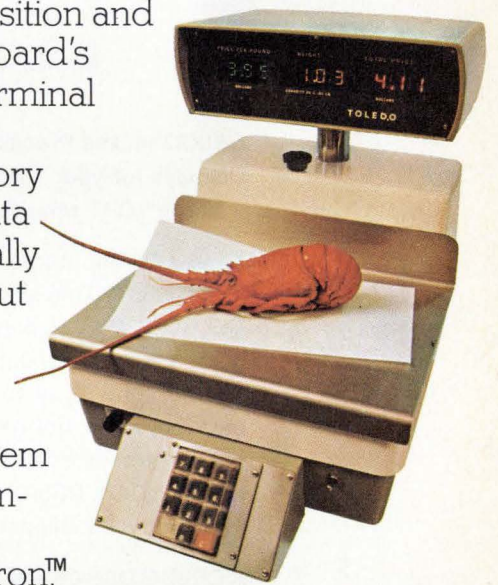
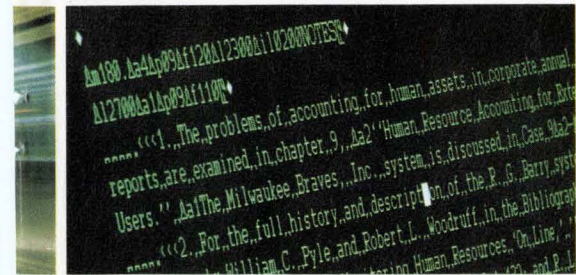

# The "Above-Average" Sub-System by Celco

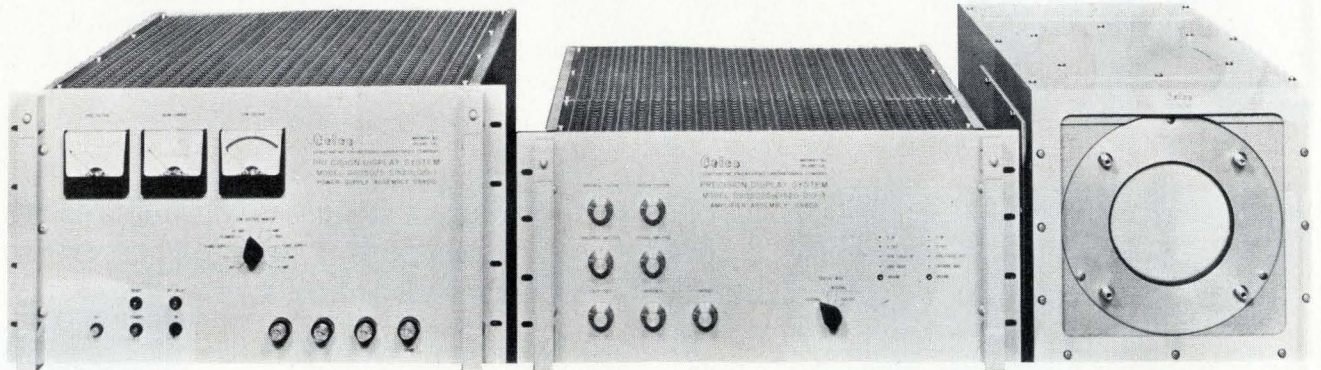

CELCO makes Precision CRT Displays for your "above-average" CRT requirements.

Need a CRT spot-size as small as 0.00065"? This standard CELCO 5" CRT display is being used for Satellite Photography. They needed the best they could get. You can get performance like that too with CELCO's DS5-065 Precision CRT Display.

A CELCO DS5-08 with 0.1% linearity, and spot size of 0.0008" is being used by another CELCO customer for Nuclear Photography Film Recording. Special features include programmable Raster Generators, and triple-layer and articulated shielding for ambient fields from earth's field and from dc to RF fields.

Fingerprint Scanning is the job of CELCO's DS5-10 Optical Character Recognition System for one of our customers. They needed that wide 2.5 MHz deflection bandwidth for high-speed scanning of vast amounts of data. And the DS5-10 has a settling time of

10 microseconds to 0.1% large signal, and 350 nanoseconds to 0.02% small signal settling time. Spot-size is 0.001".

One CELCO customer is using our 5" Color Display System for color separation and color photo scanning. One display does all that!

If your needs are "above-average" but your budget is below-average, CELCO also makes a 5" Precision CRT Display System especially for you that's ideal for your Low-Cost Film-Scan applications. Or if your display needs are larger, CELCO makes standard precision 7" and 9" CRT displays.

Our DS5-075 provides NASA with a 0.00075" spot-size for their Viking Orbiter and Viking Lander satellite photography. They needed 0.01% repeatability too. And they got it. From CELCO.

Two different customers with "above-average" display needs are using CELCO CRT Display Systems for Astronomy Research. One is an observa-

tory; they're keeping their eye on the Sun. The other is recording their Stellar Observations with a CELCO CRT Display System.

High-speed map making is the task of another CELCO customer using a CELCO precision display for topographical projects.

CELCO displays are helping a leading Oil Company in their oil explorations. While another CELCO display is being used in Eye Research.

Maps and satellites, eyeballs and oilwells. All "above-average" display requirements. If your needs are ABOVE-AVERAGE, you need a CELCO "above-average" Precision CRT Display System.

(Don't you think so too?)

Call CELCO for your "above-average" CRT Display System.

UPLAND CA 714-982-0215  
MAHWAH NJ 201-327-1123  
(average is so . . . ho-hum to us.)

CONSTANTINE ENGINEERING LABORATORIES COMPANY  
1150 E. Eighth Street, Upland, CA 91786

70 Constantine Drive, Mahwah, NJ 07430





# the 'best buy' counters are here!

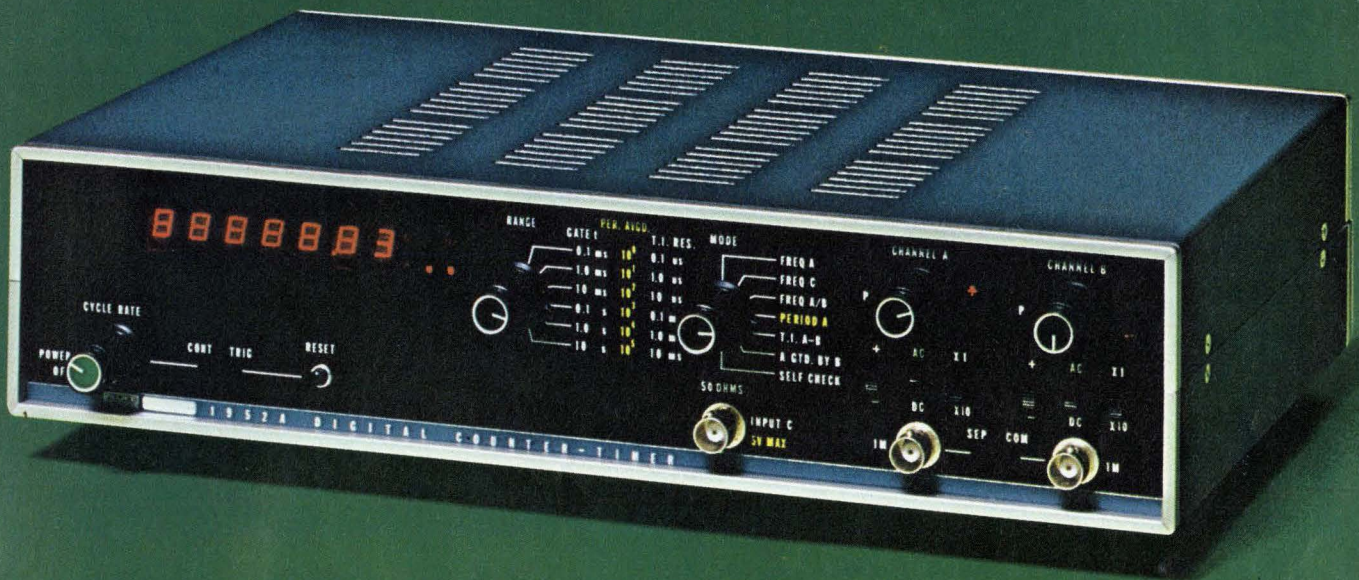

Now is the time for all of us to carefully consider every purchase.

For instance, if you are planning to purchase a new counter/timer, we invite you to take a flinty eyed look at the new Flukes. Nowhere in the entire market place are there better buys. Nowhere will you find a counter line where owner benefits are constantly raised and at the same time owner costs are being lowered.

Take our Model 1952 for instance. Here's an instrument which counts from DC to 80 MHz or 515 MHz optionally. It offers 50 mV sensitivity. It provides six functions: 1. frequency, 2. frequency ratio, 3. single period, 4. multiple period average, 5. time interval measurement, and 6. gateable totalize. Read-out is 7-digit LED or optionally 8 and 9 digits. Matched input channels feature full control of coupling, slope and trigger level. Features include units annunciation, overflow, gate and trigger level status lamps. Optionally you can add BCD output and a TCXO with improved temperature stability. Yet the base price is only \$695. Add every option we've got and you're still under \$1400.

Or look at our Model 1980A VHF/UHF Telecommunications Frequency Counter. Here's the precision instrument to service



mobile land, sea, and air communications systems quickly, accurately. Measure frequencies in the field or in the lab from 5 Hz to 515 MHz with a sensitivity of 50 mV over the entire range. Read frequency from a 6-digit LED display. For total portability, add a snap-on battery pack for completely portable operation with up to 5 hours continuous use. And the cost of this little gem is only \$795. Add all of the options and you're still under \$1200.

Then there's our blue plate special, the full five function Model 1950A. Measure frequency, frequency ratios, single periods, multiple period averages, or totals. Features include 6-digit LED display with automatic annunciation, variable trigger level control with status lamps and a switch selectable input attenuator. For field use, remember the instrument weighs only 5 pounds and will operate from 12 vdc.

Optional features include BCD output and TCXO for super stability as well as full accuracy. Price of the basic unit is just \$445. All the options are less than \$300 more.

So you see, the Fluke counter attack has been launched with a vengeance. Perhaps you should join our army.

In the continental U.S., dial our toll free number 800-426-0361 for the name and address of your nearest local source. Abroad and in Canada, call or write the office nearest you listed below, John Fluke Mfg. Co., Inc., P.O. Box 7428, Seattle, Washington 98133. Phone (206) 774-2211. TWX: 910-449-2850. In Europe, address Fluke Nederland (B.V.), P.O. Box 5053, Tilburg, The Netherlands. Phone 013-67-3973. Telex: 844-52237. In the U.K., address Fluke International Corp., Garnett Close, Watford, WD2 4TT. Phone, Watford, 33066. Telex: 934583. In Canada, address ACA, Ltd., 6427 Northam Drive, Mississauga, Ontario. Phone 416-678-1500. TWX: 610-492-2119.



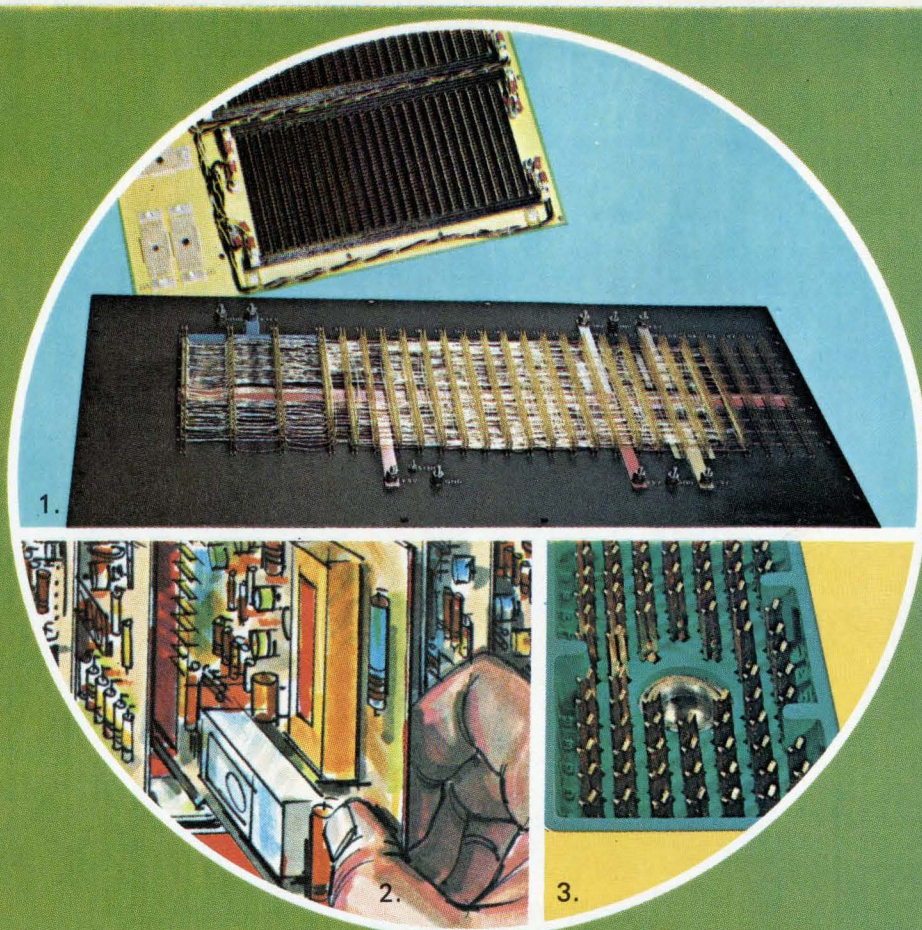

# Elco Helps Solve Three Common Connector Problems

1. SAVE MONEY ON METAL PLATE BACKPLANES.
2. GET COOLER, TIGHTER PC CARDS.
3. DOUBLE CONTACT DENSITY, 1/2 THE PRICE.

1. Cost saving backplanes — wire wrapped for you . . . to your specs. Elco offers more variations of metal plate backplanes — card edge, blade and tuning fork and other two-piece connectors. Like Series 5420. With fork and blade connectors: single, doubles, males, females. All with .025" square posts on .100", .125" or .150" centers. And squared and offset grids. Also ground voltage plane systems to meet just about any electrical requirement. We'll wire wrap your backplanes, too.

2. Keep tightly packed PC cards cooler . . . with a Varipak® II modular enclosure system. They take up to 41 cards and connectors in a row. With ample open space for cooling air to flow between them. The Varipak II system is available in 32 standard models. With an almost infinite variety of configurations. All off our distributor's shelf for immediate delivery.

3. Get twice the contact density . . . at about half the cost. With Elco's new I/O rack and panel and cable-to-cable connectors (Series 8026) that feature contact spacing on .100" and .125" centers. Available with 33, 75 and 117 crimp contacts on a .100" grid.

With 55 and 79 contacts on a .125" grid. Automatic wire wrappable contacts for metal plate backplanes also available. All use new Varicon™ low withdrawal force contact (MIL-C-55302 type). Equal or better quality than pin-and-socket counterparts at much less cost.

For full details on better packaging, contact your local Elco representative or distributor, or:

Elco Corporation  
Willow Grove, Pa. 19090  
(215) 659-7000

Elco Corporation  
2200 Park Place  
El Segundo, Calif. 90245  
(213) 675-3311



Operations in USA, Australia, Belgium, Canada, Denmark, England, France, Germany, Israel and Japan. Sales offices throughout the world. In Europe, Elco Belge, 77 Blancefloerlaan, Antwerp, Belgium, Tel. 03-190064. In the Far East, Elco International, TBR Building, 2-10-2 Nagatacho, Chiyoda-ku, Tokyo 100, Japan, Tel. 580-2711/5. Copyright © 1973 Elco Corp. All rights reserved.

# Probing the news

Analysis of technology and business developments

## Postal R&D adjusts to reality

That's what the Postal Service says as it once again changes its automation targets, but some suppliers are skeptical

by William F. Arnold, Aerospace Editor

The U.S. Postal Service discovery that it can't simultaneously automate handling of both letter and package mail has served to kill for now the old letter-mail portion of the much-heralded multibillion-dollar program to put electronics to work delivering the mail [*Electronics*, Nov. 6, 1972, p. 67]. Although this is bad news for electronics companies expecting large contracts in the near future, it looks like good news in the long run.

What the service has in mind is expected to be explained to industry at a briefing scheduled in February. Alden J. Schneider, assistant postmaster general for research, says: "The R&D program is now adjusted to reality. We now know the difference between what we'd like to invent and what we can invent." He and other postal officials say that the highly automated bundle of sorters, cullers, encoders, and readers under test at the Cincinnati operational test bed were being pushed into development too fast and now will be re-evaluated. Those that warrant further development will be continued, and those that don't will be redeveloped. This means that the service:

- Intends to complete its evaluation and testing for a full automated letter-mail-processing system by the end of 1975, when it should be ready to begin planning full deployment. Some equipment that meets specifications could be installed before then, however.

- Is thinking about a competitive "flyoff" between U.S. and foreign equipment, notably code desks. The service may buy the best available for the price, declares Schneider, who was impressed by ITT and Tele-

funkon mail equipment he saw in Belgium, Sweden, and West Germany during a recent swing through Europe. He was so impressed that he's been sending sacks of "dead" letters to see if the equipment can handle them. If the foreign equipment can, it will be tested along with U.S.-manufactured gear during Postal Service evaluations toward the end of the year, Schneider says. A culler from Toshiba of Japan already is under test.

- Plans to build a 100,000-square-foot operating test site at its Rockville, Md., laboratories to test devel-

opmental equipment by processing mail diverted from the Washington, D.C., area.

- Wants to start a \$100 million demonstration system for electronic mail transmitted by satellite. A top-side decision is expected in a few weeks, but logic indicates that digital mail is the only way to stem the rising tide of paper mail engulfing strained postal facilities. The goal would be to create within 10 years a six-city system that could transmit color images with the quality of pictures in *National Geographic* magazine across the country within two

### Industry vs Postal Service

In words that are sure to inflame already disgruntled potential contractors, U.S. Postal Service R&D chief Alden J. Schneider declares flatly that "American industry is not hungry" for contracts. "In the 14 months that I've been here, no one from an electronics company has called on me" to discuss what the service might need or offer ideas.

But the companies see it another way. Here are some thoughts on the subject from a manager at a large U.S. firm developing equipment for the Postal Service's research and engineering group: "The big challenge for us is to find out who's in charge and make him believe he has the authority to do something. Things have been in a tizzy for over a year—all their programs have been hurt. We're still anticipating something good out of it, though, and we're going to hang in there."

And a man within the postal headquarters itself says the research and engineering group is in a "turmoil—they don't know what to do since they dropped the letter-code mail-sort system."

Schneider asserts that mainframe manufacturers, for example, should realize the advances in minicomputer technology and offer suggestions about networking the smaller computers. Other ideas that companies might have advanced are electronic mailboxes and stamp machines that would signal when they're inoperative or empty, he says.

Schneider snorts that the problem with most vendors is that they're more intent on "trying to sell you what they have instead of listening to what you need." Even "when we throw them out of here the third time, they still don't get the message," he says.

Schneider, a chemical engineer and retired Army officer, has been executive vice president for marketing with the Mobay Chemical Co., Pittsburgh, Pa., and vice president and general manager for consumer service, fine papers, and forest products at the American Can Co.

---

## Probing the news

---

minutes, Schneider forecasts.

Even if these new plans anger or unnerve U.S. contractors—some of whom are thoroughly disenchanted with the Postal Service—postal officials stress that the agency is on a new competitive course. Its own market surveys indicate that it will have to offer reliability and error-

## Not quite

Besides the advanced optical character reader (see story), postal officials maintain that many electronic/mechanical developments aren't quite up to speed because they can't operate continuously in the real postal world. For example, these officials point out that the prototype automated carrier sequencers—one by IBM at the Rockville, Md., labs and another by Burroughs at Cincinnati—work fine with neat mail in the laboratory, but jam when they handle bent or frayed real mail.

Sometimes the problems are mechanical. The service has requested Burroughs to fix an older-model single-position letter-sorting machine. It has been brought in for a redesign of the pin anchoring one of many diverting



Electronics abroad

## Dutch space computer to be busy

18-pound machine from Philips to control attitude, run experiments, and store data aboard Astronomical Netherlands Satellite

by John Gosch, Frankfurt bureau

When the Dutch launch their astronomical satellite in September, the attention of scientists and aerospace experts will most likely focus on a small on-board black box because success of one of Europe's most ambitious scientific space missions to date depends on its performance. The so-called Astronomical Netherlands Satellite (ANS) will carry an 18-pound Philips computer that will handle a variety of functions that once would have needed a much larger system.

The tasks are part of a six-month space mission with three scientific experiments. One is to measure the brightness of a large number of stars in the ultraviolet range of the spectrum to extend the existing classification of stars. Another calls for investigating pulsars and measuring

the radiation from so-called "soft" X-ray sources with wavelengths from 2 to 55 angstroms. The third experiment is to measure "hard" X-rays at 0.3 to 6 Å. The three experiments will be carried out for the Dutch universities of Groningen and Utrecht and for the U.S.-based Massachusetts Institute of Technology. The satellite also is to help Dutch companies develop an industrial aerospace capacity.

The computer will control the attitude of the spacecraft to within one minute of arc—no small feat with a three-axis-stabilized space vehicle weighing only 300 lbs.

In addition, the computer will store the observation programs for several on-board experiments and collect and process their data. It also will retain the attitude, house-

keeping, and scientific data for specific periods and dump it on command, as well as provide the clock signals for the satellite's experiments, telemetry equipment, and other subsystems.

The \$25 million ANS, which is part of the Netherlands' national space program, was developed by the aerospace firm Fokker-VFW and Philips Gloeilampenfabrieken, Europe's largest electronics company. The ANS is scheduled for midsummer delivery to the Western Test Range at Vandenberg Air Force Base, Calif., where it will be launched atop a Scout rocket into a 300-mile near-polar orbit.

**Ground control.** To keep project costs within specified limits, Dutch space officials decided to control the satellite from only one ground terminal. This means that the ANS must carry all measurement programs and the observation data for 12 consecutive hours before contact with the terminal is established. Not only that, but the demand for some 100 observations during these 12-hour periods requires storing the experimental results and the commands for operating the satellite and the scientific instruments when there is no ground contact. This calls for a computer with a large memory capacity.

Also, since the attitude control subsystem has to make calculations and logic decisions, a processing capability is needed. And because the computer also must be capable of adapting the mission to new celestial discoveries that might be made, it must be programmable. Finally, it must meet tight weight and space limitations.

As G.J.A. Arink, Philips subsys-

**Keep 'em flying.** This 18-lb computer was developed by Philips to fly aboard the Astronomical Netherlands Satellite. It will handle data from experiments and control the satellite.

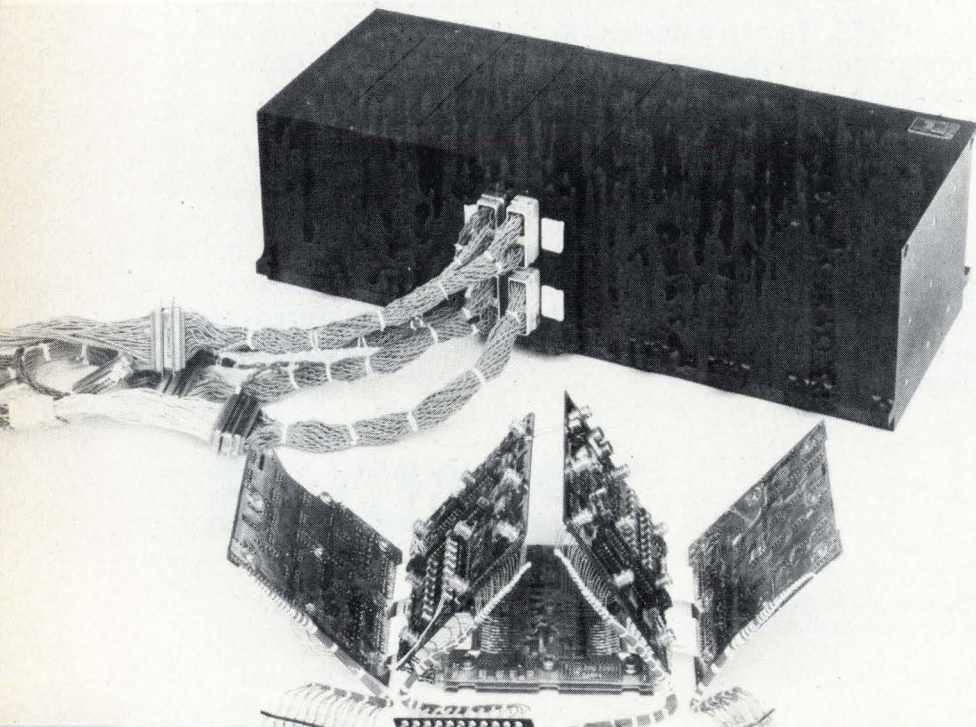

# The digital world is a COS/MOS world.

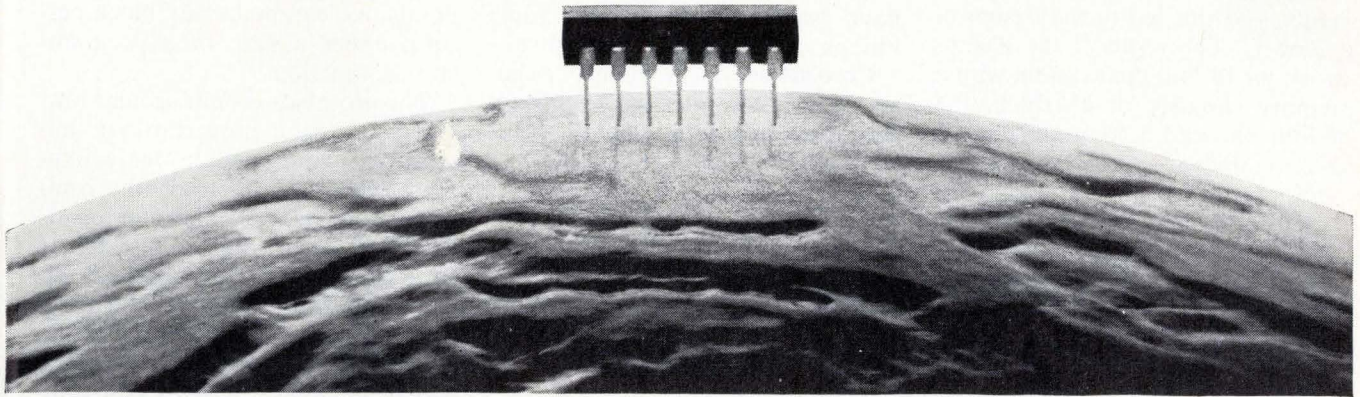

RCA COS/MOS widens your world of digital applications. It offers a combination of features that can't be matched by other digital technologies.

Features like ultra-low power consumption... 10 microwatts per gate! This permits high chip-packing density, use of small power supplies, and a money-saving reduction in cooling requirements.

So COS/MOS is ideal for battery-operated equipment. No longer do you need to be tied down by the power cord.

COS/MOS circuits work great from 3 to 15 volts. That means you can use inexpensive power supplies without fancy regulators. You can use long wires and simple low cost P.C. boards without worrying about signal attenuation.

COS/MOS noise immunity is among the highest of any technology (typically 45% of supply voltage), making it suitable for use in high noise environments such as the automotive and industrial control industries.

The stable transfer character-

istics of COS/MOS typically change less than 3.0% over the full military temperature range. So you can place COS/MOS circuits just about anywhere without worrying about them being overheated.

And you get more system cost effectiveness in the broad selection of COS/MOS circuits: from simple gates like the CD4011 Quad NAND to highly complex functions like the CD4057 Arithmetic Logic Unit.

Let RCA, originator and the world's largest producer of the industry standard CD4000 Series, introduce you to the world of digital COS/MOS. We believe you'll soon be convinced that RCA COS/MOS is the best answer for your digital system designs.

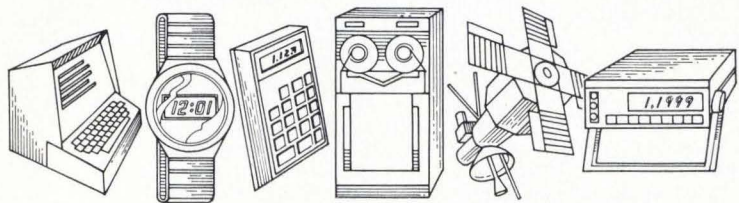

Send for complete data packet, including the new 1973 COS/MOS Product Guide. Write: RCA Solid State, Section 70J-25A, Box 3200, Somerville, N.J. 08876. Or phone: (201) 722-3200.

**RCA** Solid State  
products that make products pay off

International: RCA, Sunbury-on-Thames, U.K., or Fuji Building, 7-4 Kasumigasaki, 3-Chome, Chiyoda-Ku, Tokyo, Japan. In Canada: RCA Limited, Ste. Anne de Bellevue 810, Canada.

## Probing the news

tems manager for the ANS computer, points out, "None available at the time our project was started in 1970 could meet the ANS requirements, and this led to the design of our own." The result of the Philips effort: an 18-lb digital system with a memory capacity of nearly half a million bits and a computer only a

third of a cubic foot in volume that operates on less than 8 watts. By contrast, aerospace computers existing at the time the Dutch project was started were twice as heavy and consumed up to 50 w, Arink says, emphasizing that better computers have been developed, even while Philips was working on its version.

**Core memory.** The Philips designers chose a core memory to prevent loss of stored information in case of

a temporary power failure. Of modular design, the memory consists of seven identical blocks, each with a capacity of 4,096 16-bit words. Six of the blocks are for data storage, and one is for the programs. A signal from ground control, Arink points out, can make any block perform either a data or a program-storage function.

The processor is built around low-power transistor-transistor-logic microcircuits and medium-scale integrated devices. All in all, the computer uses 160 ICs. The memory is designed with 20-mil lithium-ferrite cores that come from Philips' Elcoma division. Amperex, the company's U.S. subsidiary, supplies the X and Y driver-group selectors, which are hybrid circuits. Two dc-to-dc converters deliver +16 v and -5 v to a three-module and a four-module memory group, respectively.

Each of the computer's memory blocks consists of a four-wire, 3-d core-memory stack, the associated X and Y drivers, sense amplifiers, and the inhibit-driver circuits. The centralized circuitry of the timing and decoding logic for the memory serves all seven blocks.

**Attitude control.** One of the most complex functions the computer must perform is that of digital attitude control. For this, it must interface with the satellite's various sensors, actuators, and the attitude-control logic. The logic first points the satellite so that the sun is inside the field of view of the sun sensors. Using data from the horizon, star, and sun sensors and from the hard X-ray experiment, the computer then calculates the points to set the torque on the reaction wheels for each of the satellite's three axes. This calculation is made in one of six fine-control modes.

The horizon sensor measures the direction of two lines tangential to the earth's surface with respect to the satellite's X-axis. From these measurements, the computer determines the angle between that axis and the direction to the center of the earth. On the basis of this information and the outputs of the fine sun sensors, the computer calculates once a second the torque setpoints corresponding to certain attitude-control modes. □

# Our new IC Op Amp Tester is a cheap little know- it-all.

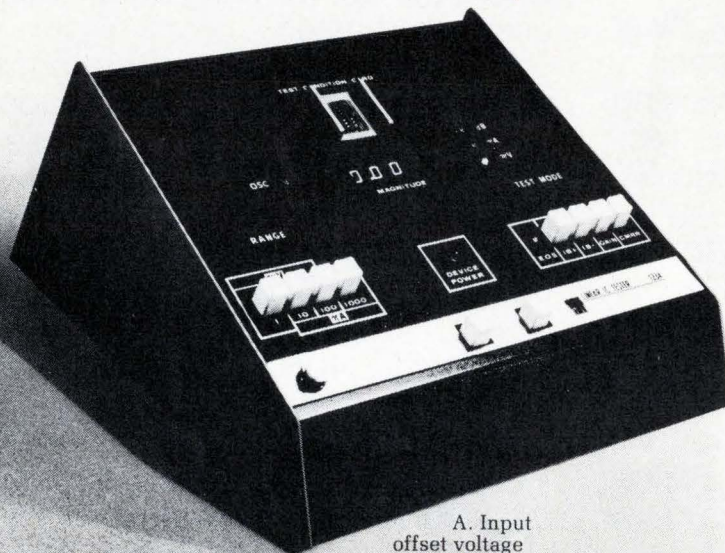

- A. Input offset voltage (Eos).
- B. Bias current, inverting input (IB-).
- C. Bias current, non-inverting input (IB+).
- D. DC open loop gain.
- E. DC common mode rejection ratio (CMRR).
- F. Oscillation detection.

All you really need to know about our New Model 1234 IC Op Amp Tester is that it costs less than \$700 and is smart enough to do the following:

1. Test virtually all IC op amps, monolithic and hybrid, in DIP and TO-5 configurations with or without plastic carriers.

2. Perform the six most important measurements previously accomplished only by testers costing at least three times as much. These are:

Now you can't afford NOT to weed out your incoming disasters and sort your devices by accurate test results.

Write for the complete information on this new tester, our companion instrument to the Model 1248 functional tester for digital ICs. Electro Scientific Industries, 13900 NW Science Park Drive, Portland, Oregon 97229, Phone (503) 646-4141, Telex 36-0273.

**esi**  
ELECTRO  
SCIENTIFIC

Openings:  
Application Engineers,  
Product Manager.



# Linear COS/MOS... RCA's CA3600E premieres

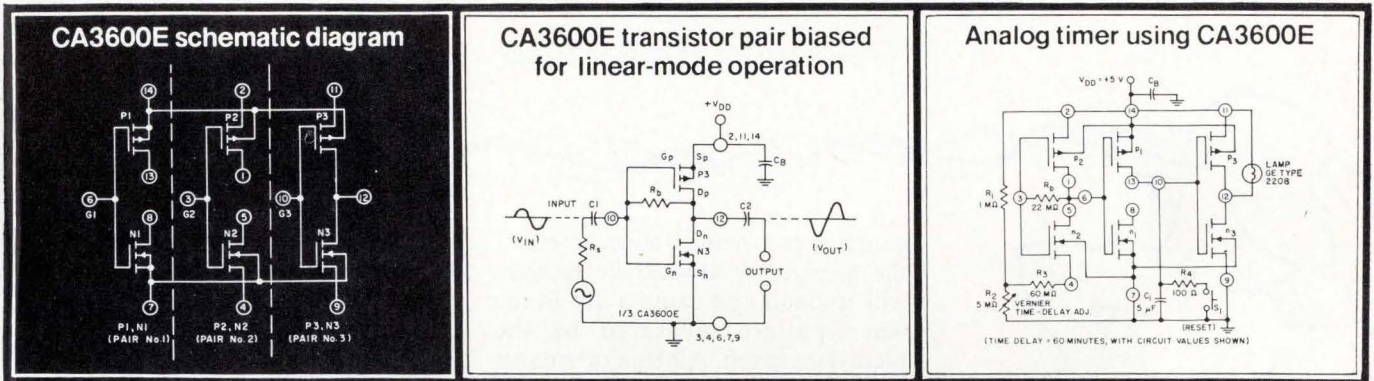

Meet the linear IC with the advantages of COS/MOS. The new RCA CA3600E Transistor Array... three pairs of complementary enhancement-type MOS (p-channel/n-channel) transistors on a single chip.

The CA3600E is designed for a great variety of applications requiring virtually infinite input impedance, wide bandwidth, matched characteristics, lower power consumption and general purpose circuitry.

And that's not all. With the new CA3600E you get performance advantages that include square-law characteristics, superior cross-modulation performance, and a greater dynamic range than bipolar transistors.

Whether you're working in timing, sensing and measuring or any other applications, or if you're tired of fighting beta variation in your bipolar circuit, let your "linear" imagination run wild. The features offered in the new CA3600E COS/MOS Linear IC

are too good to pass up.

- Virtually infinite input resistance/100 gigohms
- Each transistor rated for operation up to 15V and 10 mA
- Low gate-terminal current/10 picoamps
- No "popcorn" (burst) noise
- Matched p-channel pair/gate-voltage differential ( $I_D = -100\mu A$ ) ...  $\pm 20mV$  (max)
- Stable transfer characteristics over a temperature range of  $-55^\circ C$  to  $+125^\circ C$
- High voltage gain/up to 53dB per COS/MOS pair.

Supplied in the 14-lead dual-in-line plastic package, the CA3600E is available in production quantities from your local distributor or direct from RCA.

For complete data sheet/application note write: RCA Solid State, Section 70K-8, Box 3200, Somerville, N.J. 08876. Or phone: (201) 722-3200.

**RCA Solid State**  
products that make products pay off

International: RCA, Sunbury on Thames, U.K., or Fuji Building, 7-4 Kasumigaseki, 3-Chome, Chiyoda Ku, Tokyo, Japan. In Canada: RCA Limited, Ste. Anne de Bellevue 810, Canada.

Parapsychology

# ESP: cause for serious thought?

Using electronics to explore mental mysteries, researchers are beginning to think about the next step—applications

by Gerald M. Walker, Associate Editor

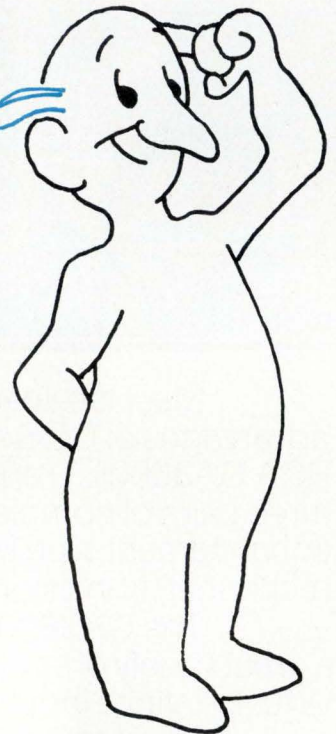

stimulus is a name known to either the receiver or sender, the receiver will respond and cause a dip in the wave pattern measured by the plethysmograph. A blank or a name unknown to either should produce no change in the base-line pattern. In this way, experimenters hope to establish communications with a "dot" (dip) and "dash" (steady) message pattern of a pen recorder. It's slow, but the method has achieved 67% accuracy with as many as three or four participants.

This experiment, conducted at Newark College of Engineering, Newark, N.J., is only one of many now taking place in this country and abroad. Their aim is to understand and eventually apply ESP. The ever-growing pile of documentation resulting from such scientifically controlled investigations in the last few years has made ESP a respectable topic in scientific circles and has begun to attract engineers.

The nation became aware of this change when NASA, certainly not given to frivolous public demonstrations, conducted an ESP experiment with an astronaut in space. And for another indication of respectability, engineers attending the IEEE Intercon in New York next month will receive first-hand information on ESP at a technical session. Although there's no doubt about the seriousness of these efforts, the question remains: are the results useful?

**Critics.** On the one hand, critics still maintain that it's impossible to develop a science—much less practical engineering development—out

**A man wearing** a finger plethysmograph, an instrument used to record pulse changes, waits quietly in a locked room. Inside another room in a building an eighth of a mile away, a second participant holds a stack of file cards with names written on them.

The two are about to begin an experiment to establish a primitive form of mental communication, a Morse Code tapped out by extrasensory perception (ESP) rather than a telegraph key. Some of the names on the file cards are sensitive to the receiver—they're friends and relatives—and some are sensitive to the sender. The remainder of the cards either have names selected at random from a telephone directory or are simply blank.

At the appointed time, the sender concentrates on the name written on each card. The idea is that if the

of phenomena that cannot be measured or controlled reliably. On the other hand, there's a tendency on the opposite side to confuse ESP with the recent fad for the occult or supernatural, causing many persons to believe anything, so long as it provides the kicks associated with magic. The IEEE/parapsychology session may help answer the skeptics and, at the same time, shake off what one researcher calls the "creative overbelief" of the faddists.

First of all, what is parapsychology? Murlan S. Corrington, principal member of the engineering staff at RCA's Advanced Technology Laboratories, Camden, N. J., an ESP avocationist who organized the IEEE panel, calls parapsychology "a science concerned with the investigation, especially by experimental means, of events that are apparently not accounted for by natural law (as

# 1974 solid state databooks

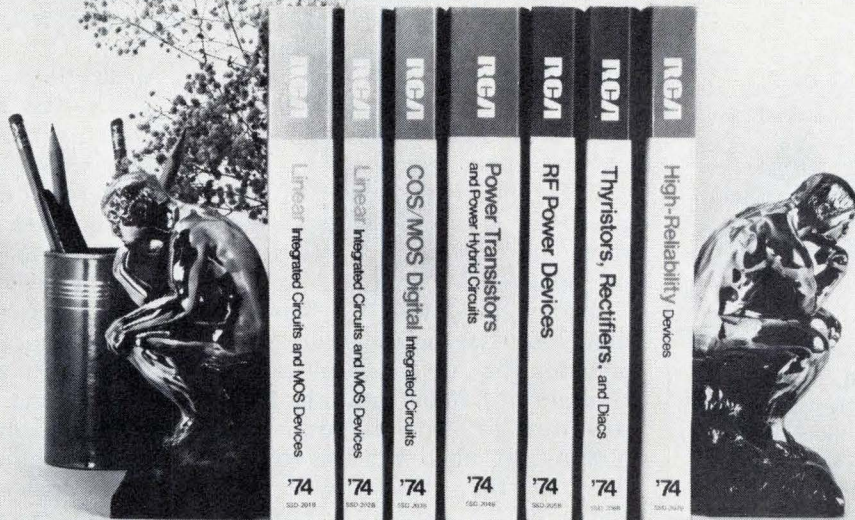

## Your guide to state-of-the-art in RCA Solid State devices.

Get off to a fast start in 1974 with RCA's Solid State DATABOOK Series. You'll find the new seven volume series an invaluable desk reference... with all the technical data you need about RCA devices at your fingertips.

The new Solid State DATABOOK Series has been expanded, revised, and improved to bring you up-to-date information on all RCA commercial solid state devices through January 1, 1974.

You get the latest Technical Data Sheets and Application Notes on all devices, including digital COS/MOS and linear IC's, power transistors, hybrids, RF and microwave devices, thyristors, rectifiers—and, for the first time, a new volume on RCA "High-Reliability" devices to MIL-STD-883 and MIL-M-38510.

Designed to save you time in locating data, each volume provides a comprehensive subject index with reference to both volume number and page number, and a complete cross-

reference index of RCA development-to-commercial devices. The price of the seven volume set is \$14.00. This includes a subscription to "What's New in Solid State" to keep you aware of all new devices and literature available from RCA in 1974.

Send the coupon along with your check or money order (payable to RCA Corporation). If the coupon is missing, write: RCA Solid State, Section 70-B-7, Box 3200, Somerville, N.J. 08876.

RCA Solid State  
Section 70-B-7, Box 3200  
Somerville, New Jersey 08876

- Please rush my order for the seven-volume 1974 RCA Solid State DATABOOK Series. My cost, only \$14.00.  
 Provide prices for individual DATABOOKS.

Name/Title \_\_\_\_\_

Company \_\_\_\_\_

Address \_\_\_\_\_

City \_\_\_\_\_ State \_\_\_\_\_ Zip \_\_\_\_\_

Enclose payment by:  Check  Money Order

Offer good only in U.S. and Canada. Direct other inquiries to RCA sales offices or distributors.

**RCA Solid State**  
products that make products pay off

# This digital L-C Meter pays for itself!



Priced at only \$550, Systron-Donner's unique digital L-C meter can pay for itself in 60 days. That's because its automatic digital readout saves hours of measuring time. Model 9400 measures inductance from 0.1  $\mu$ H to 100 mH and capacitance from 0.1 pF to 100  $\mu$ F with an accuracy of  $\pm 1\%$ . BCD systems interface is standard.

Applications? Incoming inspection, production testing, component identification, general lab use—to name a few.

Once you use this digital L-C meter you'll swear by it. **So take us up on this offer:**

Yes, I'd like to try your L-C meter for 10 days at no cost or obligation.

Name \_\_\_\_\_

Company \_\_\_\_\_

Street \_\_\_\_\_ City \_\_\_\_\_

State \_\_\_\_\_ Zip \_\_\_\_\_ Phone \_\_\_\_\_

For literature, contact your local Scientific Devices office or Systron-Donner at 10 Systron Drive, Concord, CA 94518. Phone (415) 682-6161.



**SYSTRON-DONNER**

## Probing the news

presently known) and that are considered to be evidence of mental telepathy, clairvoyance, and psychokinesis."

This definition is a large umbrella covering experiments with dreams, use of precognition to solve problems, analysis of energy fields emanating from humans, application of thought to cause such physical responses as throwing a switch, and recently well-publicized attempts to identify emotions in plants.

Although investigations into parapsychology date back to 1884 when the University of Pennsylvania approved a grant to look into "modern spiritualism," it was not until 1969 that the American Academy for the Advancement of Science granted affiliation to the Parapsychology Association. This blessing, together with the realization that the Russians were well ahead of the U.S. in researching these phenomena, has not only pushed ESP into respectability, but interested more universities, research labs, hospitals, and the Government in trying to harness the power of positive thinking.

So far, much of the electronics effort in parapsychology has been tuned toward discovering what ESP is not. "We know that telepathy is not electrical or magnetic energy, and it cannot be shielded," says John Mihalasky, professor and head of the Parapsychology Communication Project at Newark College of Engineering and a speaker at the

IEEE session. "But because we do not entirely understand this energy doesn't mean we cannot use it. After all, we didn't know everything about electrical energy when we first started using it, and we still don't understand electricity entirely. That's why I think the time has come for EES to begin investigating biocommunication, using the engineering approach to open up applications."

**Applications coming?** James D. Beal, a systems engineer from NASA/Huntsville, another IEEE speaker whose interest is primarily in understanding human energy fields and their relation to health, also believes that the time for applications has arrived. For example, he suggests that minicomputers can play a role in real-time feedback to train people to use ESP. Contrary to the popular notion that only certain "gifted" individuals, such as mediums and spiritualists, have ESP, many researchers are convinced that almost anyone can be trained to recognize and use extrasensory perception, although, some are better at perfecting the skill than others. Work at Stanford Research Institute conducted by Russell Targ, for instance, has shown that precognition—foretelling the future by time spans of seconds, minutes, or longer—can be taught. For some individuals it's a matter of spotting a precognitive thought that might otherwise have been ignored. This, in some respects, is what executives who make decisions on a hunch or "gut feel" are doing.

"For hundreds of years, we have

## ESP invades IEEE

Intercon program chairman J.A.A. Raper's interest in plants more or less got the parapsychology session on this year's technical program. Murlan Corrington of RCA, whose avocation is research to explain spiritual faith healing, sent Raper, who is manager of advanced circuits and control for the Defense Electronics division of General Electric's Electronics Laboratories, Syracuse, N.Y., articles on emotions in plants.

Raper, an avid gardener, got interested in plant communication in particular and parapsychology in general. Later, he invited Corrington to organize a panel for Intercon. "My first reaction," Corrington recalls, "was, 'He must be out of his mind.' But after thinking it over, I realized that parapsychology is scientifically respectable and proceeded to put together the panel. It should give engineers a chance to listen and decide if they believe it or not. They'll find that they can't just laugh it off."

Raper adds, "Don't expect to see anyone in a peaked hat or carrying a crystal ball. The only darkening of the room will be to show slides."

# Logic testing breakthrough

the first practical alternative for testing digital cards

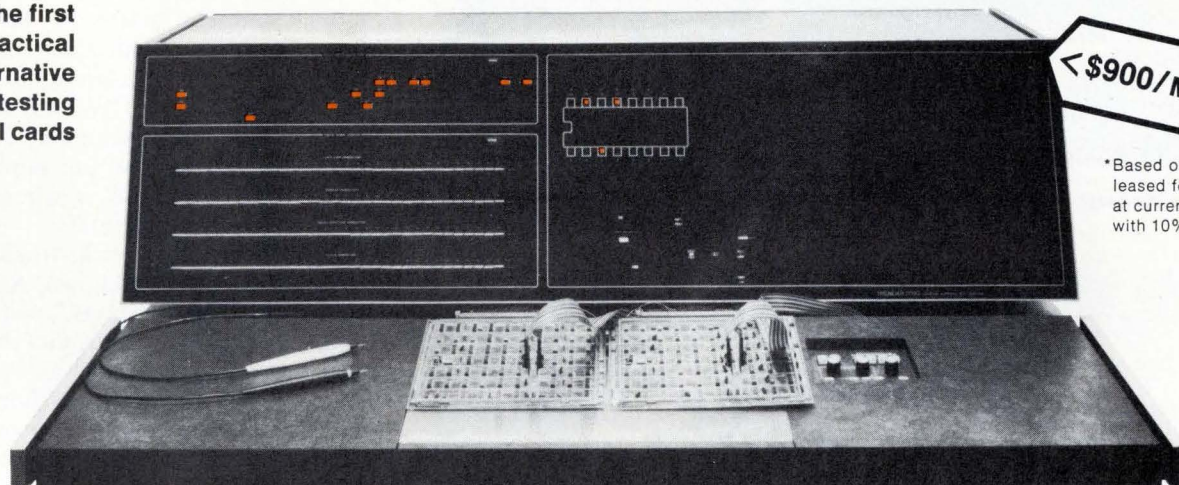

< \$900/Mo.\*

\*Based on \$29,000 leased for 3 years at current rates with 10% residual.

## Why the swing to TRENDAR?

Up to 4,000,000 tests per second . . . circuits are exercised more completely than with any other method. Sequence-dependent faults are triggered because the TRENDAR test station is not memory-limited.

**FAULTRACK® finds faults: single . . . multiple . . . and loop faults that defy software systems.** It is a universal procedure applicable to all digital logic troubleshooting. Faults leave a track: abnormal logic states are sensed and displayed automatically by the TRENDAR 2000 Test Station. Eight FAULTRACK aids include comparative I/O test, comparative IC test, logic states monitor, in-circuit IC test, race catching probes, variable clock rate, and differential propagation delay test.

**Result No. 1 . . . more boards per hour than with any other commercial tester.** Users report a 10X increase in productivity per man-hour.

**Result No. 2 . . . higher confidence level in the tested board.** Users report 90% reduction in final-product test board rejects, and corresponding major reduction in field service problems caused by board marginalities.

Get the TRENDAR story today. Contact your local Fluke TRENDAR representative or call Noel Lyons at 415/965-0350. Demonstrations are available in your region. Our users are our references. Ask about them.

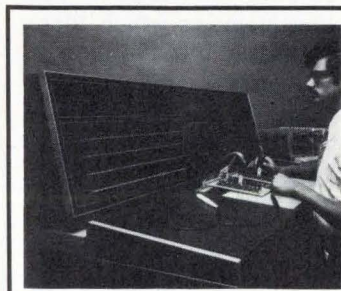

**LOGICESTER™ Centers Operating**  
LOGICESTER board testing centers are operating in the West, Midwest, and East. They perform commercial test and repair services at low cost . . . and provide contract support for TRENDAR users. Ask about them.



The **TRENDAR 1000 LOGICESTER™** is a program compatible portable tester for use in factory and field. Priced at \$5975, it provides the full 4,000,000 per second test rate of its big brother.

**FLUKE**

**TRENDAR**

® subsidiary of John Fluke Mfg. Co., Inc.

500 Clyde Avenue, Mountain View, California 94043 • 415 / 965-0350 TWX 910-379-6573

Europe, Fluke (Nederland) B.V., P.O. Box 5053, Tilburg, Netherlands, Tel. 013-673973. Telex 52273.

U.K., Fluke International Corp., Garnett Close, Watford, WD2 4TT, Tel. Watford (0923) 33066, Telex 934583

Circle No. 181 for TRENDAR 2000/1000. No. 182 for LOGICESTER™

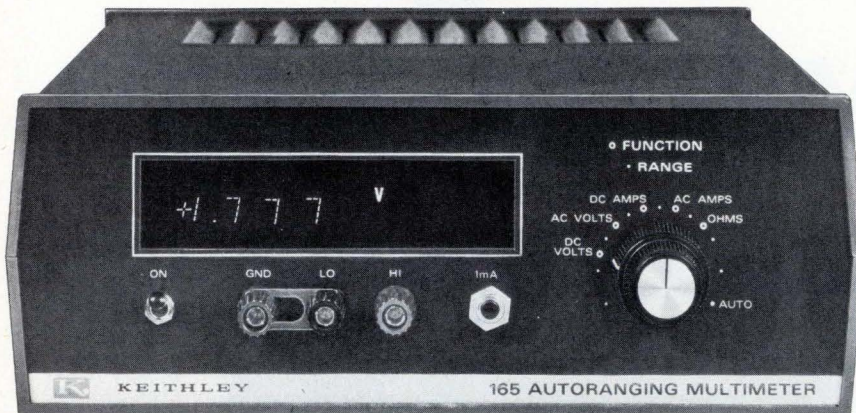

# NEW...

## 5-Function DMM gives 32 automatic or manual ranges of measuring power.

The new Keithley Model 165 Autoranging Digital Multimeter...virtually a complete test bench in a box. This unique DMM gives you more measuring power over wider limits than any comparable instrument:

- 10  $\mu$ V to 1000 V dc
- 10  $\mu$ V to 500 V rms ac, 20 Hz to 20 kHz
- 10 m $\Omega$  to 200 M $\Omega$
- 1 nA to 2 A dc
- 0.1  $\mu$ A to 2 A rms ac, 20 Hz to 20 kHz
- 50 amps ac and dc with optional shunt

But that's not all. The 165 is fully autoranging and it boasts a fuseless solid-state overload protection that really protects! There's more features you'll like — such as a low (10 mV) input drop on amps; 100 millivolts applied to the unknown on ohms; and...a built-in 1 mA current source that will turn on diode junctions so you can measure both forward and back resistances.

You'll really like the measuring power that the Model 165 gives you — all for the little price of only \$495...get complete data or a demo now.

**KEITHLEY**  
INSTRUMENTS  
U.S.A. 28775 AURORA ROAD, CLEVELAND, OHIO 44139  
EUROPE: 14, AVENUE VILLARDIN, 1009 PULLY, SUISSE

developed the logical, objective side of the human brain," comments E. Douglas Dean, another Newark College of Engineering ESP researcher on the IEEE program. "Parapsychology attempts to develop the intuitive, subjective side, to train people to use telepathic communication," he adds. In his talk, "Channel Capacity for Telepathy Channels," Dean will explain how this form of communication can be measured. "While we've achieved reliability, telepathy is still very slow—about 1 bit per minute." Dean adds, "and this is where we need more development."

**Monitoring.** Beal's talk, "Field Effects, Known and Unknown, Associated with Living Systems," will also point the need for electronics development. Specifically, NASA's Beal believes that monitoring of humans with small, solid-state, noncontact devices, such as MOS field-effect transistors, is of extreme importance in capturing data on body-energy fields. Also, and more difficult, antennas and amplifiers would have to be developed.

Of more direct interest to every EE, Mihalasky's talk will cover use of the subconscious mind to solve problems. He contends that when the average engineer runs out of logical textbook paths to solving a problem, he throws up his hands in defeat. However, research conducted since 1962 in precognition has indicated that another path to solution of such problems may exist in that direction.

Oddly enough, Mihalasky acknowledges, "I'm not a 100% believer in ESP. As an engineer, I'm used to experiments in which there is accurate repeatability—you can hold all variables but one to analyze that one variable. In the soft sciences, like economics or psychology, which involve behavior of people, it's impossible to get this kind of repeatability.

"There are always going to be uncontrolled variables, especially for something like telepathic communications." And he chuckles, "We're not going to put the telephone company out of business for at least 10 years." □

# Improve your hybrid yields with **SINGLE-CHIP TC ZENER CHIPS** from **DICKSON**

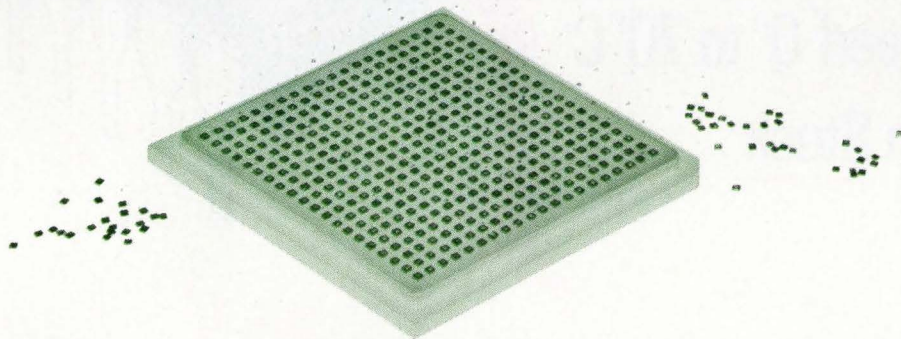

You can now design temperature compensated voltage reference diodes in your hybrid circuits with assurance that temperature coefficients will meet your design requirements. Dickson provides them on a single-chip, 100% tested, to help save time, simplify circuit fabrication and improve your yields.

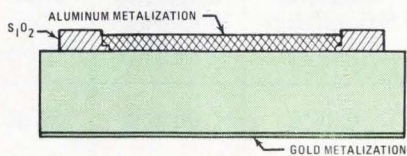

CROSS SECTION OF SINGLE CHIP TC ZENER

Each 37 mil square Dickson chip contains *two totally passivated junctions* with a 6.2 Volt or 6.4 Volt temperature compensated reference. Temperature coefficients to 0.0005%/°C are available. The chips are electrically equivalent to the JEDEC 1N821-829 and 1N4565A-4584A series.

The Dickson chips have gold metalization on the back, compatible with all common die bonding and soldering

techniques. Aluminum metalization on upper surface is compatible with ultrasonic and thermocompression wire bonding.

FOR COMPLETE TECHNICAL INFORMATION contact your local Dickson Sales Representative, or write to Dickson.

AVAILABLE IN ASSEMBLIES, TOO!

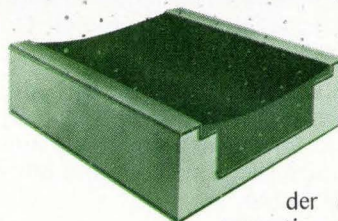

Dickson "single-chip" TC diodes are also available bonded in a ceramic channel for ease of handling and testing. These LID's are available with solder coated runners for reflow

mounting or with gold runners for wire bonding. In addition, Dickson supplies a wide variety of components in chip assembly form to hybrid manufacturers. Ask for details.



**DICKSON**

ELECTRONICS CORPORATION

PHONE (602) 947-2231 TWX 910-950-1292 TELEX 667-406  
P.O. BOX 1390 • SCOTTSDALE, ARIZONA 85252

"Where Quality Makes the Difference"

# LOW COST IC D/A'S...made easy!

8 & 10-bit Models  
Internal Reference  
100% Power Burn-In  
Specs guaranteed 0° to 70°C  
Available From Stock  
From \$9.95\*

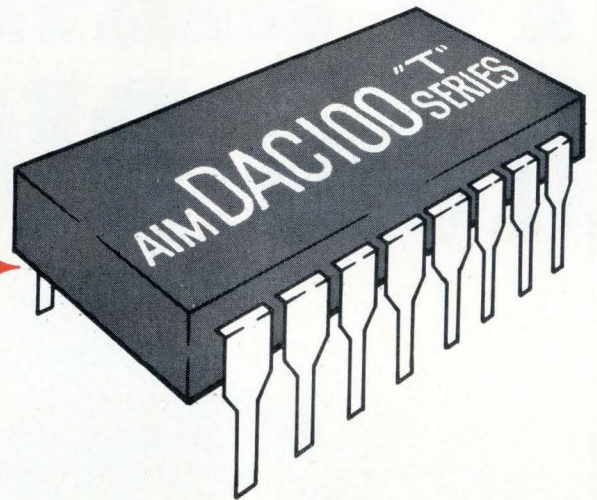

## COMPLETE FAST CURRENT OUTPUT DAC IN A 16-PIN DIP!

At last — an I.C. D/A converter that's easy to apply! The aimDAC 100 series provides its own internal reference voltage for low full-scale tempco and high supply rejection without complex external circuitry — and the fast current output settles in 250ns for use directly in high-speed A/D converters. Need a voltage output? Just add an op-amp — the tracking feedback resistor's already in the package! (Use our monoOP-01 High Speed Op Amp for total settling in less than 1.0 $\mu$ sec!)

Every aimDAC 100 guarantees its critical linearity and tempco over the entire 0° to 70°C temp range — and all devices are 100% burned-in for maximum stability and reliability. Military temperature range models and MIL-38510 processing are available, too.

Best of all, aimDAC 100's are available from stock — try one and see how easy I.C. D/A conversion can be!

\* 100 pc. quantity

### AIMDAC 100 "T" SERIES

Application	Guaranteed Max. Linearity 0° to 70°C	Guaranteed Max. Tempco 0° to 70°C	Price @ 100 pcs.	Model*
10 BITS	0.05%	60 ppm	\$26.00	aimDAC 100 ACT1(T2)
10 BITS	0.1%	60 ppm	\$17.00	aimDAC 100 BCT1(T2)
8 BITS	0.2%	60 ppm	\$12.00	aimDAC 100 CCT1(T2)
8 BITS	0.3%	120 ppm	\$ 9.95	aimDAC 100 DDT1(T2)

\* T1 models contain internal feedback resistor for +10V,  $\pm$ 5V operation  
T2 models contain internal feedback resistor for +5V,  $\pm$ 2.5V operation



1500 SPACE PARK DRIVE, SANTA CLARA, CALIFORNIA 95050  
TEL. (408) 246-9225 • TWX 910-338-0528 • CABLE MONO

#### AUTHORIZED DISTRIBUTORS

NEW YORK METROPOLITAN AREA Harvey Radio, Woodbury, N.Y.: (516) 921-8700 • NEW ENGLAND AREA Gerber Electronics, Dedham, Mass.: (617) 329-2400 • UPSTATE NEW YORK Harvey Federal Electronics, Binghamton, N.Y.: (607) 748-8211 • NORTHEAST Newark Electronics, Woburn, Mass.: (617) 935-8350 • BALTIMORE-WASHINGTON Whitney Distributors, Baltimore, Md.: (301) 944-8080 • PHILADELPHIA Hallmark Electronics, Huntingdon Valley, Pa.: (215) 355-7300 • MICHIGAN RS Electronics, Detroit, Mich.: (313) 491-1000 • SOUTHEAST Kirkman Electronics, Winston-Salem, N.C.: (919) 724-0541 • EAST CENTRAL Pioneer/Cleveland, Cleveland, Ohio: (216) 587-3600 • Pioneer/Dayton, Dayton, Ohio: (513) 236-9900 • CENTRAL Hallmark Electronics, Elk Grove Village, Ill.: (312) 437-8800 • Minneapolis, Minn.: (612) 925-2944 • St. Louis, Mo.: (314) 521-3800 • TEXAS-OKLAHOMA Sterling Electronics, Houston, Texas: (713) 623-6600 • Dallas, Texas: (214) 357-9131 • SOUTHWEST Sterling Electronics, Albuquerque, N.M.: (505) 345-6601 • Phoenix, Ariz.: (602) 258-4531 • WEST Westates Electronics Corp., Chatsworth, Calif.: (213) 341-4411 • Sterling Electronics, San Carlos, Calif.: (415) 592-2353 • Intermark Electronics, Sunnyvale, Calif.: (408) 738-1111 • Denver, Colo.: (303) 936-8284 • Salt Lake City, Utah: (801) 359-0531 • San Diego, Calif.: (714) 279-5200 • Santa Ana, Calif.: (714) 540-1322 • Almac-Stroum, Seattle, Wash.: (206) 763-2300 • Portland, Ore.: (503) 292-3534.



Avionics

## FAA points to foreign markets

U.S. manufacturers hear that there's money to be made in equipment sales to nations in Africa, Asia, the Pacific—and China

by Williams F. Arnold, Aerospace Editor

Nearly two years after the Federal Aviation Agency launched a program to help U.S. avionics and electronics manufacturers compete in foreign markets by highlighting South America [*Electronics*, Feb. 14, 1972, p. 94], the agency held its second briefing, this time unveiling potential markets in two-thirds of the world, including the Peoples' Republic of China, Asia, Africa, and the Pacific. But, although the briefing for manufacturers' representatives featured juicy lists of instrument-landing systems, radars, and communications systems, it remains to be seen if the FAA joint effort with the Commerce Department and the Import-Export Bank can help U.S. companies crack those markets.

On paper, the attempt looks promising. What the agency gave was a country-by-country breakdown prepared by the International Civil Aviation Organization (ICAO) of civil-aviation requirements to bring each country's air system up to date. Because the figures represent only international requirements and not the domestic needs to match the international requirements, actual dollar values are hard to estimate and may exceed what's indicated, Charles O. Cary, assistant FAA administrator for international aviation affairs, told the meeting. He did, however, figure that the African market alone might be worth \$250 million. In something of a coup, the FAA beat

ICAO in publishing estimates of the requirements in the Asia-Pacific regions.

However promising the effort looks, certain problems face U.S. companies competing abroad. Among them: former colonial countries tend to favor the former colonial power, such as the French-speaking African countries; "a number of countries don't have an effective planning capability" so that "procurement doesn't follow as rapidly as we'd like," Cary says; and internal needs, such as food problems in some African countries, may overshadow avionics programs.

**Financing.** In addition, there are two other big competitive problems. In financing "it's hard to beat soft loans, even when the U.S. company is the low bidder," acknowledged Strauss S. Leon of Commerce's Overseas Business Opportunities division. Foreign-government-backed companies can offer countries 2% long-term loans, whereas the best that the U.S. can provide is 10% down and shorter terms. And, al-

though one U.S. company can compete on one item, it's hard for a consortium of U.S. firms to compete, partially because of antitrust laws, against one foreign company offering a complete line of wares, such as France's Thomson-CSF. Admitting that it was "an uphill fight," Leon suggested that the tack might be to convince foreign governments that U.S. diversity makes its companies a better selection.

FAA Administrator Alexander P. Butterfield told the attendees that he was "personally interested in international affairs" and promoting U.S. equipment abroad. Commenting on the already stiff competition from Europe and Japan, he had said that the "Soviet Union is so obviously reaching out" and that "China soon will be highly competitive." Because of the fuel crisis, "I foresee a shifting of emphasis" from aircraft sales to air-traffic-control equipment and navigational aids, he had said.

A possible market in China intrigued some. In three years, U.S.-China trade has jumped from practically nothing to \$800 million (at 12-to-one in U.S. favor), and Philip T. Lincoln Jr., State Department officer for China, indicated that more trade is likely. Since the country has no all-weather airports, it is interested in building some, he says, noting its purchase of 10 Boeing 707s. But he said it was a "special market" with "special

**Market taking off.** The Chinese People's Republic has bought 10 of these 707s and now finds it must build some all-weather airports.

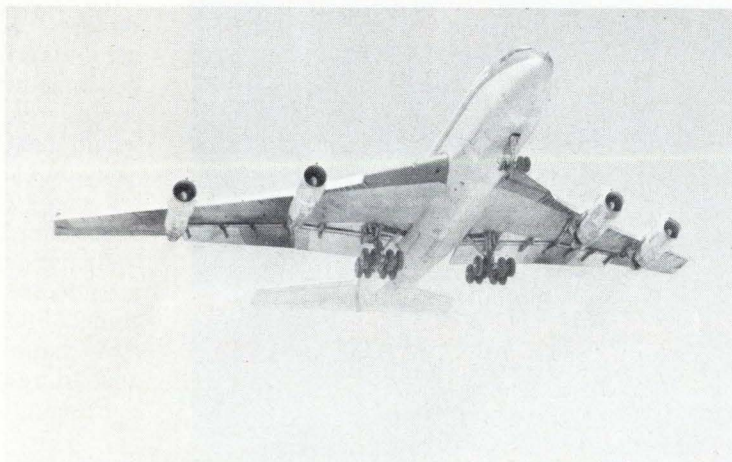

When performance counts!

At  
Eastern Air Devices  
we think custom  
instrument motors  
are as important  
as standards.  
That's why  
we make both.

**HC EAD** Eastern Air Devices, Inc.  
Dover, N.H. 03820 • (603) 742-3330 • TWX: (510) 297-4454

Syn & Ind Motors • Gearmotors • Fans • Blowers

Circle 90 on reader service card

## Probing the news

considerations" where "export-control matters are applicable in some cases."

**Consulting.** To help work their way into a market, Cary suggested that U.S. companies get in on the ground floor as consultants by helping countries develop plans and then selling them to the proper authorities. He mentioned two countries that appear promising. Iran is discussing a possible joint study with the FAA, and Malaysia "has ambitious plans to expand" to help tap its rich store of raw materials. Leon assured the companies that the Government has a new philosophy and that "the embassy teams were there to help U.S. companies" get the "big-ticket products."

Industry reaction to the meeting was mixed but generally skeptical. "I learned there's a market for direction-finding systems in Asia," says Jules Cardon, manager of navigation and meteorological systems for Servo Corp. of America, Hicksville, N.Y., which makes systems used by the FAA. The meeting gave useful industry information about real markets, thought Frank B. Brady, senior staff representative with Singer-Kearfott. "You're here to see what you missed," said William Tull, president of Tull Aviation, Armonk, N.Y. Is there a market? "Sure there is. *When* is the question."

Angrier views were expressed by another trio, Kenneth L. Allen, marketing manager for World-Wide Wilcox Inc. of Vienna, Va., and Michael S. Kinsey, marketing representative, and Eberhard R. Jaekch, area representative with the International division, both of Crouse-Hinds Co., Syracuse, N.Y. "It's just rhetoric," Kinsey declared, indicating that until the Government could do something to make U.S. companies more competitive, firms would feel "the same frustration." They pointed out that Britain's Plessey won a Cairo contract because it could offer 20-year, 2% financing.

At the close of the meeting, each attendee received a packet that included books outlining each country's requirements, and the names and addresses of foreign and U.S. representatives to contact. □

Circle 91 on reader service card →

# 1937-1973



# The Danameter.

## \$195.



### 1 Year Battery Life.

In a digital instrument, you'd expect to fool with a battery regularly, recharging it or replacing it.

Not with The Danameter.

The battery will last you at least one year. And even if you find a way to wear it out, you're only

talking about 69¢.

### Liquid Crystal Readout.

The specifications on the Danameter show at a glance that this is a more accurate instrument than the one it's designed to replace.

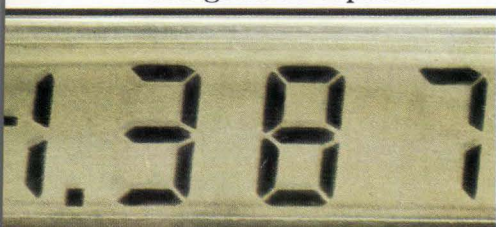

Yet there is another type of inaccuracy The Danameter solves—in an even more dramatic way.

These are the errors that occur every day in reading an analog voltmeter. Scales are hard to separate. Increments of measurement are greatly restricted. Precise readings are difficult to make.

When you measure with The Danameter, you interpret nothing. All you are shown is a number that is precisely the information you require.

It's accurate to a degree that you never imagined possible in an instrument at this price.

Once you have selected the proper function position, The Danameter instantly interprets, selects, and converts your information. It shows in a large liquid crystal display that adjusts to all light conditions. Even direct sunlight.



### Automatic Polarity.

In measuring voltage, you're accustomed to swapping leads to get a reading.

The Danameter instantly determines polarity, and then displays it as either positive or negative. All in a fraction of a second, with no help from you.

### Almost indestructible.

The Danameter has only one function selector. It's recessed behind the molded edges of its cyclac case. You can drop it on concrete. You can kick it down the hall.

When you pick it up, it'll be working perfectly.

It's the first true portable instrument of its kind. For \$195.

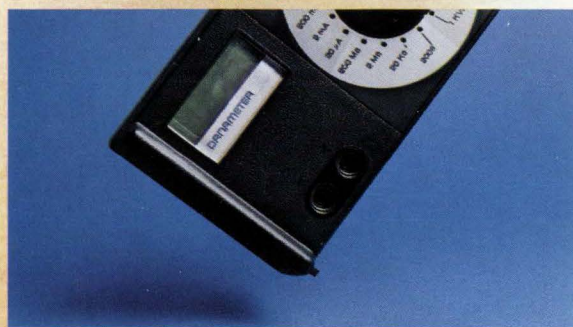

# 1974.



Actual size

## Model 2000 Danameter Specifications

Warranty: 1 year.

Measurement Functions: (4) DC volts, DC current, AC volts and ohms.

Typical Specifications:	
<b>DC Volts</b>	
Ranges	2V, 20V, 200V, and 1KV
Resolution	1mV
Overload protection	1000V DC or peak AC, any range
Accuracy	±(.5% Rdg. + .05% Range)
Polarity	Automatic
Input Resistance	10 Megohms
Normal mode rejection	50 dB min. at or near 60 Hz

AC Volts	
Ranges	2V, 20V, 200V, and 1KV
Resolution	1mV
Overload protection	1000V peak AC, 250V DC, any range
Accuracy	±(1.5% Rdg. + .15% Range) to 5 KHz
Input Resistance	2 Megohms

DC Current	
Ranges	20 $\mu$ a, 2 mA, 200 mA and 2A
Resolution	.01 $\mu$ a
Accuracy	±(1.5% Rdg. + .1% Range)
Overload protection	250V DC or RMS

OHMS	
Ranges	200 $\Omega$ , 20K $\Omega$ , 2M $\Omega$ and 200M $\Omega$
Resolution	.1 ohm
Accuracy	±(2% Rdg. + .15% Range)
Maximum current through unknown	1 mA
Overload	250V DC or RMS

General	
Battery	One 9V dry battery
Est. battery life	1 year at normal usage
Test leads	Included
Size	4"H x 7 $\frac{1}{4}$ "W x 2 $\frac{1}{4}$ "D
Weight	1 lb.
Overload	Fully protected on all ranges

Price	
Model 2000 Danameter	\$195.00

Accessories	
<b>Part No.</b>	
2040	R.F. Probe (to 200MHz)
2030	H.V. Probe (to 30Kv)
2020	Carrying Case
2060	Extra Test Leads

**Contact your nearest Dana representative. Ask him to show you The Danameter.**

Alabama, Huntsville — (205) 534-9771  
 Arizona, Phoenix — (602) 957-9110  
 California, Los Angeles area — (213) 772-7320  
 California, Sunnyvale — (408) 245-3700  
 California, La Jolla — (714) 459-3351  
 Colorado, Denver — (303) 771-0140  
 Connecticut, Hamden — (203) 281-0810  
 Florida, Orlando — (305) 894-4401  
 Illinois, Chicago — (312) 539-4838  
 Indiana, Indianapolis — (317) 253-1681  
 Kansas, Shawnee Mission — (913) 722-1030  
 Maryland, Wheaton — (301) 942-9420  
 Massachusetts, Wakefield — (617) 246-1590  
 Michigan, Farmington — (313) 477-7700  
 Michigan, Kalamazoo — (616) 349-9666  
 Minnesota, Minneapolis — (612) 537-4501  
 Missouri, St. Louis — (314) 567-3636  
 New Jersey, Fort Lee — (201) 224-6911  
 New Mexico, Albuquerque — (505) 255-2330  
 New York, Rochester — (716) 328-2230  
 New York, Vestal — (607) 785-9947  
 New York, Metro New York Area — (516) 487-4949  
 New York, Syracuse — (315) 437-6666  
 North Carolina, Burlington — (919) 227-3630  
 Ohio, Dayton — (513) 278-5873  
 Ohio, Cleveland — (216) 333-5650  
 Ohio, Worthington — (614) 888-4466  
 Oklahoma, Norman — (405) 364-8320  
 Pennsylvania, Pittsburgh — (412) 824-3760  
 Pennsylvania, Blue Bell — (215) 542-1490  
 Texas, Houston — (713) 686-9627  
 Texas, Dallas — (214) 358-4643  
 Texas, San Antonio — (512) 828-0937  
 Utah, Salt Lake City — (801) 272-3861  
 Washington, Seattle — (206) 763-2755  
 Wisconsin, Brookfield — (414) 786-1940

### Canada:

B.C., Vancouver — (604) 732-7317  
 Manitoba, Winnipeg — (204) 475-1732  
 Nova Scotia, Halifax — (902) 455-0670  
 Ontario, Downsview — (416) 638-9218  
 Ontario, Ottawa — (613) 728-4624  
 Quebec, Montreal — (514) 735-4565

### Europe:

B	— Brussels	02-33 96 00
CH	— Mutschellen	05754655
D	— Darmstadt	06151-26661
DK	— Naerum	01-804200
F	— Paris	027 5686
GB	— Luton	582-24236
I	— Milan	02-4982451
N	— Oslo	02-674590
NL	— Baarn	02154-6110
S	— Solna	820410
SF	— Tapiola	90-460 844



**Dana Laboratories, Inc.**, 2401 Campus Drive, Irvine, California 92664, U.S.A.  
 Telephone (714) 833-1234, Teletype 910-595-1136, Telex 678-341

Other countries: Contact DANALAB INT'L Headquarters 119/121 Rue Anatole France, 1030 Brussels, Tel.: 02-41 45 50/Tlx: 23662

# Raster-scan tube adds to flexibility and lower cost of graphic terminal

An ingenious scan-conversion algorithm recasts computer data into a form that drives a raster-scan display in real time; interaction of the display with the computer is also optimized

by Daniel E. Thornhill\* and Thomas B. Cheek,\*\* *Adage, Inc., Boston, Mass.*

□ The graphic display of computer output, particularly in the case of complicated images, is still a costly proposition. On the other hand, TV-like raster-scan tubes and their supporting circuitry are inexpensive. The chief obstacle to their use in computer terminals, however, has been the complexity of converting computer data into the raster-scan signal format.

That obstacle has been overcome by a new approach to graphic terminal design, in which a real-time scan-conversion algorithm keeps to a minimum the amount of local memory the display device needs and also optimizes the device's interaction with the computer. The display device is a raster-scan monitor, which promises great flexibility in system design.

Just as alphanumeric symbols are the normal language elements for text presentation, so pictures of graphic entities are the language elements of mathematics, mechanics, architecture, and many other fields. While some of these elements might be presented as special symbols by an alphanumeric-only generator, or constructed from a small repertoire of "vector symbols" (often called limited graphics), others are too complex in shape and positioning to be so handled. General-purpose graphics—in which a vector can be drawn between any two points in the display field—are the only complete answer.

Several different approaches have been used in building graphic displays (see "The other types of graphic display," p. 97). In some, memories store descriptions of the objects to be displayed (vectors, letters, numerals), while in others, the memories store a series of points that make up the actual image on the display. At first glance, the image-oriented memory seems most suitable for a raster-scan device, but the object-oriented memory turns out to have more advantages.

A simple form of object-oriented memory is characteristic of the most primitive cathode-ray-tube displays used with computers. This memory contains a "display list" of words that are successively addressed to control the CRT beam. Changing any part of the image requires merely the changing of corresponding words in the list.

The image-oriented memory, on the other hand, be-

cause it contains a point-by-point representation of the visual image, is likely to be much larger than an object-oriented memory. Even so, the use of image-oriented memories is convenient in some display technologies, and it has been encouraged by the radical decrease in cost of semiconductor memories in recent years. Small display memories that cost 10¢ a bit a few years ago are now down to ½¢ to 1¢ a bit and still getting cheaper.

Meanwhile, substantial cost reductions and performance improvements have occurred in other analog and digital circuit elements as well. Moreover, the cost per bit for certain display devices with intrinsic storage is still lower, since the memory is not involved in refreshing an image, only in storing it initially. Some of these devices can hold over a million bits, so that for very complex images—an integrated-circuit mask or a surface-contour diagram, for example—storage displays using image memories are best.

But image-oriented memories lack some of the advantages of the object-oriented display list systems—notably the capability of computer interaction with a displayed object. For example, when two objects cross each other, the object memory "knows" that two points are overwritten at the intersection, and it can remove one without disturbing the other. But when stored in an image memory, the intersection data is lost; an attempt to remove the object can unexpectedly change the other, as illustrated in the sequence shown in Fig. 1.

In dynamic display situations, this problem can be

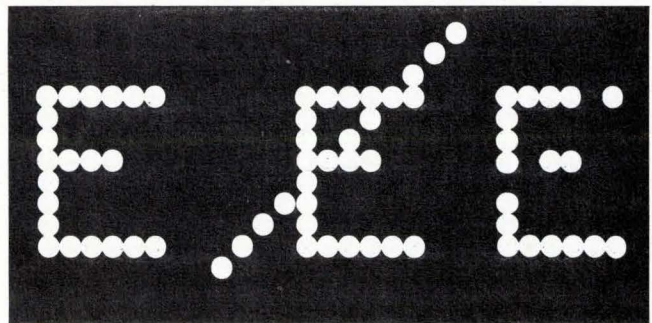

1. **Imperfect image.** If one of two overlapping images is removed from a display driven by an image-oriented memory, the data at their intersections is lost, and only fragments of the second image remain.

\*Now with Softech, Inc., Waltham, Mass.

\*\*Now with Tektronix, Inc., Beaverton, Ore.

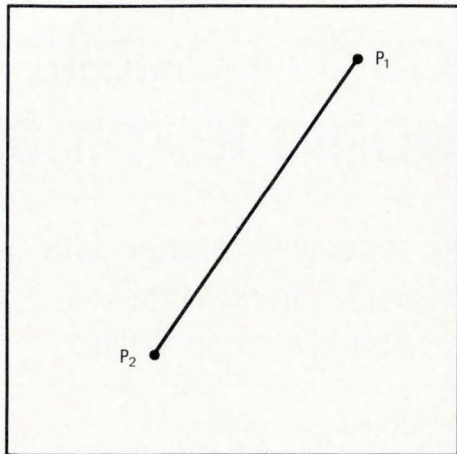

(a)

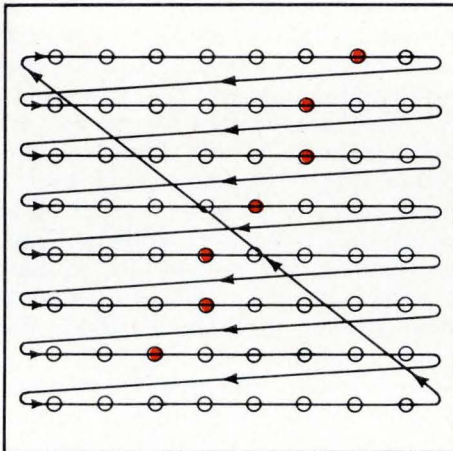

(b)

**2. Scan conversion.** In a raster-scan display, a vector (a) must be converted into a sequence of dots (b). Conversion adds a series of precisely timed intensity pulses to the electron beam so that the dots are properly placed. (On an actual screen, adjacent dots overlap slightly, so that the line appears to be continuous.)

devastating. For example, to show an airplane moving over a background map, the plane outline is commonly drawn, erased, and redrawn slightly displaced to show movement. For object-oriented representations, this procedure is straightforward, because the lines making up the airplane and the map are stored independently; but for the image-oriented representation, when the airplane outline overlaps the points defining the map, it progressively erases its path across the map. The computer can compensate for this effect, but only at considerable processing expense.

A similar problem is found when data is to be read back from the memory. Characters and vectors in an

**INITIAL DISPLAY LIST**

START IN 1A  
DRAW VECTOR TO 3A  
START IN 2A  
DRAW VECTOR TO 2B  
START IN 3B  
DRAW SYMBOL "A"

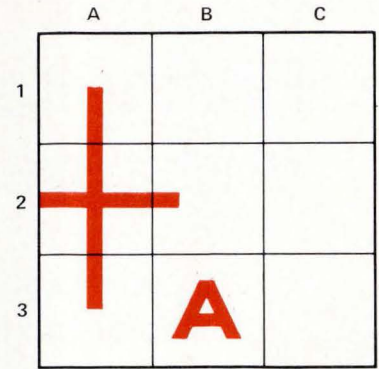

**REFORMATTED DISPLAY LIST**

VECTOR 1A  
SKIP TO 2A  
VECTOR 2A-1  
VECTOR 2A-2  
VECTOR 2B  
SKIP TO 3A  
VECTOR 3A  
SYMBOL 3B

**3. Memory representation.** In a programmed-path display, the display list at top left describes the picture. But when the picture is overlaid with the simplified cell structure shown here, the display list is reformatted, as on the bottom left. Items 2A-1 and 2A-2 distinguish between the two different display components in cell 2A.

image memory are only collections of dots, difficult to recognize as single entities, and often impossible to identify uniquely; they provide no indication that they belong together. Therefore, if interaction is needed, there must be a secondary memory to store a display list. To change the picture, the dots associated with the display list items to be removed must be erased, then the dots for the replacement items must be plotted. With an object memory, on the other hand, the display can be altered directly.

For example, text—strings of words—in an object list can be easily edited, while text editing in an image memory requires separate storage and additional manipulation. Similarly, tasks involving blinking or moving vectors, characters or sections of the image, are easy with object memories, but very difficult with image memories. For instance, image-storage graphic terminals usually perform poorly on text editing tasks that alphanumeric terminals, which use object memory lists, handle with ease.

**Pros and cons of raster-scan devices**

For computer display applications, standard raster-scan monitors have certain obvious advantages. They are by far the most inexpensive general-purpose display components available and come in a variety of sizes, resolutions, and brightness levels. They readily handle gray scale, color, and video mixing. They are the only display devices with a simple, widely accepted interface specification. Monitors of different sizes, wall-sized projectors, hard-copy units, and recorders from different manufacturers can be easily connected together. The fixed beam path and constant beam speed of raster-scan systems require inherently simple compensation and can work with a digital driving source. The display signal can easily be transmitted thousands of feet along a single line to feed multiple display units and can easily be handled by switching systems.

But raster-scan systems also have drawbacks. The



## The other types of graphic display

The simplest display systems, used with the earliest computers, generally had two digital-to-analog converters that drove the deflection plates or coils in a cathode-ray tube. A stream of values fed into the converters caused the CRT beam to trace out any desired pattern. These values came from a "display list," which was fed repeatedly to the CRT to maintain or "refresh" the volatile image. This "programed-path" arrangement was simple, reliable, and relatively inexpensive, but also very slow. It could plot only a few thousand points on the screen without annoying flicker—only 50 to 100 characters or a few dozen vectors—and it required the computer's entire processing capability to draw a picture.

From experience with the programed-path display, two things were learned. First, complex pictures that don't unduly burden the processor require special-purpose pattern generators. Second, refreshing the display image should not require processor attention.

By the early 1960s, vector generators, character generators, high-speed CRT beam-deflection systems, and independent display-list memories were being included in display systems. For example, the input to a vector generator might be a word containing the coordinates for one or both end points of a vector, and the generator would translate these into positions on the screen, adding blanking and unblanking signals to turn the beam on and off. Or a word might represent an alphanumeric character with a code of several bits, which a character generator would translate into a series of deflection and blanking instructions for the beam.

With these sophisticated subassemblies, systems could display several thousand characters and over a thousand vectors without flicker. In addition, once the computer had loaded the display-list memory, the picture could be maintained with almost no load on the computer. But these new display terminals cost \$100,000 or more, limiting computer graphics to experimental interactions and a few specialized commercial and military applications.

The next big step was to break the cost barrier. Major cost factors were the display-list memory and the high-speed refresh circuitry, both of which were necessary because the displays could only retain images by being constantly rewritten. An image that did not have to be continually rewritten could be generated more slowly, with less expensive circuitry, and would not need refresh memory. These advantages were first embodied in the direct-view storage tube (DVST).

Besides a conventional electron gun, the DVST contains a set of flood guns that keep a written image glowing indefinitely. Consequently, graphic terminals with DVSTs need trace out an image only once. The tube lowered circuit costs, eliminated memory elements, and could display more complex pictures than even the most expensive refresh CRT systems. Prices of graphic terminals fell immediately to less than \$15,000, and today such terminals cost less than \$4,000—a price drop that has dramatically expanded the number installed.

But the DVST terminal does have some drawbacks. Because of the physics of image storage, for example, brightness and contrast are not as good as in the conventional CRT, nor can the user control these parameters. True gray and color presentations are not possible. Also, DVSTs are complex to build, are available in only a limited number of tube sizes, and are considerably more expensive than regular CRTs.

In addition, while the user can add continuously to the stored image in a DVST, he cannot simply erase parts of an image—instead, he must erase the entire screen and write out a new, slightly different image. Also, the relatively slow erase and writing speeds of the DVST make some operations quite cumbersome, and a dynamic graphic display is next to impossible.

A technology competing with the DVST is the electrical read-out storage tube. Like the DVST, it stores the display image as a charge pattern written by an electron gun. However, it has no flood guns or phosphor. Instead, the stored pattern is sensed but not altered in a "read mode" in which the electron gun scans the image target and feeds the output to a raster-scan monitor.

This tube overcomes most of the disadvantages of the DVST, but it requires two analog subsystems—the deflection circuits and the raster-scan monitor—instead of one. This causes some problems of stability and maintenance, and because the read-out scan only samples the signal, the viewed image is less detailed than the written image.

Another commercially successful technique stores the raster signal for the display images on a magnetic disk, from which a monitor is refreshed. The signal is stretched out along one or more linear tracks around the disk.

The most radical departure from previous display technology, however, is the plasma panel, which is a thin sandwich of two flat pieces of glass enclosing a layer of gas. A vertical set of address wires is bonded to one plate, and a horizontal set is bonded to the other. Each intersection of these address lines locates a cell. The proper voltages applied with proper timing to one wire in each set ionizes the gas at the intersection, causing it to glow. A different voltage-time combination quenches the discharge. Once the gas is ionized, a sustaining signal keeps it glowing in the absence of the writing signal, so that the panel has a DVST-like memory, but can be selectively erased.

Among other advantages, the plasma panel is digitally driven and provides a crisp distortion-free image. Since it is flat and thin, it can be combined with a rear projector, or the display picture can be copied from the back side of the panel. But the resolution is currently limited to a relatively coarse 70 points per inch. Color and gray scale, though possible, are not at present offered commercially. Worst of all, panel costs are high and unlikely to fall rapidly because extensive circuitry and tight tolerances are necessary.

Meanwhile, the original programed-path refresh CRT systems have not been ignored. On the contrary, they have been given new emphasis for the low-cost market. Programed-path units draw picture elements in an order determined by the computer, so that operations such as enlarging or rotating one element on the screen independently of others are straightforward. These displays present high-quality images and allow maximum flexibility in picture interaction. Light pens can be used to point at objects, which are readily identified by correlating the word being processed with light detection by the gun.

But in such systems the display and its drivers form a complex analog subsystem requiring high-speed signal generation. In addition, compensation circuits are necessary, to correct nonlinearity, pincushion distortion, and problems arising from varying beam speed and fast, random beam positioning. This analog subsystem is still relatively expensive, in spite of declining component prices.

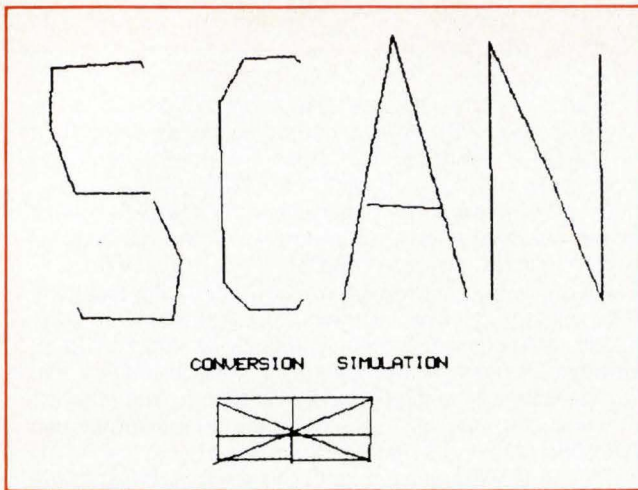

**4. Scan simulation.** When a reformatted display list, like the one that is shown at the bottom left in Fig. 3, is processed through a simulated display generator, this is the image that results.

biggest has already been mentioned—the fact that converting the normal computer format into the raster-scan signal format is quite complicated. Then, too, the fixed scan-line positions quantize the beam position, so that picture quality suffers, particularly on 525-line monitors. Quality is considerably better on 800- or 1,000-line monitors, but these units are much more costly and require as much as four times the signal bandwidth. Moreover, light-pen operation is more complex, because the timing of the light pen's output is not easily associated with the object being pointed at.

#### The scan-conversion problem

The beam path in a raster-scan monitor is fixed, and only beam intensity can be varied. To draw a single vector, the system generates a beam-intensity signal consisting of pulses properly spaced in time to show the desired pattern on the screen. More than one vector calls for additional pulses interspersed with one another in a single stream, requiring all vectors to be processed simultaneously.

Consequently, scan conversion begins with a display list of highly encoded words, interpolates the points of each vector between its start and end points, and produces a train of properly timed pulses contributed by all the vector words. The result is a composite pattern on the screen (Fig. 2).

This scan-conversion operation is easier to describe than to implement. To synchronize it directly with the beam's scan position would require each intensifiable screen location to be checked against every word in the display list to see if the beam should be intensified at that location. Since the beam in a 525-line monitor dwells only about 100 nanoseconds at each location, checking every word in the display list of perhaps several thousand words would be extremely difficult.

In the past, the problem has been handled in two steps. First, the display list was processed sequentially, and the pulse trains corresponding to the various vectors were stored in a memory array containing, in its simplest form, one bit associated with each image point. This memory is called a bit-per-element map, or bit

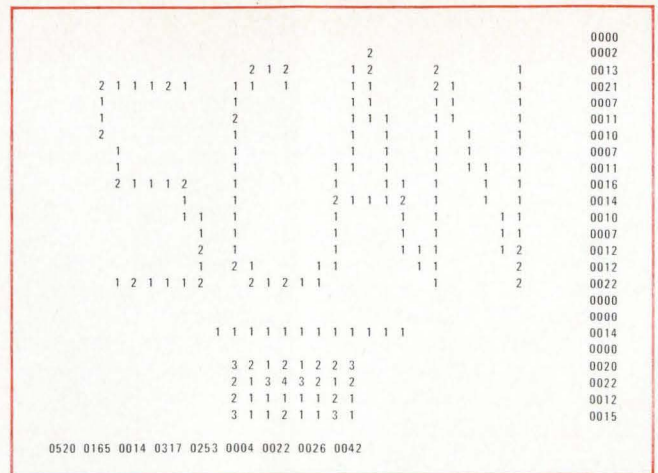

**5. Scan analysis.** An analysis program for the simulated display of Fig. 4 lists the contents of each cell, the totals for each scan line, and the total for the whole picture. The picture requires (in octal notation) 520 words of memory, to specify the contents of 253 cells.

map. Second, after the display list had been completely processed, the bit map was scanned, and its output drove a monitor.

However, even though the newest memories have a low cost per bit, bit maps are big—over 300,000 bits for 525 lines in black and white—and therefore expensive. Color pictures, which require three bits for each image point, exceed a million bits per map. A 1,000-line monitor uses even more. By contrast, the original display list may require fewer than 40,000 bits to produce good black-and-white pictures and fewer than 50,000 bits for color or gray-scale pictures.

To regain the advantage of smaller memories and simpler manipulation of object-oriented representations, while retaining the advantages of raster-scan devices, Adage Inc. undertook a three-year feasibility study of real-time conversion from a display list to a raster-scan signal. If an object-oriented display list could be processed 30 times per second, the raster-scan format signal could be fed directly to a monitor without the intermediary of a bit-map memory. But since a whole display list generally cannot be processed this quickly, the approach in the feasibility study was to consider only a small portion of the display list for each location, to keep the processing at a reasonable level.

In any picture produced from a display list, several areas of the screen contain one or more image elements—vectors or alphanumerics. In general, the smaller the area, the fewer the elements (although the relationship is certainly not linear). Therefore, dividing the display list into smaller sublists for portions of the display area reduces the amount of data to be processed for each display location.

The basic subdivision scheme has two parts (Adage has applied for patents on the novel aspects of this scheme). First, the display list is processed into a few dozen sublists which are sorted and stored in the local display-list memory. Each sublist corresponds to a single horizontal band across the picture. If a vector occupies parts of more than one band, it is stored as a number of shorter vectors, each entirely within one band. Since vectors are generally rather short, most of

them lie either in one band or across the boundary of two bands. Alphanumerics, on the other hand, are required to be wholly within a band.

Second, the display list for each band is directly converted in real time for display, without using a bit map. Each screen location is checked only against the words in the sublist corresponding to the band containing that location, rather than against the whole display list. In this way, the amount of information processed by the scan-converter is much reduced.

As implemented at Adage, another step is taken between the two described above: the horizontal bands are divided into cells, making a grid of approximately square areas. Preprocessing the display list, more slowly than in real time, generates a new list of short vector segments and symbols, each contained totally within a single cell. These are then placed in the order of the cells on the display, starting from the upper left and ending at the lower right. Now each location is checked only against the sublist for a cell.

Since the scan conversion is carried out in essentially this order, the segments can be stored in a sequential memory, such as a shift register. The display task then becomes one of scan-converting only the contents of a single cell in real time, rather than processing the entire display list for each intensifiable location.

### Making good use of the memory

Vectors and characters tend to group, leaving large areas of the screen empty—although these areas are located differently in different images. Thus the memory has to handle both cells with multiple contents, as where lines cross, and cells with no content. Since giving each cell a fixed amount of storage would be inefficient, a quasi-associative memory scheme was chosen.

In this scheme, there are three important aspects. First, some cells may contain more than one item and may need several words to describe them completely. Second, some cells contain alphanumeric symbols, which are stored in the list in the same way that vectors are stored. Finally, address words skip empty cells, which means no memory words are wasted on blank areas of the screen.

The words representing the contents of vector and al-

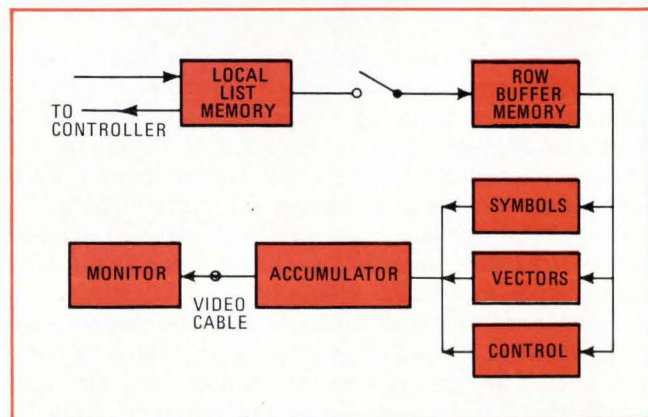

**6. Display generator.** The local list memory holds picture information in an object-oriented representation. Vector and symbol generators convert this into raster-scan format, and the accumulator collects the data to feed serially to the monitor.

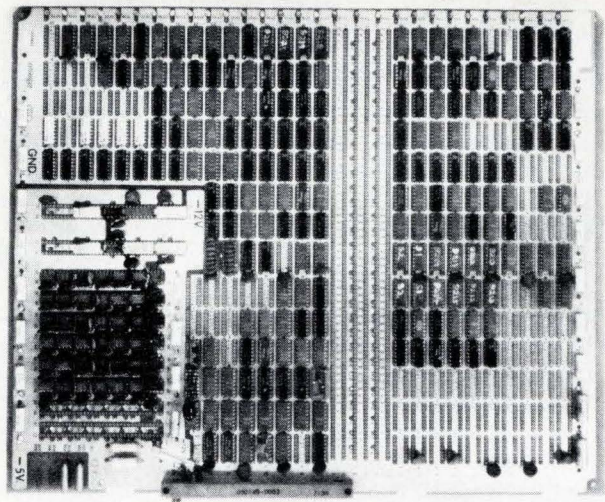

**7. Prototype.** Built to amplify results obtained by simulation, this display generator contains a total of 270 integrated circuits, among which are 51 memory circuits and their associated drivers.

phanumeric cells are stored sequentially in memory, using one word of memory for each character or vector segment in a cell. Each word includes a bit that identifies whether the word describes a vector or a character. Another bit can identify the word as an address, blocking both the vector and character interpretation. Only a single address word is required to represent any number of unoccupied contiguous cells. This skip capability averages the storage capacity, so that a simple image covering the whole screen and a highly detailed image in one corner can fit in the same amount of memory.

For example, Fig. 3 shows a simple display, consisting of nine cells arranged in three rows and containing two vectors and a character. The cells are processed from left to right in each row, and from top to bottom by rows, and the display items are ordered in this sequence in the memory representation.

The first item in the list is the segment of the vertical vector in cell 1A. Since cells 1B and 1C contain nothing, an address word is inserted that specifies no display action in any cell of the top row except 1A. The raster lines, of course, extend across the whole screen, so that the image in 1A in general takes several horizontal sweeps to complete. Then the display skips to cell 2A. In this cell are two different vector segments. Part of the horizontal vector extends into cell 2B. An address word skips cell 2C and, after 2A and 2B are complete, goes directly to cell 3A, which contains the last part of the vertical vector. Finally in cell 3B is a symbol represented by the last word in the list.

Although the display memory's primary purpose is storing the picture, it is a general-purpose read-write memory. Therefore, if the picture being displayed doesn't occupy the whole memory, the rest is available for other uses—for instance, storing additional pictures and storing graphic and text modifiers.

Off-screen pictures can be stored by extending the range of the address words. Each additional bit in the address doubles its range. But for displays of ordinary resolution, the extra range is available without extend-

ing the word length just for this purpose, since, in general, vector and character codes require more bits than an address code.

With the extended range, paging and scrolling can be done simply by resetting a "display-top" address instead of reconstructing the whole picture. Information about protected data can be stored within the picture memory itself rather than in an external memory. This information is essentially sequential in nature, just like the cell contents for the picture, so it can be stored in the same way.

Scan conversion is combined with the memory representation in an algorithm for vector and text editing. Suppose, for example, a vector is to be added to an existing image. First, the vector is divided into a sequence of cell contents in order of cell location. Then, starting from the beginning of the memory, a search is made for the address of the uppermost or leftmost location of the vector. If it is found in the memory, indicating that another vector passes through that cell, the new vector is simply appended to the list, intersecting the previous vector. If the address isn't found, the added vector is to be in a new cell, and an appropriate address word and the content are inserted in the display list. Then the search for the next sequential address is made, and so on, until the whole vector has been inserted on one pass through the memory. Vectors are deleted in the same way—matching vector words and appropriate address words are removed from the memory. Text editing is similar to vector insertion and deletion.

Since the whole memory modification process is one of inserting and deleting in an ordered list, sequential memories are the appropriate storage medium. Expanding and contracting their contents is much easier than inserting words in a random-access memory. As observed earlier, the sequential memory is also appropriate for display generation.

This scheme has been tested on some actual pictures,

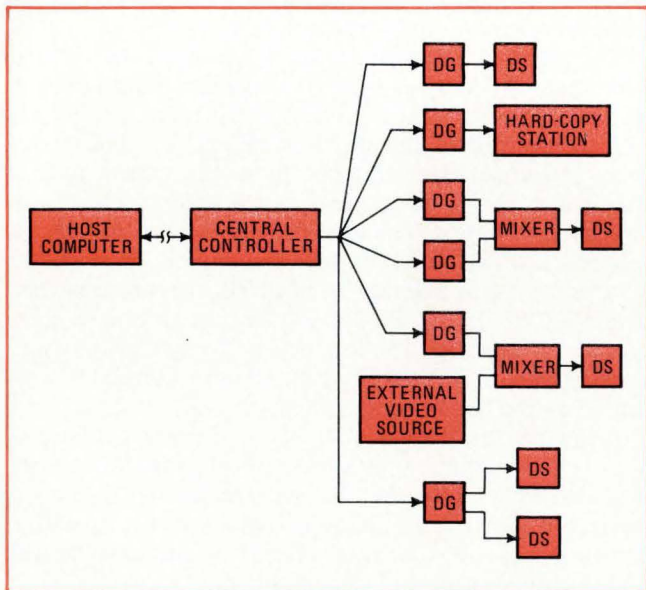

**8. Complex display system.** A display can consist of as little as a computer, a generator, and a monitor, or it can be much more complicated and take varied forms like those shown here. DG and DS stand for display generator and display station, respectively.

covering many applications, on a simulator that was programed with a direct-view storage-tube terminal connected to a minicomputer.

Each picture was stored as a list of cell contents in the minicomputer memory. This provided a check of the software necessary to preprocess a picture. Programs were then written that simulated the functions of the vector generator and symbol generator of the real-time scan-converter hardware. These programs processed the cell contents and produced the dot-by-dot scan representation of the picture, which was then plotted on the display (Fig. 4). Finally, an analysis program plotted the number of elements in each cell, and totals for each row and for the whole picture. This verified theories on picture density, and permitted an estimate of how much memory the picture would require (Fig. 5).

The simulation had several useful results. It demonstrated, long before hardware was built, that the scheme worked, and gave an impetus to further development. It showed that, as had been anticipated, the cell boundaries were not apparent in the pictures. It proved that significant pictures could be stored in 2,000 words of memory. It suggested several variants on the hardware and software schemes, which were tried out. And it permitted experiments with different cell sizes, to find the most efficient size, various memory representation schemes, and different combinations of hardware and software vector and symbol generator techniques—all before any hardware was built.

### The experimental display generator

Once the display generator was completely specified as a result of the simulation, a hardware prototype (Fig. 6) was necessary to drive a raster-scan monitor. No computer could simulate the scan-conversion algorithm fast enough to generate a real-time raster-scan signal.

In the prototype, a local list memory stores item and address words that describe individual cells. All the words associated with a particular horizontal row of cells are loaded into the row buffer memory, and thence fed to a control element and to either a vector or a symbol generator. While the memory is feeding the data out, the list memory is disconnected, and a controller can read, load, or reload it without interfering with the scan-conversion operation and without causing the screen to flicker.

The symbol generator uses a conventional approach—a read-only memory containing a dot matrix representation of the various characters. However, the vector generator is rather more complicated, to cope with the thousands of different vectors that can be drawn in cells of reasonable size. It generates the pattern from the start and end points in the cell, by calculating the slope of the line, and successively adding this value to the start position on each scan line.

The control section translates bits associated with each list word into color, gray scale, or blinking data. The control section and the generators feed an accumulator which combines the contributions of the various words until the section of the scan line within the cell is completely described. When it is complete, the pattern is dumped serially to the raster-scan monitor while the next cell is processed. An averaging circuit be-

tween the accumulator and the monitor (not shown on the block diagram) smoothes out the variable processing rate of the generators and supplies a continuous drive signal for the monitor.

The prototype board is shown in Fig. 7. It runs on a 6.3-megahertz clock and contains 270 integrated circuits, including 51 MOS memory circuits and drivers. Besides the memory and raster-scan conversion logic, the board also contains keyboard circuits, and a cursor generator. Most of the logic was designed with standard TTL components; a few Schottky elements were used. The system contains no adjusting potentiometers, except those in the monitor.

### System considerations

To be useful, a display generator must be part of a system. The most straightforward system is a display generator driving a monitor under the control of a computer. In more complex applications a powerful (and expensive) computer supports multiple terminals in any of several configurations. Some of the possibilities for a system are shown in Fig. 8.

Many large systems avoid cluttering up the primary processor and improve response time by incorporating satellite processors to handle trivial tasks such as data editing, input-output transfers, and communications control. The Adage experimental system includes a satellite processor, which can readily divide vectors into cell contents. It can also process keyboard inputs, move the cursor, and do local editing.

The experimental station (Fig. 9) consists of the monitor and a keyboard, which contains cursor keys, editing keys, transmission keys, and general function keys, in addition to the standard alphanumeric keyboard. Cursor keys move an alphanumeric cursor (underline) or a crosshair graphic cursor. Editing keys signal both character and line-editing functions. Transmission keys cause edited text to be sent to the host computer. For flexibility, the general function keys may be interpreted and processed by the local computer, or sent on to the host computer.

### Doing better

The system can be readily expanded. Features such as color or gray scale are obtained by adding a few extra bits to the display memory words, and are implemented by expanding the assembler and video signal generator.

An impressive feature, derived from the raster-scanning principle on which the system is based, is the capacity to show shaded background regions. This is achieved by specifying, for an individual vector, the intensity or color not only for the individual points through which it passes, but also for all points to its right on each scan line that intersects it. Thus a shaded area can be specified by adding an extra bit to the vectors along its left side to specify shade, and then letting the other vectors along its right side set the normal background. The assembler gives the shading intensity or color to each element on the scan line that is not otherwise specified by foreground information.

The use of standard video signals opens the way for combining a raster-scan terminal with a variety of tele-

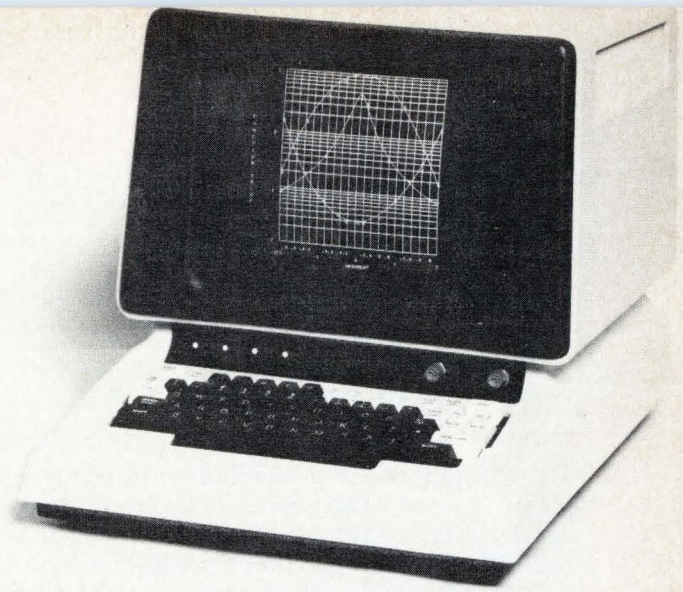

**9. Display station.** Twelve-inch raster-scan monitor is able to present both graphic and alphanumeric data. The keyboard provides cursor control as well as text-editing functions.

vision-based components such as TV-projection equipment, video-tape recorders, cameras, and hard-copy devices. These pieces of equipment can be interconnected with almost no special engineering, because the television signal standard is complete and widely accepted.

Of particular interest is equipment that mixes video signals from different sources. For example, computer-generated images and microfilm or slide images can be picked up by a video camera and displayed simultaneously on the same terminal. Or signals from two or more display generators can be mixed. In this way, one generator can be made to display background information, while others produce changing data. Alternatively, data from multiple display generators can be combined in images with a complexity beyond the capability of a single generator.

A further advantage of the raster-scan scheme is its adaptability to higher-resolution monitors by somewhat more complex circuitry. Among other things, such monitors require larger cell sizes and more parallel operation because of the increased beam speed.

### What lies ahead

The very powerful and very expensive graphic systems will continue to have an important place in high-performance command-and-control systems. Image-oriented systems will be used to produce complex, high-density pictures requiring little interaction. But for much interesting and practical work, real-time scan conversion of object-oriented displays offers an attractive alternative for graphic-system users.

Graphic displays have long been more promising than practical, because the equipment has been expensive, software support has been inadequate, and potential users have simply not been aware of the possibilities. Now technology is turning the tide with low-cost and high-performance equipment, a growing storehouse of applications programs, and increasing sophistication among computer system users. During the next few years graphic terminals will probably appear in more and more purely commercial roles, rather than in just experimental environments. □

# Designer's casebook

## External gate doubles counter speed

by Jeffrey Mattox

United States Air Force, L.G. Hanscom Field, Bedford, Mass.

The counting rate of a standard synchronous up/down binary or decade counter can be doubled without altering the clock frequency. A single external gate does the trick for the count-up or the count-down mode.

The ability to double the counting rate is useful for applications where a counter must be advanced at twice the normal rate, as in racing the digits to set a digital-clock stage. The extra gate can also be used to halve the counting rate, depending on the logic level of the controlling signal.

Both the decade counter (for example, a type 74192) and the binary counter (for example, a type 74193) have two clock lines—one for the count-up mode, and the other for the count-down mode. The clock input that is not being used is usually tied to the supply line. For ei-

ther type of counter, there is a counting flip-flop for each output bit.

By sensing the counter's least significant output bit and lowering the alternate-clock input at the proper time, the least significant bit is kept static, and the second counter flip-flop receives all the primary clock pulses. In addition, the state of the least significant bit locks out the alternate-clock input from the other counting flip-flops. For an up-counter, the least significant bit must be high; for a down-counter, it must be low.

The circuit of (a) shows a type 74193 binary counter connected for the count-up mode. The alternate-clock input, in this case the count-down input ( $C_D$ ), is controlled by a NAND gate. When the DOUBLE input goes high, the  $C_D$  input is brought low as soon as the least significant bit is high. The least significant bit remains high until the DOUBLE input returns to the low level. Meanwhile, the count frequency appears to double.

The circuit of (b) is for the count-down mode. It is similar to the one for the count-up mode, but an OR gate is used instead and the DOUBLE control signal must be inverted. The CARRY and BORROW outputs of the counter operate normally so that the doubled counting rate may be carried to the next stage. □

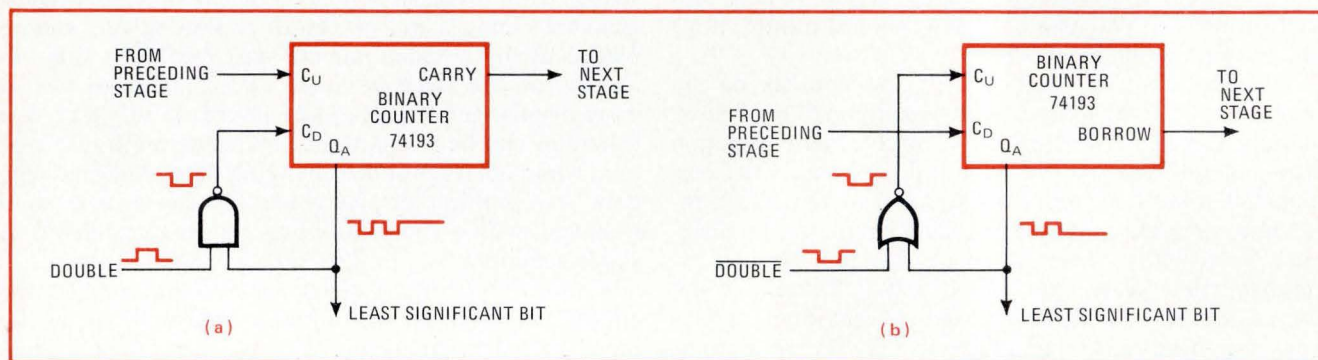

**Twice as fast.** External gate can double or halve the counting rate of either a decade or binary up/down counter, depending on the logic level of the control signal. The actual clock frequency remains the same. Here, the operating speed of a binary counter is doubled for both the count-up mode (a) and the count-down mode (b). The counter's unused alternate-clock input goes to the controlling logic signal.

## Eliminating current spiking from dc-to-dc converters

by Carlo Venditti

Charles Stark Draper Laboratory, MIT, Cambridge, Mass.

When the two inverter transistors in a push-pull dc-to-dc converter conduct at the same time, current spiking will occur and at worst destroy the circuit, at least degrade its efficiency. These undesirable effects can be prevented by delaying a clock pulse train with standard logic circuits.

Ideally one transistor turns on as soon as the other turns off. But because of their storage time constants,

one is often still on when the other is beginning to conduct. All risk of simultaneous conduction will, however, be eliminated if the square-wave base drive signals to the transistors are made asymmetrical. The delay provided by logic gates ensures that, for a short length of time, there is no current drive signal at all. This delay can be fixed (constant) or controlled by feedback.

The figure shows two ways of designing a nonspiking static push-pull dc-to-dc converter. In (a), the current-drive delay time is fixed, and in (b), the delay depends on a feedback signal. In both cases, the transistor on-time is made smaller than the transistor off-time.

There are two output voltage levels for the converter in (a)—5 and 25 volts at a current of 300 milliamperes. The converter in (b) has just the one 5-v 300-mA output. Although a clock pulse generator operating at 80 kilohertz is used to synchronize each converter, the

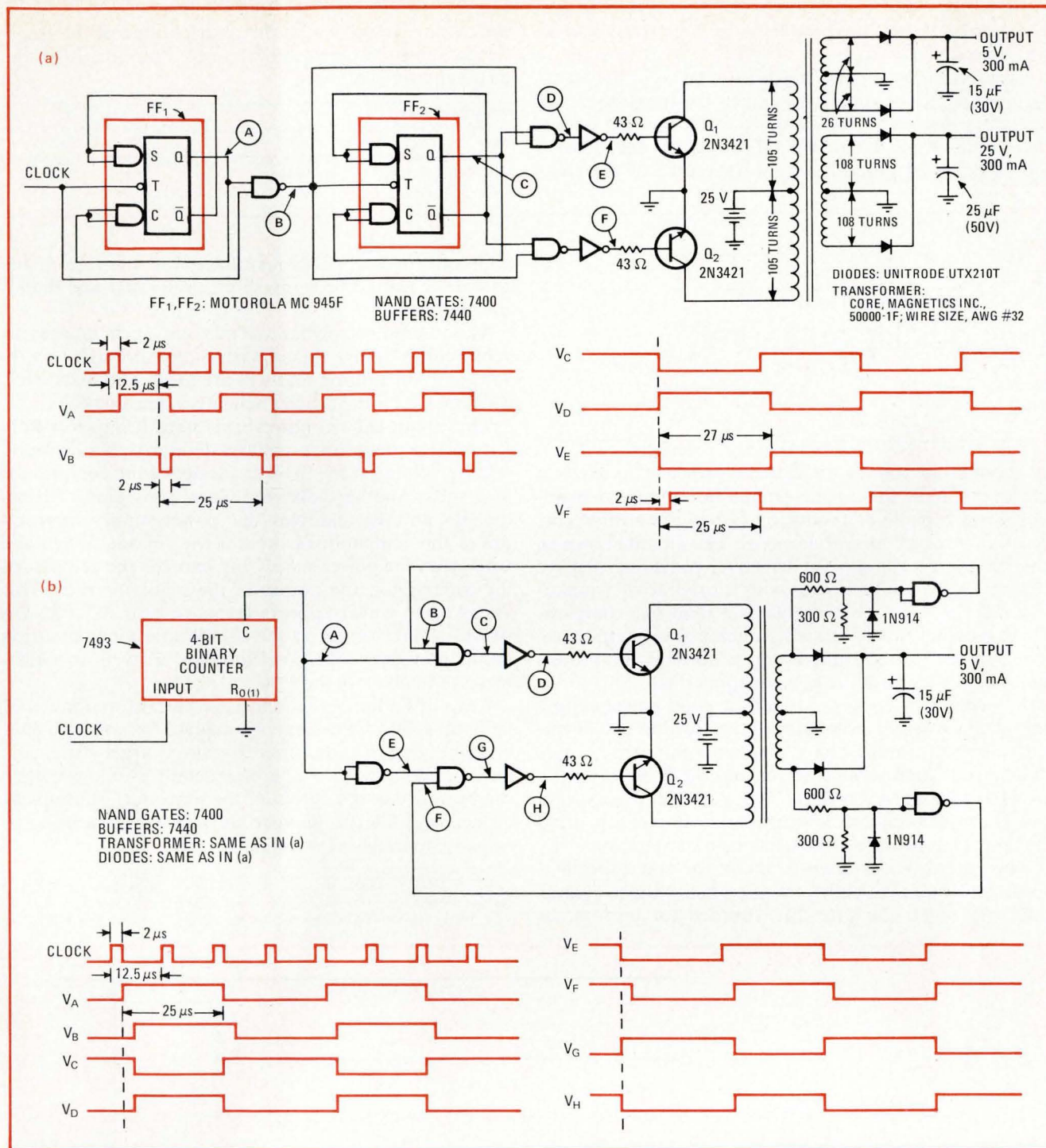

**Improving dc-dc converter efficiency.** These dc-dc converters employ push-pull inverter transistors that switch at 20 kilohertz. Conventional digital ICs are used to delay the drive signals to the switching transistors so that these devices cannot conduct simultaneously, causing unwanted current spikes. The converter in (a) has a fixed delay, while the delay of the converter in (b) depends on a feedback signal voltage.

switching frequency is only 20 kHz in each case, and the nominal transistor on/off time is 25 microseconds (total period of 50  $\mu$ s).

In the fixed-delay circuit of (a), flip-flops FF<sub>1</sub> and FF<sub>2</sub> generate the basic square-wave drive for transistors Q<sub>1</sub> and Q<sub>2</sub>. The flip-flops divide the clock frequency down from 80 to 20 kilohertz, and the NAND gates provide the delays for the transistor drive signals.

The resulting asymmetrical driving waveforms have an on-time of 23  $\mu$ s and an off-time of 27  $\mu$ s. This means

that each transistor experiences a 2- $\mu$ s delay in its drive signal. For the transistors used here, this delay prevents current from flowing into the transformer primary for 0.5  $\mu$ s. The width of the delay pulse (2  $\mu$ s here) is too wide if the converter's output ripple voltage increases and too narrow if there is no deadband for the transformer primary current.

In the feedback-adjusted-delay circuit of (b), a binary counter, rather than flip-flops, divides the clock frequency down to 20 kHz. NAND gates again provide the

appropriate delays for producing asymmetrical transistor drive signals.

The feedback voltage, which is taken from the transformer secondary, determines when the transistors turn on, while the reference voltage from the counter output determines when they turn off. To delay the turn-on feedback signal properly, the storage time of the recti-

fier diodes, as well as the flux flyback time of the transformer, must be taken into account. For circuit (b), the deadband time is  $0.3 \mu\text{s}$ . □

#### BIBLIOGRAPHY

Alphonso H. Marsh, "Gating Scheme Maximizes dc-dc Converter Efficiency," *Electronic Design*, June 22, 1972, p. 100.  
Robert F. Downs, "Minimize Overlap to Maximize Efficiency in Saturated Push-pull Circuits," *EDN/EE*, Feb. 1, 1972, pp. 48-50.

## SCR crowbar circuit fires quickly and surely

by Steve Summer  
Hauppauge, N.Y.

A monolithic voltage regulator's presence in an SCR crowbar circuit makes the circuit fast-acting, dependable, and capable of producing fast-risetime drive currents as large as several amperes. The circuit shown in the diagram is simple yet effective, providing a drive current of 200 milliamperes with a risetime of 1 microsecond. The 723-type IC regulator is used as a comparator that contains its own stable reference voltage source. The setpoint of the comparator establishes the protection voltage level for the power-supply bus.

A satisfactory crowbar circuit for good power-supply protection generally asks a lot of the crowbar SCR. Typically, power supplies have large output capacitances that impose high surge currents and  $di/dt$  levels on the crowbar SCR when it is fired. These large current surges can cause SCR failure or degradation if the SCR drive current is inadequate or soft (has a slow risetime).

The gate drive required to attain the SCR's specified surge and  $di/dt$  capability may be many times greater than the worst-case gate drive needed for turn-on. In

addition, for best  $di/dt$  resistance, the risetime of the gate drive should be quite short, preferably less than a microsecond.

Many simple crowbar circuits use such devices as zener diodes to fire the crowbar SCR. Although this results in a soft turn-on that will fire the SCR at least once, the dependability of such a scheme is questionable.

The circuit shown, however, is hard-firing. Resistors  $R_1$  and  $R_2$  make up a voltage divider that nominally sets the voltage at the inverting input of the comparator to 2 volts. Another voltage divider, consisting of resistors  $R_3$  and  $R_4$ , samples the power-supply bus and drives the comparator's noninverting input. When the voltage on the power-supply bus exceeds the setpoint of the comparator, the output of the regulator rises. This voltage rise, which appears across resistor  $R_5$ , adds (in phase) to the voltage at the comparator's noninverting input, providing rapid regeneration, as well as a fast-rising pulse to drive the SCR.

Resistor  $R_6$  limits the SCR drive current to about 200 milliamperes, a value that is adequate for sensitive-gate or amplifying-gate devices. To obtain larger drive currents of up to several amperes, an emitter-follower stage can be added at the output of the regulator. The capacitor acts as a filter to prevent the crowbar from firing in response to transient voltages. □

Designer's casebook is a regular feature in *Electronics*. We invite readers to submit original and unpublished circuit ideas and solutions to design problems. Explain briefly but thoroughly the circuit's operating principle and purpose. We'll pay \$50 for each item published.

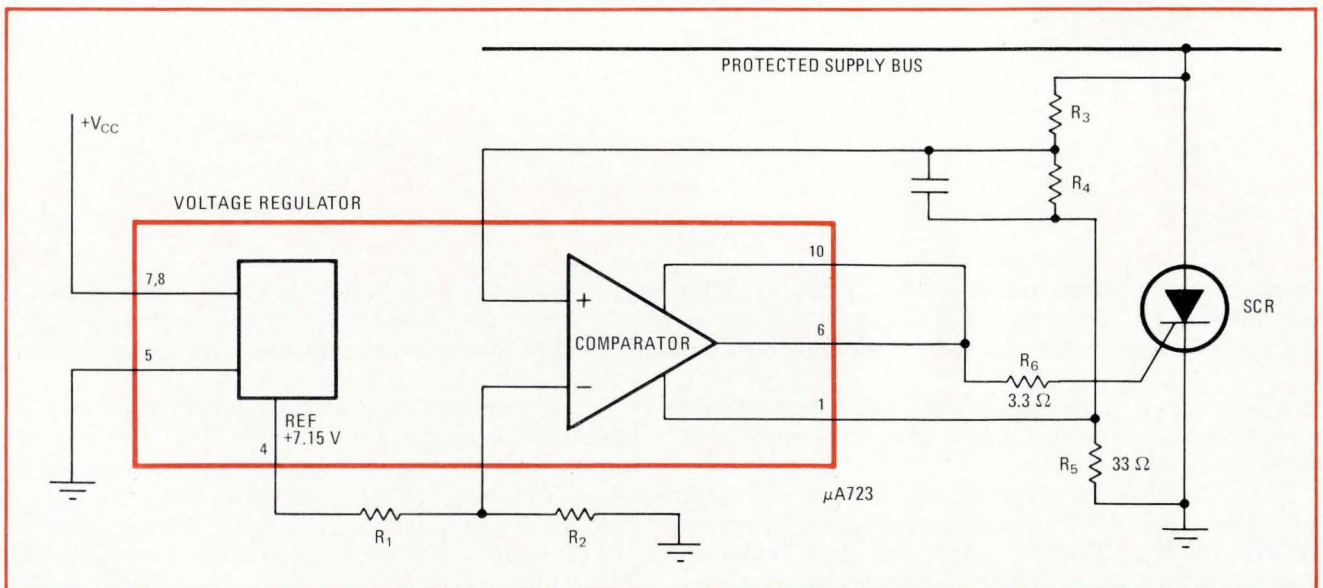

**Hard-firing SCR.** Crowbar protection circuit employs an IC voltage regulator to produce a fast-risetime large-value gate drive current for the SCR. The regulator, which is used as a comparator, has its own voltage reference source. When the voltage on the power-supply bus exceeds the set point of the comparator, the regulator's output voltage increases, producing a large fast-rising pulse that fires the SCR.



# 150 Microwatt Triple Op Amp

The L144 monolithic triple op amp draws only  $50\mu\text{A}$  of current per amplifier, from a  $\pm 1.5\text{ V}$  supply. What's more, it is

**AVAILABLE NOW FROM YOUR LOCAL DISTRIBUTOR!**

L144 features include:

- Monolithic triple op amp in DIP or Flatpac packages
- Wide power supply range— $\pm 1.5\text{ V}$  to  $\pm 15\text{ V}$
- Internal compensation
- Programmable power dissipation
- Programmable input bias current
- Single programming resistor
- 80 dB gain with  $20\text{ K}\Omega$  load
- Cost effective: \$1.63 per single op amp<sup>(1)</sup>

<sup>(1)</sup>L144CJ 100-piece price

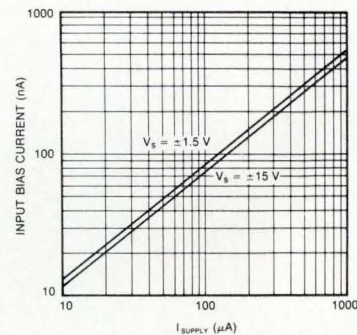

Applications examples:

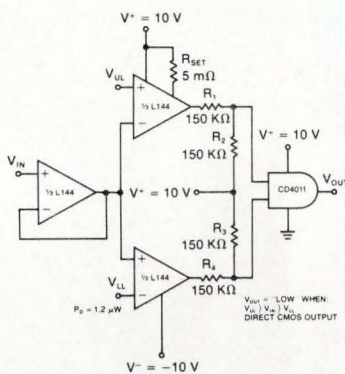

DOUBLE-ENDED LIMIT COMPARATOR

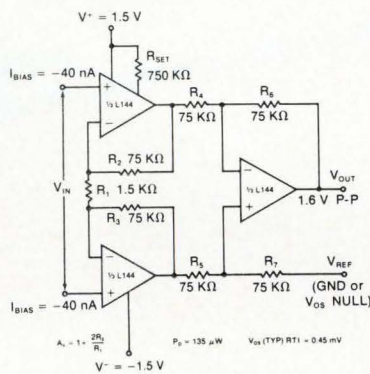

INSTRUMENTATION AMPLIFIER

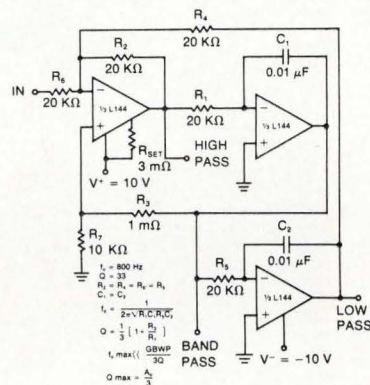

ACTIVE FILTER

The L144 is a practical industry-standard operational amplifier for use when low current drain, low voltage, low power, or very small physical size are controlling criteria. If your circuit requirements are unique—and whose aren't—our applications people are eager to help.

For complete information

**write for data**

IC Applications: (408) 246 8000, Ext. 120



**Siliconix incorporated**

2201 Laurelwood Road, Santa Clara, California 95054

**FREE!**

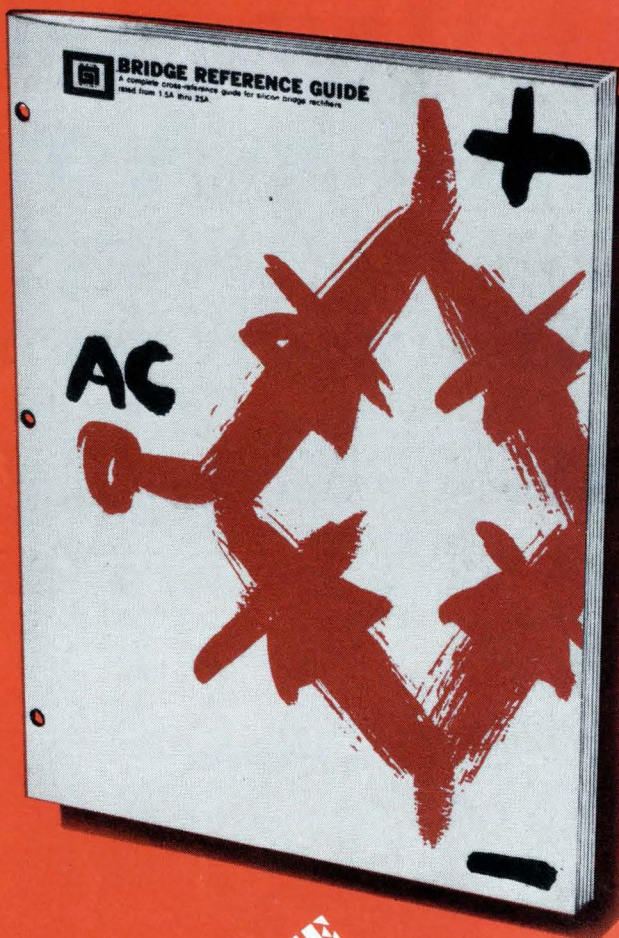

**REFERENCE**

# CROSS YOUR BRIDGES BEFORE YOU GET THEM

The industry's most comprehensive bridge rectifier cross-reference guide is now yours for the asking... free, from General Instrument, the world's largest manufacturer of bridge rectifiers up to 25 amperes. For your copy call the toll-free number below (In New York State call 516-733-3357) or write: General Instrument Corporation, Semiconductor Components Division, 600 West John Street, Hicksville, N.Y. 11802.

## 800-645-1247

**GENERAL INSTRUMENT CORPORATION  
SEMICONDUCTOR COMPONENTS**



# Radar in auto on collision course tightens passengers' seat belts

By using a pulsed-doppler approach, developers of a Japanese experimental safety car were able to design a reliable but potentially inexpensive radar-controlled restraint system

by Teruo Kondoh and Kazuhiro Ban, *Mitsubishi Electric Corp., Amagasaki*, and Masami Kiyoto, *Nissan Motor Co., Yokosuka, Japan*

□ To reduce the number of automobile crashes, or at least to minimize their ill effects, car radars are being intensively researched in the United States, Europe, and Japan. Opinions differ on precisely what function they should perform (see "Radar for the U.S. roads," p. 109), but everyone agrees on the difficulty of building a reliable and low-cost system, one that will track distance and velocity under all driving conditions and at the same time bend to the auto makers' mass production demands.

In Japan this work has been supported by a Government plan for development of an experimental safety vehicle that will insure the survival of its occupants when it crashes into a barrier at 80 kilometers per hour (50 mph). As a participant in this program, Nissan Motor Co. Ltd. in December delivered three experimental vehicles to the Japanese Government for evaluation. These cars feature a radar sensor system (Fig. 1) in which radar target acquisition and signal processing cause "preloaded" seat belts to tighten about passengers

the moment the logic circuits decide that a crash is inevitable.

The radar sensor was developed jointly with Mitsubishi Electric Corp., and it works with either the seat belt or an air bag restraint. After a series of preliminary studies starting in 1971, the joint team concentrated on two approaches; a two-frequency doppler system, and a pulsed-doppler system. Each of these two radars can indicate both the distance and the relative velocity between auto and target—the two prerequisites for this collision safety system's success—but the pulsed-doppler approach was adopted for the actual vehicle.

The pulsed-doppler radar's major appeal is that it hardly interferes at all with similar systems on other vehicles. It can measure distance almost as accurately as conventional pulsed radar, and relative velocity nearly as accurately as continuous-wave radar. The system lends itself to the use of digital integrated circuits for signal processing and to microwave ICs for the microwave portions, both of which can easily be mass-pro-

**1. Radar car.** Transmitting and receiving antennas in the system diagram are mounted on the front outside corners of the test car (photo). This radar system is designed to trigger a seat-belt preloader, right of diagram, that tightens around passengers at the moment a dangerous collision becomes unavoidable. However, the radar sensor has also been installed and tested as part of an air-bag restraint system.

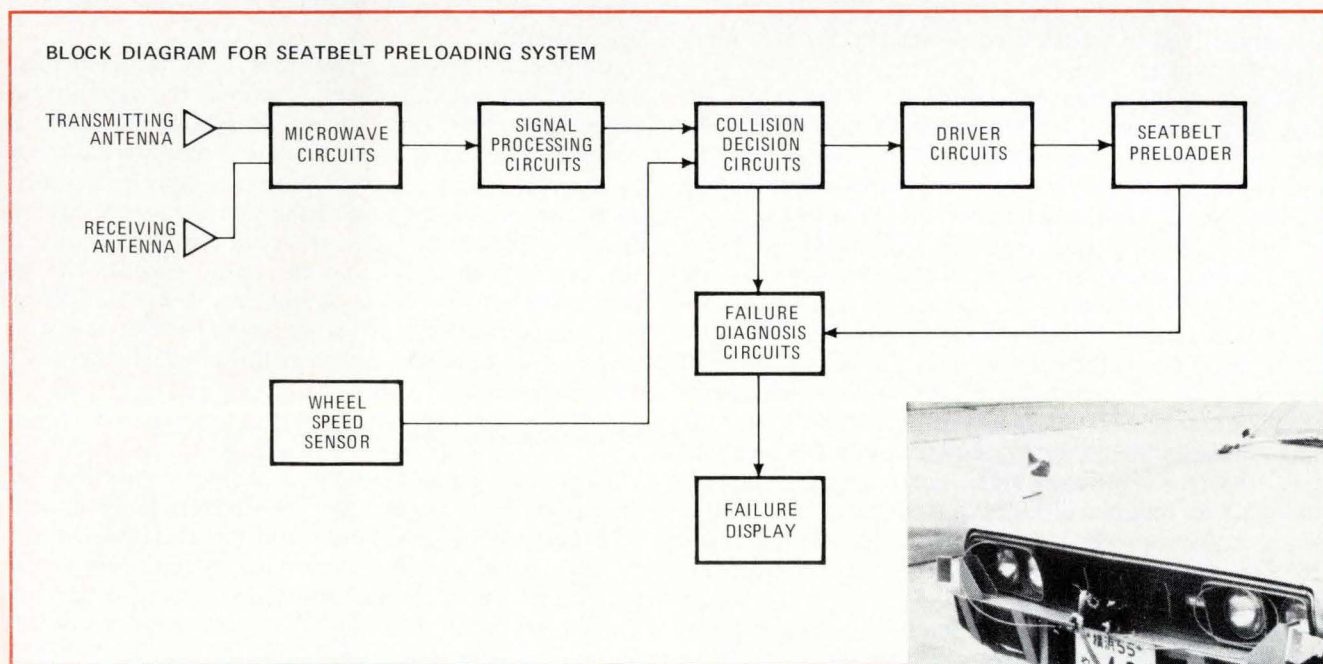

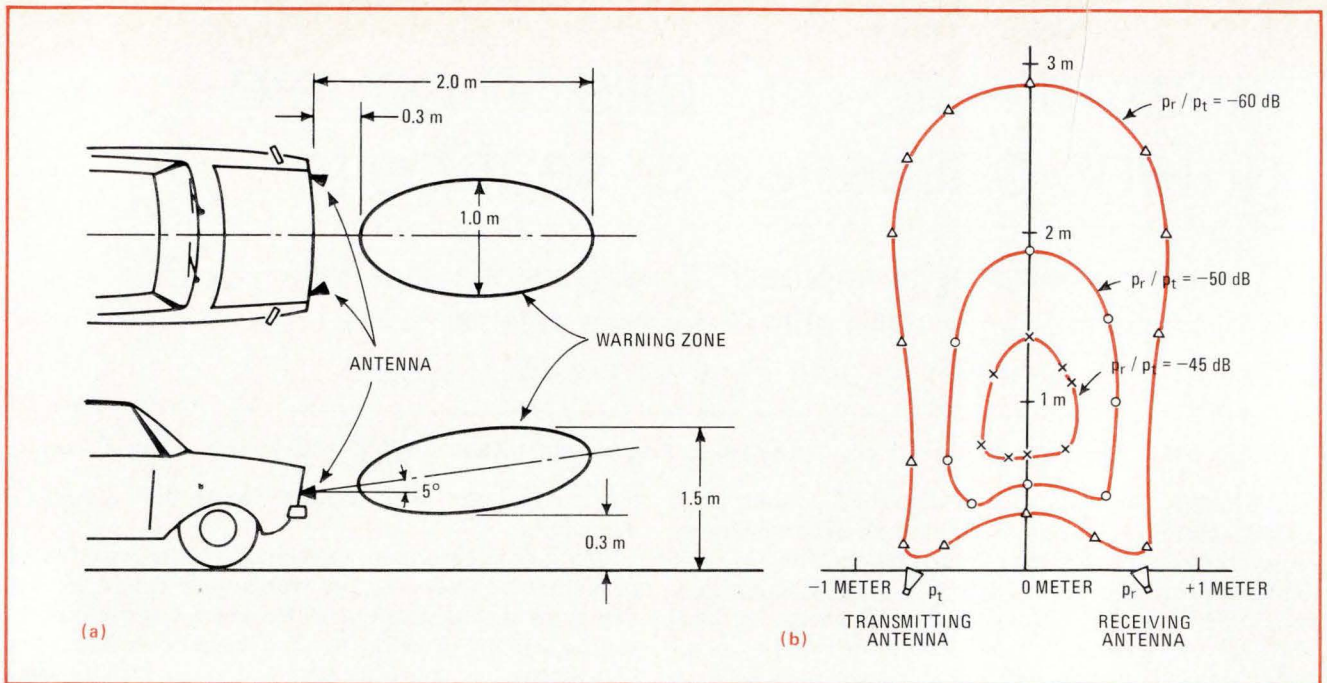

**2. Driving patterns.** Radar antennas are canted slightly upward to reduce ground clutter in target coverage (a.) and placed at the outside corners to obtain a 3-meter antenna pattern (b.). The sensor is designed to function for collisions occurring at 32 kph.

duced. Also, radiated output power is three to four orders of magnitude smaller than that required for continuous-wave radar, so that the biological hazard becomes negligible.

### Unambiguous distance measurement

The target-reflection characteristics and the antenna characteristics are important when using microwave radar for collision detection. Figure 2 shows the approximate warning region mapped by the antenna pattern. The antennas are tilted upward enough to eliminate reflection from projections on the road, but not so far upward that strong reflections are returned from tunnel ceilings and other overhead objects that are not dangerous. The reflection characteristic of Fig. 2b is the ratio of received to transmitted power ( $P_r/P_t$ ) as a function of distance.

However, the reflection coefficient of the target car can vary by more than 20 decibels depending on the number of passengers it contains. This suggests the coefficient can also vary with other parameters, including car size, shape, load, and angle to the radar beam.

The receiving and transmitting antennas were mounted on the front corners of the test cars. The test target, a 150-millimeter-diameter metal pole, was chosen as a practical obstacle because it has an almost constant reflection coefficient and gives a good indication of the radiation characteristics of the radar antenna system. For a standard target like this metal pole, the range can be determined with reasonable precision from the received power level. For most other targets, though, no reliable distance information is available from received-power level, and instead, the frequency change obtainable with a doppler system provides this information for all targets.

The performance criteria chosen by Nissan (see table) for the proximity and relative-speed sensor used to trig-

ger the passenger protective device are based on practical experience of automobiles. A car coming within two meters or less of an object and closing in on it at a relative velocity of 32 kph cannot possibly be braked in time to prevent a collision. The only recourse is to operate the restraining device in hope of reducing injuries to the occupants. The time by which detection precedes an anticipated collision depends on the speed of the car. For example, a car traveling at 160 kph moves almost a meter in 20 milliseconds.

Highway experience prompted researchers to choose a street lamp pole as a practical detectable object. A car will usually run down smaller objects than the pole without harm to its passengers, whereas a collision with a lamp pole is a serious accident that requires the seat-belt restraint.

A collision is sensed in two steps. First, target acquisition, or "Range On," occurs as soon as the distance between the target and the car on which the radar is mounted falls below a preset value, actuating the range logic circuits and starting the excess-speed measurement. Second, completion of the excess-speed measurement, or "Speed On," indicates both that the distance is below a set value and that the speed exceeds the set value. These two conditions indicate that a dangerous collision is inevitable. If, however, the driver takes action to avoid the collision before this point, the belts will not be triggered.

### How pulsed doppler works

The experimental system is adjusted so that the Speed On signal is generated at an average distance of 1.75 meters between antenna and target. However, this distance is adjustable if either the system designer or the regulatory authorities so desire. During road tests, the actual variation in minimum range at which the Speed On logic circuits were actuated was less than 0.1

meter indicating the close tolerances possible.

In addition to processing range and relative closing velocity data unambiguously, the Mitsubishi pulsed-doppler radar system has two other important features. A maximum-range limitation prevents acquisition of harmless targets, and the system has hardly any probability of interference from similar systems on other cars. The receiver is of the homodyne type, in which a very small fraction of the transmitter power provides the local oscillator signal. This zero-beat mode of reception directly demodulates the received signal to baseband to recover modulation information, in this case the doppler frequency signal.

The reflected pulse can be received only for the duration of the transmitted pulse. Pulses are spaced far enough apart for the reflection from one transmitted pulse to have disappeared by the time the receiver is enabled by the local oscillator signal of the next transmitted pulse. At the same time, the difference between the speeds of the radio waves and of the car makes separation between pulses negligible with respect to the distance the car advances between pulses.

The maximum range at which this system can detect targets is about 1.9 meters. Spacing between transmitted pulses is 4 microseconds, which corresponds to a target distance of 600 meters. There is no danger of spurious pickup of a target at this distance, however, because even with 100% reflection the signal would be too weak. Relative velocity information, which is recovered from the doppler frequency shift of the received signal, is proportional to both the relative velocity and the transmitter frequency. For the transmitter frequency of 10 gigahertz used in this system, the wavelength is 0.03 meter. A doppler shift of 1 hertz occurs if in 1 second the transmitting and receiving antennas move half this distance, 0.015 meter, closer to the target along the propagation direction.

However, the receiving and transmitting antennas are separated by 1.4 meters to assure coverage of an area

60% to 70% of the width of the car (Fig. 2). Thus the distance that the antennas actually advance toward the target in the direction of the radar wave propagation is less than the distance moved by the car and becomes an even smaller portion of that distance as the car approaches the target. This is because the angle between the car's path and the radar propagation path increases.

When the car is 1.75 meters from the target—the average distance at which the Speed On signal is generated—the decrease in radar path length is 0.9288 of the decrease in distance between car and target. Thus for a relative velocity between car and target of 32 kph, or the minimum closing velocity at which the system operates, the distance along the radar path decreases at a rate of  $8.9 \times 0.9288$  meters per second. This gives a doppler frequency of 550.4 Hz.

However, the system counts cycles at the doppler frequency, instead of making steady-state frequency measurements. Since only eight cycles are required for this measurement, the system goes into action before the car has advanced a further 0.2 meter toward the target—a distance that varies only slightly with speed.

The system transmits one pulse of microwave signal every 4  $\mu$ s, or a quarter of million pulses per second, or a total of more than 450 pulses for each cycle of a 550.4-

#### AUTO RADAR PERFORMANCE REQUIREMENTS

Detection time	20 to 100 ms before collision
Alarm region width	60 to 70% of car width
Distance	1 to 2 meters before vehicle
Relative speed	32 kph (20 mph) or more
Minimum detectable object	Street lamp pole
Wall face collision angle	Perpendicular $\pm 15^\circ$

## Radar for the U.S. roads

To date, the development of car radars in the United States has tended to center around "headway control"—automatic braking of the vehicle, based on the acquisition and tracking of constant targets at high speeds on open highways. These headway-control radar systems are not intended to handle the confusion of bumper-to-bumper urban traffic, but are designed basically for cruising conditions.

The approach has the advantage of keeping ultimate control in the hands of the driver while at the same time imposing on him the safety responses to speed and braking designed into the radar-accelerator-brake system. It would tend to rein in the reckless driver, but allow for human judgement by providing an option to override the radar system. Essentially it's a collision-avoidance radar system.

The Nissan/Mitsubishi application, on the other hand, is a collision safety radar in that it activates restraint devices, either a preloaded seat belt or an air bag. As U.S. auto makers have been facing the possibility of a Govern-

ment-mandated air bag system in 1976, there has been considerable interest in the design of a fail-safe means of deploying the bag in a collision. (If the seat-belt interlock systems added to this year's model cars prove to work, implementation of the air bag requirement could be postponed). So far, U.S. development has tended toward a deceleration sensor designed to fire the air bag at the instant before collision—admittedly a tricky requirement for a sensor circuit. In addition, the air bag system will need some means of alerting the driver to a failure requiring its immediate repair and an onboard recorder to indicate when the failure alert was flashed. This last requirement is to cover post-accident investigation in which a driver may be held responsible for injury or death caused by ignoring the air bag failure warning.

A radar collision sensor as part of a restraint system based on speed and distance may be more precise than the deceleration sensor. But it is certainly a more complex solution and therefore potentially more expensive than the deceleration concept.

Hz doppler frequency. Therefore, the output of the mixer (Fig. 3) consists of 450 samples per cycle of the doppler frequency rather than a 550.4-Hz demodulated signal. A sample-and-hold circuit is used to stretch the extremely short pulse samples from the mixer into a staircase approximation of the doppler frequency signal. So even if the car is traveling at five times the assumed 32 kph, more than 90 samples for each cycle of doppler frequency are available.

### The system configuration

Apart from the pyramid horn antennas, all microwave circuits in the radar system are in one unit (Fig. 3). The microwave circuits of the original experimental set, with the exception of the Gunn oscillator, are all fabricated as two ICs. In the latest configuration, the Gunn oscillator is also on a microwave IC.

The modulator driver contains two general-purpose high-speed TTL packages and one transistor. Another circuit in the transmitting and receiving unit is the sample-and-hold circuit that follows the mixer. The sample-and-hold circuit must be located near the mixer to minimize stray capacitance, because input rise and fall times are around 1 nanosecond and pulse lengths range up to an order of magnitude larger.

The continuous-wave microwave energy generated by the Gunn oscillator is turned into short pulses by the modulator. Most of the energy is radiated from the transmitting antenna, but a small portion is fed into the mixer as the reference signal for homodyne detection. The other mixer input is the reflected microwave energy picked up by the receiving antenna. Since a portion of the transmitted pulse is the reference signal for homodyne detection, only that portion of the received signal arriving during the duration of the transmitted pulse is detected.

The logic circuits produce a target acquisition or Range On signal when the peaks of two cycles of the doppler signal exceed a preset threshold level. In general, electrical noises from the on/off operation of automobile lights, blinkers, and other electrical devices generate a single transient peak. A very large attenuation in these noises is obtained by designing the Range On logic to respond only to two recurrent peaks, so that

the effect of most transients is negated.

The Range On signal switches the doppler signal into the input of a four-stage, scale-of-two counter designed to generate an output when the peaks of eight cycles of the doppler frequency signal are counted. This operation is completed in the time required for seven complete cycles of the doppler frequency.

At the first count a time delay circuit is also actuated, and this circuit generates a reset signal just after the interval required by the counter to register the lowest allowable speed. If the counter output signal has been generated before the reset signal, the coincidence of these two signals actuates the logic to produce the Speed On signal. Time required for this speed measurement is slightly less than 13 milliseconds.

If the system requirement were merely to produce a "System On" response at a *fixed distance* from a target, regardless of the actual speed at that time, the circuits described so far would be sufficient. This is because in the pulsed doppler system, the System On signal is effectively the logical output of an AND operation requiring Range On and Speed On outputs.

However, a preferable mode of operation is one in which a *fixed time* elapses from the generation of the System On output to collision at any speed above a preset minimum. In this mode of operation, which the experimental system uses for the air-bag restraint, the generation of the Speed On signal involves a time delay that is an inverse function of relative velocity.

This time delay is implemented by an up-down counter, two clock generators, and associated logic and switching circuits. A high-frequency clock is gated into the up terminal of the counter during one cycle of the doppler frequency. Next, a low-frequency clock is fed into the down terminal, and it reduces the previously counted value until a preset count is reached, at which time an actuating signal is generated.

For example, in this system clock frequencies of 93.9 kHz and 1,000 Hz have been chosen. The preset count at which the actuating signal is generated is 30. For the minimum speed at which this system operates, 32 kph, the up count reaches 171 during one cycle of doppler frequency, or 1.817 milliseconds. The down count then starts and continues at the rate of one count per milli-

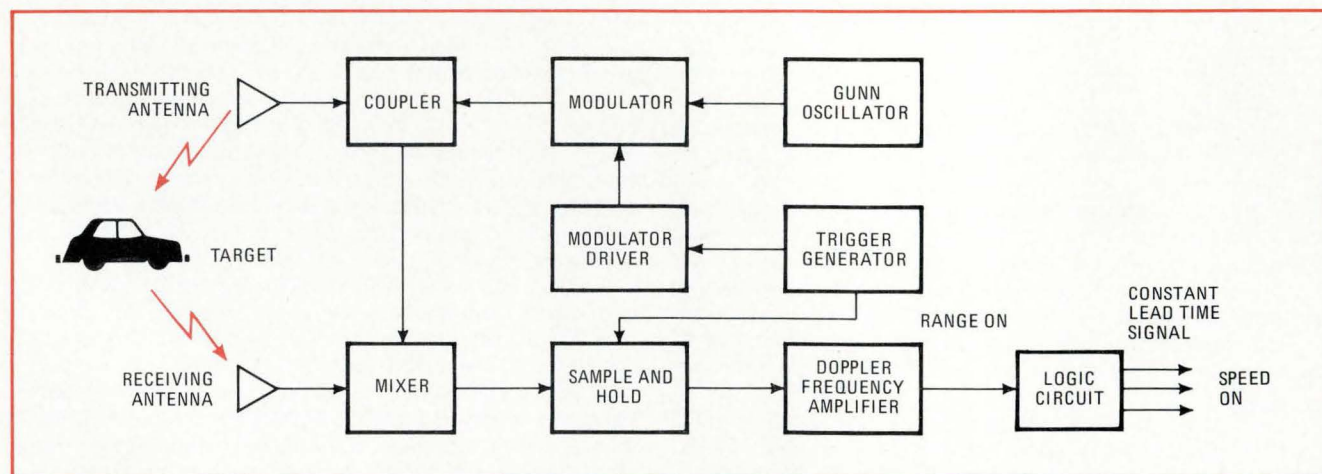

**3. Target practice.** In the test car, all microwave circuits, with the exception of the two outside antennas, are in one unit. The low-frequency circuits, logic circuits, power supply, and seat-belt trigger are included in a separate signal-processing unit.

second for 141 milliseconds, at which time the counter reaches the preset value of 30 and the actuating signal is generated. A similar calculation shows that at a speed of 64 kph the delay is 55 milliseconds. These values will give an approximately constant lead time if the Speed On signal is generated 1.5 meters before the collision.

### Two microwave ICs used

The system measures distance with a precision that is inversely proportional to the switching speed of the modulator circuit. In the experimental unit, carrier switch-on and carrier switch-off time are both about a nanosecond or less. Any increase in the switching time will increase the uncertainty in distance measurement because transmitted and therefore reflected, radar signals are less than steady-state values during the switching period.

The balanced mixer must have low output-terminal stray capacitance and excellent balance with respect to the reference signals in order to achieve the required characteristics. The output of the mixer is directly sampled and held to reproduce the doppler signal. A large stray capacitance at the mixer output terminals would result in delay of the output signal and attenuation of its amplitude, both of which would degrade the precision of the distance measurement.

When the mixer is unbalanced with respect to the reference signal, the unbalanced component appears at the output terminal. This component is sampled and held in the same manner as the signal component, and results in direct-current offset voltage. Superposition of this dc component on the signal reduces the dynamic range of the signal from the target that can be handled. This limits to a very narrow range the level of the signal from which distance information is obtained. In the worst case, the unbalanced component saturates the sample-and-hold circuit.

Fabrication of the modulator circuit as a hybrid microwave IC has several advantages over a discrete design: the small size reduces the stray capacitance seen by the modulator driver and thus aids in speeding up the switching time; the rigid structure is unaffected by vibrations of a moving automobile; and an IC lends itself to mass production.

The modulator drive circuit is designed to operate with high efficiency from the low power-supply voltage available in a car. It includes two commercially available high-speed ICs and a high-speed switching generator. In addition, the circuit configuration lends itself to fabrication as an MSI device.

The balanced mixer also is a hybrid IC, which uses two diodes. Although a one-diode mixer would be cheaper, the second diode eliminates coupling loss between the reference and received signal. The main reason that a balanced mixer was chosen, though, is that its dc bias can be directly coupled to a sample-and-hold circuit. This bias, which is determined by the level of the reference voltage, decreases the dynamic range of the circuits through which the received doppler signal passes. The balanced mixer feeds no dc voltage to its output terminal and is thus equivalent to a single mixer with the operating point at zero volts.

The diodes used in the balanced mixer are beam-lead

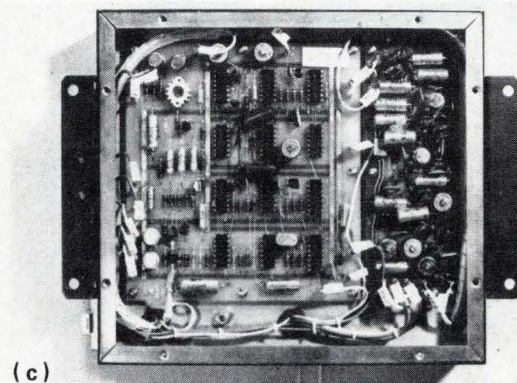
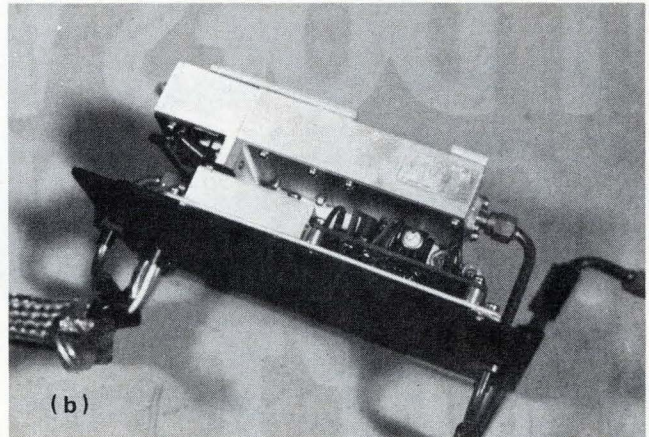

**4. Four-wheeled doppler.** The complete radar system (a), consisting of antennas, microwave-circuitry unit, and signal-processing unit, uses ICs throughout. The original microwave unit (b) has two microwave ICs—the switching and the mixer circuits. The logic circuits in the signal processor (c) are also ICs.

Schottky-barrier types which can easily be ultrasonically bonded to the microwave IC. Furthermore, no manual assembly is required during the fabrication of the diode, thus keeping the cost down for the performance achieved.

On the other hand, it proved to be difficult to inspect the beam-lead diodes until after they were bonded onto the microwave IC, making it impossible to select a matched pair before bonding. This difficulty was surmounted by bonding any two diodes onto the circuit and then adjusting the tap on an externally mounted resistor to get a zero current output from the mixer. □

**NEW ISOPLANAR  
CMOS.  
IT DOES WHAT  
COMMON CMOS  
CAN'T.**





Fairchild's new high-density Isoplanar CMOS costs about the same as ordinary CMOS.

And uses the same popular 4000 series pinouts for direct plug-in replacement.

After that, Fairchild CMOS leaves common CMOS far behind.

**"Isoplanar." It makes a difference.**

In the first place, Isoplanar fabrication reduces chip area substantially. Which means Fairchild CMOS designers have had plenty of room to include full buffer circuitry with every CMOS device. Even SSI.

Conventional CMOS utilizes buffered outputs only on MSI and driver devices. So a conventional unbuffered CMOS 2-input NAND Gate, for example, is organized like this:

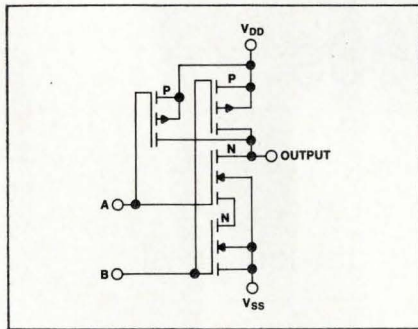

A Fairchild fully-buffered NAND Gate, on the other hand, looks like this:

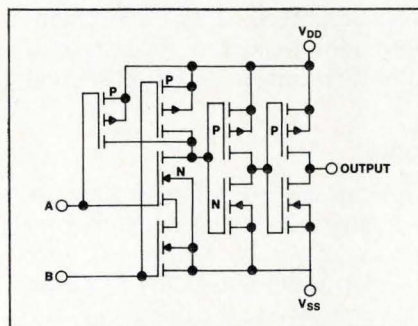

The device utilizes small geometry input and logic transistors to generate the required logic function, then utilizes low impedance output buffers.

For the system designer, there are several benefits:

1.

*Highest guaranteed noise immunity.*

Because buffering permits an increase in voltage gain, transfer characteristics are almost ideal.

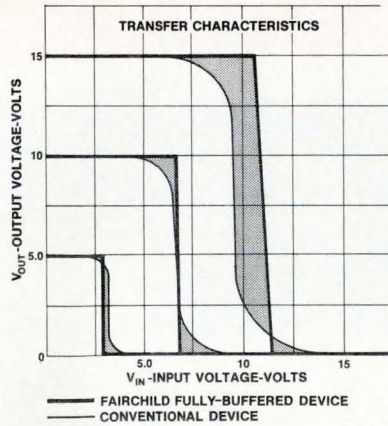

As a result, guaranteed noise immunity limits for Fairchild CMOS Gates are the highest in the industry.

2.

*At last, standardized outputs.*

Full buffering also means that output drive characteristics are finally standardized across all part types. And every husky Fairchild CMOS device drives a guaranteed 400 uA at 5 volt power supply.

Which means it can drive low power TTL and low power Schottky TTL directly.

3.

*Increased system speeds.*

With the buffers in service, output impedance and propagation delay in CMOS Gates become independent of the input pattern. Just look at the typical propagation delay for a Fairchild fully-buffered 34012 4-input NAND Gate vs. a conventional 4012 4-input NAND Gate at 15pF output capacitance.

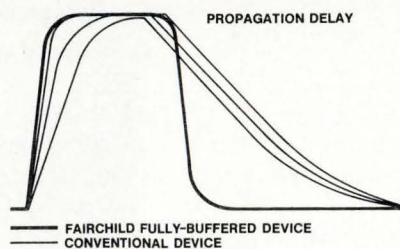

With 1, 2, or 3 simultaneous logic changes, conventional CMOS Gates exhibit differing propagation delays with input pattern. Fairchild CMOS doesn't.

System speeds using fully-buffered CMOS are sharply improved.

Add to that the inherent speed advantages of Isoplanar manufacture — including silicon

gate self-alignment and reduced sidewall capacitance — and you've got CMOS that beats all others.

**Fairchild CMOS. Think of it like TTL, only not so hungry for power.**

If you really want to see what CMOS can do for you, maybe you should think of it like TTL. Only in some ways, better.

Because instead of burning up 10mW per gate, Fairchild CMOS requires only 10nW at static conditions. That's only one-millionth of the power needed for TTL.

Fairchild CMOS also works over a broad 3V to 15V power supply range.

It's more immune to noise. (And makes less noise itself.)

It operates from -40°C to +85°C, commercial. And from -55°C to +125°C, military.

And instead of a dc fanout of 10 like TTL, Fairchild CMOS fanout is almost unlimited.

**Just tell us what you want. We deliver.**

Right now, a variety of Fairchild CMOS devices are in-stock and available for sampling, with more devices on the way.

*Available now.*

- 34001 Quad 2-Input NOR Gate
- 34002 Dual 4-Input NOR Gate
- 34011 Quad 2-Input NAND Gate
- 34012 Dual 4-Input NAND Gate
- 34023 Triple 3-Input NAND Gate
- 34025 Triple 3-Input NOR Gate
- 34027 Dual JK Flip-Flop
- 34028 One-of-Ten Decoder
- 34030 Quad Exclusive-OR Gate
- 34811 Quad Exclusive-NOR Gate

*Available soon.*

- 34019 Quad AND/OR Select Gate
- 34049 Hex Inverter
- 34050 Hex Buffer
- 34512 Digital 8-Chn. Multiplexer

Just check the devices that interest you, and call your Fairchild Sales Office or Distributor.



## Product development profile

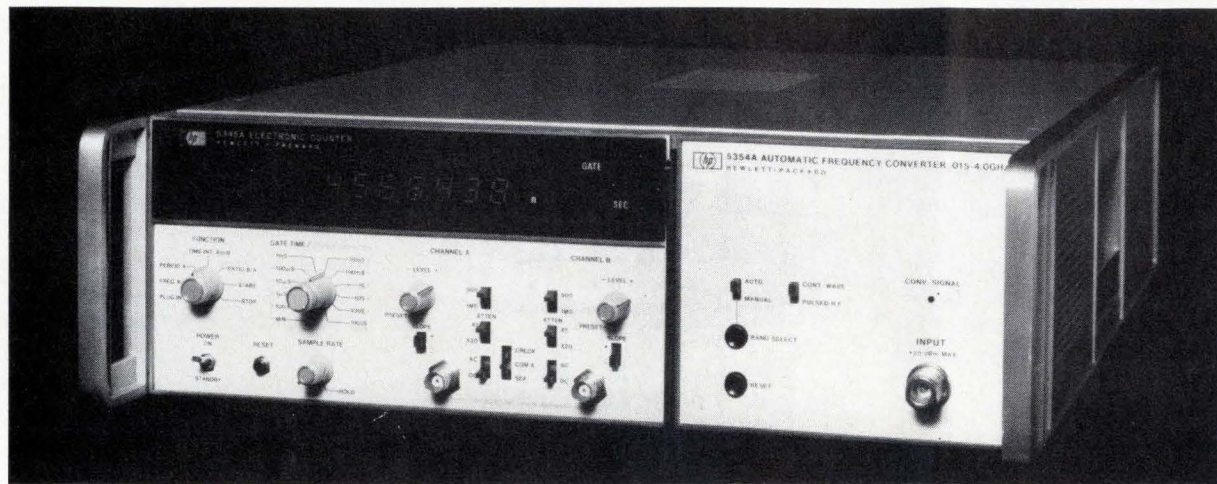

# The HP 5345A: a counter for the 1980s

How do you design a successor to one of the most successful instruments ever built?—especially when the specifications are impossible to meet because the necessary components don't exist

by Jim Sorden, Hewlett-Packard Co., Santa Clara, Calif.

□ In the past few years, makers of electronic instruments have been challenged by the rapidly increasing demands for higher precision in frequency and time measurements. Spectrum-crowding, sophisticated radars, and new solid-state oscillators have all generated pressing needs for instruments to measure the frequencies of continuous-wave and pulsed-rf signals with high accuracy and high resolution.

At the same time, the enormous advances in the technology of integrated circuits have far outpaced the capabilities of instruments that can measure time intervals and other related parameters of importance to IC users—particularly those in computer and data-communications equipment. To try to close this technology gap, Al Bagley, Hewlett-Packard's division manager for frequency and time products, in 1969 initiated an effort to build a counter that would upgrade measurement performance. He set these major design goals:

- Direct-count capability of 500 MHz.
- Define system architecture that would be necessary to measure pulsed-rf and high-speed digital signals.
- Make sure that the instrument's front panel could accommodate a wide variety of plug-in accessories, a capability that has accounted for much of the success of the earlier HP-5245 series.

I was assigned the task of defining the new machine

and heading up the project. My background in the design and development of computers, nuclear instrumentation, and fast ICs of emitter-coupled logic proved valuable in attacking the three major design goals that Bagley had set.

### Step 1: Design and logic

The fundamental problem was to design a 500-MHz logic family. H-P was already developing 500-MHz pre-scaling binaries [*Electronics*, Dec. 7, 1970, p. 63]. Jože Furlan, formerly a professor at the University of Ljubljana, Yugoslavia, was asked to tackle the theoretical circuit-analysis and IC-design problems because he had considerable experience in IC and device analysis.

Before he returned to his native Yugoslavia in late 1970, he had successfully developed a fine family of 450-MHz digital circuits. This represented at least a 150-MHz improvement over the previous highest-speed logic family.

For a variety of technical reasons, however, it was still felt that the 500-MHz logic goal would have to be attained before a successful product could be launched. The IC technology was yielding 2.5-GHz transistors and 550-MHz binaries, but gates capable of operating at 500-MHz still were in the future.

The breakthrough came in the winter of 1970-71

when Art Muto, previously a graduate student in circuit and network theory at the University of California at Berkeley, succeeded in discovering a series of circuit techniques allowing Hewlett-Packard to stretch the IC gates into the 600-MHz range. Two years had gone by since the initiation of the project, but by the spring of 1971, the goal of the 500-MHz family of logic circuits was in sight.

Muto's design used emitter-emitter logic ( $E^2L$ ).  $E^2L$  is almost identical to emitter-coupled logic, except for its output configuration. An  $E^2L$  output is an open collector (Fig. 1a), whereas the output of an ECL gate is an emitter follower (Fig. 1b). The output levels provided by an  $E^2L$  circuit working into a 50-ohm load are approximately 0.0 v and -0.8 v, whereas standard ECL-output levels are about -0.8 v and -1.6 v.

$E^2L$  circuits have no intrinsic speed advantage over ECL. What makes them attractive for high-speed applications is their ability to drive the 50-ohm transmission lines commonly used in high-frequency circuitry.

An ECL circuit would need special external biasing to be able to work into 50 ohms. And if the biasing were done right, ECL could work as fast as  $E^2L$  under those conditions, but it would be at the expense of much greater circuit complexity and power consumption.

#### Meanwhile, back at the drawing board

Concurrent with the development of the 500-MHz logic, the system architecture had to be defined. After many paper designs for the new counter, we concluded that a minimum-risk system would combine a reciprocal-counter with a calculator-type digital processor.

Unlike a conventional counter, which measures the number of input events that occur during an internally defined gate time, a reciprocal counter measures the time between events and calculates the frequency from the period. An advantage of this approach is that measurement resolution is independent of frequency.

Using a calculator-type processor would not only make single-shot pulsed-rf measurements possible, it would also satisfy the requirement that the system be capable of working with a great variety of plug-ins. The calculator approach makes plug-ins easy to handle because formatting, data manipulations, calibration procedures, and compensation can be built into the calculator's routines.

In August 1969, Ron Felsenstein, a recent graduate of MIT, was chosen to look into the specific economics of an algorithmic state machine that used  $T^2L$  and ROM technology. Many held little hope for economic success, since it was felt that  $T^2L$  was much too expensive and that the design would necessarily have to be complex. As things turned out, however, the density of ICs was increased from small-scale integration to medium scale, shift registers were replaced by RAMs, and the hoped-for price reduction of  $T^2L$  came. The basic calculator-type reciprocal processor provided the only hope for making meaningful pulsed-rf measurements, so when the processor cost got down to less than 10% of the total instrument cost, the future of the reciprocal calculator-type process architecture was assured.

This reciprocal technique, coupled with the 500-MHz time base (assured by the concurrent development of

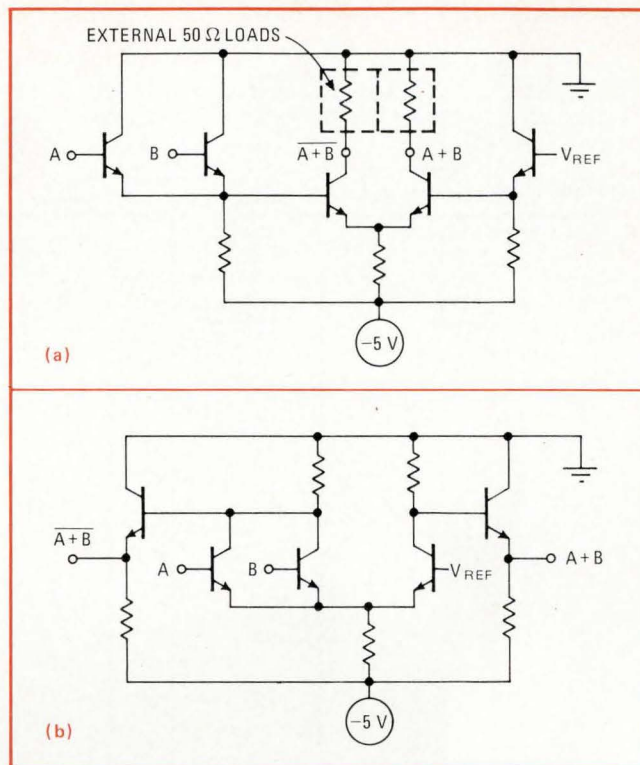

1. Fast.  $E^2L$  circuit (a) differs from conventional ECL circuit (b) in that it can drive 50-ohm loads because its output is an open collector. Frequency response of  $E^2L$  circuit extends beyond 650 MHz.

the 500-MHz IC logic) yields three-digit i-f resolution measurements for 1-microsecond pulsed rf. With microwave heterodyne converters, four- or five-digit readings of radar pulses are obtainable. Although this represents quite an accomplishment, five-digit measurements are not adequate for a large class of microwave pulsed-rf measurements; therefore, we continued to look at schemes for improving resolution.

Through the summer of 1971, Muto and I experimented with various techniques for improving resolution through averaging. Some measurement results were well within expected error limits, but many others simply did not make sense. We concluded that the lack of a firm theoretical understanding of time-interval-averaging had to be overcome before frequency-averaging could succeed.

It was known that time-interval-averaging would not work under all conditions. We decided that the dropout problem with that technique might be solved by the use of a jittered time base. However, since a statistical model for time-interval-averaging did not exist, the value of our suggestion remained to be proven. David Chu, a long-time instrument designer in the division, was completing his Ph.D. work at Stanford. The author of several papers on statistical processes, Chu appeared to be a perfect choice for the task. He ultimately succeeded in detailing the mechanics and theoretically substantiating that band-limited noise added to the time base would solve the dropout problem. A firm foundation had been built for time-interval-averaging, and the future of frequency-averaging appeared bright.

Chu's work showed that, to accurately average time intervals, the counter's gating signal would have to

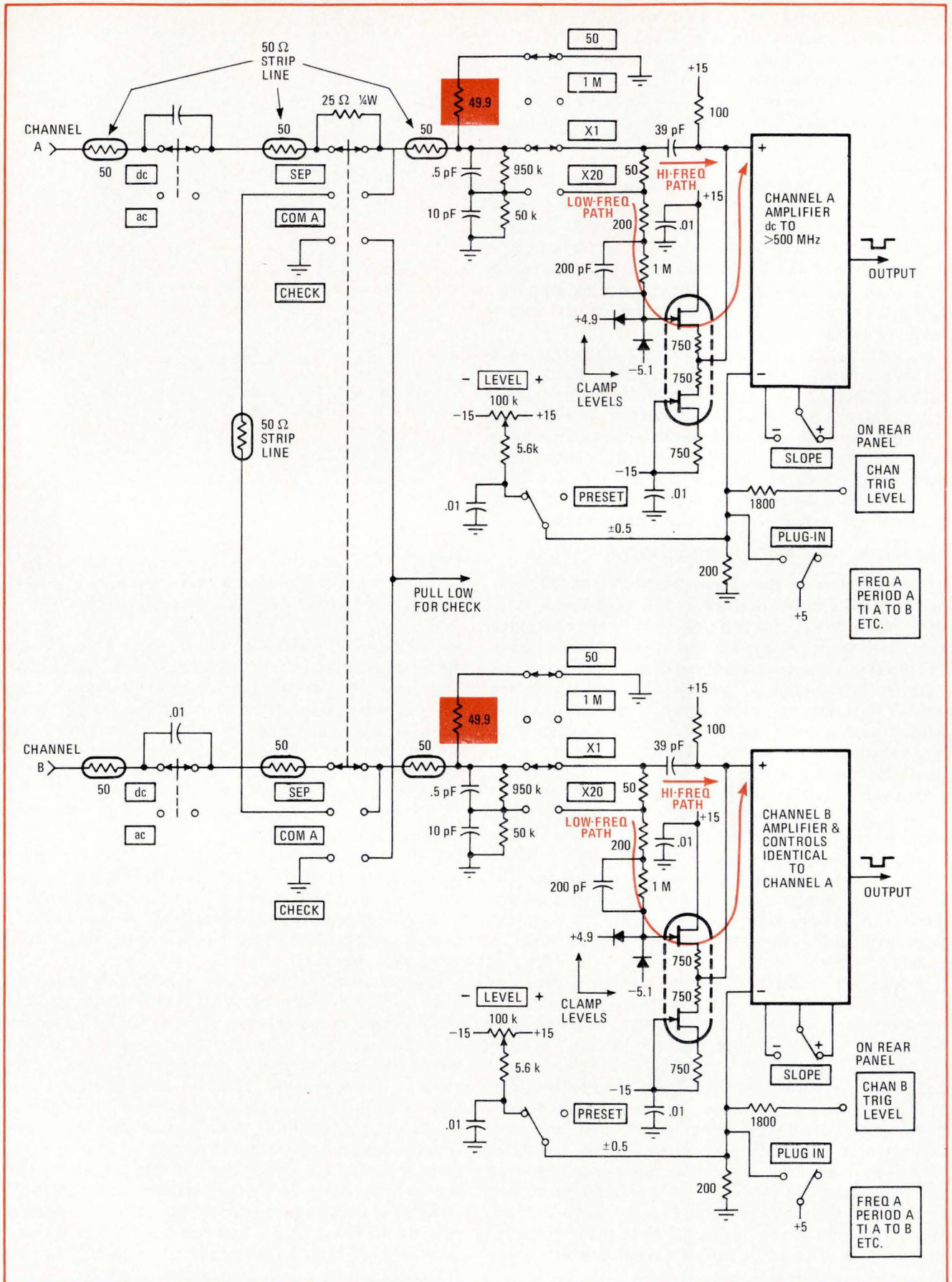

**2. Monolithic.** Direct-coupled, three-stage, IC amplifier spans dc to 500 MHz. Capacitors  $C_{E1}$  and  $C_{E2}$  are parallel combinations of small MOS units whose values are adjusted at the second metal layer to compensate for variations in the processing of the semiconductor wafers.

maintain a uniform phase distribution around the counter's clock period. Measurements made when the distribution is not uniform lead to an average value that is biased away from the true average value, no matter how many intervals are averaged. This occurs whenever the repetition rate of the incoming signal has any harmonic or subharmonic relationship to the counter's clock frequency.

Since dithering the clock with noise destroys these harmonic relationships, the use of a noise-modulated clock guarantees valid averaging results, regardless of input frequency. In the final instrument, jitter of slightly more than one period is added to the clock by phase-modulating the time base multiplier at its 100-MHz multiplication point with band-limited gaussian noise when the counter is in the averaging mode.

### The input amplifiers

During the early years of the project, there was much discussion as to what configurations the counter's input amplifiers should take. One idea was to build a frequency-only mainframe, such as one in the predecessor 5245 series. To achieve the desired 500-MHz bandwidth and accommodate pulsed-rf and digital work, the instrument would need a dc-coupled, 50-ohm amplifier because a high-impedance 500-MHz amplifier was not thought possible. However, the 50-ohm system would not solve low-frequency, high-impedance applications. If the machine could not service both high and low frequencies, the new counter could never be considered a general-purpose instrument.

A second idea was to use a two-input amplifier system to measure both frequency and time intervals. This would more fully utilize the power of the chosen recip-



**Speed demons.** Group Leader Jim Sorden (left) examines fast logic design with engineers Art Muto (center) and Steve Upshinsky.

## Leading up to the 5345A

In 1961, the 5245 family of general-purpose high-frequency plug-in counters was launched by Hewlett-Packard Co. It was to become one of the most successful families of instruments ever developed, providing the 1960s with a then high-technology 50-MHz direct-count machine. A late addition to the family, the 5248, extended this direct-count range to 150 MHz.

Single-shot time-interval plug-ins gave the family the ability to measure time intervals down to 10 nanoseconds, while a line of rf plug-ins gave frequency coverage up to 18 GHz. The line proved to be a phenomenal success with sales of well over 20,000 of one single model: the 5245L. The success of the 5245L is perhaps better appreciated when one realizes that there are more of them in operation today than all other high-performance counters combined.

The success of the 5245 series led H-P to develop a higher-priced and much higher-performance counter and also to develop a series of lower-cost, lower-performance units. The advent of reasonably priced TTL in the late 1960s combined with the H-P invention of an oven-temperature-stabilized analog time-interval interpolator led the company to build the 5360A computing counter in 1969. This is a 10-MHz reciprocal counter, in which the interpolator provides a 1,000-point vernier between each of the 10-MHz time ticks, accuracy within 1 nanosecond, and 100-picosecond resolution. It now is the world's

standard instrument for time-interval measurements.

Microwave plug-ins extend its useful frequency range to 18 GHz. To extend system-measurement power of the 5360A, it can be outfitted with a calculator-type keyboard and/or system programmer. It has only one drawback—the \$6,500 starting price tag. With systems, accessories, and calculator, the price can exceed \$10,000. Clearly, although the 5360A offered the experimenter an improvement over any other alternative, its price kept it from becoming the electronics industries' general-purpose high-performance standard for most applications.

By 1969, inexpensive digital ICs led many manufacturers of frequency counters to develop less-expensive, less-powerful alternatives to the enduring 5245. For around \$1,500, several manufacturers, including Hewlett-Packard, offered instruments that count directly to 50 MHz and have built-in time-interval capability and a room-temperature crystal time base. These instruments represented excellent value for the dollar, but in no way improved or even equalled the performance of the 5245 series. Alternatively, the 5360A proved not to be cost-effective as a general-purpose laboratory counter.

At a basic price of \$3,450, the 5345A is expected to do for the next dozen years what the 5245 family did for the last dozen—provide the measurement capability needed by contemporary technology at a price suitable for a general-purpose laboratory instrument.

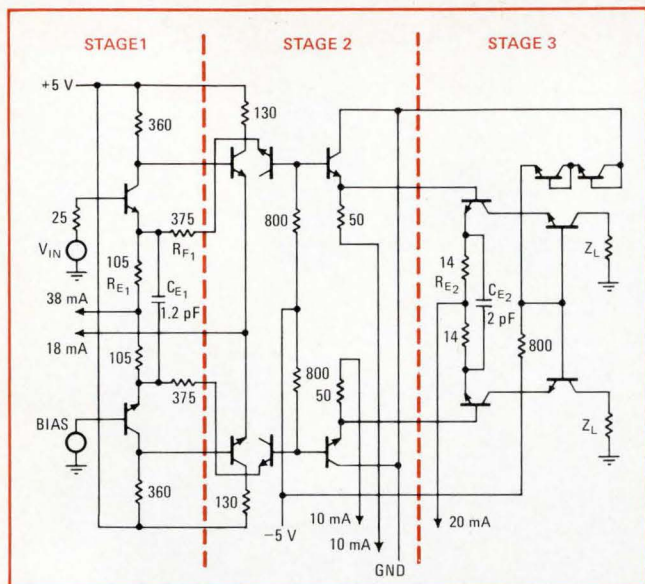

**3. Dual attenuators.** Input attenuator is a 50-ohm stripline design. Breaking the connection between terminating resistor (shaded area) and ground provides a 1-megohm input resistance (in parallel with 30 pF) for low-frequency signals. COM A position of front-panel switch puts input amplifiers in parallel to aid pulse-width measurements; good match is maintained by use of 50-ohm power-splitter.

rocal technique, but it only emphasized the problem of serving both the high- and low-frequency applications.

A three-input solution was also proposed and appeared, for a while, to be the most practical alternative. A 50-ohm dc-coupled amplifier could be built for high-frequency applications and two high-impedance amplifiers could be built for measuring time intervals and low frequencies. This was a concept similar to one appearing in the lower-performance 50-MHz and prescaling counters of the period.

Even a four-input counter was suggested. This unit would contain two 50-ohm channels for high-frequency and time-interval measurements, and two high-impedance channels for low-frequency applications. The final design had two inputs.

Before the issue was resolved, virtually everyone in the division with frequency-counter experience, as well as many salesmen in Hewlett-Packard's worldwide field organization, had become involved. The success of the product truly hinged on the definition and development of an ideal input-amplifier configuration.

### Three-stage design

While discussions of a reasonable compromise raged, the engineering team was busily trying to build the amplifier as a high-impedance dc-to-500-MHz high-sensitivity IC design. Steve Rattner, who had been working toward a Ph.D. in electrical engineering at the University of California at Berkeley, was recruited for this most difficult project. Steve had the experience in circuit design, as well as a solid working knowledge of both hybrid and monolithic integrated-circuit design. In November 1970, he was finally able to demonstrate the practicality of building a high-impedance monolithic IC with greater than the target 500-MHz bandwidth.

Rattner's design consists of the three-stage circuit



**Averagers.** Theoretician David Chu (left) discusses implementation of time-interval-averaging technique with designer Ron Felsenstein.

shown in Fig. 2. The first stage is a series-shunt feedback pair with the ratio  $(R_{E1} + R_{F1})/R_{E1}$  determining the low-frequency gain. MOS-capacitor  $C_{E1}$  affects the gain at high frequencies and is chosen for optimum amplifier response.

The second stage is a low-output-impedance dc-level shift with emitter-follower impedance-conversion to minimize loading on the first stage. The dc level is shifted by using the reverse-emitter-base breakdown on a transistor with the collector open to reduce any offsets caused by leakage currents.

The third stage is a compensated cascode, chosen to reduce the Miller effect for amplifier options that use large load resistors. Third-stage gain is determined by an emitter-series resistor,  $R_{E2}$ , and capacitor  $C_{E2}$ .

A unique characteristic of this amplifier is the compensation of the over-all response by adjusting  $C_{E1}$  and  $C_{E2}$  at the second metal layer. The second metal is used to interconnect small MOS capacitors to obtain a total capacitor value that will compensate for variations in wafer processing. The capacitor values are determined from the  $f_t$  of the test transistor and the value of a test resistor on the wafer.  $C_{E1}$  and  $C_{E2}$  are selected to give the desired amplifier response.

When the design of the high-impedance amplifier was far enough along for us to be sure it would work, the counter-development team committed itself to choosing and building the most flexible, highest-performance configuration that had been proposed. When Rattner transferred to H-P's IC Process Development group, Steve Upshinsky carried on the work.

In two years he completed the high-sensitivity, dc-coupled, wideband, high-impedance amplifier with each of two inputs connected to a 50-ohm stripline input attenuator (Fig. 3). When the attenuator is terminated by a 50-ohm resistance, the input signal sees 50 ohms, but when the terminating resistor is switched out of the circuit, the input resistance is about 1 megohm.

In March 1972, we built the first prototype incorporating all the features we had hoped for. It took another year of development to perfect the various parts of the 5345A and to obtain the cost objective of building a general-purpose counter that could be afforded by most customers. Having completed the development in February 1973, it took another year to get the instrument, with all of its complexities, into full production. □

# IC with load protection simulates power transistor

Equivalent to an npn power transistor, this integrated circuit provides overload protection and thermal limiting on the chip; the device's high gain and fast response reduce the need for off-the-chip compensations

by Robert C. Dobkin, *National Semiconductor Corp., Santa Clara, Calif.*

□ Power circuitry must have excellent overload protection. Often, power devices drive loads of unknown magnitude that are external to the systems containing the devices. When they drive many low-level circuits, such as voltage regulators in parallel, a device failure can often destroy an entire system. The most common failure mode for power transistors is a collector-to-emitter short circuit, and when the power transistor is destroyed, full supply voltage may be applied to any following low-level circuitry, usually with fatal results. It is therefore important to include protective circuitry in a power system to limit overloading.

Now, an extremely high degree of protection has been built into an integrated circuit that simulates a single power transistor (Fig. 1). This IC power transistor, the LM195, provides current limiting, safe-area limiting, and, thermal-overload protection. Current limiting controls the peak current through the chip to a safe level below the fusing current of the aluminum metalization. At high collector-to-emitter voltages, safe-area limiting reduces the peak current to further protect the power transistor.

If, under prolonged overload, power dissipation causes chip temperature to rise toward destructive levels, thermal limiting turns the device off. The inclusion of on-chip thermal limiting makes this device especially attractive in applications where normal external protective designs are ineffective or too costly.

## Applications

In addition to being used in linear applications, the IC can interface transistor-transistor logic or complementary-MOS logic to power loads. The input-current requirement of 3 microamperes is small enough so that one C-MOS gate can be used to drive more than 400 of these devices.

The combination of low input current with high base-to-emitter drive capability makes the device especially useful for driving power loads from digital logic. The IC has low input capacitance, which permits it to be driven easily from high-impedance sources—even at high frequencies. Available in a standard TO-3 power package, the monolithic structure ties the emitter, rather than the collector, to the case, which effectively bootstraps the base-to-package capacitance.

The device is especially valuable in such circuits as lamp drivers, solenoid drivers, and switching regulators,

which do not dissipate much power during normal operation. However, during overload, the full supply voltage times the minimum output current must be dissipated. Without a large heat sink, standard power transistors are quickly destroyed.

The device is fully protected against any overload condition when it is used below the maximum voltage rating. The current-limiting circuitry restricts the power dissipation to 40 watts, and at a collector-to-emitter voltage of 20 v, 2 A are available. However, like standard transistors, power dissipation in use is limited by the size of the external heat sinks.

A 40-v, 25-ohm load can be switched on or off in a relatively fast 500 nanoseconds. The limiting factor on over-all speed is the protective and biasing circuitry around the output transistors. The LM195 acts like an ordinary power transistor, and its operation is almost identical to that of a standard power device.

## Protection

Thermal limiting permits the use of smaller heat sinks than conventional circuitry. With only current limiting, the heat sink must be designed to dissipate worst-case overload power at maximum ambient temperature. But, since this device heats up and then thermally limits dur-

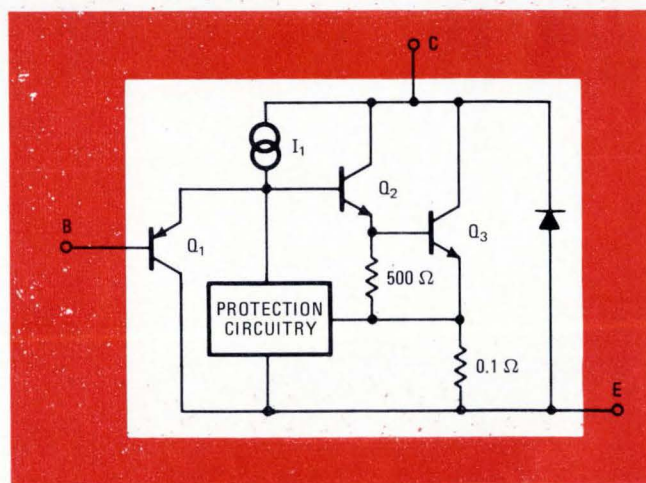

**1. Overload-proof.** What appears to the user as a standard three-terminal power transistor is actually a monolithic integrated circuit that provides extremely high resistance to blowout and overload. Included in the protective circuitry are thermal-limiting, current-limiting, and safe-area protection.

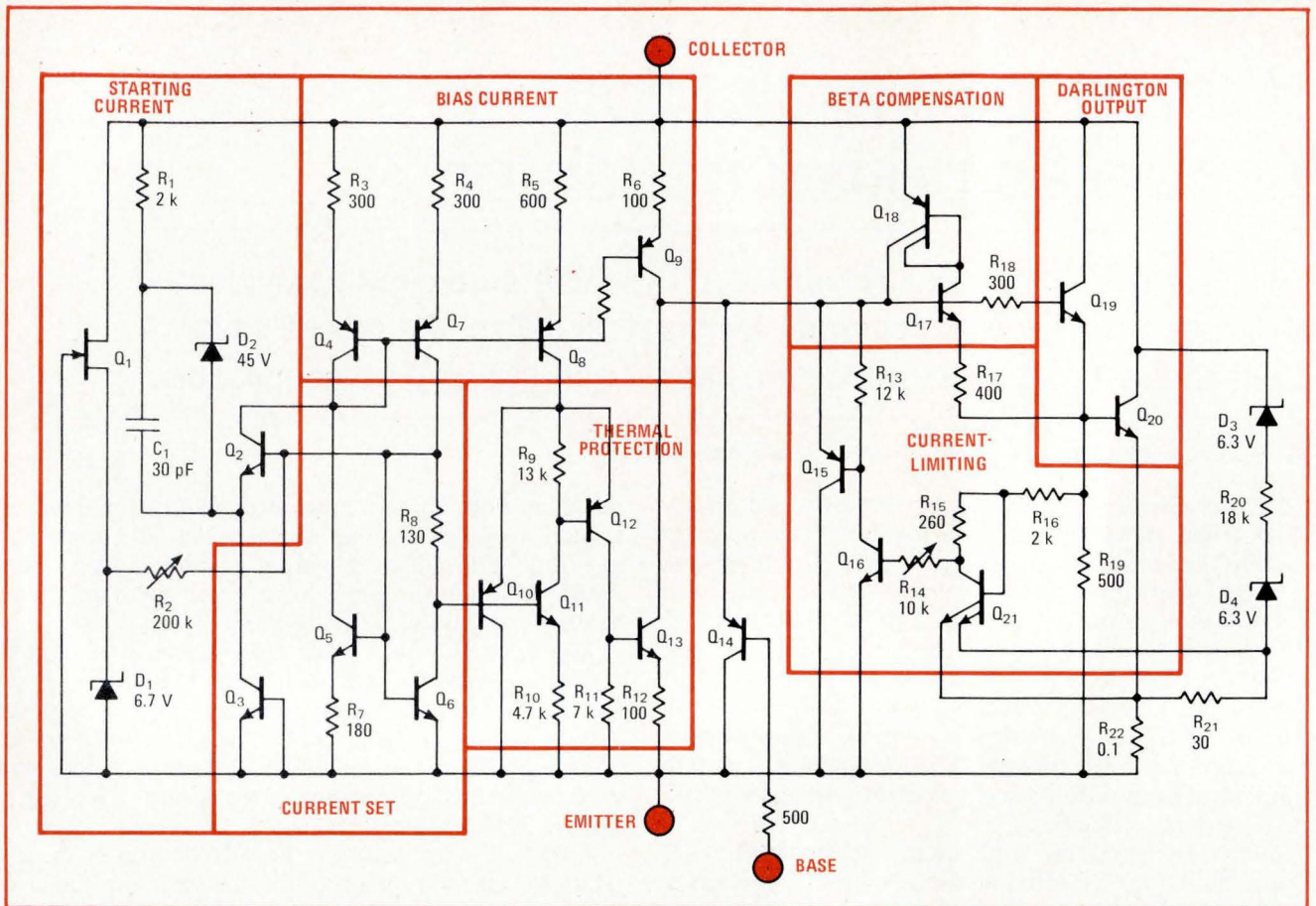

**2. Single power transistor.** Monolithic power transistor consists of seven separate sections, each of which provides unique features that were either difficult to design in the circuit or require complex processing. The emitter output travels from Q<sub>20</sub> through the 0.1-ohm resistor in the lower right-hand corner. The output transistor in the schematic actually fills up half the chip area.

**3. Chip partition.** Over one half of the area is taken up by the output transistor, which is partitioned into 10 sections to provide balanced power flow and thermal distribution.

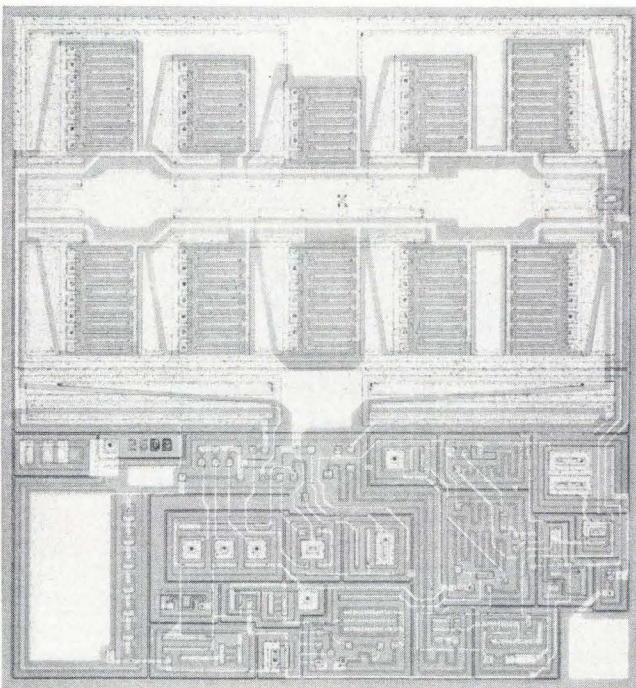

ing overload, the size of the heat sink may be significantly reduced.

A primary design goal was to have the monolithic power transistor function as nearly as possible like a conventional discrete power device. However, the protective circuitry on the chip causes some slight differences. Because of the input pnp transistor, the base current is negative, and it flows out of the base lead.

Input pnp transistor, Q<sub>1</sub>, drives a power Darlington pair, Q<sub>2</sub> and Q<sub>3</sub>. Transistor Q<sub>1</sub>, made by standard IC processing, has a reverse-base-emitter breakdown in excess of 40 v. At input voltages in excess of about 1 v, the input pnp becomes reverse-biased, and no current is drawn from the base lead. This allows the power transistor to be driven from a low-impedance voltage source without damage by excessive base current. In fact, it is possible to drive the base with as much as 40 v, even though the collector-to-emitter voltage is low.

Thus, in addition to decreasing the required drive to 3 μA, Q<sub>1</sub> isolates the base drive from the protective circuitry, ensuring that the device is protected, even with large base drive. This reverse base current from Q<sub>1</sub> gives another advantage over standard devices, since it can be used to bias-drive circuitry, thereby eliminating some external components.

Input transistor Q<sub>1</sub> and the npn Darlington pair Q<sub>2</sub> and Q<sub>3</sub> are biased by the internal-current source I<sub>1</sub>. These three composite transistors yield a total current



gain in excess of  $10^6$ . Because of  $Q_1$  and  $I_1$ , the transistors turn on, rather than off, when the base is opened.

Since most power circuits already include a shunting base-emitter resistor to absorb any leakage currents, this should cause few problems for designers. When the device is turned off,  $I_1$  is shunted from the base of the Darlington by  $Q_1$  and appears at the emitter terminal E. This emitter current flowing with the device turned off sets the minimum load current to about 2 mA—not a severe restriction for a power transistor.

### Circuitry

A detailed schematic (Fig. 2), shows the circuitry, which is biased by four current sources,  $Q_4$ ,  $Q_7$ ,  $Q_8$ , and  $Q_9$ . The operating current, set by  $Q_5$  and  $Q_6$ , is relatively independent of supply voltage. Field-effect tran-

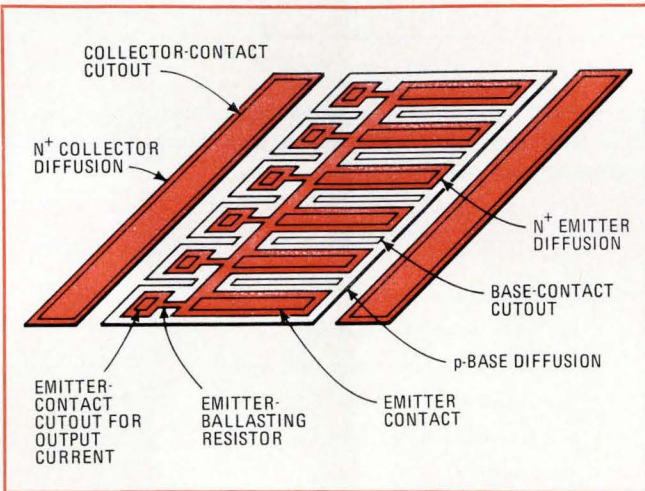

**4. Output section.** Output transistor is triple-diffused, interdigitated structure made by standard IC processing. It features an emitter-ballasting resistor in each finger of the section of the device. Metalization is designed to eliminate any unbiasing caused by small voltage drops along the emitter fingers.

**5. Op-amp power.** High-frequency quasi-complementary output is accomplished with a standard op amp to drive an npn and pnp-equivalent output stage. Reducing  $C_1$  increases bandwidth, but could lead to oscillation problems. The 40-watt output from each LM195 is three times higher than is currently available in monolithic op-amp chips and doesn't require complex heat-sinking.

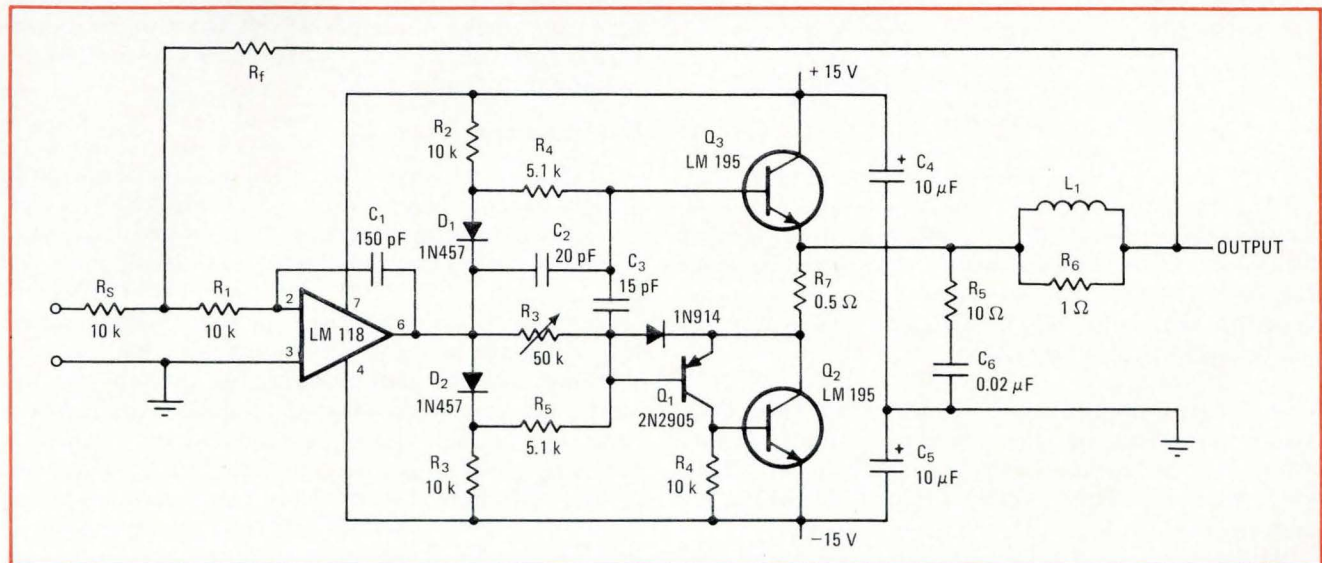

sistor  $Q_1$  and resistor  $R_2$  ensure reliable starting of the bias circuitry, while diode  $D_1$  clamps the output of the FET, limiting the starting current at high supply-voltage levels.

Output transistors  $Q_{19}$  and  $Q_{20}$  are driven from  $Q_{14}$ . Current limiting independent of temperature is provided by  $Q_{21}$ ,  $Q_{16}$ , and  $Q_{15}$ . The double-emitter structure of  $Q_{21}$  allows the power limiter to decrease the output current as input voltage is increased, creating an approximately ideal constant power ( $I_c \times V_c = K$ ), graphed as a hyperbola, rather than the non-ideal straight-line fold-back limiting that is typical of power devices.

Transistor  $Q_{13}$  thermally limits the device by removing the base drive at high temperature. The actual temperature sensing, done by  $Q_{11}$ ,  $Q_{12}$ , and  $Q_{10}$ , regulates the voltage across the temperature sensors so that the thermal-limiting temperature is independent of supply voltage. As temperature increases, the collector current of  $Q_{11}$  increases, while the base-emitter voltage ( $V_{BE}$ ) of  $Q_{12}$  decreases. Finally,  $C_1$ ,  $Q_2$ , and  $Q_3$  boost operating currents during switching to obtain faster response time, and  $Q_{17}$  and  $Q_{18}$  compensate for variations in current gain ( $h_{FE}$ ) of the power devices.

A photomicrograph of the chip (Fig. 3) shows that more than half the die area is needed for output transistor  $Q_{20}$ . Actually, the output transistor consists of many individual small transistors connected in parallel with a common collector. Partitioning the power device into 10 base sections spread across the chip provides better power handling than a large single device. Between the base diffusions are  $n^+$  collector contacts. Each of the 10 sections has an individual emitter-ballasting resistor to ensure current-sharing between sections. One of the resistors senses the output current for current limiting.

A detail of one of the base sections (Fig. 4) shows the interdigitated structure with alternating base contacts and emitter stripes. Since the emitter current varies exponentially with the drop in the base-emitter voltage,

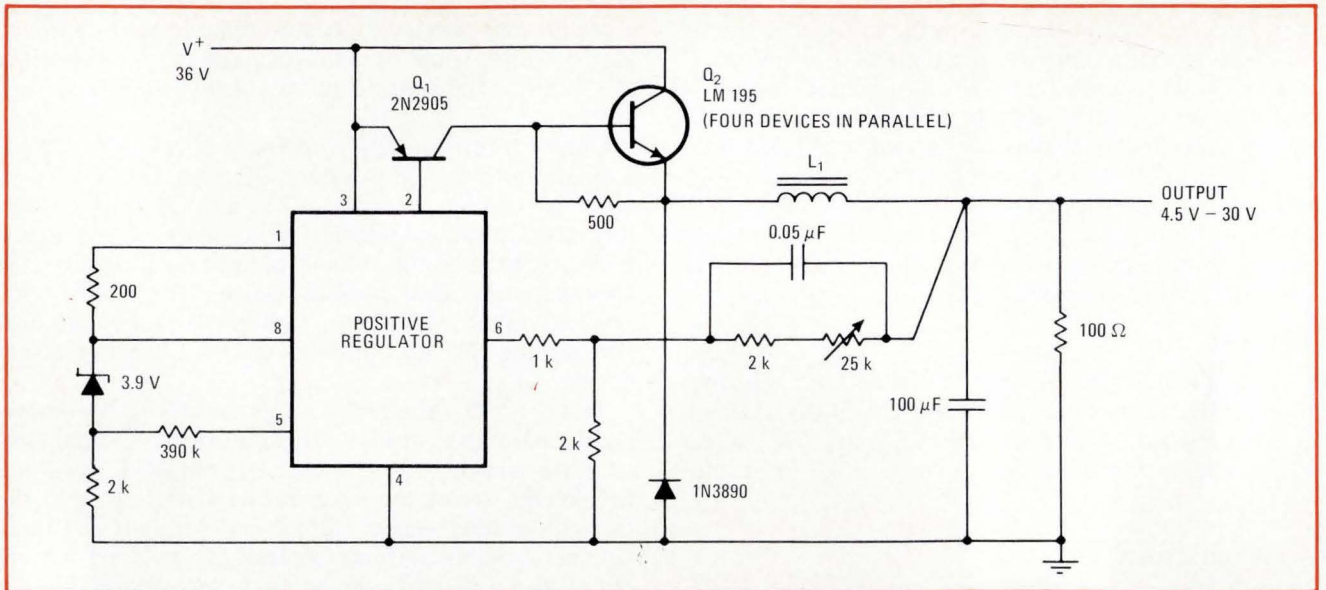

**6. Regulator power.** Switching regulation is achieved by applying positive feedback independent of supply voltage to the positive regulator. Negative feedback, delayed by  $L_1$  and the output  $C_2$ , causes the regulator to switch with the duty cycle, thereby automatically adjusting itself to provide a constant output. Input current regulation to 3 microamperes allows connection of many units in parallel.

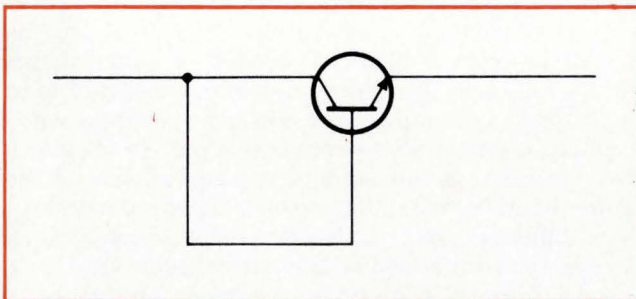

**7. Limited power.** An efficient power regulator with only a 2-volt series voltage drop may be simply constructed with this device by utilizing the on-chip protective circuitry. Device automatically limits current and power dissipation.

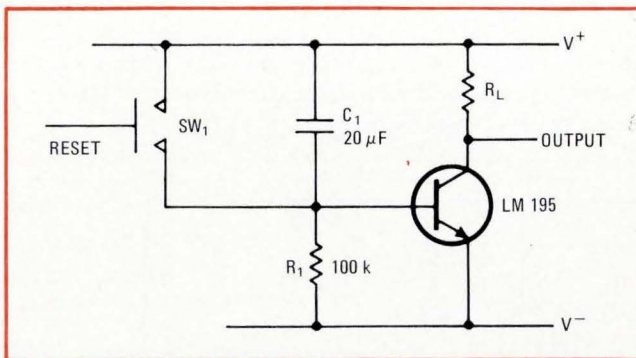

**8. Power delays.** Since large output resistances may be used with the monolithic power transistor, and since the device has a high gain, long time delays may be obtained. Capacitor  $C_1$  charges towards  $V^-$  and de-energizes the load when its charge causes the voltage across  $R_1$  to drop below 0.8 V.

even millivolt drops along an emitter stripe can have a significant effect on the emitter's current density. Aluminum metalization runs the length of the emitter stripe to prevent lateral voltage drops from debiasing a section of the stripe at high operating currents.

All current in each stripe flows out through these bal-

#### TYPICAL PERFORMANCE

Collector-to-emitter voltage	40 V
Base-to-emitter voltage (maximum)	40 V
Peak collector current (internally limited)	2 A
Reverse base emitter voltage	20 V
Base-to-emitter voltage ( $I_C = 1 A$ )	0.9 V
Base current	3 $\mu A$
Saturation voltage	2 V
Switching time (turn on or turn off)	500 ns
Power dissipation (internally limited)	40 W
Thermal-limit temperature	165°C
Maximum operating temperature	150°C
Thermal resistance (junction to case)	2.3°C/W

lasting resistors, where they are summed. This partitioning yields a large safe area, as well as good power-handling capability. The table shows the device's performance characteristics.

#### How it's used

Despite its protective circuitry, certain precautions are still needed. The device can be destroyed by excessive collector-to-emitter voltage or improper power-supply polarity. Low-level, high-frequency oscillations can occur when the device is used as an emitter-follower. A 5-kilohm to 10-kilohm resistor in series with the base lead will eliminate the possibility of oscillation.

If more power handling capability than 40 w is required, several devices may be paralleled. In linear circuitry, all devices should be mounted on a common heat sink to equalize case temperatures. The internal emitter resistors will then ensure equal current-sharing within about  $\pm 10\%$ . With switching circuits, as long as the drive is large enough (greater than 1 V) to turn all

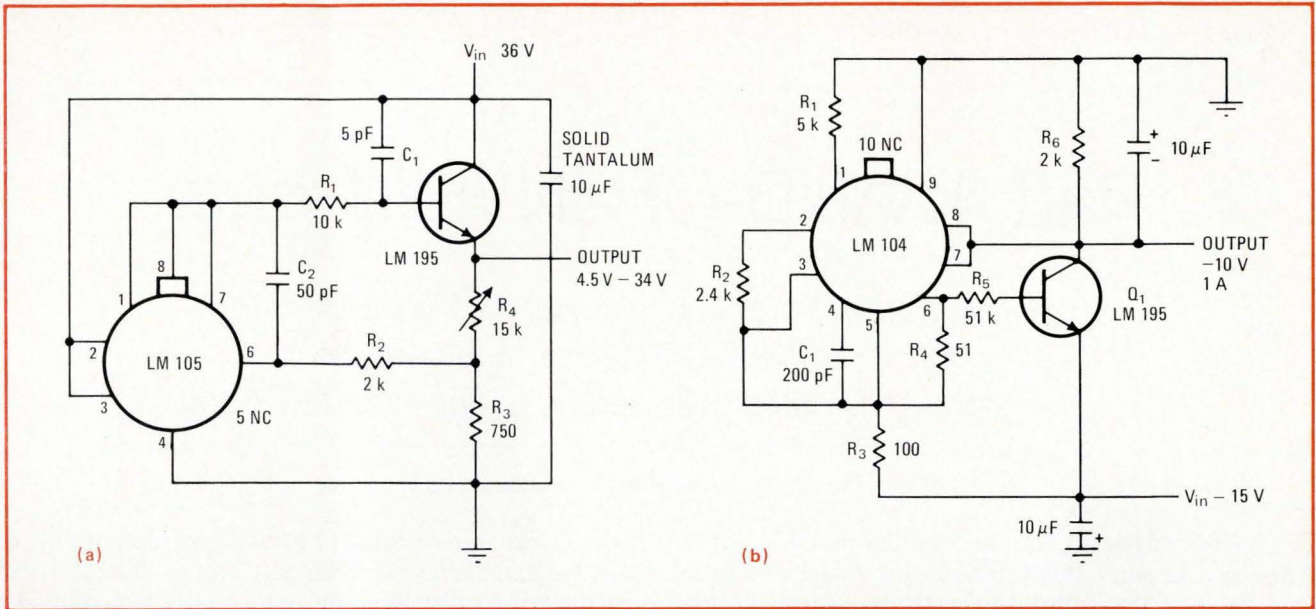

**9. Power regulation.** The monolithic power transistor allows simple positive (a) and negative (b) regulators to be built. The high gain of the transistor means that large changes in output may be accomplished with only small changes in the current the IC has to supply.

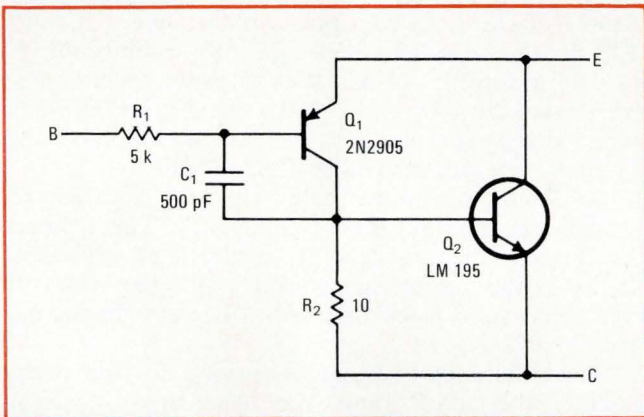

**10. Pnp power.** Small-signal input transistor  $Q_1$  feeds the power npn  $Q_2$ , which actually does most of the power amplification. Since the device gain is so high, resistor  $R_1$  and capacitor  $C_1$  are needed to frequency-compensate the loop against oscillations.

devices on, it is not necessary to use a common heat sink.

Figure 5 shows a power operational amplifier with a quasi-complementary output stage. The circuit provides full output to 20 kHz. The capacitance of  $C_1$  may be reduced to 15 pF to extend full power response to 150 kHz. If more than about 1.5 A of output current is needed, several transistors can be paralleled for the output stage.

A 6-A switching regulator is shown in Fig. 6. An LM105 positive-voltage regulator is used as the amplifier reference for the switching regulator. The circuitry is fairly standard—with two exceptions. Positive feedback to induce switching is obtained at the emitter of the internal drive transistors (pin 1), rather than from the emitter. In this way, the positive-feedback switching voltage is independent of supply voltage. Switching from the emitter would result in dependence of the feedback voltage upon power-supply voltage.

A two-terminal current/power limiter is shown in

Fig. 7. The base and collector are shorted, which turns on the monolithic power transistor. If the load current exceeds 2 A, the device protects the load by limiting the current. If the overload remains on, the device will go into thermal limiting. In normal operation, only 2 v are subtracted from the applied input voltage, which keeps efficiency high.

Figure 8 shows a time-delay circuit. Upon application of power, capacitor  $C_1$  slowly charges toward  $V$  through  $R_1$ . When the voltage across  $C_1$  decreases below about 0.8 v, the load is de-energized. And since a high resistance can be used, long delays can be obtained with small capacitor values.

Figures 9a and 9b show how the device can be used with standard ICs to make positive or negative voltage regulators. Since its current gain is so high, both circuits have load regulation within 2 mv. They are both fully overload-protected and will operate with a differential input-to-output voltage of only 2 v.

Current regulators are difficult to protect because the current is already fixed. Circuits to limit the voltage across the current regulator may allow excessive current to flow through the load. About the only method that protects both the regulator and the driven circuitry is thermal limiting.

### Simulating a pnp

Only the equivalent of an npn power device is available. A complementary-pnp integrated circuit is not possible, since current monolithic technology can only produce good high-power npn transistors.

However, a pnp may be simulated in a quasi-complementary configuration, as shown in Fig. 10. A low-current npn drives the power-output device. Resistor  $R_1$  protects against destruction of the pnp by overdrive, and in conjunction with  $C_1$ , frequency-compensates the high-gain feedback loop against oscillations. Resistor  $R_2$  sets the operating current for the pnp and limits the collector current. □

## Part 4: AND-OR-INVERT gate

Computer model can duplicate the performance of an AND-OR inverter that consists of four AND gates, followed by a four-input NOR gate

by John R. Greenbaum and Wayne A. Miller, *General Electric Co., Syracuse, N.Y.*

□ Like the earlier models described in this series of articles on computer-aided design, the model developed here for the AND-OR-INVERT gate duplicates the performance of a specific TTL integrated circuit. In this case, the IC is the type RSN54L57 gate, a radiation-hardened device.

As noted in Fig. 1, the RSN54L57 IC consists of four AND gates and one NOR gate. Three of the AND gates can accept three inputs at the same time, while the fourth can only accept two inputs at a time. If the output of each AND gate is not true, the circuit's output is logic 1. When the output of any one of the AND gates is true, the circuit's output becomes logic 0. The table of electrical characteristics describes the behavior of the circuit for various signal and supply conditions.

### Modeling the AND-OR-INVERT gate

Figure 2 shows the computer model for the RSN54L57 AND-OR inverter. Also shown in the figure are the model descriptions for the Sceptre (System for Circuit Evaluation and Prediction of Radiation Effects) analysis program and the Circus-2 (Circuit Simulator) analysis program. The two model subprograms needed to complement the model descriptions are listed, too.

The model has three inputs (A1, A2, and A3) for AND gate A, three inputs (B1, B2, and B3) for AND gate B, three inputs (C1, C2, and C3) for AND gate C, and two inputs (D1 and D2) for AND gate D. The logic level of the circuit's output (V OUT) is established by one of the subprograms, function F57. The other subprogram, function FCP3, determines the model's delay characteristics.

If any of the input signals to any of the four AND

gates is less than or equal to 0.8 volt, the output of each of these gates is intermediately set equal to logic 1. After these intermediate values are established, they are all tested to determine the output of the over-all circuit.

When all the gate outputs are logic 1, function F57 sets voltage source E1 equal to 3.0 v, which represents a logic 1. If all the gate outputs are not logic 1, function F57 becomes equal to 0.3 v (logic 0), establishing the value of voltage E1 as logic 0. In this way, function F57, which simulates the exclusive-OR logic function, determines the signal voltage of dependent source E1 and, therefore, the output voltage of the model.

To obtain the proper delay characteristics for the model, time constant R1-C1 is adjusted. This is necessary because the time delay ( $t_{pd1}$ ) associated with an increase in the output signal level is different from the time delay ( $t_{pd0}$ ) associated with a decrease in the output signal level.

When the Sceptre program is used for the design analysis, the model's time delay is adjusted by varying the value of capacitor C1 through function FCP3. If the voltage across capacitor C1 is less than the output signal level, this subprogram sets C1 equal to 300 picofarads plus a small variable capacitance that depends on the value of capacitor voltage. On the other hand, if capacitor voltage is equal to or greater than the output signal level, capacitor C1 is set equal to 450 pF plus a small variable capacitance that, again, is dependent on capacitor voltage.

This small variable capacitance is included to provide a better duplication of the performance of an actual type RSN54L57 device. A normal RC time-constant curve deviates too much from the waveshape needed

This article is the fourth in a five-part series on simplified, but accurate, computer models for common digital ICs. The models are developed on the basis of device terminal behavior, instead of by the classical method of modeling each transistor and diode junction in the IC. The NAND gate was covered in Part 1 in the Dec. 6 issue, the flip-flop in Part 2 in the Dec. 20 issue, the monostable multivibrator in Part 3 in the Jan. 24 issue, and the shift register will be in an upcoming issue.

FIG. 1 AND-OR-INVERT GATE CIRCUIT

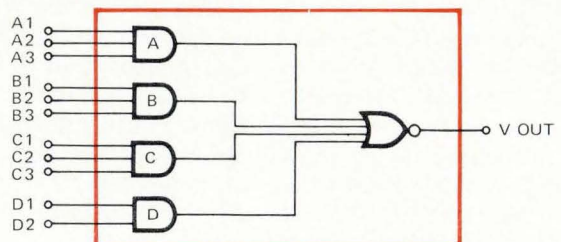

## ELECTRICAL CHARACTERISTICS

Parameter	Conditions	Minimum	Maximum
$V_{in(1)}$ Logic 1 input voltage required at all input terminals of either AND section to ensure logic 0 at output	$V_{CC} = 4.5 \text{ V}$	1.9 V	
$V_{in(0)}$ Logic 0 input voltage required at one input terminal of each AND section to ensure logic 1 at output	$V_{CC} = 4.5 \text{ V}$		0.8 V
$V_{out(1)}$ Logic 1 output voltage	$V_{CC} = 4.5 \text{ V}$ $V_{in} = 0.8 \text{ V}$ $I_{load} = -100 \mu\text{A}$	2.4 V	
$V_{out(0)}$ Logic 0 output voltage	$V_{CC} = 4.5 \text{ V}$ $V_{in} = 1.9 \text{ V}$ $I_{sink} = 2 \text{ mA}$		0.3 V
$I_{in(0)}$ Logic 0 level input current (each input)	$V_{CC} = 5.5 \text{ V}$ $V_{in} = 0.3 \text{ V}$		-0.18 mA
$I_{in(1)}$ Logic 1 level input current (each input)	$V_{CC} = 5.5 \text{ V}$ $V_{in} = 2.4 \text{ V}$ $V_{CC} = 5.5 \text{ V}$ $V_{in} = 5.5 \text{ V}$		10 $\mu\text{A}$ 100 $\mu\text{A}$
$I_{OS}$ Short-circuit output current	$V_{CC} = 5.5 \text{ V}$ $V_{in} = 0$ $V_{out} = 0$	-1 mA	-15 mA
$I_{CC(0)}$ Logic 0 level supply current	$V_{CC} = 5.5 \text{ V}$ $V_{in} = 5 \text{ V}$		0.99 mA
$I_{CC(1)}$ Logic 1 level supply current	$V_{CC} = 5.5 \text{ V}$ $V_{in} = 0$		0.8 mA
$t_{pd0}$ Propagation delay time to logic 0 level	$V_{CC} = 5 \text{ V}$ $C_L = 50 \text{ pF}$ $R_L = 4 \text{ k}\Omega$		60 ns
$t_{pd1}$ Propagation delay time to logic 1 level	$V_{CC} = 5 \text{ V}$ $C_L = 50 \text{ pF}$ $R_L = 4 \text{ k}\Omega$		90 ns

for accurate performance simulation.

And once again, as for the other computer models, when the Circus-2 analysis program is used, the model's time delay is adjusted by varying resistance, as opposed to capacitance. Here, for the AND-OR-INVERT gate, resistor R1 is varied by subprogram RR57.

All the model's signal input impedances are represented as zero-valued current sources, JA1 through JD2, which implies that the impedances of all the input signal terminals, A1 through D2, are infinite. Although the inputs do have measurable varying impedance values, this assumption is a first-order approximation that pro-

**FIG. 2 MODELING THE AND-OR-INVERT GATE**

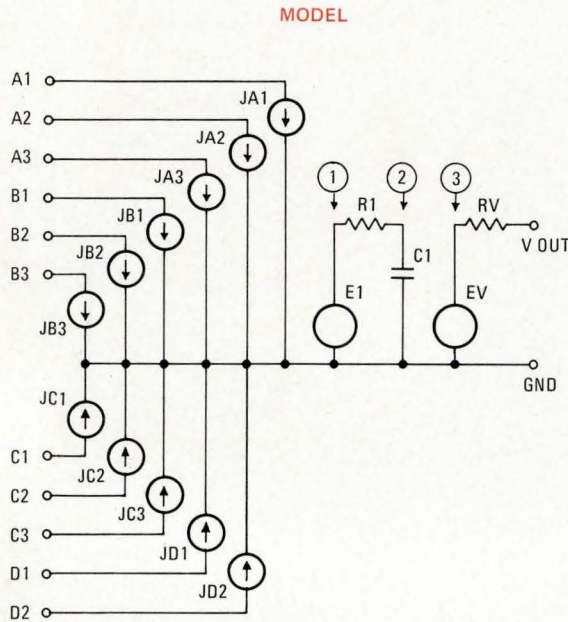

FOR SCEPTRE: E1 = f(F57), C1 = f(FCP3), EV = f(VC1)  
 FOR CIRCUS-2: V1 = f(F57), R1 = f(RR57), VV = f(V.C1)

**CIRCUS-2 DESCRIPTION**

MODELS  
 MODEL NAME = AND-OR-INVERT GATE  
 EXTERNAL NODES = (A1,A2,A3,B1,B2,B3,C1,C2,C3,D1,D2,V OUT,GND)  
 TOPOLOGY  
 JA1,A1,GND  
 JA2,A2,GND  
 JA3,A3,GND  
 JB1,B1,GND  
 JB2,B2,GND  
 JB3,B3,GND  
 JC1,C1,GND  
 JC2,C2,GND  
 JC3,C3,GND  
 JD1,D1,GND  
 JD2,D2,GND  
 V1,1,GND  
 R1,1,2  
 C1,2,GND  
 VV,3,GND  
 RV,3,V OUT  
 JV,V OUT,GND

EQUATIONS  
 A1 = AA1  
 A2 = AA2  
 V1 = F57(V.JA1,V.JA2,V.JA3,V.JB1,V.JB2,V.JB3,V.JC1,V.JC2,V.JC3,  
 1V.JD1,V.JD2)  
 D(V1,T) = 0.  
 R1 = RR57(V1,V.C1,A1,A2,D(R1,V.C1))  
 VV = V.C1  
 D(VV,V.C1) = 1.  
 RETURN  
 END

END OF INPUT

DEVICES  
 DEVICE NAME = RSN54L57, MODEL NAME = AND-OR-INVERT GATE  
 SINGLE VALUED PARAMETERS  
 JA1=0,JA2=0,JA3=0,JB1=0,JB2=0,JB3=0,  
 JC1=0,JC2=0,JC3=0,JD1=0,JD2=0,JV=0,  
 C1 = 100E-12, RV = 100, AA1 = 300, AA2 = 450

**SCEPTRE DESCRIPTION**

MODEL RSN54L57 (A1-A2-A3-B1-B2-B3-C1-C2-C3-D1-D2-V OUT-GND)  
 AND-OR-INVERT GATE  
 ELEMENTS  
 JA1,A1-GND=0.  
 JA2,A2-GND=0.  
 JA3,A3-GND=0.  
 JB1,B1-GND=0.  
 JB2,B2-GND=0.  
 JB3,B3-GND=0.  
 JC1,C1-GND=0.  
 JC2,C2-GND=0.  
 JC3,C3-GND=0.  
 JD1,D1-GND=0.  
 JD2,D2-GND=0.  
 E1,GND-1=F57(VJA1,VJA2,VJA3,VJB1,VJB2,VJB3,VJC1,VJC2,VJC3,VJD1,VJD2)  
 R1,1-2=100.  
 C1,2-GND=Q2(E1,VC1,300.E-12,450.E-12)  
 EV,GND-3=X1(VC1)  
 RV,3-V OUT=100.  
 JV,V OUT-GND=0.  
 FUNCTIONS  
 Q2(A,B,C,D)=(FCP3(A,B,C,D))  
 OUTPUTS  
 VJV(V OUT), PLOT

**MODEL SUBPROGRAMS**

```

1 CF57      FOR AND-OR-INVERT GATE
2           FUNCTION F57(A1,A2,A3,B1,B2,B3,C1,C2,C3,D1,D2)
3
4 C         OUTPUT STATE GENERATOR
5 C
6           NA=0
7           NB=0
8           NC=0
9           ND=0
10          X=0.8
11          IF(A1.LE.X.OR.A2.LE.X.OR.A3.LE.X) NA=1
12          IF(B1.LE.X.OR.B2.LE.X.OR.B3.LE.X) NB=1
13          IF(C1.LE.X.OR.C2.LE.X.OR.C3.LE.X) NC=1
14          IF(D1.LE.X.OR.D2.LE.X) ND=1
15          F57=0.3
16          IF(NA.EQ.1.AND.NB.EQ.1.AND.NC.EQ.1.AND.ND.EQ.1) F57=3.0
17          RETURN
18          END
1 CFCP3    CAPACITOR SELECTION FOR AND-OR-INVERT GATE
2           FUNCTION FCP3(A,B,C,D)
3 C
4           IF(A-B)10,20,20
5           10 FCP3=C*B/3. + C
6           RETURN
7           20 FCP3=C*B/3. + D
8           RETURN
9           END
    
```

vides reasonably accurate results. For greater accuracy, current sources JA1 through JD2 can be modeled in diode-equation format or as tables of functions relating current to applied voltage.

The same sort of reasoning is true for the model's output signal terminal. The impedance (resistor RV) associated with this terminal is fixed at 100 ohms as a first-order approximation, which is sufficient for most voltage and load conditions. To duplicate actual output impedance variations, of a practical AND-OR-INVERT gate, resistor RV can be made a variable function of load voltage and load current. □

## Microwave leakage monitor is economical but sensitive

T. Koryu Ishii and Thomas A. Panfil  
Marquette University, Milwaukee, Wis.

You can build a simple and inexpensive microwave-leakage monitor that is as sensitive as its costly counterparts and can operate without a power source of any kind. This detector is completely passive, offers an inherent self-test capability, and is ready to operate at all times.

The potential radiation hazard<sup>1</sup> of microwave leakage from household microwave ovens<sup>2</sup>, industrial microwave heating and drying equipment, and microwave communications and navigation systems has been widely publicized. Industrial consumers, as well as the general public, are concerned about the safety of their currently installed equipment. Needless to say, monitoring the almost unavoidable low-level microwave power leakage can greatly enhance the safety of operating microwave devices.

A variety of microwave-leakage detectors is available today, but most of them cost too much for household and industrial consumer use. In some models, an electrical discharge tube is used to indicate leakage power level. But since this type of detector does not give any indication at the low leakage levels achieved by well-designed equipment, it does not have any inherent self-test capability, and its failure can go undetected.

The photographs show the front and rear views of an economical yet highly sensitive microwave leakage monitor—it consists of a type 1N263 crystal detector and a milliammeter. The performance of the monitor is de-

termined by the sensitivity of the meter and the crystal mounting configuration.

The milliammeter used here has a coil resistance of 730 ohms and a full-scale-deflection current of 1 milliampere. The crystal detector is soldered to the small lugs attached directly to the meter studs, which act as an antenna and an open-circuited transmission line. The inductance of the meter coil behaves as a radio-frequency choke.

The microwave monitor is calibrated with an approved standard device. The microwave radiation power density is measured at some point, the standard device is then removed, and the monitor is positioned at the same point. Since the monitor is direction-sensitive, its orientation must be adjusted to maximize its deflection. The deflection and power level are then recorded, and the procedure is repeated for other power levels until the meter is fully calibrated.

Graph 1 is a plot of the calibrated meter's response with respect to distance from a leakage source. (The meter is always oriented to maximize its deflection.) A full-scale deflection on the calibrated meter represents 2 milliwatts per square centimeter. As the plot indicates, this simple monitor is capable of detecting leakage levels in the neighborhood of 1  $\text{mw}/\text{cm}^2$ , which is the safety standard set by the U.S. Government Department of Health, Education, and Welfare for new domestic microwave ovens.

Graph 2 shows the monitor's directional sensitivity. In this case, the orientation angle of  $0^\circ$  means that the direction of the crystal detector is parallel to the microwave electric field. As the figure illustrates, the half-value orientation angle is only  $50^\circ$ , but the meter's sensitivity rapidly degrades to zero thereafter.

A more sensitive microwave-leakage monitor can be made by using a milliammeter that has a greater sensitivity. For example, if a meter with a coil resistance of

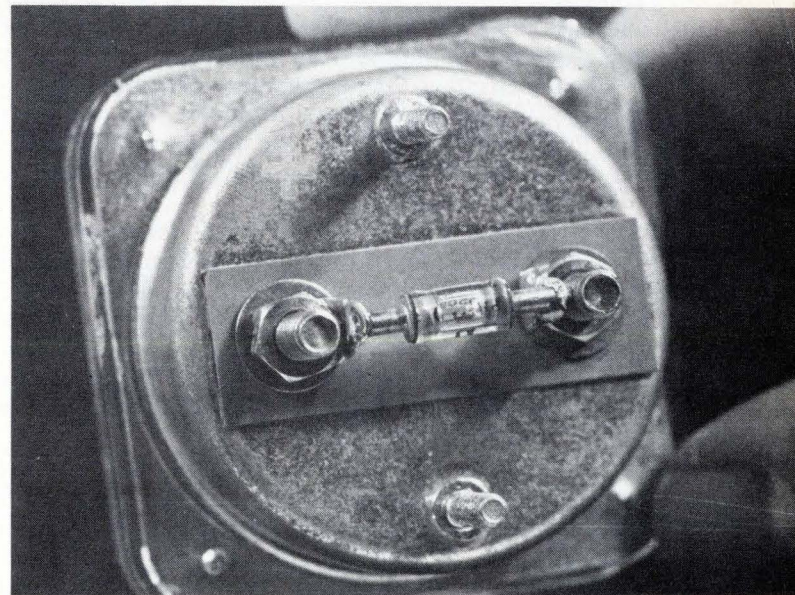
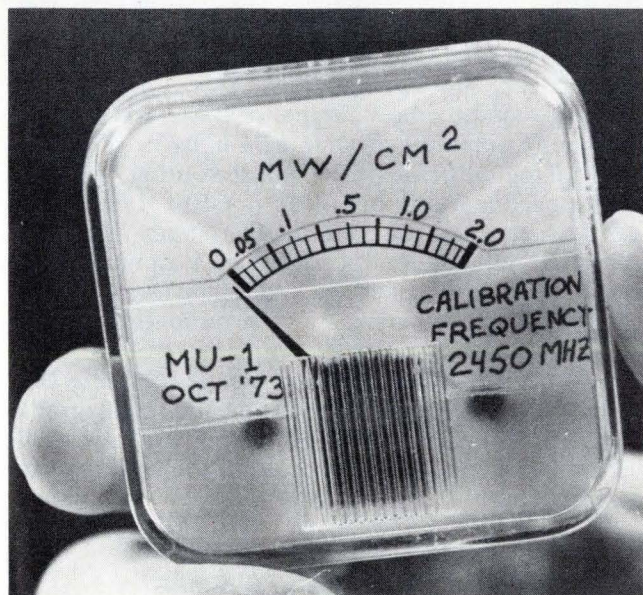

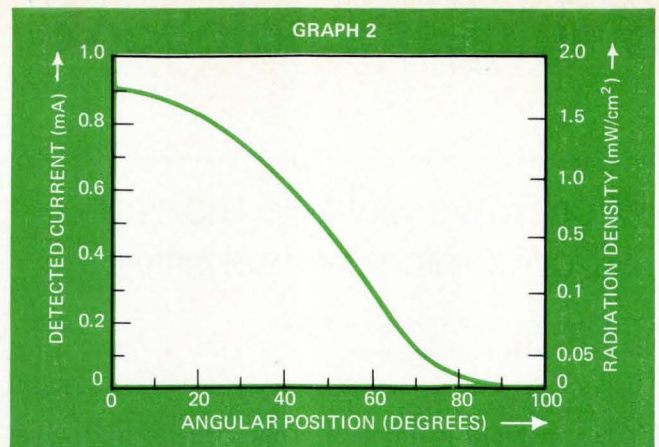
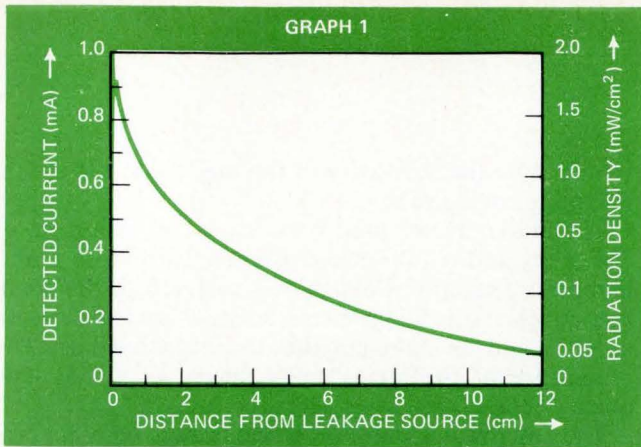

640 ohms and a 200-microampere full-scale deflection is used, the full-scale sensitivity of the leakage monitor increases to 0.05 mW/cm<sup>2</sup>, which represents an improvement of a factor of 20. □

#### REFERENCES

1. W.H. Walter, K.C. Mitchell, P.O. Rustan, J.W. Frazer, and W.D. Hurt, "Cardiac Pulse Generators and Electromagnetic Interference," *Journal of the American Medical Association*, Vol. 224, Issue N12, pp. 1,628-1,631, 1973.
2. Richard Davis, "Microwave Oven Controversy Sizzles," *Microwaves*, Vol. 12, No. 5, pp. 9-19, May 1973.

## Nonsequential counter design makes use of Karnaugh maps

by Glen Coers  
Texas Instruments, Components Group, Dallas, Texas

The design of a nonsequential binary counter—one that does not count in a 0-1-2-3-4-5-6-7 sequence—can be considerably simplified by the use of Karnaugh mapping techniques. Such a counter is sometimes needed in digital systems where certain functions must be controlled in a nonbinary sequence.

To illustrate the technique, we will design a three-bit counter for a 0-2-4-5-3-7-1-6 sequence. After listing the desired counter states in their proper sequence, as done in (a), the present-state and next-state conditions can be compiled, as shown in (b). Next, three Karnaugh maps, the ones labeled NSM<sub>A</sub>, NSM<sub>B</sub>, and NSM<sub>C</sub> in (c), are used to represent the next-state conditions.

The minterm locations on the next-state maps are determined by the present-state variables. The value for that location is obtained from the next-state table. Since three bits are involved, three J-K flip-flops will be needed to implement the counter.

Six other maps are now constructed—three are to determine the logic functions required at the J inputs of the flip-flops, while three are for the K inputs of the flip-flops. These maps, which are drawn in (d), are labeled J<sub>A</sub>, J<sub>B</sub>, J<sub>C</sub>, K<sub>A</sub>, K<sub>B</sub>, and K<sub>C</sub>, where J<sub>A</sub> and K<sub>A</sub> represent the inputs of flip-flop FF<sub>A</sub>, J<sub>B</sub> and K<sub>B</sub> the inputs of flip-flop FF<sub>B</sub>, and J<sub>C</sub> and K<sub>C</sub> the inputs of flip-flop FF<sub>C</sub>. (TTL flip-flops will be used.)

The locations of the variables that are true are noted on the J-input maps by Xs, indicating that the state of the variable can be either logic 0 or logic 1. (This permits maximum reduction of circuitry.) For example, on the J<sub>A</sub> map, the true locations of variable A are marked

with an X wherever variable A is logic 1 on its next-state map, NSM<sub>A</sub>. These locations are 110, 100, 111, and 101.

The remaining locations on the J-input maps are filled in with the remaining values on the appropriate next-state map. The leftmost four locations on the J<sub>A</sub> map, for instance, are identical to the leftmost four locations on the NSM<sub>A</sub> map.

Similarly, the appropriate logic functions can be determined for the K inputs. For these however, the locations of the variables that are false are filled in with Xs to mark the "don't care" (can be either logic 0 or logic 1) positions. And the remaining locations are filled in with the proper inverted data from the next-state map. The K<sub>A</sub> map, for example, contains Xs whenever variable A is logic 0 on the NSM<sub>A</sub> map, and inverted data from NSM<sub>A</sub> in the remaining locations.

The logic functions represented by these J-input and K-input maps can be reduced by grouping through Karnaugh mapping techniques. These groups are noted on the map by the colored enclosures. The variables within these groups establish the logic function needed at a particular flip-flop input.

The J<sub>A</sub> input requires a signal of B+C, which means that the Q output of flip-flop FF<sub>B</sub> must be ORED with the Q output of flip-flop FF<sub>C</sub> and the output of that OR gate applied to the J input of flip-flop FF<sub>A</sub>. Likewise, input J<sub>B</sub> requires an OR gate ( $\bar{A} + C$ ), input J<sub>C</sub> an AND gate ( $A\bar{B}$ ), input K<sub>A</sub> an OR gate (B+C), input K<sub>B</sub> an OR gate ( $A + \bar{C}$ ), and input K<sub>C</sub> an AND gate ( $\bar{A}\bar{B}$ ). The negated variables, of course, are taken from the  $\bar{Q}$  outputs of the flip-flops.

Now the nonsequential binary counter design is complete. The circuit of (e) shows what the final configuration looks like. The states of its three output lines agree with the truth table in (b) and proceed in the nonbinary sequence of (a). □

Engineer's notebook is a regular feature in Electronics. We invite readers to submit original design shortcuts, calculation aids, measurement and test techniques, and other ideas for saving engineering time or cost. We'll pay \$50 for each item published.



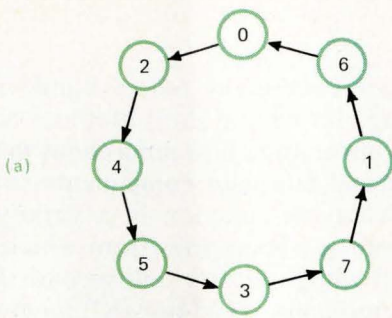

(b)

TRUTH TABLE							
PRESENT STATE			NEXT STATE				
	A	B	C	A	B	C	
0	0	0	0	2	0	1	0
2	0	1	0	4	1	0	0
4	1	0	0	5	1	0	1
5	1	0	1	3	0	1	1
3	0	1	1	7	1	1	1
7	1	1	1	1	0	0	1
1	0	0	1	6	1	1	0
6	1	1	0	0	0	0	0

(c)

NSM <sub>A</sub>				
C \ A B	00	01	11	10
0	0	1	0	1
1	1	1	0	0

NSM <sub>B</sub>				
C \ A B	00	01	11	10
0	1	0	0	0
1	1	1	0	1

NSM <sub>C</sub>				
C \ A B	00	01	11	10
0	0	0	0	1
1	0	1	1	1

(d)

J <sub>A</sub>				
C \ A B	00	01	11	10
0	0	1	X	X
1	1	1	X	X

$B \text{ AND } C \rightarrow B+C$

J <sub>B</sub>				
C \ A B	00	01	11	10
0	1	X	X	0
1	1	X	X	1

$\bar{A} \text{ AND } C \rightarrow \bar{A}+C$

J <sub>C</sub>				
C \ A B	00	01	11	10
0	0	0	0	1
1	X	X	X	X

$A \text{ AND } \bar{B} \rightarrow A\bar{B}$

K <sub>A</sub>				
C \ A B	00	01	11	10
0	X	X	1	0
1	X	X	1	1

$B \text{ AND } C \rightarrow B+C$

K <sub>B</sub>				
C \ A B	00	01	11	10
0	X	1	1	X
1	X	0	1	X

$A \text{ AND } C \rightarrow A+C$

K <sub>C</sub>				
C \ A B	00	01	11	10
0	X	X	X	X
1	1	0	0	0

$\bar{A} \text{ AND } \bar{B} \rightarrow \bar{A}\bar{B}$

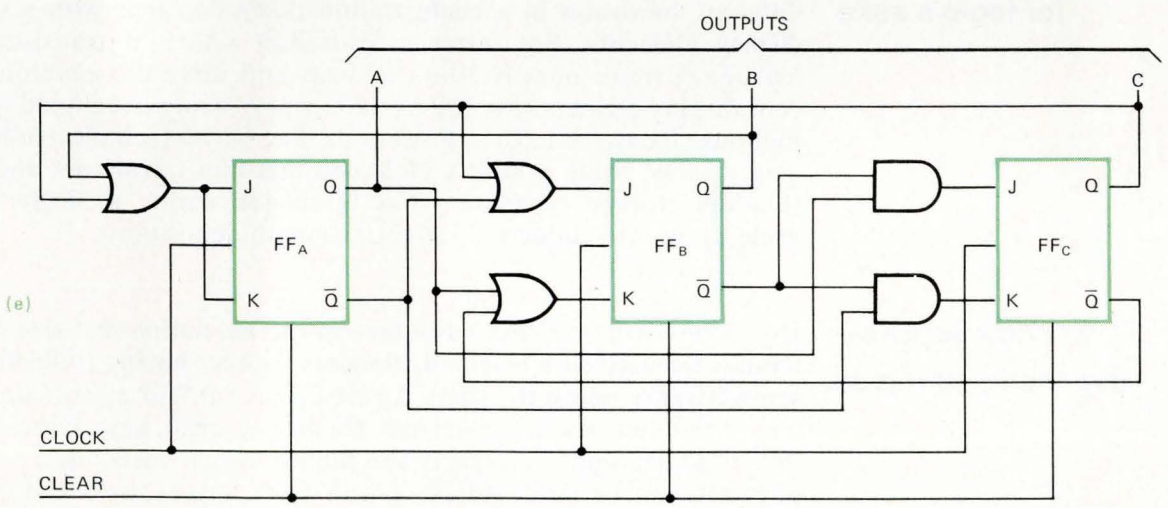

**Designing a counter.** Karnaugh mapping, a design procedure that is normally applied only to binary designs, can also be used for synthesizing a nonsequential counter. The three-bit binary counter designed here has a 0-2-4-5-3-7-1-6 sequence (a). From the truth table (b) of this counter's next-state outputs, the next-state map (c) can be drawn for each of its three output lines. The next group of maps (d) establish the logic function required at each input of the three J-K flip-flops needed to build the counter. The final circuit is shown in (e).

## Today's amorphous materials make lasting memories

Don't dismiss amorphous semiconductors out of hand. Though they got a bad name a few years ago for having short lifetimes and low reliability, **today it's much better understood how amorphous materials work and how to formulate them and fabricate components with them.** By now, they're performing a valuable function in a variety of designs, chiefly in "read-mostly" memories—memories from which data can be retrieved in nanoseconds but which require milliseconds for new data to be written into them. **Amorphous "read-mostly" memories used to deteriorate after a few hundred write/erase cycles, but no more—once written, data can be read out indefinitely without degradation.** One unit under test has been read without interruption at a 5-megahertz rate for 14 months, which is nearly 200 trillion cycles.

## Attach a resistor to silicon substitutes for selenium rectifiers

Here's some more help on "How to replace a selenium with a silicon rectifier," an item that appeared on this page on Dec. 20, 1973, but said nothing about **the differences in forward voltage drops of the two rectifiers.** According to Donald M. Russell Jr., manager of industrial/commercial business development at Sylvania's Electronic Systems group, Waltham, Mass., **capacitor failure often results from a direct substitution unless a series-dropping resistance is also added.** Failure is due to the higher voltages produced by the inherently lower internal resistance of the silicon rectifier. To be safe, says Russell, **approximately 1.2 to 1.5 ohms of series resistance should be added for each plate (cell) of the selenium rectifier.** A typical eight-cell selenium rectifier is then replaced by a silicon rectifier in series with a 10-ohm resistor.

## Big displays take to thin-film transistors for logic's sake

Thin-film transistors are becoming something more than a laboratory curiosity, having found a use as a logic technique for large displays. The advantage of this kind of transistor is that it **can be formed on many different substrates in a configuration that's coplanar with sensors or display elements.** For instance, cadmium selenium transistors with leakage currents of only 10 nA address and drive the electroluminescent display element in a 100-by-120 display being developed at Westinghouse Research Labs in Pittsburgh. **The 6-by-6-inch electro-luminescent display, using a matrix of 24,000 thin-film transistors and 12,000 thin-film storage capacitors, was fabricated during a single vacuum cycle** by an interconnected series of vacuum depositions.

## Eschew screws—use tubing and glue

Here's how you can **take advantage of the resolution and size of those miniature, multi-turn pc-board trimmers without having to fiddle with a screwdriver to adjust the shaft.** A small piece of rigid plastic tubing and one of the new acrylic superglues are all you need, says James E. Trulove of Oklahoma City, Okla. The tubing, which costs just a few cents per foot, can be easily adjusted with your fingers, or it can accept a standard control knob. For many popular trimmers, the tubing should have an outside diameter of 1/4 inch or less and an inside diameter of about 1/8 inch. **Use the glue only on the inner surface of the tubing, and take care to leave a gap between the tubing and the body of the trimmer.** The bond should be firm within a few minutes and completely hardened in several hours.

# The first at this price!

$\pm 1\mu\text{V}$  resolution / 5 full functions / 26 ranges  
Lead-compensated ohms



For immediate information on Systron-Donner's new Model 7205 5½-digit Multimeter, call us collect on our *Quick Reaction* line: (415) 682-6471. Or you may contact your Scientific Devices office or S-D Concord Instruments Division, 10 Systron Drive, Concord, CA 94518. *Europe:* Systron-Donner GmbH, Munich, W. Germany; Systron-Donner Ltd., Leamington Spa, U.K.; Systron-Donner S.A., Paris (Le Port Marly) France. *Australia:* Systron-Donner Pty. Ltd. Melbourne.

SYSTRON  DONNER

Albuquerque, (505) 268-6729; Baltimore, (301) 788-6611; Boston, (617) 894-5637; Burlington, NC (919) 228-6279; Chicago, (312) 297-5240; Cleveland, (216) 261-2000; Denver, (303) 573-9466; Dayton, (513) 298-9904; Dallas, (214) 231-8106; Detroit, (313) 363-2282; Ft. Lauderdale, (305) 721-4260; Hamden CT (203) 248-9361; Huntsville, AL (205) 536-1969; Houston, (713) 623-4250; Indianapolis, (317) 783-2111; Kansas City, KS (913) 631-3618; Los Angeles, (213) 641-4800; Minneapolis, (612) 544-1616; New York City area (201) 871-3916; Norfolk, (703) 499-8133; Orlando, (305) 424-7932; Philadelphia, (215) 825-9515; Phoenix, (602) 834-1682; Rochester, NY (716) 334-2445; San Antonio, (512) 694-6251; San Diego, (714) 249-6642; San Francisco area (415) 964-4230; Seattle, (206) 454-0900; St. Louis, (314) 731-2332; Syracuse, (315) 457-7420; Washington, DC area (703) 451-6500

Circle 131 on reader service card

# a new STANDARD for JUMPERS

**FLAT**

**ROUND**

Electrical jumper's round wire has been flattened by applying a rolling process to original round conductor. Intermediate portion is subjected to unidirectional rolling material which sets their 1/2 flattened intermediate portion flat. It is sandwiched between two flat plates of metal flattened. The flattening operation the conductor portion is perfectly made line of either end of the wire for

NO STRESS HERE

Stress of flexure extends over entire flat cross sectional area

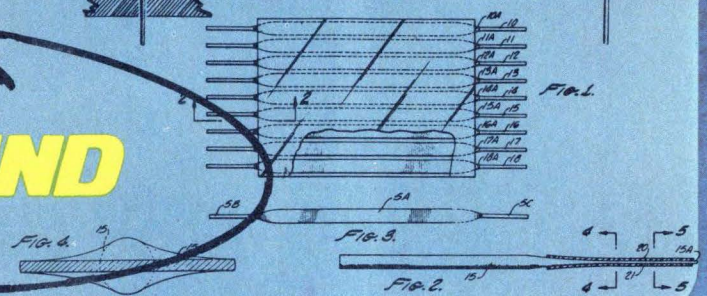

U.S. PATENT NO. 3,601,755

## from Ansley

Ansley's new patented FLEXSTRIP® Jumpers have flat conductors laminated between high performance insulating materials and are available from stock in thousands of part numbers. The flatness gives them flexibility where it's needed ... the round contacts insert easily into p.c. board holes or sockets. This combination of flat/round provides a generous radius when flexed, thus eliminating stress from the contacts.

Here's what this means to you ... no broken conductors ... easy insertion of ready to solder contacts ... no fault

assemblies ... reliable interface ... lower installed cost ... available from stock.

Specify FLEXSTRIP® Jumpers. Flex them a hundred or a thousand times and there'll be no failures.

Ansley's FLEXSTRIP® Jumpers come in standard lengths; four options of insulation; 2 to 60 conductors; .050, .100, .125, .150 or .200 conductor center distances and four pin configuration options. Specials, too, of course.

Contact your Ansley representative.

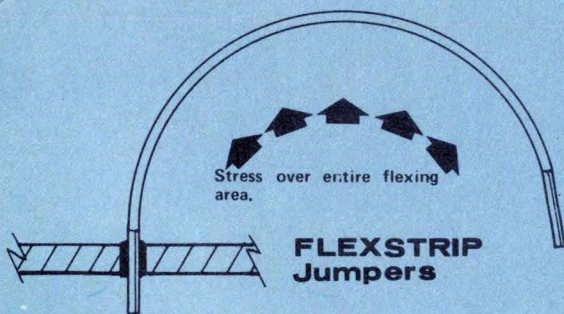

Bend at weakest point ... where break will occur.

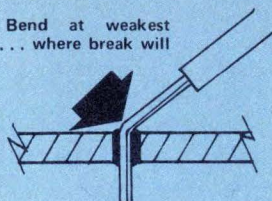

Conventional wiring

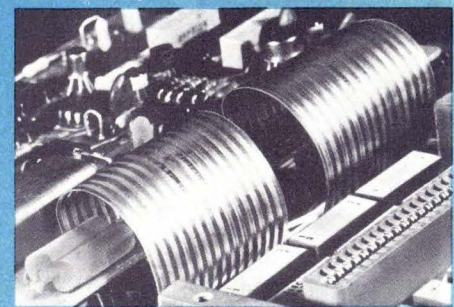
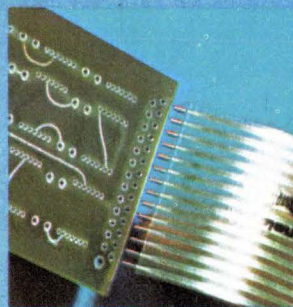

Photo courtesy of Computest Corp.

## Ansley

ANSLEY ELECTRONICS CORP.  
 Subsidiary of Thomas & Betts Corporation  
 3208 Humboldt St., Los Angeles, Ca. 90031  
 Tel. (213)223-2331, TWX 910-321-3938

## Low-voltage reference is ultra-stable

Hybrid module with output between 3 and 10 volts uses amplified difference of two forward-bias voltage drops to provide close temperature-tracking

by Joel DuBow, Components Editor

Many logic and instrumentation systems could use a low-voltage reference, so that all of their circuitry could be driven off the same  $\pm 5$  volts as drives the logic. The only hindrance has been the unavailability of an off-the-shelf temperature-stable low-voltage reference. For reference voltages larger than 6 v, temperature-compensated zener diodes have been used, and these require bias voltages of 10 v or greater. Lower-voltage references require custom design and often consume precious power. Forward regulator diodes, sometimes used as reference elements, have a relatively large temperature coefficient of 400 parts per million/ $^{\circ}$ C.

A module developed recently by Codi Semiconductor works at any voltage between 3 and 10 v and, further, provides a temperature coefficient of typically 10 ppm over the full military range of  $-55^{\circ}$ C to  $+125^{\circ}$ C. Called the DRD1011, it also features a low power dissipation (1 milliwatt nominal), low impedance, and operation from low-voltage power supplies (typically 3 v with current modules). Over narrower than the full mil-spec operating ranges, virtually zero temperature coefficients are possible.

Initial applications for the module will be in the high-precision area, since it will cost upwards of \$50 per unit. Delivery is expected to take 6 to 8 weeks.

Basically, the device uses the difference in forward-bias voltage of two silicon diodes to drive an operational amplifier. One of the diodes is heavily doped to reduce its band-gap to that of germanium. But the temperature coefficients of the heavily doped diode and the more lightly

doped standard diode track almost identically over decades of forward current, whereas, if a germanium diode had been used, the temperature variation would not have been as uniform. The forward-bias differ-

ence between these two paralleled diodes, typically 0.412 v, is fed into an op amp and amplified to give the desired output voltage. Lower voltage references, such as those used in biomedical equipment, are possible

**A new low.** In the configuration shown in schematic (top), outputs from two diodes are fed into an op amp. At the output, 3 to 10 volts are available in the packaged modules. The curve (bottom) demonstrates the close temperature-tracking of the differential voltage.

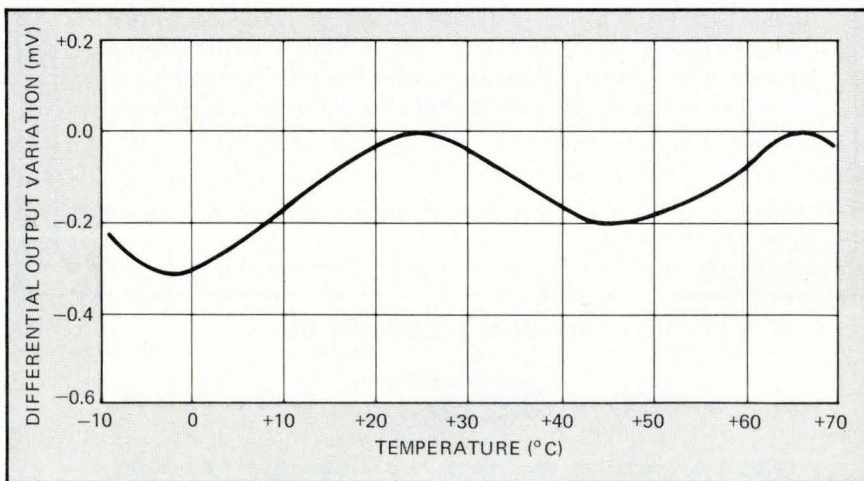
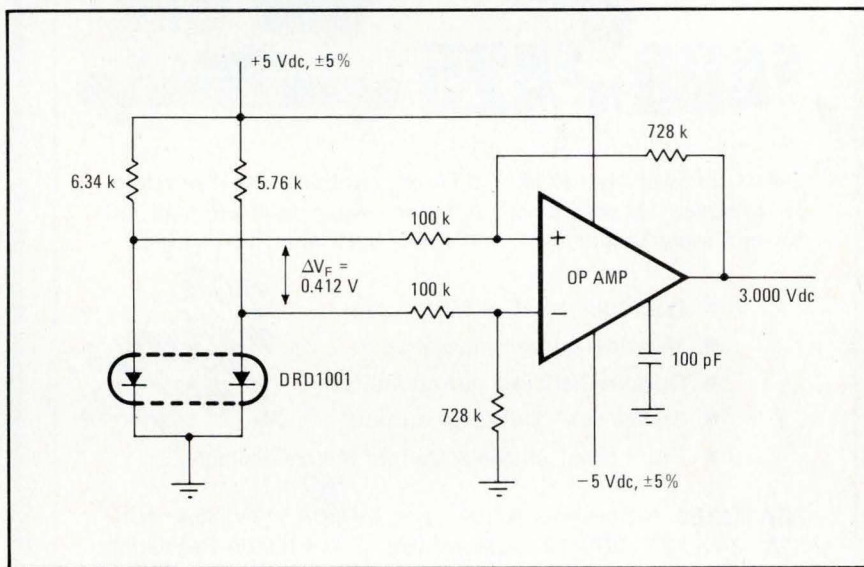

your best value is a

# TRYGON

## SYSTRON - DONNER POWER SUPPLY

### QUALITY/RELIABILITY/SERVICE

### VPH Series

Up to 30VDC

Up to ~~50~~<sup>60</sup> AMPS

**\$400 to \$425**



The ValuPower Half Rack . . . There is nothing like it in size or performance at that price! A truly unique innovation in DC Power Supply Technology . . . it's your best value in a half rack.

- Low noise for IC & Systems use
- Very low output impedance
- Optional Self-Test output indicator
- Choice of six slot range outputs
- Front panel voltage & Current Meters available

*20% more current at the same price!*

**FEATURES** • Standard Ratings are; 5V/<sup>60</sup>50A, 12V/35A, 15V/31A, 24V/22A, 28V/19A, Dual  $\pm 15V/13A$  • 0.02% Regulation • less than 1mV RMS ripple • 5mV Peak-to-Peak Ripple • 0.05% Stability • Unique patented Automatic non-linear current foldback overload protection circuit • Thermostatic Thermal Protection • Remotely Programmable • Remote Sensing • Compatible with rack adapters for multiple output power applications. • Designed to meet UL Recognized Component Index Requirements.

Write directly or call your local Scientific-Devices sales office for complete specifications and applications.

**TRYGON ELECTRONICS**  
SUBSIDIARY

**SYSTRON**  **DONNER**

CORPORATION

1200 Shames Drive, Westbury, N.Y. 11590 (516) 997-6200

The Systron-Donner Instruments Group:

Concord Instruments  Computer Systems  Datapulse  Kruse Electronics  Microwave  Trygon Electronics

### New products

with a more expensive op amp.

The high doping has the effect of narrowing the bandgap through impurity banding. At very high doping levels, the impurity energy levels become broadened into impurity bands in which conduction can take place, or in which ionization to the conduction band is so probable that the effective bandgap of the semiconductor is reduced. At even higher doping levels, the periodicity and crystallinity of the material is affected and the band structure itself could be altered.

Thus the high doping alters the turn-on voltage of the diode, but the temperature variation and current-voltage characteristics are governed by the same equations governing conventional silicon diodes, with the only difference being the energy gap constant. Hence the close tracking—1 part in 200—of the output voltage over a wide temperature range.

Virtually zero temperature coefficient can be achieved by matching the known, positive tempco of the op amp to a numerically equal but negative tempco of the reference element. This is readily done by controlling the latter's fabrication parameters. In addition to temperature stability, the reference element also achieves regulation—a 5% power variation yields only a 0.0002% output variation.

Multijunctions enable the designer to specify a range of junction-voltage values in multiples of 0.4 v.

**Reduces power.** Initial units of the DRD1011 were supplied to NASA and Columbia University for use in comparators monitoring power supplies in the amplifier chain of a satellite, and a factor of 100 in power reduction was achieved.

Sy Glasser, assistant to the general manager at Codi, says that its low-voltage requirement makes the module compatible with hybrid and integrated-circuit design using TTL and C-MOS logic. He foresees many possible applications for the units in control systems, computers, and power supplies. With the same technology, ultra-stable references up to 15 v can also be built.

Codi Semiconductor, Pollitt Dr., Fairlawn, N.J. 07410 [338]

# AFTER YOU USE OUR PPS, THERE'S ONLY ONE THING WE'LL KNOW ABOUT YOUR MACHINE DESIGN:

## IT JUST GOT BETTER.

Even if you're already using MOS/LSI circuits, our new PPS (Parallel Processing System) offers you a whole new set of potential advantages: Improvement of the design characteristics of machines such as professional and programmable calculators, business machine terminals, system controllers, etc. Reduction of their development time. And their circuit costs.

**And PPS offers these potential advantages while enabling you to keep system design responsibility solely in your own hands.**

Here's how it works.

The PPS is based on a powerful one-chip CPU controlled by ROM microprogramming and possessing its own discrete I/O capabilities. The other building blocks are compatible ROM/RAM, ROM, RAM and I/O

circuits plus a crystal-controlled clock generator circuit. The entire system—except for one ROM circuit—is pre-designed to work in a variety of machines, performing the arithmetic and logic functions of a four-bit parallel microprocessor.

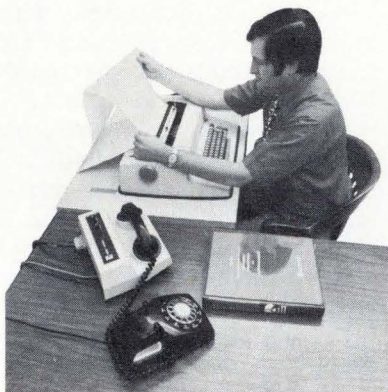

The one ROM circuit that is *not* completely pre-designed is the one that's uniquely designed for your machine. By you. Through microprogramming. Our only involvement,

besides providing the PPS circuits, is to provide you with plenty of design aids: A time-tested program for microprogramming through Tymshare or G.E. . . . special equipment for micro-program assembly and ROM emulation . . . evaluation board for prototype testing . . . programmer's reference manual, and all required documentation.

Drop us a line on your company letterhead and we'll send you additional information so you can make your own microprocessor comparison. Address your request to: Microelectronic Device Division, Rockwell International, Marketing Services, P.O. Box 3669, Anaheim, California 92803, U.S.A.

**Write us today for an appointment for a PPS demonstration at IEEE in New York.**



**Microelectronic Device Division**  
Rockwell International

...where science gets down to business

# Testing ICs at high temperatures

Production-type handler permits rapid checkout of MOS RAMs and other circuits in DIPs to spot failure modes in high-density applications

**Doubts that MOS circuits** will operate reliably in memory-system hot spots has spurred development of a production-test handler that may change procedures for testing logic and linear ICs, as well as MOS circuits. The machine, which couples to most high-speed automatic test systems, allows dynamic tests at elevated temperatures to be made for only a fraction of a cent more than room-temperature tests. And the company, International Production Technology, claims that testing by the method is much less expensive than it is with manual and low-volume test-handling equipment because a high-speed handler dramatically reduces test-system overhead.

The machine was reportedly developed at the urging of computer manufacturers concerned about the validity of guard-band testing of MOS dynamic random-access-memory circuits, and it is the first of a new series of high-temperature test handlers designated IPT-500.

In guard-band testing, the circuits are tested at room temperature, and test limits are set to allow for anticipated changes with temperature of IC characteristics. The technique is almost universally used for commer-

cial circuits, and testing at temperature extremes is usually limited to dc-parameter testing of high-reliability and precision linear circuits, or to quality-control checks. Because of this, IPT says, it has never been economically feasible to develop high-temperature, high-volume dynamic test machines.

But now that memory systems with high packing densities are going into production, the company explains, computer manufacturers are concerned that heat concentrations in memory-card assemblies will aggravate the temperature-sensitive failure modes of MOS RAMs. These include, for example, changes in memory-access time and on-chip leakage currents that may result in loss of data.

IPT's solution is a heat-soaking system into which is built a test head and a DIP-handling and sorting subsystem similar to the IPT-700 test handler. The latter, widely used for room-temperature dynamic testing, is loaded with shipping tubes by an automatic system coupled to the handler and sorted into six shipping tubes.

As the DIPs are fed from the shipping tubes in the IPT-500 system, they are placed on small, metal blocks on a 104-position carousel in a round, hot-air chamber. The carousel revolves to a station that transfers the DIPs, one by one, to a test fixture. The fixture is interfaced to the test system through an adapter and the system's performance board (the circuit that transmits and receives test signals through the test connector).

After testing, each DIP is transferred to a shuttle that loads the device into one of six shipping tubes.

Good circuits may be loaded into four tubes and rejects into two tubes, for instance, or the circuits may be sorted into six performance grades.

The carousel speed, which governs soak time and the temperature of the hot air, may both be varied to raise the circuit temperature from ambient to as high as 125°C at handling rates as fast as 3,600 units an hour. Test throughput will vary with length of the test routine, since 3,600 units an hour is the zero-test-time rate normally specified for handlers. Test temperature is regulated by a closed-loop control and is digitally displayed on the control panel.

The IPT-500 system is normally unattended, except for loading and unloading of shipping tubes. A ram elevates the chamber housing for servicing of the handling mechanism, test head, or performance board. A standard handler takes standard 14- to 18-pin DIPs. Changeover kits will be available for eight-pin minidips and for large-scale IC DIPs with a maximum of 40 leads. The machine interfaces with Adar, E-H Research, Fairchild, Macrodata, Tektronix, and Teradyne test systems.

IPT says the handler provides an economical alternative to guard-band tests of LSI, bipolar digital and linear ICs, and MOS memories. Compared with the IPT-700, which handles 5,000 DIPs an hour, rather than 3,600, the new machine adds only about 280 milliseconds of test time per unit and about 1/20th of a cent to labor and amortization costs.

International Production Technology, 1140 W. Evelyn Ave., Sunnyvale, Calif. 94086 [339]

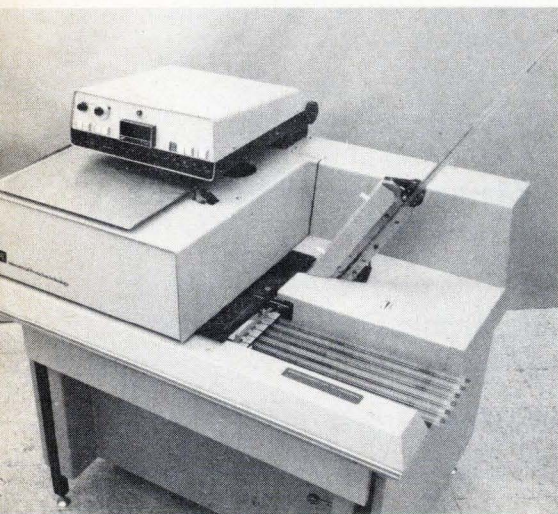





## Computer terminals for non-computer people.

Say you're the manager of a textile mill. Or a parts warehouse. Or a factory. Your people have to enter data — vat levels, crane positions, logged time, whatever — into a remote computer.

You've got a bit of a problem. Because no matter how good your forklift operators and production supervisors are, they're probably not computer experts.

We've got the solution. The RT01 and RT02 remote terminals.

They're simple to operate and extremely reliable, with few moving

parts and no fussy CRT displays. And the RT02 models will even prompt the inexperienced operator, spelling out on the display what information is needed next.

The RT01 has 16-key input and numeric I/O display. The RT02 has 16-key or 58-key input and an alphanumeric I/O display.

They're both ASCII-compatible, so you can interface them to any computer that has a Teletype port. And they're both light enough to be portable.

The prices are down-to-earth, too.

From \$600 to \$1500, depending on the options you want.

The RT01 and RT02 from Digital. Remote terminals that people can get close to. Write, and we'll tell you more.

We're Digital Equipment Corporation, Logic Products Group, Maynard, Mass. 01754. (617) 897-5111, ext. 2785.

In Canada: P.O. Box 11500 Ottawa, Ontario, K2H 8K8. (613) 592-5111.

In Europe: 81 route de l'Aire, 1211 Geneva 26. Telephone: 42 79 50.

**We think terminals are so important, we give you a choice.**

**digital**

# Instruments measure low-level signals

French firm invades U.S. market with digital nanovoltmeter and a lock-in amplifier for sinusoids that are buried in noise

by Arthur Erikson, Managing Editor, International

One of the most difficult problems that electrical engineers have to deal with is the detection and measurement of low-level signals—both those that are intrinsically small and those buried in noise. Tekelec-Airtronic, a French company that has made a specialty of instruments for low-level measurements, is now introducing to the market two products that tackle the problem—a digital nanovoltmeter and a lock-in amplifier with digital readout of amplitude and phase.

When potential levels get down

below 10 nV, it takes top-notch hardware and a lot of care to measure it. A jiggle of the voltmeter can cause a faulty reading, there's always a chance of unintentional thermocouples, and thermal drift is a problem. Still, plenty of applications require working with voltages that low: comparing standard cells, detecting nulls on high-resolution bridges, measuring myoelectric potentials, and checking contact resistances at low currents, for example.

Engineers and scientists who have

to work at nanovolt levels can get help with Tekelec's TE 925, a digital nanovoltmeter that gives direct readout of voltages down to 1 nV, with noise guaranteed at a maximum of 2 nV peak-to-peak. Stability is held to maximum drift of "several nanovolts" for 24 hours. The price, still not set, will run around \$2,000.

Crucial to the instrument's performance is its optoelectronic chopper, points out Georges Alon, Tekelec's director general. The instrument is built around four photodiodes—two paired with detectors for chopping and two for thermal stabilization.

The chopper itself and the transformer that boosts the chopped-input level by several thousand times ride on a shielded mount that damps out motion transmitted to it through the instrument chassis. "The chopper-amplifier principle is classic," says Alon, "but we took particular care with the shielding and the mechanical mountings."

The input resistance of the chopper is better than 30 megohms on low ranges and the figure goes up to 50 on high ranges. The output integrator has a variable slope. That speeds readings on the 10- and 100-microvolt ranges if the input level is 10% or more of full scale. At 10  $\mu$ V, for example, a measurement takes six seconds with the "fast" filter switched into the integrator; otherwise, 30 seconds are needed.

Tekelec paired the chopper amplifier with an MOS LSI analog-to-digital converter so the combination has the operating features usual for digital voltmeter that work at "normal" voltages. There are six ranges from 10  $\mu$ V full-scale to 1 V full-

**Checking weak signals.** Digital nanovoltmeter (below) gives direct readout of values down to 1 nanovolt. Lock-in amplifier (top) automatically tracks signals buried in noise.



# When the questions are about enclosures, Optima has beautiful answers.

Whether packaging small, digital multimeters or a huge, communications center, you need enclosures with structural integrity, access, and versatility. Doing their job and doing it well.

How do you get them? Consider the alternatives... job shop?... in-house construction?... a manufacturer? To decide, it is important to ask the right questions and get the right answers.

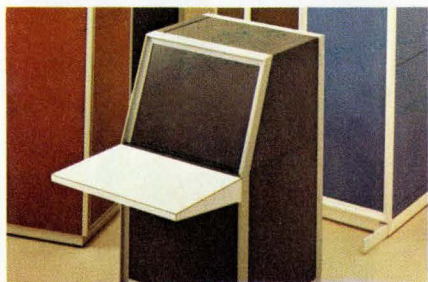

## Sales Appeal

*The first ten seconds of display for an electronics unit focus simply on its style, color and finish. They won't break a sale—the equipment inside does that. But they can sure help make one.*

- Is an industrial designer with packaging skills involved?
- Can you get the superior vinyl finishes so much in demand today? Or woodgrains? Or special textures?
- Is a total range of designer colors on hand?

## Versatility

*An important sales tool is the ability to adapt to the changing needs of a client.*



## The Optima Line

Our line of enclosures for electronics is the product of finding good answers to tough questions. Whether your question is component access, cooling, special applications or new product development and even safe shipping—we're ready!

Ready with Small Cases in 24 sizes from 133.6 to 1445.4 cubic inches; Instrument Cases and Racks in 124 sizes for 19- and 24-inch panels; Desk Consoles which are adaptable systems of instrument housing, counter and storage space; and the unique combination of chassis and case—Optima 17.

- Does a source offer hundreds of configurations to choose from? If, for instance, your client is thinking vertical rack, but wants the operator seated, can you offer a console-desk?
- Does a client need a ventilating grille? a blower? stabilizers? Wouldn't drawer slides help his operations? What about writing surfaces, storage areas, drawers, casters? Are they in production, on line and ready to go?

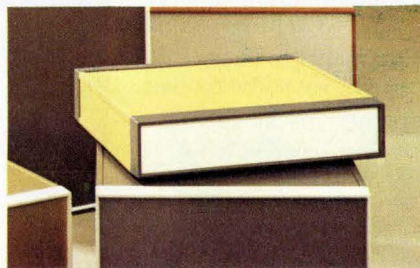

## Customer Service

*Are your own needs being served?*

- Can you get personal service from engineers, designers, and production people?
- Can you get special applications assistance?
- Does your source have a knowledgeable customer-service representative?

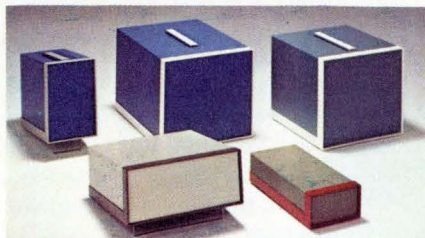

Computer scheduled manufacturing assures you of top quality control. We finish each unit inside and out with rugged vinyl and assemble them for final inspection—including most options and accessories—right at the plant.

Optima is the best answer. No question about that.

Write Optima Enclosures, 2166 Mountain Industrial Blvd., Tucker, Ga. 30084 or call (404) 939-6340.

# OPTIMA

# Need additional memory for your minicomputer?

## FABRI-TEK can supply it.

Fabri-Tek has the add-on system that's made for your mini . . . ready for off-the-shelf delivery. Plus, you're assured of unquestioned reliability and guaranteed availability through the use of high volume "field proven" core memory.

### CHECK THESE PRICES\* —

PDP-8 Series . . . . .	24k words/\$5200	ea. @ qty. 1
PDP-11 Series . . . . .	16k words/\$4180	ea. @ qty. 1
	64k words/\$12,560	ea. @ qty. 1
PDP-12 Series . . . . .	24k words/\$5200	ea. @ qty. 1
Nova 1200 Series . . . . .	32k words/\$6825	ea. @ qty. 10
HP 2114 & 2100 Series	24k words/\$6060	ea. @ qty. 1

Another plus is our on-site or factory service capability by a highly trained professional staff.

More new models. And ease of interface, too. Because all of Fabri-Tek's Add-On Memories are plug compatible and contained in an external enclosure with power supply.

This approach features the following:

1. Ability to utilize a core memory with a "track record" because the form factor or design doesn't have to change with each introduction of a new mini add-on.
2. No more than one card slot is used within the CPU to configure the maximum amount of core memory.
3. No additional power drain on your CPU power supply.

They're all available in 8k word increments to larger than the maximum allowable word size for some models.

Also . . . we're not new in the core memory business. For over a decade our product line has consisted of a wide range of cores, planes, stacks, and core memory systems.

Who could ask for anything more?

You, we hope. For more information, write or call:

\*Prices subject to change without notice. U.S. prices shown.

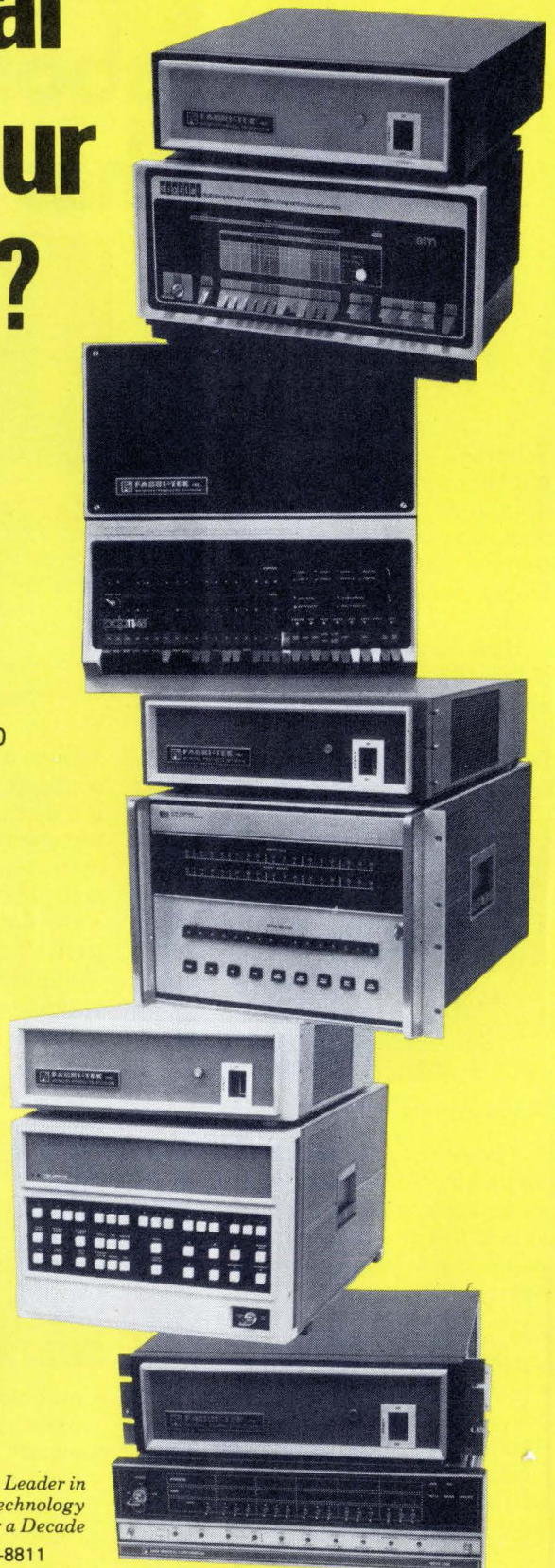

**FABRI-TEK** INC.  
**COMPUTER SYSTEMS**

*Leader in  
Memory Technology  
for Over a Decade*

5901 South County Road 18 • Minneapolis, MN 55436 • (612) 935-8811

<b>SALES OFFICES IN:</b>	Chicago (312) 437-4116	Denver (303) 753-0631	New Jersey (201) 964-4770	Sunnyvale (408) 739-4780	Hong Kong K210191	Tokyo (03) 432-6901
	Boston (617) 969-5077	Dallas (214) 233-0872	Long Beach (213) 420-2493	Phoenix (602) 266-4448	Toledo (419) 865-6693	Munich 089-755-8298
						United Kingdom 01-903 1923/5

## New products

scale, and they can be selected automatically, manually, or by remote programming. There's 100% over-range on each scale and 100% zero adjustment.

The output shows up on a 19,999-count liquid-crystal display, a standard panel readout module that Tekelec produces itself. There's also a BCD readout compatible with TTL levels, plus isolated and nonisolated analog outputs to drive recorders. For programmed range-switching, automatic inhibition is possible on the lower ranges to counter noise at the source.

**No knob-twiddling.** The way to recover a low-level sinusoid buried in noise is deceptively simple in principle. Compare the unknown signal with a reference that's kept in phase, and the random noise can be averaged out. Or to put it another way, pull out the buried-in-noise signal by synchronous detection with a known reference signal.

Generally, a lot of knob-twiddling on a synchronous detector setup is needed to get the phase of the unknown signal and the reference signal close enough together to start tracking. The need for this twiddling, maintains Tekelec-Airtronic, soon will be eliminated. The company plans to start delivering its lock-in amplifier early in the second quarter of 1974.

**Simple to use.** The \$2,000 Autophase TE 9700 is no harder to use than a simple oscilloscope, says Robert Miquel, Tekelec's product manager for low-level-signal instruments. "All you have to do," he says, "is set the gain for the input signal and adjust the time-constant for the integration of the detected signal. The Autophase does the rest."

For the automatic tracking, Tekelec puts to work an aperiodic phase-shifter that was developed at the French Commissariat à l'Énergie Atomique's electronics laboratory in Grenoble. Essentially, the phase-shifter picks off the zero-crossings of the reference signal and generates a square wave whose frequency matches that of the fundamental. This square wave is integrated until the next zero crosses the unknown

## DIGITRAN<sup>®</sup> Makes all kinds of Digital Switches... DIGISWITCH<sup>®</sup> MINISWITCH<sup>®</sup> MINILEVER<sup>®</sup>

List prices for each switch series shown below start at \$3.00 per switch module or less... only \$2.50 per switch module for our new Series 23000 SNAP-IN SLIMSWITCH. That's only 25¢ to 30¢ per switch function for a 10 position switch... less than the price per function of most toggle, pushbutton, lever, slide or rotary switches. Check our quantity discounts. We think you'll agree...

# Digitran makes economy switches too!



SERIES 23000  
SNAP-IN SLIMSWITCH



SERIES 29000  
ECONOMY MINISWITCH



SERIES 25000  
SNAP-IN MINISWITCH

Send for details today.

There is a Digitran distributor and a sales engineering group in your area. Just dial EEM (800) 645-9200 (Toll-free) to find out who they are.

See pages 1148 and 1149, Vol. 2, of the 1973-74 EEM Directory for more DIGITRAN products.

MORE SWITCHES FROM THE  
**DIGITRAN<sup>®</sup>**  
COMPANY  
Division of Becton, Dickinson and Company [B D]  
835 South Arroyo Parkway / Pasadena, Ca 91105  
Phone: (213) 449-3110 TWX 910-508-3794

## New products

Hi!—I'm  
**PLASMAC**

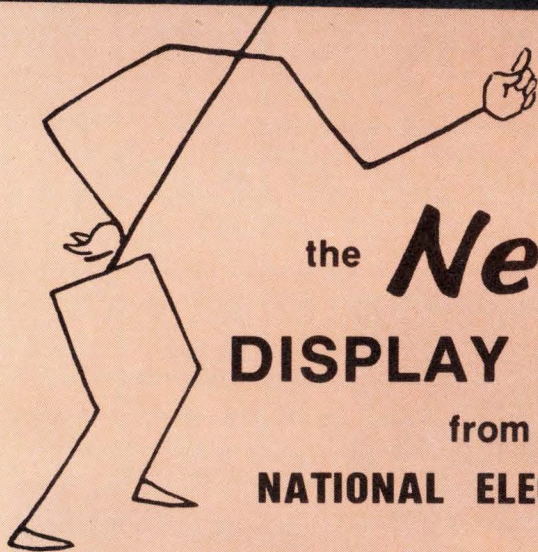

the **New**  
**DISPLAY PANEL**  
from  
**NATIONAL ELECTRONICS**

- Numeric, alpha numeric and fixed messages are available in a single panel.
- Custom design displays to suit your needs.

Call or write for full details



**NATIONAL ELECTRONICS**

a varian division  
geneva, illinois 60134 (312) 232-4300

Circle 142 on reader service card



SALON INTERNATIONAL DES

**composants  
électroniques**

**PARIS 1-6 / 4 / 74**

COMPONENTS - MEASURING  
MATERIALS - EQUIPMENT

Organisation S.D.S.A. - 14, rue de Presles 75740 Paris Cedex 15

FRENCH TRADE SHOWS 1350 Avenue of The Americas  
NEW YORK, N.Y. 10019 Tel.: (212) 582-4960, 1

input signal, so the voltage obtained represents the phase angle. Integration of the detected synchronous signal gives the magnitude.

Tekelec uses four shifters in cascade in the TE 9700, one for each 90° quadrant of possible phase angle. The instrument's internal logic selects the correct phase quadrant so that the user does not have to find it himself by using a selector switch. No switching is necessary to select input-frequency ranges; the full range capability, 0.5 to 1.0 kHz, is handled as a single range.

Readout is through a 3½-digit liquid-crystal display calibrated in rms volts for magnitude, degrees for phase, and a dc voltage for baseline offset. There's also a small horizontal analog meter to show which way the input signal is moving. Full-scale sensitivity is 1 mV rms and the absolute phase accuracy is within ±5° at 50 kHz and ±10° at 100 kHz. Acquisition time is 30 seconds, at most.

**Few restrictions.** Inputs can run as high as 50 v rms at 50 kHz, decreasing to 7 v rms at 100 kHz. The common-mode-rejection ratio for ac inputs is 120 decibels at frequencies up to 500 hertz. The maximum input for dc signals is 13 v. The reference input can be as high as 220 v rms at frequencies as high as 100 Hz. There are few restrictions on the reference waveform. The two main ones: the waveform must cross its mean only twice per cycle, and the pulse duration must be at least 1 μs.

There is a long list of potential uses for the Autophase. At the top is telecommunications equipment, particularly checking out low-level signals that have passed through filters, attenuators, and network correctors. There are all sorts of applications in pure electronics, ranging from analysis of microwave diffraction to measuring parasitic capacitances in semiconductors. Among the many other possible applications are servo systems, vibration and acceleration studies, electro-optics, and anywhere that it's necessary to determine the magnitude and phase of low-level signals.

Tekelec Inc. 31829 La Tienda Drive, Westlake Village, Calif. 91361 [340]

# You know TRW for chassis and engine parts.

## But do you know our resistor capability?



While you no doubt know TRW Automotive Worldwide, you may *not* know TRW/IRC—the resistor branch of the family.

TRW/IRC offers the broadest line of fixed resistors in the business—used by the *billions* in consumer, industrial, and military applications. This is a total resistor technology: carbon comp.'s, Metal Glaze™, wirewound, thin-film, networks, strips, and resistive functions for specific applications. We can give you *any* of the proven technologies, at reliability levels to meet automotive demands.

In fact, our resistors are already designed into automotive safety devices, electronic controls, ignition systems, fuel injection, adaptive brake systems and, of course, AM and FM radios, and mobile communications equipment.

TRW/IRC offers a high-volume, multi-source (four domestic plants) production capability. *Plus*

the packaging know-how for cost-effective interfacing with your assembly equipment. So get to know us. Send for the TRW/IRC Resistors Catalog. TRW/IRC Resistors, an Electronic Components Division of TRW, Inc., Greenway Road, Boone, N.C. 28607. (704) 264-8861.

**TRW/IRC Fixed Resistors  
Greenway Rd., Boone, N.C. 28607**

**Please send your latest catalog  
on TRW/IRC Resistors for  
Automotive Applications**



Name \_\_\_\_\_ Title \_\_\_\_\_  
Company \_\_\_\_\_  
Address \_\_\_\_\_  
City \_\_\_\_\_ State \_\_\_\_\_ Zip \_\_\_\_\_

# TRW<sup>®</sup> IRC RESISTORS

## Components

**Proximity sensor is versatile**

---

Non-contact unit offers wide sensitivity adjustment, remote operation by battery

---

Providing self-contained system components for detecting, monitoring and controlling virtually anything of any material that the eye can see—solid, liquid or gas—a series of non-contact sensors developed by Scientific Technology Inc., Mountain View, Calif., offer wide sensitivity adjustment. They can, for instance, see a transparent surface or see through it, at the user's option. Also, they can detect color and texture changes and read codes.

When used as proximity sensors, the standard range of the model 3093 Omniprox series is 24 inches for a 90% reflectance surface and 15 in. for an 18% reflectance surface. With a retrotarget, the beam make-or-break range is 20 ft. Longer-range units are also available. A light-emitting diode is provided for alignment and as an operation indicator.

Unaffected by ambient light, even bright sunlight, the 3093 also ignores environmental contaminants such as dust or fog because a form

of automatic gain control maintains the preset sensitivity.

Input-power requirement of the 3093 is 100 milliamperes at 12 volts ac or dc, so remote battery-operation is practical. Output is an active logic pulldown from 10 V dc to zero. The signal will sink 100 mA or source 10 mA. Auxiliary control and output options include time delays, relays, and customer-specified interface circuitry. Any number of 3093 sensors may be interconnected to provide multisensor controls.

The sensors are sealed in a rugged aluminum housing that is 1½-inch square by 3.9 in. long. Price is \$96.50, and delivery time is three weeks. Quantity pricing and special configurations are available.

Scientific Technology Inc., 1157 San Antonio Rd., Mountain View, Calif. 94043 [341]

---

Yellow LEDs are rated from 0.4 to 6 millicandela

Twenty-five new yellow light-emitting diodes, which are additions to Xciton's line of red and green LEDs,

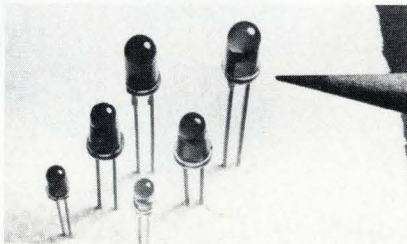

emit at rated luminous intensity with a forward current of 10 milliamperes. Light output of the yellow lamps extends from 0.4 millicandela typical to 6.0 mcd minimum. All of the devices in the line are made with gallium phosphide produced by Xciton's liquid-phase epitaxial process. Lens packages available are 0.125, 0.160, or 0.200 inch in diameter. Devices are also offered for snap-in mounting in front panels and printed-circuit boards, in addition to a choice of narrow or wide viewing angles to meet a wide range of indicator and illuminator applications. The light output of each diode is individually

graded at the factory to assure compliance with customer specifications and to ensure exact matches for second-source items. Prices range from 49 cents to \$1.95 in quantities of 1,000.

Xciton Corp., Shaker Park-5 Hemlock St., Latham, N.Y. 12110 [342]

---

Proximity switch handles up to 100 watts of power

The model 325 proximity switch can sense ferrous metals at a distance of ¼ inch. The device, which operates directly from 110 volts ac, can switch up to 100 watts without the need for an external power supply. The system is encapsulated in a steel housing 1 inch in diameter by 3½ in. long and 6 feet of color-coded leads. A threaded hole accepts standard conduit fittings. The switch is sensitive only on the front face, and the units can be mounted side by side without interference. Price is \$65.

Technical Electronic Products Co., 52500 Southdown Rd., Utica, Mich. [475]

---

Thermistor probes work up to 300° fahrenheit

Suitable for temperatures up to 300°F, thermistor probes with Teflon leads and epoxy coating offer a resistance range from 300 to 300,000 ohms. Other specifications include a close-tolerance thermistor resistance—to ±1% over relatively wide temperature ranges to ±0.5% at specific temperatures or over narrower temperature ranges. Diameter is 0.100 inch, and the customer specifies lead length. Price can be as low as 50 cents.

Western Thermistor Corp., 303 Via El Centro, Oceanside, Calif. 92054 [344]

---

Digital recorder heads handle 0.150-inch tapes

A series of digital recorder heads for 0.150-inch-wide tape cassettes is available in either single- or two-

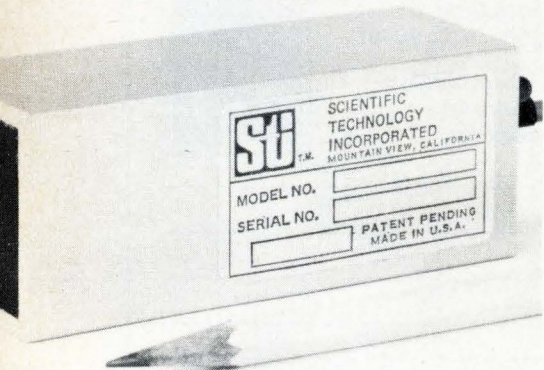



*A flexcircuit for the "Silent 700."*

# We did it for Texas Instruments.

The "Silent 700.\*" A powerful improvement over data terminals using conventional paper tape and noisy impact printers.

To help keep the Model 733 ASR teletypewriter silent, Texas Instruments needed a way to provide 42 conductors between the thermal print head and its electronics. And to do it without using a bulky, stiff, relatively heavy 42-conductor cable.

A Schjeldahl flexcircuit was the answer.

Dynamic characteristics of this application dictate a requirement for one million flexes without conductor failure. This called for conductors, insulation and adhesive to be something more than ordinary materials.

For improved reflow soldering of closely spaced connections, pad areas are electrolytically plated. And the flexcircuit had to be producible in volume.

An almost continuously flexing flexcircuit. Schjeldahl did it for Texas Instruments.

 **Schjeldahl Company**

Electrical Products Division  
Northfield, Minnesota 55057  
Phone: (507) 645-5633

*The state of the art people in volume flexible circuits*



# And we can do it for you.

# OUR ANGLE: The FIRST Digital Phase Angle Voltmeter



... This NEW DPAV provides complete analysis of complex AC waveforms at discrete frequencies and displays the results on a high readability  $4\frac{1}{2}$  digit display. Parameters measured are Total, Fundamental, In-Phase, and Quadrature voltage plus Phase Angle. Phase angle is displayed directly in degrees from  $0^\circ$  to  $360^\circ$  with a resolution of  $0.1^\circ$ .

The Model 220 operates phase-sensitively at a single factory-set frequency from 30 Hz to 32 KHz. The Model 225 has the capability of operating with two to four pre-specified frequencies. Both models have a total voltage measuring capability from 30 Hz to 100 KHz.

The DPAV can be used on the bench or in Automatic Test (ATE) applications. Remote programming,  $10M\Omega$  input isolation auto ranging, and BCD output options allow for complete hands-off operation necessary in automated test consoles. Priced from \$2950.00.

Let our sales engineering representative demonstrate our NEW angle to you. Call toll-free (800) 645-9200 for his name and address.



**NORTH ATLANTIC industries, inc.**

200 Terminal Drive, Plainview, New York 11803 • Phone (516) 681-8600  
California District Office: 13418 Wyandotte Street, N. Hollywood, CA 91605 • Phone (213) 982-0442

Circle 146 on reader service card

## COMPARE ! MITEL CM7200

The first Touch Tone Receiver

under \$150.00\* with C.O. rating.

AVAILABLE OFF THE SHELF

\* 1K QUANTITY

A COMPLETE LINE OF TONE

SIGNALLING COMPONENTS AVAILABLE

**MITEL Canada Ltd** box 1089 Kanata, Ottawa, Ont. (613) 836 2118

### New products

channel models in a read-after-write format. The devices are for recording densities up to 4,800 flux reversals per inch. Bifilar write-windings are standard on these models and permit the use of push-pull write circuits. Moreover, the model 150 heads offer 6-in. color-coded twisted leads which facilitate assembly and obviate problems of heat damage. Write-read feedthrough of the heads is less than 5% of output voltage without external shield.

Brush Magnetic Heads division, Forgfo Corp., Front and Reagan Sts., Sunbury, Pa. 17801 [343]

### Uhf circulator covers 300 to 500 MHz range

The model V3T41 ultra-high-frequency circulator operates from 300 to 500 megahertz and provides good electrical characteristics over a 15%

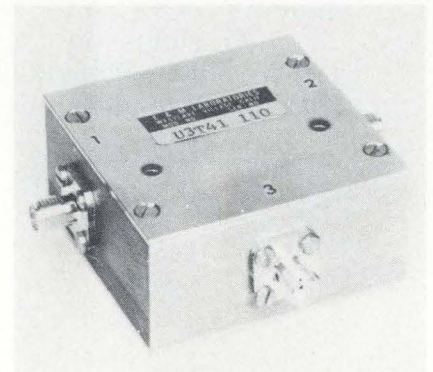

bandwidth under conditions specified in military standards. Applications include transmitters, receivers, and transceivers in biomedical and space telemetry systems.

E & M Laboratories, 5388 Sterling Center Dr., Westlake Village, Calif. 91361 [346]

### Miniature capacitors are rated from 0.47 to 5,000 $\mu$ F

Axial-lead miniature aluminum electrolytic capacitors are available with capacitance ratings from 0.47 to 5,000 microfarads. Voltage range is from 6.3 to 450 volts dc. Designated the TD series, the devices are

# TIGHT?



# WRITE.

There's plenty of room for growth in Québec. This coupon could be your key to wide-open expansion opportunities.

We've taken the lid off the TELECOMMUNICATIONS AND COMPUTER industry in Québec. Researched our assets thoroughly. Identified some exciting investment and expansion opportunities. We've compiled the information you need —

everything from labor data to market availability — in one concise, comprehensive report prepared for us by Fantus, the largest firm of location consultants in the world. And we've made it easy for you to get together with the Québec Department of Industry and Commerce — in Boston, Chicago, Dallas, Los Angeles or New York.

Write. And we'll send you the facts. Québec. We're interested in the same things you are.

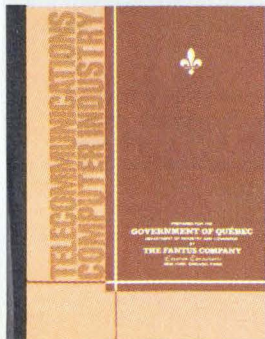

 **Québec**

name \_\_\_\_\_

company \_\_\_\_\_

address \_\_\_\_\_

**Department  
of Industry and Commerce**  
1 Place Ville Marie, Montréal, Québec

E-2

# Tansitor

Specialists in  
Tantalum Capacitors

## FOIL TYPES

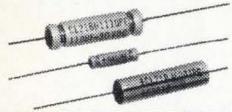

Tubular Style  
CL, CLR or TE  
Elastomer or  
Hermetic Seals



Rectangular Packages  
CL or TE 51, 52, 53, 54  
Tantalum to Glass  
Hermetic Seal



Special Designs  
WF, TES, THS  
Volumetrically efficient  
Filter Capacitors



Custom Modules  
Wide range of ratings  
designed to meet  
your requirements

## WET TYPES

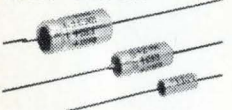

CL 65, CL 67, CLR65  
Elastomer or  
Hermetic Seals  
Standard or High Cap



Rectangular Packages  
CL or TE 55  
Hermetic Seal  
High Cap Values

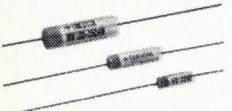

Miniature Wets  
Most Volumetrically  
efficient Capacitor  
Low DC Leakage

## MINIATURE SOLIDS



Type HA Cylindrical  
Type TC Rectangular  
Axial or Radial Leads  
Subminiature size



Type ET and EZ  
Cylindrical, Axial Leads  
Metal Case Epoxy Seal  
Miniature size

For more information on TANSITOR capacitors, call your local Tansitor Representative, or contact:

### TANSITOR ELECTRONICS

Division of Aerotron, Inc.  
West Road, Bennington, Vermont 05201  
Phone: (802) 442-5473 TWX: (710) 360-1782

## New products

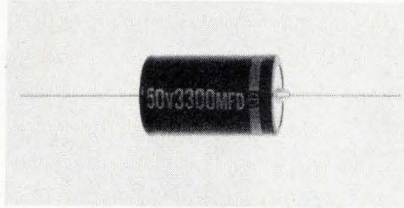

covered in a thermoplastic insulating sleeve and are designed for the temperature range from  $-25^{\circ}\text{C}$  to  $+85^{\circ}\text{C}$ . Quantity price is, for example, 10 cents for a  $100\text{-}\mu\text{F}$  unit at 16 V.

International Components Corp., Farmingdale, N.Y. 11746 [345]

Accelerometer measures  
from 0.1 to 50,000 g

A line of triaxial accelerometers uses a new piezoelectric-crystal composition to provide simultaneous measurement of acceleration in three mutually perpendicular axes. The units, which measure from 0.1 to 50,000 g, feature detach-

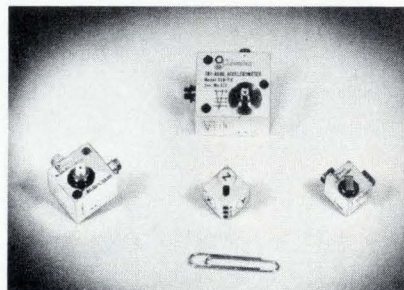

able low-noise cable assemblies and are for use in aerospace, military and industrial applications. Two series are available, the 500-TX series and the microminiature 600-TX types, which weigh less than 8 grams and occupy 0.082 cubic inch. Columbia Research Laboratories Inc., MacDade Blvd. and Bullens Lane, Woodlyn, Pa. 19094 [347]

Bridge rectifiers withstand  
high transient energy

The AL series of medium-current single-phase-bridge silicon rectifiers occupies less space than usual and

CIRCUIT-STIK introduces

# GP BOARDS

GENERAL PURPOSE  
CIRCUIT BOARDS  
Plug-in & Chassis Mounting  
and ELECTRONIC  
PACKAGING MATERIALS

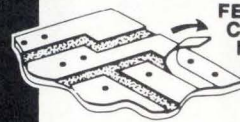
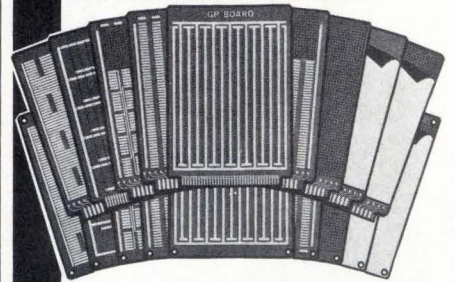

FEATURING  
CIRCUIT-STIK'S  
NEW CUT &  
PEEL BOARDS

## GP CIRCUIT BOARDS

### HIGH QUALITY

- FR-4 Blue Epoxy Glass
- Computer "DRILLED", High Accuracy Holes (not punched)
- Mil-Spec Plating
- Precision Routed Edges

### VERSATILITY

- Mix All Types of DIP Sockets (8 to 40 Leads)
- Low, Medium and High Profile Interconnections
- Hybrid Designs for Mixing Discretes and Sockets
- Designed for Edge Connector "Plug-In" or Chassis Mounting
- RFI Shielding

### HIGHEST DENSITY

- Up to 50 DIP's on one  $4\frac{1}{2}'' \times 6\frac{1}{2}''$  Plug-In Card
- Plus Space for 50 Decoupling Capacitors

### COMPLETENESS of STANDARD DESIGNS

- Choose from 74 Off-the-Shelf Boards
- 4 Sizes of Boards available

### APPEARANCE

- Beautiful Gold, Blue and Bright Tin

### FULL LINE of ACCESSORIES (HIGH QUANTITY PRICING AVAILABLE)

- Sockets - Low and Standard Profile, P.C. and Wire Wrap - Molded Nylon and Highest Quality Gold Contacts
- Adapterplugs
- Connectors
- Card Pull Handles

### EPOXY GLASS BOARD MATERIALS

- 76 Standard off-the-Shelf Boards
- Including Unclad, Copper Clad, Cut & Peel Copper Clad, Pre-etched "X-Y" Pattern and Plated thru Hole Copper Clad
- .100" Grid Hole Pattern or Undrilled

SEND FOR YOUR FREE CATALOG

**circuit-stik**®

P.O. BOX 3396  
Torrance, California 90510  
Phone (213) 530-5530



# beautiful and functional



## NEYETCH<sup>®</sup> COMMUTATORS AND SLIP RINGS...

are made of solid, wrought, non-porous noble alloys which afford low noise and extremely long life with no possibility of base metal contamination. In contrast to conventional printed circuit commutators, which are electroplated with thin layers of noble metal, extremely low tolerances can be held with Neyetch. And, too, the fabrication cost is reduced to a minimum by the elimination of machining or stamping operations.

Neyetch commutators and slip ring assemblies have proved superior for both commercial and military applications and are widely used in potentiometers, video tape recorders, radios, encoders, aircraft instruments, sonar, timers, switches, marine instruments and such. Ney plays a leading part in many products with low energy electrical precision contact components including switch assemblies, welded and staked assemblies, wire forms, flat spring contacts, plastic molded brush and contact assemblies, rivet head contacts and complete assembled components. For our catalogue, write The J. M. Ney Company, Bloomfield, Connecticut 06002.

the precious world of

# NEY

# The long-billed heat sucker would like you to meet her family.

Our good friend, the Heat Sucker (better known as a Hughes heat pipe), is now the proud mother of an entire flock: round and flat bills, flexible round bills and the cold mounted plate bill. Each variant feels right at home in electronic, chemical and mechanical equipment; industrial processing; and medical applications. Anywhere you might need thermal control.

Heat Suckers come in various sizes: 3/16" to 1" diameter, 6" and 12" lengths. They have thermal transport capabilities of 10 to 2,000 watts covering temperature ranges from: -90°C to +200°C.

Since the birds have mass migrated to our shelves, you can order right off the shelf for as little as \$37.00 (less in quantity)

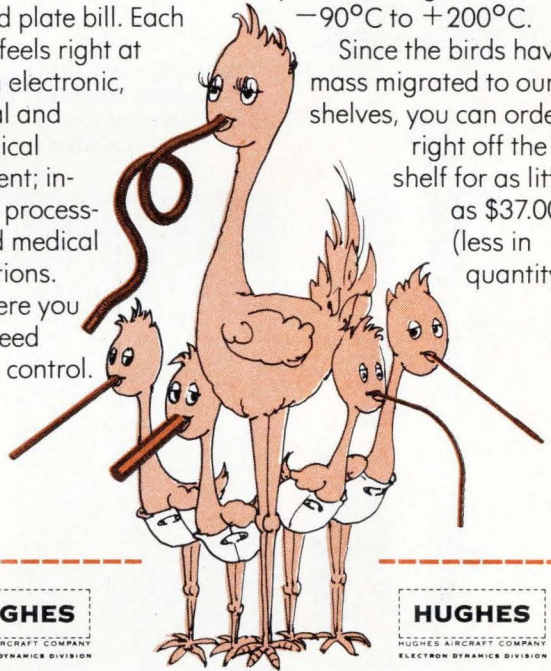

**HUGHES**

HUGHES AIRCRAFT COMPANY  
ELECTRON DYNAMICS DIVISION

**HUGHES**

HUGHES AIRCRAFT COMPANY  
ELECTRON DYNAMICS DIVISION

Celebrate along with us. Send the coupon and get a cigar and literature. Hughes Electron Dynamics Division, Advertising Dept., 3100 W. Lomita Blvd., Torrance, California 90509. Or call (213) 534-2121, Ext. 451.



Name \_\_\_\_\_

Company \_\_\_\_\_

Address \_\_\_\_\_

City \_\_\_\_\_ State \_\_\_\_\_

Zip \_\_\_\_\_ Telephone \_\_\_\_\_

E 2



**Ever Since the  
One-Tube RF-Amplifier/Detector  
Was the Hottest New Idea  
in Communications...**

If it's experience that counts in ability to design and build antenna insulators, nobody can touch Lapp! Solving problems—both electrical and mechanical—with insulators has been our business for more than 50 years.

Structural guy insulators . . . antenna strain insulators . . . base insulators for both self-supporting towers and guyed masts with strength ratings up to 9,000,000 lbs. ultimate. In fact, the bigger they are, the better off you are when you rely on Lapp's know-how.

Write for new catalog of  
Lapp RF Insulators and Assemblies:

LAPP INSULATOR DIVISION  
INTERPACE CORPORATION  
LE ROY, N. Y. 14482

Heavy-duty tower base insulators featuring triple "compression-cone" insulators



Double strain insulator assembly for radials of top-loaded vertical radiators

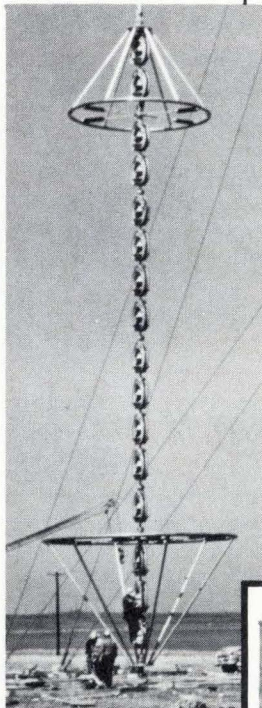

Large structural-guy insulator assembly with grading rings

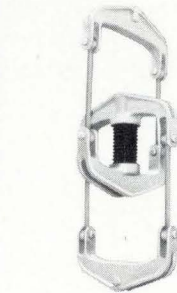

New design fail-safe structural guy insulator featuring compression post insulator, increased leakage and flashover ratings

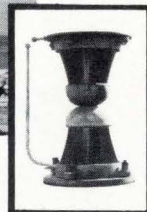

Moderate-duty mast base insulator

**Antenna Tower  
Insulators** by

**Lapp**



**New products**

can withstand high transient energy. The units contain double-diffused junctions and offer current ratings of 10 amperes or 25 A. All models handle voltages from 50 to 1,000 V

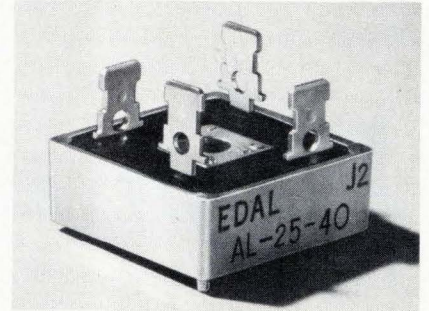

(peak inverse voltage). They also offer high temperature capability and low leakage current.

Edal Industries Inc., 4 Short Beach Rd., East Haven, Conn. 06512 [348]

**Solid-state relays  
switch up to 280 volts**

For applications in computers, control systems and consumer products, a line of solid-state relays are single-pole single-throw devices. A dc-input version is called the model MSR200B, and an ac version is designated the MSR202B. The dc model energizes with an input of 2.5 volts and de-energizes at 1.4 v, while the ac model energizes with 90 v ac or 45 v dc. Both models switch up to 280 v ac rms at a 10-ampere load current. Prices range from \$13.10 to \$22, depending on quantity and type.

Monsanto Commercial Products Co., 3400 Hillview Ave., Palo Alto, Calif. 94304 [349]

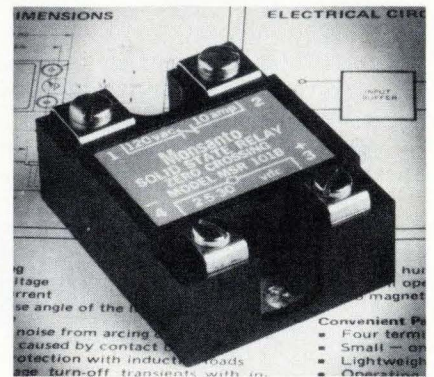

# Sweep from 1 to 18 GHz this easy

**select  
and  
read  
with  
six  
choices**

## Replace 6 Klystron Signal Generators with one Model 9535 — from 1 to 18 GHz.

Narda's newest generator/sweeper, Model 9535, is easy and quick to use —

- .05% accurate frequency digi-wheels — calibrated output power
- Provide 200 KHz resolution with excellent reset-ability
- Calibrated internal power meter
- Distance viewing provided—no mistaking frequency
- Push-button functions are illuminated for optimum visibility
- Calibrated controls with human engineered benefits

It eliminates the octave-band limitations and the associated cost and accuracy problems of ordinary sweepers and signal generators. It is now possible to test at all points over the range of 1 to 18 GHz. Because of the single set-up, it is ideally suited for military and commercial applications where frequency ranges overlap or where the single range of interest straddles multi-octave bands, or for the changing ranges of ECM systems.

Save man hours every day by eliminating plug-ins and warm-up time — eliminate BWO tube replacement budgets, plus getting crystal stability with phase-lock capability.

**Write for the full details now** — there are a lot more benefits to know about.

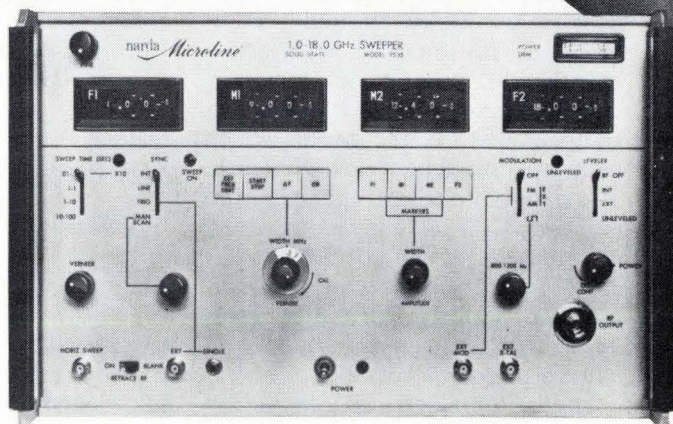
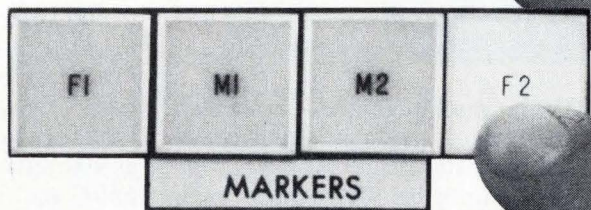
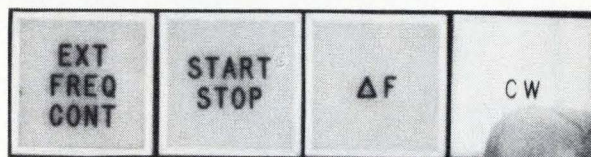
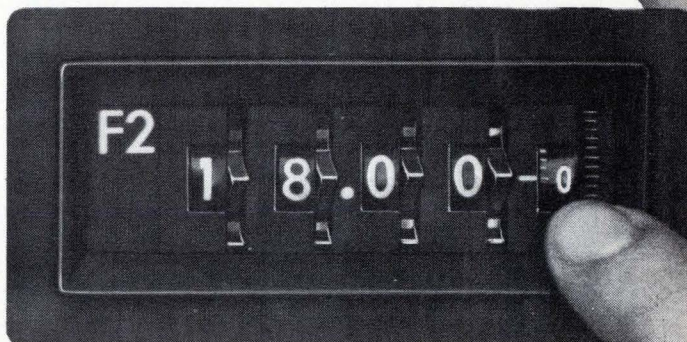
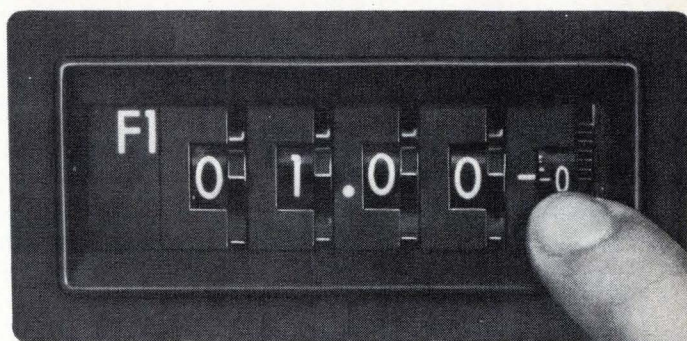

*wherever microwaves go...* **narda**

THE NARDA MICROWAVE CORPORATION • PLAINVIEW, L.I., NEW YORK 11803  
516-433-9000 • TWX: 510-221-1867 • CABLE: NARDACORP PLAINVIEW NEWYORK

235

Circle 151 on reader service card

---

## New products

---

Instruments

# Amplifiers have low price tags

---

Instrumentation-type units based on techniques for high-volume CATV market

---

The usual route from high technology to mass markets seems to have been reversed for a line of new hybrid broadband instrumentation amplifiers made by TRW Semiconductors, a leader in cable-television components with 200,000 amplifiers in the field. The new line of devices, based on designs for high-volume CATV line amplifiers, sell for \$26 to

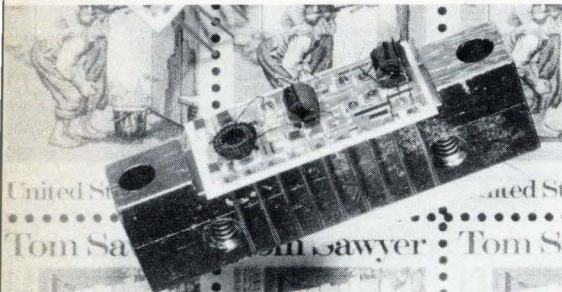

\$350 in small quantities—lower than similar parts made in small quantities for instruments.

Bill Faulkner, CATV sales engineer, expects the amplifiers to find use in aerospace ground instruments, rf instruments, field instruments, and communications circuitry. The devices are packaged in standard CATV configuration, which includes a small heat sink with each. The nine-pin package operates from  $-20$  to  $80^{\circ}\text{C}$ , is 1.775 inch long, 0.585 in. wide, and 0.830 in. high, and is epoxy-sealed. The broadband amplifiers operate as high as 500 megahertz, with outputs to 1 watt and amplification of 30 decibels.

TRW's amplifiers are made by thin-film hybrid techniques, and their alumina substrates provide good dielectric isolation, thermal conductivity, and mechanical strength. The gold-sandwiched copper conductors and cermet resistors

are etched photochemically, and resistance values are trimmed with lasers. Six transistors are used in the amplifiers (the 15-dB amplifiers use four). Push-pull circuitry brings about low power consumption and therefore low die temperatures.

State-of-the-art, high-linearity transistors are used, and special selections are available to meet specific requirements. Inputs and outputs are matched at 50 ohms, and two  $B^+$  terminals are provided, one for a preamplifier, one for the final stage, providing a convenient means of maintaining constant rf output by varying the final-stage supply voltage.

A typical amplifier, the \$88 CA870, has a minimum power output of 400 milliwatts from 100 to 400 MHz. Unleveled broadband response is  $\pm 1$  dB, gain is 29 dB, and 1 mW input is required for full output. Input and output impedances are 50 ohms with 1.5:1 VSWR. Operating power is 24 v at approximately 300 milliamperes. Noise figure is 12 dB, and reverse isolation is 30 dB.

Other modules include CA860 for 10 to 200 MHz, 30 dB gain and 400 mW output for \$80; CA804 for 100 to 500 MHz, 26 dB, 350 mW, at \$180; CA801, 10 to 400 MHz, 30 dB, 400 mW, at \$115; and CA806, 100 to 400 MHz, 30 dB, 1,000 mW, at \$350. Faulkner says that outputs to 1.5 w at 400 MHz are possible in selected units, and, at the other end, lower-performance units are priced as low as \$26. Delivery is off-the-shelf.

TRW Semiconductors, 14520 Aviation Blvd., Lawndale, Calif. 90260 [351]

---

## FET tester requires no setup information

A push-button-operated tester, called the model TF26 Touch Tone Cricket, allows solid-state testing of transistors and FETs without any knowledge of the device under test being required. No setup book or data on lead configurations is necessary. The test leads can be connected in any order. The push-button operation, coupled with an npn-pnp button, tests all possible combi-

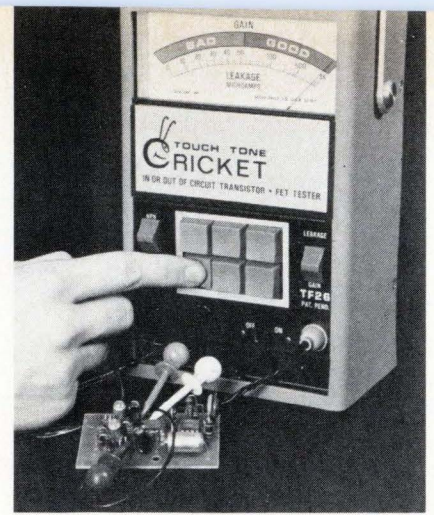

nations of basing for any transistor or FET. Price is \$140.

Sencore Inc., 3200 Sencore Dr., Sioux Falls, S. D. 57107 [354]

---

## Frequency meter covers from 57 to 63 hertz

The model 200 digital-display frequency meter uses a quartz crystal oscillator as the time standard and covers the range from 57 to 63 hertz. Accuracy is to within 0.01 Hz for input variations in voltage and wave shape from  $0^{\circ}$  to  $65^{\circ}\text{C}$ . Further, the instrument is not affected by changes in position, magnetic field, or vibration. Input-voltage range is 100 to 135 volts, and the input is used as both signal and power source. Price is \$495.

Herbst Associates Inc., 43 Peniston Ave., E. Hanover, N.J. 07936 [353]

---

## Strip-chart recorder spans 10 mV to 10 volts

The model SR-255B strip-chart recorder for industrial, laboratory, and educational applications gives a choice of four front-panel switch-selectable calibrated ranges—10 millivolts, 100 mv, 1 v, and 10 v. A variable span-capability extends the range to 100 v full scale if desired. Chart speeds of 10 down to 0.01

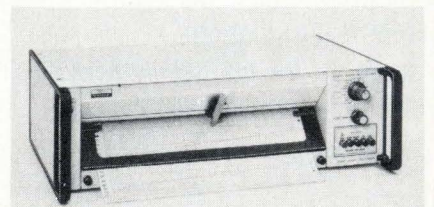



Even when it was only \$35 an ounce, gold was expensive. That's why we started long ago to reduce the amount of gold in our contacts to a minimum.

In 1958 we developed a really reliable gold dot contact. And no matter what anyone else says, only silver and copper are better electrical conductors than gold

(but gold doesn't oxidize or corrode).

Over the years we've been able to reduce the cost because we reduced the gold.

And we've been reducing the amount over the years without reducing the mechanical or electrical quality of our connectors.

Now, after all these years, we

find out that we not only reduced cost but we've been making our own small contribution to solving our country's gold problem.

And all because we wanted to design a more economical, more reliable gold-contact connector.

**GTE SYLVANIA**

Circle 153 on reader service card

## Our small contribution to solving the gold problem.



## New products

inch or cm per minute are also provided, and these are accurate to within 0.5%. Price is \$335.

Heath/Schlumberger Instruments, Benton Harbor, Mich. 49022 [359]

### Fourier signal analyzer speeds transform time

The model 5451B Fourier analyzer eliminates the cost of a hard-wired processor in almost all situations, thanks to the microprogramming capability in the unit's minicomputer. Real-time power spectrum analysis

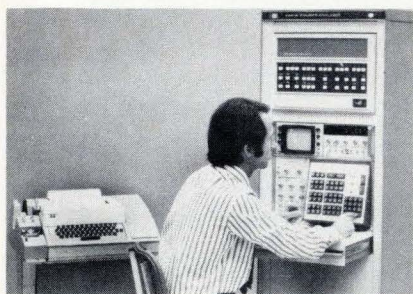

is possible up to 3,000 hertz. It also speeds transform time and provides greater real-time bandwidth than previous models. Standard equipment includes a two-channel a-d converter prewired in the factory to allow the addition of two or more channels—four channels of data can be simultaneously digitized, each to a bandwidth of 100 kilohertz. Price is \$42,500 for a complete system.

Hewlett-Packard Co., 1501 Page Mill Rd., Palo Alto, Calif. 94304 [356]

### Low-priced pulse generator covers 1 Hz to 10 MHz

Priced at \$99, a pulse generator is designed to cover the frequency range from 1 hertz to 10 megahertz and has a pulse-width range of 50 nanoseconds to 1 second. Other features of the model BP1 include a duty cycle of up to 95%, an output compatible with TTL, DTL, and RTL, and use of socket-mounted inte-

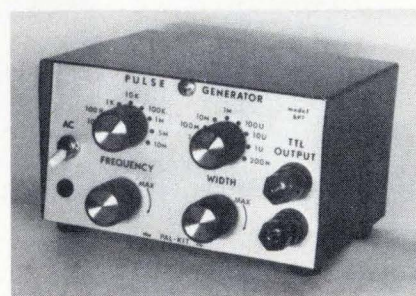

grated circuits for ease of maintenance.

The PAL Kit Co., Box 1056, Minnetonka, Minn. 55343 [357]

### Five-inch oscilloscope has 10-MHz bandwidth

An oscilloscope, called the model 455, has a 5-inch face, is designed for a 10-megahertz bandwidth, and offers a vertical sensitivity of 10 mv/cm. Applications include TV servicing and varied industrial uses. The scope accepts a camera or light-

# New 150MHz Counter Why settle for less

- Simple Operation
- Direct Reading in Hz, KHz, MHz
- 5Hz to 150MHz Range
- 25 mv Sensitivity to 80 MHz
- 50 mv Sensitivity to 150MHz
- Reliable Solid State Circuit Design
- Rugged Construction
- Large 6 Digit Display with Memory

## Options

- Unique I.F. Subtraction
- TTL Compatible BCD Output
- 8 Digit Display

# \$395

Contact your local Monsanto Representative today or call: **United Systems Corporation**, 918 Woodley Road, Dayton, Ohio 45403, Ph: (513) 254-6251, subsidiary of



Model 115A

# Monsanto



GOLD "CROSSPOINT" CONTACTS

# STRIKE GOLD

PLUNGER STEM

## ...every time you depress a CHERRY KEYBOARD SWITCH

Cherry's unique gold "crosspoint" contacts plus simplified electronics enhance reliability and provide long life . . . low profile . . . lower power consumption . . . low, low cost. The crossed knife-edge contact configuration has been tested to 50,000,000 operations and beyond. Available from stock with a wide variety of key legends and colors. Or, buy them as part of a keyboard package, ready to slip into your panel. Either way is economical the Cherry way.

When you need keyboard switches or complete keyboards for numerical control, calculators, computer terminals or other applications, strike gold with Cherry—and save silver at the same time.

**FOR A FREE TEST SAMPLE** and a copy of our latest complete-line catalog just TWX 910-235-1572 . . . or PHONE 312-689-7700 . . . or circle appropriate reader service number.

RETURN SPRING

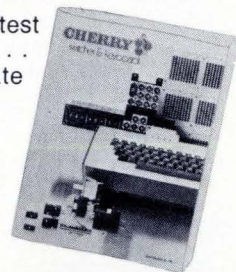

# CHERRY



**CHERRY ELECTRICAL PRODUCTS CORP.**  
3608 Sunset Avenue, Waukegan, Illinois 60085

Cherry Worldwide: (Subsidiaries) Hirose Cherry Precision Co., Ltd., Tokyo • Cherry Mikroschalter GmbH, Bayreuth, Germany  
• Cherry Electrical Products (U.K.) Ltd., St. Albans, Herts • (Licensee) G.W. Engineering Pty. Ltd., Sydney



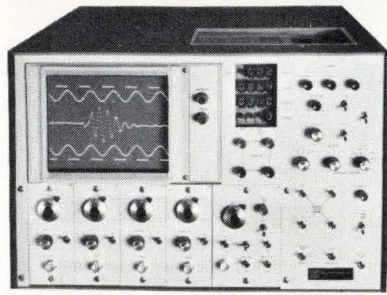

## ERDAC III are just the thing you need.

It's the one, portable unit that does the work of a scope and Polaroid. tape recorder, digitizer, chart recorder, and digital meter.

ERDAC III a 4-channel recording, display, and test instrument, weighing only 50 lbs., has all these fully integrated features:

1. Stores up to 20 hours of analog data on reusable, high quality cartridges digitally, with each record addressed for instant test comparisons.
2. Displays all 4 channels at one time. See, measure, compare incoming or recorded signals.
3. Captures transients with a dynamic cursor for exact pretrigger setting and accurate X & Y axis measure-



ments with a CRT, 7 digit display, and 3 trigger modes.

4. Makes your time more effective with output formatting: digital parallel = computer interface (binary) digital serial = telephone data transmission via modem analog parallel = X-Y plot of any pair of channels with 18 crystal clocked reproduction rates from 1 Hz to 1 MHz.
5. Fits the move toward mini-computer-based data acquisition systems and programmable signal processing with powerful versatility for new applications without costly add-ons. No planned obsolescence. Need help with an application? Call Dan Antos— 518-371-7474.

**M** **MACRODYNE INC.**  
Box 186 A, RD 2  
Mechanicville, New York 12118

Circle 156 on reader service card

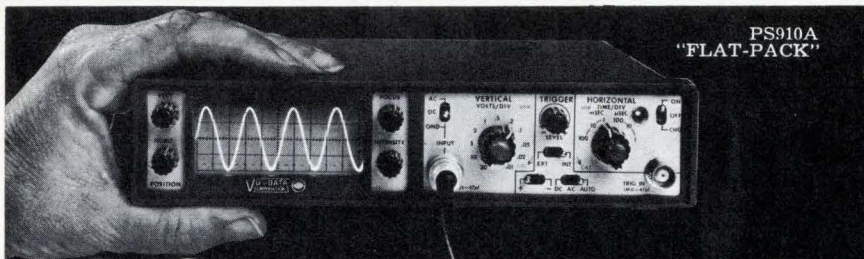

# 20MHz ... and small enough to fit in your brief case!

- Mini-portable Oscilloscope • Battery or AC powered
- DC-20 MHz bandwidth • 10 mV/div sensitivity
- Recharging circuitry • Rack mountable • Laboratory Quality

The PS900's are the first mini-portable scopes to bring lab-quality to "on-site" DC to 20 MHz test and measurement applications. These are "true" portables, since they are of rugged construction, small size (will fit into your tool kit or brief case) and light weight (only 7 pounds with batteries), and since they will operate from internal batteries for up to 5 hours. Recharging circuitry is included, and standard "C" size cells can be used . . . nickel-cadmium, alkaline or in a pinch, even common flashlight batteries!

- Interested? Call Bill Kraus at (714) 279-6572, or write us at 7170 Convoy Court, San Diego, California 92111.



PS920A  
"STACK-  
PACK"

Two configurations are available . . .  
"FLAT-PACK"—  
1 3/4" H x 8 1/2" W x 12" D  
"STACK-PACK"—  
3 1/2" H x 4 1/4" W x 12" D

AVAILABLE NOW FROM

**\$595**

From the leader in Multi-Channel Monitor Oscilloscopes

**VU-DATA CORPORATION**

## New products

hood and has a low-parallax, high-contrast graticule with both amplitude and vector display index.

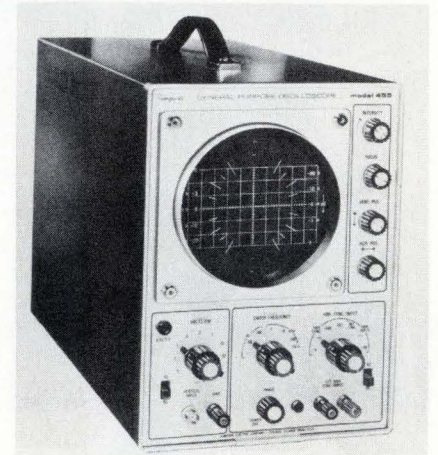

Sweep frequency is adjustable from 1 hertz to 200 kilohertz in five overlapping ranges. Price of the oscilloscope is \$295.

Simpson Electric Co., 5200 W. Kinzie St., Chicago, Ill. [358]

IC memory tester  
is microprogramed

The M-10 integrated-circuit-memory test system is offered with built-in time clocks. Test programs can be stored on tape, and test setups are possible using low-cost test jigs, manual or programed clocks, and simplified operator controls. Options include a magnetic-tape cartridge, video display, printer, and 8-bit microcomputer. The unit can also be expanded from 16 to 80 data-word bits and 16 to 24 address bits. Price is in the \$25,000 range.

Micro Control Co., 1364 Buchanan Pl., Minneapolis, Minn. 55421 [360]

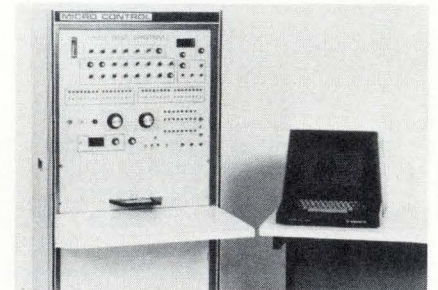

# State of the art vs. state of the economy.



**True RMS to DC measurements  
at a truly low price. The Model 440 from  
Analog Devices. \$62 for the model J,  
\$70 for the model K.\***

At 1½" x 1½" x 0.4", it's smaller, to give you more freedom to design.

And you'll want to design with it. Because the Model 440 offers a high accuracy of 0.35% for the J and 0.1% for the K. Along with a high crest factor of 10, simultaneous one-step RMS calculation of the DC and AC component of any complex waveform, and a response time of 10 milliseconds. It's also a pin-compatible replacement for current RMS devices.

In addition, offset errors can be completely eliminated using an external adjustment, a feature usually found only in much higher priced models.

Best of all, the Model 440 saves you money.

You can check out one or both before May 1, 1974 at the trial price of \$42 for the J and \$50 for the K. Either way, you can't go wrong. Neither can the Model 440.

So give us a call. It's the fastest way to get all the facts on the Model 440. Which is just another member of our full line of non-linear circuits.

We also bring you a complete line of log amplifiers and log elements. Multipliers. Dividers. And multifunction devices.

Analog Devices, Inc.,  
Norwood, Mass. 02062



\*In quantities of 1-9.

**Call 617-329-4700  
for everything you need to know about non-linear circuits.**

# Sometimes it's easier to get the picture from a picture.

The 22-run executed from the I-formation begins with a fake from the quarterback to the fullback, then a handoff to the tailback. The fullback leads the tailback off right guard as the center blocks out on the middle linebacker and the other linemen block man-to-man, kicking their men to the outside to open a lane straight ahead. This leaves the tailback facing the safetyman one-on-one.

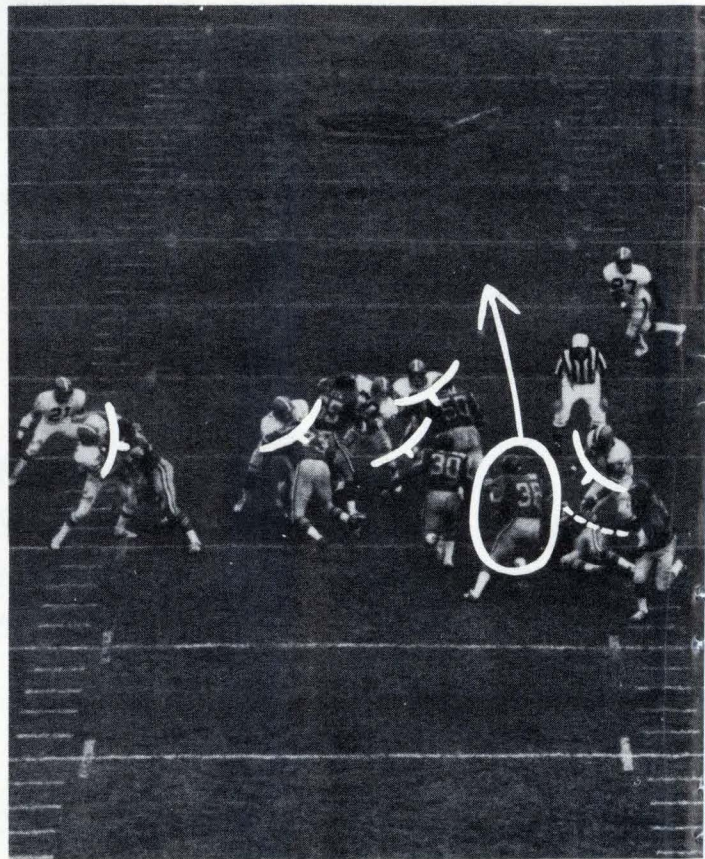

The picture on the right says the same thing as the words on the left. But so much faster. And clearer.

And when you consider the growing mountains of data you have to deal with, pictures become more a necessity than a luxury.

To answer the need in the burgeoning industrial and commercial markets, Hughes has used its high technology to develop advanced methods for the sensing, storage and display of pictorial data.

Now, this image processing tech-

nology has developed into a whole family of components, systems, subsystems and software. Our products include image memories, image processors,



**HUGHES**  
HUGHES AIRCRAFT COMPANY  
INDUSTRIAL PRODUCTS DIVISION  
IMAGE DEVICES

**Creative Image Processing.**

special display systems, graphic terminals, direct view storage tubes, scan converter tubes, visible and IR sensors.

We also have an applications engineering staff available to provide systems support and OEM assistance. (Both our products and our services can be tailored to your special requirements.)

Today, more than ever, Hughes is ready to help you get the picture. For a new Creative Image Processing Capabilities brochure, write: 6855 El Camino Real, Carlsbad, California 92008. Or call (714) 729-9191.

### Semiconductors

# Memory writes while it reads

16-bit LSI device provides 10-ns access to any 4 bits as new data is being entered

Signaling a new trend in random-access-memory technology, a 16-bit multiport register file developed by Motorola is capable of reading 4 bits and/or writing 2 bits at the same time. Designated the MC10143L, the device provides 10-nanosecond access to any 4 bits while simultaneously writing in the new data. Since the memory is organized into eight 2-bit words, two read operations and a write operation can be accomplished simultaneously.

Data is stored by two sets of eight latches. Each bit of a word has a separate write-enable for design flexibility. Writing occurs on the positive transition of the clock, while data is enabled by having the write-enables at a low level when the clock makes a transition. Read-out is accomplished at any time by enabling the output gates.

This LSI device, part of the MECL 10,000 series, has fast operating speeds. Clock to data-out is typically 5 nanoseconds, and read-enable to data output is 3.5 ns. Power dissipation is 610 milliwatts, and the unit is available in a 24-pin DIP ceramic package for the commercial temperature range of  $-30^{\circ}\text{C}$  to  $+85^{\circ}\text{C}$ .

The ECL outputs drive transmission lines directly, which eliminates translator delay times. Outputs can be ORed together, or several register files can be combined on a single bus. Included to reduce the number of external components are on-chip decoders and write amplifiers. One application envisioned for the device is an interface between a higher-speed unit and a lower-speed unit where it is desirable to move data in two directions at the same time. Other appli-

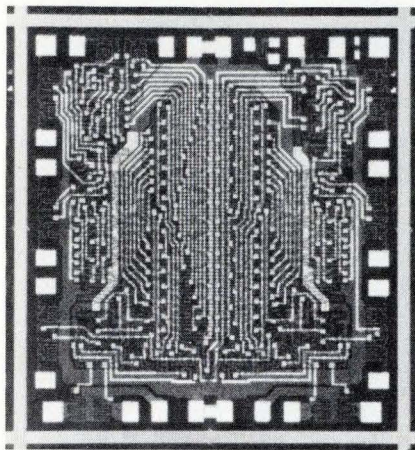

cations include register files and multiple-accumulator applications.

The MC10143L is available from stock at \$29 each in quantities of 100 to 999.

Motorola Inc., Semiconductor Products Division., P.O. Box 20924, Phoenix, Ariz. 85036 [411]

### Eight-bit addressable latch operates in four modes

Designated the model Am9334, an eight-bit addressable latch is pin-compatible with the like-numbered circuit manufactured by the Fairchild Camera & Instrument Corp. The device operates in four modes: addressable latch, memory, clear, and eight-channel demultiplexer. The latch, which offers an average propagation delay of 22 nanoseconds, contains eight individual parallel outputs and an active-low common clear and input-enable. Price of the Am9334 in a dual in-line package is \$4.85 in 100-lots. In a molded package, it is priced at \$3.57 in the same quantities. Temperature range is  $0^{\circ}$  to  $75^{\circ}\text{C}$ .

Advanced Micro Devices Inc., 901 Thompson Pl., Sunnyvale, Calif. 94086 [412]

### Power transistors are npn—pnp complements

The models 2N5883/5 and the 2N5884/6 npn-pnp complementary power transistors have identical electrical characteristics. Offering a

collector-to-emitter rating of 60 to 80 volts and a continuous collector-current rating of 20 amperes, the units are suited for use in high-power amplifiers and converters. Other applications include power-switching, motor controllers and class D amplifiers. The transistors are packaged in JEDEC TO-3 cans and dissipate up to 200 watts at  $25^{\circ}\text{C}$ . Prices range from \$2.84 to \$3.22 each in 100-lots.

Silicon Transistor Corp., Katrina Rd., Chelmsford, Mass. 01824 [413]

### Matched-transistor arrays offer low-noise performance

A series of matched-transistor arrays delivers a gain-bandwidth product ( $f_T$ ) of 2.5 GHz. They are suited for applications in the front ends of instrument amplifiers or in i-f amplifiers because of their low-noise performance. The arrays comprise matched bipolar npn elements. Three devices are offered: two matched pairs called the SL360C and the SL362C and a differential pair called the SL3145.

Plessey Semiconductors, 1674 McGaw Ave., Santa Ana, Calif. 92705 [414]

### Clock circuit supplies multiple functions

An MOS LSI circuit for clock applications allows for either a four- or six-digit multiplexed display to be used, besides providing for a.m. and p.m. indication and 24-hour alarm setting. Designated the model MK 50250N, the device has a 60-hertz pulse rate. Other features include power-failure indications, intensity control, and compatibility with gas-

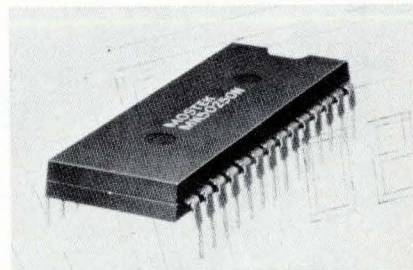

# TRIMLINE ENCLOSURES BY PREMIER METAL PRODUCTS CO.

337 Manida St., Bronx, N.Y. 10474/(212) 991-6600

OVER 1300 ITEMS IN OUR CATALOG



Complete catalog  
and prices on request.

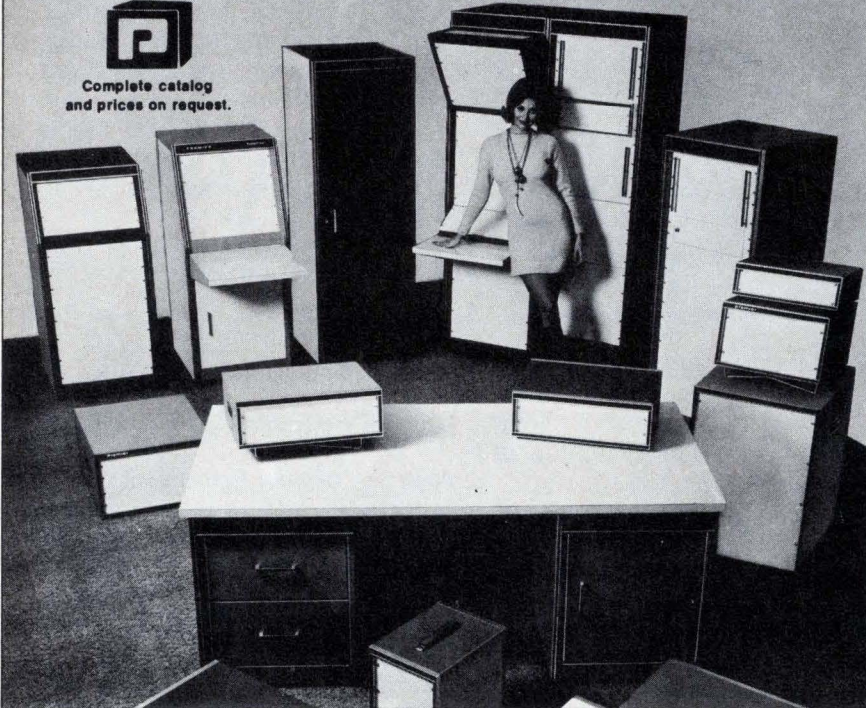

Circle 160 on reader service card

## OPEN-LINE REED RELAYS

Quality Engineered at Low Cost  
Broad Line . . . From Distributor Stock

An exceptionally high quality line of Form A and Form C open frame reed relays — with up to 6 contacts (Form A) and 4 contacts (Form C) per relay! Available in standard coil voltages 5 to 48 VDC . . . Capable of switching up to 1/2 amp, 250 VDC (Form A) or 1/4 amp, 28 VDC (Form C). Only .350" high by 1.125" long, with terminals on .1" or .15" grid spacing. Electrostatic and electromagnetic shielding optional. Top performance at low cost . . . Tailored to fit your cost/environmental requirements.

Phone, wire or write.

**ELEC-TROL, INC.**

26477 N. Golden Valley Road  
Saugus, California 91350  
(213) 788-7292  
TWX 910-336-1556

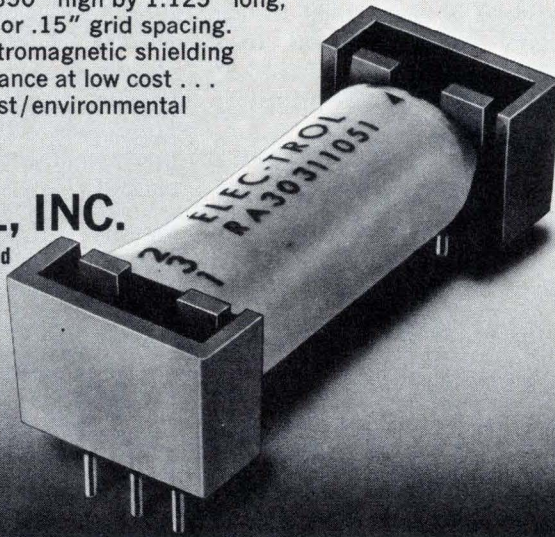

1973-74  
**eem**  
VOL. TWO

160 Circle 212 on reader service card

### New products

discharge or LED displays. Price is \$6.25 each in quantities of 100.

Mostek Corp., 1215 W. Crosby Rd., Carrollton, Texas 75006 [416]

Op amp provides slew rate  
of 10 volts per microsecond

The model SG741S/741SC operational amplifier is offered with a guaranteed minimum slew rate of 10 volts per microsecond. This specification makes the device suitable for use with analog-to-digital converters and in all applications requiring a large power bandwidth; minimum power bandwidth of the device is 150 kHz. Settling time is 3.0  $\mu$ s. Price is from \$1.25 to \$4.95 in 100-lots, depending on temperature range and packaging.

Silicon General Inc., 7382 Bolsa Ave., Westminster, Calif. 92683 [415]

Op amp designed for use with  
single positive supply

The model CA3 401E quad operational amplifier is a monolithic device designed specifically for applications using a single positive power supply. The device requires no external compensation and has a 3-picoFarad capacitor on the chip to maintain closed-loop stability in each of the four independent amplifiers. Unity-gain bandwidth is typically 5 megahertz, and typical input bias current is specified at 50 nanoamperes. Price in quantities of 100 to 999 is 75 cents each, or 70 cents for a chip version.

RCA, Solid State Division, Box 3200, Somerville, N.J. 08876 [417]

Panel-mounting diode  
emits yellow light

The model MLED850 diode emits yellow light and shares the same package and panel-mounting design as the Motorola 650 red and 750 green light-emitting diodes. Applications for the device are varied, but

Electronics/February 7, 1974



# Program over 1200 N/C drilling commands an hour.

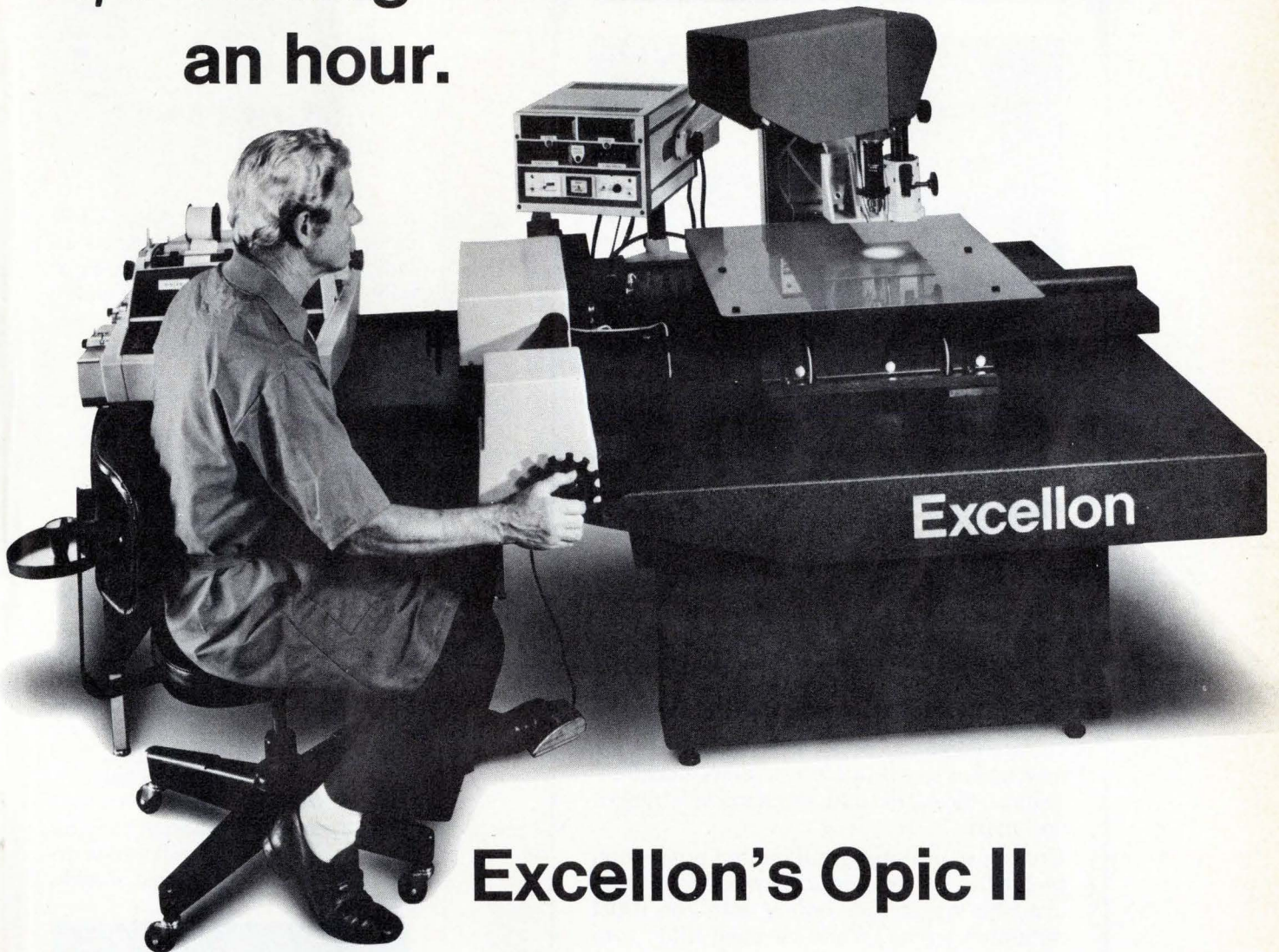

## Excellon's Opic II

You're looking at the best way we know of to produce printed circuit board programs for any EIA standard N/C drilling machine. This includes our own Excellon Mark III, the Monomatic 7 and the Quadramatics.

Excellon's Opic II.

It's fast and accurate. And it's uncomplicated.

Simply place your art, negatives or boards on the 25" x 25" work table.

Then control X-Y axis table travel either electrically (at 120-inches a minute), or by manually operating the fine-adjustment hand-wheels. Air bearings virtually eliminate friction, and ball nut lead-screws prevent backlash.

When the pad is centered on the 10-power, 6-inch scope, press the footswitch and the X-Y coordinates are entered on the tape.

Then you're ready to proceed to the next hole. (And you can proceed in **inches** or **millimeters**, whichever you prefer.)

In addition, the Opic II, with

$\pm 0.0001$ " resolution, can be used to **inspect** art work or p.c. boards.

There's much more you should know about this outstanding optical programming/inspection center. And you'll find it all in our Opic II brochure.

Call or write Dick Hogan, Sales Manager, today. His number is (213) 325-8000.

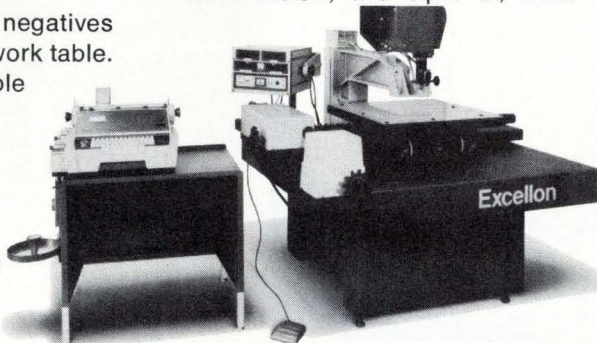

### Excellon Automation

A Division of Excellon Industries

23915 Garnier Street

Torrance, California 90505

Phone: (213) 325-8000

Telex: 67.45.62 Cable: Excellon Torrance

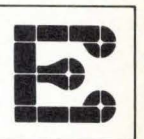

Excellon Sales and Service in ENGLAND • FRANCE  
SCANDINAVIA • W. GERMANY • HOLLAND • AUS-  
TRALIA • HONG KONG • TAIWAN • JAPAN

# Centralab perspective:

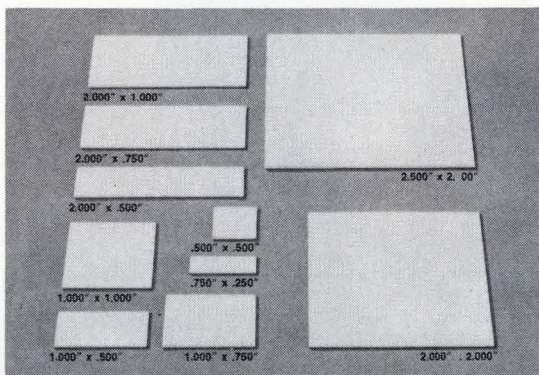

## 95% Alumina Substrates Now you can get standard sizes from your Centralab Distributor.

For the first time, anywhere, your Centralab Distributor is now stocking 10 of the most popular sizes of substrates. He can provide fast delivery on 100 to 10,000 pieces at prices as low as 5 cents each, depending on size and quantity. All are 95% alumina . . . white . . . in .025" thickness . . . 25-50 microinch surface finish . . . for up to 1700°C use. They match your specifications for dimensional tolerance, dielectric and mechanical strength and more.

Until now, prototype and limited production quantities of ceramic substrates were only available on factory orders with the usual minimum billing. We've changed that . . . to help you quickly and economically meet your need for the finest precision substrates.

**Get complete specifications from your Centralab Distributor or send coupon.**

Centralab Distributor Products  
5757 N. Green Bay Ave. Dept. AS-2  
Milwaukee, Wisconsin 53201

Name: \_\_\_\_\_

Company: \_\_\_\_\_

City: \_\_\_\_\_ State \_\_\_\_\_ Zip \_\_\_\_\_

DISTRIBUTOR PRODUCTS



**CENTRALAB**  
Electronics Division  
GLOBE-UNION INC.

## New products

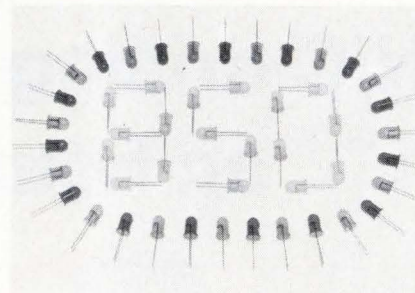

the company expects the yellow diode will find particular use as an indicator of standby situations. Price is 89 cents each for 100 to 999 units.

Motorola Semiconductor Products Inc., Box 20912, Phoenix, Ariz. 85036 [418]

## FET op amp offers 10-mHz bandwidth

A FET operational amplifier that requires no external compensation offers a unity-gain slew rate of 50 V per microsecond, a bandwidth of 10 megahertz, and a maximum input bias current of 15 picoamperes. Designated the AD528, the device is internally compensated for unity-gain applications. This provides a 60° phase margin to ensure stability and eliminate ringing and overshoot in the transient response. External feed-forward compensation may be added to increase the slew rate to over 100 V/μs and almost double

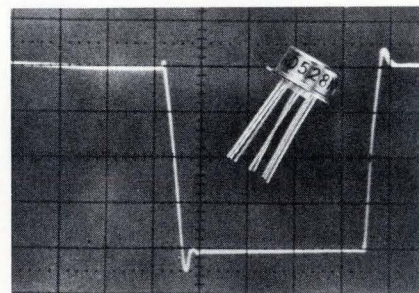

the bandwidth. And, if desired, settling time to 0.1% can be reduced to less than 1 microsecond with a single external capacitor. Prices for the various models range from \$42 to \$12, depending on specifications, operating temperature, and quantity.

Analog Devices, Rte. 1 Industrial Park, Box 280, Norwood, Mass. 02062 [419]

# The first name in sweep generators is also no. 1 in price/performance value.

Telonic Sweep Generators have a lot more built into them than just components. For example — more experience and application know-how than you'll find in any instrument; operating features we've incorporated from talking to hundreds of users; dependability based on designs that are field-proven in thousands of locations. Today, Telonic sweepers give you a lot more than just specs. They give you maximum instrument for your investment.

SWEEP GENERATORS				DISPLAY OSCILLOSCOPES	
	Model 1202	Model 1204	Model 1205	Model 121	Model 122
Frequency (MHz)	.1-100	1-500	1-1500	Single Trace	Dual Trace
Sweep Width (MHz)	.1-100	.2-500	.2-600	11" Diagonal	
Output (dBm)	+13	+10	+7	15	
Flatness (dB)	±.25	±.25	±.50	1	
Linearity (%)	2	1	1	1, 10, 100 mv, 1v	
Markers	Single and Harmonic			100 mv	
Circuits	Solid State/Modular			10 K ohms	
Price	895	1095	1395	495	695
				Modes	
				CRT	
				V Bandwidth (kHz)	
				H Bandwidth (kHz)	
				V Sensitivity/div.	
				H Sensitivity/div.	
				Input Imped.	
				Price	

Who was it that said, "investigate before you invest"? We have a new 60-page catalog on sweepers, oscilloscopes, and detectors. We would like you to investigate it, it's free.



**TELONIC INDUSTRIES, INC.**

21282 Laguna Canyon Road • Laguna Beach, Calif. 92652  
Tel: 714 494-9401 • TWX: 910 596-1320



# Two new DIVA Disc Systems maximize your mini.

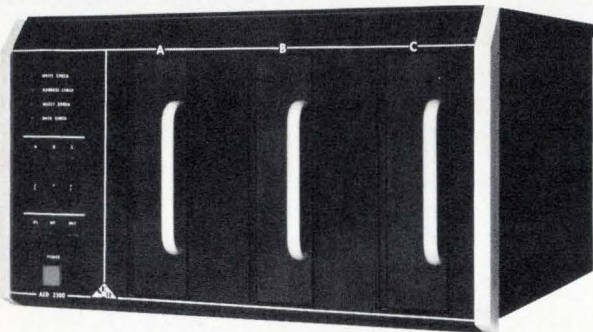

## Floppy disc system with big disc drive features.

DIVA's Floppy disc system is not just another floppy drive. It's a complete disc system with drive, controller electronics, and computer interface. It has features and options usually found only on large systems: initial program load, overlap seek, logical select switches, write protect switch, DMA or program I/O, and the capacity to handle up to 3 additional drives per unit. A universal bus allows simple interfacing to any minicomputer. Standard interface is available for Data General, DEC, Interdata, H-P, Varian, Texas Instruments, and Honeywell minis. Priced so you can toss out punched tape, card or cassette devices and benefit from all the advantages of disc-type storage.

### Short Specs for Quick Comparison

**Capacity/disc:** 2.5 megabits (262 Kbytes/disc)

**Access time:** 10 ms, track-to-track  
10 ms, settle @ final track  
10 ms/track slew rate

**Latency (avg):** 80 ms

**Data transfer rate:** 250 Kbits/sec (30.2 Kbytes/sec)

**Tracks/disc:** 64

**Recording density:** 3200 bpi

**Media life:** 64 megapasses

For fast details, call DIVA, Inc. at any of the numbers listed. Or send for descriptive literature.

Circle 164 on reader service card

## Cartridge disc system that's software & hardware, plug-to-plug compatible with PDP 11.

DIVA's cartridge disc system is an inexpensive replacement for DEC's RK 11/RK 02, and RK 05 cartridge disc drives, with which it is completely compatible. Both DIVA and DEC drives can be intermixed in the same operating system and cartridges freely interchanged between them. Unit select logic is built into DIVA's system so up to 4 drives can be operated from a single controller. The system is a self-contained, random-access storage system, complete with controller, power supply, and interconnecting cables. It uses an IBM 2315 type cartridge and Diablo Series 31 type drives. It's ideal for small to medium size computer systems.

### Check Specs

**Capacity/drive:** 1,228,800 data words

**Recording density:** 2200 bpi

**Access time:** 15 ms, track-to-track

**Average latency time:** 15 ms

**Data transfer rate:** 22.2 microseconds per word (1.44 Mbits/sec)

**Rotation speed:** 1500 rpm

**Transfer path:** NPR, DMA

**Environment:** 60-90°F, 20-80% RH

For fast details, call DIVA, Inc. at any of the numbers listed below. Or send for descriptive literature.

**DIVA, Inc./**607 Industrial Way West/Eatontown, N. J.  
07724/Phone: 201-544-9000/TWX 710-722-6645

Circle 165 on reader service card



Mini  
maximizer  
systems

## New products

Microwave

### Gunn oscillator puts out 250 mW

Line of Ku-band cw sources delivers 5 to 250 mW; units tunable within  $\pm 100$  MHz

Developed primarily for use as pump sources for parametric amplifiers, a line of Gunn-diode oscillators has been introduced by Varian Associates' Solid State West division. Models in the VSU-9002 series are tunable within a  $\pm 100$ -megahertz range from any specified center frequency between 12.4 and 18 gigahertz.

Standard models in the series deliver cw power ranging from 5 to 250 milliwatts, making them also suitable for a wide variety of general-purpose applications. Each os-



cillator, however, is factory-adjusted to operate at only one selected combination of center frequency and output power.

The Gunn-effect oscillators are designed to be biased from an 8-volt direct-current power supply with up to 0.01% regulation, although dc supplies of as much as 10 volts can be used. For proper operation, load VSWR must be maintained below 1.2 over the full frequency range covered.

Cooling is achieved by attaching the oscillator to a heat sink which maintains the unit's case temperature at 50°C or below. Rf power is coupled out of the oscillator via Ku-band UG-419/u waveguide.

Typical of the new series is model VSU-9002S6, a 100-mW unit that operates at a maximum bias current of 0.6 ampere. Maximum pushing factor is 20 MHz/V, measured from the operating bias voltage to 1 v below this voltage. Pulling factor is 15 MHz maximum when operating into a VSWR mismatch of 1.2. Typical fm noise is 20 Hz rms when measured in a 1-kilohertz bandwidth 10 kHz from the carrier.

For this model, frequency/temperature coefficient is up to 600 kHz/°C, although other versions exhibiting smaller coefficients can be supplied on request.

In addition to the standard models described above, other units can be provided on special order, either at a fixed frequency or tunable up to  $\pm 350$  MHz and more.

Prices for the VSU-9002 series range from \$190 for the VSU-9002S1 (5-mw output) to \$930 for the VSU-9002S9 (250-mw output). The 100-mw VSU-9002S6 discussed above is \$385. Delivery is about 45 days.

Varian Associates, Solid State West Division, 611 Hansen Way, Palo Alto, Calif. 94303 [401]

### Microstrip detector operates from 1 to 18 gigahertz

Two stripline-microstrip detector modules are compact units, designated MA-7707H and MA-7077J, respectively. They can be used for radar applications, in stripline or microstrip installations, as power monitors and feedback-loop detectors. Dynamic range is 70 decibels,

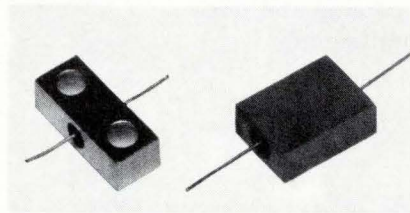

and square-law characteristics are maintained for input-power levels below -20 dBm. Response is linear above 0 dBm, and frequency range is from 1 to 18 gigahertz. Price for one to nine modules is \$40 each. Delivery is from stock.

Microwave Associates Inc., Northwest Industrial Park, Burlington, Mass. 01803 [403]

### Waveguide components offer broad frequency range

With bandwidth ratios of 3.6:1 and 2.4:1, a line of broadband waveguide components is said to have a broader frequency range in a smaller waveguide size than conventional rectangular waveguides.

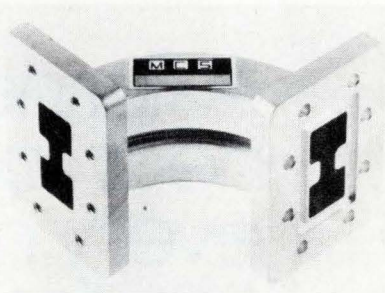

VSWR is 1.08, with an insertion loss of 0.05 dB maximum. The components can be pressurized to 30 psig; and bends, straight sections, adapters, windows, transitions, and flat or grooved flanges are available in aluminum, brass, copper, silver, or silver-plate.

MCS Corp., 1307 S. Myrtle Ave., Monrovia, Calif. 91016 [404]

### FET built for amplifiers, oscillators up to X band

Designated the GAT 3, a gallium-arsenide field-effect transistor is an n-channel device designed for use in amplifier and oscillator applications up to X-band frequencies. Specifications include a gain of 8 dB and a noise figure of 6 dB at 8 GHz, and a gain of 6 dB and noise figure of 8 dB at 12 GHz. A chip version can be directly mounted on a microstrip, and a unit mounted in a leadless invert-

**Flameless  
Compressed-Air  
Heat Torches** —  
Lightweight and  
portable for  
pinpoint  
intense heat  
performance.

**Heat Blowers** — Built for  
continuous 24-hour duty.

**New! Master-Mite™ Gun**  
— Lightweight  
versatility  
with three  
interchangeable  
nozzles and  
heat ranges.

**Standard  
Heat Gun**  
— Compact  
and  
economical,  
die-cast  
aluminum  
housing.

250° to 1,000° F.

**Chrome Heat Gun** — Designed for  
labs, R & D, and professional use.

# A flameless heat tool for every need. Master makes them all

Master offers you the world's most complete line of flameless heat tools. Each one is precision built for rugged dependability and versatile performance. And every Master heat tool features a complete line of attachments for every production need.

Heat Guns and Blowers are available in U.L. and L.A. approved models. CSA approved in Canada. In Canada, contact Martin Industrial Sales, P.O. Box 576, 4445 Harvest Road, Burlington, Ontario.

Send for your free 12-page catalog and price list on the world's most complete line of flameless heat tools.

**MASTER**  
appliance corporation  
Racine, Wisconsin 53403

## New products

ing-device package is also available. Price is \$184 for the chip version and \$248 for the packaged unit.

Plessey Semiconductors, 1674 McGaw Ave., Santa Ana, Calif. 92705 [406]

**Coaxial attenuator sets**  
cover dc to 12.4 or 18 GHz

The models AS-5A and AS-6A coaxial attenuator sets cover dc to 12.4 gigahertz and dc to 18 GHz, respectively. Each set consists of four attenuators with an average power rating of 5 watts at 25°C, stainless-steel bodies, and type N connectors.

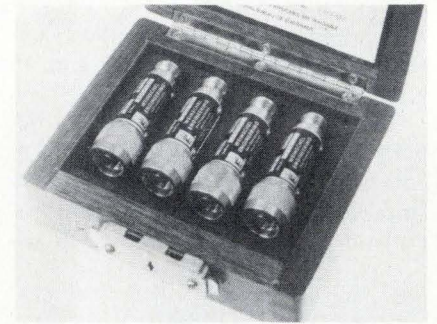

Attenuation values provided in each set are 3, 6, 10, and 20 dB. Four model 1 attenuators in the 5A set are calibrated at dc, 4, 8, and 12.4 GHz, and four model 2 attenuators in the 6A set are calibrated at dc, 4, 8, 12.4, and 18 GHz. Price is \$250 for the model 5A and \$310 for the 6A.

Weinschel Engineering, Box 577, Gaithersburg, Md. 20760 [405]

**Coaxial contacts fit**  
rack and panel connectors

A line of matched-impedance coaxial contacts enables rack and panel power connectors to transmit high-frequency signals. The units are designed to fit inserts for #12

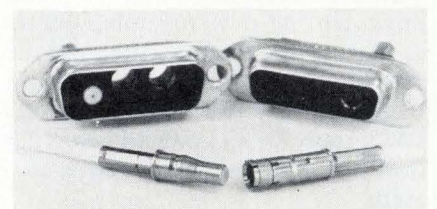

# We improved our micro resist.

New KODAK Micro Resist 747 is the purest, most stringently controlled resist we've ever made.

It's filtered to a value of 0.5 micrometer, and there are less than 10 parts per million of metal ions. (Less than three parts per million each of sodium, lithium, potassium, tin, or gold.) Viscosity and solids are also closely controlled.

And there are processing solu-

tions of equally high quality: KODAK Micro Resist Developer, Thinner, and Rinse. All of which help you get more uniform coatings and better process reliability. And *that* means economy.

There's convenience, as well. This negative-working resist comes in four ready-to-use viscosity grades: 30, 45, 60, and 110 centistokes.

# We couldn't improve our offer.

## Technical assistance.

We'd be pleased to share our experience in microelectronics with you. As a start, why not send for the comprehensive six-page data sheet on KODAK Micro Resist 747? Or have a representative demonstrate it for you. Either way, just use the coupon.



Eastman Kodak Company

PHF

Dept. 412-L, Rochester, N. Y. 14650

Please have a representative demonstrate KODAK Micro Resist 747.

Please send detailed information.

Name \_\_\_\_\_

Title \_\_\_\_\_

Company \_\_\_\_\_

Address \_\_\_\_\_

City \_\_\_\_\_ State \_\_\_\_\_ Zip \_\_\_\_\_

For information on sales outside the U.S. and Canada, contact the International Photographic Division, Eastman Kodak Company, Rochester, N. Y. 14650, U.S.A.

2-48

designed  
by Grayhill  
as the  
world's  
smallest  
rotary switch

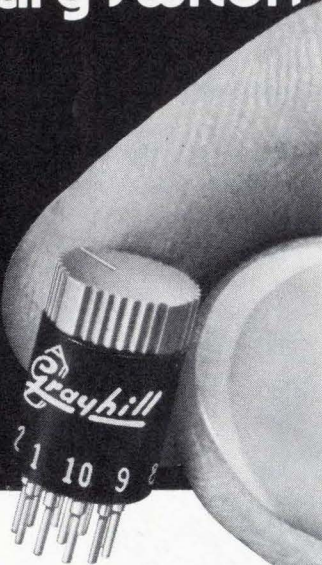

10 positions, 1 or 2 poles,  
diameter less than .300"

- Non-shorting...wiping contacts  
...rated to make or break 15,000  
cycles minimum at logic loads.
- Now available with integral knob  
...as well as screwdriver or  
shaft operated.
- For communications circuits,  
electronic stopwatches, and  
other low voltage applications  
where size is critical

As the pioneer in switch microminiaturization, we present our Series 75, designed as the smallest the state of the art permits. If you think that small switch means big price... guess again. Here's a lot of switch in a tiny package at a cost that's surprisingly low. Write for Bulletin #237 describing these miniature switches... and consult EEM for more information on Grayhill products.



561 Hillgrove Avenue • LaGrange, Illinois 60525  
(312) 354-1040

## New products

size contacts in the series-17 connectors made by Amphenol. The contacts act as miniature 50-ohm, matched-impedance, coaxial connectors, and they operate in the 0-to-4-GHz range, with a VSWR of less than 1.45 for a mated pair. Peak voltage rating is 500 v, and dielectric-withstanding voltage is 1,500 v rms.

Amphenol, Rf division, 33 E. Franklin St., Danbury, Conn. 06810 [407]

Detector amplifiers  
improve log linearity

The LD1100 series of detector amplifiers is designed to optimize logarithmic linearity over a wide dy-

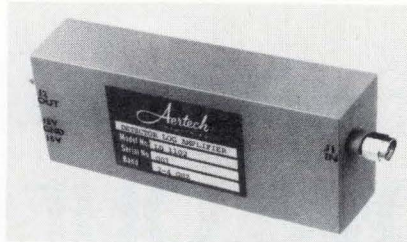

namic range. Typical values are  $\pm 0.2$  dB from near tangential signal level to 0 dBm. Self-compensating, balanced logging stages hold variations over temperature to within 0.75 dB (typical) over the range from  $-54$  to  $+71^\circ\text{C}$ . Prices are \$750 to \$825.

Aertech Industries, 825 Stewart Dr., Sunnyvale, Calif. 94086 [408]

Fixed attenuator operates  
from dc to 18 GHz

A medium-power fixed attenuator, designed for panel-mounting, operates across the frequency range of dc to 18 GHz. The model 304 has an input power capacity of 2 watts average. Attenuation is available at

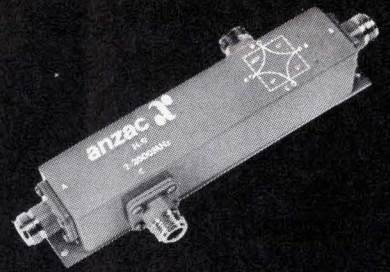
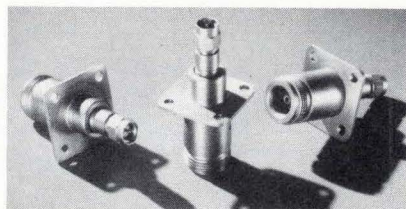

## BROADBAND HYBRID JUNCTION

MODEL H-9

- 10 Octave Coverage  
(2MHz-2 GHz)
- 30dB Min Isolation
- 6" x 1 3/4" x 1 1/2"
- \$380/Stock Availability

anzac  
ELECTRONICS



39 Green Street, Waltham, Mass.  
(617) 899-1900 • TWX 710-324-6484

Circle 213 on reader service card

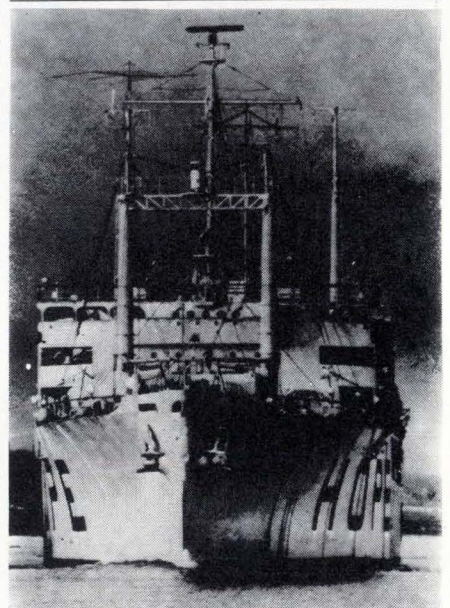

## S.S. HOPE, M.D.

Doctor... teacher... friend to  
millions on four continents—  
this floating hospital is a  
symbol of America's concern  
for the world's disadvantaged.

Keep HOPE sailing.

PROJECT  
HOPE

Dept. A, Washington, D.C. 20007



# DuMont photomultipliers: highlights of a great collection.

Large and low noise  
(type K1328) for whole body  
or Cerenkov counters.

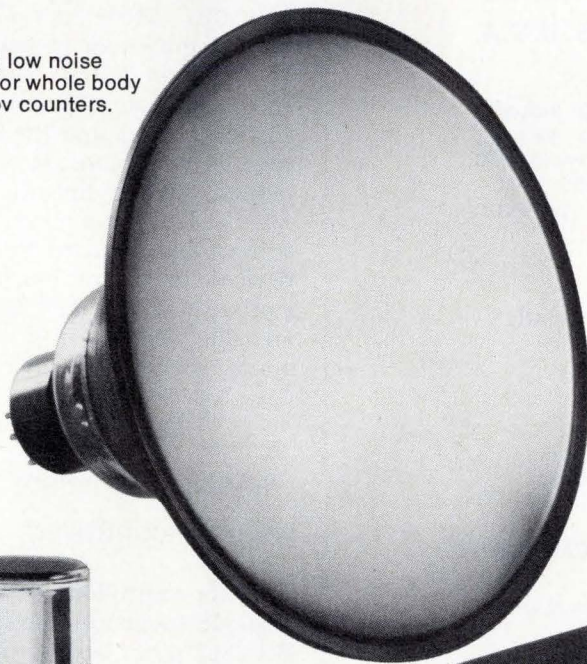

High stability S11 and S20  
(types KM6364 and KM2898) for  
punched card or  
paper tape reading.



Extended Red S20 and S1  
cathode (types KM2357, KM3054) for  
laser detection and  
demodulation or  
laser Ramas spectroscopy.

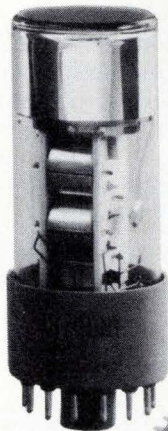

Broad response cathode  
(types KM2800, KM3068)  
for spectroscopy.

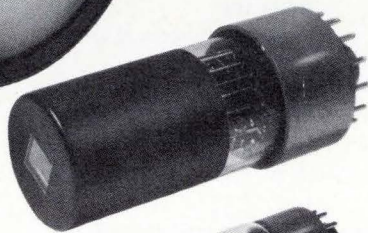

Small and rugged  
(type 7860) for rocket  
shots or oil well logging.

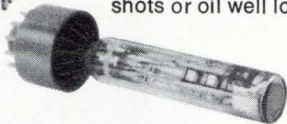

UV alkali telluride  
and halide cathodes  
(types K1688 and K1466)  
for solar blind astronomy  
or plasma research.



Windowless electron  
multipliers (type SPM)  
for soft x-ray or  
particle detection  
and mass spectrometers.

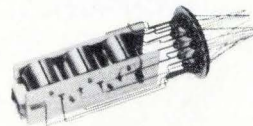

DuMont's range of PMT's is extraordinarily broad. You may never require any photomultiplier outside it. But if you should, call on us. Call on us, too, for CRT's, DVST's, scan converters and storage tubes. In fact, for optimum performance for your dollar with tubes backed by DuMont professionalism and over fifty years of expertise, contact: DuMont Electron Tubes & Devices Corporation, 750 Bloomfield Avenue, Clifton, N. J. 07015, (201) 773-2000.

All tubes with either box and grid dynodes for high current stability or with venetian blind dynodes for lowest noise.

**DuMont**



# international coil winding association

(Devoted Entirely To The Coil Winding Industry)

PRESENTS

## COIL WINDING CHICAGO '74

CONVENTION & EXHIBITION

21, 22, 23, SHERATON O'HARE HOTEL  
May, 1974 ROSEMONT, ILLINOIS, U.S.A.

Devoted exclusively to the coil winding industry this event is being held yet again to serve as a platform for presentation of specialized papers on new materials and techniques and a showcase for displaying the latest product developments.

### CONVENTION:

Papers will be presented by Internationally recognised authorities in various fields of coil winding.

### PRODUCT DISPLAY:

Covering the entire spectrum from coil winding machines to custom built coils.

### EUROPEAN AND HEAD OFFICE

Cleveland House  
344A Holdenhurst Road  
Bournemouth BH8 8BE  
Hampshire  
England  
Telephone: Bournemouth 38738  
Telex: 417123

### NORTH AMERICAN OFFICE

Suite 106  
3158 Des Plaines Avenue  
Des Plaines  
Illinois 60018  
U.S.A.  
Telephone: (312) 696-1688

Please send all details   
 We are interested in a booth of ..... sq.ft.

NAME ..... please complete in  
 BLOCK LETTERS

POSITION .....

COMPANY .....

ADDRESS .....

PRODUCTS .....

CHI

### New products

any value from 1 through 20 dB in 1-dB increments. Connectors are stainless-steel type N, female, to SMA, male. Price for one to nine units is \$55 each.

Midwest Microwave, 3800 Packard Rd., Ann Arbor, Mich. 48104 [409]

Transistor oscillators  
cover 6 to 12.4 GHz

Completing a family of YIG-tuned oscillators that tune over all of X band, three new types cover 6 to 12.4 GHz. Model AV-7700M provides a minimum power output of 10 mW from 7 to 11 GHz, the AV-7800M puts out 5 mW over the 8-to-12.4-GHz band, and the AV-7600M covers 6 to 12.4 GHz, also with a 5-mW output. Tuning linearity is within  $\pm 0.05\%$ . Dc circuit power dissipation is  $\frac{1}{8}$  of that required by bulk-effect devices. In lots of 100, the 7800M is priced at \$1,160; the 7700M, \$1,215; and the 7600M, \$1,195.

Avantek Inc., 3175 Bowers Ave., Santa Clara, Calif. 95051 [361]

GaAs oscillators are  
varactor-controlled

Varactor-controlled bulk gallium-arsenide oscillators, designated the WJ-2863 series, are for operation in the 12- to 18-GHz region. The units provide a typical minimum output power of +13 dBm over any 3.5-GHz segment of Ku band. Each oscillator contains an integral isolator, voltage regulator and proportionately controlled heater.

Watkins-Johnson Co., 3333 Hillview Ave., Palo Alto, Calif. 94304 [410]



# Some of the best things about our new Digivac<sup>®</sup> 1000 are what you can't see.

When you look at our vacuum fluorescent readout, you won't see the low voltage requirements making it directly compatible with available MOS IC logic packages.

You won't see the exclusive mica substrate which supplies mechanical strength and helps emphasize lighted segments through a desirable halo effect.

You won't see the low cost, lower than competing readouts with fewer customer advantages.

Of course, there are things about our Tung-Sol<sup>®</sup> Digivac 1000 you can see.

Like the Digivac 1000's brightness. 50% more brightness and greater uniformity than ever before.

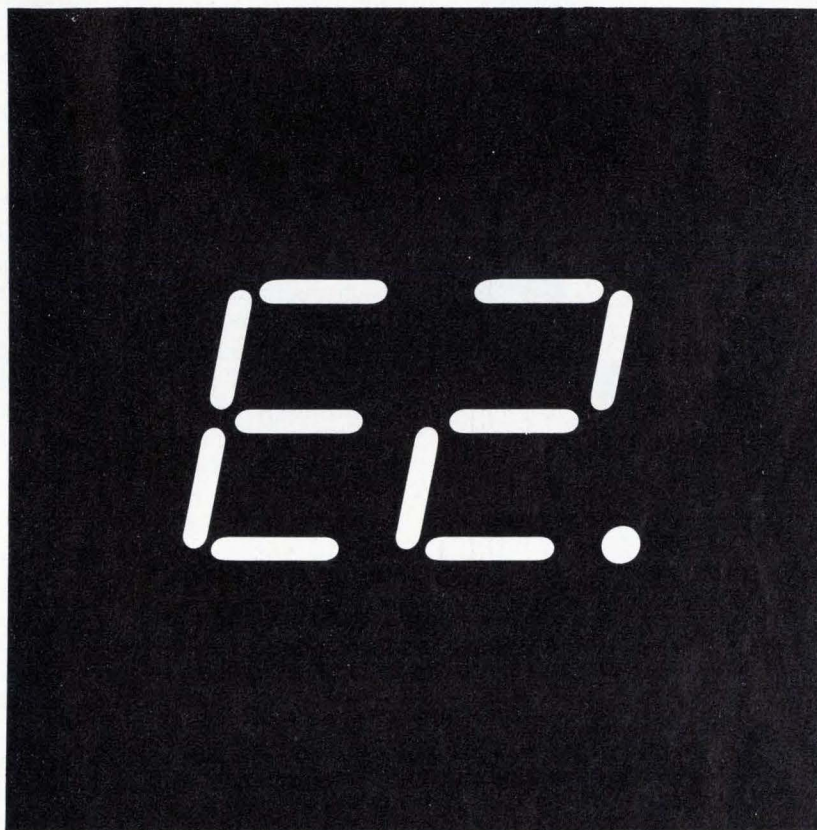
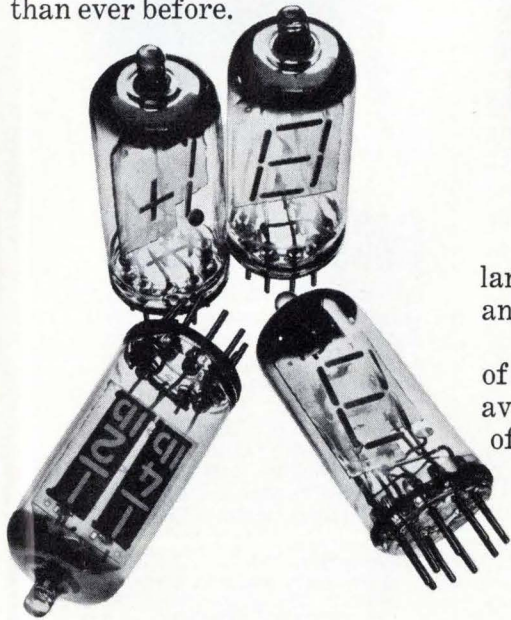

You can see the flexible language with alpha, numerical and symbolic figures.

You can see the wide range of colors, including white, available with common types of filters.

And because of the unique construction, you can see the accurate viewing assured from virtually any angle.

With the Digivac 1000 readout, whether you see it or you don't... it's still nice to know it's all there.

For additional information on the Digivac 1000, write to: Tung-Sol Division, Wagner Electric Corporation, 630 W. Mt. Pleasant Avenue, Livingston, New Jersey 07039.

*Wagner makes other quality products in volume for the electronics industry, including bridges, power supplies and subsystems, silicon rectifiers, resistors, miniature lamps and status indicators. And Wagner offers contract manufacturing.*

## **WAGNER<sup>®</sup>**

**We've got a lot more riding for you.**

®Trademarks Wagner, Tung-Sol and Digivac, Reg. U.S. Pat. Off. and Marcos Registrados

# Bridge Rectifiers



## IBR

### SILICON AVALANCHE INTEGRATED BRIDGE RECTIFIERS



Stud Mount



TO-3 outline  
mounting  
flange



Press-fit

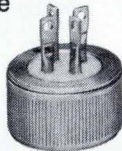

- 10A and 25A ( $I_O$ ) single phase full-wave bridges
- 15A & 36A ( $I_O$ ), 3 $\phi$  full-wave bridges
- 100V, 200V, 400V, 600V ( $V_R$ )
- 250V, 450V, 650V minimum avalanche voltages ( $V_{BR}$ ) permit lower PRV safety factors in design considerations
- Fast recovery series, 200 nsec. ( $t_{rr}$ )
- Low junction-to-case thermal impedance ( $Z_{\theta JC}$ ), 1°C/W or less allows operation at full rated load to 100°C, TC.
- 2000V minimum circuit-to-case insulation
- Three mounting options: Press-fit, Stud Mount, and TO-3 outline mounting flange.

**\$2.50** ea.

(10 A, 200 V, TO-3 mounting 1000 qty.).



**VARO**

**VARO SEMICONDUCTOR, INC.**

P.O. BOX 676, 1000 NORTH SHILOH,  
GARLAND, TEXAS 75040  
(214) 272-4551 TWX 910-860-5178

## New products/materials

A very thin copper epoxy glass laminate, called Micaply, is available for the construction of hybrid microcircuits and for high-density multilayer circuit-board applications. The material consists of an epoxy-glass substrate, clad on one or both sides with a copper layer 0.0001 inch thick. Gold or nickel conductor patterns are plated, with the copper cladding as a plating electrode. The copper is then removed by immersion in a suitable etchant.

Mica Corp., 10900 Washington Blvd., Culver City, Calif. 90230 [476]

A single-component plastic adhesive, designated type 515, is for use at temperatures to 400°F in bonding such dissimilar materials as ceramics, glass, metals, and plastic. The material requires no mixing, weighing, or activator, and it cures at temperatures as low as 330°F in 45 minutes. Available as a premixed paste, 515 is provided in pint containers at \$18.75 each or in quarts at \$29.50. Delivery is from stock.

Aremco Products Inc., Box 429, Ossining, N.Y. 10562 [478]

A one-part copper-filled adhesive, called Conduct X 5002, has a typical cured-volume resistivity of 0.001 ohm-cm or less, and it may be applied to a variety of substrates including glass, metals, plastics, and ceramics. A wide range of curing conditions, from 85°C to 150°C, may be used. The material can also be cured by infrared radiation or by electric current. Price is said to be about 25% that of silver-filled systems that provide comparable properties.

Electro-Kinetic Systems Inc., 2500 E. Ridley Ave., Chester, Pa. 19013 [479]

High-purity copper anodes called 3-C can be used for all types of copper-electroplating systems. The anodes are said to eliminate the possibility of introducing contaminants into the bath from the anode, and they corrode uniformly with a minimum of sludging. Gagging and diaphragming are eliminated in most instances. Round, rectangular, and oval sizes in continuous cast or rolled types are available in a selec-

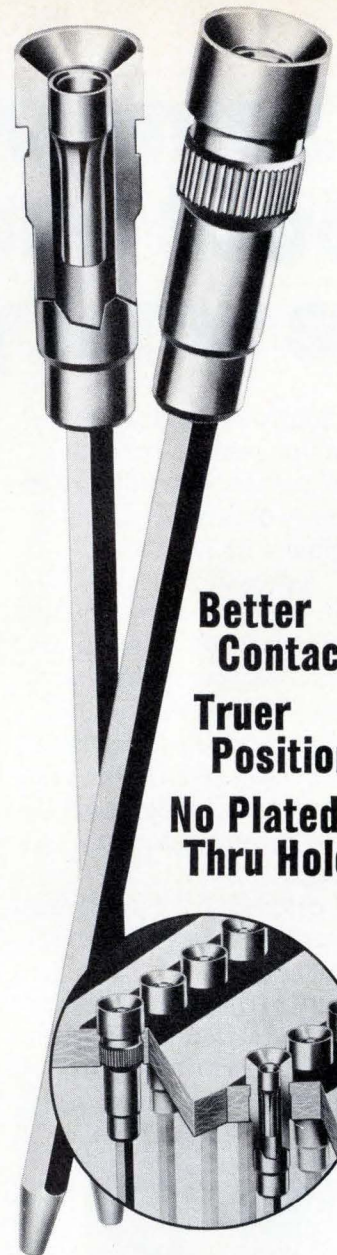

**Better  
Contacts  
Truer  
Positions  
No Plated-  
Thru Holes**

## EMC's Pin-in-Board

Still best! EMC's high density Wire-Wrap® non-warping epoxy panels assure accurate true position, especially on 1/8" boards. Edgeboard finger patterns, power and ground planes, and new TIP-DIPTM for double density! Funnel-Entry® design simplifies lead insertion; Nuri-Loc® terminals\* prevent twist during wrap. Standard and Custom panels for every requirement, too.

**ELECTRONIC MOLDING CORP.**  
96 Mill St., Woonsocket, R. I. 02895  
Phone (401) 769-3800

Write or phone for latest  
Computer Products Catalog



\*Patented

# fact

This fully loaded, high-performance DMM costs you less



yet it equals or exceeds the performance of any other comparable DMM.

**At \$1295, Data Precision's Tri-Phasic™ Model 2540A1 is the best buy in the entire DMM field.**

A fully loaded, high performance precision instrument, our top of the line 5½ digit model provides a basic accuracy of  $\pm 0.001\%$  f.s.  $\pm 0.007\%$  reading  $\pm 1$  l.s.d. for six months, documented by full test data and Certificate of Conformance.

Functions include: DC volts, AC volts, 2-wire and 4-wire resistance, DC/DC ratio, AC/DC ratio.

1  $\mu\text{V}$  to 1000 VDC. 1  $\mu\text{V}$  to 500 VAC. 1 milliohm to 12 megohms. Autoranging, auto-polarity. Isolated BCD output. Remote triggering and remote ranging.

All of the Data Precision DMM's — the 5½ digit 2500 Series models, and the 4½ digit 2400 Series models — incorporate our exclusive Tri-Phasic™ conver-

sion, Isopolar™ referencing and Ratiohm™ resistance measurement design features.

And, if you need only 4½ digits, the 2400 Series is the world's most accurate 4½ digit DMM, starting at \$580.

Data Precision Corporation  
Audubon Road  
Wakefield, MA 01880  
(617) 246-1600

*To arrange a demonstration phone your local sales office listed below.*

AL	(205) 536-1941	GA	(404) 252-5360	MO (W)	(816) 737-0066	OH (S)	(513) 298-3033
AZ	(602) 948-8410	HI	(808) 262-6286	MO (E)	(314) 731-2331	OR	(503) 238-0001
CA (N)	(408) 733-9000	IL	(312) 593-0282	NC	(919) 275-3725	TX (N)	(214) 234-4137
CA (S)	(714) 540-7160	IN	(317) 293-9827	NJ	(215) 925-8711	TX (S)	(713) 461-4487
CO	(303) 449-5294	MA	(617) 273-0198	NM	(505) 265-6471	UT	(801) 268-3181
CT	(203) 525-7647	MD	(301) 552-2200	NY (N)	(315) 446-0220	WA	(206) 763-2210
FL (S)	(305) 581-6611	MI	(313) 482-1229	NY (S)	(516) 482-3500	CAN (W)	(416) 661-1404
FL (N)	(305) 727-3205	MN	(612) 781-1611	OH (N)	(216) 243-7430	CAN (E)	(514) 731-9328

 **DATA PRECISION**  
...years ahead

# Buy the Ballantine 3/24 DMM

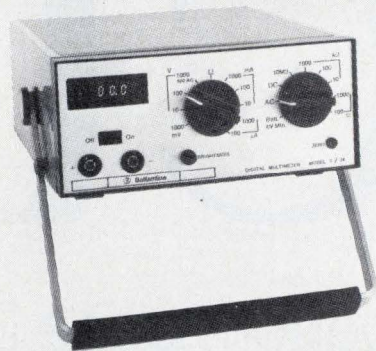

## 24 Ranges — 3 Full Digits

- AC Volts, AC Current, Ohms, DC Volts, DC Current
- Fully Overload Protected
- 300 Hour Dependable Battery Life
- Pocket Size — Weighs Under 2 Pounds
- 0.2% DC Accuracy — AC to 20 kHz

Available from Stock  
Factory/Distributor

**\$195**  
complete



**Ballantine Laboratories, Inc.**  
P.O. Box 97, Boonton, New Jersey 07005  
201-335-0900, TWX 710-987-8380

Circle 174 on readerservice card

# BUILD

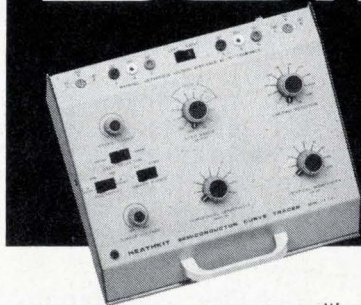

## the new HEATHKIT® Semiconductor Curve Tracer

ONLY  
**\$89.95\***



Send for your  
**FREE**  
Heathkit  
catalog

This easy-to-build kit lets you see on your oscilloscope screen the operating parameters of virtually all types of semiconductors. Use it for sorting, inspecting, testing of bipolar transistors, diodes, SCRs, triacs, FETs, etc. The IT-1121 Semiconductor Curve Tracer can be used with any scope with horizontal sensitivity of 0.5 V/div. and vertical sensitivity of 1 V/div. All major controls are stepped in a 1, 2, 5 sequence for maximum parameter resolution. Kit includes connecting leads, extra test leads for large devices or in-circuit testing, comprehensive fully illustrated manual. Order one for your lab today.

Kit IT-1121, 11 lbs. ....89.95\*

HEATH COMPANY, Dept. 53-2  
Benton Harbor, Michigan 49022

Please send FREE Heathkit Catalog.  Please send IT-1121. Enclosed is \$89.95, plus shipping.

Name \_\_\_\_\_

Address \_\_\_\_\_

City \_\_\_\_\_ State \_\_\_\_\_ Zip \_\_\_\_\_

\*Mail order prices; F.O.B. factory. TE-301

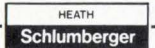

## New products/materials

tion of phosphorized compositions. Refinery for Electronics Inc., Materials Division, Jersey Ave., Jersey City, N.J. 07302 [480]

**Created specifically** for microelectronics applications, Ablebond 66-1 is a one-compound non-migrating electrically conductive epoxy adhesive with a volume resistivity of 0.002 ohm-cm and a shear strength of 1,600 psi. The material is available in 1-ounce jars or 1-cc syringes, and is said to cost about a fifth as much as gold-filled epoxies.

Ablestik Laboratories, 833 W. 182nd St., Gardena, Calif. 90248 [401]

**A nonflammable solution** for the inspection of computer-tape signals is designed to enable users to view these signals. Called Magne-Vue, the material provides a fast indication of the tape signal when the integrity of tape-handling equipment is in question. The material is available in 7-ounce cans packed 36 to a carton. Price is \$2.39 per can. Quantity discounts are available.

Megasales Inc., P.O. Box 548, Dayton, Ohio 54501 [402]

**Eccofoam Q-G** and **Eccofoam Q-R** are pure silicon-dioxide ceramic foams suited to applications where low electrical loss is important. Eccofoam Q-G has a density of 0.4 g/cc and a dielectric constant of 1.4. Eccofoam Q-R has a density of 0.72 g/cc and a dielectric constant of 1.7. Price of material Q-G is \$50 for a sheet measuring 12 by 18 by 3 inches, and material Q-R is priced at \$80 for a sheet measuring 12 by 18 by 4½ inches.

Emerson & Cuming Inc., Canton, Mass. 02021 [403]

**A standard III-V material** for the manufacture of light-emitting diodes and LED displays is a thin-film gallium-arsenide-phosphide epitaxial wafer priced at \$14 per square inch. With its development, the price of existing thicker epitaxial films made by the company will be reduced to \$16 per square inch.

Monsanto Commercial Products Co., 800 N. Lindbergh Blvd., St. Louis, Mo. 63166 [404]

# "We subjected the Augat plug-in socket panel to an accelerated-life test in order to induce contact failure.

## "We failed."

Dave Fillio  
Principal Engineer, Component & Materials Engineering  
Honeywell Information Systems

"We needed an interconnection system for controllers on the H716 mini-computer that could help us meet four basic requirements:

"High density to get as much as possible into a small package and still meet the increasing customer demand for a broad range of peripherals, each requiring a separate controller.

"The capability of automatically wiring, with a minimum of two-levels.

"Flexibility to permit anticipated design changes and still allow us to meet a very tight schedule.

"And finally, all these features had to be available in a standard product.

"The most logical approach seemed to be printed wiring boards. But to accommodate all our controllers could have required as many as eight boards. And we couldn't afford the room. Also, when recycling changes are taken into consideration, the design cycle of printed wiring boards becomes too long and, consequently, too costly.

"Multi-layering offered a minimum of flexibility, and it, too, was rejected.

"The only practical solution was the plug-in socket panel. And of all the vendors, Augat was the only manufacturer that could provide a completely uniform, broad range of standardized products, the lowest possible profile and maximum reliability.

"The reliability tests we

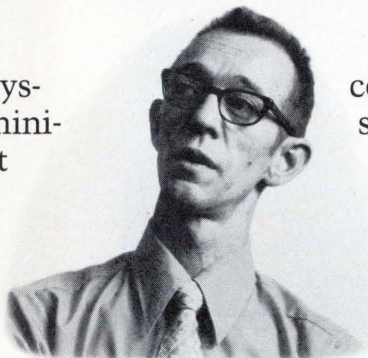

Dave Fillio

conducted on the Augat machined sockets included environmental exposures, accelerated-life, vibration, thermal shock, and durability. All tests with the Augat system were positive.

"From a field service standpoint, a key consideration with increasingly complex and flexible systems like the H716 is keeping them on the air at all times. Because of the reliability of the Augat interconnection system, we've had no reports of machine down-time associated with the Augat product since the introduction of the H716 eight months ago."

More and more companies like Honeywell are realizing that Augat socket-panels are an economical, reliable and totally flexible solution to interconnection problems, including development, production and field service requirements.

Augat's precision-machined tapered entry contact has made Augat the reliability standard for the industry. As

the world's leading manufacturer of socket panels and other IC interconnection products, Augat is ready to help you solve your interconnection problems.

Call or write today for a free brochure and complete product information. Augat, Inc., 33 Perry Avenue, Attleboro, Massachusetts 02703. Represented and distributed internationally.



The H716

# AUGAT

Circle 175 on reader service card

# Noise sensitivity problems go away

with Topaz Ultra-Isolation Transformers

Box-shielding techniques achieve maximum coupling between windings while offering a very low impedance for common-mode noise to ground.

Primary to secondary effective interwinding capacitances of:

0.005 picofarads  
0.001 picofarads  
0.0005 picofarads

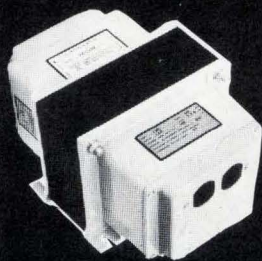

#### SPECIFICATIONS:

**Common-Mode Noise Rejection:**  
to more than 145 dB.

**Transverse Noise Suppression:**  
greater than 125 dB at 1 kHz.

**Input/Output Voltages Available:**  
115, 230, 240 and 480 VAC  
at 50 or 60 Hz.

**Models Available:**  
125 VA to 20 kVA 1 phase;  
3 kVA to 60 kVA 3 phase.

**Priced from \$75.00**

## TOPAZ

ELECTRONICS

SOLUTIONS TO  
POWER PROBLEMS

3855 Ruffin Road, San Diego, CA 92123

Phone (714) 279-0831

Circle 176 on reader service card

## UP YIELDS

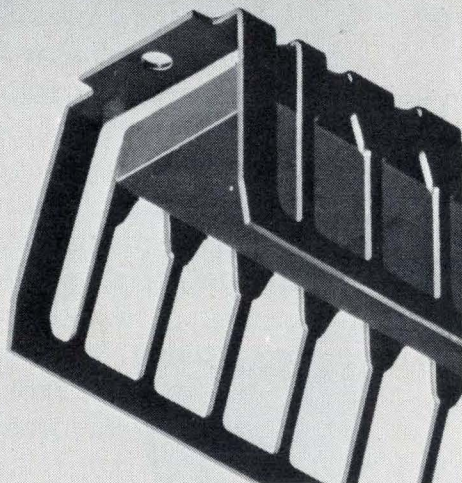

Up electrical yields with low-temperature hermetic sealing.

The Diacon 8 to 36 lead package systems for surface-sensitive devices saves assembly time and other packaging costs.

For information, call or write...

### DIACON, INC.

4812 Kearny Mesa Road  
San Diego, California 92111  
(714) 279-6992

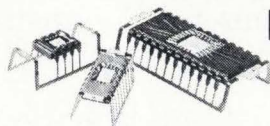

176 Circle 216 on reader service card

## New literature

**Magnetic-tape drives.** A brochure from Diva Inc., 607 Industrial Way West, Eatontown, N.J. 07724, contains specifications and descriptions of a series of magnetic-tape drives that are said to offer the capabilities of drives used with large computers. Circle 421 on reader service card.

**Silicon rectifiers.** Edal Industries Inc., 4 Short Beach Rd., East Haven, Conn. 06512. Subminiature high-voltage silicon rectifiers are described in a bulletin that also presents electrical ratings, performance curves, and specifications. [422]

**Sapphire products.** Crystal Systems Inc., Box 1057, Salem, Mass. 01970, has issued a brochure containing specifications and price information on sapphire products, including rod stock, windows, and substrates. [423]

**Laser illuminators.** International Laser Systems Inc., 3404 N. Orange Blossom Trail, Orlando, Fla. 32804. YAG-laser illuminators are described in a four-page brochure that includes specifications. [424]

**Modems.** A four-page catalog, available from the Vadic Corp., 505 E. Middlefield Rd., Mountain View, Calif. 94040, describes the company's line of modems and automatic dialers. [425]

**Strip-chart recorders.** Tracor Westronics, Box 4619, Fort Worth, Texas 76106, has released a short-form catalog describing strip-chart recorders and digital indicator systems. [426]

**Signal conditioner.** Vishay Instruments, 64 Lincoln Highway, Malvern, Pa. 19355. Bulletin 80 describes the company's model BA-4 signal conditioner, consisting of a seven-stage dc amplifier, plus-minus shunt-calibration network, and bridge completion. [427]

**High-frequency instruments.** General Radio, 300 Baker Ave., Concord, Mass. 01742 describes 10 instruments for rf and microwave applications in a 12-page brochure. Included are reflectometers, admit-

Electronics/February 7, 1974



# MONO-KAP™



**RADIAL LEADED  
MONOLITHIC CAPACITOR**

Underneath its epoxy coating, it's got a chip for a heart — a USCC/Centralab ceramic chip capacitor, 100% monolithic construction. Solid reliability for business machines, computer and communications use; rugged enough to meet mil-spec requirements yet priced for commercial applications.

Capacitance from 4.7 pF to 10 Mfd, working voltages 50 to 200 VDC and a variety of dielectric characteristics.

Best of all — AVAILABLE. USCC has recently improved chip capacitor deliveries . . . now radial leaded

Mono-Kaps are available in as little as 12 weeks for non-stock items.

Remember. USCC/Centralab or your local Centralab industrial distributor.

We deliver.

**USCC**

**USCC/Centralab**

Electronics Division • Globe-Union, Inc.



2151 North Lincoln Street ■ Burbank, California 91504  
(213) 843-4222 ■ TWX: 910-498-2222

# \$500\*

## BALANCED

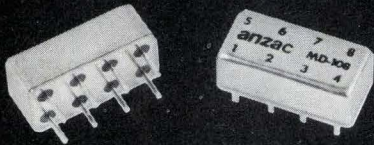

### MIXER

MODEL MD-108

- DC - 500 MHz
- 7dB Conversion Loss
- 30dB Isolation
- 8 - Pin Relay Header

\* 500 piece qty. 1-49 pieces (\$7.00)  
50-499 pieces (\$6.00).

**anzac**  
ELECTRONICS



39 Green Street, Waltham, Mass.  
(617) 899-1900 • TWX 710-324-6484

Circle 178 on reader service card

## PINPOINT HEAT

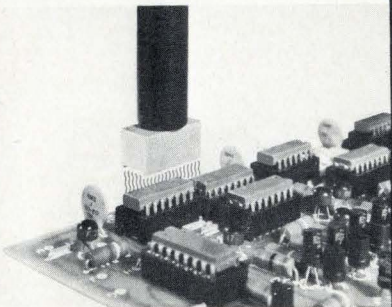

Heat any I. C. or semiconductor component to its rated temperature with a heat probe. Accuracy  $\pm 1/2^\circ\text{C}$ . Or check the component's temperature with a thermocouple probe. Accuracy  $\pm 1^\circ\text{C}$ . Model 810 Thermo-Probe does both. Reads out directly in  $^\circ\text{C}$  and  $^\circ\text{F}$  on a large  $4\frac{1}{2}$ -inch meter. Temp. Range  $+25^\circ\text{C}$  to  $+250^\circ\text{C}$ .

PRICE \$272.50 F.O.B. South Laguna

Models with other temperature ranges available.  
For details write to:

**MTI** MICRO-TECHNICAL  
INDUSTRIES

P. O. Box 287 South Laguna, CA 92677  
(714) 545-3734

### New literature

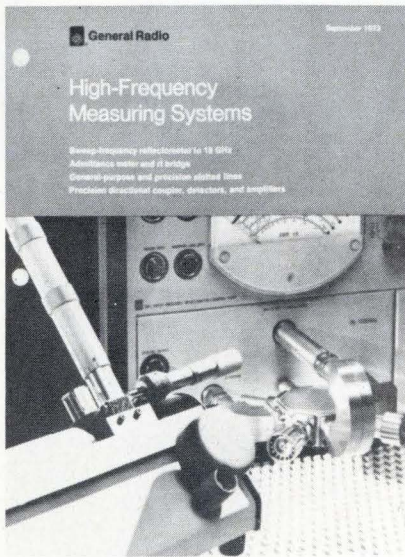

tance meters, standing-wave meters, bridges, slotted lines, detectors, amplifiers, and precision directional couplers. [428]

**Laser-scribing.** Electroglas Inc., 150 Constitution Dr., Menlo Park, Calif. 94925, has published an eight-page booklet on the process of laser-scribing semiconductor products. [429]

**Journal index.** An index to five recent years of the Hewlett-Packard Journal is available from Hewlett-Packard Co., 1501 Page Mill Rd., Palo Alto, Calif. 94304. Issues from September 1968 through August 1973 are indexed chronologically and by subject in the 16-page leaflet. [430]

**Computer tape deck.** Bulletin 498-20 from Gould Inc., Instrument Systems division, 3631 Perkins Ave., Cleveland, Ohio, describes the model 6400 OEM digital tape deck. The two-page publication gives features, performance, specifications, and options. [431]

**SCR drivers.** A 76-page catalog describes SCR drive systems, such as speed controls, dc motors and isolation transformers manufactured by Seco Electronics Corp., 1001 Second St. South, Hopkins, Minn. [433]

**Keyboards.** A 72-page catalog from Cherry Electrical Products Corp., 3600 Sunset Ave., Waukegan, Ill.

## The pollution problem.

### Maybe your engineers deserve a little help.

The engineers' will be the ones to find the technical solutions to pollution problems. There's no doubt about it.

But pollution is a people problem, too. And the engineers' technological approach to pollution isn't going to solve people problems.

Maybe this booklet can help. It lists some of the things all people can do to fight pollution. And with all the people supporting your engineers we'll have a better chance of winning the fight.

For a free copy or a list of bulk rates write to Keep America Beautiful, Inc., Box 1771, Radio City Station, New York, New York 10020.

### Keep America Beautiful

Advertising contributed for the public good

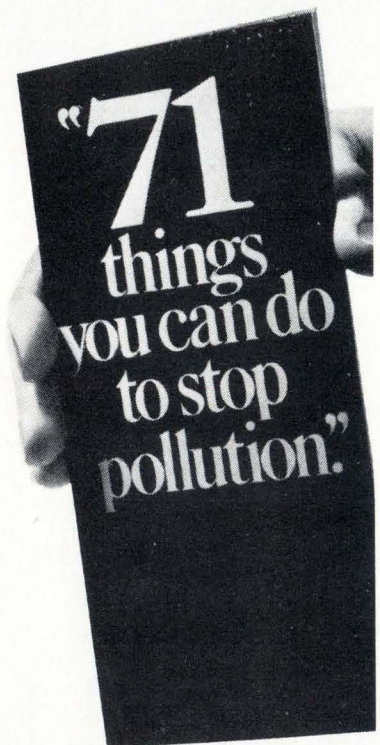

**People start pollution.  
People can stop it.**

# Another introductory offer to new members of the ELECTRONICS AND CONTROL ENGINEERS' BOOK CLUB

	404/445 <b>ELECTRONIC CIRCUITS MANUAL</b> by J. Markus Pub. price, \$22.00 Club price, \$15.75		286/515 <b>INTEGRATED CIRCUITS: A Basic Course for Engineers and Technicians</b> by R. G. Hibberd Pub. price, \$10.25 Club price, \$8.45
	637/458 <b>DESIGNING WITH TTL INTEGRATED CIRCUITS</b> by Texas Instruments Inc. Pub. price, \$19.50 Club price, \$13.50		100/810 <b>MOS/LSI DESIGN AND APPLICATION</b> by Carr & Mize Pub. price, \$18.50 Club price, \$13.50
	404/437 <b>SOURCEBOOK OF ELECTRONIC CIRCUITS</b> by J. Markus Pub. price, \$21.50 Club price, \$17.50		313/059 <b>HANDBOOK OF SEMI-CONDUCTOR ELECTRONICS, 3/e</b> by P. Hunter Pub. price, \$29.85 Club price, \$21.50
	484/368 <b>COMMUNICATION SYSTEMS DESIGN</b> by P. F. Panter Pub. price, \$19.50 Club price, \$13.50		287/341 <b>STANDARD HANDBOOK OF ENGINEERING CALCULATIONS</b> by T. G. Hicks Pub. price, \$19.50 Club price, \$14.25
	491/364 <b>THE DESIGN OF DIGITAL SYSTEMS</b> by J. B. Peatman Pub. price, \$15.50 Club price, \$11.75		124/035 <b>HANDBOOK OF PHYSICS, 2/e</b> by Condon and Odishaw Pub. price, \$37.45 Club price, \$14.95
			773/777 <b>NOMOGRAPHS FOR ELECTRONICS</b> by R. L. Peters Pub. price, \$27.50 Club price, \$19.95
			649/170 <b>OPERATIONAL AMPLIFIERS</b> by Tobey, Graeme & Huelsman Pub. price, \$15.00 Club price, \$11.50
			353/387 <b>MINICOMPUTERS FOR ENGINEERS &amp; SCIENTISTS</b> by G. Korn Pub. price, \$17.75 Club price, \$10.50
			209/731 <b>STANDARD HANDBOOK FOR ELECTRICAL ENGINEERS, 10/e</b> by Fink and Carroll Pub. price, \$34.85 Club price, \$24.95

**ANY ONE**  
of these great professional books  
for only \$ **1.00**  
VALUES FROM \$8.45 to \$37.45

Special \$1.00 bonus book comes to you with your first club selection

## Save time and money by joining the Electronics and Control Engineers' Book Club



HERE is a professional club designed specifically to meet your day-to-day engineering needs by providing practical books in your field on a regular basis at below publisher prices.

**How the Club operates:** Basic to the Club's service is its publication, the *Electronics and Control Engineers' Book Club Bulletin*, which brings you news of books in your field. Sent to members without cost, it announces and describes in detail the Club's featured book of the month as well as alternate selections which are available at special members' prices.

When you want to examine the Club's feature of the month, you do nothing. The book will be mailed to you as a regular part of your Club service. If you prefer one of the alternate selections—or if you want no book at all for that month—you notify the Club by returning the convenient card enclosed with each *Bulletin*.

As a Club member, you agree only to the purchase of four books over a two-year period. Considering the many books published annually in your field, there will surely be at least four that you would want to own anyway. By joining the Club, you save both money and the trouble of searching for the best books.

### MAIL ATTACHED POSTPAID CARD (If card removed, send coupon below)

**ELECTRONICS AND CONTROL ENGINEERS' BOOK CLUB**  
582 Princeton Road, Hightstown, New Jersey 08520

Please enroll me as a member of the Electronics and Control Engineers' Book Club and send me the two books indicated below. I am to receive the higher priced of the two for just \$1, and my first selection at the special Club price. A small charge for postage and handling will be included. These books are to be shipped on approval, and I may return them both without cost or further obligation. If I decide to keep the books, I agree to purchase as few as four additional books (including this first selection) during the next two years at special Club prices (guaranteed 15% discount, often more).

Write Code No. of  
bonus book  
here

Write Code No. of  
first selection  
here

Name \_\_\_\_\_

Address \_\_\_\_\_

City \_\_\_\_\_

State \_\_\_\_\_ Zip \_\_\_\_\_

E33240

## IMMEDIATE DELIVERY

Minis & Peripherals  
DEC—HIS—NOVA  
SEL—HP—MOHAWK

CPU, Card, Printer, Tape, Disk  
NEW • MOHAWK 4320 PRINTERS

PDP 11 PERIPHERALS  
CPU, MEMORY

PDP 8 CPU \$1500

\$750 Minis

TELETYPE 35 & 37  
DEC & HONEYWELL Modules  
617/261-1100

Send for Free Report "Maintenance of Computers"

AMERICAN USED COMPUTER CORP.  
P.O. Box 68, Kenmore Sta., Boston, MA 02215  
member COMPUTER DEALERS ASSOCIATION

CIRCLE 952 ON READER SERVICE CARD

## free catalog

POTTING APPLICATORS  
MANUAL OR AIR OPERATED

2 1/2cc 6cc 12cc 30cc  
FOR POTTING, ENCAPSULATING ETC.

PHILIP FISHMAN CO., INC.  
7 CAMERON ST. WELLESLEY, MASS. 02181

CIRCLE 953 ON READER SERVICE CARD

## FREE CATALOG

HARD-TO-FIND PRECISION TOOLS

Lists more than 1700 items—pliers, tweezers, wire strippers, vacuum systems, relay tools, optical equipment, tool kits and cases. Also includes four pages of useful "Tool Tips" to aid in tool selection.

TENSEN TOOLS  
4117 N. 44th Street, Phoenix, Ariz. 85018

CIRCLE 954 ON READER SERVICE CARD

## FREE ALARM CATALOG

Full line of professional burglar and fire alarm systems and supplies. 80 pages, 400 items. Off-the-shelf delivery, quantity prices.

mountain west alarm  
4215 n. 16th st., phoenix, az. 85016

CIRCLE 956 ON READER SERVICE CARD

## EMPLOYMENT OPPORTUNITIES

### POSITIONS VACANT

Positions Available—Electrical & Electronic Eng's. Over 1000 US client co's pay our fees for selected technical referrals. Est. 1959. Send resume with presal. Atomic Personnel, Inc., Box L, 1518 Walnut St., Phila., Pa. 19102.

## AUTOTRACK MOUNT

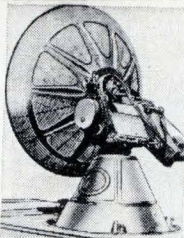

### AUTOTRACK SCR-584 RADARS

360 degree azimuth, 210 degree elevation sweep with better than 1 mil. accuracy. Missile velocity acceleration and slewing rates. Amplidyne and servo control. Will handle up to 20 ft. dish. Supplied complete with control chassis. ALSO in stock 10 cm. van mounted radar system. Conical scan. PPI 6 ft. dish. Ideal for S band telemetry, weather, balloon trk. missile trk, rocket trk. ECM range. Write for complete data. 600 pg. instr. bk. avail. at \$25 ea.

### 1 MEV LINEAR ACCELERATOR

Dual Mode, Ion or Electron. RF Drive, 300 KHZ at 45 KW. Includes control console, RF unit, accelerator, etc.

### MOD IV HIGH RESOLUTION TRACKER

Instrumentation radar, freq. 8.5-9.6 GHz, Pwr. 250 KW, .1 mil tracking accuracy. 6' Fresnel lens antenna with 4 horn monopulse feed. Tracking range 50 or 200 miles. Formerly used as range safety radar at Cape Kennedy.

### PULSE MODULATORS

245 KW LINE PULSER Output 16 KV at 16 amp. .25  $\mu$ s at 4000 PPS.  
405 KW FLOATING DECK PULSER Output 20 KV at 20 amp. 1  $\mu$ s to 10 milisecond pulse.  
500 KW LINE PULSER Output 22 KV at 28 amp. 4/1.75/2.25  $\mu$ s at 2500/550/300 PPS.  
1 MW HARDTUBE MIT MODEL 9 Output 25 KV at 40 amp. .25-2  $\mu$ s at .002 D.C.  
2.0 MW LINE PULSER Output 30 KV at 70 amp. 1/2  $\mu$ s at 600/300 PPS.  
3 MW LINE PULSER Output 39 KV at 75 amp. .25/1  $\mu$ s at 500 PPS.  
10 MW LINE PULSER Output 76 KV at 135 amp. 2.5  $\mu$ s at 350 PPS.  
17 MW LINE PULSER Output 17 KV at 1000 amp. 2-5  $\mu$ s at 150-200 PPS.

### HV POWER SUPPLIES

6.3 KV @ 5 Amp; 20KV @ 1.3 Amps; 35KV @ 1.5 Amps; 28KV, 70MA; 12KV @ 800MA; 18KV @ 2.25 Amps; 17.5KV @ 1.8 Amps.

## RECON DRONE CONTROL RADARS

X Band systems autotrack and search complete with plotting boards. Fully mobile van mounted. Gives PPI, slant range, altitude data. Ground to air control links and beacons also in stock. AN/MPQ-29 & AN/LPW-1

## RADAR DATA MICROWAVE LINK

Freq. 7.1-7.9 GHz, Pwr. 100 mw., 4 channels. Transmits video, pulse, synchro, and voice information. Mfr: Motorola.

## SPARE PARTS IN STOCK

Nike Ajax, Nike Hercules, M-33, MPS-19, TPS-1D, TPS-10D, FPS-6, SPS8, SCR-584, HIPAR.

## RADAR & RF PKGS.

34ghz 40kw Pulse RF pkg  
24ghz 40kw Pulse bomb toss system  
16ghz 130 kw Pulse B-58 search radar system  
X BAND SEARCH 40 KW PULSE WEATHER RADAR  
X BAND AUTOTRACK 250KW PULSE M-33 compl w / plot boards  
X BAND BEACON 400 W PULSE AN/DPN-62  
X BAND AUTOTRACK 50KW PULSE B-47 fire control complete  
C BAND WEATHER RADAR 250 KW PULSE  
C BAND HEIGHT FINDER  
AN/FPS-26 5 megawatt output.  
AN/TPS-37, 1 megawatt output.  
C BAND 1 MEGAWATT AUTOTRACK  
10ft dish mortar locator MPQ-21  
C BAND 285KW PULSE Search AN / SPS-5  
S BAND AUTOTRACK 500 KW PULSE 10' DISH  
S BAND 1 MEGAWATT COHERENT AN / FPS-18  
S BAND 1 MEGAWATT PULSE NIKE ACQ.  
S BAND 5 MEGAWATT HEIGHT FINDER AN / FPS-6  
S BAND BEACON 1 KW PULSE  
L BAND 500KW PULSE AN / TPS-1D / E  
L BAND 5 to 20KW PULSE  
400mhz 1KW CW AN / FPS-23  
225mhz 1 MEGAWATT PULSE AN/TPS 28  
2-30mhz 100KW PULSE  
CW 950-5ghz 150 WATTS  
CW 1.5mhz-10 5ghz 5 WATTS  
CW 7.4 GHZ 2 KW  
AN / GPG-1 SKYSWEEP TRACKER

HUNDREDS MORE IN STOCK  
LARGEST RADAR  
INVENTORY  
IN WORLD.  
WRITE  
FOR  
CATALOG  
ON YOUR  
LETTERHEAD

## Radio-Research Instrument Co. INC.

3 Quincy St., Norwalk, Conn. 06850 • 203-853-2600

CIRCLE 951 ON READER SERVICE CARD

## NOW IS THE TIME ... TO HIRE A STUDENT THIS SUMMER.

First, it's later than you think, with schools closing on different semester schedules, and students torn between lining-up "sure" jobs now or gambling that something in their chosen field will come along later.

Second, and most important, it's in our industry's best interest to encourage and hold its life-blood by providing practical experience in their future profession.

And, since there'll always be more applicants than openings, you'll be able to select the cream of the crop, then

evaluate them with an eye towards hiring, when as coveted graduates, the job market might well be in their favor.

Because we believe this program is of mutual benefit to both employer and employee alike, we again offer our services as a clearing-house.

Just fill out and return the coupon below, and we'll include your organization in a free listing to be sent to Placement Directors and Department Heads at leading colleges and universities across the nation.

## Free summer help listing

MAIL TO: ELECTRONICS/POST OFFICE BOX 900/NEW YORK/NY 10020

NAME/TITLE (of individual to be contacted)

ADDRESS: (Mailing address of your personnel office)

ORGANIZATION: (Firm, Company, Government Agency or Institution)

TYPE AND NUMBER OF STUDENTS SOUGHT: Electronics Aerospace

Mechanical Electrical Other Preferences (Draftsman, etc.)



2/7/74

## New literature

60085, provides information on the company's line of keyboards and switches. [434]

**Calculators.** The first of a new quarterly publication dealing with the relationship between calculators and software is available from Tektronix Inc., Box 500, Beaverton, Ore. 97005. Called "Calculations", each issue will be devoted to a specific application. [435]

**Rotary switch.** A rotary switch that is 1 inch in diameter, for commercial and military applications, is described in a technical bulletin from Oak Industries Inc., Switch division, Crystal Lake, Ill. 60014 [436]

**Disk memories.** A buyers' guide on disk memories has been published by Engineered Data Peripherals Corp., 1701 Colorado Ave., Santa Monica, Calif. 90404. All aspects of disk selection are covered, as well as comparisons with other kinds of memories. [437]

**Communications.** Amperex Electronic Corp., 230 Duffy Ave., Hicksville, N.Y. 11802. A 640-page applications book contains 24 reports written to aid the communications-design engineer in bringing the power-amplifier stage of communications equipment from the drawing board to production in the shortest period of time. [438]

**Thermocouple indicators.** Doric Scientific Corp., 3883 Ruffin Rd., San Diego, Calif. 92123. A reference catalog gives specifications, options, and prices for a line of digital thermocouple indicators. [432]

From SOLITRON

# thick film S.I.P. (Single In-line Package) resistor networks

Available  
by the  
handful  
or the  
carload!

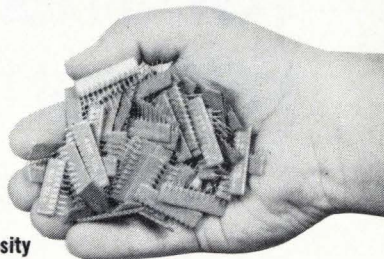

- Increased component density
- Decreased handling/assembly time
- Unlimited circuit configurations
- Excellent delivery

**Also available:**

Voltage divider networks for up to 10,000 WV dc.  
RC networks for greater component density.  
Micro-networks for complete circuit component requirements.

**Technical data:**

Resistance to 100 Megohms.  
Tolerances to  $\pm 0.5\%$ .  
Power ratings to 1 Watt/Resistor.  
T.C.'s to  $\pm 50\text{PPM}/^\circ\text{C}$ .  
Temperature range  $-55$  to  $+150^\circ\text{C}$ .  
Up to 20 terminals.

For further information, contact:

**solitron devices, inc.** Hybrid Products Division  
256 Oak Tree Road, Tappan, N.Y. 10983  
Tel. 914-359-5050 TWX: 710-576-2654 Telex: 137346

Circle 183 on reader service card

## Own your own holder to hold your own!

Hold your own copies of Electronics in specially designed slipcase holders. They'll keep your Electronics library neat and handy—a permanent information file, issue by issue.

Just complete the coupon and mail to Jesse Jones. He'll process your order upon receipt, postpaid.

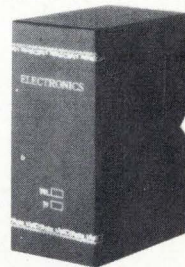

**ELECTRONICS BOXER**  
Jesse Jones Box Corporation  
2250 E. Butler St., Philadelphia, Pa. 19137

Please send me:  boxes @ \$4.25 each;  3 boxes @ \$12.00;  6 boxes @ \$22.00.  
My check or money order is enclosed.

Name: \_\_\_\_\_

Address: \_\_\_\_\_

City: \_\_\_\_\_ State: \_\_\_\_\_ Zip: \_\_\_\_\_

## QUICK LOOK SELECTION GUIDE FOR DIGITAL THERMOCOUPLE INDICATORS

SEVEN SEPARATE SERIES  
FOR SINGLE OR MULTIPOINT  
MONITORING

DOZENS OF RANGES  
EVERY AVAILABLE T/C TYPE

from only \$299<sup>00</sup>

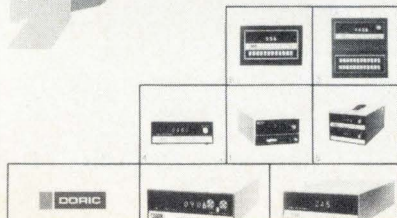

PUBLIC SERVICE

SALON INTERNATIONAL DES

# composants électroniques

PARIS 1-6 / 4 / 74

COMPONENTS - MEASURING  
MATERIALS - EQUIPMENT

Organisation S.D.S.A. - 14, rue de Presles 75740 Paris Cedex 15

FRENCH TRADE SHOWS 1350 Avenue of The Americas  
NEW YORK, N.Y. 10019 Tel.: (212) 582-4960, 1

Circle 217 on reader service card 183

# Bonds are for making retirement easier.



U.S. Savings Bonds can help you keep a firm grip on your future. Join the Payroll Savings Plan where you work, right now. Get a start on your nest egg and make sure there'll be some glitter in your golden years.



## Take stock in America.

Buy U.S. Savings Bonds  
Now E Bonds pay 5 1/2% interest when held to maturity of 5 years, 10 months (4% the first year). Bonds are replaced if lost, stolen, or destroyed. When needed they can be cashed at your bank. Interest is not subject to state or local income taxes, and federal tax may be deferred until redemption.

 The U. S. Government does not pay for this advertisement. It is presented as a public service in cooperation with The Department of the Treasury and The Advertising Council.

### Advertising Sales Staff

**Pierre J. Braudé** [212] 997-3485  
Advertising Sales Manager

**Atlanta, Ga. 30309:** Joseph Lane  
100 Colony Square, 1175 Peachtree St., N.E.  
[404] 892-2868

**Boston, Mass. 02116:** James R. Pierce  
607 Boylston St. [617] 262-1160

**Chicago, Ill. 60611:**  
645 North Michigan Avenue  
Robert W. Bartlett (312) 751-3739  
Paul L. Reiss (312) 751-3738

**Cleveland, Ohio 44113:** William J. Boyle  
[716] 586-5040

**Dallas, Texas 75201:** Charles G. Hubbard  
2001 Bryant Tower, Suite 1070  
[214] 742-1747

**Denver, Colo. 80202:** Harry B. Doyle, Jr.  
Tower Bldg., 1700 Broadway  
[303] 266-3863

**Detroit, Michigan 48202:** Robert W. Bartlett  
1400 Fisher Bldg.  
[313] 873-7410

**Houston, Texas 77002:** Charles G. Hubbard  
2270 Humble Bldg. [713] CA 4-8381

**Los Angeles, Calif. 90010:** Robert J. Rielly  
Bradley K. Jones, 3200 Wilshire Blvd., South Tower  
[213] 487-1160

**New York, N.Y. 10020**  
1221 Avenue of the Americas  
Warren H. Gardner [212] 997-3617  
Michael J. Stoller [212] 997-3616

**Philadelphia, Pa. 19102:** Warren H. Gardner  
Three Parkway  
[212] 997-3617

**Pittsburgh, Pa. 15222:** Warren H. Gardner  
4 Gateway Center, [212] 997-3617

**Rochester, N.Y. 14534:** William J. Boyle  
9 Greylock Ridge, Pittsford, N.Y.  
[716] 586-5040

**San Francisco, Calif. 94111:** Don Farris  
Robert J. Rielly, 425 Battery Street,  
[415] 362-4600

**Paris:** Alain Offergeld  
17 Rue-Georges Bizet, 75 Paris 16, France  
Tel: 720-73-01

**Geneva:** Alain Offergeld  
1 rue du Temple, Geneva, Switzerland  
Tel: 32-35-63

**United Kingdom & Scandinavia:** Keith Mantle  
Tel: 01-493-1451, 34 Dover Street, London W1

**Milan:** Robert Saidel  
1 via Baracchini, Italy Phone 87-90-656

**Brussels:** Alain Offergeld  
23 Chaussee de Wavre  
Brussels 1040, Belgium  
Tel: 13-73-95

**Frankfurt/Main:** Fritz Krusebecker  
Liebigstrasse 27c, Germany  
Phone 72 01 81

**Tokyo:** Tatsumi Katagiri, McGraw-Hill  
Publications Overseas Corporation,  
Kasumigaseki Building 2-5, 3-chome,  
Kasumigaseki, Chiyoda-Ku, Tokyo, Japan  
[581] 9811

**Osaka:** Ryji Kobayashi, McGraw-Hill  
Publications Overseas Corporation, Kondo  
Bldg., 163, Umegae-cho Kita-ku, Japan [362] 8771

**Australasia:** Warren E. Ball, ITO Box 5106,  
Tokyo, Japan

### Business Department

**Stephen R. Weiss, Manager**  
[212] 997-2044

**Thomas M. Egan,**  
Production Manager [212] 997-3140

**Carol Gallagher**  
Assistant Production Manager [212] 997-2045

**Dorothy Carter,** Contracts and Billings  
[212] 997-2908

**Frances Vallone,** Reader Service Manager  
[212] 997-6057

### Electronics Buyers' Guide

**George F. Werner,** Associate Publisher  
[212] 997-3139

**Regina Hera,** Directory Manager  
[212] 997-2544

# IN WIRE WRAPPING

# ok<sup>®</sup> HAS THE LINE...

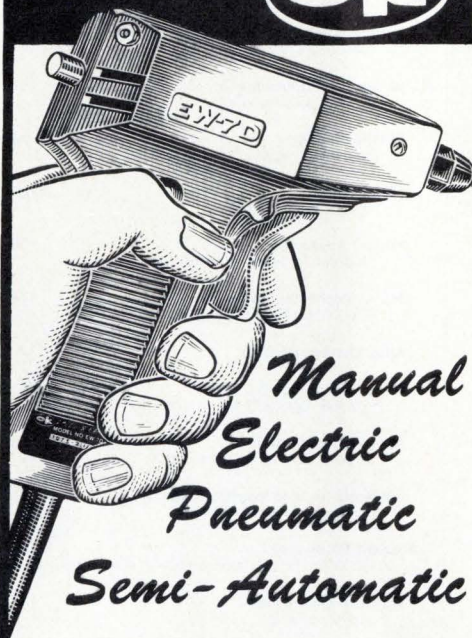

*Manual  
Electric  
Pneumatic  
Semi-Automatic*

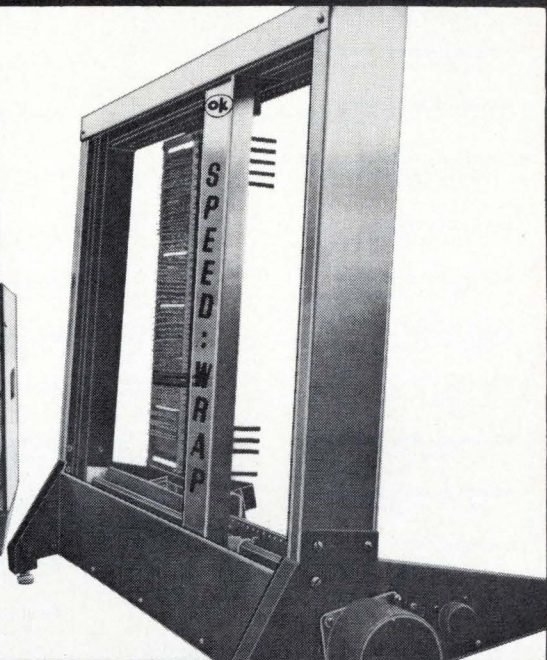
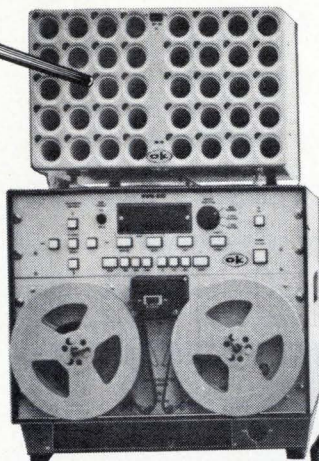

## OK MACHINE AND TOOL CORPORATION

3455 CONNER STREET, BRONX, NEW YORK, N.Y. 10475 U.S.A.  
TELEX NO. 12-5091 PHONE (212) 994-6600 TELEX NO. 232395

Circle 185 on reader service card

## ALCOSWITCH

New and improved snap action design. Push-On/ Push-Off or Momentary option. Molded-in gold flash terminals & silver contacts. Diallyl Phthalate case. High torque bushing resists mechanical abuse. Rated 6 amps @ 125 VAC.

### PUSHBUTTONS

MPA-6 SERIES



1, 2, 3, 4  
POLES

**ALCO<sup>®</sup>** ELECTRONIC PRODUCTS, INC.  
1551 Osgood Street, North Andover, Mass. 01845

Circle 236 on reader service card

## ALCOSWITCH

Molded-in heat sink terminals with gold finish. Fine silver contacts. Internal and external isolation barriers between poles & terminals. Anti-push-in toggle. PC or wired terminals. Many lever options. Rated 3 amps @ 250VAC or 6 amps @ 115VAC.

1, 2, 3, AND 4 POLES

NEW MTA SERIES

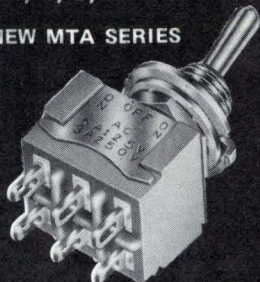

**ALCO<sup>®</sup>** ELECTRONIC PRODUCTS, INC.  
1551 Osgood Street, North Andover, Mass. 01845

Circle 219 on reader service card

## Easy Access At Newest Plant Site In Rochester, New York

The Outer Loop Industrial Park is right next to a freeway system that connects you with the New York State Thruway and the World. Expressways also lead you straight to the profitable Rochester market.

Neighboring companies know the benefits of this fine location on Rochester's west side. Some of them are Eastman Kodak, Bendix Corporation, 3M Company, General Motors, and Ragu Foods.

Railroad service is available on-site and an airport served by three major airlines is minutes away via the freeways. The Port of Rochester, a few miles to the north, has deep water accommodation for ocean-going vessels.

For more information, contact Robert J. Hall, Director of Area Development, Rochester Gas and Electric Corporation, 89 East Avenue, Rochester, New York 14649 or call (716) 546-2700, ext. 2466.

We know more about sites in our nine-county area than just about anyone else. Contact us for information on available facilities from 10,000 to 800,000 square feet.

**RGE** ROCHESTER GAS AND ELECTRIC  
89 EAST AVENUE, ROCHESTER, N.Y. 14649 • 546-2700

Circle 220 on reader service card

# Electronics advertisers

February 7, 1974

<b>Advanced Micro Devices</b> Keye/Donna/Pearlstein	10-11	<b>Eastern Air Devices</b> Weston Associates Inc.	90	<b>Krohn-Hite Corp.</b> Impact Advertising Inc.	5
* <b>Advanced Micro Devices</b> Keye/Donna/Pearlstein	6E	<b>Eastman-Kodak Co. GMD GD</b> <b>Photofabrication Microelectronic</b> Rumrill Hoyt Inc.	167	■ <b>Lapp Insulator Div. Interpace Corp.</b> Wolff Associates Inc.	150
<b>Alco Electronic Products Inc.</b> Marketronics Advertising	185	‡ <b>Elco Corporation</b> Mort Barish Associates Inc.	74	<b>Lockheed Electronics Co.</b> McCann-Erickson Inc.	187
<b>Allan Bradley Company</b> Hoffman, York, Baker & Johnson Inc.	34	<b>Elec-Trol Inc.</b> S. Michelson Advertising	160	<b>Macrodyne Inc.</b> Rochards, Fagone & Associates Inc.	156
■ <b>Amphenol Connectors Division,</b> <b>Bunker Ramo Corp.</b> Marsteller Inc.	32, 33	<b>Electro Scientific Industries</b> Commark Group	80	<b>Marco-Oak</b> Jansen Associates Inc.	28-29
■ <b>Analog Devices, Inc.</b> Schneider Parker Guy Inc.	157	<b>Electronic Measurements Inc.</b> Hill Advertising Agency	45	<b>Master Appliance</b> Klau-Van Pietersom-Dunlap, Inc.	166
<b>Ansley Electronics Corp.</b> S. Michelson Advertising	132	■ <b>Electronic Modling Inc.</b> The Williams Company	172	<b>Micro-Technical Industries</b> R.E. Sylvester Advertising Agency	178
<b>Anzac Electronics</b> Ken Puleo Advertising	168, 178	■ <b>Electronic Navigation Industries</b> Hart Conway Co., Inc.	14	<b>Mitel Canada Limited</b>	146
■ <b>Augat Inc.</b> Creamer, Trowbridge, Case & Bastford Inc.	175	<b>Electronics &amp; Control Engineers Book Club</b> 179-180	181	<b>MOS Technology Inc.</b> Henry S. Goodsett Advertising Inc.	56-57
<b>Ballantine Laboratories Inc.</b> MLF Graphics	174	<b>Erie Technological Products Inc.</b> Altman Hall Associates Advertising	27	<b>Mostek Corporation</b> David W. Evans Inc./Texas	15
<b>Bausch &amp; Lomb, Inc.</b> Wolff Associates Inc.	188	‡ <b>Excellon Industries</b> Graham & Sparkman Advertising Etcetera	161	<b>Motorola Semiconductor Products Inc.</b> E.B. Lane & Associates Inc.	61
‡ <b>Beckman Instrument Inc., Hellipot Div.</b> N.W. Ayer/Jorgensen/MacDonald Inc.	49	* <b>Excellon Industries</b> Elgin Davis Inc.	55, 5E	■ <b>Narda Microwave</b> McCarthy, Scelba, DeBiasi Advertising Agency Inc.	151
‡ <b>Bussmann Mfg. Division of McGraw-Edison Co.</b> Henderson Advertising Company	55	<b>Fabri-Tek Inc.</b> Midland Associates Inc. Marketing and Advertising Services	140	<b>National Electronics</b> Lea Advertising	142
■ <b>CELCO(Constance Engineering Laboratory Co.)</b> Stano Advertising	72	<b>Fairchild Semiconductor Inc.</b> Carson/Roberts Inc. Adv. Division of Ogilvy & Mather Inc.	112-113	■ <b>The J.M. Ney Company</b> Cooper Advertising Inc.	149
<b>Centralab Electronics Div. Glove-Union Inc.</b> Action Communicators	162	<b>Fluke Manufacturing Co., John</b> Bonfield Associates	73	* <b>Nippon Kogaku K.K.</b> K & L Advertising Agency	67
<b>Cherry Electrical Products Corp.</b> Kolb/Tookey and Associates Inc.	155	<b>Fluke Trendar</b> Lincoln Associates Inc.	85	<b>North Atlantic Industries Inc.</b> Diversified Corporate Services, Inc.	146
<b>Circuit Stik Inc.</b> Haaga Advertising	148	■ <b>General Electric Co., Semiconductor</b> <b>Products Department</b> Advertising & Sales Promotion Syracuse Operation	38	<b>OK Machine &amp; Tool Corporation</b> Ted Kostew Advertising & Sales Promotion	185
■ <b>Coll Winding International Exhibitions Ltd.</b> Colonsay Communications	170	■ <b>General Instrument Corporation,</b> <b>Semiconductor Comp. Div.</b> Norman Allen Associates Inc.	1-2 106	* <b>Philips Elcoma</b> Intermarco Nederland	62, 64
<b>Communications Transistor Corp.</b> Hall Butler Blatherwick Inc.	9	<b>Gouvernement DU Quebec, Ministere</b> <b>De L' Industrie ET Du Commerce</b> J. Walter Thompson Company Limited	147	* <b>Philips N.V. Pit/T&amp;M Division</b> Brookies Communications Systems S.A.	68-69
■* <b>Computer Components Inc.</b>	10E	■ <b>Grayhill Inc.</b> Stral Advertising Company Inc.	168	‡ <b>Piher International</b> Scott MacTaggart Advertising	67
■ <b>Dale Electronics Inc. Sub. of</b> <b>Lionel Corporation</b> Swanson, Sinkey, Ellis Inc. Advertising	4th Cover	<b>GTE Sylvania, Parts Division</b> Doyle, Dane, Bernbach Inc.	153	‡ <b>Precision Monolithics Inc.</b> Marlborough Associates Inc.	88
<b>Dana Laboratories</b> Dailey & Associates	91-94	<b>G.T. Schjeldahl Co.</b> Chuck Ruhr Advertising Inc.	145	■ <b>Premier Metal Products Corp.</b> Commercial Press Inc.	160
<b>Data General Corporation</b> Scall, McCabe, Sloves Inc.	12-13	■ <b>Guardian Electric Mfg. Co.</b> Kolb/Tookey and Associates Inc.	58	<b>RCA-Solid State Division</b> Marsteller, Inc.	79-81-83
■ <b>Data Precision</b> Allied Advertising Agency Inc.	173	■ <b>Heath/Schlumberger Scientific Instruments</b> Advance Advertising Services	174	‡ <b>Rental Electronics, Inc.</b> Humphrey Browning MacDougall, Inc.	62
■ <b>Datascan Inc.</b> McCarthy, Scelba and DeBiasi Advertising Agency Inc.	188	■ <b>Hewlett Packard Electronics Products Group</b> Corporate Marketing Communications	17 to 26	<b>Reticon Corporation</b> Kassler Noble Advertising	53
■ <b>Datei Systems Inc.</b> John Dolan Advertising	3rd Cover	<b>Hughes Aircraft Company</b> Foote Cone & Belding	47, 149 158	<b>Rochester Gas &amp; Electric Corp-Ad Group</b> Hutchins/Darcy Inc.	185
<b>Diacon</b> Grant Rogondino Millard Inc.	176	■ <b>ILC Data Device Corporation</b> Marchin Weltman Advertising Inc.	16	<b>Rockwell International Electronics Group</b> Campbell-Ewald Company Advertising	135
‡ <b>Diacon</b> Gardner DeSpain & Associates	64	<b>Intel Corp.</b> Regis McKenna Inc.	70-71	<b>Rohde &amp; Schwarz</b>	1E
■ <b>Dialight Corporation</b> Michel-Cather Inc.	2nd Cover	■ <b>Intronics</b> Impact Advertising Inc.	6	<b>Schauer Manufacturing Corp.</b> Nolan, Keelor & Stites	30
<b>Dickson Electronics Corporation</b> N. A. Winter Advertising Agency	87	<b>Keithley Instruments Inc.</b> Chagrin Valley Marketing Associates	86	<b>Schneider Electronics Corporation</b> F. M. Field & Company, Inc.	54
<b>Digital Equipment Corporation</b> Schneider Parker Guy Inc.	137			<b>Scientific Atlanta/Optima Division</b> Raniere, Saslaw, Mohr and Associates, Inc.	139
<b>Digitran Company, The</b> Swarts Associates	141			<b>S. D. S. A.</b> Public Service	142, 183
<b>Diva Inc.</b> Halloff & Caine Company	164			<b>Signetics Corp., Sub. of Corning Glass Works</b> Hall Butler Blatherwick, Inc.	30, 31



■ Solitron Devices, Inc. Tobias Associates, Inc.	183
‡ Sorensen Company, A Unit of Raytheon Company Provandie Eastwood & Lombardi Inc.	52
■ Sprague Electric Company Harry P. Bridge Company	8
■ Systron Donner Concord Instruments Fred Schott & Associates	84, 131
■ Tansitor Electronics Devey, Thompson & Vignola Advertising, Inc.	148
Tekelec Airtronic S. P. F. D.	4E
Tektronix, Inc. McCann Erickson, Inc.	43
* Teledyne Relays S. Michelson Advertising	74
Teledyne Semiconductor Regis McKenna, Inc.	7
Telonic Ind. Inc. Jansen Associates, Inc.	163
Teradyne, Inc. Quinn & Johnson, Inc.	77
Thermalloy Warren-Guild	50
‡ Thomas & Betts Company McCarthy, Scelba, DeBiasi Advertising Agency, Inc.	68-69
‡ Thomson CSF/Dumont Raniere, Saslaw, Mohr and Associates, Inc.	169
* Thomson CSF/Dumont Raniere, Saslaw, Mohr and Associates	8E, 9E
Toko, Inc. Hakuhodo, Inc.	187
■ Topaz Electronics Jansen Associates, Inc.	176
TRW/IRC Resistors Gray & Rogers, Inc.	143
■ Trygon Electronic Subsidiary of Systron Donner Corporation RAMA Advertising	134
United Systems Corp., A sub. of Monsanto Co. Advertising & Merchandising, Inc.	154
■ Unitrode Corporation Culver Advertising, Inc.	37
U. S. Capacitor Corp. S. Michelson Advertising	177
■ Varo Semiconductor, Inc. Warren-Guild	172
Vu-Data Manning-Bowen and Associates	156
Wagner Electric Corporation Coordinated Communications, Inc.	171

### Classified & Employment Advertising

F. J. Eberle, Manager 212-971-2557

<b>EQUIPMENT (Used or Surplus New) For Sale</b>	
American Used Computer Corp.....	182
Philips Fishman Company.....	182
Jensen Tool & Alloys.....	182
Mountain West Alarm.....	182
Radio Research Instrument Co. Ltd.....	182

■ For more information on complete product line see advertisement in the latest Electronics Buyer's Guide  
\* Advertisers in Electronics International  
‡ Advertisers in Electronics domestic-only edition

# SOLID RELIABILITY

## Micropackaged pulse transformers with outstanding performance.

Toko pulse transformers are proven performers in the electronics world, and are known for compactness, reliability and product quality which are hard to beat. Make your selection from our list of standard types or let us design a unit specifically for your application.

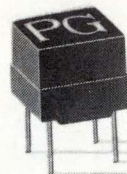

### Standard Types

Type	Turns ratio	Primary inductance	ET Constant (min.)	Leakage inductance (max.)	Interwinding capacitance (max.)	DC resistance (max.)	Connections
PGWB 4-1AA	1:1	1.8	1.2	0.10	8.0	0.20	A (LCED)
PGWB 10-1AA	1:1	11.0	2.5	0.15	12.0	0.20	A (LCED)
PGBB 8-1AA	1:1	38.0	3.5	0.15	8.0	0.20	A (LCED)
PGRB 10-1AA	1:1	134.0	5.0	0.15	12.0	0.20	A (LCED)
PGRB 16-1AA	1:1	340.0	10.0	0.15	18.0	0.30	A (LCED)
PGXB 22-1AA	1:1	1,400.0	20.0	0.20	25.0	0.35	A (LCED)

### Technical Data

● Operating temperature range: 0~70°C ● Storage temperature range: -40~+100°C ● Insulation resistance: (At 250 VDC) More than 10<sup>8</sup> M  
● Package: Transfer molding (epoxy) ● Environmental test: Units satisfy MIL-STD-202D ■ For detailed information, please contact our sales department.



## TOKO, INC.

Head Office: 1-17, 2-chome, Higashi-Yukigaya, Ohta-ku, Tokyo, Japan

New York: Toko New York Inc.

350 Fifth Avenue, New York, N.Y. 10001 U.S.A. Tel: 565-3767

Los Angeles: Toko, Inc. Los Angeles Liaison Office 3440 Wilshire Blvd., Tishman Building, Suite 1106 Los Angeles, Calif. 90010, U.S.A. Tel: 380-0417

Düsseldorf: Toko Elektronik G.m.b.H. 4 Düsseldorf, Lakronstrasse 77, W. Germany Tel: 0211-284211

Circle 184 on reader service card

Years ago we made a decision to let the other guys knock out all of the simple printed circuit boards they could make. We wanted the tough jobs.

Multilayer and two-sided PCs. Complex drilling, printing and plating.

And we wanted to do them better than anybody in the business. Since then, we've been doing

more of the hard work than anyone. And delivering it on time. With precision and economy.

We built a reputation on hard work. We're not about to take things easy now.

If you've got a tough job, call us at (213) 722-6810 collect. Or write Data Products Division, 6201 East Randolph Street, Los Angeles, California 90040.

## We built a reputation on hard work.

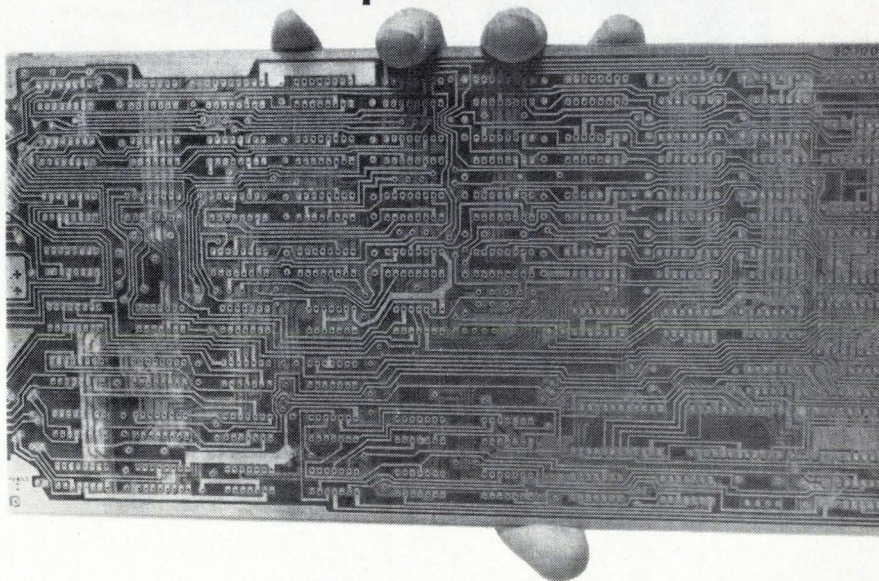

Lockheed Electronics—First In Complex PCs

15 YEARS OF LEADERSHIP IN ELECTRONICS, 1959-1974.

# THE CHAMP

...PICTURE TAKER



Visual images are fleeting—so, for the record, ... you need pictures. No telling when or how often they can prove invaluable.

That's why so many of your peers are routinely snapping pictures while looking at specimens and samples with Bausch & Lomb's StereoZoom 7 visual-photographic system. The Champ's superb optical system which gives unbeatable visuals will put the images on film right while you're looking. And they will be

available as often as you want to refresh your memory, make comparisons, prove points.

There's a choice of most camera formats with the new Integrated Cameras, Series II with optional exposure meter. They're integral, but do not interfere with the optical system and interchange to fit varying needs.

**Be ready. Write for our new Stereomicroscope catalog 31-15 and our free demonstration offer.**

**BAUSCH & LOMB** 

SCIENTIFIC OPTICAL  
PRODUCTS DIVISION

62302 Bausch Street, Rochester, N.Y. 14602

StereoZoom, Reg. T.M.  
Bausch & Lomb.

For Literature Circle #188 on Reader Service Card.  
For Demonstration Circle #231 on Reader Service Card.

## go portable

### Introducing THE Digital Panel Meter for Portable Instruments

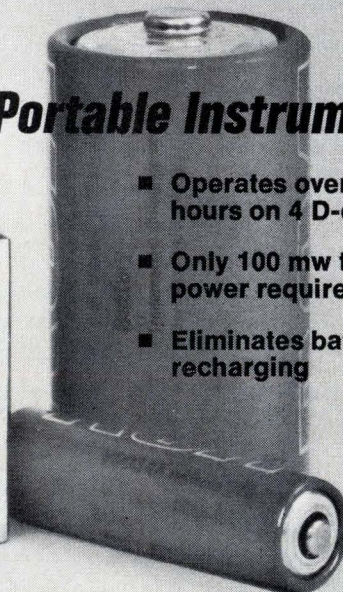

- Operates over 600 hours on 4 D-cells
- Only 100 mw total power required
- Eliminates battery recharging

NOW, make your portable instruments smaller, lighter, less expensive and more reliable. With the Datascan Model 820 battery powered DPM, you also get a bright, reliable and readable 3½ digit LED display, 0.1% (of reading) accuracy, battery input voltage from 4.8 to 8.0\* volts and an attractive miniaturized metal case that's only 3.5" deep x 2.5" wide x 1.3" high.

To get complete specs or to arrange for a demonstration, call or write. We're anxious to help you GO PORTABLE.

\*other ranges available.



Datascan  
Electronic  
Products

P.O. Box 785  
1111 Paulison Ave.  
Clifton, N.J. 07013  
Telephone: (201) 478-2800

**Datascan**