

JUNE 12, 1975

SILICON ON SAPPHIRE STRETCHES C-MOS PERFORMANCE/115

Here come the 16-k RAMs/80

Electronics and industry: Steel's new ally/104

FOUR DOLLARS A MCGRAW-HILL PUBLICATION

Electronics®

**AUTOMATION
COMES
TO THE
OFFICE**

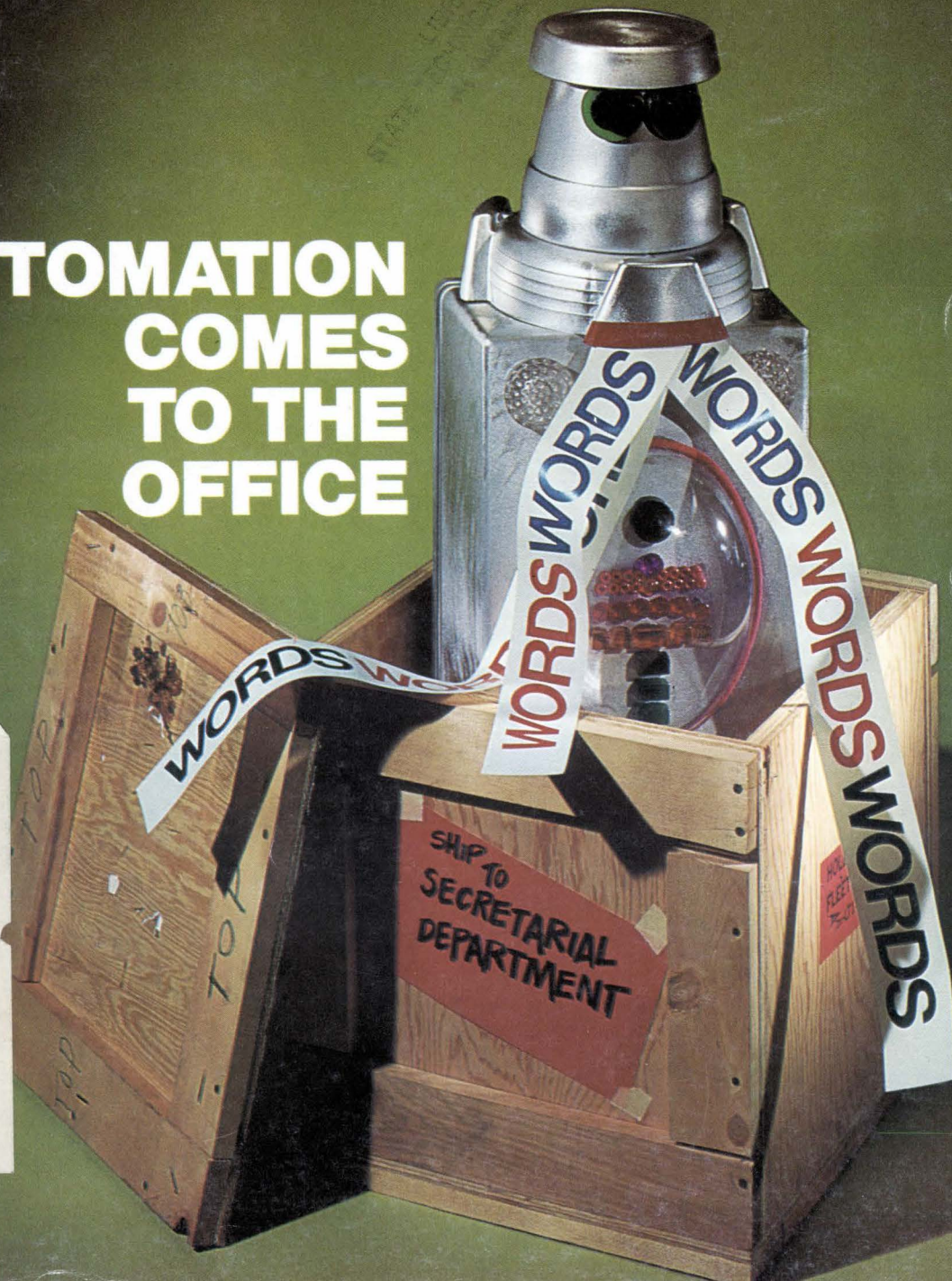

3470 TCM596 HCSA9 JUN75
STATE TECH INST
LIBRARY
5963 MACON COVE
MEMPHIS TN
38134

BRAND-REX TAPE CABLE® - SOMETHING FLAT TO ROUND OUT THE BROADEST LINE IN THE INDUSTRY.

TAPE CABLE is a flat, flexible cable — the newest addition to the long line of Brand-Rex cables which already include bonded and woven ribbon cable, insulated copper and aluminum strip for power distribution, and a wide range of standard round configurations.

TAPE CABLE is produced in a new Brand-Rex facility in Manchester, Conn. It is available in an almost endless variety of constructions:

- Round or flat conductors, solid or stranded, bare or plated — drawn in-house to permit precise tolerance control.

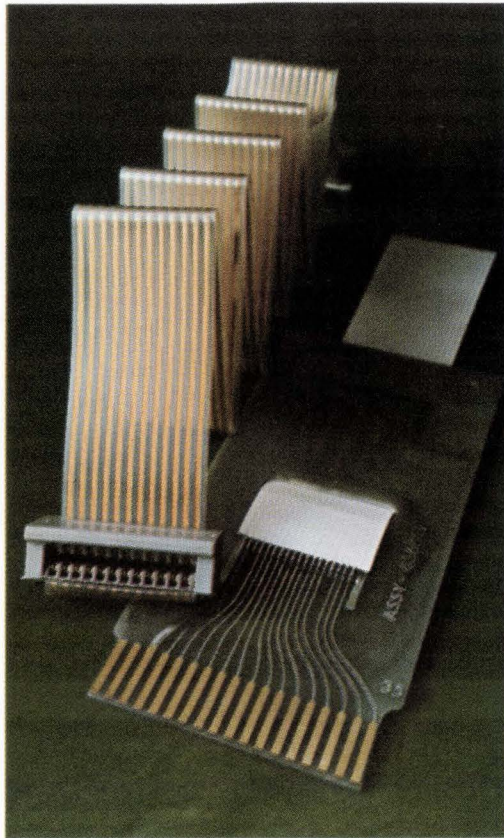

- From 1 to 200 conductors — the same or mixed cross-sections and sizes.
- Many insulation types, including PVC, polyester, Kapton*, Teflon*.
- Unshielded, or shielded on one or both sides.
- Controlled spacings to meet any electrical or mechanical requirement.
- Signal cables for digital data transmission in computers.

*Dupont Trademark

TAPE CABLE can be supplied in bulk or as assemblies. Brand-Rex's well-known design capability is yours to draw on. Where necessary, we will design TAPE CABLE systems consisting of cables terminated to printed wiring boards, connectors or flexible printed circuits for your particular application.

For complete information, send for the new Brand-Rex TAPE CABLE brochure. Brand-Rex Company, Electronic and Industrial Cable Division, Willimantic, Ct. 06226, 203/423-7771.

BRAND-REX

ELECTRONIC & INDUSTRIAL CABLE DIVISION

Other Brand-Rex Divisions:

Abbott & Co., wiring harnesses □ Nonotuck Manufacturing Co., copper wire
Pyle-National Co., electrical connectors □ Telecommunications Cable Division
Teltronics, Inc., telephone equipment and components □ Brand-Rex, Ltd. (Scotland), wire and cable.

BRAND-REX CO., A PART OF Akzo[®] INCORPORATED

Circle 900 on reader service card

Two for your budget.

Affordable spectrum analyzers that typically will make over 90% of your everyday frequency domain measurements. Easily. Accurately.

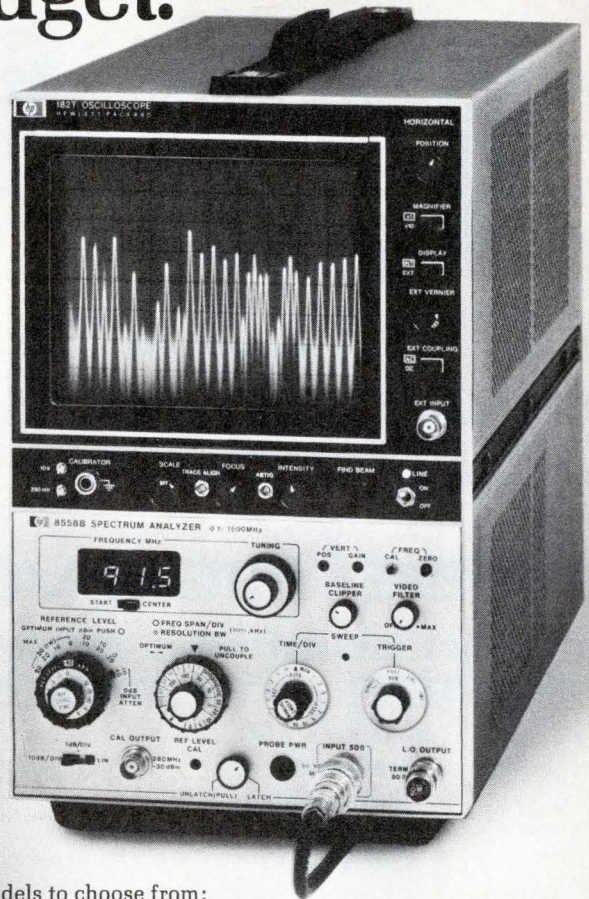
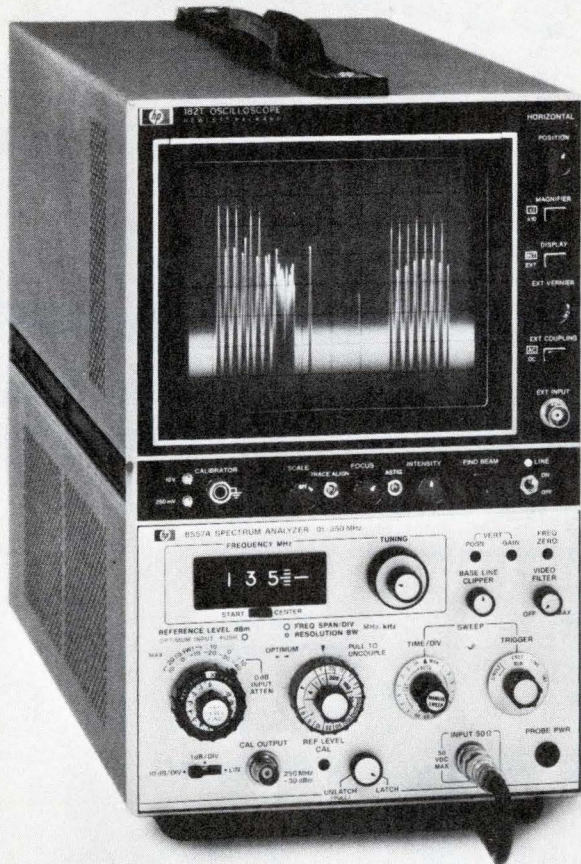

Two models to choose from; they're plug-ins for HP's versatile 180 Series Scopes.

Performance:	HP 8557A	HP 8558B
Frequency Range	10 kHz — 350 MHz	100 kHz — 1500 MHz
Amplitude Range	-117 dBm — +20 dBm	-115 dBm — +30 dBm
Frequency Response	±0.75 dB	±1.0 dB
Distortion-free Dynamic Range	>70 dB	>70 dB
Frequency Span Range	50 kHz — 350 MHz	50 kHz — 1000 MHz
Resolution Bandwidths	1 kHz — 3 MHz	1 kHz — 3 MHz
Price (Plug-in)	\$3450	\$4300

(HP 182T Large Screen Display Unit, \$1300.) Domestic USA prices.

Ease of use is another important feature of these HP Spectrum Analyzers. For most measurements you use just three controls:

1. Tune to the signal. Frequency is displayed on a digital readout.
2. Set the Frequency Span. View a wide spectrum then zoom in on your signal — resolution, sweep time, video filtering are all set automatically for optimum signal presentation.
3. Measure Amplitude Level. Read it directly from Reference Level control and CRT.

To help minimize chances for erroneous measurements, panel markings show optimum signal levels, and there's out-of-range blanking or limiting.

Economical for use on every bench, these analyzers provide the performance for over 90% of your everyday applications. This means they can relieve the need to use the more expensive high-resolution analyzer for routine measurement, with equivalent amplitude and frequency accuracy.

Want more information? Just call your nearest HP field office, or write.



Sales and service from 172 offices in 65 countries.
1501 Page Mill Road, Palo Alto, California 94304

45506A

KEPCO OPERATIONAL POWER SUPPLIES

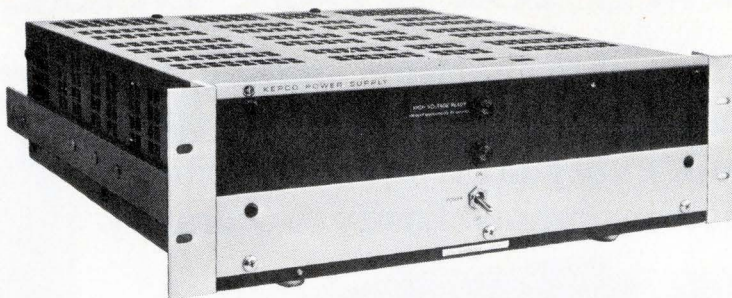
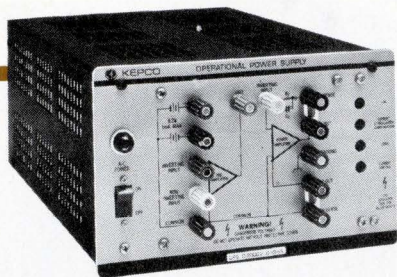

OPS group IXB

OPS 500B (0 – 500V @ 40 mA)
OPS 1000B (0–1000V @ 20 mA)
OPS 2000B (0–2000V @ 10 mA)

OPS group X

OPS 3500 (0–3500V @ 10 mA)
OPS 5000 (0–5000V @ 5 mA)

THESE HIGH VOLTAGE OP AMPS

are unipolar d-c power amplifiers capable of VOLTAGE or CURRENT stabilization, featuring:

HIGH GAIN: Open loop gain greater than 10^6 volts per volt.

WIDE BANDWIDTH: Slew rate faster than 10^6 volts per second.

LOW OFFSET:

Input offset variations:	ΔE_{io}	ΔI_{io}
For 105/125 or 210/250V a-c:	<10 μ V	<1 nA.
For no-load – full load:	<10 μ V	<1 nA.
For 8 hours (drift):	<20 μ V	<1 nA.
For temperature, per °C:	<20 μ V	<0.5 nA.

In simplified form, these instruments can be represented as a high voltage, fixed gain power amplifier, driven by a small-signal amplifier with variable gain.

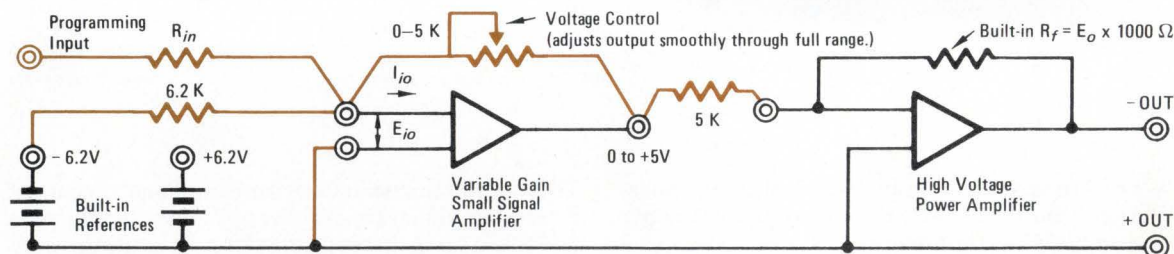

The OPS are complete high voltage power amplifiers with all of the necessary d-c supplies built-in. Their output stage is a **LINEAR SERIES PASS** vacuum tube controlled by a solid state circuit (absolutely no oscillators, SCR's or switching). As illustrated, the output of an OPS can be controlled

over its full voltage range smoothly by a small (0–5 K) passive rheostat supporting a mere 0–5V or by a voltage input (your choice), which might also be a function generator's waveform or the analog output of a Digital-to-Analog Converter, such as the Kepco SN Programmers.



Ask for your copy of the new Kepco Catalog, describing conventional power modules, laboratory supplies, the unique Kepco *Operational* Power Supplies and Digital-to-Analog Programmers.
Write Dept. AS-14

KEPCO®

KEPCO, INC. • 131-38 SANFORD AVENUE • FLUSHING, N. Y. 11352
(212) 461-7000 • TWX # 710-582-2631 • Cable: KEPCOPOWER NEWYORK



29 Electronics Review

OPTOELECTRONICS: Bell integrates optical circuits in gallium, 29
CONSUMER: Audio-video imports decline sharply, 29
RCA's VideoDisc aims at simple player in the home, 30
AUTOMOTIVE: Auto companies looking at thin-film flow meter, 31
MILITARY: Microprocessors help guide Navy target drones, 32
Rockwell develops microcomputer for the military, 34
PRODUCTION: Electron irradiation yields fast switching, 34
Circuit boards and hybrids give polyimide a try, 36
SOLID STATE: Nitride layer ups IC performance, 38
NEWS BRIEFS: 38
COMMERCIAL: Microprocessors go to the polls, 41
Independent insurance agents want their own data base, 42

52 Electronics International

SWITZERLAND: 'Electronic journalism' gear shown at Montreux, 52
FRANCE: Chronometer reads at 1 picosecond, 53
AROUND THE WORLD: 53

65 Probing the News

YOU AND YOUR CAREER: For EEs, old age begins at 40, 65
GOVERNMENT: Packard looks at industry relations, 69
COMPANIES: The other Texas semiconductor maker, 70
PHOTOVOLTAICS: Federal funding picture brightens, 75
MEMORIES: That speck on horizon is the 16-k RAM, 80

89 Technical Articles

BUSINESS ELECTRONICS: Word-processing transforms paperwork, 89
DESIGNER'S CASEBOOK: Monostable pulse width is programable, 100
Current and power limiter protects switching transistor, 101
Compact dc-dc converter yields ± 15 V from +5 V, 103
INDUSTRIAL: Part 2, Steel's special problems beckon designers, 104
SOLID STATE: Sapphire brings out the best in C-MOS, 115
ENGINEER'S NOTEBOOK: Optical sensor overcomes ambient light, 124
Calculating resistances for sum and difference networks, 125

129 New Products

IN THE SPOTLIGHT: Spectrum analyzer operates in real time, 129
IC/diode combination sharpens fm tuning, 130
SEMICONDUCTORS: Monolithic converter is ion-implanted, 135
SUBASSEMBLIES: A-d converter in DIP operates in 1.5 μ s, 146
COMPONENTS: Solid-state relay handles 400 hertz, 155
INSTRUMENTS: Monitor helps pinpoint ac transients, 163
PACKAGING & PRODUCTION: Connectors are fire-resistant, 172
MATERIALS: 182

Departments

Publishers letter, 4
Readers comment, 6
Editorial, 10
People, 14
Meetings, 20
Electronics newsletter, 25
News update, 44
Washington newsletter, 49
Washington commentary, 50
International newsletter, 55
Engineer's newsletter, 122
New books, 160
New literature, 184

Highlights

Cover: Word processing transforms the office, 89

To turn out more paperwork with fewer people, businesses are buying electronic equipment that speeds up dictation and typing. Typing/editing machines range in complexity from typewriters with a memory to time-shared computers. Innovations among dictating machines include magnetic recording disks and centralized systems.

Art Director Fred Sklenar created the cover, which was shot by photographer Syd Karson.

Must the 40-year-old EE be obsolete? 65

The Institute of Electrical and Electronics Engineers has uncovered "massive age discrimination" against its older members.

Steel firms look for electronics help, 104

Part 2 of this series on electronics and industry finds that steel companies would pay handsomely for customized electronic equipment capable of increasing the accuracy of controls in rolling mills, economizing on the use of zinc and electrical power, and reducing rejection rates.

C-MOS picks up speed from sapphire, 115

Parasitic capacitance is virtually abolished from silicon-gate complementary-MOS circuits when a thin silicon film on a sapphire substrate is used in place of bulk silicon. Speed and device density improve significantly at the large-scale-integration level of complexity, yet power requirements remain low.

And in the next issue . . .

Special report on power semiconductors . . . the 1-kilobit C-MOS random-access memory . . . a monolithic negative-resistance device that's the first of its kind.

EDITOR-IN-CHIEF: Kemp Anderson

EXECUTIVE EDITOR: Samuel Weber

MANAGING EDITORS: Lawrence Curran, *News*;
Arthur Erikson, *International*

SENIOR EDITORS: John Johnsrud,
H. Thomas Maguire, Laurence Altman,
Ray Connolly, Stephen E. Scrupski

ART DIRECTOR: Fred Sklenar

ASSOCIATE EDITORS: Howard Wolff,
Gerald M. Walker, Alfred Rosenblatt

DEPARTMENT EDITORS
Aerospace / Military: Ray Connolly
Circuit Design: Don Blattner
Communications & Microwave:
Richard Gundlach
Components: Lucinda Mattera
Computers: Stephen E. Scrupski
Consumer: Gerald M. Walker
Industrial: Margaret A. Maas
Instrumentation: Andy Santoni
New Products: H. Thomas Maguire,
Michael J. Riezenman
Packaging & Production: Jerry Lyman
Solid State: Laurence Altman

COPY EDITORS: Margaret Eastman,
Everett C. Terry, Bill Dunne

ART: Charles D. Ciatto, *Associate Director*
Patricia Cybulski, *Assistant Director*

PRODUCTION EDITOR: Arthur C. Miller

EDITORIAL SECRETARIES: Janet Noto,
Julie Gorgoglione, Penny Roberts

FIELD EDITORS

Boston: Gail Farrell (Mgr.), Pamela Leven
Los Angeles: Paul Franson (Mgr.)
Judy Phelps
Midwest: Larry Armstrong (Mgr.)
New York: Ron Schneiderman (Mgr.)
San Francisco: Bernard Cole (Mgr.)
Judith Curtis
Washington: Ray Connolly (Mgr.)
Larry Marion
Frankfurt: John Gosch
London: William F. Arnold
Paris: Arthur Erikson
Tokyo: Charles Cohen

McGRAW-HILL WORLD NEWS

Director: Ralph R. Schulz
Bonn: Robert Ingersoll
Brussels: James Smith
London: James Trotter
Madrid: Dom Curcio
Milan: Andrew Heath
Moscow: Peter Gall
Paris: Michael Johnson, Richard Shepherd
Stockholm: Robert Skole
Tokyo: Mike Mealey

PUBLISHER: Dan McMillan

DIRECTOR OF MARKETING: Pierre J. Braudé

ADVERTISING SALES SERVICE MANAGER:
Wallis Clarke

BUSINESS MANAGER: Stephen R. Weiss

CIRCULATION MANAGER: Nancy L. Merritt

MARKETING SERVICES MANAGER:
Tomlinson Howland

RESEARCH MANAGER: Margery D. Sholes

The plight of older engineers is not a happy one. Indeed, a recent report by the IEEE's Manpower Committee presents persuasive evidence that age discrimination is a fact of life in the electronics industries. To be sure, preferential treatment shown to younger engineers at the expense of veteran engineers may be unthinking, careless acts on the part of management. But there is mounting evidence that, whether carefully planned or accidental, corporate practices hit engineers who are over 40 harder than those who are younger.

On page 65 you'll find a Probing the News story on age discrimination, its recent history, and the moves that are being made to ease its threat. And, because the editors of *Electronics* feel quite strongly about the impact age discrimination can have, they have devoted this issue's editorial to detailing some of the steps the individual engineer should take. We welcome constructive suggestions on how best to deal with the problem.

Did you ever stop to think how many times a book, a magazine article, a technical report, and even a letter are typed and retyped before they are considered final? Well, the times a manuscript is redone can be numerous, and—as business is finding out—the redoing can be quite costly. Indeed, says associate editor Jerry Walker, “today correspondence can cost a company anywhere from \$5 to \$10 a page.”

That was one of the facts that he uncovered while doing research for the 10-page report on electronics and word processing that begins on page 89. As for the latest trends, he

reports that “in the last year, new, more powerful machines have begun to appear. Applications of microprocessors for control and memory, floppy disks for storage, and advanced cathode ray tubes have entered word processing equipment design.

“All of the signs thus point to steady growth of word processing; electronics technology moves in on yet another established electro-mechanical field. For the companies that have been trying to get this market off the ground for the last decade, the necessary ingredients—lower cost, greater equipment capability, and user interest—are finally beginning to coalesce.”

The second installment in our five-part series on electronics role in raising industrial productivity covers the steel industry. And the unusual problems in that vital basic industry are luring more electronics companies into the competition.

As our industrial editor, Peggy Maas, comments: “For electronics companies, there's gold in the iron and steel industry. Although there is only a handful of major steel companies and each requires no more than a half dozen of any one control system, the total value of those systems can add up. And the industry will be spending more than ever during the next two years.”

For the details on the steel industry's needs, and how electronics technology is filling more and more of them, turn to page 104.

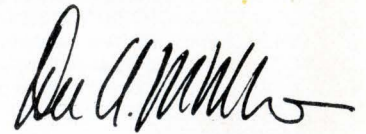

June 12, 1975 Volume 48, Number 12
95,460 copies of this issue printed

Published every other Thursday by McGraw-Hill, Inc. Founder: James H. McGraw 1860-1948. Publication office 1221 Avenue of the Americas, N.Y., N.Y. 10020; second class postage paid at New York, N.Y. and additional mailing offices.

Executive, editorial, circulation and advertising addresses: Electronics, McGraw-Hill Building, 1221 Avenue of the Americas, New York, N.Y. 10020. Telephone (212) 997-1221. Teletype TWX N.Y. 710-581-5234. Cable address: MCGRAWHILL N.Y.

Subscriptions limited to persons with active, professional, functional responsibility in electronics technology. Publisher reserves the right to reject non-qualified requests. No subscriptions accepted without complete identification of subscriber name, title, or job function, company or organization, including product manufactured or services performed. Subscription rates: qualified subscribers in the United States and possessions, Canada, and Mexico \$12.00 one year, \$24.00 three years; all other countries \$25.00 per year, except Japan and Israel \$50.00 per year, Brazil \$40.00 per year, Australia and New Zealand \$60.00 per year, including air freight. Limited quota of subscriptions available at higher-than-basic rate for persons outside of field served, as follows: U.S. and possessions and Canada, \$25.00 one year, all other countries \$50.00. Single copies: \$4.00.

Officers of the McGraw-Hill Publications Company: John R. Emery, President; J. Elton Tuohig, Executive Vice President-Administration; Gene W. Simpson, Group Publisher-Vice President; Senior Vice Presidents: Ralph Blackburn, Circulation; Walter A. Stanbury, Editorial; John D. Hoglund, Controller; David G. Jensen, Manufacturing; Gordon L. Jones, Marketing; Jerome D. Luntz, Planning & Development.

Officers of the Corporation: Shelton Fisher, Chairman of the Board and Chief Executive Officer; Harold W. McGraw, Jr., President and Chief Operating Officer; Wallace F. Trendry, Group President, McGraw-Hill Publications Company and McGraw-Hill Information Systems Company; Robert N. Landes, Senior Vice President and Secretary; Ralph J. Webb, Treasurer.

Title registered in U.S. Patent Office. Copyright ©1975 by McGraw-Hill, Inc. All rights reserved. The contents of this publication may not be reproduced in whole or in part without the consent of copyright owner.

Subscribers: The publisher, upon written request to our New York office from any subscriber, agrees to refund that part of the subscription price applying to copies not yet mailed. Please send change of address notices or complaints to Fulfillment Manager; subscription orders to Circulation Manager, Electronics, at address below. Change of address notices should provide old as well as new address, including postal zip code number. If possible, attach address label from recent issue. Allow one month for change to become effective.

Postmaster: Please send form 3579 to Fulfillment Manager, Electronics, P.O. Box 430, Hightstown, N.J. 08520.

State-of-the-Art AC Voltmeters Give You More "Measure Power" at Half the Price...



Make us prove it...

Send for the EVIDENCE today...
and/or ask for a demonstration.

Buy any one of these Ballantine ac voltmeters (Model 3045A, 3046A or 3056A)* and get even greater performance than from any two (2) of our competitor's units combined... and save more than \$400.

You'll get a rugged, line operated or portable, solid state, precision ac voltmeter that provides high accuracy, broadband (sub-audio through high frequency) ac measurements. And, it can also function as a precision-gain, wideband, ac amplifier and ac to dc converter.

Plus, Ballantine's exclusive "front panel selectable grounded or floating input" allows you to make measurements not possible with competitive, single ended units... only when floating can an ac meter be used between two off-ground ac points... only when floating can you use an ac meter as a null meter in a bridge circuit.

Now just check these specifications:

Full scale ranges 100 μ V to 300V (3045A, 3046A); 100 μ V-1000V (3056A). ■ Bandwidth 5Hz-15MHz (useable 2Hz-20MHz); ■ Accuracy to $\pm 1\%$ midband (3045A, 3046A); ± 0.2 dB (3056A); ■ Low pass filter; ■ Large, easy to read, long scale meter ■ Relative reference control for calibrated or variable dB reference ■ Rechargeable internal battery option.

*3045A — linear voltage/log dB scale, 10dB step ranging; \$415
3046A — log voltage/linear dB scale, 10dB step ranging; \$435
3056A — log voltage/linear dB scale, 20dB step ranging; \$410



Ballantine Laboratories, Inc.

P.O. Box 97, Boonton, New Jersey 07005,
Phone (201) 335-0900, TWX (710) 987-8380

Four Decades of Innovation in Electronic Instrumentation

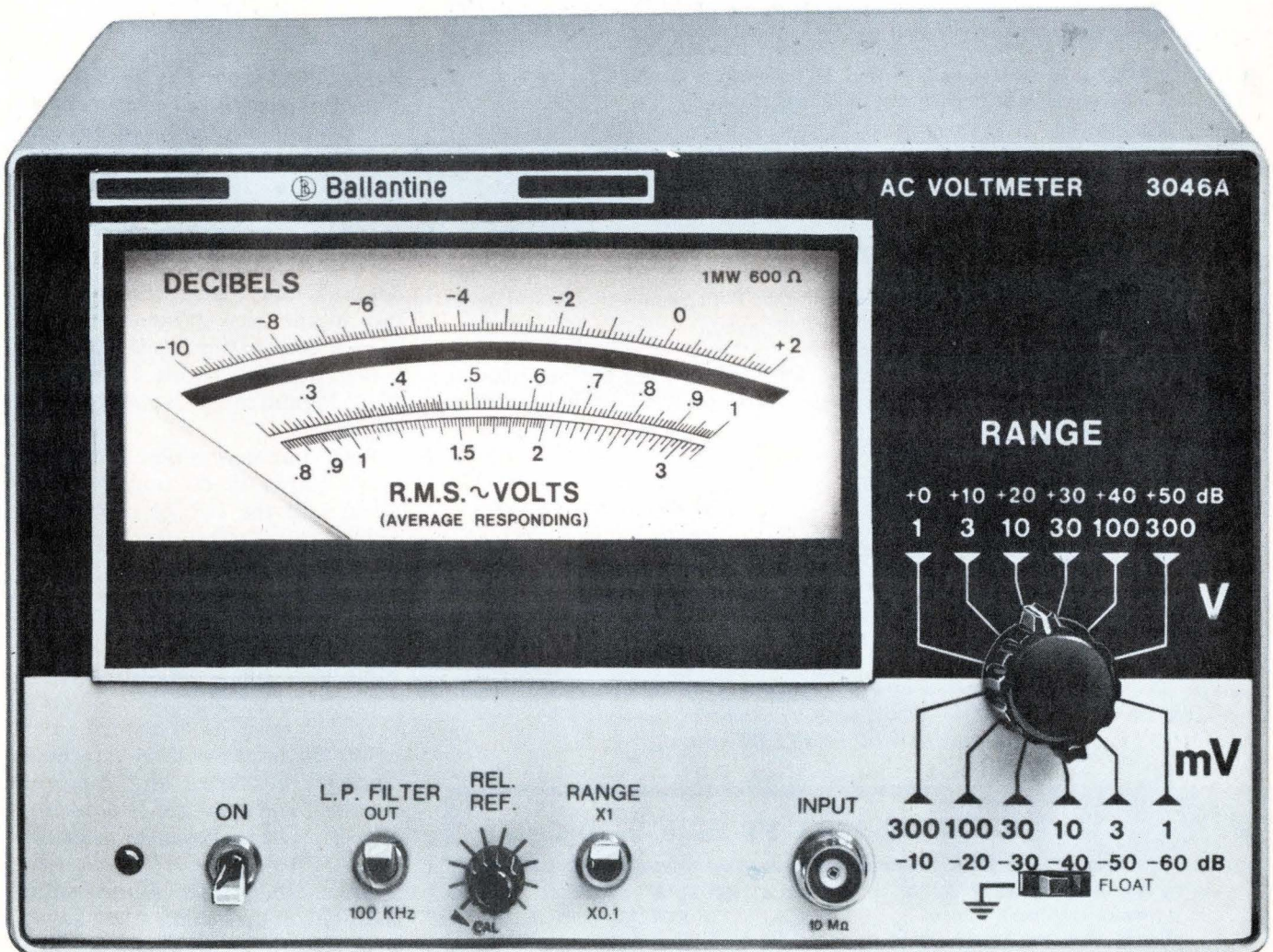

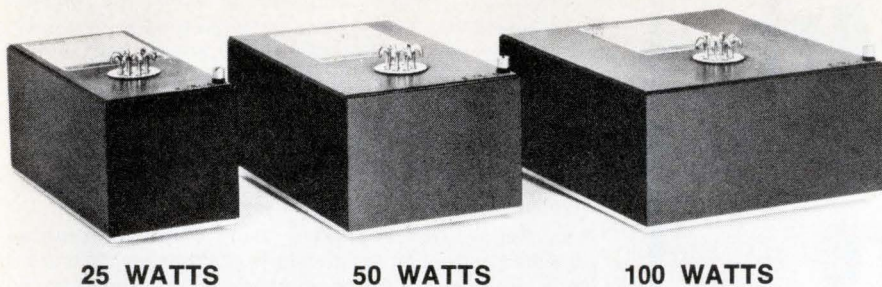

Readers comment

Chronology counts

To the Editor: Bell Labs certainly ranks among the most productive laboratories in the world, but Bell did not develop the semiconductor laser [*Electronics*, May 15, p. 70]. The first semiconductor lasers were demonstrated almost simultaneously in the fall of 1962 by R.N. Hall of General Electric, M.I. Nathan of IBM, and T.M. Quist of MIT.

Seven years later the Soviet scientist Z.I. Alferov devised the so-called double-heterostructure injection laser, which displayed a very low lasing threshold. This led to the first semiconductor laser capable of continuous operation at room temperature, developed in 1970 by I. Hayashi and his co-workers at Bell Labs. This is no doubt the achievement to which your otherwise excellent article was referring.

Forrest M. Mims
Albuquerque, N.M.

■ *Mr. Mims is correct. He and R. W. Campbell co-authored a history of the development of the semiconductor laser, "Semiconductor Diode Lasers," published in 1972 by Howard W. Sams & Co.*

Converter redescribed

To the Editor: There were inaccuracies in the New products feature, "Dc-dc converter sources have high power density" [April 3, pp. 127-128]. Permit me to set the record straight.

Since our new series F modular single-output dc-dc converters are about half the size of competitive units, they offer approximately twice the power density. For example, our 5-watt model, which measures 2 by 2 by 0.375 inches, has a power density of 3.3 watts per cubic inch. Such performance was achieved by reducing the amount of heat that must be dissipated internally. The units are built with high-efficiency converter and regulator circuitry, and they are housed in a copper package. Power transfer efficiency is 70%.

The modules offer double-output short-circuit protection—they have a

Save 5 Ways with Abbott's New 77% Efficient Power Supplies!

Abbott has a Hi-Efficiency series of power modules that can save 5 ways in your system. The Model "VN" series converts 47-440 Hz AC lines to regulated DC power and uses a new approach in switching technology that provides a highly reliable line of sixty-three high efficiency power modules.

The Model "VN" series saves in the following 5 ways:

- 1 SAVES POWER**—High frequency pulse width modulation and C/MOS digital IC control circuitry allow efficiencies of up to 77% in the Model "VN" series. This high efficiency realizes almost twice the output power per input watt than dissipative regulators.
- 2 SAVES SIZE**—Off line techniques and IC technology combine for packages of 70% less volume compared to dissipative regulators.
- 3 SAVES WEIGHT**—High efficiency means less power dissipated and less heat generated, thereby reducing or eliminating the need for bulky heat-sinking and forced air cooling. This translates into less total weight and smaller system size.
- 4 SAVES TIME**—You can quickly get the power supply you need because we have an extensive line of models to choose from. Outputs of 25, 50 and 100 watts are available at any voltage between 4.7 and 50.0 VDC. With popular voltages in stock, chances are the unit you need is available immediately.
- 5 SAVES MONEY**—At only \$282 for 25w, \$301 for 50w, and \$325 for 100w in small quantities, the "VN's" are among the lowest priced Hi-efficiency units on the market.

Abbott also manufactures 3,500 other models of power supplies with output voltages from 2.7 to 740 VDC and output currents from 4 milliamps to 20 amps. They are all listed, with prices, in the new Abbott Catalog. Included are:

60 A to DC
400 A to DC
28 VDC to DC
28 VDC to 400 A
12-38 VDC to 60 A

Please see pages 307-317 Volume 1 of your 1974-75 EEM (ELECTRONIC ENGINEERS MASTER Catalog) or pages 853-860 Volume 3 of your 1974-75 GOLD BOOK for complete information on Abbott Modules.

Send for our new 60 page FREE catalog.

abbott transistor

LABORATORIES, INCORPORATED
general offices eastern office

5200 W. Jefferson Blvd./Los Angeles 90016
(213) 936-8185 Telex: 69-1398

1224 Anderson Ave./Fort Lee, N.J. 07024
(201) 224-6900 Telex: 13-5332

Fight chassis squeeze with these miniaturized "flat oval" capacitors

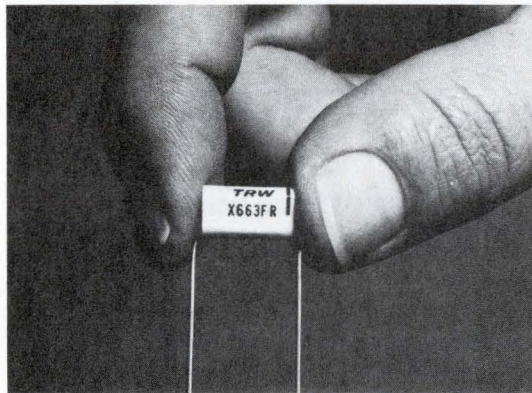

Buy yourself some elbow room—and save some weight in the bargain—with TRW's flat oval, metallized Mylar* capacitors.

This is ultra-miniaturization with *no* compromise on reliability. Capacitances: .01 to 10.0 mfd in 50, 100, 400, 600 vdc. Temp.: -55°C. to 100°C (to 125°C with derating). High IR—30,000 megohm-microfarads minimum; typically much higher. Low DF—usually less than 1.0%. Tolerances to $\pm 1\%$. Self-healing.

With their flat oval design, these metallized Mylar miniatures offer maximum space savings. And for maximum flexibility in assembly, they are available with axial or radial leads—Types X663F and X663FR respectively. Instrument quality, either way.

Write for catalog or application engineering assistance. TRW Capacitors, an Electronic Components Division of TRW, Inc., Box 1000, Ogallala, Neb. 69153. (308) 284-3611.

*Du Pont T.M. for polyester film

TRW[®] CAPACITORS

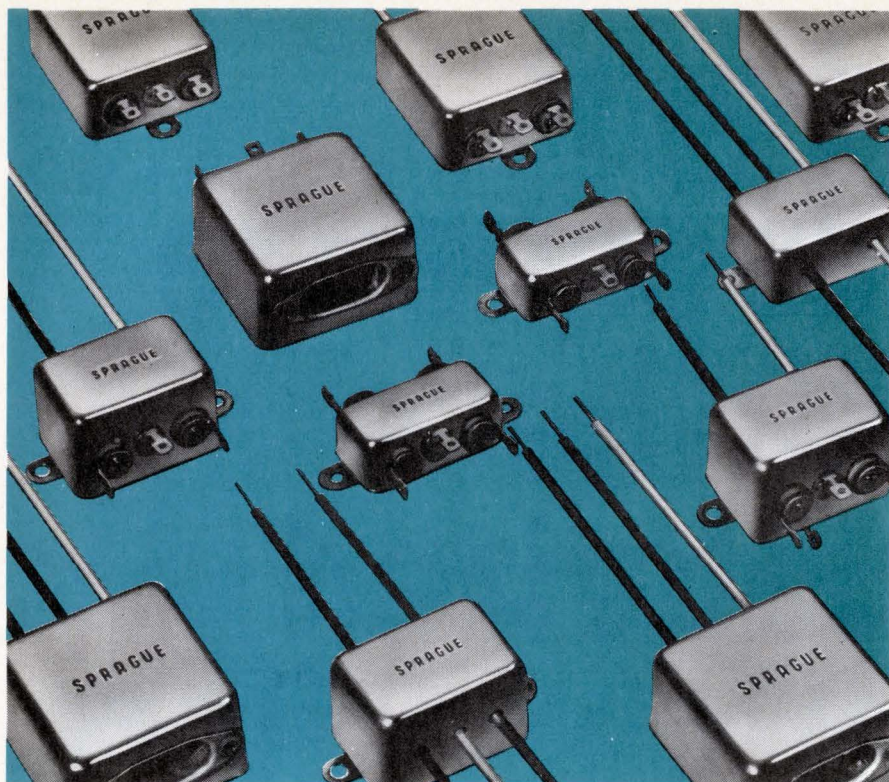

FILTERS THAT WORK. FILTERS THAT FIT. FILTERS YOU CAN AFFORD.

Sprague JX5100 Series EMI Powerline Filters give you the right blend of efficiency/size/cost.

The lower cost of these general-purpose filters makes them especially suitable for higher-volume production-assembled equipment such as computer peripherals, cash registers, credit card verifiers, electronic service instruments, etc.

Series JX5100 Filters are designed to protect equipment from line noise as well as to protect the line from equipment noise, particularly equipment with high impedance loads. Smaller in size than many filters with comparable performance, they control line-to-ground interference with a high degree of efficiency. Filtering both sides of the line, the need for two filters is eliminated.

Available in a wide variety of current ratings (1 to 30 amps) and several different terminal configurations, Series JX5100 Filters withstand a test voltage of 2100 VDC, assuring protection against high-voltage transients. Line-to-ground capacitance is only $.01\mu\text{F}$, and maximum leakage current (each line to ground, @115V, 60Hz) is 1.0mA.

Sprague maintains complete testing facilities for all commercial, industrial, and government interference specifications.

For complete technical data, write for Engineering Bulletin 8210.11 to: Technical Literature Service, Sprague Electric Company, 35 Marshall Street, North Adams, Mass. 01247.



Readers comment

nonlatchdown constant-current-limiting circuit, as well as a thermal-limiting circuit, permitting them to withstand a short for as long as eight hours at 71°C ambient. Line regulation is $\pm 0.02\%$, load regulation is also $\pm 0.02\%$, output noise voltage is held to 28 millivolts peak to peak, and isolation voltage is 500 v dc minimum.

The units can accept an input voltage of 5, 6, 12, 15, 24, 28, or 48 v. The single output can be: 3, 5, or 6 v at 1 ampere; 9 or 12 v at 500 milliamperes; or 15 v at 350 mA. In quantities of one to nine, price is \$89 or \$99, depending on the model.

Daniel T. Sheehan
Stevens-Arnold Inc.
South Boston, Mass.

Spying and lawsuits

To the Editor: Re the article "Theft of secrets: headache continues" [*Electronics*, May 15, p. 63], industrial spying is not to be condoned even in "hard economic times," but neither are lawsuits aimed at engineers who are rendered guilty until proven innocent. While a patent means "open to public perusal" it merely is a permit to prosecute. Engineers often can't afford the legal fees to prove that much "proprietary information" is common knowledge.

John J. Stapleton
East Brunswick, N.J.

Conditions unusual

*A number of readers have commented that Roland J. Turner's integrator circuit [*Electronics*, March 6, p. 82] has in fact the same transfer function as any other integrator, i.e., $-1/sCR$; and that its input impedance is just R, because the feedback arrangement makes the op amp's noninverting terminal a virtual ground.*

The author agrees that, for operation with normal frequencies and voltages, these criticisms are indeed valid. But he says the approximations that yield them are not valid under the unusual conditions of his application (seismic pulses: 100 mV at 1 to 20 Hz). We regret that these conditions were not made clear in the original article.

Super ROM!

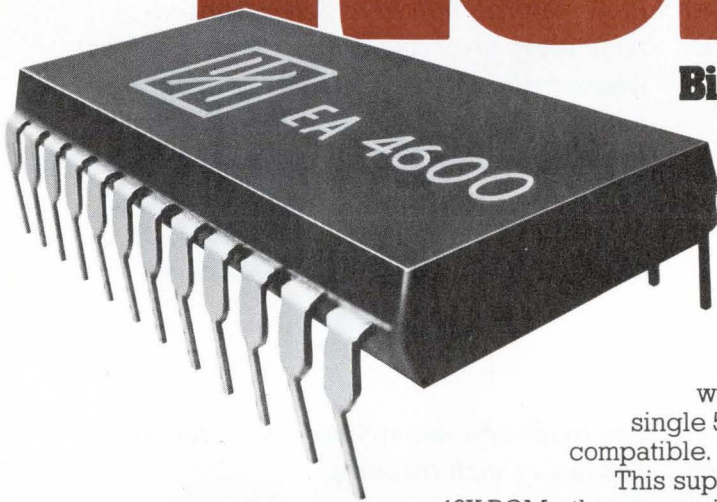

Biggest: 16K bits
Fastest: 550 ns
Simplest: one 5v supply

The new EA 4600 is the fastest 16K ROM you can buy. Guaranteed access time is 550 ns under worst-case conditions. Organization is 2048x8 convertible to 4096x4. And as if that

weren't enough, the EA 4600 operates on a single 5-volt supply and is completely TTL-compatible.

This superior ROM is pin-compatible with slower 16K ROMs: the economical 950 ns EA 4900 (\$19.50 in 100 quantities), the TMS 4800 and the MK 28000. The 4600 has 3-state outputs that can be OR-wired. Power dissipation is only .03 mW per bit. Both molded and hermetic 24-pin DIPs are available, and we deliver in eight weeks.

This N-channel wonder costs just \$29.90 in 100 piece quantities—only 0.18¢ per bit. What's more, the big storage capacity cuts both assembly and system costs, and the simple interface reduces support circuit costs.

Now you can link a microprocessor to a big 16K ROM without limiting system speed. The 4600 is fast enough for nearly all microprocessor applications.

In military systems, the EA 4600M is a natural. It's specified from -55° to +125°C. And it will meet all criteria of MIL STD 883 Level B.

Ask for our new application note on interfacing the EA 4600 with popular microprocessors. For further information phone Bob Cushman, Memory Products Marketing Manager, on our toll-free WATS line.

SuperROM comes to you from one of the lesser known world leaders in advanced ICs. Electronic Arrays has been quietly producing standard MOS/LSI products in high volume for over six years. Many are complex MOS calculator circuits which you don't see advertised. They contain advanced RAMs, ROMs and microprocessors—sometimes all three on one chip.

Look to Electronic Arrays for some spectacular product introductions in the months to come.

electronic arrays, inc., 550 e. middlefield rd., mountain view, calif. 94043 / phone (415) 964-4321 / TWX 910-379-6985 / outside california use toll-free WATS (800) 227-9962 / eastern regional office, cherry hill, NJ (609) 795-5066 / mid-america office, st. louis, MO (314) 878-6446 / western office, huntington beach, CA (714) 968-3775.



**electronic
arrays**

Editorial

Age discrimination: the problem . . .

The conclusion of the IEEE's recent report—The EE At Mid-Career—that electronics engineers experience significant age discrimination is a sobering and serious one. Indeed, the finding that older EEs are victims of the very technology that gives them livelihood—because it moves so fast that training cannot keep pace—is one of the most serious professional problems facing the engineer today. For details on the report and reaction to it, see the story on page 65.

The data on discrimination appears to be clear-cut. "Older," by the way, is defined as over 40, a cut-off figure more in keeping with sports than with a profession as socially vital as engineering. The older engineer suffers more than his younger colleague when promotions or pink slips are handed out. What's more, his hurdles appear to be higher when he makes the rounds of the employment offices.

. . . and some answers

This is a complex problem, and the solution is going to be complex, too. That's because no one person or group can tackle the problem alone. The engineer, however, is in the key position. Not only does age discrimination concern him directly, but his actions can do the most to force other groups to act on his behalf. He should:

- *First of all, given the reality of the situation, take stock of his career position. Of course any successful professional is constantly making these evaluations. Yet, after years of riding the crest of technological progress, EEs may not be used to thinking in these terms.*
- *Do all he can to make his company aware that many official and unofficial company policies and practices—though management may not realize it—are, in fact, discriminatory.*
- *Demand a share in advanced projects that will challenge his abilities and add to his expertise.*
- *Take advantage of the continuing education opportunities an employer provides and do all he*

There are, of course, reasons given for the different ways of treating younger and older engineers. Technical training becomes outmoded very fast—15 years is the estimated "half-life" of electronics engineering education. Pay scales are certainly different, with the younger engineer at a lower salary considered more "cost-effective." And there can be no doubt that the older engineer costs a company more in fringe benefits and the like.

Yet that is not all the story. There are subtle management attitudes to be factored in. What is more natural than to assign advanced-technology projects to the younger engineer, whose training seems to suit the assignment better? But what happens, then, to the enhancement of the older engineer's knowledge by experience—the on-the-job continuing education that in other professions is an accepted tool in fighting obsolescence?

can to interest management in extending its support of such training.

- *Certainly not be reticent about pointing out examples of age discrimination in hiring, promotion, or firing, especially if he is convinced management does not see the discriminatory aspect of a case.*
- *Finally, support the, so far, limited moves by such professional organizations as the IEEE—and push for more aggressive action.*

Age discrimination is not only illegal, it is wasteful. The veteran engineers should be a valuable resource, and any management that would throw away the investment it has already made in them is something less than far-sighted. What's more, a company that fails to give challenges to its older engineers is simply working out a self-fulfilling prophecy. In the words of one educator: "If someone is assumed to be over the hill and he is being given less challenging work, then he may go over the hill."

This bus is powered by pure Schottky.

The Am26S10. An absolutely super quad bus transceiver.

It's the world's fastest. 15ns propagation delay, either driving or receiving.

The drivers have open collector outputs capable of sinking 100mA at .8 volts. It can send or receive information on any normal piece of wire. It allows ideal termination of 50 ohm (or greater) transmission lines for single-ended, two-way communication.

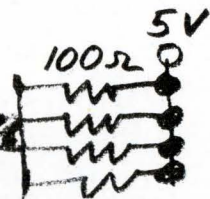
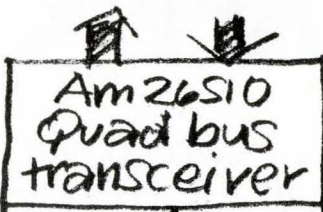

What more can we say? Lots. Compatible with Schottky TTL logic. High noise immunity. Common enable for all four bus drivers. Bus is isolated during power-down. High-performance replacement for the 55/75138. MIL-STD-883 for free.

If you'd rather have a non-inverting driver, ask us about the Am26S11. It'll get you to the same place.

Hurry. Don't miss the bus.

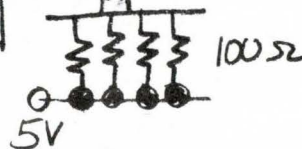

Advanced Interface.

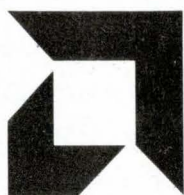

The first available 256x4 CMOS RAM

Intel's new 5101 1K silicon gate CMOS static RAM is the first easy to use nano-power RAM. It combines high density and ultralow power with a fast, fully static, 256 x 4 modular organization that eliminates clocks, interface circuits and special power supplies while minimizing package count. Now available from stock at Intel distributors, the 5101 is the ideal RAM for upgrading non-volatile, battery backup and portable equipment memory system designs.

Even at elevated temperatures, the 5101 keeps battery drain extremely low.

At 70°C, maximum standby current is 15 nA per bit, limiting standby power to 75 nW per bit.

Worst case access time (and minimum cycle time) is only 650 ns over the 0°C to 70°C temperature range.

Intel distributors also stock the M5101 for military temperature range applications. At 125°C, maximum standby current is 200 nA/bit, maximum standby power 1000 nW/bit. Worst case access time for the M5101 is 800 ns over the -55°C to 125°C temperature range.

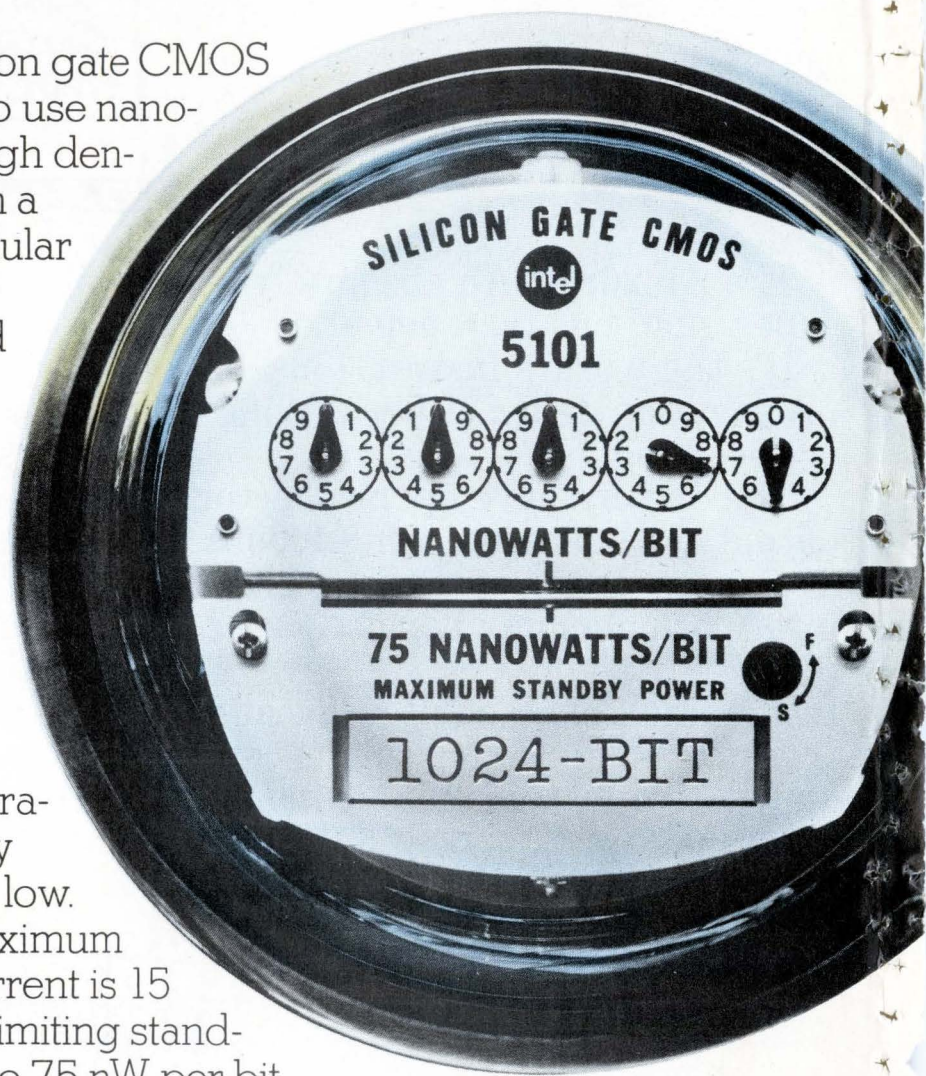

Available nanopower M. Intel's 5101.

**AVAILABLE AT
YOUR INTEL
DISTRIBUTOR**

INTEL'S 1K CMOS STATIC RAM FAMILY

PART NO.	WORST-CASE SPEED*	SIZE	PINS	STANDBY POWER/BIT	AVAIL.
5101	650 ns	256x4	22	75 nW	Now
5101L**	650 ns	256x4	22	75 nW	Now
5101-3	650 ns	256x4	22	1 μ W	Now
5101L-3**	650 ns	256x4	22	1 μ W	Now
M5101-4	800 ns	256x4	22	1 μ W	Now
M5101L-4**	800 ns	256x4	22	1 μ W	Now
M5101-5	800 ns	256x4	22	5 μ W	Now
M5101L-5**	800 ns	256x4	22	5 μ W	Now

*Worst case access times and minimum cycle times are guaranteed over full operating temperature range (-55°C to +125°C for M5101-4, M5101L-4, M5101-5, M5101L-5; 0°C to +70°C for all other types).

**Guaranteed data retention at power supply voltage as low as 2V.

The easy to use 5101 is fully static, chip enable clocking is not required during address transitions. It also interfaces directly with TTL or CMOS and operates with a single +5V supply.

The 256 x 4 configuration is optimum for any memory system organization and is an ideal building block for memory expansion. You get two chip enable inputs, four data inputs, four three-state outputs with output disable control, and read/write control. The output disable pin controls bus states, making bidirectional logic unnecessary in common I/O buses.

The 5101, with its high density and ease of use, is the ideal nanopower RAM for portable instruments and microprocessors, advanced calculators, data collection devices, process controllers, POS, OCR, medical, avionics, ground support—for any equipment demanding long battery life, or non-volatility with battery

back-up. The 5101 silicon gate CMOS RAM is in full production and in distributor stock, along with our other easy to use n-channel static RAMs.

For immediate delivery contact Almac/Stroum, Component Specialties, Inc., Cramer, Hamilton/Avnet, Industrial Components, Inc., Sheridan, and L.A. Varah Ltd.

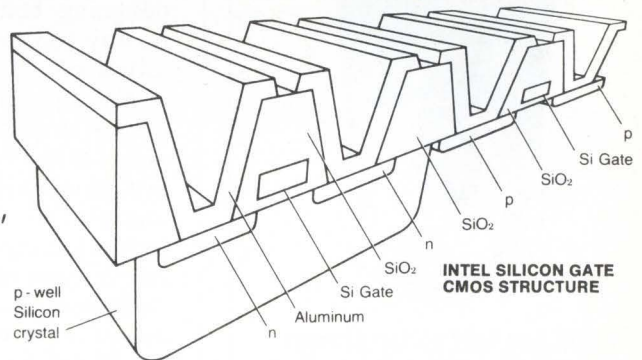

intel[®] delivers.

MORE
COMPANIES
BUY
WIRE-WOUND
RESISTORS
FROM
RCL
THAN
FROM
ANYONE
ELSE
ON
EARTH

Write for
catalog



Call our hotline for prompt
service and delivery.

(603) 627-3831

AMF

RCL Electronics

General Sales Office:
700 So. 21st Street
Irvington, N. J. 07111

People

Watson emphasizes software
at Varian Data Machines

"The battle in the marketplace will be won or lost on the basis of software," says Gordon Watson, the new engineering vice president for



New veep. Understanding the system is important to Varian Data Machines' Watson.

Varian Data Machines Inc., the Irvine, Calif., minicomputer manufacturer. "Hardware at least has technology going for it," he explains, pointing out that new and improved components are continually appearing. But while hardware inadequacies can often be minimized by designing better software, "there's no way you can compensate for *bad* software."

Watson brings to his engineering post a strong background in software. With Varian for more than five years, he is moving up from vice president for systems development. Before joining Varian he was corporate director of systems software for Computer Usage Corp., Dallas. His degree is in electrical engineering, but "I just like software better," he says. And he regards software development as a critical factor as he guides Varian's major thrust toward the end-user portion of the minicomputer business.

Watson plans for Varian to become a "major force" in the transaction-oriented data-base market as well as the message-switching market. This emphasis represents a big switch for the company—60% of its

business at one time was with low-end original-equipment manufacturers.

'Total' system. For the data-base market, Varian recently introduced a data-base-management software system called Total, and will continue to work on specialized packages that require intimate knowledge of the applications. It takes more than salesmen to sell in the systems market, Watson observes. "You have to understand the user's problem and play it back to him with alternatives to show him you understand it."

With respect to microprocessors, Watson points out that other divisions of Varian Associates, the parent company, are or will be using them. And so will Varian Data Machines. "We don't believe anyone will be a viable mini producer who doesn't support a microprocessor development"—either for peripheral equipment or for the minicomputer itself, says Watson. However, he adds that there are "strong Varian management opinions on centralizing microprocessor development." And it has not yet been decided if Watson's division will play that central role.

Data recorders are Dow's
next big challenge

Despite strong criticism from the Air Line Pilots Association, James E. Dow intends to go ahead with Federal Aviation Administration plans to evaluate and later require flight-data recorders to track pilot

Mover. FAA's Dow believes new data recorders would eventually save money.



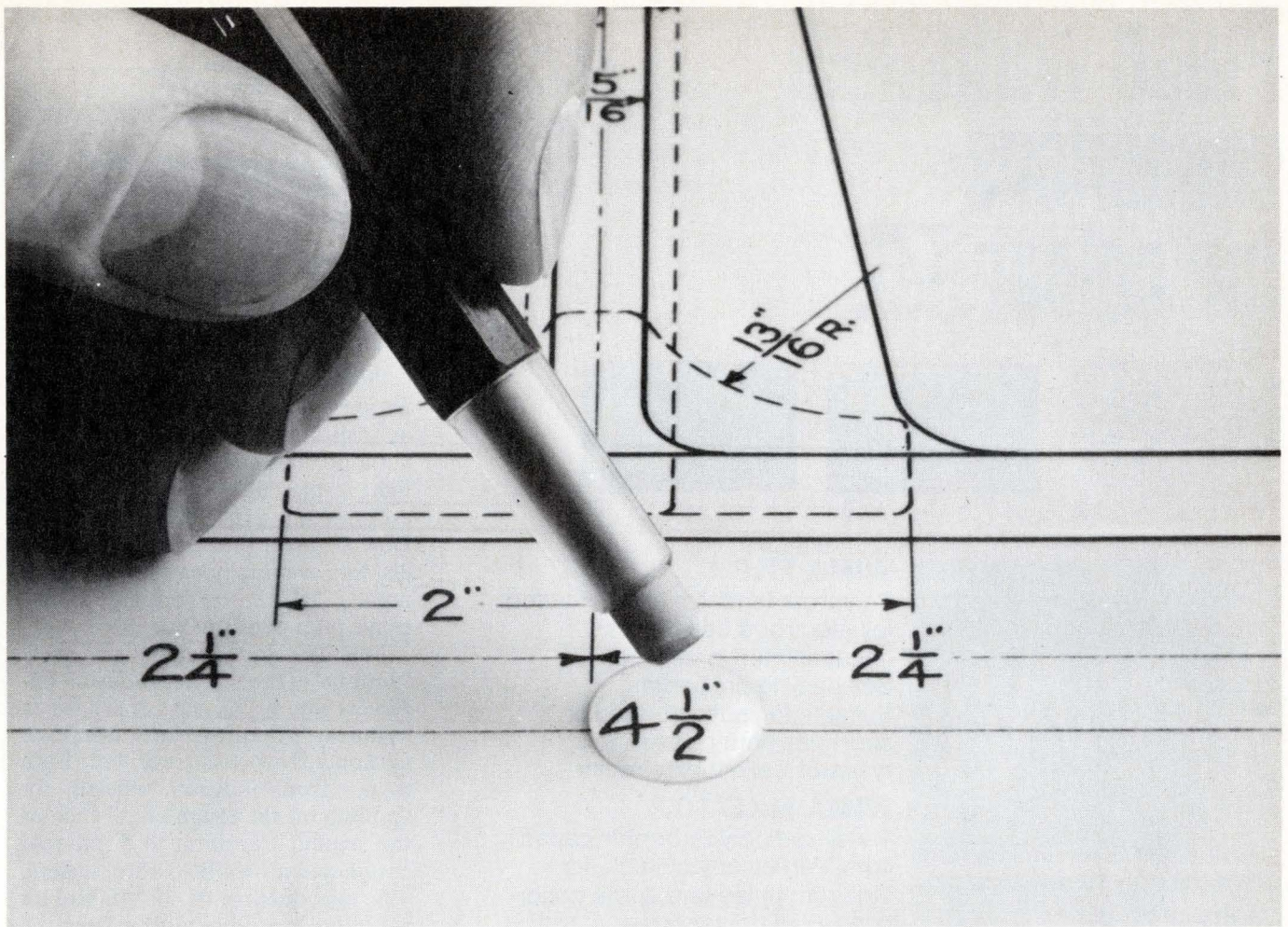

Get the drop on redrawing drudgery.

Shortcuts with Kodagraph materials can turn drafting hours into minutes.

Nobody likes to retrace a whole drawing just because a few revisions are necessary. You don't have to if you make a second original on Kodagraph wash-off film. Simply wet-erase what you don't want—using plain water and a soft eraser—draw in the new details and the job is done.

If on the other hand, you're faced with repetitive details, draw them once. And then order as many Kodagraph film or paper reproductions as you need. Cut them out,

tape down on drawing form, rephotograph and you have a new original.

When you need to restore a battered, old drawing, have a reproduction made on Kodagraph film. Stains virtually disappear. Weak lines come back strong. And you end up with a crisp, legible black-on-white print.

Get the details.

Write for information on how you can reduce drafting time with photoreproduction techniques. Eastman Kodak Company, Graphics Markets Division, Dept. R5726, Rochester, N.Y. 14650

Kodak products for drawing reproduction.



Pulse withstand capacitors for colour T.V.

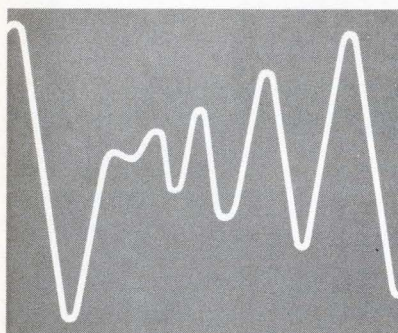
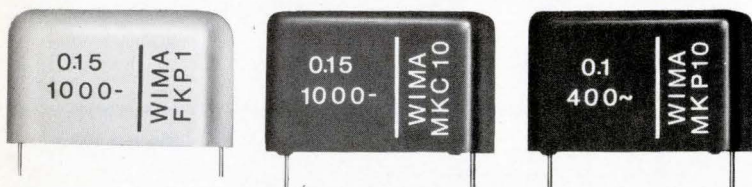

WIMA FKP 1

Polypropylene film and extended foil electrode capacitors encapsulated in cast resin. Self-healing properties. Suitable for sharp-edged or short rise time pulses in thyristor deflection circuits.

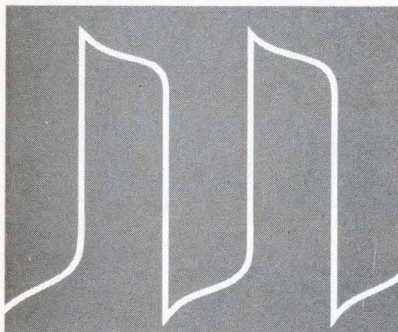

WIMA MKC 10

Metallized polycarbonate capacitors. Particularly suitable for stringent pulse and surge conditions. Low power factor at high frequencies. Self-healing properties. Plastic case design.

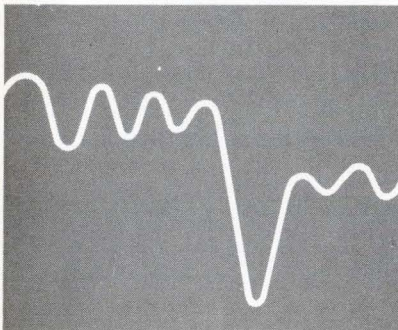

WIMA MKP 10

Metallized polypropylene capacitors in plastic cases. Self-healing properties. Suitable for both high current and pulse circuits owing to low dielectric losses.

- Other special capacitors in metal cases.
- One year successful field experience in equipment by leading manufacturers.
- Suitable for advanced solid-state equipment.
- For professional electronics.



WILHELM WESTERMANN

Spezialfabrik
für Kondensatoren
D-68 Mannheim 1
Fed. Rep. of Germany
Augusta-Anlage 56
P. O. Box 2345
Tel.: (621) 40 80 12

Write for our new catalogue.

People

and aircraft performance in the nation's aircraft [*Electronics*, May 29, p. 43]. "Although I haven't had a chance to evaluate the ALPA response [to a planning conference], it's not going to faze us. We'll work it out," says Dow, the acting FAA administrator.

"Pilots are against the recorders—period," he points out. "It's almost an institutional position. But they're very professional and will see the light in the end." Despite the cost—estimated at \$100,000 per aircraft—Dow believes that the data recorders will eventually save the airlines money, largely by helping to improve pilot performance.

Patience and pragmatism mark "Jimmie" Dow's style, industry observers say. In 32 years of service in aviation planning and administration, Dow has received high marks from industry officials for "pulling off the tough ones" such as the smooth transition to a national automated air-traffic-control system. The introduction of the flight-data recorders is another test for Dow.

The key to his success, he says, is that he "builds the bridge" between operational needs and R&D planning. Managing a technical R&D program for nontechnical users requires good communications, he says.

"It's simply a matter of making sure that the system needs are understood. I can't build hardware or draw up specifications, but I can make sure that the systems are all tied together correctly," he says. Although educated as a high-school mathematics teacher, Dow says that his lack of a technical background is not a hindrance. "It may not even be beneficial to be an engineer. An engineer tends to second-guess others. I just have to ask the right question. And the right second question," he explains with a friendly smile that belies his grizzly-bear appearance.

Dow looks forward to staying on as deputy when a successor to former FAA administrator Alexander Butterfield is named. "I know how all the pieces fit together," the acting administrator says.

N-type silicon substrate

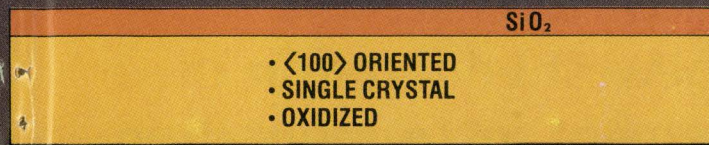

NMOS transistor and N⁺ guard ring formation

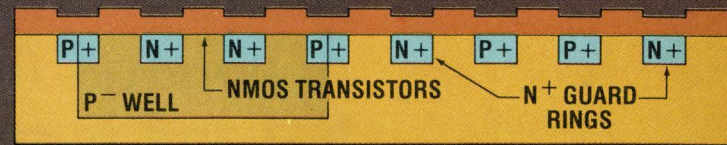

Ion implanted P⁻ well

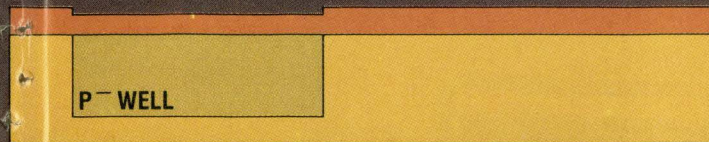

Gate oxide formation

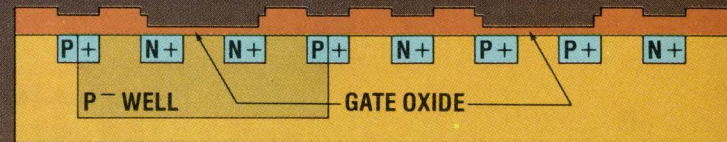

PMOS transistors and P⁺ guard ring formation

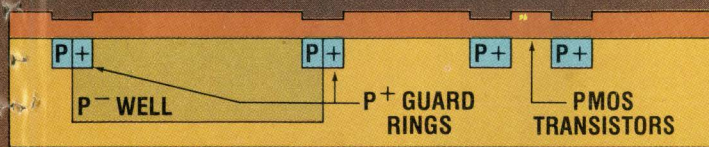

Metallization

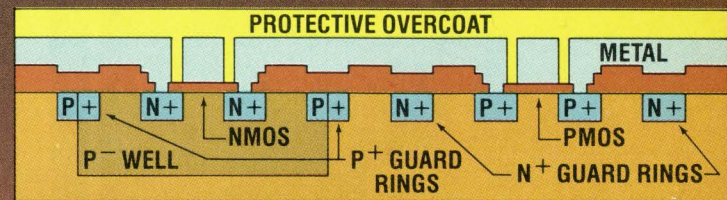

CMOS

Ion Implant

Precise control. Consistent high quality.
Uniform performance.

Texas Instruments CMOS has built-in quality right from the start. In the wafer stage, ion implant is used to maintain tight electrical parameter distributions. This ensures uniform device characteristics. Quality is further ensured through

clean oxide fabrication techniques and regular in-line process control monitoring.

Couple this quality control with the manufacturing experience of Texas Instruments and it means lower cost to you. But that's not all.

TI's experience in plastic pack-

aging is yet another benefit. Because you can get plastic CMOS that's dependable, tough, and most important, shows outstanding performance in moisture testing. In fact, it's the same plastic TI has used for hundreds of millions of Linear, TTL and MOS products.

CMOS Life Test Results			
Test	Number of Devices Tested	Number of Failures	Equivalent Hours at 55° C
Operating Life @ 125° C	572	11	12,213,997
Operating Life @ 150° C	40	3	610,688
Storage Life @ 150° C	347	0	11,104,000
Operating Life @ 55° C	78	0	118,000
TOTAL	1037	14	24,046,685
NOTE: Failure rate estimate is .064%/1000 hrs., quoted at a 60% upper confidence level, data extrapolated to 55° C, for units fabricated with and without ion implant.			

Now for reliability. TI CMOS devices have undergone more than 24-million equivalent hours of high temperature life testing. See the table.

Low cost, ion implanted CMOS in a proven plastic package is today's answer for total sys-

tem reliability.

Literature available. For a cross reference guide, reliability report and price sheet write Texas Instruments Incorporated, P.O. Box 5012, M/S 308, Dallas, Texas 75222. Or call. (214) 238-2982 or 238-4841.



TEXAS INSTRUMENTS
INCORPORATED

NORLAND INSTRUMENTS

Announces the newest generation of
test and measurement instrumentation.



The NI 2001 Programmable Calculating Oscilloscope

Here is the ultimate instrument for the acquisition, processing and manipulation of electrical data. It completely eliminates the need to compromise your requirements with a jumbled array of separate instruments. The NI 2001 is a *complete* unit that combines all the capabilities of a digital oscilloscope and a microprocessor in a single mainframe. It brings you flexibility, convenience, accuracy and reliability you won't find anywhere else.

This — the first programmable calculating oscilloscope — is the product of many years of technological research and instrumentation engineering. With the advent of microprocessor technology, Norland Instruments engineers were quick to recognize the power available to the instrument designer and first applied a microprocessor to the Norland line of medical instruments. That experience ultimately led to the use of microprocessor technology in the development of the NI 2001 — the first truly new generation of test and measurement instrumentation for the industrial and scientific user.

The NI 2001 gives you the precision of a digital oscilloscope for data acquisition and display *plus* the built-in capability of a microprocessor for data reduction. You can make exact

calculations of rise times, integrals, differentials, peak areas, RMS values, peak-to-peak measurements, n-point averaging, and an almost unlimited range of other operations. It increases your productivity by letting you measure, display, digitize, store and process data faster and more accurately than ever before. The NI 2001 will analyze data and, through conditional branching, function as a decision making instrument. It is easily programmable — without computer instructions — so repetitive operations can be completely automated. Its mainframe, through modular design, has provisions for a wide range of plug-in modules to let you expand your system to meet individual requirements. It can even be interfaced to control other equipment.

Now, consider the economics. Surprisingly, the NI 2001 mainframe is \$8,500. The instrument shown here, with monitor and two single-channel plug-ins, can be yours for \$13,400!

You've waited a long time for an instrument as versatile as the Norland Instruments NI 2001. Wait no longer. Investigate it today.

To arrange for a demonstration and complete information, send the reader service card or write Norland Instruments, Department A-1.



NORLAND INSTRUMENTS

A Subsidiary of Cordis Corporation

Norland Drive, Fort Atkinson, Wisconsin 53538 U.S.A.

For information circle 19 on reader service card.

For demonstration circle 18 on reader service card.



If you could save up to 30% without losing anything by using this new 10mm ceramic trimmer capacitor, wouldn't you want to know it?

That's exactly what we can promise you for many applications. All the performance you need for about a third less than you've been spending.

These new trimmers have five capacity ranges from 3.0pF min. to 30.0pF max. Their operating temperature range is -30°C . to $+125^{\circ}\text{C}$. And they mount interchangeably with other ceramic trimmers for PC applications. Four dielectric types available.

But check them out for yourself. Get the coupon in the mail today.



E. F. JOHNSON COMPANY /Waseca, Minnesota 56093. Dept. 3012
You bet I'd like literature and a free test sample of your new low cost trimmer capacitor if it can do what you say!

Check capacitance (pF) range needed:

- 3.0 to 8.0 3.0 to 12.0 5.0 to 13.0
 5.0 to 20.0 5.0 to 30.0

_____ Please send them directly.

_____ Please call me at: _____

Name _____

Firm _____ Title _____

Address _____
City _____ State _____ Zip _____



E. F. JOHNSON COMPANY

20 Circle 20 on reader service card

Meetings

International Conference on Communications, IEEE, Fairmont Hotel, San Francisco, June 16-18.

Nepcon East and International Microelectronics Conference, ISCM Inc. (Chicago), New York Coliseum, New York, June 17-19.

Symposium on Computer Networks—Trends and Applications, IEEE and NBS, Gaithersburg, Md., June 18.

International Conference on Fault Tolerant Computing, IEEE, Paris, France, June 18-20.

Symposium on Computing in the Mid-70s: An Assessment, ACM and NBS, Gaithersburg, Md., June 19.

Design Automation Conference, IEEE and ACM, Statler Hilton Hotel, Boston, Mass., June 23-25.

Siggraph '75, Second Annual Conference on Computer Graphics and Interactive Techniques, ACM, Bowling Green State University, Bowling Green, Ohio, June 25-27.

Nuclear and Space Radiation Effects Conference, IEEE, Humboldt State, Arcata, Calif., July 14-17.

Summer Computer Simulation Conference, ISA et al, St. Francis Hotel, San Francisco, Calif., July 21-23.

Dielectric Materials, Measurements, and Applications, IEEE, Churchill College, Cambridge, England, July 21-25.

1975 Gordon Research Conference on Solid State Studies in Ceramics, Brewster Academy, Wolfeboro, N.H., Aug. 4-8.

Symposium on the Simulation of Computer Systems, NBS and ACM, Boulder, Colo., Aug. 12-14.

Tenth Intersociety Energy Conversion Engineering Conference, IEEE, University of Delaware, Newark, Del., Aug. 17-22

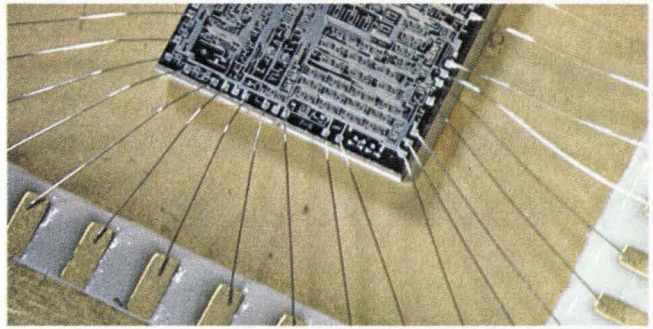

If you're planning a new product, you should know what we know about LSI.



During the past five years, we've helped our customers develop and produce numerous "dedicated" LSI subsystems in the fields of electronic timekeeping, instrumentation, medical and consumer electronics. These efforts have resulted in several outstanding product successes.

The advanced technologies of Large-Scale Integration, no matter how dramatic they may appear to be, aren't for every application.

Knowledge of the tradeoffs, pitfalls and limitations which can compromise LSI implementation is often just as important as projecting its potential benefits.

Knowing these things is our job. Things like cost/quantity tradeoffs, long-term profit analysis of the host product, how to choose the right processes to optimize performance and reliability.

If you're considering LSI, consider Micro Power first. Call us or write for some fact-filled literature on LSI—what it is, how it works, and how we can make it work for you.

We sell more than circuits. We sell solutions.

MICRO POWER SYSTEMS

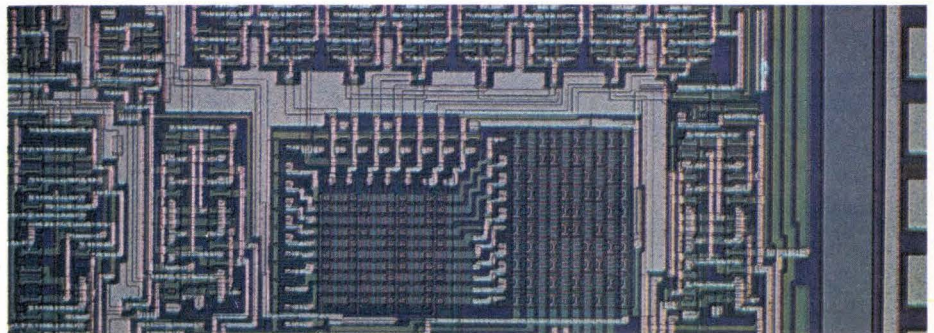
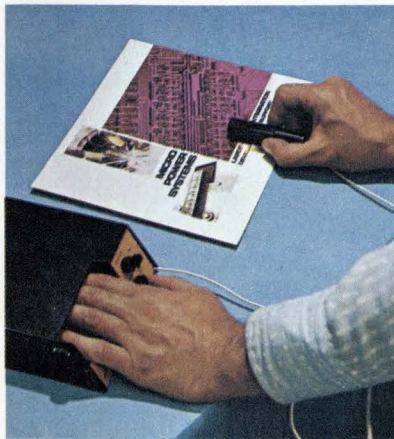

3100 Alfred Street
Santa Clara, CA 95050
Telephone (408) 247-5350
TWX 910-338-0154

MPS/Japan
21 Mori Bldg.
2-2-5 Roppongi
Minato-ku, Tokyo, Japan
Telephone 586-0371

If you wanted to hook up a computer to a system that exercises electronic calculators, how would you do it?

Singer Business Machines did it simply, with Digital.



Computer on one end. Exerciser on the other. A single off-the-shelf module and

a bit of cable in between. Simple. Beautiful.

The project manager at Singer designed it. He'd heard about our new M1705 module that contained two complete PDP-8 interfaces on a single card. And he knew just what to do with it. He put it to work on his current project, a computerized testing system for Singer's electronic calculators.

Using our Logic System Design Handbook as a guide, he put together a parallel interface between the PDP-8/e computer and the electronic exerciser he'd designed. Each M1705 module interfaces two exercisers. The entire operation of up to eight exercisers is controlled locally by a single operation at 30 times the speed the operation took by hand.

The M1705 interface saved Singer's project manager a lot of time.

And a lot of trouble. And 40% of the cost of the interface.

If you've got an interfacing problem, we can give you the same kind of support we gave Singer. You'll find standard solutions to most of your problems in the Logic Products Handbook and the Logic Systems Design Handbook. To back up the solutions, we've got the hardware: digital and analog modules, computer interfacing modules, power supplies, cables, accessories, and wirewrap capabilities. Custom design assistance, too. And field specialists to offer advice if you get bogged down.

No one else can say nearly as much.

Which is why you'll probably want to get in touch with Digital next time you have an interfacing problem.

Components Group, Digital Equipment Corp., One Iron Way, Marlborough, Mass. 01752. Digital Equipment of Canada Ltd., Box 11500, Ottawa, Ont. K2H8K8 613-592-5111. Europe: 81 Route de l'Aire, 1211 Geneva 26, tel. 42 79 50.

digital
COMPONENTS
GROUP



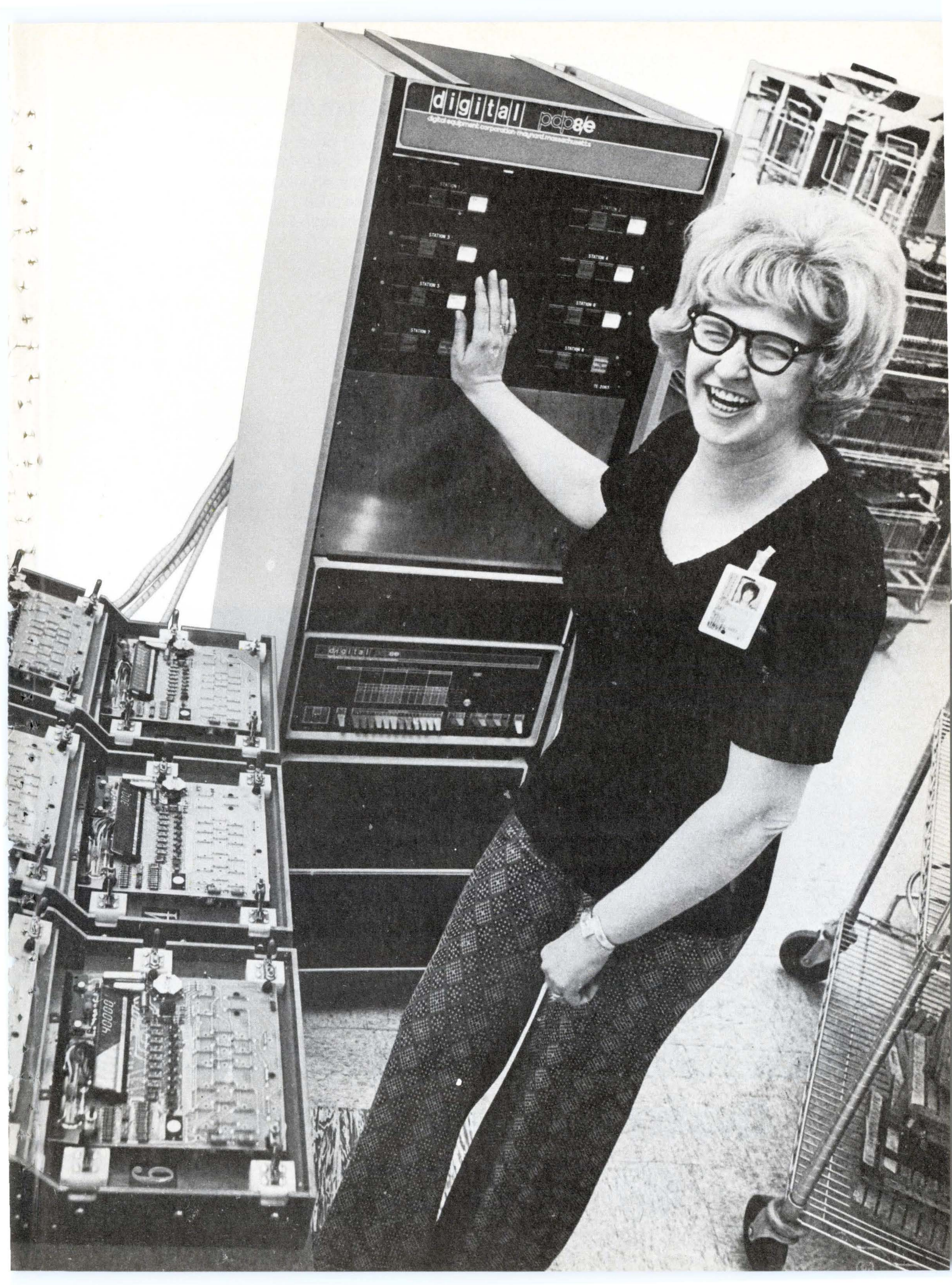

Get more for your money!

Use This New 3/8" Square Cermet Trimmer From Allen-Bradley

Our new TYPE E trimmer is a high performer with a realistic price. It has some important advantages: • Immersion seal is tested in 85°C water (not 50° or 70°). • Temperature characteristic is 100 PPM/°C for stability. • Multifingered contact for excellent adjustability. • \$0.49 each—1000 piece price. For more information call your A-B distributor or write for Publication 5219.

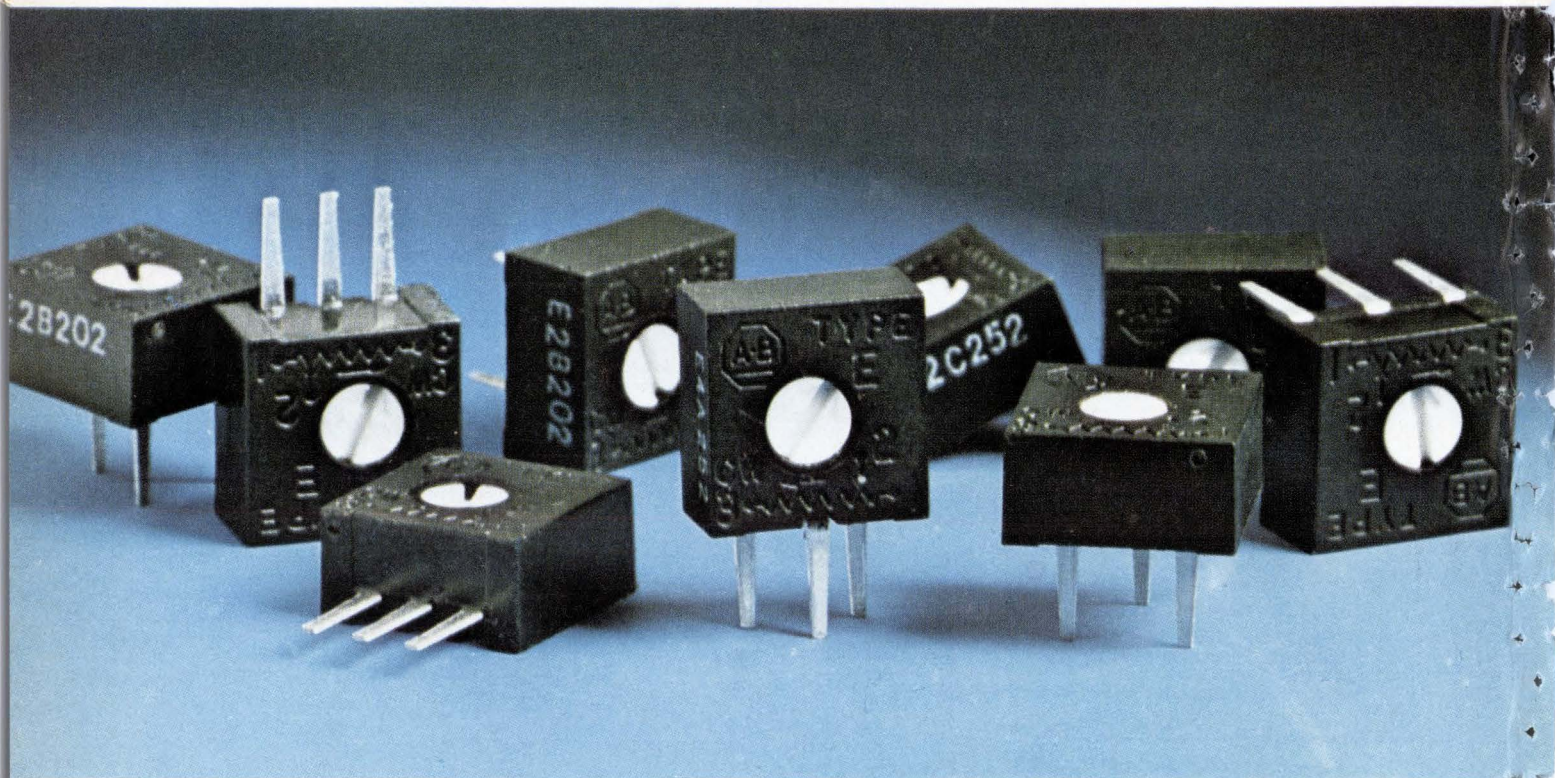
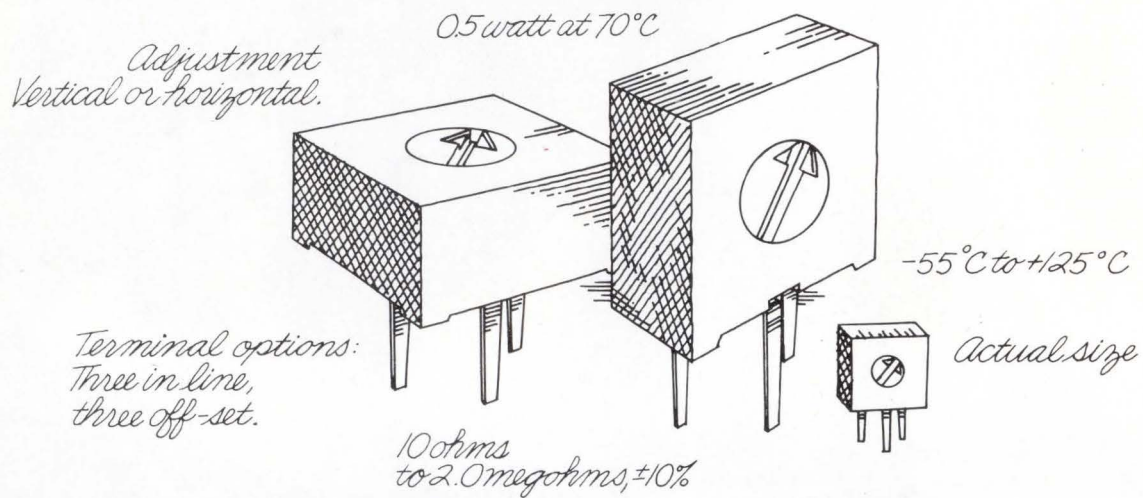

Quality in the best tradition.



ALLEN-BRADLEY

Electronics Division
Milwaukee, Wisconsin 53204

Circle 24 on reader service card

EC108

IC makers say upturn is almost here

Most major IC makers are not yet willing to talk about a boom, **but they agree that the awaited upturn is almost here.** A National Semiconductor spokesman says there has been an increase in business across the board in the last two or three months. Significantly, he says, distributor orders are up, meaning that small companies are beginning to order, and the big buyers are expected to follow. Also, customers are asking for deliveries in 30 days, a sure sign that inventories are down. National expects to see the big upturn by September.

Intel Corp.'s marketing vice president, Jack C. Carsten, agrees that more near-term deliveries are being requested—"within the next 90 days," rather than 90 days to a year. And a spokesman for Fairchild Semiconductor expects 1976 to be a strong year, preceded for Fairchild by a "modest—under 10%—recovery in the second half of this year." At RCA's Solid State division, Ben A. Jacobi, marketing vice president, says he has seen "significant improvement" in C-MOS and bipolar sales in the second quarter.

Texas Instruments officials, now preparing their five-year projections, wouldn't comment officially, **but the company expects a year-end boom.** There is strength in consumer sales—where electronic TV tuners will become a factor and where video games and video players will be important. Microprocessors also will continue to gain, as will memory sales for computer mainframes.

RCA replaces C-MOS parts; offers tighter specs

RCA's Solid State division in Somerville, N.J., has begun recalling its CD4000 A and B series C-MOS devices from distributors and is replacing them with new devices with improved specifications and guaranteed performances. **The reason, says RCA, is confusion about inconsistent specs among devices from different makers that are supposed to be interchangeable.**

A major part of the problem, says Norman C. Turner, product director, is the proliferation of C-MOS suppliers and their failure to get together on standard specifications. And he says RCA is trying to gain a competitive edge by offering specification advantages.

Tighter A series specifications include guaranteed noise margin of 1 volt, as well as the previously guaranteed 30% supply voltage. RCA will also guarantee input leakage current of 1 microampere where no level has been guaranteed to date, and 100% test to guarantee maximum quiescent current at 15 v where devices were formerly tested to only 10 v. Improvements in the B series include a 20-v maximum rating, 100% testing to guarantee maximum quiescent current at 20 v, and guaranteed input leakage of 1 microampere.

Hughes, Ebauches in license deal for digital watches

Ebauches SA, currently the world's largest producer of mechanical movements for watches but an also-ran in the digital-watch derby, has entered a **license agreement with Hughes Aircraft Co.'s Micro-electronic Products division for technology relating to electronic watches.** The Swiss firm will receive licenses both on related Hughes patents and Hughes' IC technology. Hughes, in Newport Beach, Calif., is currently the largest U.S. producer of digital watches for watch firms.

Electronics newsletter

Bendix lists MLS changes

To strengthen the scanning-beam microwave landing system's chances of being adopted as the global standard by the International Civil Aviation Organization [*Electronics*, Feb. 20, p. 78], Bendix Corp.'s communications division wants to make two significant hardware changes. First, the original Ku-band flare antenna, which airlines dislike because it means waveguide plumbing on the aircraft, **will very likely disappear in favor of altimeter inputs**. Second, instead of using C-band distance-measuring equipment as called for in the FAA's specifications, **Bendix wants to stick with the L-band DME hardware currently in use**. The changes would make for substantial cost savings for airborne and ground equipment for MLS, Bendix maintains.

Nippon Electric launches invasion of U.S. IC market

The biggest IC maker in Japan is preparing to compete head-on in the U.S. with American microcomputer and memory manufacturers. Nippon Electric Co., which had \$1.6 billion in sales last year, **has formed a subsidiary and opened a sales office and warehouse** in Lexington, Mass. The subsidiary, NEC Microcomputers Inc., will initially handle the μ COM-8 microcomputer as well as a 4,096-bit random-access memory that accesses in 150 nanoseconds, plus some TTL and ECL products.

Oak bimetal strip ends relay 'kick'

Oak Industries has come up with a method that could take the inductive "kick" out of electromechanical relays. Instead of actuating the device with an induction coil, which has problems with transients, Oak has developed **a bimetallic strip that, when heated, snaps the relay contacts into a closed position**. Although slower than conventional relays, the device will be able to handle up to 5 amperes in a standard dual in-line package and should sell for \$1, rather than the \$1.50 charged for comparable devices. The bimetallic actuators are coated with an electrical insulation and screened with resistor patterns that heat when current is applied.

Mostek to show microcomputer

After one frustrating crack at the systems business with calculators, Mostek Corp. is headed back in again—this time with microcomputers. The firm's first product—GEMS-8 for general evaluation microcomputer system—is **an 8-bit machine that will hit the market next month**.

Originally conceived to aid users in developing software for the MK-5065 one-chip microprocessor [*Electronics*, June 27, 1974, p. 30], the \$995 package can be designed into customers' applications. Mounted on one board are processor, crystal oscillator, clock-generator logic, sockets for programable-read-only-memory, 1,024-by-8-bit memory, and teletypewriter interface. The other contains 12-k-by-8-bits of add-on memory, built from 3-k random-access memories.

GEMS-8 also will be the heart of two hardware-development systems that Mostek plans to offer this fall. Both will allow users to program Mostek's multichip and one-chip calculator circuits for control applications.

The AN2538 is the lowest-cost line-powered 3½ digit DPM you can buy . . . with the performance and dependability you need. Big ½" LED display for long life and wide-angle viewing. Autozero for long term stability. High CMRR/NMRR for noise and ground-loop immunity. Very low bias current (100pA max), for error-free high-impedance. Super-regulated power supplies. All this adds up to *usable* ±0.05% accuracy.

But price and performance are only part of the breakthrough. The

AN2538 takes *full* advantage of its monolithic circuitry. It runs exceptionally cool (5°C rise) and operates over -10°C to +70°C. It has the longest MTBF ever achieved in a 3½-digit DPM—enhanced by a 96-hour, 50°C burn-in cycle. Its tough LEXAN® case meets both NEMA and DIN standards. It has a universal power transformer, for worldwide use.

Last year, we broke through the interface problem with our AN2533/53 pluggable interface, premium-performance DPM . . . still

the best for many applications. The AN2538 reflects Analogic's 200,000-DPM experience . . . experience unmatched by any other source.

Want complete data? Ready to evaluate a sample? Call Analogic's Marketing Dept. at (617) 246-0300, or your local Analogic sales office, or write today: Analogic Corp., Audubon Road, Wakefield, Mass. 01880. Also available, new 70 page Circuit Application Handbook, write on letterhead.

ANALOGIC ■
... The Digitizers

Circle 27 on reader service card

**This new
A/D
converter
CHIP*...**

**...makes
this new DPM
today's best
value, <\$69.
(in OEM quantities)**



*Building instead of buying? The MN2301 is a complete, autozeroed, dual-slope-integrating A/D monolithic converter with multiplexed BCD output. It's your best bet for any 3½ digit DPM or DVM requirement. Attractive quantity discounts. Send for complete application data!

Pro-Log microprocessor modules reduce parts count and design time, and drop assembly costs.

Design engineers using this new approach can cut system costs up to 80%.

Choose the wrong approach to microprocessor system design and you could wind up quadrupling your total cost.

The computer-oriented approach costs big money, gives you more capability than you may need.

Semiconductor manufacturers regard microprocessor-guided systems as a form of computer typified by data processing techniques.

They promote features like interrupt, built-in control panels, program loaders, direct memory access, memory capacity and throughput. But their approach is only applicable to situations where large volumes of data must be manipulated in a job that may change from hour to hour. This kind of versatility tremendously increases system costs—you wind up buying RAM memory, canned software, and such peripheral devices as tape, card, disk, keyboard and display controllers. And you need a computer programmer to design your system for you.

If you really need that kind of versatility, maybe you need a computer, not a microprocessor.

The Pro-Log Logic Processor approach does the job at minimum cost.

Pro-Log treats the microprocessor module as a logic processor especially suitable for dedicated control.

This avoids the computer-oriented requirements for software, complex peripherals and unnecessary performance. Pro-Log's microprocessor modules are normally hardwired to relay contacts, switches, push buttons, displays, or other devices instead of communicating with them through expensive controllers. Simple-to-program PROMs rather than software-directed RAMs configure Pro-Log's modules in their specific activity. Using Pro-Log's approach, system design stays with the design engineer, not the computer programmer. And our approach not only enables you to design hardware but to produce it easily and maintain it in the field.

A microprocessor module, correctly applied, can replace large numbers of logic gates and timing elements as well as the sockets, power supplies, packaging, connections and wiring that go with it. By decreasing parts and interconnections, you lower assembly and rework costs, improve reliability, and cut inventory. The simplicity of microprocessor modules lets you get into high volume production quicker.

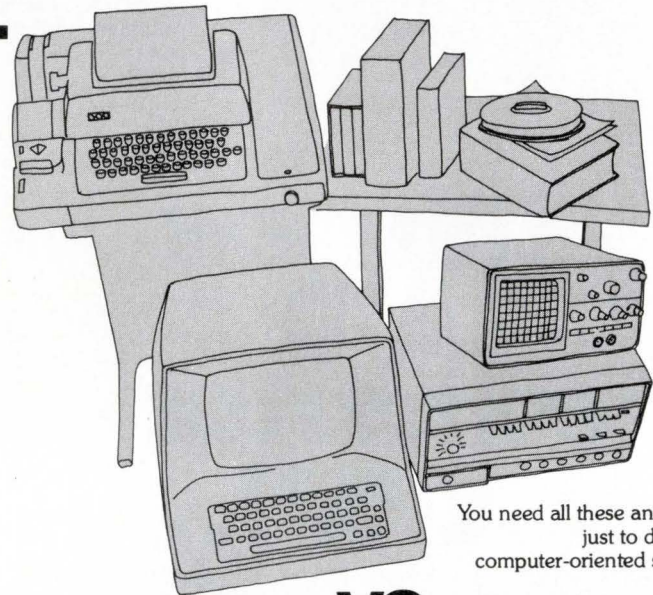

You need all these and more just to design a computer-oriented system.

VS.



These are the only tools you need to design, produce, and field-service a logic processor system: M821 system analyzer, Series 90 PROM Programmer, coding form, oscilloscope.

If that describes your product application, maybe you should be using a Pro-Log logic processor.

Only Pro-Log has the tools you need to apply the logic processor approach.

We've got the most complete line of microprocessor modules anywhere, including off-the-shelf delivery on modules using 4004, 8008, 4040, and 8080 CPU chips. We'll be delivering modules using the 6800 chip in the near future. We've got designer manuals, applications notes, instruments and test equipment, too.

Money-back guaranteed education.

Pro-Log offers two microprocessor courses nationwide.

Our one-day applications course costs \$100. If we don't convince you we've got the best approach to the use of microprocessor modules, just tell us so and we'll

give you your money back, no questions asked.

We've also got a three day hands-on course we've given to more than 1,000 design engineers in the past two years. The only two requirements are that you know what a flip-flop and a gate are. If you do, we guarantee you'll come out of our course knowing how to design, program and use microprocessor modules because you'll have done it.

Contact Pro-Log for a complete list of course schedules and locations. Also send for our free paper "Microprocessors for Dedicated Control."

PRO-LOG CORPORATION



852 Airport Road
Monterey, CA 93940
Telephone (408) 372-4593

Optical circuit combines functions in a single crystal

Experimental Bell Labs device integrates laser, waveguide, modulation on gallium-arsenide base

In a drive to integrate light-frequency circuits in semiconductor materials, Bell Laboratories researchers have scored a breakthrough. They've been able for the first time to integrate circuit functions in the combination of gallium-arsenide and aluminum-gallium-arsenide materials from which injection lasers are fabricated.

Light generated by a laser in experimental Bell devices was coupled into a waveguide and then modulated by using a reverse-biased pn junction. Moreover, it was also possible to adjust the laser-beam's divergence so that it could be coupled into an optical fiber. These capabilities are necessary if integrated optical circuits are to be built into light-frequency systems offering extremely high-capacity communications.

In fabricating the circuits, a liquid-phase epitaxy, made up of appropriate concentrations of arsenic, aluminum and other dopants in gallium melts, was grown in successive layers on a gallium-arsenide-crystal base. Franz K. Reinhart, one of the researchers, says that the basic laser structure consists of a GaAs layer no more than 1 micrometer thick, sandwiched between two slightly thicker AlGaAs layers. Reinhart, along with Ralph A. Logan, who work in Bell's Solid State Electronics Research Laboratory at Murray Hill, N.J., de-

scribed the development in a paper at the Conference on Laser Engineering and Applications sponsored by the IEEE Quantum Electronics Council and the Optical Society of America at the end of May.

Transfers. The laser energy was transferred efficiently into a low-loss waveguide built inside the laser cavity by two methods. In one method, the active GaAs layer is joined during the device growth to a similar coplanar structure of a slightly different composition in which the laser light is guided without loss. In the second, Reinhart reports, a low-loss waveguide is grown under the active layer without interfering with the laser operation, and the GaAs layer is made to terminate in a smooth taper that reflects the laser energy into the adjacent waveguide, which conducts it elsewhere in the integrated circuit [*Electronics*, Jan. 24, 1974, p. 34].

With the laser energy coupled into the low-loss waveguide section, "a number of integrated components have been added to the optical circuit," report Reinhart and Logan. "An electric field was superimposed on the waveguide, using a reverse-biased pn junction to both amplitude- and intensity-modulate the laser energy." They add that "such a junction could also be operated as a laser energy detector."

A Bragg reflection grating, ion-milled onto the waveguide's exposed region, was used to lock in the laser frequency to that determined by the grating. "By smoothly increasing the waveguide thickness adjacent to the exit face, the laser beam's divergence can be reduced to the value desired" to efficiently

couple the output from the laser into an optical fiber, explain the researchers.

A 100-nanosecond pulsed laser was used at a low repetition rate—up to only about 500 hertz—to avoid having to heat-sink the devices. But Reinhart soon expects to fabricate integrated monolithic optical circuits with a continuous-wave laser at room temperature that can be modulated "as readily as a gas laser."

Improvements. Further ahead are circuits for multiplexing and demultiplexing signals, which Reinhart says is "do-able in principle." Nevertheless, he points out that some significant improvements in the circuits must come before they can get out of the laboratory.

Multiple lasers will have to be grown on the same chip, and better control of double-hetero-structure-laser power levels is needed. Furthermore, distortion caused by spiking in the modulated output must be reduced, Reinhart notes. □

Consumer

Audio-video imports decline sharply

Imports of home-entertainment products fell by record percentages during the first three months of 1975, reflecting the domestic recession. New figures assembled by the U.S. Department of Commerce indicate that imports of color-TV receivers, the leading consumer import, registered a 37% drop to 157,000 units from 250,000 units

U.S. AUDIO/VIDEO PRODUCT IMPORTS
(in thousands of dollars)

Country of origin	January - March		% change
	1974	1975	
Japan	\$ 190,223	\$ 164,575	-13.5
Taiwan	86,940	66,889	-23.1
Hong Kong	24,502	17,779	-27.4
Korea	19,142	15,426	-19.4
United Kingdom	17,565	12,461	-29.1
Canada	9,130	4,299	-52.9
Singapore	8,048	7,977	-0.01
West Germany	5,980	5,866	-0.02
Brazil	5,294	7,388	+38.6
Mexico	3,141	289	-90.8
Others	1,306	1,994	+52.7
TOTAL	\$ 371,271	\$ 304,893	-17.9

Source: U.S. Commerce Department

during the first 1974 quarter. Monochrome-TV imports dropped nearly 39% from 1.1 million sets a year ago to 683,000 sets.

Declines in unit imports were also recorded in radio/phonograph combinations, which dropped 61%; phonographs and turntables, off 37.8%; home radios, down 35.6%; and tape recorders/players, down 15.3%. Automobile-radio imports dropped by one third to 730,000 from 1.1 million last year.

Changes. The dollar value of imports was off less sharply, however, reflecting some prices that were higher than the 1974 level. The \$304.9 million value of January-through-March imports was down almost 18% (see table). On a country-by-country basis, the import figures show some significant changes. Brazil, for example, showed the only gain with its shipments, consisting of auto radios and some first-time deliveries of color-TV receivers.

Imports of monochrome-TV also underwent some major changes. In contrast, Taiwan, the leading foreign shipper, which had shown consistent quarterly gains since 1970, shipped only 683,000 sets—down by a third. Imports from Korea, almost exclusively from Korean-Japanese joint ventures, were off by nearly one-half from 113,000 to 60,000 units. Japan, apparently phasing out of monochrome production while

transferring assembly operations to southeast Asia, shipped only 62,000 sets—a 53% decline. No shipments were reported from Mexico, which had delivered 29,000 sets in the first quarter of 1974.

Other countries posting declines in the value of shipments to the U.S. in 1975's first quarter included Hong Kong and Singapore (home radios are the major imported items); the United Kingdom (record players/changers/turntables), and Canada (auto radios).

Canada, formerly the leading foreign supplier of auto radios to the U.S. market, sustained the bulk of a 361,000-set decline. Shipments fell 70% from 425,000 to about 142,000 in the quarter. Auto-radio imports from Japan dropped by 50,000 to 273,000. The increase of auto radios from Brazil to 259,000 units from 174,000 last year was still far below the 398,000-set average in each of the last three quarters of 1974. □

VideoDisc aims at simple player unit

The design goal of RCA Corp. for its SelectaVision VideoDisc home-player unit was clear: simple circuitry at low cost. With its sights thus fixed on the consumer market, RCA is sallying forth in the color-TV

video-disk sweepstakes with a number of interesting innovations. The formal debut is scheduled for late next year [*Electronics*, April 3, p. 72], and only recently has RCA revealed the technical details.

Jon Clemens, head of signal and player systems for the VideoDisc, lists these innovations:

- Capacitance-sensing signal retrieval, which requires metallic and dielectric coatings on a vinyl disk but results in a stylus-pickup assembly that's simpler and less expensive than the Philips/MCA laser scanner [*Electronics*, April 3, p. 72].

- A grooved disk, which eliminates an expensive servo loop otherwise needed to position the stylus.

- Operation at a relatively slow 450 revolutions per minute. More material can be packed onto a disk, and unbalance, eccentricity, and warp can be more easily handled.

- An "arm-stretcher" or moving-coil transducer—not unlike a loudspeaker—which moves the stylus along the groove to correct for disk irregularities that could cause timing errors. It contains the only electromechanical servo in the system.

- Buried subcarrier color encoding. By processing the chrominance and luminance signals through interspersed comb filters, and then adding the two signals, it's possible to pack the entire video signal into a 3-megahertz bandwidth.

The disk itself contains a spiral groove. There are 5,555 turns per inch, and the center-to-center distance between adjacent grooves is 180 microinches. Picture and sound information are contained in slots cut into the bottom of the groove. The slots vary in closeness and length along the groove, but not in depth or width. They are cut into disk masters by electron beams which, unlike light beams, can be focused as finely as the system requires.

Changes sensed. As the disk rotates, the player senses changes in capacitance caused by the slots. The capacitance is formed between the metal plating on the disk surface and the metal trailing face of the sapphire stylus (see the figure

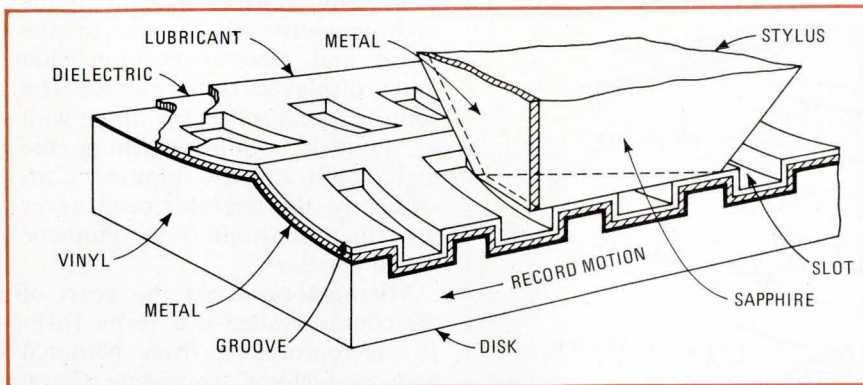

Picture store. Picture and sound information contained in slots in the video disk's grooves is sensed as changes in capacitance occurring between the player's stylus and the disk.

above). The changes are at a level of approximately 3×10^{-4} picofarad. The player converts the capacitance changes into the buried-subcarrier signal that contains picture and sound information.

The pickup arm that holds the stylus and the arm cage, shown below, is used as a resonant radio-frequency transmission line to "broadcast" the frequency-modulated signal to the player circuitry. There is no wired electrical connection to the pickup arm, making stylus and cartridge replacement simple.

The frequency modulation of the audio signals is ± 50 kilohertz on carriers at 716 kHz and 905 kHz. A video fm demodulator supplies the

buried-subcarrier-encoded video signal to the player decoder. The decoder amplitude-modulates the video onto a 5.11-MHz carrier. This translates the chroma subcarrier from 1.53 MHz to 3.58 MHz—the standard color subcarrier frequency—and puts the video at the correct frequency for use with an inexpensive one-horizontal-line delay line. The delay-line output can replace a defective line and will work for multiple-line dropouts, Clemens says.

The phase of the color-subcarrier burst signal is compared to a 3.58-MHz crystal-oscillator signal, and any error signal is applied to the arm stretcher. The same error signal

is supplied to a 5.11-MHz voltage-controlled oscillator, which is used to reduce the color subcarrier's phase error and eliminate hue errors. □

Auto firms look at thin-film meter

Microprocessor-based systems, when finally installed on automobiles to control such things as engine performance, will only be as good as the data that's fed into them. This means that accurate—and low-cost—sensors will be crucial to successful operation.

Engineers at the Electronic Products division of Corning Glass Works, Bradford, Pa., hope they have a solution to the problem of measuring the air flow needed to determine the optimum fuel/air ratio. It's a flowmeter without moving parts that's based on the phenomenon of vortex shedding, which occurs when air strikes a flat surface. The phenomenon has been applied in flowmeters in process-control systems, but these meters are much larger, and the sensing mechanism is different from Corning's.

Testing. Several automobile manufacturers are testing the Corning system, along with other air-flow measuring devices, says Corning's Meryle D. W. Adler, supervisor of resistor development. Corning would like to standardize on one size, Adler says, but each auto maker seems to want a different response characteristic. And since response depends on the blunt body's dimensions, it might be difficult to achieve this standardization, he explains. The metering technique is also applicable to fluids and gases and Corning is therefore considering marketing it as a general-purpose flowmeter.

The Corning sensor, which relies on temperature-sensitive nickel film, represents the first application of this film outside the company's temperature-sensitive resistor [*Electronics*, Oct. 3, 1974, p. 135]. The

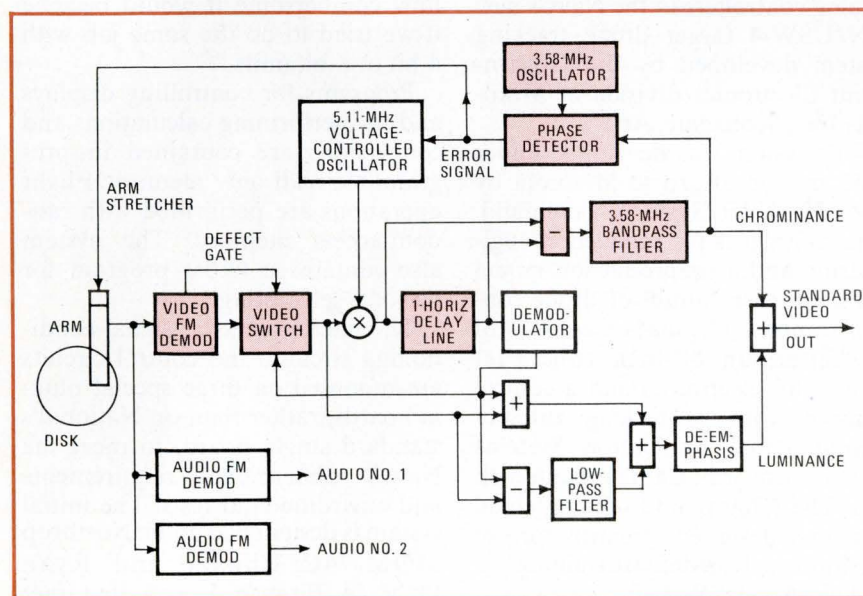

Loop. The only mechanical servo loop in RCA's VideoDisc player controls the "arm stretcher" which positions the stylus along the axis of the grooves in the disk.

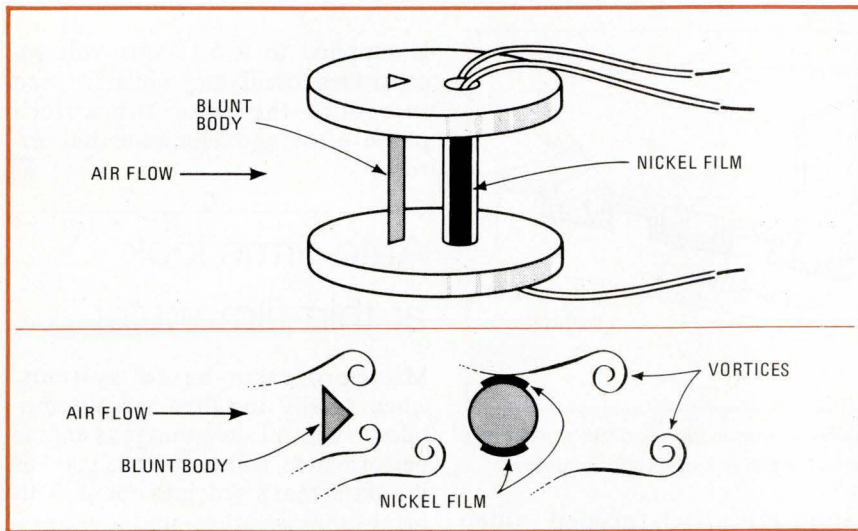

Sensor. Cooling caused by vortices shed at the edges of the blunt body (top) is detected by temperature-sensitive nickel film in Corning flow sensor. Formation of the vortices alternates between the edges with a frequency directly proportional to the flow velocity.

meter contains a sharp-edged blunt body that is placed with its flat surface perpendicular to the flow path. As air flows around the body (shown in the figure), vortices are set up—essentially, they are shed from each edge in turn. But the frequency at which the vortex formation alternates is directly proportional to the flow velocity.

Sensor. Immediately downstream from the body is a sensor consisting of two thin strips of Corning's nickel-film material deposited on a glass substrate. The films have a high temperature coefficient of resistance, low thermal mass, and a relatively large surface area so that they respond rapidly to changes in the heat-transfer characteristics of the air caused by the vortices.

As the vortices are shed from alternate sides of the blunt body, the films are cooled, causing an alternating change in their resistances. The strips are connected as two legs of a Wheatstone bridge so that the frequency of resistance change is detected as a voltage change at the bridge output.

This output is a sinusoidal signal, typically on the order of a few millivolts peak to peak and with a frequency that is linearly proportional to the stream velocity over a wide range of flow rates. Tests to date have produced reliable signals over

the range of 5 to 330 feet per second of air flow. With a body 0.1 inch wide, the meter produces a signal of 17 hertz per foot per second of air flow. □

Military

Processors guide Navy target drones

Microprocessors are replacing analog controllers in the Navy's new AN/USW-4 target drone tracking system developed by the Government Electronics division of Motorola Inc., Scottsdale, Ariz.

The system was developed under a \$3 million award to Motorola by the Naval Air Systems Command. The contract is for production engineering and a preproduction model common to a family of drone-control stations. The station consists of a shelter, an 80-inch cube that houses all electronics and a control console, with a tracking antenna manufactured by Datron Systems Inc., Chatsworth, Calif., mounted on top. The 3,300-pound self-contained system is designed primarily for use in shipboard air-defense training.

The AN/USW-4 incorporates a gyro-stabilized antenna, with sensors to determine its pitch, roll, and

yaw. The control system sends flight-maneuvering signals to the drone and receives position data that's displayed on a plotter. The control operator flies the drone with a "joystick" while watching the flight path on the plotter. Consequently, the operator need never see either the drone or the gunners' actual positions.

Microprocessor. At the heart of the control system is a 16-bit IMP-16 microprocessor from National Semiconductor Corp., Santa Clara, Calif., which functions both as a computer and as a controller. As a computer, it constantly calculates the drone's position from telemetry inputs; as a controller, the IMP-16 keeps the tracking antenna pointed at the drone.

Further, the microprocessor controls the displays and lighting of appropriate switches. Previously, analog controllers were used to track and guide the drones. "The use of a microprocessor gives far greater accuracy," elaborates David Hall, a Motorola design engineer. "We chose the 16-bit microprocessor because we do so much number-crunching in the system. Some of the parameters are quite complex—even with the 16-bit devices, we occasionally have to use double precision. You can imagine how cumbersome it would become if we tried to do the same job with 4-bit or 8-bit units."

Programs for controlling displays and for performing calculations and conversions are contained in programmable read-only memory. Flight operations are performed with random-access memory. The system also contains a PROM program for periodic self-testing.

The microprocessor, signal-conditioning circuits, and control circuits are mounted on three special plug-in boards, rather than on National's standard single board, to meet the Navy's dimensional requirements and environmental tests. The initial system is designed to guide Northrop MQM-74C Chukar and Ryan BQM-34 Firebee I and II target drones, but could accommodate other types of target drones used

You won't have to "baby" these cable testers.

The 1500 Series meets the most stringent environmental specifications for flight-line rated test equipment. These portable TDR Cable Testers are at home operating in a deluge or a sand storm. January in Alaska or August in Texas doesn't bother them. Bouncing around in an off-the-road repair vehicle or being doused with salt spray on board ship doesn't stop them either. They're small, self-contained, rugged, and battery operated.

Your maintenance crews will like the operational simplicity of these testers, and they will need little training to get results. You will like the compact size and low weight, which allow usage in tight spaces, and your boss will like the low cost of the 1500 Series.

The Cable Testers use TDR, a proven technique, to pin point faults to a fraction of an inch in short lines. In longer lines they resolve faults to within a yard as far away as 50,000 feet.

What can you test with this series? Just about any cable assembly from lamp cord to coax, plus a variety of broadband components (antennas, connectors, equalizers, sensors, etc.).

There are two testers. The 1502 for short lines provides fractional inch resolution and works up to 2000 feet. It uses a 110 ps step-test signal into 50-ohms. \$2750. The 1503 for long lines works out to 50,000 feet. It uses impulse test signals into 50, 75, 93, or 125 ohms. \$2750. Both versions are equipped for recording a "signature" of equipment characteristics using an external X-Y Recorder. Signatures can be checked on a routine basis allowing problems to be identified and corrected before catastrophic failures can occur. An optional plug-in Y-T recorder is available (option 4). Add \$475 for the convenience of this built-in chart recorder.

Your Tektronix people can provide you with information or write Tektronix, Inc. P.O. Box 500, Beaverton, OR 97077 or Tektronix Limited, P.O. Box 36, St. Peter Port, Guernsey, Channel Islands now for details on performance and applications. Be sure to ask about the Plug-in Chart Recorder Option for completely self-contained signature analysis.

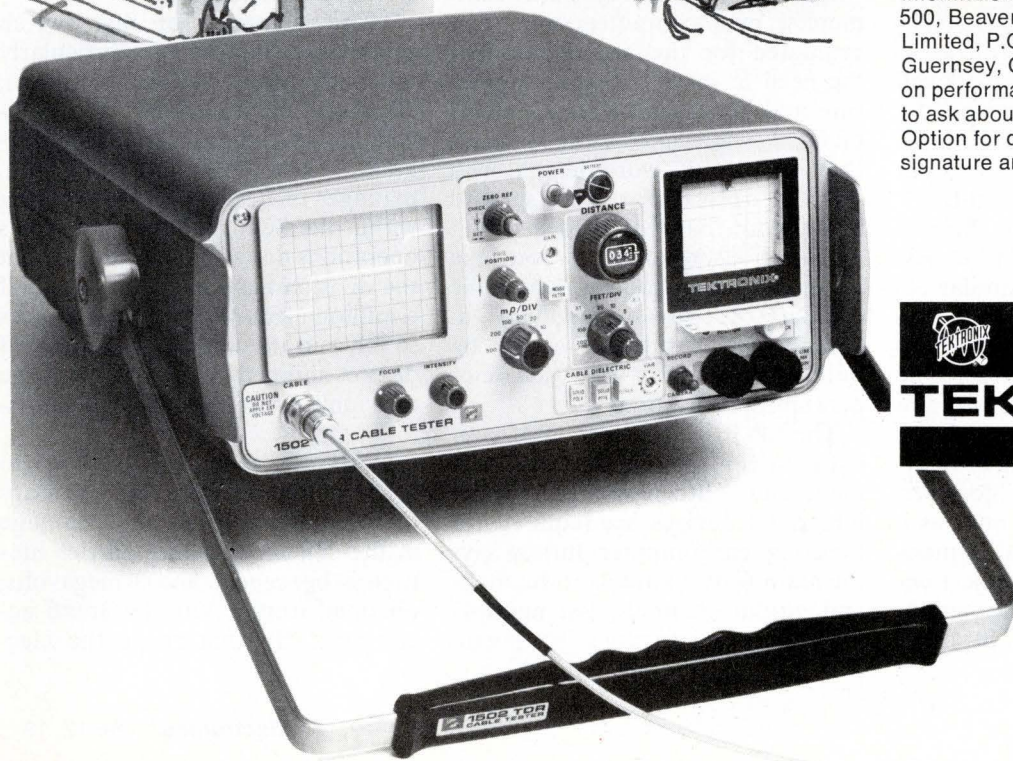
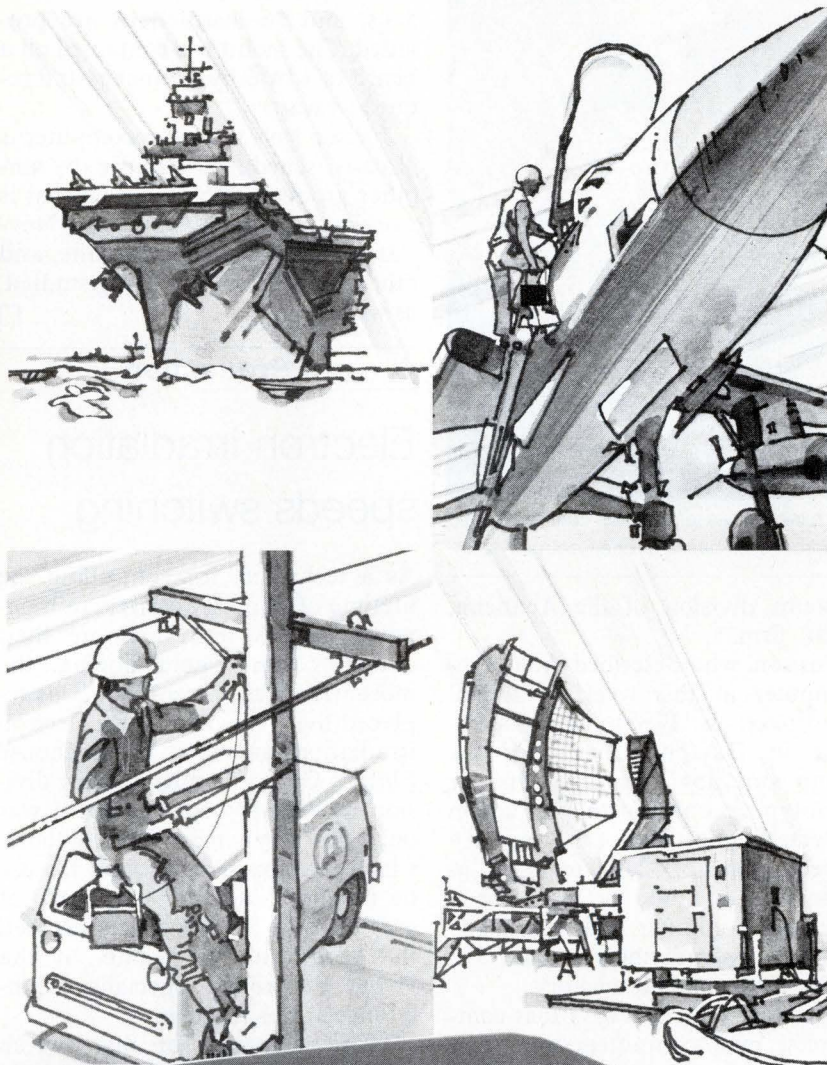

TEKTRONIX®

committed to
technical excellence

Circle 33 on reader service card

For Demonstration Circle 32
on Reader Service Card.

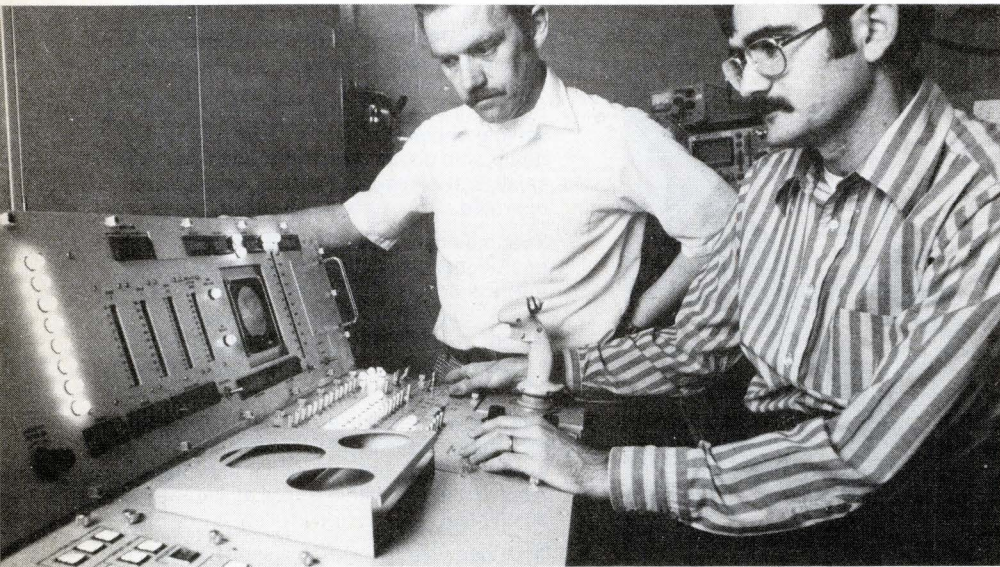

Checkup. Motorola's Ed Cosley, left, and Bill Haney examine pre-production control console and display of the company's new AN/USW-4 microprocessor-based Drone Control System.

for gunnery practice.

Included in the data received from the drone are attitude, air speed, and altitude. Control signals to drive the antenna are computed from the antenna's azimuth and elevation angles and the ship's pitch and roll angles. Azimuth and range, as corrected by the ship's attitude, are then converted into coordinates for the plotter. □

Rockwell develops microcomputer

The Autonetics group of Rockwell International Corp. has developed a military-oriented 16-bit microcomputer module that borrows from the company's commercial units.

The fully-militarized microcomputer, aside from using a new two-chip processor, is similar to Rockwell's commercial 4- and 8-bit PPS (parallel processor system) single-chip microprocessors. The new μ P-16 uses the read-only and random-access memories of the PPS, plus Rockwell's range of interface circuits. Autonetics, however, intends to sell the μ P-16 only as a module, not as individual components, says John Jurison, project engineer in charge of the computer applications group at the Strategic

Systems division of the Anaheim, Calif., firm.

Jurison, who described the microcomputer at this week's National Aerospace & Electronics Conference in Dayton, Ohio, says the group can now accept orders for prototyping units, with production expected by the end of the year. He expects prices of \$2,000 to \$2,500 in quantities of 1,000 or more for a complete computer with 8,192 bits of ROM program memory and 512 16-bit words of data memory.

Evaluated. Jurison says that commercial microcomputers were first evaluated for the application, but the need to meet military temperature and performance requirements dictated a new processor. He adds that the 16-bit word length with 50,000 operations per second throughput that was needed wasn't available elsewhere. However, the Rockwell p-MOS process, which the company is already applying to commercial products, could be militarized to meet the wide temperature specifications.

The μ P-16's processor chips consist of a control unit and an arithmetic unit. Fifteen MOS large-scale-integrated devices are required for the complete computer. Jurison says the main features are its 16-bit input and output channels, fast multiply and divide instructions (95 micro-

seconds for 16-bit multiplication) and program interrupts. Add time is 5 μ s, and 76 instructions are provided. The module is contained on a board of 4 by 6 by 0.5 inches and requires 4 watts.

Jurison says the microcomputer is already scheduled for use by another group within Rockwell that is working on the military's new Navstar global positioning satellite, and other applications are being studied, as well. □

Production

Electron irradiation speeds switching

As a technique for controlling the lifetime of minority carriers in high-power diodes—and therefore their switching times—gold doping, the more widely used technique, was replaced five years ago by an electron irradiation process at Westinghouse Electric Corp.'s Semiconductor division in Youngwood, Pa. But it was only this week that Westinghouse, which developed its process for use on rectifiers and thyristors rated at greater than 50 amperes, discussed the technique in public, at the Power Electronics Specialists Conference at Los Angeles.

"The demand for fast switch products is increasing, particularly for such products as converters, choppers in transportation applications, and in industrial rf generation," says Joseph E. Johnson, manager of design and engineering within the Semiconductor division's operations department. He says that the division has sold more than half a million electron-irradiated devices so far, and the number of irradiated devices shipped is nearly 25% of the division's entire rectifier and thyristor output.

Megavolt range. According to Johnson, the energy level necessary to do enough displacement damage in the silicon to reduce carrier lifetime is between 1 and 3 megavolts, obtained from a Van de Graaff accelerator. "In that range the elec-

Analog

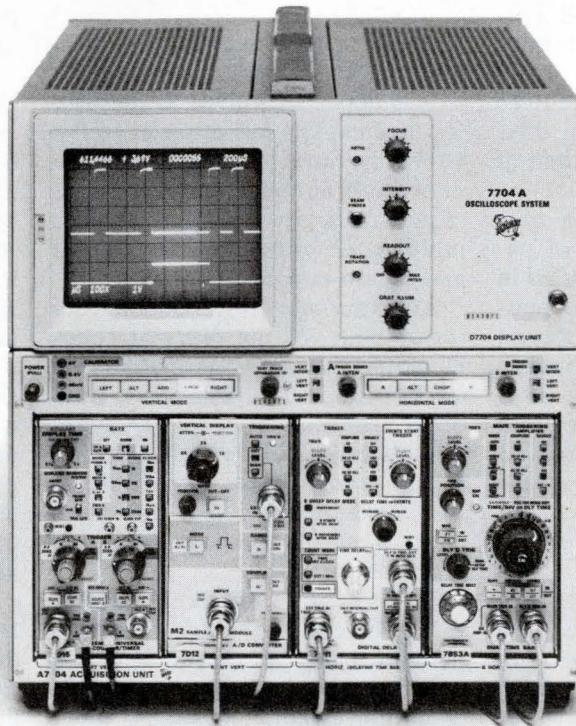

Now they work together

The interaction of analog and digital in one Tektronix instrument package makes it all possible. This innovative concept gives you the best of both techniques and opens up new opportunities for measurements that wouldn't be feasible otherwise. The analog display allows you to interpret general trends and patterns and visually select points of interest. The digital capability quickly supplies you with precise values for the points you've chosen.

Here, for example, is a unique combination of oscilloscope, sample and hold dvm, counter/timer, and digital time and events delay in one interactive analog-digital measurement package. It's made up of the TEKTRONIX 7704A 250-MHz Oscilloscope, the 7D12M2 A/D Converter, the 7D15 225-MHz Counter Timer, the 7D11 Digital Delay Unit, and the 7B53A Dual Time Base.

With this instrument system, you can delay by the actual count of pulses to look at a desired logic train window without jitter or make selective interval measurements along asymmetric data trains. You can digitally measure pulse time delays, measure voltage amplitude at selected points, or count events in frequency burst patterns.

This instrument system is only one possible configuration of an oscilloscope mainframe and digital instrumentation. Many packages that combine analog and digital capabilities may be configured, from a selection of more than 30 instrumentation plug-ins, to suit specific applications.

The 7000 Series . . .
more than an oscilloscope.

Tektronix will be conducting seminars in several areas to acquaint you with the measurement potentials available with this analog-digital measurement technique. For a schedule of seminars in your area, contact your local Tektronix Field Engineer.

Tektronix, Inc., P.O. Box 500, Beaverton, Ore. 97077. In Europe, Tektronix Limited, P.O. Box 36, St. Peter Port, Guernsey, Channel Islands.



TEKTRONIX®

committed to
technical excellence

Circle 35 on reader service card
For Demonstration Circle 34 on Reader Service Card.

trons penetrate completely through the silicon," he says, causing many small energy collision losses and a few collision losses that result in atomic displacement. The damaged center, or silicon die vacancy, as Johnson calls it, is the part of the device that reduces carrier lifetime and thus leads to improved performance, including faster turnoff time.

Following irradiation, devices show essentially no change in their parameters, even after annealing at 200° C for 2,000 hours.

Specified parameters. "In a fast-switch product, the number of parameters that have to be specified in any successful application is increasing," says Johnson. An application may require, for example, forward drop, dynamic forward drop, turn-off time and reverse recovered charge specifications. "Balancing all of these parameters requires a very flexible fabrication technique, and that's what we think we have with electron irradiation.

"Turnoff time is the most critical specification, but increased focus has been given to reverse recovered charge and reverse recovery time." Johnson says tradeoffs occur because a specification on reverse recovered charge may mean that "you've got to deliver a faster turn-off than is nominally requested in the specification."

He also says the leakage level at a given voltage is the same both before and after irradiation. "With gold doping, leakage currents would be roughly two to four times higher at a given temperature." The significance of this, according to Johnson, is that the irradiated devices can be operated at higher temperatures, and therefore higher power levels. "We think this gives us a very significant competitive advantage." Apparently there is evidence that phosphorous vacancy exists originally, but it anneals rapidly at 125° C and is transformed into the die vacancy, so that there are no changes in the turnoff time characteristics in the finished device.

The cost of electron irradiation is about the same as gold doping—a

few cents per device. Johnson also claims his yields of 90% are higher than with gold doping. □

Circuit boards give polyimide a try

Kapton, a high-temperature polyimide material made by DuPont Co., is generally known as the base for tape cable and flexible circuitry. However, the characteristics of film derivatives and glass-fiber laminates of polyimide make them suitable for multilayer printed-circuit boards and hybrid-circuit substrates.

An experimental navigational receiver built for the Navy at Johns Hopkins University's Applied Physics Laboratory, Silver Spring, Md., offers promise that polyimide might qualify eventually as a lower-cost, rugged and reliable alternative to the conventional circuit boards of epoxy glass and hybrid substrates of alumina.

"We like it," declares the laboratory's Robert Hicks. "It's more economical and, for substrates, is an easier approach to work with than [alumina] ceramic—especially when an odd shape is needed."

Hicks says the polyimide technology is being applied to other Navy programs, including oper-

ational ones of which the details cannot be revealed.

Johns Hopkins' all-polyimide hybrid packaging scheme uses multilayer boards constructed with Pyralux, a fairly new copper- or adhesive-clad Kapton, and hybrid substrates of Pyralin, a copper-clad polyimide-glass fiber laminate. Both materials are made by DuPont.

Normally, Pyralin is a relatively expensive material used for high-temperature printed-circuit boards. But for the small areas of a hybrid substrate, Pyralin is price-competitive with the alumina material conventionally used, points out Hicks. It costs about 10¢ per square inch compared to 10¢ to 70¢ per square inch for alumina substrates.

According to Hicks, advantages of either polyimide material over the conventional epoxy glass/alumina materials are: consistently higher peel strengths, better resistance to temperature, better resistance to processing chemicals and solvents, better dimensional stability after etching and baking, higher resistance to barrel cracking of plated-through holes, and an ability to be extensively reworked (hand-soldered).

A disadvantage of either material is a relatively high water absorption.

A cutaway view of one of the hybrid multilayer board assemblies is

New board. Different types of polyimide materials are being used for multilayer circuit boards and hybrid-circuit substrates. Applications at present are for military programs.

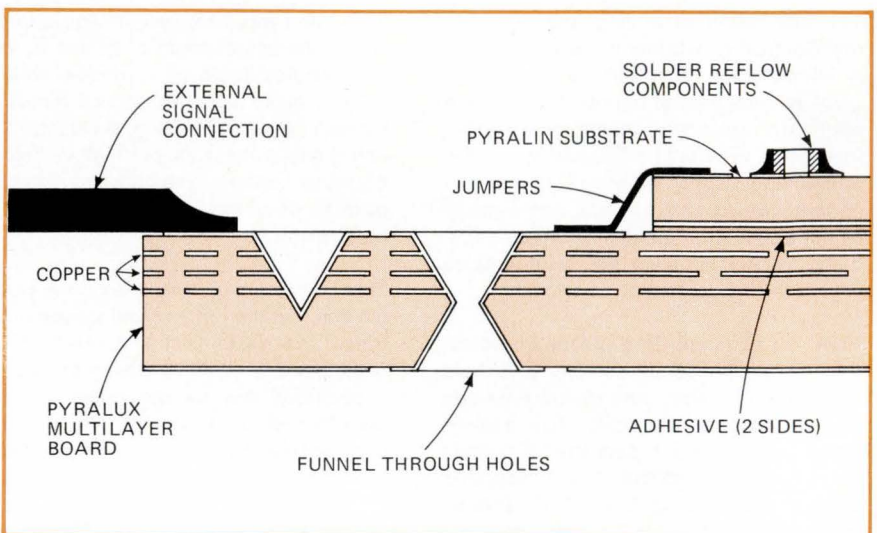

Please touch:

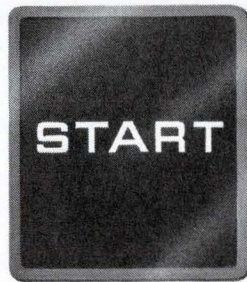

That "button" is as flat as this paper and has the same number of moving parts: none. Touch the photo and you'll know how easy it is to control things with Touch-MOS™ technology.

We engineered Touch-MOS controls for the solid-state kitchen range that does almost everything but choose your wine for dinner. The technology is such a logical alternative to dials, buttons, levers and switches that we predict a very smooth future for it.

A Touch-MOS panel is waterproof. It can be cleaned easily because the whole control panel is a single, flat piece. It's the "fashion breakthrough" that many consumer products need. It will last virtually forever. And, with fewer parts involved, it cuts your costs of assembly, inventory and repair.

Its uses are endless, from calculators, car instrument panels and airplane controls to telephones, appliances and vending machines. And Touch-MOS switching

is absolutely safe because no electrical current is involved. (Underwriters Laboratories will vouch for that.) By touching the glass panel, you interrupt an electronic field temporarily. Our custom MOS/LSI circuit responds to this and does the rest.

You should see what Touch-MOS controls can do for the system you're working on. And we'd be very glad to show you. Our long experience in custom LSI design and this new touch control will really get people turned onto your product—before the competition makes the switch.

Just get in touch with your nearest AMI sales office.

England, Swindon, Wiltshire: Swindon 31345 • France, Vincennes: (01) 374-0090 • Italy, Milan: 29 37 45 • Japan, Tokyo: (501) 2241 • West Germany,

Munich: 48 30 81 • Head Office:

3800 Homestead Road, Santa Clara
CA 95051, Phone (408) 246-0330.

AMI[®]
AMERICAN MICROSYSTEMS, INC.

first in custom LSI

Touch-MOS™ is a trademark of
American Microsystems, Inc.

shown on page 36. Instead of firing or evaporating conductive materials (techniques customarily used in thin- and thick-film hybrids), the copper-clad Pyralin substrate has its pattern subtractively etched with a standard dry-film resist technique. All active and passive components are then reflow-soldered to the copper pattern of the substrate.

The multilayer board alternates layers of photoprinted etched copper-clad Pyralux with layers of adhesive-coated Pyralux. This assembly is lined up, laminated, and then heat cured.

Novel 60° funnel-shaped through-holes are drilled in the board. These, serving to interconnect layers, are then copper-plated by an additive electroless process. Applied Physics Laboratory engineers have found the funnel-like plated-hole arrangement leads to better plating, easy inspectability and less barrel cracking. After this step, the Pyralin substrates are fixed to the multilayer board with a special adhesive, and the hybrids' interconnects are wired to board pads. □

Solid state

Nitride layer ups IC performance

Adding a silicon-nitride layer to an integrated circuit can relax the stress induced by previous processes and greatly improve performance, according to engineers at Nippon Electric Co. The main improvement they sought was higher current gain at low current levels. This goal was achieved, but the nitride layer also provided other improvements, including decreased noise and lower transistor input offset voltages and currents.

Operation of NEC's industrial linear ICs has been greatly improved, not only because the absolute value of the gain has been increased, but also because uniformity has been increased. This uniformity among devices is especially important in precision applications, such

News briefs

Electronics R&D to increase

The electronics industries plan to increase research and development expenditures by 31% in the three-year period ending in 1978, according to a survey by the economics department of McGraw-Hill Publications Co. The projected increase—an average of over 10% per year—is significant when viewed alongside the more modest 6% R&D increase planned for this year and the lack of any change in R&D spending last year. The biggest increases in expenditures were being planned by manufacturers of radio and television and of semiconductors serving the industrial electronics areas. Overall, the industries indicate that by 1978, 25% of sales will result from products not yet designed and developed.

Mostek second-sources Fairchild microprocessor

With full technical support from Fairchild Semiconductor, Mostek Corp. has decided to second-source that firm's five-chip F-8 microprocessor set. "We're taking a substantial gamble on the Fairchild part; it's got an uphill market fight," comments L. J. Sevin, Mostek's president. "But the reason we chose the F-8 was the demonstrated manufacturability of the product." Using Fairchild masks, Mostek, in Carrollton, Texas, has already obtained functional central processing units from its first wafer lot.

Bowmar exits from calculator and watch business

Bowmar Instrument Corp., which filed for Chapter 11 protection under the Federal Bankruptcy Act four months ago [*Electronics*, Feb. 10, p. 36], has stopped producing calculators and digital watches. Bowmar says its financial condition does not permit it to make these products at a loss, adding that it has closed its calculator and watch assembly facilities in Nogales, Mexico, and will close its warehouse and distribution center in Nogales, Ariz. These moves by Bowmar leave it essentially with only its Industrial Products division, which produces light-emitting diodes, some electromechanical display devices, and telecommunications test instruments.

Holmes takes over at Raytheon

D. Brainerd Holmes was elected president of Raytheon Co., Lexington, Mass., to replace Thomas L. Phillips. Phillips was elected chairman of the board in place of retiring Charles F. Adams and will remain chief executive officer. As executive vice president, Holmes headed the Government Group and Raytheon Service Co., the engineering services subsidiary.

Pulsed-laser output record claimed by Sandia

Scientists at Sandia Laboratories, Albuquerque, N.M., have produced a 4.2-kilojoule pulse of laser energy from an electron-beam-driven hydrogen-fluoride laser, making it the most energetic pulsed laser yet reported. Pulse widths for the laser ranged from 20 to 30 nanoseconds; peak power was about 200 billion watts. The 4.2-kJ pulse is nearly double the previous record pulse for a hydrogen-fluoride laser, also produced at Sandia.

IBM realigns its product development groups

IBM Corp. has realigned several of its data processing product development activities to "strengthen the company's focus on the growing importance of communications products," says Frank T. Cary, IBM chairman. The former System Development division has been designated the System Communications division to design, develop, and manufacture computer-based communications systems and terminal products. Systems development not related to communications has been assigned to the General Products division, the System Products division, and the Data Processing Product Group staff.

Advanced System Development division responsibilities for coordinating worldwide customer requirements have been reassigned, and the division discontinued.

Data General announces the one thing that may have kept you from communicating with us.

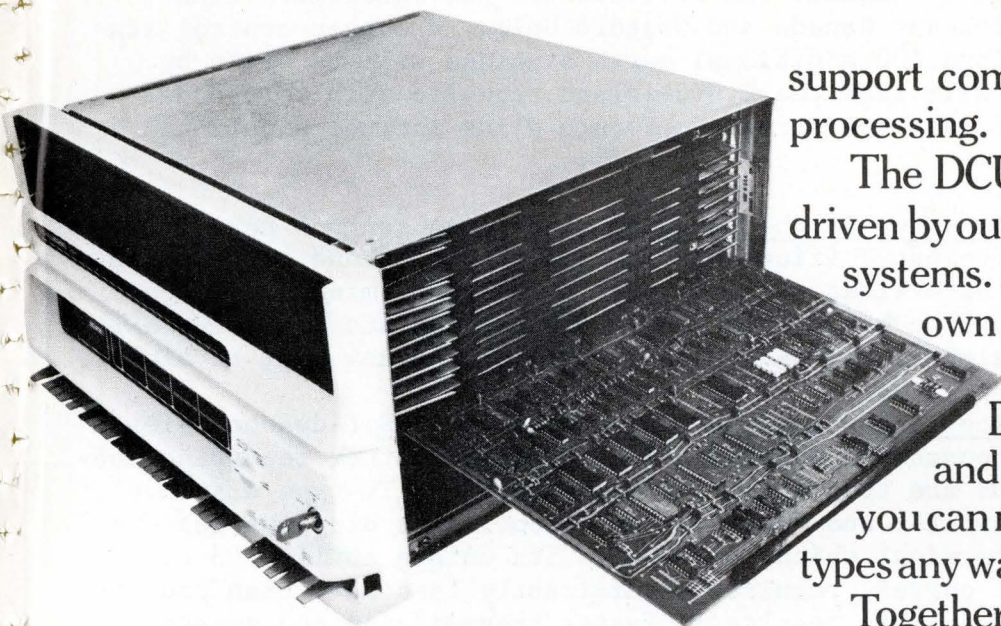

For years, Data General has been the company people have come to for basic communications networks. Because we've always made our computers, peripherals and software completely compatible with each other.

Now you can come to Data General if you want to build big, complex networks.

Because now we have the communications controller board you see here. The DCU/50 (Data Control Unit).

The DCU is designed to work in terminal, switcher, concentrator and front end systems. It takes care of line control and all the character processing. Which leaves the computer free to

support communications message processing.

The DCU is programmable and driven by our real-time operating systems. So you can define your own protocols.

Or you can use our Data General teletypewriter and BISYNC protocols. And you can mix your protocols and line types any way you want.

Together with our high density 16, 8, and 2 line synchronous and asynchronous multiplexers, the DCU gives you direct memory access for extremely high throughput, with minimal systems overhead.

And when you need more speed and more lines, you won't have to throw out anything. You can add on to what you already have.

For example, you can start off interfacing our multiplexers directly to the computer. And later on, plug in the DCU.

Which means no matter how big or small you want your network to end up, you can start off communicating with Data General.

Data General

Data General, Route 9, Southboro, Mass. 01772 (617) 485-9100. Data General (Canada) Ltd., Ontario, Data General Europe, 15 Rue Le Sueur, Paris 75116, France. Data General Australia, Melbourne (03) 82-1361/Sydney (02) 908-1366

Circle 39 on reader service card

SCIENCE / SCOPE

Indonesia's domestic communications satellite system -- first in the Eastern Hemisphere -- will be built by Hughes. It will include two satellites like those now in service for Telesat Canada and Western Union, a master control station, and nine earth stations (30 additional earth stations will be built by other contractors). They will link the 5,000-island republic with telephone, telegraph, television, and teletype service. Future plans include a national radio network.

Oil and mineral exploration crews in the Canadian wilderness can now have immediate communications with company offices and families by telephone or teletype via Telesat Canada's Anik satellites and a compact portable terminal developed by Hughes. The terminal can be erected in four hours and operates in temperatures as low as -70°F . Telesat Canada has leased five of the new mini terminals.

The National Weather Service is now testing a prototype of AFOS (Advanced Field Operating System), its proposed \$40-million all-electronic weather reporting network. Key elements of AFOS are the on-site minicomputers and TV-type displays that will replace teletypewriter and facsimile equipment. The displays feature the Hughes Conographictm terminal which, because of its unique ability to convert contour data to conic curves, requires significantly less data than conventional x-y plotting systems. This results in faster transmission and greater capacity for the network, lower storage requirements for the terminals.

Weather maps will be transmitted 20 times faster, printed matter 30 times faster than by present methods. The increased speed and capacity of AFOS will be particularly valuable for warnings of tornadoes, hurricanes, and floods. The Weather Service hopes to have about 275 of its offices automated by 1980.

R&D project leader needed. Responsibilities will include advanced device development, customer interface, presentations to top management, and establishing manufacturability. Must have PhD in solid-state physics or electrical engineering and five years of developmental work in MOS, CMOS, bipolar, and CCDs, with recent experience in silicon devices and integrated circuits. U.S. citizenship required. Please send resume and salary history to: P.A. Schneider, Hughes Aircraft Company, 500 Superior Avenue, Newport Beach, CA 92663. An equal opportunity M/F employer.

A new engineering data reduction service offered by Hughes features fast problem resolution and quick turnaround times. Inputs include real-time data from radio or telephone, analog or digital magnetic tapes, film, strip charts, punched cards, and paper tape. Outputs include quick-look form, published presentations, and computer tapes. For information, please call or write Bob Margolies, 213/391-0711, Ext. 7988, Hughes Aircraft Company, Flight Test Division, Culver City, CA 90230.

Creating a new world with electronics

HUGHES

HUGHES AIRCRAFT COMPANY

Electronics review

as in digital-to-analog converters and other devices with resistor networks, as well as in precision operational amplifiers where the base current must be included in calculations and thus must be controlled.

In NEC's version of the 741 operational amplifier, voltage offset has been reduced from typically ± 1 millivolt to ± 0.1 mv. Offset current has been also reduced, although not as dramatically. Transistors in devices made by the new process have also been improved. Low-frequency noise in the 10-100-hertz range was reduced to about 20% of its usual value, and popcorn noise was almost completely eliminated. Generation-recombination noise, caused by lattice defects, was also reduced.

Curve. Stress in wafers is caused by the order-of-magnitude difference between the thermal coefficients of expansion of silicon ($2.5 \times 10^{-6}/^{\circ}\text{C}$) and silicon dioxide ($3.5 \times 10^{-7}/^{\circ}\text{C}$). Both the silicon wafer and the silicon-dioxide layer have the same dimensions during processing, but the silicon layer shrinks more during cooling.

Consequently, the silicon-dioxide side of the wafer ends up with larger dimensions at room temperature and is convex. The stress caused by this uneven contraction— 10^7 to 10^8 dynes/cm²—decreases minority carrier lifetime and degrades transistor characteristics. Addition of the silicon-nitride layer, which has the large temperature coefficient of expansion of $3.9 \times 10^{-6}/^{\circ}\text{C}$, on top of the silicon dioxide tends to restore the wafer to its original flat state.

In one experiment, a wafer with an oxide layer had a 13-meter radius of curvature and a surface stress of 17 kilograms/cm². Adding the nitride increased the radius of curvature to 116 m—which is much closer to being flat—and reduced surface stress to -2 kg/cm².

During the manufacturing process, windows are opened as if for metalization, and the nitride layer is deposited at high temperature. Then contact windows are opened, and the wafer is metalized.

Rather than etching metal to form a wiring pattern, NEC uses

anodic oxidation of aluminum regions where conductor is not required. The resulting alumina provides further protection against ion contamination and has a temperature coefficient of expansion similar to the nitride layer. It does not cause or reduce stress, though, because it is formed at room temperature. This anodic oxidation process was developed at the company many years ago and is used in its logic ICs.

Engineers expect production cost of improved devices to be about 10% higher than that of conventional devices. But they think sales will rise sufficiently to cover the higher costs. Plans call for improved devices to start reaching customers within about six months. □

Commercial

Microprocessors go to the polls

It's no longer surprising to see semiconductor microprocessors displacing a wide variety of mechanical or electromechanical parts, but are you ready for them in voting machines on election day? That could be a possibility—and cut voting costs, too—if a Beverly Hills, Calif., company is successful.

The company, Compuvote Corp., is headed by Fred L. Carter, a former chairman of the Los Angeles County election commission. His interest in microprocessor-controlled voting machines arises from studies his commission has made of voting irregularities in the county, which has almost 3 million voters.

Los Angeles County, like many other jurisdictions, presently gives every voter at its 8,000 precincts a stylus with which he punches holes in a special card. The punched cards are then transported by couriers to a central location, where some 2,000 election-day workers are needed to check the cards to make sure the perforations are cleanly made. The cards are then counted by machine.

"You can see the security problem," points out Carter, "but, in ad-

CABLES, CIRCUITS, CONNECTORS — ONLY HUGHES PUTS IT ALL TOGETHER.

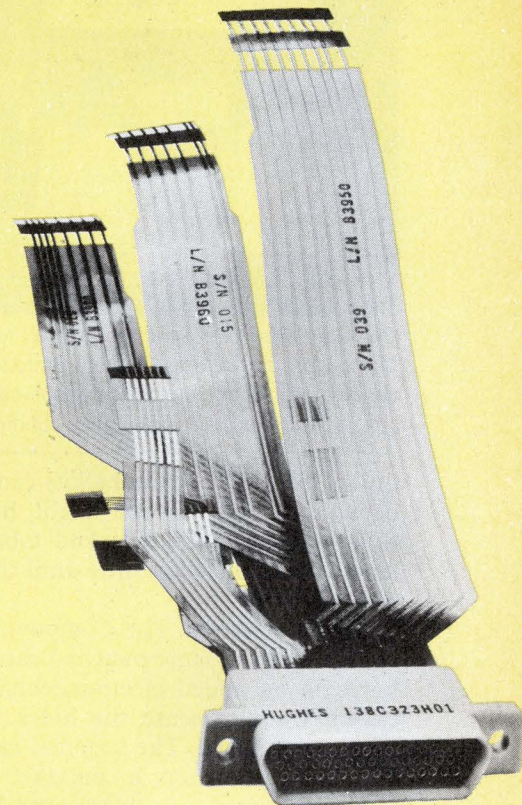

Circle 41 on reader service card

As far as we know, we're the only company that has total interconnection capability—in flat cable, flex circuits and connectors. And we've had more experience designing them for high technology applications.

But we do more than design them to work together—we also put them together for you in special assemblies.

So call the people you can count on. Call us. (714) 549-5701. Or write: 17150 Von Karman Avenue, Irvine, CA 92705.

HUGHES
HUGHES AIRCRAFT COMPANY
CONNECTING DEVICES DIV.

We crack the tough ones.

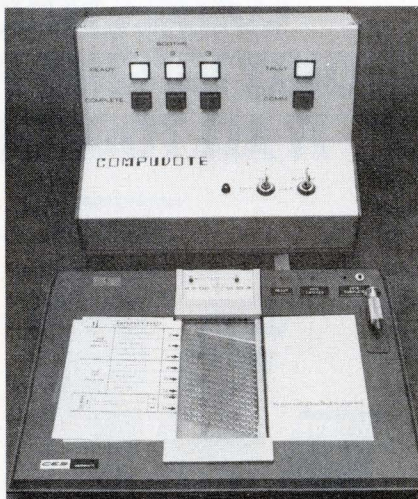

Counter. Voter selections are entered into Compuvote's microcomputer-controlled console, rear, through modified punch-card vote recorders used in Los Angeles county.

dition, 2% to 4% of the ballots can't be counted on election night because they're mutilated. And tabulation may not be finished until the next morning."

Error correction. The Compuvote system uses the same punched cards but with an added electromechanical interface to sense the holes as they are punched. The terminal can also indicate when a mistake is made—as when too many candidates are selected for an office. The card may then be exchanged for a new one. When the voting is completed, a button is pushed and the choices are entered in the memory of the local voting controller. The cards are saved for use as an audit trail in case of problems.

At the end of the election day, votes are printed out in the precinct, then chirped over telephone wires in 30 seconds to a central location. Complete returns could be posted in 80 minutes for the entire Los Angeles area. Trend precincts could be tabulated even more quickly, in response to the needs of news media. Cryptographic transmissions could be used to achieve even greater security.

The voting terminal now uses an Intel 4004 microprocessor with 1,500 bytes of programable read-only memory and 512 bytes of random-access memory. The 4004 will

be replaced by a 4040; both are slow compared to some microprocessors, but the voting process is slow enough, points out Carter, for them to be quite adequate.

A five-hour battery backup for the system is included. Up to six voting terminals can be used with one controller, permitting 256 candidates or issues, and 4,000 voters per precinct. The printer is an inexpensive Seiko calculator unit.

Carter says that the system is priced under \$3,000 per precinct—less than the \$3,800 lever-voting machines. He estimates that the system could save Los Angeles County \$150,000 to \$200,000 per major election. The company is not yet in production, but Carter has made arrangements for manufacturing and is talking to companies in the voting field about his system. □

Commercial

Insurance agents want own data base

Computer terminals could soon link 33,000 independent insurance agents to data bases and insurance company offices across the country. By developing a nationwide information system for its 33,000 members, the National Association of Insurance Agents hopes to help them compete more effectively with representatives of individual insurance companies whose own representatives sell directly to the public.

As visualized by the New York-based trade association's recently formed electronic processing implementation committee, terminals in the system will range from simple push-button telephones tied to voice-response systems to combinations of cathode-ray tubes and printers. The data bases will be situated in regional service centers, which in turn will be connected by a centralized switching system to home and branch offices of the insurance companies themselves, as well as to other service organizations and data bases. Rental charges

from an industry-wide system could exceed \$100 million annually, predicts committee chairman Thomas E. Lane of Rapid City, S.D. Monthly terminal costs (not including service) are expected to range from \$125 to \$500 per agent, depending on equipment.

Competition. "We feel we're at a competitive disadvantage with the more concentrated efforts of the major direct writers and with the expected surge of competition from life insurance companies now entering the property and casualty fields," observes Lane. He sees the system as helping members stay on top of all the myriad details of the different insurance companies' policies they handle. It will also speed up the job of obtaining price quotes, processing applications and settling claims, and it will provide low-cost accounting and billing services.

Lane's committee is currently looking for a computer service firm to actually design and implement a prototype regional network and share in the cost of developing the total system. It has retained Applied Information Development of Oak Brook, Ill., a subsidiary of System Development Corp., as a special consultant.

Another firm, Electronic Data Systems Corp., Dallas, has already conducted its own independent study—not sponsored or endorsed by NAIA, but involving key members of the association and a number of property and casualty companies. The study concludes that a regional network concept is technically feasible and also economical.

NAIA is unlikely to give any one company the entire job. "If the prototype proves successful," says Lane, "the industry-wide facility that would be necessary would be too large to come under the control of a single private vendor or company."

As the network begins to take shape, Lane's committee, with the help of its consultant and prototype companies, will write a set of specifications for the local terminals. Lane expects initial implementation by late next year or early 1977. □

NEW, FREE.

Get yours.

McMOS

McMOS

idea book



TODAY, McMOS IS THE CMOS THAT OFFERS

MORE

The only standard CMOS family fully specified at 15V

BROADEST CMOS LOGIC FAMILY FUNCTIONAL COVERAGE



& MOST MSI

An ideal mixture of the industry's richest MSI line-up and the necessary complement of simple gates and flip-flops.

new plus

mc14400

SPECIALIZED FUNCTION SERIES

They add a new dimension to McMOS. MSI subsystems for A/D logic, telephony, data handling, watchclock circuitry and eventually whatever appears most needed.

UNSURPASSED RECORD OF RELIABILITY

McMOS is establishing an envied reliability record in the sockets of users... and it's best documented too. Send for the new report.

SPRING and Summer 1975



PRICES LIKE TTL

That means low. For comparable functions, McMOS is selling competitively with TTL.

MOTOROLA MCMOS



COMPLEMENTARY MOS FOR CONTEMPORARY SYSTEMS.

MOTOROLA Semiconductor Products Inc.
P. O. BOX 20912 • PHOENIX, ARIZONA 85038

We call it the McMOS Idea Book because it's an all new 40-page compendium of useful and provocative CMOS information. Following a run-down on family data and characteristics, you'll find selection guides and logic diagrams, product previews, Application Note and Engineering Bulletin information, cross reference and interchangeability guides. And, for following up on the ideas you get, there are postage paid reply cards for getting additional specific technical information.

Got the idea? Get the book. Free.

*McMOS is a trademark of Motorola Inc.

I got the idea. Please send me a copy of the all new McMOS Idea Book. Thanks.

Name _____

Title _____

Company _____

Address _____

City _____ State _____ Zip _____



UNSINKABLE KEYBOARDS

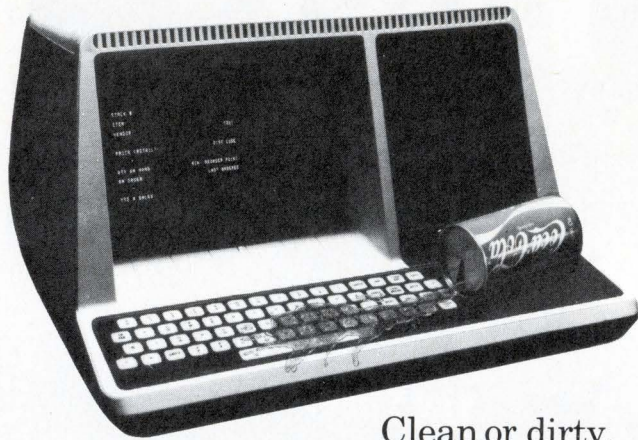

Clean or dirty, dry or wet, Chomerics' new environmentally-sealed tactile keyboards let your fingers do the talking anywhere — from the meat room to the machine shop. They are rugged, clean easily, are available in any size and cost

surprisingly little. The waterproof is only one of a broad line of unique Chomerics keyboards. Another major innovation is our Keyboard

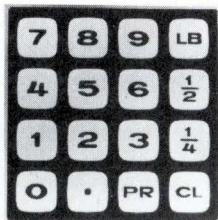

Component System unbeatable for feel, reliability and cost, and easily integrated into your end product — from calculators to computers. Switch to the leader.

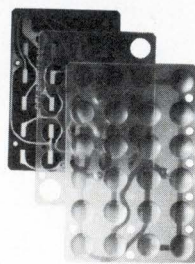

CHOMERICS

77 Dragon Court
Woburn, Ma. 01801
(617) 935-4850

News update

■ By putting two differently doped gallium-phosphide layers with integrated pn junctions on the same crystal, researchers at Siemens AG wound up with a variable-color light-emitting diode [April 18, 1974, p. 29]. But Siemens never went into volume production with its double-junction LEDs because the market never reached the size of, say, calculators. The reason: single-junction, monochrome LEDs have become so inexpensive that Siemens' parts, which require special drive circuitry, are unlikely to replace them.

■ New Mexico will be the first state to receive additional Federal funds for operating computer centers for processing Medicare claims, according to the Social and Rehabilitation Service of the Department of Health, Education, and Welfare [May 30, 1974, p. 49]. Twenty states, including New Mexico, received approval for 90% Federal funding for planning EDP systems, but New Mexico's plan recently also received approval for a 75% operating cost subsidy, an official says. "The typical plan proposes using an existing state computer system, to handle the chores."

■ As expected, United Technologies Corp.'s Norden division in Hartford, Conn., sold its millimeter-wave transceiver [April 18, 1974, p. 30] to Datran, the Vienna, Va.-based specialized data carrier. Norden sold eight of them, and that was it for sales. However, Lou Ebrel, design engineer in charge of applications, says the Bell System's Southern New England Telephone Co. is testing the transceiver, and that New York Telephone Co. has shown some interest in the system. Ebrel also says that several foreign concerns—both European and Far Eastern—would like to acquire the Norden equipment, but Norden won't sell to them because it would then have to support the equipment. Ebrel says Norden would like to make a market for it in the U. S. before venturing into foreign markets.

ANOTHER DIMENSION

has been added to the world famous family of

Simpson® 260 VOMS

the SERIES 6XL



FOR THE SPECIAL NEEDS OF THE SOLID STATE ELECTRONICS INDUSTRY

- Extra shock and drop-resistant construction, high impact, custom-molded panel and case
- Extra large viewing area with four-color (Red, Green, Blue and Black) scales, keyed to matching range panel
- 33 ranges with extra voltage, current, resistance and low-power ohms functions
- Plus — all the features of the time-honored, ever popular 260-6

260-6XL, Complete with batteries, test leads and manual \$90.00

260-6XLM, with mirror scale \$93.00

260-6XLP WITH CIRCUIT OVERLOAD-PROTECTION

Reset pushbutton releases when overload exists. Will not reset until overload condition is eliminated.

260-6XLP, complete with batteries, test leads and manual \$125.00

260-6XLPM, with mirror scale \$128.00



RANGES:

DC Volts	0-0.25; 0-1; 0-2.5; 0-10; 0-25; 0-100; 0-250; 0-500; 0-1000
AC Volts	0-2.5; 0-10; 0-25; 0-100; 0-250; 0-500; 0-1000;
DC Microamperes	0-50 (250 MV Drop)
DC Milliamperes	0-0.5; 0-5; 0-50; 0-500
DC Amperes	0-5 (250 MV Drop)
AC Amperes	6 ranges from 0-5 to 0-250 with optional Model 150 Amp-Clamp adapter.
DB Scale (1 MW 600 Ω Reference)	-20 to +10; -9 to +21; -1 to +29; +11 to +41; +19 to +49
Resistance (Standard Power)	Rx1 (6 Ω center scale), Rx100 (600Ω center scale), Rx1K (6000 Ω center scale), Rx10K (60,000 Ω center scale)
Resistance (Low Power)	Rx1 (20 Ω center scale) Rx10 (200 Ω center scale) Max. open circuit voltage only 100mV! Max. measuring power only 0.125 mW!
Size	5 1/4 x 7 x 3 1/8" (133 x 178 x 79 mm)
Weight	2.5 lbs. (1.14 kg)

ACCESSORIES

Model 150 Amp-Clamp, Catalog No. 00532 complete with a No. 00533 test lead	\$29.50
30 kV DC Probe, Catalog No. 00509	\$22.00
Grip-Tip Extension Probe, Catalog No. 00118	\$ 4.75
Rigid Case, Catalog No. 00805	\$20.50
Sheath Case, Catalog No. 01818	\$16.75
5 kV DC Probe, Catalog No. 00506	\$ 5.25
5 kV AC Probe, Catalog No. 00505	\$ 5.25

Available Now at Leading Electronics and Electrical Equipment Distributors • Write for Complete Specifications



SIMPSON ELECTRIC COMPANY

853 Dundee Avenue, Elgin, Illinois 60120 • (312) 697-2260

CABLE: SIMELCO • Telex: 72-2416

IN CANADA: Bach-Simpson, Ltd., London, Ontario

IN ENGLAND: Bach-Simpson (U.K.) Ltd., Wadebridge, Cornwall

IN INDIA: Ruttonsha-Simpson Private, Ltd., Vikhroli, Bombay



End switching puzzles

with Switchmode silicon power

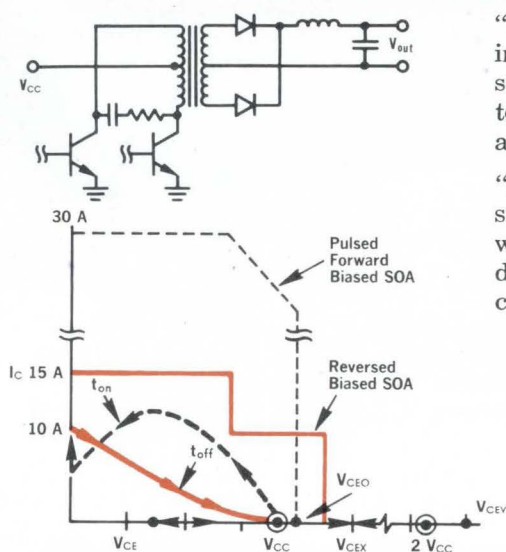

“... both blocking voltage and sustaining voltage are important in switch-mode applications. The circuit illustrated requires high blocking capability since the transistor is subjected to a substantially higher voltage than V_{CC} after turn-off...”

“... for inductive loads, high voltage and current must be sustained simultaneously during turn-off, in most cases with E-B junction reverse biased. The safe level for these devices is specified as $V_{CEX(sus)}$ at given high collector currents as shown on the reverse biased SOA curve...”
(from Switchmode *Designers Data Sheet*)

The jigsaw's complete.

It's finally been done.

Motorola did it in '72 by introducing the now industry-standard 2N6306-6308 switches... we're doing it again in '75 with the 2N6542-6547 Switchmode family.

SWITCHMODE	V_{CEV} V	$V_{CEX(sus)}^\dagger$ @ 100°C V	I_c Cont. A	$V_{CE(sat)}$ max @ $I_c, 100^\circ C$	$t_{r\uparrow}$ (max) @ $I_c, 100^\circ C$	PRICE
2N6542/3	650/850	350/450	5	2/3	800ns	\$2.25/ 2.85
2N6544/5	650/850	350/450	8	2.5/5	900ns	3.75/ 4.75
2N6546/7	650/850	350/450	15	2.5/10	1500ns	7.50/10.75

[†]Clamped inductive load

What you've had in specs up to now doesn't get you there. It might even lead you astray with incomplete info.

For example, when all you've got is forward bias SOA limits (and that's all you get from everyone else) and you need to know what happens in reverse or OFF-biased for clamped inductive loads, you've got a square peg for a round hole.

Same thing when you're trying to match a high-temperature inductive load to low-temperature resistive switching specs.

Apples and oranges.

That's when all your guesswork starts — cutting and fitting that finally leaves you at a workable, but fuzzy, point in the picture... a design without specs. An engineering never-never land.

Switchmode's* the name from now on.

Switchmode silicon power is completely spec'd to tell you exactly how the device will operate under all operating conditions; forward, reverse, clamped inductive or resistive. Actual use conditions and real-world situations. You know how far your load lines can go and still be safe. You know what $V_{CEX(sus)}$, $V_{CE(sat)}$ and

“... in most applications, a large percentage of total device power dissipation occurs during turn-off time and t_f is normally used as a figure of merit. There are, however, two portions of the turn-off waveform that can add losses and in some cases can be significant. The interval t_v is part of total storage time t_s and is defined as voltage switching time. During t_v , the V_{CE} voltage changes from saturation to clamp voltage while collector current has only decreased by 10%. The time t_t occurs after fall time and appears as a “tail” on the collector current waveform. Significant dissipation occurs during the total period $t_v + t_f + t_t$...”

(from *Switchmode Designers Data Sheet*)

2N6546 TYPICAL TURN-OFF WAVEFORM
Clamped Inductive Load

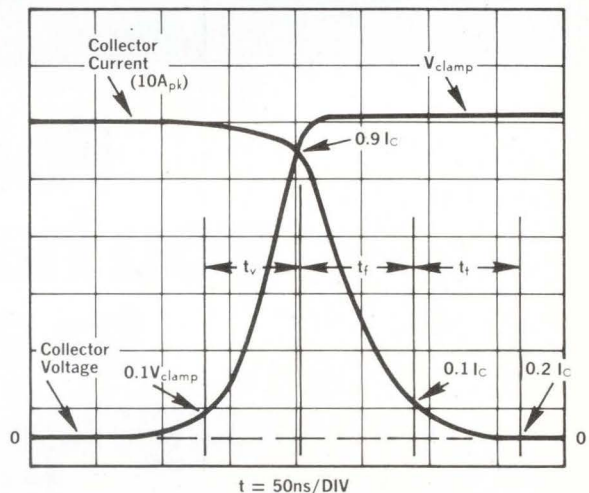

I_{CEV} are at 100° case. You know t_s and t_f performance as a function of collector current and temperature at high inductive energy. You know precisely where you stand with secondary breakdown... before it happens. The unknown is known.

• No guess work. No empiricals. No unspc'd performance.

Just solid, practical data from a pragmatic, comprehensive Designers Data Sheet. A real “first”.

These premier Switchmode units are nanosecond

fall-time fast in clamped inductive loads. 450 V sustaining at 100°C case. Up to 15 amperes continuous. Triple-diffused rugged.

The world's moving faster to lighter, quicker, efficient switching power supplies. Find out how you can move with it — send for new Switchmode data sheets, Application Notes AN588, AN719 and AN737 and Engineering Bulletin EB-39 on new approaches to switching regulators. Box 20912, Phoenix, AZ 85036.

®Trademark of Motorola, Inc.

Switchmode

You'll never go back to linear or series-pass again.

Imaginative
from Motorola, the power producer

Circle 47 on reader service card

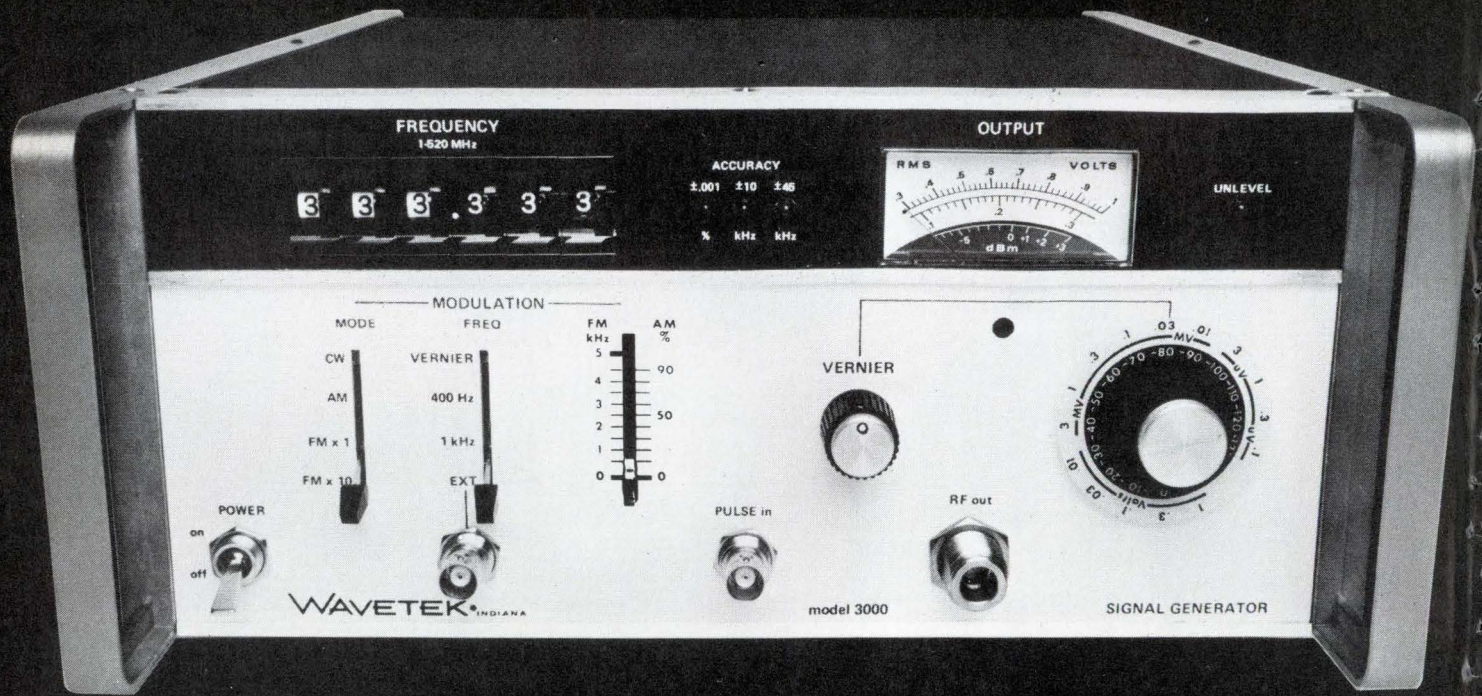

For \$1,975 you have no right to expect a signal generator like this.

For \$1,975 you should have to settle for tubes, or for a non-phase-locked generator.

But here's the Wavetek 3000, so you can toss your expectations out the window. This solid state signal generator is not only phase-locked and accurate ($\pm 0.001\%$), it's programmable as well. And it covers the entire range from 1 to 520 MHz in a single band. Yet once we've

Circle 48 on reader service card

received your order, you can expect a signal generator like this one right away... for just \$1,975.

That may not be right, but it sure is reasonable.

SPECIFICATIONS

Frequency Range: 1-520 MHz
Frequency Accuracy: $\pm 0.001\%$
Resolution: 1 kHz
Stability: Less than 0.2 ppm per hour
Output Range: +13 dBm to -137 dBm
Flatness: ± 0.75 dB

AM Modulation Range: 0-90%
FM Deviation: 0-5 kHz and 0-500 kHz
Internal Modulation Rates:
400 Hz and 1 kHz
Dimensions:
12" wide x 5½" high x 13¾" deep
Price: \$1,975

WAVETEK®

INDIANA INCORPORATED
P.O. Box 190, 66 North First Avenue
Beech Grove, Indiana 46107
Tel. (317) 783-3221 TWX 810-341-3226

Washington newsletter

Dataphone service expansion program put before FCC

A major expansion of AT&T's Dataphone digital data service (DDS) to at least 64 cities in late 1976 was disclosed by the company in an early June filing before the Federal Communications Commission. **In addition to existing authorization for 24 cities, of which five are operational, AT&T wants authority to construct facilities in 40 more cities by the third quarter of next year.** By the end of 1976, AT&T wants authority for Dataphone service in a total of 96 cities.

The company first offered DDS last December between Washington, Boston, Philadelphia, Chicago and New York. Most of the long-haul facilities in the latest application call for data-under-voice transmission in the lower end of the spectrum of existing microwave-relay systems.

AT&T witness forecasts 1977 inflation surge

The U.S. economy faces a resurgence of higher inflation and interest rates by 1977 and beyond as it makes a "vigorous recovery," a major bank economist has told a Federal Communications Commission hearing. Until 1977, said James J. O'Leary, vice chairman and chief economist of the U.S. Trust Co., the economy will pick up only moderately, beginning in the last quarter of this year. **O'Leary's forecast came during his appearance as an expert economic witness for American Telephone & Telegraph.** The FCC is holding hearings to assess AT&T's authorized rate of return on interstate service, a subject that evokes strong interest among the capital's communications-industry watchers.

O'Leary's estimates were challenged by FCC attorneys on grounds that AT&T is a customer of the U.S. Trust Co. However, he attributed his forecast to sharply higher Federal budget deficits.

FAA reduces scope of flight data network plan

The Federal Aviation Administration, under pressure from general-aviation interests, has scaled down its plans for an automated flight-service-station (FSS) network to replace the old 282-station system still in operation. Instead of 30 automated FSS centers, the FAA now wants 20. And instead of 3,500 CRT-terminals located at airports for pilot information, the pilots will rely on conventional-style telephone links to the FSS centers. **The revised plan would reduce total estimated cost from \$120 million to \$90 million, and would include about \$50 million for computers and other electronic hardware.** The program would be implemented over a 10 year period, beginning in 1979. The FSS network provides weather and route information for general-aviation aircraft.

EIA urges letup on export rules

U.S. exports of electronics and telecommunications to new markets "are non-competitive with those of our Western trading partners and others" because of excessively rigid and complex Federal controls, says the Electronics Industries Association, which urgently recommends they be eased. In a seven-point position paper adopted at its June meeting, the EIA called on the government's executive and legislative branches to consolidate export authority, which is now divided among the Departments of Commerce, Defense, and State. Attributing the problem principally to excessive Federal concern with high-technology exports as a threat to national security, **EIA called for a revaluation of controls to give "realistic weight to the proven third-country availability of identical or equivalent products or technology."**

Washington commentary

Developing the land-mobile marketplace

Just about everyone agrees that the consumer market for radio-telephone service is ready for development on a large scale. Many believe that development is long overdue, having been slowed by four years of dispute before the Federal Communications Commission. In March, however, the FCC effectively wrapped up its proceedings under Docket 18262, which calls for land-mobile communications to be developed within the 115 megahertz allocated at 900 MHz [*Electronics*, May 10, 1973, p. 29].

"Now, it is pretty much up to the industry to seize the opportunities created for it at 900 MHz," concludes the FCC's Charles A. Higginbotham, chief of the Safety and Special Radio Services bureau responsible for overseeing the program. Believing that the carriers have "a vast potential market to explore," he states, "It seems to me that the opportunities for growth and service to the public for this market are virtually unlimited," since mobile radiotelephone now has the frequency resources to "bring it within the reach of the average household."

Not everyone agrees that all the loose ends that dangle from Docket 18262 and the related action under 18261—which proposed relieving the land-mobile frequency congestion a bit by permitting sharing of unused lower uhf TV channels—have been pulled together. Notable in its disagreement is the Land Mobile Communications Council, a national confederation with obvious special interests as communications users. This council is still anxious that the FCC resolve the frequency problems between the U.S. and Canada and Mexico on lower-channel sharing near the borders of the U.S. It is pushing for an early agreement.

But the FCC's Higginbotham notes that beyond the Docket 18261 decision to expand channel sharing in some areas, plus other steps to adjust other frequency sub-allocations in the 470-512-MHz band, the FCC and the users "must concentrate our attention on 900 MHz."

Cellular solution

To best develop the 900-MHz band, the FCC has blessed American Telephone & Telegraph's cellular technology, which limits mobile user transmissions to base stations within small geographic cells. Signals are automatically switched from one cell to another as a vehicle moves through them. The communications link from the vehicle is then completed over telephone lines, eliminating bandwidth congestion. Within a month of the FCC ruling on Docket 18262, AT&T told the FCC it would begin on a

trial system in the Chicago area for 1978.

Since the FCC wants development of a nationwide, compatible, and fully interconnected mobile radiotelephone network, Higginbotham points out that "the commission does not plan to authorize any other type of system at 900 MHz until after the cellular approach has been given a fair chance."

Does this lock up another market for AT&T? Theoretically, it won't. But the reality is that the cellular concept is AT&T's own development, which it is pushing hard. Nevertheless, Higginbotham notes that the FCC "will be ready to accept applications for 900-MHz systems—at least in the private sector—as soon as our supplemental form is approved and type-accepted equipment is available." The competition with the Bell System is going to be tough, of course. It always is.

The international aspect

Some domestic communications equipment makers believe they will be able to compete with AT&T as the market develops, particularly in terms of hardware. But a possibly bigger threat than the Bell System, they believe, are international pressures over which they, as company managers, have no direct control. "Should we be forced to relinquish this band because of international treaty actions," notes one of them, "it will have a stifling impact upon availability of land-mobile frequencies in the future." As an example, he cites Canada, where a consulting engineering firm reportedly "has urged the Canadian Department of Communications to reallocate the vhf band to land mobile and move all television to uhf." Japan has already approved such a switch.

To counter such a possibility, some U.S. specialists would prefer to see the 900-MHz land-mobile band allocated worldwide. Such a move would not only expand the equipment market beyond U.S. borders, it should bring down hardware costs through larger production runs.

More importantly, it would necessitate the development of a viable domestic industry composed of multiple producers able to meet global competition. That requirement in itself would preclude AT&T's Western Electric Co. from locking up the domestic market.

Expansion of the 900-MHz allocation beyond U.S. borders is a proposition the Government should weigh carefully before it goes to Geneva in 1979 to negotiate global frequency allocations at the World Administrative Radio Conference.

—Ray Connolly

From the *Quality* DMM Specialists

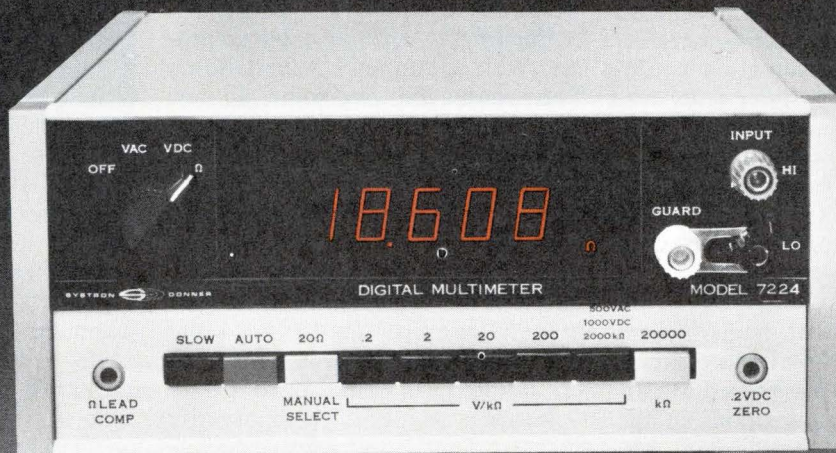

At last! True RMS in a low cost DMM.

(Buy it now... or add it later)

What's so great about true RMS? Well, did you ever have to measure distorted sinewaves? Triangles? Squarewaves? Pulses? Don't bet that you won't have to tomorrow. True RMS is the only *accurate* way to do it. And only Systron-Donner's Model 7224 lets you buy true RMS now or add it later.

The new 20,000-count, autoranging Model 7224 is a quality-built "customer's" DMM. Plug-in boards make it easy to service or to install options at any time. Outstanding features include:

- choice of **TRUE RMS** or **AC averaging**
- **0.001 ohm resolution**
- **autoranging**
- **large in-line/in-**

- plane segmented display with automatic polarity, decimal point and annunciator**
- **DC/DC ratio option**
- **5 ranges DC volts, 7 ranges ohms standard**
- **optically isolated BCD output**
- **FAST and SLOW sample rate**

Here's how to get details on the first of a new breed of quality DMM's:

In the United States, give your local Scientific-Devices office a call or contact us in Concord. Abroad, contact Systron-Donner GmbH, Munich; Systron-Donner Ltd., Leamington Spa, U.K.; Systron-Donner S.A., Paris (Le Port Marly); Systron-Donner Pty. Ltd., Melbourne.

1 Systron Drive, Concord, CA 94518 • Phone (415) 676-5000

SYSTRON  **DONNER**

For literature circle 202 on reader service card.

For demonstration circle 51 on reader service card.

'Electronic journalism' hardware steals the TV engineers' show in Montreux

The TV-broadcast engineers who flock to Montreux in late May every other year for the Swiss postal administration's International TV Symposium and Technical Exhibition are a fairly trendy group. The last time around, the "in" equipment on the exhibition floors of the Palais des Congrès at the Lake Geneva resort was station-automation equipment. This year's fashion setter was hardware for "electronic journalism"—hand-held color-TV cameras and portable video-tape recorders to report news on the spot, time-base correctors, and microwave links for instant relay to transmitters.

Hand-held. Most of the major broadcast-equipment makers went to Montreux with portable cameras they had already introduced at earlier broadcaster conventions in the U.S. and the UK. But joining the crowd at Montreux were Thomson-CSF and Ampex. The French firm showed the latest offspring of its TTV 1515 camera—an 8-kilogram portable with an independent monocular electronic finder; the unit can operate as far as 150 meters from the control interface. The American company checked in with a 7-kg camera head coupled to an 8-kg backpack that holds the sync and video-processing-circuit cards.

Like most other portable camera heads, those of Thomson-CSF and Ampex use three 1-inch Plumbicon tubes as the image sensors. Philips, which produces the Plumbicon, went one up on its competitors at Montreux with a low-light-level version of its LDK 15 portable. Instead of the conventional Plumbicon, this camera uses a 41XQ Plumbicon/channel-electron-multiplier combination for a five-fold improvement in sensitivity.

For the low-light-level version, the basic camera doesn't have to be altered. The channel-electron-multiplier unit is paired with a printed-

circuit deflection yoke that slips into the same space as a regular wound yoke. The standard LDK 15 and its base station sell for roughly \$62,000. Because the light-intensifier tubes are so special, Philips rents them on an hourly basis, which usually works out to some \$1,250 a month.

Recorders. As for portable recorders, West Germany's Robert Bosch Fernseh Anlagen put some all-new hardware into contention at Montreux with such standbys as the 2-in. quadruplex VTRs of Ampex and RCA. The Bosch company, jointly with Philips, developed a 1-in. single-head helical-scan VTR for studio work and showed it at Montreux in 1973. Philips has stuck to the scheme for its BCR series of recorders, but Fernseh has dropped it.

Fernseh achieved compatibility between 1-in. tapes recorded on different machines of the same make by shifting to a two-head helical scan and segmented fields. The two heads, running at 150 revolutions per second, alternately record or play back segmented fields of 52 lines. Six track segments make up a field. Because of the two heads, the track length is comparatively short—only 80 millimeters—and the track angle is only 14°. These factors count heavily on compatibility.

Fernseh has three versions of its new machines. There's a 20-kg portable—the BCN 20—with the tape reels stacked one above the other, which sells for roughly \$32,000 and makes broadcast-quality recordings up to 52 minutes long. Next comes the BCN 40, mainly for outside-broadcast-van use. It has side-by-side reels and records up to 95 minutes but has no time-base correction. The top of the line is the BCN 50 studio version, a \$60,000 unit with correction electronics.

To get their reporting back to the studio, electronic-age newsgatherers long have used portable microwave

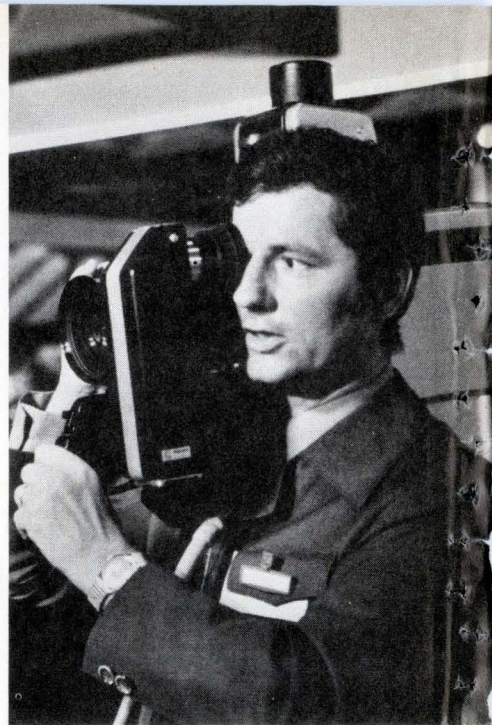

Lightweight. Philips' portable camera grabs image on 50-lux lighting.

lines. More and more, they're moving up to the 12-gigahertz band, where there's more frequency elbow room. To help them get up there, Thomson-CSF developed its TM 313 portable link and showed it to the broadcast community for the first time at Montreux. The link has an offset antenna for easy aiming. And to ease coming up on a channel in the 11.7/13.25-GHz band, the unit has knob-selection of four center frequencies spaced at 28-megahertz intervals. The link can relay a video channel and two sound channels for at least 30 kilometers with a signal-to-noise ratio larger than 67 dB.

Obviously, it wasn't all electronic newsgathering hardware at Montreux 75. Some of the other noteworthy equipment debuts:

- Siemens' Interplex single-tube color camera was designed for industrial and medical closed-circuit-TV systems. The camera faceplate has a stripe filter made of red-stop stripes and blue-stop stripes oriented in a criss-cross layout with the stripes at a 22° angle to one another. As the vidicon tube scans behind this filter, a multiplexed red-blue-green signal with a bandwidth of 5 MHz is picked off, with the luminance information coming from transparent interstices between the stop stripes. This multiplexed signal has blanking and sync bursts added to it and, as such, can drive a black-

and-white monitor. For a color monitor, there's decoding circuitry. The camera is scheduled to hit the market next year, carrying a price tag of some \$6,000. First versions will have an antimony-sulfide target for operation at light levels of 1,000 lux. A version with a silicon-diode matrix sensitive enough for 200-lux operation will follow.

■ AEG-Telefunken's prototype 100-watt, 12-gigahertz TV transmitter was developed for the German post office, which is thinking about using band-six frequencies to distribute programs to community antennas. Siemens and the ITT subsidiary Standard Elektrik Lorenz are also working on 12-GHz transmitter designs for the project. All use a special klystron developed by Valvo, a Philips-group firm.

■ Rank Cintel's Mark 3 flying-spot telecine requires each frame of the motion picture film to be electronically scanned twice to get two interlaced TV fields. The Mark 3 uses signals from a capstan drive with servo control paired with optical readout of the film sprocket holes to keep the scan of the flying spot synchronized with the moving film. Because the drive is sprocketless, the Telecine can handle 16- and 35-mm film and goes for about 10% less—at \$72,000—than earlier models. □

France

Chronometer reads at 1 picosecond

Nuclear-fusion programs are moving into sharper focus everywhere as the oil crisis speeds the search for alternative energy forms. Laser-fusion projects, in particular, are prompting development of new electronic measuring hardware capable of handling signals in the picosecond range. With the help of the French atomic energy commission, France's Thomson-CSF is now well advanced with the design of a chronometer that should be available to outside customers early next year.

A full-scale industrial prototype is

now being put together at Thomson-CSF's department of special instrumentation applications near Paris, and the sales effort is scheduled to begin this summer. The company plans to offer an instrument capable of measuring within 1 picosecond. Indeed, laboratory tests on a working model have already achieved a resolution of 0.5 ps.

Noting that resolution of even the very best instruments is limited to about 20 ps, the team figures that a chronometer has some basic advantages over all other measuring routes. For a start, explains project engineer Gabriel Lejeune, the noise level is reduced through the electrical simplicity of the equipment, and the measurement is obtained directly through an analog-to-digital converter.

The measuring operation is started and stopped by flip-flops that control a pair of Schottky diodes. They, in turn, switch the output of a constant-current generator onto a capacitor that integrates the current. The integrated signal is amplified and then fed into an

analog memory. At that stage, a multichannel analyzer can be plugged in to trace the curve of the measured signal before it is passed on to the d-a converter and switched through to the final result display.

Obstacles. Lejeune says the problem is in the handling of the input signal at the flip-flop and current generator stages. His team used fast transistors from outside suppliers and some new Schottky low-leakage, low-noise diodes developed by Thomson-CSF. Lejeune told a Paris conference on metrology late last month, "The studies consisted essentially of searching for the best signal-to-noise relationship at all levels of the circuit," while "avoiding many concessions on linearity."

Such concessions are all too easy to make. A change of a millimeter or so in the length of one of the connecting cables in the instrument can alter the displayed result by tens of picoseconds. Similarly, Lejeune explains, beat stability and other factors that could interface with the resolution and general performance must be carefully controlled. □

Around the world

Former Rank employees make color-TV sets in Denmark

A new company in Denmark, formed by former employees of a shut-down television-receiver manufacturer, plans to market two new color sets in Europe before the end of the year. The company, which for now calls itself 3F, has taken over the Rank-Arena TV-receiver plant at Horsens, Denmark. Britain's Rank Organisation had closed down this subsidiary on Feb. 1, citing high production costs.

The company will produce 22-inch and 26-inch versions of a 20-inch color set Rank had developed. Rank, however, retains its rights to the 20-in. set and an 18-in. model. As in Rank's 20-in. set, 3F will probably also use Toshiba components in its 22-in. model, which is practically ready to go, as well as in the 26-in. set. Production is scheduled to begin on the first two sets during the autumn and to reach an annual rate of 50,000 units—the plant's capacity—by the end of 1976.

Automation machinery speeds components and wiring output

Productivity, according to East Germany's electrical/electronics industry, has increased many-fold in recent years—from an index of 100 in 1955 to one of 526 in 1973. For some years during the 1970s, the annual rise in employee productivity translates into an impressive 7.4%, including both the 1970/71 and the 1972/73 periods.

One firm, VEB Elektromat, stands out with its automatic equipment for production of electronic components. It has recently introduced a bonder that can handle up to 2,500 wire bonds on integrated-circuit chips per hour, an automatic cable-harness-forming machine capable of operating at 16 meters of wire per minute, and an IC-adjustment and exposure system that charges, positions, and exposes well over 100 substrates per hour.

WESTON[®] Confesses: Every DMM we sell is used!

It's true! Each DMM with the Weston name on it is used before we'll let you use it. You would never dream of using it the way we use it.

Each and every DMM that comes off the production line is put through normal check-out procedure. Then starts the really rough part. Each unit goes through a 96-hour burn-in, for example. This may seem to you like 12 work days, or about 2½ weeks, but it's a whole lot different. For the entire period of 96 hours, each unit is on for one hour then off for 5 minutes, then on for one hour and off for 5 minutes...for 96 continuous hours. That's rough, but only the ones that pass are considered acceptable for your use... But we don't stop here.

To meet production acceptance standards, the Weston DMM line must go through rigorous vibration tests. This might mean that units have to take vibrations of 5-10 Hz for 1 hour at .4 G, then 10-50 Hz for 11 milliseconds at 2 G. We don't stop here, either. There are severe shock tests. Here, they might have to withstand 50 G's on 3 axes, for example.

In addition, there are temperature control and humidity control tests.

DMMs that pass their tests get the Weston name, so you can be sure the Weston DMM you buy new, has been used...really used!

That's good news for you.



We're either first or best. Or both.

WESTON

WESTON
Schlumberger

Circle 54 on reader service card

International newsletter

Thomson-CSF pushes color-TV displays for plane cockpits

France's Thomson-CSF is pushing hard to get its penetration color tubes into aircraft cockpits. At the Paris Air Show early this month, the French firm turned up with a prototype version of a "head-down" four-color display for military planes that can show radar maps, targets, obstacles, television images, alphanumeric instructions, and the like. **Thomson-CSF also plans eventually to switch to color in a "head-up" display developed for the Mirage**, the plane that aircraft-maker Marcel Dassault put into contention with the U.S. F-16 and F-17 for the "arms contract of the century."

Meanwhile, civil versions of a head-down system with color displays will start getting flight tests on a NORD 262 short-haul transport this fall. **The system is made up essentially of an electronic attitude-director indicator, a horizontal-situation indicator, an inertial platform, and a navigation computer.** The system's units are linked by optical fibers.

Japanese mission begins 8-plane evaluation tour

The F-18, chosen by the U.S. Navy as its next-generation fighter, has been **added to the shopping list as representative of Japan's Air Self-Defense Force start on a two-month data-collecting mission.** The selection of Japan's next mainstay fighter, coded-named FX, will come by summer 1976. Now in the running are France's Mirage-1, the British-German-Italian Multi-Role Combat Aircraft, Sweden's Viggen, and the American F-14, F-15, F-16, F-17, and F-18. **Current plans call for the field to be narrowed to three contenders** after the mission turns in its detailed report, and the final choice is to be made after a second mission reports back next spring.

UK company offers converter for TV-signal types

A brash young British company intends to challenge Marconi Communications Systems, Japan's Oki Electric Industry Co., and West Germany's Robert Bosch Fernseh Anlagen for the smallish world market for digital intercontinental conversion equipment for different television-signal standards [*Electronics*, May 29, p. 82]. Although it has yet to build the hardware, **Quantel Ltd. went into the market at the late-May Montreux television show with an offer to build 625-line/50-field-to 525-line/60-field converters for about \$230,000—less than half the price Marconi is asking for its DICE hardware.** Anthony Stalley, who led the Independent Broadcast Authority team that originally developed DICE and who now heads Quantel, says the slashed costs are possible because of "second thoughts" like a reorganized mass memory and mechanical improvements like printed backplanes instead of wire-wrapped connections.

Nippon Electric readies Russian wire-memory plant

A 10-million-bit-per-month plant to manufacture wire memories for minicomputers has been sold to Russia by Nippon Electric Co. Delivery is slightly behind schedule, but the company will soon turn over the plant in return for approximately \$2 million. Nippon Electric says approval for the deal from the Coordinating Committee for Export Control in Paris was based on a **pledge from the Russians that they would not use the wire memories for military purposes.** The plant consists of

International newsletter

three types of machinery—for plating wires, for weaving wires into memory planes, and for testing completed memories. Basic technology for wire memories was developed at the research laboratory of Kokusai Denshin Denwa Co., Japan's private overseas radio and cable system.

Unidata expected to reject bid for CII-Honeywell sales

Europe's Unidata is likely to reject any early attempt by the new Franco-American computer combine, CII-Honeywell-Bull, to sell Honeywell-Bull machines through the Unidata network. Officials at Philips, partner with Germany's Siemens and Compagnie Internationale pour l'Informatique in the joint marketing organization, stress that the Unidata contract specifies that only certain CII machines may be sold.

Despite affirmations from the French that development of Unidata models 7760 and 7770 will continue at CII, Philips executives fear that Honeywell machines would soon oust any CII-designed models. "The balance will be in the hands of Honeywell in the end," says one. No clarification of the new French company's future relationship with Unidata is expected before late this summer. Meantime, Philips is making clear that it makes "no sense at all" to discuss the Unidata problem with the French until a complete report has been completed in Paris.

Siemens uses laser, hologram to solder parts on pc boards

Researchers at Siemens AG have developed a laser-based soldering technique that allows a number of component connections **to be made simultaneously on a printed-circuit board in a one-step process.** First, a large-diameter laser beam is applied to a hologram, which splits it into several small-diameter partial beams. These fragments are then focused onto the transistor or IC pins to be soldered. The hologram determines into how many partial beams the original one is to be split and fixes the spots onto which they are to be focused. If the geometry of the setup requires it, the partial beams can also be reflected by a mirror arrangement. Thus far, the improvement in speed that the simultaneous soldering method affords over step-by-step methods has not yet been determined. But a prototype setup is expected to show the improvement to be significant.

National CSS forms time-sharing firm with French aides

National CSS Inc. of the U.S., a leader in interactive computer time-sharing, is launching a joint venture with banking and consulting partners in France. Predicting substantially faster growth in the European time-sharing and computer-services market than in its domestic market, National CSS has set up a new company, CSS France, with French project-management specialist Norbert Beyrard France and a private Paris bank, Rivaud et Cie.

National CSS is aiming to take a share of what is already a \$100 million time-sharing market in France and to develop further operations within European Economic Community countries, where it expects demand to grow at a rate of at least 30% a year into the 1980s. National CSS plans to use transatlantic circuits to service European customers for another three to five years and then to add European-based hardware.



Before you buy indicator lights, check these facts:

- LITTELITES** include Cartridge Lamps and Lampholders, Subminiature and Miniature Lampholders, and Snap-Mount Plastic Lites. We offer a wider selection among these four product groups than any other single manufacturer.
- LITTELITES** are made with all new tools and molds. This plus total in-house production capabilities make Littelites the finest quality lights on the market today.
- LITTELITES** are all U.L. Recognized or Listed and Certified by C.S.A.
- LITTELITES** Snap-Mount Plastic Lites feature unique flex arms to ensure positive retention and protection against shock and vibration. Absolutely no additional mounting hardware required.
- LITTELITES** are available off-the-shelf from a nationwide network of Littelites distributors. For large volume requirements, you can depend on a fast turn-around on orders.
- Our **LITTELITES** team of R & D and sales engineers is ready to assist you at any time with standard or special applications.

Then check the source... Littelfuse

Send for your Littelites Product Guide today!

LITTELFUSE

Subsidiary of Tracor

Circle 57 on reader service card

800 E. Northwest Highway • (312) 824-1188 • Des Plaines, Illinois 60016

Thirteen



just became your lucky number!

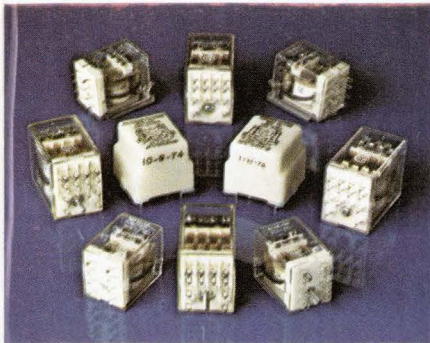

Three new 10 amp relays give you 13 small enclosed relays from which to choose.

Your Guardian Angel calls them the 1300 series, of course.

Amazing. Versatile. Small. Enclosed. Multi-pole. These five words sum up Guardian's 1300 line of 13 basic models . . . in hundreds of variations. Each relay in a choice of AC or DC, solder lug or printed circuit termination. Each with its own mating socket. Each your ideal spec for any application requiring uncompromising high quality at low, affordable price.

NEW! 1345DC relay in your choice of SPST-NO, SPST-NC or SPDT. Small in size but built to take hard knocks. Just over a cubic inch small, yet specifically designed for a minimum of 50,000 miles of maintenance free operation in automotive controls . . . or an equally amazing trouble-free life anywhere you need small size, long life and low, competitive price.

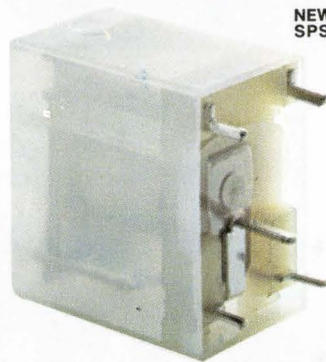

NEW 1345 SPST-NO, SPST-NC, SPDT

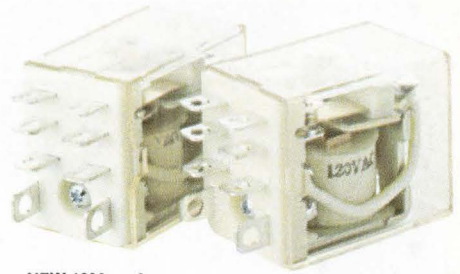

NEW 1390 and 1395 DPDT

NEW! 1390AC and 1395DC relays, DPDT with 10 amp rating in a space-saving, compact new design. To give you large control capacity in a package about half the size of competitive relays that do the same job. The cost? Just about the same as competitive units . . . in many cases quite a few cents less.

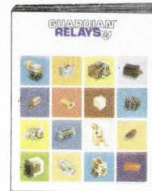

SEND FOR THE BOOK THAT TELLS IT ALL:

Guardian's 48 page relays catalog. Full of facts and specs to make selecting a relay a snap. Yours free for the asking.



GUARDIAN®

GUARDIAN ELECTRIC MANUFACTURING CO. • 1566 West Carroll Ave., Chicago, Illinois 60607

Circle 59 on reader service card

The SR-50. The SR-51.

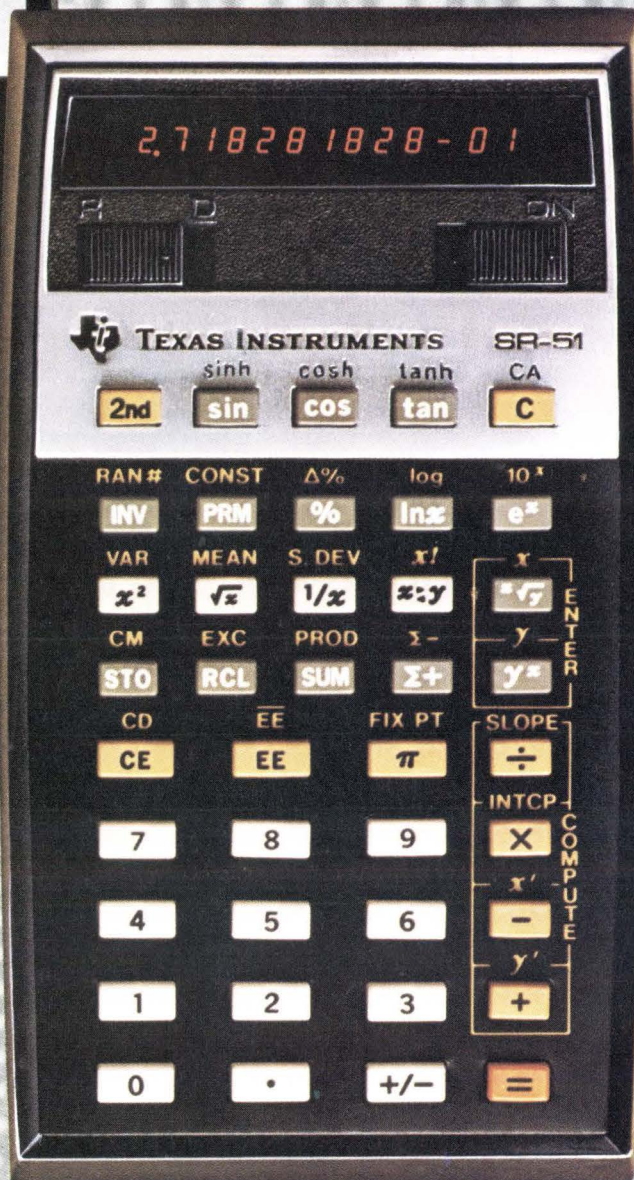
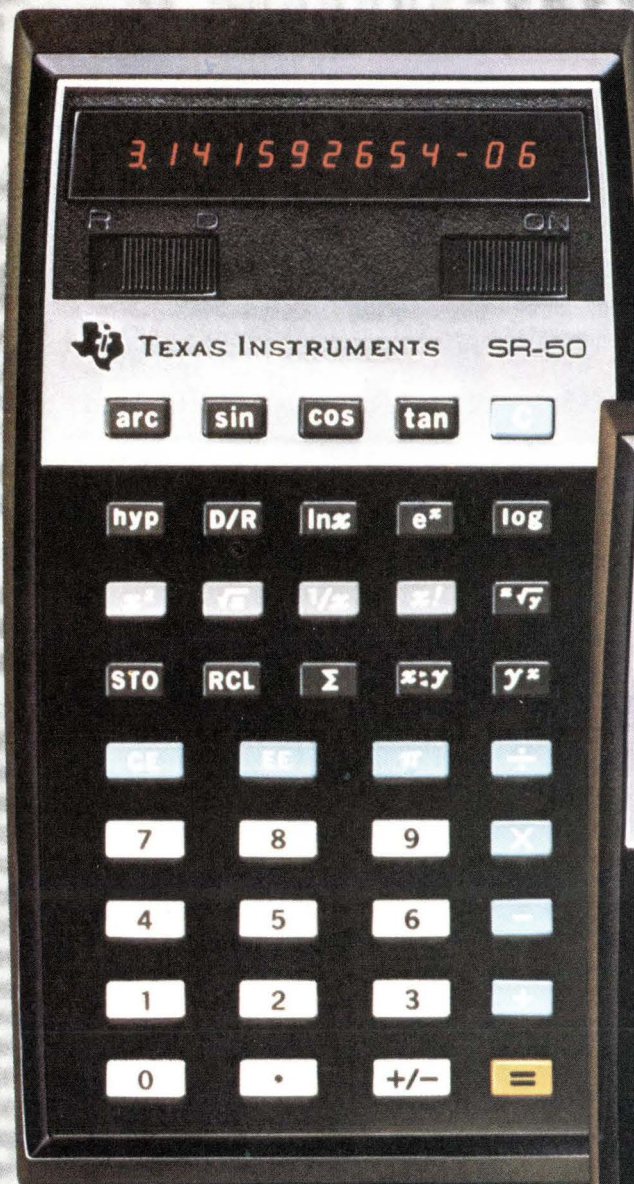

Texas Instruments is steeped in calculator technology from start to finish. We make all critical parts, and control quality every step of the way. This is the key to the exceptional quality and value of TI's professional calculators.

Capability. Quality. Value.

The technological achievement under the keyboard is still the reason TI's professional calculators offer so much quality and math power for the money.

Engineer. Scientist. Businessman. Student. If you're doing more than basic mathematics in your field, consider an SR-50 or SR-51 from Texas Instruments.

Both deliver answers you can trust—quickly and efficiently—to problems ranging from simple arithmetic to highly complex calculations. You don't have to learn special entry methods or difficult-to-master key sequences. There's a better way—TI's algebraic entry system lets you key your problem just the way you would say it. Naturally. You don't worry about losing data in stacks, or keeping track of what is in each stack, or remembering if the stack is full. The way you learned math is the way it's done. On both the SR-50 and SR-51—you can command tremendous math power with confidence—from the beginning. Power and accuracy you can really put to work.

Answers are calculated to 13 significant digits, rounded off and displayed to 10. And for maximum accuracy, all 13 are held inside for subsequent calculations.

Scientific notation is automatic when you need it. For numbers as large as $\pm 9.999999999 \times 10^{99}$. Or as small as $\pm 1. \times 10^{-99}$.



For a closer look at real math power, delve into the list. You'll see for yourself the SR-50 is a lot of calculator for the dollar. And the SR-51 does everything the 50 does and a lot more: Mean, variance and standard deviation. Linear regression. Percent and percent difference. Has a random number generator. And, offers 20 preprogrammed conversions and inverses.

Quality—it's built in right from the start. Texas Instruments designs and manufactures every critical component. From high-purity silicon semiconductor materials to

integrated circuits to light-emitting-diode displays to circuit boards to keyboards. So, we design-in and control quality—not just monitor it—at every level: Materials. Components. The complete system.

FUNCTION	SR-51	SR-50
Log, ln x	yes	yes
Trig (sin, cos, tan, INV)	yes	yes
Hyperbolic (sinh, cosh, tanh, INV)	yes	yes
Degree-radian conversion	yes	yes
Deg/rad mode selection switch	yes	yes
Decimal degrees to deg. min. sec.	yes	no
Polar-rectangular conversion	yes	no
y^x	yes	yes
e^x	yes	yes
10^x	yes	no
x^2	yes	yes
\sqrt{x}	yes	yes
$\sqrt[y]{x}$	yes	yes
$1/x$	yes	yes
$x!$	yes	yes
Exchange x with y	yes	yes
Exchange x with memory	yes	no
% and Δ %	yes	no
Mean, variance and standard deviation	yes	no
Linear regression	yes	no
Trend line analysis	yes	no
Slope and intercept	yes	no
Store and sum to memory	yes	yes
Recall from memory	yes	yes
Product to memory	yes	no
Random number generator	yes	no
Automatic permutation	yes	no
Preprogrammed conversions	20	1
Digits accuracy	13	13
Algebraic notation (sum of products)	yes	yes
Memories	3	1
Fixed decimal option	yes	no
Keys	40	40
Second function key	yes	no
Constant mode operation	yes	no

To assure you reliable performance, every calculator is subjected to severe environmental and reliability testing prior to release to production. In production, every one is thoroughly tested, then "burned-in", then thoroughly tested again. If there's any problem, we want to find it before it gets to you.

Inside, steel machine screws anchor all important structural elements—plastic welds and glue fastenings aren't good enough. A double-tough Mylar* barrier keeps dust and moisture from getting under the keyboard. The case is high-

strength, injection-molded plastic designed to take a beating. It's a quality calculator. And you know it as soon as you get your hands on one. The heft and solid feel tells you it's a fine-quality instrument even before you press a key.

The SR-50 and SR-51 are human engineered, too, for maximum comfort and efficiency. For a hand or a desktop. Keys have positive-action, tactile feedback. And the bright, wide-angle displays are easy to read at your desk or on the go. Slim. Compact. Light. In your briefcase or on your belt, you'll hardly notice just 8.3 ounces.

Technological leadership and quality craftsmanship are why Texas Instruments can offer so much value at such low prices: \$109.95 for the SR-50. \$179.95 for the SR-51.

20 Preprogrammed Conversions

FROM	TO
mils	microns
inches	centimeters
feet	meters
yards	meters
miles	kilometers
miles	nautical miles
acres	square feet
fluid ounces	cubic centimeters
fluid ounces	liters
gallons	liters
ounces	grams
pounds	kilograms
short ton	metric ton
BTU	calories, gram
degrees	gradients
degrees	radians
°Fahrenheit	°Celsius
deg. min. sec.	decimal degrees
polar	rectangular
voltage ratio	decibels

See them at your nearest TI calculator retailer. Or, send for our new fact-filled color brochure. It details the outstanding capability of both the SR-50 and SR-51 with full feature descriptions, sample problems, entry-method considerations and more. Circle the reader service number. Or write, Texas Instruments, M/S358, P.O. Box 22013, Dallas, Texas 75222



TEXAS INSTRUMENTS
INCORPORATED

SIEMENS

Where Quality is the measure

Because people depend more on electronics than ever before, quality is vital in the manufacture of components.

As one of the world's largest electronic components manufacturers, Siemens offers the complete range in more than 50,000 configurations. Capacitors. Zener and Varactor diodes. Thermistors. Microwave and optoelectronic devices. Transistors. Integrated and hybrid circuits.

For more than a century, Siemens has been a major supplier of electronic components for a wide range of applications. Telecommunications systems. Data processing equipment. Instrumentation. Process control systems. Electromedical equipment. Consumer and automotive electronics.

No newcomer to the United States, Siemens recently broadened its components capability by acquiring Dickson Electronics Corporation—a well-known U.S.-based manufacturer of quality electronic components.

To learn more about Siemens and the quality products that have helped build our reputation in such fields as electronic components, write for our latest brochure: *Siemens in the United States*.

Siemens Corporation
186 Wood Avenue South, Iselin, N.J. 08830
(201) 494-1000

...Siemens is the rule.

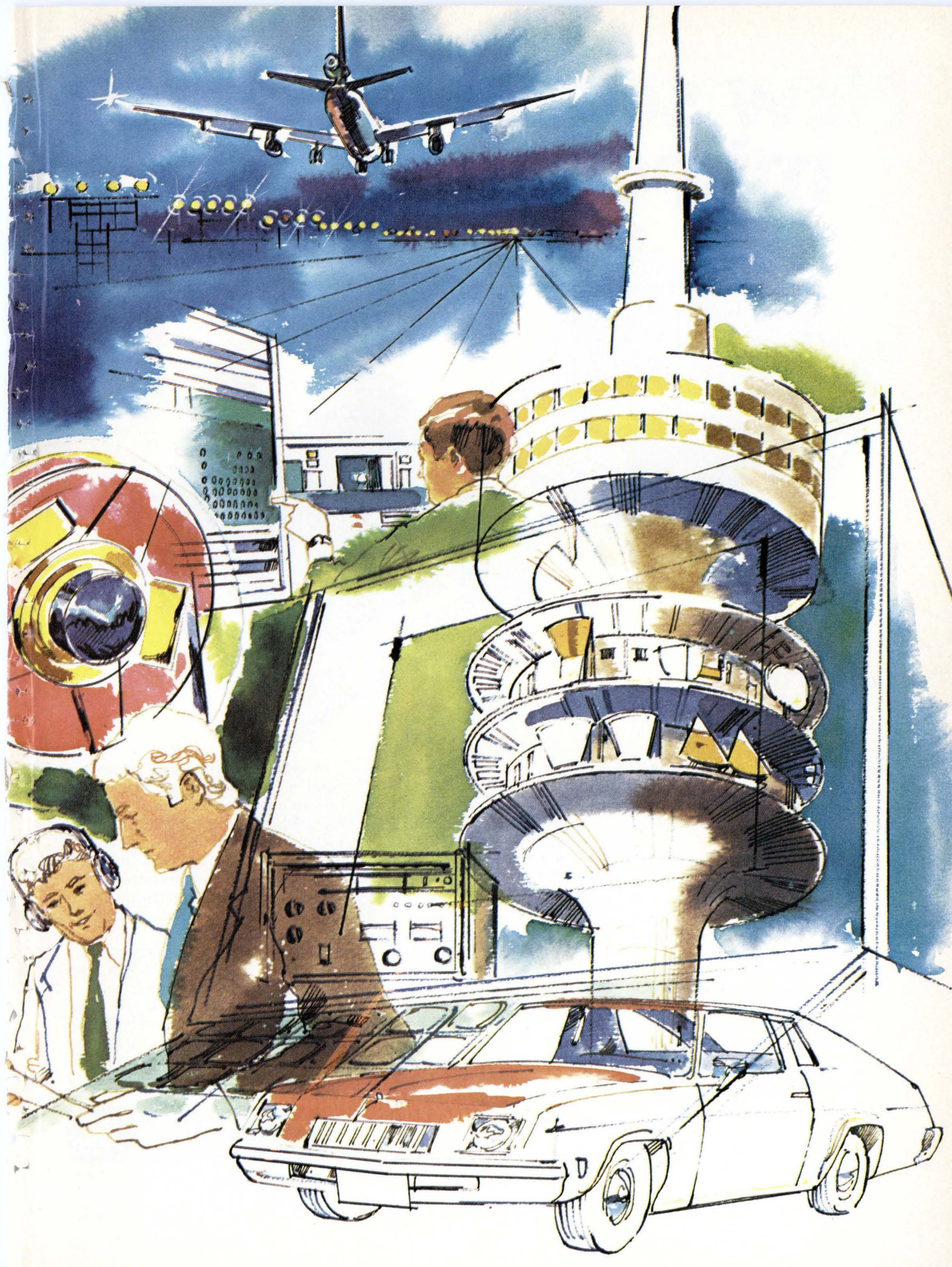

New socket cards for MICROPROCESSORS.

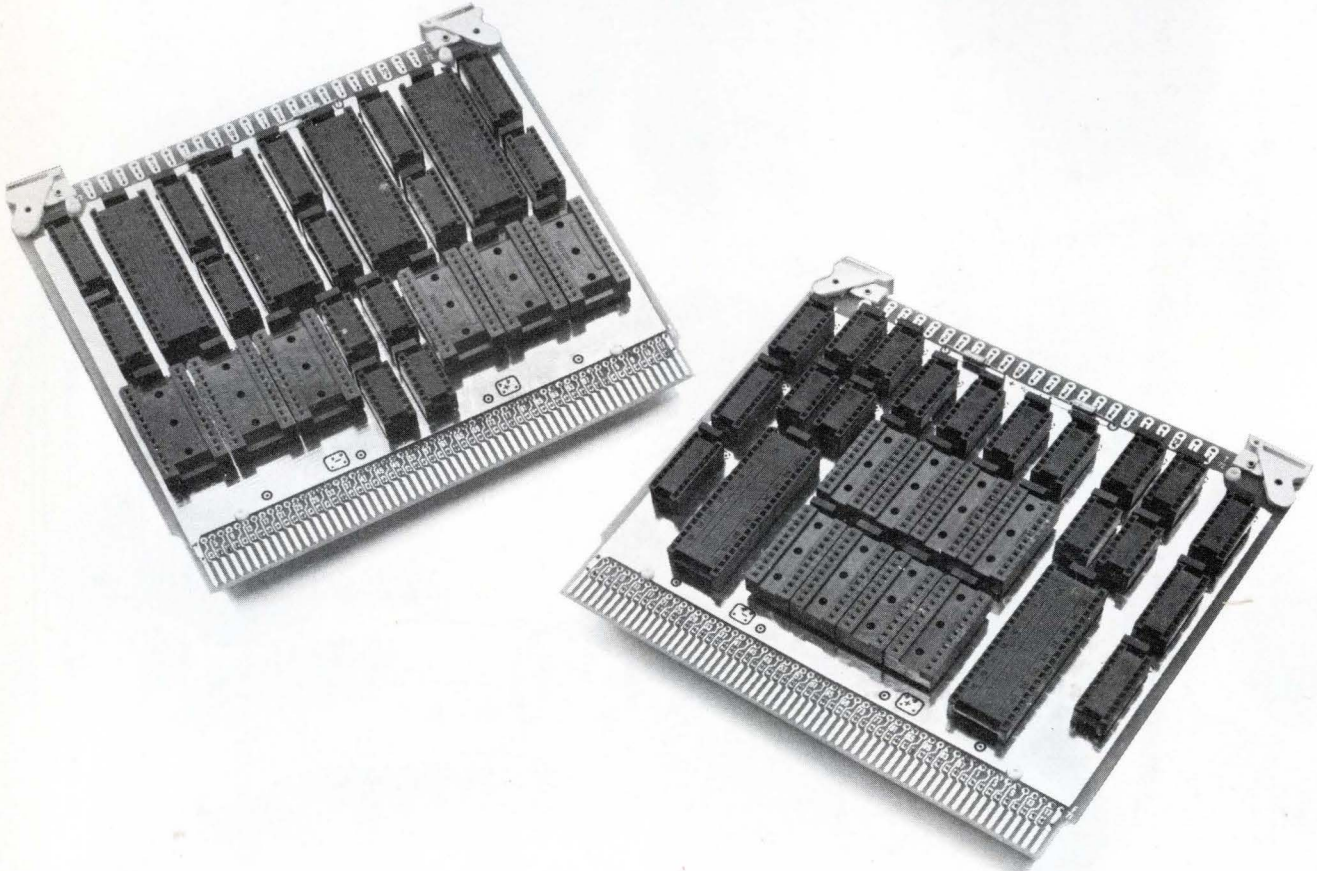

Instantly available, these two new cards are your answer to second-source problems. They enable you to change ICs and wiring for new pin patterns with great ease.

They are designed specifically for microprocessor applications, including controllers, random access memories, and erasable programmable memories. As such they are the newest in our line of 3D socket cards:

3D2017 Four 40-pin sockets, six 24-pin sockets, five 18-pin sockets, five 16-pin sockets, and four 14-pin sockets. \$124.70.

3D2018 Two 40-pin sockets, eight 22-pin sockets, four 18-pin sockets, six 16-pin sockets, and eight 14-pin sockets. \$140.70.

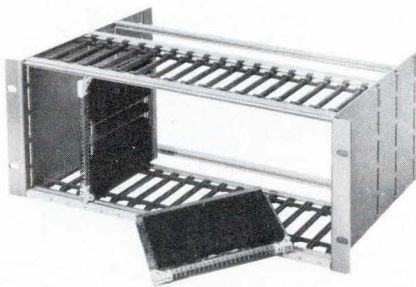

In addition, both cards provide a good ground plane for high-speed operation. They include a ceramic monolithic bypass capacitor at every socket, and provision for bypassing other voltages that may be required for chips. Power can be connected to various pins on LSI chips by means of solder tabs. And each card includes 22 built-in test points.

These cards are complemented by our line of Card-Pak card files, and our automated wiring service.

We're ready for you right now. And so is our nationwide distributor, G. S. Marshall. So call either of us today. Or, tear out this page and keep it handy until you are ready for us.

EECO

FOR PACKAGING

1441 East Chestnut Avenue, Santa Ana, California 92701
Phone 714/835-6000

Probing the news

Analysis of technology and business developments

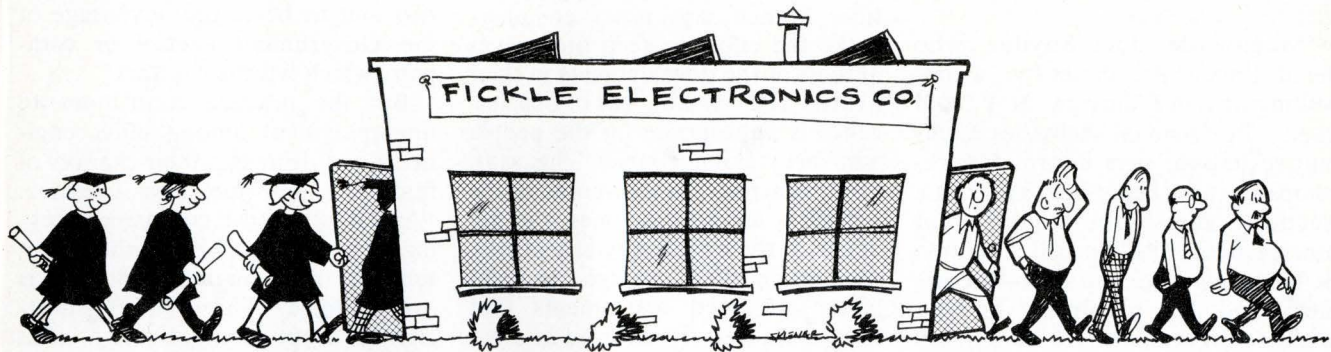

For EEs, insecurity begins at 40

IEEE report finds 'massive age discrimination' in the industry;
institute plans position statement on employment practices

by Ron Schneiderman, New York bureau manager

Discrimination, an age-old problem, is becoming an old-age problem in the electronics industries. And for EEs, "old age" begins at 40. Senior engineers who are 40 and older face "massive age discrimination," according to data compiled by the Institute of Electrical and Electronics Engineers in its new manpower study, "The EE at Mid-Career—Prospects and Problems."

"Investigations, interviews, and general experience seem to point to the fact that engineers approaching their mid-career often suffer from one form of age discrimination or another." The electronic-equipment industry, in particular, shows "a substantial discriminatory bias against older engineers." That's the conclusion of Robert A. Rivers, president of Aircorn Inc. of Union, N. H., and an IEEE director, who writes about age-discrimination patterns in the report [*Electronics*, May 15, p. 40].

Indeed, surveys taken earlier this year of the institute's 120,000 U. S. members, but not reflected in Rivers' data, indicates that a significant number of EEs feel discriminated against because of their ages—in promotions and layoffs, as well as in hiring.

The institute is planning some ac-

tion, but it's questionable if industry will be moved by any IEEE action to change such practices, if and where they exist. IEEE general manager H. A. Schulke Jr. says that the *ad hoc* Committee for Professional Opportunities for Senior Engineers formed last July and recently absorbed into the IEEE Manpower Planning Committee, is "shaping up a statement—a true IEEE position" on age discrimination and senior-engineer employment practices.

The IEEE executive committee will get a draft of the position paper at its next meeting later this month. "If we like it, we'll release at that time," says Schulke. "If not, if there is some wording in there that some committee members don't like, then we'll have to rewrite it and take it before the board of directors, who are meeting in September."

Reassessment. Also, another survey is in the works. This one, to be mailed out to some 10,000 IEEE members over the next three months, will ask specific questions designed to more accurately assess age-discrimination practices—if any—in particularly hard-hit areas of industry unemployment, such as the vicinities of San Francisco Bay and Boston, as well as Long Island in New York State.

In addition, James J. Rago Jr., a former engineer and now a psychologist with the Cleveland State University College of Business Administration, and an IEEE Manpower Planning Committee member, is proposing a pilot program for the IEEE, aimed at helping older engineers determine for themselves how to maintain and market their engineering skills.

The program—primarily a set of questionnaires—will also help the engineer establish his own "early-warning system." Most important, says Rago, "an individual assuming responsibility for his own career needs to have data as to his organizational [market] situation and his responses to it."

Rago says his research into "apparent and concealed" obsolescence situations, across-the-board cutbacks, pension-dollar reductions, and high-salary eliminations has led him to believe that the dismissed older engineer "is not appropriately valuable. The judged-obsolete individual no longer has the market value within the organizational system he once had—an intolerable divergence has opened between himself and those in authority to judge him." An early-warning system for the mid-career engineer to "assess

Probing the news

his vulnerability to catastrophe" is needed, says Rago.

Meanwhile, Joel Snyder, who heads Snyder Associates Inc., a consulting firm in Plainview, N. Y., and IEEE's Professional Activities Committee liaison, says informal workshops are now being held in 12 IEEE sections across the country for unemployed EEs. Special attention is being given to the over-40 engineer and his problems. Another eight to 10 sections will be holding similar workshops by August, says Snyder.

Reasons. Donald D. French, director of continuing education at Northeastern University in Boston, points out that there are a number of reasons age discrimination is a problem in the electronics industries. One is that as the engineer ages, his salary increases as well, and he must remain aware of his cost-effectiveness.

But the responsibility of keeping an engineer in the mainstream of technology does not belong to the individual alone, says French. "The company he works for must also see to it that he is being used to the maximum. If someone is assumed to be over the hill and he is being given less-challenging work, then he may go over the hill."

Another organization fault may rest in the division of work: "The young hotshots will demand and receive the exciting, challenging proj-

ects and leave the drudges to the older people just because they are older."

As director of continuing education, French says many engineers make the effort to keep themselves abreast of the developments in their fields. "The ongoing fear of obsolescence is appropriate for the people who are taking courses," he says. "But, generally, those who do make the effort are also the ones who are active in their professional societies, read more than average, and are given advanced assignments that keep them heavily involved in a variety of updating work."

David Goldman, vice president of the Massachusetts Society of Professional Engineers, also talks about cost-effectiveness, but he refers to it as the engineer's "half-life," which he pegs at 10 to 12 years. "Unless an engineer keeps himself up with technology, his training is obsolete after about 15 years." Goldman also notes a correlation between age and continuing education. "The older a guy gets, the less he may want to go back to school—it's a self-defeating process."

Hans C. Cherney, personnel planning manager for IBM Corp.'s System Products division laboratory at Poughkeepsie, N. Y., and chairman of IEEE's Manpower Planning and Member Employment Committee, believes, as do others, that government and industry procurement practices "probably make one of the most detrimental contributions to the problems confronting the older

engineer. The requirement to accept the lowest bid gives the bidder employing lower-paid engineers a cost advantage. This does not always turn out to be to the advantage of the Government agency or company which lets the contract."

But the practice contributes to unemployment among older engineers and decreases their chances of finding a new job, says Cherney. "Amazingly, those companies seeking new (younger) personnel often tell the older engineer that he is overqualified." This is "a very short-sighted profit point of view," adds Cherney.

Defensive. Understandably, individual companies are defensive about the issue. The response from a spokesman for Rockwell International Corp. is, "our policies prohibit discrimination on any basis, including race, sex, creed, as well as age." But most companies simply decline to comment on age discrimination, apparently on the theory that anything they don't say won't hurt them. Even the U. S. Labor Department says it is not aware of any age discrimination in the electronics industries, but is quick to add that it has no data to support the IEEE Manpower Planning Committee's findings one way or the other.

IEEE directors and companies, meanwhile, are keeping a close watch on the New York State Division of Human Relations' hearings into charges of age discrimination that were recently brought against Sperry Rand Corp.'s Sperry division in Great Neck, N. Y., by 64 of 88 engineers laid off in January. A state-agency spokesman says an initial investigation has justified scheduling the hearings. The New York Society of Professional Engineers has filed a friend-of-the-court brief in the Sperry case, while the IEEE has decided to stay out of it.

Curiously, Aircom's Rivers says he could find major instances of age discrimination only in the electronic-equipment industries. "In the aerospace industry, they lay off older people when they have to, but they hire them back." Laments Rivers, "it used to be said that engineering was a good career for life. That's not true any more." □

'Not the youngest anything'

"Mid-career is the time when you take stock. It's the time when you go from being the youngest everything to not being the youngest anything." Those opening lines, essentially, set the tone for the new 298-page IEEE manpower report, "The EE at Mid-Career—Prospects and Problems."

The report starts from a base of general trends and outlook in the influence of electronic technology and current aspects of demand patterns in EE employment. It delves into personal aspects such as problems of professional aging, character at mid-career, and dissatisfaction.

The survey also deals with over-specialization problems and corporate-policy influences. And it covers the considerations of EE educational requirements and the changing demands of the technology and the industry. Continuing education is discussed at some length, and a detailed look is taken into education's impact on job performance and its rewards. The report also sets some ground rules for self-evaluation. The soft-cover book is available from IEEE Inc., 345 East 47th St., New York, N. Y. 10017. Prices are \$15 to members and \$25 to nonmembers.

I.C. PACKAGING

Any kind you want!

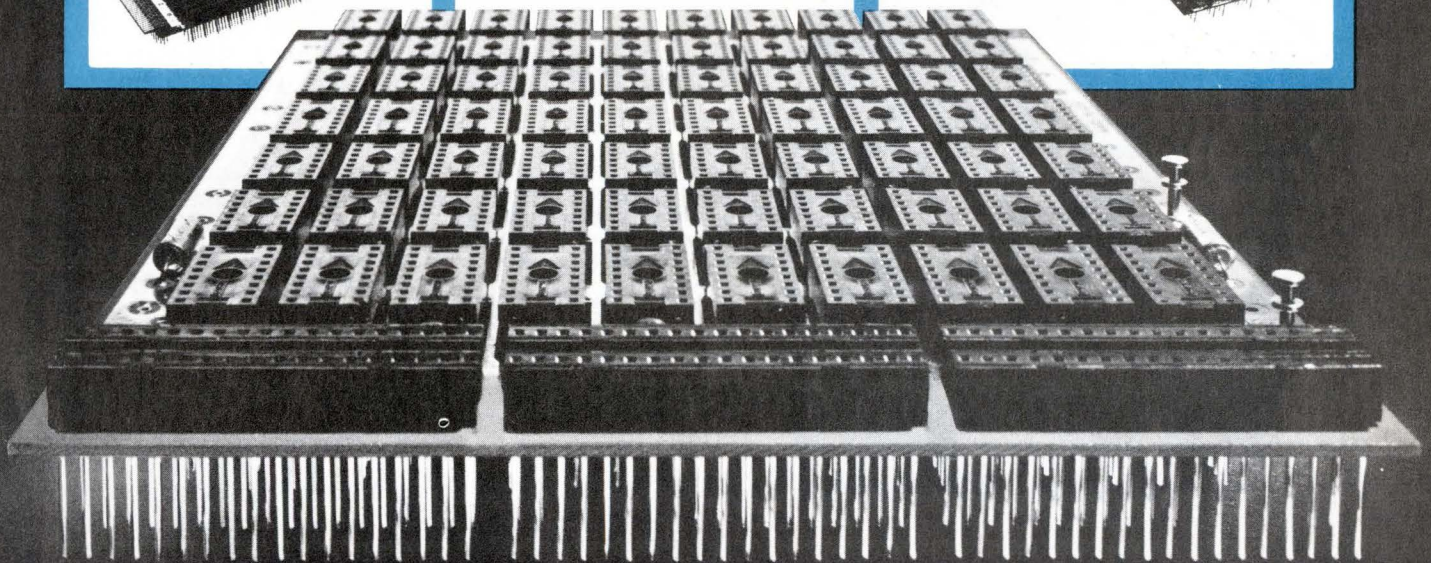
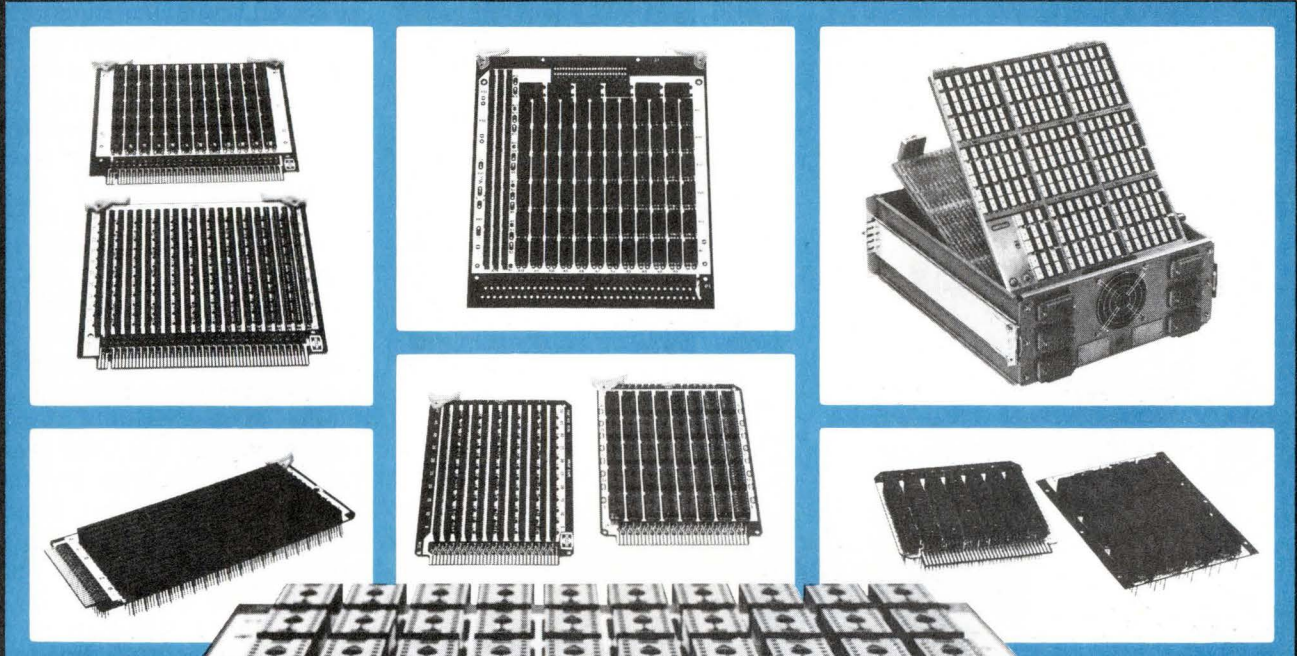

IF WE DON'T ALREADY HAVE A SOCKET CARD OR PANEL TO MEET YOUR REQUIREMENTS . . . WE'LL MAKE ONE.

We have Socket Cards that mount 14 and 16 pin devices. We have Socket Cards with universal patterns to mount everything from 8 to 40 pin devices. And our Socket Cards and Panels are available in a variety of densities and sizes.

All offer decoupling capacitor provisions for noise control with custom or standard I/O and interconnect systems available. And most important — if we don't already have a design that meets your needs we'll make one.

Our Socket Cards and Panels can save you breadboarding and prototype time . . . Save start-up costs . . . And greatly simplify field service.

For the I. C. Packaging System to meet your specific need . . . Call us . . . If we don't have it we'll make it.

3445 Fletcher Ave. / El Monte, Ca 91731
(213) 579-2300 / TWX (910) 587-3437

 **SCANBE**
CANOGA INDUSTRIES®

Circle 67 on reader service card

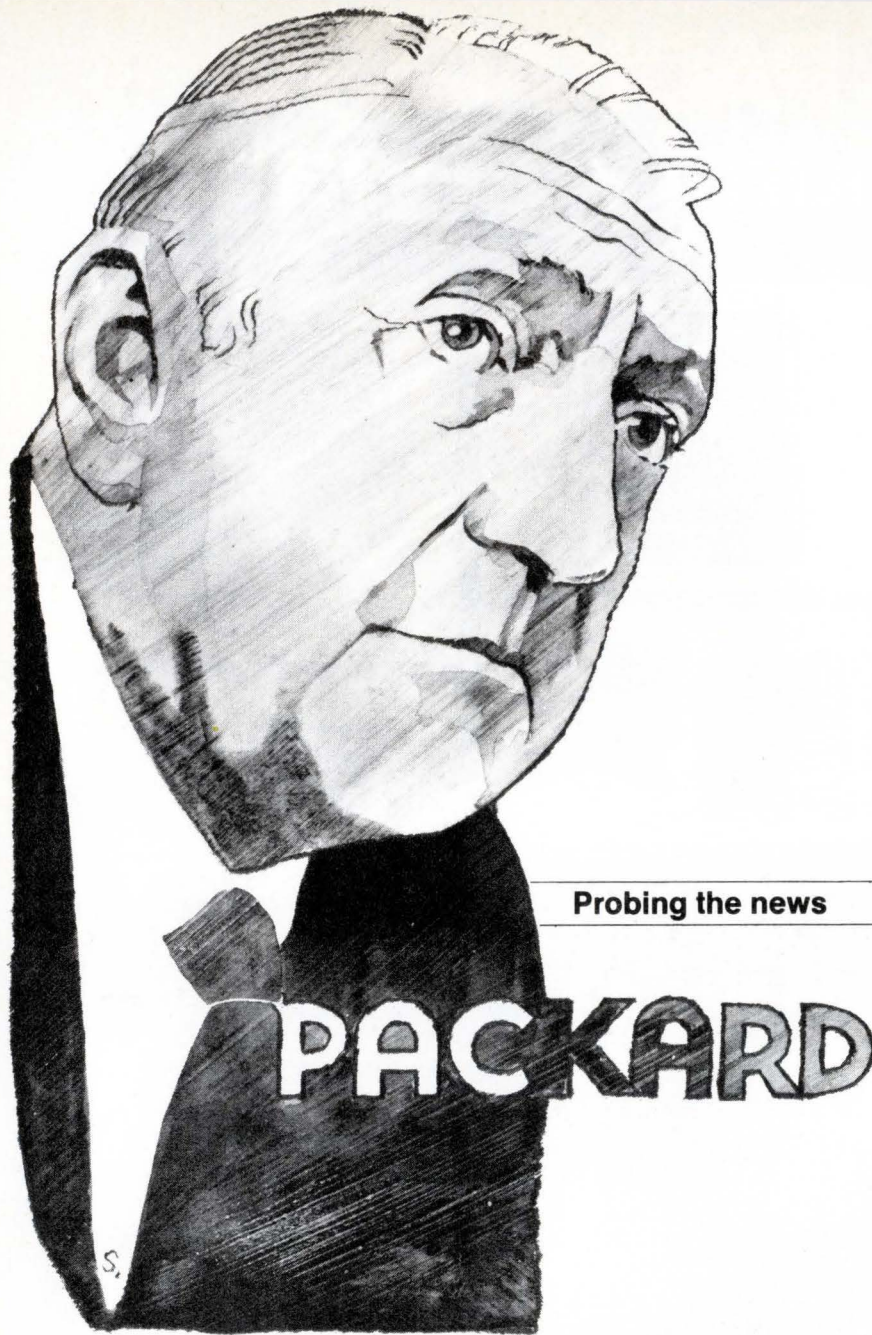

Probing the news

The former Deputy Defense Secretary takes a close look from both sides at the relationship between Government and industry and how it is changing

Few leaders of the electronics industries have also been top Federal officials. One of them is David Packard. At 62, the chairman and cofounder of Hewlett-Packard Co. is being increasingly regarded as a White House insider with closer ties to President Gerald Ford than he had to Richard Nixon, whom he served for three years until 1971 as Deputy Secretary of Defense. In a

recent interview with *Electronics*, Packard smiled, but did not deny reports that he will head the Republican fund-raising effort in President Ford's drive for the 1976 nomination and election.

As an electronics engineer who has served as both industrial entrepreneur and Government policymaker, Packard has developed some sharply defined views on the direc-

tion of the nation's economy, its technology policies, and the relationships between those people in the electronics industries and Government. Packard volunteered those views after his participation in a meeting of the Business Council, a national blue-ribbon organization of some 200 top executives.

Q.: There are increasing reports of an upturn in the national economy. What's your feeling?

A.: Well, there were mixed views expressed at this meeting of the Business Council about that. Some people thought the upturn in employment will be pretty slow. On the other hand, Alan Greenspan [White House economics adviser] said it might be surprisingly rapid. Of course, you've got two real key problems in the economy—the automobile industry and housing. I myself don't see anything that's going to happen to turn the automobile industry around in any short term. I think that in a year to a year and a half, the automobile industry could turn around. I don't see how it can happen this year.

Q.: Looking back on your Pentagon years, did you enjoy the experience? How would you compare it with private industry?

A.: Well, though we had some difficult problems and there were times when I questioned whether I had made the right decision in coming to Government, it was, overall, a very worthwhile exposure to the problems of our Government, and I am very glad I was able to do it.

Q.: In the relationship between the U.S. Government and electronics firms, you have seen the problems from both sides of the fence. How do you assess the Defense Department's operations in terms of its relations with industry and what the public gets for its defense dollars?

A.: I think the relationships between the DOD and industry have been fairly good, considering the complexity and magnitude of the problem. There has been a very strong trend toward the use of more standard commercial articles, with prices negotiated on the basis of market-established prices. That is a sound program. When you get into the other end of the spectrum—into very large development and pro-

curement programs—these, of necessity, have to be especially tailored.

They are often very complex programs, and one would like to normalize them, so to speak—that is, handle them in the same way large commercial jobs are handled—but it is very difficult to do that. A number of devices have been tried. The concept of total-package procurement was that if you could get a bid to do the whole job on some sort of competitive basis or a negotiated basis, that would work. But there was one severe shortcoming—it had to do with the central proposition that you simply cannot establish the price of a new weapon before it has been developed. You don't know what is going to be included in its capability.

Q.: How do you react to public concern about weapons cost? How do you view reports that the B-1, for example, will now cost upwards of \$80 million, or that program development costs for an Awacs could hit \$110 million each, or that one interceptor aircraft will cost \$20 million?

A.: There is a great tendency to look at the cost of some of these new weapons without thinking in terms of their capability. You cannot isolate the question on the basis of cost only. For example, if a given weapon were to cost twice as much as another but were 10 times as effective, it would be a good bargain. And that is exactly what is happening in a great many instances. It is not the cost of the individual weapon; it's really what it cost to achieve a particular military objective. Another important aspect has to do with our view of how we value human life. We ought to consider that if it costs more lives to use less costly weapons, that is not a very good course for us to take.

It was for that reason that we had to make some changes which recognized that the development period should be administered with some flexibility—that it should be done under some cost-incentive-contract structure so that, as problems are encountered in the development, you have the opportunity to trade off performance for cost or performance for time. That was essentially the way the Air Force F-15 fighter contract was structured, and I think

that program worked out very well.

The other approach, which is actually even better when it can be used, is a prototype program under which you select two contractors—you could hardly ever justify more than two—and give them the general-performance requirements of the new device, and then let them each develop it with as much freedom as possible. This was done with the Air Force A-10 close-air-support plane and the lightweight fighter.

Q.: Do you believe that the U.S. has too much of its high technology committed to defense?

A.: Let me answer that by going back a little. If you look at what has happened since World War 2, there is no doubt that the very high level of spending in electronics for radar, for microwave communications, and for a number of related areas, has been an impetus that brought about the development of some very important devices. You can start with the klystron tube or the magnetron traveling-wave tube. There were very few applications for TWTs outside the military in those early days.

In a more general sense, the very high level of electronics activity supported by the military generated a tremendously strong components industry here in the U.S. This was developed partly because of the large-volume requirements of the military and partly also by their high-quality requirements.

Moreover, military people were very wise after World War 2 to recognize that it would be to their advantage to support research and development. A good deal of that R&D was supported in colleges and universities and generally was broadly based—not oriented to specific weapons, but to the development of technology.

Q.: Do you believe that commonality of weapons among the individual services is desirable?

A.: Commonality is a very desirable thing if you start first with our NATO forces. It would be very helpful if all of our NATO allies and we had the same weapons. The procurement costs are likely to be less; interchangeability among forces is enhanced, and the support is made much easier.

Q.: What are your feelings about the

balance between American high technology for defense and such non-defense applications as medical electronics, high-speed ground transportation, and other areas where R&D is not as heavily funded by the Government?

A.: The balance is much better than it was maybe 10 or 15 or 20 years ago. There is a great deal of very important high technology, particularly in electronics, that is supported by the private sector and doesn't depend upon military support. Our own company, for example, this year is spending \$80 million to \$85 million in R&D. About \$200,000 of that will be Government-supported. For the rest of it, we are spending our own money on programs we think are important for the future. Bell Laboratories and IBM and a number of others are doing a tremendous amount of work in large-scale-integrated circuitry that is quite independent of Government support.

This is not to say that there are not some areas where Government support is important. In satellite communications, we are, mind you, just beginning to get to the point where it can be supported by commercial, nongovernment business. This was not possible five years ago, but we are just about at that juncture now. So, I see the trend as going in a very positive direction in that the electronics industries are less reliant on Federal R&D support now than they were 10 years ago. And I see no reason now why that trend shouldn't continue.

Q.: When you reflect on your experiences within the DOD, what do you consider to be the key issues there that the electronics industries could do, and should be doing, more about?

A.: Well, I think first, that industry and the DOD ought to continue to work to find ways to increase the efficiency of the procurement process. We spent a good deal of time on that issue while I was there. I think we made some progress, but I don't think we made as much as we should have. In particular, I think the fly-before-you-buy concept is something that ought to be pursued. It is off to a good start, but experience will show some ways that it can be improved. □

Companies

Mostek trims its sails

Texas semiconductor maker, having dropped financially draining calculator operation, places hopes on its 16-pin 4-k RAM

by Larry Armstrong, Midwest bureau manager

L. J. Sevin has bet his company, Mostek Corp., on the 4,096-bit random-access memory, and the outcome depends on whether or not it will be able to produce its 16-pin version of the 4,096-bit part. In that respect, the Carrollton, Texas, semiconductor maker finds itself in the same boat as many other 4-k manufacturers with fabrication problems. But Mostek also suffered from the millstone of its calculator subsidiary, Corvus—since dropped—around its neck, a disappearing market for its highly successful 4006 dynamic 1,024-bit RAM, and a serious fire at its wafer-fabrication facility in Texas.

Mostek actually had an early lead in the 4-k race as Texas Instruments Inc. had process problems with its 22-pin part. But as TI worked out its bugs, Mostek developed reliability problems, forcing it to lose the market back to TI and Intel Corp. And industry observers believe that 90% of today's shipments are still 22-pin parts.

All this trouble adds up to a projected second-quarter loss—its first since 1971. President Sevin, a conservative, yet outspoken Texan, believes that 4-k yield problems have been solved. "Given product availability, which we haven't had, and given an improvement in the economy, we will get back on the growth track," he says. "It won't be the explosive one we had before—I'm not going to let that happen again—but it will be 15% or 20% a year." First-quarter profits were \$645,000; last

year they were \$4.2 million.

Mostek lost what was sizable business from Hewlett-Packard Co. because of surface-reliability problems, but the firm is known to be shipping 4-k RAMs to Digital Equipment Corp., Burroughs Corp., NCR Corp., Control Data Corp., Sycor Inc., and Datapoint Inc. Sevin expects to sell \$1 million worth of 4-k parts this year, or about a quarter of a total market he estimates at slightly over 4 million units. He will not divulge the firm's shipping rate, but industry sources put Mostek's current output at 5,000 to 10,000 parts per week. However, skeptical observers point out that Mostek would have to produce 20,000 parts a week for a year to reach 1 million—a tall order.

Mostek's standard production part is a 150-by-176-mil metal-gate chip that's barely making money for its developers. "Our friends across town [TI] have brought prices down, so the 4-k is not going to be a big bonanza for us," Sevin comments, "But the part's now marginally prof-

itable." Sevin has high hopes for a photo-reduced version going into production. It measures 127 by 149 mils, yielding half again as many possible good dice per wafer as the current production part. And, significantly, Mostek has changed the substrate bias to -5 volts, instead of the earlier -9 v, making it compatible with Intel, Motorola, and Fairchild second-source versions.

Processing. Some of Mostek's problems apparently stemmed from the firm's SPIN—for self-aligned polysilicon interconnect n-channel—process [*Electronics*, Dec. 18, 1972, p. 30]. While it yields a tiny, contactless cell, the complex metal-gate process uses either seven or nine masking steps, depending on who's counting. "It's uniquely suited for one-transistor cells, and will also be used in our 16-k RAM," scheduled for first-quarter 1976 sampling, says Robert B. Palmer, vice president of Mostek's computer-products group.

In a new model 200-ns 4-k RAM, which will be sampled later this

Checking. Berry Cash, left, executive vice president, and L.J. Sevin, president, show off Mostek's checkbook calculator.



year, Mostek has eschewed SPIN and gone to silicon-gate n-channel. "Our fast 4-k will be a complete re-design," Palmer says. "We went to silicon gate to get immediate second-sourcing for the high-speed version.

Memories accounted for just about half of Mostek's \$60-million sales last year. A mere 50,000 4-k devices contributed to that, but by far the dominant part was the firm's proprietary 4006 dynamic 1-k RAM, of which it shipped more than 4 million units, estimates Sal Accardo, a vice president and analyst for William D. Witter Inc., the Wall Street institutional-brokerage firm.

Prices and also the profits on the 2102 static RAM, however, dipped as the firm was moving production of that static RAM from Dallas to Massachusetts and back again. Mostek's plans call for process improvements that will allow 2102 profitability, even at today's prices, which run as low as \$1.75 each in plastic packages.

Dumping Corvus. Yield problems on the 4-k RAM were not Mostek's only woes last year. Corvus Corp., its consumer-products subsidiary, lost an estimated pretax \$2.3 million, Accardo says. The decision to get out of Corvus was purely a financial one. Rights to manufacture the calculator line, and to market under the Corvus label, went to Collex Ltd., Hong Kong, a long-time chip customer. Mostek retained the digital clocks as well as a checkbook calculator [*Electronics*, April 3, p. 40], products that it will market under the Mostek brand name.

Bad business forecasting and a 1973 decision to expand front-end capacity led Mostek to the outright purchase of a \$2.6 million plant in Lowell, Mass., a building that's now up for sale. At the same time it purchased its Carrollton facility for \$1.5 million cash, and spent an additional \$2 million on capital improvements. But working off the Corvus inventory and refinancing the Carrollton plant has put it back in a comfortable cash flow position. It's paid off all debt against its \$7.5 million line of credit, and has accumulated "substantial" cash reserves, says Vin Prothro, financial vice president. □

A BARGAIN IN SOLID-STATE IMAGING:

WHAT YOU GET:

You get a 3" x 3" circuit card which contains RETICON's RL-64P image sensor and all of the associated drive and video processing circuitry. A standard ribbon cable connects the unit to your power supply (+5V, -10V) and also carries the 0 to 2V video output. The RL-64P has 64 sensing elements on 2 mil centers in a standard ceramic DIP sealed with an optical quality quartz window. The device has an integrated on-chip driver and portions of the video processing circuitry. The RL-64P is a proven device in production for over three years.

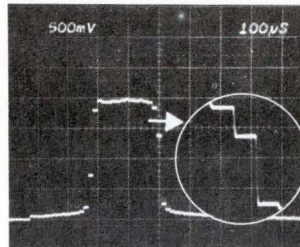
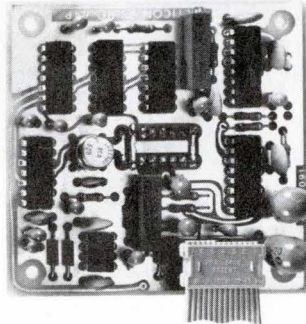
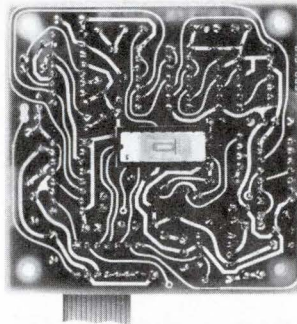

WHAT YOU SEE:

You see over 200:1 dynamic range (peak signal to peak noise) at 250 KHz. The photo shown is the actual output of a 30 mil front illuminated band imaged onto the array using 1:1 optics. The "box-car" type sampled-and-held output can be easily thresholded or A/D converted into multiple grey levels.

Applications in OCR, point-of-sale, industrial non-contact measurement and control are a natural for this unit.

Evaluate our technology with this complete imaging system. If you need higher resolution, we have an extensive line of image sensors with up to 1872 elements. We have over four years of experience in solid state image sensor and related circuit development. And there are over 70 salesmen and 15 distributors to serve you worldwide.

RETICON®

910 Benicia Avenue
Sunnyvale, California 94086
(408) 738-4266 • TWX: 910-339-9343

What's new in solid state...

More RCA Power More ways to boost

13 new types widen the range of applications, from audio to autos.

In certain high-gain applications, nothing beats a Darlington. And you gain even more when you specify RCA Darlington.

Wide selection, for instance. RCA has added 13 new types, bringing to 29 our wide choice within the popular 40-V to 120-V

range. At low prices. Ranging from \$0.85 to \$1.60 at 1K.

All these Darlington's have the ruggedness and performance you'd expect from RCA. Monolithic-chip reliability. Rugged clip-lead construction. Real-time process controls. Plus RCA power transistor experience. The kind that comes from serving volume customers in the auto, TV, computer and

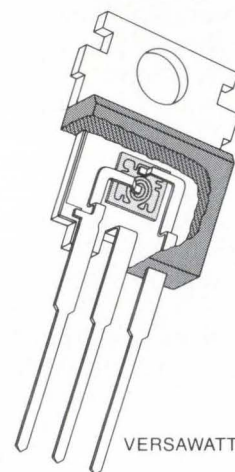

VERSAWATT CUTAWAY

power supply industries. So we know how to keep costs down and quality up.

What are RCA Power Darlington's doing today? Here are some typical ways that RCA customers are taking advantage of Darlington features. With resulting fewer components, lower cost, less space, and greater reliability. Check these applications. Then see what we'll do for you.

1 Reduce audio costs
RCA1B07 and RCA1B08, used as outputs, each replace 5 components (2 transistors, 2 resistors, 1 diode) in a 40-watt audio amplifier — for a cost saving of almost 30% on the

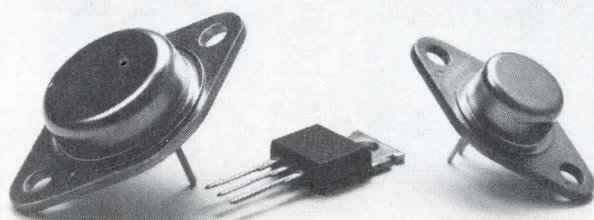

Type	Beta	Vceo	NPN/PNP
TO-3 hermetic package			
RCA8350/50A/50B	1000 @ 5A	40/60/80	PNP
2N6383/84/85	1000 @ 5A	40/60/80	NPN
2N6055/56	750 @ 4A	60/80	NPN
RCA1B07/08	1000 @ 5A	80	NPN/PNP
Plastic VERSAWATT: cost- and space-saving			
RCA8203/3A*/3B*	1000 @ 3A/1000 @ 5A*	40/60/80	PNP
2N6386/87*/88*	1000 @ 3A/1000 @ 5A*	40/60/80	NPN
2N6530/32/33*	1000 @ 5A/1000 @ 3A*	80/100/120	NPN
2N6531	500 @ 3A	100	NPN
RCA120/21/22	1000 @ 3A	60/80/100	NPN
RCA125/126	1000 @ 3A	60/80	NPN
TO-66: space-saving hermetic			
2N6534/36/37*	1000 @ 5A/1000 @ 3A*	80/100/120	NPN
2N6535	500 @ 3A	100	NPN

RCA. Powerhouse

Darlingtons. cost effectiveness.

transistors alone.

2 Simplify a regulator

Voltage regulators are being made simpler and smaller because of the Darlington's high gain. Both linear and switching types. RCA Darlingtons offer designers a choice of power in three packages, in NPN or PNP to meet circuit objectives.

3 Drive a wheel

Our 2N6385 and RCA8350B are good choices for controlling motors such as spindle and tape drives. They work with extremely low drive currents, like those available from integrated circuits. In the typical bidirectional DC motor, these types offer excellent second breakdown current characteristics which protect against plugging: the effects of back emf when reversing direction at high speed.

4 Drive a hammer

Inductively loaded computer printer hammers use the 2N6530 Darlington. Conveniently, it comes in the space-saving TO-66 package and can handle up to 120 V. Which trans-

lates into large savings due to much lower current needs.

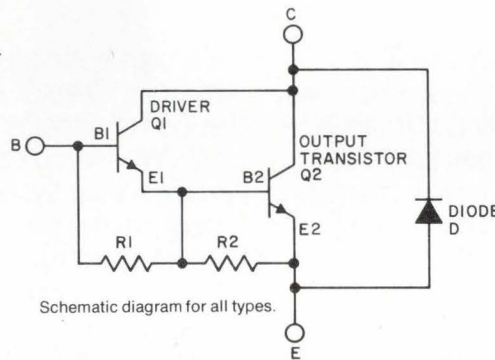

Schematic diagram for all types.

5 Spark an engine

In auto ignition, our IC-driven Darlington drives a H-V switching transistor which switches high current through an inductive load. And right

there, under the hood, RCA's high-volume quality, ruggedness and product characterization are all-important. Especially thermal fatigue capability. The 2N6385 is our hermetic type. 2N6388 is our plastic cost- and space-saver.

6 Try one! Our 1-for-2 offer

Now we'd like to know how RCA Darlingtons might help you improve your cost effectiveness. Give us the type numbers of 2 discretes you want replaced by an RCA Darlington and we'll give you the Darlington you select.

E612

**Mail to RCA Solid State,
Box 3200,
Somerville, N.J. 08876.**

Application: _____

New design? Old design?

Est. annual requirements _____

My firm buys discretes: Through distributor Direct from RCA

Distributor name _____

My name _____ Company _____

Address _____

City, State, ZIP _____

Write in the 2 discrete type numbers here

Write in the RCA Darlington type number here

RCA

Ste. Anne de Bellevue 810, Canada; Sunbury-on-Thames, U.K.; Fuji Bldg., Tokyo, Japan.

in Transistors.

Look who just tied the knot.

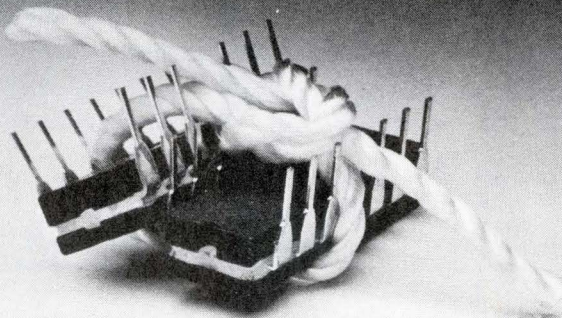

The 54C/74C and the 4000 series.

Actually, it's no great surprise. The 54C/74C and the 4000 series logic families have always been electrically compatible and now many of the functions are even pin-compatible, so you can marry them in your very own system without worrying about a family feud. You'll find mixing these two CMOS series beneficial to you in many ways. First, you'll have more available functions to choose from. So your chances of finding the right one are better. This will minimize the number of CMOS devices you need to implement the logic. And second, you can take advantage of the best personality traits of each series to optimize your system's performance. Key

features such as higher guaranteed noise margin. Greater output drive. And higher speed of specific CMOS functions.

When you're ready to tie the CMOS knot in your system, Harris can help you perform the ceremony. Harris CMOS devices are fully compatible with others in the industry and will perform in your present system without modification. And you can get immediate delivery of both logic families from your Harris Distributor.

For more information on how we can make the CMOS marriage work for you, call our CMOS Application Hot Line at 800-327-8934. Your systems will live happily ever after.

DEVICE	OUTPUT SINK CURRENT	MINIMUM
4102A	$I_{OL} (V_{OL} = 0.5V)$	0.06 ma
4042A	$I_{DN} (V_{OL} = 0.5V)$	0.20 ma
4001A	$I_{OL} (V_{OL} = 0.4V)$	0.30 ma
All 54C/74C	$I_O (V_{OL} = 0.4V)$	0.36 ma
4071B	$I_{DN} (V_{OL} = 0.4V)$	0.40 ma

This illustrates some of the variations in output drive current specified in the 4000 series, and how the 54C/74C fits within the range.

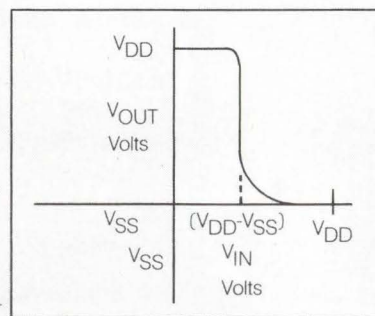

This CMOS transfer characteristic for single level gate functions is for all CMOS logic families. It is the commonality of this characteristic which is the basis of CMOS inter-family compatibility.



P.O. Box 883, Melbourne, Florida 32901 (305) 727-5430

WHERE TO BUY THEM: OEM SALES OFFICES: ARIZONA: Scottsdale, (602) 946-3556 CALIFORNIA: Long Beach, (213) 426-7687; Palo Alto, (415) 964-6443 FLORIDA: Melbourne, (305) 727-5826 ILLINOIS: Hinsdale, (312) 325-4242 MASSACHUSETTS: Wellesley Hills, (617) 237-5430 MINNESOTA: Minneapolis, (612) 835-2505 NEW YORK: Endwell, (607) 754-5464; Melville, L.I., (516) 249-4500 OHIO: Dayton, (513) 226-0636 PENNSYLVANIA: Wayne, (215) 687-6680 TEXAS: Richardson, (214) 231-9031.

SALES REPRESENTATIVES: CALIFORNIA: San Diego, (714) 565-9444 COLORADO: Denver, (303) 771-4920 FLORIDA: Oviedo, (305) 365-3283 KANSAS: Olathe, (913) 782-1177 MARYLAND: Randallstown, (301) 922-1248 MICHIGAN: Bloomfield Hills, (313) 642-0203 MISSOURI: Hazelwood, (314) 731-5200 NEW YORK: Albany, (518) 489-7408 or 4777 NORTH CAROLINA: Raleigh, (919) 828-0575 OREGON: Beaverton, (503) 643-1644 TENNESSEE: Shelbyville, (615) 684-4544 UTAH: Salt Lake City, (801) 268-3533 VIRGINIA: Falls Church, (703) 534-1673; Troutville, (703) 345-3283; Virginia Beach, (804) 481-7200 WASHINGTON: Bellevue, (206) 454-0300.

Photovoltaics

Federal funding picture brightens

Pressure from industry and Congress leads to vast increase in proposed solar-cell procurement, and silicon gets the call

by Larry Marion, Washington bureau

Production of photovoltaic cells for terrestrial power generation will probably jump by three to four orders of magnitude by 1985. That will happen if a drastically revised internal 10-year research-and-development project plan, to be sent to Congress before June 30, is approved by the Ford Administration and Congress.

Officials of the Energy Research and Development Administration have established a goal of achieving industry production equivalent to 500 to 1,000 megawatts a year by 1985, compared to the current annual production equivalent of 100 kilowatts by single-crystal silicon cells.

But ERDA's action, which backs silicon technology and relegates gallium arsenide and cadmium sulfide to laboratory status, has dismayed and puzzled companies working in those thin-film technologies. It also has left them questioning the wisdom of the decision. In the words of Lawrence W. James, a scientist at Varian Associates, the decision is a "very serious" mistake.

At least for the silicon people, the money is on the way, says Rep. Mike McCormack (D-Wash.). Rep. McCormack told industry officials at a recent conference, "We have recommended an appropriation of close to \$150 million [for all solar energy work] for fiscal year 1976." Photovoltaic R&D will receive \$29.5 million, up from \$8 million in 1975, he noted, if the Senate and the Ford Administration go along with his energy R&D subcommittee.

New role. Leonard Magid, director of ERDA's photovoltaics branch, says, "Our new role is to get indus-

try involvement in photocell production as soon as possible." A more modest photovoltaics R&D plan was presented to industry officials in February, but that plan was "hopelessly misguided," says one 10-year veteran of industry's research into low-cost silicon research.

Joseph Lindmayer, president of Solarex Corp., Rockville, Md., a major producer of photovoltaic cells for terrestrial use, says, "that type of plan totally violated the economics of the situation. But the [ERDA] philosophy has changed. They are now paying more attention to economics instead of technology. More than 50% of the challenge is economic."

Triple time. To meet that challenge, Magid and his staff have pre-

pared a new plan that "greatly accelerates" the prior plan by "stimulating" the industry to increase production and thereby reduce prices. To reduce the price of solar-cell power from \$20 per watt now to 50 cents by 1979, ERDA officials hope to buy enough solar cells to produce nearly 2 MW in the next four years—three times the February projection. ERDA's Magid says, "We want to boost production by a factor of 2.7 to 3 each year."

To further guarantee a market for solar-cell producers, ERDA has enlisted other Federal agencies. The Defense Department, the Coast Guard, and the National Oceanographic and Atmospheric Administration are reviewing their remote-

SOLAR-CELL PLANNING GOALS										
	FISCAL YEAR									
	1976	77	78	79	80	81	82	83	84	85
Engineering and analysis		Prelim. design specs		Detailed design specs						
Demonstrations	75 kW	300 kW	500 kW	1 MW	2 MW	4 MW	7 MW	10 MW		
Large-scale production	75 kW	150 kW	250 kW	500 kW	1 MW	2 MW	3 MW	4 MW		
Test and standards		Test facility operating		Solar cell performance specs						
R&D (other than silicon)					10% efficiency thin film (demo)					\$100-\$300/kW thin film feasibility (demo)

Targets. This chart of planning milestones for solar cells shows the responsibilities of NASA's Lewis Research Center in color. Other work is to be done at JPL.

LOW Phase Noise and FAST Switching Speed

... are two features of GR SYNTHESIZERS that no other 500 MHz synthesizer can match. Phase noise of GR's 1062 is the lowest available at 500 MHz... close to 100 dB down at 10 Hz from the carrier... one reason the 1062 is the popular choice for up-converting and multiplying into microwave-frequency bands. What's more, the 1062's switching speed is under 100 microseconds and guaranteed! Both features are explained in GR Application Notes; request your copies now. Other performance features include:

- DC to 160 MHz or 0.01 to 500 MHz
- Optional resolution to 0.1 Hz
- Non-harmonic spurs > 80 dB down
- A-M, F-M, and P-M capabilities
- Built-in search sweep
- Programmable (BCD parallel) frequency control
- Plug-in modular construction
- Proven record of high MTBF
- Low power consumption (60 W)

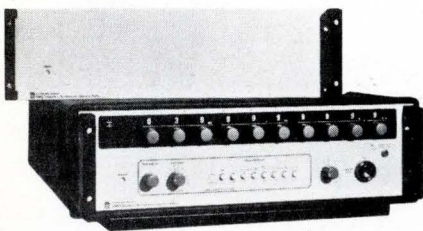

For additional information, technical assistance, or a demonstration, call or write:



General Radio

300 BAKER AVENUE, CONCORD, MASSACHUSETTS 01742

NEW YORK (N.Y.) 212 964-2722, (N.J.) 201 791-8990

BOSTON 617 646-0550 • DAYTON 513 294-1500

CHICAGO 312 992-0800 • WASHINGTON, D.C. 301 948-7071

ATLANTA 404 394-5380 • DALLAS 214 234-3357

LOS ANGELES 714 540-9830 • SAN FRANCISCO 415 948-8233

TORONTO 416 252-3395 • ZURICH (01) 55 24 20

GR COMPANIES • Grason-Stadler • Time/Data

Also available:

- Higher-frequency systems
- Keyboard frequency programmer
- Tracking synthesizer systems

Probing the news

location-power needs to determine where solar-energy technologies could be applied.

ERDA's decision will mean work for two NASA installations. The massive test-and-evaluation program will be based on a research project at NASA's Jet Propulsion Laboratory. That project, in which 10 requests for proposals went out in February [*Electronics*, March 6, p. 29], involves R&D aimed at reducing the cost of generating electricity with silicon cells. And NASA's Lewis Research Center will buy additional solar cells along with other components, such as direct-to-alternate-current converters, and package them with JPL procurements. Lewis will test, evaluate, and write specifications for cells and systems to be used by other agencies.

As for advanced-technology cells—thin-film-semiconductor compounds, such as CdS and GaAs—they will receive research funding from the National Science Foundation, Magid says, though this may change if technology improves. "At this point in time, advanced-technology research is still in NSF. There

will be a lot of basic research, but no demonstration and development."

However, for those making thin-film cells, ERDA's decision is controversial. They are predicting 10% efficient thin-film cells in 1980. The Institute of Energy Conversion at the University of Delaware has achieved 7% efficiency, and Karl Boer, institute head, says 10% is within reach.

Advanced technology is too far away, counter silicon makers. Arthur I. Mlavsky, chief scientist at Mobil Tyco Energy Corp., says, "The silicon cell is proven without dispute. The real key is, how does one make a system inexpensive?" Gene Ralph, vice president of Spectrolab, Sylmar, Calif., formerly the Heliotek division of Textron, which was recently purchased by Hughes Satellite Corp., says, "Industry has to think about today. To get funds, you can't work with a gallium arsenide or cadmium sulfide or other concepts. You can't get much business out of it." Ralph says, "With present technology, \$2-a-watt solar cells is a goal in our pocket." Cells at 18% are "right around the corner," he adds. Lindmayer says that his cells have broken the 20% efficiency barrier. □

Is ERDA making a mistake?

When the U.S. Energy Research and Development Administration decided to put its short-term money on silicon for developing photovoltaic cells, the reaction at Varian Associates was bewilderment.

Lawrence W. James, one of the investigators on Varian's gallium-arsenide concentrator solar-cell project, says, "When we talked to officials of both ERDA and the National Science Foundation at the photovoltaic conference in May, I thought they were going to give as much attention to gallium arsenide as they have to silicon—financially. If ERDA is going to be the main channel for funding, and that is devoted to silicon, while NSF picks up the so-called 'esoteric' cells, I think it is a mistake, and a very serious one."

"The fact is," he says, "we are producing high-efficiency gallium-arsenide cells on a pilot line and will be building a working array by summer. We could start manufacturing cells now for any sort of field-developmental work." To get costs down to what is considered the break-even point with conventional power plants—\$500 per kilowatt at peak—all that would be necessary is a shift to production-line volumes, James says. Referring to a paper on the economics of concentrator arrays by B.L. Slater from NASA's Lewis Research Center, James breaks down the \$500-per-kilowatt peak into \$200/kW for the gallium-arsenide cells and \$300/kW for the reflector and/or lens-array system. This comes to roughly 20 cents per watt for the cells, 30 cents/W for the array, and 50 cents/W for the entire system. Instead of looking for silicon or cadmium-sulfide cells of the lowest possible cost per square meter, says James, "we should be looking for cells capable of operating with solar concentration with the lowest possible cost per watt of power output."

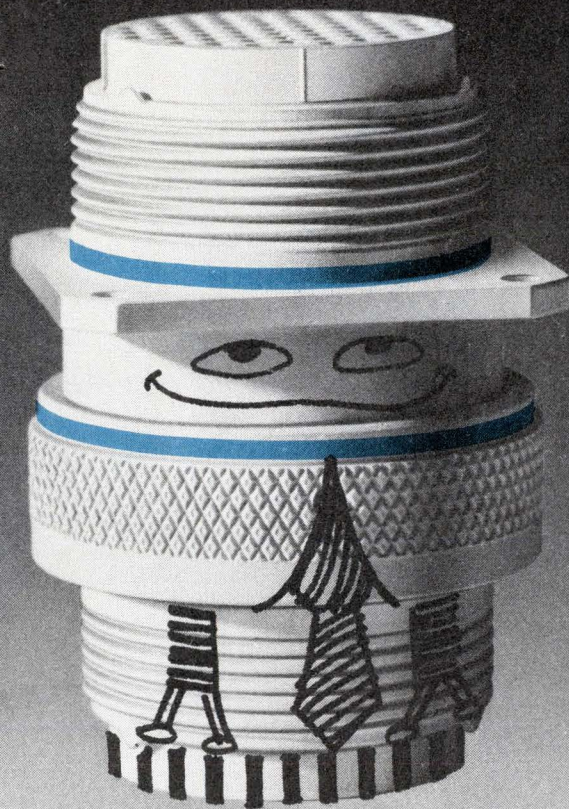

I've got D.R.*
AND YOU CAN GET IT TOO!...
in connectors with
dielectric retention from Bendix

D.R. GIVES YOU

- rear release crimp contacts—minimizes potential interfacial seal and contact damage during contact removal
- increased dielectric separation between contacts
- greater reliability plus weight savings—fewer components per connector
- hard-faced chamfered socket inserts assuring positive mating pin alignment
- improved temperature-life capability at 200°C
- optimum fuel and fluid resisting capabilities

*dielectric retention (re-ten'shun), n: an innovative method of retaining removable contacts in an electrical connector, incorporating a single dielectric wafer rather than individual metal contact retention clips

D.R. CONNECTOR DESIGNS

- are offered in MIL-C-26482, 38999 and 83723 types
- utilize common application tooling
- intermate and intermount with existing series
- are tooled in over 30 arrangements

GETTING D.R. IS EASY.

Just contact The Bendix Corporation, Electrical Components Division, Sidney, New York 13838, your nearest Bendix sales office or authorized Bendix distributor.



Introducing F100K. The first and only sub-nanosecond ECL.

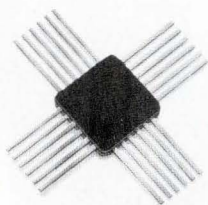

The first sub-nanosecond standard ECL series is here.

F100K.

The F100K family represents a quantum advance in ECL performance and ease of design.

Developed in cooperation with major mainframe manufacturers, this remarkable new ECL series will benefit many other maximum data-rate systems as well—including processors, instrumentation and digital communications.

And of the 24 F100K devices initially scheduled for production, 8 are available now.

F100K. The first standard family of superspeed ECL.

What makes F100K so advantageous to use?

1. Speed, of course.

Instead of the typical 2.0 ns for conventional 10K ECL gates, the typical speed for F100K is 0.7 ns. With a minimum of 0.4 ns and a maximum of 0.95 ns.

2. Speed/power.

Despite its blazing speed, F100K affords a speed/power product of just 28 pJ for SSI functions—about half the level of conventional 10K.

For more optimized MSI and LSI functions, the typical propagation delay actually drops below 0.5 ns. And the speed/power product falls below 5.0 pJ per gate.

slower than in Schottky logic families.

5. Isoplanar II fabrication.

Designed primarily for MSI and LSI complexity with a minimum of SSI functions, the F100K series is produced by Fairchild's high-density Isoplanar II process—proven for high performance as well as high yield and dependable delivery.

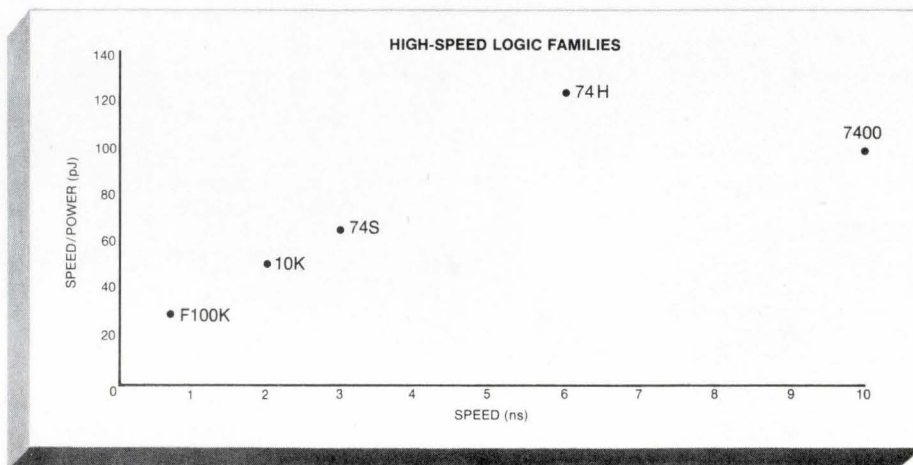

3. Full compensation.

Because F100K is fully compensated for temperature and voltage variations, the family provides almost constant DC noise margins for a more reliable system. It also provides a tighter AC window for faster clock rates with fewer timing problems.

4. Manageable edge rates.

The gate current specified for the F100K series provides a rise and fall time about equal to propagation delay. In fact, noise-generating dV/dt is

6. Compatibility.

Due to voltage compensation and standard logic levels, F100K is compatible with existing slower ECL families.

7. Memory available.

No need to worry. The F100415, a 1024x1 RAM, will be available this Quarter.

24-pins. The shape of ECL to come.

To these basic advantages, the F100K's universal 24-pin package contributes an addi-

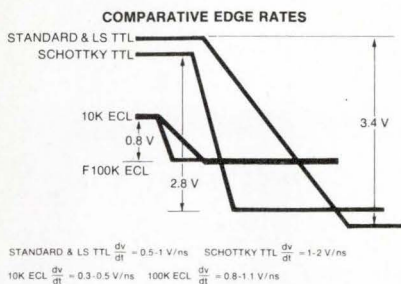

tional list of benefits. Among these are:

8. The first package format oriented to the I/O and performance requirements of super high-speed MSI/LSI.

9. The opportunity for gate densities 50% higher than conventional 10K ECL.

10. The ability to gain more flexible use from multi-purpose functions—for a simplified device inventory. For example, the 24-pin F100K Quint Gate F100102 can replace the functions of any one of four different quad gates in 10K ECL—with greater logic density besides.

FULLY-COMPENSATED ECL vs. UNCOMPENSATED ECL

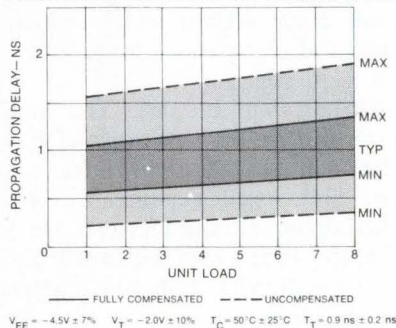

The family that's planned together plays better.

Because our F100K series was planned with the cooperation of major users, it has been designed throughout with the user in mind.

For example:

11. Common pins are always placed at the same pin location. To allow maximum use of CAD in board layout.

12. All functions flow through the package without crossover. Outputs are always located in the same general pin area. Inputs, too.

13. Inverting outputs between independent functions are placed adjacent wherever possible to permit maximum use of the wired-or-tie, even at sub-nanosecond speeds.

14. Wherever possible, mode control pins are provided to change the character of the functions. They may be controlled by standard logic levels or may be hard-wired to ground or power supply.

In fact:

Without exception, pin-outs have been assigned on the basis of system requirements and performance—not fabrication convenience.

Result—a user-oriented family that plays better all the way.

Start here.

To get you started, 8 devices are available in sample quantities today.

Fairchild F100K ECL Series

DEVICE	DESCRIPTION	1K	AVAILABILITY
100101FC	TRIPLE OR/NOR	4.50	NOW
100102FC	QUINT OR/NOR	4.50	NOW
100107FC	QUINT EXC OR/NOR	7.15	NOW
100114FC	QUINT LINE RECEIVER	5.75	NOW
100117FC	TRIPLE 2-WIDE OAI	8.00	NOW
100118FC	5-WIDE OAI	6.23	NOW
100150FC	HEX D LATCH	10.70	NOW
100151FC	HEX D FLIP FLOP	13.35	NOW
100112FC	LINE DRIVER		3RD QTR 1975
100123FC	BUS DRIVER		2ND QTR 1975
100130FC	TRIPLE D LATCH		2ND QTR 1975
100131FC	TRIPLE D FLIP FLOP		2ND QTR 1975
100136FC	COUNTING REGISTER		1ST QTR 1976
100141FC	8-BIT SHIFT REGISTER		3RD QTR 1975
100145FC	16 x 4 R/W REGISTER FILE		4TH QTR 1975
100155FC	QUAD MUX/LATCH		3RD QTR 1975
100158FC	8-BIT SHIFT MATRIX		3RD QTR 1975
100160FC	DUAL 9-BIT PARITY		3RD QTR 1975
100164FC	16-BIT MULTIPLEXER		3RD QTR 1975
100165FC	PRIORITY ENCODER		3RD QTR 1975
100170FC	MULTI-PURPOSE DEMUX/DECODE		3RD QTR 1975
100171FC	TRIPLE MUX w/ENABLE		2ND QTR 1975
100181FC	ALU		1ST QTR 1976
100415FC	1024 X 1 RAM		2ND QTR 1975

For more detailed information on the entire F100K series, write or call your Fairchild Sales Office, Distributor or Representative right now.

Semiconductor Components Group, Fairchild Camera & Instrument Corp., 464 Ellis St., Mountain View, CA 94042. Telephone (415) 962-5011. TWX: 910-379-6435.

MADE IN FAIRCHILD
No. 1 for logic and memory.

Memories

The 16-k RAM is coming

As an inexpensive and easy-to-use large-capacity part, it could steal market thunder from 4-k devices

by Laurence Altman, Solid State Editor

The memory industry is beginning to talk seriously about the 16,384-bit random-access memory. Not that the big RAM is about to burst on the scene in volume, but 16-k development programs are far more advanced than most people have thought. Gordon Moore, Intel Corp. president, says a 16-k device "may emerge before the end of the year—either from here or somewhere else."

When the device does make its appearance, even in prototype form, it will cause major repercussions among suppliers and users. That's because the 16-k RAM clearly will be the cheapest main memory for the next five years. And it will deliver mass blocks of randomly accessible bits of memory on a single easy-to-use chip in a package everyone is familiar with.

But just as this will bring joy to users of the 16-k product, it could have dire consequences for manufacturers still struggling to get their 4,096-bit units into volume production—much in the way the 4-k RAM slowed the growth of the 1103 1-k-memory market.

Why so fast? Suppliers have been able to move fast on the 16-k design because they have made such rapid progress on the n-channel silicon-gate process, which can be quickly reworked into a 16-k format. Equally important, the industry has learned to build larger and larger defect-free chips—especially ones containing memory—at good yields, so that a 200-by-200-mil memory chip is well within the production capability of a modern facility for fabricating silicon-gate devices.

Perhaps most responsible for the

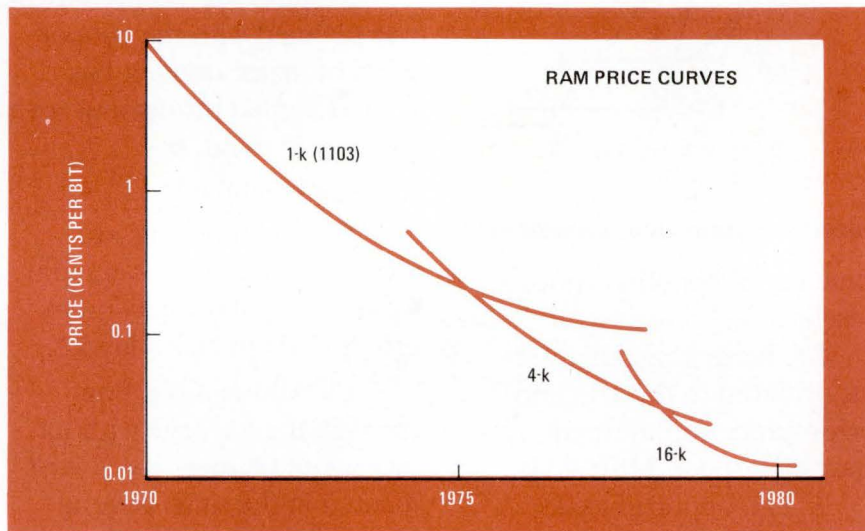

solid foundation of today's 16-k programs is an apparent agreement on a package type—something that's still not yet settled for the 4-k RAM. Most manufacturers now agree that the splintering of the market as 4-k package types proliferated slowed the utilization of the memories.

The consensus on package type for the big RAM is a 16-pin multiplexed design. Since most users—especially mainframe-memory builders—want maximum board density, the 16-pin design seems optimum, especially since the 16-k part would have to be multiplexed, anyway, if it is mounted in an 18-pin package. Of course, the possibility remains for a nonmultiplexed 16-k version—an option still apparently on the minds of designers at TI, who have not yet committed themselves to a 16-k package type.

Specifications. Memory designers disagree over just when the 16-k RAM will become a volume product, but they are in surprising agreement

on its technical details. They are:

- The 16-k RAM will be built with a single-transistor or switch-capacitor-cell design by an advanced n-channel silicon-gate process that's been tightened so that cell sizes will be in the range of 1 to 2 square mils, or about half the size of today's 4-k memory cells.
- The device will probably be put in a 16-pin package—with multiplexed inputs and common data-input/outputs—sort of, as Moore puts it "a combination of Mostek's 16-pin and TI's 18-pin 4-k design."
- The chip will be big, probably greater than 40,000 mils², which makes it about twice as large as today's 4-k design.
- The part will be fast. The first models will have access times of 200 to 300 nanoseconds, and, later, selected high-speed versions will be pushed down into the 150-ns range.
- Finally, 16-k RAMs will probably sell for less than \$10 only a year after their introduction. □

Elpower builds better T.M. solid gel batteries



and backs them with better service

Better performance—

Rechargeable Solid Gel™ maintenance-free, no cell reversal, no memory.

Better price—Elpower batteries give you more power per dollar.

Better quality—Quality so high that the Elpower battery is guaranteed not to leak...EVER...or we replace it.*

Better versatility—Elpower batteries can be operated or charged in any position; standard sizes include 6 and 12 volts, 1 AH to 24 AH.

*If used in accordance with Elpower published instructions, available upon request.

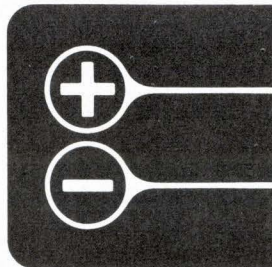

Better technical service—

Technical service and assistance with specific applications as near as your phone. Evaluation samples available.

Better delivery—One week delivery on quantities up to 500 (most models).

Better reliability—Millions of Elpower Solid Gel™ batteries presently in service and specified by leading manufacturers of emergency lighting, alarm systems, televisions, cash registers, calculators, video equipment and others with requirements for low cost reliability.

ELPOWER CORPORATION

Subsidiary of Eldon Industries, Inc.

Contact us or one of our many sales representatives for additional information.

2117 South Anne Street, Santa Ana, California 92704/Tele. (714) 540-6155/TWX 910 595-1934
In Canada: Eldon Industries of Canada Inc./50 Prince Andrew Place, Don Mills, Toronto/Tele. 449-2866

Nothing spoils computer data like cardiac arrest

If watts stop flowing in the system, bad things happen — like illogical behavior, like complete lapse of memory. Sorensen STM power supplies assure your computer of a strong heart to guard against these unwanted things.

STMs are more than reliable. Being modular switchers they are twice as efficient as series-pass types, less than half their size, and price competitive. But they have all of the advantages inherent in series-pass design.

There are 40 STMs in the series, from 3.0 to 56 Vdc, in four modular sizes. Our catalog, written especially for heart specialists, tells all about them. Simply circle the inquiry number. Sorensen Company, a unit of Raytheon, 676 Island Pond Road, Manchester, N.H. 03103. (603) 668-4500.

Sorensen
POWER SUPPLIES

Circle 83 on reader service card

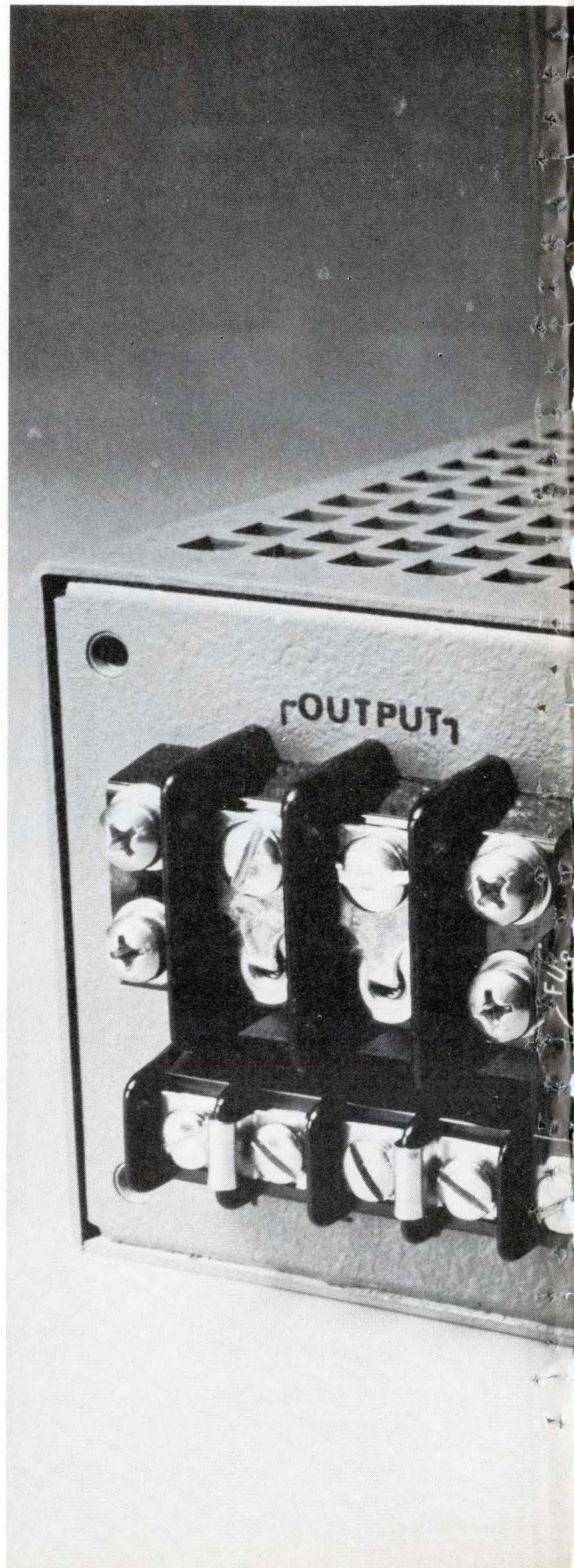

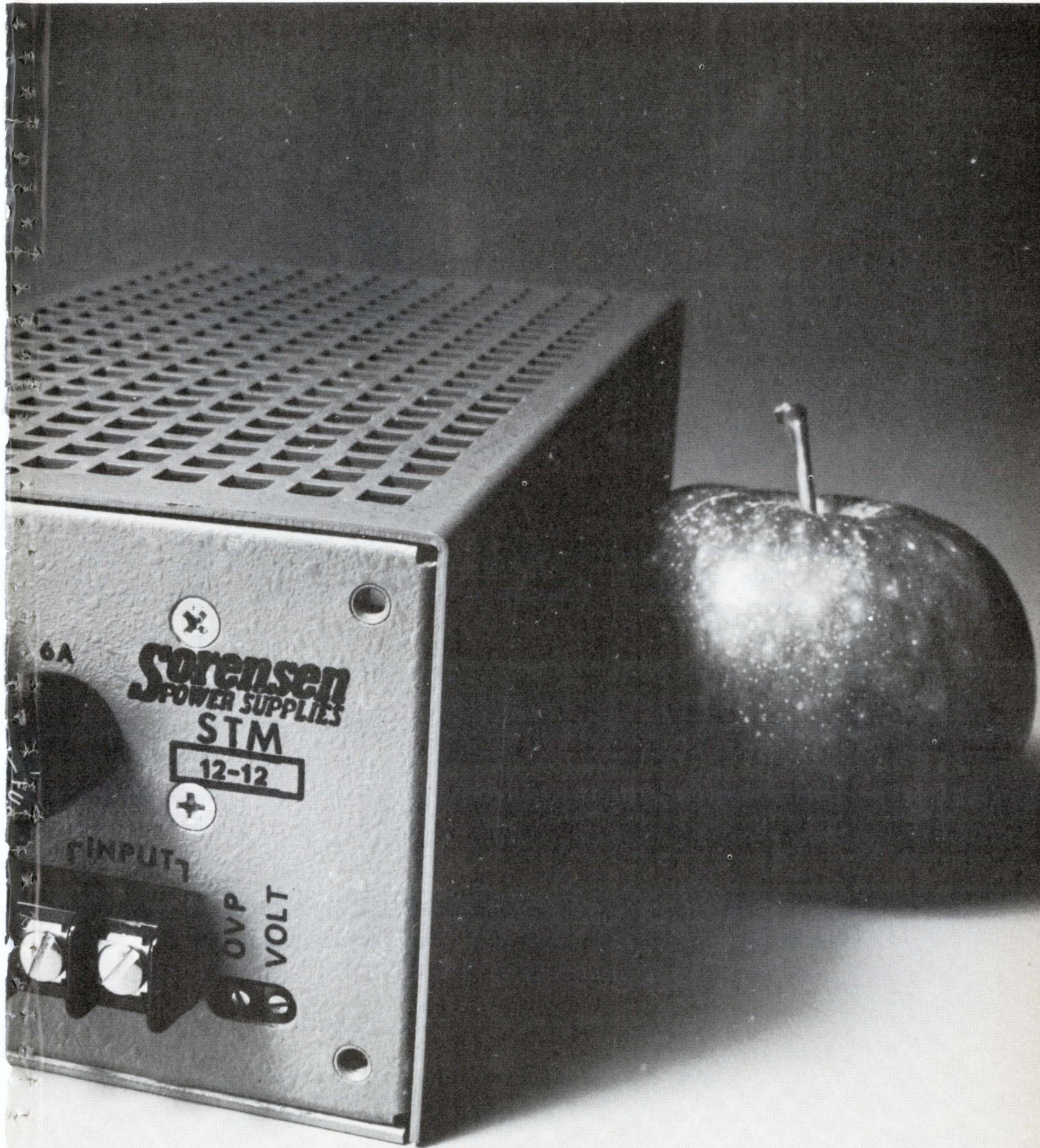

6A

Sorensen
POWER SUPPLIES

STM

12-12

+

INPUT

OVP
VOLT

Silver Futures: Bright or Dull in '75?

This new report gives our analysts' outlook for near-term silver prices. Included: background briefing, supply and demand charts, price history, and more. Free. Just mail coupon.



“Silver Situation Report”

Mail to: Merrill Lynch Commodity Division
One Liberty Plaza, 165 Broadway, N.Y., N.Y. 10006

Name _____

Address _____

City _____ State _____ Zip _____

Home Phone _____ Bus. Phone _____

Check box(es) that apply:

I have hedged in the past. I have speculated in the past.

Merrill Lynch customers, please give name and office address of Account Executive:



Merrill Lynch Pierce Fenner & Smith Inc.

© Copyright 1975 Merrill Lynch Pierce Fenner & Smith Inc.

Straight talk about IC sockets.

Integrated-circuit sockets are becoming such a household item, people are starting to forget something.

They're not all alike. And the differences can have a major impact on the performance and profitability of the products they're used in.

That's why we've decided to go over a few socket basics.

THE REASONS... AND THE RISKS.

All sockets serve basically the same purpose: they allow you to replace ICs without damaging either the IC or the PC board. In so doing, they make both design changes and field service economically feasible for you and your customer.

There's only one problem. When a socket fails, troubleshooting can be a nightmare — to a point where you'd have been better off without sockets in the first place. So it pays to be sure that the sockets you buy are right for your application.

CHOOSING THE RIGHT SOCKET.

Buying the right socket is much more than a matter of profile and price. It's matching the right one to the demands of your application.

For low-cost, high-volume products where the risk and consequences of socket failure are minimal — and where repeated IC insertion and high retention aren't required — buy the cheapest sockets that will do the job properly.

But for high-shock and vibration environments, or other situations where performance is critical, by all means get the best sockets money can buy.

At Augat, we understand these

differences. That's why we make sockets for both needs, in the widest range of sizes and specifications in the industry — from 6 to 40 contacts, on .300", .400", and .600" centers. These include low-profile, LED, and test sockets, socket carrier assemblies, and more — with PC, wire-wrapping, and solder pocket terminations.

And thanks to high-volume, automated production economies, these sockets are priced competitively despite many features you can't get elsewhere.

SMALL POINTS MAKE A BIG DIFFERENCE.

It's amazing how the finer points of socket construction can affect reliability.

Take the material the contacts are made of. For repeated IC insertion and good retention no other material can match the beryllium copper used in all Augat PC sockets. Cost alone leads other producers to use other materials.

Designs vary, too. Among low-priced sockets, Augat's new low-profile series grip the IC lead along *both* flat sides, rather than by the edge, for best contact. And they'll take the full range of lead sizes, too.

Among premium sockets, Augat's Series 500 and 700 are the only ones in the world to include the two-piece machined contact assembly designed and perfected by Augat. While stamped "equivalents" abound, their looser tolerances have given

rise to a series of pitfalls avoided by the Augat design:

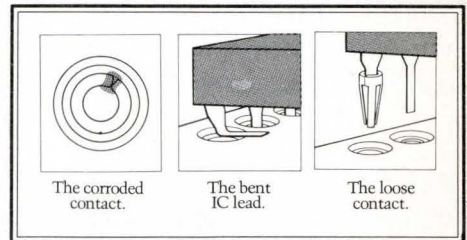

In the important matter of flow soldering, both series again provide a decisive edge. The closed-end construction completely eliminates the possibility of flux or solder wicking.

These distinctions may seem small. But taken together, they're a good indication of how well the sockets you buy will stand up under long-term use. And in a market flooded with lookalikes, they're something to shop for.

A SUPPLIER YOU CAN COUNT ON.

As the pioneer and leader in the IC interconnection industry, Augat has always been the world's prime supplier of IC sockets.

Now, after completing a multi-million dollar program of vertical integration, we're better equipped than ever to maintain that position — by providing the best sockets, the best service, and the finest distributor network in the world.

For all the facts, send today for our new brochure. We're convinced that the more you know, the more you'll come to Augat for all your IC interconnection needs.

YOU ONLY GET IT ALL FROM AUGAT.

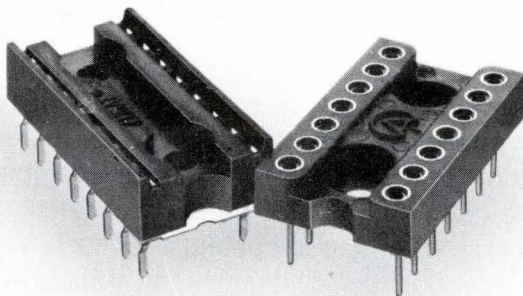

AUGAT[®]

Augat Inc., 33 Perry Avenue, P.O. Box 779, Attleboro, Massachusetts 02703. Tel. (617) 222-2202.

Europe — Augat N.V., Boulevard A. Reyers, 103, 1040 Brussels, Belgium, Tel. (02) 7369399.

Japan — Kyokuto Boeki Kaisha Ltd., New Otemachi Bldg., 2-1, 2-Chome Otemachi, Chiyoda-Ku, Tokyo 100-91, Japan, Tel. (03) 244-3788.

Canada — A.C. Simmonds & Sons Ltd., 285 Yorkland Blvd., Willowdale, Ont. M2J1S8, Tel. (416) 491-1010.

Microcomputer

A new six-volume programmed learning course from Iasis tells you **EVERYTHING** about what microcomputers are and how you can design and implement a microprocessor-based system.

Since the transistor was invented, no single electronics innovation has made such an impact as the microcomputer. Powered by tiny semiconductor chips containing computing elements with the same powers and functions previously found only in large scale digital computers, these dedicated microcomputer systems are now being applied to literally thousands of applications. Microcomputers are automating assembly lines, providing the heart of sophisticated electronic games, making "intelligent" computer peripherals even smarter, and are going so far as streamlining the operations of the fastest food chains. This revolution is occurring because microcomputers are very inexpensive—costing as little as \$30 in production volume—easy to implement into a system, and significantly reduce the time and cost of product development. But there has been one serious drawback to this exploding industry:

Training materials and courses in the basics of microcomputer technology have been virtually non-existent, and the various published manuals and texts have been undecipherable to those not already intimately familiar with ultra-sophisticated logic design.

Once a designer has the hang of it, microcomputer design is a snap. But without the fundamentals—never before available in such a readable, understandable and simplified format—microcomputer design has been unbelievably difficult. The comprehensive, step-by-step six-volume Programmed Learning Course on Microcomputers from Iasis makes the unbelievably difficult almost ridiculously simple. The authors of these texts have been involved on a professional level in the microcomputer industry since it became an industry. Their direct, first-hand experience in the whys, hows, wherefores and potentials of microcomputers

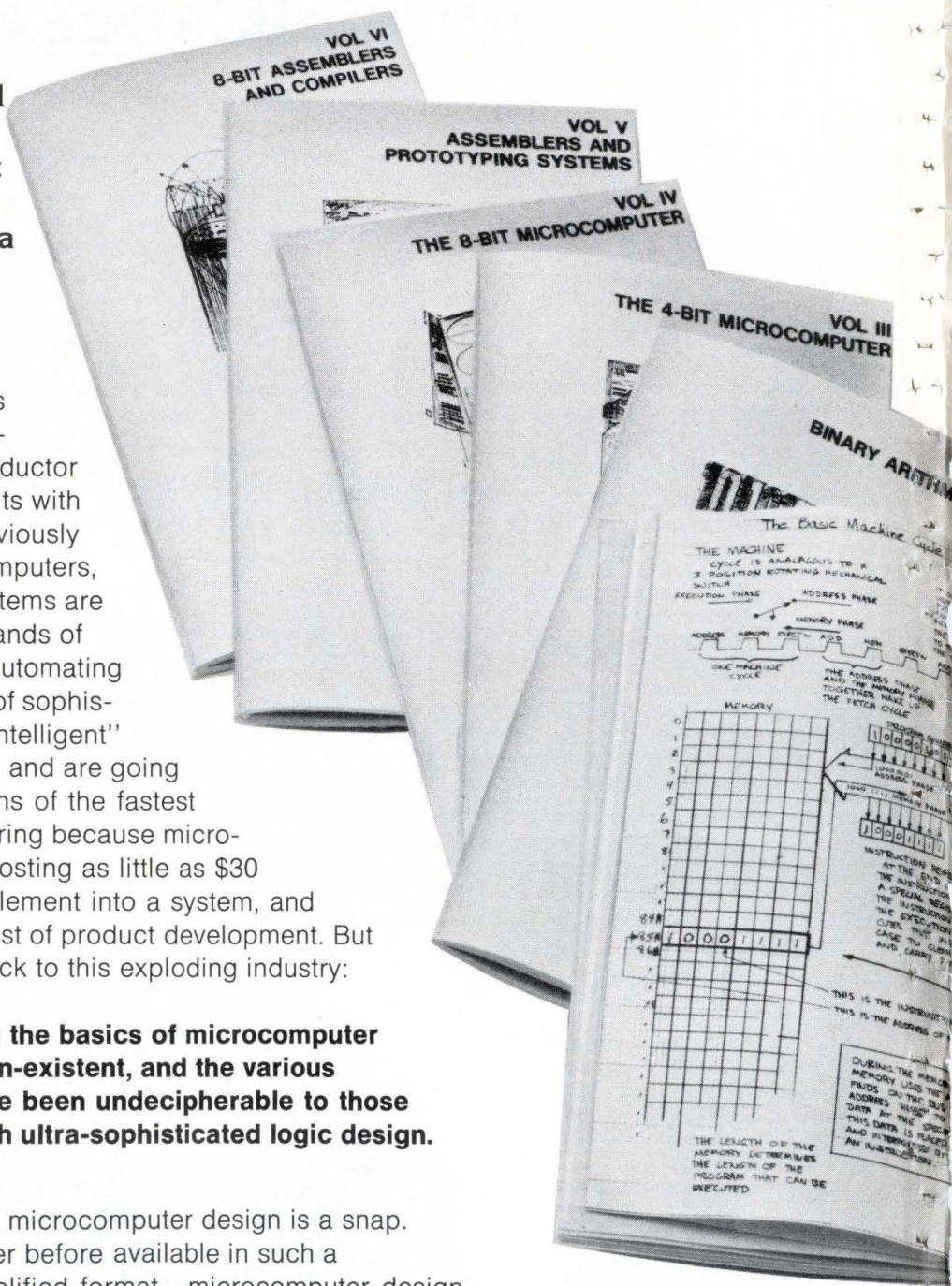

Iasis Texts:

1. Binary Arithmetic
2. Microcomputer Architecture
3. The 4-Bit Microcomputer
4. The 8-Bit Microcomputer
5. Assemblers and Prototyping Systems
6. 8-Bit Assemblers and Compilers

Finally, you can get a comprehensive training course on microcomputers that puts all the hard-to-get information at your fingertips in an easy-to-read, easy-to-understand and even easier-to-implement manner. You can get it here...now.

design is a snap.

have made this six-volume collection the most valuable and meaningful series ever published on microcomputer design. The books combine the most effective methods of programmed instruction with the entire gamut of essential information vital to the designer of a micro-based system. You begin with the ABC's of microcomputers and go through a virtual post-doctoral course... **and the unique, self-testing programmed learning lasis course enables you to understand and absorb every bit of the information every step of the way through the six volumes.**

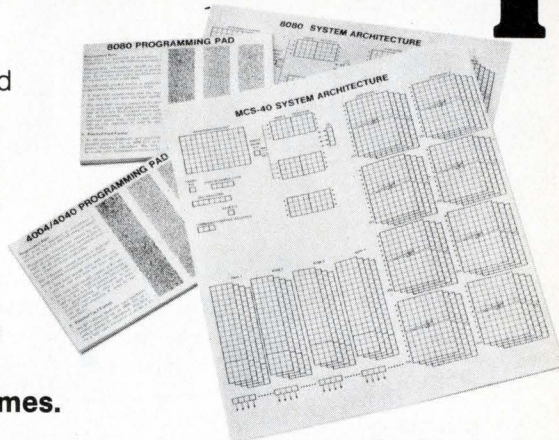

The lasis course gives you more than 700 pages of detailed, illustrated microcomputer information—including more than 1,700 self-tests you use to evaluate your progress—plus programming and design aids that make the design of practical systems very, very easy for you.

Specific details are provided on four of the industry's most versatile microcomputers—the 4004, 4040, 8008 and 8080 from Intel Corporation—but the basic design information will apply to any and all microprocessors. The six volumes you receive with the

course are: 1) BINARY ARITHMETIC; 2) MICROCOMPUTER ARCHITECTURE; 3) THE 4-BIT MICROCOMPUTER; 4) THE 8-BIT MICROCOMPUTER; 5) ASSEMBLERS AND PROTOTYPING SYSTEMS; and 6) 8-BIT ASSEMBLERS AND COMPILERS. Plus, this detailed course provides you with two programming pads and two simplified design aids so you may quickly and easily

develop both 4-bit and 8-bit microcomputer systems. Use the coupon below to order your course from lasis, Inc., 770 Welch Road, Suite 154, Palo Alto, California 94304.

Special introductory price on this remarkable new course is just \$99.50... and if it isn't everything we say it is or even more, return it within 15 days for a full refund!



iasis inc.

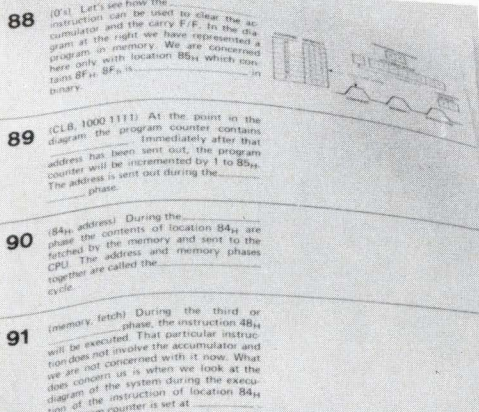

Order before July 15, and you'll save a full \$25 on the Programmed Learning Course on Microcomputers! In addition, all introductory orders will include a bonus seventh volume, the Microcomputer Applications Handbook!

(After July 15, 1975, price for the complete lasis course will be \$124.50, plus \$2.50 for postage and handling.)

Here's my check or money order (*no cash, please*). **RUSH** my 6-volume Programmed Learning Course on Microcomputers, including the bonus Applications Handbook and programming aids, to the address below. **HURRY!**

- Send one complete course for \$99.50 in U. S. funds. My payment is attached. (California residents, please add \$5.97 State sales tax.)
- Send me information by return mail on quantity discounts.

ALLOW 15 DAYS FOR DELIVERY IN THE U. S. AND 6 WEEKS FOR DELIVERY OUTSIDE THE UNITED STATES.

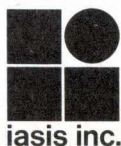

Mail today to: lasis,
770 Welch Road, Suite 154-E
Palo Alto, California 94304.

You can use your BankAmericard or Master Charge, too!

CHARGE MY ORDER TO THE CREDIT CARD NO. BELOW:

BankAmericard No. _____

Master Charge No. _____

For Master Charge, add 4-digit number immediately above your name on the card. It is _____

HERE'S MY SIGNATURE _____
(Sign here if credit card charge)

Credit card expiration date _____

NAME _____

ADDRESS _____

ORGANIZATION _____ MAIL STOP _____

CITY/STATE/ZIP _____

Surprise! \$2.95

(10-49)

Wideband Transformers

- SURPRISE! Wide bandwidths, .015-600 MHz**
- SURPRISE! Low insertion loss, 0.5 dB**
- SURPRISE! Microminiature, .230" x .270" x .300"**
- SURPRISE! One week delivery**

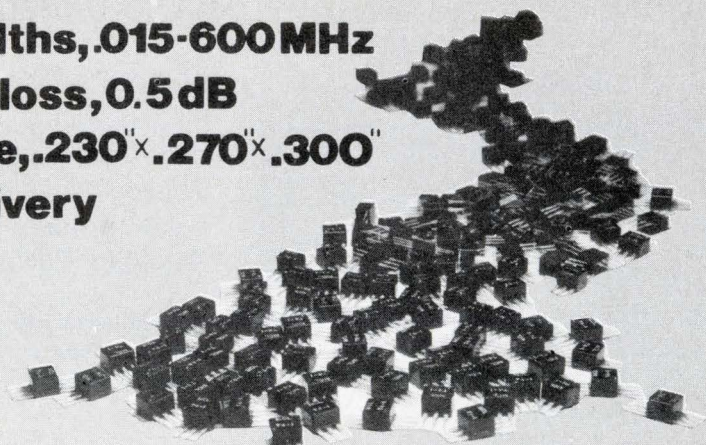

DESIGNERS KIT AVAILABLE:
 2 TRANSFORMERS OF EACH TYPE
 T1-1, T2-1, T4-1, T9-1, T16-1
 KIT # TK-1... **\$32.00**

NO "MAKE OR BUY" DECISION HERE... it costs less to buy Mini-Circuits wideband transformers and there's no delivery delay. Impedance levels from 12.5 to 800 ohms with insertion loss typically less than 0.5 dB

MODEL	T1-1	T2-1	T4-1	T9-1	T16-1
Impedance Ratio (50 Ω pri. imp.)	1	2	4	9	16
Bandwidth (MHz)	1 db loss	2-50	.05-200	2-100	2-40
	3 db loss	.15-400	.015-600	.2-350	.15-200
Price (10-49)	\$2.95	\$3.45	\$2.95	\$2.95	\$3.45

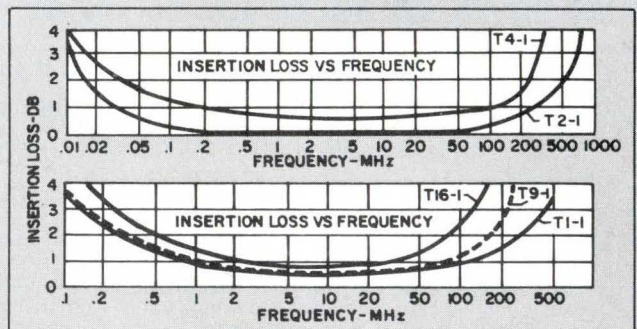

Mini-Circuits Laboratory
 A Division Scientific Components Corp

**OUR NEW ADDRESS IS: 837-843 Utica Avenue,
 Brooklyn, NY 11203 (212) 342-2500
 Int'l Telex 620156**

Foreign Sales Representatives: AUSTRALIA General Electronic Services, 99 Alexander Street, New South Wales, Australia 2065; ENGLAND Dale Electronics, Dale House, Wharf Road, Frimley Green, Camberley Surrey; FRANCE S. C. I. E. - D. I. M. E. S., 31 Rue George - Sand, 91120 Palaiseau, France; GERMANY, AUSTRIA, SWITZERLAND Industrial Electronics GMBH, Klüberstrasse 14, 6000 Frankfurt/Main, Germany; ISRAEL Vectronics, Ltd., 69 Gordon Street, Tel-Aviv, Israel; JAPAN Densho Kaisha, Ltd., Eguchi Building, 8-1 Chome Hamamatsucho Minato-ku, Tokyo; EASTERN CANADA B. D. Hummel, 2224 Maynard Avenue, Utica, NY 13502 (315) 736-7821; NETHERLANDS Coimex, Veldweg 11, Hattem, Holland

US Distributors: NORTHERN CALIFORNIA Cain-White & Co., Foothill Office Center, 105 Fremont Avenue, Los Altos, CA 94022 (415) 948-6533; SOUTHERN CALIFORNIA, ARIZONA Crown Electronics, 11440 Collins Street, No. Hollywood, CA 91601 (213) 877-3550

For complete U.S. Rep listing and product line see MicroWaves' Product Data Directory

Word processing transforms office paperwork routine

Escalating cost of handling business correspondence spells out vigorous future for electronics-based systems that are replacing traditional equipment, and the market has barely been touched

by Gerald M. Walker, Associate Editor

□ One of the last hold-outs against automation has been the business office, with its managers, secretaries, file clerks, and stenographers. But office procedures are on the threshold of important large-scale changes that have recently been made possible by high-efficiency electronics-based equipment.

The office-equipment industry has entered a period marked by application of electronic technology, a period that promises rapid market growth under the banner of "word processing." That term has been around since 1964 when International Business Machines coined it for the introduction of the first sophisticated editing typewriter using magnetic tape for storage and automatic control. IBM has easily been the dominant figure in the word-processing market ever since that time.

What is word processing? The definition can be as general or specific as the market itself. It differs from data processing in that the equipment does not deal with computations, but rather the handling of business correspondence, forms, contracts, legal documents, even medical histories.

In the traditional office, the boss who generates correspondence usually either dictates to a secretary, writes a rough draft in long hand, or records the information on a dictating machine. Once typed, at about 50 words per minute, the correspondence is often edited and retyped, again at 50 words per minute. The secretary may correct

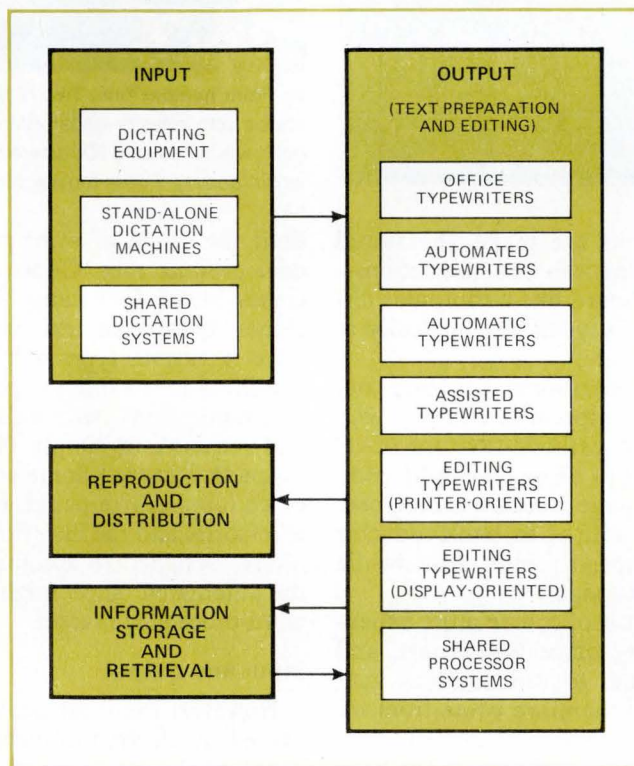

1. Words in, words out. The total word-processing market today covers these four categories. But most of the competitive action and product development in the last year has been in the input (dictation) and output (text preparation and editing) equipment.

minor errors with various erasure liquids and cards. Long documents may go through editing and retyping a number of times before a final version is ready. Larger offices may have typing pools to do the heavy transcription work. But hiring the necessary office personnel did not become a major burden until salaries and fringe benefits began to increase at a faster pace, so much so that today correspondence can cost a company anywhere from \$5 to \$10 a page.

Word-processing systems offer a new line of equipment to speed up these routines, to reduce office personnel, and to manipulate the outflow of paperwork more flexibly than is possible in the traditional setting. All of the traditional hardware has been changed. Dictation may now be made into

shared electronic-controlled recording machines that also monitor the entry and transcription of the contents, or into desk-top machines that can be actuated remotely for accepting dictation over the telephone, or to a handheld unit while out of the office.

Typing, editing, retyping, and correcting correspondence has been speeded enormously with the introduction of automated equipment. And the quality of the finished letter or document has been improved because corrections are done electronically and the typing done automatically.

Machines are now available with up to 8,000 bits of memory with which to store letters, from first draft to

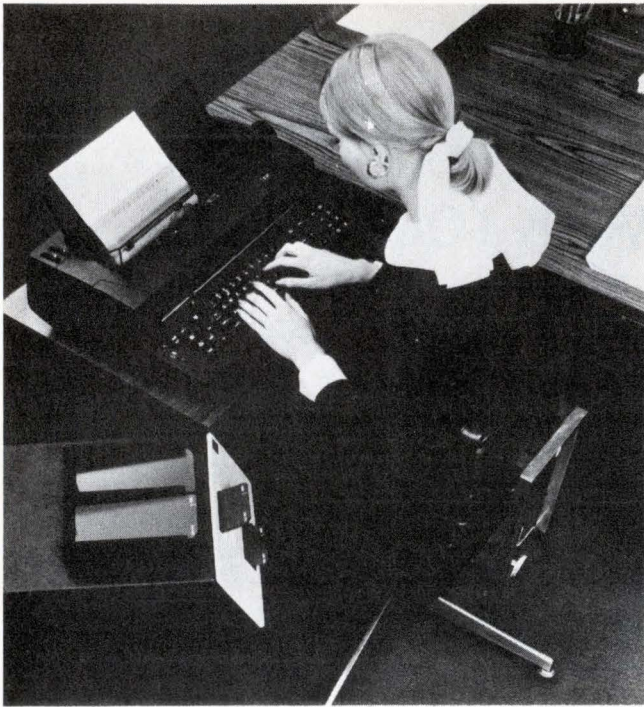

2. From number one. Two of the important word-processing machines from industry-leader IBM's extensive line are the Mag Card II (left), which has an 8,000-character memory, and the Memory Typewriter (above), a desk-top machine with 4-k memory.

last. If changes and corrections are made, the stored contents—including spacing and tab set instructions—can be changed using the keyboard like a computer terminal. Then the final version is typed automatically at speeds up to 350 words per minute.

All this means that fewer personnel can turn out more correspondence. This is especially obvious with word-processing units that have cathode-ray-tube (CRT) displays on which the material to be typed can be composed and corrected. When a page is ready to be typed, the contents of its screen are shifted to semiconductor memory which feeds a high speed printer. Meanwhile the operator goes on to the next page.

Word-processing equipment is of course more expensive than standard heavy-duty office typewriters, and the training of office personnel to use this new gear takes longer. The payoff must therefore come from increased productivity.

Like EDP systems, word processing, where it has been applied, alters the structure and procedures of the typical office paper mill, but more on this later. Conceptually the characteristics of the equipment—and much of the industry's jargon—is somewhere between the computer world and the traditional office. Moreover, in the last year, new, more powerful machines have begun to appear. Application of microprocessors for control and memory, floppy disks for storage, and advanced cathode ray tubes have entered word processing equipment design.

All of the signs thus point to steady growth of word processing; electronics technology moves in on yet another established electro-mechanical field. For the companies that have been trying to get this market off the ground for the last decade, the necessary ingredients—lower cost, greater equipment capability, and user interest—are finally beginning to coalesce.

Different office-equipment companies expand or

limit the scope of word-processing according to their own product mix. Generally, the equipment (Fig. 1) comes under four categories: input, or dictating machines; output, or text preparation and editing hardware or various types of typewriters; reproduction and distribution, meaning copiers, printing machines, and communications terminals; and information storage and retrieval, or simply the "files." (The files may be magnetic storage.) Some companies would also include office supplies like paper, typewriter ribbon, equipment accessories and the like. For that matter, even office furniture, designed to accommodate the new structure of the automated office, might be considered a part of the word-processing market.

Input and output

However, the most activity and the greatest impact caused by electronics during the last year has been in the dictating (input) and typing-editing (output) segments of this business.

By far the larger of the two markets is in the output side—in typing-editing machines. In fact, even if the \$3,000 to \$20,000 electronics-based machines had never been developed, the typewriter market would be a big one. About a million heavy-duty machines a year will be sold between 1975 and 1980, according to industry estimates. Annual dollar value during this six-year span should be about \$500 million to \$700 million. But on top of this base is the newer group of machines, which, it is estimated, will be worth over a billion dollars a year by 1980.

The latter breed of machines, in ascending order of cost and complexity, include:

- Typewriter units that have some kind of storage—either magnetic tape or card—that facilitates the revision of text before automatically preparing finished correspondence.

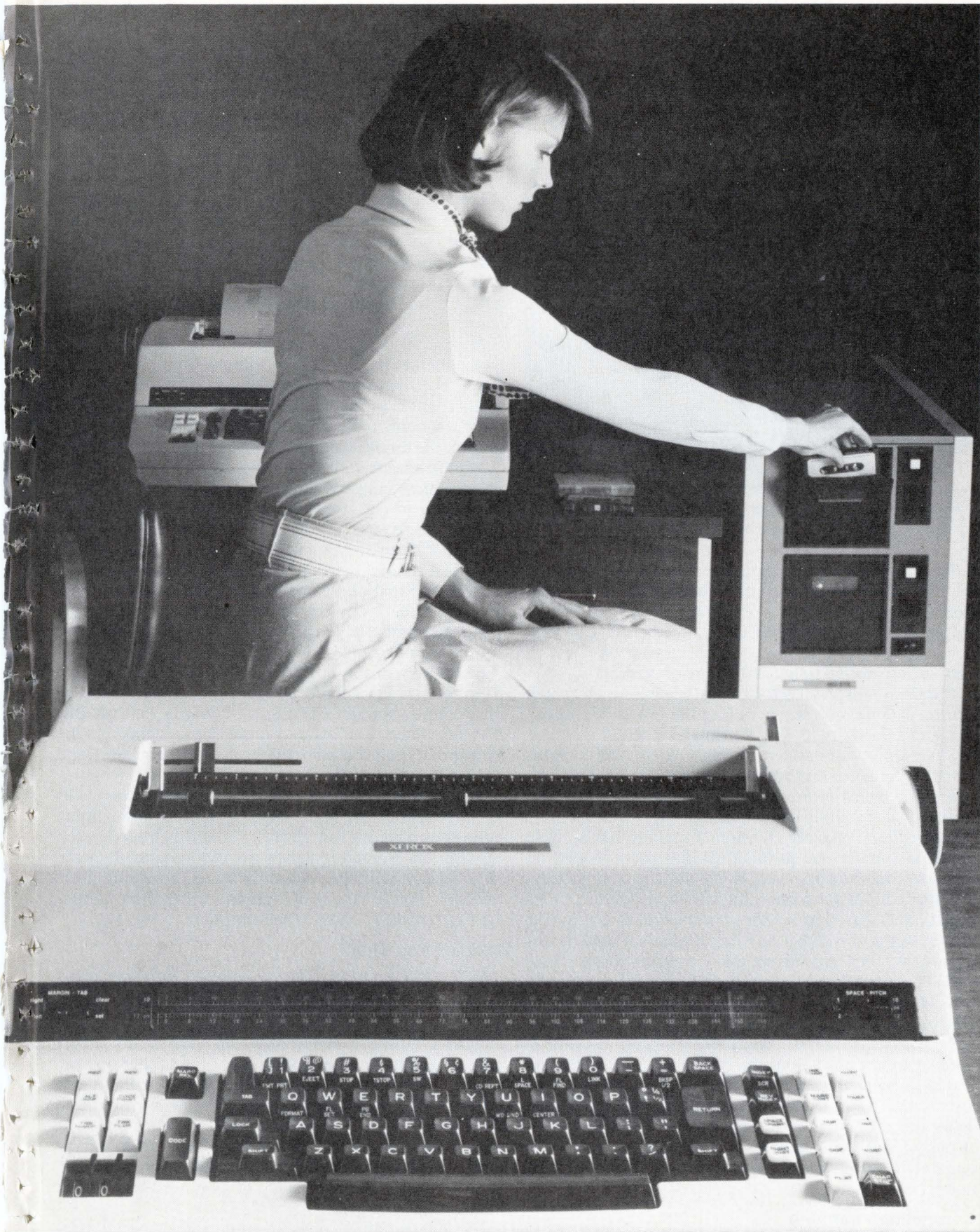

3. Enter Xerox. Entry into word processing of the office-copier giant, Xerox, with its Model 800 is heating up the competition with the other giant, IBM. Their combined efforts are bound to spread word processing to more potential users and expand the total size of the market.



4. Typing by phone. Among the automated typewriters with communications capability is this Redactron unit. It performs information merging and editing using telephone-transmitted information. Advantage of system is ability to use data from various offices.

- Printer-oriented (having printed hard-copy outputs) editing typewriters that permit the merger of material from two sources—tape and magnetic cards, for example—and that permit revision and reforming of long documents, or that have semiconductor memory which may be transferred to magnetic tape or cards.
- Electronic display CRT editing typewriters on which editing is done on a screen before the text is “dumped” to a buffer memory feeding a printer.
- Shared processor systems using time-shared computers programed for text editing and the control of a number of keyboard terminals on which inputs and printouts can be accomplished independently.

IBM Office Products Division, Franklin Lakes, N.J., which is number one in this field, has concentrated on the first two categories—magnetic-storage and printer-oriented editing machines—but will likely develop a CRT display and shared processor systems, too, as the market grows. Right now IBM's line has 10 distinct models anchored by four machines: the Communications Mag Card “Selectric” typewriter, the Memory typewriter, the IBM Mag Card II with built-in 8-k memory, and the Correcting “Selectric” typewriter. In addition, the company has two “Selectric” composers to prepare camera-ready copy for offset reproduction (Fig. 2). The IBM line is dedicated to the widest portion of the word-processing market today; that is, the segment covering the largest number of potential users. Typically, IBM has been strong in marketing, customer training, and the development of systems incorporating its hardware into office procedures.

Competition warming

Yet, despite the imposing presence of IBM, the market for electronic-based typewriters has hardly been

scratched. Only about 3.5% of the estimated 4.2 million active heavy-duty office typewriter stations have been converted to the newer machines. So the lure is tempting. Indeed a number of companies have come on stream with magnetic tape and card equipment linked to standard IBM typewriters, which one scornful business machine executive calls, “souped-up Selectrics.”

But since last fall, another big gun has been in the text-editing/preparation competition against IBM: Xerox Office Systems division, operating out of Dallas. Xerox entered the field with the Xerox 800 (Fig. 3). So, instead of a word-processing market composed of IBM and a score of relative small fry, plus a dozen or more firms tip-toeing among the product categories not occupied by the giant, competition now promises to be fierce.

A contest between two companies with vast national marketing capabilities cannot help but expand the market. And although a shakeout of some of the smaller guys is inevitable, most observers feel that there's enough room to accommodate many competitors not the financial equals of IBM or Xerox.

Manufacturers without a previous foothold in the office-products industry, however, would find it almost impossible to get into word-processing competition at this point because of the large investment required. Around 80% of the typewriter business is lease rather than buy, so a hefty front-end bankroll is vital. There is also the fact that customers expect considerable training and service back up. Finally, the technology supporting word processing is starting to move rapidly so that any entrant would need a solid engineering capability.

Firms now in the business will more than likely expand their lines, a trend already under way. There is, for example, bound to be more activity in the CRT display machines and shared-processor systems as the word-processing companies consolidate their bases and begin upgrading their customers.

Incidentally, while everyone in the business talks about educating the great majority of new users, many businesses have moved ahead on their own to develop expertise in evaluating hardware and systems. It probably means that more and more word-processing users will buy from a variety of vendors rather than hand a kind of “turnkey” order to one supplier.

Who's doing what?

Just about every competitor in the typing end of the market has had to contend with comparisons between their equipment and that of IBM. It is not surprising then that the Xerox 800 invites very specific and favorable comparisons with IBM in terms of output speeds. It's not surprising either that Xerox started with an aim on the same broad-base portion of the market that IBM has followed—the lower-price, higher-volume units. It also appears that Xerox will follow the same conservative approach to sales and product development as IBM, as there is no dazzling display of advanced technology in the new Xerox gear.

The 800 features a control console with a specially designed microprocessor similar to the Intel 8080 but without generalized instructions. Because it is a special-

purpose microprocessor, the controller design is simplified within a 1,000-byte scratch-pad memory divided into read-write and read-only segments. The arithmetic logic unit is on one chip with an I/O buffer. This controls all the typewriter operations, including ribbon advance and printer transport.

As each line of type is "played out" (printed) from the buffered memory, the microprocessor is programmed to read the next line when the printer is moving from left to right. If the next line is a complete line, the printer is instructed to type that line backwards from right to left. Printing speeds of up to 350 words per minute are possible when the machine is in this "reverse printing" mode. Actually this speed is not a new capability, because the 800 uses a printer developed by Diablo Systems for computers. Printing backwards has always been possible, and with the microprocessor available it was a simple matter to program this mode into the machine.

Redactron Corp., although producing only a little over \$16 million in revenue last year, has been one of the most aggressive word-processing companies in the application of electronics technology, particularly in its early use of MOS/LSI design. It has positioned itself a little differently from the majority of companies fighting IBM by concentrating not only on text generation, but on data filing, that is, distributing information captured at the typewriter to computer storage. Thus, to its line of automated typewriters, Redactron has added a data converter that provides bidirectional conversion of typewriter magnetic storage devices to computer-compatible tape. Cassette conversion is accomplished at 900 characters per second, card conversion at 300 characters per second. Conversion is performed on a direct-image basis, each character exactly as read. If desired, however, the information may be recorded in the nine-channel ASCII Code.

Redactron also has communicating typewriters for high-speed point-to-point contact over telephone lines from one unit (Fig. 4) to another at 300 characters per second, or for conversational communication over phone lines at 14.8 characters per second. The latter is designed for interactive exchange between typewriters in real-time situations, where for example, information is used to update a remote, active file, or where information in a central file is needed immediately at another location.

The machines also interface with TWX and Telex networks. They operate at a maximum TWX speed of 10 characters per second or at Telex speed of 6.6 characters per second.

More recently Redactron has announced development of a 1,000-line-resolution CRT display (Fig. 5). The display is 60 lines by 84 characters, generated in a raster scan rather than as vector-types.

Typing on a tube

CRT-based equipment is expected to pick up in popularity in the coming years. Installations of these machines could climb from under 10,000 units this year to about 110,000 units in 1983, according to the market research firm Frost & Sullivan Inc., New York. Projected

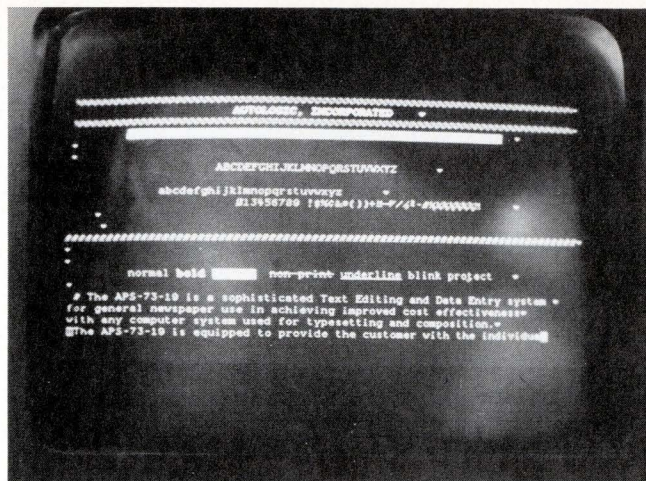

5. CRT words. Redactron's Series 500 CRT monitor uses a raster-scan tube rather than vector character generation, and has 1,000-line resolution. It will be used in the company's forthcoming line of video display automated typewriters.

revenues from sale and rental of stand-alone display machines will pass \$1 billion by the end of this decade, according to another researcher, Creative Strategies Inc., San Jose, Calif.

The CRT's main advantages can be summed up in one word: versatility. What's on the screen is exactly what the operator has punched on the keyboard. The operator can not only correct individual words by manipulating the keyboard, but also shift words, sentences, and whole paragraphs as desired. There is usually no need for preliminary drafts as with the card and tape typewriters because of the ease of using the CRT display. Even though the equipment resembles computer terminals in outward appearance, operators usually need to learn fewer computer-like procedures than with other automated typewriters. The major drawback is that the CRT machines are many times more expensive than the other automated machines.

Not many CRT display manufacturers are active now, but more are sure to make the scene. Wang Laboratories, Inc., Tewksbury, Mass., in April expanded its word-processing equipment to include a video display. Wang's original System 1222 consisted of a typewriter station, cassette station, an optional work/storage station and console extensions. It has a line buffer to provide true insertion and deletion by reorganizing each line in the buffer memory rather than whole pages of text. This means the operator can make corrections, add or delete words, or transpose words in the same sequence used on a standard typewriter; the machine carries out the instructions without need for additional operator training.

A Wang spokesman observes that printer-based systems are inexpensive compared to \$16,000 to \$20,000 CRT machines, but that the screen types are easier to use. The new system 1222 is a combination of Wang's dual-cassette typewriter and a viewing screen so that it produces a typewritten copy and a screen image for review before the final version is printed.

Three other companies that have been selling display-type units for a few years now are Linolex Corp. of

North Billerica, Mass.; Vydec of Whippany, N.J.; and Lexitron Corp. of Canoga Park, Calif. All are small companies, but Linolex was recently purchased by 3M Co. and Vydec has considerable financial backing from Exxon Corp.

Lexitron has two CRT-based text editing systems. One, the Videotype Model 911 (Fig. 6) uses IBM Executive typewriters which feature proportional spacing. It operates at 150 words per minute and costs \$17,950. The Model 921 uses a Diablo printer and puts out 360 to 400 words per minute. It costs \$20,250.

Lexitron is just coming out with a similar system, but without the printers, just the CRT, keyboard, processor, and cassette tape. It's priced about \$5,000 less than the other printer units.

An unusual aspect of the Lexitron display is that the text as it appears on the screen looks very much like a sheet of typing paper rolling up and out of the typewriter. There's even a roll bar handle at each side of the screen to move the lines up and down. So the text emerges from the bottom of the 8½-by-11-inch CRT and the lines move upward, simulating typewritten pages. The CRT holds a total of 7,200 characters. It's also possible to control the display from the keyboard, and the words can be switched to appear from the top down as in a conventional computer display.

Vydec's CRT Editor System, at \$15,500, is unusual in that it uses a floppy disk, rather than tape or cards, to store keyboard output (Fig. 7). The floppy disk, says a company spokesman, combines the flexibility of easy access (which the tape does not have) and the ease of filing that the card offers. In operation the information on the CRT is transferred to a buffered semiconductor "scratch-pad" memory, which feeds a high-speed Qume printer. (Qume printers are very much like the Diablo types in design.) The screen, a 15-inch diagonal tube, has a 60-cycles-per-second refresh rate and holds 64 lines of 97 characters each.

The advantage of the display-type word processors over the magnetic-storage/print-out equipment, editing versatility, means there is no rough draft in the usual sense because the hard copy is not run off until the page is corrected on the screen. To make any change on the CRT the operator simply uses the keyboard to position a cursor at the spot where a change is to be made and then executes the change. The user can control brightness of the screen, underline words, "draw" vertical lines, double or single space and even reverse the image to get light letters on a dark background.

Word processing by computer

While word processors owe much of their technology to computers, they are essentially stand-alone machines. The only direct interface with computers is through a converter to store magnetic tape or card data in a computer memory. However, there is the option of shifting the control logic of the stand-alone units to a central computer and simply putting the operator's printer typewriter on a time-shared hook up.

To date, these shared-logic systems have not been attractive to many word-processor users because of the inconveniences of waiting in line for shared time, or be-

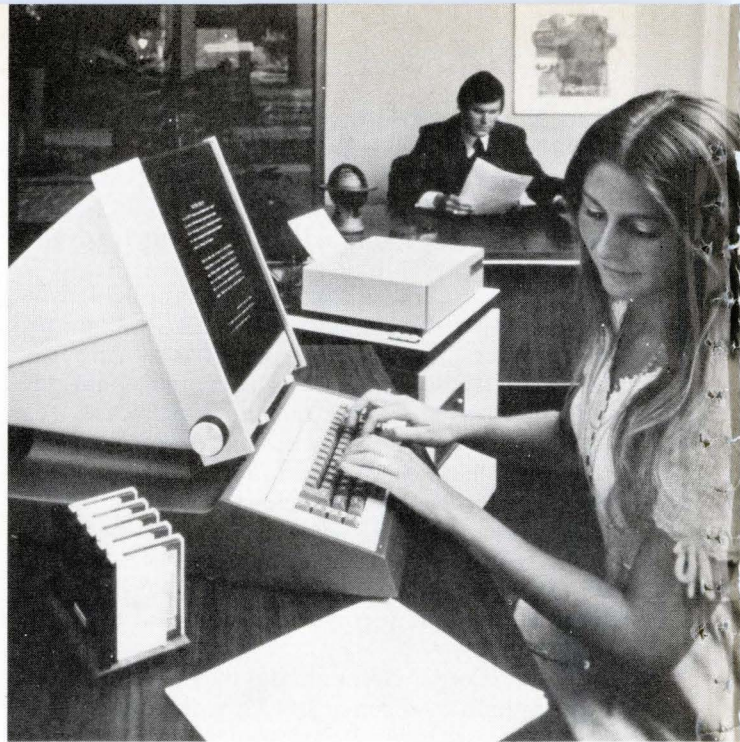

6. Video words. The Lexitron Videotype Text Processor Model 911 features a display that's oriented like a standard typewriter. When the operator types or turns the "roll-bar" handles on the side, the text "rolls up" from the bottom of the screen.

cause of the printer down-time should the central computer fail.

But there are certain companies with large amounts of documents to edit and move around, and for whom a time-shared word-processing hookup becomes very appealing. One equipment maker has called these applications the "rarefied air of word processing." The market in "rarefied air" is said to be only \$20 million today, but will be worth as much as \$350 million by the end of the '70's.

One company specializing in time-shared word processing is Bowne Time Sharing Inc., New York, which grew out of a software business originally offered by Service Bureau Corp. until IBM spun it off in 1969. Thereafter, Bowne took the service bureau concept and translated it into a word-processing service called Word/One. The key change was to shift from data calculation to document manipulation.

Bowne leases keyboard terminals and provides programs for text editing and the like. In document management, users approach "data-base" control from computer memory of a size not possible with stand-alone machines. Even though future stand-alone units will carry more editing logic, computer control of documents with the potential of a national communications network will increase the need for time-shared word processing, Bowne believes. Thus a large part of this company's investment will be in establishing and extending communications networks.

Shared logic systems, however, need not be time-shared in the service-bureau sense of the word. LCS Corp. of Springfield, Mass., for example, was started in 1970 by a group of lawyers dissatisfied with their magnetic tape, stand-alone machine. The LCS Compu-Text is a shared-logic system consisting of a Digital Equip-

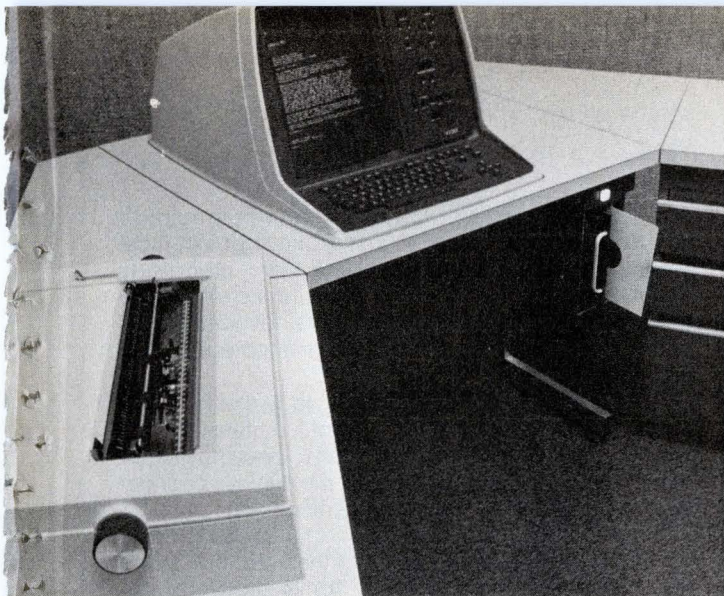

7. Screened words. Using a floppy disk for data storage, the Vydec 1145 has a vector-drawn CRT display for text editing. When the letter is ready for typing, the information is "dumped" into a buffered-memory controller which runs a high speed printer.

ment Corp. PDP-8E minicomputer and an IBM "Selectric" typewriter. The minicomputer stores lengthy legal documents that are chopped up to prepare standardized texts rather than retyped. This boiler-plating routine is so important in law firms that even a 150-word-per-minute typewriter can't deliver fast enough. Although the system put together by the company was originally aimed at law offices, other users who must handle large amounts of standard documentation at high speed have become interested. LCS does not manufacture or service. What it does do is supply the hardware, training, and back-up assistance. Since the DEC minicomputer and the IBM typewriters have not been modified, their makers are still responsible for service maintenance even though the hardware is sold as part of the LCS system.

Slicing a smaller pie

The input side of word processing is a much smaller market than the output side, but there are fewer competitors slicing up the pie.

The external appearance of dictation equipment has not changed as radically as typing equipment, as far as the user is concerned. There's still a microphone or its equivalent (some hook the telephone into a dictating system). The changes have occurred in the over-all arrangements in taking dictation. There are now centralized dictation stations, or "tanks." In these systems input and output is measured automatically so that transcription work loads may be evenly distributed among transcribers.

Also, the familiar desk-top dictation recorders are being used for more communications tasks than just letters because the old belt-type machines are being replaced by more flexible cassette tape recorders. And in today's word-processing environment, the busy executive may routinely carry a personal, hand-held dictation machine, or else he can telephone to a 24-hour central dictation recorder to convey information to his office from outside.

According to a report from Frost & Sullivan, shipments of all types of dictation equipment will grow by 22% from 486,000 units in 1974 to 593,000 units in 1979. The value of these shipments, Frost & Sullivan estimates, based on retail or installed prices, will rise by 24% from \$188 million in 1974 to \$234 million in 1979.

These figures cover portables, desk-top units, individual "tanks" and centralized systems. Right now the desk tops and portables are almost even in percentage of units sold; 51% and 47% respectively. These percentages will change only slightly by 1979, says Frost & Sullivan, to 47% for portables, 45% for desk tops. Assisting the growth of portables undoubtedly will be the ability to communicate dictation by telephone from the field to an automatic office recorder at any time of day.

Before long the distinctions between portables and desk-top units will probably disappear, while the individual tanks and central systems will also merge into something called "group systems." This means that people will be using personal machines for making "notes" and reminders, and group systems for lengthy, formal dictation. Equipment coming on the market in the last year or so has emphasized this trend.

In dictation equipment, IBM Office Products division once again has a dominant role. In fact IBM is the only major word processing company to offer both input and output systems, not to mention office copiers. The main reasons other word processing firms have not seen fit to straddle input and output systems are that dictation does not offer the same profit potential as output equipment, users are not necessarily attuned to buying a complete input and output line of products from one supplier, and marketing both types of equipment requires vast resources. In addition, the technologies of both are widely divergent.

The major technological debate in the dictation-equipment business is the choice of recording media. These are split among tape cassettes, endless-loop tanks, and the old standby—recording belts. Last March, however, IBM added yet another recording format with its 6:5 Cartridge System (Fig. 8).

Each cartridge holds 25 magnetic disks, each a little over 3 inches in diameter. Each disk stores six minutes of dictation, which IBM says should accommodate 94% of all dictation sessions. A desk-top recorder will handle two cartridges, or 50 disks, thereby providing up to five hours of total recording capacity—hence the name 6:5 for six minutes per disk, five hours per machine.

The 6:5 is actually a series of products that not only includes a basic recorder and transcriber, but a shared microphone recording arrangement, telephone-to-recorder hook ups, and a telephone message taker. A portable recorder that accepts the magnetic cartridges is due on the market in 1976. Prices begin at \$645 for the recorder, \$645 for the transcribing unit, \$750 for the remote systems, and \$575 for the portable.

Why did IBM choose to push a completely different recording media into the dictation arena? According to the company the cartridge format offered ease of operation, reliability, and the systems flexibility it was searching for. All audio recording techniques were analyzed, including magnetic bubbles, before deciding

on the disk/cartridge configuration. But competitors see the IBM move as a ploy that will only muddy a market already muddied by competing recording media. It's still too early to tell how users will respond.

Tanks for the memory

Dictaphone Corp., Rye, N.Y., which traces its beginning to the original Bell and Tainter invention, has evolved recently into applying more and more electronics thanks to the reception given its original "thought tank" systems. At the beginning of this year, the company brought out the Thought Tank System 193. Designed to increase productivity in offices with high-volume dictation and transcription requirements (Fig. 9). System 193 complements Dictaphone's earlier thought tank system developed for individual use.

The thought tank consists of a mike or a phone to transmit dictation to the recording "tank," a rectangular box containing tape drives and an endless loop tape. When the user is dictating, the secretary can start transcribing immediately from the beginning of the endless loop while the boss can continue to dictate further down the loop. It's also possible to switch to other tanks should dictation exceed the 60-minute capacity of one tank.

The heart of the System 193 is a monitoring console called the Word Controller. The console monitors the transcriptions being done by as many as eight typing stations. It keeps the office manager informed of the word-processing center's daily input, output, backlog, and individual output rates of the typing staff. The manager can then govern the flow of work being typed by checking the console.

The console contains an analog computer built around two quad op amps and several discrete components; the next generation will most likely convert to digital electronics and a programmed microprocessor to monitor all typing stations.

Another feature in the 193 is an automatic means of eliminating those pauses during dictation that could slow down the typist during transcription. And it works without clipping words after the break in speech. The "on and off" for pauses is accomplished with a standard voice-actuating switch, VOX circuit. Clipping protection is done with a bucket-brigade delay line. No matter when the VOX circuit starts the recording, all the sound goes through the bucket brigade. In playback none of the words are lost if the voice-actuating switch fails to turn on in the right instant, because the sound delayed in passing through the bucket brigade is on the tape.

In other words, the bucket brigade reconstructs any sound that might be lost in the slow start up of the voice actuating switch. Sometimes this arrangement introduces unwanted sounds, but it does ensure that there are no clipped words.

Lanier Business Products, Atlanta, Ga., has an endless-loop dictation system called the Nyematic VIP system. It features an "electronic note pad" for the secretary's desk that is basically a light indicator built into a desk holder. When dictation begins, the light on the pad holder alerts the secretary to begin transcription. The light goes out when the secretary has completed what-

'Take a letter, and bring the CRT'

Many secretaries view word processing as a monster of automation, but hostile attitudes show signs of moderating as more companies adopt word processing and more secretaries become accustomed to the systems. In many cases, women's rights advocates have come to recognize word processing as potentially liberating.

On the plus side, word-processing systems, when properly organized, establish new office hierarchies of typists and administrative assistants, opening a new career path for secretaries. One individual is no longer so completely tied to the career of one boss.

On the other hand, some secretaries have castigated typing centers as little more than glorified typing pools, impersonal and isolated. Administrative assistants may find themselves cut off from other career paths. They note that many women enter businesses as secretaries or "girl Fridays" with ambitions to move out into other roles. The word processing set-up may not accommodate these desires.

In the end, successful management of a word processing center is like management in any other field—dependent on the motivation and desires of the individuals involved. The point is that the need for adjustments can't be ignored.

ever playback is required.

Lanier is also enthusiastic about its new \$1,595 Tel-Edisette, a central dictation system that has automatic loading and recording of 12 standard cassettes (Fig. 10). A Work Unit Programmer allows the word-processing-center manager to select from one to nine separate dictation inputs per cassette, ranging from a single dictation for one cassette done for rush work to continuous dictation from three to six remote positions using all 12 cassettes in order.

Because of the multiple uses to which the Tel-Edisette system will be put, there are a number of fail-safe features designed to help prevent confusion in the word-processing center. An anti-reverse feature prevents other dictators from listening or backing up into the dic-



8. Disk dictation. The new IBM 6:5 Cartridge System for dictation employs magnetic disks, each disk holding six minutes of dictation, and 25 disks to a recording cartridge. Each recorder will hold two cartridges, thereby providing up to five hours of total capacity.



9. Thought control. Dictaphone's new Thought Tank System 193 provides the ability to set up a word processing center serving several correspondence originators with a centralized transcribing operation. Here a marketing manager at the company's Rye, N.Y. headquarters (top, left) dictates over the telephone-like mike to the thought-tank Word Controller console which monitors incoming and completed dictation. The Word Controller supervisor (above) can direct dictation to the correspondence secretary (left) from the console. Other administrative secretaries use individual thought tanks to handle short messages or requests, such as arranging travel reservations.

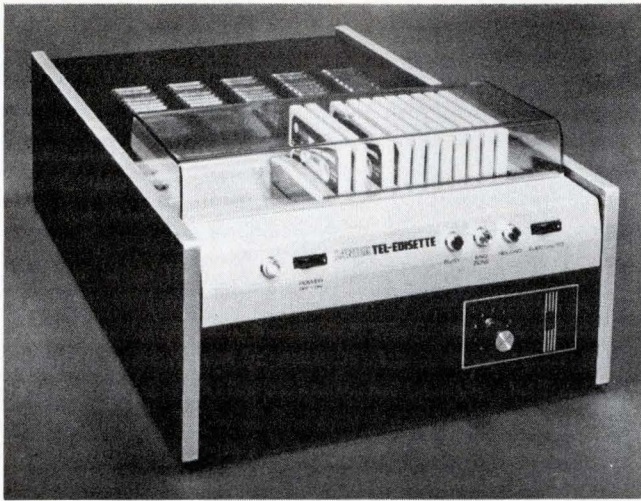

10. Talkative. A central dictation machine, the new Lanier Tel-Edisette, holds 12 standard audio cassettes that can be used in any of nine different recording modes covering one dictation per cassette, dictation shared with others, or telephone messages.

tation of another user in the shared mode. Antiforward automatically stops the machine and provides a "ready" tone after the dictator listens to or reviews the last word dictated.

When a dictator hangs up the telephone-mike before completely listening to all dictation, the Tel-Edisette automatically runs the tape forward to the end of the dictation and stops. A lockout feature prevents dictation during the changing of a cassette and an automatic search moves by empty cassette positions until a tape is loaded into one of the 12 positions.

The Tel-Edisette provides for audio and light warning to the dictator when the end of recording time on a cassette is near, and another audio and light provide a warning when the recorder is completely full. In addition, a jammed cassette can be ejected and another cassette reloaded automatically.

. . . but does it all work?

As mentioned earlier, installation of a word processing system to gain the full benefits in productivity promised by the equipment usually alters the traditional office. There have been a number of failures along the way, particularly in the early days, as a result of poor planning in the transitional stage.

A large New York advertising agency threw in the towel, reverting to its old slow-but-sure methods. An airline rushed into one mode of word processing only to find it wasn't the best way to go, and had to switch to a second type of equipment and system. An electrical/electronics conglomerate found that concepts that worked well for departments with a large volume of form-letter correspondence did not work well in departments that handled a wider variety of correspondence.

But on the whole, the small percentage of companies that have gone through a shakedown cruise with word-processing systems have realized the promised benefits. Some offices have been able to reduce secretarial payrolls or to free secretaries for less routine tasks, and at the same time handle bigger work loads. Word process-

ing appears to be delivering on two main goals, increased output and higher quality of correspondence at greater speed than before.

Productivity statistics are tossed around liberally by word-processing companies. For example, average typing speed for a complete job has been estimated to be 10 words per minute for conventional typing, 30 for magnetic-tape automatic typewriters, and 2,000 by computer-assisted word processing.

One office using CRT display equipment increased lines typed per day from 20% to 25%; and nine operators in one year did the work that previously would have required more than 30 typists. In another case, an industrial trade association using automated typing equipment has claimed a productivity increase of 50% to 100% in a year.

As for dictation systems, an airline boosted throughput of dictated correspondence by 57% in its first year using a centralized installation. A manufacturer using a tank-type system speeded turnaround time—the time elapsed between dictation and finished work—from a day or more to 2½ hours. Some letters are almost ready as soon as the dictation is finished. A state-government agency cut 13 secretaries from a staff of 20, but manages to put out the same amount of correspondence from 60 authors. These are just a few examples.

Changes precipitated by word processing can involve a whole company, a single department, or one typing station, depending on how elaborate the system. IBM, for one, has put a great deal of planning into how to arrange a word-processing center and has initiated variations of its basic plans at various IBM facilities. Essentially, the IBM plan divides the secretarial force into typists and administrators; some do only correspondence, using automated machines, while others function as aids to the "principals," the managers who are the source of the correspondence output.

This plan has many possibilities. In a big office, the typists could end up at a formal central pool. Administrative secretaries or assistants could become managers, taking over some of the details previously done by their bosses. At smaller operations, secretaries may alternate between typing and administrative tasks or some may be typists, some administrators, and others may swing between both functions.

Another user of its own word processing system is Dictaphone, which has installed a System 193 at corporate headquarters in Rye, N.Y. Here, too, one group of secretaries specializes in transcribing dictation under the guidance of a supervisor, while another group of secretaries acts as administrative assistants to department principals.

To establish such word processing programs, physical changes are imperative. Different types of office furniture, even completely remodeled rooms, are important in setting up efficient arrangements for typists and administrative assistants. Word processing not only changes the way an office runs, it changes how it looks. The many manufacturers, banking on the belief that companies will pay more to automate the office, are confident that word processing will change other people's paperwork into a profitable business. □

"Smart" but friendly!



INTRODUCING THE 6010A SYNTHESIZED SIGNAL GENERATOR

The first signal generator to incorporate a microprocessor.

The Fluke 6010A is a remarkable new instrument—a smart but friendly (easy to use) general purpose signal generator. It's a versatile 7 digit, 10 Hz to 11 MHz instrument with performance comparable to instruments costing twice our \$2,495.*

The key to the 6010A is . . . automation.

The Fluke 6010A features free-form entry of frequency in Hz, kHz, or MHz. Stores and recalls up to ten preset frequencies, modulation and attenuator settings by pushing a single button . . . a unique capability.



This feature is particularly important in any kind of repetitive testing, where tediously punching in a 7-digit number exposes the operator to error. It also radically shortens the time required by the testing sequence.

The microprocessor plays a part in several other operations, including *automatic range selection* and *automatic justification* (the unit automatically justifies the entry on the bright, 7-digit LED readout to give the greatest possible resolution).



A sophisticated bench oscillator that's easy to use.

For all its sophistication, the 6010A works easier than any other instrument of its kind.

Continuous tuning is possible with Frequency Edit which consists of a large dual-concentric rotary knob.

The bright digit denotes the tuned decade. The bright digit can be "decremented" or incremented with complete wraparound and carryover.

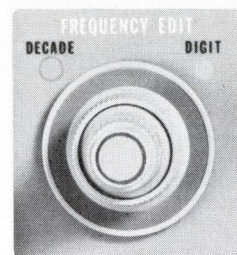

The 6010A is self-checking.

Spacewise, the unit measures only 5¼" x 8½" x 19", so it takes up minimum space on the work bench.

Interfaces directly with ASCII systems.

The 6010A fits easily into an auto-testing system, because expensive interfacing is not needed. The unit "handshakes" directly with most ASCII (IEC) systems; the microprocessor handles the interfacing problems.

Here's price/performance without peer. And, it is backed by Fluke's second-to-none reputation for engineering, reliability and service.

For data out today, dial our toll-free hotline: 800-426-0361.

John Fluke Mfg. Co., Inc., P.O. Box 43210, Mountlake Terrace, WA 98043

For a demo circle #99. For literature only circle #98.

For information on the rest of the Fluke line, see EEM or the Gold Book.



*U.S.A. price

Monostable's pulse width is programmable

by C.F. Reeves
Del Mar, Calif.

Variable-width pulses are required in many systems, and the widespread use of microprocessors as control elements makes numerical control of the pulse widths increasingly important. A numerically controlled one-shot multivibrator can be built that is particularly useful when the pulse-width range required is impractical or unattainable with conventional RC-time-constant one-shots.

For each input trigger pulse, the circuit produces an output pulse whose width is determined by an input binary number. The number may be taken from binary or binary-coded-decimal (BCD) sources such as shift

registers, counters, bistable latches, thumbwheel switches, or the like.

Functionally, the circuit is identical to the conventional one-shot in that it has one stable state and one temporary or quasistable state. The fundamental difference lies in the timing element that determines how long the circuit can remain in the quasistable state. In the conventional one-shot, this monostable period is set by the time constant of a resistor-capacitor network. The circuit shown here sets the monostable period by counting a preselected number of periods of a clock oscillator.

The range is thus limited only by the number of counter stages used. In Fig. 1 gates 2A and 2B form a clock oscillator that is gated on by a high logic level at pin 1. Resistors R_1 and R_2 and capacitor C_1 set the frequency at 10 megahertz. Gate 2C is an inverting buffer for the output pulses from the clock.

The input trigger pulse loads the counter chain (components 3 through M) with the number supplied by the binary data source. Simultaneously the trigger sets an

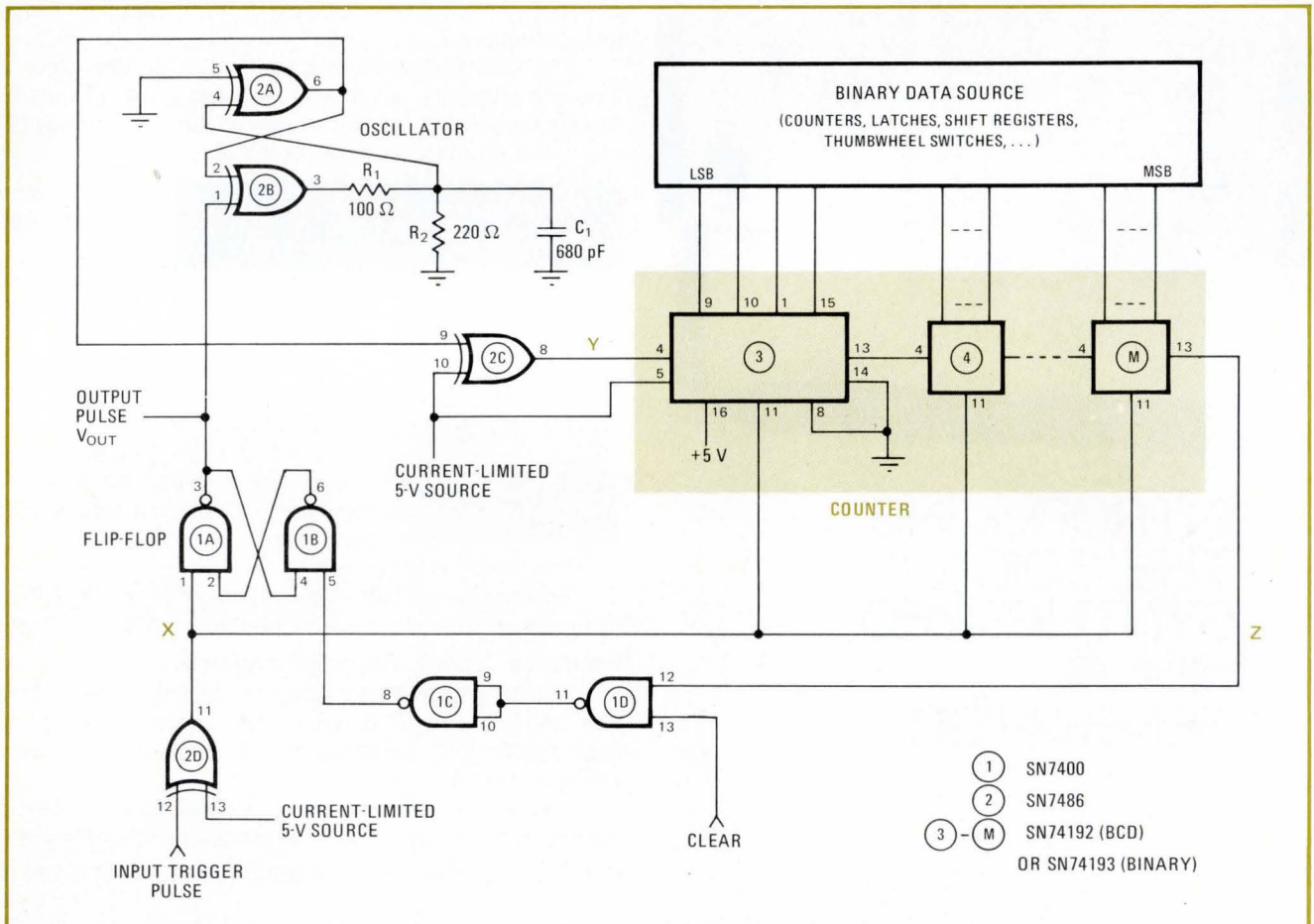

1. By the numbers. Binary number set into counter from data source determines duration of output pulse from this monostable circuit when input trigger pulse is applied. Output voltage V_{OUT} is high while counter counts the given number of cycles from the oscillator, as shown in Fig. 2. Typical applications for this circuit include variable-time-delay generation and pulse-code modulation.

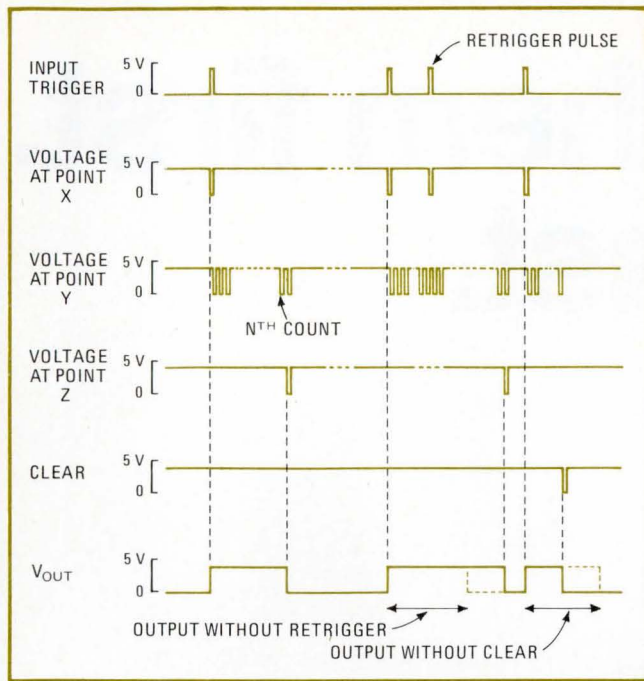

2. Count. Waveforms for one-shot multivibrator in Fig. 1 illustrate operation. Input trigger makes V_{OUT} high and starts oscillator. Counter counts N cycles of oscillation (where N is decimal value of binary number set on counter by control source), then makes V_{OUT} low and stops oscillator. A trigger pulse applied during operation prolongs output pulse through countdown of newly loaded number. Output can be cut off at any time by grounding the clear terminal.

R/S flip-flop (1A and 1B), the output of which gates on the 10-MHz clock oscillator. The clock pulses cause the counter chain to count down to zero, whereupon the borrow pulse is generated at point Z. The borrow pulse resets the R/S flip-flop, disabling the clock oscillator and terminating the output pulse.

The width of the output pulse is determined by the binary input data and the clock frequency according to the following relationship:

$$PW = (N + 1)/f_c$$

where N is the decimal value of the binary input number, and f_c is the clock frequency. The numerator is $(N + 1)$ instead of N because the counter generates the borrow pulse when leaving the zero state rather than when entering it. The output pulse-width range is determined by the number of 4-bit counter stages, K , and is expressed as $1:10^K$ for BCD input data and $1:16^K$ for binary input data. As the waveforms of Fig. 2 show, the one-shot is retriggerable. When an input trigger pulse occurs while the counter chain is counting down from a previous trigger, the chain simply reloads with the value of the binary data source and begins a new countdown. The result is a single elongated pulse. An additional circuit feature is that the output pulse may be terminated at any time by applying the logic zero to the "clear" input terminal. □

Designer's casebook is a regular feature in Electronics. We invite readers to submit original and unpublished circuit ideas and solutions to design problems. Explain briefly but thoroughly the circuit's operating principle and purpose. We'll pay \$50 for each item published.

Current and power limiter protects switching transistor

by R.M. Stitt

Burr-Brown Research Corp., Tucson, Ariz.

Although a switching transistor dissipates little power in normal operation, it must be protected from destructive current and power overloads. Current-limiting alone is not sufficient protection; power-limiting is also necessary. But fortunately, a few components can be added to conventional current-limiting circuitry to provide power-limiting. A voltage rise across a transistor is sensed and used to cut down the drive current.

To understand why current-limiting alone fails to provide adequate protection, consider a switching transistor controlling a 100-ohm load connected to a 100-volt supply. The power dissipated in the load might be about 100 watts, but the maximum power dissipated in the transistor is merely the load current times the transistor's saturation voltage (if switching losses are neglected). The load current is about 1 ampere, so the transistor dissipates less than 1 w. A designer might use a 3-w device and provide a current-limiting level of 1.5 amperes.

Suppose, however, that the load is short-circuited so

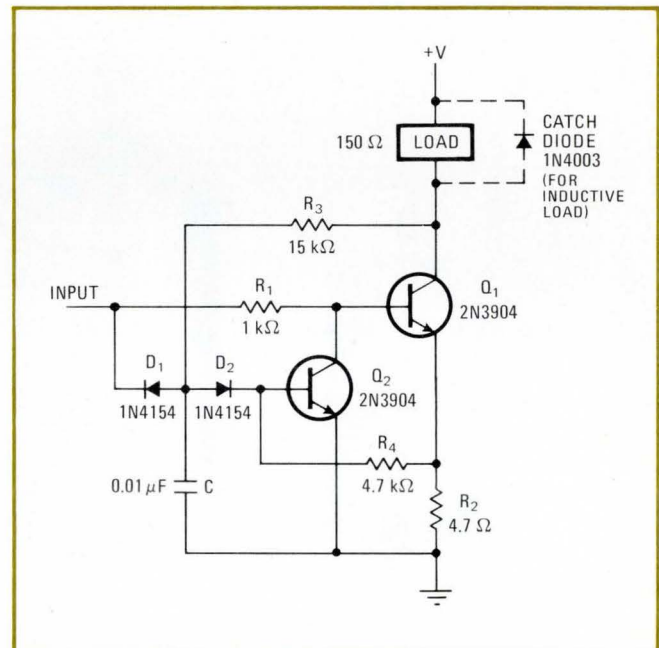

Two-way protection. Switching transistor Q_1 is protected against excess current and/or excess power dissipation. If load current approaches limit, IR_2 drop turns on transistor Q_2 to shunt base drive from Q_1 . A voltage rise across Q_1 acts through R_3 to turn on Q_2 and turn off Q_1 . Capacitor C provides delay that allows Q_2 to saturate with each new cycle, and lets power-limiter ignore transient high currents. Diodes D_1 and D_2 reset power-limiter when input is low.

We made them first. To last.

Available now from Singer: Size 8 and 11 Bu/weps synchros designed to meet the latest requirements of MIL-S-20708C specifications.



You can get these synchros in the following Bu/weps types:

Size 8	Size 11
26V 08CX4c	26V 11CX4c
26V 08CDX4c	11CX4e
26V 08CT4c	26V 11TX4c
	26V 11CDX4c
	11CDX4b
	26V 11CT4d
	11CT4E

We'll be happy to send you drawings and technical details on request. Also for Kearfott Size 5 Bu/weps CX, CDX and CT units, and Size 11 and 15 resolvers. Units with the same characteristics but different Bu/weps shaft variations are also available. Write for information to the Singer Company, Kearfott Division, 1150 McBride Avenue, Little Falls, N.J. 07424.

SINGER
AEROSPACE & MARINE SYSTEMS

Kearfott, the first to design Bu/weps size 5, 8 and 11 synchros, has over the years constantly made them better. These units are used in fire control systems, radar, navigation, missile functions and other applications requiring a high level of precision, endurance and reliability.

These Kearfott synchros operate over the entire temperature range of -55°C to $+125^{\circ}\text{C}$. They are DOD qualified and listed in the QPL.

(They can also meet reasonable cost requirements in computers, electronics and other types of business equipment.)

that the collector of the switching transistor is connected directly to the 100-v supply. Then the transistor dissipates 150 w, which destroys it.

To prevent this destruction, a power-limiter is required. Power-limiting can be added to a standard current-limiter by use of only four simple components. In Fig. 1, Q is the switching transistor, and the conventional current-limiter is formed by Q₂, R₂, and R₄. The power-limiter consists of capacitor C, diodes D₁ and D₂, and resistor R₃. To illustrate the operation of the circuit, assume that Q₁ is saturated and in normal operation. As the load current increases, the voltage drop across R₂ increases, turning on transistor Q₂ and thus shunting drive current away from the base of Q₁. Therefore, Q₁ begins to come out of saturation, so its collector voltage rises. This voltage across Q₁ further turns on Q₂ through R₃ and regeneratively turns off Q₁.

Diodes D₁ and D₂ form a switch so that the collector

voltage of Q₁ is sampled only when its input is high. This switch also resets the power-limiting circuitry with each cycle of the input. The value of capacitor C is chosen to give the power-limiting portion of the circuit a turn-on delay, allowing time for Q₂ to become saturated. This delay also permits higher current transients to flow during switching, such as those that might occur in a switching regulator in which the catch diode must be discharged during each cycle.

The current-limiting portion of the circuitry is active at all times, protecting the switching transistor from current overloads. The circuit was set up to be driven by a TTL-level signal and to switch a 100-mA load at 400 Hz to +15 v. The protection circuit can easily be modified for nearly any input and output configuration. If a pnp-transistor switch is to be protected, transistor Q₂ should also be a pnp, and the polarities of D₁ and D₂ should be reversed. □

Compact dc-dc converter yields ±15 V from +5 V

by Thomas Durgavich
Massachusetts Institute of Technology, Cambridge, Mass.

Many digital systems use a few operational amplifiers that require voltages of +15 v and -15 v, when all other elements require only 5 v. Both the +15 v and -15 v can be supplied at 10 milliamperes by a dc-to-dc converter that is compact enough to be built right on a printed-circuit board.

In this circuit, the NE555 operates as an astable multivibrator at 100 kilohertz with a 75% duty cycle. The value of frequency need not be exact, but this waveform

has been found to optimize operation of the circuit.

The pulse train from the multivibrator drives the base of transistor Q to switch current on and off in the primary coil of transformer T. When the current is switched off, a spike of about 20 v occurs at the collector of Q. This voltage, rectified by D₁ and filtered by C₁ and R₁, is regulated by a simple zener-diode regulator to yield +15 v.

Simultaneously, a voltage spike appears across the secondary coil of transformer T. Because the transformer provides dc isolation, the higher-voltage end of the coil can be grounded to make the pulse negative. This voltage is also rectified, filtered, and regulated to yield -15 v.

This circuit is ideal when space is critical because small low-valued tantalum capacitors and a tiny pulse transformer replace the larger components that would be used in a conventional ±15-v supply. □

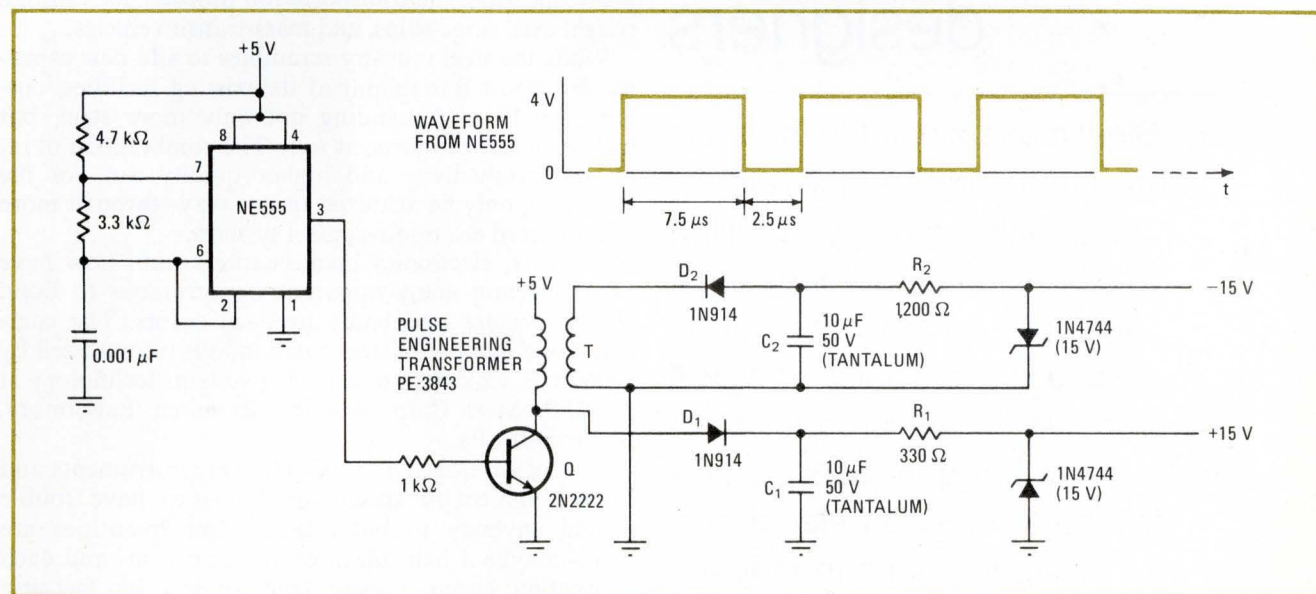

Space saver. Bipolar dc-to-dc converter operates from 5 volts and produces ±15 volts to supply op amps. Major advantage over conventional supply is small size, allowing assembly right on circuit board with other elements of system that it serves.

Part 2

Steel's special problems beckon control-system designers

Steel makers want to increase throughput and reduce rejects; and, although they're willing to pay handsomely, they must often rely on their own efforts because electronics firms will not tackle limited production of specialized designs. Second of a five-part series on electronics applications in industry

by Margaret A. Maas, *Industrial Editor*

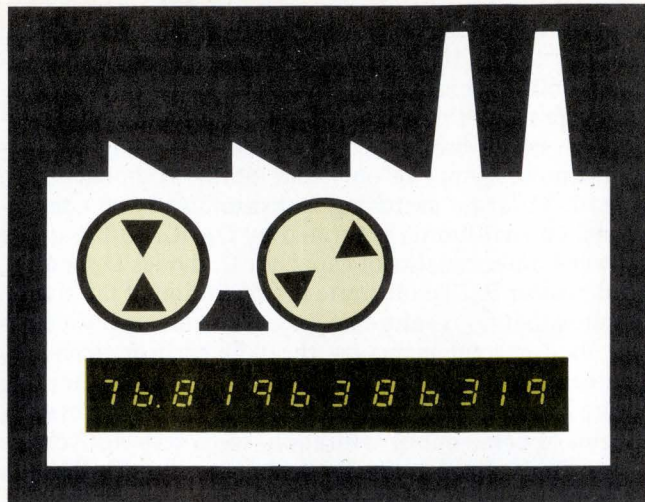

□ For electronics firms, there's gold in the iron and steel industry. Although there is only a handful of major steel companies and each requires no more than a half dozen of any one control system, the total value of those systems can add up to an impressive tab. And the industry will be spending more than ever during the next two years.

The McGraw-Hill Economics Department estimates that the iron and steel industry's capital spending budget in 1976 will be just about double its 1974 expenditures. This leap upward is being stimulated chiefly by two events. The removal of price controls last year made it profitable for steel companies to expand, and anticipated future demand for the metal has made it imperative that they begin expansion now.

Although the steel industry expects depressed demand throughout 1975, the American Iron and Steel Institute predicts a worldwide shortage by 1985. Major contributors to the increasing shortage will be demands from oil and gas producers for new refineries and pipe lines, from the coal industry for more mining equipment, and from the transportation industry for railroad freight cars, cargo ships, and mass-transit vehicles.

While the steel industry scrambles to add new capacity and boost throughput at its existing facilities, customers will be demanding not only more steel, but higher-quality products, as well. The combination of increased productivity and higher quality can, for the most part, only be achieved in one way—through more sophisticated electronic-control systems.

However, electronics manufacturers until now have been rejecting many apparent opportunities to build control systems and badly needed sensors. The complaint of a number of steel companies is summarized by William E. Coleman, manager of systems technology at the U.S. Steel Corp. Applied Research Laboratory, Monroeville, Pa.:

"We've developed a lot of electronic instruments and controls to meet our specific needs, but we have trouble getting anybody to build them. Our quantities are small—maybe a half dozen of any one item—and each application requires some field engineering because each mill is a little different. We're not in the electronics business; we're in the steel business. And what we really

need is a specialty electronics company that would be willing to custom-build our designs. For the most part, no one wants to do custom work."

On the positive side, however, a few electronics manufacturers are working with steel companies to develop systems to increase the accuracy of controls in rolling mills, reduce the rejection rate of the finished product, save increasingly expensive zinc in the galvanizing operation, and even to save excessive charges on electrical power by controlling equipment loads.

Controlling the rolling mill

Probably the most prevalent piece of steel equipment is the rolling mill. There are perhaps 2,000 rolling mills in North America, each a target for gage controls, ranging from a \$45,000 microprocessor system to a multimillion-dollar computerized operation. Since the hot mill is the most highly automated piece of equipment in a steel facility, it is doubtful that any new hot mill would be built today that wouldn't be computer controlled.

Gage control depends predominantly on accurate control of the rolling mill where about 80% of all steel eventually ends up. Rolling—literally squeezing metal between a set of rolls—converts ingots into strip, bar, rod, plate, I-beam, and other shapes. An ingot that starts out 40 inches thick may eventually end up 0.005 in. thick or even thinner. Until the steel reaches about 0.2 in. thick, it is rolled hot—usually at about 2,400°F—because hot steel is more plastic and therefore easier to roll than cold.

Accurate gage control at the rolling mill depends on a number of factors that are interrelated in a strongly nonlinear fashion. These factors include the initial thickness, the gap between the work rolls, the roll force, the temperature of the steel, strip tension, the type of alloy, mill speed, and the stiffness of the mill.

Mill conditions are not static. As the roll force increases, the mill stand in which the rolls are mounted literally stretches like a spring. At the same time, rolls wear and become eccentric, while changes in temperature stretch or shrink both the product and the mill.

The incentive behind gage controls is theoretical minimum weight. Theoretical minimum weight,

adopted in 1970, lets the buyer specify the length, width, and thickness of the sheet, and a plus tolerance on each dimension. The supplier may not roll below the specified dimensions, but his products may be slightly larger.

The buyer pays only for the minimum weight of the steel specified by the nominal dimensions. If the steel falls below these dimensions, it is rejected, but if it is above, the supplier must bear the cost of the extra steel. The result, declares the U. S. Steel's Coleman, is that "the whole industry is in the throes of trying to make a major step in gage control."

Adapting to the facts

One way to handle the complex interrelationships among mill variables is through adaptive control systems such as those built by the Westinghouse Electric Corp. Industry Systems division, Pittsburgh, Pa. Initially, the operator enters, usually through a cathode-ray-tube terminal, the material thickness, the alloy, and set point. Then, by means of a complex mathematical model, the Westinghouse W2500 process-control computer calculates the initial mill conditions and adjusts roll gap and roll speed accordingly (Fig. 1).

As the strip passes through the first stand, a thickness gage measures the material and compares it to the target thickness for the first stand. If the thickness is off target, the computer calculates the necessary adjustments to succeeding stands in order to compensate for the error. The system times the corrections so that they are made just as the off-gage strip arrives at a stand.

At the same time, the system uses the initial output to recalculate the equation variables and then readjusts the settings on the first stand for incoming material. This procedure is repeated continuously throughout the rolling operation.

Basically, thickness in a hot mill is controlled by adjusting the roll gap. Tension, which is a function of line speed and the gap setting on each stand, is held constant by a looper, a roll that moves up and down to take up any slack in the metal.

In a cold mill, both roll gap and strip tension are manipulated to get the desired thickness. Some companies

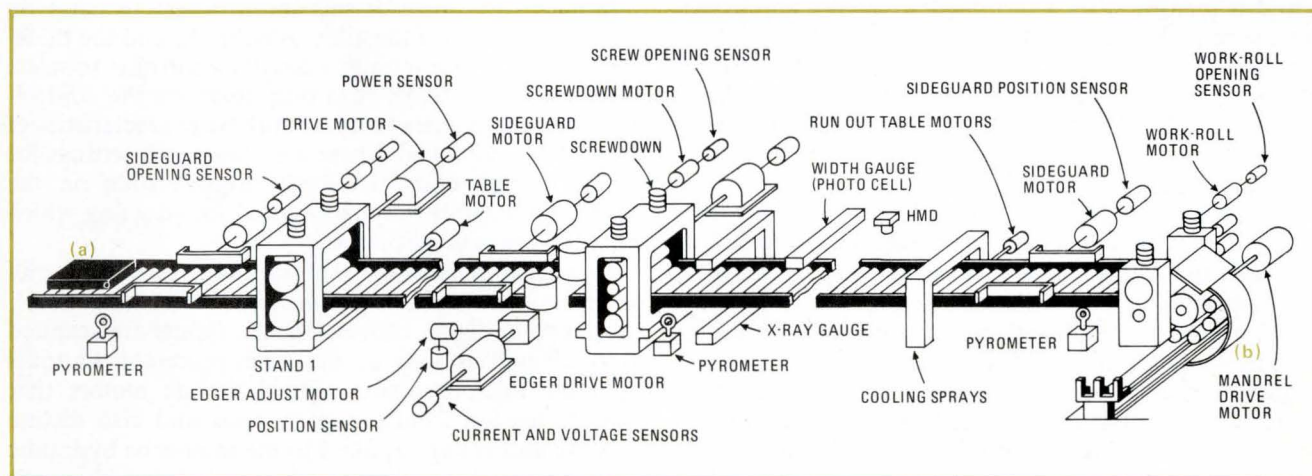

1. Hot strip mill. Steel enters mill as slab (a) and exits in strip form (b). Sensor inputs to the computer-control system include pyrometers for temperature measurement, X-ray gages for thickness measurements, and load cells to sense roll force.

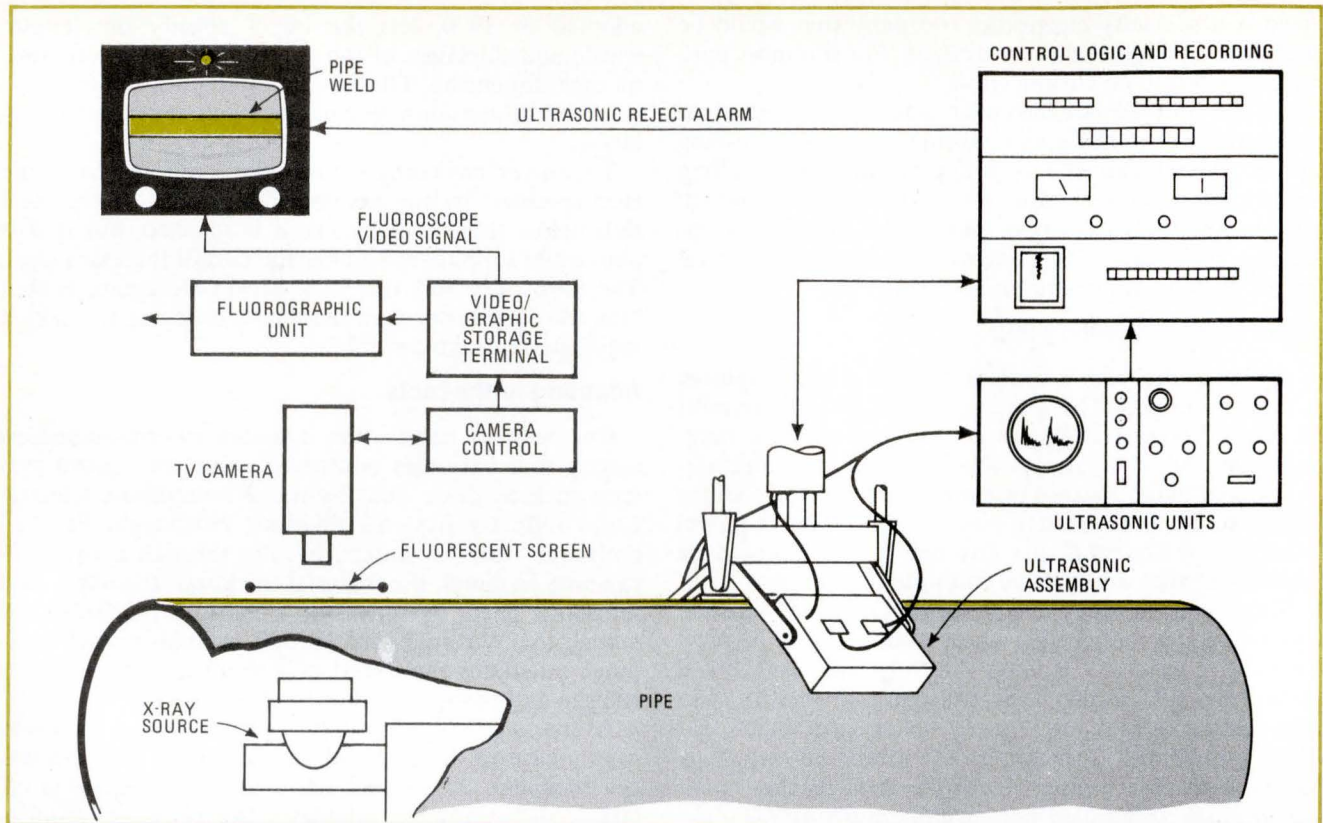

2. Tandem Inspection. After a flaw in the pipe weld is detected by the ultrasonic transducers, the rejection signal is stored in a shift-register memory until the rejected area is in view of the fluoroscope. At that point, the signal triggers an alarm on the TV screen, and simultaneously, a cursor appears on the screen to call the operator's attention to the defect. Inconsequential weld variations will not trigger an alarm.

use a tensiometer to adjust strip tension. A tensiometer is a roll mounted a few inches higher than the plane in which the strip is traveling. As the strip passes over this raised roll, tension on the strip creates a downward force, which is sensed by a load cell mounted in the bearing housing.

Other sensor inputs to the computer include roll gap, which is measured either by a linear variable differential transformer on the hydraulic cylinder of the electrohydraulically controlled roll or by a pulse tachometer that counts the revolutions of motor-driven screws. Strip speed is measured by a tachometer, usually an electromagnetic pickup mounted on the roll shaft, and strip temperature is detected by radiation pyrometers. Either X-ray or nuclear gages measure the thickness, and roll force is measured by a load cell mounted in each stand.

Microcomputers tackle the small mill

For single-stand rolling mills, where a computer dedicated to automatic gage control would be an overkill or for older multistand mills that can't justify the expense of computer control, Industrial Nucleonics, Columbus, Ohio, has developed a microprocessor-based controller [*Electronics*, March 20, p. 31].

"Single-stand mills are relatively simple to control; there are fewer interactions and only one roll gap to worry about," points out John Underwood, senior product engineer at Industrial Nucleonics. "But in a multistand mill, any change to roll-separating force, interstand tension, or strip thickness has intertwining effects,

that can send thickness transients echoing up and down the mill. You have to walk a tight line between instability and suboptimal control."

The Industrial Nucleonics controller is used in conjunction with the company's Accuracy 510 nucleonic thickness gage. The thickness gage contains an isotope source whose emission is measured by an ion chamber. As the radiation penetrates the steel, the ion chamber is conditioned to provide a voltage proportional to the deviation from the thickness set point. Typically, thicknesses from 0.0005 to 0.5 in. are measured.

Initially, the operator sets thumbwheel switches on the control panel for the alloy to be rolled and the thickness desired. These settings allow the controller to select from the programable read-only memory the control-algorithm parameters that best suit the characteristics of the metal being rolled. There are also switch settings for simple or differential backlash compensation on the screws that control roll loading and for selecting which variables are to be displayed.

An analog multiplexer samples the gage output, mill speed, motor currents, roll force, and sheet tension. After analog-to-digital conversion, the inputs are scanned every 20 milliseconds by the microprocessor. Outputs from the microprocessor control the dc motors that regulate tension from the entry reels and also dictate the time and voltage applied to the motors or hydraulic actuators that open and close the gap between the work rolls.

In addition to the gage and controller modules, which

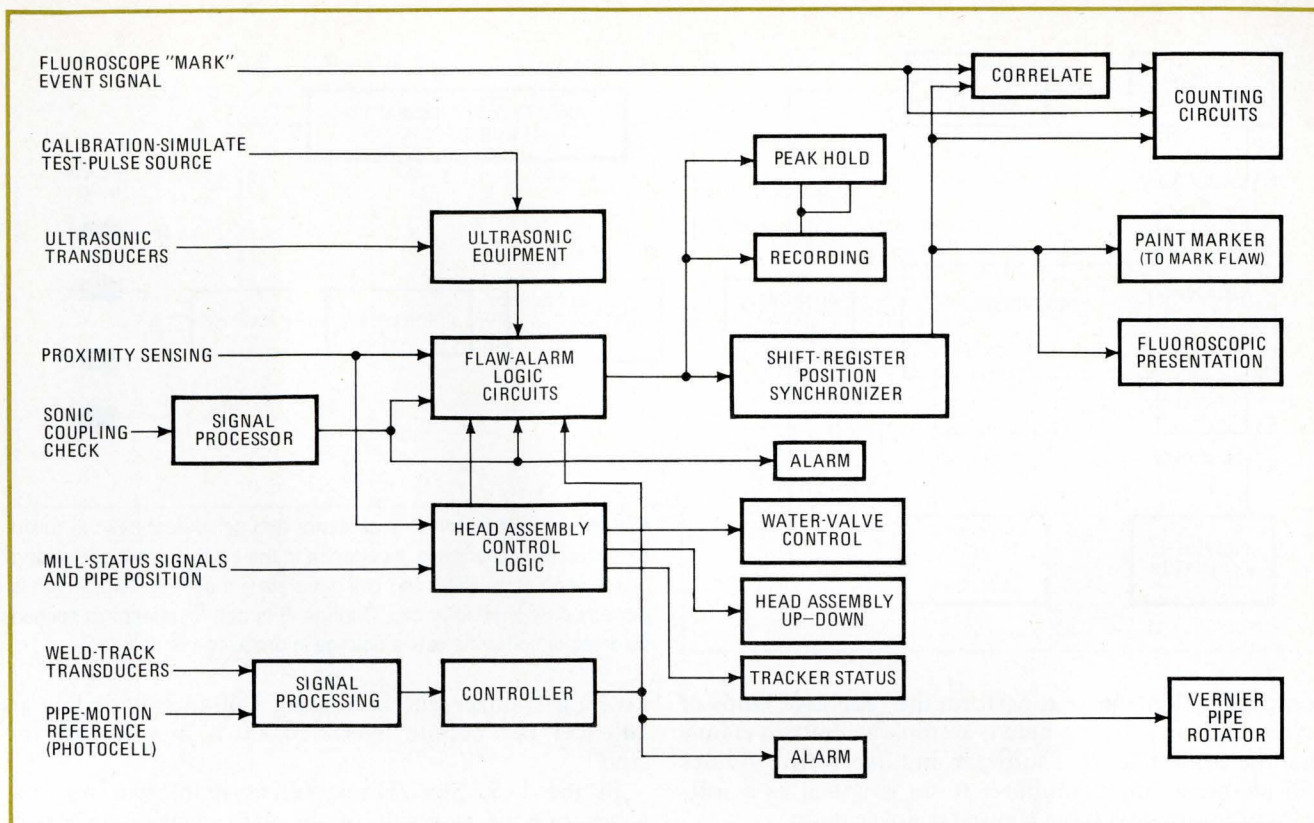

3. System status. One check on operating conditions is the sonic coupling signal sent from the inactive ultrasonic receiver that picks up energy transmitted through the pipe by the active transmitter. Welds are automatically tracked, and the system counts both the number of pipes tested and the number of defects located. Defect signal also triggers a paint sprayer to mark the position of flaw.

can be purchased separately, Industrial Nucleonics also offers a microprocessor-based target-optimization module. The logic in the module computes the actual thickness range produced by the mill, compares it with the customer's order tolerance, and then automatically shifts the gage target to the most economical setting within tolerance set point.

Cooling to order

As the hot strip leaves the last stand, it travels 400 to 500 feet over a runout table to the coiling reel. As it traverses the table, the strip, which is about 1,600°F at this point, is cooled by water sprays. Typically, there are five separately controlled spray banks above and below the runout table.

The cooling temperature is carefully specified by the customer because it affects the metallurgical properties of the steel. If it is not carefully controlled, the coil could be rejected. Regulating cooling sprays on the runout table of a hot-strip mill sounds like a simple task, but it is not. Many variables affect the process nonlinearly.

A cooling temperature-control system tested at Armco Steel used a learning network developed by Adaptronics, McLean, Va. A learning network carries mathematical modeling a step further than does the adaptive-control method.

The network, which now exists as a software program, is fed input variables and their associated outputs. Based on this data, the network not only decides

how the variables are interrelated, but also decides whether or not the variables are significant. If new sensor data becomes available, the learning network may reconstruct the algorithm completely.

Unlike adaptive control, input data can be any variable that may be related to the output—not merely the standard process measurements such as temperature, pressure, flow, and speed. Data may be colors, sounds, vibrations or any process variable—an advantage in processes where there is no way to instrument the conventional variables.

"At Armco," says Roger Barron, president of Adaptronics, "the system, which was programed on an IBM 1800 process-control computer, had seven inputs—desired coiling temperature, the finishing temperature as the strip exits the last stand (the difference between these two temperatures represents the heat that must be removed), the speed and thickness of the strip, its width, its hardness, and the number and configuration of the sprays chosen from eight above the table and seven underneath it."

Based on assumed initial conditions, the sprays were preset. When the strip emerged from the last stand, the prediction was repeated according to actual temperature and speed of the strip. If the measured variables deviated in any way, the number of sprays was modified.

So far, Adaptronics only sells the learning network in software form, but it is also building a hardware/software version. The hardware will be modular

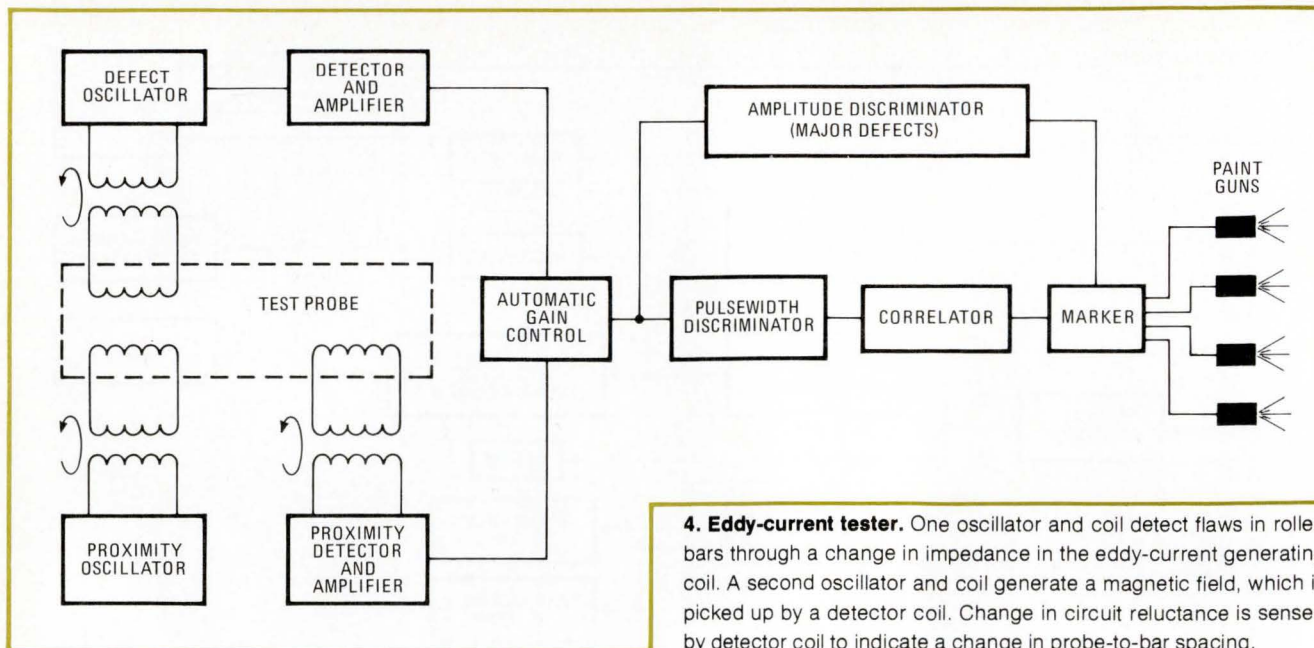

4. Eddy-current tester. One oscillator and coil detect flaws in rolled bars through a change in impedance in the eddy-current generating coil. A second oscillator and coil generate a magnetic field, which is picked up by a detector coil. Change in circuit reluctance is sensed by detector coil to indicate a change in probe-to-bar spacing.

computing elements that perform the repetitive kinds of arithmetic the learning network employs. Barron claims that the combination of software and hardware modules will enable a small computer to do as much as a software program on a large computer now can do.

"A typical network will take anywhere from a handful to hundreds of modules, depending on the complexity of the math model," Barron says. Each module will handle two inputs and have one output. Once the modules are all interconnected, the result will be a special-purpose computer to be used with a regular central-processing unit. The CPU will supervise the repetitive calculations performed by the modules, while it performs the nonrepetitive type of calculations itself.

Saving zinc in galvanizing

To prevent corrosion, the rolled strip is often coated with a protective layer of zinc. Galvanizing involves passing steel through a molten-zinc bath at speeds ranging from 55 to 700 feet per minute. As the strip emerges from the bath, air knives—essentially channels through which low-pressure ambient-temperature air is directed—blow the molten zinc to the desired thickness. Regulating air pressure controls thickness of the coating, and adjusting the knife position controls distribution of the coating.

There are only 330 galvanizers in the entire world, but a global shortage of zinc has these galvanizers excitedly eyeing the zinc-saving benefits of computerized coating control. The cost of a computerized system may range from \$300,000 to more than \$1 million, making a dollar total sufficiently attractive to induce Honeywell and U.S. Steel to work out a cooperative marketing arrangement for such a system [*Electronics*, Feb. 6, p. 46]. The computerized system is based on a control algorithm and software developed by U.S. Steel for a Honeywell process-control computer.

Jim Bell, Honeywell's acting manager of metal, mining, and ceramic sales, claims, "This system will

save a galvanizer who is running a 60-inch-wide line at 500 feet per minute over \$50,000 a month—just on zinc."

In the U.S. Steel/Honeywell system, two nuclear gages, one on each side of the strip, continuously traverse the strip, sampling the thickness every half second on the forward pass. The nuclear gages interface directly to the computer, producing binary-coded-decimal signals proportional to the thickness.

On the return traverse, the computer uses the accumulated gage measurements to calculate the average coating weight on each side, the total weight for both sides, and the coating weight at the test locations specified by the American Society of Testing Materials. In addition, the computer compares the measured thickness to the target thickness and uses the resulting error signal to calculate the necessary adjustments to both knife pressure and knife position.

Sensor inputs to the computer include air pressure, which is measured by a transistorized pressure transducer, and knife position, which is sensed by a potentiometer. To determine line speed, the computer counts contact closures of a reed switch actuated by a magnet mounted on the drive rolls.

Inspecting critically

Detecting flaws during the manufacture of steel is more critical for some applications than for others. Off-shore oil rigs and trans-Alaskan pipelines face severe environments, and failures could be catastrophic, not only to the environment, but also to human life.

Now, U.S. Steel, in cooperation with Imagex Inc., Mentor, Ohio, has developed a tandem ultrasonic and fluoroscopic test system that tests welded pipe to American Petroleum Institute and Arctic specifications. The system has nearly eliminated false alarms produced by inconsequential weld variations.

To detect flaws in pipe, the pipe is rolled into position over an X-ray source that is mounted on a long boom

extending down the center of the pipe (Figs. 2 and 3). As the pipe comes into position, a photocell senses where the end is and establishes the zero position for determining flaw location. The ultrasonic head comes down automatically and centers itself over the weld.

Inside the head are two transmitter/receivers—one pair for each side of the weld. As the head rides along the pipe, plastic shoes restrain the water that serves as a sonic coupling between the pipe and transducer.

Since the two transmitter/receivers share the same pulse/receiver module in the ultrasonic analyzer, they are connected into a simple multiplex system that operates them alternately. As one transducer transmits, part of the energy passes through the pipe to the opposite receiver, which picks up the transmission and signals the system diagnostics that a good sonic coupling exists between the opposite transducer and the pipe.

As the pipe begins moving, a magnetic pickup mounted on the drive rolls calculates the length of the weld that has passed the X-ray source. The weld is kept in position over the source by a specially designed weld tracker—two metal cones that ride the weld with their apexes almost touching. Each cone drives a digital tachometer, and as long as the weld is in position, the counts from the two tachometers are equal.

If the weld skews, say to the left, the weld will ride a larger diameter on the cone at the left than on the cone at the right. This size difference causes the cone on the left to slow down and the one on the right to speed up. For correction, rotatable guide rolls mounted along the pipe rotate the pipe counter-clockwise until the tachometer counts are again equal.

As the ultrasonic system scans the weld, a flaw counter is triggered by any imperfection causing a signal in excess of the limit set by the American Petroleum Institute standards. This signal is stored in a shift-register memory until the flaw is in view of the fluoroscope. At that point, the signal trips an alarm lamp, and a cursor appears on the fluoroscopic screen. The cursor follows the imperfection and alerts the operator to examine that area with particular care. In addition, a 35-millimeter camera, upon command, takes pictures of the flaw. The pictures are comparable to conventional radiographs, but cost a fraction of the time and money required to produce a radiograph.

Testing rolled bars

To inspect rolled bars traveling up to 150 feet per minute, John Hoffman of Bethlehem Steel's Homer Research Laboratories, Bethlehem, Pa., designed an inspection system that uses eddy currents generated by a high-frequency oscillator. The eddy-current probe rotates in a helical path around the moving bar at speeds up to 1,600 revolutions per minute. Its maximum speed depends on the bar diameter. As the probe rotates, it is held at a minimum preset distance from the bar.

The probe is located inside a floating head that can move plus or minus a half inch vertically or horizontally to accommodate bars that are not straight. The probe, rotated by a variable-speed motor, is coupled to the defect-detection circuits through one channel of a three-channel rotary transformer that rotates with the probe.

A high-frequency oscillator drives the test-probe coils and generates eddy currents on the bar surface. A defect disrupts the orderly flow of eddy currents; the deeper the defect, the greater the disruption. The defect is detected as a change in impedance in the test probe's coil, which is amplified and filtered to produce a signal that has an amplitude proportional to the defect depth.

To prevent variations in the distance between probe and bar from affecting the defect-signal amplitude, thereby resulting in an erroneous assessment of defect depth, automatic-gain-control circuits are used. Automatic gain control is achieved by a second oscillator and coil that are sensitive to spacing, rather than to defects. As the distance between bar and probe varies, the reluctance path between the coil and bar changes. This change is detected, and the signal automatically varies the gain to provide a constant test sensitivity (Fig. 4).

One of the difficulties in testing with eddy currents is distinguishing between defect signals and noise caused by surface roughness, scale, electrical interference, and short, shallow defects that are not large enough for rejection. Bethlehem Steel overcomes this by analyzing signals by means of pulse-width discrimination and signal correlation. The pulse-width discriminator (Fig. 5) identifies as a defect any eddy-current signal that exceeds a preset amplitude and also decreases in amplitude from its peak value to half its peak value in less than a predetermined time.

Harmful surface defects, such as seams, are longitudinal or continuous and will therefore be detected by the rotating probe at approximately the same circumferential position on the bar for successive probe scans. (Fig. 6) Defects that are deep but short are processed by conventional amplitude discrimination. They can be readily detected because the signals they produce greatly exceed the amplitude of noise signals or correlated signals from seams.

Savings on power

Steel production, particularly in electric-arc furnaces, consumes vast amounts of electricity. To prevent excessive loads on the generating facilities, utilities "encourage" large customers to stay below a certain power usage level by levying a surcharge when they exceed it. Known as a peak-demand billing, the process includes the basic energy cost plus a surcharge which is based on the highest amount of energy used in any demand interval over the entire month.

One way to hold peak demand, and therefore surcharges, to the lowest possible level is to use a power-demand controller such as the system offered by Leeds & Northrup Co., North Wales, Pa. "The people who have the most obvious need for this are those who consume irregular amounts of energy," points out Jim Stewart, L&N application specialist.

Inputs to the power-demand controller are two signals supplied by the power company—an end-of-interval pulse and a kilowatt-hour pulse. The end-of-interval pulse marks the end of each time interval over which peak demand is calculated for that customer, while the kilowatt-hour pulse signals each kilowatt hour used.

The controller, a special-purpose, hard-wired com-

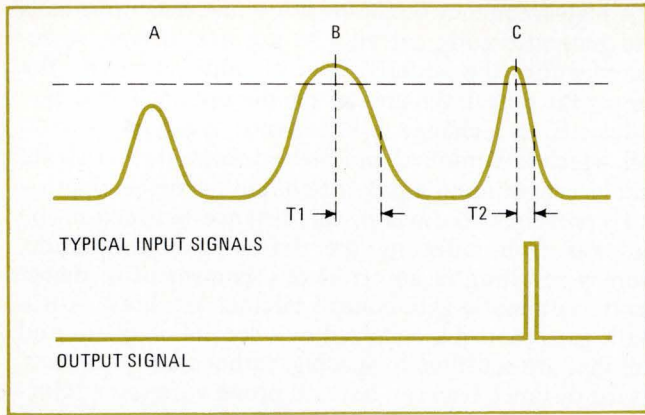

5. Pulse-width discriminator. In eddy-current testing, signal A, generated by shallow surface scratches in bars does not exceed a preset amplitude. Signal B, which is characteristic of loose surface scale, exceeds the amplitude, but does not decay fast enough. Signal C from a typical surface defect, exceeds preset limit and also falls off to half the peak value in less than the preset period.

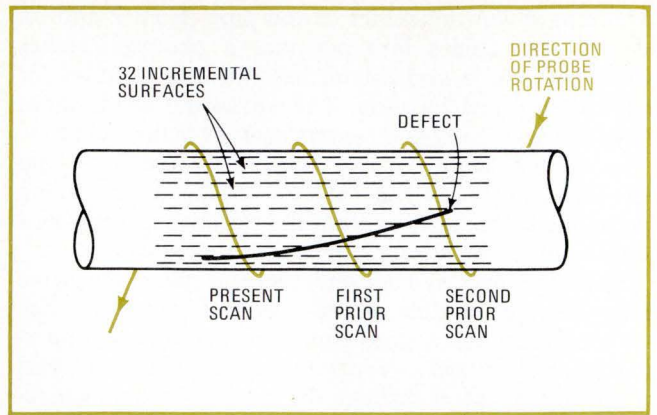

6. Locating the probe. As eddy-current probe rotates around an advancing bar, an encoder divides bar circumference into 32 increments. When defect signal is delivered by the pulse-width discriminator, the increment and scan number are stored, and the circuits correlate the present defect signal with signals for the same position in a preselected number of previous scans.

puter, continuously calculates an allowable average-power consumption, based on the contracted peak-power limit, the power already consumed, and the time remaining in the interval. If power consumption is projected to exceed the demand limit, the controller begins shedding loads in a preset fashion. The system begins by shutting off the least critical loads first—for example, air-conditioning or a nonessential furnace.

To prevent unnecessary cycling, the system does not shed loads the instant the average allowable power is exceeded. Instead, it delays control action until as close to the end of the interval as possible. In that way, normal cyclical variations in loads may compensate for high demand earlier in the interval.

“Though power-demand control has been around for years, it has only been in recent years that the system has become economically justifiable for the smaller user,” says Stewart. “With the declining cost of solid-state devices, we have been able to cut our price by almost a third in the last six years. This factor, combined with the rising cost of energy, has greatly expanded the field of application.”

Seeking sensors

Probably the product having the greatest potential for development in the steel industry is the sensor. Unfortunately, the temperature of molten steel can be measured only intermittently by disposable thermocouples. “It would be fantastic if we could economically measure the temperature of molten steel continuously,” says U.S. Steel’s Coleman. “Typically we would want to measure 3,000°F within 10°.”

Still another problem occurs in rolling ingots. When steel is cast, the top of the ingot will shrink underneath the skin, leaving an invisible void called a pipe. This void must be cut off before the ingot is rolled. If not, it will propagate down the strip as the material goes through the mill, and literally blow the mill apart.

Operators usually can tell from experience where to cut, but the cuts are made conservatively to make sure that the entire void is removed. Steel companies need

some technique to locate these voids accurately to save steel. X-rays will not penetrate a 40-inch-thick ingot, and ultrasonic sounding has not been satisfactory.

Still another sensor is needed to determine the solid/liquid steel interface in a continuous casting. In continuous casting, molten steel flows into a bottomless water-cooled mold. As it leaves the mold, a thin skin of solidified steel surrounds the still-liquid center.

The semisolid strand, as it is called, is withdrawn from the mold by rotating pinch rolls. If it is withdrawn too fast, the skin is too thin, and there is danger of puncturing it, causing molten steel to flow out onto to floor. However, no sensor has been developed that can determine the interface between the molten steel and the solidified skin.

“I want better optical tools for dimensional measurements,” says Sam Prellwitz, U.S. Steel’s section supervisor of measurement research. “There are laser systems for measuring the diameter of wire and rod, but I would like a method that could simultaneously and inexpensively measure the cross-sectional dimensions of a rolled shape like an I- or H-beam—the width and thickness of the flanges, the thickness of the web, the orientation of the flange with respect to the web, whether it’s bent or toed out. But the problem is cost-effectiveness.”

Prellwitz suggests that microprocessor technology may open new possibilities for instrument manufacturers in the steel industry. “I hope to see the instrument supplier use more microprocessor technology to overcome some of the inherent linearity problems of transducers. For example, the whole range of temperature sensors is inherently nonlinear. You could linearize them with a micro by plugging in a ROM with the proper data for that thermistor.”

Whether it’s for a single sensor or a complete computerized control system, the iron and steel industry represents one of the healthier long-term customers for electronics firms. The industry’s needs are unique, and, for many applications, the unit counts are low. But for the companies willing to specialize, the iron and steel industry is a ready and willing customer. □

MOS

**The LEADER
Now in Calculator
Arrays**

**Next in
Microprocessor
Systems**

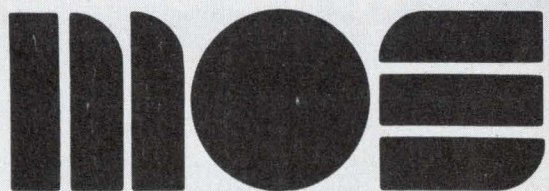

MOS TECHNOLOGY, INC.
VALLEY FORGE CORPORATE CENTER, NORRISTOWN, PA. 19401 (215)666-7950

MOS Brings You The COMPLETE Calculator System!

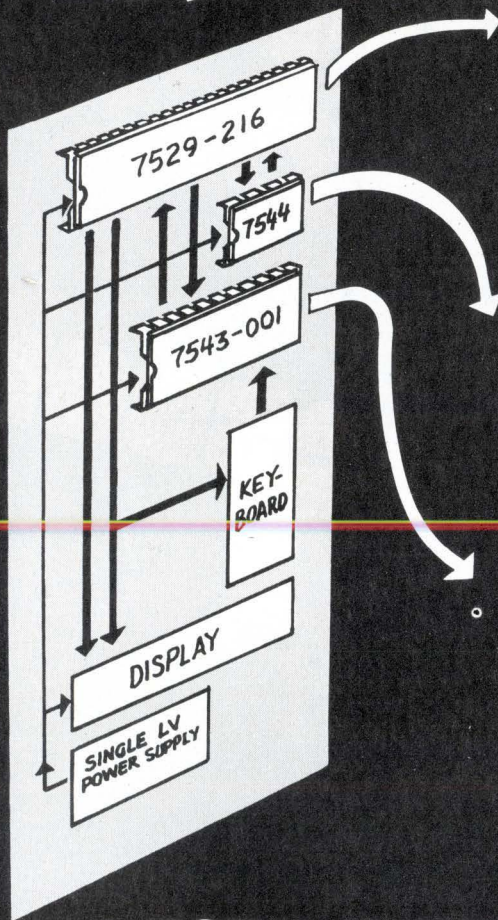

A SCIENTIFIC CALCULATOR ARRAY

- Full Scientific Functions
- Algebraic Entry
- Select 12 (or 9) Digit Displays
- Fixed or Floating Point Operation
- Scientific Notation

+ A 10 WORD MEMORY BUFFER ARRAY

- 10 User Addressable Memories
- 5 Parenthesis Levels
- Full Memory Arithmetic

+ A PROGRAMMER ARRAY

- 72 Key Memory
- Load, List, Edit, Execute, or Clear Programs
- Powerful Programs with Direct or, Conditional Branch and Programmed Halts

A TOTAL SYSTEM

- Single, Low Voltage Power Supply
- Minimum Power Dissipation
- Your Choice of Displays (LED or Fluorescent)
- Minimal External Components

HEADQUARTERS—

MOS Technology, Inc., 950 Rittenhouse Rd.,
Norristown, Pa. 19401 (215) 666-7950

EASTERN REGION—

Mr. William Whitehead
MOS Technology, Inc., 410 Jericho Turnpike, Suite 312,
Jericho, N.Y. 11753 (516) 822-4240

WESTERN REGION—

MOS Technology, Inc., 2172 DuPont Dr., Suite 221,
Patio Bldg., Newport Beach, Calif., 92660 (714) 833-1600

...for Programmable! Scientific Calculators! with Extended Memory!

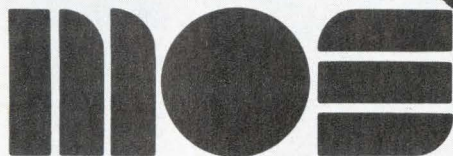
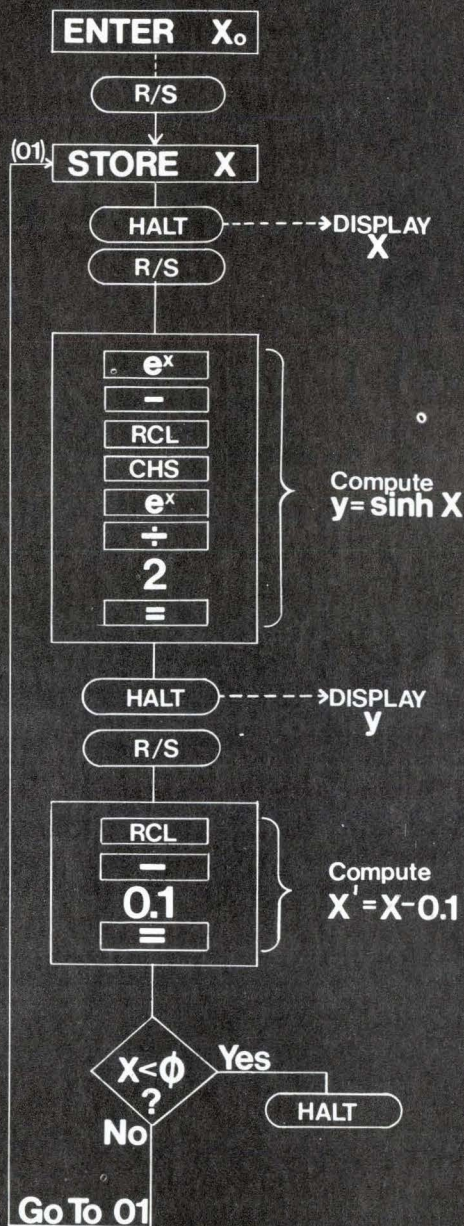
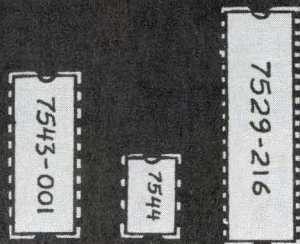

MOS TECHNOLOGY, INC.
VALLEY FORGE CORPORATE CENTER, NORRISTOWN, PA. 19401 (215) 666-7950

NEXT * From **MOE** The **COMPLETE** Microprocessor System

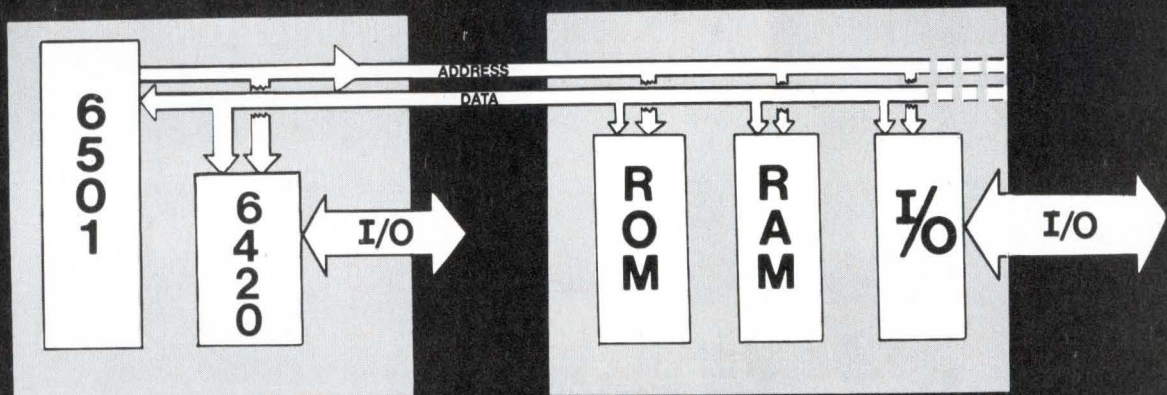

- The Lowest Price 8 Bit Microprocessor System
- Highest Benchmark Performance

With

- Flexible Organization
Two Chips for Small Systems.
Add More as You Need Them.
- Full Addressing Capability
Up to 65k Bytes
Programmable I/O and DMA
- "6800" Type Bus Management
- N-Channel Process for Speed
- Single +5V Power Supply

* (Samples to present customers in July)

MOE
MOS TECHNOLOGY, INC.
VALLEY FORGE CORPORATE CENTER, NORRISTOWN, PA. 19401 (215) 666-7950

Sapphire brings out the best in C-MOS

When thin-film silicon on sapphire substrates replaces bulk silicon, complementary-metal-oxide-semiconductor technology achieves much better performance; costs should drop as volume rises

by S. Sheffield Eaton, *RCA Solid State Division, Somerville, N.J.*

Semiconductor manufacturers are in the midst of a technological controversy, and its outcome will affect the way digital circuits are built in the future. The debate concerns whether a silicon-on-sapphire materials system, in combination with metal-oxide-semiconductor technology, is a practical means for achieving high-performance large-scale integration.

SOS is particularly attractive for complementary-MOS designs, and less so for n-channel MOS designs, because it allows the chip designer to add LSI levels of speed and density to the low power, ease of use, and noise-immunity of C-MOS. Indeed, established C-MOS manufacturers like RCA's Solid State division, Somerville, N.J., and Solid-State Scientific Inc., Montgomeryville, Pa., have already built C-MOS-on-sapphire random-access memories and high-speed counters and timers. They are also well along on the single-chip microprocessors and peripheral circuits

needed to make up an entire micro-computer system.

The controversy does not center on whether SOS offers high LSI performance, which it undoubtedly does, but on whether this performance is worth the extra trouble and expense of obtaining and processing the thin-film sapphire substrates.

Opponents of the technology note that sapphire substrates today cost up to 10 times more than equivalent bulk silicon substrates. Supporters of SOS reply that a substantial increase in demand will reduce this price, which in any case is offset by the economies of simpler device processing and more relaxed fabricating rules.

The argument has become more heated with the appearance of other circuit techniques—integrated injection logic and LSI forms of transistor-transistor and emitter-coupled logic—which lend themselves to conventional silicon processing and which many semicon-

ductor manufacturers believe may provide high LSI performance at less cost than SOS. Proponents of this view include Texas Instruments, National Semiconductor, Fairchild Semiconductor, and others, and they point to the new I²L microprocessors and memories [*Electronics*, Feb. 6, p. 83] and Schottky TTL and ECL LSI processors as proof that the new and improved forms of bipolar logic are the way to go.

There the debate rests. The next few years will see who wins.

The article that starts below presents the case for silicon-on-sapphire C-MOS designs, comparing them with conventional C-MOS technology. Also presented is the range of products achievable with SOS and the performance specifications they either attain or can be expected to attain. Finally, some of the problems associated with SOS are presented, and some solutions to them given. —Laurence Altman

□ Complementary-MOS circuits built on sapphire substrates have several advantages over those built on bulk silicon. They are faster, they have tighter, smaller circuit features, and, once the starting material has been prepared and polished, they are easier to build.

They are faster because the insulating sapphire reduces junction and other parasitic capacitance that slows down the operation of bulk silicon circuits. They are half the size because three levels of interconnect allow tight packing of devices and because the guardbands generally used for transistor isolation in bulk silicon substrates are eliminated. Yet the process requires only a third the steps of conventional C-MOS.

The simplicity of the process should eventually make the cost of C-MOS-on-sapphire circuits competitive with, and maybe lower than, that of bulk C-MOS circuits, even though unpolished sapphire substrates in large quantities presently cost about six to seven times more than the others. Also lowering the cost will be higher yields, again because of the simpler processing but also because silicon-on-sapphire circuit operation is little affected by mask and oxide defects over inactive sapphire regions.

Speed and power, the principal measures of device performance, depend on the amount of transistor current available and the magnitude of the internal node

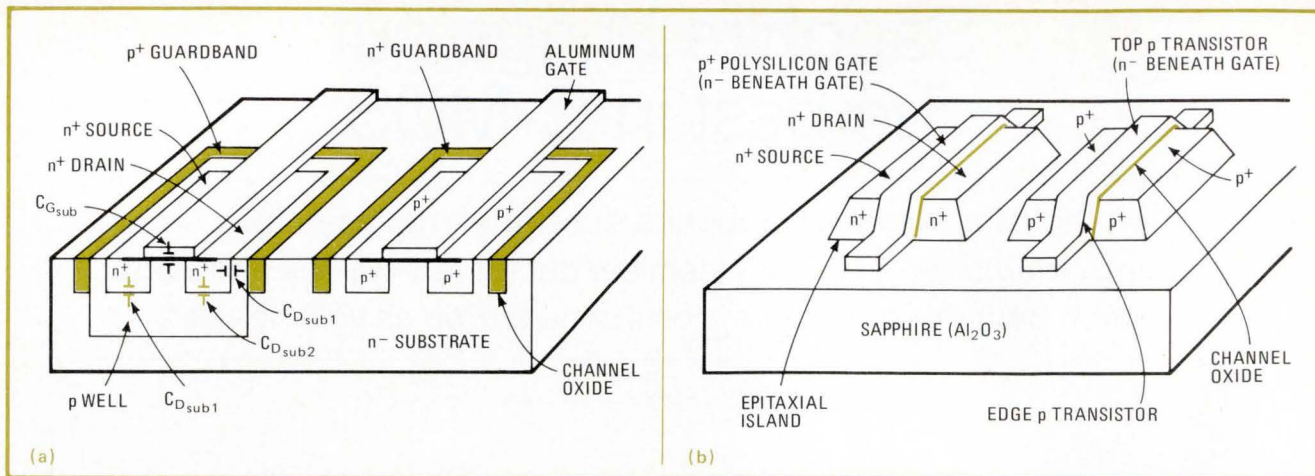

1. How sapphire helps. The capacitance between drain and substrate and between gate and source-drain diffusion in the bulk-silicon C-MOS structure (a) slows down operation. In sapphire, low-capacitance transistor (b) is smaller and faster.

TABLE 1: CAPACITANCES IN BULK AND SOS TRANSISTORS

Capacitance source	Capacitance			Units
	Symbol	Aluminum-gate bulk	Silicon-gate SOS	
Gate-substrate	C_{Gsub}	0.25	0.25	pF/mil ²
Drain-substrate (sidewall)	C_{Dsub1}	0.1	—	pF/mil ²
Drain-substrate (base)	C_{Dsub2}	0.1	—	pF/mil ²
Gate-drain	C_{GD}	0.04	0.01	pF/mil

capacitance that this current must charge and discharge. For a given current, the amount of power required to operate the transistor is proportional to the value of this node capacitance—the smaller, the better. Also, for a given internal resistance, the transistor RC time constant is proportional to the capacitance, and the lower the capacitance, the faster the transistor operation.

Fewer stray picofarads

Figure 1 shows cross sections of C-MOS transistors on bulk silicon and sapphire substrates and labels all the important internal capacitances, values for which are listed in Table 1. These values demonstrate that an SOS transistor has very much less node capacitance than a bulk transistor. In fact, almost all its capacitance is that between gate and substrate (C_{Gsub}), which is the only capacitance necessary for the proper operation of an MOS circuit—any other capacitance merely increases power dissipation and slows switching speed. In contrast, nearly half the capacitance of an aluminum-gate bulk transistor is parasitic.

Over the years several methods have evolved for reducing the parasitic capacitance. Perhaps the most significant is the self-aligned silicon-gate process, which increases available current by lowering transistor threshold voltages and decreases gate-to-drain or Miller capacitance by eliminating much of the gate-to-drain overlap. Nevertheless, this and other bulk processes still

suffer from the large drain-to-substrate capacitance that occurs along the base and edges of the drain diffusions.

In the SOS process, however, the drain-to-substrate capacitance is negligible. As shown in Fig. 1b, the diffusion capacitance of the SOS transistor is almost entirely eliminated because the diffusions are driven down to the sapphire and the transistors are formed in the resulting islands of silicon. Consequently, the junction capacitance remaining along the channel periphery is many orders of magnitude below the gate-to-substrate capacitance. Since almost all the capacitance associated with each internal circuit node is due to the essential gate capacitance, the self-aligned silicon-gate SOS process has the lowest value of parasitic capacitance in all of today's MOS technology.

Nor does this achievement depend on complex processing. First, an intrinsic silicon epitaxial layer is deposited over the entire sapphire substrate and implanted with n-type impurities. Next, islands of silicon are defined where transistors are desired. Polysilicon gates, doped and defined above a thermally grown channel oxide, are then used as a mask for the source and drain diffusions. Lastly, a thick layer of oxide is deposited over the entire wafer, and contacts are opened to the diffusions and gates. The thick oxide minimizes crossover capacitance between the final metalization and the underlying polysilicon gates, which can also be used as an additional interconnect level. In all only six photomasks are required, including a final mask for bond pad openings in the protective oxide layer.

How SOS transistors operate

Unlike bulk C-MOS processes, in which all p and n transistors share a substrate, each SOS transistor has its own substrate insulated electrically from the others by the sapphire—no direct connection is made to any substrate. But substrate potentials remain fixed (at least in the dc case) for standard enhancement-type transistors at one diode drop below or above the source potential. Since source and substrate voltages move together, the dependence of the threshold voltage on source potential, which is often a problem in bulk silicon processes, is eliminated.

In bulk MOS processes, transistors can operate in either enhancement or depletion modes. SOS processes, however, add a third type of operation called deep depletion. Figure 1b shows the structure of SOS enhancement-type p and deep-depletion n transistors.

While the operation of the SOS p-channel transistor is governed by the usual depletion and inversion regions formed in the substrate, the SOS n-channel transistor works quite differently. The same n-type substrate used for the p-channel transistors is also used between the standard n⁺ source and drain diffusions. With zero gate voltage (OFF condition), the contact potential difference of -0.8 V between the p⁺ gate and n⁻ substrate is enough to fully deplete the epitaxial layer down to its full depth. The threshold voltage then becomes the positive gate voltage at which the depletion region depth is just equal to the epitaxial layer thickness. More positive gate voltage then shrinks the depletion region and accumulates the charge on the surface, allowing more and more current to flow (Fig. 2).

A deep-depletion process, in which a single substrate type and concentration suffices for both p and n transistors, is primarily selected for its simplicity and also to obtain low p- and n-threshold voltages of about half a volt. But there is also a more complex, double-epitaxial process, in which islands for the p-channel transistor are defined in a uniformly doped n-type epitaxial layer. A masking oxide then protects these islands while n-channel transistors are being defined in a second p-doped epitaxial layer.

For either deep-depletion or double-epitaxial silicon-gate processes, three levels of interconnect are possible, giving the designer plenty of flexibility in laying out an LSI circuit. The aluminum metalization, polysilicon gate layer, and silicon islands defined in the epitaxial layer can all be used for interconnections. The polysilicon and epitaxial layers cannot cross, however, if they are intended to be electrically independent of each other; otherwise, the potential of the polysilicon would modulate the conductivity of any underlying silicon, which in the self-aligned process must be lightly doped.

All three interconnection layers can be placed over sapphire, eliminating the capacitance between the interconnections and the diffusions that is present in most bulk processes. Capacitance remains, however, between interconnection lines located on the same level. For example, two metal lines spaced 0.3 mil apart produce approximately 0.002 picofarad per mil. Even this small amount, taken together with crossover capacitance, may be equivalent to the gate capacitance of small transistors and can reduce the speed of an SOS circuit if care is not exercised in layout.

SOS transistor characteristics

For high-speed capability it is also desirable to maximize the current available from a given transistor geometry. This in turn is a function of the carrier mobility in the epitaxial layer or, more specifically, the surface channel mobility. Conflicting data comparing SOS mobility to that of bulk silicon has been published in recent years. In practice, the current available from SOS transistors appears to be equal to or slightly less than

the current obtainable from bulk transistors.

Another important design parameter is transistor threshold voltage, which affects the speed of digital circuits and determines their minimum operating voltage.

Each SOS transistor actually consists of two transistors in parallel—one conventionally formed along the top of the silicon island and the other formed along the island edge (Fig. 1b). The island edges are sloped in the [111] crystal plane as opposed to the [100] plane along the top. Now, it is well known that the fixed charge (Q_{ss}) in an oxide that is thermally grown over [111] silicon is greater than the charge in oxides grown over [100] silicon. Consequently, a lower voltage is necessary to fully

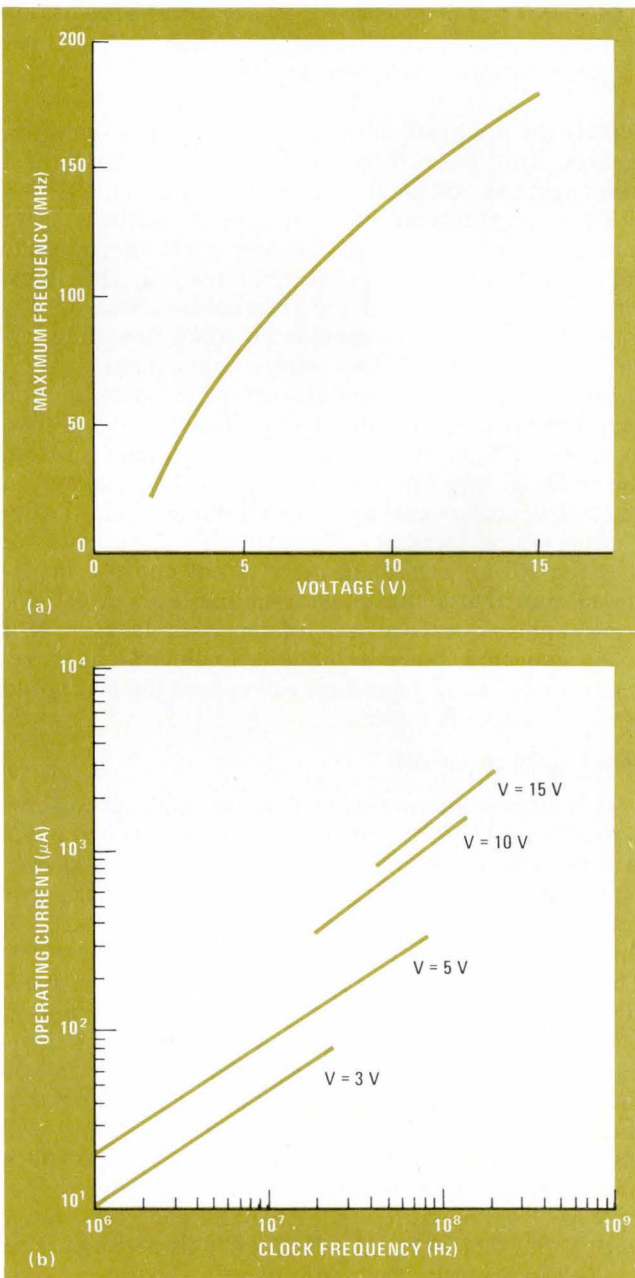

2. Quick counter. At 10 V, silicon-on-sapphire dynamic counter has a frequency of 130 MHz (a). Of course, at high frequencies power consumption goes up. The relationship of operating current to frequency is shown in (b) for several values of supply voltage.

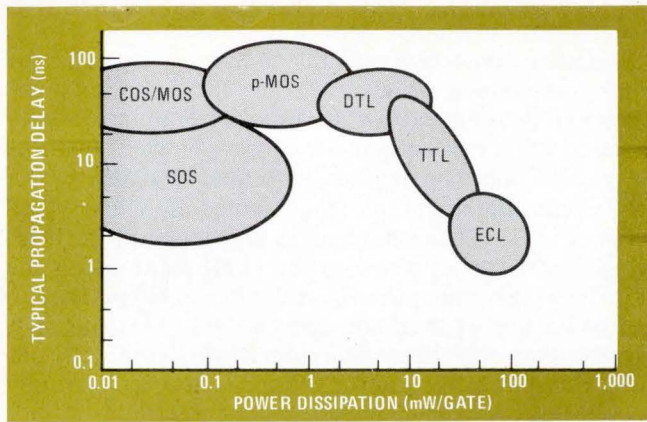

3. Good speed-power product. A C-MOS-on-sapphire gate can operate almost as fast as a TTL gate but at much lower power—0.1 mW per gate for SOS but 10 mW per gate for TTL.

deplete the epitaxial substrate, and the n threshold decreases. Also, the p threshold increases because now a more negative voltage is required for inversion.

Thus, the threshold of the n edge transistor is lower than the threshold along the top, while the opposite condition holds for the p-channel transistor. The difference between edge and top thresholds—about 0.3 V—must therefore be accommodated when designing circuits for low-threshold low-voltage applications.

In practice the quiescent dissipation of C-MOS built on sapphire substrates appears to be somewhat higher than in bulk C-MOS, probably because carrier lifetimes within the epitaxial substrate are shorter. Transistor leakage, in general, decreases as the effective lifetime within the depletion region increases. There is also some evidence that the silicon epitaxial layer is not entirely single-crystal and that a thin polycrystalline layer at the silicon-sapphire interface may influence the leakage. It is to be expected, however, that technological improvements in epitaxial deposition will reduce the leakage to about that of bulk C-MOS.

Making SOS pay off

It is important to realize that the high-speed, low-power promise of SOS technology is best exploited in LSI circuits. The speed of single gates or flip-flops is only marginally better than in those made with bulk MOS substrates, since nearly all speed-limiting capacitance for these circuits arises from external interconnections. Therefore it would offer only a slight advantage to redesign the standard SSI and MSI 4000 C-MOS family in SOS.

In LSI circuits, however, the speed is limited by internal node capacitance, and since this is smaller in SOS than in any other present-day technology, it follows that the power-stage delay product of SOS LSI circuits will also be lowest. In fact, the propagation delay per stage of a string of C-MOS-on-sapphire NOR gates operating at 10 V has been measured in the 1- to 2-nanosecond range with about 4-ns rise and fall times. This is comparable to the best Schottky TTL performance.

Figure 2, which shows speed and power characteristics for SOS dynamic counters operating at various supply voltages, indicates that speeds to 80 megahertz are possible at 5 V with a power consumption of only

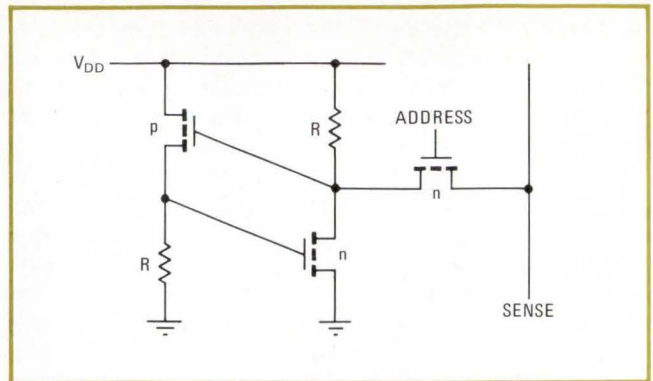

4. Fast. A C-MOS-on-sapphire, 1,024-bit, static random-access memory can operate at less than a 100-ns access time. Future designs may adopt a compact Siemens cell that substitutes two resistors for two of the five transistors in a conventional cell.

about 2 milliwatts. Standard TTL counter circuits, by contrast, operate to about 30 MHz with power consumption in the 200-mW range. Power-stage delay products for various technologies are compared in Fig. 3.

An attractive feature of SOS circuits is their retention of nearly all the assets of bulk C-MOS circuitry—operation from a single power supply, low quiescent dissipation, high noise immunity, tolerance of temperature variations, and high input impedance. In addition, SOS offers complete isolation between transistors and interconnects, a lower power-stage delay product, higher radiation resistance, and about double the density.

Essential for LSI purposes, this high density results from the design freedom provided by three layers of interconnects and from the use of silicon islands, the spaces between which can be much narrower than the discretely diffused guardbands of standard C-MOS. Also helpful is the elimination of gate overlap in silicon-gate processes and the smaller size of the transistors, which can be as tiny as is consistent with reliable photoresist definition of the silicon islands and gates.

To illustrate the end result, the smallest possible C-MOS-on-sapphire inverter, complete with contacts to its gate, drain, source, and output, occupies about 2 mil², as against the 4 mil² of a bulk C-MOS inverter.

Applying SOS

When all the tradeoffs are taken into account, the areas where C-MOS-on-sapphire technology can best be applied are in timekeeping, memories, microprocessors, high-speed counters, level shifters, and multiplexing. All these applications require a high degree of circuit complexity plus fast, low-power operation.

Timekeeping applications that rely on quartz crystal oscillators for high accuracy have traditionally used C-MOS frequency dividers for low-power operation. The power consumption is most severely restricted in wrist-watches, where a 32-kilohertz crystal is typically chosen to obtain the 15-to-20-microampere maximum operating current necessary for a year's battery life.

But this crystal frequency is not optimum from either a cost or performance standpoint. High frequency AT- or SL-cut crystals above 1 MHz offer two to three times lower cost, higher Q, and improved shock, aging, and

temperature characteristics. Small SL-cut crystals are currently available at 1 MHz, but to retain the advantages of AT-cut crystals in wristwatch sizes, a crystal frequency of 4 MHz or greater at present appears necessary. C-MOS-on-sapphire frequency dividers with transistor thresholds as low as 0.05 V have been operated at speeds up to 25 MHz at 1.6 V. Circuits with more conservative thresholds of half a volt typically run to 8 MHz and operate at about 5 μ A at 1.6 V and 4 MHz. Total crystal oscillator and counter power consumption averages about 12 μ W at 4MHz and 7.5 μ W for a single-cell 1-MHz system.

One 4-MHz timing chip (the RCA TA6778) has a 23-stage SOS counter and oscillator. One output is provided after the seventh counting stage to drive standard 32-kHz bulk timekeeping circuits. Two other outputs are provided at 0.5 hertz for driving stepping motors. The frequency of all outputs may be adjusted digitally; 122-part-per-million steps for each binary increment are applied to three control pins for a total of 854 ppm. Speeds to 80 MHz are possible with a 5-v supply.

Besides wristwatches, other timekeeping applications include wall clocks and auto clocks. In both, SOS circuitry offers low-power operation using high-frequency AT-cut crystals. (The use of these conventional, low-cost crystals is possible because the restrictions on size are removed.) The RCA TA6779 is an example of a device intended for single-cell clock applications. It has two outputs at 32 kHz for driving synchronous clock motors. Another circuit is planned for driving stepping motors.

SOS memories and microprocessors

For SOS chips, the most important single application may yet prove to be memories. Dominating the memory market today are bipolar devices, fabricated with transistor-transistor logic, emitter-coupled logic, or Schottky TTL, and bulk MOS devices, which use mainly n-MOS and C-MOS and may be static or dynamic in operation. Now MOS memories can be further subdivided into

those with bulk and those with insulating substrates.

Table 2 lists the different advantages of each memory type, including the RCA TA6780 SOS device. Scheduled for introduction in 1975, the TA6780 should operate at access and cycle times of 100 nanoseconds, close to that of bipolar memories but with a fortieth of the power consumption. Other advantages include low standby dissipation, a property that is inherent in C-MOS circuitry and virtually solves the problem of memory volatility. A small backup battery is enough to keep cell information intact, and the main power supply is no longer essential. Nor is the voltage of the backup critical since memory retention is relatively independent of the supply voltage. In short, no other memory technology has all the desirable SOS characteristics of high speed, low power, wide operating temperature range, and ease of use.

Tradeoffs between these characteristics have of course to be made in the design of SOS memories. The RCA TA6780 1024X1 developmental memory strikes a balance between speed and ease of use. Applications include cache memories, point-of-sale terminals, peripherals, calculators, microprocessors, and minicomputers.

Other types of SOS memories, for example, a 20-to-30-ns, 16-word-by-4-bit memory would be useful in small cache memories requiring very high speed. Penetration into the mainframe market also will be possible as the price of SOS memories decreases.

To minimize memory-cell density in bulk MOS circuits, many manufacturers have used dynamic cells that must be refreshed periodically to restore cell information. When this approach is used with SOS technology, a higher refresh rate is required due to the higher source-drain transistor leakage. Still, new techniques may yet eliminate or ease this restriction, and the memory cell developed by Siemens presently appears promising.

Nicknamed "ESFI" for "epitaxial silicon films on insulators," the cell substitutes two isolated resistors for two transistors in a conventional five-transistor cell (Fig.

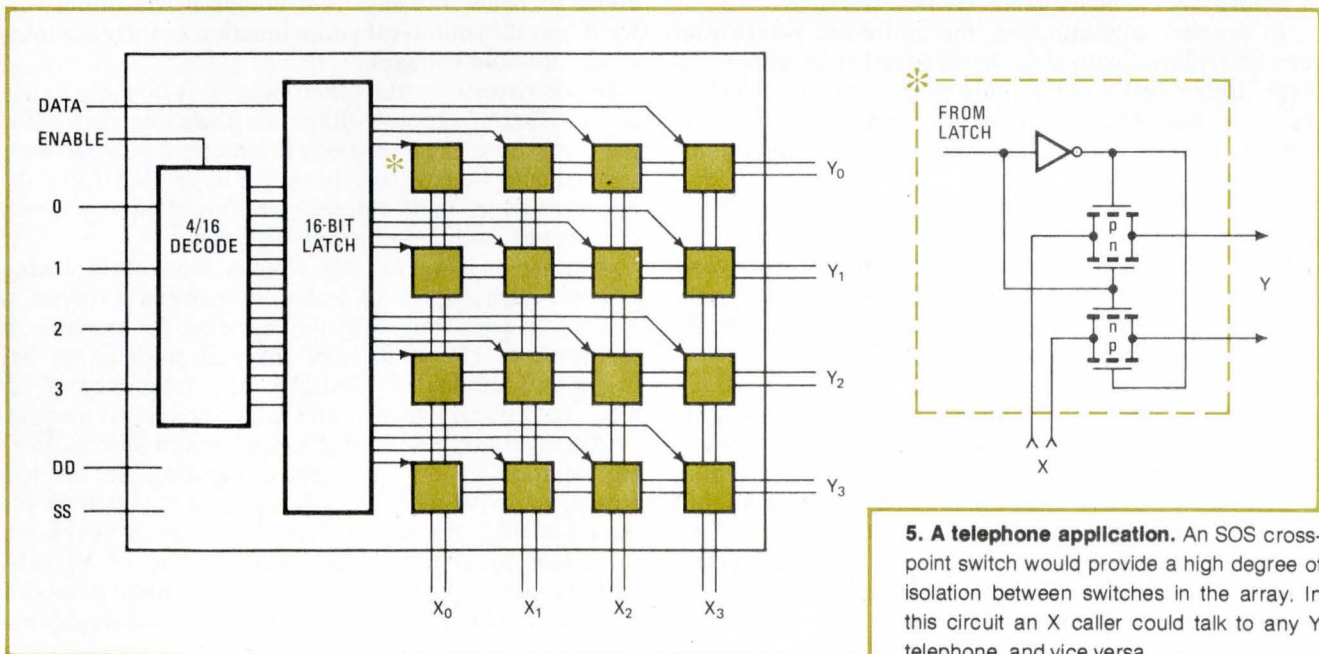

5. A telephone application. An SOS cross-point switch would provide a high degree of isolation between switches in the array. In this circuit an X caller could talk to any Y telephone, and vice versa.

TABLE 2: VARIOUS MEMORY TYPES AND PROCESSES

Memory type	Access time (ns)	Read cycle time (ns)	Operating dissipation (mW)	Standby dissipation (mW)	Power supplies (V)	Peripheral circuitry required	Output	Temperature range (°C)	Approximate price (100-k quantity) (¢/bit)	Pulsed chip select	Number of pins
Bipolar Schottky 256-bit 3100	60	70	650	650	5	None	Three-state	0 to 75	1.5	No	16
Bipolar TTL 1,024-bit 93415	90	100	650	650	5	Pull-up load	Open collector	0 to 75	1.0	No	16
Bipolar ECL 1,024-bit 95415	45 (typ)	55 (typ)	650	650	-5.2 -2	Pull-down load	Open emitter	0 to 75	1.3	No	16
Static n-MOS 1,024-bit 2102-1	500	500	300	300	5	None	Three-state	0 to 70	0.5	No	16
Charge pump n-MOS 1,024-bit 7001	60	180	650	0.5	15 8 -3	-Charge pump oscillator -Sense amplifier -Chip select driver	Differential open drains	0 to 70	0.7	Yes	22
Dynamic n-MOS 4,096-bit 7004	150	300	500	0.4	12 5 -5	-Circuitry for 64 cycle refresh -Sense amplifier	Differential	0 to 70	0.2	-	22
Static bulk C-MOS 256-bit CD4061	380	550	40 at 10 V and 1- μ s cycle time	0.1 at 10 V	Single supply 3-15	None	Three-state	-55 to 125	6	Yes	16
Static SOS C-MOS* 1,024-bit TA6780	120	130	15 at 10 V and 1- μ s cycle time	1 at 10 V	Single supply 3-12	None	Three-state or open drain	-20 to 85	1	No	16

All data is worst case except where noted. *Specifications are objective.

4). The cell becomes much smaller since fewer cross-overs and contacts are needed and since the resistors, electrically isolated by nature of the SOS process, occupy a small area. No guardbands are necessary.

In another configuration, the addressed n-transistor can be replaced with a diode that further decreases cell area. Either cell looks promising for possible development of SOS 4,096-bit static memories. Other applications include read-only memories and programable logic arrays.

SOS technology should also suit microprocessors since all the advantages of C-MOS circuitry could be retained at the high packing densities required to keep cost down. System clock rates up to 15 MHz at 10 V should be possible with basic machine cycle times (typically eight clock pulses) of about 0.5 microsecond.

In counter applications, circuit outputs normally clock at some submultiple of the input frequency. This application is ideal for SOS circuits, since all high-frequency operation is on-chip. Besides the timekeeping applications already mentioned, SOS counters should also be useful in communication equipment where high-speed divide-by-N counters could be used in frequency synthesizers. Portable operation will also be possible because of low power drain.

In bulk silicon circuits it is often difficult to use more

than one supply voltage on the same chip since, for many transistors, the wafer itself forms a common substrate. Source voltage is then restricted because voltages above or below the substrate potential will either forward-bias the source-substrate junction or increase transistor threshold voltages.

In SOS circuits, on the other hand, it is possible to use any number of supply voltages on the same chip without a substrate effect or diode interaction. SOS circuitry, then, should be particularly useful in level-shifting applications or in single-chip integrations of circuits which operate best at different supply voltages.

Another opening for SOS circuits is in multiplexing where a high degree of isolation between switches is needed. In telephone switching systems, for example, a minimum of 110 decibels of crosstalk attenuation between any terminals is desirable at a frequency of 1.5 kHz. SOS transmission gate switches, controlled by C-MOS inverters, could offer sapphire and silicon-dioxide isolation at low quiescent dissipation. In an SOS crosspoint switch (Fig. 5), an addressable latch stores the on-off data for all switches. Then any X telephone subscriber could talk to any Y (or group of Y) subscribers over a pair of switched lines. Other potential multiplexing applications include high-speed single-line digital switches, which need low on-chip capacitance. □

For microwave measurements, see a specialist.

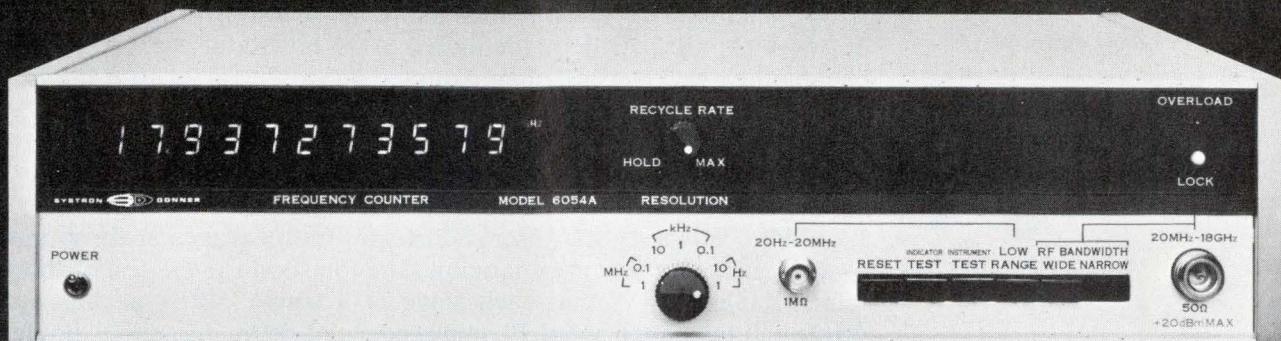

Systron-Donner's newest automatic counter offers more...

Systron-Donner, pioneer of automatic microwave counters, has done it again. S-D's completely new Model 6054A counter offers more of everything that's vital in frequency measurement.

... **Coverage:** Complete microwave coverage from 0.02 to 18 GHz in one band with one connector input.

... **Dynamic Range:** No dead zone! Operative over the complete range up to +30 dBm (1 Watt).

... **Protection:** Unlike other counters offered to date, the Model 6054A provides early warning of pending overload conditions via flashing LED's.

... **FM Tolerance:** Full channel loading and heavily modulated signals with rates up to 10 MHz are measured easily with S-D's new FLACTO™ technique.

... **Speed:** Fast acquisition and 1 Hz resolution in one second are provided over the entire frequency range.

... **Display:** Standard 11-digit LED readout gives you fully displayed readings up to 18 GHz.

... **Information:** In the U.S., call or write Systron-Donner at 1 Systron Drive, Concord, CA 94518. Phone (415) 676-5000. Or contact your nearest Scientific Devices office. Abroad, contact Systron-Donner GmbH, Munich; Systron-Donner Ltd., Leamington Spa, U.K.; Systron-Donner S.A., Paris (Le Port Marly); Systron-Donner Pty. Ltd., Melbourne.

SYSTRON  DONNER
CORPORATION

Engineer's newsletter

4-k RAMs to cost \$6 by December

Designers of memory systems will be glad to know that 4,096-bit RAM prices are moving briskly downwards in step with the learning curve, despite some suppliers' difficulty in producing the chips in volume. **The memories are selling at about \$8 each in 10,000 lots and should reach \$6 each by year end.** Estimates now are that they'll settle at under \$4 within the next two years, helped along by pressure from the oncoming 16,384-bit parts. And incidentally, 1,024-bit static RAMs are really cheap—they were recently being quoted at \$1.65 each in 10,000 lots.

Exorcizing logic-race conditions

Need a simple way of overcoming the perennial problem of logic race in long chains? Brother Thomas McGahee, of Don Bosco Tech, Boston, Mass., suggests you insert additional buffer stages at those inputs to the logic chain that are changing state too soon for the rest of the system. McGahee says that **each stage of a single 7407-type hex buffer driver will introduce about 20 nanoseconds of delay** into either the leading or the trailing edge of every incoming waveform.

Sockets can replace burn-in fixtures

Burning in large quantities of components or IC? **Before ordering special fixtures, consider using solderless "breadboard" sockets and buss strips.** The sockets accept almost any component, and to wire busses and sockets you simply push stripped No. 22 solid wire into the holes. Setting an example, Continental Specialties, the New Haven, Conn., manufacturer of these breadboard items, burns in many of its own LED logic-state indicator clips by plugging them into fixtures built out of its own sockets and busses, meters, and power supplies. All sockets and buss strips are completely reusable.

Lasers can seal electronic packages

How can you hermetically seal a hybrid-IC package with a really hot heat source without damaging bonded-lead wires? And how can you seal the case of a lithium battery which has an insulating separator made out of polyethylene, a material with a low melting point? Answer: use a pulsed laser system.

Laser welders can achieve a power density of greater than 10^6 W/cm² for short pulses. For this reason, **accurate laser sealing need not heat adjacent areas excessively or harm temperature-sensitive material internally.** Other information on the uses of pulsed lasers is contained in a series of application notes from Raytheon Company, Laser Advanced Development Center, 130 Second Avenue, Waltham, Mass. 02154.

Pinning down the calculator market in Europe

If your company is involved in calculators and associated components, your export and international marketing people might be interested in a new study of the European market. It covers all types of calculators (table-top, pocket, and so on), **defines the market by country, equipment segment and category, examines the distribution channels,** and gives names and addresses of major customers.

The 90-page study comes complete with graphs and charts. It can be bought from Creative Strategies GmbH, 12 Stiftstrasse, 6200-Wiesbaden, West Germany.

—Stephen E. Scrupski

More built-in features...



YOU GET	WHAT IT DOES	WHY IT'S IMPORTANT
Autoranging	Automatically selects the most suitable gate time (or period averages) for highest resolution of the signal without overflowing	Virtually no training required to operate the counter. Ideal for production line or student use
Autoranging Hysteresis	A 20% hysteresis in the switching thresholds eliminates redundant up range/down range commands	Allows measurements to be made on signals containing large amounts of frequency or phase modulation
Autoreset	A new measurement sequence is started every time a front panel switch is activated	Avoids measurement delays – the first reading obtained is always the correct one
Period Mode	Measures the time duration of a single cycle or multiple cycle averages of the input signal	Enables high resolution of low frequencies, a feature not available with "frequency only" counters
Leading Zero Suppression	Blanks all zeros to the left of the first significant digit or decimal point	Makes the display easier to interpret (e.g. 425 is easier to read than 000425)
LSI/MOS Design	This advanced circuitry requires very little power yet provides an exceptionally high performance to price ratio in a small robust package	Keeps your power bill down (the 1900A uses only 6.5 watts), saves your muscles when toting (weighs only 2¾ lbs), and makes it easy to afford (only \$349)

- PLUS:**
- 25 mV Sensitivity
 - Traditional Fluke Quality
 - Coast-to-Coast Service
 - Rechargeable Battery (Optional)
 - Parallel Data Output (Optional)

...with the **Fluke 1900A**
80 MHz multi-function counter
for only \$349

US Price FOB Buffalo, N.Y., Options Extra

FLUKE
 COUNTER DIVISION

John Fluke Mfg. Co., Ltd.
 Counter Division
 P.O. Box 1094, Station D
 Buffalo, N.Y. 14210
 Phone (716) 842-0311
 TWX 610-492-3214

Low-cost optical sensor overcomes ambient light

by Helge H. Mortensen
National Semiconductor Corp., Santa Clara, Calif.

A low-cost solid-state optical system can be useful for measurements of light transmission or reflection in medical applications, in the manufacture of paper, textiles, and paint, and in smoke detection. This optical measurement system, which uses the conventional light-chopping technique to overcome ambient light and electrical noise, can be built for about \$13.

The system (Fig. 1) consists of a light-emitting-diode source, a photodiode sensor, operational amplifier A₁, driven by the sensor, integrator operational amplifier A₂, which is connected to the output from A₁ only when the LED is off, and op amp A₃, which is connected to the output from A₁ when the LED is on. A clock drives transistor Q to turn the LED on and off, and also drives field-effect-transistor switches S₁ and S₂ to connect either A₂ or A₃ to the A₁ output.

The waveforms in Fig. 2 illustrate the operation of the system. When the LED is on, the material being tested transmits some light to the sensor. The trans-

mitted light, plus ambient light, produces a photosensor current that is converted and amplified in A₁. Electrical noise also contributes to the output from A₁.

To make the system insensitive to the ambient light and electrical pickup, the output from A₁ when the LED is off is fed to the integrator, consisting of A₂ and C₁. The integrator output is applied to the non-inverting terminal of A₁ as an offset voltage to cancel the unwanted output, reducing the voltage from A₁ to zero when the LED is off.

When the clock turns the LED on again, it also opens S₁ to disconnect the integrator from the A₁ output. However, capacitor C₁ holds the offset voltage on the noninverting terminal, so that the net voltage from A₁ results only from the LED light.

The effect of the integrator is to measure the magnitude of the ambient light and noise while the LED is off, remember this magnitude, and subtract it from the incoming signal when the LED is on. The output from A₂ is a measure of the ambient light and noise.

While the LED is on, FET switch S₂ is closed, so the output from A₁ is applied to capacitor C₂. The capacitor holds this voltage during the off period, while S₂ is open. Thus S₂ and C₂ constitute a sample-and-hold circuit. Amplifier A₃ serves as a simple output buffer, delivering the over-all output signal to whatever indicating meter or control circuit is to be driven by the optoelectronic measurement system. □

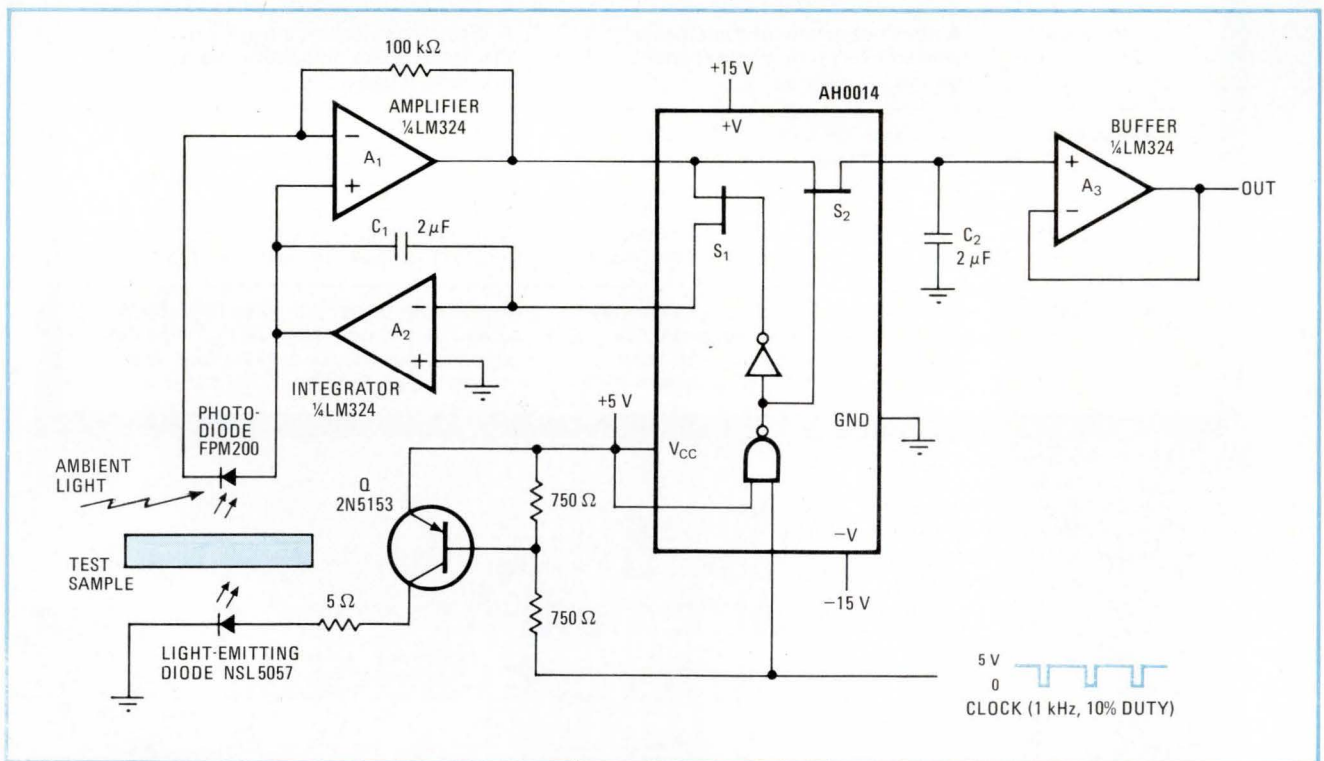

1. Keeping It light. Despite presence of ambient light, optoelectronic measurement system accurately indicates optical absorption or reflection by test sample. (For reflection measurement, geometry is changed so that LED light bounces from sample to sensor, instead of passing through sample.) Effects of stray light and electrical noise generate offset voltage that is subtracted from total voltage when LED is on.

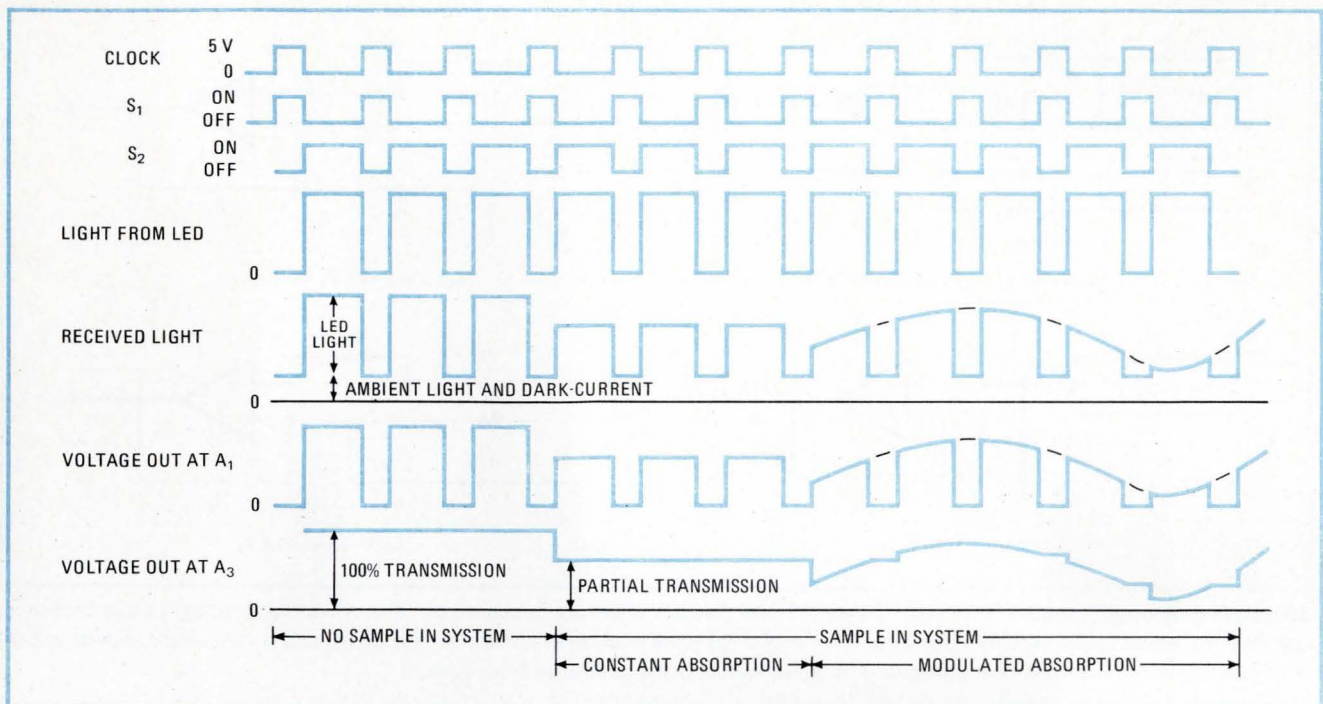

2. Chopping it right. Timing diagrams and waveforms illustrate operation of optoelectronic sensing and measurement system. Amplifier output is connected to integrator while LED is off, and integrator generates offset voltage to cancel outputs caused by ambient light and spurious voltages. When LED is on, amplifier output is connected to sample-and-hold and buffer, but offset still cancels background signals. (Proportions of timing diagrams are distorted for clarity. To avoid excessive dissipation, actual duty cycle of LED is 0.1.)

Calculating resistances for sum and difference networks

by D. Sheingold
Analog Devices Inc., Norwood, Mass.

Whenever signals must be added and/or subtracted, a few simple computations will yield resistance values that provide equal resistive loading at the two inputs of an operational amplifier to minimize offset-current errors. The loading resistance can have any desired value.

Figure 1 shows the general sum or difference network; it produces an output voltage given by

$$E_o = a_1 V_1 + a_2 V_2 + \dots - (b_1 V_{101} + b_2 V_{102} + \dots)$$

where the V_s are input voltages. The voltages that are to be added (V_1, V_2, V_3, \dots) are applied to the noninverting terminal of the operational amplifier through resistors R_1, R_2, \dots , and the voltages that are to be subtracted (V_{101}, V_{102}, \dots) are applied to the inverting terminal through resistors R_{101}, R_{102}, \dots . Shunt resistor R_0 or R_L and feedback resistor R_F complete the network. The values of all the resistors are found by these simple rules:

- Decide what composite load resistance, R_p , should be presented to the input terminals of the op amp. A value of 5 kilohms for R_p provides good bandwidth and low

noise pickup without too much loading of the input sources or the output.

- Add up the positive coefficients (call this sum Σa).
- Add up the negative coefficients (call this sum Σb), and add 1.00.
- If Σa is greater than $(1 + \Sigma b)$, the network must include an R_L (for gain). If Σa is less than $(1 + \Sigma b)$, the network must include an R_0 (for attenuation). If Σa is equal to $(1 + \Sigma b)$, neither R_L nor R_0 is used.
- Find R_F by taking the larger of Σa or $(1 + \Sigma b)$, and multiplying it by R_p . (The number that multiplies R_p here is called the closed-loop gain or "noise gain.")

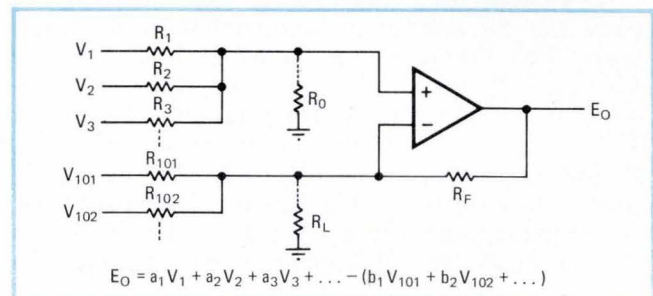

1. Summing circuit. Output voltage from operational amplifier is sum of positive and negative terms that are related to input voltages by positive or negative coefficients. Signs of terms depend on which input terminal is fed, and magnitudes of terms depend on voltages and resistances. Simple procedure determines resistance values that yield the desired output while making op-amp input terminals see equal resistive loadings of any desired level. Circuit may include balancing resistor R_0 or R_L or neither, but never requires both.

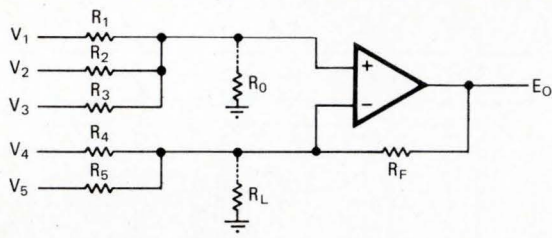

(a) $E_O = 0.3 V_1 + 2 V_2 + 1.5 V_3 - 2 V_4 - V_5$

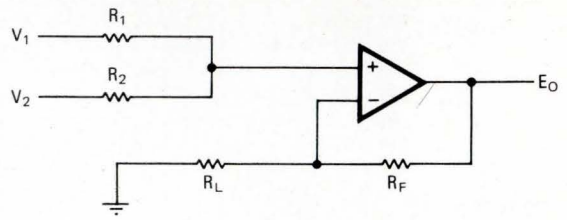

(b) $E_O = 0.6 V_1 + 0.8 V_2$

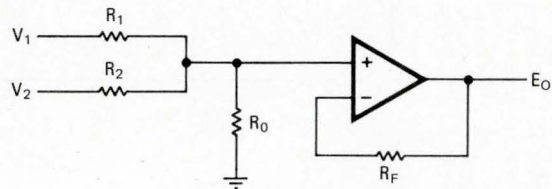

(c) $E_O = 0.1 V_1 + 0.3 V_2$

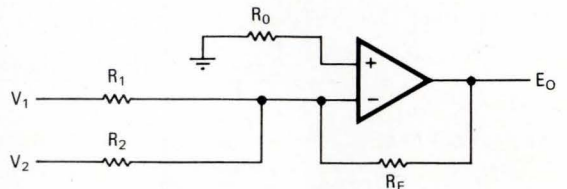

(d) $E_O = -0.3 V_1 - 1.2 V_2$

2. Sample problems. Examples in text refer to these circuits. Resistor values are calculated on basis of 5-kilohm loading, a value chosen for convenience, at each input terminal of op amp. The circuit in (a) is the most general adder-subtractor; (b) and (c) are simple adders; and (d) is an inverting adder. Each example highlights a particular feature of the calculation procedure.

■ R_L or R_0 is equal to R_F divided by the absolute value of $(1 + \Sigma b - \Sigma a)$.

■ The value of each of the other resistances is found by dividing R_F by the associated coefficient: i.e. $R_1 = R_F/a_1$, $R_{102} = R_F/b_{102}$, and so forth.

As an example, the resistors for the network in Fig. 2(a) can be found by following the above rules:

Choose $R_p = 5 \text{ k}\Omega$
 $\Sigma a = 3.8$
 $(1 + \Sigma b) = 4.0$
 $(1 + \Sigma b) - \Sigma a = 0.2$ (An R_0 is needed.)
 $R_F = 4 \times 5 \text{ k}\Omega = 20 \text{ k}\Omega$ (Closed-loop gain is 4.)
 $R_0 = 20/0.2 = 100 \text{ k}\Omega$
 $R_1 = 20/0.3 = 66.7 \text{ k}\Omega$
 $R_2 = 20/2 = 10 \text{ k}\Omega$
 $R_3 = 20/1.5 = 13.3 \text{ k}\Omega$
 $R_4 = 20/2 = 10 \text{ k}\Omega$
 $R_5 = 20/1 = 20 \text{ k}\Omega$

As a check, the parallel combination of R_1 , R_2 , R_3 , and R_0 is $5 \text{ k}\Omega$, and parallel combination R_4 , R_5 , and R_F is also $5 \text{ k}\Omega$. (There is no R_L in the network.) The gains for V_4 and V_5 are $-20/10 = -2$, and $-20/20 = -1$, respectively. The gain for V_1 is the product of noise gain and attenuation (in the voltage divider that consists of R_1 and the parallel combination of R_2 , R_3 , and R_0); this product is $4 \times 0.075 = 0.3$. The gain for V_2 is $4 \times 0.5 = 2$, and the gain for V_3 is $4 \times 0.375 = 1.5$.

A second example is the summing circuit in Fig. 2(b).

Again choose $R_p = 5 \text{ k}\Omega$
 $\Sigma a = 1.4$
 $(1 + \Sigma b) = 1 + 0 = 1.0$
 $\Sigma a - (1 + \Sigma b) = 0.4$ (An R_L is needed.)
 $R_F = 1.4 \times 5 \text{ k}\Omega = 7 \text{ k}\Omega$ (Noise gain is 1.4.)
 $R_L = 7/0.4 = 17.5 \text{ k}\Omega$
 $R_1 = 7/0.6 = 11.7 \text{ k}\Omega$
 $R_2 = 7/0.8 = 8.8 \text{ k}\Omega$

A check of these results shows that both input terminals are loaded by parallel resistance combinations equivalent to $5 \text{ k}\Omega$, the gain for V_1 is $1.4 \times 0.428 = 0.6$, and the gain for V_2 is $1.4 \times 0.57 = 0.8$.

Another summation problem is shown in Fig. 2(c).

Let $R_p = 5 \text{ k}\Omega$
 $\Sigma a = 0.4$
 $(1 + \Sigma b) = 1$
 $(1 + \Sigma b) - \Sigma a = 0.6$ (An R_0 is needed.)
 $R_F = 1 \times 5 \text{ k}\Omega = 5 \text{ k}\Omega$ (Noise gain is 1.)
 $R_0 = 5/0.6 = 8.3 \text{ k}\Omega$
 $R_1 = 5/0.1 = 50 \text{ k}\Omega$
 $R_2 = 5/0.3 = 16.7 \text{ k}\Omega$

The load on the inverting terminal is only R_F , which is $5 \text{ k}\Omega$. The load on the noninverting terminal, consisting of the parallel combination of R_0 , R_1 , and R_2 , is also $5 \text{ k}\Omega$. The gain for V_1 is the product of noise gain multiplied by attenuation, or $1 \times 5.5/55 = 0.1$. The gain for V_2 is $1 \times 7.1/23.8 = 0.3$.

The last example, which is not as trivial as it looks, is the calculation of resistances for the inverting adder in Fig. 2(d).

Let $R_p = 5 \text{ k}\Omega$
 $\Sigma a = 0$
 $(1 + \Sigma b) = 2.5$
 $(1 + \Sigma b) - \Sigma a = 2.5$ (R_0 is needed.)
 $R_F = 2.5 \times 5 \text{ k}\Omega = 12.5 \text{ k}\Omega$ (Noise gain is 2.5.)
 $R_0 = 12.5/2.5 = 5 \text{ k}\Omega$
 $R_1 = 12.5/0.3 = 41.7 \text{ k}\Omega$
 $R_2 = 12.5/1.2 = 10.4 \text{ k}\Omega$

A check of these results shows R_1 , R_2 , and R_F in parallel have a total resistance of $5 \text{ k}\Omega$. Gain for V_1 is $-2.5 \times 0.02 = -0.3$, and gain for V_2 is $-2.5 \times 0.48 = -1.2$. □

Engineer's Notebook is a regular feature in Electronics. We invite readers to submit original design shortcuts, calculation aids, measurement and test techniques, and other ideas for saving engineering time or cost. We'll pay \$50 for each item published.

Don't forget NITRON for off-the-shelf ROMs. At competitive prices.

If you're a communications or computer equipment manufacturer, you should know more about NITRON. We're a high-volume producer of a broad line of N-channel read-only memories (ROMs). We can meet your needs with a completely new line of off-the-shelf or mask-programmable

devices (all exact replacements for Motorola units) that represents state-of-the-art technology at competitive prices.

Before you forget, check the items that interest you in the coupon below. We'll supply the facts you need, promptly and with no obligation.

NITRON A division of **MCDONNELL DOUGLAS** 

NITRON
10420 Bubb Road, Cupertino, CA. 95014

Please tell me more about the ROMs I've checked below,
each corresponding to the Motorola MCM series number.

NAME _____ COMPANY _____
TITLE _____ ADDRESS _____
CITY _____ STATE _____ ZIP _____

High-speed, low-power, N-channel, 8K and 16K ROMs:

- NCM6560 Series 1Kx8 or 2Kx4 (mask programmable) ROM
- NCM6570 Series 128x7x9 row character generator (mask programmable)
- NCM6580 Series 128x7x9 column (mask programmable)
- NCM6590 Series, our *all-new* 2Kx8 (mask programmable)

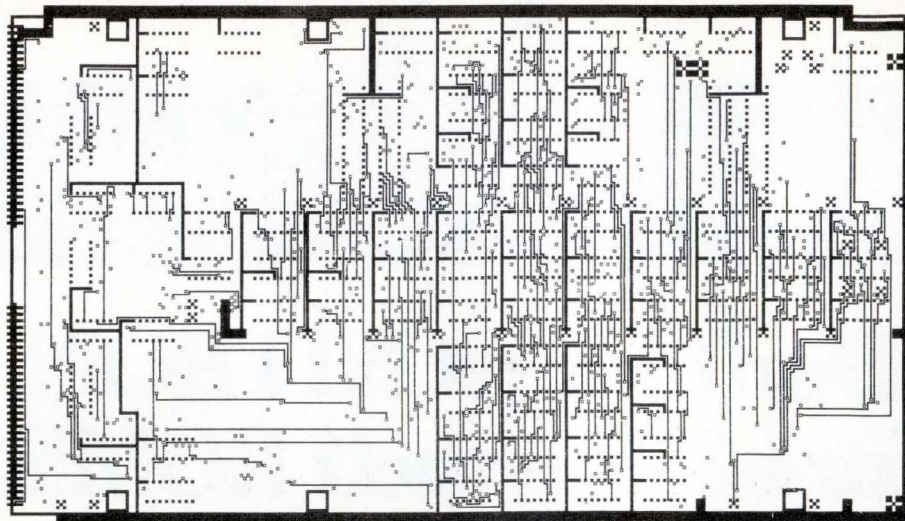

By the time your drum plotter turns this out, a Gould printer/plotter can turn it out 400 times.

If what you're looking for is higher plotting speed and lower plotting cost, we've got something that can give you both. And something else besides.

A Gould electrostatic printer/plotter. The one that makes your old drum plotter remarkably underproductive. The one that gives you a useful printing capability in the bargain. A Gould plotter is so fast, it can turn out this plot in only 2 seconds — versus an average 13½ minutes for your old drum plotter.

And what gives that Gould plotter its blinding speed is its direct on-line operation to your computer. Whether it's the PDP-8/E, PDP-9, PDP-11, PDP-15, HP2100, Nova/Supernova, H316/516, Raytheon 704, UNIVAC 1108, IBM 360/370, CDC 3000/6000, Interdata 70 and more.

In addition to output speeds up to 400 times faster, a Gould printer/plotter gives you a lower unit cost, as well as lower paper cost. Better-looking output, since there's no ink to smudge, clog or run out of. Few moving parts for quiet operation, high reliability. Software that's up-

ward compatible with the leading drum plotter. Without any sacrifice in mainframe CPU time.

And, in addition to everything else, it gives you an alphanumeric printing capability that also lets you compile management reports at speeds up to 3000 lines per minute.

Users will tell you that a Gould electrostatic printer/plotter makes their computer-aided design system truly interactive since output of modified data for verification can be quickly obtained. And by producing hardcopy output in a matter of seconds — instead of the many minutes it can take with older methods — time savings are maximized.

This all adds up to the best printing/plotting hardware and software available anywhere. And it's backed by Gould's own factory trained service technicians.

To learn more about Gould electrostatic printer/plotters — get in touch with Gould Inc., Instrument Systems Division, 3631 Perkins Ave., Cleveland, Ohio 44114 U.S.A., or Kouterveldstraat 13, B 1920, Diegem, Belgium.



GOULD

New products

Spectrum analyzer operates in real time

Analysis ranges of single-channel instrument extend from 0 to 20 hertz to 0 to 100 kHz, and an on-line bandwidth of 5 kHz is standard

by Andy Santoni, Instrumentation Editor

Spectrum analysis can be useful in locating such problems as signal-frequency dropouts in transmission lines or vibration and noise in mechanical systems. The technique can also be applied in signal-pattern-recognition studies or in analyzing communications systems such as those using frequency-shift-keying methods.

To get the most out of spectrum-analysis techniques in these applications, the instrumentation must operate in real time. Spectra must be measured at once, without delays for frequency sweeping.

The model FFT 512/S from Rockland Systems Corp. is a single-channel real-time spectrum analyzer with 12 analysis ranges from only 0 to 20 hertz at the low end to 0 to 100 kilohertz. Corresponding nominal resolution varies from 0.05 to 250 Hz. Standard real-time bandwidth is 5 kHz, and real-time bandwidth of 10 kHz is a \$2,090 option.

The basic unit, which measures 8¾ inches high, 17 in. wide and 21 in. deep, is priced at \$7,900. Using a fast Fourier transform time- to frequency-domain-conversion technique, the model FFT 512/S accepts analog or digital inputs and produces both digital and analog outputs to drive such peripherals as a chart recorder.

Within the instrument, calculations are performed by a 74181 transistor-transistor-logic 4-bit arithmetic/logic unit operating under control of a programable read-only memory. This design yields higher-speed data-handling capability than presently available micro-processor chips, says Joseph Flink, Rockland system's vice president

for product development.

The processor calculates 512 spectral lines for any input signal, and 400 of these lines, uniformly spaced for any analysis bandwidth selected, are displayed. This method reduces aliasing errors that can be caused by insufficient sampling of high-frequency waveforms. An alternate mode permits two separate 200-sample analyses to be performed and compared.

As a \$980 option, the FFT 512/S can include a ⅓-octave mode. In this mode, the analyzer can simulate 33 filters, each ⅓-octave wide, from 25 Hz to 40 kHz.

A cursor is provided, and alphanumeric readout of the cursor's position is displayed on a 10-by-8-centimeter CRT screen. The amplitude readout is calibrated with respect to the input signal in rms volts or with respect to a reference signal selected by the operator. Frequency is measured in hertz or cycles per

minute. An auxiliary cursor identifies harmonics or sidebands of the main cursor's frequency.

For analog signals, the linear dynamic range of the FFT 512/S is greater than 66 decibels, and the minimum detectable dynamic range is typically 70 dB. Dynamic range for digital signals is 72 dB. Input signals from 0.5 microvolt rms to 32 V rms can be measured.

Data analysis can be continuous or triggered either when the signal crosses a selectable threshold or when an external pulse is applied. When the data provides the trigger, a selectable pre- or post-trigger offset is available.

The spectrum analyzer can be expanded to perform cross-channel analysis by combining two model FFT 512/S units with the \$7,400 model FFT 512/C cross-channel adapter.

Rockland Systems Corp., 230 West Nyack Rd., West Nyack, N. Y. 10994 [338]



IC/diode tandem sharpens fm tuning

Combination of voltage-stabilizer chip and reference diode minimizes inaccuracies and drift in high-fidelity receivers

by John Gosch, Frankfurt bureau manager

If a new component both saves customers some money and makes equipment perform better, then it looks like a winner. And that's what Philips in the Netherlands thinks it has with its multistabilizer integrated circuit TCA750 and the associated temperature-compensated voltage reference diode BZV38. The combination, from the company's Electronic Components and Materials division (Elcoma) in Eindhoven, helps minimize inaccuracies and drift in the tuning circuitry in high-fidelity fm receivers.

If modern varactor tuners are to operate properly, the voltage applied to them must be stabilized against changes in both temperature and input voltage to less than 0.5%. Further, the stabilizing time must be less than 1 second.

When used with the BZV38 reference diode, the IC not only provides a stable tuning voltage with a short stabilizing time, but also supplies stabilized voltages for the rest of the receiver circuitry. Discrete stabilized power supplies are no longer needed. The IC also generates automatic frequency-control signals.

Once produced in volume, the combination will cost less than the discrete components it replaces. The TCA750 multistabilizer and the BZV38 reference diode will be offered for sale worldwide this fall, says Ted van Moorsel, products manager.

With the two components, receiver drift is all but eliminated. The stabilizing time for the BZV38 is about 0.8 second, and at ambient temperatures of 10° to 60°C the diode's temperature coefficient is such that its reference voltage

changes by no more than 20 millivolts, or 0.3%, according to Arnold Garskamp, who designed the combination.

By contrast, in a conventional receiver the tuning tends to drift immediately after the receiver is switched on. This is due to the reference diode's long stabilizing time—maybe as much as two minutes—to ambient-temperature changes, which affect other components too.

To facilitate operation, an fm receiver should be tunable by only one control, Garskamp says. Also, the user should have a fast, simple, and reliable means for preselecting his favorite stations.

A conventional fm receiver has two controls for tuning to a station: a tuning knob and an automatic-frequency-control switch. But with the TCA750, the afc is automatically switched by a touch contact on the tuning knob.

Stays locked. Also, when an ordinary receiver is tuned to a weak signal, its afc tends to shift if a strong station is close by. With the TCA750, however, the performance of a weak station is improved because the afc can be switched by a frequency-dependent voltage from the i-f tuned circuits by electronic tuning control. This restricts the capture range of the afc and keeps it locked to the desired station.

Again, on a conventional receiver it is all but impossible to tune from a strong station to an adjacent weak one because the afc holding range is too wide. However, by combining the tuning knob's touch-contact-operated afc with electronic tuning control (as would be done in a TCA750-equipped receiver), the afc

is switched off as soon as the operator begins tuning. He can therefore tune to a weak station. Then, after he has released the knob, the afc switches back on.

The TCA750 provides still other advantages. The afc voltage is superimposed on the tuning voltage *before* it is attenuated by the tuning potentiometer, so that the afc correction factor remains virtually constant over the receiver's whole tuning range. In an ordinary receiver, on the other hand, the afc voltage is superimposed on the tuning voltage *after* attenuation. As a result, the afc correction factor is high at low frequencies and decreases with increasing frequencies.

Stations preset. Elcoma's new components also improve receivers with preselected tuning, which sometimes catch the wrong station because the afc is not switched off during preselection. With the new combination, the afc becomes ineffective since the tuner is disconnected when selecting preset stations. And since the audio pre-amplifier stages are also switched off during selection, interstation noise is absent.

In addition to improving receivers with manual and preselected tuning, the TCA750/BZV38 combination may be part of an electronic-search tuning system. Such a system would provide continuous search-tuning over the fm band with a short automatic stop on the center frequency of each station that has a signal strength above a threshold. A non-stop tuning facility can easily be provided as an alternative.

Philips Gloeilampenfabrieken, Elcoma Division, 523 Eindhoven, The Netherlands [339]

VACTEC brings you BLUE

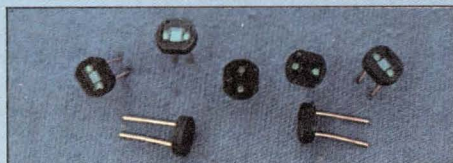

Unlike our little Japanese friend, photodetectors have always been insensitive to blue. Until now.

Vactec's latest development is a new Blue Enhanced Silicon (BES) photodiode with exceptionally low dark current for efficient response in the blue region (200 - 400 nm). Made in Missouri, U.S.A., it performs equally well in an expensive Japanese SLR camera or in an American-made colorimetric analyzer as well. And you'll like the price, which could be as big a breakthrough as blue sensitivity.

Vactec also introduces a new line of PIN photodiodes that operate at high voltages, low noise levels, and fast rise times, with about half the blue sensitivity of the BES photodiode. For larger areas, Vactec offers a complete range of Blue Enhanced Silicon photovoltaic cells up to 1 1/8" diameter.

Vactec now supplies the broadest line of photodetectors in the industry, including:

- silicon solar cells
- hi-speed/low-leakage silicon cells
- NPN phototransistors
- NPN photodarlington
- CdS & CdSe photoconductors
- CMOS & bi-polar custom ICs
- opto-couplers
- a) LED/photoconductor
- b) LED/phototransistor or darlington
- c) lamp/photoconductor
- selenium photovoltaic cells

Call or write today:

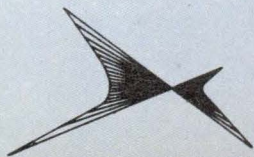

Vactec, Inc.

**2423 Northline Industrial Blvd.
Maryland Heights, Mo. 63043
(314) 872-8300**

Circle 131 on reader service card



Breakthrough in mass termination.

Lower-cost coaxial ribbon cable assemblies. In any length.

New AMP coaxial ribbon cable is just that—true coax in ribbon form. With no compromises.

No degradation in system performance.

Solves the long-existing coaxial cable termination problem.

We can provide complete assemblies for your specific requirements. In any length, with 6 to 26 positions. The assemblies come in 50-, 75- or 93-ohm ratings, on .100-inch grid spacing. And 95-ohm rating on .125-inch spacing. Connectors mate with .025² posts—either 90° board-mount pin headers or I-O posts.

Revolutionary patented concept with drain wire parallel to center conductor, permits low-cost gang stripping and terminating, and still further demonstrates AMP's leadership in quality solutions to termination problems.

For information on AMP coaxial ribbon cable that gives you true coaxial performance, and reasonable price, call (717) 564-0100, circle the Reader Service Number, or write AMP Incorporated, Harrisburg, PA 17105.

AMP is a trademark of AMP Incorporated.

Circle 133 on reader service card

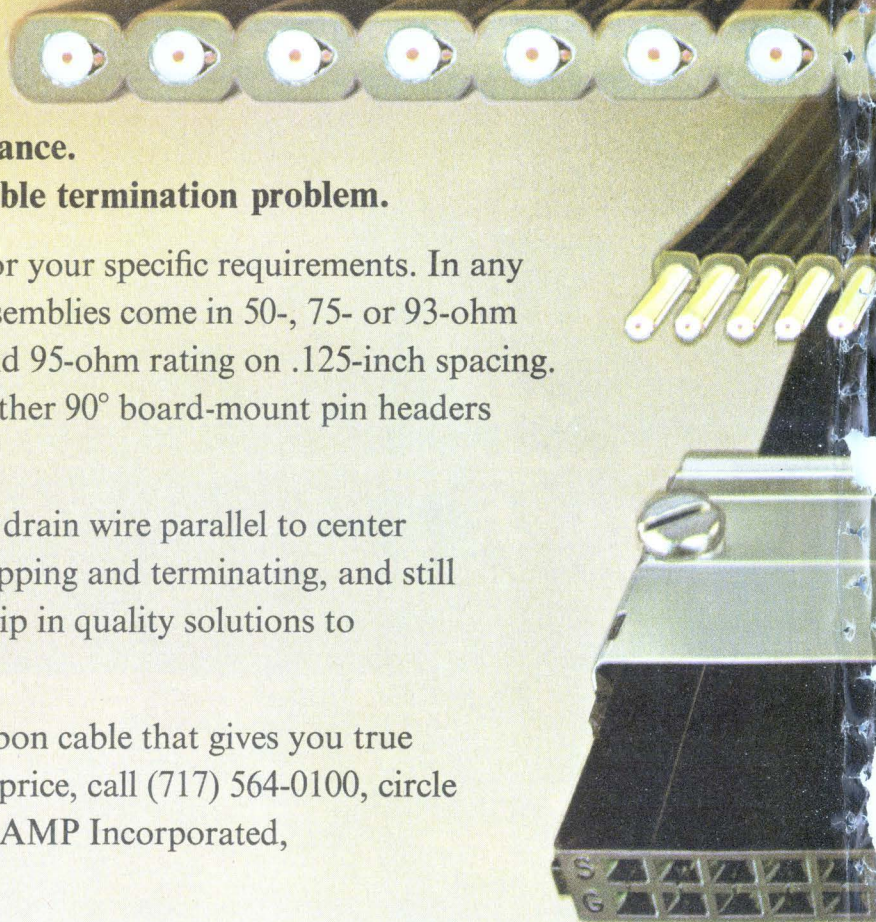

The ribbon is made up of individual coaxial cables, each with a solid center conductor and a foil-wrapped drain wire shield. The drain wire is not spirally wound around the dielectric, but runs parallel with the center conductor. This feature allows the cable to be cut anywhere and yet be consistently and reliably terminated.

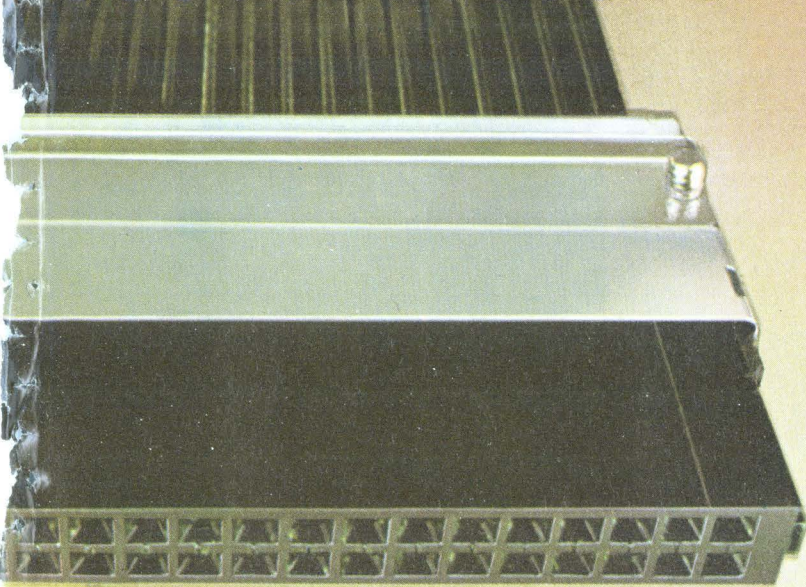
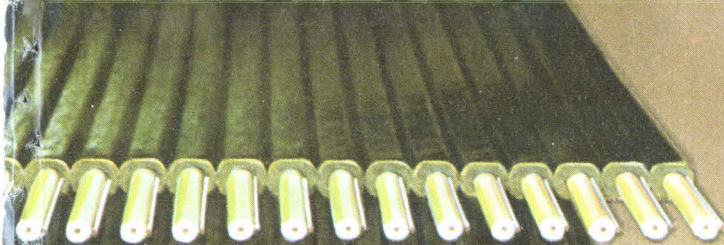
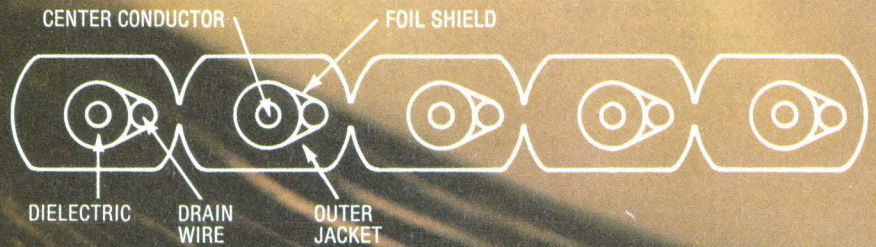

AMP
INCORPORATED

Why Parylene works where other microelectronic protection fails:

Controlled conformality

There's a uniform coating of parylene all the way around the half-mil tip of this phonograph needle. That's true conformality, and only parylene gives it, in precisely controlled thicknesses from .002 to 3 mils, in one step. Unlike spray or dip coatings, parylene won't bridge or puddle, or thin out at sharp edges, creating potential failure points. The parylene coating is completely uniform, no matter how dense or intricate the module. And because it's applied at room temperature, there's no component discomfort.

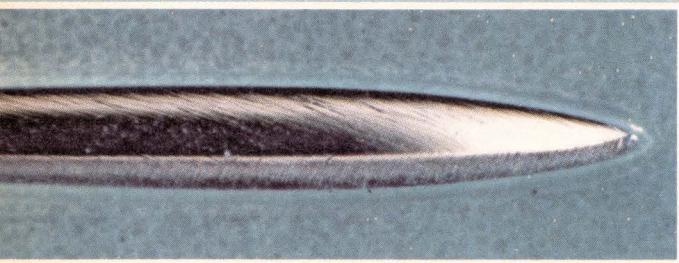

Crevice penetration in hybrids

This beam lead has a 0.3 mil parylene coating all the way to the weld. Parylene penetrates deep within small crevices, maintaining clearance while putting a coherent coating under beam leaded chips and air bridges. No area is left unprotected, preventing shorts and allowing the designer great latitude in component spacing and sizing. And parylene secures loose debris while preventing breakoff of pigtailed during shock and vibration loadings.

Lead Strengthening

It took up to 75 grams pull to break these 1 mil wires. Bare 1 mil aluminum wires, for instance, exhibit bond strengths of 3-5.5 grams; coated with 1 mil of parylene, pull strength increases by 60-70 grams.

So wire and bond are stronger, and sideward shorts and loop collapse during extreme g-loads are prevented. Parylene coatings will penetrate the less than 1 mil clearance between beam lead bonded chips and the substrate, giving such strong coating coverage that the chip cannot be lifted without destroying it.

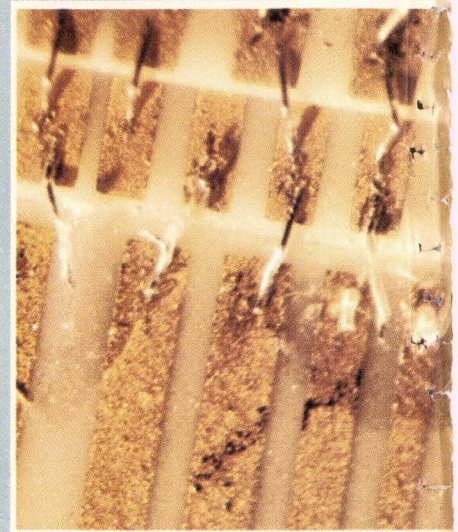

Δ200°C thermal shock protection

This hybrid microelectronics relay has undergone 200 45-minute cycles from -120 to 80°C, simulating earth-orbiting conditions. This X-ray shows all leads remain intact. Parylene protection was at work, on the transformer core and then the whole assembly before packaging (TO-116). There was no appearance of corona up to 5000 V_{dc}; leakage was reduced from 10μA to <.001μA at 1000V. RTV encapsulation suffered dimensional mismatch, straining and snapping leads, with 500 V/mil bulk breakdown.

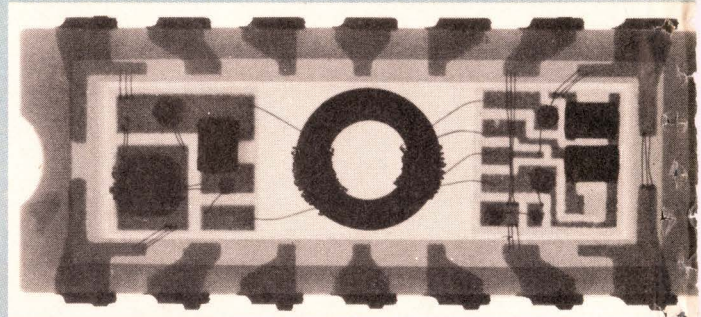

X-ray courtesy NASA Lewis Research Center and Sterer Eng. & Mfg. Co.

Broad cost effectiveness

These are some of the circuit modules now being protected with a conformal coating of parylene. Because nothing else offers parylene's combined protection against thermal cycling, shock, vibration, humidity, solvents, radiation, ionic contamination. Better barrier protection than liquid coatings like silicones, epoxies, and urethanes. On hybrids you can combine parylene with a hermetic seal for optimum environmental protection . . . and parylene alone will often do the job, and at less cost than hermetic seals. Parylene is compatible with active devices, and meets the tough requirements of MIL-I-46058C.

For long term reliability, parylene provides a cost-effective solution.

Union Carbide invented the parylene system. Various patents apply; commercial use of the patented technology is licensed. Write for our 16-page brochure: Union Carbide Corp., 270 Park Avenue, Dept. RFB-65, New York, N.Y. 10017. For instant communication, and information about a trial run at reasonable cost, call Bill Loeb at (212) 551-6071.



In Europe: Mr. H. Torre, Union Carbide Europe S.A., 5 Rue Pedro-Meylan, 1211 Geneva 17. In Japan: Mr. N. Fusada, Tomoe Engineering Co. Ltd., Shin Shin Kai Bldg., 14-1 Nihonbashi 3-Chome, Chuo-Ku, Tokyo.

Circle 134 on reader service card

New products

Semiconductors

IC converter is ion-implanted

8-bit analog-to-digital device uses p-channel MOS, will sell for \$7.95 in 100s

Combining an almost textbook circuit with its sophisticated high-yield ion-implanted p-channel MOS technology, National Semiconductor Corp., has built an eight-bit analog-to-digital converter that will sell for about \$7.95 each in 100-up quantities. Designated the MM4356/5356, the a-d converter contains a chain of 256 identical resistors connected in series, 255 analog switches, a high-impedance input comparator, output latches, and control logic on a single 120-by-123-mil monolithic chip.

In the 4356/5356, conversion is performed using a successive-approximation technique where the unknown analog voltage is compared to the voltages at the resistor tie points by means of analog switches. A 10-volt reference applied across the series-resistor chain establishes 256 precision voltages against which the unknown input voltage is compared by the switches under logic control.

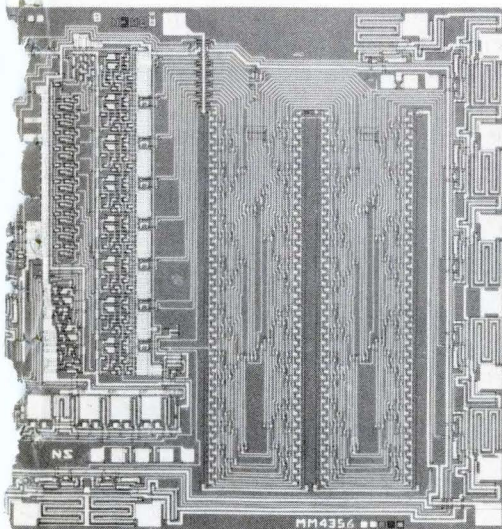

"This is the kind of circuit that is shown to a fledgling engineering student to explain in simple terms what an a-d converter is all about," says Dean Coleman, marketing manager for converter products at National. "Then the textbook is taken away and he's told that's not the way it's done in the 'real' world. Mainly, it's not done because it is extremely hard to match that many resistors, let alone get them all into a reasonably sized package."

What allows National to do this, says Coleman, is the use of ion implantation in conjunction with its LSI p-MOS technology. To form the resistors—which are in essence merely metal gates over p-channels—ions are implanted within a very shallow layer (typically 0.1 to 0.8 micrometer deep) along the silicon surface. The result is channels with a sheet resistance roughly 20 times greater than a correspondingly doped diffused layer of 2-to-4-micrometer thickness, and with matching tolerances on the resistor channels of about $\pm 1\%$. "This gives us the tight process control we need to control the matching on so many resistor channels without significantly raising the production costs or reducing the yields," Coleman says.

To the user this all translates into an 8-bit a-d converter with a linearity within half a least significant bit, an input impedance in excess of 100 megohms, and a conversion time of as little as 18 microseconds. Supply voltages are +5 V and -12 V, and power dissipation for the 18-pin epoxy B dual in-line package (4356) or the 18-pin ceramic DIP (5356) is approximately 170 milliwatts.

National Semiconductor Corp., 2900 Semiconductor Dr., Santa Clara, Calif. 95051 [411]

Line receivers and drivers operate at 35 megahertz

Signetics Corp. says its new set of tristate quad differential line receivers and drivers have double the in-

dustry-standard packaging density and, at 35 megahertz, double the industry-standard speed. The various operating modes of the drivers, which are designated the 8T100/101, are controlled by two lines. These lines can be manipulated to make the drivers operate in single-ended or multiplexed configurations. The tri-state capability—40-milliampere source at 1.8 volts and 40-mA sink at 0.5 V—allows disabled drivers in a multiplexed system to stay on a line without loading it. The differential feature, when used with a suitable line receiver, eliminates the troublesome ground loops and common-mode noise of single-wire transmission. The 8T101, unlike the 8T100, has clamping diodes from output to supply voltage on all drivers to suppress positive line reflections on the outputs.

The receivers, designated the 8T110/111, receive differential input signals and convert them to TTL levels. Common strobe and output-enable lines are provided for all the receivers.

Both receiver/driver pairs are driven by a single +5-V power supply; there is no need for a negative supply. All of the drivers and receivers are housed in 16-pin dual in-line packages and sell for \$3.84 each in 100-up quantities. Sample units will be available in July.

Signetics Corp., 811 East Arques Ave., Sunnyvale, Calif. 94086 [413]

Data-communications circuit designed for microprocessors

The latest data-communications circuit developed by Western Digital Corp. is a third-generation LSI device especially suitable for use with microprocessors. The programable model UR1671B asynchronous/synchronous transmitter/receiver (Astro) is apparently the only such chip on the market. The n-channel silicon-gate part interfaces a serial data-communications channel with a parallel digital system. Compatible with IBM Bisync and other commonly used communications modes,

...a first!

LSI in S/D MODULES

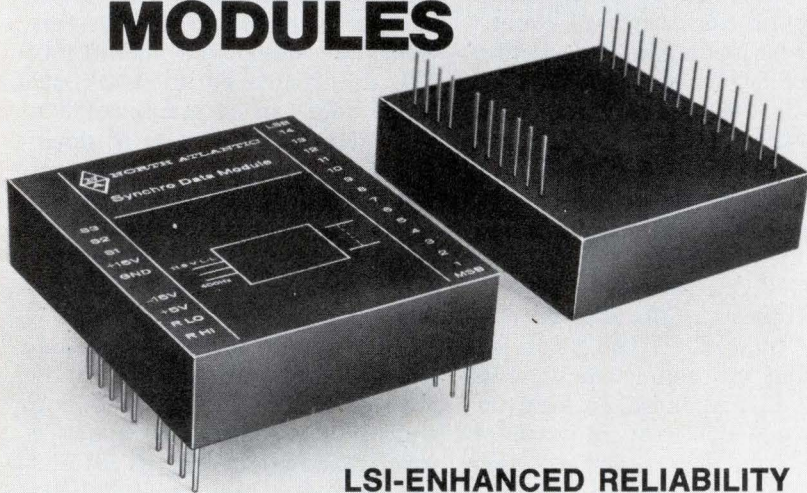

**LSI-ENHANCED RELIABILITY
HIGHEST SPEED & ACCURACY
DDC PIN-TO-PIN COMPATIBILITY
COMPANION D/S**

North Atlantic's LSI/85 series of S/D modules is today's choice. Why? Better performance and better reliability through an industry-first application of LSI! For example, 3-minute accuracy all the way up to 1440°/sec. And, operation to +85°C with an optional choice to +105°C. And even DDC pin-pin compatibility. Plus, the companion North Atlantic 785 D/S modules. And, most important to you, all this at more than competitive prices!

Both S/D and D/S series come in a full range of operating characteristics: 11.8V to 90V, 60Hz or 400Hz, 10-bit or 14-bit. Call your local sales representative today for all the good news about *the giant killers* with prices under \$500 in quantity.



NORTH ATLANTIC
industries, inc.

200 TERMINAL DRIVE, PLAINVIEW, NEW YORK 11803
phone: (516) 681-8600

Circle 136 on reader service card

DESIGN ENGINEERING
TECHNOLOGY AND CUSTOM
MANUFACTURING
FOR THE
ELECTRONICS INDUSTRY

PRECISION MACHINED
FINISHED PARTS AND CLOSE
TOLERANCE SHEET METAL
ASSEMBLIES
PROTOTYPES • PRODUCTION



**HARMONY ENGINEERING
CORPORATION**

200 NORTH THIRD STREET, MINNEAPOLIS, MINNESOTA 55401
CALL (612) 336-5784

LET US
SAVE YOU
TIME &
MONEY



New products

it can handle data rates as high as 1 megabaud.

The chip works on a multiplexed bus, of the kind used by microprocessors. Richard M. Perrin, manager of product design engineering at Western Digital, sees applications in all kinds of data-communications terminals, processors, and multiplexers.

In its synchronous mode, the Astro has selectable 5- or 8-bit characters and is synchronized after only two successive sync characters. On-line diagnostic capability is provided, as are overrun and framing for transmission-error detection and parity checks.

The TTL-compatible device is packaged in a 40-pin plastic cavity package and requires ± 5 volts and +12 v. The Astro is priced at \$30 in quantities of 100; samples are available now.

Western Digital Corp., 3128 Red Hill Ave.,
P. O. Box 2180, Newport Beach, Calif.
92663 [414]

Eight-channel digit driver can sink 500 mA/channel

Designed to interface low-power MOS circuitry with large, power-consuming light-emitting-diode displays, the DS8863 LED digit driver contains eight independent Darlington circuits, each of which can sink as much as 500 milliamperes. Offered in an 18-pin plastic dual in-line package, the unit requires a maximum of 2 mA of input current, so it can interface directly with MOS

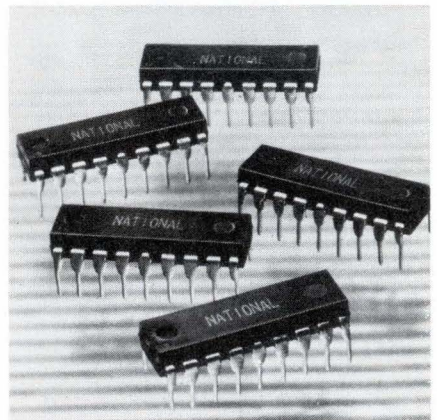

136 Circle 211 on reader service card

Electronics/June 12, 1975

This switch doesn't need an umbrella



If your product must work outdoors this sealed Cherry switch will work!

We built an umbrella *around* a switch . . . by putting our subminiature snap-action switch inside a sturdy housing and injection molding epoxy plastic that encapsulates the switch and leads to seal out dirt and moisture.

It's watertight and weatherproof. Making it the ideal switch for use in autos, trucks, boats, snowmobiles, power mowers, outdoor vending machines . . . just about any product subjected to extreme weather, dust, dirt, grease, grime or spray.

The watertight, weatherproof "inside switch" is our reliable E62 subminiature, proven over more than a decade in millions of demanding applications. In this new sealed switch design, its stainless steel coil spring mechanism and reliable rock-wipe contact action are protected by a double enclosure plus a rubber boot on the actuator. So that when it rains . . . it works!

TEST A FREE SAMPLE OF THIS NEW SEALED SWITCH. Just PHONE (312) 689-7700 or TWX (910) 235-1572, or write on your letterhead.

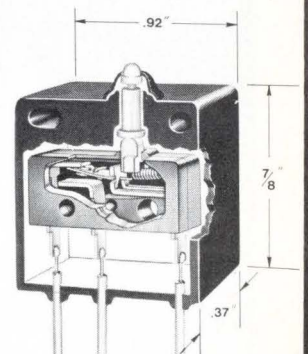

ACTUAL SIZE

We put a switch inside
. . . so it's watertight
and weatherproof!

CHERRY



CHERRY ELECTRICAL PRODUCTS CORP.

3608 Sunset Avenue, Waukegan, IL 60085

Cherry Worldwide: (Subsidiaries) Hirose Cherry Precision Co., Ltd., Tokyo • Cherry Mikroschalter GmbH, Bayreuth, Germany
• Cherry Electrical Products (U.K.) Ltd., St. Albans, Herts • (Licensee) G.W. Engineering Pty. Ltd., Sydney



Circle 137 on reader service card

Ben would have liked you.

Ben thought that there had to be more to lightning than just fire in the sky. So he ignored what people told him and did a little rainy-day research on his own.

Determined curiosity—like Ben's—has guided your imaginative progress in the microelectronics field. At Kodak, we have combined extensive research with a deep understanding of your industry, so that our skilled representatives can help improve your product or production techniques.

We try to make your job

a little easier, a little more efficient.

For more information about our products for microelectronics, write Eastman Kodak Company, Dept. 412L (48-C), Rochester, N. Y. 14650.

RESULTS COUNT

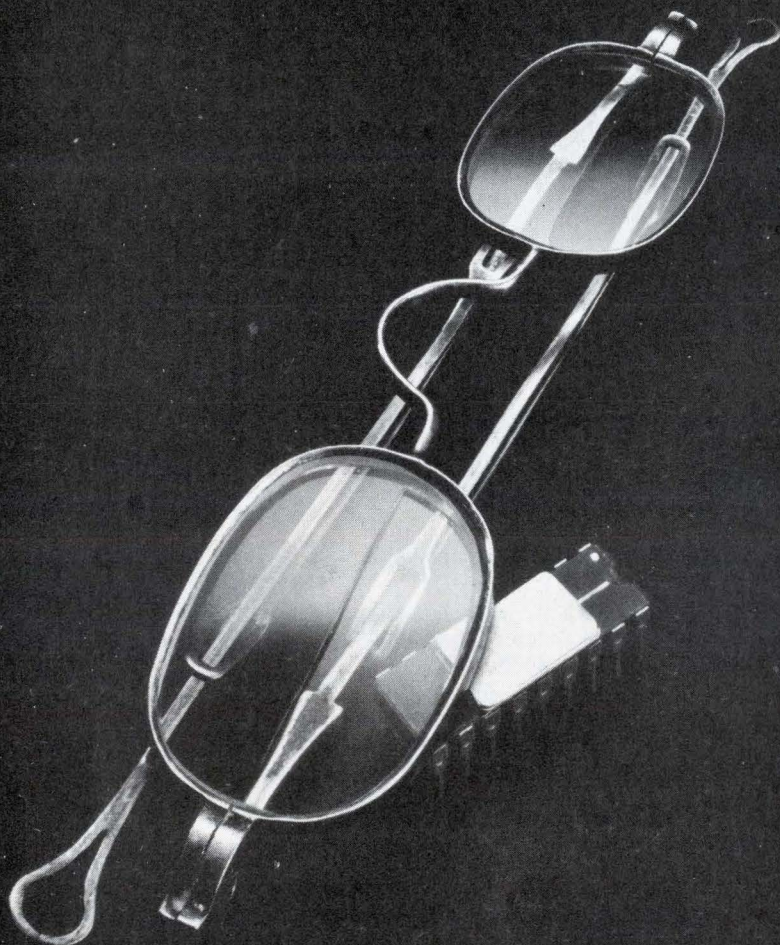

New products

clock and calculator circuits. The driver is designed for use in display systems that employ LEDs in a common-cathode multiplexed configuration. It is priced at \$2.70 in hundreds.

National Semiconductor Corp., 2900 Semiconductor Drive, Santa Clara, Calif. 95051 [416]

3½-digit dual-slope a-d converter is monolithic

Combining both analog and digital circuitry on a single silicon chip, the MN2301 is an auto-zeroing dual-slope a-d converter suitable for use in a 3½-digit panel meter. Needing only a system clock, an integrating capacitor, and two current reference supplies to generate 3½-digit binary-coded decimal outputs, the p-MOS device has an input resistance in excess of 1,000 megohms, a bias current below 100 picoamperes, and a voltage drift of only 3 microvolts per degree Celsius. Housed in a 28-pin dual in-line package, the MN2301 consumes less than 300 milliwatts from a standard ±15-v supply. The unit is priced at \$24 in lots of 100 pieces; delivery time is 30 days.

Analogic, Audubon Rd., Wakefield, Mass. 01880 [415]

10:1 frequency divider operates at 200 MHz

Able to operate at rates up to 200 megahertz, a frequency divider can be programmed by means of two ECL-compatible inputs to divide by either 10 or 11. The model SP8690 provides both true and inverted ECL outputs as well as a separate open-collector output for driving C-MOS or TTL circuits. Drawing only 14 milliamperes at 25°C, the device typically dissipates only 70 milliwatts and can supply 10 mA into an ECL load. The SP8690 vhf 10/11 divider is available in two versions: the SP8690A is rated over the full military temperature range from

Why you can afford the very finest in function generators.

Because Interstate's new F77 truly is a universal signal source. With F77's 0.00002 Hz to 20 MHz range, you can test with frequencies from infrasonics through video, and beyond. There are 6 output waveforms, 7 operating modes, and precision interface controls (waveform inversion and a 5/95% waveform variable symmetry vernier, for example) that can be actuated with remarkable variations. And output amplitude is specified at 15 volts p-p into 50 ohms — that's 50% more voltage swing than most 20 MHz function generators provide.

Because the F77 also incorporates a very capable, independent sweep generator offering linear and logarithmic performance, with a selection of auxiliary outputs. Sweep up or down, sweep reset control, and continuous, triggered, burst, sweep-and-hold modes, too. Interstate's special frequency dial has a direct-reading sweep limit cursor, plus two calibration scales (X1 and X2) to improve resolution and permit continuous tuning across the 20 Hz-to-20 KHz audio band.

Because this function generator is the first of its kind to deliver real pulse generator capability. The F77 produces a 15 ns rise time pulse to 20 MHz with



constant width setability from 30 ns to 10 milliseconds, and full offset and mode flexibility. The generator's fully-calibrated attenuator gives you 15-volt unipolar pulses into high impedance loads, particularly useful for testing MOS, or millivolt pulses down to 1.5 mv.

Because there's also a constant duty cycle pulse (in addition to F77's standard pulse) for a variety of digital signal response applications. Circuit sensitivity to duty cycle on/off times can be tested using varying pulse rates without adjusting the width control.

Because the F77 can be used as an analog power amplifier to amplify externally applied signals as much as 600%. Even TTL pulses can be amplified to drive 50-ohm loads, and the resulting output has controlled dc offset and attenuation.

Because the F77 gives you many other high performance and human engineering features, like VCF capability for sweeping frequency-sensitive devices, and "oscilloscope-style" triggering with a variable start-stop phase control to generate haversines and havertriangles. There's even a "brown-out" switch to allow the instrument to operate at low line voltages.

Because the F77 only costs \$1,095.*

*U.S. price; other 20 MHz Series 70 models available from \$695.

Subsidiary of A-T-O Inc.

INTERSTATE ELECTRONICS CORPORATION

707 E. Vermont Ave., P.O. Box 3117, Anaheim, California 92803 (714) 772-2811

Circle 139 on reader service card

This is a rack-full of counter capability.

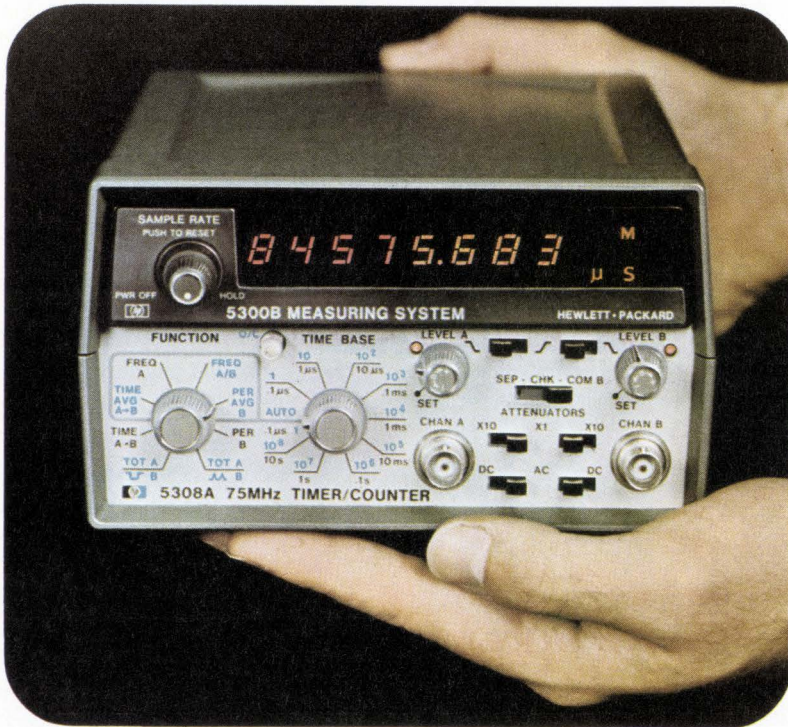

HP's new 75 MHz Timer/Counter is easily held in your hands. Take a look at the front panel: Never before has there been so much counting capability in such a small package at such a small price. Seven other modules snap on to convert to other instruments — including a DMM — or to connect to the HP Interface Bus.

Features include: 1 nsec time interval averaging • autoranging of frequency, frequency ratio, period average, time interval average • full complement of triggering controls, monitor LEDs • preset ECL and TTL thresholds • an astonishingly low price of only \$910* total for 5308A module with 5300B mainframe. *Domestic USA price only.

HEWLETT *hp* PACKARD

Sales and service from 172 offices in 65 countries.
1501 Page Mill Road, Palo Alto, California 94304

02503

Circle 140 on reader service card

Cost Cutter

NEW Electronics Buyers' Guide... Easy-to-use, single volume source for:

- Data on over 4,000 products
- Over 6,000 company listings and phone numbers.
- **EBG EXCLUSIVE:** quick access to over 1000 catalogs through a Direct Inquiry Service. The international world of electronics at your fingertips. Find suppliers... fast... accurately... and locally! For your copy send \$20.00 (USA and Canada only; elsewhere send \$30.00) to address shown below.

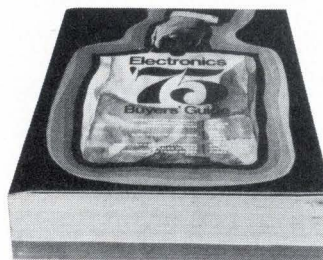

Electronics Buyers' Guide

A McGraw-Hill Publication
1221 Ave. of the Americas, New York, N.Y. 10020

New products

-55° to 125°C and sells for \$45 each in hundreds; the commercial model SP8690B is rated from 0° to 70°C and is priced at \$14 in similar quantities. Both units are housed in a 16-pin ceramic dual in-line package.

Plessey Semiconductors, 1674 McGaw Ave., Santa Ana, Calif. 92705 [417]

200-ns C-MOS static RAM pulls less than 50 nW/bit

A 512-bit complementary-MOS static random-access memory, the model 2222, has a typical access time of 200 nanoseconds and when operating consumes less than 50 nanowatts per bit. The device's standby power requirement is less than 4 nW/bit. Organized in a 512-by-1-bit configuration, the memory is expected to have applications in portable battery-operated equipment, military gear, and medical instrumentation—uses in which minimum power consumption is a major design consideration.

Housed in a 16-pin dual in-line package, the 2222 comes in two versions: the 2222D with a guaranteed access time of 350 ns, and the 2222AD with an access time of 450 ns. Pricing on the 2222D is \$30 each in small quantities and \$20 in hundreds. The 2222AD sells for \$18.75 in small lots, and \$12.50 for 100-up. Deliveries are from stock for small lots. Quantities of 1,000 to 5,000 pieces have a delivery time of four weeks, and 5,000 to 25,000 pieces require six to eight weeks.

Nortec Electronics Corp., 3697 Tahoe Way, Santa Clara, Calif. 95051 [418]

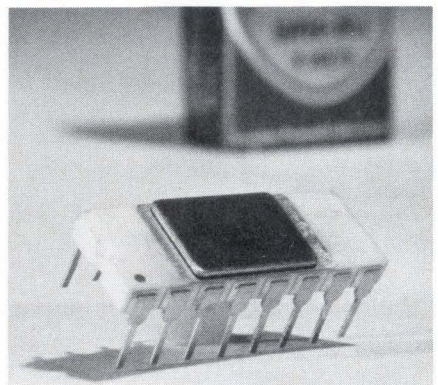

introducing the Solitron S² PAK

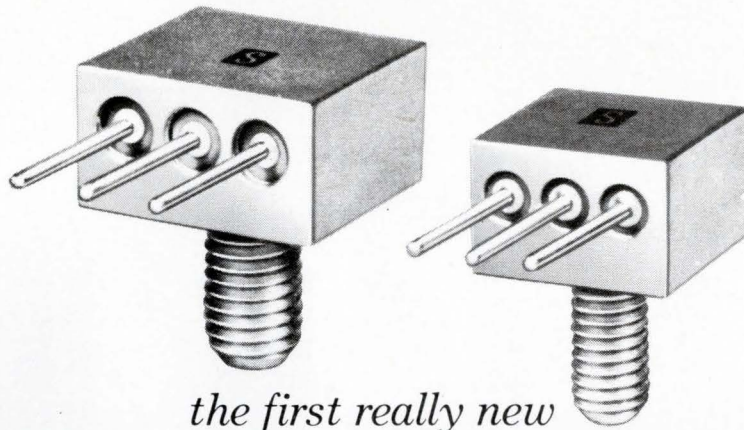

*the first really new
power transistor package design in years!*

Solitron announces the first major breakthrough in high reliability power transistor packaging in twelve years. We named it the S² PAK (Square Pack)...a 3-leaded low profile, seam-welded package that offers far greater reliability and performance than conventional cases used in space, military and industrial applications. □ Our S² PAK is of all copper construction with a steel stud and features an isolated collector.

It has the capability to handle up to two times more current than equivalent conventional types (typical S² PAK thermal resistance of 0.7° C/W as compared to 1.2° C/W for the same size chip). □ Now available in two sizes, the S² PAK-1 may be used as a replacement for the TO-111, and the S² PAK-2 for TO-61 and TO-63 versions.

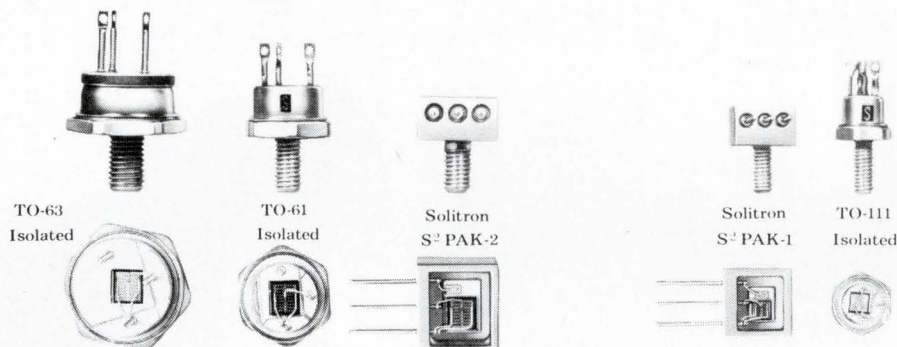

In comparison to conventional "TO" packages, significant S² PAK reliability and performance characteristics are:

- Increased power dissipation (higher wattage per unit area).
- Weld splash free devices (seam-welded process).
- Low profile compact construction — higher package density.
- Elimination of all external crimp-weld.
- Copper core ceramic feed-throughs, eliminating potential failure of pin separation.
- Capability of 300°C high temperature aging.

All Solitron SDT and JEDEC 2N type devices are offered by us now in S² PAK designs with standard leads or custom formed. Although a new design, current pricing for S² PAK cases in high reliability

applications is comparable to the cost of conventional packages.

For the full story on the Solitron S² PAK, including prices and delivery, contact us today.

Solitron
DEVICES, INC.

1177 Blue Heron Blvd./Riviera Beach, Florida 33404
(305) 848-4311/TWX: (510) 952-7610

PLANTS IN: CALIFORNIA • FLORIDA • NEW YORK • ENGLAND • HONG KONG • MEXICO

Compare Multiwire:™

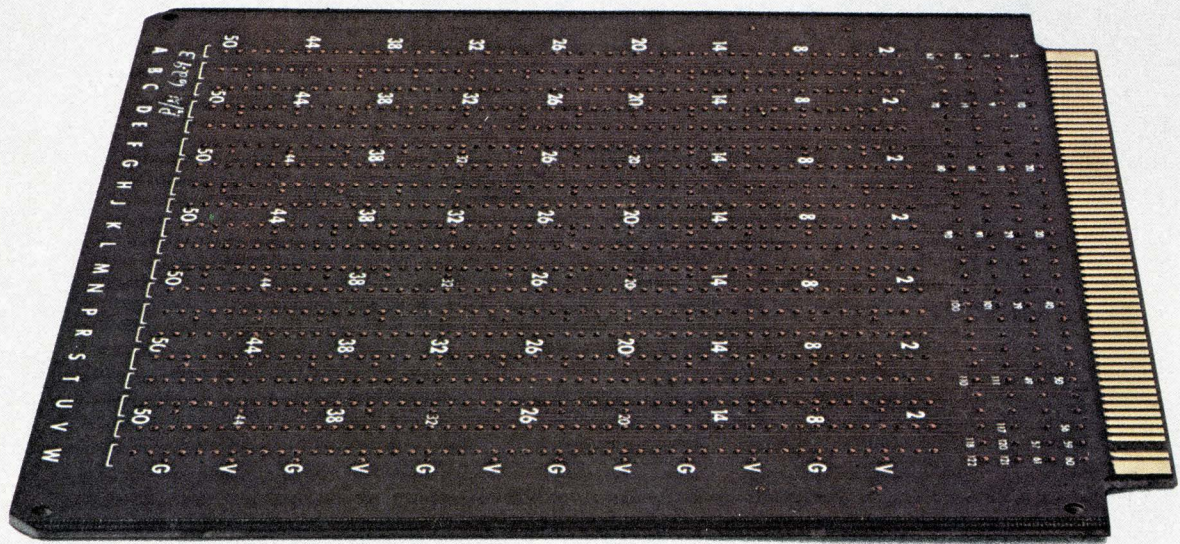

costs less than wirewrapping...

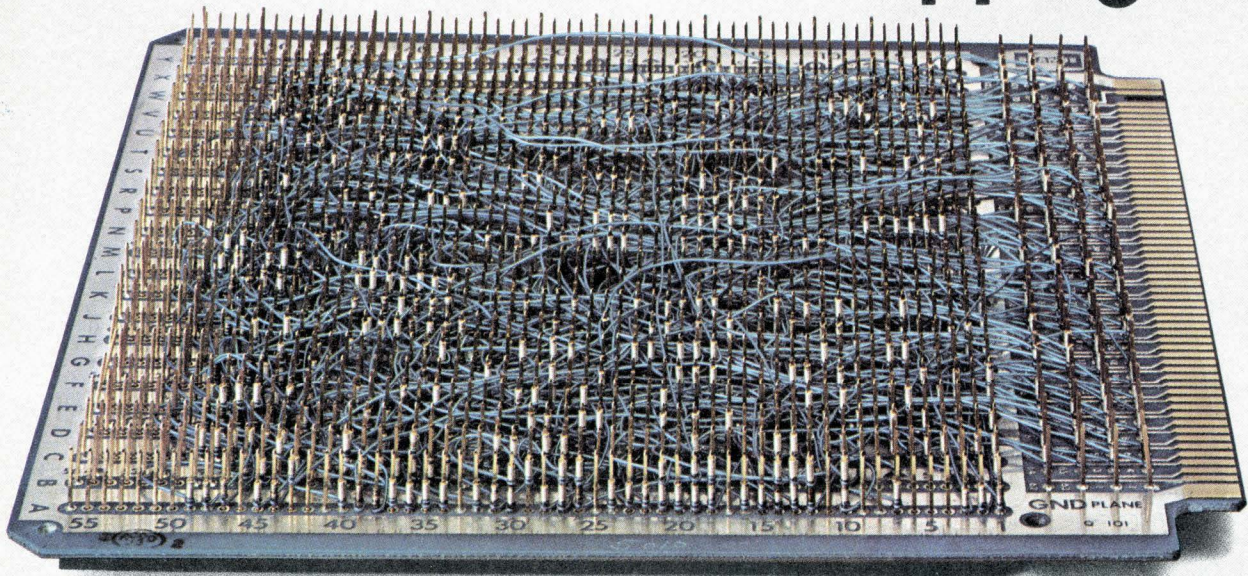

works better than multilayering.

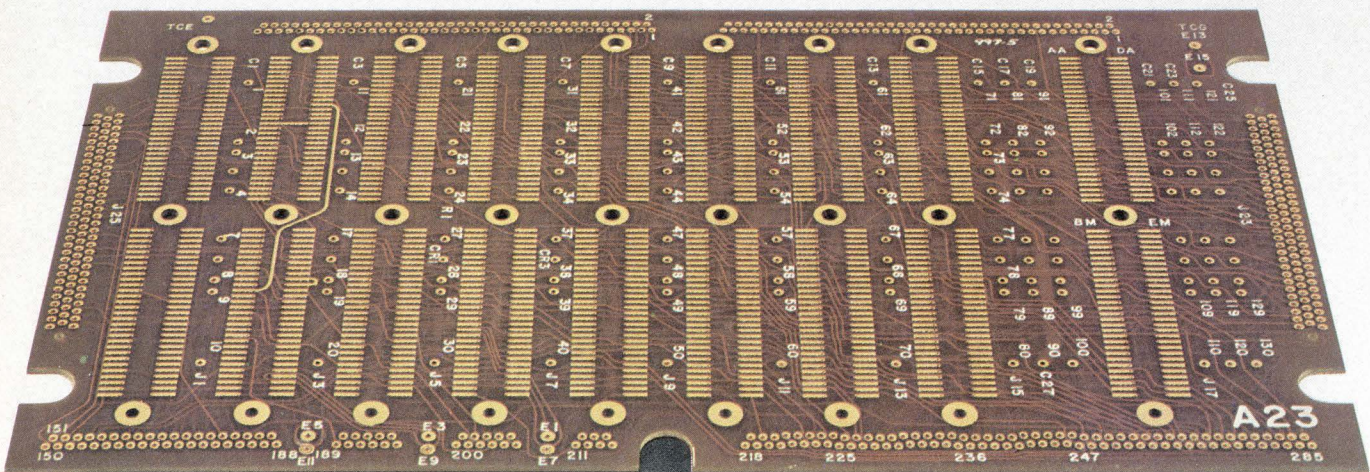

Two major systems — wirewrapping and multilayering — have been used for complex electronic interconnection in the last 15 years. Despite improvements and refinements, each still has inherent disadvantages. That's why Multiwire was created by Photocircuits. It overcomes the disadvantages of wirewrapping and multilayering.

A Multiwire board is basically a customized pattern of insulated wires laid down on an adhesive-coated substrate by a machine operating under numerical control.

Multiwire vs. wirewrapping.

Today, interconnection costs are more important than ever. So take a long, hard look at a key advantage of Multiwire panels. They cost much less than wirewrapping in small or production quantities.

Here's an example of how much less: a Multiwire replacement of a 60 DIP wrapped-wire panel. Total tooling costs were just \$750. In order quantities of 1000 pieces, the Multiwire boards at \$45 each were more than \$30 less than the wrapped-wire panel. (A 40% cost savings.) Multiwire prices also include a 100% continuity check.

But cost is not the only reason for the superiority of Multiwire over wirewrapping. There are also design advantages. For example, Multiwire offers two-dimensional packaging density equal to wirewrapping. But with Multiwire panels, you reduce board-to-board spacing. And Multiwire weighs much less too. So it can contribute substantially toward improving the envelope or three-dimensional package of your product.

Electrically, Multiwire is also superior. The extreme repeatability of the manufacturing process provides much higher electrical reliability as received — this is an important cost-saving factor. In addition, you get the controlled impedance characteristics required without variations.

Multiwire vs. multilayering

With Multiwire, reliability goes up and inspection cost goes down. Multiwire doesn't need extensive inspection — like multilayering does — for nicks, pinholes, hairline cracks, spacing violations and bridging. Yet Multiwire regularly yields better than 99% reliability at incoming inspection.

Compared to multilayering, designing a new Multiwire board is a far simpler operation. Component locations and a wiring list are all we need. Our computer-aided system does the rest.

Since the computer also takes care of deletions and/or additions, engineering changes are simplified. What's more, Multiwire makes it easier to find paths for interconnections, because the insulated wires can cross one another. For these reasons we can deliver finished Multiwire boards to your door in weeks rather than months.

The advantages of Multiwire over wirewrapping and multilayering vary from case to case. We'd like to help you evaluate possible time, cost, design and reliability benefits. For information and price estimates, call the Multiwire Marketing Department at 516-448-1111.

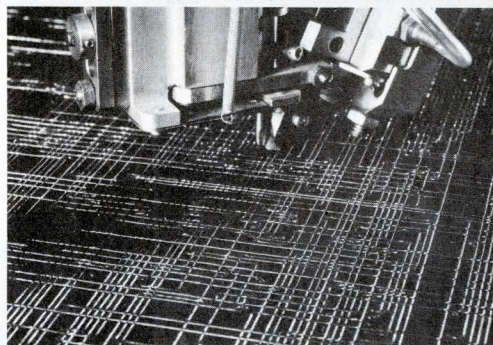
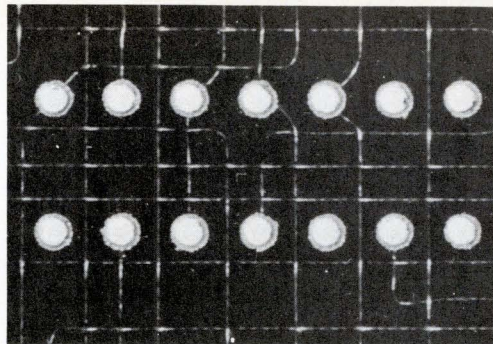

	Wrapped panels	Multi-layers	Multi-wire
Design & tooling cost	Low	Very High	Low
Design & tooling time	Short	Very Long	Short
1st piece delivery	Short to Very Short	Long	Short
Board cost in small quantities	High	High	Medium
Board cost in production quantities	High	Medium	Medium
2 dimensional packaging density	High	High	High
3 dimensional packaging density	Medium	High	High
Weight	High	Low	Low
Ease of changes	Excellent	Poor	Good
High speed electrical characteristics	Fair to Poor	Excellent	Excellent
Interchangeability with other techniques	Fair	Excellent	Excellent
Repairability	Excellent	Poor	Good
Controlled impedance	Poor	Good	Good
Electrical reliability as received	Fair	Good	Excellent

Multiwire from Photocircuits

Division of Kollmorgen Corporation, Glen Cove, New York 11542



Our computer selects the right Culligan water deionizer service system for you in 60 seconds!

First of all, with our DI Service System, you buy no water treatment equipment, do no regeneration or maintenance work. Your Culligan Man owns the deionizers, and he guarantees the performance. Installation is quick, takes minimum lead time.

Computer In-put—Your Culligan Man fills out a standard form which indicates the quantity, flow rate, and quality of ultra-pure water required. This, with a sample of your water, is

sent to our home office laboratory.

What Computer Does—It calculates the type and size of deionizers; number of service tanks; frequency of exchanges; gives efficiency ratings. Your installation is customized to be accurate, economical, flexible, top-performing.

Your Inquiry is Welcome—Simply call your local authorized Culligan dealer. His response will be prompt, and there is no obligation.

Culligan WE TREAT WATER SERIOUSLY™

Franchised dealers in the U.S. and 91 countries. Culligan International Headquarters, Northbrook, Illinois 60062. Franchises available.

Subassemblies

DIP unit converts 8 bits in 1.5 μ s

Hybrid analog-to-digital
converter consumes
maximum of 1.55 watts

Fast 8-bit analog-to-digital converters are nothing new, but the MN5100 from Micro Networks is the first to combine a maximum conversion time of 1.5 microseconds with a size allowing it to be housed in a 24-pin dual in-line package.

Further, the hybrid device can accommodate nine different voltage input ranges by means of a resistor network that is tapped at nine places and brought out to nine pins. This capability is a side benefit that comes from using a 24-pin DIP to house the converter—a move that was necessitated by the circuit layout employed to achieve the device's high speed.

The input voltage ranges are: 0 to +5 volts, 0 to +10 v, 0 to +20 v, 0 to -5 v, 0 to -10 v, 0 to -20 v, -2.5 v to +2.5 v, -5 v to +5 v, and -10 v to +10 v. This wide range of voltages means the same converter can be used in a variety of end products, thus simplifying purchasing, and cutting required inventories.

If the user is willing to sacrifice resolution for speed, the MN5100 can be connected to a simple external TTL circuit which makes it into a 6-bit converter with a 900-nano-second conversion time, or a 5-bit converter with a 600-ns conversion time. This trick aside, the MN5100 is a completely self-contained device requiring no external trimmers or other components to achieve its performance, which includes a maximum nonlinearity of half a least significant bit (LSB) over the temperature range from 0 to 70°C. Maximum full-scale error is 1 LSB over that range, and zero error is within half a LSB at 25°C.

The MN 5100 uses a standard

± 15 -v power supply plus a +5-v logic supply. Maximum total power consumption is 1.55 watts, although a typical figure is 1.1 w. This is half to a third of the power consumption of competitive units.

A military version of the converter, the MN5100H, is the same as the standard unit except that it meets its specifications over the temperature range from -55 to +85°C.

The MN5100 sells for \$195 in quantities of 1 to 24 pieces, while the MN5100H has a corresponding price of \$295. Delivery time is two to four weeks.

Micro Networks Corp., 5 Barbara Lane, Worcester, Mass. 01604 [381]

100-A switching supply regulates to within 0.01%

"Unique" is a word rarely applicable to power supplies, but a high-frequency switched supply from Adtech Power Inc. deserves the designation. The supply employs silicon controlled rectifiers, yet it operates at a high switching rate usually associated with transistor supplies. The result is a small unit with an output of 100 amperes at 5 volts and excellent regulation of under 0.02% variation for a 0 to 100% load current change, or for the 95- to 140-v line change that occurs in brown-outs, for example.

The secret to the supply is the Adtech Controfluxer tuned saturating inductor used for regulation. The Controfluxer provides inherent line regulation over the 95-to-140-v range, so only load regulation must be provided electronically. This is readily accomplished by exploiting the inductor's frequency sensitivity. The switching rate of the SCRs is constantly adjusted to keep the output on voltage. The switching itself occurs at the zero-crossing point, eliminating electromagnetic interference with both the load and input—a common problem with SCR supplies that use phase shifting to maintain regulation.

SCR supplies are considered more reliable than transistor supplies be-

cause of the smaller number of failure modes of the devices and the simpler circuitry. A single SCR can also handle higher current, and George Mousel, president of Adtech, says the same basic circuitry can be used for a 1,000-ampere supply. Multiple transistors would be required for much lower current. He also says higher voltages are easy to provide, and he expects many future high-power memory and computer systems to adopt a higher regulated voltage, such as 7 v, with on-card regulation of individual modules.

The power supply also maintains full regulation during shutdown, has automatic overvoltage protection, and folds back with overcurrent to 30% of output voltage rather than the typical 70%. Efficiency is high, as in all switching supplies, at 68% typical.

The unit operates from 120 to 180 v dc, or 95 to 140 v ac at 47 to 440 hertz. Higher voltages and three-phase operation are optional. The model CDS-5-100 is 16¼ inches long, 7⅞ in. wide, and 5-1/16 in. high. It weighs 17 pounds. Cooling is by convection, with no fan required, and operating temperature range is 0 to 40°C, derating to 30% at 70°C. The unit is priced at \$595 in single quantity; a 60-ampere version is \$25 less.

Adtech Power Inc., 1621 South Sinclair St., Anaheim, Calif. 92806. [390]

Plastic package cuts price of resistor nets

In its first significant move into the passive-component marketplace, National Semiconductor has started volume production of a family of thin-film plastic-packaged resistor networks selling for "much less" than 35 cents each in lots of 100,000. The 35-cent figure is significant because it is typical of the prices of thick-film resistor networks in ceramic packages. Hence, National hopes to be able to compete with thick-film networks—at least in applications for which users need net-

5PPM/°C and a 20 year end-of-life... all in Angstrom's new SAR precision metal film resistors!

And that's not all! The new SAR Series of precision resistors is backed by Angstrom's 15 year old reputation for providing a quality product that will outlast the equipment it's used in. Write for complete technical specifications today!

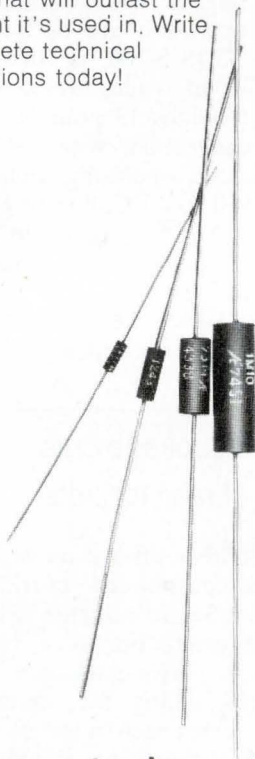

**angstrom
precision, inc.**
one precision place
hagerstown, maryland 21740
telephone: 301-739-8722
twx: 710-853-6834

New products

works in very large quantities. Ceramic-packaged thin-film networks typically sell for several dollars per device as does the recently introduced plastic-packaged thin-film network by Beckman [*Electronics*, May 29, p. 139].

Dean Coleman, National's resistor products marketing manager, says the RA07, RA08, RA12, RA13, RA14, and RA15 family are arrays of seven to 15 equal-value resistors packaged in high-reliability epoxy-B dual in-line packages—the same ones used in the firm's MOS, linear, TTL, and transistor lines.

The six basic types in National's new line, he says, will contain 77 values in each type, or 462 values in the entire product line—from 22 ohms to 100,000 ohms. All have absolute value tolerances of $\pm 2\%$ or 2 ohms, whichever is larger.

Many designers are afraid to use plastic thin-film resistor networks, arguing that an hermetic ceramic package is needed to protect the thin films from moisture. Coleman admits that ceramic packages are more resistant to environmental conditions. "But," he says, "in most circuit situations, ceramic is unnecessary. Ceramic meets and exceeds by many orders of magnitude the specifications of the circuit designer—and he pays for it. Our epoxy-B molded-plastic process meets the realistic needs of the designer and at a much lower cost."

Testing the devices, in most cases, he says, is much more stringent than it is for ceramics. The devices are all put through a 1,000-hour moisture-and-temperature-resistance test at 85° C and 85% humidity. "In 1.5 million resistor-test hours, typically only two to three resistors have drifted," he says.

Resistor matching is within 0.2%.

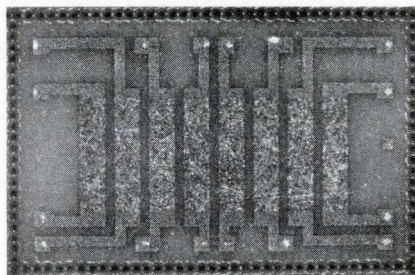

and absolute temperature coefficient is 80 ppm/°C. Maximum power dissipation is 0.25 watt per resistor and 2 W per package at 25°C. Overload resistance shift is 0.5%, maximum; rise time is 5 nanoseconds.

National Semiconductor Corp., 2900 Semiconductor Dr., Santa Clara, Calif. [383]

Data-acquisition system made for IMP microcomputer

Designed to work with National Semiconductor's IMP microprocessor series, the DT1721 data-

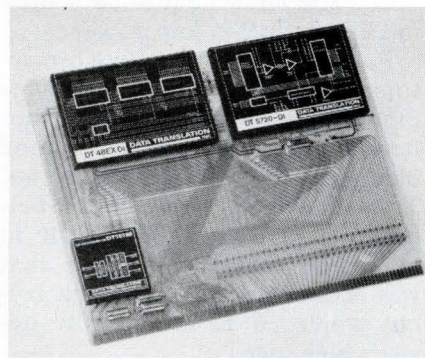

acquisition system includes a 12-bit analog-to-digital converter, a sample-and-hold amplifier, up to 64 channels of analog multiplexing, and an isolated power supply. Offered on a standard 8.5-inch-by-11-in. IMP board, the system, in its 16-channel configuration, sells for \$725 in unit quantities. President Fred Molinari claims that the DT1721 is the first low-cost analog peripheral designed specifically for a major microcomputer. Delivery of the system is from stock to two weeks.

Data Translation Inc., 109 Concord St., Framingham, Mass. 01701 [384]

D-a converter contains another d-a converter

Within its modular DAC1132 digital-to-analog converter, Analog Devices Inc. has placed another one: the two-chip AD562, a converter

New from Potter & Brumfield

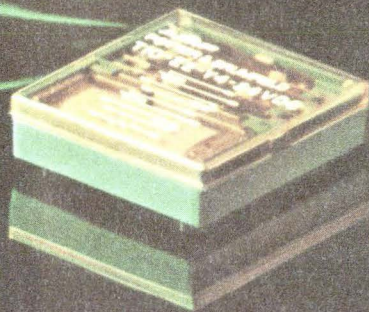

The lowest profile 3 amp relay we've ever offered!

The P&B T10 Series relay is lower than many other circuit board components. Only 0.375" high, it's ideal for high-density applications. Permits pc boards to be mounted on 0.5" centers!

T10 relays provide 0.1 to 3 ampere switching @ 30VDC. Coil ratings are 6, 12, 24, and 48VDC. Permissive make, gold-flashed silver contacts are noted for low contact bounce, long operating life. Bifurcated contacts for low level switching are available on special order.

Designed for low cost general purpose applications, the T10 is ideal for use in tele-communications, copy and reproduction machines, computer and peripheral equipment.

For additional information, contact the Potter & Brumfield sales representative or authorized distributor nearest you, or write Potter & Brumfield Division AMF Incorporated, Princeton, Indiana 47671. Telephone 812 385 5251.

Potter & Brumfield

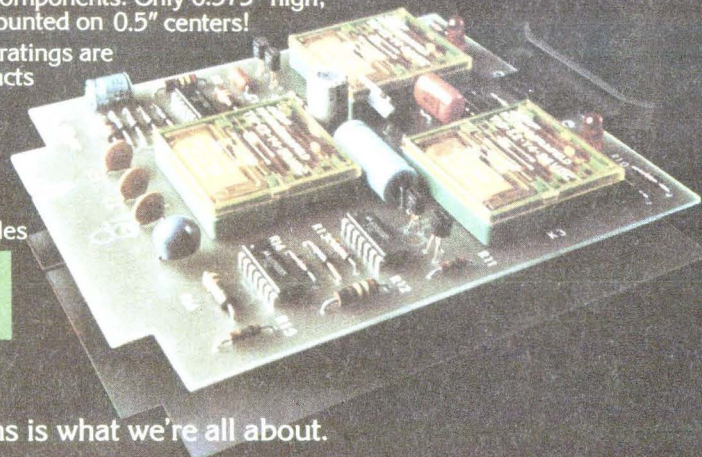

Solving switching problems is what we're all about.

Circle 147 on reader service card

Dialight sees a need:

(Need: The widest choice for your every application.)

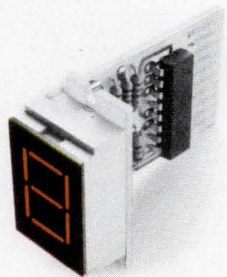

730 SERIES Your choice . . . a red or green LED readout with large 0.625" characters . . . low power, operates with standard IC power supply levels. Comes in plus-minus module. Display uses standard or high brightness LEDs for maximum light output arranged in a seven-segment format. Available with or without on-board decoder/driver. Unique lens design generates bright, highly legible characters.

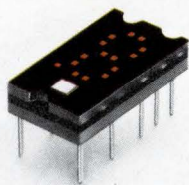

745-0007 LED hexadecimal display with on-board logic operates from 5 to 6 volt supply, low power consumption. Integral TTL MSI chip provides latch, decoder and drive functions. 0.270" character display has wide angle visibility and mounts into standard 14-pin DIP socket.



Dialight, the company with the widest choice in switches, LEDs, indicator lights and readouts, looks for needs . . . your needs . . . and then they develop solutions for your every application. No other company offers you one-stop shopping in all these product areas. And no other company has more experience in the visual display field. Dialight helps you do more

with these products than any other company in the business, because we are specialists that have done more with them. Talk to the specialists at Dialight first. You won't have to talk to anyone else. Send for your free new copy of Dialight's current catalog.

DIALIGHT

Dialight, A North American Philips Company
203 Harrison Place, Brooklyn, N. Y. 11237
(212) 497-7600

See Dialight.

New products

which consists of precision current switches and a highly stable thin-film resistor network [*Electronics*, Oct. 3, 1974, p. 139]. In addition to the AD562, the DAC1132 contains a precision reference source, a fast output amplifier, and an input storage register built in standard transistor-transistor logic. A complete 12-bit converter, the DAC1132 requires only two external potentiometers for gain and offset adjustments. It is packaged in a 2-by-2-by-0.4-inch module and is priced at \$159 for one to nine units.

The DAC1132 has two unipolar and three polar output ranges: 0 to +5 volts, 0 to +10 v, -2.5 to +2.5 v, -5 to +5 v, and -10 to +10 v, all at 10 milliamperes. The unit has a maximum nonlinearity of less than half a least significant bit, plus a settling time of 2 microseconds to within 0.01% of final value for a 10-v step. Monotonicity is guaranteed over the full temperature range from 0 to 70°C.

A companion a-d converter is reported to be on the way. Analog Devices Inc., Route 1 Industrial Park, Norwood, Mass. 02062 [385]

100-kHz f-to-V converter has less than 5 mV ripple

Available in three different temperature-coefficient versions, the model 911 frequency-to-voltage converter typically has less than 5 millivolts of peak ripple on its out-

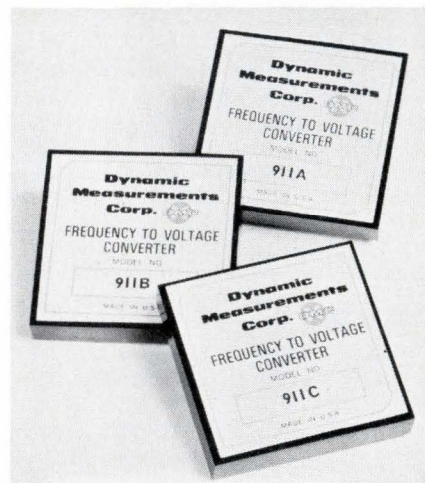

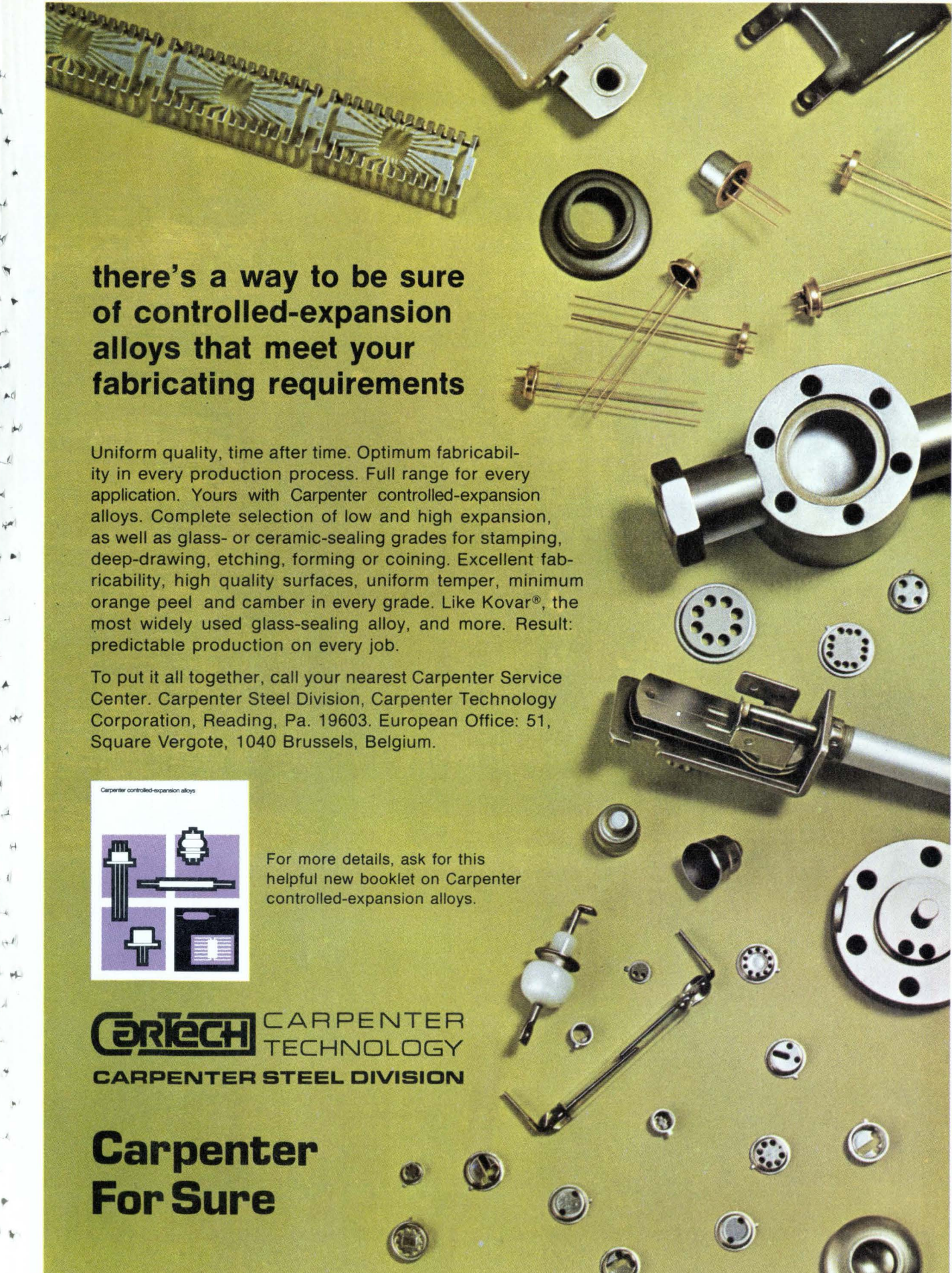

**there's a way to be sure
of controlled-expansion
alloys that meet your
fabricating requirements**

Uniform quality, time after time. Optimum fabricability in every production process. Full range for every application. Yours with Carpenter controlled-expansion alloys. Complete selection of low and high expansion, as well as glass- or ceramic-sealing grades for stamping, deep-drawing, etching, forming or coining. Excellent fabricability, high quality surfaces, uniform temper, minimum orange peel and camber in every grade. Like Kovar®, the most widely used glass-sealing alloy, and more. Result: predictable production on every job.

To put it all together, call your nearest Carpenter Service Center. Carpenter Steel Division, Carpenter Technology Corporation, Reading, Pa. 19603. European Office: 51, Square Vergote, 1040 Brussels, Belgium.

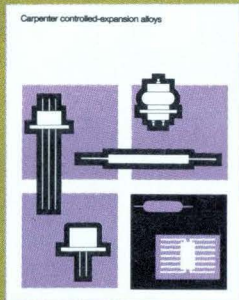

For more details, ask for this helpful new booklet on Carpenter controlled-expansion alloys.

CARTECH CARPENTER
TECHNOLOGY
CARPENTER STEEL DIVISION

**Carpenter
For Sure**

Hewlett-Packard introduces
a smaller uncompromising calculator,

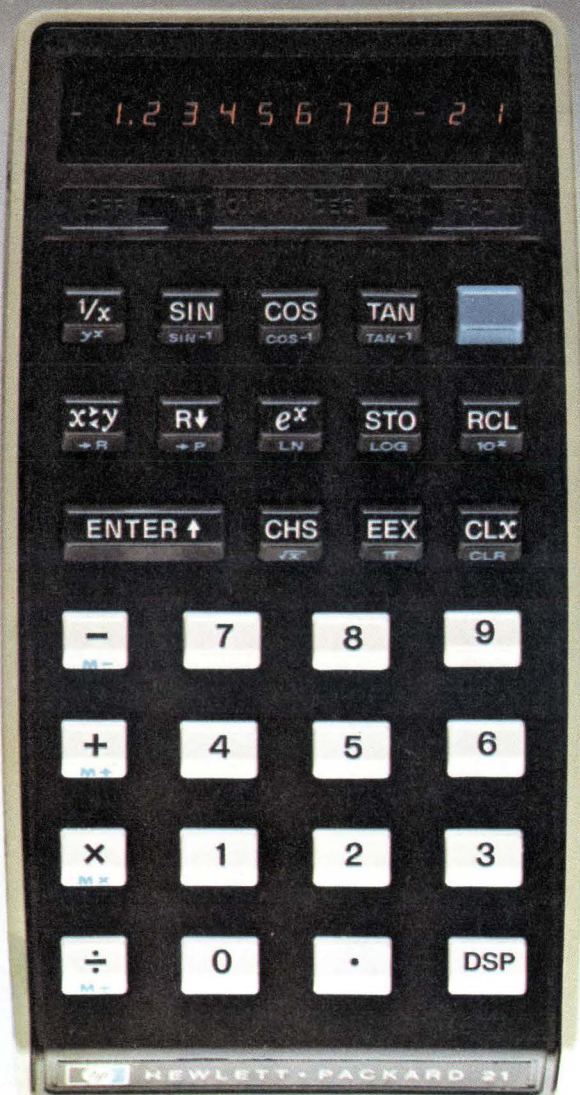
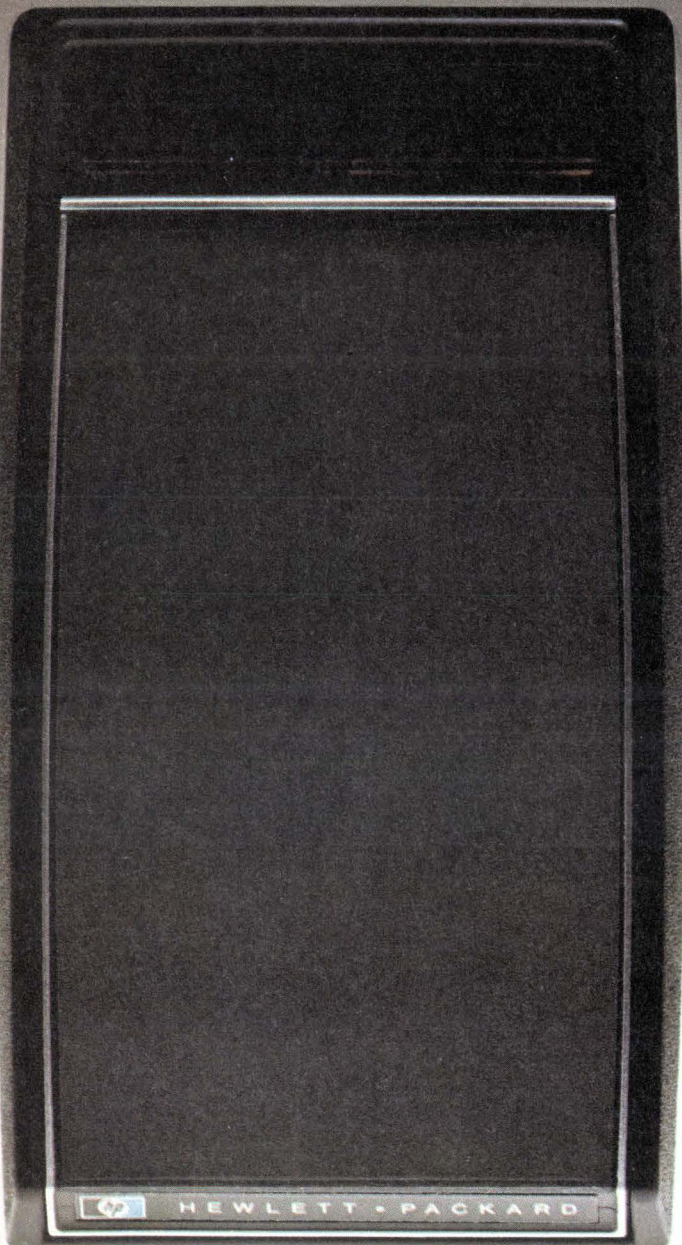

the new HP-21 Scientific. \$125.00*

Now \$125.00* buys:

- **32 pre-programmed functions and operations**, including rectangular/polar conversion, register arithmetic and common log evaluation.
- **Smaller size.** 6 ounces vs. 9 ounces for our traditionally-sized pocket calculators.
- **Display formatting.**
- **HP's unique and efficient RPN logic system.**
- **HP's quality craftsmanship.**
- **An unbeatable price:performance ratio.**

Here are the details:

32 pre-programmed functions and operations. The HP-21 performs all log and trig functions, the latter in radians or degrees. It's our only calculator short of the HP-45 that lets you:

- convert polar to rectangular coordinates, and back again ($\rightarrow P, \rightarrow R$);
- do full register arithmetic ($M+, M-, M\times, M\div$);
- calculate a common antilog (10^x) with a single keystroke.

The HP-21 also performs all basic data manipulations ($1/x, y^x, \sqrt{x}, \pi$) and executes all pre-programmed functions in *one second or less*.

Full display formatting. The Display key (DSP) allows you to choose between fixed decimal and scientific notation and lets you control the number of places displayed. (The HP-21 always uses all 10 digits internally.)

When a number is too large or small for fixed decimal display, the HP-21 switches automatically to scientific, so you never have to worry that the calculator will confuse a smaller number with zero.

Finally, if you give the HP-21 an impossible instruction, the Display spells E-r-r-o-r.

RPN logic system. Here's what this unique time-and-error-saving logic system means for you:

- You can evaluate *any* expression without copying parentheses, worrying about hierarchies or re-structuring beforehand. Your calculator remembers what's where—automatically.
- You can solve *all* problems your way—the way you first learned in beginning algebra, the way you now use when you use a slide rule.

- You solve *all* problems—no matter how complex—one step at a time. You *never* work with more than two numbers at once.
- You get continuous and immediate feedback. You see *all* intermediate answers *immediately*, because your calculator executes each function immediately after you press the function key. *You watch it happen.*
- You can easily recover from errors. You can back-track when you err, because your calculator performs all operations sequentially.
- You can re-use numbers without re-entering them. Your calculator becomes your scratch pad.

HP quality craftsmanship. One reason Nobel Prize winners, astronauts, conquerors of Everest, America's Cup navigators and over 750,000 other professionals own HP calculators. Here are four examples of it:

- Every key on every calculator is double injection molded, so the symbol it carries won't wear off. Every function key has a positive click action, so you know for sure the function has registered when you press one.
- There's a moisture barrier under the keyboard to protect the calculator's innards from coffee, tea, milk, what-have-you.
- It's no accident that the OFF-ON switch operates as smoothly as it does. We greased it with silicone when we installed it. It's also no accident that it moves in a horizontal plane. That's to prevent it from moving when you put the calculator into its carrying case or your shirt pocket.
- The heavy gauge plastic case is designed to withstand a long tumble to a hard floor. Incredibly, one HP pocket calculator once withstood a trip through a snow-blowing machine. The case cracked, but the machine worked.

800-538-7922 (in Calif. 800-662-9862). The numbers to call for a "hands-on" demonstration. We'll give you the name of a dealer near you, and we'll send you detailed specifications of our new HP-21. Challenge it with your problems. See for yourself how much performance \$125.00* can buy.

HEWLETT  PACKARD

Sales and service from 172 offices in 65 countries.
Dept. 214T, 19310 Pruneridge Avenue, Cupertino, CA 95014

Circle 151 on reader service card

Today, it makes more sense than ever to test the big 3 against it.

MATSUO DIPPED TANTALUM CAPACITORS

1. ✓ **Matsuo builds them better & pretests longer** Matsuo builds on lead frames — the quality mode of construction. Then pretests for 48 hours at full voltage.
2. ✓ **Matsuo has lowest failure rate** Our standard failure rate is only 2% per 1,000 hours — 60% confidence level. Selected units at 1% per 1,000 hours. What we deliver, delivers!
3. ✓ **Matsuo provides better leakage control** Our standard units are .01XCV. Selected capacitors are .001XCV. Ten times better when you need it.
4. ✓ **Matsuo saves costly assembly time** Matsuo lead spacing is fixed — always the same to fit assembly board quickly, easily. Positive leads are longer — touch tells assembler, eliminates examining. Leads are square — "bite" corners so Dip stands upright even during soldering. Each feature saves you costly assembly minutes.
5. ✓ **Matsuo prices are competitive and then some** All the features, all the quality are yours at unbeatable prices. Test us here, too!

These days with Dipped Tantalum Capacitors readily available, shouldn't you be sure you're getting the most for your money. All we ask is that you test Matsuo Dips against the one you're using. And that, we think, says more about the way we build our Dips than anything else!

For engineering samples, literature, prices, write or call

MATSUO ELECTRONICS

831 SO. DOUGLAS ST., EL SEGUNDO, CA 90245 / (213) 679-0379

New products

put and is linear within 0.01% from 10 hertz to 100 kHz. Capable of supplying 20 milliamperes, the unit sells for \$78 in small quantities in its 30-ppm/°C version. Higher-priced versions have tempcos of 20 ppm/°C and 10 ppm/°C. The 911 family, which is packaged in standard 2-by-2-by-0.4-inch modules, is available from stock.

Dynamic Measurements Corp., 6 Lowell Ave., Winchester, Mass. 01890 [386]

Hybrid units convert

12 bits in 10 microseconds

Two analog-to-digital converters, the ADC85C and the ADC85, are capable of making 12-bit conversions in 10 microseconds or 10-bit conversions in 6 μ s. The converters have operating temperature ranges of 0 to 70°C and -25 to 85°C for the ADC85C and ADC85, respectively. Each unit is complete with an input-buffer amplifier, a reference, and a user-adjustable clock. All they need to become operational are power supplies of ± 15 v and +5 v plus logic-control signals. The converters can handle five input ranges: 0 to +5 v, 0 to +10 v, and ± 2.5 , ± 5 , and ± 10 v. Three parallel digital output codes are offered: complementary bipolar offset binary (COB), complementary two's complement (CTC), and complementary straight binary (CSB). The CSB and COB codes are also available in serial form.

The converters are linear to within 0.0122% $\pm 1/2$ LSB for the 12-bit models and within 0.05% $\pm 1/2$ LSB for the 10-bit units. If the user is willing to trade off a couple of bits for increased speed, the ADC85 has a short-cycle feature that allows it to convert 8 bits in only 4 μ s.

Pricing on the converters, in quantities of one to 24 pieces, is \$160 for the 10-bit ADC85C, \$185 for the 10-bit ADC85, \$195 for the 12-bit ADC85C, and \$225 for the 12-bit ADC85. Small-quantity deliveries are from stock to about two weeks.

Burr-Brown, International Airport Industrial Park, Tucson, Ariz. 85734 [387]

digital or analog



Heath's new power supplies set new performance standards

- Choice of four DC outputs: 0-7.5 V, 0-15 V, 0-30 V or 0-60 V
- 3½-digit or 3½" meter readout
- Constant voltage and constant current operation
- Remote voltage and current programming
- Precise load and line regulation — ±0.05% voltage, ±0.1% current
- Complete output protection
- Remote sensing automatically compensates for lead voltage drops
- Available factory assembled or in easy-to-build kit form

Heath's versatile new 2700-Series DC power supplies do much more than just provide the right voltage and current — they set new standards for precision and ease of operation.

Digital or analog readout. These power supplies are the first in their price range to offer a choice of readouts. The digital models have two-decade autoranging to provide high resolution for low voltage and current settings.

Constant current and constant voltage operation. And it's true constant current, not simple current limiting. Adjust two controls to get the voltage and current you need. And if one supply doesn't deliver exactly the output you require, just connect them in series or parallel — with no loss of regulation!

Remote programming and sensing. For systems use and remote applications, both voltage and current can be programmed. And all supplies provide remote sensing at the load to automatically compensate for voltage drops due to long leads and connectors.

Output protection. You don't have to worry about these power supplies. Short circuit operation or accidentally applied high voltages can't harm them.

All 2700-Series power supplies are available in easy-to-build kit form or completely factory assembled and calibrated. Either way you get a power supply that offers more performance per dollar than anything the competition can offer. Send for the latest Heath catalogs and get complete details.

Model	Readout	Maximum Rated Output		Price*
		Volts	Cur.	
IP/SP-2700	Analog	60 V	1.5 A	\$169.95 kit \$255.00 assem.
IP/SP-2701	Digital	60 V	1.5 A	\$219.95 kit \$340.00 assem.
IP/SP-2710	Analog	30 V	3.0 A	\$169.95 kit \$255.00 assem.
IP/SP-2711	Digital	30 V	3.0 A	\$219.95 kit \$340.00 assem.
IP/SP-2720	Analog	15 V	5.0 A	\$169.95 kit \$255.00 assem.
IP/SP-2721	Digital	15 V	5.0 A	\$219.95 kit \$340.00 assem.
IP/SP-2730	Analog	7.5 V	10.0 A	\$169.95 kit \$255.00 assem.
IP/SP-2731	Digital	7.5 V	10.0 A	\$219.95 kit \$340.00 assem.

HEATH COMPANY		HEATH Schlumberger	
Dept. 510-060 Benton Harbor, Michigan 49022			
<input type="checkbox"/> Send my free '75 Heathkit Catalog. <input type="checkbox"/> Send my free Heath Assembled Instruments Catalog.			
Name _____			
Title _____			
Address _____			
City _____		State _____ Zip _____	
*MAIL ORDER PRICES; F.O.B. FACTORY. TE-323			
PRICES & SPECIFICATIONS SUBJECT TO CHANGE WITHOUT NOTICE.			

Circle 153 on reader service card

Compare The Data.

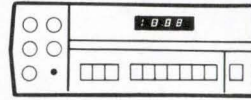
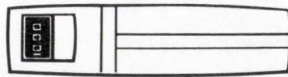

		HP970A	Fluke 8000A	Data Precision 245
Number of Digits		3½	3½	4½
Functions	DCV, ACV, Ohms	Yes	Yes	Yes
	DCmA, ACmA	With ext. shunts (\$47)	Yes	Yes
Resolution		.09%	.05%	.005%
Normal Maximum Display		1099	1999	19999
Overrange		10%	100%	100%
Ranging		Auto only	Manual only	Manual only
Basic DC Accuracy		±(.7% rdg. ±.2% range)	±0.1% reading ±1 LSD	±.05% reading ±1 LSD
Display Size		.125"	.250"	.33"
AC Freq. Response		45Hz-3.5KHz	45Hz-20KHz	30Hz-50KHz
Recharge While Using		No	Yes	Yes
Price (with batteries)		\$310	\$349	\$295

From manufacturers' published specifications.

Here's a comparison of the three leading portable digital multimeters.

The top three.

Data Precision, Fluke and Hewlett-Packard.

But the word "leading" in this case can be very misleading.

Because only one of the three — Data Precision's Model 245 — is a 4½ digit instrument. All of the others are 3½.

Check the facts and figures.

Compare the price, accuracy, resolution and features.

We think the Model 245 speaks for itself.

**Data Precision Corporation,
Audubon Road,
Wakefield, MA 01880
(617) 246-1600**



DATA PRECISION®
...years ahead

New products

Components

Solid-state relay works at 400 Hz

Rated at 140 or 280 V ac, the unit is offered in versions from 2.5 to 40 A

Most solid-state relays are designed to operate at normal 50- or 60-hertz line frequencies and will not perform properly on the 400-Hz power of many avionics systems and portable sources. Demand for this application has been increasing, however, says Richard W. Fox, applications manager at Crydom division of International Rectifier, and for that reason, the company has developed a standard line of high-current 400-Hz relays.

The new relays match the company's standard units in physical characteristics and most electrical specifications, but include the special filter and phase-compensation circuitry needed for operation at the higher frequency.

Fox says that the modifications required to produce the new relays were not major since Crydom already uses an anti-parallel arrangement of silicon controlled rectifiers (SCRs) instead of the more common triac for its power output stages. "Our design is more expensive," he says, "but it pays off since most triacs don't operate well at 400 Hz. They have to be severely derated, while the SCRs can operate ef-

ficiently at the higher frequency." He adds that special units can be supplied to operate up to 800 or 1,000 Hz for unusual applications.

Contact ratings for the new relay line range from 2.5 amperes to 40 A at either 100 to 140 volts ac or 200 to 280 v ac. Fox says that 480-v ac units could be supplied, but there seems to be little demand for them.

All of the relays have the same standard configuration: 2.25 inches long, by 1.75 in. wide, by 0.87 in. high. The input and output terminals are polarized, with the outputs being larger and farther apart than the inputs to help prevent accidental wrong connections.

The relay inputs are compatible with standard transistor-transistor-logic levels: they have an input impedance of 1,500 ohms.

Response time is a maximum of half a cycle of the ac power line plus 2 milliseconds. Zero-point switching is standard to prevent transient surges and radio-frequency interference. Input coupling is through an opto-isolator that provides input/output isolation in excess of 10 gigohms and 1,500 v.

The relays, whose model numbers range from 4D1202 through 4D2440, all have a minimum dv/dt rating of 100 v per microsecond and a minimum holding current of 20 milliamperes. A typical 25-A, 120-v unit (4D1225) has a 175-A rms one-cycle surge-current rating, a 40-A 1-second overload rating, a maximum contact drop of 1.6 v, and a maximum off-state leakage of 4 mA. The units are rated for operation over the temperature range from -30° to 80°C. Prices range from \$15 to \$42 each in quantities of 100 pieces.

Crydom Controls Div., International Rectifier Corp., 1521 Grand Ave., El Segundo, Calif. 90245 [341]

Ni-Cad cell maintains high capacity under heavy loading

A 1.2-ampere-hour tab-weld sub-C nickel-cadmium cell, the General Electric 41B001 AG 26, will deliver almost full capacity under high dis-

\$125

it's so easy to take . . .

You can replace your thermopile with a SBN PYROELECTRIC DETECTOR.

- BROADBAND RESPONSE—
UV to microwaves
- HIGH SENSITIVITY—
> to 125 V/W
- FAST RESPONSE—
better than 5ns
- NO CRYOGENICS—
operates from -40°C to 90°C
- RUGGED AND
NONHYGROSCOPIC

This package includes a sensing element plus a integral FET and fits a standard 9 pin miniature tube socket. Available from stock for only \$125.00.

Call us at 216/248-7400 with your IR detection and measurement problems.



HARSHAW

THE HARSHAW CHEMICAL COMPANY
DIVISION OF KEWANEE OIL COMPANY

Crystal & Electronic Products Department
6801 Cochran Road • Solon, Ohio 44139
(216) 248-7400

Circle 155 on reader service card

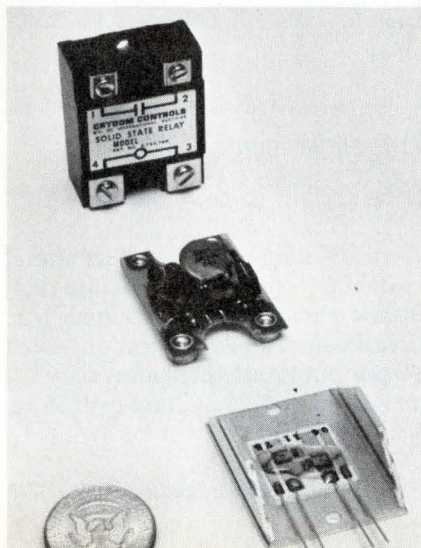

SLIM-MOX

**NOW VICTOREEN
QUALITY COSTS LESS
THAN A DOLLAR.**

Victoreen announces SLIM-MOX, our new, thick-film, flat substrate resistor.

Compact in design, it carries with it all the quality and dependable performance you have come to expect from Victoreen.

SLIM-MOX, right now, is available from stock in a wide range of standard resistance values. More important, SLIM-MOX will deliver the same proven performance in high-voltage applications that you find in more expensive resistors with more bulk.

Specify SLIM-MOX in any standard resistance value and your unit cost will be less than one dollar in OEM quantities. Truly a major cost breakthrough for resistors designed for miniaturized

electronic networks and equipment, or other critical applications that demand stability and reliability.

Standard tolerance is $\pm 15\%$ for all standard resistance values which include 1, 2,

5, 10, 20, 50, 100, 200, 500, 1000, 2000, and 5000 megohm. All in stock. With a voltage coefficient of better than 5 ppm/volt, full-load drift typically less than 0.5% in 1000 hr at 70°C, and 250 ppm TCR or less to 5000 megohm, SLIM-MOX is a little, big performer. For less than a buck. From a name you know you can count on. Victoreen.

**Victoreen Instrument Division,
Sheller-Globe Corporation,**



SHELLER-GLOBE CORPORATION

**10101
Woodland
Avenue,
Cleveland,
Ohio 44104**

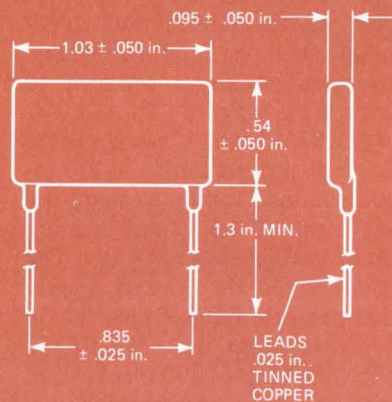

SLIM-MOX SPECIFICATIONS

Resistance Range	1M-5,000M
Power Rating @ 70°C	2W
Maximum Operating Volts (Applicable above critical resistance)	10,000V
Available Tolerance	15%
Critical Resistance	50M
Max. Service Temperature	150°C

New products

charge rates (see curves). Instead of using the normal nickel-screened steel substrate, this new cell combines a patented stipple steel substrate with a high-density plaque material. The result gives as much as 20% improvement in deliverable capacity over 1-Ah edge-weld units at discharge rates up to 15C.

An earlier edge-weld sub-C cell with a 1-Ah capacity held up well under heavy loading, but the higher-density, 1.2-Ah, tab-weld

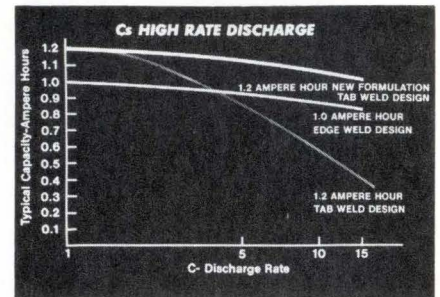

unit suffered severe capacity falloff under heavy discharge rates (see curves).

The new sub-C cell, which sells for about \$1/Ah, can sustain a C/10 charge rate for an indefinite period. Its operating temperature range is 5° to 50°C for charge and -20° to 50°C for discharge. Storage temperature range is -40° to 50°C. The steel-encased cell weighs 1.5 ounces, has an internal impedance of 12 milliohms, and can supply up to 20 amperes continuously.

Sub-C cells measure about 0.875 inch in diameter by 1.6 inches long, and are used extensively in portable electric tools and scientific and medical instrumentation.

General Electric Co., Battery Business Dept., P. O. Box 861, Gainesville, Fla. 32602 [343]

DIP slider switches
provide up to 8 positions

A line of slide switches offers lateral switching action in a miniature dual in-line package while retaining true break-before-make operation. Each 16-pin plastic DIP measures only 0.3 inch wide by 0.55 in. long by 0.33 in.

High Efficiency Single Output DC/DC Converters



INCREDIBLE!

UP TO 90% EFFICIENT DC/DC CONVERTERS

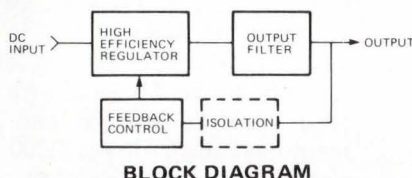

FEATURES

Wide Input Range: 2:1 Ideal for Battery Applications

- 9 to 18 Vdc — 12 Volt Battery
- 18 to 36 Vdc — 24 Volt Battery
- 35 to 70 Vdc — 48 Volt Battery

**Output Power for TTL, MOS and PLASMA DIGITAL
DISPLAY APPLICATIONS**

Voltage	OUTPUT	PRICE (1-9)
	Current	
5 Vdc	up to 3000 mA	\$30.95 to 94.95
12 Vdc	up to 2000 mA	49.95 to 69.95
15 Vdc	up to 2000 mA	49.95 to 69.95
24 Vdc	up to 500 mA	49.95 to 69.95
180 Vdc	up to 30 mA	55.95 to 65.95
250 Vdc	up to 30 mA	59.95 to 69.95

Other Voltages, Currents and Pin Configurations
are Available Upon Request.
Please Contact Us With Your Application.
We Probably Have an Off-The-Shelf Solution.

**SEND FOR OUR FREE 1975 COMPONENT SELECTION AND REFERENCE GUIDE
OUR GSA CONTRACT NUMBER IS-GS-00S-28288**



SEMICONDUCTOR CIRCUITS, INC.
306 RIVER STREET • HAVERHILL, MASSACHUSETTS 01830
TEL. (617) 373-9104 • TWX. 710-347-0269

high, including the slider mechanism. A spring-loaded double-ball-bearing detent action ensures smooth switching and positive location of each switch position. The simplest unit in the SW40 family is a single-pole eight-position device, but switches with up to four poles and four positions are available. The contacts can switch a resistive load of 250 mA at 30 V dc. In quantity, prices range from \$1 to \$3.95, and delivery is from stock.

Minelco Div., General Time, 135 South Main St., Thomaston, Conn. 06787 [344]

**Pressure transducer
handles 25 channels**

A 25-channel solid-state pressure transducer, the KPM-25, is an electrically scanned device intended for the measurement of static and quasi-static pressures. Housed in a rugged 1.5-inch by 1.5-in. by 0.5-in.

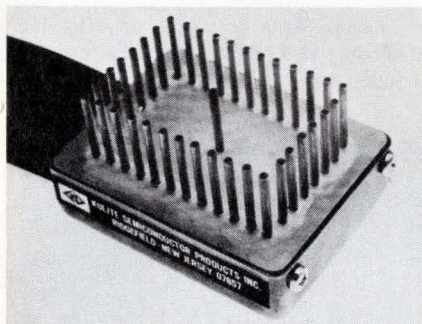

package, the unit is available in pressure ranges up to 100 psi with a mean full-scale output of 75 mV at 5-V excitation.

Kulite Semiconductor Products Inc., 1039 Hoyt Ave., Ridgefield, N. J. 07657 [346]

**Small, high-power resistors
operate to 275°C and 6,000 V**

Type MS power film resistors, which have values from 10 ohms to 30 megohms, are designed for high-voltage, high-power operation at temperatures up to 275°C. The small size of the series is typified by the MS 310, which measures 1.25

YOU CAN DO IT YOURSELF...

WITH UNIVERSAL'S MECHANIZED ELECTRONIC ASSEMBLY MACHINES

For over 15 years Universal has been supplying Mechanized Electronic Assembly Equipment to nearly all the leading computer, communications, aerospace, automotive and consumer electronics companies in the world, regardless of their size. We feel we have given them the "in-house" capability to build their products profitably. We can do the same for you with:

- Axial Lead Component Processing Equipment.
- Transistor, DIP and Axial Lead Prepping Equipment.
- Transistor, Disc Capacitor and Axial Lead Taping Equipment.
- Disc Capacitor, DIP, Transistor, SIP and Axial Lead Insertion Equipment.
- As well as Pin Insertion and Wire Termination Equipment.

Universal's Semi-Automatic and Computer Controlled Systems reduce cost, improve quality and give your company the "in-house" production capability to assemble all your electronics . . . you can do it yourself. For details on how to purchase or lease a Universal Electronic Assembly Machine, call or write today.

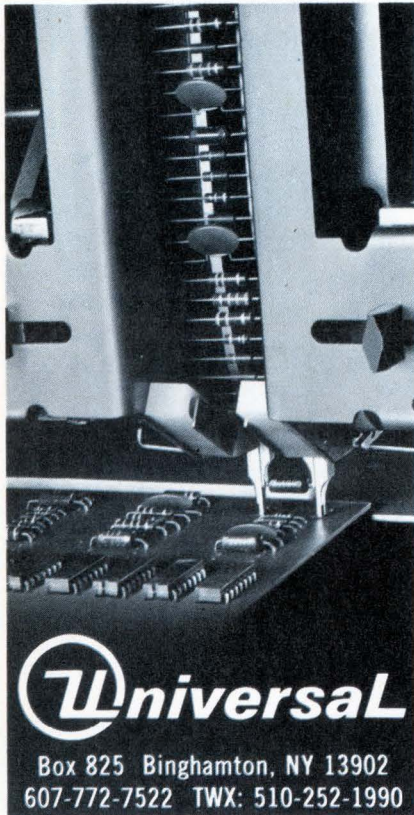

Universal

Box 825 Binghamton, NY 13902
607-772-7522 TWX: 510-252-1990

New products

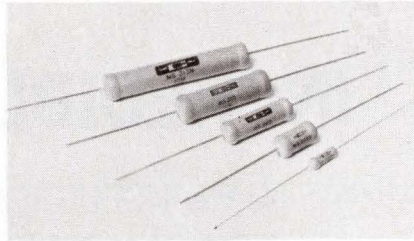

inches long by 0.375 in. in diameter and has a power rating of 10 W and a maximum voltage rating of 4,500 V. The MS 150 configuration is only 0.188 in. long and can dissipate 0.5 W, while the MS 313 is 2 in. long and can withstand 6,000 V. All MS resistors can be delivered with tolerances as tight as 0.1%, and all of them have the 0.1% per 1,000 hours stability that is characteristic of Micronox film resistors.

Caddock Electronics Inc., 3127 Chicago Ave., Riverside, Calif. 92507 [345]

Contactless potentiometer uses Hall-effect element

A contactless potentiometer incorporates a magnetoresistive element based on a Hall-effect transducer to provide a low-torque, bounceless, noiseless, and explosion-proof device. Designed for extreme environments, the LP-18S is expected to have broad applications in angle-, position-, displacement-, and tension-sensing devices as well as in motor commutation, switching, and general servomechanism use. The LP-18S is 21 mm in diameter. Sample quantities are available from stock.

DKI Div., 5430 Rosecrans Ave., Lawndale, Calif. 90260 [347]

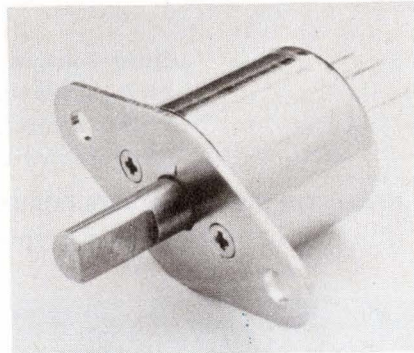

...OR WE CAN DO IT FOR YOU

WITH UNIVERSAL'S MECHANIZED ELECTRONIC ASSEMBLY SERVICES

When you don't have the capacity to do all your own component preparation, assembly or wire wrapping—or when it doesn't pay you to do it yourself—let us do it for you, with no capital investment on your part. Working for you are the industry's most automated facilities including:

- Axial Lead Component Taping, Sequencing and Insertion.
- Transistor Prepping, Taping and Insertion.
- DIP Insertion.
- Pin Insertion.
- SIP Insertion.
- Computer-Aided Design Accessibilities.
- Wire Termination.
- Complete Systems Assembly.
- And, of course, complete testing for all services.

Universal's Mechanized Electronic Assembly (MEA) Division services provide close-tolerance production, on-time delivery and substantial savings in direct labor cost from two locations: Binghamton, New York, and Palatine, Illinois. Write or phone today for full details on what Universal's MEA can do for you.

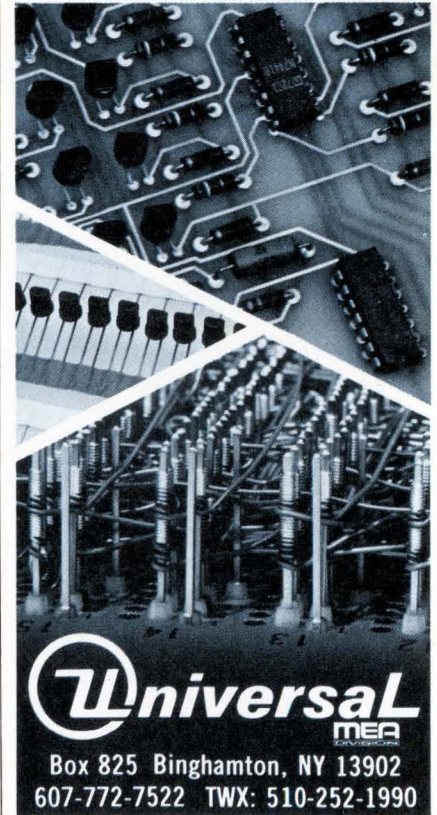

Universal
MEA

Box 825 Binghamton, NY 13902
607-772-7522 TWX: 510-252-1990

For the Protection of ALL ELECTRONIC CIRCUITS

FUSETRON® dual-element — time-delay fuses



Avoid nuisance opening, yet get full short-circuit protection. Available from 1/100 amp. to 40. Size 1/4 x 1 1/4 in. and 9/32 x 1 1/4 in.

TRON® rectifier fuses



Provide extremely fast opening and high degree of restriction of let-thru current to protect Solid State Devices. Ampere rating 1/2 to 1000 in voltages up to 1500.

BUSS GLASS TUBE FUSES "quick-acting"

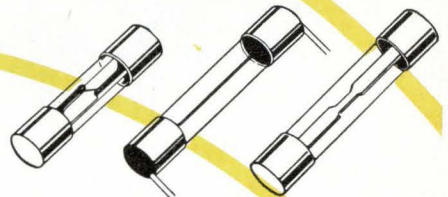

Provide high speed action to protect delicate instruments and apparatus. Available from 1/500 to 30 amp. Sixe 1/4 x 1 in. and 1/4 x 1 1/4 in.

BUSS Signal-Indicating Alarm-Activating FUSES

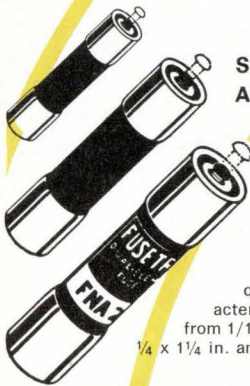

Available with time-delay or quick-acting characteristics. Available from 1/10 to 30 amp. Size 1/4 x 1 1/4 in. and 13/32 x 1 1/2 in.



TRON® Sub-Miniature Pigtail Fuses

Size only .145 x .300 in. Glass tube permits visual inspection. Hermetically sealed. Available from 1/200 to 15 amp.

BUSS Fuses for TELEPHONE COMMUNICATIONS Similar equipment

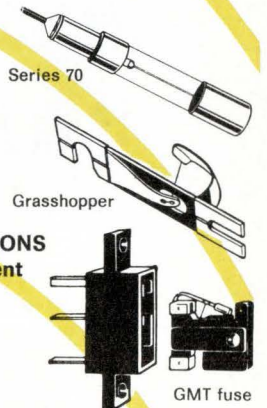

Series 70

Grasshopper

GMT fuse

HLT holder

BUSS Sub-Miniature GMW fuse



and HWA fuseholder. Full size .270 x .250 in. with window to check fuse element. Available 1/200 to 5 amp.

BUSS SNAP-LOCK FUSEHOLDER



Rear panel mount fuseholder for 1/4 x 1 1/4 in. fuses. Snaps into place. Specify HTA-00 for space saver type, HLD-00 to take visual indicating fuses. HKP-00 for standard fuseholder. HJM-00 to take 1/4 x 1 in. fuses.

HKP

panel mounted fuseholder for 1/4 x 1 1/4 in. fuses.

HKA

lamp indicating, signal-activating fuseholder.

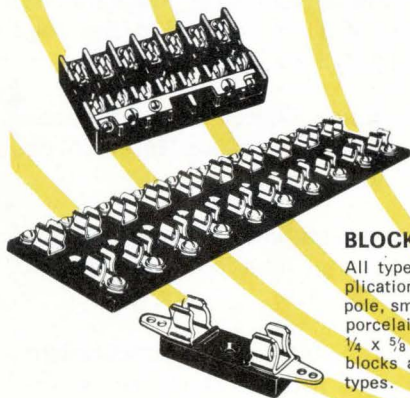

BLOCKS FOR BUSS FUSES

All types available for every application. Single pole, multiple pole, small base, laminated base, porcelain base for fuses from 1/4 x 5/8 in. up. Also signal fuse blocks and special blocks of all types.

BUSS® FUSES

For Quality — Reliability

For anything you need in protecting electronic circuits and devices —

Write for Bulletin SFB

— See for yourself —



BUSSMANN MANUFACTURING
a McGraw-Edison Company Division
St. Louis, Missouri 63107



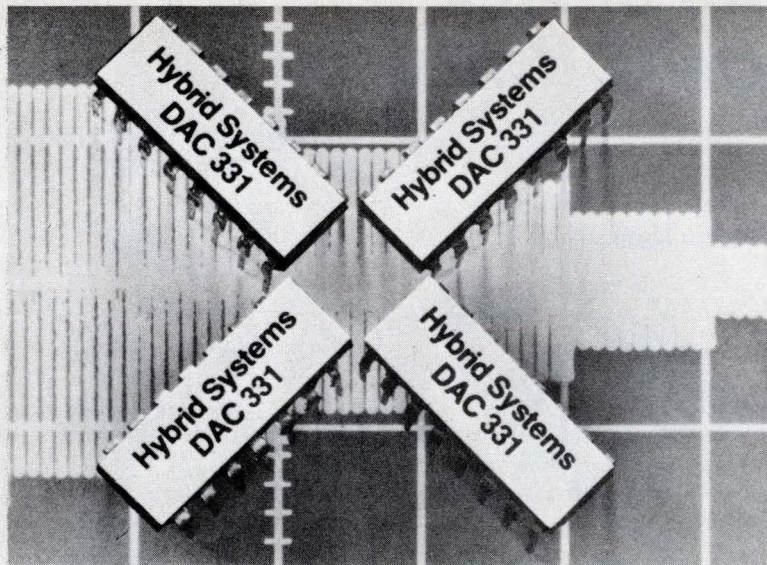

Multiplying DAC \$9.90

This is the lowest cost multiplying DAC anywhere. Hybrid Systems' 16 Pin, dual-in-line, CMOS/TTL DAC 331 offers some outstanding advantages:

- Linearity tempco of 1PPM/°C.
- True 8 and 10 Bit accuracy, linearity and drift. (We laser-trim our own thin-film networks).
- 20 mW power dissipation.
- Can accept AC or DC signals.
- Low feedthrough — better than 0.1% at 10kHz.
- Use your choice of output amplifiers for optimum flexibility.
- Pin-for-Pin compatibility with the AD7520.

And finally, there's the price:

	<u>1-9</u>
DAC 331-8 (8 Bits)	\$ 9.90
DAC 331-10 (10 Bits)	\$19.00

For Fast Action, Call:
(617) 272-1522 (or TWX 710-332-7584). In Calif.: (714) 992-4090.
European Headquarters: Hybrid Systems GmbH, 61 Darmstadt,
Luisenplatz 4, Germany. Tel. 6151 291595. TELEX 841-419390.

Hybrid Systems

CORPORATION

Burlington, Massachusetts 01803

New Books

Liquid Crystals for Electronic Devices, Edward L. Williams, Noyes Data Corp., 263 pp., \$36.

Handbook of IC Operational Amplifiers, George B. Rutkowski, Prentice-Hall, 321 pp., \$14.50.

Basics of Electricity and Electronics, Matthew Mandl, Prentice-Hall, 388 pp., \$15.95.

Introduction to Digital Filtering, ed. R.E. Bogner and A.G. Constantinides, John Wiley & Sons, 198 pp., \$19.50.

Television Troubleshooting, Clyde N. Herrick, Reston Publishing, 230 pp., \$14.95.

Statistics for Technology, Christopher Chatfield, Halsted Press, 359 pp., \$6.95 (paper).

Pattern Recognition Principles, J.T. Tou and R.C. Gonzalez, Addison-Wesley, 377 pp., \$19.50.

Delta Modulation Systems, R. Steele, Halsted Press, 379 pp., \$32.50.

High Rupturing Capacity Fuses, E. Jacks, Halsted Press, 280 pp., \$15.75.

Electricity for Technicians, Abraham Marcus and Charles M. Thomson, Prentice-Hall, 500 pp., \$13.95.

Digital Design with Standard MSI and LSI, Thomas R. Blakeslee, John Wiley & Sons, 357 pp., \$19.95.

Electronic Circuit Behavior, Daniel L. Metzger, Prentice-Hall, 426 pp., \$15.95.

Instrumentation in Industry, Harold E. Soisson, John Wiley & Sons, 563 pp., \$24.95.

The Founders of Electrochemistry, Samuel Ruben, Dorrance & Co., 107 pp., \$5.95.

Technology Mathematics Handbook, Jan J. Tuma, McGraw-Hill, 370 pp., \$15.95.

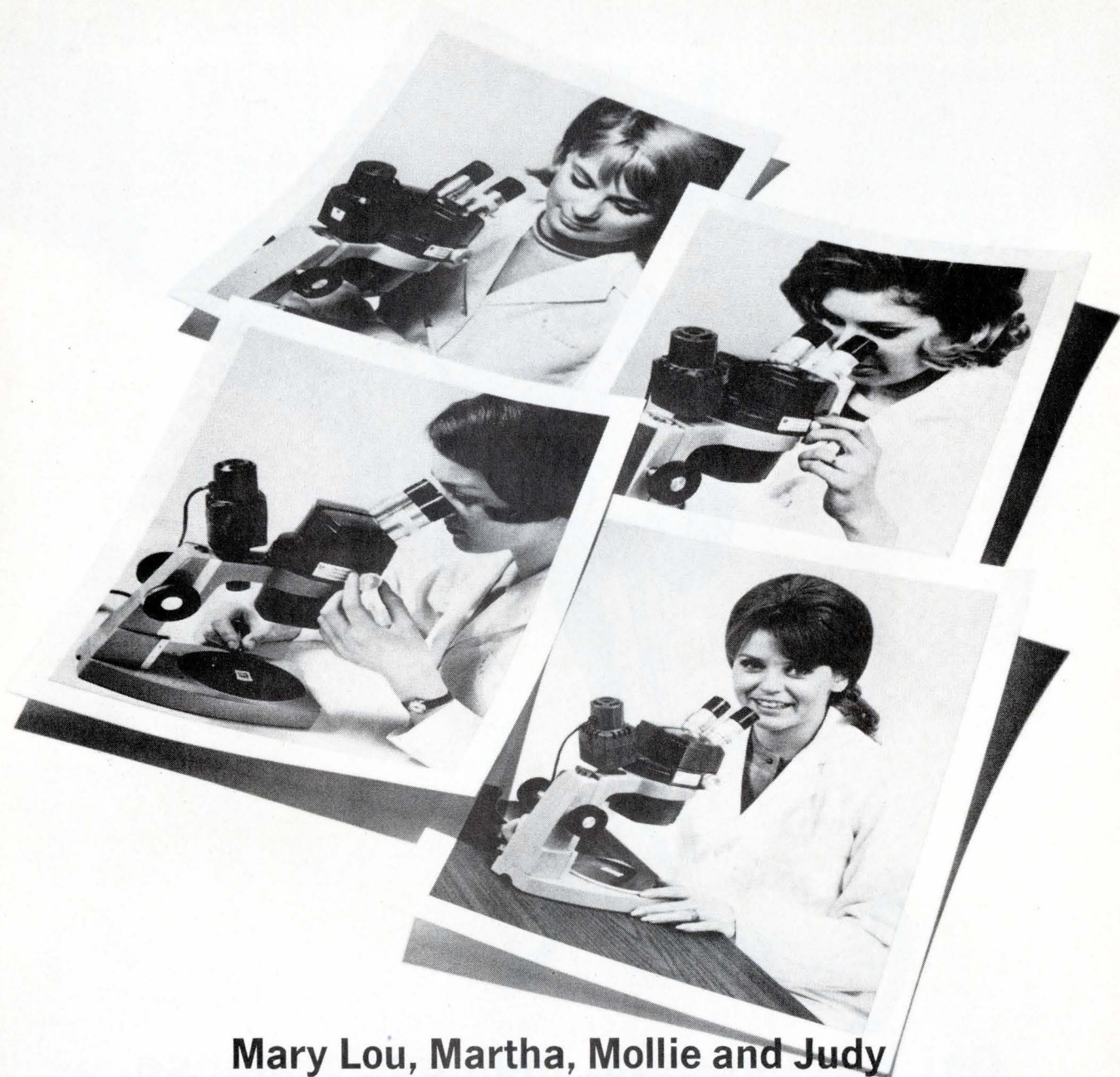

**Mary Lou, Martha, Mollie and Judy
are sold on the AO STEREOSTAR[®] Zoom Microscope.**

Here's why.

The AO STEREOSTAR Zoom stereoscopic microscope was specifically designed for convenience, working ease and optical performance.

Zoom controls are located on both sides for convenience. It eliminates awkward reaching when changing magnification. The high resolution optical power pack may be rotated 360° to accommodate most any assembly or inspection situation. Full optical equipment offers a magnification range of 3.5x through 210x.

Working distance of 4.0 inches is maintained at all magnifications in basic models, and if that's not enough, add a 0.5x

auxiliary lens to make it 5.7 inches.

STEREOSTAR Zoom microscope assures a wide field of view, up to 2.25 inches with the 10x high eyepoint eyepieces. It also features an extremely efficient illuminator that stays cool even after long hours of continuous use.

See for yourself. Contact your AO dealer or sales representative for a convincing demonstration.



**AMERICAN OPTICAL
CORPORATION**

SCIENTIFIC INSTRUMENT DIVISION • BUFFALO, N.Y. 14215

Stop spinning your wheels looking for the unit you need.



Get a souped-up, high performance, customized power supply in record time.

When you need a power supply to meet a specific need, don't start from scratch. We'll modify one of our custom jobs to work like it was made just for you.

Our supplies have proven track records. They've met the challenge of commercial quantity needs, military quality needs, hi/lo voltage/current combinations, and come up winners every time.

Our champions include the Model 502 switching design, 5VDC, 150 amp mini-computer supply that can function in master or slave mode in parallel operation. The Model 774 linear design bank terminal supply with a high power to cost ratio enabling throw-away replacement. The long lasting mini-CRT display supply. And the programmable voltage, multi-application guided missile system supply that delivers better than 2 watts per cubic inch at 75 percent-plus efficiency. Plus many more — there's one that fits your needs.

Give us the green light to modify a custom supply for you.
You'll get the checkered flag every time.

NCR

NCR Corporation

Scott Electronics Division 2525 Shader Road
P.O. Box 7637 Orlando, Florida 32804 (305) 295-5850

New products

Instruments

Unit locates ac transients

Disturbance monitor senses direction of currents as well as voltage parameters

A power-line monitor that not only measures voltage transients and other line disturbances but also determines the direction of the transient current can help users pinpoint the sources of line problems. Like its



predecessor, the model 3401, the new 3402 can detect, count, and record power disturbances such as voltage dips and surges, transients, and frequency deviations for single- and three-phase voltages of 50 and 60 hertz, over a range of 100 to 480 V ac. Voltage levels can be accurately set to a resolution of 0.5 volt. When a preset level is exceeded, the disturbance is detected, categorized and counted with a printer that logs the day, hour, and minute, and identifies the event by code. Transients having rise times as fast as 0.2 microsecond can be detected. Frequency variation beyond preset limits of $+\frac{1}{2}$, 1, 2, and 4 hertz from base frequency can also be detected and recorded.

With the addition of a plug-in printed-circuit board containing the analog detection and digital processing circuitry, a current monitor probe, a current sensitivity switch, an added column to the printer, and a current-monitor BNC plug, the old monitor becomes the 3402, with the

additional capability of determining whether the transients come from the load or the source, and identifying their polarity.

By moving this device back and forth along a line, the source of a disturbance, if it is internal, can usually be traced to a specific location.

Based on techniques invented at the U.S. Navy's Civil Engineering Laboratory, Port Hueneme, Calif., by K. T. Huang, the 3402 has a minimum voltage sensitivity of 40 volts peak, but is adjustable anywhere from 40 to 995 V with a front-panel 10-turn "low magnitude transient" potentiometer. Current sensitivity is 10 amperes minimum and is adjustable to low, medium or high with another switch on the rear panel.

The instrument is capable of measuring transients with pulse widths ranging from 0.2 μ s to 100 μ s. Maximum time between voltage and current transients is 5 μ s (sampling window is narrowed by the width of the transient).

Measuring 8.75 by 17 by 17.2 inches and weighing about 40 pounds, the 3402 consumes about 40 watts. Current delivery time is five to six weeks, and the price is \$5,300.

Programmed Power Inc., 141 Jefferson Dr., Menlo Park, Calif. 94025 [351]

Frequency comparator offers high resolution

With a frequency comparator from Arbiter Systems, oscillators can be directly calibrated with resolutions approaching one part in 10^{11} . An internal precision reference is derived from TV network color burst signals, which use rubidium oscillators



Catch a Logic Pulse



The TEKTRONIX P6401 Logic Probe positively identifies logic states (high, low, abnormal, open, over voltage) of TTL and DTL circuitry. No level setting or adjustments; just touch and see.

To catch a single pulse as narrow as 10 ns, switch the probe to store. At the occurrence of a pulse, the indicator lamp (red for high, green for low) will light and remain lit until reset.

To detect the coincidence of logic levels at two points, simply connect a strobe lead to the second point.

For complete specifications and ordering information, write Tektronix, Inc., P.O. Box 500, Beaverton, Ore. 97077. In Europe, write Tektronix Limited, P.O. Box 36, St. Peter Port, Guernsey, Channel Islands.



TEKTRONIX

committed to technical excellence

Circle 163 on reader service card
For demonstration circle 215 on reader service card

SCHOTT

Makes Light Flexible

. . . UV-Light, too



Fiber optics for industry and science.
Flexible or rigid light guides
IR-, visible- and UV-spectrum (2,700–200 nm)

Multiple applications in

- Precision Engineering
- Measurement and Control Engineering
- Optoelectronics
- Medical Applications
- Photography
- Laboratory Work
- Traffic Engineering
- Vehicle Equipment
- Communications and other fields

SCHOTT – a specialist for UV-light guides, changeable message traffic signs, low loss cables.

SCHOTT – your reliable partner in the solution of problems, from the glass fiber to the component, from the description of your problem up to the complete item.

OF 019

Schott Optical Glass Inc.,
York Avenue DURYEA, PA 18642/USA
telex 837 423, phone 001-717-457-7485

New products

monitored by the National Bureau of Standards, and is compared with the oscillator under test [*Electronics*, March 10, p. 107].

The \$3,000 Arbiter unit provides a complete system for calibration, including TV reception. All that is needed is a TV signal, ac power, and an input from the unit under test.

The comparator regenerates 3.58-megahertz color subcarrier, then multiplies it to 100 MHz. A comparison is made with a frequency of 100 kHz, 1 MHz, 5 MHz, or 10 MHz, also multiplied to 100 MHz.

Four resolution ranges are provided from 1×10^{-8} to 1×10^{-11} . The lowest resolution-range comparison takes 1 second; the highest, 1,000 seconds. After selecting a network station, thumbwheel switches are used to enter the network signal's offset from atomic time, as published by NBS.

An internal timer can be set to stop comparisons at the hour and half-hour station breaks, when the local stations take control, and indicators tell when input signal strength is lost or no color subcarrier is present.

Arbiter Systems Inc., 1402 Norman Firestone Rd., Goleta, Calif. 93017 [352]

Dual-beam scope added to 5000 series

When viewing simultaneous signals on an oscilloscope, reliance on the alternate mode can lead to phase errors between the displayed waveforms, while the chopped mode only allows viewing of half the waveform. One way around this dilemma is to use a true dual-beam scope, one with two electron sources, two vertical deflection systems, and two horizontal deflection systems.

The model 5444 true dual-beam oscilloscope is an addition to Tektronix' 5000 series line. A typical system would consist of a 5443 acquisition unit, a D44 display unit, a 5A44 dual time base, and two 5A45 vertical amplifiers and be priced at \$4725.

With this combination, the 5444

The AILTECH 360 Frequency Synthesizer is a high performance unit whose modular design simplifies integration into specific systems and general laboratory set-ups.

Providing high-speed, direct synthesis from 10 KHz to 180 MHz, the 360 offers many outstanding features, among these:

• **Spectral Purity:**

Non-harmonic spurious signals 100 dB below the output from 10 KHz to 60 MHz (94 dB from 60 to 180 MHz).

Phase noise floor typically -138 dBc/Hz from

10 KHz to 60 MHz (-132 dBc/Hz from 60 to 180MHz).

• **High Speed Programmability:**

Frequency remotely programmable (BCD parallel) with less than 20 μ sec switching time (typically 10 microseconds) with no settling time.

Modular Design Assures Ease of Application
Expensive modifications or redesign often required for systems integration are virtually eliminated with the AILTECH 360.

RECOGNIZED FOR ITS STANDARD OF EXCELLENCE IN TEST INSTRUMENTS

AILTECH INTRODUCES A HIGH PERFORMANCE, HIGH SPEED FREQUENCY SYNTHESIZER

...With modular construction to simplify systems applications

...at prices comparable to indirect synthesizers.

MAIN FRAME

The main frame contains the basic synthesizer modules, frequency standard (optional), power supplies, and manual control circuits. The unit shown in the illustration provides 11 front panel decade switches for manual setting of frequency, and can also be remotely programmed.

RF PLUG-IN SECTION

The plug-in contains the RF circuitry which determines the frequency range of the synthesizer and the frequency control logic. Remote programming of the synthesizer is through a connector at the rear of the plug-in.

FREQUENCY EXTENDER

This module is provided whenever AILTECH's 360 is used with a plug-in operating above 18 MHz. It consists of an RF assembly, mounted on a tray which is installed as a unit, into the bottom of the main frame.

MODULATION MODULE

The modulation module is installed in the RF plug-in. It contains the levelling, modulation, and output circuitry. The basic unit shown offers levelled output, 13 dB attenuation, and external linear amplitude modulation.

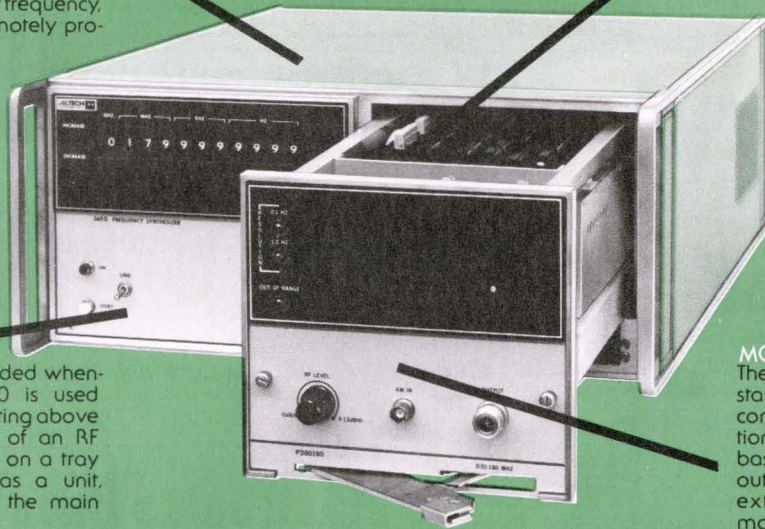

CHARACTERISTICS ALL ITS OWN

Frequency Selection—manual pushbuttons or BCD remotely programmable; Frequency Resolution—typically 1 Hz, with 0.1 Hz available as an option; Reference Oscillator—optional internal oven stabilized, crystal controlled 10 MHz oscillator can be built-in or supply your own 5 or 10 MHz external reference.

Levelled Output—0 to +13 dBm, continuously variable, ± 0.5 dB flatness (1 to 180 MHz).

Seeing is Believing...the best way to appreciate our efforts is to see the 360 in operation with your application. As soon as you tell us about your requirements, we'll arrange for a no obligation demonstration.

EAST COAST OPERATION • 815 BROADHOLLOW ROAD • FARMINGDALE, NEW YORK 11735
TELEPHONE: (516) 595-6471 • TWX: 510-224-6558

WEST COAST OPERATION • 19535 EAST WALNUT DRIVE • CITY OF INDUSTRY, CA. 91748
TELEPHONE: (213) 965-4911 • TWX: 910-584-1811

INTERNATIONAL OFFICES • FRANCE — La Garenne-Colombes, Telephone 7885100, Telex 842-62821
GERMANY — Munich, Telephone (089) 5233023, Telex 841-529420
UNITED KINGDOM — Crowthorne, Telephone 5777, Telex 851-847238
JAPAN — Tokyo, Telephone (404) 8701, Telex 781-02423320 (Nippon Automatic)



Classified section FOR EMPLOYMENT AND SALES OPPORTUNITIES

CLASSIFIED SALES REPRESENTATIVES

Atlanta.....Miriam Curth.....404/892-2868
 Boston.....Nancy Jones.....617/262-1160
 Chicago.....Bill Higgins.....312/751-3733

Cleveland.....Connie Byers...216/781-7000
 Dallas.....Gerry Ambrose 214/742-1747
 Denver.....John Ryan.....303/266-3863
 Detroit.....Mac Huestis.....313/873-7410

Houston.....Rick Ofstie.....713/224-8381
 Los Angeles.....Stan Kasson.....213/487-1160
 New York.....Holt Buchanan.212/997-3593
 Dave Hawksby.212/997-3593

Philadelphia.....Dan Ferro.....215/568-6161
 Pittsburgh.....Pam Petika.....412/391-1314
 San Francisco.....Mary Kenny.....415/362-4600
 XEROX 400 TELECOPIER.....212/997-6800

RATES \$46 per advertising inch (7/8"). Commissionable.

SIZES 7/8" to 10" deep in widths of one column (1 1/2"), two (3 1/2"), three (5 1/2"), and four (7").

CLOSING Two weeks prior to mailing.

MAILING One week prior to issue date.

ISSUE DATE Every other Thursday.

AD ORDERS/BOX NUMBER ANSWERS

Send to Electronics, Post Office Box 900, New York, N.Y. 10020.

DESIGNER

Designer of high power inverter systems for induction heating at 1-3-10 KHz levels. Must be capable of basic design and manufacturing development. Equity available to right person, in an established company. Send resume's to

P-7716 ELECTRONICS
 CLASS. ADV. DEPT.,
 P.O. BOX 900, N.Y., N.Y. 10020

SALES REPS WANTED

Established manufacturer of Load Cells, Pressure Transducers & Instrumentation is seeking experienced reps familiar with strain gage type transducers. Send particulars to:

A. L. DESIGN, Inc.
 23 Sedgemoor Ct.
 Williamsville, N. Y. 14221

ELECTRONIC ENGRS, senior and junior expd in industrial photocell devices, circuitry design, prototypes.

A Edelman, Pres.; Photobell Co., Inc., 12 East 22nd St., New York, NY 10010

POSITION VACANT

Electrical Engineer — DC Motor Design experience or background in other electrical machinery design. BSEE desirable. Project Engineer—BSEE degree. Experience in electromagnetic industry involved in the design of rotating equipment. Experience should include both analytical design and practical development of electromagnetic equipment. Should be familiar with solid state devices and circuit design. Background in automotive-type electrical products desirable. Chief Product Engineer—BSEE. Supervise and develop necessary products, projects, and relative requirements of the company and meet with foreign executives. Electrical

POSITION VACANT

Engineer-Design and application experience in controls for multiple horsepower DC motors operated from batteries. 3-5 years working experience in these areas. Send resumes and salary requirements in complete confidence to C.E. Daly, The Prestolite Company, P.O. Box 931, Toledo, Ohio 43694. An Equal Opportunity Employer. Minority and female individuals are encouraged to apply.

These ads,

will be preprinted in **ADVANCE JOB LISTINGS**, a weekly bulletin mailed to actively job-seeking readers who want to be the first to know about openings both in and out of their field. This means advertisers receive extra and early replies before their ad appears in print from career-conscious readers—like yourself—who want to beat the pack and get in on the ground floor. For AJL subscriber information, write: **ADVANCE JOB LISTINGS** PO BOX 900/NY, NY 10020

This new Section,

featuring only recruitment and sales opportunities advertising, is designed to provide:

Readers—over 70,000 EE's and technical managers—with a useful and convenient employment market-place to consult whenever they're thinking about their future and bettering themselves. (Like when they're reading **ELECTRONICS** to combat job obsolescence.)

Advertisers—with low competitive rates (see above), pre-screened qualified circulation, bonus **ADVANCE JOB LISTINGS** preprint (see left), and free **ELECTRONICS MANPOWER REGISTER** searches and resumes.

To find out more about any of the above, contact the Classified sales representative in the McGraw-Hill regional office nearest you (see above), or write to:

We believe we offer both reader and advertiser alike the most complete recruitment program offered by any electronics publication. (And, **ELECTRONICS** is the technical magazine for technical people.)

ELECTRONICS
 Post Office Box 900
 New York, NY 10020

Energy Saver

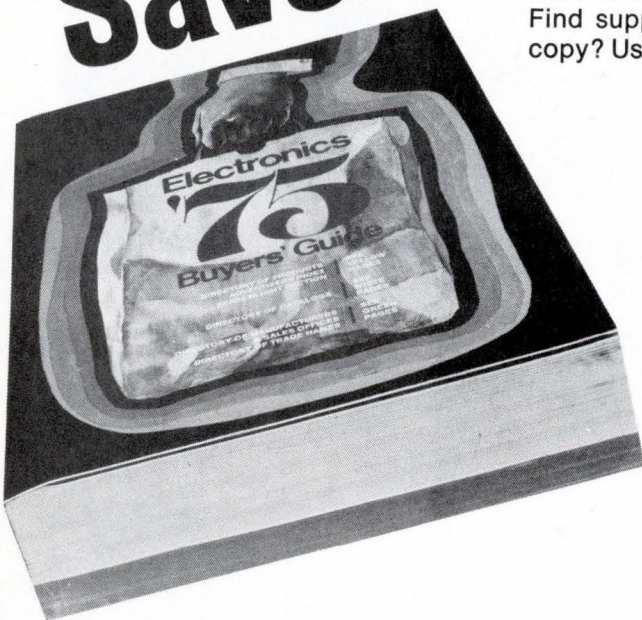

NEW Electronics Buyers' Guide Easy-to-use, single volume source for:

- Information on over 4,000 products
- Over 6,000 company listings and phone numbers—both home and field offices
- **EBG EXCLUSIVE:** quick access to over 1000 helpful catalogs through a timesaving Direct Inquiry Service.
- More than 1,400 pages of data

Here is the international world of electronics at your fingertips. Find suppliers...fast...accurately...and locally! Don't have a copy? Use coupon, below.

Electronics Buyers' Guide

A McGraw-Hill Publication
 1221 Ave. of the Americas • New York, N.Y. 10020

Yes, send me _____ copies (copy) of the energy saving Electronics Buyers' Guide. I've enclosed \$20.00 (USA and Canada only; elsewhere send \$30.00). Full money back guarantee if not satisfied.

NAME _____

COMPANY _____

STREET _____

CITY _____

STATE _____ ZIP _____

New products

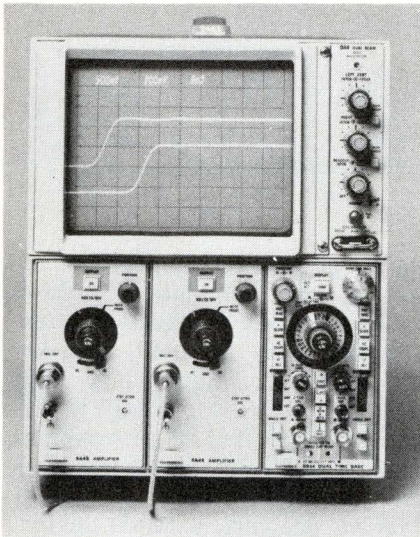

can display one signal at two sweep speeds or two signals at the same or different sweep speeds. A waveform and a delayed, magnified version of the same waveform can be viewed simultaneously.

With other plug-ins, up to four repetitive waveforms at 60 megahertz, or eight waveforms at reduced bandwidth, can be compared in the alternate or chop mode. Multiple-trace, single-shot events can be compared at sweep speeds up to 100 microseconds per division in the chop mode.

The 5B44 dual-time base has a sweep speed of 5 nanoseconds per division.

Alphanumeric readouts document the sweep speed and vertical deflection factor for each beam on the 6½-inch diagonal cathode-ray tube screen of the 5444. In addition a user-addressable readout option programs the 544 to write data, up to two 10-character words, on the screen.

Tektronix, Inc., P.O. Box 500, Beaverton, Ore. 97077 [353]

Hi-Pot tester has fully automatic test cycle

Intended for dielectric-withstand and ground-continuity tests as required by Underwriters Laboratories and similar institutions, the EPA Hi-Pot features a fully auto-

DIB

DUAL IN-LINE BRIDGE

An integrated bridge rectifier in a miniature dual in-line package

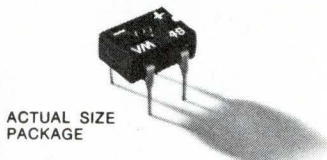

ACTUAL SIZE PACKAGE

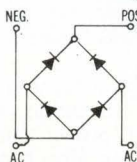

- 4-pin, low-profile DIP
- Leads on standard .10" (2,54 mm) grid
- Compatible with automatic testing, handling and inserting
- Reduces labor & material costs
- Glass-passivated diodes
- Meets moisture resistant requirements of MIL-STD 202, method 106C
- 1 Amp at 40°C (I_o)
- 25V to 1000V (V_{RRM})

Call Charlie Merz 214/272-4551 for more information

Design us in . . . we'll stay there

VARO SEMICONDUCTOR, INC.

P.O. BOX 676, 1000 N. SHILOH, GARLAND, TEX. 75040 (214) 272-4551 TWX 910-860-5178

Circle 167 on reader service card



VARO

Hit Switcher



For the highest efficiency in your power switching circuits the fast switching 2N6340 series of STC Power Transistors features a max. fall time of 250 ns. at 10 Amps. with V_{CEO} sus. up to 150 Volts.

Whatever your power transistor needs you can get the *RIGHT* one.

FROM



THE POWER SOURCE

KATRINA ROAD, CHELMSFORD, MA 01834 (617) 256-3321

Get complete data on these and other STC Power Transistors

THE POWER SUPPLY A MANAGEMENT TEAM COULD LOVE

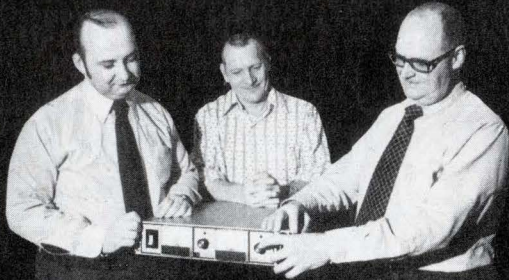

If you're an engineer, or in engineering management, you might find our new SCR Series Single Phase Input Power Supplies very attractive. They provide 800, 1600 or 2400 watts of power and precise 0.1% regulation in both voltage and current modes (for higher power ask about our three phase input SCR units). All offer the highest power output per mechanical volume in the industry.

Check these superior benefits:

- * High Efficiency
- * Remote Sensing
- * Remote Programming
- * Series or Parallel Operation
- * 5 Year Warranty
- * Rack or Bench Mount
- * Overvoltage Protected (optional)
- * Constant voltage or current with automatic crossover
- * Optional Input Voltages

For applications assistance and technical information, phone TOLL FREE (800) 631-4298

VOLTAGE	CURRENT	CV-rms RIPPLE	CC-rms RIPPLE	% EFF.	AC input I NOM.E.	PRICE \$
0-7.5	100	75 mv	1000 ma	63	13	650
	180	80 mv	1920 ma	65	26	850
	250	80 mv	2990 ma	66	20	1100
0-10	80	75 mv	600 ma	65	13	600
	150	80 mv	1200 ma	68	26	850
	210	80 mv	1680 ma	69	19	1100
0-20	40	60 mv	120 ma	67	13	600
	80	80 mv	320 ma	70	25	800
	120	80 mv	480 ma	73	18	1000
0-40	20	60 mv	30 ma	68	13	500
	40	100 mv	100 ma	75	24	750
	60*	100 mv	150 ma	80	18	900
0-60	13	70 mv	15 ma	70	13	500
	26	90 mv	39 ma	81	23	850
	40	90 mv	60 ma	81	18	1000
0-80	10	80 mv	10 ma	77	12	500
	20	120 mv	30 ma	83	21	850
	30**	100 mv	35 ma	82	18	1000
0-150	5	150 mv	5 ma	80	10	500
	10	200 mv	13 ma	87	20	850
	15	200 mv	20 ma	84	18	1000
0-300	3	250 mv	3 ma	85	6	550
	5	300 mv	5 ma	87	20	850
	8	300 mv	8 ma	85	17	1000
0-600	2	700 mv	2 ma	87	6	650
	3	700 mv	4 ma	88	20	850
	4	750 mv	5 ma	85	17	1100

*Specify Model No. SCR40-58

**Specify Model No. SCR80-28



ELECTRONIC MEASUREMENTS INC.

405 Essex Road, Neptune, N. J. 07753
Phone: (New Jersey) 201 - 922-9300 • (Toll-Free) 800 - 631-4298
Specialists in Power Conversion Equipment

New products



matic test cycle for simplicity of operation, and automatic shutdown for high-voltage lockout at failure. The unit may be used wherever non-destructive high-voltage tests are required. Its test voltage is pre-set and is indicated on a front-panel meter. Two Hi-Pot models are available: the M100A meter reads only total leakage current, while the meter on the M100B reads either total leakage current or the real (resistive) part of the leakage current at the touch of a switch. The M100A is priced at \$800 while the M100B sells for \$850.

EPA Electronics Inc., 220 Demeter St., East Palo Alto, Calif. 94303 [354]

Universal counter is bus-compatible

Add a \$350 option to the \$1,300 basic price of the model 5328A universal counter and you have a flexible medium-priced instrument that can be connected into any HP Interface Bus measurement system. In its simplest form, the 5328A can measure frequencies to 100 megahertz, single-shot time intervals to a resolution of 100 nanoseconds, and repetitive events to a resolution of 10 picoseconds. Arming capability, previously available only in higher-priced instruments gives precise control over the start of a measure-



MICRO NETWORKS DATA CONVERSION PRODUCTS



Your Logical Choice...

is MICRO NETWORKS D/A and A/D converters because you ...

- Get distinctive advantages in performance, size and reliability.
- Achieve overall cost savings.
- Obtain superior performance with MN's advanced circuit design and precision nichrome resistors which maintain TC ratios of 1 ppm.
- Can readily select the right conversion product for your requirements from a broad choice of over 100 standard products.
- Buy long-term stability and maintenance free operation—made possible by our laser trimming technique.
- Get adjustment free products—effecting a labor savings by eliminating the need for trim pots.

MICRO NETWORKS' MIL range converters guarantee operation to specifications from -55 to +125C and MIL-STD-883 Class B processing is a standard option with MN products.

When selecting a converter compare before you buy. To learn more about our product send for new short form catalog today.

Tel: 617 852-5400



MICRO NETWORKS
CORPORATION

324 Clark Street, Worcester, MA. 01606

MN301 ... 6 Bit D/A
MN3000 ... 8 Bit D/A
MN3004 ... 10 Bit D/A
MN343 ... S/H complete with holding capacitor
MN2000 ... 10 Volt .05% reference unit

MN502 ... 8 Bit A/D
MN5060 ... Low power, 60mw, 8 Bit A/D
MN312 ... 12 Bit D/A
MN3850 ... 12 Bit D/A
MN5200 ... 12 Bit A/D

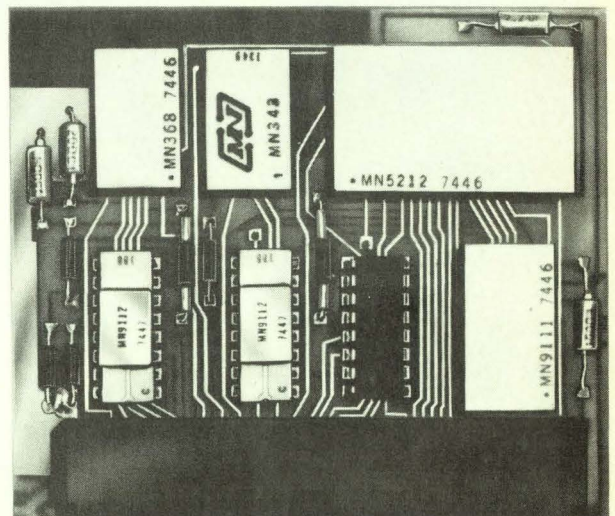

New! A miniature full MIL range adjustment-free 16-channel Data Acquisition System, Model MNA 7000.

Circle 169 on reader service card

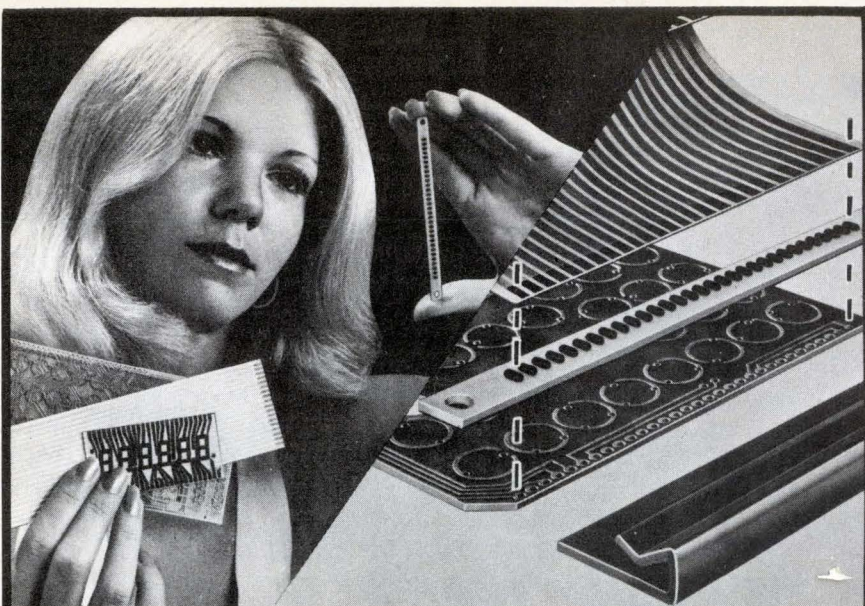

CONDUCTIVE CONNECTOR STRIPS

• Conductive and resilient elastomeric multiple connecting device • Standard contact spacing: 0.050" centers and 0.100" centers • Mounting holes are provided in carrier frames • Can be supplied with adhesive on sides for positioning and mounting • Applications include: Inter-connections of PC boards, liquid crystal displays and flat cable connections • Speeds assembly and reduces package volume.



EASTERN-DIVISION • 129 DERMODY ST. CRANFORD, N. J. 07016 (201) 272-5500
WESTERN-DIVISION • 427 OLIVE ST. SANTA BARBARA, CALIF. 93101 (805) 963-1867

Circle 170 on reader service card

Hot Semis? Get relief fast!



IERC



Heat Sinks

INTERNATIONAL ELECTRONIC RESEARCH CORPORATION / A SUBSIDIARY OF DYNAMICS CORPORATION OF AMERICA / 135 WEST MAGNOLIA AVENUE, BURBANK, CA. 91502

170 Circle 219 on reader service card

New products

ment. An eight-digit display and a non-ovenized crystal time base are standard. Extra-cost options include the interface-bus module, an ovenized oscillator, two digital-voltmeter modules, 512-MHz frequency-measuring capability, and a high-performance package which greatly expands the instrument's time-interval-measuring capability.

Inquiries Manager, Hewlett-Packard Co., 1501 Page Mill Rd., Palo Alto, Calif. 94304 [355]

Digital capacitance meter includes autoranging

The ECD model 100 is a hand-held, battery-operated, 3½-digit auto-ranging capacitance meter that measures capacitances from 200 picofarads full scale to 200 millifarads full scale in 10 automatically selected ranges. The meter, which has a maximum resolution of 0.1 pF, has an offset control which allows the stray capacitance of different test clips to be nulled out. The numeric readout is by means of a large (0.6-inch high) liquid crystal display, while the capacitance units are indicated by means of small light-emitting-diode lamps. The price of the meter is \$289; delivery is from stock to four weeks.

ECD Corp., 232 Broadway, Cambridge, Mass. 02139 [356]

1-MHz sweep/function generator sells for \$350

A low-cost sweep/function generator with a 50-ohm output impedance, the model 196A offers sine, triangle, square, pulse, and sweep waveforms over a frequency range of 0.1 hertz to 1 megahertz. Rise times of the square and pulse waveforms are less than 100 nano seconds, and a separate TTL-compatible output has a rise time of less than 25 ns. Price of the 196A is \$350; the unit is stocked locally.

Exact Electronics Inc., 455 S.E. 2nd Ave., Hillsboro, Ore. 97123 [357]

Electronics/June 12, 1975

HERMES LOOP ANTENNA

THREE SAMPLE SITES
ON THE NORTH AMERICAN
CONTINENT —

DIFFERENT LATITUDES
DIFFERENT CLIMATE

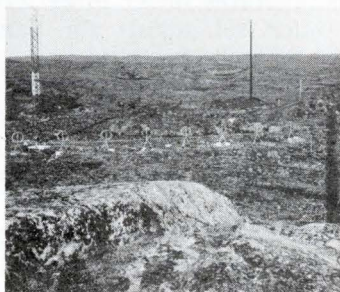

FROBISHER BAY, CANADA

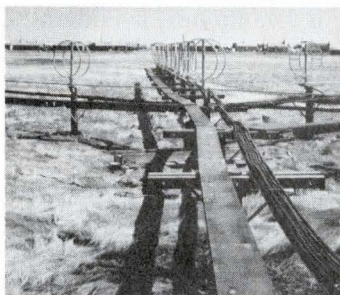

MARSHFIELD, MASS.

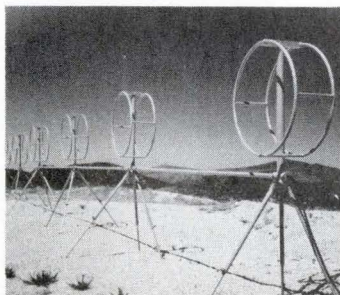

NEAR SAN DIEGO, CALIF.

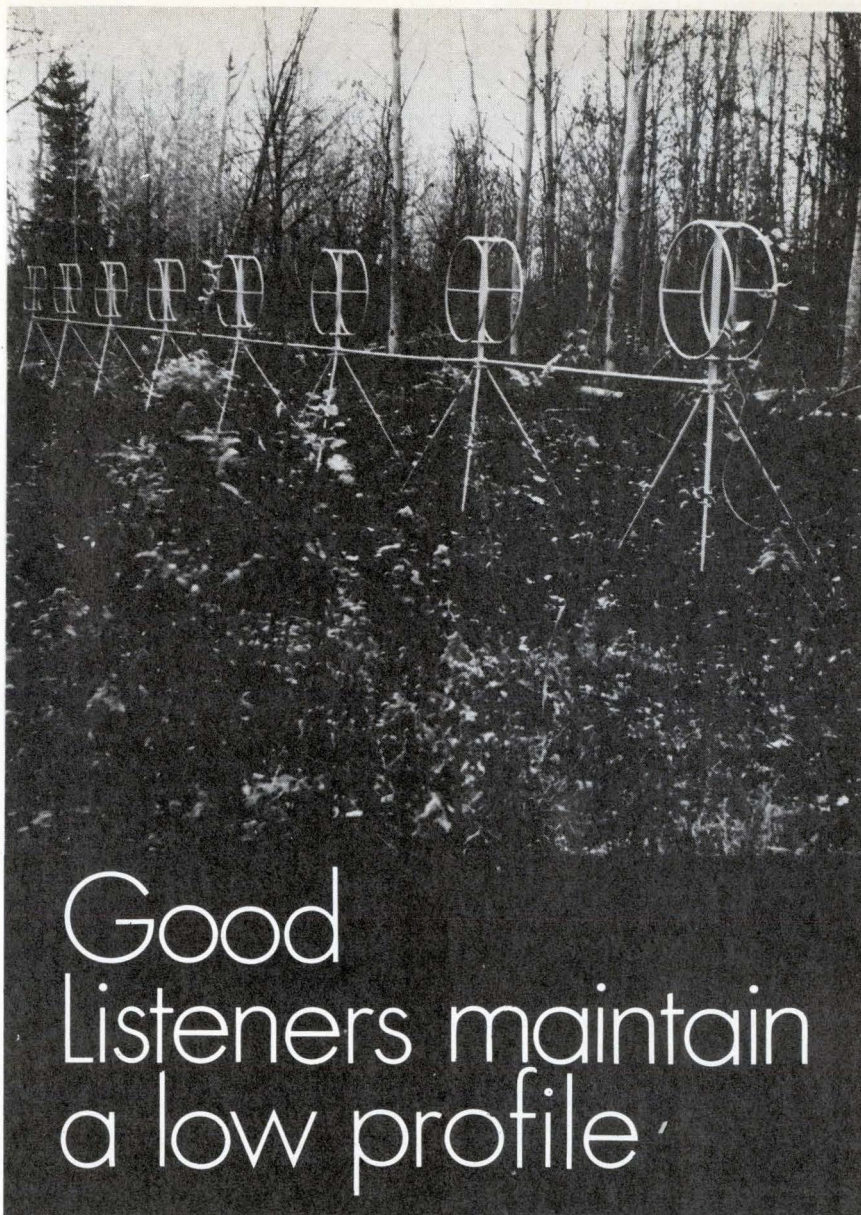

Good
Listeners maintain
a low profile

Even in the solitude of the forest depths, from rooftops, arctic tundra, swamps to sweltering tropics, 'neath snow, sand or ice,

the Hermes Loop antenna keeps an ear to the sky.

The amazing aperiodic antenna does away with vast log periodic and rhombic arrays - those towering antenna farms.

Excellent directional characteristics in rosette configuration, the Hermes loop antenna provides an omnidirectional broadband receiving array in space merely 1/100th that of the traditional antenna farm.

More than 53 government agencies around the world have pressed the loop antenna into service.

A new, even more compact version is available. Only Hermes Electronics makes it.

**2-32MHz
BROADBAND**



ASK US Send for our Brochure

Hermes Electronics Limited

Suite 315

2020 F Street NW

Washington, DC 20006 USA

202-296 2978

TWX 710 822 1106

1 **MADE**

AMERICAN

Tolerance
SCHAUER
1-Watt
ZENERS

Immediate Shipment
Low Prices

ANY voltage from 2.0 to 16.0

Quantity Price each

1-99	\$1.07
100-499	.97
500-999	.91
1000-4999	.86
5000 up	.82



All welded and brazed assembly

No fragile nail heads

Write for complete rating data and other tolerance prices.

Buy the kit-
Save a lot



Kit contains a 51-piece assortment of SCHAUER 1% tolerance 1-watt zeners covering the voltage range of 2.7 to 16.0. Three diodes of each voltage packaged in reusable poly bags. Stored in a handy file box. Contact your distributor or order direct.

A \$54.57 value for
ONLY \$24⁵⁰

Semiconductor Division

SCHAUER
Manufacturing Corp.

4514 Alpine Ave. Cincinnati, Ohio 45242
Telephone: 513/791-3030

New products

Packaging & production

Connectors are fire-resistant

Units for consumer and industrial jobs also come in standard nylon housing

A low-cost electronic connector from Amphenol exceeds the new standard of Underwriters' Laboratories for flame-resistant plastic parts in consumer electronics gear.

Recent public and Government

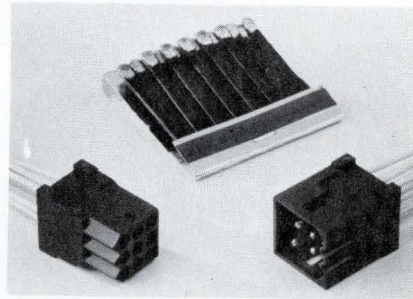

concern about fires in television sets has prompted manufacturers, to take a closer look at the flammability of plastic parts. The Consumer Product Safety Commission, for example, is now developing mandatory safety standards for TV sets, and Underwriters' Laboratories will require a more flame-resistant plastic in all consumer products starting July 1, 1977.

"Connector manufacturers have been pushing for a flame-retardant material for years, but no one had been able to come up with one," explains Oscar Rothchild, product manager for what Amphenol calls the 332 Series connectors. "The major difficulty was designing the part so that it could be molded from a flame-retardant material, which is less flexible than straight nylon because of the additives."

Connectors with housings of the flame-retardant material are designated Fire-Plug; the same connector with standard nylon housing is called Econo-Plug. For applications

requiring color coding, Econo-Plug connectors are available in six standard colors.

The series is completely interchangeable and matable with competitive connectors and is designed for use in appliances, computer peripherals, vending machines, transportation, and instrumentation, as well as home entertainment equipment. Mounting latches and wings on the connector lock the housing into panel cutouts with a 10-pound insertion force and, when mounted, the connector resists accidental push-out forces of 35 lb or more. The latch self-adjusts for panels from 1/32 to 3/32 inch thick.

To prevent accidental unmating, locking tabs are provided on connectors with two, three, six, and nine contacts, while contact retention force keeps the connector mated on 12- and 15-contact sizes. Both pin and socket contacts are bright tin-plated brass, and the three terminal sizes can be used with wire sizes from 14 to 30 AWG. Contact resistance is 3 milliohms maximum; current rating is 1 to 12 amperes, depending on wire size. Mating force is 24 ounces per contact maximum; unmating force, 4 oz per contact minimum.

The connectors are designed for a maximum operating voltage of 250 volts, with a dielectric-withstanding voltage of 1,800 v. A nine-contact plug and receptacle sells for 12 cents per pair in 10,000-piece quantities in the flame-retardant material; price for standard nylon versions is about 1 cent per mated pair less. Contacts loose or on reels are priced at 0.7 cent each in 100,000-piece quantities from stock.

Amphenol Industrial Division of Bunker Ramo Corp., 1830 South 54th Ave., Chicago, Ill. 60650 [391]

Bonded-overlay technique modifies circuit boards

Quick fixes or circuit modifications may force an engineer to squeeze extra wiring and components on an already frozen printed-circuit

5 reasons why the Keithley model 168 should be your number 1 digital multimeter

1. Autoranging. All you do is connect the signal to the two-terminal input and push the function you want. The 168 takes it from there to save you time.

2. 5 Functions. Dc voltage from $100\mu\text{V}$ to 1000V , ac voltage from $100\mu\text{V}$ to 500V , ac and dc currents from $0.1\mu\text{A}$ to 1A and resistance from $100\text{m}\Omega$ to $20\text{M}\Omega$.

3. Hi-Lo Ohms. Select ranges with 1-volt drop for turning on semiconductors or 100 millivolts for keeping them off.

4. Full 1-Year Guarantee. It's a Keithley, no less. And that means all specs including accuracy are guaranteed for a full year. Maintenance is easy too.

5. Low Price. Only \$315 puts the Model 168 in your hands. A complete line of accessories gives the 168 even more versatility.

The Model 168 Autoranging DMM will make your job easier . . . and that should make it your number 1 choice. Send for full details or phone (216) 248-0400 for a right-away demo.

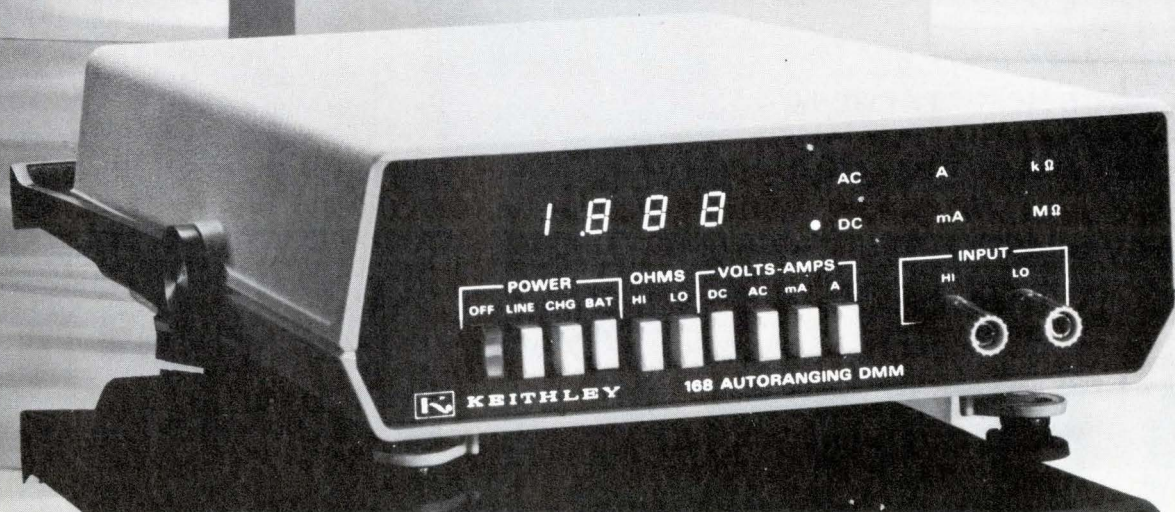

**KEITHLEY
INSTRUMENTS**
U.S.A.: 28775 AURORA ROAD, CLEVELAND, OHIO 44139
EUROPE: 14, AVENUE VILLARDIN, 1009 PULLY, SUISSE

GREAT GUNS!

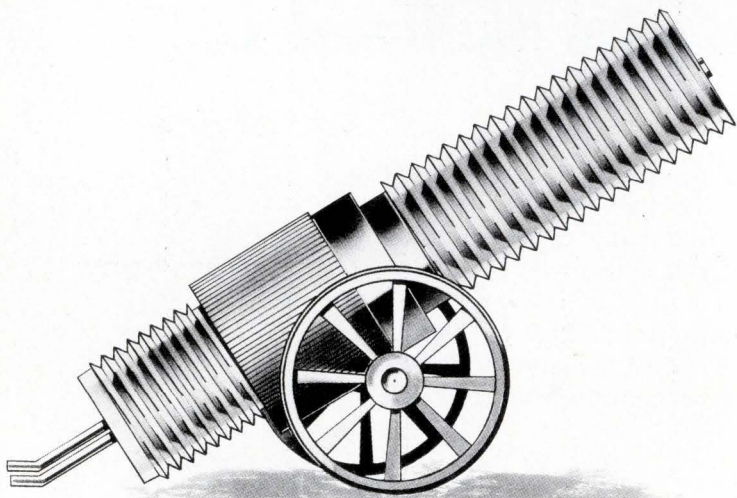

WE'RE SHOOTING DOWN THE PROBLEMS

in the selection of Magnetic and Digital Pickups — often a most difficult decision.

AIRPAX is a leading manufacturer of passive and active digital pickups to provide the most effective and accurate means of converting mechanical motion into usable voltage control signals, without mechanical linkage, by accurately detecting moving ferrous discontinuities.

OUR AMMUNITION!

"MAGNETIC PICKUPS AT WORK"

... a 20 page text on theory and applications. SEND FOR IT TODAY.

AIRPAX Controls Division
P.O. Box 8488
Fort Lauderdale, Florida 33310

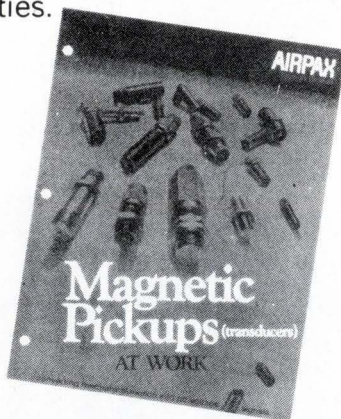

AIRPAX™

174 Circle 174 on readerservice card

New products

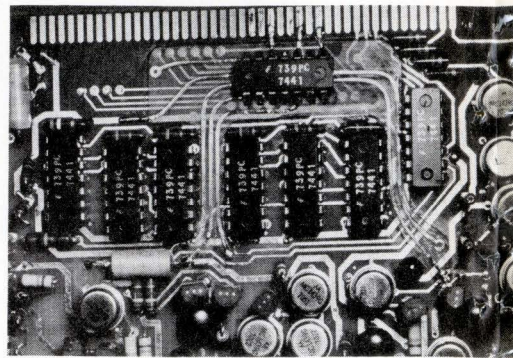

board—and all too often the reworked board turns out to be unreliable.

A new process developed by Blakesley Electronics, an Indiana manufacturer of circuit boards, could end most modification troubles. A thin, 10-mil layer of copper-clad FR-4 epoxy glass, with the modified pattern subtractively etched on it, is bonded to an existing board by a special adhesive. The photo above shows how a 14-pin DIP plus its wiring was added to a densely packed board. A Midwest tape recorder manufacturer is currently evaluating the method by replacing a pattern for two discrete transistors with an overlay for a single-can dual transistor.

The overlay method practically eliminates the need for jumper wires and will not damage components and wiring already on the board. All a user has to do is remove any of the unnecessary printed wiring, bond on the overlay, and solder from the plated connection of the overlay to the printed wiring or lands of the modified board.

Any additional components are then soldered to the surface of the bonded overlay. This can be thought of as a limited form of the multilayering technique, and, in fact, an assembled two-sided board can be converted to a three- or four-layer board if desired.

According to Wayne Blakesley, the originator of this method, the overlays will be made on a custom basis and furnished to customers to do their own modifications on the spot.

Cost of the overlay should be slightly more than in-house repair

SHIFT INTO HIGH PERFORMANCE WITH A 4K STATIC RAM

FULLY STATIC: The SEMI 4402 is a fully static 4K RAM. That's important. For one thing, it means you can now design a 250 nsec MOS memory system around a 4K device without worrying about refresh or charge pump circuitry. For another, static RAMs are inherently less susceptible to soft bit error problems than comparable dynamic devices.

350 NANOSECOND CYCLE: The SEMI 4402 4K static RAM has a *complete cycle time* of just 350 nsec and 200 nsec maximum access time. That makes it the fastest 4K static RAM in production. Now you can design a truly high performance MOS memory around a static 4K device.

AVAILABLE NOW: The SEMI 4402 4K static RAM is here now. We're already delivering it to customers at the memory system level. And it is second sourced by a major supplier of MOS devices.

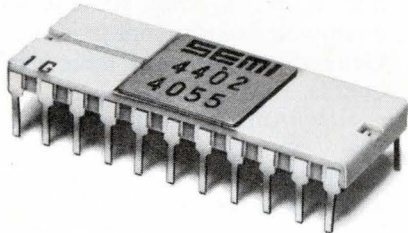

LOW POWER: The SEMI 4402 4K static RAM has similar power levels to

comparable dynamic devices. However, power conservation is achieved by the Chip Select Input, which causes the 4402 to enter a low power standby state whenever it is unselected. Normal V_{DD} is 12 Vdc, but V_{DD} can also be reduced to 5 volts without risking loss of stored data. And the 4402's differential output results in inherently high noise immunity memory systems.



PERFORMANCE TESTED: Like all SEMI NMOS components, the 4402 4K static RAM must meet our own tough test standards, since we use it in our memory systems — for example the MICRORAM 3400N. With our reputation riding on its performance, you may be sure the acceptance standards are high indeed. In fact we 100% ac and dc test our components twice — at wafer and again in the package.

MODEL SELECTION:

In addition to the 4402, EMM SEMI offers you a complete line of static NMOS RAM and ROM components to meet your design needs. Make your selection from the adjacent chart.

Part No.	Bit Org.	Access Time
RAMS		
SEMI-1801	1024 x 1	90 nsec.
SEMI-1802	1024 x 1	70 nsec.
SEMI RA-3-4256	256 x 4	1 usec.
SEMI RA-3-4256B	256 x 4	1 usec.
ROMS		
SEMI RO-3-4096	512 x 8	500 nsec.
SEMI RO-3-5120	512 x 10	500 nsec.
SEMI RO-3-16384	4096 x 4	1.0 usec.

More new products to come... additional 4K static RAMs, ROMs.

PROVEN TRACK RECORD: At EMM we've been making memory components and systems since 1961. Unlike memory suppliers who market components only, all

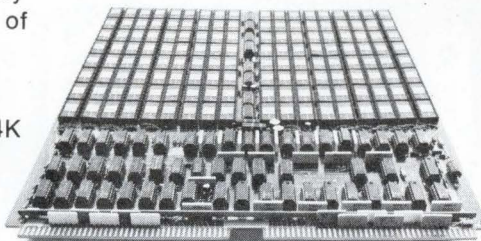

EMM components are all performance proven in our own systems. When you buy from EMM, you get the benefit of the unusually high acceptance standards we

impose on ourselves, as well as our years of experience in meeting the needs of the memory marketplace. If you'd like further information about any of the products featured here, or any other EMM components or systems, contact your local EMM office today.

EMM SEMI

A division of Electronic Memories & Magnetics Corporation
3883 North 28th Avenue, Phoenix, Arizona 85017
Telephone (602) 263-0202

Circle 175 on reader service card

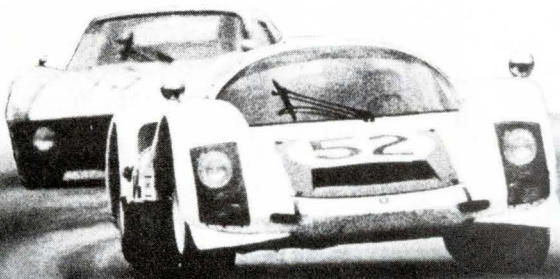

WORLD'S LIGHTWEIGHT CHAMP!

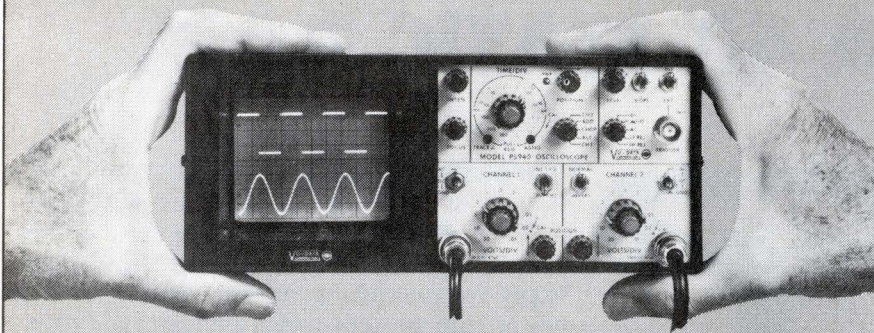

A 9½ pound, dual-trace 20 MHz scope that fits in a briefcase . . .

- Mini-portable Oscilloscope
- Battery, AC or DC powered
- DC - 20 MHz bandwidth
- Computerized triggering
- Delay line
- 10 mV/div sensitivity
- 21 sweep ranges to 100 nsec/div

If you're tired of working with the "Heavyweights," but still need a high performance portable scope that can handle your trouble-shooting needs, then consider Model PS940A. This dual-trace "mini-scope" provides all the basic features and quality of a sophisticated lab scope, yet its weight and size make it easy to carry to every job—at the plant or in the field. And it is simple to operate. Computerized triggering guarantees a stable CRT display at all times. Also, both traces can be vertically positioned in the DC coupled trigger mode without the need for trigger level readjustment.

AVAILABLE NOW FOR ONLY \$1145

INTERESTED? Call Hal Wardein at (714) 279-6572, or write to us at 7170 Convoy Court, San Diego, California 92111. For local ordering information, dial TOLL-FREE 800-645-9200; in N.Y. State call collect (516) 294-0990.

From a Leader in Mini-Portable Oscilloscopes



Circle 220 on reader service card

STOP TRANSIENT NOISE

ELIMINATE ERRORS IN YOUR COMPUTER OR INSTRUMENT SYSTEM

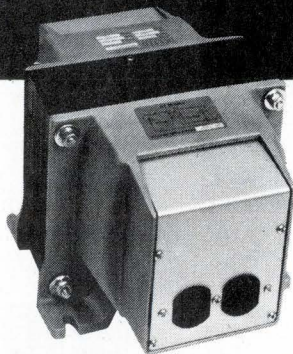

DELTEC DT series isolation transformers are designed for data loggers and process control systems. These isolators drastically reduce memory and transmission errors caused by transient noise on commercial power lines generated by industrial electrical equipment.

Common Mode Rejection is 140dB and interwinding capacitance is less than 1 femtofarad (0.001 pf).

Models are available from stock from 250 VA to 5 KVA. 3 Phase and special models available. For detailed specifications write or call:

DELTEC

CORPORATION

3849 Gaines St., San Diego, CA 92110
Telephone (714) 297-4466

176 Circle 176 on reader service card

New products

using customary procedures, the company says.

Blakesley Electronics, Box 686, Syracuse, Ind. 46567 [392]

Socket boards are designed for minicomputer interfacing

Although the minicomputers they make all have provision for extra input/output interfacing boards, neither Digital Equipment Corp. nor Data General desires to stock pre-wired cards for every special-pur-

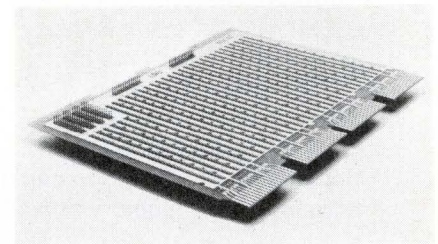

pose interfacing problem that might come along. Users therefore have had either to buy special wire-wrappable boards from DEC or Data General, or else make their own pc boards.

Now Augat has introduced two new series of interface packaging boards with IC patterns on one side and wire-wrap pins on the other. Socket boards 8136/LG 411 and LG 412 are for the DEC PDP-8, board 8136/LG 498 is for the PDP-11, and boards 8136/LG 413 and LG 414 are designed for the Data General Novas. The new boards are directly interchangeable with manufacturer-supplied boards.

The new boards, with two-ounce tin-plated-copper voltage and ground planes offer improved characteristics in V_{CC} and ground distribution over comparable DEC and Data General units. In addition, the Augat boards have more than 2.5 times the planar density of conventional two-sided boards or one-sided socket cards. For example, for the PDP-8, DEC offers a special wire-wrappable card with 40 to 50 IC sockets; the comparable Augat LG 411 has provision for 110 16-pin ICs.

Either two-level or three-level

Electronics/June 12, 1975

CUSTOM CLADS

Engineered materials don't always fall into neat little packages. We know that, and want the design engineer to have maximum flexibility within the area of reasonable manufacturing techniques. If you're "Blue Skying" designs or have a difficult requirement, why not call Mr. Harry Friedman at (617) 695-9312. Or write, Polymetallurgical Corp., 262 Broadway, North Attleboro, MA 02761. 

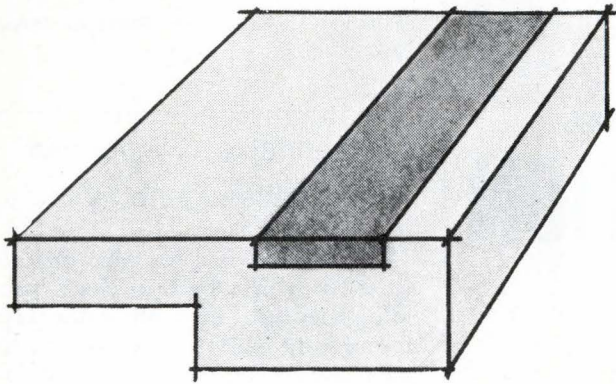

Circle 221 on reader service card



Check Out Central Mississippi For Higher Profits

Ideal For Profit-Oriented Electronics Manufacturers

- Abundant & Trainable Labor Force
- Low Cost Location
- Lower Construction Costs
- Lower Site Costs
- Available Industrial Buildings
- Room For Expansion
- Financial Incentives
- Deep South's Distribution Center

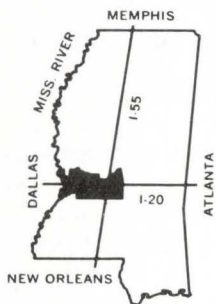

For detailed information about Hinds, Rankin and Warren Counties in Central Mississippi write or call:

Harry McLemore or George Kurts
CENTRAL MISSISSIPPI
DEVELOPMENT DISTRICT

Post Office Box 22548
Jackson, Miss. 39205
Telephone (601) 948-6354

Circle 222 on reader service card

What's Practical Automation Doing With Digital Printers?



Everything New!

When we designed our new miniature Matri-Dot Series of alphanumeric digital printers, we dedicated them to you and your customers. Matri-Dot printers represent a significant breakthrough in design, performance, and price.

Built like a Practical Automation Printer means . . .

1. **Smallest Size** . . . only 3½"W x 3"H x 9"D
2. **Lowest Price** . . . \$140 in 100 unit quantity
3. **Full Alphanumerics** . . . a complete 63 character set 0
4. **Ribbonless Printing** . . . unique inked platen lasts for 75,000 lines
5. **Standard Interfaces** . . . RS232C and others
6. **18 Columns** . . . 110 character per second print rate

Six sound reasons to take the next important step . . . ask for a demonstration and become convinced!



**PRACTICAL
AUTOMATION,
INC.**

Trap Falls Road ■ Shelton, Connecticut 06484
Tel: (203) 929-5381

Circle 177 on reader service card

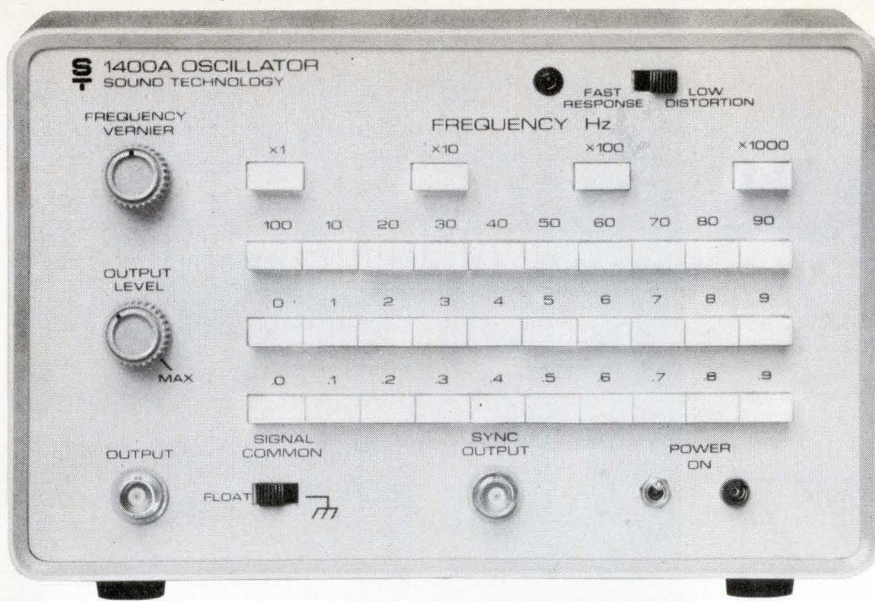

ULTRA-LOW DISTORTION OSCILLATOR

10 Hz-110 kHz: pushbutton tuned for high repeatability, 3-digit resolution. **FLOATING OUTPUT:** selectable by panel switch. **ULTRA-LOW DISTORTION:** typically .001% in audio range (see curve). **FAST SETTLING:** settles to .001% distortion in 5 seconds. Faster alternate mode. **FREQUENCY RESPONSE:** flat within 0.2 dB. **PRICE:** only \$610.

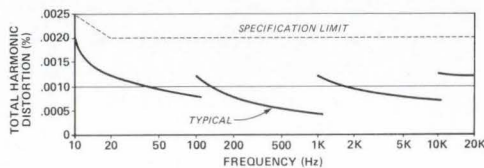

CALL NOW

Call Larry Maguire or Bob Andersen now for full information on this important new Model 1400A.

ST SOUND TECHNOLOGY
1400 DELL AVENUE
CAMPBELL, CALIFORNIA 95008
(408) 378-6540

Circle 178 on reader service card

Own your own holder to hold your own!

Hold your own copies of Electronics in specially designed slipcase holders. They'll keep your Electronics library neat and handy—a permanent information file, issue by issue.

Just complete the coupon and mail to Jesse Jones. He'll process your order upon receipt, postpaid.

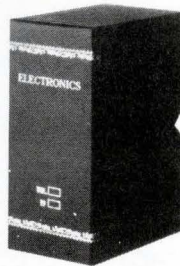

ELECTRONICS BOXER
Jesse Jones Box Corporation
2250 E. Butler St., Philadelphia, Pa. 19137

Please send me: boxes @ \$4.25 each; 3 boxes @ \$12.00; 6 boxes @ \$22.00.
My check or money order is enclosed.

Name: _____

Address: _____

City: _____ State: _____ Zip: _____

New products

wire-wrap pins containing precision, two-piece machined contact assemblies with either tin- or gold-plated outer sleeves are available for the new boards. Approximate prices per IC pattern vary from \$0.80 to \$1.50 depending upon board variations and quantity. Delivery time for the interface packaging boards is from stock to four weeks.

Augat Inc., 33 Perry Ave., Attleboro, Mass. 02703 [393]

\$300 portable IC tester has built-in pattern generator

The Evaluator is a portable digital-IC tester with a built-in clock, pattern generator, and comparator. The four-pound battery-operated instrument uses reference boards containing good integrated circuits for comparison testing of all transistor-transistor and diode-transistor logic,

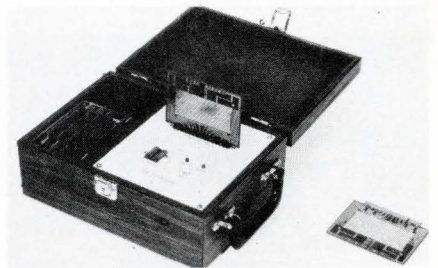

as well as complementary-MOS and other 14- and 16-pin ICs. The unit, powered by six AA nickel-cadmium cells, can perform 10,000 1-second tests from one fully charged set. Five commonly used reference boards are supplied with the Evaluator. Price is \$300.

fut-heuristic devices, P. O. Box 1117, Reseda, Calif. 91335 [394]

Ground-plane DIP boards intended for fast TTL

Designed to work with high-speed transistor-transistor logic, several new additions to Vero's line of circuit boards for dual in-line packages are provided with copper ground planes. The new boards, which are

SIEMENS

Cost-Effective Solutions to Semiconductor Test Problems

APPLICATION:

Verification of semiconductor memory performance from device to system level.

WHAT TO LOOK FOR IN A TESTER:

High speed microprocessor.
Independent X & Y addressing.
Off-the-shelf device interface.

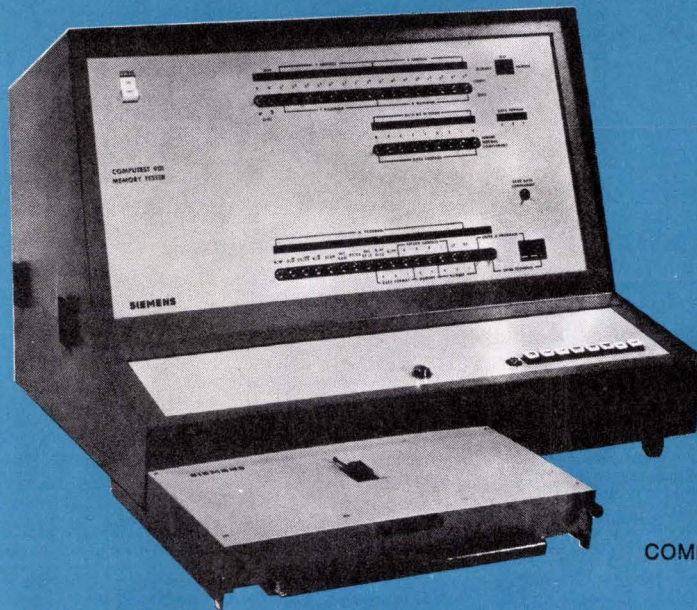

COMPUTEST MODEL 901

Semiconductor testing demands a practical low-cost solution. To check performance of semiconductor memory from the device through the system level requires memory-oriented addressing capability, a stable clock system, performance compatible device interface and real-time error detection. It's all found in the Computest Model 901 benchtop memory tester.

The Computest 901 has an easy-to-use, 10 MHz microprocessor, independent X & Y address generator, and a flexible, multi-channel clock. A com-

plete inventory of RAM/ROM interface modules puts the 901 to work for you immediately.

The Computest 901—flexible, versatile, tailored in price and performance for semiconductor memory testing from device to system level.

For additional information contact:
John Lalley (609) 424-2400.

Siemens Corporation
Computest Products

3 Computer Drive, Cherry Hill, N.J. 08002 (609) 424-2400

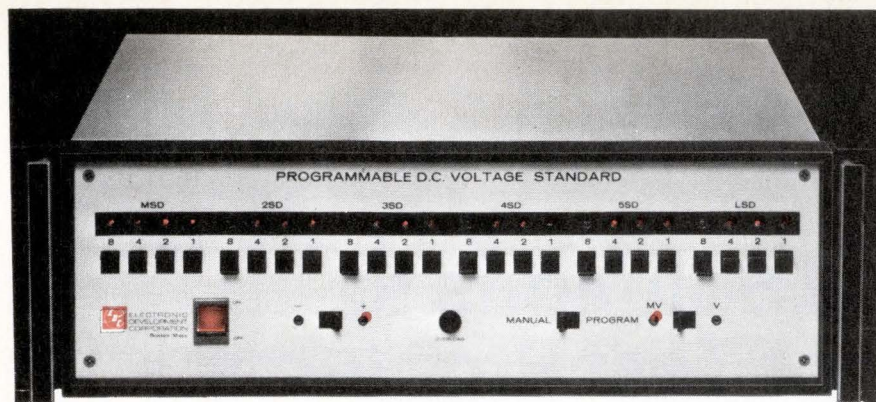

programmable microvolts for \$1,485

The EDC third generation 501 H has:

- Speed:** 50 μ s switching and settling time
- Ranges:** 100 mV, 10 V, 100 V, 200 V DC
- Resolution:** 1 ppm to steps of 0.1 μ V
- Accuracy:** \pm 0.005% of programmed value
- Programming:** TTL, BCD 8-4-2-1; other codes available including binary and ASCII
- Options:** Added resolution, ranging, CMOS compatibility
- Accessories (field installable, plug-in):** Serial-to-parallel converter, memory register, opto-isolators, ranging amplifier

For complete specs and prices on the 501 H and other EDC calibrators and standards, circle reader service number. To evaluate the 501 H in your application call Bob Ross at 617-268-9696.



Circle 180 on reader service card

New products

compatible with several of the company's existing card files, are offered with double-sided gold-plated edge contacts on either 0.156-inch or 0.1-inch centers. Like previous Vero DIP boards without ground planes, the new boards are prepunched with holes 0.040 in. in diameter on a 0.1-by-0.1-inch matrix so that they can handle any combination of DIPs. A typical price is \$10.60 for a board of 4.5 in. by 6.5 in. designed to mate with a dual 40-pin edge connector.

Vero Electronics Inc., 171 Bridge Rd., Hauppauge, N. Y. 11787 [395]

Analyzer tests 8008 microprocessor chips

A portable analyzer to test the model 8008 microprocessor displays cycle data, chip status, and time-state data. Capable of working with any system containing the 8008, the M-821 analyzer allows a user to perform tests in either a single-step static mode or in a dynamic mode. In the step mode, the program is

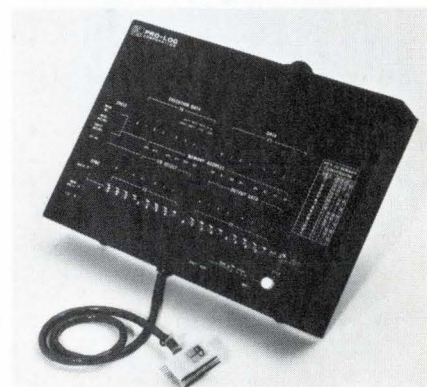

stepped through each memory cycle. In the run mode, data is captured and displayed without interfering with the program. The analyzer interfaces with the system under test by means of an 18-pin dual in-line package connector that clips onto the 8008 package. Operating from standard 115-v ac lines, the M-821 weighs only 4.5 pounds and comes packaged in an aluminum box. Small-quantity price is \$550; delivery is from stock.

Pro-Log Corp., 852 Airport Rd., Monterey, Calif. 93940 [396]

temperature registration

with self-adhesive temperature indicating dots

CELSIPOINT[®] 37°C - 260°C
dot \varnothing 10 mm

Temperatur-Indikatorpunkte
von 37°C bis 260°C
Temperature Indicating Dots
from 37°C to 260°C

A product of
DIPL. ING. ERNEST SPIRIG
CH-8640 RAPPERSWIL
SWITZERLAND
Telex 75400 Phone 055 27 44 03

CELSIPOINT

DIPL. ING. ERNEST SPIRIG CHEMOTECHNIK
CH-8640 RAPPERSWIL PO BOX 160 SWITZERLAND
PHONE 055 / 27 44 03 TELEX 75400

SPIRIG

reliable

economic

versatile

resistant
to water,
vapors, oil,
liquids

CELSIPOINT dots put
on any surface will
register any max. tem-
perature exceeded. At
rated temperature the
inner white circle
changes in parts of second
irreversible to black.

CELSIPOINT[®]
registered Trademark of

GAUSSMETERS



model 811

high accuracy
excellent repeatability
rugged

Bell gaussmeters measure magnetic field strength from .0001 gauss to 100,000 gauss. There are six gaussmeter models and 110 probe models for each gaussmeter. The resulting combinations meet the challenging requirements of all magnetic field measurement applications.

F. W. Bell has the experience and know-how to offer you the best instruments that are available. Your local representative is equipped to give you a demonstration. Use the inquiry card to find out how these instruments can benefit you.

"Trade in your old gaussmeter — call us for details."

4949 Freeway Drive East
Columbus, Ohio 43229
Phone: 614/888-7501
TWX: 810-337-2851

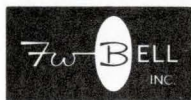

a subsidiary of Arnold Engineering

Circle 224 on reader service card

Facts.
The Brush 2400 delivers more of them with less fuss, bother and cost than any other oscillograph you can buy.

And it does it on a wide 100mm channel and at a remarkable 30Hz. Available in 2, 3 and 4 channel models with all the Brush exclusives, of course.

For the full Brush 2400 story, write Gould Inc., Instrument Systems Division, 3631 Perkins Avenue, Cleveland, Ohio 44114. Or Kouterveldstraat 13, B 1920 Diegem, Belgium.



 **GOULD**

Circle 225 on reader service card

OUR METAL CONE CRTs HAVE 3 ADVANTAGES— PRICE, PERFORMANCE AND AVAILABILITY.

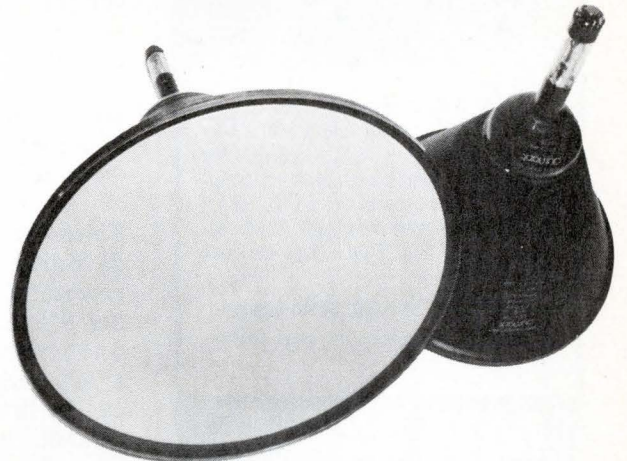

For the same price you'd pay for the all-glass type, DuMont can quickly furnish 16", 19" and 22" metal cone CRTs that offer distinct advantages both for the equipment designer and the end user. The designer will appreciate the weight he can save by eliminating EMI or personnel safety shields. (None are necessary with metal cone construction.) The user will find that the self shielding of the metal cone provides a uniform focusing field, while the high-transmission, uniformly thick faceplate is the flattest screen obtainable for any large-diameter CRT. The sum of these advantages is an extremely sharp edge-to-edge presentation with the smallest possible parallax error.

With the addition of a multi-persistence or multicolor phosphor screen these metal cone CRTs are ideal for displays that integrate low repetition video with computer generated data in radar and process control displays. Air traffic control, manufacturing process control, training simulators, interactive displays and computer terminals are some of the typical applications.

Typical tubes are briefly described below. Many other models are available.

	22 Inch Tubes		16 Inch Tubes	
	KC 3008	KC 3025	K 1222	KC 2745
Useful Screen (in.)	20.00	20.00	14.37	14.37
Focus / Deflection	M/M	M/E	M/E	M/M
Deflection Angle	53°	62°	53°	53°
Line Width (in.)	0.015	0.020	0.018	0.022
Standard Phosphor	P31	P7	P7	P7

For more complete information contact us at 750 Bloomfield Ave., Clifton, N.J. 07015, Tel. (201) 773-2000.

DuMont 

A Subsidiary of THOMSON-CSF

Circle 181 on reader service card

181

PINPOINT HEAT

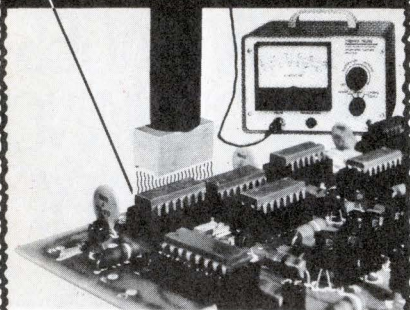

Heat any I. C. or semiconductor component to its rated temperature with a heat probe. Accuracy $\pm 1/2^\circ\text{C}$. Or check the component's temperature with a thermocouple probe. Accuracy $\pm 1^\circ\text{C}$. Model 810 Thermo-Probe does both. Reads out directly in $^\circ\text{C}$ and $^\circ\text{F}$ on a large $4\frac{1}{2}$ -inch meter.

PRICE \$272.50 F.O.B. South Laguna

Models with other temperature ranges available. For details write to:

MTI MICRO-TECHNICAL INDUSTRIES

P.O. Box 287 South Laguna, CA 92677
714 545-3734 • TWX 910-587-3425 MICRO OHM ELM

Circle 226 on reader service card

High-Accuracy Phase Meters

0.5 Hz to 2 MHz
Digital or meter
readouts
As low as \$1050



930 E. Meadow Dr. Palo Alto, Ca. 94303
(415) 321-7428

Circle 182 on reader service card

New products/materials

A thermally conductive silicone rubber compound is usable as a stress-free encapsulant, as a repairable adhesive/sealant, and as a flexible mold compound. Castall 1200 is a two-part room-temperature-vulcanizing material that cures with very little shrinkage, and is rated for operation over the temperature range from -100° to 300°C . Available in black or white, it sells for about \$69 per gallon.

Castall Inc., East Weymouth, Mass. [476]

Thick-film resistors, conductors, and dielectrics are among the two dozen new items included in catalog number 845 from Thick Film Systems. The screen-printable pastes include a 600 series resistor material that can be fired at 600°C on glass and ceramic substrates. Also included are colored dielectric formulas that retain their color after firing, and various precious-metal, precious-metal-alloy, and copper-conductor formulations. The copper paste must be fired in a nitrogen atmosphere.

Thick Film Systems Inc., 324 Palm Ave., Santa Barbara, Calif. 93101 [477]

High-temperature space cloth, Ecosorb SC-HT, is an open-weave glass-fiber cloth that has been treated with a lossy resin to make it semiconductive. The material is coated to ensure its stability at temperatures up to 300°F . Resistivity values from 100 to 1,500 ohms per square, measured at 3 GHz, are available.

Emerson & Cuming Inc., Canton, Mass. 02021 [478]

Pure copper in the form of 99.999% single crystals is available for conductivity and alloy studies in five standard diameters from 0.25 to 1.5 inch and in four standard lengths from 1 to 6 in. The crystals are normally sold in random orientation, but specific orientations within 1° of the major axis are available at extra cost. A typical crystal 0.25 in. diameter by 1 in. long costs \$140.

Aremco Products Inc., P. O. Box 429, Ossining, N. Y. 10562 [479]

digital pyrometer for \$146^{25*}



LINEARIZES OUTPUT OVER THERMOCOUPLE RANGE 0° TO 2400°F WITH 1° RESOLUTION

- J, K, T, E, B, R & S Thermocouple Models with 0.2% Conformity
- Open Thermocouple Indication
- RTD Model with 0.1° Resolution
- Pre-Calibrated Plug-in Sensor Modules
- Dual Slope, Automatic Zero
- 13mm ($\frac{1}{2}$ inch) LED Display
- Parallel BCD Output
- Automatic Cold Junction Compensation
- Remote Control of HOLD and BLANKING
- DIN Case with Screw Terminal Inputs
- 500V Analog to Digital Isolation (Option)
- Digital Set Point Alarm (Option)
- 0 - 1V Linearized Analog Output (Option)
- 2 Year Warranty

*OEM quantities

FOR IMMEDIATE RESPONSE

Write: Newport Laboratories, Inc.,
630 E. Young St., Santa Ana, CA 92705
Call Collect: (714) 540-4686
In Netherlands, Call:
Amsterdam (20) 45-20-52
In W. Germany, Call:
Sprendlingen 6103-63041

NEWPORT

Circle 227 on reader service card

GE's June, 1975 miniature catalog has over 500 data changes that could affect your current design. Send for it. It's free.



(3-5169)

NEW. June '75 Miniature Lamps:

40 pages. 500 changes. Data covers over 500 miniature lamps ranging up to 20,000 hours rated average life. With a design voltage range of from 1.2 to 55, and candle-power range from .02 to 250. Diameter range from $\frac{1}{32}$ " to $2\frac{1}{16}$ ".

Circle Product Card # 103



(3-6252R1)

NEW. Feb. '75 Sub-Miniature Lamps:

24 pages. 91 changes. Data covers over 210 sub-miniature lamps. Diameters $\frac{1}{4}$ " and smaller. Rated voltage 1.3 to 60. Candle-power range from .006 to 15. Rated average lamp life up to 60,000 hours.

Circle Product Card # 104

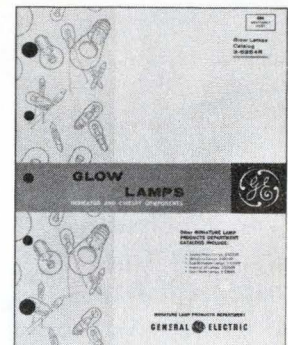

(3-6254R)

NEW. Dec '74 Glow Lamps:

8 pages. 50 changes. Data covers 83 Neon Glow Indicator and Circuit Component lamps. Diameters ranging from $\frac{1}{4}$ " to $1\frac{3}{4}$ ". Wire terminal lengths $\frac{1}{2}$ ", $\frac{5}{8}$ ", $\frac{3}{4}$ " and $1\frac{5}{16}$ ".

Circle Product Card # 105

To get the catalogs you need, free of charge, circle the product card number shown under each catalog, or write General Electric, Miniature Lamp Products Department, 3382-M, Nela Park, Cleveland, Ohio 44112.

GENERAL  ELECTRIC

You don't have to buy a new car to get an electronic ignition.

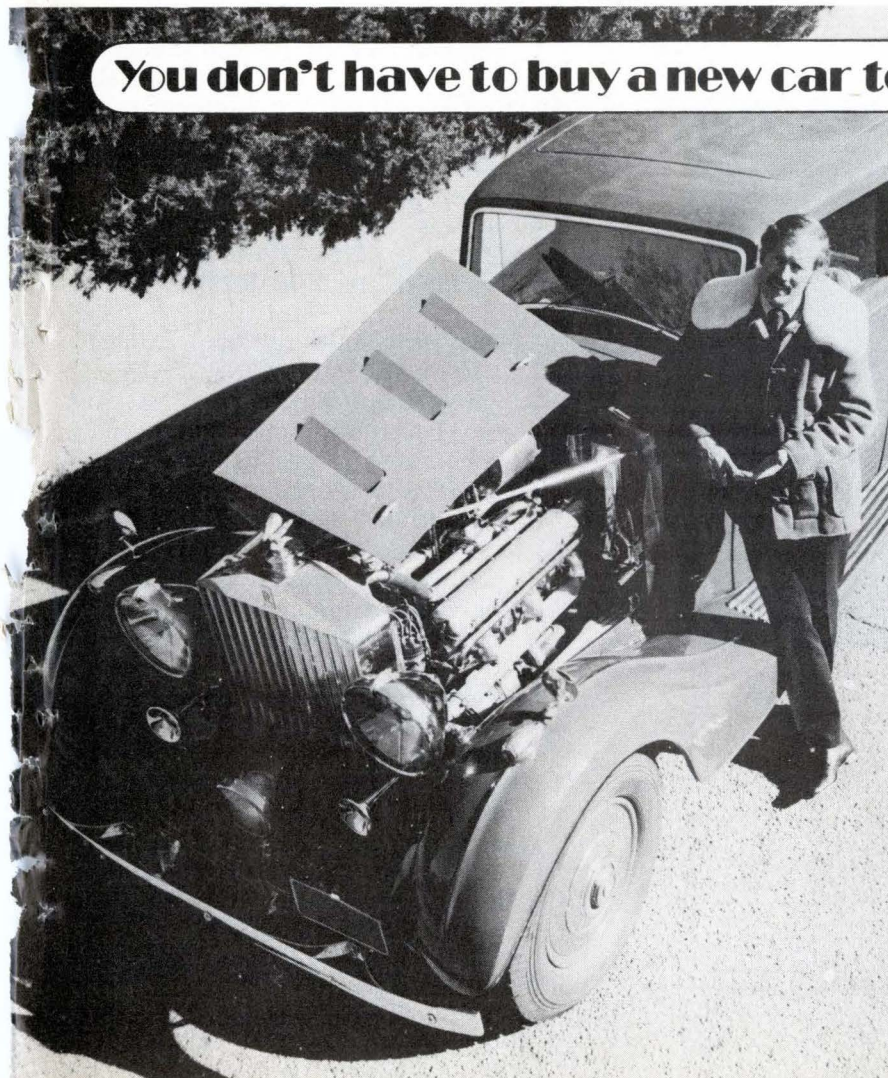

Let's face it. After 37 years, even a Phantom III can use a lift. That's why I put a Delta Mark Ten B Capacitive Discharge Ignition on my Phantom . . . to give her a spark I'd pit against any '75 model car. I went to Delta because they aren't Johnny-come-latelys. Delta's been making electronic ignition systems for over a decade.

Whatever kind of car you drive, you can give it the same great Delta performance I gave mine.

- Mark Ten B Capacitive Discharge Ignition Systems are manufactured by Delta Products, Inc., a company with a conscience, and with a proven record of reliability both in product and in customer relations.
- The Mark Ten B really does save money by eliminating the need for 2 out of 3 tune-ups. Figure it out for yourself. The first tune-up or two saved pays for the unit, the rest is money in your pocket. No bunk!
- Because the Mark Ten B keeps your car in better tune, you actually can save on expensive gasoline.
- With a Mark Ten B, spark plugs stay clean and last longer . . . fouling is virtually eliminated.



I want to know more about Mark Ten B CDI's. Send me complete no-nonsense information on how they can improve the performance of my car.

Name _____

Address _____

City _____ State _____ Zip _____



DELTA PRODUCTS, INC.

P.O. Box 1147, Dept. E, Grand Junction, Colo. 81501
303-242-9000

Mark Ten B,
assembled \$64.95 ppd
Mark Ten B, kit \$49.95 ppd

Standard Mark Ten,
assembled \$49.95 ppd
Deltakit® \$34.95 ppd

Circle 183 on reader service card

New

A P terminal & distribution strips

solderless plug-in universal breadboarding elements

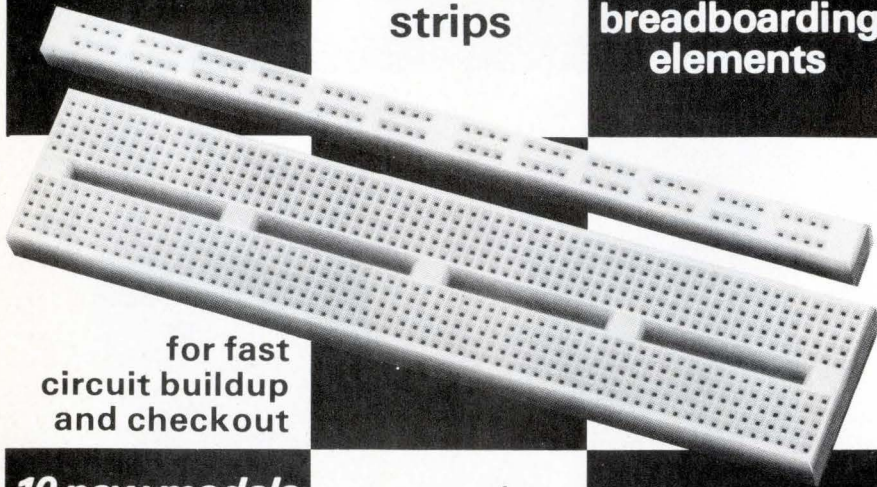

for fast
circuit buildup
and checkout

**10 new models
starting at \$2**

expanded capacity
at lower cost

All products are guaranteed
to meet or exceed
published specifications

accommodate
all DIP sizes

•
easy hookup with
22-ga. solid wire

•
free catalog



A P PRODUCTS INCORPORATED
Box 110-E, Painesville, Ohio 44077
(216) 354-2101 • Twx 810-425-2250

Circle 184 on reader service card

Presenting in your corner: **THE ELECTRONICS BOXER!**

Why mess around when you can have the ELECTRONICS BOXER clean up your copies—keep them in top condition.

And, it's easy and inexpensive to keep the ELECTRONICS BOXER in your corner. Just complete the coupon and mail. Your order will be processed immediately, postpaid.

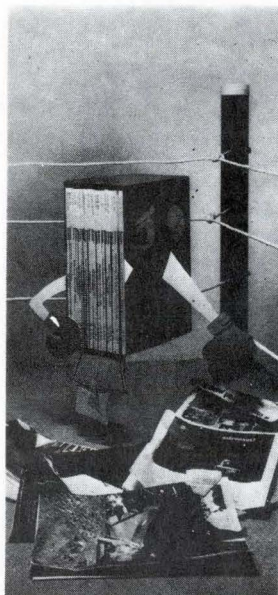

ELECTRONICS BOXER

Jesse Jones Box Corporation

2250 E. Butler St., Philadelphia, Pa. 19137

Please send me: boxes @ \$4.25 each;
 3 boxes @ \$12.00; 6 boxes @ \$22.00

My check or money order is enclosed.

Name _____
Address _____
City _____ State _____ Zip _____

New literature

SCRs. The specifications, ratings, and characteristics of silicon controlled rectifiers are discussed in a four-page application note put out by the Semiconductor division of International Rectifier Corp., 233 Kansas St., El Segundo, Calif. 90245. Material on forward and reverse characteristics, turn-on time, turn-on voltage drop, di/dt ratings, critical dv/dt, and turn-off time is included. Circle 421 on reader service card.

Digital switches. Digitran's 40-page general catalog includes, in addition to standard product data, such valuable reference information as digital switch theory, switching techniques, and a glossary of thumbwheel switch terms. A complete listing of current prices is bound into each catalog, which can be obtained from The Digitran Co., 855 South Arroyo Parkway, Pasadena, Calif. 91105 [422]

Electrical contacts. A four-page application note assesses the strengths and weaknesses of various metals and alloys used for electrical contacts. Entitled "Handbook on Electrical Contacts; Materials and Processes Make the Difference," the note is available from Deringer Mfg. Co., 1250 Town Line Rd., Mundelein, Ill. 60060 [423]

Data entry. A 68-page book entitled "How to Evaluate and Select a Data Entry System" is priced at \$6.95 and may be ordered from Entrex Inc., Publications Dept., 168 Middlesex Turnpike, Burlington, Mass. 01803. Documented with tables, charts, and glossaries, the book guides the user through the processes of selecting equipment and implementing a data-entry system. [424]

High-voltage testing. Two booklets—"Basic Facts About High-Voltage Testing" and "Armature and Stator Testing Notebook"—published by Slaughter Co., discuss in detail the whys and hows of high-voltage and leakage testing. Slaughter Co., Moore and Hailey Streets, Ardmore, Okla. 73401 [425]

Fast Fourier transforms. The system parameters involved in defining a fast Fourier transform requirement, as well as Fourier methods, the basic Fourier transform, the discrete Fourier transform, and the fast Fourier transform, are covered in a 13-page pamphlet offered by Spectra Data Inc., Att: William Morgan, 18758 Bryant St., Northridge, Calif. 91324 [426]

Calculator programs. Two handbooks containing programs for use on the recently introduced HP-55 programmable calculator [*Electronics*, Dec. 26, 1974, p. 109] sell for \$10 each. "HP-55 Mathematics Programs" and "HP-55 Statistics Programs" contain general descriptions of the programs, formulas used in each program solution, numerical examples, user instructions, program listings, and register allocations. The books may be ordered from Inquiries Manager, Hewlett-Packard Co., 1501 Page Mill Rd., Palo Alto, Calif. 94304 [427]

Reference diodes. A six-panel pocket reference guide cross-indexes 270 popular temperature-compensated reference diodes by temperature coefficient, zener voltage, test current, and maximum dynamic resistance. Using the guide, engineers can quickly determine the appropriate 1N number for various devices with temperature coefficients from 0.01 to 0.0005%/°C. Also listed are static characteristics for 37 tunnel diodes and 10 backward tunnel diodes. Microsemi-conductor Corp., 2830 So. Fairview St., Santa Ana, Calif. 92704 [428]

Brushless motors. An 18-page illustrated brochure describing applications and principles of electronic (brushless) dc motors using Hall-effect devices is available from Siemens Corp., Power Engineering Division, 186 Wood Avenue South, Iselin, N.J. 08830. The brochure serves as a primer for the design or applications engineer and includes sections on speed control and motor construction. [429]

EVEN AN OIL BATH WON'T STOP THIS FLATPACK.

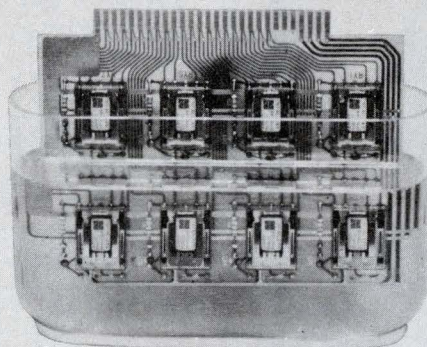

This NFE relay will mechanically switch 10^8 times under the worst operating conditions and live for 5×10^6 at 1 A, 30 VDC resistive and 10^6 at 2 A, 30 VDC. Life expectancies that double those of standard flatpacks used under hostile conditions. NFE relays come in 2 Form C and 4 Form C types with coil voltages of 6, 12, 24, 48, or 60 V. They measure .425" H x .772" (2C) or .953" (4C) W x 1.165" L. Great for dense P/C board mounting. Operate power: 300 mW for the 2C; 480 mW for the 4C. That's half the power needed for comparable flatpacks. There are no other flatpacks like them. Send for full NFE relay specs.

Relays for advanced technology.



Arrow-M Corp. 250 Sheffield St., Mountainside, N.J. 07092 U.S.A.
Telephone: 201-232-4260

Circle 185 on reader service card

NEW FROM AUGAT.

Programming jumper plug assembly gives you more flexibility at lower cost than DIP switches. Available in standard units of from 1 through 9 poles. Special assemblies available with contacts on both .100" and .300" centers. Available now from your Augat distributor.



AUGAT®

Augat Inc., 33 Perry Avenue, P.O. Box 779, Attleboro, Massachusetts 02703

Name _____
Title _____
Company _____
Address _____
City _____ State _____ Zip _____

GAS SENSING SEMI-CONDUCTOR

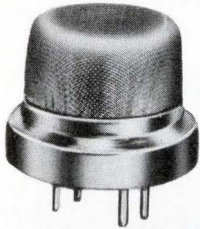

FIGARO GAS SENSOR

'75 New Models, some with highly sensitive CO sensor, now on the market.

Please contact the address below directly for catalogs and price/delivery information.

FIGARO ENGINEERING INC.

3-7-3, Higashitoyonaka, Toyonaka City,
Osaka 560, Japan/Phone: (06) 849-2156
Cable: FIGARO TOYONAKA
Telex: 05286155 FIGARO J

Circle 186 on reader service card

RENT A MINI 1 DAY DELIVERY DEC PDP 8I(4K) DEC PDP 8L(8K) ASR 33

FOR SALE

MINIS DEC • DG • CAI • GTE
HP • HIS • IBM • INT
LOCK • MICRO • SEL
VARIAN • XLO

PRINTERS MDS 4330—\$2950
CDC 9322—\$2500
DP 2440 — \$7500

CARD READERS GDI 100 \$950
\$450

PAPER DIGITRONICS 2500 \$350
TAPE CHALCO • BRPE 21 \$250

MAG PERTEC • WANGCO
TAPE POTTER • AMPEX

617-261-1100

AMERICAN USED COMPUTER CORP.
P.O. Box 68, Kenmore Sta., Boston, MA 02215
member COMPUTER DEALERS ASSOCIATION

Circle 229 on reader service card

New literature

Switch noise. An article called Tech Tips 2-4, available from the Semiconductor Division, Westinghouse Electric Corp., Youngwood, Pa. 15697, tells how to eliminate 120-cycle line noise and radio-frequency interference from power-controller circuits that use inexpensive bi-metallic switches. [430]

Power semiconductors. A broad line of power Darlingtons, power transistors, rectifiers, zeners, and varactor diodes is described in a 28-page catalog published by TRW Semiconductors, 14520 Aviation Blvd., Lawndale, Calif. 90260. Designated Catalog No. 100, the publication includes complete electrical and operating specifications for devices that are designed for use in such applications as switching regulated power supplies, motor controls, electronic ignitions, instruments, and battery-operated equipment. [431]

English/metric converter. Particularly useful to engineers working with wire and cable, an English/metric converter in slide-rule form is being offered by Continental Wire and Cable Corp., Box 1863, York, Pa. The chart covers wire sizes from 0.5 square millimeter to 400 mm². [432]

Business abroad. A compact book called "A Basic Guide to Exporting" is available from the U. S. Department of Commerce, Domestic and International Business Administration, Washington, D.C. 20230. The 52-page, digest-sized book outlines the steps that take a businessman into the world marketplace and lists the wide range of assistance available from government and private sources. [433]

Relays and steppers. A 48-page catalog provides specifications, drawings and applications information on general-purpose relays and stepping relays available from Guardian Electric Manufacturing Co., 1550 West Carroll Ave., Chicago, Ill. 60607. The publication replaces all previous Guardian relay catalogs. [434]

There's no RF energy crisis with RCA power tubes.

RCA's combined families of regular and large power tubes not only comprise the broadest line of such tubes in the industry, but they range in power all the way up to 250 kW... and in frequency to 1450 MHz.

Covering almost every major power tube application area, the RCA line also includes a comprehensive array of cavities and circuits. These cavities and circuits are specifically designed to enhance the advantages of RCA's power tubes. Together they achieve a total power package unmatched for reliable high performance.

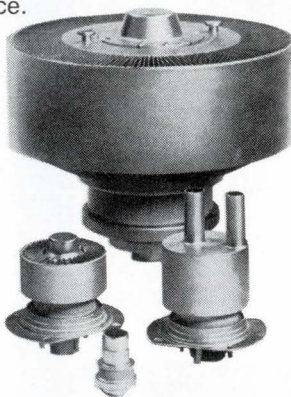

For more information on the entire RCA power tube line, call your RCA Representative or RCA Industrial Tube Distributor, or complete and return the coupon.

**RCA Lancaster — where
people and technology
make the difference.**

Manager, Power Tube Marketing
RCA, New Holland Avenue, Bldg. 100
Lancaster, Pa. 17604

____ Please send me the RCA Power,
Frequency and Application Chart.

____ Please have an RCA Representative
call me. Telephone _____

— This is your mailing label. Please print. —

Name _____

Company _____

Street _____

City _____

State _____

Zip _____

RCA Power Tubes

When Precision and Reliability Really Count... Count on Oki Electric Dry Reed Switches!

De-activated Rhodium Contact* ensures you of superb reliability ever achieved!

*Patent pending

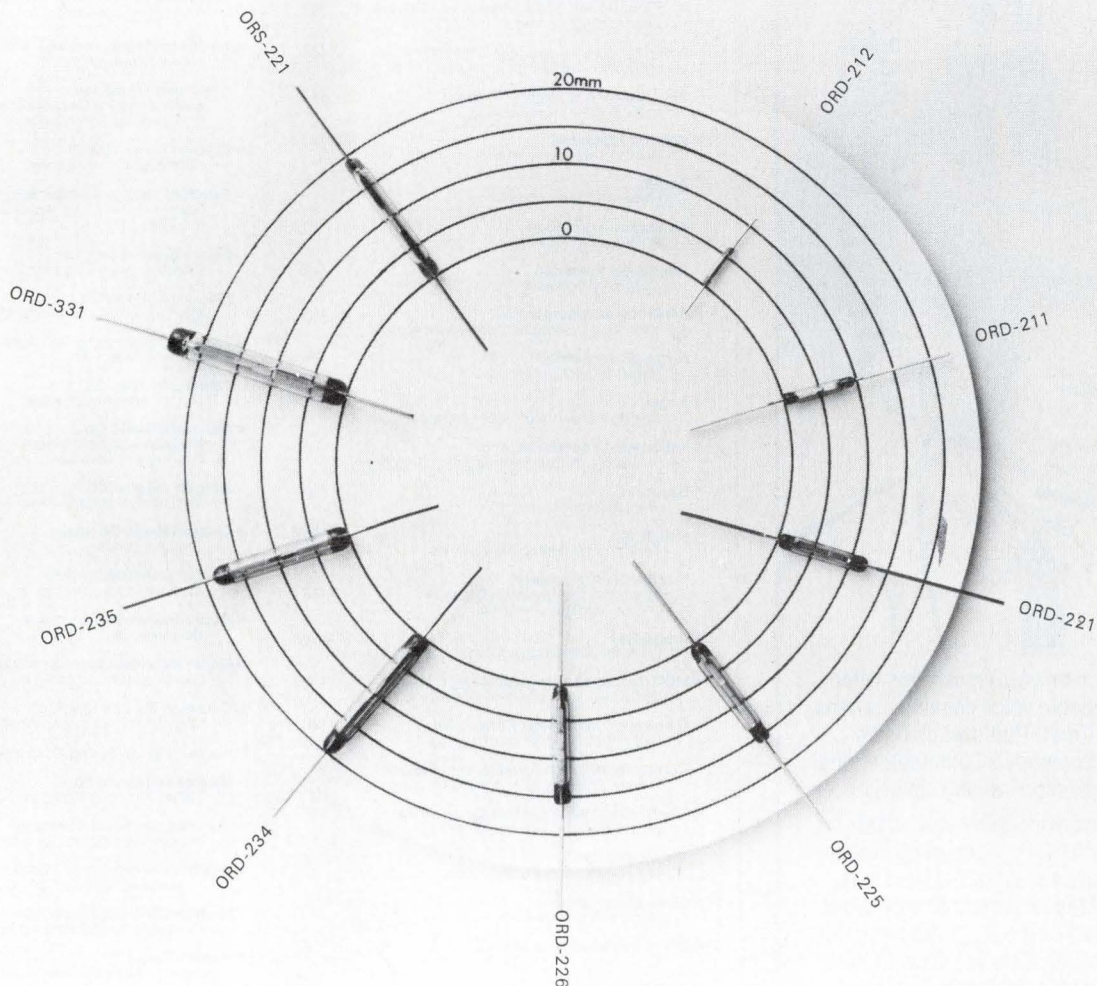

ORD-212
electronic digital wrist watch/
camera/micro precision instrument

ORD-211
micro measuring instrument/
automobile/micro precision
instrument

ORD-221
desk-top calculator/reed relay/
automobile/tuner

ORD-225
desk-top calculator/automobile/
data terminal/reed relay

ORD-226
automobile/level sensing device

ORD-234
automobile/reed relay/electrical
home appliance

ORD-235
high frequency transmission
equipment/radio telecommunication
equipment

ORD-331
automobile/electrical home
appliance/control equipment

ORD-221
telecommunication equipment/
office machine

JAPAN
OKI Electric Industry, Co., Ltd.
10-4-3 Shibaura, Minato-ku, Tokyo
Tel. 03-454-2111
Twx. J22627

WEST GERMANY
OKI Electric Europe GmbH
4000 Düsseldorf, Berliner Allee 22
Tel. 0211-15046 & 7
Twx. 8587218

U.S.A.
OKI Electronics of America, Inc.
4031 N.E. 12 Terrace
Ft. Lauderdale, Florida 33308
Tel. 305-525-8201
Twx. 5109559837

OKI Electric Overseas Corporation
850 3rd Avenue, New York, N.Y. 10022
Tel. 212-371-2054~2057
Twx. 223217

Circle 187 on reader service card



OKI
electric
industry
company, Ltd.

There's no one system for every communications problem

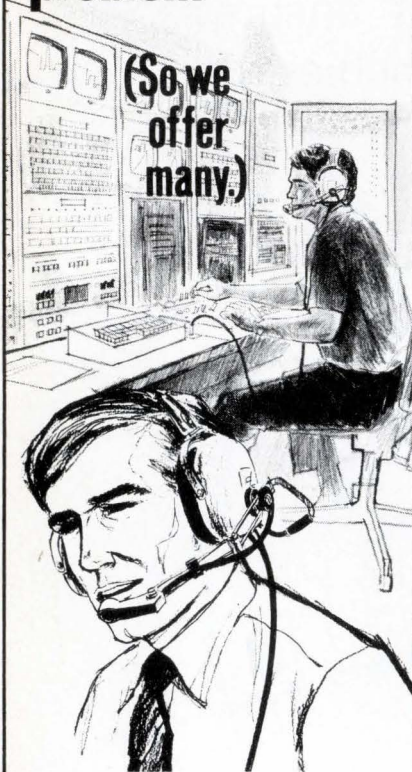

We turn on voice messages when dependable voice communications are critical. That's when David Clark Company's Communications Systems offer reliable solutions.

Because your communications problems vary, so do our Intercom Systems, modules and headsets. We'll tailor a system to solve your every voice message problem. Our compatible modules provide the building blocks for custom intercom installations.

From missile sites to theaters, large construction jobs to remote oil drilling sites, TV studios to shipyards, our Intercom Systems help you hear while suppressing ambient noise.

For more information, call or write today.

from "the quiet people" at

David Clark COMPANY
INCORPORATED
360 Franklin St., Worcester, Mass. 01604

Electronics advertisers

June 12, 1975

■ Abbott Translator Labs Inc. Technical Advertising Agency	6	Dipl. Ing. Sprig Buerof. techn. Werbung	180
* Adelsy Studio CPM	16E	Eastman Kodak Co.— GMD GD Photofabrication-Microelectronic Rumrill-Hoyt, Inc.	138
Advanced Micro Devices Keye Donna Pearlstein	11	‡ Eastman Kodak Company, Graphics Markets Division-Engineering Data System Micrographics J. Walter Thompson Company	15
* AEG Telefunken Werbeagentur Dr. Kuhl GmbH	57	■ Edmund Scientific Company Chittick Egan Advertising	192
Alltech Snow & Depon	165	EECO The Greer Agency	64
■ Airpax Electronics, Inc. Group Three Advertising Corporation	174	Electronic Arrays, Inc. Bonfield Associates	9
‡ Allen Bradley Company Hoffman, York, Baker & Johnson, Inc.	24	Electronics/Deluxe Classics Gumpertz/Bentley/Fried/Scott	190
* American Microsystems, Inc.	58-59	Electronic Development Corporation Advertising Assistance, Inc.	180
American Microsystems, Inc. Wilton Coombs & Colnett Inc., Advertising	37	■ Electronic Measurements, Inc. Hill Advertising Agency	168
American Optical Corp., Fiber Optics & Industrial Prod. Division Wilson, Haight & Welch, Inc. Advertising	161	Electronic Memories and Magnetics Corporation S. Michelson Advertising	175
American Used Computer Corporation McDavitt Advertising	186	‡ Elpower Corporation Roar Advertising Agency	81
AMF/Potter & Brumfield Division Fuller & Smith & Ross, Inc.	147	Fairchild Semiconductor, Inc. Caron/Roberts, Inc. Advertising, Division of Ogilvy & Mather, Inc.	78-79
■ AMP Incorporated Aitkin-Kynett Company, Inc.	132-133	Figaro Engineering, Inc. Standard Advertising, Inc.	186
* Ampex Cassy and Hull Limited	4E	Floating Point Systems Montgomery, Carlson & Linde, Inc.	191
Analogic Corporation Analogic Advertising	27	■ Fluke Manufacturing Co., John Bonfield Associates	99
Angstrom Precision Kenmart Advertising	146	John Fluke Mfg. Co., Ltd. Lennox Marketing Limited	123
AP Products Incorporated Marketing Communications Associates	184	■ General Electric Co., Miniature Lamp Division Carr Liggett Advertising, Inc.	183
Arrow-M Corporation Halloff & Caine Associates	185	General Magnetics McCarthy, Scelba, DeBiasi Advertising Agency, Inc.	3rd Cover
■ Augat Creamer Trowbridge, Case & Basford, Inc.	87,185	■ General Radio Company Grad Associates	76
■ Ballantine Laboratories, Inc. McCarthy, Scelba, DeBiasi Advertising Agency	5	* Golden Gate Enterprises Associated Ad Ventures, Incorporated	159
* Bayer AG Werbeagentur	33	■ Gould Instruments Systems Marsteller, Inc.	128
Bell, F.W. Technical Marketing Services, Inc.	181	■ Gould Inc./Instrument Systems Division Carr Liggett Advertising, Inc.	181
The Bendix Corporation Electrical Components Division D'Arcy-MacManus-Masius	77	‡ Guardian Electric Mfg. Co. Kolb/Tookey and Associates, Inc.	58-59
Brand-Rex Creamer, Trowbridge, Case & Basford, Inc.	2nd Cover	Harmony Engineering Corporation	136
‡ MGR/Bussmann Manufacturing Division Media/Marketing Service Center, Inc.	159	Harris Semiconductor Tucker Wayne & Company	74
Carpenter Technology Corporation Beaumont, Heller & Sperling, Inc.	149	■ Harshaw Chemical Company Industry Advertising Company	155
Central Mississippi Development District Godwin Advertising Agency, Inc.	177	■ Heath/Schlumberger Scientific Instruments Advance Advertising Services	153
■ Cherry Electrical Products Corporation Kolb/Tookey & Associates, Inc.	137	Hermes Electronics Limited Public & Industrial Relations Limited	171
Chomerics, Inc. The Brightman Company, Inc.	44	■ Hewlett Packard Dancer Fitzgerald Sample, Inc.	150-151
■ Clairex Corporation Marquardt & Roche, Inc.	4th Cover	■ Hewlett Packard Bozell & Jacobs/Pacific	140
* C.P. Clare International N.V. Markcom	11E	■ Hewlett Packard Bozell & Jacobs/Pacific	1
Culligan USA Alex T. Franz, Inc.	144	Hughes Aircraft Company Foote, Cone & Belding/Honig	40-41
Data General Corporation Scall, McCabe, Sloves, Inc.	39	Hybrid Systems Corporation Henry Scammell Associates	160
‡ Data Precision Allied Advertising Agency, Inc.	154	Iasis Warr Foote & Rose	86-87
David Clark Fern/Hanaway, Inc.	188	Individualized Instructions, Inc. Jordan Associates	191
* Delta Design, Inc. Marketing Directions	19E	Intel Corporation Regis McKenna, Inc.	12-13
Delta Products, Inc. The William Loughran Company	183	International Electronic Research Corporation McCarron, Kane, Inc.	170
■ Deltac Manning/Bowen and Associates	176	■ Interstate Electronic Corporation Chris Art Studio, Inc.	139
■ Dialight Corporation Michel-Cather, Inc.	148		
Digital Equipment Corp.— Components Group Schneider Parker, Inc.	22-23		

■ ITT Cannon	24
■ Jenaer Glaswerk Dip.-Kfm Hjalmar Hartenfels	164
■ Johnson Company, E.F. Martin Williams Advertising	20
■ Keithley Instruments Chagrin Valley Marketing Associates	173
■ Kepco, Inc. Weiss Advertising	2
‡ Littelfuse, Inc. LF Advertising, Inc.	57
* Logabax	14E
■ Matsuo Electronics of America Perkal Advertising, Inc.	152
■ Merrill, Lynch, Pierce	84
■ Micro Networks Corporation Briant Advertising	169
■ Micro Power Systems Associated Ad Ventures, Inc.	21
■ Micro Technical Industries R.E. Sylvester Advertising Agency	182
■ Mini-Circuit Lab	88
■ MOS Technology, Inc. Henry S. Goodsett Advertising, Inc.	111-114
■ Motorola Semiconductor Products, Inc. E.B. Lane & Associates, Inc.	43,46-47
* National Semiconductor GmbH	154
■ Newport Labs Manning/Bowen and Associates	182
■ Nitron a division of McDonnell Douglas Corporation J. Walter Thompson Company	127
■ Norland Instruments Action Communicators	18-19
■ North Atlantic Industries, Inc. NOAT Advertising Company	136
■ Okl Electric Industry Co., Ltd. Standard Advertising, Inc.	187
■ Oxy Metals Starter	10E
* Paramic Mainostoimisto AS Luotonen Oy	18E
* Philips N.V. Pit/T&M Division Brookies Communications Systems SA	2E-3E
■ Photocircuits Ries Cappiello Colwell, Inc.	142-143
■ Polymetallurgical Corporation Horton, Church & Goff, Inc.	177
■ Practical Automation, Inc. Carol Marketing Associates	177
■ Primo Co., Ltd. General Advertising Agency, Inc.	192
■ Projects Unlimited Inc. Dayton, Ohio The Parker Advertising Company	189
■ Pro-Log Corporation Tycker-Fultz	28
■ Radio Research	190
■ RCA Industrial Tube Products Al Paul Lefton Company, Inc.	186
■ RCA—Solid State Division Marsteller, Inc.	72-73
■ RCA Electronic Components Al Paul Lefton Company	189
■ RCL Electronics, Inc. Morway Advertising Agency	14
■ Reticon Corporation The House Agency	71
* Rohde & Schwarz	1E
* S.A.F.T. U.N.C.C.	54
■ Scanbe Manufacturing Corporation Wheeler & Company	67
■ Schauer Manufacturing Corporation Nolan, Keelor & Stites	172
* Schlumberger Delpire Acvico	17
■ Scott Electronics Chapman & Castello Advertising, Inc.	162
■ Semiconductor Circuits SCI Advertising Group	157

APPLIANCE & INDUSTRIAL MAINTENANCE TESTERS • OSCILLOSCOPES • PICTURE TUBE TESTERS • VOMMETERS • AF, RF & SWEPT FREQUENCY TESTERS • AC LEAKAGE TESTERS • SOLID STATE VOLTOHM METER • ISOTAPS • GENERATOR • BATTERY CHARGER • PORTABLE AC VOLTMETER • TESTER

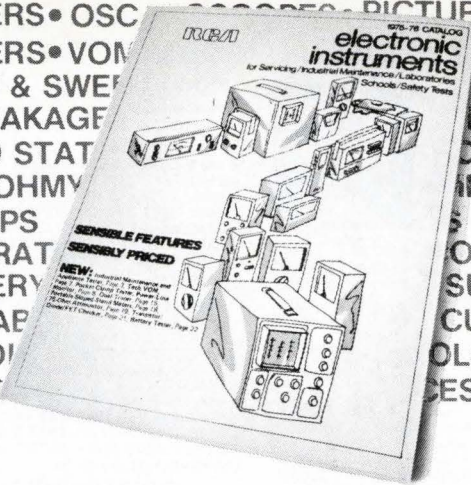

RCA Test Instruments... The broad line for a wide range of applications.

Whether it's for use in consumer or industrial electronics, laboratories, schools, safety tests or for everyday electrical or electronic maintenance, there's an RCA Electronic Instrument for your application.

And you can find out about them all in the new 1975 RCA Electronics Instruments Cata-

log. It's yours free for the asking. Just contact any one of the more than 1,000 RCA Distributors worldwide. Or write RCA Distributor and Special Products Division, Cherry Hill Offices, Camden, N.J. 08101.

RCA Electronic Instruments

Circle 189 on reader service card

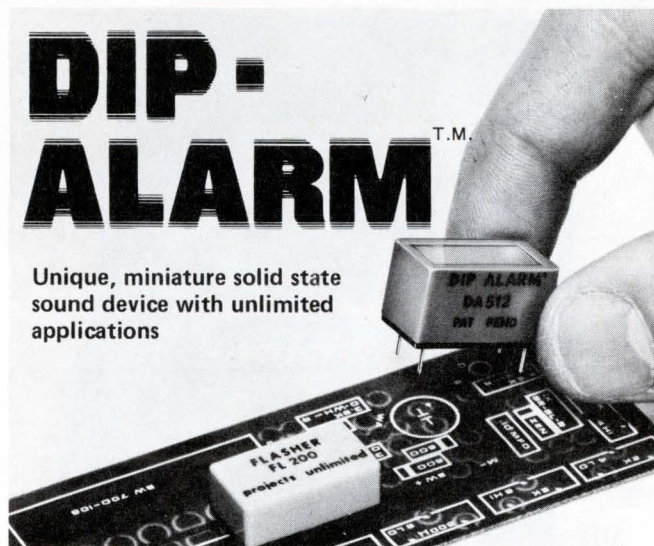

Unique, miniature solid state sound device with unlimited applications

- Plugs into DIP sockets or PC boards
- Rugged, reliable, loud
- Models for 3, 5, and 12 VDC, 35 mA
- Dependable solid state construction means no mechanical contacts, arcing or RF noise
- 76 dB at 400 Hz tone radiates in all directions for positive alarm, warning, fault detection
- Use in conjunction with DIP-FLASH™ for pulsing operation.



projects®
unlimited

3680 Wyse Road
Dayton, Ohio 45414
Tel. 513-890-1918
TWX 810-450-2523

RF-PACKAGES—MICROWAVE SYSTEMS

WORLD'S LARGEST RADAR & MICROWAVE INVENTORY

AUTOTRACK ANTENNA SCR-584 RADAR SYSTEM

360 deg AZ 210 deg EL. 1 mil. accuracy. Missile vel. accel. and slew. rates. Amplitude control. Handle up to 20 ft. dish. Compl. control chassis. ALSO in stock 10 cm. van mounted rad. system. Conical scan. PPI. 6 ft. dish. 300 pg. instr. bk. on radar \$25



RF SOURCES

CW: 300-535KHz 500W; 2-30MHz 3KW; 4-21MHz 40KW; 24-350MHz 100W; 385-585MHz 1KW; 750-985MHz 10KW; 95-8.8GHz 150W; 1-1.5GHz 110W; 1.7-2.4GHz 10KW; 4.4-5GHz 1KW; 8.8-11GHz 200W. Many more.

UHF: 1 Megawatt 210-225MHz 5μsec 180 PPS; 14KW 400-420MHz .0002DC; 1KW 400-700MHz .002DC.

L BAND: 1KW 1-1.5GHz .1DC; 500KW 1.2-1.35GHz 2μsec 400PPS.

S BAND: 1KW 2.4-2.6GHz .75μsec 1200PPS; 250KW 2.7-3.3GHz .8μsec 1600PPS; 500KW 2.7-3.1GHz .8μsec 1600PPS; 1 Megawatt 2.7-2.9GHz 1μsec 1200PPS; 5 Megawatts 2.75-2.85GHz 2.5μsec 400PPS.

C BAND: 225KW 6275-6575MHz .4μsec 680PPS; 250KW 5.4-5.8GHz .5μsec 680PPS; 1 Megawatt 6GHz 1μsec 1000PPS.

X BAND: 100W 9.2-9.5GHz .5μsec 1000PPS; 1 KW 8.9-9.4GHz .001DC; 65KW 8.5-9.6GHz .001DC; 250KW 8.5-9.6GHz .0013DC; 400KW 9.1 GHz 1.8μsec 450PPS.

Ku-K BAND: 50KW 16.4-16.6GHz .001DC; 135KW 15.5-17.5GHz .0006DC; 40KW 24GHz .0007DC; 40KW 35GHz .0004DC.

PULSE MODULATORS + H.V.P.S.

245 KW LINE Output 16 KV 16 A. 25 μs 4000 PPS.
405 KW FLOATING DECK Output 20 KV 20 A 1 μs to 10 millisecc pulse.

500 KW LINE Output 22 KV 28 A. 4/1.75/2.25 μs 2500/550/300 PPS.

1 MW HARDTUBE MIT MODEL 9 Output 25 KV at 40 A. 25 2 μs .002 D.C.

2.0 MW LINE 30 KV 70 A. 1/2 μs 600/300 PPS.

3 MW LINE Output 39 KV 75 A. .25/1 μs 500 PPS.

10 MW LINE 76 KV 135 A. 2.5 μs 350 PPS.

17 MW LINE 17 KV 1000 A. 2-5 μs 150-2000 PPS.

SEND FOR FREE 24 PG. CATALOG

MOD IV HI-RES MONOPULSE TRACKER

Instrumentation radar; freq. 8.5-9.6 GHz. Pwr: 250 KW. 1 mil. accu. Trk. Rng. 50 or 200 mi.

RADAR SYSTEMS

K BAND MONOPULSE 40KW E-34

KU BAND SEARCH 135KW B-58

X BAND MISSILE CONTROL NIKE AJAX/HERC

X BAND FIRE CONTROL 250KW M-33

X BAND WEATHER/SEARCH 250KW AN/CPS-9

X BAND AIRBORNE TRACKER 50KW B-47

X BAND MOBILE TRACKER 40KW AN/MPQ-29

X BAND WEATHER/SEARCH 40KW AN/SPN-5

X BAND TRANSPONDER 100W AN/DPN-62

C BAND HGT. FDR. 5MW FPS-26; 1MW TPS-37

C BAND SEARCH 285KW AN/SPS-5B/D

S BAND HEIGHT FINDER 5MW AN/FPS-6

S BAND SEARCH COHERENT 1MW AN/FPS-18

S BAND ACQUISITION 1MW NIKE AJAX/HERC

S BAND TRACKER 10' DISH 500KW AN/MPQ-18

S BAND MORTAR LOCATOR 250KW AN/MPQ-10A

L BAND SEARCH 40' ANTENNA 500KW AN/FPS-75

L BAND SEARCH 500KW AN/TPS-1D/GSS-1

UHF SEARCH 1MW TPS-28

DRONE CONTROL SYSTEMS

UHF COMMAND SYSTEM AN/URW-14

X BAND DATA LINK AN/UPW-1

X BAND TRACKER AN/MPQ-29

X BAND TRACKER AN/MSQ-51

SHORAN Type CPN-2A Freq 290-330 MHz
Pwr 30KW consists of trans., recv., monitor, etc.

SPARE PARTS IN STOCK

Nike Ajax, Nike Hercules, M-33, MPS-19, TPS-1D, TPS-10D, FPS-6, SPS8, SCR-584, HIPAR. Many more, write.

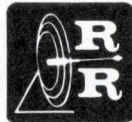

**Radio
Research
Instrument
Co., Inc.**

3 QUINCY ST., NORWALK, CONN. 06850
(203) 853-2600

Circle 190 on reader service card

Could you build a \$200 Rolls?

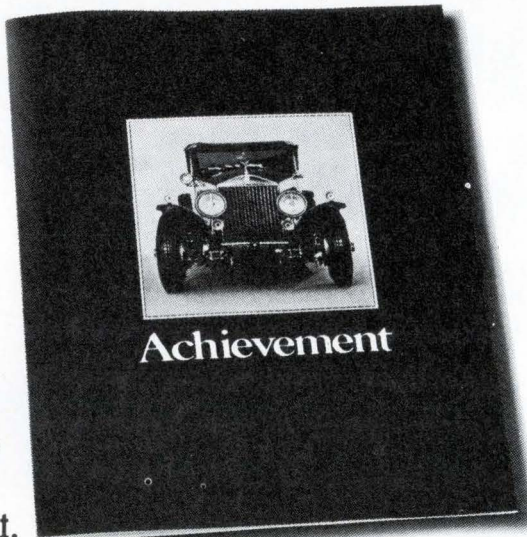

Achievement

Send for this free brochure and find out.

The classic Rolls Royce Phantom II Sedan Coupe. 26-1/2" long. Reproduced in exact 1/8 scale in Pocher d'Italia's incredibly authentic car model kit. You build it with nuts and bolts and screws. No painting, no special tools needed. Doors, hood and trunk open. Steering, crankshaft, connecting rods, gears, fan, generator operate. Windows open. Headlights turn on. 2,199 separate parts of brass, stainless steel, copper, rubber, high-impact plastic. Complete details on this and three other classic car kits from \$100 in our free full-color brochure.

Deluxe Classics, Dept. WE9
5900 Wilshire Boulevard, Suite 2760
Los Angeles, California 90036

Please send me your free full-color brochure.

Name: _____

Address: _____

City: _____

State/Zip: _____

190 Circle 265 on reader service card

* Sescosem Bazine Publicite	52,15E
* SGS Ates McCann-Erickson	9E
‡ Siemens Corporation Stiefel-Raymond Advertising, Inc.	62-63
‡ Siemens Corp.— Electronic Systems Division, Computest Products	179
JL Associates	
Silicon Transistor BBF Group, Inc.	167
Simpson Electric Company Amerad Advertising Services, Inc.	45
Singer Company, Kearfott Division Gaynor & Ducas, Inc.	102
Soltron Devices, Inc. Transistor Division William E. Haselmire Advertising, Inc.	141
* Sorensen AG Agentur IFF AG	20E
■ Sorensen Grover and Erickson, Inc.	82-83
Sound Technology Frank Burkhard Company	178
Spectral Dynamics Company Mesa Copy	15
Sprague Electric Company Harry P. Bridge Company	8
* STS SpA Studio Dr. Giuliano Blei	63
■ Systron Donner Concord Instruments Fred Schott & Associates	51,121
Technit TWP Advertising	170
‡ Tektronix, Inc. Tektronix Advertising	33,35,163
‡ Texas Instruments Incorporated, Components Group Tracy-Locke Advertising, Inc.	17,60-61
Thomson CSF/Dumont Ranriere, Saslaw, Mohr and Associates, Inc.	181
■ TRW/Capacitors Gray & Rogers, Inc.	7
■ Union Carbide Corporation J.J. Lane, Inc.	134
Universal Instrument Corporation Commercial Art Service Graphics	158
* U.S.C.C. S. Michelson Advertising	12E-13E
■ Vactec, Inc. Coleman & Associates Advertising	131
Varo Semiconductor, Inc. Warren-Guild	167
Victoreen Instrument Division Dix & Eaton, Inc.	156
■ Vu-Data Manning/Bowen and Associates	176
■ Wavetek Indiana Chapman Michetti Advertising	48
‡ Weston Instruments, Inc. Schaefer Advertising, Inc.	54
Wiltron Company Frank Burkhard Company	182
Wima, Westermann Oliver-Beckmann GmbH	16
* Yokogawa Electric Works Limited General Advertising Agency, Inc.	81

Classified & Employment Advertising

F. H. Eberle, Manager 212-997-2557

EQUIPMENT (Used or Surplus New) For Sale
Design, A.L. Inc.166
Photobell Co. Inc.166

■ For more information on complete product line see advertisement in the latest Electronics Buyer's Guide
* Advertisers in Electronics International
‡ Advertisers in Electronics domestic-only edition