

Micro/Systems Journal™

For the Advanced Computer User



Memory Addressing on the 80386

see page 18

Also in this issue:

A Review of the Concurrent DOS 386.....	28
The Intel Inboard 386	34
Software Link's PC-MOS/386	38
Program Interfacing to Microsoft Windows, Part VI	52
A Linker for Turbo Pascal.....	62



SHATTER THE PERFORMANCE BARRIER

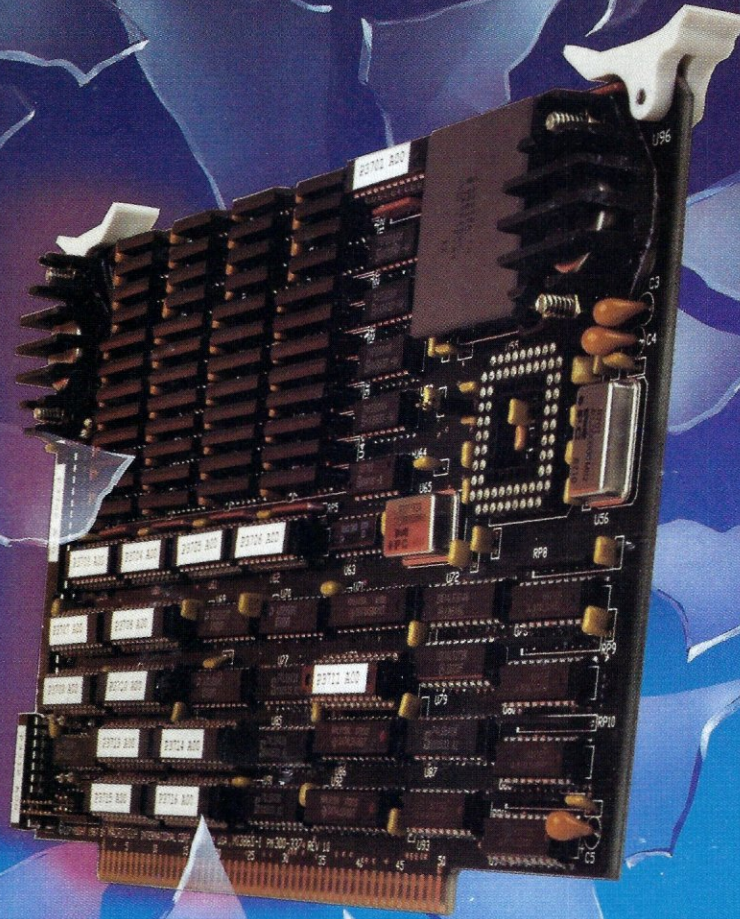

PLUG 386 POWER INTO YOUR S100

Announcing the MI386S, the 80386 satellite board for your S100. Drop one into your system and watch it take off. Or add several and prepare for a performance explosion.

It's packed with a full megabyte of 32 bit wide, dual ported, 100 ns, 4-way interleaved dynamic RAM, a 16 MHz 80386 processor, and an optional 80387 math coprocessor.

The powerful MI386S software, compatible with Concurrent DOS, provides a comprehensive and well-honed interface to your system.

Run more programs and more users faster than ever before. A must for the multi-user system. A boon to the single user.

The MI386S. Another first from Macrotech. For more information contact Macrotech International Corporation, 21018 Osborne, Bldg. 5, Canoga Park, CA 91304.

FAX 818-700-1982 • TELEX 910-997-0653
818-700-1501 • 800-824-3181

 **MACROTECH**

Concurrent DOS is a trademark of Digital Research Inc.

Think fast! Pick the better fit...

Get our 5th Year Bonus!
Mention this ad when ordering
and get your choice of a V-20-8
(replaces 8088) or \$20 off on
your Battery Backup purchase!

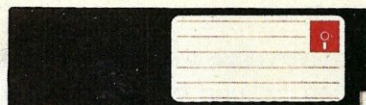

FLOPPY DISK.

- Fills time between coffee breaks
- Makes a hard disk seem *fast*
- Your computer appears busy (even if you aren't!)
- Wears out moving parts

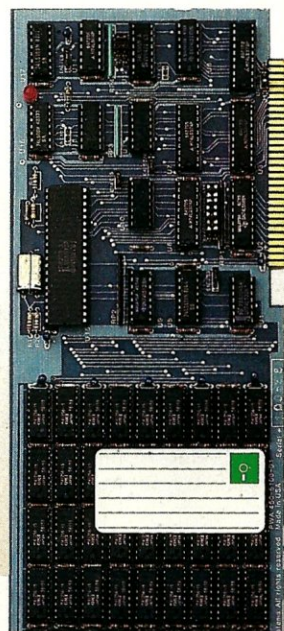

SEMIDISK Disk Emulator.

- Gets that job done *NOW*
- Makes a hard disk seem *slow*
- Maximizes your productivity with anything from databases to compilers
- Totally silent operation

...for YOUR demanding tasks.

SURPRISE! *Neither* is memory mapped, so they don't affect your precious Main Memory. *Both* retain data indefinitely - even with the computer turned off.

THE SEMIDISK SOLUTION. You could invest in a series of "upgrades" that turn out to be expensive band-aids without solving your real problem. Even those "Accelerator" and "Turbo" boards do little to speed up disk-bound computers. If your applications spend too much time reading and writing to disk (and whose don't?), you won't want to settle for anything less than a SemiDisk disk emulator. The SemiDisk comes in 512K and 2Mb capacity. More boards may be added to make up to an 8 Megabyte SemiDrive!

SPEED THAT'S COMPATIBLE. PC, XT or AT, if you need speed, the SemiDisk has it. How fast? Recent benchmarks show the SemiDisk is from 2 to 5 times faster than hard disks, and from 25% faster (writing) to several times faster (random reads) than VDISK and other RAMdisk software that gobble up your main memory.

MEMORY THAT'S STORAGE. Using our small external power supply, with battery backup, your data remains intact through your longest vacation or even a seven-hour power failure!

CELEBRATE WITH US! Now, SemiDisk celebrates its fifth birthday with a special offer for IBM-PC owners. Buy a SemiDisk now and we'll include an 8 MHz V-20 microprocessor (replaces the 8088) to make your new SemiDisk run even faster. Don't need the V-20? We'll take \$20 off the price of your Battery Backup Unit!

	512K	2Mbyte
IBM, PC, XT, AT	\$495	\$ 795
Epson QX-10	\$495	\$ 995
S-100 SemiDisk II	\$795	\$1295
S-100 SemiDisk I	\$299	-----
TRS-80 II, 12, 16	\$495	\$ 995
Battery Backup	\$130	\$ 130

**Someday you'll get a SemiDisk.
Until then, you'll just have to...wait.**

SemiDisk



SemiDisk Systems, Inc., 11080 S.W. Allen Blvd., Beaverton, Oregon 97005 (503) 626-3104

If you thought all file managers were alike, think again. Think Btrieve.

Btrieve stands out as the one file management system for programmers who are serious about productivity. With Btrieve, your programs can use simple subroutine calls to store, retrieve, and update records. It's the file handling solution rich in functionality to meet your needs now and in the future, as your requirements grow and change.

Bfast. With Btrieve you develop fast applications, with ease. Written in assembly language for IBM PC's, Btrieve uses b-tree algorithms with automatic balancing for fast, efficient file indexing.

Bsafe. Btrieve is the only file manager with automatic file recovery. Two levels of database integrity provide complete fault tolerance in the event of accidents or power failures.

Bflexible. Develop your PC applications with the capabilities you need most. Capabilities such as: unlimited open files, unlimited records per file, 24 indexes per file and a maximum file size of 4 gigabytes. All this with Btrieve plus access from any programming language.

Bconnected. When your applications require networking, think Btrieve. A single version runs on all DOS 3 LAN's, including IBM PC Network and Novell Advanced NetWare. Btrieve is also available for Xenix and other multi-tasking operating systems.

Broyalty Free. No royalty payments on your applications. Ever.

Bsure. Btrieve comes with comprehensive documentation and unrivaled technical support for trouble-free software development. And you can add Xtrieve to supply your end users with even more, a menu-driven report writer and query system.

Think Btrieve. Make your programming performance stand out. Contact SoftCraft.



SoftCraft

A NOVELL COMPANY

P.O. Box 9802, #917

Austin, Texas 78766

(512) 346-8380 Telex 358 200

Btrieve, \$245; multi-user Btrieve, \$595; Xtrieve, \$245;
multi-user Xtrieve, \$595 (for report generation, add \$145 for single-user and \$345 for multi-user).
Requires PC-DOS or MS-DOS 2.X, 3.X or Xenix. Btrieve and Xtrieve are registered trademarks of SoftCraft Inc.

Editorial

Founder and Editor	<i>Sol Libes</i>
Technical Editors	<i>Stephen R. Davis</i> <i>Don Libes</i>
Associate Editors	<i>Lennie Libes</i> <i>Susan Libes</i>
Contributing Editors	<i>A.G.W. Cameron</i> <i>Michael Cherry</i> <i>Ian F. Darwin</i> <i>B.J. Hall</i> <i>Charles H. Strom</i>
Consulting Editor	<i>Michael Swaine</i>
Managing Editor	<i>Thomas M. Woolf</i>
Copy Editors	<i>Carol Dondrea</i> <i>Rhoda Simmons</i>

Production

Art & Production Director	<i>L. Clay</i>
Art Director	<i>Kate Paddock</i>
Assoc. Art Director	<i>Kobi Morgan</i>
Typesetter	<i>Lorraine Buckland</i>

Circulation

Director of Circulation	<i>Maureen Kaminski</i>
Subscription Supv.	<i>Kathleen Shay</i>
Newsstand Sales Coordinator	<i>Larry Hupman</i>
Fulfillment Coordinator	<i>Francesca Martin</i>
Circulation Asst.	<i>Sarah Frisbie</i>

Administration

Director of Finance	<i>Kate Wheat</i>
Business Manager	<i>Betty Trickett</i>
Accounting Supv.	<i>Mayda Lopez-Quintana</i>
Accounts Payable Asst.	<i>Luanne Rocklevitz</i>
Accts. Receivable Asst.	<i>Patricia Albert</i>

Advertising

Advertising Director	<i>Richard Mixer</i>
National Account Mgr.	<i>Dwight Schwab</i>
Southwest Accounts Mgr.	<i>Tami Beaulieu</i>
Advertising Coordinator	<i>Shaun Hooper</i>

M & T Publishing, Inc.

Chairman of the Board	<i>Otnar Weber</i>
Director	<i>C. F. von Quadt</i>
President and Publisher	<i>Laird Foshay</i>

Micro/Systems Journal (ISSN #8750-9482) is published monthly (as of January 1988) by M & T Publishing, Inc., 501 Galveston Dr., Redwood City, CA 94063; (415) 366-3600. Second-class postage paid at Redwood City and at additional entry points.

Article Submission: Please write the editors at *Micro/Systems Journal*, Box 1192, Mountainside, NJ 07092 or call (201) 522-9347 to see if there is interest in a particular subject. Please do not send the article unless we ask for it.

If you are interested in reviewing hardware or software please write telling us your interests, your background, and include a sample of your writing.

Send a stamped self-addressed business size envelope (to NJ address) for a copy of our Author's Guide.

Address Correction requested: POSTMASTER: send Form 3579 to *Micro/Systems Journal*, Box 3713, Escondido, CA 92025.

Change of Address: Please send old label and new address to: *Micro/Systems Journal*, Escondido, CA 92025.

Customer Service: For subscription problems, call: Outside California: (800) 321-3333; Within California: (619) 485-9623.

Correspondence: Editorial Office: Box 1192, Mountainside, NJ 07092; (201) 522-9347. The editor may also be contacted via MCI Mail (SLIBES). Business Office: 501 Galveston Dr., Redwood City, CA 94063; (415) 366-3600.

Advertising Rates: Available on request. Call (415) 366-3600 or write to: *Micro/Systems Journal*, 501 Galveston Dr., Redwood City, CA 94063.

Subscription rates: U.S.: \$29.97 for one year, \$56.97 for two years. Canada & Mexico add \$14 per year for airmail; \$6 per year surface mail. Other countries add \$24 per year for airmail.

Entire contents copyright © 1987 by M & T Publishing, Inc.; unless otherwise noted on specific articles. All rights reserved.

Micro/Systems Journal™

For the Advanced Computer User

About the cover: Systems based on Intel's 32-bit 80386 microprocessor are arriving in significant numbers. Systems with the processing power of minicomputers now sit on the desktop. In this issue we review three hardware implementations and two multitasking/multiuser operating systems that exploit the features of the 386.

Feature Articles

Memory Addressing on the Intel 80386 by Howard Vigorita.....	18
The 386 has five addressing modes. What are they? When and how do you use them?	
Program Interfacing to Microsoft Windows by William Wong.....	52
Part VI—Conclusion: Menus, Dialog boxes, memory management, atoms, communications, printing, the clipboard, dynamic linking, dynamic data exchange, and a look at Version 2.0 and OS/2's presentation manager.	
Dealing with the DB-9 Serial Port	58
As the 9-pin serial connector gains popularity, there is a growing need to connect to the established 25-pin connector.	
A Linker for Turbo Pascal by Sung Soh.....	62
Overcoming Turbo Pascal's inability to support large memory models.	

Product Reviews

Micronics 80386 System Board by Charles H. Strom.....	22
Upgrading an AT to a 32-bit with a low-cost motherboard replacement.	
Concurrent DOS 386 by Alex K. H. Soya.....	28
Digital Research's new 80386 multitasking, multiuser operating system.	
Intel Inboard 386 by Hank Kee.....	34
Upgrading an AT the easy way with an 80386 plug-in co-processor board.	
Software Link's PC-MOS/386 by Charles H. Strom.....	38
A low-cost multitasking, multiuser operating system with some rough edges.	
Intel iSBC386 by Jeff Duntemann.....	46
An evaluation of the motherboard used in many 386-based systems.	

Columns

The C Forum by Don Libes.....	12
Using the varargs package for writing and calling functions with varying arguments.	
Turbo Pascal Corner by Stephen Randy Davis.....	14
A look at the Turbo Optimizer tools and how to use the VAR prefix in declaring Procedure definitions.	
The Scientific Computer User by A. G. W. Cameron.....	66
Technical word processor update, FORTRAN translators and a look at Lotus's Freelance Plus chart and plot program and Concept Software's Screen Manager Library for C.	
The UNIX File by Ian F. Darwin.....	72
A look at GNU—a public domain UNIX clone development project.	

Departments

Editor's Page by Sol Libes.....	4
News, Views & Gossip by Sol Libes.....	6
Mail	10
New Products	76
Classifieds	80
The Advertiser's Index	80

Editor's Page

Sol Libes



Will The 386 Leapfrog The 286?

It is estimated that by the end of the year more than 200,000 80386 systems will be running DOS applications. By the end of next year, that number may reach one million. The combination of higher clock speed, 80387 math coprocessor, and caching circuitry enable these machines to run standard DOS and DOS applications at two to four times the speed of an IBM PC/AT. When 32-bit software is run, speed will improve by several times this amount.

Three of the very early 386 hardware products are reviewed in this issue. We will be reviewing more in upcoming issues, including complete 386 systems, 386 accelerator cards, and 386 piggyback boards.

OS/2, the new operating system for the PS/2 series from IBM/Microsoft, is still not here yet and is not expected for several more months. Although it will have added features such as multitasking, increased memory addressing, and larger disk drive management, it is nevertheless a 286 operating system. This means it will have limitations and problems and it will not be able to take advantage of the 386's architecture. Steve Ballmer, manager of system software at Microsoft, has called the 286 a "brain-damaged" processor.

In the meantime, several 386 operating systems have already arrived. Two are reviewed in this issue, and several more will be released shortly. We will be reviewing them and related products in future issues. The 386 is an excellent device for multi-user systems, and we can expect to see several implementations of UNIX.

Some software publishers have taken another tack. They have written 386 extensions to DOS. This approach enables a user to run standard DOS Version 3.2 as the operating system and to run one or more 386 32-bit application programs.

Examples of such extensions are DESQ-view Version 2.0, the PharLap 386/DOS-Extender, and A.I. Architects OS/386 DOS extension.

A large number of 32-bit 386 software development packages have already been released. PharLap Software and Microsoft have released 386 assembler/linker packages. MetaWare has introduced both C and Pascal compilers. And Lahey has released a 32-bit version of their popular FORTRAN-77.

The combination of 386 hardware and software means that mainframe processing speeds and capabilities will now be available on desktop machines. Sources at A.I. Architects, for example, claim that the performance of its 386 Humming-Board running at 20 MHz executes the Dhystone C benchmarks (registers) 5.8 times faster than a DEC VAX-11/780, 1.3 times faster than a DEC VAX-8600, and 1.5 times faster than an IBM 4381-2. This XT/AT plug-in card contains 16/20 MHz 386, 387, memory cache, and 2 to 24 Mbytes RAM.

There is a general feeling in the industry that software developers will leapfrog over the 286 and concentrate on developing software for the 386. The reason for this is that the 386 is designed for true multitasking whereas the 286 is not. IBM and Microsoft have already indicated that PC application software will require extensive modification to run in the multitasking protected mode of the OS/2 (a 286-based operating system).

The 386 provides a third mode of operation: the virtual mode, which allows multiple 8086 address spaces to be created, each protected from the others and from the operating system. Thus, most 8086 applications will execute without modification, and no matter how badly behaved an application is, it will not affect other applications. This means that one can have several multiple terminate-and-stay-resident (TSR) programs (for example, Sidekick) without having a conflict, and

the features of TSR programs can be greatly expanded. Communications programs will be able to run comfortably in the background, and data interchange between applications can occur without having to go in and out of each application.

Application software reportedly will run more slowly under the OS/2-protected mode than it does under 386 DOS extension software running in protected mode or virtual mode.

The amount of application software that will be available to run under OS/2 Version 1.0 will probably be limited, as many software developers see OS/2 as an interim product.

Another interesting 386 development is the introduction of UNIX with Microport's DOS-Merge/386, which allows the running of multiple MS-DOS programs in an emulation mode. These new UNIX implementations also include Ethernet controllers, TCP/IP, and Sun Microsystems NFS networking and X Window support. These last facilitate the movement of graphics-oriented displays around a network of dissimilar systems. §

***M/SJ* is Cheaper by the Dozen in 1988!**

Starting in January, *Micro/Systems Journal* will come to you EVERY MONTH! That means you will get twice as many articles providing detailed, technical insight into PC systems integration. In future issues of *M/SJ*, look for special articles on:

- Local Area Network Systems
- Interfacing to PS/2
- Interfacing to OS/2
- C Software Development Tools
- PC Multiuser Operating Systems
- and much more

Don't miss a single issue! Turn to page 56 and subscribe today!

EVEN MORE POWER AND FLEXIBILITY BRIEF 2.0

Users and industry press alike have unanimously proclaimed BRIEF as the best program editor available today. Now, the best gets better, with the release of BRIEF 2.0.

Straight from the box, BRIEF offers an exceptional range of features. Many users find that BRIEF is the only editor they'll ever need, with features like real, multi-level Undo, flexible windowing and unlimited file size. But BRIEF has tremendous hidden power in its exclusive macro language. With it, you can turn BRIEF

into your own custom editor containing the commands and features you desire. It's fast and easy.

Jerry Pournelle, columnist for BYTE magazine summed it all up by saying BRIEF is, "Recommended. If you need a general purpose PC programming editor, look no further." His point of view has been affirmed by rave reviews in C JOURNAL, COMPUTER LANGUAGE, DR. DOBB'S JOURNAL, DATA BASED ADVISOR, INFOWORLD AND PC MAGAZINE.

One user stated "BRIEF is one of the few pieces of software that I would dare call a masterpiece." Order BRIEF now and find out why. BRIEF 2.0 is just \$195. If you already own BRIEF, call for upgrade information.

**TO ORDER CALL: 1-800-821-2492
(in MA call 617-337-6963)**

As always, BRIEF comes with a 30 day money-back satisfaction guarantee.

**Solution
Systems™**

541 Main Street
Suite 410J
So. Weymouth, MA 02190
(617) 337-6963

Look at these BRIEF 2.0 enhancements!

Main Features:

- All new documentation with tutorials on basic editing, regular expressions **and** the BRIEF Macro Language.
- Setup program for easy installation and configuration. (Requires no knowledge of the macro language)
- Increased speed for sophisticated operations like Undo and Regular Expression Search.
- Expanded regular expressions, with matching over line boundaries.
- More block types, with marking by character, line or column.
- Command line editing (move cursor, add and delete characters, specify command parameters).
- Support for more programming languages.
- Optional borderless windows.
- Enhanced large display support, including wider displays.
- Reconfigurable indenting for C files (supports most indenting styles).

Basic Features:

- Full multi-level Undo
- Windows
- Edit many files at once
- File size limited only by disk space
- Automatic language sensitive indentation

Plus the basic
features that made
BRIEF SO popular!

Requires an IBM PC or compatible with
at least 192K RAM.
BRIEF is a trademark of UnderWare, Inc.
Solution Systems is a trademark of Solution Systems.



News, Views & Gossip

by Sol Libes

Random Gossip & Rumors

Don't junk those old PC or XT clunkers! It is rumored that **Intel** is readying an XT version of its Inboard-386/AT card to sell for about \$700 (with zero memory) and just under \$1,000 with a Megabyte of RAM on board. Replace the old CGA display with a VGA card and display and the machine will run OS/2 as well, or better, than a new IBM PS/2 Model 50 costing more than three times the price. Or, try an XT replacement 386 motherboard. There are already a half-dozen available. (What a potential market! With about 9 million PCs and XTs waiting to be upgraded to the 386, expect to see specialty dealers whose only business will be reworking PCs and XTs.)

Also look for **Compaq** to shortly introduce a 386-based portable computer to scoop **IBM's** introduction of a 286-based portable. Two 386 portables are already being marketed by **PC Discount** (Houston, Texas) and **Storage System Engineering Service** (Santa Clara, Calif.).

Paradise Systems (San Francisco, Calif.) is reportedly shipping sample quantities of a single-chip VGA display controller to OEMs. Several PC clone makers are expected to show machines at the November Comdex trade exhibition. These units will include this chip, along with 3½-inch drives, to run OS/2 with a PS/2-compatible BIOS. The question now is whether they will advertise these systems as PC- or PS/2-compatible systems?

IBM is expected to announce a replacement for the RT in February. It is rumored to be the PS/2 Model 90, which will use either a 20-MHz 386 or new RISC processor and an extended VGA controller. It is expected to compete against the new Sun Microsystems RISC and DEC MicroVax-III systems.

IBM also is expected to release versions 3.4 and 3.5 of PC-DOS shortly. Version 3.4 reportedly fixes some 3.3 bugs, and 3.5 will contain drivers for new large capacity hard disk drives/controllers.

Apple is said to be developing an 80386 coprocessor card for its hot-selling new Mac-II system. Reports indicate that the Mac-II and Mac-SE are gaining significant acceptance in the corporate world.

Word has it that **Microsoft** has begun development of a 386 version of OS/2,

with possible release scheduled as early as the first quarter of 1989.

Atari is rumored to be developing a new desktop system designed to serve the workstation market. However, Atari's new system is based on the Transputer 32-bit microprocessor from England rather than the Motorola 68020. The Transputer boasts performance that is four times better than the 68020. The big problem, however, may not be the hardware design but the software. First and foremost is the development of an operating system—the likelihood is that it will be a port of UNIX. There are reports that prototypes of this system have already been seen at Atari. Then again, there have been other times that Jack Tramiel has shown a prototype product that never made it into production.

QMS (Quality Micro Systems of Mobile, Ala.) is said to be readying the first color laser printer for introduction by the end of this year. The price is expected to be somewhere between \$20,000 and \$30,000.

The Business of Software and Micros

Microsoft has been referred to as a "software monopoly." This label probably comes from the company's large number of recent acquisitions, and Bill Gates' belief that there is a need for Microsoft to compete in virtually every software market. However, if one looks at the software sales figures, Microsoft is far from the number one market position needed for a monopoly. The title would better fit IBM.

Datamation magazine's recent study of software companies showed that Microsoft ranked only eleventh in the field. Although sales for 1986 increased 60 percent over the previous year to more than \$260 million, Microsoft was far behind the leaders: IBM (more than \$5.5 billion), Unisys (\$861 million), DEC (\$560 million), NEC (\$507 million), Fujitsu (\$389 million), Siemens (\$387 million), Hewlett-Packard (\$375 million), Hitachi (\$331 million), Nixdorf (\$299 million), and Lotus (\$283 million).

It should be noted that five of the top ten software companies in the survey were foreign, including three Japanese firms.

By contrast, Datamation's recent study of the top micro manufacturers indicated

that of the top ten, only three were foreign companies, and two of those were Japanese. Naturally, IBM led the field (\$5.65 billion), followed by Apple (\$1.8 billion), Olivetti (\$1.3 billion), Tandy (\$997 million), Unisys (\$800 million), NEC (\$697 million), Compaq (\$625 million), AT&T (\$600 million), Toshiba (\$581 million), and Zenith (\$548 million).

Micros are now a substantial part of IBM's business. Last year, IBM did in excess of \$48.5 billion in sales, of which the largest single area was still mainframe sales (\$14.45 billion). Peripheral sales were second (more than \$11.2 billion), and maintenance third (more than \$7.4 billion). Micros ranked fourth, and software sales ranked fifth. However, software showed the biggest growth for IBM last year and probably will overtake IBM's micro and maintenance business this year. While hardware prices have gone down, software prices have gone up.

80386 Versus the 68020

When **IBM** announced its PS/2 Model 80, a 386-based system, much earlier than expected and began shipping units months earlier than expected, it was not to meet the competitive challenge offered by the Compaq DeskPro 386. Rather, it was Apple's Mac-II that had IBM worried. **Apple**, number two in the microcomputer game (see story below), showed a healthy sales increase of 11.1 percent last year compared to IBM's small 2.7 percent increase. At the same time, Apple's market share increased while IBM's share decreased. Further, most of Apple's share increase has been in the business area. By comparison, Compaq ranks seventh in the micro race and is essentially an IBM clone, which makes the company vulnerable to IBM's changing marketing tactics.

Both IBM's and Apple's new systems are based on 32-bit microprocessor chip sets; the Intel 80386 versus the Motorola 68020. The systems are designed for multiprocessing workstations with color graphics windowing user interfaces. If you compare their respective features and specs, you can note their similarities. IBM hopes that the PS/2 Model 80 with OS/2 V1.1 will head off the Mac-II, in the same way the PC stopped the Apple-II's advancement into the business community in the early 80's. The model 80 with OS/2 is designed to be a "Mac-II killer."

However, Apple is once again proving itself the technological leader in the PC marketplace. The Mac has grown from a plaything to a sophisticated system. For

Powerful Concurrent DOS 386 Multiuser Multitasking Operating System



MAXIMUM PERFORMANCE . . . Unleash the Power of the 386!

Concurrent™ DOS uses the power of the 386 to efficiently combine its multiuser, multitasking design with the added value of DOS compatibility. Up to ten users can share the resources of a single system through easy-to-connect serial terminals as configured. Digital Research provides tools for those VARs and OEMs needing to expand beyond ten users.

MAXIMUM COMPATIBILITY . . . Runs Multiuser Applications While Simultaneously Running Many Popular PC-DOS Applications.

The applications running on your current system (Lotus® 1-2-3®, dBase®III, WordPerfect® and many more) are still usable and don't have to be replaced with "work-alikes" and "compatibles." Multiple DOS applications can be run from serial terminals while the system console can execute as many as four applications concurrently.

MINIMUM INVESTMENT . . . Protect Your Development Investment with Easy Migration within the Intel® Microprocessor Family.

Take advantage of developed and proven application software that provides solutions for businesses that range from medical practices to manufacturing floors. A library of Concurrent DOS multiuser applications already exists to meet the diverse requirements of many end-user environments.

FEATURES:

- PC DOS 3.3 Compatible.
- Supports IBM® Personal System/2™ Model 80, Compaq® Deskpro® 386 and 100% Compatibles.
- Executes Multiple Applications on Serial Terminals.
- Simultaneously Executes Up to 255 Different Tasks.
- Supports Multiusers Sharing System Resources.
- Easy to Install and Operate.
- Full Complement of Development Tools and Over 1000 Business Solutions Available.
- AT Performance at the Serial Terminals.
- Serial Port Configurability Up to 38.4K Baud.

Call Today and Receive a FREE Poster of Single-User and Multiuser Concurrent DOS Applications.

1-800-443-4200.

 **DIGITAL RESEARCH®**

example, Apple's new Multifinder software brings Presentation Manager-type multiprocessing to the Mac more than a year before it will appear on the IBM PS/2. And Apple's new HyperCard software introduces a new, powerful, easy-to-use, graphics-oriented database management system for the Mac. Business users now have another reason, beside easy-to-use desktop publishing and powerful graphics development, to buy the Mac.

One of the most important features of these systems are their compatibility with the models that preceded them. In the case of IBM, it was compatibility with the PC/AT (based on the 80286) and DOS. In the case of the Mac-II, it was compatibility with the Mac-I (based on the 68000). Both the PS/2 Model 80 and Mac-II can run software designed for their predecessors. However, OS/2 with the Presentation Manager will require substantial rewrites of current DOS software while Apple's new Multifinder can multiprocess most of the old Mac software.

On to the Next Generation

Both Intel and Motorola are already hard at work on their next generation of microprocessors, and IBM and Apple are designing their next generation of micros. Intel is rumored to have already shipped early prototype 80486 samples to IBM. Intel is promising that the 486 will be software-compatible with the 386.

Motorola, on the other hand, has disclosed that its 78000, will be a non-compatible, RISC-based device. Motorola is taking a real gamble here by abandoning software-compatibility. Intel discovered this several years ago when it introduced the 432, a 32-bit chip set, with a very advanced architecture. But, the 432 was not compatible with Intel's popular 8086 16-bit device. System designers had to start from ground zero on a whole new learning curve, and very few companies were willing to make the necessary long-term investment. With so few companies interested in the 432, Intel could not make its own investment in support for these devices.

Fortunately, Intel recognized its mistake early and redirected its R&D efforts into the 286 and 386. Although the 286 and 386 represented a step backward in terms of technology when compared to the 432, they proved to be what the market wanted and they put Intel back into profitability. Let's hope that the Motorola 78000 does not end up impaled on the cutting edge of technology the way the Intel 432 did.

OS/2 News

Microsoft is waging a promotional campaign for OS/2 and its Presentation Manager, the scale of which we have never before seen in the personal computer industry. Almost a year before the product was to be released, Microsoft began conducting seminars and selling software developer kits, which included a beta version of OS/2 Version 1.0 (without the Presentation Manager). By early July, they had already sold an estimated 2,000 developers kits at \$3,000 each, and they will probably sell another 2,000 kits in the fall. That's about \$12 million in sales for a beta product! I guess that goes to prove that advertising and sales promotion really pay. Microsoft and IBM will have had 4,000 beta testers actually paying to help them develop, debug, and tune the product.

Microsoft began shipping copies of its Presentation Manager specifications to software developers in mid-August. It is a three-volume set weighing eight pounds! No word as yet on when Microsoft plans to ship the product.

PS/2 News

As reported in the last issue, overall sales of the PS/2 Models 30, 50, and 60 have been lackluster so far although corporate acceptance seems promising. Many dealers are overstocked and offering discounts. Although the typical discounts have been in the order of 30 percent, discounts as great as 35 percent have been advertised.

Sales are expected to pick up with the release of the OS/2 operating system, the availability of more Micro Channel plug-in boards, and the introduction of application software that takes advantage of the PS/2's Micro Channel. However, by then many clone makers will be offering high-performance AT-compatibles and 80386-based systems with many PS/2-compatible features (e.g. 1.44 Mbyte 3½-inch floppy disk drives, VGA display controller) and running OS/2.

PS/2 Clone News

IBM is offering a license to PC clone makers for the PS/2 utility patents. This license would allow manufacturers to provide the same functional features as the PS/2 systems, but would not provide copies of the design technology (such as chip design, microcode, and so on). In other words, IBM will not license its hardware-design patents, copyrights, and trademarks for the Micro Channel.

Reports are that IBM is asking for royalty payments of one to three percent. The

one percent royalty would be on all cloned products (PC, XT, AT, and PS/2 with retroactive payments), while the three percent royalty would apply to cloners who wish only to license selected products. IBM has reportedly had licensing discussions with several Taiwanese and Korean manufacturers, as well as U.S. and Japanese firms.

In the meantime, **Chips and Technologies** is already sampling a chip set for the PS/2 Model 30 and is promising samples of chip sets for the Models 50/60 and Model 80 by year end.

Paradise Systems is already shipping production quantities of a VGA chip to OEMs. It appears likely that this chip will appear on plug-in cards for PC/XT/AT systems and on new 286 and 386 system boards. These products are expected to be shown at Comdex in late November.

In an effort to avoid legal suits, PC clone makers are expected to implement the non-patented features of IBM's PS/2 (VGA, 3½-inch disks, OS/2) on high-speed AT-compatibles before turning to IBM's costly licensing and expensive development of Micro Channel emulation. It seems unlikely that clone makers will begin shipping Micro Channel compatibles until early '89. When they do ship, these systems should offer enhancements over IBM's PS/2 Micro Channel machines.

Cloners (such as Compaq, Tandy, Zenith, PC's Limited, and so on) are currently enjoying very strong sales of enhanced high-speed AT compatibles. Industry sources indicate that these companies are well along in developing Micro Channel-compatible prototypes. However, strong sales of enhanced ATs are expected to continue well into 1988, giving clone companies plenty of time to evaluate their PS/2 compatible system plans.

RISC on the PC

No sooner did Sun Microsystems introduce its new top-of-the-line Sun-4 series of RISC-based 10-Mips machines, which claim performance equal to a VAX 8800 system, than **Definicon Systems** (Newbury Park, Calif.) introduced a coprocessor board for the PC using the same chip set. Definicon was able to do this because the chip set was developed jointly by Sun and Fujitsu, with Sun offering licensing of the chip set, operating system, and software development tools to others. The Definicon coprocessor board will run under DOS using the PC for all I/O. This will bring a new level of performance to the PC for applications such as CAD, which sorely needs it. §

Announcing - the database development system that you designed.

db_Vista III™

C PROGRAMMERS-

We asked what you wanted in a database development system and we built it!

db_VISTA III™ is the database development system for programmers who want powerful, high performance DBMS capabilities ... and in any environment. Based on the network database model and the B-tree indexing method, db_VISTA III gives you the most powerful and efficient system for data organization and access. From simple file management to complex database structures with millions of records, db_VISTA III runs on most computers and operating systems like MS-DOS, UNIX, VAX/VMS and OS/2. It's written in C and the complete source code is available, so your application performance and portability are guaranteed! With db_VISTA III you can build applications for single-user microcomputers to multi-user LANs, up to minis and even mainframes.

RAIMA'S COMMITMENT TO YOU: No Royalties, Source Code Availability, 60 days FREE Technical Support and our 30-day Money-Back Guarantee. Extended services available include: Application Development, Product Development, Professional Consulting, Training Classes and Extended Application Development Support.

HOW TO ORDER: Purchase only those components you need. Start out with Single-user for MS-DOS then add components, upgrade ... or purchase Multi-user with Source for the entire db_VISTA III System. It's easy... call toll-free today!

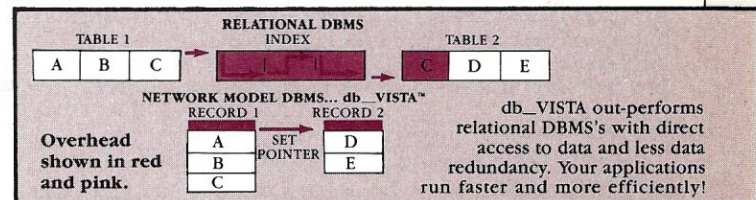

db_VISTA out-performs relational DBMS's with direct access to data and less data redundancy. Your applications run faster and more efficiently!

The db_VISTA III™ Database Development System

1 db_VISTA™: The High Performance DBMS

The major features include:

- Multi-user support for LANs and multi-user computers.
- Multiple database access.
- File and record locking.
- Automatic database recovery.
- Transaction processing and logging.
- Timestamping.
- Database consistency check utility.
- Fast access methods based on the network database model and B-tree indexing. Uses both direct "set" relations and B-tree indexing independently for design flexibility and performance.
- An easy-to-use interactive database access utility.
- File transfer utilities for importing/exporting ASCII text and dBASE II/III files.
- A Database Definition Language patterned after C.
- Virtual memory disk caching for fast database access.
- A runtime library of over 100 functions.
- **Operating systems:** MS-DOS, UNIX V, XENIX, VMS, OS/2.
- **C Compilers:** Lattice, Microsoft, IBM, Aztec, Computer Innovations, Turbo C, XENIX, and UNIX.
- **LAN systems:** LifeNet, NetWare, PC Network, 3Com, SCO XENIX-NET, other NET-BIOS compatible MS-DOS networks.

2 db_QUERY™: The SQL-based Query.

- Provides relational view of db_VISTA applications.
- Structured Query Language
- C linkable.
- Predefine query procedures or run ad-hoc queries "on the fly".

3 db_REVERSE™: The Database Restructure Program.

- Redesign your database easily.
- Converts all existing data to revised design.

All components feature royalty-free run-time distribution, source code availability and our commitment to customer service. That's why corporations like ARCO, AT&T, Hewlett-Packard, IBM, Northwestern Mutual Life, UNISYS and others use our products.

db_VISTA III™ Database Development System

db_VISTA III™	\$595 - 3960
db_QUERY™	\$595 - 3960
db_REVERSE™	\$595 - 3960
db_VISTA™ File Manager	Starts at \$195

We'll answer your questions, help determine your needs and get you started.

CALL TODAY!



1-800-db-RAIMA



(that's 1-800-327-2462)

RAIMA™
CORPORATION

3055 112th Avenue N.E., Bellevue, WA 98004 (206)828-4636
Telex: 6503018237MCIUW FAX: (206)828-3131

there is mail . . .

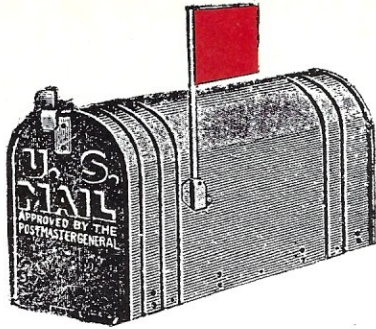

We welcome your letters, with their comments, compliments, criticism, and suggestions. We do not have the staff to answer all letters personally. All letters become the property of M/SJ and may be subject to editing. We do not print letters that do not include a name and address.

Please send your letters to: Micro/Systems Journal, Box 1192, Mountainside, NJ 07092.

Ask Questions and Get Responses in Batch File Modifications

Dear M/SJ:

I found Bill Roger's program ("Asking Questions and Getting Responses in an MS-DOS Batch File," M/SJ, May/June 1987, pp. 62-64) useful and ingenious. My thanks to him for sharing it, and to you for printing it. Because I am currently using Mix C (Version 2.5.2), I had to make some changes to the program.

I also removed as many nonstandard usages as possible. Unfortunately, unbuffered keyboard input and visual display output could not be accomplished without resorting to nonstandard calls (see highlighted comments in Listing 1).

The most substantive change was replacing the line referring to the function *strchr* (bottom of page 63) with a *for* statement. Apparently *strchr* is a nonstandard function, and is not supplied with all C compilers. I also tightened the code, changed variable names, enhanced the commenting, and made other aesthetic adjustments. (See Listing 1.)

Sidney L. Sanders
Geneseo NY

Listing 1

BATch INTERaction allows an MS-DOS batch file to prompt the user for a single character, and to choose its next action based on user's response. It sets the ERRORLEVEL according to response given by the user; and takes advantage of the batch facility's ability to take alternate actions based on the ERRORLEVEL's value.

To use, command line BATINTER arg1 arg2...argN is placed in a batch file, where:

arg1 is an optional string of characters taken as a table of valid single-character responses from user. If omitted, 0123456789 is assumed. Maximum table size is 80 characters. arg2...argN are optional strings comprising prompt to be displayed when program is ready for single-character response. If omitted, Character ? is assumed. Maximum length of prompt is 80 characters.

Examples:

```
BATINTER ZQPD (Z)eke, (Q)uinn, (P)at, or (D)an?
BATINTER JBLMRX
BATINTER
```

In the second example, default prompt will be used, and in the third example, the default table and default prompt will be in effect. When BATINTER runs, it displays the prompt and waits for the user to type a single character that matches a character in the table. When it receives a matching character, BATINTER immediately sets the ERRORLEVEL equal to offset of matching response in the table and terminates. In the first example above, BATINTER would wait for a Z, Q, P, or D. If the user types Z, the ERRORLEVEL would be set to 0. If Q is typed, ERRORLEVEL will be set to 1, and so on. In a batch file, the sequence

```
:
BATINTER arg1 arg2...argN
IF ERRORLEVEL n GOTO a
IF ERRORLEVEL n-1 GOTO b
IF ERRORLEVEL n-2 GOTO c :
```

will cause the next action taken in batch file to be determined by the user's response to BATINTER's prompt. Note that successive tests of ERRORLEVEL should be from highest to lowest, because expression ERRORLEVEL k evaluates to TRUE if value of ERRORLEVEL is equal to or greater than k.

```
#include <stdio.h>
int  errlev=-1; /* ERRORLEVEL returned to MS-DOS */
int  index; /* Index for accessing array elements */
char dfprompt[]="Character? "; /* Default prompt */
char dfrsptab[]="0123456789"; /* Default response table */
char resp; /* Single-char response from user */
char *matchptr; /* Pointer to matching char in response table */
char prompt[81]; /* Prompt string */
char rsptab[81]; /* Response table */
```

```
main(argc,argv)
int  argc;
char *argv[];
{ /* Begin main */
if(argc>2)
strcpy(rsptab,dfrsptab); /* Default table */
else
strcpy(rsptab,argv[1]); /* User-supplied table */
if(argc>2)
for (index=2;index<argc;index++){ /* User-supplied prompt */
strcat(prompt,argv[index]);
strcat (prompt," ");}
else
strcpy(prompt,dfprompt); /* Default prompt */
printf("%s ",prompt);
while(errlev<0){ /* Find char in table that matches response */
printf("\b\b"); /* Erase unmatched response */
resp=getch(); /* NONSTANDARD unbuffered keyboard read */
putch(resp); /* NONSTANDARD unbuffered vdu out */
for(matchptr=rsptab;*matchptr!=resp;&&*matchptr!='\
0';matchptr++){
if(*matchptr!='\0') /* If matchptr isn't
pointing */
errlev=(int)(matchptr-rsptab); /* to a NUL, it's point-
ing to */
printf("\n"); /* a matching char in
rsptab */
exit(errlev); /* set ERRORLEVEL and exit */
} /* End main */
```

Sidney L. Sanders
Geneseo, NY

Lahey Computer Systems, Inc. Sets a New FORTRAN Standard!

Introducing the latest addition to our line of FORTRAN Language Systems—
Lahey Personal FORTRAN 77.

What you Get With Lahey Personal FORTRAN 77:

Lahey Experience.

We are experts in designing and implementing FORTRAN Language Systems. Lahey has been producing mainframe implementations since 1967 and a PC FORTRAN (F77L) since 1984. In fact, F77L was named the "EDITOR'S CHOICE" among PC FORTRANs by *PC Magazine*. This 20 year span of specialization has been incorporated into the design of our revolutionary Lahey Personal FORTRAN 77.

LAHEY SLASHES COMPILATION TIME.

Compilation times (in seconds) for Whetstone Program (WHETS3H.FOR)

Test conducted on IBM AT running at 6MHz with 80287.

Product	Version	Price	Compilation Time (seconds)
Lahey	Personal FORTRAN 77 Version 1.0	(\$95)	11.57
Microsoft	FORTRAN Version 4.0	(\$450)	54.08
Ryan McFarland	FORTRAN Version 2.21	(\$595)	88.95

Customer Support:

Our philosophy is that customer relationships begin, rather than end, at the point of sale. Services include free technical support, electronic bulletin board for fast service and information access, and newsletters to keep you up to date.

Purchasing the Lahey Personal FORTRAN 77 gives you our FORTRAN experience, a feature loaded product, industry leading compilation speed, and quality technical support; all for **\$95**.

International Representatives: Canada: Barry Mooney & Assoc., Tel. (902)6652941 • England: Grey Matter Ltd., Tel. (0364)53499 • Switzerland: DST Comp. Services, Tel. (022)989188 • Denmark: Ravenholm Computing, Tel. (02)887249 • Australia: Comp. Transitions, Tel. (03)5372786 • Japan: Microsoft Inc., Tel. (03)813822
MS-DOS & MS FORTRAN are trademarks of Microsoft Corporation.



Feature Loaded:

- Full implementation of the ANSI X3.9-1978 FORTRAN Standard
- Fast Compilation (see chart)
- Popular Language Extensions highlighted in the manual
- Source On-Line Debugger
- English Diagnostics and Warning Messages
- LOGICAL*1, LOGICAL*4
- INTEGER*2, INTEGER*4
- REAL*4, REAL*8, and DOUBLE PRECISION
- COMPLEX*8, COMPLEX*16
- Recursion
- 31-Character Names
- Trailing Comment
- Cross Reference and Source Listings
- 64 KB Generated Code
- 64 KB Stack Storage
- 64 KB Commons, Constants and Saved Local Data
- Math coprocessor requirement gives maximum performance
- 350 Page User Manual

SYSTEM REQUIREMENTS:

256K Ram MS-DOS (2.0 or later)
Math Coprocessor Chip (8087 or 80287)

\$95

Lahey is setting the
PC FORTRAN Standard.

TO ORDER

1-800-548-4778

Lahey Computer Systems, Inc.

P.O. Box 6091

Incline Village, NV 89450

Telephone: (702) 831-2500

TELEX: 9102401256

If you want to program in FORTRAN - Lahey is the Source

- Please send me ___ Lahey Personal FORTRAN 77 copies @ \$95.00 each
Disk Format ___ 5 1/4" ___ 3 1/2"
Add \$2.50 for shipping and handling per unit
Nevada residents add applicable tax

TOTAL ENCLOSED _____

SEND ME INFORMATION:

- Lahey Personal FORTRAN 77
 A future release not requiring math coprocessor
 LCS Software Products

ENCLOSED

___ Check ___ Visa ___ Master Card ___ AMEX

Number _____

Expiration Date _____

Signature _____

Name _____

Company _____

Address _____

City _____

State _____ Zip _____

Phone _____

Send to: Lahey Computer Systems,
POB 6091, Incline Village, NV 89450-6091

Lahey

Computer Systems Inc.

C Forum

Don Libes

varargs —Varying Arguments

This column features tips and techniques for using the C language productively. It discusses typical problems with using C and their solutions. Reader suggestions, comments, and questions are encouraged. Address them to "The C Forum," Micro/Systems Journal, Box 1192, Mountain-side, NJ 07092.

"varargs" is the name of a package that allows one to write portable code that passes varying numbers and types of arguments to a function.

C, of course, already lets you pass arbitrary parameters, in spite of how you may have them declared. (It's not a bug, it's a feature!) However, doing it portably is difficult because bypassing the C parameter mechanism requires understanding and handling of each machine's architecture.

Some implementations push parameters on the stack going down. Some do it going up. Depending on the type of parameter, a different amount of space may be pushed. Some systems do not even use a stack but pass all parameters through registers. And some machines use a combination of both stack and registers.

Because of this variety of implementations, there is no standard way, for example, to figure out how many arguments have been passed. Popular conventions for doing so include: (1) passing the number of arguments as the first argument, (2) terminating the argument list with a special value, such as NULL, or (3) providing a way of indirectly deducing the number of arguments (for example, by counting the %s in a *printf()* format).

C's approach to parameter types is no different than the way it handles the number of parameters. The compiler simply doesn't check that they match between caller and callee. No information is passed

as to what types the calling subroutine used. If you don't use *lint*, you are on your own.

Compiler writers would have you believe that efficiency is the reason why you can't find out how many arguments you've been passed. However, many languages do support this. For example, some provide a system variable that contains the number of arguments used to call the current procedure.

Certainly, stronger type checking in the original design would have helped immensely. For example, Ada and C++ handle much of the support for function overloading at compile-time. Whatever the reason for this lack, however, we must live with the result.

Using varargs

varargs provides a portable means of writing and calling functions with varying arguments. It was designed by Andrew Koenig of Bell Labs and has been implemented for most implementations of C.

As you will see, the syntax of varargs is unusual. It allows us to access parameters in unorthodox ways. By hiding it with macros, we gain the ability to handle variable arguments on any sensible architecture and C compiler, and to do so in a portable manner. (There are machines for which varargs cannot be implemented, but then C doesn't work very well on such machines either.)

Portable printf()

printf() is a classic example of a routine that cannot be correctly declared in C. The problem is that we don't know the types and number of all the arguments at compile-time. Most implementations of *printf()* use nonportable mechanisms for reading the arguments, often doing it in assembler. It can, however, be written portably in C. A skeleton *printf()* is shown in Listing 1.

varargs.h is a header file that defines the macros necessary to use varargs. This is called *stdarg.h* in the current X3J11 draft C standard.

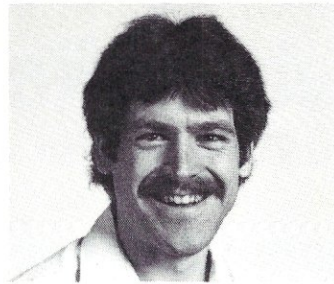

The comment */*VARARGS*/* is a directive to *lint*. *Lint* will turn off argument type checking for the following function.

All varargs subroutines take only one argument, *va_alist*. The declaration for *va_alist* is *va_dcl* (without a semicolon). If you already know some of the argument types, do not declare them. You must get them through the varargs package, anyway.

va_list arg declares an object that will point into the argument list. We can step *arg* to the next argument in the list or move it back to the beginning of the list and start over. You can use any name—it doesn't have to be *arg*. You can also declare multiple objects that can point to different places in the argument list.

To initialize *arg* to the beginning of the argument list, say *va_start(arg)*. *va_end(arg)* should be called at the end of processing the argument list, whether or not you want to reread it with *va_start()*.

To read the next argument, call *va_arg()*. The first parameter is an object of type *va_list*. The second parameter should be the type of the expected object after the parameter casting rules have been applied. Thus, to read an integer, we use *va_arg(arg,int)*. To read a *float*, we use *va_arg(arg,double)* since *floats* are promoted to *doubles* in function calls.

In our *printf()*, we get the format by calling *va_arg(arg,char *)* since it is a string. *next_type()* (which is left to the reader as an exercise) returns the formatting type of the next argument. From this we can infer the type of the argument.

The Future of varargs

It is possible to support varargs without having to worry about the automatic promotion problems. One solution is to have a C operator, *promote()*, that takes a type and returns the type after parameter promotion. However, *promote()* requires compiler support, and it is not in the ANSI X3J11 draft C standard as of this date.

varargs is called *stdarg* in the X3J11 draft C standard. It originally appeared in AT&T and Berkeley versions of UNIX but

is now available in most C compilers. It is certainly easy enough to support, and if you don't have it, you should ask your C compiler vendor for it, or try writing it yourself.

It is likely that the final C standard will look slightly different from the mechanism described here. However, any changes should be minor syntactic differences.

A Related Problem—`dprintf()`

Suppose we already have `printf()`, but we would like to write a function that uses it underneath. I have in mind a function that I call `dprintf()`. `dprintf()` takes all the same parameters as `printf()`, with one addition. This extra parameter is compared against a global `int`. If the parameter is larger than the global, `printf()` is called, otherwise nothing happens.

This function is especially useful for controlling diagnostics. If I want a lot of debugging information, I set `global_error_level` to 10. Lower numbers print out less information. And if I don't want any debugging information, I set it to 0 so that none of the `dprintf()`s output anything.

By passing the debug level as an argument to the program, I don't have to recompile the program in order to turn on any level of diagnostics. This code appears in Listing 2.

Actually, this was my second attempt. My first attempt never made it past `cc` because I could not figure out how to declare `args`. No matter how I declared it (`char`, `int`, `char *`, and so on) or passed it (`args`, `&args`, `*args`), `printf()` never saw the second argument. What it did see was a lot of "stack junk." The problem was that `dprintf()` got the stack with a good list of arguments, but all that I could pass to `print()` was the address of my stack. I couldn't pass the stack itself!

My second version has the arguments stated explicitly. It, however, also has problems. First of all, I have arbitrarily limited myself to four arguments. No matter what number I pick, there is always the possibility that it will be exceeded. The second problem is that I have declared every argument as an `int`. This actually worked pretty well since `chars` are always converted to `ints`, and pointers (the other thing that I print out frequently while debugging) fit into `ints` on my machine. Nonetheless, I could not print out `doubles` because they didn't fit into `ints`, so I always got the wrong answer. I didn't want to declare all the arguments as `doubles` either, because then the `ints` would not be handled correctly.

Although it might appear that `varargs` could be useful here, it doesn't completely solve the problem. `varargs` still requires that you determine the types of the arguments. I just wanted to pass everything on to `printf()` uninterpreted.

`vprintf()` and Friends

The solution to the problem is to use a set of routines that are defined to take `varargs`-style parameters as their arguments.

These were also written by Koenig (who evidently did a lot of struggling with these same problems). `vprintf()` is similar to `printf()`. Both have a (`char *`) format as the first argument. However, instead of an optional list of untyped arguments such as `printf()`, `vprintf()` has a second argument declared to be of type `va_alist`.

Does this look familiar? Yes, it is the same `va_alist` from the `varargs` package! Now we can correctly rewrite `dprintf()` as shown in Listing 3.

Just as with `printf()`, there are two other varieties of `vprintf()`. They are, naturally, `vsprintf()` and `vfprintf()` (Listing 4).

Like with `printf()` and `fprintf()`, `vprintf()` and `vfprintf()` return the number of characters output, while `sprintf()` and `vsprintf()` return a pointer to the beginning of the output buffer.

Conclusion

Passing varying argument may seem distasteful at first, but this is probably because it was not originally possible to do so portably. Nonetheless, it is a legacy of C. And done correctly, elegant functions such as `printf()` are possible.

Using `varargs`, it is always possible to write portable code. The only pitfall you must be aware of is `vararg`'s use of C's rules on promotion of for-

mal parameters. Otherwise, `varargs` is a delight to use. `varargs` is already available in most C compilers, and it (or something very much like it) will definitely be in the ANSI C standard. §

Don Libes is a computer scientist working in the Washington, D.C. area. He works on artificial intelligence in robot control systems.

Listing 1

```
#include <varargs.h>

/*VARARGS*/
printf(va_alist)
va_dcl/* No semicolon! */
{
    va_list arg;
    char t, *fmt;

    va_start(arg);
    fmt = va_arg(arg, char *);
    while (t = next_type(fmt)) {
        switch (t) {
            case 'c': /* character */
                print_character(va_arg(arg, int));
                break;
            case 'd': /* integer */
                print_integer(va_arg(arg, int));
                break;
            case 's': /* string */
                print_string(va_arg(arg, char *));
                break;
            case 'f': /* float */
                print_float(va_arg(arg, double));
                break;
            . . .
        }
        va_end(arg);
    }
}
```

Listing 2

```
dprintf(error_level, fmt, arg0, arg1, arg2, arg3, arg4)
int error_level;
char *fmt;
int arg0, arg1, arg2, arg3, arg4;
{
    if (global_error_level >= error_level)
        printf(fmt, arg0, arg1, arg2, arg3, arg4);
}
```

Listing 3

```
/* really dprintf(error_level, fmt, args...) */
dprintf(va_alist)
va_dcl
{
    int error_level;
    char *fmt;
    va_list args;

    va_start(args);
    error_level = va_arg(args, int);
    fmt = va_arg(args, char *);
    if (global_error_level >= error_level)
        vprintf(fmt, args);
    va_end(args);
}
```

Listing 4

```
char *vsprintf(s, fmt, args)
char *s, *fmt;
va_list args;

int vfprintf(stream, fmt, args)
FILE *stream;
char *fmt;
va_list args;
```

Turbo Pascal Corner

Stephen R. Davis

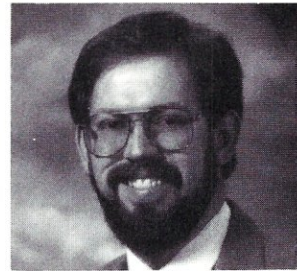

VAR Variables

I am sad to report that I have been caught in a lie. Sometimes you believe so strongly that something must be a certain way that it never occurs to you to check it out. Fortunately, I caught myself this time so that I can come clean before any of you embarrass me. But first to the Turbo Pascal product news.

I have yet to hear anything about the next version of Turbo Pascal, the one with the user interface found in the newer Borland languages. I doubt that much effort is being expended in this direction considering the amount of programmer's time going into the "Great Language Wars of 1987." This, you may know, is the confrontation being waged between Borland and Microsoft. It started last year with the Campaign of the BASICs (Turbo BASIC versus Quick BASIC).

Last summer, a second front was opened at C (Turbo C versus the soon to be introduced Quick C). Although good for programming in general, these crusades direct attention away from Turbo Pascal. This, in turn, makes it unlikely that a new version of Pascal will be introduced any time soon. (Now if Microsoft would just introduce Quick Pascal and turn this into a three front war!) In any case, I will relay any military intelligence on the topic as I intercept it.

Turbo Optimizer

After my last review I felt that if I reported on another product from the people at TurboPower Software someone was going to accuse me of being on their payroll. However, here I go again.

Turbo Optimizer is a collection of three programs: Turbo Library Compactor (TLC), Turbo Object Optimizer (TOO), and Turbo Object Librarian (TOL). TOL is a librarian that allows the programmer to store commonly used code segments in such a way that they can be called up and

inserted into new programs without being recompiled. Since Turbo Pascal is so fast at compilations, this one did not excite me particularly, but the other two did indeed catch my attention.

The Turbo Object Optimizer (TOO) is an execution optimizer for Turbo Pascal. Turbo is well known for its compilation speed but not for the quality of the object code generated. Although it is not bad, Turbo-generated machine code is not comparable to the code from a good optimizing compiler. TOO accepts as input the .COM file that Turbo Pascal generates and attempts to improve it. TOO's job is complicated by the fact that it does not have access to the source code, as an optimizing compiler normally would.

The Turbo Library Compactor (TLC) attempts to reduce the size of .COM files generated by Turbo Pascal by removing sections of "dead" code that no one calls. As noted in an earlier column, Turbo Pascal saddles each .COM file it generates with the entire 10K of Turbo library—whether the file uses any of it or not. We saw that users could avoid having the library included by building a chain utility and creating .CHN files rather than .COM files; however, the TLC makes this trick less necessary because it automatically removes the majority of this library from small programs. It can also remove any user procedures that are not invoked anywhere.

In practice, both the TOO and the TLC made a noticeable improvement. The TOO can increase speed by as much as 30 percent, although 20 percent is about average. Not much to get excited about perhaps, but this is a 20 percent increase in speed with basically *no effort*. The TLC reduces .COM programs an average of 8K. For typical, rather small Turbo programs this can represent a respectable decrease. Both TOO and TLC can be applied to the same .COM for a double savings.

A special "tiny" mode can reduce specially written programs even further than

that—some very small programs to as little as 100 bytes! This can be very useful indeed when using Turbo Pascal to build terminate-and-stay-resident programs such as those described in *M/SJ*, July/August 1985.

TOO works only with programs generated by PC-DOS Turbo Pascal, Versions 3.00 and later. It requires a PC, XT, AT, or a compatible, and 256K of memory. Source code is available at extra charge. Order lines are open seven days a week at (800) 538-8157 (or, in California, [800] 672-3470) ext. 830. Cost is \$75 from the company, but I have seen it for as low as \$65 from mail-order sources such as the Programmer's Connection.

VAR Variables

The lie I mentioned above has to do with how Turbo Pascal passes arrays as arguments to subroutines. First a little background. There are two ways to pass a parameter to a function: by value or by reference. When passing by value, a copy of the parameter is passed to the subroutine. For example, assume the variable X contains the value 10. If X is passed by value, then the value 10 is passed to the subroutine. The subroutine does not have access to the original 10, but to a copy of it. When passing by reference, the original parameter is passed to the subroutine—no copy is made. In our example, the subroutine gains access to the original 10 by passing the address of X.

Pascal allows the user to specify whether passing is to be done by reference or value. In the absence of any indication to the contrary, Pascal passes by value; however, the programmer may override this by tacking the keyword VAR to the beginning of the parameter name, as in:

```
Procedure Test (a : integer;  
               VAR b : integer);
```

In this case, the variable *a* is passed by value, whereas the variable *b* is passed by reference.

Call or write
for the latest catalog



DISCOVER PARADISE

Programmer's Paradise Gives You Superb Selection, Personal Service and Unbeatable Prices!

Welcome to Paradise. The microcomputer software source that caters to your programming needs. Discover the Many Advantages of Paradise...

- Lowest price guaranteed
- Latest versions
- Huge inventory, immediate shipment
- Knowledgeable sales staff
- Special orders
- 30-day money-back guarantee

Over 500 brand-name products in stock—if you don't see it, call!

We'll Match Any Nationally Advertised Price.

	LIST	OURS
386 SOFTWARE		
ADVANTAGE 386 C	895	805
ADVANTAGE 386 PASCAL	895	805
PHARLAP 386/ASMLINK	495	419
MICROPORT SYSTEM/386	799	699
386 SCO XENIX SYS V COMPLETE	1495	1195
ARTIFICIAL INTELLIGENCE		
ARITY STANDARD PROLOG	95	79
GOLDEN COMMON LISP	495	455
MICROSOFT LISP	250	155
PC SCHEME	95	85
SMALLTALK V	99	85
TURBO PROLOG	100	65
TURBO PROLOG TOOLBOX	100	65
ASSEMBLERS/LINKERS		
ADVANTAGE DISASSEMBLER	295	265
ADVANTAGE LINK	395	359
ASMLIB	149	125
EZ-ASM	70	65
MICROSOFT MACRO ASSEMBLER	150	95
PASM86	195	109
PLINK86PLUS	495	275
QUELO 68000 X ASM	545	509
RELMS CROSS ASSEMBLERS	CALL	CALL
UNWARE CROSS ASSEMBLERS	CALL	CALL
VISIBLE COMPUTER 80286	100	89
BASIC		
BETTER BASIC	199	129
DB/LIB	99	89
MACH 2	75	59
MS QUICKBASIC	99	65
TRUE BASIC	100	69
TURBO BASIC	100	65
DATABASE TOOLBOX	100	65
EDITOR TOOLBOX	100	65
TELECOM TOOLBOX	100	65
XENIX/UNIX PRODUCTS		
SCO XENIX SYSTEM V-COMLETE	1495	1195
SCO XENIX OPERATING SYSTEM	695	599
MICROPORT SYSTEM V/AT	549	475
MICROPORT SOFTWARE DEV. SYS.	249	209
OTHER SCO & MICROPORT	CALL	CALL
ADVANTAGE C++	695	CALL
BTRIEVE	595	455
C-TERP	498	379
INFORMIX ESQ/LC	749	CALL
INFORMIX 4GL	1500	CALL
INFORMIX SQL	995	CALL
MICROSOFT LANGUAGES	CALL	CALL
PANEL	625	535
PANEL PLUS	795	675
REAL TOOLS	149	89
RM/COBOL	1250	949
RM/FORTRAN	750	549
C++		
ADVANTAGE C++	495	479
PFORCE ++	395	209
C COMPILERS		
C86PLUS	497	375
DATALIGHT OPTIMUM-C	549	105
HIGH C	595	CALL
LATTICE C	SPECIAL PRICE	500 CALL

	LIST	OURS
LET'S C W/CSO DEBUGGER		
MICROSOFT C	450	269
QUICK C	99	65
TURBO C	100	65
C INTERPRETERS		
C-TERP	300	229
INSTANT C	500	379
RUN/C	120	79
RUN/C PROFESSIONAL	250	155
C LIBRARIES		
ASYNCH MANAGER	175	135
BASIC-C	175	129
C-FOOD SMOGASBORD	120	95
W/SOURCE CODE	300	179
C TOOLS PLUS	175	135
C UTILITY LIBRARY	185	119
C-XPERT	295	249
ESSENTIAL COMMUNICATIONS	185	125
COMMUNICATIONS PLUS	250	189
GREENLEAF FUNCTIONS	185	125
GREENLEAF COMM LIBRARY	185	125
GREENLEAF SAMPLER (TURBO C)	95	79
MULTI-C	149	135
PFORCE	295	209
RESIDENT C W/SOURCE	198	CALL
TIMESLICER	295	265
W/SOURCE CODE	1000	895
TURBO C TOOLS	129	99
COBOL		
FPLB	149	129
MICRO FOCUS COBOL PRODUCTS	CALL	CALL
MICROSOFT COBOL	700	439
MICROSOFT SORT	195	129
REALICS	995	785
REALIA COBOL	995	785
REALMENU	1145	899
RM/COBOL	950	759
RM/COBOL-85	1250	999
RM/SCREENS	395	315
SCREENIO	400	CALL
DEBUGGERS		
386 DEBUG	195	155
ADVANCED TRACE-86	175	119
BREAKOUT	125	89
C-SPRITE	175	119
PERISCOPE I	345	289
PERISCOPE II	175	139
PERISCOPE III 8 MHZ	995	825
PERISCOPE III 10 MHZ	1095	899
PFIX 86 PLUS	395	209
T DEBUG PLUS	60	49
XVIEW86	60	49
DISK/DOS/KEYBOARD UTILITIES		
BACK-IT	100	89
BOOKMARK	100	79
COMMAND PLUS	80	69
INTELLIGENT BACKUP	150	135
NORTON COMMANDER	198	75
ADVANCED NORTON UTILITIES	150	89
PDISK	145	89
FILE MANAGEMENT		
BTRIEVE	245	185
YTRIEVE	245	185
REPORT OPTION	145	99
BTRIEVE/N	595	455
XTRIEVE/N		
REPORT OPTION/N	595	455
C-TREE	345	269
R-TREE	295	239
C-TREE/R-TREE BUNDLE	650	519
DBC III	250	169
DBC III PLUS	750	595
INFORMIX PRODUCTS	CALL	CALL
PACT MANAGER	249	219
EDITORS		
BRIEF	195	CALL
W/DBRIEF	275	CALL
CVUE W/SOURCE CODE	250	199
EDJ	195	155
EMACS	295	265
EPSILON	195	149
KEDIT	125	99
PC/EDT	250	229
PC/VI	149	109
PI	195	155
PMATEPRO	195	109
SPF/PC	195	145
VEDIT PLUS	185	129
XTC	99	79
FORTRAN COMPILERS		
LAHEY FORTRAN	477	CALL
LAHEY PERSONAL FORTRAN 77	95	89
MICROSOFT FORTRAN	450	269
RM/FORTRAN	595	399
FORTRAN UTILITIES/LIBRARIES		
ACS TIME SERIES	495	389
DOCUMENTER	129	115
DIFF-E-Q	495	445
FORTLIB	125	109
FORTTRAN ADDENDA	165	139
GRAFLIB	175	169
GRAFMATICS/PLOTMATICS	135	119
MATHPAC	495	445
NO LIMIT	129	115
SSP/PC	350	269
GRAPHICS		
ADVANTAGE GRAPHICS (C)	250	225
ESSENTIAL GRAPHICS	250	185
GSS GRAPHIC DEV. TOOLKIT	495	375
HALO	300	285
HALO (5 MICROSOFT LANG.)	595	389
METAWINDOW PLUS	275	229
TURBOWINDOW/C	95	79
TURBO HALO (FOR TURBO C)	100	79
LINT		
PC-LINT	139	99
PRE-C	295	155
MODULA-2		
FARBWARE MODULA-2	90	79
LOGITECH MODULA-2	99	79
APPRENTICE PACKAGE	99	79
WIZARD PACKAGE	199	159
MAGIC TOOLKIT	99	79
WINDOW PACKAGE	49	39
ROM PACKAGE AND CROSS	299	239
RUNTIME DEBUGGER	89	75
REPertoire	299	239
OPERATING SYSTEMS		
MICROPORT SYSTEM V/AT (COMPLETE)	549	465

	LIST	OURS
SCREEN SCULPTOR		
SYSTEM BUILDER	125	95
IMPEX	150	129
REPORT BUILDER	130	115
TURBO.ASM	99	69
TDEBBUGLUS	60	49
TURBO ASYNCH PLUS	100	79
TURBOEXTENDER	85	65
TURBOHALO	129	99
TURBOMAGIC	99	89
TURBO MASTER	125	99
TURBO NUMERICAL METHODS	100	65
TURBO OPTIMIZER	75	65
TURBO POWER TOOLS PLUS	100	79
TURBOPOWER UTILITIES	95	79
TURBOWINDOW/PASCAL	95	79
SCREEN DISPLAY/WINDOWS		
C-SCAPE	279	CALL
CURSES W/SOURCE CODE	250	169
GREENLEAF DATA WINDOWS	225	155
W/SOURCE CODE	495	289
JVACC FORMAKER	995	449
JVACC JAM	750	669
MICROSOFT WINDOWS	99	65
MS WINDOWS DEVELOPMENT KIT	500	309
PANEL	295	215
PANEL PLUS	495	395
PANEL/PC	129	95
PANEL/TC	129	95
QUICKSCREEN	195	175
SCREEN ACE	195	169
SCREENSTAR W/SOURCE	198	155
VITAMIN C	225	165
VC SCREEN	99	85
WINDOWS FOR DATA	395	315
VIEW MANAGER	275	199
ZVIEW	245	169
ADDITIONAL LANGUAGES		
ACTOR	495	419
HS/FORTH	395	359
JANUS/ADA C PACK	95	89
LATTICE RPG II COMPILER	750	629
MASTER FORTH	125	115
PC/FORTH	150	109
PERSONAL REXX	125	99
THE WEINER SHELL	199	179
ADDITIONAL PRODUCTS		
ADVANTAGE VCMS	379	329
BASTOC	495	CALL
CARBON COPY PLUS	195	179
CODESIFTER	119	85
DAN BRICKLIN'S DEMO PROGRAM	75	59
DB2C	299	CALL
FLOW CHARTING II	229	205
MAGIC PC	195	179
NORTON GUIDES	100	65
PFINISH	395	225
POLYTRON PVCS	CALL	CALL
SOURCE PRINT	95	75
TP2	249	199
TREE DIAGRAMMER	77	69
VENTURA PUBLISHER	895	CALL

	LIST	OURS
SCO XENIX SYSTEM V (COMPLETE)		
	1295	995
WENDIN-DOS OTHER MICROPORT, SCO, WENDIN PRODUCTS		
	99	79
PASCAL COMPILERS		
MICROSOFT PASCAL	300	185
PASCAL-2	350	329
TURBO PASCAL	NEW V. 4.0	100 65
TURBO PASCAL DEV LIB	NEW	395 259
TURBO PASCAL ADD-ONS		
ALICE	95	69
DOS/BIOS & MOUSE TOOLS	75	69
FLASH-UP	89	79
GSI PASCAL DEBUGGER	50	45
METRAYTE DATA ACQ. TOOLS	100	89

NEW PRODUCTS

PI EDITOR—Lightning fast editor with all the features of today's most popular programmer's editors and more. Among PI's 200+ commands and features are support for unlimited windows in any size, scrolling of windows simultaneously, background printing, and multiple file support. PI also has extensive language support for Assembly, Basic, C, and Pascal. Single stroke compile, and see your source and compilation errors simultaneously. Much more, and PI benchmarks faster than our leading selling editors. List: \$195 Ours: \$155

RTC PLUS—Translator for converting either FORTRAN or RATFOR to C. No need to hand translate most of your code. RTC PLUS is perfect for translating FORTRAN libraries, and any FORTRAN code where I/O is concentrated in a few routines. List: \$450 Ours: \$399

JVACC APPLICATION MANAGER (JAM)—Powerful application generator for creating, testing and modifying forms and windows. A unique application shell is created to create, and then specify control flow between the screens and windows. List: \$750 Ours: \$679

THE AUTOMATED PROGRAMMER—Programming system for numerical computation that enables a computer to recognize and process mathematical, engineering, and scientific problem specs. Computational formulas are translated into FORTRAN. The AUTOMATED PROGRAMMER offers a range of output choices from structured reports to pictures. Computational results may be embedded in complex 2D text and graphic "IMAGE" formats. Ours: \$895

	LIST	OURS
SCREEN SCULPTOR		
SYSTEM BUILDER	125	95
IMPEX	150	129
REPORT BUILDER	130	115
TURBO.ASM	99	69
TDEBBUGLUS	60	49
TURBO ASYNCH PLUS	100	79
TURBOEXTENDER	85	65
TURBOHALO	129	99
TURBOMAGIC	99	89
TURBO MASTER	125	99
TURBO NUMERICAL METHODS	100	65
TURBO OPTIMIZER	75	65
TURBO POWER TOOLS PLUS	100	79
TURBOPOWER UTILITIES	95	79
TURBOWINDOW/PASCAL	95	79
SCREEN DISPLAY/WINDOWS		
C-SCAPE	279	CALL
CURSES W/SOURCE CODE	250	169
GREENLEAF DATA WINDOWS	225	155
W/SOURCE CODE	495	289
JVACC FORMAKER	995	449
JVACC JAM	750	669
MICROSOFT WINDOWS	99	65
MS WINDOWS DEVELOPMENT KIT	500	309
PANEL	295	215
PANEL PLUS	495	395
PANEL/PC	129	95
PANEL/TC	129	95
QUICKSCREEN	195	175
SCREEN ACE	195	169
SCREENSTAR W/SOURCE	198	155
VITAMIN C	225	165
VC SCREEN	99	85
WINDOWS FOR DATA	395	315
VIEW MANAGER	275	199
ZVIEW	245	169
ADDITIONAL LANGUAGES		
ACTOR	495	419
HS/FORTH	395	359
JANUS/ADA C PACK	95	89
LATTICE RPG II COMPILER	750	629
MASTER FORTH	125	115
PC/FORTH	150	109
PERSONAL REXX	125	99
THE WEINER SHELL	199	179
ADDITIONAL PRODUCTS		
ADVANTAGE VCMS	379	329
BASTOC	495	CALL
CARBON COPY PLUS	195	179
CODESIFTER	119	85
DAN BRICKLIN'S DEMO PROGRAM	75	59
DB2C	299	CALL
FLOW CHARTING II	229	205
MAGIC PC	195	179
NORTON GUIDES	100	65
PFINISH	395	225
POLYTRON PVCS	CALL	CALL
SOURCE PRINT	95	75
TP2	249	199
TREE DIAGRAMMER	77	69
VENTURA PUBLISHER		

The difference is important. Variables passed by value and modified in a subroutine will retain their old values when the program returns to the calling procedure. Variables passed by reference and modified will "stay modified" in the calling routine.

Which technique is better depends on the application. Passing by reference is more flexible since it allows the procedure to "return" multiple values by storing them into the parameters. Passing by value eliminates the chance for side effects in subroutines that change the values of these parameters unexpectedly. However, there is a

If performance means anything to you at all, always pass arrays of any size by reference by using the VAR prefix in front of their declarations in Procedure definitions.

big problem with passing by value: How does one pass an array by value?

To pass an array by reference, the program merely passes the address of the array, just as with a simple variable. The subroutine can use this address to access the entire array. No matter how large the array, the size of its address is always the same. To pass an array by value, however, the program must copy the entire array onto the program stack to be passed over to the subroutine. If the array is large, this will use up a large amount of stack space and a great deal of time will be spent copying values around. For example, passing an array X declared ARRAY [1..1000] OF INTEGER would involve passing 2000 bytes (2 bytes per integer) to the subroutine.

Of course, there is an easy way out of this problem: Pass simple variables by value, but pass arrays by reference, whether they are labeled VAR variables or not. This is a logical escape, and the manual for Turbo from Borland implies in several places that this is, in fact, the case

Listing 1. Experiment to determine how arrays are passed to procedures in Turbo Pascal

```
Program Experiment;

Type
  data = array [1..80] of integer;

Var
  b, c : data;

Procedure Change (b:data; var c:data);
Begin
  b[1] := 11;
  c[1] := 12;

  writeln ('inside the procedure Change');
  writeln ('b = ', b[1], ' c = ', c[1]);
  writeln;
End;
Begin
  b[1] := 1;
  c[1] := 2;

  writeln ('before the call');
  writeln ('b = ', b[1], ' c = ', c[1]);
  writeln;

  Change (b, c);

  writeln ('after the call');
  writeln ('b = ', b[1], ' c = ', c[1]);
  writeln;
End.
```

Listing 2. Output from program experiment

```
before the call
b = 1 c = 2

inside the procedure Change
b = 11 c = 12

after the call
b = 1 c = 12
before the /
```

with Turbo Pascal. It seemed so logical that I knowingly asserted this over and over again in this column and others. Unfortunately, it ain't so!

Examine the program in Listing 1. Notice how the arrays B and C are first initialized. They are then passed to a procedure that sets them to some new value. Upon returning, the main program prints them out to screen to see whether the change "took" or not. Now examine the output from this program in Listing 2. Since C is a VAR variable and, therefore, passed by reference, we are not surprised that the value stays changed upon returning from the procedure.

Now look at B. If it were also being passed by reference, we would expect it to stay changed, but it isn't. A quick exami-

nation of the .COM file reveals the awful truth: The entire array is copied onto the stack before the procedure is called. This apparently always happens in this situation, regardless of the size of array B. I stand corrected.

The moral to this story is: If performance means anything to you at all, *always* pass arrays of any size by reference by using the VAR prefix in front of their declarations in Procedure definitions. Not doing so will cost your program needless time and memory. §

Stephen Randy Davis is a senior systems programmer for a defense contractor in Greenville, Texas, where he programs various microprocessors. He is also working on his Masters in physics.

Now, just \$129 and supports
Microsoft C 5.0 and QuickC

Blaise puts the Accent on C with C TOOLS PLUS/5.0™

Enhance your Microsoft C programming environment with C TOOLS PLUS/5.0™—a new, quintessential library of C functions. C TOOLS PLUS/5.0 from Blaise Computing Inc. puts a prime accent on quickly building professional applications using the full power of Microsoft C Version 5.0 and QuickC. Now you can concentrate on program creativity by having full control over DOS, menus, interrupt service routines, memory resident programs, printer and keyboard control, and more!

C TOOLS PLUS/5.0 prebuilt libraries are ready to use with either QuickC or the Microsoft C Version 5.0 command line environment. Complete documented source code is included so that you can study and adapt it to your specific needs. Blaise Computing's attention to detail, like the use of full function prototyping, cleanly organized header files, and a comprehensive, fully-indexed manual, makes C TOOLS PLUS/5.0 the choice for experienced developers as well as newcomers to C.

Continuous refinement of Blaise Computing's library products has produced a collection of tools that are unsurpassed for reliability, functionality and ease of use. Built upon the widely acclaimed C TOOLS PLUS, C TOOLS PLUS/5.0 includes such highly-developed features as:

◆WINDOWS

- Stackable, removable.
- Optional borders, cursor memory.
- Accept user input, formatted output.
- "print" window-oriented output. **NEW!**

◆INTERRUPT SERVICE ROUTINES

- Capture DOS critical errors and keystrokes.
- Install hardware interrupt handlers.

◆RESIDENT SOFTWARE SUPPORT

- Install, detect and remove memory resident programs.

◆MENUS

- Horizontal and pulldown. **NEW!**
- Lotus-style support. **NEW!**

◆INTERVENTION CODE

- Schedule C functions at specified times, intervals or with a "hot key". **NEW!**
- Take full advantage of DOS, even from memory resident programs. **NEW!**

◆FAST DIRECT VIDEO ACCESS

- All monitors, even EGA 43-line mode.

◆PRINTER CONTROL

- Access BIOS print functions. **NEW!**
- Control the DOS PRINT utility. **NEW!**

◆UTILITIES AND MACROS

- Take advantage of DOS file structure.
- Manipulate data types, far & near pointers. **NEW!**
- Access any memory areas with fast "peek" and "poke" macros. **NEW!**

C TOOLS PLUS/5.0 supports the Microsoft C Version 5.0 and QuickC compilers, requires DOS 2.00 or later and is just \$129.00.

C ASYNCH MANAGER™ Version 2.0 IMPROVED!

C ASYNCH MANAGER is a library of functions designed to help you incorporate asynchronous communication capabilities into your application programs. Version 2.0 has been rewritten especially for Microsoft C Version 5.0 and Borland's Turbo C. Simultaneous buffered input and output to both COM ports at speeds up to 9600 baud, XON/XOFF protocol, modem control and XMODEM file transfer are among the many features supported and is priced at just \$175.00.

Blaise computing Inc. has a full line of support products for both Pascal and C. Call today for your free information packet.

BLAISE COMPUTING INC.

2560 Ninth Street, Suite 316 Berkeley, CA 94710 (415) 540-5441

THE BLAISE
E N U

VIEW MANAGER \$275.00

General screen control; paint screens; block mode data entry or field-by-field control with instant screen access. For C or MS-Pascal.

Turbo C TOOLS \$129.00

Windows; ISRs; intervention code; screen handling and EGA 43-line text mode support; direct screen access; DOS file handling and more. For Turbo C.

Turbo POWER SCREEN

COMING SOON! General screen management; paint screens; block mode data entry or field-by-field control with instant screen access. For Turbo Pascal.

Turbo POWER TOOLS PLUS \$99.95

Screen and window management including EGA support; DOS memory control; ISRs; scheduled intervention code; and much more. For Turbo Pascal.

Turbo ASYNCH PLUS \$99.95

Interrupt driven support for the COM ports. I/O buffers up to 64K; XON/XOFF; up to 9600 baud; modem and XMODEM control. For Turbo Pascal.

PASCAL TOOLS/TOOLS 2 \$175.00

Expanded string and screen handling; graphics routines; memory management; general program control; DOS file support and more. For MS-Pascal.

ASYNCH MANAGER \$175.00

Full featured interrupt driven support for the COM ports. I/O buffers up to 64K; XON/XOFF; up to 9600 baud; modem control and XMODEM. For MS-Pascal.

KeyPlayer \$49.95

"Super-batch" program. Create batch files which can invoke programs and provide input to them; run any program unattended; create demonstration programs; analyze keyboard usage.

EXEC \$95.00

NEW VERSION! Program chaining executive. Chain one program from another in different languages; specify common data areas, less than 2K of overhead.

RUNOFF \$49.95

Text formatter for all programmers; flexible printer control; user-defined variables; index generation; general macro facility. Crafted in Turbo Pascal.

LIGHT TOOLS \$99.95

Windows; ISRs; EGA 43-line text mode; direct screen access; DOS file handling and more. For the Datelight C compiler.

TO ORDER CALL TOLL FREE

800-333-8087

TELEX NUMBER 338139

Yes! Send me the prime accent!
Enclosed is \$_____ for _____ copies of _____
 Please send me more information on your products.

CA residents add Sales Tax. Domestic orders add \$4.00 for
UPS shipping, \$10.00 for Federal Express standard air.

Name: _____ Phone: (____) _____
Address: _____ State: _____ Zip: _____
City: _____ Exp. Date: _____

VISA or MC#: _____

Microsoft
is a registered trademark of
Microsoft Corporation. QuickC
is a trademark of Microsoft Corporation. Turbo C
is a registered trademark of Borland International.

Memory Addressing on the Intel 80386

*A Critical Look at the Newest
Intel Processor Generation*

by Howard Vigorita

When Intel announced the 80386, I recall reading that its segmentation scheme of address formation was so abstract that only systems programmers and compiler writers were likely to grasp it. Now the 80386's operating modes are causing similar confusion. Recently it has been heard that, unlike the 286, the native mode of the 386 is the protected mode. And from time to time, it is claimed that the 386 has anywhere from two different operating modes on up.

There seem to be two fundamental modes on the 386: real 386 and protected 386. The real 386 mode is a superset of the 8086, 186, and the real 286 modes of its predecessors, with some differences. If the differences are avoided, programs written for the older processors will be upwardly compatible, and the 386 can be seen as simply a faster processor with added instructions and registers.

As on the 286, the 386 comes up in real mode on reset. At the same time, the real 386 mode cannot take advantage of all the 386 features, such as 32-bit addressing, protection, paging, and hardware-assisted task switching. The only major difference between the 286 and 386 in this area is

that the 386 can return to real mode from protected mode without being reset.

The 386's protected mode is characterized by 32-bit addresses and operands, as well as by the ability to provide multilevel rings of protection, virtual memory paging, and rapid task switching. The beauty of the 386's protected mode is that 32-bit operation and paging can be enabled or disabled by default in any combination. That comes to four protected mode possibilities, plus real mode, for a total of five modes.

A code segment that uses 32-bit addresses by default is called a USE32 segment in Intel terminology. When 32-bit addresses and operands are disabled by default, 16-bit addresses and operands are presumed. This code segment is called a USE16 segment, and it emulates the 286's protected mode. Although the default address and operand length can only be set together as a pair, the use of 1-byte instruction prefixes can override and reverse either of them on an individual instruction basis. That brings us up to nine modes of operation.

A variation of the 286 mode is the virtual 8086 emulation mode (V86 mode). V86 mode looks just like real 386 mode except that V86 mode can be entered and

exited via task switching, and peacefully coexists with protection and paging. Intel supports V86 mode with a piece of software called the V86 monitor, which is intended to be bound to the system's 386 kernel. This monitor allows whole 8086 operating systems to run as a V86 task, with an 8086 application as a V86 subtask. Through special software hooks into the CPU, the monitor intercepts I/O and interrupts, but only engages the task gate overhead of calling the coresident 32-bit protected mode operating system when required. The V86 mode, like the real 386 mode, forms effective addresses in the same way as the 8086. With the V86 mode we now have ten modes of operation.

Effective address formation is still at the heart of the Intel scheme of things. On the 8086, effective addresses are formed by taking the value in a segment register, multiplying it by 16 (shifting it left 4 bits), and then adding the result to a pointer register. The segment register can be considered a pointer itself, albeit a pointer to memory on a 16-byte boundary (often called a paragraph).

The 286 and 386 are more unusual by an order of magnitude. In the protected mode, the segment register is no longer a pointer

386

to real user code or data. Instead it contains something called a "selector." Within the 16-bit selector, 13 bits constitute a record number for access to a database called a "descriptor table." The descriptor table is somewhat different from the databases familiar to most programmers. The records are all 8 bytes long, but they have a number of different formats. The code segment register selects an "executable segment descriptor," while other segment registers usually select "data segment descriptors," which may be of the "expand down" variety for optimal stack usage.

In addition, there are five types of "gate descriptors." Gate descriptors are special descriptors that, instead of pointing directly to code segments, point to other executable descriptors that, in turn, point to code segments. Gate descriptors are generally used to provide regulated, indirect access to processes of a higher privilege level, or to other tasks. A call gate is used in protected mode, for example, by far JMP and CALL instructions, which in real mode need a segment as part of the operand. The other gates are trap, interrupt, and task gates, and a collection of system segment gates.

In protected mode, the descriptor tables

are where the action is. Thus in protected mode, the 386 segment registers select records from a descriptor table. A linear address is formed by fetching a 32-bit segment base address from the appropriate descriptor, and adding it to the user's pointer register. The descriptor also sets the segment size (from 1 byte to 4 gigabytes) and contains privilege information. Tests are performed to see if the intended memory reference will be permitted. The days of reading or writing to memory not allocated to you for that purpose will be gone. *That's* protection.

Once the linear address is in hand, the on-chip paging hardware translates further to a physical address. This step is optional. If paging is implemented, the linear address is broken into three parts: a 12-bit physical offset, a 10-bit page table record, and a 10-bit page directory record. Two tables are referenced: a page directory table and a page table. The page directory record is fetched and points to one of a number of page tables. The page table record is then fetched and contains a 20-bit page number as well as flags indicating whether the page has been written to (dirty bit) and is present in memory. Pages are 4K long. The final physical address is obtained by con-

catenating the page number (20-bits) to the physical offset (12-bits from the linear address). Pages can be swapped from disk or slower memory. Figures 1 and 2 illustrate how translation works.

Address translation is the key to physical hardware independence. It is crucial in a multitasking environment. All segment, interrupt, and I/O requests undergo descriptor and/or page translation. The operating system remaps by simply patching a translation table. Therefore, concurrently running programs will never know it when the video RAM is switched out from under them.

With all this translation and checking going on, the 64K question is: What happens to processor performance in protected mode? Considering that the 386 does no on-chip instruction or data caching in the ordinary sense, its performance is remarkable. The buffering it does do is in connection with translation tables. The segment registers are unusual in that they are actually wider than they appear. Only a 16-bit portion is visible; a hidden portion acts as a descriptor buffer. Subsequent address calculations and privilege checks consume no additional cycles. Page table records are also retained in a 32-register cache called a

“translation lookaside buffer.” But there’s no getting around it, instructions that access descriptor or page tables for the first time are going to take longer.

Figure 3 lists comparative cycle times for instructions that force access to a descriptor table. They are all segment-changing, I/O, or interrupt instructions. When comparing 286 and 386 instructions that purge the prefetch queue, note that the 386 fetches operands and addresses in one cycle, whether these are 8-, 16-, or 32-bits long. The 286 always fetches 1 byte per cycle.

Any other gotchas? I’ve already alluded to a few. 8086 or 286 code that uses the LOCK prefix may trigger an undefined

Address translation is the key to physical hardware independence. It is crucial in a multitasking environment.

opcode exception (INT 6) if used with other than a limited set of instructions. Noticeably absent from this acceptable set are the string instructions. And even when it is effective, the memory protected from coprocessor interference is now limited to the memory area defined by the destination operand of the instruction so prefixed, instead of to the entire physical address space. This need only be of concern to designers of multiprocessor systems.

In V86 mode, page translation seems to be required if multiple V86 tasks are desired since descriptor translation is bypassed. The new instructions are somewhat of a problem also. Some of them overlap with the NEC V20 unique instructions.

All those protected mode 286 operating systems already out there will probably need some adjustment if they’re to run as a task under a full-featured 386 kernel. The task state segment (TSS) is a structure in memory in which the processor saves its registers when multitasking. TSSs are very different on the 286 and 386—after all,

Figure 1. In protected mode, a linear address is formed by fetching a 32-bit segment base address from the appropriate descriptor and adding it to the user’s pointer register.

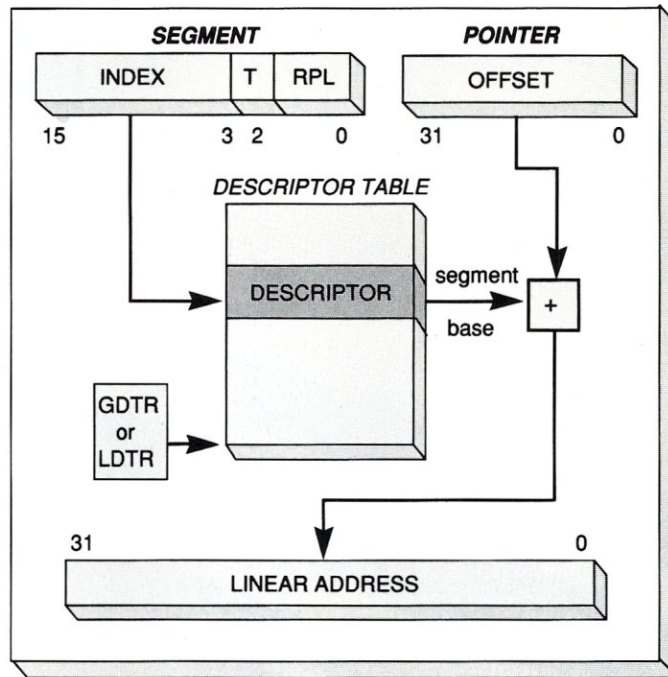

Figure 2. Once the linear address is formed, the on-chip paging hardware translates further to a physical address.

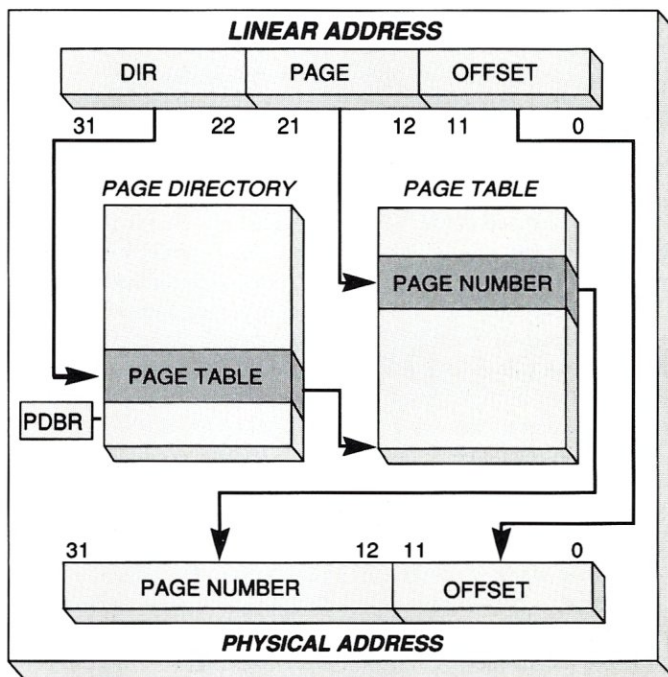

Figure 3. Here is a list of comparative cycle times for instructions that force access to a descriptor table.

	386 protected	V86 & 386 real	286 real
MOV seg,r16	18	2	2
MOV seg,mem16	19	5	5
POP seg	21	7	5
LDS	22	7	7
CALL imm32	34+m	17+m	13+n
CALL mem32	38+m	22+m	16+n
RET (far)	32+m	18+m	15+n
JMP imm32	27+m	12+m	11+n
JMP mem32	31+m	17+m	15+n
IN acc,imm	6(1)	12	5
	26(2)		
IN acc,DX	7(1)	13	5
	27(2)		
INT nn	59(3)	37	23+n
	99(4)		
	316(5)		

Notes
 m = Target instruction component count
 n = Target instruction byte count
 1 = I/O privilege level permits port access
 2 = Port access intercepted or V86 mode
 3 = Via gate to same privilege level
 4 = Via gate to different privilege level
 5 = V86 to 386 protected mode via task gate

the 386 has more registers. If the 386 kernel were prevented from changing registers that the 286 suboperating system doesn't save and restore (for example, Page Directory Base Register), it would be little more than a 286 system itself. The more practical approach would be to use 386 TSSs throughout.

What enhancements would I like to see on the 486? Tops on my list would be on-chip data, code, and stack caches, as well as more data registers. And while we're at it, what about adding a Z80-styled alternate register array? There's no reason why there can't be a megabyte or two on-chip for registers and caches.

Regardless of how many modes you think the 386 has, one thing is clear. Intel is committed to upward compatibility throughout the 8086 family. With that, and its top-notch performance, the 386 has an excellent chance of achieving what has so far eluded the 8086 family: parlaying its microcomputer dominance into a stonger position in the multiuser marketplace. §

Howard Vigorita is an attorney on the staff of the United States District Court in New York and serves as vice president of the New York Amateur Computer Club.

What you see is what you get . . . and send!

Transfer Protocol: Modem7/CRC Packet Size: 128 Files: 1

Block #	of	Kbytes	%	Time Remaining	Errors			Total Kbytes
					Consec	File	Total	
31	522	3	5	5:06	0	0	0	3

Errors:

Status: Transfer in progress

[MEX File Transfer]



[CTL-C to abort]

Sending: >ANYFILE.AQC

Announcing Version 1.6 of **MEX**, the communications software with a view from the top. Regardless of your level of sophistication, **MEX** can put you on top of the data transfer game and keep you there. For the executive on the go, our new pull-down transfer screen and easy-to-use menus reduce the complexities of modem communications to a few keystrokes. For the advanced user, **MEX's** greatly enhanced script processor offers a complete programming language for development of highly secure custom applications. If communication is money in your business, **MEX** may be the best investment you make this year.

Two options available:

MEX-PC is the most complete modem software you can buy. Allows you to switch between menu-driven and command-driven communications at will. Makes full use of Hayes AT command set, with overlays available for most other modems. Features include: complete script processor programming language; user-definable keystrokes; auto-dial and auto-baud-set phone libraries; all popular protocols, including

MODEM-7 batch transfers **\$59.95***

XMODEM CRC/XMODEM CHECKSUM/KERMIT/COMPUSERVE A/128 or 1K BLOCKS

MEX-PAC — All the features of **MEX-PC**, plus:

()A remote module that allows you to run your office computer from home, and vice versa; and

()Terminal emulation that lets your PC masquerade as a DEC VT52/100 or Televideo 925 terminal for on-line communication with mainframes. **\$99.95***

Versions available for IBM-PC and compatibles, Tandy 2000 and most CP/M machines.

MasterCard, VISA welcome

**Give us a toll-free call at
1-800-NITEOWL**

In Wisconsin, 1-414-563-4013

NightOwl Software, Rt.1 Box 7, Ft. Atkinson, WI 53538

* plus shipping; Wisconsin residents add 5% sales tax.

The Micronics 80386 System Board

by Charles H. Strom

The Compaq 386 was the first 80386 MS-DOS-compatible computer to receive wide exposure, and the system still serves as the industry standard. Recently, I had the opportunity to acquire a system that is basically a Compaq 386 clone, an AT-form-factor system board designed and manufactured in the United States by Micronics Computers (formerly known as Four Star). Micronics initially configured complete systems, but now has gone into full-time system board production. The system reviewed here was configured by Dyna (a clone manufacturer) and is sold by Servu, although the Micronics board is available from other sources as well.

The system received for review consisted of the Micronics board with 1 Mbyte of static column RAM, a Western Digital floppy/hard-disk controller, a Seagate ST4038 hard disk, 360K and 1.2-Mbyte Toshiba floppy disk drives, and a Quimax AT-style keyboard. I added a Tseng EVA/480 display card, an additional megabyte of RAM, and an

I/O board containing a parallel and two serial ports. Servu will supply the system board with 1 Mbyte of RAM for \$1,595, and a complete monochrome system is available for approximately \$3,400.

As in the Compaq, there is a single, 32-bit expansion connector that can accept a memory expansion board. The standard

configuration has 1 Mbyte of static column chips soldered in, with sockets for another 1 Mbyte. An optional piggyback board is available for \$335 that allows expansion to 4 Mbytes using 256K chips. The system can accommodate up to 10 Mbyte of RAM in its full configuration. Of course, the similarity to the Compaq cannot extend to the use of Compaq's BIOS. Micronics uses both the Phoenix and Award chips.

The system is supplied with several utilities on disk, including a SETUP program to set the clock/calendar, configuring the drives, and so on. Also supplied is a SET-SPEED utility that allows the operator to slow the system speed in several steps to that of a 4.77 MHz PC. Since the seven AT-style expansion slots run at 8 MHz, I had little reason to slow things down. The only time I did so was when I used my Irwin tape drive for backups. (This backup device is designed for the external floppy disk connector on a PC or XT, but Irwin supplies a board that plugs into an AT and allows

The 80386 System Board Recently Introduced by Micronics

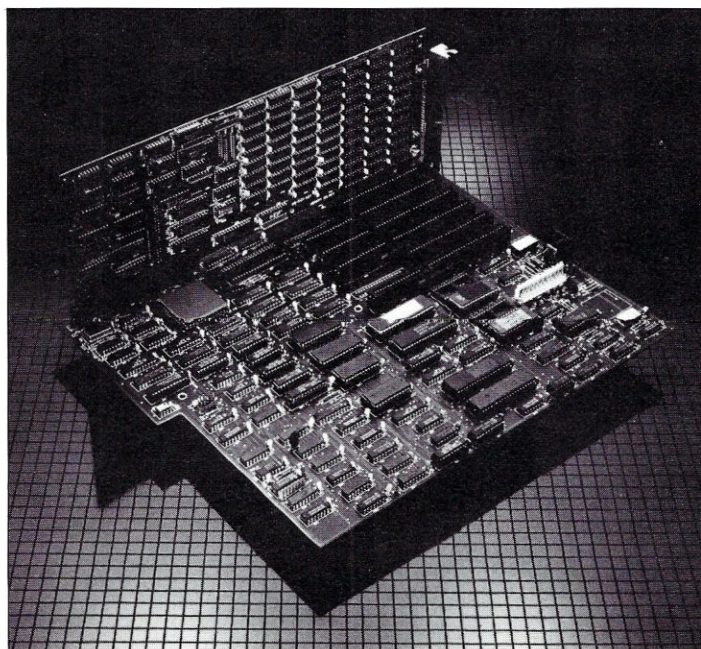

Make \$500/hr.

Now develop DBMS applications 10 times faster for only \$199 with MAGIC PC — or your money back!

Database programmers, why waste your time hacking out code? Imagine how much faster and more profitable you'd be if you could whip up powerful database applications without the time-consuming coding pains... Introducing Magic PC from Aker, your professional dream come true. It's not another line-by-line syntax treadmill like any DBMS or 4GL. Finally you can program as quickly as you design, while you delegate all the mundane and redundant coding tasks to Magic PC.

Program 10 times faster

Develop relational database applications 10 times faster using a visual design-driven interface.

Op	Type	Description	Prefix	Path	Status	Exp. #
30	Link	Link A	Customer	Exp.		
31	Link	Link B	Customer	Exp.		
32	Link	Link C	Customer	Exp.		
33	Link	Link D	Customer	Exp.		
34	Link	Link E	Customer	Exp.		
35	Link	Link F	Customer	Exp.		
36	Link	Link G	Customer	Exp.		
37	Link	Link H	Customer	Exp.		
38	Link	Link I	Customer	Exp.		
39	Link	Link J	Customer	Exp.		

Instead of writing mountains of "how to" procedural code, you quickly place your program design specs in Execution Tables and Magic PC's engine executes them automatically. Don't lose any more time editing and debugging programs by hand.

Incredible Zoom power

Line	Item	Type	Description	Quantity	Unit Price	Total Price
100	XXXXXXXXXXXXXXXXXXXX	A	XXXXXXXXXXXXXXXXXXXX	1	999.99	999.99
101	XXXXXXXXXXXXXXXXXXXX	A	XXXXXXXXXXXXXXXXXXXX	1	999.99	999.99
102	XXXXXXXXXXXXXXXXXXXX	A	XXXXXXXXXXXXXXXXXXXX	1	999.99	999.99
103	XXXXXXXXXXXXXXXXXXXX	A	XXXXXXXXXXXXXXXXXXXX	1	999.99	999.99
104	XXXXXXXXXXXXXXXXXXXX	A	XXXXXXXXXXXXXXXXXXXX	1	999.99	999.99
105	XXXXXXXXXXXXXXXXXXXX	A	XXXXXXXXXXXXXXXXXXXX	1	999.99	999.99
106	XXXXXXXXXXXXXXXXXXXX	A	XXXXXXXXXXXXXXXXXXXX	1	999.99	999.99
107	XXXXXXXXXXXXXXXXXXXX	A	XXXXXXXXXXXXXXXXXXXX	1	999.99	999.99
108	XXXXXXXXXXXXXXXXXXXX	A	XXXXXXXXXXXXXXXXXXXX	1	999.99	999.99
109	XXXXXXXXXXXXXXXXXXXX	A	XXXXXXXXXXXXXXXXXXXX	1	999.99	999.99
110	XXXXXXXXXXXXXXXXXXXX	A	XXXXXXXXXXXXXXXXXXXX	1	999.99	999.99

Magic PC's phenomenal Zoom power magically co-executes related programs

through nested Zoom windows smoothly with auto data scrolling in all directions. While Zooming, query and transfer data across windows or even Zoom deeper.

No more maintenance!

Change your programs on the fly without any manual maintenance responsibility. Magic PC automatically updates your changes online since all the data describing your design (data dictionary, programs and menus) make up a single file, self-maintaining Integrated Library.

Magic PC does it all

Design your entire database application with only one comprehensive development system. Generate both online programs (screens, windows, menus), as well as batch programs (reports, updates,

import/export, etc.) with full color and graphics. You no longer fall between the cracks dealing with separate and inconsistent programming utilities.

Free LAN features

Develop multi-user applications for local area networks with Magic PC's automatic support for file and record locking security.

Quick prototyping

Prototype a complete working application in just hours and get immediate customer feedback to finalize the design. It's a true time-saver.

Stand-alone runtime

Distribute your applications and protect your design with a low cost runtime engine. It has the friendliest end-user visual interface you've ever seen with built-in, menu-driven and syntax-free data retrieval power.

Jeff Duntemann, PC Tech Journal:

"Magic PC is probably the best integrated database application generator that we have seen... very smooth system, and smoothness comes at a premium these days." Also recommended by PC Magazine, PC World, PC Week, Computer Language, Data Based Advisor and many more around the world.

Try it for \$195

If you develop database applications for a living, you can't afford not to try Magic PC for yourself right now. For \$19.95 you'll get the Magic PC Tutorial software and documentation for hands-on evaluation, complete with a step-by-step guide to develop an Order Entry sample application in just a few hours.

Magic PC ~~\$695~~ \$199

No kidding! For a limited time only, save almost \$500 off the \$695 list price, and get the complete unprotected Magic PC software for only \$199 at our special introductory non-resale price.

Money back guarantee

Even at \$199 you can't go wrong with our no-risk guarantee: keep it only if it makes magic for you, or we'll buy it back within 30 days less \$19.95 restocking fee.

System Requirements:
IBM PC, XT, AT, PS/2
and 100% compatible.
PC-DOS 2.0 or later,
512K, hard disk. All
trademarks
acknowledged.

Call this toll-free number now with your credit card or COD charge. Dealer pricing available.
800-345-MAGIC • in CA 714-250-1718

Or send this order coupon with your payment to:
Aker 18007 Skypark Cir. B2, Irvine, CA 92714
— Magic PC at ~~\$695~~ \$199 (add \$10 P&H)
— Magic PC Tutorial at \$19.95 (add \$5 P&H)

In CA add applicable tax
Name _____
Company _____
Address (no POB) _____
City/St/Zip _____
Phone _____
1 2 3 4 5 6 7 8 9 0
Check enclosed, or charge: VISA MasterCard AMERICAN EXPRESS
Acct. No. _____

Exp. Date _____
Name on card _____
Signature _____

\$199
~~\$695~~

MAGIC PC
The Visual Database Language

by **AKER**

THE CURE FOR COMMON CODE

Are you getting the recommended monthly allowance of C, Assembly, Forth, Pascal, BASIC or Modula-2? Subscribe to *Dr. Dobb's Journal of Software Tools* and you won't catch any nasty bugs again!

Each month the Doctor brings you aid for ailing algorithms and the cure for common code. For the latest developments in software design and pages of code that will make you a more productive programmer, take the Dr. Dobb's prescription.

For more than a decade, the programming elite have known *Dr. Dobb's Journal* to be the foremost source of software tools. Subscribe now and get your monthly dose from the Doctor.

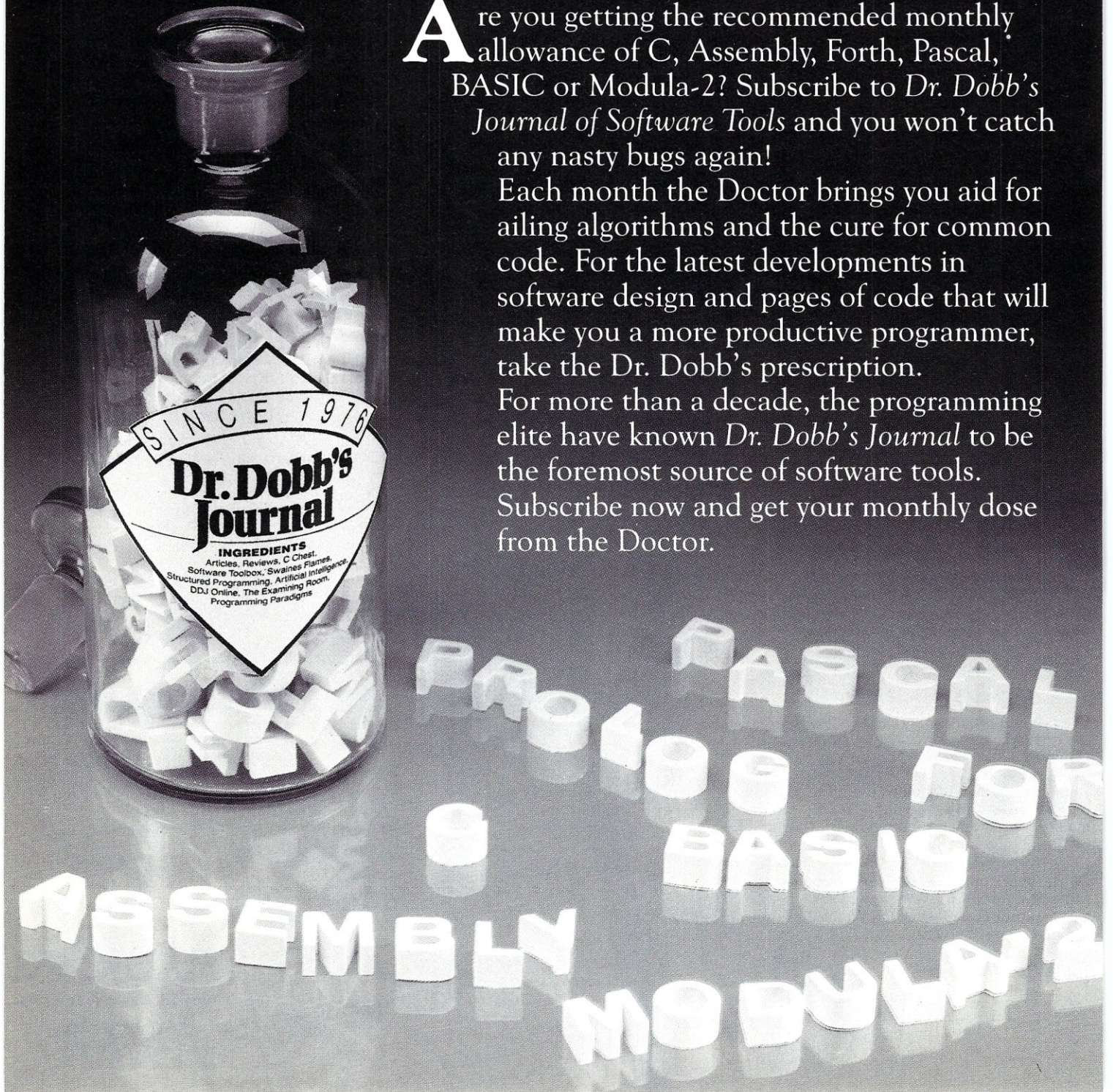

Figure 1. MIPS benchmark tests results

BENCHMARK PERFORMANCE RELATIVE TO =>	IBM/PC 4.7 MHz	IBM/AT 8 MHz	COMPAQ 386	ACTUAL MIPS
General instructions	6.79	1.97	1.00	1.12
Integer instructions	14.58	2.28	1.00	2.45
Memory to memory	5.82	1.79	1.00	1.38
Register to register	18.35	2.39	1.00	3.30
Register to memory	6.04	1.81	1.00	1.86
<i>Overall performance</i>	<i>8.44</i>	<i>2.04</i>	<i>1.00</i>	<i>2.02</i>

Figure 2. PC Magazine laboratory benchmark series

	TIME IN SECONDS	SPEED INDEX RELATIVE TO 4.77 MHz PC	SPEED INDEX RELATIVE TO 8 MHz AT
1. 128K NOP loop:	2.09	4.80	2.00
2. Do-Nothing loop:	1.86	5.30	2.00
3. Integer add loop:	0.99	10.00	2.20
4. Integer multiply loop:	0.61	16.40	2.00
5. String sort and move:	1.32	8.00	2.20
6. Prime number sieve:	1.82	8.50	2.30
<i>Bench21—Version 1.31: Processor speed benchmark test</i>			
	TIME IN SECONDS	SPEED INDEX RELATIVE TO 4.77 MHz PC	SPEED INDEX RELATIVE TO 8 MHz AT
8086/8088 instruction set	4.29	7.50	2.10
<i>Bench28—Version 1.01: Processor speed instruction mix test</i>			
	TIME IN SECONDS	SPEED INDEX RELATIVE TO 4.77 MHz PC	SPEED INDEX RELATIVE TO 8 MHz AT
Floating point (no 80287):	22.30	7.00	1.60
Floating point (with 80287):	3.35	1.50	0.90
<i>Bench29—Version 1.01: Floating point and math coprocessor test</i>			

the drive to be used through its connector. When using this combination, it became necessary to slow down the clock to prevent BIOS parity error messages.)

Another useful utility is RELOCATE, which allows both BIOS and EGA BIOS code to be moved to high-speed memory. The memory map is identical to the Compaq in that the upper 384K of the first megabyte of RAM is dedicated to system use. The RELOCATE utility moves the code to this area, allowing full speed access. The speed enhancement is significant.

Lastly, Micronics includes an expanded memory driver (Lotus/Intel/Microsoft standard), functionally similar to Compaq's CEMM.SYS. This driver allows programs such as Lotus 1-2-3 to take advantage of the extra memory in order to expand the maximum size of a spreadsheet, to run the FLASH expanded memory disk cache program, and to perform other functions.

The system board has a socket for an 80287 numeric processor that can run at 4 MHz, 8 MHz, or 10 MHz, depending on switch positions (although in the last case, actual crystal replacement is necessary). I removed the 80287 from my 80286 system and had no trouble installing it in the new board. It is unfortunate that Micronics did not include a socket for the 80387, but they have just informed me that a piggyback board will shortly be released that plugs into the 386 socket. The 386 and a 387 may in turn populate the piggyback. It is also rumored that Intel may release an 80387 in a package pin-compatible with the 80287 to complement the (also rumored) 80386 in a 80286 pin-compatible package.

The balance of the hardware in the tested configuration is familiar AT-compatible technology. The disk drive is probably a little slower than the ideal for a speed demon such as this, but virtually any ST-506-compatible drive should work. Some video boards might have problems with the system because of its speed, but the Tseng used for testing operates flawlessly.

I do have one serious complaint—the designers neglected to include a hardware reset button on the system. Therefore, in order to do a hard reset (when Ctrl-Alt-Del fails), it is necessary to completely power-down the system, which is not only annoying but potentially damaging to the equipment. (Interestingly, IBM also omits the reset button on its PC and PS/2 systems.)

Compatibility

The best way to give a new system a thor-

Minimize Turbo Pascal compile time.

Dramatically reduce debugging time.

Tmark allows Turbo Pascal to continue compiling without returning to line 1.

Tmark is a utility that fixes an annoying limitation of Turbo Pascal. Normally, every time Turbo finds an error while compiling, it must start compiling again from the very beginning. Tmark changes that. It allows Turbo to resume compiling from where you fixed the error, not back at line 1.

Tmark runs Turbo Pascal as a child process. This allows Tmark to monitor Turbo as it compiles your program. When Tmark detects that Turbo is about to issue an error message, it saves, on disk, an image of the memory and registers used by Turbo Pascal up to that point. Once you have fixed the error, Tmark will restore Turbo to its state before the error was found. Turbo will then resume compiling—from the fix.

Tmark will also save up to 7 images at designated lines in a program. When Turbo encounters a line which begins with {TMARK}, Tmark will save an image. You can resume compilation at any of these lines.

Don't lose another minute of compiling time, order Tmark now!

- Not memory resident
- Does not take over any software interrupts. If Turbo Pascal runs on your system, so will Tmark.
- Not copy protected

Tmark™



Only \$80

Visa/MC accepted. Add \$2 for shipping in U.S., \$5 overseas

Tangent Designs, Inc.

P. O. Box 896
Lake Forest, IL 60045
(800) 356-2750 Outside Illinois
(312) 295-0030

Turbo Pascal is a registered trademark of Borland International. Supports Turbo versions 3.01 and above, with 8087 or BCD.

ough workout is to use it every day as one's main system. In fact, I have been running a variety of software on this machine and have experienced no trouble at all. Modem programs such as Qmodem, Pro-Yam, PC-VCO and Procomm, work fine. Word processors (WordStar 4 and Microsoft Word), spreadsheets (SuperCalc 4 and Lotus 1-2-3), and utilities such as Norton and Media Master, also operate flawlessly. And, of course, all the DOS 3.2 utilities perform as they would on an AT, only much faster. In addition, there are no hardware or software problems running a parallel Epson FX-80 printer nor a Hewlett-Packard serial Laserjet printer.

80386 Software

In addition to increased speed, the best reason to purchase an 80386 system is to run 80386 software. I had the opportunity to test several such packages. Quarterdeck, the authors of DESQview, supply an expanded memory simulator similar in concept to that supplied by Micronics and Compaq. However, QEMM.SYS goes them one better by implementing a subset of the AST/Quadram/Ashton-Tate expanded memory specification. This allows DESQview 1.3 to use all the available 80386 memory for running concurrent applications. I have always been a fan of DESQview. Its ease of use (there is little need to read the manual) and multitasking capabilities are now coupled with the ability to run multiple large applications. DESQview and QEMM.SYS ran flawlessly, permitting, for example, xmodem protocol file transfers from GENie while simultaneously running utilities in a 256K DOS window.

Another recent development in the 80386 software scene is Digital Research's Concurrent DOS 386. I will leave a discussion of the details of CDOS 386 for the review in this issue and just say that I have been running it for several weeks on the Micronics System straight out of the box with no problems whatsoever. (See page 28 for a review of Concurrent DOS 386.)

Lastly, I had the opportunity to beta test a newcomer to the operating system scene, PC-MOS/386 from The Software Link of Atlanta, Ga. PC-MOS, like CDOS 386, is a stand-alone operating system designed to replace PC-DOS. It supplies all the existing functionality of the Microsoft operating system while enhancing it with features tailored to the increased speed and memory addressing power of the 80386. It was developed on a Compaq 386 but runs satisfactorily on the Micronics system. One small

glitch is that the BIOS reports a memory error on boot-up, but there is no apparent ill effect, and PC-MOS behaves properly. It is unclear at this point if there is a hardware problem, or a BIOS or software incompatibility of some sort.

Benchmarks

No review of an 80386 computer is complete without a suite of tests benchmarking speed. The Norton Sysinfo (SI) utility Version 3.10 reports that the system is equivalent to an 18.7 IBM PC. I understand that this is identical to results on the Compaq 386. MIPS, a popular benchmark program from Chips & Technologies, Inc. (available in the PC/Blue public domain software library), produced the timings shown in Figure 1.

PC Magazine has developed an exhaustive series of benchmarks and has released them into the public domain. I ran several of the CPU/memory tests from Version 4 of the series as shown in Figure 2.

The benchmark series is apparently not set up to correctly identify and deal with an 80386 microprocessor, for the last benchmark was littered with garbage characters in the locations where "80386" and "80287" should have appeared. The results, however, seem to make sense in light of the 4 MHz operation of the numeric processor as opposed to 5.33 MHz on an 8 MHz AT.

Conclusion

I am very pleased with the Micronics 80386 system. It offers the blazing speed of the new generation of compatibles at a very affordable price. The manufacturer does not appear to have cut corners in design and fabrication of the computer. I am eagerly looking forward to many happy hours investigating the new 80386 software that is just now starting to appear on the market. §

Charles H. Strom is Director of Laboratories and Associate Director of Technical Services in the Department of Chemistry at New York University.

Product Information

Micronics Computers Inc.
110 Pioneer Way, Bldg. D
Mountain View CA 94041
(415) 962-0102
SERVU
3008 Oakbridge Dr.
San Jose, CA 95121
(408) 274-8112

DIGITAL RESEARCH COMPUTERS

(214) 225-2309

S100 EPROM PROGRAMMER

OUR NEWEST DESIGN, FOR FAST EFFICIENT PROGRAMMING OF THE MOST POPULAR EPROM'S ON YOUR S100 MACHINE. COMES WITH MENU DRIVEN SOFTWARE THAT RUNS UNDER CP/M 2.2 (8 INCH). PC BOARD SET CONSISTS OF (S100) MAIN LOGIC BOARD REMOTE PROGRAMMING CARD AND SIX PERSONALITY MINI BOARDS FOR 2716, 2532, 2732, 2732A, 2764, AND 27128. SOLD AS BARE PC BOARD SET ONLY WITH FULL DOC. SOFTWARE FEATURES "FAST" PROGRAMMING ALGORITHM. FOR Z80 BASED SYSTEMS.

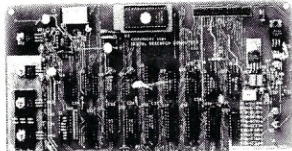

PC BOARD SET, FULL DOCUMENTATION, 8 IN. DISKETTE WITH SOFTWARE.

PRICE CUT! \$39⁹⁵

64K S100 STATIC RAM

\$99⁰⁰ KIT

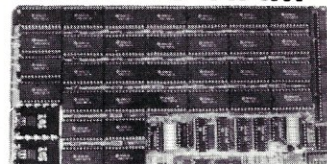

LOW POWER!
150 NS ADD \$10

BLANK PC BOARD WITH DOCUMENTATION \$49.95

SUPPORT ICs + CAPS \$17.50

FULL SOCKET SET \$14.50

FULLY SUPPORTS THE NEW IEEE 696 S100 STANDARD (AS PROPOSED)

ASSEMBLED AND TESTED ADD \$50

FEATURES: PRICE CUT!

- * Uses new 2K x 8 (TMM 2016 or HM 6116) RAMs.
- * Fully supports IEEE 696 24 BIT Extended Addressing.
- * 64K draws only approximately 500 MA.
- * 200 NS RAMs are standard. (TOSHIBA makes TMM 2016s as fast as 100 NS. FOR YOUR HIGH SPEED APPLICATIONS.)
- * SUPPORTS PHANTOM (BOTH LOWER 32K AND ENTIRE BOARD).
- * 2716 EPROMs may be installed in any of top 48K.
- * Any of the top 8K (E000 H AND ABOVE) may be disabled to provide windows to eliminate any possible conflicts with your system monitor, disk controller, etc.
- * Perfect for small systems since BOTH RAM and EPROM may co-exist on the same board.
- * BOARD may be partially populated as 56K.

128K S100 STATIC RAM/EPROM BOARD

JUST OUT! USES POPULAR 8K X 8 STATIC RAMS (6264) OR 2764 EPROMS. FOR 8 OR 16 BIT DATA TRANSFERS! IEEE 696 STANDARD. LOW POWER. KITS ARE FULLY SOCKETED. FULL DOC AND SCHEMATICS INCLUDED. 24 BIT ADDRESSING.

NEW! \$59⁹⁵ BARE PC BOARD \$219⁰⁰ 128K RAM KIT \$139⁰⁰ 128 EPROM KIT

256K S-100 SOLID STATE DISK SIMULATOR!
WE CALL THIS BOARD THE "LIGHT-SPEED-100" BECAUSE IT OFFERS AN ASTOUNDING INCREASE IN YOUR COMPUTER'S PERFORMANCE WHEN COMPARED TO A MECHANICAL FLOPPY DISK DRIVE.

PRICE CUT!

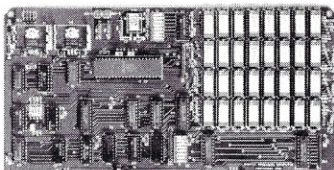

- FEATURES:
- * 256K on board, using +5V 64K DRAMS.
 - * Uses new Intel 8203-1 LSI Memory Controller.
 - * Requires only 4 Dip Switch Selectable I/O Ports.
 - * Runs on 8080 or Z80 S100 machines.
 - * Up to 8 LS-100 boards can be run together for 2 Meg. of On Line Solid State Disk Storage.
 - * Provisions for Battery back-up.
 - * Software to mate the LS-100 to your CP/M* 2.2 DOS is supplied.
 - * The LS-100 provides an increase in speed of up to 7 to 10 times on Disk Intensive Software.
 - * Compare our price! You could pay up to 3 times as much for similar boards.

CLOSE OUT! BLANK PCB ONLY: \$24⁹⁵

BLANK PCB (WITH CP/M* 2.2 PATCHES AND INSTALL PROGRAM ON DISKETTE) \$24⁹⁵
(8203-1 INTEL \$29.95)

#LS-100

1 MEG. S-100 SOLID STATE DISK SIMULATOR!
WE CALL THIS BOARD THE "LIGHT-SPEED-100" BECAUSE IT OFFERS AN ASTOUNDING INCREASE IN YOUR COMPUTER'S PERFORMANCE WHEN COMPARED TO A MECHANICAL FLOPPY DISK DRIVE.

LS 100 II NEW!

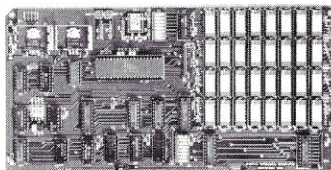

- FEATURES:
- * 1 Meg. on board, using +5V 256K DRAMS. (With Parity)
 - * Uses new Intel 8203-1 LSI Memory Controller.
 - * Requires only 4 Dip Switch Selectable I/O Ports.
 - * Runs on 8080 or Z80 S100 machines.
 - * Up to 4 LS-100 boards can be run together for 4 Megs. of On Line Solid State Disk Storage.
 - * Provisions for Battery back-up.
 - * Software to mate the LS-100 to your CP/M* 2.2 DOS is supplied.
 - * The LS-100 provides an increase in speed of up to 7 to 10 times on Disk Intensive Software.
 - * Compare our price! You could pay up to 3 times as much for similar boards.

BLANK PCB (WITH CP/M* 2.2 PATCHES AND INSTALL PROGRAM ON DISKETTE) \$59⁹⁵
(8203 1 INTEL \$29.95)

(ADD \$50 FOR A&T)

\$259⁰⁰

#LS-100 II (FULL 1 M.B. KIT)
1 MEGA BYTE!

ZRT-80 CRT TERMINAL BOARD!

A LOW COST Z-80 BASED SINGLE BOARD THAT ONLY NEEDS AN ASCII KEYBOARD, POWER SUPPLY, AND VIDEO MONITOR TO MAKE A COMPLETE CRT TERMINAL. USE AS A COMPUTER CONSOLE. OR WITH A MODEM FOR USE WITH ANY OF THE PHONE-LINE COMPUTER SERVICES.

- FEATURES:
- * Uses a Z80A and 6845 CRT Controller for powerful video capabilities.
 - * RS232 at 16 BAUD Rates from 75 to 19,200.
 - * 24 x 80 standard format (60 Hz).
 - * Optional formats from 24 x 80 (50 Hz) to 64 lines x 96 characters (60 Hz).
 - * Higher density formats require up to 3 additional 2K x 8 6116 RAMS.
 - * Uses N.S. INS 8250 BAUD Rate Gen. and USART combo IC.
 - * 3 Terminal Emulation Modes which are Dip Switch selectable. These include the LSI-ADM3A, the Heath H-19, and the Beehive.
 - * Composite or Split Video.
 - * Any polarity of video or sync
 - * Inverse Video Capability.
 - * Small Size: 6.5 x 9 inches.
 - * Upper & lower case with descenders.
 - * 7 x 9 Character Matrix.
 - * Requires Par. ASCII keyboard.

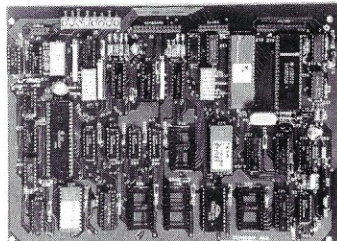

\$89⁹⁵ A&T
#ZRT-80 ADD \$50
(COMPLETE KIT, 2K VIDEO RAM)

OUR BEST SELLER!

FOR 8 IN. SOURCE DISK OR PC-XT FORMAT 5 1/4 IN. ADD \$10

THE NEW 65/9028 VT ANSI VIDEO TERMINAL BOARD!

* FROM LINGER ENTERPRISES *

A second generation, low cost, high performance, mini sized, single board for making your own RS232 Video Terminal. This highly versatile board can be used as a stand alone video terminal, or without a keyboard, as a video console. VT100, VT52 Compatible.

- FEATURES:
- * Uses the new CRT9128 Video Controller driven by a 6502A CPU
 - * On-Screen Non-Volatile Configuration
 - * 10 Terminal Modes: ANSI, H19, ADM-5, WYSE 50, TVI-920, KT-7, HAZ-1500, ADDS 60, QUME-101, and Datapoint 8200
 - * Supports IBM PC/XT, and Parallel ASCII Keyboards
 - * Supports standard 15.75 kHz (Horiz.)
 - * Composite or Split Video (50/60 Hz)
 - * 25 X 80 Format with Non-Scrolling User Row
 - * Jump or Smooth Scroll
 - * RS-232 at 16 Baud Rates from 50 to 19,200
 - * On Board Printer Port
 - * Wide and Thin Line Graphics
 - * Normal and Reverse Screen Attributes
 - * Cumulative Character Attributes: De-Inten, Reverse, Underline and Blank
 - * 10 Programmable Function Keys and Answerback message
 - * 5 X 8 Character Matrix or 7 X 9 for IBM Monitors
 - * Mini Size: 6.5 X 5 inches
 - * Low Power: 5VDC @ .7A, ± 12VDC @ 20mA.

MICRO SIZE!

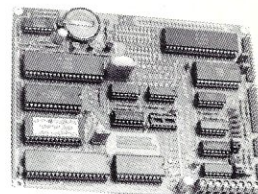

\$79⁹⁵ FULL KIT

w/100 Page Manual
ADD \$40 FOR A&T

OPTIONAL EPROM FOR PC/XT STYLE SERIAL KEYBOARD: \$15
SOURCE DISKETTE: PC/XT FORMAT 5 1/4 IN. \$15

Digital Research Computers

P.O. BOX 381450 • DUNCANVILLE, TX 75138 • (214) 225-2309

TERMS: Add \$3.00 postage. Orders under \$15 add 75¢ handling. No C.O.D. We accept Visa and MasterCard. Tex. Res. add 6-1/4% Tax. Foreign orders (except Canada) add 20% P & H. Orders over \$50 add 85¢ for insurance.

Concurrent DOS 386

*DRI's Multitasking, Multiuser
386 Operating System*

by Alex K. H. Soya

The 32-bit 80386 chip from Intel has been the talk of the town among programmers and hardware designers for some time. Compaq was the first manufacturer to ship an 80386-based system (DeskPro 386), which is AT compatible. Recently, many clone manufacturers have introduced 80386 systems as part of their product line. Unfortunately, however, no software has existed to take advantage of the 80386 architecture. The 8086 PC-DOS/MS-DOS operating system can be used on the 80386, but in real mode, which means that it cannot use the advanced features for which the 80386 chip is intended. Digital Research, in the meantime, has been producing the Concurrent DOS 86 multitasking, multiuser operating system for use with the 8086 (see *MS/J*, May/June 1987) for over two years. Now, the British office of Digital Research, Inc. (DRI) has modified Concurrent DOS 86 to take advantage of the 80386 chip and has recently introduced Concurrent DOS 386, an 80386 operating system that truly uses the 80386 advanced features. DRI provided us with a copy of its new operating software and we put it through its paces.

The 80386 Chip

The Intel 80386 chip is a 32-bit microprocessor designed primarily to support multitasking, multiuser operating systems and high-level languages. Thus it offers features useful to implementing operating systems and high-level languages.

The 80386 is compatible with the earlier 8086 and 80286 processors. To remain compatible with its predecessors, the 80386 processor can run in one of several modes.

Real mode refers to the 8086-compatible mode of operation. When it is reset, the processor is placed into real mode. In this mode the 80386 looks just like the 8086 chip. As noted, the PC-DOS/MS-DOS operating system runs on 80386-based systems in real mode.

The 80386 protected mode is a superset of the 80286 protected mode functions. The additional functions include memory paging, a larger addressing space, an enhanced Task State Segment (TSS), and more sophisticated I/O privilege functions.

The most useful mode from the user's point of view is the virtual 8086 mode. In this mode the 80386 offers full compatibil-

The Concurrent DOS 386 from DRI offers an operating system designed for the 80386's advanced features.

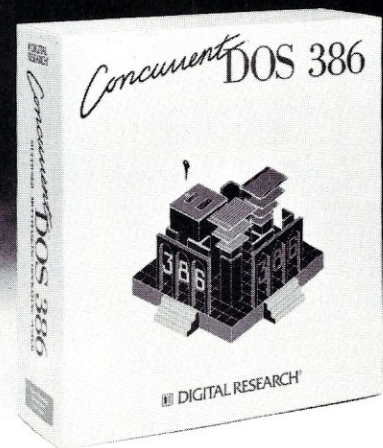

386-DOS™

A MULTITASKING, MULTIUSER CONCURRENT™-BASED OPERATING SYSTEM

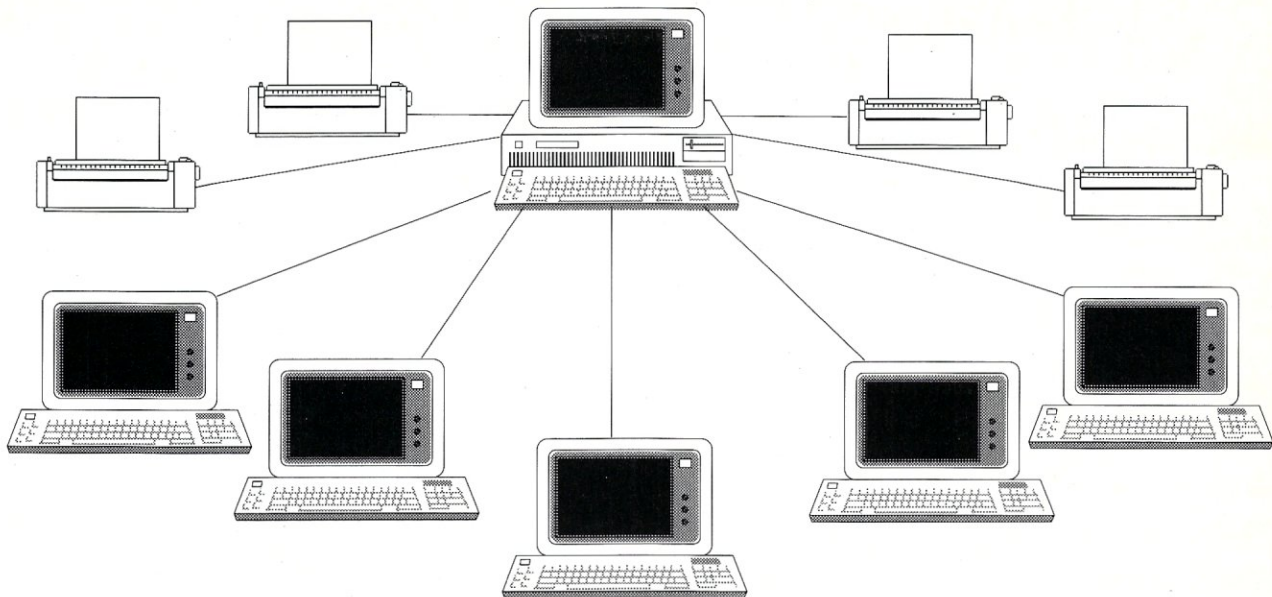

386-DOS™ from **Concurrent Controls, Inc.** is a multitasking, multiuser operating system for **80386**-based microcomputers that combines power and flexibility with an easy-to-use interface and a virtually unlimited capacity for growth.

POWER

Supports up to **16 MB of RAM**
Utilizes power of **80386**-based machines
Supports **1 to 19 users**
3 parallel printers and **1-18** serial printers
Supports **intelligent I/O boards** for increased performance

EASE OF USE

Familiar **PC-DOS** interface and commands
Continue to use many **PC-DOS programs**
Menu-driven installation and maintenance

FLEXIBILITY

Use **PC-DOS media** and **commands**
Use with **your choice** of serial port board
Configure each serial port as a **terminal, printer, device** or **remote**.
User configurable **IRQ lines**, polled or interrupt driven, and port buffer size.

SUPPORT

Prompt, professional phone support
Dealer, system integrator and **programmer** levels of support available

CCI provides versions of 386-DOS™ optimized for use with many vertical market solutions such as INMASS™, BRAVO™ and Digital Dining™. With 386-DOS™ your installations can grow from a multitasking, single-user station to a multiuser system and can be networked at any time — all on the same operating system — reduce learning curves and training time — increase VAR upgrade sales & profits.

AVAILABLE NOW! SPECIAL SUPPORT FOR WYSE FLASHER™ I/O BOARD!

COMING SOON - SMARTSCREEN™ - WITH SUPPORT FOR PC-DOS PROGRAMS AT YOUR MULTIUSER STATIONS!

Concurrent is a trademark of Digital Research Inc. FLASHER is a trademark of Wyse Technologies. INMASS is a registered trademark of MC Software, Inc., BRAVO is a trademark of Armour Systems, Inc, Digital Dining is a trademark of Menusoft, 386-DOS and SMARTSCREEN are trademarks of Concurrent Controls, Inc.

CONCURRENT DOS MULTIUSER, NETWORKING AND PROCESS CONTROL SPECIALISTS

CDOS MODIFICATIONS - CUSTOM DESIGN - CONSULTING - TROUBLESHOOTING - C LANGUAGE TECHNOLOGY

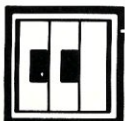

CONCURRENT CONTROLS, INC. (415) 648-2174

3770 24th Street, Suite 206, San Francisco, CA 94114 FAX (415)648-0340

ity to 8086 applications, while the operating system can take advantage of the 32-bit features, including the larger addressing space, paging, protection, and multitasking features.

To get a more detailed description of the 80386 and its specific features, consult the Intel 80386 programmer's guide.

Concurrent DOS 386 Installation

Concurrent DOS 386 is shipped on four 5¼-inch PC-DOS/MS-DOS formatted floppy disks. The installation procedure is simple. The user boots the system on the first disk and answers a few straightforward questions on easy-to-read menus.

The major advantage of Concurrent DOS 386 compared to the 8086 version of the operating system is its ability to take advantage of the 80386 memory management functions.

Concurrent DOS 386 allows for many custom-made options. The user may select among language, keyboard, and printers for various international versions of clones.

The supported languages are: English (American), English (British), French, German, Danish, Norwegian, Swedish, Italian, and Spanish. By selecting a particular language, the user ensures that the proper character set (with any special characters) will be loaded. Some of the prompts are displayed in the selected language.

Other items that may be selected include disk drive characteristics, color monitor scroll mode, and serial port assignments.

I installed Concurrent DOS 386 on a Compaq DeskPro 386 with a 40-Mbyte hard disk. The operating system supports both PC-DOS/MS-DOS and CP/M media type drives. At first I installed Concurrent DOS 386 to use the entire 40-Mbyte drive as a single PC-DOS/MS-DOS media

partition. However, with this configuration PC-DOS/MS-DOS could no longer access the hard disk, as PC-DOS/MS-DOS limits the partition size to 32 Mbyte. I thus repartitioned the hard disk into two PC-DOS/MS-DOS partitions: 32 Mbyte as drive C and the remainder as drive D. Concurrent DOS 386 allows partition editing with its own version of FDISK.EXE.

The User Interface

Concurrent DOS 386 may be booted from a floppy disk or from the hard disk. On the hard disk it is possible to boot Concurrent DOS 386 directly when the power is switched on, or after booting PC-DOS/MS-DOS by typing LOAD386. I set up my own system to boot Concurrent DOS 386 directly from the hard disk and to boot PC-DOS/MS-DOS from a floppy for those rare times when I want to run PC-DOS/

MS-DOS.

The command line interface to Concurrent DOS 386 is identical to that of Concurrent DOS 86 XM. I thus felt immediately at home and did not have any difficulties in finding my way around the system. (For a detailed review of Concurrent DOS XM, refer to *MS/J*, May/June 1987.)

Concurrent DOS 386 has the same utilities as Concurrent DOS 86: FILE MANAGER, a screen-oriented file and application manipulator; CARDFILE, an electronic index card manager; DREDIX, a simple full-screen editor; WMENU, a window manager that allows window sizes, location, and colors on virtual consoles to be varied; and RUNMENU, a menu manager that allows the system manager to design fancy menus to guide the user through applications without ever having to issue a single DOS command.

Figure 1. The memory map for the application looks identical to that of the PC environment—the bottom 1 Mbyte contains the operating system image, the application memory space, video RAM, and application memory.

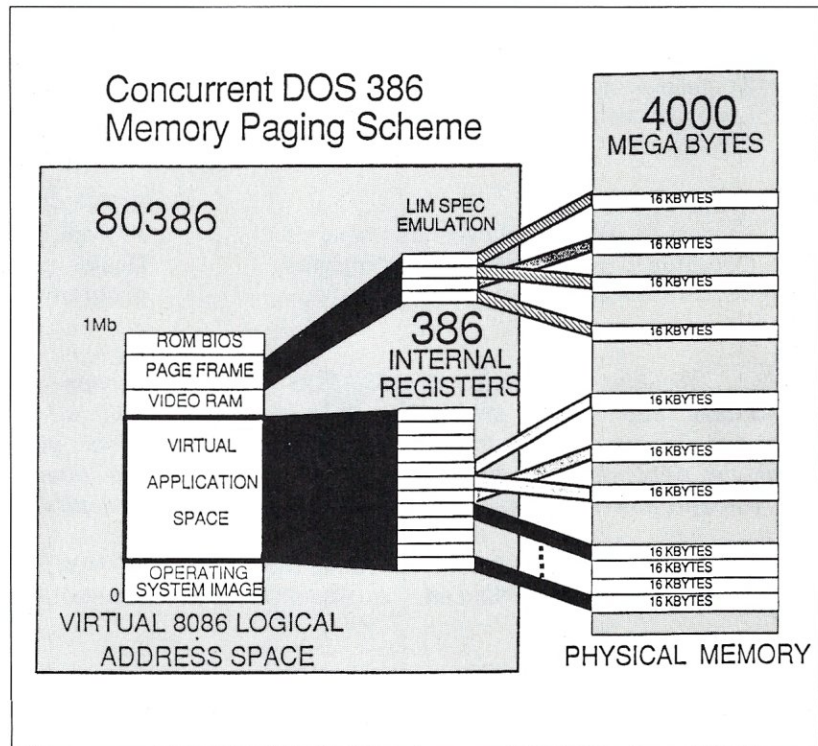

Let's Get Technical

Concurrent DOS 386 allows existing PC-DOS/MS-DOS applications, as well as CP/M-86 and native mode Concurrent DOS applications to run in a multitasking, multiuser environment. The major advantage of Concurrent DOS 386 compared to the 8086 version of the operating system is the way in which memory management functions are performed.

Under Concurrent DOS 86, the directly addressable memory was limited to 1 Mbyte, plus up to 8 Mbytes of paged memory conforming to the LIM/EEMS (Lotus, Intel, Microsoft/Enhanced Expanded Memory Specification). The 80386 version, however, uses 80386 memory management functions to perform paging of up to 4,000 Mbytes (or 4 gigabytes) of physical memory into the virtual application space. In reality, the amount of memory is limited by the physical restrictions of the hardware—in the case of a Compaq Deskpro 386, this is 16 Mbytes. In the near future, we should see systems that exceed this limit.

To the application, the memory map looks identical to that of the PC environment. The bottom 1 Mbyte contains the operating system image, the application memory space, video RAM, and BIOS ROMs. The remaining 3,999 Mbytes may be used as paged application memory. When Concurrent DOS 386 assigns memory to a process, it sets up a memory page descriptor that can be used by the 80386 paging registers to map any 16K chunk of physical memory to any area in the application space. When a task switch occurs, the paging registers are loaded to point to the physical memory pages belonging to the next process serviced by the CPU. Figure 1 shows a graphic representation of the paging memory mechanism.

This scheme allows several applications to run within their own 1-Mbyte addressing space. But what about applications that need more than 1 Mbyte of memory? In the PC-DOS/MS-DOS environment, such applications (for example, Symphony) use EMS memory from specially designed EMS memory cards. Concurrent DOS 386 emulates the LIM specification and thus allows applications designed to take advantage of EMS cards to work correctly under Concurrent DOS 386.

Compatibility

As there is already a wealth of software available for PC-DOS/MS-DOS and Concurrent DOS XM, it is important that Concurrent DOS 386 be able to use the existing software base. Many of the multitasking operating systems (including Microsoft's announced ADOS) will not run existing applications. Under Concurrent DOS 386 two modes of compatibility must be considered: (1) native mode Concurrent DOS applications and (2) PC-DOS/MS-DOS applications.

In Concurrent DOS native mode, applications have access to advanced operating system features. Many of these features are intended for multiuser applications and include items such as shared file access, file/record locking, interprocess communications, resource management, and many more. I tested Concurrent DOS 386 with several native mode applications including CALLME, my own remote console manager software. CALLME uses some very sophisticated techniques to make itself an extension to the operating system. I did not expect it to run under Concurrent DOS 386 without modification and thus was surprised when it did. Other Concurrent DOS applications I tested included New Word 3.1 from New Star Software (recently acquired from Micropro, which now markets the PC-DOS/MS-DOS version of New Word as Wordstar Version 4), CP/M-86 Turbo Pacal by Borland, Aztec-C by Manx Software, Spell Binder from Lexisoft,

Introducing multi-channel communications boards 400% faster than what you're probably using now.

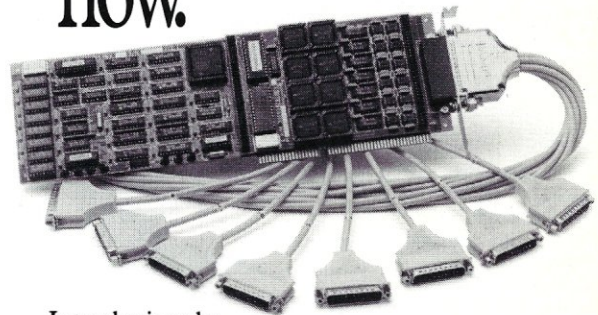

Introducing the DIGIBOARD COM/Xi Series front-end processor. Intelligent multi-channel communications boards 400% faster than the industry standard.

Like our popular COM/X Series, they provide users of PC/XT/AT-compatible computers with four or eight individually addressable serial ports. But with the new COM/Xi series we've added:

- an 80188 co-processor operating at 10 MHz
- 256K of dual-ported RAM + 16K of ROM, all accessible to user/programmers for application and security software development
- a modular design that allows us to custom-tailor I/O to individual customer requirements.

On-board intelligence means more speed for multi-user operating systems and multi-channel data collection and dissemination.

And makes the new DIGIBOARD COM/Xi Series a more intelligent choice for you.

DigiBoard
Plugging you into Tomorrow.

Call 1-800-344-4273. In Minnesota, (612) 922-8055.

and many public domain Concurrent DOS applications. All ran quite well. I am confident that the native mode of Concurrent DOS 386 is identical to that of its 8086 counterpart.

The PC-DOS/MS-DOS emulation under Concurrent DOS 386 seems to be even better than that of the 8086 version. On my test list were GEM, Wordstar 4.0, Supercalc 3, dBASE 2, Turbo Pascal, and a multitude of public domain and shareware applications. I had trouble with a few games that were written using timing loops rather than the system clock. These

games were so fast that they were impossible to play.

PC-DOS/MS-DOS applications that give trouble in any multitasking, multiuser environment are TSRs (terminate-and-stay-resident). These applications usually attempt to overlay interrupt vectors or portions of the PC-DOS/MS-DOS operating system. In a multitasking environment, such a practice is quite dangerous. Not all TSRs, however, are doomed to failure. Well-behaved TSRs work well under Concurrent DOS.

Terminate-and-stay-resident applica-

tions may be written for the Concurrent DOS native mode by detaching a process from the console. The difference between native mode detaching and PC-DOS/MS-DOS stay-resident functions is that native mode processes can continue execution in the background. Through the use of queues and system flags, other processes may send signals to the detached process.

Even though Concurrent DOS is a multitasking, multiuser operating system, PC-DOS/MS-DOS applications are not written for a multitasking environment. It is thus not possible to get a PC-DOS/MS-DOS application to share the same files across several terminals. Only native mode Concurrent DOS applications can do this.

The version of Concurrent DOS 386 supplied for this review emulated the PC-DOS/MS-DOS version 2.1 environment. According to DRI, Concurrent DOS 6.0, which should add PC-DOS/MS-DOS 3.3 compatibility, is in development. This means that future versions of Concurrent DOS 386 will implement the PC-DOS/MS-DOS 3.3 file/record locking functions, thus allowing multiuser PC-DOS/MS-DOS applications to be used.

The 8086 version of Concurrent DOS uses the commands COMSIZE and ADDMEM to allocate memory partitions to DOS applications. Under Concurrent DOS 386 these commands still exist but behave slightly differently. By default, the entire virtual application space (between 300K and 400K, depending on configuration) is assigned to the DOS program. ADDMEM and COMSIZE are now used to reduce the amount of memory assigned to DOS applications, rather than to add memory (as is the case with the 8086 version of Concurrent DOS). As the application space is paged out during context switches, this scheme is easier to handle from the user's point of view.

Networking

Local area network (LAN) support is available under Concurrent DOS 386 through the use of the already existing DRNET 1.2 network interface software. Through DRNET, multiple Concurrent DOS-based workstations may communicate with one another. DRNET supports Arcnet, Ethernet, Token-Ring, Omnet, and, if speed is not important, even RS-232.

My personal system is based on Arcnet cards from CompuPro and Standard Microsystems. I have an 80286-based CompuPro under Concurrent DOS 5.0 with 130 Mbytes of hard disk storage, a CSS AT clone running Concurrent DOS

• Z Best Sellers •

Z80 Turbo Modula-2 (1 disk) \$89.95

The best high-level language development system for your Z80-compatible computer. Created by a famous language developer. High performance, with many advanced features; includes editor, compiler, linker, 552 page manual, and more.

Z-COM (5 disks) \$119.00

Easy auto-installation complete Z-System for virtually any Z80 computer presently running CP/M 2.2. In minutes you can be running ZCPR3 and ZRDOS on your machine, enjoying the vast benefits. Includes 80+ utility programs and ZCPR3: The Manual.

Z-Tools (4 disks) \$169.00

A bundle of software tools individually priced at \$260 total. Includes the ZAS Macro Assembler, ZDM debuggers, REVAS4 disassembler, and ITOZ/ZTOI source code converters. HD64180 support.

PUBLIC ZRDOS (1 disk) \$59.50

If you have acquired ZCPR3 for your Z80-compatible system and want to upgrade to full Z-System, all you need is ZRDOS. ZRDOS features elimination of control-C after disk change, public directories, faster execution than CP/M, archive status for easy backup, and more!

DSD (1 disk) \$129.95

The premier debugger for your 8080, Z80, or HD64180 systems. Full screen, with windows for RAM, code listing, registers, and stack. We feature ZCPR3 versions of this professional debugger.

Quick Task (3 disks) \$249.00

Z80/HD64180 multitasking realtime executive for embedded computer applications. Full source code, no run time fees, site license for development. Comparable to systems from \$2000 to \$40,000! Request our free Q-T Demonstration Program.



Echelon, Inc.

885 N. San Antonio Road • Los Altos, CA 94022

415/948-3820 (Order line and tech support) Telex 4931646

Z-System OEM inquiries invited.
Visa/Mastercard accepted. Add \$4.00
shipping/handling in North America, actual
cost elsewhere. Specify disk format.

5.1 XM with a 27-Mbyte hard disk, a floppy-based PC under PC-DOS/MS-DOS with CompuPro CPLINK, and the DeskPro 386 under Concurrent DOS 386 with the 40-Mbyte drive, all hooked together over the network. This gives me a total on-line storage of 200 Mbytes on any of the above systems, even the floppy-based PC.

The procedure for adding the network software to Concurrent DOS 386 is identical to that for adding it to Concurrent DOS 86. The version of DRNET used for Concurrent DOS 86 is used with Concurrent DOS 386 as well.

Setting up a network system is not a trivial task, it requires some careful planning and thought in order to allow maximum utilization of available resources. DRNET 1.2 works well in this environment. One of the major advantages of DRNET under Concurrent DOS versus PC-DOS/MS-DOS-based networks is that no special network versions of application software are needed. The network mechanism is completely transparent to the applications.

Also, each node in the network may be a server as well as a client. There is no need for a dedicated server system. It is thus possible to log in from any node into any other node.

Devices that may be mapped across the network include printers, disk drives, and queues. Through the use of mapped queues, processes can communicate with each other over the network. Thus it is feasible to use separate CPUs to work on portions of the same application. This feature is useful for multiprocessor environments.

Summary

The 80386 CPU provides many sophisticated features not possible with 8086-compatible operating systems. Concurrent DOS 386 provides a multitasking, multi-user environment with downward compatibility for applications from 8086 environments by letting these applications run in the virtual 8086 mode.

The major advantage of Concurrent DOS 386 is its ability to take advantage of the 80386 memory management functions. The multitasking, multiuser ability of Concurrent DOS 386 allows expensive resources to be shared in a cost-effective manner. Another important advantage to business users is that the operating system offers a familiar user interface; this makes training personnel already familiar with PC-DOS/MS-DOS or the 8086 version of Concurrent DOS unnecessary. §

Alex Soya is Manager of Research and Development at Concurrent Research, Inc., Satellite Beach, Florida, where he is responsible for the development of computer applications aimed at multiuser environments. He holds a degree in computer science from the Florida Institute of Technology and his interests include operating systems, data communications, system utilities, real time and scientific programming.

Product Information

Concurrent DOS 386
3-user version: \$395
10-user version: \$495

Digital Research Inc.
60 Garden Ct.
Monterey, CA 93942
(408) 646-3896

If You Have Turbo C You Have Half Your C-Programming Vehicle

Turbo C is a great compiler but there is one vital cog missing — debugging. Without it, you have to spend an awful lot of energy to go a short distance.

Gimpel Software's C-terp, long recognized as the leading C interpreter, now fully supports Turbo C with complete compatibility guaranteed.

Interactive Debugger — Our debugging facilities include split screen (code in upper portion, dialog in lower), breakpoints (sticky, temporary, line/function, cursor-directed), display of structures and arrays, execution of any expression (even those involving macros), function traceback with arguments, watch expressions and watch conditions (watchpoints). Our watch expressions can be structs or arrays. We catch out-of-bounds pointers!

No Toy — Full K&R with ANSI enhancements. Multiple-module with a built-in automatic make. It has virtual memory option (with optional direct use of extended memory) and a shared symbol option for those big programs. It supports graphics, dual displays and the EGA 43-line mode.

Links to external libraries — (both code and data, automatically) which can call back to interpreted functions. Function pointers are compiler compatible.

100% Turbo-C compatible. — Same header (.h) files, data alignment, bit field orderings and preprocessor variables as your compiler. We link in your compiler's library.

Our reconfigurable editor — is multifile and comes with a configuration script to mimic Turbo's editor.

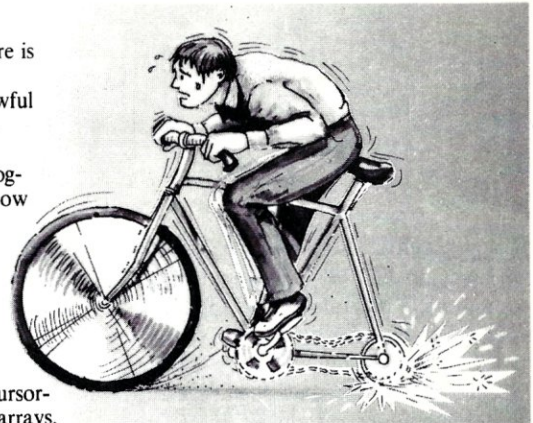

The missing wheel that will turn your half-cycle into a bicycle

C-terp

Order C-terp today!
Call (215) 584-4261

Introductory Price for Turbo C-terp:
\$139.00

VISA, MC, COD — 30 day money back guarantee

C-terp Version 3.0 is also available for the following compilers:
Microsoft, Lattice, Aztec, C86, and Mark Williams (\$298) and Xenix (\$498).



C-terp is a trademark of Gimpel Software, and Turbo C of Borland International.

Intel Inboard 386

*Upgrade a PC/AT to the 80386 with a
Plug-In Card*

by Hank Kee

When Compaq introduced its 386 system in September of 1986, I began to think of switching to a 286-based IBM PC/AT but the price seemed a little steep. Also, having previously been burned by "advanced technology," I was concerned that critical programs might not run on the Compaq and I would be stuck with a white elephant.

So when Intel announced the Inboard 386, a plug-in 386 processor board for the IBM PC/AT, it aroused my interest. I could upgrade rather than scrap my current system, and if any programs would not run, I could just remove the Inboard, converting the system back to its previous capabilities.

The Intel Inboard 386 is a full-length plug-in accelerator card for converting an IBM PC/AT from a 16-bit 80286-based system into a 32-bit 80386-based system. It also adds some functional features. Not only does it boost the processing speed of the AT, but it runs the new multiprocessing/multiuser 32-bit software now coming to the market for 386-based systems.

But could a modified AT dressed up with a different

processor offer real advantages? The objective of this review was to try to answer the following questions:

- Was compatibility maintained for a system containing interconnect boards such as 3278 emulators, Token-Ring adapters, and Ethernet links?
- Is this a real 32-bit system, or is it a warmed-over 16-bit system?
- What software can take advantage of such a system?

Benchmarking the Inboard

Intel provided me with one of its early production Inboard 386 cards. The first thing I did was run some of the standard speed benchmark tests used to evaluate XT- and AT-compatible systems. The tests I ran were the CPU2, Landmark, and MIPS tests, all of which are in the PC/Blue and some other public domain software libraries. I was also able to run the tests on the Compaq 386 system that was available. The results indicate that an IBM PC/AT equipped with the Intel Inboard 386 is comparable in performance to a Compaq 386, if not slightly better (Figures 1 and 2).

Installation

Installing the Inboard 386 is not difficult, but it can be a bit perplexing. First, the 80286 processor chip has to be removed from the AT motherboard. A connecting ribbon cable containing a logic circuit is then installed from the original 80286 socket to the Inboard card.

The interconnecting cable provided with the Inboard is designed specifically for systems that are physically and electrically compatible with the IBM PC/AT. Some AT-

Intel's Inboard 386, a plug-in processor board to upgrade the IBM PC/AT

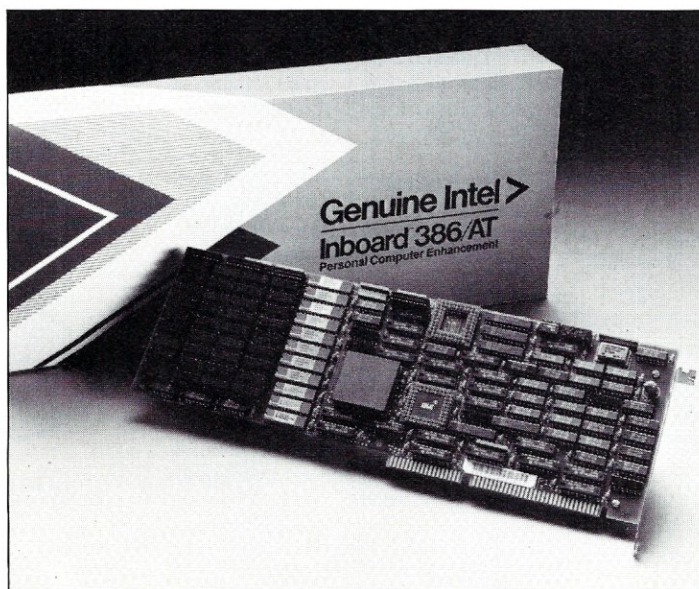

Until now, LANs have had no parallel.

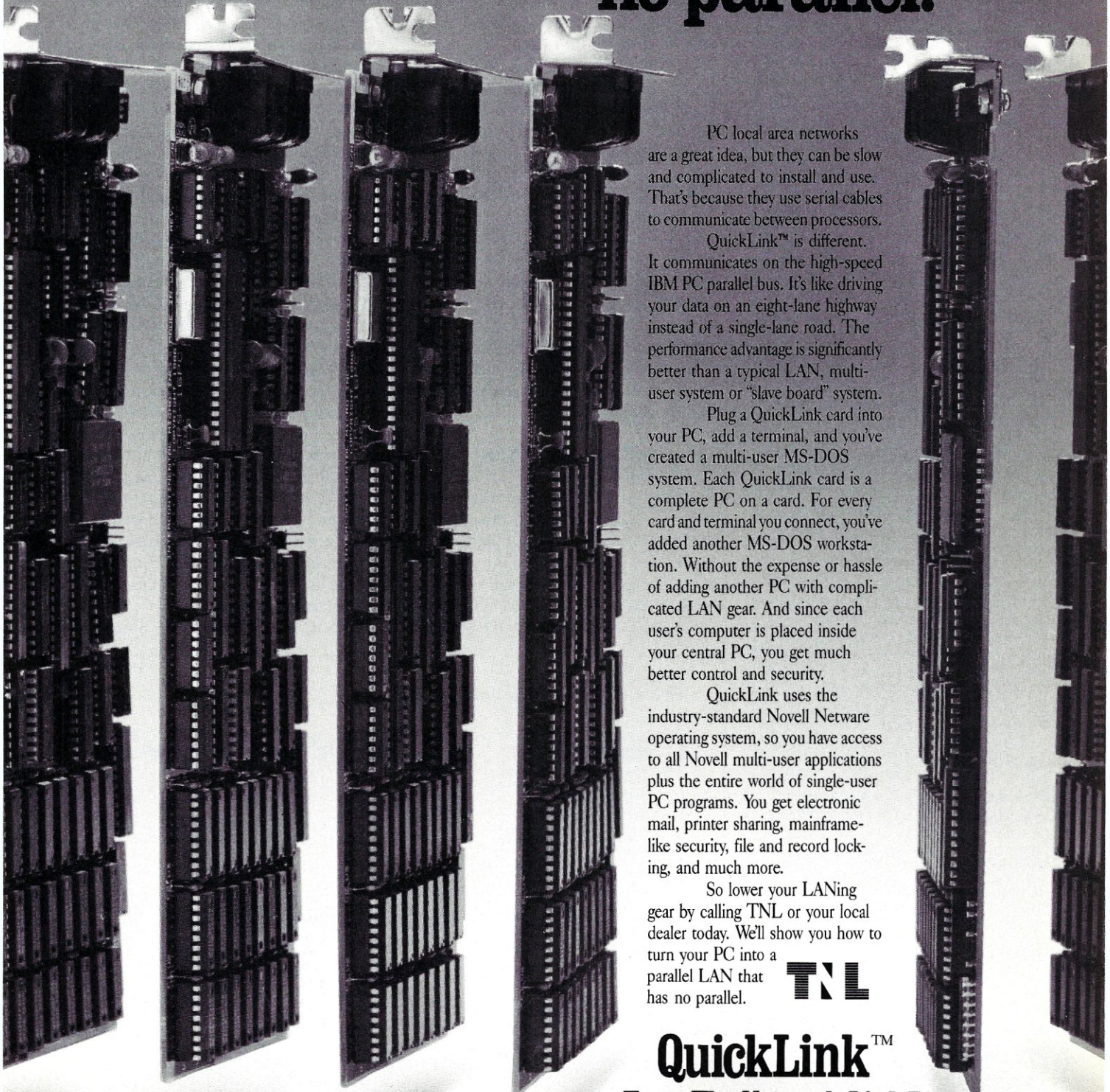

PC local area networks are a great idea, but they can be slow and complicated to install and use. That's because they use serial cables to communicate between processors.

QuickLink™ is different. It communicates on the high-speed IBM PC parallel bus. It's like driving your data on an eight-lane highway instead of a single-lane road. The performance advantage is significantly better than a typical LAN, multi-user system or "slave board" system.

Plug a QuickLink card into your PC, add a terminal, and you've created a multi-user MS-DOS system. Each QuickLink card is a complete PC on a card. For every card and terminal you connect, you've added another MS-DOS workstation. Without the expense or hassle of adding another PC with complicated LAN gear. And since each user's computer is placed inside your central PC, you get much better control and security.

QuickLink uses the industry-standard Novell Netware operating system, so you have access to all Novell multi-user applications plus the entire world of single-user PC programs. You get electronic mail, printer sharing, mainframe-like security, file and record locking, and much more.

So lower your LANing gear by calling TNL or your local dealer today. We'll show you how to turn your PC into a parallel LAN that has no parallel.



QuickLink™
From The Network Link™

3303 Harbor Blvd., Building H-10, Costa Mesa, CA 92626. (714) 549-9380

QuickLink developed by InterContinental Microsystems Corp. and manufactured for TNL.

COMBINE THE
RAW POWER OF FORTH
WITH THE CONVENIENCE
OF CONVENTIONAL LANGUAGES

HS / FORTH

Yes, Forth gives you total control of your computer, but only HS/FORTH gives you implemented functionality so you aren't left hanging with "great possibilities" (and lots of work!) With over 1500 functions you are almost done before you start!

WELCOME TO HS/FORTH, where megabyte programs compile at 10,000 lines per minute, and execute faster than ones built in 64k limited systems. Then use AUTOOPT to reach within a few percent of full assembler performance — not a native code compiler linking only simple code primitives, but a full recursive descent optimizer with almost all of HS/FORTH as a useable resource. Both optimizer and assembler can create independent programs as well as code primitives. The metacompiler creates threaded systems from a few hundred bytes to as large as required, and can produce ANY threading scheme. And the entire system can be saved, sealed, or turnkeyed for distribution either on disk or in ROM (with or without BIOS).

HS/FORTH is a first class application development and implementation system. You can exploit all of DOS (commands, functions, even shelled programs) and link to .OBJ and .LIB files meant for other languages *interactively!*

I/O is easier than in Pascal or Basic, but much more powerful — whether you need parsing, formatting, or random access. Send display output through DOS, BIOS, or direct to video memory. Windows organize both text and graphics display, and greatly enhance both time slice and round robin multitasking utilities. Math facilities include both software and hardware floating point plus an 18 digit integer (finance) extension and fast arrays for all data types. Hardware floating point covers the full range of trig, hyper and transcendental math including complex.

Undeniably the most flexible & complete Forth system available, at any price, with no expensive extras to buy later. Compiles 79 & 83 standard programs. Distribute metacompiled tools, or turnkeyed applications royalty free.

HS/FORTH (complete system): \$395.
HS/FORTH: Tutorial & Ref (500 pg) \$ 59.
Forth: Text & Reference (500 pg) \$ 22.
HS/FORTH Glossary \$ 10.
GIGAFORTH Option (Beta release) \$245.
(Native Mode from SOFTMILLS, INC.)

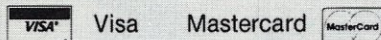

HARVARD SOFTWORKS

PO BOX 69
SPRINGBORO, OH 45066
(513) 748-0390

compatible systems use a different 286 chip package and will require a different interconnecting cable. The Sperry Micro IT, AST AT, and the Compaq 286, for example, all require the nonstandard LCC cable (also available from Intel). Also, some so-called AT compatibles do not have removable 286 processor chips or have different bus structures (such as the AT&T 6300+) and hence cannot be converted. It is advisable to check with Intel if you are unsure about system compatibility.

The Inboard is available with 0K memory (you can populate the rest yourself at a much lower cost) or 1 Mbyte of factory-installed on-board memory. Also available is a 2-Mbyte daughter board to bring the Inboard up to a total capacity of 3 Mbytes.

The Inboard will work with 0K of memory using the memory on the AT motherboard. Performance suffers, however, dropping to half that achievable with on-board memory. The memory on the Inboard functions as a 32-bit wide memory system with a memory caching circuit. When there is no on-board RAM, the 386 uses the standard 16-bit-wide memory system that does not have caching, and so performance suffers.

Connectivity and Compatibility

Since I connect systems to LANs and mainframes, I am concerned with connectivity—in other words, connecting the system to the outside world via different communication adapter boards. All too often this is a crucial test for PC-compatible systems. I have found that many so-called compatibles cannot support the IBM To-

ken-Ring or IBM 3278 emulation adapters. I was therefore pleased to see that an IBM PC/AT equipped with the Intel Inboard functioned properly with the Token-Ring and 3278 adapters installed.

Software compatibility was another concern. I ran many of the standard PC application programs without any problem. But my prime interest was in the new 386 software. Since this software was designed to run on a Compaq 386, I was interested to see if there would be problems running 386 programs on a converted AT.

I tested Quarterdeck's new release of DESQview (Version 2.0 with the 386 extension), Concurrent DOS 386 from Digital Research (DRI), and PC-MOS/386 from Software Link. All three operate in the true 80386 32-bit mode and provide multitasking/multiuser facilities. After testing each, I began wondering why there should be so much interest in OS/2, which is only a 286-based operating system.

DESQview operated in much the same way as the existing PC version. In fact, regular extended or EMS memory works just as EEMS does. Each task can be maximized for memory utilization. Up to 255 tasks could be initiated under DESQview, provided the resources are there. (Anything more than a dozen would just be an academic exercise.) It worked well. Programs need not be well behaved to function. Best of all, I was not dependent on a mouse in order to run a few tasks. Using Inboard with DESQview was like having a window to the world with computerized speed and multitasking.

DRI's Concurrent DOS 386 operating

Figure 1. Benchmark test results

BENCHMARK	PC/XT	INBOARD 386	COMPAQ 386
1. Mixed Instructions Repetition	10.00	0.98	1.15
Effective 8088 clock speed	4.77 MHz	48.67 MHz	41.47 MHz
2. Eratosthenes Sieve 10 reps	3.68	0.44	0.38
<i>CPU2: Speed checker benchmark program (time in seconds)</i>			
		INBOARD 386	COMPAQ 386
Performance relative to PC/XT		12.3x (19.9 MHz)	12.5x (20.2 MHz)
<i>Landmark CPU speed test: Speed version .99</i>			

system was also a delight to operate. Although designed for the Compaq 386, the Inboard had no problem running it. Most PC-DOS programs ran concurrently with no problems since Concurrent DOS 386 provides DOS Version 2.x compatibility (Version 3.x compatibility is reportedly being developed). Only programs that went into selective operating system calls were vulnerable to failure. The copy I tested was a beta-test copy, yet the product appeared to be in a finished form since all the features were there and I encountered no bugs.

I also tested a beta copy of Software Link's PC-MOS/386 operating system. This product was designed for the Compaq DeskPro-386, as well, but there was no problem installing and running it on the Inboard. PC-MOS/386 appears, however, to need further development, which will no doubt happen with its formal release and subsequent updates.

I am not a speed enthusiast and I am not particularly concerned with multitasking, but there are times when I wish I could have a little more processing speed and the ability to run another task in the background without seriously affecting performance. The combination of the Intel Inboard 386 with an AT-compatible system seems like a very logical approach.

Summing Up

The Intel 80386 provides the increase in performance that has been sorely needed for true multitasking on the PC. The Compaq 386 was the first system to deliver this level of performance, but at a price. The Intel Inboard 386 provides an

alternative upgrading to a Compaq 386 for those who already own an IBM PC/AT or compatible system. §

Hank Kee is in charge of computer support at a large banking institution. He is also co-librarian of the PC/Blue public domain software library, and operates the New York Amateur Computer Club electronic bulletin board system ([718] 539-3338 or [718] 539-3560).

Product Information

Connecting Cables

PCIB3001—for IBM PC/AT	\$200
PCIB3002—for AT-compatibles	\$200

Intel Inboard 386 AT

(less connecting cable)

PCIB3000—0K memory	\$1795
PCIB3010—1-Mbyte RAM	\$2295

Intel Personal Computer-Enhancement Operation

Mail Stop CO307
5200 N.E. Elam Young Pkwy.
Hillsboro, OR 97124
(800) 538-3373

80387 Math Coprocessor

PCNC8387-16	\$795
-------------	-------

Piggyback Memory Boards

PCIB3110—1 Mbyte on board (2 Mbyte in system)	\$645
PCIB3120—2 Mbyte on board (3 Mbyte in system)	\$1145

Figure 2. MIPS (from Chips and Technologies, Version 1.20)

BENCHMARK	PERFORMANCE RELATIVE TO:		ACTUAL MIPS	
	IBM/PC 4.77 MHz	IBM/AT 8 MHz	COMPAQ 386	INBOARD 386
General instructions	5.64	1.64	0.83	0.93
Integer instructions	11.11	1.74	0.76	1.87
Memory to memory	2.93	0.90	0.50	0.69
Register to register	18.31	2.38	1.00	3.29
Register to memory	3.54	1.06	0.59	1.09
<i>Overall performance</i>	<i>6.32</i>	<i>1.53</i>	<i>0.75</i>	<i>1.57</i>

goodbye dBase!



dBASE Programmers

**You need it!
You can handle it!
dB2c is here now!**

dB2c Offers:

- Version 2.0 complete with Translator and File Handlers.
- Extensive implementation of dBASE III+ with over 200 functions and commands in C source code.
- Contains our own File Handlers plus interfaces for Lattice's dBC and Faircom's c-tree.
- Supports screen I/O with ANSI.SYS or fast assembler routines.
- Support for Microsoft, Lattice and Turbo C compilers.
- Tutor features of translation combined with familiar syntax of the library eases the transition to 'C'.
- One version supports MS-DOS, Xenix, Unix, OS-9 and Concurrent DOS.

are you
ready?

dB→C
Toolkit \$299



DAVID J.
MARSH

Call or Write:

SOFTWARE
CONNECTION, INC.
POB 712, Ely, MN 55731
(218) 365-5097

The Software Link's PC-MOS/386

by Charles H. Strom

A Low-cost 80386 Multitasking, Multiuser Operating System

Every day we hear of more 80386 micro-computer systems being introduced. It seems a given in the industry that software always lags far behind hardware. An excellent example is IBM's PC/AT, an 80286-based system introduced in 1984, and the operating system for it, OS/2, which will not be available until 1988—a four-year lag. With the 80386 systems, however, such is not the case.

Within nine months of the introduction of the first 80386 system (the Compaq DeskPro 386), several 80386 operating systems have been announced. I would like to introduce and give an overview to one of these systems, PC-MOS/386, from The Software Link. The Software Link is best known for MultiLink and LanLink, two networking products that run in conjunction with PC/MS-DOS. PC-MOS/386 (referred to as "MOS" in the balance of this article) is the company's first foray into the operating system market.

Overview

A primary design goal of this operating system was to maximize compatibility with as many PC/MS-DOS 3.2 applications as possible. The virtual 8086 mode of the 80386 allows this while taking advantage of the protected environment. Along with virtual mode, paging allows each multiple application to see the same 640K PC/MS-DOS address space. Lastly, MOS is said to support 32-bit native mode, although no examples of such code were on hand to test. MOS takes advantage of the design of the microprocessor and its ability to directly address large blocks of RAM to support both multitasking and multiuser operation.

Multitasking

Three versions of the operating system support one, five, and twenty-five users. Actually, "MOS" stands for modular operating system; it is easy to upgrade to the multiuser versions by simply adding a module. In all cases, multitasking is available (within the limits of available RAM) by defining memory partitions as needed. For example, an "ADDTASK 384" will create an additional partition of 384K. Keying Alt-1 will switch to partition 1, Alt-2 to partition 2, and so on. The maximum partition size is approximately 640K. Utilities are also included to remove or resize partitions. When more than one process is running—whether due to a sin-

gle user running several tasks, several users each running a task, or some combination—there are two types of priority assignments: (1) the SLICE subcommand controls the number of time slices (of approximately 1/18 second duration) devoted to each task and (2) the PRIORITY subcommand allows eight levels of priority. A task with lower priority will not execute until all higher priority tasks are complete. The power and flexibility of these commands illustrate the careful planning that went into MOS.

Multiuser

Many of the details discussed above can also be applied to multiuser configurations of MOS. A variety of terminals is supported, including Zenith's Z-19; the Tele-video 910, 912, 920C and 925; the ADM-3A, ANSI terminals; and so on. Also, any of the PC-compatible terminals (such as the Kimtron KT-7 and Wyse WY-60) can be used. Even dumb, teletypelike terminals can be used. Since there is provision for a user-defined terminal driver, almost any hardware will work.

Note that MOS treats remote terminals as monochrome displays. At present, graphics are not supported because The Software Link has yet to develop the necessary driver, but a CGA version is expected soon. The company does market a product called PC-Emulink, which allows a CGA-equipped computer to serve as a

Upgrade your technology

The software technology available to programmers of IBMcompatible personal computers is truly amazing. And newer, more powerful development packages appear all the time. But until now, finding out about these important products has been a difficult and time consuming task.

FREE Buyer's Guide. The New 76 page Programmer's Connection Fall 1987 Buyers Guide contains individual descriptions of over 500 titles of programmer's development software by over 150 manufacturers. Each description covers major product features as well as any software or hardware requirements and version numbers. In the box on the right are some examples of the types of descriptions you'll find in our Buyer's Guide.

No Hidden Charges. The low discount prices in our Buyer's Guide are all you pay. We don't charge extra for UPS Ground shipping, credit cards, COD orders, purchase orders, sales tax (except Ohio) or special handling (except for non-Canadian international orders).

Guarantees. We offer FREE 30-day no-risk return guarantees and 30-day evaluation periods on most of our products.

Latest Versions. The products we carry are the latest versions and come with the same manufacturer's technical support as if buying direct.

Large Inventory. We have one of the largest inventories of programmer's development products in the industry. Most orders are shipped within 24 hours.

Noncommissioned Staff. Our courteous salespeople are always ready to help you. And if you aren't sure about

your needs, our knowledgeable technical people can give you sound, objective advice.

Experience. We've specialized in development software for IBMcompatible personal computers since 1984 and are experienced at providing a full range of quality products and customer services.

How to Get Your Copy.

There are two ways for you to receive your FREE copy of the Programmer's Connection Buyer's Guide: 1) Mail us a card or letter with your name and address; or 2) Call one of our convenient toll free telephone numbers.

If you haven't yet received your Programmer's Connection Fall 1987 Buyer's Guide, act now. Upgrading your programming technology could be one of the wisest and most profitable decisions you'll ever make.

CALL TOLL FREE

USA: 800-336-1166

Canada: . . . 800-225-1166

Ohio & Alaska

(Collect): . . 216-494-3781

International: 216-494-3781

Telex: 9102406879

Easylink: 62806530

Programmer's Connection
7249 Whipple Ave. NW
North Canton, OH 44720

Blaise C TOOLS PLUS/5.0

List \$129 Ours \$99

C TOOLS PLUS/5.0 is a library for Microsoft C that can provide you with a full spectrum of general-purpose utility functions. Included are functions that take advantage of the machine features of IBM-compatible personal computers and DOS and complement the standard compiler library. Almost all functions are written in C using techniques most suitable for good C program design. Some of the areas covered are: extensive string handling; screen handling including support for multiple monitors and the EGA; general utility and keyboard functions; DOS memory management; windows that can be stacked, removed and accept user input; intervention code; and interrupt service routine support for truly flexible resident applications. CTOOLS PLUS/5.0 includes all source code, complete examples and a comprehensive reference manual.

Supports Microsoft C 5.0 and Microsoft QuickC.

ESP Command Plus

List \$80 Ours \$69

Command Plus is a powerful, bootable MS-DOS command processor fully compatible with COMMAND.COM. Many new features are included that will help you increase your speed, productivity and ease of programming. These include a history processor that lets you recall and edit previously entered commands using the cursor keys. The alias facility allows the creation of command macros with replaceable parameters. Other features include: regular expressions in filenames; directory and argument stacks; a command line

editor; access to environment variables; a MOVE command; and Browse, a full screen file viewer. Command Plus also includes SCRIPT, a batch processor that uses a Pascal-like language that features: integer and string variables; boolean, math and string operators; CALL, FOR/WHILE, GOTO, IF/THEN/ELSE, and SWITCH statements; and display and file access routines. Enhancements to DIR include sort options and file attrib display. COPY options include selection by date/time range, and recursive sub-directory processing.

Requires 48K memory. Version 1.2.

Meridian Software AdaVantage Compiler 2.0

List \$795 Ours \$735

The Meridian AdaVantage Compiler is a fully validated implementation of the Ada language. The compiler generates native 8086 code in the Intel standard object format. A linker is provided to create stand-alone executable files for MS-DOS. The Meridian AdaVantage Compiler package includes the compiler, linker, library management tools, support packages, runtime libraries and a configuration tool. In addition to the standard Ada packages, support packages are provided to make integer, floating point and text I/O more convenient to implement. The compiler also provides a pragma INTERFACE used to make calls to subprograms written in 8086 assembly language, Meridian Cor Meridian Pascal. A source level debugger will be available in late 1987.

Requires hard disk and 640K memory. Runtime fees apply if more than 99 copies are sold. Version 2.0.



The Free Programmer's Connection Fall '87 Buyer's Guide.

ai - expert systems

Table with 3 columns: Product Name, Price, and Contact Info. Includes items like 1st-CLASS by Programs in Motion, EXSYS Development Software by EXSYS, etc.

ai - lisp language

Table with 3 columns: Product Name, Price, and Contact Info. Includes items like Golden Common LISP by Gold Hill, Golden Common LISP Developer by Gold Hill, etc.

ai - prolog language

Table with 3 columns: Product Name, Price, and Contact Info. Includes items like Arity Combination Package, Expert System Development Pkg, File Interchange Toolkit, etc.

ai - smalltalk language

Table with 3 columns: Product Name, Price, and Contact Info. Includes items like Smalltalk/V, EGA/VGA Color Option, Goodies Diskette, etc.

ai - texas instruments

Table with 3 columns: Product Name, Price, and Contact Info. Includes items like Arborist Decision Tree Software, PC Scheme Lisp, Personal Consultant Easy, etc.

ada language

Table with 3 columns: Product Name, Price, and Contact Info. Includes items like AdaVantage GSA-Validated by Meridian Software, AdaVantage Utility Packages, DOS Environment Package, etc.

apl language

Table with 3 columns: Product Name, Price, and Contact Info. Includes items like APL PLUS PC by STSC, APL PLUS PC Spreadsheet Mgr by STSC, APL PLUS PC Tools Vol 1 by STSC, etc.

assembly language

Table with 3 columns: Product Name, Price, and Contact Info. Includes items like 386 ASM/LINK Cross Asm by Phar Lap, 8088 Assembler w/Z-80 Translator by 2500 AD, ASM LIB Function Library by BCSoft, etc.

basic language

Table with 3 columns: Product Name, Price, and Contact Info. Includes items like db/Lib for QuickBASIC by AJS Publishing, Finally by Komputerwerk, ASM LIB Function Library by BCSoft, etc.

blaise products

Table with 3 columns: Product Name, Price, and Contact Info. Includes items like ASYNCH MANAGER Specify C or Pascal, C TOOLS PLUS/5.0, KeyPlayer Super Batch Program, etc.

borland products

Table with 3 columns: Product Name, Price, and Contact Info. Includes items like EUREKA Equation Solver, Reflex: The Analyst, Sidekick, Superkey, etc.

Table with 3 columns: Product Name, Price, and Contact Info. Includes items like Turbo Lightning and Word Wizard, Turbo Lightning, Turbo Lightning Word Wizard, Turbo Pascal and Tutor, etc.

c compilers

Table with 3 columns: Product Name, Price, and Contact Info. Includes items like C86PLUS by Computer Innovations, DeSmet C w/Debugger & Large case, DeSmet C w/Debugger only, etc.

c interpreters

Table with 3 columns: Product Name, Price, and Contact Info. Includes items like C-terp by Gimpel, Specify compiler, C Trainer with Book by Catalyx, Introducing C by Computer Innovations, etc.

c utilities

Table with 3 columns: Product Name, Price, and Contact Info. Includes items like Blackstar C Library by Sterling Castle, C++ by Guidelines w/Version 1.1 kernel, c-tree & r-tree Combo by FairCom, etc.

cobol language

Table with 3 columns: Product Name, Price, and Contact Info. Includes items like COBOLspII by Flexus, FPLIB for Realia COBOL by BCSoft, Micro Focus COBOL See Micro Focus Section, etc.

css products

Table with 3 columns: Product Name, Price, and Contact Info. Includes items like Combo Package by Custom Software Systems, PC/SPELL Spelling Checker, PC/TOOLS UNIX-like Utilities, etc.

debuggers & profilers

Table with 3 columns: Product Name, Price, and Contact Info. Includes items like 386 DEBUG Cross Debugger by Phar Lap, Advanced Trace-86 by Morgan Computing, Codesmith-86 by Visual Age, etc.

disk utilities

Table with 3 columns: Product Name, Price, and Contact Info. Includes items like Back-It by Gazelle Systems, Disk Optimizer by Softlogic Systems, Disk Technician by Prime Solutions, etc.

dos utilities

Table with 3 columns: Product Name, Price, and Contact Info. Includes items like Advanced Norton Utilities, Command PLUS by ESP Software, etc.

Table with 3 columns: Product Name, Price, and Contact Info. Includes items like Desqview from Quarterdeck, FANSI-CONSOLE by Hersey Micro, Mace Utilities Paul Mace Software, etc.

essential products

Table with 3 columns: Product Name, Price, and Contact Info. Includes items like C Utility Library, Essential Comm Library with Debugger, Essential Comm Library Software Only, etc.

forth language

Table with 3 columns: Product Name, Price, and Contact Info. Includes items like CFORTH Native Code Compiler by LMI, FORTH/83 Metacompiler Specify Target, PC/FORTH by Laboratory Microsystems, etc.

fortran language

Table with 3 columns: Product Name, Price, and Contact Info. Includes items like 50 MORE-FORTRAN by Peerless Scientific, ACS Time Series by Alpha Computer Service, AUTOMATED PROGRAMMER by KGK Automated, etc.

greenleaf products

Table with 3 columns: Product Name, Price, and Contact Info. Includes items like Greenleaf C Sampler for Turbo C & QuickC, Greenleaf Comm Library, Greenleaf Data Windows Library, etc.

help utilities

Table with 3 columns: Product Name, Price, and Contact Info. Includes items like HELP/Control by MDS, On-line Help from Opt-Tech, SoftScreen/HELP by Dialectic Systems, etc.

lattice products

Table with 3 columns: Product Name, Price, and Contact Info. Includes items like Lattice C Compiler ver 3.2 from Lattice, with Library Source Code, C Cross Reference Generator, etc.

metagraphics products

Table with 3 columns: Product Name, Price, and Contact Info. Includes items like LightWINDOW/C for Datatight C, FontWINDOW, FontWINDOW/PLUS, etc.

micro focus products

Table with 3 columns: Product Name, Price, and Contact Info. Includes items like Micro Focus COBOL/2, Micro Focus Level II COBOL w/Animator, Level II COBOL, etc.

microport products

386 Unlimited License Kit	249	209
AT Unlimited License Kit	249	209
DOSMerge286 Run DOS and UNIX together	149	129
DOSMerge386 Run DOS and UNIX together	CALL	CALL
System V/386 Combination	799	699
386 Runtime System	199	169
386 Software Development System	499	429
Text Preparation System	199	169
System V/AT Combination	549	465
AT Runtime System	199	169
AT Software Development System	249	209
Text Preparation System	199	169

microsoft products

Microsoft BASIC Compiler for XENIX	695	419
Microsoft BASIC Interpreter for XENIX	350	209
Microsoft C Compiler w/CodeView New Version	450	269
Microsoft COBOL Compiler with COBOL Tools for XENIX	700	429
	995	609
Microsoft FORTRAN Optimizing Compiler/CodeView	450	269
Microsoft FORTRAN for XENIX	695	419
Microsoft Learning DOS	50	36
Microsoft MACH 10 with Mouse & Windows	549	369
Microsoft MACH 10 Board only	399	279
Microsoft Macro Assembler New Version	150	93
Microsoft Mouse for IBM PS/2	CALL	CALL
Microsoft Mouse Bus Version	CALL	CALL
Microsoft Mouse Serial Version	CALL	CALL
Microsoft Pascal Compiler	300	179
for XENIX	695	419
Microsoft QuickBASIC	99	63
Microsoft QuickC	99	63
Microsoft Windows	99	63
Microsoft Windows Development Kit	500	299
Microsoft Word New Version	450	269

mks products

MKS AWK	New	75	65
MKS RCS Revision Control System	New	189	155
MKS Toolkit with MKS VI Editor		139	109
MKS Trilogy with AWK, CRYPT & Korn Shell New		119	99
MKS VI Editor by MKS	New	75	65

modula-2 language

LOGITECH Modula-2 Development System New	249	199	
Modula-2 Compiler Pack New	99	79	
Modula-2 Toolkit	169	139	
LOGITECH Modula-2 ROM Pkg	299	239	
LOGITECH Modula-2 Window Pkg	49	39	
Macro2 Macro preprocessor by PMI	89	79	
ModBase by PMI	89	79	
ModGraph by TEQNA	New	50	45
Repetoire by PMI	89	75	
Science & Engrg Tools by Quinn-Curtis	75	67	
Universal Graphics Library by Quinn-Curtis	130	119	

mouse products

LOGIMOUSE BUS with PLUS Pkg by LOGITECH	119	98
with PLUS & PC Paintbrush	149	119
with PLUS & CAD Software	189	153
with PLUS & CAD & Paint	219	179
with First Publisher New	CALL	CALL
LOGIMOUSE C7 with PLUS Pkg, Specify Connector	119	98
with PLUS & PC Paintbrush	149	119
with PLUS & CAD Software	189	153
with PLUS & CAD & Paint	219	179
with First Publisher New	CALL	CALL

Microsoft Mouse See Microsoft Section

other languages

ACTOR by Whitewater Group New Version	495	419
CCS MUMPS Single-User by MGlobal	60	50
CCS MUMPS Single-User Multi-Tasking	150	129
CCS MUMPS Multi-User	450	359
Marshal Pascal by Marshal Language Systems	189	165
Pascal-2 by Oregon Software	395	325
Personal REXX by Mansfield Software	125	99
SNOBOL4+ by Catspaw	95	80

other products

Carbon Copy Plus by Meridian Technology	195	159
Dan Bricklin's Demo Pgm by Software Garden	75	57
Dan Bricklin's Demo Tutorial	50	45
Fast Forward by Mark Williams	70	59
Instant Replay by Nostradamus	150	CALL
MicroTEX Typesetting from Addison-Wesley	295	CALL
Printer Drivers New	CALL	CALL
Net-Tools by BCSoft	149	129
Norton Guides Specify Language New	100	75
OPT-Tech Sort by Opt-Tech Data Proc	149	99
PC/TOOLS by Custom Software	49	45
Screen Machine by MicroHelp	79	59
SuperSort by LifeStyle New	139	119

phoenix products

Pasm86 Macro Assembler version 2.0	195	108
Pdisk Hard Disk & Backup Utility	145	99
Plantasy Pac Phoenix Combo	995	595
Pinfish Execution Profiler	395	209
Plix86plus Symbolic Debugger	395	209
PforCe Specify C Compiler	395	209
PforCe++ Specify C Compiler and C++	395	209
Plink86plus Overlay Linker	495	275
Pmaker Make Utility	125	78
Pmate Macro Text Editor	195	108
Pre-C Lint Utility	295	154
Ptel Binary File Transfer Program	195	108

polytron products

PolyBoost Software Accelerator Special Price	80	54
PolyDesk III	99	72
PolyDesk III Archivist	50	42
PolyDesk III Cryptographer	50	42
PolyDesk III Talk	70	52
PolyLibrarian Library Manager	99	89

PolyLibrarian II Library Manager	149	129
PolyMake UNIX-like Make Facility	149	129
PolyShell Special Price	149	105
Polytron C Beautifier	50	45
PolyXREF Complete Cross Ref Utility	219	185
PolyXREF One language only	129	109
PVCS Corporate Version Control System	395	329
PVCS Personal	149	129

program mgmt utilities

Interactive EASYFLOW by Haventree New Version	150	125
PrintQ by Software Directions	89	84
Quit Computing Combo Package	250	199
QMake Program Rebuild Utility	99	79
SRMS Software Revision Mgmt System	185	159
Sapiens MAKE & VB New	439	379
Sapiens MAKE New	179	155
Source Print by Aldebaran Labs	97	75
TLIB Version Control System by Burton	100	89
Tree Diagrammer by Aldebaran Labs	77	67

raima products

dbQUERY Single-User Query Utility	195	129
Single-User with Source Code	495	389
Multi-User	495	389
Multi-User with Source Code	990	699
dbVISTA Single-User DBMS	195	129
Single-User with Source Code	495	389
Multi-User	495	389
Multi-User with Source Code	990	699

sco products

Complete XENIX System V by SCO	1295	994
Development System	595	499
Operating System Specify XT or AT	595	499
Text Processing Package	195	144
Lyrix by SCO	595	449
SCO Professional 1-2-3 Worklike for XENIX	795	595
SCO XENIX-NET	595	495
XENIX System V 386 by SCO New	CALL	CALL

softcraft products

Btrieve ISAM Mgr with No Royalties	245	184
Xtrieve Query Utility	245	184
Report Option for Xtrieve	145	99
Btrieve/N for Networks	595	454
Xtrieve/N	595	454
Report Option/N for Xtrieve/N	345	269

text editors

Brief & dBrief Combo from Solution Systems	275	CALL
Brief	195	CALL
dBrief Customizes Brief for dBASE III	95	CALL
de by David Livshin New	75	65
Epsilon Emacs-like editor by Lugaru	195	147
KEDIT by Mansfield Software	125	98
Micro/SPF by PHASER SYSTEMS	175	139
Microsoft Word New Version	450	269
PC/VI by Custom Software Systems	149	99
SPF/PC by Command Technology Corp	CALL	CALL
Vedit Plus by CompView	185	128

turbo pascal utilities

ALICE Interpreter by Software Channels	95	66
DOS/BIOS & Mouse Tools by Quinn-Curtis	75	67
Flash-up Windows by Software Bottling	90	78
MACH 2 for Turbo Pascal by Micro Help	69	55
MetraByte D/A Tools by Quinn-Curtis	100	89
Science & Engrg Tools by Quinn-Curtis	75	67
Screen Sculptor by Software Bottling	125	91
Speed Screen by Software Bottling	35	32
System Builder by Royal American New Version	150	129
IMPEX Query Utility	100	89
Report Builder New Version	130	115
TDebugPLUS by TurboPower Software	60	49
Tmark by Tangent Designs	80	69
Turbo EXTENDER by TurboPower Software	85	64
Turbo OPTIMIZER by TurboPower	75	65
with Source Code	125	98
Turbo Professional by Sunny Hill	70	45
TurboHALO from IMSI	129	98
TurboPower Utilities by TurboPower	95	78
TurboRef by Gracon Services	50	35
TURBOsmith Source Debugger by Visual Age	99	89
Universal Graphics Library by Quinn-Curtis	130	119

wendin products

Operating System Toolbox	99	79
PCNX Operating system	99	79
PCVMS Similar to VAX/VMS	99	79
Wendin-DOS Multitasking DOS	99	85
Wendin-DOS Application Developer's Kit New	99	85
XTC Text Editor w/ Pascal source	99	75

xenix/unix products

Btrieve ISAM File Mgr by SoftCraft	595	454
C-terp by Gimpel, Specify compiler	498	379
c-tree ISAM Mgr by FairCom	395	315
dBx with Library Source by Desktop AI	550	419
DIRECTORY SHELL 286		
by American Mgmt Sys New	349	295
DIRECTORY SHELL 386		
by American Mgmt Sys New	495	415
DOSIX Console Version by Data Basics	400	349
DOSIX User Version by Data Basics	200	179
Micro Focus Products See Micro Focus Section		
Microport Products See Microport Section		
Microsoft Products See Microsoft Section		
PANEL Plus by Roundhill Computer Systems	795	535
REAL-TOOLS Binary Version by PCT	99	89
Library Source Version	599	539
Complete Source Version	999	729
RM/COBOL by Ryan-McFarland	1250	949
RM/FORTRAN by Ryan-McFarland	750	549
SCO Products See SCO Section		

Terms are subject to change.

©1987 Programmers Connection, Inc.

LOWEST PRICES

Due to printing lead times, some of our current prices may differ from those shown here. Call for latest pricing.

FREE SHIPPING

Orders within the USA (including Alaska & Hawaii) are shipped FREE via UPS. Express shipping is available at the shipping carrier's standard rate with no rush fees or handling charges. To avoid delays when ordering by mail, please call first to determine the exact cost of express shipping.

VISA and MasterCard are accepted at no extra cost. Your card is charged when your order is shipped. Mail orders please include credit card expiration date and authorized signature.

CODs AND POs

CODs and Purchase Orders are accepted at no extra cost. No personal checks are accepted on COD orders. POs with net 30-day terms (with initial minimum order of \$100) are available to qualified US accounts only.

SALES TAX

Orders outside of Ohio are not charged state sales tax. Ohio customers please add 6% Ohio tax or provide proof of tax-exemption.

INTERNATIONAL ORDERS

Shipping charges for International and Canadian orders are based on the shipping carrier's standard rate. Since rates vary between carriers, please call or write for the exact cost. International orders (except Canada), please include an additional \$10 for export preparation. All payments must be made with US funds drawn on a US bank. Please include your telephone number when ordering by mail. Due to government regulations, we cannot ship to all countries.

VOLUME ORDERS

Volume orders may qualify for additional discounts. Call us for special pricing.

SOUND ADVICE

Our knowledgeable technical staff can answer technical questions, assist in comparing products and send you detailed product information tailored to your needs.

30-DAY GUARANTEE

Most of our products (excluding books) come with a 30-day documentation evaluation period or a 30-day return guarantee. Please note that some manufacturers restrict us from offering guarantees on their products. Call for more information.

MAIL ORDERS

Please include your telephone number on all mail orders. Be sure to specify computer, operating system and any applicable compiler or hardware interface(s). Send mail orders to:

Programmer's Connection
7249 Whipple Ave. NW
North Canton, OH 44720

USA 800-336-1166
CANADA 800-225-1166
OHIO & ALASKA (Collect) 216-494-3781
TELEX 9102406879
EASYLINK 62806530

INTERNATIONAL 216-494-3781
CUSTOMER SERVICE 216-494-8899

Hours: Weekdays 8:30 AM to 8:00 PM EST.



fully supported remote graphics device. The necessary driver to support dumb, CGA-compatible terminals is expected in a future release. Functions that are available at present include dual intensity, cursor movement and addressing, and full support for function keys, the Alt key, and the special keypad keys (home, end, page up, and so on), among others.

To set up the operating system for multiuser operation, the \$SERIAL.SYS device driver is used. This specifies the port addresses, buffer size, handshaking, and other parameters. The manual also describes the simple steps required to set up a modem as a remote terminal, thus supporting remote access to the system.

Device drivers

One of MOS' strengths is its support of device drivers. Unlike the situation with PC/MS-DOS, device drivers can be dynamically added to and removed from MOS at any time through the use of .ADDEV and .REMDEV commands. This simple process eliminates the need for shutting down the system and rebooting to change the environment, as is often necessary when running PC/MS-DOS. The Software Link supplies several special

drivers including cache, extended memory emulator, RAM disk, and NETBIOS drivers. This last driver allows each of multiple partitions to emulate a stand-alone machine on a LAN, thus allowing the system to run LAN software or intertask communication with file and record locking. Of course, the dynamic allocation and deallocation of device drivers will operate nicely with any driver, not just those that The Software Link provides. This capability is a big plus.

General Commands

MOS is designed from the ground up as a complete replacement for PC/MS-DOS. It capitalizes on the user's knowledge of the latter by employing familiar command names and syntax. There are two basic command groups, *intrinsic* and *extrinsic*. The former are resident in \$\$SHELL.SYS and are always available in memory. Examples are *DIR*, *ERASE*, *MD*, *CD*, and so on, while the latter include *FORMAT*, *DISKID*, *FILEMODE*, and so on. The *HDSETUP* command replaces *FDISK* and allows an active partition larger than PC/MS-DOS' 32-Mbyte limit. The downside, of course, is that PC/MS-DOS will no longer operate correctly on such a partition.

Rather than listing every MOS command and its corresponding PC/MS-DOS command, let it suffice to say that MOS offers all that PC/MS-DOS has and then some. There are both an editor (sporting line- and screen-oriented modes) and a debugger. *DEBUG* has some enhancements over PC/MS-DOS' debugger. For example, a *SWAP* command allows the screen to alternately display the actual program and the debugger. In addition, you can use a terminal for *DEBUG* while running the application on the main console.

The BATCH Command

Once again, MOS builds on PC/MS-DOS by enhancing the batch processor. BATCH allows nesting of batch files. There is a command that permits changing directories within a batch file and returning to the original directory. There are also *CALL/RETURN*, *FOR IN DO*, *GO TO*, and *IF* constructs. This is not an exhaustive list, but it serves to illustrate the power of the batch processor.

Compatibility

The Software Link explains that MOS is designed to run most applications that were written to execute under PC/MS-DOS in the 8086 mode. The operating system is said to fully support the monochrome mode at all terminals, and CGA on both the main console and at remote CGA terminals (as previously mentioned, the latter is possible in theory but presently is supported only through the use of remote computers and an add-on package). EGA is supported on the main console only.

Unfortunately, The Software Link says very little about the issue of compatibility with PC/MS-DOS applications. In order to get a feel for compatibility, a shotgun approach was used, running numerous applications. In every case, text-mode applications (WordStar, Supercalc 4, dBASE III, Microsoft Word in character mode, and so on) operated flawlessly. It was a simple matter to run several of these applications simultaneously in several partitions.

Several communications programs were also tried, since the power to perform xmodem file transfers in the background while doing other tasks in the foreground is extremely useful. Procomm, Qmodem, and Pro-YAM offered no problems.

Graphics applications were a different story, however. The hardware configuration for testing includes a Tseng EVA/480 display board, which may be among the

New! Hire a Pro for Your New Turbo 4.0

Turn on the power of Turbo PROFESSIONAL 4.0, a library of more than 300 state-of-the-art routines optimized for Turbo Pascal 4.0. You'll have professional quality programs finished faster and easier.

Turbo PROFESSIONAL 4.0 includes complete source code, comprehensive documentation and demo programs that are powerful and useful. The routines include:

- Pop-up resident routines
- BCD arithmetic
- Virtual windows and menus
- EMS and extended memory access
- Long strings, large arrays, macros, and much more.

Turbo PROFESSIONAL is only \$99.

Call toll free for credit card orders.

1-800-538-8157 extension 830

1-800-672-3470 extension 830 in CA

Satisfaction Guaranteed or your money back within 30 days.

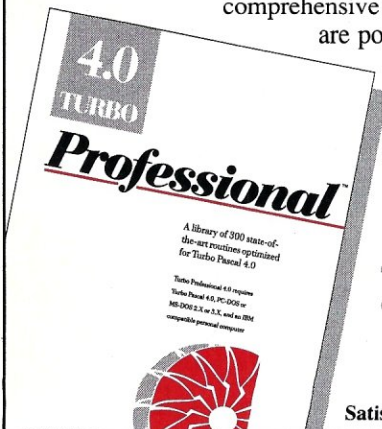

Turbo Pascal 4.0 is required. Registered owners of Turbo Professional by Sunny Hill Software may upgrade for \$30. Include your serial number.

For other information call 408-438-8608, 9 AM to 5 PM PST. Shipping & taxes prepaid for US and Canadian customers, others please add \$6 per item.



TurboPower Software 3109 Scotts Valley Dr., Suite 122 Scotts Valley, CA 95066

C and Pascal on:

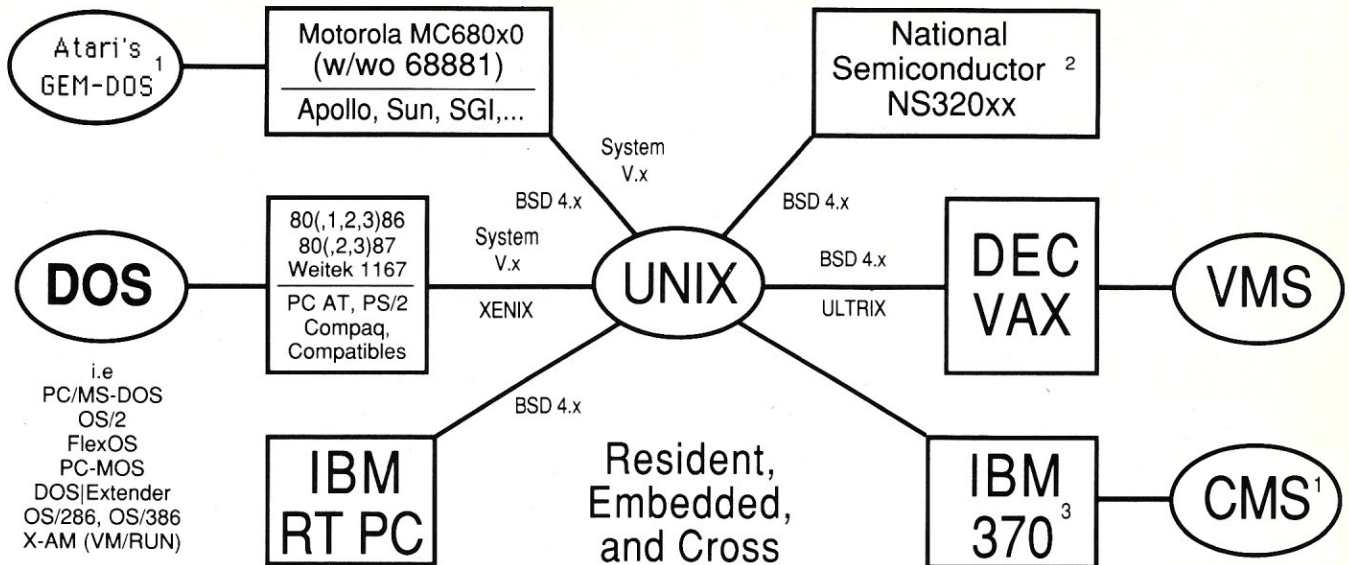

We cut our teeth on UNIX, but have become famous on MS-DOS, which we enhanced with our UNIX-like **DOS Helper™** utilities: find (including tar), fgrep, cat, ls, mv, tail, uniq, and wc; and our superior optimizing compilers:

Professional Pascal™ and **High C™** on the PC are now well-respected by organizations such as Ansa, Ashton-Tate, AutoDesk, Boeing (BCS), Daisy Systems Corp., Deloitte Haskins & Sells, Digital Research, GE, IBM, Lifetree, Migent, Multimate, NYU, Silvar-Lisco, Sky Computers, Symantec, Xerox/Ventura, ...and *Computer Language* magazine; *Dr. Dobbs' Journal*; *PC Tech Journal*; *PC Magazine*; and the *Journal of Pascal, Ada, and Modula-2*.

We supplied the **first** compilers generating **32-bit protected-mode code for the 80386** under MS-DOS (since 11/86). And our newly upgraded MS-DOS real-mode compilers were used by Symantec for their Q&A™ product to exploit the power of the 80386 real-mode instruction set. (**HC v1.4 and PP v2.7 released May 1987.**)

Our **C Validation Suite** will blow your C compiler out of the sea, while our C compiler tracks the emerging ANSI Standard and generates tighter code with far better lint-like feedback help than competing compilers.

And you'll love **Professional Pascal's** Ada-like packages, true data abstraction, C-like bit manipulation, and much more, along with the tight code that is linkable with **High C**, or other C, object modules (and vice versa).

Our **Translator Writing System (TWS)** goes far beyond LEX and YACC, with fully automatic error recovery...

All uniformly implemented on UNIX, VMS, CMS, MS-DOS, FlexOS, ...

Professional developers in need of industrial-strength tools contact:



MetaWare Incorporated
903 Pacific Avenue, Suite 201
Santa Cruz, CA 95060-4429

(408) 429-6382

Telex: 493-0879 (META UI)
PC Tech Journal's conclusion:

The Clear Choice for Large Programming Projects.

Name _____
Company _____
Address _____
City, ST _____ Zip _____
Phone (____) _____

MSJ 1187

Product:

Platform:

Circle what interests you:

PP HC TWS Helper (DOS only)

V.x 4.x DOS FlexOS VMS CMS

Sun Apollo Atari VAX 370

8086-family 80386 680x0 32032

© 1987 MetaWare Incorporated. MetaWare, High C, Professional Pascal, and DOS Helper are trademarks of MetaWare Incorporated. Others/ owners: Ada/DoD; Apollo/Apollo; Atari/Atari; DEC,VAX,VMS/DEC; FlexOS,GEM-DOS/DRI; IBM,RT PC/IBM; MS-DOS/Microsoft; Q&A/Symantec; Sun/Sun Microsystems; UNIX/AT&T.

Footnotes: 1. Atari, CMS versions available 10/87. 2. NS320xx version by special order. 3. UNIX not yet available on 370.

best of the breed of hybrid video boards, supporting monochrome text, EGA, and CGA applications virtually seamlessly under PC/MS-DOS. MOS was another story. For example, Ventura Desktop Publisher could be loaded and executed except that the lower half of the EGA screen was obliterated by a solid pattern. Autocad's menus were fine, but when the system was instructed to draw a screen, it did not display. Similarly, Microsoft Word, in its default graphics mode, crashed the system. During consultation with the MOS technical support people, they verified that cor-

rect operation of EGA applications is currently a problem, but added it is a high priority for the next release.

The package comes with a notice that all users of the first release (1.01) will be upgraded to the next version some time in the next several months, free of charge. Hopefully, this is, indeed, one of the areas that will receive attention in the next release. A pure EGA-only card might have been more successful, and a CGA-equipped machine would have certainly operated correctly with graphics applications.

In summary, MOS does not get a strong positive vote as far as compatibility with graphics applications that do work satisfactorily under PC/MS-DOS, but The Software Link will probably address this area in the next version.

Performance

I ran several benchmarks (Norton, MIPS, and Version 4 of the *PC Magazine* benchmarks) under MOS and compared them to results under PC/MS-DOS. In every case, results were identical. Of course, these tests were conducted with only one MOS partition active. The tests show that there is no unusual overhead encountered under MOS.

Summary

PC-MOS/386 is an ambitious effort on the part of a small firm to leapfrog over Microsoft and offer a protected environment operating system on the 80386. And the effort has succeeded while maximizing compatibility with existing applications. Some kinks remain in the handling of graphics applications and there are a few minor bugs in some of the commands, but in general, MOS is a successful alternative to waiting for OS/2. Multitasking and multiuser operation on a 386 is a reality.

MOS' pricing is also attractive, with the single-user version at \$195, the five-user version \$595, and the twenty-five-user version \$995. And discounted products are already appearing in the marketplace. MOS certainly bears serious investigation by all PC/MS-DOS users with 80386 systems. §

Charles Strom is Director of Laboratories and Director of Technical Services manager of the Department of Chemistry for New York University and is actively involved with microcomputer facilities development at the university. He is also the PC sysop on the GENie national time-sharing service.

TASKVIEW

ROCK SOLID MULTITASKING!

Packed with the power you need, TASKVIEW takes you beyond the limits of DOS.

- Communicate while you edit
- Compile while you print
- Load up to 5 megabytes of programs
- Manage resident utilities
- Time-slice multiple jobs
- Cut & paste between programs

TASKVIEW lets you load up to 10 of your favorite applications and switch between them at a keystroke. They can even continue to run while you work on something else! TASKVIEW is the BEST multitasker you can buy. Just ask our customers.

"Thanks for a wonderful product!"

"TASKVIEW is the only multitasker I own which runs efficiently & correctly both on my Zenith Z-151... and on my Orchid 286e... I also have DoubleDOS, DESQview, TopView, Windows, and Concurrent PC-DOS".

"Fantastic! What DoubleDOS, MS-Windows, and all the other 'stuff' should have been!"

"My BBS is now up 24 hours, 7 days a week thanks to TASKVIEW."

"Thanks! I needed that!"

TASKVIEW requires an IBM PC, XT, AT or Jr compatible, and PC or MS DOS 2.x to 3.x. To get your copy, call toll free:

(800) 367-0651

or send \$79.95 + \$3.00 S&H (\$8.00 Intl.) to:



Sunny Hill Software

PO Box 55278, Seattle, WA 98155-5278

For more information call (206) 367-0650

DoubleDOS trademark Softlogic Solutions. Concurrent PC-DOS reg. trademark Digital Research Corp., MS Windows trademark Microsoft Corp., DESQview trademark Quarterdeck Office Systems, Inc. TopView trademark IBM Corp.

Product Information

PC/MOS-386 Operating System

\$195 (single user)

\$595 (five user)

\$995 (twenty-five user)

The Software Link

3577 Parkway Lane

Atlanta, GA 30092

(800) 451-5465

(800) 387-0453 (Canada)

(404) 448-5465 (GA)

(404) 263-1006 (OEM/Int'l sales)

(404) 448-5465 (Reseller/VAR sales)

DEBUGGING SWAT TEAM

*Order Eco-C88 Rel. 4.0 New Modeling Compiler
and get C-more at no extra charge!*

Seek and Correct

You already know that fast compilation does not mean fast program development. Backing up for bogus error messages and removing the bugs takes time. Eco-C88's "Seek and Correct" three-way error checking finds even the most elusive bugs, clearing the path for swift program development.

Double Barrel Error Checking

Eco-C88 nails **syntax errors** cold and tells you about the error in plain English. And there's no avalanche of false error messages, either. Other compilers can generate up to four times the number of error messages actually present; they leave it up to you to guess which ones are real. You'll be more productive with Eco-C88 because there is no guess work.

Eco-C88 provides ten levels of **semantic error** checking. You can select from almost no checking to the fussiest you've ever seen. Eco-C88's "picky flag" finds subtle errors that slip by other compilers.

Eco-C88 also features:

- All data types, plus ANSI Enhancements
- Robust library, including many new ANSI functions
- CED editor with online function help, split windows, compile-edit-link capability
- New, expanded manual with sample programs for the library functions

C-more Source Code Debugger

Finally, if a really nasty bug persists, put C-more, our source code debugger, to work. With C-more you can watch your program as it executes, single-step it, set simple or conditional breakpoints, test complex expressions, use variables as indexes into other variables, initialize and trace variables, examine CPU registers, display results with printf()-type options and much more. C-more can help you track down bugs in minutes rather than days.

The price for Eco-C88 is \$99.95. And, for a limited time, we'll give you our C-more debugger at no extra charge.

Ecosoft Inc.

6413 N. College Ave.
Indianapolis, IN 46220

(317) 255-6476 (Tech Info)
(800) 952-0472 (Orders)

Memory Options

Model	Code Size	Data Size
Small	64K	64K
Compact	64K	1 Meg
Medium	1 Meg	64K
Large	1 Meg	1 Meg

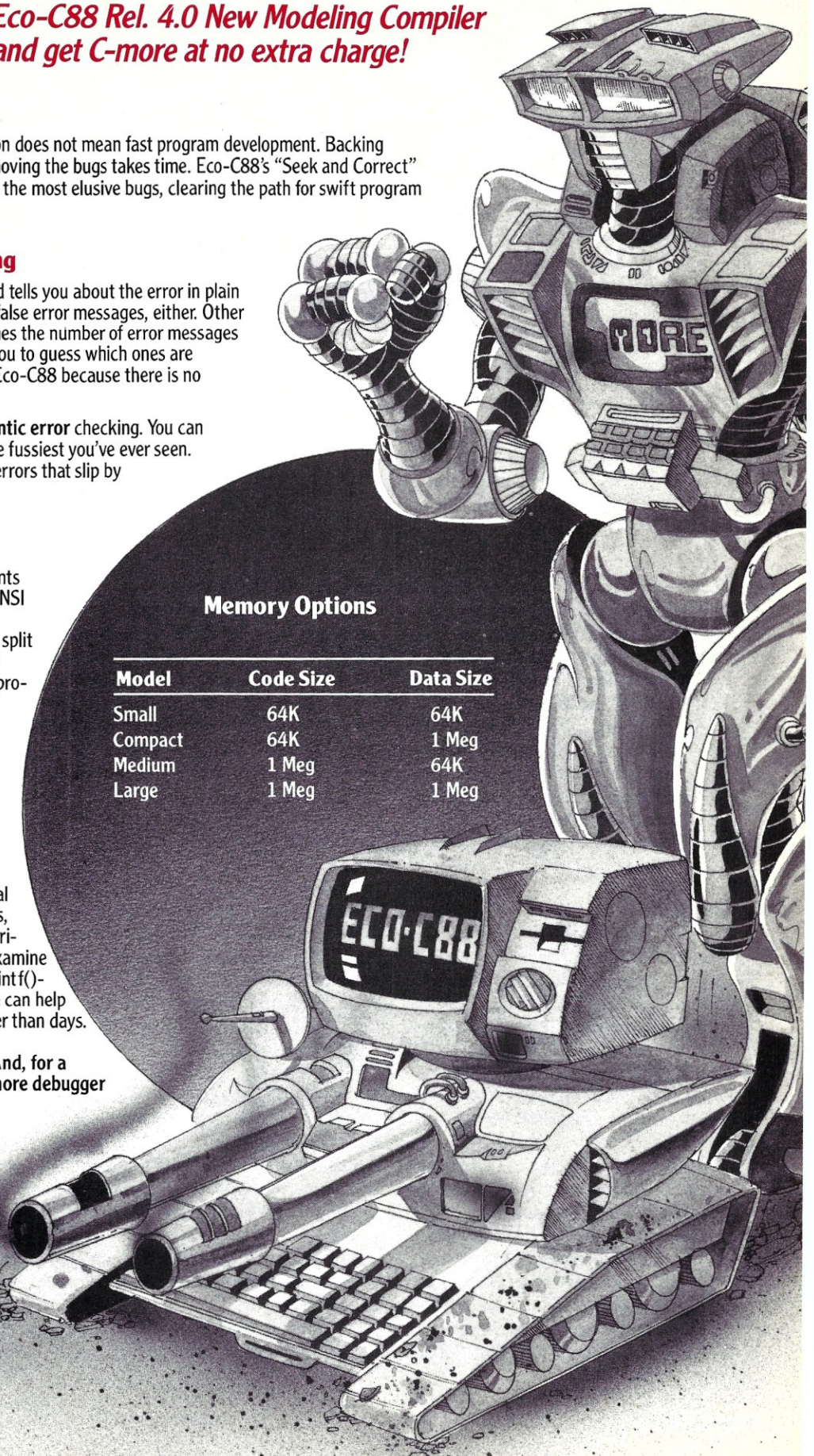

Intel's iSBC 386AT

by Jeff Duntemann

A lot of people (myself included) were surprised at the speed with which the mail-order clone companies began offering 32-bit 80386 systems. Behind the surprise was the fact that Intel had quietly begun shipping OEM quantities of its iSBC 386AT motherboard. The iSBC 386AT, installed in an AT-clone cabinet, allows a highly IBM compatible 386 machine to be assembled with virtually no engineering. Many mail-order 386 compatibles incorporate the board, which is also available via some Intel distributors.

Overview

The iSBC 386AT has the same physical dimensions as the IBM PC/AT motherboard. It can thus be installed in any case designed for IBM PC/AT or compatible motherboards. The iSBC 386AT has $512K \times 8$ of socketed RAM that runs with effectively one wait state at both the 16-MHz and 6-MHz processor clock rates. It contains eight expansion slots: two 8-bit PC-compatible slots, four 16-bit AT-compatible slots, and two 32-bit slots of Intel's own design (and used nowhere else to my knowledge). The 32-bit slots will accept 8-bit cards but are keyed to prevent insertion of 16-bit cards. While the 32-bit slots operate at the full 16-MHz clock rate, the 8- and 16-bit slots operate at 8 MHz. Up to 16 Mbytes of RAM may be installed on the bus. The AT-compatible ROM BIOS is

from Phoenix Technologies.

An AT-compatible keyboard may be plugged into the DIN-style keyboard connector. A CMOS battery-operated real-time clock chip also contains 50 bytes of nonvolatile RAM to hold setup information during power-down periods. Unlike the IBM PC/AT, there are RS232C serial and Centronics-compatible parallel ports on the board.

Memory Architecture

Over the past year or two, the speed of processors has begun outrunning memory systems. The absurdity of cranking up a 4.77-MHz PC to 9.54 MHz and then throttling the effective clock speed back to 6 MHz by adding wait states is only now being recognized. The key to machine performance is not CPU speed but memory architecture and access time.

IBM's PC/XT-286 appears to operate much more quickly than its 6-MHz 80286 processor would suggest because it is running its memory system without wait states. Both the 6-MHz and 8-MHz PC/AT's run with one wait state, and most *turbo* boards without on-board memory that are sold for the 8-bit PC/XT bus add two or more wait states to allow the fast CPU to work with the much slower XT bus and memory.

A wait state is simply an extra bus access cycle requested of the CPU by exter-

nal hardware. This extra cycle merely provides a pause while the memory system (or some other system running more slowly than the CPU) does what it must and catches up to the CPU.

The relationship between clock speed and wait states is not a simple one. In order to operate at 16 MHz with zero or one wait state, the 80386 would require very fast DRAM in the 50–60 ns range. DRAM chips with access times of less than 100 ns are still premium parts and very expensive by microcomputer standards.

To keep the price of the memory system down, more cleverness is required of the memory system. The iSBC 386AT's memory system takes advantage of the reason why wait states are necessary to begin with: DRAM refresh. Once you read data from a DRAM, you must allow a period of time to pass before reading it again to *refresh* it at least once between reads.

The iSBC 386AT memory system is split into two banks, and successive 32-bit (4-byte) blocks of memory alternate between the two banks. In other words, Bank A contains memory locations 0–3, Bank B contains memory locations 4–7, Bank A contains memory locations 8–11, Bank B contains memory locations 12–15, and so on, with every other 32-bit block of memory belonging to every other memory bank. Since the 80386 fetches memory from the bus 32 bits at a time, successive

FOR YOUR PC 20,000 FILES

— AS CLOSE AS YOUR MODEM —
BBS 414-964-5160

Exec-PC, the country's largest electronic Bulletin Board System (BBS), has the most extensive online collection of software available anywhere. Yours for the asking.

What the magazines say: "... *The biggest, meanest, most oft-dialed and technologically audacious BBS this side of Silicon Gulch.*"

Milwaukee Magazine, June 1987.

"*Exec-PC, the bulletin board answer to SuperStation WTBS, connects PC users continents apart. The big board caters to business PC users, many of whom treat it 'as a dirt-cheap [PC] consulting service,' according to system operator Bob Mahoney. 'Some of the foremost experts in the country call this system,' he says. Exec-PC's storehouse includes 20,000 public domain programs, ten conference areas ranging from CAD to hardware acceleration, and some of the slickest conferencing and electronic mail (E-mail) software to scroll across a screen.*"

Reprinted by permission of *PC World*, 501 2nd St. Suite 600, San Francisco, CA 94107, Vol. 5 issue 7, July 1987 p. 72

(Note: We now have 20 conference areas.)

WHAT YOU COULD HAVE

Would you like public domain and shareware word processor programs, communications programs, or excellent database management systems? How about personal money managers, or General Ledger programs? If that is not enough, look at the 1000 games and 7500 free business oriented programs, utilities, tutorials, and reviews. This gives you everything from hard disk reorganization and backup to stock market management systems. We also maintain the *entire PC-SIG collection* online, the 800+ diskette collection of public domain software from California.

WHO HAS IT?

Exec-PC owns and operates the nation's largest electronic Bulletin Board System. Through our BBS, our huge software collection is available to anyone who has access to a modem and a telephone line. We have more than 20,000 individual files available for immediate download to your computer, 24 hours a day, every day.

WHAT IT IS

The BBS consists of a large computer with BIG disk drives (more than 1 gigabyte!) and many phone lines connected to it. The computer currently has 32 phone lines, allowing it to talk to 32 callers at once. It receives about 700 calls per day. Using the BBS is easy, since it is menu driven and you simply choose what you want to do.

WE SURE HAVE FILES

A typical user will call the BBS, ask the BBS to show what files are new since his or her last call, find files of interest, then transmit those files across the phone line. After hanging up, the caller can examine and use the new software.

WE SURE DO TALK

Our BBS also has an active conference system where hundreds of people share ideas and solutions. Some conferences include: PC General Topics, Communications, For Sale, Programming, Desktop Publishing, LAN, Graphics, Hardware Speedup, PCjr, CAD/CAM, Private e-mail, etc. Why pay expensive consultants when there are hundreds of experts available in our forums and conferences?

HOW DO I ACCESS THE SYSTEM?

The Exec-PC BBS is available through either direct dial-up, or through a new service called Telenet PC Pursuit. Long distance callers enjoy PC Pursuit because it allows unlimited long distance calling for \$25 per month. The PC Pursuit service is offered by GTE/Telenet. Contact them at 1-800-835-3638.

HOW TO CALL THE EXEC-PC BBS

1. Set your asynchronous modem for any speed up to 2400 baud.
 2. Start up your communications program.
 3. Dial 414-964-5160.
 4. Hit a few carriage returns to tell the BBS you are there.
- The BBS will ask for your name, then you will be guided into the menus.

IT IS FREE, BUT

You can call the BBS at any time without registering. You can tour the system, read messages, and download some of our files. For greater access privileges you may register at the following rates: \$15 for 3 months or \$45 for one year. You may subscribe online with VISA or MC, or by credit card, check or money order with the form below. Paid registration allows one hour of full access per day.

Exec-PC, Inc.

P.O. Box 11268 Shorewood, WI 53211

Voice Orders 414-242-2173 **BBS 414-964-5160**



Exec-PC BBS Registration Form

BBS 414-964-5160

TO: Exec-PC, Inc. • P.O. Box 11268 • Shorewood, WI 53211

YES! Register me on the Exec-PC BBS for full access to the country's largest collection of PC software plus thousands of informative messages and conferences.



1 Year \$45

3 Months \$15

Check Enclosed

Visa

MasterCard

Credit Card Account # _____

Expires ____/____

Name _____ date _____

Company (optional) _____

Street _____

City _____ State _____ Zip _____

Telephone (_____) _____

Name you will use for Logon to BBS (required)

First _____ Last _____

Four Character Password _____

memory accesses will alternate banks. This allows the 386 to read 32 bits from Bank A, and then immediately read another 32 bits from Bank B, because while Bank B is being accessed, Bank A can be refreshed. When it is time for the third access to be made, Bank A has been refreshed and is ready to be accessed.

This alternate-bank system allows the use of 120 ns DRAM at 16 MHz with only one wait state. The DRAM chips are 64K × 4, with each bank arranged as 256K × 8. This setup is the reason why there is only 512K and not 640K DRAM on the board. The alternate-bank system requires two identical banks of DRAM, but there is no convenient way to create two 320K banks of DRAM without covering the motherboard with 64K chip sockets. This is a serious problem, as I will describe in more detail below.

The 80386 CPU contains another trick called *address pipelining*, which essentially puts the next address out on the bus while data at the current address is still being fetched. Address pipelining allows the slower memory system to get a head start on the next memory read if the next read is in the alternate or *nonbusy* memory bank.

The downside of this memory system trickery is that it is not possible to flatly state that the memory system runs with one or two or any number of wait states. Normal code tends not to be consistent in accessing memory neatly in alternate 32-bit chunks, and successive accesses to the same bank trigger a three-wait-state penalty. For example, the 80386's prefetch queue, when active, always reads 32-bit blocks from alternating memory banks. If a register-intensive code sequence is running and the 80386's prefetch queue is constantly in use, the system will run with one wait state. However, as soon as the prefetch queue must be purged (for example, if a jump instruction is executed) the situation becomes much more complicated. Remarkably, the repeating string instructions set off a veritable explosion of wait states, especially the STOSB and MOVS instructions that write sequential data 1 byte at a time, because they write four times in succession within a single memory bank. In practice, the number of wait states on the bus depends heavily on the nature of the code being executed, but the chances of incurring a wait-state penalty above the normal one wait state are about 50 percent.

The iSBC 386-AT contains two 32-bit expansion slots of Intel's own design.

Table 1. Performance Tests

Peter Norton's SI Utility rates the iSBC 386AT at 18.7. The best single-value benchmark, however, is Landmark Software's SPEED which takes memory system performance into account, and which rates the iSBC 386AT at 15.6, a rough equivalent to the IBM PC/AT running at 15.6 MHz.

A PERFORMANCE SUMMARY	
Landmark SPEED	15.6 MHz AT equivalent 8.3 times PC/XT performance
Peter Norton's SI Utility	18.7

PC Labs' benchmarks below substantiate my own findings with regard to memory/memory compilation performance. (I compiled a 740-line Turbo Pascal source file for a "whereis" utility in 7.4 seconds going from memory to memory on a PC, and in 1.8 seconds on the iSBC 386AT.)

TEST	TIME IN SECONDS	SPEED INDEX RELATIVE TO 4.77 MHz PC	SPEED INDEX RELATIVE TO 8.0 MHz AT
1. 128K NOP loop	2.09	4.8	2.0
2. Do-nothing loop	1.87	5.3	2.0
3. Integer add loop	1.10	9.0	1.9
4. Integer multiply loop	0.66	15.2	1.8
5. String sort and sort	1.59	6.7	1.8
6. Prime number sieve	1.98	7.8	2.1
7. 8086/8088 instruction set	4.94	6.5	1.8

Chips & Technologies MIPS seems to indicate that the iSBC 386AT has the same speed as an 8-MHz IBM AT, which simply isn't the case. In general, benchmark tests are poor substitutes for loading real applications. My favorite is Microsoft Windows, which runs faster on the iSBC 386AT than on anything without a 386.

	IBM XT 4.77 MHz	IBM AT 8.0 MHz	COMPAQ 386	INTEL 386 AT
1. General instructions	6.48	1.88	0.95	1.07
2. Integer instructions	14.08	2.19	0.96	2.35
3. Memory to memory	5.48	1.69	0.94	1.30
4. Register to register	17.81	2.31	0.97	3.20
5. Register to memory	5.68	1.71	0.94	1.75
6. Performance rating	8.05	1.94	0.95	1.93

These slots are actually expansions of the PC/XT-style 8-bit bus rather than the PC/AT's 16-bit bus. Eight-bit expansion boards may be plugged into the forward portion of a 32-bit slot, but, as noted earlier, the slot is keyed to prevent insertion of a 16-bit board.

The 32-bit extension is little more than the 80386's 32-bit addressing machinery brought from the CPU chip to the bus. The 32-bit slots are obviously intended for memory boards rather than other peripherals, which stand to gain little from being redesigned as 32-bit devices. Intel sells a 2-Mbyte, one-wait-state memory board for these slots, and very recently Fortron Corporation has begun offering a similar 2-Mbyte board for the Intel 32-bit bus. This latter allows up to 4 Mbytes of 32-bit RAM, using currently available expansion boards. Intel has announced but has not yet shipped an 8-Mbyte, 32-bit RAM board for the 32-bit bus. These boards offer the same alternate-bank structure and address pipelining features used on the motherboard, and are otherwise similar except that they are extended memory rather than real-mode memory and cannot be mapped into the lower 640K.

This leads us to the single largest defect of the iSBC 386AT design: There is no way to install true 32-bit RAM between the 512K and 640K boundaries. The motherboard sockets cannot be reconfigured for other types of chips, and the 32-bit boards can be used only as extended RAM past 1 Mbyte. The only way to make the board into a 640K system is to fill the missing 128K with a 16-bit expansion board in one of the 16-bit slots. A number of 128K short-slot memory boards were designed to fill out the original PC/AT's 512K RAM system to 640K (the name TophAT comes to mind), and these will work here.

The problem is that the 80386 is really designed for 32-bit memory fetches, and 16-bit boards can only output one 16-bit word, rather than one 32-bit word per access. It thus takes the 386 at least twice as long to read the same number of bytes from 16-bit RAM. And if that were not problem enough, the iSBC 386AT operates its 8- and 16-bit slots at an effective clock rate of 8 MHz to allow full hardware compatibility with boards designed for the standard PC/AT. Finally, neither alternate-banking nor address pipelining work for 16-bit memory. Accesses to 16-bit memory installed on the bus can take as much as five times as long as comparable accesses to true 32-bit memory.

The memory organization of PC-DOS Version 3 aggravates the situation further from an operational standpoint. DOS and RAM-resident utilities are loaded into low-memory, below transient applications. The more resident utilities you load, the higher into memory your transient programs get bumped. Ultimately, the lion's share of your fast 32-bit RAM is taken up by DOS and resident programs that execute only rarely, while the bulk of executing code in your transient application may venture above 512K and slow the effective speed of the machine to a relative crawl.

From a memory perspective, the iSBC 386AT would be best applied as a 386 native mode machine, running native mode applications in memory above 1 Mbyte. As native mode operating systems for the 386 are quite new and as yet unproven, little software is available for them, and this promise must, for now, go unfulfilled.

Math Coprocessor Module

The iSBC 386AT contains a socket for the 80387 math coprocessor. The 80387 is the 80386's partner in floating-point math, and is only now becoming available. To fill the gap, Intel has been offering SBCMath, a small daughterboard that plugs into the 80387's pin grid array (PGA) socket. SBCMath contains a 10-MHz 80287 coprocessor, with glue logic to make the 287 electrically equivalent to a 387. Intel says little about the SBCMath module other than that it operates at 10 MHz, asynchronously to the CPU. The company also does not promise that the daughterboard's performance will be equivalent to that of a real 387. The boost in calculation speed is significant, however, when 8087/287/387 knowledgeable code is run on the board. No 80387 was available for comparison, but SBCMath was tested in conjunction with this review.

Intel has disclosed a compatibility problem between the 387 and 386 on early production motherboards. The affected boards carry the number 149422-0XX or 137406-0XX. These boards, however, do work with the SBCMath 80287 coprocessor module.

Setup and Configuration

The iSBC 386AT's electrical design is not impressive. The lack of custom LSI means that the board is tightly packed with ordinary DIP devices, and a truly appalling number of jumper wires was used on all of the boards I examined. Worst of all, no DIP switches are used to facilitate hardware configuration. Instead, no fewer than

14 separate header pin groups are scattered across the board, and default configurations are set by jumpering the pins with shorting blocks.

The jumpers specify things such as the power-up default monitor type, enable/disable keyboard reset, the enable/disable serial and parallel ports, the number and type of extended RAM boards, serial port IRQ number, and coprocessor presence or absence. Although most of these conditions will change only rarely, some of them (such as the default monitor type) change often enough to make locating and changing the shorting blocks an intrusive nuisance. Furthermore, some of the header pin groups are located beneath the mass of cables running to the disk drives and are difficult to change without pulling the machine completely apart.

Once the power-up default conditions are set with the shorting blocks, however, setup of other system parameters is done AT-style, using a SETUP utility provided with the iSBC 386AT. SETUP allows the battery-sustained clock/calendar chip, the diskette drive number and types, the fixed disk number and types, the base and expansion memory, and the installed display adapter to be set. SETUP understands an impressive 47 different fixed disk drives, with capacities up to 127 Mbytes. The list is large, but no facility is included for entering specs for a drive type that is not yet part of the list. If you have an unlisted drive, it may run poorly or not at all if you install it as a drive with close but not identical specs.

The Phoenix ROM BIOS supports the peculiarly named *deturbo* mode, an effective 6-MHz slowdown of the system clock that is included to accommodate sensitive copy-protection schemes. Effective clock speed may be toggled between 6 and 16 MHz with the Ctrl-Alt-1 (keypad) and Ctrl-Alt-2 (keypad). Again, these hot key codes are fixed in ROM and cannot be changed. The speed may also be changed under program control by outputting a control value to I/O port 64h.

Software Compatibility

The iSBC 386AT is extremely IBM compatible from a software perspective. The failures I observed were universally due to copy-protection schemes. Most schemes that failed at 16 MHz passed when the board was throttled down to 6 MHz. The exceptions were boot-only games, since the boot operation must always occur at 16 MHz. Interestingly, one boot-only game that booted at 16 MHz ran in the

same way at 16 MHz as at 4.77 MHz: Gerald Kuperberg's venerable J-Bird. Kuperberg is apparently one of the few game designers clever enough to design CPU speed *out* of his code.

The list of business and software development products that I ran successfully on this machine over a six-month period is long indeed, and the following is only a part: all Borland products, Microsoft Windows, C, Pascal, Quick BASIC, GEM, Ventura Publisher, In-A-Vision, Lotus 1-2-3, Framework II, Crosstalk XVI, Word Perfect, Wordstar, Paradox, Smalltalk V, Personal T_EX, Logitech Modula 2, and Halo DPE. In general, my experience would imply that any non-copy-protected PC-DOS business application that will run on an 8-MHz AT will run on the iSBC 386AT. Games and very low level developer's tools might not.

Quarterdeck Office Systems' DESQview, in its latest release, offers support of the 80386's virtual 86 mode, and allows as many DOS partitions as memory will support, with very effective text windowing. DESQview installed easily and ran without incident.

Far more interesting, if somewhat more sensitive, is the Software Link's PC MOS/386, a true native mode 386 operating system that does not require DOS to be present. Rather, it replaces DOS with a native code 386 operating system that shares a compatible API with PC-DOS 3.1. PC MOS introduces a speed penalty somewhat like that of Xenix: noticeable but not crippling. This is to be expected, since the copy I tested supports up to five users and any reasonable number of tasks.

PC MOS/386 took some tinkering to install, but once installed it ran fairly well. Now and then, however, the system simply "went away," implying that the product has not yet reached maturity.

Hardware Compatibility

Hardware compatibility is a more difficult test to pass, since board products are more timing sensitive than software. Even with a bus that operates at an equivalent clock speed of 8 MHz, 386 timing is different enough to cause problems. The Periscope Submarine board and Tall Tree Systems' JLASER both caused problems that the vendors admitted were unavoidable in current releases.

Board products that ran without incident included the Bernoulli Box 10 × 10 controller, Microsoft and Logitech Mouse bus cards, Paradise Autoswitch EGA, MDS Genius VHR video controller, IBM's

Game Control Adapter, Tecmar's Graphics Master, D.C. Hayes' 1200B internal modem, and a number of "generic" clone boards containing extended RAM and serial or parallel ports. Several AT-style disk controllers also worked well. Peripherals such as printers, plotters, modems, and mice that operate through standard serial and parallel ports should work without difficulty. Table 1 summarizes all the performance tests.

Conclusion

The iSBC 386AT advantages are that it is fast and can run *hypervisors* like DESQview that allow you to turn ordinary applications into resident applications by putting each in its own virtual 86 partition. True native mode reliable multiuser operating systems such as PC MOS/386, Concurrent DOS-386, and Xenix are now available for the 386, and if you need multiuser ability, the iSBC 386AT is a contender.

As a real-mode superfast AT-compatible, however, the board has an extremely serious shortcoming: It can contain only 512K of fast 32-bit RAM. If you need 640K, you will bleed away the greater part of the CPU's speed advantage in a torrent of wait states and inefficient 16-bit memory accesses every time code is executed above 512K.

Also, the 32-bit extended memory boards are expensive and hard to find. Intel offers a 2-Mbyte extended memory board and has promised an 8-Mbyte board, but has made no effort to market the memory boards widely. At the Spring Comdex Exposition, Fortron Corporation was showing a \$700 2-Mbyte board for the Intel 32-bit bus, but it was not available in time to be evaluated here.

Minor problems, such as jumper blocks all over the board, imply that the board was never really intended to become a mass-market product. Rather, it resembles more strongly the engineering evaluation boards from microprocessor companies.

Better 80386-based motherboards will soon be available (for example, the ALR 386/2 and ZEOS International units) based on the Chips & Technologies' 386 AT Chipset. At its current street price of \$2000, the iSBC 386AT is no longer especially competitive. §

Jeff Duntemann has written about the microcomputer industry since 1977. He is the author of Complete Turbo Pascal and Turbo Pascal Solutions, and is Editor in Chief of Turbo Technix Magazine.

Where to Buy the Intel iSBC 386AT Board

The Intel iSBC 386AT motherboard is sold by most electronics parts distributors that distribute Intel components.

The board is also available from several PC board-level product vendors, including:

Compubyte Inc.

236 German Blvd.
Yaphank, NY 11980
(516) 924-1618

Sabet Electronics

2644 Forest Grove Dr.
Richardson, TX 75080
(214) 644-8306

386 Corp.

14126 Sherman Way,
Ste. 562
Van Nuys, CA 91405
(818) 904-1386

The Intel iSBC 386AT motherboard is also used in systems offered by several mail-order vendors, including:

Corvus Systems Inc.

160 Great Oaks Blvd.
San Jose, CA 95119
(408) 281-4100

Eltech Research Inc.

1725 McCandless Dr.
Milpitas, CA 95035
(408) 942-0990

KayPro Corp.

533 Stevens Ave.
Solano Beach, CA 92075
(800) 452-9776

Laser Digital

1024 Morse Ave.
Sunnyvale, CA 94086
(800) 846-4225,
(408) 747-1966 in CA

Lolir Computer

13933 N. Central #212
Dallas, TX 75243
(214) 234-8056

PC Discount

2758 Bingle Rd.
Houston, TX 77055
(800) 843-7042

THE PROGRAMMER'S SHOP

helps save time, money and cut frustrations. Compare, evaluate, and find products.

RECENT DISCOVERY

OS/286 & 386 - Access 16M RAM in 286, 386 native mode. DOS interface, access. Use existing compilers or 32-bit FORTRAN, C, PASCAL. PC \$ 495

AI-Expert System Dev't

Arity Combination Package PC \$ 979
 System - use with C MS \$ 229
 Auto-Intelligence PC \$ 739
 CxPERT - shell for C MS \$ 259
 Experteach - Powerful, samples PC \$ 339
 Exsys PC \$ 289
 Level 5 MS \$ 659
 Intelligence/Compiler PC \$ 739
 T.I.: PC Easy PC \$ 435
 Personal Consultant Plus PC \$2589
 Turbo Expert-Startup (400 rules) PC \$ 129
 Corporate (4000 rules) PC \$ 359

AI-Lisp

PC Scheme LISP - by TI PC \$ 85
 Star Sapphire MS \$ 459
 TransLISP - learn fast MS \$ 79
 TransLISP PLUS MS \$ 149
 Others: IQ LISP (\$239), IQC LISP (\$269)

AI-Prolog

APT - Active Prolog Tutor - build applications interactively PC \$ 49
 ARITY Prolog - full, 4 Meg Interpreter - debug, C, ASM PC \$ 229
 COMPILER/Interpreter-EXE PC \$ 569
 MicroProlog Prof. Comp./Interp. MS \$ 439
 Prolog-86 - Learn Fast MS \$ 89
 Prolog-86 Plus - Develop MS \$ 199
 TURBO PROLOG by Borland PC \$ 69

Basic

BAS_C - economy MS \$ 179
 BAS_PAS - economy MS \$ 135
 Basic Development System PC \$ 105
 Basic Development Tools PC \$ 89
 Basic Windows by Syscom PC \$ 95
 BetterBASIC PC \$ 129
 Exim Toolkit - full PC \$ 45
 Finally - by Komputerwerks PC \$ 85
 Inside Track PC \$ 49
 Mach 2 by MicroHelp PC \$ 55
 QBase - screens MS \$ 79
 QuickBASIC PC \$ 69
 Quick Pak-by Crescent Software PC \$ 59
 Quick-Tools by BC Associates PC \$ 109
 Stay-Res PC \$ 59
 True Basic PC \$ 79
 Turbo BASIC - by Borland PC \$ 69
 Turbo BASIC Database Toolbox MS \$ 69

FEATURES

XENIX 386 Toolkit by Santa Cruz. Tools & OS kernel support 4 Gigabyte address space, demand paging, virtual memory paging. Includes MSC, MASM, debugger, file utilities, more. PC \$ 379

HUMMINGBOARD 386-Develop 2.6 or 7.9 times faster than a 8 MHZ AT, AT or XT addin board uses dual processors for Speed and Hardware Debugging. 16 MHZ or 20 MHZ. Call about Benchmarks, Trial Program.

"FREE" Software

Instant Programmer's Help for MSDOS developers by Second City Software. Memory-resident (TSR) utility lets you access valuable programmer's reference material from within any program. OS services, BIOS calls, ASCII codes, line and box drawing characters, video modes, keyboard scan codes, interrupts, 8088 assembly language, memory maps, FCB.

Normally \$79. With any order over \$250 by 11/30/87 get **Instant Programmer's Help** (with 2-month life span) **FREE**.

Our Services:

- Programmer's Referral List
- Compare Products
- Help find a Publisher
- Evaluation Literature FREE
- BBS-7 PM to 7 AM 617-740-2611
- Dealers Inquire
- Newsletter
- Rush Order
- Over 700 products
- National Accounts Center

C Language-Compilers

AZTEC C86 - Commercial PC \$499
 C86 PLUS - by CI MS \$359
 Datalight C - fast compile, good code, 4 models, Lattice compatible, Lib source. Dev'rs Kit PC \$ 77
 Datalight Optimum - C MS \$ 99
 with Light Tools by Blaise PC \$168
 Lattice C - from Lattice MS \$269
 Let's C Combo Pack PC \$ 99
 Microsoft C 5.0- Codeview MS \$275
 Microsoft Quick C MS \$ 69
 Rex - C/86 standalone ROM MS \$695
 Turbo C by Borland PC \$ 69

C Libraries-Files

C Index by Trio/PLUS MS \$319
 BTree by Soft Focus MS \$ 69
 CBTREE - Source, no royalties MS \$ 99
 CTree by Faircom - no royalties MS \$315
 rtree - report generation PC \$239
 dB2C Toolkit V2.0 MS \$249
 dbQUERY - ad hoc, SQL-based MS Call
 dbVISTA - pointers, network. Object only - MSC, LAT, C86 Call
 Source - Single user MS Call
 dBx - translator to library MS \$299

C-Screens, Windows, Graphics

C Worthy Interface Lib. PC \$249
 Curses by Aspen Scientific PC \$109
 dBASE Graphics for C PC \$ 69
 ESSENTIAL GRAPHICS - fast PC \$185
 FontWINDOW/PLUS PC \$229
 Graphic C - new color version PC \$279
 Greenleaf Data Windows PC \$159
 w/source PC \$269
 Light WINDOWS/C-Datalight C PC \$ 79
 TurboWINDOW/C - for Turbo C PC \$ 79
Windows for C - fast PC \$189
Windows for Data - validation PC \$319
 Vitamin C - screen I/O PC \$159
 View Manager - by Blaise PC \$199
 ZView - screen generator MS \$129

Atari ST & Amiga

We carry full lines of Manx & Lattice.

Call for a catalog, literature and solid value

800-421-8006

THE PROGRAMMER'S SHOP™

Your complete source for software, services and answers

5Vi Pond Park Road, Hingham, MA 02043
 Mass: 800-442-8070 or 617-740-2510 9/87

RECENT DISCOVERY

ACTOR by Whitewater Group - Graphic, object-oriented language for prototyping, interactive programs and MS Windows applications. Fast feedback, integrated editor, debugger. Call to multiple languages. PC \$419

DBASE Language

Clipper compiler PC \$399
 dBASE II MS \$329
 dBase III Plus PC \$429
 dBASE III LANPack PC \$649
 DBXL Interpreter by Word Tech PC \$139
 FoxBASE+ - single user MS \$349
 Quicksilver by Word Tech PC \$439

DBASE Support

dAnalyst PC \$ 89
 dBase Tools for C PC \$ 65
 dBrief with Brief PC Call
 dBC ISAM by Lattice MS \$169
 Documentor - dFlow superset MS \$229
 Genifer by Bytel-code generator MS \$279
 QuickCode III Plus MS \$239
 R&R Report Generator MS \$139
 Seek-It - Query-by-example PC \$ 79
 Silver Comm Library MS \$139
 Tom Rettig's Library PC \$ 79
 UI Programmer - user interfaces PC \$249

Fortran & Supporting

50:More FORTRAN PC \$ 95
 ACS Time Series MS \$465
 I/O Pro - screen development PC \$129
 MS Fortran - 4.0, full '77 MS \$279
 No Limit - Fortran Scientific PC \$109
 PC-Fortran Tools - xref, pprint PC \$165
 RM/Fortran MS Call
 Scientific Subroutines - Matrix MS \$129

Multilanguage Support

BTRIEVE ISAM MS \$185
 BTRIEVE/N-multiuser MS \$455
 GSS Graphics Dev't Toolkit PC \$375
 HALO Development Package MS \$389
 Graphics PS \$205
 Hoops Graphics Library PC \$549
 Informix 4GL-application builder PC \$789
 Informix SQL - ANSI standard PC \$639
 NET-TOOLS - NET-BIOS PC \$129
 Opt Tech Sort - sort, merge MS \$ 99
 PANEL MS \$215
 Panel Plus MS \$395
 Pfinish - by Phoenix MS \$229
 Polyboost - speed I/O, keyboard PC Call
 Prime Factor FFT - 8087/287 PC \$145
 PVCS Corporate or Personal MS Call
 QMake by Quilt Co. MS \$ 79
 Report Option - for Xtrieve MS \$109
 Screen Sculptor PC \$ 89
 SSP/PC - 145+ math routines PC \$269
 Synergy - create user interfaces MS \$375
 Xtrieve - organize database MS \$199
 ZAP Communications - VT 100 PC \$ 89

FEATURE

HI-SCREEN XL - unlimited overlapping windows, pull-down, popup, Lotus menus, on-line help support. Field checking, scrolling. Screen capture, more. Multi-language support. PC \$129

Note: All prices subject to change without notice. Mention this ad. Some prices are specials. Ask about COD and POs. Formats: 3" laptop now available, plus 200 others. UPS surface shipping add \$3/item.

Program Interfacing to Microsoft Windows

by William Wong

Part VI— Conclusion

This series of articles has a twofold purpose. First, its intent is to give readers considering purchasing the Microsoft Windows Toolkit and writing a Windows application an insight into what is involved. Its second purpose is to help readers who have purchased the Toolkit or attended a Microsoft Windows seminar to write a typical application.

This final article of William Wong's series on interfacing to Microsoft Windows gives an overview of the major features not yet presented. Complete coverage of each feature would require a much longer article. Currently, the only book available on programming with Windows is *Windows Programming Secrets* by Kris Jamsa, published by Osborne/McGraw-Hill, Berkeley, Calif., although Microsoft will shortly release a book by Charles Petzold. The Microsoft Windows Programmers Toolkit is another good source of information.

Menus and Dialog Boxes

Menus and dialog boxes are the most apparent common items between applications. Windows helps by providing support in a standard fashion, making applications easy to learn once users understand the basic Windows interface.

Menus and dialog boxes are resources created by the resource compiler program, RC. The text input to RC was described in Part II (*MS/J*, March/April 1987) of this series. It can be created by using a text editor or by using the dialog editor program, DIALOG. The dialog editor provides a graphic interface showing what a dialog box will look like.

Each item in a dialog box can be identified, and its status can

be queried by an application. A dialog box is displayed using a Windows function that handles the interaction with the user. Applications can use additional hooks to modify this interaction as necessary. In fact, an item in a dialog box, such as a button, is a child window in which the item is drawn.

Menu bars and pull-down menus are created in a similar fashion. There is a limit to what a pull-down menu can contain and the menus do not have to be used. It is up to the application to provide the interaction necessary for its operation.

The main limitation of menus and dialog boxes is that they are bound to an application, and dynamically loading a menu from a different file is a complex procedure.

Dialog boxes and menus simplify programming under Windows; they also make programs look and feel as though they are part of Windows.

Memory Management and Atoms

Windows provides memory management at two levels: local and global. Local memory management is similar to that found in C and DOS, in which a single contiguous space is managed. A local heap is contained within a global data segment and is accessible to a single instance of a Windows application program. A global heap is a collection of segments in the memory made available to Windows when it starts.

Memory blocks or segments are referenced using handles or pointers. The latter can be used only when a block is locked. Blocks can be FIXED, MOVABLE, or DISCARDABLE. C provides the idea of a FIXED memory block that will never move. Windows provides the idea of MOVABLE blocks. A MOVABLE block can change positions during a garbage collection operation, which is normally invoked when a new block needs to be allocated and there is not enough memory available. Windows first moves all MOVABLE blocks to one end of the allocation area and tries to fulfill the memory request. If this fails, Windows starts removing DISCARDABLE blocks from memory. A memory allocation

HOW TO WRITE A WINDOWS APPLICATION IN TEN MINUTES.

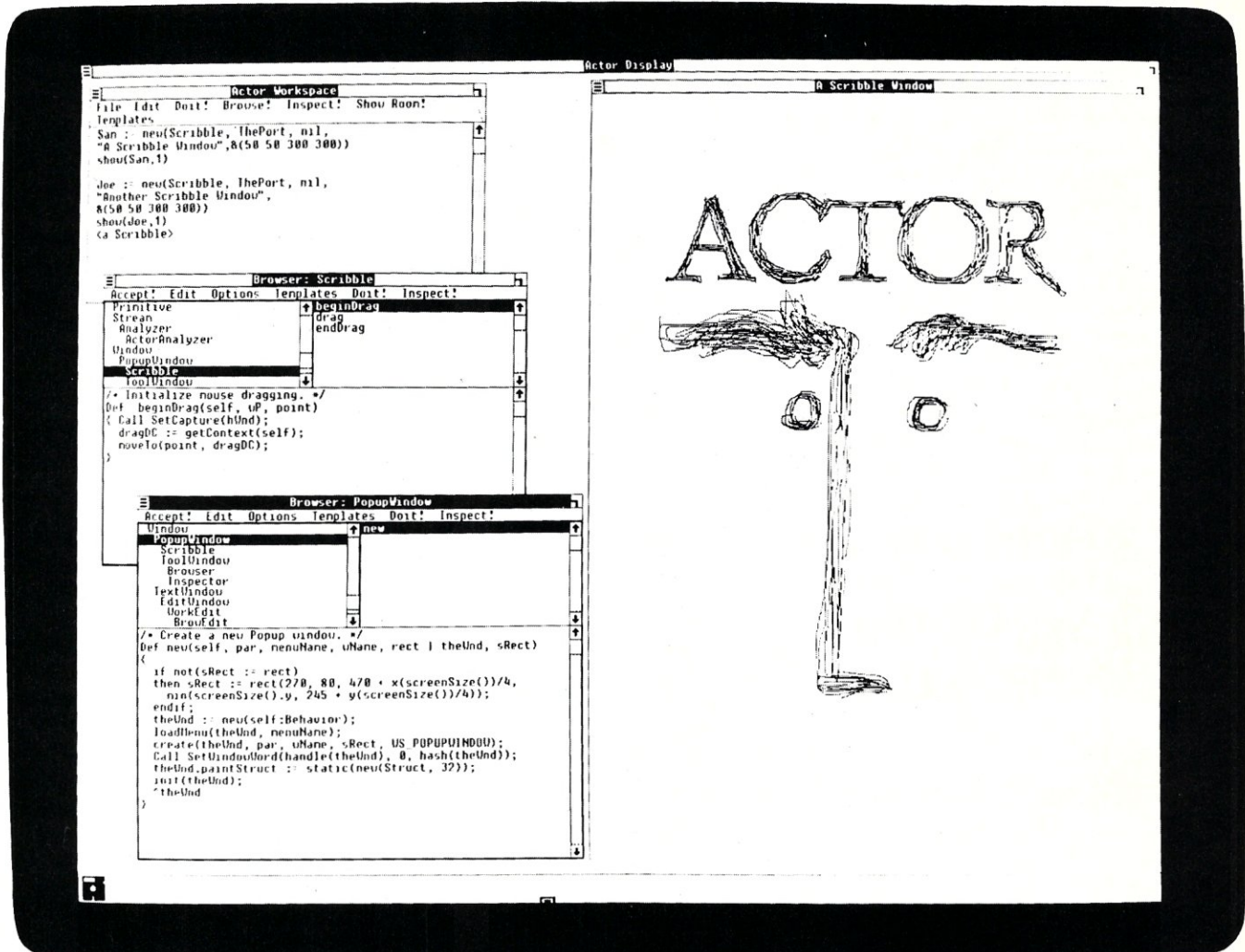

Actor™ is a new language that combines Microsoft® Windows with object-oriented programming. This means you can produce mouse and window applications very quickly.

For example, we created a simple "paint" program, and used it to draw the Actor logo you see on the screen. The whole program only took ten lines and ten minutes. Part of it is in the middle window on the left.

Above, you see the commands that initialized the paint window and made it appear on the screen. Below, some code that's built into Actor, specifying window behavior. Through a process known as "inheritance," it's called into play automatically.

Try programming in this new way, and you'll never go back.

Find out about Actor.
Call The Whitewater Group®, (312) 491-2370.

Technology Innovation Center
906 University Place, Evanston, IL 60201



request fails if there is insufficient memory after performing this process.

MOVABLE and DISCARDABLE memory blocks are a bit tough to access without the additional support from Windows. Essentially, a lock can be placed on a block so it will not move. The application is given a pointer to the current location of the block. It can then manipulate the data and should unlock the block when the application has finished using it. Windows is then able to move a block, but an application must no longer use the pointer to the block. The locking process must be performed each time an application needs access to the data in the block, so the overhead can be expensive for frequent accesses. This approach provides a virtual-memory-like environment and also a cooperative environment like that of nonpreemptive multitasking.

Data and code segments can be movable. Functions in MOVABLE segments require a special preamble and postamble to make sure that a function is in a fixed location when being executed. Windows supplies this support, so it is just a matter of indicating what functions are being used in this fashion.

A block can be marked as DISCARDABLE when it may not be needed, although marking it does not necessarily unallocate it. It is up to the application to reload the data if it has been discarded and is needed again. Blocks in the local heap can be marked such that a function will be called when the block is about to change state. A limited form of virtual memory can be maintained using this facility.

Atoms are text strings that can be added to but not deleted

from a Windows-maintained database. Atoms differ from the more conventional memory management support just described but provide a facility that is indispensable. The atom database is used for window class identification as well as being the basis for the Dynamic Data Exchange (DDE) protocol.

Each atom has a number associated with it, and this number can be set at any time. The name of the atom provides a common access method—two applications simply need to know the name of an atom to share data. Each atom also has a unique handle associated with it.

One way to use the atom facility is to allocate a global memory segment and place its handle in the atom database along with an atom. Other programs can then obtain access to the global data using the handle.

Like everything else in Windows, the protocol and data format are cooperatively maintained. Windows imposes no specific use on the atom facility—in fact, the value associated with an atom need not be used. The atom handle is often used to provide a common and unique name for messages exchanged between windows of different applications.

The atom facility and memory management support do not provide a virtual-memory environment, so resources are limited. Adding atoms to the atom database uses up memory resources.

Communications

Access to communication devices under DOS is done by direct hardware manipulation or through the ROM BIOS serial port support. Windows advances the state of the art through its communications driver. A Windows application can open a serial device and specify handshaking methods and buffer sizes, leaving much of the work of sending and receiving data to Windows.

The communications interface is standard among Windows implementations and hides the hardware from the application. It also allows a Windows application to operate in the nonpreemptive multitasking mode without significantly impairing other programs that may be running at the same time. Communication programs that do not use Windows communication support must either hog the processor by polling the communications port or the programs must include custom interrupt driver communications support.

Windows' communications support is somewhat limited and does not provide high-speed handshaking, which may be necessary for some communication protocols. The support is normally adequate for terminal emulation or file transfer protocols such as XMODEM or Kermit, however.

A communications object has a handle associated with it, as do most Windows objects. The communications object must be released by an application program before it terminates.

Printing

Printing using Windows is one of the more difficult tasks, even for text-based output. Essentially, the information to be printed needs to fit into memory unless the printer driver can send drawing-oriented commands in the same way PostScript printers can. Most other printers use a technique called banding.

Banding requires several passes over the drawing database supplied by the application. Each band is set up as a memory device context, and the application draws the picture using the memory device context and then sends the bit map to the printer. The memory device context is clipped to the banding region. The band is then printed and the printer starts printing again. The process is repeated for each band until the application terminates.

WE WELCOME YOUR ARTICLES!

Starting with the January issue, *Micro/Systems Journal* will be providing technical articles, columns, and reviews to computer system integrators every month. We are seeking new authors with innovative ideas and system applications that can be shared with other professionals. For example, over the next few months we plan to offer articles about:

- *Local Area Network Systems*
- *Interfacing to the PS/2*
- *Interfacing to the OS/2*
- *C Software Development Tools*
- *PC Multiuser Operating Systems*
- *386 Software Development Tools*
- *UNIX on the PC*

We would welcome your contributions on any of these subjects. Please contact:

Thomas Woolf
Managing Editor
Micro/Systems Journal
501 Galveston Drive
Redwood City, CA 94063
(415) 366-3600

STOP

THIS UNINTERRUPTIBLE CONFUSION !

When it comes to Uninterruptible Power Systems, you've heard it all before . . . "the newest breakthrough," "the best," or "the latest." But ask them to prove it and they're hard-pressed. At Clary, we can prove it.

We have created the world's smallest and most advanced on-line UPS for both micros and minis—the first UPS designed specifically for non-linear loads.

Unlike others, our systems are not repackaged or redesigned from traditional technologies. Clary manufactures over 100 varieties of on-line UPS—from 360VA to 37.5kVA—tailored to your specific application:



ONGUARD PC SERIES

Finally—you can have complete on-line protection for your micro-computer for nearly the price of an off-line system.

- Supports (2) AT's or (3) XT's
- Dual output provides 480VA additional filtered power for non-critical peripherals
- On-line, Sinewave Output
- Smallest, Quietest & Lightest

ONGUARD SERIES I & II (400VA to 3KVA)

ONGUARD is the first UPS designed specifically for the non-linear power supplies found in all of today's micro and minicomputers. It can support more non-linear computer load than any other equally rated UPS.

- Universal Voltage & Frequency Converter
- On-line, Sinewave Output
- World's Smallest 3kVA-plug compatible with IBM S/36 or equal
- Rack Mountable (up to 3kVA)

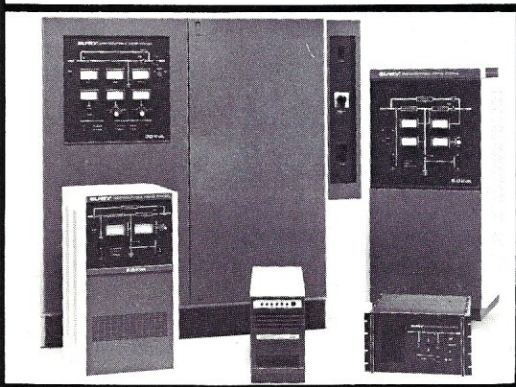
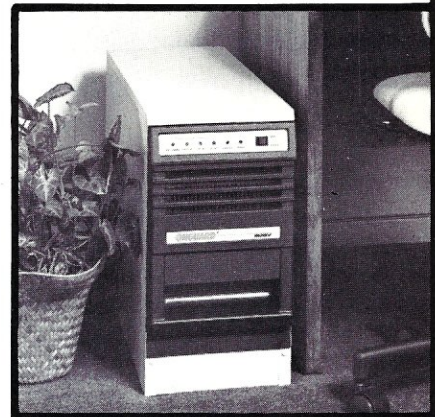

SERIES III & IV (3.75KVA to 37.5KVA)

Field upgradable single and three phase units. Fully transistorized for quiet, lightweight and efficient operation. 10 years of proven field history and the highest demonstrated MTBF.

- True "on-line" operation (inverter powers the load continuously) providing protection many other UPS systems cannot
- Quiet & Efficient
- Nationwide Service Network
- Immediate availability and easy installation

CLARY CORPORATION

320 West Clary Avenue
San Gabriel, CA 91776 (818) 287-6111 x678

Why puzzle when you don't have to?

Micro/Systems Journal has the answers. Whether it's networking, systems integration, programming, or scientific computing questions, *M/SJ* will lead you out of the maze of microcomputer mayhem. With each issue you'll find comprehensive coverage of all the technical information that will keep you up-to-date with the ever-changing microcomputer industry. You'll get the hands-on, nuts and bolts information, insight, and techniques

that *M/SJ* is famous for providing . . . in-depth tutorials, reviews, hints, the latest on multitasking, languages and operating systems. So stop your puzzling . . . subscribe right now and the answers will be yours. Simply drop the attached card in the mail—that's all there is to it.

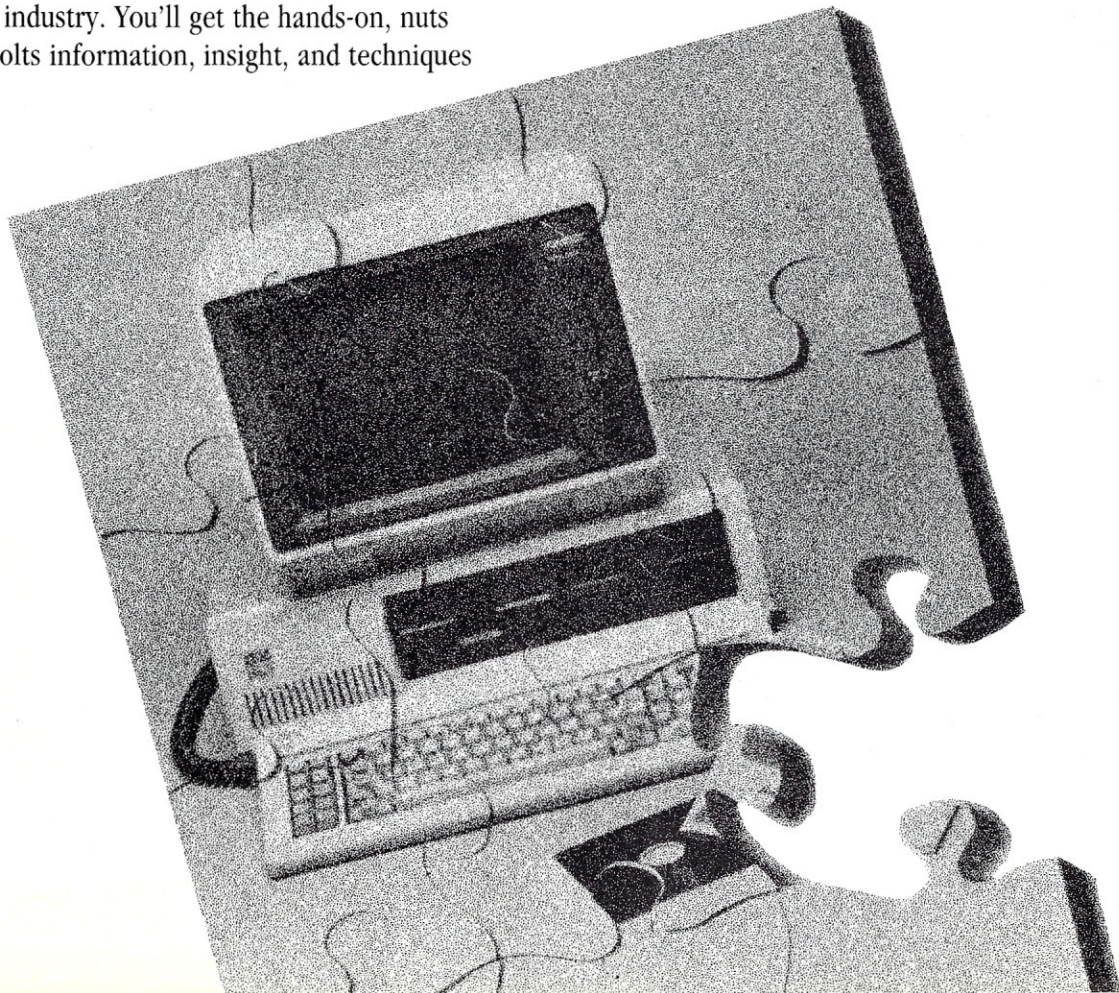

The Clipboard

The clipboard is both an application and a special Windows object that can be owned and manipulated. The clipboard application is really a simple program that can call a display function associated with the clipboard. There is only one clipboard and its owner is the last program that put something into it. Any application can read from the clipboard.

The clipboard is accessed using several functions. But an application must be able to support one or more display methods, such as text, graphics, metafile, and so on. The number and type are not designated, but any application looking at the clipboard can recognize the type of formats available and choose the best one.

The clipboard is normally used to exchange data between programs under user control. The data in the clipboard can be proprietary and may only be recognized by a corresponding program.

Dynamic Linking and Dynamic Data Exchange (DDE)

Windows requires a completely different .EXE file format that is similar to OS/2's. This format is required to support the memory management methods as well as the link between an application and Windows. A Windows application calls a Windows function directly instead of using a software interrupt, as in DOS. This approach requires the .EXE file to contain the name of the called functions so that Windows can resolve the reference when the program is loaded. This process, called dynamic linking, provides an efficient interface and allows the environment to be flexible. It is even possible for an application to use the dynamic linking mechanism to access non-Windows functions. This is done by creating a dynamic link library module that can be loaded upon request. The dynamic link process provides one method of intertask communication because multiple programs can have access to a dynamic link function.

Dynamic Data Exchange (DDE) is a mechanism that is built upon existing Windows functions, including the dynamic link facility, atoms, and message passing. DDE allows tasks to exchange data, notify other tasks when data is available, and receive information in an asynchronous fashion. DDE functions allow a program to identify a service using the atom facility, which maintains a unique name for the service. Other programs can then

WRITING WINDOWS APPLICATIONS

Windows applications cannot be written in MASM or C alone. This is because the linker must understand Windows objects (for example, icons, dialog boxes) and linking to Windows is through a special call linkage, not an INT instruction.

To write a windows application program, you need the Windows Toolkit (\$500 list, but discounted to as little as \$309) and the latest version of either Microsoft C, MASM, or Pascal. Microsoft conducts seminars for windows application programmers at which the Windows Toolkit package is distributed. Programmers who buy the Toolkit without attending the seminars are handicapped because the manuals contain little theory. This series of articles should assist programmers who buy the Toolkit without attending the seminars to write Windows application programs. It should also help seminar attendees.

The Whitewater Group (Technology Innovation Center, 906 University Pl., Evanston, IL 60201; (312) 491-2370) has introduced Actor, a lower-cost alternative to the Microsoft Windows Toolkit. Its documentation is poorer than that of the Toolkit, however, because it deals primarily with the Actor programming language.

access this service using the same name. A service also provides several subservices that are named in the same fashion. DDE communication begins when a second task identifies a service and obtains the associated window handle from the atom facility. It then sends a message to the window requesting the service.

The data that can be exchanged may be single records, a stream of records, or complete records of information when available. The data can include text or binary data as well as window or memory handles. DDE is a standard protocol that Microsoft supports and recommends, and is being included in more and more applications, allowing a flexible working environment.

DDE has many applications. It is one method for linking a spreadsheet to another program—for example, linking a graphing program to a communications program that returns the latest stock quotes. The DDE facility will become more important as more programs that support it become available—for example, OS/2 Version 1.1, which will contain the Presentation Manager.

Windows 2.0, OS/2, and the Presentation Manager

Windows, Version 1.03, has been available for some time. The next major release, which has already been demonstrated by Microsoft, will be Windows 2.0. From a programming point of view, little will change with Windows 2.0. There are some protocol changes and some additional functions, but existing applications will run under it.

Windows 2.0 has one major change for users—tiled windows are no longer the norm; pop-up windows are everywhere. Windows 2.0 improves the user interface in other ways, too. For example, the up and down arrows, which were on the side slider, have now moved to the top-right portion of the title bar. This allows quick scrolling using the buttons with the mouse by simply moving left or right and pressing the mouse button.

OS/2's Presentation Manager will look a lot like Windows 2.0. The new pop-up windows will be there along with other improvements. Applications designed for Windows will not run under the Presentation Manager without major changes, however, for several reasons. First, OS/2 is a preemptive multitasking system whereas Windows is nonpreemptive. Second, the programming interface is based upon a new set of functions that are a combination of Windows and an IBM mainframe graphics interface. The new features should allow better performance of multitasking programs and shorten the development cycle for new programs.

Summary

Microsoft Windows is a viable base for developing PC-DOS/MS-DOS applications. Movement from 1.xx to 2.x is painless, but porting applications for either version of Windows with OS/2 and the Presentation Manager becomes more difficult.

Developing new applications for Windows is a new approach to programming. Windows applications require a great deal of initial support, making small and simple programs impossible, although creation of programs becomes easier once a familiar program base is built.

Program development with the Microsoft Windows Toolkit is a high-cost, high-performance investment. Practical development requires an AT-class machine with at least a 20-Mbyte hard disk.

Hopefully, this set of articles has presented the Windows development environment in a light that shows its magnitude as well as its flexibility. §

Bill Wong is president of Logic Fusion, Inc., 1333 Moon Dr., Yardley, PA 19067, a systems software development firm.

Dealing with the DB-9 Serial Port

by Sol Libes

IBM changes interface connectors on its mainframe and minicomputers frequently, most often just to hurt the competition. When it introduced the PC/AT, it introduced a new connector for its RS-232-C serial port—a DB-9 instead of the old DB-25-type connector. The DB-25 had been in use for so long that it had become a standard for serial interfacing. This time I agree with IBM's decision to change connectors. And other manufacturers are also switching as they see the advantages.

The RS-232-C serial interface standard has been defined by the Electronic Industries Association (EIA). *RS* stands for Recommended Standard, and the *C* indicates that this is the third version of the standard. The standard utilizes a 25-pin connector, and manufacturers generally agreed on the DB-25-type connector with the modem (the Data Communications Equipment, or DCE) being a female connector and the terminal or computer (the Data Terminal Equipment, or DTE) being a male connector. Until the introduction of the IBM PC, however, manufacturers used male and female connectors as they wished.

The EIA standard defines the function of 20 of the 25 pins, and it specifies how many must be used. There was a time when modem interfaces used most of the pins. Over the years, however, modem hardware interfaces have become simpler

as computers and modems have become more intelligent. The current generation of modems uses only nine lines. Serial interfaces to printers require even less wires—typically only three.

Why then use a 25-pin connector when a 9-pin connector will do? As computers get physically smaller, the room for connectors becomes more limited. Also, manufacturing costs have become more important in today's highly competitive marketplace. It

is therefore only natural that computer manufacturers seek a connector better suited in size and cost to today's needs.

The DB-25 25-pin serial connector will no doubt be a thing of the past in a few years. Unfortunately, today it is still popular, and it is often annoying to have to connect a serial modem or printer with a DB-25 connector to a computer with a DB-9 serial I/O connector.

It is not difficult to make up a DB-9 to

Figure 2. RS-232 pin functions

RS-232C Name	DB-25	DB-9	Connector Pin Nos. Signal Name	Signal Direction
AA	1	*	(Chassis Ground)	common
BA	2	2	TxD (Transmit Data)	output
BB	3	3	RxD (Receive Data)	input
CA	4	7	RTS (Request to Send)	output
CB	5	8	CTS (Clear to Send)	input
CC	6	6	DSR (Data Set Ready)	input
AB	7	5	SG (Signal Ground)	common
CF	8	1	DCD (Data Carrier Detect)	input
CD	20	4	DTR (Data Terminal Ready)	output
CE	22	9	RI (Ring Indicator)	input

* not used

FREE!

Turbo C[®] (Borland) or QuickC[™] (Microsoft)

(with C Business Library or C Starter Package, limited time offer.)

FREE — even if you **ALREADY OWN Turbo-C or QuickC** — see special offer.*

POWER WINDOWS[™]

**MOST POWERFUL YET
POP-UP WINDOWS FOR**

*Menus/Overlays
Help Screens
Messages/Alarms*

**ZAP ON/OFF SCREEN
FILE-WINDOW MANAGEMENT
AUTOMATIC**

*Horizontal & Vertical Scrolling
Word Wrap & Line Insertion
Cursor/Attributes/Borders*

*The most powerful, flexible and easy
to use windowing package available!
Many types of menus. Highlighting.
Move data between files, keyboard,
program and windows. Status lines.
Change size/location/overlapping.
Move/add/delete/cascade windows.
Full source code. No royalties.
3 disks\$129.95*

C FUNCTION LIBRARY

**BEST YOU CAN GET
400 FUNCTIONS
FULLY TESTED**

**SUPERB DOCUMENTATION
BETTER FUNCTIONS**

*Most complete screen handling plus
graphics; cursor/keyboard/data
entry, 72 string functions with word
wrap; status and control; utility/DOS
BIOS/time/date functions; printer
control & more. Special functions.
Functions you NEED but don't have!
Full source code. No royalties.
4 disks\$129.95*

C BUSINESS LIBRARY

**INCLUDES C FUNCTION LIBRARY, POWER
WINDOWS, SUPERFONTS FOR C, B-TREE
LIBRARY, ISAM
ALL for\$299.95
(A \$440 VALUE)**

SUPERFONTS FOR C

SUPER SIZE CHARACTERS

*Monochrome adapter
Color/graphics adapter*

8 FONT LIBRARIES

*Dramatic high impact screens/titles/
messages. Use with or without
windows. Great for projection TV.
Create own font & image libraries or
use ours. Use with windows for
special effects or animation. Full
source code. No royalties.
Font and Function Library ...\$49.95*

B-TREE LIBRARY & ISAM DRIVER

POWERFUL DATA MANAGER

Fixed/Variable length records

**FAST! EASY TO USE!
16.7 MILLION RECORDS/FILE
16.7 MILLION KEYS/FILE**

*Fast B-tree indices. Add/remove
keys Find first/last/next/any key. Find
keys by Boolean selection. Read/
write/delete or add records to file.
Full source. No royalties ...\$129.95*

C STARTER PACKAGE

**INCLUDES C FUNCTION LIBRARY, POWER
WINDOWS, SUPERFONTS FOR C
ALL for\$199.95
(A \$310 VALUE)**

COMPATIBILITY: IBM PC/XT/AT & compatibles. Microsoft C, Lattice, Mark Williams, Aztec, CI 86, Datalight, Turbo C, any ANSI or full K&R compiler.

DEPTH: Data Entry/Power Windows (the most powerful professional windowing package) and C Function Library (the most extensive and useful library available) plus the speed, power and flexibility of the B-TREE and ISAM library. All work together to make your project go FAST!

**NO MATTER WHAT ELSE YOU HAVE, GET THESE...
DON'T PAY MORE AND GET LESS!**

SPECIAL OFFER

If you already own Turbo C or QuickC we will credit up to the full purchase price of your QuickC or Turbo C on purchase of C Business Library or C Starter Package.

Free Turbo C or free QuickC are limited time offers subject to termination without notice.

"We save man-months... make that man-years... on our projects by using Entelekon libraries."

J.M. Scroggins,
Systems Consultant

ORDER FORM	PRICE	QTY.	TOTAL
C Function Library	129.95		
Power Windows	129.95		
Super Fonts for C	49.95		
B-tree & Isam	129.95		
C Starter Package	199.95		
C Business Library	299.95		
TEXAS RES. ADD 7.25% TAX		Shipping \$5.00 UPS Ground	TOTAL
PAYMENT: <input type="checkbox"/> VISA <input type="checkbox"/> MC <input type="checkbox"/> CHECK			
CARD # _____	EXPIR DATE _____		
NAME _____			
ADDRESS _____			
CITY _____		STATE _____	
ZIP _____		PHONE _____	

THE C POWER FAMILY ... YOUR COMPLETE SOURCE FOR C

Entelekon[™]

12118 Kimberley, Houston, TX 77024

713-468-4412

VISA-MASTERCARD-CHECK-COD

SINCE 1982

Figure 1. DB-9 to DB-25 interconnections

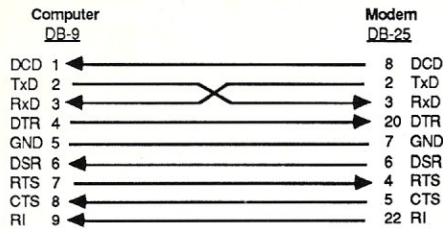

Figure 3. Null modem wiring, DB-9 to DB-25

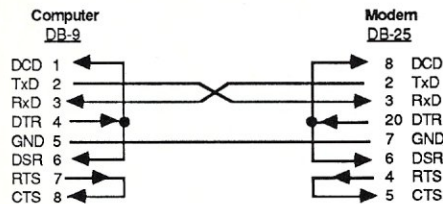

Figure 4. Null modem wiring, DB-9 to DB-9

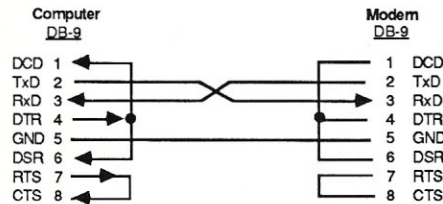

Figure 5. DB-9 to Diablo 630 interconnections

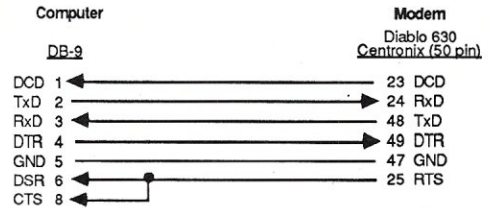

Figure 6. DB-9 to Qume Sprint 9/45 interconnections

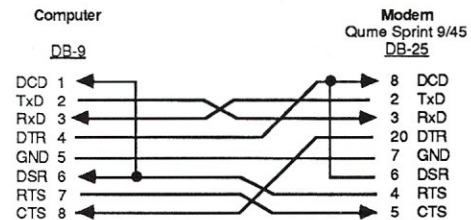
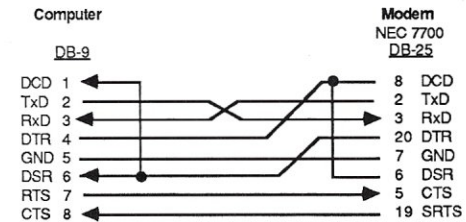

Figure 7. DB-9 to NEC 7700 interconnections



NEW!

Documentation is a PAIN!

... without **DocuMotion™**

We've found that well indexed and easily accessed documentation is a powerful tool and asset. Now you can simply pop up **DocuMotion** to access, display and print your documentation. **DocuMotion** builds indexed document libraries from documentation contained in your source code or any text file.

DocuMotion for programmers:

- Your documentation is available ANYWHERE, ANY TIME.
- Access, display and print your documentation by name or by user-defined categorization trees.
- 19 function Microsoft Windows-style menu bar.
- Powerful print & copy functions.

DocuMotion for the PC:

- Runs memory resident or non-resident on any IBM PC/XT/AT or compatible.
- Compatible with all popular memory resident programs.
- Requires only 93K RAM.
- LAN compatible.

DocuMotion is for YOU:

Call NOW 1-612-884-5860

At a special introductory price of **ONLY \$159.95** with ANSI 'C' document library.

Demo disk for \$10.00 that puts the ANSI 'C' library functions on-line.

DocuMotion for project mgrs:

- Programmers produce more and better documentation.
- Reduced function redundancy.
- Greater programmer productivity.

NWP - Intelligent Solutions, Inc. P.O. Box 20478 Bloomington, MN. 55420-0478

DB-25 adapter cable. You need three parts: a DB-9S female connector with hood assembly, a DB-25P male connector with hood assembly, and some nine-conductor shielded cable. I keep the cable length short, typically about one foot. The hood assemblies should be metal or metalized plastic to reduce EMI-RF radiation, and the shield should be connected to the metal parts of the connectors. The cable assembly should be constructed as shown in Figure 1. Figure 2 provides information on the function of each line.

A null modem type connection is used when connecting one computer to another computer or a terminal to a computer. The wiring for a null modem type cable using DB-9 to DB-25 connectors and DB-9 to DB-9 pin connectors is shown in Figures 3 and 4.

Several printers also use serial interfaces. It is unfortunate that there is no standard pinout for serial printers—for example, the Diablo 630 uses a Centronix 50-pin connector. The cable wiring for this machine is shown in Figure 5. Many serial printers use the DB-25 connector. The wirings for two popular serial printers (the Qume Sprint 9/45 and NEC 7700) using the DB-25 connector are shown in Figures 6 and 7. §



RealWorld

ACCOUNTING SOFTWARE

-Version 4.0

-All Modules

-Multiuser

for

PC-MOS/386

Concurrent-Dos / CPM86

Upgrades Available

for

Release 2.1, 3.0, 3.1

MASTER DISTRIBUTOR

Paul Black & Associates
1524 Eubank Blvd. N.E. Suite 2
Albuquerque, NM 87112
505-298-7044

DEALER INQUIRIES INVITED

\$59 C DATA ENCRYPTION

Data Encryption Standard (U.S. government standard FIPS PUB46) in Microsoft "C". Includes compression & telecomm formatting, allowing faster transmission & less storage space plus compatibility with any computer or service. Complete "C" source code \$249.

\$29 CASINO CARD GAMES

Just like you've seen in Vegas and Atlantic City! You get BlackJack, Slot Poker, and a "bluffing" game of Draw Poker! BlackJack allows play variations & tracks statistics. Super card graphics & windows. CGA or Mono.

\$59 POPUP TIME & BILLING

InsideTrac records billable and non-billable time and expenses for attorneys, CPAs, and consultants. Different billing rates for multiple employees, detail & summary time period billing reports, built in help manual and popup menu operations.



HAWKEYE
GRAFIX Inc

BOX 1400, OLDSMAR
FLORIDA 33557
DIAL 813-855-5846

Step into the Future

Introducing *Stony Brook*

MODULA-2

for 8086 family machines



Some day, the other
Modula-2 compilers
might have what we
have NOW:

SPEED

- Compiles 5K lines / minute on PC/AT
- Runs Sieve faster than Microsoft C V4.0

FLEXIBILITY

- Generates Microsoft standard objects
- Supports 6 memory models + mixed model
- Interfaces directly to other DOS languages (you don't have to throw out your C code!)

POWER

- Full Modula-2 language
- + Array and record constants
- + Substrings and sub-arrays
- + Tailorable procedure calling

REPertoire by PMI,
indexed file and
screen management
package included free!

PLUS OS/2 and Microsoft Windows compatible NOW

The generated code is compatible with OS/2 and Microsoft Windows. Runtime libraries will be available soon.

Stony Brook

INC
SOFTWARE

Forest Road
Wilton, New Hampshire 03086
(603) 654-2525

Compiler and DOS runtime
library objects only:

\$195

No other
Modula-2
compiler
comes close!

Above plus editor, source
debug, make utility, and
runtime library sources:

\$345

Add \$5 shipping and handling in North America, \$15 for over-seas orders. VISA and MasterCard accepted.

★ **Special introductory offer:** Purchase and pay for the complete system before Oct. 31, 1987 and get The Watcher execution profiler by Stony Brook Software — a \$60 value — free.

A Linker for Turbo Pascal

by Sung K. Soh

Expanding Turbo Pascal's Code Space Using a Module

Turbo Pascal compiles quickly, produces tight code, and, with its built-in editor, is convenient to use. Turbo Pascal, however, does not support large memory models; compiled-code size must be smaller than 61K. As the built-in library of Turbo Pascal occupies about 10K, a programmer can use only about 50K for code space. Using overlays is not an attractive prospect, especially when unused memory is available. Most programmers have a collection of procedures and functions that are used again and again in a variety of programs. In Turbo Pascal, those procedures and functions have to be included and compiled every time such subprograms are used. This repetition may increase compile time needlessly.

This article describes a method of overcoming this code-size restriction. A separate file of Turbo Pascal source code that contains frequently used procedures and functions is compiled by Turbo Pascal into a .COM file. This .COM file is used as a library module, and the functions and procedures included in it can be called from other Turbo Pascal programs (master module). The compiled library module is loaded onto the heap space of the master module during run time, so a library module, once prepared, neither occupies precious code space nor wastes compile time. Currently, there are several commercial

packages on the market that accomplish the identical task. Presented here is a do-it-yourself method without the automation and convenience of commercial packages, but it is free and gives the user complete control over the linking process. It has been tested on Turbo Pascal Version

3.01A and is likely to work on Versions 2.0 or 3.x without modification.

LIBRARY MODULE

Begin by collecting Turbo Pascal subprograms (procedures and functions) in one or more Pascal source files. They must be

Listing 1

```
{ This program tests Turbo Pascal Linker
(C) Copyright 1987 by Sung K Soh
Only personal, non-commercial use by Micro Systems Journal
readers allowed.
All other rights reserved. }

{$I TEST1.PAS}
{$I TEST2.PAS}

{ Procedure linker will generate necessary call instructions to
enable calling of module procedures from main program. }

PROCEDURE linker;
BEGIN
  INLINE($58/                                { POP AX }
    $2E/$A3/*+23/                             { MOV CS:* + 23, AX }
    $8B/$E5/                                   { MOV SP, BP }
    $5D/                                       { POP BP }
    $58/                                       { POP AX }
    $2E/$A3/*+13/                             { MOV CS:* + 13, AX }
    $D1/$E6/                                   { SHL SI,1 }
    $BB/* + 23/                               { MOV BX, * + 23 }
    $03/$DE/                                   { ADD BX,SI }
    $2E/$FF/$17/                              { CALL CS:[BX] }
    $EA/$00/$00/$00/$00);                   { JMP Return Address }
END;

{ Main block of module. Replace test1/test2/ sequence by a list
of subprograms to be called by far call. }

BEGIN
  INLINE($B4/$00/                             { MOV AH, 0 }
    $CD/$21/                                   { INT 21 }
    test1/test2/linker+7);                  { List Of Addresses }
END.
```

C CODE FOR THE PC

source code, of course

C Source Code

Bluestreak Plus Communications (two ports, programmer's interface, terminal emulation)	\$400
Greenleaf Data Windows (windows, menus, data entry, interactive form design)	\$315
Barcode Generator (specify Code 39 (alphanumeric), Interleaved 2 of 5 (numeric), or UPC)	\$300
GraphiC 4.0 (high-resolution, DISSPLA-style scientific plots in color & hardcopy)	\$275
Vitamin C (MacWindows)	\$200
Greenleaf Communications Library (interrupt mode, modem control, XON-XOFF)	\$160
Greenleaf Functions (296 useful C functions, all DOS services)	\$160
Essential C Utility Library (400 useful C functions)	\$160
Essential Communications Library (C functions for RS-232-based communication systems)	\$160
PC/IP (CMU/MIT TCP/IP implementation for PCs)	\$100
B-Tree Library & ISAM Driver (file system utilities by Softfocus)	\$100
The Profiler (program execution profile tool)	\$100
Entelekon C Function Library (screen, graphics, keyboard, string, printer, etc.)	\$100
Entelekon Power Windows (menus, overlays, messages, alarms, file handling, etc.)	\$100
QC88 C compiler (ASM output, small model, no longs, floats or bit fields, 80+ function library)	\$90
CBTree (B+tree ISAM driver, multiple variable-length keys)	\$80
ME (programmer's editor with C-like macro language by Magma Software)	\$75
Wendin PCNX Operating System Shell	\$75
Wendin PCVMS Operating System Shell	\$75
Wendin Operating System Construction Kit	\$75
EZ_ASM (assembly language macros bridging C and MASM)	\$60
Multi-User BBS (chat, mail, menus, sysop displays; uses Galacticomm modem card)	\$50
Heap Expander (dynamic memory manager for expanded memory)	\$50
Make (macros, all languages, built-in rules)	\$50
Vector-to-Raster Conversion (stroke letters & Tektronix 4010 codes to bitmaps)	\$50
Coder's Prolog (inference engine for use with C programs)	\$45
PC/MPX (light-weight process manager; includes preemption and coroutine packages)	\$45
Biggerstaff's System Tools (multi-tasking window manager kit)	\$40
TELE Kernel (Ken Berry's multi-tasking kernel)	\$30
TELE Windows (Ken Berry's window package)	\$30
Clisp (Lisp interpreter with extensive internals documentation)	\$30
Translate Rules to C (YACC-like function generator for rule-based systems)	\$30
6-Pack of Editors (six public domain editors for use, study & hacking)	\$30
ICON (string and list processing language, Version 6 and update)	\$25
LEX (lexical analyzer generator)	\$25
Bison & PREP (YACC workalike parser generator & attribute grammar preprocessor)	\$25
C Compiler Torture Test (checks a C compiler against K & R)	\$20
PKG (task-to-task protocol package)	\$20
A68 (68000 cross-assembler)	\$20
Small-C (C subset compiler for 8080 and 8088)	\$20
tiny-c (C subset interpreter including the tiny-c shell)	\$20
Xlisp 1.5a (Lisp interpreter including tiny-Prolog in Lisp)	\$20
List-Pac (C functions for lists, stacks, and queues)	\$20
XLT Macro Processor (general purpose text translator)	\$20
C Tools (exception macros, wc, pp, roff, grep, printf, hash, declare, banner, Pascal-to-C)	\$15

Data

DNA Sequences (GenBank 48.0 of 10,913 sequences with fast similarity search program)	\$150
Protein Sequences (5,415 sequences, 1,302,966 residuals, with similarity search program)	\$60
Webster's Second Dictionary (234,932 words)	\$60
U. S. Cities (names & longitude/latitude of 32,000 U.S. cities and 6,000 state boundary points)	\$35
The World Digitized (100,000 longitude/latitude of world country boundaries)	\$30
KST Fonts (13,200 characters in 139 mixed fonts: specify T _E X or bitmap format)	\$30
NBS Hershey Fonts (1,377 stroke characters in 14 fonts)	\$15
U. S. Map (15,701 points of state boundaries)	\$15

The Austin Code Works
11100 Leafwood Lane
Austin, Texas USA 78750-3409

Voice: (512) 258-0785
BBS: (512) 258-8831
Email: FidoNet 1:382/12

Free surface shipping on prepaid orders

MasterCard/VISA

tested thoroughly, as errors may be difficult to locate after their incorporation into a library module. Global variables may be used in the library module, but they will share the same data space with the master module. If you have to use global variables, it is a good idea to copy the variable declaration statements of the library module and place them exactly in the same order at the start of the master module, before any other global-variable declarations of the master module. This ensures that the shared global variables will be assigned identical addresses when they are referenced by the library module and by the master module. Avoiding use of global variables in the library module makes

**... a library module,
once prepared,
neither occupies
precious code space
nor wastes
compile time.**

the module more portable and is recommended.

Make a list of library-module subprograms that will become "public," i.e., the subprograms that can be called from the master module located outside the code segment of the compiled module. Note that other "private" subprograms may exist in the compiled module, and that they may be called freely from within the module, but they will be inaccessible from outside the module. This inaccessibility helps in hiding unnecessary details, and thus makes the compiled module more modular. Assign tag numbers 0, 1, 2, and so on to the public subprograms.

Now create a Turbo Pascal source file that will be compiled to produce the library module by modifying Listing 1. Replace the {SI} compiler directives, which include TEST1.PAS and TEST2.PAS, so that they will include your subprograms instead. Include the procedure linker, which acts as an intermediary between the library module and the master module, just before the start of the main block of the library-module program. The main program of the module is used to store the addresses of the subprograms. Replace the list of the names of the library subprogram

in the in-line code, *test1/test2/* in Listing 1, with the names of your public subprograms. They must be ordered corresponding to the tag numbers assigned. For example, if you have three subprograms named *proc0*, *proc1*, and *proc2*, corresponding to tag numbers 0, 1, and 2, respectively, you then replace *test1/test2/*

with *proc0/proc1/proc2/*.

Now compile the prepared source with Turbo Pascal using the C compiler option, so the resulting .COM file will be saved on disk for later use.

PREPARING INC FILE

After the compiled library module is pre-

Listing 2

```
{ LINKER.INC
(C) Copyright 1987
by Sung K Soh
Only personal and noncommercial use by Micro Systems Journal
readers is allowed.
All Other Rights Reserved. }

{ Include this file in the main program to use compiled module. }

TYPE FilenameString = STRING[80];

VAR LinkerAddr : ^INTEGER;

PROCEDURE initialize_linker(Filename:FilenameString);

VAR F : FILE;
    FIB : ARRAY[0..37] OF INTEGER ABSOLUTE F;
    size: INTEGER;

BEGIN
  {$I-}
  ASSIGN(F,Filename);
  RESET(F);
  FIB[1]:=1;
  Size:=FILESIZE(F);
  FIB[1]:=128;
  GETMEM(LinkerAddr,Size+256);
  MOVE(MEM[CSEG:0],LinkerAddr^,128);
  BLOCKREAD(F, MEM[SEG(LinkerAddr^):OFS(LinkerAddr^)+256],
    FILESIZE(F));
  CLOSE(F);
  {$I+}
  IF IORESULT<>0 THEN Writeln(^G,'Link Failed')
  ELSE
    BEGIN
      LinkerAddr:=PTR(SEG(LinkerAddr^),OFS(LinkerAddr^)+Size+244);
      LinkerAddr:=PTR(SEG(LinkerAddr^),LinkerAddr^);
    END;
  END;

{ Copy procedure and function declarations to be called and
include the inline code. Note that SI will be set equal to the
serial number of module which must match the reverse order of
addresses stored in the compiled module. }

PROCEDURE test1(VAR x:REAL;i,j:INTEGER);
BEGIN
  INLINE($BE/$00/$00/           { MOV SI, 0 }
    $0E/                         { PUSH CS }
    $BB/LinkerAddr/             { MOV BX, LinkerAddr }
    $FF/$2F);                   { JMP [BX] }
END;

FUNCTION test2(g:REAL):INTEGER;
BEGIN
  INLINE($BE/$01/$00/           { MOV SI, 1 }
    $0E/                         { PUSH CS }
    $BB/LinkerAddr/             { MOV BX, LinkerAddr }
    $FF/$2F);                   { JMP [BX] }
END;
```

pared, you must prepare an INC file, which will be included in the master module whenever subprograms in the library module are called. It can be prepared by modifying Listing 2. Replace subprograms test1 and test2 in Listing 2 with function or procedure declarations of the subprograms in the library module. In the case of the previous example, they will be declaration statements for proc0, proc1, and proc2. Copy the in-line code for test1 and test2 of Listing 2 for each and every subprogram that replaces test1 and test2. Change the second byte of the in-line codes, \$00 and \$01 for test1 and test2, respectively, with the tag numbers you assigned for the library subprograms: \$00 for proc0, \$01 for proc1, \$02 for proc2, and so on. These tag numbers are assigned to the source index register SI before calling the procedure linker in the library module, so the procedure linker can determine which library module is called.

USING THE LIBRARY MODULE

Compile your master module, which includes the INC file just prepared, using the `{S}` compiler directive before any reference to the library subprograms are made. After the `{S}` directive is used, the

library subprograms can be referenced as if they are declared in the master module. Before any library subprograms are called and before any heap space is used by a pointer variable in the run time, however, the procedure `initialize_linker` in the INC file must be called with the file name of the compiled library file as the argument.

The main program of the module is used to store the addresses of the subprograms.

It must not be called again. For example, if the file name of your compiled library module is LIB.COM, then the following statement must be executed before any subprogram in it can be called:

```
Initialize_Linker('LIB.COM');
```

CONCLUSION

A Turbo Pascal linker program that works similarly to the ones on the market is described. It expands the effective code size of Turbo Pascal beyond 64K, yet the internal workings of the linker are transparent to the calling program and the subprograms called. The described method may be easily automated by users. §

Dr. Soh is an assistant professor of chemical engineering at the University of Detroit. He is also vice-president of SoftTech, Inc., which specializes in mathematical and engineering software for PC-DOS/MS-DOS microcomputers. He can be reached at the University of Detroit at (313) 927-1410 or at SoftTech, Inc., (313) 544-8544.

The author has an automated version of the described method available. It can be purchased for \$15.00 and is in PC-DOS/MS-DOS format only. Orders can be placed with SoftTech Inc., 14640 La Belle, Oak Park, MI 48237; (313) 544-8544.

U.S. Postal Service STATEMENT OF OWNERSHIP, MANAGEMENT AND CIRCULATION <small>Required by 39 U.S.C. 3685</small>		
1A. TITLE OF PUBLICATION Micro/Systems Journal		1B. PUBLICATION NO. 8 7 5 0 9 4 8 2
2. DATE OF FILING 10/1/87		3A. NO. OF ISSUES PUBLISHED ANNUALLY 6
3. FREQUENCY OF ISSUE Bi-monthly		3B. ANNUAL SUBSCRIPTION PRICE \$20.00
4. COMPLETE MAILING ADDRESS OF KNOWN OFFICE OF PUBLICATION (Street, City, County, State and ZIP Code) (Not printers)		
501 Galveston Drive, Redwood City, CA 94063		
5. COMPLETE MAILING ADDRESS OF THE HEADQUARTERS OF GENERAL BUSINESS OFFICES OF THE PUBLISHER (Not printers)		
501 Galveston Drive, Redwood City, CA 94063		
6. FULL NAMES AND COMPLETE MAILING ADDRESS OF PUBLISHER, EDITOR, AND MANAGING EDITOR (This item MUST NOT be blank)		
PUBLISHER (Name and Complete Mailing Address) Laird Foshay, 501 Galveston Drive, Redwood City, CA 94063		
EDITOR (Name and Complete Mailing Address) Sol Libes, Box 1192, Mountinside, NJ 07092		
MANAGING EDITOR (Name and Complete Mailing Address) Tom Woolf, 501 Galveston Drive, Redwood City, CA 94063		
7. OWNER (If owned by a corporation, its name and address must be stated and also immediately thereunder the names and addresses of stockholders owning or holding 1 percent or more of total amount of stock. If not owned by a corporation, the names and addresses of the individual owners must be given. If owned by a partnership or other unincorporated firm, its name and address, as well as that of each individual must be given. If the publication is published by a nonprofit organization, its name and address must be stated.) (Item must be completed.)		
FULL NAME H & T Publishing, Inc.		COMPLETE MAILING ADDRESS 501 Galveston Drive Redwood City, CA 94063
8. KNOWN BONDHOLDERS, MORTGAGEES, AND OTHER SECURITY HOLDERS OWNING OR HOLDING 1 PERCENT OR MORE OF TOTAL AMOUNT OF BONDS, MORTGAGES OR OTHER SECURITIES (If there are none, so state)		
FULL NAME Markt & Technik		COMPLETE MAILING ADDRESS Bang-Pinsel-Strasse 2 8013 Haar bei Munich West Germany
9. FOR COMPLETION BY NONPROFIT ORGANIZATIONS AUTHORIZED TO MAIL AT SPECIAL RATES (Section 4212 DMM only) The purpose, function, and nonprofit status of this organization and the exempt status for Federal income tax purposes (Check one)		
<input type="checkbox"/> (1) HAS NOT CHANGED DURING PRECEDING 12 MONTHS <input type="checkbox"/> (2) HAS CHANGED DURING PRECEDING 12 MONTHS (If changed, publisher must submit explanation of change with this statement.)		
10. EXTENT AND NATURE OF CIRCULATION		AVERAGE NO. COPIES EACH ISSUE DURING PRECEDING 12 MONTHS
		ACTUAL NO. COPIES OF SINGLE ISSUE PUBLISHED NEAREST TO FILING DATE
A. TOTAL NO. COPIES (Net Press Run)		21,840
		25,377
B. PAID CIRCULATION		
1. Sales through dealers and carriers, street vendors and counter sales		3,497
		5,864
2. Mail Subscription		13,059
		12,823
C. TOTAL PAID CIRCULATION (Sum of 10B1 and 10B2)		16,556
		18,687
D. FREE DISTRIBUTION BY MAIL, CARRIER OR OTHER MEANS SAMPLES, COMPLIMENTARY, AND OTHER FREE COPIES		1,936
		1,755
E. TOTAL DISTRIBUTION (Sum of C and D)		18,492
		20,442
F. COPIES NOT DISTRIBUTED		
1. Office use, left over, unaccounted, spoiled after printing		1,017
		1,025
2. Return from News Agents		2,331
		3,910
G. TOTAL (Sum of E, F1 and 2 - should equal net press run shown in A)		21,840
		25,377
11. I certify that the statements made by me above are correct and complete		
SIGNATURE AND TITLE OF EDITOR, PUBLISHER, BUSINESS MANAGER, OR OWNER		
Laird Foshay, PUBLISHER		

ISIS

CP/M MSDOS

COMPLETE SOURCE CODE INCLUDED!

ICXPDS: eXchanger now supports the 5 1/4"iPDS format. Manipulation of ISIS-II files using your computer system was never easier.

ICXMDS: Same as ICXPDS, but for MDS 8" systems.

IMXPDS: Reads/Writes 5" iPDS disks on PC's and AT's.

TELEDPLUS: Enhanced serial file transfer program for CPM, ISIS, or MS-DOS.

ISE: Emulator gives the CPM and MS-DOS user access to all the ISIS-II languages and utilities.

ACCELER 8/16: CP/M-80 emulator for MS-DOS. Enables PC's to run ISE. (no source code, V-20 incl.) **\$89 each**
\$250 any 3 above

UDI: The 8086 ISIS Emulator runs all UDI applications. **\$300**

ZAS Development Package: Z-8 and Z-8000 Assembler for CP/M, ISIS, and MS-DOS.

Request a catalog of our products!



Copyrights CP/M Digital Research, Inc.
ISIS-II and iPDS Intel Corp. MSDOS Microsoft

Western Wares 303-327-4898
Box C • Norwood, CO 81423

The Scientific Computer User

by A. G. W. Cameron



FORTTRAN Translation and Freelance Plus

Technical Word Processors

In this column I want to catch up on some software reviews. First, however, I would like to draw your attention to some extensive reviews of technical word processors (TWPs) that have resulted from a project of the IBM PC Technical Special Interest Group of the Boston Computer Society.

This project had two phases. The first phase dealt with the ability of TWPs to reproduce various types of equations, matrices, and diagrams. The work on this was done in 1985 and the report was published in the January 1986 issue of the *Notices of the American Mathematical Society*. The second phase, in 1986, posed a tougher benchmark: the automatic generation of numbering schemes as part of the generation of equations, tables, figures, references, chapters/sections, lists, headers, footers, footnotes, endnotes, and indexes. The report on this effort is much more extensive, covering some 68 pages of small type in the January, February, and March issues of the *Notices of the American Mathematical Society*. You can get a reprint of it for \$12 from Carl Hein, Dunster House Apt. 7, Swanson Rd., Boxborough, MA 01719.

I was involved in both of these efforts to some extent, having volunteered to try to do the benchmarks using \TeX . I succeeded, but only by subjecting \TeX to some tortures that it was never intended to handle. For example, you are not supposed to draw diagrams or prepare such things as indexes with plain \TeX , but the program is powerful and general enough to handle such tasks. It was a tremendous learning experience for me. The report

makes interesting reading and I recommend it to you.

RTC Plus

Cobalt Blue has produced a translator program to convert FORTRAN and RATFOR programs to C (\$450). The first version sent to me for review handled only the RATFOR-to-C translation. However, revisions that allowed some translation of FORTRAN also began arriving, so I held off the review until the FORTRAN translation seemed to have stabilized. That now appears to be the case, although I have no doubt that further improvements will be made.

It is the job of a compiler to translate a higher level language to assembly language; thus, a compiler is in fact a translator program. The target language is generally quite simple, but, being low level, it issues many instructions for every higher level statement that is translated. In the case of a translator program such as the one under review, both the original and target languages are high level and are likely to have very different syntaxes. Hence, the task of the translator program is generally more difficult than that of a simple compiler. It is not surprising, then, that RTC Plus neither claims nor delivers the ability to do 100 percent translations.

First, a word about RATFOR since this is generally not a well-known language. I reviewed both RATFOR and the Software Tools computing environment in the September 1983 issue of *Microsystems* magazine. *Software Tools* was in the first instance a book by B. W. Kernighan and P. J. Plauger (Addison-Wesley, Reading: 1976). These authors showed how to write a large number of utilities in a largely machine-independent way (only the lowest level made contact with the system). At the time, C was not widely available; most computing systems had FORTRAN in common. Thus Kernighan and Plauger wrote a FORTRAN preprocessor as one of

the utilities and called it RATFOR (Rational FORTRAN). They also wrote all of the utilities in RATFOR, including RATFOR itself. RATFOR has many structures that are borrowed from the C language.

The Kernighan and Plauger utilities generally duplicated those available in UNIX. Thus there was established the Software Tools User Group (STUG), which had as its goal bringing some of the advantages of UNIX to other systems that could compile the tools using FORTRAN. STUG also promoted the use of RATFOR as a substitute for C on systems that did not have it.

The occasion for my previous reviews was the porting of Software Tools to CP/M. There was a subsequent port of Software Tools to PC/MS-DOS. The company responsible for these ports (Carousel MicroTools) has long since ceased to do business, and it is not likely that there are many RATFOR users presently using microcomputers. But RATFOR is generally available on UNIX systems, and it is possible that a number of people who have used it there would wish to transport their RATFOR programs to microcomputers and then convert them to C. That was probably the original motivation behind the development of RTC Plus.

I did not become a confirmed user of RATFOR. Generally, the FORTRAN compilation process was long enough, and the addition of the RATFOR preprocessing time on the front end became too frustrating. What I did learn were the techniques used to translate RATFOR statements into FORTRAN. I found it useful to apply some of these techniques in writing FORTRAN programs, and thus I would characterize my exposure to RATFOR as a learning experience that let me write better FORTRAN programs. With the establishment of IF ... THEN ... ELSE statements in FORTRAN 77, even the use of some of these special procedures ebbed away.

**THE ULTIMATE IN COMPACT CP/M
COMPATIBLE COMPUTERS**

DSB-8100

Features:

- Hitachi 64180 CPU running at 6MHz (executes a super-set of Z80 instruction set)
- 256K dynamic RAM
- 8K EPROM with boot / monitor program standard, up to 32K EPROM optional
- 1773 Floppy controller supports 40 and 80 track 5 1/4" and 3 1/2" drives
- Host / target SCSI port can use DMA for all transfers
- Two RS-232 serial ports support asynchronous communications up to 38,400 baud
- Centronics type parallel printer port
- CP/M 2.2 optional
- Power requirements: +5V at 1.0A
+12V at .05A
- Size: 6-3/4" x 3-7/8"

\$365.00 Quantity discounts

Compatible board with 512K RAM and 6 serial ports also available.

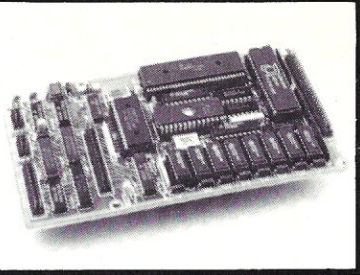

Davidge Corporation
P.O. Box 1896
94 Commerce Drive
Buellton, CA 93427
(805) 688-9598

Davidge

**A Reliable PC/XT Compatible
for the
Cornerstone of Your Products**

NEW! Announcing The **SLY40-XT** **NEW!**

- Small Board Size (4-1/4" By 9-1/4"), Four Layer
- High Integration — Composed of just 17 Low Power CMOS ICS
- NEC's 8 MHZ V40
- One Megabyte of Zero Wait State RAM
- Ideal For Tough Industrial, OEM and Portable Applications
- American Made and Fully Supported by Slicer

PC and XT Are Trademarks of International Business Machines

MasterCard		Slicer Computers Inc.
Visa		3450 Snelling Ave. So.
Check		Minneapolis, MN 55406
Money Order		612/724-2710
C.O.D.		Telex 501357 SLICER UD

Software Tools

For Programmers & Non-Programmers

Get 'State of the Art' performance and save valuable time with these high quality utilities!

Opt-Tech Sort™

Opt-Tech Sort is a high performance Sort/Merge/Select utility. It can read, sort and write a file faster than most programs can even read the data. Example: 1,000 records of 80 bytes can be read, sorted and a new file written in less than 10 seconds (IBM XT). Opt-Tech Sort can be used as a stand-alone program or called as a subroutine to over 25 different programming languages.

All the sorting, record selection and reformatting facilities you need are included. A partial list of features includes: The ability to process files of any size. Numerous filetypes are supported including Sequential, Random, Delimited, Btrieve, dBASE II & III and many others. Up to 10 key fields can be specified (ascending or descending order). Over 16 different types of data supported. Powerful record selection capability allows you to specify which records are to be included on your output. Record reformatting allows you to change the structure of your output record and to output special fields such as record numbers for use as indexes.

MS-DOS \$149.

★ NEW ★ Xenix \$249.

★ NEW
★ VERSION

On-Line Help™

★ NEW
★ VERSION

On-Line Help allows you to easily add "Help Windows" to all your programs. On-Line Help is actually two help packages in one. You get BOTH Resident (pop-up) and Callable Help Systems.

The resident version allows you to add help to any system. Your Help System is activated when the "Hot Keys" that you specify are pressed. You can then chain between help windows in any manner you desire.

The callable version allows you to easily display help windows from your programs. A simple call to the help system makes the window appear. The original screen is automatically restored when the help window is cleared. On-Line Help is callable from over 20 different languages.

You have full control over the help window content, size, color and location.

MS-DOS \$149. **Demo \$10.** (apply toward purchase).

Scroll & Recall™

Scroll & Recall is a resident screen and keyboard enhancement. It allows you to conveniently scroll back through data that has gone off the top of your display screen. Up to 27 screens of data can be recalled or written to a disk file (great for documenting systems operations). Also allows you to easily recall and edit your previously entered DOS commands without retyping. Scroll & Recall is very easy to use. It's a resident utility that's always there when you need it. MS-DOS \$69.

Visa, M/C, AMEX, Check, Money Order, COD or Purchase Orders accepted.

To order or to receive additional information just call and receive immediate highly qualified attention!

Opt-Tech Data Processing

P.O. Box 678 — Zephyr Cove, NV 89448
(702) 588-3737

Rack & Desk PC/AT Chassis

A Fresh Approach

Integrand's new Chassis/System is not another IBM mechanical and electrical clone.

Appearance, power, thermal, reliability and EMI problems that plague other designs have been solved.

An entirely fresh packaging design approach has been taken using modular construction. At present, over 40 optional stock modules allow you to customize our standard chassis to nearly any requirement. Integrand offers high quality, advanced design hardware along with applications and technical support all at prices competitive with imports. Why settle for less?

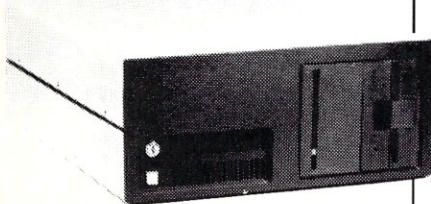

Rack & Desk Models

Accepts PC, XT, AT Motherboards and Passive Backplanes

Doesn't Look Like IBM

Rugged, Modular Construction

Customize with over 40 Stock Panels

Excellent Air Flow & Cooling

Optional Card Cage Fan

Designed to meet FCC

204 Watt Supply, UL Recognized

145W & 85W also available

Reasonably Priced

Made in USA

INTEGRAND
RESEARCH CORP.

Call or write for descriptive brochure and prices:

8620 Roosevelt Ave. • Visalia, CA 93291

209/651-1203

TELEX 5106012830 (INTEGRAND UD)

EZLINK 62926572

We accept BankAmericard/VISA and MasterCard

IBM, PC, XT, AT trademarks of International Business Machines. Drives and computer boards not included.

The RTC program was developed to translate RATFOR into C, but there is a much bigger market for translating FORTRAN programs into C. Thus Cobalt Blue developed FRAT, a program for translating FORTRAN into RATFOR—just the opposite of the normal approach. The standard sequence of operations using the Cobalt Blue scheme has four stages: (1) Use FRAT to convert FORTRAN (.for extension) to RATFOR (.r extension); (2) use PRTC, a RATFOR preprocessor, to produce an intermediate file characterized by a .rc extension that normally disap-

pears after processing (unless there are errors); (3) use RTC to produce a nearly final C program (.cc extension); (4) finally, use a postprocessor CPOST to clean up a few things and produce the final C program (.c extension).

There are two levels at which these procedures can be used. Someone who wants a rough-and-ready translation to C can just go ahead and run these programs blindly. Some errors may be flagged that will need to be corrected before the translation sequence will go to completion. The experienced user may modify the FOR-

Listing 1

This is a Fortran recipe from Numerical Recipes. Given an array DATA of length N, the program returns its mean as AVE and its variance as VAR.

```
SUBROUTINE AVEVAR(DATA,N,AVE,VAR)
C.....Copyright (c) 1985 Numerical Recipes Software
DIMENSION DATA(N)
AVE = 0.0
VAR = 0.0
DO 11 J = 1, N
AVE = AVE + DATA(J)
11 CONTINUE
AVE = AVE / N
DO 12 J = 1, N
S = DATA(J) - AVE
VAR = VAR + S * S
12 CONTINUE
VAR = VAR / (N - 1)
RETURN
END
```

Listing 2

```
Program translated to Ratfor:
# Translated by FRAT, v1.23, on 6-21-87 at 18:23:13
subroutine avevar(data, n, ave, var)
#.....Copyright (c) 1985 Numerical Recipes Software
dimension data(n)
ave = 0.0
var = 0.0
do j = 1, n {
ave = ave + data(j)
11 continue
}
ave = ave / n
do j = 1, n {
s = data(j) - ave
var = var + s * s
12 continue
}
var = var / (n - 1)
return
end
```

Listing 3

```
The Cobalt Blue C version:
#include <stdio.h>
#include <f77c.h>
#include <swtdef.h>
```

TRAN code somewhat before submitting it to translation, and will make use of many command line switches on these different programs. Cobalt Blue warns that many FORTRAN constructs will have to be rewritten to get a good translation, and that certain statements, such as those containing I/O statements will have to be hand-translated in any case. One can envision that a truly clever translation process would do all these things automatically. I suppose the Cobalt Blue translation process may make significant progress toward this goal in subsequent versions.

I tested RTC Plus by using it to translate 202 FORTRAN routines taken from *Numerical Recipes*, by W. H. Press, B. P. Flannery, S. A. Teukolsky, and W. T. Vetterling (Cambridge University Press, New Rochelle, New York: 1986), which I have mentioned before in this column. These routines form a library of procedures that do not have I/O statements, although a few of them use complex numbers that RTC Plus does not like either. The advantage of using these routines is that Press, *et. al.*, are bringing out a version of their recipes in C, and Bill Press kindly provided me

Listing 3, continued

```

/*Translated by PRTC-RTC, v1.42, on 6-21-87 at 18:23:44*/
/*Translated by FRAT, v1.23, on 6-21-87 at 18:23:13*/
VOID /*FUNCTION*/ avevar(data, n, ave, var)
int *n;
float data[], *ave, *var;
{
  int j;
  float s;
  /*.....Copyright (c) 1985 Numerical Recipes Software */
  (*ave) = 0.0;
  (*var) = 0.0;
  {int tmpa_0 = (*n);
  for(j = 1; j <= tmpa_0; j += 1 ){
    (*ave) = (*ave) + data[j - 1];
    L_11:
    ;
  }}
  (*ave) = (*ave) / (*n);
  {int tmpa_1 = (*n);
  for(j = 1; j <= tmpa_1; j += 1 ){
    s = data[j-1] - (*ave);
    (*var) = (*var) + s*s;
    L_12:
    ;
  }}
  (*var) = (*var) / ((*n) - 1);
  return;
} /* end of func */

```

Listing 4

```

The Numerical Recipes C version (alpha copy):
void avevar(data,n,ave,svar)
/* Copyright (c) 1987 Numerical Recipes Software */
/*200401*/
float data[],*ave,*svar;
int n;
{
  int j;
  float s;
  *ave = (*svar) = 0.0;
  for(j = 1; j <= n; j++) *ave += data[j];
  *ave /= n;
  for(j = 1; j <= n; j++) {
    s=data[j] - (*ave);
    *svar += s * s;
  }
  *svar /= (n - 1);
}

```

S-100 Products

Turbo Slave I	\$395 \$410
Earth Net-100	\$395 \$410

PC Products

Earth Net PC	\$375 \$395
--------------	-------------

Prices & Shipping
& Handling CIA COD

System Manager

List \$375

**Complete TurboDOS
Network Security
Package**

- All Menu Driven
- Restrict Drives and User Areas
- Log ON/OFF Record Keeping
- Full Electronic Mail
- Display System Status
- Talk-Send Messages to Another Processor
- Runs on All TurboDOS Systems

We Support Large TurboDOS
Systems With Multiple Masters
We Support the Following OEM's
Earth ICM ICD L/F Teletek
Dealer Discounts

**Multi-User
Networking
Specialists**



2834 N. Milford Rd.
Milford, MI 48042
(313) 685-3877

TurboDOS is a registered trade mark of Software 2000, Inc.
System Manager © Loddentech Technology LTD

with an alpha copy of these routines. These provide an independent human-translated set of C programs against which the translations can be compared.

Of these 202 FORTRAN routines, 36 encountered some problem and did not go to completion. A common problem would be a statement like *ERROR: intrinsic function args must all be the same type, (pass2)*, which would be a complaint against a common FORTRAN coding practice. RTC Plus also does not like to have array dimensions passed to a subroutine. In a few cases, internal errors were reported, which Cobalt Blue has warned is not supposed to happen but may happen due to as yet unreported bugs.

Perhaps we should dwell less on the unfortunate 36 routines that failed and consider that 166 were translated satisfactorily. These routines have what a C programmer would consider very clumsy C, but most of them should do what they are supposed to do. You can get the flavor of the translation process by looking at the code in Listing 1. This is a short and simple FORTRAN routine, AVEVAR, which provides the mean and variance of an array of numbers. Listing 2 shows the translation to RATFOR and then to C; also shown for comparison is the hand-translated version of this subroutine.

The goal of a good compiler is to provide tight and efficient machine language code. From Listing 3 we can see that RTC Plus does not presently produce tight and efficient C code. But many will find it helpful in partially automating the translation process.

Freelance Plus

Freelance Plus is an interactive chart and plot program published by the Lotus Development Corporation and available for \$495. I was interested in seeing if this type of program was becoming particularly useful for scientific work. I found it somewhat disappointing in that respect, but then I was probably expecting too much. The program does what it was designed to do quite well.

In some respects it operates in the same way as a paint program. Its use of PC monitors, however, is restrictive. If you want to see things in color, you need an EGA monitor, since a CGA monitor shows only monochrome. The program works well with a Hercules card, and input can come from the keyboard or a mouse.

Work is normally done with a number of graphic elements: text, lines, arrows, rectangles, circles, arcs, marker symbols,

and polygons. You can also do freehand drawing on the screen, however. Text is generated with a subset of the Hershey vectorized fonts and with thick sans serif fonts called "Swiss" (meaning Helvetica style). These can be rotated and scaled. Also available are software raster fonts in fixed sizes called "Sigma" fonts. The other graphics elements are usually created on the screen and then manipulated by translation, rotation, scaling, flipping, or other distortions. Clearly, the intended purpose of these operations is to prepare presentation material. Scientists may find the material useful for this purpose, since much of their work involves proposal writing. But I do not find it useful for presenting scientific results.

In addition to supporting output on graphics screens, Freelance Plus supports some film recorders, a variety of plotters, a number of dot-matrix printers, and the Hewlett-Packard Laserjet. The lack of support for page description languages such as PostScript is surprising and disappointing. Much of what Freelance Plus is trying to accomplish involves the same kinds of manipulations that are available in PostScript.

A number of scientists input data into Lotus 1-2-3 spreadsheets for analysis and plotting. For most purposes, that is as far as they need to go. However, 1-2-3 files (as well as a few other kinds of files) can be input into Freelance Plus and manipulated further. One might want to add boxed labels, for example, to a scientific plot. Scientists may find the program useful for this type of work.

As for my personal preference, I find it more useful to approach the problem of plotting in a different fashion. In most cases I am plotting one or more dependent variables against an independent one, and the dependent variables are obtained from a FORTRAN computation of some sort. In these cases I find it useful to write a FORTRAN program to utilize this data in preparing a PostScript file to be sent to an Apple LaserWriter. This can use the LaserWriter's internal fonts, which look at least as good and usually better than the Freelance Plus fonts.

There is also an interactive plotting program called Mongo that was developed by John Tonry at the Center for Astrophysics. The program is easy to use for graphics primitives and has the advantage that all the interactive commands have equivalent FORTRAN calls that can be included in FORTRAN programs. It was developed on a VAX, and the program has spread so

that it is now available on Sun workstations and on PCs. Both of the latter implementations take output to a LaserWriter. I would be more attracted to Freelance Plus if it had these capabilities.

The Screen Manager

While we are on the subject of screen displays, I would like to take brief note of The Screen Manager, a series of program elements published by Concept Software (\$149.95). Libraries and calling sequences are provided in assembler, C, and FORTRAN that allow the display of windows of arbitrary shape (as long as they are rectangles) on the screen. Text may be written to these windows (or read from them). The windows may be visible or invisible and can overlay one another. They can also be moved around the screen at will. Foreground, background, and border colors and other attributes can be changed at will. Cursors are maintained for all windows in use. Windows and their contents can be stored to and recalled from disk files.

The libraries sent for review included Microsoft C and FORTRAN, Lattice C, and Lahey FORTRAN. Probably other compilers and more recent versions of the above compilers are available now.

These routines are more likely to be of interest to commercial program developers than to typical scientists, who often develop a FORTRAN program and then run it once to get the answer to some problem. But quite a few programs become production items, run many times. In such cases, it may be worthwhile to display results in specific windows on the screen while the program executes. These libraries allow you to do that. §

A. G. W. Cameron is professor of astronomy at the Harvard-Smithsonian Center for Astrophysics.

Addresses

Addison-Wesley Publishing Co., 1 Jacob Way, Reading, MA 01867; (617) 944-3700.

Cambridge University Press, 510 North Ave., New Rochelle, NY 10801; (800) 431-1580; (914) 235-0300 in NY and Canada.

Cobalt Blue, Lightfoot & Associates, Inc., 1683 Milroy, Ste. 101, San Jose, CA 95124; (408) 723-0474.

Concept Software, P.O. Box 26981, Las Vegas, NV 89126.

Lotus Development Corp., 55 Cambridge Pkwy., Cambridge, MA 02142; (617) 494-1192.

SUCH A DEAL!



DAVE -

change our Ad in Micro Systems. Blow out
RAM 22's and 286 201 Boards. \$195.00 for
the 201/286 CPU Boards. \$250.00 for the
RAM 22's. Tell the readers to update from
CP/M and/or the dual CPU Boards. Tell 'em
about the \$575.00 upgrade to Concurrent
4.1E from any DRI o/s and the upgrade to
Concurrent 5.0 from any DRI o/s (\$625.00)
Be sure they send in their original DRI Master
Disks. Let them know we have 64 K SPUZ
and 256K SPUZ boards (for users who want
to run 8 bit tasks) at swap Meet prices.
All this stuff is available at participating dealers.
(TELL THEM TOO!!!)

B.G.

7/17/87

DAVE - 
SEND THEM
THIS. B.G.

B.G.
NO TIME TO
DO A SLICK
AD!
7/17/87 DAVE

How to Order: These products may be ordered through participating CompuPro dealers, or you may order directly from us. Send check or money order (do not send cash) to: **CompuPro-Swap, 26538 Danti Ct., Hayward, CA 94545-3999**

Be sure to enclose the description and quantity of the items desired, your UPS shipping address (no P.O. Boxes, please!) and a daytime phone number. Also enclose \$5.00 shipping and handling, California residents enclose 7% sales tax. Remember, these items are sold on an as-is (no warranty) basis. All sales are final. All items are subject to prior sale and are first-come-first-served, so get your orders in quickly. If an item is out-of-stock, your money will be refunded, or we may substitute a functionally equivalent or better product. Please allow 6 to 8 weeks for delivery. **Note: Credit Card and Phone Orders will not be accepted. We cannot answer questions about these products on the phone either. If you don't know what they are or how to use them, you shouldn't buy them.** Subject to prior sale.

CPU 286 (8 MHz 3 cycle)
RAM 22 (256K-8/16 bit xtrs)

\$195
\$250

CompuPro™

The UNIX File

Ian F. Darwin



A Public Domain UNIX Clone and a C Programming Book for UNIX Users

This column discusses the UNIX operating system. If you have comments or questions about UNIX or this column, please write to Ian Darwin at Box 603, Station F, Toronto, Ontario, Canada M4Y 2L8. If you have UNIX mail access to the uucp network, mail "ihnp4!-darwin!ian." Internet users should try "ian@darwin.uucp" or "ian@sq.com." I can't always answer immediately, but I will get back to you; electronic mail gets answered first!

What's GNU? Source for You

The GNU project is another attempt to rewrite a UNIX-like system without any reference to AT&T source code. And it could lead to a full-function, UNIX-like system that you can get for free, with full source code to put up on any 386 system.

But GNU will not spell the end of companies that make their living by supporting commercial UNIX systems. Since people are free to sell supported GNU systems, however, some of those companies may well switch from selling supported UNIX (which they must distribute without source) to supported GNU (distributed with source). There is a place for public domain programs and systems in the technical community. Most business computer users want a stable, established product, so they will continue to buy AT&T UNIX from vendors who will provide ongoing support for it.

However, GNU should someday keep older UNIX systems alive and support new

ones, as well as freeing people from AT&T's source-level pricing policies. For now, the Free Software Foundation has a number of GNU subsystems available, including the Emacs editor, a C compiler and source debugger, a chess program, and a compiler-compiler tool, and more software is being released as it is completed.

GNU (the "g" is pronounced) is a project of the Free Software Foundation (FSF), and is intended to produce a working clone of Berkeley UNIX. The FSF is primarily run by Richard M. Stallman, who is perhaps best known in the computing community for having invented a comprehensive editor program called Emacs. Emacs differs from most editor programs in several ways. For example, it allows you to change every mapping of a key to a command. The Emacs default simply inserts into the edit buffer printable characters that you type. But if you prefer the feel of an editor like *vi* in which letters are commands, you can simply map the letters to the appropriate commands, which can make Emacs look like *vi*, or WordStar, or KED/EDT, or almost any other screen editor. (Just try making WordStar look like Emacs!) Some editors allow limited mapping of function keys, but I know of no other editor that is completely reprogrammable. Yes, I do mean programmable. You aren't limited to changing the key-to-function mapping; you can also replace the existing functions, or even add your own, if you can write them in the LISP programming language.

Stallman invented the Emacs editor, originally as a set of Editor MACroS for an enhanced MIT TECO editor. His view is that an editor is not an Emacs unless it is extensible, customizable, and self-documenting. His original Emacs ran on MIT's Incompatible Timesharing System (a pun on CTSS, the Compatible Time Sharing System) and was later ported to TOPS-10 and TOPS-20. An early Emacs clone was Multics Emacs, written by Ber-

nie Greenberg using MacLisp as its extension language, rather than obscure TECO macros. Later clones included James Gosling's UNIX Emacs, which uses the MockLisp extension language, a language with LISP syntax but not LISP data structures. Gosling's Emacs is now sold and maintained by Unipress. There are several microcomputer Emacs-like editors that aren't true Emacs because they are not extensible or self-documenting, but they have screens and default keyboard mappings that look like real Emacs. They are more powerful than the editors most micro vendors provide.

Stallman has also been instrumental in shaping the MIT AI lab over the years, and in developing the ITS timesharing system, a multiuser, networked operating system. Recently, Stallman came out with a new Emacs called GNU Emacs. The good news is that it can be copied and customized by anyone, because full source is always provided. The curious news is that it's perhaps the first text editor to come complete with a political ideology wired in.

Stallman gives away software free but maintains the right to control how it is redistributed by copyrighting all the software in the name of the Free Software Foundation. The copying policy is clearly stated in every program and manual FSF distributes. GNU Emacs even has a key combination that displays the copying policy. You can copy the software for any purpose, but must always give credit to the FSF as the originator. Further, if you modify the software and then redistribute it, you must make clear that you are distributing a modified copy, saying who modified it, and when. Finally, if you distribute a binary-only copy, you must distribute an offer of free matching sources, available to anybody, and assignable. In other words, anyone who gets a binary program must be able to get the matching sources. The recipient can redistribute the binary, as well as redistribute the right to get the matching sources.

As for prices, the copying policy says you can charge anything the market will bear for GNU software, but the price must include sources or the offer of sources. There can be no additional fee for source code. There is also an explicit lack-of-warranty statement; since you don't pay commercial rates for the software, it's only fair that you not hold the Free Software Foundation responsible for any problems you may have, and the no-warranty statement makes that explicit.

Some detractors label Stallman a communist. Others call him an eccentric. To those who believe in what he's doing, he's an idealist or evangelist, putting his own professional survival on the line to show the world a better way to make computers more useful. Whatever the ideology, FSF has produced some large and impressive works. Although a full UNIX-like system isn't ready yet, the following items have already been released, including:

- GNU Emacs—A full Emacs editor, including LISP function extensibility;
- bison—A replacement for the *yacc* parser generator;
- gcc—A C compiler, compatible with the draft ANSI C standard, with code generators for the VAX, 68000, and 68020 (gcc tries to make it easy to write new code generators; it's not limited to the preceding machines, and comes with info about porting to other processors. Users have written, and contributed, prototype code generators for the NS32032 and the IBM 370);
- gas—The GNU assembler, currently in beta test;
- gdb—A source-level debugger for the C language;
- chess—A serious chess-playing program;
- Scheme—A “simplified, lexically scoped dialect of LISP,” developed primarily at MIT; and
- miscellany—FSF also distributes MIT's X Window System (which is in the public domain) and a version of the *Hack* adventure game.

That's only what is available already. Stallman also has GNU shell (*gsh*, a *cs*h emulation), which is in alpha test, and most of the commonly used UNIX utilities working in-house. The kernel will probably derive from the MACH project at Carnegie-Mellon University, or possibly from the TRIX system written at MIT. And most of the rest of a UNIX clone is now in test or development. Many people in the UNIX community and other parts of the

industry (VAX/VMS users, non-UNIX supermicro users) support the idea of a full-blown, UNIX-like system with source availability, and they are contributing their time and energy to expand and improve this software. It's hard to say when the system kernel and utilities will be released, but new software is released periodically and eventually there will be a working kernel and utilities for a full UNIX-like system.

What will it mean? People who want to do kernel development on a Berkeley-like UNIX system will no longer need to obtain an AT&T source license (which costs about \$60,000 for System V) and then get a Berkeley license; they can get the whole

**To the owner
of an orphaned
68000 or similar
computer . . .
GNU will mean that
a UNIX-like system
with source code
is now available. . . .
GNU is designed for
modern processors that
will continue to be
popular . . .**

package from FSF for the cost of a tape. Better yet, they can get it from a friend for no cost at all!

To the owner of an orphaned 68000 or similar computer—those whose manufacturers have gone bankrupt or who have stopped supporting older machines—it will mean that a UNIX-like system with full source code is now available. One can even envision small entrepreneurs making a modest living by supporting orphaned UNIX computers. Such machines, which now sell for about \$4,000, might make good systems for hobbyists willing to port GNU.

What will GNU mean to owners of smaller machines? Recall that GNU is meant to be a clone of Berkeley UNIX, not of V6 or V7. GNU is designed for modern processors that will continue to be popular over the next few years, not for processors (like the 8088) that have been obsolete for years. Berkeley UNIX is not small. Don't

ever expect to run GNU on your PC/XT, nor probably on your AT or on your PDP-11. For such machines, Tanenbaum's MINIX system (described in this column in the May/June 1987 issue of *M/SJ*) is a better bet. MINIX is also a UNIX system clone, but one designed from the start to run on small systems. Version 7 of Comer's XINU system (reviewed here in the March/April 1987 issue of *M/SJ*), while not a UNIX clone, does have some of UNIX's functionality, and was designed for use on the LSI-11 processor.

GNU expects 32-bit integers and 32-bit pointers, with 8-bit-byte addressing. It also requires at least 1 Mbyte of RAM, and a sizeable hard disk—40 Mbyte is a bare minimum capacity but 80 Mbyte is the recommended minimum. To be able to use demand paging and relocation, expect to upgrade an existing 68000 to a 68010 or 68020 chip, plus have a memory management unit, such as the M68451. Inexpensive machines like the Macintosh 2 or an existing UNIX supermicro are good candidates. A full-blown 80386 system with adequate RAM and hard disk also would make a good GNU machine.

By contrast, MINIX will work on a PC with 256K and two floppies, but keep in mind that it's MIN-ix, a minimal UNIX clone. MINIX is owned by Prentice-Hall and they do not encourage copying. They allow minor copying, on author Andy Tanenbaum's insistence, but not large-scale redistribution. For example, posting Tanenbaum's complete MINIX distribution to the USENET network or on a bulletin board system would be discouraged. And Comer's XINU is copyrighted—you cannot legally give it to your best friend.

FSF, on the other hand, actively encourages people to copy GNU and give it to their friends. It also provides tape duplication services because such services are convenient for some recipients and also because these services provide an easy way for users to donate money to the GNU project in a way justifiable to management. There is no attempt, though, to prevent massive duplication by anybody. If you can find a million people who will buy it from you, then that's a million more who have heard of free software, which is the goal of the FSF. You can post GNU software to the net, assuming the net is happy with its size, or put it up on a BBS, as long as you follow the copying policy.

Interestingly, vendors of UNIX and UNIX-like systems are encouraged to distribute GNU software with their systems. Again there is no license fee, but the copy-

ing rules must be followed. FSF software also comes with extensive documentation. If you order the software from them, you pay a modest fee for the tape and shipment. You can also order neatly printed copies of the manuals.

For details on what's currently available, current copying policies, status, and future plans, contact the Free Software Foundation Inc., 1000 Mass Ave, Cambridge, MA 02138, or call (617) 876-3296.¹

A Book on C for Berkeley Users

In contrast to books that attempt to cover all aspects of using various UNIX systems, Nigel Horspool at the University of Victoria has written *C Programming in the Berkeley UNIX Environment* (Prentice-Hall, Scarborough, Ontario, Canada, 1986). The book is aimed at students who have some programming experience and includes such topics as the standard C library; system calls and library routines; debugging (there are cursory comments on *adb*, *sdb*, and some detail on *dbx*, whereas most UNIX books cover only one of these); advanced system features such as pipes, and signals; and an overview of networking and terminal handling. Appendixes cover the *vi* text editor, the

¹ John Gilmore of Nebula Consultants provided significant information on GNU and Emacs for this section. Portions of this column were derived from material copyrighted by Gilmore and by the Free Software Foundation.

Berkeley shell *esh*, and summaries of the C language and the library calls. There is a list of answers to the exercises and an index. Many topics that are commonly omitted or inadequately discussed in other books, such as correct use of C language header files, the *make* program, and so on, are included here.

The book discusses only Berkeley UNIX and C; it makes no attempt to cover other UNIX variants. That is at once the book's strength and its greatest weakness. Although it does cover the relevant material, it does not take enough pains to detail what is portable to other UNIX systems and what is not. I suspect this may be simply because Horspool has not been exposed to enough other systems. For example, he uses the library function *bcopy* as though it were a standard part of all UNIX systems, which it's not. He refers to *mail* (with a lowercase m) as the program that prints a header list and reads your *.mailrc* file, but on non-Berkeley UNIX systems that name invokes a different mail program, and the one he describes is invoked (if it's available at all) under the name *Mail* (capital M) or *mailx* (mail extended). And he states that Kernighan and Pike's *The UNIX Programming Environment* is "intended to be a companion to System V UNIX" because it omits the Berkeley system calls; in reality, Kernighan and Pike have described a common subset of Research UNIX (V7/V8), System V UNIX, and (with a few exceptions) Berkeley UNIX.

In fairness, Horspool does refer the reader who is interested in portability to

another source. Having administered UNIX systems myself in both the commercial world and academia, and having taught undergraduates about UNIX, I contend that students should not emerge thinking that they know the one true UNIX version. They should be taught what is portable and what isn't. All the world is not a VAX, nor does all UNIXdom run 4.2BSD. More footnotes on the differences would be a big help, as would more consistency. For example, in the discussion of signal handling, Horspool explains the correct procedure for checking whether signals are currently being caught, but not one of his examples uses it. And he introduces *malloc* on page 48, with examples, but he does not mention until page 108 that you must check the return value from it. It has been my experience that students rely heavily on examples, often starting to experiment with some feature of the system by typing in an example from a book, so it is important that the examples be correct.

Despite these minor flaws, the book covers the material that it promises. Recognizing that no one book will satisfy every UNIX user all the time, I would recommend that this book be given serious consideration for use in undergraduate teaching. §

Ian Darwin is Director of Research and Development for SoftQuad Inc., Toronto developers of quality UNIX-based publishing software. Ian previously administered UNIX systems, and organized and taught the undergraduate UNIX course, at the University of Toronto.

PERISCOPE™

POWER

...Keeps you going full steam ahead when other debuggers let you down. With four models to pick from, you'll find a Periscope that has just the power you need.

... Start with the model that fits your current needs. If you need more horsepower, upgrade for the difference in price plus \$10! And don't worry about having a lot more to learn... Even when you move to the most powerful model, Periscope III, an extra dozen commands are all that's involved.

Periscope's software is solid, comprehensive, and flexible. It helps you debug just about any kind of program you can write... thoroughly and efficiently. Periscope's hardware adds the power to solve the really tough debugging problems.

Periscope requires an IBM PC, XT, AT, or close compatible (Periscope III requires hardware as well as software compatibility); DOS 2.0 or later; 64K available memory; one disk drive; an 80-column monitor.

Top-of-the-line Periscope III with real-time, hardware breakpoint board.

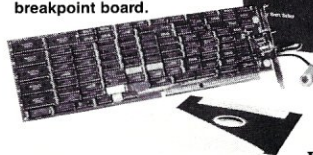

Periscope I includes a half-length board with 56K of write-protected RAM; break-out switch; software and manual for \$345.

Periscope II includes break-out switch; software and manual for \$175.

Periscope II-X includes software and manual (no hardware) for \$145.

Periscope III includes a full-length board with 64K of write-protected RAM, hardware breakpoints and real-time trace buffer; break-out switch; software and manual. Periscope III for machines running up to 8 MHz is \$995; for machines running up to 10 MHz, \$1095.

Call Toll-Free for free information or to order your Periscope today!

MAJOR CREDIT CARDS ACCEPTED.

800-722-7006

The
PERISCOPE
Company, Inc.

14 BONNIE LANE
ATLANTA, GA 30328
404/256-3860

New Products

When contacting vendors, please mention that you read about their products in Micro/Systems Journal.

Manufacturers who would like to have their hardware products listed here should send their news releases to the Managing Editor, Micro/Systems Journal, 501 Galveston Dr., Redwood City, California 94063.

PC-COMPATIBLE HARDWARE

Hi-Res ADC/DAC Card

The A/D12B32 is an Analog-to-Digital/Digital-to-Analog Converter for PC compatibles. The ADC can monitor up to 32 inputs with 12-bit conversion. Input configuration (single- or double-ended) and gain (1x, 2x, 5x or 10x) is programmable on a per-channel basis via software provided with the unit. Input voltage ranges from -5V to +5V. Two 8-bit DAC outputs and 32-TTL parallel I/O lines (plug-compatible with optoisolator modules from ICD) are also provided.

The A/D12B32 is \$995, and is manufactured by Industrial Computer Designs Inc., 31364 La Baya Dr., Westlake Village, CA 91362; (818) 889-3179.

Break 640K Memory Barrier on an AT and Run Concurrent Sessions

The Software Link AT Gizmo and Multi-Link Advanced software are a hardware/software combination that allow AT-compatible machines to run most PC applications in multiple sessions. It provides a shared-processor, multiuser, multitasking system that lets up to 17 applications/users share the AT. The Gizmo is a card that attaches to the 80286 motherboard and re-maps memory creating up to 8 Mbytes of extended memory when used with an Intel Above Board-286. Each user/application can occupy up to 600K of memory in multiple partitions. All applications can now take advantage of the LIM (Lotus/Intel/Microsoft) expanded memory. Up to 16 ASCII terminals can operate with a single host AT-compatible using standard RS-

232 connections. Record- and file-locking are provided for multiuser and networking support of applications such as RBASE System V, Smart and dBASE-III Plus.

The suggested retail price for Multi-Link Advanced is \$595, and a multitasking-only version (MTO) is \$195. The AT Gizmo is \$295. All are available from: The Software Link, 8601 Dunwoody Pl., Ste. 632, Atlanta, GA 30338; (404) 998-0700. The Above Board-286 has a suggested retail price of \$745 (with 512K RAM) and is available from Intel Corp., 5200 N.E. Elam Young Pkwy., Hillsboro, OR 97124; (800) 538-3373.

AT Replacement Battery

International Battery Corp. has announced the Tadiran replacement lithium battery for AT-compatibles. The battery is listed by Underwriters Laboratories and hence has passed all UL tests for aging,

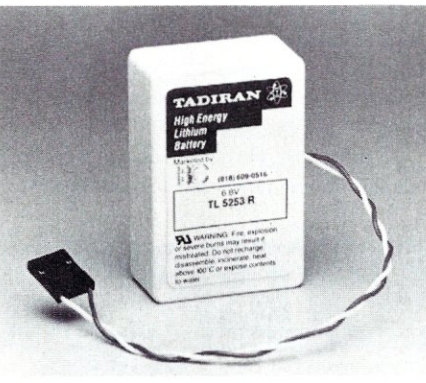

short-circuit, crush, heat and fire tests. The unit is guaranteed for three years in-use and ten years of shelf life.

The IBC Tadiran replacement battery is \$27.50 and can be ordered directly from IBC, 6860 Canby Ave., Ste. 113, Reseda, CA 91335; (818) 609-0516.

Compact, Rugged PC/XT Compatible

Slicer has introduced the SLY40-XT Turbo, a PC/XT-compatible that company sources state is ideally suited for industrial applications. This computer is composed of 17 low-power CMOS integrated circuits and resides in a 4¼-

inch × 9¼-inch printed circuit board. It uses an NEC 8-MHz V40 and supports one full megabyte of zero-wait-state RAM. The SLY40-XT Turbo also fea-

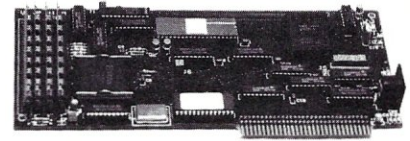

tures up to 64K of ROM, a PC/XT keyboard connector, an 8087 socket, and a serial port.

For more information, contact Slicer, 34509 Snelling Ave. South, Minneapolis, MN 55406; (612) 724-2710.

OTHER HARDWARE PRODUCTS

Co-Processor Controls Clock Rate

Everest International Marketing Inc. has introduced Zipper, a 80287 math co-processor that can be set to its own optimal clock speed (up to 10.6 MHz) without changing crystals or math chip. The resulting acceleration of all programs that make constant calls to the chip is ideal for such applications as CAD/CAM/CAE and spreadsheets. The Zipper board plugs right into the 80287 socket (no expansion board) and the existing chip is placed on the Zipper board. The Zipper can then control the 80287's independent clock. With the Zipper is a software interface, the Zip-It utilities, that allow interactive control of the math chip's clock speed.

Zipper carries a suggested retail price of \$159. For more information, contact Everest International Marketing, 633-470 Granville St., Vancouver, British Columbia, V6C 1V5; (604) 684-4187.

2.2 Gigs on One Cassette

Emerald Systems has adapted helical-scan recording technology used in video recording and introduced VAST, Virtual Archival Storage Technology. The recording technology uses the familiar approach to magnetic recording but at greater data density and speed. Using helical scan, a disk can be backed up to tape at a speed of 15 Mbytes per minute. Emerald's new VAST Device can store up to 2.2 Gbytes of data on a single tape cassette the size of a pocket cal-

COMPETITIVE EDGE

1421 E. Goldsmith • Plymouth, MI 48170 • (313) 451-0665

SPEED SHOP SINCE 1980

100% AT™ COMPATIBLES 286's & 386's

Velocity 286-12™ 12 MHZ, 1024K, 40MB, 28ms Hard Disk, EGA Card P/S/C 640 x 480 .	\$2095.
Velocity 286-10™ 10 MHZ, 1024K, 40MB, 28ms Hard Disk, EGA Card P/S/C	\$1950.
Velocity 386-16™ 16 MHZ, Reduced Foot Print, 1.2 Floppy, Size Case, 200 watt	\$1695.
Velocity 386-20™ 20 MHZ, Many Options, 40MB, 28ms Hard Disk, EGA Card P/S/C .	\$3895.

VELOCITY 286-XT AT POWER AT XT PRICE

286-XT 6/8 MHZ 80286, 640K, 360K Floppy Zomb HD, Mono Monitor	\$1295.
286-XT 6/12 MHZ 80286 Operation, 640K, 360K Floppy, Zomb HD, Mono Monitor . . .	\$1395.
8088-XT 4.77/8 MHZ 8088, 640K, 360K Floppy Zomb HD	\$ 995.
Add \$125 for 1.2 HB Floppy Option on 286-XT or 8088 XT	\$ 125.
Mitsubishi 19" Color Monitor 1024 x 768-6920 LPAG	\$1695.
Toshiba T3100 at Laptop — LiCmited Quantity	\$2695.

Hard Disks Available to 224 Megabytes on XT or AT™ Compatibles

HARD DISK DRIVES

ST251, 40 MB, 39ms	\$495.
ST225, with XT Controller	\$299.
Miniscribe 6053 42MB 28ms	\$679.
ST225 20MB, 65ms	\$269.
Miniscribe 70MB, 28ms	\$875.
Toshiba 70MB, 25ms	\$1095.

MONITORS

NEC Multi Sync EGA	\$549.
Samsung EGA 640x350	\$425.
Samsung Std. Color	\$309.
Samsung Amber Flat	\$119.
EGA Card, EGA, CGA, MPA	\$209.
CE EGA 640x480, 132 Column	\$229.

BASE AT \$995.

10 MHZ 80286
1.2 MB Floppy-Hard Disk/Floppy Controller, 640K RAM, AT™ Style Keyboard Clock, 192 Watt Power Supply, Set-Up Software, 1 Year Limited Warranty.

NOVELL, ZENIX™, ALLOY SOLD & SUPPORTED

12 MHZ 80286 Zenix System, 8 Serial, 1024K, 40MB, 28MS, EGA-640x480 .	\$3495.
3 User Alloy Slave System, 10MHZ, 80286, 40MB, H.D., 1024K	\$4195.
2 User (2) AT Compatibles, 640K, 10MHZ, 80286's, (1) 30MB, H.D. Novell 86 .	\$5295.

2, 4, 8, 16, 31 USER SYSTEMS AVAILABLE

S-100, All CompuPro®, Lomas, Teletex Boards at Lowest Prices.

Desktop Publishing Systems and upgrades available.

XT & AT are trademarks of International Business Machines. CompuPro is a registered trademark of VIASYN. Xenix is a trademark of MicroSoft.

culator. Originally developed for high-end storage for desktop PCs (beyond 250 Mbytes), but company sources say it is ideal for use with LANs and file services with disk volumes beyond 183 Mbytes.

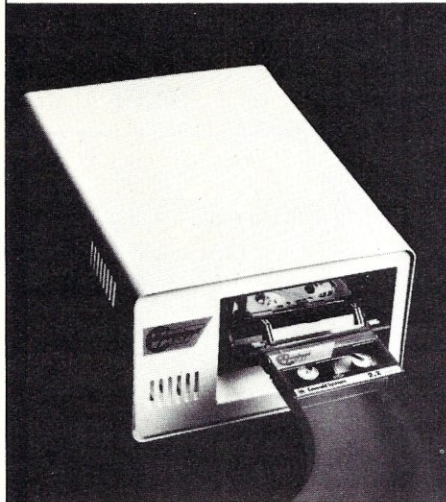

The VAST Device sells for \$69.95, and cassettes are available in four sizes: 250 Mbytes, 500 Mbytes, 1.0 Gbytes, and 2.2 Gbytes. For more information, contact Emerald Systems Corp., 4757 Morena Blvd., San Diego, CA 92117; (619) 270-1994.

Power Loss Shutdown

Electronic Specialists have announced the PLS Power Loss Shutdown unit to protect microcomputers operating on UPS or SPS power supplies. It powers down the system if commercial AC power has not yet been restored when the UPS or SPS batteries have discharged. This prevents undesired



computer and power system start-up after a power outage. Models with adjustable AC line drop-out voltage level also are available to accommodate the inherent brownout protection capabilities of most UPS systems.

The PLS is \$150 and is available from Electronic Specialists, Inc., 171 S. Main St., Natick, MA 01760; (800) 225-4876.

NEW SOFTWARE PRODUCTS

SQL Applications for 286/386

Oracle Corporation has released SQL*QMX, a query and report writer that allows users of 286 and 386 machines to develop SQL-based applications under DOS 3.1+. The new product is a compatible superset of IBM's Query Management Facility (QMF) and like QMF, provides a reporting and two query environments: Query-By-Example (QBE) and SQL commands. The easy-to-use report formatting capabilities also allow flexible presentation of query results, either interactively or in hard copy.

SQL*QMX operates with IBM PCs running Professional ORACLE and is priced at \$395. For more information, contact Oracle Corp., 20 Davis Dr., Belmont, CA 94002; (415) 598-8157.

Lifeboat for Graphics Programmers All at C

Lifeboat Associates has introduced a new graphics library for C programmers, Advantage Graphics. According to Lifeboat executives, Advantage Graphics provides C programmers with an expanded, comprehensive set of drawing functions, and the added performance necessary for designing multiple-window applications. The package also offers Advantage Plot, full support for a broad range of plotters. The Advantage Graphics library supports IBM PS/2 Models 30, 50, 60, and 80, as well as the PC/XT/AT. It is also compatible with a wide variety of C language compilers, including Lattice C, Microsoft C, and Borland Turbo C.

The Advantage Graphics library is available for \$250.00. For more information, contact Lifeboat Associates, 55 S. Broadway, Tarrytown, NY 10591; (914) 332-1875.

FORTRAN Programming Utilities

Fortran Power Tools from PJN International offers a collection of programming utilities to simplify program development on the PC. For example, the cross-reference utility not only generates source code with detailed cross-referencing maps for variables, subprogram calls, and labels, but it also can scan multiple sources files to compile an alphabetical list of subpro-

grams and tree diagrams of global routines. Other utilities in the library include file print, routine extract, file append, case change, and more.

Fortran Power Tools runs on IBM-compatible systems with DOS 2.0 or higher. It is available for \$119.95, plus \$3.50 shipping and handling, from PJN International, P.O. Box 200423, Austin, TX 78720; (512) 258-1235.

Easing Software Installation

The Software Factory has created a new set of tools to assist application and software developers when installing new software. EZ-Install provides a thorough installation program that offers more than printed installation instructions of .BAT files. EZ-Install allows the programmer to check disk and memory space, check files, check disk drives and directories, check DOS versions, and to give messages or take appropriate actions.

Along with EZ-Install, The Software Factory has introduced EZ-Paint, screen painter that allows the end user to interact with your program through menus and forms. Using the screen-painting technique, EZ-Paint provides control over foreground and background colors, color intensity, line font, field choices, text placement, menu choice threading, and other elements.

EZ-Install is available for \$99; EZ-Paint for \$40. For more information, contact The Software Factory, 15301 Dallas Pkwy., Ste. 750, Dallas, TX 75248; (214) 490-0835.

Software Configuration Management Utility

The Boston Software Works has released Version 6 of its BSW-Make software configuration management utility. Patterned after the UNIX-make utility, BSW-Make Version 6 automatically constructs program executables using information in a "makefile," which assures developers that only those files that have been modified since the program was last built will be compiled or assembled and linked into a new program executable. The Version 6 is now available for PCs running MS-DOS/PC-DOS, and for DEC VAX computers running VAX/VMS.

BSW-Make Version 6 sells for \$89.95 for MS-DOS. For more information, contact The Boston Software Works, 120 Fulton St., Boston, MA 02109; (617) 367-6846.

9-Track Tape Subsystem

for the IBM PC/XT/AT
XENIX or
MS-DOS.

The solution to your
micro/mainframe
communications
problem is
available today!



Qualstar's new
1/2 inch 9-track
MINISTREAMER™ brings full ANSI data interchange capability
to the PC. Now you can exchange data files with virtually any
other computer using 9-track tape.

Available in both 7" and 10 1/2" versions, the MINISTREAMER
weighs in at only 27 pounds and uses less desk space than an
ordinary sheet of paper, yet provides full 1600/3200 BPI
capability at an affordable price. Up to 134 megabytes of data
(depending on format) can be stored on a standard 10 1/2" reel of
tape, thus making the MINISTREAMER a highly-reliable answer to
your backup requirements as well.

Tape subsystem includes tape drive, coupler card, cables,
dust-cover and MS-DOS or XENIX compatible software.
Prices start at \$2,995.

386 READY!

Discover the many advantages
9-track tape has over other
Micro/Mainframe links.

Call us today!

QUALSTAR®

9621 Irondale Avenue,
Chatsworth, CA 91311
Telephone: (818) 882-5822

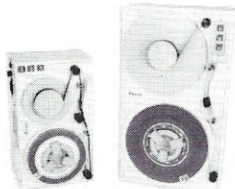

MULTITASKING AND MULTIUSER PERFORMANCE FOR 27¢ PER DAY

With **OPERATING SYSTEM TOOLBOX**, the Software
Construction set that allows you to build your own custom
operating system.

With **PCNX**, Wendin's PC version of Bell Laboratories'
incredible UNIX Operating System.

With **PCVMS**, A system similar to the VAX/VMS
Mainframe Operating System that brings an elegant set of
services to the PC.

FROM WENDIN . . . of course!

**EACH PRODUCT IS PRICED AT ONLY \$99.00,
AND INCLUDES SOURCE CODE ON DISK.**

If you average that cost out, that's only 27¢ per day for one year.
THE REST OF YOUR LIFE IT'S FREE!

*** **MENTION WHERE YOU SAW THIS AD** ***
WHEN YOU ORDER AND RECEIVE FREE A
HIGH QUALITY PEN AND PENCIL SET IN A DELUXE GIFT BOX
COMPLIMENTS OF WENDIN.



**ORDER HOTLINE
(509) 624-8088**

Wendin is a registered trademark of
Wendin, Inc. PCNX, PCVMS, and
Operating System: Toolbox, are
trademarks of Wendin, Inc.

WENDIN®

BOX 3888
SPOKANE, WA 99220-3888

Working beyond the horizon to develop the operating systems of tomorrow
© Copyright 1987 Wendin, Inc. (509) 624-8088

HIGH PERFORMANCE RAM

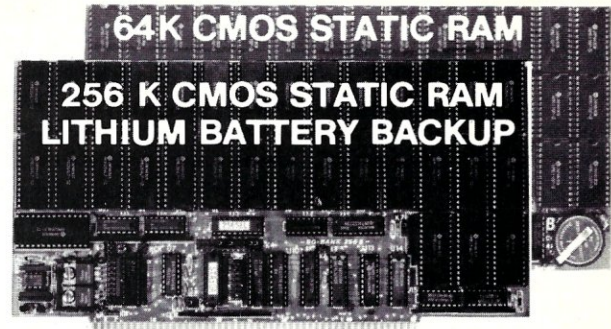

✓ COMPARE

	8/16 BIT DATA	Bank Selection MPM, OASIS CROMIX-D	10 Megahertz Speed	Software Write Protect	Battery Backup Option
Compupro Ram 22	✓	NO	✓	NO	NO
Octagon 256K	✓	NO	✓	NO	NO
Cromemco 256KZ II	✓	NO	NO	NO	NO
Dynamic Boards	✓	✓	NO	NO	NO
BG-Bank 256S	✓	✓	✓	✓	✓

GUARANTEED IN YOUR SYSTEM CROMIX-D • MPM • CCS • OASIS • AMOS

✓ **PLUS:** 8/16 BIT TRANSFERS • 24-BIT EX. ADDRESSING
8-12 MHZ • 2K DESELECTS • RAM-EPROM MIX
IEEE 696/S-100 • LOW POWER • FULLY STATIC

LITHIUM BATTERY BACKUP avoids power failure crashes intel-
ligently. Unique POWER-FAIL-SENSE circuit allows processor to
save register information and disable board before POWER
FAILURE CRASHES memory.

BG BANK 256S..... \$329 Battery Backup \$129
BG BANK 64S..... \$249 Battery Backup \$99

**MEGABYTE MADNESS
FOUR 256S CARDS**

**BG COMPUTER APPLICATIONS, 206 Brookside,
Bryan, Texas 77801. International orders add 30%.
(409) 775-5009**

Classifieds

Micro/Systems Journal accepts *Classified Ads*. The charge is \$6/line (3 lines minimum, 7 lines maximum); 40 characters max./line. Three times frequency \$15/line; six times \$25/line; non-profit clubs \$2/line. Logos, special type, etc. are extra charge. Check must accompany ad copy. Send to M & T Publishing Inc., 501 Galveston Dr., Redwood City, CA 94063.

DOS User's Group

Quarterly Newsletter discounts on Third Party Products. Latest DOS news, demo diskettes. DOS Tutorials. Annual membership fee: U.S. \$25, Canada & Europe \$35. DOS User's Group, P.O. Box 26601, Las Vegas, NV 89126.

ENGINEERING SOFTWARE

Circuit Design and Analysis Programs. FREE CATALOG and TUTORIAL GUIDE. BV Engineering, 2200 Business Way, #207, Riverside, CA 92501; (714) 781-0252.

RAM DISK

S-100, 2 MEG, PORT I/O. New, Warranted, \$725. S. Lugert, 439 Peck Slip Sta., N.Y.C., N.Y. 10272, or call (718) 622-0654.

DISK CONVERSION: Most CP/M and MS-DOS formats. 48 hour turnaround. Reasonable rates. Personal service. For information call or write: RH Associates, 2211 Mark Ct., Silver Spring, MD 20910; (301) 587-6230.

Listings are available on disk

Why spend hours reinputting the proven programs we print? The source code that accompanies the articles published in *Micro/Systems Journal* is available on MS-DOS disk. If you are interested in any of the programs offered in this issue, or want more information about programs from past issues, please feel free to contact us. Please be sure to specify the issue. To order sent \$14.95 to:

Micro/Systems Journal
501 Galveston Dr.
Redwood City, CA 94063

SQL.PAS

Make stack, queue, and list standard data types in Turbo Pascal (\$9.95). PSW, Box 10072, McLean, VA 22102-8072.

Compupro 816A, S-100, 88/85, 256K, 512K Mdrive, 2-8" Qumes, Wyse 100, Hayes 300, Pascal MT+86, Aztec C86, Vedit 80/86, MS-Basic 80, dBASE, SuperCalce, 2000 hrs, \$2,500. Neil (404) 255-8007.

Compupro 8/16 S-100 SYSTEM, Disk 1A SSI CPU 85/88, 576k, IF4, 2-8" 1/2ht drives, TV1 970 terminal. CP/M-816, C-DOS, much software \$2,500/offer. Steve (919) 481-1300.

Multiline TBBS

No busys. Doors include download on first call, electronic mail, multiple sigs, CB chat. North county San Diego non-profit group has remote access nodes 24 hours, 300/1200/2400 bps. Line #1: (619) 749-2741; #2: 749-2589; #3: 566-6329; #4: 727-0202; #5: 749-8465. Voice: 749-0322.

KAYPRO '83, XEROX 820-I, AND BIG BOARD-I owners—Blazing fast assembly language device drivers provide windows, sprites, mouse support, and more. ONLY \$49.95 FLEXISOFT, 3987 Valley View Dr., Ashland, KY 41101; (606) 325-3736.

C VIDEO TAPE

Unlock the secrets of C! See source code examples reveal every nook and cranny of K&R. 6-hour tape takes you from novice to expert. Review it again and again. Good for reference. Comes with book; \$39.95. Applied Logic, 2309 Royce Dr., Arlington, TX 76016; (817) 275-4631.

FOR SALE: Compupro 816/C system with 286 CPU and 1MB memory, 16 ports, 20MB cartridges, 5 Wyse terminals, lots of software. Best Offer. (312) 393-2900.

S-100. Lomas based MS-DOS sys, upgraded Vector MZ, more. Gary Van Cott, Box 1879, Grafton, VA 23692. (804) 898-3680.

Advertiser Index

Aker Corporation.....	23
Alloy Computer Products	82
Applied Logic.....	80
Austin Code Works.....	63
BG Computer Applications	79
Blaise Computing Inc.....	17
BV Engineering.....	80
Clary Corporation.....	55
Competitive Edge.....	77
CompuPro/Viasyn.....	9
Concurrent Research	73
Davidge Corporation.....	67
Digiboard.....	31
Digital Research Computers	27
DOS User's Group.....	80
Echelon Inc.....	33
Ecosoft, Inc.....	5
Entelekon.....	71
Exec-PC Inc.....	47
Flexisoft	80
Gary Van Cott	80
Gimpel	32
Goodall Computer Systems.....	29
Harvard Softworks	36
Hawkeye Grafic Inc.....	61
House Sub. Ad.....	24,56
Integrand Research Corporation.....	68
Intercontinental Microsystems	35
Lahey Computer Systems Inc.....	11
Lodden Technology Limited.....	69
Macrotech International.....	C-2
MetaWare Inc.....	43,73
Night Owl.....	21
NWP Intelligent Solutions, Inc.....	60
Opt-Tech Data Processing.....	67
Paul Black Associates	61
PD-SIG: THE TIBBS	80
PC TECH.....	73
Periscope Co., Inc.....	75
Power Software	80
Programmer's Connection	39,40,41
Programmer's Paradise	15
Programmer's Shop	51
Qualstar Corporation.....	79
Quarterdeck Office Supplies.....	81
Raima Corporation.....	9
RH Associates	80
S. Lugert.....	80
Semi-Disk Systems.....	1
Slicer Computer.....	67
Softcraft, Inc.....	2
Software Connections, Inc.....	37
Solution Systems	7
Sound Inc.....	80
Stephen R. Lund.....	80
Stony Brook Software, Inc.....	61
Sunny Hill Software	44
Tangent Designs, Inc.....	26
Turbo Power	14,16
Turbo Power Software.....	42
Wendin.....	79
Western Ware.....	65
Whitewater Group.....	53
Wyte Corporation.....	73

How to tell the difference between DESQview™ 2.0 and any other environment.

Selecting DESQview, the environment of choice, can give you the productivity and power you crave, without the loss of your old programs and hardware. If you like your existing programs, want to use them together, transfer data between them, print, sort, communicate with or process-in-background, yet still have the need to keep in place your favorite PC(8088, 8086, 80286 or 80386), DESQview is the "proven true" multitasking, multi-windowing environment for you. Best of all, DESQview 2.0 is here now, with all the money saving, time saving, and productivity features that others can only promise for the all-too-distant future.

And with DESQview's new graphics enhancements for Hercules, CGA, EGA, and VGA, Version 2.0 still offers the same award winning and pioneering features for programs that earned DESQview its leadership, only now you can also run desktop publishing programs, CAD programs, even GEM™, Topview™, and Microsoft Windows™ specific programs. In some cases you'll add as little as 10-40K to your system overhead. Now you can have multi-tasking, multi-windowing, break the 640K habit too and still get an auto dialer, macros, menus for DOS and, for advanced users, a new complete application programmer's interface capability. No wonder that over the years, and especially in recent months, DESQview, and now DESQview 2.0 have earned extravagant praise from some of the most respected magazines in the industry. "Product of the Year" by readers vote in InfoWorld. "Best PC Environment" by popular vote at Comdex Fall in PC Tech Journal's "System Builder" Contest. "I wouldn't want to run an IBM



One picture is worth a thousand promises.

Attention Programmers: For more information about Quarterdeck's API, and future 386 program extensions, call us today.

SYSTEM REQUIREMENTS

IBM Personal Computer and 100% compatibles (with 8086, 8088, 80286 or 80386 processors) with monochrome or color display; IBM Personal System/2 • Memory: 640K recommended; for DESQview itself 0-145K • Expanded Memory (Optional): expanded memory boards compatible with the Intel AboveBoard; enhanced expanded memory boards compatible with the AST RAMpage • Disk: Two diskette drives or one diskette drive and a hard disk • Graphics Card (Optional): Hercules, IBM Color/Graphics (CGA), IBM Enhanced Graphics (EGA), IBM Personal System/2 Advanced Graphics (VGA) • Mouse (Optional): Mouse Systems, Microsoft and compatibles • Modem for Auto-Dialer (Optional): Hayes or Compatible • Operating System: PC-DOS 2.0-3.3; MS-DOS2.0-3.2 • Software: Most PC-DOS and MS-DOS application programs; programs specific to TopView 1.1, GEM 1.1 and Microsoft Windows 1.03 • Media: DESQview 2.0 is available on either 5 1/4" or 3 1/2" floppy diskettes

Rush me DESQview 2.0! Today!

No. of Copies	Media 3 1/2"/5 1/4"	Product	Retail Price ea.	Total
		DESQview 2.0	\$129.95	\$
		Shipping & Handling	USA \$ 5.00 Outside USA \$ 10.00	\$
		Sales Tax (CA residents)	6.5%	\$
		Amount Enclosed		\$

Payment: Visa MC AMEX Check

Credit Card: Valid Since _____ / _____ / _____ Expiration _____ / _____ / _____

Card Number: _____

Credit Card Name: _____

Shipping Address: _____

City: _____ State: _____ Zip: _____ Telephone: _____

Mail to: Quarterdeck Office Systems, 150 Pico Boulevard, Santa Monica, CA 90405.
NOTE: If you own DESQview call us for a special upgrade offer, or send in your DESQview registration card. AST Special Edition users included.

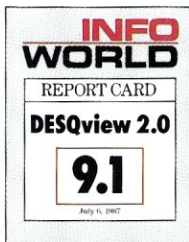

Quarterdeck Office Systems • 150 Pico Boulevard, Santa Monica, CA 90405 • (213) 392-9851

DESQview is a trademark of Quarterdeck Office Systems. AboveBoard is a trademark of Intel Corporation. Hayes is a trademark of Hayes MicroComputer Products Inc. IBM, PC, Personal System/2 and TopView are trademarks of International Business Machines Corporation. Microsoft Windows and MS are registered trademarks of Microsoft Corporation. Mouse Systems is a trademark of Metagraphics/Mouse Systems. RAMpage is a trademark of AST Research, Inc. GEM is a trademark of Digital Research. Hercules is a trademark of Hercules.

or compatible computer without DESQview™—InfoWorld, Michael Miller. "A colossus among windowing environments"... "will run almost anything"—PC Week, Marvin Bryan. "Windows, promises, but DESQview delivers"—MICRO-TIMES, Birell Walsh.

No other environment has consistently pioneered features, openness, and productivity. See for yourself. Send in the coupon. The possibilities are endless with DESQview 2.0.

PC-PLUS™

High Performance Network Solutions



Unlike traditional LANs, PC-PLUS' on-the-bus architecture puts the computing power where you need it — with the data — inside the server.

PC-PLUS: The LAN Engineered for Shared Data

Any local area network can connect PCs. PC-PLUS, however, is engineered to optimize multiuser access to shared databases. We put a PC — or AT — on a card that *plugs into the server*. Putting your computing power on the same bus as your data. Giving you high bandwidth *where you need it*. Without the transmission overhead that steals performance on most LANs.

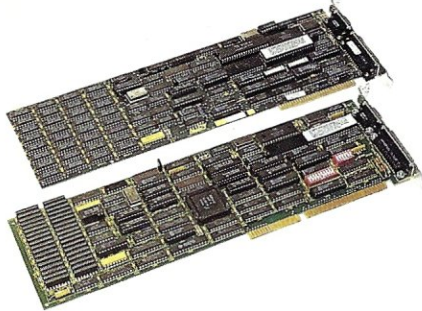

PC-PLUS Gives You the Power You Need

Our plug-in cards come as 8 MHz PCs or 8 MHz ATs — to match your computing needs exactly. And PC-PLUS networks can *deliver* that power — proven by benchmarks. Power to get your job done. Power to grow into new applications without sacrificing performance.

PC-PLUS is Easy to Install and Use

We put the computing engines all in one place — in the server. Not spread all over the building. And our LAN software is truly easy to install. Use PC-PLUS with your choice of AT compatible servers or with Personal System/2™. Add a card and terminal to grow. Simple RS-232 twisted-pair data cables — no expensive rewiring with coax. You can often use existing telephone cable. Convenient packaged solutions, including Alloy's NTNX™ network software.

PC-PLUS Runs With Personal System/2

With Alloy's new HI/2™ Micro Channel™ interface, you can connect PC-PLUS to IBM's new Personal System/2 Model 50, 60 or 80 computers. Use Alloy's 4,

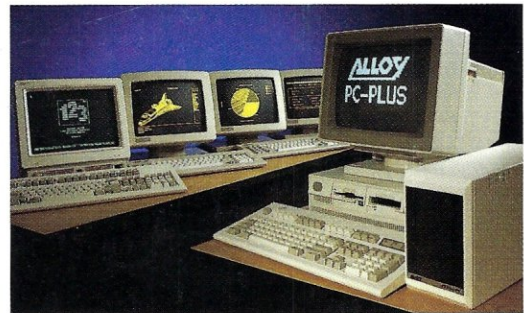

8, 12 or 16 slot expansion boxes to build PC-PLUS networks with PS/2 file servers. Or choose our PLUS4/PS for a simple, preconfigured 4 workstation network.

PC-PLUS: Find Out Before You Invest

A local area network is a long term investment. Today's applications are just the beginning. Make sure your choice is ready for tomorrow — with mainframe connections, remote access, graphics and the power for growing database applications. To find out more about PC-PLUS, call or write Alloy today at (617) 875-6100.

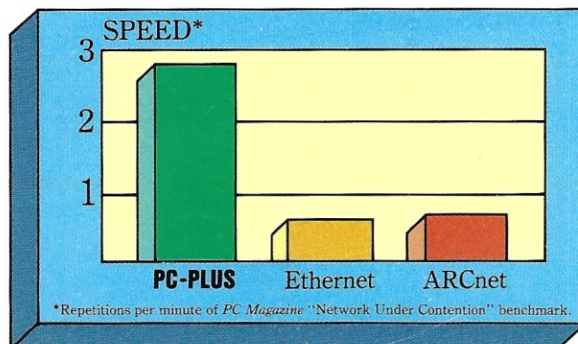

PC-PLUS™
The No-Nonsense Network

ALLOY
COMPUTER PRODUCTS