

micro systems

LIBRARY
STATE TECHNICAL INSTITUTE
AT MEMPHIS

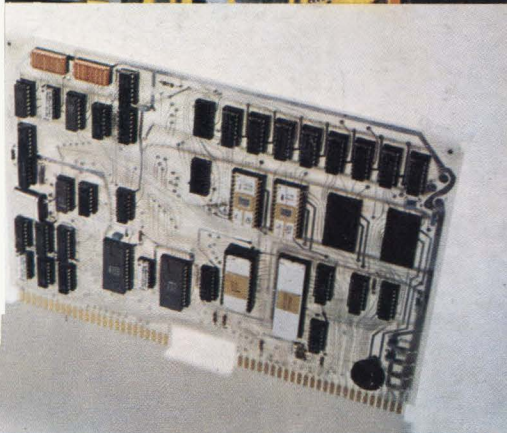

SOFTWARE COMPATIBILITY: Myth vs Realities
GIULI MASTERING THE MICRO
A New Way To Sell Industrial Microcomputers
Part 2 - DATA ACQUISITION - A Technology Profile

The Genie.

The Codex Multipoint Network Control System. MNCS. A real Genie that can put you in total control of your high speed multipoint network.

Wish for remote monitoring... You've got it. Wish for complete diagnosis of a system problem... Yours. Wish for restoration of a function so that you are assured of continuous system operation... It's yours. And you control it all from the central location with no human intervention at the remote site required.

Our Genie works like magic. So do our Fast-Poll* Multipoint Modems.

Codex Fast-Poll modems include a wondrous "gearshift" operation to provide the fast RTS/CTS response time of 9 milliseconds typical of 2400 bps units yet with

the high inbound data throughput of a 4800 bps modem. And they offer proven reliability, performance, and economy because they include the latest advances in MOS/LSI technology.

On the outbound side the LSI 48FP, LSI 72FP, or LSI 96FP offer 4800, 7200, or 9600 bps speeds respectively to provide the maximum in completely automatic operating performance in dedicated multipoint configurations. So order the Codex Genie to make you the master of your multipoint network and the Fast-Poll slaves will grant your every wish.

codex
We'll get you through



member of
IDCMA

Codex Corporation, 15 Riverdale Avenue, Newton, Massachusetts 02195 Tel: (617) 969-0600 Telex: 92-2443 Codex Europe S.A., Bte 7/Av. de Tervuren 412, B-1150 Brussels, Belgium Tel: 762.23.51/762.24.21 Telex: 26542. Offices and distributors in major cities throughout the world.

CIRCLE NO. 1 ON INQUIRY CARD

*Patent Pending

While other mini-makers have been pushing & shoving...

**one company
has quietly
become
number 2*.**

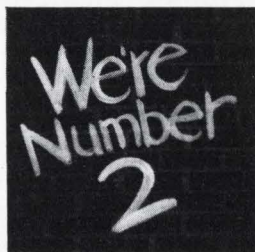

They've quietly shipped over 9,000 computers. In fact, over 400 of their minis are going to OEM's every month.



Because so many computer makers use their minis, they're often called the Computer Company's Computer Company.



Others deliver a mini or two to get an OEM roped in... then make them wait for 9 months. While this quiet company ships quantities in 45 days.



They offer a full family of compatible micros thru midis. With price/performance, technology, features and benefits to delight the most demanding designers.



And all the software you'll ever need. Field-proven. In thousands of installations. Plus a variety of support services, and other protection to their customers. Over 300 OEM's use their minis. It's...

 **DIGITAL COMPUTER CONTROLS INC**

The Quiet Mini-Maker. We're Number 2.

For further information, contact: Digital Computer Controls, Inc.,
12 Industrial Road, Fairfield, N.J. 07006, (201) 575-9100

TWX 7107344310

*In the number of minicomputers currently being shipped to Original Equipment Manufacturers.

CIRCLE NO. 2 ON INQUIRY CARD

If you're designing a system to run NonStop™

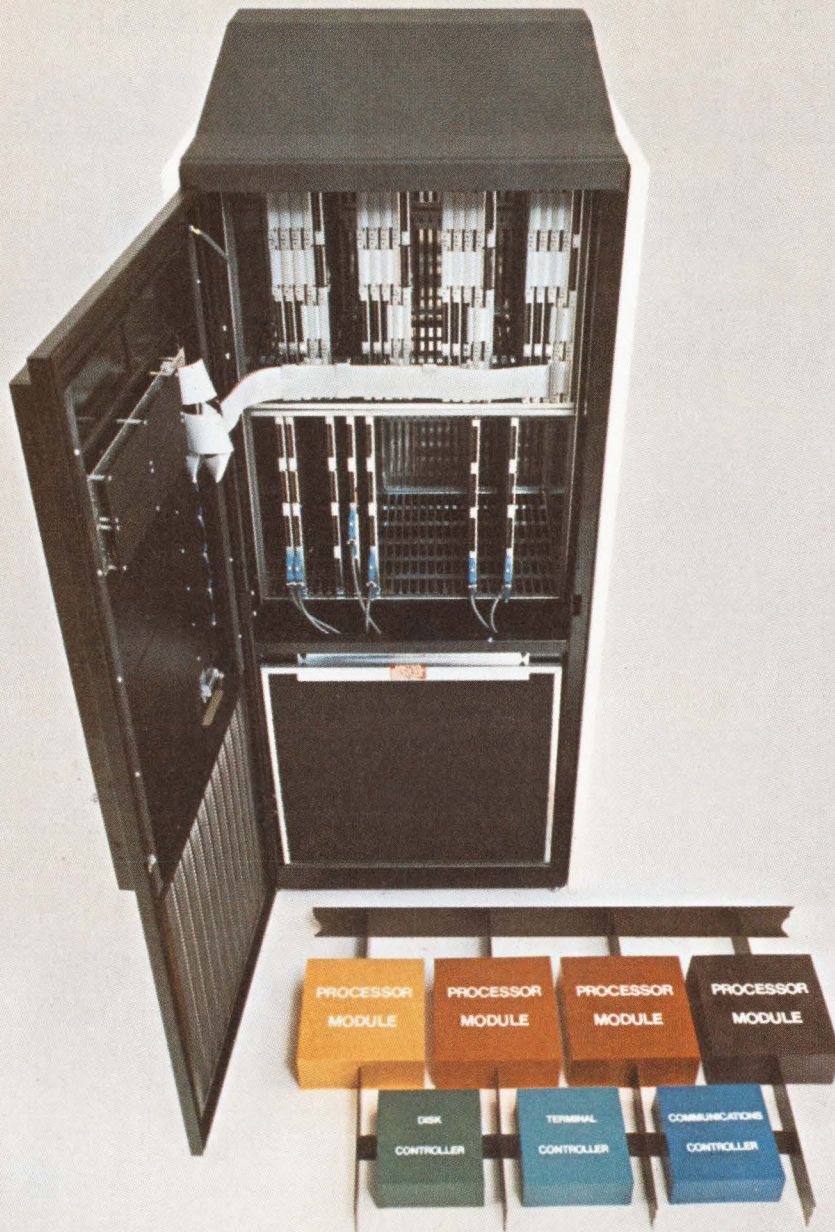

stop!

Don't Tie Your Terminals To A Single Processor System—Give Your Customers Tandem NonStop™ Performance!

The Tandem 16 is a true multiple processor system that won't shut down with component failure. Any failure that occurs can be repaired without shutting down the system; and, a failure in one module will not contaminate data in another module or cause deterioration in the data base.

The diagram illustrates Tandem modularity and how multiple processors can be added to increase capacity as needs grow. Existing hardware and software are retained, and additional processors can be added without interrupting system operation!

Banks, distributors, credit card processors, transportation companies—anyone needing uninterrupted on-line transaction processing will be delighted with the Tandem 16 NonStop system performance and economy. Someday, all on-line transaction processing will be handled by multiple processor systems that won't shut down! Someday is today! Tandem is doing it right now, with multiple processor systems starting under \$80,000.

Tandem Computers, Inc., 20605 Valley Green Drive, Cupertino, Ca 96014, or Tandem Computers, Inc., GmbH Bernerstrasse 50A Frankfurt 56, Germany.

Call Sam Wiegand, VP Marketing, at 800-538-9360 for more information about the computer that won't shut down!

TANDEM

CIRCLE NO. 3 ON INQUIRY CARD

Publisher S. Henry Sacks
Assoc. Publisher William A. Gannon
Editor-in-Chief Stanley Klein
Associate Editor Barbara A. Reynolds
Technical Editor Dan M. Bowers

CONSULTING & CONTRIBUTING EDITORS

Boris Beizer Walter A. Levy
Ralph Berglund Efrem Mallach
Maurits de Regt Terry Miller
Ken Falor John A. Murphy
Ivan Flores Carol A. Ogdin
James I. Leabman Malcolm L. Stiefel

ART/PRODUCTION DIRECTOR
John W. Kelley, Jr.

PRODUCTION ASSISTANT
Sally Haskins

ADVERTISING PRODUCTION
Manager Bernard Greenside

ASS'T TO PUBLISHER
Pamela E. Smith

CIRCULATION DEPARTMENT
Carol Grace, Mgr.

All correspondence regarding circulation, advertising, and editorial should be addressed to the publication offices at:

MINI-MICRO SYSTEMS
5 Kane Industrial Drive
Hudson, MA 01749
(617)562-9305

SALES OFFICES

Sales Mgr. Robert J. Bandini
Mktg. Service Mgr. Melvin L. Hayden

NORTHEAST

Melvin L. Hayden, 5 Kane Industrial Drive, Hudson, MA 01749 (617)562-9305

MID-ATLANTIC, MIDWEST AND SOUTH

Robert J. Bandini, 1214 Post Road, Fairfield, CT 06430 (203)255-6293

WEST COAST

David E. Pearson, 7135 W. Manchester Ave., Suite 3, Los Angeles, CA 90045 (213) 670-5651

Published monthly and copyrighted 1976 by Modern Data Services, Inc., 5 Kane Industrial Drive, Hudson, MA 01749. The contents of this publication (in excess of 500 words) may not be reproduced in whole or in part without written permission.

SUBSCRIPTIONS: Circulated without charge by name and title to U.S.-based corporate and technical management, systems engineers, and other personnel who qualify under our qualification procedures. Available to others at the rate of \$18.00 per year; single issues \$1.75. Subscription rate for all foreign subscriptions is \$25.00 per year (12 issues).

POSTMASTER: Send Form 3579 to: Circulation Dept., Mini-Micro Systems, 5 Kane Industrial Drive, Hudson, MA 01749. Controlled Circulation postage paid at Long Prairie, MN.

Back issues of MINI-MICRO SYSTEMS (formerly Modern Data) are available on microfilm. Contact University Microfilms, 300 North Zeeb Rd., Ann Arbor, Michigan 48106 for ordering information.



OCTOBER 1976 • VOLUME 9 • NUMBER 10

mini-micro systems

17 ON SITE AND INSIGHT

A New Way To Sell Industrial Computers

Control Logic is setting up a nationwide network of dealerships as a new way to market industrial microcomputers.

24 PRODUCT FOCUS

30 DATA COMMUNICATIONS

30 DATACOMM NEWS

36 MASTERING THE MICRO

Continuing the series of first-hand accounts on what it takes in patience and know-how to apply the micro to real products.

44 COMPCON ABSTRACTED

Micros are where the action is as shown by abstracts of six key papers.

52 STIEFEL ON SOFTWARE

Software Compatibility: Myth vs. Realities

56 NETWORKS: WHERE COMPATIBILITY PAYS OFF

Integrating microprocessors into an existing minicomputer.

58 DATA ACQUISITION — A TECHNOLOGY PROFILE

66 MINICOMPUTERS IN DATA ACQUISITION: A CASE STUDY

Eaton Corp. engineers use a Hewlett-Packard system to cut the time needed to conduct fatigue tests on vehicle parts by an order of magnitude and the cost by half.

COVER CREDIT:

Microcomputer Replaces Men. Crane manufacturer Harnischfeger Corp. is replacing human operators with microcomputers from its Control Logic Inc. subsidiary. Shown is the CPU board of the 8080-based MM1 microcomputer.

DEPARTMENTS

- 4 LETTERS
- 8 NEWS & COMMENT
- 12 INTERNATIONAL NEWS
- 21 DC DATASCAN
- 22 CORPORATE & FINANCIAL
- 71 NEW PRODUCTS
- 76 BOOKSTORE
- 78 NEW SOFTWARE & SERVICES
- 79 NEW LITERATURE
- 80 INDEX TO ADVERTISERS

SUBSCRIPTION CARD OPPOSITE PAGE 1
READER INQUIRY CARD OPPOSITE PAGE 80
BOOKSTORE ORDER CARD OPPOSITE PAGE 80

GETTING VENDORS STRAIGHT

To the Editor:

The information on Ultimacc Systems Inc., which appeared in the "Product Profile, Small Business Computers" in the July issue, was outdated. First, Ultimacc Systems, founded in 1969, was acquired by Storage Technology Corp. in Louisville, CO, in August, 1975 when the name of our company was changed to STC Systems Inc. Our

product, a custom turnkey business system, retains the ULTIMACC name, however.

Now, with regard to the July issue chart on pages 54 and 55, the corrected information follows.

**William McGarry, Mktg. Coordinator
STC Systems Inc.
Paramus, NJ**

MANUFACTURER Model No.	CPU		DATA ENTRY TERMINAL		CARD READER		DISK		MAG TAPE		PRINTER		
	Word Length (Bits)	Memory Capacity (Kbytes)	Type	No. of Units	Columns	Speed (cpm)	Capacity (Mbytes)	Type	No. of Units	Type	No. of Columns	Speed (lpm)	Speed (cps)
STC SYSTEMS INC.													
Ultimacc 2000	16	32-64	Video	1-8	80		5-40	Reel	1-4	Matrix	132		165
Ultimacc 3000	16	32-256	Video	1-63	80		5-40	Reel	1-4	Serial	132		165
Ultimacc 3370	16	32-256	Video	1-63	80		5-1000	Reel	1-4	Line	132	300-900	

OTHER PERIPHERALS ¹	COMMUNI- CATIONS ²	PROGRAMMING LANGUAGES	MODES OF OPERATION ³	TYPICAL PRICES			COMMENTS
				Purchase	Mo. Rental	Maintenance/ Month	
PTR	A	Assembler	O/M (15)	41K →		285	Includes Application Software
	A	Basic		60K →		415	
	A	Fortran IV		75K → 150K → 100K → 300K →		700	

To the Editor:

A reference to the Hewlett-Packard computer line (Minicomputer Profile) in the August issue is out of date. In May, Hewlett-Packard introduced the 3000 Series II with an access time of 300 nanoseconds and a cycle time of 700 nanoseconds. The profile gave 900 nanoseconds as the core memory time. Also, the core memory in the new series has been replaced with semiconductor memory that ranges from 128 Kbytes to 512 Kbytes.

**Jerry Marstall
Sales Representative, Computer System
Hewlett-Packard Co.
Lexington, MA**

To the Editor:

In the July issue article on microprocessors, Motorola is given as the second source for the AMD 2900 family of devices. That is incorrect. Raytheon Co.'s Semiconductor Div. is the only alternate source to be on the market with the product and a software package to support it.

**Dan E. Andersen
Manager, Marketing Communications
Semiconductor Div., Raytheon Co.
Mountain View, CA**

KUDOS TOO

To the Editor:

The profile on small business computers in the July issue is superb. As a minicomputer software house and consulting firm, we are often called by potential buyers to give a brief run-down on the relative merits of small business computers on the market. I have found the product profile to be very helpful as a reference source in such cases and would like to know how I can obtain reprints to hand out.

**Glenn Barber, Director
Mini-Computer Services Center, Inc.
Altadena, CA**

(Editor's Note: MINI-MICRO SYSTEMS magazine sells reprints on articles that appear in the magazine. The minimum order is 100, and price quotes will be supplied upon request.)

To the Editor:

The Systems-On-A-Chip Scorecard in the July issue contains outdated data on NEC Microcomputers, Inc. 8-bit microprocessor. More than a year ago, NEC did offer a 42-pin, 8 bit microprocessor, designated μ PD753, but at no time did NEC ever have a part designation μ COM-8. In essence, NEC is now a second source to Intel for the 8080A microprocessor.

**George W. Muller, Vice President
NEC Microcomputers, Inc.
Lexington, MA**



Accupower,[™] the uninterruptible power system from Emerson is now keeping over 200 computer installations on line.

You'll get an all solid-state design ...and protection from outages, brownouts and fluctuations. Plus complete voltage frequency and transient control.

Carefully check all the Accupower[™] features. Including its design simplicity, high reliability and efficiency, and easy maintenance. Minimum installation costs.

The number of repeat customers is an excellent way to judge performance...Emerson will show you the largest list of repeat customers in the industry. Call (714) 545-5581. Or write Emerson Electric Company, attention UPS Marketing, 3300 South Standard St., Santa Ana, Ca. 92702.

CIRCLE NO. 4 ON INQUIRY CARD

MORE BYTES FOR YOUR 2 BITS



Microprocessor based peripherals from XEBEC provide more storage and capability for less money on your **DEC, D.G. and HP Minicomputers.**

Patent Pending **THE XEBEC 1000**
(Very smart controller)

Perhaps you have always known that disk, tape and floppy systems from DEC, DG and HP cost way too much for what you get. If you have never carefully researched the alternatives, you should consider THE XEBEC 1000, a new breed of minicomputer memory system. At the heart of each low cost system is the most powerful controller available. Many new features are made possible by the controller's schottky microprocessor chip set. This high speed microprocessor has been trained by XEBEC engineers to be **PLUG COMPATIBLE AND PROGRAM TRANSPARENT.**



XEBEC 1500
CARTRIDGE DISK SYSTEM
(More features than ever)



XEBEC 1200
FLEXIBLE DISK SYSTEM
(World's fastest floppy)



XEBEC 1900
MAGNETIC TAPE SYSTEM
(12.5 IPS to 125 IPS)



XEBEC 1700
STORAGE MODULE SYSTEM
(300 MB for \$27,500)



2985 Kifer Road, Santa Clara, California 95051
(408) 988-2550 TWX 910-338-0130

CIRCLE NO. 5 ON INQUIRY CARD

990/10 OEM minicomputers.

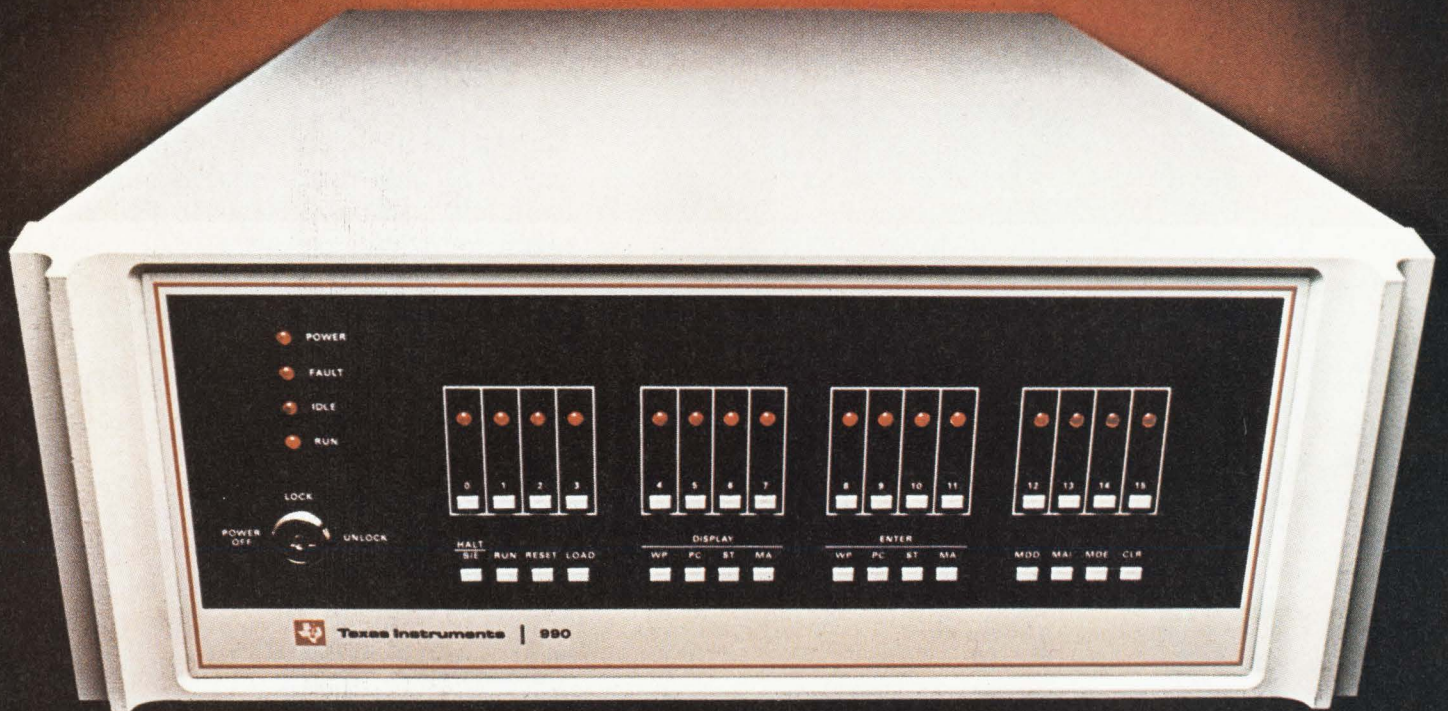

Built, backed and priced to sharpen your competitive edge.

TEXAS INSTRUMENTS.

The 990/10 minicomputer from TI brings superior value to both you and your customers.

Starting with field-proven hardware, the 990/10 delivers the reliability you expect from TI. And all the off-the-shelf support you need for user applications. You get standard software languages, a broad choice of peripherals and nationwide service.

Built for more processing power.

The 990/10 is the most powerful member of the 990 computer family. Its architecture provides features that give you maximum processing power for your money. Like hardware multiply and divide. A 16-level hardware

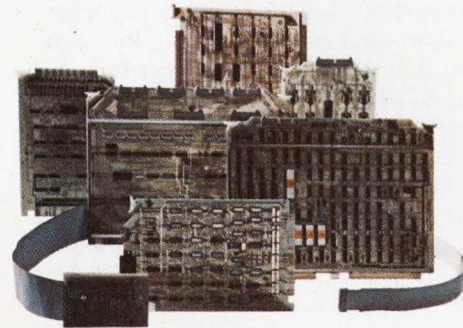

Peripheral Interface Modules

interrupt structure. 16 registers arranged in a workspace concept. I/O that's directly programmable through the Communications Register Unit (CRU) and autonomously through a high-speed data bus. And bit, byte and word addressing of memory.

Built for system flexibility.

In small or large configurations, the 990/10 design provides surprising flexibility for a small investment.

The CRU, with up to 4096 I/O lines, reduces interfacing costs by keeping controller complexity to a minimum. The TILINE* asynchronous high-



Model 913 Video Display Terminal

speed data bus can support both high- and low-speed devices and takes advantage of design simplicity for simultaneous data transfer between peripherals, the CPU and memory.

With the 990/10, you get a powerful instruction set with an extended operating feature that allows hardware to take over operations that software would normally execute. An optional mapping feature provides memory protection and memory expansion to 1 million words. And, optional error-correcting memory corrects single-bit errors for increased system reliability.



DS 25/50 Disc Drives

Full peripheral support.

As well as a range of standard peripherals, disc storage to 90 million 16-bit words and magnetic tape with 800 and 1600 bpi options are available for low-cost mass storage and back-up.

A choice of software.

With common higher level languages, FORTRAN IV, COBOL and Multiuser BASIC, plus the 990/10 assembly language, you have all the tools you need for an efficient application program.

Both the disc-based and memory resident operating systems give you modularity and flexibility for system generation to meet application de-

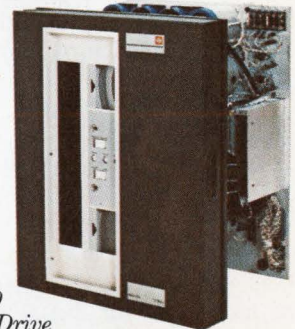

Model 979 Tape Drive

mands. We offer program development aids for creating and testing software, and communications software to support synchronous or asynchronous data transmission.

Backed with nationwide service.

Our responsibility to you doesn't end with the sale. We follow through with complete system training, plus a nationwide factory service network.

The TI 990/10 minicomputer. We build it, back it and price it the way you and your customers want it. You can start configuring a system now with our 990 Computer Systems Handbook on the upward-compatible family of the TMS 9900 microprocessor, 990/4 microcomputer and 990/10 minicomputer. For your free copy, send a letterhead request to Texas Instruments Incorporated, P.O. Box 1444, M/S 784, Houston, Texas 77001.



TEXAS INSTRUMENTS

INCORPORATED

CIRCLE NO. 6 ON INQUIRY CARD

*Trademark of Texas Instruments.

BELL COMPETITOR GIVES UP

DATRAN has conceded defeat in its efforts to compete with AT&T's Dataphone Digital Service (DDS). Wyly Corp., the parent company, could not find a buyer or additional financing for the eight-year old Data Transmission Co. subsidiary, so decided to quit rather than to compete against Ma Bell. Wyly, however, still hopes to recover some of its luckless investment. It has filed an antitrust suit against AT&T for \$285 million in damages, charging that AT&T forced DATRAN out of the digital communications market by using DDS rates that are anticompetitive and by subsidizing those rates with its regulated voice service. In June, the FCC indeed declared that the DDS rates are anticompetitive.

DATRAN has asked AT&T, Western Union, Southern Pacific Communications, MCI and ITT to provide service for its 150 customers. Besides the customers, other losers were Wyly Corp. and Swiss investor Walter Haefner with a combined loss of \$100 million, antenna supplier Nippon Electric Co. and contractor Bechtel Co.

Despite large losses, DATRAN never surpassed \$1 million in annual revenues. Its Datadial switched digital service covered 18 cities, using DATRAN's lines along with those leased from AT&T and Southern Pacific Communications.

The Wyly subsidiary was founded in 1968 as an all digital network. In 1972, after the FCC's 1971 decision to allow specialized common carriers, DATRAN along with several other carriers received FCC approval. That same year, AT&T filed to establish a "data under voice" service to five cities. DATRAN started its service in 1973, serving Dallas and Houston. By 1974, AT&T filed to operate its DDS data under voice service, but with rates 40 percent below those of DATRAN. DATRAN always maintained voice grade lines were inefficient for digital transmission, but 40 percent cheaper rates are hard to fight. In June of this year, the FCC found that "AT&T deliberately understated the actual cost of providing the service." But by that time, DATRAN's phone was already on its way to being disconnected.

MONOLITHIC MEMORIES GETS OUT OF μ C

One year after it entered the microcomputer market, Monolithic Memories, Inc. is getting out. The microcomputer and MOS markets were too full and too competitive to make a quick profit, so the Sunnyvale (CA)-based firm is going back to its regular business of PROMs, ROMs, and LSI devices. The company introduced its second microcomputer at this year's NCC. The 16-bit Micromini 3 was based on the company's LSI microprocessor and 22-pin 4K RAMs and was to be software and I/O compatible with Data General's Nova 2 and 3. But the pricing game, especially in 4K RAMs, was too much for the company.

COMPUTER IN A CAR

If your car doesn't start on winter mornings, a microcomputer could be the answer. General Motors will be the first company to try the theory in production models with its 1977 Olds Toronado. Rockwell International designed a special PMOS 10-bit microcomputer for the car's Misar timing system, which will later be used in other models.

One chip of the two-chip set contains a CPU with A/D conversion circuitry; the second chip is a 10K-bit ROM with specially developed data curves in three-dimensional format with preprogrammed instructions.

Rockwell is evidently confident of success since it split its Microelectronic Device Division into four operating entities, one of which is automotive LSI. Calculator and consumer electronics, microprocessors, and modems will be the other divisions.

MEMORIES BY FAIRCHILD

Backed by its semiconductor and systems capability, Fairchild Camera and Instrument Corp. will manufacture and sell three types of memory systems. Board level through card cage systems will be marketed to general purpose users by Fairchild's component sales force. Large custom memory systems will be sold to mainframe manufacturers for use in their systems. And Fairchild advanced technology systems, including I²L and CCD, will go to the peripheral and mini-computer market. The Memory Systems Division, a new division within the Instrumentation Systems Group, will begin to manufacture the products by the end of the year.

MICROS BOOST SEMICONDUCTOR MARKET

The sales plateau is over for the semiconductor industry, according to a recent Frost & Sullivan study. Worldwide semiconductor sales were \$2.2 billion in 1975 and should reach \$3 billion this year and \$5.1 billion by 1984. F&S attributes most of the growth to microprocessors and memories, although the short-term profits outlook for these products is uncertain. As micros take over, discrete components will die. U.S. manufacturers, however, cannot rest on their laurels, since Japanese companies like NEC and European companies like Philips and Siemens are expanding their semiconductor facilities not only in their own countries, but also in the U.S. Another problem confronting semiconductor manufacturers is "overnight obsolescence." This was the case with 4K RAMs: as volume shipments began, the 16K RAM was introduced. For more information on the study, write *Frost & Sullivan, Inc., Customer Service, 106 Fulton St., New York, NY 10038.*

WHAT'S COMING

- Nov. 2-11 SC/MP Applications.** National Semiconductor course held in Cleveland, OH, and Detroit, MI. Contact Thomas Harper, (305)661-7969.
- 8-11 International Purdue Workshop Industrial Computer Systems.** West Lafayette, IN. Contact Dr. T.J. Williams, 102 Michael Golden, Purdue University, West Lafayette, IN 47907.
- 8-11 Info '76.** McCormick Place, Chicago, IL. Contact Clapp & Polick, Inc., 245 Park Ave., New York, NY 10017.
- 15-17 Third Annual Computer Security Conference.** Roosevelt Hotel, New York. Contact John O'Mara, Computer Security Institute, 43 Boston Post Rd., Northboro, MA 01532.
- Dec. 6-16 Designing with Microprocessors.** Pro-Log course held in Monterey, CA, and St. Louis, MO. Contact Ed Lee, Pro-Log Corp., 2411 Garden Rd., Monterey, CA 93940.



Announcing a giant increase in the NOVA line.

Towering above is the new top of the NOVA® line. The NOVA 3/D.

It features a new Memory Management and Protection Unit that lets you do both on-line multitasking and batch operations. Concurrently. For instance, applications that need real-time multi-terminal software and on-going program development.

Plus, the NOVA 3/D features a new, economical, 32K-word MOS memory module. Which is something no other major minicomputer has.

All of which makes the NOVA 3/D more NOVA computer, at a lower price, than you've ever seen before.

What's more, the NOVA 3/D also has all the things that have made NOVA the most popular name in minicomputers.

Things like extended NOVA line instructions. Reliable high-speed MOS and economical 16K-word core memory modules.

The single-board CPU design concept Data General pioneered. The same concept that led to our removeable single-board power supply module.

Plus all the other things you've come to expect from a company like Data General.

Things like field-proven, real-time operating systems: our mapped Real-time Disc Operating System, diskette-based Disc Operating System, and our Real-Time Operating System. They're compatible with the entire NOVA line of computers.

Things like high-level FORTRAN IV and FORTRAN 5, as well as easy-to-work-with extended BASIC. Also fully NOVA-line compatible.

Things like the complete and completely-compatible line of Data General peripherals. All you could ever need to put together any system you could ever need. Including 10 to 90 megabyte discs, diskettes, and our new 30 and 60 cps terminal printers.

And when you do business with Data General, you get the kind of total systems support you can only get from a major computer manufacturer. Everything from sales and systems engineering to field service, training, and special systems design.

Write for information on the new NOVA 3/D. Or call your local sales office.

And see what the NOVA line is up to now.

NOVA 3/D

Data General

• Data General, Route 9, Southboro, Mass. 01772, (617) 485-9100. Data General (Canada) Ltd., Ontario. Data General Europe, 15 Rue Le Sueur, Paris 75116, France. Data General Australia, Melbourne (03) 82-1361

NOVA is a registered trademark of Data General Corp.

CIRCLE NO. 7 ON INQUIRY CARD

The Critical Event

**DATA COMMUNICATIONS
INTERFACE '77**

**Fifth Annual Conference
and Exposition**

**March 28-30, 1977
Georgia World Congress Center
Atlanta, Georgia**

Co-Sponsored by
DATAMATION
Magazine



Data communications creativity and productivity forge ahead as critical milestones are being achieved by a growing world of users and suppliers. The focal point for sharing such progress will be our **fifth** national conference dedicated to data communications. Plan to attend the event where significant issues are resolved and cost-effective directions are established. Come to Data Communications INTERFACE '77 - the critical event.

Co-sponsored by DATAMATION magazine, INTERFACE '77 continues to be the forum for information on all aspects of data communications. On March 28-30, Atlanta's fabulous new Georgia World Congress Center will host over 150 leading professionals addressing issues critical to productive use of data communications systems and services. Hundreds of exhibits worth millions will demonstrate state-of-the-art capabilities. And thousands of attendees will be exchanging the latest concepts and experiences in the real world of data communications.

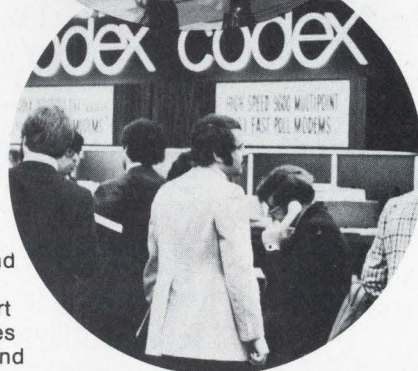

Registration Fees	3 Full Days	Single Days, Each
- 1st and 2nd attendees, each	\$95	\$50
- 3rd and more attendees, each	\$50	\$25

Program Productivity

Our conference goal is to offer complete management programs to build on each attendee's background.

For beginners, our DataComm School emphasizes fundamentals for management decision-making, rather than technical details.

For the more experienced attendees knowledgeable in computers or communications, sessions are offered on networking and operations management.

For those advanced in applying datacomm, there are comprehensive Product, Service and Technology Workshops.

And for everyone, Application Workshops span EFTS, point-of-transaction, distributed computing systems, remote computing services, etc.

INTERFACE with Us

Plan today to be on the right path tomorrow - the critical path - to data communications success. Start by registering for Data Communications INTERFACE '77 - your next critical event. Send us the coupon below or call (800) 225-4620 (toll-free); (617) 879-4502 in Massachusetts.

Register for INTERFACE '77 now!

**For Instant Registration
or Information,
call Toll-Free
(800) 225-4620**

Within Massachusetts, call Collect (617) 879-4502

My check is enclosed! Bill me! Tell me more!
 I'd like to exhibit!

NAME _____ / TITLE _____

ORGANIZATION _____

ADDRESS _____

(No. & Street)

(City)

(State)

(Zip)

TELEPHONE () _____

Other associates who should receive information.

NAME _____ / TITLE _____

NAME _____ / TITLE _____

DataComm INTERFACE, Inc., 160 Speen Street, Framingham, Mass. 01701



Perkin-Elmer Puts It All Together

The Products and The People to Meet
Your Growing Data Processing Needs

PERKIN-ELMER DATA SYSTEMS

Call Toll Free 800 631-2154
or Write Perkin-Elmer Data Systems
Tinton Falls, New Jersey 07724

CIRCLE NO. 8 ON INQUIRY CARD

AFRICA COMES OUT OF THE DARK

Computers are not unknown in Africa, but they're not easily found either. Even in expanding economies like that of Nigeria, automation is still at the manual typewriter stage. But if the economy keeps expanding as it has been, Nigeria is a wide open market for computers. Although there are over 105 commercial banking and insurance firms in the country, only two banks and six insurance firms had computers in 1975. In fact, there were only 40 computer installations in the entire country, according to a U.S. Dept. of Commerce report. "Nigeria has the largest present and potential market for business equipment of the subSaharan nations. That market should more than double in the next three to five years because of the soaring volume of office work generated by the expanding economy," the report adds.

FOOTHOLDS ABROAD

Centronics in Australia. Sigma Data Corp. is distributing Centronics Data Computer Corp. (Hudson, NH) printers in Australia and New Zealand. Sigma is a Centronics OEM customer. The previous distributor, Standard Telephones and Cables, will continue as a Centronics OEM customer.

Prime in Saudi Arabia. Saudi Computer and Management Consultants will handle Prime computer sales in Saudi Arabia, Kuwait, the Gulf States, Syria, Iraq, Yemen and other Arab countries.

MEDIA III - your complete peripheral systems source for all Data General, or D/G-emulating computers

Simple disk controllers to turnkey storage systems

- On-line storage capacities from 10 to 320 megabytes.
- Single controller board in CPU controls up to 4 disk drives.
- Compatible with manufacturer's software.
- Two CPUs can share same disks.
- Transfer rates to 1.2 megabytes/sec.
- Low cost • Outstanding reliability.

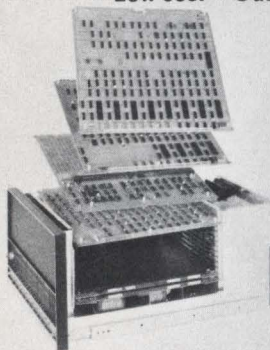

We are now the largest independent manufacturer of peripherals for Data General computer users. Check our price/performance specs and see why.

MEDIA III

2259 Via Burton
Anaheim, CA 92806
(714) 870-7660 • (914) 592-8812 • TWX 910-591-1150

CIRCLE NO. 9 ON INQUIRY CARD

Rapidata in London. As its first step outside the U.S., Rapidata, Inc. is expanding its financial remote access computer services to London. The Baker Street office in London will tie into the company's New Jersey computer center via transatlantic cable.

Monolithic Memories in Japan. MMI Japan KK, a wholly-owned Monolithic Memories (Sunnyvale, CA) subsidiary, will market and support the company's line of bipolar MOS RAMs, PROMs, ROMs and LSI devices.

MINI-MICRO FAIR IN EUROPE

It's not the Hannover Fair or SICOB of Paris, but a Swiss show just for minis and micros. *International Minicomputers, Microcomputers and Microprocessors '77* will be held in the Palais De Exposition in Geneva, Switzerland from May 24-26. Mini/micro, component, test equipment and peripheral manufacturers will exhibit and technical experts will talk on mini/micro applications in industrial and process control, finance and service industries. For information, contact: *Joseph Maurer, Industrial & Scientific Conference, Management, Inc., 222 West Adams St., Chicago, IL 60606.*

MODULAR PROCESS CONTROL IN BRITAIN

Britain's new MEDIA digital monitoring and control system features "data highways, which provide continuous access to information in any sequence and allow commands to be given at any point." Each MEDIA module is a plug-in 7.8 x 4.4-inch PC board that contains A/D and D/A converters, multiplexers, computer and peripheral interfaces. Modules for a particular system can be selected with a configurator. The British company, GEC-Elliott Process Instruments, Ltd., welcomes inquiries from U.S. customers and prospective manufacturers under license in the U.S. Contact: *J.L. Harbinson, Export Manager, Century Works, Lewisham, London SE137LN England.*

QUICKLY AROUND THE WORLD

Supply depots of a British pharmaceutical distributor will communicate using a network control system based on Racal-Milgo, Ltd., modems, line switchers, status displays, line adapters and test equipment. The \$175,000 contract with Macarthys, Ltd. will link 22 distribution depots with the central computer in Romford, England. Conrac Corp.'s Artemis network management system will control telephone traffic in Brazil. Embratel, the Brazilian telephone company, will use Artemis to gather and analyze data and to control traffic at major toll offices throughout the country. The \$5 million contract is Conrac's largest telephone order to date.

The results of the fifth annual market survey among buyers of minicomputers, microprocessors and miniperipherals are now available in a special 80-page report.

See ad on page 68.

DP Dialogue

Notes and observations from IBM that may prove of interest to data processing professionals.



The brass foundry is one of more than 100 separate work zones at Price Pfister monitored by the online production control system.

It's a DL/1 World at Price Pfister

When the Price Pfister Brass Manufacturing Company moved its "chained" data files to Data Language/1 or DL/1 recently, it also moved into a new world of flexibility and economy of operation.

And for the Pacoima, California, company, it was a move that has made a world of difference in controlling manufacturing and distribution operations to help maintain profit and customer service levels.

Price Pfister is a subsidiary of Norris Industries, Inc., and a major supplier to plumbing wholesalers and contractors, with a nationwide network of five regional warehouses. Its catalog of fittings, faucets and fixtures contains some 4,000 finished items—which incorporate

10,000 separately identified parts and subassemblies.

At the company's headquarters facilities, order entry and production and inventory control are handled online by an IBM System/370 Model 145, using 3277 Display Stations for direct entry of orders and shipments. At four remote warehouses, data is entered through 3735 Communication Terminals.

"Under DL/1," says Joel Brust, director of information systems, "we can easily add a new data field or change the data structure in other ways without affecting any of our 1,100 sales and manufacturing programs except the ones that directly use the revised data.

"In our online order processing system, for example," Brust continues, "we

can tailor the content and format of the 3277 display to suit our needs. One feature we've added to the system is order inquiry by the customer's own order number as well as by name; this has proven to be very helpful in getting the right answer to the customer, fast."

DL/1 will enable Price Pfister to maintain a complex file structure that relates every finished item to all its parts and subassemblies, and—in the other direction—each inventoried part to all the finished items on which it is used. DL/1 is an IBM program that organizes such "chained" files, and permits user programs to access the data through a simple interface.

Price Pfister converted to the 145 in
(Continued on 4th page)

Average Annual Incidence of Breast Cancer in Hawaii (Rate per 100,000 Females) 1968-1972

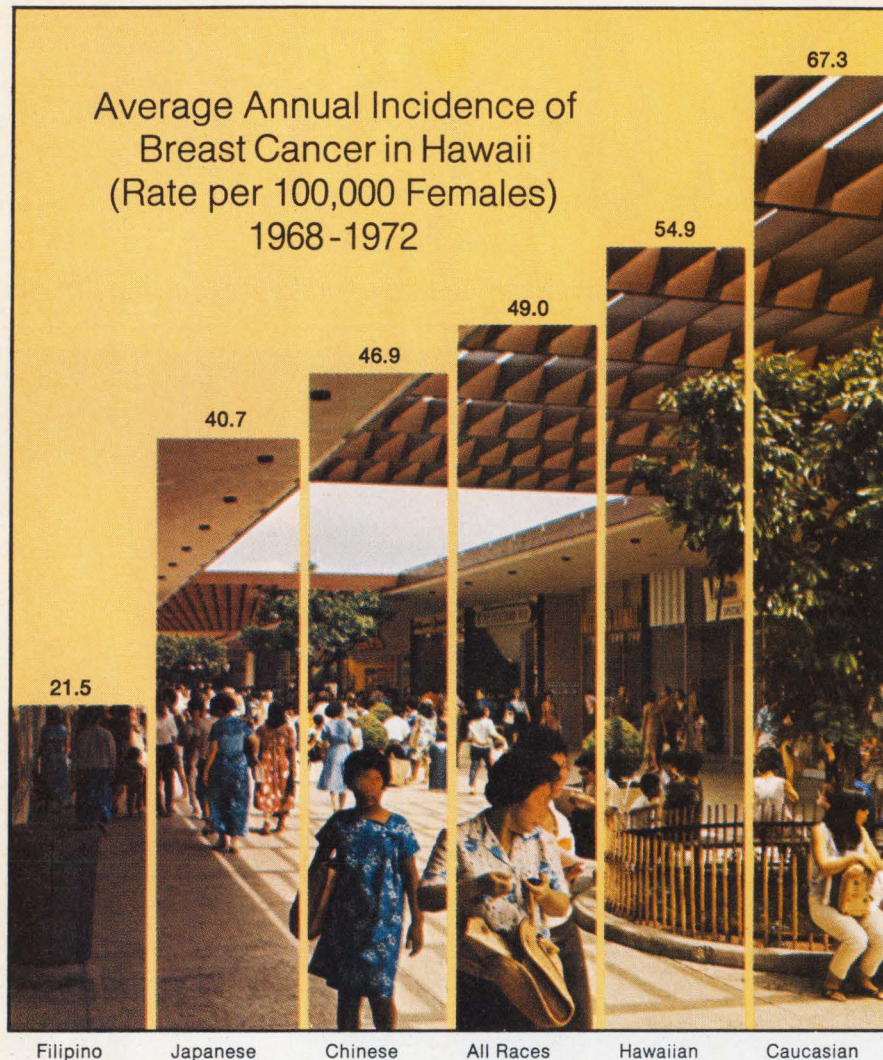

The unique racial mix in Hawaii gives researchers an opportunity to study the environmental and genetic factors which may influence susceptibility to various forms of cancer. This graph is based on 910 cases of intraductal breast carcinoma reported to the Hawaii Tumor Registry from 1968-1972.

Computerized Data Base Aids Cancer Researchers in Hawaii

Is there any relationship between a woman's height and weight and the possibility that she may contract breast cancer? Or between racial origin and the tendency to get a specific form of cancer? Could diet or occupation have any influence on a person's susceptibility to cancer?

These are all questions currently being researched at the Cancer Center based at the University of Hawaii. Scientists and doctors trained in a wide range of disciplines including biology, chemistry, genetics, epidemiology, biophysics, immunology and virology are studying the correlation among many factors which may be related to causing cancer.

The Center, funded largely by the National Cancer Institute, maintains a

large computerized data base stored in the University's IBM System/370 Model 158. It includes information such as the birth and marriage records and ethnic backgrounds of over 200,000 families living in Hawaii.

Many Factors Involved

"We begin with the belief that there is more than one condition which can influence susceptibility to cancer," explains Dr. Lawrence H. Piette, Director of the Cancer Center. "These conditions may include exposure to or the presence of a specific virus, the existence of a particular carcinogen in the environment and/or a genetic predisposition to the disease. Any one of these factors alone will not necessarily cause cancer, but in combination they are more likely

to increase the probability the disease may occur."

Hawaii provides an excellent "laboratory" for studying cancer because of the unique racial mix of the population. Data collected by the Tumor Registry program, part of the state's Department of Health, indicate that the seven major racial groups in Hawaii — Japanese, Filipino, Chinese, Korean, pure Hawaiian, part Hawaiian and Caucasian — have different incidences of cancer at different ages, despite the similarity of environment.

Heredity or Environment?

"We want to determine the relationship between the environmental and genetic factors in connection with the disease," says Dr. Piette. "For example, we know that the incidence of breast cancer in Japanese women who have migrated to Hawaii is higher than for those who have remained in Japan. On the other hand, the propensity of the offspring of Hawaiians of Chinese ancestry to get a rare form of cancer called nasal pharyngeal carcinoma seems only slightly affected by environmental change. In both cases, we'd like to find out why, now that we have identified broad correlations."

For instance, the data base has been used to test the validity of the hypothesis that women who are taller and heavier relative to the average for their race show a higher risk of getting breast cancer. First postulated by a team of Dutch researchers, this theory appears to be substantiated for the women whose records form the Hawaiian data base. However, Dr. Piette cautions that simple correlations only tell part of the story. Many other factors, such as the age of a woman during her first pregnancy and her estrogen profile, may also be very significant in determining susceptibility to breast cancer.

"We were fortunate that Hawaii already had good record keeping programs," says Dr. M. P. Mi, a geneticist and director of data communications. "Our goal now is to incorporate additional kinds of data such as blood type and fingerprints. Most people aren't aware that fingerprints can help determine racial origin, a significant fact in a population with extensive intermarriage."

"Most of our work is still in the preliminary stages," comments Dr. Mi. "As we move into multivariate analysis—correlating many factors—we will be able to get increasingly specific results. We feel our work can help develop hypotheses which can be followed up in later studies. The more we know about the disease, the better our chances will be for earlier diagnosis by identifying high risk groups and, in many cases, effecting cures."

Putting the Computer Where the Users Are

Interactive computing is making data processing and problem-solving power directly accessible to end users and programmers alike. End users can engage in personal computing to solve specific business, financial, engineering, design or similar problems. DP professionals can work interactively for faster creation and testing of programs.

And with facilities now available from IBM, interactive computing is easy to use, powerful in developing solutions, and adaptable and economic to implement.

End User Computing

For the end user—the financial planner, engineer, marketing specialist—personal computing provides simple procedures for using the computer to solve spur-of-the-moment or one-time problems. Each user gets his results promptly at his terminal.

A financial planner can make cash flow projections. A marketing man at a terminal can structure a new type of sales analysis for a sales program. An engineer can solve an equation or try alternative approaches to a design problem, working creatively and interactively with the computer.

A computation can be of any size. Applications which are too small to put through the program development cycle may be entirely feasible when implemented directly by the user.

For the user who wishes to solve unique problems, three user-oriented IBM languages are easy to learn and simple to use at a terminal (see box). And a constantly growing set of IBM prepackaged interactive programs supports such applications as economic analysis, simulation and modeling, statistics, forecasting, project management and data base access.



Financial planners and other professional people can solve problems and test alternatives, using VSPC to interact directly with the computer.

Developing Applications

For the programmer, interactive computing provides a new level of productivity. He can submit programs for test directly and receive results back promptly. Working interactively, he receives immediate indication of any coding errors rather than, as in the past, waiting to obtain a test run.

DP managers have found that interactive application development has greatly increased productivity. At

Playtex Inc., for example, programmers who had been putting an average of seven lines of code per day into final form were able to produce 70 final lines a day. This significantly shortened application development time, and the resulting programs proved more reliable and easier to maintain.

Use of interactive computing by professionals throughout the organization relieves the programming staff of work which users can now do for themselves, and greatly reduces the cost of developing small-scale or occasional-use programs.

At the same time, this use of personal computing frees programmers to focus on more demanding, production-oriented applications. Similarly, computer operators are relieved of queuing the unscheduled jobs, which users can now enter directly, and of delivering printouts of results which can be received directly at the terminal.

With interactive computing, the organization and its people make use of the full power of multiprogramming. Professionals can access the system simultaneously without interfering with ongoing batch or scheduled work. Programmers can increase productivity. And both can develop new approaches to the computer and better understanding and use of its potential.

IBM Facilities for Interactive Computing

Three IBM languages are designed specifically for problem-solving under Virtual Storage Personal Computing (VSPC):

1. *VS BASIC*. Powerful, yet simple to use, it is adaptable to a wide range of business and general applications.
2. *VS APL* is a broadly applicable interactive language particularly well suited to the creation of business and commercial programs.
3. *VSPC FORTRAN* is an interactive version of FORTRAN, the estab-

lished language for mathematical and scientific programming. It is designed specifically for use under VSPC.

Professional programmers using IBM interactive computing under the Time Sharing Option (TSO) or the Virtual Machine/Conversational Monitor System (VM/CMS) for application development may work in any of the standard IBM programming languages: COBOL, PL/I, FORTRAN, APL, RPG II, or Assembler.

New Techniques Aid John Hancock Programmers

Two years ago, John Hancock Mutual Life Insurance Company became one of the first users of the Improved Programming Techniques. Now it is reaping benefits in more orderly application development, program quality and maintainability, lower development costs, and schedule adherence.

"We find the six techniques to be synergistic," says Robert C. Volante, vice president for systems and programming. "You get the most benefit by introducing them early in program development—at the level of analysis and design—and all together."

Using the techniques, each development step is a group operation rather than an individual activity. One of the techniques is *Team Operations*, under which a project is organized into groups, each with a chief programmer, a backup programmer, and a team librarian who keeps track of source code and manages documentation.

During *Top-Down Development*, detail program design and coding proceed from the top or control portions of the program down to the finest levels of detail. Under *Structured Programming* certain architectural forms are adhered to in writing the program, making it more regular in form and simpler to read and interpret.

A program is developed as a group product, "publicly owned" rather than proprietary to individuals, by conducting *Structured Walkthroughs*: formal group procedures for verbally analyzing and validating programs and modules.

"You see the real beauty of these methods when a specification change pops up half way through a major project," says Volante. "When the customer asks for a change, we can rapidly find every affected point in the system with a look at our HIPO diagrams and structured code." *HIPO* (Hierarchy plus Input-Process-Output) *Documentation* is used to describe small, functionally defined modules, serving first as a tool for design of the program and then as permanent documentation.

"Our users are happier too," Volante

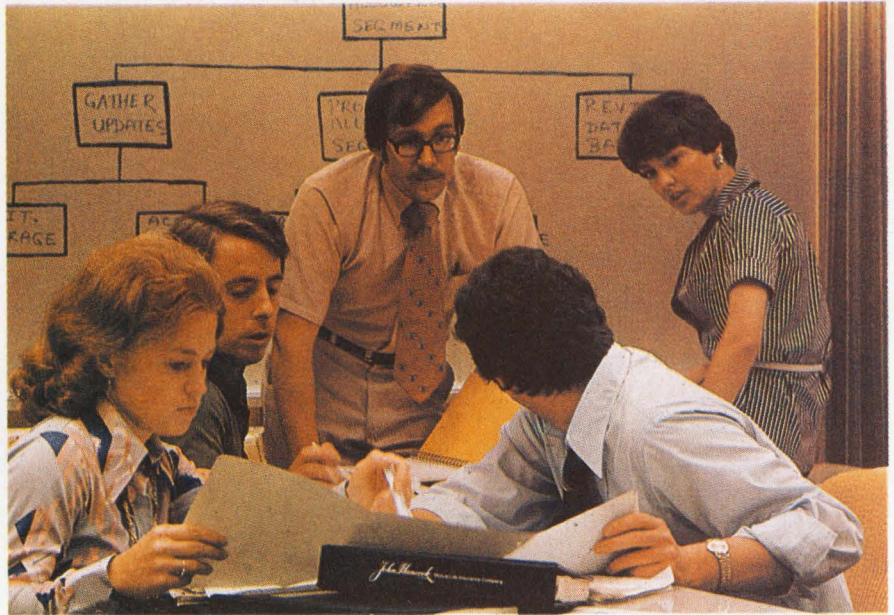

EDP education at John Hancock is directed by Nancy Bern (right), assisted by senior instructors (left to right) Cindy Gasik, Jack Grady, Ted Pierce and Dan Steele.

says. "One, after attending a structured walkthrough, told us: 'Now I understand what I'm getting before the system is installed.'"

Notes Nancy Bern, director of EDP education: "The intrinsic discipline of the walkthrough," she adds, "prevents errors. People get oriented to doing the job correctly."

The *Development Support Library* and the team organization, Bern says, relieve programmers of clerical work, making better use of their time.

"When IBM presented the techniques to us in early 1974," Volante says, "there was an intuitive reaction here that this addressed important issues for us. We started people through the two-week IBM course on the techniques, and launched three pilot projects."

"Two of the projects are now complete," Volante continues. "In spite of the 'learning curve' effect, they were finished within our time and cost estimates. But the real benefits came in testing and maintenance. With top-down

design and programming, integration testing proceeds in parallel with development. We find that our systems are better tested, and that new programs run correctly from the start.

"About 60% of our programmer-analyst time goes into maintenance," Volante says, "and the techniques are especially helpful there. Programs are easy to read and people have little trouble picking up one another's work."

"Once people get accustomed to the methodology," he adds "they don't want to go back. We've now trained 200 EDP people and more than 50 end users, and the people who haven't been through the course yet are eager to go. Now we've moved up on the learning curve, and projects are beating their schedules."

There are about 12 projects in various stages under Improved Programming Techniques, he says, including a very large online system. "Our efforts have really paid off," he asserts; "we won't turn back."

It's a DL/1 World...

(Continued from first page)

October 1975, and at that time started to shift its chained files from DBOMP (Data Base Organization and Maintenance Processor) to DL/1. "The 145 easily handles DL/1 and teleprocessing under CICS/VS (Customer Information Control System/Virtual Storage)," Brust says, "and the increased capacity permits us to do material requirements

planning and production scheduling on a weekly cycle, rather than on a monthly one.

"The online system continuously tracks some 11,000 items of work-in-process inventory through 100 work zones. By revising the production schedules weekly, we've been able to hold down inventory imbalances and avoid uneven loading of the work centers. Switching to a weekly cycle enabled us to cut work-in-process inventory by six percent."

DP Dialogue appears regularly in these pages. As its name suggests, we hope *DP Dialogue* will be a two-way medium for DP professionals. We'd like to hear from you. Just write: Editor, *DP Dialogue*, IBM Data Processing Division, White Plains, N.Y. 10604.

IBM®

Data Processing Division

a new way to sell industrial computers

Control Logic Inc. is setting up a nationwide network of dealerships as a new way to market industrial microcomputers. The move means another opportunity for the computer entrepreneur to cash in on the exploding micro market.

Control Logic Inc. produced one of the first eight-bit microcomputers to be used in industrial applications. The L-series micro, introduced in 1973, was based on Intel's 8008 chip and was the first microcomputer system to be sold with software. But the device did not catch on in a big way because the Natick (MA)-based company did not promote the product heavily, and other companies, especially Process Computer Systems, Inc. in Flint, MI, eventually captured the market lead instead.

So to regain a dominant position, Control Logic, a subsidiary of Harnischfeger Corp., is trying a new approach to industrial microcomputer marketing. It is setting up dealerships throughout the U.S. that will provide full service to industrial customers and that will not just act as a sales outlet. "We think we can do twice as much business going this route as by sticking with sales reps only," says Al Vitale, Control Logic's president.

Vitale plans to take on two dealers each month over the next few years, and such a scheme could open new entrepreneurial opportunities for the engineering consultant. The company is already advertising for dealers in *Electronic News* and the *New York Times*, and Control Logic's regular sales reps, too, are on the lookout for prospective dealers.

Sales reps and dealers work together under Control Logic's scheme. The rep identifies a sale and closes it, and the dealer, which takes over at this point, pays the rep a 10 percent commission. The dealer then designs and supports the turnkey system, charges the customer for support time, and collects at least 15 percent on the price of the hardware. Under the arrangement, the sales reps can approach unsophisticated prospective industrial customers.

THE ONLY ONE

Control Logic is the only micro company marketing to industry in this fashion. All others use sales reps, though dealerships are widely used to sell hobby microcomputers, such as the MITS Altair line and IMS Associates Imsai 8080 line. But these are general purpose machines geared to the retail sector. More important, the dealers do not give support or service.

Already, Control Logic has taken on four dealers — who went through in September what will be a standard five-day training course at the company's Natick home office. David Zlotek, a consulting engineer who launched his Manchester

(NH)-based Hampshire Electronic Consultants three years ago, is typical of the manpower pool from which Control Logic plans to draw. Zlotek's firm designs small computer-based systems.

Other dealers have similar backgrounds. Jim Parks of Scottsdale Control Systems in Cleveland has also been designing microcomputer-based systems for two years. Eugene Fleisher's South River (NJ)-based Infoscope, Inc., also a



DEALER DEVELOPMENT SYSTEM FOR \$20,000 is studied by Fred Hildebrand, Al Vitale, and dealers Frank Milos and David Uotek.

consulting firm, recently designed a microcomputer-controlled assembly line that turns out disposable diapers. "Consulting firms or systems houses will probably make up most of our dealers," Vitale says.

Both dealers and Control Logic reap benefits from the relationship. The dealers support customers by designing, installing and maintaining Control Logic-based systems. Control Logic, in turn, gives the dealer a 25 percent discount on its eight-bit microcomputer products and process interface cards. Dealers can copy Control Logic software that ranges from a floating point package to a disk operating system without charge, except for the Fortran compiler. Control Logic also does national advertising, provides sales con-

Imagine a microcomputer

Imagine a microcomputer with all the design savvy, ruggedness, and sophistication of the best minicomputers.

Imagine a microcomputer supported by dozens of interface, memory, and processor option boards. One that can be interfaced to an indefinite number of peripheral devices including dual floppy discs, CRT's, line printers, cassette recorders, video displays, paper tape readers, teleprinters, plotters, and custom devices.

Imagine a microcomputer supported by extensive software including Extended BASIC, Disk BASIC, DOS and a complete library of business, developmental, and industrial programs.

Imagine a microcomputer that will do everything a mini will do, only at a fraction of the cost.

You are imagining the Altair™ 8800b. The Altair 8800b is here today, and it may very well be the mainframe of the 70's.

The Altair 8800b is a second generation design of the most popular microcomputer in the field, the Altair 8800. Built around the 8800A microprocessor, the Altair 8800b is an open ended machine that is compatible with all Altair 8800 hardware and software. It can be configured to match most any system need.

MITS' plug-in compatible boards for the Altair 8800b now include: 4K static memory, 4K dynamic memory, 16K static memory, multi-port serial interface, multi-port parallel interface, audio cassette record interface, vectored interrupt, real time clock, PROM board, multiplexer, A/D convertor, extender card, disc controller, and line printer interface.

MITS' peripherals for the Altair 8800b include the Altair Floppy Disc, Altair Line Printer, teletypewriters, and the soon-to-be-announced Altair CRT terminal.

Introductory prices for the Altair 8800b are \$840 for a kit with complete assembly instructions, and \$1100 for an assembled unit. Complete documentation, membership into the Altair Users Club, subscription to "Computer Notes," access to the Altair Software Library, and a copy of Charles J. Sippl's Microcomputer Dictionary are included. BankAmericard or Master Charge accepted for mail order sales. Include \$8 for postage and handling.

Shouldn't you know more about the Altair 8800b? Send for our free Altair Information Package, or contact one of our many retail Altair Computer Centers.

mits inc. 2450 alamo s.e. albuquerque new mexico 87106

Prices, delivery and specifications subject to change. Allow up to 60 days for delivery.

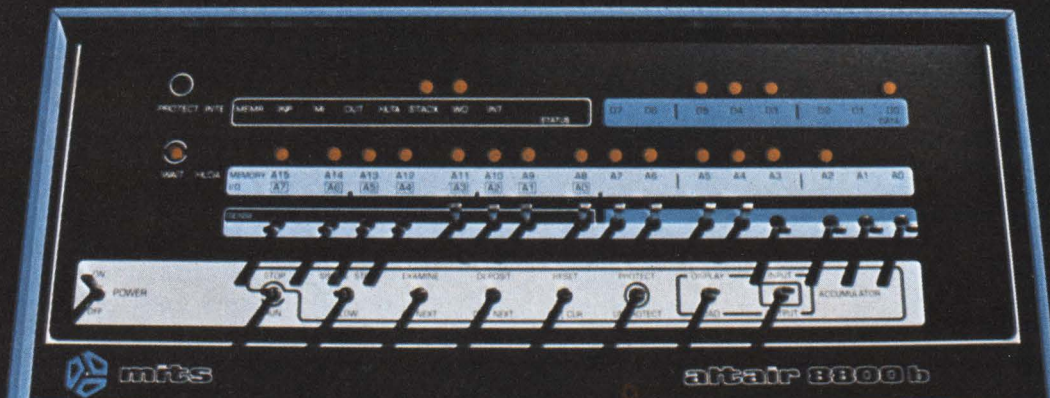

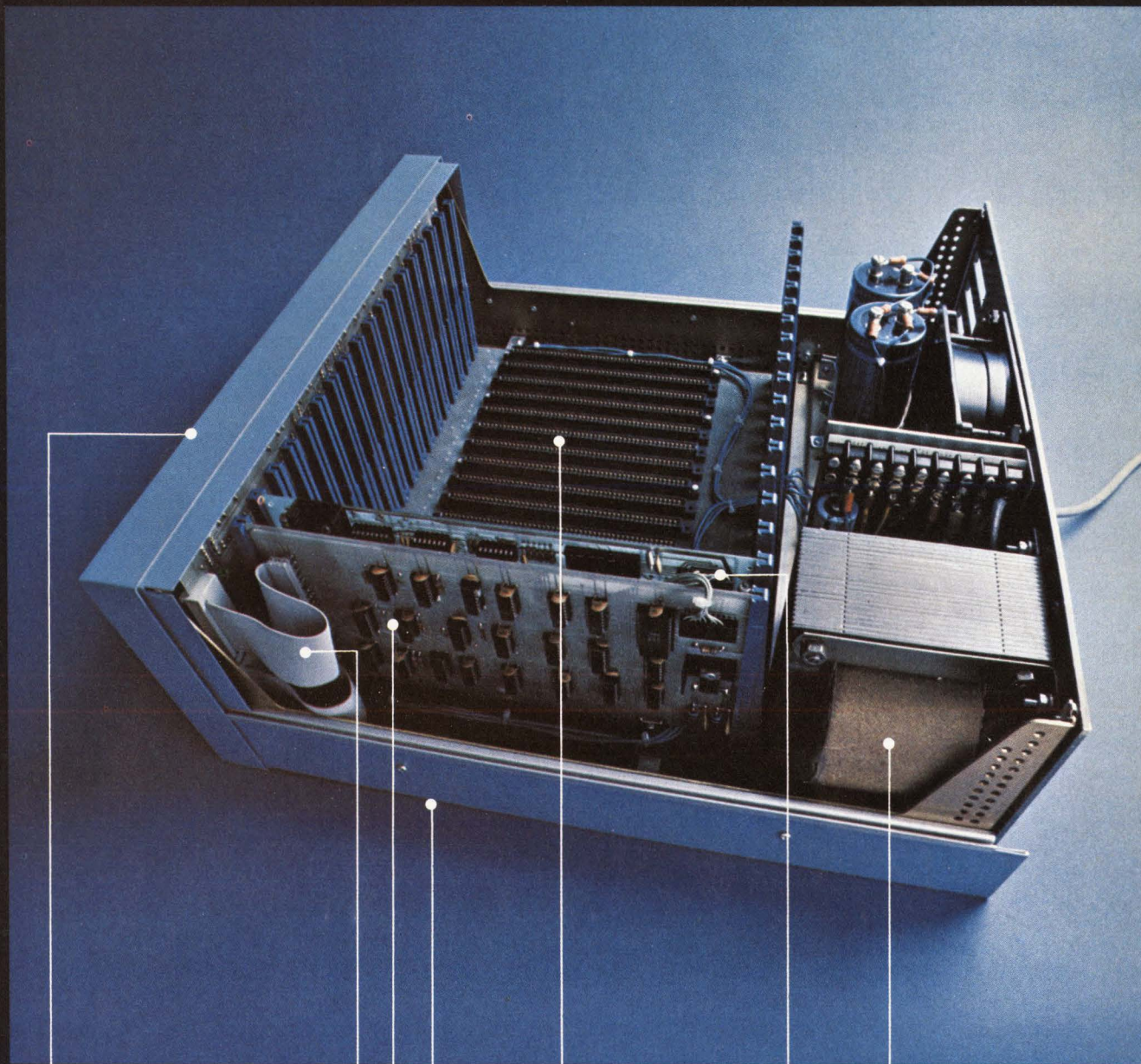

Redesigned front panel. Totally synchronous logic design. Same switch and LED arrangement as original Altair 8800. New back-lit Duralith (laminated plastic and mylar, bonded to aluminum) dress panel with multi-color graphics. New longer, flat toggle switches. Five new functions stored on front panel PROM including: DISPLAY ACCUMULATOR (displays contents of accumulator), LOAD ACCUMULATOR (loads contents of the 8 data switches (A7-A0) into accumulator), OUTPUT ACCUMULATOR (Outputs contents of accumulator to I/O device addressed by the upper 8 address switches), INPUT ACCUMULATOR (inputs to the accumulator from the I/O device), and SLOW (causes program execution at a rate of about 5 cycles per second—for program debugging).

Full 18 slot motherboard.
Rugged, commercial grade Optima cabinet.

New front panel interface board buffers all lines to and from 8800b bus.

Two, 34 conductor ribbon cable assemblies. Connects front panel board to front panel interface board. Eliminates need for complicated front panel/bus wiring.

New, heavy duty power supply: +8 volts at 18 amps, +18 volts at 2 amps, -18 volts at 2 amps. 110 volt or 220 volt operation (50/60 Hz). Primary tapped for either high or low line operation.

New CPU board with 8080A microprocessor and Intel 8224 clock generator and 8216 bus drivers. Clock pulse widths and phasing as well as frequency are crystal controlled. Compatible with all current Altair 8800 software and hardware.

altair 8800-b

CIRCLE NO. 10 ON INQUIRY CARD

NOTE: Altair is a trademark of MITS, Inc.

 mits

2450 Alamo SE/Albuquerque, NM 87106/505-243-7821

tacts, and renders engineering support when needed. Zlotek, who expects to boost revenues by 50 percent this year because of the tie to Control Logic, exclaims, "we're excited about our dealership."

A GEOGRAPHICAL ANGLE, TOO

Control Logic's marketing scheme also exploits an interesting geographical angle. The company is especially interested in employing dealers who are specialists on local industry. Laurence Hanson's California-based Hanson Electronic Controls designs computer systems used in the wine and asphalt industries, for example. Dealer Parks, on the other hand, knows the heavy industry companies in Cleveland and is a specialist on their monitoring and control equipment requirements. Zlotek's Hampshire Electronic Consultants specializes in designing numerical control systems largely as applied to New England's light industry.

Zlotek has a notably big ambition. He would like to turn around the textile industry in New England "that is dying," he says. "The microcomputer could make it profitable again."

Although dealers are locally based, they are part of a Control Logic national network. A Maine dealer who needs a paper processing system, for example, can contact an Oregon dealer who may have already designed such a system. "We learn a lot from talking to each other," says Zlotek.



Paul Mercandetti, Control Logic Director of Dealer Programs, conducts the first five-day dealer workshop.

Control Logic places great emphasis on a potential dealer's technical qualifications. "These are far more important than financial strength," says Fred Hildebrand, vice president for marketing at Control Logic. And President Vitale adds, "Candidates will have to be able to offer realtime applications programming ability, a technical ability to configure microcomputer hardware, and the capacity for field support on all products sold."

FINANCES ARE IMPORTANT

But Vitale does not intend to ignore financial matters altogether. A dealer, for example, will need to have at least sufficient capital to purchase a Control Logic development system that costs \$20,000, though parent Harnischfeger will finance a dealer at a rate 4 percent above prime. The development system contains a CPU, 24K memory, CRT, paper tape, printer, floppy disk, disk operating system and Fortran compiler. In fact, this is the only inventory that a dealer must stock, and it is to be used to demonstrate the Control Logic line.

Unlike a sales force, dealers will not have to meet sales quotas. Instead, Control Logic expects that dealers will derive added business by designing the software and inter-

facing that goes into a microcomputer system. And in a \$50,000 system, the hardware costs less than \$10,000; software development and interfacing account for the rest.

This, too, plays right into Control Logic's strategy. The company, with more than 1200 logic card products, markets one of the most complete lines in the industry. "A dealer will be able to meet 90 percent of his interfacing needs from the products that we sell off-the shelf," says Hildebrand.

Jim Parks anticipates that he will sell only six microcomputers during his first year as a dealer, but he uses more than 100 control and interface cards on each one. "The key to success," he says, "is interfacing the process to the computer."

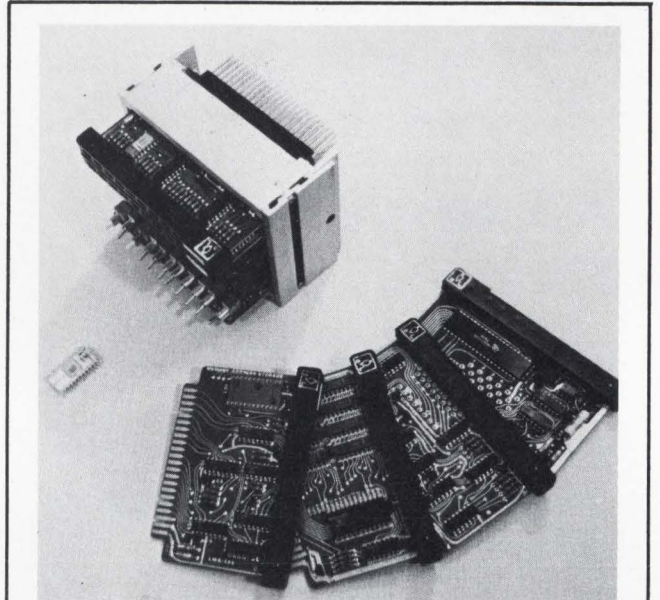

Control Logic produces a full line of 8080-based M series microcomputer cards and over 1200 C series control cards. The 4.5 in. x 3 in. microcomputer PC boards include a processor, memory cards, and device control cards. C series DTL and TTL micrologic cards, which are compatible with M series modules, include gate/flip-flop cards, arithmetic logic, counters and A/D and D/A converters. Control Logic also markets microcomputer development systems (M series shown), peripherals, and software.

Control Logic veers off in other directions, too, from the way other competitors go. To explain the merits of the new dealership approach, Vitale emphasizes that prospective microcomputer users in industry need heavy hand holding. "Specialists are required to computerize specialized industrial processes," he says. But Ed Lee, president of Monterey (CA)-based Pro-Log Corp. disagrees. The company also markets a line of industrial microcomputers, and Lee insists that "an engineer in industry without any software expertise can design and document a system once he has taken the design and programming course offered by Pro-Log." Dealer Fleisher resolves the dispute. "The Pro-Log approach works well on programs that contain less than 1000 words," he explains, "but an expert is necessary to do more complicated programming."

All of the jockeying is over a market that Hildebrand places at \$25 million in 1975, and which he expects to double each year into the foreseeable future. And Control Logic wants to make certain that it participates in that growth. "A lot of hard-wired controllers need to be replaced," he quips. "And sales reps cannot do all of the job." ■

NONTAXABLE SOFTWARE

The Tennessee Supreme Court decided recently that neither operating systems nor application programs were "tangible" or taxable personal property. It was the first state supreme court decision on the matter, according to Boston (MA)-based *Computer Law and Tax Report*. The Commerce Union Bank of Tennessee argued that the logic or intelligence of a program is "intangible." The State of Tennessee maintained that software was like a record or film and therefore taxable. In its favorable ruling for the bank, the Supreme Court said that mag tapes and disks, unlike records and film, only transmit information and it's information, not the tape, that's being purchased. Information since it can not be seen, weighed, measured or felt, is not tangible property. Now it's up to other states to decide.

NASA ON DATA BASES: TODAY AND TOMORROW

Today's bibliographic scientific data bases will become full text data bases and eventually will be solution-oriented information data bases. That's how

NASA's Director of Scientific and Technical Information Harold Pryor sees it. His comments were part of the Federal Govt./Kodak Symposium held in January in Williamsburg, VA. By bibliographic, Pryor means data bases that contain descriptive citations and index terms to technical documents and articles. A user searches the data base with key words from the original indexing vocabulary. Coming soon are entire document data bases, according to Pryor. Key word indexing will evolve to natural language indexing. Farther than near future lies the "pure information" data base, which will contain verbal and numerical data and formulas, physical laws and experimental results. The user will not search for a document for information, but instead will access solutions. And he will inquire orally instead of by keyboard.

NEW PUBLICATIONS

Special Symposium on Advanced Hybrid Computing (July, 1975) by Aldric Saucier, Army Material Command.

Symposium abstracts focus on recent hardware and software advances that make possible an advanced hybrid computer system with automatic patch-

ing and remote terminal access for time slicing the system. The system will be easily programmed, yet still maintain the 30:1 cost and speed advantages over pure digital systems for solving dynamic problems.

Order No: AD-A022 660/5WC

Price: \$7.50

Advanced Hybrid Computer Systems, Applied Dynamics International.

Solid-state switching devices and LSI technology have made an advanced hybrid computer system for non programmers possible. The cost savings of hybrid over digital systems is discussed along with new operating techniques.

Order No: AD-A023 057/3WC

Price: \$9.00

Multiprocessor Systems for Reliability: A Cooperative Study by J.R. Taylor, Atomic Research Establishment.

Multiprocessor and multicomputer systems are compared, and software techniques for multiprocessor systems are discussed.

Order No: AERE-R-7102

Price: \$5.00

Order from: *NTIS, U.S. Dept. of Commerce, 5285 Port Royal Rd., Springfield, VA 22161.*

Our line.

MERGERS AND ACQUISITIONS

Pertec Corp. has agreed to acquire iCOM, Inc., manufacturer of microprocessor-based subsystems for microcomputers. The company uses the Pertec FD400 and FD500 flexible disk drives in its microperipherals.

Harris Corporation has completed its plans to acquire M&M Computer Industries, Inc. (Orange, CA) from The Singer Company for an undisclosed amount of cash.

EG&G, Inc. has agreed to buy Identicon. Terms of the proposed acquisition will provide for the exchange of 50,000 shares of EG&G common stock for the outstanding capital stock of Identicon.

United Telecommunications, Inc. has agreed to acquire Standard Computer Corp. United Telecom will issue 227,500 shares of its common stock for the business and assets of Standard Computer. The number of shares issued by United may be adjusted due to the exercise of Standard Computer's stock options and warrants.

Trilog Associates, Inc. and Comshare, Inc. jointly announced an agreement whereby Trilog's Employee Benefits Services operation will be acquired by

GAINS AND SETBACKS

Data 100's (Minneapolis, MN) second quarter earnings held their own as order rates picked up, especially on its key-to-disk system, Keybatch. Second quarter earnings were \$1,073,000 before an extraordinary item, or \$.28 per share, on revenues of \$28,435,000. This compares with last year's income of \$935,000, or \$.26 per share, on revenues of \$22,506,000. For the six months, Data 100's income before an extraordinary item was \$1,893,000, compared with last year's \$1,735,000.

Data General Corp. (Southboro, MA) is taking it all in as the economy improves. The third 12-week period revenues increased 62 percent over the same period last year, or \$39,624,000 vs. \$24,873,000. Earnings after taxes were \$4,621,000 or \$.48 per share, compared to \$2,915,000 or \$.35 per share for the same period last year. Earnings for the 36-week period ended June 5, 1976 were \$12,140,000 vs. last year's \$8,597,000.

Fairchild Camera and Instrument Corp. (Mountain View, CA) increased its second quarter sales by 62 percent, compared to the same quarter last year, as worldwide component bookings exceeded billings. Second quarter earnings were \$2,858,000, or \$.52 per share, on record sales of \$111,753,000. Year-earlier income was \$3,287,000, or \$.61 per share, on sales of \$68,964,000.

Hazeltine Corp. (Greenlawn, NY) increased its second quarter earnings to \$.35 per share. That combined with an Air Force settlement and tax loss carryover brought net income for the quarter to \$2.05, compared to last year's loss of \$.17 per share. Revenues for the quarter were \$23,800,000, compared with \$21,100,000 last year.

Inforex, Inc. (Burlington, MA) increased its second quarter revenues about six percent to \$15,476,000, compared to last year's \$14,582,000. Earnings

CFI 1316 Series Disk Packs

The beginning of the line. Proven and field-tested. Designed for use with IBM 2311, Singer System 10 and CDC equipment, among others.

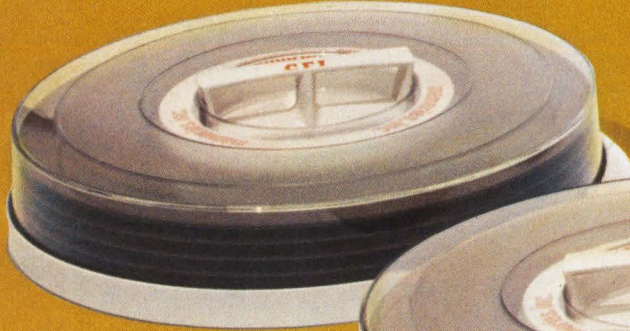

CIRCLE NO. 13
ON INQUIRY CARD

CFI 3336 Series Disk Packs

Largest product in the line, in both size and storage capacity. First disk pack to use servo track control. Available in two versions. Model 1-100 megabytes, Model 11-200 megabytes. Configurations available for CDC, Honeywell, NCR, DEC and Data General, among others. CIRCLE NO. 12 ON INQUIRY CARD



CFI 2316 Series Disk Packs

The most versatile product in the line. Available in many different sector configurations, data densities and track densities. Compatible with all major disk drives, including the Univac 8440.

CIRCLE NO. 11 ON INQUIRY CARD

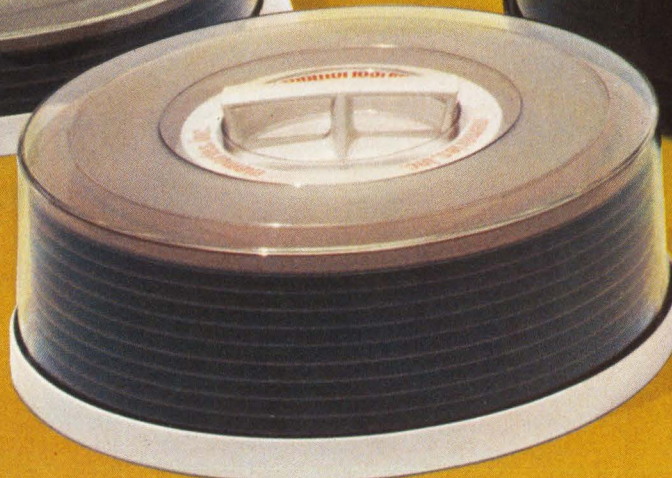

for the quarter doubled from last year's \$192,000 or \$.07 per share to \$499,000 or \$.17 per share.

Motorola's (Schaumburg, IL) semiconductor and automotive products group helped increase company second quarter earnings to \$22 million or \$.78 per share from last year's \$11 million or \$.42 per share. Revenues were up to \$383.5 million, compared to \$345 million in the same quarter of last year. Chairman Robert Galvin attributed the improvement to the economic upswing and organizational and operational changes in the two groups.

Pertec Corp. (Marina del Rey, CA) had to absorb Computer Machinery Corp., which was less than profitable, so first quarter revenues increased, but earnings dropped. Revenues totaled \$21 million, compared to \$13 million in the same quarter of last year. Net income was \$874,000 or \$.17 per share vs. \$956,000 or \$.31 per share last year. Pertec will expand even more if its plans to purchase microperipheral supplier, iCom, go through.

Prime Computer, Inc. (Framingham, MA) is staying on its profitable track with a second quarter increase in earnings of 180 percent, or \$442,000 compared to \$157,000. Sales for the second quarter were \$4.8 million, compared to \$2.7 million last year.

Wang Laboratories, Inc. (Tewksbury, MA) came close to doubling its fourth quarter earnings from those of last year. Net earnings totaled \$2.9 million or \$.57 per share vs. last year's \$1.5 million or \$.29 per share. Revenues were up 27 percent from last year's \$24.9 million to \$31.7 million.

Western Peripherals (Anaheim, CA) started shipping disk and tape controllers for minis last September. Its first year earnings were \$57,940 or \$.10 per share on sales of \$538,744.

Comshare for 122,500 shares of Comshare common stock. Trilog will become a wholly-owned division of Comshare and will continue operations in Philadelphia under its current president, Donald J. Devine.

Tymshare, Inc. has completed the acquisition of the business and operations of Medical Data Systems, Inc., Mahwah, NJ, for 82,000 shares of Tymshare common stock.

Intel Corp. has agreed to purchase AutEx, an interactive computer service. Terms of the agreement call for the exchange of 1-1/2 registered shares of Intel common stock for each share of AutEx common stock.

CYCON TO BE REORGANIZED

Cycon, Inc., (Sunnyvale, CA) a manufacturer of A/D and D/A converters, has filed for reorganization under the provisions of Chapter XI. In the company's reorganization plan, it is proposed that Cycon will sell its assets and goodwill to CPS, Inc., a Sunnyvale based firm, subject to approval of their creditors and a confirmation by the court.

CFI Trident Disk Packs/Storage Module

The newest products in the line. Uses 3336-11 particle-oriented disk. Available for use with all Trident-type drives having storage capacities of 25, 50 and 80 megabytes. Also available in storage module configurations for CDC and Hewlett/Packard type drives.

CIRCLE NO. 14 ON INQUIRY CARD

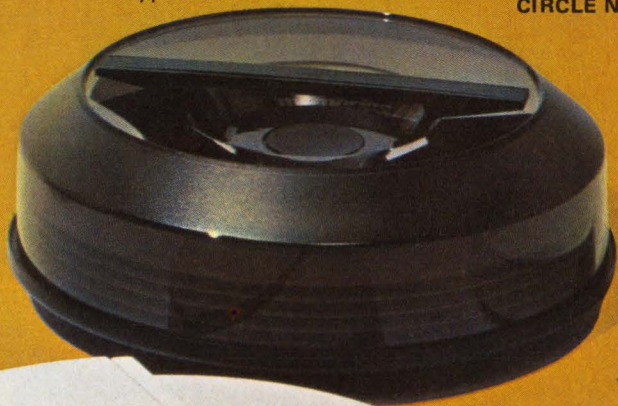

CFI 5440 and 2315 Series' Disk Cartridges

The most popular products in the line. CFI Memories is the world's largest supplier of disk cartridges. We make them in every version, compatible with every computer and peripheral manufacturer. They're available in 100 TPI, 200 TPI and 400 TPI densities.

CIRCLE NO. 15 ON INQUIRY CARD

Before IDEA, programmers had to use Fortran or Cobol to create INFOS files. Even for them, it was time consuming and tricky. But IDEA lets up to 16 unsophisticated terminal users create and access INFOS files.

Although IDEA interacts with INFOS and the RDOS operating system, it's almost a language in itself. Users can design and store CRT screen formats with the Screen Format Generator. The IDEA compiler has over 40 simple English-like instructions so unsophisticated users can specify what to do with the data. The Online Multiterminal Monitor runs the user-created program and manages the terminals. Each terminal can handle its own application or all terminals can handle one.

Unlike another Eclipse access program — CAM — IDEA has features to create files as well as access the files. CAM is designed more for multiterminal communications than for file access.

The IDEA/INFOS combination is similar, but not identical to, Hewlett-Packard's DEL/IMAGE software for the 3000 Series II. DEL is a data entry language that lets a user design screen formats and edit data at the terminal. But unlike the INFOS file management

system, IMAGE is a full fledged data base, which means its files are centralized and nonredundant, but more complicated to set up.

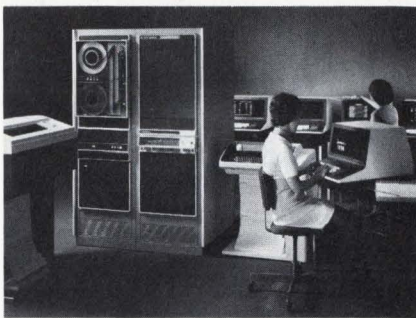

DG'S SMALLEST IDEA. The \$120K system is designed for online order entry and processing, customer service, inventory control, and claims processing.

Data General also upgraded its C/300 memory. A new memory allocation and protection (MAP) unit doubles the memory capacity to 512K bytes and provides hardware protection for user programs in dual programming applications. And it will take fewer memory boards to reach maximum capacity now too. Following HP's lead, DG is offering 64K-byte MOS boards using

either Texas Instruments' or its own 4K RAM chips. DG also doubled the density of its core boards to 32K. With the new memory, the C/300 becomes the C/330.

The Hartford Insurance Group has been helping Data General work out the bugs of the IDEA/330 system in the last few months. Hartford will use the system to write policies with input coming from a CRT in every branch office. William Harrison, Hartford assistant vice president, estimates IDEA knocked six months off of system programming time.

Data General also took another step into the commercial IBM territory with the RJE80 software package. The package emulates IBM 2780 and 3780 remote job entry terminals so that a Nova or Eclipse computer can communicate with an IBM mainframe.

Price of a minimum C/330 system with 192K bytes of core, 10MB disk, mag tape, 300-lpm printer, Dasher terminal, CRT console with four CRTs, and RDOS, INFOS, COBOL, RPG II, RJE80 and utility software is \$120,500. The IDEA software alone is \$3000, including two days of onsite support.

CFI Abraxas III Disk Cartridge Cleaner-Verifier

To help maintain our line. Completely portable and self-contained unit cleans and mechanically tests both front and top loading cartridges. Prevents costly head crashes and reduces or eliminates soft errors caused by damaged or dirty disk cartridges.

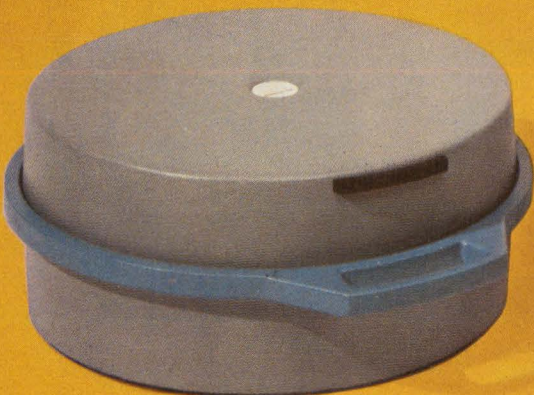

CIRCLE NO. 20 ON INQUIRY CARD

CFI Abraxas IV Magnetic Tape Cleaner

Keeps our tape line clean. Safe and effective. Removes contamination which can seriously affect the operational capabilities of magnetic tape.



CIRCLE NO. 21 ON INQUIRY CARD

product focus

A MINI FLOPPY FOR MICROS

It's not often that an independent tries to establish a defacto standard in an IBM market, but floppy drive manufacturer Shugart is giving it a go. The Sunnyvale (CA)-based company has designed a floppy drive about half the size of an IBM 3740 drive, with one-fourth the capacity and about two-thirds the price. Shugart says there's a need for a random access peripheral that fits with microcomputers and ter-

minals and that is competitive in size and price with the tape cassette.

To achieve the smaller size and price, Shugart had to give up some performance. The DC (instead of AC) motor turns the disk at 300 instead of 360 rpm. Bit density is 2600 bpi instead of 3200. The result is a lower transfer rate (125K bps vs. 250K bps) and a slower access time (566 msec vs. 286 msec). The 90 kilobytes formatted capacity is one-third that of IBM's 250 kilobytes. The soft error rate is 1 in

10^8 , compared to a regular floppy's 1 in 10^9

But on the positive side of the trade-off, Shugart's SA400 minifloppy measures 5-3/4 inches and weighs 3 pounds, compared to 8-1/4 inches and 14 pounds for a standard floppy drive. Single quantity price is \$390; Shugart's IBM-compatible floppy, the SA800, costs \$600. The disk is the same diskette-type construction, only smaller: 5-1/4 inches vs. the 3740's 8 inches.

Other manufacturers tried other

SMALL STORAGE

CRITERION	SA400 MINIFLOPPY	IBM-COMPATIBLE FLOPPY	3M MINI CARTRIDGE	PHILIPS CASSETTE	3M CARTRIDGE
Unformatted capacity	110KB	400KB	100KB	720KB	2870KB
Transfer Rate	125K bits/sec	250K bits/sec	2.5K bits/sec	24K bits/sec	48K bits/sec
Recording Density	2600 bpi	3200 bpi (double density also)	800 bpi	800 bpi	1600 bpi
Avg. Access Time	566 msec	300 msec	20 sec	20 sec	20 sec
Typical Drive Size	3.25 x 5.75 x 8.0 in.	4.62 x 8.55 x 14.25 in.	5 x 5 x 5 in. +5 x 12 in. PCB	4 x 6 x 8 in.	7 x 9 x 12 in.
Typical Weight	3 lbs.	14 lbs.	3.25 lbs.	5 lbs.	5 lbs.
Drive Price, Including Electronics	\$390	\$600	\$550	\$750	\$1000

Data supplied by Shugart Associates

We take your business personally

We have made a major commitment to R&D and to the continuous refinement of the manufacturing process. We will continue to develop technologically advanced products for both the end-user and OEM.

We have also made a major commitment to a nationwide network of independent representatives. The men who sell and service our line have proven themselves to be the best in their field. That's why they represent CFI. They work hard to earn your business by giving you the kind of personal attention and professional service you just can't get any place else.

A nearby CFI representative is waiting to show you how you can get all the care and quality we put into our products and all the personal attention you could ever want at prices your accountant will appreciate. And that's really the bottom line.

Call us toll-free for the name of your local representative, 800/854-3290. Or write: CFI Memories, Inc., 305 Crescent Way, Anaheim, CA 92801.

CFI memories, inc.



floppy designs before IBM set the standard. But once the standard is set, it's an uphill battle for any unique type of drive. In its favor, Shugart is second only to IBM in terms of the floppy drive market and possibly more important, Shugart is not really competing with the floppy, but with the cassette and mini cartridge. So maybe there is something of a standard — at least in

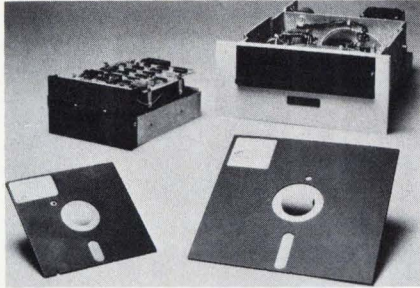

SHUGART'S ALTERNATIVE. Half the size and two-thirds the cost.

the microcomputer and terminal market — in this new drive. Even micro-peripheral supplier, iCOM, soon to be part of Pertec, is evaluating the drive for future products. And General Systems International is reportedly designing a similar drive.

DEC'S NEW BUSINESS SOFTWARE

Digital has a new operating system for its PDP-11-based small business systems. Commercial Transaction System



A LOWER PRICED DATASYSTEM 530. By using the PDP-11/34 instead of the 11/40, Digital can drop the price 15 to 20 percent to \$60,000.

(CTS) will replace the Commercial Timesharing System (also CTS) for the Datasystems 350 through 570. For the Datasystem 500 line, CTS adds transaction processing to the single or multi-keyed ISAM file management system. A new data entry mode, DECform, allows the user to design data entry formats, run predetermined edits and process or store the data. In another move toward upward compatibility, DEC's modified Cobol, Dibol, can now be run on the Datasystem 500 in addition to the Datasystem 300 line. The most widely used languages, such as Cobol '74 (Level 1), Fortran IV, Basic Plus 2 and RPG II, are also available on the 500.

On the hardware side, DEC's Datasystem 530 has a new configuration using the PDP-11/34 instead of the 11/40, which makes it 15 to 20 percent less expensive than the previous offering. Prices start at \$60,000.

One Datasystem 300 member, the 350, will also use the new operating system with Decform. Although the 350 is PDP-11 based, it is part of the PDP-8 based 300 line. But then, what's in a name?

Your line.

800/854-3290

(In California 714/776-8571)

CFI memories, inc.



With GE's TermiNet[®] 9600 Communication Controller you can emulate IBM 2780, 3780 and Univac DCT-1000 remote print stations

If you've been waiting for a fast, versatile and efficient remote print station at an affordable price, wait no more. By interfacing the TermiNet 9600 Communication Controller option with one of General Electric's line printers, you have in one small package, not only emulations for popular remote print stations, but added features like:

- A variety of printer speeds to match your network capacity up to 340 lines per minute
- Throughput that can be upgraded as your workload increases

- Improvements in throughput and cost without changing central site software

And the best part is that you can have this kind of application flexibility.

This kind of network efficiency. This kind of high performance in a price range you can justify.

for under \$500 per month*

Write General Electric Company,
Terminet 794-18, Waynesboro,
Virginia 22980.

For your special kind of needs—A special kind of printer

GENERAL  ELECTRIC

CIRCLE NO. 22 ON INQUIRY CARD

DAVID TALKS

David (Digitally Activated Voice Information Device) is a line of voice response systems, including both software and hardware interfaces for the DEC PDP-8 and PDP-11, DG Nova series and an asynchronous microprocessor-driven voice response device. The Model S-232 can be used in local or remote sites. David's voice is generated by a digitally-driven, completely solid

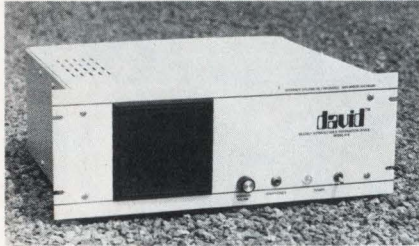

state speech synthesizer. Prices range from \$6750 to \$47,500, depending on model and configuration. *Interface Systems, Inc., Ann Arbor, MI.*

Circle No. 77 on Inquiry Card

REMOTE BATCH TERMINAL

Unitech's UT-2 programmable terminal has a 12K-byte microprocessor-based communications processor, card reader, synchronous communications adapter, line printer console plus communication software. It is software compatible with larger Unitech machines and it operates to 4800 bps with RS-232C compatible modems. Prices start at \$700 per month. *Unitech, Inc., Austin, TX.*

Circle No. 75 on Inquiry Card

TERMINALS

Tymshare's (Cupertino, CA) new Model 325 30-cps terminal prints the full ASCII set of 96 upper- and lowercase characters on an extra-wide, 132- or 158-column line



length. Variable 10/12 cpi settings and interchangeable fonts make it suitable for reports. It handles an original form and up to five copies on various size forms. An integrated 10-key numeric pad is standard. Price is \$4114.

Circle No. 61 on Inquiry Card

Multiterm's (Redondo Beach, CA) 8080 microprocessor-based terminal prints up to 45 characters per second using Diablo's HyType II mechanism. All logical circuitry, memory, microprocessor, power supply, and keyboard are contained in a single desktop unit. The terminal has an RS-232C 25-pin interface connector with ASCII code. The terminal's self-diagnosis feature prints messages when problems occur internally, or in the communications or host system. Single quantity price is \$2875.

Circle No. 60 on Inquiry Card

The new *LogAbax (Los Angeles, CA)* programmable terminal prints 180 cps and can communicate with any processor. The microprocessor in the LX1010 lets it talk in any existing protocol, code or mode. For example, it can be used as a private line polled device, emulating a 2740 Mod II. It can be used the next minute as an ASCII-compatible time sharing device. Or it can be used a moment later as a 2741, with or without APL. Lease price is about \$200 per month.

Circle No. 62 on Inquiry Card

Randal Data Systems, Inc. (Torrance, CA) has a floppy batch terminal with complete editing and data search capability. The new send/receive store-and-edit terminal is plug-compatible with existing RS-232



data terminals. Over 2400 addressable lines of 128 characters can be accessed from the RDS/FSDR or from any asynchronous CRT or keyboard/printer terminal. Prices start at \$1995.

Circle No. 63 on Inquiry Card

HP, DEC, NOVA, MICRODATA, disc storage users

What does IBM and Microcomputer Systems have in common? We both have a customer proven microprogrammed disk controller: IBM in the large system world and Microcomputer Systems in the mini world.

The **MSC-1000 Intelligent Controller** microprogramming allows operating system flexibility by permitting your mini to perform the functions it was designed to handle, while the **MSC-1000** gets on with the business of handling the disk system.

Low cost, high performance. We use fewer parts to give us high reliability giving you greater up-time. We don't just build and ship—we run exhaustive diagnostic testing in a realtime environment.

- Multiple Sector Data Transfer
- Automatic Self-test
- Over-lapped Seek
- Automatic Track Seek and Verify
- Write Protected Track Declaration and Detection
- Defective Track Flagging and Sensing
- Operator Fault Analysis Panel
- Error Recovery

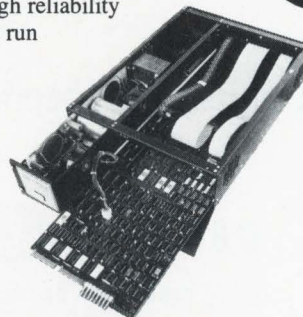

microcomputer systems corporation
440 Oakmead Parkway • Sunnyvale, California • 94086 • (408) 733-4200

CIRCLE NO. 23 ON INQUIRY CARD

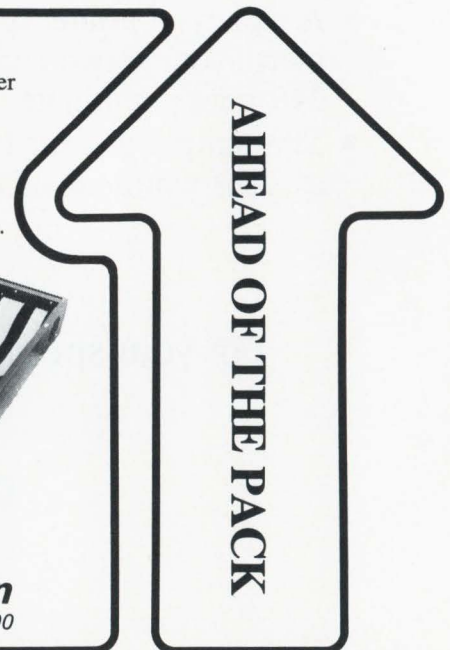

Who says colors have to be confined to the outdoors? Not Tab. Our Data Media® Cabinets are available in 24 exciting colors to help you harmonize, match, contrast or just plain add color to any office or data processing environment. And if our 24 colors don't excite you, pick the colors you want and we will customize our Data Media Cabinets to create the precise colorful environment you want. Incidentally, Tab Data Media Cabinets are known for their versatility in providing safe, efficient storage for disks, cartridges, cards, tapes, cassettes, binders, printouts, or whatever else you need filed where you can get at it fast.

Ask your local Tab representative for our colorful brochure for data media storage systems. Tab Products Company, 2690 Hanover Street, Palo Alto, California 94304

TAB
PRODUCTS CO

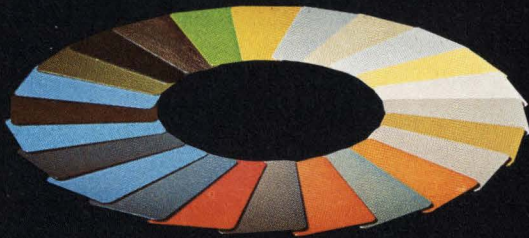

Whatever the Colors

Whatever the Media



We've got your Cabinets

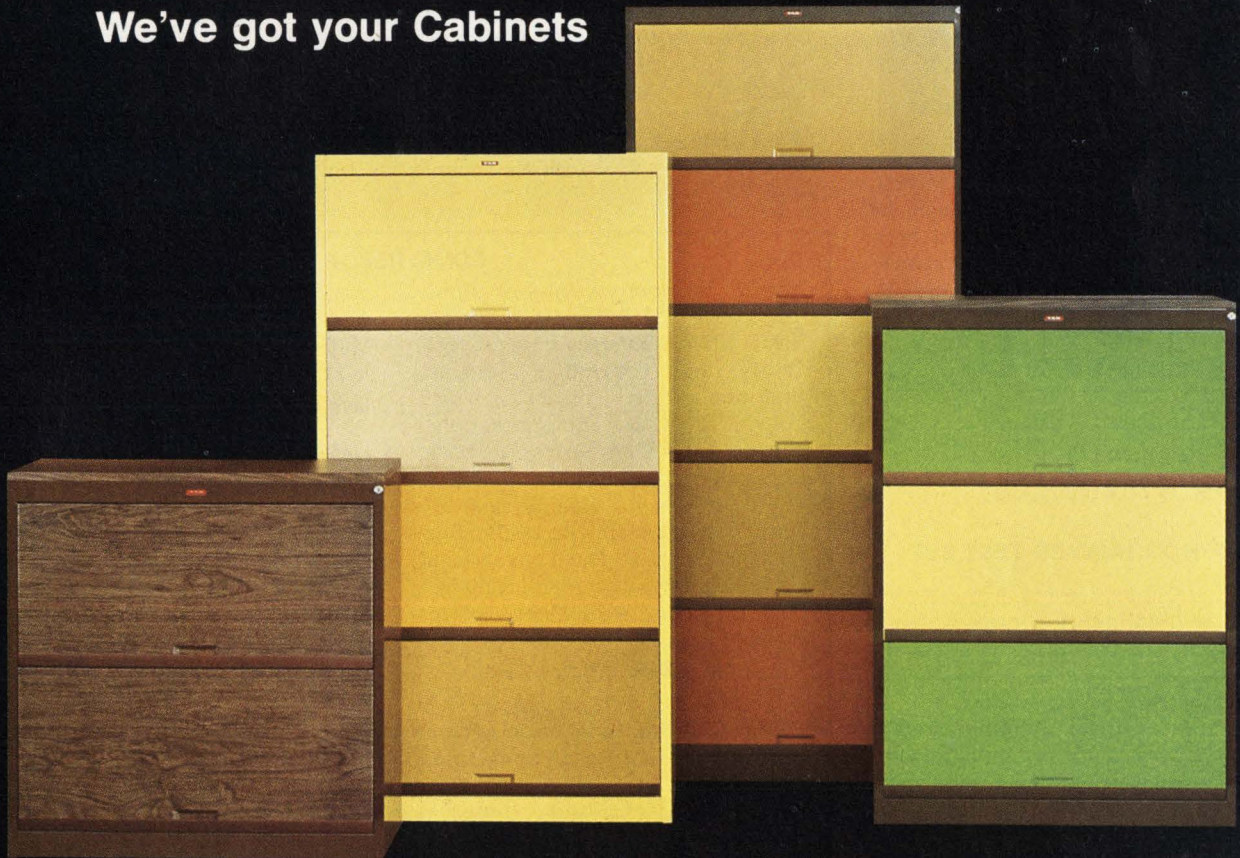

TERMINAL CONTROL UNIT

The TCU-8 terminal control unit reduces the number of computer ports, modems and transmission lines required in a non-pollled, multiple-terminal data communications network. Via a time sharing technique, the TCU allows one computer port or modem to service up to eight terminals and can be cascaded for extra capacity. Terminals can be collocated with the TCU or extended any distance from the TCU via conventional or limited distance modems. The control unit handles data rates up to 9600 bps. Price is \$995. *Syntech Corp., Rockville, MD.*

Circle No. 74 on Inquiry Card

MULTIPOINT DIAGNOSTICS

The Codex Multipoint Network Control System identifies the portion of a network that is malfunctioning and then uses alternate facilities to restore network operation. It operates through a frequency division multiplexed secondary channel so that many of its functions can be performed without interrupting data on the high-speed

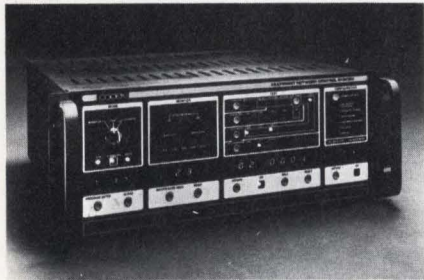

channel. A master control console is the user's interface to multipoint network. It can control up to eight multipoint lines, each of which can have up to 30 drops. The remote card set interfaces the system to Codex LSI fast poll modems introduced last December. Price of the master control console is \$4950. The remote card set is \$895. *Codex Corp., Newton, MA.*

Circle No. 71 on Inquiry Card

MICROPROGRAMMED TEST SET

The TC-100 data communications test set can be used in tech control systems or as a portable testing device. It simulates and tests all components of the data network, including communications circuits, modems, terminals and computer ports. Both system hardware and software can be tested. The unit fits in 5-1/4 inches of rack panel space. *Dynatech Laboratories, Inc., Alexandria, VA.*

Circle No. 72 on Inquiry Card

MODEMS AND MUXES

Modem Kit. The Pennywhistle 103 Acoustic Coupler kit can be used either as an acoustic coupler (with the telephone handset) or it can be wired directly into the telephone via a DAA. In either case, the modem will operate in both the half-duplex (unidirectional) or full-duplex (bi-



directional) modes. Its three-stage active filter prevents noise and harmonics from getting through. The Pennywhistle kit includes everything needed to build the entire unit. All electronic components mount on a single 5 by 9-inch PC board. The kit also includes all chassis parts, speakers, speaker grilles, muffs and line cord. Price of the kit is \$109.95. *M&R Enterprises, Sunnyvale, CA.*

Circle No. 64 on Inquiry Card

Synchronous Time Division Multiplexer. The bit interleaved TDM 1251 lets a user configure data networks of various speeds. It monitors each channel display online at both ends and has an automatic channel

alarm system. It provides users with control of both the local and remote TDMs right to the terminal interface. Each individual channel can be looped back without affecting operation of any other channel. *General DataComm Industries, Inc., Wilton, CT.*

Circle No. 66 on Inquiry Card

19,200-BPS Line Sharing Device. Paradyne's LSD transmitter/receiver provides full duplex data communications at 19,200, 16,800, 14,400, 12,000 and 9,600 bps over unconditioned voice grade channels (3002 lines). To operate over this range of speeds, the LSD uses two independent voice band channels, each operating at speeds of up to 9600 bps.



The Line Sharing Device has built-in diagnostics and an unattended self-monitoring capability that automatically switches down the speeds of the associated modems whenever channel degradation threatens data transmission capability. *Paradyne Corp., Largo, FL.*

Circle No. 65 on Inquiry Card

COMM REPORTS

World Telecommunications Directory. Frost & Sullivan's 1200-page 1976 edition lists government regulatory and controlling agencies, common carriers and PTTs, which provide domestic and international service for 45 countries. Domestic and international public switched, telex and leased line services are described in detail with tariffs. Specialized services such as packet switching networks are also included. The Directory with three updates costs \$950.

Circle No. 68 on Inquiry Card

Executive Telecommunications Planning Guide. In addition to comprehensive interstate and international rate schedules digested for quick-reference, this loose-leaf edition from the Center for Communications Management, Inc. provides a variety of traffic tables, interface

standards and a complete list of U.S. rate centers and V&H coordinates. Material is updated monthly. Price is \$195.

Circle No. 69 on Inquiry Card

Online Communications Tariff Guide. DMW Telecommunication Corp.'s pricing guide is an online program on the Automatic Data Processing/Cyphernetics network. It helps in planning, designing or managing large leased line voice or data networks. The program computes prices for leased line telecommunication networks. It automatically prices individual point-to-point lines, groups of point-to-point lines, and individual multipoint lines for a variety of tariffs, including all Bell System interstate leased offerings such as HiLo, DDS, and Telpak.

Circle No. 70 on Inquiry Card



Your mother does not like to be interrupted when she's busy.

It's too bad your big computer has such a busy schedule. But that's the way your mother was meant to work.

That steady job stream has been very carefully planned out to make the most of your mother's time.

Which, unfortunately, has made it tough for your mother to handle things that don't fit into the schedule. Things like demand reports, online data entry and unplanned jobs.

But that doesn't mean you can't do the unexpected. All you have to do is get your big computer a little help. A computer that can do the jobs your mother can't handle.

A Data General commercial ECLIPSE computer.

The commercial ECLIPSE computer is smaller than the big computers you may be used to using. But it has the things big computers have. A commercial instruction set that even has an EDIT function, for example. And large memory configurations.

This computer also has incredibly easy-to-use interactive data entry/access software called Idea that speeds program development and use. And speeds use of business-oriented files maintained by our INFOS data management system with multilevel keyed access.

The COBOL that's available with the commercial ECLIPSE computer is the highest level implementation of ANSI '74 COBOL standards.

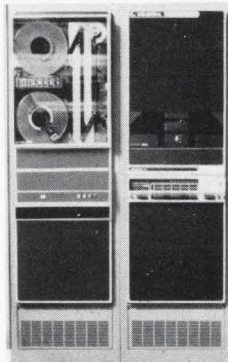

It's a complete language system that comes with features like an interactive debugger, and an integrated SORT/MERGE. Plus it also includes an IBM-compatible RPG II and real-time FORTRAN.

Most important, this computer has a communications ability that lets you interface to your big computer. For example, when talking to an IBM system, the ECLIPSE computer can emulate 3780/2780 and HASP procedures. Or just be itself.

And wherever you put this computer, you can plan on it doing more than one thing at a time. Up to 16 Idea applications and remote job entry concurrently, for example.

Or one Idea application using up to 16 terminals while a COBOL program processes previously entered data. Or simultaneous program development and communications.

It's all from a major computer manufacturer, Data General. Which means you get full software support, a range of system and field engineering services, financing alternatives, compatible peripherals and much more.

Write for more information.

That way, your mother will be able to work the way she was meant to.

And you won't have to interrupt her when she's busy.

COMMERCIAL ECLIPSE COMPUTERS: BECAUSE YOUR MOTHER NEEDS A LITTLE HELP

Data General

ECLIPSE is a registered trademark of Data General Corporation. INFOS is a trademark of Data General Corporation.

• Data General, Route 9, Southboro, Mass. 01772, (617) 485-9100. Data General (Canada) Ltd., Ontario. Data General Europe, 15 Rue Le Sueur, Paris 75116, France. Data General Australia, Melbourne (03) 82-1361/Sydney (02) 908-1366.

CIRCLE NO. 25 ON INQUIRY CARD

BELL'S DIVERSION

"Don't fire 'til you see the whites of their eyes," is Computer Industry Association President A.G. Biddle's advice to the opponents of the Bell monopoly bills presently before Congress. Biddle maintains that AT&T Chairman John deButts introduced the Bell consumer acts in an election year not to have them passed that year, but the following year. By then, the issue will be old hat to the press and will no longer receive front page attention. Without the competition of negative front pages, AT&T can then start its media blitz. So Biddle advises, "Save your energies until the real battle begins."

PDP-11 COMM INTERFACES

Digital Equipment Corp. has three new communication interfaces for its PDP-11 minis. Operating on DECNET under its DDCMP protocol is the DMC11 single high-speed line synchronous interface. A microprocessor implements the DDCMP protocol functions. Price is \$2145. The first of DEC's multi-protocol interfaces, the DUP11, handles SDLC, HDLC, DDCMP and older eight-bit protocols such as BSC. The

program-interrupt driven interface operates with synchronous modems at speeds up to 9600 bps. Price is \$1375. The DZ11 multiplexer interfaces eight or sixteen asynchronous terminals to PDP-11s. Price of an eight-line DZ11 is \$2100; for sixteen lines, it's \$3400.

DATA-PATCH MODULE

Data-Patch modules give quick access to digital data telecommunication circuits at low cost. Most technical control facilities require "normal-through" jack sets to interconnect telephone lines, modems, and computer ports in a standard configuration for normal operation. When problems develop, patching is a quick means of substituting spare modems or computer ports for system restoration. The new DPM-2-1 module gives patch access to test or spare equipment. *Atlantic Research Corp., Alexandria, VA.*

Circle No. 76 on Inquiry Card

INTERNATIONAL PACKET NETWORK

A Canadian network and a U.S. network are exchanging packets to form the first international packet switching network. The Trans-Canada Telephone Systems Datapac network and Cupertino (CA)-based Tymshare's network will interconnect sometime in 1977, shortly after Datapac is put into operation. Tymshare's network, Tymnet, now serves about 70 cities in the U.S. and Canada. Both networks will use the SNAP protocol, which is based on the recently CCITT-approved X.25 network interface protocol. (CCITT is the international standards organization for the telecommunications industry.)

EFTS GROWTH

"Of the 80 billion retail transactions predicted for the nation in 1983, some 5.2 billion will be automated," says American Bankers Association Executive Vice President Willis Alexander. "Cost savings in 1983 are estimated at 14 cents per transaction — a total savings nationwide of \$700 million annually," he adds. This year, despite legal and regulatory constraints at the state and the federal level, six times as many banks will install pos terminals than last year, he says. That means six percent of all commercial banks in this country will be using these terminals compared with only one percent in 1975. And among the banks with assets of more than \$200 million, 20 percent will be electronically hooked up to pos terminals.

TALKING INTERFACE

The *Wavetek* (San Diego, CA) audio response unit talks back to CRTs, Touch Tone or transaction telephone terminals over 110, 150 or 300-baud voice grade lines. Its prerecorded vocabulary of a maximum of 124 words is transmitted at 0.5-second intervals. Multifrequency tones from Touch Tone

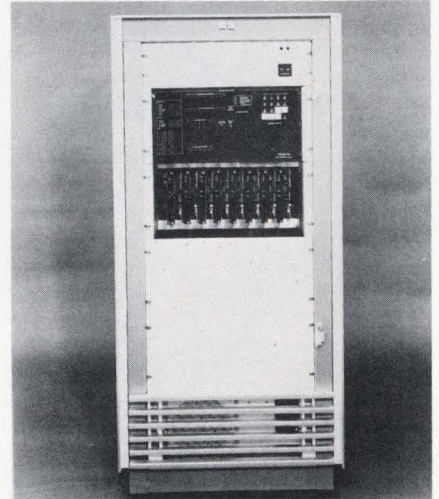

telephones are translated into digital information by the receiver data set and transmitted to the host. A microprocessor-based controller handles terminal multiplexing and message transmission over the communications channel. Also under microprocessor control, the word multiplexer selects and transmits the analog message to the terminal. The host can be anything from an IBM 370 to a mini, as long as it has 1200 baud asynchronous lines. Prices hover around \$25,000.

Circle No. 73 on Inquiry Card

PERIPHERAL ADAPTER

Printers, plotters, card readers, and disk/tape storage units can be interfaced to CRTs or teleprinters with the Peripheral Equipment Adapter. It allows up

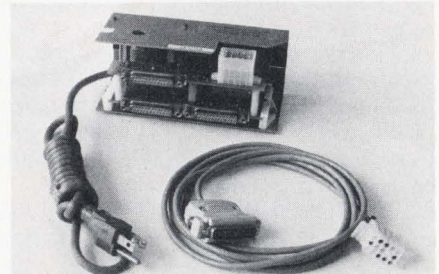

to three devices with either RS-232 voltage or 20 mA current loop interface. For terminal systems requiring more devices, adapters can be cascaded. Price in single quantity is \$135. *United Data Services Co., Inc., Phoenix, AZ.*

Circle No. 67 on Inquiry Card

BEEMAK TABCARD HOLDERS

FOR SYSTEM 3—80 COL.—51 COL.
RACKS — TRAYS — ACCESSORIES

BP100
80 col.

BP200
80 col.

BP500

BP900
96 col.

51 col.
BP300

Holders with magnets or adhesive strip. Spring clips for attaching to shelves.

R100-18
Racks made with any holder in any design or size.

BP950 for System 3.
Unbreakable carrier protects cards traveling thru plant. Visible, accessible.

Vinyl envelopes available with adhesive back or magnets.

BEEMAK PLASTICS

7424 Santa Monica Blvd., Los Angeles, Calif. 90046
Phone: (213) 876-1770

CIRCLE NO. 26 ON INQUIRY CARD

MEMORY AT WORK

Minicomputer Memories.

When you want add-in/add-on memory for the major minicomputers, deal directly with the memory experts at EMM.

Lower cost. Up to twice the memory for your money from EMM. And you have a choice . . . core or semiconductor.

Improved performance. Faster throughput. Higher density. The latest advances in memory system design.

Immediate availability. You get the system you want when you want it.

A full year's warranty. You get one year unconditional warranty against defects in workmanship and performance.

TYPICAL PRICES*

Minicomputer Model	Capacity	Minicomputer Co. Price	EMM Price
Data General Nova 1200	8K Words	\$2,000	\$ 860
	16K Words	\$3,500	\$ 1,230
	32K Words	Not Avail.	\$ 2,400
Interdata 7/16, 7/32	32K Bytes	\$5,000	\$ 2,000
General Automation SPC-16	16K Words	\$4,600	\$ 2,000
DEC PDP-11 Core Add-On Unibus	32K Words	\$9,800	\$ 5,190
DEC PDP-11 NMOS Add-On Fast Bus	64K Words	Not Avail.	\$19,000
DEC PDP-11 Core Add-In	16K Words	\$4,500	\$ 1,825
DEC LSI-11 Add-In	16K Words	Not Avail.	\$ 1,590

*All prices for single unit quantities.

AND NOW ANNOUNCING . . .

**Add-On core or NMOS memory for the DEC PDP-11/70.
256K Bytes in a 5¼" chassis for only \$18,500! Available Now.**

EMM

COMMERCIAL MEMORY PRODUCTS

A Division of

Electronic Memories & Magnetics Corp.

12621 Chadron Ave., Hawthorne, Calif. 90250

(213) 644-9881



See us at the Mini-Microcomputer Show in San Francisco, Oct. 19-21. Booth 229-230.

CIRCLE NO. 27 ON INQUIRY CARD

MASTERING THE MICRO

Continuing the series of first-hand accounts on what it takes in patience and knowhow to apply the micro to real products. Here, Robert Giuli, who founded a time sharing service and microcomputer design firm, tells of his madcap race against time to develop a micro-based control system to be used to destroy deadly nerve gas at the Rocky Mountain Arsenal.

EXPERIENCES WANTED

Have you used a micro and want to share that experience? Tell us briefly about what you went through, and MINI-MICRO SYSTEMS will provide all the back-up editorial support necessary to chronicle the micro application in an accurate and telling style on those descriptions chosen. The experience can even be an unfortunate one, just as long as you learned lessons helpful to others who are attempting to master the micro.

The microcomputer development effort I will discuss traces back to a directive from President Ford. My experiences on the job as head of a team effort illustrate just how effective microprocessor technology can be when applied to projects that have severe time pressures. They also illustrate that Murphy's Law — that if anything can go wrong, it does — still operates even in the hot-shot microprocessor world.

The saga begins long before I personally became involved. Officials of the huge Stapleton International Airport in Denver wanted to expand a runway into space occupied by the U.S. Army Rocky Mountain Arsenal in Denver. The space, however, held a large cache of canisters containing liquified nerve gas. Some canisters had deteriorated, and crystals that had formed on the outside indicated that they were leaking. The ensuing uproar caused President Ford to order the softball-size canisters to be destroyed, and a facility had to be constructed to do the job.

The design of the disposal facility fell to the Army Corps of Engineers. The Corp., electing to modify an existing structure in Denver and to design a totally automated system, selected Stearns-Roger Inc. in Denver as the contracting engineers under a \$15 million award.

THE OPERATING SYSTEM

The system that Stearns-Roger came up with involves many automatic,

sequential steps. Inside the sealed-off building, machines pick up the canisters one at a time, place them on a conveyor belt, and route them to a huge punch that punctures the metal shell. The liquid drains into a tank that contains neutralizing chemicals, and the empty canister proceeds to an oven where it is melted down. Doors open and close at frequent intervals along the way, and a scrubber as part of the system also automatically cleanses the air vented to the outside. The system also incorporates automatic equipment to moni-

Studies by Stearns-Roger's engineers, however, showed that a microcomputer-based system would be best. Each of the sundry tasks appeared routine to handle, and the necessary interfaces appeared simple to build. So the engineers opted for the Intel 4040 micro and then subcontracted out the actual design.

This was in February, 1975, but by August, no microcomputer design was forthcoming because the subcontractor had not been made aware of the situation's gravity. Now, the micro-

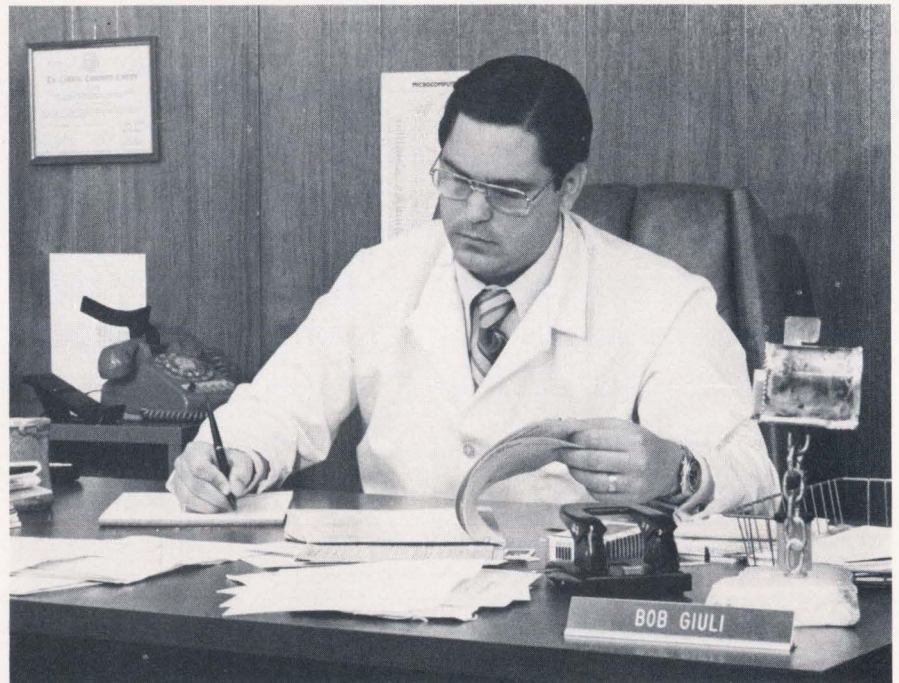

Robert Giuli, President, Giuli Microprocessing Inc., San Jose, CA.

tor and control steam pressure, oven temperature, and valve operation. In addition, an extensive alarm system, to assure fail-safe operation, alerts technicians to any malfunction or other anomaly anywhere in the system — immediately as it is detected.

Such an operation is clearly a candidate to be managed by any one of a dozen types of computer systems.

computer had become the critical element in the rush project. Stearns-Roger was projecting further slippages of several months that carried potential losses of up to \$250,000 a week in additional labor charges and other overhead costs. More urgent, the public was becoming impatient over the delay. I was on a fishing expedition in the Sierra Madre mountains at this

and now PARADYNE PRESENTS the Teleprocessing Answer Man

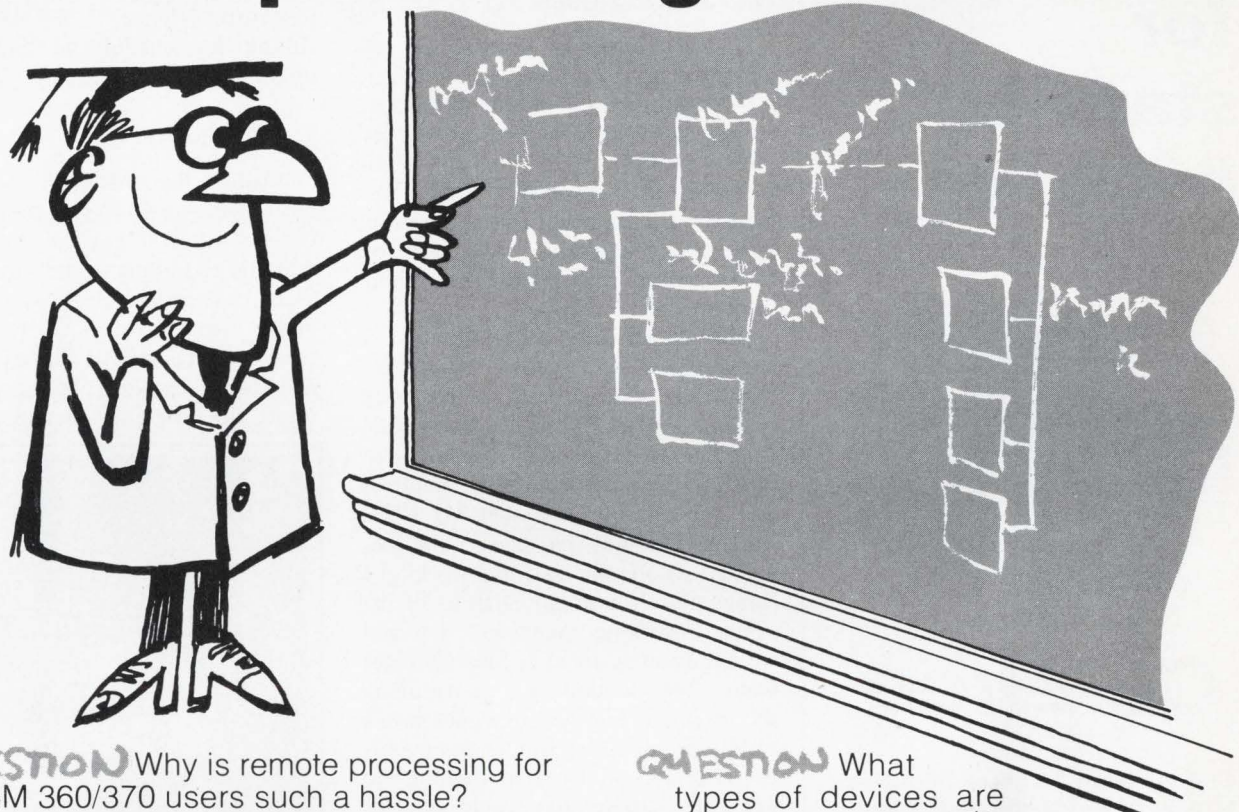

QUESTION Why is remote processing for IBM 360/370 users such a hassle?

ANSWER Because the host processor is over-burdened handling error control and error correction, rather than doing data processing.

QUESTION How can the system overhead required for remote processing be eliminated?

ANSWER Do all computer processing in local mode, regardless of location of I/O devices.

QUESTION How is this possible?

ANSWER Use the **PARADYNE PIX II SYSTEM.**

QUESTION What types of devices are available with **PIX II?**

ANSWER Local peripheral devices, CRTs, line printers, card readers, magnetic tape, card punches.

QUESTION What software is available with **PIX II?**

ANSWER All local software that is available to the host CPU.

QUESTION How can a person find out more about this **PIX II System?**

ANSWER Call your local PARADYNE sales office.

"PIX II MAKES REMOTE PROCESSING SIMPLE."

paradyne

Paradyne Corporation

8550 Ulmerton Road Largo, Florida 33540 813-536-4771 TWX 810-866-0432

Sales Offices:

Boston (617) 965-4850
Chicago (312) 858-6310
Cincinnati (513) 793-2853
Dallas (214) 661-0242

Detroit (313) 559-5360
Hartford (203) 563-8105
Los Angeles (213) 822-1530
New Jersey (201) 778-1112
New York (212) 661-5790

Philadelphia (215) 293-0940
San Francisco (415) 574-0902
Tampa (813) 536-4771
Washington, D.C. (703) 548-4453

International Sales Offices: Canada, Europe, Japan

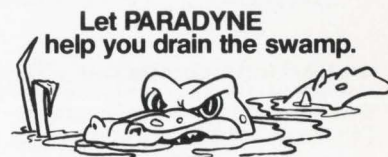

CIRCLE NO. 28 ON INQUIRY CARD

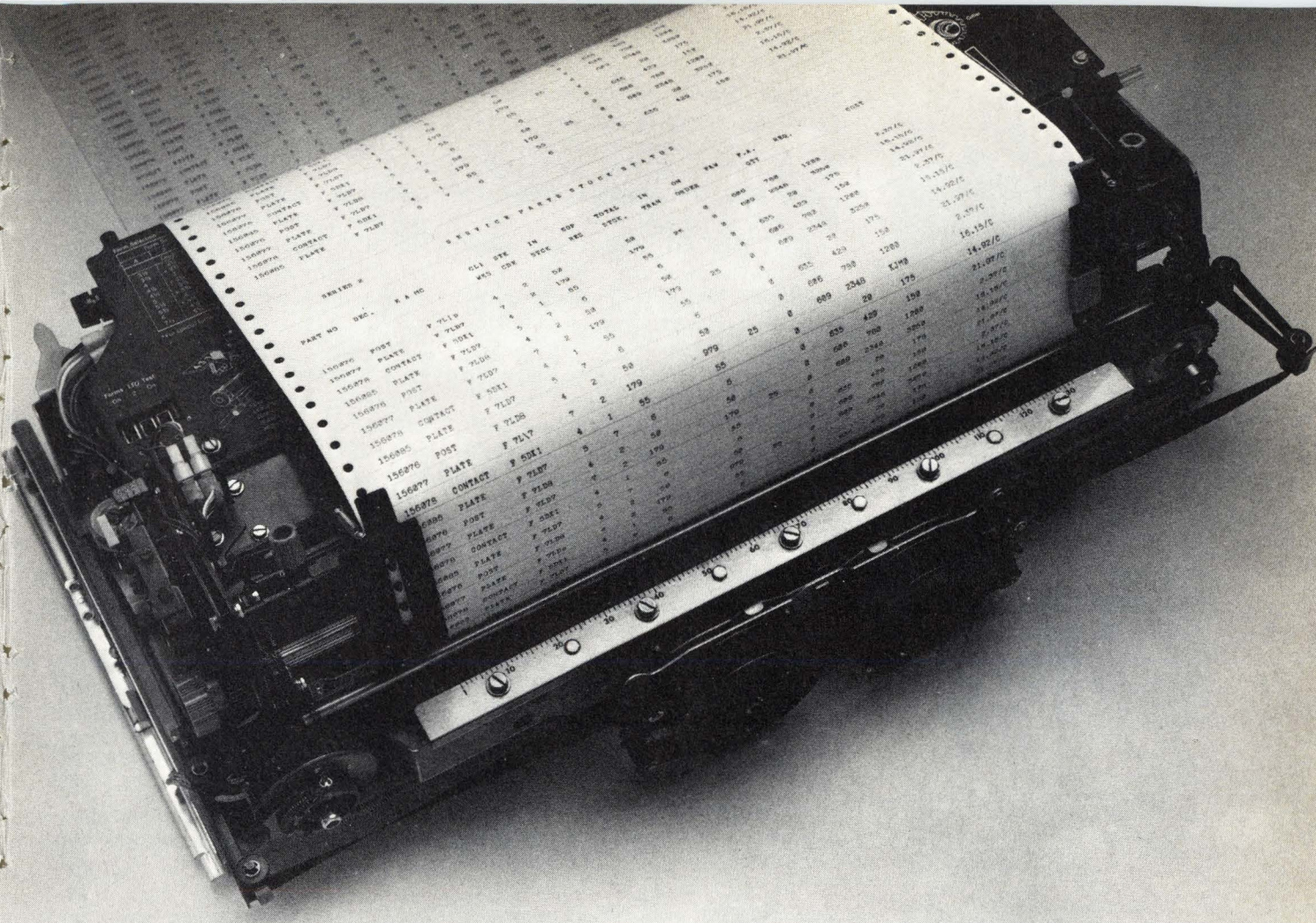

**The Teletype® model 40 OEM printer.
When you look at it from price and performance,
you'll find it difficult to look at anything else.**

The fact of the matter is simply this:
We don't think any other printer can even come close to the model 40.

And that's no idle boast. Not when you consider the facts.

Consider: Where else can you get a 132-column, heavy-duty impact printer that delivers over 300 lines per minute for less than \$2000, or an 80-column printer for under \$1400?

The big reason behind the model 40's price/performance advantage is our unique design.

Even though it operates at speeds of more than 300 lpm, wear and tear is less than you'd find in a conventional printer operating at considerably slower speed. Fewer moving parts and solid-state components add up to greater reliability and reduced maintenance.

Here's something else to consider: Where else can you get a printer that delivers the kind of flexibility and reliability the model 40 offers?

For complete information, please contact our Sales Headquarters at: 5555 Touhy Ave., Skokie, Ill. 60076. Or call Terminal Central at: (312) 982-2000.



**The Teletype model 40 OEM printer.
Nothing even comes close.**

Teletype is a trademark and service mark registered in the United States Patent and Trademark Office.

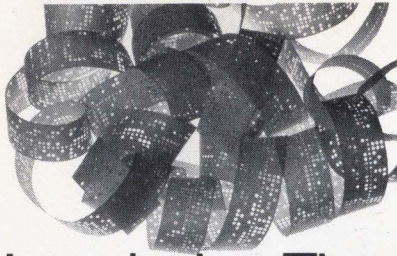

Introducing The FlexiFile Family From Tri-Data... FlexiFile 10



....requires

NO software modification in your present system. Tri Data provides an RS-232 coupler for data communications interface. So you can replace your data set or terminal. Connected between the terminal and modem, the FlexiFile 10 can serve as a recording device for both units. And you can replace high speed paper tape... 816 feet per single floppy disk.

FlexiFile 11

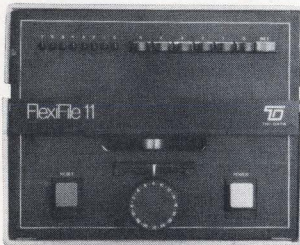

is user-defined. It's as easy as pushing the reset switch. 8 LED'S indicate each operating mode. 6 input switches let you determine the operating mode... using your own protocols, control words, and commands. The FlexiFile 11 is Microprocessor Controlled and floppy disk based. Our fully modular interfaces include an RS 232 coupler, and IEEE-488 Instrumentation Bus, and an 8' Bit Parallel Bus.

Complete program loading and on-line storage. Stand alone or rack mount options.



Tri-Data
800 Maude Ave.
Mountain View, Ca.
94043
415-969-3700

New York 201-947-2092
TWX: 910-379-6978

CIRCLE NO. 31 ON INQUIRY CARD

activities. Now, with this overall approach, we could implement the design in just two months, and I congratulated myself on steering the project back on schedule during my first week on the job.

But then two jolts, one after another, destroyed that complacency:

MISSING TOOLS: For one, Stearns-Roger programmers — who were to do the bulk of the coding — did not have the necessary microcomputer program development tools. They did not have a computer that was programmed to do assemblies; they did not have access to a PROM programmer; and they did not have a CPU analyzer to monitor software progress during the debugging.

Without such basic tools, a clever designer can still program, integrate, and debug a microcomputer. But the politically, volatile schedule did not afford the luxury of beeswax and string. The errors alone introduced when programs are manually assembled would have caused unacceptable delays. Instead I recommended that Stearns-Roger programmers purchase a PROM programmer and a CPU analyzer and that they tie into my Giuli Microprocessing Inc. time-sharing service, since the time could not be spared to evaluate, select, and contract for another service, Stearns-Roger management agreed. My time-sharing system by Basic Time-sharing in Sunnyvale, CA, is a multiterminal computer that is supported by disk files and a fast printer. My company had already developed a 4040 assembler as well as assemblers for eight other microprocessors. And, as important, Stearns-Roger programmers in Denver could use the company's WATS line to access my system in San Jose, CA.

Now, with all the ducks in a row, the programming proceeded rapidly. The programmers, after developing detailed functional flowcharts, entered the source code into my system in San Jose via terminals. The assembled programs and the object code were then transmitted back to Denver over the same telephone lines. The Stearns-Roger people used the paper tape punched out locally to feed and load a small internal RAM in a PROM programmer. That RAM's contents can be modified, and the content then written into a UV-erasable PROM. In this fashion, a programmer took but one or two minutes to install a program in a 256-byte PROM.

Then, programmers did the debugging on the prototype itself. They clip-

ped the CPU analyzer onto a CPU chip to display the microcomputer address, data, and control buses in realtime. An analyzer, it turns out, is invaluable for debugging hardware-software interfaces. It is the programmer's equivalent of an electronic engineer's oscilloscope. Furthermore, the software experts could change a program by simply copying one PROM into another, minus the changes. The current program status was "captured" every few days by incorporating all of the patches into the source code in the computer in San Jose and then by re-assembling and burning a new master set of PROMs to be used in debugging.

UNIONS VS. MICROS: My problems were all now solved, I thought. But then I got another surprise. Local unions can become part of a debugging process when introducing a sophisticated electronics system into a conventional construction project. I was ignorant of union rules and traditions and could have easily caused three separate walkouts. The closest call came after installation: I had gone into the building with a few tools to fix a problem in one of the micros. But that is a no-no, according to the electrical union rules. Union people had to work on electrical things — and the computers were obviously electrical. One problem: The electricians were not familiar with microprocessors. They could not understand, for example, why the 5-volt power bus could not be connected directly to 110 A.C. In some instances, the electricians connected a 12-volt relay to a 200-volt source. At one point, we even had to remove the computer from the building to rewire the backpanel. The job required a crane!

TO THE FINISH LINE

By now, I had become accustomed to the unexpected... but no new jolts came, and we made the schedule exactly on the deadline date. Each microcomputer incorporated into the facility was demonstrated on December 30, 1975 and the system went online in early 1976. The alarm microcomputer, it turned out, contained 4000 bytes of code; the control micro 2500, and each system had about 160 bytes of RAM as work space. The system, designed to destroy 42 canisters a day, can actually handle 70 canisters on good days. Nevertheless, the facility is expected to run three shifts through December 1977 before it disposes of all the canisters at stake. ■

After we sell you a mini, we don't run off.

We've been building computer systems and supporting our users for over 20 years.

So when you buy our Level 6 minicomputers, you get compact, flexible, exceptionally configurable minis that are reliable, serviceable, and attractively priced.

To help you use them, we have the educators, the systems analysts, and the

knowledge and experience that only a worldwide mainframe manufacturer like Honeywell can offer.

And to help you keep them running, we have a field maintenance force of over 3500 in the United States alone.

The point is, when you need support, you don't have to hunt for it.



Honeywell Information Systems,
200 Smith Street, MS 487, Waltham, Massachusetts 02154

- Please send me the book on Level 6 minicomputers.
- Please have one of your Sales Representatives contact me.

Name _____ Title _____

Company _____

Address _____

City _____ State _____ Zip _____

Phone _____

Honeywell

CIRCLE NO. 32 ON INQUIRY CARD

Under New

Management

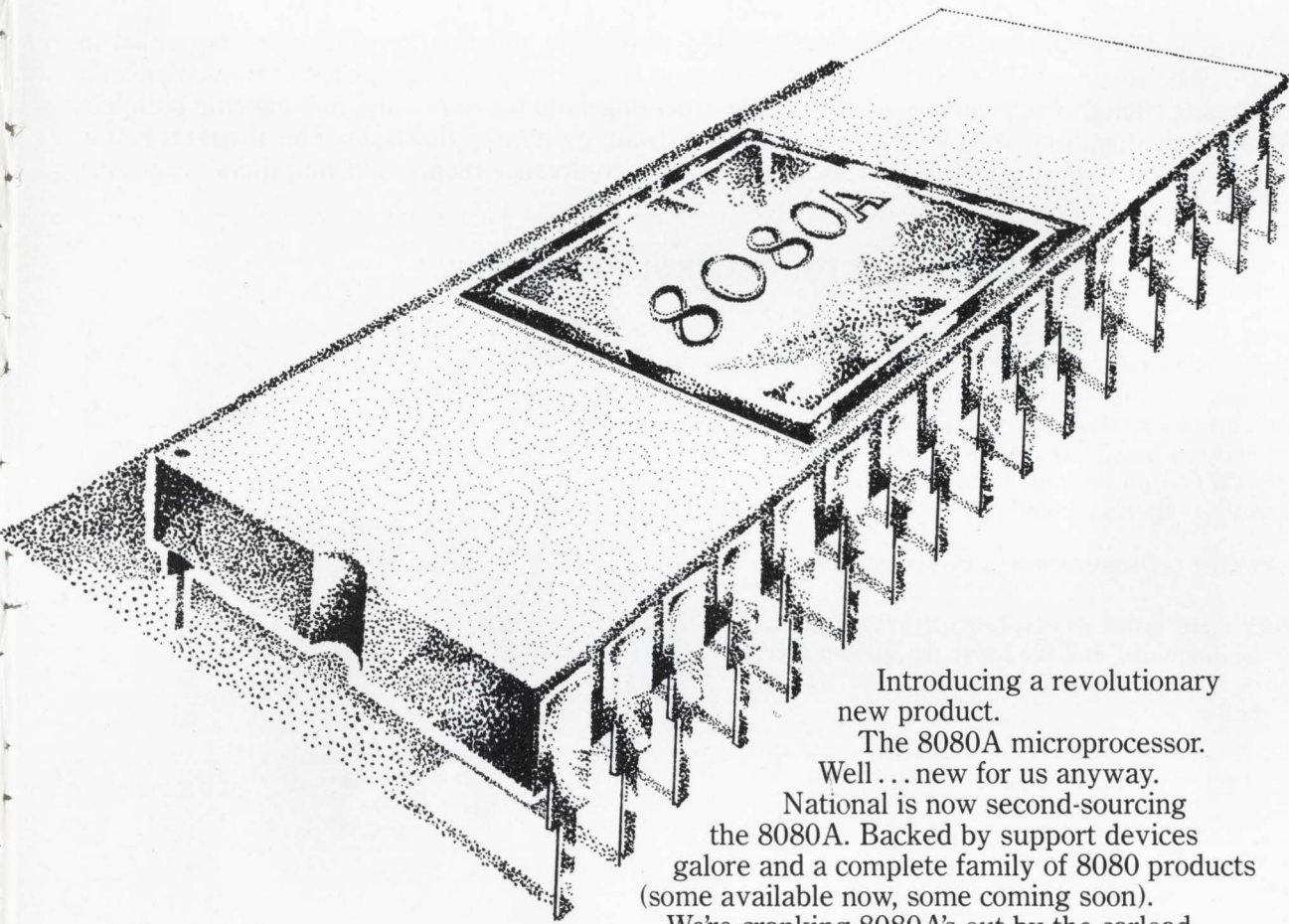

Introducing a revolutionary new product.

The 8080A microprocessor.

Well... new for us anyway.

National is now second-sourcing the 8080A. Backed by support devices galore and a complete family of 8080 products (some available now, some coming soon).

We're cranking 8080A's out by the carload.

Delivery (as many as you want) is no problem.

So if the other guy's line is busy, you might give us a call.

National Semiconductor Corporation
2900 Semiconductor Drive,
Santa Clara, CA 95051

Gentlemen,

Please send your passel of prolific pontifications about your INS8080A, support devices, and related family products.

NAME _____ TITLE _____

COMPANY _____

ADDRESS _____

CITY _____ STATE _____ ZIP _____

 **National Semiconductor**

COMPCON abstracted

Micros are where the action is as shown by six key papers that are abstracted below.

The IEEE Compcon '76 Computer Conference celebrated the second industrial revolution in September in Washington, DC. The steam engine started the first revolution. The microprocessor launched the second and it is still undergoing change. Engineers are continuously squeezing more bits on a chip, making chip architecture more sophisticated, and creating software to fit the hardware to more applications. The abstracts below of six Compcon papers impart a feeling of this sweep and the conference theme — "Computers . . . By the Millions, For the Millions."

SEMICONDUCTOR TECHNOLOGY TRENDS

Jerry Luecke of Texas Instruments forecast I²L (integrated injection logic) would challenge MOS technology by 1980 in the performance and cost arenas. He arrived at the projection through use of a semiconductor manufacturer's tool that measures performance. The equation relates the speed-power product (SP) to propagation delay through a logic gate (t_p) and gate power dissipation (P_D).

$$(SP \text{ (picojoules)}) = t_p \text{ (nanoseconds)} \times P_D \text{ (microwatts)}$$

Lower t_p values mean faster speeds; lower P_D values mean lower power consumption; and the lower the speed-power product number, the higher the performance. The figures below tell the results:

YEAR	TYPE OF LOGIC	t_p (nsec)	P_D μ W	SPEED-POWER PRODUCT (Picojoules)
1965	TTL	10	10	100
1967	TTL	5	20	100
1968	TTL	30	1	30
1970	TTL (Schottky)	3	20	60
1972	TTL (low power)	10	2	20
	ECL			
1967	ECL	2	30	60
1974	ECL	0.7	43	30
	MOS			
1970	PMOS	200	0.1	20
1973	NMOS	100	0.1	10
1973	CMOS	30*	1.0*	30*
1974	SOS	15*	0.05*	7.5*
	I ² L			
1975	I ² L	35	0.085	3.0
1976	I ² L	20	0.05	1.0
1980	I ² L	10	0.10	1.0

*1MHz

Logic Performance Developments

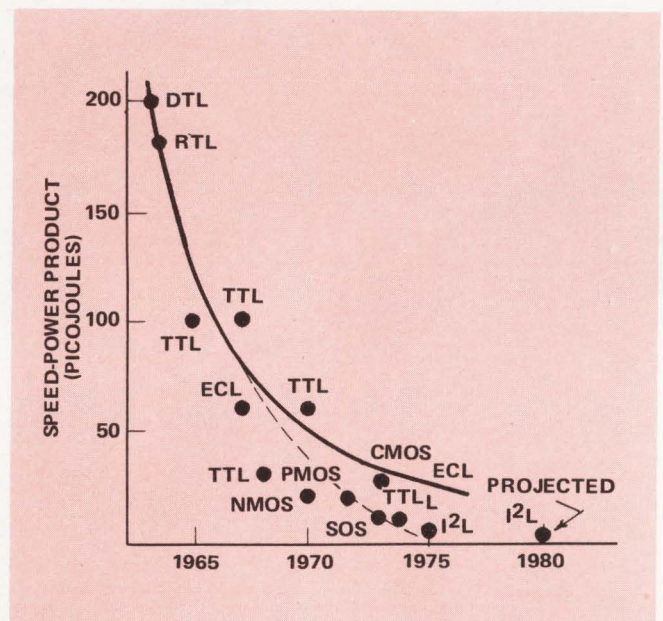

Speed-Power Product Lineup

In sum, MOS technology has paced the gains in high functional density designs, though I²L technology now challenges that position. Two years ago I²L was not even a match for MOS. I²L now has a t_p at 35 nanoseconds and P_D at 85 microwatts per gate. This is two times better performance than the best MOS devices, and Luecke now projects that I²L will improve the speed-power product by a factor of three by 1980, thus helping to replace MOS at the highest levels of integration. Silicon on sapphire technology would also be a contender by then except that the substrate and the manufacturing costs are high. Low-power Schottky technology will take over intermediate integration levels. And in low-speed applications, PMOS and NMOS will reign, at least for a little while.



We're somewhat ahead of the pack.



Nashua's Calcomp "Trident" Disc Packs

Nashua is so in tune with today's market that our technological and manufacturing capabilities enable us to often be out there with the right magnetic media right on the heels of the drive manufacturers themselves. It may shake up our accounting people at times to come out with new products before there is that large a demand for them. But it does give drive users an alternate, independent source for computer supplies right from the start.

Our extensive experience and expertise also enables Nashua to provide the full range of products within a particular drive's configuration requirements (as, for example, our fast turnaround on the family of disc packs for the advanced Trident series drives). And our capabilities keep us on top of the market supplying a complete selection of dependable magnetic media for all current configurations specified by drive manufacturers.

Nashua 4460 Series of 5-high disc packs are specifically designed for Calcomp "Trident" storage drives. These advanced disc packs are capable of storing 27,400,000... 54,700,000... and 82,100,000 Bytes of data.

But Nashua even goes beyond that. We offer a planned program specifically designed to service the needs of both O.E.M.'s and systems houses. That means Nashua is geared to working with you during the design stage of any new memory modules to fit your own special requirements.

You'll find that Nashua computer products meet or exceed all specifications in all instances. They come to you complete, with all factory recorded servo information.

We may be fast, but we're thorough.

NASHUA
CORPORATION
Nashua, New Hampshire 03060.
O.E.M. Sales Offices
Nashua, NH - (603) 880-2769
Oakland, CA - (415) 655-9361

Applied Data Communications
announces

*** COST EFFECTIVE SYSTEMS
Based Upon
MINI-PERIPHERALS
and
MICRO PROCESSOR
TECHNOLOGY**

SERIES 70 WORK STATION

- Dual floppy disks
- Line printer
- CRT
- Optional memory to 65K

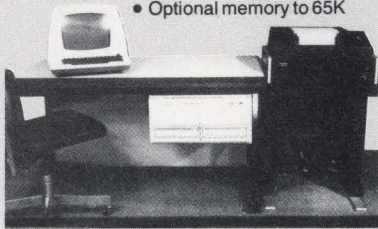

SERIES 70 MICRO SYSTEM

- Floppy disc
- 3M tape cartridge
- Line or character printer
- CRT
- Optional memory to 65K
- Optional operator console



SERIES 70 COMPUTER SYSTEM

- Dual floppy disc
- 3M tape cartridge
- 10MGBYTE cartridge disc.
- CRT
- Line or character printer
- Optional memory to 65K



***Featuring**

- Extended business basic software
- Full line of support peripherals
- Multi-port communications capability

ADC APPLIED DATA
COMMUNICATIONS

1509 East McFadden Avenue
Santa Ana, California 92705
Telephone: (714) 547-6954
(603) 434-0909

**SEE US
AT MINI/MICRO
SHOW
BOOTH
305**

CIRCLE NO. 35 ON INQUIRY CARD

**16K RAM – FROM MICROS
TO MAINFRAMES**

The generation of the 16K RAM is here, said Derrel Coker and Ken Davis of Mostek Corp. — microprocessor systems, minicomputers, and even large mainframes will soon contain the memory devices in quantity, as they now employ 4K RAM. Engineers can now build a 64K by eight-bit system — typically, a microprocessor's maximum addressable memory — on a double-sided PC board in less than 50 sq. in. of space. 16K RAM access times range from 350 nanoseconds to less than 150 nanoseconds, and like the 4K predecessor, the more dense memory devices can be used in read/write storage, shift registers, buffers, and even FIFO configurations.

So far most 16K RAMs use the same address multiplexing technique and the same 16-pin package as do the 4K RAM. This simplifies system upgrades. However, Mostek has two new 16K RAM features — page mode operation and read while write memory. These give the memories an added advantage in minicomputer and mainframe applications. Read while write memory enables a read operation to begin at one address and a write operation also to begin at the same address and within the same memory cycle even before the data is accessed from the memory. Page mode speeds up successive memory operations at multiple column locations on the same row address without increasing the operating power. A 16K RAM with a 250-nanosecond access time, for example, has a page access of 165 nanoseconds.

BUBBLES – STATUS AND PROSPECTS

Ten years ago, scientists at Bell Labs began to search for an improved memory material besides Permalloy, and came up with bubble memories, based on garnet substrates, according to H.S. Chang at the IBM T.J. Watson Research Center. Now Hitachi has a 32-kilobyte bubble memory and Rockwell International also has a 100-kilobyte unit although the technology is still new.

Characteristic	'76	Before '80	After '80
Bubble Density (bits/ in ²)	10 ⁶	10 ⁷	> 10 ⁸
Speed			
Data rate (MHz)	0.1-0.25	1	> 1
Access time (msec)	0	1	< 1
Chip capacity (bits)	10 ⁶	10 ⁸	10 ⁹ - 10 ¹⁰
Storage medium	Garnet	Garnet	Garnet Amorphous film
Application examples	POS Calculator	Space-flight recorder	Large file Data base
		Main memory extension	
Competition	CCD	CCD BEAMOS Fixed-head disks and drums	CCD BEAMOS Moving-head disks

Bubble Progress

Bubble memories at about 0.2 cents per bit as systems price cost about the same as CCD memories. But they are about 100 times slower! But the technology has other things going for it. It has a simple structure so that the memories

can have greater bit densities and lower cost than CCDs. Scientists must develop better systems and chip approaches, however, to achieve the kind of bit densities that they want — 10^5 to 10^6 bits on a chip at .02 cents per bit. The present "major/minor" loop configuration slows down the memory and a better decoder organization and sensor design could speed things up. Start and stop capability can also be used to eliminate latency delay.

Bubble memories will shrink in size after 1980 because different types of materials will be found, such as amorphous films. By then, bubbles should have bit densities of 10^9 bits on a chip and moving head disk manufacturers should begin to worry about competition.

INTELLIGENT PERIPHERAL CHIPS

Now that the CPU is on a chip, users are demanding enhanced memories, controllers, clock generators, and bus transceivers, said Henry M. Blume, Jr. of Intel Corp. But even more important, users are demanding intelligent peripheral chips so that the microprocessor doesn't have to be devoted almost entirely to peripheral control.

And to do just that job, Intel is working on more than 10 advanced programmable peripheral chips, including a peripheral interface, communication interface, DMA controller, floppy controller, and CRT controller. The CRT

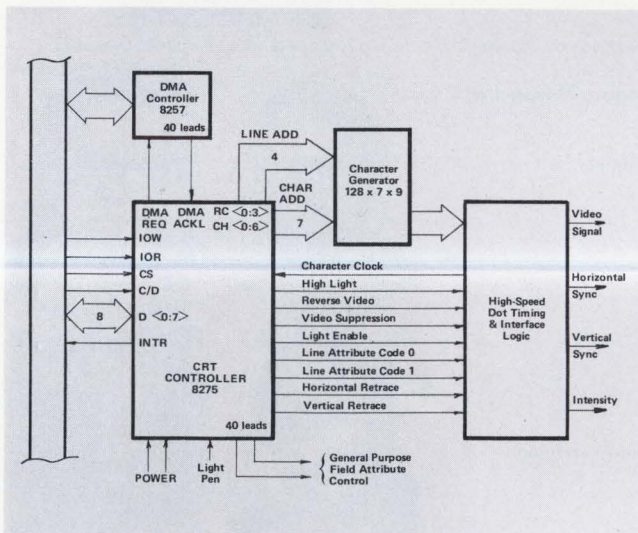

CRT Controller Chip

controller is the most sophisticated. It is actually a dual bank, 80-byte (row) memory: one bank rotates output for each line on the CRT row, and the other bank is input via DAM request from bulk memory.

A MICROPROCESSOR NETWORK DEVELOPMENT SYSTEM

To do microprocessor software development, users can obtain basic tools by using either a time sharing network or a program development system. In each case, the software to be developed is tied to the development system, which, in turn, is tied to a specific microprocessor. This poses design problems, especially when the microprocessor is to be part of a network. Structure and behavior of the processor or the network cannot be represented consistently. And no tools to simulate an entire network are available at a high enough level and with sufficiently large instruction set.

TWO

NEW FOR OEM

Miniature

PAPER TAPE PUNCH & READER

Unique brushless DC motor affords small size and top performance

Epson's miniature punch/reader pair strips away bulk, adds reliability and cuts OEM cost.

Compare these value features

6110 Paper Tape Punch has:

- Long life steel punchblock
- Operation at 50 characters per second
- Easy to design control circuit
- Price in OEM quantities less than \$200

6510 Paper Tape Reader has:

- Photoelectric reading of 400 characters per minute
- Built-in read and magnet-drive circuits
- TTL input/output signals employed
- Magnet brake that stops on character
- Reliable capstan roller tape drive

Customer must supply controller for both 6110 and 6510.

Complete factory parts, repair and customer training located at our Torrance main office.

Write or call for complete information

EPSON

EPSON AMERICA, INC.

2990 W. Lomita Blvd., Torrance, CA 90505
(213) 530-6533

EPSON products are manufactured by SHINSHU SEIKI CO., LTD., Japan

You are cordially invited to participate in the

THIRD ANNUAL COMPUTER SECURITY CONFERENCE & EXHIBITION

sponsored by

Computer Security Institute

IF YOU HAVE AN URGENT NEED TO KNOW ABOUT...

- ★ Data & software security
- ★ Physical security
- ★ Fraud & embezzlement
- ★ E.D.P. auditing
- ★ Risk analysis
- ★ Disaster recovery
- ★ Privacy
- ★ Data communications security

YOU'LL WANT TO HEAR...

DONN B. PARKER, Senior Information Processing Analyst, Stanford Research Institute
 "Thinking Like the Enemy - A Methodology for Deterrence & Detection of Computer Crime."

DR. RUTH M. DAVIS, Director, Institute for Computer Sciences and Technology, National Bureau of Standards
 "Computer Security: Will There Be a Confrontation with Technology or Management or Both?"

BRANDT ALLEN, Professor of Business Administration, University of Virginia
 "The Biggest Computer Frauds - And the Lessons Learned."

ROBERT P. BIGELOW, Attorney at Law
 "Legal Risks - Management Myopia"

DICK BRANDON, President, ACT - Brandon Company
 "Stimulating Top Management Awareness & Involvement."

PETER S. BROWNE, President, Computer Resource Controls
 "Risk Analysis - The Necessary First Step."

ROBERT H. COURTNEY, Manager of Data Security and Privacy, IBM Corporation
 "Software Security - A Practical Perspective"

DAVID D. FRIESEN, Vice President, First Data Corporation
 "A Disaster Recovery Case History: First Data Corporation."

BELDEN MENKUS, Management Consultant
 "Selection Guidelines for Physical Security Systems."

NICHOLAS G. VIVONA, Manager Standards Development, The Travelers Insurance Co.
 "Developing a Strategy for Data Communications Security."

JOSEPH J. WASSERMAN
 "The Role of EDP Auditing - Past, Present & Future"

PLUS: "Privacy: Problems, Trade-Offs & Opportunities"

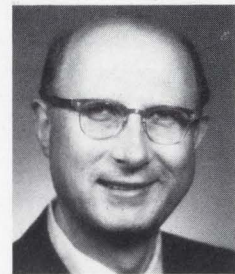

Donn B. Parker Conference Chairman



Dr. Ruth M. Davis Keynote Speaker



Brandt Allen



Robert P. Bigelow



Dick Brandon



Peter S. Browne



Robert H. Courtney



Belden Menkus



Nicholas G. Vivona

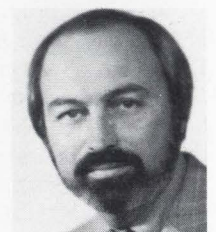

Joseph J. Wasserman



Second Annual Conference - 1975
 New York City

Computer Security Event of the Year

NOVEMBER 15-16-17, 1976 • NEW YORK CITY
The Hotel Roosevelt • Madison Avenue at 45th Street

PROGRAM FORMAT

FORMAL PRESENTATIONS: Each morning you'll hear four speakers describe the very latest developments in their fields. You will also have an opportunity to raise questions, seek clarification, or to rebut in the Q & A period following each presentation.

ROUND TABLE WORKSHOPS: Will reinforce the concepts offered in the formal presentations. You'll be working in an informal "shirt sleeves" atmosphere...structured for maximum interchange.

SPECIAL INTEREST SESSIONS: These "extra" evening sessions are geared to your special needs and interests. The final schedule of topics will be determined by attendee questionnaire input (see Conference Questionnaire on the clip-out coupon). Here's a great opportunity to exchange ideas and experiences with the speakers and fellow attendees.

HOSPITALITY HOUR: An excellent chance for you to meet with fellow attendees and speakers prior to the formal program in a relaxed and informal atmosphere.

EXHIBITION: You'll have the opportunity to attend the National Computer Security Exhibition...the first exhibition devoted solely to computer security. A partial listing of the companies participating includes: Pyrotronics, *fire Protection*...Cullinane, Bi-Hex, Pansophic, *software*...Denco, *water detection*...Schlage, Identimat, *physical access controls*...CalComp, *automated tape library*...Dranetz Engineering, *power line disturbance analyzer*...ADT, *total security systems*.

IMPORTANT BENEFIT: CONSULTING

Looking for answers to a specific problem? We'd like to help. Send us an overview of the problem and we'll see to it that an appropriate speaker reviews it prior to the Conference. We will then arrange for you to discuss it with him...at lunch, the hospitality hour, or whenever it is mutually convenient.

REGISTRATION FORM AND CONFERENCE QUESTIONNAIRE

Crime by Computer Inside Equity Funding
Computer Security Institute
43 Boston Post Road • Northboro • Massachusetts 01532 • (617) 393-3666

Please enter _____ reservation(s) in my name for
THIRD ANNUAL COMPUTER SECURITY CONFERENCE & EXHIBITION
November 15-16-17, 1976 • New York City • the Hotel Roosevelt

- Check enclosed* Bill my Company Bill me
*Make check payable to the "Computer Security Institute"
 Send me more information on the Conference.
 Send me more information on Computer Security Institute membership.
 Please send a room reservation card for the Hotel Roosevelt.
 Sorry, I can't make it this time, but send me information on the next program.

Name _____ Title _____
Company _____ Phone () _____
Address _____
City _____ State _____ Zip _____

Please list names of additional attendees on separate sheet.

Please remove my name from your mailing list.

REGISTRATION INFORMATION

If you plan to attend, please complete the "Special Interest" questionnaire below.

REGISTRATION FEE: The registration fee of \$445 for the three day program is payable in advance and includes the cost of the Exhibition, continental breakfasts, luncheons, coffee breaks, workshops, workbook, and the hospitality hour. Cancellations...registrations canceled thru November 8, 1976 will be refunded in full. After that, a \$75 service fee will be charged. However, substitutions will be accepted.

GROUP REGISTRATION: Your company might want to take advantage of this unique program and send a "team." Company team registrations are:

Second person \$395
Each additional person \$375

For information on large group rates, please call the Computer Security Institute.

SPECIAL OFFER: If your check accompanies this registration and is postmarked no later than November 1, 1976 you will receive a complimentary copy of Donn B. Parker's best seller *Crime by Computer* OR Raymond L. Dirk's *Inside Equity Funding: The Great Wall Street Scandal*. Simply indicate the book of your choice by checking the appropriate box on the clip-out form.

REGISTRATION: Reservations will be accepted on a first-come, first-served basis. For an immediate reservation call (617) 393-3666. Or use the clip-out form below.

If you plan to attend the Third Annual Computer Security Conference & Exhibition, please use this survey to indicate topics you would like to see discussed in the "Special Interest" sessions. Rank order in terms of your own personal interest...with #1 being your first choice. Rank order as many as you wish.

- () Risk Analysis
() Computer Crime
() Personnel Security
() Fraud & Embezzlement
() Physical Security
() Vital Records Management
() Operating Systems Security
() Data Communications Security
() EDP Insurance
() EDP Auditing
() Privacy
() Unstructured "Give and Take"
() Industry Related Problems
 Please list industry _____
() Job Related Problems
 Please list job function _____
() Other _____



EVERY
BIT
BETTER!

RAISE YOUR SPEED LIMIT.

Lack of speed can kill your production output. Now, you can increase your speed with 282 feet of error free computer tape, certified at 800 bpi after assembly in cassette.

The new ROBINS Digital Cassettes are available in two types:

ANSI/ECMA: which complies with the American National Standards Institute and the European Computer Manufacturers Association standards.

PHILIPS: which conforms to the standard Philips specifications.

from ROBINS "The Problem Solvers."

Write for full line catalog.

ROBINS

INDUSTRIES CORP. data products division

75 Austin Blvd., Commack, L.I., N.Y. 11725 • 516/543-5200

CIRCLE NO. 38 ON INQUIRY CARD

Software Engineers

Our client, CONTROL LOGIC, INC., an expanding Massachusetts based corporation, is a leading manufacturer of MICROCOMPUTERS and INDUSTRIAL AUTOMATION SYSTEMS and requires several Software Oriented Technical Personnel to staff current needs. These positions offer unusual long term growth opportunities in a stable, highly personal and individualistic environment.

- **PROJECT MANAGER**
Supervise Microcomputer Programmers in the performance of Real-time Systems Applications for the Industrial Automation Market.
- **SYSTEMS APPLICATIONS ENGINEER**
Provide Technical Sales Support in the conceptualization, proposal preparation and presentation phases of Industrial Automation Programs.
- **SYSTEMS PROGRAMMER**
Specialist in Operating Systems, Editors, Compilers, Assemblers and Loaders.
- **MICROCOMPUTER PROGRAMMERS**
Knowledgeable in Assembly and FORTRAN for Real-time Control Systems. Ability to assume project responsibility helpful.

Salary ranges for these positions are quite competitive and client will not quibble for a few dollars.

Naturally, all fees and charges are assumed by client company and they are an equal opportunity employer. Please send your resume including salary history in confidence to:

NP/a

NORMAN POWERS ASSOCIATES
P. O. Box 221, Saxonville, Mass. 01701
Phone: 617-877-2025

Charter Member Mass. Professional Placement Consultants, Inc.

CIRCLE NO. 37 ON INQUIRY CARD

Case Western Reserve Univ., however, has devised a software development system based on a PDP-11/45 that can adapt to different microprocessors and to microprocessor networks, according to Paul G. Drongowski and Charles W. Rose in the Dept. of Computer Engineering and Information Sciences. The so-called Network Microprocessor contains an embedded machine description in each of three software processors — assembler, compiler, and simulator. By simply changing the processor description, the software processor can be applied to different microprocessor families.

The metaMicro assembler has a declaration section to describe the target microinstruction and the instruction fields, followed by a user program. Microinstruction assembly is simply a translation process, resembling macro expansion, as shown below:

```
instr i[1]<15:0> $      ! microinstruction declaration
field  CLKR = i<0> ,    ! load register R enable
       CLKS = i<1> ,    ! load shift register enable
       CLKB = i<2> ,    ! load register B enable
       CLKC = i<3> ,    ! load shift count register enable
       CLKD = i<4> ,    ! load D register enable
       SFLD = i<5> ,    ! swap byte enable
       EFLD = i<15:8> , ! 8 bit emit (constant) field
       BMUX = i<7:6>$   ! 8 register multiplexer control
```

```
struct R = (load (CLKR=1), ! register definitions
shifter = (load (CLKS-1) call(BMUX=2) ),
B = (load (CLKB=1) ),
count = (load (CLKC=1) ),
D = (load (CLKD=1) call ( ) $
```

```
funcnt swap(breg) = (SFLD-1; BMUX-3), noop( )=(call ( ) )$
macro emit(N) = noop( ) ; EFLD-N$
```

```
set
R <D$                                ! no shift or swap
```

```
begin
shifter <D; count <emit (1)$ R < shifter $ ! right shift
```

```
end
begin
shifter <D; count <emit(-1)$ R < shifter $ ! left shift
```

```
end
begin
B < D$ R < swap(b)$                ! swap bytes
```

```
end
tes
```

Metamicro Assembles a Shift Emulation Program

The compiler is based on Bell and Newell's Instruction Set Processor language. ISP statements define the digital system in terms of registers and data transfers. Statements look like this:

condition → structure ← f(struct, struct, . . .) ; separator

If a condition is true, data operator "f" is applied to the argument registers and the result is stored in the destination register. If no "condition" exists, the transfer is performed. Although ISP statements describe the behavior of one processor at a time, Case Western extended the language with a "port" construct for exchanging data and control signals between processors. A "wait" signal was also added so processors could be synchronized.

A NetSim ecologist and a kernel control the simulation on the system. The ecologist accepts a description of the network and links ISP output modules to match the network interconnections. The kernel provides the runtime operations on the simulation program by scheduling processes, simulating large memories, and interpreting interactive debug commands from the user. If the system needs to be modified after simulation, the user changes programs and registers transfer descriptions and runs the task again.

Case Western hopes to have the Network Microprocessor up and running by the end of the year.

MICROPROCESSOR-BASED ENERGY MANAGEMENT

Energy management systems originally were used to control energy consuming equipment in a single building. Honeywell, however, uses a microprocessor to extend the system to building complexes, reports Gideon Shavit in Honeywell's commercial division. Now, special features can be added virtually at will via changes in programming rather than by hardware modifications. The system can also be extended easily by simply adding memory, peripherals, and I/O interfaces.

Honeywell's Alpha/Delta 1000 comes with a microprocessor, memory for operating software, loading interface, universal asynchronous receiver/transmitter for up to 10 transmission channels, and a 16-bit tristate bus connecting the UARTs to the microprocessor. In operation, the central processor polls the status of each I/O device by sending the address that is unique to each device through the UART. When a device is addressed, it responds by transmitting a status word.

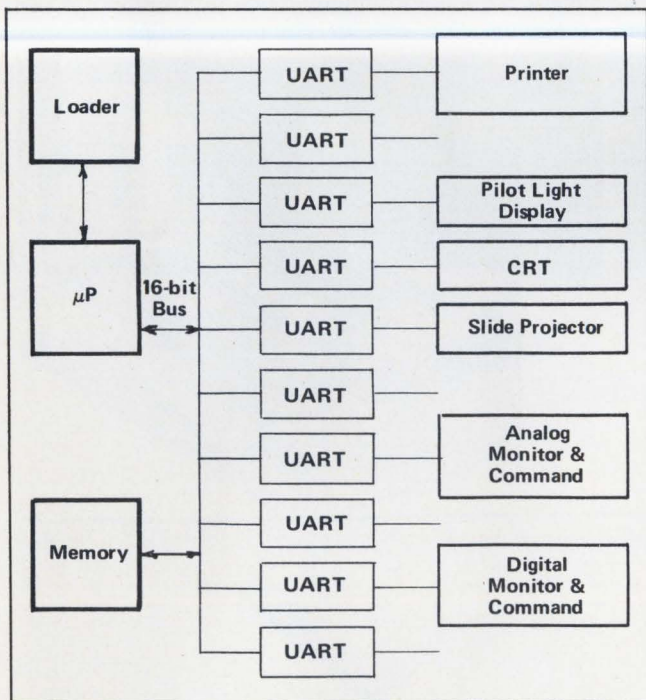

μP-Based Energy Management System

Users can add other energy management algorithms, too, such as a start/stop program. The program monitors indoor space temperature and outdoor temperature and starts up the energy systems at the latest time possible to still produce a comfortable temperature for soon-to-arrive occupants. Users can also control the mix of outdoor and indoor air.

BIG PLANS

FOR YOUR LITTLE OLE *LSI-11?

WILL YOU TRUST YOUR DATA TO
A FLOPPY?

- ★ SEE PFYSTAR FOR A REAL DISK.
- ★ *LSI-11 COMPATIBLE.
- ★ *RK-05 COMPATIBLE.
- ★ HARD DISK SPEED, CAPACITY AND LIFETIME.
- ★ LOW COST, HIGH PERFORMANCE, DEC COMPATIBLE.



CALL PFYSTAR AT (714) 635-7282
FOR THE DETAILS AND THE SURPRISING LOW
PRICE



pfyStar

MICROCOMPUTER PRODUCTS
1681 WEST BROADWAY
ANAHEIM, CALIFORNIA 92802
(714) 635-7282

*TM-DIGITAL EQUIPMENT CORP.

CIRCLE NO. 39 ON INQUIRY CARD

WP Embedded Controllers
for your Tape and Disc drives
are best on all your
PDP-11 & NOVA computers

*Because
they
are*



- Available for all PDP-11, NOVA and NOVA-emulating computers
- Usable with virtually all tape and disc drives
- PE and NRZ compatible up to eight drives (tape)
- Usable with four single, dual or ten-high drives (disc)
- Lowest in cost

SEND FOR COMPLETE INFORMATION



western peripherals™

(714) 991-8700 • TWX: 910-591-1687 • Cable: WESPER
1100 Claudina Place, Anaheim, CA 92805

CIRCLE NO. 40 ON INQUIRY CARD

Software Compatibility: Myth vs. Realities

Some so-called family micros produced by the traditional minicomputer vendors can use an existing, extensive library of minicomputer software. The manufacturers are promoting this feature to the hilt, naturally, but contributing editor Stiefel explains when this kind of software compatibility is meaningful and when it is not.

Compatibility between one generation of equipment and another surfaced as a critical issue in the computer industry when International Business Machines Corp. announced the 360 family of computers in 1964. Users faced a nightmare to convert from the prior generation 1400 line; they had to either run existing programs in what was an inefficient emulation mode or rewrite them entirely. The same arduous procedure, however, was necessary when upgrading equipment within the older 1400 product line, and the 360 family did eliminate that problem. All of the machines in the series were software compatible. They had common instruction sets and compatible operating systems, compilers, and utilities.

Years later, when the 370 family came on the scene, IBM demonstrated that compatibility among generations of computers could also be achieved. Indeed, the IBM 370, which was software compatible with the 360 series, could not have succeeded in the marketplace if it had required customers to go through another horror like the 1401-to-360 conversion. And now, we even can look forward to a fourth IBM computer generation to contain micro-programmed operating systems implemented more in hardware than in software (we pray), and, most important, still compatible with the 360 and 370 generations in user applications.

MINI-MICRO MILIEU VS. MAXI WORLD

All of this history and the computer industry's acceptance by now of software compatibility might suggest that the concept is equally desirable in the mini-micro world where three manufacturers — Digital Equipment Corp., Data General Corp., and Texas Instruments — are promoting microprocessor and microcomputer products on the basis that they are software compatible with older generation minicomputers. For DEC, this would be the LSI-11 and the PDP-11 for Data General, the MicroNova and the Novas, for TI, the 990/04 and 990.

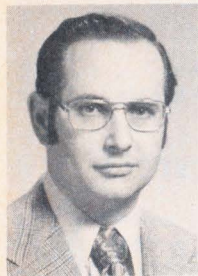

Malcolm Stiefel

But the maxi world dogma that compatibility is a good thing does not necessarily hold in the mini-micro milieu, and such promotion unqualified is only a partial truth. In the big computer world, users primarily worry about upward compatibility — the capability to use the same software on more powerful and larger new generation machines. But a typical systems designer who is contemplating a micro-

processor is not ever likely to move up to a minicomputer. His company is selling the micros as a system component. The small size is critical to the design, whether the

But the maxi world dogma that compatibility is a good thing does not necessarily hold in the mini-micro milieu.

product be an instrument, intelligent terminal, electronic game, or calculator. Upgrading such applications to use minicomputers is unthinkable.

DOWNWARD COMPATIBILITY IS THE ISSUE

Downward compatibility, not upward, is the issue in the new generation of ultra-small computers. Many companies who already sell a minicomputer-based process control system, communication net, or computer peripheral, may



Data General's MicroNova microcomputer family is compatible with the Nova minicomputer architecture and supported by Nova software.

want to turn to a microprocessor to shrink the package, reduce cost, or gain other advantages, and downward compatibility can be a definite plus in such cases. An original equipment manufacturer already locked into a PDP-11 or a

FIND OUT WHERE THE PARADE IS GOING AND GET IN FRONT OF IT.

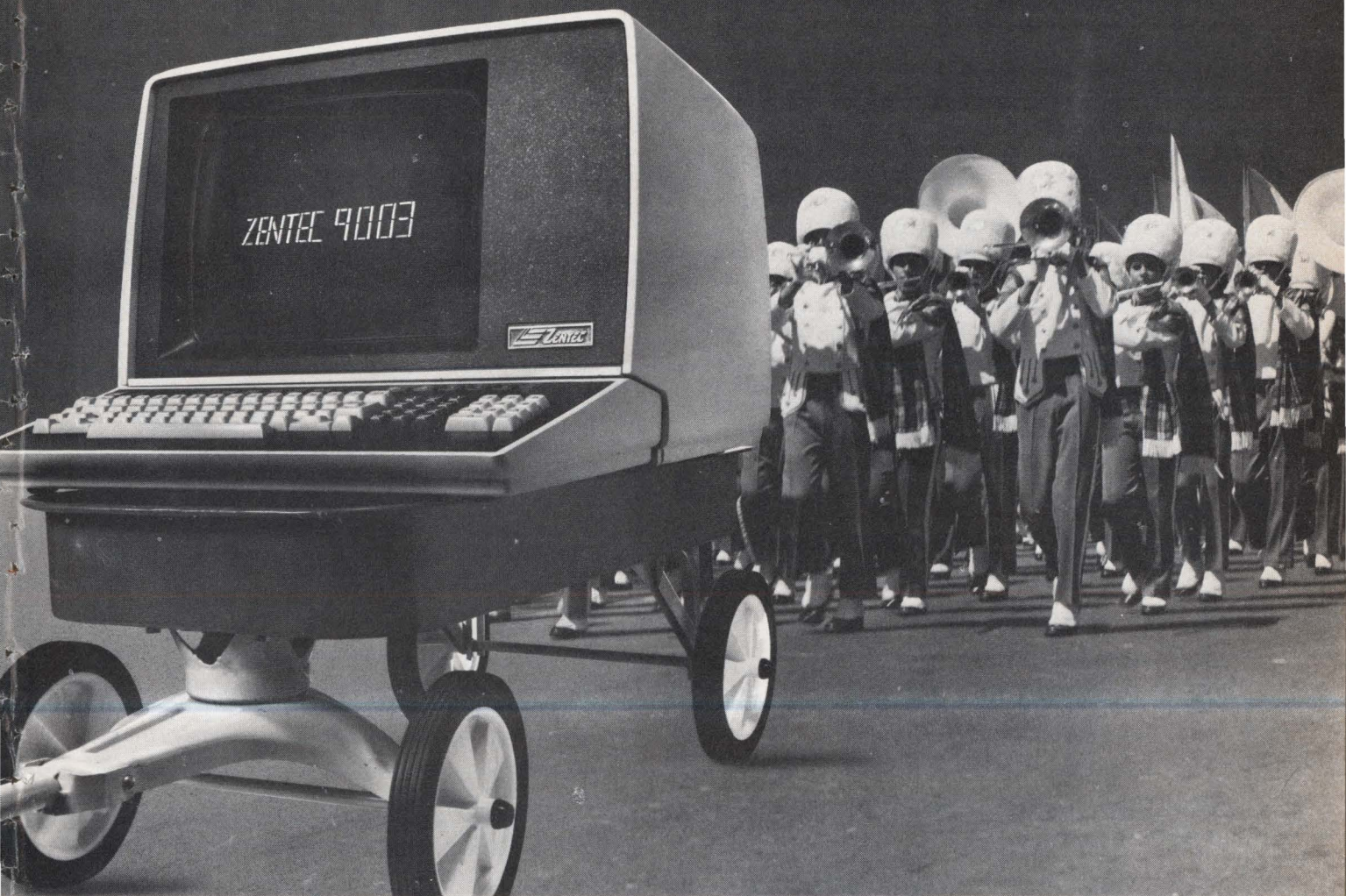

That's leadership.

You know where the parade is going. So do we: Distributed Processing. Putting the power where you need it means you get information when you need it. No fumbling. No bumbling. That's why we built the Zentec 9003 user programmable intelligent terminal. Not just intelligent... programmable.

Do it your way.

The 9003 is designed to solve a wide range of problems. That's why we provide comprehensive

sets of microcomputer firmware programs in either PROM or ROM... plus a RAM option that provides true programmability. What's more, you can add the peripherals you need, when and where you need them.

Keep it simple and dependable.

As often as not, your operator isn't a programmer. Thus, simple and understandable operation is vital. That's why we build the 9003 to be easily understood and operated.

And, easily maintained.

Test it yourself.

We do. Every single 9003 goes through exhaustive tests before we deliver it to you. That means you get a nice surprise... no surprises. You just put the 9003 to work and watch it perform. But that's not surprising. At Zentec, we know where the parade is going.

Distributed Processing From

The Zentec logo consists of a stylized, italicized 'Z' symbol followed by the word 'ZENTEC' in a bold, sans-serif font.

Call us for information:

- Santa Clara (408) 246-7662 • TWX 910-338-0572
- Southern Calif. (714) 998-9680 • TWX 910-593-1339
- Midwest (312) 297-8550
- Boston (617) 879-7530 • TWX 710-380-0105

- New York (914) 949-6476 • TWX 710-568-1335
- Philadelphia (215) 688-7325 • TWX 510-668-2995
- Washington (301) 656-3061 • TWX 710-824-0093
- United Kingdom (0442) 61266 • TLX 851-825629

- West Germany 0611-634037 • TLX 841-416608
- Austria 425451 or 421675 • TLX 847-74737
- Switzerland 041-831043 • TLX 845-72231
- Netherlands 01720-94044 • TLX 844-34111

CIRCLE NO. 41 ON INQUIRY CARD

Nova minicomputer could turn to the counterpart micro-computer that uses existing software to create a lower-cost system. Conceivably, an electronics company could introduce a micro-based data logger that would handle two or three input lines with each operating at a data rate of 10

Many companies who already sell a minicomputer-based process control system, communication net, or computer peripheral, may want to turn to a micro-processor to shrink the package, reduce cost, or gain other advantages, and downward compatibility can be a definite plus in such cases.

samples per second to fill out a mini-based system having 12 or more input lines with each handling 100 samples per second.

In such a case, the designer choosing a so-called family micro gains another big advantage — superior software quality. The software generated by the semiconductor micro makers is still relatively new and unproven, while legions of users have shaken the bugs out of the programs developed by the mini companies. Their micros use the same assemblers, compilers, debugging aids, math subroutines, and other program development software as well, and these are reliable, well designed, and documented. (Texas Instruments may be an exception since its minicomputer line has been on the market for only about two years.)

MORE ADVANTAGES

The family micro also has another advantage. A sizeable pool of trained personnel exists. These experts, already experienced on a specific minicomputer, can step right into

the act and, relatively quickly, begin to produce useful programs and other work on the micro. Such an advantage, however, will narrow as the semiconductor vendors develop their software and build up a trained work force.

Having made a case for the family micro, I quickly add that not every software package offered by Data General or Digital Equipment Corp. qualifies for a Good House-keeping seal, and bad mini programs will not improve when used on a micro. Moreover, a micro with its limited memory and limited I/O typically uses but a small percentage of the substantial software libraries developed by the mini-makers. That's because most packages are application oriented, geared to systems having large memories and specific mini-computer configurations. Even general purpose programs,

A micro with its limited memory and limited I/O typically uses but a small percentage of the substantial software libraries developed by the mini-makers.

such as device-to-device utilities, are often designed to run under specific operating systems that are not available on the microprocessor.

THE DRAWBACKS

Family micros have still other drawbacks. Typically, the devices are slower than some stand-alone counterparts. The MicroNova CPU chip, for example, takes 2.4 microseconds to add two, 16-bit words, and this compares to Intel's 8080A-1 chip that takes 1.33 microseconds to add two 8-bit bytes. The MicroNova chip also is more expensive. It sells for \$225 in a single quantity and \$114 in 100-lot quantities compared to the 8080A-1's price of \$78 for one unit and \$40 in 100-lot quantities.

In the final analysis, a family micro gives a clear benefit when:

- a product that already employs a family minicomputer is to be scaled down to incorporate a micro-processor.
- a product will number about 50 or less.

We have already shown that software compatibility is obviously desirable in a network application, though cost and performance considerations should still take priority. And as for the low production-run system, the cost of software, which often outstrips hardware and fabrication costs, is a significant proportion of total cost. In this case, the designer should also give a high priority to the thoroughly developed software products available on the family microprocessor.

WHERE COMPATIBILITY IS RULED OUT

And finally, compatibility as a factor can be ruled out entirely whenever a computer-based system is to be massed produced, as in an automobile application. In such mass production, hardware and fabrication costs dominate, not software, so a user is justified to choose the micro that

And finally, compatibility as a factor can be ruled out entirely wherer a computer-based system is to be massed produced.

achieves the best throughput, lowest cost, or other over-riding criterion. Moreover, some day, soon, compatibility as a factor — be it upward, downward, sideways, or upside down — will vanish as a selection criterion as all vendors improve their micro software across-the-board.

FREE

The New Minicomputer Accessories FALL CATALOG

The 24-page Minicomputer Accessories Catalog is jammed with 210 standard (but hard to find) products—disk cartridges, I/O cables and connectors, racks, cabinets, printout binders and a lot more.

MCA's same day shipment program can have urgently needed products in your hands within 48 hours. And MCA backs its products with a "no-nonsense" guarantee. You're assured of quality, speed and economy from MCA.

Call (415) 969-5678 or write for your free Fall MCA Catalog.



MCA-1976
MINICOMPUTER ACCESSORIES CATALOG

The easy, one-source way to order a full line of supplies, accessories, cables and connectors for minicomputers.

Name _____

Title _____

Company _____

Address _____

City _____ State _____ Zip _____

Type of minicomputer: Manufacturer _____ Model _____

Mail to:

MCA MINICOMPUTER ACCESSORIES

1015 Corporation Way, P.O. Box 10056-M, Palo Alto, CA 94303

CIRCLE NO. 42 ON INQUIRY CARD

Simplicity

The ultimate in sophistication.

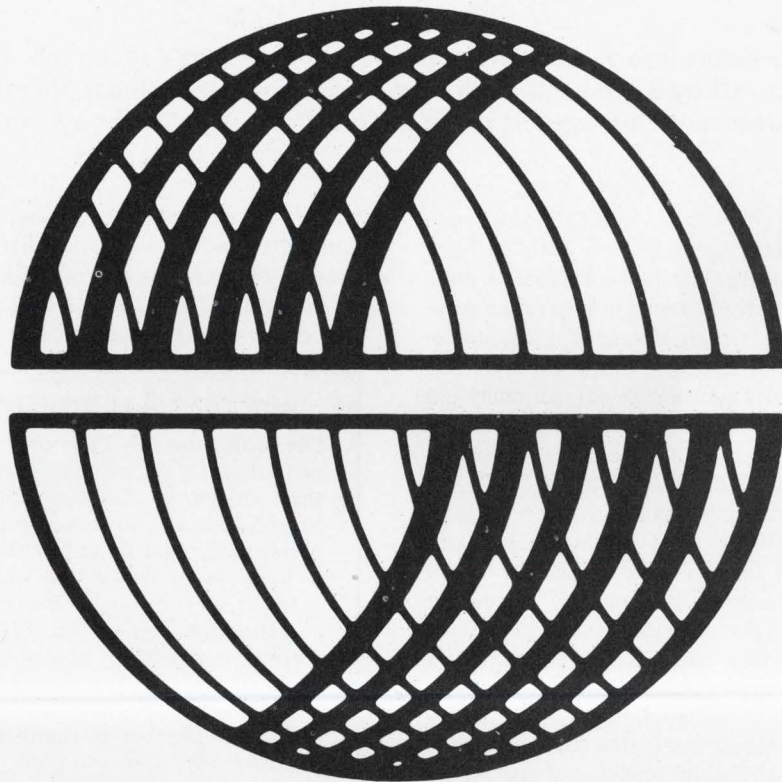

The Sphere System 540

Most computer systems are enormously complicated and expensive. The Sphere System 540 is the exception! Sphere micro-technology has produced an uncompromising computer system at a truly affordable price.

The key to the Sphere System 540 is design innovation. Sphere has simplified the circuitry throughout the entire system. Size and complexity have been reduced, while flexibility improved.

The Sphere System 540 features a full ASCII keyboard plus numeric keypad and cursor control

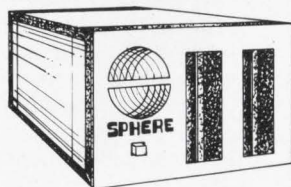

keys . . . a video screen with a 2,000 character display. The system is complete with a Dual Floppy Disc and Operating System, a high level language and 80 character per line printer.

By incorporating the latest in technology every phase of the Sphere System 540 is an uncomplicated as the state-of-the-art will permit. This simplicity of design means ease of operation and trouble-free performance.

All For Less Than \$12,000

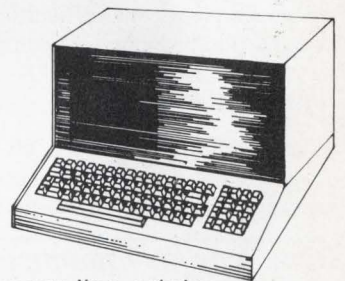

Write for information
940 North 400 East
North Salt Lake, Utah 84054 • (801) 292-8466

CIRCLE NO. 43 ON INQUIRY CARD

NETWORKS: where compatibility pays off

ROBERT VAN NAARDEN / Digital Equipment Corp.

Integrating microprocessors into an existing minicomputer system is a sticky job. If the mini, however, is one manufactured by a vendor that also produces a software compatible microcomputer, then the job becomes more manageable when the systems integrator chooses that micro as well.

The functional difference between a minicomputer and microcomputer tends to blur because they both perform similar jobs. The micro, however, can be economically justified where a minicomputer would result in processing overkill. And equally important, programming of a microcomputer is quite different from that of a minicomputer. The microcomputer, bound by its microprocessor, generally has to be programmed at the assembly level when used in limited-scope systems, such as a simple factory inspection system. And programming at the assembly level calls for many extra detail steps so that cost savings realized on hardware may be lost on software. This is particularly true where a short word-length microprocessor requires a large number of executions to perform specific functions.

Programming microprocessors becomes even more sticky when they are to be integrated into a network hierarchy — an arrangement in which one or more microprocessor systems communicates with a minicomputer or other big machines. Under such circumstances, the developer must then be familiar with the assembly language of the microprocessor and also with the programming used in the other computer. And if there is a great diversity between the two language forms, the difficulties in developing and debugging application programs are compounded.

WHY THE PROBLEM

The problem of linking a micro to a mini in a network arises because the organizational structure of many microprocessors vary from that of the typical minicomputer. Most mini-

One way to minimize such programming incompatibility is to develop a microprocessor with effectively the same instruction set — and hence, assembly language — as an existing minicomputer line.

computers are standardized on 12- or 16-bit word lengths, but many microprocessors have incompatible 8-bit and even 4-bit word lengths. One way to minimize such programming incompatibility is to develop a microprocessor with effectively the same instruction set — and hence, assembly lan-

ROBERT VAN NAARDEN, who joined Digital Equipment Corp. in 1970 as a design engineer, is manager of LSI-11 microcomputer market and product development. Van Naarden holds an M.S. in electrical engineering/computer science from Northeastern University and is currently working towards an M.B.A. at the same university.

guage — as an existing minicomputer line, and some minicomputer vendors, including Digital Equipment Corp., have created just such a family of small computers.

Besides software compatibility, family-type microcomputers can also use standard minicomputer hardware inter-

HOW THE LSI-11 DIFFERS FROM THE PDP-11

Physically, the LSI-11 is organized around a basic set of four chips, rather than around one chip, to reduce the complexity of design and fabrication. Organizationally, the LSI-11 has minicomputer features, but performance and functional sacrifices obviously have to be made to achieve the small size. One key difference is that the LSI-11 does not have the normal uni-bus structure used in the PDP-11. Instead, it uses a narrow bus which, however, is sufficient for the microcomputer's more limited applications, and the signals carried by the bus are time-multiplexed to reduce the number of channels that otherwise would overcrowd the narrower path.

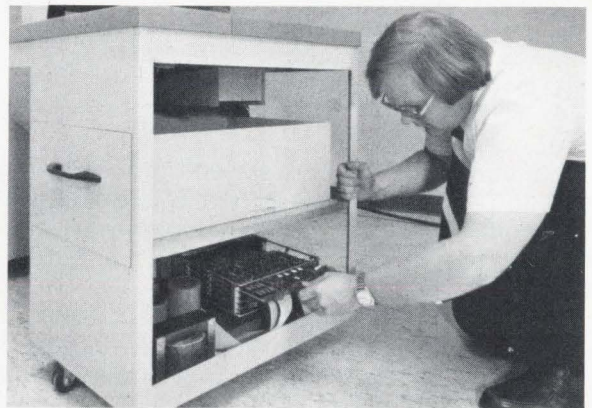

The LSI-11 central processing module consists of a single board that is 8-1/2 x 10-1/2 inches in size. The board contains the LSI-11 microprocessor, a 4K-word semiconductor memory, control logic, bus transceivers, and microprogrammed read-only memories, or so-called microms. The microms, which serve as the control store for the microprocessor, emulate the PDP-11 instruction set. Interestingly, the actual micro-operations within the chip set actually differ from that of the PDP-11 operation, but this is achieved at a level that does not involve the user. To a design engineer, the LSI-11 is simply a device that can be programmed in the same manner as can any PDP-11.

faces because operationally they "look like" the counter-part mini. And all of this results in a big gain: The family micro can be integrated more easily into systems that already use the same vendor's minicomputer.

A TYPICAL APPLICATION

A major midwest photo finishing laboratory applied this principle just recently when it employed LSI-11 microcomputers as controllers on a photography developing and printing system that already incorporated the PDP-11/35 minicomputer. The new photo finishing system can run 25 printers simultaneously, a feat that was impossible with just one central processor. This is because data, such as the brightness of a light source, can now be handled by the microprocessor at the local level and this unburdens the central processor. Because such data handling can be transferred "down line," functions that were previously impossible to incorporate, such as automatic focusing, now become very straight forward to engineer into the system.

The family micro can be integrated more easily into systems that already use the same vendor's minicomputer.

In the new system, the one LSI-11 unit in the printer remains in communication with the central PDP-11/35 where work order instructions are stored. Thus, as a negative enters the system to be printed, the computer checks an order file to determine exposure and other specifications, and the local LSI-11 adjusts the equipment to produce the conditions specified, and then it automatically triggers a print cycle.

WHERE COST IS CUT

The original computer-based photo finishing system was not nearly as sophisticated. True, it used a PDP-11/35 as the central element, but all of the controllers to run the different photo printers in the system were special-purpose, hard-wired devices with each requiring a different electronic assembly. Now, one basic controller based on the LSI-11 micro employs programming to handle all variations, and the quantity production of the basic hardware has cut the system's cost significantly. The photo lab gained yet another advantage by turning to a compatible microcomputer. It could begin to work on software development while still waiting delivery of the first LSI-11 microcomputer.

This photo finishing application shows that systems development in an hierarchical network becomes very much easier when a microcomputer shares the same programming techniques as that of a larger computer. Independent microcomputers, on the other hand, are limited by the unique language they use, and systems integrators must resort to large, inefficient programs to integrate the devices into an existing computer installation or system.

All of this capability to add intelligence to existing products has important industrial implications. Such intelligent devices permit systems developers either to expand existing computer-controlled capabilities or to develop individual instruments that have a common "intelligence box" that can be readily integrated into an hierarchical system. Either approach permits a systems designer to develop a more effective and lower cost hierarchy than can be achieved were he to choose a minicomputer network alone or to mix micros with non-compatible minis. ■

MINITERM 1202

Desk-Top Terminal

So small and quiet, you hardly know it's there . . .



Hospital Environments



Engineering or Laboratory



Programming Applications

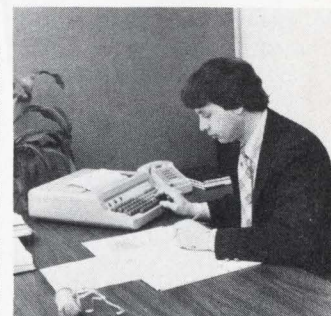

Management Offices

or there . . .

or there . . .

or there . . .

or there . . . and we guarantee it!

COMPATIBLE with all popular mainframes and minicomputers; RS232 standard

FAST 30 cps; three times faster than TTY

EXCLUSIVE FEATURES 3-mode keyboard (TTY, Typewriter, Numeric); up to 4K buffer memory option

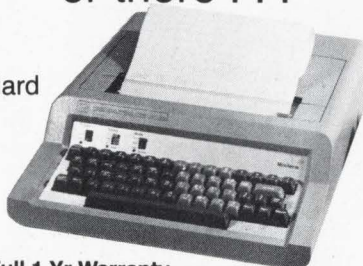

* Full 1 Yr Warranty



COMPUTER DEVICES INC.

9 Ray Avenue
Burlington, MA 01803 (617)273-1550

CIRCLE NO. 57 ON INQUIRY CARD

DATA ACQUISITION~ a technology profile

DAN M. BOWERS / Technical Editor

Minicomputers and miniperipherals have fundamentally altered the data logging business, and MINI-MICRO SYSTEMS explained how in a "Data Acquisition and Logging" Technology Profile in September 1975 issue (when the magazine was then called Modern Data). At that time engineers were beginning to incorporate microprocessors into data logging instruments, though merely as components to replace wired logic. But the latest designs use microprocessors to replace minicomputers and even larger machines to perform online control and analyses. The trend is now in a stage of late infancy, and the in-depth reviews given below on some pioneering products indicate the new technological direction under way in the dynamic field.

Systems designers and engineers from a cross section of companies and backgrounds — instrumentation, minicomputers, special systems — are moving both their companies and products along lines that exploit the new business climate created by the microcomputer. The individual profiles — which follow a short summary of where DA stood last year — deal only with standard, off-the-shelf data acquisition and logging products now on the market. Companies that specialize in custom DA systems, like those commonly used in aerospace, are not included.

The data acquisition industry is surprisingly innovative — how could an industry that is preoccupied with such ho hum products as strip chart recorders and "listing" printers be among the pioneers who have forged ahead into the world of microprocessor control systems? Strange as it may seem, though, the industry has always been progressive. It was among the first to adopt cassette and cartridge tape drives several years ago, for example, and it got another technological boost when minicomputer companies and other manufacturers of minicomputer front-ends invaded the industry, also several years ago.

Indeed, advanced systems dominate the field. In the September 1975 survey, which encompassed 68 data acquisition and logging equipment manufacturers, only 12 companies offered just a simple logger — compared to 27 companies that marketed either minicomputer control systems or minicomputer front-ends to be used on data acquisition systems. And most interesting, some nine companies had already incorporated a microprocessor into equipment. As further background, prices on the data acquisition and logging equipment covered in the MINI-MICRO SYSTEMS survey ranged from \$3000 for a simple logger that contains either a visual readout or a listing printer up to \$15,000 and higher for complete high speed and high-capacity systems.

DATA ACQUISITION VENDORS

ADAC CORP.

Adac specializes in data acquisition front ends to be used on Digital Equipment Corp. PDP-8s, PDP-11s, and LSI-11s and Data General Novas and Eclipses. The systems, which

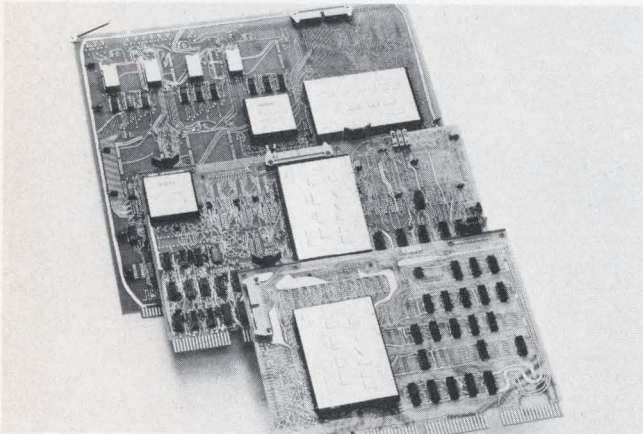

Adac's Minicomputer Front End Data Acquisition System

use PC boards that fit into a host minicomputer or an extension box, digitize to 12 bits. The A/D throughput is 35 kilohertz. Prices range between \$900 and \$2000 on typical systems.

ACUREX AUTODATA

(formerly Vidar Autodata Inc.)

The Autodata-9, a new generation microprocessor-controlled data acquisition system, offers up to 1000 input channels and a scan rate at 24 channels per second. Replaceable PROM memories are used to linearize and scale the analog signals. Options include Printers, a CRT console, conventional magnetic tape, paper tape, cassette tape, calculators. The system can also be linked to a computer or terminal by means of a modem. The Autodata-9 can serve either as a stand-alone unit or as a front end to a computer-controlled, real time data acquisition system. And it accepts inputs from every popular type of sensor used in conventional data acquisition applications, such as process monitoring, environmental testing, meteorology, and laboratory R&D.

BLH ELECTRONICS

BLH manufactures a multichannel scanning system for strain gauges, temperature sensors, and other transducers or sensors that generate a DC voltage. The system employs a Data General Nova-1210 4K computer, Teletype console, and twin cassette tapes. It accommodates up to 500 input channels and scans 10 channels per second. An operator interacts with the computer console only, and never has to fool with software which is integral to the system.

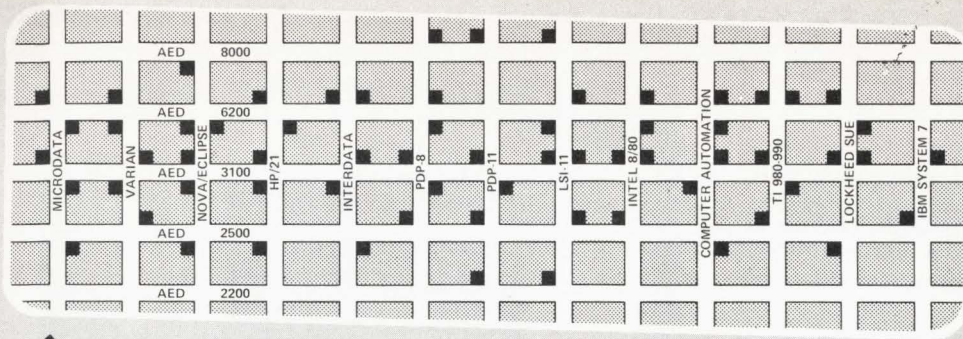

Deep in California lies Disk City, a rapidly-growing metropolis offering the world's most complete selection of rigid and floppy disk systems. The streets are computers and the avenues plug-compatible disk controllers. Cost-effective disk systems appear at no less than sixty-six locations. These systems range in size from the tiny hard-sectored AED 2500 floppy to the AED 8000 skyscraper, which fully emulates RP11-C/ROP3 or 4231/4231A. Middle range units include the soft-sectored floppies; IBM-compatible 3100's and double-density 6200's, and the RK-11/RK-05 compatible 2200 Cartridge Disk System. So come to Disk City—it may be the best move for you and your data.

 **Advanced Electronics Design**, 754 N. Pastoria St., Sunnyvale, Calif. 94086. Phone: (408) 733-3555 Telex: 357489

CIRCLE NO. 45 ON INQUIRY CARD

Welcome to Disk City

Population: Sixty-six systems and still growing



BURR-BROWN RESEARCH CORP.

Burr-Brown is one of the first companies to offer analog peripherals to be used on the popular selling microcomputers — Motorola's Exorciser, M-6800, and the Intel Intellec MDS 800 SBC 80/10, and Intel Intellec 8. These systems, whose analog input and output interfaces are electrically and mechanically compatible with microcomputers, plug

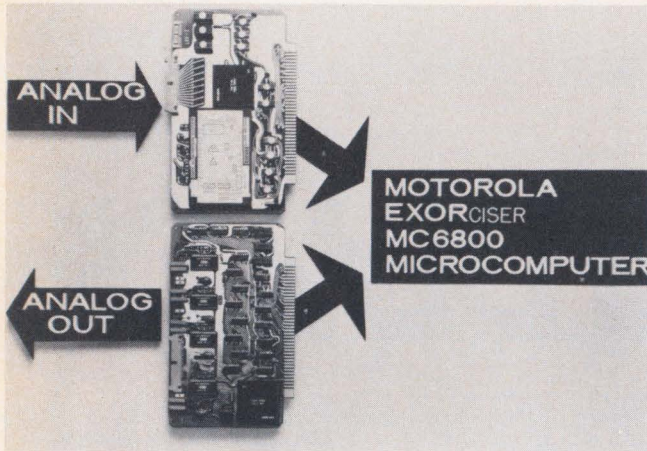

Burr-Brown's Microcomputer Front End

directly into the small computers, connecting directly to the bus. The analog cards in turn connect to Burr-Brown's modular data acquisition systems, which include multiplexor and 12-bit A/D. The microcomputer treats and addresses each analog system as memory. Prices on all standard 16-channel models is \$695 per board in small quantities, to \$295 for an OEM version in 100-lot quantities.

COMPUTER PRODUCTS, INC.

Computer Products markets an analog input as a front end data acquisition system to operate under computer control, especially a minicomputer. The company also manufactures input-output expanders and other peripheral controllers to be used on computers. The analog input system which uses dry reed switches or mercury relays, has a sampling rate at 200 channel per second, digitizes to 13-bit resolution, and accommodates up to 512 input channels. Another model, a

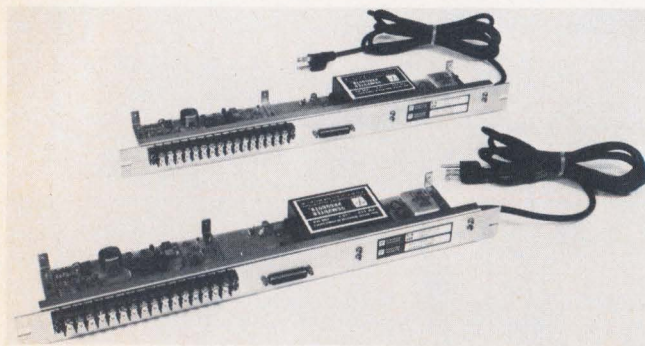

Two (2) RTP7420/30 Limited Distance Modems

low level analog input system having 12-bit resolution, samples up to 8000 channels per second and has a capacity of 64 channels. And a high end analog input system has 128 channel capacity, a 20,000 channel per second scan rate, and 13, 14, or 15 bit conversion accuracy. Systems begin at around \$2000.

CONSOLIDATED CONTROLS CORP.

Consolidated Controls has a line of digital indicators having plug-in parameter boards for a variety of transducers; this month, though, the company is introducing a microproces-



Consolidated Controls 90MC Field Programmable Data Logger and Monitor

sor-based field programmable data logger and monitor, the 90MC. The unit, has an integral keyboard, numeric display, and printer and a capacity of 112 inputs (or 1000 inputs if remote multiplexing is used), a scan rate at 100 points per second, internal data storage on all points, and a choice of three A/D converters. Memory is battery protected and a user can program the unit in the field.

DATA GENERAL CORP.

Data General's data acquisition and control subsystem, announced this year, enables industrial users to interface Nova and Eclipse computers to sensors and control devices. The subsystem accommodates up to 1000 lines and has a

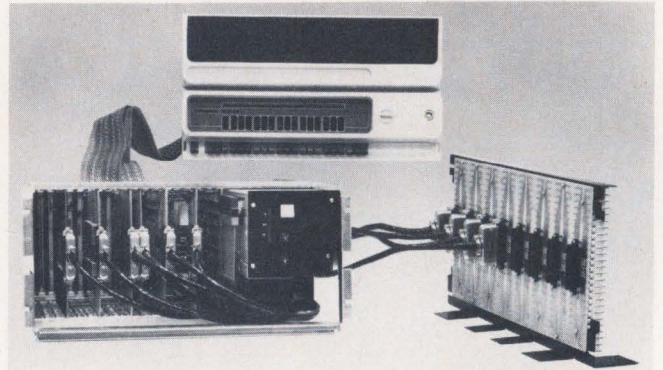

Data General's Access Manager Package

12 bit resolution, and a 50 KHz conversion speed. It offers both digital and analog capability and can be dual-ported to a second Data General computer. Data General's Sensor Access Manager package provides software support.

DATA TRANSLATION, INC.

Data Translation, starting as a producer of A/D and data acquisition modules, has moved into minicomputer and

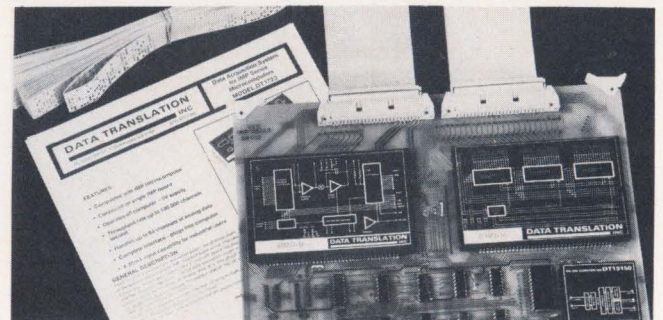

Data Translation Inc. Data Acquisition System for IMP Series Microcomputers

microcomputer compatible data acquisition systems. The company's basic product is a 12 bit, 16 channel OEM module which sells for \$175 in 100-lot quantities. The

company also announced recently a single board system to be used with the Intel SBC 80/10 and the National Semiconductor IMP and Pace microcomputer series. The Intel version, priced at \$795 in 100-lot quantities, makes possible a complete analog input-output computer system priced at only \$1100. The National Semiconductor versions, at 16 channels, expandable to 64 channels, sell for \$1195.

DATUM, INC.

Datum's System-70, a modular large-scale, data acquisition, data reduction, and automatic control system, is built around Data General and Digital Equipment Corp. mini-computers and a full complement of peripherals and software. The company also markets an analog input subsystem as a separate module to engineers who want to implement their own systems. The module, which interfaces directly to a minicomputer through the DMA port, contains up to 2016 input channels with 12 bit resolution and 20,000 samples per second. Diagnostic software is included.

DIGITAL EQUIPMENT CORP.

Digital provides the AR-11 analog real time system as a plug in card to be used on the PDP-11. Each card contains a 16-channel multiplexor, and 10 bit A/D and D/A converters. Digital also markets an industrial control subsystem that interfaces plant signals, actuators, and sensors to the PDP-8 or PDP-11. A remote version, which can be located up to one mile from the processor, handles up to 256 digital or analog inputs and up to twelve units can be interfaced to one computer. Data are transmitted at one megabit per second, limited by the coax connections.

DORIC SCIENTIFIC Division of Emerson Electric Co.

Doric's new Digitrend 240, a microprocessor-controlled, programmable process monitor, accommodates up to 1000 sensors and operates by monitoring exceptions. It includes an integral listing printer and an optional CRT-keyboard

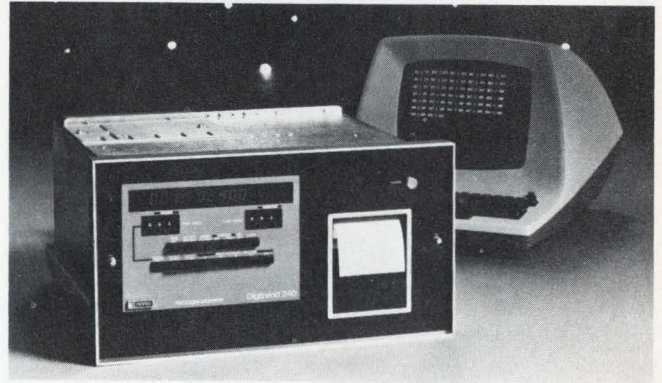

Doric's Digitrend 240 Process Monitor

terminal. This system is one of the first of a new breed of microprocessor-controlled conventional data logging instruments, and is not a data acquisition system for computer input.

ECTRON CORP.

Ectron provides an amplifier-per-channel data acquisition system having a general purpose digital interface and 14-bit digitizing resolution. Useful system configurations begin above \$5000.

**New...
from Delta**
DISPLAY AND STORAGE SYSTEM

Introducing the **DELTA 4700**: the data storage and handling system that reduces computer time, lowers data processing costs, and simplifies data handling for text editing, data entry, and data storage and retrieval applications.

- Store and access up to 1.25 million characters
- Up to 16 kilobytes of read/write memory (up to 64K option)
- Data manipulation, including Read/Write, Modify, Search and Copy.

The **DELTA 4700 System** also:

- Is backed by nationwide customer service in over 150 locations
- Offers compatibility with IBM 3740 formats
- Includes a confidence diskette for diagnostics
- Optionally contains a Disk Monitor System for assembly and text editing of programs, along with a separate terminal/disk debug package
- Is supplied with full documentation—hardware and software.

Contact us today for more information.

Delta Data Systems Corporation

Woodhaven Industrial Park
Cornwells Heights, PA 19020
(215) 639-9400

DELTA DATA SYSTEMS, LTD.
London 01-580-7621

Service in over 150 locations in the U.S. and 13 European countries and Canada

**New...
from Delta**
USER PROGRAMMABLE DISPLAY TERMINAL

Introducing the **DELTA 4500**: The new display terminal with round-the-clock reliability that's ready to solve your problem now, at a price that's hard to beat.

Use the **DELTA 4500** for applications such as:

- Text Editing
- Data entry
- Data retrieval
- Multi-format storage

The **DELTA 4500** also:

- Is backed by nationwide customer service in over 100 locations
- Supports peripherals such as floppy disks and printers
- Interfaces Burroughs and other computers
- Is supplied with full documentation - hardware and software
- Contains integral resident assembler, debug package and text editor

Contact us today for more information.

Delta Data Systems Corporation

Woodhaven Industrial Park
Cornwells Heights, PA 19020
(215) 639-9400

DELTA DATA SYSTEMS, LTD.
London 01-580-7621

Service in over 150 locations in the U.S. and 13 European countries and Canada

See us at INFO'76 - Booth No. 730

CIRCLE NO. 46 ON INQUIRY CARD

CIRCLE NO. 47 ON INQUIRY CARD

MFE 5000



*Most Reliable
Best Price/Performance*

BUFFERED DATA TERMINAL

- MICROPROCESSOR CONTROLLED
- PROGRAMMED SEARCH
- FULL EDIT
- EXTENSIVE ERROR DETECTION/CORRECTION
- ANSI/ECMA COMPATIBLE
- FULL COMMUNICATIONS
- ATTRACTIVE AND FUNCTIONAL STYLING
- QUANTITY PRICING

Call or write Maury Kirby.



MFE CORPORATION
Keewaydin Drive, Salem, N.H. 03079
Tel.: (603) 893-1921 • Tlx 710 366-1887
Telex 94-7477

CIRCLE NO. 49 ON INQUIRY CARD

La Monte Trading Company

Specialist in marketing The European and "Third World" computer markets. We provide complete export administration for your international marketing.

Complete facilities to assist you with your marketing strategy, whether it is a joint venture, subsidiary establishment, negotiating licensing agreements or direct export.

**"When You Think International"
Think of:**

**La Monte Trading Company
5129 Edgewood Place
Los Angeles, California 90019**

CIRCLE NO. 48 ON INQUIRY CARD

ELECTRONIC MODULES CORP.

EMC started as a manufacturer of digital modules, went through a phase of producing custom control systems, and now markets a high-grade data acquisition system, called dataSpan 1000. The systems handle problems ranging up to several thousand data points. A smaller system, Mite-e-Mux, covers 500 data points at a distance of up to four miles. EMC DA systems are minicomputer-based, and the company markets them to specialized industries, such as petrochemical and power generation, and installs the systems on a turnkey basis.

ESTERLINE ANGUS INSTRUMENT CORP.

Esterline Angus, one of the oldest data logging manufacturers, has introduced a fully packaged microprocessor-controlled data acquisition system which has unusual flexibility in applications because it uses RAM, ROM and PROM memories. The system which is programmed via a front panel keyboard accommodates up to 248 channels and has an integral listing printer and numeric display. It scans up to 25 channels per second, and provides formatted



Esterline Angus Key Programmable Data System

digital output for magnetic recording or computer processing. Options include paper tape, magnetic tape (cartridge or conventional), teletypewriter terminal, and data communications interfaces. ROMs, programmed at the factory, allow the user to specify arithmetic functions, gain, scan, and other parameters that are then selected by push button from the front panel.

GOULD, INC.

Gould, another old line data logging company (previously Brush Instruments Co.), markets the 6100 data logger to be used in mobile, marine, airborne, and other severe field environments. The 6100 scans up to 16 analog and digital

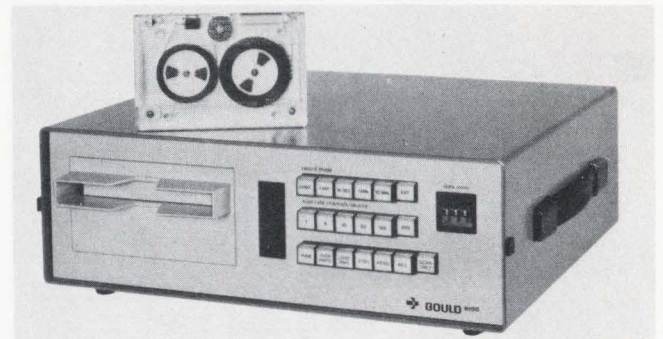

Gould 6100 Data Logger/Reader

inputs with 12-bit resolution and a rate at up to 200 points per second. Data, recorded on 3M cartridge tape, can also be routed to a minicomputer, programmable calculator, Teletype, and CRT.

INTRODUCING AN INNOVATION IN DISC CONTROLLER DESIGN

DIVA'S COMPUTROLLER V

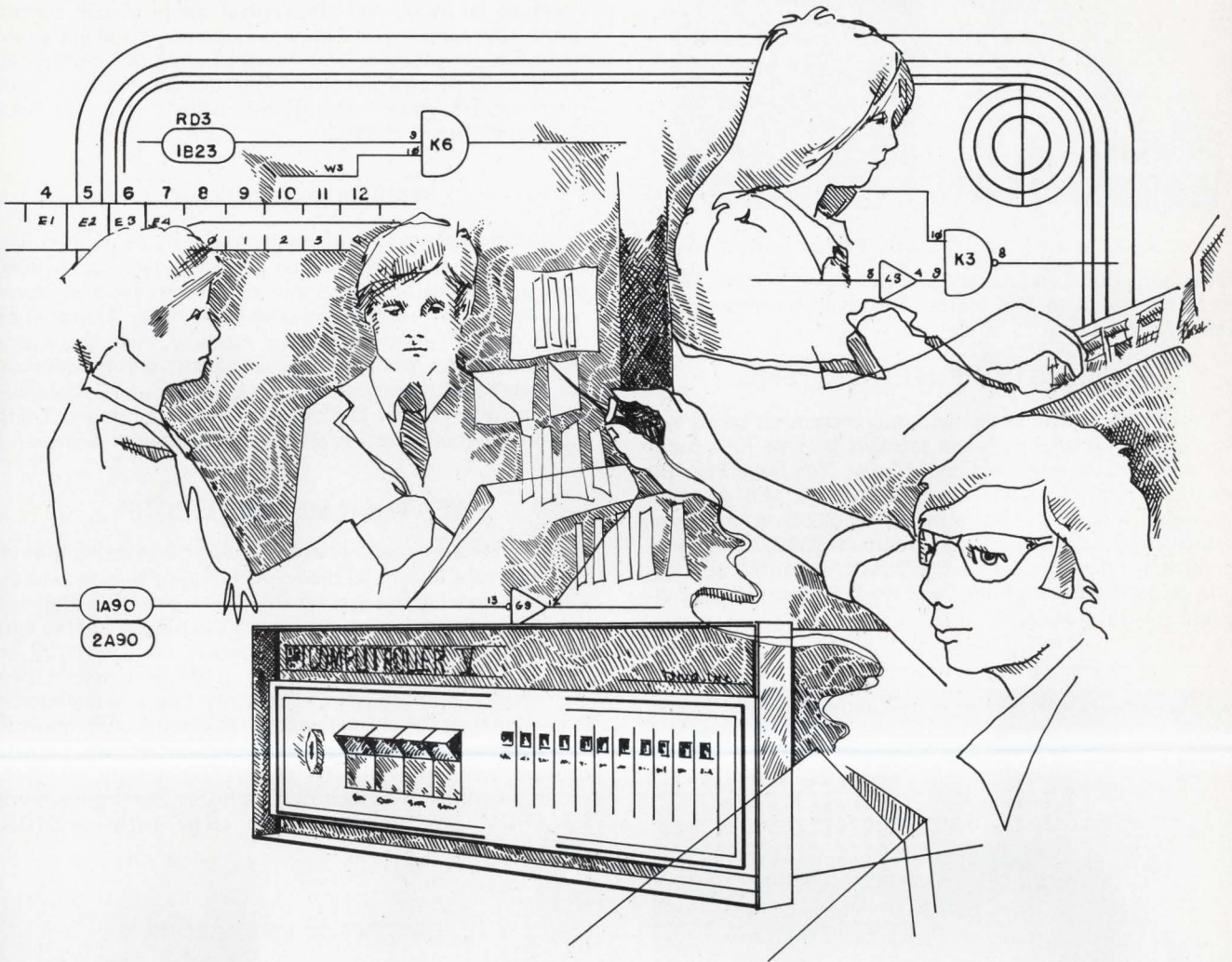

Perhaps you don't realize that you have an alternative to expensive disc storage capability with NO software changes.

Introducing **DIVA's COMPUTROLLER V**, a new addition to DIVA's intelligent line of disc controller systems.

The genius of this design provides you with the following benefits:

- Microprocessor Technology
- Total Software Transparency
- Full Error Correction—Completely Self-Contained
- Built-In Self-Testing Diagnostics
- Expandable 240 Word FIFO Buffer
- Interfaces to DEC, DG, and Interdata Minicomputers
- Dual Processor Support

- Compatible with all Ampex, CDC, Calcomp and ISS Drives
- Cost Effective Mass Memory Storage (5 m/bytes to 300 m/bytes per spindle)
- Eight Spindles per Computroller

DIVA for mass storage . . .
 "The original mini-maximizer"



For complete technical specifications and pricing information—call or write us today—

DIVA INC., 607 Industrial Way West, Eatontown, N.J. 07724 (201) 544-9000;

Los Angeles (213) 991-0321; Chicago (312) 956-0688; Phoenix (602) 991-4141; Boston (617) 275-1436; Washington D.C. (703) 435-1299; New York/New Jersey (201) 542-8093.

NON-LINEAR SYSTEMS, INC.

Non-Linear markets the S-9 acquisition and control system. This is a fully integrated, general-purpose computerized system, which starts at around \$25,000 installed, including personnel training. It accommodates up to 600 mixed

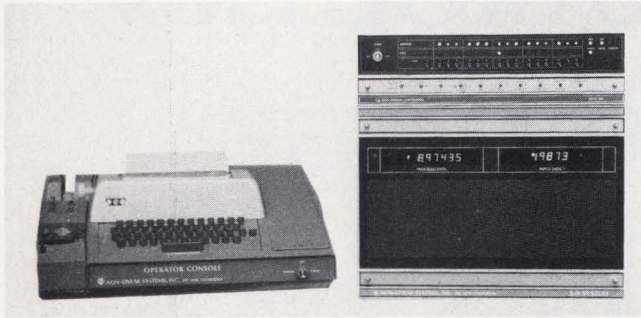

Non-Linear Systems' S-9 Data Acquisition and Control System

analog and digital inputs, and the processor, a Nova-1200, can be expanded to 16K words. The company uses its own Basic-III software.

PROCESS COMPUTER SYSTEMS

PCS makes microcomputers and microcomputer-based systems, including peripherals and software that are fully packaged and contain keyboard and display. The SuperPac 180 begins at under \$1000 in quantities of 50, and the rack mountable MicroPac 180 is priced at \$695 in the same quantity. A single-board-microcomputer is \$300. All systems are geared to data acquisition and industrial control applications, but the OEM user must add the input-output capability and control software.

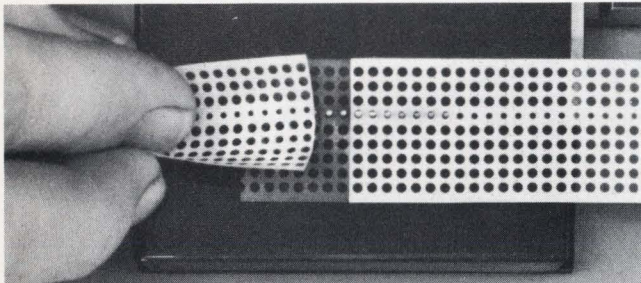

**Some people
get all
the breaks.**

They use IDEAL pressure-sensitive tape patches. These extra long patches (actually 37% longer) can take care of almost any break, except coffee breaks. And they stick resolutely to all tapes, even oiled tapes. The back comes right off and the fully-punched, perfectly aligned holes prevent the loss of a single character. Get all your breaks. With IDEAL pressure-sensitive tape patches.

For additional information, write us: Donald Inc., PO Box 104 Ridgewood, NJ 07451 (201) 444-6573.

DONALD Inc.
You can't splice it any finer.

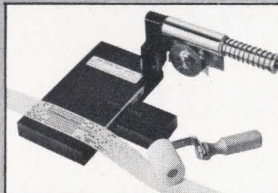

CIRCLE NO. 50 ON INQUIRY CARD

THIOKOL CORP.

Thiokol is heavily into both remote data stations and the telemetry links that communicate data from remote stations to central locations. Each remote data station, which is ROM and microprocessor-controlled, with up to 32K bytes of memory, accepts up to 16, 32-bit digital inputs and 64 channels of analog input which are digitized with 10 bit accuracy. A station includes self-test facilities and operating software, and one central computer can control up to 100 remote units that can operate at temperatures that range from -22 to 100 degrees F, 15,000 ft. altitudes, and 0 to 98 percent humidity. Optional accessories include thermoelectric generators and banks of solar cells. The price of a station begins at \$4000.

TRANSMATION, INC.

Transmation markets two minicomputer-based data acquisition and control systems that accommodate up to 3200 data points and that are scanned at rates that vary from once each two seconds to once each hour. Transmation offers a complete range of system modules, including analog amplifiers, strip printers, console panels, remote stations, CRT-keyboard, floppy disk, and chart recorders. The PDP-11 minicomputer has 28K maximum words of core. Transmation commonly installs all systems on a turnkey basis.

WEATHER MEASURE CORP.

Weather Measure markets every geological instrumentation and accessory known to man, including individual data acquisition and logging equipment, chart recorders that use paper or magnetic tape, and a complete programmable data acquisition system. The M732 system, controlled by an integral microcomputer that has RAM and PROM programming, has an 88 channel capacity that is scanned at a maximum rate of 20 per second under program control. The packaged unit has digital displays, and is available with conventional magnetic tape output, paper tape, teletypewriter or printer. The factory customizes user requirements via PROM programming. Prices range between \$7000 and \$15,000.

REFERENCE LITERATURE

For further information on the systems, use the reader inquiry numbers listed below.

COMPANY	READER INQUIRY NO.
Adac Corp., Woburn, MA	80
Acurex Autodata, Mountain View, CA	81
BLH Electronics, Waltham, MA	82
Burr-Brown Research Corp, Tucson, AZ	83
Computer Products, Inc., Ft. Lauderdale, FL	84
Consolidated Controls Corp., Bethel, CT.	85
Data General Corp., Southboro, MA	86
Data Translation, Inc., Framingham, MA	87
Datum, Inc., Anaheim, CA.	88
Digital Equipment Corp., Maynard, MA	89
Doric Scientific, San Diego, CA	90
Ectron Corp., San Diego, CA	91
Electronic Modules Corp., Timonium, MD.	92
Esterline Angus Instrument Corp., Indianapolis, MN	93
Gould, Inc., Cleveland, OH	94
Non-Linear Systems, Inc., Del Mar, CA	95
Process Computer Systems, Flint, MI.	96
Thiokol Corp., Ogden, UT	97
Transmation, Inc., Rochester, NY	98
Weather Measure Corp., Sacramento, CA	99

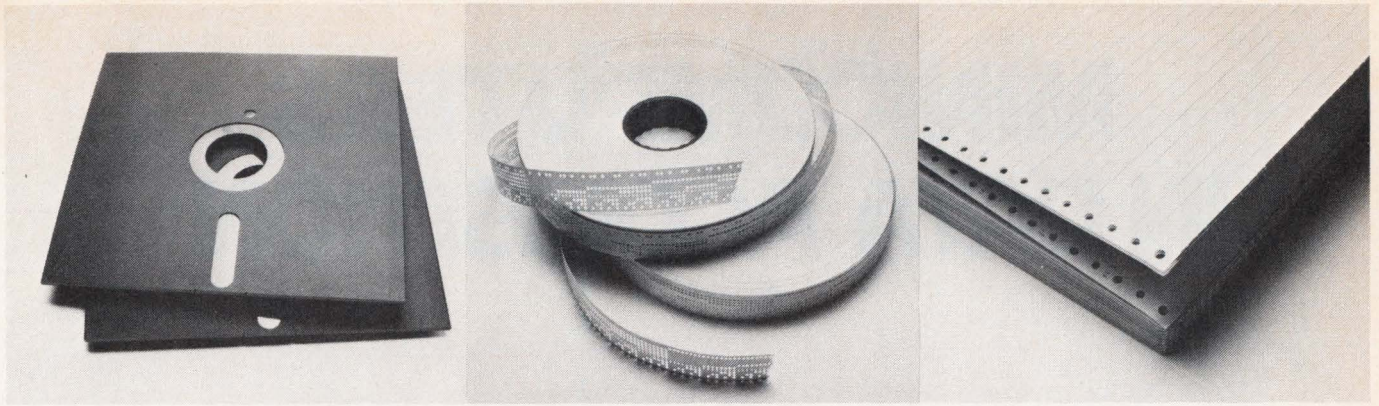

WE'LL READ, TYPE, RECORD, PRINT, PUNCH, SPOOL AND REPRODUCE FOR JUST ABOUT ANYBODY.

We believe everybody has the right to choose the best computer system to fit specific business needs.

That's why we make the best peripheral equipment for just about any configuration.

And that's why behind that claim we've put over 100 years of experience in precision engineering and gaining electronic capabilities to meet the demands of almost any system.

So, today, we have the equipment for whatever media is best for you.

PRINTERS

We have a whole group of matrix printers to pick from, in various speed ranges and all with superb accuracy and neatness.

For instance, there's our new 4540 matrix, with a revolutionary printing head, high speed printing, and economical cost.

PAPER TAPE

If paper tape meets your needs, we've got high quality readers, spoolers, or punches for your choosing.

Take our Facit 4020 Paper Tape Reader or Facit 4070 Tape Punch, for example. They're already seen with some of the best computers in the world.

FLEXIBLE DISKS

And, if you're looking for flexible disk drive, we can work together, too.

Our single floppy disks are expertly designed for easy installation, safe disk handling, and one of the fastest access times around.

Even better, our dual floppy disks give you all the same precision and accuracy, plus twice the data capacity of the single machine for only a fraction more investment.

And the special box-in-a-box construction, with its ability to reduce the problems created by heat and increase reliability, is something you won't find in any other flexible disk drive.

So, whatever Facit peripheral you choose for your needs, you've selected our choice piece. Because they're all made to work hard, work long, and require a minimum amount of maintenance.

In fact, we honestly feel that no other OEM manufacturer offers a better performance to price ratio. It's just part of the Facit belief that all our equipment should make work easier and more efficient for everybody.

If you'd like more information about our equal opportunities in peripheral equipment, send us the coupon below. We think you'll find Facit has the right idea about all your business needs.

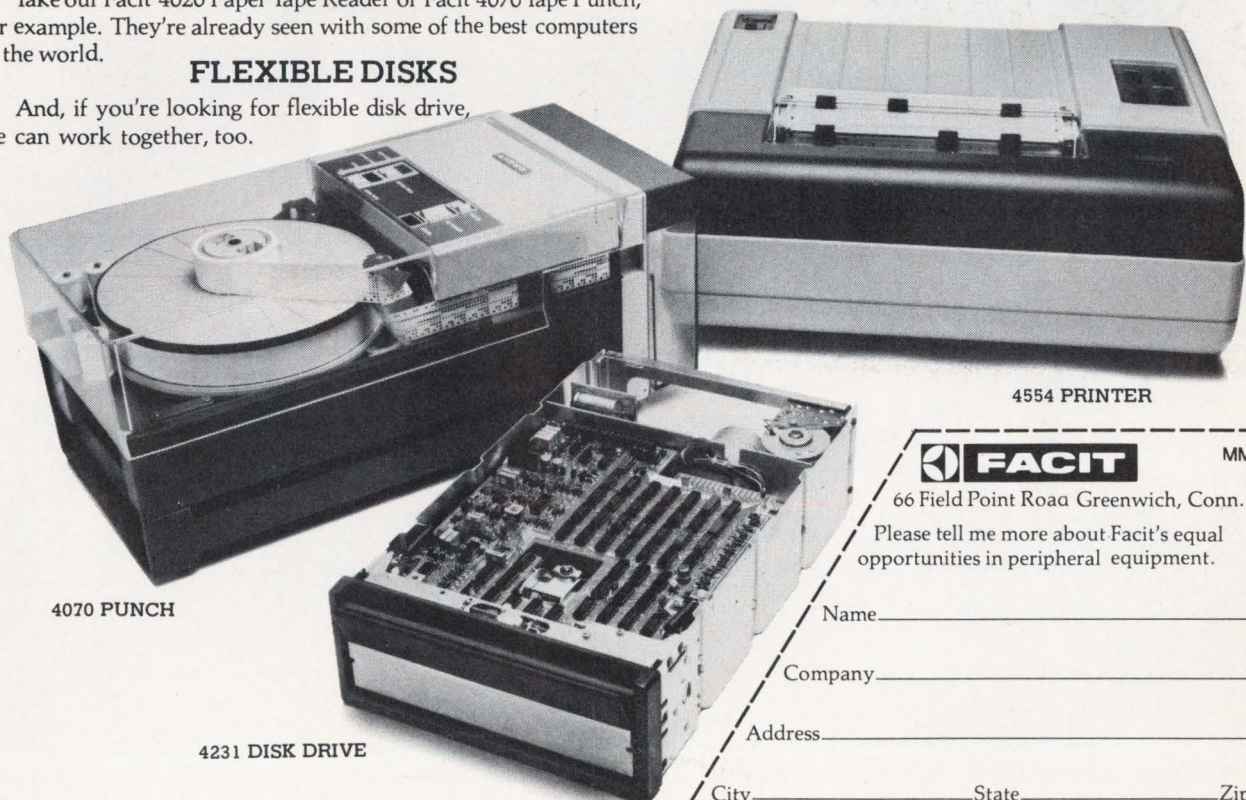

4070 PUNCH

4231 DISK DRIVE

4554 PRINTER



MMS1076

66 Field Point Road Greenwich, Conn. 06830

Please tell me more about Facit's equal opportunities in peripheral equipment.

Name _____

Company _____

Address _____

City _____ State _____ Zip _____

CIRCLE NO. 51 ON INQUIRY CARD

MINICOMPUTERS IN DATA ACQUISITION: a case study

STANLEY KLEIN / Editor-in-Chief

Eaton Corp. engineers use a Hewlett-Packard system to cut the time needed to conduct fatigue tests on vehicle parts by an order of magnitude and the cost by one-half.

Testing brakes, transmissions, axles or other dynamic components adds considerably to the cost of marketing such vehicle components. So test engineers at Eaton Corp.'s Engineering and Research Center in Southfield, MI, fighting to cut such costs, have turned to a powerful minicomputer data acquisition and processing system to slash the time spent on testing while simultaneously increasing test effectiveness.

The computer, a Hewlett-Packard 9601E measurement and control system, runs several tests at once, administers tests unattended, and processes test data in real time. Says Gopal Singh, a principal engineer at the test center, "The system has helped to accelerate the time that it takes to do

life-testing from years or months to weeks — the benefits pay for the cost."

WHAT EATON TESTS

The Eaton center performs two basic types of tests. Static structural tests are the most straightforward. A component is loaded into a test cell, and the computer monitors up to 16 channels of stress and strain data, and it also does preliminary data reduction. Endurance or fatigue testing on brake systems and axles, on the other hand, requires both the test system and the computer to operate unattended for hundreds of hours to simulate a vehicle's "lifetime." In such fatigue tests, the computer calibrates both measuring

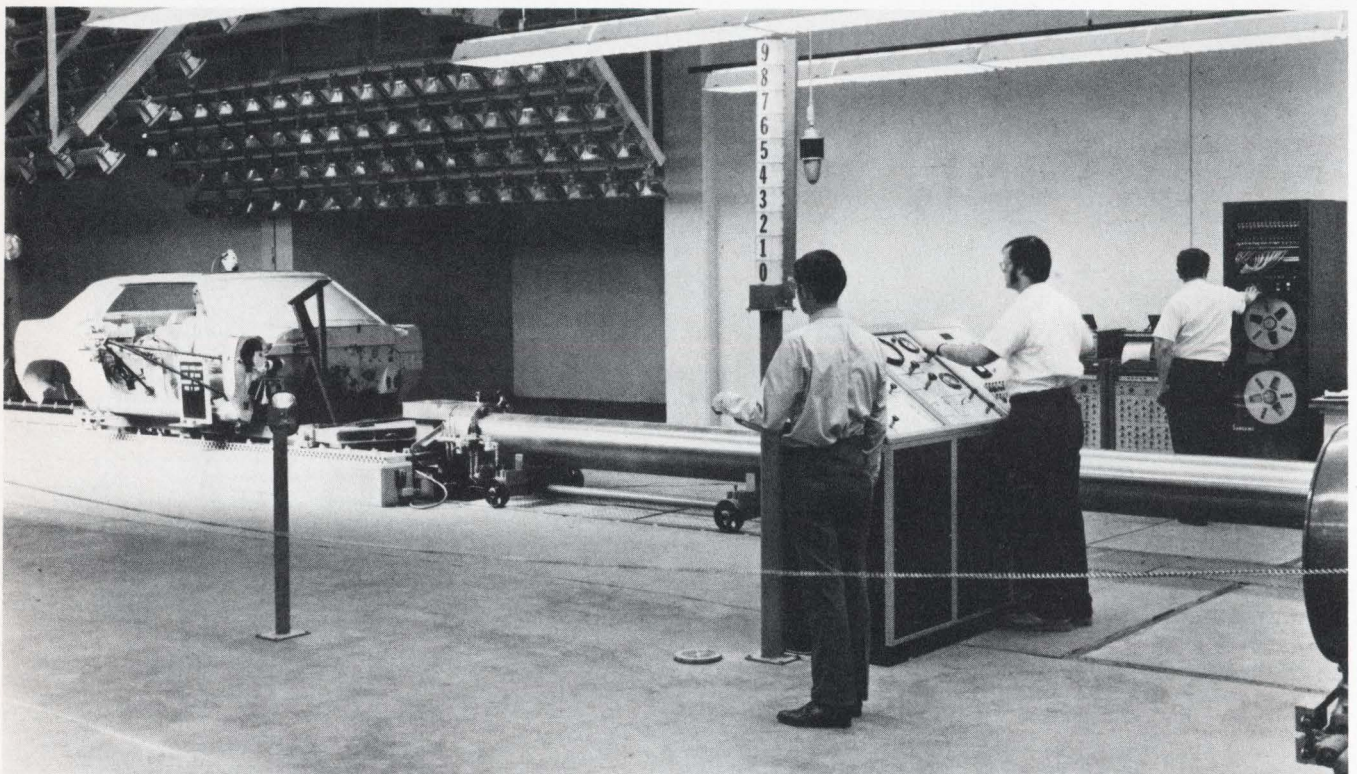

Eaton Corp.'s test engineers use an elaborate minicomputer-based data acquisition system to test vehicle axles, brakes, transmissions, and other parts.

devices and sensors and scans temperature, pressure, and other readings to determine if they are within preset values. Should they be out of range, the computer then makes an adjustment automatically or sounds a warning to technicians.

Furthermore, plans are under way to use the computer in even more sophisticated ways — to generate fatigue profiles, synchronize multiple channels, and monitor crack formation and propagation on truck axles and other major components. To do this, the computer will simulate the conditions that ensue as different parameter values are applied, and then it will order the most appropriate tests to be carried out. In essence, "the computer will learn from experience," Singh says.

THE TEST SET-UP

The Eaton test set-up consists almost entirely of Hewlett-Packard equipment, including a model 2100 minicomputer having 32K core memory; an analog-to-digital converter; a disk memory subsystem having a 5 megabyte capacity; an integrating digital voltmeter; a digital I/O; magnetic tape unit; and various input/output units. It also uses an advanced, disk-based real time executive software operating system to permit multiprogramming and simultaneous use of the system by different users on different tasks. RTE permits real-time operation so that measurements taken by the computer can be used to control subsequent operations.

HOW TESTING IS CONDUCTED

Because most vehicle subsystems fail as the result of fatigue, the endurance tests get the biggest workout at the Eaton center. After engineers design a new truck axle or other vehicle component to be manufactured by Eaton, other engineers devise realistic ways to test the unit. As a classic approach, the test engineers heavily instrument a prototype part with strain gauges, temperature sensors, and other measurement devices and then mount the setup in a vehicle for testing on highways, gravel roads, jounce ditches, potholes, body twistors, obstacles, and skid stops. The road testing lasts about 20 hours, and the data is recorded by means of a mobile test laboratory that accompanies the test vehicle. The lab contains transducers, signal conditioners, transmitters, and receivers, and other instrumentation that record axle loads, strains, and so on in analog form on magnetic tapes.

Later, at Eaton's data reduction section, the punched tape is converted on magnetic tape to a digital format. Typically, an analog-to-digital signal converter that runs at four times the rate at which the data were originally collected takes 2-1/2 hours to digitize ten hours of road testing.

ENTER THE COMPUTER

The computer massages the raw field data, now in a digital form. It rearranges, processes, calibrates, linearizes, catalogs, and analyzes the data to yield so-called fatigue profiles. Design engineers use these to conduct further laboratory tests. Each fatigue profile describes either an axial, horizontal, or torsional plane of loading, though additional computer processing can synchronize the separate profiles or combine them into a single one. Next, the computer duplicates the profiles on mylar punch tapes, and these are used

The Flex 80 Protects 66 Floppy Disks



ONLY
\$49.95
Ea.

**FILES, ACCESSORIES, for
MICROFILM; DATA and WORD PROCESSING.**

**Fiche &
Jacket Envelopes** **\$7.50** Archival Quality
Per M in lots of 5M

Write For
FREE CATALOG



"Worldwide Distribution From"
ADVANCE ACCESS GROUP

10526 W. Cermak, Westchester, IL 60153
312/562-5210

CIRCLE NO. 53 ON INQUIRY CARD

New! Model 640 Low Cost* Loader Reads 350 Characters per Second

**All solid state photo-electronic components.
Reads all standard 5,6,7 or 8 level tapes.
Smooth, quiet, AC drive.**

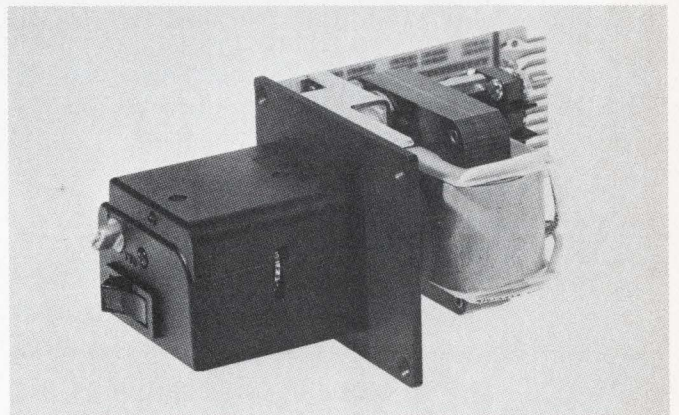

Provides reliable, high speed data entry. Data amplifiers and "character ready" output available for CMOS or TTL interfaces. Fanfold box available.

The Model 640 is the newest addition to the Addmaster line of quality paper tape equipment.

*only \$151! (1-49 units; substantial quantity discounts available.)

Addmaster Corporation, 416 Junipero Serra Drive, San Gabriel, California 91776. Telephone: (213) 285-1121.

CIRCLE NO. 52 ON INQUIRY CARD

announcing

1976 minicomputer- microprocessor market survey

The results of the fifth annual market survey among buyers of minicomputers, microprocessors and miniperipherals are now available in a special 80-page report.

The report features over 60 cross tabulations showing share-of-market statistics for all major vendors of minicomputers, microprocessors, microcomputers and miniperipherals.

The survey participants reported having 39,000 minis in place as of January 1, 1976 — accounting for nearly 30% of the total installed base of minicomputers in North America.

The survey respondents took delivery on more than 21,000 minicomputers in 1975 at a reported value of \$536 million. The respondents' purchase plans for 1976 include 28,000 minis at a total value of \$733 million.

microprocessors

Nearly one-half of the 5,700 sites represented among the survey replies reported having an active interest in microprocessors.

The respondents reported plans to buy 362,000 microprocessors in 1976 and another 576,000 (up 59%) in 1977. The microprocessor vendors being considered, the distribution by application and word length, and the factors considered most important by prospective buyers of micros when choosing a vendor are tabulated and analyzed in this year's survey report.

miniperipherals

The survey participants reported plans to buy an unprecedented quantity and assortment of peripherals in 1976 for interconnection with their minis and micros. Here is a partial list.

Type of Peripheral	Qty to be Purchased By Survey Participants
CRT Terminals	45,558
Mag Tape Transports	10,276
Floppy Disk Drives	9,909
Disk/Cartridge Drives	13,285
Line/Serial Printers	12,357
Teleprinters	18,466

to order

To purchase a copy of the 1976 survey report, fill in the coupon and clip it to your letterhead or company purchase order. No telephone orders accepted.

MODERN DATA SERVICES, INC.
5 Kane Industrial Drive/Hudson, MA 01749

Please enter my order for one copy of the *1976 Minicomputer-Microprocessor Market Survey* at \$295 per copy including U.S. postage.

Payment enclosed Bill me Purchase Order Number _____

Name _____

Company _____

Street _____

City _____ State _____ Zip _____

to control the hydraulic cylinders that create the laboratory test loads.

Once the tests are underway, the computer electro-hydraulic loading cylinders, and other instrumentation run unattended, often for the duration of a component's "life-time" plus a safety margin — all the while supervised by the programmed computer. The computer continuously measures parameter values to compare them with preprogrammed limits, and should the conditions warrant, it shuts down the test automatically.

The programming also includes steps to handle an aborted test. Should the computer stop a turbine engine due to excessive temperatures, for example, it may restart the test after the engine cools. The program typically calls for a limit of five test restarts before it shuts down the system permanently, though some parameters that go out of whack, because they are not critical, do not cause the system to shut off.

ADVANTAGES OF TIME COMPRESSION

The raw field data that goes into the fatigue profile, although collected over a short period, do make an excellent sample of the loadings that the axle is likely to undergo when in actual use. Moreover, most loadings on the axle are non-damaging, such as freeway cruising, and by extracting such data, the duration of truly damaging loads can be calculated. Twenty hours of field operation, it turns out, includes only about one hour of damaging loads under real operating conditions, according to Eaton's Singh.

Eaton's engineers accelerate life testing by using just such a time compression technique. Thus an axle on an industrial lift-truck, having a life expectancy of 2000 cycles when run on a military standard track, can be tested in the laboratory in less than 50 hours. The computer speeds fatigue testing in other ways, too. Data reduction takes less time than under previous systems by an order of magnitude! What used to take 10 months now takes only one month, and the attendant cost reduction is one-half to one-third.

SMART TEST SYSTEMS TO FOLLOW

Singh plans still more complex testing, especially to have the computer go through a "learning" process. It will work this way. When testing a steering system, for example, a fast left turn requires a certain valve opening. The computer will try different openings and eliminate those that do not give the best turning radius. And having "learned" from the experience, it will not retest such rejected valve openings. Singh also plans to use the computer to develop a tape of design options, just as an engineer would do. But the computer, of course, is much quicker at this job. The same technique can be applied to other vehicle functions as well. In essence, Singh says, "the computer performs the tedious tasks, executes the tests accurately and efficiently, and enables us to better simulate real-life conditions." ■

IF YOU HAVE A "NEED TO KNOW"
ABOUT COMPUTER SECURITY
SEE THE AD ON PAGE 48.

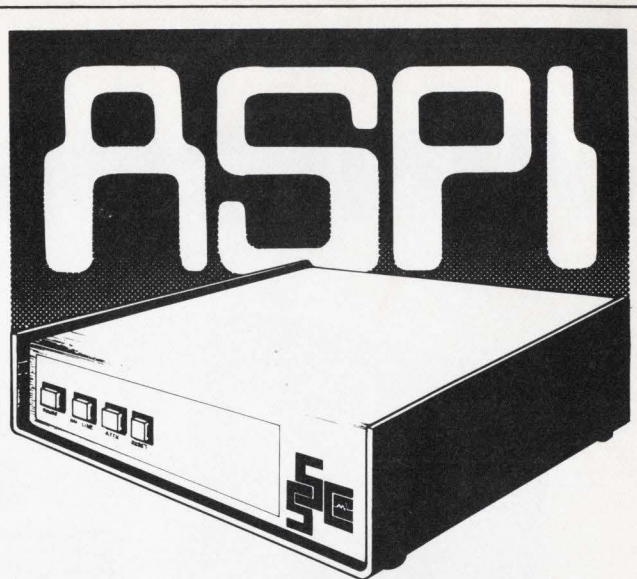

ASYNCHRONOUS SYNCHRONOUS PROGRAMMABLE INTERFACE

- CODE CONVERSION
- MODE CONVERSION
- BAUD RATE CONVERSION



SSC CORPORATION

5 Research Road
Salt Lake City, Utah 84112
Phone (801) 582-2680

Cost effective concentrators,
Multiplexors and message
switchers. Fully compatible
with all major main frames -
(IBM, Honeywell, Burroughs, etc.).

CIRCLE NO. 55 ON INQUIRY CARD

GRAPHICS

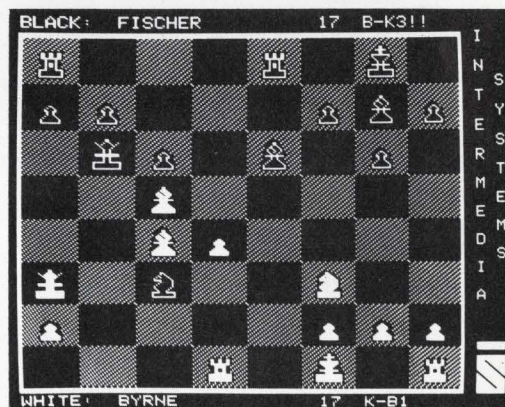

MOVE TO INTERMEDIA SYSTEMS GRAPHICS

DEC PDP-11* series
HP 2100 series

IMMEDIATELY AVAILABLE FROM

intermedia systems

10601 South De Anza Blvd. Cupertino, CA 95014 (408) 996-0900

*Reg. TM Digital Equipment Corporation

CIRCLE NO. 54 ON INQUIRY CARD

MINICOMPUTERS

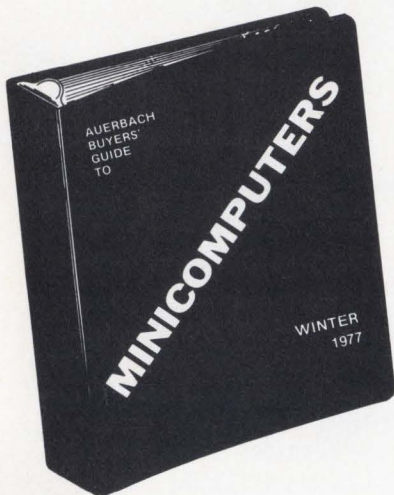

THE \$59 BUYERS' GUIDES

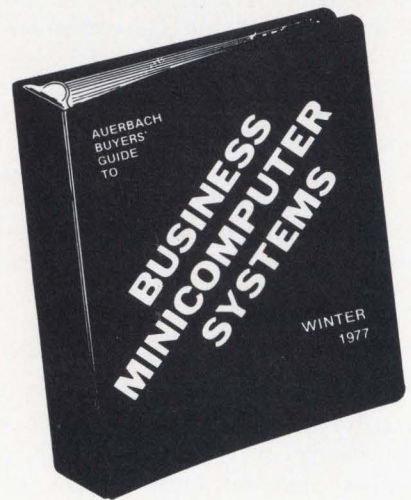

MINICOMPUTERS

Save yourself and your company time and money.

If your job is to purchase, use, compare or recommend general purpose minicomputers, this one-volume, non-updated, looseleaf buyer's guide is just what you need. Over 400 pages of up-to-date, fact-filled, totally objective information on the leading and most currently marketed general purpose minicomputers.

In-depth reports on the most important models...hundreds covered in specification charts.

Special section on *microprocessors* and a complete *directory* of the leading EDP vendor companies.

BUSINESS MINICOMPUTER SYSTEMS

This non-updated looseleaf buyers' guide, containing over 400 pages, analyzes the most important business minicomputer systems — both U.S. and selected European — marketed in the U.S.

Authoritative and dependable guidelines provided on the system's basic function...price...configuration...compatibility, performance and competitive advantages.

Includes search charts for easy comparisons, a basic overview on business minicomputer systems and a directory of the leading EDP vendor companies.

There is no duplication between these two volumes

AUERBACH Publishers' information has been the most trusted in the computer field for over 20 years. We are the worldwide authority — on minicomputers and business minicomputer systems — for current and totally objective evaluation and selection information.

AUERBACH Publishers Inc.
6560 North Park Drive,
Pennsauken, N.J. 08109
609-662-2070 Telex 831 464

AUERBACH Publishers Inc.
c/o MINI-MICRO SYSTEMS 5 Kane Industrial Drive • Hudson, MA., 01749

Please send me the following AUERBACH BUYERS' GUIDES:

AUERBACH Buyers' Guide to
MINICOMPUTERS

- Winter 1977 issue \$59
 Winter 1977 and Fall 1977 issues \$99

AUERBACH Buyers' Guide to

BUSINESS MINICOMPUTER SYSTEMS

- Winter 1977 issue \$59
 Winter 1977 and Fall 1977 issues \$99

NAME _____ TITLE _____
COMPANY _____
ADDRESS _____
CITY _____ STATE _____ ZIP _____

TELEPHONE (AREA CODE) _____

- Check Enclosed Bill my company (add \$4.00 for postage and handling)

AUTHORIZED SIGNATURE _____

MAKE ALL CHECKS PAYABLE TO AUERBACH PUBLISHERS, INC.

MMS-10

EDIT OPTION FOR LA36

DEC's microprocessor-based BSR option for the LA36 Decwriter II lets a user prepare, edit, update, and store messages for batch transmission at rates up to 300 baud. A store-and-forward capability minimizes communication line charges in both data processing and communication applications. With the option, editing functions can be performed faster than with magnetic or papertape. The power supply, control unit, ROM for instructions, and RAM for data storage are included in the one-board option. Single unit prices range from \$495 for 4K RAM board to \$998 for 16K RAM version. *Digital Equipment Corp., Maynard, MA.*

Circle No. 134 on Inquiry Card

OEM 19-INCH GRAPHICS DISPLAY

The 619 display monitor provides stored displays of combined alphanumeric and graphic information from analog sources and digital computers. The 19-inch bistable storage tube eliminates the need for memory devices to refresh the display and provides high information density with excellent

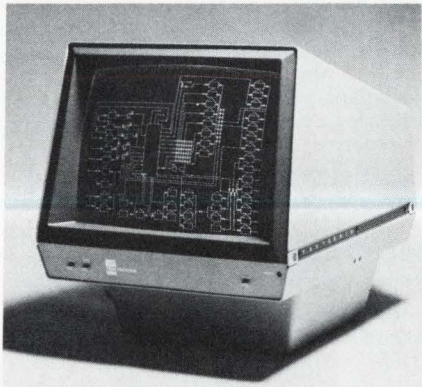

resolution. Storage and refresh modes are both controllable by the OEM's computer. The 619 is plug-to-plug compatible with the Tektronix 4631 Hard Copy Unit. OEM price is \$7125. *Tektronix, Inc., Beaverton, OR.*

Circle No. 139 on Inquiry Card

THREE-WAY CONTROLLER FOR INTEL

Keyboard, display, printer and calculator features are all contained in the one-board KDP/C controller designed for Intel's 8080-based SBC 80/10 or Intellec MDS. The on-board calculator performs four basic arithmetic functions. The display driver is compatible with a seven-segment, 12-digit plasma display. The user can enter data on the controller keyboard. And if printing is necessary, the controller interfaces with a Victor Comptometer matrix printer. Price is \$295 in quantities of 100. *Cybernetic Micro Systems, Palo Alto, CA.*

Circle No. 135 on Inquiry Card

NEW DISK CARTRIDGE

The Memorex Mark III-F front-loading disk cartridge incorporates a unique door and latch assembly that makes the cartridge more reliable because plastic flexing and distortion are eliminated. A redesigned interior allows greater clearance between the cartridge cover and disks. As a result, higher density disks may be used. The 2315-type cartridge provides up to 126 megabits of unformatted storage capacity. *Memorex Corp., Santa Clara, CA.*

Circle No. 141 on Inquiry Card

POWER SUPPLY FOR ALTAIR 8800

Parasitic Engineering's constant voltage power supply kit for the Altair 8800 eliminates the effects of power line fluctuations. The power supply delivers full output (8 volts at 12 amps, ± 16 volts at 1 amp) even when the line voltage is as low as 90 volts. A custom-wound ferro-resonant constant voltage (C-V) transformer replaces all three of the standard Altair 8800 power transformers. Price of the kit is \$75, postpaid. *Parasitic Engineering, Albany, CA.*

Circle No. 177 on Inquiry Card

A lot of companies offer plug-compatible disk storage systems for minicomputers.



Since 1970, we've provided over 2500 customers with a lot more than the plug.

Like total software support for most popular minicomputers, especially those from DEC and Data General. Like 30-day delivery ARO. Like field-proven reliability backed by millions of hours of operation. Like super-fast access to a wide range of storage options—from 2.5 million to 1 billion bytes per system.

When you're the best, it's hard to be humble. So, if it sounds like we're tooting our horn a bit hard, it's because we think you should know about the price/performance advantages our disk systems have over those offered by the minicomputer manufacturers.

For complete technical specifications and pricing information, write or telephone us today. We'll also be happy to discuss how our disk systems are maximizing the performance of minicomputers for a growing list of Fortune-500 customers. Like IBM, Univac, Dupont, 3M Company, Western Electric, Dow Chemical, Xerox, Westinghouse, Polaroid, Eastman Kodak, TRW, CBS, CDC, DEC ...

System Industries
535 Del Rey Avenue
Sunnyvale CA 94086

SALES/SERVICE OFFICES
Boston: Stu Oremland, (617)492-1791 New York City: Ron Caruso, (201)461-3242 Washington D.C.: Dave Jenoff, (703)525-3135 Cincinnati: Phil Jacobs, (513)661-9156 Los Angeles: Steve Pricer, (714)752-8904 Sunnyvale HQ: Lynne Hodges, Dick Milligan, (408)732-1650 United Kingdom: Pip Smith, Chris Ibbott, (4862)70725

"See us at the Mini/Micro Show—Booth 210"

CIRCLE NO. 56 ON INQUIRY CARD

TERMINAL FLOPPY

The TD-1 TermiDisk is a microprocessor-based floppy system for onsite or remote data terminals. File management and editing programs are resident on a single diskette although up to four diskettes are permitted. Communication with terminals and modems is with RS-232 or current-loop interfaces. Two ports are provided, each capable of communication with five, six, seven or eight-bit data at 50 to 19,200 baud. Base price is \$2450. *International Computer Products, Inc., Dallas, TX.*

Circle No. 162 on Inquiry Card

MICROCOMPUTER ACCESSORY BOARD

E&L Instruments accessory board with 2K RAM, Teletype interface, PROM sockets and audio cassette interface

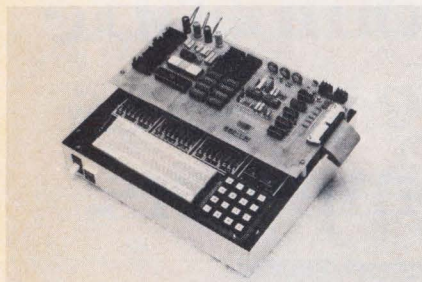

plugs into the company's MMD-1 microcomputer. Price of the assembled board is \$200; \$150 in kit form. *E&L Instruments, Inc., Derby, CT.*

Circle No. 185 on Inquiry Card

MOS FOR LSI-11

The Mastermind 8K and 16K-word modules have a 500-nanosecond access time and 800-nsec cycle time. Prices for the 8K MOS start at \$875; 16K versions start at \$1450. *Memory Systems, Inc., Hawthorne, CA.*

Circle No. 155 on Inquiry Card

DATA ENTRY TERMINAL

The Datacorder is a self-contained accounting terminal using a microprocessor with 8K RAM, expandable to 12K. Data is entered via a full alphanumeric keyboard and calculator pad.



Prompting messages and keyed input are displayed on a 32-character display. All data is stored on a Philips cassette. A journal tape printer is provided to give a printed audit trail of numeric quantities that are entered. Prices range from \$3970 to \$5875. *International Entry Systems, Inc., Seattle, WA.*

Circle No. 176 on Inquiry Card

PROM PROGRAMMERS

Texas Microsystems, Inc. (Houston, TX) has a PROM programming system for Intel's Intellec 8/Mod 80 development system. Included in the Model 2730PROM programming system is software, documentation, two boards with ribbon connector, and programming tape to prepare interface PROMs for the conversion system. Price is \$365.

Circle No. 157 on Inquiry Card

Prom Programmings, Inc. (Mountain View, CA) has two very small programmers (2-1/2x6x8 inches) for ultraviolet erasable PROMs. Each fits into a briefcase for use in the field. Front panel LEDs indicate the state of the address and data lines for both the master PROM and the copy. Two toggle switches set all the machines cycles. Price for programmer with read/write modify capability is \$795, for copy only, it's \$650.

Circle No. 158 on Inquiry Card

MULTIPLEXER FOR DG

This single-board multiplexer includes eight synchronous communication I/O channels, a line printer controller, and a real-time clock. Each channel is RS-232C compatible and will interface Data General minis to local terminals or data sets in half- or full-duplex operation. Eight different baud rates from 110 to 9600 are jumper-selectable. Single quantity price is \$2995 with quantity discounts available. *STC Systems, Inc., Maywood, NJ.*

Circle No. 160 on Inquiry Card

PRINTERS

Japanese Matrix. Tokyo-based Juki Industrial Co., Ltd., produces a double-head Model 5703 matrix printer with an output of 75 lines per minute at 132 characters per line, and the single-head Model 5701, which prints 50 lines per minute. Base priced at \$2400 and \$1900, the printers use a 7x9" matrix print head, which has been successfully life tested to 150 million characters without failure. *Juki Machinery Corp. of America, Costa Mesa, CA.*

Circle No. 137 on Inquiry Card

2400-LPM. The interface signals of the 8210 electrostatic line printer have been arranged to allow easy interfacing with most known microprocessor systems. The 80-column 2400-line per minute printer sells for \$3000. A 132-col. version is also available that prints 1400 lpm. *Houston Instrument, Austin, TX.*

Circle No. 138 on Inquiry Card

SMART CARTRIDGE DRIVE

The 8080A-based 3M Data Cartridge Recorder uses a dual 128-character buffer for asynchronous communications via RS-232/TTY interfaces with data rates up to 9600 baud. A search mode enables any sequence of up to



32 alphanumeric characters of actual data to be used as an identifier. Price of a single track version is \$1795; \$1995 for a four-track unit. *Columbia Data Products, Inc., Baltimore, MD.*

Circle No. 170 on Inquiry Card

DATA RECEIVER

The Telxon 650 Data Receiver accepts asynchronous data transmissions from Telxon's line of portable data entry terminals. Connected to an IBM 029 key-punch, the receiver controls the punching of a four-digit sequence number on each card. A 12-character display panel provides a search look-up for previously received data. A 202C modem is included. *Telxon Corp., Houston, TX.*

Circle No. 183 on Inquiry Card

MICRO CARTRIDGE DRIVE

The Micro-Drive Model 101 uses the 3M DC100A data cartridge. Its small size (4-1/2x4x3 inches) and simple cartridge retaining mechanism make it suitable for microcomputers and data terminals. Read/write speed is 25 ips; rewind/search speed is 75 ips. Price in quantity of 100 is \$470. *Instrumentation Technology Corp., Northridge, California.*

Circle No. 168 on Inquiry Card

μP-BASED EDITING TERMINAL

The VT71/t desktop display terminal for the printing and publishing industry is designed around DEC's LSI-11 microcomputer. It permits internal storage of up to 40,000 characters (160 newspaper column inches) of copy. In addition to the standard typewriter keyboard, the VT71/t offers two, color-coded, 18-key keypads for text editing and copy dispatching, plus 16 memory keys at the top of the standard keyboard that enable the user to custom-design certain editing functions. The basic VT71/t, including the LSI-11 microcomputer with 12K words of memory, is priced at \$7250. A full 28K memory unit costs \$9750. *Digital Equipment Corp., Maynard, MA.*

Circle No. 179 on Inquiry Card

μP PARALLEL TO SERIAL INTERFACE

The Model 840 standalone serial interface for four- or eight-bit microprocessor cards performs the parallel-to-serial conversion task in hardware rather than in software. By adding several of these cards, one microprocessor can communicate with multiple terminals or serial devices. The card uses three four-bit data paths to interface with any TTL compatible microprocessor input/output parts. It has both RS-232 and 20 mA teletype full duplex interfaces for serial data transmission. Price is \$140 in quantity of 25. *Data Works Instrumentation, Chatsworth, California.*

Circle No. 178 on Inquiry Card

3M CARTRIDGE MICRO INTERFACE

Qantex 3M cartridge systems can now be interfaced to DEC LSI-11 and Altair 8800 microcomputers. The interface card is imbedded in the microcomputer to provide 22.3 to 180 megabits of storage. Price of the Altair interface is \$415. *North Atlantic Industries, Inc., Qantex Div., Plainview, NY.*

Circle No. 187 on Inquiry Card

GRAPHICS TERMINAL KIT

This 9-1/2x13-inch PC board contains all the electronics necessary to display an array of cells 64 wide by 96 high on a standard video monitor or modified television set. The graphics terminal contains its own 6144-bit static memory and thus may be driven by any computer system having a TTL compatible eight-bit parallel interface. The unit is available in kit form only and is sold less power supply, chassis, and monitor for \$98.50. *Southwest Technical Products Corp., San Antonio, TX.*

Circle No. 171 on Inquiry Card

ARRAY PROCESSOR FOR HP2100

Hewlett-Packard's 2100 Series computational capabilities can be greatly expanded with the MAP programmable array processor. All of the MAP's basic units — CSPU-executive controller, arithmetic processor, and I/O scrolls — operate independently of each other, and can take advantage of the three separate, internal high speed memories. The special SNAP II software, which interfaces to HP's RTE-3, provides a one-step procedure for initiating complex, real-time mathematical operations. One simple Fortran command

instead of a sequence of steps allows the complete operation to be performed. Prices for MAP with hardware and software interfacing start at \$8400. *CSP, Inc., Burlington, MA.*

Circle No. 182 on Inquiry Card

MICROCOMPUTER DEVELOPMENT

The AMI 6800 Microcomputer Development Center can act as a system for microcomputer hardware and software design and development, as a general purpose data processing system, or as an intelligent communications terminal. It includes a special-purpose CRT and a dual-drive floppy. For hardware development, the system offers remote front panel and ROM simulator functions, a modular bus-oriented PC card cage supported by general purpose breadboard cards, extender cards, EPROM programming capability, and MDC self-testing firmware. Software development programs include FDOS-II disk operating and file management system, text editor, symbolic assembler, extensive debugger, trace program, self-test programs, and COM telecommunications package. Price with 16K bytes of memory is \$10,500. *American Microsystems, Inc., Santa Clara, CA.*

Circle No. 161 on Inquiry Card

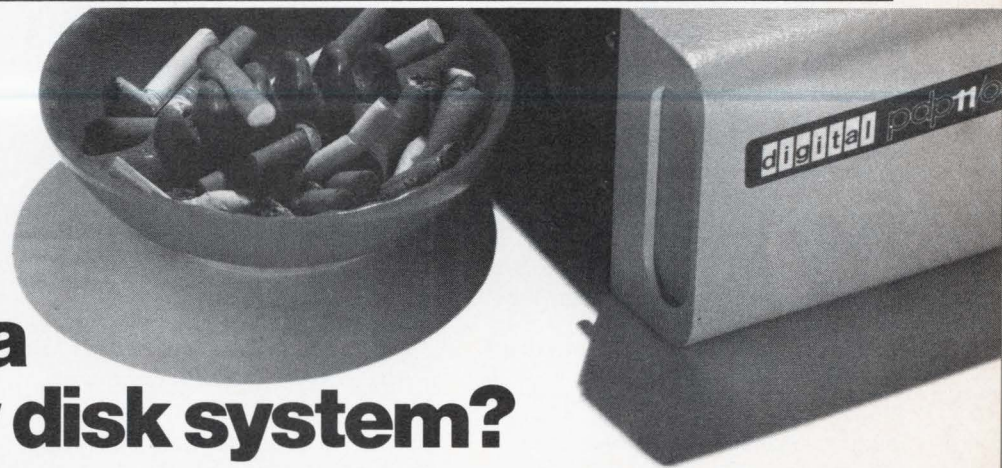

Waiting for a DEC™ floppy disk system? Try ours now, while you wait.

Our DSD 210 floppy disk system has more useful features than the DEC RX01 yet costs less.

To prove it, we have a demonstration plan which lets you use our system while you're waiting for DEC.

We won't tell you to cancel your DEC order. We suspect you'll come to that conclusion all by yourself.

For demonstration plan details contact Data Systems Design, Inc., 1122 University Avenue, Berkeley, CA 94702, telephone (415) 849-1102.

DEC is a registered trademark of the Digital Equipment Corporation.

We don't have to sell our system; it sells itself. Here are a few reasons why.

	DEC RX01	DSD 210
Hardware compatibility	PDP-8,-11 LSI-11	PDP-8,-11 LSI-11
Software compatibility	All DEC operating systems	All DEC operating systems
IBM 3740 Format	Yes	Yes
Write protect	No	Yes
Self-testing microprocessor	No	Yes
Error alert lights	None	Four
Field-proven Shugart drive	No	Yes
Price, single 2-drive unit	\$4,095	\$3,295
Delivery	4 months	Immediate

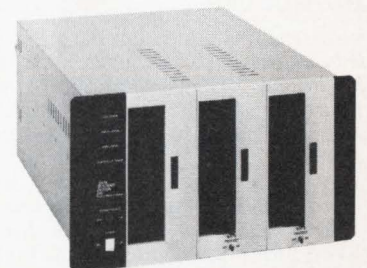

Data Systems Design

D/A SYSTEM FOR LSI-11

Adac Corp.'s digital to analog system is compatible with DEC's LSI-11 and PDP-11/03. The Model 600-LSI-11D has one 5x8-1/2-inch PC board with bus interface, DC/DC power converter, scope control and either one, two, three or four 12-bit D/A converters. Price in single quantity for system with four D/A converters is \$850. *Adac Corp., Woburn, MA.*

Circle No. 190 on Inquiry Card

BIG WINCHESTER

Control Data Corp. has an extra large Winchester-type drive with a 400-mega-byte disk capacity. Each CDC 33801 disk storage unit consists of two drives, with one to four units configured in a single string. Up to four strings — 32 drives with a total capacity of 12.8 billion data bytes — can be attached to the universal CDC 38302 storage control unit. Prices for a 370-compatible unit start at \$44,840. *Control Data Corp., Minneapolis, MN.*

Circle No. 164 on Inquiry Card

PROM BOARD

Microtec's 8K/16K PROM board is plug-compatible with Intel's SBC 80/10, SDK-80 and the Intellec MDS-800. Either fusible link bipolar PROMs such as the 3604, or light erasable MOS PROMs, such as 8704s and 8708s, may

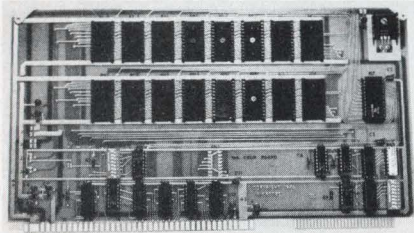

be used. The masked ROM equivalents of these PROMs may also be used. Switches and jumpers allow the selection of PROM type and the base address of the board. *Microtec, Sunnyvale, CA.*

Circle No. 173 on Inquiry Card

DUAL-PORT CLUSTER CONTROLLER

The GDS 300 controller permits up to 16 terminals to be interfaced with either one or two computers, even when the computers are different models. It can accommodate any combination of CRTs, keyboards and can mix a video signal from an outside source with computer data to provide a combined display. Another feature is a very fast parallel interface at 1 mega-byte per second as well as serial communications up to 9600 bps. *Goodwood Data Systems, Ogdensburg, NY.*

Circle No. 188 on Inquiry Card

BOARDS AND BOXES

The *Astral 2000 Microcomputer Kit* is shipped with power supply, cabinet, front panel components, motherboard (backplane), processor board and one 8K RAM board. The 6800-based processor operates in serial and in parallel. Both RS-232 and 20mA current loop interfaces are provided by a serial I/O socket on the processor board. The processor has a custom 2K monitor ROM and built-in provisions for "cycle-stealing" DMA. The 8K static RAM is expandable to 56K. Processor actions may be sequenced ac-

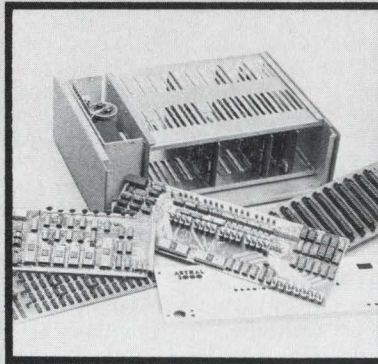

ording to real-time using the three sets of dual seven-segment LED displays. The same set of displays may be used to output programs in hex for software debugging. Astral's 8K Basic contains many unusual features such as a floating point package that lets the user choose the number of significant digits. A partially assembled Astral goes for \$995; assembled, it's \$1250. A fully assembled Gemini-68 processor or 8K RAM board is \$245. Astral Basic on mag tape or paper tape with documentation is \$35. *M & R Enterprises, Sunnyvale, CA.*

Circle No. 142 on Inquiry Card

The *GRC11/03-RSX Microcomputer System* is based on Digital Equipment Corp.'s 11/03 CPU (LSI-11 in a box) and the RSX11 Real-Time Executive. For under \$17,000, the package has a CPU with hardware multiply/divide, floating point, 20K-word RAM, Unibus port, 1960-character CRT, 75-lpm printer, dual floppy and the software. *General Robotics Corp., Hartford, WI.*

Circle No. 144 on Inquiry Card

The *ICS Processor System* is a desktop Intel 8080-based microcomputer. Two floppies, two communication channels and a 16K-byte RAM are standard. *Intelligent Computer Systems, Mountain View, CA.*

Circle No. 145 on Inquiry Card

The *Pacer Desktop Microcomputer* is based on National Semi's Pace or SC/MP microprocessor. Two four-digit displays and a 38-character keyboard let the user examine and modify register or memory location contents and perform decimal to hexadecimal conversion. Options include a TTY or RS-232 interface with line assembler, PROM programmer, prototyping board and extended memory board. *Project Support Engineering, Sunnyvale, CA.*

Circle No. 143 on Inquiry Card

Microcomputer with MOS Technology 6502. Etcetera from *Electronic Tool Co. (Hawthorne, CA)* features an eight-bit CPU, a 40-key keyboard, programmable eight-digit display, I/O interfaces, power supply, 1K RAM and 256-bytes EA-ROM. Software available includes a resident assembler, I/O handlers, diagnostics and other support tools.

Circle No. 127 on Inquiry Card

6800 Microprocessor Card for Altair. Learn the differences between the 8080A and the 6800 by adding a card to an Altair 8800. The MC 6800 from *MRS (Hawthorne, CA)* attains control by a software command. Software or a front panel stop switch can return control to the 8080A. Price for the completely assembled kit is \$180.

Circle No. 126 on Inquiry Card

8080A/9080A System and Support Cards. The fully assembled system card from *Microcomputer Associates, Inc. (Santa Clara, CA)* includes an 8080A CPU, 1Kx8 static RAM, 2Kx8 PROM sockets, programmable peripheral interface, crystal clock and 24 bidirectional I/O lines. The 4.25x7-inch card is priced at \$375 in single quantity. Its support card has a 8Kx8 PROM and 4Kx8 RAM for \$595. A software support package has four preprogrammed PROMs with assembler, editor and monitor for \$995.

Circle No. 125 on Inquiry Card

Altair 8800b with 8800A μ P. This new Altair from *MITS (Albuquerque, NM)* has a completely redesigned front panel and new CPU in addition to the power supply and 18-slot mother board. The 8800A microprocessor has twice the instruction set of the 8080A with a 2- μ sec cycle time, can directly address 256 I/O devices and 65K of memory. Price is \$840 in kit and \$1100 assembled.

Circle No. 128 on Inquiry Card

RUGGED PRINTER

This 400-lpm matrix printer meets the requirements of MIL-E-16400 and NACSEM 5100. A unique dual format switch can change print formats from 80-column, 10 cpi to 132-column 17 cpi. *Miltope Corp., Melville, NY.*

Circle No. 148 on Inquiry Card

DUMB CRT KIT

Lear Siegler's dumb terminal (ADM-3) is available in kit form. The hobbyist can have a full 24-line, 12-inch screen capable of displaying 1920 uppercase characters for \$875. The 64-character set used in the ADM-3 CRT is generated by a 5x7 dot matrix. The kit comes with a CRT assembly, which is pre-mounted in the cabinet, and a display electronics assembly with pre-mounted keyboard control and power supply. Price of ADM-3 assembled is \$1280. *Lear Siegler, Inc., Anaheim, CA.*

Circle No. 132 on Inquiry Card

μP POWER SUPPLY

The SMP Series open-frame power supplies is compatible with the 6800, 8080, 9080, PACE, SC/MP and F8 microprocessor families. The multiple

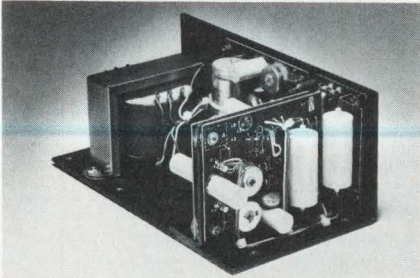

output units offer various combinations of 5, 9 and 12 vdc that directly interface with individual microprocessor operating levels. Single unit price is \$69. *Standard Power, Inc., Santa Ana, CA.*

Circle No. 136 on Inquiry Card

TAPE MODULE TRANSPORT

EMM's new transport doesn't use a cartridge or cassette, but a tape module that encloses 300 feet of 1/4-inch tape and a four-track head. The Bulk Data Storage Unit (BDSU) stores 16.8 megabits using industry standard block recording, or up to twice that capacity with high density techniques. Developed for severe environments, the BDSU is available in single, dual and custom transport configurations. The transport assembly houses the drive motor and electronics, and accepts the fully interchangeable plug-in tape module. Production deliveries of the BDSU will start about April 1977 at an OEM-quantity price of \$5000. Price of the tape module will be \$595. *Electronic Memories & Magnetics, Chatsworth, CA.*

Circle No. 156 on Inquiry Card

ROM CONTROL STORE FOR HP 21MX

With the HP 13047A control store board, the HP 21MX user has 2048 words of microcode storage, which allow him to implement the full 4K-word microcode. The board uses chips that can be programmed with a prom writer. The HP 13047A mounts directly into the I/O section of any 21MX processor. Price is \$450. *Hewlett-Packard Co., Palo Alto, CA.*

Circle No. 180 on Inquiry Card

TWO IN ONE CASSETTE

Into an aluminum suitcase, Qantex fits two 3M cartridge recorders, power supply, formatter and interconnecting cables. The Model 2710 has interfaces for DEC and DG minis, as well as the Intel 8080. Both recorders read and write at 1600 bpi, phase encoded. Price for dual recorder in single quantities is \$3900; a single recorder version is \$3100. *North Atlantic Industries, Inc., Qantex, Plainview, NY.*

Circle No. 159 on Inquiry Card

A GET ACQUAINTED OFFER 3 months - \$15

with this price you cannot afford to miss the newest service to the newest Billion-Dollar Industry:

mini-micro news

a fortnightly newsletter

MINI-MICRO NEWS is *Mini-Micro Systems'* fortnightly hotline serving the users, vendors, and observers of mini-computers, microcomputers, microprocessors, small business computers, miniperipherals, minisoftware, intelligent and remote batch terminals, word processing systems, data entry systems, industrial automation systems, and all of the variety of products which make this the most exciting of all industries.

NEWS / INTERPRETATION / ANALYSIS / FORECASTS

Flashing the news quickly to its readers is only one of the services of MINI-MICRO NEWS

Mini-Micro Systems has always been ahead of the field in perceiving long-term trends, in addition to its major strength in organizing and classifying the products in our fast-changing industry. *Mini-Micro Systems'* offspring, MINI-MICRO NEWS, reports and analyzes the up-to-the-minute news against the background of what we perceive to be the direction of the industry.

ALL THIS AND CPC TOO

The Computer Product-Line Clearinghouse, a constant feature of MINI-MICRO NEWS, provides, for the first time *anywhere in any industry*, a free medium of exchange between potential buyers and sellers of rights to product-lines, inventions, subsidiaries, whole companies, etc.

In the boom years to come, you can't afford to miss CPC.

Subscription Department

MINI-MICRO NEWS / 5 Kane Industrial Drive / Hudson, MA 01749

PAYMENT OF \$15 is enclosed.

I would like to subscribe for a full year at \$75.

NAME _____ TITLE _____

COMPANY _____

STREET _____

CITY _____ STATE _____ ZIP _____

NOTE: for air mail outside of US/Canada - add \$20.

book review

SYSTEMS DESIGN AND DOCUMENTATION — An Introduction to the HYPO Method by *Harry Katzan, Jr., Van Nostren Reinhold Co., New York. 151 pages plus index, \$12.50.*

Take a company organization chart. Erase the names, replacing the president's name with the name of a system (e.g., Payroll). Put the names of the functions that comprise the system where the names of the vice presidents used to be. For example, "Update Master File with Employee Status Changes" instead of "Vice President, Marketing." Replace "VP Administration and Finance" by "Capture Hours Worked." And so on. If you wish, go to the next level, filling in the names of subfunctions (e.g., Validate Input Format, Print Edit Listing) within each function. Now give each box a number. You have just completed the hierarchical (the "H" in HYPO) function chart for system design. Are you excited? No? Well, wait a bit. There's more.

Take a blank piece of 8-1/2 x 11-inch paper. Turn it sideways. Draw three vertical rectangles on the page, side-by-side, leaving about 1-1/2 inches between adjacent rectangles. Label the box on the left "Input," call the middle box "Process," and name the last box "Output." Draw a detailed information flow diagram for one function in the system (e.g., "Update Master File with Employee Status Changes") showing the various tasks comprising the functions, their inputs, and outputs. Connect the elements with lines and arrows. Be careful to leave inputs, outputs, and processes inside their respective large rectangles. Repeat the procedure for every other function in the system. If you wish, repeat the steps at the subfunction level. That's "YPO" of HYPO.

The name is new, but the game is the same. HYPO gives the systems programmer no additional advantages, but does offer some disadvantages. HYPO works for simple cascaded series of functions. But HYPO's constraints of putting all inputs on the left, all processes in the middle, and all outputs on the right can make a complex system seem worse than it is. To preserve the artificially imposed geometry, the designer winds up with an incomprehensible spider web of connecting lines. For complex systems, it is far better to arrange the process boxes on the page to minimize the crossing of lines as the Lord had originally intended. But if you're hyped anyway, get Katzan's book. In a few years, it's bound to be a collector's item — the last remaining shred of evidence that HYPO ever existed.

— Malcolm L. Stiefel

Malcolm L. Stiefel is a regular contributor to this magazine.

Question:

*How do you stay informed
in an industry
that never stops changing?*



Photo: IBM, Corp.

NEW

1. INFORMATION MANAGEMENT SYSTEMS: DATA BASE PRIMER

Vivian Prothro. Designed for the businessman considering a data base system, this heavily illustrated book outlines problems in file design and the overhead in processing, and also describes the best data base features relative to flexibility, simplicity, and practicality. Illus., 160 pp., 409-8, \$12.50, Oct. '76

NEW

2. INFORMATION AND DATA IN SYSTEMS

Borge Langefors and Kjell Samuelson. The newest volume in the Petrocelli/Charter Information System Series, this book provides a background for the design of information systems by presenting the elements of information and data as well as their uses. Illus., 192 pp., 349-0, \$14.95, Oct. '76

3. CDP REVIEW MANUAL: A DATA PROCESSING HANDBOOK

Roger A. MacGowan and Reid Henderson. Intended for use in preparation for advanced positions requiring greater breadth of EDP knowledge, for the CDP Examination or other exams involving data processing skills, this book is also a convenient single reference work covering all of the essential principles of data processing. Illus., 632 pp., 056-4, \$14.95

Answer:

Look to Petrocelli/Charter, the Computer Science Professionals,
for books covering every aspect of the field.

4. INFORMATION SYSTEMS ARCHITECTURE

Borge Langefors and Bo Sundgren. This is the first volume on a data base design that provides an integrated treatment of information and data elements, system structuring for data transport reduction, and data base file structuring. All explanations are computer independent. Illus., 366 pp., 300-8, \$19.95

5. BEST COMPUTER PAPERS—1975

Isaac L. Auerbach. A compendium of papers judged best among scores written in 1974. Twenty-three contributors represent a significant contribution to the state-of-the-art and to the growing literature on computer science. Illus., 257 pp., 319-9, \$17.50

6. PROJECT MANAGEMENT IN DATA PROCESSING

Susan Wooldridge. A handbook dealing with non-technical problems all managers face in the day-to-day course of their supervisory responsibilities. Valuable coverage is given to methods of preventing high turnover of staff, missed deadlines, exceeded budgets, and friction in working with other departments. Illus., 160 pp., 327-X, \$12.95

7. HOSPITAL COMPUTER SYSTEMS AND PROCEDURES, VOL. I: ACCOUNTING SYSTEMS

Raymon D. Garrett. This is the first volume in a unique series designed for the professional who must apply his knowledge of data systems to the specific task of automating hospital functions. Illus., 288 pp., 326-1, \$14.95

NEW

8. HOSPITAL COMPUTER SYSTEMS AND PROCEDURES, VOL. II: MEDICAL SYSTEMS

Raymon D. Garrett. Discusses in detail two common medical applications: the clinical laboratory and electrocardiographic processing. Problems are treated from the EDP viewpoint, with enough of the medical technology explained to make the procedures meaningful. Illus., 326 pp., 338-5, \$14.95

9. SYSTEMS AND MANAGEMENT ANNUAL—1975

C. West Churchman and Robert W. Wesner. Satisfies the urgent need for an authoritative up-to-date sourcebook of the current directions that this field may take in the future. Illus., 620 pp., 318-0, \$24.95

10. TOP-DOWN STRUCTURED PROGRAMMING TECHNIQUES

Clement L. McGowan and John R. Kelly. Addressed primarily to programmers. The first book to define structured programming—computer science's newest methodology—and set forth its application. "I would recommend that every programming organization obtain copies of this book and make it mandatory reading for anyone connected with computer activity."—Datamation. Illus., 288 pp., 304-0, \$14.95

11. STRATEGIC PLANNING OF MANAGEMENT INFORMATION SYSTEMS

Paul Siegel. A basic guidebook for the executives, computer scientists and other system-oriented specialists planning a management information system. Illus., 320 pp., 279-6, \$16.95

12. LINEAR OPTIMIZATION FOR MANAGEMENT

Sang M. Lee. The first book to provide an introductory, comprehensive and up-to-date treatment of linear optimization techniques for managerial decision-making. Includes: an up-to-date presentation of goal programming at the introductory level, applications derived from real-world problems, and an analysis of problems through the computer. Illus., 448 pp., 322-9, \$14.95

13. THE DESIGN OF MANAGEMENT INFORMATION SYSTEMS, 2ND ED.

Don Q Matthews. This newly revised edition of the best selling Design of Management Information Systems brings management into contact with the computer system as the optimum tool for obtaining objectives through an efficient flow of information. Expanded to include such up-to-date topics as system concepts, security, privacy, and interactive systems. Illus., 221 pp., 320-2, \$12.95

14. GERT MODELING AND SIMULATION: FUNDAMENTALS AND APPLICATIONS

Laurence J. Moore and Edward R. Clayton. The book examines the basic concepts of GERT modeling while presenting the necessary information for using the GERT-III simulation package and a description of the output provided by the program. Especially for the analysis of the stochastic (probabilistic) systems. Illus., 230 pp., 328-8, \$14.95

15. RELIABLE SOFTWARE THROUGH COMPOSITE DESIGN

Glenford J. Myers. A set of design measures strategies, and techniques for designing reliable software. Illus., 160 pp., 284-2, \$11.95

From the 100 Best Books of 1974* . . .

16. INFORMATION TECHNOLOGY: THE HUMAN USE OF COMPUTERS

Harry Katzan, Jr. The computer as friend and ally . . . a top technocrat's look at the electronic marvel that is here to stay. Covers the impact of computers on people, basic computing concepts, and programming languages. 200 pp., 059-9, \$12.95

17. SO YOU'RE GOING TO AUTOMATE

Jack Munyan. Invaluable primer for controllers, small businessmen, and accountants. Sets forth guidelines to be used when converting from a manual (semi-automated) accounting system to a fully automated accounting system. Points out potential problems and how to avoid them. Includes DO's and DON'Ts for converting six major accounting functions: accounts receivable, accounts payable, payroll, cost center analysis, inventory control, and general ledger. 271 pp., 317-2, \$10.00

18. HOW TO USE POCKET CALCULATORS

Pierre R. Schwob. Provides fundamental methods of using a pocket calculator with four standard features (+, -, ×, ÷), floating decimal point, automatic constant, and algebraic logic. The material is subdivided by approaches to particular types of problems: the solution of percentages; banking and financial problems; measurement conversions; probability and statistical calculations. Illus., 176 pp., 335-0 \$10.95

See inside back cover
to order.



PETROCELLI/CHARTER

a division of Mason/Charter Publishers, Inc.

MECHANICAL DESIGN ON CYBERNET

A Mechanical Design Library developed by Cincinnati (OH)-based Structural Dynamics Research Corporation is available in interactive or batch mode on CDC's Cybernet. The 66 structural and mechanical engineering programs are grouped into five categories, including section analysis, frame analysis, rotating machinery analysis, system simulation and data analysis, and general purpose structural analysis. *Control Data Corp., Minneapolis, MN.*

Circle No. 214 on Inquiry Card

μP DESIGN COURSES

Pro-Log's three-day courses will teach hardware designers how to design and properly document microprocessor-based systems. The courses use several Pro-Log microprocessor systems to give each attendee hands-on experience with the widely used four-bit 4004 or eight-bit 8080 microprocessors. Courses will be held throughout the country through December. Price for tuition and materials is \$300. *Pro-Log Corp., Monterey, CA.*

Circle No. 202 on Inquiry Card

DATAPPOINT COBOL

Datapoint Cobol is an implementation of ANSI-68 Cobol (Levels 1 and 2) with selected ANSI-74 features also included. Cobol programs compile on Datapoint's 5548 Advanced Business Processor (48K user memory) with disk storage. Any 5500 processor can execute the programs. One-time charge is \$2500 plus \$20 per month for maintenance support and documentation. *Datapoint Corp., San Antonio, TX.*

Circle No. 203 on Inquiry Card

ANTI-FRAUD SERVICE

Software Review Corp. has a group of experienced programmers who read client software to detect fraud and determine program quality. Each programmer has a minimum of 10 years applications programming experience. Fees for the service can be on a daily consulting basis or a yearly retainer basis. *Software Review Corp., York, PA.*

Circle No. 215 on Inquiry Card

2260 EMULATOR

The Raytheon Remote Emulator System emulates IBM's 2260 Display System on the company's PTS-100 intelligent terminal. A single cartridge disk drive stores the host-provided screen formats and transactions — all compatible with 2260 protocol. *Raytheon Data Systems, Norwood, MA.*

Circle No. 205 on Inquiry Card

VARIAN REMOTE JOB ENTRY

Varian's TEN 04/RJE allows a Varian computer to functionally emulate a Univac 1004 remote job entry terminal. Using the TEN 04/RJE, the Varian computer can communicate with the Univac computer and perform local processing concurrently. Price is \$2500. *Varian Data Machines, Irvine, CA.*

Circle No. 211 on Inquiry Card

UTILITY PROGRAMS FOR INTEL

The ISIS utility programs augment the Intel MDS 800 ISIS DOS program development system capabilities. They perform memory loading, memory dumping, disk file listing and diagnostic-only program assembly functions. Program object code is delivered on an Intel MDS 800 ISIS DOS-compatible floppy with detailed usage instructions. Price is \$35 per program plus a \$30 diskette preparation charge. *Tempress Microelectronics, Los Gatos, CA.*

Circle No. 207 on Inquiry Card

STRUCTURED PROGRAMMING FOR DG

SFORT implements a superset of Fortran, allowing "GOTO-less" programming using statements like: IF, ELSE, ENDIF, DOFOR, DOWHILE, DOUNTIL, PROCEDURE, and PERFORM. Other statements control the program listing. The program runs on any Data General Nova or Eclipse computer under RDOS Rev. 3 and higher, in 20K of memory. Price is \$975 for mag tape or perpetual lease. *Hycom, Inc., Irvine, CA.*

Circle No. 206 on Inquiry Card

EASY RETRIEVAL

EASY (Exception Analysis System) is a data base retrieval system for Basic/Four computers. It's not a language, since there aren't any intricate grammatical formats, protocols, or procedures to be memorized. Instead instructions use words like COST, PROFIT and PRICE. Using the step-by-step procedure, the user only has to respond to a few questions in order to create a totally new report. *Basic/Four Corp., Los Angeles, CA.*

Circle No. 212 on Inquiry Card

INTERDATA FORTRAN VI

Interdata's Fortran VI for its 32-bit Megamini is a superset of ANSI Standard X3.9-1966 with a full range of real-time extensions. It has powerful Debug facilities. Run-time options include Batch, which compiles programs in a batch environment; Test, which checks for subscript limits; and Trace, which allows variable tracing. Price is \$500. *Interdata, Oceanport, NJ.*

Circle No. 204 on Inquiry Card

μP CROSS ASSEMBLER

The MINmic 1165 cross assembler for MOS Technology family of microcomputers runs under the DEC's RT 11 operating system for the PDP-11. Written in Macro 11 assembler language, it requires less than 5K words for a minimum system. The cross assembler is similar to the Fortran-based cross assemblers developed by Compas and offered by MOS Technology. Price is \$900. *Computer Applications Corp., Ames, IA.*

Circle No. 209 on Inquiry Card

SYSTEM/32 LAW

Law firms are the newest area for IBM's System/32 applications. The Management System for Law Firms helps with client accounting and bill preparation. It prepares billing memos with detailed time and disbursement data necessary to prepare billings; missing time reports that identify unreported, possible overlooked, billable time; accounts receivable reports and variance reports showing law firm time investment compared to actual amount received. The Law Firm System is a companion to the recently introduced Word Processor/32. Initial charge is \$2640 and monthly license charge is \$120. *International Business Machines Corp., Atlanta, GA.*

Circle No. 201 on Inquiry Card

μP COMPILER

A general purpose microprogramming language for four-bit slice microprocessors is accessible via Remote Computing Corp.'s nationwide toll free network. DAPL currently supports the AMD2900 and Fairchild 9400, and will soon support the Motorola 10800 and MMI 6700. The microprogrammer can select any of four levels of symbols. At Level 0, the microinstructions are formed by sequences of symbolic names, binary, octal, decimal, and hexadecimal numbers. At Level 3, the microprograms can be expressed in register transfer notation. *Remote Computing Corp., Los Angeles, CA.*

Circle No. 208 on Inquiry Card

DISPLAY PROGRAM GENERATOR

The TAPGEN program generator for display terminals produces a COBOL-CICS program, a TAPGEN listing, a COBOL-CICS listing, several documentation listings and all phases required for the screen maps. With the Terminal Applications Program Generator, users can also develop data gathering systems, inquiry systems and conversational systems. TAPGEN supports IBM 2260, 2741, 3270 and 3284 terminals. Perpetual license fee is \$24,000. *C-S Computer Systems, Inc., New York, NY.*

Circle No. 213 on Inquiry Card

MINI SUPPLIES

Save money on disks, tape and printer ribbons and paper by buying from a media distributor. Twelve product sheets list media accessories for today's minicomputers. *Associated Computer Products, Trumbull, CT.*

Circle No. 258 on Inquiry Card

TAPE TRANSPORT OEM USERS MANUAL

Systems engineers can learn how to design and install an interface for Perdec's 48-vdc digital magnetic tape transports in this 20-page brochure. A number of illustrations and tables make it easy to "do it yourself." *Perdec Corp., Chatsworth, CA.*

Circle No. 263 on Inquiry Card

GA MICROCOMPUTERS

Complete technical information on the hardware and software capabilities of General Automation's 16-bit LSI microcomputers is provided in this 24-page brochure. Advanced microcomputer software - Cobol, Fortran, Basic, File Manager, Spooler and Operating Systems - is also discussed. *General Automation, Inc., Anaheim, CA.*

Circle No. 264 on Inquiry Card

INTELLIGENT CRT

Raytheon's PTS-100 programmable terminal system is the subject of this four-color, 12-page brochure. PTS-100 hardware and software, including emulation packages for the IBM 2260/2848, 3270, 2946/4505 or 2948/2915 (PARS and IPARS), are covered. Raytheon's PTS/1200 distributed processing system is also described. *Raytheon Co., Lexington, MA.*

Circle No. 278 on Inquiry Card

DG DATA COMMUNICATIONS

Minicomputer-based front end processing systems, message concentrator systems, message and packet switchers and terminal systems are featured in this 12-page brochure. Photographs show Data General users' data communications applications, and configuration diagrams illustrate the various methods of network implementation. *Data General Corp., Southboro, MA.*

Circle No. 251 on Inquiry Card

μ P-BASED PRINTERS

Qume uses a single-chip MOS/LSI microprocessor to reduce system electronics to three simple snap-in modules and perform self-testing of itself and ROM memory, carriage, print wheel, paper feed and ribbon advance. The advantages of a micro-based printer to word processing and data systems manufacturers are discussed in this six-page brochure. *Qume, Hayward, CA.*

Circle No. 262 on Inquiry Card

DATA ENTRY SOFTWARE

Incoterm's new Series 30 and Series 40 Intelligent Terminals have a new software package - IDES - described in this eight-page brochure. The Level II software package is designed for the branch office requirements of forms creation, editing and data transmission. *Incoterm Corp., Wellesley, Hills, MA.*

Circle No. 268 on Inquiry Card

MODEM FOR THE COST-CONSCIOUS

A reconditioned 2400-bps modem is described in this two-page data sheet. The Modem 3300/24 carries a new warranty and has features such as self-testing, dial backup and reverse channel. The modem sells for \$995. *International Communications Corp., Miami, FL.*

Circle No. 272 on Inquiry Card

DATA ACQUISITION

Honeywell's Supervisory Control and Data Acquisition System (SCADA) is described and illustrated in this 12-page brochure. Specifications and a typical SCADA configuration are included. The SCADA system is designed to improve operating efficiency, economy and security in power-delivery applications. *Honeywell, Inc., Phoenix, AZ.*

Circle No. 276 on Inquiry Card

NOT FREE, BUT AFFORDABLE

μ P Applications. This 56-page plan book deals primarily with the design and documentation of 4004 and 4040 microprocessor systems, but is written in terms general enough to be applicable to most other microprocessor systems, as well. As a companion book to Pro-Log's earlier designer's guide, the plan book contains numerous sample programs and experiments, demonstrating programming and program/hardware integration. Price of the plan and designer's book is \$5 each. Write *Pro-Log Corp., 2411 Garden Rd., Monterey, CA 93940.*

Remote Software Directory. This looseleaf guide of remote-access packaged software contains a package description, vendor information, software features, accessibility and where possible cost data. Vendor office addresses and local phone numbers are kept up to date in the reference section. Most programs are inquiry-oriented using an English-like language. The guide is available on a mail-order basis with the first three bi-monthly updates included in the postage prepaid cost of \$28 from *Gregory Research Associates, 1900 Greymont St., Philadelphia, PA 19116.*

TELEPRINTER SOUND ENCLOSURES

Terminal Data Corp.'s line of sound enclosures for all the leading teleprinters, word processing systems and computer printers is described in this four-page data sheet. Included are enclosures for ASR-28, -33, -37 Teletypes; IBM MC/ST, MT/ST; Xerox 800 and Centronics printers. *Terminal Data Corp., Rockville, MD.*

Circle No. 280 on Inquiry Card

BANK TERMINALS

The new generation in banking is featured in this eight-page brochure. Described is Incoterm's Series 7700 Retail Banking Subsystems, including in-lobby customer transaction facilities and cash delivery facilities as well as an integrated banking facility for through-the-wall installation. *Incoterm Corp., Wellesley Hills, MA.*

Circle No. 282 on Inquiry Card

PERTEC DISK CARTRIDGE REQUIREMENTS

The 15-page comprehensive application note covers disk cartridge storage capacity, storage and handling procedures and electrical signal characteristics required for Perdec's D36XX disk drives. Eight diagrams illustrate the cartridge and disk assembly. *Perdec Corp., Chatsworth, CA.*

Circle No. 283 on Inquiry Card

TEST AND MEASUREMENT RENTAL

This illustrated 52-page directory lists thousands of electronic test items from over 100 manufacturers and includes monthly, quarterly, and semi-annual rental rates. Types of available equipment include signal conditioners, amplifiers analyzers, calculators and computer-related equipment. *Electro Rent Corp., Mountain View, CA.*

Circle No. 271 on Inquiry Card

BURROUGHS' SELF SCAN

Burroughs' small plasma display is described in this six-page brochure. Self-Scan II is compared with CRT displays according to cost, design and performance features. Self-Scan II is available with 40 to 480 characters. *Burroughs Corp., Plainfield, NJ.*

Circle No. 265 on Inquiry Card

WANG'S PORTABLE

The 2200 Portable Computing System is Wang's alternative to IBM's 5100. This four-page brochure discusses the options and peripherals of the extended Basic system. *Wang Laboratories, Inc., Tewksbury, MA.*

Circle No. 266 on Inquiry Card

DATASCOPE
a new diagnostic tool for
data communications systems

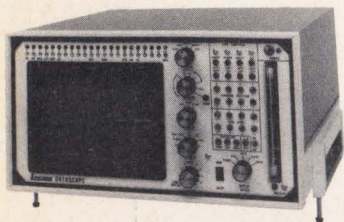

Operates on-line to:
MINIMIZE DOWNTIME
PINPOINT SYSTEM
FAILURES
DEBUG SOFTWARE

- Provides CRT display of every data link character, sent or received
- Simultaneous full duplex data stream tape recording
- Accepts all codes, line disciplines and speeds up to 9600 bps
- Switch selectable alphanumeric or hexadecimal display
- Monitors full and half duplex circuits
- Printed record available on standard teletype printer
- Designed for operating personnel, programmers and engineers
- Compatible with EIA Interface RS-232
- Lamp display of all EIA Interface signals
- Complete electrical isolation from monitored channel
- Lightweight portability . . . single compact unit
- Simple, straight forward connection



CHURCH ROAD & ROLAND AVENUE
MOORESTOWN, N. J. 08057
609 - 234 - 5700

CIRCLE NO. 59 ON INQUIRY CARD

**index to
advertisers**

ADDMASTER CORP.	67
ADVANCE ACCESS GROUP	67
ADVANCED ELECTRONICS DESIGN, INC	59
APPLIED DATA COMMUNICATIONS	46
AUERBACH PUBLISHERS INC	70
BEEMAK PLASTICS.	34
CFI MEMORIES, INC	21, 22, 23, 24, 25, 26, 27
CODEX CORP	Cover 2
COMPUTER DEVICES INC.	57
COMPUTER SECURITY INSTITUTE.	48, 49
DATA GENERAL	9, 33
DATA SYSTEMS.	73
DELTA DATA SYSTEMS CORP.	61
DIGITAL COMPUTER CONTROLS INC	1
DIVA, INC.	63
DONALD INC.	64
EAGLE-PICHER INDUSTRIES, INC	38
ELECTRONIC MEMORIES & MAGNETICS COMMERCIAL MEMORY PRODUCTS	35
EMERSON ELECTRIC CO. UPS MARKETING	4
EPSON AMERICA, INC	47
FACIT	65
GENERAL ELECTRIC CO	28, 29
HAZELTINE CORP	Cover 4
HONEYWELL INFORMATION SYSTEMS.	41
IBM CORP.	13, 14, 15, 16
INTERFACE '77	10
INTERMEDIA SYSTEMS	69
INTERNATIONAL COMMUNICATIONS CORP.	Cover 3
LA MONTE TRADING CO	62
MFE CORP	62
MITS, INC.	18, 19
MEDIA III.	12
MICROCOMPUTER SYSTEMS.	30
MINICOMPUTER ACCESSORIES	54
MINI-MICRO SYSTEMS.	75
MODERN DATA SERVICES, INC.	68
NASHUA CORP	45
NATIONAL SEMICONDUCTOR CORP.	42, 43
NORMAN POWERS ASSOCIATES	50
PARADYNE CORP.	37
PERKIN-ELMER DATA SYSTEMS	11
PETROCELLI/CHARTER.	76, Tab Card between Cover 3 & Page 80
PFYSTAR MICROCOMPUTER PRODUCTS	51
ROBINS INDUSTRIES CORP. DATA PRODUCTS DIV	50
SPECTRON CORP	80
SPHERE CORP	55
SSC CORP.	69
SYSTEM INDUSTRIES	71
TAB PRODUCTS CO.	31
TANDEM COMPUTERS, INC.	2
TELETYPE CORP	39
TEXAS INSTRUMENTS INC.	6, 7
TRI-DATA.	40
WESTERN PERIPHERALS	51
XEBEC SYSTEMS INC	5
ZENTEC CORP	53