

AMPEX

ADO[®] 100
Operation

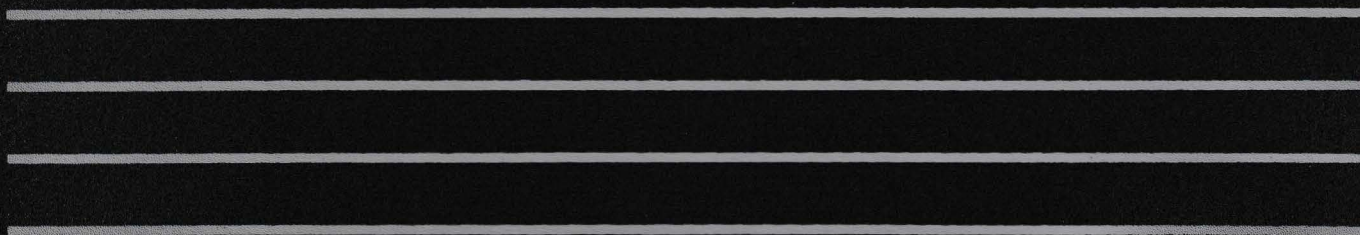

AMPEX

ADO[®] 100

Digital Special Effects System

Operation



Catalog No. 1809824-01

Issued: May 1989

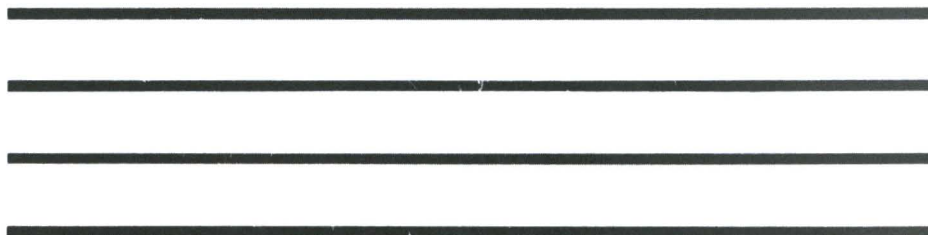

Prepared by

Ampex Corporation Technical Publications

Ampex Corporation
581 Conference Place
Golden, Colorado 80401

© 1989 Ampex Corporation
All rights reserved.
Catalog No. 1809824-01
Issued: July 1988
Printed in the U.S.A.

Technical Information

The Ampex Corporation's Technical Support Groups publish Field Engineering Bulletins (FEBs), Software Bulletins, and Instructional Packages describing approved equipment modifications, special tools and accessories, plus information on improved operating and maintenance techniques.

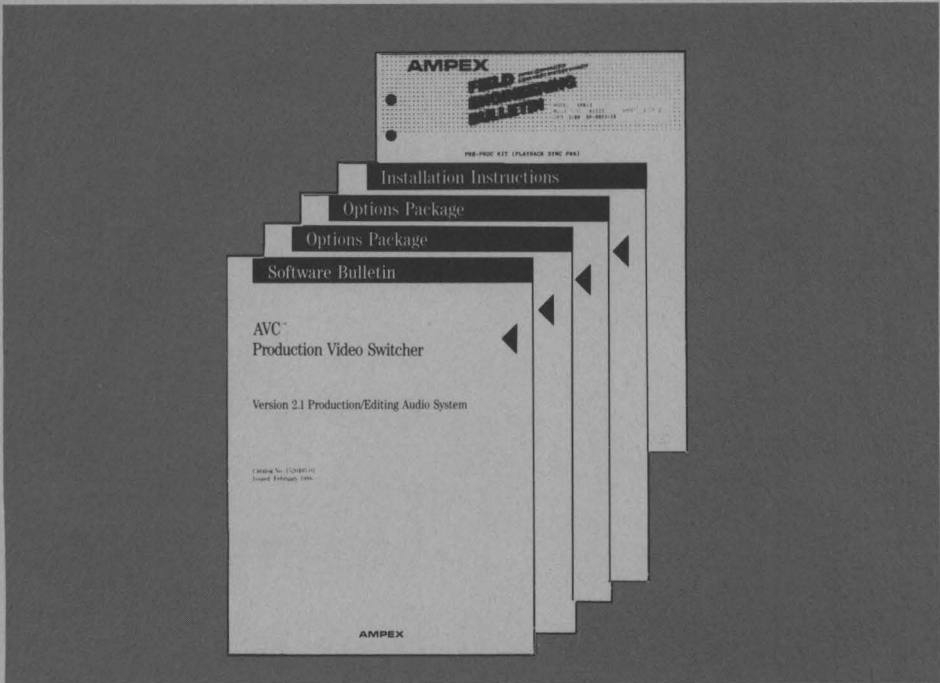

**To Receive These Bulletins Within
the Continental United States, Contact:**
Ampex Corporation
Technical Support Group
401 Broadway, M.S. 3-30
Redwood City, CA 94063-3199

**To Receive These Bulletins
Outside the United States,
Contact Your Nearest Sales Company
(See Page IV).**

Training Services

Technical (maintenance) training on this and other Ampex video, audio, disc, and instrumentation products is offered on a scheduled basis at Corporate Headquarters in Redwood City, California, and at Headquarters European Area in Reading, England. For further information regarding this training, please contact your local Ampex Sales Office.

Sales/Service Offices

United States

CALIFORNIA

Ampex Corporation
340 Parkside Drive
San Fernando, CA 91340-3098
(818) 365-8627
(818) 365-6139 (FAX)

401 Broadway
Redwood City, CA 94063-3199
(415) 367-2202

COLORADO

581 Conference Place
Golden, Colorado 80401
(303) 279-1300
(303) 279-2209 (FAX)

GEORGIA

1872 Montreal Road
Tucker, GA 30084-5709
(404) 491-7112
(800) 241-3258
(404) 496-1848 (FAX)

ILLINOIS

719 W. Algonquin Road
Arlington Heights, IL 60005-1448
(312) 593-6000

MARYLAND

10215 Fernwood Road
Bethesda, MD 20817-1198
(301) 530-8800
(301) 530-6092 (FAX)

NEW JERSEY

5 Pearl Court
Allendale, NJ 07401-1678
(201) 825-9600
(201) 825-3129 (FAX)

TEXAS

3353 Earhart Drive
Carrollton, Texas 75006-5027
(214) 960-1162
(214) 239-1667 (FAX)

WASHINGTON

6627 S. 191st Place, Suite F-101
Kent, Washington 98032
(206) 251-8182
(206) 251-8684 (FAX)

AMPEX CORPORATION
401 BROADWAY
REDWOOD CITY, CALIFORNIA 94063
(415) 367-2011

EFFECTIVE: DECEMBER 1988

International

AUSTRALIA

Ampex Australia Pty. Ltd.
P.O. Box 199
55-61 Talavera Road, Unit A
North Ryde, 2113
New South Wales, Australia
21 Terra-Cotta Drive
Blackburn
Victoria, Australia

BELGIUM

Ampex S.A. Nivelles
Rue du Progres 10
1400 Nivelles, Belgium

BRAZIL

Ampex do Brasil Electronica Ltda.
Avenida Portugal 54
Urca CEP 22291
Rio de Janeiro, RJ Brazil

CANADA

Ampex Canada Inc.
1770 Argenta Road
Mississauga, Ontario
L5N 3S7, Canada
1116-55 Avenue, N.E.
Calgary, Alberta
T2E 6Y4, Canada
729 Meloche Street
Dorval Quebec
H9P 2S4, Canada

COLOMBIA

Ampex De Colombia, S.A.
Apartado Aereo 29613
Carrera 16A Nr. 79-25
Bogota, Colombia

ENGLAND

Ampex International, EAME HQ
Acre Road, Reading
Berkshire, RG2 0QR, England

FRANCE

Ampex S.A.R.L.
Courcellor I
2 Rue Cumonsky
75017 Paris, France

GERMANY

Ampex Europa GmbH
Walter-Kolb-Strasse 9-11
6000 Frankfurt (Main) 70
West Germany

HONG KONG

Ampex World Operations, S.A.
709-711 World Finance Centre
(North Tower), Harbour City
Canton Road, Tsim Sha Tsui
Kowloon, Hong Kong

ITALY

Ampex Italiana S.p.A.
Casella Postale 10720
Roma-EUR
Italy
Ampex Italiana S.p.A.
Via Riccardo Gigante, 4
00143 Rome, Italy
Ampex Italiana, S.p.A.
Via Cristoforo Colombo, 49
20090 Trezzano Sul Naviglio
Milano, Italy

JAPAN

Ampex Japan Ltd.
P.O. Box 15
Tokyo Ryutsu Center, 6th Floor
6-1-1 Heiwajima, Ota-ku
Tokyo 143, Japan

MEXICO

Ampex de Mexico, S.A. De C.V.
Apartado Postal No. 13-615
Cerro del Otate 133
Col. Pedregal de San Francisco
Delegacion Coyoacan
Mexico D.F., 04320

NETHERLANDS

Ampex B.V.
P.O. Box 9026
3506 GA Utrecht, Netherlands
Colorado-Dreef 36
3565 BV Utrecht, Netherlands

NEW ZEALAND

Ampex New Zealand
MSAS House
7 Freight Place
Mangere, Auckland
New Zealand

SPAIN

Ampex Iberia S.A.
Calle Princesa No. 47
5th Floor C & D
Madrid 8, Spain

SWEDEN

Ampex Scandinavia A.B.
P.O. Box 7056 (Rissneleden 8)
S-172 07 Sundbyberg, Sweden

SWITZERLAND

Ampex World Operations S.A.
P.O. Box 1031
15 Route des Arsenaux
1701 Fribourg
Switzerland

VENEZUELA

OTACCA AMPEX
Apartado 76825
Caracas 1070-A
Venezuela

Safety and First Aid Suggestions

Regardless of how well electrical equipment is designed, personnel can be exposed to **dangerous electrical shock** when protective covers are removed for maintenance or other activities. Therefore, it is incumbent on the user to see that all safety regulations are consistently observed and that each individual assigned to the equipment has a clear understanding of the first aid related to electrical hazards.

In addition, the following safety practices must be followed:



Do not attempt to adjust unprotected circuit controls or to dress leads with power **on**.



Always avoid placing parts of the body in series between ground and circuit points

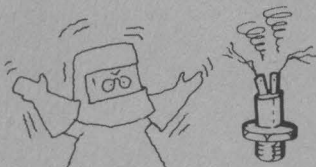

To avoid burns, do not touch heavily loaded or overheated components without precaution.

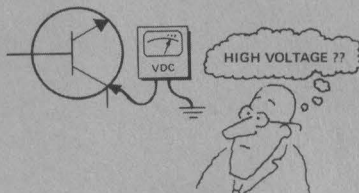

Remember that some semiconductor cases and solid-state circuits carry high voltages.



Do not assume that all danger of electrical shock is removed when power is **off**. Charged capacitors can retain dangerous voltages for a long time after power is turned off. These capacitors should be discharged through a suitable resistor before any circuit points are touched.

If someone seems unable to free himself while receiving an electrical shock, **turn power off** before rendering aid. Muscular spasm or unconsciousness can make a victim unable to free himself from the electrical power.



Don't take chances. Be fully trained. Ampex equipment should be operated and maintained by fully qualified personnel.

WARNING

DO NOT TOUCH VICTIM OR HIS CLOTHING BEFORE POWER IS DISCONNECTED OR YOU CAN ALSO BECOME A SHOCK VICTIM.

If power cannot be turned off immediately, **very carefully** loop a length of dry nonconducting material (such as rope, insulating material, or clothing) around the victim and pull him free of the power. Carefully avoid touching him or his clothing until free of power. Immediately start the appropriate first aid procedures.

Good Practices

In maintaining the equipment covered in this manual, please keep in mind the following, standard good practices:

When connecting any instrument (oscilloscope, waveform, monitor, etc.) to a high-frequency output, use the appropriate termination resistor at the input of the instrument, unless the instrument is terminally internally.

When inserting or removing printed wiring assemblies (PWAs), cable connectors, or fuses, always turn off power to the affected portion of the equipment. After power is removed, allow sufficient time for the power supplies to bleed down before reinserting PWAs.

When troubleshooting, remember that FETs and other metal-oxide semiconductor (MOS) devices may appear defective because of leakage between traces or component leads on the printed wiring board. Clean the printed wiring board and recheck the MOS device before assuming it is defective.

When replacing MOS devices, follow standard practices to avoid damage caused by static charges and soldering.

When removing components from PWAs (particularly ICs), use care to avoid damaging PWA traces.

Warning

This equipment generates, uses, and can radiate radio frequency energy and, if not installed and used in accordance with the instruction manual, may cause interference to radio communications. It has been tested and found to comply with the limits for a Class A computing device pursuant to Subpart J of Part 15 of FCC rules, which are designed to provide reasonable protection against such interference when operated in a commercial environment. Operation of this equipment in a residential area is likely to cause interference, in which case, the user, at his own expense, will be required to take whatever measures may be necessary to correct the interference.

Note

This system was tested using the shielded interconnect cables provided with the unit. Failure to use the cables provided may result in radio interference outside acceptable limits.

TABLE OF CONTENTS

Paragraph Number	Title	Page Number
------------------	-------	-------------

Section 1 General Information

1.1	Purpose and Scope Of Manual	1-1
1.2	Related Publications	1-1
1.3	General Description	1-2
1.4	System Configuration	1-3
1.5	AVC Vista Integration	1-4
1.6	Real Time Image Transformation	1-5
1.7	CCIR-601 4:2:2 Component Digital Processing	1-5
1.8	Digi-Matte Processor	1-6
1.9	Effects Storage	1-6

Section 2 Programming Effects

2.1	Introduction	2-1
2.2	3D Space Definitions	2-1
2.3	Source Space/Source Image	2-2
2.4	Target Space/Target Image	2-2
2.5	The ADO 100 World Model	2-2
2.6	Multi-pass and Global Motion Control	2-4
2.7	Basic 2D Rotation System Transformation Capabilities	2-4
2.8	3D Option Image Transformation Capabilities	2-5
2.9	Image Innovator Option Capabilities	2-6
2.10	Advanced Programming Capabilities	2-7
2.11	Programming Effects	2-7
2.12	Keyframes	2-7
2.13	Motion Path Types	2-8
2.14	Effect Recall and Running	2-10

TABLE OF CONTENTS
(continued)

Paragraph Number	Title	Page Number
Section 3 Control Console Controls		
3.1	Introduction	3 -1
3.2	Single Function Controls	3 -2
3.2.1	Joystick	3 -2
3.2.2	Fader Bar	3 -3
3.2.3	Numeric Keypad	3 -3
3.2.4	Dedicated Switch Group	3 -3
3.2.5	The ENTER key	3 -4
3.2.6	The CANCEL key	3 -4
3.3	Graphic Display and Adjust Keys	3 -4
3.3.1	Graphic Display	3 -4
3.3.2	Graphic Display Screen Layout	3 -5
3.3.3	Adjust keys and Softkeys	3 -6
3.3.3.1	Switch Adjustment Rate	3 -6
3.3.4	The <KEYF> and <RUN> keys	3 -6
3.4	Keyframe Parameter Selection Area Controls	3 -7
3.5	Center Screen Area	3 -8
Section 4 Operation		
4.1	Introduction	4-1
4.2	Menu Organization	4-1
4.2.1	Effect Edit Menus and Submenus	4-2
4.3	System Power Up	4-2

TABLE OF CONTENTS
(continued)

Paragraph Number	Title	Page Number
Section 4 Operation (continued)		
4.3.1	System Reset	4-3
4.3.2	Align the Joystick and Fader Bar	4-3
4.3.3	Changing to the Edit Menus	4-3
4.4	Target Menu	4-4
4.4.1	Background Submenu	4-5
4.5	Rotate Menu	4-6
4.6	Border Menu	4-7
4.6.1	Adjust Border Sides Submenu	4-8
4.7	Source Menu	4-9
4.7.1	Adjust Source Crop Submenu	4-10
4.8	Digimatte Menu	4-11
4.8.1	Digi-Matte Mask Submenu	4-12
4.9	Timeline Menu	4-13
4.10	KF Flags Menu	4-14
4.11	Locate Menu	4-15
4.11.1	3D Axis Submenu	4-16
4.12	Perspective Menu	4-17
4.13	Mosaics Menu	4-18
4.13.1	Adjust Mask Submenu	4-20
4.14	Softkey Submenus	4-21

TABLE OF CONTENTS
(continued)

Paragraph Number	Title	Page Number
Section 5 Disk Usage		
5.1	Introduction	5-1
5.2	Use of Floppy Disks	5-1
5.3	Disk Handling and Storage	5-2
5.4	Formatting Disks	5-4
5.5	Disk Facilities	5-4
5.6	Effect Cataloging	5-4
5.7	Listing Effects on Disk	5-5
5.8	Recalling Effects from Disk	5-5
5.9	Erasing an Effect or Group	5-6
5.10	Storing Effects to Disk	5-6
5.11	Naming and Numbering Effects	5-6
Section 6 Communications and Set-up Mode		
6.1	Introduction	6-1
6.2	Set-Up Mode	6-1
6.3	Set-Up Mode Access	6-1
6.4	System Timing Adjustment Menus	6-1
6.4.1	Video Input Menu	6-2
6.4.2	Video Output Menu	6-4
6.4.3	Blanking Submenu	6-6
6.4.4	Digimatte Menu	6-7
6.4.5	Key Output Menu	6-8
6.5	System Configuration Menu	6-9
6.6	Disk Formatting	6-10
6.7	Storing changes to the Set-Up menus	6-10
6.8	Exiting the Setup Mode	6-10

TABLE OF CONTENTS
(continued)

Paragraph Number	Title	Page Number
	Appendix	
Specifications		A-1

LIST OF ILLUSTRATIONS

Figure Number	Title	Page Number
Section 1 General Information		
1-1	ADO 100 System Configuration	1-3
1-2	System Configuration including Optional Vista Console and VistaDisk	1-4
Section 2 Programming Effects		
2-1	Axis Definition	2-1
2-2	The ADO 100 System world model	2-3
2-3	Multi-pass and Global Motion Control	2-4
2-4	Motion Path Types	2-10
Section 3 Control Console Controls		
3.1	ADO 100 Control Console Layout	3 -1
3.2	Manual operation of joystick	3 -2
3.3	Effect Edit Menu Display Sections	3 -5
3.4	Keyframe Parameter Selection Area	3 -7
3.5	Center Screen Area	3 -8
3.6	Keyframe Parameter Adjust Area	3 -9
3.7	Adjust Border Submenu	3 -10
3.8	Softkeys	3 -11
Section 4 Operation		
4.1	Menu Organization	4-1
4.2	ADO 100 System Copyright Menu	4-2
4.3	Control Console Reset	4-3
4.4	The Target Menu	4-4
4.5	The Background Submenu	4-5

LIST OF ILLUSTRATIONS
(continued)

Figure Number	Title	Page Number
4.6	The Rotate Menu	4-6
4.7	The Border Menu	4-7
4.8	The Side Submenu	4-8
4.9	The Source Menu	4-9
4.10	The Source Crop Submenu	4-10
4.11	The Digimatte Menu	4-11
4.12	The Digimatte Mask Submenu	4-12
4.13	The Time Menu	4-13
4.14	The KF Flags Menu	4-14
4.15	The Locate Menu	4-15
4.16	The 3D Axis Submenu	4-16
4.17	The Perspective Menu	4-17
4.18	The Mosaic Menu	4-18
4.19	The Adjust Mask Submenu	4-20
4.20	EFFT Submenu Area	4-21
4.21	CHAN Submenu Area	4-22
4.22	PATH Submenu Area	4-23
4.23	COPY Submenu Area	4-24
4.24	DEL Submenu Area	4-25
4.25	TRIM Submenu Area	4-26
4.26	KYPD Submenu Area	4-27
4.27	CLR Submenu Area	4-27

LIST OF ILLUSTRATIONS
(continued)

Figure Number	Title	Page Number
Section 5 Disk Usage		
5-1	Loading Disk Drive and Setting Write Enable Switch	5-1
5-2	Disk Handling and Storage	5-3
5-3	The Disk Menu	5-5
5-4	The Disk Store Menu	5-6
5-5	Changing effect or group name	5-7

Section 6 Communications and Set-up Mode

6-1	Video Input Menu	6-1
6-2	Video Output Menu	6-4
6-3	Blanking Submenu	6-6
6-4	Digimatte Menu	6-7
6-5	Key Output Menu	6-8
6-6	Configuration Menu	6-5

LIST OF TABLES

Table Number	Title	Page Number
Appendix		
A-1	Specifications	A-1

SECTION 1

GENERAL INFORMATION

1.1 Purpose and Scope Of Manual

This manual provides information for the operation of the Ampex ADO 100 Digital Optics system. It is intended as a step-by-step guide for first-time operators, and as a reference guide for experienced operators. This manual applies to all ADO 100 system configurations including basic 2D Rotation and 3D Rotation with Perspective models. This manual also provides system specifications and physical and functional descriptions. Certain features described in this manual are standard features on the 3D systems only and are identified in Section 2 of this manual.

Section 1 contains a brief outline of system use and capabilities, and a general and physical description.

Section 2 provides system definitions and effects explanations.

Section 3 describes basic keyboard controls and functions.

Section 4 describes basic system operation.

Section 5 outlines effects disk operation.

Section 6 describes system set-up and configuration menus.

Appendix provides the electrical, mechanical, and environmental specifications for the ADO 100 system.

1.2 Related Publications

For additional information, refer to the following Ampex publications, available through your local Ampex dealer or direct sales office.

- ADO 100 Technical Reference Guide, Catalog No. 1809825
- ADO 100 Parts List and Schematic Manual, Catalog No. 1809826

1.3 General Description

The Ampex ADO 100 Digital Optics system is a state-of-the-art, special-purpose graphics system that can manipulate video and key sources in real time. Sophisticated image interpolation circuits utilize Ampex's patented Double Digital Filtering (DDF) technology which guarantees extremely high quality output images, even when greatly compressed or expanded. The smooth motion and video quality of ADO systems have become an industry benchmark by which all other special effects systems are measured.

The ADO 100 system is designed to satisfy all aspects of television production; including *ENG editing, commercial post production, graphics composition, broadcasting of news and sports, and other live applications*. It combines the power and range of the ADO system digital image processing with instant on-air access to any of twenty-four pre-programmed effects, offering maximum operating flexibility in post production and live broadcasting environments.

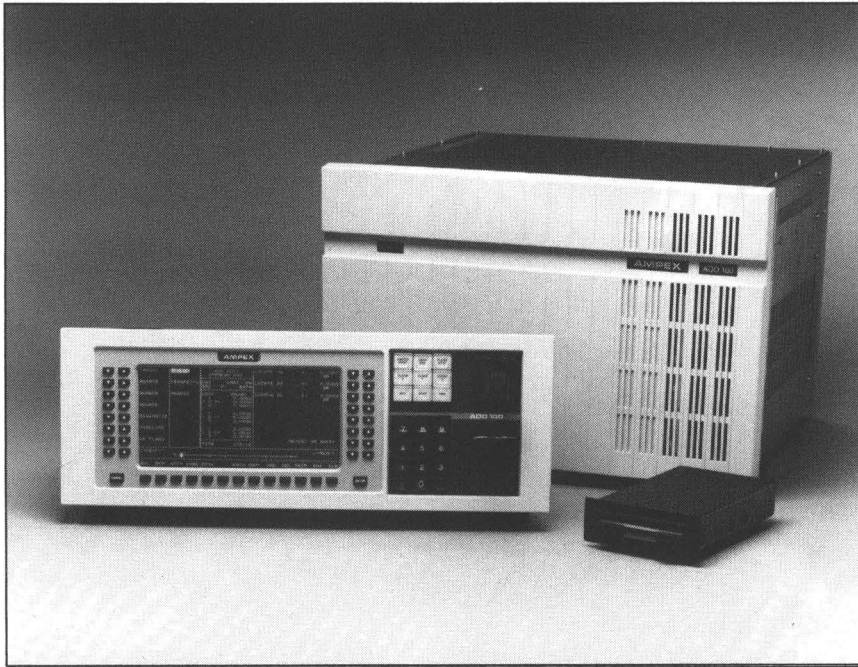

1.4 System Configuration

The ADO 100 System is available in a range of configurations to suit every application. The basic system consists of a control console, and a signal system (Figure 1-1). The control console can be either an ADO 100 Control Console or an Ampex AVC Vista™ Series Video Switcher Control Console.

The Control Console is connected to the signal system using an Ethernet coaxial cable supplied with the system.

True 3D Rotation and Perspective, and Image Innovator facilities are available as factory or field installed upgrades on the ADO 100 signal systems. All systems are equipped with a Digi-Matte™ key channel processing as a standard facility.

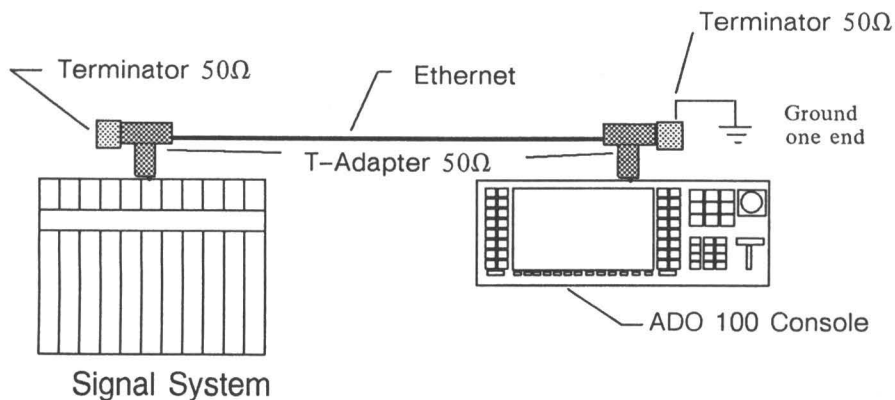

Figure 1-1. ADO 100 System Configuration

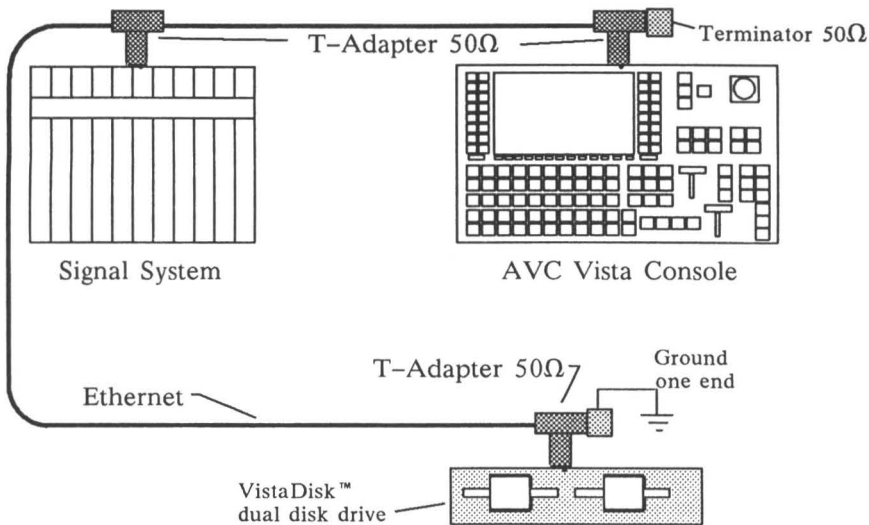

Figure 1-2. System Configuration including Optional Vista Console and VistaDisk

1.5 AVC Vista Integration

The ADO 100 signal system can be remotely operated from an AVC Vista Video Switcher system when complete switcher/effects integration is required. The AVC Vista system can completely program, run, and store the full range of ADO 100 effects. A standard ADO 100 control console is not required in these applications, however, the AVC Vista must be equipped with the following options:

- *GPSI-NET Option Communication Card, Catalog No. 1443739*
- *VistaDisk™ network dual disk drive, Catalog No. 1443731*

1.6 Real Time Image Transformation

The ADO 100 system processes images by converting analog video and key signal inputs into digital format, then storing and manipulating the digital information to achieve the desired image transformation.

Typical video sources can be provided by studio camera, video tape recorder, title generator or video switcher systems. The ADO 100 system can simultaneously transform both video and program key signals provided by the source in a single real time operation, due to the provision of a Digi-Matte key channel processor as a standard facility.

The ADO 100 system electronically maps each input picture element (called a pixel) into what is termed source space, where Rotation and Input Video Processing effects are added. It produces each pixel of the output image, in what is termed target space, by calculating the appropriate image expansion or compression required to generate a desired effect.

In order to produce a realistic and transparent quality output picture many source space pixels have to be mathematically averaged together to calculate the correct luminance, color, and positional values for the target space pixels that describe the output picture. This mathematical averaging process is referred to as *interpolation*.

The advanced interpolation process of the ADO 100 system generates transparent quality pictures by mathematically processing and digitally filtering each group of source pixels twice – once to calculate horizontal picture information, and once for vertical information, which allows precise control of target image alignment and a very low image noise level. This Ampex patented process is referred to as Double Digital Filtering (DDF) or separable processing. DDF processing circuits also provide fluid image motion, allowing slow or rapid movement of the image to be programmed with no motion jerkiness or softening of the output picture.

1.7 CCIR-601 4:2:2 Component Digital Processing

The fully component digital processing of the ADO 100 system has many advantages. Because all image decoding and processing is done digitally, image

noise, decoder drift, and other undesirable picture defects are virtually eliminated. ADO 100 system's high quality video output and internal CCIR-601 4:2:2 component digital processing ensures all broadcast standards are met without exception. The ADO 100 system also facilitates control console selection of 525 or 625 line mode operation without requiring hardware modifications.

1.8 Digi-Matte™ Processor

The Digi-Matte Processor is a dedicated key channel circuit, providing a separate channel of image processing specifically for black and white key signals. With Digi-Matte, the ADO 100 system will process an externally supplied key signal through the same transformation that it performs on the source video.

Digi-Matte allows the operator to create "flying logo" key effects, or to position moving video inside a switcher wipe pattern. With its full 5 MHz bandwidth and 256 level, 8-bit resolution, the Digi-Matte process can be used to manipulate the detailed key outputs of paint systems or the soft-edged signals from specialized chroma key systems such as the Ampex Spectrakey™.

Control console adjustment of the Digi-Matte input and output key timing ensures that the Digi-Matte output is precisely aligned with the video output, even if the inputs are out of time; under normal operating conditions there is no need to resort to external delay lines.

1.9 Effects Storage

Effects programmed by the operator can be stored temporarily in operational RAM memory or long term on a 3 1/2 inch system disc drive. Each floppy disc stores ninety-nine effects of up to ninety-nine keyframes each. To allow easy identification, individual effects and disks can be numbered and given alpha-numeric titles. Disk directories are MS-DOS® compatible and effects can be stored and copied on any MS-DOS® capable personal computer.

MS-DOS is a registered trademark of Microsoft, Inc.

SECTION 2

Programming Effects

2.1 Introduction

This section presents ADO 100 system definitions and conventions, defines basic image transformation capabilities including motion control using keyframes and motion types, and explains the ADO 100 system transformation process by the use of the ADO world model.

2.2 3D Space Definitions

The ADO 100 system transformation operates in 3D space which is designated *source space* or *target space*. These movements and rotations in space occur about three axes called x, y, and z axes. The ADO 100 system output is displayed on the operator's video monitor which is defined to have dimensions of eight horizontal and six vertical screen units.

Figure 2-1 illustrates the systems x, y, and z axis and the ADO operator's video monitor.

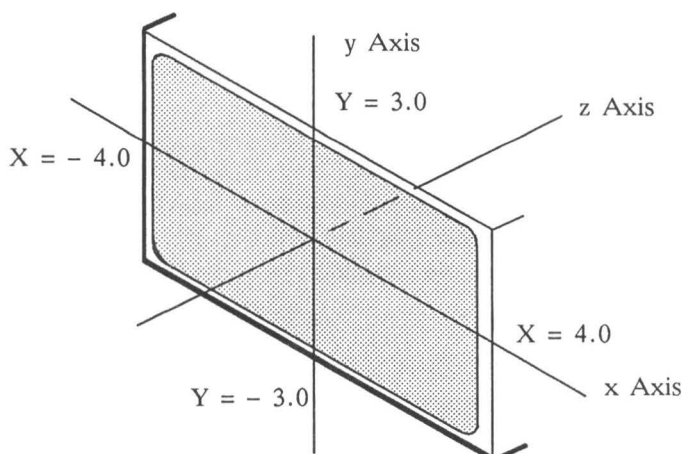

Figure 2-1. Axis Definition

- *The X Axis is horizontal, extending out on both sides from the operator's video monitor. The monitor has a horizontal (x) dimension of 8 screen units: +4 and -4 units from screen center.*
- *The Y Axis is vertical, extending up and down from the operator's video monitor. The monitor has a vertical (y) dimension of 6 screen units: +3 and -3 units from the screen center.*
- *The Z Axis is perpendicular to the x and y axes, extending into and out from the screen. There are an indeterminate number of screen units toward and away from the viewer. Negative values of z are into the screen, away from the viewer; positive values of z are out of the screen, toward the viewer. Higher negative z values appear to reduce the image; higher positive values appear to enlarge the image.*

2.3 Source Space/Source Image

Source Space is an infinite two-dimensional x-y plane onto which the ADO video input is mapped. The ADO source image can be considered a finite region, surrounded by an infinite matte background (of border color), located in source space. The transformed source space image is mapped into target space for final system output and is not directly viewable by the operator.

2.4 Target Space/Target Image

Target space is an infinite two dimensional x-y plane on which the transformed ADO output image is generated. The ADO target image can be considered a finite region, surrounded by an infinite matte background (of border or background color) and is located in target space. The transformed target space image is displayed on the operator's video monitor.

2.5 The ADO 100 World Model

The ADO 100 system transformation process is fairly complex, however, a better understanding of the system can be gained by studying the following ADO 100 world model (Refer to figure 2-2).

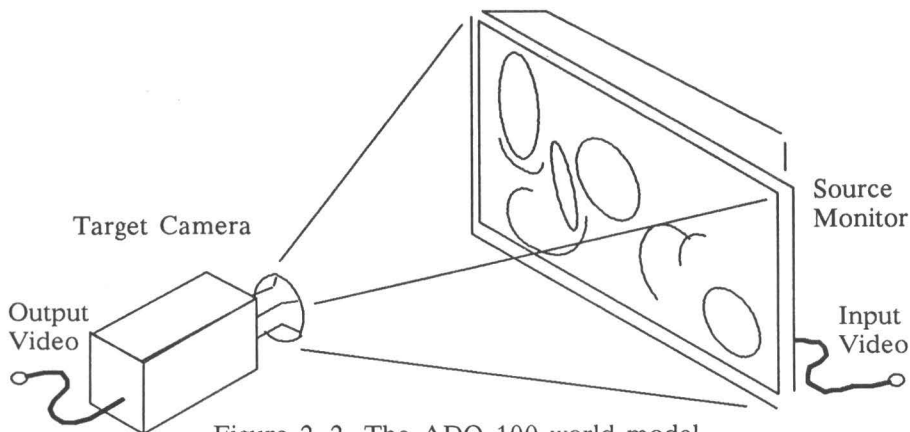

Figure 2-2. The ADO 100 world model --
Source monitor and target camera

A high quality video monitor is placed in a large viewing room with flat matte walls. The input to the ADO system is displayed on the (source) monitor and the monitor is observed by a (target) camera whose output is equivalent to that of the ADO system.

The initial alignment of source monitor and target camera is such that the target camera output seen by the operator is exactly the same as if the source monitor were viewed directly. Transformations can be applied to the source monitor or the target camera in order to generate desired special effects.

For example, by rotating and/or relocating the source video monitor in the viewing room the camera sees the source image moving and rotating in 3D space.

By zooming and/or dollying the target camera closer or further away from the source monitor, the camera field of view changes which alters 3D perspective values and final image size.

Other special effects can be generated by altering the source monitor's display characteristics such as color balance or phosphor grain size which produce solarization and mosaic effects respectively. This processing is achieved in the Image Innovator option.

Manipulation of both frozen and live pictures is possible in the ADO 100 system because the freeze command corresponds to a frozen monitor display, not a frozen camera output.

2.6 Multi-pass and Global Motion Control

Global effects can be simulated by allowing the camera to rotate independent of the source monitor (see Figure 2-3).

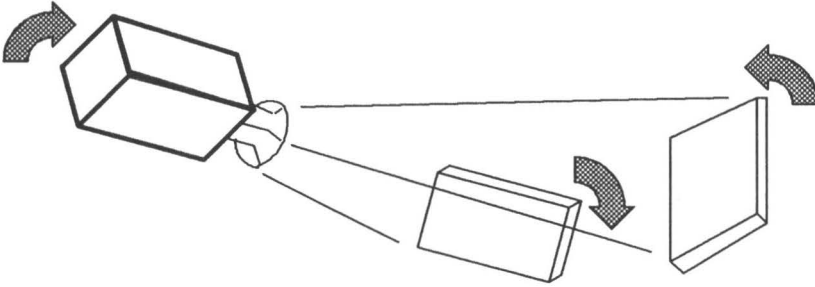

Figure 2-3. Multi-pass and Global Motion Control

By *Globally* moving or rotating the target camera around the source monitor, complex motions can be easily generated. If multiple recording pass techniques are used to generate an effect with two or more output images on the record tape, these images can be easily transformed together using the single global motion operational control.

2.7 Basic 2D Rotation System Transformation Capabilities

The ADO 100 system provides complete control over image size, position and aspect ratio. A system option enables the operator to apply true Perspective to images located and rotated in 3D space. The basic 2D system transformation capabilities include the following features:

- ✓ ● **Target** --- Permits the image to move in the horizontal or vertical directions and to change size in target space. This is analogous to panning or zooming the target camera relative to the monitor.
- ✓ ● **Rotation** --- Permits rotation of the image in source space about the horizontal, vertical, and perpendicular axes (x, y, and z). This is analogous to rotating the source monitor in front of the camera.
- **Border** --- Allows the source image to be electronically framed by a colored matte border when the ADO 100 system output is externally keyed over another video source. The border's width, luminance level, chrominance hue,

and saturation can be programmed. This is analogous to painting the frame of the source monitor a flat matte color.

- **Source Size/Aspect** --- Increases or decreases the size and changes the aspect ratio of the image in source space. This is analogous to altering the size of the source monitor display by a variable underscan control, and altering horizontal and vertical monitor drive voltages.

- **Program key** --- Generates an internal 8-bit linear output key which corresponds to the shape of the transformed image raster. It thus provides a downstream keyer or video switcher with a representative key signal with which to mix the transformed image with another video source.

- **Digi-Matte™** --- Allows the system to accept an externally supplied key, stencil, mask, or matting signal to be used to define the outline and transparency of the source image. The transformed Digi-Matte key source replaces the normal program key output when selected by the operator and its effect will be seen when externally keying the system output over another video source. Digi-Matte operation is analogous to placing an irregularly shaped mask over the source image monitor, so that only a selected portion of the source image is seen by the target camera.

- **Freeze** --- Captures a single field or frame of video from an incoming video signal, which then becomes the ADO 100 system input. A dedicated pushbutton is provided on the ADO 100 control console to manually freeze the source image while an effect is running. This is analogous to freezing the source monitor display. The target camera output is still "live" allowing complete manipulation of frozen images.

- **Mirror** --- The operator can set mirror flags to reverse images. An X mirror flag reverses the image horizontally, a Y mirror flag reverses it vertically, and an X + Y mirror flag reverses an image in both directions. This is analogous to rotating the picture tube inside the video monitor frame causing the image to be inverted.

2.8 3D Option Image Transformation Capabilities

- **Locate 3D** --- Repositions the source image allowing the viewer to see the image from a different 3D viewpoint. This is analogous to moving the source monitor around in the viewing room without adding additional rotations to it.

- **Axis Select** --- Permits off center and out of image rotation of the source image by redefining the axis origin with respect to the source. Analogous to rotating the source monitor about the edge of it's screen or another object in the room.
- **Perspective** --- Foreshortens the sides of the output video to simulate 3-dimensional depth effects. Perspective defaults to a "natural" value of 0.06, but the operator may vary the value anywhere between 0 and 9,999. This is analogous to changing the camera angle of view by moving the camera closer to the source monitor while zooming out to maintain output image size.
- **Skew** --- Alters the geometry of the source image from a rectangle to a parallelogram which slants along the horizontal axis. Skew used in conjunction with the Digi-Matte processor may be used to italicize video titles. Skew is analogous to varying the horizontal sync line-by-line on the source monitor.
- **Auto-Cube** --- This mode uses the ADO 100 systems Perspective capability and precise geometric properties to construct opposite faces of a rotating cube or any other three-dimensional solid having parallel faces, using a multiple record pass method. By using A/B auto input change mode, different images can appear on opposite cube faces. By combining global, A/B auto, and auto cube modes, six different images can appear on the six faces of a moving cube, in only three recording passes.

2.9 Image Innovator Option Capabilities

- **Mosaics** --- Increases the apparent pixel size of the source image by quantizing the picture content into a matrix of mosaic tiles. The operator can independently program the horizontal and vertical dimensions of the tiles. An internal mask generator can establish a rectangular boundary to define an active area of mosaic operation within the image. The Digi-Matte processor allows an external key signal to define an irregular boundary to the mosaic area. Mosaic is analogous to using a very coarse phosphor dot size to display the source image.
- **Posterization/Solarization** --- Posterization is achieved by restricting the luminance levels in the image to a preset number of quantized steps. Thirty-two posterization effects are provided including negative image generation and luminance reversal. Solarization is achieved by chrominance gain alteration which can enhance the color variation of the picture content. Thirty-two

solarization effects are provided including a forced monochrome mode. As with mosaic mode, an internal mask generator or the Digi-Matte input can be used to define an area of active posterization or solarization. These effects are analogous to altering the color balance and level controls of the source monitor.

- **Defocus** --- Allows the sharpness of the image to be reduced. For example, it can be used to soften the edges of graphics such as those produced by a title generator. This is analogous to defocusing the target camera lens.
- **Background Generator** --- Allows the operator to define a background color matte background behind the border matte and image. This is analogous to painting the viewing room walls a different color to the monitor screen edges.
- **Advanced border** --- Allows width and softness characteristics of the colored matte border to be changed independently on each edge of the screen.

2.10 Advanced Programming Capabilities

Global Operation --- A set of Global control parameters is provided. Complex single channel moves can be programmed much more quickly using this advanced programming aid, by breaking down motion into two simpler parts. Global programming is used extensively in creating and moving multiple sided solid objects, such as cubes using multiple recording pass techniques. Global and channel effects are totally independent from each other allowing Global changes to be made without undesirable interference to channel motion. Global operation is analogous to moving and rotating the camera viewing the source monitor in the viewing room, thus adding extra rotations and positioning effects to the output image.

2.11 Programming Effects

The operator builds an effect by creating a series of desired image positions called *keyframes* to be passed through during the effect. Complex motions and image modifications are easily created using keyframe control points. An effect may be as simple as one or two keyframes or as complex as 99 keyframes in both local and global channels.

2.12 Keyframes

A keyframe specifies the complete set of image parameters that describe the desired image position at one specific instant in time during an effect. By

creating a series of keyframes, the operator specifies a group of control points to mark the occurrence of important events at particular times during the effect. When the effect is run, the system interpolates all intermediate parameter values, on a field basis, as the effect processes in time through one keyframe and approaches another. The duration of each keyframe determines the number of intermediate frames to be interpolated before the effect reaches the next keyframe. The motion *path* type determines the manner in which the system calculates the acceleration and speed characteristics of the effect.

2.13 Motion Path Types

Motion is defined as any change in parameter values between keyframes. As the ADO 100 system calculates intermediate values between two keyframes, the source image appears to move from its position in the first keyframe to its position in the second. The type of motion path which the viewer perceives depends on the velocity and acceleration profile used to calculate the intermediate values.

The operator can select from a number of motion path options (diagrammed in figure 2-4).

- A **Smooth** motion path changes image parameter values in an uninterrupted flow, attempting to take the most graceful path between keyframes. A smooth path effect accelerates gradually from zero when leaving the first keyframe and decelerates gradually to zero when reaching the last keyframe.
- A **Linear** motion path changes image parameter values at a constant, linear rate determined by keyframe duration. A linear path effect looks similar to a bouncing ping-pong ball's motion.
- A **Hold** path changes image parameter values at a keyframe boundary. The value remains constant for the keyframe duration, then cuts to the next keyframe parameter value.
- An **Ignore** path request permits specified parameter values to be excluded from the motion path calculations for the keyframe.
- A **Break** path request modifies a smooth motion path by forcing the effect to accelerate from zero and decelerate to zero between all specified keyframes, instead of the first and last keyframes in the effect.

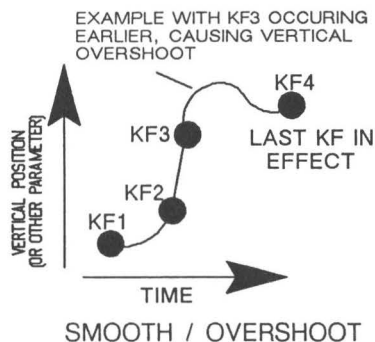
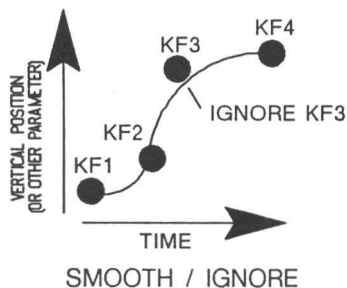
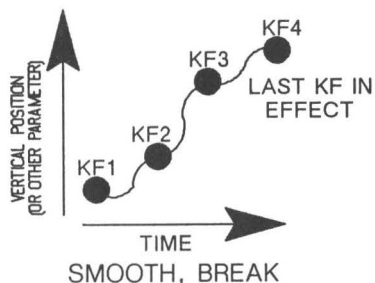
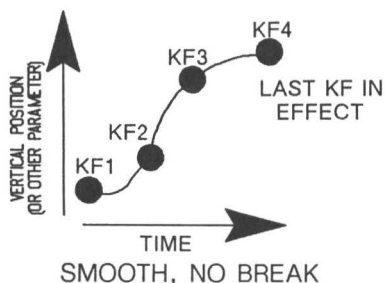
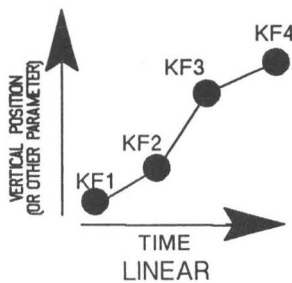
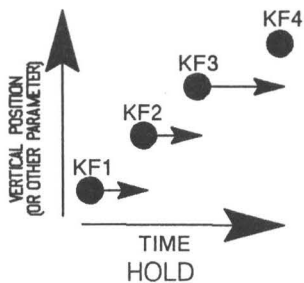

NOTE: For vertical position (all graphics),
Dot represents center of image.

Figure 2-4. Motion Path Types

2.14 Effect Recall and Running

Effects stored on a 3 1/2 inch floppy disc can be recalled to operational RAM memory for effect running. Up to 24 effects may be stored in operational memory at any one time and may be accessed in any order. A selected effect may be run manually, using the fader bar or the FWD and REV keys or under remote control from an AVC Vista video switcher or via a simple GPI contact closure.

SECTION 3

Control Console Controls

3.1 Introduction

The Control Console and associated joystick are the operator's primary controls. All keyframe parameters are set using function keys, soft keys and either the numeric keypad or joystick. Control Console and screen display layout is described in the following pages.

In the ADO 100 System, all controls, indicators, and displays are located on the console (Refer to Figure 3-1). No operator controls, except the power switch, and power voltage selection switch, are located on the Signal System.

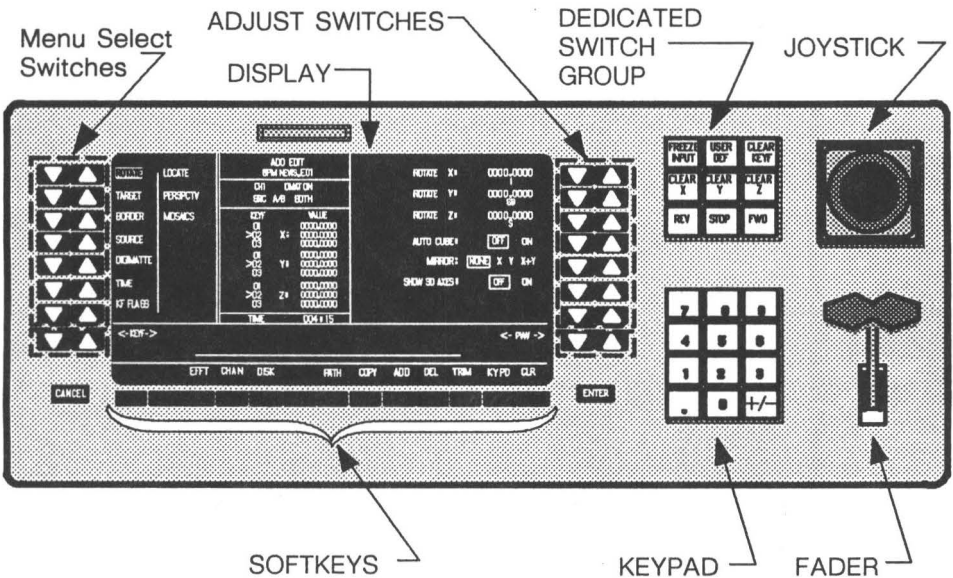

Figure 3-1. ADO 100 Control Console Layout

3.2 Single Function Controls

Except for the fader and joystick, all single function controls are momentary-contact pushbutton switches. The switch group above the keypad will illuminate when active (ON).

NOTE

Throughout this manual, all soft key function names, menus, and other messages and symbols displayed on the screen are shown in boldface; names which appear on the control console keys are shown in CAPITALS (lightface).

3.2.1 Joystick

The joystick gives the operator manual control over keyframe and setup parameters. In general, the joystick operates as follows:

- Moving the joystick to the right increases, or to the left decreases the X values.
- Moving the joystick upward increases, or downward decreases the Y values.
- Rotating the joystick's knob clockwise increases, or counterclockwise decreases the Z values.

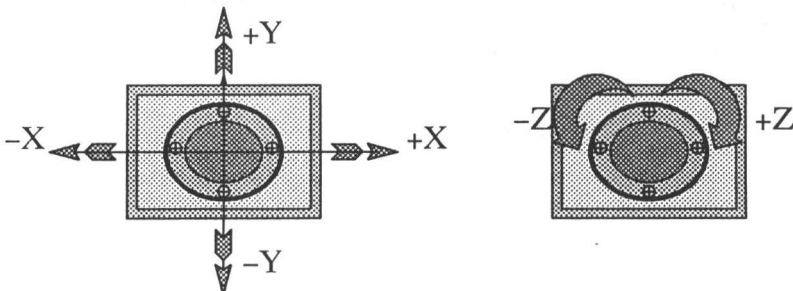

Figure 3-2. Manual operation of joystick

The joystick controls the rotation and position parameters of an image in a keyframe. The image moves in the same direction as movement of the joystick.

Joystick rotation and position parameters are continually updated and entered as the joystick is repositioned. Pressing the **ENTER** key is not required for entry of updated rotation and position parameters.

3.2.2 Fader Bar

The Fader bar gives the operator manual control of running an effect. The fader movement corresponds proportionally to movement along the timeline. End-stop fader bar position directly corresponds to the *Start* or *End* of the effect. Half way fader position corresponds to an effect half way between its *Start* and *End* positions.

3.2.3 Numeric Keypad

The numeric keypad is used in conjunction with the **KYPD** and **TRIM** softkeys for direct numeric entry of keyframe parameter values and keyframe or effect duration.

3.2.4 Dedicated Switch Group

Nine dedicated switches allow the operator control for running an effect, and/or clearing keyframe parameters within an effect to default values. The nine switches are labeled **FREEZE INPUT**, **USER DEF**, **CLEAR X**, **CLEAR Y**, **CLEAR Z**, **CLEAR KEYF**, **FWD**, **REV**, and **STOP**.

The **FWD** key runs the effect from its beginning to its completion, and the **REV** key runs the effect in the opposite direction. The **STOP** key is used to stop the currently running effect.

- To resume running a *stopped* effect, press the **FWD** or **REV** key, or press the **<RUN>** softkey in the desired direction to start the effect moving again.

The **CLEAR X**, **CLEAR Y**, **CLEAR Z**, and **CLEAR KEYF** keys are used to clear specified keyframe parameters or an entire keyframe to system specified default parameters.

The **FREEZE INPUT** key is used to freeze the video and Digi-Matte key inputs of a specified channel. The video output will remain unfrozen. The **FREEZE INPUT** is active at all times and in all operating modes including effect run.

The **USER DEF** key is not used at this time.

3.2.5 The **ENTER** key

The **ENTER** key is used to enter a new keyframe onto the timeline following the currently selected keyframe, and/or to confirm the recall or storage of an effect or group of effects to disk or to RAM memory from disk.

3.2.6 The **CANCEL** key

The **CANCEL** key is used to abort softkey functions or numeric keypad values prior to entry of that value to the system memory.

- To enter the *SETUP* or engineering mode of the ADO 100 system, press and hold down the **CANCEL** key and then press the **ENTER** key.

3.3 Graphic Display and Adjust Keys

All operational functions of the ADO 100 system can be accessed from the graphic display screen using the adjust keys positioned around the displays edge. All dedicated switch group functions are also duplicated on the graphic display screen except for the **ENTER** and **CANCEL** keys, and the fader and joystick.

3.3.1 Graphic Display

The ADO 100 system provides all operational controls via simple menus displayed on a built-in 512 x 256 pixel graphic display. The display uses the latest EL (Electro-luminescent) Display technology for high legibility and low glare, resulting in an optimum performance within control room environments. The display data is arranged into 25 lines of information, each containing 64 characters.

3.3.2 Graphic Display Screen Layout

The graphic display screen layout is subdivided into five sections; the keyframe parameter selection area, the center screen area, the keyframe parameter adjust area, the timeline display area, and the softkey display area. See Figure 3-3 for the locations of these sections.

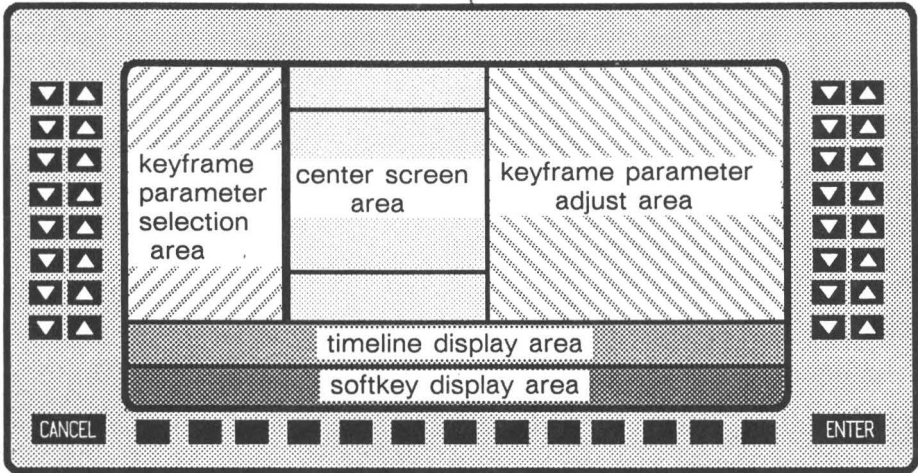

Figure 3-3. Effect Edit Menu Display Sections

- The Keyframe Parameter Selection Area provides keyframe parameter selection keys and displays available keyframe parameters.
- The Center Screen Area provides an effect status display, including effect name, operational mode, and parameter and time values.
- The Keyframe Parameter Adjustment Area allows keyframe parameter values to be adjusted and displays detailed parameter information.
- The Timeline Display Area shows the time related information of an effect.
- The Softkey Display Area provides 13 softkeys for selection of miscellaneous editing functions.

3.3.3 Adjust keys and Softkeys

The operator controls the various functions of the display screen via adjust keys and softkeys on three sides of the display. Two groups consisting of eight switch pairs are located at each side of the display, and one group of thirteen switches are located across the bottom of the display. Of the eight pairs of switches along each side of the display, the upper seven pairs on the right side are called "adjust switches." The upper seven pairs on the left side are called "menu select switches". The thirteen switches across the bottom of the display are called "softkeys". Adjust key and softkey switch function is defined by the text displayed adjacent to the switch.

Adjust key and softkey operation is not limited to a single function, but vary their function according to the mode selected by the operator. This offers a range of supplemental options within each of the selected modes.

3.3.3.1 Switch Adjustment Rate

Each adjust switch pair controls the parameter adjacent to it. They are used to select the operating modes, channels, or menus. The menus are used to enter numerical values, or storing and recalling effects. Each pair consists of an up (right) switch and a down (left) switch. To decrement the parameter, press the left switch; to increment the parameter, press the right switch. A single count change occurs when the switch is pressed one time. If either switch is held down, the parameter automatically changes at a rate which is dependent upon the parameter. To change the parameter rapidly, establish a direction by holding one switch down, then activate the rapid change by holding both buttons down.

3.3.4 The <KEYF> and <RUN> keys

The two pairs of keys labeled <KEYF> and <RUN> are located to the left and right sides of the timeline. They are used to step between keyframes in an effect, and/or preview or run an effect.

The <KEYF> up/down arrow keys are located to the left side of the timeline. These keys allow manual stepping in the forward or reverse direction to keyframes on the timeline. Pressing the down arrow key (left button) displays the previous keyframe parameters while pressing the up arrow key (right button) displays the succeeding keyframe parameters in the effect.

The <RUN> up/down arrow keys are located to the right side of the timeline. These keys are used to preview or run the effect from the current position to the end of the effect, or to an effect pause. The down arrow key runs the effect towards the beginning or start (S) or an effect (reverse direction) while the up arrow key runs the effect towards the end (E) of an effect (normal direction). If an effect pause is encountered, the effect will stop until the operator depresses either of the <RUN> keys or the **FWD** or **REV** key. Effect pauses can be added or deleted as required, and they are independent of keyframe position.

3.4 Keyframe Parameter Selection Area Controls

The keyframe parameter selection area is illustrated in detail in Figure 3-4.

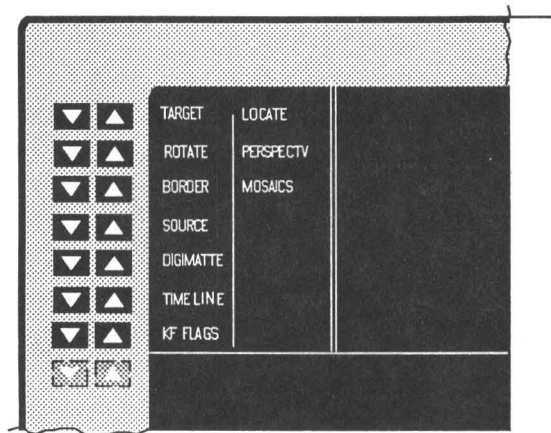

Figure 3-4. Keyframe Parameter Selection Area

The *Keyframe Parameter Selection Area* is controlled by the upper fourteen up-down pushbutton pairs located at the left of the area. This area has two columns of menu names. The left column is selected by the set of left down buttons while the right column is selected by the set of right up buttons.

For example, the **BORDER** keyframe parameter is displayed on the third row of the left hand column on this graphic screen. To select the **BORDER** menu, press the button located in the third row from the top of the left hand (down arrows) column. The **BORDER** keyframe parameter changes to inverse video (white letters on black background) indicating it is selected while the menu changes to the border parameters. Pressing the button located in the third row from the top of the right hand (up arrows) column will select the **MOSAIC** keyframe parameter menu.

The keyframe parameters listed in the right column are menus which depend on installed optional hardware.

3.5 Center Screen Area

The center screen area is illustrated in detail in Figure 3-5.

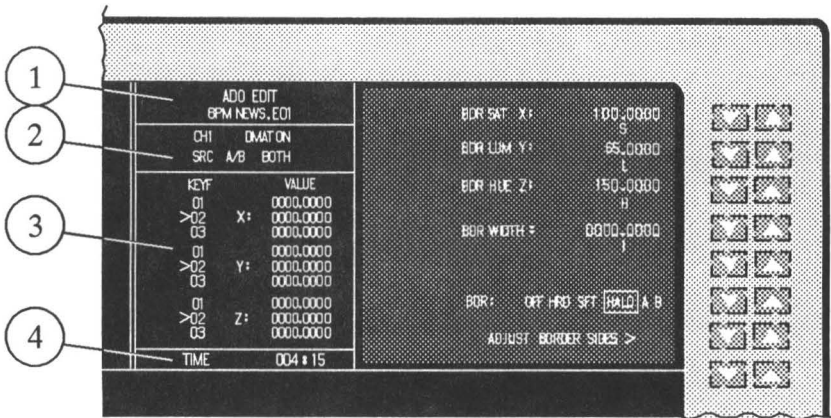

Figure 3-5. Center Screen Area

The *Center Screen area* is used as a status display area and contains four separate sections.

- The *first section* identifies the system operation mode and current effect by name and effect number.
- The *second section* identifies the current channel, Digi-Matte usage, and input source selection.
- The *third section* displays keyframe time or keyframe parameter value information as it changes throughout an effect.
- The *fourth section* displays effect duration in seconds and frames. There are no operational controls associated with the center screen display.

The *Keyframe Parameter Adjustment area* is used to adjust the keyframe parameter values in an effect. Keyframe parameters are displayed along the right hand edge of the display screen in what is referred to as a keyframe parameter menu. The menu is a list of all adjustments that relate to the selected keyframe parameter. Some keyframe parameters may have a sub menu, which is simply a longer list of adjustments that has been broken into two sections for easier operation. Within a menu the parameter adjustments are divided into two basic types.

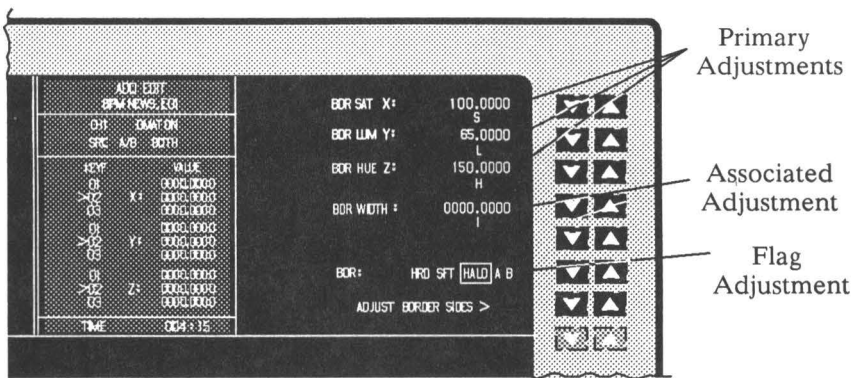

Figure 3-6. Keyframe Parameter Adjust Area

Primary adjustments which are indicated by X, Y, and Z labels that precede the displayed numeric value. Primary adjustments may be adjusted by the joystick, adjust keys, or the numeric keypad. Primary adjustment X, Y, and Z values for the current and preceding/following keyframes are displayed in the center screen section to enable quick visualization of parameter changes between keyframes.

Associated adjustments are all adjustments appearing on the menu that are not indicated by X, Y, or z labels. Associated adjustments may be adjusted from the keypad and adjust keys. An example of an associated adjustment is **BDR WIDTH: 0000.0000**. This parameter can be adjusted using the numeric keypad or the adjust keys. Non-numeric parameter adjustments are referred to as flags. An example of a flag is "BDR: HARD SOFT HALO A B" which allows selection of a range of border types. These parameters may only be adjusted by the adjust keys, as they have no numerical values.

Accessing the submenus

A submenu is a second level menu which contains additional primary and associated adjustments related to its first level menu. For example, the **BORDER** menu contains a related submenu called the **ADJUST BORDER SIDES** submenu. If a submenu exists, it can be accessed by pressing either the up or down arrow keys in the seventh row from the top of the adjust keys. No submenu exists if the display to the left side of these switches is blank.

Pressing either key alongside the submenu name **ADJUST BORDER SIDES** displays the following submenu:

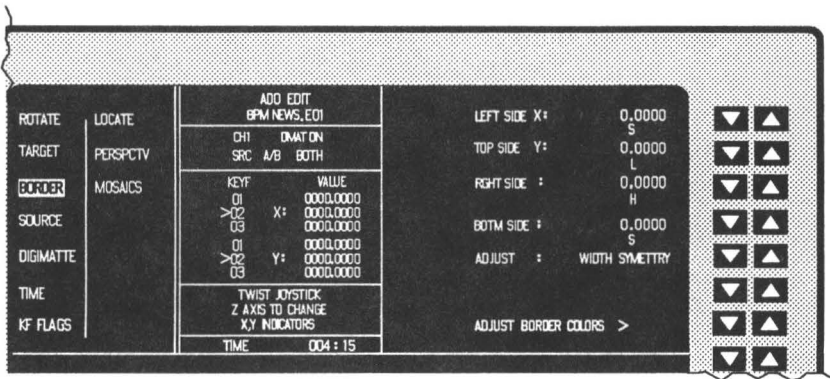



Figure 3-7. Adjust Border Submenu

Primary and associated adjustments are shown and adjusted in submenus in the same manner as for first level menus. Primary adjustments are indicated by (in this example) the X and Y labels that precede the displayed numeric value. They can be adjusted using the joystick, adjust keys, or the numeric keypad. The associated adjustments can be adjusted using the adjust keys or numeric keypad. The flag adjustments are changed using the adjust keys only.

A menu or submenu can have two sets of X and Y axis parameters such as in the above example. The Adjust Border Submenu consists of a **LEFT SIDE X:**, **TOP SIDE Y:**, **RIGHT SIDE X:**, and **BOTTOM SIDE Y:** axis adjustment. The joystick can only adjust two of the four axes at one time. In this case, the joystick switches between the **LEFT SIDE X:**, **TOP SIDE Y:** adjustments and the **RIGHT SIDE X:**, and **BOTTOM SIDE Y:** adjustments by rotating the joystick Z axis (knob) counterclockwise for **LEFT** and **TOP**, and clockwise for **RIGHT** and **BOTTOM** side adjustments. The center screen area displays the reminder " **TWIST JOYSTICK Z AXIS TO CHANGE X, Y AXIS INDICATORS** " to guide novice operators.

The *timeline display area* displays one timeline. The symbols indicate a pause, a cursor locating the current edit point, and the start and finish of each timeline.

The fader bar travel from one stop to the other represents travel along the timeline. A location cursor  displays the current position on the timeline of the effect. Repositioning the fader bar or pressing the <RUN> keys changes the position of this location cursor.

The *function select area* is used to display legends for currently active softkeys. This area changes depending on which menu is present.

The softkey function selection area comprises thirteen softkeys aligned along the bottom of the display screen.

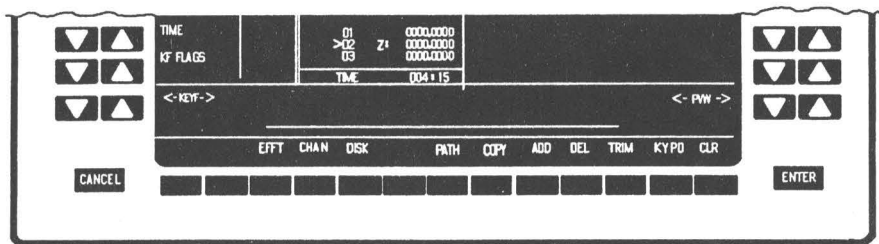

Figure 3-8. Softkeys

The softkeys provide various support menus and functions to be accessed as follows:

- *EFFT* -- allows effect storage to/from RAM memory
- *CHAN* -- selects channels for programming
- *DISK* -- accesses disk control menu
- *PATH* -- accesses motion path controls
- *COPY* -- allows parameter and keyframe values to be copied
- *ADD* -- adds extra keyframe between existing keyframes
- *DEL* -- deletes keyframe
- *TRIM* -- allows numeric keypad trimming of parameter values
- *KYPD* -- allows numeric keypad entry of parameter values
- *CLR* -- allows clearing and normalizing of parameter values

SECTION 4

Operation

4.1 Introduction

This section provides information about ADO 100 system operating modes. Control panel and screen display layouts are described in the following pages.

4.2 Menu Organization

There are two levels in the menu hierarchy; the effect edit menus, and their submenus or second level menus. Each effect edit menu is accessible from every other effect edit menu and submenu, but submenus are accessible only through its effect edit menu.

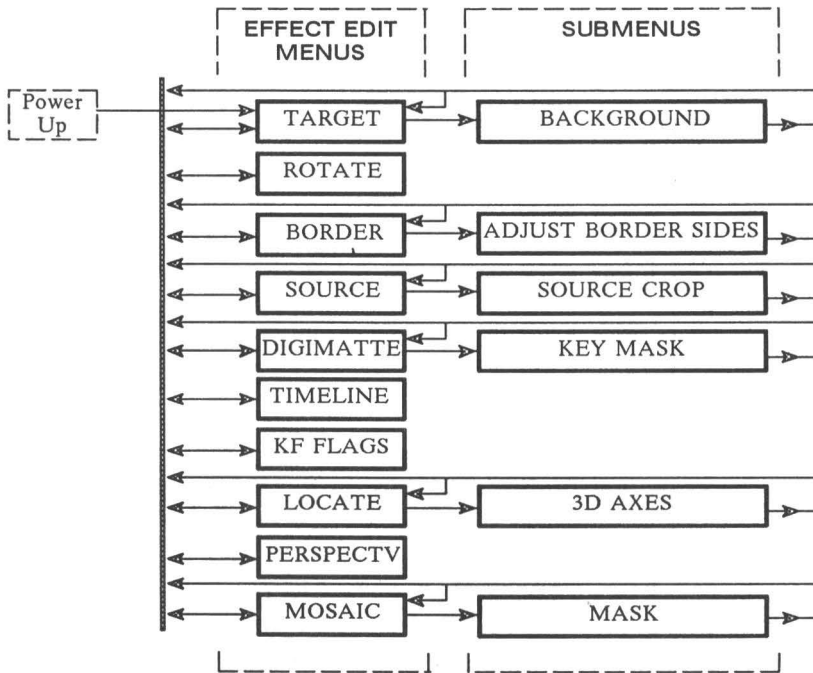

Figure 4.1 Menu Organization

4.2.1 Effect Edit Menus and Submenus

NOTE

The Effect Edit menus and Submenus are dependent on installed hardware options.

The ten effect edit menus and six submenus are described as follows:

1. *TARGET* - sets parameters for control of the X and Y position and target size.
2. *BACKGROUND submenu* - sets parameters for color background.
3. *ROTATE* - sets parameters for three dimensional rotation of the video plane.
4. *BORDER* - sets parameters for creating soft, and hard borders.
5. *ADJUST BORDER SIDES submenu* - sets parameters for adjusting border sides.
6. *SOURCE* - sets parameters for adjusting the relative size of the source image.
7. *SOURCE CROP submenu* - sets parameters for cropping image size.
8. *DIGI-MATTE* - sets parameters for setting up the Digi-Matte.
9. *DIGI-MATTE KEY MASK submenu* - sets parameters for key mask.
10. *TIMELINE* - sets timeline parameters for adding or deleting keyframes.
11. *KF FLAGS* - sets parameters for keyframe flags.
12. *LOCATE* - sets parameters for three dimensional location of the video plane.
13. *3D AXIS submenu* - sets parameters for positioning the 3D axis.
14. *PERSPECTIVE* - sets parameters for perspective.
15. *MOSAIC* - sets parameters for setting up the mosaic generator.
16. *MASK submenu* - sets parameters for size of mosaics mask.

4.3 System Power Up

When the system is powered up or reset, the first menu displayed is the copyright menu.

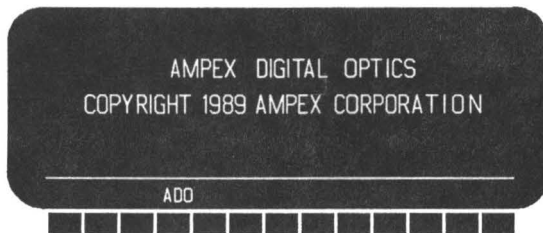

Figure 4-2. ADO 100 System Copyright Menu

SECTION 4

Operation

4.1 Introduction

This section provides information about ADO 100 system operating modes. Control panel and screen display layouts are described in the following pages.

4.2 Menu Organization

There are two levels in the menu hierarchy; the effect edit menus, and their submenus or second level menus. Each effect edit menu is accessible from every other effect edit menu and submenu, but submenus are accessible only through its effect edit menu.

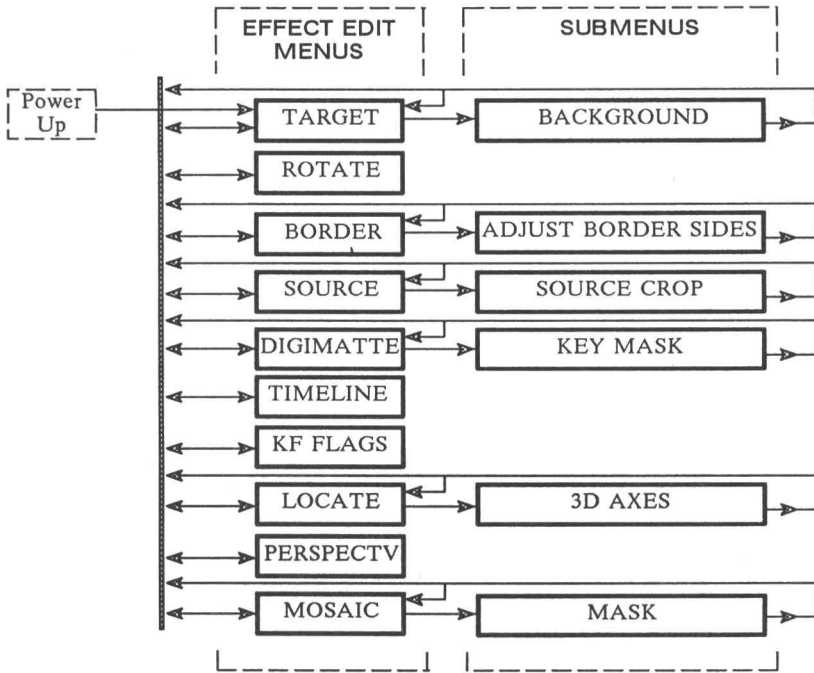

Figure 4.1 Menu Organization

4.2.1 Effect Edit Menus and Submenus

NOTE

The Effect Edit menus and Submenus are dependent on installed hardware options.

The ten effect edit menus and six submenus are described as follows:

1. *TARGET* - sets parameters for control of the X and Y position and target size.
2. *BACKGROUND submenu* - sets parameters for color background.
3. *ROTATE* - sets parameters for three dimensional rotation of the video plane.
4. *BORDER* - sets parameters for creating soft, and hard borders.
5. *ADJUST BORDER SIDES submenu* - sets parameters for adjusting border sides.
6. *SOURCE* - sets parameters for adjusting the relative size of the source image.
7. *SOURCE CROP submenu* - sets parameters for cropping image size.
8. *DIGI-MATTE* - sets parameters for setting up the Digi-Matte.
9. *DIGI-MATTE KEY MASK submenu* - sets parameters for key mask.
10. *TIMELINE* - sets timeline parameters for adding or deleting keyframes.
11. *KF FLAGS* - sets parameters for keyframe flags.
12. *LOCATE* - sets parameters for three dimensional location of the video plane.
13. *3D AXIS submenu* - sets parameters for positioning the 3D axis.
14. *PERSPECTIVE* - sets parameters for perspective.
15. *MOSAIC* - sets parameters for setting up the mosaic generator.
16. *MASK submenu* - sets parameters for size of mosaics mask.

4.3 System Power Up

When the system is powered up or reset, the first menu displayed is the copy-right menu.

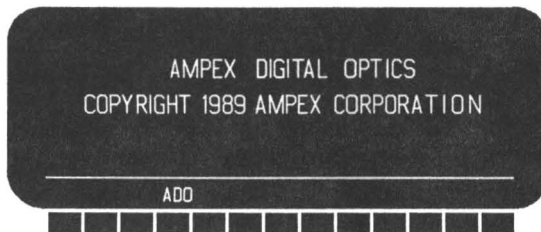

Figure 4-2. ADO 100 System Copyright Menu

4.3.1 System Reset

To reset the control console -- press the four extreme outer top and bottom adjust buttons located at the left and right sides of the display.

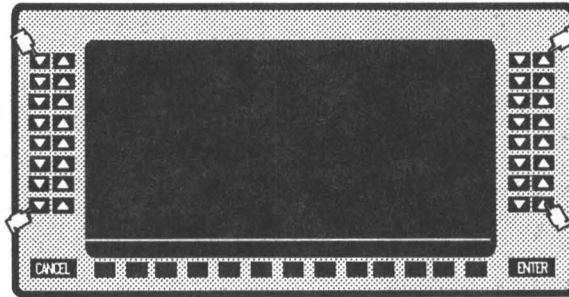

Figure 4-3. Control Console Reset

4.3.2 Align the Joystick and Fader Bar

Move the joystick to the extreme right position, then to the extreme left position, top position, and bottom position to align the joystick's X and Y value limits with the system. Next turn the joystick knob fully counterclockwise and then clockwise to align the joystick's Z value limits with the system.

Move the Fader Bar to it's upper position limit, now move the fader bar down to it's lower position limit. This aligns the fader bar limits with the system.

4.3.3 Changing to the Edit Menu

Press the ADO softkey. This displays the Target Menu.

4.4 Target Menu

Press the **Target** adjust button to enter the Target Menu.

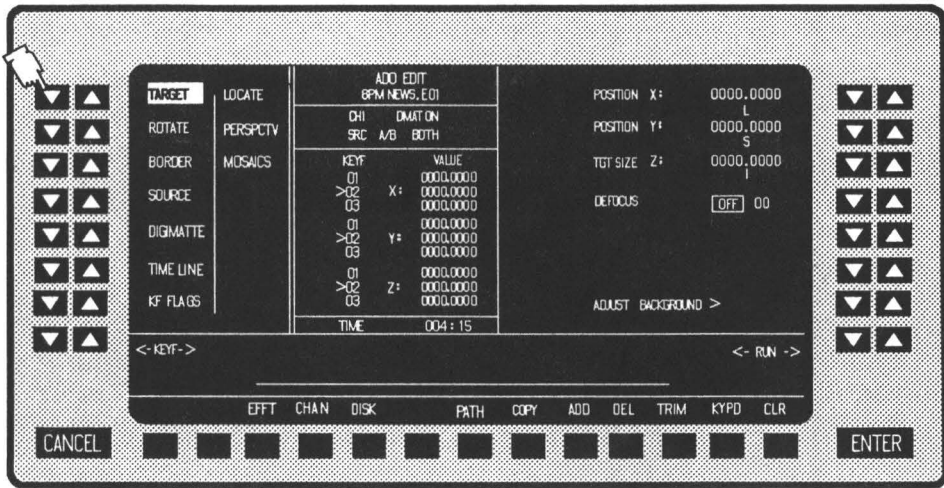
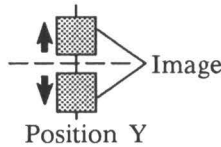
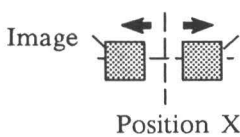

Figure 4-4. The Target Menu

The Target menu controls the X and Y position, and size of the target video. The adjustments are described below.

- The **POSITION X** adjust up-down switch pairs are used to move the image along the X axis. This adjustment does not affect the image orientation.



- The **POSITION Y** adjust up-down switch pairs are used to move the image along the Y axis. This adjustment does not affect the image orientation.
- The **TARGET SIZE Z** adjust up-down switch pairs are used to adjust the final output image size by the operator. Rotate the Z-axis control counterclockwise for smaller images, clockwise for larger images. The center of the image retains its X and Y position.
- The **DEFOCUS** adjust up-down switch pairs are used to create an effect of blurred or out of focused video controlled in thirty-two steps. (This function requires the Image Innovator Option.)

4.4.1 Background Submenu

Press the **Adjust Background > adjust** button to enter the Background Submenu.

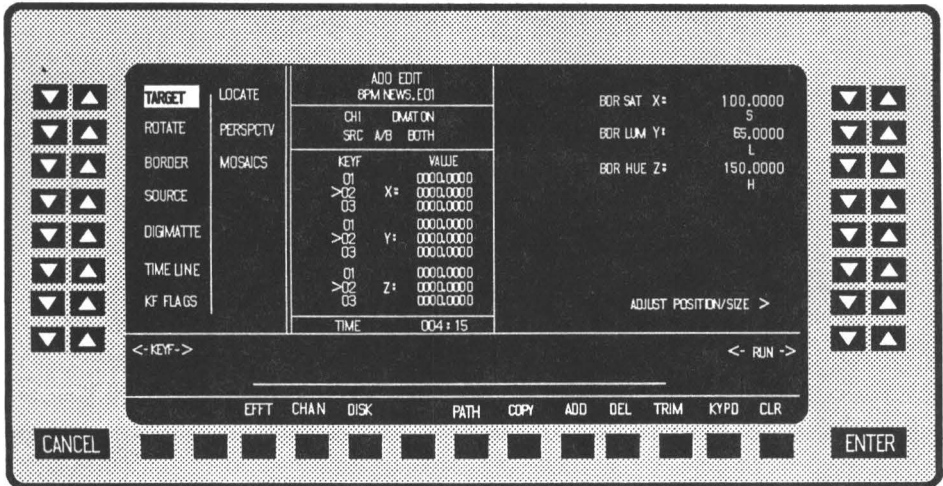

Figure 4-5. The Background Submenu

The Background Submenu controls the background color adjustments. The adjustments are described below. All the below functions require the Image Innovator Option.

- The **BKG SAT** adjust up-down switch pairs are used to set background saturation.
- The **BKG LUM** adjust up-down switch pairs are used to set background luminance.
- The **BKG HUE** adjust up-down switch pairs are used to set background hue.

4.5 Rotate Menu

Press the **Rotate** adjust button to enter the Rotate Menu.

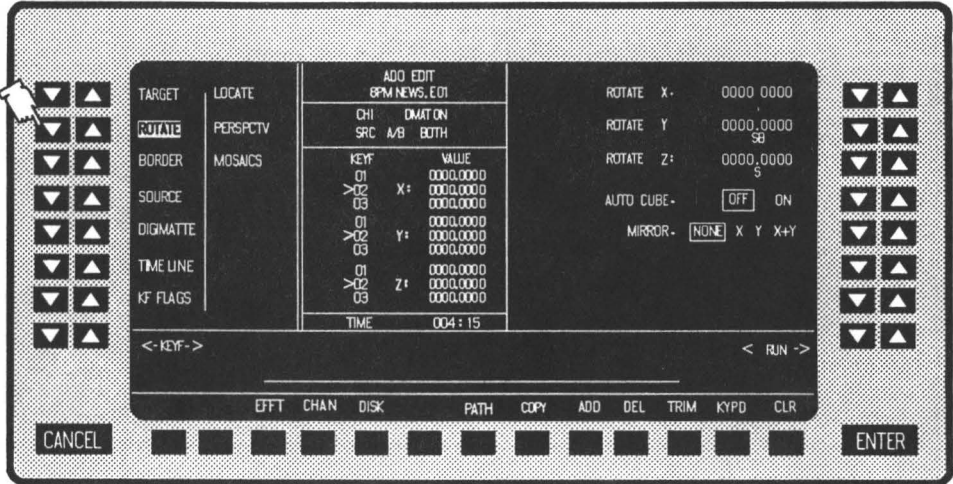
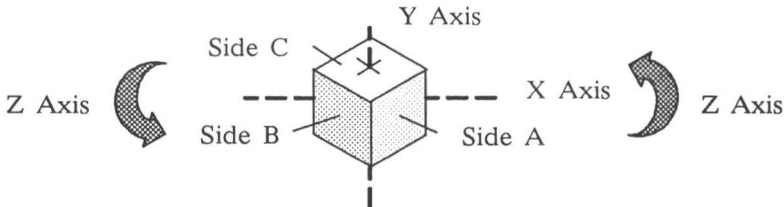

Figure 4-6. The Rotate Menu

The Rotate menu is used for three dimensional rotation of the video plane for the current channel. The adjustments are described below.

- The **Rotate X:**, **Rotate Y:**, and **Rotate Z:** adjust up-down switch pairs are used to rotate the image around the X, Y, or Z axes.
- The **AUTO CUBE** adjust up-down switch pairs are used to set up a cube of video with its sides built from different video sources. (3D Perspective System only)



- The **MIRROR** adjust up-down switch pairs are used to mirror a video source so it appear reversed.

4.6 Border Menu

Press the **Border** button to enter the Border Menu.

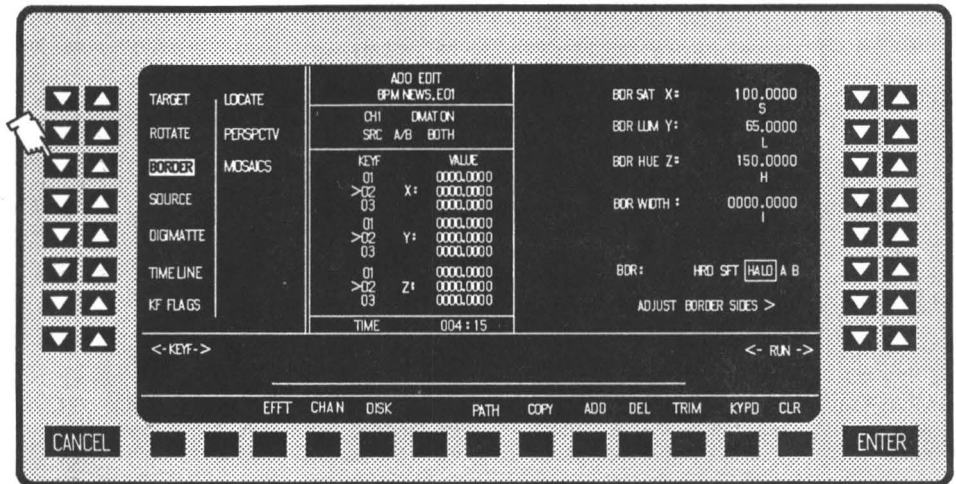

Figure 4-7. The Border Menu

The Border menu allows control of the width and softness of the border between the crop limits and remaining image area. The adjustments are described below.

- The **BDR SAT** adjust up-down switch pairs are used to set the border color saturation.
- The **BDR LUM** adjust up-down switch pairs are used to set the border color luminance.
- The **BDR HUE** adjust up-down switch pairs are used to set the border color hue.
- The **BDR WITDTH** adjust up-down switch pairs are used to adjust the border width.
- The **BDR** adjust up-down switch pairs is used to select the type of border. The selections are HRD, SFT, HALO, A, B.
 HRD -- Hard border selected, SFT -- Soft border selected, HALO A -- Hard border on inside combined with a soft border on the outside of the border. HALO B -- Hard border on outside combined with a soft border on the inside of the border. (This function requires the Image Innovator Option.)

4.6.1 Adjust Border Sides Submenu

Press the **Adjust Border Sides >** button to enter the Sides Submenu.

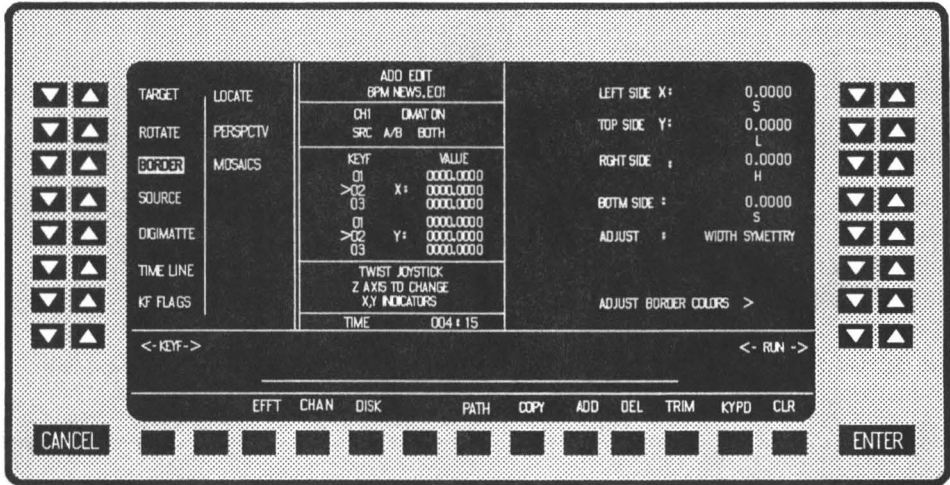

Figure 4-8. The Side Submenu

The Adjust Border Sides Submenu allows individual adjustment of each side on a border. The adjustments are described below. All the below functions require the Image Innovator Option.

- The **Left Side**, **Top Side**, **Right Side**, and **Botm Side** adjust up-down switch pairs are used to adjust the sides on a border.
- The **Adjust** adjust up-down switch pairs are used to adjust the width of each individual border side (if width selected), or adjust the symmetry (inside and outside border width).

4.7 Source Menu

Press the **Source** button to enter the Source Menu.

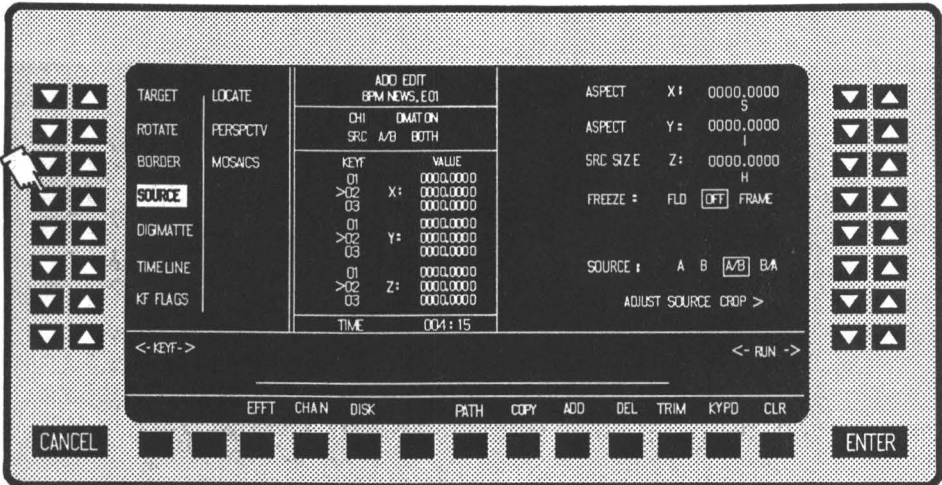

Figure 4-9. The Source Menu

The Source menu is used for adjusting the relative size of the source image in the X or Y dimensions. The adjustments are described below.

- The **ASPECT X** adjust up-down switch pairs are used to dimension the X aspect ratio.
- The **ASPECT Y** adjust up-down switch pairs are used to dimension the Y aspect ratio.
- The **SRC SIZE** adjust up-down switch pairs are used to adjust the overall size of the source image.
- The **FREEZE** adjust up-down switch pairs are used to freeze the input video and key at a keyframe.
- The **SOURCE** adjust up-down switch pairs are used to change video and Digi-Matte key as the image rotates.
 - A -- Always selects the A source video and key. When the image rotates around to the "back" side, the A image is mirrored.
 - B -- Always selects the B source video and key. When the image rotates around to the "back" side, the B image is mirrored.
 - A/B -- Initially selects the source A video and key. When the image rotates around to the "back" side, the B image appears and is mirrored.
 - B/A -- Initially selects the source B video and key. When the image rotates around to the "back" side, the A image appears and is mirrored.

4.7.1 Adjust Source Crop Submenu

Press the **Adjust Source Crop >** button to enter the Input Crop Submenu.

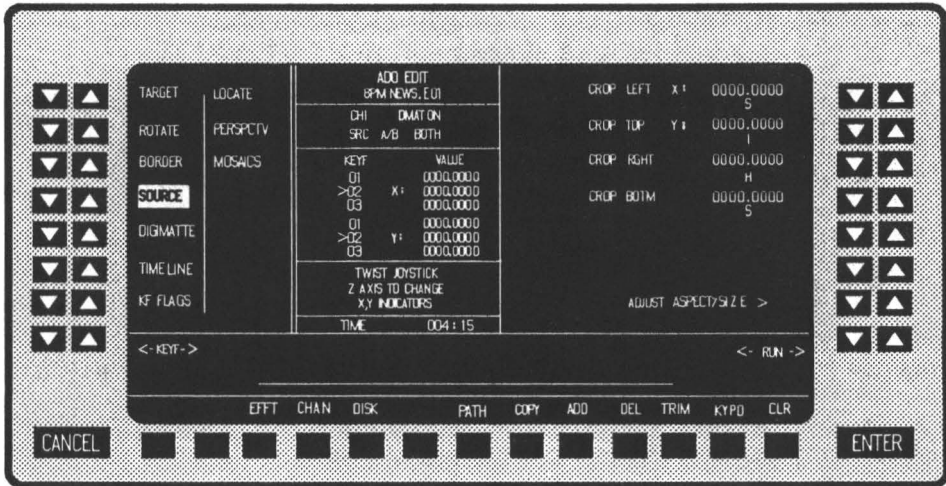

Figure 4-10. The Source Crop Submenu

The Adjust Source Crop submenu is used for adjusting video to the desired size. The adjustments are described below.

- The **Crop Left**, **Crop Top**, **Crop Right**, and **Crop Botm** adjust up-down switch pairs are used to crop the video to the desired size.

Note

Crop adjusts both the video and key.

4.8 Digimatte Menu

Press the **Digimatte** button to enter the Digimatte Menu.

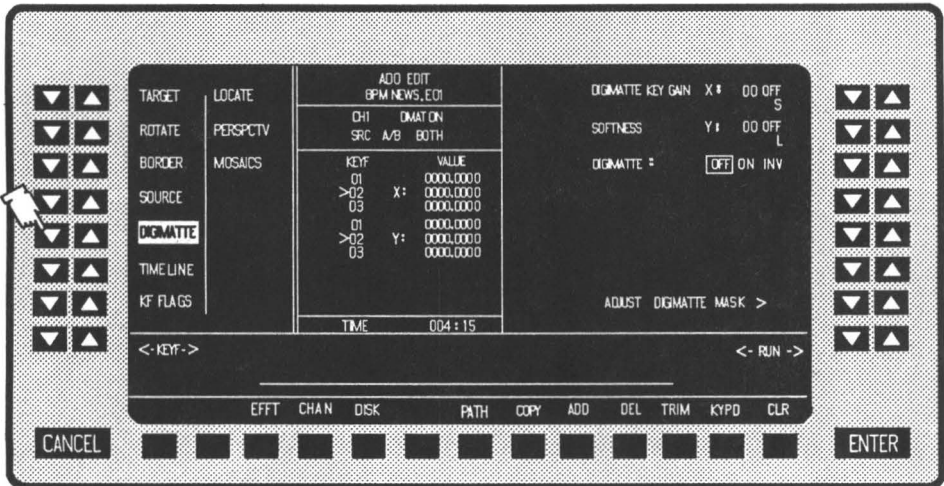

Figure 4-11. The Digimatte Menu

The Digimatte menu is used for adjusting Digi-Matte key gain, softness, and to invert the Digi-Matte key. The adjustments are described below.

- The **DIGI-MATTE KEY GAIN** adjust up-down switch pairs are used to boost the Digi-Matte key level. This is adjustable in sixteen steps.
- The **SOFTNESS** adjust up-down switch pairs are used to soften or blur the edge of fast transients in video such as titles from a character generator. This is adjustable in thirty-two steps.
- The **DIGIMATTE** adjust up-down switch pairs are used to select the Digi-Matte key as system output in place of the normal program key, and to invert the Digi-Matte key signal.

4.8.1 Digi-Matte Mask Submenu

Press the **Adjust Digi-Matte Mask >** button to enter the Key Mask Submenu.

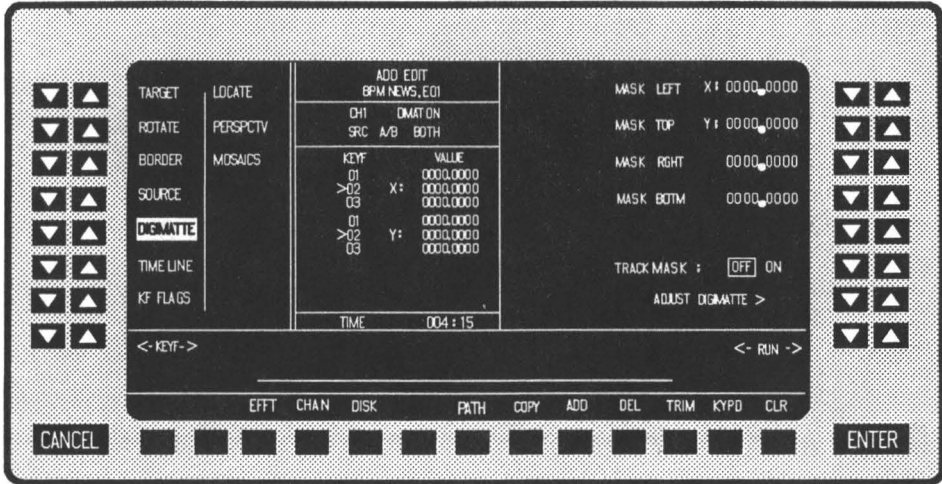

Figure 4-12. The Digi-Matte Mask Submenu

The Digi-Matte Mask Submenu is used to size the key mask. The adjustments are described below.

- The **Mask Left**, **Mask Top**, **Mask Right**, and **Mask Botm** adjust up-down switch pairs are used to adjust the active Digi-Matte key area by a rectangular key mask.
- The **Track Mask** adjust up-down switch pairs are used to move the key mask over the screen.

4.9 Timeline Menu

Press the **Timeline** adjust button to enter the Timeline Menu.

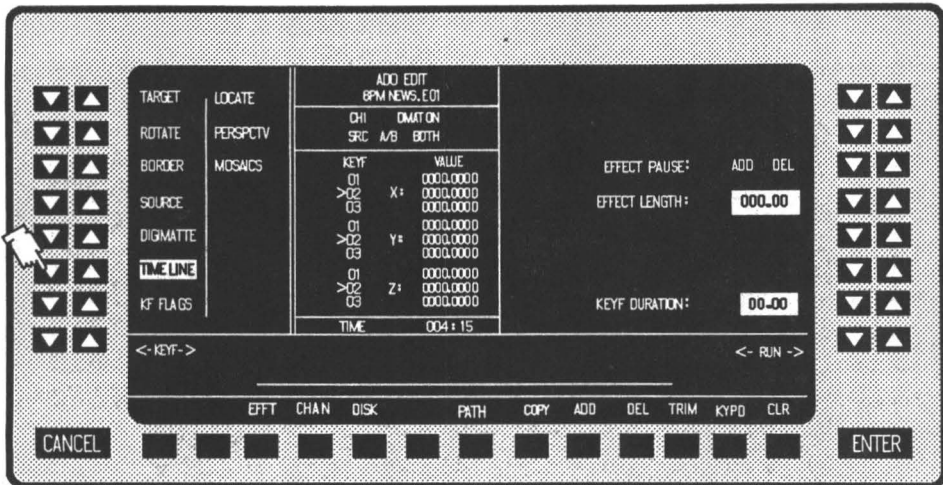

Figure 4-13. The Time Menu

The Timeline menu is used to adjust the duration of keyframes in an effect and the total effect running time. The adjustments are described below.

- The **EFFECT PAUSE** adjust up-down switch pairs are used to add a temporary stop on the timeline. The pause can be added at any location on the timeline.
- The **EFFECT LENGTH** adjust up-down switch pairs are used to scale the stored effect length to any desired time.
- The **KEYF DURATION** adjust up-down switch pairs are used to adjust the keyframe duration between two keyframes to a value other than the default time (1 second).

NOTE

The system recognizes pauses on the timeline when the effect is run using the **RUN** buttons. An effect run using the fader bar will pass by the pause.

4.10 KF Flags Menu

Press the **KF Flags** button to enter the KF Flags Menu.

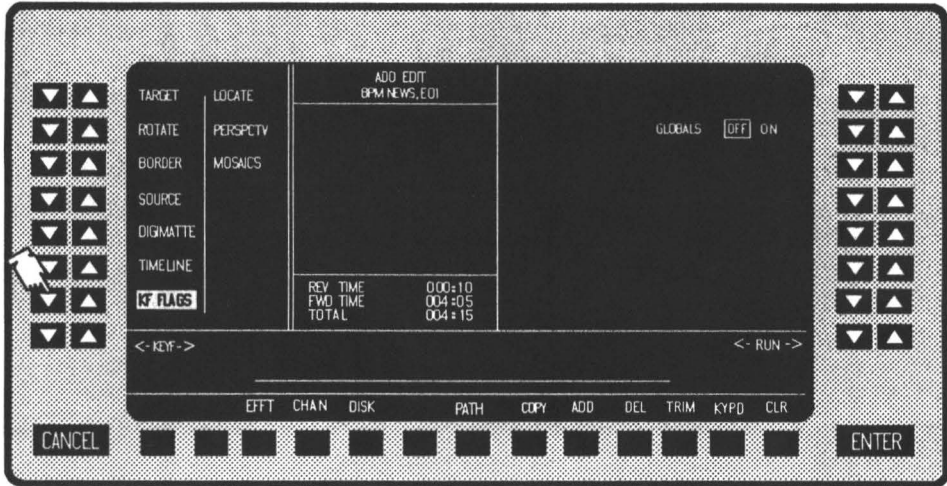

Figure 4-14. The KF Flags Menu

The KF Flags menu is used to set keyframe flags. The adjustments are described below.

- The **GLOBALS** adjust up-down switc

4.11 Locate Menu

Press the **Locate** adjust button to enter the Locate Menu. (This option requires the 3D Rotation and Perspective PWA.)

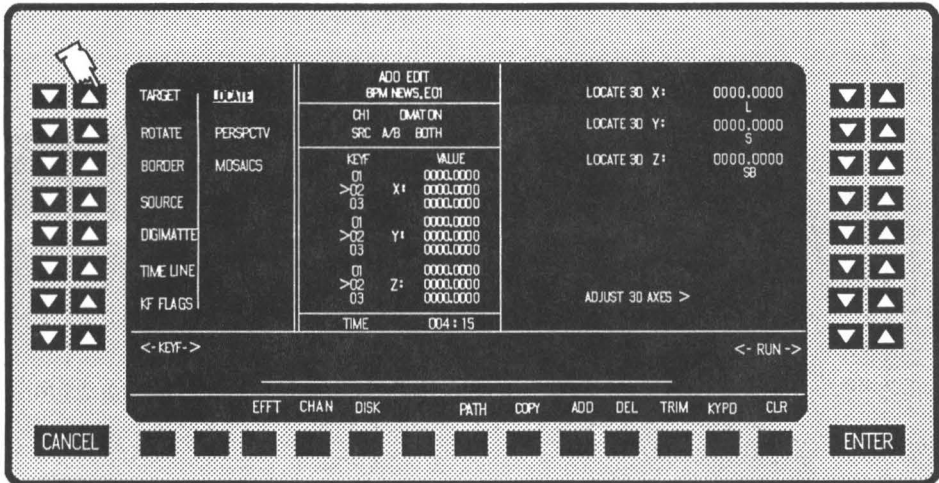
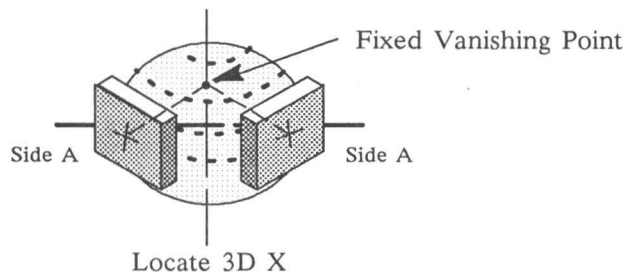

Figure 4-15. The Locate Menu

The Locate menu is used for three dimensional location of the video plane for the current channel. The adjustments are described below.

- The **Locate 3D X**, **Locate 3D Y**, and **Locate 3D Z** adjust up-down switch pairs are used to move the image along the system's X, Y, and Z axes in relationship to a fixed vanishing point, which changes the observed 3D viewpoint of the image. Adjusting the Z axis counterclockwise decreases image size by moving the image away from the viewer, and rotating the joystick (Z axis) clockwise increases the image size by moving the image closer to the viewer.



4.11.1 3D Axis Submenu

Press the **ADJUST 3D AXES >** adjust button to enter the 3D AXIS Submenu. (This option requires the 3D Rotation and Perspective PWA.)

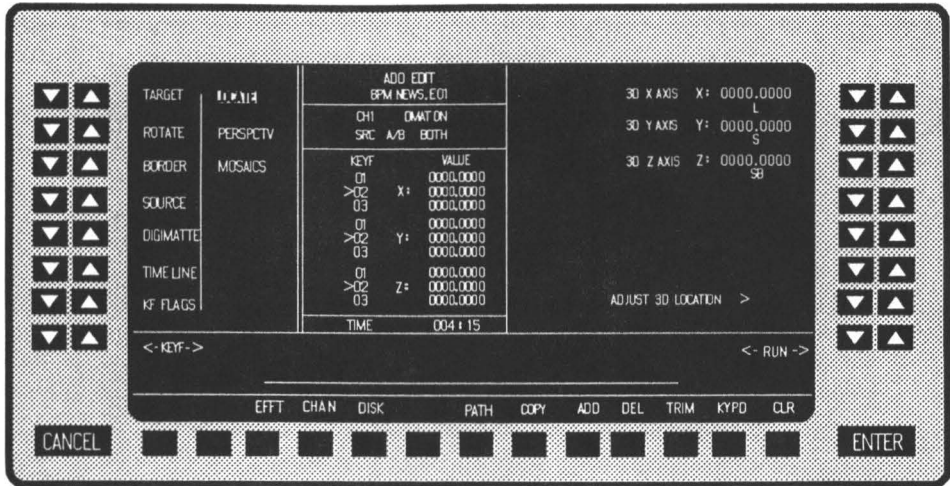
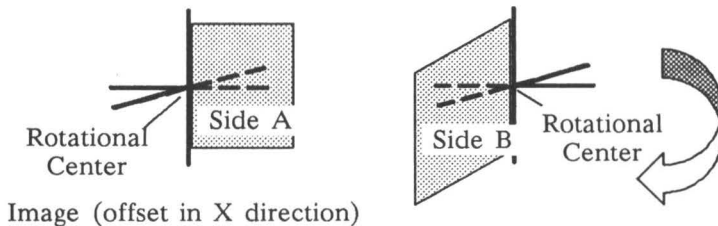

Figure 4-16. The 3D AXIS Submenu

The 3D Axis submenu is used for moving the image relative to the center point of the system axes. The adjustments are described below.

- The 3D X AXIS X, 3D Y AXIS Y, and 3D Z AXIS Z adjust up-down switch pairs are used to shift the image off the rotational center (offset). This can be used to simulate for instance a page turning in a book.

The edge coordinates of a normal aspect image as follows:
 Left edge -- Axis X = 4 Right edge -- Axis X = -4
 Top edge -- Axis Y = 3 Bottom edge -- Axis Y = -3
 For Autocube operation -- set Axis Z = 3



4.12 Perspective Menu

Press the **Perspectv** button to enter the Perspective Menu. (This option requires the 3D Rotation and Perspective PWA.)

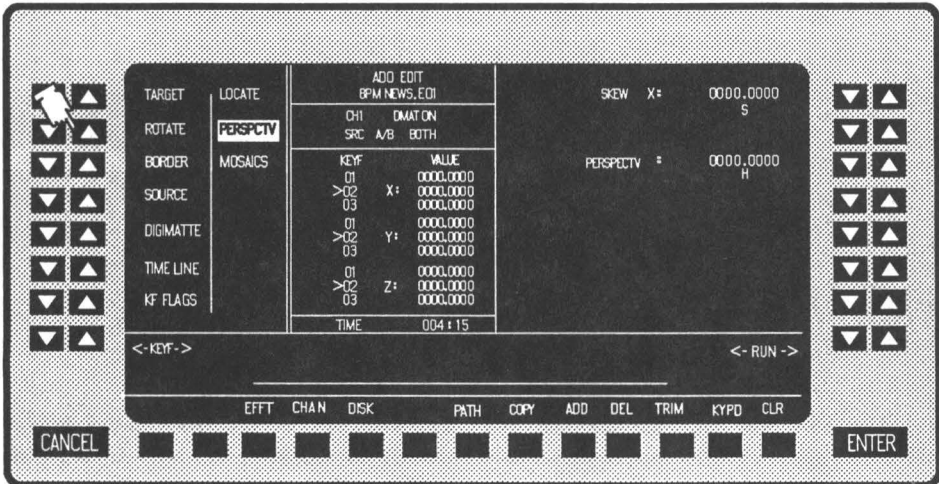
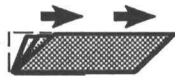
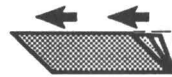

Figure 4-17. The Perspective Menu

- The **SKEW X** adjust up-down switch pairs are used to slant the vertical lines or an image to the left or right.



Skew X: positive number



Skew X: negative number

- The **PERSPECTIVE** adjust up-down switch pairs are used to adjust the vanishing point's distance from the operators eye. This allows the perspective foreshortening values applied to the image to be adjusted for enhanced illusion movement in 3D space. A perspective value of 0.000 causes the vanishing point to be infinitely far away and the system operates without perspective (as in 2D). A perspective value of 16.664 corresponds to a vanishing point positioned on the eye of the viewer and thus offers the extreme perspective effects.

4.13 Mosaics Menu

Press the **Mosaics** button to enter the Mosaics Menu.

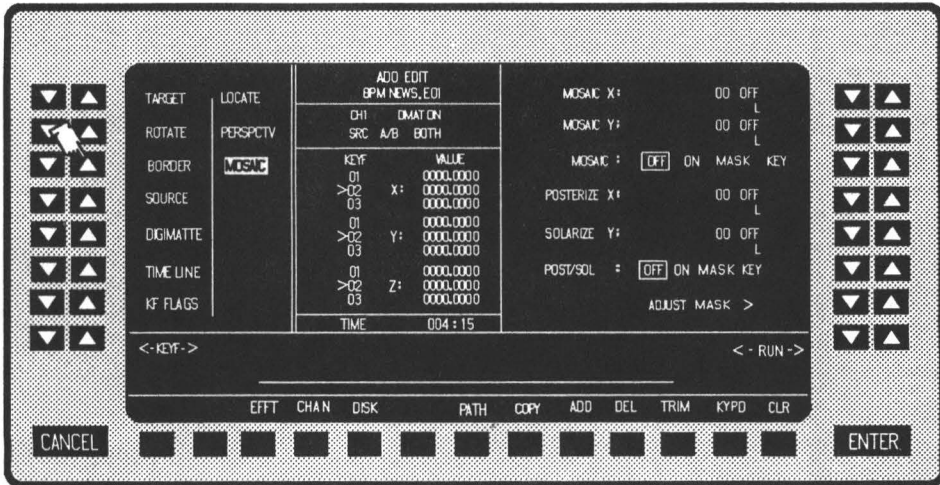

Figure 4-18. The Mosaic Menu

The Mosaic menu controls the mosaic tiling of a specified portion of the source video. The adjustments are described below. *(This option needs the Image Innovator Option PWA)*

- The **MOSAIC X**, and **MOSAIC Y** adjust up-down switch pairs are used to increase the number of tiles and tile size in the horizontal and/or vertical direction, respectively.
- The **MOSAIC** adjust up-down switch pairs are used to select mosaic **OFF**, **ON**, **MASK**, and **KEY**.
 - OFF** -- Mosaic off.
 - ON** -- Mosaic on.
 - Mask** -- Mosaic in area defined by the Mask Generator.
 - Key** -- Mosaic in area defined by the 50% level of the Digi-Matte key.
 - Mask and Key** -- Mosaics in the common area defined by the 50% level of the Digi-Matte key and the Mask Generator.

4.12 Perspective Menu

Press the **Perspectv** button to enter the Perspective Menu. (This option requires the 3D Rotation and Perspective PWA.)

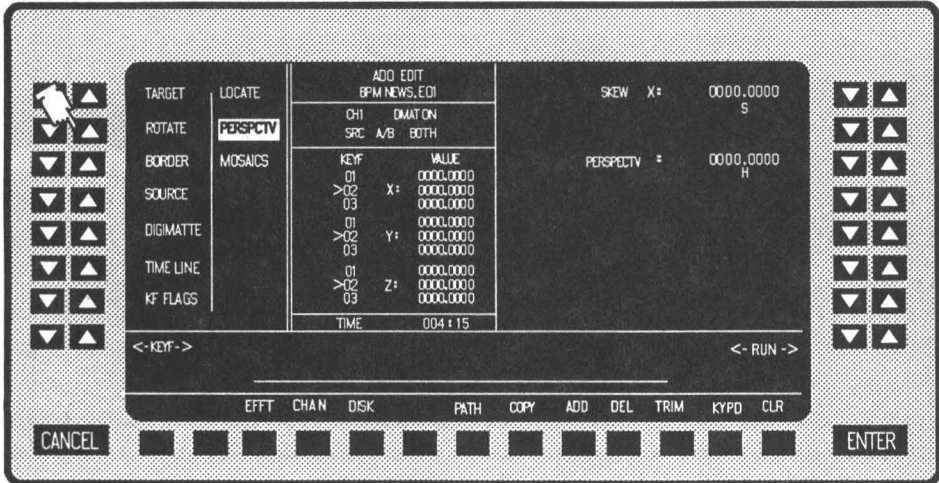
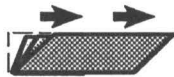
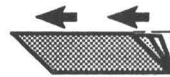

Figure 4-17. The Perspective Menu

- The **SKEW X** adjust up-down switch pairs are used to slant the vertical lines or an image to the left or right.



Skew X: positive number



Skew X: negative number

- The **PERSPECTIVE** adjust up-down switch pairs are used to adjust the vanishing point's distance from the operators eye. This allows the perspective foreshortening values applied to the image to be adjusted for enhanced illusion movement in 3D space. A perspective value of 0.000 causes the vanishing point to be infinitely far away and the system operates without perspective (as in 2D). A perspective value of 16.664 corresponds to a vanishing point positioned on the eye of the viewer and thus offers the extreme perspective effects.

4.13 Mosaics Menu

Press the **Mosaics** button to enter the Mosaics Menu.

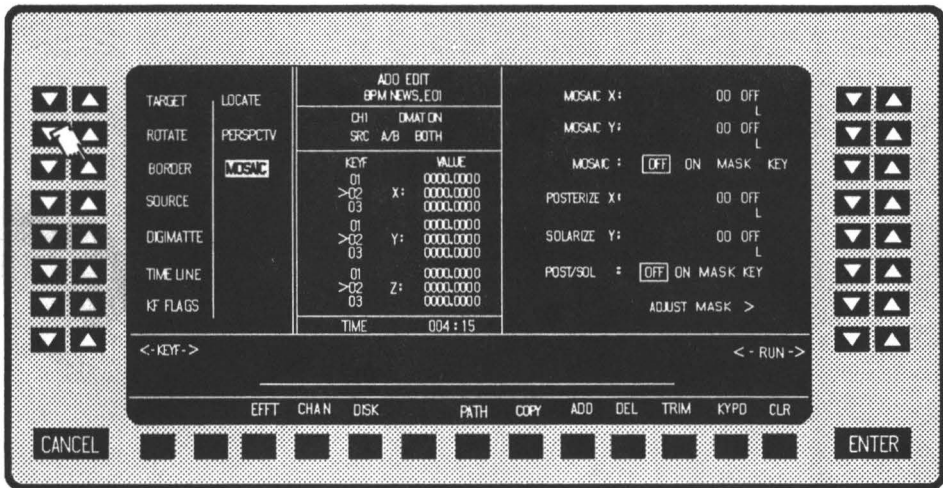

Figure 4-18. The Mosaic Menu

The Mosaic menu controls the mosaic tiling of a specified portion of the source video. The adjustments are described below. *(This option needs the Image Innovator Option PWA)*

- The **MOSAIC X**, and **MOSAIC Y** adjust up-down switch pairs are used to increase the number of tiles and tile size in the horizontal and/or vertical direction, respectively.
- The **MOSAIC** adjust up-down switch pairs are used to select mosaic OFF, ON, MASK, and KEY.
 - OFF** -- Mosaic off.
 - ON** -- Mosaic on.
 - Mask** -- Mosaic in area defined by the Mask Generator.
 - Key** -- Mosaic in area defined by the 50% level of the Digi-Matte key.
 - Mask and Key** -- Mosaics in the common area defined by the 50% level of the Digi-Matte key and the Mask Generator.

■ The **POSTERIZE X** adjust up-down switch pairs are used to adjust luminance levels of the video image. There are thirty-two separate posterize effect levels including luminance reversal.

0 - 15 used to increase the luminance gain of the image.

16 - Off

17 - 22 selects level of posterization.

23 - Off

24 - 29 used to decrease the luminance gain of the image.

30 - Off

31 - used for luminance reversal.

32 - used by Digi-Matte key to control image using the 0 - 15 luminance tables.

■ The **SOLARIZE Y** adjust up-down switch pairs are used to adjust the chroma gain of the video image. There are thirty-two separate solarize effect levels including forced monochrome.

0 - 15 used to decrease the chrominance gain of the image.

16 - Off

17 - 22 used to increase the chrominance gain of the image.

23 - Off

24 - 29 selects single color tint of video.

30 - Off

31 - used for forced monochrome.

32 - used by Digi-Matte™ key to control image using the 0 - 15 chrominance tables.

■ The **POST/SOL** adjust up-down switch pairs are used to select posterization and solarization OFF, ON, MASK, and KEY. Operation is identical to the Mosaics enable control.

4.13.1 Adjust Mask Submenu

Press the **Adjust Mask >** button to enter the Mask Submenu.

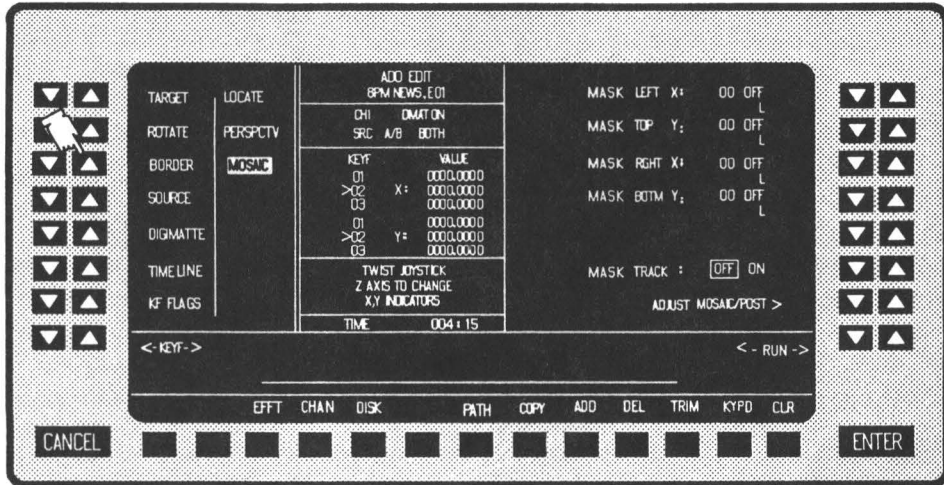

Figure 4-19. The Adjust Mask Submenu

The Adjust Mask Submenu controls a rectangular mask generator and allows the mask to be tracked by the joystick across the screen. The adjustments are described below.

- The **Mask Left**, **Mask Top**, **Mask Right**, and **Mask Bottom** adjust up-down switch pairs are used to position the sides of the mask.
- The **Track Mask** adjust up-down switch pairs allows selection of the track mask mode. In this mode, the joystick will move the key mask horizontally or vertically within the screen by adjusting all four edges of the mask simultaneously.

4.14 Softkey Submenus

Press the **AVC** softkey to return to AVC Vista Control menus. This is applicable on the AVC Vista Control Console only.

Press the **EFFT** softkey to allow an effect to be stored to/from RAM memory. Recall of the whole effect allows simple On-Air Shotbox operation. Effects can be stored or recalled by pressing the desired location number followed by the **SAVE** or **GET** submenu softkeys.

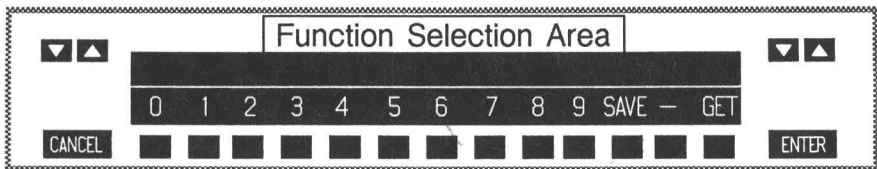

Figure 4-20. EFFT Submenu Area

Select the RAM memory location by selecting the two-digit number (01 through 24), then press the **SAVE** softkey to store effect to RAM memory or press the **GET** softkey to recall the effect from RAM memory. The system automatically returns to normal softkey operation with the completion of the **SAVE** or **GET** function. Storing or recalling an effect is canceled if the **CANCEL** softkey is pressed prior to pressing **SAVE** or **GET**.

- *To store an effect in RAM memory location 12* -- Press the following key sequence:

Press

[EFFT] → [1] → [2] → [SAVE]

- *To recall an effect in RAM memory location 12 and then run the effect* -- Press the following key sequence:

Press

[EFFT] → [1] → [2] → [GET]

Now move the fader bar or use the <RUN> controls to run the effect.

- *To store an effect in RAM memory location 2* -- Press the following key sequence:

Press

[EFFT] → [0] → [2] → [SAVE]

Press the CHAN softkey allow selection of the local channel or global channel for editing.

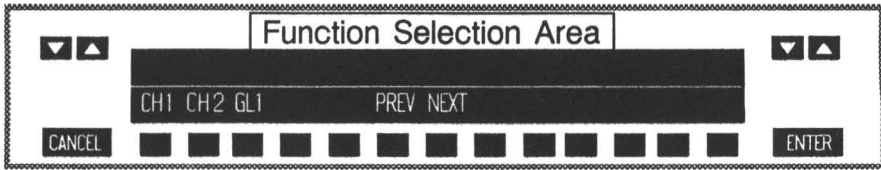

Figure 4-21. CHAN Submenu Area

- * **CH1** -- used to select channel 1 for editing.
- * **CH2** -- not used at this time.
- * **GL1** -- used to select global channel 1 for editing. This can add "effects on to an effect" for CH1 or CH2.
- * **PREV** -- used to select the previous channel. If CH2 is presently selected, pressing this button will select CH1. The selection steps through the following sequence: CH1 → GL1 → CH2 → CH1
- * **NEXT** -- used to select the next channel. If CH2 is presently selected, pressing this button will select GL1. The selection steps through the following sequence: CH1 → CH2 → GL1 → CH1

The system automatically returns to normal softkey operation with the completion of the CH1, CH2, GL1, PREV, NEXT, or CANCEL function.

NOTE

Operation of a second channel (CH 2) is not supported at this time.

Pressing the **PATH** softkey allows the operator to select the required motion type for an effect. These include **HOLD**, **SMTH**, **LIN**, **IGN**, and **BRK**. **HOLD** causes a parameter value to remain constant for a specified keyframe's duration. **SMTH** (smooth) gives smooth flowing fluid motion between keyframes. **LIN** (linear) causes a linear motion between keyframes, such as a bouncing ball. **IGN** causes a parameter to be excluded from all splining, therefore, this keyframe has no effect on the final motion path of the image. **BRK** modifies the **SMTH** motion by causing the image to rest (pause) at each specified **BRK** keyframe.

SMTH is the default motion type. Selecting a motion type other than **SMTH**, press the following key sequence:

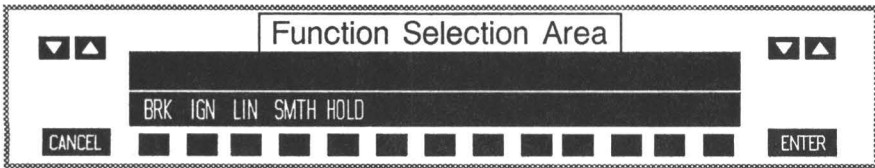
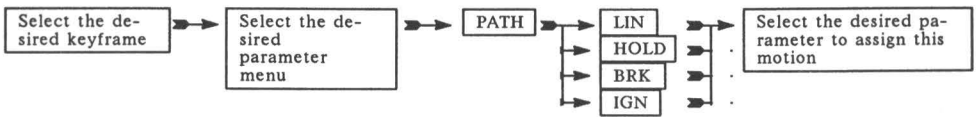

Figure 4-22. PATH Submenu Area

● To change the *ROTATE X* parameter on the *ROTATE* menu at keyframe 2 -- Press the following key sequence:
Press



Pressing the **COPY** softkey allows the operator to select a number of copy routines which permit various parameters to be copied to other keyframes in the effect. These include **PARM**, **MENU**, **KEYF**, **FROM**, **ONTO**, and **AFTR**. **PARM** allows a specified parameter value and its path type to be copied. **MENU** allows a specified menu of parameter values and their path types to be copied. **KEYF** allows all parameter values and path types in a complete keyframe to be copied. Copies can be made from a single keyframe to another keyframe in the effect, or from a specified group of keyframe to another group of keyframes.

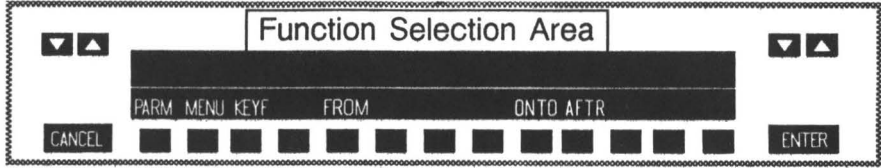
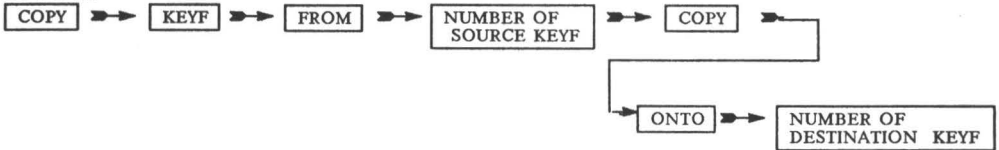

Figure 4-23. COPY Submenu Area

- To copy a whole keyframe to another keyframe -- Press the following key sequence:

Press



- To copy a whole keyframe and make it a new keyframe after the last keyframe -- Press the following key sequence:

Press

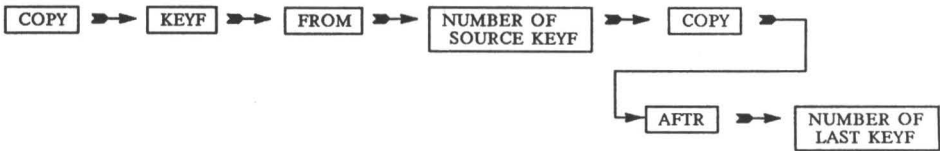

- To copy a menu from one keyframe onto another keyframe(s) -- Press the following key sequence:

Press

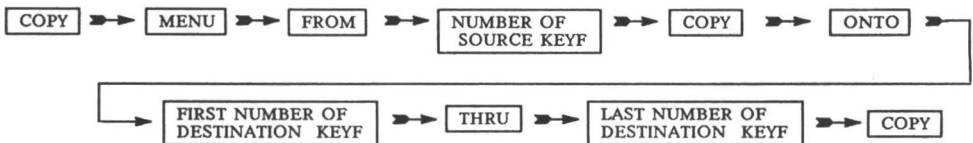

- To copy a specific parameter from one keyframe(s) to another keyframe(s) -- Press the following key sequence:

Press

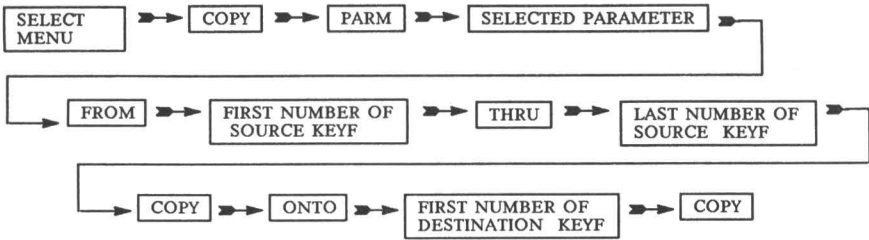

- To copy a specific parameter from one keyframe to all keyframes -- Press the following key sequence:

Press

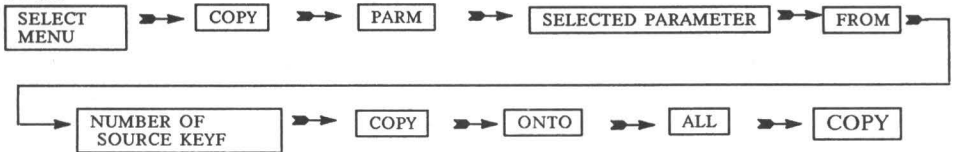

The DEL softkey menu allows single keyframes and pauses, or all keyframes and pauses in an effect to be deleted.

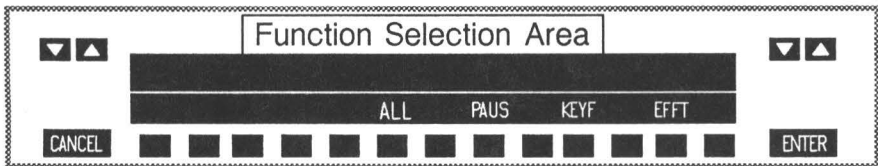

Figure 4-24. DEL Submenu Area

Before deleting a pause or keyframe, ensure that the system is positioned on the desired keyframe or pause. Use the <KEYF> and/or <RUN> controls for positioning on the timeline.

- To delete the current keyframe



- To delete keyframes in the effect



- To delete the current pause



- To delete all pauses in the effect



The **TRIM** softkey enables a numeric trim value to be applied to a parameter. The value may be entered from the softkey keypad which appears after pressing the TRIM softkey, or from the dedicated keypad located to the right of the EL display. The softkey keypad must be used on Vista integrated models.

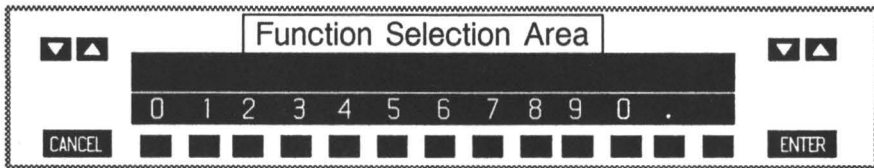
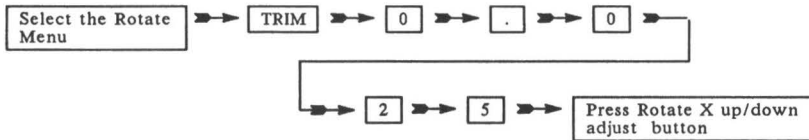

Figure 4-25. TRIM Submenu Area

- To trim an X rotation value by 0.025, press the following key sequence:



The **KYPD** softkey enables a numeric value to be applied to a specific parameter on a specific keyframe, or a specific parameter on all keyframes. The value may be entered from the softkey keypad which appears after pressing the KYPD softkey, or from the dedicated keypad located to the right of the EL display. The softkey keypad must be used on Vista integrated models.

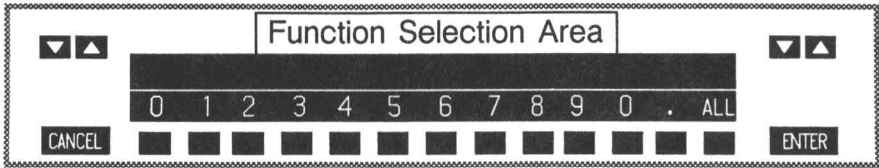
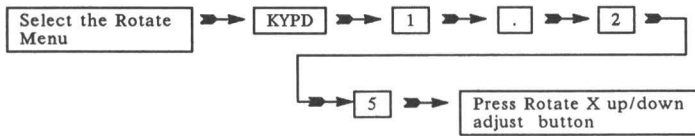

Figure 4-26. KYPD Submenu Area

The All softkey allows the required numeric value to be entered to all keyframes in the current channel.

- To enter an X rotation value of 1.25, press the following key sequence:



- To enter an X rotation value of 1.25 on all keyframes, press the following key sequence:

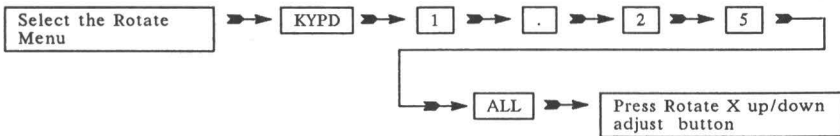

The CLR softkey enables a specific parameter, a specific menu parameter, or a specific keyframe to be reset to the system default values.

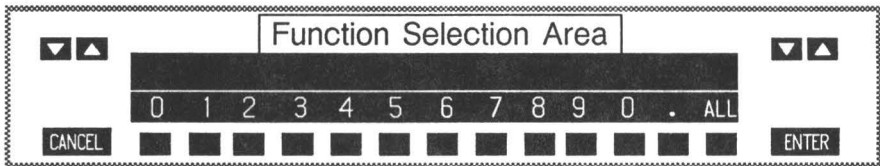

Figure 4-27. CLR Submenu Area

The All softkey allows the selected parameter to be reset to system default values for all keyframes in the current channel.

- To clear target X numeric value and motion type, press the following key sequence:



- To clear target X motion type, press the following key sequence:



- To clear target X numeric value, press the following key sequence:



- To clear target X position in all keyframes, press the following key sequence:



- To clear target X, Y, and Z and defocus parameters in a keyframe, press the following key sequence:



- To clear a keyframe, press the following key sequence:



NOTE

For rotation X, Y, and Z parameters only,
pressing the CLEAR softkeys or dedicated
keys clears the value to the nearest 90 de-
gree rotation point. A second clear operation
is required to reset the parameters to the
system default.

SECTION 5

Disk Usage

5.1 Introduction

This section provides information about disk usage, disk facilities, and use of the disk menu. It also includes information on disk handling and storage, and disk formatting.

5.2 Use of Floppy Disks

The system uses 3 1/2 inch, double-sided, double-density, soft-sectored floppy disks for storing effects. Insert a disk in the drive with its write enable switch positioned to the left side of the disk. (The write enable switch should be positioned at the left side furthest away from the disk drive when inserting it.)

The disk's write enable switch permits data recording. If the switch (black) covers the hole in the disk, the disk is write protected (refer to Figure 5-1). Slide the switch towards the outside corner of the disk and notice the hole is open; the disk is not write protected. The hole must be uncovered when storing effects. To protect data on a disk from being overwritten accidentally, slide the switch covering the hole.

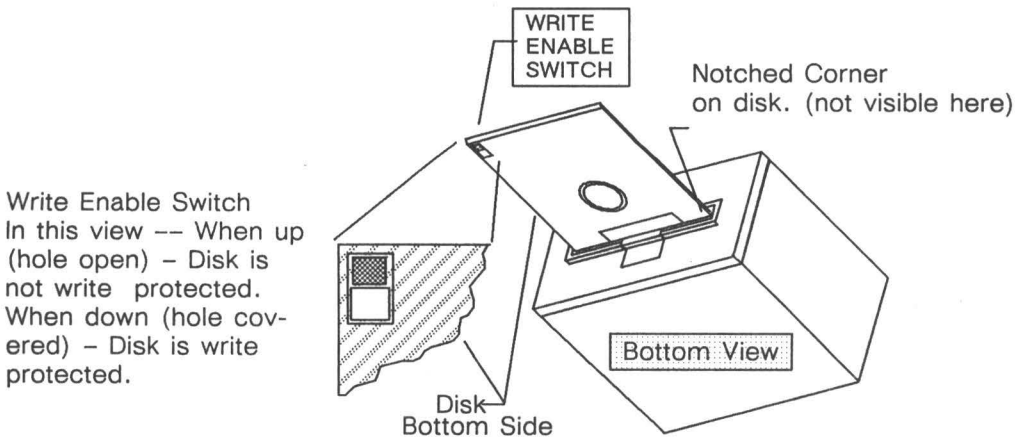

Figure 5-1. Loading Disk Drive and Setting Write Enable Switch

5.3 Disk Handling and Storage

Disks are critical to storing and recalling effects. Use care in handling and storing disks, to ensure that they operate properly and their contents are not damaged or destroyed. Be sure to follow the precautions below and see Figure 5-2.

- Protect recording surface from dust, fingerprints and debris:
 - *Do not touch recording surface exposed through read/write access slot. Hold disk only by edge.*

 - *Do not use erasers on disk.*

 - *Store disks vertically in a dust-free, covered container.*

- Do not do anything that will dent or deform disk:
 - *Do not bend or fold disk.*

 - *Do not place heavy objects on disk.*

 - *Do not use rubber bands or paper clips on disk.*

 - *Do not write on disk label with pencil or ball-point pen; use a felt pen.*

 - *Do not apply labels on top of other labels.*

- Do not use magnets or magnetized objects near disk. A magnetic field can erase or distort data on disk.

- Do not use alcohol, Freon, or thinners to clean disk.

- Do not turn disk drive power on or off while disks are inserted. You could destroy data.

- Do not expose disks to sunlight or excessive heat.

- Operate, store, and ship disks under proper environmental conditions. Follow disk manufacturer's specifications for acceptable temperature and humidity ranges.



DO NOT TOUCH
MAGNETIC SURFACE

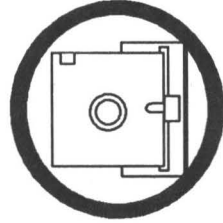

INSERT DISK CAREFULLY



KEEP DISK AWAY
FROM
MAGNETIC FIELDS

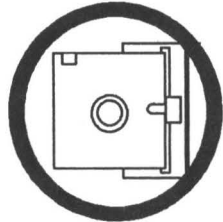

RETURN DISK TO ITS
JACKET
WHEN NOT IN USE



HANDLE WITH
CARE -
BENDING AND
FOLDING
MAY DAMAGE DISK

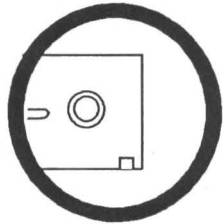

DISKS SHOULD BE
STORED AT:
10° TO 67° C
50° TO 130° F

Figure 5-2. Disk Handling And Storage

5.4 Formatting Disks

Every new disk must be formatted before it can be used. Disks containing effects no longer needed can also be reformatted, if disks are not damaged. A disk must be formatted before another disk is copied onto it.

CAUTION

BEFORE REFORMATTING A PREVIOUSLY USED DISK, BE SURE ITS EFFECTS ARE NO LONGER NEEDED. REFORMATTING DESTROYS ALL RECORDED DATA.

Disk formatting instructions are contained in Section 6 of this manual.

5.5 Disk Facilities

Disk facilities are divided between the **EDIT** and **SETUP** screens. Storage, recall, and naming functions are accessed by the **DISK** softkey located in the **EDIT** screen. Format functions are located in the **SETUP** screen.

5.6 Effect Cataloging

An ADO 100 effect programmed in the **EDIT** mode can be stored in RAM memory (for short term storage) or on a 3 1/2 inch micro-floppy disk. Each effect needs to be properly cataloged on the disk to ensure recalling the desired effect from the multitude of stored effects.

The disk menu allows one effect or a group of twenty-four effects to be stored to/recalled from disk. A disk may contain any number of effects up to a maximum of ninety-nine effects, or 3,000 keyframes.

Effects can be identified by both name and number as described below. An *EFFECT* is identified by a maximum eight character name, followed by the characters ".E" and a two character effect number. *For example, an effects name and number could be "ADOEFFECT.E15".*

5.7 Listing Effects on Disk

Pressing the **DISK** softkey in the *EDIT* screen changes the screen display to the following menu, and automatic lists all effect currently stored on the disk drive in the center screen status area.

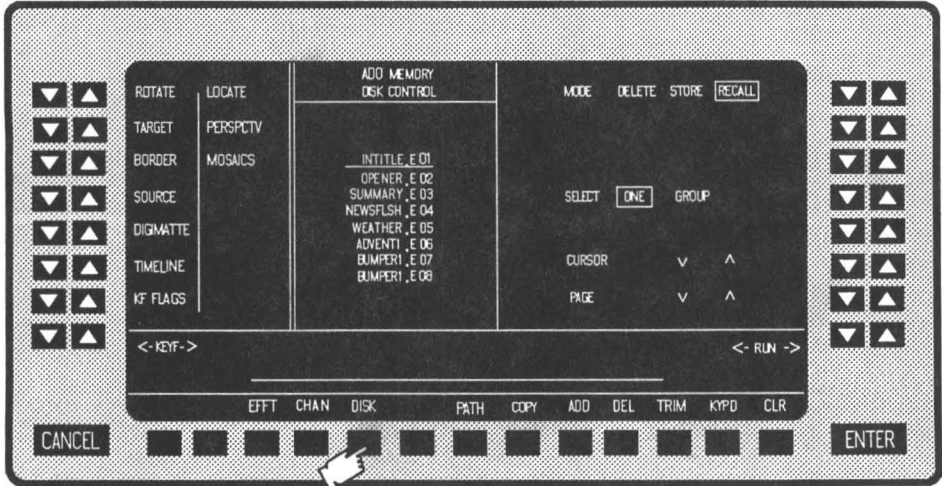

Figure 5-3. The Disk Menu

The first effect, identified by the effect number .E01 is highlighted indicating it is the effect that is selected. The **CURSOR** and **PAGE** keys are used to select a different effect. Up to ninety-nine effects can be held on the disk, and they are identified by the extensions ".E01 to .E99".

5.8 Recalling Effects from Disk

Pressing the **DISK** softkey in the *EDIT* screen changes the screen display to the following menu (refer to Figure 5-3), and automatically lists the effects currently stored on the disk drive in the center screen status area. The disk menu allows one effect or a group of effects to be recalled from disk.

Effect Recall – To recall only one effect from the disk, set **SELECT** adjust keys to **ONE**. Scroll the list of effects until the desired effect is highlighted, and then press the **ENTER** key. This will cause the selected effect to be recalled to the *EDIT* screen programming memory.

Group Recall – To recall a group of twenty-four effects, set the **SELECT** adjust keys to **GROUP**. Press the **ENTER** key. This will cause the first twenty-four effects to be recalled to the twenty-four *On-Air RAM memory locations*. The effects will not be recalled to the *EDIT* screen programming memory. This process is called *group recall* or *downloading*.

5.9 Erasing an Effect

Press the **DISK** softkey in the *EDIT* screen, and then select **ONE**. Use the **CURSOR** or **PAGE** to highlight the desired effect; change the **MODE** key from **RECALL** to **DELETE**, and then press the **ENTER** key to confirm the action. When the **ENTER** key is pressed, the warning " **WARNING EFFECT WILL BE ERASED.** " appear on the display. Press the **ENTER** key again to confirm this action, or the **CANCEL** key to abort this action.

5.10 Storing Effects to Disk

Press the **DISK** softkey in the *EDIT* screen, and change the mode key from **RECALL** to **STORE**. The following menu allows effects to be named and numbered, and then displayed.

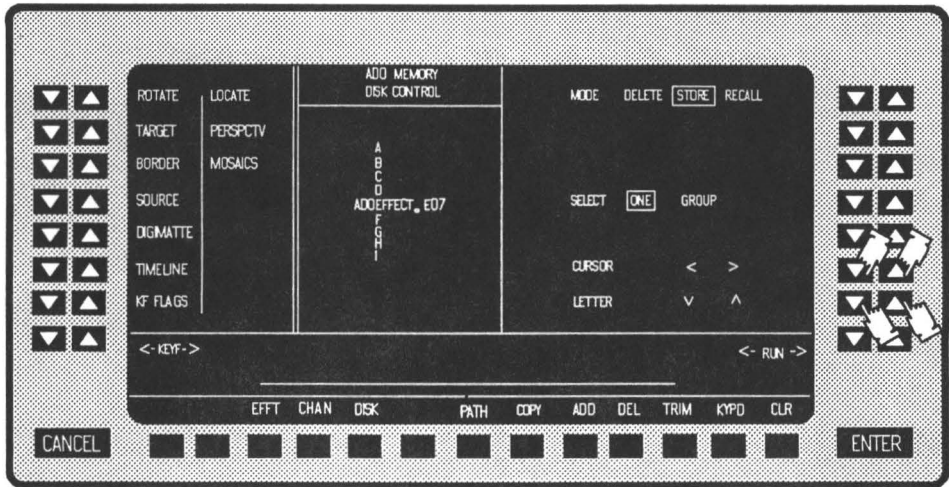

Figure 5-4. The Disk Store Menu

Effect Store – To store an effect, confirm **MODE** key is set to **STORE**, **SELECT** adjust key is set to **ONE**, and then press the **ENTER** key. This will cause the effect in the *EDIT* screen programming memory to be stored on disk with the default name and number indicated in the the center screen area.

5.11 Naming and Numbering Effects

Press the **DISK** softkey in the *EDIT* screen, and change the **MODE** adjust key to **STORE**. The center screen area changes to allow effect naming by the operator (Figure 5-5).

Effects can be identified by both name and number. The ADO 100 system automatically assigns a default name and number to an effect when **STORE** is selected.

An effect is given the eight character name "AD~~O~~EFFECT", followed by the characters **.E** and the next unused effect number.

Alternative names and numbers can be given to an effect by using the **CURSOR** and **LETTER** keys.

Use the **CURSOR** key to select which letter in the effect name is to be changed. Use the **LETTER** key to scroll the available letters and numbers until the desired letter appears in the effect name line. In Figure 5-5, the letter **E** has been changed to the letter **X**. Repeat the process until all letters and numbers have been changed as desired.

In Figure 5-5, the letters **E, F, F, C,** and **T** have been changed to the letters **X, M, P, L,** and **E** and the operator is assigning a new effect number. To store the effect with the new name and number, press the **ENTER** key. Note the **.E** character is assigned by the system, and cannot be changed by the operator.

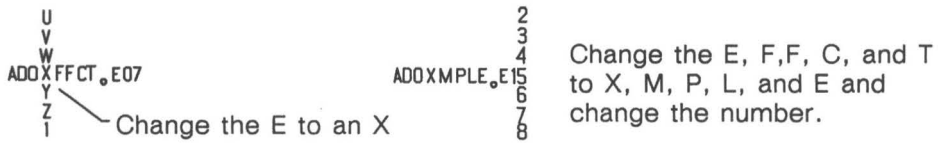

Figure 5-5. Changing effect name.

SECTION 6

Communications and Set-up Mode

6.1 Introduction

This section provides information about the ADO 100 System Communication and Set-Up operating mode.

6.2 Set-Up Mode

The Set-Up mode provides control of the following parameters:

- *System engineering parameters*
- *Format disk routines*

6.3 Set-Up Mode Access

The *Set-Up* mode is accessed by pressing and holding down the **CANCEL** key and then pressing the **ENTER** key. On AVC Vista integrated systems, press the **SETUP** softkey to access the system timing configuration menus. Press the **DISK** softkey to format disks.

When in the Set-Up mode, the system will automatically select (default to) the *VIDEO INPUT* menu.

6.4 System Timing Adjustment Menus

There are four system timing menus and one submenu provided in the **SETUP** mode on an ADO 100 standalone system. They are the *Video Input*, *Video Output*, *Digimatte Input*, and *Key Output* menus along with the *Blanking Sub-menu*. Timing can be set for A and B inputs and Rooms 1, 2, 3, or 4, or for all paths of an AVC Digi-Loop on AVC Vista integrated system.

6.4.1 The Video Input Menu

Press the **VIDEO INPUT** adjust keys to display the video input menu.

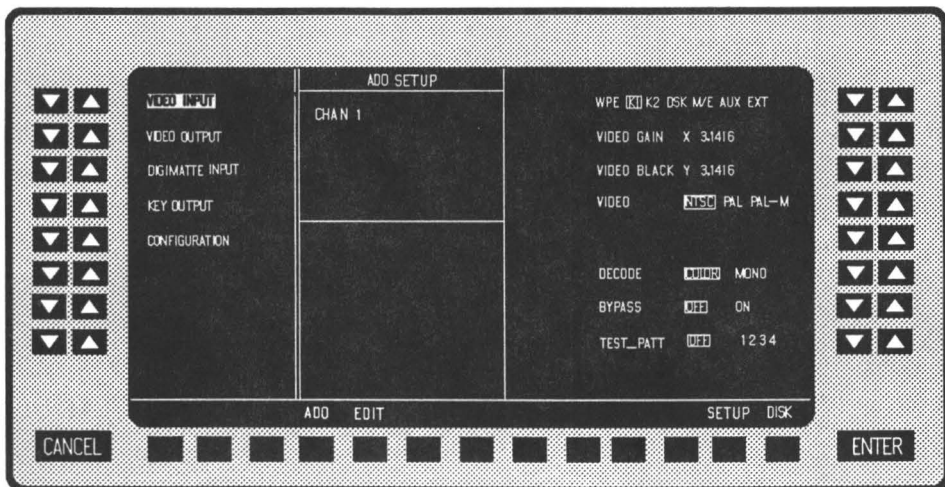

Figure 6-1. Video Input Menu

Various encoder and decoder functions can be selected on composite video systems, including television standard decoder mode, and test pattern selection.

The Video Input menu is used for setting up video input paths. The adjustments are described below.

- The **WPE**, **K1**, **K2**, **DSK**, **M/E**, **AUX**, and **EXT** adjust up-down switch pairs are used to select the Digi-Loop path providing the input video. Separate adjustments can be made for each path. In a standalone ADO 100 system, this line displays **ROOM 1(2,3,or4) A B** . Use the adjust up/down keys to select the A or B input for adjustment.
- The **VIDEO GAIN** adjust up-down switch pairs are used to adjust the level of the video source ± 10 IRE units.
- The **VIDEO BLACK** adjust up-down switch pairs are used to adjust the black level of the video source.
- The **VIDEO** adjust up-down switch pairs are used to selects the television standard of the video source.
- The **DECODE** adjust up-down switch pairs are used to select color comb filtering or monochrome bandpass filtering in the decoder.

■ The **BYPASS** adjust up-down switch pairs are used to allow the digital processing to be bypassed which allows the encoder/decoder alignment to be checked.

■ The **TEST_PATT** adjust up-down switch pairs are used to select four digitally generated test patterns to verify the alignment of the system encoder.

The encoder level adjustments are made in the Video Output Menu.

Separate adjustments can be made for each Digi-Loop path, or A and B inputs and Rooms 1, 2, 3, 4.

6.4.2 Video Output Menu

Press the **VIDEO OUTPUT** adjust keys to display the Video Output menu.

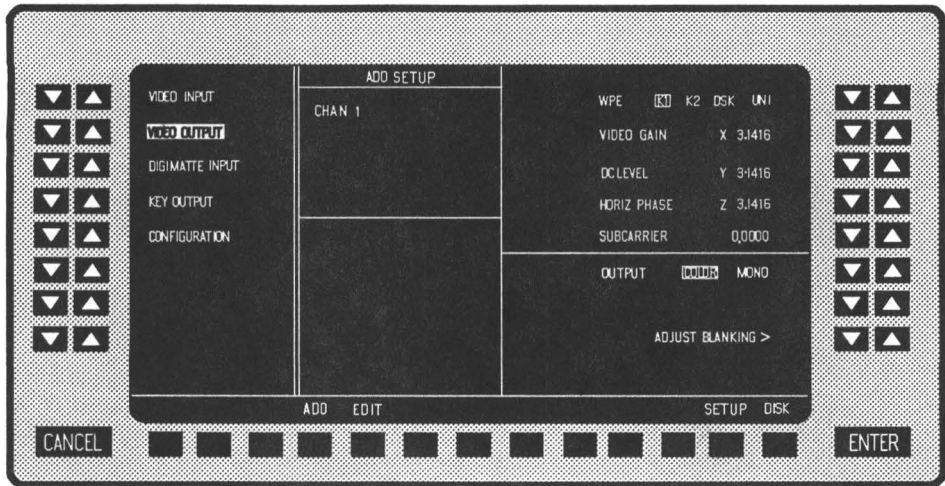

Figure 6-2. Video Output Menu

The Video Output menu is used for correctly phasing the system output to downstream mixers and switchers. The adjustments are described below.

- The **WPE**, **K1**, **K2**, **DSK**, and **UNI** adjust up-down switch pairs are used to select the Digi-Loop path to receive the ADO 100's output. In a standalone ADO 100 system, this line displays **ROOM 1(2,3, or 4)**.
- The **VIDEO GAIN** adjust up-down switch pairs are used to set the proper video gain for the system's output.
- The **DC LEVEL** adjust up-down switch pairs are used to set the proper video D.C. level for the system's output.
- The **HORIZ PHASE** adjust up-down switch pairs are used to adjust the horizontal phase timing parameter to phase ADO 100 output to downstream keyers or switchers.
- The **SUBCARRIER** adjust up-down switch pairs are used to adjust the sub-carrier phase.

■ The **OUTPUT** adjust up-down switch pairs are used to select monochrome or color output from the system.

■ The **ADJUST BLANKING >** adjust up-down switch pairs are used to select the blanking submenu.

Separate output timing parameters can be set for each Digi-Loop path or Rooms 1, 2, 3, 4.

6.4.3 Blanking Submenu

Press the **ADJUST BLANKING > adjust** keys to display the Blanking Submenu.

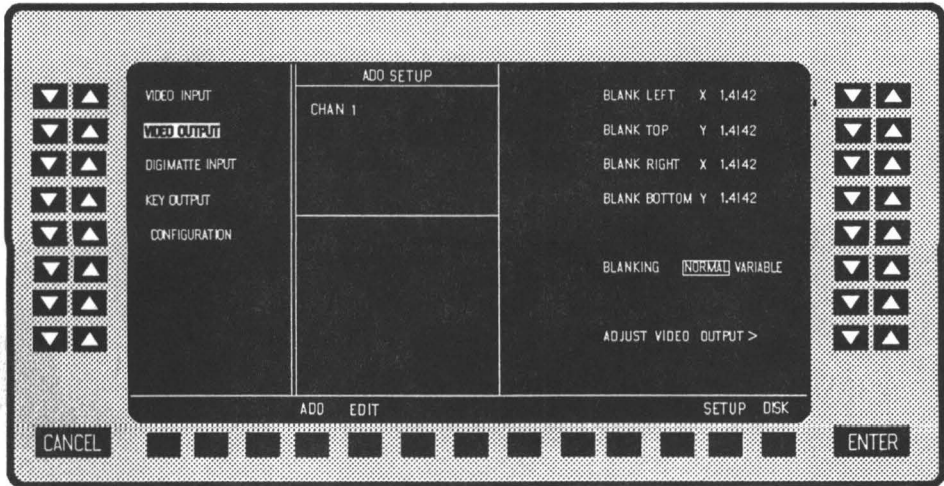

Figure 6-3. Blanking Submenu

The Blanking Submenu is used for custom house blanking requirements. The adjustments are described below.

- The **BLANK LEFT** adjust up-down switch pairs are used to adjust left edge horizontal blanking.
- The **BLANK TOP** adjust up-down switch pairs are used to adjust top edge vertical blanking.
- The **BLANK RIGHT** adjust up-down switch pairs are used to adjust right edge horizontal blanking.
- The **BLANK BOTTOM** adjust up-down switch pairs are used to adjust bottom edge vertical blanking.
- The **BLANKING** adjust up-down switch pairs are used to select between custom **VARIABLE** blanking and system default **NORMAL** blanking parameters.

Only one custom blanking setup is allowed. If custom blanking is selected, it applies to all the Digi-Loop paths or Rooms 1, 2, 3, 4.

6.4.4 Digimatte Menu

Press the **DIGIMATTE** adjust keys to display the Digimatte Menu.

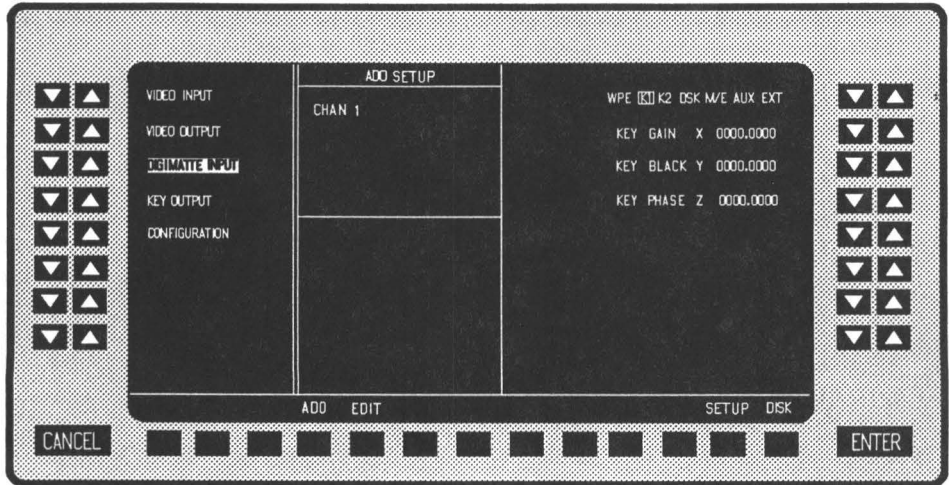

Figure 6-4. Digimatte Menu

The Digimatte Menu is used for adjusting the level and phase of externally supplied key signals. The adjustments are described below.

- The **WPE, K1, K2, DSK, M/E, AUX, and EXT** adjust up-down switch pairs are used to select the Digi-Loop path providing the key signal to the Digi-Matte. In a standalone ADO 100 system, this line displays **ROOM 1(2,3, or 4) A B**. Use the adjust up/down keys to select the A or B input for adjustment.
- The **KEY GAIN** adjust up-down switch pairs are used to adjust the input key gain.
- The **KEY BLACK** adjust up-down switch pairs are used to adjust the input key black level.
- The **KEY PHASE** adjust up-down switch pairs are used to adjust the input key phase, relative to input video.

Separate adjustments can be set for each Digi-Loop path, or A and B inputs and Rooms 1, 2, 3, 4.

6.4.5 Key Output Menu

Press the **KEY OUTPUT** adjust keys to display the Key Output Menu.

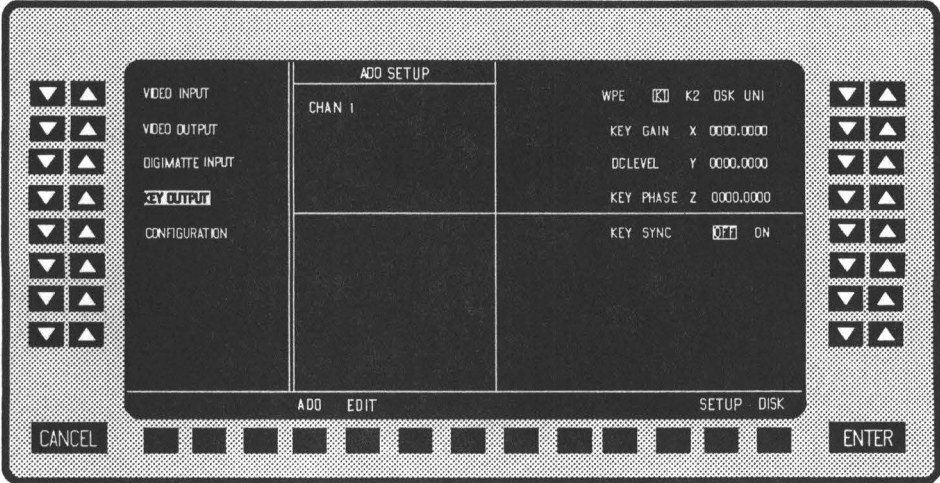

Figure 6-5. Key Output Menu

The Key Output Menu is used primarily for setting the correct phase for the program key of the ADO 100. The adjustments are described below.

- The **WPE**, **K1**, **K2**, **DSK**, and **UNI** adjust up-down switch pairs are used to select the Digi-Loop path receiving the key signal. In a standalone ADO 100 system, this line displays **ROOM 1(2,3, or 4)** .
- The **KEY GAIN** adjust up-down switch pairs are used to set the gain of the output key.
- The **DC LEVEL** adjust up-down switch pairs are used to set the D.C. level of the output key.
- The **KEY PHASE** adjust up-down switch pairs are used to set the phase of the output key relative to house reference.
- The **KEY SYNC** adjust up-down switch pairs are used to select sync on the key or no sync on the key signal.

Separate adjustments can be set for each Digi-Loop path, or Rooms 1, 2, 3, 4.

6.5 System Configuration Menu

System configuration can be verified by selecting the CONFIGURATION Menu. The center screen area displays the system options installed, and indicates if the system is communicating with the system CPU. If an option is installed but tallies NO, contact your Ampex Service Representative.

Press the CONFIGURATION adjust keys to display the Configuration Menu.

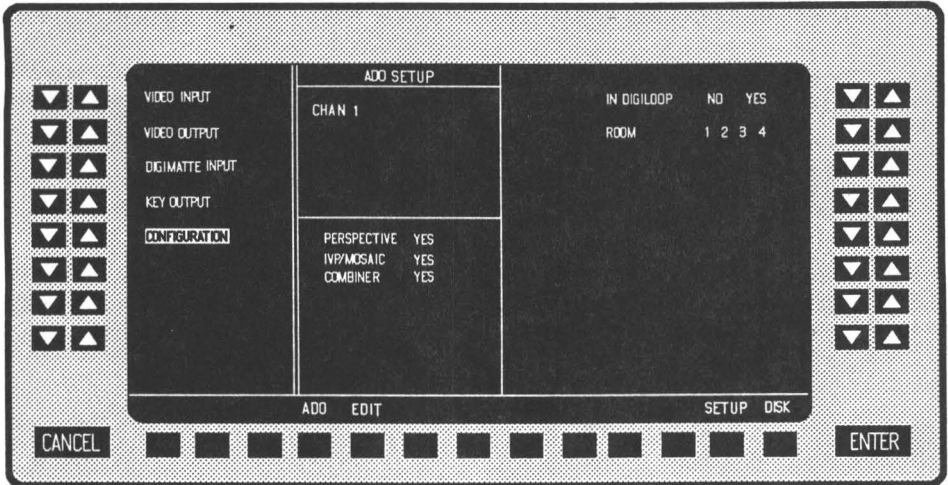

Figure 6-6. Configuration Menu

Set the **IN DIGILOOP** adjust keys to the **YES** position for operation with the AVC Vista series DigiLoop. If the AVC Vista is controlling the ADO 100 system from the Vista console, then it automatically accesses the appropriate timing parameters required for each Digi-Loop path by the normal operation of the AVC Vista Digi-Loop menu. The operator must time each Digi-Loop path before the first operation of the system. Pressing **ENTER** stores these values into non-volatile EEPROM memory for automatic recall during subsequent operation of the system.

Where ADO 100 is in the Digi-Loop but controlled from it's own control console, the operator must change the Digi-Loop selection on both the Vista Digi-Loop menu and the ADO 100 setup mode.

Set the **IN DIGILOOP** adjust keys to the **NO** position for operation in all other situations. The system can be adjusted for up to four separate timing setups designated **ROOM 1, 2, 3, and 4**. Select the desired **ROOM** by the adjust up/down buttons.

The operator must time each required ROOM path before the first operation of the system. Press ENTER to store these values into non-volatile EEPROM memory for automatic recall during subsequent operation of the system.

6.6 Disk Formatting

Pressing the DISK softkey automatically selects the *Disk Setup Menu*. This menu is used to format disks. Press the FORMAT DISK adjust up/down switches to format a blank disc. The system will display a warning that all effects contained on this disc will be erased if the disc is formatted. Press the CANCEL key to abort the action, or the ENTER key to confirm the action.

6.7 Storing changes to the Set-Up menus

To store changes on the Set-Up menus, press the ENTER key.

6.8 Exiting the Setup Mode

To exit the SETUP Mode, press the ADO softkey. Pressing this key exits the SETUP mode and then accesses the EDIT mode. If using the Vista Control Console, press the ADO softkey followed by pressing the EDIT softkey to access the EDIT mode.

Appendix A

Specifications

Table 1-1 lists *electrical*, *mechanical* and *environmental* specifications for ADO 100 digital special effects systems.

Table 1-1. Specifications
General Video

<i>Electrical</i>	
<i>Power Input</i>	<i>Signal System, Console</i> 100 - 120, 200 - 240 Vac; 50 or 60 Hz ± 2%
<i>Power Consumption</i>	
<i>Console</i>	75 Watts
<i>Signal System</i>	500 Watts
<i>Environmental</i>	
<i>Temperature Range</i>	0° to 45° C.
<i>Relative Humidity</i>	10% to 90%, noncondensing.
<i>Ethernet</i>	
<i>Ethernet</i>	
<i>Coaxial Cable used is RG58</i>	
<i>Cable length: Supplied length:</i>	100 feet (30 meters) with console 10 feet (3 meters) with signal system
<i>Max/Min length:</i>	500 feet (154 meters) 3 feet (1 meter)
<i>BNC connectors -- 50 ohms</i>	
<i>BNC T-Adapters -- 50 ohms</i>	
<i>BNC Terminator -- 50 ohms</i>	

Table 1-1. Specifications

<i>General Video</i>	
<i>Inputs: Reference Video</i>	<i>1V p-p composite, 75 Ω terminated, Composite Video or Black.</i>
<i>Outputs: Video</i>	<i>525/60 NTSC, 625/50 PAL, 625/60 PAL-M</i>
<i>Key Out</i>	<i>1V p-p , 75 Ω terminated</i>
<i>Performance</i>	
<i>Sampling standard</i>	<i>13.5 MHz, CCIR 601 component digital</i>
<i>Sub-pixel resolution</i>	<i>2.3 nanoseconds</i>
<i>Frequency response</i>	<i>\pm 0.5 dB to 5.5 MHz</i>
<i>Differential phase</i>	<i>Less than 2°</i>
<i>Differential gain</i>	<i>Less than 2%</i>
<i>K factor (2T pulse)</i>	<i>Less than 1%</i>

Table 1-1. Specifications

<i>Control I/O</i>	
<i>Console</i>	<i>Ethernet Coax, Ethernet, GPI, Disk Interface. Remote and Terminal are reserved for factory/test usage.</i>
<i>Signal System</i>	<i>Ethernet Coax, Ethernet, terminal. SCSI and Terminal reserved for factory/test usage.</i>
<i>Physical Arrangement (Dimensions and Weight)</i>	
Dimensions	
	Wide High Depth
<i>Control Panel</i>	<i>19 in. x 7.75 in. x 4.5 in.</i> <i>(48.26 cm x 19.68 cm x 11.43 cm)</i>
<i>Signal System</i>	<i>19 in.x 12.5 in. x 20 in.</i> <i>(48.26cm x 31.75 cm x 50.8 cm)</i>
Shipping Weight <i>including crate</i>	
<i>Control Panel</i>	<i>14 lbs.</i> <i>(6.35 kg)</i>
<i>Signal System</i>	<i>80 lbs.</i> <i>(36.3 kg)</i>

Table 1-1. Specifications

*Physical Arrangement (Dimensions and Weight) cont.***Service Access**

Maintain 1.75 in. (4.45 cm) adequate clearance around the top, sides, and bottom of units to ensure proper ventilation-

access to unit

minimum 35 in. (88.9 cm) in front for PC Board

extension for service.

minimum 12 in. (30.48 cm) for service between rear of unit and wall.

Air intakes are located at the front and right sides. Exhaust is located at the rear and left sides.

Recommended Maximum

To exceed these cable lengths risk degrading system performance

*Total length of Ethernet coaxial cable -- 500 ft max
(152.4 meters)*

AMPEX

Corporation

Technical Publications Department

581 Conference Place

Golden, Colorado 80401

Addendum A

ADO 100 Operation Manual

1809824-01

7/14/89

NOTES: Remove and replace the following pages or sections as indicated.

1. All of the Table of Contents
2. Page 4-13 and 4-14
3. Page 4-23 and 4-24
4. Page 4-25 and 4-26
5. All of Section 5
6. All of Section 6
7. All of the Appendix A
8. Add Appendix B

TABLE OF CONTENTS

Paragraph Number	Title	Page Number
------------------	-------	-------------

Section 1 General Information

1.1	Purpose and Scope Of Manual	1-1
1.2	Related Publications	1-1
1.3	General Description	1-2
1.4	System Configuration	1-3
1.5	AVC Vista Integration	1-4
1.6	Real Time Image Transformation	1-5
1.7	CCIR-601 4:2:2 Component Digital Processing	1-5
1.8	Digi-Matte Processor	1-6
1.9	Effects Storage	1-6

Section 2 Programming Effects

2.1	Introduction	2-1
2.2	3D Space Definitions	2-1
2.3	Source Space/Source Image	2-2
2.4	Target Space/Target Image	2-2
2.5	The ADO 100 World Model	2-2
2.6	Multi-pass and Global Motion Control	2-4
2.7	Basic 2D Rotation System Transformation Capabilities	2-4
2.8	3D Option Image Transformation Capabilities	2-5
2.9	Image Innovator Option Capabilities	2-6
2.10	Advanced Programming Capabilities	2-7
2.11	Programming Effects	2-7
2.12	Keyframes	2-7
2.13	Motion Path Types	2-8
2.14	Effect Recall and Running	2-10

TABLE OF CONTENTS
(continued)

Paragraph Number	Title	Page Number
Section 3 Control Console Controls		
3.1	Introduction	3 -1
3.2	Single Function Controls	3 -2
3.2.1	Joystick	3 -2
3.2.2	Fader Bar	3 -3
3.2.3	Numeric Keypad	3 -3
3.2.4	Dedicated Switch Group	3 -3
3.2.5	The ENTER key	3 -4
3.2.6	The CANCEL key	3 -4
3.3	Graphic Display and Adjust Keys	3 -4
3.3.1	Graphic Display	3 -4
3.3.2	Graphic Display Screen Layout	3 -5
3.3.3	Adjust keys and Softkeys	3 -6
3.3.3.1	Switch Adjustment Rate	3 -6
3.3.4	The <KEYF> and <RUN> keys	3 -6
3.4	Keyframe Parameter Selection Area Controls	3 -7
3.5	Center Screen Area	3 -8
Section 4 Operation		
4.1	Introduction	4-1
4.2	Menu Organization	4-1
4.2.1	Effect Edit Menus and Submenus	4-2
4.3	System Power Up	4-2

TABLE OF CONTENTS
(continued)

Paragraph Number	Title	Page Number
Section 4 Operation (continued)		
4.3.1	System Reset	4-3
4.3.2	Align the Joystick and Fader Bar	4-3
4.3.3	Changing to the Edit Menus	4-3
4.4	Target Menu	4-4
4.4.1	Background Submenu	4-5
4.5	Rotate Menu	4-6
4.6	Border Menu	4-7
4.6.1	Adjust Border Sides Submenu	4-8
4.7	Source Menu	4-9
4.7.1	Adjust Source Crop Submenu	4-10
4.8	Digimatte Menu	4-11
4.8.1	Digi-Matte Mask Submenu	4-12
4.9	Timeline Menu	4-13
4.10	KF Flags Menu	4-14
4.11	Locate Menu	4-15
4.11.1	3D Axis Submenu	4-16
4.12	Perspective Menu	4-17
4.13	Mosaics Menu	4-18
4.13.1	Adjust Mask Submenu	4-20
4.14	Softkey Submenus	4-21

**TABLE OF CONTENTS
(continued)**

Paragraph Number	Title	Page Number
Section 5 Disk Usage		
5.1	Introduction	5-1
5.2	Use of Floppy Disks	5-1
5.3	Disk Handling and Storage	5-2
5.4	Formatting Disks	5-4
5.5	Disk Facilities	5-4
5.6	Effect Cataloging	5-4
5.7	Listing Effects on Disk	5-5
5.8	Recalling Effects from Disk	5-6
5.9	Erasing an Effect or Group	5-6
5.10	Storing Effects to Disk	5-6
5.11	Naming and Numbering Effects	5-8
Section 6 System Set-up Mode		
6.1	Introduction	6-1
6.2	Set-Up Mode	6-1
6.3	Set-Up Mode Access	6-1
6.4	System Timing Adjustment Menus	6-1
6.4.1	Video Input Menu	6-2
6.4.2	Video Output Menu	6-4
6.4.3	Blanking Submenu	6-6
6.4.4	Digimatte Menu	6-7
6.4.5	Key Output Menu	6-8
6.5	Operation in AVC Vista Digi-loop	6-9
6.5.1	Operation in non-Digi-loop applications	6-9
6.6	Disk Formatting	6-10
6.7	Storing changes to the Set-Up menus	6-10
6.8	Exiting the Setup Mode	6-10

TABLE OF CONTENTS
(continued)

Paragraph Number	Title	Page Number
	Appendix A	
	Specifications	A-1
	Appendix B	
	Installation and Planning Guide	B-1

LIST OF ILLUSTRATIONS

Figure Number	Title	Page Number
Section 1 General Information		
1-1	ADO 100 System Configuration	1-3
1-2	System Configuration including Optional Vista Console and VistaDisk	1-4
Section 2 Programming Effects		
2-1	Axis Definition	2-1
2-2	The ADO 100 System world model	2-3
2-3	Multi-pass and Global Motion Control	2-4
2-4	Motion Path Types	2-10
Section 3 Control Console Controls		
3.1	ADO 100 Control Console Layout	3 -1
3.2	Manual operation of joystick	3 -2
3.3	Effect Edit Menu Display Sections	3 -5
3.4	Keyframe Parameter Selection Area	3 -7
3.5	Center Screen Area	3 -8
3.6	Keyframe Parameter Adjust Area	3 -9
3.7	Adjust Border Submenu	3 -10
3.8	Softkeys	3 -11
Section 4 Operation		
4.1	Menu Organization	4-1
4.2	ADO 100 System Copyright Menu	4-2
4.3	Control Console Reset	4-3
4.4	The Target Menu	4-4
4.5	The Background Submenu	4-5

LIST OF ILLUSTRATIONS
(continued)

Figure Number	Title	Page Number
4.6	The Rotate Menu	4-6
4.7	The Border Menu	4-7
4.8	The Side Submenu	4-8
4.9	The Source Menu	4-9
4.10	The Source Crop Submenu	4-10
4.11	The Digimatte Menu	4-11
4.12	The Digimatte Mask Submenu	4-12
4.13	The Time Menu	4-13
4.14	The KF Flags Menu	4-14
4.15	The Locate Menu	4-15
4.16	The 3D Axis Submenu	4-16
4.17	The Perspective Menu	4-17
4.18	The Mosaic Menu	4-18
4.19	The Adjust Mask Submenu	4-20
4.20	EFFT Submenu Area	4-21
4.21	CHAN Submenu Area	4-22
4.22	PATH Submenu Area	4-23
4.23	COPY Submenu Area	4-24
4.24	DEL Submenu Area	4-25
4.25	TRIM Submenu Area	4-26
4.26	KYPD Submenu Area	4-27
4.27	CLR Submenu Area	4-27

**LIST OF ILLUSTRATIONS
(continued)**

Figure Number	Title	Page Number
Section 5 Disk Usage		
5-1	Loading Disk Drive and Setting Write Enable Switch	5-1
5-2	Disk Handling and Storage	5-3
5-3	The Disk Menu	5-5
5-4	The Disk Store Menu	5-7
5-5	Changing effect or group name	5-8
Section 6 System Set-up Mode		
6-1	Video Input Menu	6-2
6-2	Video Output Menu	6-4
6-3	Blanking Submenu	6-6
6-4	Digimatte Menu	6-7
6-5	Key Output Menu	6-8

LIST OF TABLES

Table Number	Title	Page Number
-----------------	-------	----------------

Appendix A

A-1 Specifications		A-1
--------------------------	--	-----

Appendix B

Table 1 ADO 100 Accessories and Cable Kit		B-4
Table 2 Signal System Specifications		B-8
Table 3 ADO 100 Control Console Specifications		B-10
Table 4 ADO 100 Signal System Circuit Boards		B-11
Table 5 Voltage Selection and High/Low Switch Settings		B-14
Table 6 ADO 100 Console Mounting Dimensions		B-17
Table 7 Specifications		B-29

4.9 Timeline Menu

Press the Timeline adjust button to enter the Timeline Menu.

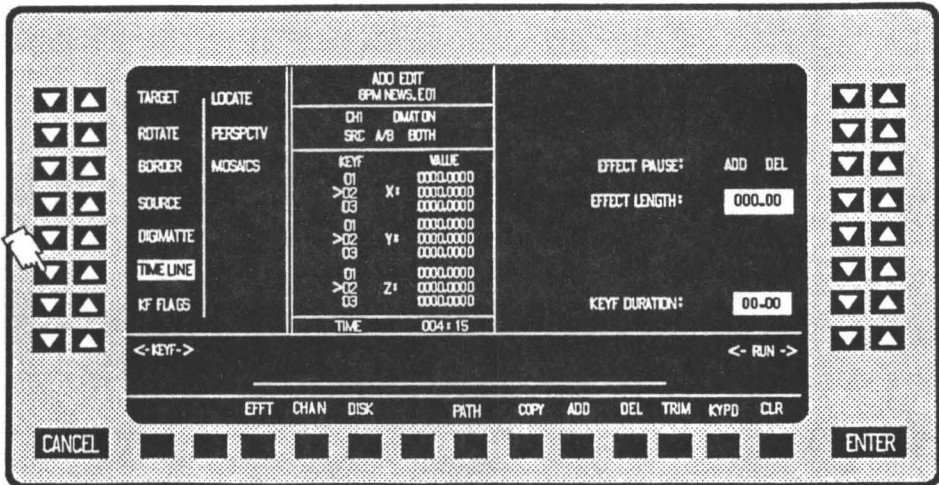

Figure 4-13. The Time Menu

The Timeline menu is used to adjust the duration of keyframes in an effect and the total effect running time. The adjustments are described below.

- The **EFFECT PAUSE** adjust up-down switch pairs are used to add a temporary stop on the timeline. The pause can be added at any location on the timeline.
- The **EFFECT LENGTH** parameter is used to scale the stored effect length to any desired time. **EFFECT LENGTH** should be entered in seconds and frames using the keypad. For example, an effect length of two seconds and twelve frames is entered as "2.12".
- The **KEYF DURATION** parameter is used to adjust the keyframe duration between two keyframes to a value other than the default time (1 second). **KEYF DURATION** should be entered in seconds and frames using the keypad. For example, a twenty frame duration is entered as "0.20".

NOTE

The system recognizes pauses on the timeline when the effect is run using the RUN buttons. An effect run using the fader bar will pass by the pause.

4.10 KF Flags Menu

Press the **KF Flags** button to enter the KF Flags Menu.

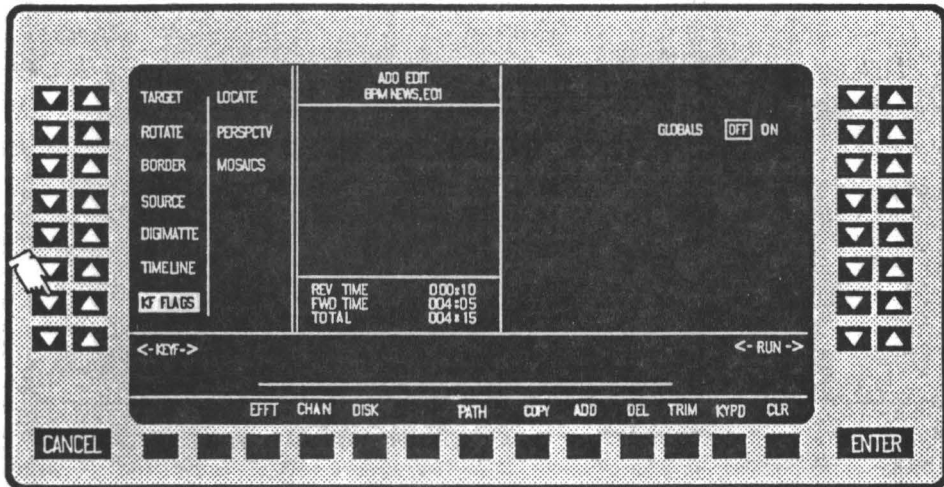

Figure 4-14. The KF Flags Menu

The KF Flags menu is used to set keyframe flags. The adjustments are described below.

- The **GLOBALS** adjust up-down switch pairs are used to enable global channel.
 - OFF -- Adjustments in the Global channel do not affect the Local channel.
 - ON -- Global parameter adjusts can be used to add "effects on effects".

NOTE

Select GLOBAL parameter adjust menus by pressing the CHAN softkey followed by the GL1 softkey.

Pressing the **PATH** softkey allows the operator to select the required motion type for an effect. These include **HOLD**, **SMTH**, **LIN**, **IGN**, and **BRK**. **HOLD** causes a parameter value to remain constant for a specified keyframe's duration. **SMTH** (smooth) gives smooth flowing fluid motion between keyframes. **LIN** (linear) causes a linear motion between keyframes, such as a bouncing ball. **IGN** causes a parameter to be excluded from all splining, therefore, this keyframe has no effect on the final motion path of the image. **BRK** modifies the **SMTH** motion by causing the image to rest (pause) at each specified **BRK** keyframe.

SMTH is the default motion type. Selecting a motion type other than **SMTH**, press the following key sequence:

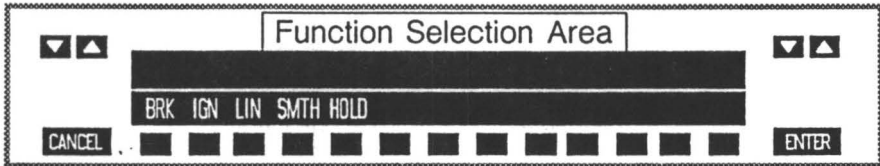
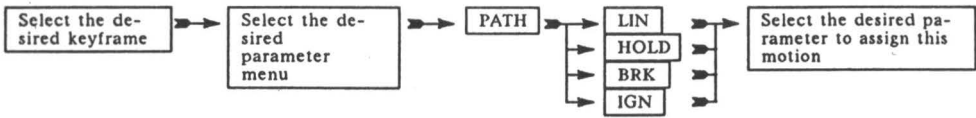

Figure 4-22. PATH Submenu Area

● To change the *ROTATE X* parameter on the *ROTATE* menu at keyframe 2 — Press the following key sequence:



Pressing the **COPY** softkey allows the operator to select a number of copy routines which permit various parameters to be copied to other keyframes in the effect. These include **PARM**, **MENU**, **KEYF**, **FROM**, **ONTO**, and **AFTR**. **PARM** allows a specified parameter value and its path type to be copied. **MENU** allows a specified menu of parameter values and their path types to be copied. **KEYF** allows all parameter values and path types in a complete keyframe to be copied. Copies can be made from a single keyframe to another keyframe in the effect, or from a specified group of keyframe to another group of keyframes.

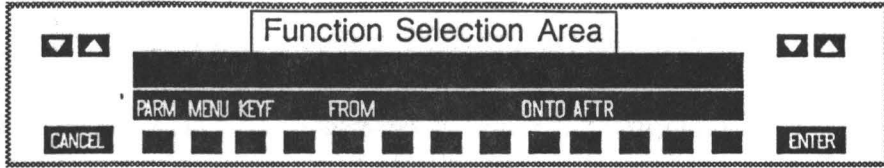
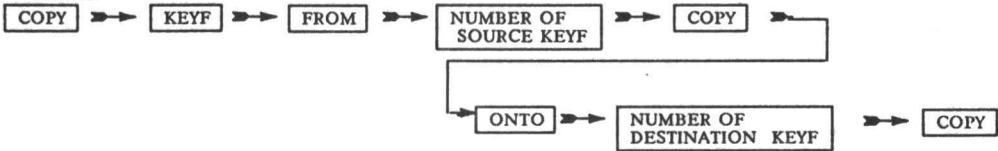

Figure 4-23. COPY Submenu Area

- To copy a whole keyframe to another keyframe -- Press the following key sequence:

Press



- To copy a whole keyframe and make it a new keyframe after the last keyframe -- Press the following key sequence:

Press

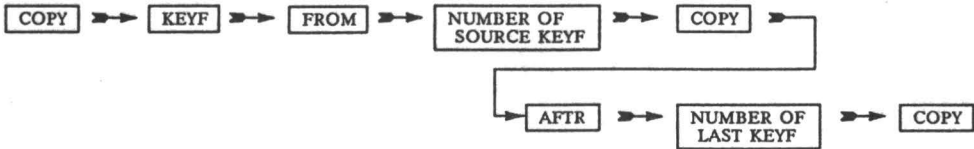

- To copy a menu from one keyframe onto another keyframe(s) -- Press the following key sequence:

Press

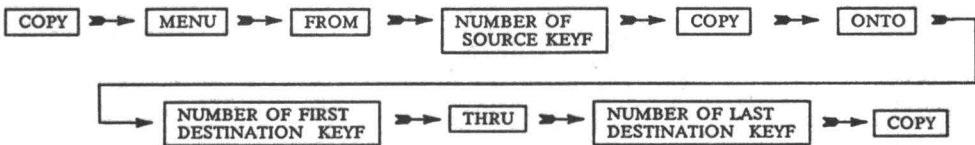

- To copy a specific parameter from one keyframe(s) to another keyframe(s) -- Press the following key sequence:
Press

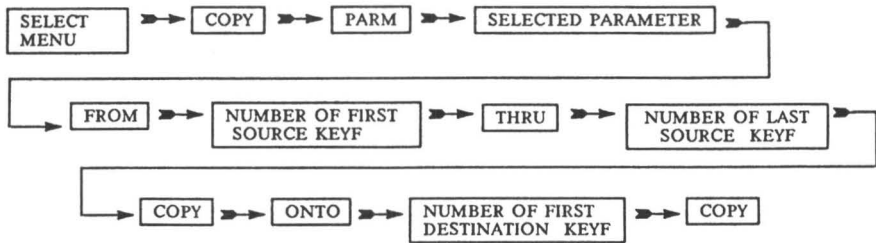

- To copy a specific parameter from one keyframe to all keyframes -- Press the following key sequence:
Press

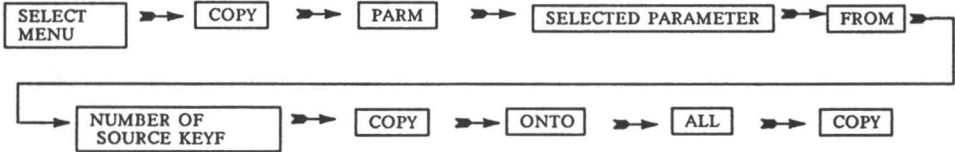

NOTE

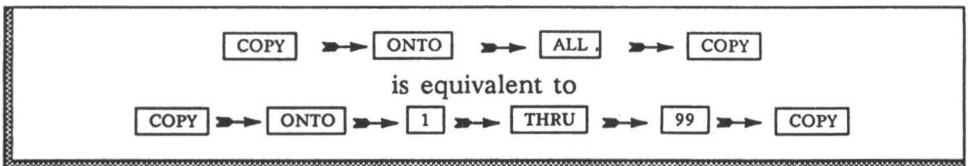

The DEL softkey menu allows single keyframes and pauses, or all keyframes and pauses in an effect to be deleted.

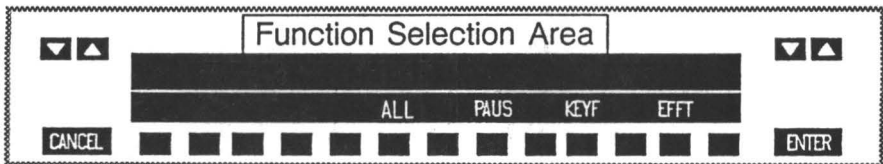

Figure 4-24. DEL Submenu Area

Before deleting a pause or keyframe, ensure that the system is positioned on the desired keyframe or pause. Use the <KEYF> and/or <RUN> controls for positioning on the timeline.

- To delete the current keyframe



- To delete keyframes in the effect



- To delete the current pause



- To delete all pauses in the effect



The TRIM softkey enables a numeric trim value to be applied to a parameter. The value may be entered from the softkey keypad which appears after pressing the TRIM softkey, or from the dedicated keypad located to the right of the EL display. The softkey keypad must be used on Vista integrated models.

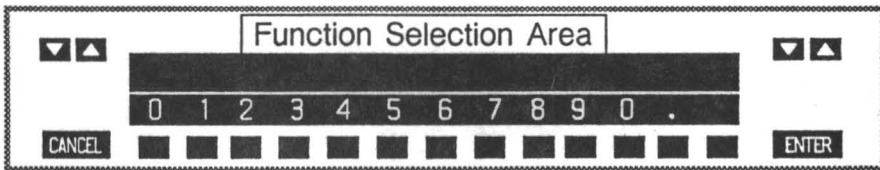
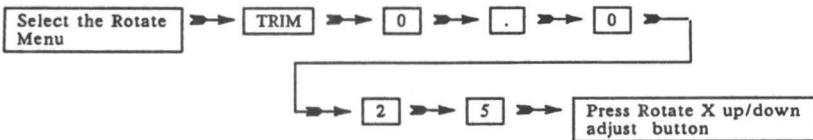

Figure 4-25. TRIM Submenu Area

- To trim an X rotation value by 0.025, press the following key sequence:



The KYPD softkey enables a numeric value to be applied to a specific parameter on a specific keyframe, or a specific parameter on all keyframes. The value may be entered from the softkey keypad which appears after pressing the KYPD softkey, or from the dedicated keypad located to the right of the EL display. The softkey keypad must be used on Vista integrated models.

SECTION 5

Disk Usage

5.1 Introduction

This section provides information about disk usage, disk facilities, and use of the disk menu. It also includes information on disk handling and storage, and disk formatting.

5.2 Use of Floppy Disks

The system uses 3 1/2 inch, double-sided, double-density, soft-sectored floppy disks for storing effects. Insert a disk in the drive with its write enable switch positioned to the left side of the disk. (The write enable switch should be positioned at the left side furthest away from the disk drive when inserting it.)

The disk's write enable switch permits data recording. If the switch (black) covers the hole in the disk, the disk is write enabled (refer to Figure 5-1). Slide the switch towards the outside corner of the disk and notice the hole is open; the disk is now write protected. The hole must be covered when storing effects. To protect data on a disk from being overwritten accidentally, slide the switch to uncover the hole.

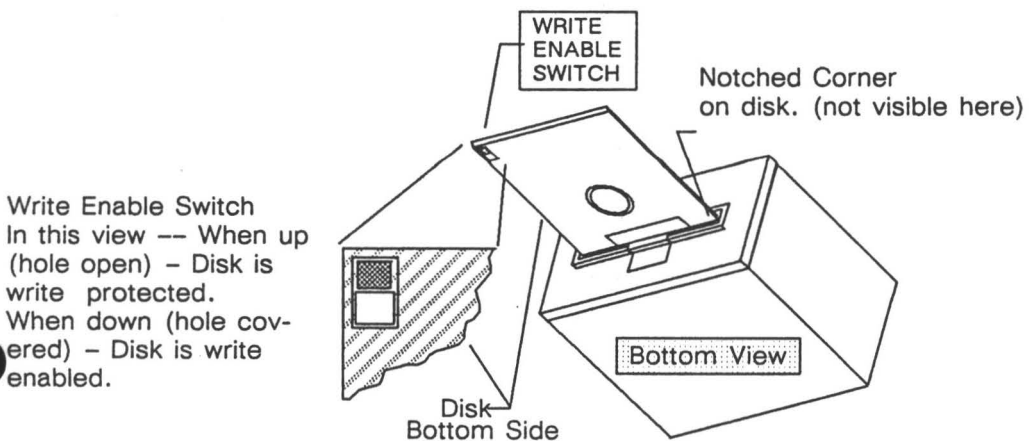

Figure 5-1. Loading Disk Drive and Setting Write Enable Switch

5.3 Disk Handling and Storage

Disks are critical to storing and recalling effects. Use care in handling and storing disks, to ensure that they operate properly and their contents are not damaged or destroyed. Be sure to follow the precautions below and see Figure 5-2.

- Protect recording surface from dust, fingerprints and debris:
 - *Do not touch recording surface exposed through read/write access slot. Hold disk only by edge.*
 - *Do not use erasers on disk.*
 - *Store disks vertically in a dust-free, covered container.*
- Do not do anything that will dent or deform disk:
 - *Do not bend or fold disk.*
 - *Do not place heavy objects on disk.*
 - *Do not use rubber bands or paper clips on disk.*
 - *Do not write on disk label with pencil or ball-point pen; use a felt pen.*
 - *Do not apply labels on top of other labels.*
- Do not use magnets or magnetized objects near disk. A magnetic field can erase or distort data on disk.
- Do not use alcohol, Freon, or thinners to clean disk.
- Do not turn disk drive power on or off while disks are inserted. You could destroy data.
- Do not expose disks to sunlight or excessive heat.
- Operate, store, and ship disks under proper environmental conditions. Follow disk manufacturer's specifications for acceptable temperature and humidity ranges.



DO NOT TOUCH
MAGNETIC SURFACE

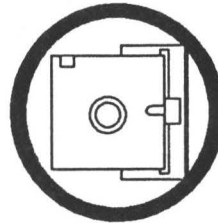

INSERT DISK CAREFULLY



KEEP DISK AWAY
FROM
MAGNETIC FIELDS

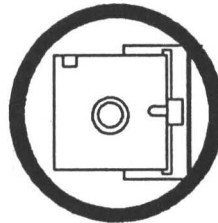

RETURN DISK TO ITS
JACKET
WHEN NOT IN USE



HANDLE WITH
CARE -
BENDING AND
FOLDING
MAY DAMAGE DISK

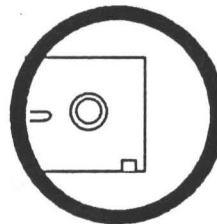

DISKS SHOULD BE
STORED AT:
10° TO 67° C
50° TO 130° F

Figure 5-2. Disk Handling And Storage

5.4 Formatting Disks

Every new disk must be formatted before it can be used. Disks containing effects no longer needed can also be reformatted, if disks are not damaged. A disk must be formatted before another disk is copied onto it.

CAUTION

BEFORE REFORMATTING A PREVIOUSLY USED DISK,
BE SURE ITS EFFECTS ARE NO LONGER NEEDED.
REFORMATTING DESTROYS ALL RECORDED DATA.

Disk formatting instructions are contained in Section 6 of this manual.

5.5 Disk Facilities

Disk facilities are divided between the **EDIT** and **SETUP** screens. Storage, recall, and naming functions are accessed by the **DISK** softkey located in the **EDIT** screen. Format functions are located in the **SETUP** screen.

5.6 Effect Cataloging

An ADO 100 effect programmed in the **EDIT** mode can be stored in RAM memory (for short term storage) or on a 3 1/2 inch micro-floppy disk. Each effect needs to be properly cataloged on the disk to ensure recalling the desired effect from the multitude of stored effects.

The disk menu allows one effect or a group of effects to be stored to/recalled from disk. One effect refers to an individual effect and a group refers to a group of effects. A group will typically contain twenty-four effects, although, it may contain any number of effects up to a maximum of ninety-nine effects. A disk may contain any number of groups up to a maximum of ninety-nine groups.

Effects and groups can be identified by both name and number as described below. An *EFFECT* is identified by a maximum eight character name, followed by the characters ".E " and a two character effect number. For example, an effects name and number could be "ADOEFFECT.E15 ". A *GROUP* is identified by a maximum eight character name, followed by the characters ".A " and a two character group number. For example, a group name and number could be "ADOGROUP.A10 ".

The group facility allows effects related to an event to be collected together under a convenient heading. For example, a group of effect names which could be collected together are " IN TITLE.E01, OPENER.E02, FOOTBALL.E19,

WEATHER.E20, OUTTITLE.E21 ". The group title for these effects might be " 9NEWS.A01 ". Other examples of group names are " 10NEWS.A02, NEWSFLSH.A33, BASEBALL.A45, or CHAIRMAN.A71 ". Valid names include only the characters A - Z, numbers 0 - 9, the dash "-", and space(s).

5.7 Listing Effects on Disk

Pressing the **DISK** softkey in the *EDIT* screen changes the screen display to the following menu, and automatically lists all groups currently stored on the disk drive in the center screen status area.

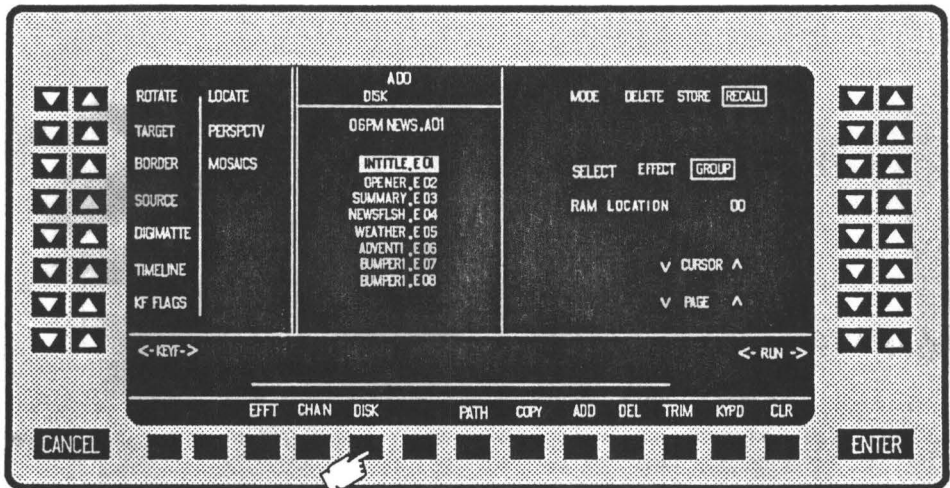

Figure 5-3. The Disk Menu

In the above example, the ADO group name " 06PMNEWS.A01 " is displayed indicating it is the selected group. To view alternate groups, first select **GROUP**, then use the **CURSOR** and **PAGE** keys. The **CURSOR** adjust keys are used to scroll up or down the group lists one group at a time. The **PAGE** adjust keys are used to scroll up or down the lists by eight groups at a time. Up to ninety-nine groups can be held on a disk and they are identified by the extensions ".A01 to .A99".

To check the contents of a group, change **GROUP** back to **EFFECT**. The center screen status area automatically lists all effects in the selected group. The first effect, identified by the effect number .E01 is highlighted indicating it is the effect that is selected. The **CURSOR** and **PAGE** keys are used to select a different effect. Up to ninety-nine effects can be held in a group, and they are identified by the extensions ".E01 to .E99". It is recommended that operators limit the number of effects in any one group to twenty-four, the same as the *On-Air RAM memory capacity* of the *EDIT* screen. This will allow easy uploading and downloading of group effects from the disk to RAM memory.

5.8 Recalling Effects from Disk

Pressing the **DISK** softkey in the *EDIT* screen changes the screen display to the disk menu (refer to Figure 5-3), and automatically lists the effects currently stored on the disk drive in the center screen status area. The disk menu allows one effect or a group of effects to be recalled from disk.

Effect Recall – To recall only one effect from the disk, change **GROUP** to **EFFECT**. Scroll the list of effects until the desired effect is highlighted, and then press the **ENTER** key. This will cause the selected effect to be recalled to the *EDIT* screen programming memory. Note that **RAM LOCATION** must be set at 0.

Alternately, the effect can be recalled to one of the twenty-four *On-Air RAM memory locations*. The RAM memory location is set by the **RAM LOCATION** adjust keys. Change the *RAM memory location* number from 0 to any number between 1 and 24, and press the **ENTER** key. This causes the selected effect to be recalled from disk to the selected *RAM memory location*. The effect will not be recalled to the *EDIT* screen programming memory. The **RAM LOCATION** adjust key resets to 0 automatically following the RAM recall, allowing recall to *EDIT* screen programming memory as the default condition.

Group Recall – To recall a group of effects, select **GROUP**. Scroll the list of groups until the desired group is selected, and press the **ENTER** key. This will cause the first twenty-four effects in the group selected to be recalled to the twenty-four *On-Air RAM memory locations*. The effects will not be recalled to the *EDIT* screen programming memory. This process is called *group recall* or *downloading*.

5.9 Erasing an Effect

Press the **DISK** softkey in the *EDIT* screen, and then select **GROUP** or **EFFECT** as desired. Change the **MODE** key from **RECALL** to **DELETE**. Use the **CURSOR** or **PAGE** keys to highlight the desired group or effect to be erased, and then press the **ENTER** key. A warning message “**WARNING EFFECT WILL BE DELETED**” appears on the display. Press the **ENTER** key again to confirm this action, or the **CANCEL** key to abort this action.

5.10 Storing Effects to Disk

Press the **DISK** softkey in the *EDIT* screen, and change the mode key from **RECALL** to **STORE**. The following menu allows effects to be named and numbered, and then displayed.

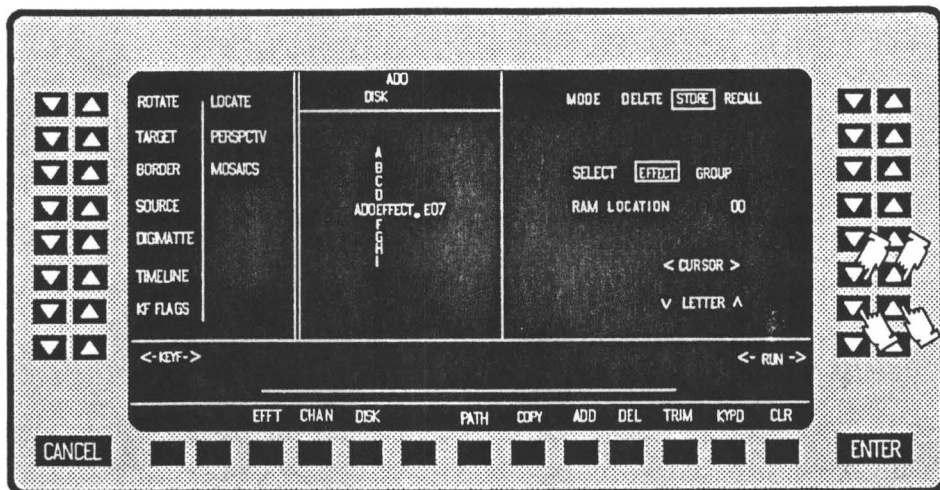

Figure 5-4. The Disk Store Menu

Effect Store – To store only one effect, confirm **MODE** key is set to **STORE**, select **EFFECT**, and check **RAM LOCATION** is set to 0. Press the **ENTER** key. This will cause the effect in the *EDIT* screen programming memory to be stored on disk with the default name and number indicated in the the center screen area.

All or any one of the twenty-four *On-Air RAM memory locations* can be stored to disk. The RAM memory location is identified by the **RAM LOCATION** adjust key. Ensure the **MODE** key is set to **STORE**, and select **EFFECT**. Change the **RAM LOCATION** number to any number between 1 and 24. Press the **ENTER** key.

This causes the effect in the selected **RAM LOCATION** to be stored on disk with the default name and number indicated by the default name in the center screen. The effect will not be recalled from the *EDIT* screen programming memory. The **RAM LOCATION** adjust key will reset to 0 automatically following a RAM store, allowing store from *EDIT* screen programming memory as the default condition.

Group Store – To store a group of effects, set the **MODE** key to **STORE**, select **GROUP**, and then press the **ENTER** key. This causes the twenty-four effects in the twenty-four *On-Air RAM memory locations* to be stored as a group with the default name and number indicated by the group name in the center screen area. The effects will not be recalled from the *EDIT* screen programming memory. This process is called *group store* or *uploading*.

5.11 Naming and Numbering Effects

Press the **DISK** softkey in the *EDIT* screen, and change the **MODE** adjust key to **STORE**. The center screen area changes to allow effect naming by the operator (Figure 5-5).

Effects can be identified by both name and number. The ADO 100 system automatically assigns a default name and number to an effect when **STORE** is selected.

An effect is given the eight character name "ADOEFFECT", followed by the characters .E and the next unused effect number. A group is given the eight character name "ADOGROUP", followed by the characters .A and the next unused group number on the disk.

Alternative names and numbers can be given to an effect by using the **CURSOR** and **LETTER** keys.

Use the **CURSOR** key to select which letter in the effect name is to be changed. Use the **LETTER** key to scroll the available letters and numbers until the desired letter appears in the effect name line. In Figure 5-5, the letter E has been changed to the letter X. Repeat the process until all letters and numbers have been changed as desired.

In Figure 5-5, the letters E, F, F, C, and T have been changed to the letters X, M, P, L, and E and the operator is assigning a new effect number. To store the effect or group with the new name and number, press the **ENTER** key. Note the .A and .E character are assigned by the system to differentiate between groups and effects, and cannot be changed by the operator.

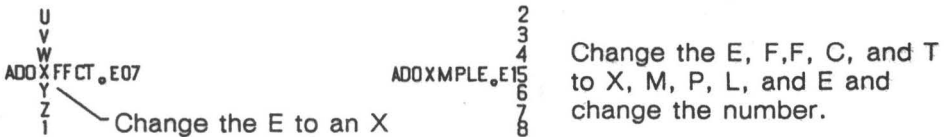

Figure 5-5. Changing group or effect name.

SECTION 6

System Set-up Mode

6.1 Introduction

This section provides information about the ADO 100 System Set-Up mode.

6.2 Set-Up Mode

The Set-Up mode provides control of the following parameters:

- *System engineering parameters*
- *Format disk routines*

6.3 Set-Up Mode Access

The *Set-Up* mode is accessed by pressing and holding down the CANCEL key and then pressing the ENTER key. On AVC Vista integrated systems, press the SETUP softkey to access the system timing configuration menus. Press the DISK softkey to format disks.

When in the Set-Up mode, the system will automatically select (default to) the *VIDEO INPUT* menu.

6.4 System Timing Adjustment Menus

There are four system timing menus and one submenu provided in the SETUP mode on an ADO 100. They are the *Video Input*, *Video Output*, *Digimatte Input*, and *Key Output* menus along with the *Blanking Submenu*. Multiple timing registers are provided to allow correct system phasing for each of the AVC Vista Digi-loop paths and for applications where the ADO 100 is shared between more than one room or video switcher (see section 6.5, 6.5.1).

6.4.1 The Video Input Menu

Press the VIDEO INPUT adjust keys to display the video input menu.

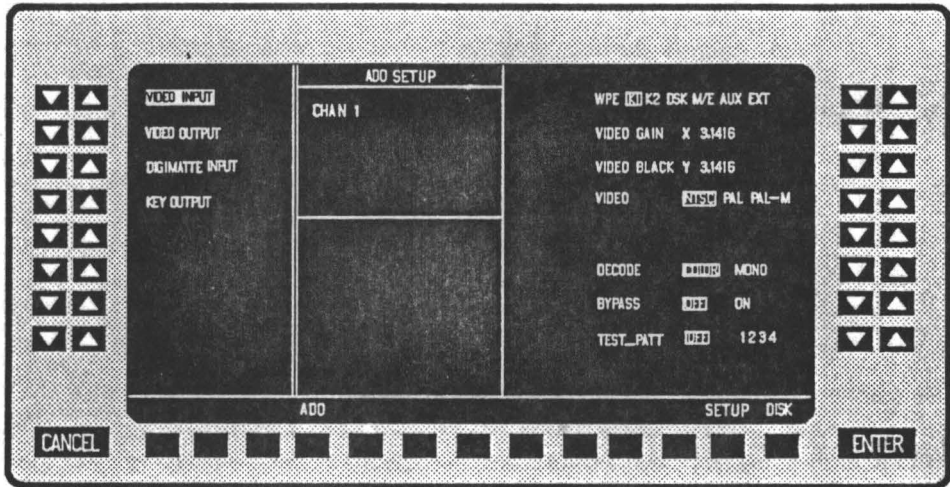

Figure 6-1. Video Input Menu

Various encoder and decoder functions can be selected on composite video systems, including television standard decoder mode, and test pattern selection.

The Video Input menu is used for setting up video input paths. The adjustments are described below.

- The WPE, K1, K2, DSK, M/E, AUX, and EXT adjust up-down switch pairs are used to select the Digi-Loop path providing the input video. Separate adjustments can be made for each path.
- The VIDEO GAIN adjust up-down switch pairs are used to adjust the level of the video source ± 10 IRE units.
- The VIDEO BLACK adjust up-down switch pairs are used to adjust the black level of the video source.
- The VIDEO adjust up-down switch pairs are used to select the television standard of the video source.
- The DECODE adjust up-down switch pairs are used to select color comb filtering or monochrome bandpass filtering in the decoder.

■ The **BYPASS** adjust up-down switch pairs are used to disable all image transformation circuits including address generators and associated digital filters. The primary purpose of the **BYPASS** mode is to allow encoder/decoder alignment to be verified. This mode may also be referred to as "A/D, D/A direct connection" although this term is strictly speaking inaccurate as both digital decoding and encoding circuits are still in the signal path.

■ The **TEST_PATT** adjust up-down switch pairs are used to select four digitally generated test patterns to verify the alignment of the system encoder.

The encoder level adjustments are made in the Video Output Menu.

Separate adjustments can be made for each Digi-Loop path.

6.4.2 Video Output Menu

Press the VIDEO OUTPUT adjust keys to display the Video Output menu.

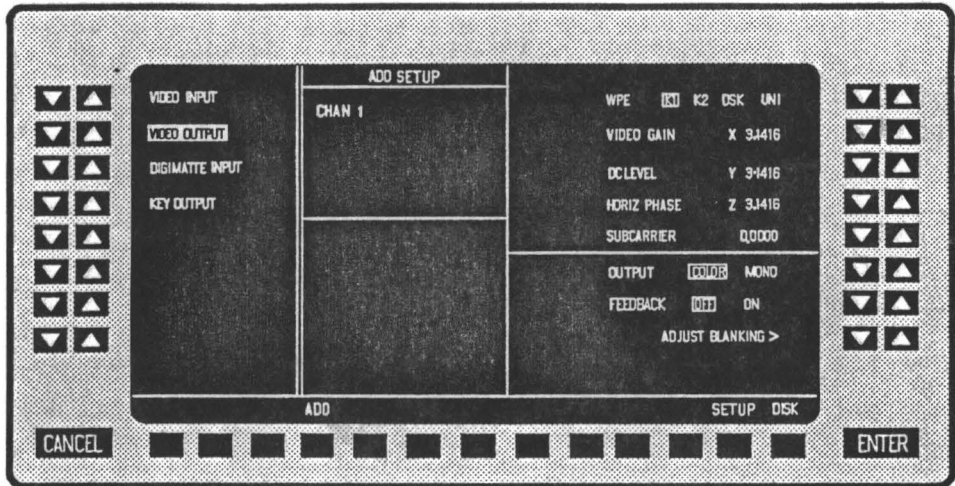

Figure 6-2. Video Output Menu

The Video Output menu is used for correctly phasing the system output to downstream mixers and switchers. The adjustments are described below.

- The WPE, K1, K2, DSK, and UNI adjust up-down switch pairs are used to select the Digi-Loop path to receive the ADO 100's output.
- The VIDEO GAIN adjust up-down switch pairs are used to set the proper video gain for the system's output.
- The DC LEVEL adjust up-down switch pairs are used to set the proper video D.C. level for the system's output.
- The HORIZ PHASE adjust up-down switch pairs are used to adjust the horizontal phase timing parameter to phase ADO 100 output to downstream keyers or switchers.
- The SUBCARRIER adjust up-down switch pairs are used to adjust the sub-carrier phase.

- The **OUTPUT** adjust up-down switch pairs are used to select monochrome or color output from the system. ✓
- The **FEEDBACK** adjust up-down switch pairs are not used at this time. Feedback selection should be set to **OFF** for normal operation.
- The **ADJUST BLANKING** > adjust up-down switch pairs are used to select the blanking submenu.

Separate output timing parameters can be set for each Digi-Loop path.

6.4.3 Blanking Submenu

Press the **ADJUST BLANKING >** adjust keys to display the Blanking Submenu.

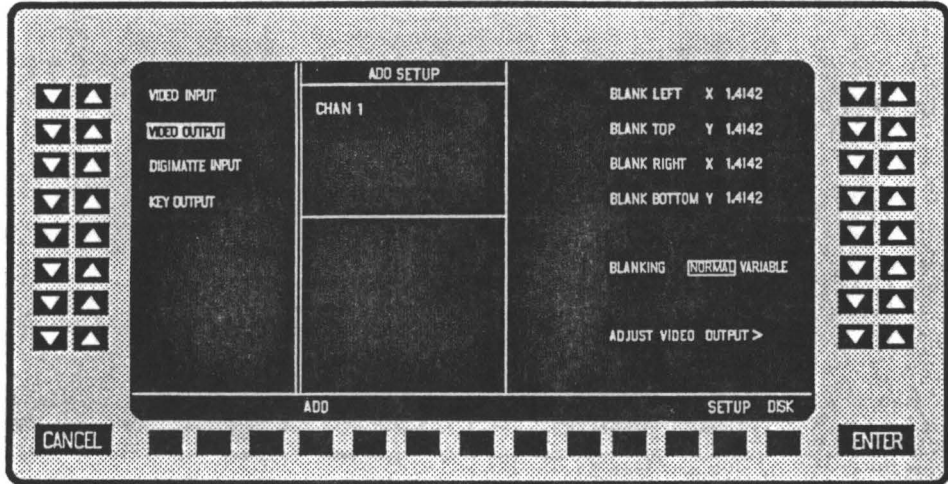

Figure 6-3. Blanking Submenu

The Blanking Submenu is used for custom house blanking requirements. The adjustments are described below.

- The **BLANK LEFT** adjust up-down switch pairs are used to adjust left edge horizontal blanking.
- The **BLANK TOP** adjust up-down switch pairs are used to adjust top edge vertical blanking.
- The **BLANK RIGHT** adjust up-down switch pairs are used to adjust right edge horizontal blanking.
- The **BLANK BOTTOM** adjust up-down switch pairs are used to adjust bottom edge vertical blanking.
- The **BLANKING** adjust up-down switch pairs are used to select between custom **VARIABLE** blanking and system default **NORMAL** blanking parameters.

Only one custom blanking setup is allowed. If custom blanking is selected, it applies to all the Digi-Loop paths.

6.4.4 Digimatte Menu

Press the DIGIMATTE adjust keys to display the Digimatte Menu.

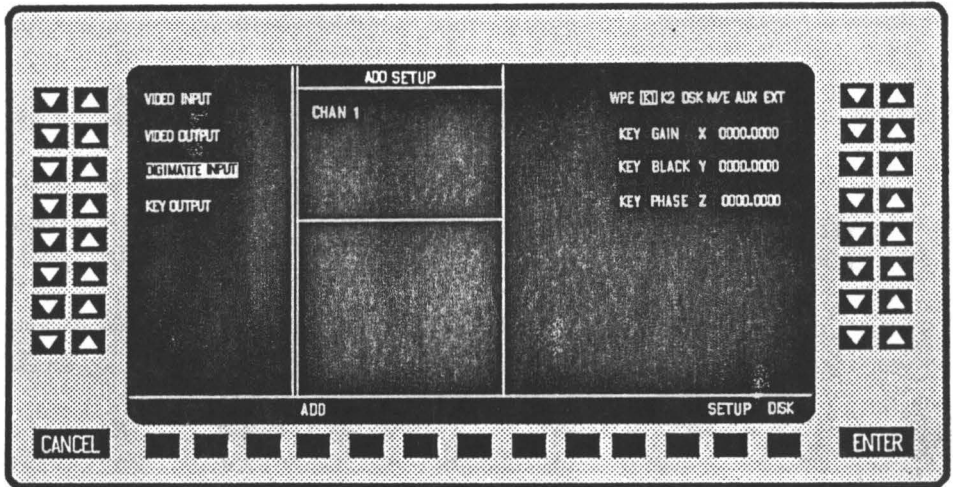

Figure 6-4. Digimatte Menu

The Digimatte Menu is used for adjusting the level and phase of externally supplied key signals. The adjustments are described below.

- The WPE, K1, K2, DSK, M/E, AUX, and EXT adjust up-down switch pairs are used to select the Digi-Loop path providing the key signal to the Digi-Matte input.
- The KEY GAIN adjust up-down switch pairs are used to adjust the input key gain.
- The KEY BLACK adjust up-down switch pairs are used to adjust the input key black level.
- The KEY PHASE adjust up-down switch pairs are used to adjust the input key phase, relative to input video.

Separate adjustments can be set for each Digi-Loop path.

6.4.5 Key Output Menu

Press the KEY OUTPUT adjust keys to display the Key Output Menu.

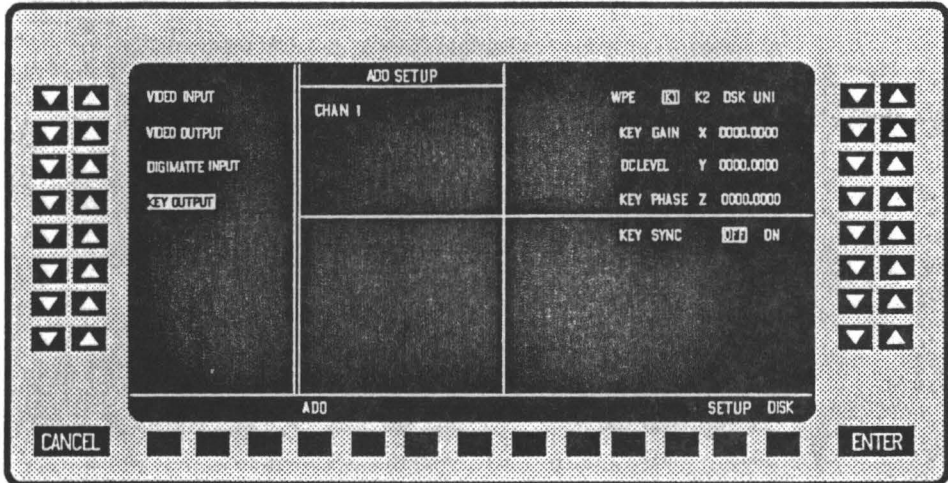

Figure 6-5. Key Output Menu

The Key Output Menu is used primarily for setting the correct phase for the program key of the ADO 100. The adjustments are described below.

- The WPE, K1, K2, DSK, and UNI adjust up-down switch pairs are used to select the Digi-Loop path receiving the key signal.
- The KEY GAIN adjust up-down switch pairs are used to set the gain of the output key.
- The DC LEVEL adjust up-down switch pairs are used to set the D.C. level of the output key.
- The KEY PHASE adjust up-down switch pairs are used to set the phase of the output key relative to house reference.
- The KEY SYNC adjust up-down switch pairs are used to select sync on the key or no sync on the key signal.

Separate adjustments can be set for each Digi-Loop path.

6.5 Operation in AVC Vista Digi-loop

Where ADO 100 is in the AVC Vista Digi-Loop but controlled from its own control console, the operator must change the Digi-Loop selection on both the Vista Digi-Loop menu and the ADO 100 setup menus to ensure correct timing in each of the Digi-loop paths.

The following timing registers are displayed on the top line of the **Video Input**, **Video Output**, **Digi-loop Input**, and **Key Output** menus. The timing registers are WPE, K1, K2, DSK, M/E, AUX, EXT, and UNI.

- *For operation in a Digi-loop setup*, select the appropriate timing register as directed in sections 6.4.1 through 6.4.5.

Press ENTER to store these values into non-volatile EEPROM memory for operator recall during subsequent operation of the system.

6.5.1 Operation in non-Digi-loop applications

- *For operation in a non-Digi-loop system configuration*
 - (1) Select the K1 timing register in each menu.
 - (2) Make any required timing adjustments.
 - (3) Store the adjustments by pressing the ENTER key.

NOTE

The K1 timing register is equivalent to using a "ROOM 1" timing register.

Similarly, using the K2 timing register is equivalent to using a "ROOM 2" register, and selecting the DSK timing register in all menus is equivalent to using a "ROOM 3" timing register. This allows independent input and output timing adjustments to be memorized for three separate "Rooms". A "Room" may equate to different video switchers in a facility such as in a news room and an edit bay.

All displayed timing registers other than K1, K2, and DSK should be ignored.

6.6 Disk Formatting

Pressing the DISK softkey automatically selects the *Disk Setup Menu*. This menu is used to format disks. Press the FORMAT DISK adjust up/down switches to format a blank disk. The system will display a warning that all effects contained on this disk will be erased if the disk is formatted. Press the CANCEL key to abort the action, or the ENTER key to confirm the action.

6.7 Storing changes to the Set-Up menus

To store changes on the Set-Up menus, press the ENTER key. Temporary changes can be made to the timing parameters, however, these changes are not stored in EEPROM memory until the ENTER key is pressed. Pressing the CANCEL key restores the original timing parameters stored in EEPROM.

6.8 Exiting the Setup Mode

To exit the SETUP Mode, press the ADO softkey. Pressing this key exits the SETUP mode and accesses the EDIT mode. *If using the Vista Control Console*, press the ADJ softkey followed by the ADO softkey to access the ADO EDIT mode.

Appendix A Specifications

Table 1-1 lists *electrical, mechanical and environmental* specifications for ADO 100 digital special effects systems.

**Table 1-1. Specifications
General Video**

Electrical	
<i>Power Input</i>	<i>Signal System, Console</i> 100 - 120, 200 - 240 Vac; 50 or 60 Hz ± 2%
<i>Power Consumption</i>	
<i>Console</i>	75 Watts
<i>Signal System</i>	500 Watts
Environmental	
<i>Temperature Range</i>	0° to 45° C.
<i>Relative Humidity</i>	10% to 90%, noncondensing.
Ethernet	
<i>Ethernet</i>	
<i>Coaxial Cable used is RG58</i>	
<i>Cable length: Supplied length:</i>	100 feet (30 meters) with console 10 feet (3 meters) with signal system
<i>Max/Min length:</i>	500 feet (154 meters) 3 feet (1 meter)
<i>BNC connectors -- 50 ohms</i>	
<i>BNC T-Adapters -- 50 ohms</i>	
<i>BNC Terminator -- 50 ohms</i>	

Table 1-1. Specifications

<i>General Video</i>	
<i>Inputs: Reference Video</i>	<i>1V p-p composite, 75 Ω terminated, Composite Video or Black.</i>
<i>Outputs: Video</i>	<i>525/60 NTSC, 625/50 PAL, 625/60 PAL-M</i>
<i>Key Out</i>	<i>1V p-p , 75 Ω terminated</i>
<i>Performance</i>	
<i>Sampling standard</i>	<i>13.5 MHz, CCIR 601 component digital</i>
<i>Sub-pixel resolution</i>	<i>2.3 nanoseconds</i>
<i>Frequency response</i>	<i>± 0.5 dB to 5.5 MHz (A/D, D/A direct connection)</i>
<i>Differential phase</i>	<i>Less than 2°</i>
<i>Differential gain</i>	<i>Less than 2%</i>
<i>K factor (2T pulse)</i>	<i>Less than 1%</i>

Table 1-1. Specifications

<i>Control I/O</i>	
<i>Console</i>	<i>Ethernet Coax, Ethernet, GPI, Disk Interface. Remote and Terminal are reserved for factory/test usage.</i>
<i>Signal System</i>	<i>Ethernet Coax, Ethernet Interface. SCSI and Terminal reserved for factory/test usage.</i>
<i>Physical Arrangement (Dimensions and Weight)</i>	
Dimensions	
	Wide High Depth
<i>Control Panel</i>	<i>19 in. x 7.75 in. x 4.5 in. (48.26 cm x 19.68 cm x 11.43 cm)</i>
<i>Signal System</i>	<i>19 in. x 12.5 in. x 20 in. (48.26cm x 31.75 cm x 50.8 cm)</i>
Shipping Weight including crate	
<i>Control Panel</i>	<i>14 lbs. (6.35 kg)</i>
<i>Signal System</i>	<i>80 lbs. (36.3 kg)</i>

Table 1-1. Specifications

Physical Arrangement (Dimensions and Weight) cont.**Service Access**

Maintain 1.75 in. (4.45 cm) adequate clearance around the top, sides, and bottom of units to ensure proper ventilation-

access to unit

minimum 35 in. (88.9 cm) in front for PC Board

extention for service.

minimum 12 in. (30.48 cm) for service between rear of unit and wall.

Air intakes are located at the front and right sides. Exhaust is located at the rear and left sides.

Recommended Maximum

To exceed these cable lengths risk degrading system performance

*Total length of Ethernet coaxial cable -- 500 ft max
(152.4 meters)*

Appendix B

Planning Guide and Installation Procedure

ADO® 100 Digital Optics Series

Special Effects Systems

Planning Guide and Installation Procedure

1.0 INTRODUCTION

This document contains installation instructions for the *ADO 100 Digital Optics Series Special Effects Systems*. These instructions include:

Section 1.2 *Parts Requirements* - A list of parts needed for installation.

Section 2.0 *Site Selection* - equipment specification for the selection and preparation of the mounting site for the *ADO 100 Signal System* and the *ADO 100 Control Console*.

Section 3.0 *Unpacking* - instructions for removing the *ADO 100 Digital Optics Series Special Effects Systems* from its shipping cartons, and for reporting damaged or missing equipment.

Section 4.0 *Mounting the ADO 100 Signal System* - instructions for preparing the site for mounting the *Signal System*.

Section 5.0 *Power Requirements* - instructions for preparing the special effects unit for operation with the power source available at the user's site.

Section 6.0 *Mounting the ADO 100 Console* - instructions for preparing the site and mounting the *Control Console*.

Section 7.0 *ADO 100 Signal System Cables* - instructions for connecting the various cables required by the *ADO 100 System*.

Section 8.0 *Installation Set-Up* - procedures for initiating system operation and verifying that operation complies with specifications after installation.

1.1 Installation Procedure Check Off

Some procedures in this section contain steps preceded by a blank line. Check or initial each step as it is completed.

1.2 Parts Requirements

This is a list of parts, cables and tools needed for a complete installation of the ADO 100 Digital Optics Series Special Effects System. All parts listed below are supplied by Ampex except when noted Customer Supplied.

Table 1. ADO 100 Accessories and Cable Kit

QUANTITY	PART NUMBER	DESCRIPTION
1	1446643 1809824-01 1444516-AA	Miscellaneous Parts Kit Operation Manual Cable Assembly, Network
2	145-736	Ethernet Terminator 50Ω BNC
2	178-069	Ethernet T-Adapter, 50Ω BNC
	Customer supplied	14 Rack Mounting Screws (#10 x 32 Imperial, M5 x 0.8 Metric)

■ *An assortment of common hand tools are used for the installation.*

Screw Driver, Saw, Drill with 1/4in. drill bit, Router.

1.3 Ethernet Coaxial Cable Installation Requirements

Components connected with Ethernet coaxial cables must adhere to the following rules.

- The total length of cable linking the system together cannot exceed 500 feet (152.4 meters).
- Each end of the network must have a 50 ohm terminator attached.
- Only one terminator should be grounded. The network may not be reliable if it is grounded in more than one place.
- Connect the T-Adapters directly to the Ethernet BNC connectors on the rear panels of the components.

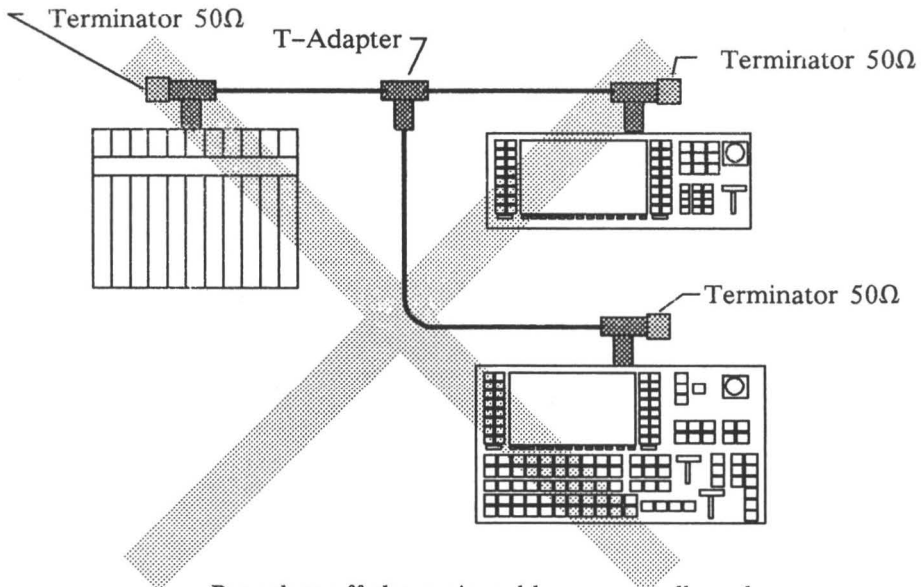
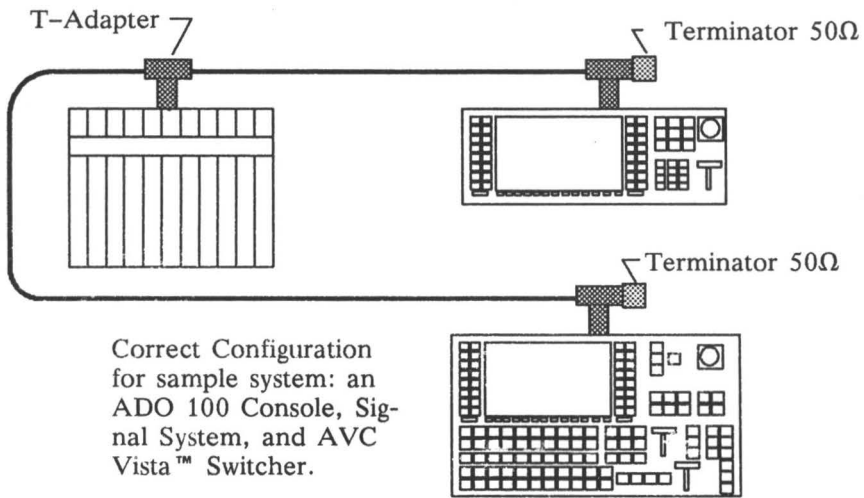
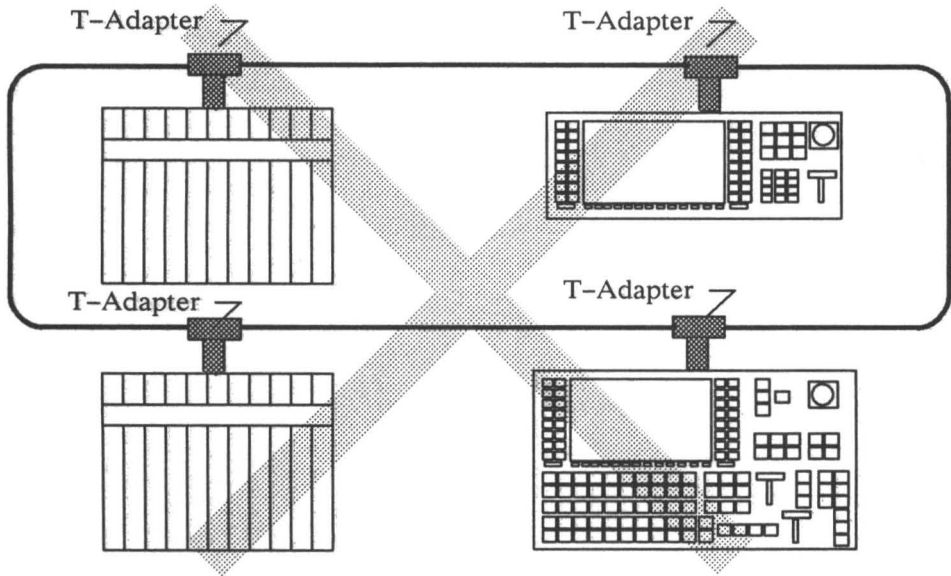

Figure 1a. Proper and improper Ethernet network connections.



The cable must have two ends with a terminator at each end; a loop has no ends.

Figure 1b. Proper and improper Ethernet network connections.

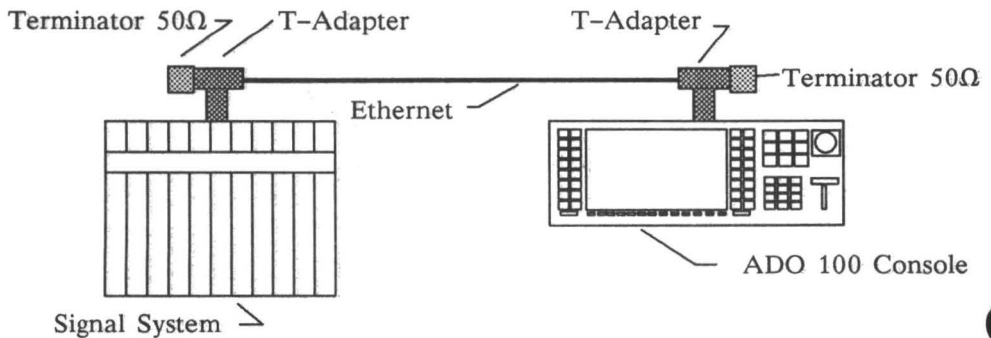

Figure 2a. Minimum System Configuration

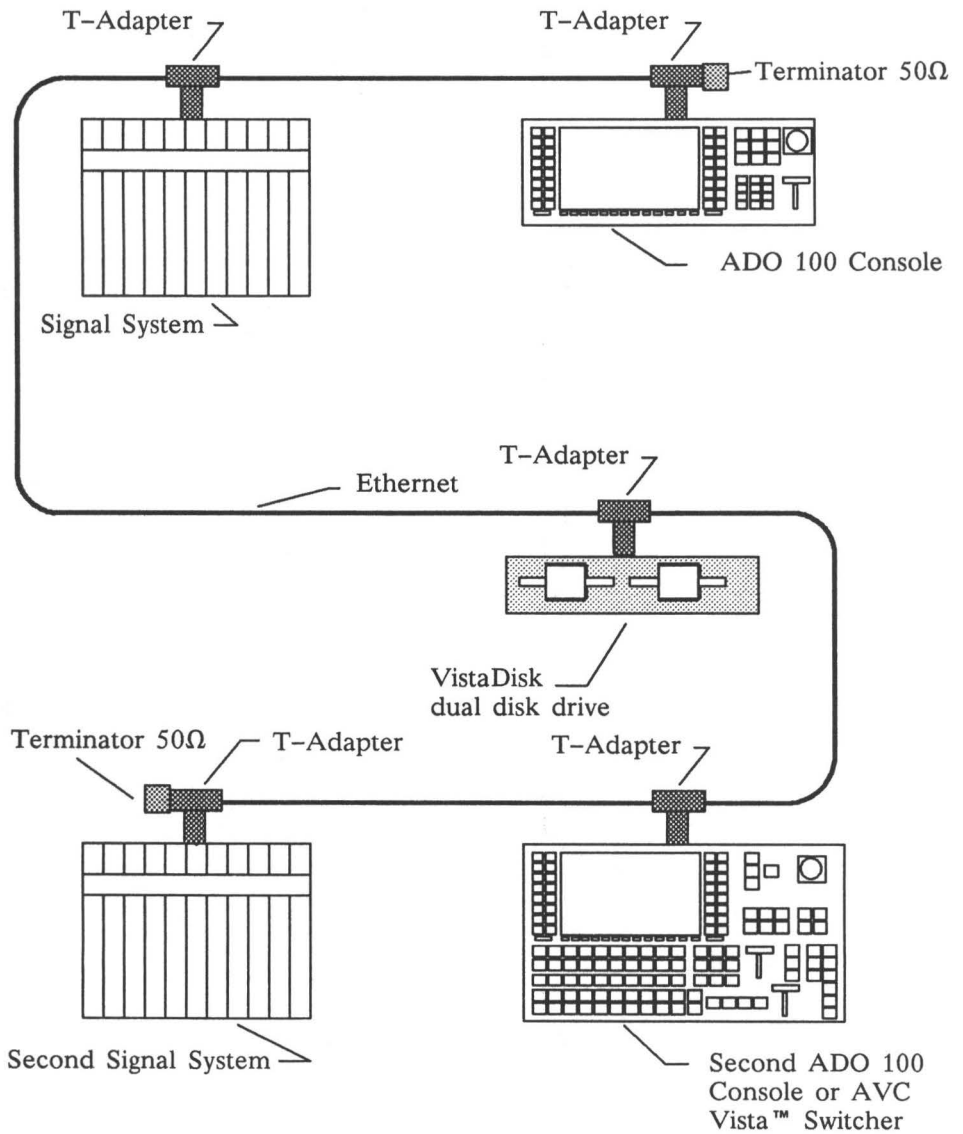

Figure 2b. Maximum System Components Network Configuration

2.0 SITE SELECTION

Use the following specifications to establish criteria for site selection and equipment installation.

2.1 Signal System Specifications

Table 2. Signal System Specifications

Mount	A floor-standing, open rack with vertical mounting members conforming to EIA Standard RS-310-B-5 is recommended. The unit requires eight (8) standard 19-inch modules of 1.75 inches (a total height of 14 inches).
Environment	Ambient Temperature: 0 to 45 degrees Celsius (room temperature or below is ideal, at a relative humidity of 5 to 90 per cent non-condensing).
Power Cable Length	The power cord must be located within 6 ft. (1.82 meters) of its power receptacle.
Clearance	Access to the front requires a minimum of 35 inches clearance for PWA extension. Access to the rear requires approximately 12 inches of clearance for making connections (using a BNC tool). To provide adequate air flow for cooling, leave clearance at the top, both sides, and rear of the Signal System chassis.

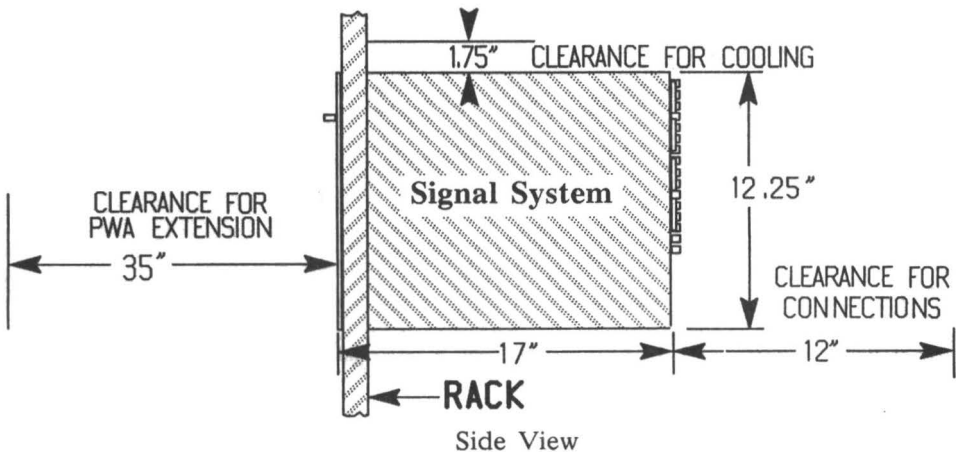

Figure 3. Signal System Dimensions and Required Clearances

2.1.1 Signal System Air Flow

There are two air flow paths in the signal system chassis, one for the circuit boards, and one for the power supply. Refer to Figure 4 below.

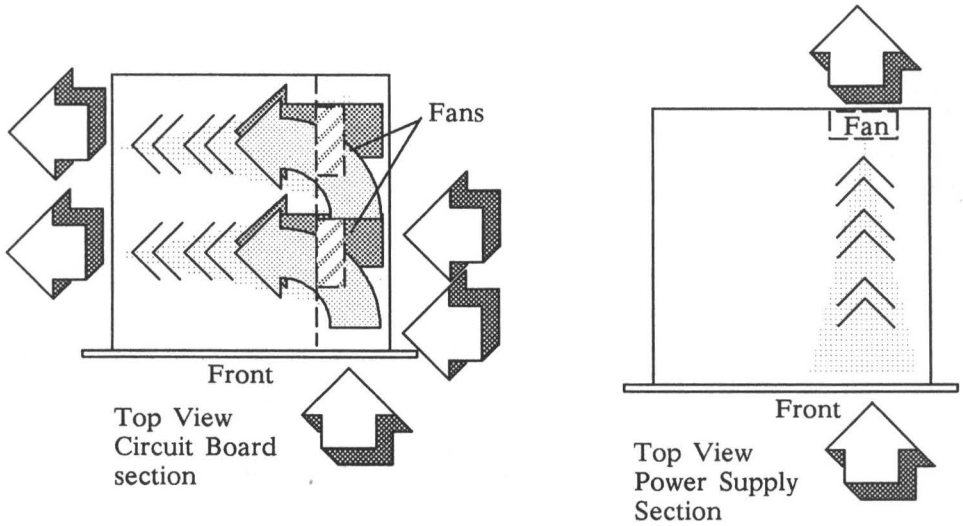

Figure 4. Air Flow for Signal System Chassis

- Allow adequate air space around the Signal System for air intake and exhaust.

2.2 Console Specifications

Table 3. ADO 100 Control Console Specifications

Mount	Optimal installation requires that the console be recessed in a desk top with a slope of from 0 to 12 degrees, with the console placed three to six inches from the front of the desk. The console may be mounted in a desk with any slope or in a vertical rack which conforms to EIA Standard RS-310-B, but operator discomfort may result.
Environment	Ambient Temperature: 0 to 45 degrees Celsius (room temperature or below is ideal) Relative Humidity: 10 to 90 per cent non-condensing.
Control Console Power Cable Length	The power cord must be located within 6 ft. (1.82 meters) of its power receptacle.
Control Console Signal Cable Length	The electronics rack assembly communicates with the ADO 100 control console or the AVC Vista™ switcher using a local ethernet network. Ethernet Coaxial cables are provided with the system. To ensure the network functions properly, cable lengths are set at 100 feet (30.4 meters) for the control console to the signal system, and 10 feet (3.0 meters) for the signal system to the Vista SPU.
Clearance	For best access, leave three to six inches free and clear of controls or protrusions around all sides.

2.2.1 Console Special Mounting Considerations

For service, the control panel bezel front edge pivots up to approximately 14 inches above the mounting surface. If mounted at slopes greater than 15 degrees above horizontal, the bezel panel will not self stop.

Place monitor screens well above the console to reduce glare on the display.

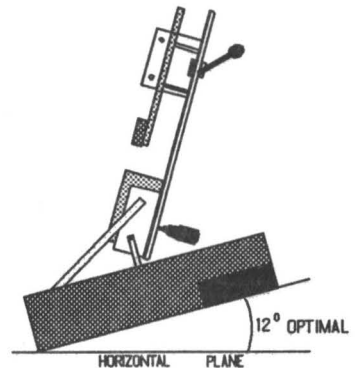

3.0 UNPACKING

The number of containers used to ship a *ADO 100 Digital Optics Unit* will vary with the number of options ordered. If there is any external damage to the containers, inform the shipping company and request that an agent be present during unpacking. Carefully unpack the boxes (no special instructions are required) and note any damage.

After all items are unpacked, check the equipment received against the packing list which accompanies the system. If there are any damages or shortages, notify the carrier and the Ampex representative immediately.

3.1 Signal System Circuit Board Arrangement

Lift the front panel to expose the power supply, and PWB's. The PWB's are numbered one through six, top-to-bottom.

The system is built using triple high Eurocard standard 366mm X 400mm PWBs. These boards have three 96-pin connectors. The one channel chassis is capable of housing 6 PWBs listed below.

Table 4. ADO 100 Signal System Circuit Boards

ITEM	CIRCUIT BOARD	PART NUMBER
1	Composite Video Interface	1446704
2	Jumper	1446783
3	Horizontal Filter/Address Generator	1446719
4	Input Processor/Frame Store	1446716
5	Vertical Filter/Address Generator	1446719
6	CPU/Timing	1446700

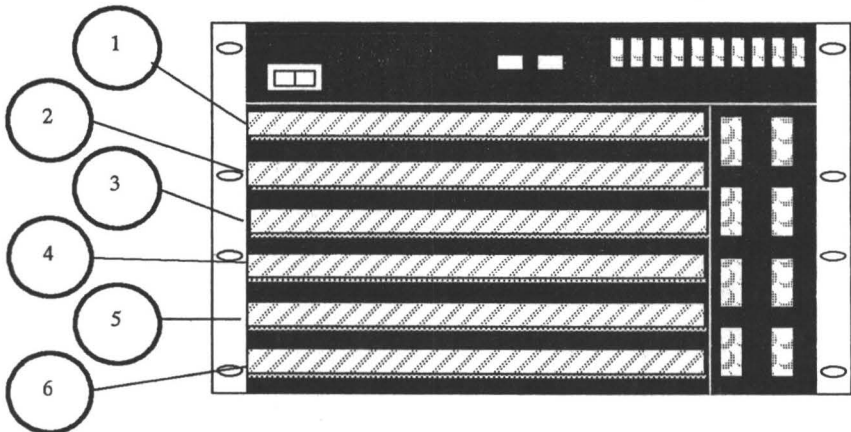

Figure 5. ADO 100 Signal System
Front View.
(front door removed)

4.0 MOUNTING THE SIGNAL SYSTEM

Install the Signal System in an (EIA Standard 310-B) 19-inch equipment rack as follows:

WARNING

The ADO 100 Signal System weighs approximately 65 pounds (29.6 kilograms). To avoid hazard to personnel when installing the switcher, either use a mechanical lifting device or sufficient personnel to support the special effects unit during installation.

STEP

1. Grip front door at both the upper left and right corners and pull away from the unit to release the door catch. Lower until fully extended.
2. Remove the two shipping screws located near the upper rear corners on both sides of the chassis. The shipping screws prevent movement of the power supply during shipment.

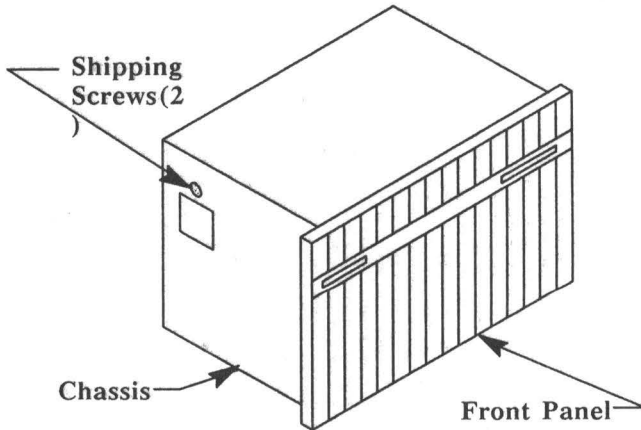

Figure 6. ADO 100 Chassis

3. Place the signal system chassis into the equipment rack, align the mounting holes, and secure in place with eight pan head machine screws (#10 x 32 Imperial, M5 x 0.8 Metric).
4. Verify that all printed circuit boards are fully seated.
5. Raise the door and secure the door catch.

5.0 POWER REQUIREMENTS

The ADO 100 Special Effects Unit is served by two power supplies, one is located in the Signal System and the second is located in the Console. The power supplies require one of the following input voltages:

- 100 - 120 Vac, 50 or 60 hertz
- 200 - 240 Vac, 50 or 60 hertz

5.1 Source Voltage Selection and Fuse Installation

STEP

1. Remove the power cord from the socket on the rear of the Signal System chassis.
2. Remove the three allen-head screws holding the power supply front cover in place.
3. Remove the two screws securing the power supply chassis to the frame.
4. Slide the power supply chassis out from the the signal system chassis until it is fully extended.

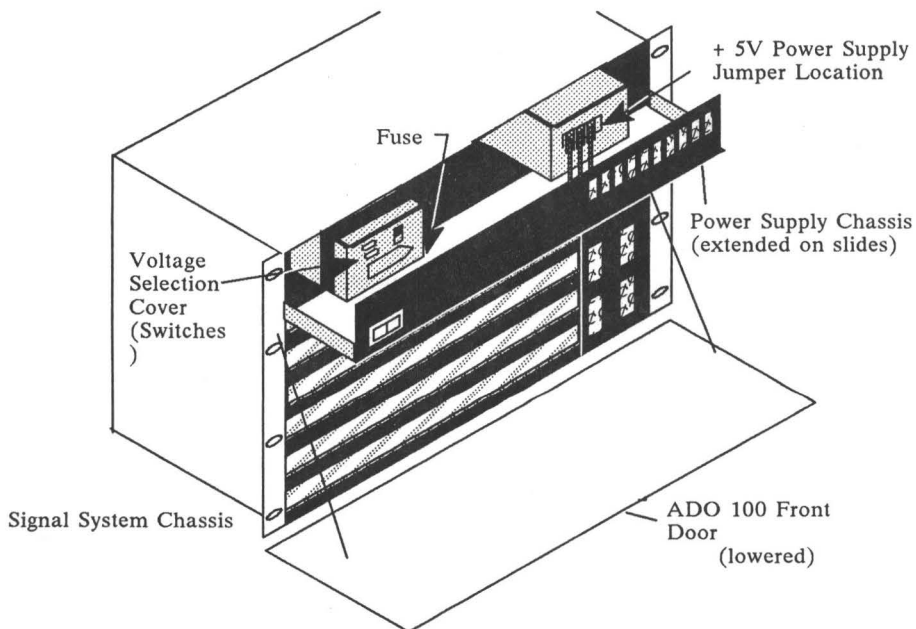

Figure 7. Power Supply Voltage Selection Switches and Fuse Location

5. Insert a small insulated screwdriver into the 115V or 230V slot located at the left side of the Voltage Selection Cover and set the switch to the proper setting. Refer to Figure 8 and Table 5.

- 6 Set the **HIGH/LOW** switch to the proper setting. Refer to Figure 8 and Table 5.

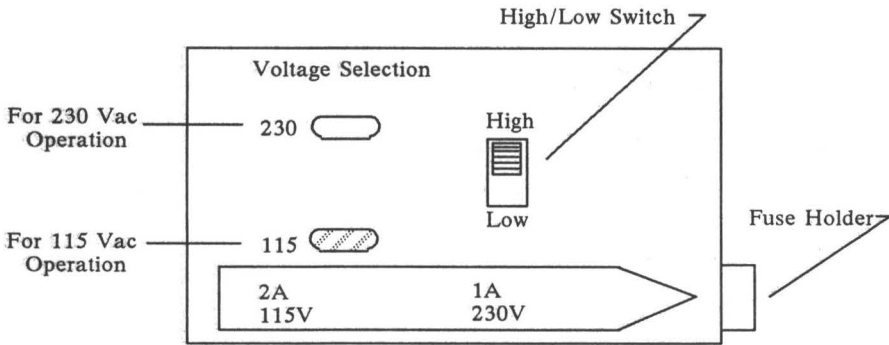

Figure 8. Front View of Power Supplies Voltage Selection Cover.

Table 5. Voltage Selection and High/Low Switch Settings

AC Line In	Voltage Selection	High/Low Switch
100 Vac	115 Vac	Low
110 Vac	115 Vac	Low
115 Vac	115 Vac	High
120 Vac	115 Vac	High
200 Vac	230 Vac	Low
220 Vac	230 Vac	Low
230 Vac	230 Vac	High
240 Vac	230 Vac	High

- 7 Remove the **fuse holder** from the socket and install a **3AG fuse** of the correct size (2.0 amperes for 100/120 volts, 1.0 amperes for 220/240 volts). Refer to Figure 8.

NOTE

Some ADO 100 systems may be supplied with a +5V power supply manufactured by ELCO Corporation (Ampex Part Number 1446683). The ELCO power supply has an automatic sensing circuit for voltage selection, and does not require strapping for nominal 115Vac or nominal 230Vac operation as described below (step 8).

8. The +5V power supply must have a jumper across the two far right screws of the AC terminal strip located at the front-upper-left corner of the power supply for 115Vac operation (refer to Figure 9). For 230Vac operation, remove jumper.

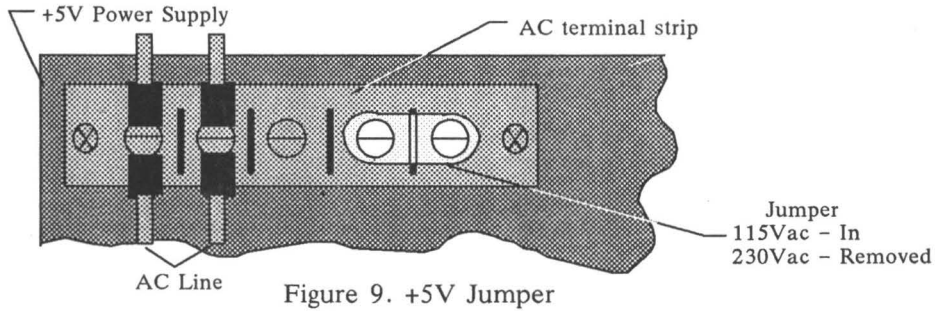

Figure 9. +5V Jumper

- ___ 9. Return the power supply to its original position in the signal system chassis.
- ___ 10. Reinstall the two screws which hold the power supply to the signal system chassis.
- ___ 11. Reinstall the power supply front cover using the three allen head screws.
- ___ 12. Insert the power cord into the power socket on rear of system.
- ___ 13. Install the correct AC power plug on the AC power cord according to the country the installation is taking place. The power cord is wired as follows:

Brown	--	Line
Blue	--	Neutral
Yellow/Green	--	Earth Ground

5.2 Console Power Supply Jumper

STEP

- ___ 1. Remove the power cord from the A.C. socket at the rear of the Control Console chassis.
- ___ 2. Open the Control Console front panel.
- ___ 3. Remove the four screws which attach the power supply cover to the top of the power supply. The power supply is located at the left side of the console tub.

4. For 115 or 230 Vac operation, position jumper as shown in Figure 10.

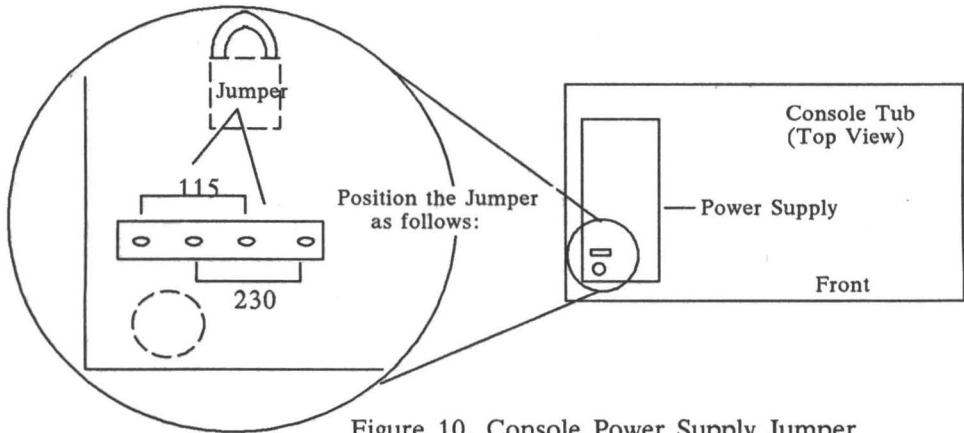

Figure 10. Console Power Supply Jumper

5. Reinstall the power supply cover.
6. Insert the power cord into the power socket on rear of system.
7. Install the correct AC power plug on the AC power cord according to the country the installation is taking place. The power cord is wired as follows:

Brown	--	Line
Blue	--	Neutral
Yellow/Green	--	Earth Ground

6.0 CONSOLE MOUNTING

The ADO 100 Console can be mounted in a standard 19-inch rack, or recessed into a counter or desk top.

6.1 Inset Console into Counter or Desk Top

STEP

- _____ 1. Prepare counter top cutout as shown in Figure 11 and Table 6.
- _____ 2. Pull the release levers and lift the bezel assembly until it stops.
- _____ 3. Lower the Console assembly into the cutout, placing the mounting flanges into the recessed portion of the cutout.
- _____ 4. Secure the Console assembly to the counter top using eight pan head screws (#10 x 32 Imperial, M5 x 0.8 Metric).
- _____ 5. Close the Console front cover and chassis and secure with the panel latches.

Table 6. ADO 100 Console Mounting Dimensions

ITEM	CONSOLE DIMENSIONS	CUTOUT DIMENSIONS
A	17.72 inches (450.0 mm) max. 17.70 inches (449.5 mm) min.	17.84 in ± 0.06 (453.1 mm ± 1.6)
B	0.62 inches (16 mm)	Rout Sides: 0.56 x 12.12 x .065 min/.080 max deep (15 mm x 308 mm x 1.6 min/2.0 max deep)
C	18.04 inches (458.2 mm)	Drill for 10-32 (M5) screws (4 places) at spacing of 18.24 inches (463.3 mm)
D	6.95 inches (176.5 mm)	7.12 in ± 0.06 (180.8 mm ± 1.6)
E	4.0 inches (101 mm)	N/A
F	1.47 inches (37.40 mm)	N/A

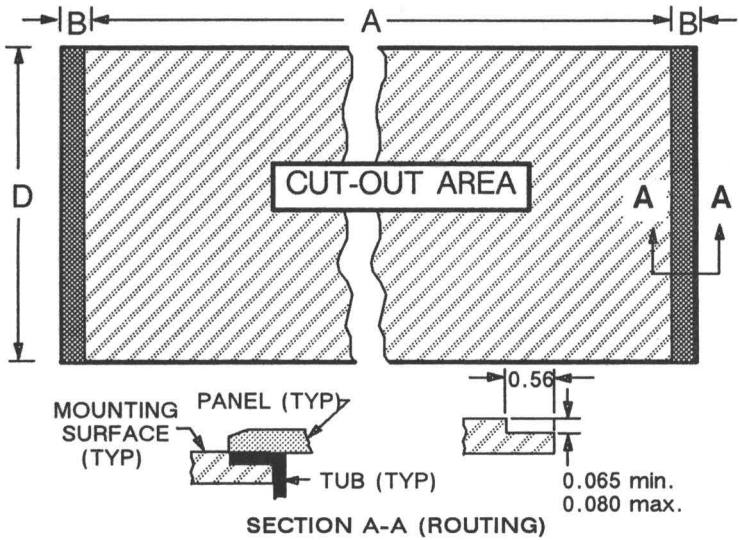

Figure 11a. Console Cutout and Routing

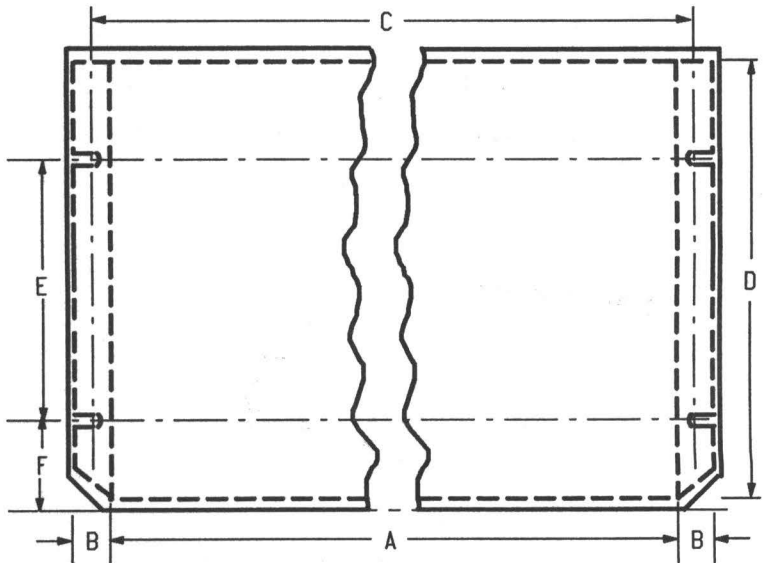

Figure 11b. Mounting Screw Location and Console Mounting Outline

6.2 Console Rack Mounting

STEP

- 1 Place the console on a level surface, hold down the chassis base and pull up on the console panel to release the panel latches.
- 2 Place the palms of each hand over the long arm of the linkage assemblies, grasp the bezel assembly and lift the unit while open.

NOTE

Before the following step, make certain that the heads of the mounting screws will fit into the recessed slots on the back of the front cover.

- 3 Place the Console assembly into the equipment rack (EIA Standard 310-B), align the mounting holes and secure in place with four pan head machine screws (#10 x 32 Imperial, M5 x 0.8 Metric).
- 4 Close the Console front cover and snap into place.

6.3 Console Connections

STEP

- 1 Insert the power cord into the power socket on the rear of system.
- 2 Plug the power cord into the appropriate A.C. wall receptacle.
3. Cable connections are listed below.

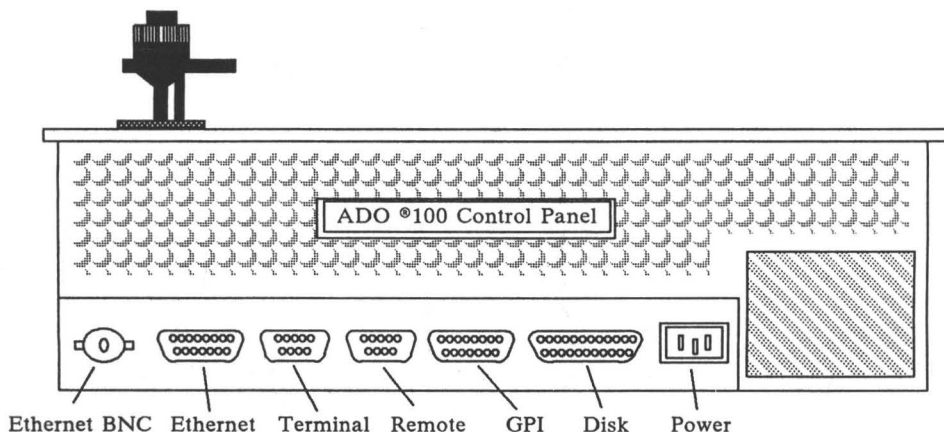

Ethernet BNC -- Used with 50 Ω coaxial cable for communication link with the signal system.

Ethernet 15-pin connector -- Used with external ethernet transceiver systems.

Terminal -- Not used at this time

Remote -- Not used at this time

GPI -- General Purpose (remote control) Interface

Disk -- Used to connect the local 3 1/2 inch disk drive.

6.3.1 GPI Remote Interface

GPI connector pin outs and functions are described below.

GPI Remote Selection Table	
Pin Number	Function
1	Freeze input video and key
2	Run effect in forward direction
3	Stop an effect
4	Run effect in reverse direction
5	Reset timeline to start of effect
6	Reset timeline to end of effect
7	Select RAM effect 1
8	Select RAM effect 2
9	Select RAM effect 3
10	Select RAM effect 4
25	Ground

GPI action is initiated by connecting one of the selected pins (1 through 10) to pin 25 (ground).

Pin numbers are moulded onto the GPI connector. Pins are numbered from right to left. Pins 1 through 13 are located on the top row, and pins 14 through 25 are located on the bottom row of the connector.

7.0 ADO 100 SIGNAL SYSTEM CONNECTIONS

Figure 10 illustrates the ADO 100 Signal System Rear Panel. The cable connections are listed in paragraph 7.1.

WARNING

To prevent electrical shock, do not remove any cover or panel secured by screws. No user serviceable parts inside. Refer servicing to qualified personnel. For continued protection against fire, replace fuses only with others of same type and ratings shown.

To prevent fire or electrical shock, do not expose this equipment to rain or moisture.



100-240 VAC

See Installation manual for Power Supply Setup Instructions

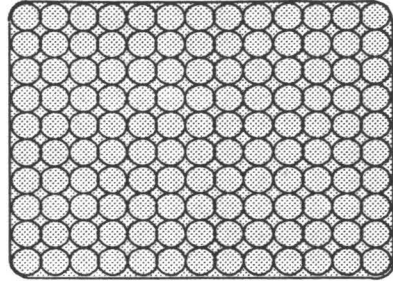

DIGITAL VIDEO

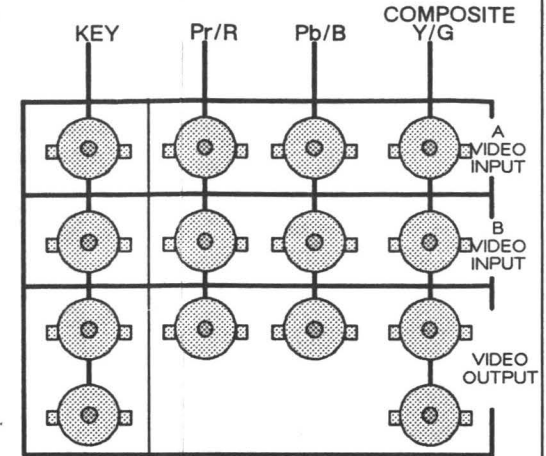
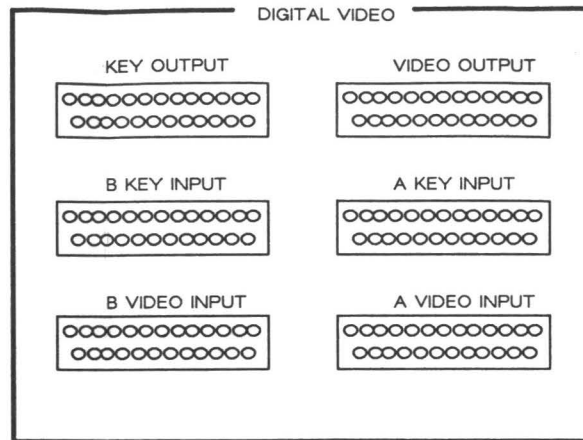

COMMUNICATIONS

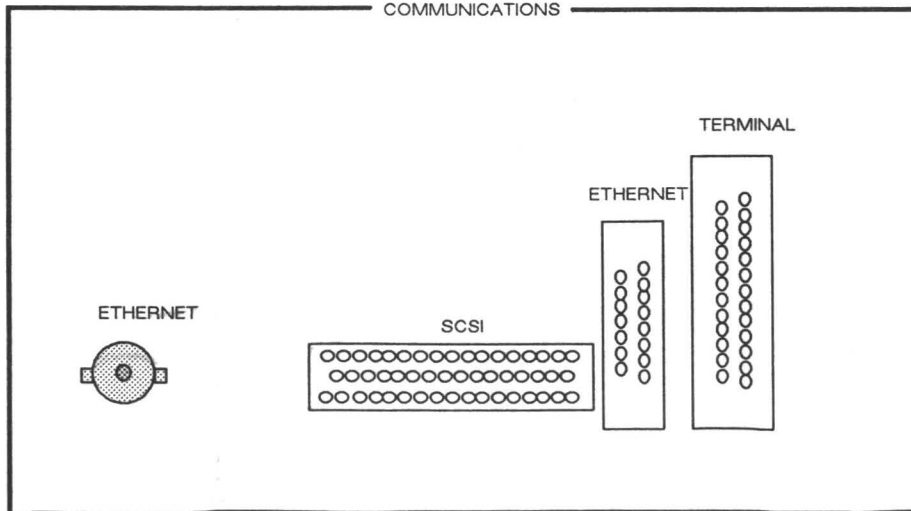

REFERENCE INPUT

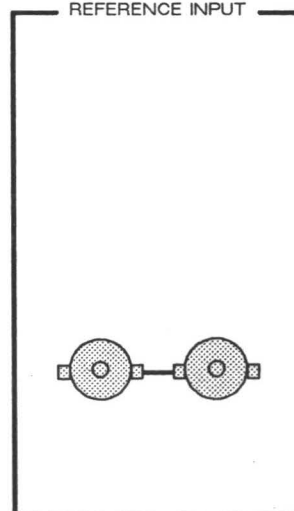

This equipment complies with the requirements in part 15 of FCC rules for a class A computing device. Operation of this equipment in a residential area may cause unacceptable interference to radio and TV reception requiring the operator to take whatever steps are necessary to correct the interference.

7.1 ADO 100 SIGNAL SYSTEM CABLE CONNECTIONS

The cable connections for the signal system are listed below.

Digital Video

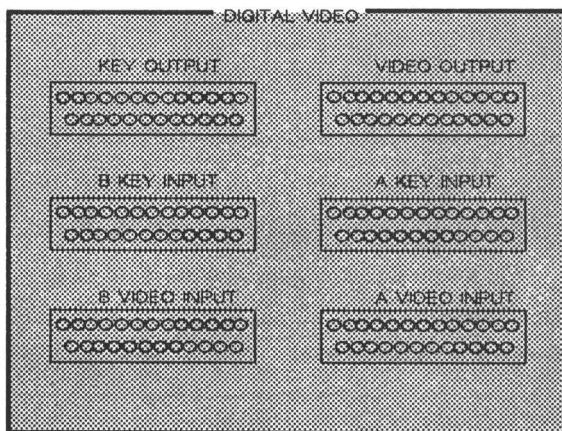

Key Output -- Not available at this time

Video Output -- Not available at this time

B Key Input -- Not available at this time

B Video Input -- Not available at this time

A Key Input -- Not available at this time

A Video Input -- Not available at this time

Analog Video Connections -- Composite

A Video Input

Key -- Key input, A channel

Pr/R -- Not used

Pb/B -- Not used

Composite Y/G -- Video Input
1V p-p
w/sync

B Video Input

Key -- Key input, B channel

Pr/R -- Not used

Pb/B -- Not used

Composite Y/G -- Video Input
1V p-p
w/sync

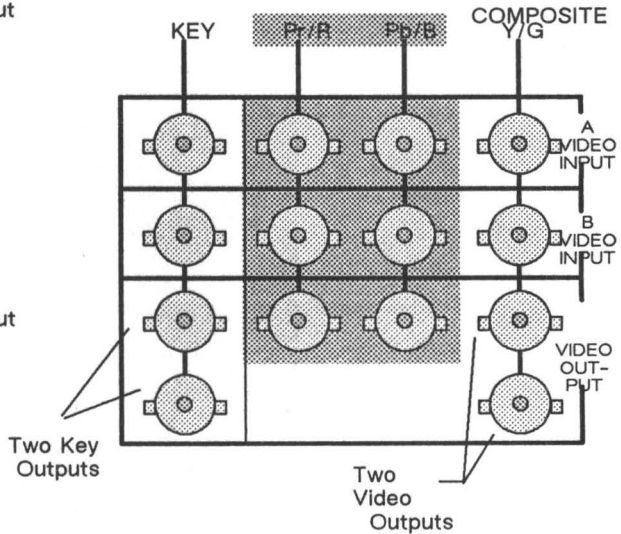

Video Output

Key -- Key Output, two outputs

Pr/R -- Not used

Pb/B -- Not used

Composite Y/G -- Video Output
1V p-p
w/sync,
two outputs

Analog Video Connections -- Component

A Video Input

Key -- Key Input

Pr/R -- Pr Component Input,
or RED signal

Pb/B -- Pb Component Input,
or BLUE signal

Composite Y/G -- Y Component Input,
or GREEN signal

B Video Input

Key -- Key Input

Pr/R -- Pr Component Input,
or RED signal

Pb/B -- Pb Component Input,
or BLUE signal

Composite Y/G -- Y Component Input,
or GREEN signal

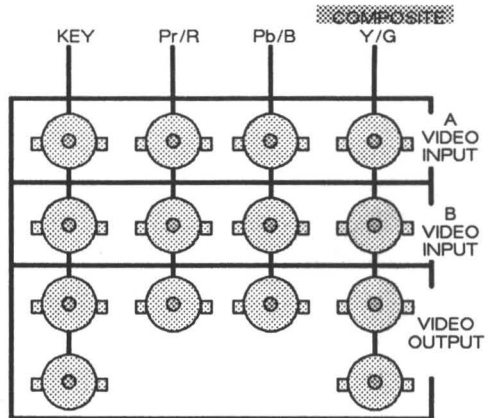

Video Output

Key -- Key Output, two outputs

Pr/R -- A Output, or RED signal

Pb/B -- B Output, or BLUE signal

Composite Y/G -- Y Output,
or GREEN signal,
two outputs

COMMUNICATIONS

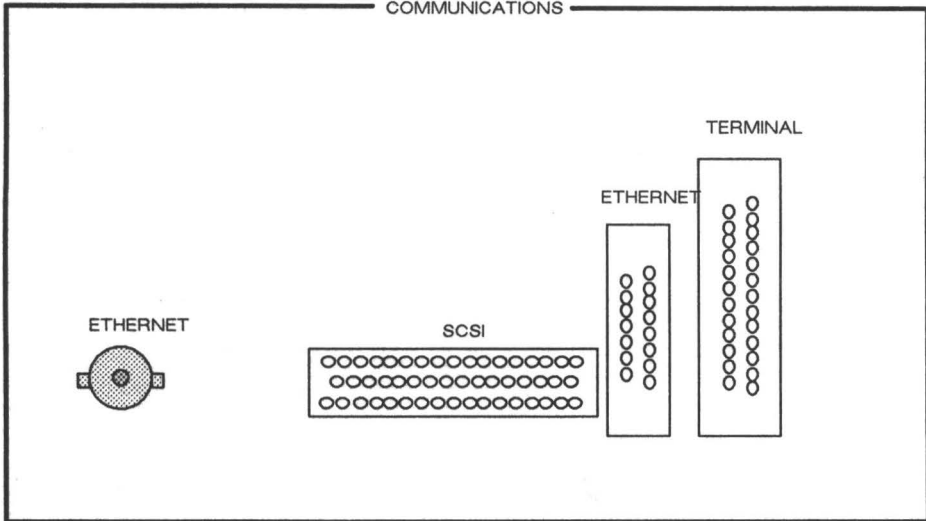

Communications

Ethernet BNC -- Use RG 58 (50 ohm) coax cable.
Use 50 ohm BNC connectors.
Use 50 ohm T-Adapters, and 50 ohm terminators
Maximum length - 500 feet (152.4 meters)

- Terminate both ends of the Ethernet cable using 50 ohm BNC terminators.

SCSI -- Not available at this time

Ethernet D Connector -- Used for external transceiver system.

Terminal -- Not available at this time

Reference Input

Reference Input -- Black burst or color bars 1V p-p loop-through.
Terminate using a 75 ohm terminator if
video is not looped through.

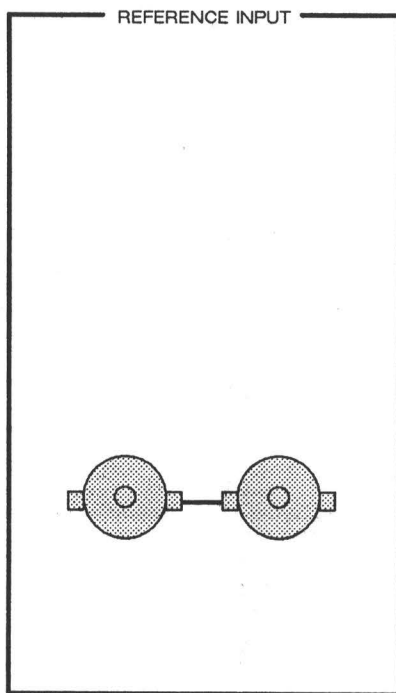

Connecting the ADO 100 to the Vista SPU Digi-Loop

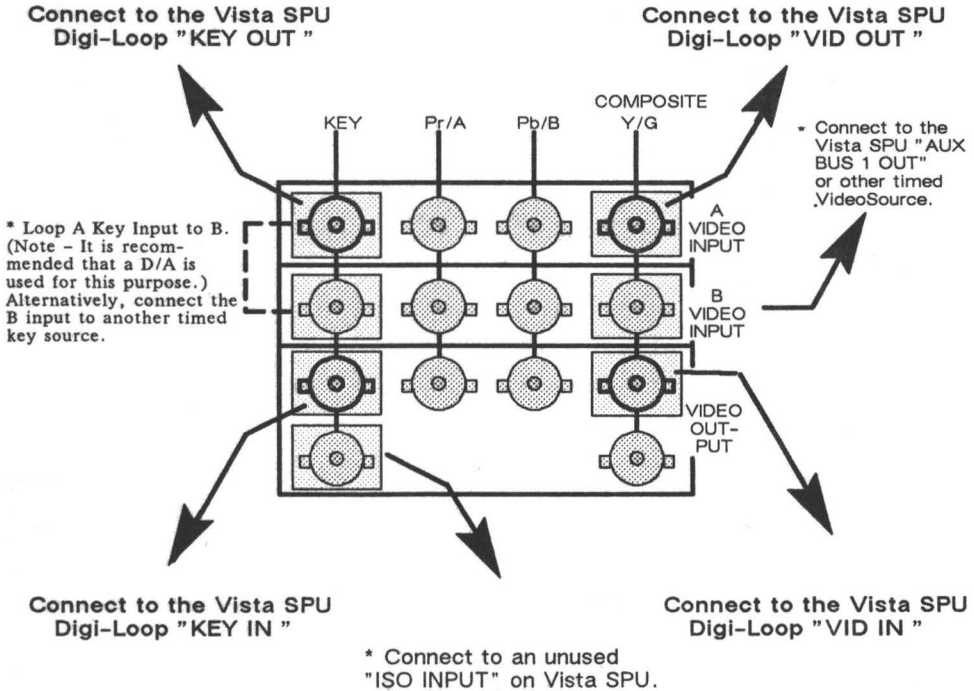

* Optional Connections to Vista Switcher.

- Connect the Vista SPU Digi-Loop connections to the ADO 100 A Video Input and A Key Input.

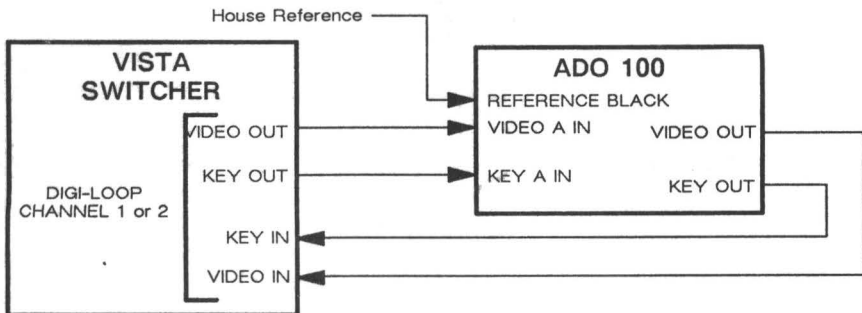

Table 7. Specifications

<i>Electrical</i>	
<i>Power Input</i>	<i>Signal System, Console</i> 100 - 120, 200 - 240 Vac; 50 or 60 Hz $\pm 2\%$
<i>Power Consumption</i>	
<i>Console</i>	75 Watts
<i>Signal System</i>	
<i>(one channel)</i>	500 Watts
<i>(two channel)</i>	1000 Watts
<i>Environmental</i>	
<i>Temperature Range</i>	0° to 45° C.
<i>Relative Humidity</i>	10% to 90%, noncondensing.
<i>Ethernet</i>	
<i>Ethernet</i>	
<i>Coaxial Cable -- RG 58</i>	
<i>Cable length: 500 feet (152.4 meters)</i>	
<i>Minimum length: 3 feet (1 meter)</i>	
<i>BNC connectors -- 50 ohm</i>	
<i>BNC T-Adapters -- 50 ohm</i>	
<i>BNC Terminator -- 50 ohm</i>	

Table 7. Specifications

<i>General Video</i>	
<i>Inputs: Reference Video</i>	<i>1V p-p composite, 75 Ω terminated, Composite Video or Black.</i>
<i>Outputs: Video</i>	<i>525/60 NTSC, 625/50 PAL, 625/60 PAL-M</i>
<i>Key Out</i>	<i>1V p-p, 75 Ω terminated</i>
<i>Performance</i>	
<i>Sampling standard</i>	<i>13.5 MHZ, CCIR 601 component digital</i>
<i>Sub-pixel resolution</i>	<i>2.3 nanoseconds</i>
<i>Frequency response</i>	<i>± 0.5 dB to 5.5 MHZ (A/D, D/A direct connection)</i>
<i>Differential phase</i>	<i>Less than 2°</i>
<i>Differential gain</i>	<i>Less than 2%</i>
<i>K factor (2T pulse)</i>	<i>Less than 1%</i>

Table 7. Specifications

Control I/O*Console**Ethernet Coax, Ethernet, GPI, Disk Interface. Remote and Terminal are reserved for factory/test usage.**Signal System**Ethernet Coax, Ethernet Interface. SCSI and Terminal reserved for factory/test usage.***Physical Arrangement (Dimensions and Weight)****Dimensions****Wide High Depth***Control Panel**19 in. x 7.75 in. x 4.5 in.
(48.26 cm x 19.68 cm x 11.43 cm)**Signal System**19 in. x 12.5 in. x 20 in.
(48.26 cm x 31.75 cm x 50.8 cm)***Shipping Weight***including crate**Control Panel**14 lbs. (6.35 kg)**Signal System**80 lbs.**(36.3 kg)***Table 7. Specifications**

Physical Arrangement (Dimensions and Weight) cont.

Service Access

Maintain 1.75 in. (4.45 cm) adequate clearance around the top, sides, and bottom of units to ensure proper ventilation-

access to unit

minimum 35 in. (88.9 cm) in front for PC Board

extention for service.

minimum 12 in. (30.48 cm) for service between rear of unit and wall.

Air intake is at the front and right sides.

Exhaust is located at the rear and left sides.

Recommended Maximum

To exceed these cable lengths risk degrading system performance

*Total length of Ethernet cable -- 500 ft max
(152.4 meters)*

8.0 ADO 100 Signal System and Console Installation Set-Up

Installation Set-Up - procedures for initiating special effects operation and verifying that operation complies with specifications after installation. Refer to the Operation Manual 1809824 for information on initiating and verifying ADO 100 operation.