



SECTION I: Test Set-up

A. Equipment Needed

1. Isolation Transformer (minimum of 500 VA rating)
Dangerously high voltages are present in this power supply. So far the safety of the individual doing the testing please use an isolation transformer. The 500 VA rating is needed to keep the AC wave form from being clipped off at the peaks. These power supplies have peak charging capacitors and draw full power at the peak of the AC waveform.
2. 0-28V Variable Transformer (Variac)
Used to vary input voltage. Recommend 10 Amp, 1.4 KVA rating, minimum.
3. Voltgemeter - Needed to measure DC voltage to 50 VDC and AC voltages to 400 VAC. Recommend 2 Digital Multi Meters.
4. Oscilloscope - Need X10 and X100 probes.
5. Load Board with Connectors
See table I for value of loads required. The entry on the table for safe load power is the minimum power ratings for the load resistors used.
6. Ohm Meter
7. Watt Meter

B. Set-up Procedure

Set-up as shown in Figure 1. You will want to monitor the input power and input voltage and the output voltage of the regulated buss, which is the +5 output with DVM's. Also, monitor the +5 output with the oscilloscope using 50mV/div sensitivity. The DVM monitoring the +5 output can also be used to check the other outputs. See text of Section III for test points within power supply.

SECTION II

A. Visual Inspection:

Check power supply for any broken, burned, or obviously damaged components. Visually check fuse, if any question check with

B. Start-up

First note the position of the input voltage select wire. This wire can be found at the end of PCB opposite the input/output connectors. Make sure wire is in position corresponding to your test set-up 230V position if you are using 115V input. For the balance of this manual we will assume 230V operation. If you prefer 115V operation divide applicable values in half.

Load power supply with minimum load as specified in Table I. Bring power up slowly with Variable Transformer while monitoring +5V output with scope and DVM and input with DVM and Wattmeter. If the Wattmeter shows significant power with low AC power being applied shut down and refer to Section III. Supply should start with approx. 80-120VAC applied and should regulate when 190VAC is applied. If output has reached 5 volts, do a performance test as shown in Section IV. If there is no output refer to Section III.

SECTION III: No Output

A. Check fuse.

If fuse is blown replace but do not apply power until cause of failure is determined.

B. Preliminary Check on Major Primary Components.

Check Thermister (R1), Diode Bridge (DB1), Power Tansistor (Q2), Catch Diode (D3), Turn-off Transistor (Q1), Emitter Resistor (R11), and D1.

C. Preliminary Check on Major Secondary Components.

Using ohm meter from output common to each output, with output loads disconnected, check for shorted rectifiers or capacitors. If +12V output is shorted also check crowbar SCR (SCR1) and Zener (Z1).

D. Check for B+

Set-up power supply and attach X100 scope probe ground to end of R11 closest to input caps. Slowly turn up power and check for B+ on the plus (+) terminal of the Diode Bridge (DB1). With input at 190 VAC this point should be between 250-300 VDC. If this is not correct check fuse, thermister (R1), DB1, and if necessary R2, D3 and finally input capacitors C6, C7.

E. Check Q1 Waveforms

Using X100 probe on case of T03 package of Q2 check collector waveform. Transistor should be switching, correct waveform is shown in Fig.3. If this is not present check for shorted junctions on Q2. If ok check base waveform. Base of Q2 is the uppermost of the two center leads on back of Q2 heatsink, Correct waveform is shown in Fig. 3. If this waveform is not present check L3, Q1, D1, and secondary components Q3, D11, D12, D5, and L4. If any of the semi conductors are found shorted or inductors open replace.

SECTION IV Performance test

Each of these test conditions should be set-up and noted to be within the limits specified in Table II.

TEST	INPUT	+5 LOAD	+12 LOAD	-12 LOAD
1	190 VAC	MAX	MAX	MAX
2	270 VAC	MAX	MAX	MAX
3	220 VAC	MAX	MIN	MIN
4	270 VAC	MIN	MIN	MIN
5	190 VAC	MIN	MIN	MIN

Table I: Load Board Values

Output	Min Load	Load R	Safe Load Power	Max Load	Load R	Safe Load Power
+5	0.45A	11.11 ohm	5 W	2.5A	2 ohm	25 W
+12	0.3A	.40 ohm	8 W	2.02A	24.24 ohm	50 W
-12	0	0	0	0.1A	120 ohm	2 W

Table II: Voltage and Ripple Spec:

Output	Min	Max	No Load	Ripple
+5	4.75V	5.25V	-	50mV-P-P
+12	11.40V	12.60V	-	150mV-P-P
-12	-11.00V	15.00V	-	150mV P-P

C1	MP. Cap 0.01uF ±20% 250VAC	068-10300010
C2	MP. Cap 0.1uF ±20% 250VAC	068-10400010
C3	Cer. Cap. 4700pF ±20% 400VAC	055-47220001
C4	Cer. Cap. 4700pF ±20% 400VAC	055-47220001
C5	MTL Poly Cap 0.22uF ±20% 250V	058-22400130
C6	Elect Cap. 100uF ±20% 250V	057-10120170
C7	Elect Cap. 100uF ±20% 250V	057-10120170
C8	Elect. Cap. 220uF +50-10% 10V	057-22120080
C9	Cer. Cap. 470pF ±10% 2KV Z5P	055-47154426
C10	Cer. Cap. 0.01uF ±20% 1KV Z5U	055-10368925
C11	Cer. Cap. 0.01uF ±20% 1KV Z5U	055-10368925
C12	Poly Cap 0.22uF ±20% 100V	058-22400160
C13	Poly Cap 0.022uF ±20% 50V	058-22300090
C14	Poly Cap 0.22uF ±20% 100V	058-22400160
C15	Elect Cap 1000uF +50 -10% 25V	057-10220040
C16	Elect Cap 1000uF +50 -10% 25V	057-10220040
C17	Elect Cap 1000uF +50 -10% 25V	057-10220040
C18	Elect Cap 330uF +100 -20% 16V	057-33120120
C19	Elect Cap 330uF +100 -20% 16V	057-33120120
C20	Elect Cap 470uF +50 -10% 25V	057-47120110
C21	Elect Cap 2200uF +50 -10% 16V	057-22220020
C24	MTL Poly Cap 0.22uF ±20% 250V	058-22400130

STATEMENT

THIS DOCUMENT CONTAINS DATA AND INFORMATION
 PROPERTY TO ASTEC COMPONENTS LTD. THIS
 DATA AND INFORMATION SHALL NOT BE DISCLOSED,
 REPRODUCED OR REPRODUCED IN WHOLE OR IN PART
 WITHOUT THE EXPRESS PRIOR WRITTEN AUTHORIZATION
 OF ASTEC COMPONENTS LTD.

D1	Rectifier RGP10A	226-10400050
D2	Rectifier RGP10J	226-10400060

A	5/9/80	D		TITLE COMPONENT CODE LIST	AA11330
B		E			
C		F			
					Sheet 1 of 4 A-4

<u>CODE</u>	<u>DESCRIPTION</u>	<u>PART NUMBER</u>
D3	Rectifier RGP10M	226-10400100
D4	Rectifier 1N4001GP	226-10400080
D5	Silicon Diode 1N4606	212-10700210
D6	Rectifier Assembly	853-00200190
D7	Rectifier Assembly	853-00200190
D8	Rectifier Assembly	853-00200190
D9	Rectifier RGP10B	226-10400070
D11	Silicon diode 1N4606	212-10700210
D12	Silicon diode 1N4606	212-10700210
D13	Rectifier 1N4001GP	226-10400080
DB1	Bridge rectifier KBP10	226-30500010
IC1	Regulator TL431CLP	211-10800100
L1	Filter Choke Coil Assembly	852-20100140
L2	Filter Choke Coil Assembly	852-20100140
L3	Base Choke	328-00100030
L4	Choke 1.5mH	328-00100010
L5	Filter Choke coil assembly	852-20100180
L6	Filter choke coil assembly	852-20100180
L7	Choke Coil	328-00100060
Q1	NPN transistor SD467	209-11700460
Q2	Power Transistor	853-00400050
Q3	PNP transistor SB561	210-11700350

A	5/g.'80	D		TITLE COMPONENT CODE LIST	AA11330
B		E			
C		F			

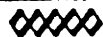

ASTEC COMPONENTS LTD.

HONG KONG

Sheet 2 of 4

A-4

<u>CODE</u>	<u>DESCRIPTION</u>	<u>PART NUMBER</u>
R1	Thermistor 4R ±10%	258-40970015
R2	Resistor carbon film 330K±5% ½W	240-33406033
R3	Resistor metal oxide film 220R ±5% 1W	248-22106052
R4	Resistor metal oxide film 33R±5% 2W	248-33006063
R5	Resistor carbon film 1K±5% ½W	240-10206022
R6	Resistor carbon film 27R ±5% ½W	240-27006022
R7	Resistor carbon film 68R ±5% ½W	240-68006022
R8	Resistor metal oxide film 120R ±5% 1W	248-12106052
R9	Resistor carbon film 10R ±5% ½W	240-10006022
R10	Resistor carbon film 10R ±5% ½W	240-10006022
R11	Resistor metal film 0.75R ±5% 1W	247-07586054
R12	Resistor metal film 1R ±5% 1W	247-10086054
R13	Resistor carbon film 5.6R ±5% ½W	240-56906022
R14	Resistor carbon film 68R ±5% ½W	240-68006022
R15	Resistor carbon film 270R ±5% ½W	240-27106033
R16	Resistor carbon film 270R ±5% ½W	240-27106033
R17	Resistor carbon film 8.2R ±5% ½W	240-82906022
R18	Resistor carbon film 560R ±5% ½W	240-56106022
R19	Resistor carbon film 56R ±5% ½W	240-56006022
R20	Resistor carbon film 56R ±5% ½W	240-56006022
R21	Resistor carbon film 12K ±5% ½W	240-12306022
R22	Resistor carbon film 470R ±5% ½W	240-47106022
R23	Resistor metal film 4.7K ±2% ½W	247-47015022
R24	Resistor carbon film 68K ±5% ½W	240-68306022
R25	Resistor metal film 22K ±2% ½W	247-22025022
R26	Resistor metal film 2.7K ±2% ½W	247-27015022

A	5/9/80	D		TITLE COMPONENT CODE LIST	AA11330
B		E			
C		F			
 ASTEC COMPONENTS LTD.					Sheet 3 of 4
HONG KONG					A-4

<u>CODE</u>	<u>DESCRIPTION</u>	<u>PART NUMBER</u>
R27	Resistor carbon film 12R ±5% ¼W	240-12006022
SCR1	SCR C122F	227-13000010
T1	Common mode transformer assembly	852-20200950
T2	Power transformer assembly	851-10200940
T3	Control transformer assembly	852-10200680
Z1	Zener diode 5.6V ±5% 1W	222-56086002

A	5/9/80	D		TITLE COMPONENT CODE LIST	AA11330
B		E			
C		F			
 ASTEC COMPONENTS LTD.					Sheet 4 of 4
HONG KONG					A-4

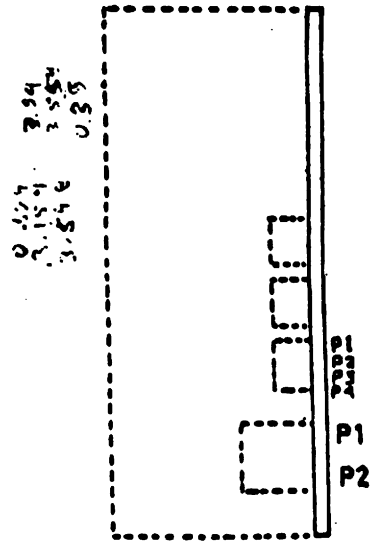
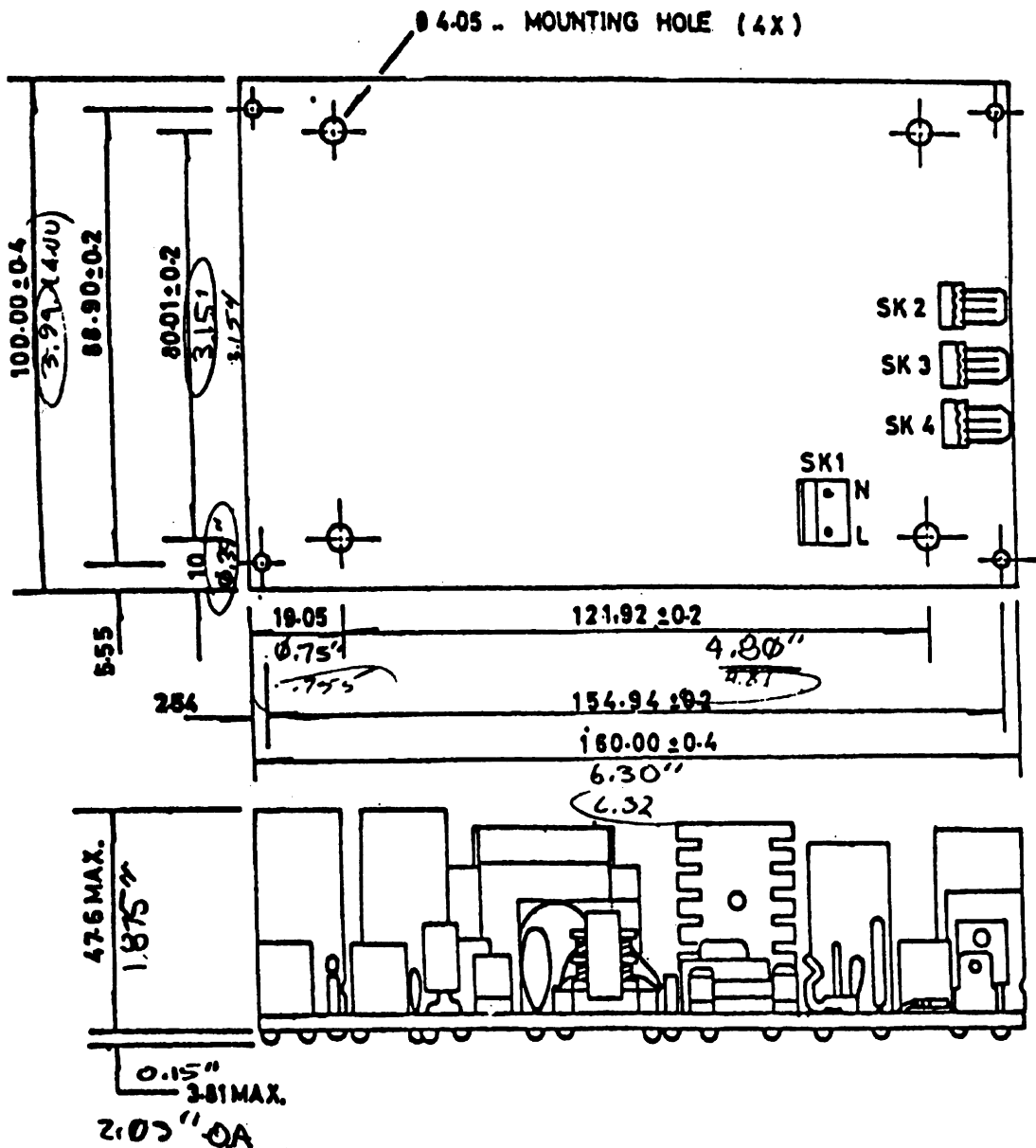

PIN ASSIGNMENT :-

FOR SK1 P1 NEUTRAL
P2 LIVE

FOR SK2/3/4

P1 -12V
P2 +12V
P3 COMMON
P4 +5V

UNLESS OTHERWISE SPECIFIED ALL DIMENSIONS ARE IN MM TOLERANCES: WHOLE NO \pm DECIMAL \pm \pm	DO NOT SCALE DRAWING	TITLE
	DATE K.N.HUI 24 OCT 80	ACB151 ASSEM
	DATE	FIRST USED ON
	DATE	MATERIAL
00000 ASTEC COMPONENTS LTD.		HONG KONG

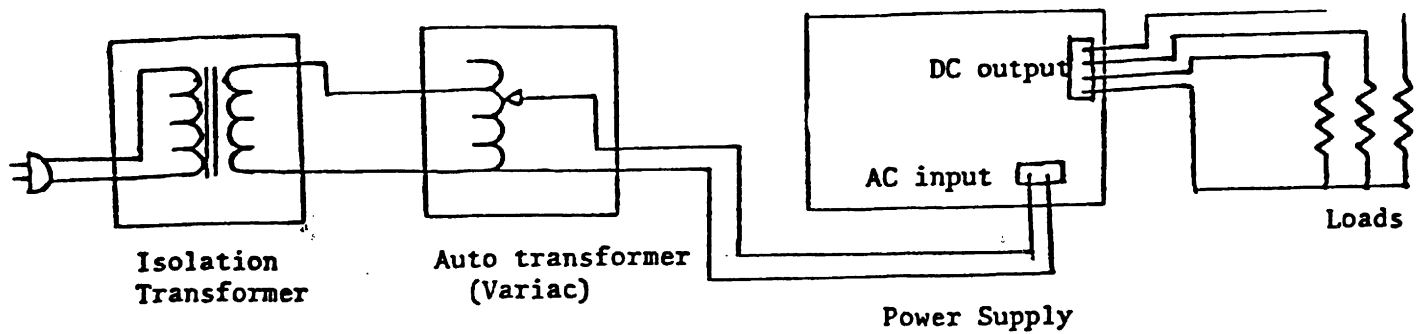
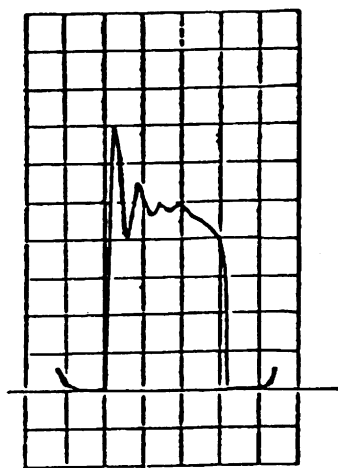

Fig. 2- Q2 Collector Waveform



100 V/Div
5 uSec/Div

Input- 240 VAC
Loads- +5@2A
+12@1A
-12@0.1A

Fig. 3- Q2 Base Waveforms

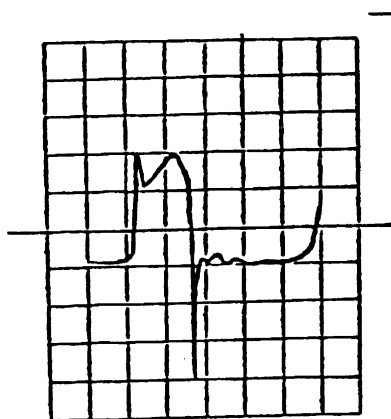

1.0 V/Div
5 uSec/Div
Input and Loads
same as Fig. 2

Fig. 4 Pin Assignment

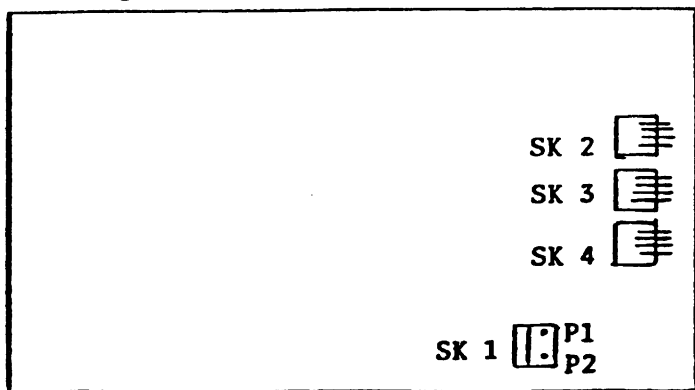

For SK 1
P1- Neutral
P2- Live

For Sk 2/3/4
P1- -12 0.1A Max.
P2- +12 2.02A Max.
P3- Common
P4- +5 2.5A Max.

R	R1	R4 R2 R5	R6-R13	R14-R18	R19-R27	R3
C	C1	C2,3,4	C24 C5 C6,7,8	C9 C10 C11 C12	C13-C21	
L/T	T1	L2 L1	T3	T2	L5-L7	
D/D		D1 Q1 D2	Q2 D4 D3	D5-D9 D11-D13 Q3		
MISC	F1	DB1			IC1	Z1 SCR 1

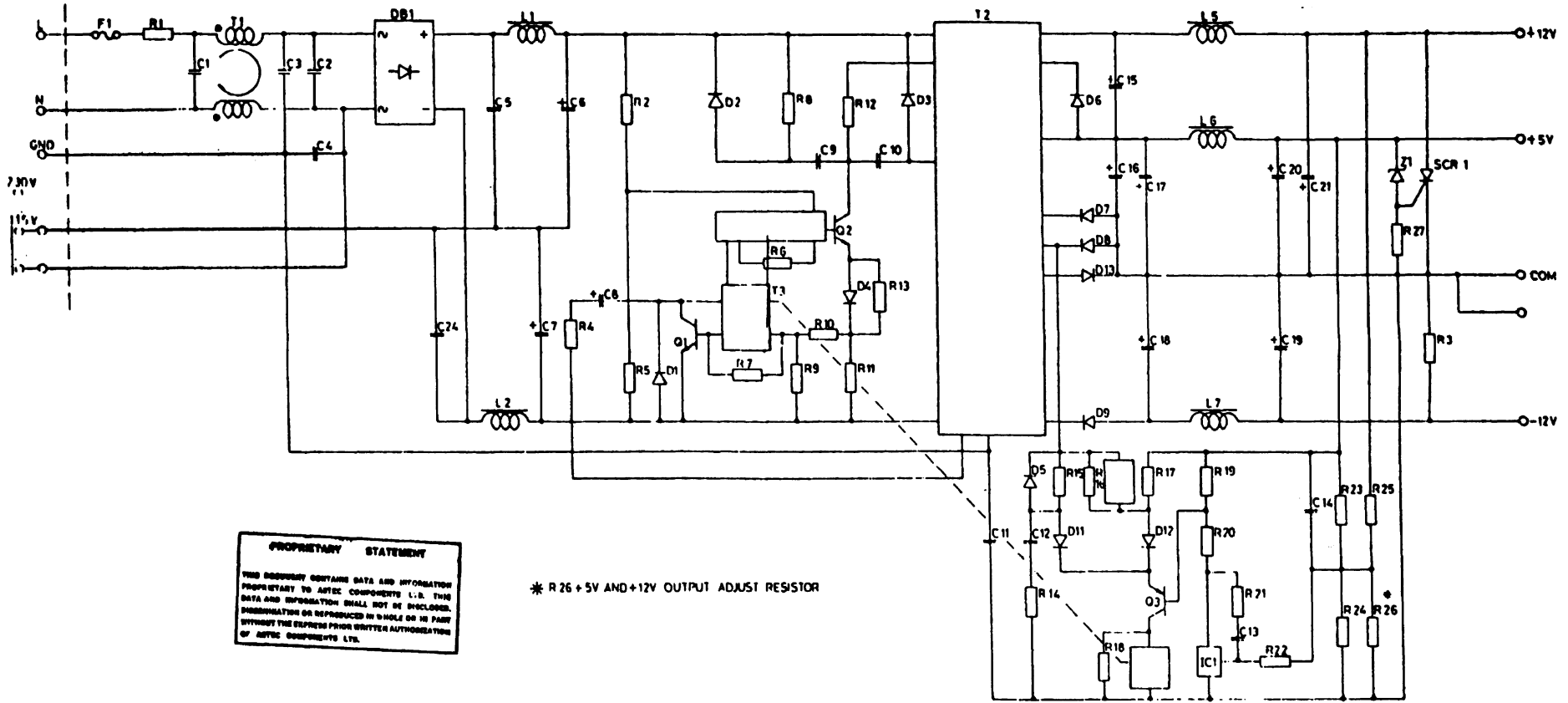

PROPRIETARY STATEMENT
 THIS DOCUMENT CONTAINS DATA AND INFORMATION PROPRIETARY TO ASTEC COMPONENTS LTD. THIS DATA AND INFORMATION SHALL NOT BE DISCLOSED, REPRODUCTION OR REPRODUCED IN WHOLE OR IN PART WITHOUT THE EXPRESS PRIOR WRITTEN AUTHORIZATION OF ASTEC COMPONENTS LTD.

* R 26 + 5V AND +12V OUTPUT ADJUST RESISTOR

PROPRIETARY STATEMENT
 THIS DOCUMENT CONTAINS DATA AND INFORMATION PROPRIETARY TO ASTEC COMPONENTS LTD. THIS DATA AND INFORMATION SHALL NOT BE DISCLOSED, REPRODUCTION OR REPRODUCED IN WHOLE OR IN PART WITHOUT THE EXPRESS PRIOR WRITTEN AUTHORIZATION OF ASTEC COMPONENTS LTD.

UNLESS OTHERWISE SPECIFIED ALL DIMENSIONS ARE IN MM TOLERANCES: WHOLE NO ± DECIMAL .X ± .XX ±	DO NOT SCALE DRAWING	TITLE (REPAIR MANUAL) CIRCUIT DIAGRAM
	DRAWN ANDY LEUNG	DATE 11 SEP 80
	CHEK	FIRST USED ON AC 8151
	DATE 11 SEP 80	MATERIAL FINISH
ASTEC COMPONENT LTD.		HONG KONG

1	MILAN DRAW	11 SEP 80	DATE	CHK	ANDY	ECN
---	------------	-----------	------	-----	------	-----