



Also: IBM in Europe, array processors, moving a dp center, and the Cray-1 at Los Alamos . . .

# Kennedy Digital Tape Transports

and the

## QUALITY EXPLOSION.

In every industry, the product sets a standard of quality. In tape peripherals, it's Kennedy.

Years of experience resulted in unique, exclusive — and standard features such as:

- A position arm anticipatory sensing system. An exclusive Kennedy feature, the linear, non-contact (MagPot) position sensor requires no lamp source and assures performance for the life of the machine.
- Interchangeable electronics on all Series 9000 transports, reduce stocking costs and down time.
- Front-accessible off-line test panel; marginal skew check; threshold scanning which automatically compensates for drop-ins or drop-outs; Read-After-Write shortened skew gate; simplified tape path and quick release hubs.

○ All models are available with either 7 or 9 track, also with 1600 IPE or 800/1600 NRZ IPE.

○ 7 and 9 track NRZ I and IPE format control units to simplify customer electronics. Also, a variety of popular minicomputer magtape controllers are available. Series 9000's performance is as impressive as its features, with data transfer rates to 72 KHz, and tape speeds from 10 to 45 ips.

Kennedy Digital Tape Transports have quite simply changed the industry by introducing the missing ingredient, quality of performance.

**KENNEDY CO.**

630 W. WOODBURY RD., ALTADENA, CALIF. 91704  
(818) 758-0259

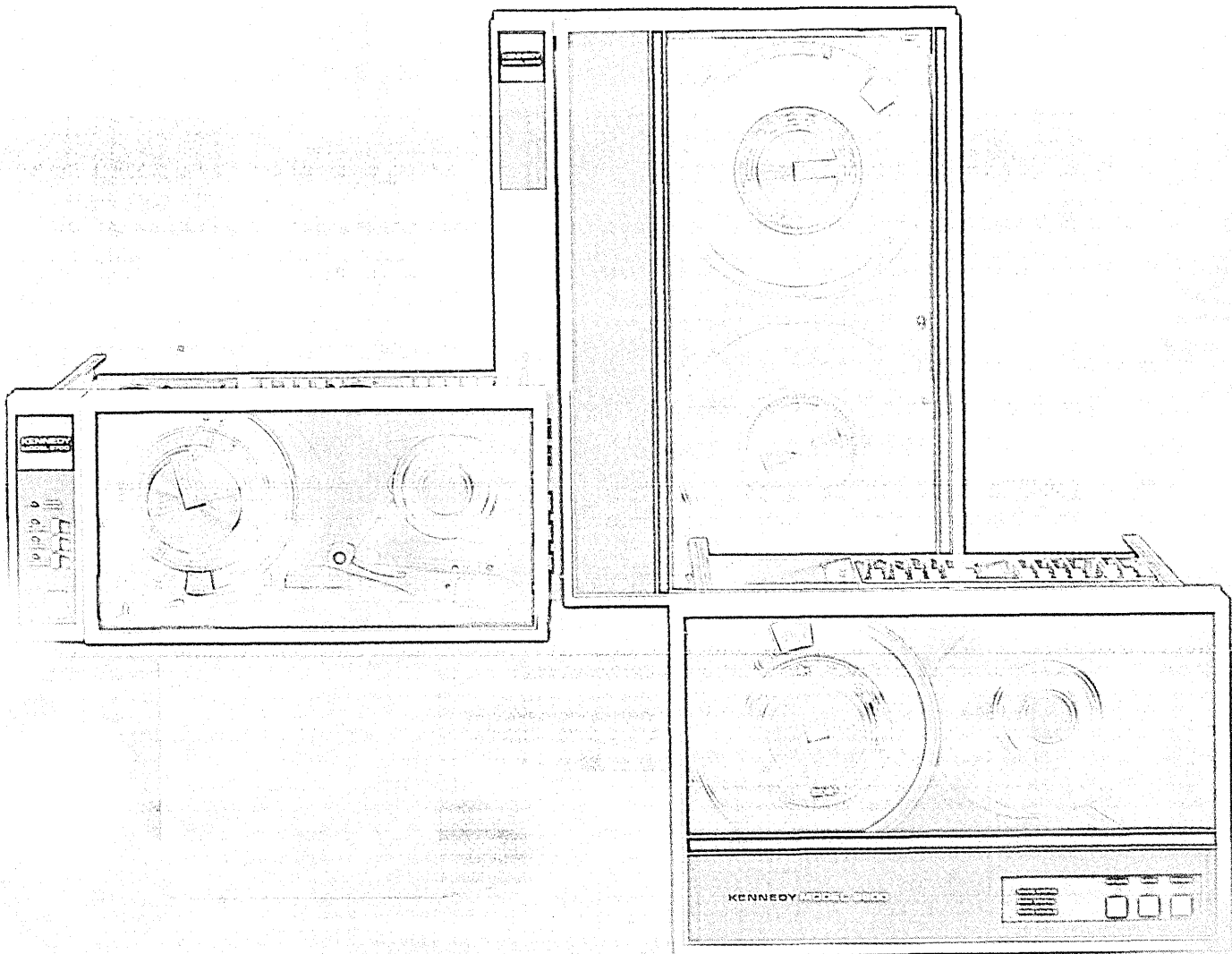

# KENNEDY'S QUALITY-COUNT ON IT

# Now appearing on your favorite network XL Distributed Processing Systems

Your Denver regional office needs up-to-the-minute reports from Los Angeles and Seattle... The central parks department in Atlanta must maintain current inventory levels of information received from six supply centers... Warehouses in Houston and Helsinki readily access the data base in Atlanta but don't need local processing. Branch offices in Calgary, Phoenix and Toronto must process orders and transmit to regional managers... Headquarters in Minneapolis needs to communicate with all regional and branch offices...

Presenting XL Distributed Processing Systems from Perce Computer Corporation. A family of microprocessor-based computer systems — and an approach to distributed processing — that works through the buzzword maze to provide state-of-the-art hardware and software solutions.

### Multi-layer processing

The distributed XL20 handles up to 64 users and various terminals. With up to 512K bytes of memory and 1M512K byte expandable I/O capability, the power and speed it can use microprocessor based flow control, data management and I/O control to give you a fast, efficient system for any type of application.

### Easy-to-use

Our intuitive user interface SubSystems (SIS) is designed to handle primary control for adding, editing, deleting and saving data and files. These are XL20's primary data processing and file management SubSystems. Access the information and files directly.

enhancing the amount of data available to any user. Order from your supply centers and warehouses.

### Introducing XL20

And introducing PC's newest XL family member XL20, a distributed system for applications requiring local intelligence, databases, communications and processing power. The XL20 offers your branch offices up to 512K bytes of memory and 1M512K bytes of storage with a built-in parallel system with a built-in control unit. The XL20 can be used to process information with a built-in control unit. The XL20 can be used to process information with a built-in control unit.

Designed with sophisticated hardware architecture and operating systems, the Perce Virtual Processing Unit (VPU) and application program can be used to manage the system. The VPU can be used to manage the system.

Order XL20 today on a limited time special. XL20 is now available in processing — now appearing on your favorite network.



PERCE  
COMPUTER  
CORPORATION

CMC DIVISION  
12910 Culver Boulevard, P.O. Box 92300  
Los Angeles, California 90009  
(213) 822-9914 TWX (910) 343-6451



## Family planning allows our 990 Computer Systems to grow as fast as you do.

When we designed our 990 Computer Family, we put a lot of thought into it. A lot of technology, too.

Our planning paid off. Today, we have large disk-based, multi-user, multi-language commercial systems, like our DS990 System. Its powerful DX10 software has over 170 system commands built in, to make light work of your office workload. Interactive or batch. We also have smaller standalone diskette-based systems, like our FS990 System. And they're all engineered to communicate with each other and to grow as your needs grow.

From the first, our plans called for software that can expand as your business does. So, when we engineered our TMS 9900 Microprocessor, we made it the first to use software that's upward-compatible with our entire line of 990 computers. Compatibility that protects your software investment.

Built into every 990 computer system is over 30

years of experience in the electronics industry, and the technical expertise and support of our worldwide organization of factory-trained sales and service engineers, backed by TI-CARE\*, our computer-automated field service dispatching and information system.

With the 990 Computer Family, you are assured of the lowest possible cost of ownership. Low purchase, maintenance and service costs. And reliable operation.

To see how our planning can keep pace with your growth, today and tomorrow, call your nearest TI sales office, or write Texas Instruments Incorporated, P.O. Box 1444, M/S 7784, Houston, Texas 77001.



**TEXAS INSTRUMENTS**  
INCORPORATED

\*Service Mark of Texas Instruments  
Copyright © 1978, Texas Instruments Incorporated

CIRCLE 74 ON READER CARD

# TEXAS INSTRUMENTS.

We put computing within everyone's reach.

## FEATURES

### 86 SELLING SMALL BUSINESS SYSTEMS

A marketing guide to the paths small business systems can travel on their way to the end user.

**Louis B. Marienthal**

### 91 SMALL BUSINESS SYSTEMS: THEY'RE EVERYWHERE

With 350,000 already installed, the boom has just begun.

**Laton McCartney**

### 94 FIRMS OF ALL SIZES CONVERT TO MINIS

Small systems are proving surprisingly versatile in the evolution of user-friendly distributed processing.

**Lawrence Richman**

### 102 IBM IN EUROPE

IBM's present and projected role in Europe has global implications. Do all roads really lead to Armonk?

**David Butler**

### 113 PUTTING THE CRAY-1 TO WORK AT LOS ALAMOS

Several times as powerful as a CDC 7600, Serial No. 1 came sans operating system, compilers, or other links to the outside world.

**Fred W. Dorr**

### 124 MEN AND MACHINES BEFORE BABBAGE

Their working calculating machines preceded Babbage's Difference Engine by as much as 165 years.

**Molly Gleiser**

### 137 THE ONLY WAY TO MOVE

When Western moved its dp center, there was too much to do, too little time, and no choice at all.

**Walter Bambrick and Benjamin A. Fong**

### 147 SOVIET SQUEEZE ON STRATEGIC MATERIALS

Computers and electronic components rely on small amounts of rare materials—which we may not always be able to get.

**Bohdan O. Szuprowicz**

### 159 SCIENTIFIC COMPUTING ON A BUDGET

Low cost array processors—scientific minicomputers—are now entering domains that had been the exclusive turf of the huge number crunchers.

**C. N. Winningstad**

### 178 TOOLS FOR TOP-DOWN TESTING

“Top-down” shouldn't end at coding.

**Paul F. Barbuto, Jr. and Joe Geller**

### 236 THE FORUM

Strangling the systems of the '80s with the technology of the '60s.

**Phillip H. Dorn**

## ABOUT THE COVER

The multfigured, multicolored landscape of small business computing is the vision of artist Mike Nichols.

## NEWS IN PERSPECTIVE

### 52 FINANCE

Computer stocks outperform the market.

### 53 ELECTRONIC FUNDS TRANSFER

Momentum gathers but public awareness still is low.

### 55 COMMUNICATIONS

IBM's Branscomb on AT&T's ACS.

### 56 SMALL BUSINESS COMPUTERS

Pertec moves into a new market.

### 58 MEETINGS

Wescon draws big in Los Angeles.

### 67 PEOPLE

At TEC, it's all in the family.

### 68 COMPANIES

The Computer Company's successes in processing Medicaid claims.

### 72 FEDERAL GOVERNMENT

Shop talk for the Feds.

### 79 BENCHMARKS

Flook interpreted; CDC drops its terminal; Univac out of POS; Toward MVS, VM/370; Intel acquires MRI; Banks settle; Data General acquisition; A distributed gain; Ups and downs.

### 80 FOCUS

How a minicomputer helps Quinalt Indians to manage their land.

## DEPARTMENTS

- 8 LOOKING BACK
- 17 LOOK AHEAD
- 24 CALENDAR
- 39 LETTERS
- 47 EDITOR'S READOUT
- 188 HARDWARE
- 202 SOFTWARE
- 210 SOURCE DATA
- 223 MARKETPLACE
- 229 ADVERTISERS' INDEX

# The New Slimline Series From Okidata

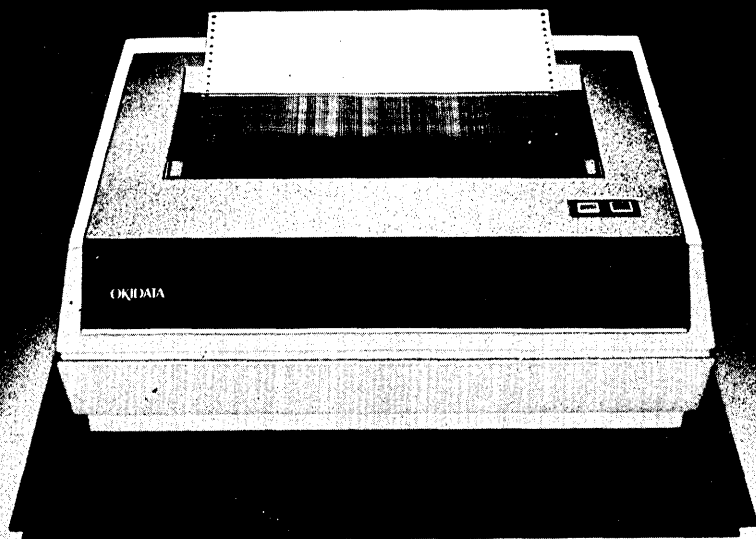

## Line Printers That Sell Minisystems

The Okidata Slimline Series, a new family of microprocessor-controlled, 132 column line printers. A wide range of speeds, options and plug-compatible interfaces, all supported with common spares.

Common spares but uncommon price, performance and reliability. OEM prices that create new mini-system opportunities, print quality that helps sell the businessman and Okidata reliability and maintainability—unmatched in the industry. A 500,000,000 character head warranty and stored program machine history that replaces customer installation records.

The Slimline, available in 300, 250, 160 and 125 LPM models. Twelve program-selectable fonts, 5 x 7, 7 x 7 and 9 x 7 characters, and graphics capability. The Slimline, backed by a worldwide sales and service organization.

# OKIDATA

Okidata Corporation  
111 Gaither Drive  
Mount Laurel, New Jersey 08054  
Telephone: 609-235-2600

CIRCLE 87 ON READER CARD

## DATAMATION.

**Editor** John L. Kirkley  
**Senior Editor** Richard A. McLaughlin  
**International Editor** Angeline Pantages  
**European Editor** Ralph Emmett  
**Products Editor** Bill Musgrave  
**Copy Editor** John Waterhouse  
**Articles Assistant** Sarah Rolph  
**Surveys Editor** Nancy Knottek  
**News Editor** Tom McCusker

**Bureau Managers**  
**San Francisco** Edward K. Yasaki  
**Los Angeles** Edith D. Myers  
**Greenwich** Angeline Pantages  
**New York** Laton McCartney  
**Washington, D.C.** Linda J. Flato

**Correspondents**  
**Atlanta** Lynn Ridlehuber  
**Boston** Vin McLellan  
**Southwest** Robert F. Alexander

**Editorial Advisor** Robert L. Patrick  
**Technical Advisor** Lowell Amdahl  
**Contributing Editors** Ralph G. Berglund  
Howard Bromberg, Philip H. Dorn, John M. Eger, William Helgason, Portia Isaacson, Louis B. Marienthal, Carl Reynolds, F. G. Withington

### EDITORIAL OFFICES

**Headquarters:** 1801 S. La Cienega Blvd., Los Angeles, CA 90035. Phone (213) 559-5111. **Eastern:** 35 Mason St., Greenwich, CT 06830, (203) 661-5400, Telex 996343. 420 Lexington Ave., New York, N. Y. 10017, (212) 682-7760. 6605 Burlington Pl., Springfield, VA 22152. (703) 569-3383. **Southwestern:** 11500 Stemmons North, Suite 152, Dallas, TX 75299, (214) 247-5221. **Western:** 2680 Bayshore Frontage Rd., Suite 401, Mountain View, CA 94043, (415) 965-8222. **Foreign:** 15 A St. Ann's Terrace, St. John's Wood, London, NW8, England; (01) 722-5088; 24 Stafford Road, Artarmon, Sydney, NSW 2064, Australia, 41-5748. **TELEX 996-343**

**Art & Production Director** Cleve Marie Boutell  
**Advertising Production Manager** Marilee Pitman  
**Production Assistant** Alberta R. Martin

### CIRCULATION

35 Mason Street, Greenwich, CT 06830  
**Circulation Manager** Suzanne A. Ryan  
**Marketing Research Manager** Deborah Dweley  
**Publisher** James M. Morris  
**Assistant Publisher** F. Douglas De Carlo



Circulation audited  
by Business Publications Audit



Member American Business Press, Inc.

**American Business Press, Inc.**



**DATAMATION** is published monthly on or about the first day of every month by Technical Publishing Company, A Dun and Bradstreet Company, 1301 South Grove Ave., Barrington, Illinois 60010; James B. Tafel, Chairman; John K. Abely, President. Executive and Advertising offices, 35 Mason Street, Greenwich CT 06830, (203) 661-5400. Editorial offices, 1801 S. La Cienega Blvd., Los Angeles, CA 90035. Published at Chicago, Ill. **DATAMATION** is circulated without charge by name and title to certain qualified individuals in the United States and Canada who are employed by companies involved with automatic information handling equipment. Available to others by subscription at the rate of \$25. Reduced rate for qualified students, \$14. Foreign subscriptions \$50, or £27.50; for airmail, additional charge \$40, or £24.50. Japan and Australia \$65, or £36.50 (air shipped). Sole agent for all subscriptions outside the U.S.A. and Canada is J. B. Tratsart, Ltd. 15-A Greenford Road, Harrow, Middlesex HA13QT, England. No subscription agency is authorized by us to solicit or take orders for subscriptions. Controlled circulation paid at Columbus OH. © Copyright by Technical Publishing Corporation. A Division of Dun-Donnelley Publishing Corporation, A Dun & Bradstreet Company, 1978—all rights reserved. \* "Datamation" registered trademark of Technical Publishing Company. Microfilm copies of **DATAMATION** may be obtained from University Microfilms, A Xerox Company, 300 No. Zeeb Road, Ann Arbor, Michigan 48106. Printed by Bestow Associates, Inc.  
Circulation Office: 34 East Putnam Avenue, Greenwich, CT 06830. POSTMASTER: Form 3579 to be sent to Technical Publishing Company, P.O. Box 2000, Greenwich, CT 06830. Publication Number: 148800. Single copy: \$3.00 in U.S.A.

# A 32K byte dual floppy microcomputer system for only \$2900\* complete.

## Standard Features:

- Dual 8" floppys store 500,000 characters on line
- 32K bytes of static RAM
- RS-232 C at 75 to 19,200 baud
- 16 line parallel I/O
- Rack or tabletop mounting
- UL-recognized power supplies
- BUS oriented computer architecture
- Four slots used — four slots open for expansion
- Comes complete with disk BASIC
- Includes Interactive Assembler/Editor
- Main processor is an ultra-fast 6502A
- Has auxiliary Z-80 and 6800 micros which allow execution of virtually all 6502, 6800, 8080 and Z-80 code!
- User programmable interrupt vectors on all three micros

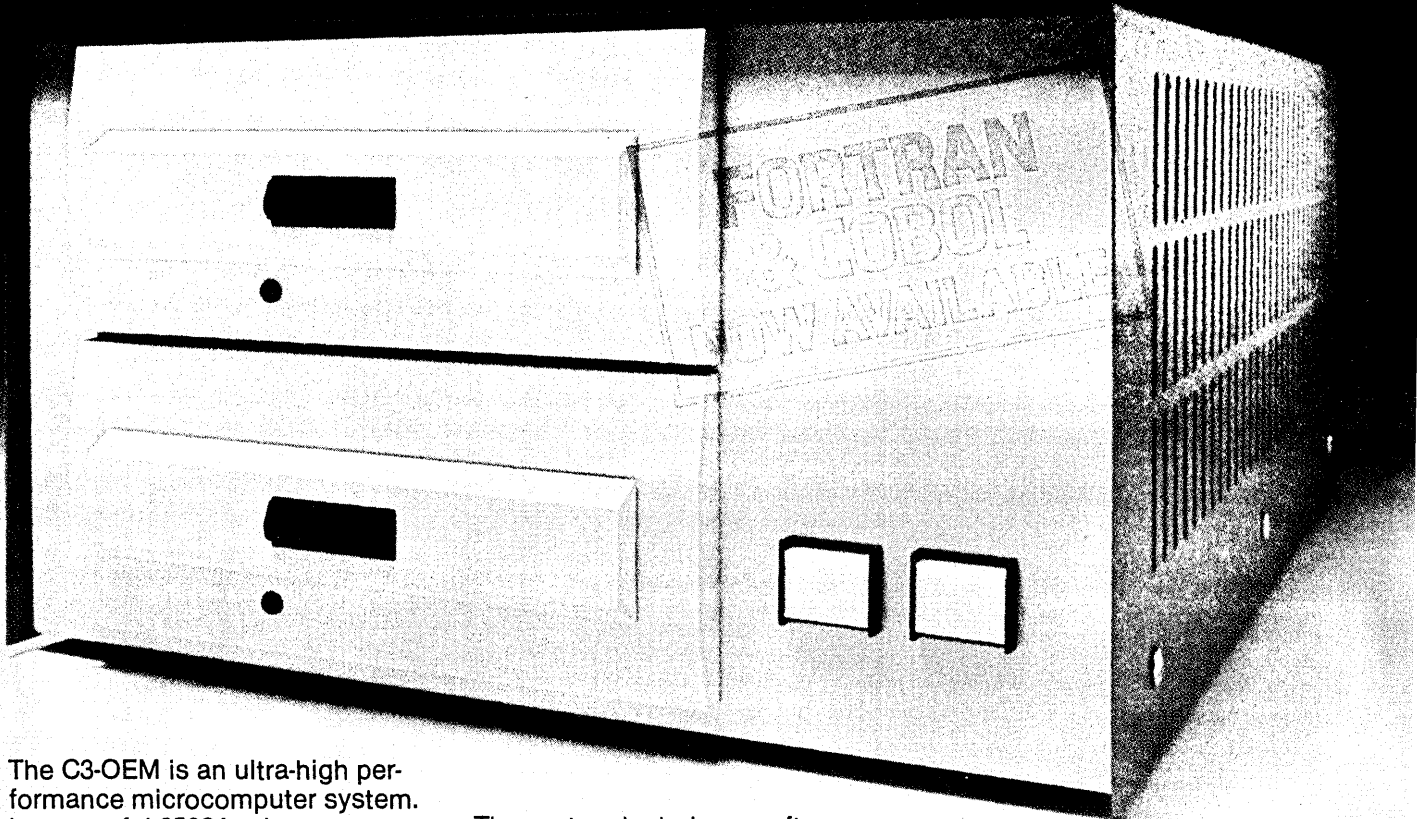

The C3-OEM is an ultra-high performance microcomputer system. Its powerful 6502A microprocessor (now triple sourced) out-benchmarks all 6800- and 8080-based computers in BASIC and machine code using the BASIC and assembler provided standard with this system.

In fact, the C3-OEM executes standard BASIC language programs at speed comparable to small 16 bit minicomputers.

Ohio Scientific has a vast library of low cost software for the high performance 6502A including an on-line debugger, a disassembler, several specialized disk operating systems and applications programs such as our word processor package and a data base management system. However, the C3-OEM is not just limited to 6502 based software. This remarkable machine also has a 6800 and a Z-80 microprocessor.

The system includes a software switch so that machine operation can be switched from one processor to another under software control!

So, one can start with existing 6800, 8080 or Z-80 programs while developing new software for the ultra-high performance 6502A.

The C3-OEM isn't cheap. It's a quality product with mechanical features like UL-recognized power supplies, a three-stage baked-on enamel finish and totally modular construction.

It is the product of Ohio Scientific's thousands of microcomputer systems experience. In fact, all the electronics of the C3-OEM have been in production for nearly a year and have field proven reliability. And, best of all, this machine is available now in quantity for immediate delivery!

A full spectrum of add-ons are now available including more memory, up to 16 serial ports, 96 parallel I/O lines, a video display, a parallel line printer interface and a 74 million byte Winchester disk drive.

\*25-49 unit price  
1-4 \$3590.  
5-9 \$3300.  
10-24 \$3100.

Phone (216) 562-3101  
or write for more information  
and the C3-OEM representative  
in your area.

**OHIO SCIENTIFIC**  
1333 S. Chillicothe Rd.  
Aurora, OH 44202

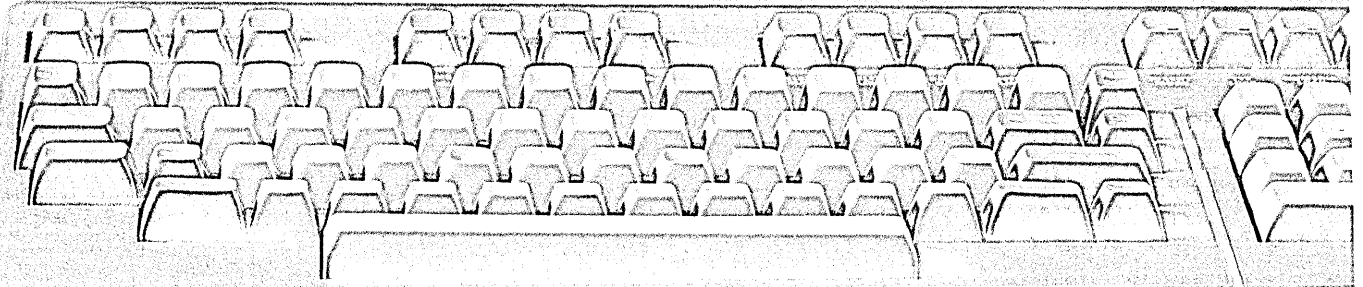
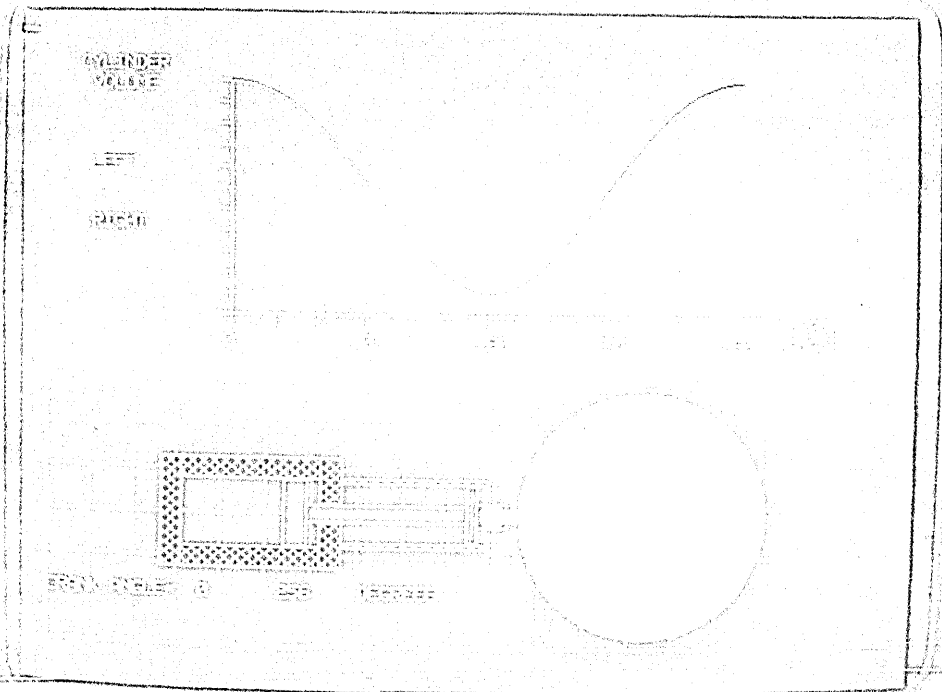



# Tektronix makes color graphics practical at last.



Graphic results can be reproduced in gray scale on our video copier or plotted in color on our digital plotters.

**Tektronix**

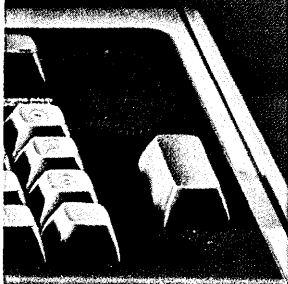

**Tektronix**

**O**ur new color graphics terminal incorporates sharp detail, powerful firmware functions and software support that sets the industry standard.

It's a combination of high performance and low price that could come only from Tektronix.

Display any 8 colors from a palette of 64, with precise control over hue, lightness and saturation. Firmware capabilities include concave and convex polygon fill; 120 user definable patterns; virtual bit mapping for unique scrolling of color graphics and alphanumerics; and a full-screen crosshair cursor that returns color information as well as x-y coordinates back to the host.

The 4027 is part of the Tektronix 4020 Series of refresh data entry, date retrieval, forms fillout and graphics terminals. So color can be an integral part of your total information capability.

**Our PLOT 10 software provides all the tools for easy yet versatile graphics.**

Our PLOT 10 Easy Graphing will produce full color pie charts, bar graphs or line graphs with shading. For the most

demanding color graphics applications, our PLOT 10 Interactive Graphics Library has modular construction and device independent design.

**Display on remote monitors or produce archival copies.**

The video output is compatible with most 60Hz, RGB 525-line video monitors. Results can be plotted in color on our digital plotters or reproduced in gray scale on our video copier. Options include expandable graphics memory up to 192K and a variety of peripheral interfaces. And as the graphics leader, we back you up with nearby sales, service and technical support.

Find out more about how Tektronix makes color graphics practical. Call our toll-free fast-answers number at 1-800-547-1512 (in Oregon call 644-9051 collect), or contact your local Tektronix office.

**Tektronix, Inc.**  
P.O. Box 500  
Beaverton, OR 97077  
**Tektronix International, Inc.**  
European Marketing Centre  
Postbox 827  
1180 AV Amstelveen  
The Netherlands  
Telephone: 020-471146

**Tektronix®**  
COMMITTED TO EXCELLENCE

Not just  
a bar code.  
A concept.



## CODE 39<sup>T.M.</sup>

an alphanumeric  
bar code with  
exceptional  
data integrity.

Why are more systems designers specifying CODE 39 whenever there is a need to track, trace, or count?

Because they recognize the many inherent advantages of this bar code concept. Advantages like accurate and rapid data input. Advantages like compatibility with existing data base systems and use by operators without keyboard training.

Because CODE 39 is alphanumeric and variable length it easily conforms to existing systems. CODE 39 can be expanded to the full ASCII character set.

CODE 39 is inexpensively produced by letterpress, offset printing and a variety of computer-controlled terminals, including Intermec printers.

### Typical Applications

*Inventory Control  
Wholesale Distribution  
Production Control  
Hospital Record Systems  
Libraries/Research*

### For more information contact:

Interface Mechanisms, Inc.,  
P.O. Box "N," Lynnwood, WA  
98036, Phone (206) 743-7036,  
TWX (910) 449-0870

# INTERMEC<sup>®</sup>

Expert in Bar Code

||| READERS ||| PRINTERS |||

CIRCLE 119 ON READER CARD

# LOOKING BACK

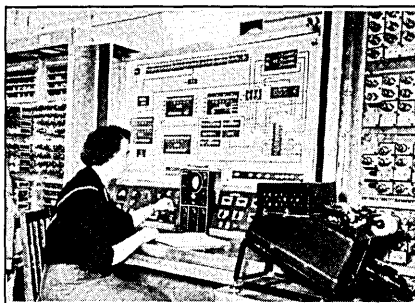

The SESM calculator in its heyday, occupied 86 sq. ft.—not counting its operator.

## September/October 1958 Beginnings

1958 seems to have been an important year for computing. Several small articles and news briefs in this issue describe a greater international involvement in the industry and herald the second generation with transistorized machines.

A news article announced that Japan was about to enter the computer market, with "at least three companies expected to be producing computers commercially" by 1959, and a short feature described computing in the U.S.S.R. circa 1958. Trial work had just begun on SESM, a Russian electronic calculator located at the Ukrainian Academy of Sciences at Kiev. The specialized machine was said to be "capable of solving linear algebraic equations having up to 400 unknown factors," and with typical Russian chauvinism, was touted as the "first of its kind to be produced in the U.S.S.R. or anywhere in Europe." The machine made extensive use of vacuum tubes as well as solid state devices and occupied a full 86 square feet of space!

Local news was dominated by IBM's announcement of its newest computer, the 7070, billed with typical IBM chauvinism as "a completely transistorized computer in the intermediate price field." IBM claimed that one-third of the installation and environmental control costs were eliminated through the use of transistors. And the company boasted time savings provided by the new com-

puters ability to "overlap machine operations. By using two tape channels, the 7070, while computing, reads or writes magnetic tapes at rates up to 125,000 characters per second," and it was said to be able to handle "several" 400 card-per-minute readers and 250 card-per-minute punches, simultaneously. Up to 50 magnetic disks could be added, providing random access storage of 24 million "digits" in addition to the core memory of 50,000 to 100,000 "digits." And to top it all off, IBM noted it had especially developed "a series of general purpose, automatic programs" for the computer and was quick to point out that the 7070 could also compile in FORTRAN.

## October 1968 Growing Pains

The theme was software and an article by Robert Head and Evan Linick, "Software Package Acquisition," outlined a future for software which echoed the ideas implied by IBM in its announcement of the 7070 ten years before. Head and Linick stated that programs would be developed as *packages* from the beginning rather than after the fact, and that software companies would begin concentrating on proprietary software as they realized that it is a lot more profitable to develop a package that could be sold many times over than to produce it under conventional single contract programming.

And, as a sign that the industry was growing up, a news brief discussed a newly issued federal directive requiring the adoption of the ASCII code. The need for standardization was recognized and the first feeble attempt at implementation was begun. Look how far we've come.

The industry was booming. Scientific Data Systems (SDS) had a full page ad, Interdata had just shipped its 100th computer, IBM was pushing PL/1, Control Data introduced the UT200, and RCA bought a page of space to recruit systems programmers. The issue also carried the first announcement of Viatron (the great white hope of the industry whose bubble burst because of financial shortsightedness.).

\*

# With SYSTEM 2000,<sup>®</sup> you get more than just a DBMS.

*You also get*

- Multiple DB/DC languages with integrated data dictionary
- Greater productivity in applications development
- Lower software maintenance costs
- Proven reliability & availability for complex applications
- Greatly improved use of your data resources
- A solid foundation for future systems

These are just a few of the special benefits of SYSTEM 2000—the most advanced data base management system on the market.

SYSTEM 2000 offers something else really unique—MRI Systems Corporation. A company which has been developing data base management systems for almost ten years. A company staffed with 200 highly skilled people. A company which believes in customer services, and stands behind its products.

Visit MRI in Austin, Texas. You'll see that with SYSTEM 2000, you get more than just a great DBMS—you get an entire company.



PROFESSIONAL  
THE DATA BASE MANAGEMENT COMPANY  
12675 Research Blvd., Austin, Texas 78759, (512) 258-5171

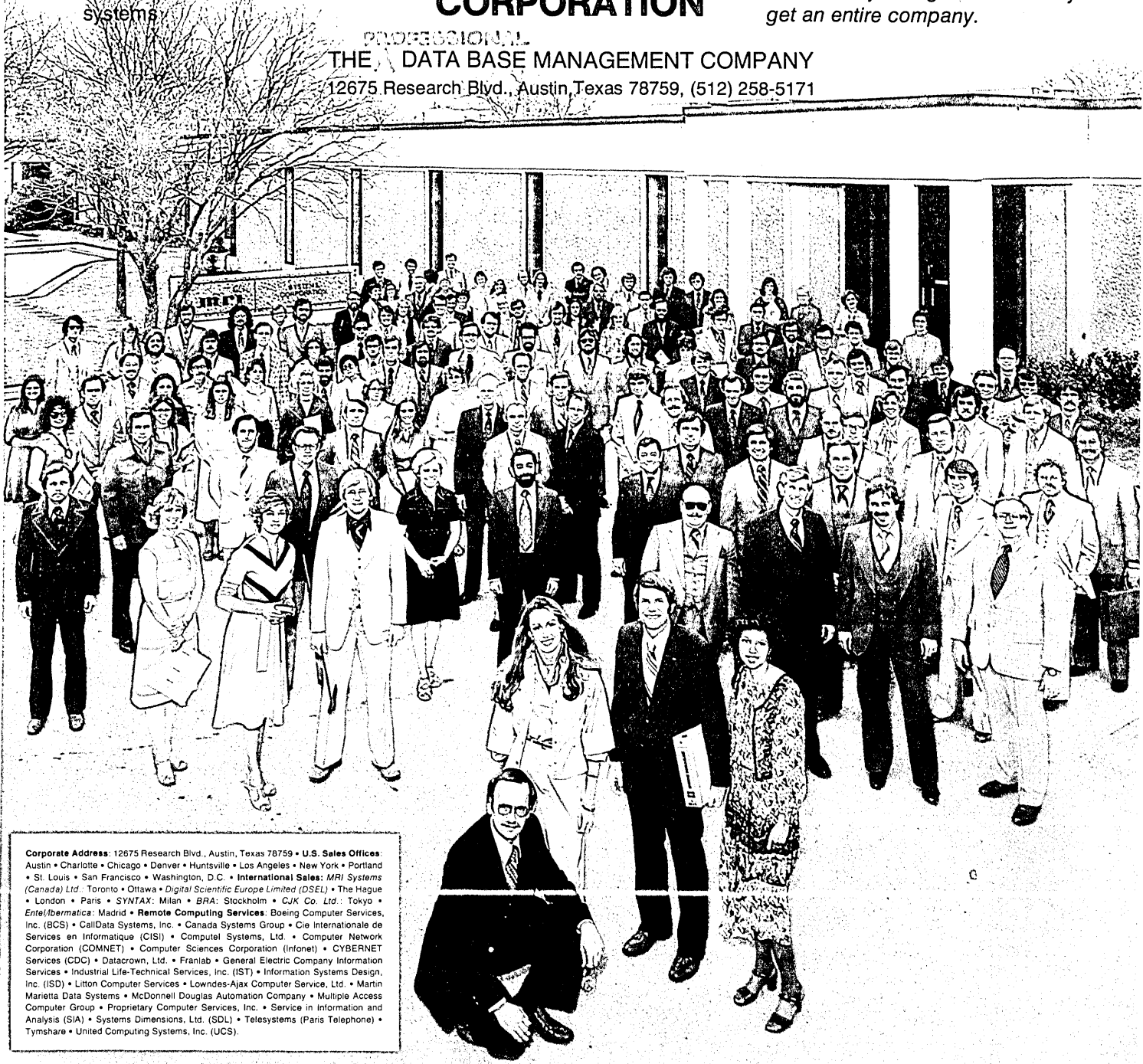

**Corporate Address:** 12675 Research Blvd., Austin, Texas 78759 • **U.S. Sales Offices:** Austin • Charlotte • Chicago • Denver • Huntsville • Los Angeles • New York • Portland • St. Louis • San Francisco • Washington, D.C. • **International Sales:** MRI Systems (Canada) Ltd.: Toronto • Ottawa • Digital Scientific Europe Limited (DSEL) • The Hague • London • Paris • SYNTAX: Milan • BRA: Stockholm • CJK Co. Ltd.: Tokyo • Entel/bermatica: Madrid • **Remote Computing Services:** Boeing Computer Services, Inc. (BCS) • CalData Systems, Inc. • Canada Systems Group • Cie Internationale de Services en Informatique (CISI) • Computel Systems, Ltd. • Computer Network Corporation (COMNET) • Computer Sciences Corporation (Infonet) • CYBERNET Services (CDC) • Datacrown, Ltd. • Fränlab • General Electric Company Information Services • Industrial Life-Technical Services, Inc. (IST) • Information Systems Design, Inc. (ISD) • Litton Computer Services • Lowndes-Ajax Computer Service, Ltd. • Martin Marietta Data Systems • McDonnell Douglas Automation Company • Multiple Access Computer Group • Proprietary Computer Services, Inc. • Service in Information and Analysis (SIA) • Systems Dimensions, Ltd. (SDL) • Telesystems (Paris Telephone) • Tymshare • United Computing Systems, Inc. (UCS)

# Design the best!

—John Jacobs, ADDS Chief Engineer



ADDS Regent is about the best **ANY** terminal money can buy. It's known best for itself.

State-of-the-art Regent uses the highest performance microprocessor components available. It's known best for itself.

In fact, our sophisticated technology means Regent is a remarkably simple terminal. It has fewer components than most of our competitors

that means fewer problems. And more Regents in your future.

From the beginning, we designed ADDS equipment to be the very best. And 65,000 installed terminals have proved us right.

ADDS Regent. Quality you can rely on.  
ADDS, Applied Digital Data Systems Inc., 100 Marcus Blvd., Hauppauge, NY 11787 (516) 231-5100.

# ADDS REGENT

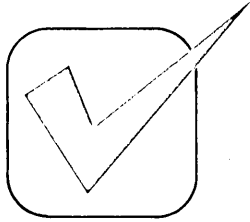

# Your best buy... HARRIS.

The "best buy" label on a product means you can expect performance, quality, ease of use and durability... all at the best possible price. You get all of these — plus the ability to grow when you need to — with a computer terminal system from Harris. We've put it all together for you: hardware, software, support and service. And Harris is a solid Fortune 500 company with the resources and experience to keep you on top. Check our "best buy" list for yourself:



## Remote Batch Terminals.

We offer the most sophisticated, flexible RBTs in the industry. Our 1600 family utilizes a communications operating system providing true mul-

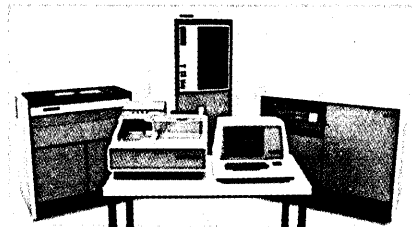

HARRIS 1620 remote batch terminal.

tiprogramming capability. One large Harris 1600 can support up to four communications jobs concurrent with other tasks such as media conversion. The 1600 already supports virtually every communications protocol in wide commercial use today and will soon support full SNA capability. Communications interfaces are available up to 56 Kbps.



## Interactive Terminals.

Our interactive terminals give you features that you can't get elsewhere. Plus-compatible 3270-mode units in our 8000 series can be easily upgraded to offer local format storage, queued transaction handling, (and spooled print available soon). These features can be combined in any mix to improve efficiency and productivity at remote 3270 sites. Our software also allows the 8000 series to emulate



HARRIS 8000 series interactive terminals.

Honeywell, Univac and Burroughs interactive protocols.



## Distributed Data Processing (DDP) Systems.

Harris DDP systems combine the proven performance of both our batch



New HARRIS 1670 distributed processing system.

and interactive products into a single multi-function terminal. As a result, Harris systems can provide all five basic DDP functions *concurrently*: local or remote batch; data entry; local interaction and remote interaction. All of these functions operate under the control of sophisticated software providing flexibility normally found only on larger mainframes.



## Software.

Every data communications terminal we make is software-

driven and is kept up to date through new software releases. That's one reason why Harris terminals continue to perform with extremely high efficiency over long periods of time.

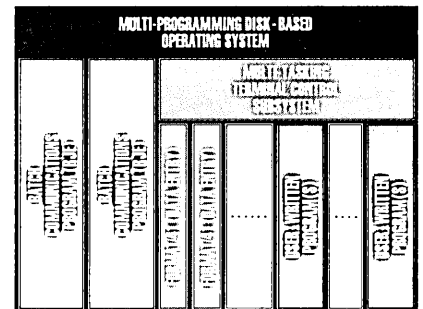

Sophisticated software architecture of Harris 1660 Distributed Data Processing (DDP) System supporting multiple RJE links, data entry, and user-written interactive programs concurrently.



## Unique Value.

No other vendor offers our range of terminal capabilities: communication protocols, breadth of product line, software and hardware features. Only one other company comes close, and on a direct comparison, you'll find Harris is a better buy.

**Make a "best buy" decision for yourself by contacting Harris Corporation, Data Communications Division, at 16001 Dallas Parkway, P.O. Box 400010, Dallas, Texas 75240, telephone (214) 386-2000.**

### INTERNATIONAL SUBSIDIARIES

Harris Systems Limited, Toronto, Canada, (416) 441-2400  
Harris Data Communications, S.A., Paris, France, 1 (043) 8125  
Harris GmbH., Frankfurt a.M., West Germany, 0611-67 80 39  
Harris Systems, Ltd., Hitchin, England, 0462-53462  
Harris Systems, Ltd. (Support Centre), Slough, England, 0753-34666

### INTERNATIONAL DISTRIBUTORS

Minidata BV, Leiden, Holland, 071-1315467  
UCC (Datacom), Ltd., Dublin, Ireland, Dublin 801981  
Data Terminal Systems, Milan, Italy, 31-62-08  
BDV Computer Products A.G., Basel, Switzerland, 061-22-8007  
AWA, Ltd., North Ryde, Australia, 888-8111  
Kenematsu Electronics, Ltd., Tokyo, Japan, 03-543-7611  
Conisa, Caracas, Venezuela, 781-8888

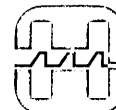

**HARRIS**  
COMMUNICATIONS AND  
INFORMATION HANDLING

*The only source you need.*

# FOR RENT

Intel's amazing new generation  
Intellec® Series II  
Microcomputer Development Systems  
... everything you'll ever need to  
develop a microcomputer-based product.

**The Intellec Models 210, 220 and 230 are the first fully integrated, packaged tools for developing and testing your microcomputer-based products. They'll each fit easily on your lab bench to help cut months from your design cycle.**

You can rent the newest generation microcomputer development systems today from REI and start taking advantage immediately of the fast, flexible and cost-efficient Intellec systems. Each can help you build a more reliable product. And because these new Intellec systems are so compact, they use less of your valuable laboratory bench space than any other microcomputer development aid on the market.

**Model 230 is the most powerful member of the Intellec Series II family, providing you two double-density floppy diskettes with over 1-million bytes of on-line data storage, 64K bytes of RAM and an integral CRT.**

The compact Model 230 also gives you a detachable, type-writer-style keyboard with upper and lower case characters and cursor controls. Its powerful ISIS-II Diskette Operating System has relocatable and linkable software and allows the use of two high-level programming languages, PL/M-80 and FORTRAN 80, plus the microcomputer industry's most comprehensive line of macro assemblers. The system has over 1-million bytes of on-line diskette storage and will support up to 2½-million total bytes. The System Monitor (in ROM memory) provides a Self-Test system diagnostic, and interfaces for a printer, paper tape reader/punch and universal PROM programmer are also provided. Model 230 gives you access to all the tools needed for your development work, including software editors, assemblers, compilers and debuggers, plus Intel's famous In-Circuit Emulators—ICE-80, ICE-85, and ICE-48.

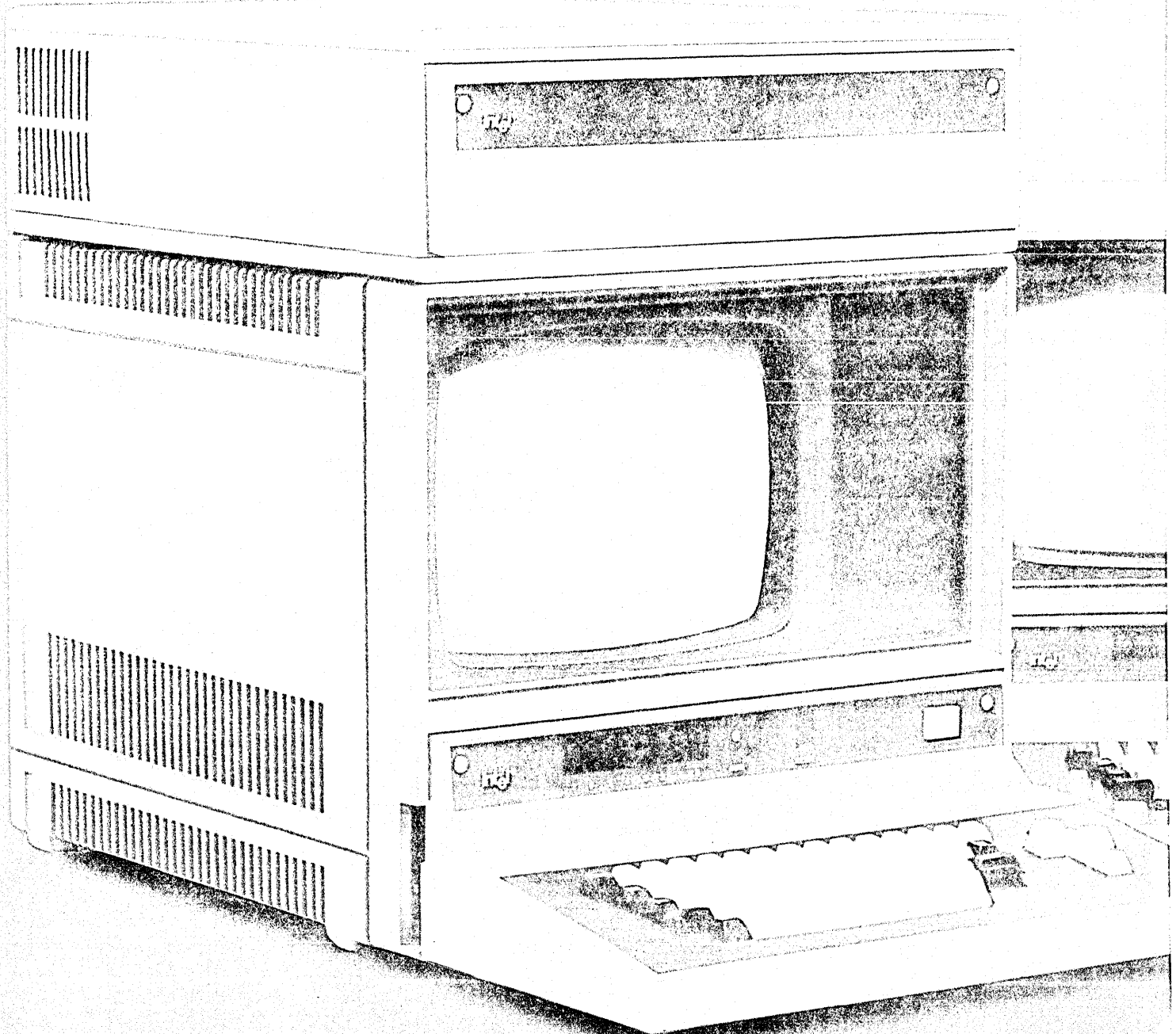

# INNOVATION

**For medium-scale system development, you can rent the Model 220. Now.**

The Intellec Model 220 is also a complete packaged development system. It has an interactive, 2,000 character CRT with typewriter-style keyboard and a full-sized 256K byte floppy diskette drive and 6-slot MULTIBUS card cage in one compact unit. Model 220 gives you 32K bytes of RAM program memory and 4K bytes of ROM. The ISIS-II Diskette Operating System has a relocating 8080/8085 assembler, and the new system interfaces directly to the ICE In-Circuit Emulators.

**The Intellec Model 210 rents for the lowest price of any packaged, full support development system available—anywhere.**

Model 210 gives you the minimum system required for the rapid, efficient development of microcomputer software. It has a ROM-based editor/assembler combination which allows the development of small 8080 or 8085 programs completely in RAM memory, which minimizes your use of paper tape. Plus, you can also rent a ROM assembler/editor for Intel's family of MCS-48 single-chip microcomputers. The compact Model 210 has 32K bytes of RAM, 24K bytes of ROM and its own microprocessor. Self-test diagnostics capability is built-in. And it's easy to get started, too. All you have to do is interface the Intellec 210 to your terminal.

**You can extend the powerful resources of an Intellec Series II system into your own prototype for fast and efficient software debug in your product's final hardware environment. Just put your product on ICE . . . ICE-80, ICE-85, or ICE-48, all off-the-shelf at REI.**

To emulate your own CPU or your entire prototype system in real-time or single-step mode, simply rent the appropriate In-Circuit Emulator module to match your system's microprocessor. And you can begin software debugging as soon as your prototype has a processor socket and bus structure.

**Capability-enhancing peripherals are available for short-term rental, too.**

You can add to the already extensive capabilities of the Intellec Series II system with a variety of immediately available peripherals. These include two Intellec Printers, two diskette-based peripherals (one single-density with 1/2-million bytes of storage, the other double-density with 1-million bytes of storage). You can also choose a high-speed paper tape reader and a universal PROM programmer . . . all of which are for rent today from REI.

RENTAL ELECTRONICS, INC.  
Another of the **AMERICAL** companies

**More than 12,871 state-of-the-art instruments . . . off-the-shelf, throughout North America.**

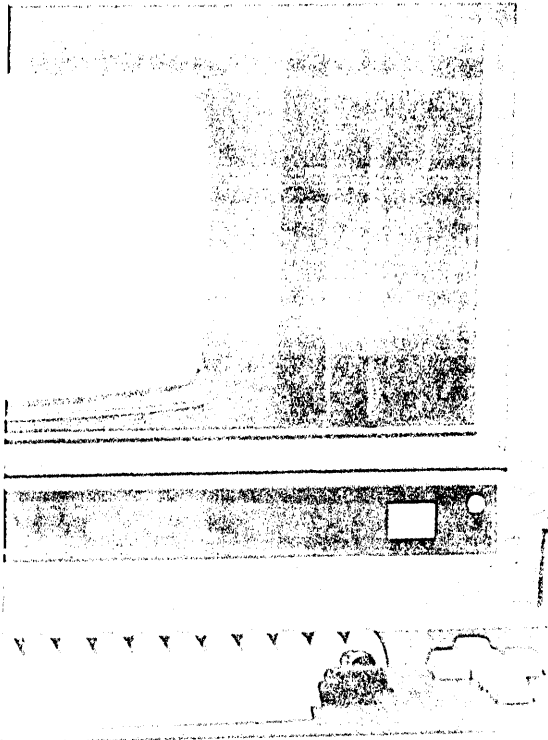

I want to know more about the Intellec Series II now!

Tell me more about:  Model 230  Model 220  Model 210

Call me at \_\_\_\_\_

Send me a copy of your free illustrated Rental Catalog.

I might be interested in buying—on a money-back guarantee—some of your late-model, well-maintained "previously owned" equipment. Send me your just-published Equipment Sales Catalog.

Also, I have a pressing need right now for the following:

\_\_\_\_\_

Please phone me immediately at \_\_\_\_\_

NAME \_\_\_\_\_ TITLE \_\_\_\_\_

COMPANY \_\_\_\_\_

ADDRESS \_\_\_\_\_

CITY \_\_\_\_\_ STATE \_\_\_\_\_ ZIP \_\_\_\_\_

PHONE NUMBER \_\_\_\_\_ EXTENSION \_\_\_\_\_

Complete this coupon and return it today to  
REI, 19347 Londelius St., Northridge, CA 91324. GSA #GS-04S-21963 Neg

Northridge, CA (213) 993-7368  
 Anaheim, CA (714) 879-0561  
 Mountain View, CA (415) 968-8845  
 Dallas, TX (214) 661-8082  
 Houston, TX (713) 780-7218  
 Burlington, MA (617) 273-2770  
 Gaithersburg, MD (301) 948-0620  
 Oakland, NJ (201) 337-3757; Ft. Lauderdale, FL (305) 771-3500  
 Des Plaines, IL (312) 827-6670; Cleveland, OH (216) 442-8080; Seattle, WA (206) 641-6444

© 1978 Rental Electronics, Inc.

Rexdale, Ontario (416) 675-7513  
 Vancouver BC (604) 684-6623  
 Montreal, Quebec (514) 681-9246

# Ampex memory for DEC System 20. Save big money.

---

ARM-20 is the Ampex memory for Digital Equipment Corporation's 2040, 2050 and 2060 computers. These Ampex add-ons are expandable in increments of 128K words to 512K in each cabinet, with a system maximum of 4 megawords.

ARM-20 provides independent four-way interleaving within each 128K sector. It executes repetitive single-word requests in 625 nanoseconds, and repetitive four-word requests within 1200 nsec. There's also a convenient reconfiguration capability and extensive diagnostics for rapid

fault isolation.

Ampex experience is every bit as impressive as Ampex performance. We've been building memories for large DEC mainframes, including KL processors, for more than ten years.

Ampex add-ons for DEC System 2040/50/60 computers are significantly less expensive. Find out how much you can save as you grow by writing Ampex Memory Products Division, 200 North Nash Street, El Segundo, California 90245. Or call Ted Conant at 213/640-0150.

## AMPEX



# THIS IS THE ONLY DECENT LOW COST 165 CPS MATRIX PRINTER YOU CAN GET IN VOLUME RIGHT NOW.

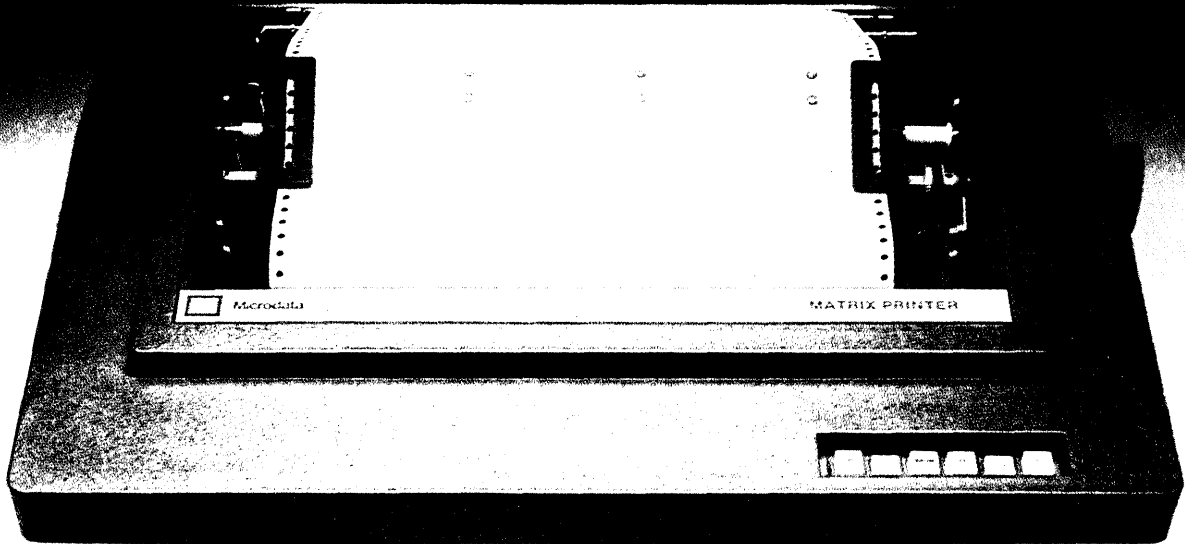

Other people make them, of course. But you can't get them in volume. Unless you're willing to wait a very long time. And in this business a printer you can't get is about as useful as all those wonderful products that haven't been invented yet.

Even if you did have a wide variety to choose from, you'd probably choose our Matrix printer anyway. Micro-processor control makes it efficient, fast and reliable. And it's programmable from your computer or optional keyboard.

Bidirectional printing and paper feed gives you true graphics capabilities. Special character sets, including foreign language alphabets, provide incredible flexibility. And when you add the optional keyboard, it becomes a remote communications terminal.

Matrix is compatible with all industry standard RS-232-C or parallel interfaces, so you can plug it in just about anywhere.

If you need a good matrix printer in volume and you can't wait forever, contact one of our local sales offices or the Director of OEM Sales, Microdata Corporation, 17481 Red Hill Avenue, P.O. Box 19501, Irvine, CA 92713. Telephone: 714/540-6730. TWX: 910-595-1764.

#### **SALES OFFICES**

Boston 617/890-2020  
Chicago 312/364-5820  
Los Angeles 714/533-8035  
San Jose 408/245-5013  
Washington, DC 703/620-3995

**Microdata OEM Products**  
A significant difference.

CIRCLE 51 ON READER CARD



# YOU SHOULDN'T HAVE TO SEE SIX DIFFERENT SUPPLIERS TO MAKE A NETWORK WORK.

Until now, putting together a distributed network for process control, experiment monitoring or test and inspection meant dealing with a lot of different companies. And you could still end up with a mish-mash of misfits.

Now, finally, there's an intelligent way to distribute intelligence. Because all the hardware and software you need is now available from a single company that specializes in systems for industrial and scientific applications: MODCOMP.

## **Classic 7810 — A new cost/performance leader for minis.**

Designed specifically for use as a satellite in a distributed network, our new Classic 7810 minicomputer gives you MODCOMP's sophisticated hardware and software capabilities at microprocessor prices.

It has the largest directly-addressable memory of any 16-bit CPU — 128 K-bytes of solid state memory. This allows you to run larger memory-resident programs so you can do more work at the satellite level and free up the host for more complex tasks. As a result, the network will operate at maximum efficiency.

The 7810 is supported by a complete set of field-proven software including MAXNET III, our network operating system. MAXINE, our new process control language. And our MAX III Real-Time Operating System which enables the 7810 to be used as a stand-alone computer.

It's available as a computer-on-a-board for OEM's. As a fully packaged system. Or as an integral part of our new process I/O system, MODACS III.

## **MODACS III — Our new modular data acquisition and control subsystem.**

MODACS III is designed to give you maximum flexibility in process control interface applications. Either as a local subsystem. Or, with the addition of the 7810, as a complete remote system in a network.

When used as a remote satellite, with our new HDLC/ADCCP/SDLC multi-drop communications link, MODACS III can be located right at the process you want to control.

This reduces your in-plant wiring requirements. The load on your host computer. And your risks as well. Because if the host goes down, the process that MODACS III is controlling doesn't have to.

For either the local or remote application it can contain up to 64 process I/O interface modules so you can hook up as many as 2,048 digital inputs or outputs; up to 1,024 wide range analog inputs; up to 256 analog outputs; a whole host of special functions; or any combination.

What does all this mean? It means that you can use MODACS III to control and monitor thermocouples, pressure transducers, strain gauges, meters, analyzers, amplifiers, potentiometers and hundreds of other analog or digital devices. In the harshest environmental conditions.

## **A complete family of real-time systems for the real world.**

If you need more performance than the 7810 and MODACS III, we've got that, too.

The MODCOMP Classic 7860 and 7870 super-minis have outperformed DEC's 11/70 and VAX. Interdata's 8/32. Prime's 400. And SEL's 32/75.

For more information, send for our MODCOMP Classic Family or MODACS III brochures.

After all, sending for one company's brochures is a lot easier than sending for brochures from a half dozen different companies.

**MODCOMP**  
Dedicated to your success

Modular Computer Systems, Inc.  
1650 W. McNab Road Ft. Lauderdale, FL 33309  
(305) 974-1380

# LOOK AHEAD

## THE TOP 40 SOFTWARE HITS

Look for a number of companies to start supplying ready to use software to the burgeoning personal and small business computer market. This new sub industry will be structured much like the record business with programs on cassettes and mini disks available at your neighborhood computer store. Program authors, like song writers, will receive royalties on gross sales. Already, Instant Software, Inc., a Peterborough, N. H. firm, has entered this field with a variety of programs that will include a set of six business packages. These will be sold through Radio Shack on a private label basis and in computer stores under the Instant label. EDS, Ross Perot's firm, is also entering this field but reportedly will target its programs at the low end of the minicomputer market.

## BICKERING OVER REORGANIZATION

Due out late this month, the final report on the Fed's dp reorganization project is expected to stir controversy, especially in government circles. Fueling this controversy is a key recommendation in the final report calling for a special assistant to the President for information technology.

The subject of bickering for months, this recommendation has been backed chiefly by private sector project workers, and strongly opposed by government dpers on the project. As a result of this irreconcilable rift, the final report will include a minority opinion, summing up the federal forces' opposition stand. Some project insiders feel this minority report will give the overall report more visibility but others claim it will only diffuse the final report's impact. In any event, one government observer predicts candidly the recommendation's survival chances are "slim to none."

## EXPERIMENT IN FRESNO

Citicorp Custom Credit Inc., a subsidiary of Citicorp, gave up on a number of major oil companies which wanted too much time and required too many levels of approval and selected USA Petroleum, Santa Monica, Calif. headquartered chain of 180 gas stations as its partner in a pilot project in data capture at the point-of-sale. Early this month, pumps at three USA gas stations in Fresno, Calif. went on-line to a Citicorp computer near New York City. Citicorp issued special versions of its "magic middle" credit cards to selected Fresno citizens who can use them to activate gas pumps and receive credit authorization at the USA stations. Jerry Fwainston, assistant operations director for USA, said each transaction will take approximately five seconds. A steady blue light authorizes a transaction. A flashing blue light means no go.

## NEW TELLER TERMINAL FROM THE U.K.

NCR's latest bank teller terminal was conceived in the U.K. which initially will be its only source. The 1780, a neater, smaller and more streamlined version of the 770, was designed with input from British bankers, said Sean Dixon-Child, director, NCR Ltd. "We're at least 12 months ahead of the

# LOOK AHEAD

competition." He said Barclays Bank already has ordered 100 of the terminals and another order for 150 is nearly firm.

IF YOU CAN'T  
BUY -- COMPETE

When Paul Shatusky was transferred to then-foundering Omnitec Data in Phoenix back in 1973, it was with instructions from its parent, Nytronics Inc., to turn the company around or liquidate it. He turned it around. He shed what he termed "some bad products" and stripped the company back to an acoustic coupler and modem manufacturer. Omnitec earned \$1.3 million in the year ended July 31 and Shatusky was predicting \$3 million for the current year. He liked what he'd done so well he tried to buy the firm. When Nytronics wouldn't sell, he resigned and last month said he was considering starting a similar company, also in Phoenix. He believes "by 1985, data communications will become a consumer product."

IBM RUMOR MILL  
GRINDS ON

With so many IBM product announcements slipping their dates -- as the rumors go -- the number and variety are mounting. The small business Pacific models, upgrades for the aging System 3 line called System 36 and 38 these days, are reportedly coming out of General Systems Div. this month. Orbit, the Series/1 based communications subsystem replacement for the 3790, is due out this month or next. E series, the long overdue replacement for the 370/115 to 138 models, is now rumored to be announced by Data Processing Div. the first quarter in 1979, probably January. And prognosticators are expecting more mid-life kickers in the form of disk drives, a smaller and cheaper version of the 3800 laser printer, performance-hyping microcode extensions, and you name it.

We've noted rumors of IBM memory price cuts (\$110K per megabyte tumbling to \$35K) for January. Reports from the field say the independents are already hawking megabyte boxes for \$25K and \$35K.

Some had expected Pacific in September, but what they got was an attached processor version of the 3031 -- the 3041. It offered, as is the 303X line pattern, more integrated function and less price than older 370s. Compared to the 158-3 Attached Processor (AP) configuration, the 3041 runs about one-third less. What's the added cost for turning a 3031 into a 3041? \$375K. A 158-3 into a 158-3 AP? More than \$500K. The 3041 Attached Processor itself isn't much cheaper (but has 16K more of buffer); it's just that all the added goodies required on the 370 model aren't necessary for the 3041. The same was true of the 3033 multiprocessor announced earlier this year; many functions, previously separately added and priced on the 370/168-3, apparently have already been built into the 3033 uniprocessor. Unbundling reversed.

RUMORS AND RAW  
RANDOM DATA

Tymshare Corp., Cupertino, Calif., has been negotiating a contract worth \$3-4 million for its Tymnet Div. to develop a private packet switched network for TRW, Inc. Telenet has a contract with Hughes Aircraft for a similar installation, but lost out on the TRW order...A dramatic influx of tourists into London to take advantage of the buying power of the British pound, has spurred sales of automated teller machines. Vendors report increasing sales of slightly modified teller machines from banks seeking to avoid long queues of tourists exchanging money.



"When we first looked at MARK IV, we weren't even interested in acquiring software — we were just doing an evaluation of data base management systems. MARK IV sounded so good that we had to take a closer look. Because of the capability and productivity improvements it offered, we decided to go with it immediately.

"We've had such tremendous success with the system that we have made it the standard programming language — the only Cobol work we do now is maintenance of existing systems.

"We're extremely happy with the way MARK IV works with our data base. We installed IMS with DL/1, and that afternoon we were processing off the data base with MARK IV.

"An important part of our success has been in getting MARK IV out to our users. For example, the Director of Budget uses the MARK IV On-Line Query Language for evaluations and projections. Our Registrar people do the same with the MARK IV batch facility. When the user can get his own report out quickly, it creates immense satisfaction and reduced costs for all of us.

"As far as the productivity of my own programmers, I've found that what takes a week-plus in Cobol takes only a day with MARK IV. We're going to use MARK IV to do all the batch work.

"When people ask me what I think of MARK IV. I tell them they can't afford **not** to look at it. I am a firm believer in the results and benefits of MARK IV. It's one of the best pieces of software I've ever used."

**Get the facts about MARK IV.** MARK IV is the most versatile and widely used software product in the world for application implementation, data management and information processing.

Six powerful models (prices start at \$12,000) are in daily use on IBM 360/370, Univac 70/90, Siemens 4004, Amdahl 470 and Intel Advanced System computers at over 1,300 installations in 44 countries. Programs in MARK IV require only about one-tenth the statements of Cobol, and users report 60 to 90% cost and time reductions on most MARK IV applications.

# "MARK IV<sup>®</sup> is the best piece of software I've ever used!"

— Al Baker, Manager, Data Base Coordination and Administration Department, University of Georgia, Athens, Georgia

**informatics inc**  **Software Products**

World's Leading Independent Supplier of Software Products

Member SIA  Software Industry Association

Informatics Inc., Software Products, Dept. D 378  
21050 Vanowen St., Canoga Park, Calif. 91304

Name \_\_\_\_\_

Title \_\_\_\_\_

Dept. \_\_\_\_\_

Computer \_\_\_\_\_

Firm \_\_\_\_\_

Address \_\_\_\_\_

City \_\_\_\_\_

State/Province \_\_\_\_\_ Zip \_\_\_\_\_

Phone \_\_\_\_\_

Views expressed are those of Mr. Baker and not necessarily those of the University.

# Graphics. Without

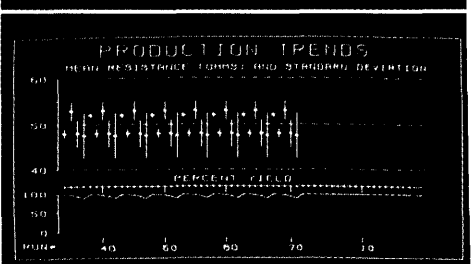
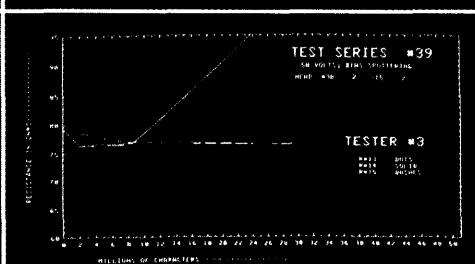
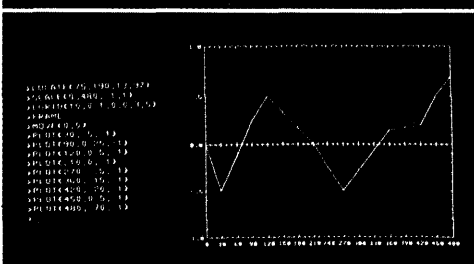
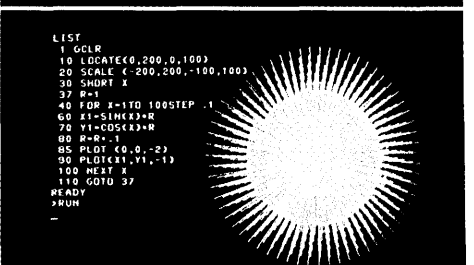
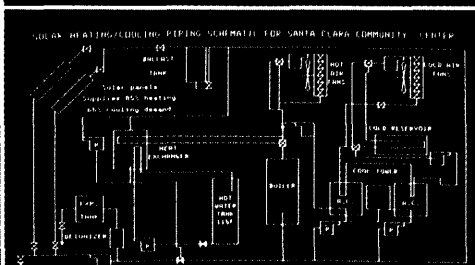
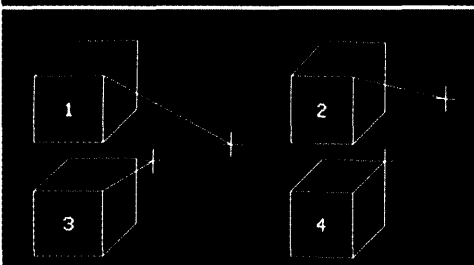
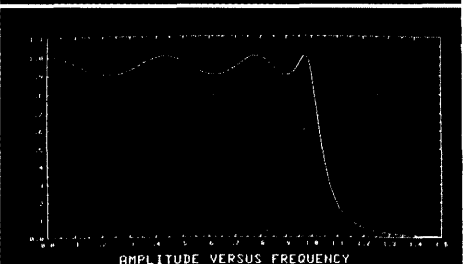
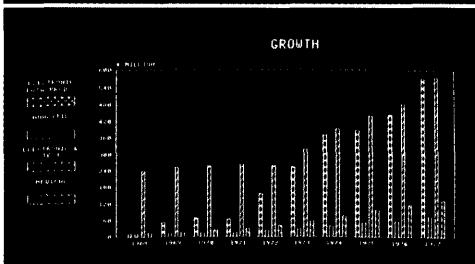
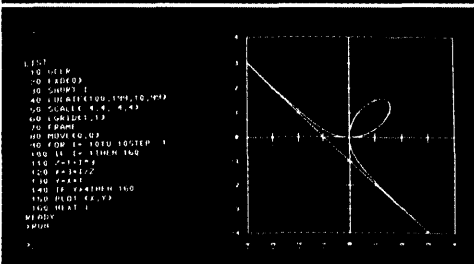
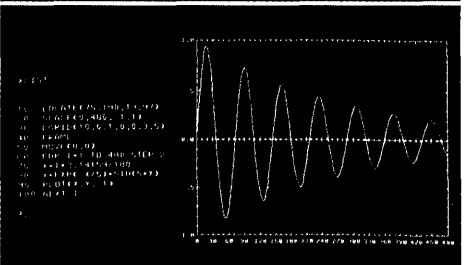
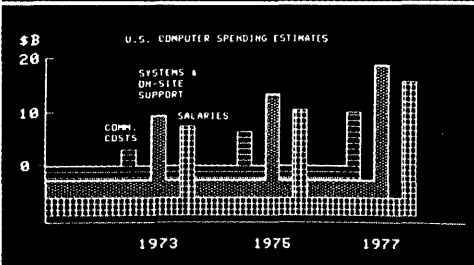
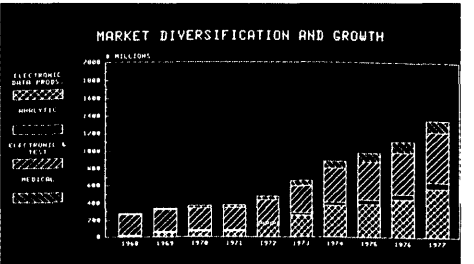
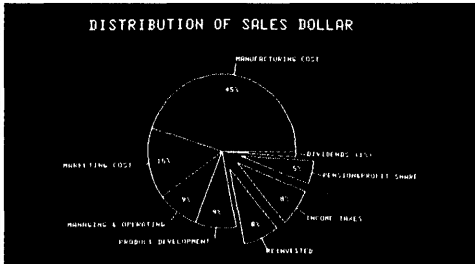
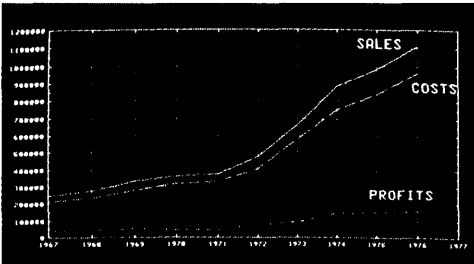

# graphics software.

You just lost your last excuse for sticking with alphanumerics. Because with HP's new 2647A Intelligent Graphics Terminal, you get graphics without digging into your CPU's software.

## A picture's worth a thousand numbers.

On an alphanumeric terminal, your data's just a screen full of numbers. But with the 2647A you can plot tabular data as a bar graph, or a pie chart, or a linear or logarithmic line graph. Quickly, with just a few keystrokes.

Now you can really see your data, not just look at it.

What's more, with the 2647A you can zoom in and out. Pan right, left, up, down. Selectively erase. Shade important areas to make them stand out. Use a rubber-band line to make a quick sketch.

Without any help from your programming department.

## It's more than smart.

The 2647A's the smart way to get graphics from tabular data without software.

But what if your CPU's output isn't tabular? Or if you'd like to plot derived data, say a three-month moving average from monthly sales figures? Or if you need more than a bar graph, pie chart or line graph?

The 2647A's not just smart, it's intelligent.

You can program it to reformat data from your CPU, or to compute more data, in easy-to-write BASIC. And you can program it in AGL, our high-level graphics language extension of BASIC. Its powerful commands, such as FRAME, AXES, LABEL, LOCATE and PLOT, put sophisticated graphics at your fingertips.

Either way, your program runs on the 2647A without

any help from your CPU.

## Hard copy's easy.

How do you get graphics into your briefcase?

The 2647A makes graphics as portable as alphanumerics. It interfaces easily with our 9872A Four-Color Plotter (which can even make overhead transparencies), and with our 7245A Thermal Plotter-Printer. All you need is an interface card, a cable and the peripheral itself.

And to keep costs down, more than one 2647A can share the same hard copy peripheral.

## You still get alphanumerics.

You don't have to give up alphanumerics to get graphics. Because the 2647A's also a programmable alphanumeric terminal for interactive use on-line or by itself.

With independent alphanumeric and graphics memories. Eight soft keys you can define to do several steps with a single keystroke. A bright, easy-to-use, high resolution display. And built-in dual cartridge tape drives for 220K bytes of mass storage.

Best of all, the 2647A with full memory and data communications interface costs only \$8300\*.

Which makes it easy to get the picture.

\*U.S. domestic list price.

Available on GSA contract number GSA-GS-006-01224

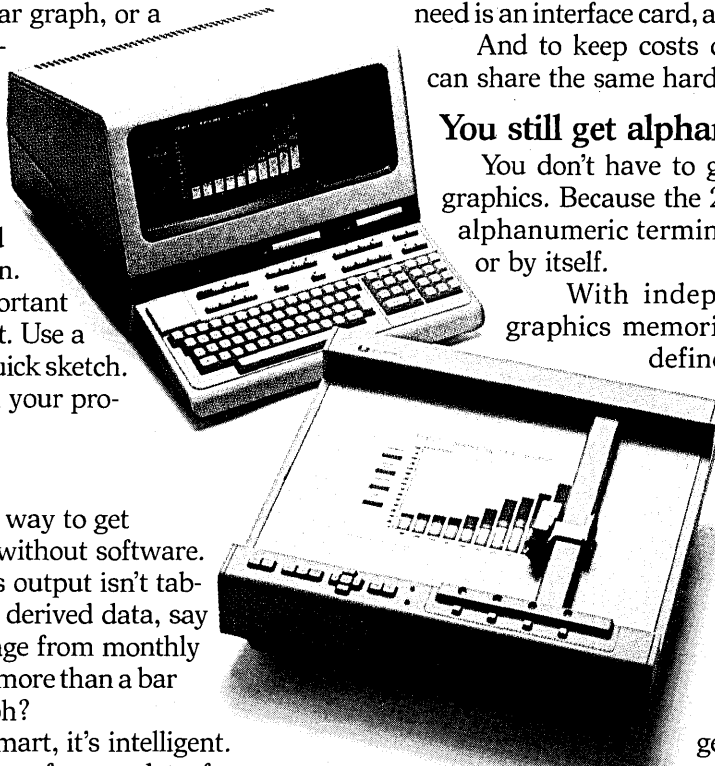

HEWLETT  PACKARD

- Send me more information about graphics without graphics software.
- Show me graphics without graphics software.

Name \_\_\_\_\_ Title \_\_\_\_\_

Company \_\_\_\_\_

Address \_\_\_\_\_

City/State/Zip \_\_\_\_\_

Phone \_\_\_\_\_

Mail to Hewlett-Packard, Attn: Ed Hayes,  
Marketing Manager, Data Terminals Division, Dept. 427,  
19400 Homestead Road, Cupertino CA 95014.

# The complete printer/plotter. Only from Versatec.

Suddenly the computer world is filled with printers that claim they can plot. Don't be fooled. Versatec gives you the best performance per dollar of any printer/plotter made.

The Versatec 1200A is more than a line printer with graphics pretensions. It gives you true plotting and gray scale quality. And it delivers that quality with more than twice the reliability and one-tenth the noise of impact devices. No wonder the 1200A is the world's most popular printer/plotter.

New enhancements. The 1200A image is darker, more consistent. Fewer adjustments are needed. One second startup time.

Exclusive features. Convenient 25° viewing angle. Variable line spacing. Easy contrast adjustment. Differential paper drive. Sealed paper compartment. And twelve other features you won't

get from other printer/plotters.

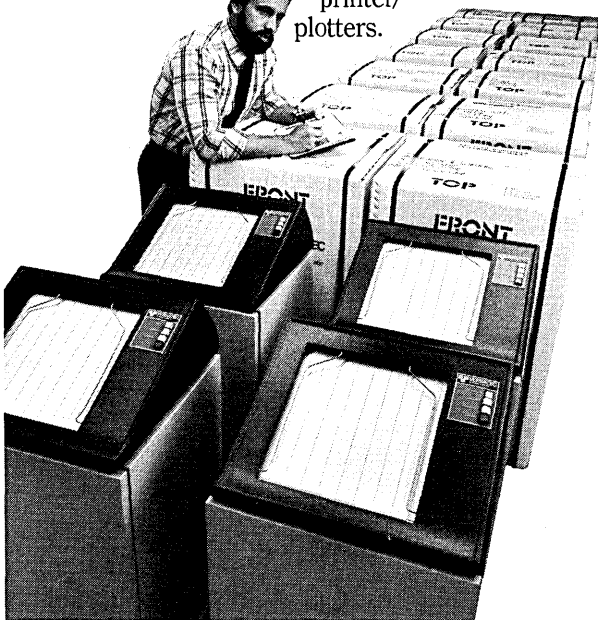

Gray scale halftones

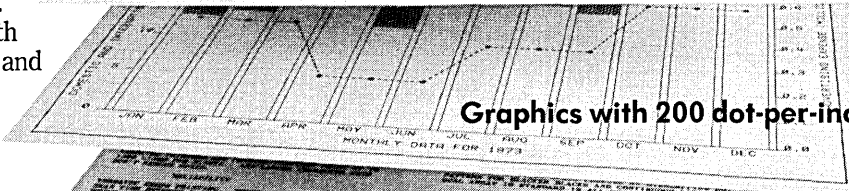

Graphics with 200 dot-per-inch resolution

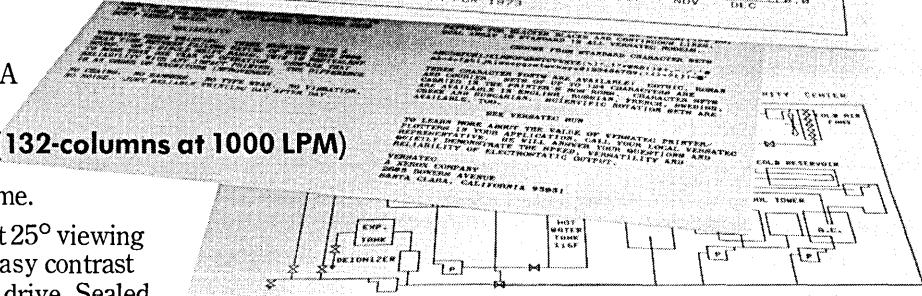

Printout (132-columns at 1000 LPM)

## CRT hard copy from display terminals

Plug-in compatibility. The Versatec 1200A interfaces with all popular computers and display terminals. Print/plot drivers and Versaplot™ graphics software link with your operating system and existing application programs.

Your investment is protected if you decide to trade up to Versatec wide plotters. The entire hardware/software interface is upward compatible.

Total support. Service Centers in 19 U.S. cities and 38 countries. Full service warranty plans. Software support. Training. Toll-free\* supplies ordering. You have it all with Versatec.

Get the complete story. Circle our readers' service number for 1200A literature and unbeatable samples.



2805 Bowers Avenue, Santa Clara, California 95051 (408) 988-2800

\*Except in California.

Versaplot is a Versatec trademark. © XEROX is a trademark of XEROX CORPORATION.



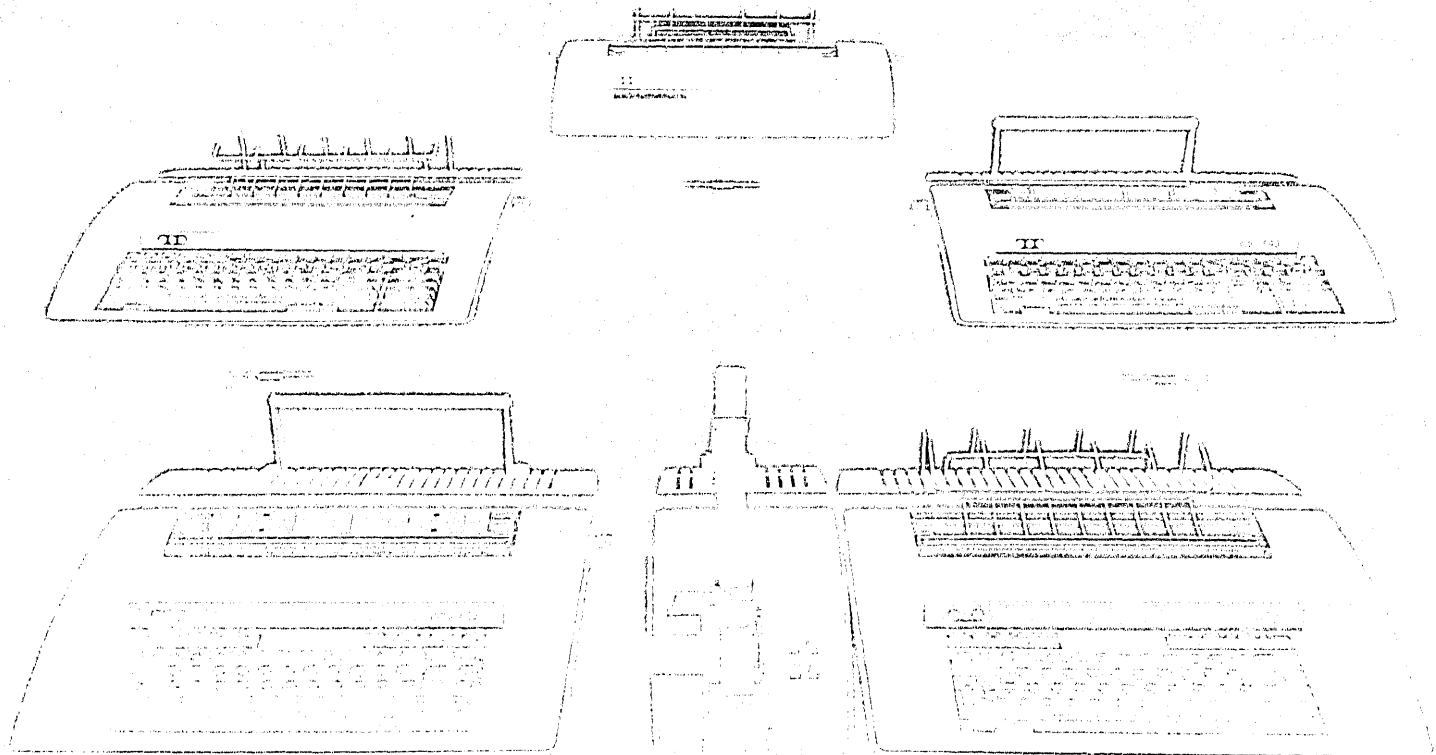

## OUR MODEL 43 TELETYPE FAMILY IS THE BEGINNING OF A NEW LEGEND

When we introduced it just a year ago, our basic line teletype Model 43 proved so sound and flexible that it's given us a new reputation for reliability and performance capabilities for message communications.

Model 43's come in a variety of configurations with either 10 column (traditional) or 132 column (modern) printers. Some units are designed for use on the switched network, others for point-to-point private-line systems. (There's also a new generation of 5-level buffered teleprinters for Teflex applications.)

The basic model 43 series operates online at 10 or 30 cps in either the half- or full-duplex mode and prints multiple copies using the 96 character ASCII code set. A wide choice of interfaces, including DDA, RS232C and DDC 20-60ma, are available for easy system integration.

With the automatic send-receive configuration, messages can be prepared offline via

a register tape, then sent at maximum terminal speed — automatically and unattended — when the tapes are ready.

Model 43's support means of storage ranging from 10 to 120 cps and provide up to 20,000 characters of storage for sending, receiving and editing. These terminals send and receive automatically via the buffer while messages are simultaneously being prepared for future transmission. They also include full forms control, the automatic answer capability and answer back.

Just like its predecessor, the legendary model 33, our model 43 family is designed for extreme reliability. The reason is simple: simplicity. Our model 43's use only five major pluggable components (still, containing the paper tape module on the ASIP), along with extensive use of LSI circuitry.

So when you think of our model 43 family, think of it as the beginning of a new legend.

### THE INDELEIBLE MODEL 43 FAMILY

Teletype Corporation, 5555 North Avenue, Dept. 1005, Skokie, IL 60076 Tel. (312) 932-2000

Teletype is a trademark and service mark of the Teletype Corporation.

# CALENDAR

## OCT.

### **IWP FALL SYMPOSIUM, OCTOBER 24-26, ST. LOUIS.**

The two and a half day program consists of panels, sessions, and workshops on all aspects of word processing divided into general, basic, and advanced levels. Close to 50 exhibitors will participate in the equipment show. Contact IWP Conference Services, Maryland Rd., Willow Grove, PA 19090 (215) 657-3220 or 4141.

### **NINTH NATIONAL CONFERENCE ON HUMAN RESOURCE SYSTEMS, OCTOBER 24-26, DALLAS.**

Featuring over 40 workshops, this event, sponsored by Information Science, Inc. (InSci), is the only annual meeting devoted exclusively to computer-based solutions to human resource planning and management problems. Contact Michael Feuche, Information Science, Inc., 95 Chestnut Ridge Rd., Montvale, NJ (201) 391-1600.

### **SECOND ANNUAL DATA ENTRY MANAGEMENT CONFERENCE, OCTOBER 30-NOVEMBER 1, SAN DIEGO.**

Human aspects will be the major focus of the conference, which includes over 30 seminars, workshops, and panel discussions concerning the Data Entry Profession. Contact Data Entry Management Association (DEMA), 16E Weavers Hill, Greenwich, CT 06830 (203) 531-4036.

### **NATIONAL MICROGRAPHICS ASSOCIATION MIDYEAR MEETING, OCTOBER 31-NOVEMBER 2, SEATTLE.**

Sessions will examine micrographics as part of the "total information handling picture" at this meeting which also introduces several new program formats including The Vendor Theatre, an on-going series of 15-minute presentations. In addition, the NMA Institute will present four simultaneous all-day seminars on October 30; the subjects are Computer Output Microfilm (COM), Micrographic Retrieval Systems, Inspection and Quality Control, and Micrographic Systems Design and Analysis. Contact Bill Sullivan, National Micrographics Association, 8728 Colesville Rd., Silver Spring, MD 20910 (301) 587-8444.

## NOV.

### **SECOND ANNUAL SYMPOSIUM ON COMPUTER APPLICATIONS IN MEDICAL CARE, NOVEMBER 5-9, WASHINGTON, D.C.**

Designed to inform health care professionals about advancements in the rapidly expanding field of medical computing, the

first day will feature tutorials on recent developments in the field, while the remaining four days are devoted to sessions concerning the representation of medical data in computer-usable form. Twenty-eight Continuing Medical Education Credit Hours are offered. Contact Glenda Snow, Dept. of Continuing Medical Education, Medical College of Virginia, Box 91, MCV Station, Richmond, VA 23298 (804) 786-0494.

### **FEDERAL COMPUTER CONFERENCE, NOVEMBER 7-9, WASHINGTON, D.C.**

Over 70 government and industry representatives will speak on the intricacies of governmental procurement. Well over 100 suppliers of data processing hardware, software, and services will participate in the exposition portion of the conference scheduled for the last two days. Contact Federal Computer Conference and Exposition, P.O. Box 368, Wayland, MA 01778 (800) 225-5926, or in Massachusetts (617) 358-5181.

### **ACM SOFTWARE QUALITY ASSURANCE WORKSHOP, NOVEMBER 15-17, SAN DIEGO.**

Covering functional and performance issues. Contact A.C. (Toni) Shetler, Xerox Corp., AI-39, 701 S. Aviation Blvd., El Segundo, CA 90245 (213) 679-4511 ext. 2035.

### **DATAPRO CONFERENCE ON MANAGING THE ORGANIZATION OF THE EIGHTIES, NOVEMBER 28-30, NEW YORK.**

Key aspects of Information Technology and the Office will be covered, culminating on the last day with five parallel workshop sessions concerned with both technical and managerial topics. Contact Don Welsher, Datapro, 1805 Underwood Blvd., Delran, NJ 08075 (609) 764-0100.

## DEC.

### **INDUSTRIAL ENGINEERING CONFERENCE, DECEMBER 4-6, ATLANTA.**

The new fall conference debuts with an Idea Exchange of informal roundtable discussions introduced to run concurrently with the regular theme sessions. Contact Conference Dept., American Institute of Industrial Engineers, Inc., 25 Technology Park, Atlanta, GA 30092 (404) 449-0460.

### **MIDCON/78, DECEMBER 12-14, DALLAS.**

Over 400 booths are committed to this year's exhibition to be held in the Dallas Convention Center and the professional program will include 35 technical topics. Contact Hal Copeland, Central Area Coordinator (214) 361-8788, or Midcon/78, 999 N. Sepulveda Blvd., El Segundo, CA 90245 (213) 772-2965.

# Q1 Corporation

## Leader in Microcomputer Systems

- In 1972, Q1 Corporation developed, manufactured and delivered the world's first microcomputer system to Litcom, a division of Litton Industries.
- Q1 Corporation was the first to introduce microcomputer systems with flexible diskette drives for external storage, which are now becoming the industry standard.
- Q1 was the first to make available on a low-cost microcomputer system the powerful PL/I programming language used on the far more expensive IBM 370 systems.
- Q1 Corporation set a fundamental new trend in the computer industry by introducing the multifunction microcomputer system, which cost-effectively replaces a wide variety of equipment including word-processing machines, accounting machines, desk-top programmable scientific calculators, and data-entry equipment.
- In 1977, Q1 delivered the world's first computer system utilizing magnetic bubble memory technology to the headquarters of the National Aeronautics and Space Administration.

Look to Q1 Corporation for the  
next major advance in microcomputer systems

# Tandem NonStop™ Systems break with balanced loads and

PAGE 2      \$SYSTEM.XRAYDATA.A700015      AUG 15 09:20:36 FOR 510

PROCESS: X    CPU 1    PIN X      AUG 15 09:20:36 FOR 513

	\$PROGRAM REPORTS ORDERS	\$SPOOL	\$SYSTEM DISC PROCESS	\$SYSTEM SYSTEM RECORDER	\$SYSTEM MEMORY MANAGER	\$SYSTEM SYSTEM MONITOR
CPU BUSY	30.0	33.6	4.01	.332	.220	.169
MSG RATE	35.7	4.70		.553	.116	.615
RECV RATE	.004	31.7	16.1	.103		.021
CHKPT RATE		1.86				
FAULT RATE	.145					
PRES PAGES	42.7	10.0		12.6		9.0
VSEN RATE						.052
BLKD WAIT	36.2	1.61	.022	.066		



SEND PAGE

XRAY lets you see what's up throughout the system, software and hardware, in enormous detail at remarkably low overhead.

The one and only multiprocessor hardware and software monitor. Tandem introduces XRAY, the first performance monitor in the computer industry to permit the balancing of all software and hardware components throughout a multiprocessor system. With measurements controlled and analyzed from any terminal in the system. Tandem designed this monitor especially for the data base/transaction environment to detect bottlenecks and permit orderly system growth, all within the lowest overhead burden on the market—less than 1%—and featuring some incredible capabilities. Among them—our exclusive graphic XRAYSCAN™ outputs. You can set your XRAY on

automatic browse, keyed for instant and in-depth analysis of trouble spots as they occur. You can program for continuous and/or exception reporting, and data is stored correlative to actual system operation in all phases of program, file, processor, controller or terminal. No one can tell you more about what you're doing. Or make it as simple to modify system set-up and operation for optimum throughput. You'll be able to spot overload situations immediately and fine-tune your system at a fraction of the previously required efforts. Powerful, efficient and flexible to begin with, Tandem NonStop Systems are brought to their full potential by XRAY.

# on-line bottlenecks fine-tuned applications.

**Measured and reported in depth.** Tandem XRAY lets you see exactly what's going on in processors, data communications lines, tapes and printers, terminals, disks, disk file opens, processes, and file opens. The depth of reporting in all categories is typified by those for processors: i.e., percent of elapsed time CPU is in use; virtual memory pages input and output per second; disk I/O transfers per second; number of disk cache hits per second; average length of CPU queue; total number of interprocessor messages sent per second; number of times per second CPU was set up to execute some process; number of terminal interactions per second; and average wait during a terminal transaction. All are available for the total system, by individual CPUs. And similar levels of reporting are available in each category. On CRT or hard-copy at your immediate option.

**We never stop.** We not only designed and built the Tandem NonStop Computer; we've never stopped perfecting it. First we added ANSI Standard COBOL and FORTRAN. And our new Remote Diagnostic Capability provides interactive analysis of what's happening right now—anywhere in the system, in both hardware and software—from any terminal as long as proper security clearances are provided. Through a modem connection, we can diagnose problems on your system straight from any Tandem service center; no lost time and no wasted efforts. And now, we've used our own XRAY to enhance system microcode in the Guardian Operating System software so that Tandem can now do with two processors what used to require three in many applications. It's not across the board, but it is typical and it is extraordinary.

**The better and the best.** The Tandem NonStop System is unique to begin with; it's the only computer built to keep right on operating even if a failure occurs in any part of the system. An on-line multiple processor system with a level of data base protection unparalleled in the industry. And that is coupled with the capability of preventing loss or duplication of any transaction even if a processor, I/O channel, disk controller or disk should fail during processing.

With a capacity of up to four *billion* bytes per file, comprehensive alternative capabilities in file structure, and up to 255 keys per file, the Tandem System is amazingly powerful and flexible. Perhaps the best part is that it's expandable without penalty, without reprogramming, without one cent of loss on the original investment. And now with XRAY, it can be precision-tuned in load factors throughout both hardware and software. See for yourself. It's worth looking into. Tandem Computers, Inc., 19333 Vallco Parkway, Cupertino, California 95014.

Toll Free 800-538-9360 or (408) 996-6000 in California.

## TANDEM

Frankfurt, Dusseldorf and Munich; West Germany.  
Uxbridge, Middlesex; England.  
Zurich; Switzerland. Toronto; Canada.  
Branch offices throughout the U.S.A.

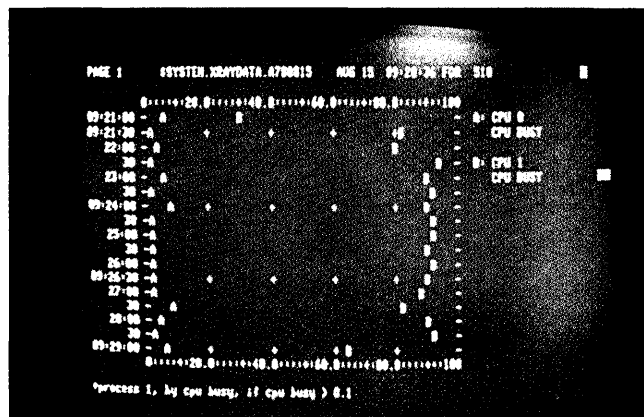

Bottlenecks are immediately visible, whether in programs and files or processors, controllers and terminals.

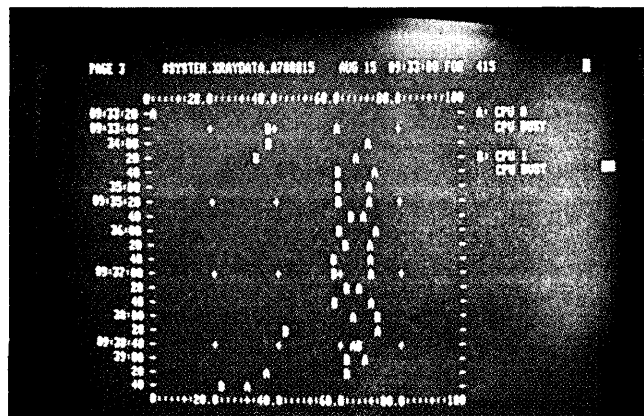

Systems can be balanced for optimum performance, exclusive in multiple processor systems with the Tandem NonStop Computer.

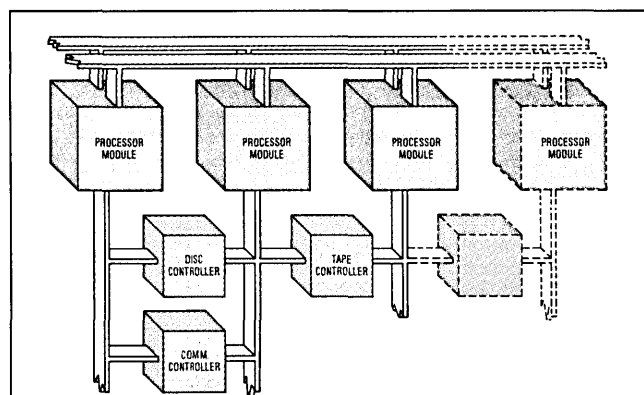

With anywhere from 2 to 16 multiple, independent processors and dual communications paths between all system modules, the Tandem NonStop Computer provides not only continuous operation, but throughput unmatched by any other system of comparable cost.

# Versatec owners,

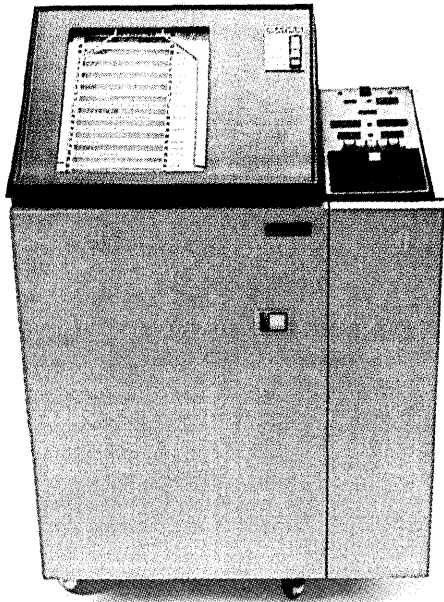

## test us.

See who your most complete source for electrostatic paper really is. See who has all the standards and all the options. Exclusive easy-reading green as well as white.

Perforated rolls. Numbered pages. Cost effective, to be sure. Try us and see. Free. All we make is the paper and toner, so we make them all we can.



### free roll

Send free roll or fanfold pack to fit my Versatec printer/plotter. I prefer to see  report grade white,  easy-reading green.

Annual Usage \_\_\_\_\_ rolls      New Customer \_\_\_\_\_

Paper Number \_\_\_\_\_

Name \_\_\_\_\_ Phone \_\_\_\_\_

Firm \_\_\_\_\_

Address \_\_\_\_\_

City \_\_\_\_\_ State \_\_\_\_\_ Zip \_\_\_\_\_

Mail to Coated Products Division, Graphic Controls Corporation, P.O. Box 1309, Buffalo, NY 14240

Or call toll free 800-828-7978  
(in New York State call 716-847-7500)

D-EV-10

CIRCLE 106 ON READER CARD

## CALENDAR

# JAN.

### HAWAII INTERNATIONAL CONFERENCE ON SYSTEMS SCIENCES, JANUARY 4 AND 5, HONOLULU.

Special interest is in computer-based decision support systems, minimicro systems, medical information systems, justice information systems, and distributed processing. Contact: Dr. Ralph H. Sprague, Jr., College of Business Admin. Univ. of Hawaii, 2404 Maile Way, Honolulu, HI 96822.

### MINI- AND MICROCOMPUTERS IN CONTROL, JANUARY 8 AND 9, SAN DIEGO.

Topics to be addressed include on-line computer control, distributed computer control systems, process control, and applications. Contact: Computers in Control Symposium, P.O. Box 2481, Anaheim, CA 92804 (714) 774-6144.

### MIMI 79, JANUARY 16-18, ANAHEIM.

The seventh international symposium on mini and microcomputers is to include "all aspects," including technology, hardware, software, architecture, design procedures, systems, modular computers, distributed processing, peripherals, education, marketing, and applications. Contact: MIMI 79 Secretary, P.O. Box 2481, Anaheim, CA 92804 (714) 774-6144.

### IMMM 79 JAPAN, JANUARY 24-27, TOKYO.

The International Microcomputers/Minicomputers Microprocessors '79/Japan Exhibition is expected to attract an audience from a wide range of companies that incorporate mini/microcomputer peripherals and components into oem machinery and equipment for many industries, as well as business, financial, and service companies throughout the Far East. Contact: Ruann International, 222 W. Adams St., Chicago, IL 60606 (312) 263-4939.

# FEB.

### MODELING AND PERFORMANCE EVALUATION OF COMPUTER SYSTEMS, FEBRUARY 6-8, AUSTRIA.

Some topics to be discussed at the international symposium are: mathematical models of computer architectures, networks and data base systems, performance evaluation of existing systems and subsystems, measurement methods and tools, statistical analysis of measurement data and simulation results, and models of computer system and software reliability. Contact: International Institute for Applied Systems Analysis, A-2361 Laxenburg, Austria.

### FLOW CONTROL IN COMPUTER NETWORKS, FEBRUARY 12-14, PARIS.

The symposium is meant to provide an opportunity for in-depth discussion. Some topics to be covered are resource allocation, interactions across architecture layers, routing, internetworking, and performance measurements and experience. Contact: I.R.I.A., Service des Relations Exterieures, Domain de Voluceau - B.P. 105, 78150 Le Chesney, France.

**Perkin-Elmer  
proudly presents the  
end of high-cost  
FORTRAN  
number-crunching.**

# Perkin-Elmer proudly presents the FORTRAN VII System. \$89,900.\*

		INTERDATA FORTRAN VII 8/32 System	DEC FORTRAN IV-Plus VAX 11/780	IBM FORTRAN H 370/158
Table Handling Binary Search (40KB Array)		26 secs	119 secs	126 secs
Matrix Manipulation (Gauss-Jordan Reduction)	100 x 100	45 secs	42.5 secs	33 secs
	200 x 200	322 secs	376 secs	263 secs
	400 x 400†	2555 secs	3774 secs	1840 secs
Sharable Development Software	editor	Yes	No	Yes
	linker	Yes	No	No
	assembler	Yes	No	No
	compiler	Yes	No	No
Small (under 40 KB) Development Modules	editor	Yes	Yes	Yes
	linker	Yes	Yes	Yes
	assembler	Yes	No	No
	compiler	Yes	No	No
Fast Compiler	(over 1500 LPM)	Yes	Yes	Yes
Optimizing Computer Technology		Global	Block	Global
Custom Microcoding Development Software		Yes	No	No
Price		\$89,900	\$167,000+	\$1,300,000+

\* Domestic U.S. price includes Interdata Model 8/32 system with 512KB of memory, 10MB disk, 800 BPI tape, Carousel console, Operating System, utilities and FORTRAN VII.

† Requires larger memory.





The new Interdata FORTRAN Systems – starting at \$89,900 – outperform the industry.

Check the comparison chart. See just how our new FORTRAN Systems chop away big chunks of run time and program development time. How they eliminate compiler overhead that wastes run time with other machines. And for all of their sophistication our new systems couldn't be easier to use.

These benchmark results might be hard to swallow until you learn more about the system behind them.

### The GO is Global Optimization.

We developed our new FORTRAN VII software to whip

through large FORTRAN problems like matrix manipulations and binary searches with ease. And we're doing it with the finest globally optimizing compiler ever developed. It slashes FORTRAN programs to the bone, achieving the fastest execution speeds possible.

### You'll swear it's a mainframe.

Start with our development compiler with its fast execution time and comprehensive error analysis. Program compilation couldn't be faster or simpler. And because we've designed to the ANSI FORTRAN 77 standards, your existing programs will run with minimal changes.

Add our proven 32-bit architec-

ture and you've got mainframe precision and convenience.

### Take your own word for it.

Call this an offer. Or call it a challenge. Run one of your most demanding programs on our new FORTRAN System today. Free. Then you'll understand our enthusiasm, and draw your own comparisons. We'll bet yours will make the ones shown in this ad seem conservative.

To learn more and perhaps reserve some system time, just send us this coupon. Or, if you'd like, call toll-free at (800) 631-2154; in New Jersey at (201) 229-6800.

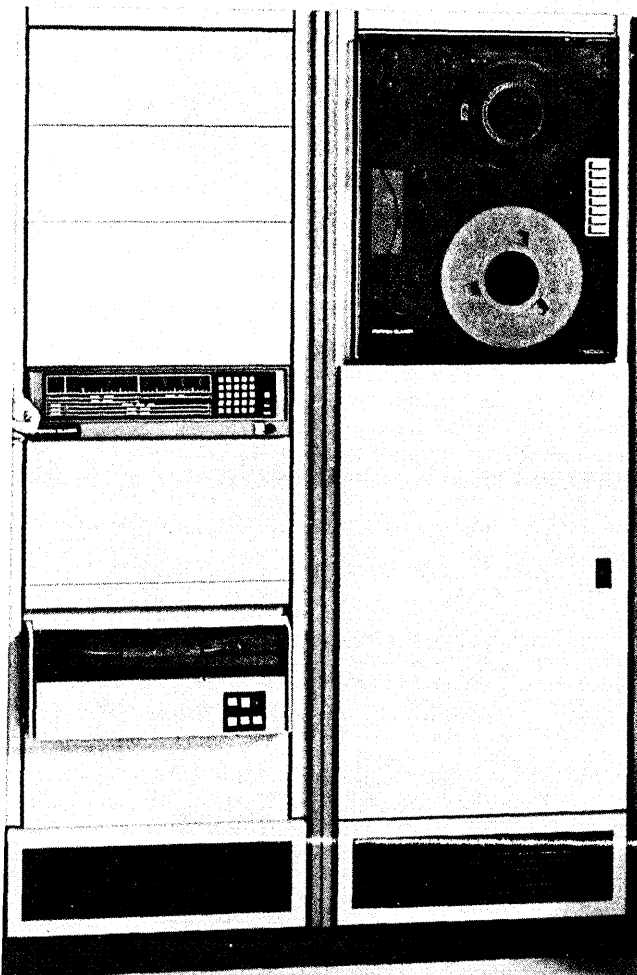

I want to know more, send me a free brochure.

I have some number-crunching problems that should test your new FORTRAN System.

For example: \_\_\_\_\_

\_\_\_\_\_

Name \_\_\_\_\_

Title/Department \_\_\_\_\_

Company \_\_\_\_\_

Street \_\_\_\_\_

City \_\_\_\_\_ State \_\_\_\_\_ Zip \_\_\_\_\_

Telephone \_\_\_\_\_

Send this coupon to: Perkin-Elmer/Interdata Division,  
2 Crescent Place, Oceanport, NJ 07757.

D-10

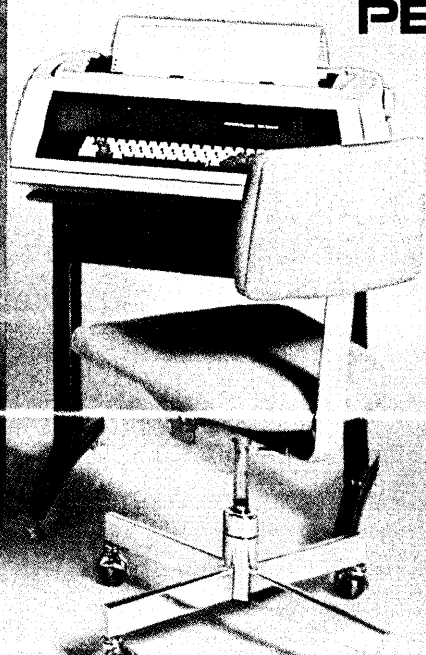

**PERKIN-ELMER**  
Data Systems

# NEW DATA

from Wiley-Interscience

## MANAGEMENT METHODOLOGY FOR SOFTWARE PRODUCT ENGINEERING

Richard C. Gunther

Here is a complete guide to managing the planning, design, construction, evaluation, documentation, distribution, and maintenance of heavy-duty computer software. The book shows how to integrate principles of top-down design, management-by-objectives, configuration management, and more, through a self-consistent set of documents and procedures which continually reinforce each other. Gunther emphasizes the production of heavy-duty software for multiple and diverse users—little-known by the developers and maintainers—and provides a methodology that assures long-range effectiveness without the need for costly mid-stream corrections.

(1-33600-9) 1978 379 pp. \$22.00

## ADVANCED ANS COBOL With Structured Programming

Gary D. Brown

An in-depth and simplified examination of the complex statements that have evolved in COBOL programming. Brown makes expertise in COBOL easier to achieve by describing the details of such advanced features as table handline, character-string manipulation, report writer, sort-merge, direct and indexed files, communications facility, and much, much more.

(1-10642-9) 1977 497 pp. \$19.95

## DATA COMMUNICATIONS

Facilities, Networks, & Design Systems

Dixon R. Doll

This book offers specific guidance on all areas of data communications—from basic terminology to detailed design methods. You'll find the latest concepts in the design, management, and application of minimum-cost, reliable networks. Doll also evaluates important data communications services and facilities, from both technical and economic perspectives.

(1-21768-9) 1978 493 pp. \$24.95

## DISTRIBUTED PROCESSING AND DATA COMMUNICATIONS

Daniel R. McGlynn

McGlynn confronts one of the most important evolutionary steps in data processing today—the process of replacement of centralized, large scale computers by interconnected networks of mini and microcomputers. He reviews systems and technologies with emphasis on the systems and designs most likely to prevail in the future and covers this rapidly expanding field's features, capabilities, and limitations.

(1-01886-4) 1978 305 pp. \$20.75

## COMPUTER STORAGE SYSTEMS AND TECHNOLOGY

Richard E. Matick

A complete source of state-of-the-art information on computer "memories"—from detailed technical analyses to cost-effective applications. The book covers all the related aspects of computer storage systems technology and relates data structure and usage to the hardware design. The author describes and examines the available storage devices and their technologies and architectures to give you an informed perspective for decision-making.

(1-57629-8) 1977 667 pp. \$29.95

Available at your professional bookstore or write to John V. Storojev, Dept. A 3356.

## WILEY-INTERSCIENCE

a division of John Wiley & Sons, Inc.

605 Third Avenue

New York, N.Y. 10016

In Canada: 22 Worcester Road, Rexdale, Ontario

Prices subject to change without notice. 092 A 3356-57

## CALENDAR

### ITA EXHIBITION, FEBRUARY 12-16, SAO PAULO, BRAZIL.

The Department of Industry and Trade Administration sponsors an exhibition of U.S.-made computers and peripherals. The Brazilian market is expected to grow more than 30% yearly, according to the U.S. Dept. of Commerce. Contact: Industry and Trade Admin., Room 4039, U.S. Dept. of Commerce, Washington, DC 20230 (202) 377-5427.

# MARCH

### AUTOMATED TECHNICAL PUBLICATIONS SYMPOSIUM, MARCH 13-15, SAN ANTONIO.

The theme is Technology Update. Presentations related to the growth of the text processing industry will be given by aerospace manufacturers, airline companies, universities, government, and computer companies. Contact: Aerospace Industries Assn. of America, Inc., 1725 DeSales St., N.W., Washington, DC 20036 (202) 347-2315.

### AUTOMATED MATERIAL HANDLING AND STORAGE SYSTEMS CONFERENCE, MARCH 14-16, ATLANTA.

Contact: The Material Handling Institute, Inc., c/o Shea Management, Inc., 1326 Freeport Road, Pittsburgh, PA 15238 (412) 782-1624.

# CALL

The Canadian Journal of Operational Research and Information Processing, *INFOR*, is offering prizes of \$50 to \$1,000 for papers accepted for a special issue devoted to practice and implementation. Full length articles such as case studies and research papers as well as short articles with suggested topics of "Analysis for Social Change," "Small Scale Information Systems," or any subject relevant to the issue theme are requested. The submission deadline for abstracts is Nov. 30; articles are due Feb. 28. Send all submissions and correspondence to Dr. Alan Saipie, Editor, Special *INFOR* issue on Practice, Stevenson & Kellogg Management Consultants, 2300 Yonge St., Toronto, Ontario, Canada M4P 1G2 (416) 483-4313.

Papers are being solicited for the 1979 IEEE International Symposium on Information Theory to be held at Grignano, Italy, next June. Two kinds of papers are sought: "long" papers of 30-minute duration and "short," 20-minute papers. Long papers will be accepted on the basis of a full manuscript; short papers on the basis of a 500-word summary. The deadline for manuscripts and summaries is Dec. 1, and should be sent to Professor M. B. Pursley, Coordinated Science Laboratory, Univ. of Illinois, Urbana, IL 61801.

Original papers are invited for the Society for Information Display International Symposium. The symposium will be held in Chicago in May and is the only global forum devoted exclusively to all aspects of information display. Abstracts and summaries should be sent no later than Dec. 11 to Leonard Klein, Palisades Institute, 201 Varick St., New York, NY 10014. \*

# Data/Switch Puts YOU in Control

The first total on-line computer configuration and management control system.

Systems configured to your needs from standard modules incorporating peripheral, coaxial, and communications switching systems, plus, energy control systems.

## (CTS-3000)

### Coaxial Terminal Switch

- CRT Terminal (Coaxial) Switch
- Matrix Sizes—4 controls x 16 CRT's  
6 controls x 16 CRT's  
8 controls x 16 CRT's
- Uniquely new in the data processing industry
- Master and individual terminal/controller selector

## (DCS-2000)

### Data Communications Switch

- EIA or TELCO switching
- 2 x 16 and 4 x 16 matrix size
- Monitor patch panel (DCS-2000/M)
- Master and individual fallback selector
- Master crossover selector

## (CPS-1000)

### Computer/Peripheral Switch System

- Matrix sizes to 8 x 24 (One system replaces several IBM 2914's)
- Redundant controls
- Nanosecond Switch Speeds
- "On-the-fly" switching
- Self diagnostics
- High speed control unit switching (IBM 2835's)
- The only remotely controlled switch system available that switches any control unit attached to IBM or IBM compatible CPU's

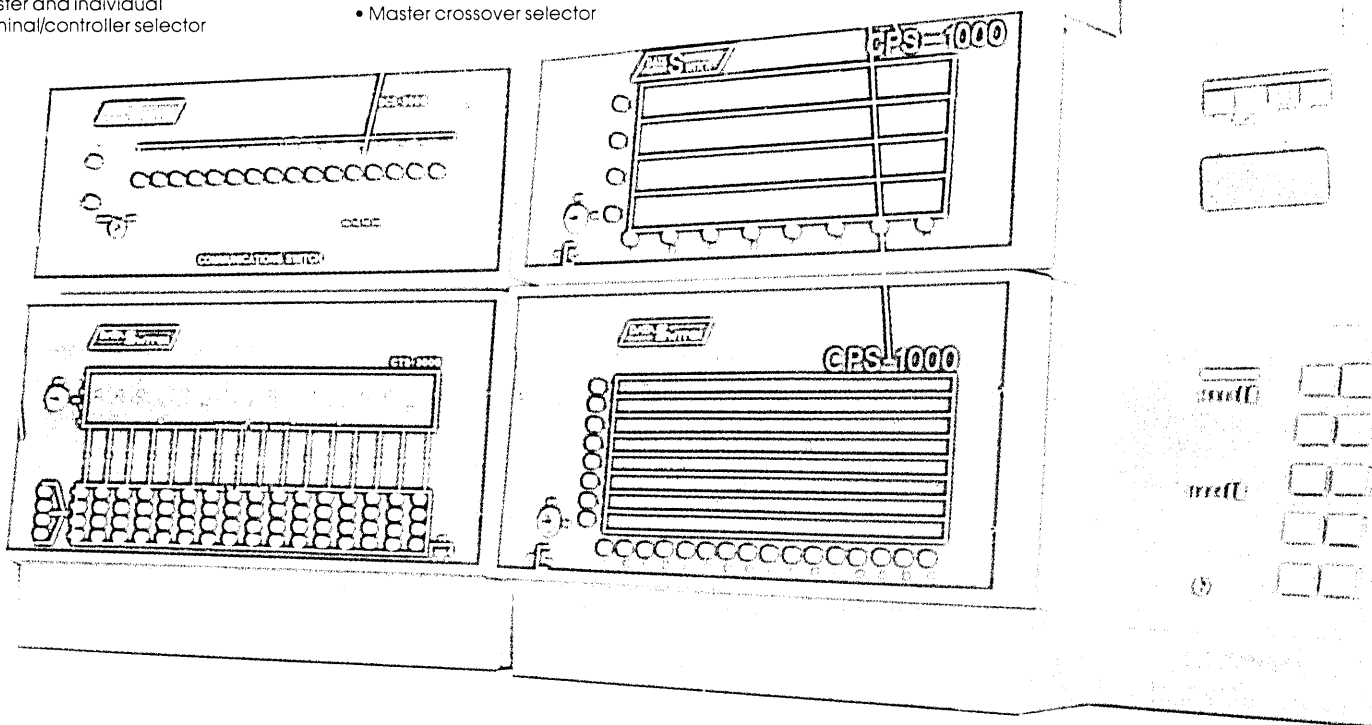

Only Data/Switch Systems have all these features:

- State-of-the-art semi-conductor switching
- Solid state reliability and performance
- Redundant power
- Remote and extended controls
- Inter-active remote controls
- Continuous configuration display
- Key secured
- Compact size
- Modular design for on-line maintenance
- Flexibility for upward compatible growth
- Worldwide maintenance service
- Single source solution



**CORPORATE OFFICES:**  
LANDMARK SQUARE  
NORWALK, CT. 06851  
(203) 853-3330

**INTERNATIONAL OFFICES:**  
FAR EAST  
NISSEI SANGYO COMPANY LTD.  
HITACHI ATAGO BUILDING  
15-12 NISHI-SHIMBASHI, 2-CHOME  
MINATO-KU, TOKYO, 105 JAPAN

**EUROPEAN**  
COMPUTER RESALE BROKERS INTERNATIONAL, LTD.  
QUEEN'S HOUSE, HOLLY ROAD  
PWICKENHAM, MIDDLESEX TW1 4EG ENGLAND

# Customer-Proven Software-- Time-Tested Hardware

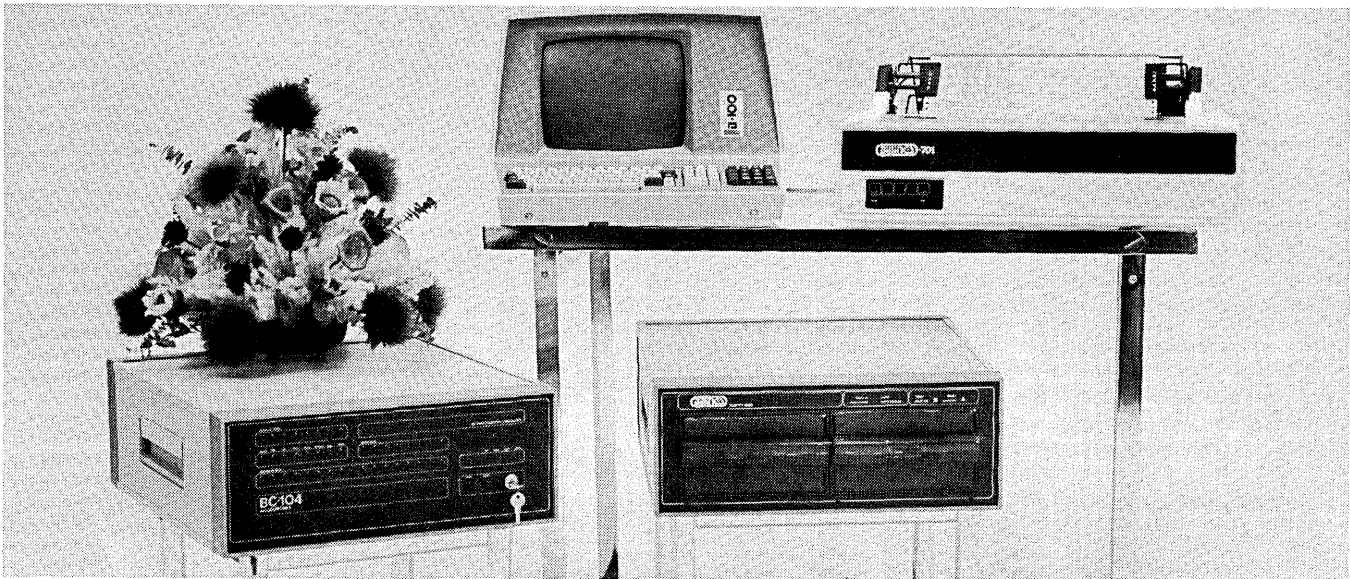

**Billings' software is powerful and professionally written. Its equipment is built to meet the highest standards. Combine hardware AND software in one low-price package and you have one of the most outstanding price-performers in the industry.**

Billings' totally integrated business accounting system was developed by a team of experts led by a CPA seasoned with years of experience working with Fortune 500 companies.

The equipment is **reliable and durable**. Manufacturing is done under strict quality control using the industry's best subassemblies.

The system offers a **wide range of optional peripheral equipment**, including hard disk capability for upgradability and expansion.

Billings dealers are knowledgeable and factory-trained in order to give **professional service and support**. (Outstanding dealership opportunities are available.)

What it all boils down to is that Billings' products are professional, sophisticated, reliable, and are priced just right!

**Call or write Billings and find out more about its products and its dealership program.**

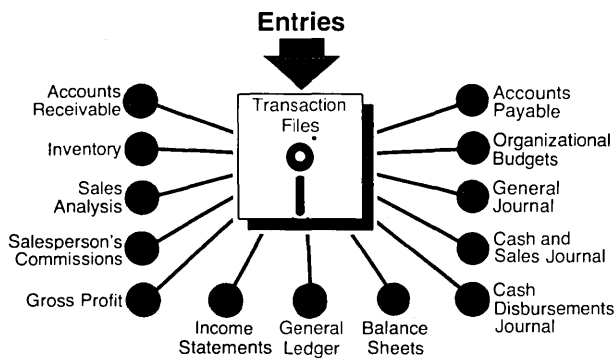

Written in FORTRAN, the powerful accounting system teams up with Billings' sophisticated micro-computer to make one of the best hardware/software systems of its kind on the market. How do we know? Our end-users tell us:

*"We carefully investigated systems offered by many computer manufacturers. We selected Billings. In terms of economy, power, confidence in the machinery and manufacturer support, Billings is superior."*

**Mr. Eugene L. Faux**  
President, Mobile Light and Maintenance

**There are many reasons why Billings system users are excited.** Systems are **immediately available** from inventory.

When you buy Billings' equipment, **the software is free.\*** (However, Billings will gladly sell its powerful software to users of other systems which incorporate an S-100 bus and use CPM. Software evaluation kits, consisting of descriptive literature and eight user manuals are available for \$50.)

\*A small handling fee is charged for manuals and diskettes.



**BILLINGS COMPUTER CORPORATION**  
2000 E. Billings Avenue, Provo, Utah 84601  
(801)375-0000

I am interested in:

information about your complete hardware/software accounting system.

your software evaluation kit. Please send \_\_\_ kit(s). \$50 is enclosed for each kit ordered. (Kit includes manuals on Payroll, Accounts Payable, Accounts Receivable, Inventory Control, General Ledger, General Journal, Cash and Sales Receipts, and Cash Disbursements.)

information on your dealer program.

NAME \_\_\_\_\_

ADDRESS \_\_\_\_\_

CITY, STATE, ZIP \_\_\_\_\_

TELEPHONE (\_\_\_\_) \_\_\_\_\_

D

# Lower mailing costs -in the bag.

Moore Speedmailer® reduces handling costs, speeds your mailings on their way.

Moore Speedmailer can eliminate your folding, inserting and sealing labor completely. You save by purchasing separate mailing envelopes, forms, return envelopes and return inserts. Save storage, inventory and handling costs too. Eliminate space requirements for equipment and postage meter rolls. Insert and seal a 10 1/2" separate mailing envelope.

Moore Speedmailer combines your forms and envelopes in a single unit. Each form goes into your computer printer directly and directly into the mail. Your mailings go out faster which reflects greater cash flow or return of investment.

Many companies are already realizing their costs of mailing favors, credit forms, purchase orders, records forms, shipping notices, acknowledgment statements, collection letters, accounts payable checks, payroll checks and other forms.

Find out how much money Speedmailer will save you. Call or write for our Mailing Systems Analysis Booklet and Speedmailer samples.



**MOORE BUSINESS FORMS, INC.**  
1001 N. WASHINGTON ST. SUITE 1000  
ANN ARBOR MI 48106-1000

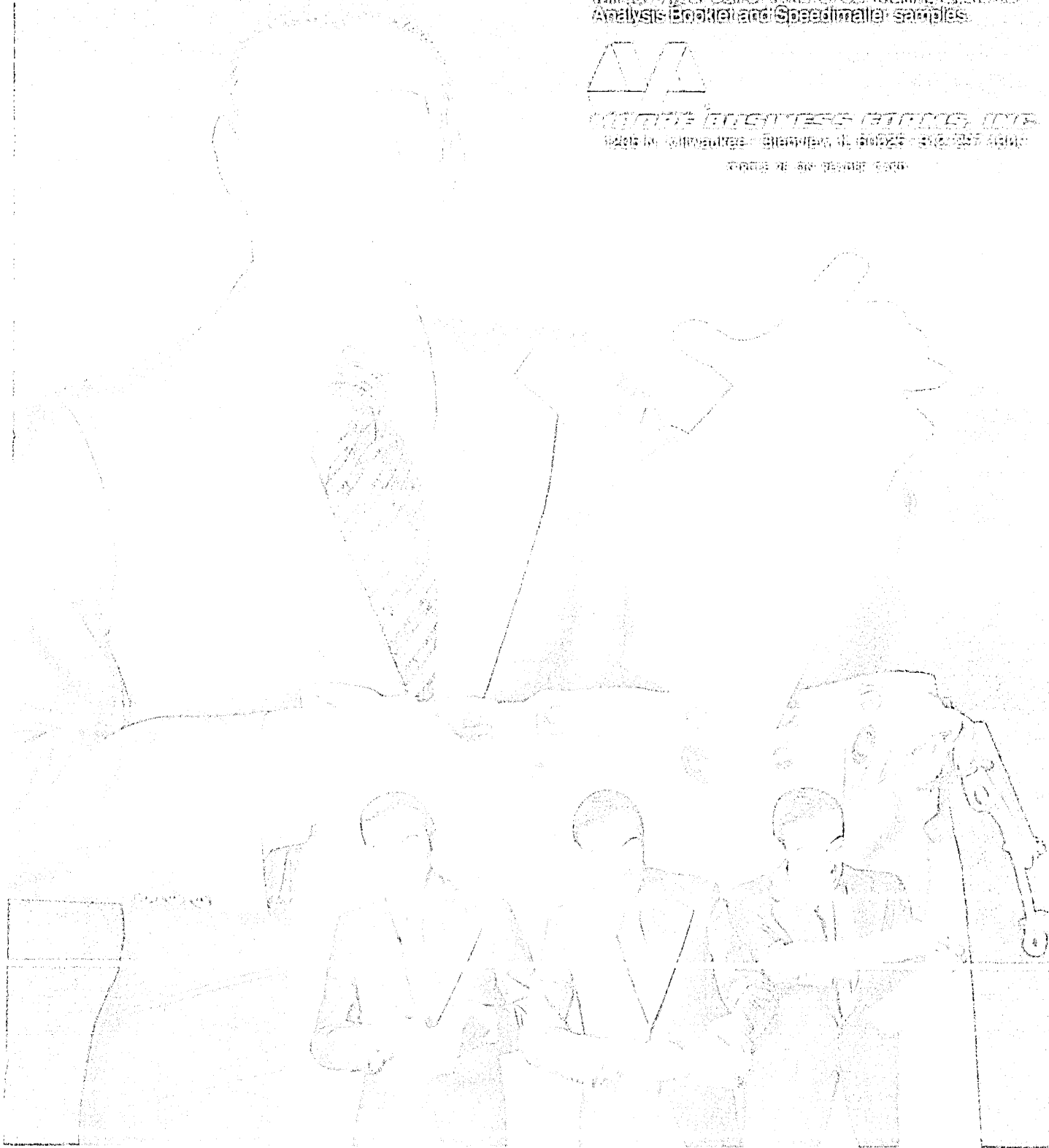



# Anyone who sells you a business computer for medical analysis needs his head examined.

At Sperry Univac, we don't try to fit your application to our computer. Because we undoubtedly have the right computer for your application.

Consider PROMIS Lab at the University of Vermont. They use our V77 Series minis for a broad range of medical applications.

Their unique Problem-Oriented Medical Information System helps them solve a lot of problems that plague medical care.

The PROMIS Lab computers aren't used just by data processing people. They're used by doctors, nurses, radiologists, pharmacists, and even patients.

All paper records in one ward have been replaced by electronic records to organize medical information; reduce dependence on human memory; and provide feedback for everyday medical problems. Simply stated, the entire system is designed with the patient's health care in mind.

Our minis make it easier for the busy medical staff to interface with the computer system. Cost effectively,

efficiently, and with real-time speed.

The fact is, we cured PROMIS Lab's problems quickly and easily.

But hardware is just the beginning.

Our network data base management system lets you integrate data into one or more logical structures for quick random access.

PRONTO, our mini distributed data processing program, boosts the efficiency of your mainframe. By taking care of all your remote computer needs. And freeing your host to do the work it does best.

And, when it comes to languages, we speak yours. Whether it's English, FORTRAN, COBOL, or RPG II.

For more information, write to us at Sperry Univac Mini-Computer Operations, 2722 Michelson Drive, Irvine, California 92713. Or call (714) 833-2400, ext. 536.

In Europe, write Headquarters, Mini-Computer Operations, London NW10 8LS, England.

Even if you don't have a medical application, we think you'll like our prescription.

**SPERRY**  **UNIVAC**  
SPERRY UNIVAC IS A DIVISION OF  
SPERRY RAND CORPORATION

# Does 100,000+ installations make Centronics better than other printer companies? **NO.**

Even though 100,000 delivered units make Centronics more experienced, it takes much more to be a better printer company. Like single source. Our 9 model 700 series of matrix printers, 4 model 6000 series of line printers, 760 series teleprinters and new non-impact electrostatic printers give us the most complete line in the industry.

Centronics has more. Competitive prices. The largest worldwide service organization of any printer company. Financial stability with a record of growth and strength unmatched in the business. And a track record of superior product reliability and customer support—whether OEM or end-user.

You know the advantages of an experienced supplier. You know the breadth of Centronics' line. And now you know why Centronics is the better printer company. Write or call today for the complete details of Centronics' full printer line. Centronics Data Computer Corp., Hudson, NH 03051. Tel. (603) 883-0111.

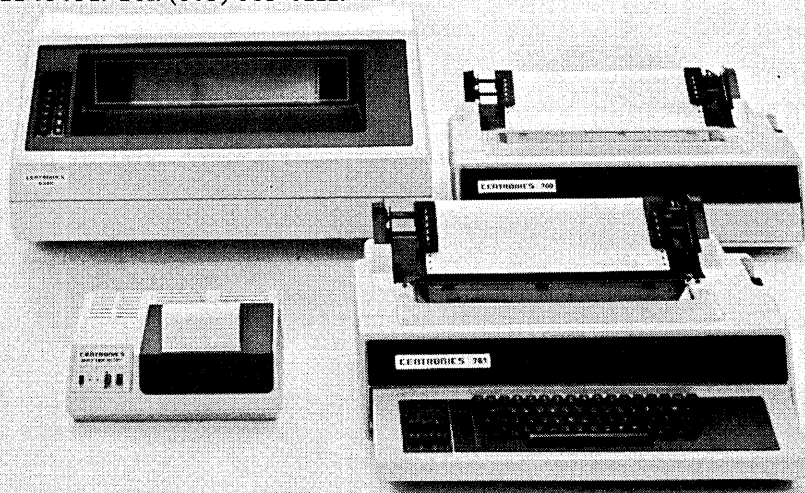

**CENTRONICS® PRINTERS**  
**Simply Better**



# LETTERS

## ANALYSIS ANALOGY

I am very much intrigued by the ideas put forth in D.C. Burnstine's letter (August, p. 34) to the effect that computer programming is more akin to manufacturing engineering than to logic design.

I believe that Burnstine's remarks have hit on the central issue of systems analysis. The analyst is indeed essentially concerned with the turning of assorted raw materials (inputs) into finished products (outputs). Most analysis activities start with a precise definition of the desired products and work from there to identify the raw materials, processes, and flow necessary to produce the products. Differences in analytic techniques boil down to differences in the degree of precision and accuracy with which the various elements of the "manufacturing" have been specified.

It would be more than "useful" to open a dialogue on this issue. It may indeed be fundamental.

LOIS A. ROSE  
Senior Staff Consultant  
Yourdon inc.  
New York, New York

Comparing programming with manufacturing is indeed apt. Mr. Burnstine's analogy has been long-standing in Sof-Tech's advocacy of software engineering.

Of particular interest are the manufacturing disciplines of process planning and design blueprinting. In process planning, one determines a sequence of operations and machining steps based on part descriptions. Tools are selected and workpiece paths are calculated with eventual production and cost in mind. The parallels in programming have just recently received widespread attention. They include: creating a process according to desired end-item specifications, describing process requirements before selecting devices to perform those functions, and reusing general-purpose tools as much as possible.

In design blueprinting, as practiced in manufacturing, the characteristics to top-down graphics, multiple viewpoints, and interface constraints are commonplace. Software development, however, usually lacks the clarity and rigor of blueprints used by construction and manufacturing enterprises. "In a

good manufacturing operation, major troubles are avoided because even the first production run does not create an item for the first time. The item was created and the steps of forming and assembly were done mentally, in the minds of designers and engineers, long

before the set of blueprints and specifications ever arrived at the production shop. That simulation is made possible only because the notations and discipline of the blueprinting methodology are so complete and so consistent with the desired item that its abstract representation con-

## PROFESSIONAL PROGRAMMING PRACTICES

I agree that, in general, today's programmers and analysts are not professionals (Forum, August, p. 199). However, there is strong need for a service ethic and standards of practice among programmers and analysts. If it confuses matters to call this professionalism then give it another name.

There is a growing concern about the quality of our output. An article in the Washington Post August 24 began by describing three cases of severe loss or injury directly traceable to program errors (an air traffic controller acting on erroneous data, a hospital minicomputer monitor failing, and a company's computer destroying valuable market information). The article went on to discuss the question of negligence. Professional

standards for computer programmers and software houses were mentioned as being needed because liability can rest on whether the action or omission being considered has violated a standard of care owed to the customer using the program.

If we, as computer programmers and systems analysts, do not develop our own standards and police ourselves then others will do it for us; we may not care for the results.

By the way, where was the summary table to which Mr. Hiltz refers in his column?

EARL C. ABBE  
McLean, Virginia

The summary table below was not printed because of lack of space. We regret neglecting to delete the reference to it.

### THE PROFESSIONAL ROLE MODEL AND DATA PROCESSING OCCUPATIONS

#### PROFESSIONAL ATTRIBUTES

Body of knowledge  
a) codified theory  
b) acquired thru formal training  
c) not available (in toto) to public

Commitment to the service ideal

Social organization

(1) Inter-group  
formal & informal community  
sanction of the profession

authority over nonprofessionals  
in area of competence

(2) Intra-group  
control of entry (into profession)  
formal certification  
formal code of ethics  
occupational culture  
identification with colleagues  
attitudinal consensus

#### PROGRAMMERS & ANALYSTS

Starting to develop.  
Acquired in a variety of ways.  
Available to the public.

No obligation to provide service.

Subject to outside influence.

Limited authority.

No control at entry.  
Not required.  
Very limited.  
May be developing.  
May be developing.  
May be developing.



# Out of disk space? No problem — just ask the boss for some more disk drives. Again.

On the other hand, you might suggest he take a look at the UCC-3/ADAM Disk Management System.

This software package can vastly increase the availability of usable disk space... *without spending a cent on expensive new hardware.* Because, chances are, your shop already has all the disk space it needs... it's just not being used efficiently.

UCC-3 eliminates disk fragmentation and maximizes DASD space usage efficiency. It produces complete reports that allow you to analyze your disk space problem. Next, based on your criteria, it will solve the problem by automatically migrating selected data sets to tape and scratching unneeded and invalid data sets. Then, UCC-3 will keep the problem from recurring by controlling data set allocation.

Don't ask your boss to buy another disk drive until you've called us at 1- (214) 688-7312 or circle 90

A Tape Mgmt System that protects data from

loss or destruction (UCC-1). Circle 91

A DOS Under OS System that lets you use DOS programs, without reprogramming, as you convert to OS (UCC-2). Circle 92

A PDS Space Mgmt System that eliminates PDS compression (UCC-6). Circle 93

A Data Dictionary/Mgr that really gets IMS under control (UCC-10). Circle 94

A Job/Recovery Mgmt System that makes restarts and reruns simple (UCC-15). Circle 95

A GL/Financial Control System that Accounting has been dreaming of (UCC-FCS). Circle 96

An IMS Database Verifier checks physical pointers, finds errors before they become problems (UCC-40). Circle 97

An IMS Database Space Utilization Program pinpoints DB loading problems (UCC-41). Circle 98

A broad line of Banking and Thrift software. Circle 99

Software packages like these. One more way—

## We're helping the computer to do more of the work.

**UCC**

P. O. Box 47911 — Dallas, Texas 75247

Canada: 797 Don Mills Road — Don Mills, Ontario M3C 1V2 • Europe: 1258 London Road — London, U. K. SW16 4EG

## LETTERS

tains all the information needed for its imaginary preconstruction." (Ross and Schoman, "Structured Analysis for Requirements Definition", *IEEE Transactions on Software Engineering*, January 1977, p. 6).

KENNETH E. SCHOMAN, JR.  
Manager, Methods Development  
SoftTech, Inc.  
Waltham, Massachusetts

### MISSING LINK

In recounting the Xerox side of history, Strassman and Willard ("The Evolution of the Page Printer," May, p. 167) neglect to mention an important developmental form—the Xerox Graphics Printer.

The xgp is a roll-fed xerographic engine based on the 813 copier, employing a crt to generate the image directly on the photoreceptor drum. Originally built as the output mechanism in the Long Distance Xerography system, it was fitted with a digital i/o interface to enable a directly coupled computer to drive it with a bit-serial representation of the image, scan-line by scan-line, operating at print densities of 128 to 306 dots/inch, and at paper speeds of 1.57 to .67 inches/second. In a sense it is the missing link between the 1200 and the 9700 printers.

To the driving and formatting software upstream in the output process, the 1200 is essentially a line printer; but the 9700, like its ancestor the xgp, is a typesetter and a plotter together. The ability to enhance the readability and usability of the displayed information, while reducing the number of pages required, is a powerful incentive to exploit the full capabilities of the device, but one with great impact on all the software supporting the output process.

The pioneer users of the xgp took this impact head-on; they had to develop most of their own support software. The Computer Science Dept. at Carnegie-Mellon Univ. developed a complete page printing system, *Xcribble*, with interactive editor and typesetting programs capable of handling multiple fonts and line drawings. Camera-ready copy for a book (*Designing Computers and Digital Systems*, Digital Press, 1972) was produced, along with numerous technical papers, under the system. The Univ. of Toronto Library Automation Systems group developed their own page formatting programs, and operated the first "computer-output-xerography" production shop. Three xgp's are still in use there, two of which produce about two hundred thousand catalog cards per week.

Strassman and Willard assert that "direct image generation on photoreceptors never reached the marketing stage"; however, brochures speak otherwise. The marketing effort was limited, but it did

result in the placing of several xgp's in commercial sites.

Though the xgp was deployed prior to the 1200, and is based on an older and slower xerographic technology, its operating life has paralleled that of the 1200. The experience of the xgp users and the Xerox employees who supported them not only demonstrated the feasibility of the page printer concept underlying the 9700, but also influenced the hardware capabilities of the 9700 and its support software.

KEITH THOMAS  
Director  
Thomas, Wharton Associates Ltd.  
Toronto, Canada

### TESTING METHODS SOUGHT

I am interested in hearing how other dp departments handle the checking out of program tests before putting new versions of programs into production. On the system I'm involved with at Equitable we now have the user do a case by case examination of every record of every file that shows up in our program comparisons. (We use a utility that compares the output of the old version of the program with the output of the new version.) For new output files, every record is checked out by the user. Even with relatively small samples, this procedure is cumbersome and usually results in a repe-

tion of the programmer's own check-out. When every program in our system is changed, the work involved is voluminous.

The result has been an absence of production hang-ups, but it is a very time-consuming and boring task for both the user and the programmers who have to spend time explaining what each test accomplished to the user.

We would like to compare our methods to what others are doing. Have other dp departments come up with a less boring and repetitious procedure that involves a balance between programmer and user check-out without a substantial increase of risk at production?

LEA BEITNER  
Equitable Life  
1285 Avenue of the Americas  
New York, NY 10019

### GOOD HUMOR

Dave Stevens ("The Ninefold Way," August, p. 155) is that rare dp manager whose humorous rhetoric accurately reflects the distress of the dp user. Witness his skillful illustration of the Third Principle (Part 3.d) in his statement of the Law of Large Numbers of the Fourth Principle. Keep up the good work!

PAUL J. NIKOLAI  
Mathematician  
Dept. of the Air Force  
Wright-Patterson Air Force Base, Ohio



This group photo of members of the governing council of the Los Angeles Chapter of the Assn. for Computing Machinery (ACM) was sent to DATAMATION by one of our authors, Barbara McNurlin (August, p. 95) so we could extract her picture to accompany her biography. Inadvertently, we selected the wrong person. Toni Shetler of Xerox, an ACM member at large and chairman of a software quality assurance workshop on functional and performance issues to be held Nov. 15-17 in San Diego, became, in our pages, Barbara McNurlin, who is the L.A. ACM chapter's newsletter editor and a feature writer for Canning publications. Others in the photo are (front row, left to right) Bob Lewis, government chairman; Edward Lee, program chairman; the real Barbara McNurlin; Ms. Shetler and (back row, left to right) Alston Householder, awards chairman; Paul Cudney, national ACM liaison; Bob Spiegler, arrangements chairman, and Warren Erikson, Spring Systems seminar chairman.

The 14-pin, with 80 columns for  
 printing, is available in a variety of  
 configurations. The 14-pin, with 80  
 columns for printing, is available in a  
 variety of configurations. The 14-pin,  
 with 80 columns for printing, is  
 available in a variety of configurations.  
 The 14-pin, with 80 columns for  
 printing, is available in a variety of  
 configurations. The 14-pin, with 80  
 columns for printing, is available in a  
 variety of configurations. The 14-pin,  
 with 80 columns for printing, is  
 available in a variety of configurations.

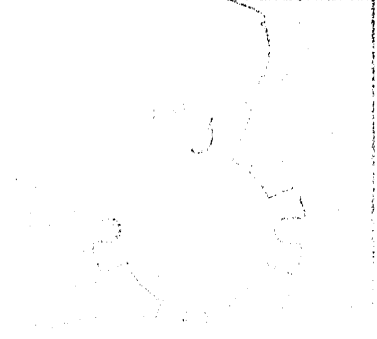

characters. Character and line editing  
 features. And final brightness control.  
 Dynamic LPT gives you all that  
 you want. It's the most compact, light-  
 weight, 14-pin dot-matrix, line and page  
 control, and character set. But the price  
 is just \$199.95.  
 Dynamic Word Control gives you  
 complete control over editing.  
 The price is just \$199.95.

*Dynamic*

A GENERAL DYNAMICS SUBSIDIARY  
 10000 WOODBURY ROAD, WOODBURY, N.Y. 11797  
 (516) 941-1000  
 CIRCLE 54 ON READER CARD

# DATA MAX™

10000 WOODBURY ROAD, WOODBURY, N.Y. 11797  
 (516) 941-1000

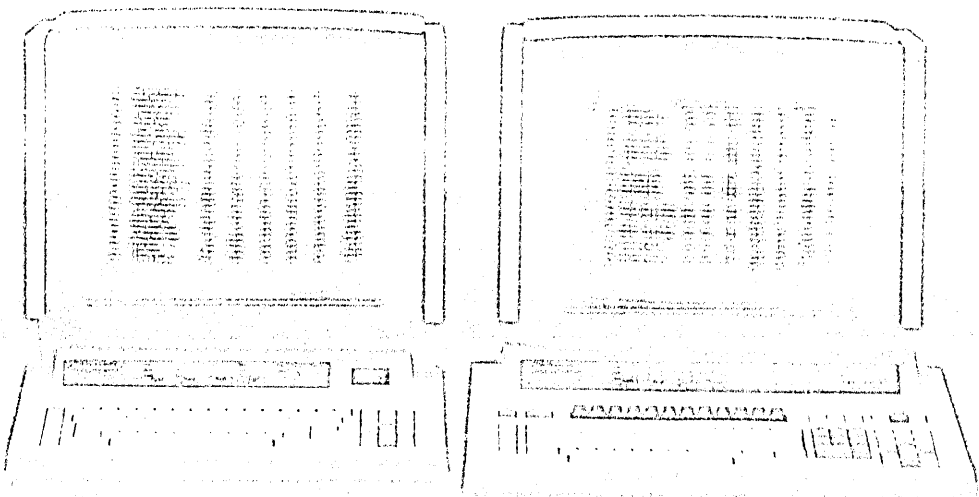



# The new Harris S123 and S570. You get the capability you need at capacities you can afford.

Harris introduces the S123 and the S570.

These two new computer systems expand the range of VULCAN, Harris's applications proven Virtual Memory Operating System, offering new products for both smaller and larger users.

Both the S123 and the S570 offer mainframe capability.

Both operate with COBOL, FORTRAN, APL, BASIC V, RPG II, FORGO, SNOBOL... and TOTAL, concurrently.

Both are versatile. From dedicated applications to broad general purpose use. Conventional batch processing to demanding real-time modes of operation. Single site to deployed computer facilities. Multiple user concurrence to concurrent multiple uses.

The difference is capacity.

The S123 is the entry level system. It has the capacity to support up to eight terminal users. 144K bytes of real memory, 768K bytes of virtual memory.

The S570 can support up to 64 terminal users. It has up to 3M bytes of real memory. 12M bytes of virtual memory.

All Harris computer systems, from the S123 through the S570, are VULCAN based. All reflect the dependability, predictability and reliability that only a highly efficient, fully matured operating system can deliver. VULCAN based also means that you can grow with Harris without a costly change in applications software and files.

If your need is distributed processing, time sharing, data base management, or any type of concurrent multi-use applications, benchmark Harris.

**Harris Computer Systems, 1200 Gateway Drive, Fort Lauderdale, Florida 33309. Telephone: (305) 974-1700. Europe: Harris Systems, Ltd., 145 Farnham Road, Slough, SL1 4XD, England.**

**All at once, it's Harris.**

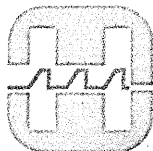

**HARRIS**

COMMUNICATIONS AND  
INFORMATION HANDLING

# **THE BTI 8000 32-BIT MULTIPROCESSOR SYSTEM. NO OTHER COMPUTER CAN GIVE YOU SO MUCH CAPABILITY FOR SO LITTLE COST.**

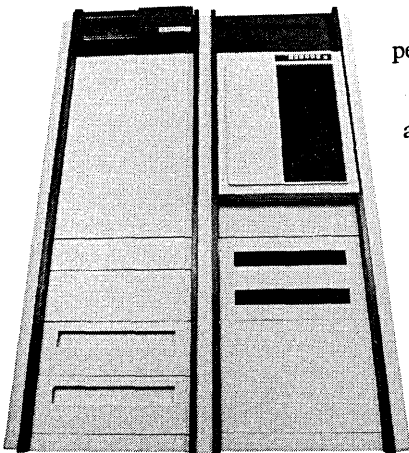

The BTI 8000 uses new hardware and software technology to offer mainframe level performance at an order of magnitude lower cost.

The BTI 8000 can concurrently support hundreds of interactive users and batch tasks.

The BTI 8000 provides multiple languages...PASCAL, FORTRAN, BASIC, RPG II and COBOL, and includes a CODASYL compliant Data Base Management System.

The BTI 8000 is enormously expandable: 1 to 8 CPUs; 256,000 to more than 100 million bytes of core; 1 to 8 parallel paths to memory; 4 to 32 I/O channels; 8 to 512 interactive ports; 1 to 128 spindles of disk storage, with 33 to 252 megabytes per spindle.

The BTI 8000 is a range of capabilities never before offered on a single computer system at anything like this cost. Prices start at \$86,850 for a ready-to-go system; just add terminals.

The BTI 8000 is an entirely new system. It's the result of four years of intensive development. And it's backed by proven experience with the BTI 4000, operating successfully at over 600 installations in the United States, Canada and Europe.

For more information, just contact the BTI office nearest you, today.

**BTI**  
COMPUTER  
SYSTEMS

BTI, 870 W. Maude Ave., Sunnyvale, CA 94086. Sales Offices: Cherry Hill, NJ (609) 662-1122; Minneapolis, MN (612) 854-1122; Chicago, IL (312) 298-1177; Dallas, TX (214) 630-2431; Sunnyvale, CA (408) 733-1122; Anaheim, CA (714) 533-7161; United Kingdom, Slough 70044.



# EDITOR'S READOUT

## THE JURY SYSTEM ON TRIAL

*"At one time in the deliberations, we had almost reached a verdict of \$158 million for Memorex. And we would have reached a verdict if the judge had said, 'all right, compromise.' But it was evident when he answered our questions that he did not want a compromise."—Albert Bratovich, juror on the IBM Memorex case.*

Way back in the year 1215, King John issued the Magna Carta, which, among other things, secured the right of trial by jury. The idea has spread through the centuries and throughout most countries of the free world.

During the 1970s, however, the notion that a party in a legal action has a right to a trial by jury is being quietly dismantled by several federal district court judges. Taken alone, litigation of the 1970s involving IBM constitutes a troubling trend. A disturbing equation appeared at work: IBM equals the computer establishment; judges equal the judicial establishment. When IBM goes before a jury, all too often the jurors' duties are preempted by a judge, who blocks the case from going to the jury and awards the decision to IBM. It is like declaring the Dallas Cowboys the winner of the Super Bowl before the game is played.

Judge Samuel Conti's recent order barring a jury from hearing a retrial of the IBM/Memorex antitrust case is just the latest in a long line of cases in which federal district court judges have blocked juries from ruling on cases involving IBM.

Last year, Judge Ray McNichols issued a "directed verdict" to IBM in its antitrust case with California Computer Products, Inc., blocking the jury off from ruling in the case. Jurors questioned by

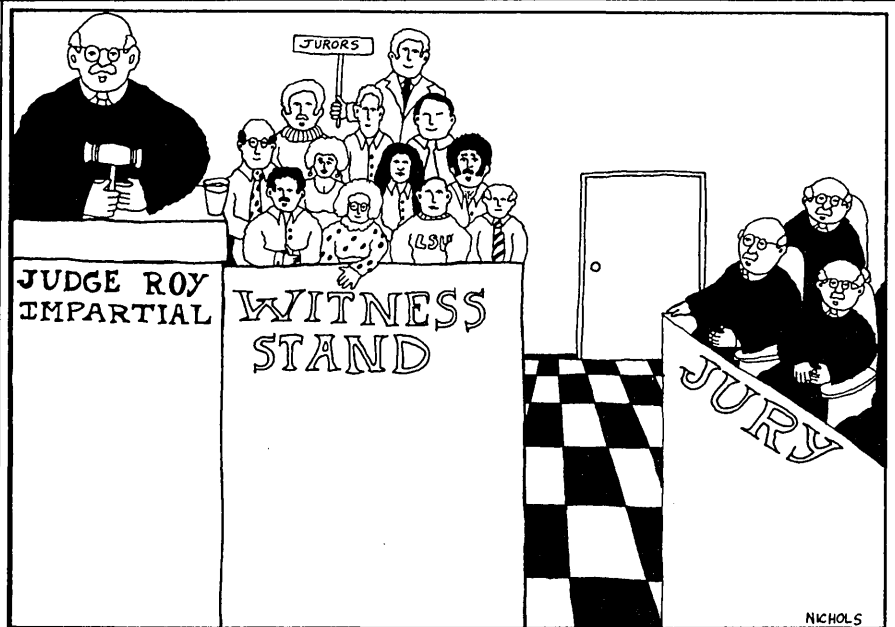

reporters after the ruling said they wanted to hear the full case.

In Las Vegas earlier this year, Judge Roger Foley did a similar thing, issuing a directed verdict to IBM in a case with Royal Data, a now defunct Las Vegas computer service firm. Royal Data, once competing with IBM for Las Vegas' credit check business, maintained that IBM employees had spread false rumors about the smaller firm. In court, after the judge and jury heard the Royal Data case, IBM claimed that Royal Data hadn't proven its case. Judge Foley agreed with IBM and the jury didn't get its chance to rule on the case.

Even juries that get the chance to rule on a case can have their problems with judges. The IBM/Catamore Enterprises case, the landmark user suit, was won by Catamore in a jury decision, only to be remanded by an appellate court of three federal judges. The original trial lasted 57 days—the longest jury trial in the history of Rhode Island—and rather than face another trial, the small jewelry company settled out of court.

The first of the IBM antitrust cases to come to trial, the Greyhound Computer Corp. suit, went the same way—

Judge Walter Craig issued a verdict in favor of IBM and the case never went to the jury. Judge Craig has since been reversed by a federal appellate court, but it took some five years to do that. Today, more than six years after a jury was sitting on the Greyhound case, a new trial has yet to be set.

On the Memorex case, one jolting aspect was that jurors—after being deadlocked for a time at 9 to 2 in favor of Memorex—said they were just minutes away from working out a compromise that would favor Memorex. (IBM's attorneys said of the jurors' affidavits, "These affidavits are incompetent and admissible.")

It is not our intention to pass judgment on IBM, whether the firm is innocent or guilty of any of the various charges leveled against it. IBM clearly dominates the computer industry and the questions posed in the various cases are important ones, questions that are capable of being resolved by the jury system. That system is not yet ready for the junk pile. When a judge tells us that juries aren't capable of judging, then what he may really be saying is that judges aren't capable. \*

New Developments from SYSTEMS...

# The New MOS

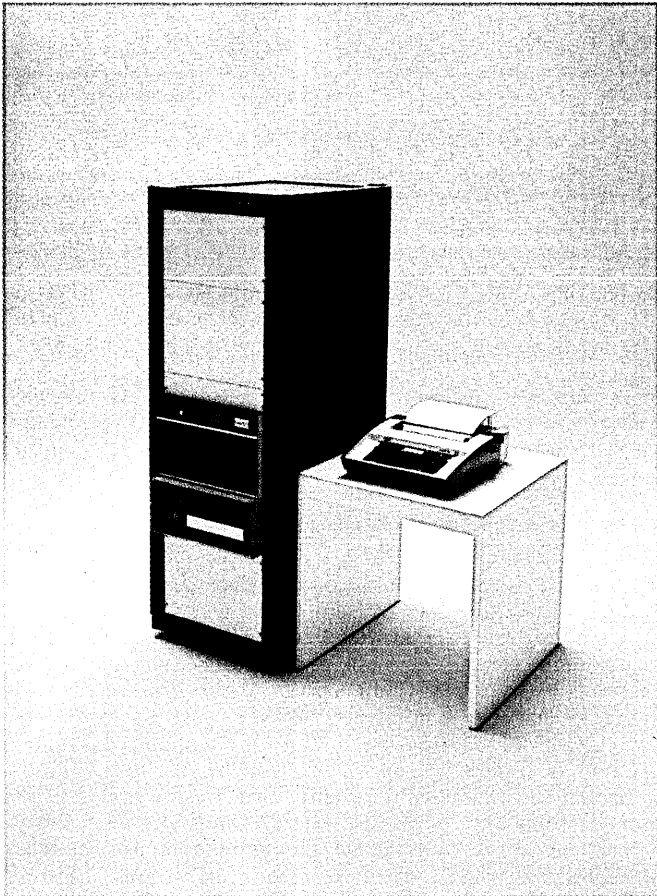

SEL 32/5720



SEL 32/5730

Until now, you've either had to forego 16-bit pricing to get 32-bit performance, or you've had to give up 32-bit performance just to keep the budget in line.

No longer. Now you can invest in a full-blown 32-bit computer system and pay no more than you would for a 16-bit computer. And not have to worry about insufficient power for future needs.

Here's why: value engineering. We've taken our high-performance 32-bit computers, and

we've done some packaging that makes sense. We've added MOS memory. Expanded and fine-tuned our operationally-proven software. Made our systems more compact, more efficient. And we put it all together for a third less money.

The result? A broad family of 32-bit computer systems, perfect for jobs that require high thruputs like telemetry, seismic exploration, or research. Or for jobs that need lots of I/O; process control, simulation, or laboratory automation.

All are upward-compatible, so you can still grow, but start with a minimal investment.

If you'd like to have real performance, but can't overlook how effectively you use your budget, talk to us. We'll make sure that when you invest in SYSTEMS computers, more dollars will flow to your bottom line.

Call us. We're easy to talk to. (305) 587-2900  
6901 West Sunrise Boulevard  
Ft. Lauderdale, Florida 33313.

# Packaged Systems.



SEL 32/5740



SEL 32/5750

# SYSTEMS

ENGINEERING LABORATORIES

CIRCLE 67 ON READER CARD

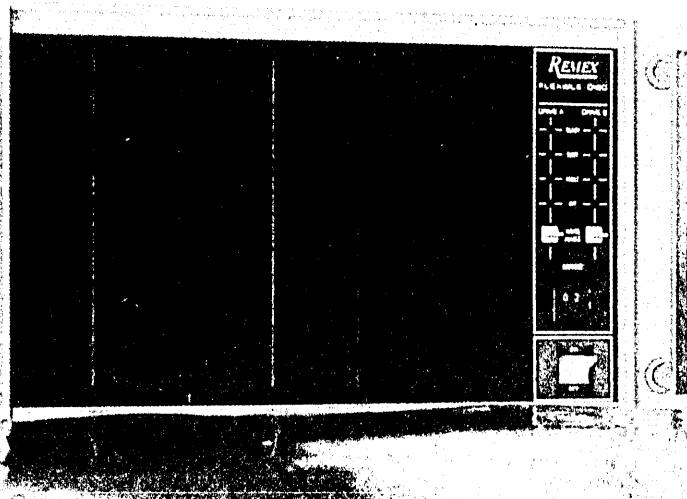

# Above DEC performance... below DEC price.

PDP/MSI-III users couldn't ask for anything better. A plug-compatible, software transparent, flexible disk system that costs about 25 percent less, yet has more features than DEC's RX-III system.

Each Remex-III system has an array of special status indicators. One tells you when a head is loaded. Another tells you when the system is busy completing a command. Another lets you know when an error has been detected (it stays lit until told otherwise).

And both drives in the system have a write protect switch for guarding stored data (four-drive system optional).

Otherwise, it's pretty much the same as DEC's system, with full sector buffering and selectable register address capability.

But we're even more DEC'ed out when you

need it. Our *expanded capacity* Remex-III uses 16 sector/track soft sectoring that increases storage capacity by some 25 percent and throughput by as much as 20 percent over DEC's version.

Either way, you benefit from exceptional reliability, lower costs and immediate delivery.

Call or write for complete details. Ex-Cell-O Corporation, Remex Division, 1733 East Alton St., P.O. Box C19533, Irvine, CA 92713.  
Phone: 714/557-6860. TWX: (910) 595-1715.

**Ex-Cell-O Corporation**

**REMEX DIVISION**

Paper isn't the only thing we look good on.



# PROFITS & PITFALLS OF COMPUTER DEALERSHIPS

Are declining profits attracting you to the never-never world of the small business computer--with all its apparent profit potential?

Have you already accepted the temptation to sell computers and found dollars (maybe yes?) and trouble, trouble, trouble?

INFOTEC'S handbook, **Profits and Pitfalls--A Dealer's Guide to Selling Small Business Computers**, will lead you around the trouble spots--straight to the profits!

Write for our booklet, **Profits and Pitfalls--A Dealer's Guide to Selling Small Business Computers**, and we'll also tell you about IMP. IMP makes **profits**, not problems!

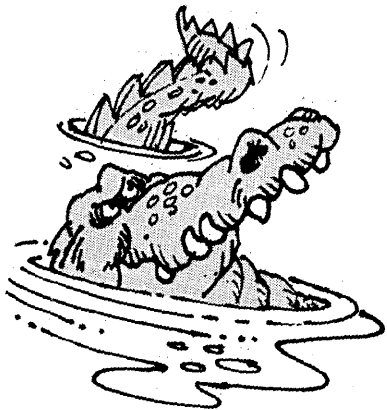

One Perimeter Road  
Manchester, NH 03103

Computer Systems of the Future

Please send me  
**Profits and Pitfalls--A Dealer's Guide to Selling Small business Computers**

Name \_\_\_\_\_ (Position)  
Company \_\_\_\_\_  
Street \_\_\_\_\_  
City/State \_\_\_\_\_ (Zip)  
Telephone \_\_\_\_\_

Infotecs is offering dealerships  
in all states east of the Mississippi  
River, but will accept inquiries  
for other regions.

d

CIRCLE 7 ON READER CARD

OCTOBER 1978 51

# NEWS

## IN PERSPECTIVE

### FINANCE

# COMPUTER STOCKS SOAR

**Computer stocks outperform the market for the first time in several years.**

Investors who've ignored the computer stocks this past year or so might understandably be gnashing their teeth and weeping copiously into the pages of the Wall Street Journal these days.

In fact, securities analysts who follow computer-related issues are saying that as a group these stocks have not performed so well since the so-called "go go" years of the late 1960s. And the numbers bear them out.

Earlier this year an investor could have snapped up any one of dozens of dp stocks that have since doubled or tripled in value. Witness this random sampling:

Stock	1978 Low	Recent Price (Sept. 18)
Datapoint	26¾	73
Mohawk Data	4⅞	12¾
NCR	36¾	64
Burroughs	58¾	83
Wyly	2	6¾
Telex	1⅞	8½
National css	12⅞	33*
Calcomp	2½	10¾
Sperry Rand	29¾	47
Harris	35½	69¼

\*After a two-for-one split

What's behind this sharp upswing in computer stock values? The stock market as a whole has been bullish lately, but that's only part of the story. In fact, for the first time in several years computer stocks are outperforming the market. Stephen T. McClellan, an analyst with Salomon Brothers, explains why:

"Most of the computer stocks underperformed in 1976 because they were going through a transition and entering into a new product cycle," he notes. "Then in 1977 when they began to ship their first new orders, their performance was in line with the Standard & Poor's Index."

Now, says McClellan, many of the computer companies have entered the optimum phase of their product cycles and are making high volume deliveries. As a result revenues and earnings are way up, and the stocks are generally outpacing all the stock market indicators.

Additionally, investor interest in computer issues has been spurred by the fact

that many firms have dramatically bolstered dividend payments. Burroughs, as an example, increased dividends four times in the past year, while other companies like NCR and Sperry Rand have sweetened the dividend pie for their investors.

Harry Edelson, a vice president of research with the brokerage firm Drexel Burnham Lambert Inc., points to another trump card computer companies now hold in the current economic climate. "The kind of inflation we're experiencing now is good for the computer companies because with labor costs going up more and more corporations are cutting back on their work force through automation."

Even if the economy should slow down, as some economists have predicted, most of the mainframe companies have sufficiently large back orders so as not to be adversely affected, analysts believe. Moreover, with much of the U.S. computer sales going outside the country, any possible down shift in the American economy won't really impact business. "People now realize that most computer stocks are antirecessionary," observes McClellan.

McClellan excludes minicomputer companies from this assessment. "The mini group is on a different product cycle and is much more economically sensitive as a leading indicator of a weakening economy," McClellan says.

This possible vulnerability has already shown up in a decline in orders from the oem's and systems houses to which many of the mini vendors sell, analysts say. Digital Equipment, especially, seems to be lagging the market, registering what several analysts feel to be a disappointingly low increase in earnings this year. The financial community attributes this to the fact that the firm's delivery lead times were so long last year many oem's double ordered to ensure sufficient shipments. Now with deliveries coming in, they've cancelled many redundant orders.

However, an analyst who follows DEC closely notes that most of the firm's deliv-

**Investor interest also has been spurred by higher dividend payments.**

ery and production difficulties have now been rectified. Also, he says, DEC is planning to make a host of product announcements this month and later in January. As a result, DEC should experience a good showing from here on out, he believes.

Another question mark in several analysts' minds involves the service companies. Although firms like National css and Automatic Data Processing have

performed exceedingly well in the present market upswing, the financial community is chary about this group's movement into the hardware business. Past attempts to gain a foothold in this

### **An exception may be the service firms and their movement into the hardware business.**

business—ADP's efforts to sell Microdata computers, for example—have generally been disappointing.

Also analysts point up that the acquisition binge many service concerns have gone through lately may soon show up

negatively in the form of diluted earnings. "Some of the service firms are having real difficulties absorbing everything they've acquired and this is going to hurt them," one analyst reasons.

These minor forebodings aside, the long term outlook for most computer issues is generally viewed as outstanding. And the consensus is that one company in particular—IBM—should really take off next year. "IBM lags the other mainframers' product cycle by a year, and it will enter its own optimum phase in 1979," notes Edelson. "That should be IBM's year."

—Laton McCartney

billion, for its 185 member banks in the U.S. Paul L. Abraham, BankWire chairman and senior vice president of the First National Bank of Kansas City, described the system as "the first of a new class of payments mechanisms that will not only execute funds transfers, but offer a broad range of additional banking asset management services as well." It was developed over a three year period at a cost of some \$10 million and was designed to accommodate more than three times today's payments message volume, at speeds up to 30 times faster than its predecessor system, BankWire I, which ceased operations at the end of June.

The network has two computerized message switching centers, one in New Jersey, already operational, and one in Dallas which will become operational in December. Three types of messages are supported: funds transfer messages, miscellaneous reimbursement messages, and administrative messages. The average message takes less than two minutes to deliver after entry into the system.

Each of the two switching centers has a totally redundant, or duplicated set of computers, message storage files, and related equipment. In the event of failure of any equipment component, the duplicate component is automatically switched to operational mode within seconds.

Membership in BankWire is voluntary and the organization operates as a not-for-profit cooperative. Each member bank pays a basic fee of 60 cents for each BankWire II funds transfer message as well as paying for its own individual BankNet terminals. Suppliers of major equipment and service components for BankWire II are Rockwell International, Western Union Data Services Co., and the Incoterm Corp., a division of Honeywell, Inc.

On the international level, the Society for Worldwide Interbank Financial Telecommunication (SWIFT) completed its first year of live operation last May. In the same month, the ten millionth message was input into SWIFT. Traffic has continued to increase since then at an accelerated rate.

### **Automated teller machines stand out as the EFT service with the highest level of awareness.**

"We expected a drop in the summer," said J. E. Tilley, administration director, "but it didn't come." Biggest using country consistently has been Germany which Tilley attributed to a strong currency, more international sales and, consequently, more international payments.

The origins of SWIFT date back to the late '60s, he said, when a number of banks of Europe "linked themselves to work for more effective use of comput-

## **ELECTRONIC FUNDS TRANSFER**

# **EFT: MOMENTUM GATHERS**

**But public awareness is generally low worldwide.**

When the prestigious American Bankers Assn. (ABA) convenes in Honolulu late this month, the many aspects of Electronic Funds Transfer (EFT) will dominate discussions; and technology to make EFT offerings possible will be the big thing at the 200-booth exhibit.

Interest in what the U. S. banks are doing in EFT is the prime drawing card for the record number of international attendees expected, probably sharing that honor with the Hawaiian climate and other charms of the islands.

All this when public awareness of EFT is generally low worldwide. A mid-year U.S. survey of consumer views on changing payment services showed that awareness and availability are still low and that none of the six EFT services studied has achieved any significant level of usage on a nationwide basis.

The survey, conducted by Payment Systems, Inc. and Darden Research Corp., studied automated teller machines, preauthorized charges to checking accounts, direct deposit of payroll, telephone bill paying, automatic check approval at point-of-sale (POS) locations, and banking at point-of-sale.

It showed that automated teller machines (ATM's) stand out as the EFT service with the highest level of public awareness. Almost three-fourths of the adult population is familiar with this service, it said, although they rank it below check guarantee at the point-of-sale in appeal. Consumers, said the report, perceive preauthorized charges to checking as having the highest level of availability among

EFT services, and one out of six study respondents uses this service.

In considering consumer awareness of EFT, bankers are concerned that it be favorable. The Electronic Money Council, started in mid-1977 as an ad hoc group of 24 depository financial institutions which jointly undertook the funding of a research study to determine public awareness of EFT services, has launched a campaign to win over public opinion on the side of EFT and has hired



JOEL TILLEY—Summer drop didn't happen.

the public relations firm of Burson-Marsteller and two consumer affairs writers, Sylvia Auerbach and Barbara Quint, to help do this.

In EFT areas not so visible to consumers and where consumer awareness is not a great concern, mainly electronic transfers among financial institutions themselves, momentum has been gathering.

BankWire II, the outgrowth of a planning study completed in 1972 by the Monetary and Payments System (MAPS) committee of the ABA, late last spring began processing more than 18,000 messages a day, valued at more than \$20

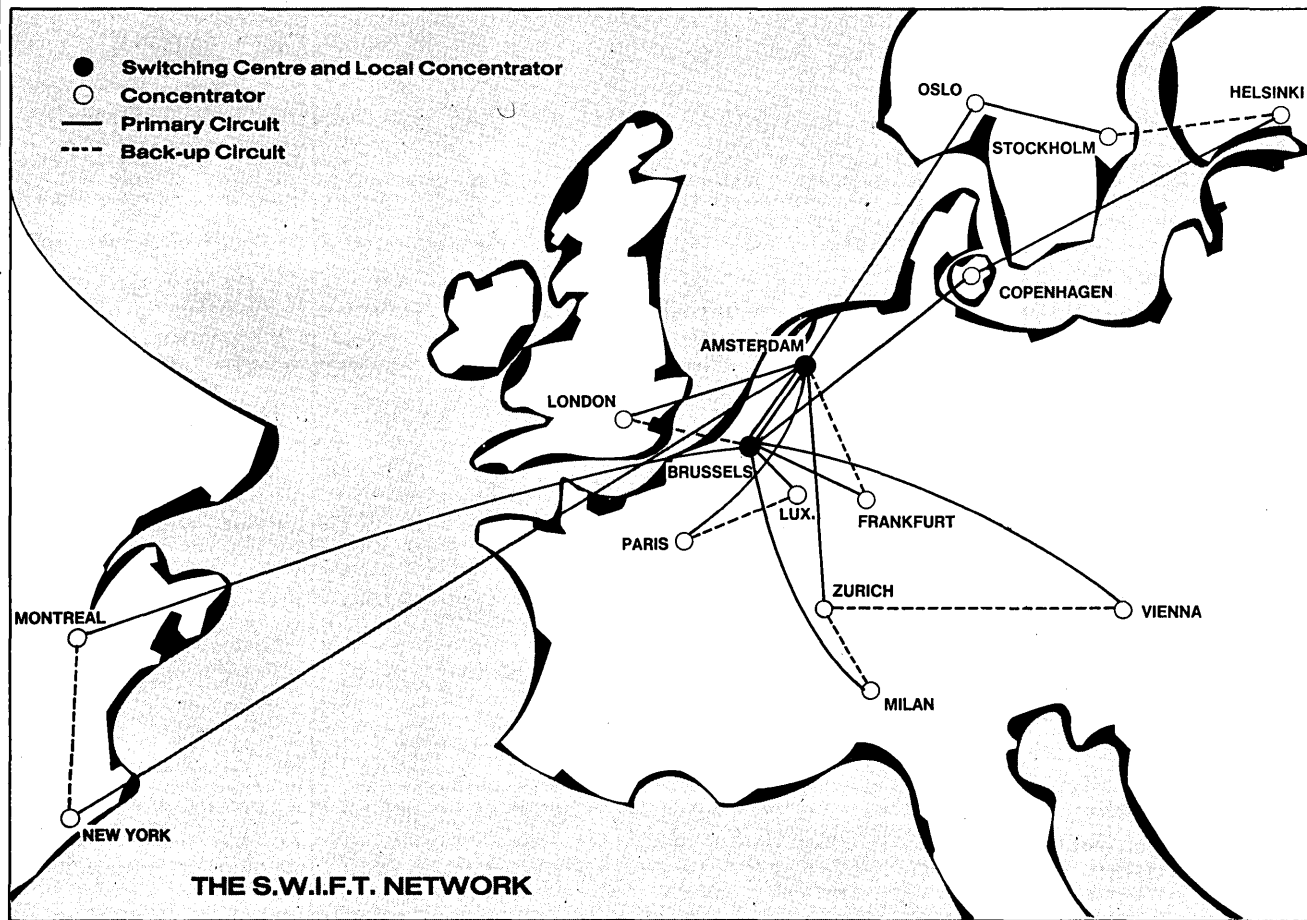

SWIFT—Its network covers most of Western Europe and North America.

ers.” The Algemene Bank Nederlands was the moving force.

The notion of an international message switching system was first discussed in December 1970 at a meeting in Frankfurt attended by 36 representatives of seven countries, including Belgium, France, West Germany, Great Britain, Italy, the Netherlands, and the United States.

It was decided that a feasibility study was in order. It was dubbed Message Switching Project (MSP) and Logica Ltd. of London was awarded a \$117,600 contract to conduct it.

“Logica said yes, go ahead,” Tilley recalled, and SWIFT was formally formed as a Belgian company in May 1973. Its by-laws were accepted by 15 founding countries and Carl Reuterskiöld, present general manager, was named as its first permanent employee.

Today the permanent staff numbers more than 160 in Belgium, New York, and the Netherlands. Tilley was the second permanent employee and is one of four executive directors who reflect the international nature of SWIFT. Tilley is an American. The other three are Dutch, French, and Canadian.

Today SWIFT has 19 member countries, the newest being Greece, accepted by the board of directors this summer after some 12 to 15 months of negotiations. Bank unit members total more than 571.

While German banks are the biggest users of the SWIFT network, Italian

**The average message takes less than two minutes to deliver after entry into the system.**

banks, once that country went live, came on fastest and Tilley attributed that to the fact that “they found it a viable alternative to the Italian post office,” not noted for its speed or reliability.

To become a member of SWIFT a financial organization first has to be deemed a bank by its peers in a member country. Next comes approval by the board of directors.

Participation in SWIFT activities by members has changed as the organization has matured. Originally, said Tilley, it was mostly bank data processing people. “Now they’re more from the mainstream of banking.” But SWIFT conducts seminars for member banks on a regular basis and some appeal to each level.

Although “International” is part of its name, SWIFT isn’t truly international yet but it’s getting there. Japan as a country and 42 of its banks are members, but they are not yet connected to the network which is expected to happen early next year. “There is a lot of interest in South America and we have been talking to banks in New Zealand, Australia, Hong Kong, and the Philippines,” Tilley said.

SWIFT’s tariff is based on a cost-recovery system which means it allocates its costs to users within the frame of predetermined objectives which always reflect the nonprofit status of the organization. This includes provision for recovery over a five year period of development costs. There is a one-time connection charge, a unit charge per message based on a fixed annual charge based on estimated usage, and a transmission charge for all messages effectively input into the system.

The SWIFT network covers most of Western Europe and North America. It is a two-center financial control system. Banks connect their own terminals to programmable concentrators in each country. Messages are temporarily stored at the operating centers so that users are



able to input transactions even if the receiver's terminal is not available at input time. Also, terminals operating at different speeds and using different protocols can be connected.

Each operating center features fully duplicated computer configurations. Tilley said a two-center design was used for increased security. "Should one center become unavailable through natural catastrophe, industrial action, or sabotage, the other could take over since it has

### Today SWIFT's permanent staff numbers more than 160 in Belgium, New York, and the Netherlands.

enough capacity to handle the entire traffic load." Communication between operating centers and concentrators is via dedicated telephone lines operating at 9600bps. Data is protected by encryption. Line protocol, Tilley said, is "close" to ISO (International Standards Organization) standards and is Burroughs oriented. Burroughs is primary equipment supplier to SWIFT. The equipment is on lease, but SWIFT has a purchase option.

New users can connect to the network via computer based terminals or Telex. Most use computer based terminals. Many use SWIFT's Interface Device (SID), a terminal system developed by SWIFT to minimize the effort required to interface to and use its network. The SID is designed around a range of standardized modules which banks can combine to suit their own operational requirements. Three manufacturers were selected by SWIFT to supply SID hardware: Burroughs, General Automation, and International Computers Ltd. Software for the SID's was developed by the manufacturers but is supplied and maintained by SWIFT. The SID's don't lock out other suppliers, said Tilley. "IBM has a SWIFT package and supports its own software."

Why is SWIFT headquartered in Belgium? "Well," said Tilley, "one of the founding ideas was that it be a politically neutral organization. NATO is here. The Common Market is headquartered here. Internationally, there is a cost advantage in terms of travel and communications."

And Belgium is out front in many ways in automated banking. Automated clearing started in Belgium in the early '70s as it did in the U.S. Here, it's still moving slowly. In Belgium, some 90% of all payment items are cleared via automation through the Association of Belgian Banks.

England is right up there too with its Banks Automatic Transfer Center (BATS) which utilizes an ICL-based computer center in North London. "The banks cooperate and fund it (BATS)," said Sean Dixon-Child, financial applications director for NCR Ltd., London. "Four large banks (Barclays, Midland, National

Westminster, and Lloyds) cover the whole country and that makes it easier." BATS has been in operation for about 10 years and, said Dixon-Child, it handles direct deposit of payroll to employee banks for most of the U. K.'s white collar workers. "It hasn't caught on among blue collar workers yet."

Britain's banks also are cooperating for the future. Dixon-Child said. He described the IBRO (InterBank Research Organization, which is looking ahead 10 years at such things as the possibility of a multibank network.

Nontechnical problems continue to inhibit EFT acceptance everywhere but their nature is varied. Unions are worried about the use of ATM's in the U. K., said NCR's Dixon-Child, but it is from a safety standpoint. "They are concerned about exposure risks to bank employees replenishing the machines."

In Belgium, union concern is more directly related to job security. Unemployment in Belgium is running at 8½% to 9%, said Carl Holsters, senior marketing officer for Famibank, a Brussels subsidiary of Citibank. "They (the unions) are concerned with anything they think hints at job reduction and they think off-premise ATM's do."

C. J. Crousse, marketing director, financial and government installations for NCR in Belgium, said a union mailing piece in late August sent to bank employees described ATM's as a job threat.

In the U.S. the big problem with use of ATM's continues to be the question of whether they constitute branches, a question being answered on a state by state basis and in the courts.

In Texas, where voters last year rejected a revision of state law which has restricted ATM use, a network of ATM's may yet come to pass. Electronic Data Systems Corp. is talking to financial institutions about setting up a number of

standalone systems that would have non-communications links with the banks, and thus probably would be outside the restricting law. The machines would belong to EDS which would make available cash withdrawal on the basis of certain account information it would obtain from participating financial institutions.

An apolitical inhibitor of widespread use of ATM's has been that few have proven cost effective. A group of savings banks in Sweden has uncovered a finan-

### Direct deposit of payroll hasn't caught on among blue collar workers yet.

cial benefit from ATM's that might cause many banks to take a second look at their figures. The group determined that due to the use of ATM's being readily available in Sweden, customers of the savings banks are taking out smaller amounts of money than they used to, leading to a higher level of deposits.

Privacy concerns continue to plague EFT development. Tilley of SWIFT said most of its member countries have "legislation in force or pending governing transborder data flow which is strongly linked to concern for privacy." He feels SWIFT took a long stride toward allaying privacy fears when "we managed to convince the Swedish Data Inspection Board that we don't have a data base. It will have a good effect on others."

And bankers dealing more directly with the general public, still fear public fear of computers. Belgium's Famibank has 49 branches which are on-line all day to a system based on two NCR Criterion 8550s which has been live since July 16, 1977 with 99% uptime. The bank is proud of the technical capabilities of its system but, said Holsters, "in marketing we play down the computer and play up the services."  
—Edith Meyers

## COMMUNICATIONS

# BRANSCOMB ON ACS

### Says new Bell service is an entrepreneurial venture with substantial technical risk.

For telecommunications marketers and policymakers, the gut issue these days is competition vs. regulation. To set better boundaries between these conflicting service categories, IBM vp and chief scientist Lewis Branscomb proposes that a "crisper distinction" be made between regulated common carrier and unregulated competitive services. And the bottom-line answer in this sorting out, he main-

tains, "lies in the deregulation of value-added services."

In his keynote address early last month to the Institute of Electrical & Electronics Engineers' 17th computer society international conference (Comcon 78), Branscomb told the Washington gathering that AT&T's Advanced Communications Service (ACS) would be a good test of the value-added deregulation principle. Spouting the IBM line on ACS, he described the new Bell service as "clearly an entrepreneurial venture which has substantial technical risk. . . ."

Branscomb said ACS also "moves far down the path toward the offering of data processing services by a monopoly carrier." But he's just as sure that the broad-based service will cost the Bell System "a very substantial amount of money to

develop.”

“The fact that it (ACS) is to be built on (AT&T’s) Dataphone Digital Service (DDS) indicates,” he contended, “that there is a clear boundary between what could be regulated and could be left unregulated.” His reasoning is as follows: “If all of the add-on facilities in ACS, beyond DDS, were left totally unregulated and provided to the customer in a competitive marketplace, the value-added services provided by ACS could succeed or fail against other service alternatives.”

The cost of ACS’s transmission facility, he pointed out, would then be the standard DDS customer charges. Therefore, he reasoned, “anyone, carrier or not, should be able to offer ACS-like service built on the resale of DDS facilities.”

Citing the unregulated resale of communications service as a “crucial policy issue,” Branscomb said he hopes the new Communications Act will explicitly assure that the vacillating Federal Communications Commission has authority to deregulate this area. And underlying this

**“Anyone, carrier or not, should be able to offer ACS-like service built on the resale of DDS facilities.”**

deregulation drive is the need, he emphasized, for policymakers “to assure for the nation transparent data services.”

Such services, he maintained, should allow new and varied applications on an unregulated basis. They should also, he claimed, be a big boon to users by providing them with “a homogeneous set of base functions.” These facilities, he further argued, would also benefit distributed dp system users who have large volumes of high-speed files for program transmission between network nodes.

While telecommunications and computer industry watchers agree on the need for such a transparent data services setup, they question how this goal can be translated into the pending Congressional legislation. Most also have serious doubts whether the new communications measure, as currently drafted, is fundamentally workable.

Some of these concerns were voiced at another Comcon panel session that delved into the impact of the FCC’s second computer inquiry. Consultant Bernard Strassburg, former chief of the FCC’s Common Carrier Bureau, admitted he had “some degree of question” over the bill’s fallout on domestic common carriers. The proposed changes in this area, he said, are “all in the name of decriminalizing competition.”

While such intent may be laudable, Strassburg believes the act’s pro-competitive objectives “could be refined . . . without substituting a whole new set of



IBM’S DR. LEWIS M. BRANSCOMB—ACS is likened to dp offerings by a monopoly carrier.

regulatory standards.” Another former bureau head, Walter Hinchman, agreed with his predecessor.

Like Strassburg, Hinchman “applauds” the bill’s goals, but he added that he too has “serious questions on whether the current bill would further those goals.” Dubious about “one-shot legislative solutions,” Hinchman also worried about the bill’s “apparent abandonment of existing public interest guidelines. . . .”

On the subject of public interest, another Comcon panelist, Toby Julian of AT&T, reiterated his company’s concern over deregulation which he argued was “inappropriate and not in the public interest.” The whole deregulation issue, he protested, has been “misunderstood, especially as it relates to terminal equipment.” Bell’s Dataspeed 40/4 terminal offering, he pointed out, “has not sub-

mitted other terminals to regulation.”

Julian further confirmed AT&T’s “desires to compete fully and fairly” in the telecommunications marketplace. On the “fairly” side, he admitted to the harms from “potential cross-subsidization,” but he also insisted that existing regulatory controls in the area of cost accounting can prevent such potential abuses by the giant company.

As to competing “fully,” Julian cryptically defined what this meant by saying that Bell was committed to providing “the broadest possible range” of data communication services to meet user needs and wants. While conceding there is “some regulatory uncertainty” over exactly what services the company will be allowed to market, he emphatically declared that AT&T would continue to dole out its Dataspeed equipment and gear up for its ACS offering.

Joseph Kittner, a senior partner in the law firm of McKenna, Wilkinson & Kittner, countered Julian’s comments, saying that the AT&T’s rhetoric “begs the question . . . of what is a communications

**AT&T speaker says deregulation is “inappropriate and not in the public interest.”**

service.” AT&T’s description of a communications service, particularly with regard to ACS, covers a very broad area, he claimed. And the company’s real intent, he argued, is an unsuitable grab “into the competitive, unregulated marketplace.”

“The public,” Kittner charged, “doesn’t need carriers to reach into this marketplace under the umbrella of a protected, regulated monopoly.” AT&T, he declared, “obviously wants to get into data processing as a regulated monopoly by calling it data communications. That is the gimmick—the gimmick that gets them into the field.”

—L. F.

## SMALL BUSINESS COMPUTERS

# VERY SMALL COMPUTERS

**Pertec Computer Corp. turns its MITS hobbyist operation into offerings for small business use.**

The arrival of giants Heath Corp. and Tandy Corp. in the hobbyist computer market has sent many smaller competitors scurrying to safer grounds—away from the hobbyist and onto what is called

the very small business computer market. One of these, Pertec Computer Corp., says it’s confident it will be successful in that market after a shaky and somewhat schizophrenic start when it acquired the granddaddy of hobby computer manufacturers, MITS, Inc., a year ago last May.

MITS, an Albuquerque, N.M., firm had gained fame primarily for the Altair computer it sold in kit form to hobbyists in 1975, the year that generally is considered the first year of the hobbyist phenomenon. In 1976, the company recorded sales of \$6 million, mainly by marketing it through the mail and some 250 hobby computer stores. But Pertec, a well known supplier of peripherals to the minicomputer market, stopped shipping



B. ALLEN LAY—Key to success is finding the right dealer.

computers in kit form last June. It said it wanted to concentrate instead on selling the MITS model 300 line of systems for the very small business computer market.

When word got out that Pertec's venture into the hobbyist market was a money loser in what otherwise seemed to be a booming market, rumors began to fly that Pertec, whose total 1978 revenues were \$108.5 million, might be planning either to sell or dump its venture into the personal computer market.

B. Allen Lay, a senior vice president who has been running the small computer systems business for Pertec, says it was his company's plan all along to acquire MITS as an entry to the small business computer market. He said the company intended to use the hobby market to finance the transition.

And last summer Ryal Poppa, the youthful looking 44-year-old former IBM salesman who is Pertec's chairman, president and chief executive officer, allayed the fears of a sellout at a stockholders meeting. He admitted that the company's Microsystems Division (the name of a group handling MITS and a micro-peripheral line called ICOM that Pertec had acquired in 1976) had indeed been losing money. But he said the division would break even between October and December and finally become profitable in Pertec's fourth fiscal year quarter, between January and March 31.

Certainly what Pertec looked for when it acquired MITS and what it got were light years apart. Revenues of \$12 million for the division in FY 1978 (ended last March 31) were 40% below expectations. Lay, who at 43 recently assumed responsibilities for three additional divisions after the resignation of Don M. Muller, Pertec's executive vice president and

chief operating officer, doesn't exactly say he found the MITS operation in Albuquerque in a shambles. But he does admit that because it sold kits it was more of an assembly company than a manufacturing company—"a manufacturing firm in the most rudimentary form."

And Pertec did, indeed, find that many of the dealers it inherited through the MITS acquisition were aiming at the small business market, not the hobbyists. Poppa admitted to stockholders last August that dealers were complaining of late deliveries and inadequate testing of software—in other words, dealers "felt we weren't responsive."

So the company poured resources into applications software packages, and into programs to get dealer support. It also began developing its own new computer—the PCC 2000 (page 195)—which it introduced this month as the first of several products it will offer as an indication of its commitment to the small business market.

Although the company won't say what

### **Pertec's \$12 millions in small computer sales last year were 40% off target.**

it considers to be a profitable level of sales, a close observer of the industry, Steve Cottrell of Creative Strategies International, has been forecasting sales of about \$23 million for the division in FY 1979. (Poppa recently said he thought it would be closer to \$16 million.)

But Cottrell, a senior analyst with the marketing research firm, cautions that the IBM 5110 and offerings from Digital Equipment Corp. are formidable competitors to anything Pertec might have.

At present, Pertec offers the MITS 300 line—a hard disk system in the \$20,000 range and a slightly lower priced floppy disk based system. The new PCC 2000, a floppy based system, is in the \$13,000 range at retail prices.

Some dealers grumble over that price. A Los Angeles dealer, Allen Kopita, of Micronic Computer Systems, says the model 2000 essentially is a replacement for the floppy disk based MITS system and the price difference isn't significant. He says he'd have liked Pertec to come up with a much lower priced system that would provide dealers with a wider offering to the mix of customers they're selling.

Creative Strategies' Cottrell agrees in a way. He thinks the next entrant to the market will be Texas Instruments with a much lower priced system and plenty of marketing clout. "Pertec isn't bringing anything new to the game" with the PCC 2000, says Cottrell.

Besides, Lay says that applications software for the PCC 2000 "aren't directly integratable" with the MITS line, al-



RYAL POPPA—Not all dry cleaners have the same requirements.

though they can be converted. That, Cottrell, offers users the "most risk strewn path they can find."

But this is a strange business. "Getting a good grip on the personal computer business is like trying to get more than a fleeting glimpse of a leopard," says a recent study of the industry by Cottrell's company. Take, for instance, Rebecca Willis who left The Computer Company in Richmond, Va., last year to open the Delphi Computer Center in Englewood, Colo., and became a Pertec dealer.

"We're designing our own packages to run on both the 2000 and the MITS 300 with some software changes," she said, indicating that software oriented dealers aren't all that concerned about having to adapt the six software packages Pertec offers with its PCC 2000 either to previously sold MITS systems or to the specifications of new customers.

Poppa warned dealers recently at a meeting outside of Los Angeles that they take risks in addressing some markets. "If a dealer sells a system to a dry cleaner, he makes a mistake if he believes he can meet the requirement of every dry cleaner in the country. The salesman might think the customer is typical, but that is rarely the case."

He advised dealers to "find an expert in that field already—a CPA or management consultant—and work with him." Cado Systems (August, p. 54), which along with Basic Four, Wang Laboratories, Data General, and IBM generally are considered competitors with Pertec in that market, already has a program for its dealers to work with CPA's, but George Ryan, the Cado chairman, doesn't want to discuss it. "We don't want to give away our secrets to competitors," says Ryan, indicating the uniqueness of competition

## NEWS IN PERSPECTIVE

in this brand new and very young market.

Pertec's Mr. Lay is convinced the key to success in this business is in finding the right kind of dealer. Pertec has lined up about 60 of them and insists they handle the Pertec line exclusively. Typical of this infant industry, most (about 80%, says Lay) are startups, "people who have left IBM, Burroughs, or what have you, and have raised about \$100,000 and have software and systems experience." Kopito in Los Angeles, for instance, was involved in software development and market planning at Scientific Data Systems and at Xerox Corp., which acquired SDS in 1969.

Probably the biggest problem facing companies in this field, says Kopito, are the varied interests of prospects. "They're the most cost conscious of any computer prospects I've encountered," he says. They include small business firms, but also professionals—doctors, dentists, lawyers—and all have heard of "older" systems, such as the IBM System/34 and System/3 and many of the lower priced systems, as well.

"They learned of these systems at hobby shops. Then they read magazines. They don't know about applications software. And they don't understand business dp. But they do understand price, and that puts the pressure on a company

such as ours selling a system in the \$13,000 range against something they've heard of in a hobby shop costing \$6,000."

Creative Strategies, in a report issued last spring, identifies the very small business segment as a market consisting of 1.3 million businesses with annual sales of \$100,000 to \$500,000. It thinks that this group (along with about 200,000 govern-

### Some dealers think the new offering should be priced much lower.

ment establishments and nonprofit organizations that fall into the same size category) will be buying about \$1 billion worth of systems by 1982, compared with just over \$100 million this year. Unit shipments will grow to 143,000 in 1982, compared with about 2,000 systems sold in 1977. And, of course, as prices tumble due to technological innovation, growth will be astronomical. Soon, the report says, it will become increasingly possible to sell a general dp system for around \$5,000 because the software prices will go down also.

And the market research firm thinks that IBM will have an important role in that market, not only with its 5110 (for which it received 6,000 orders two months after announcing the system in January), but with a computer it is devel-

oping that will be priced under \$9,000.

"There are many first-time users who love the prestige of having an IBM computer, whatever the cost," says Cottrell.

Meanwhile, Pertec continues to recruit dealers. It eventually will have about 200. Lay said it will offer the dealers some software support services and provide maintenance through its own service company—PCC Service Div., an organization of 400 customer engineers in 80 locations. Additionally, the company recently completed an arrangement with Control Data's Commercial Credit Services Corp. subsidiary to provide financing. Dealers will be able to finance 100% of their inventory for 30 days or smaller amounts of the inventory for up to a year. Their customers will be able to get financing on equipment they buy for up to five years.

Says Lay, "Up to now when a dealer sold a customer, he had to explain to him all about computers and then had to turn around and do the same thing with the customer's banker. Commercial Credit understands the business and that's one less hurdle for the dealer."

In such a market, says an observer, "it would be difficult not to sell a lot of computers."

—Tom McCusker

## MEETINGS

# WESCON DRAWS BIG

### Attendance surpasses pre-show predictions.

A maxi crowd turned out for what was billed as "The Micro/Encounter."

It was the 1978 Western Electronic Show and Convention (Wescon) last month in Los Angeles. The attendance—42,784—surprised show organizers who had felt optimistic in their pre-event predictions of 35,000. It was a high for Wescon in the '70s, the previous high having been more than 45,000 in the boom year (for electronics) of 1969.

The show ran smoothly enough, with little queuing at the registration desks, except for some traffic congestion around the Los Angeles Convention Center thanks to that unfortunate fact of Southern California Life: Everybody drives everywhere.

One Los Angeles newspaperman didn't. He tried to. He headed his car toward the Convention Center where he had a Wescon interview date. He found the congestion around the parking entrances a little too much. He returned in his car to his office and walked across

town instead.

As the title of the convention promised, microprocessors were a dominating feature both in technical sessions and in the record 912-booths-strong exhibit halls. But there was the usual complement of components, instruments, and production and packaging equipment—the stuff of which Wescon was born back in 1958.

Probably the most attention-getting technical announcement to come out of the 1978 Wescon was that by Rockwell International of production versions of quarter-million-bit bubble memories.

Rockwell introduced three levels of bubble memory products: a basic 256Kbits bubble memory device (RBM256); a one megabit linear bubble memory module (RLM658) and a programmable control module (RCM650), both based on the 256K device; and a one-quarter megabyte development system composed of two linear modules (RLM658) and one control module (RCM650), and a Rockwell System 65 microcomputer development system.

Malcolm B. Northrup, vice president of Rockwell's Microelectronic Devices group, said he expects 1979 to be a "learning period" for applications of bubble memories. He projected "volume use" in the 1980s.

Personal computers were, of course,

hot discussion topics both in the meeting rooms and in the halls. Frank J. Burge, Regis McKenna, Inc., Palo Alto, Calif., chose to compare them to pianos and sewing machines. "The way you sell more pianos is to make it easy to play. And that's why piano lessons are an important ingredient in every successful retail store sales plan. Make it easy to play and you sell more." Pianos are fun, Burge said. "Computers are more fun. The piano challenges the imagination. The com-

### The home computer, like the piano, represents a major family investment.

puter expands it. And both have a feedback system that is a source of enormous pleasure and satisfaction."

Burge pointed out that the home computer, "like the piano, represents a major family investment. And parents will justify the decision on the basis of its contribution to the development of their children. But, unlike the reluctant child piano player, parents soon find their children are spending hours with their computer, writing programs, teaching themselves more and more. And if the piano in the home brought credit to the parents, the home computer is an even bigger status symbol. A symbol of cul-

# Get more than just hardware with your 303X add-on.

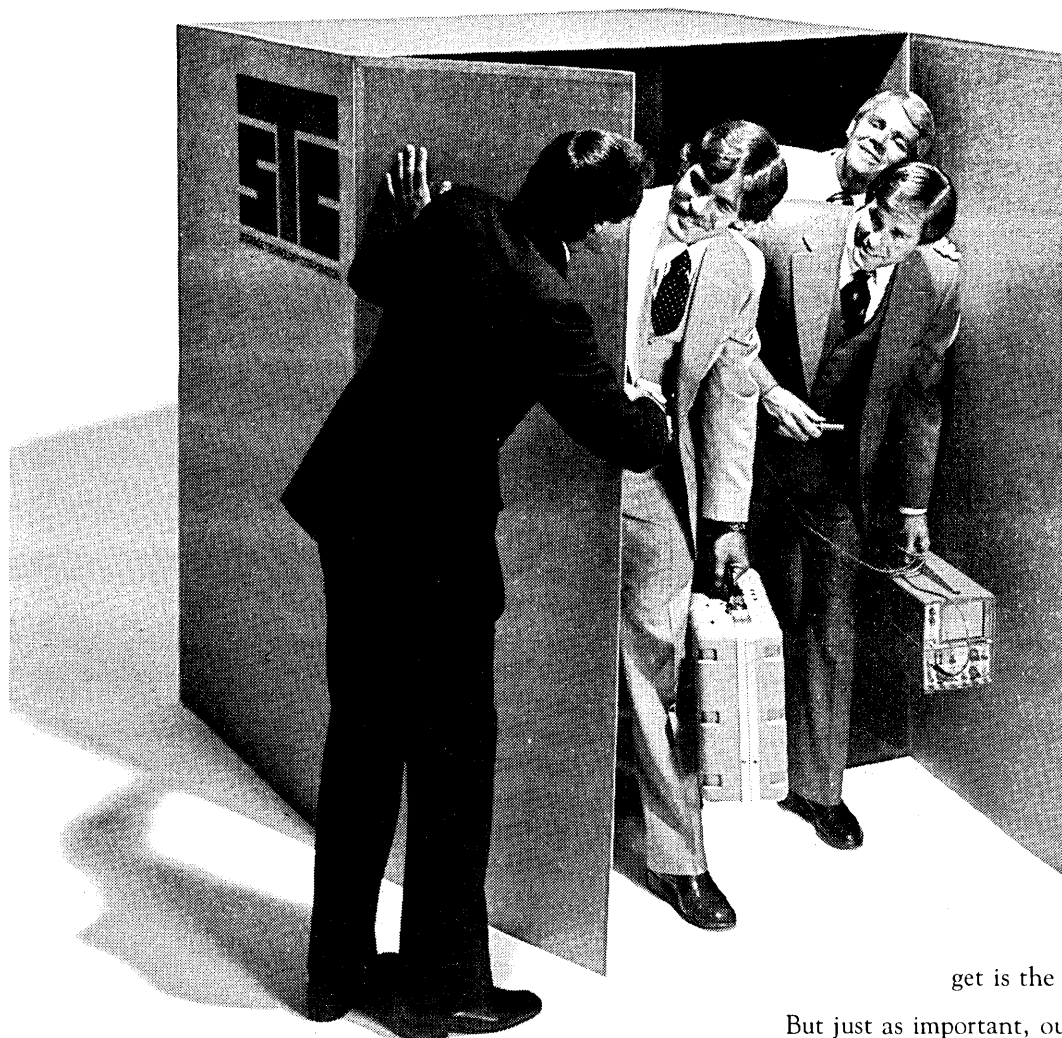

When you get 303X add-on memory from Storage Technology Corporation, the first important bonus you get is the fact that it's available today.

But just as important, our STC field engineers have over 250 Mbytes of large system add-on

memory under their belts. So they have the experience to get you up and running fast.

They're the same people who now service your

STC tape and disk products 24 hours a day, seven days a week. Which means that when you add on our add-on memory, you needn't add on another vendor.

STC add-on memory uses the latest MOS technologies. That means fewer components to reduce failures, cut power consumption, and slash heat dissipation.

Modular design makes for an easy growth path, because all you do to add additional capacity is plug additional cards into our cabinet. And built-in diagnostics and extensive maintenance aids produce the shortest possible MTTR, at the lowest possible cost.

Yet, with all the extra value you get with STC add-on memory, one of the best reasons to choose it is still price. Because ours costs 30% to 50% less than IBM's.

So you can either buy somebody else's 303X add-on. And get a box of hardware. Or you can buy ours. And get much, much more.

For the complete STC add-on memory story, call your local STC sales office. Or contact Don Vermeer (303) 497-6046, 2270 South 88th Street, Louisville, Colorado 80027.

**STORAGE TECHNOLOGY CORPORATION**

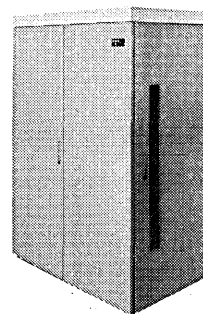



WESCON—The micros were there as predicted but so were components, instruments, and production and packaging equipment—and a lot of people.

tural elevation to the nth power.”

In comparing computers and sewing machines, Burge called sewing a creative activity. “It’s fun. Personal computing is more creative and more fun. Every year, six million students learn sewing in school. Students are just beginning to learn about computers in school. And low cost personal computers are making computers almost as affordable in the classroom as the sewing machine. By 1979, 750,000 students a year will be learning about computers in our primary and secondary schools.”

Charles I. Peddle, Commodore Business Machines, talked about personal computers and kitchen tables. He guessed that 25% of Commodore’s PET computers have found their original application on somebody’s kitchen table but added, “we expect that over 75% of the machines sold will sometime or other be used on somebody’s kitchen table.”

He said most of the computers Commodore has sold have already been put to work. “Many of the customers are buying a PET for their laboratory, education, or for some aspect of their business. The analogy in this progression between personal computers and the scientific cal-

culator should not be lost on anyone. Many of the original scientific calculators were expensive, about the same price as a personal computer, and were purchased by very similar people for the same reasons. It was only after the innovators who could see a way to use the calculators had purchased them and

**“People’s time-share service: a gigantic classified ad to match the buyers to the sellers.”**

showed their purchases to others, either at work or in the home, that the market started to develop to the point that the cost came down which, of course, broadened the market.”

Doug Evered, corporate product marketing manager, Pertec Computer Corp., Los Angeles, talked about a segment of the market for microcomputer systems that he thinks is being sold short, the small business market (see preceding story). “The expectations are that small business systems selling for under \$20,000 will grow from today’s level of \$400 million in sales per year to a mid-1980s plateau of over \$1 billion. I personally feel that the market is being under-

estimated. These forecasts are based on growth that can be projected if nothing changes. We are in an industry where radical changes are a way of life.”

A different kind of computer use from the home was described by Dr. David H. Chung, vice president, Umtech, Inc., a “people’s time-share service.” It must, he said, “be low in cost. It must not charge more than \$5 per hour at its entry phase, and cannot exceed the \$2 per hour limit at its mature stage.” He said the response time should be less than two seconds on the average. He envisions the service as functioning as “a gigantic classified ad to match the buyers to the sellers.”

“If it is possible to develop one low cost microcomputer to satisfy one customer at a remote terminal,” said Dr. Chung, “then the said commonality suggests the employment of a large number of identical microcomputers to handle the high volume inherent in the people’s time-share service. Since these identical microcomputers must share vital resources, especially the data base and the communication equipment, these microcomputers have to be interconnected into a network.”

Richard D. Cuthbert, applications

# For same-day small package delivery to 109 cities- Guaranteed!...

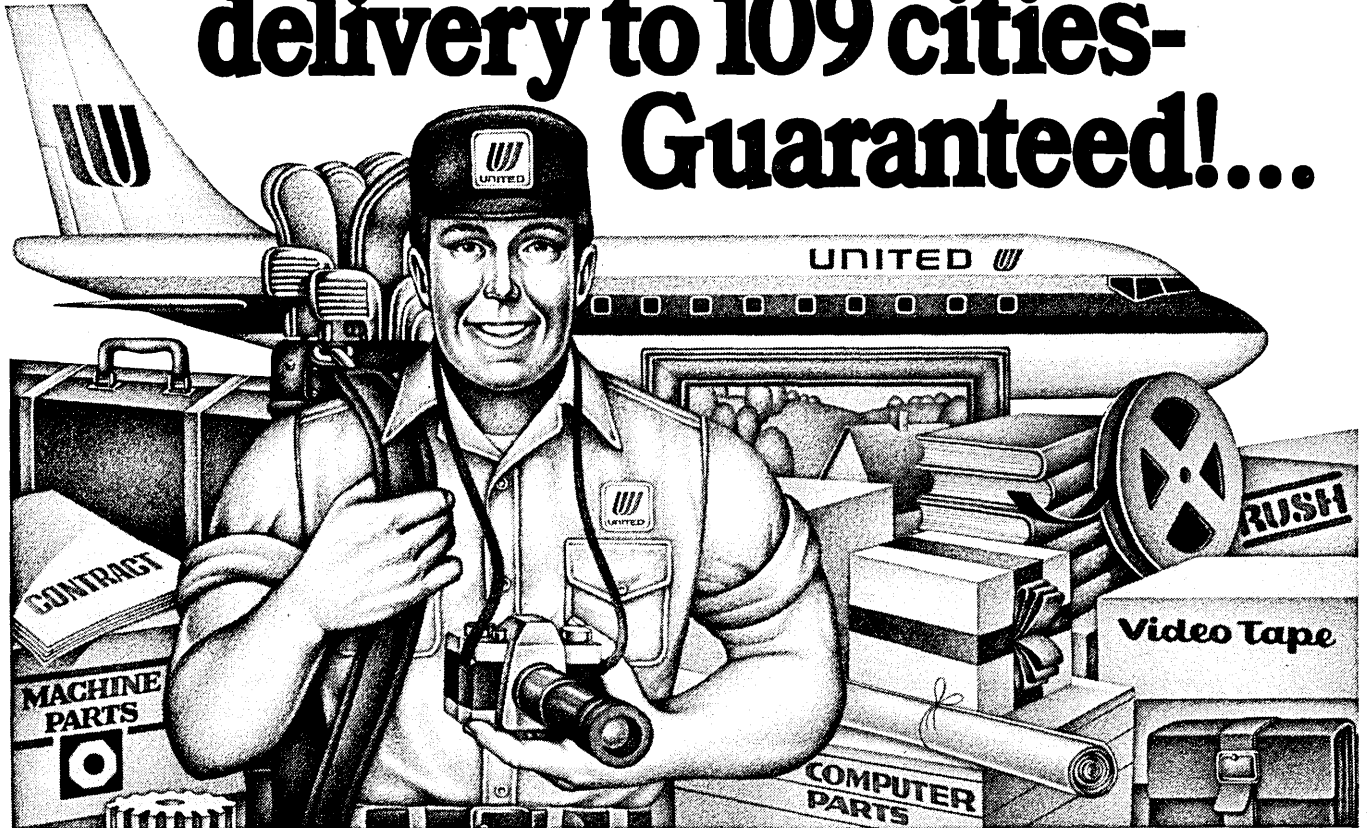

# Think Big.



## It's as easy as 1,2,3.

1. Take your important small package to United's Small Package Dispatch Center in the passenger terminal at least 30 minutes before departure of the flight you choose. Prepay the charges with your American Express®, Universal Air Travel Plan, United Credit Card, or cash.

2. Phone your addressee with the flight number, arrival time and SPD receipt number.

3. Your package is ready for pickup at the destination baggage area within 30 minutes of arrival.

## Here's our guarantee:

We're so confident your package will make it on the flight you choose, we'll refund 50% of your charge if it doesn't.

## Almost anything goes.

Film, legal documents, advertising material, medical supplies—whatever you want, as long as it weighs less than 50 pounds and measures no more than 90 inches in total dimensions (length, plus width, plus height).

## A small price to pay.

SPD between New York and Los Angeles costs only \$38.50. Between Chicago and New York, \$27.50. (Rates effective January 1, 1978, and subject to change.)

## SPD door-to-door, call (800) 638-7340.

Maryland call: 269-6470/Honolulu, Hawaii call: 842-5252/Hilo, Hawaii call: 935-9144  
We guarantee pickup and delivery to 3800 communities any time of the day or night, any day of the year, for a very reasonable price.

**UNITED AIRLINES CARGO**

# Think United.

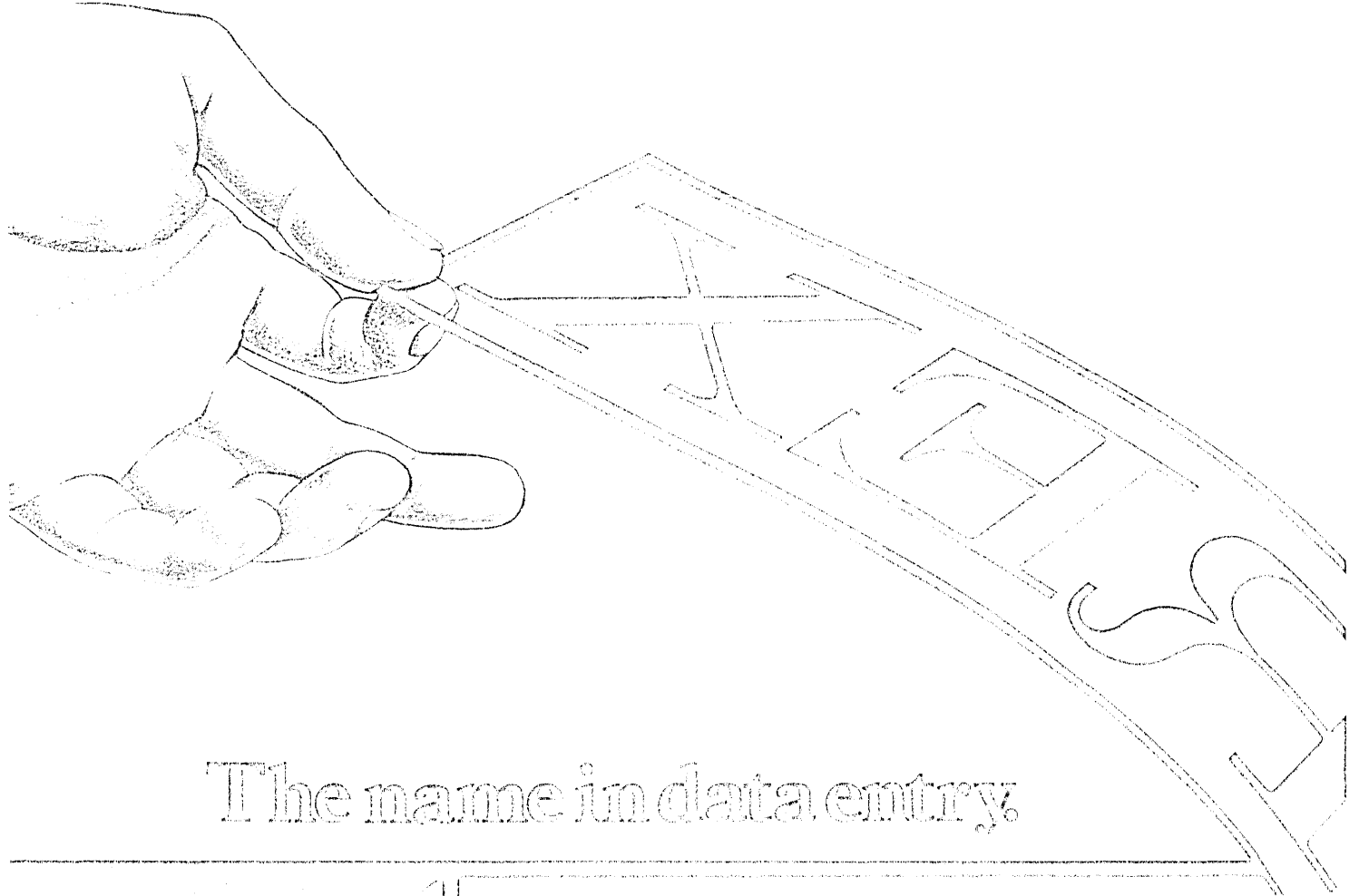

The name in data entry:

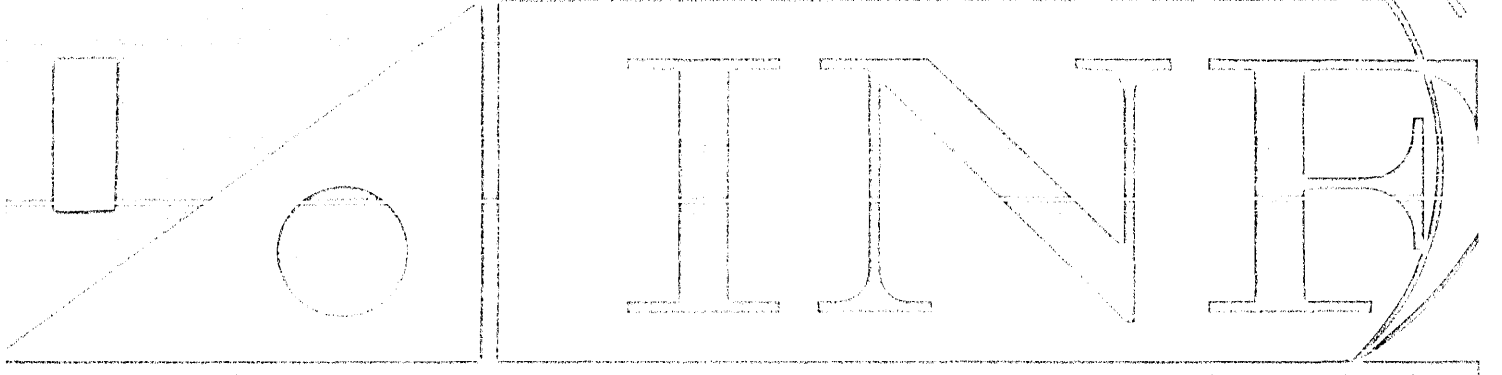





The name in  
intelligent terminal systems.

INFOREX

You've known us for years as the name in data entry. Since 80% of distributed data processing is data entry oriented, Inforex has a strong edge when it comes to designing and supporting an intelligent terminal system.

The Inforex System 7000.

It features interactive COBOL, virtual memory, concurrency, and interactive debugging. Cluster or stand-alone terminals, large local data storage.

A few innovations that

are making us the name in intelligent terminal systems for distributed data processing.

Plus a support team rated number one by DEMA\*.

Look closer, the name is INFOREX.

\*Data Entry Management Association survey available on request.

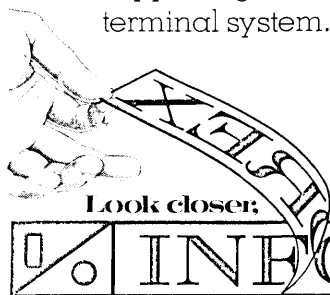

**Look closer:**

*Distributed data processing, data entry, and information management worldwide.*

**INFOREX**

**there is no alternative.**

21 North Ave., Burlington, MA 01803 Dept. B10 (617) 272-6470

CIRCLE 116 ON READER CARD

## NEWS IN PERSPECTIVE

manager, Professional Calculator Div., Texas Instruments, Inc., was concerned with improving the productivity of professionals and his suggested solution was, not surprisingly, the personal programmable calculator. He said a test conducted within TI with the TI-59 Professional Programmable Calculator showed both an increase in the personal productivity of professionals and a reduction of load on time-sharing and other large scale computer facilities.

Dr. John J. Wavrik, Mathematics Dept., Univ. of California at San Diego, feels the personal programmable calculator "may well be the key to bringing

**The analogy between the personal computer and the scientific calculator should not be lost on anyone.**

the computer revolution to students." He sees six types of uses in education: to illustrate and clarify parts of the current mathematics and science curricula; to implement numerical methods for solving problems; to use in simulations introducing concepts; to present concepts or practice in the form of games; to provide computer literacy; and to provide programming training.

Dr. Wavrik believes that use of programmable calculators will mean many students will begin to do much of their learning at home. He said he has been using them with children as young as eight years old although he has had to prepare written material appropriate for them. "PPC's have not been designed with school children in mind. Both the machines and the instruction booklets that come with them are directed at scientists and engineers."

He believes "the main hope for talented students is for them to learn outside the schools. There is a great need for written material to make this possible."

Talented students at the university level were among those honored at Wescon. Winners in the Wescon/78 student electronics marketing awards program were Philip Walden, first prize, a UCLA graduate student in business administration; Johnnie Koon, second, a

He has an awesome responsibility...

# So why is this man smiling?

Regardless of the number and location of entrances; the variation in access levels; or the number of employees. Cardkey has an access control system for you. It can signal alarms for attempted entry by unauthorized persons, or if an air conditioner fails or in the presence of smoke. The level of system sophistication can be as simple or as complex as you need. We can install in high rise offices, manufacturing plants, EDP centers, research areas new buildings or old. The facility is protected—He is protected, That's why he is smiling.

## CARDKEY —of course.



**Cardkey**

ACCESS CONTROL SYSTEMS  
20339 NORDHOFF STREET  
CHATSWORTH, CALIFORNIA 91311  
(213) 882-8111/TELEX: 651-375

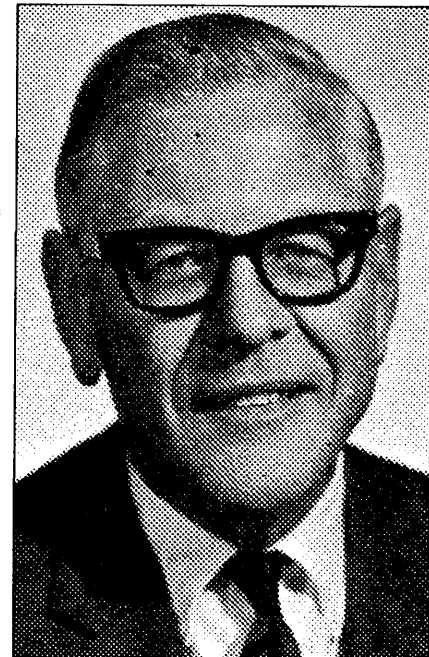
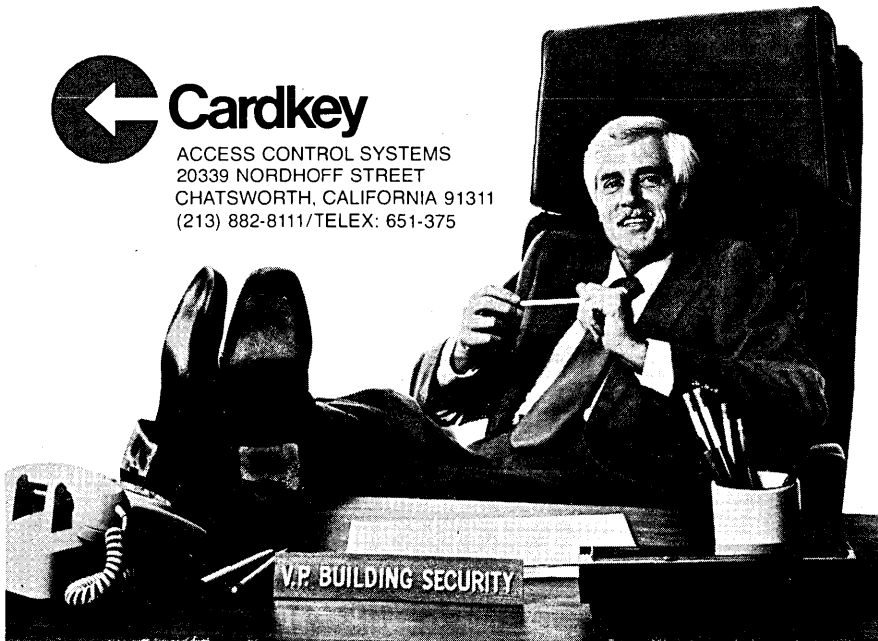

TED SHIELDS—A Wescon winner.

graduate business student at San Diego State; and Brad Wolfe, third, an undergraduate at Cal State Northridge.

Last year, Wescon established the Don Larson award, named for Wescon's former general manager and given to a person voted by the board of directors as having made either a single contribution or many to the event. This year it went to Ted Shields who has been connected with Wescon since its beginnings. He is a former assistant general manager and handled the show's public relations for many years. He served Wescon 1978 as adviser to the Professional Program Committee.

—E.M.

# Pick a number. Any number.



I700

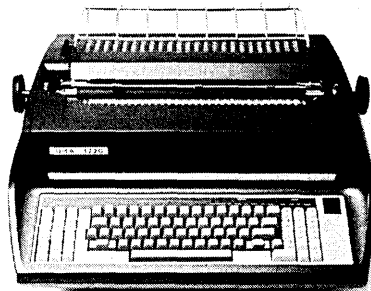

I720



I760

The next time you pick a terminal, you don't have to gamble about which one to choose. Because Xerox has a number of communications terminals that are just right for you.

Like our 1700 and the new 1720. Both pay off with low cost operation, sharp, crisp characters from Diablo's HyType II print mechanism, 45 cps, and a full range of easily-changeable type styles. The 1720 also offers switch selectable ASCII and 2741—compatible codes. And when you consider that both terminals come with other features usually optional or not even available on most terminals, you know that you've placed a good bet.

If you're doing on-line applications, then the Xerox 1760 is your lucky number. The new 1760 has an impact

matrix printer, which gives you both upper and lower case, rapid quality printing, and automatic bi-directional printing. The ASCII Coding lets you connect to almost any hardware and software system around. And if speed is the name of your game, the 1760 prints up to 200 cps.

For more information write Xerox Data Systems Division, Dept. A1-12, 701 S. Aviation Blvd., El Segundo, CA 90245.

With the Xerox 1700, 1720, and 1760 there's no reason to take chances the next time you choose a terminal. Because each one of our numbers is a winner.

## XEROX

# LOOK

*If you're about to invest in a data entry, distributed data processing, or small business computer system, we at Nixdorf think you should step back and take a long, hard look at who you're buying the system from and what it is you are buying. Because what you don't know about vendor policies and your own equipment needs could be costly.*

# BEFORE

*A lot of computer companies will leave you in the lurch after they sell you their hardware. We won't. We've been making computer systems for over a quarter of a century, and we back up everything we sell with total product support. Our systems have a reputation for reliability and superior software that few can match. Still, we keep over half of our 9,000 employees in the field to support and service our more than 60,000 installations in 26 countries around the world. We have over 100 sales and service locations in North America alone.*

# YOU

*Successful data processing installations — like the many Nixdorf systems that are cutting costs and solving problems for customers in manufacturing, wholesale distribution, banking, insurance and communications — begin with a careful analysis of the customer's equipment requirements. We think our "Computer Buyer's Checklist" can help you nail down your "real" equipment needs. Stop shopping for a computer and start looking for a computer company. One that will deliver what you need today, and be there if you need help tomorrow.*

# LEAP.

*Take a closer look at Nixdorf and your hardware requirements before you leap into that next computer buying decision. It's a long way down. To obtain a copy of the "Computer Buyer's Checklist," call toll free 800-225-1484 or write: Nixdorf Computer Corporation, 168 Middlesex Turnpike, Burlington, MA 01803.*

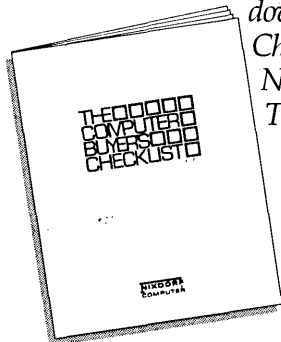

**NIXDORF**<sup>®</sup>  
**COMPUTER**

PEOPLE

# ALL IN THE FAMILY

**TEC took a new name, but control remained in the family.**

In an age and an industry where too many entrepreneurs have started companies from scratch only to have control snatched from their hands when growth set in and the going got good—or bad—it's a rarity to see one who not only has kept control of his firm himself, but has kept it in the family.

Byron Hamilton was a sophomore in high school when his father, Don V. Hamilton, incorporated Transistor Electronics Co. in Minneapolis, as an indicator lights manufacturer. Just last June, the younger Hamilton succeeded his father as president and chief operating officer of the company, now called TEC Inc., headquartered in Tucson, Ariz., 340 employees strong, and doing more than \$13 million a year in business.

"Dad was a manufacturer's rep for electronic components in Minneapolis," Byron Hamilton recalled of the firm's formative days. "Univac in St. Paul



RAY MANLEY

BYRON HAMILTON—"No money in airports."

wanted a large quantity of a special kind of indicator light. Dialight, which dad repped, wouldn't do it so dad hired an engineer who designed the lights to Univac's specs." That was the beginning of a line of indicator lights which now numbers 6,000 stock types and is supple-

mented by custom lights.

"The first indicator lights had transistors in them," said the company's new president, which was the reason for the original name. It was officially changed to TEC, Inc. eight years ago. "Indicator lights were the backbone of the company until our crt line was started in 1965. Deliveries of crt's began in the late '60s and in 1974 they took over from the indicator lights as accounting for the company's largest volume of business." Crt's now account for roughly two-thirds of TEC's business, he said, and the share is increasing steadily year by year.

While still in high school, Byron worked for his dad's firm doing assembly during Christmas vacations and in the accounting department during the summer. He continued working in the accounting department while studying business at the Univ. of Minnesota, which he attended until he was drafted into the Army in 1964. His Army service consisted of playing trumpet for two years in an Army band in Missouri. After discharge, he attended St. Cloud State College in Minnesota for one quarter.

In the meantime, his dad, who had been vacationing in Arizona for some 15 years, decided he liked the southwest state well enough to live there. In 1966,

IMMEDIATE  
DELIVERY!!!



MINI PACKAGE **CATALOG**

- ▶ NOT A DIRECTORY ...
- ▶ A single source for more than 200 mini-packages in inventory.
- ▶ Most can be shipped to you in 20 to 48 hours.
- ▶ Descriptive Narratives ... Low prices (none higher than \$970) ...
- ▶ End User, Turnkey Supplier, Software Consultants ... A universal volume that will help you cut costs and increase profitability.
- ▶ DISTRIBUTOR INQUIRIES INVITED

**ENCLOSED IS MY CHECK FOR \$29.95**

(check must accompany order)  
plus \$5 for postage and handling to:

RSI Inc. 140 Sylvan Ave.  
Englewood Cliffs, N.J. 07632  
201-947-6104

Name \_\_\_\_\_ Title \_\_\_\_\_  
Company \_\_\_\_\_  
Address \_\_\_\_\_ City \_\_\_\_\_  
State \_\_\_\_\_ Zip \_\_\_\_\_ Phone \_\_\_\_\_

CIRCLE 128 ON READER CARD

**America's largest selection of COMPUTER SUPPLIES and ACCESSORIES from**

**VISIBLE** PLANNING FOR TOMORROW'S COMPUTERS TODAY!

100 pages with 2,527 products including binders and binder storage...systems and programming aids...magnetic tapes, disk packs, flexible disks...CRT terminal stations...microfiche retention and retrieval systems PLUS much, much more. All at prices that save you money! Just mail the coupon today or call toll-free at 800/323-0628. (In Illinois call 312/377-0990.)

Send for **FREE** catalog!

Visible Computer Supply Corporation D10  
 TWO LOCATIONS TO BETTER SERVE YOU:  
 Division Headquarters West Coast  
 3628 Stern Drive 1615 S. Stockton St., P.O. Box 1  
 St. Charles, IL 60174 Lodi, CA 95240

Name \_\_\_\_\_  
 Firm Name \_\_\_\_\_  
 Address \_\_\_\_\_  
 City \_\_\_\_\_ State \_\_\_\_\_ Zip \_\_\_\_\_

CIRCLE 137 ON READER CARD

## NEWS IN PERSPECTIVE

Don Hamilton and his wife packed up and moved. Hamilton opened a research and development laboratory for his company's crt operations in a posh facility he had built in the hills outside of Tucson, which still is a Tucson landmark although TEC doesn't own it anymore.

After his quarter at St. Cloud, Byron was persuaded by his father to move to Tucson and attend the Univ. of Arizona. He attended one semester then left to join a component rep firm TEC had started in Tucson. There he caught the flying bug. He became a Cessna dealer, acquired a Cessna 421 Golden Eagle,

**"On the whole the growth has been fairly steady but, in the past two years, the rate has been higher."**

bought an airport, and opened a flight school. He soon learned, he said, "there's no money in airports." He sold most of his operation in 1973 and donated the airport to Pima County. He joined TEC full time in 1972 as general manager of the systems division. He became a senior vice president in 1973, and secretary in 1977.

Byron is not the only one of Don

Hamilton's sons working at TEC. For awhile all three were there, but Bruce Hamilton left his position as executive vice president of marketing and engineering earlier this year to go into real estate. The youngest of three, Barry, is in the company's manufacturing operation.

Byron Hamilton said the company has lost money in only two of its 20 years. "On the whole, the growth has been fairly steady, but in the past two years the rate has been higher."

The firm operated from both Tucson and Minneapolis from 1966 until July of 1975 when, its youthful president said, "the doors were locked in Minneapolis." The manufacture of crt's was moved to Tucson in 1971 to bring it closer to the R&D operation. The indicator light operation was moved in '75.

TEC in the past year set up its own direct sales force to handle its peripheral products including crt's, floppy disk memory systems, and an electrostatic printer. Indicator lights are still handled by components reps.

—Edith Myers

*This advertisement is not an offer to sell or a solicitation of an offer to buy these securities. The offering is made only by the Prospectus.*

New Issue



300,000 Shares  
**Cullinane Corporation**  
 Common Stock  
 (\$.10 Par Value)

Price \$20 Per Share

Copies of the Prospectus may be obtained from any of the several Underwriters only in states in which such Underwriters are qualified to act as dealers in securities and in which the Prospectus may be legally distributed.

**Hambrecht & Quist**

<b>The First Boston Corporation</b>	<b>Donaldson, Lufkin &amp; Jenrette</b> <small>Securities Corporation</small>
<b>Drexel Burnham Lambert</b> <small>Incorporated</small>	<b>Goldman, Sachs &amp; Co.</b>
<b>Lehman Brothers Kuhn Loeb</b> <small>Incorporated</small>	<b>Kidder, Peabody &amp; Co.</b> <small>Incorporated</small>
<b>Smith Barney, Harris Upham &amp; Co.</b> <small>Incorporated</small>	<b>Paine, Webber, Jackson &amp; Curtis</b> <small>Incorporated</small>
<b>Allen &amp; Company</b> <small>Incorporated</small>	<b>L. F. Rothschild, Unterberg, Towbin</b>
<b>Oppenheimer &amp; Co., Inc.</b>	<b>New Court Securities Corporation</b>
	<b>Prescott, Ball &amp; Turben</b>

**Thomson McKinnon Securities Inc.**

August 2, 1978

## COMPANIES

# MEDICAID'S HIS GAME

**The Computer Company was a successful subcontractor in three major claims processing contracts.**

What's in a name? A lot if your firm is cleverly dubbed The Computer Company. Formed in 1969, the diversified Richmond, Va., company concedes that

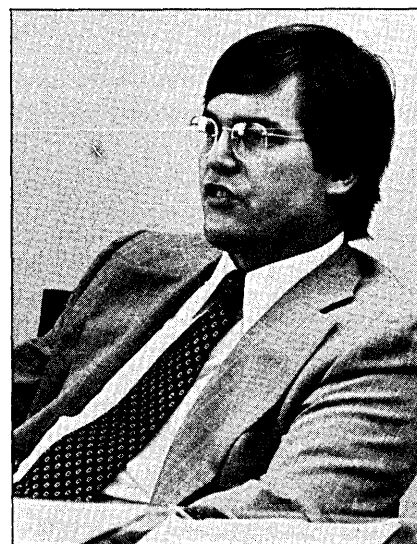

WALTER WITSCHHEY—Medicaid and related social services dp market is now a very competitive market.

# The **FORCE** in distributed data entry systems...

**out-of-this-world  
performance...  
at down-to-earth  
prices!**

*Series 2 is the new standard  
by which all other distributed  
processing systems will be  
measured. Get the performance  
leader — at down-to-earth prices!*

*Consolidated Computer has already installed over 20,000 KEY-EDIT terminals.*

## **Series 2 KEY-EDIT® 2022**

**Replace remote batch and communications terminals with a multi-tasking stand-alone KEY-EDIT system.**

For high-performance communications in a data entry environment, you can't ask too much of the KEY-EDIT 2022. It combines the full capabilities of a high-speed remote batch terminal with a powerful multi-tasking virtual memory key-entry stand-alone processing system. You can do more with a KEY-EDIT 2022 because you get more!

- Communications protocols compatible with major computer manufacturers at speeds up to 9600 bps
- Concentrators to support multiple local or remote 480/1920 character terminals with printers
- Spooling facilities to disk or tape • Sort/merge capability • Catalogued JCL routines • Expandable core storage to 256K bytes • Expandable disk storage to 120M bytes • Wide variety of optional peripherals • Powerful programming language

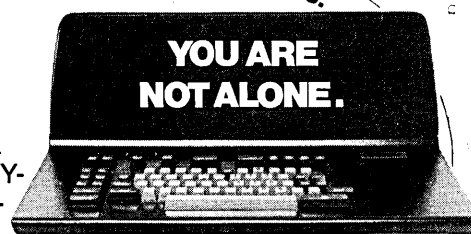

**CONSOLIDATED  
COMPUTER** INTERNATIONAL  
INC.

1604 South Edwards Drive, Tempe, Arizona 85281 (602) 968-7245

## NEWS IN PERSPECTIVE

its memorable moniker carries IBM connotations. "On occasion it creates that initial confusion," admits company president Walter Witschey, "but once that confusion is cleared up, the name is unforgettable."

Particularly unforgettable to three industry companies—Systems Development Corp., Bradford National Corp., and Computer Sciences Corp.—all of which won lucrative Medicaid processing deals with the subcontracting help of The Computer Company.

No newcomer to the social services scene, the small Southern firm broke into the Medicaid market six years ago with a

system tailored for the State of Virginia. And it's this successful system, which borders on being a benchmark, that has been transplanted in various forms to states across the country to power Medicaid programs.

The most recent system spin-off is in California where Computer Sciences captured a hotly contested contract to handle the state's mammoth Medi-Cal claims processing and billing chores. Sharing its system know-how and some of the "wealth" from this coveted \$129 million contract, The Computer Company was CSC's co-bidder on the winning proposal.



JOINT PROPOSAL made to State of California filled 17 binders.

# TEAC MT-2: THE VALUE-PACKED CASSETTE DATA PACK

MORE PERFORMANCE FOR LOWER PRICE

### The case for digital cassette

An all-round winner, digital cassette is easier to handle, lower in cost and smaller than floppy disk. Data transfer rate is approximately 40 times faster than Kansas City Standard audio cassettes. And operating cost is considerably lower than conventional data cartridges.

### Maximum reliability

Small size is no detriment to this unit's reliability and precision. Soft error rate is better than  $1 \times 10^{-9}$  bits. MTBF is 10,000 hours—real durability, and tape-life spans an outstanding 1000 passes or more thanks to superior transport design.

### Easier maintenance

The uncomplicated structure of the MT-2 is another big plus. Two reel motors and a disc encoder are the only moving parts—fewer servicing problems, less spare-parts storage and lower maintenance cost.

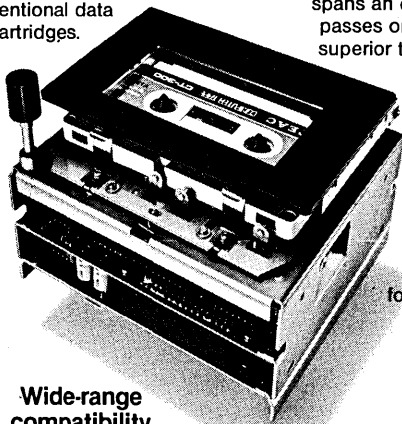

### Wide-range compatibility

The MT-2 is totally compatible with ISO, ANSI, JIS and ECMA phase encoding standards. You can read tapes recorded on other machines complying to these standards, and vice versa.

### Easy microprocessor interface

The MT-2 is available in four versions, two of which incorporate a unique interface controller developed by TEAC especially for this unit. It features a simplified design, and lets you connect the MT-2 to the bus lines of 8080, 6800 and Z-80 or equivalent series microprocessors for greater flexibility and convenience than conventional, high-priced outboard devices.

The low-key company has had a streak of subcontracting successes, culminating in August with the California victory. Its first subcontracting win came in the spring of 1977 when the State of New York awarded Bradford National a contract to design, develop, and implement its Medicaid system. The New York deal was the first such Medicaid contract for novice Bradford which brought on board The Computer Company as its more savvy subcontracting partner. A similar scenario was played out in the fall of 1977

### System's "high velocity" gives health provider his claims money in an average of 13 days.

when SDC pulled the company in as a subcontractor on its successful bid to handle Florida's state Medicaid processing.

Under the agreements, the company's main subcontracting work has been in consulting and systems design to convert and modify the Virginia system to the requirements of the individual state Medicaid programs. Funded chiefly by the Feds and implemented by the states, the Medicaid program provides "cradle to grave" health care to the indigent.

The COBOL-compatible programs that make up the Virginia system are modular, allowing easy switchover to the various states. One of the biggest advantages of the system, which has been running in Virginia for over six years without a hitch, is its proven ability to detect fraud or abuse. Witschey claims the system "will typically deny or reduce charges on about 22% of the claims dollars submitted." And this is done, he explains, through the software "in conjunction with a very large historical data base."

TEAC CORPORATION: 3-7-3, Naka-cho, Musashino, Tokyo, Japan. U.S.A.: Triple I Incorporated, 4605 N. Stiles, P.O. Box 18209, Oklahoma City, OK 73118  
England: International Instruments Ltd., Cross Lances Rd., Hounslow, Middx. W. Germany: nbn Elektronik Starnberg, 813 Starnberg, Max-Emanuel-Str. 8 France: Tekelec Airtronic S.A., Cite des Bruyeres, Rue Carle-Vernet 92 Sevres Holland: SIMAC Electronics,

**TEAC**

Vernstraat 20, Veldhoven Italy: A.E.S.S.E. S.R.L., Corso Lodi, 47 20139 Milano Norway: Rodland & Rellsmo A.S., Gladveien 3A, Oslo 6 Sweden: Scantele ab, Tengdahl Sgatan 24, 11641 Stockholm Denmark: Danbit, Plantagevej 23, 2680 Scolorid Strand Switzerland: Wenger Datentechnik, Bruderholzstrasse 45 4053 Basel Australia: Jacoby, Mitchell Ltd., P.O. Box 70, Kingsgrove, N.S.W. 2208



Once a claim from a Medicaid provider, such as a doctor, is received, the system performs extensive medical, financial, and diagnostic edits which readily pick up on anything questionable. Another plus, according to Witschey, is the system's "high velocity" on turn-around provider payments. That means the provider gets his claims money in an average of 13 days, says Witschey.

In addition to the subcontracting side, The Computer Company has also garnered some more direct Medicaid business from other states. In the summer of 1977, the pharmacy portions of the State of North Carolina's Medicaid program began running off the firm's system. In Delaware, the company began serving this summer as that state's "fiscal intermediary," handling all Medicaid tasks.

Following the Virginia contract, The Computer Company also picked up smaller systems deals in several states. All were in the social services area, but none of these contracts was on the scale of the Virginia venture. The company's second chance to test its Medicaid muscle didn't come until approximately three years after the successful Virginia experience.

In 1975 the company won a large competitive procurement to develop, implement, and operate the State of Arizona's Medicaid system. But unfortunately the state never received any benefits from this system. And that's because right when the system designed by the company was ready to roll the state Supreme Court blocked Medicaid

### **It opened Richmond's first retail computer store, Computers-To-Go Inc.**

funding. "As a result," a chagrined Witschey points out, "Arizona is the only state which has no Medicaid program."

Witschey, who left IBM to form his company, seems to take the Arizona stalemate in stride. He's looking toward the future—the near-distant future when his company will be bidding in various states on other competitive procurements for fiscal intermediary services.

About 50% of The Computer Company's business is concentrated in the Medicaid trade, the processing side being larger than the subcontracting side. The company's fortuitous plunge into the field in the early 1970s was a natural outgrowth, Witschey says of the company's original focus on facilities management.

Founded in 1969, the firm, backed by a handful of Richmond investors, initially provided facilities management and APL time-sharing services. Today, the more diversified company has expanded into still other dp realms.

Currently, 12% of The Computer

Company's revenues come from its Commercial Services Div. which doles out various processing services in narrowly focused areas. In one of these areas, the medical field, the firm supplies administrative service to physicians in group practice.

In support of this service, the company has an Automated Practice Control System (APCS) which it either operates on its own gear or installs in a group practice that already has the necessary hardware. It also sells a turnkey package for the service, using Texas Instruments mini-computers and terminals along with the

APCS software.

The company's division which handles these hardware sales also oversees retail operations which were launched two years ago when The Computer Company opened Richmond's first retail computer store. Called Computers-To-Go Inc., the store peddles Pertec's line of Altair microcomputers.

Another 12% of The Computer Company's revenues stem from its micro-media services which include computer output microfilming, film processing, and archival document filming. Additionally, the company sells COM viewers,

# **Now AJ talks to Vadic. Vadic talks to AJ. At 1200 baud!**

Though Ma doesn't particularly care for acoustic coupling, we know that *you* do.

So we've designed the new AJ 1234 to work with the thousands of Vadic VA34XX modems you and others like you have installed. And our own new AJ 1255 modem.

The AJ 1234 is an originate mode acoustic coupler *and* modem in one—designed to speed up your data communications with 1200 baud full duplex operation.

It can simultaneously send and receive asynchronous or synchronous coded data at switch-selectable speeds up to 1200 baud.

With full duplex transmission, you eliminate line turns and maximize data throughput. And full duplex protocol is far simpler for both computer and terminal. The results are faster communications and cost savings.

The AJ 1234 includes all the major features that have made AJ couplers and modems so popular. Plus Vadic VA34XX and AJ 1255 compatibility.

So don't let Ma stop you from talking to Vadic at 1200 baud full duplex. AJ will come to the rescue. Get in touch with your nearest AJ office. Or write Anderson Jacobson, Inc., 521 Charcot Avenue, San Jose, California 95131, (408) 263-8520. In Canada, Anderson Jacobson Canada Ltd./Ltee. (Available in the U.S. and Canada only.)



## **The AJ 1234.**

**ANDERSON  
JACOBSON**

## NEWS IN PERSPECTIVE

reader/printers, and cameras.

While the firm's Medicaid consulting, systems design, and processing work represent the bulk of its business, the company also pulls in an additional 25% in revenues from its APL time-sharing setup. These remote computing services are mainly aimed at the airline industry and electric power utilities.

The company offers two system products for these markets. One is the AIR-MARKET system which consists of a special data base language along with a series of specifically tailored airline industry data bases. The other system, called ATOMIC, is targeted at the require-

ments of maintaining nuclear power generating reactors.

The company's own processing power comes from two cpu's—an IBM 370/155 and a 370/145. Familiar with "the IBM way," Witschey spent four years working as a systems engineer and marketing rep for the mighty mainframer. But that was after he got a B.A. in physics from Princeton and an M.B.A. from the Univ. of Virginia in operations research.

Commenting on his company's initial 1972 move into Medicaid, Witschey candidly confides that the then-tiny firm was uncertain "whether we would be able to move out nationwide" with its system.

But several years and many contracts and subcontracts later, The Computer Company's Medicaid move has been more than vindicated.

"When the California system becomes operational, then nearly 40% of the Medicaid claims in the country will be running on derivatives of the Virginia system," Witschey proudly points out.

He is also "just delighted" over the California win. And he should be since it represents the company's biggest subcontracting success to date. Playing the businessman and bureaucrat, he declares the California award "represents not only a good piece of business for us and certainly a wonderful contract for Computer Sciences, but also a terrific choice for the government and people of California."

Witschey however is hesitant to comment on his business rival, Texas millionaire H. Ross Perot whose Electronic Data Systems company has, until recently, been the firmly entrenched dp supplier in the health care field. California's recent ousting of EDS proves one thing, Witschey maintains, and that's that the Medicaid and related social services dp market "is now a very competitive market—one in which these kinds of contracts are vigorously fought for."

Over the last nine years The Computer Company has gone from first year start-up revenues of \$70,000 to revenues of \$9.75 million last year. Witschey predicts the company's revenue growth rate this year (ending next March) will "be in excess of 40%." By year-end, he plans to boost his 325 full-time employee workforce by 75.

The company also has new product plans in the works but Witschey is vague on the details, saying only that these product efforts "are related to the four areas of our business." But the company's "major business expansion," he acknowledges, will come from the social services and time-sharing segments.

—Linda Flato

## For people who can't stand failure: Sola's Uninterruptible Power Source.

Some people can't stand failure—for good reason. A power blackout or brownout can mean downtime—even disaster—when it crashes a computer system or brings emergency operations to a standstill.

Sola's UPS supplies uninterrupted AC in the event of a power failure. But when the UPS isn't generating emergency power, it's hard at work in another way—isolating the critical load from line transients and noise. This added function is vital to the accuracy of computers and other sophisticated

electronic instrumentation.

Even under an extreme -20% brownout condition, the Sola UPS continues to provide regulated AC output, while maintaining maximum reserve battery capacity. What's more, harmonic distortion is limited to an impressive 3% maximum.

When you consider uninterruptible power sources, consider one that also provides maximum brownout protection. Call or write today for the Sola UPS brochure.



1717 BUSSE RD., ELK GROVE VILLAGE, ILLINOIS 60007 (312) 439-2800

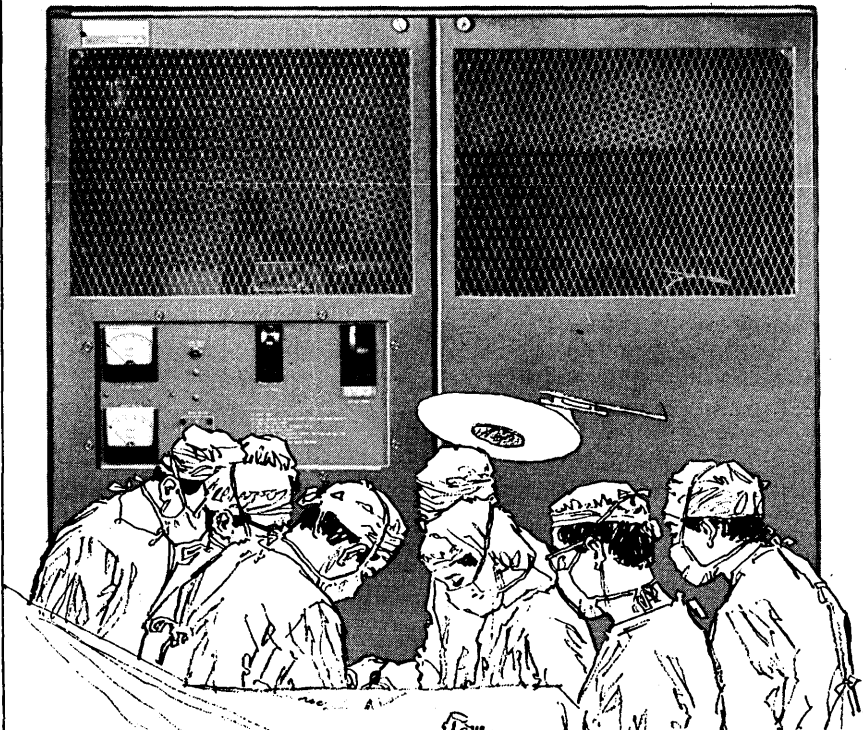

CIRCLE 129 ON READER CARD

## FEDERAL GOVERNMENT

# SHOP TALK FOR FEDS NOV. 7-9

**First Federal Computer Conference  
tackles reorganization, GSA buying  
inefficiencies.**

"It's like a little NCC," say organizers of the first Federal Computer Conference to be held Nov. 7-9 in Washington, D.C.

It's also timely, given the rash of press

reports about sloppy buying practices by the government's procurement agency, the General Services Administration, and the impending final report by a task force of how the government should buy computers and computer services more efficiently. (And it also starts on election day.)

In fact two sessions will address these questions. Walter W. Haase, deputy associate director of information systems policy with the Office of Management and Budget, will report on some key pro-

### Rep. Jack Brooks invited to a forum.

posals arising from the President's Federal Data Processing Reorganization Project. He'll lead a panel discussion Nov. 8 on reorganization proposals in which the speakers will explore their impact on future federal dp operations. One proposal would create a special assistant to the President for information technology—a proposal which some in the OMB believe duplicates what OMB does at present.

The GSA's assistant commissioner for agency services and dp procurement, George W. (Whit) Dodson, Jr., will lead a program discussing the GSA's teleprocessing services program, somewhat tainted in recent months by irregularities in its huge contract to Computer Sciences Corp. Under the contract, issued five years ago, CSC's Infonet Div. captured all of the government agency teleprocessing business, but recently this business was made competitive through the teleprocessing services program. Dodson will lead a panel in which a complete run-down on the program will be given, including an agency case study of vendor selection.

The conference, which has been in the planning stages since mid-1977, is staged by DATAMATION magazine and Federal Education Programs, an organization headed by Dr. William A. Saxton, who is the conference chairman, and Morris Edwards, who is the program chairman. DATAMATION provided consulting services and promotional facilities. Saxton, who formerly staged a data communications conference in Washington, said the idea for a federal computer conference grew out of his data communications conference. "Many government people felt a broader conference should be staged annually, along with an exposition by vendors selling in that \$7.5 billion market."

So, Saxton says, "we've come up with what we feel is a little NCC (National Computer Conference, a broad interest conference and exposition which last summer drew 57,000 persons to the Anaheim Convention Center).

Saxton says he has no idea of what this year's turnout will be, although he'll have

a better guess later this month as the advance registrations start to come in. But Saxton is confident that the conference will be a success.

"The federal dp community wanted one—had even thought of staging their own—and finally turned to private enterprise to do it," he said. Whatever the turnout this year, Saxton already has planned a second conference in 1979, to be held at the Sheraton-Park Hotel (site of this year's conference) in Washington Nov. 6-8.

Theme of this year's conference, "Targeting for Improved ADP Performance," is especially significant in view of much

discussion within the federal dp community about getting more efficiency out of computer purchases. Saxton said he had no trouble lining up as advisers to the conference top dp people from 20 government agencies as well as an industry liaison committee consisting of four trade organizations and six computer related publications.

Two luncheons, one a government related event, the other an industry oriented affair, will feature speakers from each group. Richard M. Harden, special assistant to the President for information management, will discuss the use of computers and information resources in the

## INTERACTIVE REPORTS:

SYSTEMS CORPORATION

### There's a UNIX Workbench on the VAX

By the time you read this, the first VAX Workbench will be installed and running. The programmers will be busily coding away in their specially designed environment and the secretaries will be meeting their powerful new helper. Words will flow—text, code, documentation, reports, correspondence—among users, perhaps between machines, sometimes even to remote sites and often to phototypesetters, inkjet printers, typewriters, CRT terminals. Maybe even to a voice synthesizer.

You may think this sounds like a pretty diverse set of uses for a single system, especially a mini-based system. But the VAX Workbench is just the latest in an exciting series of super-achieving systems that began with UNIX\*, an excellent, general purpose, humanized timesharing system.

These UNIX-based systems, initially developed for PDP-11 minis, have turned out to be addictive. One system grew from a single PDP-11 with a user community of 16 to a network of seven such minis serving 1100 users. In only four years. The site? Bell Laboratories. The system? Programmer's Workbench.

The Programmer's Workbench was to provide a stable computing environment dedicated to large software development projects whose end products might run on large target mainframes such as the IBM 370/168 or the Burroughs 7700. It was to separate the development from the execution environment because large mainframes tend to maximize the speed and efficiency of the machine rather than that of the user.

A Workbench provides a single system, possibly multi-CPU, with a uniform set of tools for software development. There are tools to help software designers specify the dependency graph of their modules, allowing the system to positively prevent the inadvertent compilation of a module without the recompilation of all dependent modules. The command language allows powerful modules to be built quickly for automating procedures that turn routine

\*UNIX is a Trademark of Bell Laboratories

housekeeping over to the machine—a great timesaver. Remote Job Entry facilities use such capabilities to greatly reduce the effort required to interact with target machines.

Other tools automate many of the control functions of project management. The Source Code Control System (SCCS) provides the functional equivalent of a program librarian constantly available to control and document changes to software. Outstanding text editing tools combine with SCCS on the Workbench to foster the integration of development and documentation.

We've been licensing and supporting INTERACTIVE System/One (IS/1), our enhanced revision of the UNIX Timesharing System, for a year now. More recently we completed our supported IS/1 Workbench, fully compatible with IS/1. And now we're working on a protocol for private packet switched networks.

We have a full range of products to complement our systems. A two-dimensional screen-oriented text editor for CRT's. No more typed commands with INed, just easily remembered function keys. Split screens, multiple files, cut and paste—a real text processor. Plus INTERACTIVE text editing machines, terminals that reduce the load this hard working, responsive editor puts on your CPU. And an electronic message system (INmail) and superior formatting (IN-roff) for use with final copy output devices, even real world phototypesetters.

Our newest product puts IS/1 Workbench tools on DEC's fast, new 32-bit mini. This means that our VAX customers can enjoy Workbench advantages on the world's fastest mini with full access to VMS software such as COBOL and BASIC-Plus-2.

We offer software licenses with a range of support options, as well as DEC hardware. With full system integration. Call us.

INTERACTIVE Systems Corporation  
1526 Cloverfield Boulevard  
Santa Monica, CA 90404, 213-829-7741

1050 17th Street, NW  
Washington, D.C. 20036, 202-659-3920

## NEWS IN PERSPECTIVE

government at a luncheon Nov. 8. The industry luncheon keynoter the next day, Nov. 9, is Dr. Gene M. Amdahl, chairman of Amdahl Computer Corp. and a former chairman of the Computer and Communications Industry Assn., an organization representing 57 U.S. computer firms.

First day of the three-day event will be devoted to professional enhancement seminars covering subjects such as systems analysis and design, data base concepts and systems, privacy and security, computer performance evaluation, data communications, federal dp procure-

ment, programmer productivity, and the automated office. These seminars, the organizers reported, are tutorial in nature covering topics fundamental to dp activity and subjects of special concern to the federal computer community (see box).

Sessions on Nov. 8-9 will consist of presentations covering issues and answers, management and product workshops, technology questions, and a federal services showcase. The federal services showcase will include the presentation on GSA administered services as well and reports on in-house consulting

and software services and education and training programs within the federal dp community.

For example, the product workshops will cover such topical subjects as word processing systems, data base management systems, mini and micro terminals, and mass storage devices and peripherals.

An exposition, to be held Nov. 8-9, has attracted 110 companies, including all but one mainframe manufacturer (Control Data Corp.), a half dozen minicomputer manufacturers, three suppliers of microfilm equipment, and numerous service and software companies who sell in the \$7.5 billion federal dp market. (A study done privately for the conference sponsors indicated that the Feds paid that amount for dp products and services in FY '78, not counting another several \$billions of dp products embedded in classified military systems. The study estimated that this would soar to \$15 billion in 1985.)

One software exhibitor, c-s Computer Systems, Inc., of New York, has rented a meeting room at the Sheraton-Park to hold a "forum" Nov. 8 at which it's invited Rep. Jack Brooks (D-Tex.) to take part in an issues and answers airing of his recent criticism of the House Appropriations Committee report on procurement.

# BROOMALL'S SCAN-GRAPHICS™ SYSTEMS

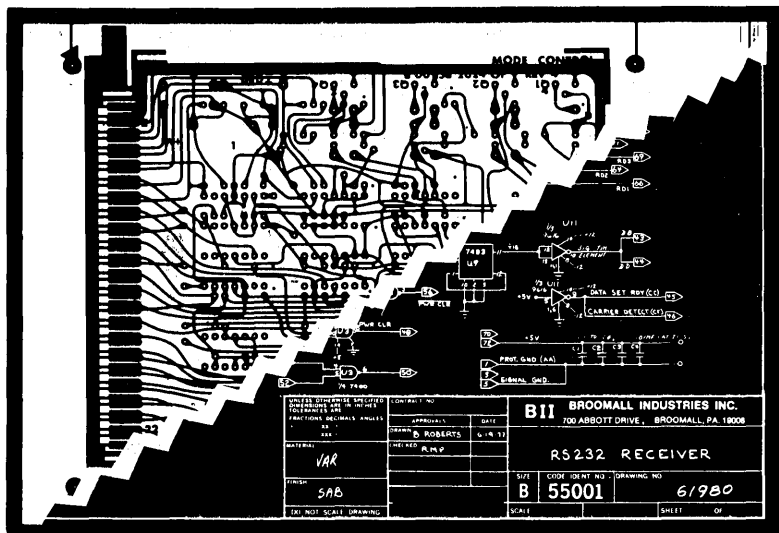

The world's first completely automatic digitizing systems ... the most advanced range of interactive computer graphics systems ever developed for creating a digital data base from graphic hard copy. Broomall's new Scan-Graphics Systems with RAVE™, Raster to Vector software programs can scan, process, store, display and modify original documents (maps, engineering drawings and illustrations) in a fraction of the time required by manual equipment. The result is a more accurate and economical data base than ever before possible. Systems are available for handling a variety of input media such as originals, reproductions, microfilm, fiche.

Call or write today for complete information.



**Broomall Industries, Inc.**  
700 Abbott Drive  
Broomall, Pa. 19008  
Telephone: (215) 328-1040

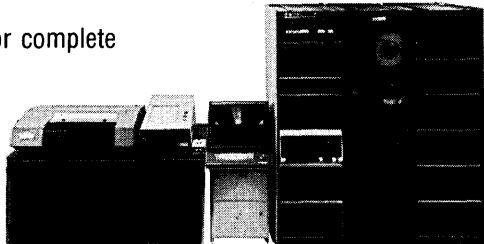

### Theme: Targeting for improved dp performance.

The committee came down heavily in its "staff investigative report" on procurement inefficiencies related to acquisition based on lowest prices.

The company which specializes in language and systems conversion software and has developed a product called c-s Tran to convert IBM model 1401 object decks to third generation COBOL, said it also will invite representatives from the federal user community and from the appropriations committee staff to the conference to be held on the evening of Nov. 8. In late September it still hadn't received replies to its invitations, but a spokesman said, "Whoever shows or doesn't, it's bound to add some fuel to one of the latest federal fires."

A variety of registration fee arrangements are offered: \$125 for the professional enhancement seminar only and \$235 for the professional enhancement seminar and two days at the conference; \$75 for one day at the conference and \$135 for two; and \$190 for the professional enhancement seminar and one day at the conference. Slightly higher rates are charged to nonfederal government registrants.

Further information on registration and program content is available by calling 800-225-5926 (in Massachusetts the number is 617-358-5181, collect). \*

# Tab's Mini-Handlers make Man-Handlers obsolete.



## **Tab's New Mini-Burster and Two-Part Decollator Consolidate Big Forms Handling Features into Two, Versatile, Table-Top Components.**

Now any small or medium size business can afford big forms handling speed and efficiency with the addition of Tab's 2444 Mini-Burster and 2422 Two-Part Decollator. Tab's Mini-Handlers take the mess and time consuming labor out of forms handling and provide you with ready-to-use data, fast!

## **TAB's New Model 2444 Mini-Burster Delivers Performance for Under \$1000!**

The Mini-Burster is innovatively designed for simplicity, versatility, and performance, when handling single light-weight forms, multi-part forms, card stock, mailers, or checks of any size. The 2444 features a slide safety cover with interlock switch, variable speeds of up to 200 feet/minute, and a jam detector that stops burster activity should forms not stack properly.

## **Your Forms Processing Will Be Easy as Duck Soup with the Addition of Tab's 2422 Two-Part Decollator.**

When you combine Tab's 2422 Table-Top Decollator with the versatility of the 2444 Mini-Burster, you have all the necessary components for swift, efficient printout handling and processing. The 2422 can decollate stacks of forms up to 8" high at speeds up to 450 feet per minute. For complete information, contact your local Tab representative or write Tab Products Company, 2690 Hanover Street, Palo Alto, California 94303.



**TAB**  
PRODUCTS CO

# BUG!

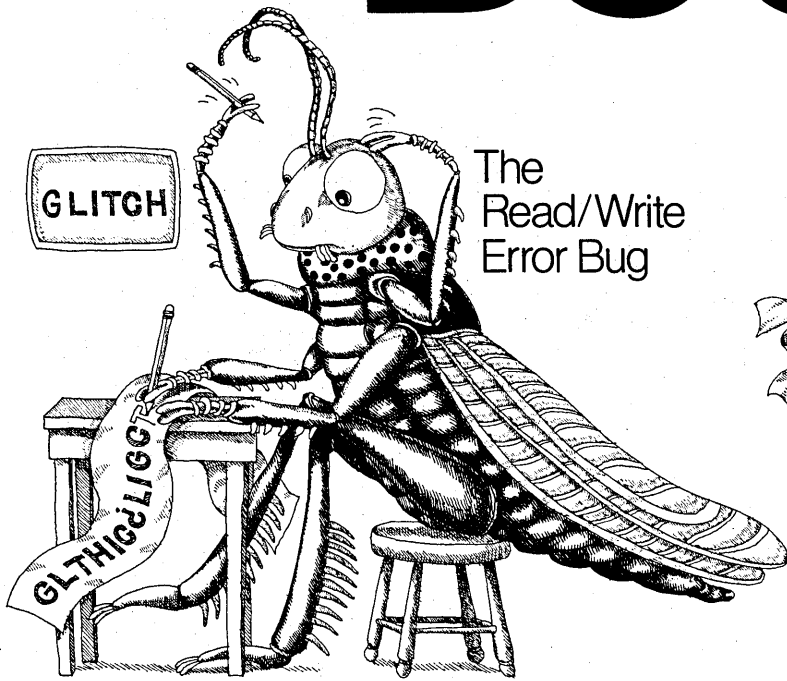

The  
Read/Write  
Error Bug

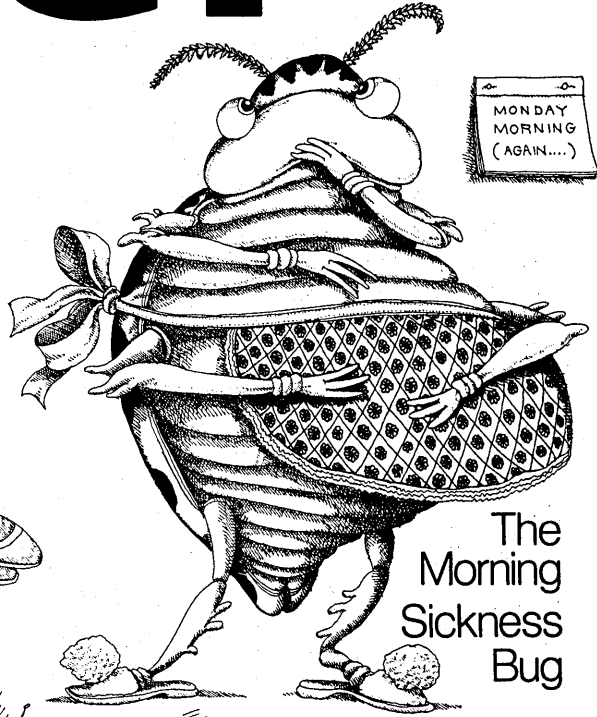

The  
Morning  
Sickness  
Bug

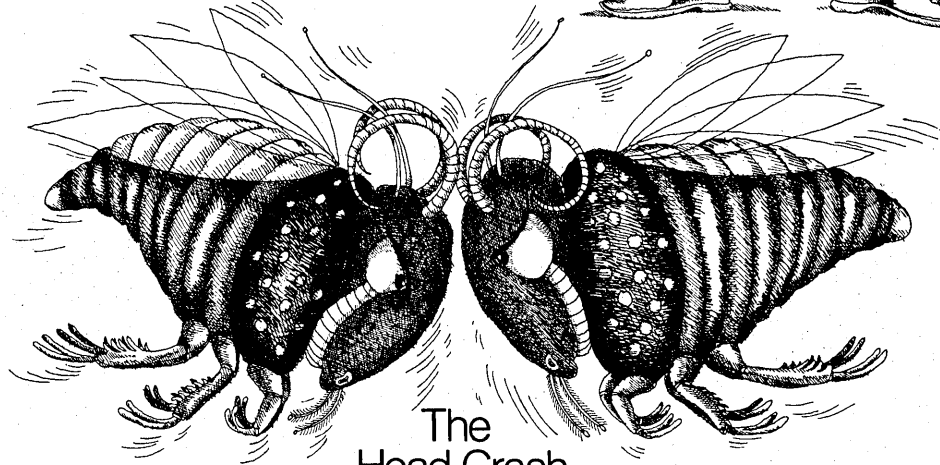

The  
Head Crash  
Bug

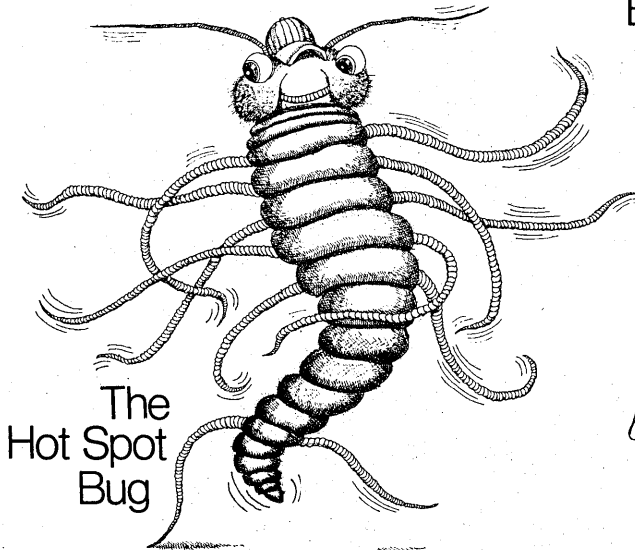

The  
Hot Spot  
Bug

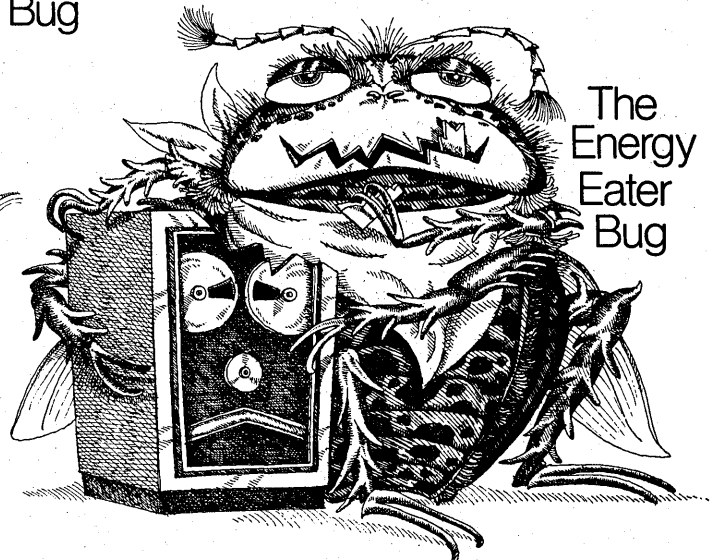

The  
Energy  
Eater  
Bug

# CONTROL!

**EDPAC Process Cooling Systems have a proven record of eliminating computer "bugs" by maintaining exact control of the environment. Now, two additional computer room problems have been solved — energy costs and system monitoring reliability.**

The EDPAC "ECX" System attacks the Energy Eater Bug by reducing cooling system energy requirements. Compressor operation is reduced and cooling energy costs drop by as much as \$10,000 annually in a typical 5,000 sq. ft. room.

The EDPAC "ECX" System is available for new or retrofit application, and payback will be about two years in most computer rooms.

**And, as added protection against any malfunction in the environment control:**

The EDPAC Dyna-Monitor, an advanced, microprocessor, plug-in, module device that offers, for the first time, an absolutely reliable monitor of the room environment and the cooling system.

It provides a 14 point readout of potential environment problems, and a 7 point display of the cooling

system functions. The microprocessor uses logic, memory, and electronic switching to achieve system reliability that far exceeds components that are wired into the control system.

An audible alarm calls instant attention to any problem. The visual LED system identifies the malfunction and stays on until reset by service personnel, even if the problem has rectified itself. This allows technicians to identify problems that may not be present when they visit the site.

EDPAC Process Cooling Systems are engineered to protect your computer room investment by eliminating operating "bugs" and computer downtime. Contact your local EDPAC Representative now, or: Send for FREE BOOKLET — HOW TO GET THE BUGS OUT.



Please rush me your money saving booklet.

Please have an EDPAC Representative call and bring me an Energy Eater Bug T-Shirt.



Name \_\_\_\_\_

Title \_\_\_\_\_

Company \_\_\_\_\_

Address \_\_\_\_\_ Zip \_\_\_\_\_

Phone \_\_\_\_\_

Mail to: AC Manufacturing Company, Cherry Hill, NJ 08034

D108

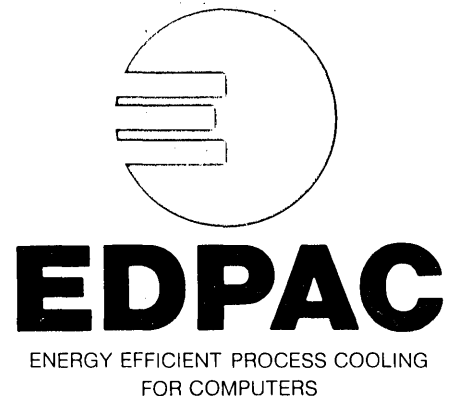

EDPAC is a product of AC Manufacturing Company

Small business computers that can't handle a lot of functions simultaneously or can't expand inexpensively just aren't suited to small businesses. So when we designed our system we slyly solved the flexibility problem.

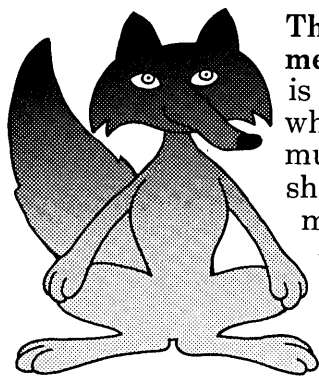

Jacq™ is our mascot and we claim all rights to him.

There's more to us than meets the eye. Our secret is Multi-Tracking.™ It's what allows us to track multiple operators sharing any program in memory. Technically, our systems software automatically generates re-entrant code. Automatically is our "secret sauce." It means you can

add word processing or accounting or order entry to the tasks you're already programmed for, and multiple users can share them without having to write re-entrant code for the new task. And in overload situations any work station can handle any task at any time.

**Multi-Tracking is the right track for word processing too.** In a clustered terminal situation or when adding stations to the Jacquard System you don't have to duplicate expensive equipment.

So for the price of eight simple automatic typewriters you can have a word processing system with eight stations and two printers that can be used for formatting all business documents. You can even sort address lists by 20 criteria for direct mail programs.

The more you grow the better we look. If you can't afford "putting on the dog" check these system costs.

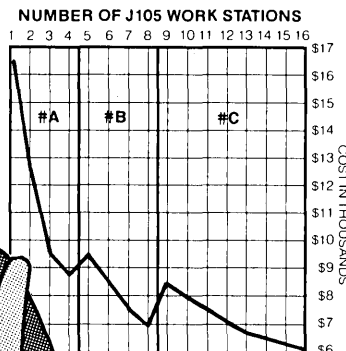

A. Word processing system with one printer. B. Expanded storage and second printer. C. 24 MB of Disc storage. A third high-speed printer for rough drafts.

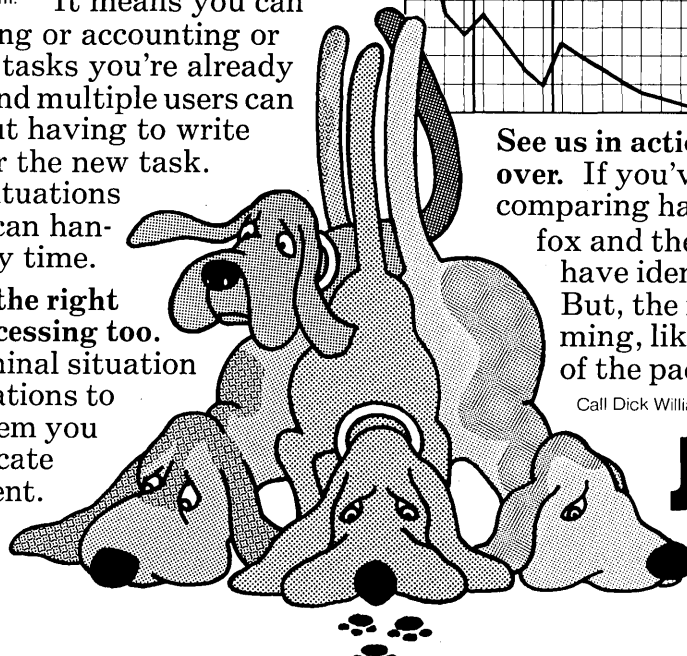

See us in action and your hunt will be over. If you've been hot on the trail comparing hardware, remember, the fox and the hound, like computers, have identical inventory of parts. But, the fox's superior programming, like ours, keeps him ahead of the pack.

Call Dick Williams, 1639 Eleventh Street, Santa Monica, California 90404 Phone (213) 393-9784 TWX (910) 343-6967

**Jacquard Systems**

Interested Distributors Please Write

# To Keep Ahead Of The Pack You Need A Computer That Will Process Words & Data Simultaneously.

IWP Booths 611, 613 or SAID Booths 842, 844. NCC Booth 2115.



## BENCHMARKS

**FLOK INTERPRETED:** The U.S. Supreme Court's June rejection of a bid by Dale R. Flook, an employee of Atlantic Richfield Co., for a patent for his computer program for readjusting the warning alarms used in hydrocarbon processing systems has been interpreted by Martin A. Goetz, chairman of the Assn. of Data Processing Service Organization's (ADAPSO) Software Protection Committee. "The Supreme Court did not rule against the software industry nor for the hardware industry," said Goetz, a senior vice president of Applied Data Research, Inc. "It ruled against the patenting of formulas, principles, or laws of nature." Goetz's position paper, "The Flook Patent Opinion Signals That Inventive Software Processes Are Patentable Subject Matter," says that if there is an inventive use of a process, even if that process is a formula, principle, or law of nature, the entire process can be viewed as patentable subject matter under U.S. Code 101.

**CDC DROPS TERMINAL:** Control Data Corp. canceled plans to market the C-760, an intelligent terminal it introduced last June at the National Computer Conference. This despite the fact that the company had oem agreements with a number of systems houses to supply the terminal under the name Pegasus. The company said it shipped a small number of evaluation units to field offices and systems houses but not to end users. "Based on our study and analysis of test market results, the product was deemed not to meet market needs," said a spokesman. Prices for the C-760 were to range from \$8,700 to about \$13,000.

**UNIVAC OUT OF POS:** Sperry Univac is the latest dropout in the supermarket point-of-sale business. The company said it took the action because growth of scanning had not met earlier predictions. Over a five year period, Univac installed a total of 70 checkout units of which 12 have used a laser scanner for automatic reading the Universal Product Code (UPC) symbol. Left in the competition are IBM, NCR, National Semiconductor, and Sweda, a division of Litton Industries.

**TOWARD MVS, VM/370:** Members of Guide, the IBM business users group, are moving toward MVS and VM 370 operating systems and away from SVS, DOS/VS and non-VS operating systems. A Guide membership survey indicated that use of MVS will grow from 330 users at the beginning of this year to some 607 by the end of 1979. VM/370, offered both as a migration tool for operating system conversions and for production environments, is expected to grow in use from an



**UPS AND DOWNS**—Ken Payne, a wide receiver for the Philadelphia Eagles, scores against the Houston Oilers in a preseason game. Payne's and other key Eagles players' biorhythms are being calculated regularly by a Sperry Univac 90/70 computer in Blue Bell, Pa., as are those of key players for the Eagles' oppo-

nents. The computer charts the physical, intellectual, and emotional ups and downs of the players and provides the information to Philadelphia television station WCAU-TV, which analyzes it and weighs it with other factors to assess a given game's outcome. \*

early 1978 installed base of 85 to 157 users by 1980. The survey indicated that DOS/VS usage, dominant in the lower-end 370 machines, will drop off from an early 1978 installed base of 381 to 237 users in early 1980.

**INTEL ACQUIRES MRI:** Intel Corp., Santa Clara, Calif., which is developing a data base computer, enhanced its capability to enter the computer main-frame business with an agreement to acquire MRI Systems Corp., Austin, Texas. MRI develops and distributes data base management software. Simultaneously, Intel changed the name of its Memory Systems Div. to Commercial Systems. The value of the proposed acquisition of MRI was not disclosed.

**BANKS SETTLE:** Citibank, N.A. and Chase Manhattan Bank, N.A. resolved a suit brought by the Assn. of Data Processing Services Organizations (ADAPSO) in a New York Federal Court by voluntarily agreeing to provide computer services through totally separate subsidiaries. The ADAPSO suit asked for a declaratory judgment against Citibank and the Comptroller of the Currency requiring the bank to restrain from selling or leasing data processing services and the comptroller from authorizing national banks to sell such services. Citibank has agreed to operate its Interactive Computer Center as a totally separate business which will not use "Citibank" in its name. Chase Manhattan, ADAPSO said, has indicated to the Comptroller of the Currency that it will

operate Managistics, Inc., a computer payroll firm it is in the process of acquiring, as a separate profit center with separate management, personnel, facilities, and equipment.

**DATA GENERAL ACQUISITION:** Data General Corp. has agreed in principle to acquire a 50% interest in Nippon Mini-Computer Corp. of Japan in exchange for an exclusive license to Nippon to manufacture and sell Data General products made in Japan. Nippon also will be licensed on a nonexclusive basis in certain other countries in the Far East, including India, China, North and South Korea, and the Philippines. The transaction is subject to approval by various Japanese and U.S. government authorities.

**A DISTRIBUTED GAIN:** Distributed data processing will account for 30% of data processing hardware by 1982, said Input, a Menlo Park, Calif., based research firm. The prediction was based on a study entitled: "Distributed Data Processing Systems: Applications, Performance, and Architecture." Input said the study showed that the growth of DDP in the next five years will not significantly impact large host computer shipments. "The growth will develop most importantly in shipments of minicomputers and small business computers. In fact," said Input, "approximately 20% of the total of systems shipped will be in dedicated DDP environments, yielding a market value of \$1.6 billion." \*

# HOW THE QUINAULT INDIANS MANAGE THEIR LAND

Minicomputer in Taholah, Washington, provides data bases for management decisions

by Tom McCusker, News Editor

Gary Morishima first heard of the Quinault Indian Nation in the late '60s when the tribe announced it was closing to the public the beaches of its reservation on the State of Washington's Olympic Peninsula. Howard Shipley became familiar with the tribe when he left "big city" life in Seattle to settle down as a police officer in the tiny Pacific Coast town of Taholah, Wash., at the mouth of the Quinault River which runs through the reservation.

Today, Morishima, 34, and Shipley, 32, play key advisory roles in an ambitious program by the Indians to restore their 190,000 acres of reservation land to a manageable forest property. In the process, the 2,000 member tribe also is assuming from federal agencies greater control of its land and other natural resources.

Computers have been important tools.

The tribe uses an interactive Prime computer system, made by Prime Computer, Inc., Wellesley Hills, Mass., to do much of its work. Housed in the one-story trailer-like forestry building in Taholah, the computer is used to maintain forestry and fishery records, analyze field data, provide information to help the Indians acquire land, develop feasibility and research studies, simulate resource production models, and evaluate the impact of management policies.

Earlier, much of this work was done by sharing time on a CDC 6400 some 150 miles away at the Univ. of Washington. "The usage became so heavy that communications charges were prohibitive," says Morishima, a former systems analyst at Boeing Co. in Seattle who works for the tribe as a technical adviser to its department of natural resources and economic development.

Shipley, a systems analyst who functions as chief programmer in Taholah, once operated his own computer software firm in Seattle. He left Seattle after being divorced to join the police force in Taholah. When Morishima, whose wife Dorothy had been acting as chief programmer for the Indians, learned of Shipley's computer background, he persuaded him to get back into the business. "One day I walked in for my paycheck as

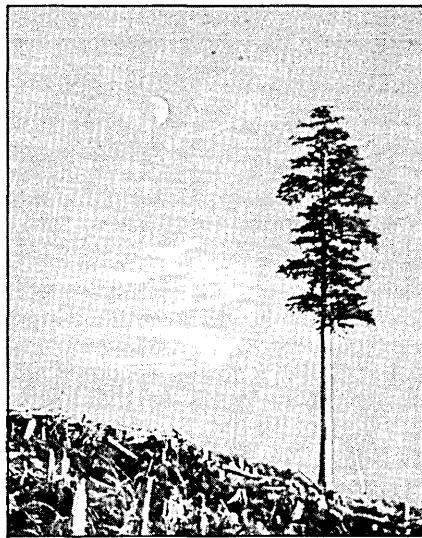

IS THAT ALL THERE IS? the Indians ask in a booklet called "Portrait of Our Nation."

a cop and the next day I was working in the computer room," says Shipley.

All of the information gathered and processed provides the Quinault management with the tools to analyze data and develop effective management policies to reach economic and governmental self-sufficiency.

The Quinault Reservation is a triangular shaped mass of land with the base running along the Pacific Ocean coast and the apex inland at Lake Quinault. Lives of Quinault Indians historically have been tied to the salmon that return to their rivers each year. The runs of Chinook, coho, chum, steelhead, and blueback salmon provided the bases for their culture and economy. They settled along the river banks in small family groups to harvest and process the salmon. There was no formal government, and land ownership was an alien concept. The land, ocean, and rivers were part of a spiritual and cultural heritage that could not be owned or sold.

But by the late 1700s, their way of life was changed drastically as Spanish, English, and Russian explorers searched the Pacific Coast for furs and the mythical Northwest passage. In 1855, the Quinault River Treaty ceded nearly a third of the

Olympic Peninsula to the U.S. Two decades later, President Ulysses S. Grant established 300 sq. mi. within the peninsula as the Quinault Reservation.

During the next century, the federal government allotted the Quinault land to individual Indians for farming in an attempt to assimilate them into the mainstream of American life by forcing them to give up the practice of communal land tenure. Virtually all of the Quinault land was allotted by 1933, even though the coarse, gravelly soil largely was unfit for agricultural use.

During this period, many millions of dollars worth of timber was harvested from the Quinault's forest land under the supervision of the Bureau of Indian Affairs. The land paid a terrible price.

Says Joseph B. Delacruz, the Quinault Nation president: "For more than 50 years, our lands have been managed to meet the demand for short-term profit, with no thought to the future. This harvest produced mountainous accumulations of logging residue and brush that cover thousands of acres of once productive forest land."

He says, "Streams that once supported large salmon runs are now clogged with silt and debris, and land ownership problems caused by allotment become worse each passing day. Today, the prospective yield from Quinault forest lands may be as low as 3% of its potential. By 1986, all of our virgin forests will be cut, and annual timber yields will fall dramatically."

Serious questions regarding the Bureau of Indian Affairs' management of the Quinault resources eventually resulted in Congressional investigations and four lawsuits were filed by the Quinault Indians against the U.S. government and the BIA, alleging mismanagement of their timber resources.

"The BIA's management of our land and timber can best be termed 'forestry by omission,'" the Indians said in a recently published booklet on their nation called, "Portrait of Our Land."

The booklet, of which about 2,000 copies have been printed, explains how the Quinault Indians are going about their program to restore the land and reduce their dependence upon federal management. Their goals are to establish competent, tribal-controlled forestry and



QUINAULTS closed their beaches in late '60s to keep out persons pilfering and littering their natural beauty.

fishery programs, develop tribal businesses, aggressively acquire land, and implement training programs for their people.

Morishima's second encounter with the Quinault Nation—other than the news he read about them closing down the beaches along the Pacific because surfers and others had been littering the area and pilfering driftwood—was at the Univ. of Washington in 1969 where Morishima was doing post-graduate work in forestry. Morishima, an American of Japanese descent, left his job at Boeing to become involved in environmental subjects at the university. "Today," he says wistfully, "I feel that the militancy you once found among young persons concerning environmental concerns and concern for their fellow man seems to have disappeared, or at least diminished from the days of the '60s during the Viet Nam war."

Representatives from the Quinault Nation showed up at the university to ask for help and one of Morishima's professors suggested that a class project might be launched to study their prob-



FOR 50 YEARS the land was managed to meet the demand for short-term profit. The result: mountainous accumulations of logging residue and brush covering thousands of acres.

lems. Morishima, who was interested in land management problems, prepared a report which reached the Ford Foundation. The foundation liked Morishima's reasoning and hired him as a Ford Foundation Fellow, assigning him to the Quinault Nation for five years to help the Indians cope with their land management problems. At the end of the grant in 1974, Morishima went on the nation's payroll as an adviser.

The Quinault Reservation is located in an area of very heavy rainfall—70 to 120 inches a year. The climate creates ideal conditions for growing trees. Its lands once supported dense forests of commercially valuable coniferous trees, primarily western red cedar, western hemlock, Sitka spruce, and Douglas fir.

An essential element of the Quinault's forestry program is an inventory that locates and quantifies available resources. Satellite and aerial photographs have been used to generate map overlays and color-coded summaries that represent macro-level vegetation patterns. Micro-level information about the number, size, and condition of tree and brush

species, as well as slope and soil data, routinely is collected during field surveys. After the information is gathered, it is put into the computer system and is processed and analyzed. Then it can be accessed, summarized, and updated by Quinault foresters.

By interpreting the photos, management quickly can identify new and old growth forests, brush, slash (logging residues), and roads. Using the data base, the Quinaults can develop forest simulation models, estimate rehabilitation costs, examine the impact of alternative development strategies, and assess land market value.

Morishima says the Indians acquired the Prime computer a year ago last June through a contract with the BIA which purchased the system according to Quinault specs under what is called an Indian self-determination contract. The system is configured with 512K bytes of main memory; 80MB of disk storage; one 9-track, 45ips tape drive; a 200 lpm printer from Tally Corp.; 16 three-phone ports; 7 terminals; and an Execuport, a terminal which Shipley and others use to take home for programming work in off hours. The FORTRAN language is used in 80% of the applications, while BASIC also is used and some COBOL. Soon, RPG II will be used for reporting information.

The Prime system is used to develop feasibility studies that determine which forestry and fishery projects have the best chance for commercial success as tribal industries. Some of the industries currently owned and operated by Quinaults are a fresh and frozen seafood processing plant, a tribal shake mill, and a forest products company that is relogging cedar slash for the shake and shingle market.

The computer also is used to measure and track timber harvesting operations and in assisting in numerous accounting applications.

A significant benefit derived from the use of computers on the reservations, Morishima says, is the strengthening of professional discipline among Quinault resource managers. In the process of transforming raw data into usable information, the staff must become intimately aware of the need to collect data in efficient form and also must clearly specify the assumptions behind these decisions.

"Taking action without adequate information is a dangerous practice that can result in serious consequences," says Morishima. "The Prime system helps us make the right decisions in our effort to rehabilitate and manage our reservation's natural resources."

The reservation's tribal government also is seeking to acquire land allotments from the original allottees and their many descendants who've inherited smaller and smaller parcels over the

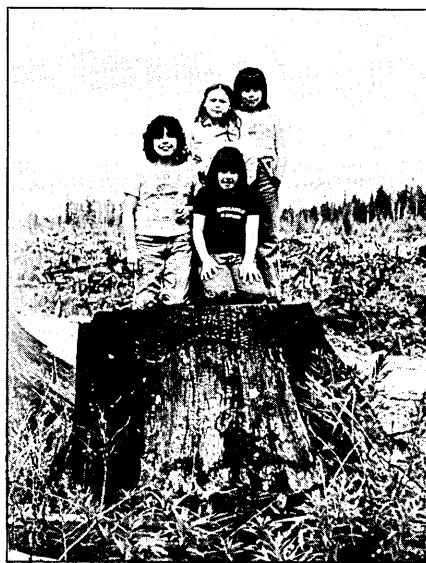

QUINAULT Nation seeks to provide economic health on behalf of those to come.

years. About 800 acres already have been acquired—small numbers because only about 15% of the 4,000 allotment land owners live on the reservation. The nation needs to own the land to manage a forestry program.

The Prime system is used to store and analyze complex ownership, inventory and resource information used by their management to examine market trends and Quinault land value. The data is used in property acquisition negotiations.

Computers also are used to salvage the nation's salmon fishing industry which since the early 1940s has been well below historic levels. Two factors contributed to this: past logging activities and increased commercial and sports fishing in the ocean, the former choking the rivers and the latter depleting the number of salmon that return to the rivers.

The computer is being used to store, retrieve, and analyze large quantities of data on harvests, water temperature, chemical analysis analyses, and fish growth. The Indians hope eventually to integrate all aspects of the fisheries program into one tribally managed resource development effort—from egg fertilization and diet production to harvest management and disease control—including fish processing, product marketing, and shipping to local markets.

The program begins with incubation and rearing of salmon in two hatcheries. After the stocks are reared, the smolts are tagged and transported to satellite stations where they're held for a brief time before release. The fish feed and grow in the vast nutrient-rich waters of the North Pacific for about two to four years. At that time, an instinctive homing impulse

impels the fish to return to the specific body of water from which they migrated. As the fish return to the river they're harvested by tribal fishermen and some are spawned for stock propagation to begin the cycle again.

The computer is used in studies that determine the migration timing of natural and hatchery salmon and to improve the production potential of natural salmon populations. Soon, the computer will be used in about 20 applications that include the effect of stock density on salmon production, in formulating diets to produce the highest quality salmon, and in studying salmon reproduction to ensure future runs.

It also will be used for hormone experimentation, stress reduction testing, vaccine development, disease resistance studies, and to help compute the volume of migrating salmon. Several simulation models will help evaluate how Quinault fishery prepropagation and restoration efforts will impact the reservation's economy.

A labor force is being trained to develop the Quinault forest and fishery resources as the nation works eventually to manage all aspects of their reservation. An educational program is being developed to train tribal members in such computer-assisted programs as reading, spelling, mathematics, and writing. Morishima thinks this program should start within the next year. Plans also are being developed to include the use of resource management games as part of the school curriculum to help acquaint Quinault children with reservation problems and the management techniques needed to solve them. Quinault kids, like any others, really get turned on by "machines where you can get answers by pressing a button," said Morishima. "And it wasn't just the computer that turned them on. They were excited when we only had a Teletype communicating with the computer in Seattle."

Reflecting on what he has accomplished for the Quinaults over the past nine years, Morishima talks of the need for tools to "make effective management decisions" to achieve the nation's goals of land restoration and self-determination. "Good decisions can't be made without adequate information, and that's where computers fit in.

"Our forests are a precious resource that must meet today's needs," says Morishima. "But this heritage must be managed in the interests of future generations of Quinault people. Computer systems, such as the Prime system, will help us evaluate management decisions before they are practiced on our lands. We hope that our children—and their children after them—will remember us not in shame, but with pride of a stewardship well performed." \*

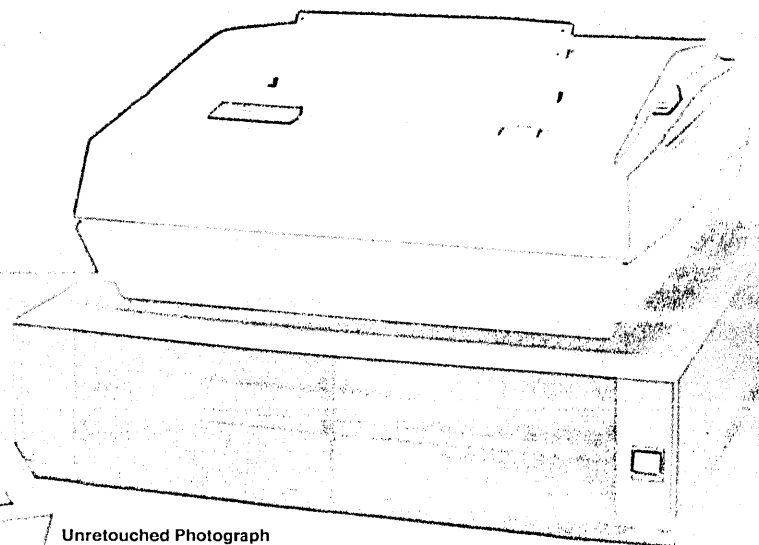
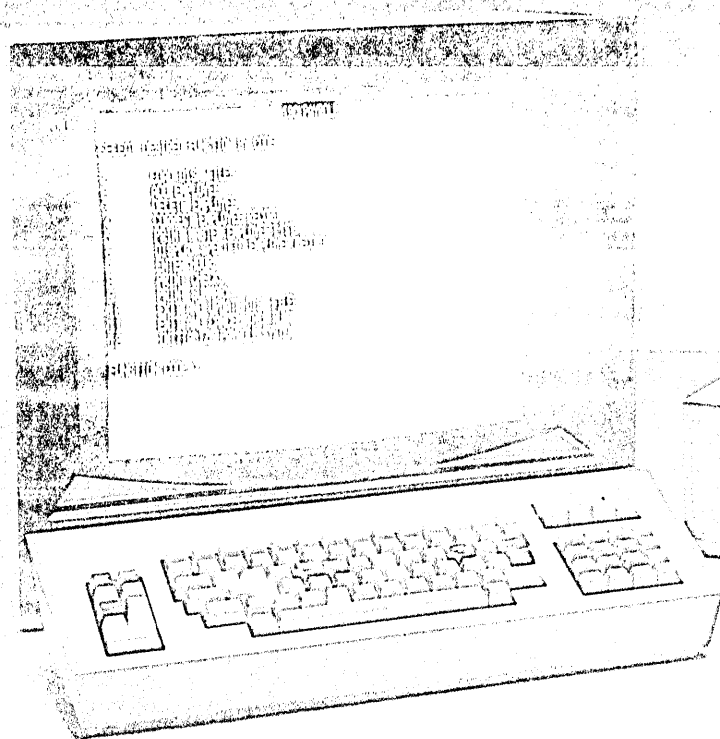

Unretouched Photograph  
of Screen

Since 1973, Intelligent Systems Corporation (ISC) has combined sound research and development with aggressive marketing to give the industry unparalleled performance at phenomenal prices. In color. Now for the newest addition to our product line: the Intecolor 8070 Series I Business System. The complete small system. It features our 19" color display and 8080A micro computer. Also available in a 13" color display version, with an additional built-in mini disk drive (8071).

It includes a 110 CPS bi-directional

desk-top printer, a dual 8" floppy disk drive for 512K bytes of storage, Intecolor Business BASIC with print using and double precision. Optionally available: FORTRAN IV with double precision. Software by Microsoft®

The price? \$4,900, 100 piece price. Just \$7,000 on a single lot basis. For the business system even small companies can afford. Contact your local ISC sales representative for a demonstration of how the Intecolor Series I Business System can solve your business problems. A payroll software package

is included free with purchase. Terms—5% prepaid, or net 20 days.  
**Color Communicates Better**

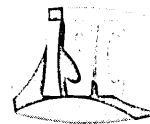

**Intelligent Systems Corp.**

5965 Peachtree Corners East  
Norcross, Georgia 30071  
Telephone 404-449-5961 TWX: 810-766-1581

**ISC SALES REPRESENTATIVES:** AL (also MS): Huntsville 205/883-8660. AZ (also NV): Phoenix 602/956-5300. CA: Los Angeles 213/476-1241 or 213/937-5450. Goleta 805/964-8751. Mountain View 415/964-9300. San Diego 714/292-8525. Irvine 714/557-4460. CO (also WY): Denver 303/759-0809. FL: Ft. Lauderdale 305/776-4800. Melbourne 305/723-0766. Orlando 305/425-5505. Valparaiso 904/678-7932. GA: Atlanta 404/455-1035. IL (N.) (also IN, WI): Northbrook 312/564-5440. KS (also W, MO, NB): Shawnee Mission 913/362-2366. LA: Mandeville 504/626-9701. MD (also DC, VA): Bethesda 301/656-3061. MA (also ME, NH, RI, VT): Framingham 617/879-7530. MI: Madison Heights 313/588-2300. MN (also SD, ND): Minneapolis 612/822-2119. MO (E.) (also S, IL, IA): St. Louis 314/821-3742. NM: Albuquerque 505/265-5655. NY (also CT, NJ): Holcomb 716/657-6291. White Plains 914/949-6476. NC: Durham 919/682-2383. OH (also KY): Cleveland 216/267-0445. Dayton 513/434-7500. OK: Oklahoma City 405/528-6071. OR: Portland 503/620-5800. PA (E.) (also DE): Wayne 215/688-7325. PA (W.) (also WV): Pittsburgh 412/892-2953. SC: Columbia 803/798-3297. TN: Knoxville 615/588-2417. TX (also AR): Austin 512/451-5174. Dallas 214/661-0300. Houston 713/780-2511. San Antonio 512/828-0937. UT: Salt Lake City 801/973-7969. WA (also ID, MT): Bellevue 206/455-9180. EUROPEAN EXPORT SALES: Techexport, Inc., Cambridge, MA 617/661-9424. ENGLAND: Techex, Ltd., Bournemouth 0202-293-115. FRANCE: Peritex, Rueil 749-40-37. SWITZERLAND: Interrest, AG, Bern 031-224481. AUSTRALIA: Anderson Digital Equip., Mt. Waverly, Victoria, Melbourne 543-2077. CANADA: Cantec Rep., Inc., Ottawa, Ont. 613/255-0363. Pointe Claire, P.Q. 514/694-4049. Toronto, Ont. 416/675-2460. CANADA: Datamex, Ltd. (Distributor) Dorval, Que. 514/636-9774. Ottawa, Ont. 613/244-1391. Toronto, Ont. 416/787-1208. Vancouver, B.C. 604/684-8625. CENTRAL & SOUTH AMERICA, MEXICO, CARIBBEAN: American Business Systems, Atlanta, GA 404/394-9603. FAR EAST: Computers International, Los Angeles, CA 213/382-1107



## IBM Series/1 efficient

IBM's Series/1 Intelligent Data Entry System is a valuable set of programs designed for interactive key-to-disk data entry with the IBM Series/1 Computing System. Intelligent Data Entry can be put to work at just about any site in your organization where data is captured. What's more, it's so easy to use and install, you can be productive almost immediately.

And with Series/1 full-function capability distributed to your remote sites, you can enhance service to user departments economically

and efficiently, without tying up your central system.

---

### Fast productivity

Series/1 Intelligent Data Entry can be adapted quickly to just about any data entry job. It provides simple-to-use features that lead the user through job definition and formatting. Operator productivity is emphasized even more by time-saving features that minimize keystrokes, and error-checking functions that reduce mistakes made during data entry.

In addition, the system offers optional prompting features that guide the operator step by step through each task. And by moving data entry to where it's handled by those most familiar with it, you can reduce costly errors.

---

### Remote Job Entry

Remote Job Entry programs can eliminate a great deal of document handling by logically organizing information and transmitting it to or from a host computer. Programs are provided for batch com-

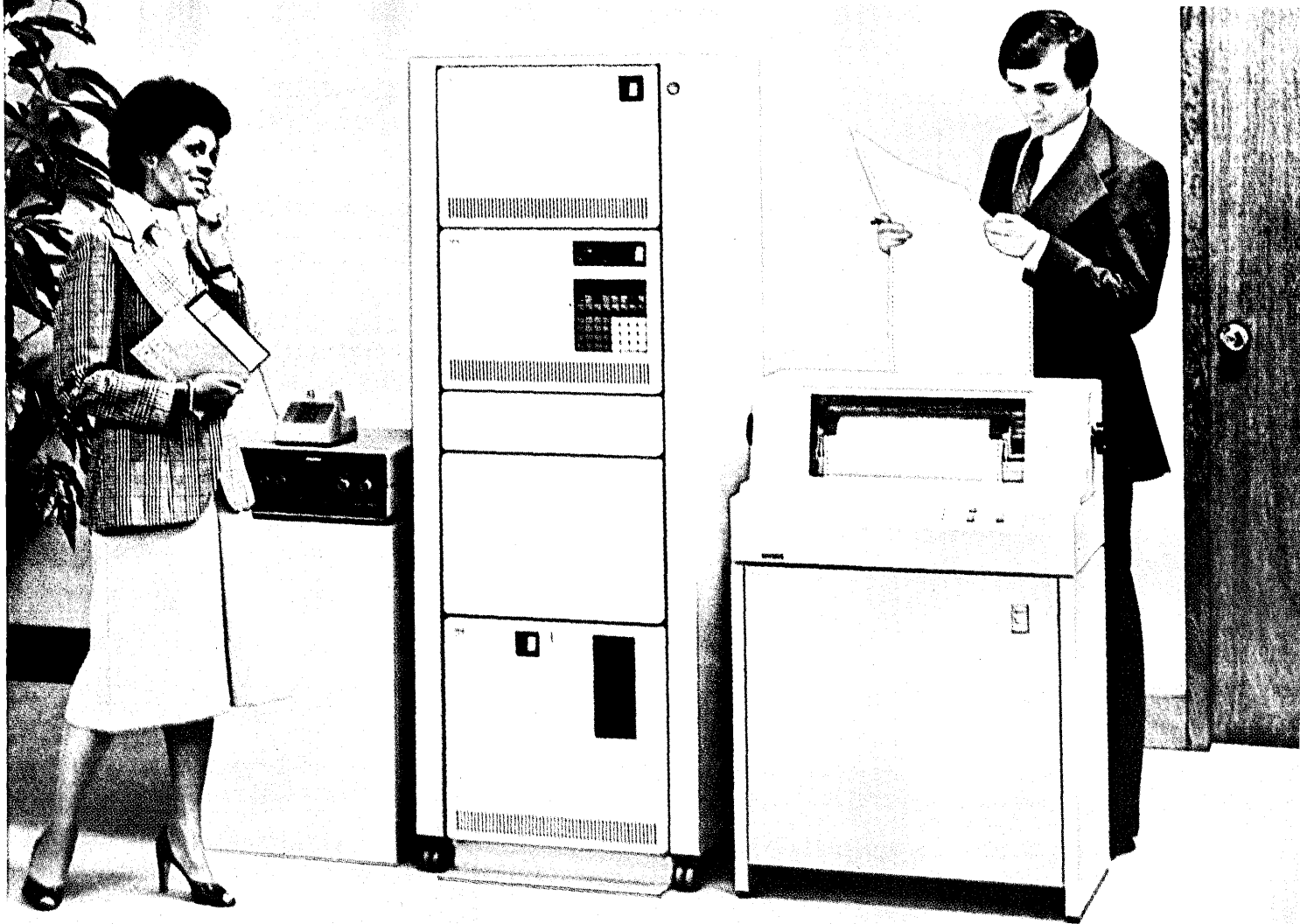

Series/1: Data Entry plus a whole lot more.

# Intelligent Data Entry System is a fast, solution to your data entry problems.

munications that link remote data entry with a central site. Remote Job Entry and other applications can operate concurrently with data entry so local programs can be run while the data entry function is being used.

## Ready to grow with you

Series/1 is a computing system with a broad range of modular hardware and software that gives you the flexibility to build the data processing system you want. It can be used standalone or online with a

host computer. And it comes with a three-month warranty and an optional monthly Maintenance Plan.

To find out more about how Series/1 can ease your data entry

*The IBM Series/1 offers a broad range of modular features for a flexible, low-cost data processing system.*

problems, contact your Series/1 marketing representative or write the IBM General Systems Division, P.O. Box 2068, Atlanta, GA 30301.

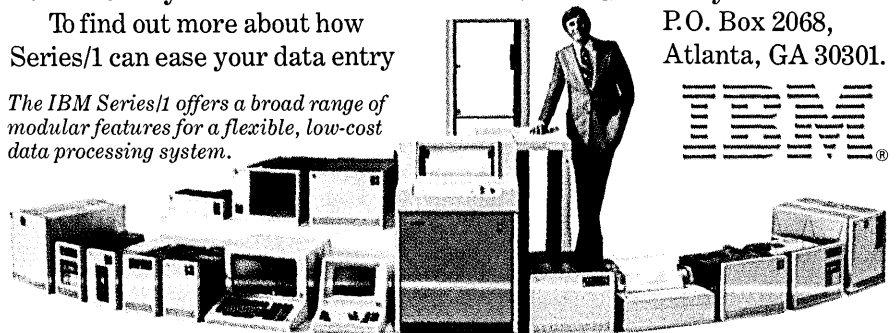

**A small computer can make a big difference.**



ILLUSTRATION: JOSE LUIS QUILEZ



With a boom on in the small business systems market, minicomputer marketers are finding a variety of ways to bring their products to the end user.

# SELLING SMALL BUSINESS SYSTEMS

by Louis B. Marienthal

In the beginning, before about 1970, the structure of marketing computer systems was simple. The industry was called Snow White and the Seven Dwarfs, and there was the IBM way of selling and seven copies thereof.

Minicomputers, mostly developed in the last decade, complicated the marketing channels. Tens of thousands of small organizations (or odd parts of big organizations) were suddenly able to afford minicomputer systems with a new low price tag and the promise of operating without professional data processing personnel.

The equipment was new, a discontinuity in the development of computers, creating a temporary opportunity for the founding of new computer manufacturers with modest original financing. Ironically, while two of the original Seven Dwarfs were cashing in, 20 or 30 new computer companies with names now recognizable were being formed.

The new set of companies selling to the new set of customers could not follow the IBM marketing pattern. Direct selling and support for the individual end user were too costly relative to the price of the systems and the financial strength of the vendors. Thus, marketing patterns new to the computer business were invented or borrowed from other older industries.

Of course IBM and most of the surviving Seven Dwarfs still sell directly equipment large and small, and several of the new companies have followed IBM's example. But a substantial proportion of minicomputer systems and most of the newer microcomputer systems are being delivered to the end users via middlemen: distributors or oem's.

Here we examine the major marketing channels for minicomputer systems, primarily those minis bought by small businesses. While classifications of social, economic or business activities are always arbitrary, four major plans with some variations will be described: (1) traditional direct selling, (2) geographical distributors, (3) oem's, and (4) retail stores.

## TRADITIONAL DIRECT SALES

Direct sales is, of course, the traditional pattern. The vendor defines a geographical territory and buys or rents an office. The vendor hires salesmen, systems engineers, and maintenance engineers who serve customers from their base in the company offices. The salesmen generally have a quota and are paid commissions on sales and installations.

IBM, Burroughs, NCR, and Univac had the offices, the policies, the personnel, and the organizational hierarchy (branch, district, and region) in place long before minicomputers. These old main-line companies also had a style of support suited to a sale of a system that costs \$300,000 and up. This style required modifications for a system that would cost a maximum of \$100,000.

Some of the new minicomputer vendors attempted to create the same kind of marketing organization and facilities as those already in place for the older computer companies. Basic IV, Wang, and Nixdorf currently deliver almost all of their product to end users via their own marketing organizations.

The direct sales vendors offer operating system software and applications packages. The latter are mostly horizontal—payroll, accounts payable, general ledger—that apply to nearly every type of business. IBM and, in some

few cases, the other vendors can afford vertical application packages (applications directed to a single industry). When a vertical package exists, the sales office will assign one or more salesmen to concentrate on the defined market.

The systems software and application packages are developed by the vendor or purchased from a software house and delivered to the sales offices typically with elegant documentation. But the installation of a system in a customer's office is still a problem: there is no one in the sales office to make the modifications required by the individual customer.

As a practical solution, most computers sold directly are installed with some assistance from an outside programmer or software house. The vendor or the local sales office may have an approved list of reputable software help; sometimes the individual salesman has a private list of moonlighters.

Financial arrangements between salesman and outside programmer are not unknown. If work is scarce, the salesman might get a finder's fee. If customers are in queue for installations, the programmer might share the salesman's commission.

The vendors are not happy with the involvement of outsiders in the success of their installations. All the vendors attempt to make their packages as generalized and flexible as possible so that options can be selected in the field. To avoid programming modifications in the field, Univac even delivered BC-7 software without source code. IBM has its customizing facility. The aim is to use modestly paid installers who select the options and train the customer's personnel. But so far, on-site programming help is usually required.

The old-line companies have rental plans for both hardware and

## The distributors call themselves "ironmongers . . ."

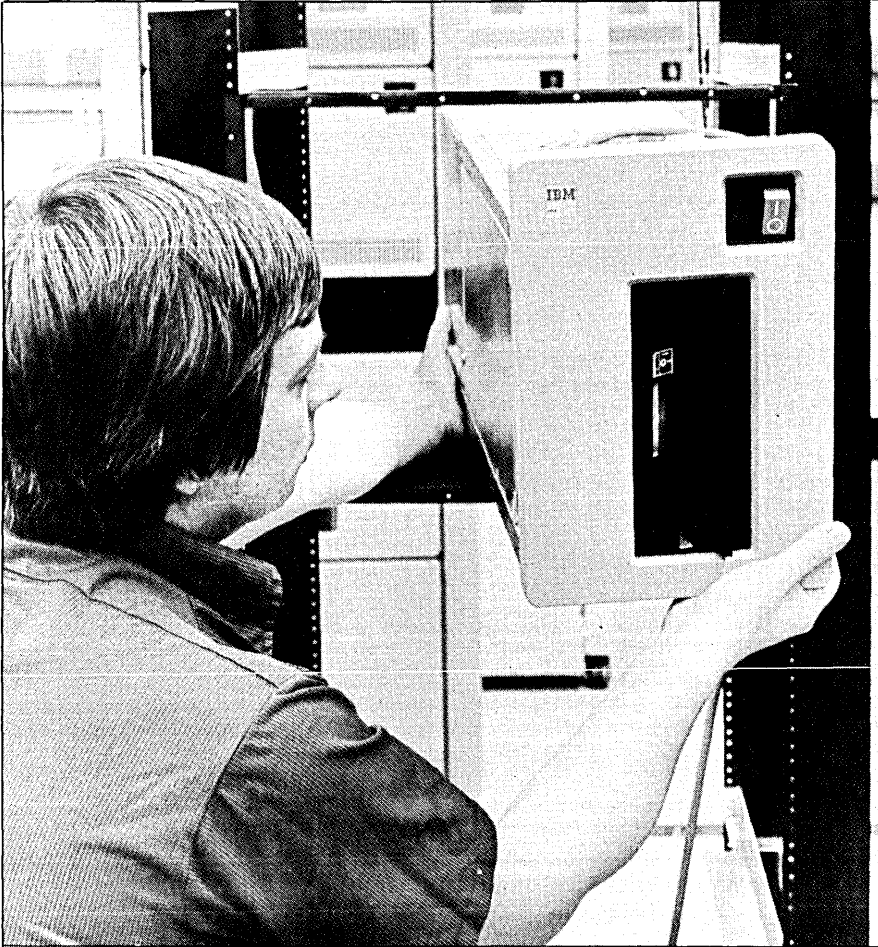

IBM chose not to go the full support route when it announced its Series/1. Atlanta shipped the iron, and minimal software, but most of the software contribution came from outsiders, such as systems houses.

software. For any modifications that may be required, the independent contractor will be paid directly by the end user. The charges for modifications can be a significant proportion of the total system cost.

### A DIFFERENT APPROACH

Datapoint has developed an interesting variation on direct marketing. Originally the company concentrated on selling terminals to large computer users via its own sales organization. The terminals gradually evolved so that they now serve very effectively as standalone small-business systems. But the sales force is still oriented (by the compensation plan) toward multiple sales and away from the one-off installation in a small business that required much hand-holding.

To sell to the individual small user, Datapoint has invented the "software representative." This is a small

business, screened by Datapoint, that finds and sells the small-business customer. The sales contract is between Datapoint and the end user, but the representative gets a reasonable commission (20%). The representative also sells his own software, and Datapoint does not participate in these revenues. The Datapoint organization supports the software representative with literature, information, and operating system software; the Datapoint salesman helps out where possible, and he receives a commission for sales made by his string of representatives.

If a company cannot afford to open a nationwide network of sales offices, one reasonable substitute is to franchise territories. Under this plan, independent businesses are established as authorized distributors with the right to sell equipment within a specific geographic area. The distributor usually agrees not to sell competing makes of equipment, to maintain a sales force and

premises, and to fulfill a sales quota. Microdata (Reality), Qantel, and CADO sell through distributors.

A network of distributors is not completely incompatible with company owned offices. Basic IV started with offices in a few key cities and distributors in the secondary markets, and the company continues to use and expand on this dual marketing plan. If a distributor in a key market does not meet quota, the computer company can take the franchise away and open its own office.

### AN IN-PLACE RESOURCE

Potential distributors of computer systems exist everywhere because there are many existing sales organizations selling crt's, printers, modems, and other peripherals. Thus, a new computer company can quickly set up a national sales organization by appointing distributors.

The computer company supplies the hardware, sales materials, and operating system software to the distributor. The local company hires its own salesmen, rents the office, and works out its own plan for applications software. The manufacturer rarely supplies application packages but tries to sponsor interchanges among the distributors. Some distributors have large staffs of programmers and elaborately packaged applications. Others use local software houses and moonlighters.

The distributor is, of course, a small business and thus more flexible than the branch sales office of an old-line computer company. So, a three-way arrangement among distributor, software house, and customer can take many forms. The programming can be done under contract to the customer, or the distributor can subcontract the programming. In the latter case, the distributor can deliver a turnkey system, and the customer will make the final payment on the total package only when satisfied with the programming.

The distributor gets a discount in the range of 35% to 40% off list and jealously guards his territory. Problems do arise with sales to companies with branch offices in other territories. Also the computer company might reserve a vertical market or a class of large customers for direct sales. There is much room for discord.

The emphasis is on moving hardware. The distributors call themselves "ironmongers," and they often sell computer systems with the same exuberant methods as other salesmen employ

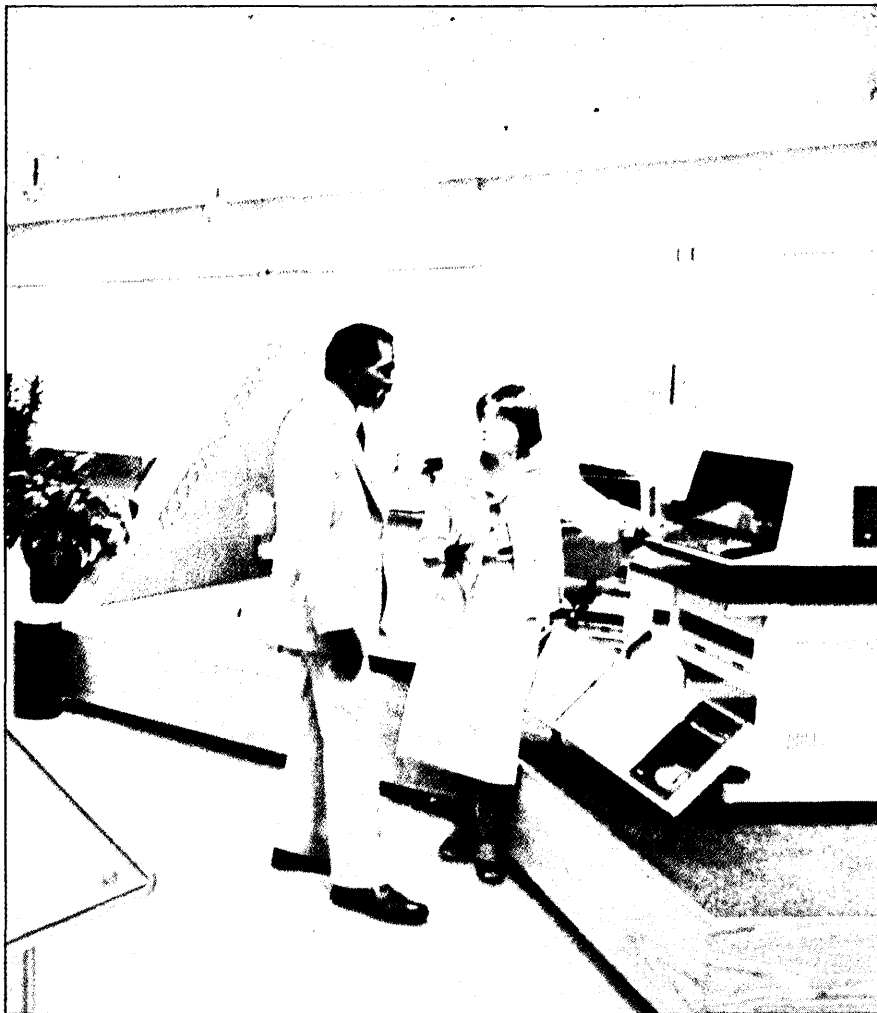

DEC moved into a shopping center in Manchester, N.H., this summer, opening its first retail outlet. Customers can "kick the tires" and buy off the floor.

with industrial machinery. Software is considered (1) a necessary evil, or (2) the packaging that sells the product. This is not to imply that systems delivered by distributors are inferior to those delivered via other marketing channels; hit and run tactics do not work because the territory is limited and referrals are important.

### VALUE-ADDED SOFTWARE

For purposes of this article, an oem is a business that buys computer equipment from one or more manufacturers, adds software, and sells functioning computer systems to end users. They do not have territories, but for practical reasons most operate in one local area. They are not contractually restricted to one product line, but again for practical reasons they tend to concentrate on one computer and one operating system. They use multiple hardware vendors to fill out a product line or to substitute for an inferior crt or printer.

Like distributors, oem's have their own offices, close their own sales, and carry their own receivables. Some are two-man shops; some have 50 or more employees. Many oem's try to specialize in one vertical market.

Many oem companies are partnerships between a salesman and a programmer/analyst. Successful oem's usually have professional sales people on board, but the focus of the business is often the software. Many oem's were formerly software houses specializing in supporting large installations that switched to minis, changing the potential customer base from big companies to small. An oem earns a discount on equipment (10% to 40%) that the pure software house misses.

The oem delivers a bundled system, and the customer often takes an investment tax credit on the full bundled price that includes hardware, software, and miscellaneous services. When a system is not bundled, only the hardware is eligible for investment tax credit. Here the oem's and the distributors that supply turnkey systems have an important sales advantage over the old-line computer companies that sell or rent hardware and software separately.

Most of the important minicomputer manufacturers sell through oem's as a supplement to their own direct sales efforts. The big national accounts and the big local multiple users are sold directly; the oem's pick up the rest of the business

which includes the one-off sales and multiple sales into a vertical market of small users, e.g., CPA's. This is the plan of DEC, Data General, Hewlett-Packard, Texas Instruments, General Automation, Interdata, and others. In most manufacturers, salesmen are assigned to deal with oem's like any other multiple-unit customer.

The DEC oem's are attached to the separate wings of the DEC marketing structure, which is broken down by type of end user: medical, engineering, small business, commercial oem, and others. The breakdown is not clear, and one potential customer can receive competing proposals—for a Model 340 from one oem and an 11/34 System from another.

Most of the manufacturers assign the same salesman to oem's and to direct customers. Most of the time the salesman gives the oem a big-company image and supports the oem's efforts to close a sale. Sometimes the salesman will learn of a contact made by an oem and then rush in with a competing proposal. In Southern California, the Data General oem's are reluctant to bring prospects into the DG sales office for a demonstration.

The IBM Series/1 and the Honeywell Level 6 are product lines designed specifically to be sold through oem's. Honeywell created a new sales force to support the oem's, and the Level 6 is not sold directly on the local level to end users. The product seems to be doing very well, no thanks to the main-line Honeywell sales organization, which has been known to deny the existence of Honeywell minicomputers.

### RETAIL STORES EXPAND THEIR PRODUCT LINES

While IBM and the other old-line computer companies have been scaling down to enter the mini market, the tiny hobby computers have been upgraded into small systems suited to serious laboratory or commercial purposes. The hobby computers have been sold through retail stores since 1975, and no doubt one of the first systems sold was turned to some commercial application.

Pertec sells the MITS line of equipment through retail stores exclusively; some are company-owned, some are independent. On July 31, 1978, DEC opened its first retail store in Manchester, N.H., to sell small systems. And Data General sells some of its MicroNovas through retail stores.

If big companies support their retail outlets with well-designed commercial applications, the customer who

## The pattern of Snow White and the Seven Dwarfs has been permanently broken.

can use the application without modification may find a bargain. But modifications are always a problem. A local store may have a coterie of young whiz kid hobby programmers without experience in the commercial problems of cyclical processing, purging, file controls, and general operation over a long span of time. Pertec set up a special department to answer phone calls from customers who had purchased MITS systems and locally created software packages.

The retail stores sell products that are generally classed as microcomputer systems, but the distinction between micro and mini is hardly clear cut. Texas Instruments sells, directly and through oem's, one series of computers that includes a mini and a micro; DEC and Data General are not confining their sales of micros to retail stores. No doubt in the near future most of the manufacturers will be selling micro systems through their existing marketing channels, and the capacity of the systems sold through retail stores will grow to match the existing minis.

### AN EYE TO THE FUTURE

It may be that computer functions will become standardized to the point where a small businessman will order an "accounts-receivable computer" from a local retail store or sales office in the same way that his father ordered an NCR bookkeeping machine. If the products become standardized, the big companies with national distribution will gradually gain a major share of the sales of purely financial systems at the low end of the price scale.

Packages do not work too well in applications related to the guts of a business—sales and production. Computers are purchased for their flexibility, and the users want the computer system to perform for their purposes; they do not want to change ways of doing business to conform to some prepackaged computer system. For operational functions, someone will have to be available to tailor the computer systems. The retail stores and company sales offices are having more trouble with the tailoring than are the independent oem's and distributors.

Successful oem's specialize into a vertical market. Their industry know-how and software thus become a capital asset that returns income whenever a bundled system is sold that requires a minimum of modifications. Working in a vertical market in a local geographical area, the oem is under great pressure to satisfy the customer. The unhappy

customer can hold up payments and be a negative reference.

The end user will probably get a better system from an oem than from a pure software house working as a stringer for a distributor or local sales office of a manufacturer. The pure software house often has the fee set by the hardware vendor; thus, the incentive is to complete the specified work as quickly as possible. There is no income from the hardware sale, and the experience built with each job relates to the manufacturer's software being modified, not to a capital asset of know-how that can be delivered with greater profit each succeeding job.

The new minicomputer manufacturers and the independent middlemen were first accepted by small-business customers. And the small businessman continues to be more willing than the big-company executive to buy Brand X from the local middleman.

The small businessman looks for a manufacturer that is profitable—one likely to be in business for the next five years—and has a good reputation for maintenance. The equipment must be expandable, which means the ability to add another disk drive or printer. He does not care about continuity of product line for the next three generations of computers.

The small businessman, who is usually an owner, is often more down-to-earth than the executive in a big business, who is almost always a hired professional manager. The small businessman would never think that "capability in data processing" was an asset worthy of investment. He does not want a glass palace. He buys equipment to do a job that will save money or increase sales, and the payoff period must be short; when he buys a \$60,000 computer he expects to gain \$100,000 worth of function within two years.

The local middlemen will be a permanent part of the data processing industry. They should have continuing success in dealing with small businessmen. The oem or distributor with two or three principal owners and five or six hired employees is a small business, and one of the owners has much in common with the small businessman he is trying to sell. The small organization can specialize in a short list of businesses, and the firm can call on impressive local references.

The salesmen of the traditional vendors may not be as successful with small businessmen as with dp managers. The sales branches of the traditional vendors are part of a big-company hierarchy, which is fine when dealing with a

dp department within another big-company hierarchy. The branches will probably have an advantage in selling to big companies; the local oem or distributor will probably have an advantage in selling to small businesses, especially where tailoring is important.

### ROOM FOR THE MIDDLEMAN

The pattern of Snow White and the Seven (Me-Too) Dwarfs has been permanently broken. What was once an industry only for giant corporations now has room for the small local middleman (and some small- to medium-sized manufacturers). Indeed, the industry requires the middleman to serve the thousands of new small-business customers.

The small middleman organizations provide a workplace for the entrepreneurial computer professional who was restricted to software houses up until a few years ago.

The oem's and distributors are an altogether beneficial development in data processing, providing a new outlet to talent and enterprise and delivering quality service to data processing customers. The local middlemen are doing very well in competition against the highly structured traditional vendors—at least in the small business market. The new manufacturers of mini and microcomputer systems are happily accepting the local middlemen as a means of avoiding huge investments in national marketing and applications support. \*

### LOUIS B. MARIENTHAL



President of Pacific Data Systems, Culver City, Calif., an oem of Texas Instruments, Mr. Marienthal has been associated with DATAMATION

for 11 years. He began working in data processing in 1956 on the Univac I. He was with John Diebold in New York and London, and Peat, Marwick, Mitchell & Co. as manager of dp consulting in their Los Angeles office.

He worked for seven years as an independent consultant helping small- and medium-sized businesses to use computers.

# SMALL BUSINESS SYSTEMS: THEY'RE EVERYWHERE

by Layton McCartney

Walk into almost any small business today—the “Mom and Pop” pharmacy on the corner, or the insurance brokerage office down the block—and there is a good chance you’ll find a computer.

The so-called small business system in fact has become one of the hottest items in the data processing industry. Some 350,000 or so of these machines have already been installed around the U.S., and the boom is really just getting under way. Today everyone from the traditional mainframe and minicomputer vendors to many of the microcomputer firms that sell their machines in computer stores are making a run at this market. And now one mini vendor has gone so far as to open its own retail outlet to bring in additional small business trade.

With a full-blown system that can handle chores like inventory control, payroll, and accounts receivable now available for \$15,000 or less, the local automotive parts distributor, the medical clinic or solo doctor in private practice, and the small law firm can all afford their own machine.

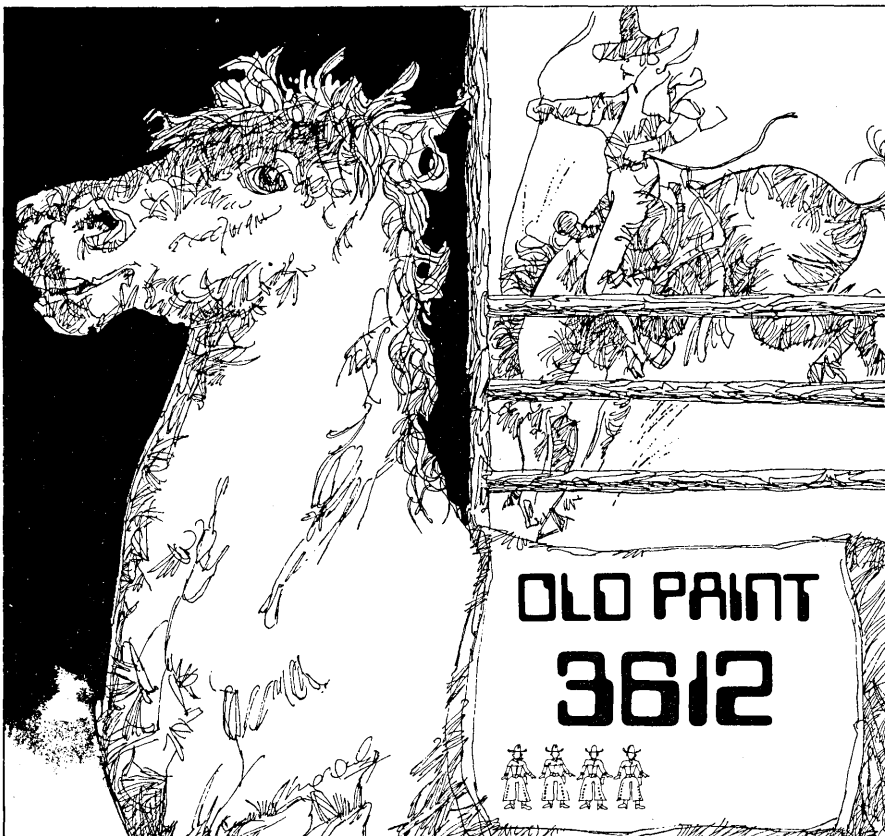

Cowboys still take lumps wrestling steers and staying astride bucking broncos, but life on the professional rodeo circuit may be a little easier now that the Professional Rodeo Cowboy Assn. in Fort Collins, Colorado has installed its own small business computer.

The computer, an IBM System 34, keeps track of what cowboys are riding in which rodeos, randomly pairs performers with the animals they will ride, rope or wrestle, and maintains an ongoing record of all the members' point standings and earnings for the year.

“Our central entry application is analogous to a reservation system,” says the organization’s data processing manager Tim Schiel. The only difference is that the cowboy who calls the association over one of its 20 WATTS lines that are open 16 hours a day books a ride on

a Brahman bull rather than a seat on a 747.

Before the association installed a computer, Schiel says, cowboys had to rely on the various contractors who provided livestock to the rodeo for the information they needed. The contractors might rent a couple of telephones for a few days, while perhaps saving their best animals for their favorite cowboys.

Now all the contractors give complete information about their animals to the association well before each rodeo, and the cowboy knows the computer, not the contractor, has selected his mount for each event.

Moreover, with the computer, association members can ask to be scheduled to appear in a particular event or on a particular day during the rodeo.

**Y**ou may think of a cemetery only as a place to be avoided on dark nights, but operating one involves many of the problems of running any small business—problems that a small business computer can help solve.

At least that's what Garnet Waddill, president of the Mount Moriah Cemetery and Funeral Home in Kansas City, Mo., thinks. Waddill recently purchased a Data General CS/40 computer and now has what he believes is the first fully automated cemetery operation in the country.

The Data General machine performs all the usual business chores—accounting, payroll, and the like. It also monitors the organization's nursery operation, enabling Waddill to determine which types of plants and shrubs are selling best and what in inventory has to be replenished.

Additionally, the system generates daily routing schedules for the lawn care service that tends Moriah's 100 acres.

Like many businessmen Waddill's biggest concern is communicating with his managers and keeping track of how effectively they're handling their operations. In total, Moriah employs 75 persons including a salesforce and managers for each of the major business segments (two funeral homes, two cemeteries, the flower shop and nursery).

The computer generates monthly reports from each of these groups as well as commission statements for each salesperson. "It's made our entire operation much more efficient," Waddill says. Now if the computer could just be programmed to drive away ghosts.

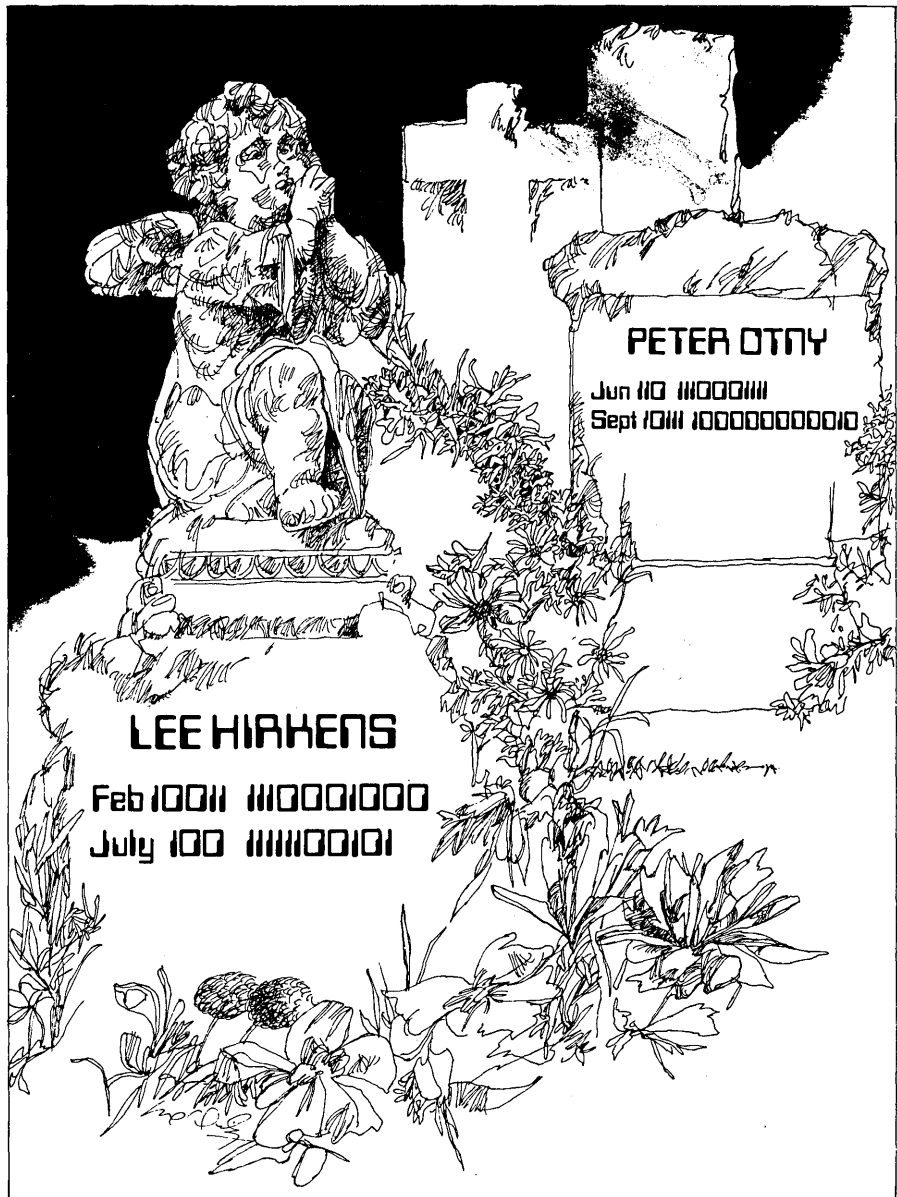

**A**llan Turoff is a toy and games designer who created the popular game "Boogle." A few months ago Turoff went out and bought himself an Apple microcomputer. Turoff didn't buy the machine as a toy. He's using the machine's graphic and computational capabilities in his design work. "It's like electronic clay," says Turoff. "I can do all kinds of things with it."

Turoff, who works in a tiny office tucked away in Manhattan's East Side, has learned BASIC and soon expects to be writing his own programs. He is by no means unique.

A physician in Alabama, a North Carolina life insurance salesman, a Greenwich Village restaurant owner, and a New York sports car magazine publisher have gone through similar experiences. And they are using the systems in their businesses, often installing the machines themselves without professional assistance and writing their own software. "It's the wave of the future," says Turoff.

**T**he vice president of a New Jersey-based drug manufacturer first brought his in to the office hidden under a raincoat. A Midwestern marketing executive carries his to and from work hidden in a canvas tennis bag.

These are the secret computer users, a small but increasing contingent of corporate executives who've gone around their corporate data processing departments and acquired a small computer for their own use.

How are they buying these machines? Often directly from retail computer stores who specialize in selling microcomputers for business or dedicated applications. One such store in Manhattan has sold a half dozen such systems to executives in *Fortune 500* companies in the past few months. In only one instance did the firm's data processing department approve, or even know about the sale.

Sometimes the executive buys because he's tired of waiting in line to

have a job done on the company's big mainframe. Or perhaps he simply wants his own machine to play with. At any rate the phenomenon seems to be here to stay. As Portia Isaacson, a computer store owner in Texas and a contributing editor to this magazine, has noted: "Data processing departments have a favorite commandment—thou shalt not buy computers; we shall buy them for you. So, as a result, we have a new phenomenon—the secret computer."



**W**hether or not a record ever hits the "Top 40" may now depend on a computer.

Yes, small computers are now being used in recording studios to make sure your favorite rock and roll singer or band comes off sounding in top form. Actually, the computer "mixes" the various tape tracks being recorded and enables the sound engineer to cut several different versions of the same recording—one for AM radio, another, longer version for FM and perhaps a third for the discos.

Use of computers in the recording business is relatively new, and there's no telling what the long term effects are going to be. "Some bright young sound mixer will get a hold of this technology and do things with it that will revolutionize the industry," says Don Sinsabaugh, executive vice president of the Computer Systems Store in New York. \*

A look at experiences of some who have converted.  
Many vendors provide software aids to simplify conversion of programs and files.

# FIRMS OF ALL SIZES CONVERT TO MINIS

by Lawrence Richman

Some small business computers aren't especially small and neither are the uses to which they've been put. This surprisingly versatile product is growing from its initial concept—a turnkey minicomputer “package” designed to fill the gap between accounting machines and medium-scale computer systems—to become a major resource for managers of medium and large data centers.

In 1977, DATAMATION's survey of small business computers identified 88 suppliers (more than 100 if you included turnkey vendors) who offered 249 different systems. Current estimates put the number of such suppliers at more than 750 and the number of systems at close to 2,000. This 800% increase in less than 12 months is an indicator of major changes in the nature of the purchasing habits of U.S. corporations and the expectations of users of data processing resources.

Small business systems have advanced the evolution of large-scale data processing away from the big, centralized cpu with numerous peripheral devices, complex software, dependence on expensive technical personnel and, worst of all, remoteness from the user. Computer systems are becoming “friendlier” to the user and in the process the dp manager is evolving from a technical production supervisor into a true “information manager” and “change agent” with major responsibilities for the attainment of organizational goals. Could this be called “distributed processing”?

Small business computers once were assembled from minicomputer components to enable the entry-level user to automate basic accounting functions. The classic configuration consisted of a

general purpose 32K cpu, 5MB disk, 165cps serial printer, one or two crt terminals, and a pretty work desk and cabinet to hide all the electronics. Along with this simple “package” came all the supervisory and applications software necessary to run the system. System suppliers provided operator and supervisor training and detailed instruction guides for complete self-sufficiency under normal operating conditions. With the possible use of floppy disks for multiple terminal configurations, basically this is the low end of the spectrum today.

KLC Corp., Pasadena, a turnkey vendor that specializes in small systems for the apparel industry, reports that one user, a service bureau which previously had been using a \$2 million IBM 360/50 (with 250MB of disk, four tape drives, a 1403 printer, several key punch/key verify stations and a card reader), was converted to a \$250,000 Four-Phase model 490 (with 240MB disk, one tape drive, one 900 lpm printer, seven crt terminals). Chris Connelly, systems engineer at KLC, says the user went from \$10,000 per month in hardware and personnel costs to \$5,000 per month with the Four-Phase system. It also was able to eliminate raised flooring and climate control equipment in the process.

## ADVANCED USES

Hunt Chemical Co., Palisades Park, N.J., has gone far beyond single-site automation in its search for improved control over inventory, interbranch transfer payments, and other transactions involving data communications. A supplier of specialty chemicals for photographic and photocopying needs, Hunt upgraded from a Honeywell 115 tape/disk standalone system, plus an outside time-sharing serv-

ice, which had cost \$15,000 per month, to a Honeywell Series 60/Level 62 communications-oriented small business system.

## LEARNED OVER THE PHONE

Beacon Bay Enterprises, Inc. Newport Beach, Calif., recently installed a Basic/Four System 200 to enable it to handle the increased volume of accounting data, especially payroll, generated by their 10 car wash locations. “We learned to operate the system over the phone.” That's the way Linda Kendall, Beacon's treasurer, characterizes the extreme simplicity of installation of this class of computer. Basic/Four has limited the System 200 to what it calls “preplanned applications” only and does not enable the user to do any of his or her own programming.

Another first-time user, Micronics International, Anaheim, Calif., installed a Data General CS/40 system with the help of a turnkey consultant. Micronics, a manufacturer of electronic and security components for missile systems, wanted a method for controlling 30 concurrent projects, its many subcontractors, and a complex scheduling environment. The company was growing at a 30% annual rate and its project status reports were falling behind. Now, says Larry Resch, the vp and general manager, the new system gives management insight into all aspects of the business, especially project management, inventory control, and accounting. The four-terminal system has provided further control over purchasing, detailed labor distribution, and the ability to “flag problems months in advance.”

Selected after serious consideration of four other vendors, the configuration includes a 480KB host





computer with four 80MB disks, a 1,200 lpm printer, a card reader, three crt terminals and COBOL/FORTRAN compilers plus six Level 6, model 33 minicomputers and six Level 6, model 23 minicomputers, COBOL oriented and 64K words each, in a distributed processing environment. The company, with sales of \$84 million, is linking 12 branches in a message switching system that handles order entry, inventory control and payroll applications on-line, by-passing troublesome mail service.

Ralph J. Ciccone, Hunt's director of management information systems, cites a new perpetual inventory system which has reduced investment in inventory from \$7 million to \$5.5 million, a 21% decrease, as one of the major benefits of his distributed processing environment. He says installation was exceptionally easy because Honeywell, like most suppliers, has software aids to simplify the conversion of programs and files. In Hunt's case, the conversion was from MSR COBOL to ANSI COBOL. Honeywell's JCL and high-level operating system also minimized the need for retraining Hunt's dp personnel.

Another Honeywell user in Connecticut, a \$14 million plastics company, switched from an IBM System/3 to a Series 60/Level 62 in November 1976. It acquired a 176KB cpu with four communications lines, a 96 column card reader, two read-only printers, a 400 lpm printer, 10 distributed crt terminals and Honeywell's Information Management System package to process 220 programs in a high-volume order entry environment.

The system accepts orders from an order clerk, validates stock status, produces packing slips and shipping documents, and adjusts inventory to reflect the transaction. Warehouse personnel are given aisle, row, and bin for picking one of 8,000 spare parts. The shipping clerk accesses customer files for shipping instructions and billing information. Then weight, time, date, and transporter are entered into the system to complete the transaction record.

All back orders, invoices and management reports are produced in a batch mode. The system also forecasts sales of units, options and performs materials requirements planning, bill of materials processing and customer credit analysis reporting. With a lead time of up to six months to get certain vital components into inventory, this user soon would be out of business without the system.

The plastics company, which doesn't want to be identified, reports that although sales have doubled, inventory has decreased 40%. Users, they note, are getting spontaneous responses to vital inquiries on a computer system which was easy to install and to maintain and which has minimal dependence on technical personnel.

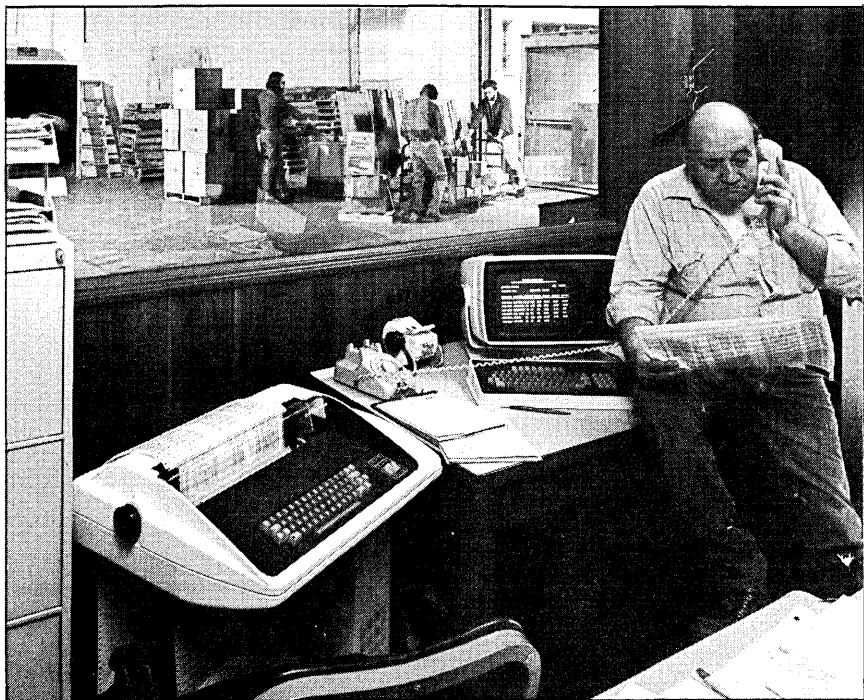

Computer systems are becoming "friendlier" to the user.

## LARGE APPLICATION

Fodesco, Inc., a \$60 million Brook Park, Ohio, producer of specialty chemicals whose sales have doubled every four years has upgraded gradually from an IBM 360/20 to an IBM System/3, model 15, and then to a Hewlett-Packard 3000/11 over a three year period. It services 2,500 customers with more than 2,500 different products in its Foundry and Steel Industries divisions.

James J. Bolin, director of financial systems and controls, says his company's evolution toward distributed data processing was "the best management decision we ever made."

The most recent conversion replaced an IBM S/3 consisting of a 96KB cpu, four tape units, 200MB disk storage, 1,100 lpm printer, and associated equipment to produce and process 96-column cards with an H-P 3000/11 with 256KB core storage, no tape or card capability, equivalent disk storage, but with 16 crt terminals and communications capabilities. Data entry is provided on an Inforex key-to-disk system.

Upgrading to an H-P 3000/111 involves increases in core and disk capacities only, according to Fosco plans, plus an evolution from RPG II to COBOL programs. Bolin says simplicity of installation and the impressive power of small business computers enabled Fosco to "convert small company systems at our leisure over several years. We were able to establish priorities and follow a master plan" for installation.

The current system supports 10 plants and 20 warehouses in a distrib-

uted environment to process order entry, inventory control, customer service and manufacturing management functions. "Users love it," says Bolin. "We've given them inquiry capability but not the programming capability." Retaining centralized control but providing remote usability to users allows them to process all time-sensitive transactions without the risk of letting them alter programs of files haphazardly. "They can look but they can't touch," Bolin says, "because all file updates are done in batch mode only with immediate edit of all remote input to reduce run times for edits and file maintenance later."

The main surprises in the conversion process were that Fosco's RPG programs were converted fully over a weekend and that IBM's sort is alpha/numeric while H-P's sort is numeric/alpha. H-P provided schools for operators and programmers and lots of support. "We selected H-P because of cost, direction and the method of getting there," says Bolin. "Since we were their first installation in this area, we got lots of attention. There were no major hardware or software problems although we did have some power line difficulties."

General Mills' Consumer Food Group is one of a number of major organizations implementing small business computers in a distributed environment. This \$1½ billion Minneapolis-based group of General Mills Corp. wanted to supplement two dual Burroughs B6700 mainframes with a network of minicomputers to improve user satisfaction among its six plants nationwide, primarily for warehouse and inventory manage-

ment functions. It already had a traditional centralized batch operation with a large data communications network which handled order processing, inventory, and RJE on a Datapoint dial-up system. It was, in effect, already doing distributed data processing to some extent.

Gary G. Specker, the General Mills director of systems and data processing, describes the selection of an H-P 3000 as a difficult decision in the search for reliability, flexibility, growth potential, and low cost. In 1976, H-P appeared to have the most attractive on-line capabilities and General Mills eventually implemented six systems with, variously, 512KB cpu, 1 to 300MB disk units, 8 to 20 crt terminals, built-in tape drives and a total of four low speed (300 lpm) printers. The systems have full data communications capabilities on Hewlett-Packard's DS 300 communications network and they all use H-P's IMAGE data base language as well as COBOL. The systems are relatively specialized and dedicated to distributed functions specified by corporate headquarters. One is for order processing, another for purchasing control, a third for network control, two others for time-sharing applications, and the last for basic business systems.

General Mills still is in the midst of installing the full network and will have its first plant system in operation by next December. But the hardware selection process for the first six small business computer systems uncovered so many benefits that they have changed from the original plan for new applications. The new expanded three-year distributed data processing plan is to link 14 units for handling several key applications currently processed on the dual B6700 system. The only real surprise, says Specker, has been that the learning curve for programmers is longer than originally estimated, despite the fact that General Mills' basic programming language application was not changed. Designing around a more limited resource created some difficulties for operations involving data communications and data base software. All existing applications software was rewritten for on-line operation without significant problems.

In evaluating the success of General Mills' use of small business computers in a large-scale computing environment, Specker points to the performance objectives: increased user control and having a reliable on-line minicomputer-based system. From a financial standpoint, hardware operating costs have stabilized and the software would have been rewritten anyway, so the over-all return on investment is also very favorable.

Another major corporation which has adopted small business computers in a large-scale computing environment is Foremost-McKesson, Inc., the \$3 billion San Francisco processing and distribu-

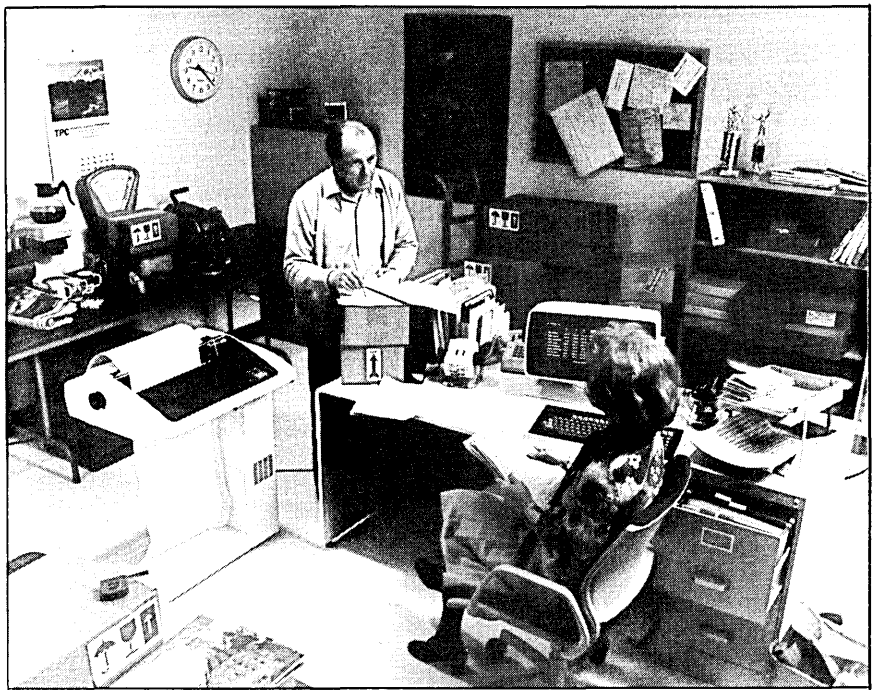

Microcomputer powered CS/20 from Data General is aimed at such small businesses as retail stores, professional services offices, and small manufacturers.

tion company. It plans to operate a large distributed data processing system involving up to 135 sites on an internal data communications network. All field applications are tied into one of two corporate data centers for accounts receivable and inventory management functions on IBM 370/158 mainframes.

Joel Johnson, director of information services, says the company will be operating approximately 100 small business computers of various types within a year and a half. More than 70 already are installed. Among four major divisions, all IBM users, McKesson Chemical Co. has five S/3 model 12s, McKesson & Robbins Drug Co. has 15 S/34s, 26 S/32s, and 25 360/20s, Foremost Foods uses two centralized 370/158s and McKesson Wine & Spirits currently uses a service bureau for the bulk of its data processing. The systems perform order entry, billing, customer service, and inventory management, while the larger systems process all other applications.

## HARDWARE UPGRADE

Johnson characterizes the installation of the distributed system as primarily a hardware upgrade, since software conversion was relatively smooth. He says the decision to stay with IBM was out of consideration for ease of conversion and training plus "reasonably competitive costs." A user of IBM 360/20s for years, the company outgrew them and experienced severe systems limitations until they converted to the S/32 network. Its first S/32 was scrutinized and approved before the rest

were installed. Foremost eventually wants to operate exclusively on IBM S/34s but, until the field staff gains more experience, it is installing new small business computers at the rate of six per month while operating on a combination of S/32s and S/34s that are run as 32s to keep the conversion simple.

All old applications run in RPG while emphasis for all new ones will be in COBOL. The company maintains a permanent field staff of ten persons to install new systems throughout the nation and Johnson places great emphasis on uniformity and central control of a distributed data processing network with detailed procedures for every aspect of its operation.

"New equipment, fresh out of the oven, is normally prone to all types of problems," Johnson observes. "But we had surprisingly few real problems."

Benefits from the network, he says, include increased inventory turns, control of discounting, new applications functions, and control over the number and impact of hardware and applications failures. He says he's looking forward to an IBM announcement of system expansion—S/36, perhaps?

## WHERE IT'S GOING

Manufacturers build systems for two basic types of customers—small users who are beginners and use them in standalone environments, and large users with multiple systems in a distributed processing environment. And there is an important category of medium size companies replacing batch oriented systems with on-

**Your first dispersed processing system.**

# These eight factors will make you or break you:

## 1. Broad hardware range

Your field sites probably don't have uniform needs, so Datapoint offers everything from the desk-top model 1500 to the modular, large-scale Attached Resource Computer™ system, with the peripherals to complement them. You pick the amount of power you need—and can afford.

## 2. Upward growth capacity

Datapoint dispersed processors are a compatible family with common file structures, common operating systems and common languages. When you want to expand, you don't have to start from scratch again.

## 3. Complete system software

Datapoint offers ANSI (and interactive) COBOL, BASIC, RPG, and Assembler, plus our own popular DATA-BUS®/DATASHARE® family of languages. Each system comes with a powerful Disk Operating System and utilities like SORT, EDIT and INDEX to get you up and running fast.

## 4. Versatile communications

Dispersed processing relies entirely on communications to be effective.

Datapoint processors can talk to mainframes, minis, and each other. Batch or real-time, attended or unattended, ready now, not "soon."

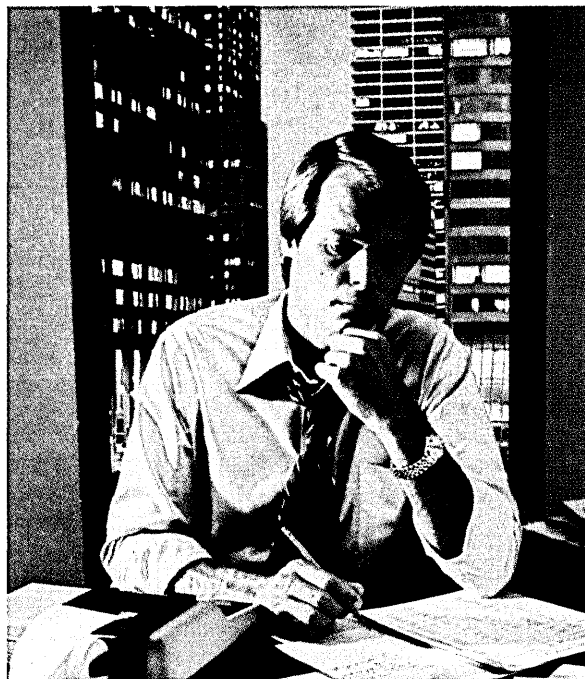

*You have a lot riding on this decision. With over 25,000 systems installed worldwide, Datapoint's experience can help you.*

## 5. Ease of programming & use

The comprehensive Datapoint software library enables your programmers to be more productive than ever. And system operations are so simple, everyone will want to use it. Which is the whole point.

## 6. Support and service

Our systems engineers are trained to help you find the right configurations, get you over the bumps, and keep you informed of new developments. And since machines sometimes need service, Datapoint has over 500 Customer Service Representatives just a phone call away, using our special toll-free service line.

## 7. Financial flexibility

We can fit your financial needs. Buy outright, lease (1, 2, 3-year terms), or even rent month-to-month. You select the arrangement that's best for you.

## 8. Vendor reliability

Datapoint has been growing steadily for ten years. With over 25,000 systems installed worldwide, and thousands of satisfied customers, you can count on us being there.

Take advantage of Datapoint's experience. Fill in and mail the coupon or call the office nearest you.

### DATAPPOINT CORPORATION



The leader in dispersed data processing™

*Send me more information on Datapoint's dispersed processing systems.*

Name \_\_\_\_\_ Title \_\_\_\_\_

Address \_\_\_\_\_ Firm \_\_\_\_\_

City \_\_\_\_\_ State \_\_\_\_\_ Zip \_\_\_\_\_

Datapoint Corporation Attn: Marketing Communications#M62  
9725 Datapoint Drive San Antonio, Texas 78284

# Datapoint can help.

## Datapoint Sales Offices

### HOME OFFICE:

9725 Datapoint Drive  
San Antonio, Texas 78284  
(512) 699-7151

### SALES OFFICES:

Albany/(518) 459-7781  
Atlanta/(404) 325-2212  
Boston/(617) 890-0440  
Charlotte/(704) 527-5300  
Chicago/(312) 298-1240  
Cincinnati/(513) 984-5057  
Cleveland/(216) 351-1775  
Columbus/(614) 890-7686  
Dallas/(214) 661-5536  
Denver/(303) 321-8286  
Des Moines/(515) 225-9070  
Detroit/(313) 855-2900  
East Hartford/(203) 289-9364  
Greensboro/(919) 299-8401  
Honolulu/(808) 833-2110  
Houston/(713) 680-2200  
Indianapolis/(317) 299-4253  
Irvine/(714) 752-9073  
Kansas City, MO./(816) 474-2160  
Los Angeles/(213) 385-0395  
Louisville/(502) 893-2531  
Memphis/(901) 761-3080  
Miami/(305) 621-4335  
Milwaukee/(414) 453-1425  
Minneapolis/(612) 854-4054  
Nashville/(615) 361-5981  
New Jersey/(201) 368-0070  
New Orleans/(504) 831-8101  
New York/(212) 971-9270  
Oklahoma City/(405) 942-8714  
Orlando/(305) 896-1940  
Philadelphia/(215) 667-9477  
Phoenix/(602) 265-3909  
Pittsburgh/(412) 344-6800  
Portland/(503) 644-5575  
Richmond/(804) 353-3858  
Rochester, N.Y./(716) 248-2616  
San Antonio/(512) 734-8982  
San Francisco/(415) 398-2888  
Seattle/(206) 455-2044  
Stamford/(203) 359-4175  
St. Louis/(314) 878-6595  
Tampa/(813) 879-8216  
Toledo/(419) 474-5766  
Tulsa/(918) 664-2295  
Washington, D.C./(703) 841-7600

Sales offices in 29 international cities.

Although only 10% of today's small business computers are in a distributed environment, this will rise to 40% in three years.

line small business computers or who sometimes select a mini as a standalone system.

Hal Pray, manager of small business systems marketing with Data General Corp., says only 10% of today's small business computers are in a distributed environment. He says that within the next three years, this will rise to 40%.

Pray cites applications such as order entry which require a good interactive system, not a batch mode, for effective operation in most companies. Today's small business computers have overcome the early problems of distributed networks with assembler-level programming and limited software. Ease and speed of installation plus upward compatibility are the key factors in the growth of this market, Pray says.

Bill Krause, marketing manager for Hewlett-Packard's General Systems Div. hits on another critical element. The business systems must interface with people. His forecast for the market covers two major segments. "In the technology/product area, price-performance ratios will improve dramatically due to further advances in VLSI technology. Terminals will become more specialized (e.g., point-of-sale, inventory control, etc.), but there probably will not be a major decrease in their costs. Rather, systems will be made more 'friendly' to the user. Increased software functionality will take greater advantage of improvements in price-performance."

"In the customer needs area, distributed data processing will fit the needs of large, decentralized organizations because operating managers want their own control," Krause says. "Cost of applications development and software maintenance is increasing and, therefore, user productivity must increase to pay for it. This must occur through systematizing, automating, and integrating business functions." He says, "Advances in microprocessors technology will be used to improve ease of use, functionality, and friendliness."

Both Krause and Jim Elder, IBM's manager of account programs in the General Systems Div., believe that industry specialization among suppliers is growing. IBM has been organized along industry lines for years and Elder sees the trend increasing as distributed systems become more common. Elder also sees the trend toward the dispersal of computing power away from big cpu's as a new area which will generate "more computing cycles for the large mainframes" and, hence, make better use of their power.

Irwin Jacobs, Digital Equipment

Corp.'s vp of commercial oem, sees the process as supplying an alternative to increased centralization. "Most companies," he says, "have to go through a philosophical process to allow dp departments to provide better service to users." He feels that the trend in distributed data base utilization is to take it out of the skilled university user environment and give it to the average business user in a "bullet-proofed" system. This is to protect user files and programs from each other's mistakes while providing computer services to people at the source of data. "In a data base environment," says Jacobs, "all functions are no longer unsophisticated."

All suppliers stress the importance of easy installation and upward compatibility to users. Hal Pray places special emphasis on the importance of R&D in this market because, he says, "We are dealing with a very sophisticated buyer in the distributed processing field. Users benchmark systems, install a pilot, and thoroughly prove it out before making large investments." He says that mean time between failures and mean time to repair factors must compare favorably with large-scale systems.

Users enter the data at its source, thereby taking responsibility for its accuracy, and accept crt displays in place of hard copy for many applications. This allows an immediate turnaround for transaction-oriented applications such as order entry and customer service functions which are time sensitive while, at the same time, it allows centralized control over file updates, program modifications, and new systems development. Thus, many opportunities for error are eliminated, the user maintains an illusion of local control over his applications, and data processing management can acquire new visibility throughout the organization. \*

## LAWRENCE RICHMAN



Mr. Richman, a consultant and writer, has produced numerous portfolios on dp management problems for Auerbach

Publishers, Inc. He has held staff and marketing positions with computer vendors for 15 years, including a five-year stint with IBM. He's now executive director of Cal-Sec, Inc., a San Diego company that trains people in security.



# “New from Control Data... ...the complete line of miniperipherals for the Series/1.”

“If you’ve already included a Series/1 in your ddp strategy, you should know that you can get even higher performance with our new Certainty Series of miniperipherals. We engineered it around the Series/1 architecture, retaining the important cycle steal feature. And the Certainty Series is available today. A complete line of competitively-priced products to help you get even more out of your Series/1.

“Our display stations for example. No longer must you use expensive video cabling. Or restrict their location to within 500 feet of the cpu. Certainty display stations use low cost digital cabling. So you can put your terminals where your people are—to up to 4,000 feet from the cpu.

“Or our Certainty line printer that gives you clean, crisp printing at 720 lpm. It can also cut your paper usage by 30% when you use its compressed pitch option.

“And now you can add up to 240 Mbytes of removable storage with our Storage Module Drive. Now its popular format attaches to your Series/1.

“Controllers? You won’t see any in our product line. Because we’ve incorporated all controllers and interface logic into our hardware. All of these products are ready right now to be plugged into the Series/1.

“And anyone who buys our miniperipherals gets our commitment to remain current with all releases of IBM operating software. Control Data knows how important support is. More than 4,800 Customer Engineers in our worldwide maintenance organization support our products. Our Education Company can train your people. Our Professional Services Division can help you program your applications. Even financing for your purchase is available through Control Data’s financial subsidiary, Commercial Credit.

“Let us show you how our Certainty Series makes your Series/1 strategy even sounder. For data sheets and more information, call today. 612/482-4379.”

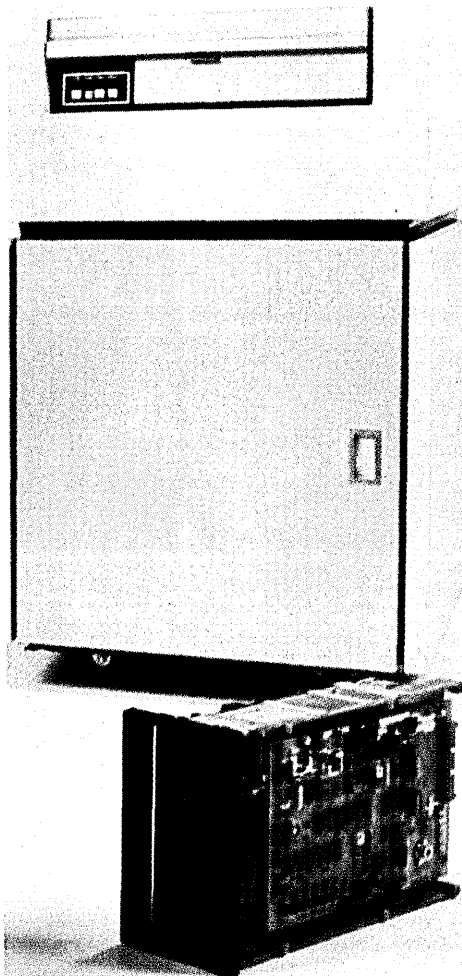

Larry Eaton, General Sales Manager  
Miniperipheral/Terminals Division  
Control Data Corporation

**GD** CONTROL DATA  
CORPORATION

**More than a computer company**

CIRCLE 23 ON READER CARD



CIVIS...  
I.B.M.U.S.

1850

1850



Is IBM a gentle giant bringing Europe the benefits worldwide technology? Or a rapacious intruder emasculating indigenous suppliers?

# IBM IN EUROPE

by David Butler

In this article I describe IBM's position in Europe now, and speculate about its future over the next five years. Included is a discussion of IBM's role as an employer, as a supplier, as a political force, and (most importantly) as one of a number of forces seeking to influence the future of information systems in Europe.

First let us look at IBM in its capacity as an employer. The backbone of the European operation is a corporation known within IBM as EMEA—Europe, Middle East, and Africa. The geographic coverage of EMEA extends from Ireland to Pakistan and from Iceland to South Africa. EMEA employs over 90,000 people in Europe, of whom 77,000 are in the European Economic Community (EEC)—an area of particular sensitivity for reasons which will be explained later. Any notion that the European operation is just a marketing front for alien technology and products—which is true in the case of some multinational companies—is rapidly dispelled by a glance at the activities in Europe. One of the major research division laboratories is situated at Rueschlikon near Zurich and is working, among its many other projects, on the application of Josephson junctions. This is probably a key technology for the future. There are six development laboratories in Germany, the U.K., France, Sweden, Holland and Austria. Their projects and products touch upon almost every aspect of IBM's range, though their current contribution to the upper end of the processor range appears somewhat limited. There are 14 product manufacturing plants situated in seven

countries, with products which range from components to assembled processors and which cover, as far as one can see, the entire product range up to 370/168 and 3033. There are also 23 industry and product support centers all but one of which are in Europe. There are a total of over 500 centers for bureau operations, training, and sales within EMEA. At least 450 of them must be in Europe.

What I have written so far is intended to show the scope and scale of IBM efforts in Europe, and to demonstrate that theirs is a balanced effort of research and development, production and marketing rather than just a sales offshoot of the U.S. firm. IBM is also unlike many other American-based multinationals in that its top management in Europe consists entirely of Europeans. It is not so surprising that the presidents and managing directors are Europeans. Good public relations might dictate that. It is more unusual that the financial controllers—the moneymen who actually run American business—are also indigenous. Two more statistics which illustrate IBM's involvement in Europe may be of interest. In 1977 IBM paid over \$700 million in taxes in Europe, of which \$640 million was in the EEC. This fact appears to have a dual significance. First, it shows that if IBM were doing what so many American multinationals are accused of doing, laundering their profits back home, then you would have to conclude that they were doing it with uncharacteristic ineptitude. Second, IBM may feel that the size of its tax bill is a timely reminder to those public officials who spend their time seeking to limit IBM's role in Europe, of just who pays their wages.

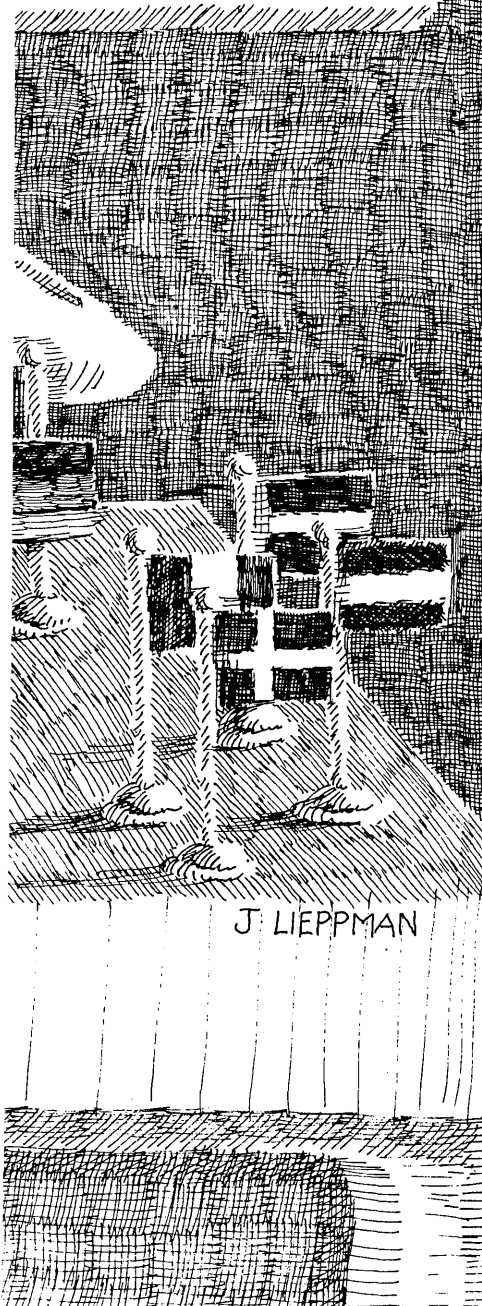
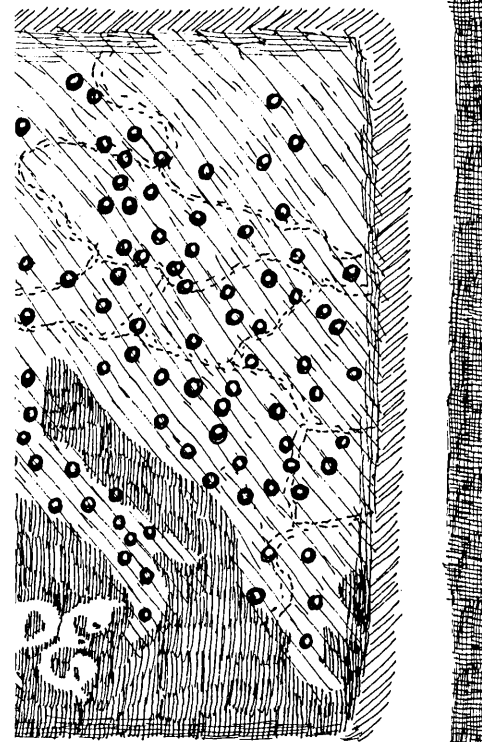

ILLUSTRATION BY JEFFREY LIEPPMAN

## If Europe is being raped by IBM, it is clearly being raped in the most gentlemanly and socially responsible way possible to imagine.

In addition to its tax bill, IBM has recently been at pains to point out that it made purchases in 1977 from European subcontractors of over \$1 billion.

So much for the quantitative aspects of IBM's role in Europe as an employer. It should be evident by now that IBM's basic European strategy is to be a good citizen, to pay its taxes and to hire local labor. One might feel that this policy is pursued for commercial rather than altruistic reasons: in my view virtue is rare enough in this world to be cherished wherever and wherever it is found. The policy has a unique basis and a paradoxical outcome. Its basis is worth a moment's consideration.

Americans tend to appoint other Americans to top jobs in their European subsidiaries. This is not because they mistrust or despise Europeans but because they find perfectly understandable cultural gaps between themselves and the most talented of Europeans. In the course of periodic review meetings it is extremely difficult to bridge these cultural gaps. Both Europeans and Americans tend to emerge from such close encounters equally convinced of the total ignorance of the other side. Anyone who has ever worked for an American company will instantly recognize the syndrome. Now the clever answer to this problem is to have American top management in Europe. The cultural gap then exists locally, between manager and manged: but since local top management is on the job all the time, seeking to educate and to understand the local workforce, the problems are more likely to be solved.

Why is IBM different? How can it afford to have European top managers in Europe? The answer, I believe, is simple and staggering. IBM has been even cleverer than the other American multinationals. It has created *its own culture* which is powerful enough to override the differences between American and European. The top management of IBM in Europe can be entrusted to Europeans because the fact that they work for IBM is culturally more significant than the fact that they are English, German, Italian, or even (incredibly) French. This fact becomes even more astonishing when one reflects that similar efforts on the part of the United Nations and the EEC have met with only limited success. You have to go back to the Roman Empire to find a comparable situation, when the status of a *civis Romanus* overrode nationality, as in the case of St. Paul.

The nature of that internal IBM culture is subtle and diffuse. It contains disparate and even contradictory elements. The famous story of Vin Learson telling a top manager to "get his ass out

and fix a sales loss" coexists with an almost fanatical concern for the aspirations and problems of the individual. In God's army even the humblest private is a saint. The conviction that the growth of corporate revenue and profit are also part of a near-divine mission is not a particularly easy one to sell to Europeans. They have seen too many near-divine missions, from Attila the Hun to the Third Reich, to react with less than scepticism. But if you doubt the success of IBM in imbuing its European managers and workers with its own overriding culture, may I ask you to reflect upon this simple fact: at IBM's Greenock plant in the U.K., which is situated in one of Britain's industrial relations disaster areas, there has never ever been a strike.

A senior manager from IBM once told me that the world is wholly mistaken in its view of the corporation. "People think our strength lies in our marketing," he said. "We're good at marketing, but that's not our real secret. The real strength of IBM is its organization." In so far as organization has permitted and fostered the growth of the dominant transnational culture in Europe, he was right.

The paradoxical conclusion of the triumph of IBM's internal culture is that the European top management has made IBM in some important respects more European than the Europeans. If you look at the total volume of all goods delivered in Europe by IBM, you will find that 90% of them were manufactured in Europe. IBM thus sees itself fulfilling an important role in import substitution. And given the reliance of some European-based firms on alien components and peripherals, are they really more genuinely European than IBM? In 1976, the European Commission produced a document entitled "A Four-year Programme for the Development of Informatics in the Community." I'll discuss this paper in more detail later. For the moment, however, let us note that according to the commission's figures, the share of the peripherals market in the EEC claimed by alien suppliers was no less than 83%. IBM later published a document headed as "Comments on" the four-year plan. In fact, of course, it is a fierce and sometimes contentious rebuttal of most of the commission's main policies. It does point out that within the 83% is included all IBM production of peripherals, including that which takes place *within* the EEC. IBM also points out that production from EEC-based companies taking place *outside* the EEC does not count as import.

I quote this example not to appear to criticize either IBM or the EEC for the

misuse of figures, but rather to illustrate the way statistics can be interpreted to reflect a greater or lesser degree of "Europeanness," depending upon the viewpoint of the interpreter.

Let me summarize this argument which IBM puts forward to support its claim to be regarded as and treated as a good European company by quoting from a policy statement issued by IBM in response to the EEC's four year plan:

"We believe that IBM is as European as any other company in Europe. Our record in Europe so far as employment, manufacture and R&D are concerned, entitles us to be so considered. IBM within the Community contributes in many ways, directly and indirectly, to the national economies. Our direct contributions, in the form of investments, jobs, taxes and exports are very significant. Our indirect contributions include the availability of products and services which, although almost entirely produced in Europe, are the consequence of the most advanced worldwide international effort, and assist industry and administration in the Community."

It is of the utmost importance for everyone concerned with IBM, as customers, competitors, regulators or observers, to recognize that the corporation's attempts to make its European operation genuinely European are far removed from the cynical window-dressing which uninformed critics claim they are. They are policies which are consistently supported, rigorously applied, and astonishingly successful.

### THE EUROPEAN COMMISSION AND IBM

Why then does anyone question the role of IBM in Europe, now or in the future? If Europe is being raped by IBM, it is clearly being raped in the most gentlemanly and socially responsible way possible to imagine: wooed would perhaps be a better term. In order to attempt to answer these questions, I propose to analyze the recommendations of the commission of the EEC. Later I will touch upon future developments which will alter IBM's role and perhaps modify the extent to which we in Europe might seek to limit that role.

The views and recommendations of the commission are set out in a number of reports issued in October and November 1976. The reports were prepared in response to a resolution of the Council of the European Communities (July 15, 1974) which asserts among other things that "the structure of the data processing industry in the world is unbalanced." The Council also stated its belief that "it is desirable to prepare, in the

medium term, a systematic Community programme to promote research, industrial development and applications of data processing. This programme would provide for the coordination of national promotion and Community financing in appropriate fields of joint European interest, with the central aim of ensuring that by the early 1980s there is a fully viable and competitive European-based industry in all the fields concerned."

The response of the commission included a 140-page report on the developments in data processing in the Community in relation to the world at large, as well as the draft four-year plan and the necessary enabling resolutions. In the full awareness that the degree of summarization necessary for this paper may introduce accidental distortions, let me offer a brief analysis of the commission's recommendations.

The commission sees two main areas of activity as critical—standardization and collaboration. In this way the commission hopes to create a large, advanced, and homogeneous market in Europe in the era of convergence and distributed processing. Moreover, in terms of identifying the enemy, the report comes sharply to the point. "IBM," it states on its second page, "does not dominate the world of distributed processing. . . . but it is developing a range of systematic strategies to penetrate and command these new markets: its System 32, aimed at the minicomputer market, its PBX switch 3270 (sic), its Systems Network Architecture offering an all embracing network and software concept, its capability as one of the largest electronic component manufacturers in the world. Moreover, a manufacturer who dominates the world market-base for central processors can also shape, limit and control the market for many different types of terminals and attached peripherals if that manufacturer continues to control the standards, interfaces and software which condition information and communication systems as a whole."

An interesting note has crept into the report at this point, though it is not very powerfully developed. IBM is seen here not just as a competitor to the European-based computer suppliers, but also to the suppliers of equipment and services in communication-based networks. The most obvious class of organizations in this category is the European PTT's, a point to which I shall revert.

In the area of standards, the commission wishes to see an increase in the Community interests in international standards bodies, including presumably the ISO and the CCITT. Further than this, however, it wishes to see Community

standards adopted where no global standards exist and to have these treated as the base for public sector procurement in the Community. The first such standard (proposed in fact before the four-year plan) is to be a common language for real-time applications. A further proposal has also been tabled to study ways of improving portability and reducing conversion costs.

The coordination of public procurement policy is seen as a key area, since public purchase accounted in 1976 for some 20% to 30% of the Community market. The commission sees as a good example the behavior of the U.S. government, which insists upon certain standards, such as COBOL, and where IBM's market share was then just over half its total market share (36% public sector against 68% total market). The commission wishes to see open tender for data processing equipment by 1980.

Collaboration between Community members is seen initially as joint programs between public research centers concerned with systems, presumably including such bodies as the National Computing Center in Britain and the Gesellschaft für Mathematik und Datenverarbeitung in the German Federal Republic. These centers are also envisaged as local "agencies" to help with the standards and procurement work. The commission also recommended some long term studies into areas where current statistical or other information is inadequate, such as the structure of the market, the impact of systems on employment, and the problems of security and privacy.

The commission's report now turns to the important question of support for the data processing industry. This question is of key significance not only in money terms but also psychologically. Many of IBM's European critics, while unable to question the facts underlying its good neighbor policy, will argue that it can afford to behave responsibly because of its dominant position. Moreover, they attribute this dominance to the support given to IBM by the U.S. government, and claim that Europe must do the same for its industry.

The commission considers that the current support schemes in the Community have "permitted the European industry to survive." I wonder how many recipients of government largess would agree? I know for a fact that senior managers within ICL believe the public money they have received has less than compensated them for the cost and inconvenience of mergers wished on them by the government: but let that pass. In the U.S. the federal government was esti-

mated in 1976 to spend some \$12 to \$16 billion on data processing. The space program created new tools and new skills. In Europe, on the contrary, different solutions in different countries have been sought to common problems. "The result," says the commission, "has frequently been that only a company with the multinational market power of IBM has been able to impose common solutions, based frequently upon applications developed to meet U.S. needs. The smaller European-based companies, rooted in national markets, have often found it difficult to obtain a Europe-wide return on their investments, and have been unable to muster the resources needed to attack all sectors of the market."

The solution, in the eyes of the commission, is to bring users together in key sectors, to define their requirements jointly, to support and promote joint developments to meet such needs, and to encourage the European industry (hardware and software) to meet such needs—a sort of European society for the (hopeful) abolition of redundant effort. The commission envisages a scheme for granting up to 50% of the cost of such developments.

In the service and software sector, the commission found a much more pleasing picture. The market, some \$1.8 billion in 1975, was expected to grow to \$4 billion by 1980. Fifty-seven percent of this revenue was secured by European firms, who were also substantial exporters. No general support system for the service industry is required. Where individual projects can be identified as related to the standards and portability issues, however, Community funds may be available to support them.

The next issue to which the commission addressed itself is finance. Once again the target is clearly identified: "The most urgent need for a Community activity is in the field of leasing. Its established market position and gigantic internal rental income give IBM a permanent advantage in relation to other competitors who must constantly raise external finance to fund growth. This disadvantage is aggravated by inflation and recession, which together reduce the amounts of credits which companies can raise in relation to their equity base. . . ."

In a market growing by some 13% per year, it would seem a reasonable objective for the European-based industry to aim to increase its market share to 41% of the European market by 1979 and some 50% by 1985. Such a growth would require some 5,000 MUA (Million Units of Account, an EEC term; this translates into

# The two dominant technical and economic trends conditioning IBM's global strategy are the convergence of technologies and vertical integration.

roughly \$6.5 billion) of finance in the next five years.

On the basis of these projections, and given present financing arrangements, it may be estimated that industry may obtain some 50% of these funds from the private banking system. For the remainder, further financial mechanisms would appear necessary.

What solution was the commission able to offer? At the time of its report the leading option seemed to be a special fund set up through the European investment. But opposition within the Community was seemingly encountered, for this particular flag was no sooner run up the mast than hastily pulled down and furled away for more study.

Turning to support for research and development, the commission notes the vast expenditures of the U.S. government in these areas and the major advantages accruing to IBM as a result. It also hints that if the experiment of Unidata had proved successful, it might have formed an ideal vehicle for Community-sponsored research. But with the collapse of Unidata it was left with no such vehicle, and makes no recommendations in the area. Concerning CII-HB the commission comments that in the formal sense it is a European-based firm since over half its shares are held in France. "But it remains doubtful," says the report, a rare note of tetchiness creeping into the officialese, "where the real power lies." Yes indeed. Clearly there was no dancing in the streets of Brussels at the announcement of this piece of Franco-American perfidy.

Although unable to recommend general R&D support, the commission nevertheless proposed a scheme to finance developments in minis, peripherals, terminals, and other intelligent devices, which it groups under the unattractive heading of "peri-informatic." The proposed support would total some 30 MUA (approximately \$39 million) over four years.

A special and streamlined method of evaluating projects eligible for support was also proposed under the title of the "Community Premium Scheme."

## IBM'S REBUTTAL

So much then for a very brief analysis of the commission's proposals for the future of data processing in Europe, largely designed, as is apparent, to cope with the threat of continued or increased IBM dominance. It is interesting to note that the arguments deployed by the two parties are not so much in conflict as on totally different planes. While the commission argues that

European data processing must be strengthened and that this must necessarily be to the relative detriment of IBM, IBM is eager to establish itself as a bona fide member of the European community—note the small "c." This lack of a common level of discourse is even more apparent when we turn to the points contained in IBM's rebuttal. The document is a brief one and does not cover all the proposals. But with a tone of some asperity it warns us that "failure to address any specific point made by the European Commission should not be taken as implying our agreement with the Commission's views and proposals." A summary of IBM's counter to the commission is set out below.

1. IBM harshly criticises the commission for its alleged failure to consult users and suppliers, leading to a partial and unbalanced view of the true position.

2. IBM rejects the commission's view of itself as a "dominant" force, particularly as by its own admission its statistics leave a great deal to be desired. Very astutely, too, IBM alleges that the reference to its alleged domination is highly improper in view of the fact that the commission is currently investigating IBM under its antimonopoly powers.

3. IBM rejects out of hand the notion of "European standards." It argues that the world standard-making bodies must be supported to the full, not undermined by separatist activities.

4. IBM argues that portability of systems is too narrowly interpreted in the commission's findings. Indeed the transfer of systems unchanged from one generation to another would produce ossification.

5. On public procurement policy IBM predictably switches to the offensive. Governments need the best computers. If IBM in any particular case has the best computers, and if the European-made content of them is the highest on offer, why should discrimination against IBM take place? IBM terms this position "paradoxical and unhealthy."

6. How should the Community support data processing? IBM's answer is simple, engaging, and presented with a good deal of chutzpah. The Community should encourage the widest and most beneficial usage of computers by improved education, supporting *application* development and better telecommunications facilities—and leave the choice of hardware and software to be resolved by the mechanism of the free market.

These are some of the specific comments made by IBM, in addition to those of a more general or comprehensive

nature already mentioned.

## IBM'S GLOBAL STRATEGY

It is clear from the foregoing sections that there are two very different views about IBM and its role in Europe. Is it a gentle giant, decently integrated into its host environment and dutifully bringing to Europe the benefits of worldwide technology? Or is it a rapacious intruder, using its world monopoly power to emasculate the small and brave indigenous supplier? Or is the answer to both questions paradoxically affirmative?

I believe a sensible answer to this conundrum can emerge only from an examination of IBM's global strategy at the very highest level of policy. Accordingly I propose to venture momentarily outside the strict terms of my brief.

There are at present two dominant technical and economic trends conditioning IBM's global strategy. They are the convergence of technologies and vertical integration. Let me explain what I mean by these shorthand phrases.

A few years ago the computer, telecommunications, and office product industries were very distinct. Their underlying technologies were different and their markets were separate. In the telecommunication markets of Europe, for example, the most important skills were those of electromechanical engineering and negotiation with the telephone administrations of the world. Today we see a much changed picture. Nearly all the largest communications contracts—such as that for Saudi Arabia recently won by a transatlantic consortium—feature electronic switching. In these ways processor technology is occupying the heartland of the communications business.

The process of vertical integration in the computer industry is as yet less well developed. But there is clearly a sense in which the underlying technology of the computer industry is also changing. A few years ago the dominant skill was the ability to achieve cost-effective and reliable batch fabrication of electronic components. Now you can buy them in retail stores. "We produce," says IBM in its rebuttal, "integrated circuits for our own consumption only." But how precious is this special skill in an era when the computer industry is just one of the consumers of the ubiquitous IC?

Recent research done by Butler Cox & Partners suggests that the entry of National Semiconductor into the mainframe business is not just an isolated phenomenon, but a forerunner of a long term trend reflecting objective factors. Why should the IC suppliers continue as



passive suppliers to the computer industry, when they can (in association with others) supply their products to the end user? Naturally the plans of each IC supplier vary: in general however they will tend to aim for the fastest-growing market sectors.

The two dominant technical and economic trends, convergence and vertical integration, are going to create a great deal of noise in the market for integrated systems. Companies will stumble into each others markets. The lawyers and the regulators will go crazy as the old market barriers between data processing and communications crumble around them. For example, there is AT&T's announcement of its new ACS service. It represents a frontal assault on an important sector of IBM's American market and marks the long-awaited declaration of commercial war between IBM and Bell.

IBM's response to the new challenges is fourfold. First, it has created for itself in Europe a small but important foothold in the field of integrated voice and data switching, through the 3750. Second, it has moved through Satellite Business Systems Inc. into the market for satellite communications. Third, it has strengthened its range of office products in the expectation of growing markets for word processing, electronic mail, and office automation. Fourth, it has perished, despite a disappointing market response to date, with the development of SNA as an overall network concept. It is clear from all this that IBM recognizes the challenge and sees itself as able to respond across the board—in computing, in telecommunications, and in office automation. It is probably the best placed company in the world to do so.

If you were a fly on the wall at Armonk, I think you would hear the following broad-brush picture of the future: "Convergence and vertical integration are going to create utter chaos in the market for information systems in the widest sense of that term. We are big enough and clever enough to respond to all the technical challenges we can foresee. We also have a unique advantage in knowing how to sell both to dp managers and administration managers—very different kinds of customers. We expect the legal and regulatory chaos to be so great that we may win lots of prizes that seem today to be impossible. We might be able to enter the market for public telephone exchanges once the 3750 replacement has proven to the PPT's that we are really nice to know. All our current competitors are going to find the going much, much tougher than we will. They will be wrapped up in half-baked schemes to buy

an IC business while we already have one. They will be introducing themselves to telecommunications managers who already have a generation's experience of using our switches. Of course it will be hard, but we will emerge in a decade from now in the same position of strength in relation to the convergent systems market as we now have in the computer market."

It would be a bold man who would bet against IBM achieving this aim.

## IBM IN EUROPE 1978-1983

The time has come to venture upon a number of specific forecasts about IBM's activities in Europe over the next five years. None of my suggestions will surprise the knowledgeable observer of this fascinating company. But I believe there is plenty of material for profound thought to be found in these probabilities.

1. IBM's relations with the European Community will continue to be tense and occasionally acrimonious. The absence of a serious level of discourse between the two has been rendered more acute rather than less by the published exchanges to date. I would rate it even money that there could be a serious political or regulatory battle between them.

2. IBM will sustain and even increase its efforts to be seen as a good guy in Europe. It will tolerate the use of plug-compatible peripherals and even alien processors with better grace than might be expected. The prizes in the long-term battle are too great to be imperiled by short-term cussedness.

3. IBM's impending battle with AT&T will worry the European PTT's. IBM will respond by trying to strengthen its links with the PTT's. It will also take a leading role in the work of standardizing communications methods and protocols, whilst hoping that progress is not too dramatic. It will even try to adapt SNA to accommodate the aspirations of the PTT's in the area of public packet switching. But it will still be seen as a threat in this area.

4. Look for the most spectacular developments in the area of end user terminals, supported by a replacement for the 3750. In most other areas IBM will want to appear to be soldiering on—even plodding. But it will try to follow up its success in selling the 3750 (largely achieved by impressing user managers with the *service*) with terminals designed to blow the end user's mind.

5. Look for a series of new software aids. In an era of scarce manpower, the supplier who can offer a substantial increase in the productivity of analysis and programmers has a powerful and

perhaps decisive sales aid. Just by turning out what's in the unreleased locker, IBM could steal a march on its rivals.

6. Look for a phased transfer from the current DB/DC products to a new family. Although in theory IBM embraces the Relational Model, it will not release a program product until it has established a migration path for IMS users. This will prove a difficult task.

7. IBM has an Achilles heel. It often happens that yesterday's strength is tomorrow's weakness. I mentioned earlier that IBM's great triumph in Europe was its ability to create its own internal culture and to make this the dominant unifying force among the various nationalities. I believe this still to be true. But I am not sure that it will remain true throughout the quinquennium under review. Purely as an outsider I would hazard that this unique IBM spirit has been created, nurtured, and propagated by a series of wholly exceptional men who, by family connection or sheer ability, reached the top in IBM and dominated their environment. My judgment is that for the moment such inspirational leadership is not available to the company, that the place of messianic leadership has been taken by corporate planners, lawyers, and moneymen.

Earlier, I compared IBM with the Roman Empire. Let me end with two questions of a deliberately fanciful kind. Has IBM passed the age of Augustus, reached the age of Tiberius, and is it headed for the age of Caligula, Nero, and Claudius? And could it rise (as it must) to the challenge of convergence if it became (as it might) just another company? \*

## DAVID BUTLER



Presently chairman of Butler, Cox & Partners, Ltd., David Butler began as a programmer in 1962, moved into systems design and project management, and became a consultant in 1965. He has written numerous articles on computing and allied topics and in 1977 won first prize in the National Computing Centre computing essay competition for a paper on computers and communications. For the past few years he has worked intensively in those areas where computers, telecommunications, and office automation converge into a single discipline.

What do you call a  
powerful new minicomputer that can  
expand up to 2 megabytes of main memory  
at \$32k per megabyte, that can handle up to  
960 megabytes of disc storage, that's  
available with manufacturing software,  
and does on-line processing  
at 4000 transactions  
an hour?

# Powerful. The HP

The latest addition to our very successful HP 3000 family combines a new high in performance with a new low in memory price.

With more powerful hardware and software, the Series III offers twice the throughput of the Series II. We made the most of the latest LSI technology by using 16K RAMs to offer error-correcting main memory up to 2 megabytes. At the same time, we dropped its price 46 percent to just \$32K per MB. Our new optional 120 MB disc also cuts disc memory cost/MB by 46 percent and increases storage to 960 megabytes.

## On-line transaction processing made easier.

So more people can get more out of the system at the same time, we speeded up our operating system. With the help of our latest Multiprogramming Executive, MPE III, people at dozens of terminals can simultaneously enter and update the data base, develop programs or solve problems. And they can use any of six languages, too.

In addition, you can either handle a wide variety of different jobs or dedicate the system to single high-volume tasks—without changing operating software!

MPE III also gives you some features previously found only on expensive mainframes. Multi-point terminal support is one. You can cut your communications costs substantially by hooking up a string of terminals on a single cable, with a 9600 baud line speed.



Private volume disc files is another asset. A set of commands allows you to interchange disc volumes without powering down and reconfiguring the system.

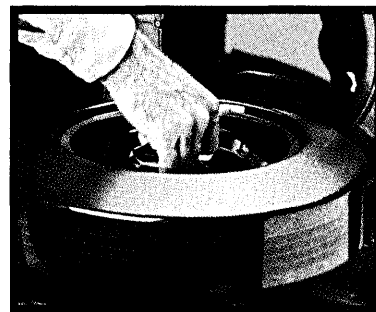

## A faster, more flexible data base manager.

We've improved our award-winning Data Base Management scheme, IMAGE/3000, to make it operate about 20 percent faster. And our new associative locking scheme lets several users update the data base at the same time.

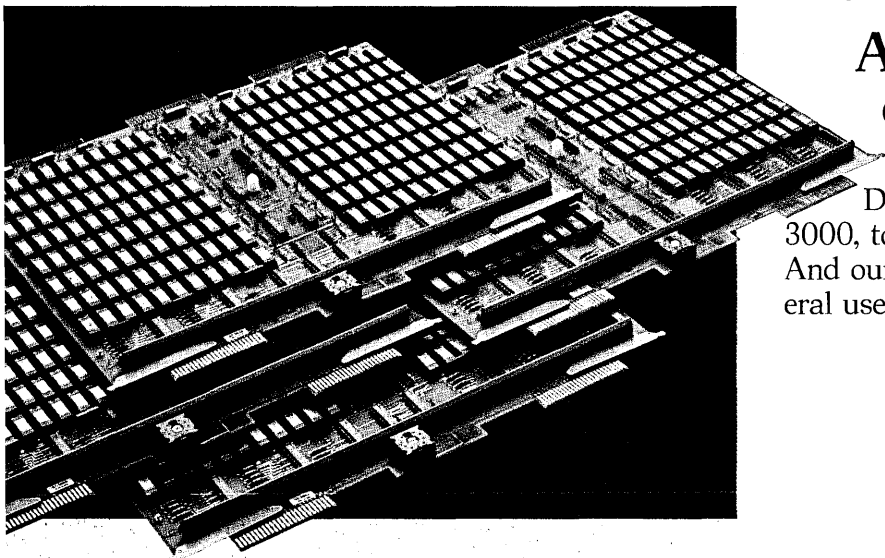



# 3000 Series III.

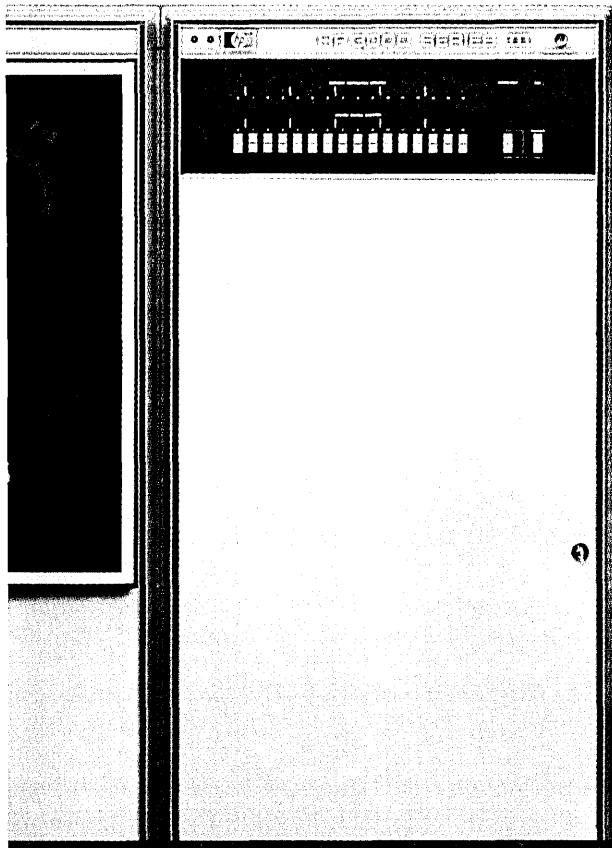

## New tools for manufacturers.

We're also introducing an applications software package, MFG/3000, that will help shape up inventory control and material requirements planning.

Designed for manufacturing companies of all sizes, it's already proved to be a real time and money saver, easy to install and operate. (In developing the program here at Hewlett-Packard, we reduced our own inventories, too!)

## Consulting help to get you started.

While we're making it easier to use the HP 3000, we still want to give you all the personal help we can. So we've added a number of consultants in on-line transaction processing and manufacturing to our field force.

They'll help you through the critical first phase of planning and installation.

With all these advantages, and system prices starting at

A new feature of DS/3000, our networking software, gives you easy access to remote data bases. For a large company, this can obviously lead to a much more efficient distribution of data, as well as making management information even more speedily available than before.

\$115,000, don't you owe yourself a closer look? Call your nearest HP office listed in the White Pages and ask about a hands-on demonstration of the powerful Series III, the new head of HP's business systems family. Or write to Hewlett-Packard, Attn: Bill Krause, Dept. 429, 11000 Wolfe Road, Cupertino CA 95014.

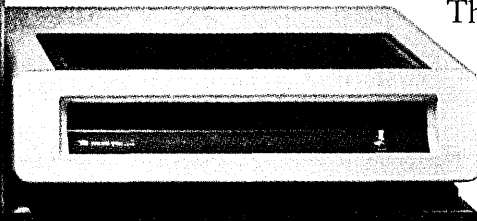

HEWLETT  PACKARD

*Performance test results available on request.  
All prices are U.S. domestic list.*

47803HPG27

# This disk drive packs 10 Megabytes in unit one-third the size of conventional drives.

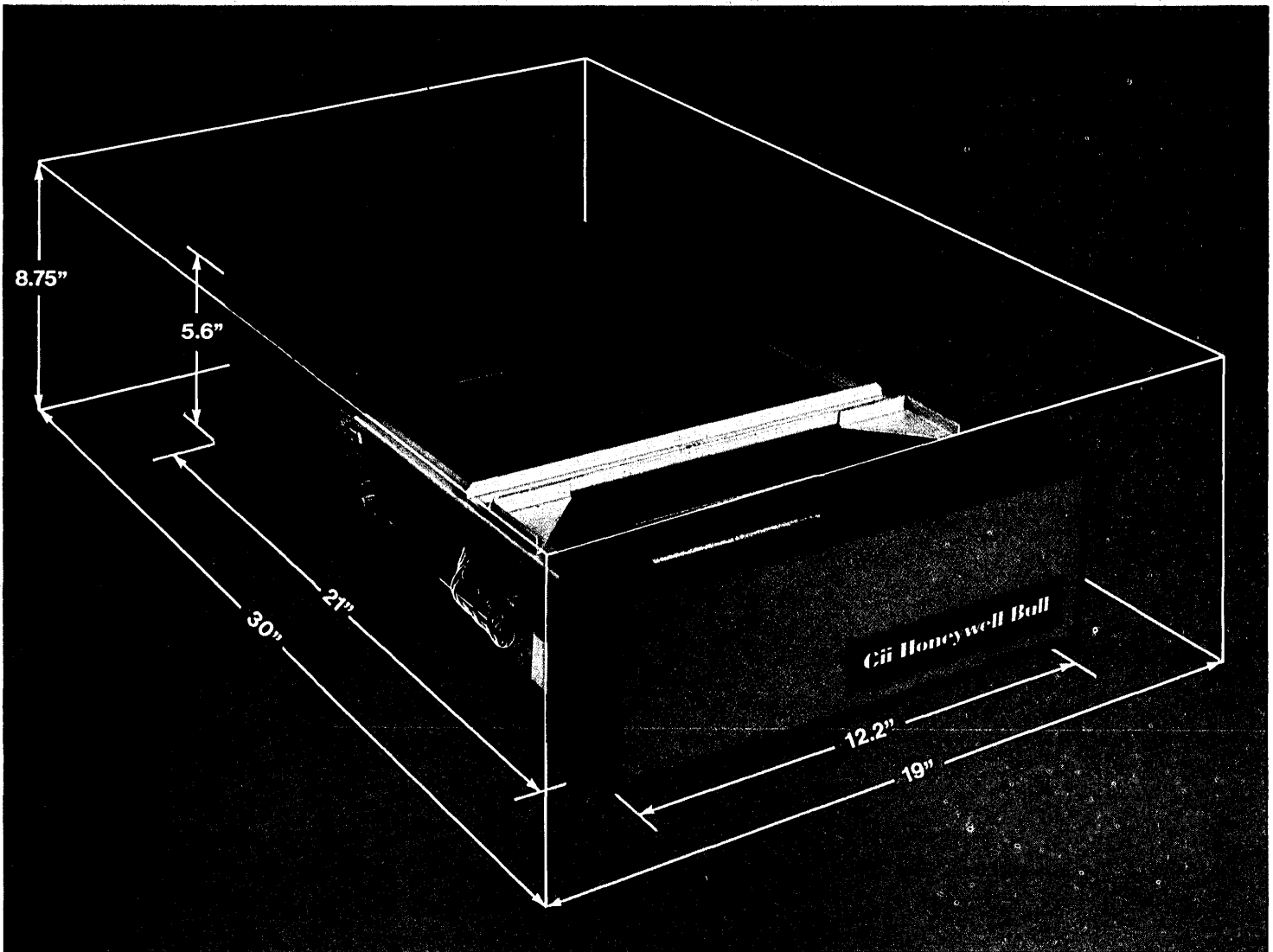

OEMs and systems builders will want to take a hard look at this D120 MidiDisk drive (the first of a family) that combines large disk state-of-the-art technology in an unusually compact package.

Its performance advances include:

**Operating Versatility.** Three D120 units can be mounted vertically in a 19-inch rack. A table-top version is available also.

**Midi-Cartridge.** The D120 uses a flat, ultra-thin midi cartridge which measures only 11" square, is less than one inch thick, and weighs only 2.8 pounds.

**Speed.** A fast 920 kilobytes per

second. (Densities of 4,750 B.P.I., and 500 T.P.I.)

**Accuracy.** Data-imbedded, servo-tracking techniques for head positioning eliminate the need for a transducer, thermal compensation, or head alignment techniques. This simplified mechanism rules out any need for preventive maintenance.

**Power Savings.** The midi cartridge is self-ventilated (operates at 3600 rpm). No air blower is required. (After startup, total power consumption is only 100 watts.)

**Reliability.** The spindle is an integral part of the brushless dc motor. There are no belts or pulleys, no

electronic/mechanical adjustments to make. And head loading is controlled automatically to prevent damage in the event of a failure.

**Available:** Controllers for industry-standard microprocessors.

For price and delivery information, contact: **In North America** — Jean-Paul Garodel, Honeywell Information Systems, 200 Smith St. (MS 464), Waltham, Mass. 02154. 617/890-8400, x 2019.

**In Europe** — Alain Kiffer, Cii Honeywell Bull, 6 Avenue des Usines, 90001 Belfort, France. (84) 228200.

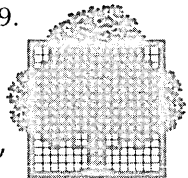

**Cii Honeywell Bull**

# THE CRAY-1 AT LOS ALAMOS

by Fred W. Dorr

The rapid advances being made in personal computers and microcomputers at the small end of the computing scale sometimes tempt us to believe that the need for large machines is disappearing, but that simply isn't true. There are applications which cannot yet be handled by even the largest existing computers, and organizations which must accept the risks of pioneering the use of new supercomputers just to come a little closer to successfully processing those applications.

The Los Alamos Scientific Laboratory (LASL) is one of those organizations, and has been one since the 1940s. LASL is one of the largest multidisciplinary, multiprogram national laboratories in the United States. Managed for the Department of Energy by the Univ. of California, the lab's mission is the application of science and technology to solve national problems in nuclear weapons development and in energy supply and conservation. It is one of the nation's two sources of nuclear weapon design and development (the other is the Lawrence Livermore Laboratory) and thus its largest single responsibility is that of providing nuclear weapon designs for our nation's and the free world's stockpile.

About 85% of the lab's total effort is related to nuclear studies, the remaining 15% to energy programs such as fossil, solar, and geothermal energy, electricity transmission and storage, and regional energy assessment and policy analysis. Nuclear research is being carried on in laser fusion, laser isotope separation, safeguards for nuclear material, and calculations of reactor safety, but the weapons program soaks up nearly 60% of all computer processing resources, and is expected to continue to do so.

Modern nuclear weapon design is among the most difficult of technical fields of research in which the nation is presently engaged. The physical environment of a nuclear explosion is clearly

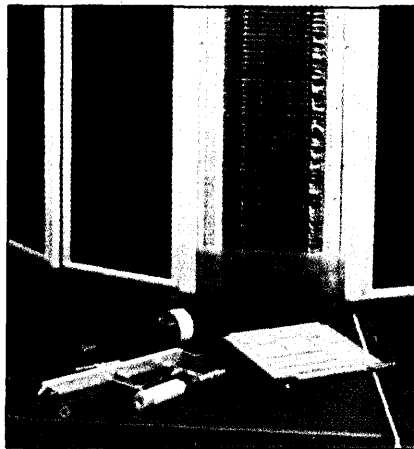

beyond the reach of everyday experimental means, involving temperatures more typical of a stellar atmosphere, as well as other hazards. This environment is sufficiently remote from normal scientific endeavor that the lab must sponsor its own supporting research, without which significant advances in weapons design are impossible.

To do its research and design, LASL has historically acquired the newest supercomputers as quickly as they have become available. (See Fig. 1.) Computers have played an essential role in the U.S. weapons program from the earliest days of the Manhattan Project, which led to the development of the atomic bomb. Since that time, the weapons program has continued to be one of the most important driving forces for the development of ever more powerful large scale scientific computers.

The primary use of supercomputers in the weapons program is for modeling and analysis of physical phenomena in support of nuclear weapon design. By developing and using such models, weapon designers are able to conduct literally hundreds of "experiments" on the computer. This process allows investigation of many design options and results in performance standards unobtainable without computers.

## SUPER— SCALE PROBLEMS

The extraordinary dependence of nuclear weapon design on computers arises from three factors:

1. Nuclear weapons must meet high standards of performance, including near-perfect safety and reliability.

2. A nuclear weapon is a complex device which operates in an extremely short time at conditions of temperature and pressure which cannot be duplicated in the laboratory and are achievable only in nuclear tests.

3. It is difficult to obtain sufficient test data, not only because of economic and political constraints, but also because of the technical problems of instrumenting a nuclear explosion. Further, data from nuclear tests generally provide only indirect measures of what is happening and require extensive calculations for interpretation.

The nuclear weapon design process places formidable demands upon computer resources, because of the complexity of nuclear weapons and the nature of the design process itself. Weapon design requires many iterations for optimization and short turnaround times to meet schedules. During its design period, a single nuclear weapon may require the equivalent of one year (approximately 8,000 hours) of computer time on the most powerful machines available.

Furthermore, the systems of programs (called "codes" at LASL) involved in this modeling process are extremely complex, and tax the resources of even the largest supercomputer. One nuclear weapon design model currently operational on LASL's CDC 7600s consists of about 90,000 lines of FORTRAN code with 67 overlays, and requires 9 hours of central processor time and 10 million words of disk storage for its execution. One special model used to validate production versions requires 30 to 40 hours of 7600 time and 200 million words of disk.



This single quadrant of LASL's central computing facility houses more computing power than most large scale installations have. Visible are a CDC 7600 (right rear) and

three other quadrants, each with as much hardware, plus the Cray-1.

COMPUTER	POWER
MANIAC-I	0.006
IBM-701	0.006
IBM-701	0.006
IBM-704	0.01
IBM-704	0.01
IBM-704	0.01
MANIAC-1 I	0.01
IBM-7030	0.3
IBM-7090	0.07
IBM-7090	0.07
IBM-7094	0.1
IBM-7094	0.1
CDC-6600	1
CDC-6600	1
CDC-6600	1
CDC-6600	1
CDC-7600	5
CDC-7600	5
CDC-7600	5
CDC-7600	5
CDC-CYBER-73	0.75
CDC-CYBER-73	0.75
CRI-CRAY-1	20

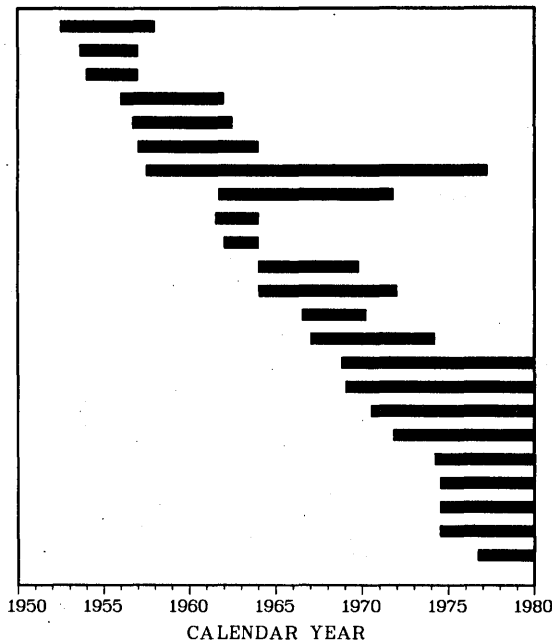

Fig. 1. Beginning with its inception for work on the World War II Manhattan Project, the Los Alamos Scientific Laboratory has always had the most powerful computers available. Its most recent acquisition, the Cray-1, is about four times as powerful as the lab's last supermachine.

Typically a better model, one with greater predictive ability, includes one or more of the following: more accurate and complete physics detail, increased dimensionality (two or three dimensions instead of one), higher spatial resolution (finer area mesh), and higher temporal resolution (smaller time steps).

In addition, the utility of improved models increasingly relies upon enhanced interactive computing capabilities, which can be very costly in computer resources. For example, extending a 200-zone model from one dimension to two with the same resolution requires 400 to 800 times as many calculations and at least 200 times as much storage.

Therefore, more capable computers can lead to progress in several aspects of nuclear weapon design including improved safety and survivability, improved security and command/control, reduced overall cost (dollars, resources, special nuclear materials), reduced size and weight, tailoring of effects (heat, radiation, etc.), improved operational flexibility, and improved reliability.

A broad spectrum of models is presently used. Supercodes, the largest of them, run from 1 to 10 hours and typically require all of the hardware resources of the fastest available com-

# THE INTEGRATED COMPUTER NETWORK

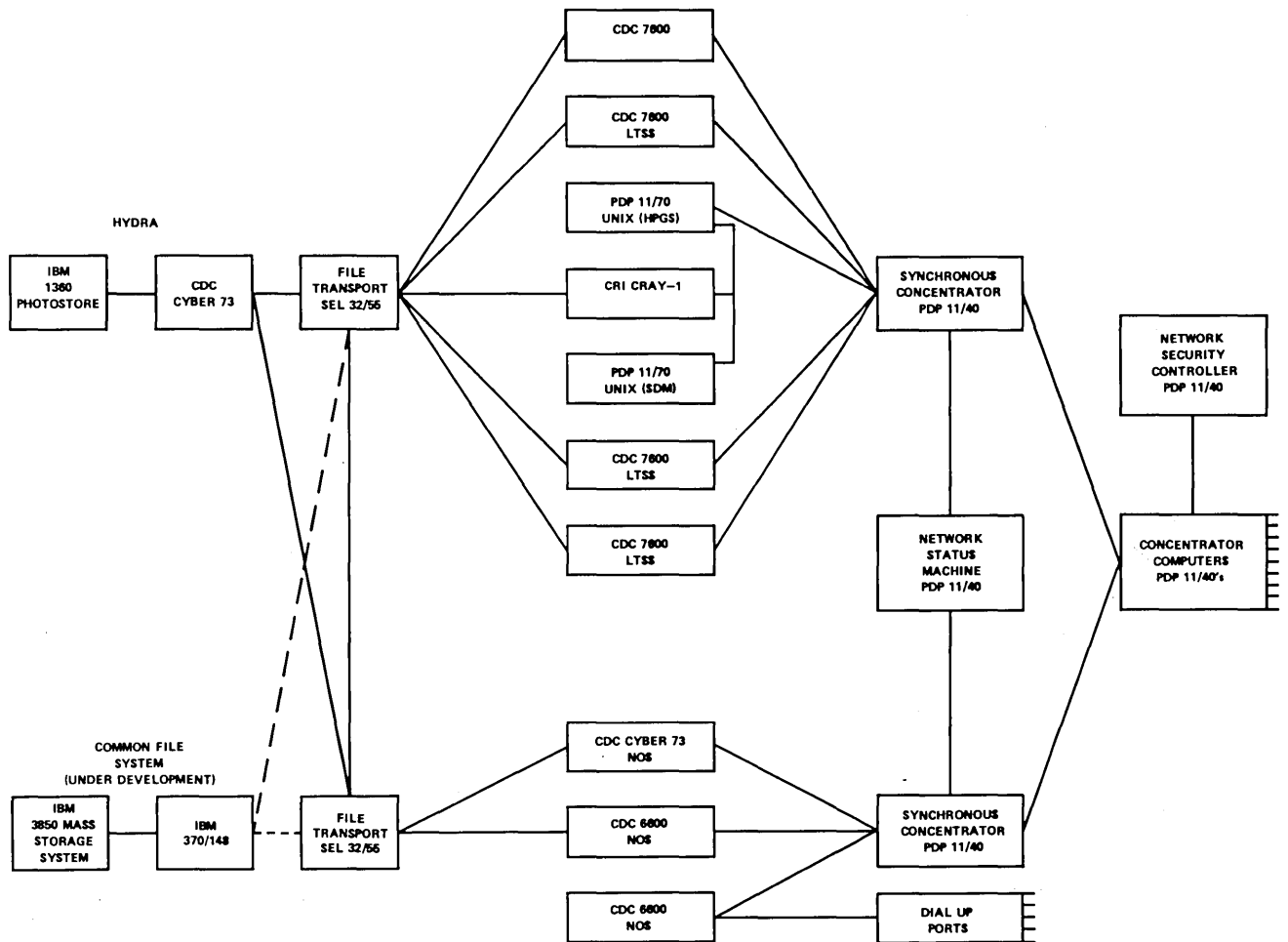

Fig. 2. LASL's central computer facility includes the Cray-1, four CDC 7600s, and an assortment of other machines. So

far, the Cray machine is being used as a process-only component and access is through a 7600 or a DEC PDP-11.

To concurrently support several weapon projects and pursue other advanced nuclear concepts, LASL requires several of the most powerful scientific computers available. A logical representation of the LASL Integrated Computer Network is given in Fig. 2. The meanings of the unfamiliar abbreviations are:

**LTSS** (Livermore Time-Sharing System): An operating system for the CDC 7600, developed at the Lawrence Livermore Laboratory

**HPGS**: High Performance Graphics System (under development at LASL)

**DEMOS**: operating system for the Cray Research Inc. Cray-1 (under development at LASL)

**SDM**: Software Development Machine

**NOS**: Network Operating System for CDC 6600 and Cyber computers, developed by CDC

The workhorse of the LASL Central Computing Facility is the CDC 7600; four are installed. Three other computers (two CDC 6600s and a CDC Cyber 73) provide time-sharing service through the NOS operating system. (Note that one of the CDC 6600s can be accessed by users with no security clearance through the dial-up facilities, so

it does not have a connection to the large mass storage systems.)

Access to the network is provided through a variety of terminal ports. We distinguish between ports that are connected to concentrator computers and dial-up facilities, since the latter have access only to the "uncleared" 6600. User access to the computers is validated at sign-on by the Network Security Controller, a PDP-11 based system which checks the person's ID, security level, and requested network path.

Common mass storage is provided by two systems, each with a capacity of approximately one trillion bits. The Hydra system consists of an IBM 1360 Photostore, which writes data on photographic film and develops the film to ensure permanence of the storage. A CDC Cyber 73 using a locally developed operating system serves as a control computer for the Photostore.

Hydra is scheduled to be replaced during 1979 by the Common File System, currently under development. It will consist of approximately 60 billion bits (7½ billion bytes) of 3330 and 3350 disks and an IBM 3850 Mass Storage System, which uses 3-inch wide magnetic tape cartridges as a storage medium. The 3850 has an on-line capacity of approximately 1.6 trillion bits. An IBM 370/148 with the OS/VS1 operating system will serve as a controller.

puters. Utilization of these codes is significantly enhanced through runtime interaction with the users, which we provide through high performance graphics systems and through use of COM for graphics output.

Programs that provide support for supercodes are typically shorter (10 to 30 minutes), but require high data transmission rates and interactive access through graphics terminals. They may generate very large transient data files.

There are also a large number of small batch codes which typically run less than 1 hour and require no user interaction during execution. These also use COM for graphics output.

Finally, there are a large number of small interactive codes which typically demand fast time-sharing response to user requests through keyboard terminals. These codes may also require graphics output to terminals and may interactively access large data bases.

The scientific codes are almost exclusively written in FORTRAN. (A locally developed language called MODEL, based on PASCAL with the addition of abstract data types, is being used as a systems implementation language for our newest supercomputer's operating system.)

As should be evident, one of the primary challenges of large scale scientific computation is the management and interpretation of information. In fact, this problem gets worse every time a faster supercomputer is acquired! We attack this problem through high performance graphics, interactive terminal graphics, COM graphics, mass storage systems, data base management systems, etc.—but, even though conditions improve, the problem doesn't ever really go away. This environment encourages the use of color graphics, both movies and single frames, for the effective interpretation of numerical calculations.

The central computers are operated 24 hours a day, 7 days a week. The daytime workload primarily consists of support codes for supercodes (typically examining the results of last night's supercode run, or setting up tonight's supercode run), together with small batch (less than 5 minutes) and interactive codes. The nighttime and weekend workload primarily consists of supercodes and the longer small batch codes (up to 1 hour), together with a small amount of interactive work.

LASL administrative data processing primarily is done on the Cyber 73 with NOS. Here extensive use is made of COBOL and the System 2000 data base management system.

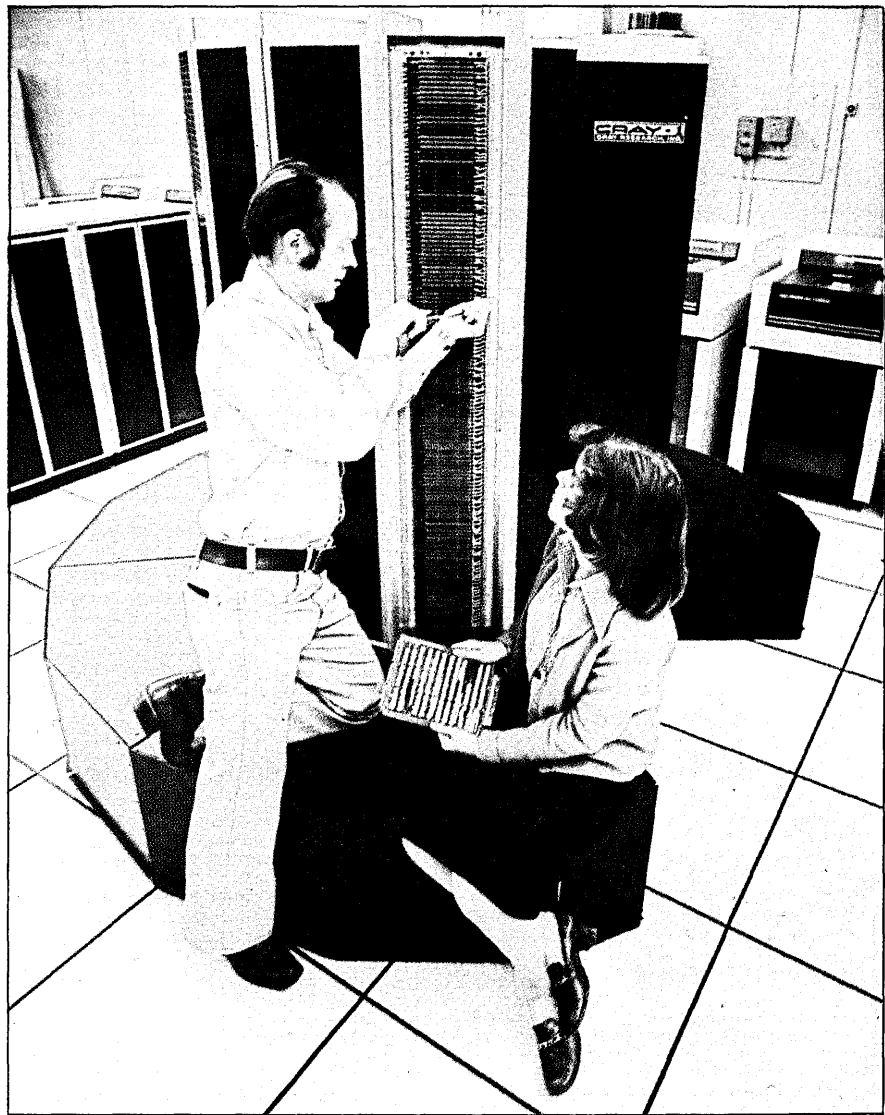

Fixes are still required from time to time, even though the infant mortality rate for components should have ceased being a big factor. The best reliability seen to date for a 20-day period has been: 95% availability, 0.38 hours mean time to repair, and 7.08 hours mean time to failure. The 7-hour figure may not be great compared to more common large scale cpu's, but the amount of work processed in those 7 hours may be equivalent to 70 hours worth on the "more reliable" machine.

Major standalone computing installations include an IBM 360/50 engineering system, IBM 1401(!) and PDP-11/40 systems used for special administrative data processing jobs, and a complex of SEL and PDP-11 minicomputers for real-time control and data analysis at the Los Alamos Meson Physics Facility. In addition, there are approximately 300 more minicomputer systems currently installed at the laboratory, most of which are dedicated to specific tasks such as data acquisition or control of experiments.

### THE NEW NUMBER CRUNCHER

The newest supercomputer installed at the lab is the Cray Research Inc. Cray-1, which is currently accessed through the other

time-sharing machines. Two PDP-11/70 computers with the Bell Laboratories' UNIX time-sharing operating system serve as support processors for the Cray: one (HPGS) is an interactive design station providing high performance graphics, and the other (SDM) is for development of the DEMOS operating system being produced for the Cray by the lab's staff.

Seymour Cray was the principal architect of the CDC 1604, 6600, and 7600 computer systems. The C-1 is his newest machine. Serial No. 1 was installed at LASL on April 1, 1976, and was replaced by Serial No. 4 on September 12, 1977. We learned some interesting lessons during that period.

The first task undertaken with an early version of a new supercomputer is the estimation of its potential perfor-

The Cray had to be at least twice as fast as a CDC 7600 on scalars, five times as fast on big vectors.

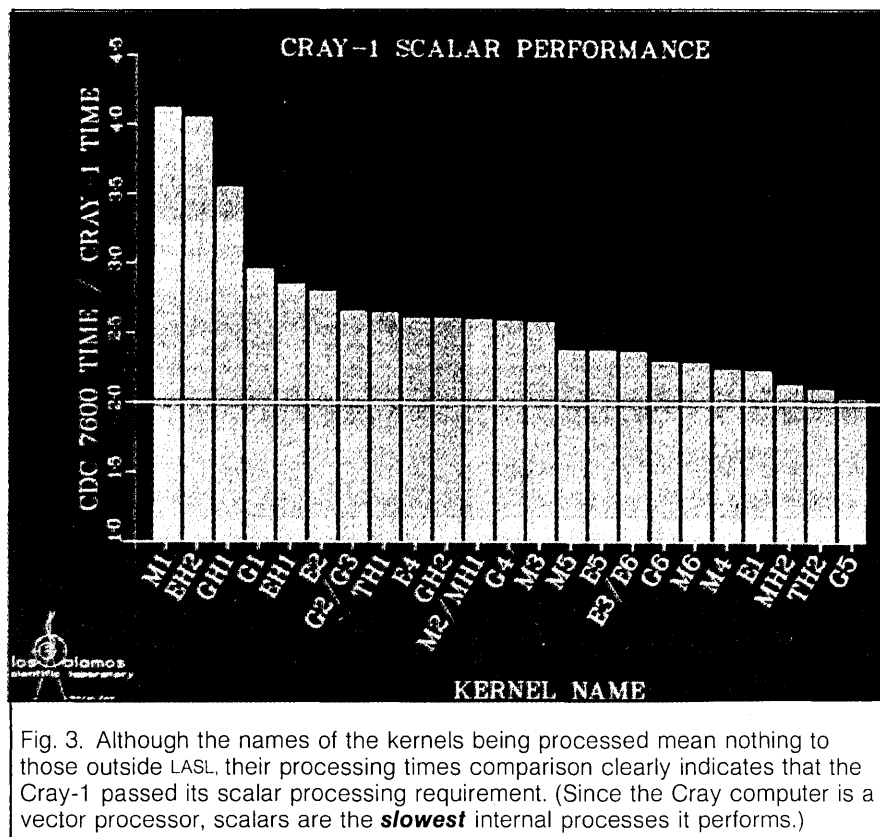

Fig. 3. Although the names of the kernels being processed mean nothing to those outside LASL, their processing times comparison clearly indicates that the Cray-1 passed its scalar processing requirement. (Since the Cray computer is a vector processor, scalars are the **slowest** internal processes it performs.)

mance to see if it is worth having. Because the hardware may be unreliable and the software is usually extremely primitive, this can be a very demanding job.

LASL began evaluating Cray-1 performance on April 1, 1976, to determine whether it should be considered for procurement. The evaluation was conducted for the Energy Research and Development Administration, a predecessor of the Department of Energy, with technical consultation by the Federal Computer Performance Evaluation and Simulation Center (FEDSIM), a consulting branch of the U.S. Air Force. LASL and ERDA wanted to verify that the computer could meet workload speed and reliability demands.

Performance threshold criteria were formally established in three areas: scalar-processing speed, vector-processing speed, and reliability. The 12- to 15-person evaluation team faced several serious problems in testing those criteria. First, there was very little software for the machine; for example, no FORTRAN compiler was operational then. Second, only limited I/O capabilities were available, so it was difficult to run programs on the Cray-1. Finally, CRI had agreed to provide the machine at no expense to the government for only six months, which imposed an inflexible deadline for com-

pletion of the evaluation.

The scalar performance threshold criterion was that the Cray-1 should be at least twice as fast as a CDC 7600 on the designated LASL workload. This criterion was established to estimate "worst case" performance by a supercomputer that had both scalar- and vector-processing modes.

The degree to which a computer's vector-processing capabilities can be used depends on the inherent parallelism in a given code and the effectiveness of recognition of this parallelism by the users through assembly language programming or by special compilers. Because both these factors could only be estimated for the Cray-1, a special scalar-performance speed test was adopted for the evaluation.

In fact, testing the scalar-processing speed was the most time-consuming phase of the evaluation. We adopted a sampling technique to determine whether the Cray-1 met this criterion, because lack of FORTRAN prevented running entire code segments. We identified the most time-consuming LASL production codes by a workload analysis, and drew small samples from them for implementation in assembly language on both the Cray-1 and the CDC 7600. The speed ratios of the 23 implemented assembly language ker-

nels are shown in Fig. 3. The sampling techniques were selected to provide 90% confidence that the Cray-1 would perform scalar processing at least twice as fast as the CDC 7600, assuming that assembly language coding for both was equivalent. Although the kernels are unknown to outsiders, it is clear from the figure that the Cray-1 passed this test.

The threshold performance criteria for vector processing were that the C-1 should perform operations in vector mode at speeds 3, 4, and 5 times faster than a CDC 7600 for vectors of lengths 20, 100, and 500 elements, respectively. The machine was tested on a set of small vector programs for these vector lengths, and average speed ratios of five vector functions for the given lengths were 3.39, 4.50, and 5.12, respectively. Thus, the Cray-1 met the vector-processing speed criteria as well.

The LASL reliability requirements specified 80% minimum for availability, one hour maximum for mean time to repair, and 4 hours minimum for mean time to failure. We adopted a conservative and demanding reliability testing procedure by running a test program for over 600 hours on the machine during the six month evaluation. The reliability test program was designed to exercise the machine several times as much as a production workload would. The computer met all reliability criteria. The best performance data for 20 successive days were 95% availability, 0.38 hour MTTR, and 7.08 hours MTTF. The most common type of problem encountered was an intermittent single-bit memory parity error. Partly as a result of this evaluation, CRI made error-correcting memory optional on the Cray-1, beginning with Serial No. 3.

## TYING IT IN

The critical shortage of LASL computational capacity required that the Cray-1 be made productive as soon as possible. The operation mode used during evaluation was inadequate for production. During the evaluation, the codes executed on the C-1 were written in assembly language and assembled on the Data General Eclipse maintenance control unit (MCU), a part of the Cray configuration. The binary output from the assembler was then shipped over the MCU/Cray-1 link, loaded into memory, and executed. Upon completion of execution, the user examined memory locations and registers to get the results. The obvious bottlenecks were the MCU link (which could be used by only one user at a time), the lack of a FORTRAN

# The operating system, when finished, will have resident hierarchical files, multitasking, support for mass storage facilities, and network interfaces.

compiler, and the lack of adequate supporting software.

To provide more effective access to the Cray-1 as quickly as possible, we developed a link between it and a CDC 7600 running the Livermore Time-Sharing System. We chose the LTSS system because the pre- and postprocessing programs for production code kernels were already running on it.

The Cray-1 to LTSS link was developed mostly from existing network components. A PDP-11/40 using a modified version of existing network software was used to link the -1 to a 7600. The 7600 to PDP-11 part of the link also was created from existing hardware and software. The Cray-1 to PDP-11 part required development of new hardware and software. The first jobs were run across the link in late November 1976, the first user codes went across in December 1976, and the Cray-1 to LTSS link was generally available by January 1977.

This link allowed time-sharing users to submit jobs to the Cray-1 and retrieve the output on a 7600. Utility software was written to convert between the file formats of the Cray-1 and LTSS.

We established a project to ensure that a FORTRAN compiler would be available for early production requirements. The approach was based upon cross-compilation. A 7600 FORTRAN compiler was modified to generate Cray assembly language code. By the first quarter of 1977, the cross-compiler was running successfully on LTSS and we began scalar optimization. The steps involved in compiling and executing a FORTRAN program on the Cray-1 during this period were as follows:

1. Prepare the FORTRAN program, input data, and control statements on the LTSS machine. (Cray-1 jobs are queued on two LTSS machines, but only one 7600 can communicate with the Cray-1 at a time.)
2. Compile the program on LTSS using the crosscompiler to produce Cray assembly language code. (The cross-compiler could have been made to produce assembled machine language code, but we preferred to take advantage of Cray's very efficient assembler.)
3. Send the Cray assembly language program, input data, and control statements across the link to the Cray-1.
4. Assemble the program and execute it on the Cray-1.
5. Send the output across the link to LTSS.
6. Process the output on LTSS.

We also developed an I/O library, mathematics library, support utilities, accounting procedures, and security soft-

	CDC 7600	CRI CRAY-1
Minor cycle time	27.5nsec	12.5nsec
Word length	60 bits	64 bits
Vector registers	none	8 registers, 64 words each
Memory capacity (K = 1,024 words)	64K words SCM 500K words LCM	1M words
Memory access time	220nsec	137.5nsec
Approximate price for cpu	\$4.5 million (c. 1970)	\$4.8 million (1978)

ware to meet early production requirements. Now that these are running, Cray-1 usage is already saturated, after adding in the time used for software development (such as dedicated time for operating system testing and enhancement).

The moral of this story so far is: *The evaluation and effective utilization of an early version of a new supercomputer require considerable amounts of foresight, hard work, and patience.*

Someone contemplating the use of a new supercomputer should not underestimate the massive effort required by both systems and applications personnel before the system can achieve its full potential. A generous portion of patience is needed when things go awry, as they most certainly will.

## WHAT'S AHEAD

We are developing DEMOS, a new Cray-1 operating system, to provide a foundation for long-term, efficient Cray-1 use at LASL. Our goals are that DEMOS be: able to deliver the Cray-1 resources to the user, internally consistent, simple and easy to use, extensible and adaptable, fast (consume less than 5% of the cpu cycles), small (take up less than 10% of the memory), able to meet security requirements, and integrated into the existing network.

We are developing our own operating system, rather than using vendor-supplied software, for several reasons. We had to supplement the vendor-supplied software, which was incomplete, to meet our early production requirements. Our users require an operating system tailored to their special and changing needs for running very large codes. The Cray-1 must be incorporated into the existing network. Finally, the Cray-1 operating system must be able to communicate with an interactive graphics system through the network at very high rates.

The first major components of

DEMOS will be available in mid-1978, and more will follow at regular intervals. The major items in this development are as follows:

*Resident file system.* The file system will provide a hierarchical directory structure compatible with the directory structure being developed for the LASL Common File System. It will include efficient buffered I/O for user programs, provide a resident file storage facility that should make the Cray-1 convenient for LASL users, and should reduce the network link traffic required to support the machine.

*Multitasking system.* The multitasking structure will enable users to represent job complexities at the command language level, which has the potential for avoiding program-to-program I/O. This system will provide for multiprogramming user jobs.

*Network interface.* The full network interface will allow the Cray-1 to be accessed from any other worker computer in the central network, rather than just the current selected front-end machines. It will include the system utilities necessary to allow users to direct jobs and files to appropriate worker computers. It will also include support for mass storage systems, especially the Common File System.

Application code conversions have proceeded, for the most part, through the use of a "vectorizer" program. This preprocessor translates FORTRAN source code to a modified FORTRAN program which can access the Cray-1 vector hardware capabilities, either through the use of "vector primitives" (in-line calls to vector instructions) or through changes which make the code more tractable for a vectorizing FORTRAN compiler. Potential supercomputer users should realize that these conversions for large codes can be very time-consuming and difficult.

Even though CRI has made good progress in the software area over the last two years, the second moral of our story is already evident:





**We can design, install and maintain *any* telecommunications system—large, medium or small.**

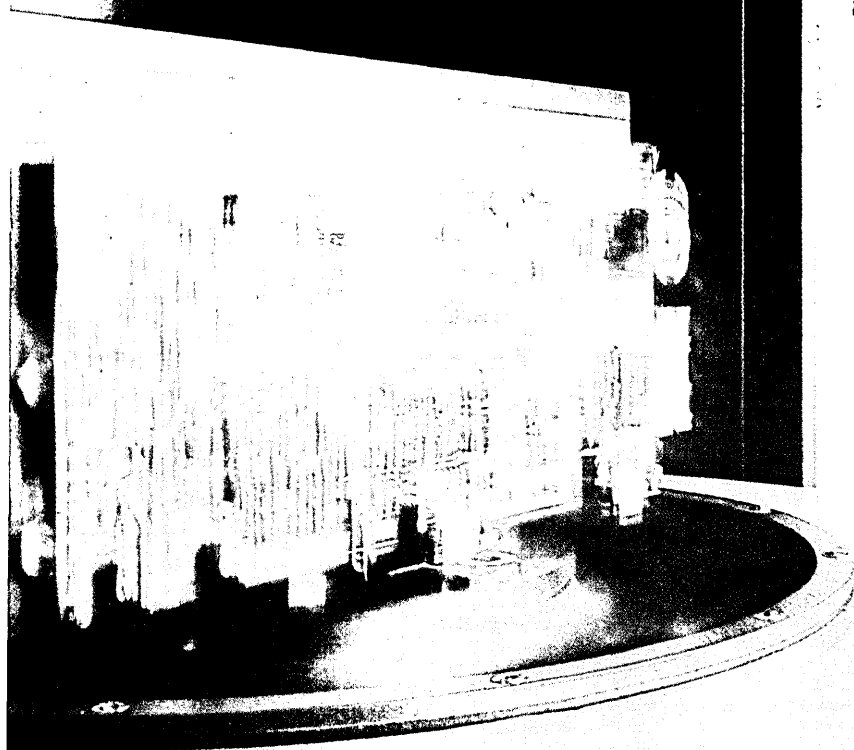

Go on, test our imagination.  
Because when we at Cable and Wireless say 'any', that's precisely what we mean. No matter what you're looking for in a telecommunications system—we can provide it.

Our global organisation is uniquely qualified to plan, design, engineer and install complete telecommunications systems for you. Be it telephony, telex, telegraphy, television, data.

We can operate, manage and maintain the system; train technicians, engineers, managers and operators.

Our up-to-the-minute expertise is relied on by national and international organisations, oil companies, airlines and aviation authorities, banks and shipping the world over.

So, if you feel you'd like more information, why not do a little communicating yourself. Contact us.

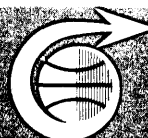

**Cable & Wireless**

**Always a step ahead of today's communications.**

Cable & Wireless Ltd, Mercury House, Theobalds Road, London WC1X 8RX. Tel: 01-242 4433. Telex: 23181

CIRCLE 12 ON READER CARD



Fig. 4. The management and interpretation of the information produced actually becomes more of a problem as computers become faster. Los Alamos users frequently turn to interactive graphics, as illustrated here in the use of an Evans & Sutherland Picture System 2, and COM graphics, which is produced in movie and slide form.

*Software development and conversion costs, both for systems and applications, may be staggering for a supercomputer with a new architecture.*

With this sort of conclusion, you may ask whether our effort has been worthwhile. In our opinion, the answer is a resounding *Yes!* The laboratory's mission requires the early utilization of new supercomputers to provide additional capabilities for nuclear weapon design, and the Cray-1 has been a success in two key areas:

**Performance.** Scalar Cray-1 production codes are now running 2.3 to 2.8 times as fast as their CDC 7600 counterparts on a typical production calculation. And the first (partially) vectorized production codes have speed ratios of about 3.4.

**Reliability.** With the error-correcting memory installed in Serial No. 4, reliability measures improved to 97% availability, 0.7 hour MTTR and 25.3

hours MTF during the first five months of 1978.

In the future we will develop a High Performance Graphics System (HPGS) and the use of support processors for supercomputers.

The HPGS (Fig. 4) consists of a PDP-11/70 with UNIX and an Evans & Sutherland Picture System 2. It is being designed to provide highly interactive graphics support for production codes executing on the Cray-1. The target transfer rate between the Cray-1 and the HPGS (through the network) is at least 1Mbps. At that speed, the user should be able to monitor the progress of a production code and interrupt it to do local processing on the PDP-11/70 (for example, re-zoning a mesh whenever code difficulty in solving the problem is anticipated). The hardware for the HPGS has been delivered, and the software is under development.

The Cray-1 will use support processors to provide peripherals and software not directly available to its users.

For example, magnetic tape processing, file printing, and file editing for C-1 programs can be done on support processors. In the future, we may even be able to do interactive debugging through support processors.

Long-range plans attempt to accommodate a growing LASL requirement for distributed computing, primarily because small computers are becoming increasingly cost effective for certain tasks, such as the interactive text editing required to set up the input for a large production job, and such as interactive graphical analysis of production job output. Also, distributed computing gives users more control over their computing facility, may give them better response time for certain types of jobs, and can lower data communications cost. Further, we may be able to use the extensive software of some small computers to improve user interaction with the central facility.

Thus the lab will have a great deal of computing horsepower, spread around in conveniently accessible form. Still there won't be "enough," even with one of the world's most recent supercomputers. Despite the enormous advances made in computing technology, at both the small and large ends, current computers are inadequate to represent even the well-known aspects of nuclear physics. The best computer models in use today are still relatively crude approximations of the physical characteristics and performance of nuclear phenomena.

In short, computer capability is the major factor limiting further advances. For the foreseeable future, improved computers well above and beyond the power of the Cray-1 will continue to be required. \*

## FRED W. DORR



Mr. Dorr spent nine years at the Los Alamos Scientific Laboratory, and was last the head of the computing division, with total responsibility for the hardware and software of the integrated computer network which includes the Cray-1. He recently joined Schlumberger to work on corporate-wide computer planning in that firm's Ridgefield, Conn., research center.

# Raytheon's <sup>PTS/1200</sup> MARK I & II

## The distributed processing machines.

Distributed processing means different things to different people.

To Raytheon, it means delivering the maximum number of capabilities within a user's data communications network at the lowest possible cost.

That was one criterion for designing our PTS/1200 MARK I and MARK II distributed processing systems. Judge for yourself if the capabilities of the MARK I and MARK II meet the standard we set:

**Multiple emulation capabilities.** The system can operate immediately in most existing networks. MARK I and II support 3270 interactive (dumb and intelligent), 2780 and 3780 batch, HASP remote job entry, and a variety of non-IBM protocols, with SDLC batch/interactive in the future. Concurrent interactive and batch operation is supported on some models.

**Intelligent controllers.** You can program as little or as much power as you want into your system. PTS/1200 systems offer

up to 128K-byte controllers capable of managing up to 20 peripheral devices.

**Terminal power.** Multiple screen sizes, up to 24 terminals per controller, a variety of keyboard options, programmable function keys, and numerous operator prompting aids are available with every terminal.

**Rapid applications expansion.** Every MARK I and II comes with a feature we call intelligent 3270-type operation. It lets your 3270-type applications add local format storage, local printing, direct data base access and updating, and either batch or transaction operations. The MARK I or II applications program decides when to go to the host, so your operators never have to get involved.

**Data base storage,** for local applications processing.

PTS/1200s are expandable from 10MB to 252MB of disk storage, with powerful memory management software techniques that assure efficient data base operations.

**Network enhancement.** A distributed processing system with truly enhanced capabilities should allow you to do more with your network than simply transfer data. PTS/1200 systems let you add teleprinters to your terminal lines, or run batch and interactive jobs concurrently, or perform remote program development in any host CPU language, or debug, load and operate downline multipoint lines.

Not bad features for a system that is priced starting at \$850 a month, including maintenance, for a four-terminal, 10MB disk, 165 CPS printer configuration.

When we decided to call MARK I and II "The Distributed Processing Machines," we wanted to be sure they were worthy of what you want in a modern terminal-based product.

**Raytheon terminals. 60,000 now, and growing fast.**

Tell me more about Raytheon's MARK I and MARK II distributed processing systems.

My current network consists of: \_\_\_\_\_ terminals using \_\_\_\_\_ protocol linked to \_\_\_\_\_ host mainframe.

Name: \_\_\_\_\_

Title: \_\_\_\_\_

Company: \_\_\_\_\_

Street: \_\_\_\_\_

City: \_\_\_\_\_

State: \_\_\_\_\_ Zip: \_\_\_\_\_

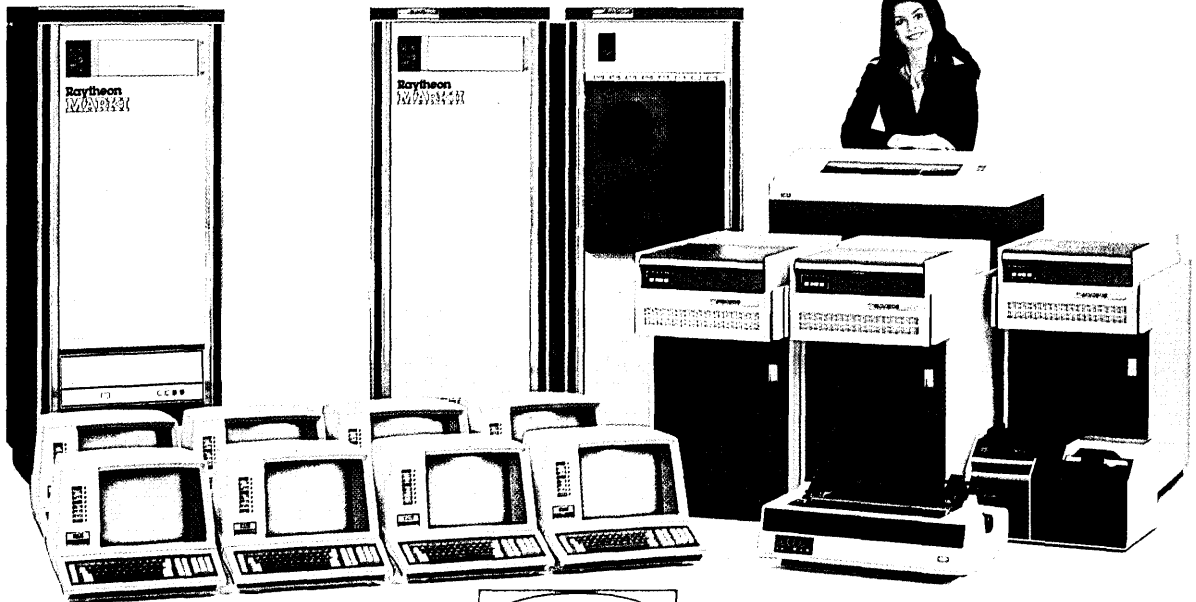

### RAYTHEON DATA SYSTEMS

Intelligent Terminals □ Distributed Processing Systems □ Word Processing Systems □ Minicomputers □ Telecommunications Systems

1415 BOSTON-PROVIDENCE TURNPIKE · NORWOOD, MASSACHUSETTS 02062

Call Director, Field Marketing, at (800) 225-9874 (toll free) Inside Massachusetts call (617) 762-6700 · TWX: 710 336-0646 · TELEX: 92-4408

Word Processing Division: Lextron Corporation, 9600 DeSoto Avenue, Chatsworth, California 91311 (213) 882-5040

ALBANY (518) 458-7434 · ATLANTA (404) 321-3064 · BOSTON (617) 237-4190 · CHICAGO (312) 694-4420 · CINCINNATI (513) 772-2200 · DALLAS (214) 661-9722 · DENVER (303) 371-0990 · DETROIT (313) 358-3990 · GREENSBORO (919) 294-5811 · HARTFORD (203) 289-8281 · HOUSTON (713) 496-0100 · KANSAS CITY (816) 561-9333 · LOS ANGELES (714) 979-5800 · MIAMI (305) 592-3884 · MINNEAPOLIS (612) 854-2666 · NEW YORK CITY (212) 661-2790 and (212) 895-2567 · PHILADELPHIA (609) 665-8466 · PITTSBURGH (412) 281-2117 · SAN FRANCISCO (415) 692-4640 · SEATTLE (206) 453-0650 · TULSA (918) 663-7852 · WASHINGTON, D.C. (703) 979-6100 · OVERSEAS AMSTERDAM (020-93-0787) · FRANKFURT (49-6196-48829) · SYDNEY (61-2-297721)



# Tbar's IBM Plug Compatible Channel/Peripheral Switch

T-BAR 4x12 Channel/Peripheral Switch Installation

## For more efficient use of peripherals

T-BAR's 3915/3916 matrix switches for use with ITEL, AMDAHL and IBM 360/370 type computers permit load balancing by sharing printers, tape drives, discs and front ends between CPU's. Greater configuration flexibility is attained by using the larger T-BAR matrix sizes — up to 12 computer channels and 12 strings of up to 4 peripherals each — 12x12.

The 3915/16 computer switch speeds system restoral when mainframe trouble occurs. Pushing a button interchanges peripherals between a failed and back up system or reconfigures a computer room for multiple tasks on the same mainframe.

The switch can be controlled from an operator's position up to 200 ft. away.

**Tbar**® INCORPORATED

COMPUTER SWITCH DIVISION  
141 Danbury Road, Wilton, CT 06897.  
Telephone: 203/762-8351. TWX: 710/479-3215.

# Fits in

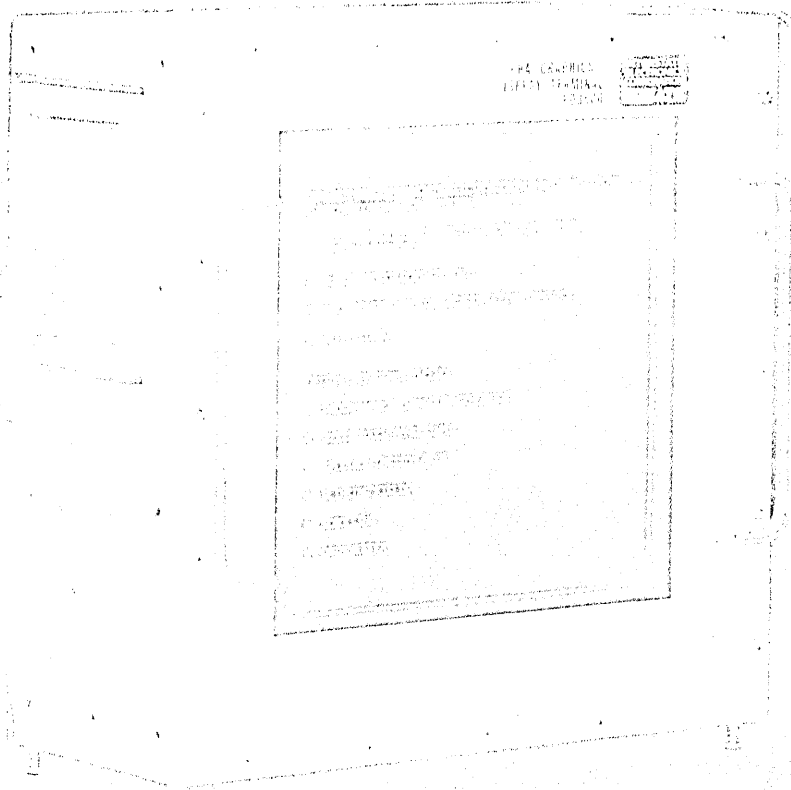

## New PD 3500 Plasma Display. Available now.

We've sliced the Plasma Display panel off our popular alpha/graphic terminal. And we wrapped it up tight inside a new, militarized package only 6 inches deep (plus handles... and they fold).

The rugged, lightweight display module features the same big plasma panel with low life-cycle cost, the same flicker-free performance, the same bright image and high contrast ratio as our lower-cost PD 3000. Functionally, they're identical.

But the PD 3500 display is skinny enough to fit into tight spots.

Like submarine compartments, aircraft cabins, helicopters and gun platforms...anywhere operating space is scarce.

Both its ruggedized power supply and keyboard are remote, connected by cable. So they go where they fit best, too.

We're proud to introduce the economical PD 3500 with the 6-inches-thin display. There's nothing else like it anywhere.

And it's available for delivery, right now.

Write for the complete PD 3500 data package to Interstate Electronics Corporation, Don Poulos, Computer Products, 1001 East Ball Road, P.O. Box 3117, Anaheim, California 92803.

**INTERSTATE  
ELECTRONICS  
CORPORATION**

SUBSIDIARY OF 

Information Processing and Display.  
Systems. Products. Services.

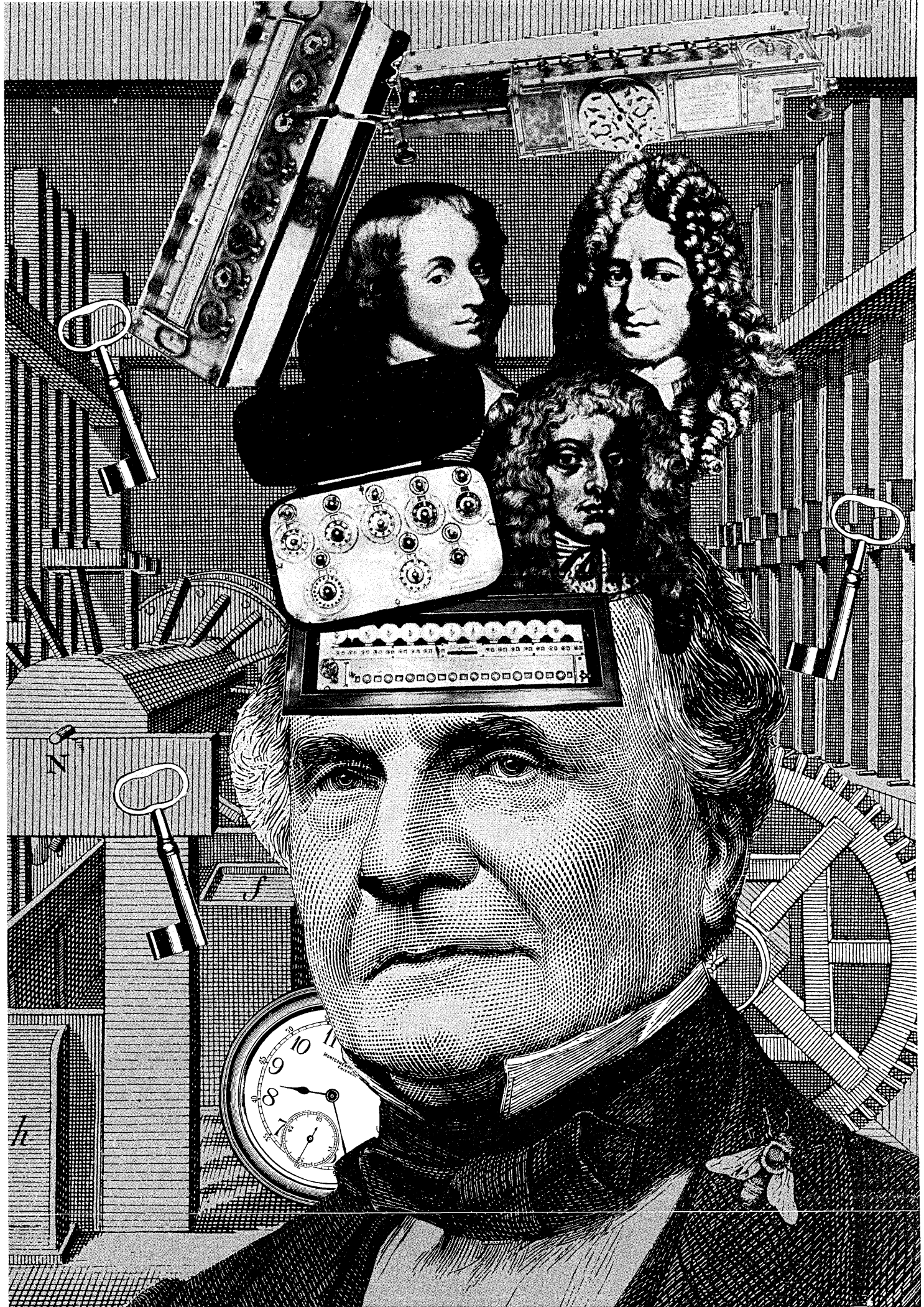

These three men built operating calculators more than a century before Babbage did.

# MEN AND MACHINES BEFORE BABBAGE

by Molly Gleiser

The calculator is generally thought of as the brainchild of Charles Babbage, who produced his Difference Engine and designed his Analytic Engine some 150 years ago. In fact, however, Babbage stood on the shoulders of men before him who earlier saw the necessity for counting tools. Three men, in particular, had built operating calculators more than a century before Babbage built his.

## PASCAL'S ARITHMETIC ENGINE

The first real calculating machine was produced in 1647 by Blaise Pascal, a man of astonishing breadth of vision even for those days of nonspecialization.

Born in central France, he was the son of a lawyer and the grandson of the nation's treasurer. His mother died when he was three, and his father, a most child-centered man, chose to educate young Blaise himself. This had an unanticipated effect on the boy.

His father's method of teaching was to always appeal to reason while keeping the material well within the child's grasp, and this led him to postpone teaching his son math. As a result, the subject acquired such a rarity value for young Blaise that he began to construct it for himself: when he was 12, his father found him on the floor figuring out that the angles of a triangle add up to two right angles. By the age of 16 he produced an essay on conic sections which was of such sophistication that the great Descartes could not believe it the work of a boy.

Shortly thereafter his father was appointed tax commissioner at Rouen. This indirectly triggered the invention of the world's first mechanical calculator,



BLAISE PASCAL  
1623 - 1662

which Pascal produced in about 1647 to help his father in his tax work.

About the size of a cigar box, the "Arithmetic Engine" used wheels and a stylus to perform its operations. The principle was identical with that used in today's taximeter: digits from 0 to 9 were arranged on wheels, and turning one wheel a full revolution caused its neighbor to be advanced one notch.

Endless problems arose: difficulties in finding skilled workmen, a watchmaker who tried to cash in with imitations, and the problems of accurate machining—which Pascal never quite overcame. He completed 50 machines, in brass, but they broke down frequently due to inaccurate gear cutting and were thus unmarketable.

Unfortunately for the computer business, instead of perfecting his device Pascal then turned his crystal clear mind to other problems. He worked on the

Toricellian tube—a tube of mercury up-ended over a bowl of mercury, the basis for barometers. If the mercury were supported by atmospheric pressure, then the height of the mercury in the tube should be less at the top of a mountain than at the bottom. He had his brother-in-law hike to the top of a mountain, the Puy de Dome, to prove it.

He also invented the hypodermic syringe and the hydraulic press.

Pascal had always been delicate, and by his early to mid-20s his efforts had strained him unbearably. On the advice of doctors, he decided to relax by playing cards, attending the salons of great ladies, and traveling around the countryside in a coach and four.

Not that he could give up mathematics. When a friend asked him to solve two problems of practical use to gamblers, within a few weeks he came up with a mathematical thesis which is the basis for much of the probability theory we use today. At the same time he refined his generalized theory of numbers and devised an arithmetic triangle, from which Leibniz later deduced integral calculus.

But in the middle of all of this activity, he suffered some kind of personal crisis. From his writing it appears he may have fallen in love. Was he rejected? We do not know. At any rate, he began to fall into a catastrophic depression from which he was saved by a mystic experience which even he could not describe. He withdrew to a religious community and devoted himself to prayer and to writing.

It may be for his writing, oddly enough, that this scientific genius is best known today. Many of his aphorisms like "The heart has its reasons that reason does not know" are still familiar.

But he wasn't completely lost to

Pascal completed 50 Arithmetic Engines, but they were unmarketable.

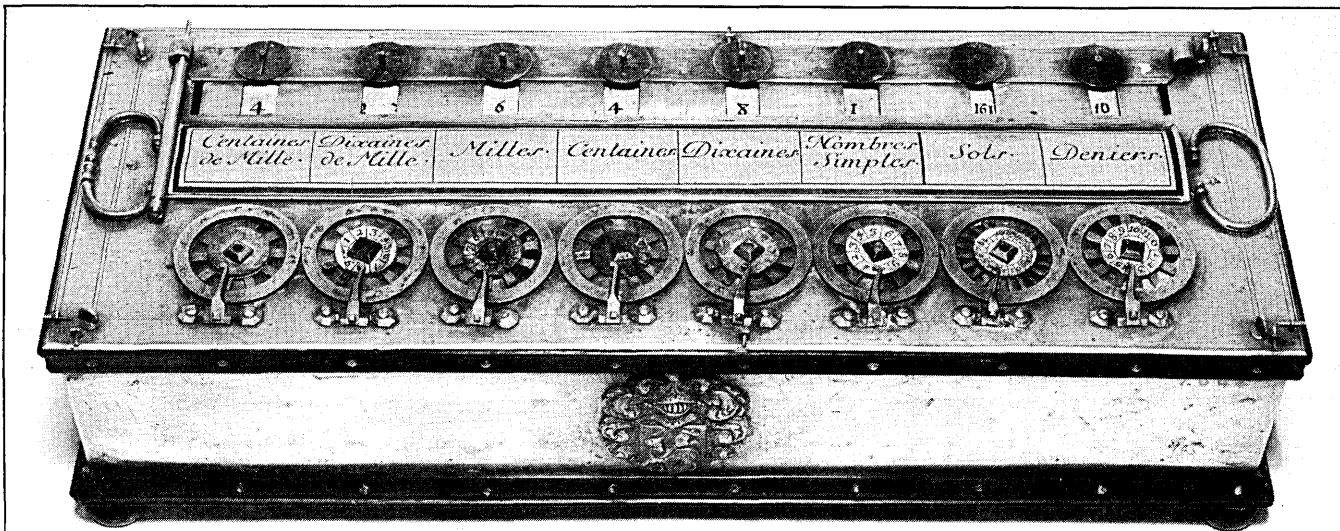

PASCAL'S ARITHMETIC ENGINE  
1647

Pascal's was the first real "calculating" machine. A series of stylus-operated wheels bearing numbers from 0 to 9 are so geared that each wheel advances one number when the wheel to the right has made a complete revolution. By adjustment of the metal strip at the top, the machine can

be made to perform either addition or subtraction. Eight Pascals are known to exist. Four are in the Musee du Conservatoire Nationale des Arts et Metiers in Paris; one at Dresden; one at Clermont-Ferrand; one in the Leon Parce collection; and one in the IBM collection.

science, even though it became just a toy or diversion for him. He solved the mathematics of the cycloid, a major mathematical problem of the day, to distract himself from toothache. He also devised the first public transport system of Paris.

He died at 39 in 1662, 150 years before Babbage produced the Difference Engine which has since so obscured Pascal's device.

**MORLAND'S MULTIPLYING CALCULATOR**

The second mechanical calculator known to us was produced by Samuel Morland about 20 years after Pascal's. Like Pascal's, which had been pressed into tax service in France, Morland's first device was also intended for adding and subtracting currency, this time English currency.

Like Pascal, though far less familiar today, Morland was a man of broad genius and his calculating devices consumed only a fraction of his time and interest.

He was born in England in 1625, at a time when the country was riven with conflict. The followers of Charles I, Royalists who believed in the divine right of kings, battled the Puritans, who believed in Parliamentary rule. Protestants clashed with Roman Catholics. And struggles over taxes abounded just as today. As a boy Morland took an oath to

the king, but he later transferred his allegiance to the other side in the more liberal atmosphere of Cambridge. His ability to switch sides was to show up to his advantage again later in his life.

Deciding against following his father into the ministry, he took to studying mathematics. He had a special interest in the arrangement of numbers, and in 1650 published a "Perpetual Almanack" on a single sheet; it's sometimes found engraved on antique snuffboxes and sundials.

By this time, the Parliamentarians had executed Charles I, his heir, Charles II, had fled to France, and a republic was formed under Oliver Cromwell. A good deal of opposition for it existed though, and plots appeared and disappeared in a murky haze. Morland, who had accompanied the English Ambassador to Sweden to arrange a treaty of amity, now became highly valued for his ingenuity, and was admitted to the "most intimate Affairs of state."

His function was in the secret serv-

The portraits, photographs of equipment, and information for captions included in Dr. Gleiser's feature were provided by the IBM Corp. The company has taken a strong interest in preserving the history of data processing, and the materials—including the machines themselves—are from the IBM collection.

ice, and he invented what was then recorded as the "most subtle secret of opening letters in the world." The actual process involved breaking the seal on the letter, copying the contents and decoding them if necessary, and reproducing the seal so that the recipient would never know his letter has been tampered with.

While engaged in this espionage, Morland read of a plot to entice Charles II back to England with promises of a takeover backed by 500 foot soldiers and 2,000 horses. Actually men were to be stationed in the woods near the house where Charles was to sleep, and at an appropriate signal they were to rush in and murder him.



SIR SAMUEL MORLAND  
1625 - 1695



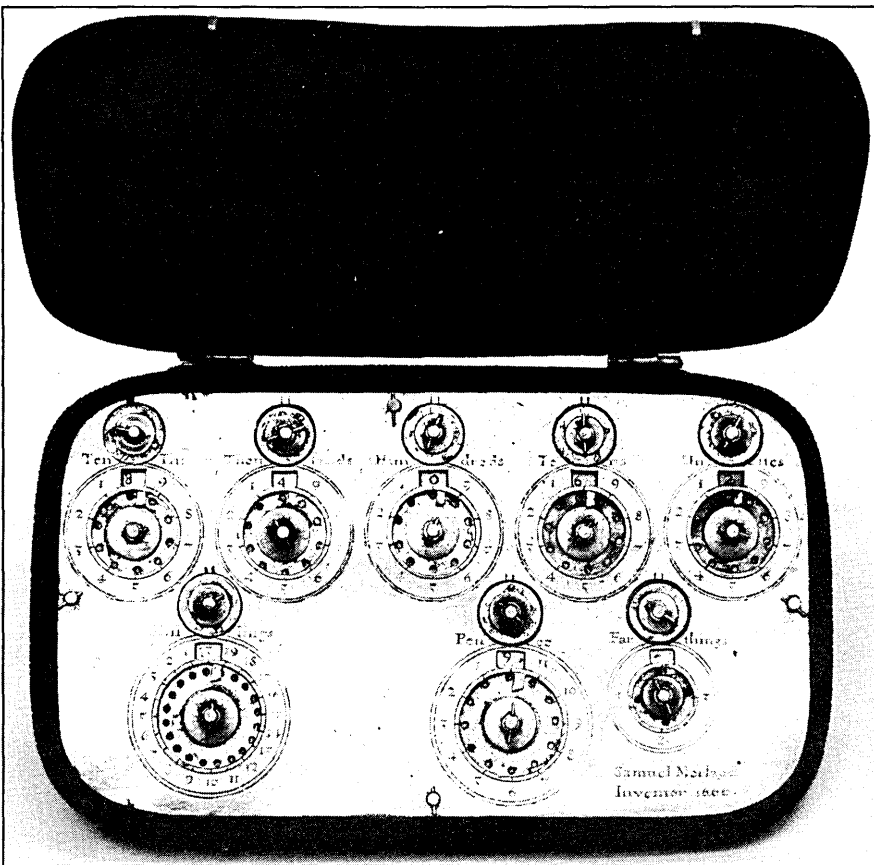

MORLAND'S ADDING MACHINE  
1666

This calculator was similar in principle to Pascal's device. It was fabricated by Humphrey Adamson, a skilled craftsman who was one of the first makers of the pendulum clock designed by Huygens. In the words of the inventor, it was a "new and useful instrument for addition and subtraction of pounds, shillings, pence and farthings."

Morland's machine used little wheels, each of which had a simple projection that turned a companion wheel at each revolution so as to perform a carry. The carrying was not automatic, however, for the operator had to remember to add the extra digits indicated on the auxiliary dials.

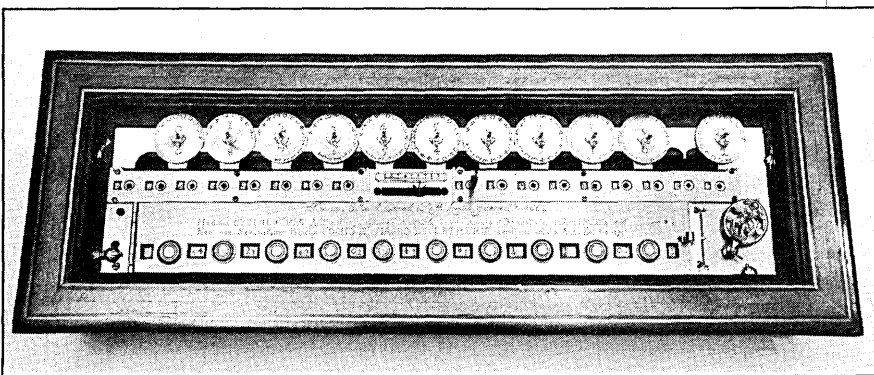

MORLAND'S MULTIPLYING CALCULATOR  
c. 1673

Although invented earlier, this device was not published until 1673, when it had already been superseded by the altogether superior one of Leibniz.

Morland had independently applied himself to the central problem of mechanical calculation: that of making a digital machine capable of multiplying automatically. He achieved only part of the automation, using an arrangement similar to that of Napier's Bones, arranged on a series of small discs that could be picked out and set by hand. Although the idea was attractive, it was not quite good enough to be useful in practice.

Morland's eyes must have widened. All about him heads were falling. Hands, ears, and tongues were lopped off and order was only maintained by a standing army. Clearly in this atmosphere a man's main aim must be survival. Morland now ensured he had a foot in either camp by becoming a double agent and tipping off the king. As a reward, when Cromwell died and Charles II finally regained the throne, he knighted Morland and gave him a pension.

Pensions in those unsettled days were not secure, however. They often fell into arrears, were not paid, or were sold as not being worth their face value. So Morland had to take his engineering seriously; with it went the chance of grants as well as profits. And thus was born Morland's contribution to computing.

In 1617 John Napier had invented a calculating device known as "Napier's Bones," an arrangement of numbers written on strips of wood or bone which, laid together in the right way, led to the desired result. Morland's first invention derived from Napier's. It provided a method of constructing triangles to scale from given data by using graduated rods and circles. Sine, cosine, and tangent of any angle could be read off the machine. Of course such a machine could not be a commercial success, so Morland looked around for something with more popular appeal.

He had probably heard of a calculating device owned by Charles I. It consisted of a large ring sundial of silver that could be used "in resolving many questions of arithmetic," and for "other rare operations to be wrought by it in mathematics." Morland had also almost certainly heard about Pascal's machine while he was in Sweden.

Anyway, he now constructed an adding and subtracting machine with gear wheels operated by a stylus. Addition was performed by turning the wheels clockwise, subtraction by the reverse. Only four inches by three inches and less than a quarter of an inch thick, this was in some ways the forerunner of the electronic pocket calculator.

The 17th century man in the street was not impressed. Pepys, the famous diarist, saw it at a dinner and pronounced the machine for "casting up £.s.d. . . . very pretty but not very useful," while Robert Hooke, a rival inventor, recorded in his diary: "Saw Sir S. Morland's Arithmetic engine Very silly—"

But more was to come, including a Multiplying Calculator in 1673. Morland was now in full stride as an inventor. He designed a speaking trumpet that carried

speech almost three miles. He was involved in the development of a private printing press for the king, designed a variation of the barometer, and developed a method to weigh anchors that used a pawl to prevent the anchor from running away. His home in Kennington near London was full of fascinating gadgets, such as a mechanical rotisserie he used to roast meat and eggs.

These inventions were trivia compared to his contribution in the area of one of the greatest engineering problems of the day: raising water to drain mines and supply homes. He produced a pump on a commercial scale so successfully he could supply the King's household with water from the Thames for 14 pence (about 10¢) a day instead of 60 pounds (about \$120).

His fame spread to France where he went to help raise about a million gallons of water a day from the Seine to supply the gardens and fountains of the Palace of Versailles. Unfortunately, his engine was rejected, the French Exchequer paid him nothing, and at home his patron Charles II died.

From then on his career declined. He had already outlived four wives. He married a fifth, supposing her to be an heiress, but she turned out to be penniless and he divorced her. An attempt to sell his espionage service to the new king failed. He went blind. He died on the day after Christmas in 1695, more than 200 years before even mechanical calculators like his became popular.

## LEIBNIZ'S CALCULATING MACHINE

As might be expected, his calculating device was far superior to any other built to that time.

Like Pascal he was something of an infant prodigy and no narrow specialist. He danced over the fields of law, politics, math, science, religion, and philosophy with the abandon of a child let out of school early. Unlike Pascal, he enjoyed excellent health and was gifted with a buoyant temperament. That was to prove lucky.

His father had left the family affluent. Just before he died he gestured toward his library and told his 6 year old son to "Take, read," and it was here that Leibniz was largely self-educated. By the age of 8 he had taught himself Latin, and at 15 entered the Univ. of Leipzig. When the university later refused this young upstart his doctorate in law because of his youth, he transferred to the Univ. of Alt-

Gottfried Wilhelm von Leibniz, born in Leipzig in 1646, was by far the greatest scientific genius of his day. And

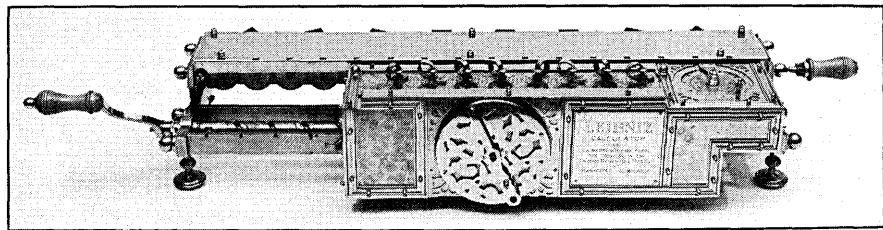

LEIBNIZ CALCULATION MACHINE (Replica)  
1694

A half century after Pascal developed arithmetic machines, Leibniz took the next great step forward. His was the first to multiply and divide directly, as well as to subtract directly without resorting to complement arithmetic.

Although there may have been minor flaws in the design and perhaps major technical problems in construction, Leibniz's invention was based on important principles, many of which were to be used in later mechanical calculators. These innovations included the principle of simultaneous entry of all digits in a multiple-digit number, entry of numbers into the accumulator from a movable carriage, the stepped cylinder, delayed and sequential carry, the cycle counter, and reversible rotation.

One machine was built about 1694 and now is preserved in the Library in Hanover, West Germany. Another machine, built in 1704, has disappeared.



GOTTFRIED WILHELM VON LEIBNIZ  
1646 - 1716

dorf, where he upstaged 20th century symbolic logic the same year by publishing a plan for a symbolic language applicable to all reasoning processes. The university responded by offering him the Professorship of Law.

But Leibniz had a great liking for seats of power and diplomacy instead, and with his sparkling wit and limitless mental energy he had no trouble ingratiating himself with an influential patron.

He became the protege of the Archbishop of Mainz, one of the most powerful men in Europe, who sent him to Paris, the world's cultural capital, with instructions to attempt to divert Louis XIV from the march on Holland.

Although Leibniz never did get through to the king, he found it easy to gain favor with such figures as Huygens, the world's leading mathematician.

Leibniz was 26, an age at which

most mathematicians have reached their peak after years of hard study. He had had practically no contact with the subject. Yet starting almost from scratch, he invented calculus, announcing the notation used today: a long *f*, the initial letter for the word summa, for integration; and a *d* for differentiation.

Meanwhile, realizing his deficiencies in arithmetic—he had never been drilled in the multiplication tables as had most children—he designed a calculating machine that would do more than just the addition and subtraction of the Pascal machine.

The Leibniz calculator consisted of a series of stepped cylinders, each carrying nine teeth of varying lengths. Smaller gears were set above them, each representing a digit of the multiplicand and placed so as to be engaged by that number of the long gears' teeth. Each complete turn of the set of long gears registered the multiplicand once; the multiplier was expressed by the number of times the long gears were turned.

Although the machine established many important principles to be used three centuries later in mechanical calculators, it was mechanically unreliable, like Pascal's, and unmarketable. The Archbishop of Mainz had died, and Leibniz, who had sunk his fortune in the machine, was forced to accept an offer as librarian to the Duke of Brunswick in Hanover.

He was 30, and his most creative mathematical period was already over. From then on his energies were spread over other projects, and he wasn't to return his attention to computing devices ever again, leaving them for Babbage to play with.

He wrote a history of the Brunswick family to justify his patron's political ambitions, and made paper plans for

# The 8500M Microprocessor Based Intelligent Graphic Computer Terminal

*A Major Advance In Raster Graphics*

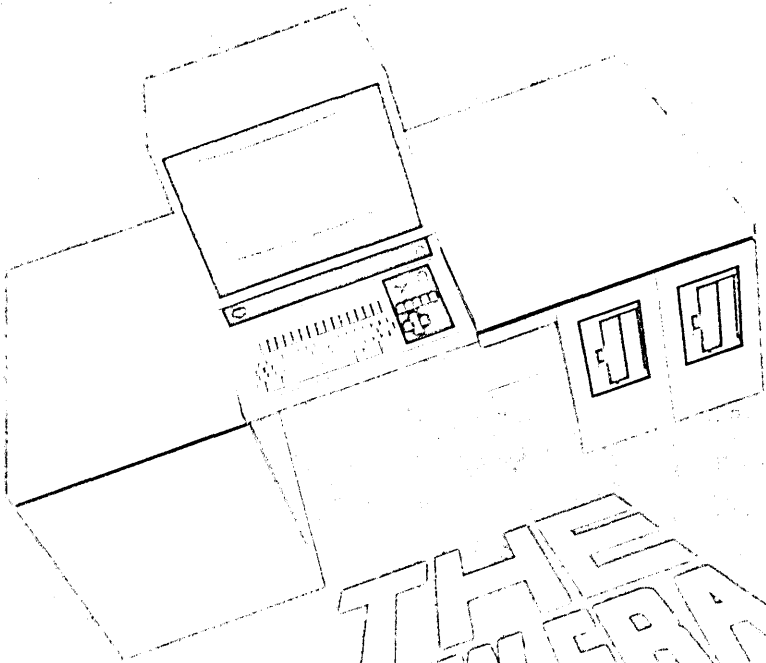

- Sophisticated graphic capability including full color generation, selective erase, shaded and textured vectors, windowing and scaling.
- Extensive self-contained computing capabilities.
- Simultaneous full gray scale multiple graphics/character processing and display.
- 4096 x 4096 viewable matrix.
- High resolution raster scan presentation.

Typical applications ○ image digitization and analysis ○ computer aided design ○ medical image processing ○ industrial process control ○ flow control including air, marine, and ground traffic control ○ system simulation ○ cartography ○ simplified presentation of complex financial, economic, and scientific data ○ high speed graphics structure and security identification systems.

# THE NEW ERA IN RASTER GRAPHICS

*Call or write for descriptive literature...*

detailing all outstanding features, options, specifications and prices.



**PRINCETON ELECTRONIC PRODUCTS, INC.**

P.O. Box 1061 • North Brunswick, N.J. 08902 • (201) 297-4448 • TWX 710-480-2882

# The Printer Store

Digital Associates Corporation

## Data General Users: Save \$4800 on our 600 LPM printer replacement.

For \$4800 less than Data General's 600 LPM drum printer you can now get Digital Associates' 600 LPM drum printer (DAC-2260) for your Nova and Eclipse. The DAC-2260 is a direct replacement utilizing DMA for the Nova and Eclipse 4215 printer and is plug compatible with either Data General minicomputer system. Similar savings are available with our higher speed 900 and 1250 LPM printers, both plug-to-plug replacements, designed for higher performance minicomputer applications.

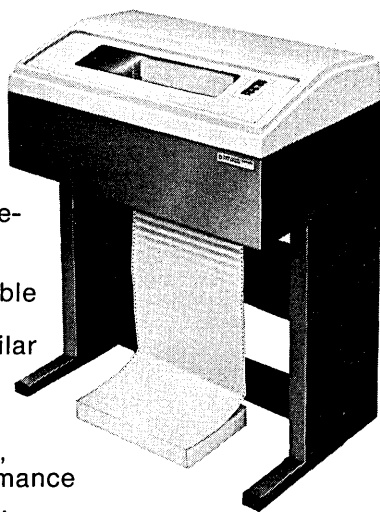

### Or switch to ChainTrain quality.

The DAC CT-6644 is a 600 LPM ChainTrain printer that is a plug-to-plug replacement for the Nova and Eclipse 4215. It upgrades your printing to letter quality, and saves you \$4300 against Data General's 600 LPM printer. It comes with Nova or Eclipse interface (including DMA), installation and maintenance service.

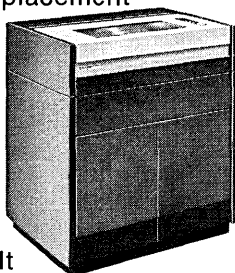

### Save on printers for PDP-11,

IBM Series/1 and System/3, DEC PDP-8 and DEC 20, Hewlett-Packard (including 3000 Series) and most other minicomputer systems. All offer tremendous savings and you can choose from ChainTrain, drum, band, Charaband or dot matrix technology. Digital Associates' Printer Store is the alternative source for minicomputer line printer systems with installation and complete maintenance service available on a nationwide basis.

various contrivances, such as improved smokestacks, nails with spurs attached so they wouldn't pull out easily, and wagon wheels that wouldn't stick in mud.

He was once asked to set up an operation to pump water out of some of his patron's mines, and built a system based on windmills to do it. Unfortunately, when the inspector arrived to see the operation, the wind failed and Leibniz's grant was terminated.

He wrote great numbers of letters—some 15,000 of them—founded the Berlin Academy of Sciences, and even tried to unite the Protestant and Catholic churches. Religion occupied a great deal of his time, in fact, and Leibniz even brought a little of his old love, mathematics, to it. He endowed the binary number system with religious significance: if 1 represented God, he could prove that God created the world (1) out of nothing (0).

His best known activities in his last 40 years were in philosophy, where the most interesting of his work was the theory of monads. He suggested monads were the basic units, centers of force not particles, with force fields around them—a theory which has gained renewed attention in the mid-20th century.

None of this brought him great success, however, and his star declined. Finally, after losing popularity at court, he became a forgotten man, at least in his own time. His death in 1716 went almost unnoticed.

Thus none of these three men who built calculating devices before Babbage received any great benefit from having done so. The machines were mechanically unreliable and never became popular. Certainly none of the men made money on them. Perhaps in more than one way the machines and the men were ahead of their time; the world was neither ready to build nor to employ such devices.

The machines were laid to rest even before their inventors were, and neither the devices nor the men were to be fully appreciated until much later. \*

### MOLLY GLEISER



Dr. Gleiser was born in England and came to the U.S. as part of the fabled brain drain in 1952, to work at places such as Ohio State Univ. and

MIT. Later she worked on solar energy, long before it was fashionable, at the National Physical Laboratory of Israel. After doing more on thermodynamics at the Lawrence Berkeley Laboratory until 1970, she turned to freelance writing and editing.

Digital Associates Corporation, 1039 E. Main St., Stamford, CT 06902  
Call Toll Free 800-243-9054

If you're thinking of a  
powerful, portable,  
programmable scientific and  
engineering computer  
with BASIC, Graphics,  
an IEEE interface and  
Interchange  
there's only one computer  
to think of...

For more information, call 1-800-368-7000 or write to: [www.ti.com](http://www.ti.com)

# THINK

The easy-to-use, BASIC, scientific and engineering computer you buy on a calculator budget.

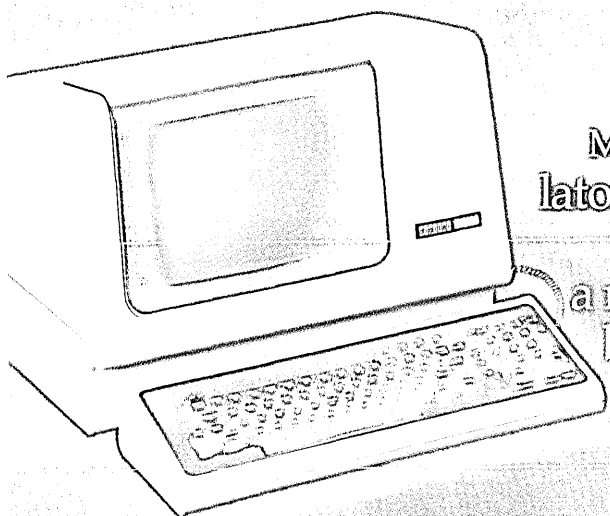

MINC does everything a desk-top calculator does and a lot more.

For about the same price you'd pay for a minimal desk-top calculator, you can buy MINC, the easy-to-use, complete computer system. MINC comes with ready-to-run graphic, scientific and laboratory programs. This Digital system has its own graphics terminal, built-in IEEE interface, one million character dual floppies, and three serial-line interfaces—all in a cart that you can wheel from job to job.

Plug MINC in, turn it on, and you can plot charts, solve complex engineering and statistical problems, control instruments and acquire data. It's all BASIC to MINC.

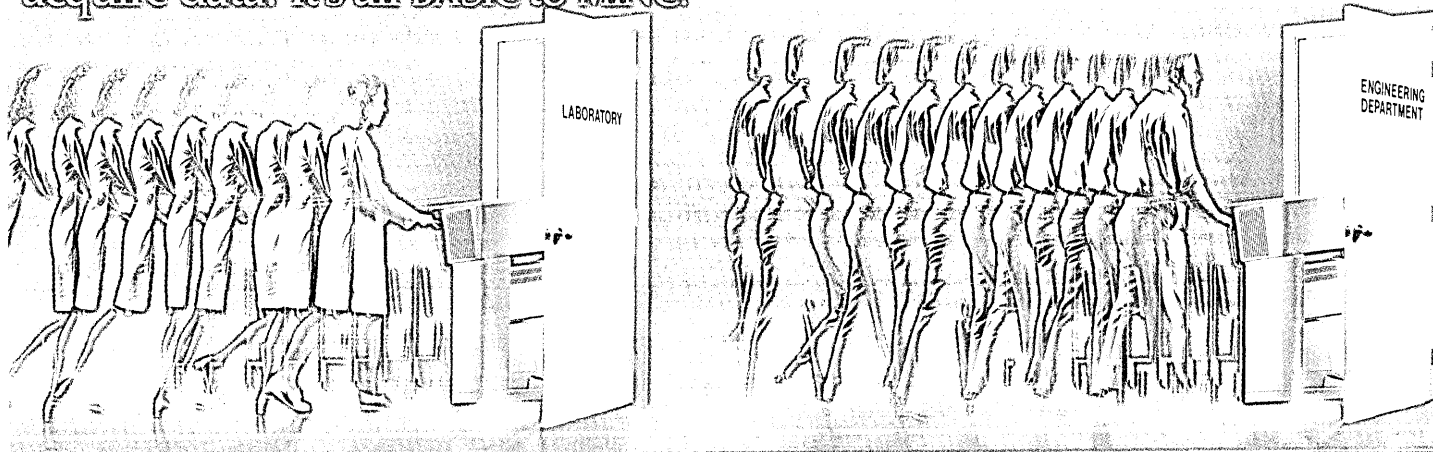

# MINC

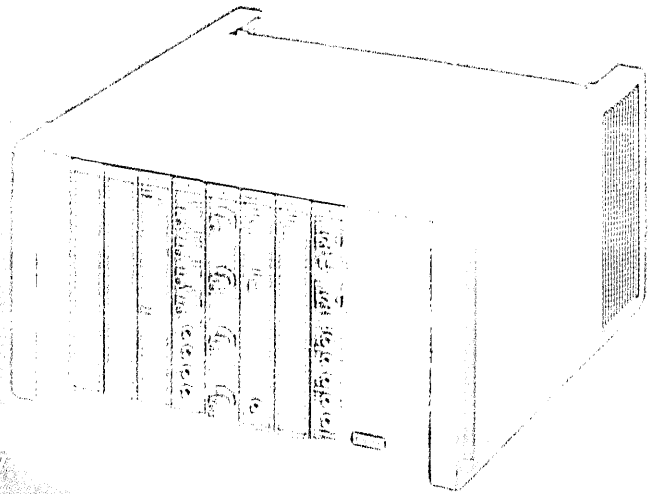
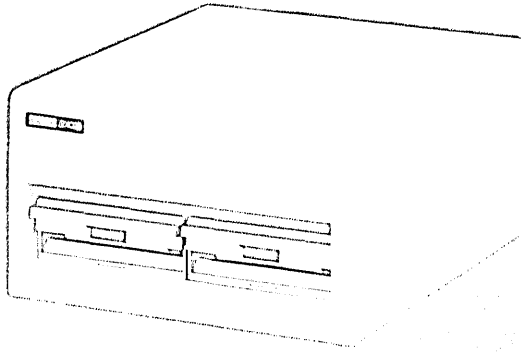

And, if you want to go beyond BASIC, you can. You can add FORTRAN and other high-level languages. You can add special input/output modules.

More system. More functionality. Built, not more money.

For more information or a MINC demonstration, contact your local Digital Sales Office or Jack Sawyer, Product Manager, Laboratory Data Products Group, Digital Equipment Corporation, Marlborough, Massachusetts 01752. Telephone (617) 431-9511, Ext. 6969. European headquarters: 12, av. des Morgines, 1213 Petit-Lancy/Geneva. Tel: 93 33 11. In Canada: Digital Equipment of Canada, Ltd.

digital

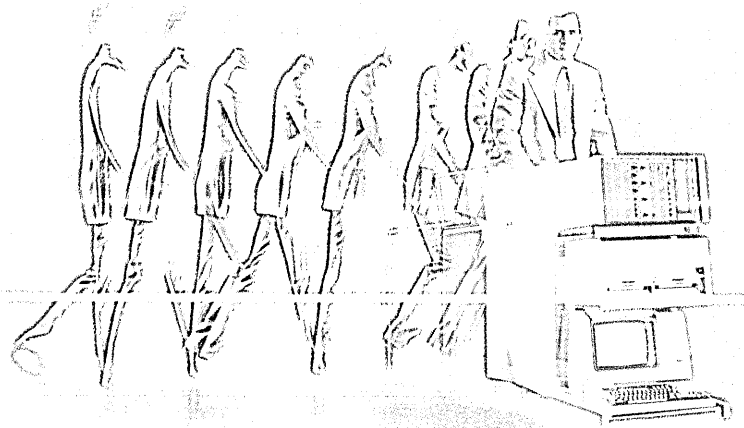
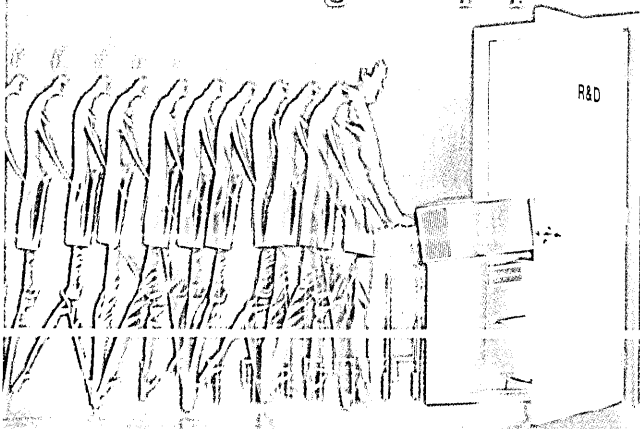

# What makes MINC run.

MINC is the complete laboratory system that you can have up and running the same day it is delivered. The standard system includes:

- Mobile MINC Cart
- PDP-11 Microcomputer
  - 60,000 characters of solid state memory
  - Integral floating point
  - Line-frequency clock
  - Interface for Video Graphics Terminal, optional line printer and two additional ASCII format serial-line devices (total of 4)
  - IEEE Interface
  - Automatic program load and Diagnostic Module
- Twin, front-loaded Floppy Disk Drives
  - A million characters of random access memory
  - Double-density recording (DMA)
- Video Graphics Terminal with separate keyboard
- MINC Box with slots for eight optional laboratory interface modules including:
  - Analog-to-Digital Converter (16 channels)
  - Analog Multiplexers
  - Analog Preamplifiers
  - Real-time Clocks

Digital-to-Analog Converters (4 channels)  
Digital Outputs (16 lines)  
Digital Inputs (16 lines)

- ENHANCED BASIC software for computation, graphics and instrument control
- Application software
- Complete Documentation including:
  - "Unpacking and Installing MINC"
  - "Introduction to MINC"
  - "MINC Programming Fundamentals"
  - "MINC Programming Reference"
  - "MINC Graphic Programming"
  - "MINC IEEE Bus Programming"
  - "MINC Lab Module Programming"
  - "Working With MINC Devices"
  - "MINC System Index"

For more information or a MINC demonstration, contact your local Digital Sales Office or Jack Kay, MINC Product Manager, Laboratory Data Products Group, Digital Equipment Corporation, Marlborough, Massachusetts 01752. Telephone (617) 481-9511, Ext. 6969. European headquarters: 12, av. des Morgines, 1213 Petit-Lancy/Geneva. Tel: 93 33 11. In Canada: Digital Equipment of Canada, Ltd.

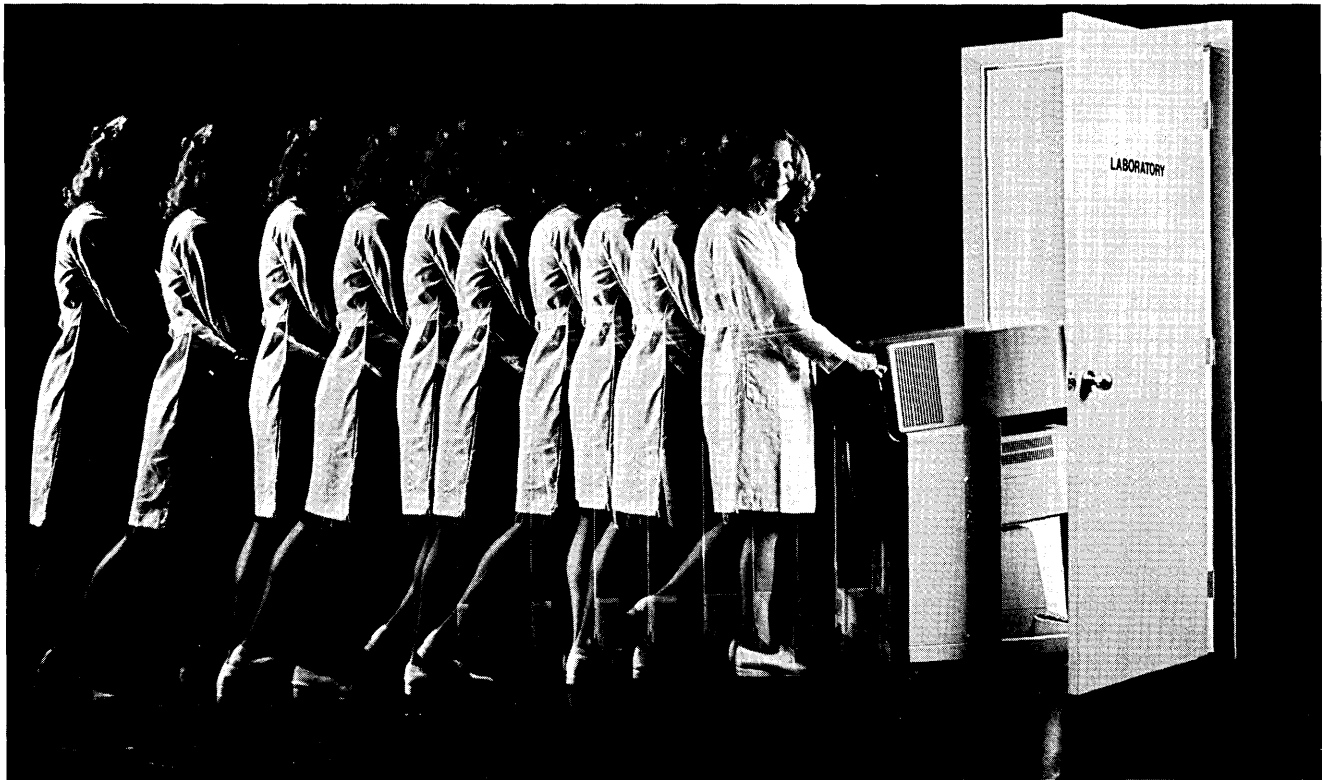

digital



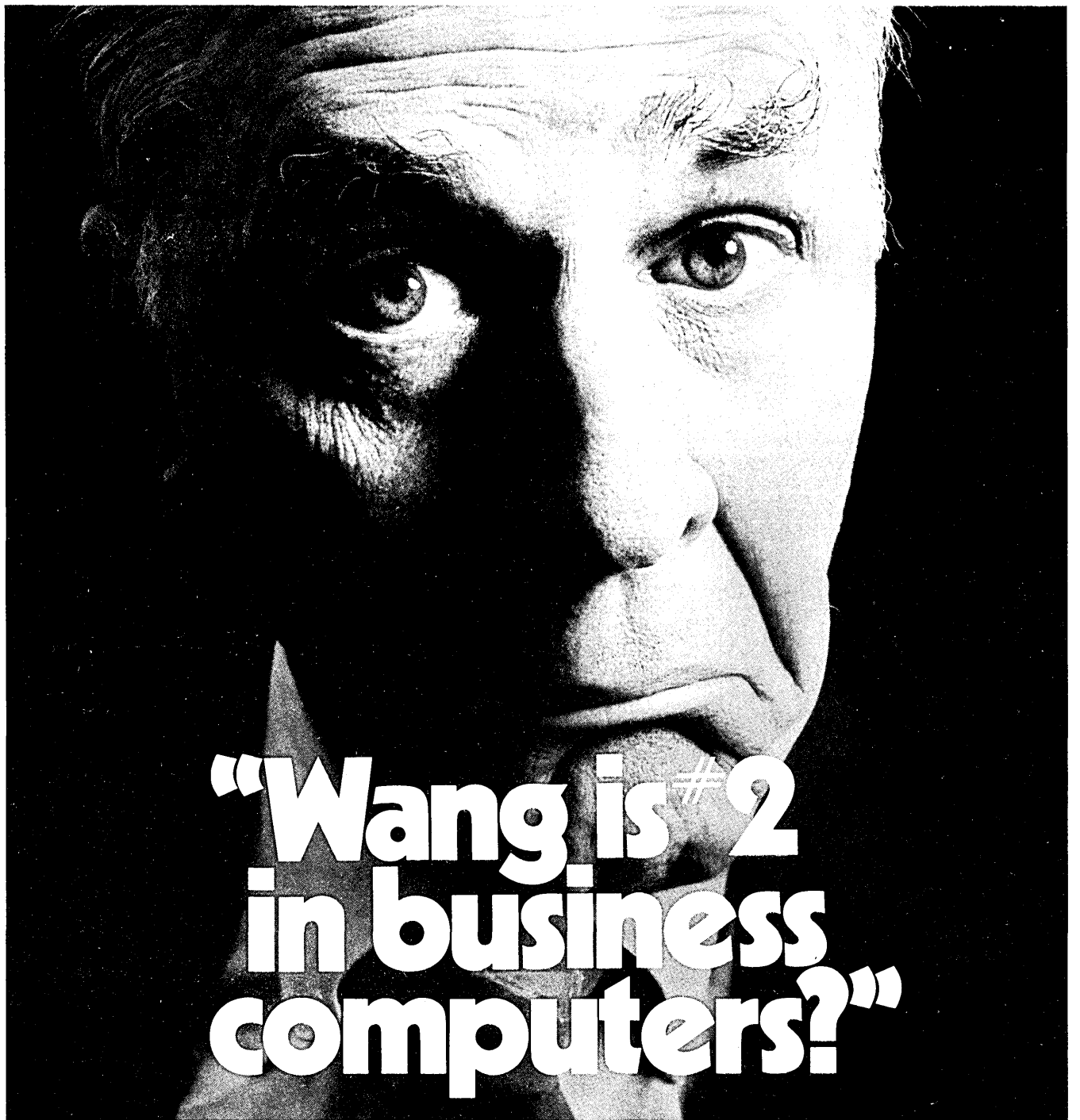

# “Wang is #2 in business computers?”

International Data Corp. and Dataquest rank us second only to IBM.\*

In small business computers, of course.

No mystery why. It's simply that Wang's hungrier than most. A little more aggressive. More responsive.

And we're not about to stop at small victories.

Whether you're in the market for a desktop computer, or a virtual storage system to complement an IBM mainframe, Wang is a logical choice for several reasons.

Our systems can grow as your needs grow. They're modular. Ex-

pandable. The giant's? Check it out. Every time you outgrow one system you have to chuck it out.

Since controlled growth is critical to your business, shouldn't you be a little more critical of your computer company?

As for value, nobody gives you performance like ours for prices like ours. We've got a technological reputation second to none.

And, we've built a sales and service team bigger than some computer companies ten times our size.

Wang offers a broad line of computers to help you with specific needs. From \$5,000 to \$500,000.

Write Wang Laboratories, Inc., Lowell, MA 01851.

Or call (617) 851-4111.

I want to be more critical about my computer company. Send me information on your line of computers.

Name \_\_\_\_\_

Title \_\_\_\_\_ Phone \_\_\_\_\_

Company \_\_\_\_\_

Address \_\_\_\_\_

City \_\_\_\_\_ State \_\_\_\_\_ Zip \_\_\_\_\_

**WANG** DP86/D108

**Computers and Word Processors.**  
Wang Laboratories, Inc., Lowell, MA 01851

\*Units installed. IDC's EDP Industry Report, 4/22/77; updated 1/1/78 for EDP/IR Review & Forecast Issue. Dataquest Mini-computer Industry Service Report, 2/3/78.

# how DOCU-MATE™ and the structured filing concept improve systems and programming productivity

A thorough and complete data processing documentation library is like motherhood and the flag. Everyone is in favor of it. The real problem lies in organizing it and making it work. That's where our DOCU-MATE System comes in. Starting with the problems, we designed solutions in the form of products that make it easy to file and access virtually every size and shape of documentation . . . to intermix different sizes and shapes in the same filing equipment . . . to move documentation from filing to reference mode and vice-versa while keeping it in the same filing device . . . and to structure workable standards for managing and controlling all documentation.

The heart of the DOCU-MATE System is the hanging cartridge. It provides center hook lateral filing or end hook drop filing . . . snaps open or closed with the flick of a finger . . . and has highly visible end and top labeling areas.

filing and referencing equipment that allows almost unlimited flexibility in the planning of central documentation libraries and development support libraries, and individual work stations.

since its introduction, it is now in use by over 3,000 companies in the U.S.



A Subsidiary of Barry Wright Corp.

For complete details circle reader's service number or write to: Wright Line Inc., 160 Gold Star Blvd. Worcester, Mass. 01606

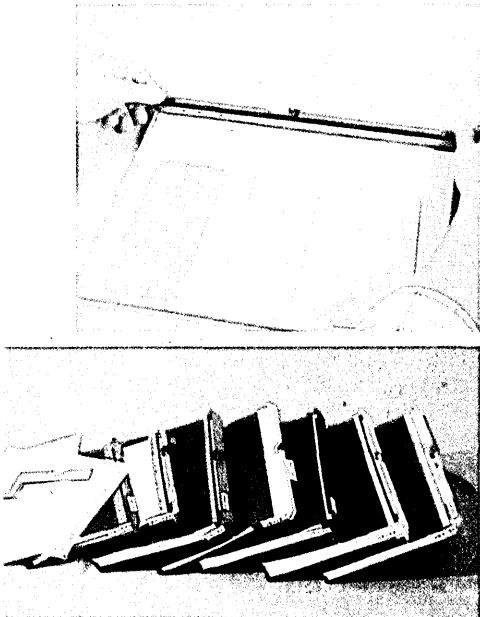
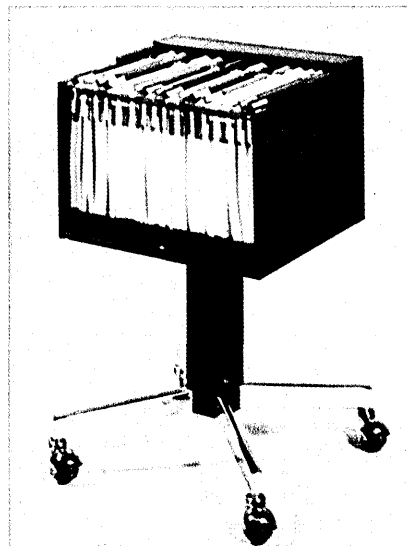

Along with other DOCU-MATE filing devices, cartridges fit compatibly into a wide variety of

The DOCU-MATE System is the key you are looking for to make your documentation library system work. It will help you to improve project control, increase systems and programming productivity, improve interdepartmental communications and reduce the cost of maintaining your documentation system. In less than two years

CIRCLE 108 ON READER CARD

The makings of a first class crisis: four computers, 200 pieces of hardware, 800 cables, a simultaneous upgrade, strikes, rain, and nondelivery.

# THE ONLY WAY TO MOVE

by Walter Bambrick  
and Benjamin A. Fong

Moving day at the data center can be quite an experience, especially if the center has plenty of hardware tightly jammed on several floors of the corporate headquarters, and cabling intertwined like well mixed spaghetti under the floors.

And especially if the on-line computer functions are of the ultracritical kind that can bring the company to its corporate knees with any extensive outage.

Add in some strikes among the building trades putting up the new dp structure. Throw in some natural disasters like the wettest winter in California this century. Then mix with some key failures in delivery by key suppliers.

Those are the makings of a first class crisis, and those were Western Airline's circumstances in early 1978.

Western had to move its data center. Increasing passenger traffic was forcing its Passenger Airlines Reservations System (PARS) off its 10 year old IBM 360/65s and onto IBM 370/158s. But the conversion from the two old 360 systems with their 2314 disks to the two newer machines with 3340 disks would demand more than the 6,200 square feet of computer room space that was available. Expansion was impractical.

The 65s were experiencing increasing failure rates. Technology had passed them by. The operating system driving the reservation system was Release 5 of the Airlines Control Program but IBM was up to Release 9.1. Western's customized version of PARS, called "ACCU-RES," was performing well on the 65s but volumes were rapidly approaching the absolute

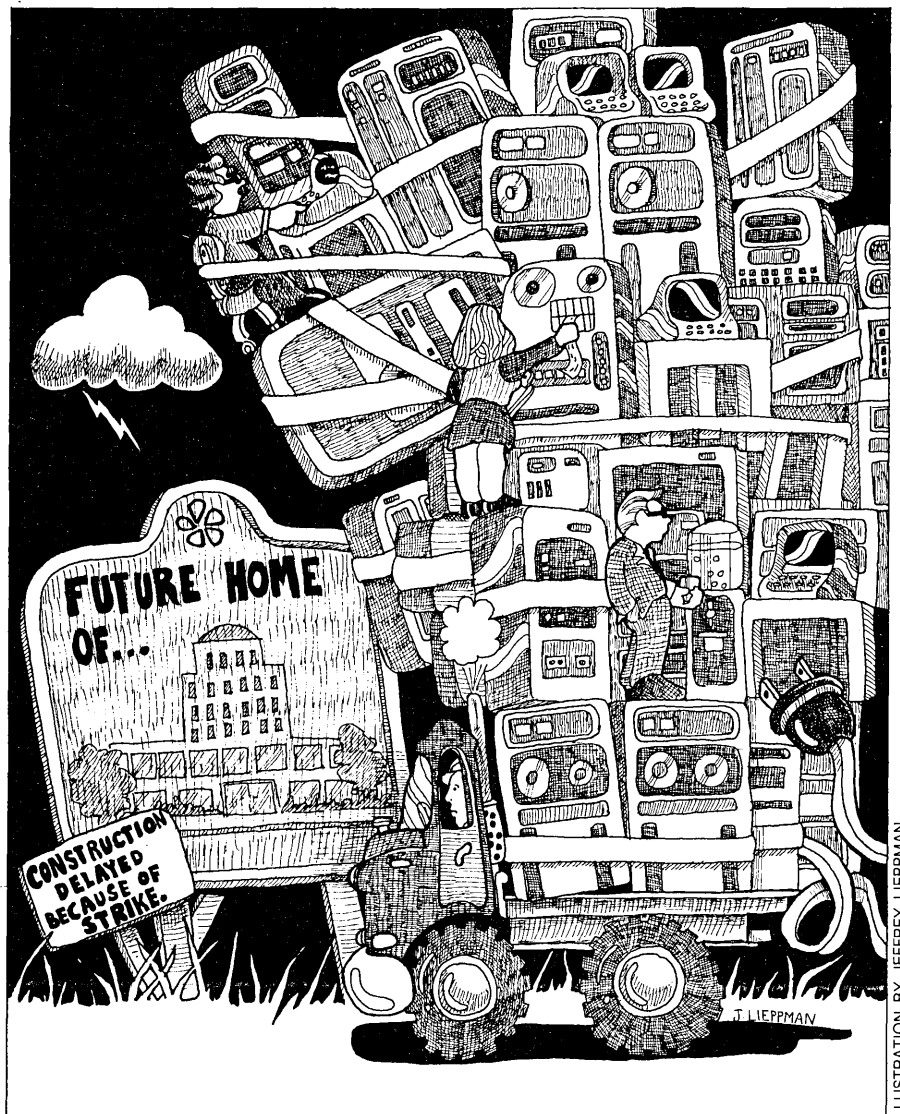

ILLUSTRATION BY JEFFREY LIEPPMAN

The new approach, forced by the vendor's nondelivery, required remaking all the plans.



Floor space was the big problem in conversion. Although it was possible to find space for the primary IBM 370/158 cpu and its backup alongside the existing primary IBM 360/65 and its backup in the 6,200 square feet in the old building, there was no conceivable way to find room for the extra forest of disks that would be required for the conversion.

limits of second generation hardware. Christmas is peak time for all American trunk lines, and Western doubted it would be able to make it through the coming 1978 holiday season without an upgrade first.

Western Airlines, the oldest continuously operating airline in the U. S., flew its first mail flight between Los Angeles and Salt Lake City, by way of Las Vegas, in April, 1926. Now, 52 years later, it is eighth in size among the nation's airlines and serves 43 cities from Anchorage to Mexico City and from Honolulu to Miami. More than 10,400 employees keep a fleet of 78 modern jets in the air. And much of the whole operation critically depends on having ACCU-RES up.

The reservations system services 1,400 reservation terminals in the continental U. S., Hawaii, Alaska, Canada, and Mexico. Each of these requires three second or less response as a design criteria. As business built up to over a million passengers per month, peaks of 116,000 messages/hour had been reached. Cpu utilization approached 85%. The 65s were out of steam.

Performance measurements indicated the 158s and 3340 drives, equipped with the fixed head feature, would handle the anticipated load well into the 1980s within the three second response time criterion. Therefore, it was decided to convert ACCU-RES from the 65s to the 158s, and this required upgrading to ACP9.1 The problem was floor space.

Western had considerable 370

experience. A 370/158 had been installed in 1976. VM/370 and MVS had been brought up on it and heavy use was made of CMS for program development.

But any PARS system demands an operating mainframe and a backup computer for reasonable security. Converting from 360s to 370s required two of each. Two 360s and two 370s with a large complement of peripherals don't fit well into 6,200 square feet of floor space. The cpu conversion alone could be effected, but there just was not enough space for sufficient disk drives—and imagine the cabling snarls.

It was decided to build a new, larger facility which would provide sufficient space for the foreseeable future for both computer systems and their staffs.

Uninterruptible power and improved air conditioning were some of the design criteria for the new facility. A Teledyne UPS (Uninterruptible Power Supply) which could output 600KVA was to be the heart of the backup systems. Immediate backup power was to be provided by 260 storage batteries, kept continually charged. Two stand by generators, fed from an underground 7,000 gallon fuel tank buried nearby, were to be available for extended outages. Backup cooling adequate for the computer room and its machinery was also required.

The building, to be designed and built by Tishman Construction, and rented by Western on a long term lease,



In addition to four mainframes and their peripherals, some 800 cables had to be unplugged, extricated from the underfloor spaghetti, and reconnected at the new site.

was laid out as a four level structure with a computer room in the basement and three floors of space planned for programming and systems staffs.

The basement facilities were large enough for four of the largest computers built, each with a full complement of peripherals. The rest of the space was more than adequate in every respect too.

## THE WINDOW CAME TOO SOON

By the time Western and Tishman were about ready to begin construction, timing constraints were reviewed. Consideration set in. There were problems:

1. The new building had to be completed by the beginning of May, 1978, and to save costly lease extensions, all moves by computer staffs and other staffs had to be completed by the end of June.

2. Summer's rush of passenger traffic, always the heaviest and most prolonged that Western faces during the year, begins in late May.

3. The next such "window" after the first few weeks of May, would not occur until midfall.

The consensus seemed to be that there was just not enough time to do all that had to be done, even if everything went perfectly. Construction was planned to begin in July of 1977. The reservations system had to be up and running in the new building on the 158s before May 15, 1978. That left, at most, 10½ months.



Using a moving company which specializes in transporting dp gear has some advantages. Data Transportation, for example, provided this unusual "Power-Krawl" for carrying sensitive electronic boxes up stairs.

Western's first step was to retain a management consulting firm to assist its small dp planning staff in developing a move plan. The Diebold Group, Inc. from New York was selected and charged with the task of developing an approach that would fit the project into this tight time frame, but yet provide enough flexibility to react to problems as they occurred. Most insiders felt it was impossible.

Diebold responded with a proposal that two committees be set up under the chairmanship of a senior executive of the airline, preferably someone outside of dp. The senior of these committees, to be called the General Move Committee, was to be made up of senior personnel from every department involved in the move in any substantial way. It was to meet once a month to review plan performance, make key decisions for adjusting the plan, and report its findings to senior management.

The second committee, the DP Committee, was to be made up of dp senior management involved either in the move or in the upgrade of the system. It was to meet once a week, have responsibilities similar to that of the other group but was to report to the senior committee.

Western's vice president of communications was named chairman of both committees. Our director of hardware and software systems was named the junior committee's representative on the senior body. The Diebold Group's representative sat on the senior committee and jointly reported on progress with the communications vp.

In addition, Diebold drew up a first attempt at an overall PERT chart with some 120 activity nodes, lined out primarily by functions to be performed within each operating staff. Though necessarily rough, the chart put the whole task into perspective. It also began to

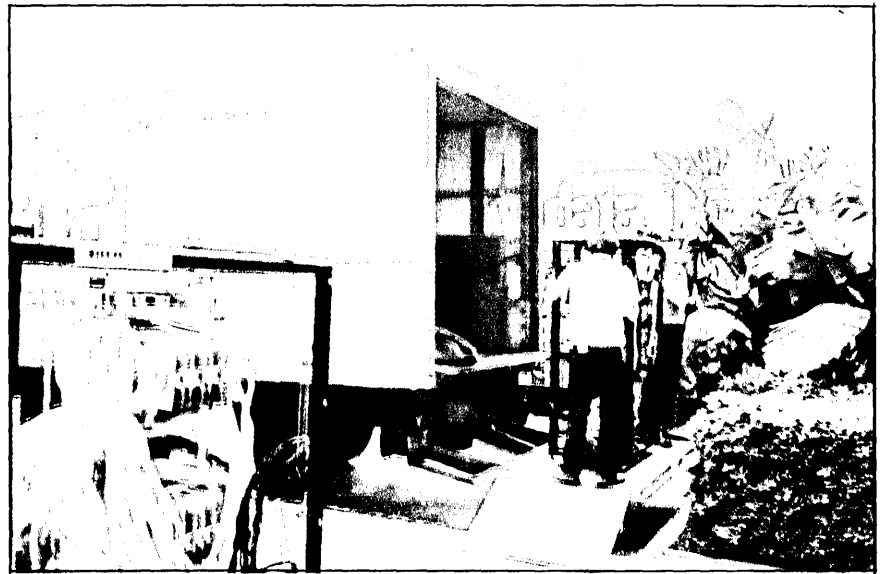

The move involved transporting 200 electronic frames from two floors of one building to the basement of another. To make it work, the moving firm had to be brought into the picture early to work with the staff move team in creating a move plan and to learn where all the boxes would go.

allot milestone dates which had to be met if there was to be any hope of success.

Diebold also supplied half a dozen more detailed backup charts, particularly well developed in the data processing area and less detailed in others such as communications, building development, and the financial actions. Virtually all proved inadequate in the long run but the basic charts proved to be a foundation on which the Move Committee could build. Staff members were directed to either accept the proposed PERT charts for their areas or replace them with more detailed ones of their own. All staffs upgraded the charts to some extent, learning about project control in the process. Surprisingly, most of the basic premises held up well and key performance dates in most instances were

found to be rather accurate.

### 1,200 ACTIVITY NODES

Data processing's role was, of course, the largest. Dp faced both an upgrade, to be completed before the actual move got underway, and the physical move of most of its equipment and people. The director assigned the upgrade to his manager of real-time systems programming, and the move to his manager of systems programming.

Each was given authority to cross all departmental boundaries within the dp organization, calling for all resources needed to get his tasks done on time. Both faced formidable obstacles in meeting schedules they, themselves, eventually drew up. The upgrade was less demanding, however, in that its time frame was

### WHEN THE SYSTEM IS DOWN, SO IS WESTERN AIRLINES

The ACCU-RES reservation system is the lifeblood of Western's operation. It *must* run 24 hours per day, 7 days per week, not only for making flight arrangements, but for other critical operations such as calculating aircraft loading and balance prior to every departure. Cargo placement must be optimized for the number of passengers on the plane, the best center of gravity, and optimum fuel utilization in flight; it takes a computer to do that job right.

It's much more than its name implies. ACCU-RES handles most of the standard applications all airlines have: flight schedules, seat inventory, recording passenger names and other information required for smoothing his or her way from seat reservation to ticket

purchase to baggage pickup.

There are approximately 1,600 program segments in the system for performing data manipulation, calculations, and running displays. Automatic ticketing, fare quotation, and credit validation are also performed for some 1,400 field agents using either IBM 2915s, Incoterm, or Raytheon crt terminals. In fact, the only passenger-related service *not* performed by ACCU-RES through the terminal network is passenger seat selection; this is done as a standalone, distributed application by minicomputer systems in each airport.

Knowing what this "reservation" system does makes it clear that when ACCU-RES isn't functioning, neither is Western Airlines. ❁

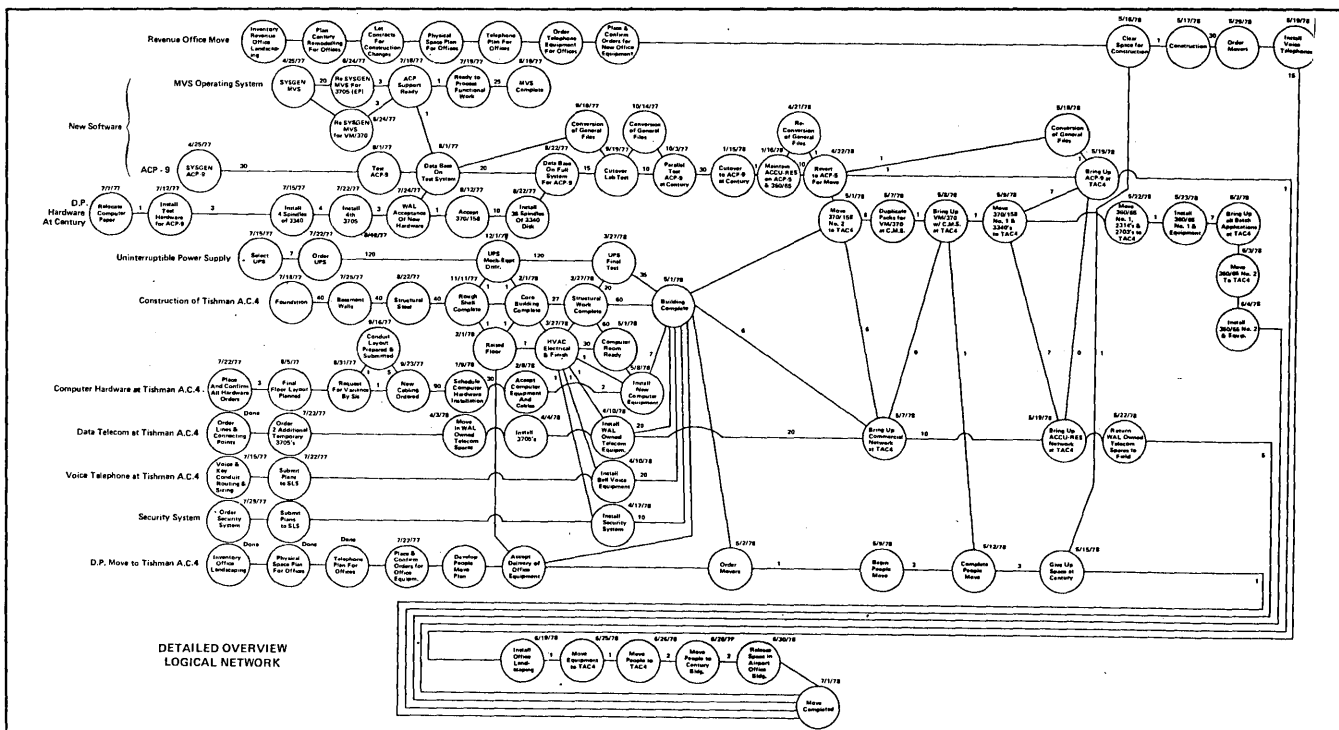

PERT charting proved essential. It was quickly found that the duration of events presented no problem, but that their timing and interdependencies were critical. This overview network, developed early in the planning phase, was later

expanded to include several hundred activities; several detailed layouts were created separately for unusually complex activities.

more comfortable; it would be completed several months before the physical move was to begin.

The job of managing the move proved immense. However, imbued with the concept that planning was all important, the manager in charge began to prepare an immensely detailed set of instructions, divided into three parts.

The first was an overall Facility Move Plan which further dissected the move into five phases, four of which were roughly keyed to the installation or removal of each of the four computers. Phase 5 was the removal and return to suppliers of some interim hardware. Each of the five phases was supported by a PERT chart and a computer configuration chart showing hardware installed in that phase and its interconnections.

The second document, which ran more than 100 pages, was a highly detailed one called the Computer Hardware Move Plan. Again the same five phases were used. The plan covered every step of every node on the PERT charts in as much detail as Western's hardware planners, in concert with supplier planners, could conceive. It referenced every hardware box and virtually every cable. It also included a detailed floor plan of the new data center which contained placement instructions for every piece of equipment.

The third document was the Computer Operations Move Plan, again set up in the same five phases. It outlined how Operations would move, as the computers moved, so that maximum uptime would be maintained for all critical

systems.

Marketing officials at Western have estimated that downtime on the reservations system, particularly during daylight hours, costs \$250,000 an hour. There was no room for error.

Luckily, all three documents were prepared in SCRIPT/370, IBM's CMS document generation system, because all three of them were changed and regenerated, in a hurry, several times.

Now Western had a plan for better or worse. As involved people began to review it, some curious facts emerged. Timing data had started out on a best guess basis with the thought that the move team could always return and correct any times that proved wrong after an overall plan was developed.

But most of the carefully detailed tasks were of very short duration. What eventually showed through was that task sequences and dependencies were far more important than their timing. Only minor adjustments were ever made to the timing estimates.

Walkthroughs had been planned for the move team but without physically unplugging the 800 cables and 200 electronic frames involved, effective rehearsal proved virtually impossible. Since timing was not critical, the rehearsal idea was soon discarded. In its place the team worked with the moving company to tag and identify each box and each cable by phase and to keep accurate records of all such tagged parts.

The mover played a critical part from planning time on. Data Transporta-

tion, a Bekins company specializing in crating and shipment of computers and their peripherals, was Western's choice for this key role. The equipment to be moved was worth \$ millions. Damage delays could cost \$ millions in lost revenue. The choice was made carefully.

Data Transportation was picked because of its specialization, which has led it to develop some very unusual equipment for moving sensitive electronic boxes, such as carriers that "walk" up steps.

Data joined the Move Team in putting together the detailed Computer Hardware Move Plan. Its movers, with the team members, learned and listed the exact locations of every box and cable in the two floors of computer room. In the new room being built nearby, they aided the Move Team in laying out the exact locations of every item on or under the new raised floor.

Insurance proved an interesting problem. Special insurance covering the value of the equipment in the course of the move was expensive and would serve little or no purpose in guaranteeing the success of the move. If a major item of equipment was destroyed in the move, the insurance would pay for its replacement but could do nothing to avoid the downtime which would result. Since downtime was the major fear, it was decided to forego special insurance.

Nor was there any real way a backup installation could be used to protect the project. A reservations computer is the heart of a complex communica-

# THE FIVE PHASES

Western's PERT chart for moving its dp center from its Century Boulevard location to the new Tishman Airport Center No. 4 (TAC IV) had several hundred activity nodes. The most important are listed here, with dates for the start of each phase.

## HARDWARE MOVES

### PHASE I (March 15, 1978)

Move 370/158, D, 3340 disks, and peripherals to TAC IV.

Test the moved hardware using a VM System.

Move the production VM System onto 370/158 D at TAC IV from the 370/158 C at the Century facility.

Activate RJE and remote terminal communications between Century and TAC IV facilities.

Bring up all CMS time-sharing in a remote mode from TAC IV, while continuing all batch production and test at the Century facility on the 360/65 OS/MVT system.

### PHASE II (April 7)

Move 158 C and peripherals from the Century facility to TAC IV. The 360/65s continue running ACP-5 and production OS/MVT in batch mode at the Century facility.

Verify the reliability of the moved hardware and its ability to operate the VM System on 370/158 C.

Cable 158 C to permanent 3340 disks.

Begin operation of the VM System on 370/158 D while testing 370/158 C. Test the switching of VM/370 back and forth between the 370 systems.

Checkout the test ACP-9 in preparation for the ACCU-RES conversion to ACP-9.

### PHASE III (May 1)

Convert ACCU-RES to ACP-9 on 370/158 and 3340s.

Bring up MVS System for ACP-9 off-line support under VM/370 on 370/158.

Continue OS/MVT batch and Intercomm teleprocessing systems at the Century facility on 360/65 A while 360/65 B is relocated to TAC IV.

Test 360/65 B and associated periph-

als and bring up an OS/MVT System on it.

Move OS/MVT batch onto 360/65 B at TAC IV from the Century facility.

At this juncture, all data processing functions will be functioning at TAC IV.

### PHASE IV (June 1)

Move and install 360/65 A and any remaining hardware left at Century.

Bring up OS/MVT production systems on both 360/65s.

### PHASE V (June 21)

Remove and return to lessors all interim computer hardware after the completion of the move and installation of the 360/65s at TAC IV.

## DP OPERATIONS

The computer operations group coordinated very closely with the other groups, drawing up its own phase activities to go along with the overall sequences. During the moving period, from March 15 to June 30 (from Phases I through IV), no new implementations of commercial applications were allowed.

### PRE-PHASE I

Ensure supplies are at TAC IV (i.e., tape, disk, paper, etc.).

Develop system software to support the hardware at TAC IV.

Sysgen MVS System independent of OS shared libraries.

OS/MVT test and production libraries separated to different physical disk packs.

Test and batch Intercomm libraries and make data base files independent of production Intercomm libraries and files.

Develop software to support the 3780 RJE workstation and cpu to cpu remote job entry.

Have available 3705 Communication Controller emulator programs.

**PHASE I** (370/158 D moved to TAC IV) Provide courier service between new and old sites.

Test moved 370/158 D hardware for reliability.

Restart development of ACP-9 at TAC IV.

Move VM production system to TAC IV.

Move MVS production system to TAC IV.

Copy MVS System to 3350 disks.

Move Intercomm test system to TAC IV.

Move OS/MVT test workload to 360/65 A.

Separate UCC ONE tape library data base.

Activate remote job entry facility.

Make available 3780 backup facility.

Test interim 3705 Communication Controllers.

**PHASE II** (370/158 C moved to TAC IV) Test 370/158 C hardware reliability at TAC IV.

Switch VM production to 370/158 C at TAC IV.

Switch ACP-9 development to 370/158 D at TAC IV.

**PHASE III** (360/65 B moved to TAC IV) Activate ACP-9 production system at TAC IV.

Activate ACP-9 test system at TAC IV.

Test 360/65 B hardware for reliability at TAC IV.

Move OS/MVT System to TAC IV.

Move production Intercomm to TAC IV.

Combine UCC ONE data bases at TAC IV.

Test switching capabilities of 370s at TAC IV.

**PHASE IV** (360/65 A moved to TAC IV) Test moved 360/65 A hardware for reliability.

Move production OS/MVT and Intercomm systems to 360/65 A.

Move test OS/MVT and Intercomm systems to 360/65 B.

Test backup capabilities of systems.

### PHASE V

Stabilize all operating systems into their final operating configuration at the TAC IV facility. \*

## Without the upgrade, the move, and those PERT charts, Western wouldn't have handled the extra traffic.

tions network. In effect, to move it would require duplicating all the telephone lines coming into the Los Angeles center. Installing still another set going to another backup computer would have been an impossibly large project. Rather the move was designed to back up itself.

### STRIKES, RAIN, AND NONDELIVERY

Initial preparations had begun in April of 1977. By June the first cut at the master plan had been completed. The move team had completed its package by August. The builder cooperated and submitted his PERT chart by September. All other cooperating staffs fed in their plans during the fall. By December everything was set. The whole plan seemed reasonable.

Then it began to fall apart, the disintegration was much faster than its creation.

Two strikes caused the builder some problems, but it had enough leeway built in that the strikes' long range effect seemed minimal. But then the rains came to Southern California—the rainiest winter season this century settled in with a vengeance—and all of the time cushions began to erode.

The worst blow was a totally unexpected one. The plan had been to bring up ACP9.1 on the 158s in January of 1978, immediately after handling reservations for the 1977 holiday rush. That would give Western four months' experience running the new system before moving it to the new building early in May.

We intended to bring in a third 370/158 on short term lease into the new building. ACCU-RES running on the first 370/158 and backed up by the second would be switched, then, to the third, in the new building, with the second remaining as backup. Then the first 370/158 would be moved to the new building where it would be used as backup, while the second machine would be returned to the supplier.

In December, 1977, IBM advised that the third 370/158, on order for nearly a year, could not be delivered as promised. After searching fruitlessly for an alternate machine, we decided to forego the update in January and make it an integral part of the move itself.

Instead of updating in January Western chose to continue running the Reservations System on the two 360/65s until the first week in May. Then, after the two 370/158s had been delivered and brought up, Western planned to upgrade to ACP9.1 on the 370/158s as the last step of Phase 2 of the move. Far more dangerous than the other approach, which would

have separated the two projects, this latter plan was attractive in that it reduced interim hardware equipment charges by \$350,000

The new approach necessitated a complete change in all the plans. If typists had to retype all the documents, the task would have been monumental. However, the three documents produced by the Move Team were on SCRIPT/370, the disk storage text processing system. Within a week a new plan was generated and distributed.

Meanwhile, it was raining and the rain was inhibiting the builder from meeting his key target dates. One, in particular, was going to be missed by several critical weeks. Tishman had requested a Temporary Certificate of Occupancy which some of the suppliers insisted was required before equipment could be installed in the new building.

The Move Team, monitoring the plan on a daily basis, reported to the DP Move Committee that this one failure was going to destroy the whole plan. In turn, the General Move Committee reviewed it in search of a solution. It appeared we would be a month late because of weather in getting the certificate and the suppliers could not proceed without it. Or could they?

In an impassioned appeal, the suppliers were requested to demand of their senior management why work could not proceed without such a certificate. After all, it appeared to be just a work rule and rules are made to be broken.

Somewhat surprisingly, the suppliers agreed. Work proceeded without the certificate and the first two phases went like clockwork in a partly finished building.

The 158s ran without air conditioning the first weekend, but the room was cool and damp. Then Western was advised the Uninterruptible Power Supply would be three weeks late. We would have to run ACCU-RES for those three weeks on raw, unfiltered power. The gamble was becoming riskier.

### FINALLY, THE CUTOVER

Luck was with us. On Saturday, May 6, Western began the cutover late at night in a partly finished computer room in an unfinished, almost empty building. By Sunday noon the upgrade was complete, and it was obvious the whole move was an unqualified success. Even the unfiltered power was to cause no problems.

From then it was downhill. By collapsing assigned activity times, the Move Team was able to improve on its schedules by two full weeks. Every date on the

whole schedule was met or bettered.

Western management has reviewed the operation to see what, if anything, could have improved the approach. The consensus has been, however, that the PERT approach and its careful consideration of dependencies and interrelationships reduced everything to scheduled events, making the whole project simple.

A few days after the May 6 cutover to the new operating system and the 370/158 hardware, Western was into its Memorial Day traffic. Unexpectedly, airline traffic and the reservations system traffic began to break all records. The load continued through the summer, unabated. Now it is apparent that without the upgrade, the move, and those PERT charts, Western would not have made it.

The move succeeded because all tasks were reduced to manageable pieces to be accomplished on a given day. If we were to do it again, we'd do it the same way. ❁

### WALTER BAMBRICK

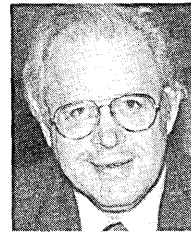

Mr. Bambrick, Canadian-born vp of data processing and systems for Western Airlines, has more than 20 years of

experience in dp management, including stints with the Diebold Group and Piper Aircraft Corp. A graduate of Carleton Univ. in Ottawa, he began his dp career while in the Royal Canadian Air Force.

### BENJAMIN A. FONG



A California native, Mr. Fong has more than ten years' experience in aerospace data processing. He is currently director of computer

technology for Western Airlines, where he had previously held the post of manager of systems programming. Before joining Western, he was with Lockheed and the Rocketdyne Division of Rockwell International.



# An E-sized performance in 13.5 seconds.

Gould's 5400 printer/plotter will produce an E-sized drawing in 13.5 seconds. That's faster than any computer-related interactive printer/plotter. With a paper width of 36" and a speed of 3.25"/second, the 5400 generates over 48 separate sheets of hardcopy per minute.

Designed for applications with the most demanding hard copy requirements, the 5400 is ideal for computer-aided design, scientific data plotting, and business applications such as PLEAT/CIPMI, Gamma, and others.

Gould's professional interactive plotter system ensures high contrast dry

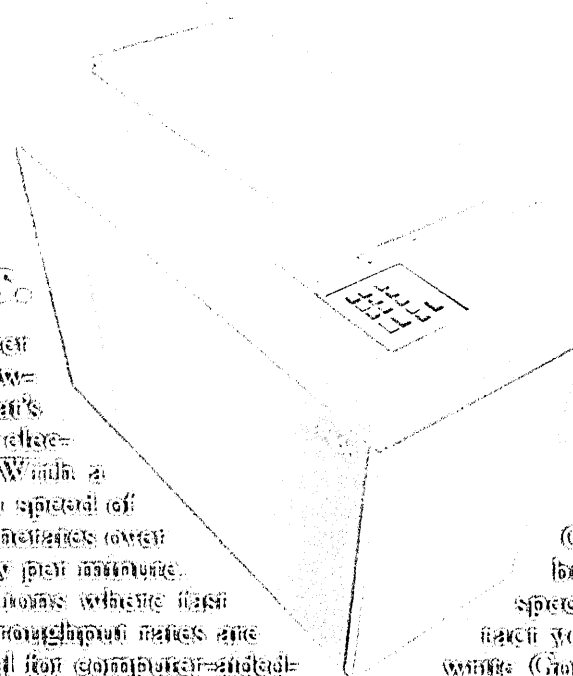

hardcopy even at the highest resolution. Plotting speed of the 5400 is 3.25"/second. The 5400 also has a built-in 24-pin dot matrix printer. In addition, a separate high-speed thermal plotter can be purchased. A user-oriented control panel features a unique LPII system for continuously monitoring paper supply.

For additional information on Gould 5400 printer/plotter capabilities, contact your nearest Gould representative. Or write Gould Inc., Information Systems Division, 3631 Parkways Avenue, Cleveland, Ohio 44114 ((216)) 361-3315. For brochures call toll free ((800)) 325-6400.

For more information call ((800)) 324-6600.



# Introducing DEC SYSTEM-2020 full-function APL.

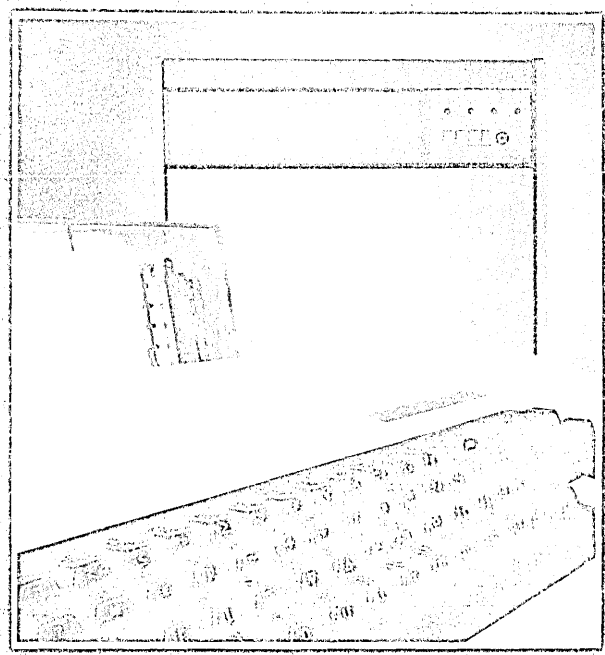

# In the world's lowest cost mainframe APL system.

It took the world's lowest cost mainframe to configure the world's lowest cost full-function APL package. The new DECSYSTEM-2020 APL System. Just \$199,500.

Based on a five year system life, that works out to less than half the cost of outside APL services.

And compared with other systems offering a similar level of APL functionality, the new DECSYSTEM-2020 package comes in, incredibly, at about *one-fourth* their cost.

For \$199,500, here's what you get:

- DECSYSTEM-2020 Mainframe CPU;
- 4 APL Terminals with Full APL Character Set;
- Complete APL Software;
- TOPS-20 Virtual Memory Operating System;
- One Megabyte of Main Memory;
- 67 Megabyte Disk Drive;
- High Speed Tape Drive.

With the DECSYSTEM-2020, you really do get full-function APL. The same APL that runs on our largest DECSYSTEM-2060

mainframe, recognized as being among the best in the industry. It comes complete with features like an extended file system, divide-quad functions, error analysis and recovery, and dyadic format function.

You also get all the features and benefits that are making the DECSYSTEM-2020 one of the hottest mainframes to hit the market in years.

Things like surprising ease of use, thanks to its fully developed interactive mainframe software, comprehensive system utilities, and specially designed architecture. And unmatched ease of upgrading that allows you to move up through the entire DECSYSTEM-20 family of mainframes without ever giving up your investment in software.

The new DECSYSTEM-2020 APL System.

For DP Managers, the world's lowest cost.

For APL users, everything they want, in their very own mainframe.



All Digital mainframe systems are now available to qualified OEMs.

**digital**

Please send your new 24-page color brochure, **DECSYSTEM-2020 — the World's Lowest Cost Mainframe.**

A-10-8

Please contact me.

Name \_\_\_\_\_

Title \_\_\_\_\_

Company \_\_\_\_\_

Address \_\_\_\_\_

City \_\_\_\_\_ State \_\_\_\_\_ Zip \_\_\_\_\_

Telephone \_\_\_\_\_

Send to: Digital Equipment Corporation, MR1/M-49, 200 Forest St., Marlboro, MA 01752. Tel. 617-481-9511, ext. 6885.

UDS has the ideal instrument for verifying data integrity in your communications system. It's the new COMTEST microprocessor-based network analyzer. It weighs only 24 pounds, it fits under an airplane seat, and it can give you complete confidence in your data communications network.

The COMTEST analyzer normally stores both EBCDIC and ASCII disciplines in its integral PROM modules. SDLC is available as an option. A keyboard input allows easy modification of these standard disciplines to accommodate your specific system checkout needs. In addition to half- or full-duplex network monitoring it can serve as an emulator for your CPU or for various terminal devices. It also has loop testing capability for verifying modem and line performance. Built-in self-test capability is also included.

COMTEST is designed for the ultimate in user convenience. Twelve basic commands permit you to verify the performance of your entire datacomm system. The data dialog is displayed, either in hex pairs or clear English text, on a 16-line, 512-character CRT. For complete confidence in your datacomm system, arrange a COMTEST demonstration. Contact Universal Data Systems.

**COMTEST  
MEANS  
CONFIDENCE**  
in your datacomm system

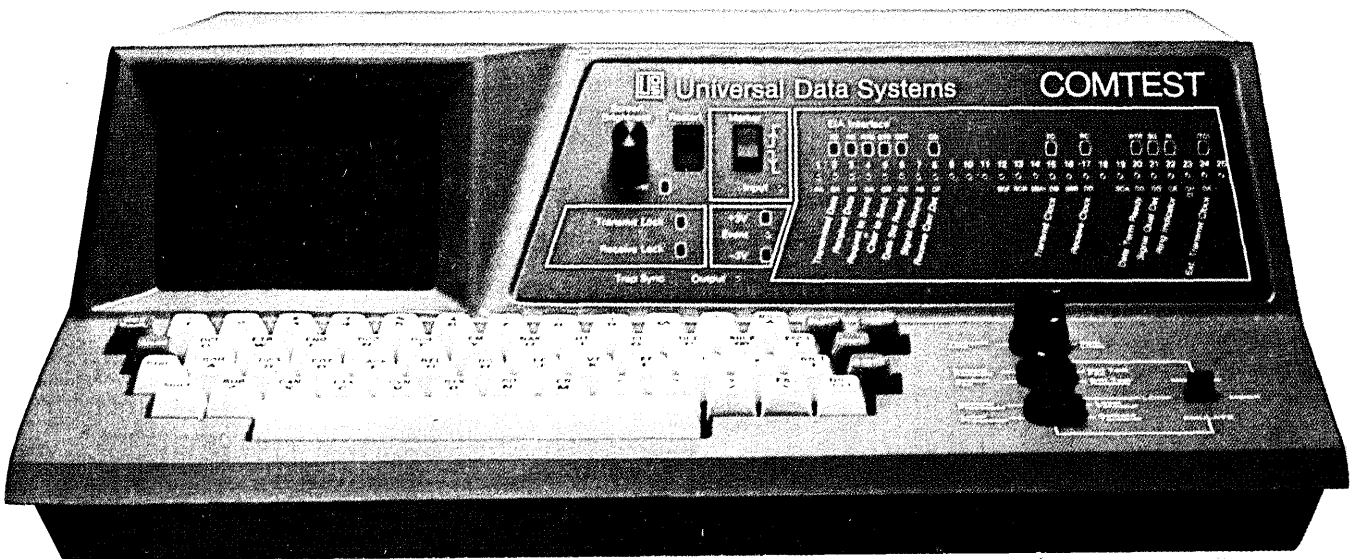

**UDS** universal  
data  
systems ICOMA  
4900 Bradford Drive, Huntsville,  
Alabama 35805 • 205/837-8100

Computer equipment prices may rise, performance or reliability may fall, and spares may be in short supply.

# SOVIET SQUEEZE ON STRATEGIC MATERIALS

by Bohdan O. Szuprowicz

If the price of gold continues its upward trend, data processing managers may soon face yet another form of computer crime: the stripping of computer circuit boards, IC panels, and connectors for the precious metals they contain.

While proper security measures will prevent this overt type of robbery, computer end users will probably not escape still higher equipment prices in the future. Escalating materials costs, for reasons not unlike those behind the OPEC oil embargo of 1973, and subsequent worldwide inflationary pressures may turn out to be the root cause.

Additional cost and price increases may become inevitable due to critical materials shortages caused by international tensions or the formation of cartels. Particularly vulnerable are those strategic metals whose sources of supply are few and are found predominantly in southern Africa or Soviet Bloc countries.

Countries, industries, and manufacturers threatened with possible materials shortages resort to various measures to protect their investments and operations from such disruptions. These include resource and industry protectionism, materials stockpiling by producing and consuming countries, intensified efforts to find substitute materials or to develop new technology using cheaper or more abundant materials. All these measures can impact equipment end users unexpectedly through rapidly rising prices, discontinued models, and shortages of replacement parts.

There was a time when the United States produced more raw materials than it consumed. In that era supply was primarily determined by demand, and since adequate sources existed within the borders of the United States no one gave much thought to access as such. Various materials then were just as critical to specific industries as they are today, but whether for commercial or military applications, their availability was simply a

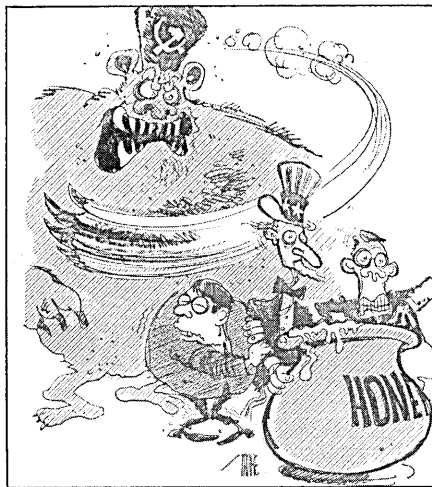

matter of capital, investment, and time.

Those days are gone, perhaps forever, and the United States has become a materials deficient nation. It now depends on imports for more than 50% of its demand for at least 20 critical materials—ranging from common metals such as aluminum to exotic ones like columbium, and even ordinary mica, widely used in electronics. The dangers of high import dependence are of course best illustrated by the OPEC oil embargo: price escalation, shortages, inflation, and the drop in the value of the dollar. But while oil is perhaps the most important single commodity susceptible to cartelization, it is not the only one. Gold and precious metals used in electronics are another such group of commodities.

Electronics in general, and precision equipment in particular, are the largest industrial users of gold after the jewelry industry. Also used are silver and other precious metals such as platinum, palladium, rhodium, and osmium, all of which are vital to ensure reliability of electrical contacts and those maximum speeds demanded of modern data processing and telecommunications equipment. Another platinum metal, iridium, has the distinction of being the most cor-

rosion resistant element known in the world and has obvious application in dp systems operating under rugged industrial or outer space conditions.

Only tiny amounts of these precious metals are used in individual dp components, but even small quantities of those materials command increasingly higher prices in today's markets. Everyone wonders at the price of gold which hit another all time high of \$215/troy ounce (1.097 av. oz.) in August 1978. But platinum reached a high of \$280/ounce, and such exotic metals as iridium or rhodium command market prices of over \$300 and \$500/ounce respectively. No wonder equipment manufacturers are constantly struggling to find suitable substitutes to maintain their profit margins and stay competitive while living up to previously announced product specifications.

## WHY THE SHABA PROVINCE?

Recent shortages of cobalt are a good example of what can happen. If you had to replace an electric motor in your equipment lately you already experienced the end user effects of the Shaba Province invasion. Cobalt steels are used in the manufacture of permanent magnets because of strong magnetic properties of the metal. Using cobalt steels, smaller motors of greater power can be manufactured. A typical computer installation has several dozen electric motors in disk drives, printers, tape transports, and such. There are many more in your car and on the average at least four in your home. Now, you can bet, your next burnt-out replacement will cost you considerably more than the last.

It all came to a head in May 1978 when Marxist rebels from Angola, reportedly backed by Soviet, Cuban, and even East German advisors and arms, invaded the southern portion of Zaire in central Africa. They did not invade the country as a whole in support of some popular revolution, but zeroed-in specifically on the rich Shaba Province where

some of the largest copper mining areas in the world are located. Cobalt is a by-product of copper production in Zaire, and the country is believed to contain over 60% of all the cobalt reserves in the world. The United States, on the other hand, must import 98% of its cobalt, and much of it comes either from Zaire or from Belgium which processes Zairean ores.

As a result of disturbances and shutdowns of copper mines, cobalt supplies were also affected. American Metals Corp., a New York distributor of cobalt from Zaire, was forced to put its customers on a 70% allocation basis. Although the firm courageously kept the price stable at \$6.85/pound, cobalt prices skyrocketed to as high as \$20 immediately in transactions from end user stockpiles. The U.S. Department of Commerce considered the situation serious enough to propose licensing U.S. exports of cobalt and cobalt-bearing scrap exports to prevent international speculation and to conserve domestic stocks of the metal.

The cobalt brouhaha was not entirely unexpected, nor was the Shaba invasion the first such attempt to take over the area by Marxist forces. A similar invasion took place almost exactly a year earlier, and even in the early 1960s the secession and fight for what was then called Katanga was in fact only a prototype action which has since repeated itself with disturbing frequency.

At least one strategic materials study group, Charles River Associates of Cambridge, indicated in a study following the 1977 Zaire invasion attempt that cobalt prices could run up to \$10/pound in the short-run and would zoom to as much as \$70/pound if Zaire was cut off completely as a source.

Besides in permanent magnets, cobalt is also used in the manufacture of high quality heat resistant alloys and super steels for turbine blades of jet engines, in silicon-carbide tools, and in petroleum catalysts, and as a result is a very important strategic metal. The United States, Western Europe, and Japan are highly vulnerable to any major disruptions in cobalt supplies. The Soviet Union, on the other hand, is a major cobalt producer in its own right, and together with Cuba is probably the second largest cobalt producer in the world.

### RICHES RINGED BY MARXISTS

But cobalt is only one strategic material that comes from the troubled southern African countries of Zaire, Zambia, Rhodesia, Namibia, Botswana, and South Africa. And neighboring Angola, Mozambique, and Congo are already Marxist regimes, which adds to our discomfort. Fortunately those neighbor countries are not the major suppliers of strategic materials to the West. Nevertheless, they provide convenient staging

points, training grounds, and arms supply depots to various "liberation" forces that may plan to take control of the more strategic areas. In addition they hinder the transportation of strategic materials from the African hinterland of Zaire, Zambia, and Rhodesia to the outside world because they control the railways to the nearest ports. This in itself causes shipping delays and high transportation costs, and forces producers to ship their products through ports in the troubled country of South Africa.

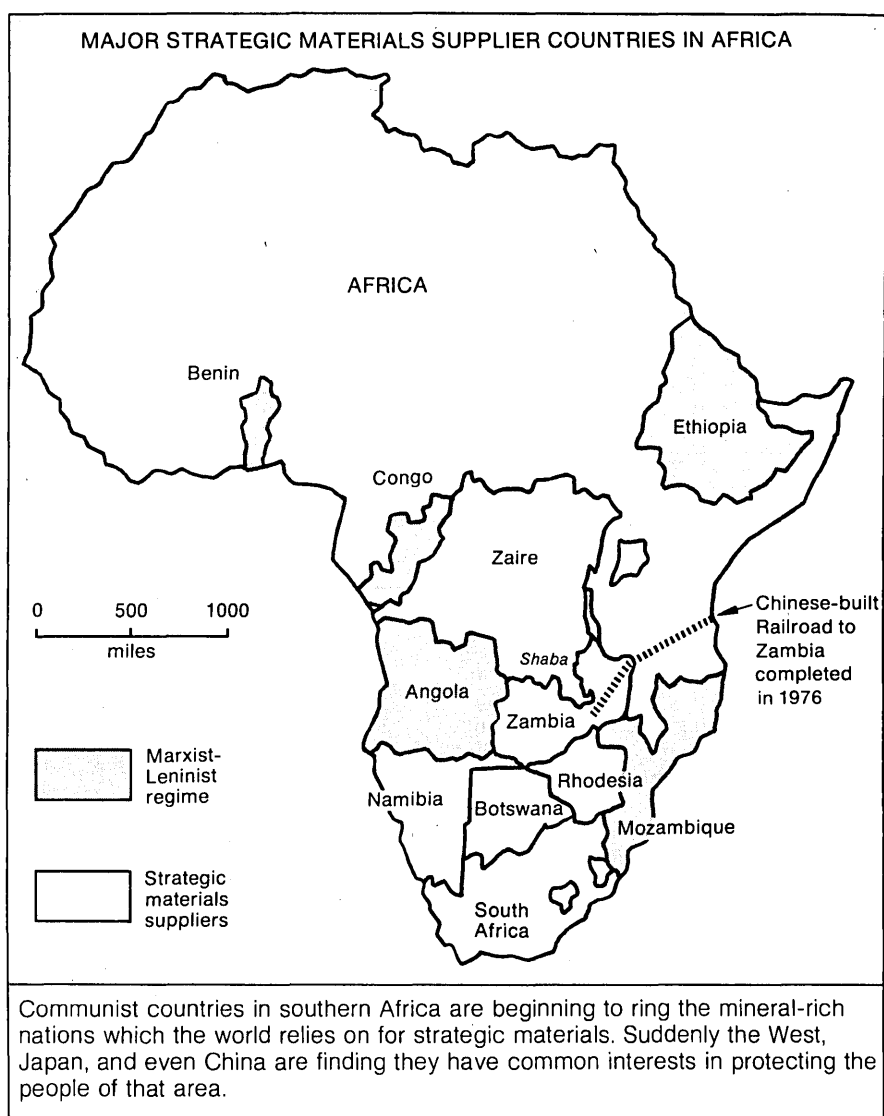

Among the 20 or so of the most strategic materials that make up the U.S. Joint Chiefs of Staff "critical imports list" there are many metals and minerals that are imported from Zaire and South Africa, and many of those are used in electronics.

What is somewhat disturbing to many U.S. military observers and to our European allies is the fact that whereas the United States relies heavily on imports and will become even more dependent in the next decade, the Soviet Union is practically self-sufficient. Its imports of aluminum, tin, fluorspar, tungsten, and barite are all below 50% of consumption. What's more, deposits of all of those

materials are known to exist in the Soviet Union; the Soviets are believed to be taking advantage of low prices on international markets and a relative abundance of supplies at present. They could, if they had to, develop their existing domestic resources of those materials and become completely self-sufficient even if they were completely cut off from all the foreign sources. They simply do not need southern African resources.

The situation is not as favorable for China, although that country too is believed to possess vast untapped resources. China depends on imports of such strategic materials as cobalt, platinum, chromium, nickel, magnesium, and to a lesser degree even aluminum, gold, vanadium, lead, copper, and high quality steel. It is interesting to note here that in chromium, cobalt, platinum, and nickel, China and the United States are both heavily dependent on imports from identical foreign sources. More interesting still is the fact that the largest known resources and production of chromium, cobalt, and platinum metals are located in the southern African countries that have become so unstable in recent years. This in fact is one of those seldom dis-

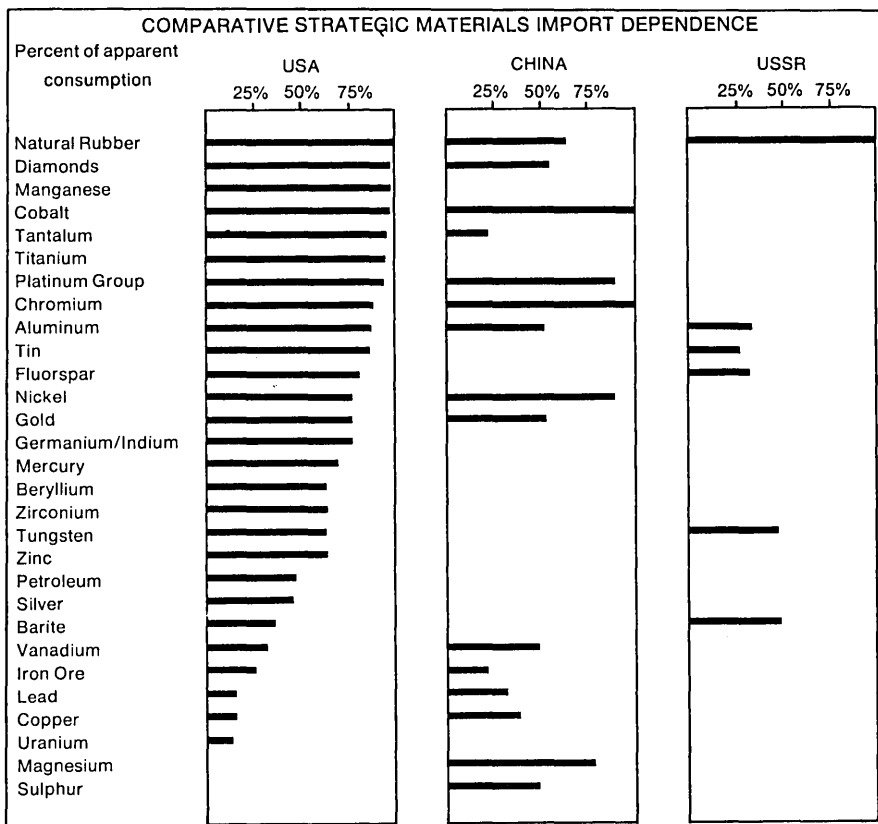

(Source: Compiled by 21st Century Research in September 1978 from data developed by U.S. Joint Chiefs of Staff, U.S. Bureau of Mines, National Foreign Assessment Center, and U.S. Congress Committee on International Relations.)

Once the U.S. was a self-sufficient country in terms of resources, but no longer. Now it must rely on outside sources for some important materials. China is less dependent on the world outside its borders, the Soviet Union almost completely self-sufficient.

cussed "common interests" of China and the United States that concerns the Soviets very much. Western Europe and Japan, which also rely on southern African sources for the same strategic materials, are of course also intensely concerned about the future of that area.

What makes Zaire a prime target for recurrent invasions and a possible Marxist takeover is not only its dominant position as a supplier of cobalt and copper to the free world, but its potential wealth in other critical minerals; a vast, extremely fertile and unexploited agricultural region; and its strategic location. In fact Zaire is already the world's largest source of industrial diamonds and has exploitable resources of gold, uranium, nickel, tungsten, aluminum, lithium, and other metals that must be imported by the United States, Western Europe, Japan, and even the People's Republic of China.

Some observers believe that the fall of Zaire under Soviet influence would almost certainly lead to the fall of neighboring Zambia's pro-Western government and would eventually seal the fate of Rhodesia and Namibia. Control of those countries together with an existing Marxist Angola and Mozambique would then present the Soviets with a powerful base to confront and perhaps even take over South Africa itself.

### A SOVIET MONOPOLY

To understand the far-reaching implications of such a scenario and how it would affect the West, it is necessary to look at the role played by Zaire, Zambia, Rhodesia, and South Africa in supplying the free world with strategic materials vital to its industries and defense. Those four countries produce a very large proportion of the world's supply of chromium, cobalt, antimony, copper, diamonds, germanium, gold, manganese, platinum metals, palladium, rhodium, ruthenium, osmium, iridium, uranium, and vanadium. Combined with existing Soviet and COMECON production of those same materials, a Marxist takeover of southern Africa would give the Soviet Union a virtual monopoly over at least 13 of the most strategic materials in the world.

The Soviet Union would then control over 80% of global production of such materials as chromium, probably cobalt, gold, diamonds, all the platinum metals, and germanium at the very least. Such a possibility is in fact believed to have a potentially much more devastating effect on Western economies than the OPEC oil cartel, which after all controls only 52% of the production of a single commodity. But even control of one or two additional countries such as Zaire, Zambia, or Rhodesia would create

unique opportunities for Soviet controlled cartels in several strategic materials.

Although various Western groups dismiss such "worst case" scenarios as simple scare stories, they often forget that predictions of the possibility of the OPEC cartel were also not given much credence either. It is nevertheless a fact that the present political and racial situation in southern Africa combined with the unique strategic materials resource base of those countries presents the Soviets with an opportunity of the century to attempt to "bury the West." There is also no question whatsoever that they are very well aware of it.

A takeover of Zaire, Zambia, Rhodesia, and South Africa would give the Soviets control over from 40% to almost 100% global production of most of the strategic materials in the world. Not only electronics but aircraft, aerospace, missiles, nuclear weapons, steels, petrochemicals, machine tools, and other crucial industries of the West, Japan, and even China could be held up for ransom economically and politically in the best OPEC tradition.

Actually this possibility may have been conceived in the Soviet Union a long time ago, but with a relatively small navy in previous years and relatively poor African "connections" it was not practical for the U.S.S.R. to put it into effect. Some Sovietologists claim that Lenin himself in one of his forecasting moods observed that final communist takeover of western Europe cannot be accomplished without first gaining control of southern Africa, which even by Lenin's time had long been known to provide the minerals lifeblood to most European industries.

That the Soviets would not hesitate to implement strategic embargoes to get their way once they control southern African resources has already been demonstrated by their moves against China in the early 1960s. Until the Sino-Soviet split China obtained all of its cobalt, chromium, platinum, and even oil from the Soviet Union. After the Soviets pulled out their technicians from China they also cut off supplies of strategic materials. This move played havoc with China's industrial development, and the country was forced to start a search for new sources. Eventually Albania and southern Africa sources, accessed through the construction of an expensive 1,100 mile long Chinese-built railroad from Tanzania into the heart of Zambia, assured China of the necessary supplies.

Now even those sources are being threatened, and as a result communist China and the capitalist West find themselves rallying to defend similar vital interests in southern Africa.

An example of how much effect Soviet actions can have in the strategic materials market was seen in 1977. The Soviet Union, which produces about 50%

of global output of platinum, suddenly withdrew its supplies from the international market without warning, claiming a need to stockpile platinum for manufacture of commemorative medals for the Moscow Olympics in 1980. As a result platinum prices skyrocketed during the last year or so, shooting up by at least \$100/ounce to its high of \$280/ounce this August. The only other significant platinum supplier, controlling over 45% of the global market, was South Africa. You might want to think about that when you buy your souvenir at the Moscow Olympics hard currency boutique.

This shows that it is not even necessary for the Soviet Union to gain control of southern African resources to create materials shortages and price escalations in specific industries. It is sufficient that they support various revolutionary movements which demand nationalization of domestic resources and control of production and new investment. The resulting political disturbances and economic disruptions will have a significant effect anyway if the countries and specific materials are well chosen.

Since the OPEC countries organized their most successful cartel in 1973, other countries that are leading producers of copper or bauxite began considering the possibility of organizing cartels in those and other commodities. Importing nations that depend on such foreign suppliers reacted by stockpiling, developing substitutes, or by offering special foreign aid and credit arrangements to ingratiate themselves with the cartels. But actual cartels in single commodities other than oil have limitations and have not been very successful in the long-term.

Fortunately some projects to track such developments and forecast and prevent further disturbances are already under way.

### U.S. FORCED TO PAY ATTENTION

After the OPEC embargo of 1973 a series of materials shortages developed in several industries, and the U.S. Department of Defense took the initiative and established a Materials Shortages Steering Committee. Its purpose is to identify the importance of all the strategic and critical materials to various industries and DOD research, development, and production programs, and to prevent future cost and schedule impacts similar to those that occurred in 1973 and 1974. Since the military establishment represents about 25% of the total electronics market in the United States, the activities of this committee should be of some interest to the computer industry as well.

The committee assembled an impressive membership from key government agencies, nonprofit think tanks, and industrial organizations. While government groups represented range from the

### PERCENT OF GLOBAL PRODUCTION CONTROLLED BY SOVIET BLOC AND SOUTHERN AFRICAN COUNTRIES

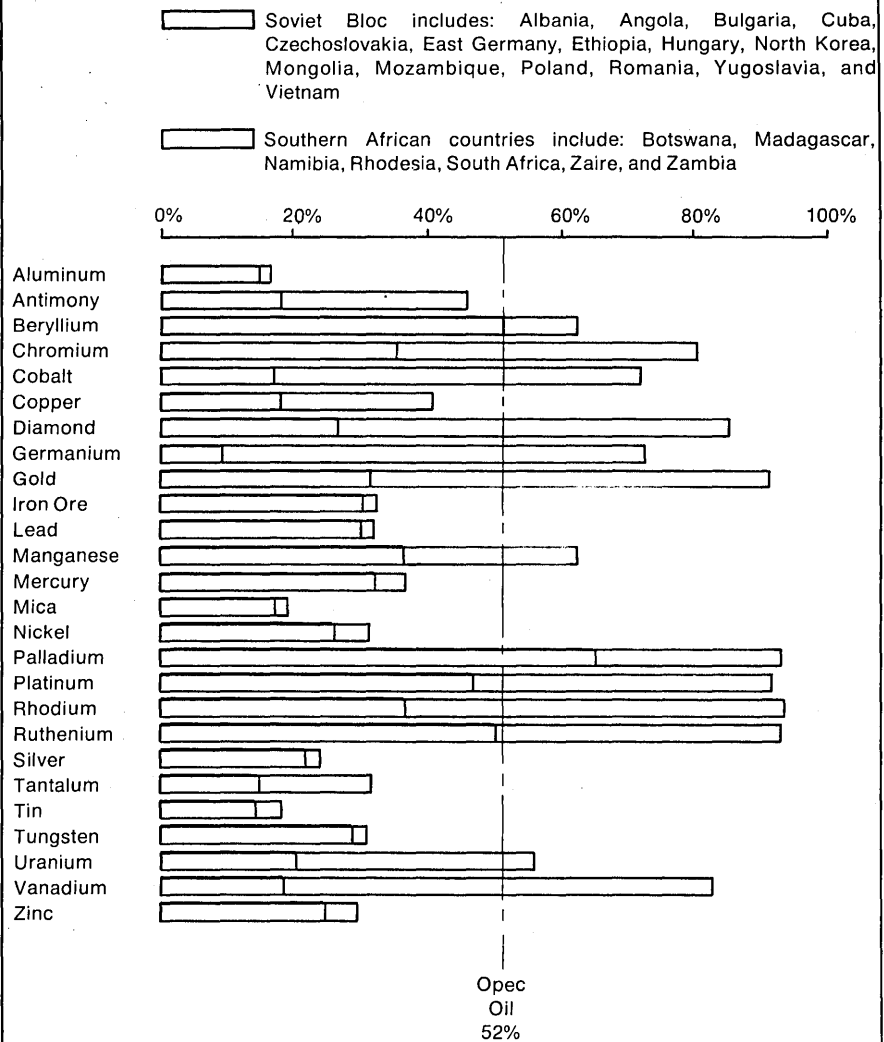

If the Soviet Bloc countries were allowed to take control of the mineral-rich southern African nations, the result would be a supercartel of far greater proportions than OPEC ever dreamed of. Even without the African states, the Soviets have great leverage over prices and availability of many materials.

Department of State, the CIA, and Department of Commerce, to the Department of the Interior and NASA, industrial representation comes primarily from mining and metal processing industries. Aerospace, shipbuilding, and petroleum industries are also participating, probably as the major strategic materials consuming industries. Perhaps it's time that electronics and data processing industries also played a larger role in this activity because of their importance to the defense effort.

One early outcome of the committee's activities was a Strategic Materials Management Information Program (SMMIP) which was undertaken by the Battelle Inst. under a DOD contract. It is an attempt to develop a data base to assist in materials supply and demand management. The Air Force also formed its own task group and developed a checklist of events and conditions that could lead to a possible materials shortage. In

assessing the SMMIP the Air Force pointed out that the system did not have the capability to forecast the impact of materials shortages on finished equipment products such as used by the Air Force. In this respect the computer industry is somewhat similar as an end user of equipment rather than of basic materials, and needs a different data base to properly forecast the effects of materials shortages on finished products such as computers or peripherals.

Computer end users are seldom concerned with the shortages or escalating costs of materials. Such problems primarily fall into the domain of the purchasing and production departments of equipment manufacturers. But the fact is that the semiconductor industry is running a constant race against the cost of labor and materials.

In a few years when VLSI technology reaches its physical limits of miniaturization and becomes widely used



# IDMS...the DBMS for the second time around.



If you were a forward thinker who installed a then-available DBMS in the early days, congratulations. But if you're still using it, condolences. That antiquated DBMS needs patching, updating and requires too much hardware and too many people.

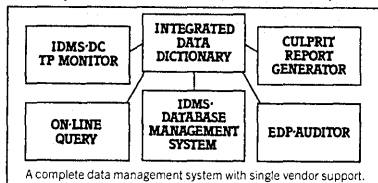

Solution? Convert to IDMS. Users who have done it report dramatic increases in performance and substantial people and mainframe savings.

Example: a major U.S. bank converted from

IMS to IDMS in a database/datacommunications environment for its CIF file. Results? Entry operators reported on-line response times cut from 20 seconds to under 2 seconds. IDMS used only half a previously saturated computer and 1½ people were freed from full-time technical support.

If you have an IBM 360, 370 or 303X computer and would like to see what IDMS can do for you, write or call Cullinane Corporation, 20 William Street, Wellesley, Mass. 02181, (617) 237-6600.

**Cullinane Corporation**



# Database: Cullinane

	Avionics	Assemblies	Batteries	Business Machines	Cables	Capacitors	Connectors	Contactors	Cryogenics	Dielectrics	Diodes	Electrical Steels	Electroplating	Ferrites	Fiber Optics	Gyroscopes	Heat Sinks	Insulation	Infrared Detectors	Instruments	Lasers	LEDs	Magnets	Memories	Microphones	Microwaves	Night Vision	Nuclear Instruments	Printed Circuits	Packaging	Rectifiers	Semiconductors	Solar Cells	Solder	Superconductors	Thermistors	Transistors	Transducers	Telecommunications	X-ray Apparatus	Xerography									
Aluminum	•	•		•	•											•											•	•																						
Antimony			•																																															
Beryllium			•					•								•				•																														
Cadmium			•									•	•																																					
Chromium										•																																								
Cobalt																																																		
Columbium																	•																																	
Copper				•																																														
Diamond																																																		
Gallium																																																		
Germanium										•																																								
Gold																																																		
Indium																																																		
Iridium																																																		
Lead																																																		
Lithium																																																		
Mercury																																																		
Mica																																																		
Nickel																																																		
Osmium																																																		
Palladium																																																		
Platinum																																																		
Rhodium																																																		
Ruthenium																																																		
Selenium																																																		
Silver																																																		
Silicon																																																		
Strontium																																																		
Tantalum																																																		
Tellurium																																																		
Tin																																																		
Uranium																																																		
Vanadium																																																		
Zinc																																																		
Zirconium																																																		

Some rare materials, and some unusually pure forms of more common substances like silicon, are critical to the manufacture of computers and other electronic equipment. More readily available materials can be substituted,

unbeknown to the user, but this affects the performance and reliability of the resulting product; thus, similar looking products may have quite different operating characteristics.

In Japan, China, and the Soviet Bloc, cost of labor and access to materials will become much more important than they are today. Control of access to strategic and critical materials will then become an absolute necessity.

Materials do not represent as big a percentage of the end product value in electronics manufacture as in other industries. Electronics production is a labor intensive industry and as a result even significant price increases in individual materials can be diffused within the end product. But this is not possible when access to critical materials is denied and substitutes must be relied upon.

Manufacturers are constantly substituting more economic materials to keep their costs down, although in some cases equipment reliability or performance must suffer as a result. There is obviously a limit even to this type of innovation and an informed end user can

benefit by anticipating inevitable future price increases by keeping track of where some of the vulnerable strategic materials are used in his installation and perhaps stocking critical spares. He can also make more intelligent decisions evaluating the trade-offs between performance and reliability of competitive equipment based on use of specific materials as critical components.

Some interesting tools and procedures are now being developed to help the concerned end user and the manufacturer to make such evaluations. The DoD Materials Shortages Steering Committee and some of its participating member organizations addressed themselves to the problem of defining how critical any particular materials are to the nation's industries and security.

The U.S. Army War College Strategic Studies Group identified the most critical materials by applying a "vulner-

ability index" to all materials of which the United States imported 50% or more of its requirements.

The "vulnerability index" takes into account availability of domestic resources and substitutes, number and location of foreign suppliers as well as the ideology of those suppliers, U.S. strategic stockpile objectives, the number and volume of production facilities, regulatory restraints, energy consumption requirements, and percent use by the Department of Defense. Not surprisingly, chromium turned out to be the most vulnerable material, with platinum metals very close behind. Cobalt and tantalum also ended up within the top eight most vulnerable metals. In the case of chromium and platinum, major sources are predominantly in southern Africa and the Soviet Union.

Another useful tool is the "substitutability matrix" being developed at the

# Introducing the NEC Trimliners™

## **New line printers. New industry standard.**

A line printer must work. That's the first standard. NEC's new Trimliner™ printers are workhorses. Designed for very heavy 30-40% duty cycles. 3000-hour MTBF. Innovations that eliminate many common printer failures. Five years of in-use development. Result: a new standard in printer performance.

A line printer must fit all its intended applications. Standard #2. NEC's Trimliner family comes initially in two models—300 and 600 LPM. 48- to 128-character fonts. The five most popular interfaces. Result: use it anywhere.

A line printer must enhance your system. Standard #3. NEC's Trimliner printers offer more operator ease-of-use features as standard equipment. 6 or 8 LPI. Electronic vertical format control. Up to 136 characters per line. Forms length switch. Automatic band alignment. Single or double

line feed. Audio alarm. All standard. Result: your systems product becomes more attractive.

A line printer must be inexpensive—to buy and to use. Standard #4. With all their extra features included in the basic price, NEC's Trimliner printers provide the best value-per-dollar in the industry. They cost the same as competitive printers. And they offer 90 per cent parts commonality for lowest-cost sparing. Modular design that delivers a 30-minute MTTR. Ribbon life of 500,000 impressions. Result: a new standard in printer economics.

A line printer must be quiet. Elusive standard #5. NEC Trimliner printers operate at 62 dBA with sound cabinets, and at 65 dBA in pedestal and table-top models. Better than OSHA standards. Result: unmatched quietness in a line printer.

NEC's Trimliner line printers join the highly successful NEC Spinwriter family of character printers as the industry's newest, trimmest, most compact line of quality printing devices.

Send us your business card  
and we'll send you the details.

## **NEC Information Systems, Inc.**

Eastern Office: 5 Militia Drive, Lexington, MA. 02173, (617) 862-3120  
Central Office: 3400 South Dixie Drive, Dayton, OH. 45439, (513) 294-6254  
West Coast Office: 8939 S. Sepulveda Blvd., Los Angeles, CA. 90045, (213) 670-7346

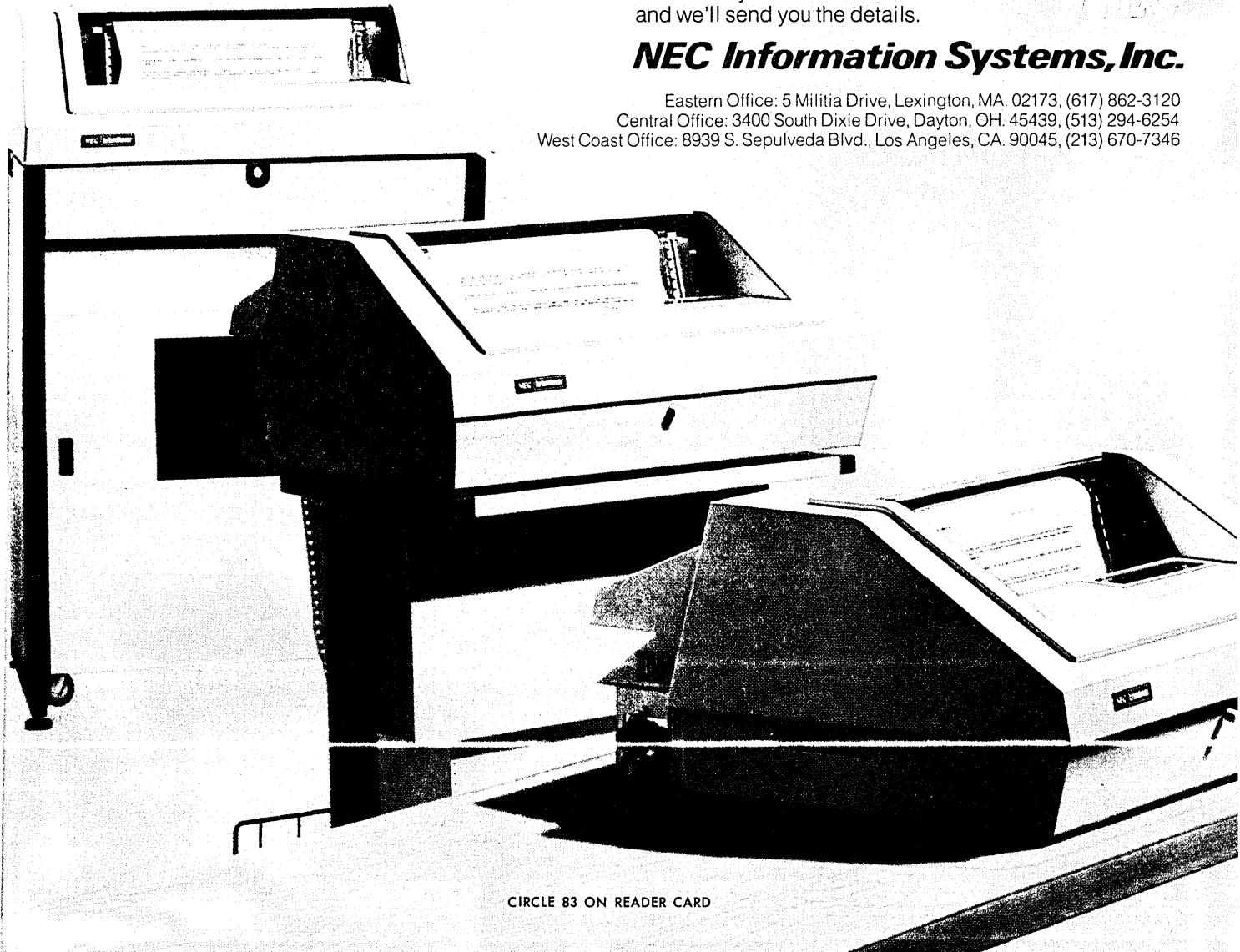

CIRCLE 83 ON READER CARD

## End users should brace themselves for unexpected and even unreasonable price escalations.

U.S. Bureau of Mines of the Department of the Interior. This matrix shows possible alternatives for each industrial material, but it probably needs additional refining in the form of particular trade-off characteristics data for specific substitutions and applications. Also at the Bureau of Mines, another matrix forecasting anticipated problems with industrial materials for the next four decades may prove of value to manufacturers and end users alike.

Although materials substitution is the obvious first step in the face of a developing shortage, computer end users are really limited to a choice of alternative equipment because they have little control over the use of materials in the manufacturing process. Most of the substitution work is done by a manufacturer who is struggling to produce high performance equipment at competitive prices. He probably faces price escalation clauses from his materials suppliers and at the same time must work to keep the end user price reasonable.

Due to the escalation in the price of gold since 1973, for example, gold plated parts often are being given thinner films of gold or are being plated with alloys of gold to reduce the use of the yellow metal as its cost goes up. In some printed circuits, palladium or tin-lead alloys replaced gold completely, but sometimes at a cost that the end user may not even know about. Tin, for example, grows "whiskers," particularly on fine circuits, and clearly cannot provide as reliable a contact as gold or platinum—which are very resistant to the corrosion and high temperatures that may occur simultaneously. These fine differences in the use of critical materials can make or break the reliability of seemingly identical electronic devices.

### BUILDING STOCKPILES

A good indicator of what materials are considered more strategic than others at any one time as a result of international events and current foreign policy is the U.S. Strategic Stockpile. It is administered by the Federal Preparedness Agency of the General Services Administration and in recent years was valued at over \$8 billion. The stockpile contains over 30 strategic and critical materials and is designed to compensate for interruptions of imports in the event of a conflict. It is said to contain estimated supplies of up to three years of the most critical materials.

Although periodic sales and additions to the stockpile indicate changing importance of specific materials, it is not

normally used in peacetime for price stabilization or to meet temporary shortages of materials. Thus, if the Soviets continue to gain control over strategic materials sources by various means short of war, our own strategic stockpile may not be used quickly enough to counteract any resulting disruptions.

A new development since 1976 is the proposal in Congress to create an Economic Stockpile, as separate from the Strategic Stockpile. Its purpose would be to minimize any possible embargo effects on the industry, assure stability of prices, and full employment in the event of future disruptions in supplies due to cartel action or political change.

But stockpiles mean costly and noninterest bearing investments, and although the same concept can be applied by individual manufacturers, only the largest companies can afford to play this game. Some studies already made showed that those who tried to build up stocks of gold at times when they felt the prices were relatively low hardly made out any better than those who bought gold at market prices whatever they were when they actually needed the metal.

Even European countries which are much more dependent on imports of industrial materials than the United States, do not maintain any national stockpiles to speak of, and are literally at the mercy of their foreign materials suppliers. They also view attempts to create an American Economic Stockpile with some suspicion because this would give the U.S. considerable muscle in control of strategic materials prices. On the other hand, those nations are even more concerned at the continuing instability in southern Africa and the looming possibility of Soviet control over their sources of strategic materials.

The end user or manufacturer who is not involved in defense work and may not have ready access to some of the strategic materials monitoring programs can now turn to a few commercial sources for information and advice. Charles River Associates of Cambridge, Mass., is a small think tank that specializes in special studies of strategic materials problems. Chase Econometrics of Bala Cynwyd in Pennsylvania offers a metals market forecasting service and is considering the development of a strategic materials information service. Frost & Sullivan, a market research organization based in New York, is preparing a strategic materials study designed to inform the corporate executive of the potential problems and available solutions to this perplexing problem.

The future is definitely uncertain,

but it appears that a concerted effort of all Western powers, Japan, and even China, may be required to assure the free world of necessary access to those strategic resources. Until alternative sources are developed, economic substitutes found, and new technologies introduced, the heavy dependence on imports from southern Africa will make strategic cartelization a threat we must live with.

These problems also generate new opportunities for investment and technological innovation which will undoubtedly come into play. An informed data processing community may well make its own contribution by reviewing standards and restrictions with an eye to reducing use of strategic and critical materials—and directly helping our foreign trade balance to boot.

Computer end users are also naturally placed to conceive and develop a strategic materials data base that could be used to forecast the effects of sudden shortages and price instabilities on end products such as disk drives, printers, terminals, or minicomputers. This would provide the data processing executive with an additional planning tool that he may badly need in the future. It would also provide a framework for a more general system that will be of value to end users of other industrial equipment, some of whom are much more affected by the cost and availability of imported materials.

In the short run, however, computer end users should brace themselves for unexpected and even unreasonable price escalations despite the rapid reductions in the cost of a bit of memory. How well they are able to protect themselves will depend how wisely they choose their equipment in the future. ❁

### B.O. SZUPROWICZ

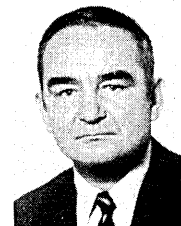

Mr. Szuprowicz is the president of 21st Century Research, an international market research firm based in North Bergen, N.J. Previously a vice president and research director of High Technology West, a Los Angeles investment research organization, he has also held engineering and management posts at Boeing, Convair, IBM, CEIR-Control Data, Computer Usage Corp., Canadair, and others.

It's that light. Only 1.9 grams.

The result: Telex' new minicomputer tape drives have the lowest capstan inertia in the business. And the industry finally gets reliable 125 ips 800/1600 and 1600/6250 bpi tape drives to fit a 19" x 24" space.

Its walls are only 1/1000-inch thick, yet the capstan's patented design and manufacturing process assures strength, absolute roundness and users get a more consistent data rate.

Benefits accrue throughout the system:

Motor load and heat are reduced. Cooling blowers and hoses are eliminated. Reliability is increased.

Less inertia, combined with Telex' patented tape path, enables the drives to run full speed forward to full speed reverse in a mere 0.13 inches (a new record).

This rapid-fire, yet gentle action makes possible true, high-density 0.3-inch interrecord gap recording. There's no time lag for write, backspace, and read operations. And none of the usual program restrictions.

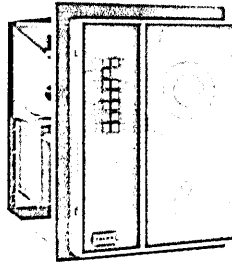

Users get quick access to data in all modes of operation. And IBM compatibility to boot.

It's what the new GCR/6250 bpi format is all about.

Learn more about how speeds and densities can be easily upgraded in the field...how up to eight of these new drives can run off a single microprocessor-based Telex formatter... and how we've cut maintenance time through modular construction and simple diagnostic routines.

From the Golden Gate to Boston, smart OEMs are talking Telex. Contact: Dan O'Neill, Telex Computer Products, Inc., 6422 E. 41st St., Tulsa, OK 74135. Telephone: (918) 627-1111.

**TELEX**<sup>®</sup>

Tape drive miniaturization . . . in a big way.

**This SuprLite<sup>®</sup> capstan blew  
halfway to Alcatraz when we dropped  
it off the Golden Gate.**



CIRCLE 65 ON READER CARD

# Our "smart" microimage terminal pulls its own weight.



# And reduces the strain on your computer.

Nothing reduces the strain on your computer like the Kodak IMT-150 microimage terminal. Because no other microimage terminal "thinks" the way ours does.

The IMT-150 terminal is the first on-line information retrieval terminal from Kodak to incorporate distributed logic into its mode of operation. Blocks of search information from your mini or mainframe computer are "down loaded" to the microcomputer-based IMT-150 terminal in lightning-fast bursts. Then, relying on its own intelligence, the IMT-150 terminal performs real time, on-line information look-ups.

The ability of the IMT-150 terminal to think on its own reduces its dependence on your computer, freeing it for weightier computer tasks. So your EDP operation runs leaner,

smoother, more efficiently overall.

There's a lot more to tell about the Kodak IMT-150 terminal. For example, it reduces look-up errors, because it stops at precisely the document you want. There's no backtracking or machine overshoot. It eliminates expensive magazines that require leaders and trailers. It can store more than 10,000 letter-size documents in a 4" x 4" x 1" magazine. And it delivers dry, sharp hard-copy prints on demand.

Want to find out more about how to take the strain off your computer?

Send the coupon. It will bring you everything you need to know about the new Kodak IMT-150 microimage terminal, the microfilm reader-printer that pulls its own weight.



## The Reducing Machines Kodak IMT equipment

Eastman Kodak Company  
Business Systems Markets Division  
Dept. DP8687, Rochester, NY 14650

Please send me more information about Kodak IMT equipment

Please have a Kodak representative contact me.

\_\_\_\_\_  
Name

\_\_\_\_\_  
Company

\_\_\_\_\_  
Title

\_\_\_\_\_  
Address

\_\_\_\_\_  
City

\_\_\_\_\_  
State & Zip

\_\_\_\_\_  
Phone

# Why Branch Automation at Mellon Bank Means More for Less:

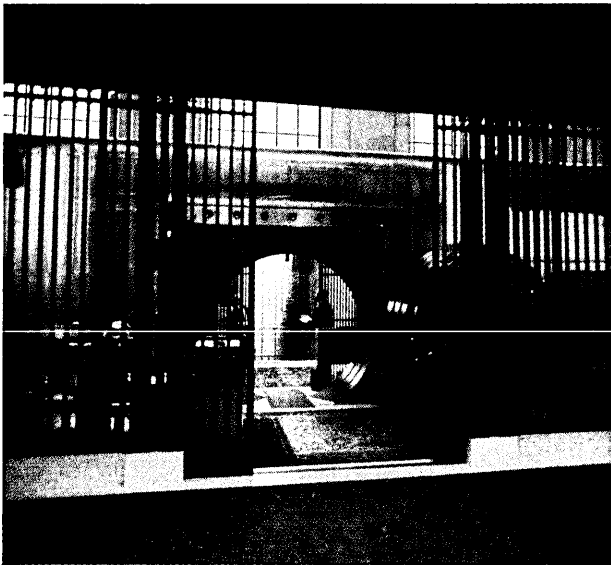

## INCOTERM<sup>®</sup>

Tellers accomplish more with less effort. Customers get better service in less time. The bank gets more speed and more reliability for less money, less paperwork and less manpower.

By sharply truncating costly paperwork, Mellon Bank's new Branch Office Automation Program increases teller efficiency, improves customer relations, facilitates administrative functions and provides potential for future development. It is an INCOTERM system throughout.

Pittsburgh's Mellon Bank is the seventeenth largest commercial bank in the United States, with 107 branches in Western Pennsylvania. INCOTERM teller terminals are handling new account entry, cash proof and branch balancing, as well as account inquiry for demand deposits, CD's, commercial loans, lines of credit, student savings, safety deposit boxes, floor plan and personal trusts. And INCOTERM equipment has found numerous other applications in the diverse, dynamic Mellon environment:

in the Central Reference File; in controlling the \$4 billion-a-day Money Transfer System; in managing the \$10 billion Trust Department — sixth largest in U.S.; in serving Mellon Bank International. In fact, Mellon Bank thinks so highly of their automation program that they're making the same technology available to their correspondent banks across the country.

More could mean less for you as well. For further information, call or write.

More power  
to your  
terminal.

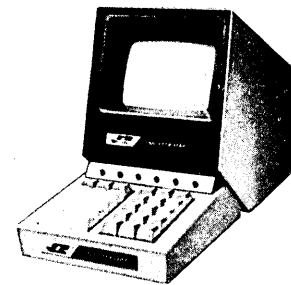

**INCOTERM<sup>®</sup>**  
CORPORATION

A Subsidiary of Honeywell Inc.  
65 Walnut Street, Wellesley Hills, Massachusetts 02181  
Telephone: (617) 237-2100



Scientific computing today doesn't necessarily mean investing in a machine the size of the Astrodome with a price tag equivalent to the national debt. Low cost array processors coupled with minis are the answer.

# SCIENTIFIC COMPUTING ON A BUDGET

by C. N. Winningstad

Low cost scientific computers today provide highly attractive cost/performance alternatives to their large mainframe cousins. In many dedicated applications, they even rival the larger machines on a straight performance basis—at upwards of ten times reduction in cost.

Conventional minicomputers with floating-point hardware options may suffice for relatively undemanding scientific applications. Increasingly, however, minis are being used as front-end I/O processors for very fast, programmable array processors. In fact, such array processors can be thought of as the minicomputers of the scientific world.

## SCIENTIFIC VS. COMMERCIAL

But before discussing low cost approaches to scientific computing, first the differences between scientific computers and general purpose systems should be mentioned.

The design of the scientific computer is optimized for handling long strings of iterative calculations on large arrays of data. The dp machine, on the other hand, is optimized for performing file manipulations and handling I/O communication with a variety of peripherals. Scientific computers are also required to perform their iterative computations on large data arrays in reasonable lengths of time. Because of this high throughput re-

quirement a number of successful scientific computers employ a vector oriented design. In the more sophisticated machines, a high degree of parallelism in arithmetic and memory units is used to enhance throughput.

Scientific computers have been around as long as there have been computers. In fact, file oriented machines came after numerically oriented machines. Scientific machines have, however, tended to fall into two groups—versatile, high performance, but equally high priced machines, and relatively low cost, hardwired machines dedicated to one type of calculation. The obvious benefits to be gained from computerizing scientific calculations in a wider range of applications have led to an equally obvious need for versatile, low cost scientific computers. Let's look at the ideal requirements for such a machine.

The first goal is low cost. The multimillion dollar price tag of the most powerful large mainframe scientific computers, such as the Cray 1 or the CDC Cyber series, may be justified in highly sophisticated applications—especially if multitasking or time-sharing is involved. But many dedicated applications simply cannot afford such equipment.

Precision maintained over long strings of calculations is vital. For serious scientific work, the equivalent of six decimal digits of accuracy is probably minimum, with most applications requiring greater precision. At the same

time, numbers over a very large dynamic range must be accommodated. The later requirement makes a floating-point data format a virtual necessity.

Very high throughput on numerically intensive calculations is also required. While exact throughput needs vary with the application, it is probably fair to set one million floating-point operations per second (1 megaflop) as a minimum for calling a machine a scientific computer.

Since most scientists and engineers are not programming experts, the scientific computer should be easy to program. Furthermore, the user should be able to address the machine in a language consistent with his discipline. There is an inherent conflict between the need for ease of programming (higher level language, hence machine-level coding inefficiency) and the need for maximum throughput. It is, therefore, highly desirable that a library of efficiently coded subroutines be available for standard mathematical operations.

Ideally the scientific computer should be capable of efficiently performing all mathematical operations encountered over the gamut of scientific and engineering operations. Both real and complex data should be readily handled. Operating speed should accommodate real-time applications. And a variety of means of communicating with the outside world should be available. In practice, some of these versatility and

Ideally the scientific computer should perform all the mathematical operations encountered over the gamut of scientific and engineering operations.

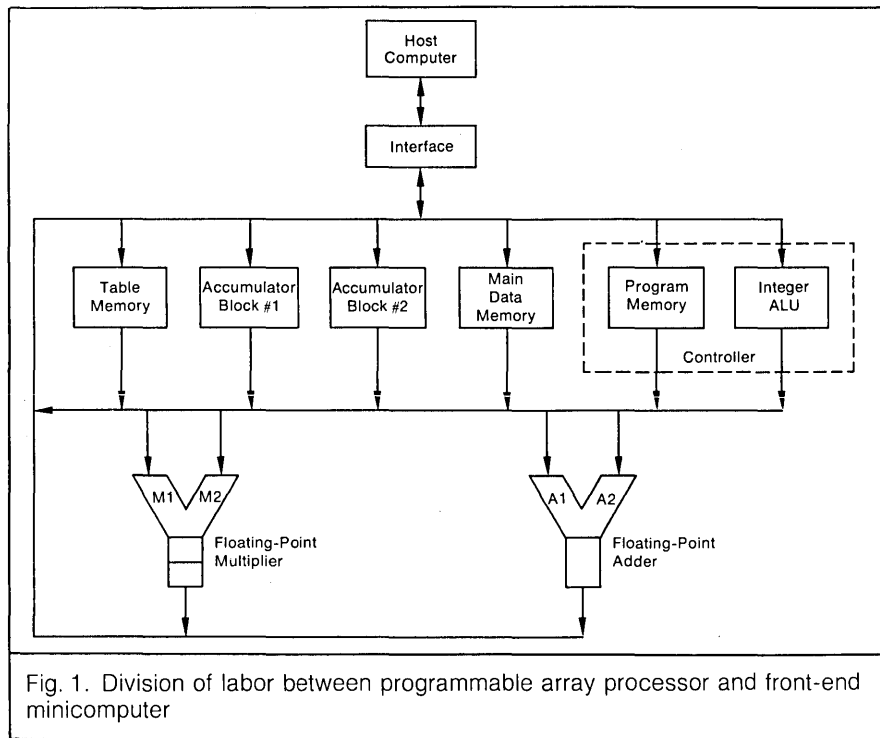

Fig. 1. Division of labor between programmable array processor and front-end minicomputer

flexibility factors may be traded off against the real needs of the application in order to satisfy the low cost criterion.

A high degree of reliability is a must. Specifically, the mean time between failures (MTBF) should substantially exceed the run time of the longest program required in the application. Otherwise piecemeal programming techniques will be required.

What major factor can be traded off to hold to the low cost criterion while achieving all, or at least most, of the above goals? Perhaps sacrificing the multitasking or time-sharing capability of larger machines is the most obvious. That capability is by definition not required in dedicated applications—which is just where low-cost scientific computers are most needed.

Highly desirable, although not absolutely vital, is the ability of the scientific computer to exhibit flexibility by interfacing with a wide range of commonly available equipment including minicomputers, large mainframe computers, and peripherals.

## MINICOMPUTERS FOR SCIENTIFIC COMPUTING

By definition commonly recognized large mainframe scientific computers such as Control Data's 6600, 7600, and Cyber series or the Cray I are omitted from this article as too expensive for dedicated applications.

Lower cost machines frequently found in dedicated scientific applications are often conventional minis selected from the high end of a line, such as Digital Equipment Corp.'s PDP-11 series (PDP-11/70), Data General's Nova/Eclipse line (Eclipse 130), Systems Engineering Laboratory's SEL 32/50, or Perkin-Elmer's Interdata 8/32.

These machines are basically scaled down versions of the scalar oriented large mainframes. However, many have floating-point arithmetic unit options to facilitate a degree of scientific computation.

Advantages of the minicomputer are basically three: There is a wide variety of architectures and prices available to fit varying applications; because of its design, the minicomputer is well suited for dedicated dp operations when it is not in use for intensive scientific calculations; and minicomputers exhibit extremely versatile I/O capabilities, allowing the inputting of data from experiments or data bases, and outputting to recorders, graphic devices, or ordinary data storage.

But set against these advantages are some very serious drawbacks. If floating-point arithmetic hardware is not included, the mini's capabilities, particularly dynamic range, are so limited as to make it very difficult to scale data and perform calculations for serious scientific work. Software implementation of floating-point operation makes throughput totally unrealistic for numerically in-

tensive calculations. Floating-point hardware is an improvement, but only a factor of 10 to 30 (100 times or more is desirable). The most common floating-point format (24-bit binary mantissa, 8-bit binary exponent) results in only 6 decimal digits of accuracy and a dynamic range of only  $10^{\pm 65}$ . Using Hexadecimal notation (25-bit mantissa and 7-bit exponent) extends the dynamic range to  $10^{\pm 124}$ , but truncation errors due to hexadecimal normalization on repeated calculations reduce mantissa accuracy to an unacceptable 20 bits. Minicomputers are inherently lacking in the throughput needed for serious scientific computation. Going to double precision to enhance accuracy and dynamic range usually further degrades throughput.

All of this is not to say that minicomputers have no place in scientific computation. It would be more accurate to say that their role is being redefined. The versatile I/O and file manipulation capabilities of the minicomputer make it an excellent front-end processor to which a vector-oriented processor optimized for scientific computation may be attached. Fig. 1 illustrates the division of labor between the front-end, file-oriented mini and the arithmetic-oriented array processor.

## ARRAY PROCESSOR

For this article, array processor is defined as a programmable, low cost, vector oriented machine designed for iterative calculations on large arrays of data. It is characterized by a degree of precision, dynamic range and throughput consistent with the needs of scientific computing, and by an ability to deal readily with both real and complex numbers.

(Array processor is used here in the sense of a processor optimized for dealing with large arrays of data, not in the sense of a machine consisting of an array of many parallel processors, such as the Illiac IV.)

In fields such as radar signal processing, speech analysis and synthesis, design engineering and many more, there has long been a need for an inexpensive machine capable of precisely solving a limited set of problems such as Fast Fourier Transforms (FFT), matrix operations, correlations, convolutions, coordinate translation and rotation, statistical analysis, etc. This led to the development of hardwired boxes optimized to perform one, or at most a few, of these functions. Relatively simple design tended to hold production cost down. On the other hand, versatility was limited for any one machine. Amortization of de-

# APPLICATIONS OF SIGNAL PROCESSING

by Mike Michels

The use of digital signal processing has become prevalent only within the last decade, prompted primarily by the discovery of the Fast Fourier Transform (FFT) algorithm in 1965. However, the diversity of applications is impressive.

Interestingly, the techniques used in the various applications have many similarities. All of them employ either direct use of the FFT or related functions, such as correlation, which can be obtained using the Fourier Transform as an interim step. Some of these applications are:

## SPEECH PROCESSING

Considerable progress has been made at a number of research organizations, particularly at Bell Labs, toward computerized analysis, recognition, and synthesis of speech. One important objective of this research is the provision of human/computer speech communication. Other worthwhile goals include development of new techniques for speech therapy, improvements in voice communications, and the like.

An experimental system which allows human/computer voice communication over a phone line has been operating for a number of years at Bell Labs. The computer makes a simulated airline reservation by carrying out a question/answer dialogue with the phone caller. Vocabulary for both recognition and synthesis of speech by the computer, and wide variations in voice quality—including various accents—are possible.

As part of the same research, the computer has been able to verify a voice as belonging to a stated caller's identity for a large number of potential callers.

A number of products which use digital signal processing for automatic voice response systems are now on the market. These are generally called *vocoders*. Commercially available speech recognition systems are not as numerous, but they are coming.

## SEISMIC DATA REDUCTION

When it comes to sheer volume of number crunching, the seismic exploration people probably do more of it and have been at it longer than anyone else.

The sounds given off by surface explosions, or earth pounders (called vibracizers), reverberate through the earth much like they would among a range of mountains. It is possible to record these reverberations, and through extensive processing of the recorded signals, plot the geological structure of the earth surrounding the noise source. The probability of existence of oil or mineral deposits, plus other facts, can then be determined from these structure plots.

Off-shore exploration, in particular, would be virtually impossible without digital signal processing, which is often performed by computers on board the exploration ships.

The same techniques used for seismic data reduction are largely applicable to the locating of embedded flaws in materials through ultrasonic reverberation. Such techniques are extremely valuable for examining critical structural members (pipes, walls, rotational elements) where X-rays cannot be used. The required safety of nuclear plants has been an incentive toward such developments.

The sounds given off by operating machinery have long been recognized as indicating the health of the machinery. For example, most people can immediately sense a new rattle or other sound from their car. In most critical applications, however, the human ear is not sensitive enough to recognize the meaningful sounds. Indeed, some of the sounds may be in the ultrasonic range.

By periodically sampling, processing, and comparing the sound signature of a piece of machinery with previously processed signatures from the same machine, many facts can be ascertained concerning deterioration of the health of a machine.

## COMPUTER AIDED TOMOGRAPHY

Tomography is literally "section graphics"—the graphic display of a cross section of a piece of material. The field is about five years old, and the main use to date has been in graphing cross-sections of the human body by the use of X-rays.

Unlike ordinary X-ray photographs, which are produced directly by X-ray radiation on a photo-sensitive film (resulting in shadows on the film), Computer Aided Tomography (CAT) displays are created by a computer after it processes the sensed X-ray signals.

Basically, an X-ray beam is rotated about the body, and the amount of absorption measured at various angles. A two-dimensional FFT then results in a two dimensional display of the absorption characteristics of various parts of the body in the plane through which the X-ray beam was rotated.

The big advantage of CAT is that a given display is not influenced by material in front of or behind the plane of interest, as is the case with ordinary X-ray photos. In fact, a three-dimensional picture can be obtained from multiple CAT displays, each displaced a small finite distance from the adjacent one.

Much of the development incentive for digital signal processing has come from the military, particularly in the field of underwater acoustics. Processing to achieve signal enhancement (recognition

## RADAR PROCESSING

As in underwater acoustics, the main problem in the use of radar is to detect a desired signal in the presence of unwanted or uninteresting signals, called clutter. The filtering characteristics of the FFT are used with complex signal modulation schemes (a "chirp" transmitted pulse) to isolate the wanted signal return. The FFT is particularly useful to detect Doppler shifts in the return signal caused by target velocity.

We have all seen photographs of the planets and other space objects taken from space vehicles and transmitted to earth, sometimes from great distances. Because of communication problems the raw photo data received on earth are often of very poor quality, containing noise, and not very sharp.

Just as the FFT can be used to filter and enhance audio signals, these photo data can be enhanced by judicious use of two-dimensional FFT processing. In particular, low level noise can be suppressed, and the contrast and definition in a photo may be varied, by various types of frequency filtering.

In addition, since the aberration characteristics of a lens system can usually be determined by tests, photographic data may be altered to remove these aberrations from the photo image, giving a more precise definition of the field of view.

The human nervous system is an excellent producer of signals capable of being analyzed through digital signal processing. For example, it is known that significant variations in EEG signals occur preceding a stroke, and that many stroke patients have secondary strokes following a first one. Thus, computer monitoring of EEG signals of stroke patients can lead to early warning of secondary strokes, with possible prevention.

A large part of nature is continually producing signals which can be analyzed and synthesized through digital signal processors. Even business statistics, such as stock market quotations, provide opportunities to use the FFT and related processing. Since the field is so new, we have hardly scratched the surface. ✱

---

Mr. Michels is a senior staff engineer with Operating Systems, Inc., Woodland Hills, Calif.

ADM 31



ADM 42



300 Series  
Ballistic Printer

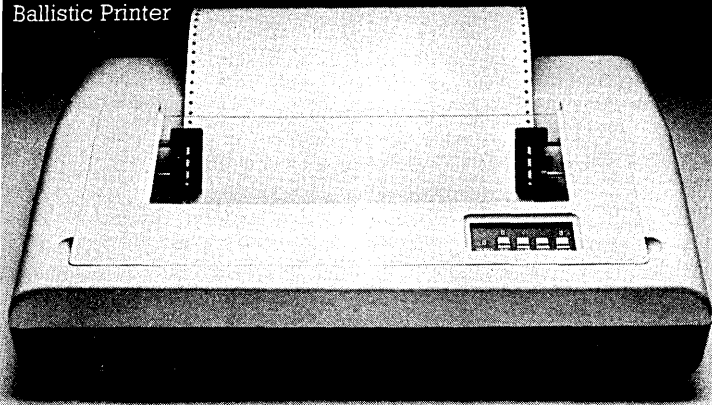

VDP 410

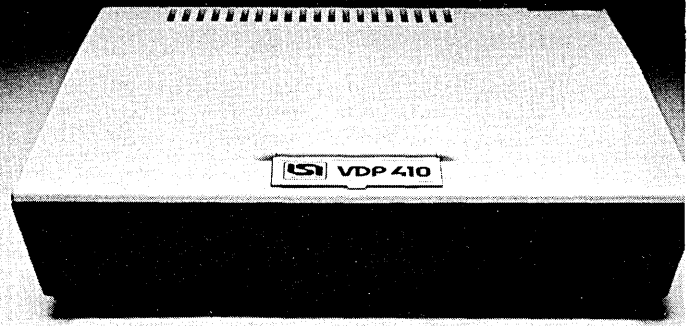

VDP 1000

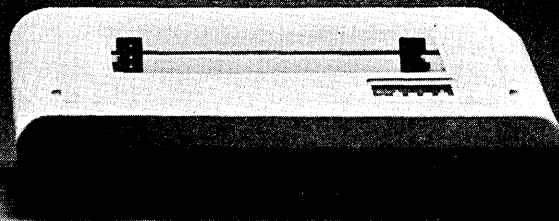
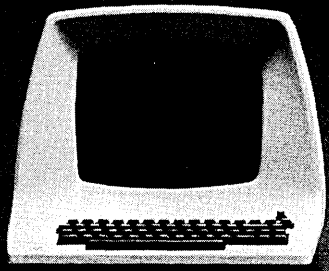

VDP 1000  
Data System



POSTEC

# These products were designed by our customers.

At Lear Siegler, we listen to our customers.

As a result, we build all our products from your point of view. So you get what you want, and we get what we want.

That's the way we've always done things at LSI. And it's the way we'll always do them.

Our new line of products reflects that philosophy. All five products come with features you said you needed.

## THE ADM-31 PROVES 2 PAGES ARE BETTER THAN ONE.

A lot of people need a smart terminal with a full two pages of display. But can't get them. Not even on terminals costing several times what they want to spend.

So we listened. And then gave them the ADM-31. A low-cost, high-reliability desktop CRT terminal with a full two-page display. As standard equipment—not as an option.

We made the ADM-31 completely self-contained, with a keyboard, control logic, character generator, refresh memory, and interface. Along with full editing, formatting, and protected fields capabilities. What's more, it has a microprocessor which makes it even more reliable and easy to use. And the ADM-31's behavior modification even gives you a factory installed personality.

If this sounds like just the thing you need, it should come as no surprise. After all, you were the one who told us what you wanted.

## THE ADM-42 DOES EVERYTHING BUT THINK FOR ITSELF.

Our customers told us they wanted a semi-intelligent terminal.

One with flexibility of format, security, editing, interface, and transmission. They wanted a full two-page display as standard equipment. An optionally extended memory capable of adding data space up to a maximum of 8 pages. Behavior modification. 16 function keys for 32 separate commands. And a 25th line established and reserved exclusively for status indicators and messages up to 79 characters.

So our engineers designed the ADM-42.

A terminal that actually seems to get smarter the more you use it.

## THE 300 BALLISTIC™ PRINTER COMES WITH BELLS & WHISTLES STANDARD.

Our customers said they'd like to see bells and whistles as standard equipment.

And that's what we gave them.

The 300 is a low-cost printer with a built-in microprocessor that gives you 15 switch selectable form lengths, 15 perforation skip over formats, and full horizontal and vertical tabulation control. Plus a non-volatile forms retention system that retains these programmable settings when power to the printer is turned off.

And like all our Ballistic Printers, the 300 dependability originates with its ingeniously simple, patented Ballistic Print Head. Which lets it purr along at a respectable 180 cps.

So when you buy our 300 Series Ballistic Printer, there's only one thing we won't offer you much of.

Options.

Because, on the 300, most of them are standard.

## OUR VDP-410 KNOWS HOW TO KEEP THINGS UNDER CONTROL.

A lot of OEMs said they needed a building block for system development.

Something that would give them the flexibility to configure a variety of systems.

So we built the VDP-410. The intelligent controller in the plain brown box.

It's a low-cost, 16-bit CPU with enough speed and ports to support a variety of peripherals. And it lets OEMs build a multitude of systems. From communications controllers without external storage capabilities, to sophisticated timesharing systems with a string of terminals, printers, and disks.

The OEMs said they wanted something simple, intelligent, and powerful. So we built it.

Because what was a good idea to OEMs turned out to be a real brainstorm for us.

## THE VDP-1000 SPEAKS YOUR LANGUAGE.

People told us they needed a complete small data system with the attributes of larger, more expensive systems.

So our engineers came up with the VDP-1000.

It comes standard with a choice of BASIC, COBOL, or ASGOL\* programming languages. A virtual memory operating system (VMOS).

A 16-bit CPU, 32K, 16-bit words of dynamic RAM, the world-renowned Dumb Terminal™ a 180 cps, bi-directional 300 Ballistic Printer, and a 10 megabyte cartridge disk. The VDP-1000 is also available with a 1.25 megabyte floppy disk.

Once you've got the basic system, you can add additional storage as you need it. Or want it. It's up to you.

## ALL OUR SMART IDEAS EVOLVED FROM A DUMB ONE.

That means the proven reliability and cost-effectiveness of the Dumb Terminal go into everything we make. And we make something for just about any requirement you may have. That's why we're known as the complete terminal company.

That's the way you wanted it.

And the fact that we listen to you is what keeps you coming back to us. Again and again.

Lear Siegler, Inc./Data Products Division, 714 Brookhurst Street, Anaheim, CA 92803; (800) 854-3805. In California (714) 774-1010. TWX: 910-591-1157. Telex: 65-5444.

Dumb Terminal™ terminal is a trademark of Lear Siegler Inc., Data Products Division.\*ASGOL is a copyright of RMD & Associates, Inc.

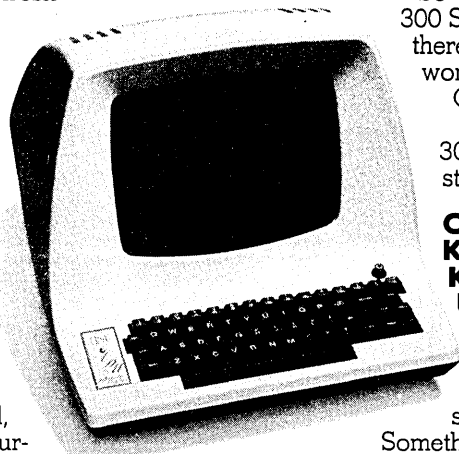

## Lear Siegler, Inc. We hear you thinking.



LEAR SIEGLER, INC.  
DATA PRODUCTS DIVISION

Besides being a lot less expensive, the better array processors sometimes rival the large machines for pure performance.

sign over a small number of applications tended to push cost up. Since they were hardwired, these array processors were by definition nonprogrammable. The advent of microprogramming (implemented with submicrosecond ROM's) marked the next step in low cost array processor evolution. Now machines could be designed which, by interchanging ROM's, could be "hardware programmed" to perform a variety of functions.

As writable control store (implemented with submicrosecond RAM's) became less expensive, it was feasible to substitute it for ROM in the design of low cost array processors. Now the array processors could be said to be truly programmable. This fully programmable array processor, coupled with a front-end minicomputer for I/O and file manipulation, today provides low cost scientific computing with excellent performance for dedicated applications. Besides offering more favorable cost/performance than large mainframe scientific computers (on the order of \$100,000 compared to several million dollars), the better array processors sometimes rival the large machines for pure performance.

## DIFFERENCES IN ARRAY PROCESSOR DESIGN

Array processors fall into two distinct classes: special purpose and general purpose. Design of the former is optimized for a specific application, such as signal processing in a given radar system. General purpose array processors, which we will concentrate on here, are designed to perform a wide range of scientific computations under program control.

Fundamental to the array processor's performance is the design of its floating-point arithmetic unit. Most use complete floating-point hardware similar to that used in large scale scientific machines. Rounding algorithms performed after each arithmetic operation minimize truncation errors. For further cost reduction, however, some array processors use block floating-point techniques. In this approach, all of the data upon which calculations are to be performed is not normalized as it would be in a true floating-point system. Instead, only the largest number in the data block of interest is normalized. All other numbers in the block are shifted by the same number of places as was required to normalize the largest number. Thus all numbers in the data block have the same exponent and the cost of implementing complete exponent processing hardware is eliminated. Results are renormalized

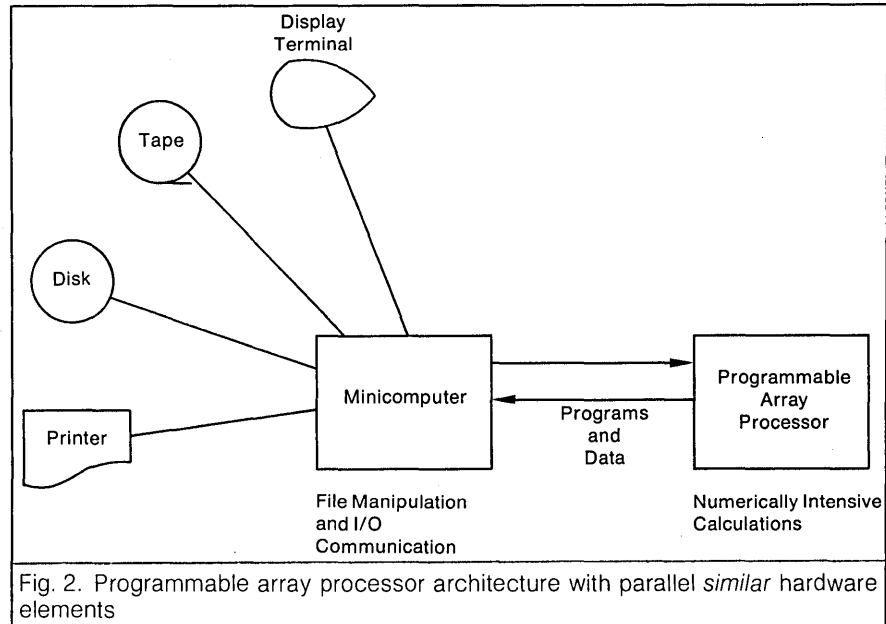

Fig. 2. Programmable array processor architecture with parallel similar hardware elements

(perhaps after a series of calculations) only when an overflow is encountered. Cost is reduced for some minimal scientific computing requirements. For serious scientific calculations involving many iterations, however, the block floating-point approach may introduce unacceptable amounts of computation "noise" due to truncation errors and exceeding the machine's dynamic range.

Precision and dynamic range of the array processor's floating-point arithmetic unit are determined by word length, format (binary or hexadecimal), and by the number of bits assigned to the mantissa and the exponent respectively. Some available array processors use a 32-bit floating-point word the same as their minicomputer cousins. This provides 6 digit accuracy, as stated earlier, and speed becomes the array processor's primary advantage. Trade-offs between binary and hexadecimal coding as well as the throughput trade-off in going to double-precision were discussed earlier. A further possibility exists for upgrading precision and dynamic range without significantly sacrificing speed. Since floating-point format conversion must, in general, take place between the front-end minicomputer and the array processor, a 38-bit word may be used. For example, the Floating-Point Systems AP-120B uses a 38-bit word; the mantissa contains 28 bits and the binary exponent has 10 bits. With slight increase in hardware, precision is increased to between 8 and 9 decimal digits and dynamic range is increased to  $10^{\pm 153}$ .

Another design difference among array processors is the choice of asyn-

chronous or synchronous operation. The machine illustrated in Fig. 2 is an example of asynchronous architecture, while the one in Fig. 3 is synchronous. Asynchronous machines promise highly efficient operation and ready modular expansion to meet specific applications. Since all elements of the machine (arithmetic units, memories, I/O, etc.) are allowed to run at their individual optimum speeds, there is little waste of hardware time. This, of course, must be paid for in more complex communication protocols between the various elements than is the case for synchronous array processors. It also means programming is more complex than for the synchronous machine since the programmer must coordinate operation of all elements. In principle, modular arithmetic, memory, or I/O elements can be added to the asynchronous array processor to closely tailor its computational power to the requirements of the application. Problems of communication and programming, however, increase with expansion.

As in other computer systems, reliability is easier to achieve in array processors by employing a synchronous design. Debugging a synchronous machine requires testing only the machine's limited number of possible states as opposed to the unlimited number encountered in asynchronous designs. Variations in coincidence of backplane noise due to the changing phase angles between clocks in an asynchronous machine are especially troublesome when the high speed logic circuitry used in array processors is involved. By careful attention to a choice of dissimilar parallel

# "Our 33502, with 635 megabyte capacity, is the better business decision."

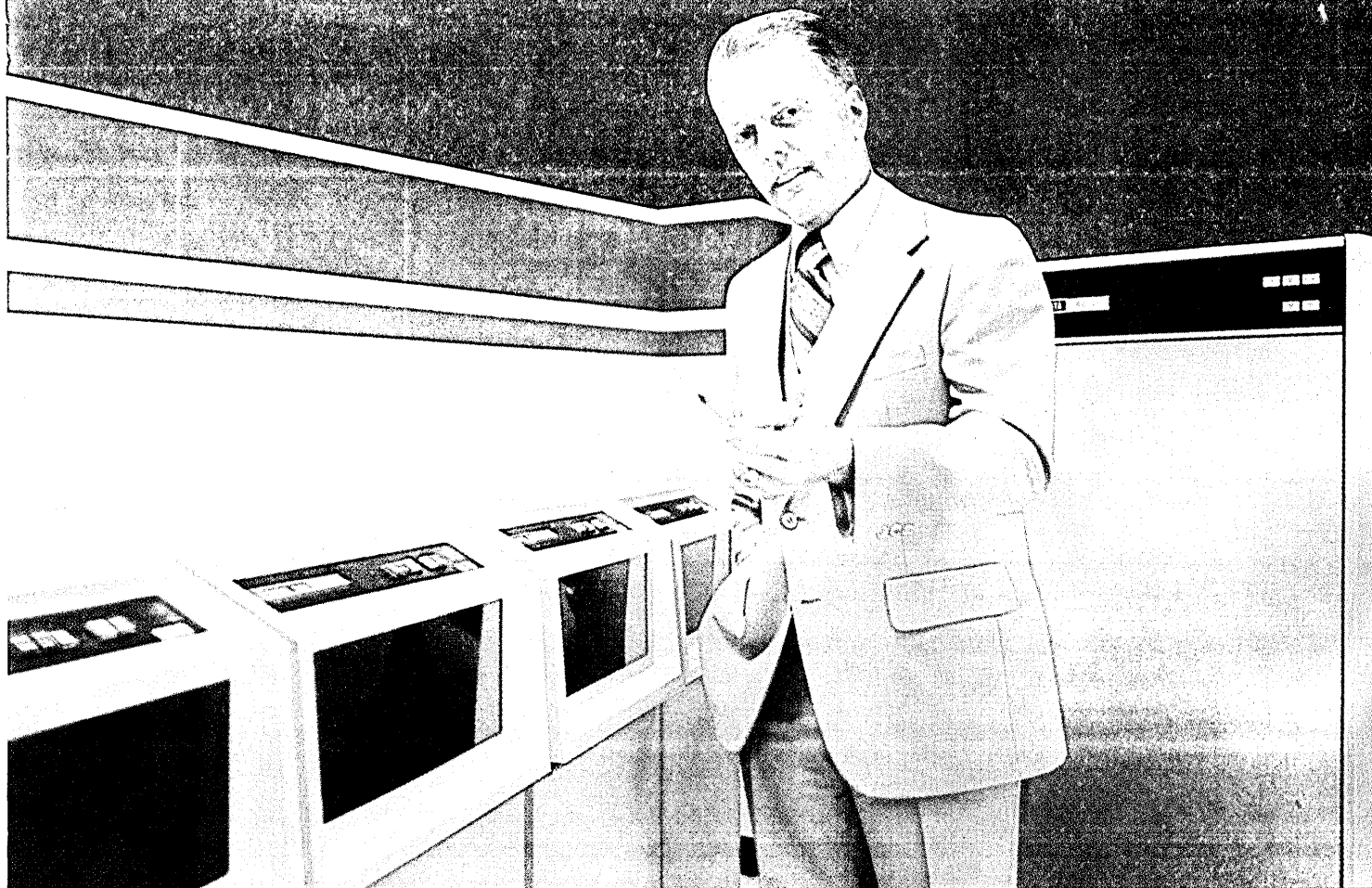

*Jim Cron, General Sales Manager, Peripheral Systems/Marketing*

"Our 33502 has twice the capacity of an IBM 3350. So you can save dollars and floor space. And the improved technology behind our new 33502 data module offers other advantages.

"Better performance, for example. Track-to-track access time is twice as fast as what 3330/3350 technology can offer. Average access time is faster too—19 milliseconds per 317.5 Mbyte logical volume. And you get more optional fixed head storage—1.72 Mbytes instead of only 1.14 Mbytes.

"Another technological innovation is our dynamic dual access. It gives you up to 25% greater throughput over a comparable switch configuration. And if you have a multiple CPU installation, we can offer you both string switch and dual access to provide four data paths to each spindle.

"And when you choose Control Data's 33502, you needn't worry about conversion or com-

patibility problems. It is totally compatible with all IBM 3330/3350 disks and controllers. Our Storage Controller lets you intermix 100MB, 200MB, 317.5MB, 400MB, 635MB— even Mass Storage all on the same unit.

"Besides technical considerations, there are many other reasons that make the 33502 a better business decision. Control Data's reputation is for reliability, service support and broad product experience. And there are more reasons. For the full story contact your local representative, or call 612/553-4158."

**CD CONTROL DATA CORPORATION**

**More than a computer company**

CIRCLE 43 ON READER CARD

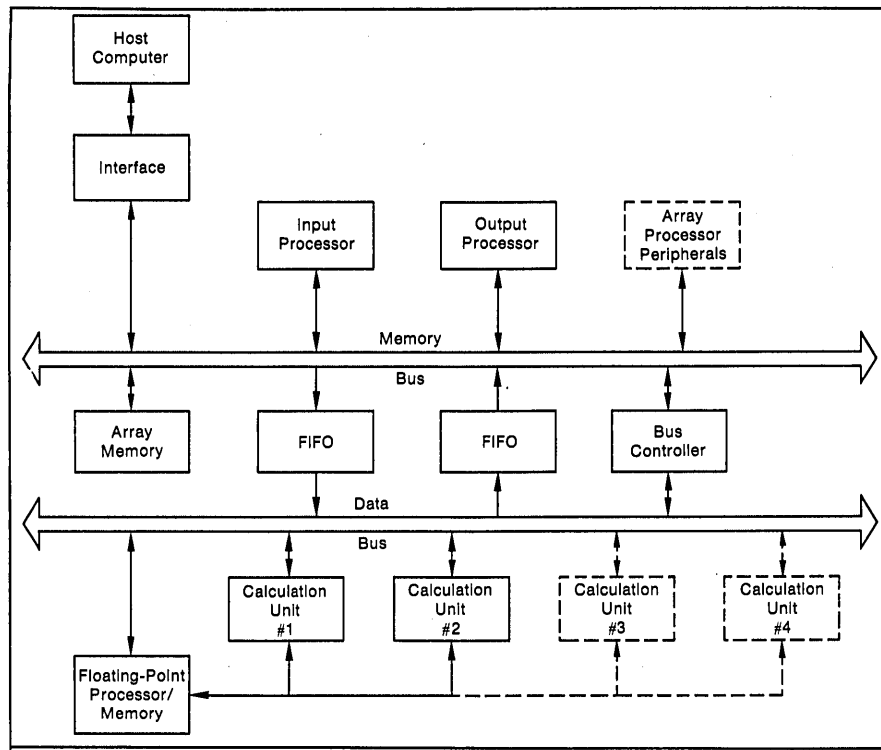

Fig. 3. Programmable array processor architecture with parallel *dissimilar* hardware elements

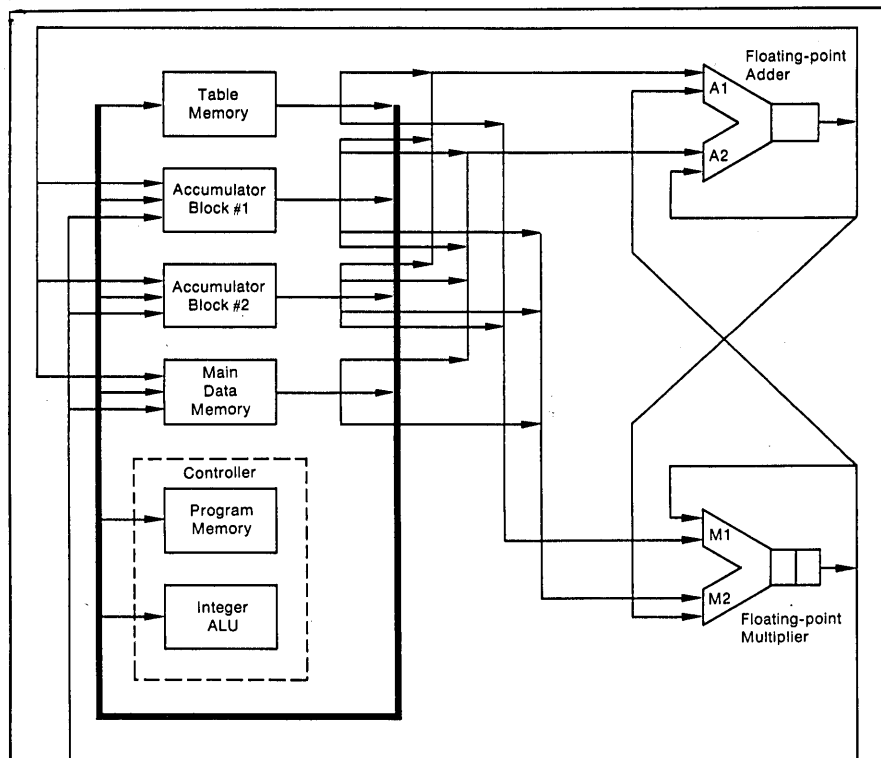

Fig. 4. Multiple parallel data paths assure minimum delays in supplying operands to floating-point arithmetic units

architectural elements and by employing multiple parallel data paths, synchronous designs can in large measure achieve the efficiency inherent in asynchronous machines.

By providing parallel data paths such as shown in Fig. 4, the ability of a synchronous array processor to truly perform operations such as floating-point

calculations, data fetches, table look-ups, and i/o operations in parallel is assured. This in turn means that minimum delays are encountered in supplying operands to the floating-point arithmetic units and in removing resultants for storage. A high degree of the arithmetic unit's potential throughput is realized in actual calculations.

## WHAT TO LOOK FOR

Before buying any low cost computer for scientific work, requirements of the specific application should be carefully assessed and compared against the variety of array processors (and minicomputers) available. Much of the selection advice below is implied in the preceding sections, but it is helpful to look at it as a check list.

1) Be sure precision and dynamic range are adequate for the application. Remember precision must be maintained over iterative calculations. The smaller machines offer word sizes of 16, 24, 32 and 38 bits, depending on the vendor.

2) What throughput requirements are inherent in present and future applications? Consider actual throughput on real problems, not just maximum potential throughput. Require vendors to run benchmark problems typical of your application. This precaution is especially important on modular machines where a large number of parallel units are needed for the application.

3) Look for a machine with a large library of standard math subroutines and be sure to talk to a user who has actually tried them. Besides eliminating the need for much routine programming effort by the user, such a library is an indicator of how easy the machine is to program. For an easily programmed machine it is likely that the vendor will have developed an extensive, efficiently coded, thoroughly debugged math library.

4) What languages are available for programming the machine? For non-programming experts, it is highly desirable that a higher level language, such as FORTRAN, be available. On the other hand, for applications where maximum throughput (hence efficient coding) is paramount, an easily understood and easily used assembly language is also important. How about debugging facilities? Can you single-step through a program on the machine?

5) Flexibility needed is determined by the number of different types of computations to be performed. Unless you have only one or a very few types of calculations to perform, hardwired scientific processors will not suffice. Complete software programmability is needed to move readily from one application to another. For applications involving both numerically intensive calculations and file manipulation, a programmable array processor coupled to a front-end minicomputer covers both areas.

6) It is desirable that the array processor be capable of interfacing



# THE COMMANDING GENERAL

**Why our new General Ledger System enjoys  
a commanding lead over the competition.**

Attention!

Our new General Ledger/Financial Analysis System, G/L PLUS, deserves a twenty-one gun salute. Because even though it's brand new, its remarkable features have promoted it into a leadership position over everything else on the market.

First of all, the system is simple to use, with a revolutionary file design that allows unsurpassed efficiency and flexibility.

Secondly, the system is easy to maintain. We made it so compact that it comprises only 18 programs instead of the typical 50 to 200.

It's also the most comprehensive system available. Because we filled it with unusual features like automatic interface to any application subsystem; extensive planning and modeling facilities; complete user-defined editing and user-controlled error recycle; and comprehensive graphic reporting.

And of course, we included features like multi-corporate processing of both accounting and statistical data; extensive capabilities for any financial reporting requirement; consolidations, cost allocation, fixed and variable budgeting, exception reporting, foreign currency translation, and more.

Finally, there's a user-support program that includes not only installation, but a special user training school.

Now our Commanding General, G/L PLUS, is ready to stand inspection whenever you're ready.

If you'll contact Maurice Giguere, we'll be proud to pass in review.



**MCCORMACK & DODGE CORPORATION**  
381 Elliot Street, Newton Upper Falls, MA 02164, (617) 964-6610

CIRCLE 78 ON READER CARD

# Now can divide

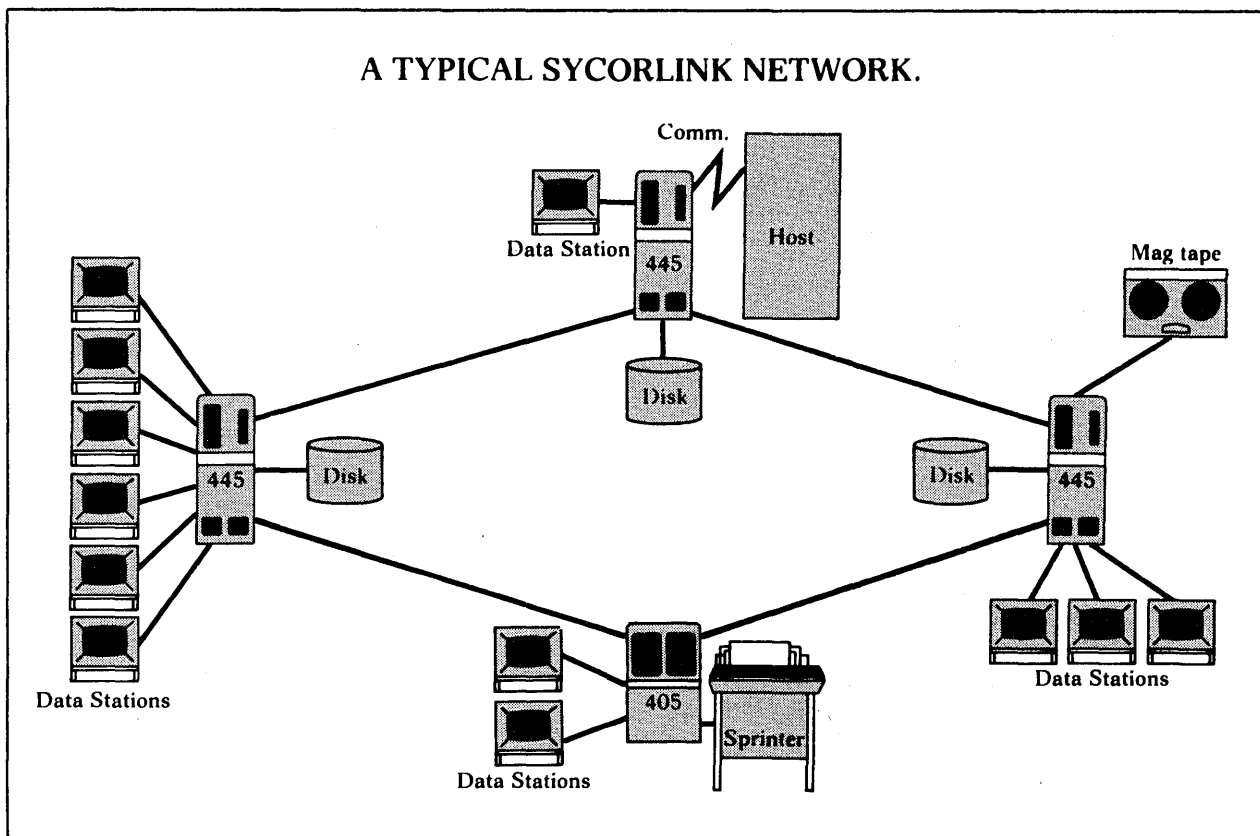

Sycorlink™ is a revolutionary resource sharing feature that lets you distribute the power and resources of computer systems throughout your organization. And conquer the problem of providing all your departments with the services they're looking for. At a price you're looking for.

In a nutshell, the Sycorlink networking feature is distributed processing the way it was meant to be.

## Put the power of your network at every work station.

With Sycorlink, every system in the network

can be tailored to handle the processing tasks of individual departments. And at the same time give authorized users in any department the power to access the files and peripherals of every other system in the network.

A user at any work station can access any file on any disk in the network. At the push of a key. Any file on any disk can be printed on any printer in the network. Any file can be transmitted to the host.

Any system in the network can process data from any file on any disk located at any other node in the network. And a system can be dropped out for maintenance or service

# you and conquer.

without disrupting the flow of data to and from any other node.

## **Match the workhorse to the work load.**

The Sycor 405 and 445 distributed processing systems can be mixed and matched in a Sycorlink network to create individual processing nodes with just the right amount of power for a specific department or location.

And while each node may be individually configured, it can access the files of another node just about as fast as its own files. Communicating this fast within the network allows nodes to share expensive peripherals, such as a line printer. So any way you put it together, your Sycorlink network has the performance capability that can get your job done. The way you want it done.

This means you never have to overequip any location, paying for power you don't need. Your first step in building your distributed processing network is the right one — with nothing to trip you up down the road.

## **Get started on a no-detour growth path.**

The upward compatibility of the Sycor 400 series lets you grow your network without redesigning your system or replacing hardware. We call it planned nonobsolescence.

As your needs at a specific site grow, our compatible 405 and 445 systems let you upgrade without reprogramming or introducing unfamiliar hardware to your operators.

## **Install systems up to a half mile apart.**

A Sycorlink network permits installation of systems up to a half mile away from each other. The systems are connected to each other by coaxial cables. This lets you increase your computer power simply by adding another system to the network. Without reprogramming.

Sycor's security-conscious software makes sure all disk files can be protected to prevent unauthorized access. You get peace of mind. And costs are kept to a minimum.

## **Link up your departments with Sycorlink. Call 800-521-2838 toll-free.**

Sycor pioneered the concept of distributed data processing more than ten years ago. Since then we've been at the cutting edge of distributed processing technology. With over 100 service centers located within a half-hour drive of 1750 North American cities, and 40,000 systems installed, we're ready to help you bring your users state-of-the-art service in distributed processing. They deserve it.

To find out more about how Sycorlink can help you conquer distributed processing problems, call Tony Fazio, VP Sales, at the number above. In Michigan, call collect, 313-995-1170. Or write Sycor, Inc., Ann Arbor, Michigan 48106.

Better yet, contact a nearby sales office. We're in the Yellow Pages under Data Processing Equipment.

**Sycor puts computer power where the work is.**

TM

# SYCOR<sup>®</sup>

A Northern Telecom Company

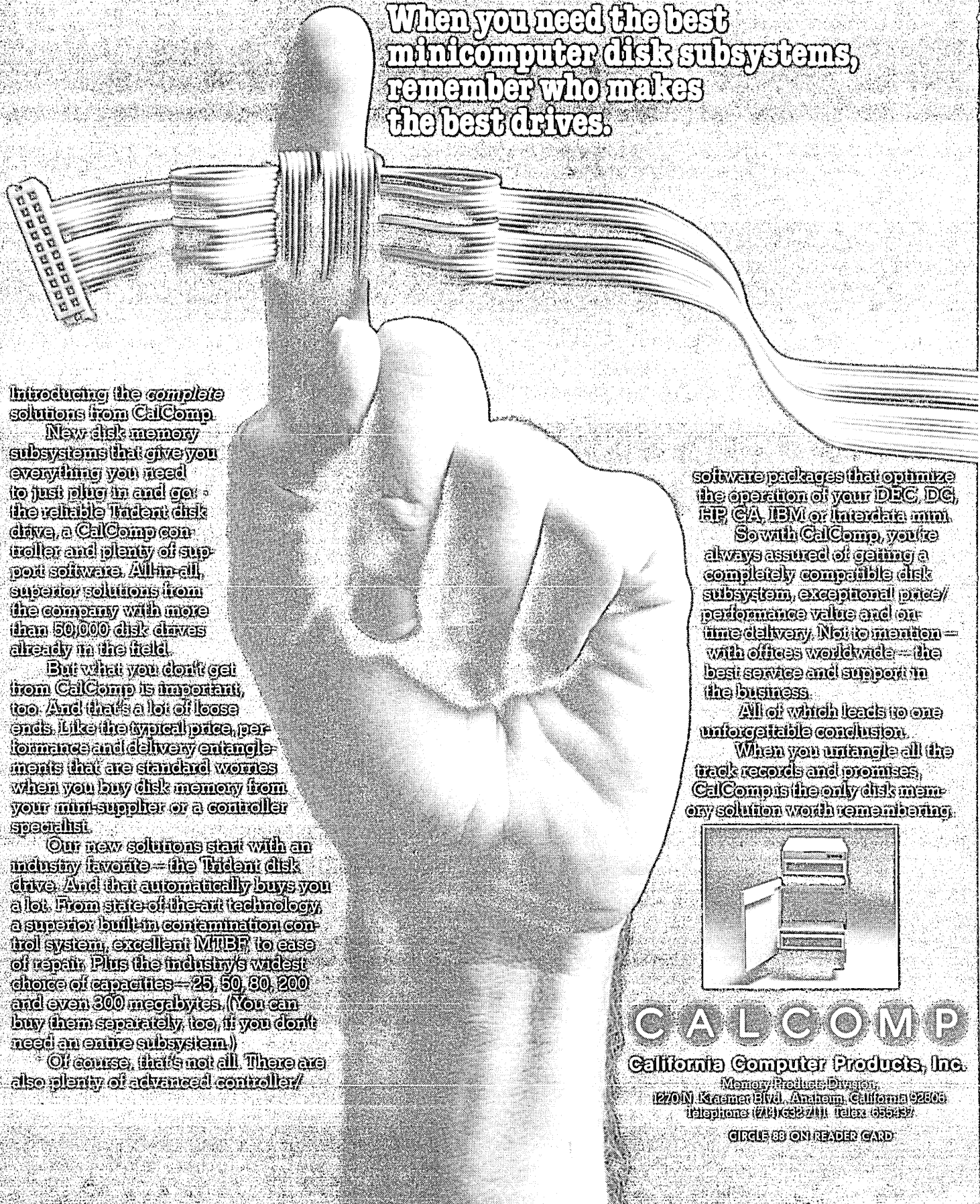

**When you need the best  
minicomputer disk subsystems,  
remember who makes  
the best drives.**

**Introducing the complete  
solutions from CalComp.**

New disk memory subsystems that give you everything you need to just plug in and go: the reliable Trident disk drive, a CalComp controller and plenty of support software. All-in-all, superior solutions from the company with more than 50,000 disk drives already in the field.

But what you don't get from CalComp is important, too. And that's a lot of loose ends. Like the typical price, performance and delivery entanglements that are standard worries when you buy disk memory from your mini-supplier or a controller specialist.

Our new solutions start with an industry favorite -- the Trident disk drive. And that automatically buys you a lot. From state-of-the-art technology, a superior built-in contamination control system, excellent MTRBF, to ease of repair. Plus the industry's widest choice of capacities -- 25, 50, 80, 200 and even 300 megabytes. (You can buy them separately, too, if you don't need an entire subsystem.)

Of course, that's not all. There are also plenty of advanced controller/

software packages that optimize the operation of your DEC, DG, HP, CA, IBM or Interdata mini.

So with CalComp, you're always assured of getting a completely compatible disk subsystem, exceptional price/performance value and on-time delivery. Not to mention -- with offices worldwide -- the best service and support in the business.

All of which leads to one unforgettable conclusion.

When you untangle all the track records and promises, CalComp is the only disk memory solution worth remembering.

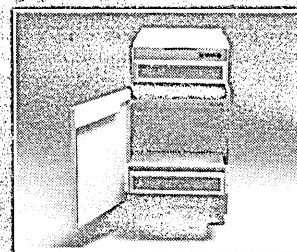

**CALCOMP**

California Computer Products, Inc.

Memory Product Division  
12701 N. Kraemer Blvd., Anaheim, California 92806  
Telephone (714) 638-7111 Telex 655457

CIRCLE 68 ON READER CARD

# The Incredible 8K Cache

Actual  
Size

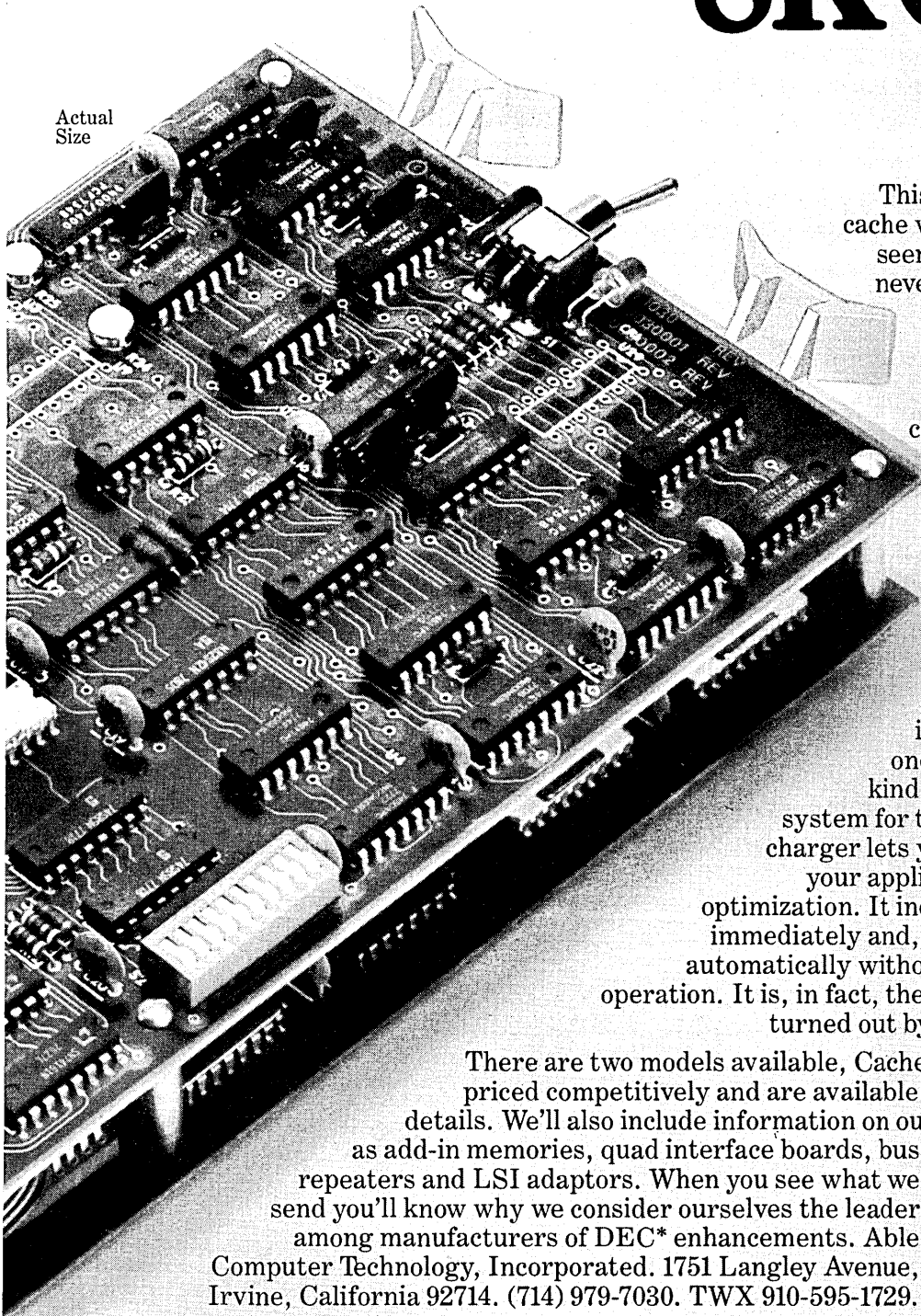

This is the ultimate version, the 8K cache with everything. You have never seen one like it before, and you may never see another. Designed for the 11/34, 11/35 and 11/40, it has byte and address parity, upper/lower limit switches, on-line/off-line manual switch control, activity indicator lights, 8K bytes of memory (4K words) providing a capacity four times that of competitive units and an interconnect board design which consumes no extra space in the computer.

That's why there is always room in your computer for this incredible cache. You should put one there, especially if you are the kind of guy who likes to optimize his system for top performance. Our 8K super-charger lets you tailor performance to match your application and to establish hit-ratio optimization. It indicates hit rate and parity error immediately and, if errors are detected, shuts off automatically without ever interfering with system operation. It is, in fact, the only intelligent buffer memory turned out by an independent manufacturer.

There are two models available, Cache/434™ and Cache/440™. Both are priced competitively and are available off-the-shelf as usual. Write for details. We'll also include information on our other buffer memories as well as add-in memories, quad interface boards, bus repeaters and LSI adaptors. When you see what we send you'll know why we consider ourselves the leader among manufacturers of DEC\* enhancements. Able Computer Technology, Incorporated, 1751 Langley Avenue, Irvine, California 92714. (714) 979-7030. TWX 910-595-1729.

## Able, the computer experts

\*DEC is a registered trademark of Digital Equipment Corporation.

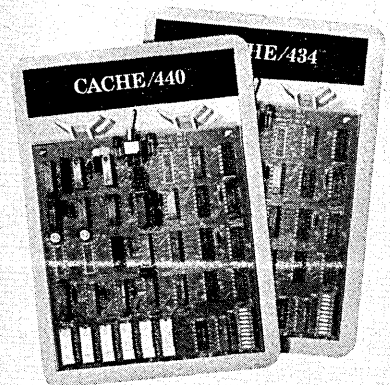

## Expect more work on solving the I/O bottleneck and adding precision without unduly sacrificing speed.

directly to a range of peripheral devices including disks and A/D and D/A converters.

7) Mean time between failures for the minicomputer/array processor combination chosen should be much longer than the longest program run time in the application. Otherwise piecemeal solutions will be required.

### THE FUTURE

As knowledge about low cost, programmable array processors continues to spread, these machines can be expected to take over more and more serious scientific computation tasks from large scale, time-shared scientific computers and from conventional dp oriented minicomputers. It is reasonable to expect that work will be concentrated on solving two problems which presently represent limitations in some applications. One is the bottleneck encountered in getting data in and out of the array processor through the rather slow I/O channels of the front-end minicomputer. The other is providing added precision (without unduly sacrificing speed) for the applications where double-precision is truly necessary.

Let's look at the I/O problem first.

Scientific applications cover a broad spectrum ranging from highly computationally intensive applications, where I/O is a trivial part of the total run time, to more I/O intensive cases where transfer of data in and out of the array processor requires as much (or more) time as the calculations. When computation time greatly exceeds I/O time, I/O time can, in a well designed unit, be hidden behind computation time without the effective throughput of the array processor being degraded. For cases where I/O time exceeds computation time, however, all of the I/O time cannot be masked and throughput drops. In actual fact, array processors connected to front-end minicomputers, such as a PDP-11/34, are probably seldom operating more than 30% of the time. Thus, there seems little immediate incentive for making array processors faster. A ten times speed increase would only mean that the array processor ran 3% of the time.

Two means of overcoming the I/O bottleneck suggest themselves. In general, more modern minis with faster I/O channels, such as the PDP-11/70, the SEL 32/55 or the Interdata 8/32, can be used as hosts. It is to be expected that such front-end minis will be increasingly selected for I/O intensive applications. For cases where moderate amounts of I/O are

involved, such hosts may make it possible to increase overall throughput by building faster array processors.

Another approach is to bypass the front-end minicomputer for large block data transfers. As an example, two-dimensional FFT's on very large arrays (perhaps 1024 x 1024 data points) make it economically infeasible to store all of the data within the array processor. A more cost-effective approach is to store the bulk of the data on disk and perform the FFT in parts. Rather than allow slow minicomputer I/O channels to reduce throughput, the array processor can be fitted with a direct, high-speed I/O port to the disk. Also, in applications involving very fast incoming data from a fast A/D converter in a real-time application a direct I/O port could help to keep an inexpensive minicomputer host from being completely overwhelmed.

Looking at the I/O bottleneck from another point of view, there are many applications where not realizing the full throughput potential of the array processor is quite tolerable. But why let the array processor sit idle a large part of the time? It is to be anticipated that array processor manufacturers will satisfy such applications with lower cost, reduced speed machines.

Turning to the problem posed by

# New Remote Control System lets you reconfigure your data network in seconds or switch to backup anywhere your telephone line reaches.

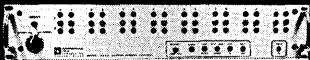
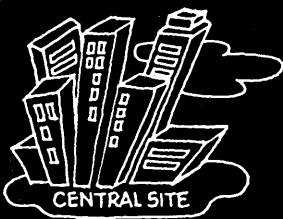

Now, from one tech control command center, you can assure uninterrupted data communications anywhere on the globe. Our microprocessor based 8900R Remote Control System gives you remote status reporting from every station in your data network. When trouble occurs, it enables you to reconfigure your network or switch to backup equipment at the remote site in seconds

— right from your tech control center. The 8900R, IDS's newest advance in remote tech control.

- City to city network control using any asynchronous dial-up or leased line modem link.
- Allows remote control of all standard IDS series 8900 A, B switches.
- Can be expanded to control up to

4096 A, B switches at each site.

- LED's automatically indicate status of remotely controlled switches.
- Proprietary error correction technique assures error free remote operation.
- Microprocessor based.
- Key lockout to prevent accidental A, B switching.

 **INTERNATIONAL  
DATA  
SCIENCES, INC.**

7 Wellington Rd., Lincoln, R.I. 02865 • Tel: (401) 333-6200 • TWX: (710) 384-1911 Export: EMEC, Box 1285, Hallandale, Florida 33009

CIRCLE 121 ON READER CARD

double-precision applications, we must first distinguish between where double precision has been used in the past and where it is truly needed. Often cases where single precision was inadequate have been handled by going automatically to double precision because that is all that was available. Many of these calculations could, however, be handled by using extended precision. Where existing application programs involve large investments in time and money, array processors will need to provide double-precision hardware if they are to be used. For many new application programs, on the other hand, it may make more economic sense to use a lower cost, extended-precision array processor and handle any small portions of the program truly needing double precision in software. Extended precision, however, will not suffice in all cases. An extensive need for double precision is encountered in areas such as weather calculations, plasma physics, structural engineering, and solution of differential equations by arithmetic approximation.

Array processor manufacturers can be expected to offer an increasing range of machines tailored to fit specific applications. This will be recognized as directly parallel to the earlier evolution of dp oriented minicomputers. Primary per-

formance features which will be traded off against cost include:

- 1) array processor speed
- 2) single precision vs extended precision vs double precision hardware
- 3) direct, high speed I/O ports for the array processor
- 4) sophistication of the front-end or I/O computer

Speed achieved by low cost, programmable array processors is leading to serious consideration of their use in such complex applications as multidimensional calculations (for example in three-dimensional fluid-flow calculations involved in simulating wind tunnels). As the number of dimensions increase, size of data bases involved increases geometrically. At the level of three-dimensional calculations, it is economically undesirable to store the entire required data base in array processor core memory. Increased activity can, therefore, be expected in developing algorithms needed for partitioning large problems (in order to make use of mass storage) without greatly reducing array processor throughput.

As knowledge concerning programmable array processors spreads they are moving into applications previously dominated by large mainframe scientific machines. More importantly they are

extending the power of scientific computing to applications which previously simply could not afford it. For many scientists and engineers, the stand-alone array processor represents a new view of computers—a computer that waits for you rather than you for the computer. \*

### C. N. WINNINGSTAD



Mr. Winningstad is president, chairman of the board, and a founder of Floating Point Systems, Inc. Holder of a BS in electrical

engineering and an MBA, he helped develop television broadcast antennas in the late '40s, high-speed (sub-nanosecond) electronics at the Univ. of California Radiation Lab during the '50s, and digital measurement instruments at Tektronix during the '60s. In 1970, Winningstad and several colleagues started Floating Point Systems with the initial intent of supplying floating point hardware for computers, primarily those used in geophysical applications.

## COMPLETE AND MAIL THIS COUPON FOR THE FULL STORY ON DAY-FLO® PRE-INKED ROLLERS

- Please  send me brochures describing Day-Flo Pre-Inked Rollers;  
 contact me, immediately, concerning my particular application.

Name \_\_\_\_\_  
 Firm \_\_\_\_\_  
 Address \_\_\_\_\_  
 City \_\_\_\_\_ State \_\_\_\_\_ Zip \_\_\_\_\_  
 Phone \_\_\_\_\_

Consider Dayco's complete line of microporous pre-inked rollers. Custom designed to fit your system or application.

Pre-inked rollers for credit card printers, check encoders, character printers, print-outs, ribbon re-inking, high-speed character printers, on-line marking and a

number of other printing and marking applications.

For the full story on the finest and most complete line of pre-inked rollers made, phone 513/226-5866. Or complete and mail this coupon to: Dayco Corporation, Marketing Services, 333 West First Street, Dayton, Ohio 45402.

**DAYCO**  
CORPORATION



PRINTING PRODUCTS DIVISION

© 1978 Dayco

CIRCLE 38 ON READER CARD

OCTOBER 1978 173

# TEXT-5<sup>®</sup>

## THE SYSTEM DESIGNED FOR THE PRODUCTION OF TECHNICAL PUBLICATIONS.

Powerful text editing and large data base management was a major design requirement for the TEXT-5, along with the ability to compose both military and commercial formats and produce high quality photocomposed camera-ready copy.

Composition requirements are easily achieved without complex coding structures imposed upon the operator. TEXT-5 was designed for upward expandability to keep up with your Publication Department's changing environment.

We know your production problems and have designed the TEXT-5 system to fulfill both your current and future needs.

Write or call us and we will be delighted to send you a complete package on our products.

1050 Rancho Conejo Boulevard  
Newbury Park, California 91320  
(805) 498-9611 (213) 889-7400  
TWX: 910-336-1541



**AUTOLOGIC  
INCORPORATED**

Manufacturer of the APS-5  
Family of Phototypesetters





# Solving data comm problems doesn't have to be expensive.

Until now, identifying data comm problems has been reserved for the specialists.

Introducing...the trim, 11-lb 832 Data Comm Tester from Tektronix. It helps identify and solve most data comm problems the first time without calling the specialist.

Take this new 832 Data Comm Tester to the field and use it in either the passive monitor or active simulation modes. In the monitor mode, capture data and control line status to identify problems.

Once you've identified the problem, the 832 allows you to stimulate the suspected equipment off-line to troubleshoot or verify performance without the use of expensive CPU time. "The quick brown fox..." and six other messages are stored in the 832. Or, tailor the stimulus pattern to your own needs with a user-definable PROM or a front panel entry.

The 832 is also easy to operate and learn. Since it doesn't require extensive data comm knowledge to operate, service people require less training time.

For under \$2000, it costs only a fraction as much as the equipment you've had to buy in the past to perform similar functions.

For more information about the 832 Data Comm Tester, call your nearest Tektronix office or call our automatic answering service toll free on 1-800-547-1512. Oregon residents call collect on 644-9051.

For availability outside the U.S., please contact the nearest Tektronix Field Office, Distributor or Representative.

CIRCLE 86 ON READER CARD

**Tektronix**<sup>®</sup>  
COMMITTED TO EXCELLENCE

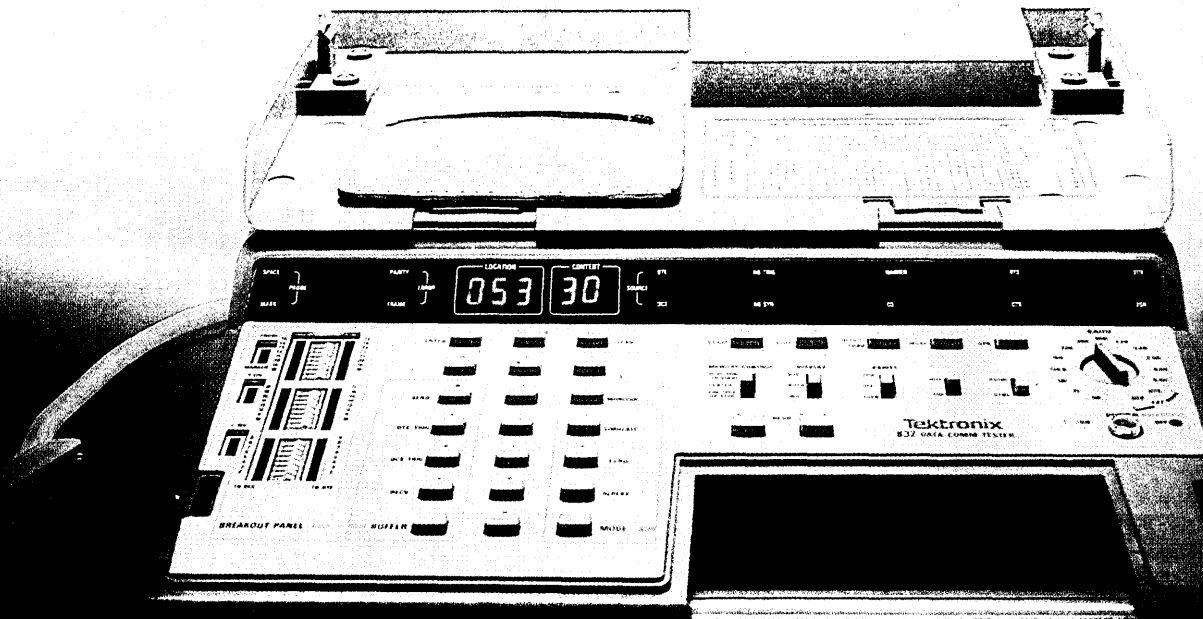

## THE 832 DATA COMM TESTER

# DEC, Data General, H-P communications costs are down

If you're supporting remote terminals on your DEC, Data General, or H-P system, with more than one terminal per location, chances are you are paying a fortune in communications costs and probably not even running the terminals as fast as you'd really like to. And to add insult to injury, you have to put up with the occasional phone line 'glitch' which drives your CRT's crazy.

What you really need is a smart little box that will provide error control for your terminals and allow several of them to share one telephone line, contending for the line when they need it, not each paying for a dedicated transmission facility all day.

Well, look no further. MICOM SYSTEMS, INC., one of the pioneers in the application of microcomputers for data communications, has put it all together in the Micro800 Data Concentrator. The Micro800 represents a major breakthrough in low-cost data concentration, sometimes referred to as 'statistical multiplexing'. Allowing up to 16 terminals to share a single phone line, it requires absolutely no changes to the hardware and software you have installed today. And prices start as low as \$1150 for a 2-channel unit.

Hundreds of Micro800's are already in service, installed by the user as painlessly as plugging in a terminal. And with some of our customers supporting four 2400 bps CRT's on a single 2400 bps line, no wonder they're delighted!

What's more, with the Micro800, transmission errors are gone forever. We even have a single channel configuration for lone terminal installations.

Send for complete details today... better still, why not call and order a pair on a 30-day sale-or-return basis. No strings attached! We know you'll love it.

**Still squeezing data through the old-fashioned way?**

**Concentrate. It's cheaper!**



**MICOM** *MicroComputers for DataCommunications*

MICOM SYSTEMS, INC. • 9551 Irondale Avenue • Chatsworth, California 91311 • Telephone 213/882-6890 • TWX 910/494-4910

# Jim Frazier put over 150,000 businesses in touch with government.

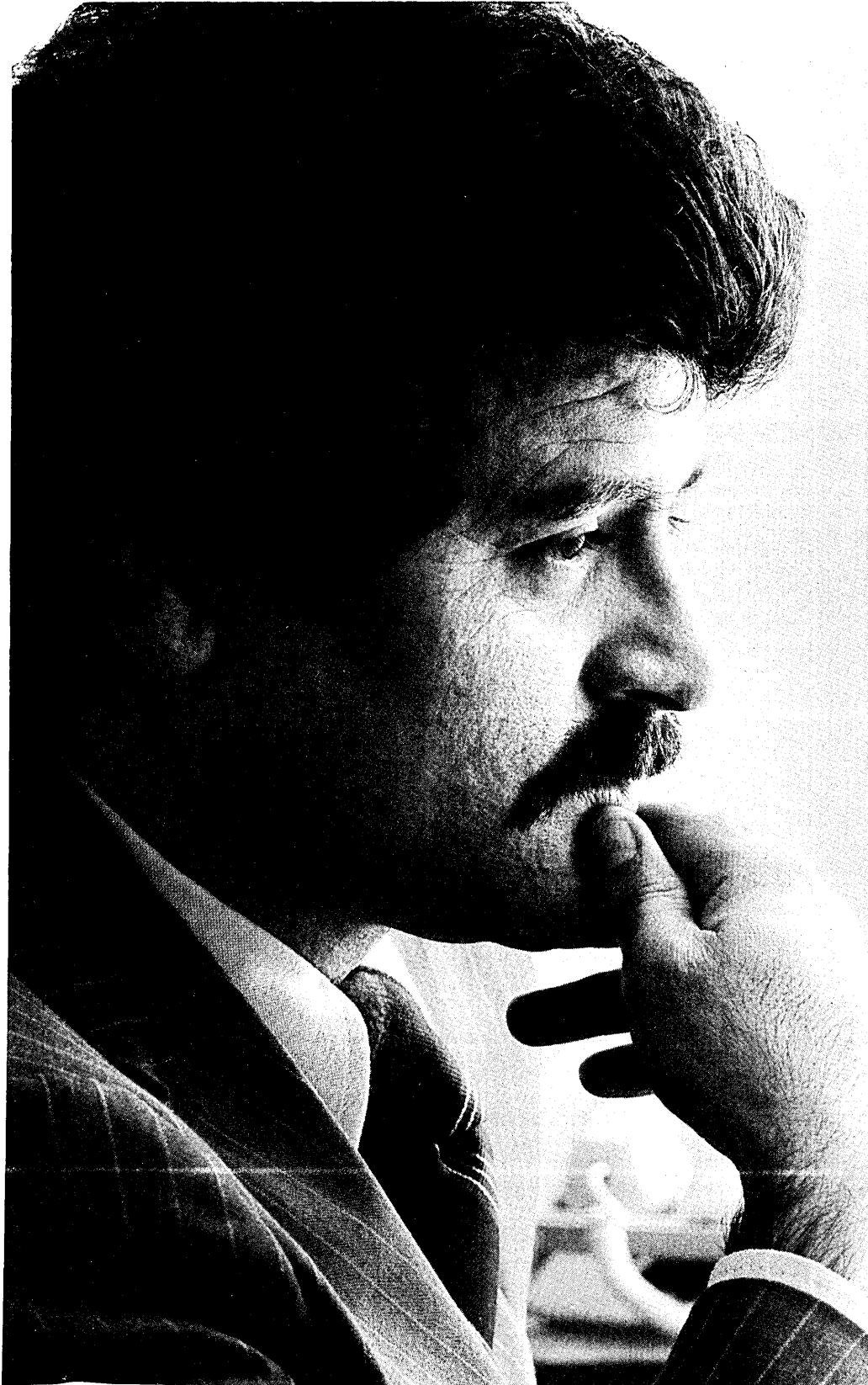

A government agency planned on sending out questionnaires to business.

But the questionnaires were long and involved, and many respondents would obviously need help.

Jim Frazier, a Bell System Sales Supervisor to the Federal Government, recommended setting up an incoming WATS line—an 800 number—that 150,000 businesses could contact.

Then he suggested setting up outgoing WATS lines—so if businessmen couldn't be helped on the spot, they'd be called back.

And, finally, he set up a program to train employees in how to answer business inquiries courteously and effectively.

This is all by way of saying that Jim Frazier is one of a number of dedicated, creative Bell System representatives serving federal departments and agencies.

You'll find that their first step—before making recommendations—is to understand how your department or agency operates.

What they recommend can make things go smoother and easier for you.

No question about it.

**The system is the solution.**



**Bell System**

# TOOLS FOR TOP-DOWN TESTING

by Paul F. Barbuto, Jr.  
and Joe Geller

One of the more common sights we've seen is for a programmer to code a program (sometimes even a structured program using top-down design) from beginning to end, have it keypunched, and then begin testing. At this point the programmer proudly proclaims to have written 100 lines of code per day. Of course there's a big difference between 100 lines of code per day and 100 lines of *debugged* code per day. When testing begins, the programmer is faced with most of the problems that have traditionally plagued programmers trying to get their systems to work. When processing errors occur, the programmer has very little knowledge of where the code error is located.

Oh, the programmer may know that the program abended with an addressing exception in statement 246 at offset OCEF, but is statement 246 in error? Or are the variables defined incorrectly? Or is statement 10 or 35 or 117 wrong with the error propagating down to statement 246?

In other words, with structured programming and top-down structured design, we can write programs which initially are more error free, but for those errors that exist, we still have the traditional problems of testing and debugging.

This is where top-down implementation (top-down coding and testing) comes in. Top-down coding and testing mean precisely that. You start with a top-down design and code *and test* the modules at the highest level. At this level the code consists mostly of references to lower level modules, possibly with some control structure such as DO WHILE loop.

Once each module is coded, it is tested. The program is fairly simple at this point, so there probably won't be too many bugs, but those there are will be found quickly and eliminated before they

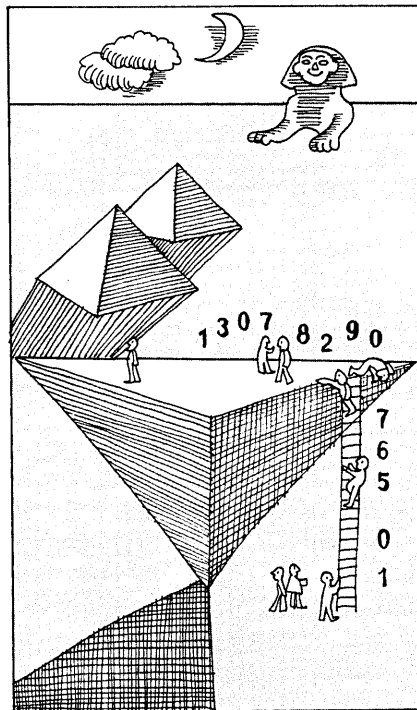

can cause more problems. Since the lower level modules are referenced, these modules will have to exist in some form for the program to execute. The proper form at this point is a simple module whose main function is to allow execution to continue. It may be necessary to return a dummy value in order to accomplish this. It is also very useful for the stub to give some indication that it has executed. By showing what modules have been executed, we can trace the program flow and ensure that it does what we intend.

After this first version of the program is working, the next level is coded using stubs for the level below. This version is then tested and debugged, and so on until the lowest levels (which are detailed code, generally with only locally bounded control logic) are coded and tested. Actually, only one module at each level is coded and tested at a time,

followed by the other modules at that level.

When a given module is written, everything else written to that point is working. Bugs that occur are most likely to reside within the new module. Since bugs are fixed as they are introduced, you are not faced with the problem of three dozen bugs interacting to produce results which cannot be traced to any one section of code.

When modules are coded, they should conform to a node of the tree and therefore can be identified by node number as well as by name. This number should appear in the program listing to identify the module's relationship to other modules, and upon execution should appear on the system output to show the flow of execution.

## WHAT HAPPENED WHERE

With just a little thought, it is possible to design and code some structured testing tools to make the whole process easier. The basic design specifications of a package to assist top-down testing are:

1. to enable simple and rapid insertion and removal of debugging code
2. to trace a program's execution in a form which relates information about its structure
3. to be absolutely transparent during production
4. to provide automatic documentation of *implied* program structure which can be compared with *design* structure

Such a testing tool can be implemented either in a language which provides some sort of macro facility or by using a separate preprocessor which recognizes debugging-oriented coding and either sets up for debugging, or for production based on a parameter. If properly designed in the preprocessor case, the debugging information can be included on comment cards and no preprocessing is necessary before production compilations.



# Fresh, ripe information.

One of Germany's largest fruit importers has learned that—just like strawberries—invoicing and sales information is only good when it's fresh. The firm uses Mohawk Data Sciences Series 21 distributed data processing systems to transmit information between headquarters and branches throughout the country.

For more than a decade, Mohawk Data Sciences has developed, manufactured, sold and supported innovative information handling products that solve business problems—like order entry, invoicing, sales analysis, accounting, and

inventory management—for customers throughout the world.

Our newest product, Series 21, provides managers with the tools they need to communicate local information to central mainframe computers quickly and accurately. Series 21 ensures that the information you need is processed and transmitted where you want it, when you want it.

We've dedicated ourselves to meeting those needs for our 7,000 customers in 60 countries. From 300 company loca-

tions in the United States, Canada, Western Europe and South Africa, our 3,800 employees together with a fast-growing distributor network are working to bring you the finest available information equipment and support.

Your local Mohawk Data Sciences sales representative can show you how Series 21 can meet your information processing requirements.

**MS<sup>D</sup>**

1599 Littleton Road, Parsippany, New Jersey 07054 • (201)540-9080

Series 21 is a trademark of Mohawk Data Sciences

## Mohawk Data Sciences

CIRCLE 54 ON READER CARD

OCTOBER 1978 179

# “OCR SAVES MONEY”

Quotes from just a few of our users

“Our Laser OCR-One has enabled us to reduce our keypunching staff by over 50%. The savings from this alone amount to about \$10,000 a month.”

George M. Jordan  
Systems Analyst  
**Westinghouse Credit Corporation**

“OCR data entry saves Erie County, NY \$300,000 a year. We really couldn't have gotten by without scanning and our Laser OCR-One.”

Gerald E. Wilson  
Director of Data Processing  
**County of Erie, NY**

“The use of the Laser OCR-One is a significant factor in the processing of our daily warehouse productivity information. Our ability to produce timely and accurate reports for this application has resulted in a cost savings of \$5,000 per week.”

James N. Hickey  
Data Processing  
Operations Manager  
**Allied Supermarkets, Inc.**

“Our Laser OCR-One scanner has given us the ability to balance taxes faster than it's ever been done before. In addition, handling the county payroll with scanning has reduced our data processing costs substantially.”

Charles E. Martin/Director  
**Lake County Data Processing Agency, IN**

“Our dramatic sales growth might well not have been possible without the use of optical character recognition technology and the Laser OCR-One. It has enabled us to improve our client service. And that's what our business is all about.”

James W. Schemmel  
Vice President  
**Fulfillment Corporation of America**

For information on how you can cut data entry costs with the Laser OCR-One system, contact

Billy Graham  
Vice President/Marketing

**Optical Business Machines, Inc.**  
804 W. New Haven Avenue  
Melbourne, FL 32901

Call toll-free(800) 327-6429





# GOOD NEWS TRAVELS EAST.

TI's *Silent 700\** Model 765 Portable Data Terminal is an excellent companion on business trips, because it weighs only 17 pounds and fits under your airline seat. It also has an exceptional memory for sales orders, real estate listings, insurance information, newspaper stories or other data entry functions. Non-volatile bubble memory retains data even with the power source off. The 765 can spend all day with you gathering and editing information, then transmit to your host computer at night when phone rates are lower.

The 765 is virtually silent when you're entering data on its typewriter-like ASCII keyboard, and printing data using its 30 characters-per-second thermal

**TI is making immediate deliveries on 765 Portable Bubble Memory Terminals.**

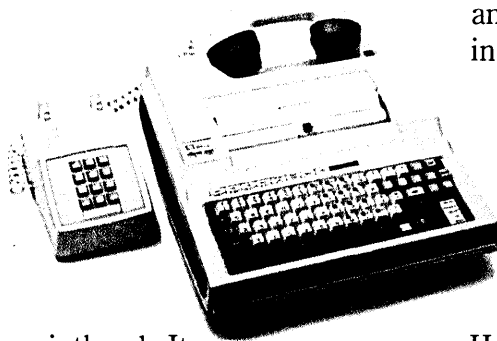

printhead. Its microprocessor-based control assures reliability and high-performance capabilities.

Behind every 765 is over 30 years of TI experience in the electronics industry and the technical expertise and support of our worldwide organization of factory-trained sales and service engineers. And they are backed by TI-CARE†, our nationwide automated service dispatching and field service management information system.

Put bubble memory to work for you now. For more information, contact your nearest Texas Instruments Sales Office, or write Texas Instruments Incorporated, P. O. Box 1444, M/S 7784, Houston, Texas 77001, or phone (713) 937-2016. 

**TEXAS INSTRUMENTS**  
INCORPORATED

Copyright © 1978, Texas Instruments Incorporated \*Trademark of Texas Instruments †Service Mark of Texas Instruments

# TEXAS INSTRUMENTS.

**We put computing within everyone's reach.**

The tools take a month or so to develop, and return that investment nearly immediately.

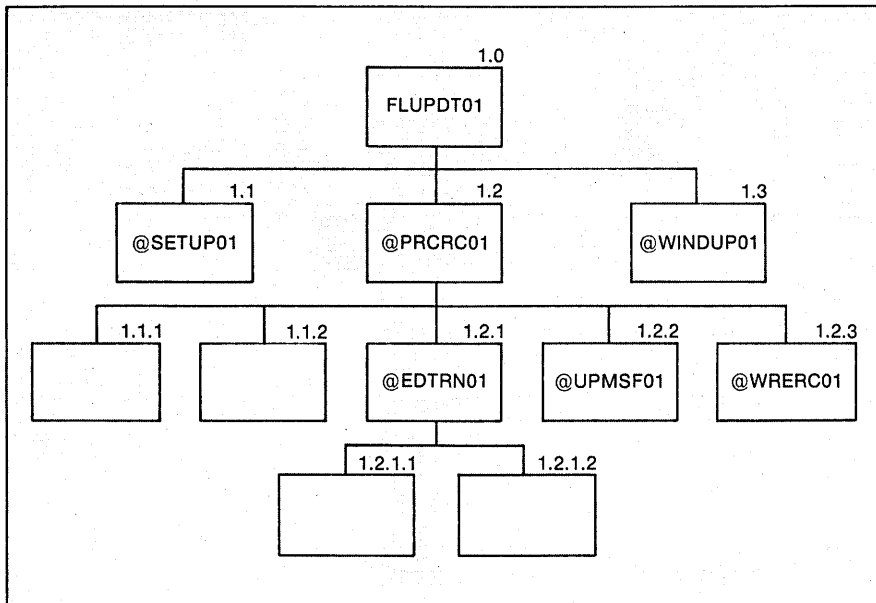

Fig. 1. A few simple tools can make top-down testing much easier. Among them are debug routines which print a message each time a module is entered or exited, and programs which deduce the program's hierarchy from those print comments (as was done by the program TREES for the sample system above).

In a nutshell, one needs to be able to have certain comments printed out easily during execution, at least ones which relate to entering and leaving different modules. We've done this with a preprocessor program for FORTRAN which translates comments containing CT in columns one and two into print statements. The comments cards must be translated only before test compilations and are transparent during production compilations.

In PL/I, all four specifications have been met in a system we call GOODS. Specification 1 can be met by using a preprocessor variable to cause the conditional compilation of debugging code.

Specifications 2 and 3 are met by preprocessor procedures we have named DOWN and UP. DOWN marks the descent down the hierarchy when entering a module and UP indicates leaving the module to return upward in the hierarchy. DOWN has two parameters, the module name and some character string which is passed to a subroutine to be printed in debug mode or changed into a comment in production mode. Additionally, DOWN can generate a hierarchy node number or verify one if one is included in the string.

An example of a skeleton module coded for use with GOODS is:

```

DOWN(1.2@PRCRC01, PROCESS
RECORDS)
/* BODY OF MODULE */
UP
  
```

DOWN and UP, central parts of the GOODS system, are PL/I preprocessor procedures which oversee the generation of debug subroutine calls, print statements or comments depending upon whether this is a test or production compilation. Debug subroutine calls enable one to perform other types of automatic testing, such as counts or the reporting of special data values. A variation we have used includes a subroutine to check the CPU timer and print out the CPU time consumed during a module's execution. This can be of use in optimizing critical sections of code.

Each DOWN and UP is translated into a subroutine call or a PUT statement during testing. During execution, a line is printed indicating the start and end of processing each module. This provides immediate feedback as to whether the program is executing its modules in the expected sequence. In addition it localizes any errors. We can see not only what module the program bombed in, but also what sequence of modules was executed up to that point. If intermediate data values are also printed, we can determine at a glance exactly where the program went wrong without additional debugging runs.

The final specification is automatic hierarchy documentation which with GOODS is met by a separate program called TREE. TREE reads our Include library, traces all Includes, and diagrams

the hierarchy contained therein using DOWN and UP as the source of structure information. TREE draws a hierarchy corresponding to Fig. 1.

The tools we use are not complex and sophisticated ones. In fact, they are straightforward, and simple to implement to boot. The FORTRAN preprocessor which translates comments cards into print statements was written in half a day—and has returned that investment many, many times over.

GOODS itself took about half a man-month, and TREES another month (we already had some routines for accessing members of a partitioned data set).

The point is that none of them required a great investment or special skills. Their effective use does require some restraint or dedication to implementing and testing in a top-down manner. But given that, and these simple tools, the software world becomes a great deal easier to live in. \*

## PAUL F. BARBUTO, JR.



Mr. Barbuto is a senior consultant and external accounts representative for computer services at the Univ. of Idaho.

His 16 years of dp experience has been primarily in a university environment, and his primary interests have been in decision tables, problem oriented languages, and programmer productivity.

## JOE GELLER

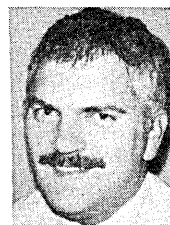

Mr. Geller is a senior programmer for the Information Sciences Div. of the Rockland Research Inst., where he is involved in the

production of systems for the mental health field and also researches program development methodologies. For a time he served as manager of the Programming and Technical Operations Dept. there. His other experience includes teaching mathematics at New York Univ.



# Discover

the most organized (and inexpensive) way to keep up with what's new in computer techniques and management—

## The Library of Computer and Information Sciences

Take any 3 books for only \$3.95 (values to \$60.00)

if you will join now for a trial period and accept only 3 more books—at handsome discounts—over the next 12 months

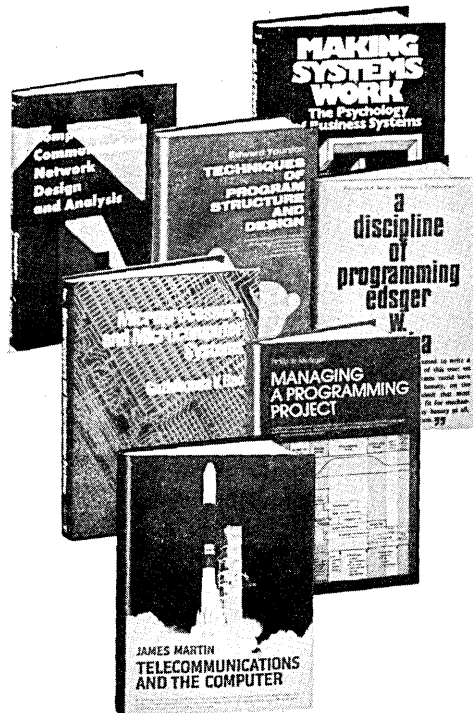

**84385. TOP-DOWN STRUCTURED PROGRAMMING TECHNIQUES.** *Clement McGowan and John R. Kelly.* Practical solutions in actual-code serve to introduce the revolutionary concept. \$14.95

**62620. MICROCOMPUTER HANDBOOK.** *Charles J. Sippl.* Detailed references to the technology and applications of microprocessors. \$19.95

**60405. MANAGING A PROGRAMMING PROJECT.** *Philip W. Metzger.* Sound advice on how to manage a project from the definition and design stage through testing to installation and operation. \$15.00

**52900. HIGH LEVEL COBOL PROGRAMMING.** *Gerald M. Weinberg et al.* An advanced guide to proper and efficient COBOL usage. Introduces "sheltered programming" concepts, stresses modular design and maintainability of code. \$17.95

**59920. MANAGEMENT: Tasks, Responsibilities, Practices.** *Peter F. Drucker.* A brilliant task-focused handbook of the skills, techniques and tools a good executive needs. \$17.50

**39970. COMPUTER ARCHITECTURE.** Second Edition. *Caxton C. Foster.* Covers microprogramming, switching circuitry, memory speed increases in mainframes. \$16.95

**82560. TECHNIQUES OF PROGRAM STRUCTURE AND DESIGN.** *Edward Yourdon.* Over 300 illustrative problems, 90 valuable references, and four demonstration projects. \$19.50

**70110. PRINCIPLES OF DATA-BASE MANAGEMENT.** *James Martin.* Covers data structures, security, file storage, real-time vs. non-real time, more. \$19.95

**32485. ALGORITHMS + DATA STRUCTURES = PROGRAMS.** *Niklaus Wirth.* A classic work on structured programming with practical examples. \$19.95

**42303. A DISCIPLINE OF PROGRAMMING.** *Edsger W. Dijkstra.* A world-renowned computer scientist forges some impressive new programming tools to solve problems that range from the everyday to the complex. \$19.95

**62865. MODERN METHODS FOR COMPUTER SECURITY AND PRIVACY.** *Lance J. Hoffman.* Coverage of the technical and non-technical areas of protecting computer systems and data from accidental or deliberate misuse and theft. \$17.95

**62651-2. MICROPROCESSORS AND MICRO-COMPUTER SYSTEMS.** *G. V. Rao.* Highlights the latest microelectronic and microcomputer technology. Counts as 2 of your 3 books. \$24.50

**78350. SIMULATION WITH GPSS AND GPSS V.** *Bobillier, Kahan, and Probst.* A detailed approach to the effective planning and execution of simulation experiments and projects. With concrete examples. \$18.50

**39890-2. COMPUTER DATA-BASE ORGANIZATION.** *James Martin.* How you can use the latest design and implementation techniques to improve your data system's real-time accessibility and improve flexibility—at the lowest possible cost. Counts as 2 of your 3 books. \$26.50

**39980-2. COMPUTER-COMMUNICATION NETWORK DESIGN AND ANALYSIS.** *Mischa Schwartz.* An organized, quantitative approach to the design of communication networks. Counts as 2 of your 3 books. \$21.50

(Publishers' Prices shown)  
**81845. SYSTEM/370 JOB CONTROL LANGUAGE.** *Gary DeWard Brown.* A highly readable introduction to JCL that also offers key information on the 370 operating system. Includes descriptions of hardware devices and access methods and reference to many useful JCL features. Softcover. \$12.50

**80150. STANDARDIZED DEVELOPMENT OF COMPUTER SOFTWARE.** *Robert C. Tausworthe.* Excellent "how to do it" guide that shows you how to incorporate principles and techniques of structured programming in the development of large-scale systems. Over 100 well-chosen diagrams and flowcharts. \$19.95

**53795-2. HOW TO MANAGE STRUCTURED PROGRAMMING.** *Edward Yourdon.* Based on the author's highly popular seminar series, this offers a detailed step-by-step presentation of just what programmer productivity techniques (PPT) can do for the DP manager. Counts as 2 of your 3 books. \$21.50

**41785. DEBUGGING SYSTEM 360/370 PROGRAMS USING OS AND VS STORAGE DUMPS.** *D.H. Rindfleisch.* A superior guide to storage dump debugging. Methods for COBOL, FORTRAN, PL/1 and assembly language programs. Illustrations, examples, sample dumps. \$19.95

**82730-2. TELECOMMUNICATIONS AND THE COMPUTER.** *James Martin.* Updated edition of the classic reference covers network structures, transmission media, international standards, and much more. With over 100 diagrams and illustrations. Counts as 2 of your 3 books. \$29.50

EXTRAORDINARY VALUE!

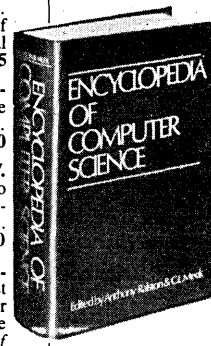

**44900-3. ENCYCLOPEDIA OF COMPUTER SCIENCE.** Edited by *Anthony Ralston and Chester L. Meek.* More than 1550 outside pages of information on every aspect of computer science—from algebra to automata theory, from basic terminology to string-processing languages. 470 articles by 208 experts. Over 700 charts, tables, graphs, and diagrams. Counts as 3 of your 3 books. \$60.00

If the reply card has been removed, please write to  
The Library of Computer and Information Sciences  
Dept. 7-A4B, Riverside, N.J. 08370  
to obtain membership information and an application.

# FOR OFFICES THAT WANT TO KEEP IT QUIET, THE NEW TALLY HUSH-TONE KEEPS THE LID ON NOISE.

If printer noise disturbs your office serenity, you'll appreciate the mel-low decibels of the whisper-quiet Tally Hush-Tone. Our special acoustically designed enclosure attenuates printing noise level down to an unheard of quiet level. When not printing, the Hush-Tone is totally quiescent.

Available at 125 and 200 lines per minute, the Tally Hush-Tone is easy to live with, easy to operate. And easy on the pocketbook. It's the newest member of the Tally T-2000 series—the most reliable (and lowest cost of ownership) line printers you can buy. Remember, Tally line printers never need adjustments, lubrication nor preventive maintenance.

And you can always count on consistent print quality.

The Tally Hush-Tone. You get more than quiet performance. You get up-time performance.

Call or write today. Tally Corporation, 8301 South 180th Street, Kent, Washington 98031. Phone (206) 251-5500.

**TALLY<sup>®</sup>**  
**PRINTERS**  
**WORLDWIDE**

OEM SALES OFFICES  
Boston (617) 272-8070  
New York (516) 694-8444  
Chicago (312) 885-3678  
Los Angeles (213) 378-0805  
Miami (305) 665-5751  
Philadelphia (215) 628-9998  
San Jose (408) 247-0897  
Seattle (206) 251-6730  
San Antonio (512) 733-8153  
Washington, D.C. (703) 471-1145  
BUSINESS SYSTEMS SALES  
Orinda, CA (415) 254-8350



# Look at what Edutronics acquired when McGraw-Hill acquired Edutronics.



McGraw-Hill liked what they saw in Edutronics. That's why they acquired us. But the fact is, now we have more to offer than we ever did before.

Edutronics/McGraw-Hill is still a leading audio-visual training systems company, but now we can give you the total resources of a Fortune 500 company which is dedicated to "Serving the Worldwide Need for Knowledge."

McGraw-Hill gives us, and you, access to the most knowledgeable EDP and management development authors in the world. We have additional capital to increase product development and customer service. And we're

able to serve you throughout the world.

Edutronics/McGraw-Hill is ready to help you now with training systems from entry level to leading edge for the user, EDP professional and advance theoretician. Whatever you need.

Of course, you can still take advantage of our unique modular training systems in data processing, management development and communications. And we continue to offer a dynamically growing catalog of multi-media training materials.

Edutronics/McGraw-Hill. We're everything we used to be and a whole lot more.

Training is an investment. Write or call us today and find out what investing with us can do for you.

#### **Edutronics/McGraw-Hill**

55 Corporate Woods  
9300 West 110th St.  
Overland Park, Kansas 66210

Toll Free **1-800-255-6324**

Please send additional information.

Please have sales representative call.

Name

Title

Company

Hardware  O.S.

Address

City

State  Zip

Phone



## **Edutronics/McGraw-Hill**

# HARDWARE

## OFF-LINE

In case there's any question about the size of the personal computing market, we hear Centronics is shipping some 1,700 printers a month to Tandy Corp., the Radio Shack folks, for integration into the latter's TRS-80 small business systems. In case you've mislaid your handheld, that's 20,400 a year.

And Tandy/Radio Shack isn't the only major micromaker to market Centronics' printers: Apple Computer recently signed a resale agreement whereby it will distribute the printers through more than 300 retail outlets.

A friend of ours notes that IBM has been building 3420 tape-drives only in France for about five years. But lead times have grown to roughly 12 months, so 3420 manufacturing is starting up in Tucson. Our friend wonders if this means the French have less drive than their American counterparts?

Texas Instruments recently received another patent -- this one in Japan -- for pocket calculators. What makes this patent special is its origin and scope: the Japanese patent covers "personal-sized, battery-operated calculators which have their main electronic circuitry in a single integrated circuit chip." Needless to say, Japanese manufacturers aren't overjoyed at the prospect of paying retroactive royalties to August of 1974.

Hewlett-Packard unveiled its fall line in mid-September and early October. In addition to the Amigo (aka HP300), this month's Spotlight, the lineup includes the 3000 Series 33, an entry-level member of the 3000 series in the \$75K to \$200K price range; the 2608A 400 lpm printer, with graphics capabilities, and priced at \$9,250; and the firm's lowest priced crt to date, the 2621A at \$1,450 (\$2,550 with integral printer).

## DESKTOP SYSTEM

A bit over a year ago, three executives from Diablo Systems, including its then-president George Comstock, left that Xerox company to form a small business systems company. The F-85 "desktop data processing system" represents the new company's first offering. In a single cabinet, the company packages an 8085-based microcomputer with up to 64KB of memory, a pair of minifloppy drives, 165cps impact matrix printer, crt, and keyboard. And there's room for expansion with additional crt's (up to four), auxiliary floppy or fixed disk drives, and communications interfaces.

System software includes the DX-85 operating system (multitasking optional), D-BASIC compiler/interpreter, utilities, and diagnostics. Applications software is in the works, with general accounting (general ledger, accounts payable, accounts receivable, etc.) on top of

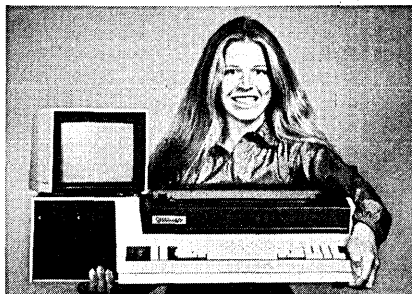

the list. From that point on, the vendor plans to go vertical, selecting several industry segments each year, and developing extensive software for each. Software houses may find the F-85 attractive; D-BASIC is designed for business applications. It compiles to an intermediate code, which is then interpreted. Software can be distributed in this compiled form, providing the same sort of protection to a software vendor that distributing object code only does.

The F-85 will be marketed primarily through distributors. Data Dimensions has already signed up to sell to the Fortune 1000 accounts. Service will be contracted to third parties, except in the San Francisco Bay Area, where the vendor will do maintenance. Pricing on F-85 systems starts at \$13,500. Applications packages will sell for \$550 apiece. DURANGO SYSTEMS INC., Cupertino, Calif.  
**FOR DATA CIRCLE 360 ON READER CARD**

## HIGH-SPEED PRINTER

The PEP-6510 use a xerographic technique to print 13,000 lpm on plain paper. Character formation combines fiber optic techniques with an opaque character drum somewhat akin to the drum in an impact drum printer. The PEP-6510's character set appears as transparent characters on the drum. A light source, fed by

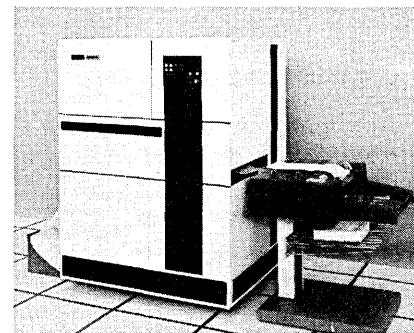

fiber optics, functions in place of hammers in an impact printer: when the desired character is in position the light source pulses, charging the character pattern on a light-sensitive drum. From then on things work pretty much like an office photocopier, with the drum's charge picking up toner, which is then transferred to the paper, producing the final output.

Internally, the PEP-6510 uses the ASCII character codes. An imbedded minicomputer controller can handle conversion from EBCDIC or other codes. The standard printing format is 14 characters to the inch, and 8 lines to the inch, letting the user put the contents of a 14 1/8 by 11-inch computer form on 8 1/2 by 11-inch paper. An off-line version, the PEP-6510-1, which accepts mag tapes recorded at 800bpi or 1600bpi, sells for \$65,000. Oem's can buy the basic printing unit, ready for interfacing, for \$40,000 in quantities of 11. Production deliveries are slated for the first quarter of next year, with deliveries taking three to six months. ARO. UPFSTER CORP., Hauppauge, N.Y.  
**FOR DATA CIRCLE 352 ON READER CARD**

## BIG DISK

This vendor has doubled the capacity of its IBM 3350-compatible disk drives: The model 33502 packs 635MB on each of its two spindles. The increase in capacity is the result of increasing the number of

# Nobody can shrink computer print-out costs the way 3M can.

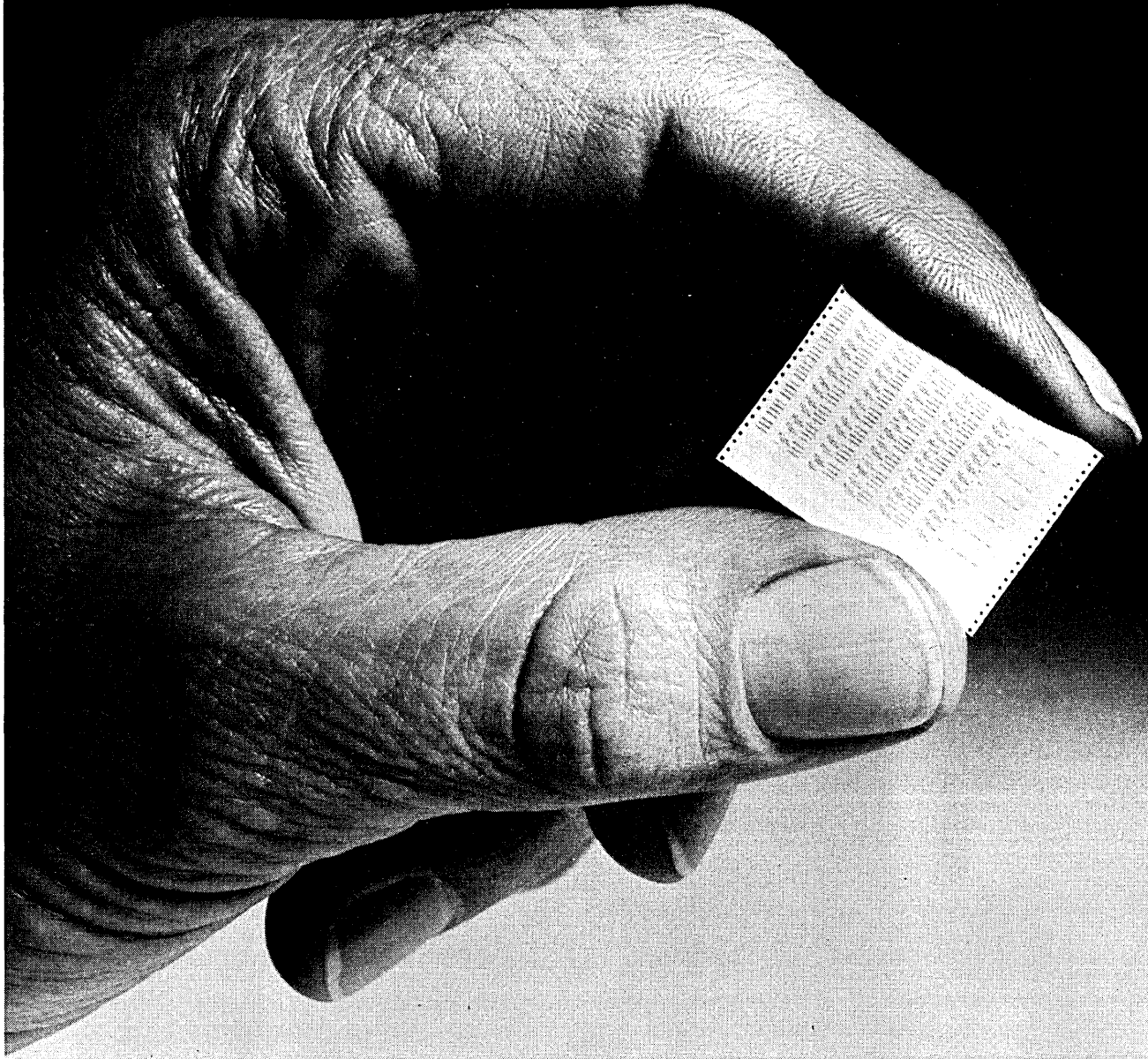

Your company probably pays a nickel a page for every computer printout. But print the data on microfilm and each page costs little more than a penny.

What's more, 3M's newest dry Computer Output Microfilm System prints up to ten times

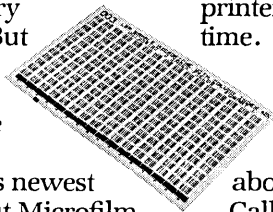

faster than the average impact printer. You save costly computer time.

And because it's dry, the 3M System operates in the computer room environment. No worries about liquids or chemicals. Call your local 3M Business Products Center or write

Microfilm Products Division,  
3M Company, St. Paul, MN  
55101.

**THE  
MANAGEMENT  
OF INFORMATION**

**3M**  
COMPANY

**Talk with the microfilm systems people.**

## HARDWARE

recording surfaces to 20 per spindle, and increasing the number of tracks per inch. The mainframe sees each spindle of the 33502 as two 3350 spindles, making use of the new drives transparently to the host. Operating specs are essentially the same as those for the 3350, except access time has been reduced to 19msec, on an average. Following IBM nomenclature, the drives are offered in A2, B2, and C2 models; the A2 and C2 units, which include drives, storage modules, and control adaptor units, sell for \$59,600. The B2, which connects to an A2 or C2, sells for \$50,250. Optional fixed-head storage, which adds 1.72MB per spindle (3.44MB per 33502) adds \$12,750 to the price. CONTROL DATA CORP., Minneapolis, Minn.

FOR DATA CIRCLE 357 ON READER CARD

## CARD READER

The 300cpm CR-300 card reader is intended for use with minicomputers. The tabletop unit includes the reader mechanism, 450 card input hopper and 450 card stacker, and electronics. The vendor says its patented vacuum feed mechanism is sufficiently forgiving to tolerate

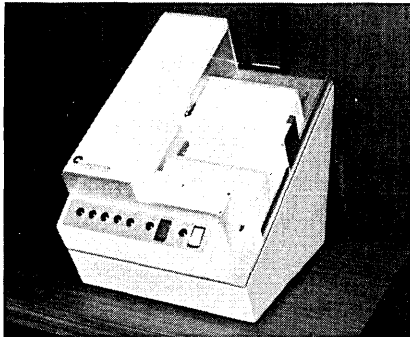

worn or damaged cards with few jams. A Documentation-compatible interface is available at no additional charge. The CR-300 lists at \$2,875; oem discounts can bring the price below \$2,000. Deliveries take 45 days. CARDAMATION CO., Frazer, Penn.

FOR DATA CIRCLE 358 ON READER CARD

## ACOUSTIC COUPLER/MODEM

The model 1234 acoustic coupler/modem offers 1200bps full duplex operation; it is compatible only with Vadic's 34XX series of modems. The unit can operate synchronously or asynchronously with switch-selectable transmission speeds. It has an RS232 terminal interface. Connection to the phone link can be through the acoustic coupler or a direct connection via a manual DAA. The 1234 sells for \$895 in singles. ANDERSON JACOBSON, INC., San Jose, Calif.

FOR DATA CIRCLE 359 ON READER CARD

## FIXED HEAD DISK REPLACEMENT

Systems integrators seeking an alternative to head-per-track disks in LSI-11-based microcomputer systems may be interested in this vendor's SDV11 Superdisk. Occupying one quad board that plugs into the micro's bus, the SDV11 pro-

vides 512KB of charge-coupled device storage. The solid-state disk replacement is said to offer access times of less than 100usec, making it attractive as a systems device. Under DEC's RT-11 operating system, the SDV-11 provides 1,024 logical storage blocks for system software, commonly needed data, or program swap-

## HARDWARE SPOTLIGHT

### SMALL COMPUTER SYSTEM

Amigo is one friendly little computer. In addition to having a HELP command (which gets explanations for various commands), Amigo keeps an indexed copy of its manual stored on its integral 12.7MB disk. During a demonstration we saw an operator ask, "How do I build a file?" and Amigo displayed the first page of the manual's section on file creation. "It doesn't understand English," said our host, "it only recognizes certain keywords." To demonstrate, he entered a question Amigo couldn't quite fathom; instead of saying "Huh?" Amigo opened the manual's index to the first occurrence of the keywords. We were then free to scroll through the index and select an appropriate looking entry.

The user interface includes eight software defined function keys along the right side of the operator's crt. The operating system makes use of these, changing their meanings to fit the context. For instance, when entering and editing a BASIC program, softkeys can call up HELP, OOPS! (which restores a mistakenly edited line to its original state), TEST (compile and test), SPLIT SCREEN (allowing two parts of the program to scroll independently for comparison purposes), and other useful functions.

BASIC is widely extended for business applications, while the other language available on Amigo is industry standard RPG II. Again it's friendly, with softkey assistance. Softkeys can EXPAND or COMPACT program lines, identifying each field without making the programmer count columns. There is one useful extension to RPG: a pre-processor which can make several terminals appear as one input file (useful with programs developed for batch systems).

Amigo's Interactive Display System (IDS) functions as operator's console, programming stations, and applications terminal. The microprocessor based display can be partitioned into independent windows performing different display functions. The standard system display consists of five areas: a single line environment area at the top of the screen, labels for the



softkeys along the right of the screen, a single line command window at the bottom of the screen, an error message line below the command line, and a display window which occupies most of the screen displaying general data. Applications programs can window the screen as desired.

In the cabinetry below the IDS resides Amigo's processor and memory, 12.7MB of fixed disk, and power supply. Amigo's cpu is based on the same three silicon-on-sapphire (SOS) chips used in the vendor's concurrently announced 3000 Series 33, a new \$70,000 entry level member of its existing 3000 series. That's not to say the Amigo has a 3000 series cpu: both processors are tailored by microcode for their intended applications. Still, having those three chips in common may be why Amigo is also known as the Model 300.

Amigo is intended for oem's and sophisticated users who will develop applications software and install the system for dedicated transaction processing applications. As such, the fact that Amigo is programmable only from the console makes sense. Once installed, Amigo should have a fairly long life: it can expand to 260MB of disk, 16 terminals, and 1MB of main memory. An entry level system, consisting of processor with 256KB of memory, IDS, 1MB floppy, and either Business BASIC or RPG, sells for \$36,500. Deliveries are scheduled to begin in January. HEWLETT-PACKARD CO., Palo Alto, Calif.

FOR DATA CIRCLE 365 ON READER CARD

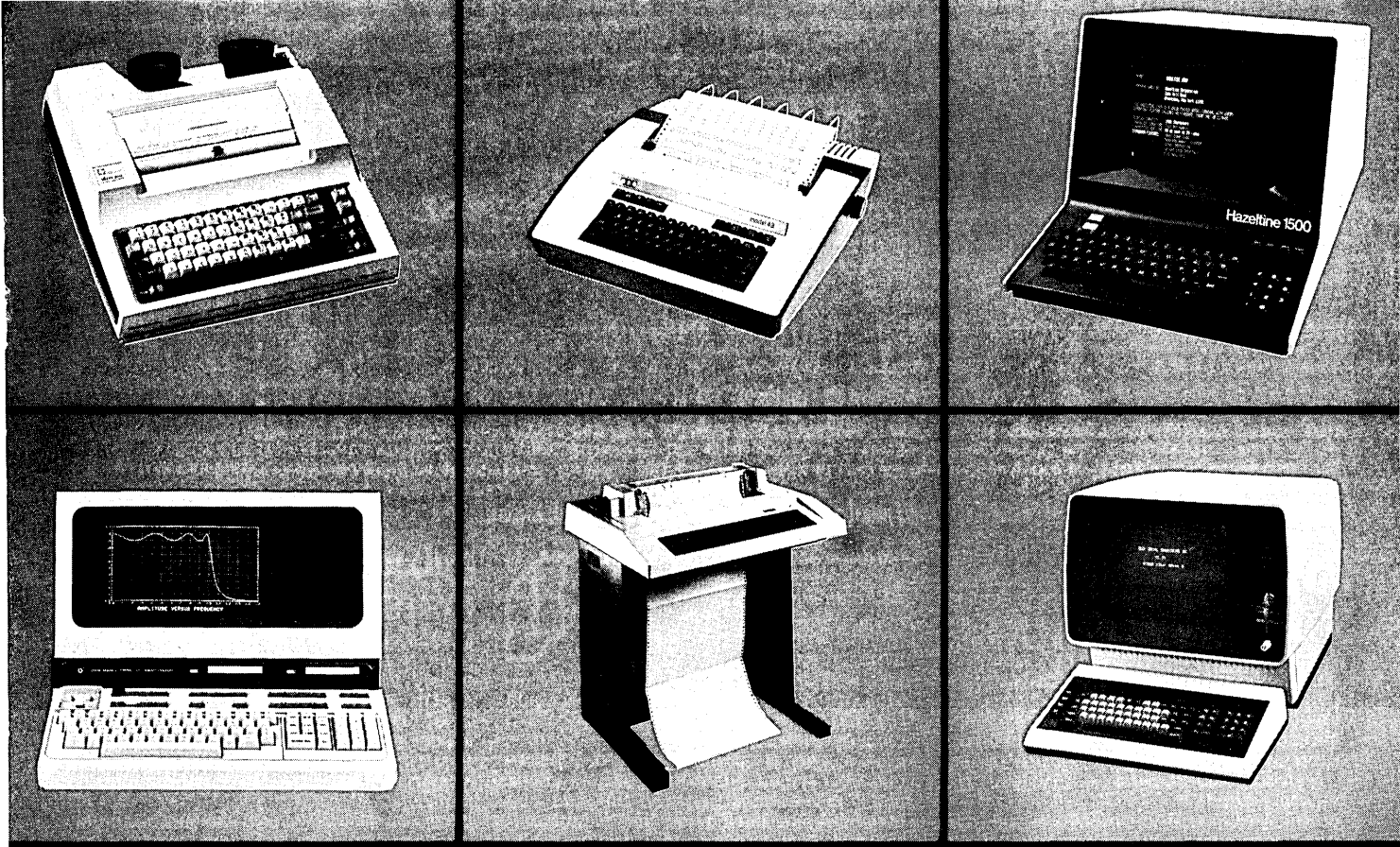

# Leasametric rents I/O terminals for all your short-term requirements.

## From a day to a decade.

Now you can rent the latest CRT terminals, teleprinters and protocol monitors by the day, week, month or longer. Choose the datacomm equipment you need from the world's largest and most diverse rental inventory of telecommunications equipment. Top manufacturers like Teletype, Texas Instruments, Lear Siegler, DEC, Hewlett-Packard, Diablo, GE and Hazeltine. We even stock the newest IBM 3270 plug-compatible units from Courier and Telex!

## Nationwide service facilities.

All equipment is inventoried and serviced by rental specialists at Leasametric's 24 regional Inventory Centers across the U.S. and Canada. There's one near you to guarantee quick turn-around during emergency situations.

In the event of a failure, we'll replace malfunctioning equipment with a fully-operational unit

within hours. You deal directly with Leasametric's applications engineers and technicians who are geared to respond to your emergency problems quickly and efficiently.

## Only one monthly charge.

When you rent from Leasametric you pay just one low monthly rate. There's no extra installation/take out fee, no add-ons, no monthly maintenance or repair costs. We take care of everything.

Call your nearest Leasametric Inventory Center today for immediate delivery of the latest CRT terminals, teleprinters and protocol monitors. Ask for your FREE EDP Equipment Rentals brochure outlining our many services and programs.



Division of Metric Resources Corporation  
1164 Triton Drive, Foster City, CA 94404

INVENTORY CENTERS: San Francisco, CA (415) 342-7111; Los Angeles, CA (213) 768-4200; Anaheim, CA (714) 634-9525; San Diego, CA (714) 565-7475; Houston, TX (713) 988-1000; Chicago, IL (312) 595-2700; Boston, MA (617) 272-6520; Midland Park, NJ (201) 444-0662; Long Island, NY (516) 293-5881; Washington, D.C. (301) 881-6700; Orlando, FL (305) 857-3500; Dayton, OH (513) 898-1707; Philadelphia, PA (215) 583-2000; Denver, CO (303) 429-7900; Minneapolis, MN (612) 854-3426; Dallas, TX (214) 661-9193; Atlanta, GA (404) 491-1155; Seattle, WA (206) 455-3080; Baltimore, MD (301) 444-5144; Kansas City, KS (816) 474-2280; Phoenix, AZ (602) 258-1225; Norfolk, VA (804) 627-4411; Toronto, Ontario (416) 676-1897; Syracuse, NY TBA.

**We've  
reduced digitizers to  
two words.**

**Bit Pad™  
Bit Pad™  
Bit Pad™  
Bit Pad™  
Bit Pad™**

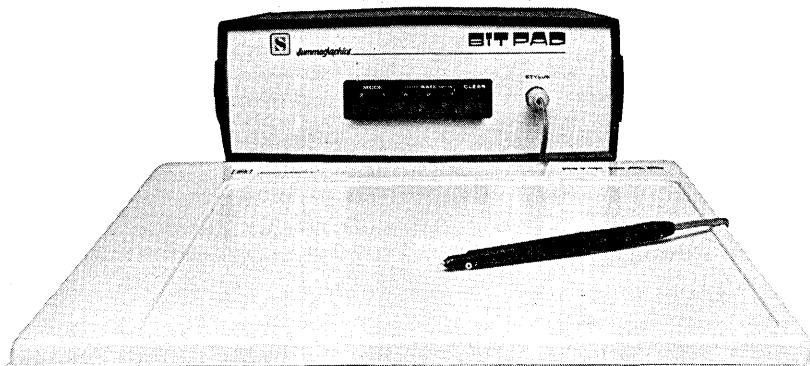

Bit Pad is the low-cost digitizer for small computer systems. Better than a joystick or keyboard for entering graphic information, it converts any point on a page, any distance into its digital equivalents. It's also a menu for data entry. You assign a value or an instruction to any location on the pad. At the touch of a stylus, it's entered into your system.

Who can use it? Anyone from the educator and the engineer to the hobbyist and the computer games enthusiast. The data structure is byte oriented for easy compatibility with small computers, so you can add a power supply, stand alone display, cross-hair cursor and many other options.

Bit Pad by Summagraphics. The leading manufacturer of data tablet digitizers. Bit Pad. The only words you need to say when considering digitizers.

**\$1,000 creativity prize.** Just write an article on an original Bit Pad application and submit it to any national small-computer periodical. If the editors publish it—and the decision is solely theirs—Summagraphics will pay you \$1,000.



**Summagraphics®**  
corporation

35 Brentwood Ave., Box 781, Fairfield, CT 06430  
Phone (203) 384-1344. TELEX 96-4348

**Dealer inquiries invited**

CIRCLE 131 ON READER CARD

## HARDWARE

ping. The single quantity price for an SDV11 is \$7,500, with deliveries quoted at 90 days. GENERAL ROBOTICS CORP., Hartford, Wisc.

FOR DATA CIRCLE 353 ON READER CARD

## MICRO DEVELOPMENT SYSTEM

The Straplex development system provides the hardware and software needed to develop 8080-based systems written in higher-level languages; assemblers are available for this vendor's Pace and 8060 microprocessors, with a Z-80 assembler reportedly in the works. The system includes a crt display, keyboard with special function keys, chassis with four slots available for user expansion, dual 256KB floppies, 50cps printer, 64KB of RAM, bootstrap and diagnostics in PROM, and



software. An In-Circuit Emulator and a PROM programmer are offered as options. Software includes a macro-assembler, FORTRAN, BASIC, an editor, and utilities. Those special function keys on the keyboard can be used to call up the language processors, editor, debugger, or other often-needed system software. A Straplex system, as described above, sells for \$13,800. Deliveries are scheduled to begin this month. NATIONAL SEMICONDUCTOR CORP., Santa Clara, Calif.

FOR DATA CIRCLE 361 ON READER CARD

## PORTABLE TERMINAL

The em-t5 is a 30-pound portable printing terminal compatible with IBM 3275 bisync communications. The unit in-

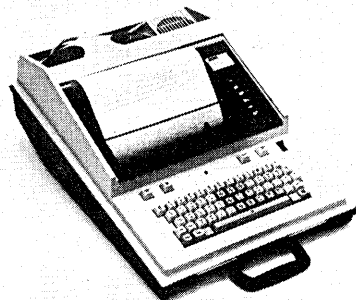

cludes a 2400bps modem and a bisync processor with 2KB of memory. The EBCDIC terminal simulates 3275 unformatted display mode and can be operated in poll/select mode. Intended for



# THE EXPANDED CONVERSATIONAL MICRO BEE 1 MAKES IT EASY!

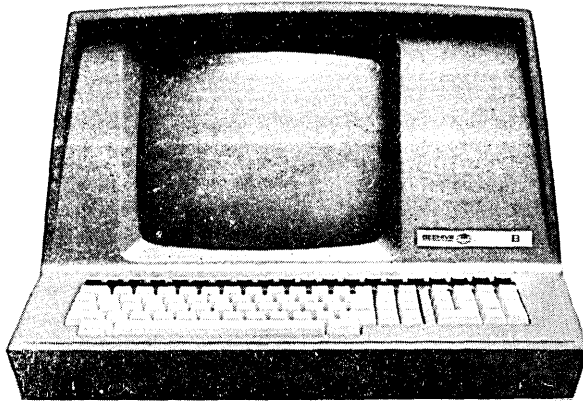

**EASY**  
to interface  
**EASY**  
to maintain  
**EASY**  
to operate  
**EASY**  
to buy!

## features

**Status Line**  
**Self Diagnostics**  
**Memory Lock**  
**Read Status**  
**Video Attributes**  
**Line Drawing**  
**128 ASCII Character Set**  
**14 Key Numeric Pad**  
**Time of Day Clock**

Beehive International's Micro Bee 1 is an 8085A microprocessor controlled terminal offering numerous user oriented features, such as self-diagnostics, which ensures at a glance that the terminal is operating correctly. The status line is used extensively by the Micro Bee 1 system firmware to display modes of operation, error messages, communication protocol data as well as a status message showing optional switch configurations.

Among the Micro Bee 1 features is the ability to evoke the memory lock condition that allows the operator or host computer to lock a portion of the display memory while retaining the capability to enter or receive data in the unlocked portion of the display memory. Sixteen non-displayable character cells are available on each line for establishing character and field attributes. Other visual features include normal, reverse, blink, underline and half intensity video levels. The line drawing graphics capability allows for the creation of forms on the display using the vertical and horizontal line feature.

The expanded characteristics of the Micro Bee 1 include X-Y

addressing, read cursor address, invisible memory address pointer, 128 ASCII characters set with descenders, 25 x 80 line format, and read terminal status.

## OPTIONS

- 20 milliamp current loop
- Twelve function keys, cursor control keys, auxiliary on/off keys plus a serial buffered bidirectional peripheral interface



**BEEHIVE**  
**INTERNATIONAL**

**USA:** 4910 Amelia Earhart Drive • Box 25668 • Salt Lake City, Utah 84125  
Phone (801) 355-6000 • TWX 910-925-5271

**EUROPE:** Schiphol Airport • Building 70 Schiphol East • Amsterdam, The Netherlands  
Phone 020-451522 • Telex 15284

**Now, the best batch terminal is distributed only by DDI.**

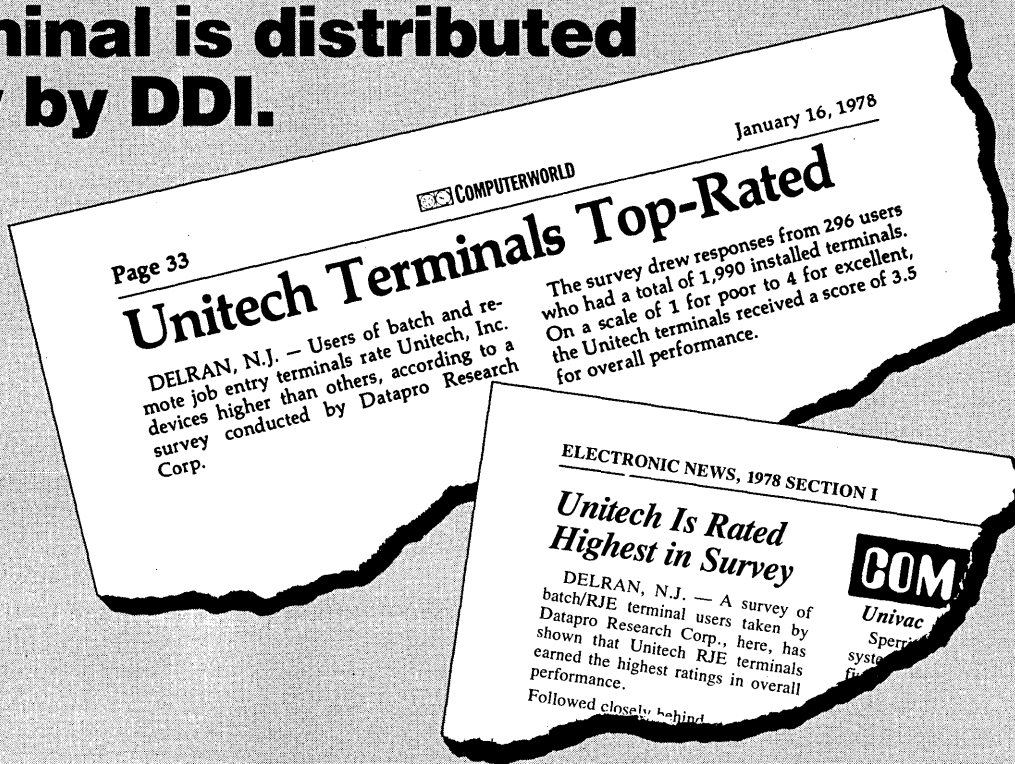

**And so is the best data entry system.**



DDI and Unitech have joined to provide you with a total product/service package that has no equal in meeting your present needs — and as you expand.

Among batch terminals, our Unitech UT-2 Programmable Batch Terminal has already earned the industry's highest performance rating from users. It provides ultra reliable hardware and powerful software...operating up to 9600 b.p.s. and compatible with IBM, UNIVAC, CDC and other host systems.

**THE EXCITING NEWS IN DATA ENTRY**  
Now, Unitech's new Data Entry Station Cluster (DESC) introduces expandability and versatility that promise even higher ratings from users.

DESC provides you up to four work stations with CRT's, up to eight floppy disc drives, an optional serial/line printer, and a programmable cluster controller. You can start with one work station, and expand as your needs grow without costly modification or replacement of equipment.

**YOU HAVE TOTAL CAPABILITY**

With DESC, you have the capability of doing off-line data preparation and data entry, remote job entry, and remote output report printing. What's more, DESC is user programmable in extended BASIC for a wide range of business applications.



Software allows synchronous or asynchronous communication at data rates up to 9600 b.p.s. with a variety of host systems and other terminals.

**YOU GET MORE FOR YOUR MONEY**

With DDI, you get the advantages of one-vendor service plus favorable pricing that assures maximum price/performance.

**FOR MORE FACTS**, call our nearest branch office. Or contact our home office: Data Dimensions, Inc., 51 Weaver St., Greenwich, Ct. 06830. Tel: (203) 661-1700.

**Data Dimensions, Inc.**

**America's leading terminal supplier.**

**BRANCH OFFICES:** New York City (212) 687-2030 • Morris Plains, N.J. (201) 267-2311 • Philadelphia (609) 662-2833 • Washington, D.C. (202) 686-5150 • Cincinnati (513) 769-0680 • Detroit (313) 358-2600 • Chicago (312) 858-3770 • Atlanta (404) 433-2023 • Dallas (214) 387-2222 • Houston (713) 961-4711 • Los Angeles (213) 990-9200 • San Francisco (415) 349-7262

CIRCLE 31 ON READER CARD

## HARDWARE

inquiry and response applications, the em-t5 also provides editing capabilities for data entry. The unit's dot-matrix thermal printer can run at 10cps or 30cps; a 256 character buffer (optionally 512 characters) allows data transmission at 2400-bps (half- or full-duplex). The em-t5 lists at \$5,000. Oem discounts are offered. Deliveries are quoted at 120 days. NCR CORP., Terminal Systems Div., Ithaca, N.Y.

FOR DATA CIRCLE 362 ON READER CARD

## DESKTOP COMPUTER

The PCC-2000, a desktop microcomputer system, will be sold through this vendor's nationwide network of more than 60 exclusive MITS dealerships. Consisting of an 8085-based cpu with 64KB of memory, dual 8½-inch double density floppies, 12-inch crt, and keyboard, the system is intended for commercial applications. Qume and Centronix printers are offered as options. Unlike other MITS computers, which use the widely accepted S-100 bus, the PCC-2000 has a newly designed bus dubbed the P-100.

Software for the PCC-2000 includes

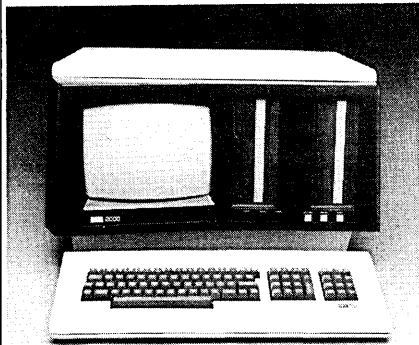

the vendor's Disk Extended BASIC Operating System, and applications packages for General Ledger, Accounts Payable, Accounts Receivable, Payroll, Inventory Management, and Word Processing. Applications programs will carry price tags in the \$1,000 range.

The final price a customer pays will be set by his local MITS dealer; the manufacturer says it should be less than \$13,000, including a printer. Marketing efforts are slated to commence at the beginning of next month. PERTEC COMPUTER CORP., Microsystems Div., Chatsworth, Calif.

FOR DATA CIRCLE 356 ON READER CARD

## PRINTER CONTROLLER

An extension to this vendor's line of PDP-11 interfaces allows DEC's recently announced VAX-11/780 to use line printers from Centronics, Dataproducts, Data 100, General Electric, and other manufacturers. The line printer controller has software compatibility with DEC diagnostics. The controller, with 15-foot cable, sells for \$650 to \$1,250, depending

## PDP-11, NOVA, Level 6, MDS 800/888, ZDS/MCZ Z80, EXORcisor, COSMAC

and other users... attend our free software seminars and find ideas they can put to work. Ideas about a new approach to programming — FORTH — a fully interactive stand alone disk base OS, a multi-level language with combined assembler, compiler and interpreters; an extensible dictionary using indirect threaded code; and much more. Results? Program development time cut 50 to 90%, memory requirements slashed 30 to 80%, run time optimized and applications that are transportable. We know this sounds farfetched. Let us prove it.

OK, sign me up for FORTH's free software seminar in:

- |  |  |
|--|--|
| <input type="checkbox"/> Anaheim, Oct. 5             | <input type="checkbox"/> Oakland, Oct. 18      |
| <input type="checkbox"/> Palo Alto, Oct. 19          | <input type="checkbox"/> Orlando, Oct. 31      |
| <input type="checkbox"/> San Fernando Valley, Nov. 9 | <input type="checkbox"/> Boston, Nov. 15       |
| <input type="checkbox"/> New York City, Nov. 16      | <input type="checkbox"/> Philadelphia, Nov. 17 |
| <input type="checkbox"/> Dallas, Dec. 14             | <input type="checkbox"/> Houston, Dec. 15      |
| <input type="checkbox"/> Other                       |  |

Send me more information on  miniFORTH  microFORTH  
 Application Programming Services

Name/Title \_\_\_\_\_

Firm \_\_\_\_\_ Phone (\_\_\_\_) \_\_\_\_\_

Address \_\_\_\_\_

City/State/Zip \_\_\_\_\_

Forth, Inc., 815 Manhattan Ave., Manhattan Beach, CA 90266. (213) 372-8493

**FORTH, Inc.**

D1078

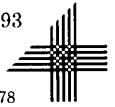

CIRCLE 105 ON READER CARD

## From the MAS-80 family of manufacturing systems...

# MAS II

## for Materials Management

Building or replacing a manufacturing system? Consider our MAS-80 family. And its newest member, MAS II.

The 20 MAS II systems include functions such as **Master Production Scheduling, Material Requirements Planning, Production Scheduling, and Shop Floor Reporting.** Plus maximum **Data Base** flexibility, and the independence to use the DBMS of your choice: IMS, TOTAL, ADABAS, IDMS and others.

To learn more about all 20 MAS II systems, just return the coupon for your free MAS II brochure.

**Martin Marietta Data Systems** We MDS Build & Run Systems

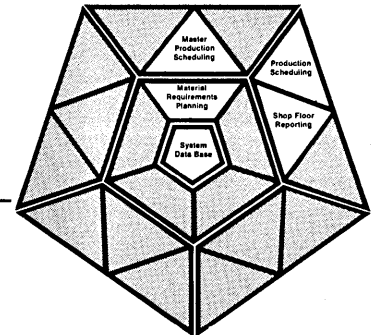

Dick Nemerson  
 Martin Marietta Data Systems  
 300 East Joppa Road  
 Baltimore, Maryland 21204

NAME \_\_\_\_\_

CO. \_\_\_\_\_

TITLE \_\_\_\_\_

PHONE ( ) \_\_\_\_\_

ADDRESS \_\_\_\_\_

CITY \_\_\_\_\_

STATE \_\_\_\_\_ ZIP \_\_\_\_\_

CIRCLE 124 ON READER CARD

# **DISTRIBUTED CONTROL.**

**How Honeywell  
can help you distribute  
your data processing,  
and still keep you  
in control.**

**I**t seems everybody is talking about distributed processing. That's understandable: the primary benefit—increased responsiveness to user needs—is an important objective.

But Honeywell is doing a lot more than just talking about distributed processing. Within our Distributed Systems Environment (DSE), we're doing something about it. We can help you with a distributed system—today.

### **We can do it right now.**

You can build a complete distributed system with standard, off-the-shelf, Honeywell Series 60 hardware and software. We offer full-line capability, from terminals, to satellite minicomputers, to network processors, to large-scale host processors. All demonstrable today.

### **Compatibility makes it possible.**

Our Series 60 host processors and satellite processors are designed for maximum compatibility. For example, the language, data base manager and transaction processor used by



our Level 6 minicomputers are subsets of host Level 66/DPS software. And our High-level Data Link Control (HDLC) protocol provides standard communications within DSE. A variety of other widely used protocols are also supported to provide compatibility with other vendor equipment.

### **The system you want.**

Modularity in both hardware and software allows you to install the right size system for today's needs, and easily modify or expand the system as your needs change or grow—without conversion, without application redesign, without hardware swapouts.

### **The control you want.**

Most likely you'll want your distributed system to reflect your company's unique structure and management style. We give you the control to make that possible. Flexibility within the Distributed Systems Environment lets you de-

termine the level of autonomy each satellite will have. You can let each satellite develop its own programs, allow it to use only host-generated programs, or you can mix the two. You can distribute or centralize application development according to your needs.

### **All with a single vendor.**

More than a decade ago, Honeywell pioneered the separation of network processing from information processing. That experience, plus our capabilities, gives you confidence as you approach distributed processing. Chances are, we can show you how to distribute your processing with greater ease, in less time, and at a lower cost.

For more information, call your local Honeywell representative. Or write Honeywell, 200 Smith Street (MS487), Waltham, Mass. 02154.

From the most complex computer systems to the simplest control devices, providing better ways to control your business has always been our business at Honeywell.

# Honeywell

## HARDWARE

on the printer interface required. MDB SYSTEMS, INC., Orange, Calif.

**FOR DATA CIRCLE 354 ON READER CARD**

### DISK MEDIA

The Mark V line of disk packs use a "particle-oriented disk" coating which is said to increase reliability and reduce head wear. Targeted for the minicomputer market, the disks are offered for front-load and top-load drives. A front-loading cartridge is available for Hewlett-Packard 7505 and similar drives; top-loading versions are available for drives from Datapoint, Wangco, Data General, and others. The cartridges are suitable for recording at up to 6060bpi and 200tpi. Prices begin at \$160. MEMOREX CORP., Santa Clara, Calif.

**FOR DATA CIRCLE 355 ON READER CARD**

### DIGITAL LINE TESTER

The TD-10 digital line tester can be used with ASCII or EBCDIC communications over asynchronous or bisynchronous lines running at speeds of up to 9600bps. It can be used as an intelligent monitor, front-end emulator, terminal emulator, or loop-back tester. Customer-selected parameters can be preprogrammed to simplify use. Two parameter sets, with a third optional set, can be selected by the customer. Each set of parameters includes data codes, formats, bit rates,

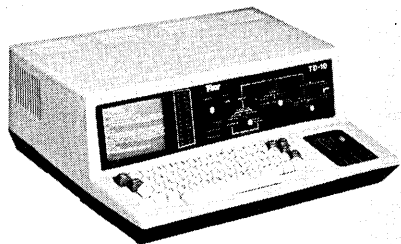

number of stop bits, sync character bit configuration, terminal response message, poll interval timing, and others. Optional protocols and character sets include SDLC, HDLC, IPARS, BAUDOT, BCD, and EBCD. The TD-10 can function as the central tester with one of this vendor's Multiple Access Switching Systems, or it can connect to communications equipment from other sources via the TD-10's RS232 interface. Base price on a TD-10 is \$9,000. T-BAR INC., Wilton, Conn.

**FOR DATA CIRCLE 351 ON READER CARD**

### COMPUTER

With its introduction, the 1800 Dispersed Processor becomes the smallest computer that can participate in this vendor's Attached Resource Computer systems. It also is the smallest unit capable of running the vendors entire range of software

products. The single-user 1800 sports 60KB of user memory, an 80-column by 24-line crt display, detachable keyboard, integral communications interface, and a dual-drive diskette module capable of storing 1MB on double density diskettes. As many as three more diskette modules can be added, and the 1800 is compatible with most of the vendor's existing line of peripherals. Software includes COBOL, BASIC, RPG, Dataform, and more; applications programs are offered in the form of the vendor's Dataccountant General Ledger, Payroll, and Professional Time Accounting packages. Both teletypewriter and standard IBM communications protocols are supported. ARC participation requires an additional interface. The 1800 sells for \$12,500, or leases for \$377 per month on a three-year contract. Maintenance is \$124 per month. DATAPOINT CORP., San Antonio, Texas.

**FOR DATA CIRCLE 364 ON READER CARD**

### CRT TERMINAL

The model 8038/UET can be used in place of Univac's Uniscope 100 or 200. The UET emulates Uniscope line protocol (synchronous and asynchronous) at data rates of up to 9600bps. External controllers are unnecessary, as the UET can plug directly into existing multiplexors or, via a modem eliminator, straight into the cpu. The terminal's 15-inch diagonal screen is organized as 24 lines of 80 characters. Keyboard features include 10 function keys, forward and backward tabs, and protected formats. An RS232 interface allows attachment of an auxiliary printer. The UET is base-priced at \$3,200. Deliveries are scheduled for 60 to 90 days ARO. OMRON ELECTRONICS, INC., Information Products Div., Sunnyvale, Calif.

**FOR DATA CIRCLE 363 ON READER CARD**

### INTELLIGENT TERMINALS

The 7500-series comprises intelligent terminals capable of standalone processing, data entry, and media conversion. The units can function independently, or communicating bisynchronously with other 7500-series terminals or computer systems. Optional peripherals common to all three include matrix printers (ranging from 50 lpm to 125 lpm), 800bpi or 1600bpi mag tape, cassette tape, and flexible disk storage. The 7510 programmable terminal with 40KB of memory, a single cassette tape drive, 9-inch crt, and keyboard sells for \$5,575; the vendor's BASIC+6 interpreter sells for \$800. The 7520 providing diskette-based data entry, and optional media conversion, starts at \$6,450. Media conversion between diskette and 800bpi mag tape adds \$15,000 to the price tag. The 7530 media conversion system (cassette to mag tape) starts at \$14,600; cas-

sette/floppy/800 bpi mag tape conversion is an extra \$16,900. The bisync communications option, common to all three models, increases the total price tag by \$1,150. Leasing plans and volume discounts are offered. NCR CORP., Dayton, Ohio.

**FOR DATA CIRCLE 384 ON READER CARD**

### PRINTER TERMINALS

Two matrix printing terminals, for use in this vendor's distributed processing systems, provide printing at 120cps, and synchronous communications rates of up to 4800bps. Both of the 132-column terminals use the vendor's VIP (Visual Information Projection) communica-

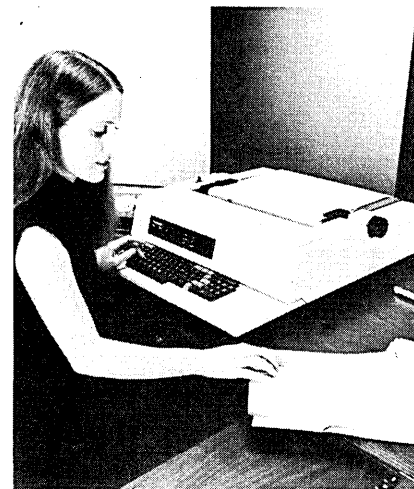

tions procedure, which allows poll and select operation, with as many as 32 of the new units multidropped on a single line. The receive only PRU1901 sells for \$4,000; the TWU1901 includes a typewriter-style keyboard and sells for \$4,500. HONEYWELL INC., U.S. Information Systems Group, Waltham, Mass.

**FOR DATA CIRCLE 385 ON READER CARD**

### TERMINAL CONCENTRATOR

The TC-3 concentrator works with DEC computers—PDP-11, DECSYSTEM-20, or VAX-11/780—and provides compatibility with software designed to work with DEC's DZ11. One local unit, which connects to the mini, can support either one or two remote units. The vendor says its SDLC-like protocol, combined with statistical multiplexing and data compression, will allow (in most applications) eight 1200bps asynchronous terminals to communicate with the host over one 2400bps synchronous line. Another configuration might link seven 2400bps terminals and one 300 lpm printer to the host via a 9600bps line. A typical configuration of a local unit, capable of running eight host asynchronous lines, and a remote unit, carries a price tag of \$5,200. COMDESIGN, INC., Goleta, Calif.

**FOR DATA CIRCLE 386 ON READER CARD**

# Each test takes us closer to absolute precision in magnetic media

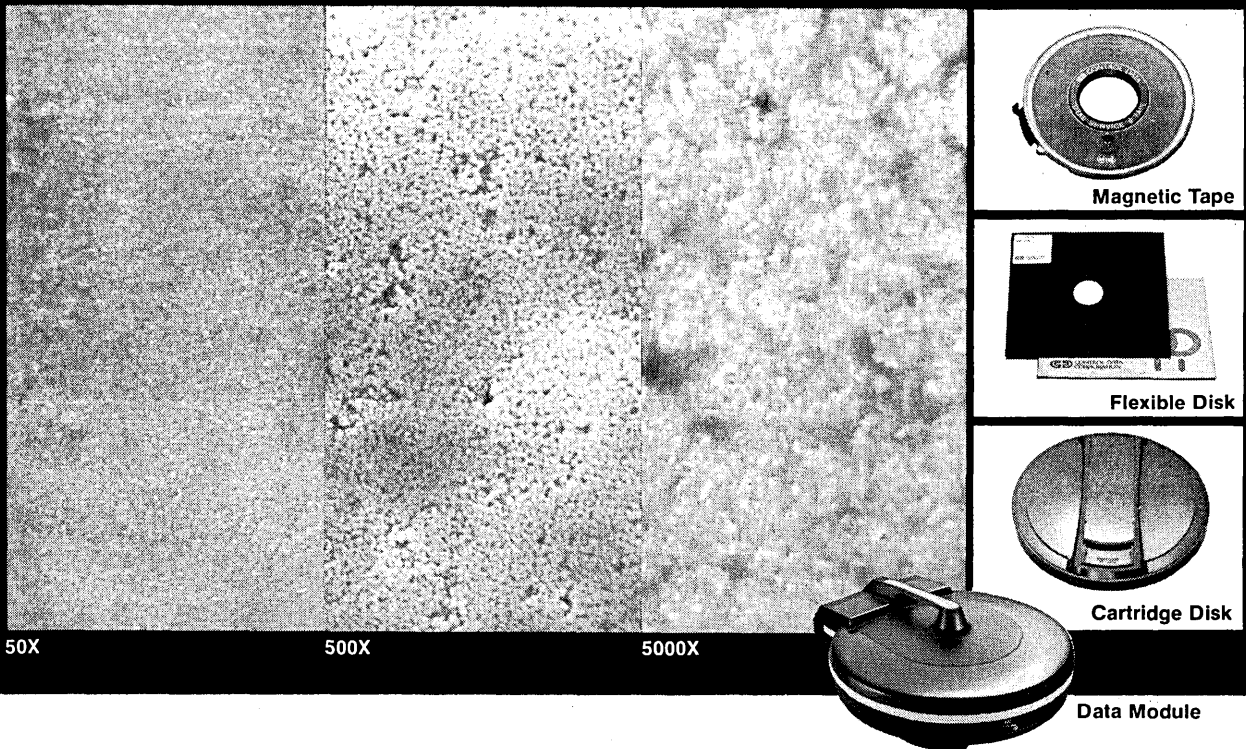

A close look at a section of disk through a scanning electron microscope taken at 50X, 500X and 5000X shows the magnetic oxide coating of the surface. The quality of the surface is of the utmost concern, because of the increasing requirement for higher densities.

Control Data has been responsible for many of the quantum jumps in information density. The higher densities and increased storage requirements of magnetic media demand absolute precision and unyielding quality control standards in their manufacture.

We supply disk packs and cartridges tested to tighter specs than industry standards... to help you prevent data loss. We even support each pack and cartridge with a unique warranty program.

We'd like to tell you more about our complete line of magnetic media. Call your local Control Data sales office. Or

send us the coupon below. We'll send you information on some of the improvements we've made. And how you can benefit from them.

Mr. W. B. Rodemann, Vice President D-108  
 Business Products Marketing  
 Control Data Corporation  
 P.O. Box 1980, Twin Cities Airport, MN 55111

Send me information on recent improvements in magnetic media.

Tell me more about:

Data Modules  Your Disk Packs for my \_\_\_\_\_ drive  
 Flexible Disks  Magnetic Tapes  Cartridge Disk

Name \_\_\_\_\_ Title \_\_\_\_\_

Company \_\_\_\_\_ Phone \_\_\_\_\_

Address \_\_\_\_\_

City \_\_\_\_\_ State \_\_\_\_\_ Zip \_\_\_\_\_

**GD** CONTROL DATA CORPORATION

**More than a computer company**

## HARDWARE

### WORD PROCESSING

The Wordplex/2 is a standalone word processing system featuring hardware and software compatibility with this vendor's larger shared logic systems. Hardware consists of a nine-inch diagonal crt, keyboard, dual minidiskette drives, and a Qume or Diablo daisywheel printer. Software allows manipulation of pages up to 128 characters wide and 128 lines deep. Since such a large page doesn't fit conveniently on a nine-inch screen, the operator can scroll up or down, and pan left or right; the screen can display 24

lines of 80 characters. Pricing will be set by the company's distributors, and "should be less than \$14,000," according to the company's marketing manager. WORDPLEX CORP., Westlake Village, Calif.

**FOR DATA CIRCLE 387 ON READER CARD**

### SERIES/1 DISK CONTROLLER

The MSC-1200 disk controller connects to an IBM Series/1 minicomputer through a single board, microprocessor-based adaptor which occupies one of the mini's I/O slots. The controller can handle up to

four industry-standard, storage module disk drives with capacities from 40MB to 300MB. Drives from Memorex, CalComp, Control Data, and others are supported. The controller is transparent to the mini, recognizing commands from software written for use with IBM's 4962 controller. Diagnostics are the exception, and the MSC-1200 gets around this



by including self-test firmware, initiated either manually or by a Series/1 program. An option provides an address translation function that allows emulation of up to 16 9.3MB 4962 drives. Scheduled for delivery by year's end, the MSC-1200 has a quantity price of \$6,890. MICROCOMPUTER SYSTEMS CORP., Sunnyvale, Calif.

**FOR DATA CIRCLE 388 ON READER CARD**

### MINICOMPUTER

It seems unlikely that the Data General engineers responsible for designing the Nova ever suspected just how popular that machine would become. Witness the raft of imitators: Keronix, DCC, and National Semiconductor, to mention a few. Now, Ampex is moving into the ersatz Nova market with a pair of processors compatible with Nova software and hardware. Its models 12 and 8 can handle up to 64K words of core or MOS memory and both feature pin-compatibility with existing Nova peripheral controllers. The model numbers come from the respective processor's cycle times: the model 12 cycles at 1200nsec, the model 8 at 800nsec. Three chassis are offered: a five slot 5¼-inch tall unit, a 13-slot 10½-inch tall package, and a 17-slot unit 22¼-inches tall. A 32-word model 12 sells for \$3,975 in quantities of 100 and is available for delivery within 120 days (evaluation units can be had sooner). The model 8 should be available by the end of this summer, tentatively priced the same as the model 12. AMPEX CORP., El Segundo, Calif. \*

**FOR DATA CIRCLE 389 ON READER CARD**

WE DESIGN FROM DC TO LIGHT!



RECEIVERS, ANALOG PROCESSING, SIGNAL GENERATION, MICROPROCESSORS, DIGITAL LOGIC, MODULATORS, TRANSMITTERS, MICROWAVE INTEGRATED CIRCUITS, COMPUTER PROGRAMS, EO/R... AND THE SYSTEMS ARCHITECTURE TO INTEGRATE THEM.

### **we design electronic countermeasures**

SYSTEMS OR DEVICES TO COUNTERACT ENEMY TARGET ACQUISITION BY ELECTRONIC SYSTEMS, USUALLY ACCOMPLISHED THROUGH JAMMING OR DECOYING TECHNIQUES.

### **technical and managerial challenges**

THE BREADTH OF TECHNICAL AND MANAGEMENT ACTIVITIES PURSUED BY OUR DIVISION SURPASSES THAT OF ANY OTHER COMPANY IN THE CHICAGO AREA: AS EVIDENCED BY THE INCREASED RESPONSIBILITIES BEING DIRECTED TO OUR TECHNICAL STAFF.

### **company growth, career advancement**

BY USING ELECTRONIC COUNTERMEASURES EQUIPMENT, SURVIVABILITY OF MAJOR PLATFORMS (AIRCRAFT, SHIPS, ETC.) IS INCREASED, AND DEFENSE DOLLARS ARE CONSERVED. THIS FACT AND OUR EXPERTISE HAVE LED TO A FANTASTIC GROWTH. WE HAVE DOUBLED IN THE PAST TWO YEARS, AND WE ARE PLANNING TO DO IT AGAIN. YOUR EXPERIENCE IN ANY OF THE ABOVE FIELDS CAN BE YOUR ENTRY TO GROW WITH US TECHNICALLY AND MANAGERIALLY. IF YOU ARE MULTI-DISCIPLINED AND/OR HAVE SYSTEM EXPERTISE, YOUR OPPORTUNITIES BECOME UNLIMITED.

**ADVANCE YOUR CAREER—  
SEND RESUME TODAY!**

MANAGER, EMPLOYMENT D10

NORTHROP CORPORATION  
DEFENSE SYSTEMS DIVISION

600 Hicks Road, Rolling Meadows, IL 60008

*Proudly An Equal Opportunity Employer (M/F/H)*

# NORTHROP

CIRCLE 165 ON READER CARD



# smart terminal for the price of dumb.

# \$580\*

*the new*

# CRT terminal

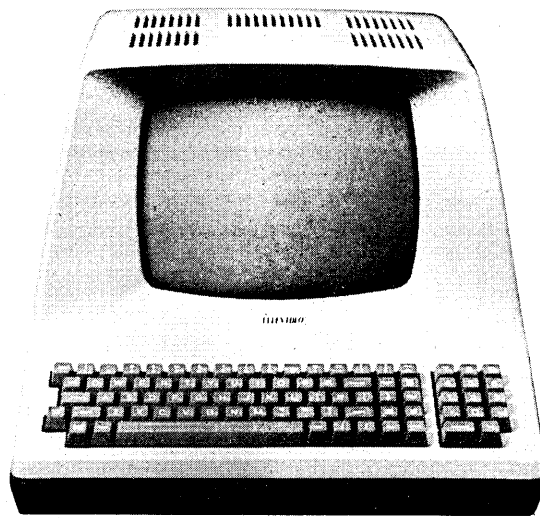

TVI™-912

**standard**

- Upper case and lower case
- 15 baud rates, 75 to 19,200 baud
- Dual intensity
- 24 x 80 Characters
- 12 x 10 Character resolution
- Numeric pad
- Programmable reversible video
- 80 storable tabs
- Character insert/delete
- Line insert/delete
- Self test mode
- Protect mode
- Block mode
- Tabbing
- Addressable cursor
- Microprocessor controlled
- Programmable underline

**optional**

- Printer port for hard copy
- Second page memory, 1920 characters
- 230 VAC ± 10%, 50 Hz

See us in booths 458 & 459 at Info 78  
McCormick Place, Chicago, Oct. 16-19



**TeleVideo, Inc.**

3190 Coronado Drive, Santa Clara, CA 95051  
(408) 246-5428 TWX 910 338-7633 "TVI VIDEO"

\*Qty: 100.

**Distributor Inquiries Invited.**



3190 Coronado Drive, Santa Clara, CA 95051  
(408) 246-5428 TWX 910 338-7633 "TVI VIDEO"

Name/Title \_\_\_\_\_  
Company \_\_\_\_\_  
Phone \_\_\_\_\_  
Address \_\_\_\_\_  
City \_\_\_\_\_ State \_\_\_\_\_ Zip \_\_\_\_\_

# SOFTWARE

## UPDATES

The name of the game is the Prisoner's Dilemma, though it has nothing to do with jails or incarceration. Robert Axelrod, an associate professor at the Univ. of Michigan, is running a computerized Prisoner's Dilemma tournament as part of a research project. It's a two player game where the contestants aren't in total conflict. At each turn both players have the option of either cooperating or defecting. If both cooperate, each gets one point. But if one cooperates while the other defects, the defector gets five points to the "sucker's" zero. The games will be played for an average of 200 moves; the tournament winner will have the highest total over all games. To enter (no money is involved) send Axelrod a FORTRAN or BASIC program which plays your strategy. All entrants will get a report on the results of the tournament, and the winner gets a trophy. Further details are available from Axelrod at the Institute of Public Policy Studies, Univ. of Michigan, 506 E. Liberty St., Ann Arbor, MI 48104.

The Consumer Computer Group of GRT has lined up a couple of "stars" for its personal computer software publishing venture. Software for the SWTPC 6800 and Processor Technology SOL on the G/2 label will include BASIC interpreters developed by Microsoft of Albuquerque, New Mexico. These tapes will sell for less than \$40. Softape of Burbank, California, will provide home entertainment packages retailing at \$14.95.

"For years we have taken steps to protect our data files by copyright, but have never had occasion to enforce those rights before," commented Ray Westphal, v.p. of Vertex Systems, Inc. The occasion was an alleged infringement of Vertex's copyright on a file of sales and use taxes. According to Vertex, A.V. Products of Wakefield, Mass., acknowledged the copyright violation, and agreed to discontinue the offending product, SUTAX (April, p. 228), which used the file.

## QUERY LANGUAGE/REPORT WRITER

From the people who brought you the SEED data base management system (August 1977, p. 162), now comes Harvest, a query language and report writer. Using English-like commands, the user can locate and display desired data. A "where" condition allows selection of data meeting specific criteria. Items referenced in a request need not be in the same record; Harvest performs all necessary navigation through SEED's CODASYL-like data base. Users can write functions in FORTRAN for performing complicated data manipulation, and these functions can link with Harvest, adding new capabilities. Harvest also can generate reports from free form report definitions. Detail lines can be sorted on as many as 15 keys simultaneously, and page headings, footings, and up to 15 control breaks can be used. Harvest, which consists of roughly 150KB of code, will initially be offered to DECsystem 10 and IBM 370 users. Conversion to other machines will be made as interest warrants. It is offered for \$6,500 on a paid up lease, or \$275 per month rental. INTERNATIONAL DATA BASE SYSTEMS, INC., Philadelphia, Penn.

FOR DATA CIRCLE 373 ON READER CARD

## FORTRAN

FORTRAN VII, for this vendor's 32-bit processors, is a globally optimizing compiler which implements most of the ANS FORTRAN-77 language specification. It also includes ISA FORTRAN extensions for industrial processing and control, and real-time extensions.

During program development, a high-speed nonoptimizing processor generates object code at an average rate of 2,000 source statements per minute. After the program is developed and debugged, it can be sent through the compiler for selective or full-blown global optimization. The vendor feels it safe to say that optimized code will run on an average twice as fast as code from its earlier FORTRAN VI compiler. (An example given to us showed a fourfold increase in execution speed, increasing to roughly 12-times as fast with use of an optional firmware enhancement.) The compiler optimizes in a number of machine-inde-

pendent and machine-dependent ways. Machine-independent techniques include constant computations and propagation, type conversions, and symbolic arithmetic. Machine-dependent methods include register allocation and choosing the best machine instruction to use in code generation. Safety features ensure that code altered for optimization produces the same results as the code written by the programmer. FORTRAN VII sells for \$5,000; the FORTRAN enhancement (which also works with FORTRAN VI) is \$6,000. The compiler needs at least 384KB of memory; 512KB is recommended. PERKIN-ELMER, Interdata Div., Oceanport, N.J.

FOR DATA CIRCLE 371 ON READER CARD

## GRAPHICS

The Terminal Independent Graphics System (TIGS) provides a means for generating graphic displays that can be output on virtually any terminal the user desires. TIGS, which runs on the vendor's Cyber 70, 170, and 6000-series, consists of three basic parts: a preprocessor for generating displays, a neutral display file where the preprocessor output is held, and a postprocessor which takes the terminal independent output of the preprocessor and translates it into device-dependent commands for a specific terminal. The postprocessor allows TIGS to work with alphanumeric terminals with limited graphics, storage tubes, raster scan devices, refresh graphics terminals, and color displays. To add support for a given terminal, only a postprocessor need be written. TIGS may be purchased for \$13,300, plus a \$500 initial fee. It can be leased for \$320 per month, plus initial fee. A Central Enhancement and Maintenance Service is optional for \$200 per month. CONTROL DATA CORP., Minneapolis, Minn.

FOR DATA CIRCLE 372 ON READER CARD

## MICROCOMPUTER BASIC

This vendor's business BASIC (which runs only on the vendor's 6512-based microcomputers) offers several interesting features not commonly seen in BASICS. String functions include the removal of leading and trailing spaces, as well as substring functions and matching. Variable

# IMS and TOTAL USERS

## YOUR DATA BASE

## &

## ASI-ST

## GO TOGETHER

More IMS and TOTAL installations have chosen the ASI-ST Data Management and Reporting System to implement data base applications than any other product. ASI-ST's dominance in data base environments is easily explained:

- Operates under all IBM 360/370 versions of DOS, DOS/VS, OS and OS/VS.
- Fully supports all TOTAL, IMS and DL/1 features including TOTAL 7 and secondary indexing under IMS/VS.
- Permits creating and updating TOTAL and IMS data bases as well as retrieval.
- Allows concurrent processing of conventional data files with IMS or TOTAL data bases.
- Supported in both batch and on-line environments.

IMS users such as *American Airlines, Dow Chemical, TWA, American Can, The Hartford, Union Carbide;* and TOTAL users like *Combustion Engineering, Northwestern Mutual Life, Anheuser-Busch, Corning Glass Works, Eli Lilly and Holiday Inns* are a few who agree ASI-ST and data base belong together. In addition, ASI-ST provides an unequalled return on investment by maximizing the productivity of both man and machine. Since ASI-ST fully supports conventional data files as well as complex data bases, these benefits are not restricted to IMS and TOTAL users. To obtain more information contact:



The Software Manufacturer

APPLICATIONS SOFTWARE, INC.

Corporate Offices

21515 Hawthorne Boulevard

Torrance, California 90503

(213) 542-4381

- DESIGN ENGINEERS
- PROGRAMMERS/SYSTEMS ANALYSTS

# You'll have a far larger role in financial terminals development with NCR/Dayton.

No other company is as solidly in the vanguard of financial terminals development as NCR. It was terminals that launched us as a major, total systems computer company, and we mean to dominate this high growth field. Our new generation of intelligent POS terminals, modular terminal-networks and firmware/software systems will help us do precisely that.



## A distinctly different environment

In our Dayton operations we have small teams with big responsibilities. Nobody is isolated or has a limited role on a single product or single function at NCR. We offer you a breadth of involvement that is both mind-stretching and career-enhancing.

As a Design Engineer you'll be at the heart of advanced microprocessor applications, distributed data processing, networking and data communications. As a Programmer/Systems Analyst you'll have total systems involvement and will see your contributions as an integral part of a working, state-of-the-art system.

# NCR

Complete Computer Systems

An Equal Opportunity Employer

## DESIGN ENGINEERS

- Microprocessor Applications
- Digital and Analog Circuits
- Electrical Control Circuitry
- Terminal Peripherals

*Familiarity with microprocessor programming helpful for all positions.*

## PROGRAMMERS/ANALYSTS

- Microcomputers
- Minicomputers
- Operating Systems
- Distributed Processing Systems
- Communications Software

*Requires background in Assembly and COBOL languages.*

We offer an outstanding compensation and benefits package, wide open career paths, and a location that offers friendly, lower-cost midwestern living at its very best.

Please send resume and current salary requirements promptly to: Mrs. Judith E. Chorazewitz, Engineering & Manufacturing-Dayton, Employment Dept. K-65, NCR Corporation, Dayton, Ohio, 45479.

## SOFTWARE

names can be as long as 80 characters. Output functions include those for screen formatting. But what seems unique is the interpreter's implementation of arrays. Arrays are dynamically allocated and different data types may be intermixed in the same array, much like a record construct. Thus an array can contain a customer ID number, customer name, a vector of back-ordered items, and a Boolean value indicating if the customer is behind in his payments. The interpreter is supplied at no cost to purchasers of the vendor's systems (32KB or larger), or for a \$10 distribution fee to existing installations. ECD CORP., Cambridge, Mass.

FOR DATA CIRCLE 368 ON READER CARD

## MICRO CROSS-ASSEMBLER

Written in ANSI FORTRAN, this cross-assembler for the M6800-series of microprocessors handles the ten new instructions for the 6801, allowing assembly of programs for the 6800, 6801, and 6802. It uses Motorola's mnemonics and pseudo-ops, and can prepare object code in absolute MIKBUG format or linkable code for use with this vendor's cross-linker or PL/W compiler. The source code for the cross-assembler sells for \$800 on magnetic tape. WINTEK CORP., Lafayette, Ind.

FOR DATA CIRCLE 369 ON READER CARD

## MULTILINGUAL WORD PROCESSING

Available for all of this vendor's word processing systems, the multilingual support package allows simultaneous preparation of documents in English, French, Spanish, and German. The package supports special characters unique to a given language, and dead keys for accents. The basic software to support multilingual operation is priced at \$1,000. Multilingual keyboards go for \$150 each, and multilingual printwheels are priced at \$75. WANG LABORATORIES, INC., Lowell, Mass.

FOR DATA CIRCLE 370 ON READER CARD

## ON-LINE INQUIRY

The Management Reporting System (MRS) provides an on-line inquiry facility to users of CICS and DL/I. An operator, without knowledge of either CICS or DL/I, can use the MRS inquiry language to extract selected data from a DL/I data base. Inquiries are sent from MRS to DL/I for processing, and the results are queued for later display at any terminal in the system. MRS requires no changes to the operating system of DL/I; some CICS control tables will need to be modified. MRS is offered for a permanent license fee of \$4,990. INFOPAC ASSOCIATES, INC., Lynbrook, N.Y.

FOR DATA CIRCLE 374 ON READER CARD

## MEDICAL BILLING

Designed for use inhouse by medical groups or clinics, or as a service center operation, this patient billing and insurance form preparation package runs on Datapoint 5500 or 6600 systems. The package builds patient master files and transaction history files, and each doctor, dentist, or clinic has a profile file, specifying system options such as account retention, statement and insurance form preparation, and delinquency control. Users create files and select reports from a video display using a menu technique. Reports include account aging, collection reports, recall notices, financial analysis summaries, and insurance forms. Claims forms for Medicare, Medicaid, and private carriers are produced on a daily basis. The software, written in RPG-II and Databus, sells for \$12,600. The vendor also offers complete turnkey systems. OCCIDENTAL COMPUTER SYSTEMS, INC., North Hollywood, Calif.

FOR DATA CIRCLE 390 ON READER CARD

## 3705 SOFTWARE

The Virtual Line Switch (VLSW) works with IBM's 3705 Partitioned Emulator Program (PEP), allows operators of asynchronous terminals to selectively connect

to either Network Control Program (NCP) or EP host applications over the same switched or leased communications

## SOFTWARE SPOTLIGHT

### DESIGN METHODOLOGY

Data Conveyor, this vendor's proprietary software design methodology, is based on the premise that office paper work, like automobiles, can be efficiently handled on an assembly line. The Data Conveyor models the paper flow implicit in an application, and an interpretive language, IAL, defines the operations needed at each point along the line. These processing steps may be rigidly defined or left for the most part in the hands of an operator.

Programming the Data Conveyor has been implemented as another piece of paper work. The system conducts a structured dialog with the user, and generates specifications, known as prescripts, for the interpreter.

Although the Data Conveyor is general in concept, its implementation is, of necessity, industry specific. The interpreter consists of many modules that handle problems encountered in a given business environment. Currently, the package is offered to the insurance

link. A speed select feature allows changing data rates, effectively replacing the NCP Multiterminal Access (MTA)

industry. We're told that it's up and running at one of the largest insurance companies in the country. A quote system, including fire, business income, general liability, glass, and four parts of crime, licenses for \$125,000 plus 20% annual maintenance and license. Custom implementation for an insurance system is quoted at six months.

The vendor says it will customize the Data Conveyor to other industries as interest warrants. Prime candidates would be commercial loans, or transportation systems.

The system currently runs on DECsystem 10s and Texas Instruments 990/10 systems with a basic memory requirement of 80KB. Each terminal needs 10KB to 20KB, depending on its use. And, of course, enough disk space must be available for the data base. The system is transportable to other computers; this requires rewriting about 15KB worth of machine dependent assembler. DATA CONCEPTS, INC., Waltham, Mass.

FOR DATA CIRCLE 375 ON READER CARD

## TERMINALS FROM TRANSNET

**PURCHASE  
12-24 MONTH FULL OWNERSHIP PLAN  
36 MONTH LEASE PLAN**

DESCRIPTION	PURCHASE PRICE	PER MONTH		
		12 MOS.	24 MOS.	36 MOS.
DECwriter II .....	\$1,495	\$145	\$ 75	\$ 52
DECwriter III .....	2,695	257	137	95
DECprinter I .....	1,795	172	92	63
VT52 DECscope .....	1,695	162	85	59
VT100 DECscope .....	1,695	162	85	59
VT55 DECgraphic CRT	2,395	229	122	84
ADM 3A CRT .....	875	84	45	30
HAZELTINE 1400 CRT ..	845	81	43	30
HAZELTINE 1500 CRT ..	1,195	115	61	42
TI 745 Portable .....	1,875	175	94	65
TI 765 Bubble Mem. ...	2,995	285	152	99
TI 810 RO Printer .....	1,895	181	97	66
TI 820 KSR Terminal ..	2,395	229	122	84
Data Products 2230 ...	7,900	725	395	275
QUME, Ltr. Qual. KSR ..	3,195	306	163	112
QUME, Ltr. Qual. RO ..	2,795	268	143	98
DATAMATE Mini floppy	1,750	167	89	61

FULL OWNERSHIP AFTER 12 OR 24 MONTHS  
10% PURCHASE OPTION AFTER 36 MONTHS

### ACCESSORIES AND PERIPHERAL EQUIPMENT

ACOUSTIC COUPLERS • MODEMS • THERMAL PAPER RIBBONS • INTERFACE MODULES • FLOPPY DISK UNITS

### PROMPT DELIVERY • EFFICIENT SERVICE



**TRANSNET CORPORATION**  
2005 ROUTE 22, UNION, N.J. 07083  
**201-688-7800**

CIRCLE 140 ON READER CARD



**U.S. ROBOTICS  
SERIES-300 MODEMS**

300 BAUD  
103/113 COMPATIBLE  
ACOUSTIC/HARDWARE VERSIONS  
ORIGINATE/ANSWER VERSIONS



**TELETYPE  
MODEL 43**

10 OR 30 CHAR/SEC  
132 COLUMNS  
UPPER/LOWER CASE

U.S. Robotics now combines the price/performance leader in 300 Baud Modems with the price/performance leader in hardcopy terminals to bring you teleprinter capability at incredible package prices.

USR-310 Originate Acoustic Coupler + Teletype Model 43 KSR = \$1195

USR-330 Originate/Auto-Answer FCC Certified Modem + Teletype Model 43 KSR = \$1365

USR-320 Auto-Answer FCC Certified Modem + Teletype Model 43 RO = \$1215

Stand alone modems and teletype available:

Teletype 43 KSR with RS232C ..... \$ 1095

USR-310 Originate Acoustic Coupler (Operates with any standard telephone) ..... \$139

	Direct <sup>1</sup>	Telco <sup>2</sup>
	Connect	DAA
	Style	Style
USR-330 Originate/Auto-Answer Modem .....	\$324	\$185
USR-320 Auto-Answer Modem .....	\$299	\$160

(\*F.C.C. Certified Package. Connection to phone lines via standard extension phone jack.)

(<sup>2</sup>Connection to phone lines via CBS-1001F DAA which can be leased from phone company for approximately \$5.00/mo. plus installation fee.)

Interfaces for stand alone modems:

USR-310 — RS232C only

USR-320 and USR-330 — RS232C and 20 ma.

(Specify with order. If both interfaces are required, add \$10 to unit price.)

All products include a 90 day warranty and optional annual maintenance package. Add 1% shipping and handling in the continental U.S.

Illinois residents add 5% Sales Tax.

**U.S. ROBOTICS, INC.**  
2440 N. Lincoln/Chicago, IL 60614/(312) 528-9045

CIRCLE 144 ON READER CARD

## SOFTWARE

facility. This allows ASCII teletypewriters and IBM 2741 terminals, operating at 10cps, 15cps, 30cps, and 120cps, to share the same communications line. The combination of speed select and line switching let a single telephone rotary support all asynchronous lines. After an operator establishes a phone link, but before any communication with the host, the operator enters a single character to select device type and speed, and another character specifying the particular NCP and EP host application desired. VLSW operates as an extension to this vendor's Network Facilities Package. The package leases for \$475 per month. COMM-PRO ASSOCIATES, Manhattan Beach, Calif.

FOR DATA CIRCLE 391 ON READER CARD

### ASSEMBLER PREPROCESSOR

SAL-11 (Structured Assembly Language) is a Macro-11 preprocessor which runs under RT-11 on DEC's LSI-11 and PDP-11 minis. It is said to aid in the use of structured programming techniques, providing a mid-level language for applications and systems programming. Control structures provided include case statements, iterative execution, conditional execution, program block definition and environment setup. It provides a standardized interface between

FORTRAN and Macro-11 programs, and gives the user facilities for writing recursive and reentrant modules. Stack and string manipulation constructs are included. The package's binary license fee is \$515. GEJAC, INC., Hyattsville, Maryland.

FOR DATA CIRCLE 392 ON READER CARD

### ELEMENTARY MATH CAI

The Elementary Mathematics Installed User Program provides computer assisted instruction (CAI) in basic concepts including whole numbers, fractions, decimals, ratios, proportion, percent, and problem solving. It allows teachers to tailor their instructions to each student by providing inventories of student proficiency, and letting the teacher prescribe lessons and practice as needed. Intended primarily for upper elementary and middle school students, the package can be used with older students having trouble in math.

The package, developed at the Univ. of Akron's CAI Center, uses a four-step strategy of instruction. For each objective (translated from educationese, that means a measurable goal) the student completes a pretest, tutorial session, drill session, and puzzle. The puzzles often require inductive reasoning of the student during the problem solving phase.

The Elementary Mathematics

package runs on any 370 running the Interactive Instructional or Coursewriter III system. A monthly fee of \$290 is charged for the first 24 months, after which charges are waived. INTERNATIONAL BUSINESS MACHINES CORP., White Plains, N.Y.

FOR DATA CIRCLE 393 ON READER CARD

### NOVA TAPE UTILITIES

The Nova Tape Utility Programs (NTUP) allow the use of IBM 360 compatible mag tapes. Written in FORTRAN and assembler, NTUP provides several reformatting and conversion capabilities. A card-to-tape routine, CTT, reads card images from a card-reader or disk and writes an unlabeled EBCDIC 10x80 output tape. Tape to disk conversions are handled by TPDSK. It reads EBCDIC tapes with 80-character records (and any blocking factor up to 51), writing a card-image file to either disk or a printer. A tape dump utility, TAPED, reads and prints tape files. The user can specify either ASCII or EBCDIC codes, record length (up to 60 words), tape drive, and a title for page heading. Subroutines are included for converting between ASCII and EBCDIC. The NTUP package, on cards, sells for \$150, including user's manual. HSC COMPUTER SERVICES, LTD., Brooklyn, N.Y.

FOR DATA CIRCLE 394 ON READER CARD

## ★ FAST DELIVERY

Call Today... Use It Tomorrow!

## ★ FLEXIBLE TERMS

Month-to-Month after 3 Months!

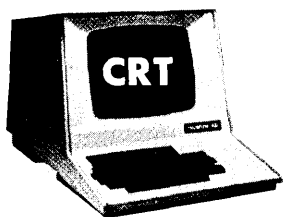

DEC: VT50,  
HAZELTINE: 1000, 1200,  
1400, 2000, 3000, CASSETTE  
LEAR SIEGLER: ADM-3A

FULL LINE OF MODEMS  
& COUPLERS AVAILABLE

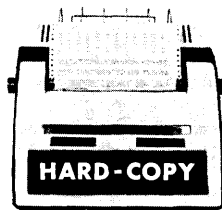

DECWRITER: LA36, LS120  
CENTRONICS: 101A, 102A, 103  
OLIVETTI: TC480 w/ PAPER  
TAPE & CASSETTE OPTIONS  
HAZELTINE: THERMAL PRINTER  
TELETYPE: 43 TELEPRINTER  
ASR/KSR 33-35-37

DEPENDABLE SERVICE for 11 YEARS  
to 5500 CUSTOMERS WORLDWIDE

GET YOUR QUESTIONS ANSWERED • CALL  
**AMERICAN TERMINAL LEASING • 617-261-1100**  
P.O. BOX 68, KENMORE STATION, BOSTON, MASS. 02215

CIRCLE 101 ON READER CARD

## DON'T BUY UPS!

(UNLESS YOU NEED IT)

Many in-depth power studies indicate a rotary filter will provide a more cost-effective solution than a UPS. Call PSC for information on how to conduct a low-cost power study and our **Series RF Computer Power System**

### SERIES RF

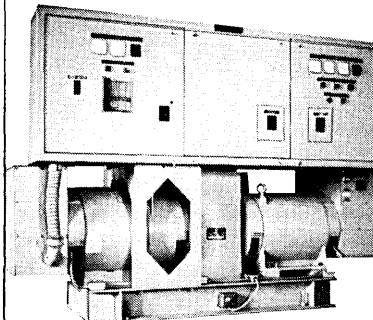

- Precise voltage regulation— $\pm 1\%$
- Total isolation from utility transients
- Ride-thru for 90% of utility disturbances
- Economically expandable to a UPS
- Single modules from 50-1200 KVA

COMPARED TO A UPS  
THE SERIES RF OFFERS

- Less cost (40% of a UPS)
- Easier installation
- Less space
- Less maintenance
- Higher efficiency
- Greater reliability

CALL MAYO TABB OR MIKE DAMERON, (804) 355-2803



**POWER SYSTEMS  
& CONTROLS, INC**

P. O. BOX 27306 • RICHMOND, VIRGINIA 23261

CIRCLE 126 ON READER CARD

*This announcement is neither an offer to sell nor a solicitation of an offer to buy these securities.  
The offer is made only by the Prospectus.*

1,269,536 Shares

# Memorex Corporation

Common Stock

---

Price \$50<sup>3</sup>/<sub>4</sub> Per Share

---

*Copies of the Prospectus may be obtained in any State only from such of the several Underwriters, including the undersigned, as may lawfully offer the securities in such State.*

Lehman Brothers Kuhn Loeb  
Incorporated

Blyth Eastman Dillon & Co.  
Incorporated

Bache Halsey Stuart Shields  
Incorporated

The First Boston Corporation

Dillon, Read & Co. Inc.

Donaldson, Lufkin & Jenrette  
Securities Corporation

Drexel Burnham Lambert  
Incorporated

Goldman, Sachs & Co.

E. F. Hutton & Company Inc.

Kidder, Peabody & Co.  
Incorporated

Lazard Frères & Co.

Loeb Rhoades, Hornblower & Co.

Paine, Webber, Jackson & Curtis  
Incorporated

Salomon Brothers

Smith Barney, Harris Upham & Co.  
Incorporated

Warburg Paribas Becker  
Incorporated

Wertheim & Co., Inc.

Dean Witter Reynolds Inc.

Bear, Stearns & Co.

L. F. Rothschild, Unterberg, Towbin

Shearson Hayden Stone Inc.

August 10, 1978

# Introducing the



STANDARD FEATURES	INFOTON 100	LSI ADM3A	HAZELTINE 1400	HAZELTINE 1500	DEC VT52	P&E FOX	BEEHIVE B-150
Z-80 MICROPROCESSOR BASED	✓						
UPPER/LOWER CASE	✓	✓		✓	✓	✓	✓
NUMERIC PAD	✓			✓	✓		✓
32 CHARACTER LINE DRAWING SET	✓						
CURSOR CONTROL CLUSTER	✓				✓		✓
READ CURSOR ADDRESS	✓		✓	✓			
DUAL INTENSITY	✓			✓			
REVERSE VIDEO	✓			✓			
COLUMNAR TAB SET	✓					✓	
SPACE OVER DATA MODE	✓	✓					
INSERT/DELETE LINE KEYS	✓						✓
25TH STATUS LINE	✓						
ADDRESSABLE PRINTER PORT	✓						
LIST PRICE	\$849	\$895	\$850	\$1,225	\$2,310	\$1,440	\$1,595

Source: DataPro Research Corp. and vendor brochures.



# new Infoton 100.

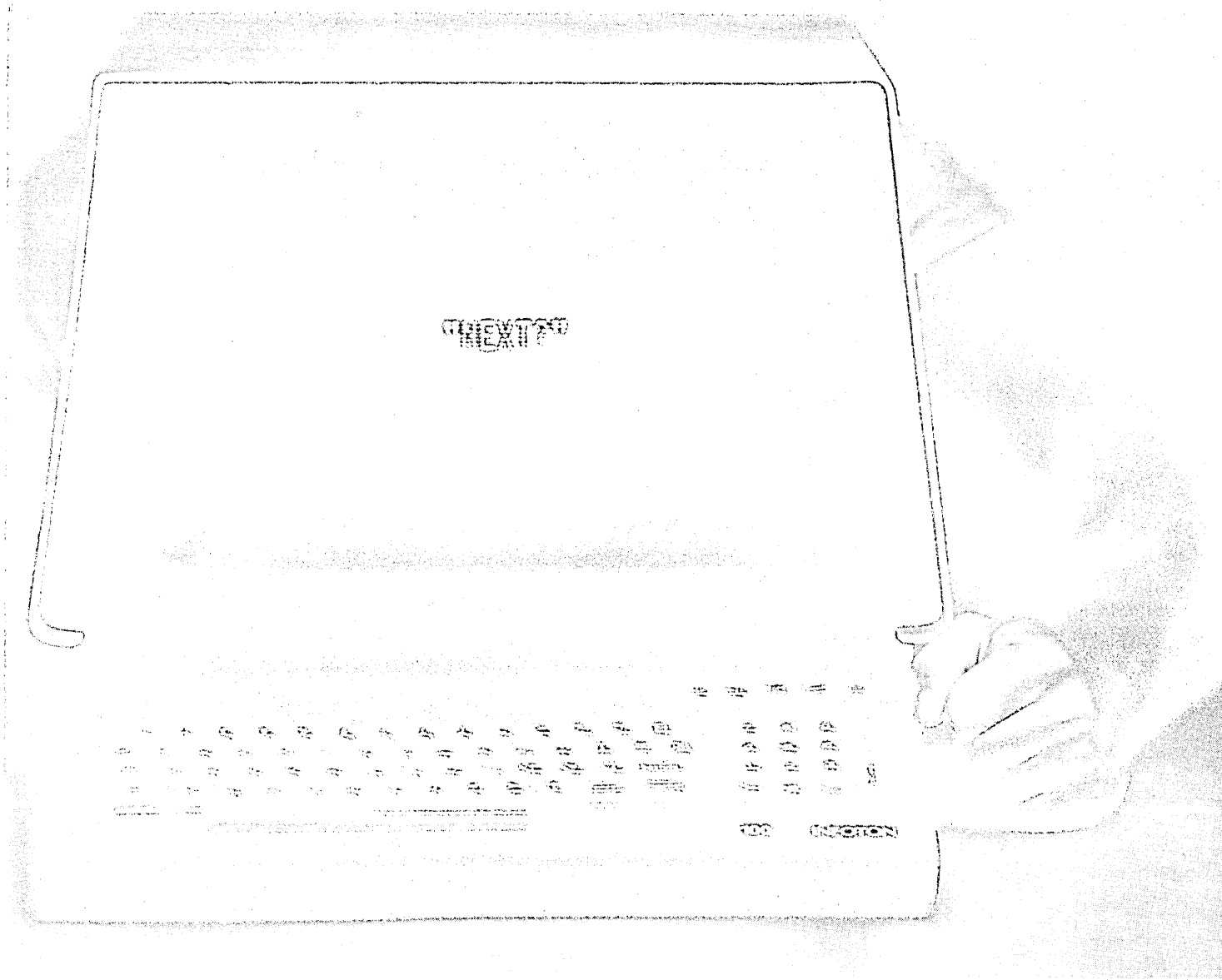

Introducing the all-new Infoton 100. An amazing, low cost data display terminal with enough muscle to flatten the competition. Hands down.

Z-80 microprocessor based, the I-100 costs just \$849, yet delivers standard features you've found only in more expensive terminals. When it isn't busy outperforming competitive terminals, it can emulate many of them. Options include Block Mode, Protected Fields, Programmable Function Keys and Composite Video.

---

We're ready to arm you with more information on the all-new I-100. Call Infoton toll-free today at (800) 225-3337 or 225-3338. Ask for Barbara Worth. Or write Barbara Worth at Infoton, Second Avenue, Burlington, MA 01803. We have offices throughout the United States, Canada and Europe. In Canada, contact Lanpar Limited, 85 Torbay Road, Markham, Ontario, L3R 1G7. (416) 495-9123.

Created by Chickering/Howell Advertising, Los Angeles



**INFOTON 100**  
A tough one to beat

# SOURCE DATA

## BOOKS

### PROGRAMMERS AND MANAGERS: A REVIEW AND A REPLY

In October, 1975, DATAMATION carried a Forum article on the professionalism of programming (p. 169) by Gerald M. Weinberg and Philip Kraft. The authors discussed certification and licensing in the context of programmer competence and working conditions, particularly the role of programmers within the organization.

The essay concluded, "The signs are unmistakable that the average programmer is nowhere near a level of programming competence that is within reason to expect. Most regret this sorry condition but have few ideas what to do with it. Yet there are signs that tomorrow will be better. The early successes of even the most primitive structured programming seem to indicate that more significant steps will soon follow. Moreover, the striking success of experiments with programming teams indicates that preoccupation with the individual programmer may be a retarding force in programming progress.

"But who is examining the question of how to certify future behavior that we now understand in the most partial way? Who is studying the qualities that will be needed in the programmer of 1980 instead of 1960?"

The gentlemen who posed that question three years ago are among those who *have* been looking at programming quality, though apparently from two rather different perspectives.

Mr. Kraft, who is an associate professor at the State Univ. of New York at Binghamton, currently on sabbatical doing research on women and minority men in computing, has recently published the book *Programmers and Managers: The Routinization of Computer Programming in the United States* (Springer-Verlag New York, Inc., 1977, 118 pp. \$6.90). Mr. Weinberg, who is president of Ethnotech, Inc., and author of the widely known *The Psychology of Computer Programming*, has written a review of Mr. Kraft's book, and Mr. Kraft has written a reply.



"They are an infection that has long burdened our species—a disease against which we must all, programmers, managers, and professors, fight to the death."

#### . . . the Review

Few knowledgeable readers will be able to believe an author who can state: "To a large extent, programmers, not their managers or even their colleagues, exercised final control over software production; only the writer of a given program could *guarantee* that a program would work the way it was supposed to" (page 56, emphasis added). Or: "Management and business school graduates are not primarily technical specialists, although many of them are that too. They are first

and above all managers with enough technical training to know what their technical employees are doing and therefore *to properly evaluate and control them*" (page 45, emphasis added).

Not only are both these statements wrong, but they contradict one another. Who among us knows a programmer who could *guarantee* that a program would work? Who among us knows management and business school graduates with enough technical training to properly evaluate and control pro-

grammers? If nobody but a programmer could guarantee work, no manager could control the programmer. In fact, as long as no individual can guarantee programs, *nobody* can control programmers or programming.

It is one of Kraft's main theses that structured programming is "the centerpiece of management efforts to de-skill programming" (page 99). The idea that structured programming reduces the skill needed to program is technically ridiculous. Of course, there are (bad) managers who devoutly wish that structured programming (or, God help us, *something*) would de-skill programming. Perhaps Kraft is saying that although these managers are *trying* to de-skill programming, it isn't working? Perhaps. But on page 62, he says, "But programming is not the same as assembly line work, *at least not yet* . . . Even the careful use of structured programming methods does *not for the present* give management absolute control over *all* aspects of software production" (emphasis added).

It would seem that he's saying that through the use of structured programming, management has achieved absolute control over most aspects of software production, and is soon to close the gap on those few aspects in which structured programming gives slightly less than absolute control.

Indeed, on page 61, he says, "*To date*, programmers have not been reduced to quite the same level of fragmented activity as autoworkers" (emphasis added).

On page 58, "Obviously, the programmer's ability to make decisions about his program, if using structured programming techniques, has been considerably reduced."

On page 59, "Structured programming, in short, has become the software managers' answer to the assembly line, minus the conveyor belt, but with all the other essential features of a mass-production workplace: a standardized product made in a standardized way by people who do the same limited tasks over and over without knowing how they fit into a larger undertaking."

I can only conclude that Professor Kraft had the misfortune to speak to some disgruntled "old boys" whose lack of skill was finally revealed to the world when programming work became public property, open to mutual criticism. Listen to what he has to say about these good old days (page 56): "Programs made in this manner (i.e., without structured programming) had distinct 'personalities' which reflected their creators. Some were terse and elegant. Others were long and highly detailed. Some programmers, because of their experience with particular languages or operating systems or even the hardware, could make the machine

'do tricks' which were mysteries to the uninitiated."

As one of those old timers whose programs had "personalities," let me confess once and for all that along with the terse, the elegant, the long, and the highly detailed, we had the bulk of the programs which were pure, unadulterated crap—mine included.

But why continue quoting error after gratuitous error? Even though Professor Kraft completely misunderstands programming, who among us will cast the first stone? At least the *way* he misunderstands is more interesting than most other current writing.

Kraft is concerned with the struggle over control of the workplace, with programming as merely the newest and liveliest battleground. We should all be concerned with this battle. True, our knowledge of programming makes us less inclined to see capitalist plots in every new programming tool. And if Kraft hadn't limited himself to the United States he might have seen that the same trends exist independent of economic philosophy.

Kraft's limited view of the world of programming leads to yet another type of error—the inability to distinguish between events as they take place and events as management-oriented writers wish they would take place. For instance, he places great emphasis on the Chief Programmer Team as "an organizational form around which to arrange the newly created fragments of programming work" (page 59). Yet there is no evidence that even 1% of programmers work in Chief Programmer Teams, *as described by Mills*, as opposed to working in "teams" within which one person has the title, "Chief Programmer."

Why is Professor Kraft unable to make the distinction between events and wishes? According to his own statement, the most important source of his analysis ". . . has been direct observation of three software workplaces" (page 66). For a consultant who has directly observed 300 or more software workplaces, it's easy to take that statement as a joke. It's also tempting to ask Professor Kraft, "How many programs did you write in the course of these field studies?" but that would be appropriate only for an anthropologist, not a sociologist. To be a sociologist, it isn't necessary to participate in the work, or even to observe as many as three workplaces. The historical and statistical perspectives give a vantage point that isn't usually available to those whose noses are pressed to the coding pad or salary chart. Kraft's hero, and mine, Harry Braverman (author of the impressive *Labor and Monopoly Capital: The Degradation of Work in the Twentieth Century*), was a notable exception to this sociological aloofness. Braverman

worked at more than a dozen different trades and manual jobs, but most sociologists contribute through their *distance*, which allows them to see things the subjects of their research can't see.

The usefulness of sociological distance is perhaps best illustrated in Chapter 5, on careers, pay, and professionalism. Kraft's tendency to liken programming work to technical work of the past proves most successful in this chapter, particularly in his description of management attempts to control the programmer's pay.

Unfortunately, not many readers are going to make it to Chapter 5—which is sad. I think Kraft wanted programmers themselves to read his book and take its message to heart.

The message hidden in *Programmers and Managers* is one that many of our colleagues do not believe, or do not believe applies to them:

"The social relations of the workplace are arrangements of people which affect more than just efficiency and productivity. They are also relations of power, of domination and subordination." (Page 3.)

I can best illustrate this truth by recording how Professor Kraft—who I know to be intelligent, well-trained, well-informed, and compassionate—could turn out such a slovenly piece of work, one that will ultimately prove a setback for his own cause. He had barely begun to learn about programmers when his superiors at the university placed a more pressing matter squarely before him—publish or perish! Now if that isn't a "relation of power, of domination and subordination," then I've never seen one. And the result? Certainly not "efficiency and productivity." Instead, we have a carelessly written compendium of the unsupported opinions of a few power-crazed managers and incompetent programmers. The truth of the university, like the truth of the programming workplace, is that some people *need* to dominate other people, their subordinates. These tyrants, regardless of what they profess, are not interested in scholarship in the university or quality in programming. They are an infection that has long burdened our species—a disease against which we must all, programmers, managers, and professors, fight to the death.

We're not any of us—managers or programmers—nearly as competent as we ought to be, or can eventually be. But many bread-and-butter programmers out there are working on their competence—working damned hard and even working with the help of their managers. It's upon these people, I believe, that the honor and dignity of our profession depends. It's to them that the warnings of possible regimentation, routinization, de-skilling, and simple oppression must be delivered.

# HUGHES

## AIRCRAFT COMPANY

MISSILE SYSTEMS GROUP  
TUCSON MANUFACTURING  
DIVISION  
TUCSON, ARIZONA

WE HAVE THE FOLLOWING  
EMPLOYMENT  
OPPORTUNITIES  
NOW!

COMMUNICATIONS  
PROGRAMMER

SIGNIFICANT EXPERIENCE IN  
COMMUNICATION CONTROL  
PROGRAMMING.

REQUIRES KNOWLEDGE OF  
ASYNCHRONOUS AND  
SYNCHRONOUS LINE  
PROTOCOL WITH  
EXPERIENCE ON TERMINALS,  
CONTROLLERS AND RJE.

PRIMARY DUTY WILL BE  
DESIGN AND MAINTENANCE  
OF TELEPROCESSING SYSTEMS  
USING BTAM AND VTAM.

OS SOFTWARE SYSTEMS  
PROGRAMMER

SIGNIFICANT EXPERIENCE  
IN OS OR VS OPERATING  
SYSTEM MODIFICATION  
AND MAINTENANCE.

CALL COLLECT OR  
SEND RESUME TO:

FRAN KEITH  
P.O. BOX 11337-LF  
TUCSON, ARIZONA 35734  
(602) 294-5211, Ext. 5484

# HUGHES

HUGHES AIRCRAFT COMPANY

U.S. CITIZENSHIP REQUIRED  
Equal opportunity M/F/HC employer

CIRCLE 157 ON READER CARD

## BOOKS

Carried in the envelope of *Programmers and Managers*, the message is going to wind up in the Dead Letter Office. It's a shame; it really is.

—Gerald M. Weinberg

### . . . the Reply

Jerry Weinberg has been doubly generous to me.

First, he has called me intelligent, well-trained, well-informed, and compassionate.

Second, he has attributed what is bad in *Programming and Managers* to the publish-or-perish pressures in universities.

I agree on both counts.

Unfortunately, neither is terribly relevant. The only thing that matters is whether or not *Programmers and Managers* accurately analyzes the social relations of the software workplace.

Weinberg's objections to the book focus on structured programming and the way it can be used by managers to de-skill programmers. Specifically, he says—rather grandly but also rather cryptically—that structured programming can't de-skill because it's "technically ridiculous." I wish he had been a bit more specific than that because I suspect if he had I might have agreed with him. Techniques like structured programming, after all, can't do anything by themselves, including lowering skill levels. That's what managers are for and that is what *Programmers and Managers* is about. The book describes management efforts—not universal successes, note, only efforts—to industrialize programming and the programmer workplace. It analyzes thirty years of strategies and tactics and techniques designed to make programming as amenable to management-set standards and control as are older and more traditional engineering occupations. And it stressed repeatedly—although apparently not enough to suit Weinberg—that the use of structured programming to de-skill is a choice some managers have made apart from the technical content of the techniques themselves. For example, in the Introduction I said:

"I have described structured programming as many programmers and managers see it; I have suggested that managers use structured programming to de-skill and control their workers. Yet, there is nothing inherent in the principles of structured programming . . . which suggests that its developers are concerned with anything except making the writing of programs a more clear-headed and self-conscious activity than it presently is. . . . Unfortunately, this is not the issue. Whatever the intentions of software scientists, it will be edp managers, not scientists, who decide *the manner in which scientific innovations will be*

*applied to the problems of profit-making and employee control.*" (Page 9, emphasis added.)

The book concluded with an Appendix devoted entirely to structured programming and the different ways people can choose to use it. In it I carefully distinguished between structured programming as 1) a problem-solving device, and 2) an engineering adjunct to the software production process, and stressed—again—that the study concerned itself primarily with the latter.

What was offered between the Introduction and the Appendix was a description of some of these specifically managerial applications of structured programming methods. In particular, I described how managers found structured programming useful in appropriating to themselves more and more of the decision-making functions which traditional idiosyncratic programming had left in the hands of programmers. It was precisely this transfer of decision-making functions which I labelled "de-skilling."

Having said this, it should be easy to see how the passages which Weinberg selectively quotes and carefully rearranges appear "contradictory." They are torn out of context from a carefully developed argument which can be summarized in the following way:

Before structured programming, programmers were relatively unaccountable because no one knew what they were doing, including their managers. Structured programming techniques (along with sophisticated hardware) have made it possible for some technically oriented management schools to turn out managers who are better equipped to monitor and evaluate programmers.

What this says is not controversial or even new: managers have won a few and programmers have won a few in the battle for control, and the struggle continues. I can't imagine that most managers will find this hard to accept.

It may also be true, as Weinberg claims, that the only managers who would want to use structured programming to de-skill programmers have to be "bad" managers. It is also irrelevant. There are so many managers around (not to mention management writers) who claim that this is exactly what they want to do that it is impossible to ignore them. And I am certainly not the only one who feels this way. At least one international consulting firm (Infotech) has recently sponsored a conference on phasing out applications programmers through, among other things, de-skilling. Are these Jerry's disgruntled "old boys" and "bad managers," or has he missed something?

I think he has missed—or ignored—quite a lot. Weinberg's posi-

## BOOKS

tion has always been that the interests of managers and the interests of programmers are the same; he has repeated that position in his review of *Programmers*. I have suggested just the opposite, at least with respect to low-level applications programmers. Frankly, I think this is what disturbs him so much, rather than the "errors" he cites. (Including the silly complaints like "[not] even 1% of programmers work in Chief Programmer Teams. . . ." No one, not the ACM, not the National Bureau of Standards, not even Jerry Weinberg, knows how many programmers there are, let alone how many of them work in Chief Programmer Teams. It is just plain irresponsible to casually toss around off-the-cuff statistics like that; when someone like Weinberg does it, one begins to suspect that even the industry's best people are capable of convenient self-deceptions). What probably upset him, too, was my suggestion that managers have been experimenting with various methods of getting rid of programmers wherever possible or, failing that, reduce them to the software equivalent of assembly line workers. And what was probably most upsetting of all was the major question underlying all this: Could efficient management control of programmers actually hinder efficient programming?

In short, *Programmers and Managers* isn't your typical inspirational how-to book designed to tell managers what they want to hear. It isn't intended to reassure them that they are smarter than the people they manage. Let's be quite clear about this: *Programmers* wasn't written for managers at all, nor, for that matter, for management consultants. It was written for programmers and it was intended to help them understand how managers control them and their work.

Finally, Weinberg's observations on the publish-or-perish pressures in universities deserve a comment. He is absolutely right, of course. Professors are under a great deal of pressure to turn out books. On the other hand, no one in the university ever pressured me to write anything other than what I believed to be true. That's more than I can say for a number of industry-oriented publishers. Most were interested in *Programmers and Managers* only if I made it into a management manual, preferably with cartoons depicting spaced-out and oafish-looking programmers generating gray hairs on the heads of their long-suffering managers. It really wouldn't have been much work to oblige them either (one publisher even offered to supply the cartoons). Undoubtedly, the rewards would have been substantial: not only tenure from my university, but all those lecture fees from management groups in return for a few funny stories about pro-

grammer incompetence and the usual pep-talk on increasing programmer productivity.

It's a shame I couldn't get myself to do it. It really is.

—Philip Kraft

## REPORTS AND REFERENCES

### DIVERSIFICATION DIRECTIONS

International Resource Development Inc.'s Directions Intelligence series discusses the strategic directions and diversification policies of a major corporation, from which threats of competition and opportunities for cooperation within the industry might be assessed. Sources for the series are annual reports, SEC 10K filings, speeches by corporate management, and, in some cases, interviews. The reports are not sponsored by or endorsed by their subjects.

The most recent report in the series examines diversification by Xerox Corp. After a six page introduction, which concentrates on the company's financial position, the report gives equal coverage to the history and the predicted future of the company's expansion and diversification. Research and development has been a major source of new Xerox products, the report finds, with 5.3% of sales being spent on R&D in 1977. A continuing trend of internal expansion is predicted, particularly in the company's horizontal activities.

Thorough discussion is given to each segment of industry in which there is thought to be potential for acquisition or product development, including the seemingly far-fetched category of office furniture.

Xerox may, it is reported, be approaching a breakthrough in the enlargement of copies, and is also expected to come up with a "personal copier." Xerox Computer Services, a major time-sharing operation, could expand with word processing and/or data base management services. Activity is also seen in the area of micrographics which would be a valuable addition to the company's strength in office automation.

The short (29 pp.), highly readable report sells for \$65. Subscription to the series, which is to include reports on Texaco, Union Carbide, and Rockwell International, is \$480 (for 12 reports). Titles presently available include Mobil Oil Corp., General Electric Corp., Procter & Gamble Co., IT&T, Exxon Corp., and IBM. INTERNATIONAL RESOURCE DEVELOPMENT INC., 125 Elm Street, P.O. Box 1131, New Canaan, CT 06840 (203) 966-5615.

### WORD PROCESSING SALARIES

An increase of 6% over the past year for



## 950 Series MICRO-DISCS

**Finest minidisc recorders.  
Technically superior,  
yet low priced.**

- Desktop & rackmount models
- Uses 5¼" minidiskettes
- Double density 200,000 characters per disc side—first in the industry
- Automatic "next location" recording
- File directory recorded on each disc
- Disc Editor—character insertion/deletion, data expansion, file update/delete/append, GO TO commands
- Character string search
- File/Batch/Binary modes
- High speed random access—all modes
- Multiple rates—110 to 9600 Baud
- Dual RS232 interfaces—terminal/modem
- 8085 microprocessor controlled—powerful

priced from \$1395.00

Also datacassette recorders  
from \$950.00  
Portable hand-held systems  
from \$825.00

**Send for full details:**

**TECHTRAN**  
INDUSTRIES, INC.

200 Commerce Drive  
Rochester, New York 14623  
Tel: 716-334-9640  
TWX: 510-253-3246  
Calif: 213-391-0507

CIRCLE 135 ON READER CARD

OCTOBER 1978 **213**

# Why you can make more money selling a computer your customers have never heard of. Randal.

**You:** I already sell computers for big-name companies. Why in the world should I sell yours?



**You:** That's a good reason. What else?

**You:** Sounds pretty good. For the sake of argument, let's say I add Randal to my line. What kind of day-to-day support can I count on?

**You:** You know, I get the feeling you guys are as aggressive as I am. How do I find out more about Randal?

?

**Randal:** A number of reasons. One, we offer the highest gross margins in the business.

?

**Randal:** Well, we won't compete with you. Our computers are sold *only* through our distributors.

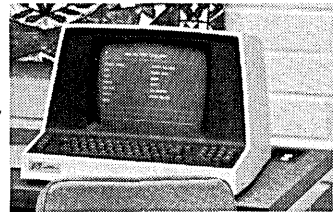

We specialize in small business computers for businesses buying their first unit...you know what a large market that is. We'll provide you with everything your customers will need, from hardware to applications software. We have basic accounting packages available, and specific applications software is *immediately* available for the medical, dental, and building supply industries.

?

**Randal:** We have full-time Account Managers in the field to help you with internal administration, applications software and system configuration. We'll give you additional training, we'll back you up with service, and support your distributorship with national advertising.

?

**Randal:** We were hoping you'd ask that. Just call this number, (213) 320-8550, collect. Or fill out this form, mail it back to us, and we'll send you more information. It was nice talking with you. Thanks.

Yes, I'm interested in a Randal Data System distributorship.

Other products sold \_\_\_\_\_

Years in business \_\_\_\_\_

Geographic coverage \_\_\_\_\_

Special applications \_\_\_\_\_

Name \_\_\_\_\_ Title \_\_\_\_\_

Company \_\_\_\_\_ Phone \_\_\_\_\_

Address \_\_\_\_\_

City/State/Zip \_\_\_\_\_

 **randal data systems, inc.**

365 Maple Avenue, Torrance, California 90503

DM/78

©Randal Data Systems, Inc. 1978

See us at Info '78 Show Oct. 16-19  
McCormick Place, Chicago, Booth #241

# SAS can give you answers in hours...



## ...instead of days.

Everybody seems to want "immediate" answers. And it's tough to explain why you can't just press a button and get the information you need.

That's why there's SAS. We've put all the data analysis tools you need for most jobs into one system. And your people don't have to master a difficult programming language to use it.

Just a few simple commands and SAS is handling retrieval,

data management, statistical analysis and report writing. All within one system.

It's so easy that one person with SAS can handle most jobs in hours or minutes ... even the ones that take days with conventional methods.

That's why more than 500 IBM 360/370 OS computer sites are already using SAS. And why those users put SAS on the Datapro Honor Roll for the second consecutive year.

There's a lot more we can tell you about SAS ... like how much less it costs than most software systems. Write or give us a call. We'll send a free booklet and answer any questions you might have. And someday soon, you might be smiling when someone asks you for one of those "immediate" answers.

**SAS** SAS Institute Inc.  
P.O. Box 10066  
Raleigh, NC 27605  
919/834-4381

## REPORTS AND REFERENCES

an experienced word processing correspondence secretary is reported by the International Word Processing Association's annual salary survey. Eight correspondence and eight administrative positions are included in the survey, which is based on data from 16,597 employees in 910 companies throughout the U.S. and Canada. The statistics are broken into private, educational, and government sectors, zip code regions, and major metropolitan areas. The next version of the study will be preceded by a study to determine whether job descriptions should be further refined. The

results of the 1978 survey are available from IWP for \$20 (\$10 for members). MEMBERSHIP SERVICES, IWP, Maryland Road, Willow Grove, PA 19090 (215) 657-3220.

### SYSTEM SOFTWARE

The latest in the Auerbach Snapshot series covers systems software. Featured in the 160 page report are descriptions of principal characteristics of major packages on the market, their operating environments, prices, and a vendor index. Tutorials about some kinds of software

are included, and there are summaries of selected topics, such as operating system enhancements, data base management, report generators and performance evaluators. AUERBACH PUBLISHERS INC., 6565 N. Park Dr., Pennsauken, NJ 08109 (609) 662-2070.

### FAST PRINTERS

A report about the IBM 3800, Xerox 9700 and 1200, and Honeywell PPS entitled *High Speed Electronic Page Printers—User Experience and Important Trends* is now available from SBS Publishing. The survey includes background, technical, and financial information, and also discusses performance; user acceptance (and

**EVEN THOUGH  
YOU'VE HELPED  
YOUR COMPANY  
DEVELOP NEW PROGRAMS...  
MAYBE YOUR COMPANY  
STILL WON'T DEVELOP YOU.**

At LRK, our client, a leader in electronics systems, recognizes the importance of continued interaction and positive rewards for the systems professional. They're involved in a series of exciting programs...and they're committed to the kinds of personal and professional satisfaction that top-of-the-line systems people have every right to expect.

If your background is in sophisticated computer or systems technology, and your education has prepared you to accept state-of-the-art challenges with an industry leader, send us your credentials. Our client offers outstanding salaries, excellent benefits, and generous relocation...and especially exciting opportunities for career enhancement.

After all, development should be a two-way street.

We are especially interested in people with experience in:

- Documentation Engineers
- Radar Software Development
- Simulation Design Engineers
- Mini-Computer Software Systems Design and Development
- Command & Decision Software Definition & Design
- Proposals Expertise For Large-Scale Systems
- Command and Control Software Development
- Micro-Processor Software Development
- Hardware/Software Integration
- Software Project Management
- Weapons Software Development
- Data Base Design

In The East:  
**703-790-8640**

LRK Associates  
Management Consultants Dept. 5505  
6845 Elm Street  
McLean, Virginia 22101

**LRK**  
**ASSOCIATES**

U.S. Citizenship Required  
representing equal employment opportunity M/F/H

In The West:  
**714-848-8494**

LRK Associates  
Management Consultants Dept. 5502  
16371 Beach Boulevard #141  
Huntington Beach, CA 92647

EXHIBIT 1  
IBM 3800 USER DISTRIBUTION  
BY INDUSTRY

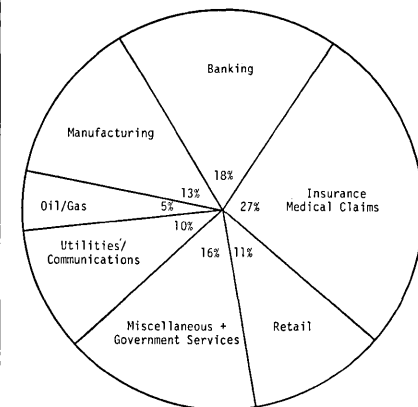

resistance); major system benefits; installation, conversion, training and maintenance; effect on the use of COM; hidden cost; desirable features for future machines; and opportunities for future systems, services, and profits. The report is 60 pages, sells for \$495, and includes 13 exhibits (one of which you see here). SBS PUBLISHING, 4320 Stevens Creek Blvd., Suite 190, San Jose, CA 95129 (408) 243-8121

### DBMS COMPARISON

*Data Base Software: Evaluation of Current Products and Future Directions* is a report offered by INPUT at the breathtaking price of \$2,500. This fee includes "consulting privileges," and INPUT tells us that the reader who calls will get to talk to the writer of the report.

The report includes discussion of the future of data base software, including the recent relational data base software, and the emergence of back-end processors, an approach that INPUT predicts IBM will not implement (it is predicted that the company will opt to integrate the function into future mass storage products).

Products compared in the report are: ADABAS (Software AG); DMS II (Bur-



## REPORTS AND REFERENCES

roughs); DMS 170, CODASYL (Control Data); DMS L100, CODASYL (Univac); IDMS, CODASYL (Cullinane); IMS or DL/1 (IBM) and TOTAL (Cincom Systems). INPUT, 2180 Sand Hill Road, Suite 320, Menlo Park, CA 94025 (415) 854-3422.

### TV TAKEOVER?

IRD would like us to acquire yet another acronym: IVT, for Integrated Video Terminal, which a new report predicts will bring together as "the centerpiece of the home" the telephone, tv set, video tape recorder, and personal computer. All this within the next four years.

The report is entitled *The Home Terminal* and is said to include details of current experiments with interactive tv, application potentials, and analysis of the eventual impact of the IVT on living patterns and the social structure. \$895. INTERNATIONAL RESOURCE DEVELOPMENT INC., 125 Elm Street, P.O. Box 1131, New Canaan, CT 06840 (203) 966-5615.

### BUBBLE, BUBBLE . . .

A \$950 report, *Bubble Domain Memory Markets*, purporting to analyze the technology and probable market trends for bubble domain products in the next five years, was available for our review only in part. Our reading of the chapters we selected—Introduction, Competitive Technologies, and Competition Within the Bubble Domain (they mean the industry)—has left us wondering who might be sufficiently interested in and yet sufficiently unfamiliar with components to warrant such general treatment of the field. The report is written for flexibility, meaning to be useful to those embarking on a project for which bubbles are being considered, as well as to potential suppliers of materials, and perhaps the curious. Yet the coverage is vague enough to be irritating. For example, the report tells us that bubbles could replace movable-head disks *if* they can catch up on a cost-per-bit basis. We learn that this is not expected to happen within the next five years, and that the writers of the report have no idea when it might happen. But beyond a mention of IBM's continuing bubble memory research effort and its possible implications, this seemingly big *if* is not pursued. The chapters that were not supplied to us are: Price/Performance Trends, Total Market for Bubble Memories 1973-83, Markets by Application, and Markets by Technology. VENTURE DEVELOPMENT CORP., One Washington St., Wellesley, MA 02181 (617) 237-5080.

### ENCYCLOPEDIA UPDATE

Newly available is the updated third edition of the *Encyclopedia of Information Systems and Services*. The over 1,000

page book references data base producers and publishers, on-line vendors, time-sharing companies, micrographic firms, libraries, government agencies, network information centers, data banks, clearinghouses, research centers, associations, and consultants. Entries include date the organization was established, name and title of administrator, staff size, related organizations, description of the system or service, publications, etc. There are 18 indexes. \$95 from GALE RESEARCH CO., Book Tower, Detroit, MI 48226 (313) 961-2242.

### SPEC CHARTS

A comparison of over 155 models of microfilm readers and reader/printers is being offered by Alltech as part of their Business Automation reference service. Also newly available is a survey of optical scanning equipment, comparing over 65 models. Each report includes a vendor directory. *Microfilm* is \$10; *OCR* sells for \$20. Alltech Publishing Co., 212 Cooper Center, North Park Drive & Browning Road, Pennsauken, NJ 08109 (609) 662-2122.

### DATA PROCESSING

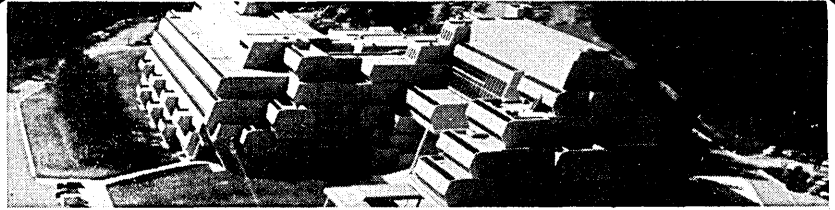

## SYSTEMS ANALYSTS, PROGRAMMER ANALYSTS SYSTEMS PROGRAMMERS

**BURROUGHS WELLCOME CO.**, a long-established manufacturer of drugs and pharmaceuticals, is seeking highly motivated, career-oriented data processing personnel.

#### SYSTEM ANALYSTS

Responsibilities will include evaluation of user requirements for business systems in the areas of manufacturing and finance, development of systems architecture, and detailed systems specifications.

Requirements include a B.S. degree in Statistics, Mathematics, Accounting, Computer Science, or equivalent experience/training as an Analyst. Minimum of four years experience as a Systems Analyst in a Data Base environment for business systems, including COBOL or PL/I, is necessary. IMS exposure a definite plus.

#### PROGRAMMER ANALYSTS

Responsibilities will include application software development in an IMS Data Base environment, including program coding, test data generation, and implementation responsibilities.

Requirements include a B.S. degree in Computer Science or equivalent experience/training as an analyst, and a minimum of three years data processing experience in all aspects of programming, testing, and debugging programs in PL/I or COBOL. Must be able to prepare documentation for users and have good oral and written communication skills.

#### SYSTEMS PROGRAMMERS

Responsibilities will include defining and programming moderately complex software such as utility programs, catalogued procedures (job control language), macros and subroutines. Will assist in or be responsible for complex software installations such as system control program generation.

Requirement include a B.S. degree in Computer Science or equivalent experience/training as a Systems Programmer and a minimum of one year experience with OS/VS1 or OS/VS2 software in systems programming or applications maintenance programming. Working knowledge of macro assembler language programming and good oral and written communication skills are also necessary. MVS experience a definite plus.

**BURROUGHS WELLCOME CO.** facilities are located in the beautiful Research Triangle Park area of North Carolina. The Triangle Park area, surrounded by Durham, Raleigh, and Chapel Hill, provides not only superior living and recreational opportunities, but also moderate winters, pollution and smog-free summers, and a reasonable cost of living.

**BURROUGHS WELLCOME CO.** offers a comprehensive, company-paid benefit package including family medical insurance, employee life insurance, sick leave, and pension program. In addition, these positions offer excellent growth potential, competitive salaries commensurate with experience/training, and a generous relocation allowance.

Systems Analysts, Programmer Analysts, and Systems Programmers who meet the job requirements and are interested in joining an innovative, dynamic organization should send a resume detailing education, training, work history, D.P. equipment and language experience, and salary requirements to: Employment Supervisor, **BURROUGHS WELLCOME CO.**, 3030 Cornwallis Road, Research Triangle Park, N.C. 27709.



**Wellcome**

If you do not have an up-to-date resume readily available, call Clyde Rush, COLLECT (919) 549-8371, Ext. 292 to apply.

All Replies Held In Confidence — All Replies Will Be Acknowledged

**BURROUGHS WELLCOME CO.**

An Equal Opportunity Employer M/F

MINORITY, VETERAN, HANDICAPPED INDIVIDUALS ARE ENCOURAGED TO APPLY  
CIRCLE 152 ON READER CARD

# You Don't Prove Reliability By Talking About It.

## You prove it by performance.

The Rapifax 100 high speed facsimile transmission system gives you proof...not promises. It's been on the market in use longer than any other high speed system. We introduced it four years ago. Since then, we've installed thousands of units around the world and established a record of reliability that, we believe, will take years to approach.

You can count on the Rapifax 100 system to provide you with reliable performance. There are no time-wasting trial and adjustment periods to suffer through. We've already done the testing... four years' worth. The system has been thoroughly proven not just in the lab under ideal conditions, but in actual use under the most demanding operating conditions by our customers around the world.

If you're in the market for high speed facsimile, why wait for things to come. The Rapifax 100 system is here, now! It's ready to give you reliable service from the first day it's installed, transmitting your documents as fast as 35 seconds and significantly reducing your telephone line costs.

And that's only the beginning. As an innovator and the leader in the industry we have developed and are continuing to develop and introduce new products and systems for the future.

For further information on the Rapifax 100 call, toll-free, 800-631-1155\* or write Rapicom, Inc., 7 Kingsbridge Road, Fairfield, New Jersey 07006.

\*Except from Hawaii and Alaska

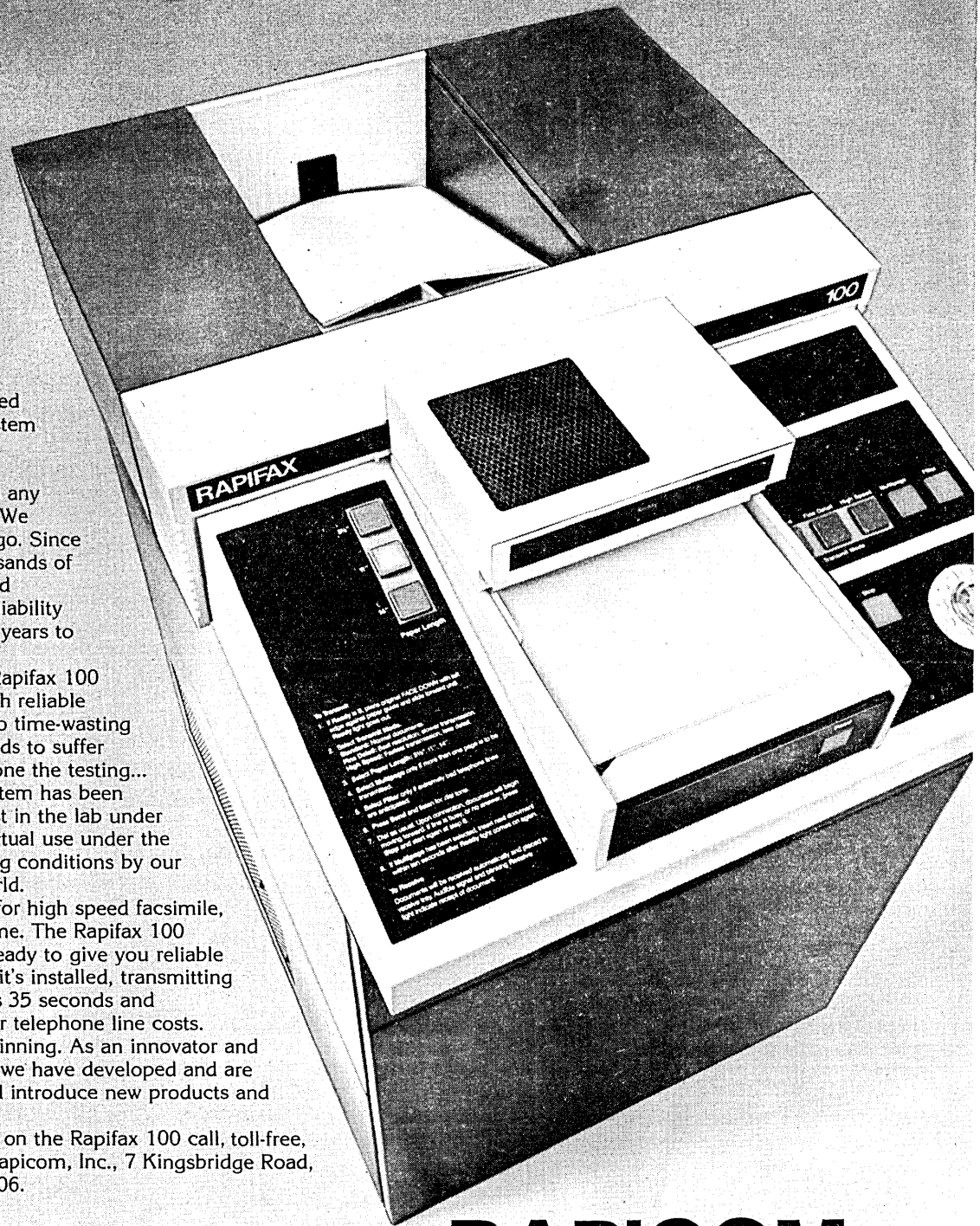

# RAPICOM

JOINING RAPIFAX CORPORATION AND DACOM, INC.

## VENDOR LITERATURE

### CONSUMER ELECTRONICS

A wide selection of calculators, digital watches, radios, and telephones are featured in this vendor's 32-page, four-color Fall '78 catalog. Both desktop and pocket calculators are offered, including models from Hewlett-Packard, Texas Instruments, Casio, and Sharp. Several dozen digital wristwatches—all using LCD readouts—are priced in the \$17.95 to \$54.95 range. Tape recorders, telephones, and telephone answering machines are also described. And there are games, running the gamut from Chess Challenger 10 to Mattel's space war offering, Space Alert. The catalog includes an order form as well as instructions for placing a phone order via the vendor's toll-free phone number. MARKLINE, Waltham, Mass.

**FOR COPY CIRCLE 376 ON READER CARD**

### SUPPLIES

Magnetic media, supplies, accessories, and microfilm retention and retrieval systems are cataloged in this vendor's 48-page booklet. Magnetic media offerings include tape, disk packs, cartridges, floppies, and cassettes. DEVOKE CO., Palo Alto, Calif.

**FOR COPY CIRCLE 377 ON READER CARD**

### DISTRIBUTED PROCESSING

"Building Your XL Distributed Processing Network," a six-page, glossy full color brochure describes this vendor's offerings for the distributed processing market. After noting some of the problems faced by companies with geographically distributed offices, the brochure describes the vendor's XL family of systems, and how they can be used to satisfy the processing needs of remote sites. Communications between systems and mainframes also are discussed. Educational services and maintenance also are covered. PERTEC COMPUTER CORP., CMC Div., Los Angeles, Calif.

**FOR COPY CIRCLE 378 ON READER CARD**

### TERMINAL

A six-page, illustrated flier describes this vendor's model 860 Desktop Printer Terminal. Print quality, and the terminal's three character sets (ASCII, APL, and graphics) are discussed, along with communications, forms control, and the keyboard. A table of specifications closes the discussion. ANDERSON JACOBSON, INC., San Jose, Calif.

**FOR COPY CIRCLE 379 ON READER CARD**

### DISK MEDIA GUIDE

This vendor of disk packs, cartridges, and diskettes has published a 70-page handbook detailing the compatibility between its media and drives from a wide selection of peripheral manufacturers and systems vendors. The booklet includes an illustration of a general

disk pack layout; a preface which includes four questions to determine if the user needs standard, certified error-free, or mapped disk packs; and a description of this vendor's part numbering system. Roughly 40-pages of tables describe disk packs and cartridges compatible with drives sold by vendors ranging from ABS to Xerox. An additional 11 pages are devoted to diskettes. A listing of the vendor's regional offices also is included. NASHUA CORP., Nashua, N.H.

**FOR COPY CIRCLE 380 ON READER CARD**

### INSTRUMENTS

Need a microcomputer development system? How about an oscilloscope, a multimeter or a power supply? This vendor offers two new catalogs describing the thousands of electronic instruments and equipment it has available for purchase or rental. The "For Rent" catalog offers descriptions of the equipment in this vendor's inventory of almost 13,000 items. The "For Sale" catalog describes 500 different products which have been removed from the rental inventory and placed on the block. Both catalogs include pricing information and terms on equipment from such manufacturers as Ampex, Biomation, Fluke, Hewlett-

Packard, Honeywell, Houston Instruments, Intel, Tektronix, and Texas Instruments. RENTAL ELECTRONICS, INC., Northridge, Calif.

**FOR COPY CIRCLE 381 ON READER CARD**

### GLOSSARY

The 40-page "Glossary of Solid State Sensing and Computer Terminology" looks like a useful pocketbook even for those who have little or nothing to do with sensing applications. Among the 463 terms defined are a number often seen in product literature: Hall effect, baud, bipolar, I<sup>2</sup>L, sos, to name a few. MICRO SWITCH, Div of Honeywell, Freeport, Ill.

**FOR COPY CIRCLE 382 ON READER CARD**

### COLOR DISPLAYS

A four-page, color brochure describes this vendor's newest color display capability for its EyeCom Image Digitizer and Display System. The EyeCom is briefly described, then the color capabilities now offered are explained. A detailed schematic illustrates how the color display fits into the overall system architecture. Specs for a color EyeCom system are included. SPATIAL DATA SYSTEMS, INC., Goleta, Calif.

**FOR COPY CIRCLE 367 ON READER CARD**

\*

## COMPUTER PROGRAM DEVELOPMENT

C F BRAUN & CO., a major engineering & construction firm, has new openings for two Sr. Engineers to develop programs in the Computer Systems Dept. at its Alhambra headquarters.

### SR. ENGINEER

MS or BS in Engineering or Computer Science with 2-5 years experience. Will interface with other systems for piping specifications, and detailing. Experience in modern interactive graphic techniques for computer aided design & drafting of 3 dimensional piping systems. Development of large computer programs with data base desirable.

### SR ENGINEER

PhD in Structural Engineering, Civil Engineering or Engineering Mechanics. Minimum of 2 years experience in the development of finite element stress analysis computer programs. Education and experience in inelastic structures, non-linear analysis and dynamics desirable. Participation in the development of programs for stress analysis of piping systems, vessels, and nuclear power plants and other structures.

**Send confidential resume to:**

**M D Valentino, Personnel Dept.**

**1000 So. Fremont Ave., Alhambra, CA 91802**

# BRAUN

**C F BRAUN & CO**  
Equal Opportunity Employer M/F

CIRCLE 166 ON READER CARD



# TRY TELLING HIM HOW TO RUN HIS KITCHEN.

He knows what makes his operation run smoothly. Like any successful businessman. And that's why we wouldn't tell you to buy a computer that tells you to change the way you operate. With our CS series of small business computers you can fit the system to your business or department, rather than change procedures that have made you successful. They're designed to work the way you work, interactively, transaction by transaction, with management reports whenever you need them. So you can quickly and easily process billings, accounts payable, accounts receivable, sales analysis, purchase analysis, inventory control and payroll. And usually for less money than doing it manually or with a service bureau.

Our CS series are all simple to operate and can keep up with your company or department as it grows. There are three distinct systems so you can buy the one that best fits your needs. From a low cost entry level system to a high capacity business system with up to 17 clustered or dispersed terminals. These systems, including our least expensive, feature COBOL, the most widely used business language. And if you need help with your applications, a network of Business System Suppliers is ready to assist you.

If you want to have your cake and eat it too, get a Data General CS system. For more details, just return the coupon.



## Data General

We make computers that make sense.

---

NAME	TITLE	COMPANY	PHONE
ADDRESS	STATE/ZIP	<input type="checkbox"/> END USER <input type="checkbox"/> BUSINESS SYSTEM SUPPLIER	

Data General Corporation, Westboro, MA 01581, (617) 366-8911. Data General (Canada) Ltd., Ontario. Data General Europe, 61 rue de Courcelles, Paris, France, 766.51.78.  
Data General Australia, (03) 89-0633. Data General Ltda., Sao Paulo, Brazil, 543-0138. Data General Middle East, Athens, Greece, 952-0557. © Data General Corporation, 1978.

CSDM10

# Sprint 5 has 43 key features for your 10 fingers.

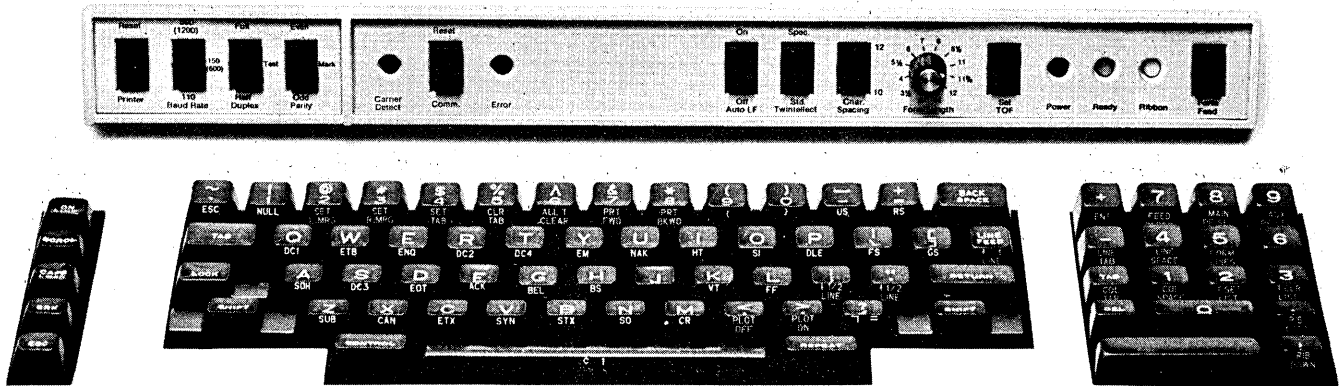

Sometimes you need more than clear, letter-quality print from a terminal. So when we designed the Sprint 5 Daisywheel Terminal, we made sure it would follow orders.

Not just the standard 128 ASCII codes, but 43 Qume-defined user-oriented commands, too.

They're special commands for dynamic positioning, paper positioning, tabbing, graphics, test diagnostics, program mode,

MultiColor™ ribbon controls, and more.

What makes it all so simple?

The fact that they're right before your eyes. Clearly labeled in green, yellow and white on the front of the standard keys.

**Qume**<sup>®</sup>  
the printed word

The Sprint 5 KSR terminal has a typewriter keyboard for communication, data entry, and programming, plus a numeric cluster for quick numeric entry. And the Sprint 5 RO functions with the same command set, received through communication lines.

The entire Sprint 5 terminal is designed to make things easier for you, the user.

Obviously, your fingers are in good hands with Qume.

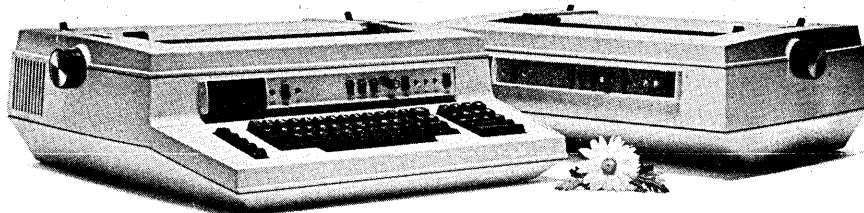

For details, contact Qume or your nearest data terminal dealer. 2323 Industrial Parkway West, Hayward, California 94545.

# The Marketplace...

## advertisers' index

### SOFTWARE SERVICES

Allen Services Corporation . . . . .	224
A.P. Publications Ltd. . . . .	225
Applied Computer Research . . . . .	223
Beemak Plastics . . . . .	225
BMS Computer Inc. . . . .	225
Cincom Systems, Inc. . . . .	223
Compudata Systems Inc. . . . .	225
C-S Computer Systems Inc. . . . .	223
DASD Corporation . . . . .	224
Dataware, Inc. . . . .	224
Duquesne Systems Inc. . . . .	225
Informatics Inc. . . . .	223
International Systems Inc. . . . .	225
Mitchell and Gauthier Associates, Inc. . . . .	223
Personnel Research Inc. . . . .	225
Plycom Services, Inc. . . . .	223
Software Consulting Services . . . . .	225
System Support Software, Inc. . . . .	224
The Computer Software Co. . . . .	224
Tone Software Corp. . . . .	226

### DP MARKETPLACE

Addmaster Corporation . . . . .	226
Nortek Inc. . . . .	226

### BUY, SELL, LEASE

D.V.I. Co., Inc. . . . .	226
--------------------------	-----

### PERSONAL COMPUTING

Data Analysis Systems . . . . .	226
---------------------------------	-----

### JOB MARKETPLACE

Affirmative Action For Professional Women . . . . .	226
E.D.P. Search, Inc. . . . .	226
Fox-Morris Personnel Consultants . . . . .	226
Hartford Graduate School . . . . .	227
Information Systems Design Inc. . . . .	227
National Personnel Consultants . . . . .	227
Parker Page Associates, Inc. . . . .	227
Raytheon Service & Co. . . . .	227
Systemation Consultants, Inc. . . . .	227
Whitlow and Associates . . . . .	227

### EDP PERFORMANCE REVIEW

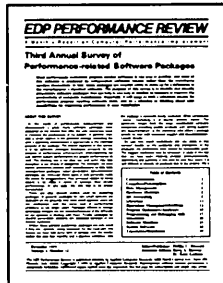

A monthly report on performance evaluation and improvement

- Tutorials
- Experiences
- Products
- Literature
- Conferences

12 Monthly Issues - \$48. per year

Includes the annual survey of performance-related software packages, plus a comprehensive bibliography of CPE literature. Write for a free sample issue.



APPLIED COMPUTER RESEARCH  
P.O. BOX 9280, PHOENIX, AZ 85068

CIRCLE 205 ON READER CARD

## Consider Cincom

### Data Base and On-Line Systems

The new TOTAL®(DB) and ENVIRON 1®(DC) Series 80 data base data communications systems are designed specifically for the needs of the '80's

Developed after a decade of experience in over 2000 customer DB/DC environments, TOTAL and ENVIRON 1 Series "80" forms the nucleus for Cincom's many end-user oriented products.

Cincom offers worldwide service and support in 42 cities and in 11 different countries. If you consider this type of product development, service and support to be important to your organization, please circle our reader service number for more information.

**Cincom Systems, Inc.**  
The TOTAL Information Systems People

CIRCLE 208 ON READER CARD

the choice of

**GENERAL HOST CORPORATION**  
*Leading Conglomerate*

**ACCOUNTING IV®  
GENERAL LEDGER**

Our software products—General Ledger, Accounts Receivable, Accounts Payable, and Standard Cost—are the choice of leaders like General Host. . . .  
*not by chance, but by design.*  
For details, call (213) 887-9121

**informatics inc.**  
*World's Largest in Software Products*

21050 Vanowen St. Canoga Pk. CA 91304

CIRCLE 221 ON READER CARD

### DEC RSTS/E USERS

From one of the pioneers in commercial data processing using RSTS. Off the shelf software ready for immediate delivery. Completely interactive. Extensively documented. Fully supported. Ideal for OEM's, service bureaus or end users. Cost effective solutions including:

- ACCOUNTS PAYABLE
- GENERAL LEDGER
- FINANCIAL REPORTING
- ACCOUNTS RECEIVABLE
- PAYROLL

For complete details, contact us at:

**Plycom** services, Inc.  
P.O. Box 160  
Plymouth, IN 46563  
(219) 935-5121

CIRCLE 228 ON READER CARD

### ACSL

The Advanced Continuous Simulation Language is a powerful but easy to use program designed for modelling the behavior of dynamic systems. Applications range from control system analysis to chemical plant models to urban dynamics.

- Interactive or Batch Graphics
- Unlimited Problem Size
- FORTRAN Compatibility
- Stiff Integration

ACSL reduces program development time by factors of two to ten: ACSL is available for CD-6000/7000, IBM 360/370, UNIVAC 1100 and SEL 32 computers. Access through UCS, CYBERNET and other national networks.

**MITCHELL AND GAUTHIER ASSOCIATES, INC.**  
P.O. Box 685, Concord, Ma. 01742  
(617) 369-5115

CIRCLE 222 ON READER CARD

### WHILE YOU'RE WAITING FOR YOUR 303X ...

Counting Down to conversion?  
Why not do the whole job this time? Retire those 1400-series programs once and for all *without* losing their capabilities.

CS-TRAN converts 1400-series *object* programs directly to ANS COBOL. (All you lose is your maintenance problem.)

**C-S Computer Systems Inc.**  
90 John Street, New York, NY 10038  
212-349-3535

CIRCLE 210 ON READER CARD

VSAM LOAD DLI/IMS VSAM UPDATE  
INTERNAL SORT — QUIKSORT

C F Report Writer • Database Utility  
C I Intelligent Utility • Mini-language  
O O Increase Programmer Productivity  
II 62 Reduce Turnaround Time

**QUIKJOB**

IBM 360/370 UNIVAC VS9  
**THE PERFORMANCE EXPANDER**  
In use by over 400 companies. Four years on "Datapro Honor Roll."  
ICP Million Dollar Software Club.  
Call Mac or Bob, (513) 435-9514, send your card with this ad, or write for more details.

VSAM RANDOM VSAM SEQNTL  
ISAM OTHER DATA BASES DBOMP

SYSTEM SUPPORT SOFTWARE, INC.  
5230 Springboro Pike • Dayton, Ohio 45439

CIRCLE 231 ON READER CARD

# Announcing A Breakthrough In 370-360 Software Technology.

TCSC announces the availability of EDOS/VS. An exciting new concept that brings software state of the art to the System/360 user and enhances performance for the System/370 user. EDOS/VS is an integrated and enhanced version of DOS/VS Release 34 that will run on both System/360s and System 370s. Some of the new features include twelve partitions, variable sized partitions, real storage system support, partitioned data sets and an extended procedure library support. Call or write for further information.

**THE COMPUTER SOFTWARE COMPANY**  
6517 Everglades Drive, Richmond, Virginia 23225 804/276-9200, Telex: 82 83 94  
Richmond • Chicago • Dallas • Los Angeles • Minneapolis • Grenchen, Switzerland • Stockholm, Sweden • Sydney, Australia • London, England • Mexico City, Mexico • Paris, France

CIRCLE 233 ON READER CARD

## RPG TO COBOL

Dataware's software translator converts RPG and RPG II programs to the industry standard ANS COBOL (DOS or OS). The translator achieves an extremely high percentage of automatic conversion (approaching 100%) of the source code.

- RPG/RPG II to PL/1
- EASYCODER/TRAN to COBOL
- BAL/ALC to COBOL
- AUTOCODER (7070) to COBOL
- COBOL to COBOL
- AUTOCODER/SPS to COBOL
- PL/1 to COBOL

For more information on our translators, please write or call today.

**Dataware, Inc.**  
495 Delaware Street  
Tonawanda, New York 14150  
(716) 695-1412

CIRCLE 212 ON READER CARD

## NEW Software Translators being developed at Dataware

In addition to our extensive line of conversion software and services, Dataware is constantly developing new software translators. Listed at the right are several which we are working on, or are actively considering. If you are interested in one or more of these or any additional translators, please let us know, so we can keep you informed.

**The Conversion Software People**

**Dataware, Inc.**  
495 Delaware Street  
Tonawanda, New York 14150  
(716) 695-1412

Please keep me informed on:

<input type="checkbox"/> NEAT 3 to COBOL	<input type="checkbox"/> DOS to OS ASSEMBLER
<input type="checkbox"/> COBOL to PL/1	<input type="checkbox"/> FORTRAN to PL/1
<input type="checkbox"/> PLAN to COBOL	<input type="checkbox"/> DIBOL to COBOL
<input type="checkbox"/> BASIC to COBOL	<input type="checkbox"/> 7080 AUTOCODER to COBOL

Name \_\_\_\_\_ Title \_\_\_\_\_  
Company \_\_\_\_\_  
Address \_\_\_\_\_  
City \_\_\_\_\_ State \_\_\_\_\_ Zip \_\_\_\_\_  
Phone \_\_\_\_\_  
 Call me - I need immediate help

CIRCLE 213 ON READER CARD

## SOFTWARE YOU SHOULD KNOW ABOUT

**DASD CORPORATION:** I'm interested in:

**TRANSLATING**

RPG/RPG II to ANS COBOL (DOS or OS)  
 SYSTEM/3 COBOL to ANS COBOL-OS  
 DOS COBOL to ANS COBOL-OS  
 DOS ALC to OS ALC  
 GE MAP to ANS COBOL-OS  
 360/20 BAL to 360/370 ALC-OS  
 AUTOCODER to ANS COBOL-OS  
 NEAT/3 to COBOL

**TSO**

Increasing my capabilities with TSO with Video Programming Tools. VIP simplifies the creation and modification of data files and will automatically flow-chart JCL procedures.

**CICS**

Saving 75% of my programming BMS coding time and automatically printing hard copy screen images with MAPGEN.

**DASD CORPORATION**  
National Marketing  
1480 Renaissance Drive,  
Suite 315  
Park Ridge, Illinois 60068  
312/299-5005

**DASD CORPORATION**

PLEASE SEND DETAILED INFORMATION TO:

NAME \_\_\_\_\_  
COMPANY \_\_\_\_\_ TITLE \_\_\_\_\_  
ADDRESS \_\_\_\_\_ PHONE \_\_\_\_\_

ALLEN SERVICES CORPORATION

**THE EXECUTOR™**  
HIGH SPEED JOB PROCESSOR

- FOR MVT, SVS, and MVS ENVIRONMENTS
- INCREASES THROUGH-PUT BY 10% TO 40%
- IMPROVES TURNAROUND TO USERS
- REDUCES OVERHEAD CPU CYCLES BY 5% TO 20%
- EXTENDS LIFE AND UTILITY OF EXISTING HARDWARE
- NO JCL CONVERSION OR MODIFICATION
- EASILY AND QUICKLY INSTALLED
- OVER 10,000,000 HOURS OF OPERATION IN OVER 150 SITES
- TECHNICAL DETAILS UPON REQUEST

**ALLEN SERVICES CORPORATION**  
212 WEST NATIONAL RD.  
VANDALIA, OHIO 45377  
(513) 890-1200

CIRCLE 203 ON READER CARD



**FREE**



**Data booklet on specialized software information systems covering:**

- \* **GENERAL SOFTWARE**
- \* **DATABASE SOFTWARE**
- \* **MICRO & MINI SOFTWARE**

**A. P. Publications Ltd**  
322 ST. JOHN STREET · LONDON, E.C.1

CIRCLE 204 ON READER CARD

**DATA PROCESSING EXECUTIVES**

IF YOUR PRESENT SALARY EXCEEDS \$20,000 PER YEAR AND YOU HAVE 5 OR MORE YEARS OF EXPERIENCE IN MANUFACTURING AND SERVICES, BANKING, DIVERSIFIED FINANCE, INSURANCE, TRANSPORTATION, RETAIL, OR UTILITIES AND WOULD LIKE TO HAVE YOUR CAREER HANDLED BY PROFESSIONALS, SEND YOUR RESUME WITH PRESENT SALARY TO:  
(CLIENT COMPANIES PAY ALL FEES)

**PERSONNEL RESEARCH, INC.**  
P.O. BOX 175  
SARASOTA, FLORIDA 33578

CIRCLE 225 ON READER CARD

**Tabcard Holders**  
For 80 col. — 51 col. — System 3 (96 col.)  
**RACKS • TRAYS • ACCESSORIES**



51 col. 80 col. 96 col. 80 col.

Racks made with any holder in any design or size.

Vinyl envelopes available with adhesive back or magnets. Special sizes

**BEEMAK PLASTICS**  
7424 Santa Monica Blvd.  
Los Angeles, Cal. 90046, (213) 876-1770

CIRCLE 206 ON READER CARD

**IBM SERIES/1 SOFTWARE**

**COBOL OPERATING SYSTEM**  
A comprehensive, interactive, multi-tasking operating system, based on ANSI 74 COBOL. Provides more effective use of the Series/1, reduced programming effort, transparency to other systems. Supports all S/1 or TTY compatible devices. Features include: re-entrant code, virtual memory and ISAM emulation, on-line programming, numerous utilities to simplify and speed programming, reduce errors. Field proven, available immediately.

**BUSINESS APPLICATIONS**  
Pre-written specialized programs in COBOL for distributors and manufacturers. Include: order processing, billing, inventory, AR, SA, AP, PR, GL. Features include: on-line files/interaction, multi CRT input/inquiry, demand reporting, menu job selection, operator prompting. Combined with S/1 modularity/reliability and IBM service, provides a low cost, high result minicomputer system. Includes on-premise training and on-going support.

**COMPUTADATA SYSTEMS, INC.**  
772 Post Road East, Westport, Conn. 06880  
(203)-226-4791  
INTERNATIONAL DISTRIBUTORS OF SERIES/1 SOFTWARE

CIRCLE 209 ON READER CARD

**All you IBM 370-360 & 303X users:**

**Meet CIMS, a powerful job accounting/system performance package you can afford.**

CIMS features complete charge-back system, zero-based budgeting, external charges, cost control, budget preparation, and much more.

Hundreds of satisfied users.

**Rent your CIMS for only \$110/month or buy at low cost.**

Call or write BMS today for details of our no-cost, no-obligation, 30-day trial.



**BMS COMPUTER INC.**  
P.O. Box 3086  
Walnut Creek, CA 94598  
(415) 938-2620

CIRCLE 207 ON READER CARD

**Do your programmers have really good tools for structured programming?**

YES	NO
-----	----

Are you one of our customers?

YES	NO
-----	----

Fantastic! Compare our tools to yours. We may surprise you.

Let us help you improve things for your COBOL and FORTRAN programmers. Our seminars and precompilers make structured programming seem natural and rewarding.

The SCOBOL and SFORTRAN precompilers give programmers languages that exactly parallel their structured designs. SCOBOL and SFORTRAN programs are translated into COBOL or FORTRAN to be processed by your compiler. The systems are distributed in source code form (COBOL or FORTRAN). Each includes the precompiler, a formatter, and a cross-referencer (for \$1200). For more information write or call

**SOFTWARE CONSULTING SERVICES**  
901 Whittier Drive  
Allentown, PA 18103  
(215) 797-9690  
Attn: Martha Cichelli

CIRCLE 230 ON READER CARD

**How do you get Project information to the top?**

**PAC II** Project plans and status often have a difficult time getting from front line management up through the chain of command in a timely, consistent manner. Now there is a way not to leave that information hanging in mid-air.

PAC II is an automated project management system for planning, budgeting, and monitoring virtually any work effort.

Easily installed and used, PAC II is equally applicable in research, engineering, construction, marketing, financial and data processing departments.

International System's project management systems are serving hundreds of clients world-wide.

For more details about PAC II contact:



**International Systems Inc.**

890 Valley Forge Plaza, King of Prussia, Pa. 19406  
(215) 265-1550

CIRCLE 220 ON READER CARD

**EDP Managers... You need QCM**

You've tried solving your performance problems with hardware monitors, sampling software monitors, unsatisfactory billing systems, SMF and RMF inadequacies, simulators, . . .

Now, try something that works! QCM.

QCM is the only complete system that precisely monitors all hardware and software processes, accurately bills all operations and improves performance . . . all on a full-time basis.

Let us show you how QCM has meant control, efficiency, confidence and dollars to our customers.

Fill in and mail the coupon or call:



**DUQUESNE SYSTEMS INC.**  
1511 Park Building  
355 Fifth Avenue  
Pittsburgh, Pa. 15222  
(412) 261-9055

I'm ready to try something that works! Please provide more information about QCM.

MVS  SVS  VSI  MVT  MFT

Name \_\_\_\_\_  
Title \_\_\_\_\_  
Organization \_\_\_\_\_  
Address \_\_\_\_\_ Telephone \_\_\_\_\_  
City \_\_\_\_\_ State \_\_\_\_\_ Zip \_\_\_\_\_

CIRCLE 215 ON READER CARD



**TONE 3**  
IS HIGH PERFORMANCE LOW OVERHEAD  
**TSO for VSI**  
CHECK THESE FEATURES

- Edit with full screen capability
- Internal reader job submit
- Output retrieval with RES support
- System maintenance
- Program development
- Data entry
- System debugging
- Text editing
- Performance monitoring support
- User command interface
- Interactive program execution
- Operations console support
- Dataset maintenance
- Catalog management
- Standard IBM TSO commands
- Enhanced 3270 usability
- Full ASCII terminal support
- No user swapping
- No TCAM
- No VS/2 overhead

**TONE** Write for Details

CIRCLE 234 ON READER CARD

**DP MARKETPLACE**

**RS232C COMPUTER COMPATIBLE PAPER TAPE TRANSMITTER/MODEL 612**

Stops and starts on character at all speeds, uses manual control or X-on, X-off 90-260 volt, 50-60 Hz power. 50-9600 baud, up to 150 char/sec synchronous or asynchronous; gated internal or external clock, RS 232C current loop or parallel output, reads 5-8 level tape, 7-11 frames per character, even or odd parity. Desk top or rack mount.



**ADDMASTER CORPORATION**  
416 Junipero Serra Drive  
San Gabriel, CA 91776  
(213) 285-1121 Telex 674770  
Addmaster SGAB

CIRCLE 201 ON READER CARD

**LSI-11/2 USERS**

**AAM-11** • Auto-answer/Auto-dial low speed modem/serial interface. Requires only a 'CBS' DAA unit. Emulates DL-11E and DN-11. Software transparent. \$650

**BUS-11** • Direct X-Y graphics display of bus activity on your oscilloscope. Selectable qualifiers and address window. Use stand-alone or connect to logic analyzer. Start/stop address strobes for software loop timing analysis. *Invaluable diagnostic.* \$300

**TEXT-11** • Screen editor package for RT-11. Use with any cursor controlled CRT. Context switch between 2 files. *What you see is what you get!* \$500

Dealer/OEM inquiries invited

**Nortek**

The LSI-11 specialists.

2432 NW Johnson • Portland, OR 97210  
503-226-3515

CIRCLE 224 ON READER CARD

226 DATAMATION

**COMPUTER ROOM FLOORING and AIR CONDITIONING**

Sell us your used computer room flooring and air conditioning.

Buy our reconditioned flooring and air conditioning (ED-PAC, LIEBERT, etc.). Completely guaranteed.

**D.V.I. CO., INC.**  
P.O. Box 33  
Paoli, PA 19301  
(215) 647-4916

CIRCLE 214 ON READER CARD

**PERSONAL COMPUTING**

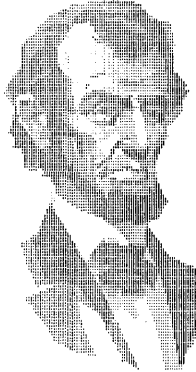

**COMPUTER PICTURES**

\$7.75 will bring you a complete set of 23 computer pictures (4 Snoopys, 5 Christmas, 6 naked ladies, Star Trek, Abe Lincoln and more) on 58 sheets of 14 7/8 X 11 paper. Data Analysis Systems, P.O. Box 162, Franktown, CO 80116.

CIRCLE 211 ON READER CARD

**JOB MARKETPLACE**

**PROGRAMMERS AND ANALYSTS**

IF YOU ARE A PROGRAMMER, PROGRAMMER/ANALYST OR SYSTEMS ANALYST AND WOULD LIKE THE MOST INDIVIDUALIZED JOB SEARCH OFFERED IN THE DATA PROCESSING FIELD TODAY, EITHER ON A LOCAL OR NATIONAL LEVEL, SEND YOUR RESUME IN CONFIDENCE TO:

**AFFIRMATIVE ACTION FOR PROFESSIONAL WOMEN, INC.**  
P.O. BOX 1301  
SARASOTA, FLORIDA 33578

"WE AGGRESSIVELY SUPPORT AFFIRMATIVE ACTION"

CIRCLE 202 ON READER CARD

**SYSGEN**

We are currently seeking the following for over 80 positions nationally.

NCP-3705 .....\$27M  
VTAM-TSO-Gen's .....\$30M  
MVS-Internals .....\$26M  
OS-MVT Gen's .....\$26M  
CP & Evaluation .....\$27M

**EDP AUDITOR'S**

Over 300 EDP Audit positions.

Audit Mgr .....\$42M  
SR. EDP Audit .....\$29M  
etc. etc. etc. etc.

We are the recognized national leaders in these fields.

Contact Skip Wall 405-525-8833  
EDP Search P.O. Box 12566  
Okla. City, Ok. 73157

CIRCLE 216 ON READER CARD

**EDP SPECIALISTS \$18-\$50,000**

SOFTWARE DESIGN ENGRS. \$18,000-\$35,000. All Sunbelt locations. Excellent growth/challenge, e.g., design software for Process Control, VA & Carolinas; Mini-computer software, Texas & Florida; Sr. design mini/micro operating systems, VA & Carolinas. Refer RS.

**PROJECT LEADER to \$32,000.** West Coast financial institution req's BS/BA w/mgmt exp to head up new systems devlpmnt. Excellent location & career path available. Refer RM.

**EDP AUDITORS to \$26,500.** "Fortune 500" firm, due to continued growth, currently has oppt'y available for sev EDP Auditors w/2+ yrs exp. Past System/Programming bkgd preferred. Full career benefits. Refer JS.

FOR FURTHER INFORMATION ON EACH OF THESE FEE-PAID POSITIONS, CALL OR SEND RESUME TO THE RECRUITMENT SPECIALIST NEAREST YOU:

PHILADELPHIA, PA 19102 - S. Burns, 1500 Chestnut St., 215/561-6300  
ATLANTA, GA 30346 - R. Spang, 47 Perimeter Center, 404/393-0933  
BALTIMORE, MD 21204 - R. Nelson, 409 Washington Ave., 301/296-4500  
CHARLOTTE, NC 28202 - J. Schwab, 1742 Southern Nat'l Ctr., 704/375-0600  
CLEVELAND, OH 44131 - A. Thomas, 5755 Granger Road, 216/749-6030  
FORT LEE, NJ 07024 - R. Mansfield, 2125 Center Avenue, 201/947-6920  
McLEAN, VA 22102 - G. Nugent, 7921 Jones Branch Drive, 703/790-1335  
NEW YORK, NY 10036 - W. McNichols, 1211 Ave. of the Americas, 212/840-6930  
PITTSBURGH, PA 15222 - J. Beck, 4 Gateway Center, 412/232-0410  
PRINCETON, NJ 08540 - R. Davis, 3490 U.S. Rte. 1, 609/452-8135  
WILMINGTON, DE 19810 - G. Whitewell, 3411 Silverdale Rd., 302/478-5150  
HOUSTON, TX 77056 - G. Lehman, 2801 South Post Oak, 713/877-1600

**FOX-morris**  
personnel consultants

CIRCLE 217 ON READER CARD

**UNIVAC  
SYSTEMS  
PROGRAMMERS**

ISD is looking for a Senior Systems Programmer to support Libraries & Processors on UNIVAC 1100 Series Systems.

Experience in Systems Support for any of the following packages:

- DMS 1100
- ASCII COBOL
- ASCII FORTRAN

ISD is a Computer Utility in the San Francisco Bay Area offering Batch & Demand remote processing nationwide.

**Please Respond To:**

Information Systems Design, Inc.  
3205 Coronado Drive  
Santa Clara, Calif. 95051  
(408) 249-8100  
Equal Opportunity Employer

CIRCLE 219 ON READER CARD

**EDP SPECIALISTS**

**SYSTEMS ANALYSTS / PROGRAMMERS, \$15,000-\$40,000.** Immediate Pennsylvania and national openings at all levels. Light experience through management. Reply in strict confidence to WEIR PERSONNEL SERVICES, J. Scheirer, 535 Court St., Reading, PA 19603 (215/376-8486).

**PROGRAMMER / ANALYST to \$28,000.** "Fortune 500" mfr. Exp. in PL/1 COBOL (SAS) use of IMS or CICS structured prog. FORTRAN TSO desirable. PROFESSIONAL PERSONNEL CONSULTANTS, 19189 W. Ten Mile Road, Southfield, MI 48075 (313/357-4810).

**SENIOR SOFTWARE ENGINEERS, \$23,600.** Our client, a manufacturer of directory assistance equip., req's degree BSEE, CS/MATH w/5-7 yrs exp in mini-computer operating systems & assembler language. Emphasis on fault tolerance with data structures & data base systems. Send resume or Call TALENT SEARCH, 607 Temple Building, Rochester, NY 14604 (716/546-5595).

*all positions listed are fee-paid*



CIRCLE 223 ON READER CARD

**PROGRAMMERS  
ENGINEERS**

with systems programming/software dev exp IBM OS systems or minicomputer assembly language sought by quality energy, mfg, systems & consulting cos. Software, hardware & real time applications opplys. \$18-29,000 SW, SE, W & NE.

Other clients seek business applications analysts & programmers with financial, mfg, or energy co applications exp Cobol, PL1, RPG, assembly \$18-27,000 SW & SE.

Confidential contacts controlled by you. Resume to J. L. Gresham, BChE, MBA will contact you at home first. Est. 1966, members AIChE. Fees paid. (713) 622-1370.

Systemation Consultants, Inc.  
employment service

1410 Post Oak Tower Houston, Texas 77056

CIRCLE 232 ON READER CARD

**THE HARTFORD  
GRADUATE CENTER**

Has an opening for a Full-Time (Resident) Faculty Member in Computer & Information Science. Minimum requirements include a Master of Science degree and practical experience in such areas as data base management, management information systems, data communications and distributed processing. Work experience in DP training would be an important asset. The position emphasizes Information Systems; ample opportunity would be afforded for consulting activity. Salary: \$20,000-\$25,000. Send resume to:

**Michael Danchak,**  
Curriculum Chairman,  
The Hartford Graduate Center,  
275 Windsor Street,  
Hartford, CT 06120.

*The Hartford Graduate Center is an equal opportunity employer.*

CIRCLE 218 ON READER CARD

**COMPUTER  
ARCHITECTS**

For definition of the next generation of Navy tactical computers. Carry out surveys and analyses of state-of-the-art developments in processors, memory, input/output, support software, and hardware packaging. Will develop benchmarks and participate in test and evaluation effort. This is an opportunity to get in on the ground floor of a significant new computer development project with very long-term potential.

Applicants must be U.S. Citizens with a technical degree and a broad background in computer science and 10 or more years experience, including work with militarized computers.

We offer excellent starting salaries, many company paid benefits, educational assistance, and a modern facility in an atmosphere that recognizes and fosters individual contribution. To arrange for an interview, please send a resume including salary history to

Mr. C. H. Overman,  
Raytheon Service Company,  
Suite 2341  
Jefferson Davis Hwy.,  
Arlington, VA 22202.



*An Equal Opportunity Employer M/F*

CIRCLE 229 ON READER CARD

**— SYSTEMS PEOPLE —  
\* THINK SNOW OR \*  
THINK WHITLOW**

We can help you move—to the South (or North, if you prefer) and up in your career. Openings are available at nearly all levels. Programmer/Analysts, Systems Programmers, Data Base and Teleprocessing are in greatest demand.

Our Information Systems Division offers you the personal service of DP specialists. Our parent firm plus over 100 associated firms give you representation to the top companies across the nation. We are members of the IPA, NACP, and the Georgia Chamber of Commerce. This assures you of a professional, confidential, ethical search. Begin your move to a new position now.

Call Jim Staal collect (404) 262-2566

**WHITLOW & ASSOCIATES**  
3390 Peachtree Road, Suite 236  
Atlanta, GA 30326

CIRCLE 235 ON READER CARD

**MINI COMPUTER  
PROFESSIONALS  
PDP/11, RSTS-E,  
BASIC PLUS, RSM-11K**

Parker Page Associates has several openings nationwide for mini computer professionals. These openings range from ACCT. applications to real time process control.

We need programmers/analysts and project managers. Salaries to \$30,000.00

Call Bill Isgrig TOLL FREE at 800-426-0342; or send resume to:

**PARKER PAGE ASSOCIATES**

P.O. Box 12308  
Seattle, WA 98111

Offices in Wash. D.C.,  
Atlanta and Portland

CIRCLE 226 ON READER CARD

**NATIONWIDE  
CAREER OPPORTUNITIES  
CALL TOLL FREE  
800-426-0342**

- PROGRAMMER ANALYSTS • PROJECT LEADERS
- SYSTEMS PROGRAMMERS • DATA BASE ADMINISTRATORS
- SALARIES TO \$40,000

Florida—Mfg. and Financial . . . . .20-24M	Texas—B.S.E.E. + Mini Exp . . . . .20-25M
Tenn.—Mfg. and IMS-Degree . . . . .21-25M	Okla.—Geophysics, F.P. Assem. . . . .29-32M
Indiana—IMS, CICS/VS, TSO . . . . .24-29M	Nebr.—Food Company . . . . .20-25M
New York—Software Eng.-Degree . . . . .23-26M	Oregon—Mfg. and Degree . . . . .20-25M
Calif.—Insurance and Mfg. . . . .22-26M	

The above represents a sample of the current opportunities available. Don't settle for less; it is your career.

Call Bill Isgrig toll free at 800-426-0342 or send your resume to him at:

**PARKER PAGE ASSOCIATES**  
P.O. Box 12308  
Seattle, WA 98111

Offices in Wash. D.C., Atlanta and Portland

CIRCLE 227 ON READER CARD

# Ask Bob Steele why he recommends AUTODIN II as a "Growth Insurance Policy" for PDP-11 system software specialists.

☞ People with two to three years of experience in PDP-11 (and there are a lot of people with that kind of experience today), are enjoying a big demand for their talent. Obviously, this is largely the result of the booming popularity of the equipment.

☞ The big question is whether the individual wants to remain in a limited (but certainly rewarding) systems environment . . . or whether he or she wants to enter the mainstream of large scale, state of the art computer communications systems.

☞ AUTODIN II is certainly the coming thing; packet switching is the coming thing . . . and the general field of network and data switching, both for very high speed interactive traffic, and for large transfers of data — This is the technology that's going to be applied in many, many different networks in the future. So it is useful background to acquire, now.

☞ The truth is, there are precious few hands-on, solid projects like AUTODIN II out there. And at CSC, we're taking the technology forward and spreading it in twenty directions! So, if you come on board to work on AUTODIN II, you're still not locking yourself into a given project, no matter how challenging. And, more doors will be opening to you within CSC for the rest of your career!

☞ AUTODIN II exposes you to virtually every dimension of value — networking, communications software, packet switching, future expansion into other types of data communications, of terminal systems, interfaces to hosts, security and privacy in software, management techniques like top down structure programming, the need to become familiar with practically every type of computer and terminal that exists and insure it can interface this network. ☞

**If you'd like to discuss current opportunities directly with Program Director Bob Steele, he will welcome your call on (800) 336-0429, or telephone him collect at (703) 533-8877. Otherwise, you are invited to forward your resume in full confidence to Dianne Reason, Dept. 394**

An illustrated design overview of AUTODIN II in addition to a variety of technical papers are also available with our compliments. Simply address your request to Dianne Reason, or to Bob Steele when you chat with him.

WE AGGRESSIVELY SUPPORT  
EQUAL OPPORTUNITY AND AFFIRMATIVE ACTION

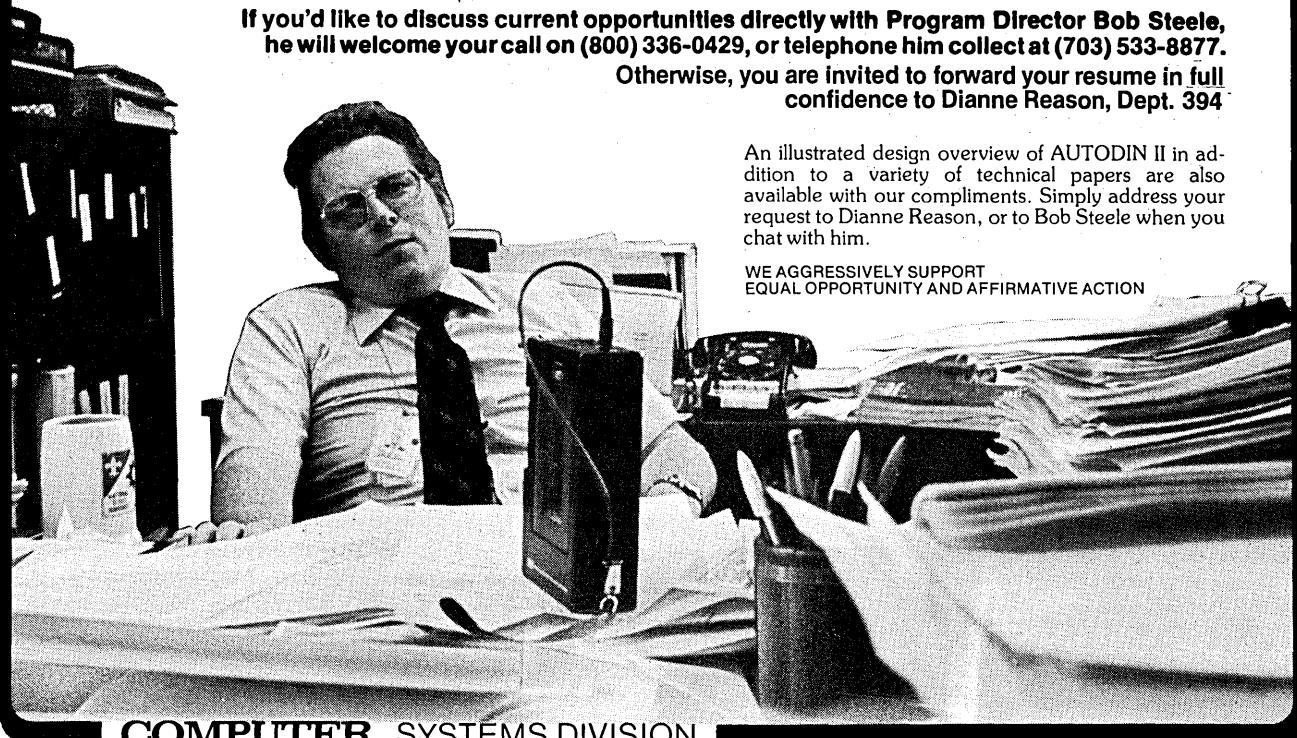

**COMPUTER  
SCIENCES  
CORPORATION**

SYSTEMS DIVISION  
6565 Arlington Boulevard Falls Church, VA 22046  
Major Offices and Facilities Throughout the World.

# ADVERTISERS' INDEX

Able Computer Technology, Incorporated	171
AC Manufacturing Company	76, 77
American Telephone and Telegraph Company	177
American Terminal Leasing	206
Ampex Corporation	234
Ampex Memory Products Division	14
Anadex, Inc.	107
Anderson Jacobson, Inc.	71
Applications Software, Inc.	203
Applied Data Communications	235
Applied Digital Data, Systems Inc.	10
Asiatic Petroleum Corporation	229
Autologic Incorporated	174
BTI Computer Systems	46
Beehive International	193
Billings Computer Corporation	34
CF Braun & Co.	219
Broomall Industries, Inc.	74
Burroughs Wellcome Co.	217
Cable & Wireless Ltd.	119
California Computer Products, Inc.	170
Cardkey Systems	64
Central Illinois Public Service Company	231
Centronics Data Computer Corp.	38
Cii Honeywell Bull	112
Cole, Warren & Long, Inc.	240
Computer Sciences Corporation	228
Consolidated Computer International Inc.	69
Control Data Corporation	100, 101, 165, 199
Cullinane Corporation	151
Data Dimensions, Inc.	194
Data General Corporation	220, 221
DatagraphiX	43
Datapoint Corporation	98, 99
DataSwitch Corporation	33
Datum, Peripheral Products Division	Cover 3
Dayco Corporation, Printing Products Division	173
Digital Associates Corporation	130
Digital Equipment Corporation	131-134, 144, 145
Eastman Kodak Company, Business Systems Markets Division	156, 157
Edutronics/McGraw-Hill	187
Ex-Cell-O Corporation, Remex Division	50
FORTH, Inc.	195
General Dynamics	230
Gould Inc., Instruments Division	143
Graphic Controls Corporation	28
Hambrecht & Quist	68
Harris Computer Systems	44, 45
Harris Corporation, Data Communications Division	11
Heath Company	239
Hewlett-Packard	20, 21, 109, 110, 111
Honeywell	196, 197
Hughes Aircraft Company	212
IBM General Systems Division	84, 85
Incoterm Corporation	158
Inforex	62, 63
Informatics Inc., Software Products	19
Infotecs	51
Infoton	208, 209
Intelligent Systems Corp.	83
Interactive Systems Corporation	73
Interface Mechanisms, Inc.	8
International Data Sciences, Inc.	172
Interstate Electronics Corporation	123, 238
ITT North Electric Power	236
Jacquard Systems	78

# IRAN

The Oil Service Company of Iran (OSCO) has been established by a Consortium of major international oil companies and operates in South Iran on behalf of the National Iranian Oil Company. Already one of the largest oil and gas producers in the world, it is substantially expanding its capacity.

Challenging opportunities are available in the OSCO Information and Computer organization for:

## TECHNICAL AND COMMERCIAL SYSTEMS ANALYSTS/PROGRAMMERS

at several levels of seniority, including project leaders.

Candidates should have a university degree in Computer Science or equivalent and, at the junior level, a minimum of four years experience in active programming and systems analysis.

- Excellent Benefits
- Family Status
- American Type School, K-12
- Tax Protection
- Annual Vacation

*If interested, please send resumé to:*

OVERSEAS RECRUITMENT DEPARTMENT  
**ASIATIC PETROLEUM CORPORATION**  
 One Rockefeller Plaza, New York, New York 10020

Asiatic Petroleum Corporation, a wholly owned Company of the Royal Dutch/Shell Group, provides recruitment services under contract to OSCO, Iran.

CIRCLE 151 ON READER CARD

## PROGRAMMERS AND ANALYSTS

Free Employment Service

Serving Northeast, Southeast and Midwest U.S.

- Scientific and commercial applications
- Software development and systems programming
- Telecommunications
- Control systems
- Computer engineering
- Computer marketing and support

Call or send résumé or rough notes of objectives, salary, location restrictions, education and experience (including computers, models, operating systems and languages) to either one of our locations. Or check the reader service card for a free sample resume. We will answer all correspondence from U.S. citizens and permanent residents and will guarantee our best efforts in a professional and ethical manner to all qualified applicants that we think we can help. Our client companies pay all of our fees.

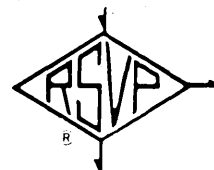

RSVP SERVICES, Dept. M  
 Suite 700, One Cherry Hill Mall  
 Cherry Hill, New Jersey 08002  
 (609) 667-4488

RSVP SERVICES, Dept. M  
 Suite 300, Dublin Hall  
 1777 Walton Road  
 Blue Bell, Penna. 19422  
 (215) 629-0595

**RSVP SERVICES**

Employment Agency for Computer Professionals

CIRCLE 162 ON READER CARD

# Quality Assurance Engineers

## CAD/CAM

We're looking for top computer professionals who want the exciting career environment our state-of-the-art quality assurance program offers.

Openings exist for applicants who know computer controlled coordinate measurement, numerical control and machine parts inspection and are qualified to develop plans and prepare computer programs for automatic parts inspection. Must also be qualified to apply statistical analysis techniques.

Prefer applicants with technical degree. To your expertise in computer systems, we offer the opportunity to add the Quality Assurance disciplines.

Our excellent benefit program includes life and medical insurance, dental and prescription drug plan, savings/stock investment and retirement plans.

Please send resume to:  
J.Y. McClure, Vice President, Quality Assurance

U.S. Citizenship Required

## GENERAL DYNAMICS

### Fort Worth Division

P.O. Box 748DAT Mail Zone 1862  
Fort Worth, Texas 76101

An Equal Opportunity Employer MF

## COMPUTER PROFESSIONALS

### You'll like working at Lockheed in Sunnyvale on the San Francisco Peninsula

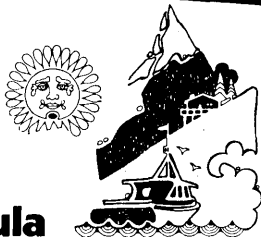

This is an excellent time to investigate the many opportunities available at Lockheed Missiles & Space Company on the beautiful San Francisco Peninsula. We're moving forward with talented professionals dedicated to meaningful programs.

Investigate the following opportunities available at all levels, entry to senior level:

- Data Processing Analysts
- Data Systems Programmers
- Scientific Programmers & Analysts
- Software Specification Writers
- Software Architects
- Environment Generators
- Test Planners
- Configuration Controllers
- Hardware Configuration Planners
- Mission Planners
- Algorithm Definition Specialists
- Documentation Specialists
- Display & Console Designers
- Information Retrieval Systems Analysts

For immediate consideration, please forward your resume to Professional Employment, Dept. DM-1078, P.O. Box 504, Sunnyvale, CA 94086. We are an equal opportunity affirmative action employer.

**LOCKHEED**  
MISSILES & SPACE COMPANY

CIRCLE 158 ON READER CARD

If you use computers as models of dynamic systems . . .

*you are a simulationist*

and

you are invited to join the Society for Computer Simulation and receive our monthly technical journal, *SIMULATION*, every month

The Society for Computer Simulation (SCS) is the *only* society whose central focus is simulation, and *SIMULATION* is the leading monthly journal devoted exclusively to simulation & closely allied computer arts.

If you are working in our field, we think you would find membership in SCS useful in many ways.

In addition to your membership in the Society for Computer Simulation, you'll receive a subscription to *SIMULATION*, the benefits of meeting and interacting with internationally recognized authorities in the field at SCS regional meetings and at national and international conferences cosponsored by SCS, and the knowledge that the information you receive through your membership in SCS will keep you informed in the rapidly advancing art of simulation.

Write for a free sample copy of *SIMULATION* and membership information.

THE SOCIETY FOR COMPUTER SIMULATION

(Simulation Councils, Inc.)

P.O. Box 2228 -D  
La Jolla, Calif. 92038



## ADVERTISERS' INDEX

Kennedy Co. ....	Cover 2
Lear, Siegler, Inc., Data Products Division .....	162, 163
Leasametric, Division of Metric Resources Corporation .....	191
Lehman Brothers Kuhn Loeb Incorporated .....	207
The Library of Computer and Information Sciences .....	183, 184, 185
Lockheed Missiles & Space Company .....	230
LRK Associates .....	216
Martin Marietta Data Systems .....	195
McCormack & Dodge Corporation .....	167
Micom Systems, Inc. ....	176
Microdata Corporation .....	15
Modular Computer Systems, Inc. ....	16
Mohawk Data Sciences .....	179
Moore Business Forms, Inc. ....	35
MRI Systems Corporation .....	9
NCR Corporation, Engineering & Manufacturing .....	204, 232
NEC Information Systems, Inc. ....	153
Nixdorf Computer Corporation .....	66
Northrop Corporation .....	200
Ohio Scientific .....	5
Okidata Corporation .....	4
Optical Business Machines, Inc. ....	180
The Pennsylvania State University .....	240
Perkin Elmer/Interdata Division .....	29, 30, 31
Pertec Computer Corporation, CMC Division .....	1
Power Systems & Controls, Inc. ....	206
Princeton Electronic Products, Inc. ....	129
Printemps Informatique .....	237
Q1 Corporation .....	25
Quest Systems Inc. ....	231
Qume Corporation .....	222
Qyx-A Division of Exxon Enterprises, Inc. ....	216A-216D
Randal Data Systems .....	214
Rapicom, Inc. ....	218
Raytheon Data Systems .....	121
Rental Electronics, Inc. ....	12, 13
RSI Inc. ....	67
RSVP Services .....	229
SAS Institute Inc. ....	215
Society for Computer Simulation .....	230
Sola, A Unit of General Signal .....	72
Source EDP .....	240
Sperry Univac Mini-Computer Operations .....	36, 37
Storage Technology .....	59
Summagraphics Corporation .....	192
Sycor .....	168, 169
Systems Engineering Laboratories .....	48, 49
Tab Products Co. ....	75
Tally Corporation .....	186
Tandem Computers, Inc. ....	26, 27
T-Bar Incorporated, Computer Switch Division .....	122
TEAC Corporation .....	70
Techtran Industries, Inc. ....	213
Tektronix, Inc. ....	6, 7, 175
Teletype Corporation .....	23, Cover 4
Telex .....	155
Televideo, Inc. ....	201
Texas Instruments Incorporated .....	2, 181, 233
3M Company, Microfilm Products Division .....	189
TransNet Corporation .....	205
United Airlines .....	61
Universal Data Systems .....	146
University Computing Company .....	40, 41
U. S. Robotics .....	205
Versatec, A Xerox Company .....	22
Visible Computer Supply Corporation .....	67
Wang Laboratories, Inc. ....	135
Wiley-Interscience a division of John Wiley & Sons, Inc. ....	32
Wright Line, A Subsidiary of Barry Wright Corporation .....	136
Xerox .....	65

## POWER SYSTEM CONTROL SOFTWARE SPECIALIST

CIPS, an investor owned utility with three digital Supervisory Control and Data Acquisition Systems and one digital Energy Management System has a career opportunity for a software oriented professional. Experience with any of the following is desirable:

- Harris Controls Microplex Computer Systems
- Harris 6024 Real Time Systems
- Interrupt Driven Real Time or Process Control Mini-Computer Systems utilizing assembly language.

A salary to match your background, an excellent benefits package and an exceptional career opportunity are what we offer the qualified applicant. Interested persons should send resume with salary history to:

H. L. Gaffney

Employee Development Supervisor

### CENTRAL ILLINOIS PUBLIC SERVICE COMPANY

607 East Adams

Springfield, Illinois 62701

An equal opportunity employer M/F

CIRCLE 153 ON READER CARD

## Even Webster's Knows About QUEST

**QUEST** (kwest). v. 1. To make a search; to go on a quest.

**QUEST SYSTEMS, INC.** n. 1. A corporation founded in 1968. 2. The largest professional recruitment firm in the U.S. functioning solely in the computer sciences; its client companies pay all employment fees, interviewing and relocation expenses. Quest is known for its deep personal commitment to relate to each candidate as an individual with individual goals. 3. Its professional staff averages over 6 years of experience in EDP recruiting (additionally, staff members have direct hands-on experience in programming, systems, hardware sales, etc.) 4. Quest is presently searching for programmers and analysts (commercial, scientific, systems software) for over 3,500 client companies in the U.S. *Quest has openings in over 700 U.S. towns and cities.* 5. Methodology — see Questsystem.

**QUESTSYSTEM** (kwest sis'tem). n. 1. Discussing with an individual what he would like to be doing in light of what he has been doing. 2. Analyzing the realities of his objectives as they relate to the current job marketplace. 3. Contacting client companies and other Quest staff personnel to identify positions of possible interest. 4. Introducing the job candidate to his prospective employers by providing complete details to each about the other, ensuring the efficacious use of everyone's time. 5. Arranging interviews. 6. If employment offers are extended, Quest assists in evaluating the responsibilities, compensation and opportunities (and relates those to the initially stated objectives). The Questsystem has been working for thousands of professionals at no expense, whatsoever. Ask your friends of their past dealings with Quest. Then, put the Questsystem to work for you. For additional information on this subject, please inquire directly to Quest Systems, Inc. (All inquiries/resumes received will be responded to immediately and in confidence.)



Call Toll Free  
**(800) 821-7700, Ext. 114**

**QUEST SYSTEMS INC®**

6400 Goldsboro Road  
Washington, D. C. 20034 (301) 229-4200

Baltimore: (301) 788-3500 • Philadelphia: (215) 265-8100

CIRCLE 161 ON READER CARD

# ADVERTISING OFFICES

Sales Manager  
**John M. Gleason**  
 Greenwich, CT 06830  
 35 Mason St. (203) 661-5400  
 Telex 996343

Eastern District Managers  
**A. Treat Walker,**  
**Warren A. Tibbetts:**  
 Greenwich, CT 06830  
 35 Mason St. (203) 661-5400  
 Telex 996343

New England District Manager  
**Warren A. Tibbetts:**  
 Manchester, NH 03104  
 112 W. Haven Rd.  
 (603) 625-9498

Midwest District Manager  
**William J. McGuire**  
 Chicago, IL 60611  
 444 No. Michigan Ave.  
 (312) 644-3970

Western District Managers  
**Alan Bolte, Jr.:**  
 Los Angeles, CA 90035  
 1801 S. La Cienega Blvd.  
 (213) 559-5111

**James E. Fillatrault:**  
 Mountain View, CA 94043  
 2680 Bayshore Frontage Rd.  
 Suite 401  
 (415) 965-8222

U.K., Scandinavia, Benelux  
**Intergroup Communications, Inc.**  
**Wallace K. Ponder,** European Director  
**Paul D. Dimmock,** Regional Manager  
 31 Lyncroft Avenue  
 Pinner, Middx, HA5 1JU  
 England  
 Tel: (01) 868 9289  
 Cables: PACOM, Pinner

Germany, Austria, Eastern Europe  
**Fritz Tauer**  
 Soltauer Strasse 85  
 D-314 Lueneburg  
 Germany  
 Tel: (0 4131) 4 38 49

France, Switzerland, Italy, Spain  
**Gerard Lasfargues**  
 32 rue Desbordes Valmore  
 750 16 Paris  
 France  
 Tel: (1) 288 90 22

Japan  
**Shigeru Kobayashi**  
 Japan Advertising Communications, Inc.  
 New Grinza Building  
 3-13 Ginza 7-chrome  
 Chuo-ku, Tokyo 104, Japan  
 Tel: (03) 571-8748

**James B. Tafel,** Chairman  
**John K. Abely,** President  
**Robert L. Dickson,** Exec. Vice President  
**Calverd F. Jacobson,** Vice President-Finance  
**Walter Harrington,** Vice President and Controller

TECHNICAL PUBLISHING COMPANY  
 A DUN & BRADSTREET COMPANY

 Business Magazines  
 Consumer Books  
 Training Systems

EDP SOFTWARE/HARDWARE PROFESSIONALS



## NCR/San Diego is making the big moves.

We have room for professionals with ideas that are big enough to spawn new divisions.

**THINK BIG** aptly describes the way we develop and implement new concepts at this pace-setting NCR facility. We design and build large-scale computer systems — with a difference. Our bold thinking pushes the state-of-the-art to anticipate the EDP needs of business in the 1980s. That boldness leads to the kind of major developments that have twice warranted setting up company divisions for new products.

### Where we're headed...

We have several major projects in work. One is our new virtual resource executive — a powerful system that combines COBOL with virtual operation. Another is a system which will provide interactive transaction processing capability for our virtual mainframes. And in the design process, we're looking for new approaches to software, firmware and testware development. On top of that, we're moving rapidly into VLSI technology with the support of NCR's own microelectronics facilities.

### We're big on resources...

You need lots of high calibre equipment and technical support to take on projects of the magnitude we handle. You'll be working with our most powerful, new generation Criterion mainframes, the latest advances from our data communications divisions, a highly interactive battery of technical support specialists. And you'll have it all at hand in a plant-complex big enough to house your grandest ideas.

### ... but small in modus operandi

We keep our project teams small. You work intimately with a few heavyweight professionals. That means, you come to grips with more of the problem, share more of the responsibility. It also means that everyone carries his or her full weight and stands out with high visibility.

### Outside — the good California life...

Our pioneering development groups are at home in Rancho Bernardo, 22 miles up the coast from San Diego. Our 114-acre hilltop location has been called "one of the 10 best-designed facilities in the nation." You'll be in the midst of California's finest recreational facilities, including 70 miles of beaches from San Juan Capistrano to the Mexican border. You'll work where others come to vacation.

### WHAT'S NEW AT NCR?

*NCR is on the move. We've mounted a major, coordinated effort, backed by ample R&D resources, to emerge up front in 1980s EDP. For example: VLSI technology, distributed network architecture with interactive transaction processing and important new functions, advanced communication and I/O protocols, high-level PASCAL-based language, powerful new virtual systems, and advanced concepts in micro-processor-based terminals.*

### Immediate openings in many areas

If you have an engineering or computer science degree (or equivalent) and a year or more of experience in one or more of the areas listed, contact us at once.

### Immediate Openings — Software areas:

- Distributed Network Architecture
- Transaction Processing
- Interactive Processing
- Data Base Design
- Performance Measurement & Analysis
- Configuration Management
- File Access Methods
- Operating System Development
- Compiler Design/Development
- Firmware Development
- Diagnostic Programming
- Test Systems Development
- MICR Proof Of Deposit Software
- Systems Architecture
- Tools Support
  - time-sharing
  - compiler designs/developments (high level block structured languages)
  - SW tools design

### Immediate Openings — Hardware areas:

- Design Automation Engineering
- MICR/OCR/OMR Engineering
- Memory Device Engineering
- Logic Design Engineering
- Systems Architecture
- I/O Subsystem Configuration
- Systems Integration Test
- Product Engineering— Mechanical, Optical, Electrical

**Mr. George Rice, Manager Professional Placement Engineering and Manufacturing, Dept. K-65, NCR Corporation, 16550 W. Bernardo Drive, San Diego, CA 92127.**

**NCR**

Complete Computer Systems

An Equal Opportunity Employer



# People join TI for love of technology. They stay for a lot of reasons.

Texas Instruments is viewed by many people as a technological leader in only one area.

To the electronics industry, we're producers of semiconductor materials and components.

To the oil industry, we're seismic data gatherers and processors who help them find petroleum-bearing formations.

To growing millions of consumers, we're the people who make calculators and digital watches.

To manufacturers of automobiles, TV yoke coils, battery cables and electromagnets, we are producers of clad metals.

The list of our major product and service areas is a long one. We've included it below.

The point is, all this diversity means extraordinary breadth of opportunity for you. Not just initially, but for as long as you're with TI. We've got a move-up environment that also lets you move *laterally* when you want to.

Find out how open-ended your



opportunities can be. And how TI has created an environment where you can prove your potential fast.

See what we're doing in:

- Microcomputers and microprocessors
- Semiconductor memories
- Linear semiconductor devices
- Microelectronic digital watches
- Calculators
- Minicomputers: hardware, software and systems featuring software compatibility with microprocessors
- Distributed computing systems for business and industry
- Electronic data terminals
- Programmable control systems
- Data exchange systems
- Advanced Scientific Computers

- Digital seismic data systems
- Air traffic control radar and Discrete Address Beacon Systems
- Microwave landing systems
- Radar and infrared systems
- Guidance and controls for tactical missiles
- Worldwide geophysical services
- Clad metals for automotive trim, thermostats and electrical contacts
- Interconnection products for electronic telephone switching systems
- Temperature-sensitive controls for automobiles and appliances
- Keyboards for calculators and for many other products.



Send for the 34-page picture story of TI people, places, and opportunities. And send us your resume in confidence to

**George Berryman,**  
P. O. Box 225474,  
Dept. CC2, MS 67,  
Dallas, TX 75265.

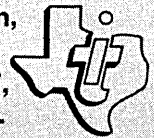

## TEXAS INSTRUMENTS INCORPORATED

An Equal Opportunity Employer M/F

CIRCLE 164 ON READER CARD

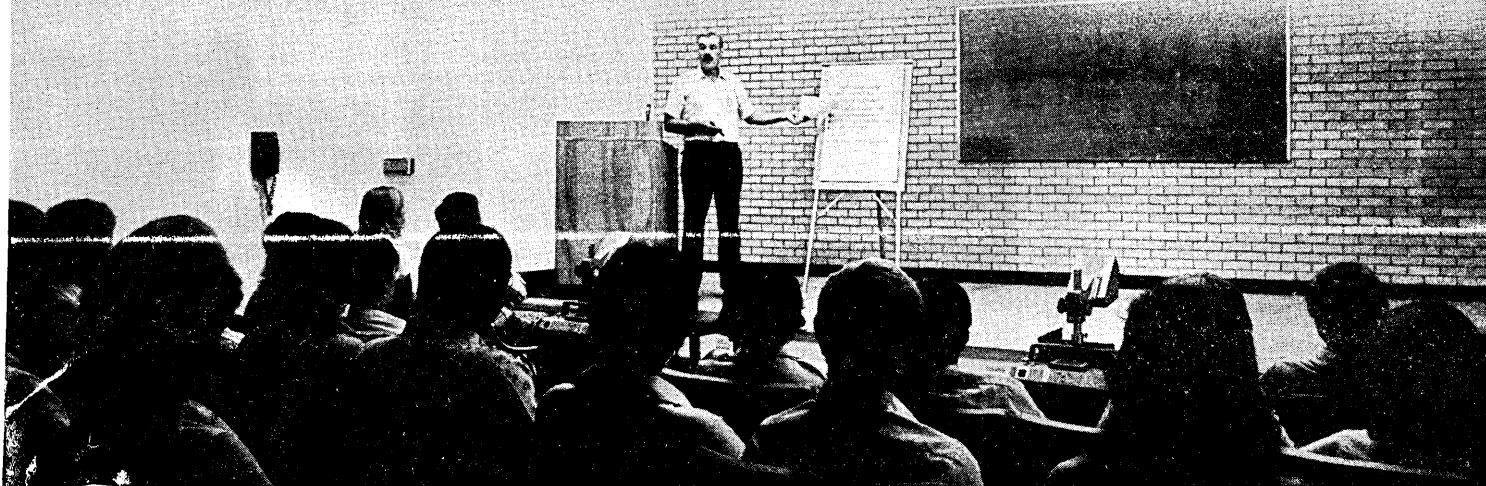

# GIVE YOUR COMPUTER A GREAT NAME.

Now Ampex, the greatest name in magnetic recording, introduces a flexible disk.

With all the quality and reliability you expect from a great name.

You've probably looked to the great names in data processing equipment when you specified your computer installation. The Ampex flexible disk is compatible with flexible disk drives from all the great names. And with drives from newer companies that will become great names in the future.

Either way, if your installation uses flexible disks, you can give it a great name today. Just call your Ampex representative. Dealer inquiries are also invited.

**YOU HAVE OUR WORD ON IT.**

**AMPEX**

Ampex Corporation, 401 Broadway,  
Redwood City, California 94063.  
Call toll-free: 800/227-8443

CIRCLE 22 ON READER CARD

**AMPEX**  
FLEXIBLE DISK

# the small business computer system most likely to succeed: EVENT 2000™



“We realize that as good as our hardware is, the EVENT Series wouldn't succeed without equally good applications programs and strong distributors.”

EVENT is the most likely to succeed because we've put it all together:

**the Hardware.** EVENT is a full-scale, proven business computer starting as low as \$12,200. And EVENT is backed by an experienced, reliable supplier of micro-based computer systems now starting its sixth successful year — Applied Data Communications.

**Software Developers.** EVENT's application packages are being written by the best software houses in the business. The vertical turnkey systems we've already packaged are selling well, and we're looking for new applications. EVENT's powerful MicroDOS®/BASIC makes program writing much easier for the software houses developing systems for us.

**Distributors.** We're expanding our existing nationwide network of EVENT distributors. We're fully supporting them with aggressive promotions, prompt deliveries, a national service organization, comprehensive training, documentation and expert technical assistance.

If you feel your application or distributorship would benefit from joining the EVENT team, please write or call me, Charles A. Morrissey, Vice President — Marketing, Applied Data Communications, 1509 East McFadden Avenue, Santa Ana, California 92705; (714) 547-6954.

## Applied Data Communications

EVENT 2000™ — the business computer system to begin with.

**ENERGY  
MANAGEMENT  
and  
ACCESS CONTROL  
and  
ALARM  
MONITORING  
and  
DATA COLLECTION  
and  
IT SAVES YOU  
MONEY!**

Now you don't have to buy or lease from separate vendors to get any combination of these important capabilities. The ITT North System 700 does it all in one expandable system!

**The Energy Management System** — performs energy load shedding to reduce peak demand — and load-cycling to reduce usage . . . and can automatically initiate plant start-up and shutdown by time of day or day of week to save money and manpower.

**The Access Control System** — through the use of special magnetic I.D. badges will check the individual's authorization to enter specified buildings, departments, doors or gates by time of day and day of week.

**The Alarm Monitoring System** — continuously monitors all specified areas of your plant operation to report any plant system malfunctions or other abnormalities, for your safety and protection.

**The Data Collection System** — gathers daily plant data including time and attendance, labor distribution, inventory, work-in-process, etc.

System 700 can be purchased or leased and the basic system cost starts under \$10,000. For more information call or write ITT North Electric Company, Power System Division, P. O. Box 688, Galion, Ohio 44833, (419) 468-8100, Telex 98-7428.

**ITT North**  
PowerSystems Division

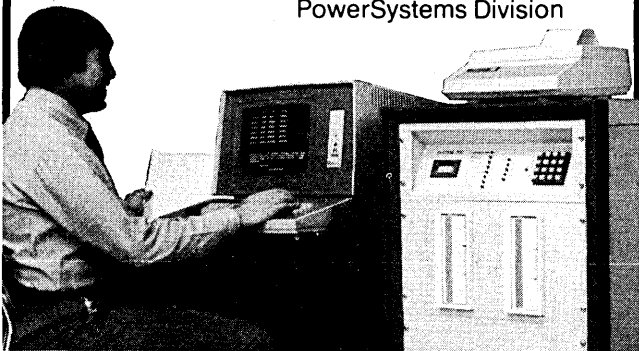

CIRCLE 122 ON READER CARD

READER OPINION

**FORUM**

**THE FED'S I/O  
CHANNEL  
INTERFACE  
STANDARD**

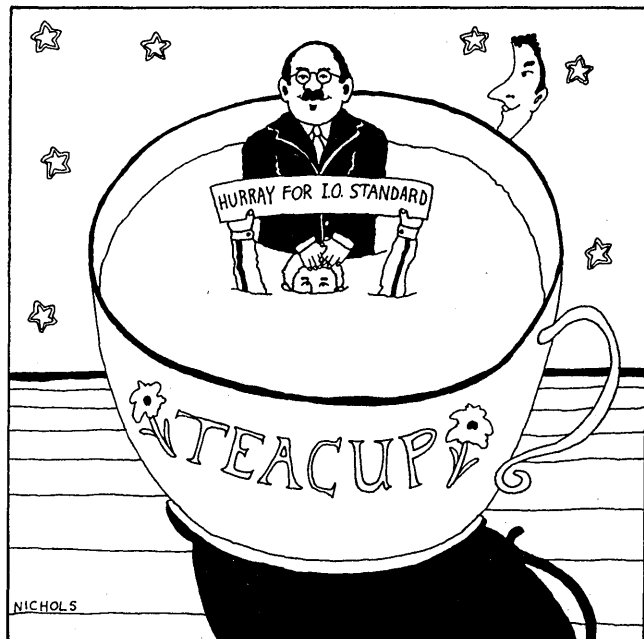

DATAMATION seems to lean toward supporting the proposed federal I/O channel interface standard (Editor's Readout, August 1978, p. 47). The editor gives us the now shopworn light bulb analogy to mull over. Like all good Californians, he worries over cost consciousness in the post-Proposition 13 era. But we already have a shop full of light bulbs (substitute tape drives, processors, or memories as appropriate), and a thriving replacement business; the real problem is that he's fighting the right battle on the wrong ground.

Let's begin by reviewing the whole mysterious process known as standards. Data processing folks have long been involved with ANSI and its predecessors. After grunting and groaning and a fair amount of hair pulling, a minimal set of standards have emerged covering such things as FORTRAN, COBOL, tape, and card formats. Some are useful (for example physical dimensions and recording characteristics for magnetic tape); a good many others are little more than waste paper—the ALGOL standard is in this class. (Probably the most widely circulated standard of all time was the beautifully prepared document describing the ANSI martini.)

There are also some *de facto* standards. IBM supported card codes were always widely accepted upon release. More current is the Intel 8080 instruction set, widely used and the base for more advanced microprocessor repertoires. BASIC, tiny or Dartmouth variety, may well become an approved standard in

the future and is already a useful and accepted norm.

The standards process is agonizing. Those who have been in the structure know that at every step politics, vote trading, and arm twisting take precedence over technical merit. No honest technician can sit through the interminable hours of agenda shuffling and procedural haggling. And, with the technicians absent, the bureaucrats take over. It becomes a game; form takes precedence over substance. This is an arena in which Washington-based players easily attain star billing because they practice the moves every day.

If anything has been learned to date about the usefulness of the standards process, it is that standards seem to work well in transfer mediums. This includes programming languages as well as physical specifications. Conversely, standards seem unlikely to succeed when dealing with internals, the *how* of any process.

#### **SOME FOE ANALYSIS**

The government is not a monolith. It has computer users as well as bureaucrats. Those who study the Washington scene have long been aware of this dichotomy. Government com-

**At every step politics, vote trading, and arm twisting take precedence over technical merit.**

puter users are very much the same as those in the private sector: they worry over the same problems of productivity, hardware evaluation, and system overhead. Because the problems are identical, it is not surprising that the government user community joins freely in the business of the two largest and most influential user groups, SHARE and GUIDE. These organizations (together they number over 3,000 installations) have long taken a firm and consistently negative position on the proposed standard.

The private sector has its share of those opposed to the standard. How is it possible, they ask, to support a channel standard on a computer that does not have anything immediately recognizable as a channel? The answer, of course, is that you don't support it. So it is not surprising to find DEC and Data General casting "no" votes even though the \$400,000 limitation rarely applies to them. Hewlett-Packard just says it isn't worth their while, the proposed channel does not offer any substantial improvement.

What of the mainframers? IBM designed and implemented the proposed standard 15 years ago. They can certainly dust off the old drawings and continue to produce it at a near zero cost. But many observers feel that IBM has a new architecture up its sleeve for future systems. The guesses vary widely, but the consensus among prognosticators is that IBM will be moving more intelligence outboard and reducing the channel to little more than a straightforward path to memory. To freeze the interface as proposed would stop this dead in its tracks.

The other mainframers find themselves in a strange position. As a matter of policy, they don't like to vote with IBM; on the other hand, they demand the right to remain architecturally independent. Burroughs, NCR, Univac, Honeywell, and CDC do not want to be locked into IBM-style systems; they all have different methods for attaching conventional I/O devices. Honeywell has gone so far as to threaten a withdrawal from any procurements in which the standard was mandatory. Why? Because Honeywell doesn't want to spend three to five years developing expensive hardware and software. Ergo, another chorus of "no" votes.

#### **THE FOLLOWERS: WHO AND WHY**

Some government agencies have taken official positions supporting the standard although few of their employees with technical credentials will com-

# PARIS printemps informatique 1979

**FOR U.S. DATA PROCESSING COMPANIES**

**March 20 - 23, 1979**

**Expanded exhibition facilities  
at TOUR OLIVIER DE SERRES**

**78, Rue Olivier de Serres, 75739 Paris Cédex 15**

**For all information, contact Pierre Jégu**

**BUREAU INTERNATIONAL DE RELATIONS PUBLIQUES**

**183, Avenue du Roule, 92200 Neuilly, France**

**Tél. : 637.24.42**

**Télex : 610769 F**

**or**

**Mrs. Carla Graydon - Graydon Associates, Inc.**

**PO Box 566 Red Bank, NJ 07701**

**Tél. : (201) 741-2690**

# Intelligent Voice Terminal can slash data-entry costs ...it's user programmable and operator compatible

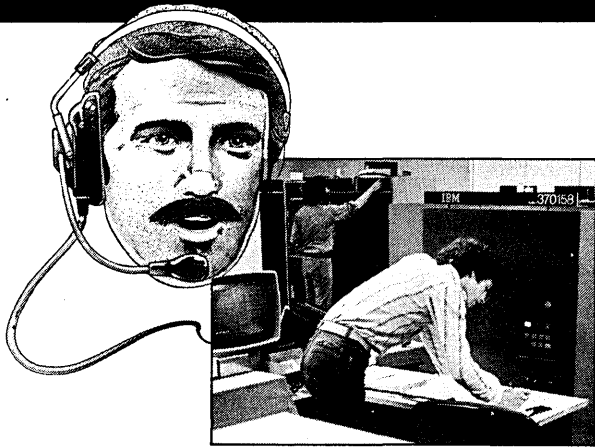

It's direct source data entry by voice, no coding or keypunch. Interstate's Intelligent Voice Terminal adapts to your present information system without expensive modification to the host CPU. Better yet, this terminal adapts to the source-user in natural terminology, normal format. The Intelligent Voice Terminal does the rest. And it's available with a full line of hardware options and peripherals:

- **Expansion**—Additional voice channels, telephone-only station, industrial remote user subsystem.
- **Input**—Microphone, telephone, wireless microphone.
- **Feedback**—16 or 32 character display, large 40-character remote display, asynchronous serial device, audio response.
- **Mass Storage**—Cassette tape, linc tape with random access files, application control processor with disc, host computer.
- **I/O Peripherals**—CRT display, plasma display, serial printers, modem, keyboard printer.

**Where do you use it?** Any place you are considering using an intelligent keyboard terminal but where "hands free" or spoken language data input is an advantage. The cost-reduction benefits can be highly significant. Call or write Daniel F. Fink, Marketing Manager, Voice Products, Interstate Electronics Corp., 1001 East Ball Road, P.O. Box 3117, Anaheim, CA 92803, (714) 635-7210.

**INTERSTATE  
ELECTRONICS  
CORPORATION**

SUBSIDIARY OF **ATO**

Information Processing and Display.  
Systems. Products. Services.

CIRCLE 117 ON READER CARD

## FORUM

ment for the record. Their stand appears to be politically motivated—the denizens of top level government jobs are not going to be caught on an issue that can backfire. HEW may vote "yes," but the gut position of the technical types at NIH or SSA remains a deep mystery.

It is easy to explain the support from the independent peripheral manufacturers: they simply do not want to re-engineer devices that can still be built and sold with high profit margins. (Wasn't that the crime of which IBM was so often accused?)

It's harder to understand why NBS has chosen to make a stand on this issue. As users, most of their experience has been in running FORTRAN programs on Univac systems; the background of replacement by interfacing *foreign* equipment is not there. Are they pushing this issue because a Congressman has been leaning on NBS to show some effectiveness in something. . . anything? Perhaps—but let us pass lightly over this view as unkind.

However, it is good to learn that the Feds want to protect their investment in computer equipment; after all, they have so much of it. But to an outside observer it would seem that there are more immediate ways of saving money. There is no sign of

**The industry is already nearly saturated with flexibility if the federal establishment can shake off their self-perpetuating paperwork burden and learn to use it.**

any shortage of IBM-compatible mainframes—for references see Amdahl, Intel, CEC, Magnuson, etc. There is no lack of IBM built systems from second sources—contact DCL, OPM, Greyhound, Randolph, Comdisco, etc. Independent peripherals? Please call STC, Telex, Memorex, Documation, etc. So what's the problem?

DATAMATION quotes NBS as claiming a government savings of \$55 million in five years by being able to procure peripherals competitively. Of course the Feds were supposed to be doing this all along—it's the whole point of the Brooks Bill.

Could it be that the government just discovered the independent manufacturers last year?

The savings is pure double talk; federal computer users have been buying compatible gear for many years. It would be very interesting to see how the proposed standard translates into this mysterious \$55-million saving. DEC contends that the NBS cost-benefit analysis used DEC figures erroneously. They should know their own numbers.

Perhaps the agencies still haven't learned the *mix and match* tactics of the private sector because, if they had, they would have calculated a far larger saving. As a percentage of the equipment that could be affected, \$55-million is far too low for an effective federal pcm program.

There is one direct result of accepting the standard that warrants further open discussion. There is a potential windfall here for the independent peripheral manufacturers if they are able, by legislative fiat, to continue to unload antiquated gear—lovely subsidy for the blessed few, hurting no one but the taxpayers.

### COMPUTER ARCHITECTURE: THE 360 LIVES

All computers have I/O gear, processors, and memories. The purpose of architecture is to connect them up in a usable way and produce an efficient base for software. The way that an I/O channel is developed is part of that architecture. But the channel concept is only one way to connect devices to the memories; other methods are available.

Remember the Burroughs B-5500? This system, with its exchange type switching, would never have met the standard.

Now would it seem that the Unibus approach of DEC's PDP-11 series could fit. Certainly the Cray-1 doesn't meet the standard, having nothing resembling a conventional channel. Do the government moguls wish all these innovative vendors to re-design their gear and become IBM look-alikes? Is the government trying, in a secretive, back door way, to force all vendors toward the architecture of the 360/370 as the de facto standard? Such a dramatic move could never be sustained through the normal standards route. Trying to achieve it on a piecemeal basis has some interesting possibilities. If moves to standardize on instruction sets begin, the pattern will come clear.

What is a channel interface anyhow? A way of making a connection between memory and an outside device. Does anybody except a computer designer really care about how the electrical signals come down the pipe? Is it even important if the bits are moved in parallel or serial transfers? One thinks not.

Given a 2,400 foot reel of half inch magnetic tape, a drive, and a COBOL or FORTRAN program, information can be transferred. This is nearly a universal truth; there are very few systems that cannot accept a tape written elsewhere so long as the physical recording characteristics are within system specifications.

Transfer is the key, not how the transfer is made. There-

**It is predictable that if the standard is adopted, the smarter federal users will quickly find the loopholes . . .**

fore, the place for the standard is at the core, the programming language, and the periphery, the physical device. How it gets done is not terribly important.

It's comforting to learn that NBS is looking out for advances in the technology and they allege that the standard can be changed in three years if such advances have been made. This is laughable, as anybody who has ever tried to change a federal standard will testify. The real time frame is roughly equivalent to the number of years necessary for the paper copies to return to dust. A breakthrough in technology? If NBS really believed this argument they would not be trying to shove a 15-year-old standard down the users' throats. In any event, discussing technology without architecture is missing the point. The change will be based on design, not the number of bits on a chip.

**CONCLUSION:  
VOTE NO  
SEVERAL TIMES**

Not only is the proposed standard not wanted, it is not needed since what it seeks to achieve is already there. It is an attempt to hand over balance sheet assets to those who are little more than engineering parasites. The industry is already nearly saturated with flexibility if the federal establishment can shake off their self-perpetuating paperwork burden and learn to use it.

It is predictable that if the standard is adopted, the smarter federal users will quickly find the loopholes to obtain exemptions for their favorite machines and go right on doing what they have always done. They've learned to beat the system by hiding general purpose systems as laboratory equipment and message switchers; other users may not be so lucky. It seems utterly wrong to strangle the systems of the '80s with the technology of the '60s. Standards make sense but not when used to promulgate 15-year-old technology as a way of overcoming bad management. Bury this standard where it belongs, back with column binary, 6-bit characters, and the SHARE standard plug-board. Why perpetuate for yet another computing generation an approach that when new was mediocre at best and is now already long behind us?

—Phillip H. Dorn

Mr. Dorn is an industry consultant and a contributing editor and advisor (sometimes dissenting) to DATAMATION. \*

# HEATH/DEC®\*

## data systems

### for lowest cost

- COMPUTER POWER WITH DEC COMPATIBILITY
- OFF THE SHELF DELIVERY
- OEM QUANTITY PRICES

#### HEATH/DEC WH11 16-BIT COMPUTER



**\$1595<sup>00</sup>**

Based on the world-famous LSI-11, the WH11 brings you amazing computer power and versatility at a great low price. And it's supplied with 4K memory and complete paper tape software including utilities plus BASIC and FOCAL — at no extra charge!

#### WH11-16 16K MEMORY MODULE

Provides 16K dynamic MOS RAM on a 5 x 8½" board. Has on-board refresh, 570 nS cycle time and 250 nS access time. DEC designation MSV11-DC.

**\$995<sup>00</sup>**

#### WH11-32 32K MEMORY MODULE

Identical to 16K at left, but with 16 additional IC's for a total of 32K memory. DEC designation MSV11-DD.

**\$1995<sup>00</sup>**

#### LA36 DEC WRITER II PRINTER TERMINAL

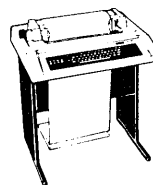

Provides hard-copy computer readout for the H11. Has 7 x 7 dot matrix print head; 10, 15 and 30 cps print speeds; variable width forms handling from 3" to 14½"; adjustable left and right hand tractors, half or full duplex operation.

**\$1495<sup>00</sup>**

#### HEATH WH27 FLOPPY DISK FOR THE H11

Dual-drive Z80 based system provides up to 512K bytes of program data and storage. Fully compatible with DEC RX01 (PDP-11/03) hardware and software — plus self test on power up, mechanical interlock, write-protect and reformatting capability. Standard IBM 3740 8" Disk Format. FULLY COMPATIBLE WITH LSI-11.

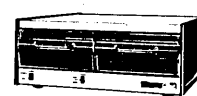

**\$2495<sup>00</sup>**

All computer products described above are fully assembled and tested, ready to operate. Qualified companies can open 30-day open accounts.

For details and ordering information, contact Heath Company, Dept. 360-460, Benton Harbor, Michigan 49022

**OR CALL  
(616) 982-3285**



Prices are mail order net F.O.B. Benton Harbor, Michigan. Prices and specifications subject to change without notice.

\*DEC is a registered trademark of Digital Equipment Corp.



New From Source Edp!

# 1978 Local Metropolitan Computer Salary Survey

Call for your FREE copy today!

Now you can compare your current salary with hundreds of other computer professionals working in or near your geographical area. Source Edp, North America's largest recruiting firm specializing in the computer field, has just compiled a timely survey of local salaries in the computer profession. The survey covers all areas of professional discipline in programming, software, information systems, marketing, etc. It shows salaries by length of experience, size of installation and includes all management levels. You can also compare your current compensation on a city by city basis with salaries paid in metropolitan areas across the U.S. and Canada as well as national averages.

For your FREE copy, call the Source Edp office nearest you.

**East:**

**Boston**  
617/482-7613  
Nashua NH  
603/880-4047  
Wellesley MA  
617/237-3120  
**Hartford**  
203/522-6590  
**New York City**  
212/736-7445  
**Philadelphia**  
215/665-1717  
**Stamford CT**  
203/329-8411  
**Union NJ**  
201/687-8700  
**Washington DC**  
703/790-5610

**Midwest:**

**Chicago**  
312/782-0857  
Northfield IL  
312/446-8395  
Oak Brook IL  
312/986-0422  
Rolling Meadows IL  
312/392-0244

**Cleveland**

216/771-2070  
**Detroit**  
313/963-0510  
Southfield MI  
313/352-6520  
**Kansas City**  
816/474-3393  
**Milwaukee**  
414/277-0345  
**Minneapolis**  
612/544-3600  
**Pittsburgh**  
412/261-6540  
**St. Louis**  
314/862-3800  
**St. Paul**  
612/771-0544

**South/Southwest:**

**Atlanta**  
404/325-8370  
**Dallas**  
214/387-1600  
**Denver**  
303/773-3700  
**Fort Worth**  
817/338-9300

**Houston**

713/626-8705  
**New Orleans**  
504/561-6000  
**San Antonio**  
512/344-0217

**West Coast:**

**Los Angeles**  
213/386-5500  
Encino CA  
213/995-8866  
Irvine CA  
714/833-1730  
Torrance CA  
213/540-7500  
**Palo Alto**  
415/328-7155  
**Portland OR**  
503/223-1131  
**San Diego**  
714/231-1900  
**San Francisco**  
415/434-2410  
**Seattle**  
206/454-6400  
**Canada:**  
**Toronto**  
416/364-2919



If unable to call, write: Source Edp, Department D-10  
721 Enterprise Drive, Oak Brook, Illinois 60521  
(When writing, please be sure to use home address and indicate position title.)

CIRCLE 163 ON READER CARD

## PENN STATE

**SYSTEM PROGRAMMERS** are needed to participate in Penn State's conversion from MVT/HASP to MVS/JES2, to help us establish an effective measurement and evaluation program, to install and support enhanced interactive services, and to develop other subsystems.

**OUR IBM 3033 PROCESSOR** provides research and instructional services to Penn State's large academic community. This computer is the hub of a network supporting 40 remote batch installations plus conversational RJE, time-sharing, and graphics terminals. High performance (over 18,000 jobs in a peak day) has been achieved by modifications and development of system programs with emphasis on manageability and system throughput.

**APPLICANTS** must have an advanced degree in Computer Science or related field, demonstrated fluency in S/370 assembler language, a sound knowledge of operating system organization and principles, and significant experience with MVT/HASP or MVS/JES2 internals. Salary and responsibilities will be commensurate with education, and experience. Send resumé, including education, professional experience, and salary history, to Dr. Donald T. Laird, Director, Computation Center, 229 Computer Building, University Park, PA 16802

THE PENNSYLVANIA STATE UNIVERSITY  
An Affirmative Action/Equal Opportunity Employer

CIRCLE 160 ON READER CARD

## MIS PROFESSIONALS

### Business Systems Development

- **VICE PRESIDENT** to \$70K
- **DIRECTORS** to \$50K
- **MANAGERS** to \$35K
- **ANALYSTS/PROGRAMMERS** to \$30K

Management and development opportunities exist for individuals who have strong experience with large scale systems and IBM hardware backgrounds (preferably with MVS, TSO, IMS, CICS, JES2, HASP and similar type background) utilizing Improved Programming Technologies.

Our clients, seeking your professional talents, are located in the Northeast, South and Midwest.

If you are interested in these outstanding opportunities, send your resume in complete confidence to, or call:

### COLE, WARREN & LONG, INC. Management Consultants

The Search Division  
#2 Penn Center Plaza, Suite 1020  
Philadelphia, Pa. 19102  
215-563-0701

(Our clients assume all search costs)

CIRCLE 154 ON READER CARD



# A \$5,700\* INTELLIGENT ALTERNATIVE FOR INTERDATA TAPE USERS

Now, Datum the leading independent supplier of peripheral systems offers Interdata/Perkin-Elmer minicomputer users another intelligent alternative. A complete Dual-Density magnetic tape system. Controller and tape drive.

Available together for \$5,700. Available from a single source; Datum. Available with worldwide service and support.

Need operating software transparency for your Interdata CPU? Datum's 1542 Controller gives you that and more. More configurations — controls any combination of speed and density — up to four tape drives can be attached. Extended operational registers en-

hance the command, status & interrupt sets, for improved definition of system performance.

A new standard of technology, the Datum D-450 Magnetic Tape Drive is user engineered. Designed for superior price/performance, a value added approach features microprocessor control for 7 or 9-track, NRZI, PE and dual density. Formats speeds up to 45 ips are standard, 75 & 125 ips are optional.

Match the features, specifications and benefits of Datum's Interdata Tape System. You too will reach the Intelligent Alternative. To find out more about how we have been caught with our prices down, contact your Datum representative.



**datum inc**

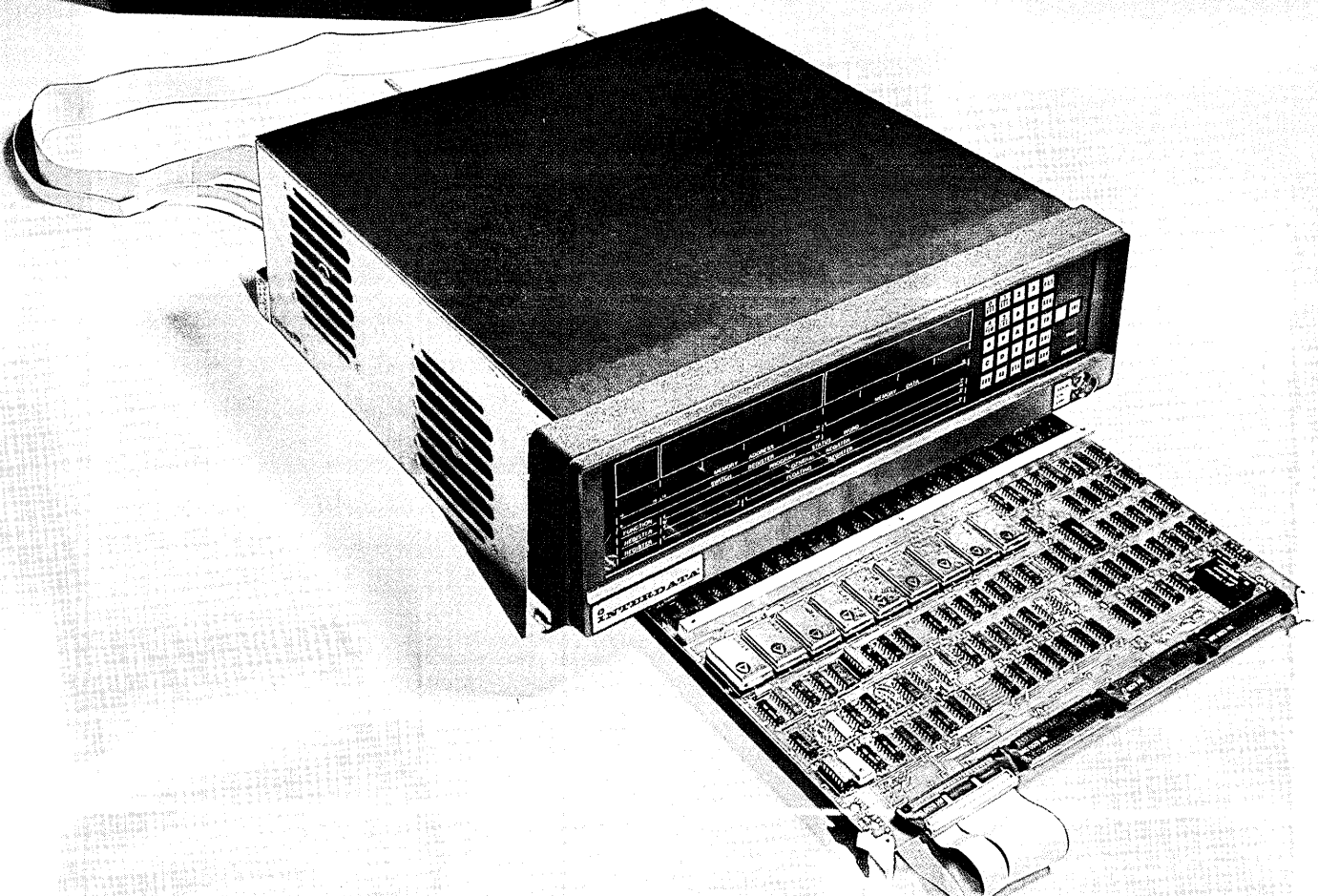

**CORPORATE HEADQUARTERS** 1363 S. State College Blvd., Anaheim, CA 92806, Tel: 714/533-6333, TWX: 910/592-1289, Telex 68-5579 • **EUROPEAN HEADQUARTERS, DATUM (ELECTRONICS) LTD.**, DATUM House, Harlington, Middlesex, England, Tel: 01-897-0456, Telex: 935-398 • **DATUM SALES OFFICES, CANADA**, Willowdale, Ontario, Tel: 416/491-6960, Telex: 06-966857 EOR TOR; **MOUNTAIN STATES**, Denver, Colorado 80232, Tel: 303/693-3414; **EAST COAST**, Mountainside, New Jersey 07092, Tel: 201/654-5590; **MIDWEST**, Des Plaines, Illinois 60018, Tel: 312/296-1064; **SAN JOSE**, San Jose, CA 95117, Tel: 408/249-5370; **NEW ENGLAND**, Framingham, MA 01701, Tel: 617/872-6911.

# A NEW PRODUCT. A NEW DIRECTION. A NEW COMMITMENT.

With each advancement of computer communications technology, a Teletype\* product has been there to meet the need.

Today, the latest Teletype product to follow in this tradition of quality, performance, dependability and price is the new 4540 Series of data terminals.

Not merely a new product, the 4540 Series represents a new direction for Teletype Corporation. A change from a philosophy of product orientation to one focusing on user-applications.

The 4540 Series also represents a new commitment. A commitment to provide a wide range of system solutions to meet user needs in computer-based systems. A commitment to customers before, during and after the sale.

The new 4540 is a keyboard-display based interactive series of synchronous terminals designed for inquiry/response, data entry and data retrieval. Operating at speeds ranging from

2400 to 9600 bps, it utilizes keyboard, display, character printer and line printer modules, as well as a controller with a simplified sub-set of software modules.

Since it truly is the state of the art in data terminals, the 4540 Series is available in several configurations compatible with the most popular standard host protocols for communications control. Initially, single-display and clustered configurations will be available, with the clustered version able to accommodate a maximum of 32 devices—including up to 8 printers. All 4540's can be coupled to multi-point or point-to-point private line facilities.

The new Teletype 4540 Series is the wave of the future. For the needs of today. Not only does it deliver the highest standards of quality and performance in the most common computer-based applications, it delivers these standards with true economy.



## THE TELETYPE 4540 SERIES. IT'S THE WAVE OF THE FUTURE.

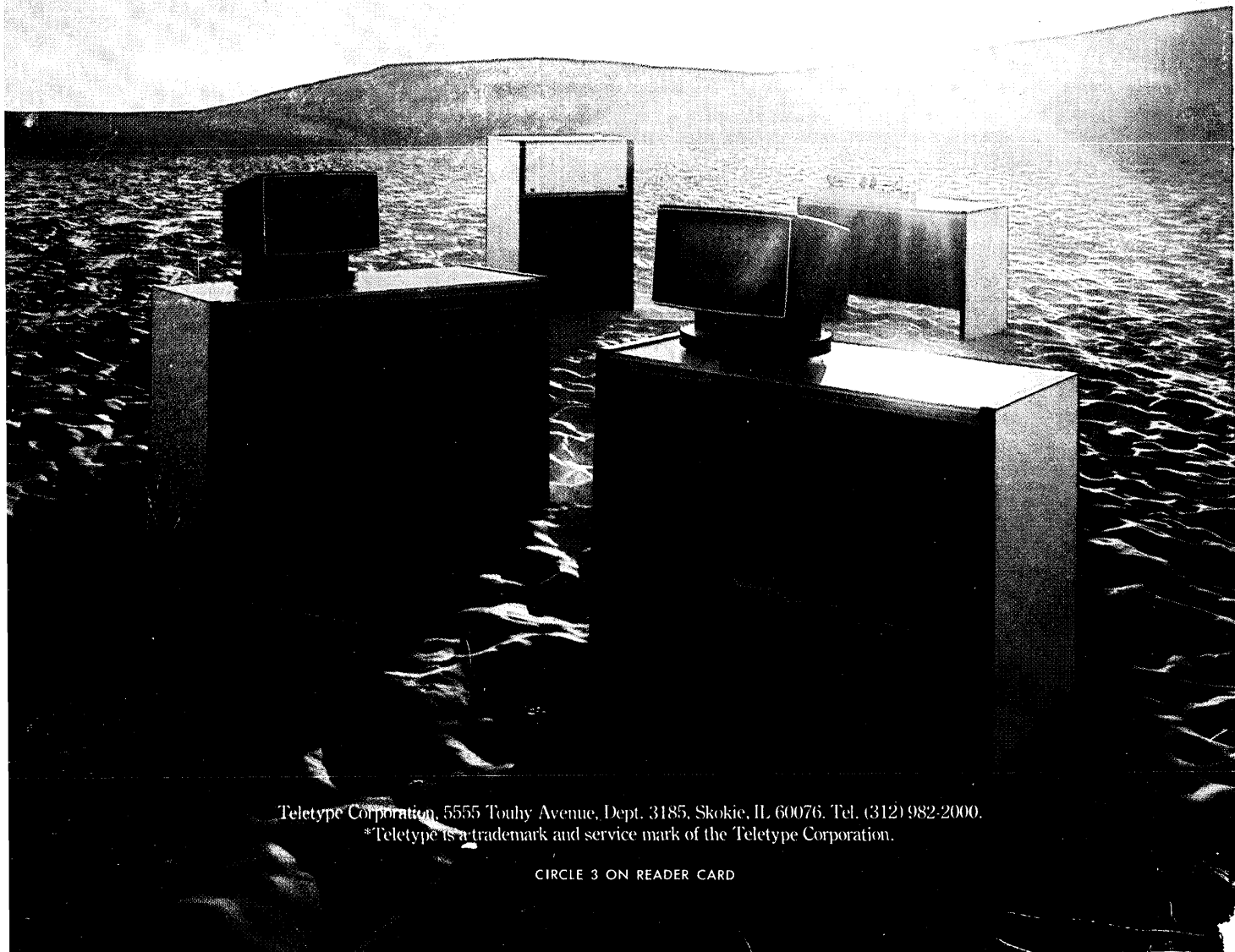

Teletype Corporation, 5555 Touhy Avenue, Dept. 3185, Skokie, IL 60076. Tel. (312) 982-2000.

\*Teletype is a trademark and service mark of the Teletype Corporation.

CIRCLE 3 ON READER CARD