

User's Manual

**PROGRAMMER'S
REFERENCE**

PERIPHERALS

015-000021-07

NOTICE

Data General Corporation (DGC) has prepared this manual for use by DGC personnel, licensees, and customers. The information contained herein is the property of DGC and shall not be reproduced in whole or in part without DGC's prior written approval.

Users are cautioned that DGC reserves the right to make changes without notice in the specifications and materials contained herein and shall not be responsible for any damages (including consequential) caused by reliance on the materials presented, including, but not limited to typographical, arithmetic, or listing errors.

NOVA, SUPERNOVA, ECLIPSE and **NOVADISC** are registered trademarks of Data General Corporation, Westboro, Massachusetts.

DATA GENERAL TECHNICAL MANUAL

**Programmer's
Reference Manual**

PERIPHERALS

I/O PROGRAMMING

I 

TERMINALS

II 

HARD COPY

III 

MAGNETIC TAPES

IV 

DISCS

V 

**ANALOG/DIGITAL
DIGITAL/ANALOG**

VI 

APPENDICES



This page intentionally left blank

PREFACE

The Programmer's Reference Manual for Peripherals is designed as a companion volume to the Programmer's Reference Manuals for the NOVA line and ECLIPSE Computers. It furnishes the general principles and the specific details needed to program input/output (I/O) transfers between standard DGC peripherals and all DGC computers.

This manual consists of several sections. Section I introduces the theory of I/O programming on DGC computers and presents several complete examples of I/O programs. The remaining sections of the manual deal with the various families of peripherals supplied by Data General Corporation. Separate chapters in each section provide the specific information necessary to program the individual peripherals in each family. Section II covers terminals; Section III covers hard copy devices. Section IV deals with magnetic tape storage devices, including industry-standard magnetic tape units and the DGC cassette. Section V covers fixed head discs, disc cartridges, and disc packs. Section VI describes analog-to-digital and digital-to-analog conversion with the Analog Data Conversion System. The appendices contain a number of reference tables which supply information about device codes, character codes, and timing figures needed for I/O operations.

Before reading this manual, the programmer should have a basic understanding of the programming of DGC computers, as described in the Programmer's Reference Manual for the NOVA line Computers (DGC 015-000023) and, where appropriate, in the Programmer's Reference Manual for the ECLIPSE Computer (DGC 015-000024). A familiarity with the operation of the DGC assembler, as described in the Assembler Manual (DGC 093-000017), is also recommended, as the programming examples are written in assembly language.

Additional information, of a more technical nature, may be found in the Interface Manual (DGC 015-000031), which describes the technical operation of the I/O bus and explains how to interface a nonstandard peripheral to any of the DGC computers.

As portions of this manual are updated, they are printed according to new typesetting specifications. This means some sections are presented in a different style than others. We ask our readers' indulgence for this unavoidable defect.

This page intentionally left blank

TABLE OF CONTENTS

SECTION I I/O PROGRAMMING

	<u>Page</u>
OVERVIEW OF INPUT/OUTPUT	I-1
INTRODUCTION	I-1
TYPES OF INFORMATION	I-1
TYPES OF INFORMATION TRANSFER	I-2
Direct Program Control	I-2
Data Channel Control	I-2
PROGRAM INTERRUPT FACILITY	I-2
SUMMARY	I-3
I/O INSTRUCTION SET	I-5
INTRODUCTION	I-5
THE TYPICAL CONTROLLER	I-5
Information Registers	I-5
Busy and Done Flags	I-6
Other Status Flags	I-6
INSTRUCTION FORMAT	I-7
Device Code Field	I-7
Flag Control Field	I-7
Operation Code Field	I-8
Accumulator Field	I-8
INSTRUCTIONS	I-9
NO I/O TRANSFER	I-9
I/O SKIP	I-9
DATA IN A	I-9
DATA OUT A	I-9
DATA IN B	I-10
DATA OUT B	I-10
DATA IN C	I-10
DATA OUT C	I-10
PROGRAM INTERRUPT FACILITY	I-13
INTRODUCTION	I-13
OPERATION	I-13
Control Flags	I-13
Interrupt Requests	I-14
Servicing an Interrupt	I-14
INSTRUCTIONS	I-15
INTERRUPT ENABLE	I-15
INTERRUPT DISABLE	I-15
SKIP IF INTERRUPTS ENABLED	I-15
SKIP IF INTERRUPTS DISABLED	I-15
MASK OUT	I-15
INTERRUPT ACKNOWLEDGE	I-15
I/O RESET	I-17

TABLE OF CONTENTS (Continued)

SECTION I (Continued)

	<u>Page</u>
PRIORITY INTERRUPTS	I-17
Interrupt Priority Mask	I-18
Priority Interrupt Handler	I-18
The Vector Instruction	I-19
VECTOR ON INTERRUPTING SERVICE CODE	I-19
DATA CHANNEL FACILITY	I-23
INTRODUCTION	I-23
Features	I-23
CONTROLLER STRUCTURE	I-23
Word Counter	I-24
Memory Address Counter	I-24
TRANSFER SEQUENCE	I-24
DATA CHANNEL MAP SELECTION	I-24
Processor Pauses	I-25
PROGRAMMING	I-25
TIMING	I-27
INTRODUCTION	I-27
DIRECT PROGRAM CONTROL	I-27
DATA CHANNEL CONTROL	I-28
PROGRAM EXAMPLES	I-31
INTRODUCTION	I-31
EXAMPLE ONE	I-32
EXAMPLE TWO	I-34
EXAMPLE THREE	I-37
EXAMPLE FOUR	I-47

SECTION II TERMINALS

INTRODUCTION TO TERMINALS	II-1
TELETYPEs	II-3
INTRODUCTION	II-3
INSTRUCTIONS	II-4
READ CHARACTER BUFFER	II-4
LOAD CHARACTER BUFFER	II-4
PROGRAMMING	II-5
Terminal	II-5
Paper Tape	II-5
TIMING	II-5
CONSIDERATIONS	II-5

TABLE OF CONTENTS (Continued)

SECTION II (Continued)

	<u>Page</u>
Input	II-5
Output	II-5
PROGRAMMING EXAMPLES	II-7
DGC DISPLAY 6012	II-9
INTRODUCTION	II-9
INSTRUCTIONS	II-10
READ CHARACTER BUFFER	II-10
LOAD CHARACTER BUFFER	II-10
CONTROL CHARACTERS	II-11
CONTROL KEYS	II-11
PROGRAMMING	II-14
Input	II-14
Output	II-14
TIMING	II-14
Input Timing	II-14
Output Timing	II-14
CONSIDERATIONS	II-15
Input	II-15
Output	II-15

SECTION III HARD COPY

INTRODUCTION TO HARD COPY PERIPHERALS	III-1
PAPER TAPE READER	III-3
INTRODUCTION	III-3
INSTRUCTIONS	III-4
READ FRAME	III-4
PROGRAMMING	III-4
TIMING	III-4
CONSIDERATIONS	III-4
PROGRAMMING EXAMPLES	III-5
PAPER TAPE PUNCH	III-7
INTRODUCTION	III-7
INSTRUCTIONS	III-8
LOAD FRAME BUFFER	III-8
PROGRAMMING	III-8
TIMING	III-8
CONSIDERATIONS	III-8
PROGRAMMING EXAMPLES	III-9

TABLE OF CONTENTS (Continued)

SECTION III (Continued)

	<u>Page</u>
CARD READERS.....	III-11
INTRODUCTION.....	III-11
INSTRUCTIONS.....	III-12
READ COLUMN.....	III-12
READ STATUS.....	III-13
PROGRAMMING.....	III-13
TIMING.....	III-14
ERROR CONDITIONS.....	III-14
PROGRAMMING EXAMPLES.....	III-15
LINE PRINTER.....	III-17
INTRODUCTION.....	III-17
INSTRUCTIONS.....	III-19
LOAD CHARACTER BUFFER.....	III-19
READ STATUS.....	III-19
PROGRAMMING.....	III-20
CONTROL CHARACTERS.....	III-21
TIMING.....	III-22
PROGRAMMING EXAMPLE.....	III-23
INCREMENTAL PLOTTERS.....	III-25
INTRODUCTION.....	III-25
INSTRUCTIONS.....	III-26
LOAD COMMAND BUFFER.....	III-26
PROGRAMMING.....	III-27
TIMING.....	III-27
CONSIDERATIONS.....	III-27
PROGRAMMING EXAMPLE.....	III-27

SECTION IV MAGNETIC TAPES

INTRODUCTION TO MAGNETIC TAPES.....	IV-1
INDUSTRY COMPATIBLE MAGNETIC TAPE TRANSPORT.....	IV-1
Data Formats.....	IV-2
Error Checking.....	IV-2
DGC CASSETTE TAPE TRANSPORTS.....	IV-3
Data Formats.....	IV-3
Error Checking.....	IV-3

TABLE OF CONTENTS (Continued)

SECTION IV (Continued)

	<u>Page</u>
INDUSTRY COMPATIBLE MAGNETIC SYSTEMS	IV-5
INTRODUCTION	IV-7
INSTRUCTIONS	IV-7
SPECIFY COMMAND AND UNIT	IV-8
READ STATUS	IV-8
LOAD MEMORY ADDRESS COUNTER	IV-9
LOAD WORD COUNTER	IV-9
READ MEMORY ADDRESS COUNTER	IV-9
PROGRAMMING	IV-10
Phase I: Initializing	IV-10
Phase II: Position the Tape	IV-11
Phase III: Read or Write	IV-12
TIMING	IV-14
ERROR CONDITIONS	IV-14
During Initializing	IV-14
During Positioning	IV-14
During Reading	IV-14
DGC CASSETTE	IV-15
INTRODUCTION	IV-15
INSTRUCTIONS	IV-16
SPECIFY COMMAND UNIT	IV-16
READ STATUS	IV-17
LOAD MEMORY ADDRESS COUNTER	IV-17
LOAD WORD COUNTER	IV-18
READ MEMORY ADDRESS COUNTER	IV-18
PROGRAMMING	IV-18
Phase I: Initializing	IV-19
Phase II: Position the Tape	IV-20
Phase III: Specify Transfer Parameters	IV-21
TIMING	IV-23
ERROR CONDITIONS	IV-23
During Initializing	IV-23
During Positioning	IV-23
During Reading	IV-23
During Writing	IV-23

SECTION V DISCS

INTRODUCTION TO DGC DISCS	V-1
DATA FORMATS ON DGC DISCS	V-2
ACCESSING	V-2
DGC DISC SUBSYSTEMS	V-3
SHARED DISC CONSIDERATIONS	V-4

TABLE OF CONTENTS (Continued)

SECTION V (Continued)	<u>Page</u>
FIXED HEAD DISC SUBSYSTEM.....	V-5
INTRODUCTION	V-5
INSTRUCTIONS	V-6
SPECIFY TRACK AND SECTOR	V-6
LOAD MEMORY ADDRESS COUNTER.....	V-6
READ STATUS	V-7
READ MEMORY ADDRESS COUNTER.....	V-7
DIAGNOSTIC	V-7
PROGRAMMING	V-7
Phase I: Specify the Parameters of the Transfer	V-7
Phase II: Initiate the Transfer	V-8
TIMING	V-9
DISC FORMAT	V-9
ERROR CONDITIONS	V-10
During Specification of the Parameters of the Transfer.....	V-10
During a Read Operation	V-10
During a Write Operation	V-10
THE 4047A AND 4047B DISC CARTRIDGE SYSTEMS.....	V-11
INTRODUCTIONS.....	V-11
INSTRUCTIONS	V-12
SPECIFY DISC ADDRESS AND SECTOR COUNT	V-12
SPECIFY COMMAND AND CYLINDER.....	V-13
LOAD MEMORY ADDRESS COUNTER	V-13
READ STATUS.....	V-14
READ DISC ADDRESS	V-14
READ MEMORY ADDRESS COUNTER	V-15
PROGRAMMING.....	V-15
Phase I: Select the Drive, Surface, Sector and Number of Sectors	V-15
Phase II: Position the Heads.....	V-16
Phase III: Read or Write	V-17
TIMING	V-19
ERROR CONDITIONS	V-20
During Initial Selection	V-20
During Head Positioning	V-20
During Reading	V-20
During Writing	V-20
THE 4048A DISC PACK SUBSYSTEM.....	V-21
INTRODUCTION.....	V-21
INSTRUCTIONS	V-22
SPECIFY DISC ADDRESS AND SECTOR COUNT	V-22
READ STATUS.....	V-23
SPECIFY COMMAND AND CYLINDER.....	V-23
LOAD MEMORY ADDRESS COUNTER	V-24
READ DISC ADDRESS	V-24
READ MEMORY ADDRESS COUNTER	V-24

TABLE OF CONTENTS (Continued)

SECTION V (Continued)

	<u>Page</u>
PROGRAMMING	V-25
Phase I: Select the Drive, Surface, Sector and Number of Sectors	V-25
Phase II: Position the Heads	V-26
Phase III: Read or Write	V-27
Format	V-28
TIMING	V-29
ERROR CONDITIONS	V-29
During Initial Selection	V-29
During Head Positioning	V-29
During Reading	V-29
During Writing	V-30
Check Error	V-30
THE 4057A DISC PACK	V-31
INTRODUCTION	V-31
INSTRUCTIONS	V-32
SPECIFY DISC ADDRESS AND SECTOR COUNT	V-32
READ STATUS	V-33
SPECIFY COMMAND CYLINDER	V-33
LOAD MEMORY ADDRESS COUNTER	V-34
READ DISC ADDRESS	V-34
READ MEMORY ADDRESS COUNTER	V-34
PROGRAMMING	V-35
Phase I: Select the Drive, Surface, Sector and Number of Sectors	V-35
Phase II: Position the Heads	V-36
Phase III: Read or Write	V-37
Format	V-38
TIMING	V-39
ERROR CONDITIONS	V-39
During Initial Selection	V-39
During Head Positioning	V-39
During Reading	V-39
During Writing	V-40
Check Error	V-41
THE 4231A DISC PACK SUBSYSTEM	V-43
INTRODUCTION	V-44
INSTRUCTIONS	V-44
SPECIFY DISC ADDRESS AND SECTOR COUNT	V-44
READ STATUS	V-45
SPECIFY COMMAND AND CYLINDER	V-45
LOAD MEMORY ADDRESS COUNTER	V-46
READ DISC ADDRESS	V-46
READ MEMORY ADDRESS COUNTER	V-46
PROGRAMMING	V-47
Phase I: Select the Drive, Surface, Sector and Number of Sectors	V-47
Phase II: Position the Heads	V-47
Phase III: Read or Write	V-48

TABLE OF CONTENTS (Continued)

SECTION V (Continued)

	<u>Page</u>
FORMAT	V-50
TIMING	V-50
ERROR CONDITIONS	V-50
During Initial Selection	V-50
During Head Positioning	V-50
During Reading	V-50
During Writing	V-51
 CARTRIDGE DG/DISC SUBSYSTEM MODELS 6045, 6050, 6051	V-53
INTRODUCTION	V-54
CONTROLLER REGISTERS	V-54
INSTRUCTIONS	V-54
Instruction Coding Conventions	V-55
Specify Disc Address and Sector Count	V-55
Specify Command and Cylinder	V-55
Load Memory Address Register	V-55
Read Status	V-56
Read Disc Address	V-56
Read Memory Address Register	V-56
PROGRAMMING	V-57
Phase I: Select the Drive, Surface, Sector and Number of Sectors	V-57
Phase II: Position the Heads	V-57
Phase III: Read or Write	V-58
Read	V-58
Write	V-59
FORMATTING	V-60
TIMING	V-60
ERROR CONDITIONS	V-61
During Initial Selection (Phase I)	V-61
Absence of Valid Status	V-61
Unsafe Error	V-61
During Head Positioning (Phase II)	V-61
Seek Retry	V-61
During Reading	V-61
End of Cylinder Error	V-62
Address Error	V-62
Checkword Error	V-62
Data Late Error	V-62
During Writing	V-62
End of Cylinder Error	V-62
Address Error	V-62
Data Late Error	V-63
MULTIPLE DRIVES	V-63
Phase I Considerations	V-63
Phase II Considerations	V-63
Phase III Considerations	V-63
DUAL PROCESSOR CONSIDERATIONS	V-64
Phase I, Initial Selection	V-64
Phase II	V-64
Phase III	V-64

TABLE OF CONTENTS (Continued)

	<u>Page</u>
6030 SERIES DG/DISKETTE SUBSYSTEM	V-69
INTRODUCTION	V-70
CONTROLLER REGISTERS	V-70
INSTRUCTIONS	V-70
Instruction Coding Conventions	V-70
Specify Command and Track	V-71
Specify Disc Address and Sector Count	V-71
Load Memory Address Register	V-71
Read Status	V-72
Read Disc Address	V-72
Read Memory Address Register	V-72
PROGRAMMING	V-73
Phase I: Select the Drive, Sector and Number of Sectors	V-73
Phase II: Position the Heads	V-73
Phase III: Read or Write	V-74
Read	V-74
Write	V-75
FORMATTING	V-76
TIMING	V-76
ERROR CONDITIONS	V-77
During Initial Selection (Phase I)	V-77
Absence of Valid Status	V-77
Unsafe Error	V-77
During Head Positioning (Phase II)	V-77
Seek Retry	V-77
During Reading	V-77
End of Track Error	V-77
Address Error	V-78
Checkword Error	V-78
Data Late Error	V-78
During Writing	V-78
End of Cylinder Error	V-78
Address Error	V-78
Data Late Error	V-79
MULTIPLE DRIVES	V-79
Phase I Considerations	V-79
Phase II Considerations	V-79
Phase III Considerations	V-79
DUAL PROCESSOR CONSIDERATIONS	V-80
Phase I, Initial Selection	V-80
Phase II	V-80
Phase III	V-80
4234 SERIES 10MB CARTRIDGE DISC SUBSYSTEM	V-85
INTRODUCTION	V-86
CONTROLLER REGISTERS	V-86

TABLE OF CONTENTS (Continued)

SECTION V (Continued)

	<u>Page</u>
INSTRUCTIONS	V-86
Instruction Coding Conventions	V-87
Specify Disc Address and Sector Count	V-87
Specify Command and Cylinder	V-87
Load Memory Address Register	V-87
Read Status	V-88
Read Disc Address	V-88
Read Memory Address Register	V-88
PROGRAMMING	V-89
Phase I: Select the Drive, Surface, Sector and Number of Sectors	V-89
Phase II: Position the Heads	V-89
Phase III: Read or Write	V-90
Read	V-90
Write	V-91
FORMATTING	V-92
TIMING	V-92
ERROR CONDITIONS	V-93
During Initial Selection (Phase I)	V-93
Unsafe Error	V-93
During Head Positioning (Phase II)	V-93
Seek Retry	V-93
During Reading	V-93
End of Cylinder Error	V-94
Address Error	V-94
Checkword Error	V-94
Data Late Error	V-94
During Writing	V-94
End of Cylinder Error	V-94
Address Error	V-94
Data Late Error	V-95
MULTIPLE DRIVES	V-95
Phase I Considerations	V-95
Phase II Considerations	V-95
Phase III Considerations	V-95
6060 SERIES DG/DISC STORAGE SUBSYSTEM	V-97
INTRODUCTION	V-98
CONTROLLER REGISTERS	V-98
INSTRUCTIONS	V-99
SPECIFY COMMAND AND DRIVE	V-99
SPECIFY CYLINDER	V-100
SPECIFY SURFACE, SECTOR AND COUNT	V-100
READ SURFACE, SECTOR AND COUNT	V-100
SPECIFY MEMORY ADDRESS	V-101
READ MEMORY ADDRESS	V-101
READ DRIVE STATUS	V-102
READ DATA TRANSFER STATUS	V-102
READ FIRST ECC WORD	V-103
READ SECOND ECC WORD	V-103

TABLE OF CONTENTS (Continued)

SECTION V (Continued)

	<u>Page</u>
PROGRAMMING DETAILS	V-103
Phase I: Select a Drive and Specify a Seek Command	V-103
Phase II: Position the Heads	V-104
Phase III: Select a Drive and Specify a Read/Write Command	V-104
Phase IV: Read or Write	V-104
Phase V: Release Drive	V-104
FORMATTING	V-109
TIMING	V-109
DETAILED COMMAND DESCRIPTIONS	V-110
Read	V-110
Recalibrate	V-110
Seek	V-110
Stop Disc	V-110
Offset Forward	V-110
Offset Reverse	V-110
Write Disable	V-110
Release Drive	V-110
Trespass	V-110
Set Alternate Mode 1	V-110
Set Alternate Mode 2	V-110
No Operation	V-110
Data Verify	V-110
Read Buffers	V-110
Write	V-111
Format	V-111
FAULT FLAGS	V-111
Drive Faults	V-111
Illegal Address	V-111
Illegal Command	V-111
Dc Voltage Fault	V-111
Pack Unsafe	V-111
Positioner Fault	V-112
Clock Fault	V-112
Write Fault	V-112
Read/Write Faults	V-112
Parity	V-112
Illegal Sector Address	V-112
ECC	V-112
Bad Sector	V-112
Cylinder Address	V-112
Sector or Surface Address	V-112
Verify	V-112
Read/Write Timeout	V-112
Data Late	V-112
ERROR CONDITIONS	V-114
During Initial Selection	V-114
During Head Positioning	V-114
During Data Transfer	V-114
DATA ERROR CORRECTION	V-115

TABLE OF CONTENTS (Continued)

SECTION V (Continued)

	<u>Page</u>
6063-6065 SERIES FIXED HEAD DISC SUBSYSTEM	V- 121
INTRODUCTION	V- 122
CONTROLLER REGISTERS	V- 122
INSTRUCTIONS	V- 123
Instruction Coding Conventions	V- 123
SPECIFY QUEUE ADDRESS	V- 123
SPECIFY MEMORY ADDRESS	V- 123
SPECIFY ALTERNATE INSTRUCTION TYPE	V- 124
READ MEMORY ADDRESS	V- 124
READ FIRST ECC WORD	V- 124
READ SECOND ECC WORD	V- 125
READ QUEUE ADDRESS	V- 125
READ STATUS	V- 125
COMMAND QUEUE FORMAT	V- 126
DISC ADDRESS	V- 126
COMMAND	V- 126
MEMORY ADDRESS	V- 126
STATUS	V- 126
USER AVAILABLE WORD	V- 126
PROGRAMMING	V- 127
WRITE	V- 127
READ	V- 127
DATA VERIFY	V- 127
JUMP	V- 128
IDLE	V- 128
READ/WRITE BUFFER	V- 128
STATUS CHECKING	V- 128
TIMING	V- 129
ERROR CONDITIONS	V- 129
Parity Error	V- 129
ECC Error	V- 129
Verify Error	V- 129
Data Late	V- 129
Sector Pulse Error	V- 130
Disc Unsafe	V- 130
Address/Data Error	V- 130
DUAL PROCESSOR CONSIDERATIONS	V- 130
DATA ERROR CORRECTION	V- 131

TABLE OF CONTENTS (Continued)

SECTION VI ANALOG/DIGITAL DIGITAL/ANALOG

	<u>Page</u>
INTRODUCTION TO DGC A/D AND D/A SUBSYSTEMS	VI-1
ANALOG AND DIGITAL DATA	VI-1
Analog Data	VI-1
Digital Data	VI-1
Analog/Digital Data Correspondence	VI-1
Digital Representations of Analog Data	VI-1
DATA ACCURACY	VI-3
4120 SERIES ANALOG/DIGITAL CONVERSION SUBSYSTEM	VI-5
CONFIGURATIONS	VI-5
Programmable Gain Option	VI-6
OPERATION	VI-7
Modes of Operation	VI-7
Conversion Sequence	VI-7
Synchronization to a Clock	VI-8
Power-Up Conditions	VI-8
Channel Numbering	VI-8
INSTRUCTIONS: SINGLE CONVERSION MODE	VI-9
Basic Controller	VI-9
Instruction Set	VI-10
SELECT CHANNEL	VI-10
READ CHANNEL SELECT	VI-10
SELECT GAIN	VI-10
READ DATA	VI-11
PROGRAMMING: SINGLE CONVERSION MODE	VI-11
Example	VI-12
INSTRUCTIONS: DATA CHANNEL MODE	VI-12
Extended Controller	VI-12
SELECT CHANNEL AND LIMIT	VI-13
READ CHANNEL SELECT AND LIMIT	VI-14
LOAD MEMORY ADDRESS COUNTER	VI-14
READ MEMORY ADDRESS COUNTER	VI-14
LOAD WORD COUNTER	VI-15
LOAD WORD COUNTER AND SELECT GAIN	VI-15
Programming	VI-16
Example	VI-16
PROGRAMMING: SINGLE CONVERSION MODE WITH DATA CHANNEL OPTION PRESENT	VI-17
TIMING CONSIDERATIONS	VI-17
Maximum Conversion Time	VI-17
Typical Maximum Conversion Rate	VI-17
Clock Settings	VI-18
Additional Considerations	VI-18

TABLE OF CONTENTS (Continued)

SECTION VI (Continued)

	<u>Page</u>
4180 SERIES DIGITAL/ANALOG CONVERSION SUBSYSTEM	VI-19
CONFIGURATIONS	VI-19
Scope Control Option	VI-19
OPERATION	VI-19
INSTRUCTIONS: D/A	VI-20
SELECT CHANNEL	VI-20
OUTPUT DATA AND CONVERT	VI-20
PROGRAMMING: D/A	VI-21
Timing and Accuracy Considerations	VI-21
Example	VI-21
SCOPE CONTROL OPTION	VI-22
Operation	VI-22
INSTRUCTIONS: SCOPE CONTROL	VI-23
SELECT SCOPE MODE	VI-23
READ ERASE STATUS	VI-23
PROGRAMMING: SCOPE CONTROL	VI-23
Example	VI-24

APPENDICES

APPENDIX A

I/O DEVICE CODES AND DATA GENERAL MNEMONICS	A-1
---	-----

APPENDIX B

OCTAL AND HEXADECIMAL CONVERSION	B-1
--	-----

APPENDIX C

ASCII-128 CHARACTER CODES	C-1
EBCDIC CHARACTER CODES	C-5

APPENDIX D

NOVA LINE COMPUTERS INSTRUCTION EXECUTION TIMES	D-1
ECLIPSE COMPUTER INSTRUCTION EXECUTION TIMES	D-2

APPENDIX E

CODING AIDS	E-1
-------------------	-----

SECTION I

I/O PROGRAMMING

- OVERVIEW OF INPUT/OUTPUT
- I/O INSTRUCTION SET
- PROGRAM INTERRUPT FACILITY
- DATA CHANNEL FACILITY
- TIMING
- PROGRAMMING EXAMPLES

This page intentionally left blank

OVERVIEW OF INPUT/OUTPUT

INTRODUCTION

Input/output is the process of moving information in a computer system between the central processing unit (CPU) and peripherals such as card readers, line printers, terminals and disc units. Some peripherals, such as card readers, enter information into the system. Some, such as line printers, transfer information out of the system. Some, such as terminals, transfer information in both directions; and others, such as disc units, store information within the system. Peripherals, therefore, can serve two main purposes, they provide the computer with a means of communicating with its surroundings, and they supplement main memory with secondary storage.

A peripheral generally consists of two units, a device and a controller, but it may also include an adapter. The device, sometimes called a drive, a transport or a terminal, is the unit with which information is read, written, stored, or processed. For example, a terminal's keyboard "reads" information; a plotter "writes" information; a magnetic tape transport "stores" information; and an A/D converter "processes" information.

The controller is the interface between the computer and the device, interpreting commands from the computer to the device and passing information between them. For example, a moving-arm disc controller can translate the track address received from the computer into positional commands for the disc drives access mechanism. Once the access mechanism positions the read/write heads, the controller translates the data words it receives from the computer into the sequence of bits required by the disc drive.

The adapter is an additional unit required by some peripherals to complete the communications link

between the device and the controller. It performs functions which are similar to those performed in either the device, the controller, or both. Since the adapter cannot be accessed by the programmer, it is usually transparent.

The communications channel through which all information passes between the computer and the controllers is called the Input/Output (I/O) bus. The central portion of the I/O bus is a 16-bit wide, bidirectional shared data bus. Since this bus is shared by all the controllers as well as by the CPU, it is, by necessity, a half-duplex bus; i.e., only one operation can occur at any time. The direction of all information transfers on the I/O bus is defined relative to the computer. "Output" always refers to moving information from the computer to a controller; "input" always refers to moving information from a controller to the computer.

TYPES OF INFORMATION

The information transferred between a computer and a controller can be classified into three types: status, control, and data. Status information tells the computer about the state of the peripheral: is it busy?, is it ready?, is it operating properly? Control information is transferred by the computer to the controller to tell the peripheral what to do. Data is the information which originates from, or is sent to, the device during reading, writing, storing, or processing.

Irrespective of the type of information transferred, is the amount of information transferred. A single bit may be transferred; a collection of bits forming a byte (or character), 16 bits forming a word, or a group of words forming a block may be transferred.

TYPES OF INFORMATION TRANSFER

Information can be transferred between the computer and a peripheral in one of two ways: under direct program control or under data channel control. An information transfer occurring under direct program control moves a word or part of a word between an accumulator in the CPU and a register in the controller. This type of transfer occurs when an appropriate I/O instruction is executed in the program. An information transfer under data channel control generally moves a block of data, one word at a time, between the computer's memory and the device, through a register in the controller. The block of data is transferred automatically via the data channel once the program, using I/O instructions, sets up the transfer for a particular peripheral.

Direct Program Control

Direct program control of information transfers, also called "programmed I/O", is a way of transferring single words or parts of words to or from peripherals. Among the peripherals which transfer data in this way are terminals, paper tape readers and punches, card readers, line printers and plotters. Since the data moves through an accumulator, it is readily available to the program for manipulation or decision making. In the case of input, for example, the program can decide whether to read another word or character based on the value of the word or character just read.

However, because at least one instruction--and most likely several since the information must be stored in memory--must be executed for each character or word transferred, direct program control can be efficient only for peripherals which do not have to transfer large quantities of information quickly.

Data Channel Control

Some peripherals, such as discs and magnetic tape transports, are used to transfer large blocks of data. In order to reduce the amount of program overhead required, these blocks are transferred under data channel control. The commands used to set up the data channel transfer are assembled in an accumulator and are transferred to the controller under direct program control. The block of data is then automatically transferred directly between memory and the controller via the data channel.

Once the data channel transfer for a block of data has been set up and initiated by the program, no further action by the program is required to complete the transfer. The program can proceed with other tasks while the block transfer is taking place. Each time the controller is ready to transfer a word from the block it requests direct access to memory. When access is granted, the word is transferred. Because several instructions do not have to be executed for each word transferred, block transfers can occur at high rates, in some cases at more than a million words per second.

Since the actual transfer of a word via the data channel could conflict with the program instructions being executed, the program pauses during the transfer of each word. This pause is transparent to the programmer with the exception that the time required for program execution is lengthened.

PROGRAM INTERRUPT FACILITY

When transferring information under either direct program control or data channel control, the program must be able to determine when the transfer is complete, so that it can start a new transfer or proceed with a task that was dependent on the transfer just completed. Peripherals have status flags which can provide the program with this needed information. The I/O instruction set allows the program to check the status of these flags and perform decisions based on the results of the checks. However, these status checks are time-consuming, so, to avoid the necessity of continually performing such tests, all DGC computers incorporate a program interrupt facility.

The program interrupt facility provides a peripheral with a convenient means of notifying the processor that it requires service by the program. This is accomplished by allowing the peripherals to interrupt normal program flow on a priority basis. When a peripheral completes an operation or encounters a situation requiring processor intervention, it can request a program interrupt of the processor. The processor honors such a request by interrupting the program in process, saving the address where the interruption occurred, and transferring control to the interrupt handling routine. The interrupt handling routine can identify which peripheral requires service and transfer control to the service routine for that peripheral. After servicing that peripheral, the routine can restore the system to the state it was in when the interrupt occurred.

For computer systems which require large amounts of I/O to many devices, a multi-level priority structure up to 16 levels deep can be established. This structure can be set up to provide rapid service to those devices which are crucial to the efficient operation of the computer system; the less critical devices are serviced in as efficient a manner as possible. The priority interrupt structure, like the rest of the program interrupt facility, is under direct control of the program.

SUMMARY

The following sections of this Introduction to I/O Programming cover, in detail, the concepts introduced above. The instructions needed to perform a direct program controlled transfer are discussed in terms of their interaction with the controller and the CPU. The mechanics of the program interrupt facility together with methods used to arrange a priority structure are presented. Methods used in performing block transfers via the data channel are followed by a general discussion of the timing concepts which should be considered when designing an efficient system for handling I/O. Finally, examples are presented which illustrate the procedures discussed in this Introduction to I/O Programming.

This page intentionally left blank

I/O INSTRUCTION SET

INTRODUCTION

Information transfers between the computer and the various peripherals are governed by the program with eight instructions which constitute the I/O instruction set. These instructions allow the program to communicate with the peripherals' controllers and to control the program interrupt facility. This manual covers only those I/O instructions used for these purposes; additional I/O instructions used for special processor functions and options are fully described in the Programmer's Reference Manuals for the ECLIPSE™ and NOVA® line computers.

The effects of specific I/O instructions necessarily depend on the peripherals to which they are addressed. However, the general functions provided by the I/O instructions (loading and reading registers, issuing control signals, and testing flags) are the same for all peripherals; different peripherals merely use the available functions in different ways. In order to understand the general functions performed by the I/O instructions and how these functions are typically used by peripheral controllers, some knowledge of the architecture of a peripheral controller is required.

THE TYPICAL CONTROLLER

From the point of view of the program, a peripheral controller operates as a collection of information registers, control registers, and status flags, with which communications are established. With these registers and flags, the program can route data between the computer and the device and monitor the operation of the device. Information registers act as temporary depositories for information being transferred between the computer and the device. For an input operation, the device places information in a register in the controller and the computer then reads the register's contents. For an output operation, the computer

places information in a register in the controller and the device can access that information when necessary. Control registers are loaded by the program and are used to control the operation of the device. Status flags are set by the peripheral to reflect its current operating conditions. The program, through the use of I/O instructions can examine these status flags and can alter some of them to change the operating state of the peripheral.

The distinction made here between registers and flags is generally one of information content. A flag contains a single bit of information, while a register is made up of a number of bits. Groups of contiguous bits in a register which convey a single "piece" of information are referred to as "fields". For example, in one of the magnetic tape controller's registers, bits 13-15 act together as a control field to select one of the eight possible tape transports in the subsystem.

The paragraphs below describe only the basic components of a typical controller. The additional structure required for a peripheral using the program interrupt facility or the data channel is discussed in the sections describing those facilities. What follows is meant only to typify the workings of a controller; controllers are tailored to the specific devices they control, so that not all fit the model given here.

Information Registers

A controller usually contains one or more information registers. Using I/O instructions, the program can load data and control information into these registers from the processor's accumulators and can read data and status information into the accumulators from them. The three types of information considered here--data, control, and status--give rise to three basic types of information registers, which are described below.

Data Registers

A data register (or data buffer) is used to store data in the controller as it passes between the device and the computer. This buffer is needed because the computer and the device usually operate at different speeds. Since the operation of nearly all peripherals involve the transfer of a word or part of a word of data between the computer and the device, nearly all peripherals controllers contain a data buffer. In the case of peripherals which transfer data under direct program control, the data buffer is directly accessible to the program. Data is transferred between the register in the controller and an accumulator in the central processor by an I/O instruction. In the case of a peripheral which transfers data under data channel control, the data is transferred directly between the register in the controller and memory. Data buffers in the controllers which use the data channel need not be--and usually are not--accessible to the program.

Control Registers

Control registers allow the program to supply the controller with information necessary for the operation of the device, such as drive or transport numbers, data block sizes, and command specification. A unit of control information is called a "control parameter". Control parameters typically allow the program to select one of a number of peripheral units in a subsystem, the operation to be performed, and the initial values for flags and counters in the controller. The program specifies control parameters to the controller with an I/O instruction wherein the desired parameters are coded into the appropriate fields of the accumulator used in the transfer.

Status Registers

Status registers are used to indicate to the program the detailed state of the peripheral. They consist primarily of status flags, but can also contain control parameters. The control parameters contained in status registers are commonly those which change during the operation of the peripheral, and are therefore of importance to the program which must check on the progress of the peripheral's operation. For example, a program transferring consecutive sectors of information on a disc in a single operation can read the current sector address and sector count during the operation in order to determine how far the operation is from completion. Status flags are set by the controller to indicate error conditions or to notify the computer of the basic state of the peripheral.

The classification of controller registers into the three types described above can only be a general one. A register may contain more than one type of information. The most common case of this occurrence is a register that serves as a control register when loaded by the program and as a status register when read by the program. The disc address/sector counter register mentioned in the preceding paragraph is an example of such a combined control and status register.

Busy and Done Flags

The Busy and Done flags are the two fundamental flags in a controller and they serve a dual purpose. Together they denote the basic state of the peripheral and can be tested by the program to determine that state. In addition, the program can manipulate these flags in order to control the operation of the peripheral. To place the peripheral in operation, the program sets the Busy flag to 1. The Busy flag remains in this state for the duration of the operation, indicating that the peripheral is in use and should not be disturbed by the program. When the peripheral completes its operation, the controller sets the Busy flag to 0 and the Done flag to 1 to indicate this fact. The setting of the Done flag to 1 can be used to trigger a program interrupt. Whether a program interrupt occurs depends on the state of the interrupt facility. However, no matter what state the interrupt facility is in, no interrupt can occur for that peripheral until its Done flag is set to 1. Therefore, the setting to 1 of the Done flag is defined to "initiate a program interrupt request". At this point, the program can either start the next operation by setting the Done flag to 0 and the Busy flag to 1, or it can idle (clear) the peripheral by setting both flags to 0.

Other Status Flags

For a relatively simple peripheral, the Busy and Done flags alone may furnish enough status information to allow the program to service the peripheral adequately. However, a more complex peripheral will generally require additional status flags to specify its internal operating conditions more completely to the program. The difference between these additional status flags and the Busy and Done flags lies in the way the program tests them. The program can test the Busy and Done flags directly with a single I/O instruction, but checking any other status flag requires that its value first be read into an accumulator from the status register. Each status flag is assigned by the controller to one of the 16 available bit positions in the status register. The program may then perform any test it requires on the status word after it is read.

Error Flags

Status flags which indicate errors or malfunctions in the operation of a peripheral are termed "error flags". Two types of error flags can be characterized, according to their effect on the operation of the peripheral when they are set. The first, or passive, type is merely set by the controller in the course of the operation when the associated error occurs. No immediate indication of this type of error is given to the program, and the operation is allowed to continue to completion. The second, or active, type of error flag is set by the controller when the program attempts to start an operation which is not allowed. In this case, the operation never begins and the Done flag is set to 1 immediately to notify the program. This type of error flag is used to prevent a severe and probably irrecoverable error from occurring. In either case, the program must respond, error or not, when it notices that a peripheral is "done". It need only check the appropriate error flag or flags before assuming that the operation it initiated was satisfactorily completed.

For example, among its many status flags, the controller for magnetic tape transports contains error flags to indicate parity errors and illegal operations. During a read operation, when a character is read with incorrect parity, the Parity Error flag is set to 1. No immediate notification of the error is given to the program and the read operation is allowed to finish. The parity error can be detected at the completion of the operation, when the program should check for errors. At this time appropriate action can be taken, such as trying to read the misread section of tape again or printing an error message on the console terminal. The Illegal flag, on the other hand, which is set when an illegal operation is attempted, prevents the operation from starting. The controller immediately sets both the Done and Illegal flags to 1 to notify the program. Illegal operations for a magnetic tape transport include writing on a tape that is write-protected and spacing backwards when the tape is at the beginning of tape marker.

INSTRUCTION FORMAT

The general format of the I/O instructions is shown below.

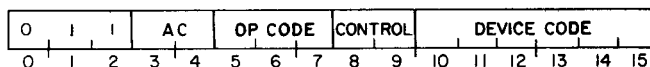

Bits 0-2 are 011 and identify this as an I/O instruction, bits 3-4 specify an accumulator, bits 5-7 contain the operation code, bits 8-9 specify a flag control function or test condition, and bits 10-15 specify the code of the device.

Device Code Field

Bits 10-15 in an I/O instruction select the peripheral that is to respond to the instruction. The instruction format thus allows for 64 device codes, numbered 0-77g. In all computers, device code 0 is not assigned to any peripheral, and device code 77g is used to implement a number of specific processor functions, such as reading the console switches and controlling the program interrupt facility. Depending on the computer, a number of other specific device codes are reserved for processor options or features. The remaining device codes are available for referencing peripherals. Many of these codes have been assigned by Data General Corporation to standard peripherals, and the assembler recognizes convenient mnemonics for these codes. The list of the standard device code assignments and their associated mnemonics is given in Appendix A.

Flag Control Field

The Busy and Done flags are either manipulated or tested by the control functions or test conditions specified in bits 8 and 9 of the I/O instructions. In those instructions which allow flag manipulation, bits 8 and 9 are referred to as the F field. The flag control commands available, along with the associated mnemonics and bit configurations and the functions typically performed, are as follows:

F field	Command	Mnemonic	Control Function
00	(none)	(omitted)	None
01	Start	S	Start the peripheral by setting the Busy flag to 1 and the Done flag to 0.
10	Clear	C	Clear (idle) the peripheral by setting both the Busy and Done flags to 0.
11	Pulse	P	Pulse the controller to achieve a special effect. The effect, if any, depends on the peripheral.

In the I/O instruction which allows flag testing, bits 8 and 9 are referred to as the T field. The bit configurations, mnemonics, and test conditions they select are as follows:

T field	Mnemonic	Next instruction is skipped if:
00	BN	<u>B</u> usy flag is 1 (<u>N</u> on-zero)
01	BZ	<u>B</u> usy flag is 0 (<u>Z</u> ero)
10	DN	<u>D</u> one flag is 1 (<u>N</u> on-zero)
11	DZ	<u>D</u> one flag is 0 (<u>Z</u> ero)

Two important features of the I/O instruction set result from the nature of the flag control field. First, because the flag control field is separate from the operation code field, a single I/O instruction can both transfer information between the controller and the computer and simultaneously control the operation of the peripheral. Secondly, the use of the flag control field as a T field allows the direct testing of a controller's Busy or Done flag in a single instruction, so that quick decisions based on the basic state of the peripheral can be made by the program.

Operation Code Field

The 3-bit operation code field selects one of the eight I/O instructions. In two of these instructions, no information transfer is specified; instead, bits 8 and 9 may specify either a control function or a flag test condition as described above. The remaining six instructions involve an information transfer between the computer and the designated peripheral controller and may also specify a control function to be performed after the information transfer has been completed. The program can, therefore, access up to six registers in any one controller. Up to three of these six registers are output registers which can be loaded by the program with either data or control information. The other three are input registers, from which the program can read either data or status information. It is entirely possible and, in fact, quite common for two different I/O instructions, one input and one output, to reference the same register in a controller. However, this is not in any way required by the nature of the I/O instruction set; potentially six different registers in a controller may be accessible to the program.

In order to give names and mnemonics to the I/O instructions in their general form, the registers in a peripheral controller which are accessible to the program are referred to with letter designations. The three input registers are called the "A input buffer", the "B input buffer", and the "C input buffer". Similarly, the three output registers are

called the "A output buffer", the "B output buffer", and the "C output buffer". Thus, for example, to read data from a peripheral controller's A input buffer, a DATA IN A instruction, with mnemonic DIA, is issued to that peripheral.

The eight operation codes, their associated mnemonics, and the instructions specified are as follows:

Operation Code field	Mnemonic	Instruction
000	NIO	<u>N</u> o <u>I</u> nput or <u>O</u> utput but <u>p</u> erform the flag control function specified.
001	DIA	Read <u>D</u> ata <u>I</u> nto the computer from the <u>A</u> input buffer.
010	DOA	Write <u>D</u> ata <u>O</u> ut from the computer to the <u>A</u> output buffer.
011	DIB	Read <u>D</u> ata <u>I</u> nto the computer from the <u>B</u> input buffer.
100	DOB	Write <u>D</u> ata <u>O</u> ut from the computer to the <u>B</u> output buffer.
101	DIC	Read <u>D</u> ata <u>I</u> nto the computer from the <u>C</u> input buffer.
110	DOC	Write <u>D</u> ata <u>O</u> ut from the computer to the <u>C</u> output buffer.
111	SKP	<u>S</u> KiP the next instruction if the test selected for the Busy or Done flag is true.

Accumulator Field

Bits 3 and 4 in an I/O instruction select one of the central processor's four accumulators: AC0, AC1, AC2, or AC3. In those instructions which involve an information transfer between the processor and a peripheral controller, the specified accumulator either furnishes the information for an output transfer or receives the information in an input transfer. In the two I/O instructions which do not involve an information transfer, the accumulator field is ignored. The assembler sets bits 3 and 4 in these instructions to 0; however, any bit combination will do, and no accumulator will ever be affected by these two instructions.

INSTRUCTIONS

A number of abbreviations and symbols are used in this manual to aid in defining how an instruction may be coded in assembly language. Abbreviations used are as follows:*

AC or ac	accumulator
F or f	flag control command
T or t	flag test command
device	device code or mnemonic

The following symbols are not coded, rather they perform these functions:

< >	Indicates an optional operand. The operand enclosed in the brackets (e.g., <f>) may be coded or not, depending on whether the associated option is desired.
=	Indicates a specific substitution is required. Substitute the desired number, letter or letters, or symbol from the class, as defined by the abbreviation for which the substitution is being made. For example, " <u>ac</u> " indicates that an accumulator specifier is required. To select AC2, code either a "2" or a symbol whose value is 2.

When describing the format of a word involved in an information transfer between the computer and a controller, the various fields and bits in the word are labeled with names descriptive of their functions. Bits in the word which are not used by the controller are shaded. Shaded bits are ignored on output and set to 0 on input.

NO I/O TRANSFER

NIO<f> device

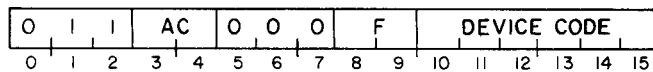

The Busy and Done flags in the controller of the specified device are set according to the function specified by F. When the assembler encounters the mnemonic NIO, it sets the AC field bits to 0. However, these bits are ignored and may have any value. The contents of all the accumulators are unchanged.

* New coding aids have been incorporated in some updated portions of this manual. Where the newer aids are used, the text specifically refers the reader to Appendix E, where they are described.

I/O SKIP

SKP<t> device

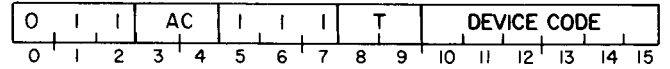

Skip the next sequential instruction if the test condition specified by T is true for the specified controller. When the assembler encounters the mnemonic SKP<t>, it sets the AC field bits to 0. However, these bits are ignored and may have any value. The contents of all the accumulators and the Busy and Done flags for the specified device remain unchanged.

DATA IN A

DIA<f> ac, device

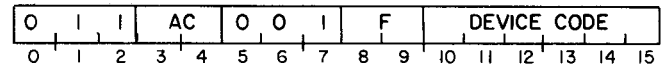

The contents of the A input buffer in the specified controller are placed in the specified AC. After the data transfer, the controller's Busy and Done flags are set according to the function specified by F. The number of information bits transferred depends on the size of the buffer and the mode of operation of the peripheral. Bits in the specified AC that do not receive information are set to 0.

DATA OUT A

DOA<f> ac, device

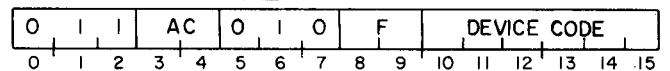

The contents of the specified AC are placed into the A output buffer in the specified controller. After the data transfer, the controller's Busy and Done flags are set according to the function specified by F. The number of information bits loaded into the buffer depends on the size of the buffer and the mode of operation of the peripheral. Any unused bits are ignored by the controller. The contents of the specified AC remain unchanged.

DATA IN B

DIB<f> ac, device

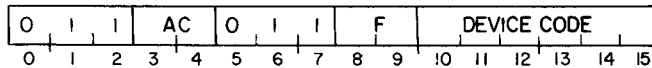

The contents of the B input buffer in the specified controller are placed in the specified AC. After the data transfer, the controller's Busy and Done flags are set according to the function specified by F. The number of information bits transferred depends on the size of the buffer and the mode of operation of the peripheral. Bits in the AC that do not receive information are set to 0.

DATA OUT B

DOB<f> ac, device

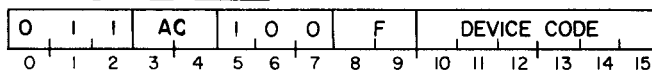

The contents of the specified AC are placed in the B output buffer in the specified controller. After the data transfer, the controller's Busy and Done flags are set according to the function specified by F. The number of information bits loaded into the buffer depends on the size of the buffer and the mode of operation of the peripheral. Any unused bits are ignored by the controller. The contents of the specified AC remain unchanged.

DATA IN C

DIC<f> ac, device

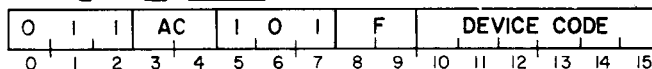

The contents of the C input buffer in the specified controller are placed in the specified AC. After the data transfer, the controller's Busy and Done flags are set according to the function specified by F. The number of information bits transferred depends on the size of the buffer and the mode of operation of the peripheral. Bits in the AC that do not receive information are set to 0.

DATA OUT C

DOC<f> ac, device

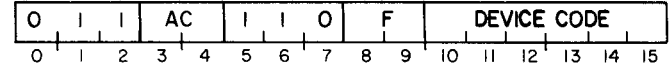

The contents of the specified AC are placed in the C output buffer of the specified controller. After the data transfer, the controller's Busy and Done flags are set according to the function specified by F. The number of information bits loaded into the buffer depends on the size of the buffer and the mode of operation of the peripheral. Any unused bits are ignored by the controller. The contents of the specified AC remain unchanged.

The single letter mnemonic for the desired control command is appended to the basic mnemonic. An NIO instruction alone with any device code is a "no-op" (that is, it has no effect). To place the high speed paper tape reader in operation, an NIOS 12, or, using the reader's mnemonic, an NIOS PTR instruction could be executed. Both of these instructions assemble as 060112₈ (0 110 000 001 001 010) and cause the reader to read one character from the tape into the controller's data buffer.

To determine when the character is in the buffer without using the program interrupt we can wait for either the Busy flag to be set to 0 or the Done flag to be set to 1. For example, giving

```
SKPDN PTR
JMP .-1
```

keeps the processor from proceeding until the reader controller has set the Done flag to 1.

Once the character has been loaded into the data buffer, the Done flag is set to 1 and the processor will continue. The character can be read into the right half of AC2 by giving

```
DIA 2, PTR
```

If another character is to be read the transfer can be made with a

```
DIAS 2, PTR
```

which brings the character into AC2, sets the Done flag to 0, the Busy flag to 1, and causes the reader to read the next character. If the data buffer contains the final character to be read from tape, giving

```
DIAC 2, PTR
```

retrieves the character and sets both the Busy and Done flags to 0, thus idling the reader.

In the remainder of this manual the discussion of each peripheral treats only the control functions and the applicable I/O transfer instructions. The skips apply to all and are the same in all cases. Giving a data-in instruction that does not apply to a peripheral (either because the peripheral is output-only or does not have the buffer specified) sets all bits of the addressed accumulator to 0 but the specified flag control function is carried out. Similarly, a data-out instruction that does not apply is a no-op except for the specified control functions. When the device code is undefined or the addressed peripheral is not in the system, any data-out or NIO instruction, a SKPBN, or a SKPDN is a no-op; a SKPBZ or SKPDZ is an unconditional skip (equivalent to a JMP .+2); and any data-in instruction simply sets all bits of the specified AC to 0.

This page intentionally left blank

PROGRAM INTERRUPT FACILITY

INTRODUCTION

When a peripheral completes an operation, the controller sets its Done flag to 1 to indicate that program service is required. The program can test the state of the Done flag repeatedly with I/O SKIP instructions to determine when this occurs. However, continual interrogation of the Done flag by the program is generally wasteful of computing time, especially when flag checks need to be done frequently in order to ensure that service is not delayed so long that the peripheral loses data. The program interrupt facility provides a peripheral with a convenient means of notifying the processor that service is required.

All peripherals which use the program interrupt facility have access to a single direct line to the processor, called the Interrupt Request Line, along which their requests for service are communicated. An interrupt request can be generated by a peripheral when the peripheral's Done flag is set to 1. The processor can respond to, or "honor", an interrupt request by interrupting the normal flow of program execution and transferring control to an interrupt handling routine. The programmer can control which peripherals may request interrupts and when the processor may start an interrupt, by manipulating a number of flags which are distributed among the processor and the peripherals.

The operation of the program interrupt facility, as controlled by these flags, is described below. Following portions of this section detail the instructions used to control the program interrupt facility, describe the implementation of a priority interrupt scheme, offer further suggestions for programming an interrupt handler, and explain the operation of the vector instruction, which allows the ECLIPSE computer to automatically perform much of its interrupt processing.

OPERATION

Control Flags

The operation of the program interrupt facility is governed by the Interrupt On (ION) flag in the central processor and by the Done and Interrupt Disable flags in each peripheral which uses the facility. By manipulating these flags, the program can choose to disregard interrupt requests altogether, or it can selectively ignore certain peripherals.

Interrupt On Flag

The major control flag for the program interrupt facility is the Interrupt On flag in the central processor. To enable the interrupt facility the program sets ION to 1, allowing the processor to respond to interrupt requests transmitted to it along the Interrupt Request Line. Setting ION to 0 disables the entire interrupt facility, causing the processor to ignore all interrupt requests.

The Interrupt On flag is manipulated by the program exactly like a Busy flag for the central processor. A Start command in any I/O instruction directed to the CPU (device code 77₈) sets ION to 1, a Clear command in such an instruction sets ION to 0. (ION is also set to 0 at power-up and when the RESET console switch is pressed.)

Interrupt Disable Flags

The controller for each peripheral which uses the program interrupt facility contains an Interrupt Disable flag which allows the program to disable interrupts from that peripheral. When a peripheral's Interrupt Disable flag is set to 1, the peripheral is prevented from making an interrupt request.

The Interrupt Disable flags of all peripherals are manipulated at once with a single I/O instruction. This instruction, MASK OUT (MSKO), sets up the Interrupt Disable flags of all peripherals connected to the program interrupt facility according to a mask contained in the accumulator specified by the instruction. Each peripheral is assigned by its hardware to a bit position in the mask. (Mask bit assignments for standard peripherals are given in Appendix A.) When a MASK OUT instruction is given, each peripheral's Interrupt Disable flag is set to the value of the assigned bit of the mask. Also, at power-up and when the RESET console switch is pressed, all Interrupt Disable flags are set to 0.

Interrupt Requests

Interrupt requests by a peripheral are governed by its Done and Interrupt Disable flags. When a peripheral completes an operation, it sets its Done flag to 1, and this action initiates a program interrupt request. If its Interrupt Disable flag is 0, the request is communicated to the CPU. If the Interrupt Disable flag is 1, the request is not communicated to the CPU; it is blocked until the Interrupt Disable flag is set back to 0. If the ION flag is 1, the processor has to honor the interrupt request as soon as it is able.

The processor is able to interrupt the sequential flow of program instructions if all of the following conditions hold:

1. The processor has just completed an instruction or a data channel transfer occurring between two instructions.

2. At least one peripheral is requesting an interrupt.
3. Interrupts are enabled; that is, ION is 1.
4. No peripheral is waiting for a data channel transfer; that is, there are no outstanding data channel requests. The data channel has priority over program interrupts.

When the processor finishes an instruction it takes care of all data channel requests before it starts an interrupt; this includes any additional data channel requests that are initiated while data channel transfers are being made. When no more peripherals are waiting for data channel transfers, the processor starts an interrupt if ION is 1 and at least one peripheral is requesting an interrupt.

Processor Response

The processor starts an interrupt by automatically executing the following sequence:

1. It sets ION to 0 so that no further interrupts may be started.
2. It stores the contents of the program counter (which point to the next instruction in the interrupted program) in location 0, so that a return to the interrupted program can be made after the interrupt service routine has finished.
3. It simulates a JMP@1 instruction to transfer control to the interrupt service routine. Location 1 should contain the address of the routine or the first part of an indirect address chain that points to the routine.

Servicing An Interrupt

The interrupt service routine (or handler) should save the state of the processor, identify which peripheral requires service, and service the peripheral.

Saving the state of the processor involves saving the contents of any accumulators that will be used in the interrupt service routine and saving the carry bit if it will be used. The state of the processor must be saved so that it may be restored before the interrupted program is allowed to resume.

Peripheral Identification

There are three ways in which the interrupt handler can identify which peripheral requires service.

1. On the NOVA and ECLIPSE lines of computers, the interrupt handler can execute a polling routine. This routine is merely a sequence of I/O SKIP instructions which test the states of the Done flags of all peripherals in use. With this method peripheral priorities are determined by the order in which the tests are performed. Note that the polling technique disregards the state of the Interrupt Disable flags. Peripherals which are masked out will be recognized if their Done flags are 1, even though these peripherals could not have caused the interrupt.
2. On the NOVA and ECLIPSE lines of computers, the interrupt handler can issue an INTERRUPT ACKNOWLEDGE instruction (INTA). This instruction reads the device code of the first peripheral on the I/O bus that is requesting an interrupt, into a specified accumulator. Note that with this method the Interrupt Disable flags are significant. Peripherals which are masked out cannot request an interrupt and, therefore, cannot respond to the INTERRUPT ACKNOWLEDGE instruction.
3. On the ECLIPSE line of computers the interrupt handler can issue a VECTOR instruction (VCT). This instruction determines which peripheral requires service in exactly the same way as the INTERRUPT ACKNOWLEDGE instruction. However, the device code obtained is not placed in an accumulator but is used as an index into a table of addresses. Besides vectoring automatically to the correct peripheral service routine, the VECTOR instruction can optionally switch stack contexts, save the state of the processor, and establish a new priority level. Because the VECTOR instruction is available only on the ECLIPSE computer, and because its operation is relatively complex, it is described later in a section of its own.

Peripheral Service Routine

After determining which peripheral requires service, the interrupt handler generally transfers control to a peripheral service routine. This routine performs the information transfer to or from that peripheral (if required) and either starts the peripheral on a new operation or idles the peripheral if no more operations are to be performed at this time.

Dismissing An Interrupt

When all service for the peripheral has been completed, either the peripheral service routine or the main interrupt handler should perform the following sequence to dismiss the interrupt.

1. Set the peripheral's Done flag to 0 to dismiss the interrupt request which was just honored. If this is not done, the undismissed interrupt request will cause another interrupt--this time incorrectly--as soon as the interrupt handler finishes and attempts to return control to the interrupted program.
2. Restore the pre-interrupt states of the accumulators and the carry bit.
3. Set the Interrupt On flag to 1 to enable interrupts again.
4. Jump back to the interrupted program. (Usually a JMP@0 instruction is given.)

The instruction that enables interrupts (usually INTEN) sets the Interrupt On flag to 1, but the processor does not recognize that the state of the ION flag has changed to 1 until the next instruction begins. Thus, after the instruction that turns interrupts back on, the processor always executes one more instruction (assumed to be the return to the interrupted program) before another interrupt can start. The program must give this final return instruction immediately after enabling interrupts in order to ensure that no waiting interrupt can overwrite the contents of location 0 before they are used to return control to the interrupted program.

The following diagram shows how normal program flow is altered during a program interrupt. The interrupt handler is shaded to indicate that this block of instructions is not interruptable since the processor sets the ION flag to 0 to disable further interrupts when the interrupt occurred. Interrupts are not enabled again until the interrupt handler executes its INTERRUPT ENABLE instruction just prior to returning control to the interrupted program.

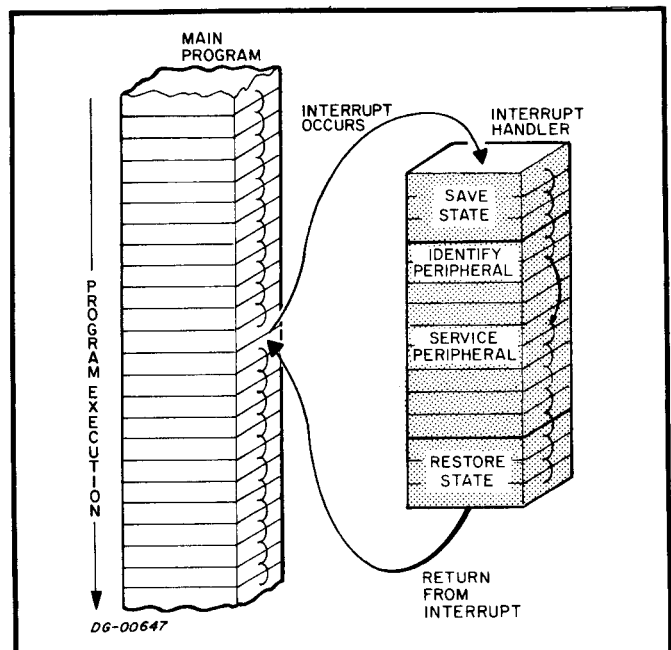

INSTRUCTIONS

The instructions which control the program interrupt facility use special device code 77_8 (mnemonic CPU). When this device code is used, bits 8 and 9 of the skip instructions test the state of the Interrupt On flag; in the other instructions these bits turn interrupts on or off by setting ION to 1 (Start command) or 0 (Clear command).

INTERRUPT ENABLE

INTEN

NIOS CPU

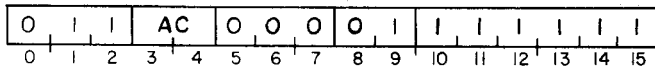

Set the Interrupt On flag to 1 to allow the processor to respond to interrupt requests. If the Interrupt On flag actually changes state (from 0 to 1), the processor will execute one more instruction before it can start an interrupt. On the ECLIPSE computer, the processor will execute one more instruction before starting an interrupt even if the Interrupt On flag was already 1. However, if that instruction is one of those that is interruptible, then an interrupt can occur as soon as the instruction begins to execute. The assembler recognizes the mnemonic INTEN as equivalent to NIOS CPU.

INTERRUPT DISABLE

INTDS

NIOC CPU

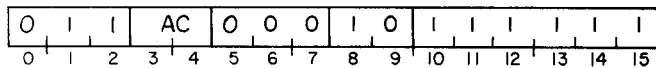

Set the Interrupt On flag to 0 to prevent the processor from responding to interrupt requests. The assembler recognizes the mnemonic INTDS as equivalent to NIOC CPU.

SKIP IF INTERRUPTS ENABLED

SKPBEN CPU

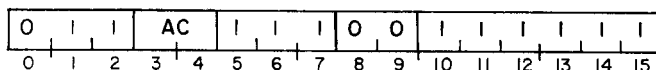

Skip the next sequential instruction if the Interrupt On flag is 1.

SKIP IF INTERRUPTS DISABLED

SKPBZ CPU

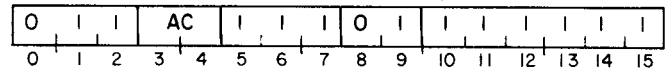

Skip the next sequential instruction if the Interrupt On flag is 0.

MASK OUT

MSKO ac

DOB<f> ac, CPU

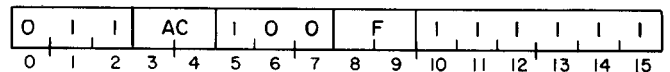

Set the Interrupt Disable flags in all peripherals according to the mask contained in the specified AC. (A 1 in a mask bit sets the flags in all peripherals assigned to that bit to 1, a 0 sets them to 0.) After the Interrupt Disable flags are set, the Interrupt On flag is set according to the function specified by F. The contents of the specified AC remain unchanged. Mask bit assignments for standard peripherals are given in Appendix A. The assembler recognizes the instruction MSKO ac as equivalent to DOB ac, CPU.

INTERRUPT ACKNOWLEDGE

INTA ac

DIB<f> ac, CPU

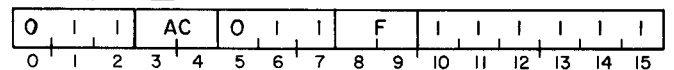

The device code of that peripheral requesting an interrupt which is closest to the processor along the I/O bus is placed in bits 10-15 of the specified AC. Bits 0-9 are set to 0. After the data transfer, the Interrupt On flag is set according to the function specified by F. If no peripheral is requesting an interrupt, the specified AC is set to 0. The assembler recognizes the instruction INTA ac as equivalent to DIB ac, CPU.

I/O RESET

IORST

DIC<f> ac, CPU

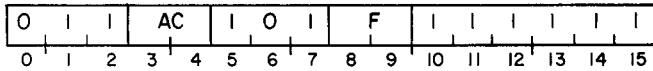

Reset all peripherals connected to the I/O bus: set their Busy, Done, and Interrupt Disable flags to 0 and, depending on the peripheral, perform any other required initialization. After the peripherals' flags are altered, the Interrupt On flag is set according to the function specified by F. The assembler recognizes the mnemonic IORST as equivalent to DICC 0, CPU--that is, as the instruction defined here with F set to 10.

If the mnemonic DIC is used to perform this function, an accumulator must be coded to avoid assembly errors. Regardless of how the instruction is coded, during execution the AC field is ignored and the contents of the specified AC remain unchanged. At power-up and when the RESET console switch is pressed, the processor performs the equivalent of an IORST instruction.

The assembler recognizes a number of convenient mnemonics for instructions that control the program interrupt.

Mnemonic	Instruction	Mnemonic Equivalent	Octal Equivalent
INTEN	INTERRUPT ENABLE	NIOS CPU	060177
INTDS	INTERRUPT DISABLE	NIOC CPU	060277
MSKO <u>ac</u>	MASK OUT	DOB <u>ac</u> , CPU	062077
INTA <u>ac</u>	INTERRUPT ACKNOWLEDGE	DIB <u>ac</u> , CPU	061477
IORST	I/O RESET	DICC 0, CPU	062677

To set up the Interrupt Disable flags according to the mask contained in AC2, give

MSKO 2
or
DOB 2, CPU

However, there is one important difference between these special mnemonics and the standard ones: mnemonics for enabling and disabling interrupts cannot be appended to them. Thus, to set the Interrupt On flag to 0 while performing a MASK OUT instruction using AC2 give

DOBC 2, CPU

Note that use of the mnemonic IORST sets the Interrupt On flag to 0. To set the flag to 1 while resetting the peripherals give

DICS 0, CPU

PRIORITY INTERRUPTS

If the Interrupt On flag remains 0 throughout the interrupt service routine, the routine cannot be interrupted, and there is only one level of peripheral priority. All peripherals that have not been disabled by the program are, for the most part, equally able to request interrupts and receive interrupt service. Only when two or more peripherals are requesting an interrupt at exactly the same time is a priority distinction made. When this happens, priority is determined either by the order in which I/O SKIP instructions are given or, if the INTERRUPT ACKNOWLEDGE or VECTOR instruction is used, by the order of peripherals along the I/O bus. In a system with peripherals of widely differing speeds and/or service requirements, a more extensive priority structure may be required. The program interrupt facility hardware and instructions allow the program to implement up to 16 interrupt priority levels.

For example, suppose that a card reader and a Teletype® are being operated at the same time. While a card is being read, an interrupt is requested as each new column of data is available, and the program must read this data within 430 microseconds, typically, before it is overwritten in the Data Buffer by the data from the next column. If the Teletype service routine takes 300 microseconds, card reader service will never be delayed longer than this, and a single-level program interrupt scheme will suffice. However, this interrupt scheme will not work if the Teletype service routine takes 600 microseconds, since a card reader interrupt request initiated soon after Teletype service is begun will not be honored in time, and a column of data will be lost. In order to avoid losing data, the program interrupt scheme used must allow the card reader to interrupt the lengthy Teletype service routine. This involves creating a two-level priority structure and assigning the card reader to the higher priority level.

In general, a multiple-level priority interrupt scheme is used to allow higher-priority peripherals to interrupt the service routines of lower-priority peripherals. A hierarchy of priority levels can be established through program manipulation of the Interrupt Disable flags of all peripherals in the system. When the interrupt request from a peripheral of a certain priority is honored, the interrupt handler sets up the new priority level by establishing new values for all peripherals' Interrupt Disable flags according to an appropriate "Interrupt Priority Mask" used with the MASK OUT instruction. Peripherals whose Interrupt Disable flags are set to 1 by the corresponding bit of this priority mask are "masked out", or disabled, and are thereby regarded as being of lower priority than the peripheral being serviced. Peripherals which are not masked out assume a higher priority than the

Teletype® is a registered trademark of Teletype Corporation, Skokie, Illinois. All references to teletypes in this manual shall apply to this mark.

peripheral being serviced. Before proceeding with the peripheral service routine, the Interrupt On flag is set to 1 so that the higher-priority peripherals may interrupt the current service routine.

Interrupt Priority Mask

The bit of the priority mask that governs the Interrupt Disable flag for a given peripheral is assigned to that peripheral by the hardware and cannot be changed by the program. Although lower-speed devices are generally assigned to higher-numbered mask bits, no implicit priority ordering is intended. The manner in which these priority levels are ordered is completely up to the programmer. By means of the priority mask the program can establish any desired priority structure, with one limitation: in the cases in which two or more peripherals are assigned to the same bit of the priority mask, these peripherals are constrained to be at the same priority level. When a peripheral causes an interrupt, a decision must be made whether to place all other peripherals which share the same mask bit with the interrupting peripheral at a higher or lower priority level. If a decision is made to mask out all peripherals which share that priority mask bit, the interrupting peripheral is also masked out.

Priority Interrupt Handler

A priority interrupt handler differs from a single-level interrupt handler in several ways. The handler must be "re-entrant". This means that if a peripheral service routine is interrupted by another, higher priority peripheral, no information required by the handler to restore the state of the machine, is lost. The two items of information which should be saved, in addition to those saved by a single-level interrupt handler, are the return address (the contents of location 0) and the current priority mask. This information must be stored in different locations each time the interrupt handler is entered at a higher level. Doing this ensures that the necessary return information belonging to an earlier interrupt is not overwritten by a higher level interrupt. A common method of storing return information for a re-entrant interrupt handler is through the use of push-down stacks.

The interrupt handler (including the peripheral service routines) for a multi-level priority scheme should perform the following tasks:

1. Save the state of the processor, that is, the contents of the accumulators, the carry bit, location 0, and the current priority mask.
2. Identify the peripheral that requested the interrupt.

3. Transfer control to the service routine for that peripheral.
4. Establish the new priority mask with a MASK OUT instruction for that peripheral's service routine and store it in memory at the location reserved for the current priority mask for that level of interrupt.
5. Enable interrupts. Now, any peripheral not masked out can interrupt this service routine.
6. Service the peripheral that requested the interrupt.
7. Disable interrupts in preparation for dismissal of this interrupt level, so that no interrupts will occur during the transition to the next lower level.
8. Restore the state of the processor, including the former contents of the accumulators and the carry bit and reinstitute the pre-interrupt priority mask with a MASK OUT instruction.
9. Enable interrupts.
10. Transfer control to the return address which was saved from location 0.

The diagram below is a simplified representation of program flow in a priority interrupt environment. Shaded areas indicate non-interruptible sections of instructions. Additional higher-priority interrupts could increase the depth of interrupts still further.

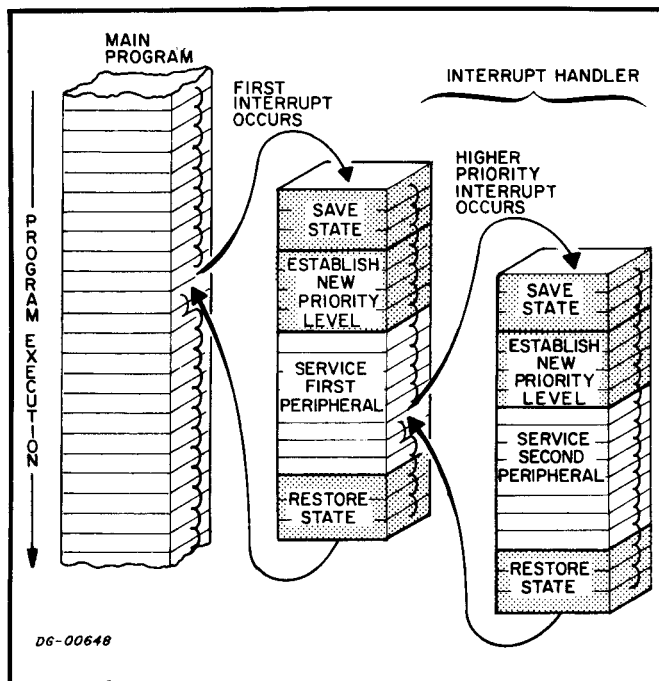

The Vector Instruction

- I The ECLIPSE line of computers incorporates an instruction which greatly reduces the burden of programming a priority interrupt system. Since this instruction is available only on the ECLIPSE line of computers, it is described separately below. In effect, the VECTOR instruction (VCT) can be used to perform the first five tasks listed above for the multi-level priority interrupt handler.

VECTOR ON INTERRUPTING DEVICE CODE

VCT <@> displacement

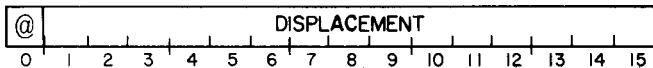
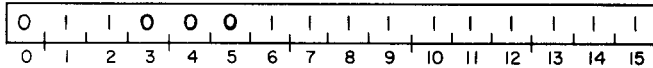

This instruction provides a fast and efficient method for transferring control from the main I/O interrupt handler to the correct interrupt service routine for the interrupting device. Bit 0 of the second word of the instruction is the "stack change bit" and bits 1-15 contain the address of a 64-word vector table. Vector table entries are one word in length and consist of a "direct" bit in bit 0 followed by an address in bits 1-15.

An INTERRUPT ACKNOWLEDGE instruction is performed. The device code returned is added to the address of the vector table and the vector table entry at that address is fetched. If the direct bit in the fetched vector table entry is 0, the address in bits 1-15 is taken to be the address of the device handler routine for the interrupting device and control is immediately transferred there by placing the address in the program counter.

If the direct bit is 1, the address in bits 1-15 of the vector table entry is taken to be the address of the device control table (DCT) for the interrupting

device. At this point, the stack change bit is examined. If the stack change bit is 0, no stack change is performed. If the stack change bit is 1, a new stack is created by placing the contents of memory location 6 in the stack limit, and the contents of memory location 7 in the stack fault. The previous contents of memory locations 40₈-43₈ are then pushed onto this new stack.

Device control tables must consist of at least two words. The first word of a DCT consists of a "push bit" in bit 0 followed by the address of the device handler routine for the interrupting device in bits 1-15. The second word of a DCT contains a mask that will be used to construct the new interrupt priority mask. Succeeding words in a DCT may contain information that is to be used by the device interrupt handler.

After the stack change procedure is performed, the first word of the DCT is fetched and inspected. If the push bit is 1, a standard return block is pushed onto the stack with bits 1-15 of physical location 0 placed in bits 1-15 of the last word pushed. If the push bit is 0, no return block is pushed.

Following this procedure, the address of the DCT is placed in bits 1-15 of AC2 and bit 0 of AC2 is set to 0.

Next, the current interrupt priority mask is pushed on the stack. The contents of the second word of DCT are logically OR'd with the current interrupt priority mask and the result is placed in both AC0 and memory location 5. This constructs the new interrupt priority mask and places it in AC0 and the save location for the mask. A DOBS 0, CPU instruction is now performed. This is a MASK OUT instruction that also enables the interrupt system.

After a new interrupt priority mask is established and the interrupt system enabled, control is transferred to the device handler by placing bits 1-15 of the first word of the DCT in the program counter.

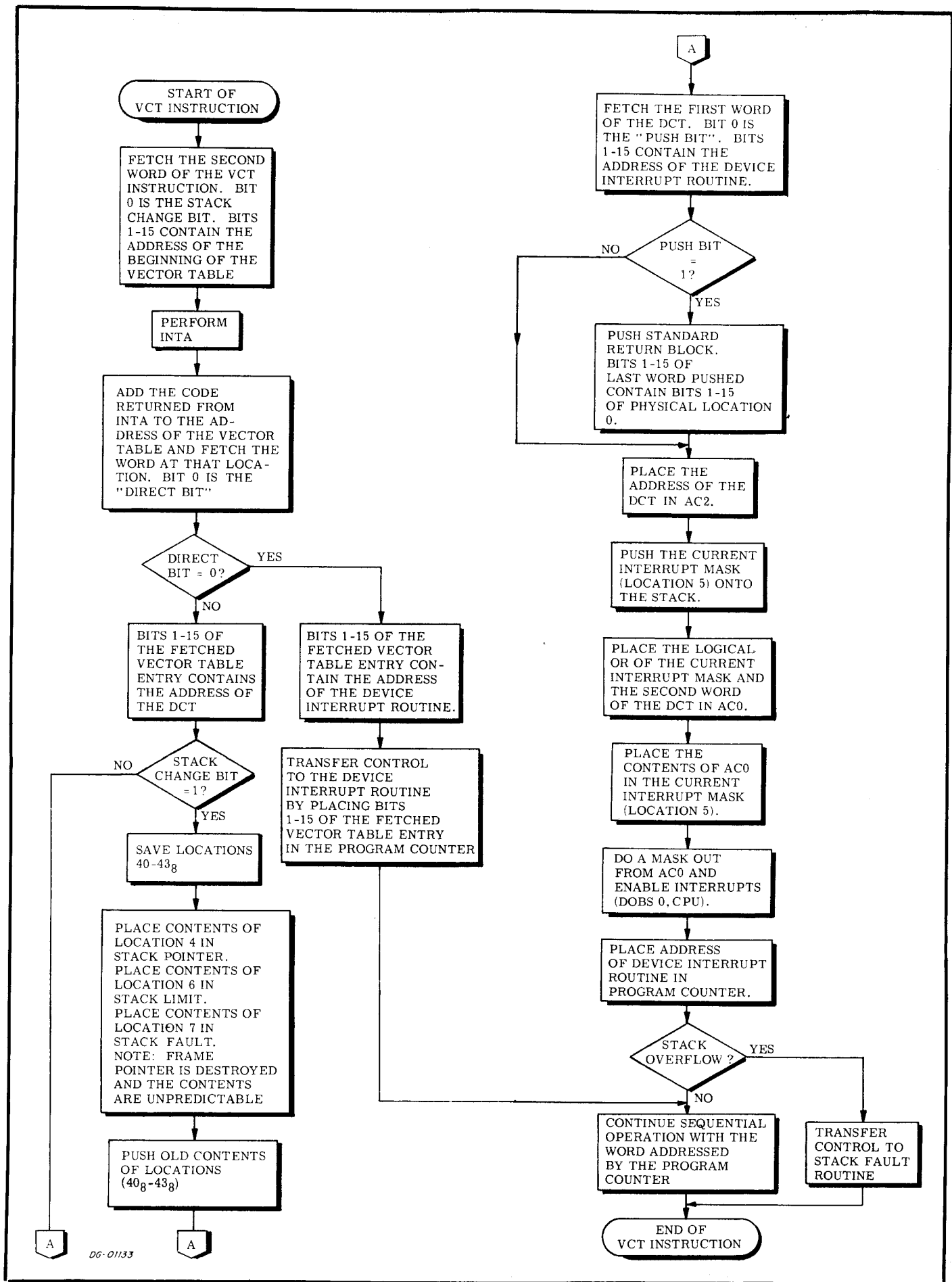

06-01133

Use of the Vector Instruction

The VECTOR ON INTERRUPTING DEVICE CODE instruction is an extremely powerful instruction. Because of the impact of interrupt latency on overall system performance, and the impact of the VECTOR instruction on interrupt latency, this instruction should be well understood before it is used.

The VECTOR instruction can operate in any one of five modes. These modes are called mode A, mode B, mode C, mode D, and mode E. In general, as one goes through the modes, from A to E, the instruction performs more work, giving the user more power, but also takes more time to execute.

For all modes, the VECTOR instruction uses bits 1-15 of the second word to address the vector table. An INTERRUPT ACKNOWLEDGE instruction is performed and the device code received is added to the address of the vector table and the word at that location is fetched. At this point, the mode selection process begins.

Which mode is used for execution is a function of the direct bit in the vector table entry, the stack change bit in the second word of the VECTOR instruction and the push bit in the first word of the DCT. The table below gives the relationship.

DIRECT	STACK CHANGE	PUSH	MODE
0	X	X	A
1	0	0	B
1	0	1	C
1	1	0	D
1	1	1	E

Note: X = Don't care

For mode A, the state of the stack change and push bits don't matter because they are never checked.

The uses of the five modes are described below.

Mode A is used when no time can be wasted in getting to the interrupt handler for a device. A device requiring mode A service would typically be a non-buffered device with a very small latency time. Alternatively, a real time process that must receive control immediately after an event could be serviced using mode A. The programmer pays for the speed realized through mode A by giving up the state saving and priority masking features of the other modes.

Modes B, C, D, and E are used to implement a priority interrupt structure. They all build a new priority mask and save the old priority mask before issuing a MASK OUT instruction that enables the interrupt system. These modes differ in the amount of time and work that they devote to saving the state of the machine.

In a priority system, there are typically two types of processes: those that operate at "base" level, and those that do not. Base level is defined as operating with all levels of interrupt enabled and no interrupt processing in progress. Non-base level is defined as operating with some interrupt processing in progress. In general, those processes that operate at base level are user programs. Those processes that operate at non-base level are the various interrupt handlers in the system.

One of the first things that the supervisor program should do when it receives an interrupt while a process is operating at base level is to change the stack environment. Two reasons lead to this conclusion. The supervisor has no control over whether or not the user has defined a stack by placing meaningful information in the stack control words. Additionally, even if the user has initialized a stack, the supervisor has no control over the size of the stack. If the user has defined a stack, but is very close to his stack limit, it would not be acceptable for a supervisor interrupt routine to fill the user's stack to overflowing. By using either mode D or E, the VECTOR instruction will change the stack environment and initialize a stack over which the supervisor has full control. At the same time, the VECTOR instruction will save the stack environment of the user so that it may be restored before control is returned to the user.

If an interrupt handler is already processing when another interrupt is received, then the stack environment has already been changed by the interrupt that occurred at base level and should not be changed again. For interrupts that occur at non-base level, modes B and C of the VECTOR instruction can be used.

The difference between modes D and E is the same as the difference between modes B and C: modes B and D do not push a return block onto the stack.

While this saves a little bit of time over modes C and E, it makes returning control to the interrupted program somewhat more complicated.

All modes of the VECTOR instruction can be combined in one vector table. Devices that require mode A service will have bit 0 set to 0 in their vector table entry. The other devices will have bit 0 set to 1 in their vector table entries, and control their modes of service by the setting of the push bit in their DCT's.

The POP BLOCK instruction (POPB) can be used to return from an interrupt handler which does not change the context of the stack. The RESTORE instruction (RSTR) can be used to return when the stack context is changed.

This page intentionally left blank

DATA CHANNEL FACILITY

INTRODUCTION

Peripherals which need to transfer large blocks of data quickly generally accomplish their data transfers via the data channel facility. The actual data channel transfers do not disturb the state of the processor since the data is transferred directly between registers in the controller and memory. This means that the amount of program overhead in the form of executing I/O instructions and loading or storing data is greatly reduced. The time required for program execution is lengthened however, since the processor pauses, as soon as it is able, each time a word is to be transferred; the transfer then occurs and the processor continues. The program need only set up the peripheral for the transfer and can then perform other, unrelated tasks.

Features

The data channel facilities in the original NOVA, NOVA 1200 series, and the ECLIPSE line of computers all provide a single speed for data channel operation. The SUPERNOVA® series, NOVA 800 series, and NOVA 2 series computers all can operate the data channel at two different speeds: standard and high speed. In addition to merely transferring data, certain arithmetic operations can be performed by the data channel in some computers. All the NOVA line computers can have the contents of any memory location incremented by 1 each time a controller requests that operation. The NOVA and SUPERNOVA computers also allow a controller to add a word to the previous contents of any memory location.

In both types of arithmetic operation, the computer sends the results back to the controller and,

if the operation increased the contents of the memory location to more than $2^{16}-1$, it sends an overflow signal.

The data channel allows many peripherals to be active at the same time, providing access to memory to individual controllers on demand. Peripherals which use the data channel operate under a priority structure imposed on them by the channel. In cases where more than one controller requests access to the data channel at the same time, priority is given to that controller which is closest to the processor on the I/O bus.

A table in Appendix D includes the maximum transfer rates for all combinations of channel speed and type of transfer.

CONTROLLER STRUCTURE

Understanding the operation of the data channel requires a knowledge of the structure of the controllers which use it. The controllers usually contain the normal Busy and Done flags, status, control, and information registers, and the program interrupt components. Additional components are added to handle the functions necessary to operate the data channel. Some of these components, generally available to the program, are in the form of additional control and status registers.

The two main registers usually added are the Word Counter and the Memory Address Counter. The Word Counter is used by the program to specify the size of the block of data to be transferred (number of words). The Memory Address Counter is used to specify the address in memory which is used in the data transfer.

Word Counter

The Word Counter is loaded, by the program, with the two's complement of the number of words in the block. Each time a word is transferred, the controller automatically increments the counter by 1. When the counter overflows, the controller terminates data channel transfers.

The size of the Word Counter varies from peripheral to peripheral, depending on the block size associated with the peripheral. Typical sizes of the Word Counter are 12 and 16 bits, allowing for up to 4096-word blocks and 65,536-word blocks, respectively. Although the Word Counter specifies the negative of the desired block size, the most significant bit of the register need not be a 1--it is not a sign bit for the number. No sign bit is necessary because the word count is treated as negative by the controller, by virtue of being incremented instead of decremented. Thus, a word count of 0 is valid; in fact, it specifies the largest possible block size. The table below further illustrates the correspondence between the desired word count and the value which must be loaded into a 12-bit or 16-bit Word Counter.

(negative) word count (decimal)	16-bit value (octal)	12-bit value (octal)
-1	177777	7777
-2	177776	7776
-8	177770	7770
-100	177634	7634
-2047	174001	4001
-2048	174000	4000
-2049	173777	3777
-4095	170001	0001
-4096	170000	0000
-4097	167777	
-8192	160000	
-32768	100000	
-65535	000001	
-65536	000000	

Memory Address Counter

The Memory Address Counter always contains the address in memory which is to be used by the controller for the next data transfer. It is loaded, by the program, with the address of the first word in the block to be transferred. During each transfer, the controller increments the Memory Address Counter by 1. Therefore, successive transfers are to or from consecutive memory locations.

TRANSFER SEQUENCE

The actual data channel transfer sequence is a two-way communication between processor and controller and proceeds as follows. When a peripheral has a word of data ready to be transferred to memory or wants to receive a word from memory, it issues a data channel request to the processor. The processor pauses as soon as it is able, and begins the data channel cycle by acknowledging the peripheral's data channel request. The acknowledgment signal dismisses the peripheral's data channel request and causes the peripheral to send back to the processor the address of the memory location involved in the transfer. Following the receipt of the address, the data itself is transferred in the appropriate direction.

At the completion of each data transfer the processor/controller interaction is over. The controller carries out any tasks necessary to complete the data transfer, such as transferring the data to the device itself for an output operation. The processor starts another data channel transfer if any data channel requests are pending, starts a program interrupt if one is being requested and there are no data channel requests, or resumes program execution.

The controller increments both the Memory Address Counter and the Word Counter during the transfer. If the word count becomes 0, the controller terminates further transfers, sets the Busy flag to 0, the Done flag to 1, and initiates a program interrupt request. If the Word Counter has not yet overflowed, the peripheral continues its operation, issuing another data channel request when it is ready for the next transfer.

DATA CHANNEL MAP SELECTION

Data channel MAP selection is performed only by certain peripheral controllers in Data General computer systems that contain more than one data channel MAP, i. e., the NOVA 3 and ECLIPSE S/220 and S/230 series computers. In these series of computers, data channel map selection occurs at DCHA time (refer to the Interface Designer's Reference, DGC 015-000031). If the data channel facility is enabled at DCHA time, DATA0 selects one of two data channel maps. If DATA0 is asserted at DCHA time, DCHA MAP B is selected. If DATA0 is not asserted at DCHA time, DCH MAP A is selected.

In this manual, a controller that performs data channel MAP selection is specifically identified as such in its controller introduction and in its controller programming summary.

Processor Pauses

The processor can pause for a data channel transfer only at certain, well-defined times, depending on the model of processor and, in the SUPERNOVA computer, on the channel speed used by the peripheral requesting the transfer. For the NOVA, NOVA 1200 series, and the standard channel on SUPERNOVA computers, data channel transfers, like program interrupts, can only occur between instructions. High-speed data channel requests on the SUPERNOVA computer, and all requests on the NOVA 800 series, NOVA 2 series, and ECLIPSE line of computers can break into program execution at certain other points in most instructions (I/O instructions are included in those that cannot be broken into.)

Priorities

In terms of priorities, program execution has priority over the data channel except at certain points in the processor's operation, at which times the data channel has absolute priority (over not only normal program execution but also over any pending program interrupt requests). At these certain points, the processor will handle all existing data channel requests, including those which are generated while data channel transfers are in progress, before starting a program interrupt or resuming normal instruction execution. Thus, if data channel requests are being generated by a number of peripherals as fast as or faster than the processor can handle them, all processing time will be spent handling data channel transfers, and program execution will stop until all the data channel transfers are made. However, when the data channel is being used at less than its maximum rate, processing time is shared between the data channel, which receives as much as it needs, and the program, which uses the rest.

When the processor pauses to honor a data channel request and more than one peripheral is requesting a data channel transfer, priority is given to the peripheral which is closest to the processor on the I/O bus. Since all peripherals operating with the high-speed data channel must be grouped together at the beginning of the bus, all requests from high-speed controllers will be honored before any from those which operate at standard speed. To use the high-speed data channel, the controller for a peripheral must be mounted inside the mainframe of the computer and must be designed to operate within the high-speed data channel time constraints. (Refer to the Interface Manual, DGC 015-000031.) A computer that has the two-speed capability is shipped with the high speed enabled for all controllers mounted inside the mainframe. (Controllers in an expansion chassis are constrained to operate at standard speed.)

PROGRAMMING

Programming a peripheral for a data channel block transfer typically involves the following steps:

1. The peripheral's status is checked, usually by testing the Busy flag and/or reading a status word and checking one or more error or ready bits. If an error has occurred, the program should take appropriate action. If no error has occurred but the peripheral is not yet ready, the program should wait for the peripheral to complete its operation. When the peripheral is ready, the program may proceed.
2. The data block in the device is located. This usually involves giving a peripheral "address" by specifying a unit number, channel number, sector number, or the like.
3. The data block in memory is located by loading the Memory Address Counter with the address of the first word of the block.
4. The size of the data blocks is specified by loading the proper value into the Word Counter.
5. The type of transfer is specified and the operation is initiated. If the peripheral is capable of several different operations, specifying the type of transfer usually involves loading a control register in the controller. The operation itself is usually initiated by one of the I/O control functions: Start, or Pulse.

Setting up and initiating the data channel operation is the major part of programming a data channel block transfer. However, if any errors could have occurred during the operation, the program should check for these errors when the operation is complete and take appropriate action if one or more have occurred.

This page intentionally left blank

TIMING

INTRODUCTION

On large systems which depend heavily on input/output, both the direct program control and data channel facilities can be badly overloaded. This overloading means that certain peripherals are seriously compromised because they lose data or perform poorly, since the system cannot respond to them in time.

This section explains how a system can be overloaded and what steps can be taken to minimize the detrimental effects.

DIRECT PROGRAM CONTROL

Nearly all peripherals operating under direct program control request program service by setting their Done flags to 1. Whether the CPU determines that the Done flag is set to 1 by repeatedly checking it or by responding to interrupt requests, there may be a significant delay between the time the peripheral requests program service and when the CPU carries out that service. This delay is called "programmed I/O latency".

When the program interrupt facility is not used, this programmed I/O latency has two components which can be calculated from the tables in Appendix D.

1. The interval between the time the Done flag is set to 1 by the peripheral and the time the flag is checked by the CPU.
2. The time required by the peripheral service routine to transfer data to/from the peripheral and set the Done flag to 0 (by idling the peripheral or instructing it to begin a new operation.

The first component can be diminished by performing frequent checks on the Done flag; the second can be diminished by writing an efficient peripheral service routine.

When the program interrupt facility is used, this programmed I/O latency has at least four components:

1. The time from the setting of the Done flag to 1, to the end of the instruction being executed by the CPU.
2. The time the interrupt facility needs to store the program counter in location 0 and simulate a JMP @1 instruction.
3. The time required by the interrupt handler to identify the peripheral and transfer control to the service routine.
4. The time required by the service routine to transfer data to/from the peripheral and set the Done flag to 0.

The programmed I/O latency may be extended by three other components:

5. The time when CPU operation is suspended because data channel transfers are in progress (see following section).
6. The time during which the CPU does not respond to the peripheral's interrupt request because the interrupt system is disabled. (For example, during the servicing of an interrupt from another peripheral.)
7. The time the peripheral's Interrupt Disable flag is set to 1 during the servicing of an interrupt of a higher level peripheral.

The first component is determined by the longest non-interruptable instruction that the CPU can execute. On the NOVA line computers, this is usually a few microseconds (unless long indirect address chains are used in several processors); on the ECLIPSE line of computers it can be considerably longer due to the presence of the WCS feature which allows the programmer to code long instructions which do not allow program interrupts to occur during their execution.

DATA CHANNEL CONTROL

The second component is also machine dependent; in general it is approximately two or three times as long as a memory reference. The third, fourth, sixth and seventh components are determined by software and account for the bulk of the programmed I/O latency. The fifth component is determined by the nature and the number of the data channel devices operating in the system.

Programmed I/O latency is important because a peripheral that must wait too long for program service from the CPU may suffer from degraded performance. The longest allowable delay between the time when a peripheral sets its Done flag to 1 and the time when the CPU transfers data to/from that peripheral and sets the Done flag to 0 is called the "maximum allowable programmed I/O latency" of the peripheral. When the actual programmed I/O latency for a peripheral exceeds the maximum allowable programmed I/O latency, the specific effects depend on the device in question. In the worst case, data may be incorrectly read or written. The maximum allowable programmed I/O latency for each peripheral can be found under Timing in the section devoted to that peripheral.

A peripheral service routine must usually perform certain computations (updating pointers to buffers, byte counter, etc.), but rarely are these computations so complex that they cannot be accomplished within the constraints of the maximum allowable programmed I/O latency. However, if several peripherals are competing for service at the same time, it may be necessary to jeopardize the performance of some of them by deferring their requests for program service until the CPU has serviced the higher priority requests. For this reason, all DGC computers incorporate the priority interrupt facility described earlier.

The object of the priority interrupt facility is to minimize the loss of important data. In order for the programmer to achieve this end, the assignment of the software priority levels should be made in the light of the following considerations:

1. the maximum allowable programmed I/O latency for each peripheral,
2. the result of exceeding the maximum allowable programmed I/O latency for each peripheral (slowdown or data loss), and
3. the cost of losing data.

Problems with time constraints can be encountered when transferring data via the data channel. When a peripheral needs data channel service, it makes a data channel request. However, the CPU can only allow data channel peripherals to access memory at certain predefined times. (At such times, it is said that data channel breaks are enabled.) In addition, there may be more than one peripheral waiting to access memory at any one time. Consequently, there may be a significant delay between the time when a peripheral requests access to memory and the time when the transfer actually occurs. This delay is called data channel latency and has the following components:

1. the time between the peripheral's request for memory access and the next data channel break, and
2. the time required to complete data channel transfers to/from higher priority (closer) peripherals that are also requesting memory access.

The length of the first component depends on the design of the CPU. In the NOVA, NOVA 1200 series, and SUPERNOVA (standard-speed) computers, data channel breaks are enabled only between instructions so that long instructions (MUL, DIV) and long indirect address chains can have a significant effect on data channel latency. In the NOVA 800 series, NOVA 2 series, ECLIPSE and SUPERNOVA (high-speed) computers, data channel breaks may be enabled during most instructions (but not during I/O instructions), so that data channel latency is reduced.

The length of the second component depends on the number of data channel peripherals operating in the system at a higher priority and the frequency of their use.

Most peripherals using the data channel control operate under fixed time constraints. Disc drives and magnetic tape transports are typical data channel peripherals. In each of these devices, a magnetic medium moves past a read or write head at constant velocity. If data is not read or written at the correct instant, the data will be transferred

to or from the wrong place on the magnetic medium. Consequently, on input, such devices must be allowed to write a word into memory before the next word is assembled by the controller, and on output, the controller must be able to read a word from memory before the surface is positioned under the write head. In either case, if the data channel latency is too long, data cannot be properly transferred. Most peripherals operating under data channel control set an error flag when this happens, so the service routine can take appropriate action to recover from the error, if possible.

The "maximum allowable data channel latency" of a peripheral is the maximum time the peripheral can wait for a data channel transfer. The range of times is from a few microseconds to several hundred microseconds. At the time the system is configured, data channel priorities should be assigned to peripherals on the basis of the following considerations:

1. The maximum allowable data channel latency of the peripheral. A peripheral with a short allowable latency usually should receive a higher priority than one with a long allowable latency.

2. The recovery time of a peripheral (i.e., how long before it can repeat a transfer that failed because of excessive data channel latency) if the peripheral can recover.
3. The cost of losing data from the peripheral if the peripheral cannot recover.

If data channel latency seems to be a problem in a system, latency might be improved by changing the coding in the programs; less frequent use of long instructions and lengthy indirect chains in the NOVA and 1200 series computers, and less frequent use of I/O instructions in the SUPER-NOVA, 800 series, and ECLIPSE line of computers. In addition, there is an upper limit on the number of data channel transfers/second that a computer can support. In cases where this limit is exceeded, the only solution is to reduce the number of peripherals using the data channel at the same time.

High data channel use reduces the speed of program execution since the processor pauses for each transfer. This may adversely affect the CPU's capacity to respond to interrupts and service those peripherals operating under direct program control.

This page intentionally left blank

PROGRAMMING EXAMPLES

INTRODUCTION

The four programs in this section illustrate various techniques of I/O programming. Some of the techniques used are: status checking; servicing of basic peripherals (Teletype, paper tape punch and reader); interrupt handling, including saving and restoring the processor state, with and without stacks, and dispatching to the proper peripheral service routine; data channel programming; priority interrupt handling; and power fail/auto restart programming. The programs are complete; if desired, each of the first three can be assembled and run on any DGC computer system with the necessary peripherals. The fourth program requires one of the ECLIPSE line of computers along with the necessary peripherals.

The programs become successively more complex in order to illustrate various programming methods and to show the costs and benefits of the use of interrupts. As the complexity increases, so does the efficiency of peripheral servicing. Example One uses no interrupts in servicing Teletype and punch. Example Two performs the same service more efficiently by using the interrupt facility. In Example Three, a priority interrupt structure is introduced to provide the most efficient service for an expanded set of peripherals which includes a paper tape reader and magnetic tape unit. Example Four, for use on the ECLIPSE computer,

utilizes the VECTOR instruction and stack facilities to perform the bulk of the tasks performed by the interrupt handler. However, the Teletype and punch service in Examples Three and Four remains functionally the same as before, so that the programming styles represented by the example programs can easily be compared.

The basic idea of each program is the same. Program computation is simulated by a short loop of arithmetic instructions. A counter in memory (LOC) is incremented on each pass through the loop in order to provide a recognizable pattern of blinking console lights. Periodically, these calculations are suspended in order to perform I/O, at the completion of which the calculations are resumed exactly where they were left off.

The operation of the programs is functionally identical with respect to Teletype and punch I/O. When a key is typed, the calculations are suspended and the character is read in, stored in a buffer, and "echoed" back to the Teletype. When the line is terminated, either by a carriage return or by the 72nd character, the entire line is output to the punch. (In order to extend the punching time for a single line, each character is punched eight times.) The buffer is then reinitialized and the program waits for more Teletype input as it continues its calculations.

EXAMPLE ONE

Example One is written without using interrupts. (The interrupt system is disabled by the initial IORST instruction.) The status of the Teletype keyboard (device TTI) is checked periodically (roughly every half a second). When a character has been typed and is waiting to be read (Done flag set to 1), the calculations are frozen and saved (at IOSR) and the character is read in (READC), stored in the buffer (STORE), and echoed back to the Teletype. If this character does not terminate the line, the frozen state of the calculations is restored (RSTOR) and the calculations are re-summed. When a carriage return is read, it is echoed and placed into the buffer as usual, after which a line feed is added to the buffer and echoed. If 72 characters are input with no carriage return, both a carriage return and a line feed are sent to the Teletype and put into the buffer. In either case

the program then loops through the buffer, punching out each character in the line eight times (NRPT=8). (A null character is output first to provide eight frames of blank leader on the tape.) When the full line has been punched this way, the program reinitializes the character buffer and resumes the calculations.

When Example One is actually run, it becomes obvious that this is not an efficient way to handle this type of I/O. The Teletype seems sluggish; the infrequent checking of the Teletype status introduces a delay before a character is echoed. In addition, while a line is being punched, no characters are recognized from the Teletype and all calculations stop (the console lights stop blinking). The obvious way to reduce this poor performance is to use the interrupt facility, as Example Two does.

EXAMPLE ONE

```
.LOC 20
BUFF-1          ;AUTO-INCREMENTING LOCATION USED AS
                ; INDEX INTO CHARACTER BUFFER

.LOC 400

; "MAIN" PROGRAM

START: IORST    ;CLEAR I/O DEVICES, TURN INTERRUPTS OFF

CALC:  ADD     0,1      ;SIMULATE USEFUL COMPUTATION
      SUB     1,2
      INC     2,3
      NEG     3,0
      ISZ    LOC
      JMP     CALC
      SKPDN  TTI       ;CHECK TTI STATUS PERIODICALLY
      JMP     CALC     ;CONTINUE COMPUTATION
      JMP     IOSR     ;IF CHARACTER IS WAITING GO GET IT

LOC:    0

; INPUT/OUTPUT SERVICE ROUTINE

IOSR:   STA     0,SAVE0  ;SAVE ACCUMULATORS THAT WILL BE USED
      STA     3,SAVE3
      MOVL   0,0        ;SAVE CARRY
      STA     0,SAVEC

READC:  DIAC    0,TTI    ;READ THE CHARACTER AND CLEAR DONE
      LDA     3,C177    ;DROP PARITY BIT
      AND     3,0
STORE:  STA     0,020    ;STORE CHARACTER IN BUFF
      SKPBZ   TTI      ;TTI READY?
      JMP     .-1       ;NO, TRY AGAIN
      DOAS   0,TTI     ;YES, ECHO CHARACTER
      LDA     3,CR     ;IS CHARACTER A CARRIAGE RETURN?
      SUB#   3,0,SNR
      JMP     CRET     ;YES, GO PROCESS IT
      DSZ    CHCNT     ;NO, DECREMENT CHCNT TO CHECK FOR LINE OVERFLOW
      JMP     RSTOR    ;NO OVERFLOW, EXIT
      MOV    3,0       ;LINE IS FULL, LOAD A CR AND
      JMP     STORE    ; JUMP BACK TO INSERT IT INTO BUFF
```

EXAMPLE ONE (Continued)

```

CRET:  LDA  0,LF      ;ADD LINE FEED TO BUFF
      STA  0,@20
      SKPBZ TTO      ;WAIT UNTIL TTO READY
      JMP  -1
      DOAS 0,TT0     ;GIVE LINE FEED
      LDA  0,20     ;CALCULATE NUMBER OF CHARACTERS IN BUFF
      LDA  3,ABUFF
      SUB  3,0
      STA  0,PCNT   ;INITIALIZE PUNCH CHARACTER COUNTER
      STA  3,20     ;RESET BUFFER INDEX TO BEGINNING OF BUFF
      SUB  0,0,SKP  ;FIRST PUT OUT 8 FRAMES OF BLANK LEADER
NEWC:  LDA  0,@20   ;GET NEW CHARACTER
SAMEC: SKPBZ PTP    ;WAIT UNTIL PUNCH READY
      JMP  -1
      DOAS 0,PTP    ;OUTPUT CHARACTER TO PUNCH
      DSZ  PRCNT   ;DECREMENT PUNCH REPEAT COUNTER
      JMP  SAMEC   ;GO PUNCH SAME CHARACTER AGAIN
      LDA  0,NRPT  ;REINITIALIZE PUNCH REPEAT COUNTER
      STA  0,PRCNT
      DSZ  PCNT    ;DECREMENT PUNCH CHARACTER COUNTER
      JMP  NEWC   ;START PUNCHING NEW CHARACTER
      LDA  0,MAX   ;ALL DONE, REINITIALIZE CHARACTER BUFFER:
      STA  0,CHCNT ; INITIALIZE CHARACTER COUNTER
      LDA  0,ABUFF ; INITIALIZE CHARACTER BUFFER INDEX
      STA  0,20

RSTOR: LDA  0,SAVEC ;RESTORE CARRY AND ACCUMULATORS
      MOVR 0,0
      LDA  0,SAVE0
      LDA  3,SAVE3
      JMP  CALC    ;RETURN AND RESUME COMPUTATION

C177:  177        ;MASK FOR DELETING PARITY BIT
CR:    15        ;CARRIAGE RETURN
LF:    12        ;LINE FEED

ABUFF: BUFF-1   ;ADDRESS OF CHARACTER BUFFER - 1
MAX:   110      ;MAXIMUM OF 72 CHARACTERS INPUT PER LINE
CHCNT: 110      ;CHARACTER COUNTER (COUNTS DOWN FROM MAX)

PCNT:  0        ;PUNCH CHARACTER COUNTER
PRCNT: 10       ;PUNCH REPEAT COUNTER
NRPT:  10       ;NUMBER OF TIMES TO PUNCH EACH CHARACTER

SAVE0: 0        ;ACCUMULATOR SAVE LOCATIONS
SAVE3: 0
SAVEC: 0        ;CARRY SAVE LOCATION

BUFF:  .BLK 112 ;CHARACTER BUFFER - ALLOW FOR 72 CHARS + CR + LF

      .END  START

```

EXAMPLE TWO

Example Two performs the same input/output operations that Example One does, but with its use of the interrupt facility it functions much more efficiently. Two major benefits of the interrupt are illustrated:

1. The program need not check the TTI status while it is performing its calculations--the calculations are interrupted automatically when there is I/O to be done. This eliminates the sluggishness encountered in Example One; in Example Two the response to typing a character appears to be immediate.
2. In the periods during which the computer is waiting for an I/O (in this case the punch) to complete an operation before starting it on another operation, a program which uses interrupts can perform other computation. When Example Two is actually run, the console lights continue to show calculations being performed while the punch is running. Note, however, that while the punching is being done, TTI interrupts must be ignored. Otherwise, a carriage return given while punching was going on would terminate the line being punched and start the new one. A program check is employed in Example Two to avoid this problem. Right after a character is read in

(READC), if a line is being punched (PCCNT > 0), the character is ignored and the interrupt is dismissed immediately. In Example Three, use of a priority interrupt scheme eliminates this problem, so that characters can be accepted from the Teletype during punching.

A polling routine is used in Example Two to determine which peripheral caused the interrupt. The I/O SKIP instructions (beginning at IHAND) are ordered so that the higher-priority devices are interrogated first. Although the order is not critical for such slow devices as are used here, it is generally good practice to check the higher-priority peripherals first.

Three other things should be noted. The first instruction (at START) is now DICS 0,CPU. This resets all peripherals as does an IORST, but it also enables, rather than disables, the interrupt facility. Secondly, Teletype output (TTO) interrupts are unconditionally ignored by merely clearing the Done flag and returning. Thirdly, for computers with the power monitor and auto-restart feature, a power fail service routine has been written. In Example Two this routine (PFLSR) merely saves the state of the processor and halts. A more involved routine, which provides auto-restart capability, is included in Example Three.

EXAMPLE TWO

```
.LOC 0
0          ;PC STORED HERE ON INTERRUPT
IHAND      ;INTERRUPT HANDLER ADDRESS

.LOC 20
BUFF-1     ;AUTO-INCREMENTING LOCATION USED AS
           ; INDEX INTO CHARACTER BUFFER

.LOC 400

;         "MAIN" PROGRAM

START:     DICS 0,CPU          ;IORST AND INTEN

CALC:      ADD 0,1            ;SIMULATE USEFUL COMPUTATION
           SUB 1,2
           INC 2,3
           NEG 3,0
           ISZ LOC
           JMP CALC
           JMP CALC          ;NO NEED TO CHECK HERE FOR TTI DONE

LOC:       0

;         INTERRUPT HANDLER

IHAND:     SKPDZ CPU          ;POLL DEVICES TO LOCATE SOURCE OF INTERRUPT
           JMP PFLSR         ;POWER FAIL INTERRUPT
           SKPDZ PTF
```

EXAMPLE TWO (Continued)

```

JMP  PTPSR      ;PAPER TAPE PUNCH INTERRUPT
SKPDZ TTI
JMP  TTISR      ;TELETYPE INPUT INTERRUPT
SKPDN TTO
HALT
NIOC  TTO      ;SPURIOUS INTERRUPT
INTEN          ;TELETYPE OUTPUT, IGNORE INTERRUPT
JMP  @0        ;ENABLE INTERRUPTS
JMP  @0        ;RETURN TO INTERRUPTED PROGRAM

```

; POWER FAIL SERVICE ROUTINE

```

PFLSR: STA  0,SAVE0  ;POWER FAILURE, SAVE ACCUMULATORS AND CARRY
        STA  1,SAVE1
        STA  2,SAVE2
        STA  3,SAVE3
        MOVL 0,0
        STA  0,SAVEC
        HALT      ;WAIT FOR POWER TO GO DOWN

```

```

SAVE0: 0          ;ACCUMULATOR SAVE LOCATIONS
SAVE1: 0
SAVE2: 0
SAVE3: 0
SAVEC: 0          ;CARRY SAVE LOCATION

```

; TELETYPE INPUT SERVICE ROUTINE

```

TTISR: STA  0,SAVE0  ;SAVE ACCUMULATORS THAT WILL BE USED
        STA  3,SAVE3
        MOVL 0,0      ;SAVE CARRY
        STA  0,SAVEC

READC: DIAC 0,TTI    ;READ THE CHARACTER AND CLEAR DONE
        LDA  3,C177   ;DROP PARITY BIT
        AND  3,0
        LDA  3,PCNT   ;IS PREVIOUS LINE BEING PUNCHED?
        MOV# 3,3,SZR
        JMP  TTIDS    ;IF YES, THEN IGNORE THIS CHARACTER

STORE: STA  0,@20    ;STORE CHARACTER IN BUFF
        SKPBZ TTO    ;TTO READY?
        JMP  .-1      ;NO, TRY AGAIN
        DOAS 0,TTO    ;YES, ECHO CHARACTER
        LDA  3,CR     ;IS CHARACTER A CARRIAGE RETURN?
        SUB# 3,0,SNR
        JMP  CRET     ;YES, GO PROCESS IT
        DSZ  CHCNT    ;NO, DECREMENT CHCNT TO CHECK FOR LINE OVERFLOW
        JMP  TTIDS    ;NO OVERFLOW, GO DISMISS INTERRUPT
        MOV  3,0      ;LINE IS FULL, LOAD A CR AND
        JMP  STORE    ; JUMP BACK TO INSERT IT INTO BUFF

CRET:  LDA  0,LF     ;ADD LINE FEED TO BUFF
        STA  0,@20
        SKPBZ TTO    ;WAIT UNTIL TTO READY
        JMP  .-1
        DOAS 0,TTO    ;GIVE LINE FEED
        LDA  0,20    ;CALCULATE NUMBER OF CHARACTERS IN BUFF
        LDA  3,ABUFF
        SUB  3,0
        STA  0,PCNT   ;INITIALIZE PUNCH CHARACTER COUNTER
        STA  3,20    ;RESET BUFFER INDEX TO BEGINNING OF BUFF
        SUB  0,0      ;FIRST PUT OUT 8 FRAMES OF BLANK LEADER
        DOAS 0,PTP
        STA  0,CCHAR  ;SAVE NULL AS CURRENT CHARACTER

TTIDS: LDA  0,SAVEC  ;TTI INTERRUPT DISMISSAL
        MOVR 0,0     ;RESTORE CARRY AND ACCUMULATORS

```

EXAMPLE TWO (Continued)

```

        LDA 0,SAVE0
        LDA 3,SAVE3
        INTEN          ;ENABLE INTERRUPTS
        JMP 00         ;RETURN TO INTERRUPTED PROGRAM

C177:   177          ;MASK FOR DELETING PARITY BIT
CR:     15          ;CARRIAGE RETURN
LF:     12          ;LINE FEED

ABUFF:  BUFF-1     ;ADDRESS OF CHARACTER BUFFER - 1
MAX:    110        ;MAXIMUM OF 72 CHARACTERS INPUT PER LINE
CHCNT:  110        ;CHARACTER COUNTER (COUNTS DOWN FROM MAX)

PCCNT:  0          ;PUNCH CHARACTER COUNTER
PRCNT:  10        ;PUNCH REPEAT COUNTER
NRPT:   10        ;NUMBER OF TIMES TO PUNCH EACH CHARACTER
CCHAR:  0          ;CURRENT CHARACTER SAVE LOCATION

;       PAPER TAPE PUNCH SERVICE ROUTINE

PTPSR:  STA 0,SAVE0 ;SAVE ACCUMULATORS THAT WILL BE USED
        STA 3,SAVE3 ;(CARRY WILL NOT BE CHANGED)

GCHAR:  LDA 0,CCHAR ;GET CURRENT CHARACTER
        ISZ PRCNT   ;DECREMENT PUNCH REPEAT COUNTER
        JMP SAMEC   ;GO PUNCH SAME CHARACTER AGAIN
        LDA 0,NRPT  ;REINITIALIZE PUNCH REPEAT COUNTER
        STA 0,PRCNT
        ISZ PCCNT   ;DECREMENT PUNCH CHARACTER COUNTER
        JMP NEWC    ;GO PUNCH NEW CHARACTER
        NI OC PTP   ;ALL DONE, CLEAR PUNCH
        LDA 0,MAX   ;REINITIALIZE CHARACTER BUFFER:
        STA 0,CHCNT ; INITIALIZE CHARACTER COUNTER
        LDA 0,ABUFF ; INITIALIZE CHARACTER BUFFER INDEX
        STA 0,20
        JMP PTPDS   ;GO DISMISS INTERRUPT
NEWC:   LDA 0,020   ;GET NEW CHARACTER
        STA 0,CCHAR ;UPDATE CURRENT CHARACTER SAVE
SAMEC:  DDAS 0,PTP  ;OUTPUT CHARACTER TO PUNCH

PTPDS:  LDA 0,SAVE0 ;PTP INTERRUPT DISMISSAL
        LDA 3,SAVE3 ;RESTORE ACCUMULATORS
        INTEN       ;ENABLE INTERRUPTS
        JMP 00      ;RETURN TO INTERRUPTED PROGRAM

BUFF:   .BLK 112    ;CHARACTER BUFFER - ALLOW FOR 72 CHARS + CR + LF

        .END START

```

EXAMPLE THREE

Example Three creates a full priority interrupt structure and provides even more efficient I/O processing. Two peripherals are added to the program: the high-speed paper tape reader, as a peripheral which requires service quickly enough that it could benefit from such a priority interrupt structure, and a magnetic tape drive, as a peripheral which uses the data channel. In addition to the Teletype and punch I/O of the previous two examples, Example Three allows a block of information to be read in through the high-speed reader, stored in a second buffer, and written out to magnetic tape. This sequence is initiated by typing control-R at any point in a Teletype input line. Doing so will store the control-R in the buffer but echo it by ringing the Teletype bell.

When the completed line is punched, any control-R's in the line are punched only once (instead of the usual eight times), and it starts the paper tape reader. For each control-R, one block of paper tape (delimited by one or more null frames) is read. After a block is read, 100-word sections of the block are written to magnetic tape via the data channel. (A block on paper tape produced by this program on the punch can be as long as $74 \times 8 = 592$ frames, equivalent to several magnetic tape records of the arbitrary length 100.) When all the writing is done, the paper tape reader is started again if there were additional control-R's input.

Priority Structure

The interrupt priority masks are set up to create the following priority structure among active peripherals, from highest priority to lowest:

- paper tape reader
- magnetic tape
- paper tape punch
- Teletype input
- Teletype output

The paper tape reader is given highest priority because it has the shortest allowable programmed I/O latency. In order to keep the reader operating at maximum speed, response to its interrupt requests must occur within 100 microseconds.

The magnetic tape unit receives next priority. Although magnetic tapes transfer data much faster than the paper tape reader, they do it through the data channel; interrupts are requested only after entire blocks of information have been transferred. Interrupt requests from the paper tape reader, which occur every frame, consequently come more frequently than those of a magnetic tape unit.

The paper tape punch and Teletype keyboard (TTI) receive priority in that order, according to their speeds. Finally, Teletype output (TTO) is always masked out, since the program does not need or want to know about TTO interrupts. There is no timing problem because Teletype output can keep up with Teletype input.

Interrupts may come from two other sources in addition to the peripherals mentioned above. If the computer includes the power monitor and auto-restart feature, an interrupt will occur if power should fail. Since power fail interrupts cannot be masked out, a power failure has priority over all other peripherals. The second other source of an interrupt is a peripheral from which the program does not expect an interrupt. (For example, an interrupt from a second terminal may occur if it is used when the program is running. The program handles such a spurious interrupt merely by clearing the interrupting peripheral's Done flag and returning to the interrupted program. The Interrupt On flag is left set to 0 during this short process; consequently, spurious interrupts, like power fail interrupts, have priority equal to that of the paper tape reader, the highest-priority active peripheral.

Priority Interrupt Handler

The interrupt handler in Example Three differs from that in Example Two in a number of ways. The reason for these differences is twofold:

1. Example Three sets up and maintains a priority interrupt structure.
2. Example Three includes programming to handle spurious interrupts and to make use of the power monitor and auto-restart feature.

The interrupt handler uses the INTERRUPT ACKNOWLEDGE instruction (INTA) to identify the source of an interrupt. The device code read by the INTA instruction is used as an index into a 64-word interrupt dispatch table (IDTAB) which contains the starting addresses of the various peripheral service routines. The main interrupt handler dispatches control to the appropriate peripheral service routine by performing a "jump indirect" (JMP@) to the correct table location. Table locations which correspond to peripherals not provided for in Example Three contain the address of the spurious interrupt handler (SIH).

In order to change the current priority level when an interrupt occurs, a new interrupt priority mask must be established. In addition, the previous value of the mask must be saved so that it can be restored when the current interrupt service is finished. In Example Three, the various periph-

eral service routines are responsible for manipulating the old and new masks. The old mask is retrieved from the location reserved for it (MASK) and stored in the routine's save area. Then a new mask, which reflects the priority structure required by the peripheral, is loaded into AC0. The new mask is established by executing two instructions: (1) DOBS 0,CPU, which is a combination of the MASK OUT and INTERRUPT ENABLE instructions, sets up the Interrupt Disable flags in the system and turns interrupts back on, so that higher-priority peripherals may interrupt the current service routine. (2) STA 0,CMASK stores a copy of the new mask in the current mask save location. These two instructions should, in general, always be given together, so that the current value of the mask stored in memory (at CMASK) matches the states of the Interrupt Disable flags. Note also that the mask must be set up at the beginning of the program, before interrupts are enabled. In Example Three a DOBS 0,CPU instruction initializes the mask to 1 to mask out Teletype output and turns interrupts on. No interrupt can occur until after the STA 0,CMASK instruction which follows immediately.

Because a higher-priority peripheral may interrupt the service routine of a lower-priority peripheral, the first portion of the interrupt handler must be written in such a way that no information vital to the currently executing service routine is lost when a higher-priority interrupt occurs. Therefore, the information of interest must be protected before interrupts can be enabled. In any priority interrupt handler, the current mask and the return address stored in location 0 must be saved. In Example Three, it is also necessary to transfer the saved values of AC0 and AC3 from the temporary locations SAVE0 and SAVE3 to the protected area special to each peripheral service routine (TSAV0 and TSAV3 for Teletype input service, for example). (The save area for each service routine is protected because Example Three is set up so that no peripheral can interrupt itself.) It is not necessary to store the values of the accumulators or Carry in a protected area before enabling interrupts. Any higher-priority service routine that interrupts a lower-priority routine before the lower-priority routine saves the values of the accumulators it needs to use is required to ensure that, upon return to the lower-priority routine, the accumulators are restored to the values they had at the time of the higher-priority interrupt. Consequently, information in Carry or the accumulators is "safe" with respect to higher-priority interrupts.

The power fail service routine has been expanded in Example Three to make use of the auto-restart feature. When a power fail interrupt occurs, the Carry and accumulators are saved, and the computer is readied for an auto-restart. This involves placing a JUMP instruction in location 0. When auto-restart occurs, the computer automatically simulates a JMP 0 instruction (note: not a JMP @0 instruction). The restart instruction stored in location 0 (JMP @RSTAD) transfers control to the restart code (RSTRT), where the state of the machine is restored and the program is picked up where it left off when power failed. Each peripheral has a software "active" flag set when it begins an operation, so the program can check on how far the operation proceeded before power failed. Since the magnetic tape unit could have lost power anywhere within the current record it was writing, the program erases a section of tape and rewrites the entire record. Note that an auto-restart will occur only if the power switch is in the "lock" position. However, if the power switch is not in "lock", the same effect can be produced manually by starting the computer at location 0.

A routine (SIH) is included in Example Three to handle spurious interrupts. It merely clears the peripheral which caused the interrupt and then returns to the interrupted program. The peripheral is cleared by executing an NIOC instruction with the device code read by the INTA instruction given earlier.

The power fail routine, the spurious interrupt handler, and the paper tape reader service routine are given "absolute" priority while they are executing. Interrupts are not reenabled by these routines, so no other interrupt is allowed to occur. Consequently, these routines need not manipulate the priority mask nor safeguard the return address stored in location 0.

In Example Three each service routine is responsible for dismissing the interrupt on its own. This involves restoring the states of Carry, the accumulators, and the previous mask, and returning to the interrupted program. The priority mask should be changed only when interrupts are disabled. Therefore, the dismissal sequence must disable interrupts before restoring the mask, then enable them and immediately jump back to the interrupted program. In Example Three, a DOBC 0,CPU is given to change the mask and disable interrupts. Then location CMASK is restored, the last of the accumulators is restored, interrupts are enabled, and control is returned to the interrupted program.

EXAMPLE THREE

```

        .LOC    0

        0          ;PC STORED HERE ON INTERRUPT
        IHAND      ;INTERRUPT HANDLER ADDRESS
CMASK:  0          ;CURRENT MASK SAVE LOCATION
RSTAD:  RSTRT     ;AUTO-RESTART ADDRESS

SAVE0:  0          ;SAVE AREA FOR MAIN INTERRUPT HANDLER AND
SAVE1:  0          ; POWER FAIL SERVICE ROUTINE
SAVE2:  0
SAVE3:  0
SAVEC:  0          ;PC AND CARRY SAVE LOCATION

FACTV:  0          ;PUNCH ACTIVE FLAG
RACTV:  0          ;READER ACTIVE FLAG
MACTV:  0          ;MAG TAPE ACTIVE FLAG

        .LOC    20          ;AUTO-INCREMENTING LOCATIONS

BUFF-1          ;FIRST INDEX INTO FIRST CHARACTER BUFFER
BUFF-1          ;SECOND INDEX INTO FIRST CHARACTER BUFFER
BUFF2-1         ;INDEX INTO SECOND CHARACTER BUFFER

        .LOC    400

; "MAIN" PROGRAM

START:  IORST     ;CLEAR I/O DEVICES
        LDA     0,RWIND ;REWIND MAG TAPE
        IOAS   0,MTA
        SUBZL  0,0     ;SET ACO TO 1
        DOBS   0,CPU   ;MASK OUT T10 (BIT 15) AND TURN ON INTERRUPTS
        STA     0,CMASK ;SAVE CURRENT MASK

CALC:   ADD     0,1     ;SIMULATE USEFUL COMPUTATION
        SUB     1,2
        INC     2,3
        NEG     3,0
        ISZ    LOC
        JMP     CALC
        JMP     CALC

LOC:    0
RWIND:  10        ;REWIND COMMAND (SELECTS DRIVE 0)

; INTERRUPT HANDLER

IHAND:  STA     0,SAVE0 ;SAVE ACO AND AC3 FOR USE WITH INTA
        STA     3,SAVE3
        SKPDZ  CPU     ;CHECK FOR POWER FAIL INTERRUPT
        JMP     PFLSR
        LDA     3,AIDTB ;GET ADDRESS OF INTERRUPT DISPATCH TABLE
        INTA   0       ;READ DEVICE CODE
        ADD     0,3     ;POINT TO CORRECT TABLE ENTRY
        JMP     @0,3    ;DISPATCH TO PERIPHERAL SERVICE ROUTINE

AIDTB:  IDTAB     ;ADDRESS OF INTERRUPT DISPATCH TABLE

; POWER FAIL/AUTO-RESTART SERVICE ROUTINE

PFLSR:  STA     1,SAVE1 ;SAVE REMAINING ACCUMULATORS
        STA     2,SAVE2
        LDA     0,0     ;GET SAVED PC FROM LOCATION 0

```

EXAMPLE THREE (Continued)

```

MOVL 0,0      ;APPEND CARRY AT LOW END
STA 0,SAVEC   ;SAVE PC AND CARRY
LDA 0,JUMP    ;SET UP RESTART INSTRUCTION IN LOCATION 0
STA 0,0
SKPDZ CPU     ;LOOP HERE WAITING FOR POWER TO GO DOWN
JMP .-1
JMP RSTOR    ;IF IT COMES BACK UP GO AHEAD AND RESTORE

JUMP: JMP QRSTAD ;INSTRUCTION FOR JUMPING TO RESTART CODE

RSTRT: LDA 0,FACTV ;WAS PTF ACTIVE?
MOV# 0,0,SZR
NIOS PTR      ;IF YES, RESTART IT
LDA 0,RACTV   ;WAS PTR ACTIVE?
MOV# 0,0,SZR
NIOS PTR      ;IF YES, RESTART IT
LDA 0,MACTV   ;WAS MTA ACTIVE?
MOV# 0,0,SZR
JSR QAMTAR    ;IF YES, GO RESTART IT

RSTOR: LDA 0,CMASK ;RESTORE CURRENT MASK
DOBC 0,CPU     ;MSKO AND INTDS
LDA 0,SAVEC   ;RESTORE CARRY AND SAVED PC
MOVZR 0,0
STA 0,0       ;SET UP RETURN ADDRESS
LDA 0,SAVE0   ;RESTORE ACCUMULATORS
LDA 1,SAVE1
LDA 2,SAVE2
LDA 3,SAVE3
INTEN          ;ENABLE INTERRUPTS
JMP 00        ;RESTART PROGRAM

AMTAR: MTAAR    ;ADDRESS OF ROUTINE TO RESTART MAG TAPE

; ROUTINE TO HANDLE SPURIOUS INTERRUPTS
SIH: LDA 3,NIOC0 ;CLEAR DEVICE THAT CAUSED THE INTERRUPT:
ADD 0,3         ;FORM AN NIOC INSTRUCTION WITH APPROPRIATE DEVICE CODE
STA 3,+.1      ;STORE THE INSTRUCTION
0              ;EXECUTE THE INSTRUCTION
LDA 0,SAVE0    ;RESTORE ACCUMULATORS
LDA 3,SAVE3
INTEN          ;ENABLE INTERRUPTS
JMP 00        ;RETURN TO INTERRUPTED PROGRAM

NIOC0: NIOC 0   ;USED TO CREATE AN NIOC (DEVICE) INSTRUCTION

; TELETYPE INPUT SERVICE ROUTINE
TTISR: LDA 0,SAVE0 ;SAVE ACO AND AC3 IN TTI SAVE AREA
STA 0,TSAV0
LDA 0,SAVE3
STA 0,TSAV3
LDA 0,CMASK     ;SAVE CURRENT MASK
STA 0,TSAVM
LDA 3,0         ;LOAD RETURN ADDRESS INTO AC3
LDA 0,TMASK     ;GET NEW MASK
DOBS 0,CPU      ;MSKO AND INTEN
STA 0,CMASK     ;UPDATE CURRENT MASK SAVE LOCATION
MOVL 3,3        ;APPEND CARRY TO LOW END OF RETURN ADDRESS
STA 3,TSAVC     ;SAVE RETURN ADDRESS AND CARRY

READC: DIAC 0,TTI ;READ THE CHARACTER AND CLEAR DONE
LDA 3,C177      ;DROP PARITY BIT
AND 3,0

```

EXAMPLE THREE (Continued)

```

STORE:  STA  0,@20      ;STORE CHARACTER IN BUFF
        LDA  3,CNTRLR  ;CHECK FOR CONTROL R
        SUB# 3,0,SNR
        LDA  0,BELL    ;ECHO CONTROL R BY RINGING BELL
        SKPBZ TTO      ;TTO READY?
        JMP  .-1        ;NO, TRY AGAIN
        DOAS 0,TTO     ;YES, ECHO CHARACTER
        LDA  3,CR      ;IS CHARACTER A CARRIAGE RETURN?
        SUB# 3,0,SNR
        JMP  CRET      ;YES, GO PROCESS IT
        DSZ  CHCNT     ;NO, DECREMENT CHCNT TO CHECK FOR LINE OVERFLOW
        JMP  TTIDS     ;NO OVERFLOW, GO DISMISS INTERRUPT
        MOV  3,0       ;LINE IS FULL, LOAD A CR AND
        JMP  STORE     ; JUMP BACK TO INSERT IT INTO BUFF
CRET:   LDA  0,LF      ;ADD LINE FEED TO BUFF
        STA  0,@20
        SKPBZ TTO      ;WAIT UNTIL TTO READY
        JMP  .-1
        DOAS 0,TTO     ;GIVE LINE FEED
        LDA  0,PCNT    ;WAIT IF PUNCHING OF PREVIOUS LINE IS NOT DONE
        MOV# 0,0,SZR
        JMP  .-2
        LDA  0,20      ;CALCULATE NUMBER OF CHARACTERS IN BUFF
        LDA  3,ABUFF
        SUB  3,0
        STA  0,PCNT    ;INITIALIZE PUNCH CHARACTER COUNTER
        LDA  0,MAX     ;REINITIALIZE CHARACTER BUFFER:
        STA  0,CHCNT   ; INITIALIZE CHARACTER COUNTER
        STA  3,20      ; INITIALIZE CHARACTER BUFFER POINTERS IN
        STA  3,21      ; AUTO-INCREMENTING LOCATIONS 20 AND 21
        SUB  0,0       ;FIRST PUT OUT 8 FRAMES OF BLANK LEADER
        INTDS          ;MAKE SURE THAT PUNCH STARTED AND FLAG SET TOGETHER
        DOAS 0,PTP     ;OUTPUT NULL CHARACTER
        ISZ  PACTV     ;SET PUNCH ACTIVE FLAG
        INTEN
        STA  0,CCHAR   ;SAVE NULL AS CURRENT CHARACTER

TTIDS:  LDA  0,TSAVC   ;TTI INTERRUPT DISMISSAL
        MOVZR 0,0      ;RESTORE CARRY AND SET UP RETURN ADDRESS
        STA  0,TSAVC
        LDA  3,TSAV3   ;RESTORE AC3
        LDA  0,TSAVM   ;GET PREVIOUS MASK
        DOBC 0,CPU     ;MSKO AND INTDS
        STA  0,CMASK   ;RESTORE MASK SAVE LOCATION
        LDA  0,TSAV0   ;RESTORE AC0
        INTEN         ;ENABLE INTERRUPTS
        JMP  @TSAVC    ;RETURN TO INTERRUPTED PROGRAM

TSAV0:  0             ;TTI SAVE AREA: AC0
TSAV3:  0             ;AC3
TSAVC:  0             ;RETURN ADDRESS AND CARRY
TSAVM:  0             ;CURRENT MASK

TMASK:  3             ;MASKS OUT TTI AND TTO

C177:  177           ;MASK FOR DELETING PARITY BIT
CR:    15             ;CARRIAGE RETURN
LF:    12             ;LINE FEED
CNTRLR: 22           ;CONTROL R
BELL:  7             ;TELETYPE BELL

ABUFF:  BUFF-1       ;ADDRESS OF CHARACTER BUFFER - 1
MAX:    110           ;MAXIMUM OF 72 CHARACTERS INPUT PER LINE
CHCNT:  110          ;CHARACTER COUNTER (COUNTS DOWN FROM MAX)

PCNT:   0             ;PUNCH CHARACTER COUNTER
PRCNT:  10           ;PUNCH REPEAT COUNTER
NRPT:   10           ;NUMBER OF TIMES TO PUNCH EACH CHARACTER
CCHAR:  0             ;CURRENT CHARACTER SAVE LOCATION

```

EXAMPLE THREE (Continued)

```

; PAPER TAPE PUNCH SERVICE ROUTINE

PTPSR: LDA 0,SAVE0 ;SAVE ACO AND AC3 IN PTP SAVE AREA
      STA 0,PSAV0
      LDA 0,SAVE3
      STA 0,PSAV3
      LDA 0,CMASK ;SAVE CURRENT MASK
      STA 0,PSAVM
      SUB 0,0 ;CLEAR PUNCH ACTIVE FLAG
      STA 0,FACTV
      LDA 3,0 ;LOAD RETURN ADDRESS INTO AC3
      LDA 0,PMASK ;GET NEW MASK
      DOBS 0,CFU ;MSKO AND INTEN
      STA 0,CMASK ;UPDATE CURRENT MASK SAVE
      MOVL 3,3 ;APPEND CARRY TO LOW END OF RETURN ADDRESS
      STA 3,PSAVC ;SAVE RETURN ADDRESS AND CARRY

GCHAR: LDA 0,CCHAR ;GET CURRENT CHARACTER
      LDA 3,CNTRL ;IS IT CONTROL R?
      SUB 0,3,SNR ;(AC3 BECOMES 0 IF CHARACTER IS CONTROL R)
      JMP PTRDR ;YES, INPUT FROM READER
      ISZ PRCNT ;NO, DECREMENT PUNCH REPEAT COUNTER
      JMP SAMEC ;GO PUNCH SAME CHARACTER AGAIN
CONTP: LDA 0,NRPT ;REINITIALIZE PUNCH REPEAT COUNTER
      STA 0,PRCNT
      ISZ PCCNT ;DECREMENT PUNCH CHARACTER COUNTER
      JMP NEWC ;GO PUNCH NEW CHARACTER
      NIOC PTP ;ALL DONE, CLEAR PUNCH
      JMP PTPDS ;GO DISMISS INTERRUPT

NEWC: LDA 0,@21 ;GET NEW CHARACTER
      STA 0,CCHAR ;UPDATE CURRENT CHARACTER SAVE
SAMEC: INTDS ;MAKE SURE PUNCH STARTED AND FLAG SET TOGETHER
      DOAS 0,PTP ;OUTPUT CHARACTER TO PUNCH
      ISZ FACTV ;SET PUNCH ACTIVE FLAG
      INTEN
      JMP PTPDS ;GO DISMISS INTERRUPT

PTRDR: ISZ RBCNT ;INCREMENT READER BLOCK COUNTER
      LDA 0,RBCNT ;IS THIS THE FIRST PTR REQUEST?
      ADC# 3,0,SZR ;(SKIP IF ACO = 1)
      JMP CONTP ;NO, CONTINUE PUNCHING WITH NEXT CHARACTER
      INTDS ;MAKE SURE READER STARTED AND FLAG SET TOGETHER
      NIOS PTR ;START READER
      ISZ RACTV ;SET READER ACTIVE FLAG
      INTEN
      LDA 0,ARUF2 ;INITIALIZE SECOND CHARACTER BUFFER
      STA 0,22 ;USE AUTO-INCREMENT LOCATION 22 AS INDEX
      JMP CONTP ;CONTINUE PUNCHING WITH NEXT CHARACTER

PTPDS: LDA 0,PSAVC ;PTP INTERRUPT DISMISSAL
      MOVZR 0,0 ;RESTORE CARRY AND SET UP RETURN ADDRESS
      STA 0,PSAVC
      LDA 3,PSAV3 ;RESTORE AC3
      LDA 0,PSAVM ;GET PREVIOUS MASK
      DOBC 0,CFU ;MSKO AND INTDS
      STA 0,CMASK ;RESTORE PREVIOUS MASK SAVE
      LDA 0,PSAV0 ;RESTORE ACO
      INTEN ;ENABLE INTERRUPTS
      JMP @PSAVC ;RETURN TO INTERRUPTED PROGRAM

PSAV0: 0 ;PTP SAVE AREA: ACO
PSAV3: 0 ;AC3
PSAVC: 0 ;RETURN ADDRESS AND CARRY
PSAVM: 0 ;CURRENT MASK

PMASK: 7 ;MASKS OUT PTP, TTI, AND TIO
RBCNT: 0 ;NUMBER OF BLOCKS LEFT TO READ FROM PTR

```

EXAMPLE THREE (Continued)

```

ABUF2:  BUFF2-1          ;ADDRESS OF SECOND CHARACTER BUFFER - 1

; PAPER TAPE READER SERVICE ROUTINE

PTRSR:  STA  1,RSV1      ;SAVE ONE MORE ACCUMULATOR AND CARRY
        MOVL 0,0        ;SINCE PTR HAS HIGHEST PRIORITY, LEAVE INTERRUPTS
        STA  0,RSV1     ; OFF, AND DON'T BOTHER WITH RETURN ADDRESS OR MASK

        DIAC 0,PTR      ;READ FRAME AND CLEAR DONE
        LDA  3,CHECK    ;GET PREVIOUS FRAME READ
        STA  0,CHECK    ;SAVE NEW FRAME
        MOV# 0,0,SNR    ;IS NEW FRAME = 0?
        JMP  ZEROF     ;YES
        STA  0,022     ;NO, SAVE IT IN BUFF2
        ISZ  RFCNT     ;INCREMENT READER FRAME COUNTER (NEVER SKIP)
SPTR:   NIOS  PTR      ;START READER FOR NEXT FRAME
        JMP  PTRDS     ;GO DISMISS INTERRUPT

ZEROF:  MOV# 3,3,SNR    ;FRAME IS ZERO, WAS PREVIOUS ONE ALSO ZERO?
        JMP  SPTR      ;YES, IGNORE LEADING BLANK FRAMES
        STA  0,022     ;NO, DONE WITH THIS BLOCK, MARK WITH 0 FRAME
        ISZ  RFCNT     ;INCREMENT READER FRAME COUNTER
        SUB  0,0       ;CLEAR READER ACTIVE FLAG
        STA  0,RACTV   ;
        LDA  1,BBUF2   ;AC1 POINTS TO BEGINNING OF BUFF2
        JSR  MWRIT    ;GO WRITE A BLOCK ON MAG TAPE

PTRDS:  LDA  0,RSV1     ;RESTORE CARRY AND ACCUMULATORS
        MOVR 0,0
        LDA  1,RSV1
        LDA  0,SAVE0
        LDA  3,SAVE3
        INTEN ;ENABLE INTERRUPTS
        JMP  00       ;RETURN TO INTERRUPTED PROGRAM

RSV1:   0             ;READER SAVE AREA: AC1
RSV1:   0             ;CARRY SAVE LOCATION

BBUF2:  BUFF2        ;ADDRESS OF BUFF2
RFCNT:  0            ;READER FRAME COUNTER
CHECK:  0            ;LAST FRAME INPUT FROM READER, USED IN IGNORING
                ; LEADING BLANK FRAMES

```

```

; MAG TAPE SERVICE ROUTINE

MTASR:  LDA  0,SAVE0   ;SAVE AC0 AND AC3 IN MTA SAVE AREA
        STA  0,MSAV0
        LDA  0,SAVE3
        STA  0,MSAV3
        LDA  0,CMASK   ;SAVE CURRENT MASK
        STA  0,MSAVM
        SUB  0,0       ;CLEAR MAG TAPE ACTIVE FLAG
        STA  0,MACTV
        LDA  3,0       ;LOAD RETURN ADDRESS INTO AC3
        LDA  0,MMASK   ;GET NEW MASK
        DOBS 0,CPU     ;MSK0 AND INTEN
        STA  0,CMASK   ;UPDATE CURRENT MASK SAVE
        MOVL 3,3      ;APPEND CARRY TO LOW END OF RETURN ADDRESS
        STA  3,MSAVC   ;SAVE RETURN ADDRESS AND CARRY
        STA  1,MSAV1   ;SAVE AC1

        DIA  0,MTA     ;READ MAG TAPE STATUS
        MOVL# 0,0,SZC  ;CHECK FOR ERRORS
        JMP  ERROR
        LIA  0,RFCNT   ;FETCH READER FRAME COUNTER

```

EXAMPLE THREE (Continued)

```

MOV# 0,0,SZR      ;MORE WRITING TO DO?
JMP  MOREM       ;YES
NIOC  MTA        ;NO, CLEAR MAG TAPE
DSZ  RBCNT      ;DECREMENT AND CHECK READER BLOCK COUNTER
JMP  MORER      ;MORE READING TO DO

MTADS: LDA  0,MSAVC ;DISMISS MTA INTERRUPT
MOVZR 0,0        ;RESTORE CARRY AND SET UP RETURN ADDRESS
STA  0,MSAVC
LDA  1,MSAV1     ;RESTORE AC1
LDA  3,MSAV3     ;RESTORE AC3
LDA  0,MSAVM     ;GET PREVIOUS MASK
DOBC  0,CPU      ;MSKO AND INTDS
STA  0,CMASK     ;RESTORE MASK SAVE LOCATION
LDA  0,MSAVO     ;RESTORE ACO
INTEN ;ENABLE INTERRUPTS
JMP  @MSAVC     ;RETURN TO INTERRUPTED PROGRAM

MOREM: DIB  1,MTA  ;READ ADDRESS OF NEXT WORD TO WRITE FROM BUFF?
JSR  MWRIT      ;GO WRITE NEXT BLOCK ON MAG TAPE
JMP  MTADS      ;GO DISMISS INTERRUPT

MORER: INTDS     ;MAKE SURE READER STARTED AND FLAG SET TOGETHER
NIOS  PTR       ;START READER
ISZ  RACTV      ;SET READER ACTIVE FLAG
INTEN
LDA  0,ABUF2    ;REINITIALIZE BUFF2
STA  0,22
JMP  MTADS      ;GO DISMISS INTERRUPT

ERROR: HALT      ;ERROR PROCESSING WOULD NORMALLY GO HERE

MSAVO: 0         ;MTA SAVE AREA: ACO
MSAV1: 0         ;AC1
MSAV3: 0         ;AC3
MSAVC: 0         ;RETURN ADDRESS AND CARRY
MSAVM: 0         ;CURRENT MASK

MMASK: 47        ;MASKS OUT MTA, PTP, TTI, AND TTO

; MWRIT WRITES A BLOCK OF DATA IN MEMORY ON MAG TAPE DRIVE 0
; SIZE OF BLOCK IS -BLKSZ
; ADDRESS OF FIRST WORD OF BLOCK IS CONTAINED IN AC1 ON ENTRY

MWRIT: DOB  1,MTA ;LOAD MEMORY ADDRESS COUNTER
STA  1,LSTAD ;SAVE LAST ADDRESS USED IN WRITING TO MAG TAPE
LDA  1,BLKSZ ;FETCH NEGATIVE BLOCK SIZE
DOC  1,MTA ;LOAD WORD COUNTER
LDA  0,WRCOM ;FETCH WRITE COMMAND
INTDS ;MAKE SURE MAG TAPE STARTED AND FLAG SET TOGETHER
DOAS  0,MTA ;INITIATE WRITE OPERATION
ISZ  MACTV ;SET MAG TAPE ACTIVE FLAG
INTEN
LDA  0,RFCNT ;NOW UPDATE READER FRAME COUNTER
ADDZ 1,0,SNC ;DECREASE IT BY BLOCK SIZE
SUB  0,0 ;IF RFCNT WAS < BLKSZ, SET RFCNT TO 0
STA  0,RFCNT ;SAVE NEW VALUE
JMP  0,3 ;RETURN TO CALLER

BLKSZ: -144 ;(NEGATIVE) BLOCK SIZE OF 100 DECIMAL
WRCOM: 50 ;WRITE COMMAND (SELECTS DRIVE 0)
LSTAD: 0 ;LAST ADDRESS USED IN WRITING TO MAG TAPE
ERCOM: 70 ;ERASE COMMAND (SELECTS DRIVE 0)

```

EXAMPLE THREE (Continued)

```

;      MTAAR RESTARTS MAG TAPE AFTER POWER FAIL
;      SEVERAL INCHES OF TAPE ARE ERASED, THEN THE RECORD
;      WHICH WAS BEING WRITTEN WHEN POWER FAILED IS REWRITTEN

MTAAR: LDA    0,ERCOM    ;ERASE SECTION OF TAPE
        DOAS   0,MTA
        SKPDN  MTA      ;WAIT TILL MTA DONE
        JMP    -1
        LDA    0,RFCNT  ;SET RFCNT BACK TO ITS PRIOR VALUE
        LDA    1,BLKSZ
        SUB    1,0
        STA    1,RFCNT
        LDA    1,LSTAD  ;FETCH ADDRESS OF RECORD TO BE REWRITTEN
        JMP    MWRIT    ;GO WRITE RECORD (MWRIT RETURNS DIRECTLY TO
                        ;AUTO-RESTART CODE)

```

CHARACTER BUFFERS

```

BUFF:  .BLK  112      ;ALLOW FOR 72 CHARACTERS + CR + LF
BUFF2: .BLK  1120    ;ALLOW FOR UP TO 74*8=592 FRAMES

```

INTERRUPT DISPATCH TABLE

```

IDTAB: SIH          ;DEVICE CODE 0
        SIH
        SIH
        SIH
        SIH
        SIH
        SIH
        SIH
        SIH
        TTISR       ;DEVICE CODE 10 = TTI
        SIH
        PTRSR       ;DEVICE CODE 12 = PTR
        PTPSR       ;DEVICE CODE 13 = PTP
        SIH
        SIH
        SIH
        SIH
        SIH
        MTASR       ;DEVICE CODE 22 = MTA
        SIH
        SIH
        SIH
        SIH
        SIH
        SIH
        SIH
        SIH
        SIH
        SIH
        SIH
        SIH
        SIH
        SIH
        SIH
        SIH
        SIH
        SIH
        SIH
        SIH
        SIH
        SIH
        SIH
        SIH
        SIH
        SIH
        SIH

```

EXAMPLE FOUR

Example Four performs the same functions as Example Three. The majority of the interrupt handling functions are accomplished using the VECTOR instruction (VCT) and the stack manipulation instructions of the ECLIPSE line of computers. Stack context is changed from the (possible) user stack to a "systems" stack when a base level interrupt occurs. Other nested interrupts do not

require a stack context change as the active stack is the systems stack.

Interrupt dismissal involves returning to a lower level service routine using the POP BLOCK instruction (POPB) after checking to determine the return is not to base level. If the return is to base level, the RESTORE instruction (RSTR) also effects a stack context change to reactivate the user stack.

EXAMPLE FOUR

FOR USE WITH THE ECLIPSE COMPUTER

```

        .LOC 0

;      RESERVED STORAGE LOCATIONS - CANNOT BE RELOCATED

        0          ;PC STORED HERE ON INTERRUPT
        \ IHA:     IHAND      ;INTERRUPT HANDLER ADDRESS
        \ SCHA:     SYSER      ;SYSTEM CALL HANDLER ADDRESS (NOT USED HERE)
        \ PFHA:     SYSER      ;PROTECTION FAULT HANDLER ADDRESS (NOT USED HERE)
        \ VSP:      VSTK-1     ;ADDRESS OF TOP OF VECTOR STACK
        \ CMASK:    0          ;CURRENT MASK SAVE LOCATION
        \ VSL:      VSTK-1+VSLN ;VECTOR STACK LIMIT
        \ VSFHA:    SYSER      ;VECTOR STACK FAULT HANDLER ADDRESS

;      ARBITRARY PAGE ZERO STORAGE LOCATIONS FOR THIS EXAMPLE

        0 RSTAD:    RSTRT      ;AUTO-RESTART ADDRESS
        \ SYSER:    HALTA 0     ;THIS EXAMPLE DOES NOT HANDLE SYSTEM CALLS,
        ;          ; PROTECTION FAULTS, OR VECTOR STACK FAULTS
        2 PACTV:    0          ;PUNCH ACTIVE FLAG
        \ RACTV:    0          ;READER ACTIVE FLAG
        \ MACTV:    0          ;MAG TAPE ACTIVE FLAG

        .LOC 20      ;AUTO-INCREMENTING LOCATIONS

        BUFF-1     ;FIRST INDEX INTO FIRST CHARACTER BUFFER
        BUFF-1     ;SECOND INDEX INTO FIRST CHARACTER BUFFER
        BUFF2-1    ;INDEX INTO SECOND CHARACTER BUFFER

        .LOC 401

;      VECTOR STACK
;
;      DEFINE THE VECTOR STACK LENGTH
        VSLN = 5*6+4 ;ALLOWS FOR 6-WORD BLOCKS FOR UP TO 5 INTERRUPT
        ;          ; LEVELS (I11, P1P, M1A, P1R, P1L) PLUS ROOM TO
        ;          ; SAVE USER STACK PARAMETERS (LOCATIONS 40-43)

        VSTK:      .BLK VSLN+13 ;RESERVE STACK AREA (ALLOW 11 EXTRA WORDS IN
        ;          ; CASE OF STACK OVERFLOW)

;      "MAIN" PROGRAM

        START:     IORST      ;CLEAR I/O DEVICES
        LDA        0,RWIND    ;REWIND MAG TAPE
        DOAS      0,MTA
        SUBZL     0,0         ;SET ACO TO 1
        DOBS      0,CPU      ;MASK OUT ITO (BIT 15) AND TURN ON INTERRUPTS
        STA        0,CMASK    ;SAVE CURRENT MASK
    
```

EXAMPLE FOUR (Continued)

```

CALC:  ADD    0,1      ;SIMULATE USEFUL COMPUTATION
        SUB    1,2      ; (MAIN PROGRAM MAY USE A STACK OF ITS OWN)
        INC    2,3
        NEG    3,0
        ISZ   LOC
        JMP    CALC
        JMP    CALC

LOC:    0
RWIND: 10              ;REWIND COMMAND (SELECTS DRIVE 0)

;      INTERRUPT HANDLER

IHAND: ISZ   LEVEL    ;HAS BASE LEVEL JUST BEEN INTERRUPTED?
        JMP   NSCH     ;NO
        VCT   @VTAB    ;YES, VECTOR WITH POSSIBLE STACK CHANGE
NSCH:   VCT   VTAB     ;VECTOR WITH NO STACK CHANGE

;      COMMON INTERRUPT DISMISSAL

DISMS: LDA   1,LEVEL  ;GET CURRENT INTERRUPT LEVEL
        SBI   1,1      ;DECREASE IT BY 1
        POP   0,0      ;GET OLD MASK
        IOBC  0,CPU    ;RESTORE OLD MASK AND DISABLE INTERRUPTS
        STA   0,CMASK  ;RESTORE MASK SAVE LOCATION
        STA   1,LEVEL  ;SET NEW INTERRUPT LEVEL
        COM#  1,1,SNR  ;GOING BACK TO BASE LEVEL?
        JMP   .+3      ;YES
        INTEN                ;NO, LEAVE VECTOR STACK AS IS, WILL BE
        POPB                ; RETURNING TO SOME OTHER SERVICE ROUTINE
        INTEN                ;RESTORE MAIN PROGRAM STACK ON WAY BACK TO
        RSTR                ; BASE LEVEL (I.E., MAIN PROGRAM)

LEVEL: -1              ;INTERRUPT LEVEL COUNTER

;      POWER FAIL/AUTO-RESTART SERVICE ROUTINE

PFLCT: @PFLSR         ;ADDRESS OF POWER FAIL SERVICE ROUTINE (PUSH R11 = 1)
        0              ;(DON'T BOTHER CHANGING MASK, SINCE INTERRUPTS
                        ; WILL BE TURNED OFF IMMEDIATELY AT PFLSR)

PFLSR: INTDIS        ;DISABLE INTERRUPTS
        SKPDZ CPU     ;IS THIS REALLY A POWER FAIL?
        JMP   REAL     ;YES
        ISZ   PFCNT    ;NO, COUNT THIS DECEPTION
        JMP   DISMS    ;GO DISMISS INTERRUPT
        HALT 0         ;HALT IF IT HAPPENS 65,536 TIMES

REAL:   LDA   0,JUMP   ;SET UP RESTART INSTRUCTION IN LOCATION 0
        STA   0,0
        SKPDZ CPU     ;LOOP HERE WAITING FOR POWER TO GO DOWN
        JMP   .-1
        JMP   RSTOR    ;IF IT COMES BACK UP, GO AHEAD AND RESTORE

RSTRT: LDA   0,PACTV  ;WAS P1P ACTIVE?
        MOV#  0,0,SZR
        NIOS  P1P      ;IF YES, RESTART IT
        LDA   0,RACTV ;WAS P1R ACTIVE?
        MOV#  0,0,SZR
        NIOS  P1R      ;IF YES, RESTART IT
        LDA   0,MACTV ;WAS M1A ACTIVE?
        MOV#  0,0,SZR
        JSR   @AMTAR   ;IF YES, GO RESTART IT

```

EXAMPLE FOUR (Continued)

```

RSTOR:  JMP    DISMS      ;GO RESTORE AND RESTART PROGRAM

FFCNT:  0                ;COUNTS NUMBER OF SPURIOUS INTERRUPTS FROM DEVICE 0
JUMP:   JMP     @RSTAD    ;INSTRUCTION FOR JUMPING TO RESTART CODE
AMTAR:  MTAAR           ;ADDRESS OF ROUTINE TO RESTART MAG TAPE

;
; ROUTINE TO HANDLE SPURIOUS INTERRUPTS
SIH:    DSZ    LEVEL      ;DECREMENT INTERRUPT LEVEL COUNTER
        JMP     .+1
        STA    0,SAVE0    ;SAVE THREE ACCUMULATORS
        STA    2,SAVE2
        STA    3,SAVE3
        INTA   0          ;READ A DEVICE CODE
        LDA    2,NSCH+1   ;GET ADDRESS OF VECTOR TABLE
        ADD    0,2        ;INDEX INTO VECTOR TABLE
        LDA    2,0,2      ;GET TABLE ENTRY
        LDA    3,ASIH     ;IS THIS A VALID DEVICE?
        SUB#   2,3,SZR    ;
        JMP     NEWIV     ;YES, FORGET ABOUT SPURIOUS INTERRUPT, GO DO NEW ONE
        LDA    2,NI0C0    ;THIS DEVICE UNDEFINED, TRY TO CLEAR IT
        ADD    0,2        ;FORM PROPER NI0C INSTRUCTION
        LDA    3,SKIP     ;FORM PROPER SKPDN INSTRUCTION
        ADD    0,3
        LDA    0,TRIES    ;INITIALIZE COUNTER FOR NUMBER OF TRIES
TRY:    XCT     2          ;EXECUTE NI0C INSTRUCTION
        XCT     3          ;EXECUTE SKPDN INSTRUCTION
        JMP     CLEAR     ;DEVICE IS CLEAR, GO DISMISS
        INC    0,0,SZR    ;COUNT THIS TRY
        JMP     TRY       ;GO TRY AGAIN
        HALT   2          ;HALT SHOWING FUTILE NI0C INSTRUCTION

NEWIV:  LDA    0,SAVE0    ;RESTORE ACCUMULATORS
        LDA    2,SAVE2
        LDA    3,SAVE3
        JMP     IHAND     ;GO TO INTERRUPT HANDLER

CLEAR:  LDA    0,SAVE0    ;RESTORE ACCUMULATORS
        LDA    2,SAVE2
        LDA    3,SAVE3
        INTEN  ;ENABLE INTERRUPTS
        JMP     @0        ;RETURN TO INTERRUPTED PROGRAM

SAVE0:  0                ;SAVE AREA FOR SPURIOUS INTERRUPT HANDLER
SAVE2:  2
SAVE3:  3

ASIH:   SIH             ;ADDRESS OF SPURIOUS INTERRUPT HANDLER
NI0C0:  NI0C  0         ;SKELETAL NI0C INSTRUCTION
SKIP:   SKPDN 0        ;SKELETAL SKPDN INSTRUCTION
TRIES:  -4000          ;TRY CLEARING DEVICE 2048 TIMES BEFORE GIVING UP

; TELETYPE INPUT SERVICE ROUTINE
TTICT:  @TTISR          ;TTI DEVICE CONTROL TABLE (PUSH BIT = 1)
        3                ;MASKS OUT TTI, ITG

TTISR:  READC:  DIAC    0,TTI    ;READ THE CHARACTER AND CLEAR DONE
        LDA    3,C177    ;DROP PARITY BIT
        AND    3,0
STORE:  STA    0,@20     ;STORE CHARACTER IN BUFF
        LDA    3,CNTR    ;CHECK FOR CONTROL R
        SUB#   3,0,SNR    ;
        LDA    0,BELL    ;ECHO CONTROL R BY RINGING BELL

```

EXAMPLE FOUR (Continued)

```

SKPBZ TTO          ;TTO READY?
JMP  .-1          ;NO, TRY AGAIN
DOAS  0,TTO       ;YES, ECHO CHARACTER
LIA   3,CR        ;IS CHARACTER A CARRIAGE RETURN?
SUB#  3,0,SNR     ;
JMP  CRET        ;YES, GO PROCESS IT
DSZ  CHCNT       ;NO, DECREMENT CHCNT TO CHECK FOR LINE OVERFLOW
JMP  TTIIS      ;NO OVERFLOW, GO DISMISS INTERRUPT
MOV  3,0        ;LINE IS FULL, LOAD A CR AND
JMP  STORE      ; JUMP BACK TO INSERT IT INTO BUFF
CRET:  LIA  0,LF   ;ADD LINE FEED TO BUFF
      STA  0,@20
SKPBZ TTO        ;WAIT UNTIL TTO READY
JMP  .-1
DOAS  0,TTO     ;GIVE LINE FEED
LIA   0,PCCNT   ;WAIT IF PUNCHING OF PREVIOUS LINE IS NOT DONE
MOV#  0,0,SZR   ;
JMP  .-2
LIA   0,20      ;CALCULATE NUMBER OF CHARACTERS IN BUFF
LIA   3,ABUFF
SUB   3,0
STA   0,PCCNT   ;INITIALIZE PUNCH CHARACTER COUNTER
LIA   0,MAX     ;REINITIALIZE CHARACTER BUFFER:
STA   0,CHCNT   ; INITIALIZE CHARACTER COUNTER
STA   3,20      ; INITIALIZE CHARACTER BUFFER POINTERS IN
STA   3,21      ; AUTO-INCREMENTING LOCATIONS 20 AND 21
SUB   0,0       ;FIRST PUT OUT 8 FRAMES OF BLANK LEADER
INTIS ;MAKE SURE THAT PUNCH STARTED AND FLAG SET TOGETHER
DOAS  0,PTP     ;OUTPUT NULL CHARACTER
ISZ  PACTV     ;SET PUNCH ACTIVE FLAG
INTEN
STA   0,CCHAR   ;SAVE NULL AS CURRENT CHARACTER

TTIIS: JMP  @.+1  ;GO DISMISS INTERRUPT
DISMS

C177: 177       ;MASK FOR DELETING PARITY BIT
CR:   15        ;CARRIAGE RETURN
LF:   12        ;LINE FEED
CNTRL: 22      ;CONTROL R
BELL:  7        ;TELETYPE BELL

ABUFF: BUFF-1   ;ADDRESS OF CHARACTER BUFFER - 1
MAX:   110      ;MAXIMUM OF 72 CHARACTERS INPUT PER LINE
CHCNT: 110      ;CHARACTER COUNTER (COUNTS DOWN FROM MAX)
PCCNT:  0       ;PUNCH CHARACTER COUNTER
PRCNT: 10       ;PUNCH REPEAT COUNTER
NRPT:  10       ;NUMBER OF TIMES TO PUNCH EACH CHARACTER
CCHAR:  0       ;CURRENT CHARACTER SAVE LOCATION

```

EXAMPLE FOUR (Continued)

```

; PAPER TAPE PUNCH SERVICE ROUTINE

PTPCT: @PTPSR          ;PTP DEVICE CONTROL TABLE (PUSH BIT = 1)
       7              ;MASKS OUT PTP, IT1, AND IT0

PTPSR: INTDS          ;DISABLE INTERRUPTS BEFORE IT'S TOO LATE
       SUB 0,0        ;CLEAR PUNCH ACTIVE FLAG
       STA 0,FACTV
       INTEN         ;ENABLE INTERRUPTS FOR REAL

GCHAR: LDA 0,CCHAR    ;GET CURRENT CHARACTER
       LDA 3,CNTRLR   ;IS IT CONTROL R?
       SUB 0,3,SNR    ;(AC3 BECOMES 0 IF CHARACTER IS CONTROL R)
       JMP PTRDR     ;YES, INPUT FROM READER
       DSZ PRCNT     ;NO, DECREMENT PUNCH REPEAT COUNTER
       JMP SAMEC     ;GO PUNCH SAME CHARACTER AGAIN
CONTP: LDA 0,NRPT     ;REINITIALIZE PUNCH REPEAT COUNTER
       STA 0,PRCNT
       DSZ PCNT      ;DECREMENT PUNCH CHARACTER COUNTER
       JMP NEWC      ;GO PUNCH NEW CHARACTER
       NIOC PTP      ;ALL DONE, CLEAR PUNCH
       JMP PTPDS     ;GO DISMISS INTERRUPT

NEWC:  LDA 0,@21     ;GET NEW CHARACTER
       STA 0,CCHAR   ;UPDATE CURRENT CHARACTER SAVE
SAMEC: INTDS         ;MAKE SURE PUNCH STARTED AND FLAG SET TOGETHER
       DOAS 0,PTP    ;OUTPUT CHARACTER TO PUNCH
       ISZ FACTV    ;SET PUNCH ACTIVE FLAG
       INTEN
       JMP PTPDS     ;GO DISMISS INTERRUPT

PTRDR: ISZ RBCNT     ;INCREMENT READER BLOCK COUNTER
       LDA 0,RBCNT   ;IS THIS THE FIRST PTR REQUEST?
       ADC# 3,0,SZR  ;(SKIP IF ACO = 1)
       JMP CONTP     ;NO, CONTINUE PUNCHING WITH NEXT CHARACTER
       INTDS        ;MAKE SURE READER STARTED AND FLAG SET TOGETHER
       NIOS PTR      ;START READER
       ISZ RACTV     ;SET READER ACTIVE FLAG
       INTEN
       LDA 0,ABUF2   ;INITIALIZE SECOND CHARACTER BUFFER
       STA 0,22      ;USE AUTO-INCREMENT LOCATION 22 AS INDEX
       JMP CONTP     ;CONTINUE PUNCHING WITH NEXT CHARACTER

PTPDS: JMP @.+1     ;GO DISMISS INTERRUPT
       DISMS

RBCNT: 0             ;NUMBER OF BLOCKS LEFT TO READ FROM PTR
ABUF2: BUFF2-1      ;ADDRESS OF SECOND CHARACTER BUFFER - 1

```

```

; PAPER TAPE READER SERVICE ROUTINE

PTRCT: @PTRSR        ;PTR DEVICE CONTROL TABLE (PUSH BIT = 1)
       63           ;MASKS OUT PTR, MTA, IT1, IT0

PTRSR: INTDS        ;DISABLE INTERRUPTS
       SUB 0,0      ;CLEAR READER ACTIVE FLAG
       STA 0,RACTV
       INTEN       ;ENABLE INTERRUPTS
       DIAC 0,PTR   ;READ FRAME AND CLEAR DONE
       LIA 3,CHECK  ;GET PREVIOUS FRAME READ
       STA 0,CHECK  ;SAVE NEW FRAME
       MOV# 0,0,SNR ;IS NEW FRAME = 0?
       JMP ZEROF   ;YES
       STA 0,@22   ;NO, SAVE IT IN BUFF2
       ISZ RFCNT   ;INCREMENT READER FRAME COUNTER (NEVER SKIP)

```

EXAMPLE FOUR (Continued)

```

SPTR:  INTDS          ;MAKE SURE READER STARTED AND FLAG SET TOGETHER
      NIOS PTR        ;START READER FOR NEXT FRAME
      ISZ RACTV       ;SET READER ACTIVE FLAG
      INTEN
      JMP PTRDS       ;GO DISMISS INTERRUPT

ZEROF:  MOV# 3,3,SNR   ;FRAME IS ZERO, WAS PREVIOUS ONE ALSO ZERO?
      JMP SPTR        ;YES, IGNORE LEADING BLANK FRAMES
      STA 0,022       ;NO, DONE WITH THIS BLOCK, MARK WITH 0 FRAME
      ISZ RFCNT       ;INCREMENT READER FRAME COUNTER
      LDA 1,BBUF2     ;AC1 POINTS TO BEGINNING OF BUFF2
      JSR MWRIT       ;GO WRITE A BLOCK ON MAG TAPE

PTRDS:  JMP @.+1      ;GO DISMISS INTERRUPT
      DISMS

BBUF2:  BUFF2        ;ADDRESS OF BUFF2
RFCNT:  0             ;READER FRAME COUNTER
CHECK:  0             ;LAST FRAME INPUT FROM READER, USED IN IGNORING
      ; LEADING BLANK FRAMES

;      MAG TAPE SERVICE ROUTINE

MTACT:  @MTASR        ;MTA DEVICE CONTROL TABLE (PUSH BIT = 1)
      43             ;MASKS OUT MTA, IT1, IT0

MTASR:  INTDS        ;DISABLE INTERRUPTS
      SUB 0,0        ;CLEAR MAG TAPE ACTIVE FLAG
      STA 0,MACTV
      INTEN          ;ENABLE INTERRUPTS

      LDA 0,MTA      ;READ MAG TAPE STATUS
      MOVL# 0,0,SZC  ;CHECK FOR ERRORS
      JMP ERROR
      LDA 0,RFCNT    ;FETCH READER FRAME COUNTER
      MOV# 0,0,SZR   ;MORE WRITING TO DO?
      JMP MOREM      ;YES
      NIOC MTA       ;NO, CLEAR MAG TAPE
      ISZ RBCNT     ;DECREMENT AND CHECK READER BLOCK COUNTER
      JMP MORER     ;MORE READING TO DO
      JMP MTADS     ;GO DISMISS INTERRUPT

MOREM:  DIB 1,MTA    ;READ ADDRESS OF NEXT WORD TO WRITE FROM BUFF2
      JSR MWRIT     ;GO WRITE NEXT BLOCK ON MAG TAPE
      JMP MTADS     ;GO DISMISS INTERRUPT

MORER:  INTDS        ;MAKE SURE READER STARTED AND FLAG SET TOGETHER
      NIOS PTR        ;START READER
      ISZ RACTV       ;SET READER ACTIVE FLAG
      INTEN
      LDA 0,ABUF2    ;REINITIALIZE BUFF2
      STA 0,22

MTADS:  JMP @.+1     ;GO DISMISS INTERRUPT
      DISMS

ERROR:  HALT 0       ;HALT SHOWING MAG TAPE STATUS WORD
      ; (ERROR PROCESSING WOULD NORMALLY GO HERE)

```

EXAMPLE FOUR (Continued)

```

;      MWRIT WRITES A BLOCK OF DATA IN MEMORY ON MAG TAPE DRIVE 0
;      SIZE OF BLOCK IS -BLKSZ
;      ADDRESS OF FIRST WORD OF BLOCK IS CONTAINED IN AC1 ON ENTRY

MWRIT: DOB   1,M1A      ;LOAD MEMORY ADDRESS COUNTER
        STA  1,LSTAD   ;SAVE LAST ADDRESS USED IN WRITING TO MAG TAPE
        LDA  1,BLKSZ   ;FETCH NEGATIVE BLOCK SIZE
        DOC  1,M1A     ;LOAD WORD COUNTER
        LDA  0,WRCOM   ;FETCH WRITE COMMAND
        INTDS          ;MAKE SURE MAG TAPE STARTED AND FLAG SET TOGETHER
        DOAS 0,M1A     ;INITIATE WRITE OPERATION
        ISZ  MACTV     ;SET MAG TAPE ACTIVE FLAG
        INTEN
        LDA  0,RFCNT   ;NOW UPDATE READER FRAME COUNTER
        ADDZ 1,0,SNC   ;DECREASE IT BY BLOCK SIZE
        SUB  0,0       ;IF RFCNT WAS < BLKSZ, SET RFCNT TO 0
        STA  0,RFCNT   ;SAVE NEW VALUE
        JMP  0,3       ;RETURN TO CALLER

BLKSZ:  -144          ;(NEGATIVE) BLOCK SIZE OF 100 DECIMAL
WRCOM:   50           ;WRITE COMMAND (SELECTS DRIVE 0)
LSTAD:   0            ;LAST ADDRESS USED IN WRITING TO MAG TAPE
ERCOM:   70           ;ERASE COMMAND (SELECTS DRIVE 0)

;      M1AAR RESTARTS MAG TAPE AFTER POWER FAIL
;      SEVERAL INCHES OF TAPE ARE ERASED, THEN THE RECORD
;      WHICH WAS BEING WRITTEN WHEN POWER FAILED IS REWRITTEN

M1AAR:  LDA  0,ERCOM   ;ERASE SECTION OF TAPE
        DOAS 0,M1A
        SKPDN M1A      ;WAIT TILL M1A DONE
        JMP  .-1
        LDA  0,RFCNT   ;SET RFCNT BACK TO ITS PRIOR VALUE
        LDA  1,BLKSZ
        SUB  1,0
        STA  1,RFCNT
        LDA  1,LSTAD   ;FETCH ADDRESS OF RECORD TO BE REWRITTEN
        JMP  MWRIT     ;GO WRITE RECORD (MWRIT RETURNS DIRECTLY TO
;AUTO-RESTART CODE)

;      CHARACTER BUFFERS

BUFF:   .BLK  112      ;ALLOW FOR 72 CHARACTERS + CR + LF
BUFF2:  .BLK  1120     ;ALLOW FOR UP TO 74*8=592 FRAMES

;      VECTOR TABLE

VTAB:   @FFLCT        ;ADDRESS OF CONTROL TABLE FOR POWER FAIL
        SIH
        SIH
        SIH
        SIH
        SIH
        SIH
        SIH
        @11IC1       ;ADDRESS OF 11I DEVICE CONTROL TABLE
        SIH
        @PTRC1       ;ADDRESS OF PTR DEVICE CONTROL TABLE
        @PTPC1       ;ADDRESS OF PTP DEVICE CONTROL TABLE
        SIH

        SIH
        SIH
        SIH
        SIH
        SIH

```

SECTION II

TERMINALS

- **TELETYPES**
- **DGC DISPLAY 6012**

This page intentionally left blank

INTRODUCTION TO TERMINALS

A terminal is a device through which the computer and its operator can interact. It has two independent parts, a keyboard, and a display or printer. The operator sends information to the computer through the keyboard, and the computer responds to the operator through the display or printer.

Characters that are transmitted between the computer and the terminal are coded in ASCII* (see Appendix C) and transmitted asynchronously. Each character is transmitted serially bit by bit between the computer and the terminal over a communications channel, at rates ranging from 110 to 4800 bits per second or "baud".

Although the terminal is two separate devices, the manner in which the devices interact with one another and the computer depends on the communications channel linking them. If the channel consists of one line from the keyboard to the computer and

a second independent line from the computer to the printer or display, the two halves of the terminal can operate independently. This full use of the terminal is termed "full-duplex operation". If only one line connects the terminal to the computer, the keyboard and the computer must share this line; thus only one of the two halves of the terminal can be operating at any one time. This use of a single line channel is termed "half-duplex operation".

When a terminal operates in full-duplex, the computer must "echo" the information received from the keyboard if it wants that information to be shown on the display or printer. However, when operating in half-duplex, the keyboard transmits the information to both the computer and the display or printer.

*American Standard Code for Information Interchange.

This page intentionally left blank

TELETYPE

SUMMARY

MNEMONIC (FIRST CONTROLLER)	
INPUT	TTI
OUTPUT	TTO
DEVICE CODE (FIRST CONTROLLER)	
INPUT	10 ₈
OUTPUT	11 ₈
MNEMONIC (SECOND CONTROLLER)	
INPUT	TTI1
OUTPUT	TTO1
DEVICE CODE (SECOND CONTROLLER)	
INPUT	50 ₈
OUTPUT	51 ₈
PRIORITY MASK BIT	
INPUT	14
OUTPUT	15
CHARACTERS/LINE	72
LINES/INCH	6
DATA TRANSFER RATE	
MAX (CHARACTERS/SEC)	
33 AND 35	10
37	15

ACCUMULATOR FORMATS

READ CHARACTER BUFFER..... (DIA)

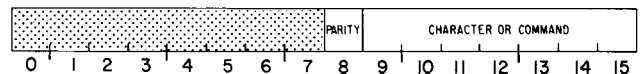

LOAD CHARACTER BUFFER..... (DOA)

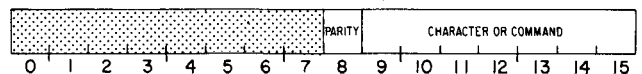

S, C AND P FUNCTIONS

- S Set Busy to 1, Done to 0 and either load the Input Buffer or write a character.
- C Set both Busy and Done to 0 and terminate all data transfers. If issued before transmission is complete, partial character codes are received.
- P No effect.

INTRODUCTION

The Teletype provides for two-way communications between the computer and the operator. The keyboard is the input device and the printer is the output device. All the exchanges of data between the keyboard and the computer and between the computer and the printer utilize a subset of the 128-character alphanumeric ASCII code shown in Appendix C.

In addition to a keyboard and a printer, certain models of the Teletype terminal are equipped with a paper tape reader/punch combination. Such terminals are designated as Automatic Send/Receive (ASR) terminals. Those which are not so equipped are designated as Keyboard Send/Receive (KSR) terminals.

Three distinct Teletype models are available from Data General Corporation: the model 33, the model 35, and the model 37. Both the models 33 and 35 operate at a data transmission rate of 10 characters per second (110 baud) while the model 37 operates at 15 characters per second (150 baud).

All three terminals print up to 72 characters per line with 6 lines to an inch. Both the models 33 and 35 printers utilize 8 1/2 inch wide paper while the model 37 requires 9 1/2 inch wide paper. The 33 and 35 are upper-case only terminals while the model 37 is full upper- and lower-case. Other differences among the various models may be found in the Operator's Reference Manual (015-000034).

INSTRUCTIONS

The following instructions and timing information are for the terminal when it is used in conjunction with a 4010 or 4077 controller.

The controller contains an 8-bit Input Buffer and an independent 8-bit Output Buffer.

The controller's Busy and Done flags are controlled using two of the device flag commands as follows:

- f=S Sets Busy to 1, Done to 0 and either reads a character into the Input Buffer or transfers the character in the Output Buffer to the printer or the punch.
- f=C Sets Busy and Done to 0, thus stopping all data transfer operations. A Clear command issued during a transfer will result in the partial reception of the code being transferred.
- f=P No effect.

Since the terminal is actually two devices, both a Busy and Done flag are available for input operations and a separate set of Busy and Done flags are available for output operations.

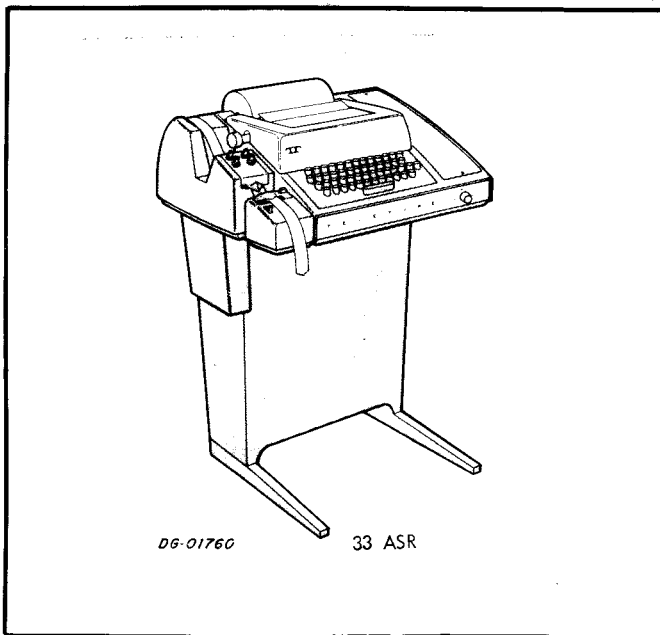

READ CHARACTER BUFFER

DIA<f> ac, TTI

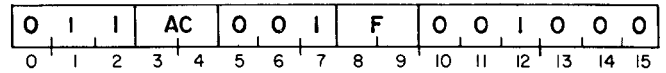

The contents of the Input Buffer are placed in bits 8-15 of the specified AC. Bits 0-7 of the specified AC are set to 0. After the data transfer, the controller's Input Busy and Done flags are set according to the function specified by F. The format of the specified AC is as follows:

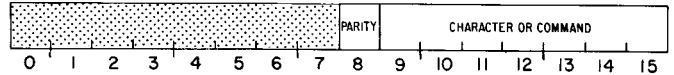

Bits	Name	Contents
0-7	----	Reserved for future use.
8	Parity	Parity bit selected at the terminal; even, odd or none.
9-15	Character	The 7-bit character or command read from the Input Buffer.

LOAD CHARACTER BUFFER

DOA<f> ac, TTO

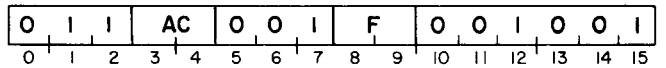

Bits 9-15 of the specified AC are loaded into the controller's Output Buffer. After the data transfer, the controller's Output Busy and Output Done flags are set according to the function specified by F. The contents of the specified AC remain unchanged. The format of the specified AC is as follows:

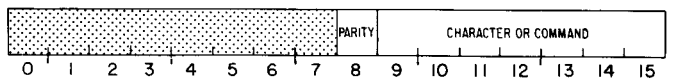

Bits	Name	Contents
0-7	----	Reserved for future use.
8	Parity	Even, odd or no parity for the 7-bit code.
9-15	Character	The 7-bit character or command transmitted to the Output Buffer.

NOTE: If a 4077 controller is used, the DOA instruction must be accompanied by S (Start).

PROGRAMMING

Terminal

Since the terminal is actually two separate devices, input and output are discussed separately.

Input

Neither full- nor half-duplex input operations have to be initialized by the program. Striking a key automatically transmits the corresponding character to the controller. After the character is assembled, the Input Busy flag is set to 0, the Input Done flag is set to 1 and a program interrupt request is initiated.

The character can then be read by issuing a READ CHARACTER BUFFER instruction (DIA). The Input Done flag should then be set to 0 with either a Start or a Clear command. This allows the next character to initiate a program interrupt request when it is fully assembled.

Output

A character is loaded into the Output Buffer of the controller by issuing a LOAD CHARACTER BUFFER instruction (DOA). The character can then be transmitted to the terminal by issuing a Start command. While the character is being transmitted, the Output Busy flag is set to 1. Upon completion of the transmission, the Output Busy flag is set to 0 and the Output Done flag is set to 1, thus initiating a program interrupt request.

Each time a character is to be sent to the terminal, the Output Buffer must be reloaded with a LOAD CHARACTER BUFFER instruction. A sequence of LOAD CHARACTER BUFFER instructions together with Start commands is used to transmit a multi-character message. The program must allow each character to be transmitted before transmitting the next character.

Paper Tape

ASR Teletypes are equipped with a paper tape reader/punch. If the model is equipped with automatic reader control (TDT), the program may turn on the reader with the command DC2 and turn it off with the command DC3 (see Appendix C).

Input

When the terminal is equipped with a paper tape reader, the data input operation is similar to reading codes sent from the keyboard. A Start command causes the next eight bit code on the paper tape to

be loaded into the Input Buffer. Issuing a READ CHARACTER BUFFER instruction will load the contents of the Input Buffer into the specified accumulator. The sequence of a Start command and a READ CHARACTER BUFFER instruction can be continued until the entire tape is read.

Output

Output to the paper tape punch is accomplished the same way as output to the printer is done. The characters or commands output are punched on the paper tape as well as being printed on the Teletype output paper.

TIMING

On both the model 33 and 35, a character is available in the Input Buffer for 21.59ms after Input Done is set to 1 before another character can overwrite the buffer. The corresponding time for the model 37 is 9.17ms. The difference in time is due to the fact that both the model 33 and 35 transmit 10 characters/second while the 35 can transmit up to 15 characters/second. If the paper tape reader is in use, the program has 3.41ms to issue another Start command to the reader after Input Done is set to 1 if the tape is to be kept in continuous motion.

NOTE: If a 4077 controller is used, the received data is double-buffered (holding register and receiver shifters), so the program has one full character time to remove the received character.

Output timing for the printer and the paper tape punch is the same on both the model 33 and 35. The program has 4.55ms to transmit another character in order to continue printing or punching at the maximum rate. The time interval for the model 37 is 3.33ms.

CONSIDERATIONS

Input

All models ignore the parity bit in the codes received for printable characters. Both the model 33 and the model 35 also ignore the parity bit in the command codes they receive, while the model 37 will not carry out the command if the parity bit is incorrect.

When the terminal is operating in full-duplex, the program must "echo" the characters if they are to be printed at the terminal.

Half-duplex operation requires a protocol to be set up between the computer and the terminal. The protocol should be formed to resolve any conflicts over the use of the transmission line.

Output

When characters are sent to the models 33 and 35, all lower case characters are printed as their upper case equivalents.

Half-duplex operation requires a protocol to be set up between the computer and the terminal. The protocol should be formed to resolve any conflicts over transmission line use.

Since the mechanical motion initiated by a Carriage Return may not be completed before the next character is ready to be printed, some programmers issue one or two NUL characters after a Carriage Return. If this is not done, the next printable character could be displaced from its correct position.

When the last character position on a line is printed, and no format control character is sent to the terminal, all succeeding characters will overprint the last character on the line until a format control character is issued. If the program issues a CARRIAGE RETURN which is not immediately preceded or followed by a LINE FEED command, the entire line will be overprinted.

PROGRAMMING EXAMPLES

The following examples show how characters are passed among the computer, the teletype printer, the teletype keyboard, the teletype paper tape punch and the teletype paper tape reader. The first example reads a character from the Teletype keyboard, the second reads a character from the Teletype tape reader, the third prints a character on the Teletype printer and, if the punch on an ASR terminal is turned on, punches the character on the tape.

EXAMPLE 1

```
; READ A CHARACTER FROM KEYBOARD

SKPDN  TTI      ;CHARACTER BUFFER LOADED YET?
JMP    .-1     ;NO
DIAC   1,TTI   ;READ CHARACTER AND CLEAR THE DONE FLAG
```

EXAMPLE 2

```
; READ A CHARACTER FROM PAPER TAPE READER

NIOS   TTI      ;START READER
SKPDN  TTI      ;FRAME BUFFER LOADED YET?
JMP    .-1     ;NO
DIAC   1,TTI   ;READ FRAME AND CLEAR THE DONE FLAG
```

EXAMPLE 3

```
; PRINT AND/OR PUNCH A CHARACTER

SKPBZ  TTO      ;PRINTER FREE?
JMP    .-1     ;NO, TRY AGAIN
DOAS   1,TTO    ;PRINT CHARACTER
```

The subroutine shown in example 4 and called by a JUMP TO SUBROUTINE instruction (JSR to TTYRD,) illustrates both reading and echoing characters on the Teletype, with Teletype interrupts disabled. It uses AC0 to store the character.

EXAMPLE 4

```
; SUBROUTINE TO READ AND ECHO TELETYPED CHARACTERS, INTERRUPTS DISABLED

TTYRD: SKPDN  TTI      ;HAS CHARACTER BEEN TYPED?
        JMP    .-1     ;NO, THEN WAIT
        DIAC   0,TTI   ;YES, THEN READ CHARACTER AND CLEAR DONE
        SKPBZ  TTO      ;IS TTO READY?
        JMP    .-1     ;NO, THEN WAIT
        DOAS   0,TTO   ;YES, THEN ECHO CHARACTER
        JMP    0,3     ;RETURN
```

The teletype may also be programmed using the program interrupt facility. This technique may be useful in cases where a number of calculations may be performed in the time between Teletype characters. The routine shown in example 5 will read a line and echo it on the Teletype using the

interrupt priority structure. It will read characters into a buffer beginning at location 1000g. It is terminated by either a carriage return or line overflow. Line overflow is terminated by the value of MAXLL (maximum line length).

EXAMPLE 5

```

;      READ A LINE USING INTERRUPTS

      .LOC    0
0      ;PC WILL BE STORED HERE WHEN AN INTERRUPT OCCURS
IHAND  ;ADDRESS OF INTERRUPT HANDLER

      .LOC    400
START: LDA    1,BUFR  ;SET UP BUFFER POINTER IN
      STA    1,23    ; AUTO-INCREMENT LOCATION 23
      LDA    1,MAXLL ;GET MAXIMUM LINE LENGTH
      STA    1,CNTR  ;INITIALIZE LINE OVERFLOW COUNTER
      SUBZL  1,1     ;SET AC1 = 1
      DOBS   1,CFU   ;MASK OUT T10 AND TURN ON INTERRUPTS
      .
      .           ;PROGRAM CAN DO USEFUL THINGS
      .           ; WHILE LINE IS BEING READ
      .
HANG:  LDA    0,CNTR ;WHEN NEED FULL LINE TO CONTINUE,
      MOV#   0,0,SZR ; HANG UP HERE UNTIL
      JMP    -2     ; READING IS ALL DONE
      .
      .
      .
BUFFER: 777       ;BUFFER BEGINS AT LOCATION 1000
MAXLL:  110      ;MAXIMUM OF 72 CHARACTERS PER LINE
CNTR:   0        ;LINE OVERFLOW COUNTER
      .
      .
      .
IHAND: SKPDN  TTI   ;MAKE SURE TTI CAUSED THE INTERRUPT
      HALT   ;ERROR - SOME OTHER PERIPHERAL INTERRUPTED
      STA    0,SAVO ;SAVE ACCUMULATORS THAT WILL BE USED
      STA    1,SAV1
      DIAC   0,TTI  ;READ CHARACTER AND CLEAR DONE
      STA    0,23   ;STORE CHARACTER IN BUFFER
      SKPBZ  T10   ;MAKE SURE T10 NOT BUSY
      JMP    -1
      DOAS   0,T10  ;ECHO CHARACTER
      LDA    1,CR   ;IS IT A CARRIAGE RETURN?
      SUB#   0,1,SZR
      JMP    +4     ;NO
      SUBC   0,0    ;YES, CLEAR ACO WITHOUT CHANGING CARRY
      STA    0,CNTR ;ZERO OUT CNTR TO INDICATE LINE DONE
      JMP    +3
      DSZ   CNTR   ;IF NOT A CARRIAGE RETURN, DECREMENT CNTR
      JMP    OUT   ;LINE NOT YET DONE, GO DISMISS
      LDA    0,TTMSK ;LINE IS DONE
      MSKO   0     ;MASK OUT T11 (AND T10) TO INHIBIT FURTHER INPUT
      OUT:  LDA    0,SAVO ;RESTORE ACCUMULATORS
      LDA    1,SAV1
      INTEN  0     ;TURN INTERRUPTS BACK ON
      JMP    00    ;RETURN TO INTERRUPTED PROGRAM

SAVO:   0
SAV1:   0
CR:     215
TTMSK:  3

```

DGC DISPLAY

6012

INTRODUCTION

The DGC Display 6012 is two separate I/O devices; a console and an alphanumeric CRT display, shown below. The console comprises a standard 53-station teletypewriter style keyboard, a supplementary 20-station keyboard and two switches. The first switch has three positions labeled LOCAL, OFF and ON-LINE. The ON-LINE position connects the terminal to the computer. LOCAL, used primarily for testing the display, puts the terminal off line from the computer and connects the keyboard to the display. OFF removes power from the device. The second switch has three positions labeled BUFFERED, PAGE and ROLL. Each position of this switch selects the terminal's operational mode.

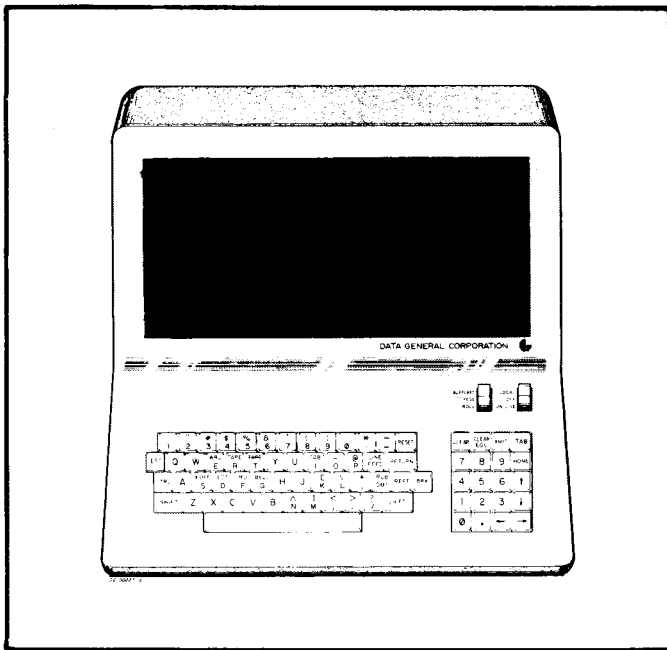

The display is a 12-inch CRT with an active area of 6 by 9 inches, formatted into a twenty-four line by 80 character page. The characters that can be plotted on this screen are taken from the standard 64 character subset of ASCII, listed in Appendix C.

The terminal operates in three switch selectable modes called Page-buffered, Page and Roll. Page-buffered mode allows an entire page of data to be entered into the terminal's memory, edited off line and then transmitted to the computer in part or in

SUMMARY

MNEMONIC (FIRST CONTROLLER)	
INPUT	TTI
OUTPUT	TTO
DEVICE CODE (FIRST CONTROLLER)	
INPUT	10 ₈
OUTPUT	11 ₈
MNEMONIC (SECOND CONTROLLER)	
INPUT	TTI1
OUTPUT	TTO1
DEVICE CODE (SECOND CONTROLLER)	
INPUT	50 ₈
OUTPUT	51 ₈
PRIORITY MASK BIT	
INPUT	14
OUTPUT	15
CHARACTERS/LINE	80
LINES/DISPLAY	24
TOTAL STORAGE	
CAPACITY (7-BIT CHARACTERS) ...	1920
DATA TRANSFER RATE	
MAX (BAUD)	4800

ACCUMULATOR FORMATS

READ CHARACTER BUFFER..... (DIA)

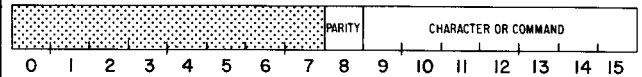

LOAD CHARACTER BUFFER..... (DOA)

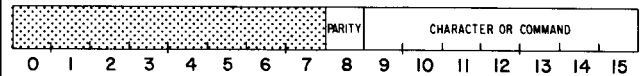

S, C AND P FUNCTIONS

- S Set Busy to 1, Done to 0 and either load the Input Buffer or write a character into the display's memory.
- C Set both Busy and Done to 0 and terminate all data transfers. If issued before transmission is complete, partial character codes are received.
- P No effect.

whole. In this mode there are six commands for positioning the cursor, and ten additional commands for defining protected and blinking areas, setting tabs, clearing areas of memory, and transmitting characters from memory to the computer.

Page mode allows a file to be transmitted to the terminal and any desired changes made simultaneously to both the information in the terminal's memory, through the terminal hardware, and the corresponding characters stored in the computer's memory, by means of software. The commands are the same for these two modes; the only difference between them is that the keyboard in Page-buffered mode is directly coupled to the display and is off line from the computer until a special transmit key is used, while the keyboard in Page mode is always on line.

Roll mode simulates a teletypewriter. In this mode there are five commands for positioning the cursor, and three additional commands for clearing areas of memory and transmitting data. All data is entered into memory locations which correspond to the bottom line of the display screen. A LINE FEED command causes all lines on the screen to move up one, the bottom line to become blank and the top line to be lost.

INSTRUCTIONS

The following instructions and timing information are for the DGC Display 6012 when it is used in conjunction with a 4010 controller.

The 4010 controller contains an 8-bit Input Buffer and an independent 8-bit Output Buffer. Since the display is actually two devices, both a Busy and Done flag are available for input operations and a separate set of Busy and Done flags are available for output operations.

The display controller's Busy and Done flags are controlled using two of the device flag commands as follows:

- f=S Sets Busy to 1, Done to 0 and either reads a character into the Input Buffer or writes the character in the Output Buffer into the display's memory.
- f=C Sets Busy and Done to 0, thus stopping all data transfer operations. A Clear command issued in during a transfer will result in the partial reception of the code being transferred.
- f=P No effect.

READ CHARACTER BUFFER

DIA <f> ac, TTI

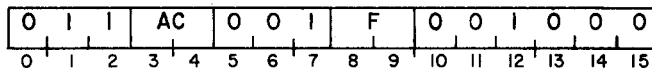

The contents of the Input Buffer are placed in bits 8-15 of the specified AC. Bits 0-7 of the specified AC are set to 0. After the data transfer, the controller's Input Busy and Done flags are set according to the function specified by F. The format of the specified AC is as follows:



Bits	Name	Contents
0-7	----	Reserved for future use.
8	Parity	Parity bit selected at the terminal; even, odd or none.
9-15	Character	The 7-bit character or command read from the Input Buffer.

LOAD CHARACTER BUFFER

DOA <f> ac, TTO

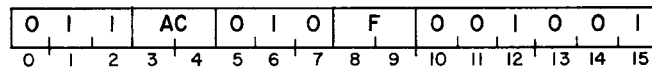

Bits 9-15 of the specified AC are loaded into the display's Output Buffer. After the data transfer, the controller's Output Busy and Output Done flags are set according to the function specified by F. The format of the specified AC is as follows:



Bits	Name	Contents
0-7	----	Reserved for future use (always 0).
8	Parity	Even, odd or no parity for the 7-bit code. Ignored by the display.
9-15	Character	The 7-bit character or command transmitted to the Output Buffer.

CONTROL CHARACTERS

The control characters for the DGC Display 6012 are described in the following format:

NAME-CODE (LOCATION) **D** and/or **ND**

Functional Description

NAME: Command Name

CODE: Octal command code

LOCATION: Keyboard location

D Destructive to some information on the screen

ND Non-destructive to information on the screen

FUNCTION: Effect of the command

START PROTECT-36 (CTRL SH N) **D**

In Page-buffered and Page modes, START PROTECT is displayed as a space and is the delimiter of the beginning of a protected region. The end of the protected region is delimited by the first TAB STOP/END PROTECT character encountered, scanning from left to right and downward on the screen from the START PROTECT character. If any command moves the cursor into a protected region, the cursor will move to the first character position following the TAB STOP/END PROTECT character for that region.

Note that every START PROTECT character should have a companion TAB STOP/END PROTECT character between it and the end of the page or the entire protection mechanism is disabled in the terminal, and all START PROTECT and TAB STOP/END PROTECT characters are displayed as spaces.

In Roll mode, START PROTECT has no effect.

TAB STOP/END PROTECT-35 (CTRL SH M) **D**

In Page-buffered and Page modes, TAB STOP, END PROTECT is displayed as a space and does one of two things; it is either a tab stop or it is the delimiter of the end of a protected region or both. If it is a tab stop, when a TAB command is issued the cursor moves to the first character position following the first unprotected TAB STOP/END PROTECT character encountered on the screen, scanning from left to right and downward on the page from the cursor position. If it is a delimiter of the end of a protected region, then the beginning of that region must be delimited by a START PROTECT character. If any command moves the cursor into a protected region, the cursor will move to the first character position following the TAB STOP/END PROTECT character for that region.

In Roll mode, TAB STOP/END PROTECT has no effect.

HOME-10 (CTRL H) or (HOME) **ND**

In Page-buffered and Page modes, HOME moves the cursor to the first position in the top line on the screen. If this position is in a protected region, HOME will move the cursor to the first position following the end protect character for that region. If issued from the processor, HOME will terminate a transmission initiated by a TRANSMIT BUFFER command.

In Roll mode, HOME moves the cursor to the first position in the bottom line of the display screen. If issued from the processor, HOME will terminate a transmission initiated by a TRANSMIT BUFFER command.

CARRIAGE RETURN-15 (CTRL M) **ND**

In Page-buffered and Page modes, CARRIAGE RETURN moves the cursor to the first character position of the line the cursor occupies. If the first position of the line is in a protected region, the cursor will move to the first position following the TAB STOP/END PROTECT character for that region.

In Roll mode, CARRIAGE RETURN moves the cursor to the first character position in the bottom line.

LINE FEED-12 (CTRL J) or (↓) **D ND**

In Page-buffered and Page modes, LINE FEED moves the cursor down the screen one line. When the cursor is in the bottom line, LINE FEED has no effect. If a LINE FEED moves the cursor into a protected region, the cursor will move to the first character position following the TAB STOP/END PROTECT character for that region.

In Roll mode, LINE FEED moves all the lines of data on the display screen up one line. The top line of the display screen is lost and the bottom line becomes blank. The cursor remains in its current position in the bottom line.

TAB-11 (CTRL I) or TAB **ND**

In Page-buffered and Page modes, TAB moves the cursor to the position following the TAB STOP/END PROTECT character encountered on the screen, scanning from left to right and downward on the screen. If no TAB STOP/END PROTECT character is found on the screen between the cursor position and the end of the page, the cursor moves to the first character position in the top line. If this position is in a protected region, TAB moves the cursor to the first position following the TAB STOP/END PROTECT character for that region.

In Roll mode, TAB has no effect.

CURSOR UP-17 (CTRL O) or (↑) **ND**

In Page-buffered and Page modes, CURSOR UP moves the cursor up one line. When the cursor is in the top line of the display screen, CURSOR UP has no effect. If the command CURSOR UP moves the cursor into a protected region, the cursor will move to the first character position following the TAB STOP/END PROTECT character for that region.

In Roll mode, CURSOR UP has no effect.

CURSOR RIGHT-30 (CTRL X) or (→) **ND**

In Page-buffered and Page modes, CURSOR RIGHT moves the cursor one character position to the right. When the cursor is in the last character position of the line, the cursor will move to the first character position in the next line down the page. When the cursor is in the last character position of the bottom line, CURSOR RIGHT has no effect. If the command CURSOR RIGHT moves the cursor into a protected region, the cursor will move to the first position following the TAB STOP/END PROTECT character for that region.

In Roll mode, CURSOR RIGHT moves the cursor one character position to the right. When the cursor is in the last character position of the bottom line, CURSOR RIGHT has no effect.

CURSOR LEFT-31 (CTRL Y) or (←) **ND**

In Page-buffered and Page modes, CURSOR LEFT moves the cursor one character position to the left. When the cursor is in the first character position of a line, the cursor will move to the last character position on the line above it. When the cursor is in the first character position of the top line, CURSOR LEFT has no effect. If the command CURSOR LEFT moves the cursor into a protected region, the cursor moves to the first position following the TAB STOP/END PROTECT character for that region.

In Roll mode, CURSOR LEFT moves the cursor one character position to the left. When the cursor is in the first character position of the bottom line, CURSOR LEFT has no effect.

CLEAR TO END OF LINE-13 (CTRL K) or (CLEAR EOL) **D**

In Page-buffered and Page modes, CLEAR TO END OF LINE erases all unprotected data from the cursor position to the end of the line, inclusive. The cursor does not change position.

In Roll mode, CLEAR TO END OF LINE erases all data from the cursor position to the end of the line, inclusive. The cursor does not change position.

CLEAR SCREEN-14 (CTRL L) or (CLEAR) **D**

In Page-buffered and Page modes, CLEAR SCREEN erases all unprotected data on the display screen. The cursor moves to the first character position of the top line. If the first position of the top line is in a protected region, CLEAR SCREEN moves the cursor to the first position following the TAB STOP/END PROTECT character for that region.

In Roll mode, CLEAR SCREEN erases all data on the screen and moves the cursor to the first character position of the bottom line. Data cannot be protected in Roll mode.

| FORCE ERASE-34 (CTRL SH L) **D**

In Page-buffered and Page mode, FORCE ERASE erases all data on the screen, including all protected areas. The cursor moves to the first character position in the first line.

In Roll mode, FORCE ERASE has no effect.

| BLINK-37 (CTRL SH O) **D**

In Page-buffered and Page modes, BLINK causes any character, or characters, between two BLINK characters to flicker on the display screen. If a single BLINK character is entered on the page, all characters from that position to the end of the page will flicker. BLINK characters are displayed as spaces and are transmitted as underscores. The cursor moves one character position to the right. In Roll mode, BLINK has no effect.

TRANSMIT BUFFER-16 (CTRL N) **ND**

In all modes, TRANSMIT BUFFER sends to the processor the contents of the terminal's memory, character by character, from the cursor position to the end of the page. Any protected regions encountered will not be transmitted. The data on the display screen will not be disturbed. TRANSMIT BUFFER moves the cursor to the last character position of the last line. If this position is protected, the cursor moves to the first unprotected position on the page. Transmission can be halted at any point by having the program issue a HOME command.

CONTROL KEYS

XMIT **ND**

XMIT allows the operator to transmit a message to the processor while the terminal is in Page-buffered mode. The message is sent by holding down the XMIT key while typing characters on the keyboard. If the terminal is operating in full-duplex and the program does not echo the characters back to the terminal, the data on the display screen remains undisturbed. If the terminal is operating in half-duplex or if the program echoes characters, then the message entered will overwrite data on the display screen.

In Page and Roll modes, XMIT has no effect.

BREAK **ND**

In all modes, while BREAK is depressed, the terminal's transmitter is disabled so that no characters are transmitted from either the keyboard or the memory.

REPEAT **ND**

The REPEAT key provides the continuous transmission of any code as long as both the REPEAT key and the code's corresponding key(s) are held down together.

SHIFT and CTRL **ND**

The SHIFT and CTRL keys produce commands or alphanumeric codes when they are depressed together with other keys.

ESC-33 (ESC) (CTRL SHIFT K) **ND**

In Page and Roll modes, ESC sends code 33, a protocol character. ESC does not work together with REPEAT.

In Page-buffered mode, ESC can be used with the XMIT key.

CTRL RESET **D**

CTRL RESET clears the entire display memory, initializes the control, and places the cursor in the first position of the bottom line.

PROGRAMMING

Since the terminal is actually two separate devices, input and output are discussed separately.

Input

Neither full- nor half-duplex input operations have to be initialized by the program. Striking a key in either Page or Roll modes automatically transmits the corresponding character to the controller.

After the character is assembled, the Input Busy flag is set to 0, the Input Done flag is set to 1 and a program interrupt request is initiated.

The character can then be read by issuing a READ CHARACTER BUFFER instruction (DIA). The Input Done flag should then be set to 0 with either a Start or a Clear command. This allows the next character to initiate a program interrupt request when it is fully assembled.

The TRANSMIT BUFFER command transmits the contents of the terminal's memory character by character to the controller.

Output

A character is loaded into the Output Buffer of the controller by issuing a LOAD CHARACTER BUFFER instruction (DOA). The character can then be transmitted to the terminal by issuing a Start command. While the character is being transmitted, the Output Busy flag is set to 1. Upon completion of the transmission, the Output Busy flag is set to 0 and the Output Done flag is set to 1, thus initiating a program interrupt request.

Each time a character is to be sent to the terminal, the Output Buffer must be reloaded with a LOAD CHARACTER BUFFER instruction. A sequence of LOAD CHARACTER BUFFER instructions together with Start commands is used to transmit a multi-character message. The program must allow each character to be transmitted before transmitting the next character.

TIMING

Input Timing

After the Input Done flag is set to 1, and before another key strike can destroy the character in the Input Buffer, the character is available for a READ CHARACTER BUFFER instruction for a time interval determined by the baud rate.

Maximum Allowable Programmed I/O Latency (ms)	Baud Rate
21.59	110
15.84	150
7.92	300
3.95	600
1.97	1200
1.31	1800
.98	2400
.65	3600
.49	4800

Output Timing

After the Output Done flag is set to 1, the program should provide another character within a time limit determined by the baud rate to keep the transmission line operating at its maximum rate.

Time Limit (ms)	Baud Rate
9.15	110
6.64	150
3.32	300
1.66	600
.83	1200
.55	1800
.42	2400
.27	3600
.21	4800

CONSIDERATIONS

The command TRANSMIT BUFFER, which is designed to be used primarily in Page-buffered mode, can also be issued when the display is in Page or Roll modes.

Input

The codes received from the terminal can be selected, at the terminal, to be 5, 6, 7, or 8 bits long with even, odd, or no parity bit. The programmer should determine the code structure used in the terminal and make sure that the controller is compatible.

When the terminal is operating in full-duplex, the program must "echo" the characters if they are to affect the display screen.

Half-duplex operation requires a protocol to be set up between the computer and the terminal. The protocol should be formed to resolve any conflicts over the use of the transmission line.

Output

The codes received by the terminal can be selected, at the terminal, to be 5, 6, 7, or 8 bits long. The parity bit is ignored in all codes received by the terminal.

When characters are sent to the terminal, all lower case characters are displayed as their uppercase equivalents.

Half-duplex operation requires a protocol to be set up between the computer and the terminal. The protocol should be formed to resolve any conflicts over transmission line use.

When operating in either Page-buffered or Page mode, characters will automatically continue to the next line when the end of the current line is reached. When the last line on the page is filled, any other characters received will overwrite the last character on the last line. When operating in Roll mode, the last character in the bottom line will be overwritten by subsequent characters. In order to avoid overwriting any line, both a CARRIAGE RETURN and a LINE FEED command should be issued.

This page intentionally left blank

SECTION III

HARD COPY

- PAPER TAPE READER
- PAPER TAPE PUNCH
- CARD READERS
- LINE PRINTERS
- PLOTTERS

This page intentionally left blank

INTRODUCTION TO HARD COPY PERIPHERALS

Hard copy peripherals are devices through which data is transferred into and out of the computer system. Data is entered into the system through input devices which read or sense coded data from paper tape or cards, and transferred out of the system to output devices which record the data on paper tape, line printer paper, or plotting paper.

Paper tape can be used as either an input or an output medium. The medium is a long strip of 1/2" wide paper or mylar tape. A series of holes located across the width of the tape represent a frame of information. Each frame contains eight bits. The information on the tape may be entered into the computer system through either a high speed paper tape reader or through a Teletype equipped with a paper tape reader. The maximum transfer rate for a high speed reader is 400 frames/second while the input rate from an ASR Teletype is either 10 or 15 frames/second, depending on the particular model used.

Information may be transferred out of the system to either a high speed paper tape punch or to a Teletype equipped with a paper tape punch. The maximum transfer rate to a high speed punch is 63.3 frames/second while the rate to an ASR Teletype is either 10 or 15 frames/second, depending on the particular model used.

Cards for input may be of two types: industry standard 12-row 80-column punched cards or 12-

row variable-format mark-sense cards. A series of 12 locations across the width of a card represents a column of information which is coded as holes in the appropriate locations on a punched card or as pencil marks in the appropriate locations on mark sense cards. The information transfer rate depends on the particular model of the card reader used and the format of the card. The range is from 150 to 1000 cards/minute.

Line printers provide high speed hard copy output for alphanumeric information. The paper is generally sprocket-fed, fan-fold and of widths ranging from 4 to 19 7/8 inches. Alphanumeric information is sent to a line printer in either 64 or 96 character subsets of ASCII code. Depending on the particular model used, information can be transferred at a rate of up to 300 136-character lines/minute.

Graphical output in the form of charts and drawings is provided by the incremental plotters. Several variations allow plotting on either a single sheet, a roll, or a fanfold stack of paper. All plotters allow the selection of 8 possible line segments which can be generated in each incremental step. The length of the basic step size may be specified upon ordering to be either metric (.05 - .25mm) or english (.002 - .010 inch). Depending on the model used, the plotter draws at either 200 or 300 steps/second.

This page intentionally left blank

PAPER TAPE READER

INTRODUCTION

Paper tape readers provide data input from standard fanfold eight-channel paper or mylar tapes at speeds of up to 300 or 400 frames/second (4011B and 6013 readers, respectively). The reader consists of a supply bin, a read station, and a receiving bin. Tape is moved from the supply bin through the read station, where each frame is read, to the receiving bin where it may be removed.

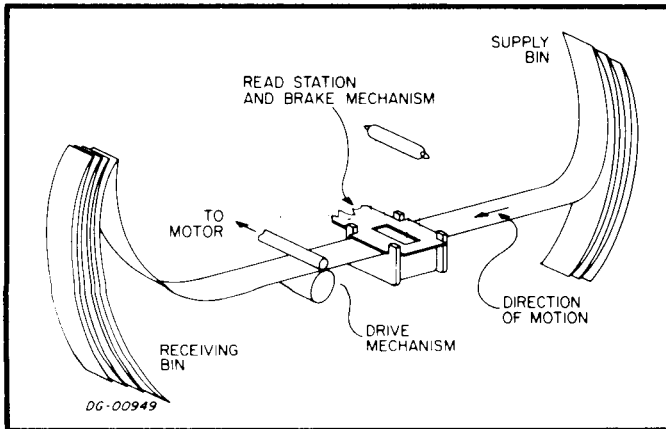

The tape format is shown below. The eight channels across the width of the tape comprise a frame. The sprocket hole is used as a timing strobe for each frame as it enters the read station. Both the code structure used for data and the interpretation of the input is determined by conventions decided upon by the programmer. Conventional ASCII paper tape code may be found in Appendix C.

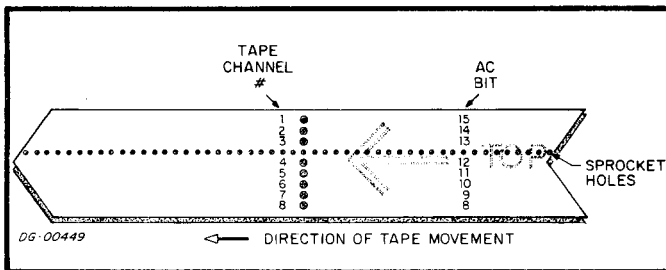

SUMMARY

MNEMONIC (FIRST CONTROLLER)	PTR
DEVICE CODE (FIRST CONTROLLER).....	12 ₈
MNEMONIC (SECOND CONTROLLER) ..	PTR1
DEVICE CODE (SECOND CONTROLLER)...	52 ₈
PRIORITY MASK BIT	11
BITS/FRAME	8
FRAMES/INCH	10
CAPACITY OF HOPPER (FEET)	100-150
MAXIMUM DATA TRANSFER RATE (FRAMES/SECOND)	300 or 400

ACCUMULATOR FORMAT

READ FRAME (DIA)

	CHAN	CHAN	CHAN	CHAN	CHAN	CHAN	CHAN	CHAN
	8	7	6	5	4	3	2	1

S, C AND P FUNCTIONS

- S Set the Busy flag to 1, the Done flag to 0, and load the Frame Buffer with the contents of the frame.
- C Set the Busy and Done flags to 0 without affecting the contents of the Frame Buffer.
- P No effect.

INSTRUCTIONS

The tape reader is driven by a controller which contains an eight-bit Frame Buffer. If a hole is punched in a channel of a frame on a tape, a 1 will be loaded into the data bit corresponding to that channel when the frame is loaded into the Frame Buffer. The sprocket hole is not loaded into the Frame Buffer, but signals the controller when a frame enters the read station.

One I/O instruction is used to program the tape reader. This instruction loads the contents of the Frame Buffer into an accumulator.

The tape reader controller's Busy and Done flags are controlled by the flag commands as follows:

- f=S Set the Busy flag to 1, the Done flag to 0, and load the Frame Buffer with the contents of the next frame on the tape.
- f=C Set both the Busy and Done flags to 0 without affecting the contents of the Frame Buffer.
- f=P No effect.

READ FRAME

DIA <f> ac, PTR

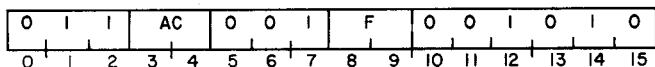

The contents of the Frame Buffer are loaded into bits 8-15 of the specified AC. Bits 0-7 are set to 0. After the data transfer, the controller's Busy and Done flags are set according to the function specified by F. The format of the specified AC is as follows:

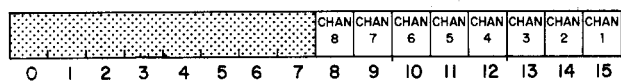

Bits	Name	Contents
0-7	----	Reserved for future use.
8	channel 8	A hole in the corresponding channel(s) of the frame read places a 1 in the corresponding accumulator position(s).
9	channel 7	
10	channel 6	
11	channel 5	
12	channel 4	
13	channel 3	
14	channel 2	
15	channel 1	

PROGRAMMING

Once the operator has loaded the tape into the reader and placed the reader on line, the program may read the tape. A Start command (NIOS) issued to the reader will load the Frame Buffer with the contents of the next frame on the tape. While the buffer is being loaded, the Busy flag is 1, and the Done flag is 0. When the buffer has been loaded, the Busy flag is set to 0, and the Done flag is set to 1, thus initiating a program interrupt request. The program may then read the contents of the buffer by issuing a READ FRAME instruction (DIA). The READ FRAME instruction loads the contents of the Frame Buffer into the specified accumulator. The program may continue reading frames by issuing a series of Start commands and READ FRAME instructions.

TIMING

The paper tape reader is capable of reading at speeds of up to 300 (4011B) or 400 (6013) frames per second. When operating at this speed, the reader takes 2.5 milliseconds to fill the Frame Buffer with the next frame on the tape. In order to keep the tape in continuous motion, the program must retrieve the data, and set Busy to 1 within 100 microseconds after the Done flag is set to 1. Waiting longer than this time forces the reader to stop and restart the tape. The programmer should not attempt to operate the reader in this manner at speeds in excess of 150 frames per second. Faster stop/start rates produce chatter and may lead to unreliable reader operation.

CONSIDERATIONS

Usually, the tape has a leader which is composed on a series of null frames. Since the contents of the Frame Buffer are indeterminate when the computer is first turned on, the frames on the leader may be used to set the contents of the Frame Buffer to 0. The leader may be ignored by checking each frame, as it is read into the buffer, for non-zero contents. Processing of the information field may begin when the program finds a non-zero frame. The program usually recognizes the end of the information field on the tape by some predetermined contents of a frame or group of frames which signify the end of tape. A second method for determining the end of tape is by counting the total number of frames in the information field on the tape.

PROGRAMMING EXAMPLES

To program the paper tape reader, all that is required are four instructions. An example of this, inserted in a program would be the following:

```
NIOS   PTR      ;START READER
SKPDN  PTR      ;FRAME BUFFER LOADED YET?
JMP    .-1      ;NO
DIAC   1,PTR    ;READ THE FRAME AND CLEAR THE DONE FLAG
```

But many times, more than one character may need to be read, and four simple instructions are not enough. In addition, there may be a leader (a number of blank frames at the beginning of the tape) which the programmer may want to ignore. The following subroutine reads a specified number of frames, ignoring the leader, and stores them, sequentially, starting at the address contained in AC2. When the subroutine is called, AC1 contains the number of characters to be read. Upon return to the main program, AC0 is untouched, AC1 contains the starting address of the data storage, and AC2 contains an address which is one more than the final address of the data. The subroutine is called with a JUMP TO SUBROUTINE instruction (JSR).

For example, to read 60 frames and store them sequentially, starting at location 4120, give:

```
      .
      LDA    1,SIXTY ;GET NUMBER OF FRAMES TO READ
      LDA    2,ADDR  ;GET BEGINNING OF BUFFER
      JSR    PTRD    ;GO TO READER SUBROUTINE
      .
      .
      .
SIXTY: 60
ADDR:  4120
```

This will call the following routine:

```

; PAPER TAPE READER INPUT SUBROUTINE, INTERRUPTS DISABLED

; CHECK FOR AND IGNORE LEADER
PTRD: STA 1,CNT ;STORE COUNTER
      STA 2,SAV2 ;SAVE AC2
AGAIN: NIOS PTR ;START READER
      SKPDN PTR ;READY?
      JMP .-1
      DIA 1,PTR ;READ CHARACTER
      MOV# 1,1,SNR ;NULL CHARACTER?
      JMP AGAIN ;YES
      JMP STORE ;NO, ENTER LOOP

; READ DATA
LOOP: NIOS PTR ;RESTART READER
      SKPDN PTR ;READY?
      JMP .-1
      DIA 1,PTR ;READ DATA
STORE: STA 1,0,2 ;STORE DATA
      INC 2,2 ;INCREMENT STORAGE LOCATION
      DSZ CNT ;DONE?
      JMP LOOP ;NO
      LDA 1,SAV2 ;RELOAD STARTING ADDRESS OF DATA
      JMP 0,3 ;RETURN

; STORAGE
CNT: 0 ;COUNTER
SAV2: 0 ;AC2 SAVE LOCATION
```

Both of these examples are inefficient because they must wait in a loop during the 2.5 milliseconds it takes to complete loading in the Frame Buffer. If there are other devices that could be serviced while waiting, or calculations that could be performed, and interrupt service routine may be useful. An example of a paper tape reader service routine in an interrupt handler can be found in example three in Part 1 of this manual.

PAPER TAPE PUNCH

INTRODUCTION

The paper tape punch provides data output to standard-fanfold eight-channel paper or mylar tapes. The punch consists of a supply bin, a punch station, and a take-up bin. Tape is moved from the supply bin to the punch station, where it is punched, and then to the storage bin where it may be removed. The punch can operate at speeds of up to 63.3 frames per second. Some punches are equipped with a program controlled ON/OFF switch.

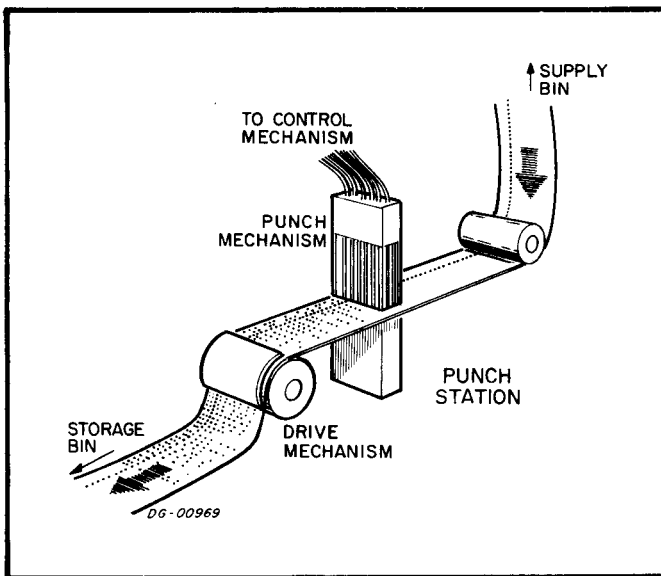

The format of the tape is shown below. The eight channels across the width of the tape comprise a frame. The sprocket hole is punched to allow the tape to be read by standard paper tape readers. Both the code structure and interpretation of the input is determined by conventions decided upon the programmer. Conventional ASCII paper tape code is listed in Appendix C.

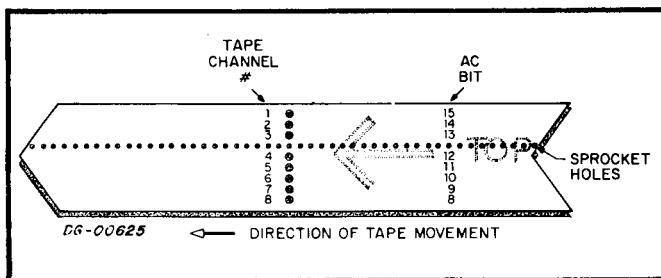

SUMMARY

MNEMONIC (FIRST CONTROLLER)	PTP
DEVICE CODE (FIRST CONTROLLER).....	13 _g
MNEMONIC (SECOND CONTROLLER)	PTP1
DEVICE CODE (SECOND CONTROLLER).....	53 _g
PRIORITY MASK BIT	13
BITS/FRAME	8
FRAMES/INCH	10
MAXIMUM TAPE LENGTH IN STORAGE HOPPER (FEET).....	300
MAXIMUM DATA TRANSFER RATE (FRAMES/SECOND)	63.3

ACCUMULATOR FORMAT

LOAD FRAME BUFFER..... (DOA)

								CHAN	CHAN	CHAN	CHAN	CHAN	CHAN	CHAN	CHAN
								8	7	6	5	4	3	2	1
0	1	2	3	4	5	6	7	8	9	10	11	12	13	14	15

S, C AND P FUNCTIONS

- S Set the Busy flag to 1, the Done flag to 0, punch the character in the Frame Buffer and advance the tape 1 frame.
- C Set the Busy and Done flags to 0 without affecting the contents of the Frame Buffer.
- P No effect.

INSTRUCTIONS

The tape punch is driven by a controller containing an eight-bit Frame Buffer. If a hole is to be punched in a channel of a frame on the tape, a 1 should be loaded into the Frame Buffer position corresponding to that channel when the buffer is loaded. The sprocket hole is not loaded into the Frame Buffer, but is punched automatically.

One I/O instruction is used to program the paper tape punch. This instruction loads the contents of an accumulator into the Frame Buffer of the controller.

The paper tape punch controller's Busy and Done flags are set according to the device flag commands as follows:

- f=S Set the Busy flag to 1, the Done flag to 0, and punch the contents of the Frame Buffer on the tape. If the automatic ON/OFF option is installed, and the power switch is off, a Start command also turns on the punch. It will not affect the contents of the Frame Buffer.
- f=C Set both the Busy and Done flags to 0 without affecting the contents of the Frame Buffer.
- f=P No effect.

LOAD FRAME BUFFER

DOA<f> ac, PTP

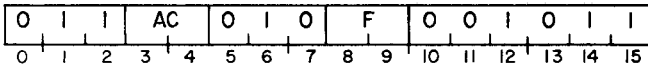

Bits 8-15 of the specified AC are loaded into the Frame Buffer. Bits 0-7 are ignored. After the data transfer, the punch controller's Busy and Done flags are set according to the function specified by F. The contents of the specified AC remain unchanged. The format of the specified AC is as follows:

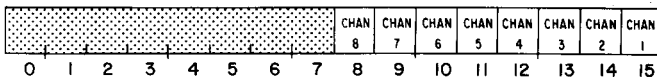

Bits	Name	Contents
0-7	----	Reserved for future use.
8	channel 8	A 1 is placed in the bit position(s) corresponding to the tape channel(s) in which a hole is to be punched.
9	channel 7	
10	channel 6	
11	channel 5	
12	channel 4	
13	channel 3	
14	channel 2	
15	channel 1	

PROGRAMMING

Once the operator has loaded tape into the punch, and placed the punch on-line, the program may punch the tape. Since the contents of the Frame Buffer are indeterminate when the computer is first turned on, the program should load the Frame Buffer using a LOAD FRAME BUFFER instruction (DOA), before issuing a Start command. Once the FRAME BUFFER has been loaded, a Start command should be issued to punch the frame. A Start command sets the Busy flag to 1, the Done flag to 0, and then punches the contents of the Frame Buffer. Once the frame has been punched, the tape is advanced, the Busy flag is set to 0, and the Done flag is set to 1, thus initiating a program interrupt request. To continue punching data, a series of LOAD FRAME BUFFER instructions and Start commands should be issued.

TIMING

The paper tape punch operates on a mechanically determined cycle time of 15.8ms and is capable of punching up to 63.3 frames/second. The first Start command issued will take effect at the point 11.3ms after the cycle has started. If the cycle has already passed this point, the punch will wait until the next cycle. Once the punch has been started, the Done flag will be set to 1 at the beginning of the next cycle, thus initiating a program interrupt request. In order to operate at the maximum speed, the program must issue another Start command within 11.3ms after the Done flag has been set to 1, otherwise, the punch must wait another cycle.

The program controlled ON/OFF option requires approximately a 1-second delay before punching may begin. If the Busy flag remains 0 for more than 5 seconds, the punch will be turned off automatically.

CONSIDERATIONS

To make loading the reader and unloading the punch easier, tapes are usually punched with leaders and trailers made up of a series of blank frames. In order to do this, the Frame Buffer should be loaded with all zeroes, and a series of Start commands issued. A Start command does not destroy the contents of the Frame Buffer, so a series of Start commands may be used to repeat any character.

Many times a predetermined frame of group of frames is also punched with the leader or trailer to signify the length of the record, or the end of data, for the program reading it later.

If the punch runs out of tape, the punching operation continues and no indication is given to the program. Therefore, the operator should verify

that sufficient tape is present for the data he intends to punch.

The standard punch must be left on all the time that it might be used as it otherwise will not respond to the program. With the automatic power ON/OFF option, the punch can be left off. Then if the Busy flag is set to 1 when the motor is off, punching is automatically delayed about 1 second while the motor gets up to speed. It can be assumed that the motor will remain on throughout any normal punching run, but if the Busy flag remains 0 for more than 5 seconds, the motor is turned off.

PROGRAMMING EXAMPLES

In order to punch a frame on paper tape, only three instructions are required. An example of punching a frame during a program would be:

```
SKPBZ  PTP
JMP     .-1
DOAS   1,PTP
```

It is often necessary to punch a block of frames. A subroutine to do this, including the punching of leaders and trailers would be similar to the following program. Upon calling the subroutine, AC1 contains the number of frames to be punched and AC2 contains the starting location where the data is stored sequentially, one character per word. Upon return to the main program, AC2 will contain an address one greater than the address of the last frame punched. For example, to punch 40 frames, stored sequentially, starting at location 1000, the following series of instructions may be used:

```
.
.
.
LDA    1,          FORTY
LDA    2,          ADDR
JSR    PUNCH
.
.
FORTY: 40
ADDR : 1000
```

These instructions would call the following subroutine:

```

; PAPER TAPE PUNCH OUTPUT SUBROUTINE
PUNCH: STA 3,RET ;SAVE RETURN ADDRESS
        JSR LEADER ;PUNCH LEADER
        NEG 1,1 ;NEGATE COUNTER
LOOP:   LDA 3,0,2 ;LOAD DATA
        SKPBZ PTP ;PTP READY?
        JMP .-1 ;NO
        DOAS 3,PTP ;YES, PUNCH FRAME
        INC 2,2 ;INCREMENT POINTER
        INC 1,1,SZR ;INCREMENT COUNTER,SKIP IF ZERO
        JMP LOOP ;PUNCH AGAIN
OUT:    JSR LEADER ;PRINT TRAILER
        NIOC PTP ;CLEAR PUNCH
        JMP @RET ;GET OUT

; PUNCH SERIES OF BLANK FRAMES
LEADER: STA 3,SAV3
        LDA 3,CNT ;LOAD COUNTER FOR BLANKS
        STA 3,CNTR ;STORE IT FOR USE
        SUB 3,3 ;ZERO AC3
        SKPBZ PTP ;READY?
        JMP .-1 ;NO, THEN WAIT
        DOAS 3,PTP ;OUTPUT NULL CHARACTER
        DSZ CNTR ;DECREMENT COUNTER
        JMP .-4 ;LOOP BACK
        JMP @SAV3 ;RETURN

; STORAGE
RET:    0
SAV3:   0
CNT:    240 ;16 INCHES WORTH OF FRAMES
CNTR:   0

```

Both of these programs must wait in loops for the entire cycle time of the punch. In many cases, an interrupt driven paper tape punch might be desirable. An example of an interrupt driven punch may be found in the examples in part 1 of this manual.

This page intentionally left blank

CARD READERS

INTRODUCTION

Card readers provide data input from standard 12-row cards at rates up to 150-1000 cards per minute. There are two types of card readers available, one which reads standard 80-column punched cards, the other which reads optically sensed mark cards and punched cards in various 12-row formats. This second type of reader is also capable of reading inter-mixed card types, one card type at a time. The following table lists various specifications of the card readers sold by Data General Corporation.

DGC MODEL NUMBER	CARD TYPE	DATA TRANSFER RATE (CARDS/MIN)	CARD CYCLE TIME (ms)	TIME BETWEEN CHARACTERS (ms)
4016C	Punch	150	400	2.01
4016D	Punch	285	200	2.0
4016E	Punch	400	150	.87
4016F	Punch	600	100	.87
4016G	Punch	1000	60	.48
4016H	Mark Sense	150	400	161*
4016I	Mark Sense	285	210	161*
4016J	Mark Sense	400	150	69*
4016K	Mark Sense	600	100	69*
4016L	Mark Sense	1000	60	40*

*Divide this number by the number of columns/card to obtain intercharacter times.

SUMMARY

MNEMONIC (FIRST CONTROLLER)..... CDR
 DEVICE CODE (FIRST CONTROLLER)..... 16g
 MNEMONIC (SECOND CONTROLLER).... CDR1
 DEVICE CODE (SECOND CONTROLLER).... 56g
 PRIORITY MASK BIT 10
 BITS/COLUMN 12
 COLUMNS/CARD..... PUNCHED..... 80
 MARK SENSE... 20-160
 MAXIMUM DATA TRANSFER RATE
 (CARDS/MINUTE).....150-1000

ACCUMULATOR FORMATS

READ COLUMN..... (DIA)

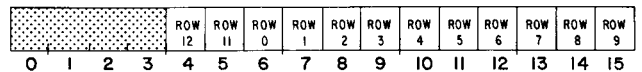

READ STATUS..... (DIB)

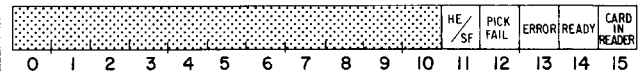

S, C AND P FUNCTIONS

- S Set the Busy flag to 1, the Done flag to 0, and pick the next card.
- C Set both the Busy and Done flags to 0.
- P Set the Done flag to 0 without affecting the Busy flag.

The reader is comprised of a card supply hopper, a read station, and a card stacker. A card is selected from the hopper by a mechanical pick, and is moved into the read station. Here it is read, one column at a time. Once the card has been read, it is moved to the card stacker where it may be stored temporarily, before being removed.

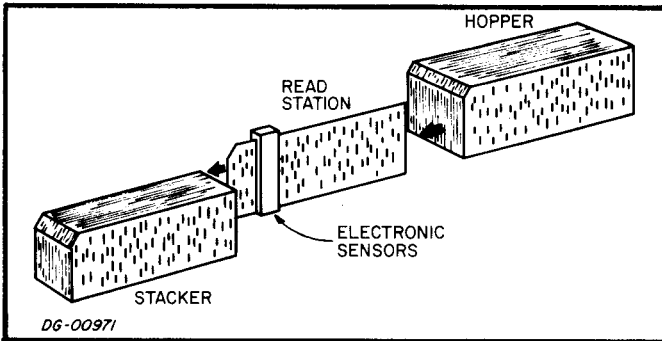

The formats of the cards are shown below. The twelve rows across the width of the card comprise a column. Cards are either standard 80-column, punched or variable format mark sense cards. Both the code structure used and the interpretation of data is determined by the programmer. The conventional Hollerith punched code is listed in Appendix C.

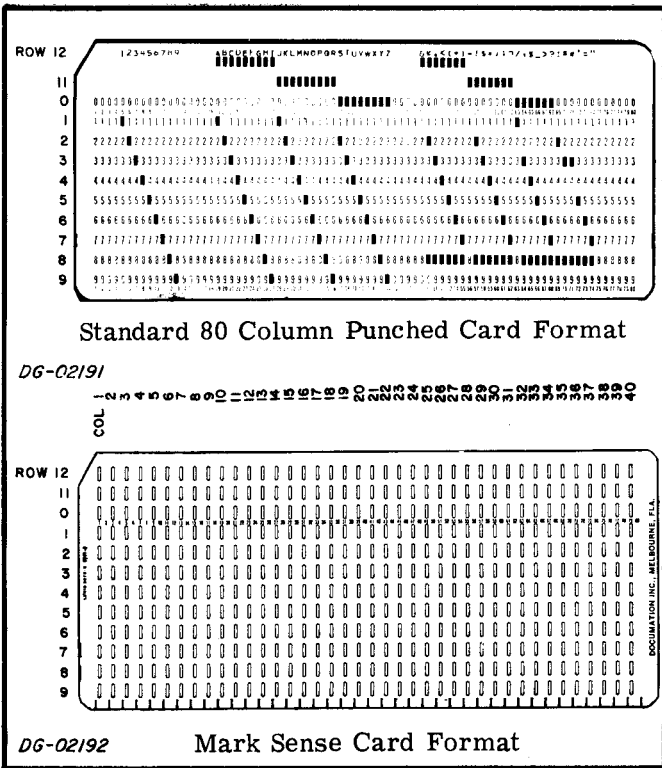

INSTRUCTIONS

The card reader is driven by a controller which contains a 12-bit Data Register and a 5-bit Status Register.

Two I/O instructions are used to program the card reader; the first reads a column on the card, and the second allows the program to determine, in detail, the status of the card reader.

The card reader controller's Busy and Done flags are set according to the three device flag commands as follows:

- f=S Set the Busy flag to 1, the Done flag to 0, and bring a card from the hopper into the read station.
- f=C Set both the Busy and Done flags to 0. If a card is in the reader, it will continue to move through the reader, but no program interrupt requests will be generated as the columns pass through the read station.
- f=P Set the Done flag to 0 without affecting the Busy flag.

READ COLUMN

DIA <f> ac, CDR

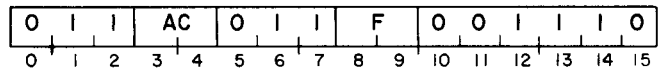

The contents of the controller's Data Register are loaded into bits 4-15 of the specified accumulator. Bits 0-3 are set to 0. After the data transfer, the controller's Busy and Done flags are set according to the function specified by F. The format of the specified AC is as follows:

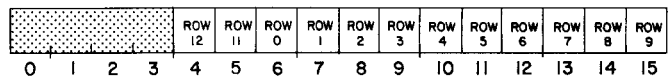

Bits	Name	Contents
0-3	----	Reserved for future use.
4	Row 12	If the row on the card is punched or marked, the corresponding bit is set to 1.
5	Row 11	
6	Row 0	
7	Row 1	
8	Row 2	
9	Row 3	
10	Row 4	
11	Row 5	
12	Row 6	
13	Row 7	
14	Row 8	
15	Row 9	

READ STATUS

DIB<f> ac, CDR

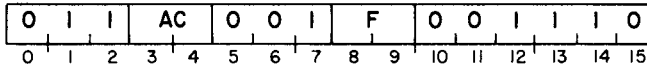

The contents of the controller's Status Register are loaded into bits 11-15 of the specified accumulator. Bits 0-10 are set to 0. After the data transfer, the controller's Busy and Done flags are set according to the function specified by F. The format of the specified AC is as follows:

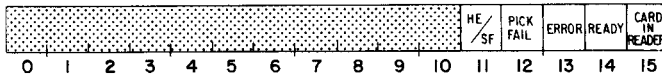

Bits	Name	Meaning When Set to 1
0-10	---	Reserved for future use.
11	Hopper Empty/Stacker Full	The input hopper has run out of cards or the output stacker is full.
12	Pick Failure	The card did not move from the input hopper into the card reader.
13	Trouble	A card is jammed in the reader or there is an electronic failure.
14	Ready	The reader is ready to take another card from the input hopper.
15	Card In Reader	A card is passing through the read station.

PROGRAMMING

When the card reader is on-line, and ready to transmit data, the program may issue a Start command to the controller. A Start command sets the Busy flag to 1, the Done flag to 0, and picks a card from the hopper. Once the first column enters the read station, the Done flag is set to 1, thus initiating a program interrupt request. The Busy flag remains set to 1 as long as the card remains in the reader.

The column may then be read by a READ COLUMN instruction (DIA). A READ COLUMN instruction loads the specified accumulator with a one in those bits corresponding to punched or marked rows in a column. A Pulse command should then be issued to set the Done flag to 0 without affecting the Busy flag. This will allow the next column on the card to set the Done flag to 1 when it enters the read station, thus initiating a program interrupt request. Usually the READ COLUMN instruction and Pulse commands are combined in a DIAP instruction.

Consecutive columns may be read by a series of DIAP instructions, waiting between each for the Done flag to be set to 1.

When the final column has been read, the card passes out of the read station, the Busy flag is set to 0, and the Done flag is set to 1, thus initiating a program interrupt request. Another card may then be loaded into the reader. Note that the Done flag serves two purposes. When combined with the Busy flag being 1, the setting of the Done flag to 1 signifies a column is ready to be read. When combined with the Busy flag being 0, the setting of the Done flag to 1 signifies the end of a card.

The controller's Status Register can be checked at any time by means of a READ STATUS instruction (DIB). Before a Start command is issued, the Status Register should be checked for the Ready flag being 1, and after the Start command is issued, it should be checked for a possible pick failure. Note that if a pick failure occurs, the Done flag is not set to 1, but remains set to 0. Thus a program interrupt request will not occur. Status should also be checked after each column is read to determine any possible errors while reading. See the section entitled Error Conditions for a more detailed discussion concerning the use of the Status Register.

TIMING

The following table contains all the relevant timing information for the various card readers available from Data General Corporation. The term "card cycle time" refers to the time it takes an entire card to be loaded, processed, and put into the

stacker. The term "maximum allowable programmed I/O latency" refers to the amount of time the program has after the Done flag is set to 1 in order to issue a READ COLUMN instruction. If the program waits longer than this time, the data from that column is lost.

DGC MODEL NUMBER	CARD TYPE	DATA TRANSFER RATE (CARDS/MIN)	CARD CYCLE TIME (ms)	TIME BETWEEN CHARACTERS (ms)	START TO EDGE OF CARD (ms) (A)	EDGE OF CARD TO FIRST COL. (ms) (B)	START TO FIRST COLUMN (ms) (A&B)	LAST COLUMN TO END OF CARD (ms)	MAXIMUM ALLOWABLE PROGRAMMED I/O LATENCY (ms)
4016C	Punch	150	400	2.01	53	6.25	59.3	170.	1.31
4016D	Punch	285	200	2.0	24	6.25	30.2	8.05	1.31
4016E	Punch	400	150	.87	24	2.6	26.6	53.5	.43
4016F	Punch	600	100	.87	24	2.6	26.6	3.48	.43
4016G	Punch	1000	60	.48	15	1.86	16.9	1.91	.24
4016H	Mark Sense	150	400	161. *	53	43.06**	Note 1	43.06***	.60
4016I	Mark Sense	285	210	161. *	24	43.06**	Note 1	43.06***	.60
4016J	Mark Sense	400	150	69. *	24	100.67**	Note 1	100.67**	.23
4016K	Mark Sense	600	100	69. *	24	100.67*	Note 1	100.67**	.23
4016L	Mark Sense	1000	60	40 *	15	175.38**	Note 1	175.38**	.13

*Divide this number by the number of columns/card to obtain intercharacter times.

**Divide the distance, in inches, from the edge of the card to the second clock mark's leading edge by this factor to obtain the time interval.

***Divide the distance, in inches, from the last column timing mark to the end of the card by this factor to obtain the time interval.

Note 1 - Add the time calculated in column B to the time calculated in column A to obtain this time.

DG-01460

ERROR CONDITIONS

The card reader's Status register is used in determining when errors have been encountered during operation. These errors may cause erroneous data, or make it impossible to read data. Three status flags: Hopper Empty/Stacker Full, Trouble, and Pick Failure are available in the Status Register to signal any malfunctions in the reader. These flags will cause the reader motor to shut off and require operator intervention for correction. Two other flags: Ready, and Card-in-Reader signal the state of the reader.

If Hopper Empty/Stacker Full is set to 1, the reader will not attempt to pick another card when a Start command is issued. The Hopper Empty/Stacker Full flag indicates that either all the cards were read (Hopper Empty) or the card stacker can hold no more cards (Stacker Full). In order to continue reading cards, the operator must either load a new deck of cards, empty the card stacker, or both.

The Trouble flag indicates several types of malfunctions, such as a card jammed in the reader or a failure in the reader's electronic sensors. The

reader will continue to attempt to read the card currently in the reader, but any data read from that card is questionable.

The Pick Failure flag is set to 1 if a Start command fails to bring a card into the read station from the hopper. Note that if a Pick Failure occurs, the Done flag is never set to 1, and the Busy flag remains set to 1. Therefore, the only means of determining a bad pick is through the Pick Failure flag. Even though a Pick Failure may occur, the controller will continue trying to pick the card until either a Clear command or an I/O RESET instruction (IORST) is issued. If continued attempts to read the card fail, including manual reloading by the operator, the card is probably defective and should be replaced. The Ready flag is set to 1 if the reader is ready to receive a Start command from the controller. Ready will not be 1 if any other Status flags are 1.

The Card-in-Reader flag is set to 1 if there is a card in the read station.

PROGRAMMING EXAMPLES

The card reader may be programmed in a manner similar to the Teletype input if one does not wish to check for errors in the reader. This is not recommended, as a malfunction in the reader may result in erroneous data. The following subroutine is one of many ways to read a card from

the card reader, checking for errors. It is called by a JUMP TO SUBROUTINE instruction (JSR) to RDCRD. When the JSR instruction is executed, AC2 should contain the address where the data will be stored sequentially. Upon return, AC2 will contain an address one greater than the final address of the data storage. The other ACs remain unchanged. The subroutine is as follows:

```

;      SUBROUTINE TO READ A CARD, WITH CDR INTERRUPTS DISABLED

RDCRD: STA      0,SAV0  ;STORE ACCUMULATORS
        STA      3,SAV3
        LDA      3,READY ;LOAD READY MASK
        IIR      0,CDR   ;READ STATUS
        AND#     3,0,SNR ;READY?
        JMP      ERROR   ;NO
        NIOS     CDR     ;PICK A CARD
        LDA      3,PIKFL ;LOAD PICK FAIL MASK
CHECK:  IIR      0,CDR   ;READ STATUS
        MOVR#    0,0,SZC ;CARD IN READER?
        JMP      LOOP    ;YES, GO TO READ COLUMN LOOP
        AND#     3,0,SNR ;PICK FAIL?
        JMP      CHECK   ;NO, CHECK AGAIN
        JMP      ERROR   ;YES

LOOP:   SKPBN   CDR     ;READY TO READ?
        JMP     .-1     ;NOT YET
        SKPBN   CDR     ;BUSY?
        JMP     EOC     ;NO,END OF CARD
        DIAP    0,CDR   ;READ DATA AND SET DONE TO 0
        STA     0,0,2   ;STORE DATA
        INC     2,2     ;INCREMENT POINTER
        JMP     LOOP    ;WAIT FOR NEXT COLUMN

EOC:    NIOC    CDR     ;CLEAR CDR
        LDA     3,TRBLE ;LOAD TROUBLE MASK
        IIR     0,CDR   ;READ STATUS
        AND#    3,0,SZR ;TROUBLE?
        JMP     ERROR   ;YES
        LDA     0,SAV0  ;RESTORE ACO
        JMP     @SAV3   ;RETURN

ERROR:  HALT     ;NORMALLY SEND MESSAGE TO OPERATOR

;      STORAGE
SAV0:   0
SAV3:   0
READY:  2
PIKFL:  10
TRBLE:  4

```

But this program wastes time waiting for the card to be picked, and then waits for each column to be brought into the read station. The following program uses the interrupt facility to accomplish the same results with a minimum of wasted time.

It is called in the same manner as the first routine, but does not return any data in the accumulators.

If time is a prime concern, the pick fail check may be eliminated, releasing about 62 microseconds for other programming. But if the pick check is eliminated and a pick fail occurs, an interrupt request will never be received from the card reader.

```

;      CARD READER SERVICE, USING INTERRUPTS

      .LOC      1
      INTRP

;      DUMMY INTERRUPT HANDLER
INTRP: SKPDZ    CDR      ;CDR INTERRUPT?
      JMP      CDRSR    ;YES, GO TO CDR SERVICE ROUTINE
      HALT          ;NORMALLY WOULD CHECK FOR OTHER INTERRUPTS

;      SUBROUTINE TO READ A CARD - JSR'ED TO BY MAIN PROGRAM

RDCRD: SKPBZ    CDR      ;READER ALREADY BUSY?
      JMP      .-1      ;YES, WAIT TILL IT'S FREE
      STA      0,SAV0    ;STORE ACCUMULATORS
      STA      3,SAV3
      STA      2,PNTR    ;STORE POINTER
      LDA      3,READY   ;LOAD READY MASK
      DIB      0,CDR     ;READ STATUS
      AND#     3,0,SNR   ;READY?
      JMP      ERROR     ;NO
      NIOS     CDR      ;PICK A CARD

;      PICK FAILURE CHECK, MAY BE OMITTED IF WAITING TIME CAN'T BE SPARED
CHECK: LDA      3,PIKFL  ;LOAD PICK FAIL MASK
      DIB      0,CDR     ;READ STATUS
      MOVR#    0,0,SZC   ;CARD IN READER?
      JMP      LEAVE     ;YES, CARD HAS BEEN PICKED SUCCESSFULLY
      AND#     3,0,SNR   ;PICK FAIL?
      JMP      CHECK     ;NO, CHECK AGAIN
      JMP      ERROR     ;YES

LEAVE: LDA      0,SAV0   ;RESTORE ACO
      JMP      @SAV3     ;RETURN TO MAIN PROGRAM

;      CDR INTERRUPT SERVICE ROUTINE - JMP'ED TO BY MAIN INTERRUPT HANDLER

CDRSR: STA      0,SAV0   ;STORE ACCUMULATORS
      STA      3,SAV3
      SKPBN    CDR      ;BUSY?
      JMP      EOC       ;NO,END OF CARD
      DIAP     0,CDR     ;READ DATA AND SFT DONE TO 0
      STA      0,@PNTR   ;STORE DATA
      ISZ      PNTR     ;INCREMENT POINTER
      JMP      EXIT      ;GET OUT
EOC:   NIOC     CDR      ;CLEAR CDR
      LDA      3,TRBLE   ;LOAD TROUBLE MASK
      DIB      0,CDR     ;READ STATUS
      AND#     3,0,SZR   ;TROUBLE?
      JMP      ERROR     ;YES
EXIT:  LDA      0,SAV0   ;RESTORE ACCUMULATORS
      LDA      3,SAV3
      INTEN    @0        ;ENABLE INTERRUPTS
      JMP      @0        ;RETURN TO INTERRUPTED PROGRAM

ERROR: HALT          ;NORMALLY WOULD SEND THE OPERATOR A MESSAGE

;      STORAGE
SAV0:  0

SAV3:  0
READY: 2
PIKFL: 10
TRBLE:  4
PNTR:  0

```

LINE PRINTERS

INTRODUCTION

Line printers provide high speed, alphanumeric, hard-copy output. Two major types of line printers are available; one using character drum impact, and the other using serial-dot matrix impact as the means of printing. The printers can receive and print one of the 64 or 96 character subsets of ASCII code shown in Appendix C.

To operate more efficiently, each line printer simultaneously prints a group of characters. In order to accomplish this, the line is divided into one or more "zones" for printing. As characters are sent to the line printer, they are stored in an area known as the "Zone Buffer". When the Zone Buffer has been filled, or the proper control character has been given, the contents of the Zone Buffer are printed in the present zone. In this manner, fewer mechanical cycles are necessary to print each line. When printing has been completed, the Zone Buffer is zeroed, and a "Zone

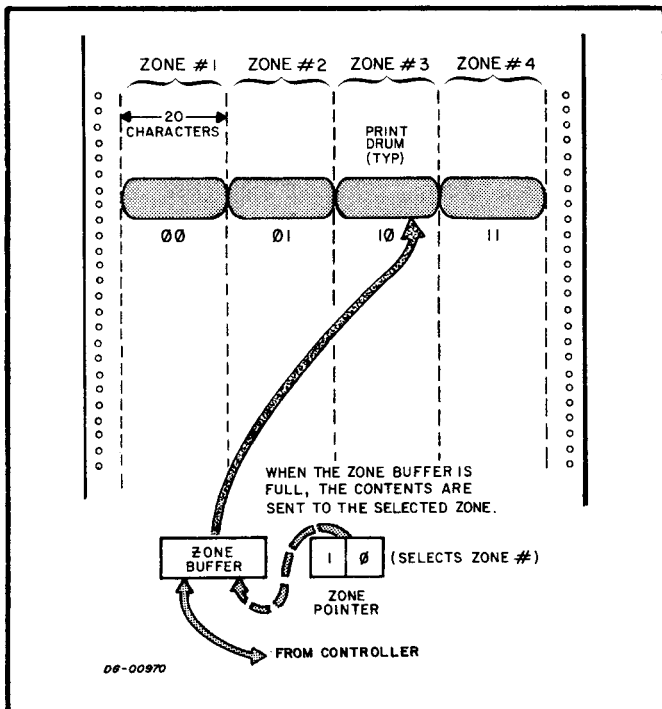

SUMMARY

MNEMONIC (FIRST CONTROLLER)..... LPT
 DEVICE CODE (FIRST CONTROLLER)..... 17₈
 MNEMONIC (SECOND CONTROLLER)... LPT1
 DEVICE CODE (SECOND CONTROLLER)... 57₈
 PRIORITY MASK BIT..... 12
 MAXIMUM CHARACTERS/LINE... 80/132/136
 LINES/INCH..... 6/8

ACCUMULATOR FORMATS

LOAD CHARACTER BUFFER (DOA)

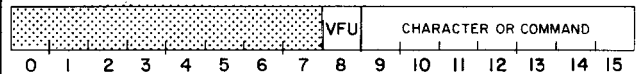

READ STATUS (DIA)

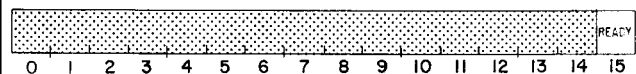

S, C AND P FUNCTIONS

- S Set the Busy flag to 1, the Done flag to 0, and load the contents of the Character Buffer into the printer's Zone Buffer.
- C Set both the Busy and Done flags to 0 without affecting the contents of the Character Buffer.
- P No effect.

Pointer" is automatically set to point to the next zone. The Zone Pointer determines the zone to be printed next. If the zone printed was the last zone on the line, or the proper control character had been given, then the Zone Pointer returns to the first zone on the line. The program may again load the Zone Buffer for printing.

The printers are all programmed in a similar manner and incorporate the following control characters: carriage return, line feed, and form feed. Paper widths may range from 4 to 19 7/8 inches, depending upon the printer. The table below lists the general parameters for the line printers offered by Data General Corporation.

Line Printer Specifications

Model	Type	Paper Width (inches)	Full Line Print Rate	Full Line Length	Zone Size	Number of Zones
4034A	Character Drum	4 to 19 7/8	256 Lines/Min	80	20	4
4034B	Character Drum	4 to 19 7/8	245 Lines/Min	132	24	5 1/2
4034C	Serial-Dot Matrix 5x7	4 to 14 7/8	165 Characters/Sec	132	132	1
4034D	Serial-Dot Matrix 7x9	4 to 14 7/8	165 Characters/Sec	132	132	1
4034G	Character Drum	4 to 16 3/4	300 Lines/Min	136	136	1
4034H	Character Drum (Upper+Lower Case)	4 to 16 3/4	240 Lines/Min	136	136	1

06-00972a

INSTRUCTIONS

The line printer is driven by a controller containing a 7-bit Character Buffer and a 1-bit Status Register.

Two I/O instructions are used to program the line printer. The first of these is used to transmit characters to the printer and the second is used to determine the status of the printer.

The line printer controller's Busy and Done flags are controlled by the device flag commands as follows:

- f=S Set the Busy flag to 1 and the Done flag to 0. The contents of the Character Buffer in the controller are transferred to the Zone Buffer of the printer. If a Start command is issued when the Zone Buffer is one character short of being full, or the last code loaded into the Zone Buffer is a control character which initiates printing, the Zone Buffer will be printed. On models 4034G and H, only a control character will initiate printing.
- f=C Set the Busy and Done flags to 0 without affecting the contents of either the Character Buffer or the Zone Buffer.
- f=P No effect.

LOAD CHARACTER BUFFER

DOA <f> ac, LPT

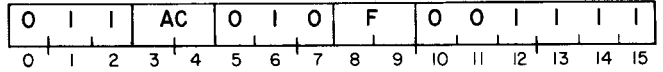

Bits 9-15 of the specified AC are loaded into the controller's Character Buffer. On serial-dot-matrix printers, bit 8 is also loaded for vertical formatting. Bits 0-7 are ignored. The controller's Busy and Done flags are set according to the function specified by F. The contents of the specified AC remain unchanged. The format of the specified AC is as follows:

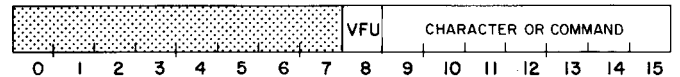

Bits	Name	Contents
0-7	----	Reserved for future use.
8	Vertical Format	On serial-dot matrix printers will cause vertical tabbing when set to 1.
9-15	Character	The ASCII code for the character to be transmitted.

READ STATUS

DIA <f> ac, LPT

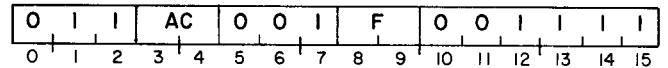

The contents of the controller's Status Register are placed into bit 15 of the specified AC. Bits 0-14 are set to 0. After the data transfer, the controller's Busy and Done flags are set according to the function specified by F. The format of the specified AC is as follows:

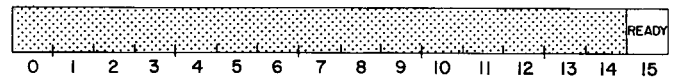

Bits	Name	Contents
0-14	----	Reserved for future use.
15	Ready	The line printer is ready to receive a character.

PROGRAMMING

Line printers are output only devices with the capability of sending status information to the program. They are programmed similarly to Teletype output in that output is one character at a time. The difference lies in the fact that line printers contain a "Zone Buffer" in which all characters are stored before printing.

Output is done through a Character Buffer in the controller. A LOAD CHARACTER BUFFER instruction (DOA) loads the contents of an accumulator into the Character Buffer of the controller. A Start command loads the contents of the Character Buffer into the Zone Buffer of the line printer. When a Start command is issued, the Busy flag is set to 1, and the Done flag is set to 0 while the contents of the character Buffer are being transferred to the Zone Buffer. Upon completion of the transfer, the Busy flag is set to 0, while the Done flag remains 0.

The contents of the Zone Buffer will be printed under the following conditions:

- Model 4034A and B - The last character transferred to the Zone Buffer either filled the zone or was one of the control characters: Carriage Return, Line Feed, or Form Feed.
- Model 4034C and D - The last character transferred to the Zone Buffer either filled the Zone Buffer or was a Carriage Return.
- Model 4034G and H - The last character transferred to the Zone Buffer was one of the control characters: Carriage Return, Line Feed, or Form Feed.

While printing, the Busy flag is set to 1 and the Done flag is set to 0. Upon completion of the print cycle, the Busy flag is set to 0 and the Done flag

is set to 1, thus initiating a program interrupt request. If the zone printed was the last zone on the line, a Carriage Return is automatically executed, except on models 4034G and H.

If a Carriage Return is executed either automatically or by a command received from the program, the line will be overwritten by the next line printed, unless the Line Feed command is issued. Line overprinting may be desired in order to obtain special characters, e.g. ≠ is obtained by overprinting a slash and an equal sign.

Formatting of the output is accomplished as follows:

Horizontal tabbing for both types of printers is done by loading the Character Buffer with a space and issuing a Start command for every column to be spaced.

Vertical tabbing operations are accomplished by loading the Character Buffer with a Line Feed command, and then issuing a Start command for every line to be spaced. Upon completion of the operation, the Busy flag is set to 0 and the Done flag is set to 1, thus initiating a program interrupt request. The serial-dot matrix printers can also perform vertical tabbing operations under the control of a vertical format tape. Tabs are placed at intervals along the tape by punching holes in the tape. Vertical formatting is initiated when the Character Buffer contains a 1 in bit 8 and is loaded into the Zone Buffer.

The serial-dot matrix printers also have a Delete command which clears all the characters previously entered into the Zone Buffer.

The line printer has a 1-bit Status Register which may be checked to determine if the printer is ready to receive data. In order to accomplish this, a READ STATUS instruction (DIA) is used. A READ STATUS instruction loads the contents of the Status Register into the specified accumulator. Status should be checked before attempting to operate the printer.

CONTROL CHARACTERS

Three Control Character Functions are available for all the line printers; Carriage Return, Line Feed, and Form Feed. The actual effects of these commands are as follows:

Carriage Return <015_g>

The present contents of the Zone Buffer are printed; when the next printable character is received, it will be placed in the leftmost position of the first zone.

Line Feed <012_g>

a) Character Drum Printers

The present contents of the Zone Buffer are printed, and the paper is spaced one line. When the next printable character is received, it will be placed in the leftmost position of the first zone.

b) Serial-Dot Matrix Printers

The paper is spaced one line. The Zone Buffer is not printed and the contents remain untouched. The next printable character received will be placed in the next position in the Zone Buffer.

Form Feed <014_g>

a) Character Drum Printers

The present contents of the Zone Buffer are printed, and the paper is spaced to the top of the next form. When the next printable character is received, it will be placed in the leftmost position of the first zone.

b) Serial-Dot Matrix Printers

The paper is advanced to the top of the next form. The contents of the Zone Buffer are left untouched. When the next printable character is received, it is placed in the next position in the Zone Buffer.

The following four control character functions are available on the Serial-Dot Matrix Printers in addition to the three commands listed above:

Vertical Tab <2xx_g>

Moves the paper until the next hole is reached on the paper control ribbon. The Zone Buffer is also loaded with the character denoted by xx. The contents of the Zone Buffer remain unchanged.

Delete <177_g>

All characters present in the Zone Buffer are deleted. The next suitable character received will be placed in the leftmost position of the present zone.

Expanded Characters <016_g>

Prints the characters double size in the horizontal axis so that instead of printing 132 characters per line, only 66 characters may be printed on a line. This function may be selected at any time prior to the Carriage Return in any line. If more than 66 characters have been entered, the excess characters are deleted.

Bell <007_g>

Generates a 2 second audible tone in the speaker at the rear of the printer. The contents of the Zone Buffer remain unchanged.

The following two commands are implemented on the model 4034D Serial-Dot Matrix Printer.

Select <021_g>

Allows the printer to receive data. This is the same as activating the printer select switch.

De-Select <023_g>

Places the printer off-line; this is the same as deactivating the select switch.

TIMING

There are two timing cycles for the programmer to be concerned with when outputting to the line printer. These are character cycle time and print cycle time. The character cycle time is the time it takes to load a character into the Zone Buffer. This time is either 2, 6, or 12 microseconds, depending upon the type of printer. Print cycle time is the time it takes to print a zone. Print cycle times vary from printer to printer, and depend upon the number of characters being printed. But, print cycle times are long enough to warrant the use of an interrupt handler for the line printer.

In an interrupt routine, characters should be output to the Zone Buffer successively. When the Zone Buffer is printing, the routine should return control to the main program. To test for the zone being printed, the program should wait the character cycle time, after the output, and then test for Busy being 1. If the Busy flag is 1, then the printer has entered the print cycle, and the routine should return control to the main program awaiting an interrupt.

To print at the maximum rate, the line printer's Zone Buffer should be completely loaded within 200 microseconds after the end of a print cycle. For timing characteristics of the various line printers, see the table of line printer specifications.

Line Printer Specifications

Model	Type	Paper Width (inches)	Full Line Print Rate	Full Line Length	Zone Size	Number of Zones	Character Cycle Time (μ s)	Print Cycle Time	Line Feed (ms)	Carriage Return (ms)	Slew Speed
4034A	Character Drum	4 to 19 7/8	256 Lines/Min	80	20	4	6	34 ms/Zone	20	4	20 ms/Line
4034B	Character Drum	4 to 19 7/8	245 Lines/Min	132	24	5 1/2	6	34 ms/Zone	20	4	20 ms/Line
4034C	Serial-Dot Matrix 5x7	4 to 14 7/8	165 Characters/Sec	132	132	1	12	5.5 ms/Character	70	2.75	70 ms/Line
4034D	Serial-Dot Matrix 7x9	4 to 14 7/8	165 Characters/Sec	132	132	1	12	5.5 ms/Character	70	2.75	70 ms/Line
4034G	Character Drum	4 to 16 3/4	300 Lines/Min	136	136	1	2	50 ms/Zone	50	--	8.3 ms/Line
4034H	Character Drum (Upper+Lower Case)	4 to 16 3/4	240 Lines/Min	136	136	1	2	50 ms/Zone	50	--	8.3 ms/Line

06-00972

PROGRAMMING EXAMPLE

The line printer may be programmed efficiently only through the use of an interrupt service routine. If interrupts are disabled, then the program must wait the entire print cycle time before it may continue processing. The following routine demonstrates a procedure for programming the line printer using interrupts.

To initiate printing, a JUMP TO SUBROUTINE instruction (JSR) to PRINT is used, where AC0 contains the starting location of the data in the form of a byte pointer (format below).

ADDRESS															POIN- TER	
0	1	2	3	4	5	6	7	8	9	10	11	12	13	14	15	
Bits	Name	Contents														
0-14	Address	Address of first word of output data.														
15	Pointer	Left or right byte of word 0 = left, 1 = right														

The routine loads the Zone Buffer, character by character, and when the zone begins to print, it returns to the main program. It tests for the beginning of the print cycle by waiting for one character cycle time in a timing loop after each character is loaded in the Zone Buffer, and then testing the Busy flag. If the Busy flag is 1, the print cycle has begun and the routine returns control to the main program.

Data is packed two characters per word, left to right, and the end of data is signified by a null character (000₈). The routine sets the byte pointer to 0 when done to signify that it is not in use, and may be called by another JSR to PRINT.

If this routine is called again before it has printed the entire file, the program waits until the file is completed.

```

; LINE PRINTER SERVICE, USING INTERRUPTS

      .LOC    1
      INTRP

; DUMMY INTERRUPT HANDLER
INTRP: SKPDZ   LPT     ;LPT INTERRUPT?
        JMP    LPTSR  ;YES, GO TO SERVICE ROUTINE
        HALT    ;NORMALLY WOULD CHECK FOR OTHER INTERRUPTS

      .LOC    300

; SUBROUTINE TO PRINT A STRING OF BYTES- JSR'ED TO BY MAIN PROGRAM
PRINT: STA    1,SAVE1 ;SAVE AC1
        LDA    1,BPTR ;LOAD BYTE POINTER
        MOV#   1,1,SZR ;IF BYTE POINTER IS NOT 0, LPT IS IN USE, SO
        JMP    -2     ;WAIT TILL DONE
        LDA    1,SAVE1 ;RESTORE AC1
        STA    0,BPTR ;INITIALIZE BYTE POINTER
        JMP    LPTDR  ;ENTER DRIVER SUBROUTINE
SAVE1: 0

; LPT INTERRUPT SERVICE ROUTINE-JMP'ED TO BY MAIN INTERRUPT HANDLER
LPTSR: STA    3,SAVE3 ;SAVE AC3
        JSR    LPTDR  ;CALL DRIVER SUBROUTINE
        LDA    3,SAVE3 ;RESTORE AC3
        INTEN
        JMP    00     ;RETURN TO INTERRUPTED PROGRAM
SAVE3: 0

```

(CONTINUED)

```

; LPT DRIVER SUBROUTINE-ENTERED FROM EITHER PRINT OR LPTSR,RETURNS VIA AC3
LPTDR: STA 0,SAV0 ;SAVE AC0
      STA 1,SAV1 ;SAVE AC1
      STA 2,SAV2 ;SAVE AC2
      MOVL 3,3 ;SAVE AC3 WITH CARRY
      STA 3,SAV3C
      LDA 0,BPTR ;LOAD BYTE POINTER
      DIA 1,LPT ;READ STATUS
      MOV# 1,1,SNR ;STATUS O.K.?
      JMP ERROR ;NO,THEN ERROR
      LDA 3,C377 ;MASK TO CHECK FOR END OF DATA
LOOP:  MOVZR 0,2 ;CHANGE BYTE POINTER TO WORD POINTER
      LDA 1,0,2 ;LOAD DATA
      MOV# 0,0,SNC ;LEFT OR RIGHT BYTE?
      MOVS 1,1 ;LEFT, THEN SWAP
      ;NO-OPS FOR DELAY-CHECK PRINTER AND PROCESSOR TIMING
      NIO 0
      NIO 0
      NIO 0
      JMP .+1
      SKPRZ LPT ;LPT STILL BUSY?
      JMP ZONE ;YES, THEN PRINTING ZONE
      AND# 3,1,SNR ;NULL BYTE?
      JMP DONE ;YES, THEN DONE
      IOAS 1,LPT ;NO, THEN PRINT
      INC 0,0 ;INCREMENT BYTE POINTER
      JMP LOOP ;GET NEXT DATA

DONE:  NIOC LPT ;CLEAR LPT
      SUB 0,0 ;SET ACO TO 0
ZONE:  STA 0,BPTR ;STORE ACO
      LDA 0,SAV0 ;RESTORE ACCUMULATORS AND CARRY
      LDA 1,SAV1
      LDA 2,SAV2
      LDA 3,SAV3C
      MOVZR 3,3
      JMP 0,3 ;RETURN

; DUMMY ERROR ROUTINE
ERROR: HALT ;NORMALLY WOULD INDICATE LPT NOT READY

; STORAGE AREA
SAV0:  0 ;STORE AC0
SAV1:  0 ;STORE AC1
SAV2:  0 ;STORE AC2
SAV3C: 0 ;STORE AC3 WITH CARRY
C377:  377 ;RIGHT BYTE MASK
BPTR:  0 ;BYTE POINTER-0 INDICATES LPT NOT IN USE

```

INCREMENTAL PLOTTERS

INTRODUCTION

Incremental plotters provide hard-copy graphical output from computer-supplied data. The plotters have three independent functions which allow ten distinct pen and/or paper movements. The three functions are x-axis movement, y-axis movement, and raise/lower pen. Eight pen and/or paper movements are possible by combining x- and y-axis commands as shown in the figure below.

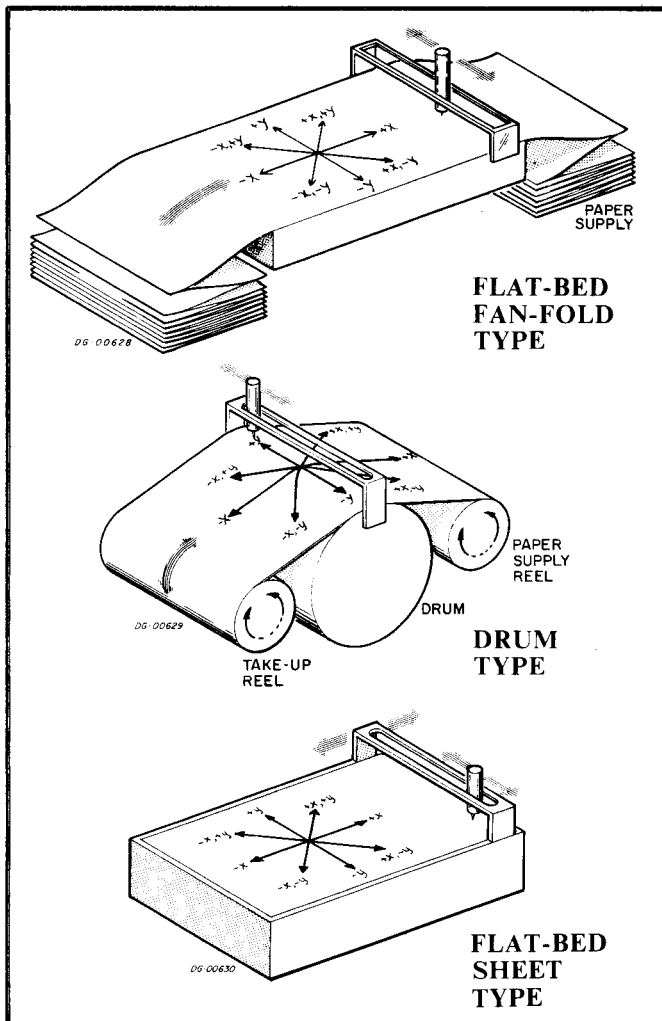

SUMMARY

MNEMONIC (FIRST CONTROLLER)..... PLT
 DEVICE CODE (FIRST CONTROLLER)..... 15₈
 MNEMONIC (SECOND CONTROLLER)... PLT1
 DEVICE CODE (SECOND CONTROLLER)... 55₈
 PRIORITY MASK BIT..... 12
 MAXIMUM PLOT SIZE
 (INCHES)*..... 31x34; 30x1440; 11x1734
 STEP SIZE* (INCHES)..... .002-.01
 (MM)..... .05-.25
 MAXIMUM RATE*
 (STEPS/SECOND)..... 200, 300

ACCUMULATOR FORMAT

LOAD COMMAND BUFFER..... (DOA)

									RAISE PEN	LOWER PEN	-Y	+Y	-X	+X	
0	1	2	3	4	5	6	7	8	9	10	11	12	13	14	15

S, C AND P FUNCTIONS

- S Set the Busy flag to 1, the Done flag to 0, and initiate the command.
- C Set both the Busy and Done flags to 0 without affecting the contents of the Command Buffer.
- P No effect.

*See plotter specification.

The combination of an x- and y-axis movement generates a line 1.414 times the length of the plotter's basic step size. The pen may also be raised or lowered, providing two more commands. Each x- or y-axis command generates one step when sent to the plotter. Any directional movement which is not included in the eight basic directions must be approximated by sequential combinations of the basic steps. The table below contains information on the basic step sizes and stepping rates for the various types of plotters available from Data General Corporation.

Plotter Specifications

Plotter	Type	Paper Size (inches)	Step	Size*	Step/Sec
4017A	Drum	12x1440	.01"	.005"	300
4017C	Drum	30x1440	.01"		
		Roll	or		
		Roll	.01mm		
4017D	Flat-bed	31x34	.01"	.005"	300
		Sheet	.002"		
			or		
			.05mm	.10mm	
4017E	Flat-bed	11x1734	.01"	.005"	300
		Fan-fold	.25mm	.10mm	

*Each plotter must be ordered with a designated step size.

Two major types of plotters are available: flat-bed and drum. Flat-bed plotters use either one rectangular sheet of paper or a fanfold stack of paper for plotting. The flat-bed plotter that uses one sheet generates lines on the x-axis by moving the entire carriage rod. On the flat-bed plotter of the fanfold type, lines along the x-axis are generated by moving the paper past the pen carriage.

Both types generate lines along the y-axis by moving the pen carriage along the carriage rod. Drum plotters use a roll of paper which unrolls from a supply reel and rolls onto a take-up reel where it may be removed. Movement along the x-axis is accomplished by moving the paper past the pen carriage, along the drum. Y-axis movement is accomplished by moving the pen carriage along the carriage rod.

INSTRUCTIONS

The plotter is driven by a controller which contains a 6-bit Command Buffer, two bits for each axis of movement.

One I/O instruction is used in programming the plotter. This instruction loads the controller's Command Buffer with the desired pen movement command.

The plotter controller's Busy and Done flags are controlled by the device flag commands as follows:

- f=S Set the Busy flag to 1, the Done flag to 0, and initiate the pen movement command contained in the Command Buffer.
- f=C Set both the Busy and Done flags to 0 without affecting the contents of the Command Buffer.
- f=P No effect.

LOAD COMMAND BUFFER

DOA<f> ac, PLT

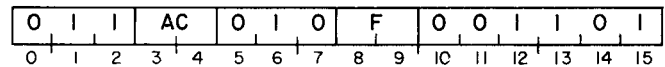

Bits 10-15 of the specified AC are loaded into the controller's Command Buffer. Bits 0-9 are ignored. After the data transfer, the controller's Busy and Done flags are set according to the function specified by F. The contents of the specified AC remain unchanged. The format of the specified AC is as follows:

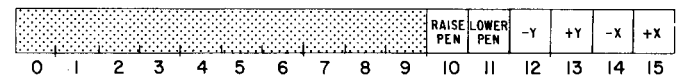

Bits	Name	Command If Set To 1
0-9	---	Reserved for future use.
10	Raise Pen	Raise the pen off the paper.
11	Lower Pen	Lower the pen to the paper.
12	-Y	Move 1 step in the minus Y direction.
13	+Y	Move 1 step in the plus Y direction.
14	-X	Move 1 step in the minus X direction.
15	+X	Move 1 step in the plus X direction.

PROGRAMMING

When the plotter has been placed on-line and the operator has positioned the paper, the pen and/or paper may be moved by the combination of a LOAD COMMAND BUFFER instruction (DOA) and a Start command. A LOAD COMMAND BUFFER instruction will load bits 10-15 of the specified accumulator into the controller's Command Buffer, ignoring the other bits. Once loaded, a Start command may be issued to move one step in the direction specified by the contents of the Command Buffer. A Start command sets the Busy flag to 1, the Done flag to 0, and sends the command to the plotter. When the plotter has completed the command, the Busy flag is set to 0, and the Done flag is set to 1, thus initiating a program interrupt request. Since a Start command does not alter the contents of the Command Buffer, a series of Start commands may be issued to repeat any step.

TIMING

The time required for a plotter to execute a command depends upon the plotting speed of the particular plotter being used. The following time intervals are measured from the time the Start command is issued to the time the Done flag is set to 1. If the plotting speed is 200 steps/second, the time required to execute any x-axis, y-axis or combination of x- and y-axis movement is 5ms. If the plotting speed is 300 steps/second, this time interval is 3.3ms. All pen-raising and pen-lowering commands in all plotters require 100ms for execution.

CONSIDERATIONS

Before the plotter is placed on-line, the operator should position the pen at a starting position which is determined by the greatest negative value of both x and y used by the plotting routine. An allowance should be made to provide for margins. After the plot is completed, the pen should always be raised to prevent damaging the plot, either by blots on the paper, or when the plot is removed.

Dotted lines may be generated by issuing a pen-raising or pen-lowering command with either an x-axis or a y-axis movement. The result of this type of command will be a line segment which is shorter than the basic step size. If a dotted line or if a line segment which is less than the step size is not wanted, the program should avoid issuing such a command.

If the program loads the Command Buffer with contradictory commands such as a plus x and a minus x together, the pen will not move along that axis. However, if a third command is specified without a contradiction, the plotter will execute that third command.

PROGRAMMING EXAMPLE

The following program illustrates the use of the incremental plotter as a stand-alone operation. The routine draws an isosceles right triangle with a dotted line dividing it in two.

```
;          PROGRAM TO DRAW AN ISOSCELES TRIANGLE ON PLOTTER
          .LOC      400
;          MAIN PROGRAM
START:    LDA      1,XLINE  ;LOAD DATA FOR +X LINE
          LDA      0,CNT1   ;LOAD # OF INCREMENTS
          JSR      LPEN    ;LOWER PEN
          JSR      DRAW    ;DRAW FIRST LINE
          LDA      1,ANGLE  ;LOAD DATA FOR HYPOTENUSE
          JSR      DRAW    ;DRAW IT
          LDA      1,YLINE  ;LOAD DATA FOR Y LEG
          JSR      DRAW    ;DRAW IT
          LDA      0,CNT2   ;LOAD NEXT # OF INCREMENTS
          LDA      2,CNT3   ;LOAD AC2 WITH # OF LOOPS
          STA      2,DSHCT  ;STORE IT
DLINE:    LDA      1,DSHD   ;LOAD DATA FOR DASHED LINE
          JSR      LPEN    ;LOWER PEN
          JSR      DRAW    ;DRAW IT
          JSR      RPEN    ;RAISE PEN
          JSR      DRAW    ;DRAW IT
          DSZ      DSHCT   ;END OF DASHED LINE?
          JMP      DLINE   ;GO BACK
          HALT
          JMP      START   ;PRESS CONTINUE TO REPEAT PROGRAM
```

(CONTINUED)

```

; SUBROUTINE TO DRAW A LINE
DRAW: STA 3,SAV3 ;STORE AC3
      STA 0,CNT ;STORE COUNTER
AGAIN: JSR TEST ;READY?
      DOAS 1,PLT ;DRAW INCREMENT
      DSZ CNT ;DONE?
      JMP AGAIN ;NO, DRAW AGAIN
      JMP @SAV3 ;YES, RETURN

; THIS ROUTINE LOWERS THE PEN
LPEN: STA 3,SAV3 ;SAVE AC3
      LDA 2,DOWN ;LOAD AC2 WITH LOWER-PEN COMMAND
      JSR TEST ;READY?
      DOAS 2,PLT ;LOWER PEN
      JMP @SAV3 ;RETURN

; THIS ROUTINE RAISES THE PEN
RPEN: STA 3,SAV3 ;STORE AC3
      LDA 2,UP ;LOAD AC2 WITH RAISE-PEN COMMAND
      JSR TEST ;READY?
      DOAS 2,PLT ;RAISE PEN
      JMP @SAV3 ;RETURN

; TEST FOR PLOTTER READY
TEST: SKPBZ PLT ;READY?
      JMP .-1 ;NO
      JMP 0,3 ;YES

;STORAGE AREA
CNT: 0 ;STORAGE LOCATION FOR SUBROUTINE COUNTER
CNT1: 600 ;LENGTH OF FIRST 3 LINES
CNT2: 10 ;LENGTH OF DASHES
CNT3: 14 ;# OF LOOPS FOR DASHED LINE
XLINE: 01 ;DRAW LINE + X
YLINE: 10 ;DRAW LINE - Y
ANGLE: 06 ;DRAW LINE -X,+Y

DOWN: 20 ;LOWER PEN
UP: 40 ;RAISE PEN
DSHD: 05 ;DRAW LINE +X,+Y
SAV3: 0
DSHCT: 0 ;COUNTER FOR DASHED LINE

.END START

```

SECTION IV

MAGNETIC TAPE

- **INDUSTRY COMPATIBLE
MAGNETIC TAPE SUBSYSTEMS**
- **DGC CASSETTE SUBSYSTEM**

This page intentionally left blank

INTRODUCTION TO MAGNETIC TAPES

Data General offers two very different types of magnetic tape subsystems, called "industry compatible" and "cassette". Since the two types are different, they are treated separately here.

INDUSTRY COMPATIBLE MAGNETIC TAPE TRANSPORTS

Industry compatible transports are popular for storing large quantities of information which the system can afford to have serially accessible. They are called industry compatible because they conform to an industry standard established so that such tapes can be moved among systems with compatible drives. These drives are therefore an invaluable tool for passing information among normally incompatible computer systems.

The basic recording medium is a magnetic material coated on one side of a long 1/2 inch strip of mylar (usually) tape. The tape is held on large interchangeable reels (up to 2400 feet per reel) which are mounted on the supply hub of any conforming transport. When the transport is recording or reading information, the tape is moved from the supply reel past read/write heads to a take-up reel. As it moves, the heads define parallel data tracks along the surface of the tape. There are either seven or nine tracks on the tape, each track having both a read head and a write head.

Two systems are used for recording data on tape: Non Return to Zero for ones (NRZI) and Phase Encoded (PE). These systems format the tape and record data bits differently. A tape written on a transport using one system can not be read on a transport using the other system. In general, the methods used for PE recording allow greater data density on the tape (higher bpi) than NRZI so that a tape can store more information.

Data Formats

Bits

Data is stored as a "magnetic event" on the tape by the write head in the transport. As the tape

moves past the write head, a sequence of data bits are written along the length of the tape. The number of data bits per inch (bpi) determines the data density for that transport. Some transports can be selected to operate at two densities.

Industry compatible tape transports contain either 7 or 9 write heads, allowing simultaneous recording of a number of parallel tracks along the length of the tape. The data bits written simultaneously by a number of heads, one bit in each track, define a character on the tape. Each character, therefore, appears across the width of the tape.

Characters and Bytes

A character is generally composed of a number of data bits and one parity bit. The data bits in a character are collectively called a byte. Seven track magnetic tape contains a 6-bit byte of data and a parity bit in each character; a 9-track tape contains an 8-bit byte of data and a parity bit.

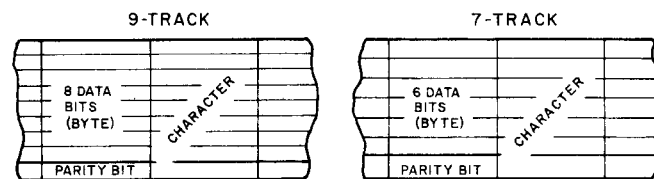

DG-00975

Since DGC computers utilize a 16-bit word length, two bytes from the tape are used to form one computer word as shown below. When a 9-track tape is used the two 8-bit bytes fill one computer word. However, 7-track tapes provide only 12 data bits for each computer word. The remaining four bits are ignored when writing data on tape. This means that all the 16-bit computer words have to be reformatted when writing a 7-track tape to avoid losing the contents of those four bits.

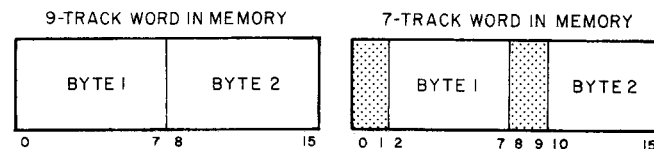

DG-00976

Records

Because the amount of data stored on magnetic tape usually contains several related computer words, the pairs of bytes on the tape for each word are grouped together to form records. A record consists of a number of words (pairs of bytes) which are separated from other records by gaps on the tape. The tape transport can only stop the tape in one of these inter-record gaps (IRG). The record is the smallest possible unit of information addressable on the tape.

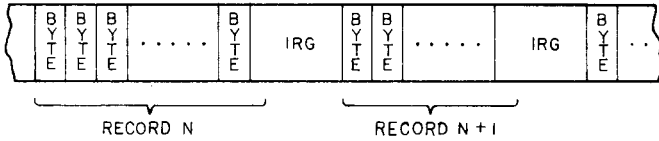

DG-00977

Files

Records can be grouped together in files. A file consists of related records and is separated from other files by delimiters called End Of File (EOF) marks.

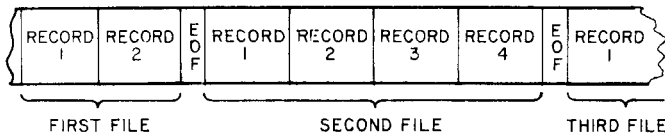

DG-00978

Beginning and End Of Tape Markers

The primary reference point on a magnetic tape is the Beginning Of Tape (BOT) marker. This indicator is a reflective tab, placed along one edge of the tape, which provides an absolute reference point for all tape operations. When an operator loads a tape on a transport, the transport positions the tape at the BOT mark. Since this placement occurs automatically on loading, the BOT position is sometimes referred to as the Load Point.

A similar reflective marker is used near the end of a tape. This indicator, called End Of Tape (EOT), is placed along the opposite edge of the tape from the BOT marker. The function of the EOT marker is to provide a warning to the programmer that the tape should not be moved forward lest it come off the supply reel.

Error Checking

NRZI

The tape passes the read heads immediately after it passes the write heads. This arrangement allows a read-after-write system of error checking which operates as follows: for NRZI systems, as each byte is received from the computer, the controller adds the correct parity bit and the resulting character is written on the tape. The character is then read by the read heads and a parity check is performed by the controller. If the parity is

incorrect, an error flag is set to 1. In addition to this lateral parity checking, a parity bit is written for each track on the tape when all the characters in the record have been written. This longitudinal parity check character (LPCC), which is separated from the data by an End Of Record (EOR) gap, is also checked by the controller in the read-after-write check system. This combination of lateral and longitudinal parity checks is also performed every time a record is read.

Nine-track tapes also have a cyclic redundancy check character (CRCC) written after the record to provide industry compatible tape formats.

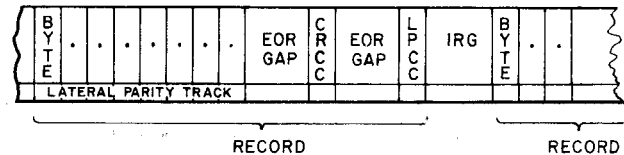

DG-00979

PE

Phase Encoded transports perform a similar read-after-write error check system. If a character in the record contains any errors, as determined by the lateral parity, an error flag is set to 1. However when a record is read, the PE transports have the capability of both detecting and correcting a bad track in the record. This error correction system operates as follows: when one of the tracks on the tape stops supplying data bits, that track is ignored for the rest of the record and the data bits for that track are reconstructed from the parity information. Thus, the failure of a single track on the tape does not mean a loss of data. If more than one track fails in a record, the data is lost. The preamble and postamble surrounding a record are used to synchronize the error correction system. They are transparent to the programmer.

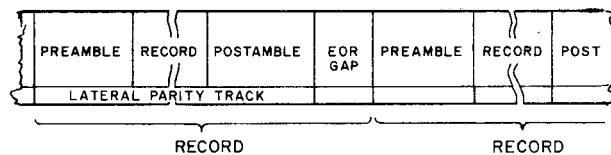

DG-00980

DGC CASSETTE TAPE TRANSPORTS

The DGC cassette tape subsystem is offered for applications where large amounts of data storage are not needed but a paper tape subsystem appears unwieldy. The data is stored on a single track of magnetic tape which is contained in a removable cassette. Each cassette contains the supply reel of tape as well as the take-up reel. When the transport is recording or reading information, the tape is moved from the supply reel past read/write heads, to a take-up reel. As it moves, the heads define a single data track along its length. There is only one track which has a separate read and write head.

Data Formats

Bits and Words

Since a DGC cassette transport records data on a single track along a length of magnetic tape, each bit of a 16-bit word is written sequentially along that track. Words are written consecutively with no gaps between them.

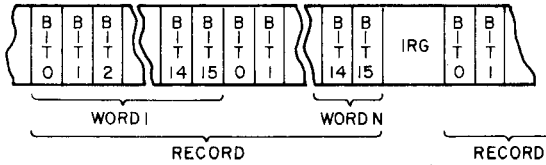

DG-00981

Records

Related words, forming a record, are grouped together and each record is separated from the adjacent records by gaps on the tape called inter-record (IRG) gaps. Just as in the industry compatible magnetic tapes, the record is the smallest addressable unit of information on a DGC cassette.

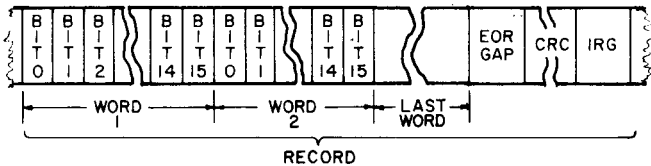

DG-00982

Files

Records can be grouped together in files. A file usually consists of related records and is separated

from other files by delimiters called End Of File (EOF) marks.

Beginning and End Of Tape Markers

Just as the larger industry compatible tapes have BOT and EOT markers, each cassette tape has a reflective leader and trailer which delimit the end of its tape. Since the cassette can be removed from the transport when the tape is positioned in any inter-record gap, each time a cassette is placed on a transport, the programmer should ascertain that the tape is at the BOT position before attempting any operations.

Error Checking

The read head is positioned so that the tape passes under it just after it passes the write head. This allows a read-after-write error check system which operates as follows: as the individual bits are written on the tape, the controller uses the bits to calculate a cyclic redundancy checkword (CRC). Once all the words in a record have been written, and an End Of Record (EOR) gap is inserted, this checkword is written.

While writing the record, the read portion of the transport reads the data from the tape and the controller independently calculates another checkword and compares it to the original checkword read from the tape at the end of the record. If these two checkwords differ, an error flag is set to 1. A similar check is performed each time a record is read.

Summary of Magnetic Tape Subsystem Specifications

Subsystem	Controller	Adapter	Transport	Number of Tracks	Density (bpi)	Tape Speed (ips)	Transfer Rate (Words/Sec)		Maximum Number of Transports/Subsystem	Storage Capacity/Unit (Million Words)	
							556 bpi	800 bpi		556 bpi	800 bpi
NRZI	4030	P R O V I D E D	4030I/P	7	556 or 800	45	12,600	18,000	8	7.5	11
			4030J/R	9	800	45	N/A	18,000		N/A	11
			4030K/S	7	556 or 800	12.5	3,480	5,000		7.5	11
			4030L/T	9	800	12.5	N/A	5,000		N/A	11
			4030M/U	7	556 or 800	75	21,000	30,000		7.5	11
			4030N/W	9	800	75	N/A	30,000		N/A	11
			6020/6022 6024	7	556 or 800	75	21,000	30,000		7.5	11
			6021/6023 6025	9	556 or 800	75	21,000	30,000		7.5	11
PE	4196	Provided with 4196A only	4196A/B	9	1600	45	36,000 @ 1600bpi	4	22 @ 1600bpi		
Cassette	4076	Provided	4080, 4081 4084, 4087 4088, 4089	1	430 (Average)	30 (Average)	750	8	.067		

DG-00984

This page intentionally left blank

INDUSTRY COMPATIBLE MAGNETIC TAPE SUBSYSTEMS

SUMMARY

MNEMONIC (FIRST CONTROLLER)..... MTA
 DEVICE CODE (FIRST CONTROLLER) 22₈
 MNEMONIC (SECOND CONTROLLER).... MTA1
 DEVICE CODE (SECOND CONTROLLER) 62₈
 PRIORITY MASK BIT..... 10
 MAXIMUM REEL SIZE (INCHES) 10 1/2
 WORDS/RECORD 2 to 65,536
 MAXIMUM STORAGE CAPACITY
 (WORDS)..... 7,500,000 to 22,000,000
 MAXIMUM TRANSFER RATE
 (WORDS/SEC) 3,480 to 36,000
 MAXIMUM ALLOWABLE DATA
 CHANNEL LATENCY (μSEC).... 432 to 13.8

DATA FORMATS

SEVEN TRACK

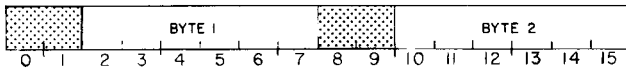

NINE TRACK

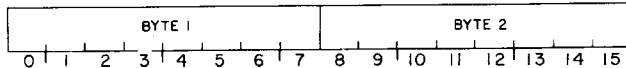

ACCUMULATOR FORMATS

SPECIFY COMMAND AND UNIT (DOA)

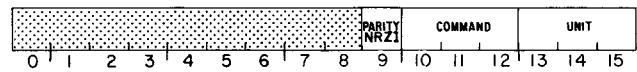

COMMANDS

000	Read	100	Space Reverse
001	Rewind	101	Write
010	Reserved	110	Write EOF
011	Space Forward	111	Erase

READ STATUS.....(DIA)

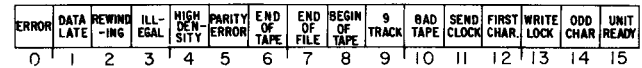

LOAD MEMORY ADDRESS COUNTER (DOB)

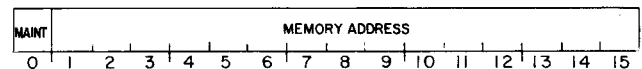

READ MEMORY ADDRESS COUNTER(DIB)

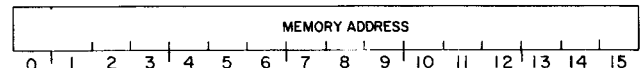

LOAD WORD COUNTER(DOC)

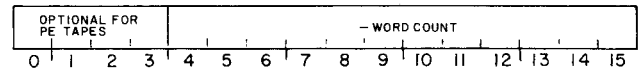

S, C AND P FUNCTIONS

- S Set Busy to 1, Done to 0 and start the command.
- C Set all error flags to 0, select unit 0 as the addressed transport and Read command.
- P No effect.

NINE TRACK NRZI TAPE FORMAT

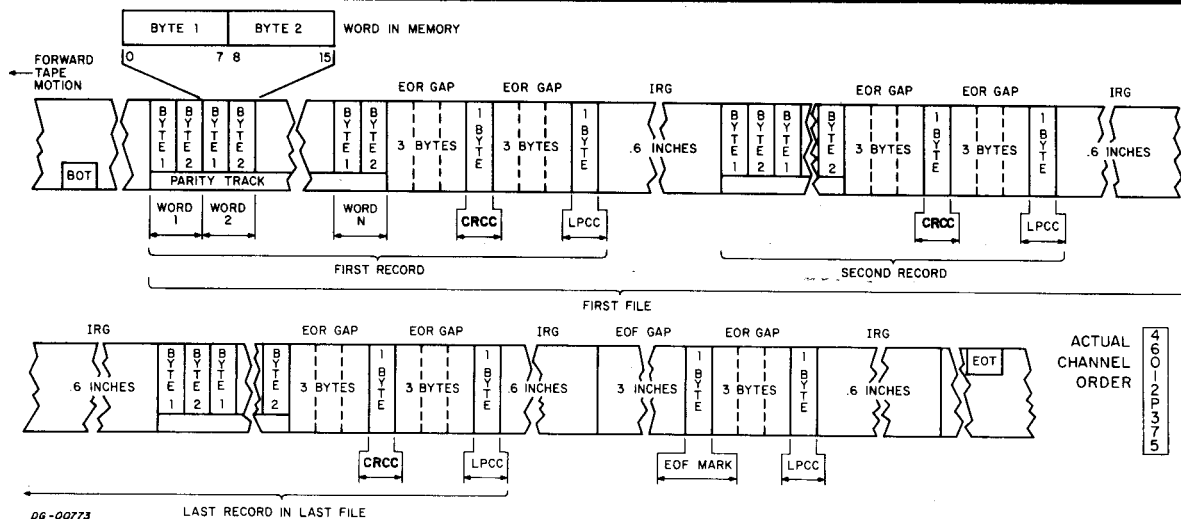

SEVEN TRACK NRZI TAPE FORMAT

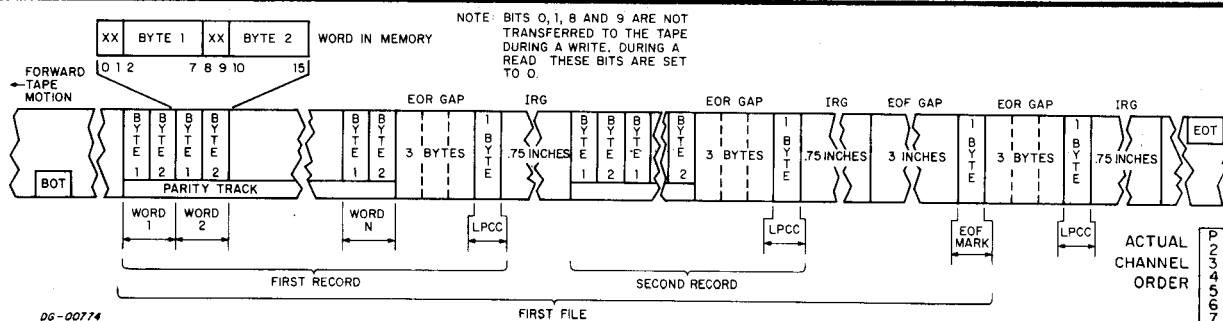

NINE TRACK PE TAPE FORMAT

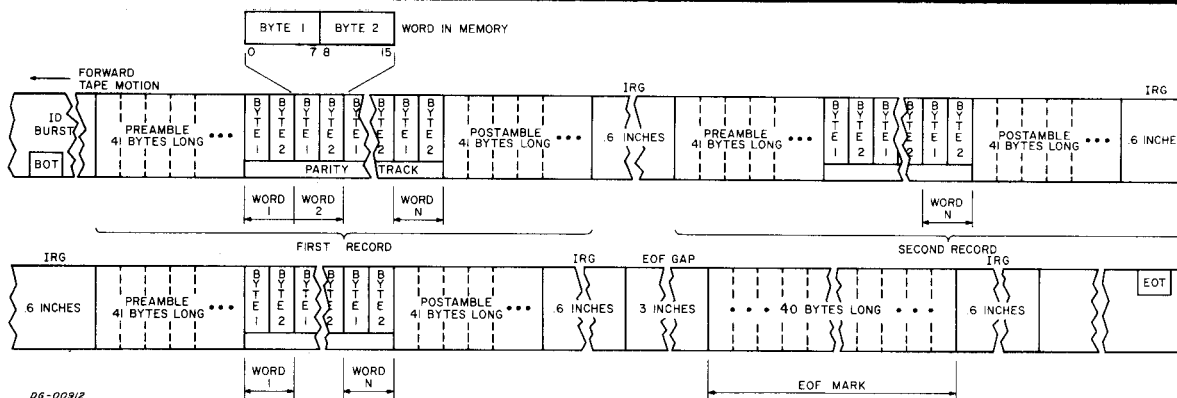

Abbreviation	Name	Description
BOT	BEGINNING OF TAPE	A reflective marker at the beginning of the tape.
CRC	CYCLIC REDUNDANCY CHECK CHARACTER	A checksum calculated from and used to validate all the data in the preceding record on 9-track tapes.
EOR	END OF RECORD GAP	A blank section of tape written by the controller to indicate either the end of the data in a record or the end of the CRC.
EOT	END OF TAPE	A reflective marker at the end of the tape.
ID BURST	IDENTIFICATION BURST	A code written by the controller on phase encoded tapes to identify them as such.
IRG	INTER-RECORD GAP	A blank section of tape written by the controller after the postamble when the tape transport stops and restarts for the next record.
	PREAMBLE	A forty-one byte field used on phase encoded tapes to synchronize the controller. It is written by the controller before each record.
	POSTAMBLE	A forty-one byte field used in phase encoded tapes to signify the end of the record. It is written by the controller.
LPCC	LONGITUDINAL PARITY CHECK CHARACTER	A character which provides the correct longitudinal parity for each track on the tape.

INTRODUCTION

Data General supplies two types of industry compatible tape subsystems, NRZI and PE. NRZI tape drives are available in both 7- and 9-track format; at 556 and 800 bits per inch (bpi); and in even or odd parity. The PE tape drive operates at 1600bpi in 9-track format. Depending on the particular transport, the data transfer rate ranges from 3,480 words/second to 36,000 words/second.

The controller used in the NRZI subsystem can simultaneously accommodate up to eight transports in any combination. The controller used in the PE subsystem can accommodate up to 4 transports. In either type of subsystem, only one transport can be reading, writing or spacing at any one time, but any number of transports can be rewinding simultaneously.

Records on the tape are composed of groups of words ranging in length from 2 to 65,536 words per record, depending on the subsystem. Files are composed of groups of records. The format of the record and file structure is shown on the opposite page. The number of files which can be placed on a reel of tape is dependent on the length of the tape, the information density, the number of words per record and the number of records per file. A full 10 1/2 inch reel of 1.5 mil tape can store more than 11 million 16-bit words in an NRZI subsystem or more than 22 million 16-bit word in a PE subsystem.

Data is verified during Write operations by a combination of lateral and longitudinal parity checks in a read-after-write error checking system. The same system is used when the tape is read.

INSTRUCTIONS

The tape transport controller contains four registers: a 15-bit Memory Address Counter, a 16-bit Status Register, a 12- or 16-bit Word Counter, and a 6- or 7-bit combined Command/Transport Select Register. The Memory Address Counter is self-incrementing and contains the memory location of the next word to be either read from or written on the tape. The Status Register contains all the information flags for the controller and the selected transport. The Word Counter contains the two's complement of the number of words to be read from or written on the tape or the two's complement of the number of records to be skipped in a spacing operation. The combined Command/Transport Select Register contains the last command issued to the tape subsystem and the unit number of the transport currently selected.

Five instructions are used to program data channel transfers to and from the tape subsystem. Three of these instructions are used to supply all of the necessary data to the controller for any tape operation. The remaining two instructions allow the program to determine, in detail, the current state of the selected tape transport.

The tape subsystem controller's Busy and Done flags are controlled using two of the device flag commands as follows:

- f=S Set the Busy flag to 1, the Done flag to 0 and set the transport in operation for the command contained in the Command Register. Providing the Illegal flag is set to 0, all error indicating flags in the Status Register are set to 0.
- f=C Set the Busy flag, the Done flag, and all error indicating flags in the Status Register to 0. The error indicating flags are: Data Late, Illegal, Parity Error, Bad Tape, End Of File, and Odd Character. After a Clear command is issued, the selected transport is unit 0 and the specified command is Read.
- f=P No effect.

SPECIFY COMMAND AND UNIT

DOA <f> ac, MTA

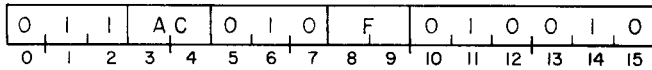

Bits 9-15 of the specified AC are loaded into the combined Command/Transport Select Register. Bits 0-8 are ignored. After the data transfer, the controller's Busy and Done flags are set according to the function specified by F. The contents of the specified AC remain unchanged. The format of the specified AC is as follows:

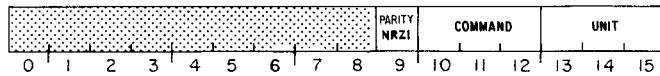

Bits	Name	Function
0-8	----	Reserved for future use.
9	Parity (NRZI)	For NRZI, 0 selects odd parity; 1 selects even parity. If even parity is selected, a series of null bytes in a record could be interpreted as an inter-record gap, resulting in an error condition. This bit is ignored by the Phase Encoded controller.
10-12	Command	Select the command for the selected transport as follows: 000 Read 001 Rewind 010 Reserved for future use 011 Space forward 100 Space reverse 101 Write 110 Write End Of File 111 Erase
13-15	Unit	Select transport 0-7 for NRZI or 0-3 for PE.

READ STATUS

DIA <f> ac, MTA

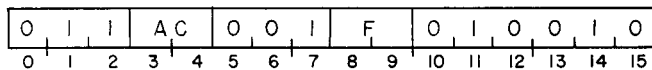

The contents of the Status Register are placed in bits 0-15 of the specified AC. After the data transfer, the controller's Busy and Done flags are set according to the function specified by F. The format of the specified AC is as follows:

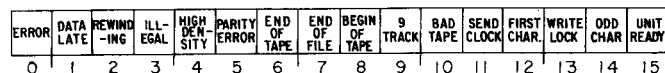

Bits	Name	Meaning When 1
0	Error	One or more of the bits 1, 3, 5, 6, 7, 8, 10 and 14 is 1.
1	Data Late	The data channel failed to respond in time to a data channel request.
2	Rewinding	The selected transport is currently rewinding.
3	Illegal	A Start command was issued to the selected transport when one of the following conditions existed: 1. The transport was not ready. 2. The command was Space Reverse and the tape was at the beginning of tape leader. 3. The command was Write, Write End Of File or Erase when the tape was write-protected.
4	High Density	The selected NRZI transport is set to Read or Write at 800bpi. This bit is always 1 for PE transports (1600bpi).
5	Parity Error	One or more bytes in the record did not have the correct parity, or in NRZI, tapes the LPCC read from the tape after the record did not match the character calculated by the controller.
6	End Of Tape	The transport has reached or passed the End Of Tape mark. Executing either a Space Reverse or a Rewind operation will set this bit to 0.
7	End Of File	The transport has encountered an End Of File mark in reading, spacing or after writing an EOF mark.
8	Begin Of Tape	The tape is at the beginning of tape mark.
9	9-Track	The selected transport is set to Read or Write a 9-Track tape. This bit is always 1 for PE transports.
10	Bad Tape	The section of tape just processed is of poor quality.
11	Send Clock	Used for maintenance.
12	First Character	Used for maintenance.
13	Write Lock	The tape on the selected transport is write-protected.
14	Odd Character	The record just read or written contains an odd number of bytes.
15	Unit Ready	The selected transport is ready.

LOAD MEMORY ADDRESS COUNTER

DOB <f> ac, MTA

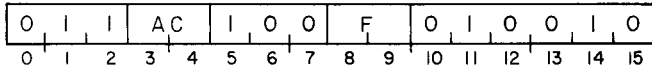

Bits 0-15 of the specified AC are loaded into the Memory Address Counter. After the data transfer, the controller's Busy and Done flags are set according to the function specified by F. The contents of the specified AC remain unchanged. The format of the specified AC is as follows:

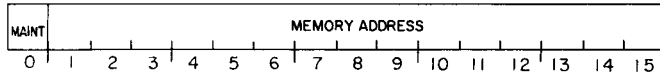

Bits	Name	Function
0	Maintenance	When set to 1, this bit places the NRZI subsystem in the maintenance mode of operation. This mode allows the cyclic redundancy check character used on 9-track NRZI tapes to be read into the memory location following the last data word in memory for the record.
1-15	Memory Address	Location of the next word in memory to be used for a data channel transfer

LOAD WORD COUNTER

DOC <f> ac, MTA

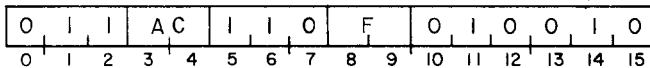

Bits 4-15 of the specified AC are loaded into the controller's Word Counter. Bits 0-3 are ignored. After the data transfer, the controller's Busy and Done flags are set according to the function specified by F. The contents of the specified AC remain unchanged. The specified AC must contain the two's complement of the number of words to be transferred with the stipulation that the minimum number of words to be transferred is 2 and the maximum is 4096 for NRZI and 65,536 for PE.

During a spacing operation, the Word Counter acts as a record counter. The specified AC must contain the two's complement of the number of records to be skipped with the stipulation that the minimum number of records to be skipped is 1 and the maximum is 4096 for NRZI and 65,536 for PE. The format of the specified AC is as follows:

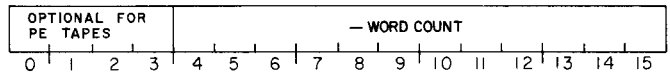

Bits	Name	Function
0-3	----	Reserved for future use in NRZI controller.
4-15 or 0-15	-Word Count	Two's complement of number of words to be transferred or records to be skipped.

READ MEMORY ADDRESS COUNTER

DIB <f> ac, MTA

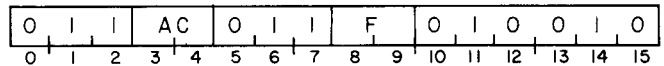

The contents of the Memory Address Counter are placed in bits 0-15 of the specified AC. After the data transfer, the controller's Busy and Done flags are set according to the function specified by F. When the Memory Address Counter is read after a Read or a Write operation, the contents point to a memory location one greater than the location of the last word transferred. The format of the specified AC is as follows:

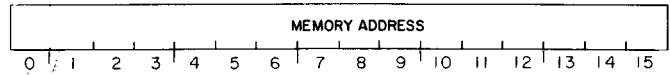

Bits	Name	Function
0-15	Memory Address	Location of the next word in memory to be used for a data channel transfer.

PROGRAMMING

The preparation of a magnetic tape subsystem for a data channel transfer can be divided into three distinct phases: I, initializing the transport, II, positioning the tape; and III, specifying the length of the transfer, the starting memory address, and issuing the tape command. Once the first two phases are completed, the program can repeatedly execute the third phase. The results of issuing commands in each phase should be checked for errors before proceeding to the next phase.

Phase I: Initializing

The desired transport is selected in Phase I by issuing a SPECIFY COMMAND AND UNIT instruction (DOA) to the controller. The Status Register is examined by a READ STATUS instruction (DIA) to determine if the tape is 7- or 9-track, high (800bpi) or low (556bpi) density, and whether the transport is in the ready state. The 7- or 9-track test is used to determine if the data has to be reformatted; the high or low density test is used to determine the times needed for data transfer; and the ready test determines if the transport is available to the program. The transport should be initialized by issuing a Rewind command if the tape is not located at the Beginning Of Tape mark. The Rewind command can be executed providing the transport is ready and the Illegal flag is set to 0. If the Illegal flag is set to 1 in the Status Register, a Clear command can be issued. The transport is then selected and a Rewind command specified by issuing a SPECIFY COMMAND AND UNIT instruction. The operation is initiated by issuing a Start command. The Start command sets the Rewinding flag to 1 in the Status Register but does not set either the Busy flag or the Done flag to 1. The controller does not initiate a program interrupt request when the rewinding operation is completed. However, the Rewinding flag will be set to 0 in the Status Register upon completion of the program.

Once the tape has been rewound and no error conditions are detected in the Status Register, the program may proceed to Phase II.

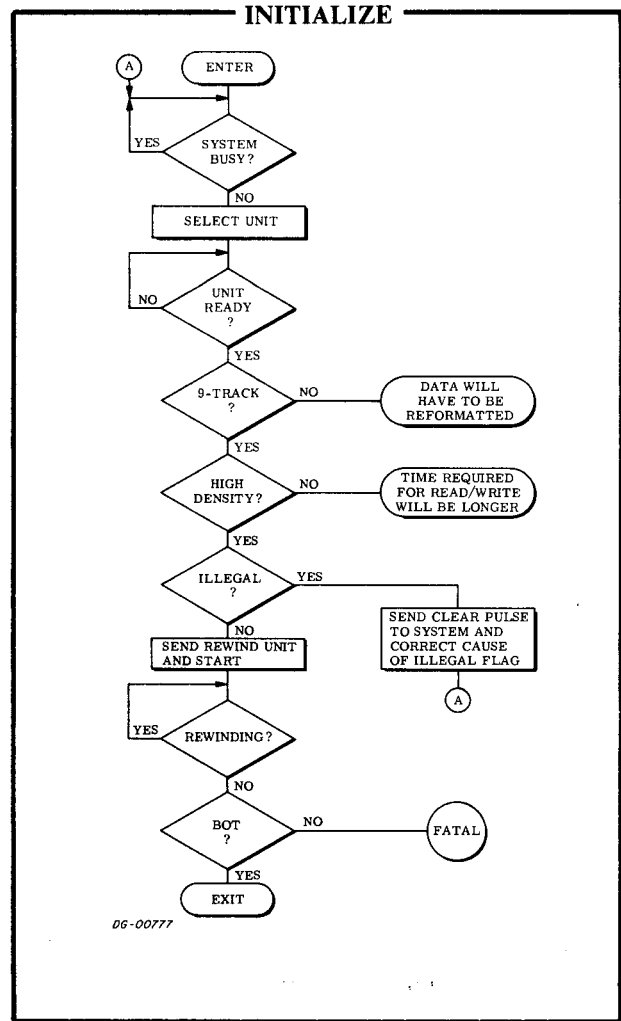

Phase II: Position the Tape

In order to access the desired record on the magnetic tape for a Read or a Write operation, the tape should be spaced to the position immediately preceding that record. During the spacing operation, the Word Counter is used as a record counter, incrementing once for each record skipped. The spacing operation terminates when the Word Counter overflows or when an End Of File mark is encountered. The minimum number of records which can be skipped in one operation is one and the maximum is 4096 for NRZI or 65,536 for PE.

The spacing operation is performed as follows: the command is loaded into the Command Register with a SPECIFY COMMAND AND UNIT instruction (DOA), and the two's complement of the number of records to be skipped is specified with a LOAD WORD COUNTER instruction (DOC). The spacing operation is initiated with a Start command appended to the last of these instructions issued. The Busy flag is set to 1 and the Done flag is set to 0 during spacing. Upon completion of the operation, the Busy flag is set to 0 and the Done flag is set to 1, thus initiating a program interrupt request.

If the desired record is contained in another file, the Space Forward command must be issued at least once for each file to be skipped. When a file is to be skipped, the Word Counter must be loaded with the two's complement of a count greater than or equal to the number of records contained in that file. Since a file may contain more than the maximum number of records which can be skipped in one operation, the Space Forward command may have to be executed several times (reloading the Word Counter each time) before the file is skipped. Every time an End Of File mark is encountered in a spacing operation, the operation stops, both the End Of File flag and the Error flag are set to 1 in the Status Register, the Busy flag is set to 0, the Done flag is set to 1, and a program interrupt request is initiated.

Once the tape drive has reached the correct file, the tape should be positioned immediately before the desired record in that file.

The Space Reverse command operates in a manner entirely analogous to the Space Forward command. After a Space Reverse command is executed as many times as is necessary to skip a file, the tape is positioned immediately after the last record in the preceding file.

Care should be taken so that a Space Forward command is not executed when the End of Tape flag is set to 1 in the Status Register.

Once the tape is in position for a Read or a Write operation and no errors are detected in the Status Register, the program may proceed to Phase III.

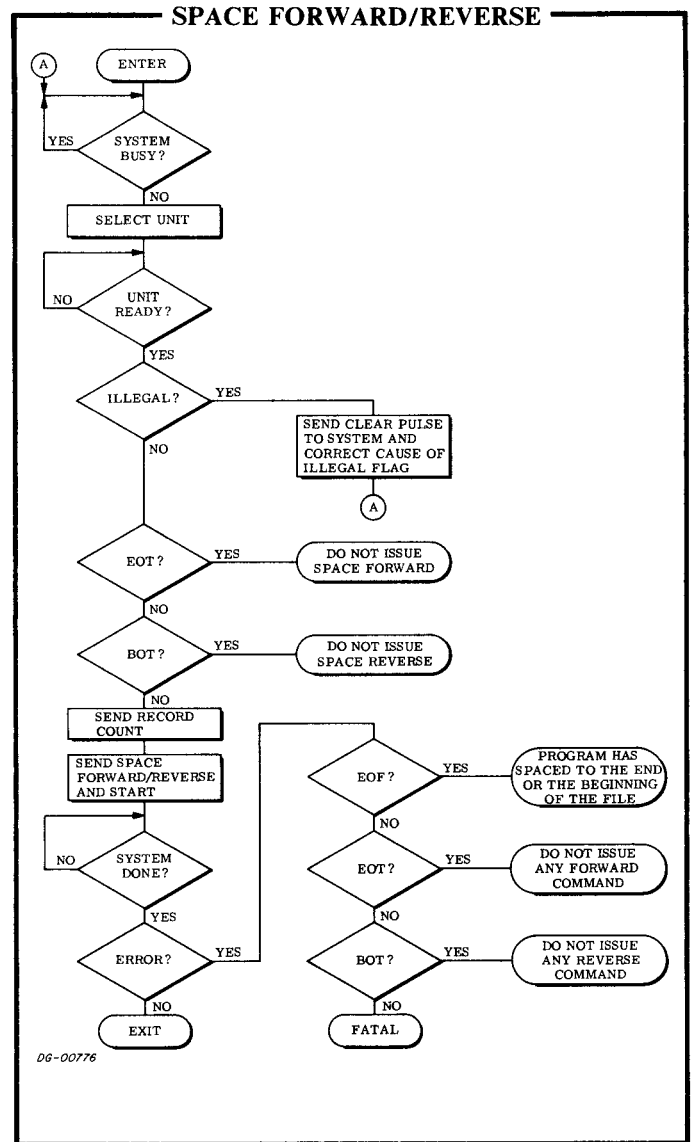

Phase III: Read or Write

Phase III consists of specifying the starting location in memory for the first word to be transferred, loading the Word Counter with the two's complement of the number of words to be transferred and issuing either a Read or a Write command together with a Start command to the desired transport.

Read

Read operations are performed as follows: the storage location in memory for the first word to be read from the tape is specified by a LOAD MEMORY ADDRESS COUNTER instruction (DOB). The two's complement of the number of words to be read is then specified by a LOAD WORD COUNTER instruction (DOC). If the record to be read is of unknown length, giving the two's complement of the longest possible record, i.e., 0, assures that the entire record will be read. The desired transport is selected and the Read command is loaded into the Command Register with a SPECIFY COMMAND AND UNIT instruction (DOA). A Start command in the last of these instructions initiates the Read operation.

Once the Read command is initiated, the tape is moved past the heads and the first two bytes in the record are assembled into one word. The word is then written into memory via the data channel. Each time a word is transferred to memory, the Word Counter is incremented by one.

The Read operation will continue until either the Word Counter overflows or the transport encounters an End Of Record gap. If the record read was of unknown length and was read by loading a zero in the Word Counter, the length can be determined by obtaining the address of the last word read into memory. This address is obtained by issuing a READ MEMORY ADDRESS COUNTER instruction (DIB). The address returned is one greater than the address of the last word written in memory by the Read operation. Therefore, subtracting the starting memory location from the address returned by a READ MEMORY ADDRESS COUNTER instruction will yield the length of the record read.

Whenever the End Of Tape flag is set to 1 in the Status Register, care should be taken to ensure that the tape does not come off the supply reel.

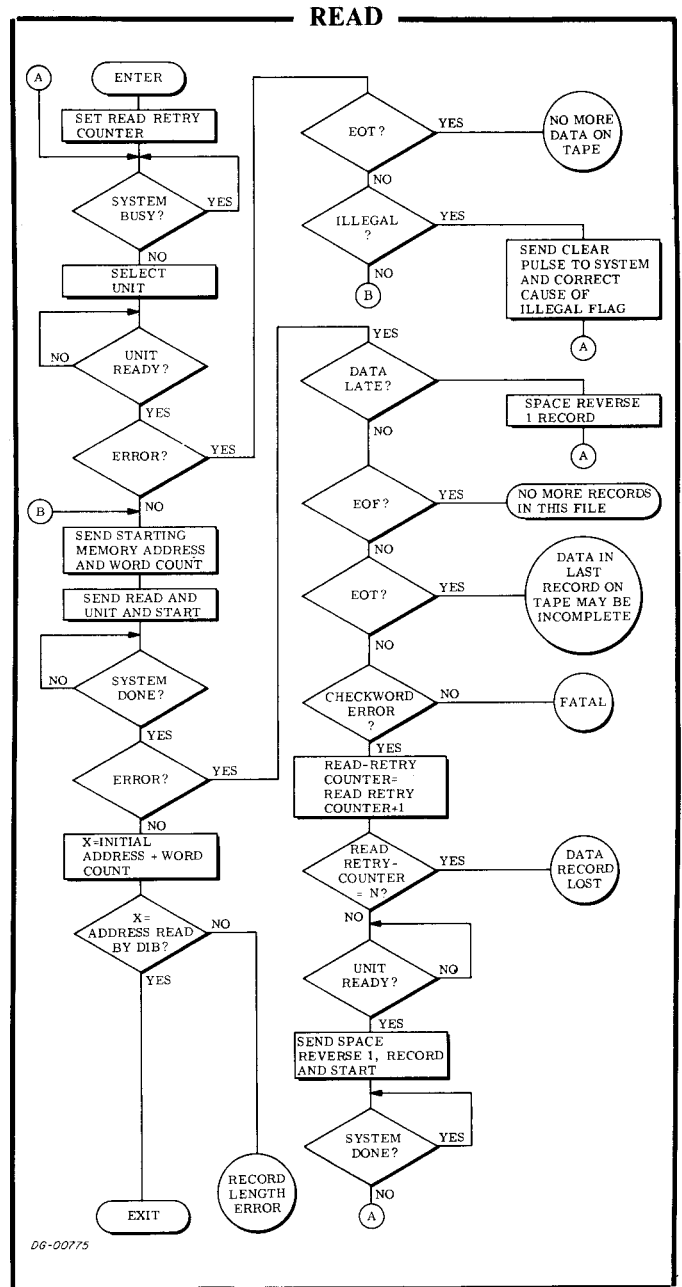

Write

Write operations (Write, Write End Of File, and Erase) are performed as follows: for a Write command, the storage location in memory for the first word to be written on the tape is specified by a LOAD MEMORY ADDRESS COUNTER instruction (DOB). The two's complement of the number of words to be written is then specified by a LOAD WORD COUNTER instruction (DOC). The desired transport is selected and the Write command is loaded into the command register with a SPECIFY COMMAND AND UNIT instruction (DOA). A Start command in the last of these instructions issued initiates the Write operation.

Once the Write command is initiated, a word is read from memory, the tape is moved past the heads, and the two bytes of the word are written on the tape. Each time the controller receives a word from memory, the Word Counter is incremented. Once the Word Counter overflows, the NRZI controller writes the cyclic redundancy check character and the LPCC character on 9-track tapes or, on 7-track tapes, the NRZI controller writes only the LPCC. The PE controller adds the postamble when the Word Counter overflows. In all cases, the Busy flag is set to 0, the Done flag is set to 1 and a program interrupt request is initiated.

Write End Of File and Erase commands are accomplished by selecting the desired transport and loading the desired command into the Command Register with a SPECIFY COMMAND AND UNIT instruction. A Start command initiates the operation.

The Write End Of File command erases 3 inches of tape and writes an End Of File mark on the tape after the inter-record gap. Upon completion of this operation, the Busy flag is set to 0, the Done flag is set to 1 and a program interrupt request is initiated. Since the transports perform a read-after-write error check, both the End Of File flag and the Error flag are set to 1 in the Status Register each time a correct End Of File mark is written.

NOTE An End Of File mark must be written in even parity on a 7-track NRZI tape.

The Erase command erases approximately 2 1/2 inches of tape each time it is issued. Erase can be used to skip bad sections of tape. Once the Erase operation has been completed, the Busy flag is set to 0, the Done flag is set to 1 and a program interrupt request is initiated.

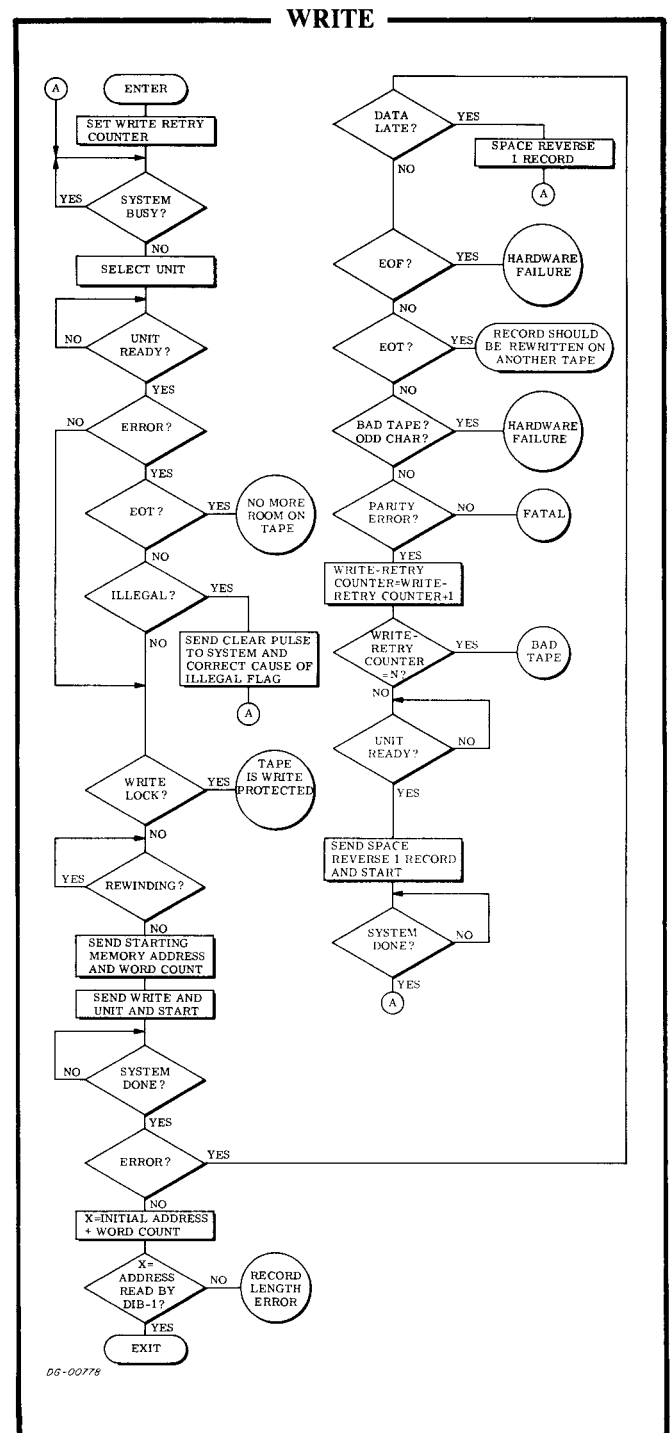

TIMING

The timing specifications and the controller's data channel rates and latencies for the various transports are listed below. All the timing considerations for the NRZI transports are identical for both the 7- and 9-track units; the differences appear when comparing 556 and 800bpi data densities. The start delays are measured from the time a Start command is issued to the time the transport

begins reading or writing a record. The stop time is divided into three segments: last character to stop, delay time, and settle time. Last character to stop is the time from the last character in the record to the beginning of the stop delay. The delay time allows the record to move completely past the read/write heads. The settle time allows the tape to stabilize in the rest position. The sum of these three times is the total stop time.

Industry Compatible Magnetic Tape Transport Specifications

Model	No. of Tracks	Tape Speed (in/sec)	Density (bpi)	Transfer Rate (Kwords/sec)				Time/Word (μ sec)				Maximum Allowable Data Channel Latency (μ s)				Start Time (ms)				Last Character To Stop (ms)				Stop Delay (ms)				Settle Time (ms)	Total Stop Time (ms)			
				556		800		556		800		556		800		556		800		556		800		556		800			556		800	
				Read	Write	Read	Write	Read	Write	Read	Write	Read	Write	Read	Write	Read	Write	Read	Write	Read	Write	Read	Write	Read	Write	Read	Write		Read	Write	Read	Write
4030I/P	7	45	556/800	12.6	18	80	56	120	84	22.5	15.0	15	10.0	.11	.07	3.5	3.5	2.5	1.7	5.0	3.3	13.0	15.6	14.8	21.5	19.8						
4030J/R	9	45	800	---	18	---	56	---	84	---	15.0	---	10.0	---	.07	---	3.5	---	1.7	---	3.3	13.0	---	14.8	---	19.8						
4030K/S	7	12.5	556/800	3.48	5	288	200	432	288	90	60	56	37	4.5	3.0	12.5	12.5	8.5	5.7	18	12	30.0	43.0	38.7	60.5	54.5						
4030L/T	9	12.5	800	---	5	---	200	---	288	---	60	---	37	---	3.0	---	12.5	---	5.7	---	12	30.0	---	38.7	---	54.5						
4030M/U	7	75	556/800	21	30	48	33.3	72	50	20.3	14.0	9.6	6.4	.08	.05	2.0	2.0	1.5	1.0	9.6	6.4	10.0	11.58	11.05	21.6	18.4						
4030N/W	9	75	800	---	30	---	33.3	---	50	---	14.0	---	6.4	---	.05	---	2.0	---	1.0	---	6.4	10.0	---	11.05	---	18.4						
6020/6022 6024	7	75	556/800	21	30	48	33.3	72	50	20.3	14.0	9.6	6.4	.08	.05	2.0	2.0	1.5	1.0	9.6	6.4	10.0	11.58	11.05	21.6	18.4						
6021/6023 6025	9	75	556/800	21	30	48	33.3	72	50	20.3	14.0	9.6	6.4	.08	.05	2.0	2.0	1.5	1.0	9.6	6.4	10.0	11.58	11.05	21.6	18.4						
4196A/B	9	45	1600	36		27.8		13.8		12.9		10.6		0.6		3.9		1.8		3.5		14.0	16.4		21.4							

ERROR CONDITIONS

During Initializing

If a Start command is given when the selected unit is not ready to carry out a command, both the Illegal flag and the Done flag will be set to 1. The Illegal flag can be set to 0 only with a Clear command or an I/O RESET instruction. The Clear command sets all the error indicating flags in the Status Register to 0 and sets the Command/Transport Select Register to 0. Therefore, unit 0 is the selected transport and Read is the specified command after a Clear command or an I/O RESET instruction is issued. The Status flags read by a READ STATUS instruction (DIA) pertain to unit 0 until another transport is selected.

During Positioning

Both the Illegal flag and the Error flag are set to 1 in the Status Register when a Spacing command is issued to a transport which is not ready or if a Space Reverse command is issued when the tape is at the BOT mark. The Busy flag is set to 0, the Done flag is set to 1, and a program interrupt request is initiated.

During Reading

If the data channel does not respond in time to a data channel request, both the Data Late flag and the Error flag will be set to 1 in the controller's Status Register, but the Read operation will continue until either the Word Counter overflows or the transport encounters an End Of Record gap on the tape. The Data Late flag indicates that at least one word on the tape was not correctly transferred to memory. If the transport encounters an End Of File mark, the Error flag, together with the End of File flag, is set to 1 in the controller's Status Register. Busy is set to 0, Done is set to 1 and a program interrupt request is initiated.

If any character in the record has incorrect parity, both the Error and Parity Error flags are set to 1, and the reading of the record will continue.

Once the transport encounters the end of the data in a record or the Word Counter overflows, the NRZI controller reads the LPCC and if the LPCC does not match the LPCC calculated by the controller, the Parity Error flag is set to 1 in the Status Register. The correct LPCC for the entire record will be read even if the program reads only a portion of the record.

During Writing

If the selected transport is not ready to receive a command or, if the tape mounted on the selected transport is write-protected and a Write operation is specified, the Start command will set the Error flag, the Illegal flag and the appropriate error condition flag in the controller's Status Register to 1. Busy will be set to 0, Done will be set to 1 and a program interrupt request is initiated.

If the data channel does not respond in time to a data channel request, both the Data Late flag and the Error flag will be set to 1 in the Status Register and for P.E. drives, the Write operation will continue until the Word Counter overflows. A Data Late flag on NRZI drives forces the record to end after the next full word. The normal EOR gaps, check characters and IRG are then written.

If the End Of File mark contains an error, the controller will interpret the mark as a short data record and a Parity Error will occur on every subsequent Read operation of that section of tape. A defective End Of File mark will also be interpreted as a data record during spacing operations. The EOF mark must be written in even parity on 7-track NRZI tapes.

DGC CASSETTE SUBSYSTEM

INTRODUCTION

Each DGC cassette has a maximum storage capacity of 67,000 words (134,000 eight-bit bytes). The actual capacity of a DGC cassette is determined by the record and file structure used. Differences in capacity are due to the amount of tape used for inter-record gaps and End Of File marks. Reducing the number of these gaps and marks allows more data to be stored on a DGC cassette. The following table gives the capacities for several schemes of storing data on a DGC cassette.

Words/Record	Records/File	Files/DGC cassette	Total Words/DGC cassette
16	16	64	16K
64	16	32	36K
128	16	22	44K
4096	14	1	56K

RECORD & FILE FORMATS

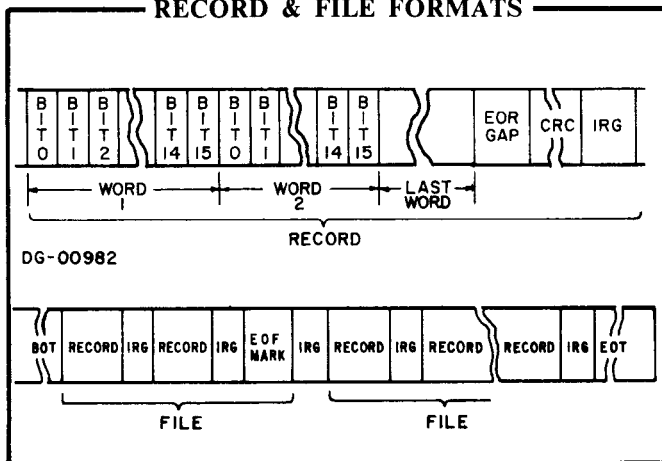

The data stored on a DGC cassette is verified by the calculation of a cyclic redundancy checkword (CRC) in a read-after-write checking system. The same system is used when a record is read.

SUMMARY

MNEMONIC (FIRST CONTROLLER) CAS	
DEVICE CODE (FIRST CONTROLLER)	348
MNEMONIC (SECOND CONTROLLER) CAS1	
DEVICE CODE (SECOND CONTROLLER)	748
PRIORITY MASK BIT	10
LENGTH OF TAPE (FEET)	200
RECORDS/FILE	1 to 4096
WORDS/RECORD	2 to 4096
MAXIMUM TRANSFER RATE (WORDS/SEC)	750
MAXIMUM STORAGE CAPACITY (WORDS/CASSETTE)	67,000
MAXIMUM ALLOWABLE DATA CHANNEL LATENCY (μ SEC)	28

ACCUMULATOR FORMATS

SPECIFY COMMAND AND UNIT (DOA)

										COMMAND	UNIT					
0	1	2	3	4	5	6	7	8	9	10	11	12	13	14	15	
000	001	010	011	100	101	110	111	RESERVED	SPACE FORWARD	100	101	110	111	SPACE REVERSE	WRITE EOF	ERASE

READ STATUS (DIA)

ERROR	DATA LATE	RE-WINDING	ILLEGAL	PARITY ERROR	END OF TAPE	END OF FILE	BEGINNING OF TAPE	WRITE FAIL	WRITE LOCK	UNIT READY					
0	1	2	3	4	5	6	7	8	9	10	11	12	13	14	15

LOAD WORD COUNTER (DOC)

- WORD COUNT															
0	1	2	3	4	5	6	7	8	9	10	11	12	13	14	15

LOAD MEMORY ADDRESS COUNTER . . . (DOB)

MEMORY ADDRESS															
0	1	2	3	4	5	6	7	8	9	10	11	12	13	14	15

READ MEMORY ADDRESS COUNTER . . . (DIB)

MEMORY ADDRESS															
0	1	2	3	4	5	6	7	8	9	10	11	12	13	14	15

S Set Busy to 1, Done to 0 and all error indicating flags to 0 and start the command. If Illegal is set to 1, S has no effect.

C Set Busy, Done and all error indicating flags to 0, select unit 0 as the addressed transport and specify a Read command.

P No effect.

INSTRUCTIONS

The DGC cassette controller contains four registers: a 15-bit Memory Address Counter, a 16-bit Status Register, a 12-bit Word Counter, and a 6-bit combined Command/Transport Select Register. The Memory Address Counter is self-incrementing and contains the memory location of the next word to be either read from or written on the tape. The Status Register contains all the information flags for the controller and the selected transport. The Word Counter contains the two's complement of the number of words to be read from or written on the DGC cassette or the two's complement of the number of records to be skipped in a spacing operation. The combined Command/Transport Select Register contains the last command issued to the DGC cassette subsystem and the unit number of the transport currently selected.

Five instructions are used to program data channel transfers to and from the DGC cassette subsystem. Three of these instructions are used to supply all of the necessary data to the controller for any DGC cassette operation. The remaining two instructions allow the program to determine, in detail, the current state of the selected DGC cassette transport.

The DGC cassette subsystem controller's Busy and Done flags are controlled using two of the device flag commands as follows:

f=S Set the Busy flag to 1, and the Done flag to 0. If the Illegal flag is 0, all other error indicating flags are set to 0, and the transport initiates the operation specified in the Command Register. If the Illegal flag is 1, the Busy flag is set to 0, the Done flag is set to 1, and a program interrupt request is initiated.

f=C Set the Busy flag, the Done flag, and all error indicating flags in the Status Register to 0. The error indicating flags are: Error, Data Late, Illegal, Checkword Error, Write Fail, and End Of File. After a Clear command is issued, the selected transport is unit 0 and the specified command is Read.

f=P No effect.

SPECIFY COMMAND AND UNIT

DOA<f> ac, CAS

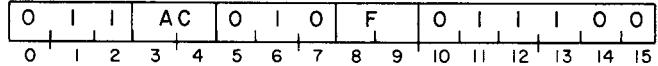

Bits 10-15 of the specified AC are loaded into the combined Command/Transport Select Register. Bits 0-9 are ignored. After the data transfer, the controller's Busy and Done flags are set according to the function specified by E. The contents of the specified AC remain unchanged. The format of the specified AC is as follows:



Bits	Name	Function
0-9	----	Reserved for future use.
10-12	Command	Select the command for the selected transport as follows: 000 Read 001 Rewind 010 Reserved for future use 011 Space Forward 100 Space Reverse 101 Write 110 Write End Of File 111 Erase
13-15	Unit	Select transport 0-7

READ STATUS

DIA<f> ac, CAS

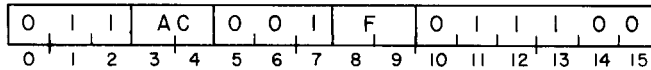

The contents of the Status Register are placed in bits 0-15 of the specified AC. After the data transfer, the controller's Busy and Done flags are set according to the function specified by F. The format of the specified AC is as follows:

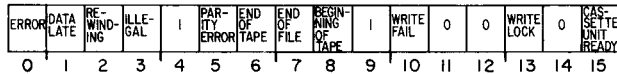

Bits	Name	Meaning When 1
0	Error	One or more of the bits 1, 3, 5, 6, 7, 8 or 10 are 1.
1	Data Late	The data channel failed to respond in time to a data channel request.
2	Rewinding	The selected transport is currently rewinding.
3	Illegal	A Start command was issued to the selected transport when one of the following conditions existed: <ul style="list-style-type: none"> • The transport was not ready. • The command was Space Reverse and the tape was at the beginning of tape leader. • The command was Write, Write End Of File, or Erase when the tape was write-protected.
4	----	Reserved for future use.
5	Parity Error	The cyclic checkword read from the tape after the record did not match the checkword calculated by the controller.
6	End Of Tape	The transport has reached the end of tape mark. Executing either a Space Reverse or a Rewind operation sets this bit to 0.

7	End Of File	The transport has encountered an End Of File mark in reading or spacing or has just written an EOF mark.
8	Begin Of Tape	The tape is at the beginning of tape mark.
9	----	Reserved for future use.
10	Write Fail	The last record written has caused a failure in the transports write electronics.
11	----	Reserved for future use.
12	----	Reserved for future use.
13	Write Lock	The DGC cassette on the selected transport is write protected.
14	----	Reserved for future use.
15	Cassette Unit Ready	The selected transport and cartridge is ready for use.

LOAD MEMORY ADDRESS COUNTER

DOB<f> ac, CAS

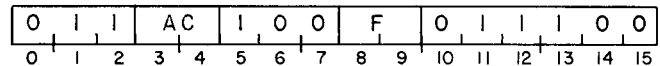

Bits 1-15 of the specified AC are loaded into the Memory Address Counter. Bit 0 is ignored. After the data transfer, the controller's Busy and Done flags are set according to the function specified by F. The contents of the specified AC remain unchanged. The format of the specified AC is as follows:

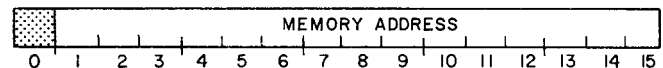

Bits	Name	Function
0	----	Reserved for future use.
1-15	Memory Address	Location of the next word in memory to be used for a data channel transfer.

LOAD WORD COUNTER

DOC<f> ac, CAS

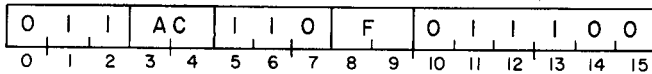

Bits 4-15 of the specified AC are loaded into the controller's Word Counter. Bits 0-3 are ignored. After the data transfer, the controller's Busy and Done flags are set according to the function specified by F. The contents of the specified AC remain unchanged. The specified AC must contain the two's complement of the number of words to be transferred with the stipulation that the minimum number of words to be transferred is 2 and the maximum is 4096.

During a spacing operation, the Word Counter acts as a record counter. The specified AC must contain the two's complement of the number of records to be skipped with the stipulation that the minimum number of records to be skipped is 1 and the maximum is 4096. The format of the specified AC is as follows:

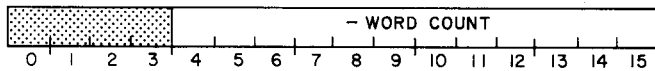

Bits	Name	Function
0-3	----	Reserved for future use.
4-15	Word Count	Two's complement of number of words to be transferred or records to be skipped.

READ MEMORY ADDRESS COUNTER

DIB<f> ac, CAS

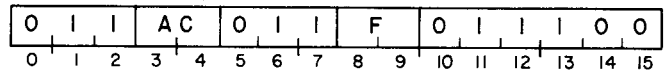

The contents of the Memory Address Counter are placed in bits 1-15 of the specified AC. AC bit 0 is set to 0. After the data transfer, the controller's Busy and Done flags are set according to the function specified by F. When the Memory Address Counter is read after a Read or a Write operation, the contents point to a memory location one greater than the location of the last word transferred. The format of the specified AC is as follows:

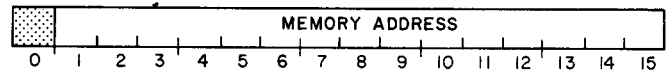

Bits	Name	Function
0	----	Reserved for future use.
1-15	Memory Address	Location of the next word in memory to be used for a data channel transfer.

PROGRAMMING

The preparation of a DGC cassette subsystem for a data channel transfer can be divided into three distinct phases: I, initializing the transport; II, positioning the tape; and III, specifying the transfer parameters. Once the first two phases are completed, the program can repeatedly execute the third phase. The results of issuing commands in each phase should be checked for errors before proceeding to the next phase.

Phase I: Initializing

Initialization of the transport is performed as follows: the desired transport is selected by issuing a SPECIFY COMMAND AND UNIT instruction (DOA) to the controller. The Status Register is examined by a READ STATUS instruction (DIA) to determine if the tape is positioned at the Beginning Of Tape mark, if the Illegal flag is set to 1, and if the transport is in the ready state. The transport should be initialized by issuing a Rewind command if the tape is not located at the Beginning Of Tape mark. The Rewind command can be executed providing the transport is ready and the Illegal flag is set to 0.

If the Illegal flag is set to 1 in the Status Register, a Clear command can be issued. The transport is then selected and a Rewind command specified by issuing a SPECIFY COMMAND AND UNIT instruction. The operation is initiated by issuing a Start command. The Start command sets the Rewinding flag to 1 and the Unit Ready flag to 0, but does not set either the Busy flag or the Done flag to 1. During this time, the program can issue instructions to any other transport which is in the ready state. The controller does not initiate a program interrupt request when the rewinding operation is completed. However, the Rewinding flag will be set to 0 and the Unit Ready flag to 1 upon completion of the operation.

Once the tape has been rewound and no error conditions are detected in the Status Register, the program may proceed to Phase II.

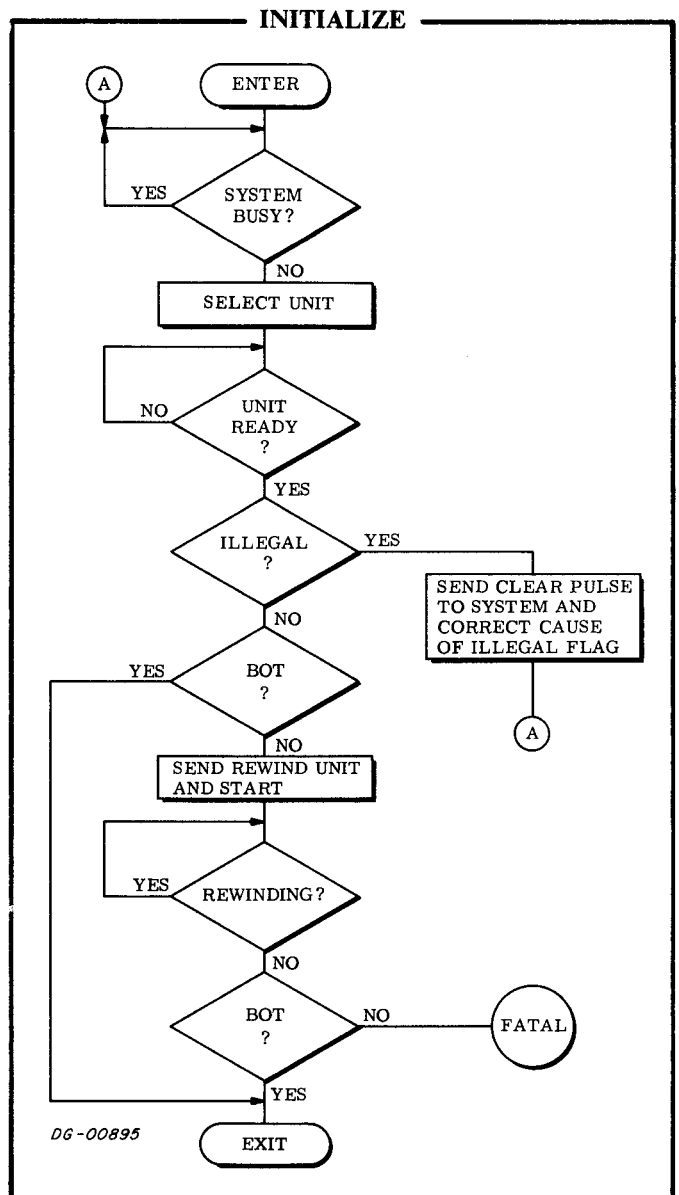

Phase II: Position the Tape

In order to access the desired record on the DGC cassette for a Read or a Write operation, the tape should be spaced to the position immediately preceding that record. During the spacing operation, the Word Counter is used as a record counter, incrementing once for each record skipped. The spacing operation terminates when the Word Counter overflows or when an End Of File mark is encountered. The minimum number of records which can be skipped in one operation is one and the maximum is 4096.

The spacing operation is performed as follows: the command for the spacing operation desired is loaded into the Command Register with a SPECIFY COMMAND AND UNIT instruction (DOA), and the two's complement of the number of records to be skipped is specified with a LOAD WORD COUNTER instruction (DOC). The spacing operation is initiated with a Start command appended to the last of these instructions issued. The Busy flag is set to 1 and the Done flag is set to 0 during spacing. Upon completion of the operation, the Busy flag is set to 0 and the Done flag is set to 1, thus initiating a program interrupt request.

If the desired record is contained in another file, the Space Forward command must be issued at least once for each file to be skipped. When a file is to be skipped, the Word Counter must be loaded with the two's complement of a count greater than or equal to the number of records contained in that file. Since a file may contain more than 4096 records, the Space Forward command may have to be executed several times (reloading the Word Counter each time) before the file is skipped. Every time an End Of File mark is encountered in a spacing operation, the operation stops, both the End Of File flag and the Error flag are set to 1 in the Status Register, the Busy flag is set to 0, the Done flag is set to 1, and a program interrupt request is initiated.

Once the transport has reached the correct file, the tape should be positioned immediately before the desired record in that file.

The Space Reverse command operates in a manner entirely analogous to the Space Forward command. After a Space Reverse command is executed as

many times as is necessary to skip a file, the tape is positioned immediately after the last record in the preceding file.

Care should be taken so that a Space Forward command is not executed when the End Of Tape flag is set to 1 in the Status Register.

Once the tape is in position for a Read or a Write operation and no errors (other than the End Of File, Error combination) are detected in the Status Register, the program may proceed to Phase III.

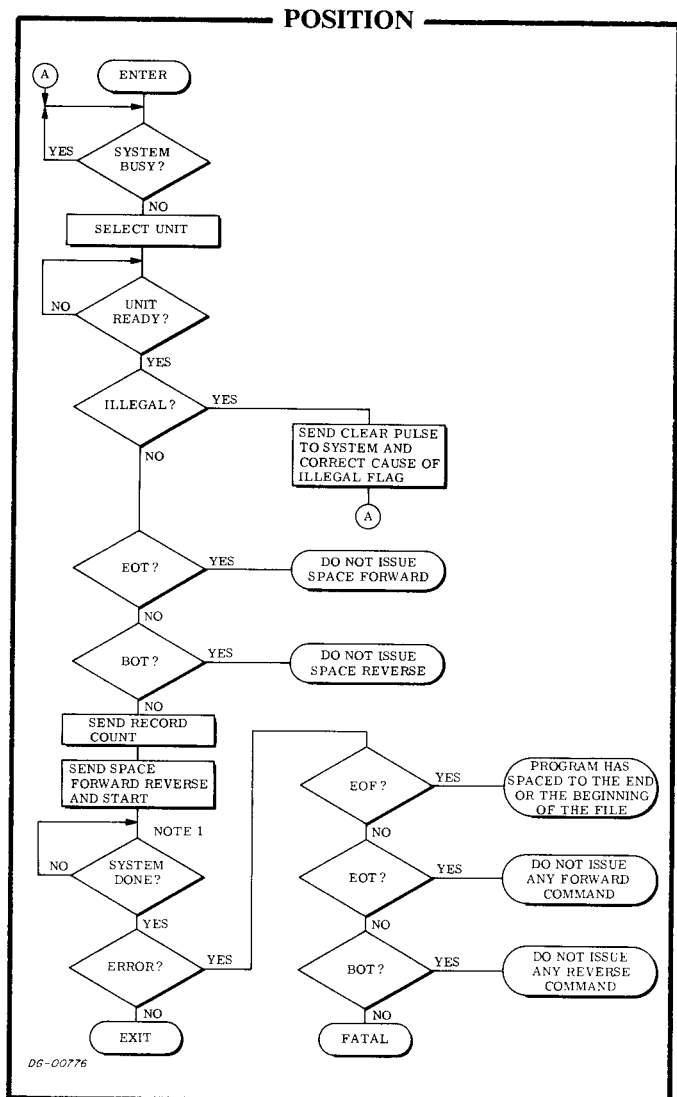

Phase III: Specify Transfer Parameters

Phase III consists of specifying the starting location in memory for the first word to be transferred, loading the Word Counter with the two's complement of the number of words to be transferred and issuing either a Read or a Write command together with a Start command to the desired transport. In addition, any Error Status flags set (Parity, Data Late, etc) should be disregarded.

Read

Read operations are performed as follows: the storage location in memory for the first word to be read from the tape is specified by a LOAD MEMORY ADDRESS COUNTER instruction (DOB). The two's complement of the number of words to be read is then specified by a LOAD WORD COUNTER instruction (DOC). If the record to be read is of unknown length, giving the two's complement of the longest possible record, assures that the entire record will be read. The desired transport is selected and the Read command is loaded into the Command Register with a SPECIFY COMMAND AND UNIT instruction (DOA). A Start command in the last of these instructions initiates the Read operation.

Once the Read command is initiated, the Busy flag is set to 1, the Done flag is set to 0, the tape in the DGC cassette is moved past the heads, and the first 16 bits in the record are assembled into one word. The word is then written into memory via the data channel. Each time a word is transferred to memory, the Word Counter is incremented by one.

The Read operation will continue until either the Word Counter overflows or the transport encounters an End Of Record gap. Upon completion, the Busy flag is set to 0, the Done flag is set to 1 and a program interrupt request is initiated. If the record read was of unknown length and was read by loading a zero (the two's complement of 4096) in the Word Counter, the length can be determined by first obtaining the address of the last word read into memory. This address is obtained by issuing a READ MEMORY ADDRESS COUNTER instruction (DIB). The address returned is one greater than the address of the last word written in memory by the Read operation. Therefore, subtracting the starting memory location from the address returned by a READ MEMORY ADDRESS COUNTER instruction will yield the length of the record read.

Whenever the End Of Tape flag is set to 1 in the Status Register, care should be taken to ensure that any command which moves the tape forward is not issued.

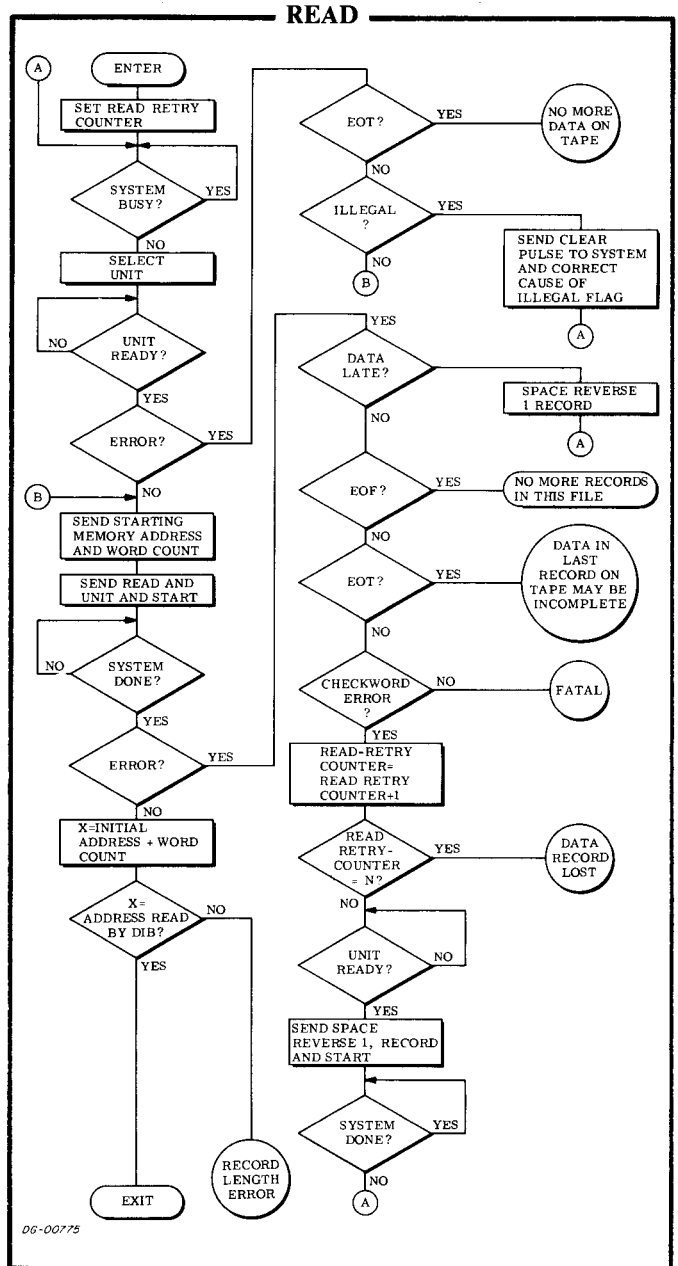

Write

Write operations (Write, Write End Of File, and Erase) are performed as follows: for a Write command, the storage location in memory for the first word to be written on the tape is specified by a LOAD MEMORY ADDRESS COUNTER instruction (DOB). The two's complement of the number of words to be written is then specified by a LOAD WORD COUNTER instruction (DOC). The desired transport is selected and the Write command is loaded into the command register with a SPECIFY COMMAND AND UNIT instruction (DOA). A Start command in the last of these instructions issued initiates the Write operation.

Once the Write command is initiated, the Busy flag is set to 1, the Done flag is set to 0, a word is read from memory, the tape in the DGC cassette is moved past the heads, and the 16 bits of the word are written on the tape. Each time the controller receives a word from memory, the Word Counter is incremented. Once the Word Counter overflows, the controller writes the cyclic redundancy checkword. The Busy flag is set to 0, the Done flag is set to 1 and a program interrupt request is initiated.

Write End Of File and Erase commands are accomplished by selecting the desired transport and loading the desired command into the Command Register with a SPECIFY COMMAND AND UNIT instruction. A Start command sets the Busy flag to 1, the Done flag to 0, and initiates the operation.

The Write End Of File command erases 2 1/2 inches of tape and writes an End Of File mark on the tape after the inter-record gap. Upon completion of this operation, the Busy flag is set to 0, the Done flag is set to 1 and a program interrupt request is initiated. Since the transports perform a read-after-write error check, both the End Of File flag and the Error flag are set to 1 in the Status Register each time a correct End Of File mark is written.

The Erase command erases approximately 2 1/2 inches of tape each time it is issued. Erase can be used to skip bad sections of tape. Once the Erase operation has been completed, the Busy flag is set to 0, the Done flag is set to 1 and a program interrupt request is initiated.

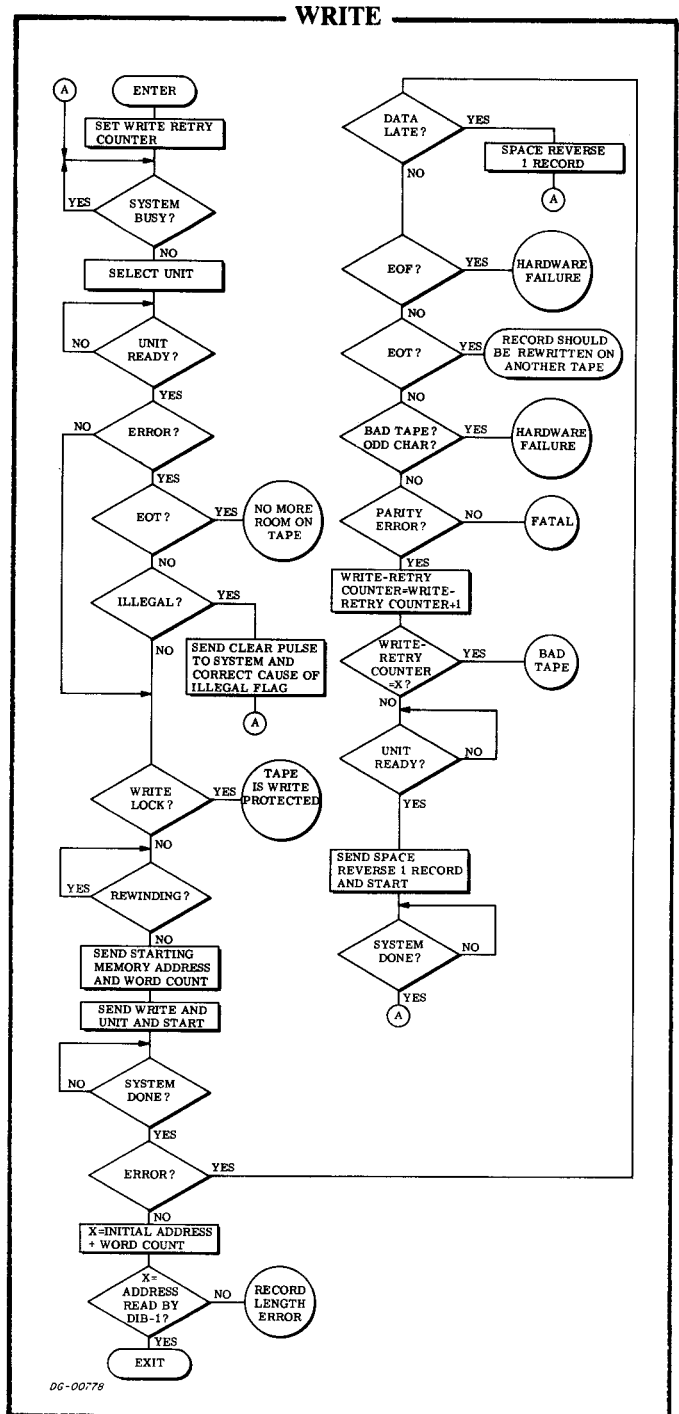

TIMING

The DGC cassette transfers one 16-bit word via the data channel every 1.34 milliseconds when performing a read or a write operation. Since the DGC cassette is a single buffered device, the data channel has only 28 microseconds to respond to a data channel request. If the data channel does not respond within this time, the Data Late and the Error flags are set to 1. When the Data Late flag is set to 1, the processing of the record continues until its normal completion. However, one or more of the words transferred contains an error.

Since the tape does not move at a constant speed because of the recording technique used for the DGC cassette transport, all references to tape speed, inter-record gaps, erased areas of tape, and information density, pertain to the average values along the length of the DGC cassette's tape. On the average, the tape moves past the heads at 30 inches per second when reading, writing, re-winding and spacing. The average bit density on the tape is 430 bits per inch.

The start and stop times for the basic DGC cassette operations are given in the table below.

	Read	Write	Space	Rewind
Start Delay	.22ms	35ms	1.3ms	2sec
Last Word To Stop	136ms	136ms	120ms	2sec

ERROR CONDITIONS

During Initializing

If a Start command is given when the selected unit is not ready to carry out a command, both the Illegal flag and the Done flag are set to 1 and a program interrupt request is initiated. The Illegal flag can be set to 0 only with a Clear command or an I/O RESET instruction. The Clear command sets all the error indicating flags in the Status Register to 0 and sets the Command/Transport Select Register to 0. Therefore, unit 0 is the selected transport and Read is the specified command after a Clear command or an I/O RESET instruction is issued. The Status flags read by a READ STATUS instruction pertain to unit 0 until another transport is selected.

During Positioning

Both the Illegal flag and the Error flag are set to 1 in the Status Register when a Spacing command is issued to a transport which is not ready or if a Space Reverse command is issued when the tape is at the BOT mark. The Busy flag is set to 0, the Done flag is set to 1, and a program interrupt request is initiated.

If a Space Forward command is issued and the tape is at the End Of Tape mark, the spacing operation continues until a Clear command is issued.

During Reading

If the data channel does not respond in time for a data channel request, both the Data Late flag and the Error flag will be set to 1 in the controller's Status Register, but the Read operation will continue until either the Word Counter overflows or the transport encounters an End Of Record gap on the tape. The Data Late flag indicates that at least one word on the tape was not correctly transferred to memory.

If the transport encounters an End Of File mark, the Error flag, together with the End Of File flag, is set to 1 in the controller's status register. Busy is set to 0, Done is set to 1 and a program interrupt request is initiated.

Once the transport encounters the end of the data in a record or the word counter overflows, the controller reads the checkword and if the checkword does not match that calculated by the controller, the Checkword Error flag is set to 1 in the Status Register. The correct checkword for the entire record will be read even if the program reads only a portion of the record.

During Writing

If the selected transport is not ready to receive a command or if the DGC cassette mounted on the selected transport is write-protected, the Start command will set the Error flag, the Illegal flag and the appropriate error condition flag in the Status Register to 1. Busy will be set to 0, Done will be set to 1 and a program interrupt request is initiated.

If the data channel does not respond in time for a data channel request, both the Data Late flag and the Error flag will be set to 1 in the Status Register but the Write operation will continue until the Word Counter overflows. The Data Late flag indicates that at least one word was not properly written.

If the End Of File mark contains an error, the controller will interpret the mark as a short data record and a Checkword Error will occur on every subsequent Read operation of that section of tape. A defective End Of File mark will also be interpreted as a data record during spacing operation.

Since the DGC cassette performs a read-after-write error check, the Checkword Error flag is set to 1 if the record just written contains an error.

This page intentionally left blank

SECTION V

DISCS

- **FIXED HEAD DISC SUBSYSTEM**
- **4047A & 4047B DISC CARTRIDGE SUBSYSTEMS**
- **4048A DISC PACK SUBSYSTEM**
- **4057A DISC PACK SUBSYSTEM**
- **4231A DISC PACK SUBSYSTEM**
- **6045 & 6050/6051
CARTRIDGE DG/DISC SUBSYSTEM**
- **6030 SERIES DG/DISKETTE SUBSYSTEM**
- **4234 SERIES 10MB CARTRIDGE DISC SUBSYSTEM**
- **6060 SERIES DG/DISC STORAGE SUBSYSTEM**
- **6063/6065 FIXED HEAD DG/DISC SUBSYSTEM**

This page intentionally left blank

INTRODUCTION TO DGC DISCS

Disc drives are popular for storing large quantities of information which must be directly accessed. The basic recording medium is a magnetic material coated on a platter. Platters come either singly or in a stack. The information on the platters is recorded or read by heads suspended near their surfaces. As the platters rotate, the heads define concentric circles of data called tracks around the surfaces of the platters. Heads can be either fixed or moving. Fixed-head discs assign one head to each and every operating track, while moving-head discs use one head for each surface so each head moves back and forth to cover all tracks.

Heads are mounted on arms to extend them out over the recording surfaces. The read/write heads together with their arms form an assembly called the access mechanism. The access mechanism on a multi-surface moving-arm disc consists of a num-

ber of arms mounted on a single post and extended like a comb between the platters. This entire mechanism moves in and out as single unit when the heads are being positioned.

The access mechanism on a multi-surface fixed-head disc also consists of a number of arms mounted on a post but the assembly does not move during routine operation of the disc. Each arm usually has many heads attached to it; each head is located over its respective track. Several posts can be located around the peripheral of the stack of platters; each post then carries its own complement of arms and heads.

The platters on some types of disc drives can be removed and exchanged. Removable single platters are called disc cartridges, removable stacks are called disc packs.

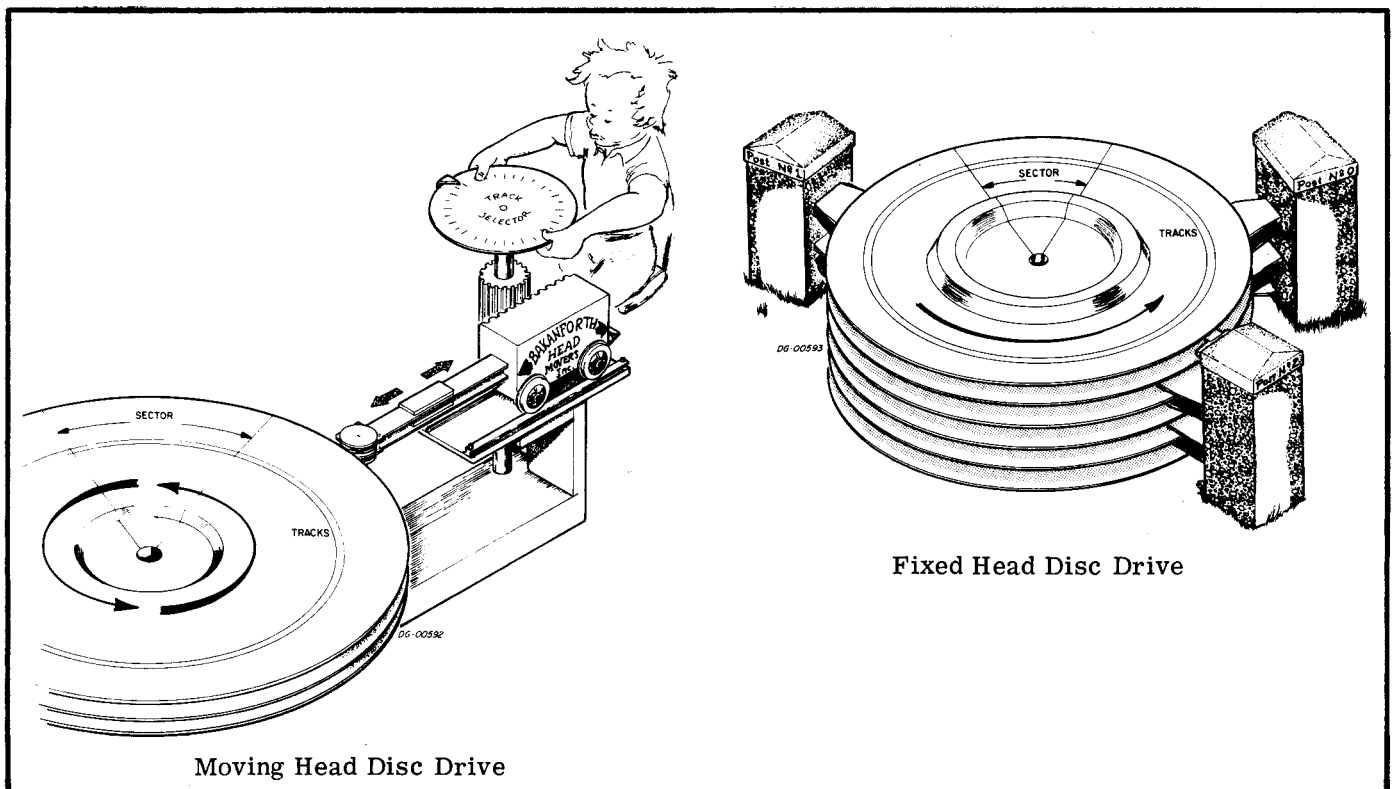

DATA FORMATS ON DGC DISCS

Data General stores data on all its disc drives in a standard format. Data is recorded serially, bit by bit, on one track at a time. Sixteen bits form a word, and 256 contiguous words form a data storage field called a sector. A sector is the smallest addressable unit of information. The number of sectors which are recorded on each track is dependent on the particular disc drive used.

In addition to the data contained in each sector, a 16- or 32-bit cyclical checkword is recorded at the end of the data field. This checkword is calculated as the individual bits of the sector are passed from the controller to the drive, to be written on the disc. Once the 256 words (4096 bits) in the record have been written, this checkword is written. Subsequently, when that sector is read, the controller again calculates a checkword from the individual bits read from the disc. This new checkword is then compared to the original checkword as it is read from the disc at the end of the sector. If the two checkwords differ, an error flag is set to 1, indicating that the data in the sector just read may contain errors.

On some discs, each sector also contains an identification field which precedes the data field. This identification field is used to verify the location of the sector before any read or write operation is performed and, in some cases, to indicate that the sector should not be used because the recording surface is defective.

The process of writing these identification fields is called formatting. All discs must be properly formatted with special programs provided by Data General before they can be used. The part numbers for these programs are given in the section dealing with the programming for each disc.

ACCESSING

The data stored in any particular sector of a fixed-head disc is accessed by first selecting the read/write head which is assigned to the track in which the sector is located and then waiting until the desired sector passes under that head. Maximum access time is therefore the sum of the times re-

quired for head selection, (on the order of 1 millisecond) and the maximum time the head must wait until the beginning of the desired sector appears, i. e., one complete revolution of the platter (≈ 17 milliseconds @ 3600rpm).

The data stored in any particular sector of a moving-head disc is accessed by first moving the access mechanism to the track which contains the sector, selecting the head for the proper track, and then waiting until the desired sector passes under that head. Maximum access time is therefore the sum of the time required to move the access mechanism (this is called a Seek operation and requires from 6 to 135 milliseconds) plus the time required to select the head (this time can overlap the time required for head positioning) plus the maximum time the head must wait until the beginning of the desired sector to appear (this time could be up to one or two complete revolutions of the platter, depending on the particular unit's synchronizing mechanism. The range is from 17 to 48 milliseconds.)

However, the average access time for a set of sectors on a moving-arm disc can be reduced because the access mechanism positions all the heads simultaneously. Once the access mechanism is locked in place, each head can access one complete track without being repositioned. This set of accessible tracks is called a "cylinder". In other words, there are as many cylinders in a disc as there are discrete positions (tracks) of the access mechanism over the surface and as many tracks in each cylinder as there are recording surfaces.

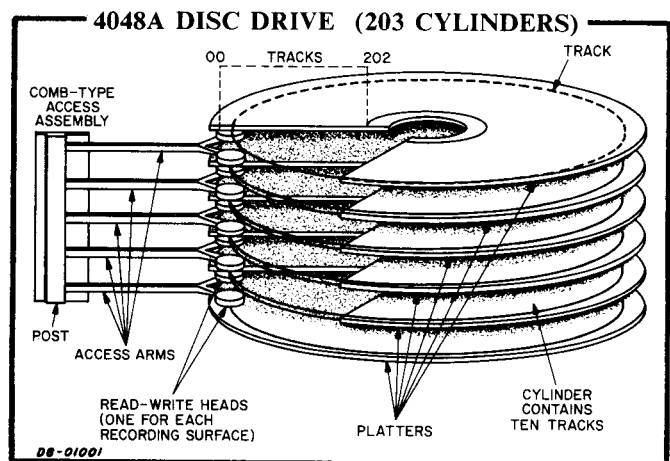

DGC DISC SUBSYSTEMS

Data General offers eight distinct moving-head disc subsystems most of which require their own particular drive units. (With the exception of the 6030 diskette subsystem and the 4234 or 6045 cartridge subsystem, the drive units from any

subsystem may not be intermixed with those of any other subsystem; 6030 Series may be intermixed with drive units from either 6045 or 4234 Series subsystems.) The following table lists the specifications, equipment requirements and maximum sizes of the various disc subsystems.

Specifications for DGC Disc Subsystems

Subsystem	Controller	Adapter	Drive Unit	Type	Number of Tracks or Cylinders	Number of Surfaces	Number of Sectors/Track	Capacity/Unit (Words)	Transfer Rate (Words/Sec)	Maximum Number of Units/Subsystem
Fixed-head (obsolete)	4019	None Required	6001/6005	1 Post	64 Tracks	8 (1)	8	131,072	122,700	1024 Tracks In Any Combination
			6002/6006	1 Post	128 Tracks		8	262,144		
			6003/6007	2 Post	256 Tracks		8	524,288		
			6004/6008	3 Post	384 Tracks		8	786,432		
4047A and 4047B	4046	4049	4047A	Cartridge	203	2	12	1,247,232	90,000	4
		4047	4047B	Cartridge and Nonremovable	203+ 203	2+2	12	2,494,464		2
4048A	4046	4048	4048A	Pack	203	10	6	3,118,080	78,000	4
4057A	4046	4057	4057A	Pack	203	20	12	12,472,320	156,000	4
4231A	4231	4231A (comes with first drive)	first drive 4231A	Pack	411	19	23	45,979,392	403,000	4
			second-fourth drive 4231B							
6045	6051 Included with 6045 subsystem	None Required	6050 6030, 6031 diskette units may be included in subsystem	Disc Cartridge and non-removable; dr diskette (see 6030)	408	4	12	5,013,504	156,250	4
4234 (2)	Included with first drive model 4234	None Required	first drive - 4234 second or fourth drive - 4235 third drive - 4236 6030B, 6031B diskette type units may be included in subsystem	Disc Cartridge or Flexible Diskette (see 6030)	408	4	12	5,013,504	156,250	4
6030 (2)	Included with model 6030 or 6031 drive	Included in the unit enclosure	first drive - 6030 or 6031 second-fourth drive 6030A or 6031A 4234F type cartridge units may be included in subsystem	Flexible Diskette or Cartridge Drive (see 4234)	77	1 (for Cartridge Drives, see 4234)	8	157,696	15,625	4
6060	Included with 6060 or 6061 drive Second controller included with 6062	Included with 6060 or 6061 drive Dual access included with 6062	First single density drive-6060 Additional single density drive-6060A First double density drive-6061 Additional double density drive-6061A	Pack	411 or 815	19	24	47,978,496 or 95,139,840	403,200	4
6063 and 6063A	Included with 6063 and 6064	None Required	First half capacity drive - 6063 Additional half capacity drive - 6063A	Integral Disc Head module	64	2 (1)	32	524,288	450,450	4
6064 and 6064A	Included with 6063 and 6064	None Required	First full capacity drive - 6064 Additional full capacity drive - 6064A	Integral Disc/Head module	128	2 (1)	32	1,048,576	450,450	4

DS-01754

(1) The number of surfaces in a fixed head disc is transparent to the programmer.

(2) Cannot be shared by two processors; for the 6030 this is true only of early models.

SHARED DISC CONSIDERATIONS

Almost all * Data General disc subsystems may be shared by two CPU's. In such a configuration, access to all or part of the subsystem is given to one processor or the other on a demand basis. The following text describes shared disc protocols for the models 6001, 4047, 4048, 4057, and 4231 series subsystems. Details of dual processor operation for other disc subsystems are described in the appropriate chapter.

In the case of the Fixed Head Disc Subsystems, no change in either the instructions themselves or the order in which they are issued is required. Access to the drive is alternated between the two CPU's if there is a conflict. As a result of sharing the subsystem, the time for accessing consecutively numbered sectors by one CPU is extended to 10.5 milliseconds/sector (average).

In the case of a Moving Head Disc Subsystem, the adapter performs certain functions which are no longer transparent to the programmer. These functions force a different instruction sequence for programming a data channel transfer. Each subsystem adapter alternates access between the two CPU's. When one of the CPU's starts an operation (seeking, reading or writing), the adapter locks out the second CPU until either the Read/Write Done flag is set to 1 for the first CPU or six seconds elapse. When a CPU is locked out by the adapter, that CPU can neither select a drive unit nor read a valid status word for any drive.

The six second lock out procedure insures that one CPU cannot seize the disc subsystem to the exclusion of the second CPU. This prevents a malfunctioning CPU from interfering with the operation of the second CPU for more than six seconds.

In addition, since either CPU can position the heads on any drive, the position of the heads in the selected drive is unknown to a CPU when it gains access to that drive. Therefore, each data transfer operation should be preceded by a Seek operation to the desired cylinder on the selected drive. If the adapter is in use when this Seek operation is initiated, the operation commences as soon as the adapter becomes free, and the other CPU is then locked out. When the Seek Done flag for the selected drive is set to 1 and a program interrupt request is initiated, the program can read a valid status word and perform a Read or a Write operation. As soon as the Read/Write Done flag is set to 1, the adapter is free to service any requests from either CPU.

Although the adapter might transfer control to the other CPU once the Read/Write Done flag is set to 1, the error indicating flags in the status register of the first computer are valid for the operation just completed. These flags are: Error, Data Late, Check Error, Address Error, End Error and the Sector Error, Head Error, and Bad Sector flags, where applicable.

One situation which can be encountered in a shared disc environment is that of losing control of the adapter during an operation due to the 6 second time out provision. The six second time interval is measured from the start of the Seek operation in the drive itself. If the program does not initiate the data transfer operation so that it has sufficient time to be completed before 6 seconds elapse, the operation will not be completed. This situation could exist if a seek error occurs and the drive is recalibrated several times before a Seek operation is successful. Then, a data transfer operation might not have enough time to be completed before the 6 seconds elapses.

A second situation could exist in that a drive might be performing a Seek or Recalibrate operation, after a seek error, when the six seconds elapse. The computer that was locked out could initiate its own Seek operation with the same drive. This condition could cause damage to the access mechanism of the drive unit.

In order to avoid data loss or damage to a drive, the program should recalibrate the drive unit after a seek error and perform a "dummy" Read operation. This dummy read should read one 256 word sector from cylinder 0 into a scratch buffer. Once the operation is completed, the adapter is free. The program can then attempt a second Seek operation to the desired cylinder and have 6 seconds to complete the data transfer.

If, after several attempts to recalibrate the drive, seek errors still occur, the drive unit should be considered inoperative. No attempts should be made to access that drive until it is repaired.

*4234 Series disc cartridge units and early 6030 series diskette units cannot share CPU's.

FIXED HEAD DISC SUBSYSTEM

SUMMARY

MNEMONIC (FIRST CONTROLLER).....	DSK
DEVICE CODE (FIRST CONTROLLER).....	20g
MNEMONIC (SECOND CONTROLLER).....	DSK1
DEVICE CODE (SECOND CONTROLLER)....	60g
PRIORITY MASK BIT.....	9
TRACKS	64-1024
SECTORS/TRACK.....	8
WORDS/SECTOR	256
TOTAL STORAGE CAPACITY	
MIN/MAX (WORDS).....	131, 072/2, 097, 152
MAXIMUM TRANSFER RATE	
(WORDS/SEC).....	122, 700
MAXIMUM ALLOWABLE DATA	
CHANNEL LATENCY (μ SEC)	14
SECTOR ACCESS TIME	
MAX/MIN (MSEC).....	18/1

ACCUMULATOR FORMATS

SPECIFY DISC TRACK AND SECTOR... (DOA)

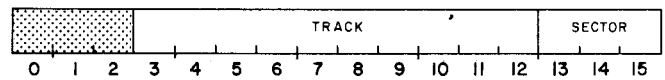

READ STATUS..... (DIA)



LOAD MEMORY ADDRESS COUNTER... (DOB)

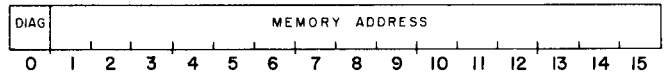

READ MEMORY ADDRESS COUNTER... (DIB)

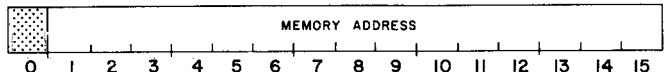

DIAGNOSTIC..... (DIC)

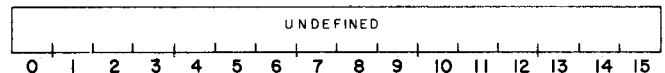

S, C AND P FUNCTIONS

S Set Busy to 1, Done and all status flags to 0 and start a Read operation.

C Set Busy, Done, Data Late and Check Error flags to 0 and stop all operations.

P Set Busy to 1, Done and all status flags to 0 and start a Write operation.

INTRODUCTION

The 6001-6008 drive units are used in the fixed head disc subsystem. These differ only in storage capacity (number of tracks). The minimum number of tracks in a subsystem is 64 (0-77g) while the maximum is 1024 (0-1777g). Each track contains 8 (0-7) sectors; each of which stores 256 (400g) 16-bit words together with a checkword for the sector. The data storage capacity is 2048 words/track. Therefore, a fixed head disc subsystem can store between 131,072 words (for the smallest configuration) and 2,097,152 words (for the largest configuration).

The average access time for any sector in the subsystem is 8.5 milliseconds. Once the sector is found, all data transfers to and from the subsystem occur at a rate of 122,700 words/second. Each transfer operation moves one 256 word sector.

Data, stored in the subsystem, can be protected from accidental overwrite by means of an operator controlled write-protection feature. This allows the operator to write-protect groups of 16 (20g) tracks.

INSTRUCTIONS

The disc drive controller contains three program accessible registers: a 15-bit Memory Address Counter, a 9-bit Status Register and a 13-bit combined Track/Sector Select Register. The Memory Address Counter is self-incrementing and contains the memory location of the next 16-bit word to be read from or written on the disc. The Status Register contains all the information flags for the disc drive. The combined Track/Sector Select Register contains the number of the desired track on the disc and the number of the desired sector which is to be read or written. There is no Word Counter available to the programmer since the data is always transferred in 256 word blocks.

Four instructions are used to program data channel transfers to and from the fixed head disc subsystem. Two of these instructions are used to supply all of the necessary data to the controller for any disc operation. The remaining two instructions allow the program to determine, in detail, the current state of the subsystem. A fifth instruction is used for maintenance purposes.

The disc controller's Busy and Done flags are controlled using all three of the device flag commands as follows:

- f = S Set the Busy flag to 1, the Done flag and all the status flags to 0, and initiate a Read operation.
- f = C Set the Busy flag, the Done flag, the Check Error and Data Late flags to 0, and terminate any Read or Write operation in progress.
- f = P Set the Busy flag to 1, the Done flag and all status flags to 0, and initiate a Write operation.

SPECIFY TRACK AND SECTOR

DOA <f> ac, DSK

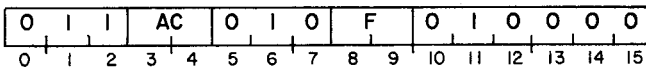

Bits 3-15 of the specified AC are loaded into the disc controller's Track/Sector Select Register. Bits 0-2 are ignored. After the data transfer, the controller's Busy and Done flags are set according to the function specified by F. The

contents of the specified AC remain unchanged. The format of the specified AC is as follows:

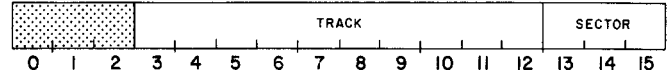

Bits	Name	Function
0-2	----	Reserved for future use.
3-12	Track	Specify the track number 0-1777 ₈ .
13-15	Sector	Select the sector number 0-7 ₈ for a Read or a Write operation.

LOAD MEMORY ADDRESS COUNTER

DOB <f> ac, DSK

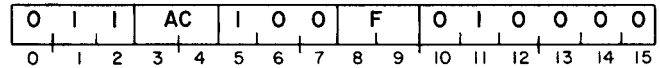

Bits 0-15 of the specified AC are loaded into the disc controller's Memory Address Counter. If AC bit is 1, the controller is put into the diagnostic mode of operation. After the data transfer, the controller's Busy and Done flags are set according to the function specified by F. The contents of the specified AC remain unchanged. The format of the specified AC is as follows:

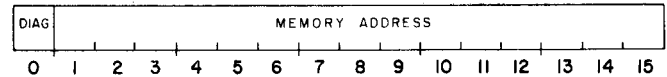

Bits	Name	Function
0	Diag	Places the controller in the diagnostic mode of operation.
1-15	Memory Address	Location of the next word in memory to be used for a data channel transfer.

READ STATUS

DIA<f> ac, DSK

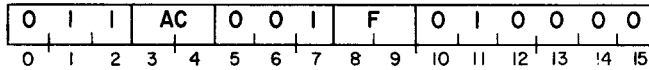

The contents of the Status Register are placed in bits 7-15 of the specified AC. Bits 0-6 are set to 0. After the data transfer, the controller's Busy and Done flags are set according to the function specified by F. The format of the specified AC is as follows:

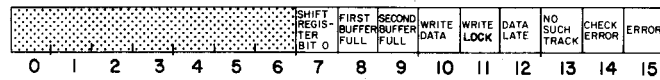

Bits	Name	Meaning When 1
0-6	----	Reserved for future use.
7	Shift Register Bit 0	Used for maintenance.
8	First Buffer Full	Used for maintenance.
9	Second Buffer Full	Used for maintenance.
10	Write Data	Used for maintenance.
11	Write Lock	The Write operation specified a track which was Write-Protected.
12	Data Late	The data channel failed to respond in time to a data channel request.
13	No Such Track	The track specified by the program is not connected to the controller.
14	Check Error	The checkword read from the disc does not match the checkword calculated by the controller.
15	Error	One or more of the bits 11-14 is set to 1.

READ MEMORY ADDRESS COUNTER

DIB<f> ac, DSK

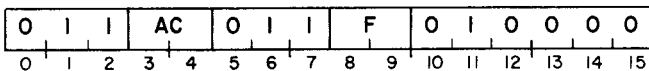

The contents of the Memory Address Counter are placed in bits 1-15 of the specified AC. Bit 0 is set to 0. After the data transfer, the controller's Busy and Done flags are set according to the function specified by F. When the Memory Ad-

dress Counter is read after a Write operation, the contents point to a memory location two greater than the location of the last word written on the disc. The format of the specified AC is as follows:

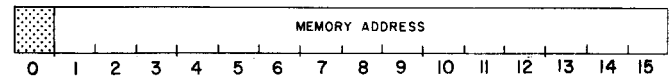

Bits	Name	Function
0	----	Reserved for future use.
1-15	Memory Address	Location of the next word in memory to be used for a data channel transfer.

DIAGNOSTIC

DIC<f> ac, DSK

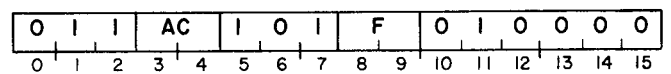

When the controller has been placed in the maintenance mode of operation by a 1 in bit 0 of the specified AC in a LOAD MEMORY ADDRESS COUNTER instruction, a DIAGNOSTIC instruction will supply a single clock pulse to the controller's logic. After the clock pulse is supplied, the controller's Busy and Done flags are set according to the function specified by F. Examples of the use of this instruction can be found in the Fixed Head Disc Diagnostic Program Listing (DGC #097-000012).

PROGRAMMING

The preparation of the fixed head disc subsystem for a data channel transfer is divided into two distinct phases: I, specifying the parameters of the transfer; and II, initiating the data transfer. The results of issuing instructions in Phase I should be checked for errors before proceeding to Phase II.

Phase I: Specify the Parameters of the Transfer

Phase I consists of issuing two instructions. They can be executed in any order. Issuing a SPECIFY TRACK AND SECTOR (DOA) instruction to the controller selects the desired track and sector to be processed. A LOAD MEMORY ADDRESS COUNTER (DOB) is then issued to specify the first location in memory to be used in the data channel transfer. Bit 0 of the specified AC must be 0 in this instruction if the subsystem is to perform a Read or Write operation.

When the program is executing successive read operations into contiguous areas of memory, the Memory Address Counter does not have to be updated after each sector is read. However, if contiguous areas of memory are to be written on the disc, the Memory Address Counter must be updated after each Write operation. This is necessary since the Memory Address Counter points to a location in memory which is two greater than the memory location of the last word written on the disc.

Once the track is specified, the status must be checked to determine if the subsystem is ready to proceed. The status is checked by examining the Busy flag of the subsystem. If the Busy flag is 0, the program can proceed to Phase II.

Phase II: Initiate the Transfer

Phase II consists of issuing either a Read or a Write command to the disc subsystem. The Read command transfers a sector (block) of data, consisting of 256 words, from the disc to the computer's memory via the data channel. A Write command transfers a block of data from the computer's memory via the data channel, and stores the data on the disc. Each of these commands is initiated by issuing one of the device flag commands. A Start command initiates a Read operation while a P command initiates a Write operation. Either of these two commands can be appended to the last of the two instructions issued in Phase I.

Read

When a Read command is issued, the Busy flag is set to 1 and the Done flag is set to 0. The controller selects the specified track and then waits until the desired sector is encountered. As the sector passes under the head, the sequential bits are read. When a word is fully assembled, the controller transfers the word to the computer's memory via the data channel. Each time a word is transferred to memory, the Memory Address Counter is automatically incremented.

Once the 256 words have been read, the controller reads the checkword at the end of the sector and compares it to the checkword it had calculated during the read operation. If the two checkwords differ, both the Error flag and the Checkword Error flag are set to 1. The Busy flag is set to 0, the Done flag is set to 1 and a program interrupt request is initiated.

Write

When a Write command is issued, the Busy flag is set to 1 and the Done flag is set to 0. The controller reads three words from the computer's memory, via the data channel, and then waits for

the desired sector to pass under the head. Each time the controller reads a word from the computer's memory, the Memory Address Counter is automatically incremented.

Once the desired sector is encountered, the bits of each word are sequentially written. When the 256 words of the sector have been written, the controller writes the checkword it calculated from the data during the Write operation. The Busy flag is set to 0, the Done flag is set to 1 and a program interrupt request is initiated.

The last two words requested from the computer's memory are not written. This means that the Memory Address Counter points to a memory location which is two greater than the address of the last word written on the disc when the Write operation is concluded.

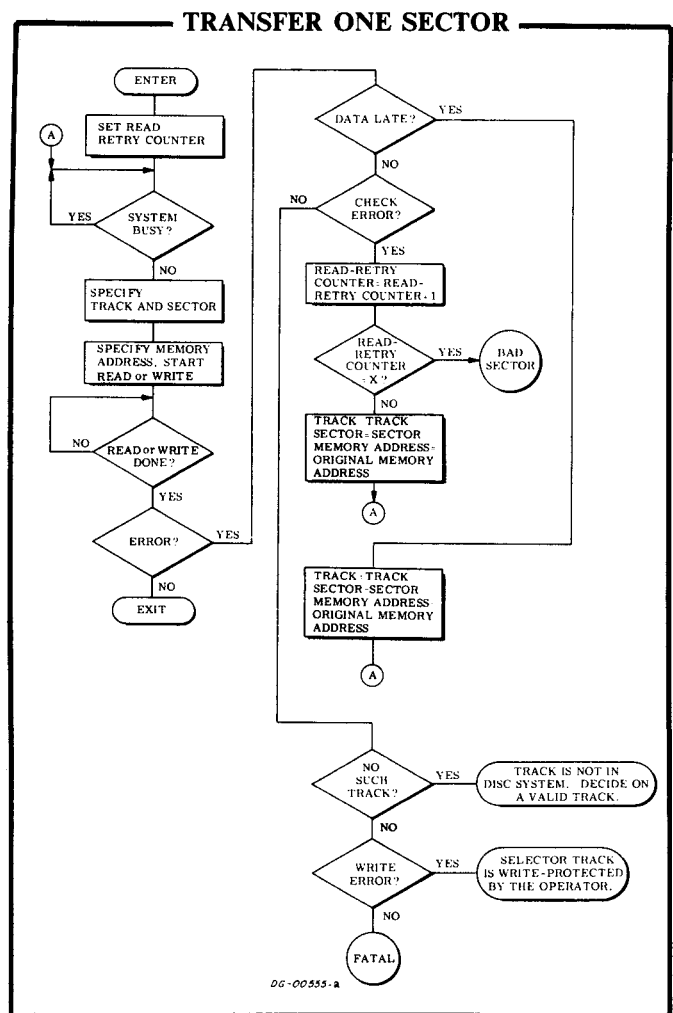

TIMING

The disc rotates at a speed of 3540rpm. Therefore, the time for a complete revolution is 16.95 milliseconds. Since there are eight sectors on a track, the time for one sector to pass under the Read/Write head is 2.12 milliseconds. If the Read or the Write command is given at the same time as the SPECIFY TRACK AND SECTOR instruction, a minimum of 1 millisecond elapses before the data transfer can begin. This allows the head selection logic to settle down. The maximum time for a sector search is 17.95 milliseconds so the average sector access time is 9.5 milliseconds.

The data segment of a sector passes under the head in 2.08 milliseconds which means the data channel requests occur every 8.15 microseconds. Since the fixed head disc system is double buffered, the maximum allowable data channel latency is 14 microseconds. If the data channel does not respond within this time, the Data Late flag will be set to 1. When the Data Late flag is set to 1, one or more words are lost but the processing of the sector continues and when the Done flag is set to 1, a program interrupt request is initiated.

When the program is processing consecutively numbered sectors, the program has 1.12 milliseconds after the Done flag is set to 1 to issue a SPECIFY TRACK AND SECTOR instruction to select the next sector, except when the sector just processed is sector 3. The program then has a 3.24 milliseconds to select sector 4 because both sectors 7 and 0 lie between sectors 3 and 4 on the disc surface. (See DISC FORMAT section.)

DISC FORMAT

The controller cannot process physically adjacent sectors on the disc surface consecutively. In order to minimize waiting time, the sectors on a track are not numbered consecutively but are interleaved in the manner shown below. For example, when the drive finishes processing sector 0 on a track, sector 4 starts passing under the Read/Write head for that track. During the interval that sector 4 is under the head, the program has sufficient time to issue the instructions necessary to process sector 1 which will pass under the head

immediately after sector 4. The interleaving of sectors is continued from one track to the next so that having completed processing sector 7 on one track, sector 0 on the next track can be processed with a minimum of time required for sector search. This numbering system is continued over all the tracks in the disc system. Eight possible configurations are under the heads at any time. These configurations of sector numbering repeat for every eight tracks. The particular arrangement is determined by the least significant octal digit in the track address.

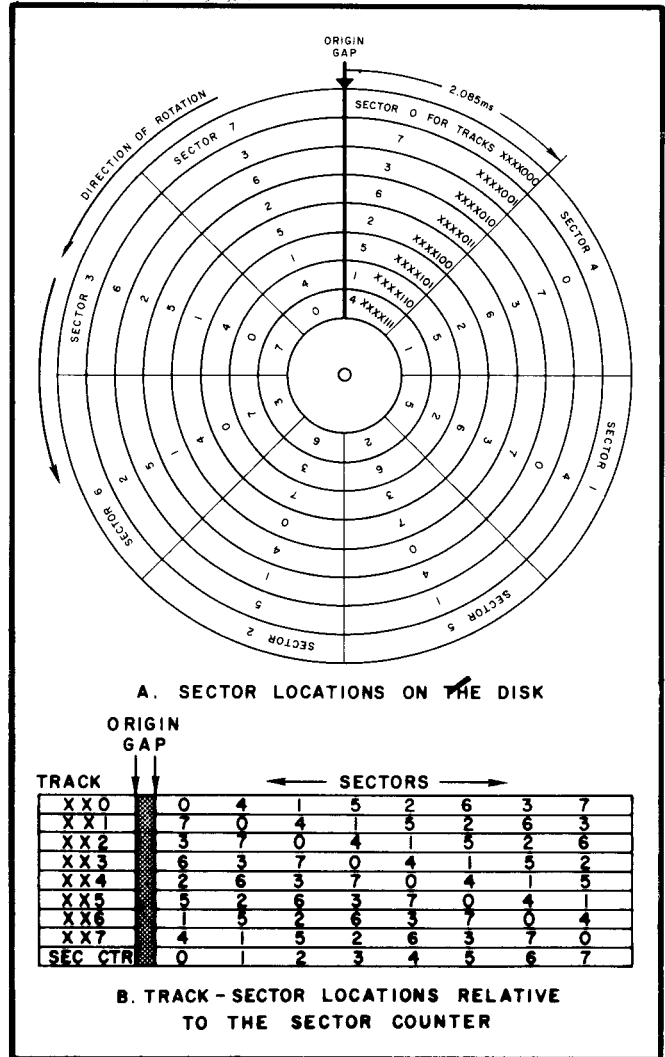

ERROR CONDITIONS

During Specification of the Parameters of the Transfer

If the track selected in the SPECIFY TRACK AND SECTOR instruction does not exist in the subsystem, no indication is given until the program attempts to perform a Read or a Write operation. When the program attempts to read or write a non-existent track, the controller terminates the operation. The Error and the No Such Track flags are set to 1; the Busy flag is set to 0, the Done flag is set to 1 and a program interrupt request is initiated. The No Such Track flag is set to 0 when the program completes a Read or a Write operation on a valid track.

During a Read Operation

After the 256 words of the sector have been read, the checkword is read and compared with the checkword calculated by the controller from the data during the Read operation. If the checkwords differ, both the Error and the Check Error flags are set to 1. The Busy flag is set to 0, the Done flag is set to 1 and a program interrupt request is initiated. The Check Error flag indicates that at least one of the words read contains an error.

If the data channel fails to respond to a data channel request in the time allowed, both the Error and the Data Late flags are set to 1. The Read

operation continues until the end of the sector; the Busy flag is then set to 0, the Done flag is set to 1 and a program interrupt request is initiated. The Data Late flag indicates that at least one word in the sector was not properly transferred to the computer.

During a Write Operation

If the track specified in Phase I is write-protected, the sector selected to receive the data is not altered. However, the controller performs all the tasks necessary for a Write operation. Words are read from memory and the Memory Address Counter is incremented as in a valid Write operation. Once the attempt to write the sector has concluded, the Busy flag is set to 0, the Error and the Write Lock flags are set to 1, the Done flag is set to 1 and a program interrupt request is initiated. The Write Lock flag is set to 0 when the program completes a Read or a Write operation on a valid track.

If the data channel fails to respond to a data channel request in the time allowed, both the Error and the Data Late flags are set to 1. The Write operation continues until the end of the sector; the Busy flag is then set to 0, the Done flag is set to 1 and a program interrupt request is initiated. The Data Late flag indicates that at least one word in the sector was not properly written.

THE 4047A AND 4047B DISC CARTRIDGE SUBSYSTEMS

SUMMARY

MNEMONIC (FIRST CONTROLLER) DKP
 DEVICE CODE (FIRST CONTROLLER) 33₈
 MNEMONIC (SECOND CONTROLLER) ... DKP1
 DEVICE CODE (SECOND CONTROLLER) ... 73₈
 PRIORITY MASK BIT 7
 SURFACE/UNIT 2
 TRACKS/SURFACE (CYLINDERS)..... 203
 SECTORS/TRACK 12
 WORDS/SECTOR 256
 TOTAL STORAGE CAPACITY/UNIT
 (WORDS) 1,247,232
 MAXIMUM TRANSFER RATE
 (WORDS/SEC) 90,000
 MAXIMUM ALLOWABLE DATA
 CHANNEL LATENCY (μ SEC)..... 22.2
 SEEK TIME MAX/MIN (mSEC)..... 135/15
 SECTOR ACCESS TIME MAX/MIN
 (mSEC) 40.5/.5

ACCUMULATOR FORMATS

SPECIFY DISC ADDRESS AND SECTOR COUNT (DOC)

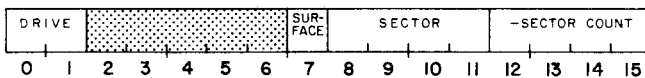

READ DISC ADDRESS (DIC)

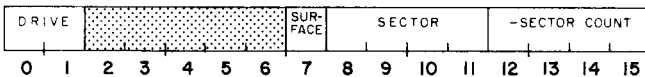

SPECIFY COMMAND AND CYLINDER... (DOA)

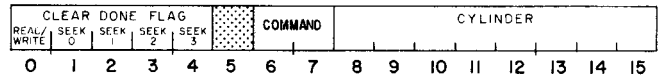

COMMANDS

00 Read 10 Seek
 01 Write 11 Recalibrate

READ STATUS (DIA)

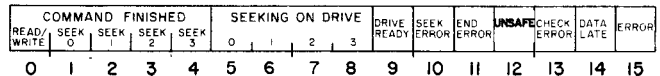

LOAD MEMORY ADDRESS COUNTER ... (DOB)

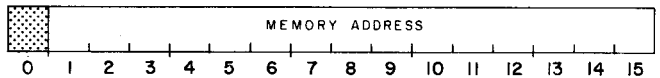

READ MEMORY ADDRESS COUNTER ... (DIB)

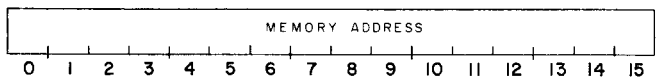

S, C AND P FUNCTIONS

- S Set Busy to one, Done to zero and start a Read or a Write operation.
- C Set Busy to zero, Done to zero and stop all operations.
- P Set Done to zero and start a Seek or a Recalibrate operation.

INTRODUCTION

The 4047 disc cartridge subsystem drives are available in two configurations: the 4047A consists of a single drive unit with a removable cartridge while the 4047B has two drives in the same package. One of the drives in the package has a removable cartridge; the other drive contains a permanently mounted disc.

Each drive unit contains a single disc with two surfaces, 0 and 1. Thus a cylinder contains two tracks. There are 203 (312_g) cylinders on a disc. Each of the two tracks in a cylinder contains 12 (0-13_g) sectors each of which stores 256 (400_g)

16-bit words and contains a checkword. The data storage capacity is 3072 words/track, 6144 words/cylinder or 1,247,232 words/cartridge. Words are transferred to and from the subsystem via the data channel at a rate of 90,000 words per second. Up to 16 sectors containing 4096 (10000₈) words can be transferred in one operation.

The controller for a disc cartridge subsystem, when coupled to the adapter, can direct the activities of up to four drive units. Any number of these units can be performing Seek operations simultaneously, but only one drive unit can be reading or writing at any one time.

INSTRUCTIONS

The disc drive controller contains four program accessible registers: a 15-bit Memory Address Counter, a 16-bit Status Register, a 16-bit combined Command/Cylinder Select Register and a combined disc Address/Sector Counter Register. The Memory Address Counter is self-incrementing and contains the memory location of the next 16-bit word to be either read from or written on the disc. The Status Register contains all the information flags for the controller and the selected drive and the seek status of the remaining three drives. Five of the flags in the Status Register are able to initiate a program interrupt request when they are set to 1. These are the Read/Write Done flag, and the 4 Seek Done flags for the drive units 0-3, respectively. The combined Command/Cylinder Select Register contains the command last issued to the subsystem and the number of the desired cylinder on the disc surface. The combined Disc Address/Sector Counter contains the surface and sector location of the active head and the two's complement of the number of sectors to be either read from or written on the disc. The Sector Counter is self-incrementing after each sector is read or written.

Six instructions are used to program data channel transfers to and from the disc pack. Three of these instructions are used to supply all of the necessary data to the controller for any disc operation. The remaining three instructions allow the program to determine, in detail, the current state of the disc pack subsystem.

The disc controller's Busy and Done flags are controlled using all three of the device flag commands as follows:

- f=S Initiate a Read, Write, Seek or Recalibrate operation, depending on the contents of the Command Register. Set the Busy flag to 1, the Done flag and all error indicating flags to 0. The error indicating flags are the Seek Error, the End Error, the Unsafe, the Check Error, the Data Late and the Error flags. Note that it is usually undesirable to initiate a Seek or Recalibrate with this command as the controller will remain busy until the operation is completed.
- f=C Set the Busy, the Done and all error indicating flags to 0 and stop all positioning and data transferring operations.
- f=P Initiate either a Seek or a Recalibrate operation, depending on the contents of the Command Register.

SPECIFY DISC ADDRESS AND SECTOR COUNT

DOC <f> ac, DKP

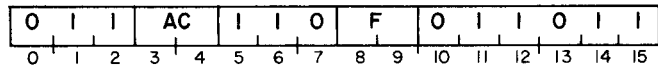

Bits 0-15 of the specified AC are loaded into the Disc Address Register. Bits 3-6 are ignored. After the data transfer, the controller's Busy and Done flags are set according to the function specified by F. The contents of the specified AC remain unchanged. The format of the specified AC is as follows:

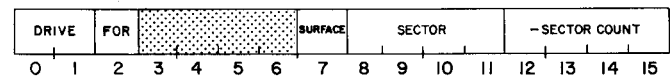

Bits	Name	Function
0-1	Drive	Select the drive number, 0, 1, 2 or 3.
2	Format	If 1, place the drive in format mode. This mode should not be used for the 4047A and 4047B subsystem.
3-6	---	Reserved for future use.
7	Surface	Select the surface number, 0 or 1, for the start of a Read/Write operation.
8-11	Sector	Select the starting sector number, 0-13 ₈ , for a Read or Write operation.
12-15	-Sector Count	Specify the two's complement of the number of sectors to be processed (maximum of 16).

SPECIFY COMMAND AND CYLINDER

DOA <f> ac,DKP

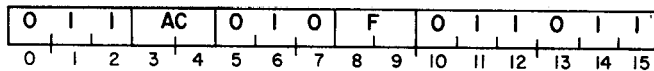

Bits 0-15 of the specified AC are loaded into the Command/Cylinder Select Register. Bit 5 is ignored. After the data transfer, the controller's Busy and Done flags are set according to the function specified by F. The contents of the specified AC remain unchanged. The format of the specified AC is as follows:

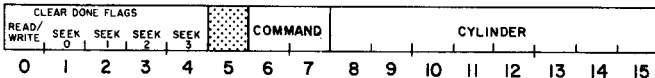

Bits	Name	Function if Set to One
0	Clear Read/Write Done	Set the Read/Write Done flag, the Check Error, the EOC, the Unsafe, and the Seek Error flags to 0.
1-4	Clear Seek Done	Set the Seek Done flags to 0 for the drives 0-3, respectively.
5	---	Reserved for future use.
6-7	Command	Select the command for the selected drive as follows: 00 Read with Start command. 01 Write with Start command. 10 Seek for the cylinder specified in bits 8-15 of this instruction with a Pulse command. 11 Recalibrate by forcing the heads to cylinder 0 on the selected drive with a Pulse command.
8-15	Cylinder	Specify cylinder number 0-312 ₈ for the selected drive.

LOAD MEMORY ADDRESS COUNTER

DOB <f> ac,DKP

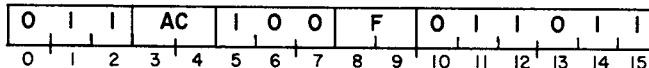

Bits 0-15 of the specified AC are loaded into the controller's Memory Address Counter. Bit 0 must be 0. After the data transfer, the controller's Busy and Done flags are set according to the function specified by F. The contents of the specified AC remain unchanged. The format of the specified AC is as follows:

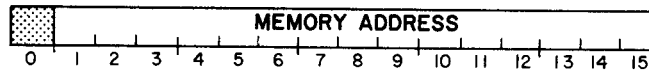

Bits	Name	Contents
0	---	Reserved for future use.
1-15	Memory Address	Location of the next word in memory to be used in a data channel transfer.

READ STATUS

DIA <f> ac,DKP

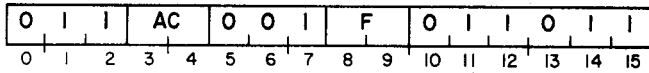

The contents of the Status Register are placed in bits 0-15 of the specified AC. After the data transfer, the controller's Busy and Done flags are set according to the function specified by F. The format of the specified AC is as follows:

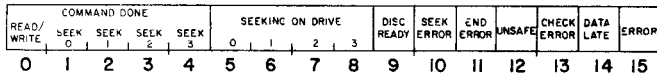

Bits	Name	Meaning When Set to 1
0	Read/Write Done	The selected drive has completed a Read or a Write operation.
1-4	Seek Done	Drive unit 0-3, respectively, has completed a Seek or Recalibrate operation.
5-8	Seeking on Drive	Drive unit 0-3, respectively, is currently performing a Seek or Recalibrate operation.
9	Drive Ready	The selected drive is ready to carry out a command.
10	Seek Error	The selected drive did not successfully carry out the Seek or Recalibrate operation.
11	End Error	The selected drive attempted to continue a Read or a Write operation which began at a valid address but extended beyond the last surface of the disc cartridge.
12	Unsafe	A malfunction exists in the selected drive.
13	Check Error	The checkword on the disc does not match the checkword calculated by the controller.
14	Data Late	The data channel failed to respond in time to a data channel request.
15	Error	One or more of the bits 10-14 is set to 1.

READ DISC ADDRESS

DIC <f> ac,DKP

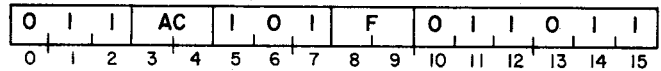

The contents of the Disc Address Register and the Sector Counter are placed in bits 0-15 of the specified AC. After the data transfer takes place, the controller's Busy and Done flags are set according to the function specified by F. The format of the specified AC is as follows:

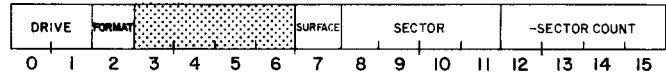

Bits	Name	Contents
0-1	Drive	Number of the drive selected.
2	Format	The selected drive is in the format mode. This mode should not be used.
3-6	---	Reserved for future use. If these bits were loaded with a SPECIFY DISC ADDRESS AND SECTOR COUNT instruction, they will be read into the specified AC when a READ DISC ADDRESS instruction is issued.
7	Surface	The surface number of the active head on the drive.
8-11	Sector	The sector number of the sector immediately following the last sector processed. If the last sector read or written was 13 ₈ , this number will be 14 ₈ even though there is no such sector. If the operation is still in progress, this is the sector currently being read or written.
12-15	-Sector Count	The two's complement of the number of sectors left to be processed.

READ MEMORY ADDRESS COUNTER

DIB<f> ac, DKP

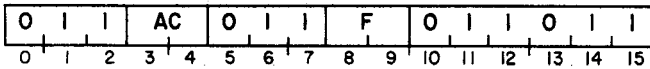

The contents of the Memory Address Counter are placed in bits 1-15 of the specified AC. Bit 0 is set to 0. After the data transfer, the controller's Busy and Done flags are set according to the function specified by F. When the Memory Address Counter is read after a Write operation, the contents point to a memory location two greater than the location of the last word written on the disc cartridge. The format of the specified AC is as follows:

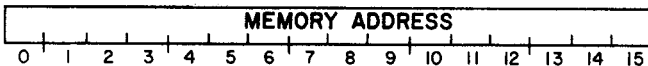

Bits	Name	Contents
0-15	Memory Address	<p>Location of the next word in memory to be used for a data channel transfer.</p> <p>If bit 0 is 1, the Read or the Write operation exceeded the capacity of a 32K machine and the excess words were transferred either to (in a read) or from (in a write) low core.</p>

PROGRAMMING

The preparation of a moving-head disc pack for data channel transfers is divided into three distinct phases: I, selecting the drive unit, the surface, the sector and the number of sectors; II, positioning the Read/Write heads over the correct cylinder; and III, starting the Read or Write operation. The results of issuing commands in each phase should be checked for errors before proceeding to the next phase.

Phase I: Select the Drive, Surface, Sector and Number of Sectors

The initial selection of a disc drive is performed as follows: a SPECIFY DISC ADDRESS AND SECTOR COUNT instruction (DOC) is issued to the controller to select the drive unit, the surface of the cartridge, the first sector to be read or written, and the two's complement of the number of sectors to be transferred in the operation. The drive units are numbered 0-3; the surfaces are numbered 0 and 1; the sectors are numbered 0-13; the maximum number of sectors which can be transferred in one operation is sixteen. Care should be taken to insure that the parameters specified in this initial selection do not exceed the capacity of the disc cartridge.

Once the drive unit is chosen, the status of that drive must be checked to determine if the drive is ready to proceed. The status is checked by issuing a READ STATUS instruction (DIA) and examining the Drive Ready flag. If the Drive Ready flag is set to 1, the program can proceed to Phase II. If it is set to 0, the program should not issue any commands to that drive unit until it is in the ready state.

Phase II: Position the Heads

The heads are positioned over the desired cylinder as follows: a SPECIFY COMMAND AND CYLINDER instruction (DOA) is issued to the controller. This instruction should contain the number of the cylinder desired and the Seek command. The cylinders are numbered from 0-3128. The instruction should also set both the Read/Write Done flag and the Seek Done flag for the selected drive to 0. The Seek operation is initiated by a Pulse command. While the drive is seeking, the Seeking On Drive flag for that drive is set to 1. When the heads have finished moving to the specified cylinder, the Seeking On Drive flag for the selected unit is set to 0 and the Seek Done flag for that drive unit is set to 1, thus initiating a program interrupt request.

The program should then check the Status Register to determine if a seek error has occurred as a result of a faulty Seek operation. If no errors have occurred, the program can proceed to Phase III.

The heads of the selected drive unit can be forced to cylinder 0 by the Recalibrate operation. A Recalibrate operation is performed as follows: a SPECIFY COMMAND AND CYLINDER instruction is issued to the controller. This instruction should contain the Recalibrate command and should also set both the Read/Write Done and the Seek Done flags for the selected drive unit to 0. The operation is initiated by a Pulse command. While the drive is being recalibrated, the Seeking On Drive flag for the selected drive is set to 1. Once the Recalibrate operation is completed, the Seeking On Drive flag is set to 0, the Seek Done flag for the selected drive is set to 1 and a program interrupt request is initiated.

When the program places a drive in the seek mode of operation, the controller is free to accept commands to the other drives under its direction. Therefore, once one or more drives are performing Seek operations, one of the other drives can perform a Read or a Write operation. If the program is simultaneously managing several drives with one controller, the error indicating flags in the Status Register apply only to the most recently selected drive unit, i. e., the unit specified in the last SPECIFY DISC ADDRESS AND SECTOR COUNT instruction issued.

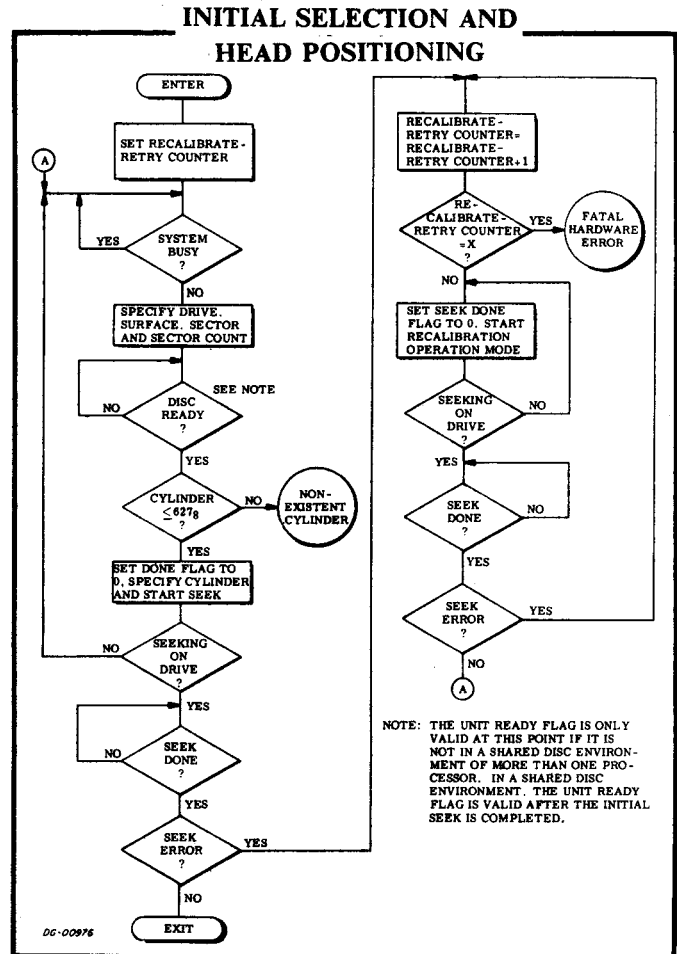

Phase III: Read or Write

A Read operation transfers blocks of data from the disc to the computer's memory, via the data channel. A block of data contains 256 words. Up to 16 blocks may be transferred in one Read operation. A Write operation transfers blocks of data from the computer's memory, via the data channel, to the disc. Again, up to 16 blocks of data may be transferred in one operation.

Read or Write operations are performed in a series of steps which are virtually identical. The parameters of the data transfer must be specified and finally the operation is initiated.

Read

A Read operation is performed as follows: the storage location in memory for the first word to be read from the disc is specified with a LOAD MEMORY ADDRESS COUNTER instruction (DOB). The number of sectors to be read and the starting sector were specified in Phase I.

The Read command is then loaded into the Command Register with a SPECIFY COMMAND AND CYLINDER instruction (DOA). It is not necessary to load the cylinder number again, but it is good practice since other disc subsystems may require this information. The Read operation is initiated with a Start command. The Busy flag is set to 1 and the Done flag is set to 0.

Once the Read operation is begun, the drive unit waits until the desired sector passes under the head and then starts reading the sequential bits of the first word in the sector. When a word is fully assembled, the controller transfers the word to the computer's memory via the data channel. Each time a word is transferred to memory, the Memory Address Counter is automatically incremented.

When the 256 words from the sector have been read, and the checkword at the end of the sector verified, the sector counter is incremented by one.

If the sector counter does not overflow, the next sector is read. This process continues until either the sector counter overflows or the last sector on the surface is read. In the case where the last sector on surface 0 is read, the sector counter has not overflowed, the drive will automatically continue the operation by reading the first sector on surface 1 in the same cylinder.

The Read operation then continues until the sector counter indicates, by overflowing, that the specified number of sectors have been read. Upon completion of the Read operation, the Busy flag is set to 0, the Done flag is set to 1 and a program interrupt request is initiated.

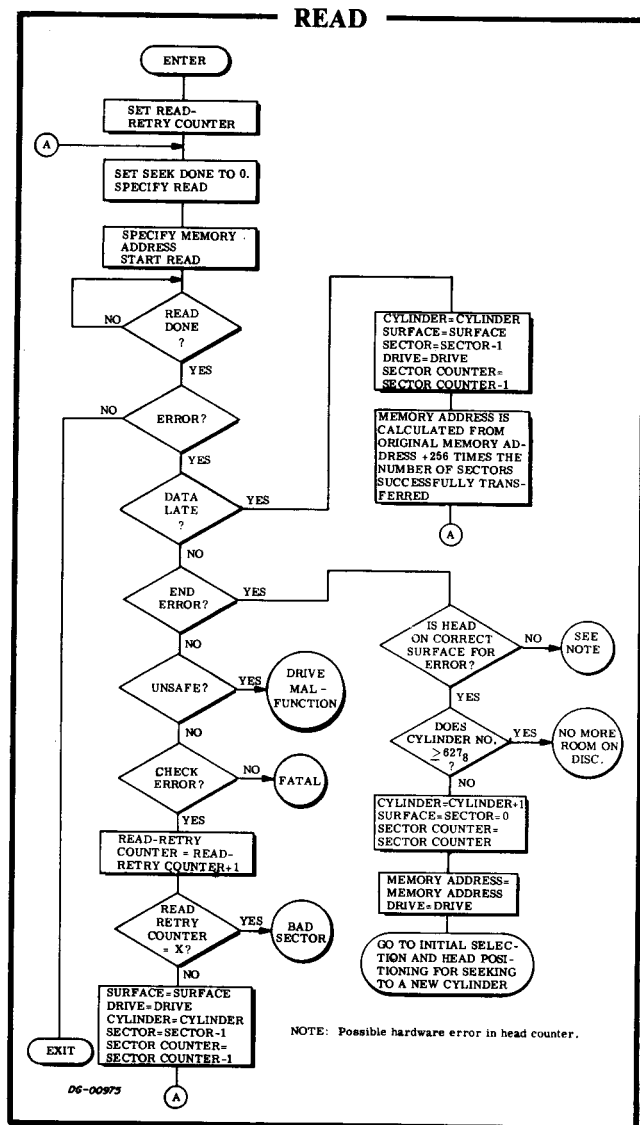

Write

A Write operation is performed as follows: the storage location in memory of the first word to be written on the disc is specified with a LOAD MEMORY ADDRESS COUNTER instruction (DOB). The number of sectors to be written and the number of the starting sector were specified in Phase I. The Write command is then loaded into the Command Register with a SPECIFY COMMAND AND CYLINDER instruction (DOA). It is not necessary to load the cylinder number again, but it is good practice since other disc drives may require this information. The Write operation is initiated with a Start command. The Busy flag is set to 1 and the Done flag is set to 0.

Once the Write operation is initiated, the controller reads two words from the computer's memory, via the data channel and then waits for the desired sector to pass under the head. Each time the controller reads a word from the computer's memory, the Memory Address Counter is incremented. Once the desired sector is encountered, the bits of each word are sequentially written. When the 256 words in the sector have been written, the controller writes the checkword it calculated from the data during the Write operation. The sector counter is then incremented by one.

If the sector counter does not overflow, the next sector is written. This process continues until either the sector counter overflows or the last sector on the surface is written. In the case when the last sector on surface 0 is written, and the sector counter has not overflowed, the drive will automatically continue the operation by writing the first sector on surface 1 in the same cylinder.

The Write operation then continues until the sector counter indicates, by overflowing, that the specified number of sectors have been written. Upon completion of the Write operation, the Busy flag is set to 0, the Done flag is set to 1 and a program interrupt is initiated.

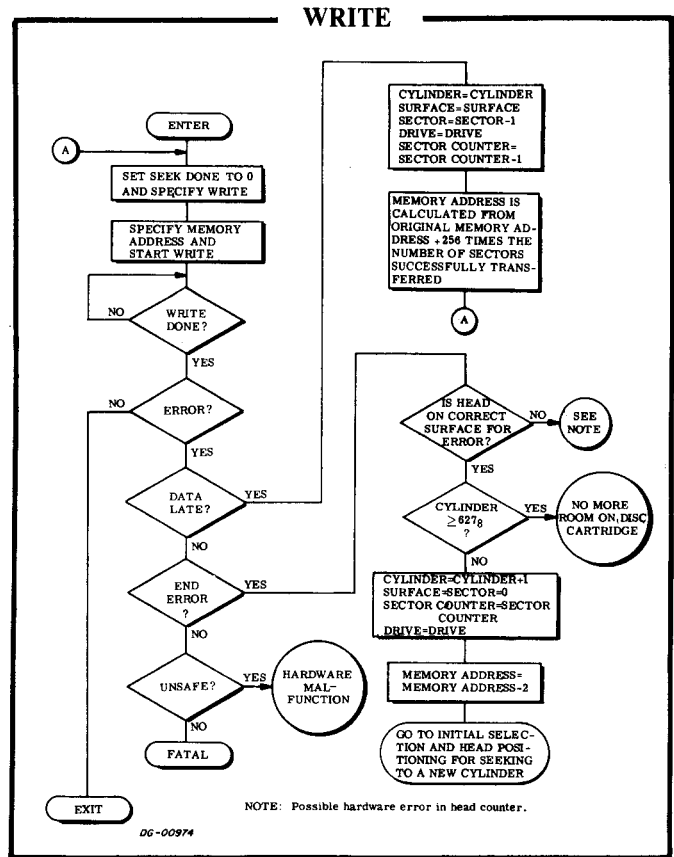

TIMING

The disc cartridge rotates at a speed of 1500 rpm; a complete revolution requires 40 milliseconds. A register, containing the identification number of the sector currently passing under the head, is used to reduce the sector accessing time. This feature allows the subsystem to carry out a Read or a Write operation the first time the desired sector passes under the head without waiting for a track address check.

Since each data record in a sector is preceded by a 0.5 millisecond gap, used for synchronization, the minimum sector access time is 0.5 milliseconds. The maximum is 40.5 milliseconds so the average is 20.5 milliseconds.

The time required to position the heads (the seek time) is dependent on the number of cylinders the heads must move past in a Seek operation. A maximum of 15 milliseconds is required to move the heads from one cylinder to the adjacent cylinder. The time required to move from cylinder 0 to cylinder 312₈, or vice versa, is 135 milliseconds, maximum.

Any time a Seek or Recalibrate operation is initiated by a Pulse command, the controller requires 50 microseconds to respond to the command. Therefore, the program must wait 50 microseconds after initiating a head movement operation before any other disc command can be issued.

A sector passes under the head in 3.33 milliseconds while the data block in the sector passes under the head in 2.84 milliseconds. Since there are 256 data words in a sector, a data channel request occurs every 11.1 microseconds. This corresponds to a data transfer rate of 90,000 words/second. Since the controller is doubled buffered, the maximum allowable data channel latency is 22.2 microseconds. If the data channel does not respond within this time, both the Data Late and the Error flags are set to 1. Once this error occurs, the processing of the current sector is completed and the command is terminated, even if the operation was scheduled to transfer additional sectors. The Busy flag is set to 0, the Done flag is set to 1 and a program interrupt request is initiated.

ERROR CONDITIONS

During Initial Selection

If the program specifies a non-existent sector (>13g) no indication of this error is given. If the subsystem then attempts a Read or a Write operation, the drive unit will search forever for that non-existent sector. The subsystem can be released from this search by having the program issue an I/O RESET instruction (IORST).

During Head Positioning

If the program issues a SPECIFY COMMAND AND CYLINDER instruction which specifies a non-existent cylinder (>312g) and then places the drive unit in the seek mode, the Seek operation is terminated. Both the Seek Error and the Seek Done flags for that unit are set to 1. When the Seek Done flag is set to 1, a program interrupt request is initiated.

If any Seek operation to a valid cylinder number results in a Seek Error, the drive unit should be recalibrated.

During Reading

As mentioned above, specifying a non-existent sector will cause the drive unit to search forever for that sector once a Read operation is initiated.

An error can occur when the subsystem is reading a series of sectors in one operation if the Read operation exceeds the number of sectors available. When the last sector on surface 1 is read and the drive unit attempts to advance automatically to the next surface, since the sector counter has not overflowed, both the Error and the End Error flags are set to 1. The sector counter is incremented and the sector address is set to 0. The Busy flag is set to 0, the Done flag is set to 1 and a program interrupt request is initiated.

If the checkword read at the end of a sector differs from that calculated by the controller, both the Error and the Check Error flags are set to 1. The Read operation is terminated, even if more sectors were supposed to be read; the Busy flag is set to 0, the Done flag is set to 1 and a program interrupt request is initiated. The Check Error indicates that at least one word in the last sector read contains an error.

If the data channel does not respond in time to a data channel request, both the Error and the Data Late flags are set to 1. The reading of the current sector continues, but once that sector has been read, the Read operation is terminated. The Busy flag is set to 0, the Done flag is set to 1 and a program interrupt request is initiated. The Data Late flag indicates that at least one word from the last sector read was not correctly transferred to memory.

During Writing

As mentioned above, specifying a non-existent sector will cause the drive unit to search forever for that sector once a Write operation is initiated.

An error can occur when the subsystem is writing a series of sectors in one operation if the Write operation exceeds the number of sectors available. When the last sector on surface 1 is written and the drive unit attempts to advance automatically to the next surface, since the sector counter has not overflowed, both the Error and the End Error flags are set to 1. The sector counter is incremented and the sector address is set to sector 0. The Busy flag is set to 0, the Done flag is set to 1 and a program interrupt request is initiated.

If the data channel does not respond in time to a data channel request, both the Error and the Data Late flags are set to 1. The writing of the current sector continues, but once that sector has been written, the Write operation is terminated. The Busy flag is set to 0, the Done flag is set to 1 and a program interrupt request is initiated. The Data Late flag indicates that at least one word in the sector was not written properly.

THE 4048A DISC PACK SUBSYSTEM

SUMMARY

MNEMONIC (FIRST CONTROLLER)..... DKP
 DEVICE CODE (FIRST CONTROLLER) 33₈
 MNEMONIC (SECOND CONTROLLER)... DKP1
 DEVICE CODE (SECOND CONTROLLER)... 73₈
 PRIORITY MASK BIT 7
 SURFACES/UNIT 10
 TRACKS/SURFACE (CYLINDERS)..... 203
 SECTORS/TRACK 6
 WORDS/SECTOR 256
 TOTAL STORAGE CAPACITY
 (WORDS) 3, 118, 080
 MAXIMUM TRANSFER RATE
 (WORDS/SEC) 78, 000
 MAXIMUM ALLOWABLE DATA
 CHANNEL LATENCY (μ SEC) 25. 6
 SEEK TIME MAX/MIN (mSEC)..... 60/10
 SECTOR ACCESS TIME MAX/MIN
 (mSEC)..... 46. 3/0

SPECIFY COMMAND AND CYLINDER... (DOA)

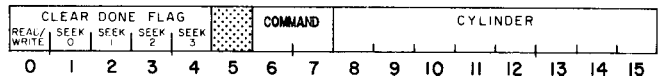

COMMANDS

00 Read 10 Seek
 01 Write 11 Recalibrate

READ STATUS (DIA)

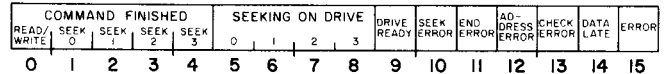

LOAD MEMORY ADDRESS COUNTER... (DOB)

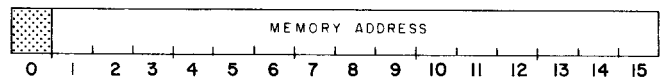

READ MEMORY ADDRESS COUNTER.... (DIB)

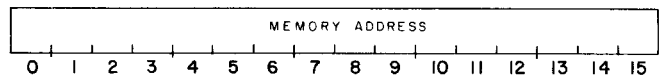

ACCUMULATOR FORMATS

SPECIFY DISC ADDRESS AND SECTOR COUNT (DOC)

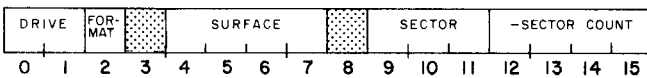

READ DISC ADDRESS (DIC)

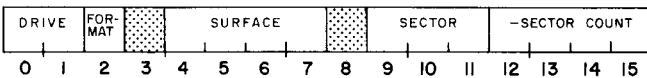

S, C AND P FUNCTIONS

- S Set Busy to one, Done to zero and start a Read or a Write operation.
- C Set Busy to zero, Done to zero and stop all operations.
- P Start a Seek or a Recalibrate operation.

INTRODUCTION

The 4048A disc pack subsystem utilizes a removable disc pack containing 10 (0-11₈) program accessible surfaces. There are 203 (0-312₈) cylinders on the disc pack. Each of the preformatted tracks in a cylinder contains 6 (0-5) sectors, each of which stores 256 (400₈) 16-bit words and contains a checkword. The data storage capacity is 1,536 words/track, 15,360 words/cylinder or 3,118,080 words/pack. Words are

transferred to and from the subsystem via the data channel at a rate of 78,000 words per second. Up to 16 sectors containing 4096 (10000₈) words can be transferred in one operation.

The controller for the subsystem, when coupled to the adapter, can direct the activities of up to four drive units. Any number of these units can be performing Seek operations simultaneously, but only one drive can be reading or writing at any one time.

INSTRUCTIONS

The disc drive controller contains four program accessible registers: a 15-bit Memory Address Counter, a 16-bit Status Register, a 16-bit combined Command/Cylinder Select Register and a combined disc Address/Sector Counter Register. The Memory Address Counter is self-incrementing and contains the memory location of the next 16-bit word to be either read from or written on the disc. The Status Register contains all the information flags for the controller and the selected drive as well as 8 flags which indicate when any drive completes a Seek or a Recalibrate operation. Any of the 4 Seek Done flags as well as the Read/Write Done flag are able to initiate a program interrupt request when they are set to 1. The combined Command/Cylinder Select Register contains the command last issued to the subsystem and the number of the desired cylinder on the disc surface. The combined Disc Address/Sector Counter contains the surface and sector location of the active head and the two's complement of the number of sectors to be either read from or written on the disc. The Sector Counter is self-incrementing after each sector is read or written.

Six instructions are used to program data channel transfers to and from the disc pack. Three of these instructions are used to supply all of the necessary data to the controller for any disc operation. The remaining three instructions allow the program to determine, in detail, the current state of the disc pack subsystem.

The disc controller's Busy and Done flags are controlled using all three of the device flag commands as follows:

- f=S Initiate a Read, Write, Seek or Recalibrate operation, depending on the contents of the Command Register. Set the Busy flag to 1, the Done flag and all error indicating flags to 0. The error indicating flags are the Seek Error, the End Error, the Address Error or Unsafe, the Check Error, the Data Late and the Error flags. Note that it is usually undesirable to initiate a Seek or Recalibrate with this command as the controller will remain busy until the operation is completed.
- f=C Set the Busy, Done and all error indicating flags to 0 and stop all positioning and data transferring operations.
- f=P Initiate either a Seek or a Recalibrate operation, depending on the contents of the Command Register.

SPECIFY DISC ADDRESS AND SECTOR COUNT

DOC<f> ac,DKP

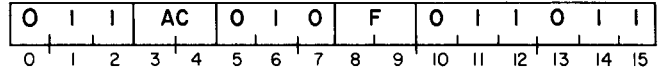

Bits 0-15 of the specified AC are loaded into the controller's combined Address Register/Sector Counter. Bits 3 and 8 are ignored. After the data transfer, the controller's Busy and Done flags are set according to the function specified by F. The contents of the specified AC remain unchanged. The format of the specified AC is as follows:

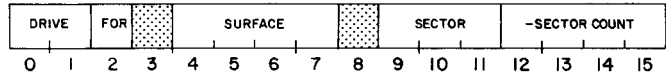

Bits	Name	Function
0-1	Drive	Select the drive 0, 1, 2, or 3.
2	Format	If 1, place the drive in the format mode.
3	----	Reserved for future use.
4-7	Surface	Select the surface (head), 0-11g, for the start of a Read or Write operation.
8	----	Reserved for future use.
9-11	Sector	Select the starting sector, 0-5, for the start of a Read or a Write operation.
12-15	-Sector Count	Specify the two's complement of the number of sectors to be read or written in one operation (maximum of 16).

READ STATUS

DIA <f> ac, DKP

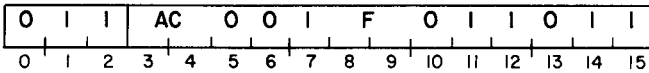

The contents of the Status Register are placed in bits 0-15 of the specified AC. After the data transfer, the controller's Busy and Done flags are set according to the function specified by F. The format of the specified AC is as follows:

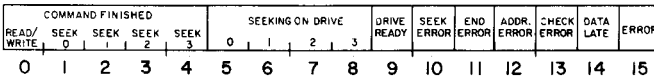

Bits	Name	Meaning When 1
0	Read/Write Done	The subsystem has completed a Read or Write operation.
1-4	Seek Done	Drive 0-3, respectively, has completed a Seek or Recalibrate operation. More than one of these bits can be set at any time.
5-8	Seeking On Drive	Drive unit 0-3, respectively, is currently performing a Seek or Recalibrate operation.
9	Disc Ready	The selected drive is ready to carry out a command.
10	Seek Error	The selected drive did not carry out the Seek or Recalibrate operation which was initiated.
11	End Error	The selected drive attempted to continue a Read or Write operation which began at a valid address but extended beyond the last surface in the disc pack.
12	Address Error or Unsafe	Either the address read at the beginning of the track did not match the specified address or a malfunction exists in the selected drive.
13	Check Error	The checkword read from the disc at the end of a sector does not match the checkword calculated by the controller.
14	Data Late	The data channel failed to respond in time to a data channel request.
15	Error	One or more of the bits 10-14 is 1.

SPECIFY COMMAND AND CYLINDER

DOA <f> ac, DKP

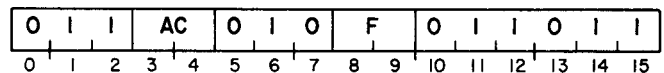

Bits 0-15 of the specified AC are loaded into the controller's combined Command/Cylinder Select Register. After the data transfer, the controller's Busy and Done flags are set according to the function specified by F. The format of the specified AC is as follows:

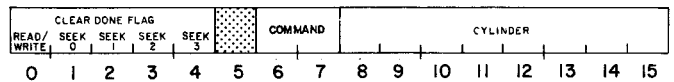

Bits	Name	Function
0	Clear Read/Write Done	Set the controller's Done flag to 0; set the following error indicating flags to 0: Seek Error, Address Error or Unsafe, End Error, and Check Error.
1-4	Clear Seek Done	Set the Seek Done flags to 0 for the drives 0-3, respectively.
5	----	Reserved for future use.
6-7	Command	Specify the command for the selected drive as follows: 00 Read with a Start command. 01 Write with a Start command. 10 Seek with a Pulse command to the cylinder specified in bits 8-15 of this accumulator. 11 Recalibrate with a Pulse command.
8-15	Cylinder	Specify the cylinder 0-312 ₈ , for a Seek, Read or Write operation.

LOAD MEMORY ADDRESS COUNTER

DOB <f> ac, DKP

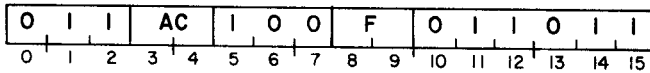

Bits 0-15 of the specified AC are loaded into the controller's Memory Address Counter. After the data transfer, the controller's Busy and Done flags are set according to the function specified by F. The format of the specified AC is as follows:

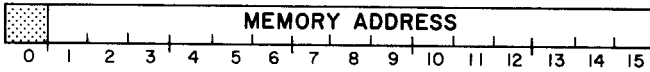

Bits	Name	Function
0	---	Reserved for future use.
1-15	Memory	Location of the next word in memory to be used for a data channel transfer. Bit 0 is loaded and read back but it does not affect the data transfer.

READ DISC ADDRESS

DIC <f> ac, DKP

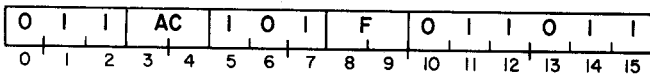

The contents of the disc address register and the Sector Counter are placed in bits 0-15 of the specified AC. After the data transfer, the controller's Busy and Done flags are set according to the function specified by F. The format of the specified AC is as follows:

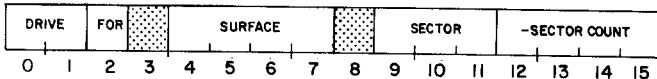

Bits	Name	Contents
0-1	Drive	Number of the selected drive.
2	Format	The selected drive is in the format mode.
3-7	Surface	The surface number of the active head on the drive. Although bit 3 specifies a surface which does not exist, if it were loaded by a DOC instruction, it will be set when read back.
8-11	Sector	The number of the sector immediately following the last sector read or written. Although bit 8 specifies a sector which does not exist, if it were loaded by a DOC instruction, it will be set when read back.
12-16	-Sector Count	The two's complement of the number of sectors left to be read or written.

READ MEMORY ADDRESS COUNTER

DIB <f> ac, DKP

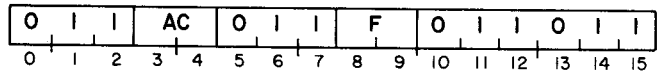

The contents of the Memory Address Counter are placed in bits 0-15 of the specified AC. After the data transfer, the controller's Busy and Done flags are set according to the function specified by F. The format of the specified AC is as follows:

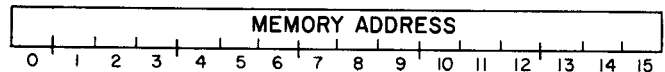

Bits	Name	Contents
0-15	Memory Address	Location of the next word in memory to be used for a data channel transfer. If bit 0 is 1, the Read or the Write operation exceeded the capacity of a 32K machine and the excess words were transferred either to (in a read) or from (in a write) low core.

PROGRAMMING

The preparation of a moving head disc pack for data channel transfers is divided into three distinct phases: I, selecting the drive, the surface and the sector; II, positioning the heads over the correct cylinder; and III, starting the Read or the Write operation. The results of issuing commands in each phase should be checked for errors before proceeding to the next phase.

Phase I: Select the Drive, Surface, Sector and Number of Sectors

The initial selection of a disc drive is performed as follows: a SPECIFY DISC ADDRESS AND SECTOR COUNT instruction (DOC) is issued to the controller to select the drive, the surface of

the disc pack, the first sector to be read or written, and the two's complement of the number of sectors to be transferred in the operation. The drives are numbered 0-3; the surfaces are numbered 0-11; the sectors are numbered 0-5; the maximum number of sectors which can be transferred in one operation is 16. Care should be taken to insure that the parameters specified in this initial selection do not exceed the capacity of the disc pack.

Once the drive unit is chosen, the status of that drive must be checked to determine if the drive is ready to proceed. The status is checked by issuing a READ STATUS instruction (DIA) and examining the Ready flag. If the Ready flag is set to 1, the program can proceed to Phase II. If it is set to 0, the program should not issue any commands to that drive unit until it is in the ready state.

Phase II: Position the Heads

The heads are positioned over the desired cylinder as follows: a SPECIFY COMMAND AND CYLINDER instruction (DOA) is issued to the controller. This instruction should contain the number of the cylinder desired and the Seek command. The cylinders are numbered from 0-312₈. The instruction should also set both the Read/Write Done flag and the Seek Done flag for the selected drive to 0. The Seek operation is initiated by a Pulse command. While the drive is seeking, the Unit Ready flag for that drive is set to 0 and the Seeking On Drive flag for the selected drive is 1. When the heads have finished moving to the specified cylinder, the Seeking On Drive flag is set to 0, and both the Unit Ready and the Seek Done flags for that drive unit are set to 1, thus initiating a program interrupt request.

The program should then check the Status Register to determine if a seek error has occurred as a result of a faulty Seek operation. If no errors have occurred, the program can proceed to Phase III.

The heads of the selected drive unit can be forced to cylinder 0 by the Recalibrate operation. A Recalibrate operation is performed as follows: a SPECIFY COMMAND AND CYLINDER instruction is issued to the controller. This instruction should contain the Recalibrate command and should also set both the Read/Write Done and the Seek Done flags for the selected drive unit to 0. The operation is initiated by a Pulse command. While the drive is being recalibrated, the Unit Ready flag for the selected drive is set to 0 and the Seeking On Drive flag for the selected drive is set to 1. Once the Recalibrate operation is completed, the Seeking On Drive flag is set to 0, the Unit Ready flag is set to 1, the Seek Done flag for the selected drive is set to 1 and a program interrupt request is initiated.

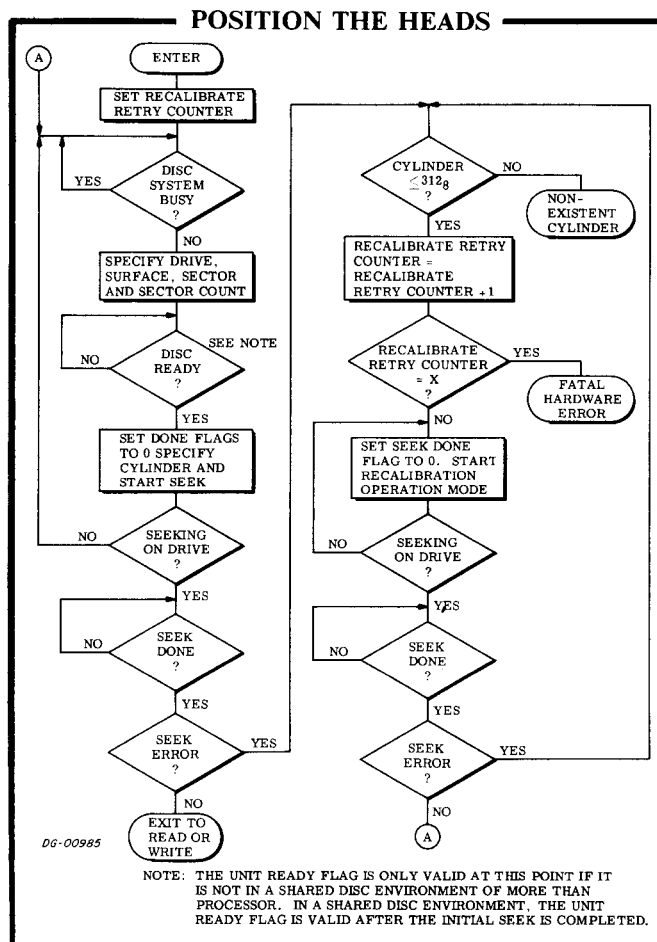

When the program places a drive in the seek mode of operation, the controller is free to accept commands to the other drives under its direction. Therefore, once one or more drives are performing Seek operations, one of the other drives can perform a Read or a Write operation. If the program is simultaneously managing several drives with one controller, the error indicating flags in the Status Register apply only to the most recently selected drive unit, i.e., the unit specified in the last SPECIFY DISC ADDRESS AND SECTOR COUNT instruction issued.

Phase III: Read or Write

A Read operation transfers blocks of data stored in the disc subsystem to the computer, via the data channel. A block of data contains 256 16-bit words. Up to 16 blocks can be transferred in one Read operation. A Write operation transfers blocks of data from the computer's memory via the data channel, and stores the data in the disc subsystem. Again, up to 16 blocks of data may be transferred in one operation. Read or Write operations are performed in a series of steps which are virtually identical. The parameters of the data transfer must be specified and finally the operation is initiated.

Read

A Read operation is performed as follows: the storage location in memory for the first word to be read from the disc is specified with a LOAD MEMORY ADDRESS COUNTER instruction (DOB). The number of sectors to be read and the starting sector were specified in Phase I.

The Read command is then loaded into the Command Register with a SPECIFY COMMAND CYLINDER instruction (DOA). It is not necessary to load the cylinder number again, but it is good practice since other disc drives may require this information. The Read operation is initiated with a Start command. The Busy flag is set to 1 and the Done flag is set to 0.

Once the Read operation is initiated, the drive waits until the address field at the beginning of the track passes under the head and performs an address check. If the address read is correct, the controller waits until the specified sector is encountered. The drive then starts reading the sequential bits of the first word of the sector. When a word is fully assembled, the controller transfers the word to the computer's memory via the data channel. Each time a word is transferred to memory, the Memory Address Counter is automatically incremented.

When the 256 words from the sector have been read, and the checkword at the end of the sector verified, the sector counter is automatically incremented by one.

If the sector counter does not overflow, the next sector is read and this process continues until either the sector counter overflows or the last sector on the surface is read. In the case where the last sector on surface 0-10g is read, and the sector counter has not overflowed, the drive will

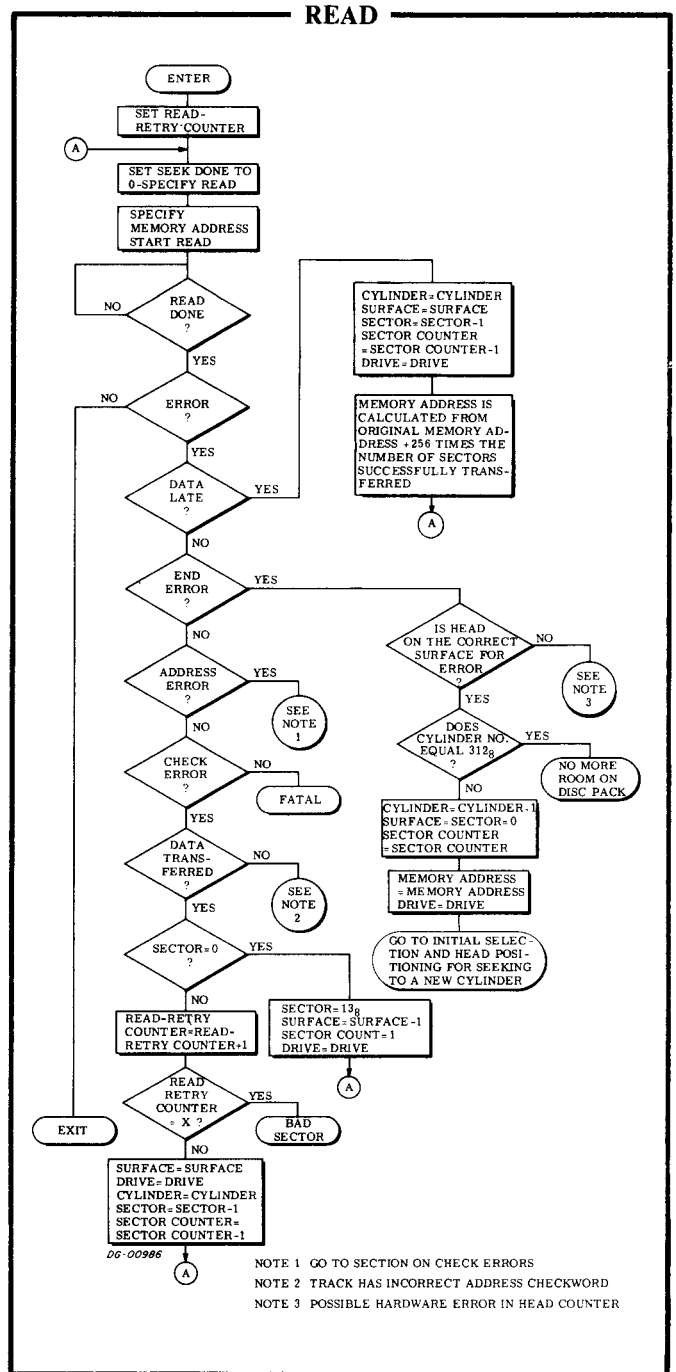

automatically continue the operation by reading the first sector on the next surface in the same cylinder.

The Read operation then continues until the sector counter indicates, by overflowing, that the specified number of sectors have been read. Upon completion of the Read operation, the Busy flag is set to 1 and a program interrupt request is initiated.

Write

A Write operation is performed as follows: the storage location in memory of the first word to be written on the disc is specified with a LOAD MEMORY ADDRESS COUNTER instruction (DOB). The number of sectors to be written and the number of the starting sector were specified in Phase I.

The Write command is then loaded into the Command Register with a SPECIFY COMMAND AND CYLINDER instruction (DOA). It is not necessary to load the cylinder number again, but it is good practice since other disc drives may require this information. The Write operation is initiated with a Start command. The Busy flag is set to 1 and the Done flag is set to 0.

Once the Write operation is initiated, the controller reads two words from the computer's memory via the data channel and then waits for the address field at the beginning of the track to pass under the head. Each time the controller reads a word from the computer's memory, the Memory Address Counter is automatically incremented. Once the address field is encountered, the address check is performed automatically. If the address read from the disc is correct, the controller waits until the specified sector is encountered. The bits of each word then are sequentially written. When the 256 words in the sector have been written, the controller writes the checkword it calculated from the data it wrote on the disc. The sector counter is automatically incremented by one.

If the sector counter does not overflow, the next sector is written. This process continues until either the sector counter overflows of the last sector on the surface is written. In the case when the last sector on surface 0-10g is written, and the sector counter has not overflowed, the drive will automatically continue the operation by writing the first sector on the next surface in the same cylinder.

The Write operation then continues until the sector counter indicates, by overflowing, that the specified number of sectors have been written. Upon completion of the Write operation, the Busy flag is set to 0, the Done flag is set to 1 and a program interrupt is initiated.

WRITE

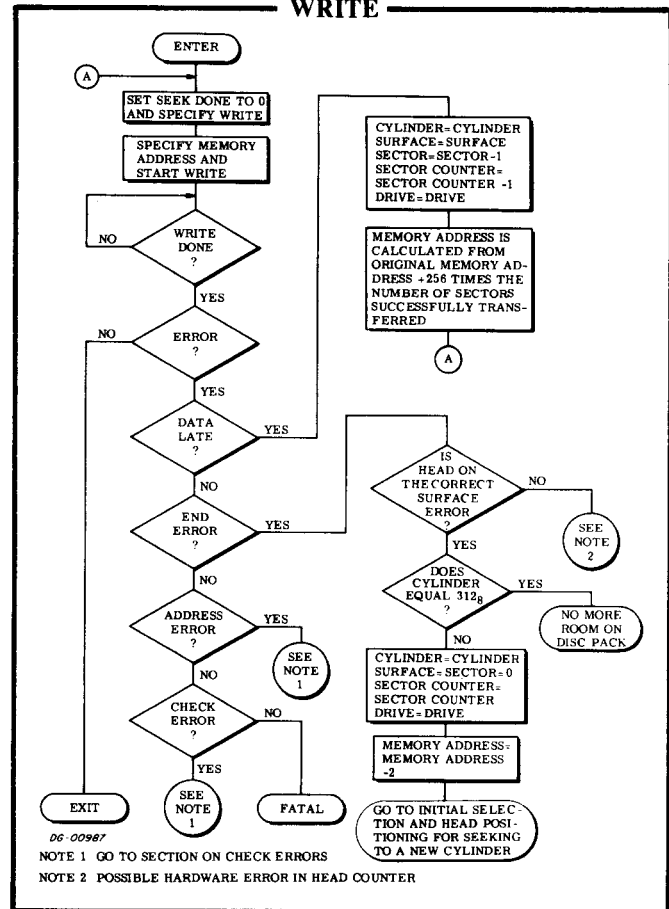

Format

A new disc pack is unformatted so a Disc Pack Formatter program is available to initialize the disc pack with the proper prerequisites for reading from or writing on the disc pack.

This program is the 4048 Disc Pack Formatter Program #096-000039 (tape #095-000072).

A disc pack may also be reformatted when repeated recalibrations of the heads do not eliminate an Address Error occurring during a Read or a Write operation. All data is lost when a disc pack is reformatted.

TIMING

The disc pack rotates at a speed of 2400rpm; a complete revolution requires 25 milliseconds. Since the controller must wait until the index point on the disc passes the head before the search for the desired sector can be started, the waiting time before starting the sector search can be as much as 25 milliseconds (average of 12.5 milliseconds). Once the search for the correct sector begins, the time taken to reach that sector depends on which sector is specified: sector 0 is reached almost immediately while sector 5 requires 21.3 milliseconds before reading or writing can commence.

The total sector access time is therefore the time required to reach the address field plus the time required to reach the desired sector. The maximum is 46.3 milliseconds (25 to reach the address field plus the 21.3 milliseconds to reach sector 5).

The time required to position the heads (the seek time) is dependent on the number of cylinders the heads must move past in a Seek operation. A maximum of 10 milliseconds is required to move the heads from one cylinder to the adjacent cylinder. The time required to move from cylinder 0 to cylinder 312₀, or vice versa, is 60 milliseconds, maximum. A Recalibrate operation requires a maximum of 300 milliseconds.

If a Seek or a Recalibrate operation is not completed within 1 second, the Seek Error and Error flags are set to 1. The Done flag is set to 1 and a program interrupt request is initiated.

A sector passes under the head in 4.17 milliseconds while the data block in the sector passes under the head in 3.28 milliseconds. Since there are 256 data words in a sector, a data channel request occurs every 12.8 microseconds. This corresponds to a data transfer rate of 78,000 words/second. Since the controller is double buffered, the maximum allowable data channel latency is 25.6 microseconds. If the data channel does not respond within this time, both the Data Late and the Error flags are set to 1. Once this error occurs, the processing of the current sector is completed and the command is terminated, even if the operation was scheduled to transfer additional sectors. The Busy flag is set to 0, the Done flag is set to 1 and a program interrupt request is initiated.

For the greatest efficiency when processing an entire cylinder, the program should be coded to process two tracks at a time since the head must wait for the index point on the surface to pass the head before each command can begin. However, after completing the processing of these two tracks, enough time is available (.5msec) to prepare the disc pack to read or write the next track without

waiting for a full rotation of the disc to correctly position sector zero. This procedure allows the head to start processing immediately after a command is issued without having to wait for the drive to search for the correct sector before beginning the operation.

ERROR CONDITIONS

During Initial Selection

If the program specifies a non-existent sector (>5g) no indication of this error is given. If the subsystem then attempts a Read or a Write operation, the drive unit will search forever for that non-existent sector. The subsystem can be released from this search by having the program issue an I/O RESET instruction (IORST).

During Head Positioning

If the program issues a SPECIFY COMMAND AND CYLINDER instruction which specifies a non-existent cylinder (>312g) and then places the drive unit in the seek mode, the Seek operation is terminated. Both the Seek Error and the Seek Done flags for that unit are set to 1. When the Seek Done flag is set to 1, a program interrupt request is initiated.

If any Seek operation to a valid cylinder number results in a Seek Error, the drive unit should be recalibrated.

During Reading

As mentioned above, specifying a non-existent sector will cause the drive unit to search forever for that sector once a Read operation is initiated.

An error can occur when the subsystem is reading a series of sectors in one operation if the Read operation exceeds the number of sectors available. When the last sector on surface 11g is read and the drive unit attempts to advance automatically to the next surface, since the sector counter has not overflowed, both the Error and the End Error flags are set to 1. The sector counter is incremented and the sector address is set to 0. The Busy flag is set to 0, the Done flag is set to 1 and a program interrupt request is initiated.

If the data channel does not respond in time to a data channel request, both the Error and the Data Late flags are set to 1. The reading of the current sector continues, but once that sector has been read, the Read operation is terminated. The Busy flag is set to 0, the Done flag is set to 1 and a program interrupt request is initiated. The Data Late flag indicates that at least one word from the sector read was not correctly transferred to memory.

During Writing

As mentioned above, specifying a non-existent sector will cause the drive unit to search forever for that sector once a Write operation is initiated.

An error can occur when the subsystem is writing a series of sectors in one operation if the Write operation exceeds the number of sectors available. When the last sector on surface 11_g is written and the drive unit attempts to advance automatically to the next surface, since the sector counter has not overflowed, both the Error and the End Error flags are set to 1. The sector counter is incremented and the sector address is set to sector 0. The Busy flag is set to 0, the Done flag is set to 1 and a program interrupt request is initiated.

If the data channel does not respond in time to a data channel request, both the Error and the Data Late flags are set to 1. The writing of the current sector continues, but once that sector has been written, the Write operation is terminated. The Busy flag is set to 0, the Done flag is set to 1 and a program interrupt request is initiated. The Data Late flag indicates that at least one word in the sector was not written properly.

Check Error

A Check Error flag is set to 1 during a Read operation if the 16-bit checkword read after the data in the sector being processed does not match the checkword calculated by the controller during the Read operation.

The Check Error flag can also be set to 1 if a checkword error is detected when verifying the home address of a track in either a Read or a Write operation. Usually the Address Error flag is also set to 1 since an error has been made in reading the track address information. However, this Checkword Error can also occur without an accompanying Address Error when the checkword read at the end of the track home address is incorrect. In both of these cases, access to all the sectors on that track is denied.

Since the Check Error flag can be set to 1 without an Address Error flag under two circumstances in a Read operation, the programmer should verify which condition caused the flag to be set to 1. If the Check Error flag is posted and the Memory Address Counter has not changed, the checkword

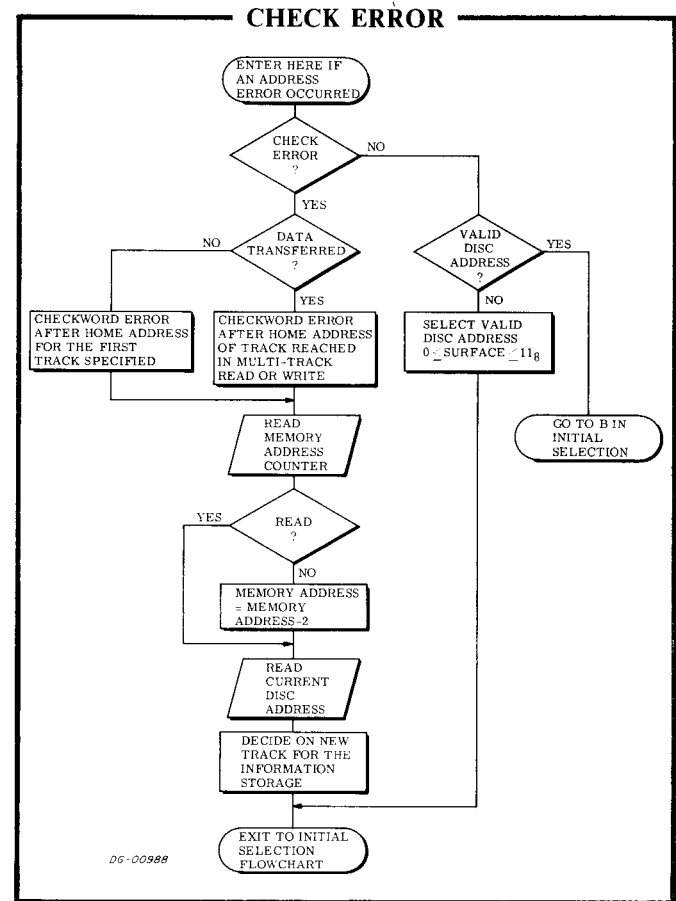

following the track home address is incorrect. In addition, if the Read operation does not extend to the next surface and data has been transferred, then the error is in the last sector processed.

However, when a Read operation extends beyond one surface, and a Check Error occurs after the last sector on the first surface is read and before the first sector on the second surface is read, the error could be in either the last sector on the first surface or in the checkword for the home address of the track in the second surface. In each of these two cases, the Memory Address Counter and the Disc Address Register will contain identical information.

These two cases can be differentiated by performing a Read operation on the last sector of the first surface. If this Read is successful, the error is in the checkword of the home address of the track on the second surface. If this is the case, then that track on the second surface is inaccessible.

THE 4057A DISC PACK SUBSYSTEM

SUMMARY

MNEMONIC (FIRST CONTROLLER) DKP
 DEVICE CODE (FIRST CONTROLLER) 33_g
 MNEMONIC (SECOND CONTROLLER) ... DKP1
 DEVICE CODE (SECOND CONTROLLER).... 73_g
 PRIORITY MASK BIT..... 7
 SURFACES/UNIT20
 TRACKS/SURFACE (CYLINDERS) 203
 SECTORS/TRACK 12
 WORDS/SECTOR 256
 TOTAL STORAGE CAPACITY
 (WORDS) 12,472,320
 MAXIMUM TRANSFER RATE
 (WORDS/SEC) 156,000
 MAXIMUM ALLOWABLE DATA
 CHANNEL LATENCY (μSEC) 12.8
 SEEK TIME MAX/MIN (mSEC)..... 60/10
 SECTOR ACCESS TIME MAX/MIN
 (mSEC) 48.2/0.2

ACCUMULATOR FORMATS

SPECIFY DISC ADDRESS
 SECTOR COUNT (DOC)

DRIVE	FOR- MAT	SURFACE				SECTOR				-SECTOR COUNT					
0	1	2	3	4	5	6	7	8	9	10	11	12	13	14	15

READ DISC ADDRESS (DIC)

DRIVE	FOR- MAT	SURFACE				SECTOR				-SECTOR COUNT					
0	1	2	3	4	5	6	7	8	9	10	11	12	13	14	15

SPECIFY COMMAND AND CYLINDER ... (DOA)

CLEAR REAL/ WRITE	DONE SEEK 0	FLAG SEEK 1	SEEK 2	SEEK 3	COMMAND	CYLINDER									
0	1	2	3	4	5	6	7	8	9	10	11	12	13	14	15

COMMANDS

00 Read 10 Seek
 01 Write 11 Recalibrate

READ STATUS (DIA)

COMMAND REAL/ WRITE	FINISHED SEEK 0	SEEK 1	SEEK 2	SEEK 3	SEEKING ON DRIVE				DRIVE READY	SEEK ERROR	END ERROR	AD- DRESS ERROR	CHECK ERROR	DATA LATE	ERROR
0	1	2	3	4	5	6	7	8	9	10	11	12	13	14	15

LOAD MEMORY ADDRESS COUNTER... (DOB)

0	MEMORY ADDRESS														
0	1	2	3	4	5	6	7	8	9	10	11	12	13	14	15

READ MEMORY ADDRESS COUNTER... (DIB)

MEMORY ADDRESS															
0	1	2	3	4	5	6	7	8	9	10	11	12	13	14	15

S, C AND P FUNCTIONS

- S Set Busy to one, Done to zero and start a Read or a Write operation.
- C Set Busy to zero, Done to zero and stop all operation.
- P Start a Seek or a Recalibrate operation.

INTRODUCTION

The 4057A disc pack subsystem utilizes a removable disc pack containing 20 (0-23_g) program accessible surfaces. There are 203 (0-312_g) cylinders on the disc pack. Each of the preformatted 20 tracks in a cylinder contains 12 (0-13_g) sectors, each of which stores 256 (400_g) 16-bit words and contains a checkword. The data storage capacity is 3072 words/track, 61,440 words/cylinder or 12,472,320 words/pack. Words are transferred to and from the subsystem via the

data channel at a rate of 156,000 words per second. Up to 16 sectors containing 4096 (10,000_g) words can be transferred in one operation.

The controller for the subsystem, when coupled to the adapter, can direct the activities of up to four drive units. Any number of these units can be performing Seek operations simultaneously, but only one drive can be reading or writing at any one time.

INSTRUCTIONS

The disc drive controller contains four program accessible registers: a 15-bit Memory Address Counter, a 16-bit Status Register, a 16-bit combined Command/Cylinder Select Register and a combined disc Address/Sector Counter Register. The Memory Address Counter is self-incrementing and contains the memory location of the next 16-bit word to be either read from or written on the disc. The Status Register contains all the information flags for the controller and the selected drive as well as 8 flags which indicate the Seek status of all the drives in the subsystem. Any of the 4 Seek Done flags as well as the Read/Write Done flags are able to initiate a program interrupt request when they are set to 1. The combined Command/Cylinder Select Register contains the command last issued to the subsystem and the number of the desired cylinder on the disc surface. The combined Disc Address/Sector Counter contains the surface and sector location of the active head and the two's complement of the number of sectors to be either read from or written on the disc. The Sector Counter is self-incrementing after each sector is read or written.

Six instructions are used to program data channel transfers to and from the disc pack. Three of these instructions are used to supply all of the necessary data to the controller for any disc operation. The remaining three instructions allow the program to determine, in detail, the current state of the disc pack subsystem.

The disc controller's Busy and Done flags are controlled using all three of the device flag commands as follows:

- f=S Initiate a Read, Write, Seek or Recalibrate operation, depending on the contents of the Command Register. Set the Busy flag to 1, the Done flag and all error indicating flags to 0. The error indicating flags are the Seek Error, the End Error, the Address Error or Unsafe, the Check Error, the Data Late and the Error flags. Note that it is usually undesirable to initiate a Seek or Recalibrate with this command as the controller will remain busy until the operation is completed.
- f=C Set the Busy, Done and all error indicating flags to 0 and stop all positioning and data transferring operations.
- f=P Initiate either a Seek or a Recalibrate operation, depending on the contents of the command register.

SPECIFY DISC ADDRESS AND SECTOR COUNT

DOC <f> ac, DKP

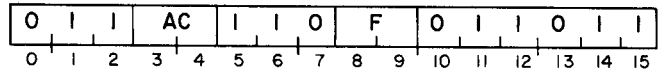

Bits 0-15 of the specified AC are loaded into the controller's combined Address Register/Sector Counter. After the data transfer, the controller's Busy and Done flags are set according to the function specified by F. The contents of the specified AC remain unchanged. The format of the specified AC is as follows:

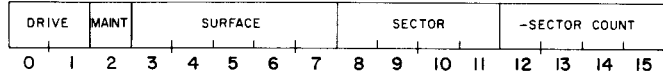

Bits	Name	Function
0-1	Drive	Select the drive 0, 1, 2, or 3.
2	Format	If 1, place the drive in the format mode of operation.
3-6	Surface	Select the surface (head), 0-23g, for the start of a Read or a Write operation.
7-11	Sector	Select the starting sector, 0-13g, for the start of a Read or a Write operation.
12-15	-Sector Count	Specify the two's complement of the number of sectors to be read or written in one operation (maximum of 16).

READ STATUS

DIA<f> ac, DKP

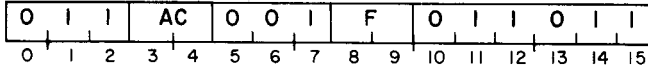

The contents of the Status Register are placed in bits 0-15 of the specified AC. After the data transfer, the controller's Busy and Done flags are set according to the function specified by F. The format of the specified AC is as follows:

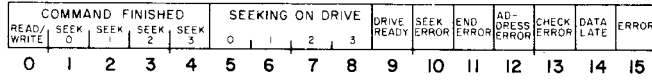

Bits	Name	Meaning When 1
0	Read/Write Done	The subsystem has completed a Read or a Write operation.
1-4	Seek Done	Drive 0-3, respectively, has completed a Seek or Recalibrate operation. More than one of these bits can be set at any time.
5-8	Seeking On Drive	Drive 0-3, respectively, is currently performing a Seek or a Recalibrate operation.
9	Drive Ready	The selected drive is ready to carry out a command.
10	Seek Error	The selected drive did not carry out the Seek or the Recalibrate operation which was initiated.
11	End Error	The selected drive attempted to continue a Read or a Write operation beyond the last surface in the disc pack.
12	Address Error or Unsafe	The address read from the address field at the beginning of the track does not match the specified address; or a malfunction exists in the selected drive.
13	Check Error	The checkword read from the disc at the end of a sector does not match the checkword calculated by the controller.
14	Data Late	The data channel failed to respond in time to a data channel request.
15	Error	One or more of the bits 10-14 is set to 1.

SPECIFY COMMAND AND CYLINDER

DOA<f> ac, DKP

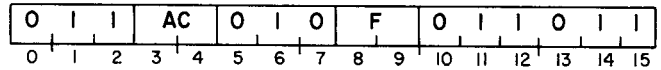

Bits 0-15 of the specified AC are loaded into the controller's combined Command/Cylinder Select Register. Bit 5 is ignored. After the data transfer, the controller's Busy and Done flags are set according to the function specified by F. The format of the specified AC is as follows:

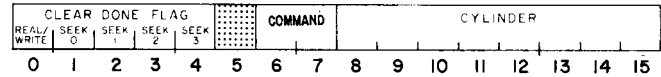

Bits	Name	Function If Set To One
0	Clear Read/Write Done	Set the controller's Done flag to 0; set the following error indicating flags to 0: Address Error or Unsafe, End Error, Check Error and Seek Error.
1-4	Clear Seek Done	Set the Seek Done flags to 0 for the drives 0-3, respectively.
5	---	Reserved for future use.
6-7	Command	Specify the command for the selected drive as follows: 00 Read with a Start command. 01 Write with a Start command. 10 Seek with a Pulse command to the cylinder specified in bits 8-15 of this accumulator. 11 Recalibrate with a Pulse command.
8-15	Cylinder	Specify the cylinder, 0-3128, for a Seek, Read or a Write operation.

LOAD MEMORY ADDRESS COUNTER

DOB<f> ac, DKP

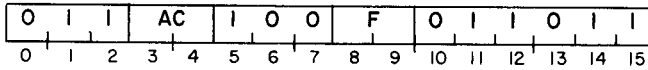

Bits 0-15 of the specified AC are loaded into the controller's Memory Address Counter. After the data transfer, the controller's Busy and Done flags are set according to the function specified by F. The format of the specified AC is as follows:

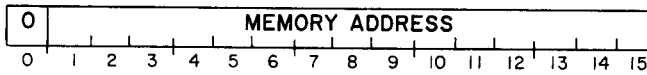

Bits	Name	Function
0	----	Reserved for future use.
1-15	Memory Address	Location of the next word in memory to be used for a data channel transfer.

READ DISC ADDRESS

DIC<f> ac, DKP

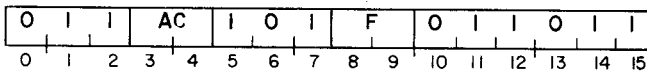

The contents of the disc Address Register and the Sector Counter are placed in bits 0-15 of the specified AC. After the data transfer, the controller's Busy and Done flags are set according to the function specified by F. The format of the specified AC is as follows:

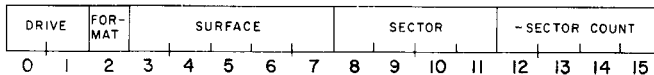

Bits	Name	Contents
0-1	Drive	Number of the selected drive.
2	Format	The selected drive is in the format mode.
3-7	Surface	The surface number of the active head on the drive.
8-11	Sector	The number of the sector immediately following the last sector read or written.
12-15	-Sector Count	The two's complement of the number of sectors left to be read or written.

READ MEMORY ADDRESS COUNTER

DIB<f> ac, DKP

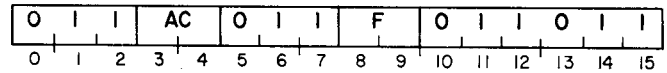

The contents of the Memory Address Counter are placed in bits 0-15 of the specified AC. After the data transfer, the controller's Busy and Done flags are set according to the function specified by F. The format of the specified AC is as follows:

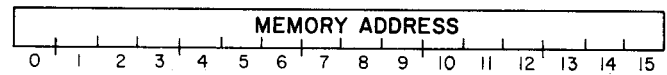

Bits	Name	Contents
0-15	Memory Address	Location of the next word in memory to be used for a data channel transfer. If bit 0 is 1, the Read or the Write operation exceeded the capacity of a 32K machine and the excess words were transferred either to (in a read) or from (in a write) low core.

PROGRAMMING

The preparation of a moving head disc pack for data channel transfers is divided into three distinct phases: I, selecting the drive, the surface and the sector; II, positioning the heads over the correct cylinder, and III, starting the Read or the Write operation. The results of issuing commands in each phase should be checked for errors before proceeding the next phase.

Phase I: Select the Drive, Surface, Sector and Number of Sectors

The initial selection of a disc drive is performed as follows: a SPECIFY DISC ADDRESS AND SECTOR COUNT instruction (DOC) is issued to the controller to select the drive, the surface of

the disc pack, the first sector to be read or written, and the two's complement of the number of sectors to be transferred in the operation. The drives are numbered 0-3; the surfaces are numbered 0-238; the sectors are numbered 0-138; the maximum number of sectors which can be transferred in one operation is 16. Care should be taken to insure that the parameters specified in this initial selection do not exceed the capacity of the disc pack.

Once the drive unit is chosen, the status of that drive must be checked to determine if the drive is ready to proceed. The status is checked by issuing a READ STATUS instruction (DIA) and examining the Ready flag. If the Ready flag is set to 1, the program can proceed to Phase II. If it is set to 0, the program should not issue any commands to that drive unit until it is in the ready state.

Phase II: Position the Heads

The heads are positioned over the desired cylinder as follows: a SPECIFY COMMAND AND CYLINDER instruction (DOA) is issued to the controller. This instruction should contain the number of the cylinder desired and the Seek command. The cylinders are numbered from 0-3128. The instruction should also set both the DP Done flag and the Seek Done flag for the selected drive to 0. The Seek operation is initiated by a Pulse command. While the drive is seeking, the Unit Ready flag for that drive is set to 0 and the Seeking On Drive flag is set to 1. When the heads have finished moving to the specified cylinder, the Seeking On Drive flag is set to 0, the Unit Ready and the Seek Done flags for that drive unit are set to 1, thus initiating a program interrupt request.

The program should then check the Status Register to determine if a seek error has occurred as a result of a faulty Seek operation. If no errors have occurred, the program can proceed to Phase III.

The heads of the selected drive unit can be forced to cylinder 0 by the Recalibrate operation. A Recalibrate operation is performed as follows: a SPECIFY COMMAND AND CYLINDER instruction is issued to the controller. This instruction should contain the Recalibrate command and should also set both the DP Done and the Seek Done flags for the selected drive unit to 0. The operation is initiated by a Pulse command. While the drive is being recalibrated, Unit Ready flag for the selected drive is set to 0 and the Seeking On Drive flag is set to 1. Once the Recalibrate operation is completed, the Seeking On Drive flag is set to 0, the Unit Ready flag is set to 1, the Seek Done flag for the selected drive is set to 1 and a program interrupt request is initiated.

When the program places a drive in the seek mode of operation, the controller is free to accept com-

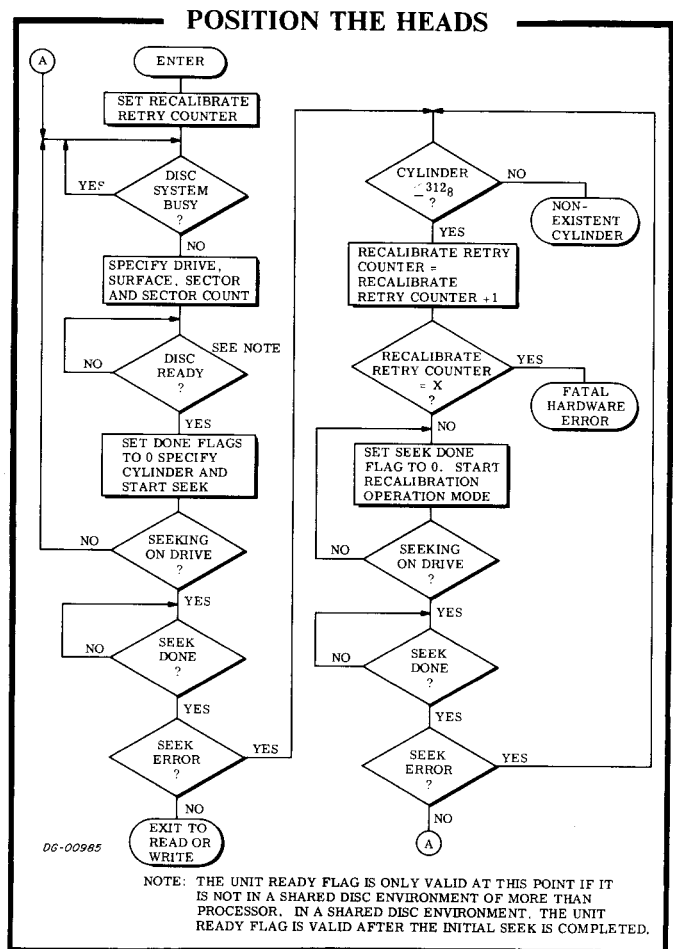

mands to the other drives under its direction. Therefore, once one or more drives are performing Seek operations, one of the other drives can perform a Read or a Write operation. If the program is simultaneously managing several drives with one controller, the error indicating flags in the Status Register apply only to the most recently selected drive unit, i. e., the most specified in the last SPECIFY DISC ADDRESS AND SECTOR COUNT instruction issued.

TIMING

The disc pack rotates at a speed of 2400rpm; a complete revolution requires 25 milliseconds. Since the controller must wait until the index point on the disc passes the head before the search for the desired sector can be started, the waiting time before starting the sector search can be as much as 25 milliseconds (average of 12.5 milliseconds). Once the search for the correct sector begins, the time taken to reach that sector depends on which sector is specified: sector 0 is reached almost immediately while sector 138 requires 23.2 milliseconds before reading or writing can commence.

The total sector access time is therefore the time required to reach the address field plus the time required to reach the desired sector. The maximum is 48.2 milliseconds (25 to reach the address field plus the 23.2 milliseconds to reach sector 138).

The time required to position the heads (the seek time) is dependent on the number of cylinders the heads must move past in a Seek operation. A maximum of 10 milliseconds is required to move the heads from one cylinder to the adjacent cylinder. The time required to move from cylinder 0 to cylinder 312, or vice versa, is 60 milliseconds, maximum. A Recalibrate operation requires a maximum of 300 milliseconds.

If a Seek or a Recalibrate operation is not completed within 1 second, the Seek Error and Error flags are set to 1. The Done flag is set to 1 and a program interrupt request is initiated.

A sector passes under the head in 2.08 milliseconds while the data block in the sector passes under the head in 1.64 milliseconds. Since there are 256 data words in a sector, a data channel request occurs every 6.4 microseconds. This corresponds to a data transfer rate of 156,000 words/second. Since the controller is double buffered, the maximum allowable data channel latency is 12.8 microseconds. If the data channel does not respond within this time, both the Data Late and the Error flags are set to 1. Once this error occurs, the processing of the current sector is completed and the command is terminated, even if the operation was scheduled to transfer additional sectors. The Busy flag is set to 0, the Done flag is set to 1 and a program interrupt request is initiated.

For the greatest efficiency when processing an entire cylinder, the program should be coded to process only one track at a time since the head must wait for the index point on the surface to pass the head before each command can begin. However, after completing the processing of a track, enough time is available (.2msec) to pre-

pare the disc pack to read or write the next track without waiting for a full rotation of the disc to correctly position sector zero. This procedure allows the head to start processing immediately after a command is issued without having to wait for the drive to search for the correct sector before beginning the operation.

ERROR CONDITIONS

During Initial Selection

If the program specifies a non-existent sector (<138) no indication of this error is given. If the subsystem then attempts a Read or a Write operation, the drive unit will search forever for that non-existent sector. The subsystem can be released from this search by having the program issue an I/O RESET instruction (IORST).

During Head Positioning

If the program issues a SPECIFY COMMAND AND CYLINDER instruction which specifies a non-existent cylinder (<312) and then places the drive unit in the seek mode, the Seek operation is terminated. Both the Seek Error and the Seek Done flags for that unit are set to 1. When the Seek Done flag is set to 1, a program interrupt request is initiated.

If any Seek operation to a valid cylinder number results in a Seek Error, the drive unit should be recalibrated.

During Reading

As mentioned above, specifying a non-existent sector will cause the drive unit to search forever for that sector once a Read operation is initiated.

An error can occur when the subsystem is reading a series of sectors in one operation if the Read operation exceeds the number of sectors available. When the last sector on surface 238 is read and the drive unit attempts to advance automatically to the next surface, since the sector counter has not overflowed, both the Error and the End Error flags are set to 1. The sector counter is incremented and the sector address is set to 0. The Busy flag is set to 0, the Done flag is set to 1 and a program interrupt request is initiated.

Each track on the disc pack is preceded by an address field. If the address read before any track does not match the contents of the disc address registers at that time, both the Error and the Address Error flags are set to 1. The Busy flag is set to 0, the Done flag is set to 1, and a program interrupt request is initiated.

If the data channel does not respond in time to a data channel request, both the Error and the Data Late flags are set to 1. The reading of the current sector continues, but once that sector has been read, the Read operation is terminated. The Busy flag is set to 0, the Done flag is set to 1 and a program interrupt request is initiated. The Data Late flag indicates that at least one word from the last sector read was not correctly transferred to memory.

During Writing

As mentioned above, specifying a non-existent sector will cause the drive unit to search forever for that sector once a Write operation is initiated.

An error can occur when the subsystem is writing a series of sectors in one operation if the Write operation exceeds the number of sectors available. When the last sector on surface 23₈ is written and the drive unit attempts to advance automatically to the next surface, since the sec-

tor counter has not overflowed, both the Error and the End Error flags are set to 1. The sector counter is incremented and the sector address is set to sector 0. The Busy flag is set to 0, the Done flag is set to 1 and a program interrupt request is initiated.

Each track on the disc pack is preceded by an address field. If the address read before any track does not match the contents of the disc address registers at that time, both the Error and the Address Error flags are set to 1. The Busy flag is set to 0, the Done flag is set to 1, and a program interrupt request is initiated.

If the data channel does not respond in time to a data channel request, both the Error and the Data Late flags are set to 1. The writing of the current sector continues, but once that sector has been written, the Write operation is terminated. The Busy flag is set to 0, the Done flag is set to 1 and a program interrupt request is initiated. The Data Late flag indicates that at least one word in the sector was not written properly.

Check Error

A Check Error flag is set to 1 during a Read operation if the 16-bit checkword read after the data in the sector being processed does not match the checkword calculated by the controller during the Read operation.

The Check Error flag can also be set to 1 if a checkword error is detected when verifying the home address of a track in either a Read or a Write operation. Usually the Address Error flag is also set to 1 since an error has been made in reading the track address information. However, this Checkword Error can also occur without an accompanying Address Error when the checkword read at the end of the track home address is incorrect. In both of these cases, access to all the sectors on that track is denied.

Since the Check Error flag can be set to 1 without an Address Error flag under two circumstances in a Read operation, the programmer should verify which condition caused the flag to be set to 1. If the Check Error flag is posted and the Memory Address Counter has not changed, the checkword following the track home address is incorrect. In addition, if the Read operation does not extend to the next surface and data has been transferred, then the error is in the last sector processed.

However, when a Read operation extends beyond one surface, and a Check Error occurs after the last sector on the first surface is read and before the first sector on the second surface is read, the error could be in either the last sector on the first surface or in the checkword for the home address of the track in the second surface. In each of these two cases, the Memory Address Counter and the Disc Address Register will contain identical information.

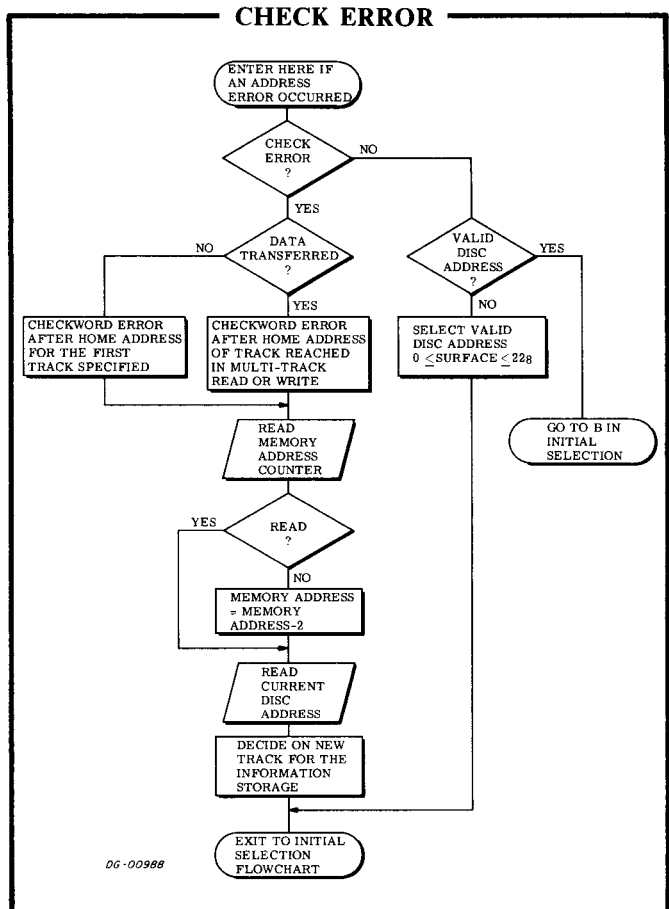

These two cases can be differentiated by performing a Read operation on the last sector of the first surface. If this Read is successful, the error is in the checkword of the home address of the track on the second surface. If this is the case, then that track on the second surface is inaccessible.

This page intentionally left blank

THE 4231A DISC PACK SUBSYSTEM

SUMMARY

MNEMONIC (FIRST CONTROLLER)..... DKP
 DEVICE CODE (FIRST CONTROLLER)..... 33₈
 MNEMONIC (SECOND CONTROLLER) ...DKP1
 DEVICE CODE (SECOND CONTROLLER)... 73₈
 PRIORITY MASK BIT..... 7
 SURFACES/UNIT 19
 TRACKS/SURFACE (CYLINDERS) 411
 SECTORS/TRACK 23
 WORDS/SECTOR 256
 TOTAL STORAGE CAPACITY
 (WORDS) 45,979,392
 MAXIMUM TRANSFER RATE
 (WORDS/SEC)..... 403,000
 MAXIMUM ALLOWABLE DATA
 CHANNEL LATENCY (μ SEC) 19.8
 SEEK TIME MAX/MIN (mSEC) 55/10
 SECTOR ACCESS TIME MAX/MIN
 (mSEC)..... 16.7/0

ACCUMULATOR FORMATS

SPECIFY DISC ADDRESS AND
 SECTOR COUNT (DOC)

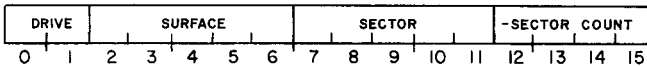

READ DISC ADDRESS (DIC)

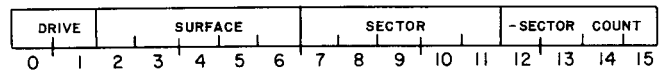

SPECIFY COMMAND AND CYLINDER .. (DOA)

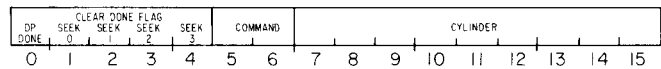

COMMANDS

00 Read 10 Seek
 01 Write 11 Recalibrate

READ STATUS (DIA)

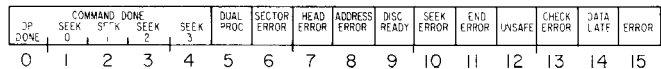

LOAD MEMORY ADDRESS COUNTER ... (DOB)

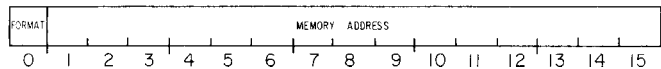

READ MEMORY ADDRESS COUNTER (DIB)

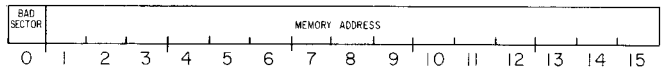

S, C AND P FUNCTIONS

- S Set Busy to one, Done to zero and start a Read or a Write operation.
- C Set Busy to zero, Done to zero and stop all operations.
- P Start a Seek or a Recalibrate operation.

INTRODUCTION

The 4231A disc pack subsystem utilizes a removable disc pack containing 19 (0-22_g) program accessible surfaces. There are 411 (0-632_g) cylinders on the disc pack. Each of the 19 tracks in a cylinder contains 23 (0-26_g) performatted sectors, each of which stores 256 (400_g) 16-bit words and contains a checkword. The data storage capacity is 5888 words/track, 111,872 words/cylinder or 45,979,392 words/pack. Words are transferred to and from the subsystem via the data channel at a rate of 403,000 words per second. Up to 16 sectors containing 4096 (10000_g) words can be transferred in one operation.

The controller for the subsystem, when coupled to the adapter, can direct the activities of up to four drive units. Any number of these units can be performing Seek operations simultaneously, but only one drive can be reading or writing at any one time.

INSTRUCTIONS

The disc drive controller contains four program accessible registers: a 15-bit Memory Address Counter, a 16-bit Status Register, a 16-bit combined Command/Cylinder Select Register and a combined disc Address/Sector Counter Register. The Memory Address Counter is self-incrementing and contains the memory location of the next 16-bit word to be either read from or written on the disc. The Status Register contains the information flags for the controller and the selected drive as well as 4 flags which indicate when any drive completes a Seek or a Recalibrate operation. Any of these 4 Seek Done flags as well as Disc Pack Done flag are able to initiate a program interrupt request when they are set to 1. The combined Command/Cylinder Select Register contains the command last issued to the subsystem and the number of the desired cylinder on the disc surface. The combined Disc Address/Sector Counter contains the surface and sector location of the active head and the two's complement of the number of sectors to be either read from or written on the disc. The Sector Counter is self-incrementing after each sector is read or written.

Six instructions are used to program data channel transfers to and from the disc pack. Three of these instructions are used to supply all of the necessary data to the controller for any disc operation. The remaining three instructions allow the program to determine, in detail, the current state of the disc pack subsystem.

The three device flag commands, Start, Clear and Pulse, initiate operations in the disk controller. They also control the setting and clearing of the Busy, DP Done and Error flags. The commands are:

- f=S Initiate a Read, Write, Seek or Recalibrate operation, depending on the contents of the Command Register. The Busy flag is set to 1, the DP Done flag is set to 0, and all Error flags except the Unsafe flag are set to 0. Note that it is usually undesirable to initiate a Seek or a Recalibrate with this command as the controller will remain busy until the operation is completed.
- f=C Stop all positioning and data transferring operations. Set the Busy flag, the DP Done flag, all Error flags except Unsafe, and the four Seek Done flags to 0.
- f=P Initiate either a Seek or a Recalibrate operation, depending on the contents of the command register. The DP Done flag and all Error flags except Unsafe are set to 0. The Busy flag is left unchanged.

NOTE: Occasionally the Unsafe flag for a drive can be cleared by issuing a Recalibrate followed by a Clear or IORST. If this procedure does not work, it may indicate a hardware failure.

SPECIFY DISC ADDRESS AND SECTOR COUNT

DOC<f> ac,DKP

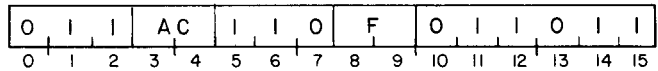

Bits 0-15 of the specified AC are loaded into the controller's combined Address Register/Sector Counter. After the data transfer, the controller's Busy and Done flags are set according to the function specified by F. The contents of the specified AC remain unchanged. The format of the specified AC is as follows:

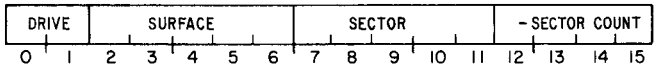

Bits	Name	Function
0-1	Drive	Select the drive 0, 1, 2, or 3.
2-6	Surface	Select the surface (head) 0-22 _g , for the start of a Read or a Write operation.
7-11	Sector	Select the starting sector, 0-26 _g for the start of a Read or a Write operation.
12-15	-Sector Count	Specify the two's complement of the number of sectors to be read or written in one operation (maximum of 16).

READ STATUS

DIA<f> ac, DKP

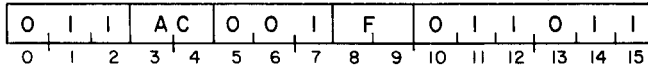

The contents of the Status Register are placed in bits 0-15 of the specified AC. After the data transfer, the controller's Busy and Done flags are set according to the function specified by F. The format of the specified AC is as follows:

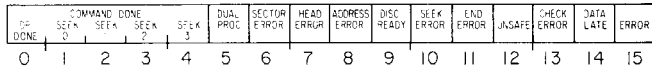

Bits	Name	Meaning When 1
0	DP Done	The subsystem has completed a Read or a Write operation.
1-4	Seek Done	Drive 0-3, respectively, has completed a Seek or Recalibrate operation. More than one of these bits can be set at any time.
5	Dual Processor	The disc subsystem is in a dual processor configuration.
6	Sector Error	Must appear in combination with bit 8, Address Error. The sector address portion of the address field is incorrect.
7	Head Error	Must appear in combination with bit 8, Address Error. The head address portion of the address field is incorrect.
8	Address Error	The address read from the address field at the beginning of a sector does not match the last address specified to the disc controller. If this bit is 1 and bits 6 and 7 are both 0, the cylinder address portion of the address field is incorrect.
9	Disc Ready	The selected drive is not performing any head movements and is ready to carry out a command.
10	Seek Error	The selected drive did not successfully carry out the Seek or Recalibrate operation which was initiated.
11	End Error	The selected drive attempted to continue a Read or a Write operation beyond the last surface in the disc pack.
12	Unsafe	The selected drive is in an unsafe condition. An IORST must be issued.
13	Check Error	The checkword read from the disc at the end of a sector does not match the checkword calculated by the controller.
14	Data Late	The data channel failed to respond in time to a data channel request.
15	Error	One or more of the bits 8, 10, 11, 12, 13, 14 in this Status Register, or the Bad Sector flag is set to 1.

SPECIFY COMMAND AND CYLINDER

DOA<f> ac, DKP

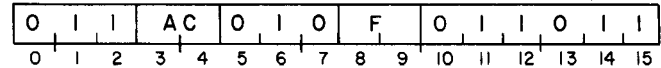

Bits 0-15 of the specified AC are loaded into the controller's combined Command/Cylinder Select Register. After the data transfer, the controller's Busy and Done flags are set according to the function specified by F. The contents of the specified AC remain unchanged. The format of the specified AC is as follows:

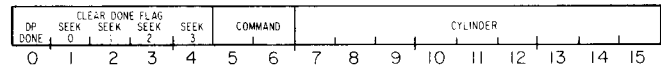

Bits	Name	Function
0	Clear DP Done	Set the controller's Done flag to 0; set the following error indicating flags to 0: Address Error, End Error, Check Error, and Bad Sector.
1-4	Clear Seek Done	Set the Seek Done flags to 0 for the drives 0-3, respectively.
5-6	Command	Specify the command for the selected drive as follows: 00 Read with a Start command. 01 Write with a Start command. 10 Seek with a Pulse command to the cylinder specified in bits 7-15 of this accumulator. 11 Recalibrate with a Pulse command.
7-15	Cylinder	Specify the cylinder, 0-632 ₈ , for a Seek, Read or Write operation.

LOAD MEMORY ADDRESS COUNTER

DOB<f> ac,DKP

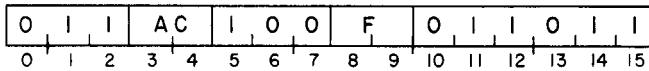

Bits 0-15 of the specified AC are loaded into the controller's Memory Address Counter. After the data transfer, the controller's Busy and Done flags are set according to the function specified by F. The contents of the specified AC remain unchanged. The format of the specified AC is as follows:

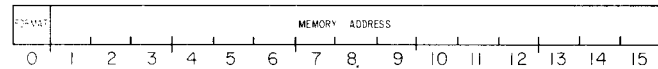

Bits	Name	Function
0	Format	If 1, place the drive in the format mode of operation.
1-15	Memory Address	Location of the next word in memory to be used for a data channel transfer.

READ DISC ADDRESS

DIC<f> ac,DKP

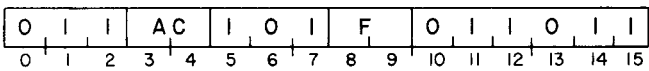

The contents of the disc Address Register and the Sector Counter are placed in bits 0-15 of the specified AC. After the data transfer, the controller's Busy and Done flags are set according to the function specified by F. The format of the specified AC is as follows:

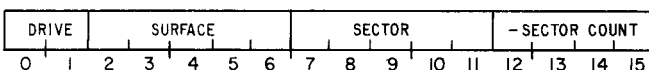

Bits	Name	Contents
0-1	Drive	Number of the selected drive.
2-6	Surface	The surface number of the active head on the drive.
7-11	Sector	The number of the sector immediately following the last sector read or written.
12-15	-Sector Count	The two's complement of the number of sectors left to be read or written.

READ MEMORY ADDRESS COUNTER

DIB<f> ac,DKP

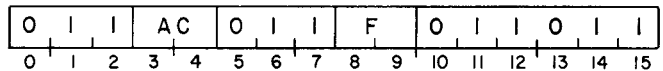

The contents of the Memory Address Counter are placed in bits 1-15 of the specified AC. A Bad Sector indicator flag is placed in bit 0. After the data transfer, the controller's Busy and Done flags are set according to the function specified by F. The format of the specified AC is as follows:

Since the contents of the eight-word buffer is indeterminate after a Write operation, the memory address returned may differ from the last word written on the disc by 1 to 8 memory locations.

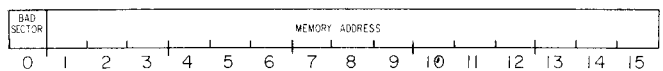

Bits	Name	Contents
0	Bad Sector	If 1, the sector was found to be unusable during formatting.
1-15	Memory Address	Location of the next word in memory to be used for a data channel transfer.

PROGRAMMING

The preparation of a moving head disc pack for data channel transfers is divided into three distinct phases: I, selecting the drive, the surface and the sector; II, positioning the heads over the correct cylinder; and III, starting the Read or the Write operation. The results of issuing commands in each phase should be checked for errors before proceeding to the next phase.

Phase I: Select the Drive, Surface, Sector and Number of Sectors

The initial selection of a disc drive is performed as follows: a SPECIFY DISC ADDRESS AND SECTOR COUNT instruction (DOC) is issued to the controller to select the drive, the surface of the disc pack, the first sector to be read or written, and the two's complement of the number of sectors to be transferred in the operation. The drives are numbered 0-3; the surfaces are numbered 0-228; the sectors are numbered 0-268; the maximum number of sectors which can be transferred in one operation is 16. Care should be taken to insure that the parameters specified in this initial selection do not exceed the capacity of the disc pack.

Once the drive unit is chosen, the status of that drive must be checked to determine if the drive is ready to proceed. The status is checked by issuing a READ STATUS instruction (DIA) and examining the Ready flag. If the Ready flag is 1, the program can proceed to Phase II, If it is 0, the program should not issue any commands to that drive unit until it is in the ready state.

Phase II: Position the Heads

The heads are positioned over the desired cylinder as follows: a SPECIFY COMMAND AND CYLINDER instruction (DOA) is issued to the controller. This instruction should contain the number of the cylinder desired and the Seek command. The cylinders are numbered from 0-6328. The instruction should also set both the DP Done flag and the Seek Done flag for the selected drive to 0. The Seek operation is initiated by a Pulse command. While the drive is seeking, the Unit Ready flag for that drive is set to 0. When the heads have finished moving to the specified cylinder, the Unit Ready and the Seek Done flags for that drive unit are set to 1, thus initiating a program interrupt request.

The program should then check the Status Register to determine if a seek error has occurred as a result of a faulty Seek operation. If no errors have occurred, the program can proceed to Phase III.

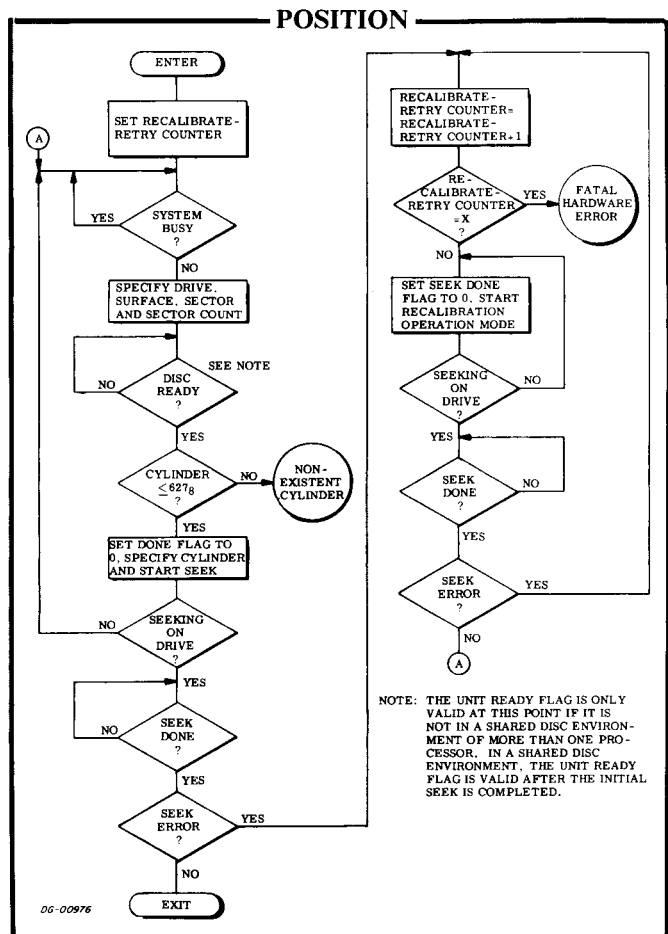

The heads of the selected drive unit can be forced to cylinder 0 by the Recalibrate operation. A Recalibrate operation is performed as follows: a SPECIFY COMMAND AND CYLINDER instruction is issued to the controller. This instruction should contain the Recalibrate command and should also set both the DP Done and the Seek Done flags for the selected drive unit to 0. The operation is initiated by a Pulse command. While the drive is being recalibrated, the Unit Ready flag for the selected drive is set to 0. Once the Recalibrate operation is completed, the Unit Ready flag is set to 1, the Seek Done flag for the selected drive is set to 1 and a program interrupt request is initiated.

When the program places a drive in the seek mode of operation, the controller is free to accept commands to the other drives under its direction. Therefore, once one or more drives are performing Seek operations, one of the other drives can perform a Read or a Write operation. If the program is simultaneously managing several drives with one controller, the error indicating flags in the Status Register apply only to the most recently selected drive unit, i. e., the unit specified in the last SPECIFY DISC ADDRESS AND SECTOR COUNT instruction issued.

Phase III: Read or Write

A Read operation transfers blocks of data stored in the disc subsystem to the computer, via the data channel. A block of data contains 256 16-bit words. Up to 16 blocks can be transferred in one Read operation. A Write operation transfers blocks of data from the computer's memory, via the data channel, and stores the data in the disc subsystem. Again, up to 16 blocks of data may be transferred in one operation. Read or Write operations are performed in a series of steps which are virtually identical. The parameters of the data transfer must be specified and finally the operation is initiated.

Read

A Read operation is performed as follows: the storage location in memory for the first word to be read from the disc is specified with a LOAD MEMORY ADDRESS COUNTER instruction (DOB). The number of sectors to be read and the starting sector were specified in Phase I.

The Read command is then loaded into the Command Register with a SPECIFY COMMAND AND CYLINDER instruction (DOA). The cylinder number must be specified in this instruction since it is used in the address check which is automatically made before each 256 word sector is read. The Read operation is initiated with a Start command. The Busy flag is set to 1 and the Done flag is set to 0.

Once the Read operation is initiated, the drive waits until the desired sector passes under the head and performs an address check. If the address read is correct, the drive then starts reading the sequential bits of the first word of the sector. When a word is fully assembled, the controller transfers the word to the computer's memory via the data channel. Each time a word is transferred to memory, the Memory Address Counter is automatically incremented.

When the 256 words from the sector have been read, and the checkword at the end of the sector verified, the sector counter is automatically incremented by one.

If the sector counter does not overflow, the next sector is read and this process continues until either the sector counter overflows or the last sector on the surface is read. In the case where the last sector on surface 0-21₈ is read, and the sector counter has not overflowed, the drive will automatically continue the operation by reading the first sector on the next surface in the same cylinder.

The Read operation then continues until the sector counter indicates, by overflowing, that the specified number of sectors have been read. Upon completion of the Read operation, the Busy flag is set to 0, the Done flag is set to 1 and a program interrupt request is initiated.

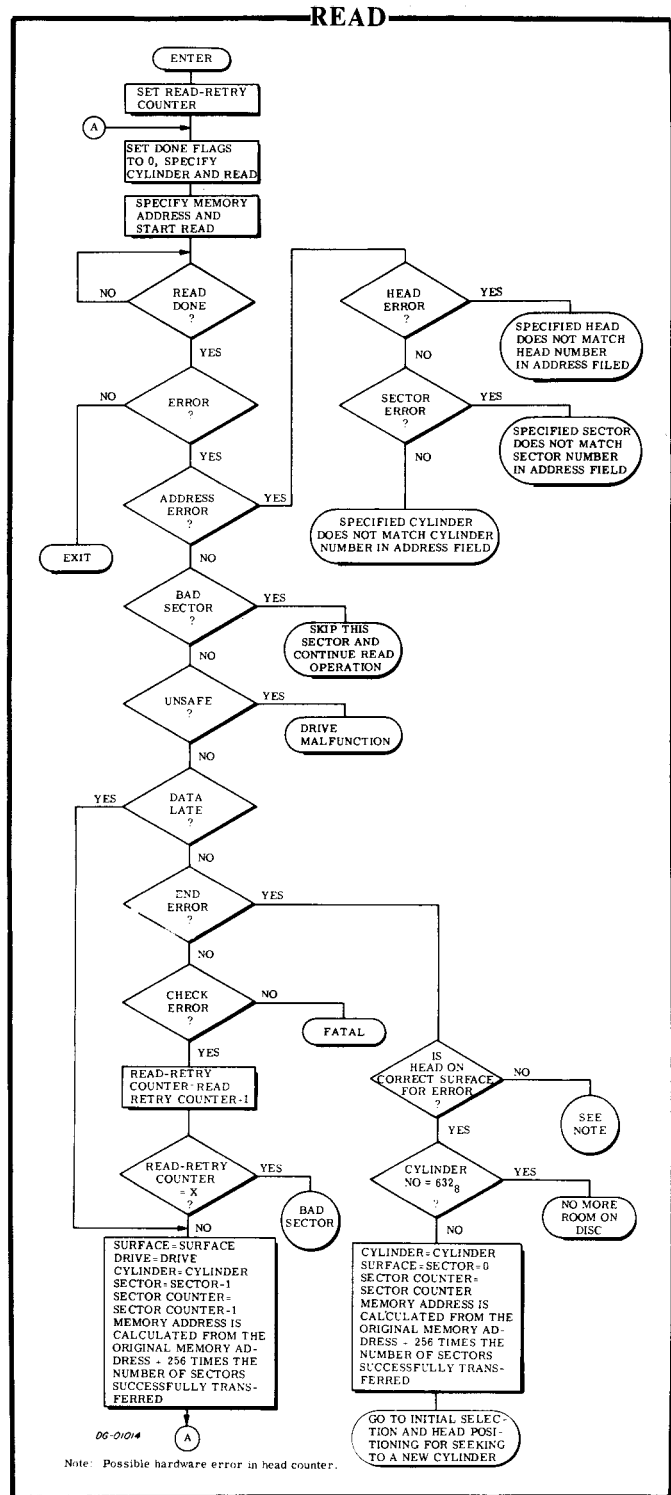

Write

A Write operation is performed as follows: the storage location in memory of the first word to be written on the disc is specified with a LOAD MEMORY ADDRESS COUNTER instruction (DOB). The number of sectors to be written and the number of the starting sector were specified in Phase I.

The Write command is then loaded into the Command Register with a SPECIFY COMMAND AND CYLINDER instruction (DOA). The cylinder number must be specified in this instruction since it is used in the address check which is automatically made before each 256 word sector is written. The Write operation is initiated with a Start command. The Busy flag is set to 1 and the Done flag is set to 0.

Once the Write operation is initiated, the controller reads eight words from the computer's memory via the data channel and then waits for the desired sector to pass under the head. Each time the controller reads a word from the computer's memory, the Memory Address Counter is automatically incremented. Once the desired sector is encountered, the address check is performed automatically. If the address read from the disc is correct, the bits of each word are sequentially written. When the 256 words in the sector have been written, the controller writes the checkword it calculated from the data it wrote on the disc. The sector counter is automatically incremented by one.

If the sector counter does not overflow, the next sector is written. This process continues until either the sector counter overflows of the last sector on the surface is written. In the case when the last sector on surface 0-21g is written, and the sector counter has not overflowed, the drive will automatically continue the operation by writing the first sector on the next surface in the same cylinder.

The Write operation then continues until the sector counter indicates, by overflowing, that the specified number of sectors have been written. Upon completion of the Write operation, the Busy flag is set to 0, the Done flag is set to 1 and a program interrupt is initiated.

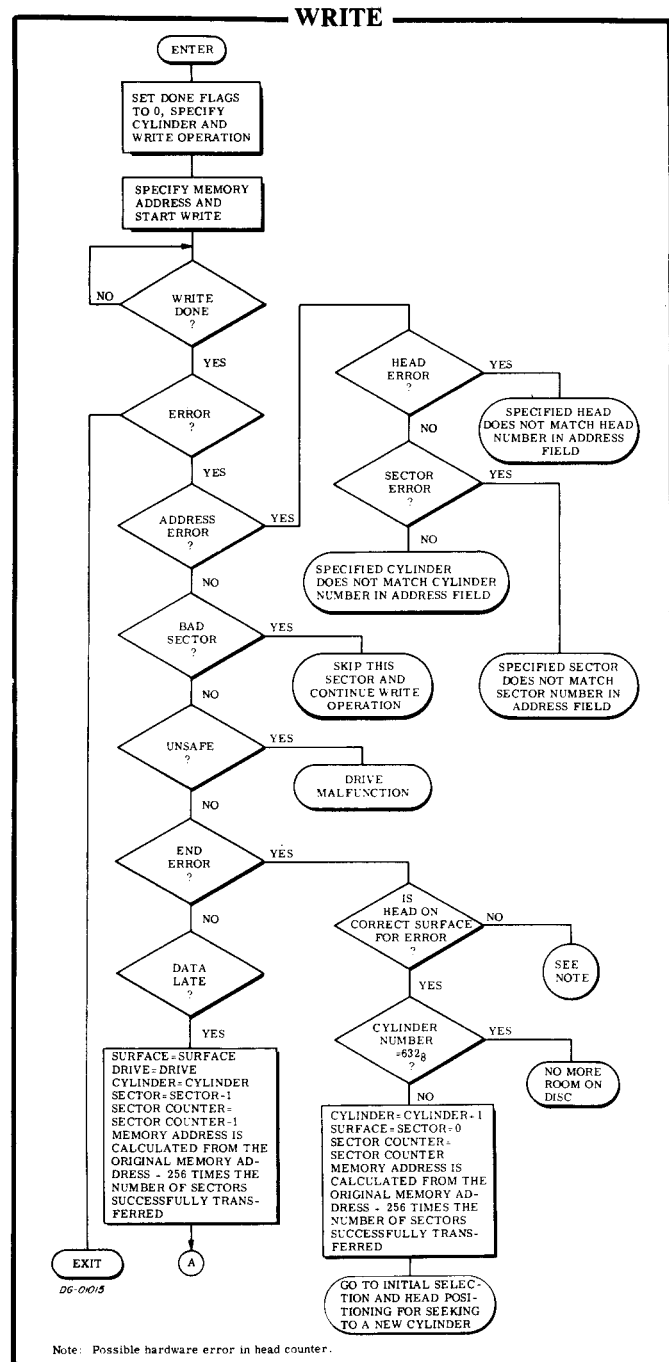

FORMAT

The disc pack used in the 4231A subsystem must be formatted so that the address check, made before every sector is read or written, can be carried out. If the disc pack is not formatted, an Address Error occurs and terminates every Read or Write operation. When the disc pack is formatted, the following information is written before every sector on the disc pack.

SYNCHRONIZATION	BAD SECTOR FLAG BIT	CYLINDER NO	SECTOR NO	SURFACE NO	SYNCHRONIZATION	AREA FOR DATA AND CHECKWORD	GAP
SECTOR							

If a disc pack repeatedly indicates address errors, the pack may be reformatted. All data on a disc pack is lost when it is reformatted.

The program is the 4231 Disc Pack Formatter Program #096-000241 (tape #095-000221).

TIMING

The disc pack rotates at a speed of 3600rpm; a complete revolution requires 16.67 milliseconds. A register, containing the identification number of the sector currently passing under the head, is used to reduce the sector accessing time. This feature allows the subsystem to carry out a Read or a Write operation the first time the desired sector passes under the head.

Since a sector is preceded by a 68 microsecond gap, used for address checking, the minimum sector access time is 68 microseconds. The maximum is 16.7 milliseconds so the average is 8.4 milliseconds.

The time required to position the heads (the seek time) is dependent on the number of cylinders the heads must move past in a Seek operation. A maximum of 10 milliseconds is required to move the heads from one cylinder to the adjacent cylinder. The time required to move from cylinder 0 to cylinder 632g, or vice versa, is 55 milliseconds, maximum.

A Recalibrate operation requires a maximum of 300 milliseconds. If either a Seek operation or a Recalibrate operation is not completed in 500 milliseconds, the Seek Error flag is set to 1.

A sector passes under the head in 730 microseconds while the data block in the sector passes under the head in 635 microseconds. Since there are 256 data words in a sector, a data channel request occurs every 2.48 microseconds. This corresponds to a data transfer rate of 403,000 words/second. Since the controller has an eight word buffer, the maximum allowable data channel latency is 19.8 microseconds. If the data channel does not respond within this time, both the Data Late and the Error flags are set to 1. Once this error occurs,

the processing of the current sector is completed and the command is terminated, even if the operation was scheduled to transfer additional sectors. The Busy flag is set to 0, the Done flag is set to 1, and a program interrupt request is initiated.

ERROR CONDITIONS

During Initial Selection

If the Unsafe flag is 1, the Unit Ready flag is 0. An I/O RESET instruction (IORST) is the only way the program can clear this flag.

If the program specifies a non-existent sector (>26g) no indication of this error is given. If the subsystem then attempts a Read or a Write operation, the drive unit will search forever for that non-existent sector. The subsystem can be released from this search by having the program issue an I/O RESET instruction.

During Head Positioning

If the program issues a SPECIFY COMMAND AND CYLINDER instruction which specifies a non-existent cylinder (>632g) and then places the drive unit in the seek mode, the Seek operation is terminated. Both the Seek Error and the Seek Done flags for that unit are set to 1. When the Seek Done flag is set to 1, a program interrupt request is initiated.

If any Seek operation to a valid cylinder number results in a Seek Error, the drive unit should be recalibrated.

During Reading

As mentioned above, specifying a non-existent sector will cause the drive unit to search forever for that sector once a Read operation is initiated.

An error can occur when the subsystem is reading a series of sectors in one operation if the Read operation exceeds the number of sectors available. When the last sector on surface 22g is read and the drive unit attempts to advance automatically to the next surface, since the sector counter has not overflowed, both the Error and the End Error flags are set to 1. The sector counter is incremented and the sector address is set to 0. The Busy flag is set to 0, the Done flag is set to 1 and a program interrupt request is initiated.

Each sector on the disc pack is preceded by an address field. If the address read before any sector does not match the contents of the disc address registers at that time, both the Error and the Address Error flags are set to 1. The Busy flag is set to 0, the Done flag is set to 1,

and a program interrupt request is initiated. The particular type of address error detected can be determined by examining both the Sector Error and the Head Error flags. Three possibilities exist:

1. If both the Sector Error and the Head Error flags are 0, the cylinder number does not match.
2. If the Sector Error flag is 1, the sector number does not match.
3. If the Head Error flag is 1, the head (surface) does not match.

When a new pack is formatted, every sector found to produce irrecoverable errors is tagged with a Bad Sector label. This appears before the address field for the sector. If the drive attempts to read or write in a bad sector, the operation is terminated, and both the Bad Sector flag (which can be read with a READ MEMORY ADDRESS COUNTER instruction) and the Error flag are set to 1. The Busy flag is set to 0, the Done flag is set to 1, and a program interrupt request is initiated.

If the checkword read at the end of a sector differs from that calculated by the controller, both the Error and the Check Error flags are set to 1. The Read operation is terminated, even if more sectors were supposed to be read; the Busy flag is set to 0, the Done flag is set to 1 and a program interrupt request is initiated. The Check Error flag indicates that at least one word in the last sector read contains an error.

If the data channel does not respond in time to a data channel request, both the Error and the Data Late flags are set to 1. The reading of the current sector continues, but once that sector has been read, the Read operation is terminated. The Busy flag is set to 0, the Done flag is set to 1 and a program interrupt request is initiated. The Data Late flag indicates that at least one word from the last sector read was not correctly transferred to memory.

If the drive stops tracking on the cylinder, the Seek Error and Error flags are set to 1. The Busy flag is set to 0 and the Done flag is set to 1, thus initiating a program interrupt request.

During Writing

As mentioned above, specifying a non-existent sector will cause the drive unit to search forever for that sector once a Write operation is initiated.

An error can occur when the subsystem is writing a series of sectors in one operation if the Write operation exceeds the number of sectors available. When the last sector on surface 22g is written and the drive unit attempts to advance automatically to the next surface, since the sector counter has not overflowed, both the Error and the End Error flags are set to 1. The sector counter is incremented and the sector address is set to sector 0. The Busy flag is set to 0, the Done flag is set to 1 and a program interrupt request is initiated.

Each sector on the disc pack is preceded by an address field. If the address read before any sector does not match the contents of the disc address registers at that time, both the Error and the Address Error flags are set to 1. The Busy flag is set to 0, the Done flag is set to 1, and a program interrupt request is initiated. The particular type of address error detected can be determined by examining both the Sector Error and the Head Error flags. Three possibilities exist:

1. If both the Sector Error and the Head Error flags are 0, the cylinder number does not match.
2. If the Sector Error flag is 1, the sector number does not match.
3. If the Head Error flag is 1, the head (surface) does not match.

When a new pack is formatted, every sector found to produce irrecoverable errors is tagged with a Bad Sector label. This appears before the address field for the sector. If the drive attempts to read or write in a bad sector, the operation is terminated, and both the Bad Sector flag (which can be read with a READ MEMORY ADDRESS COUNTER instruction) and the Error flag are set to 1. The Busy flag is set to 0, the Done flag is set to 1, and a program interrupt request is initiated.

If the data channel does not respond in time to a data channel request, both the Error and the Data Late flags are set to 1. The writing of the current sector continues, but once that sector has been written, the Write operation is terminated. The Busy flag is set to 0, the Done flag is set to 1 and a program interrupt request is initiated. The Data Late flag indicates that at least one word in the sector was not written properly.

If the drive stops tracking on the cylinder, the Seek Error and Error flags are set to 1. The Busy flag is set to 0 and the Done flag is set to 1, thus initiating a program interrupt request.

This page intentionally left blank

CARTRIDGE DG/DISC SUBSYSTEM MODELS 6045, 6050, 6051

PROGRAMMING SUMMARY

Mnemonic (First Controller)	DKP	Sectors/Track	12
Device Code	33 ₈	Words/Sector	256
Mnemonic (Second Controller)	DKP1	Total Storage Capacity (Words)	5,013,504
Device Code	73 ₈	Max. Transfer Rate (wps)	156,250
Priority Mask Bit	7	Allowable Data Channel Latency (us)	12.8
Surfaces/Unit	4*	Seek Time (max/min, ms)	70/8
Tracks/Surface	408	Sector Access Time (max/min, ms)	25/12

* Two non-removable surfaces

ACCUMULATOR FORMATS

**Specify Disc Address
and Sector Count (DOC)**

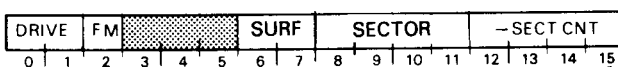

Read Disc Address (DIC)

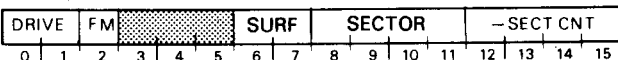

Specify Command and Cylinder (DOA)

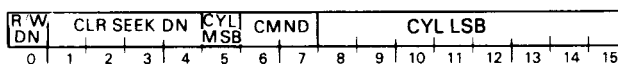

- Commands**
- 00 Read
 - 01 Write
 - 10 Seek
 - 11 Recalibrate

Read Status (DIA)



Load Memory Address Register (DOB)

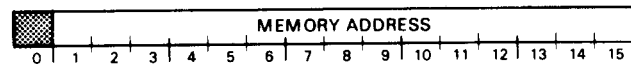

Read Memory Address Register (DIB)

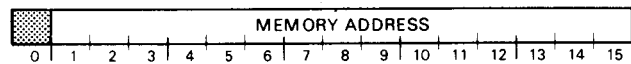

S, C and P FUNCTIONS

- f = S* Sets the Busy flag to 1, and the Done flag to 0; starts the operation specified in the command register.
- f = C* Sets the Busy flag and the Done flag to 0 and stops all data transfer operations.
- f = P* Sets the Done flag to 0 and starts the operation specified in the command register if that operation is a seek or a recalibrate.

INTRODUCTION

This disc subsystem includes a maximum of four moving-head disc drives plus one or two controllers. The drives may be disc cartridge units (model numbers 6045, 6050 or 6051), or diskette units (6030 series), intermixed in any combination. The subsystem controller occupies a single slot of the computer chassis and directs the activities of the disc drives. Control over the subsystem may be shared between two NOVA® or ECLIPSE® central processors if a subsystem controller is installed in each processor.

This section discusses the programming protocols for driving model 6045/50/51 disc cartridge units in both single- and dual-processor environments. Similar protocols for the 6030 series units are presented later in this manual.

Each disc unit contains four program-accessible surfaces. Surfaces 0 and 1 are on a platter in a removable disc cartridge; surfaces 2 and 3 are on a platter permanently located in the lower half of the drive unit. There are 408 cylinders in each unit, numbered 0-627₈. Each of the four tracks in a cylinder contains 12 sectors, numbered 0-13₈. Each sector contains an address header and a data field that stores 256 (400₈) 16-bit data words and a 16-bit check-word. The data storage capacity is 3072 words per track or 5,013,504 words per drive unit.

Data is transferred to and from the subsystem via the data channel at a maximum rate of 156,250 words per second. From 1 to 16 consecutive sectors in one cylinder (up to 4096 words) can be transferred in one operation.

CONTROLLER REGISTERS

The disc drive controller contains four program-accessible registers: a 15-bit memory address register, a 16-bit status register, a 16-bit combined command and cylinder select register, and a combined disc address register and sector counter. The memory address register is self incrementing and contains the address of the next location whose contents are to be transferred to or from the disc subsystem via the data channel. The status register contains four Seek Done

flags, a Read/Write (R/W) Command Done flag, a Unit Ready flag, a Valid Status flag, and six Error flags. The Seek Done flag and the R/W Done flag each initiate a program interrupt request when set to 1. The combined command and cylinder select register contains the last command issued to the subsystem and the number of the desired cylinder on the selected unit. The combined disc address register and sector counter contains the number of the next surface and sector to be read or written and the two's complement of the number of sectors remaining to be read or written. The disc address and the sector counter portions of this register self-increment immediately after a sector is read or written.

INSTRUCTIONS

Six instructions program data channel transfers to and from the subsystem. Three of these instructions supply the controller with all the necessary information for any disc operation. The remaining instructions allow the program to determine, in detail, the current state of the subsystem.

The device flag commands control the disc controller's Busy and Done flags as follows:

f = S Sets the Busy flag to 1, the Done flag to 0, the Address Error, End of Cylinder, Checkword Error, Data Late, and Unsafe flags to 0, and initiates the operation specified by the contents of the command register.

f = C Sets the Busy flag, the Done flag, all Error flags and all Seek Done flags to 0 and stops all data transfer operations; does not terminate a seek operation already in progress.

f = P Sets the Done flag and all Error flags to 0 and initiates the operation specified by the contents of the command register.

NOTE The **P** flag command does not affect the controller's Busy flag. If the Busy flag is 0 and the program starts an operation with the **P** command, the controller does not initiate a program interrupt request at the conclusion of the operation unless it is a seek or recalibrate. The controller initiates an interrupt at the end of all seek or recalibrate operations.

* Although 4234 series disc drives are functionally identical and electrically similar to 6045/50/51 series units, DGC does not recommend intermixing these series in the same subsystem.

Instruction Coding Conventions

In the descriptions that follow, certain coding conventions are used so the assembler can recognize the instruction and translate it correctly into machine language. See Appendix E for these conventions.

Specify Disc Address And Sector Count

DOC [f] ac, DKP

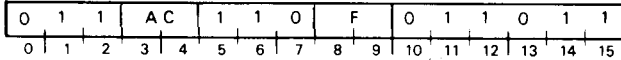

Loads bits 0-15 of the specified AC into the controller's disc address register and sector counter. After the data transfer, sets the controller's Busy and Done flags according to the function specified by F. The contents of the specified AC remain unchanged; the format of the accumulator is as follows:

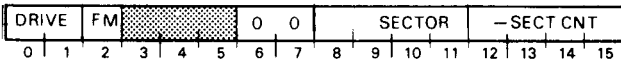

Bits	Name	Function
0-1	Drive	Selects drive 0-3 ₈
2	Format	If 1, places controller in FORMAT mode.
3-5	---	Reserved for future use.
6-7	Surface	Selects the surface (head) 0-3 ₈ for the start of a read or a write operation.
8-11	Sector	Selects the starting sector, 0-13 ₈ for the start of a read or a write operation.
12-15	-Sector Count	Specifies the two's complement of the number of sectors to be read or written in one operation (maximum of 16 ₁₀).

Specify Command And Cylinder

DOA [f] ac, DKP

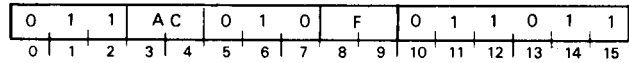

Loads bits 0-15 of the specified AC into the controller's combined command and cylinder select register. After the data transfer, sets the controller's Busy and Done flags according to the function specified by F. The contents of the specified AC remain unchanged; the format of the accumulator is as follows:

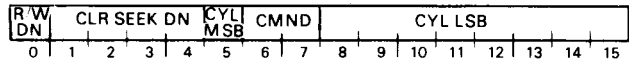

Bits	Name	Function
0	Clear R/W Done	Sets the status register's DC Done flag to 0; sets the following error flags to 0: Address Error, Checkword Error, End of Cylinder, and Unsafe.
1-4	Clear Seek Done (0-3)	Sets the Seek Done flags to 0 on drives 0-3, respectively.
5	Cylinder MSB	Most significant bit of cylinder address. Together with bits 8-15, specifies the desired cylinder.
6-7	Command	Specifies the command for the selected drive as follows: 00 Read 01 Write 10 Seek 11 Recalibrate
8-15	Cylinder LSB	Least significant bits of Cylinder Address. Together with bit 5, specifies the desired cylinder (0-62 ₇) for a Seek, Read or Write operation.

Load Memory Address Register

DOB [f] ac, DKP

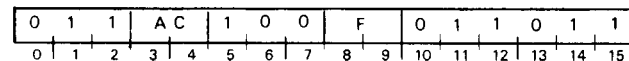

Loads bits 1-15 of the specified AC into the controller's memory address Register. After the data transfer, sets the controller's Busy and Done flags according to the function specified by F. The contents of the specified AC remain unchanged; the format of the accumulator is as follows:

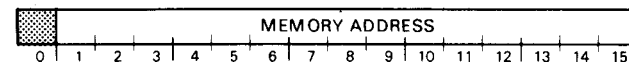

Bits	Name	Contents
0	---	Reserved for future use.
1-15	Memory Address	Location of the next word in memory to be used for a data channel transfer.

Read Status

DIA [f] ac, DKP

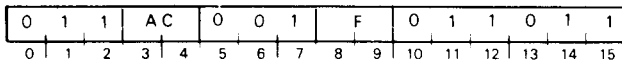

Places the contents of the controller's status register in bits 0-15 of the specified AC. After the data transfer, sets the controller's Busy and Done flags according to the function specified by F. The format of the specified accumulator is as follows:

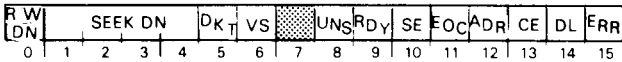

Bits	Name	Meaning When 1
0	R/W Done	The subsystem has completed a read or a write operation.
1-4	Seek Done (0-3)	Drive 0-3, respectively, has completed a seek or recalibrate operation. <i>More than one of these bits can be set at any time.</i>
5	Diskette	The selected disc is a diskette drive unit.*
6	Valid Status	When the read status command was issued, the controller had control of the disc subsystem.**
7	---	Reserved for future use.
8	Unsafe	The selected drive is in an unsafe condition. The Unsafe flag can be reset with an S, C, P, or IORST command, but this action will not remove the drive's unsafe condition. Try to remedy the unsafe condition by powering down the drive, and then restarting it.
9	Unit Ready	The selected drive is not performing any head movements and is ready to carry out a command (read, write, seek, or recalibrate)
10	Seek Error	The selected drive was not able to carry out the last seek or recalibrate operation issued.
11	End of Cylinder	The last read or write operation attempted to continue beyond the fourth surface in the disc drive unit.
12	Address Error	The address read from the address field at the beginning of a sector does not match the last address specified to the disc controller.
13	Checkword Error	The checkword read from the disc at the end of a sector does not match the checkword calculated by the controller during the sector transfer.
14	Data Late	The data channel failed to respond in time to a data channel request.
15	Error	One or more of the following bits in the status register is set to 1: 8, 10, 11, 12, 13, or 14.

*Consult 6030-series subsystem programming information in this manual.

**This bit is used in dual CPU, multiple drive environments. It allows the program to test the status of a drive unit without first issuing a dummy seek to guarantee its control of the shared subsystem. When 0, the bit indicates that the controller lost control of the subsystem before status was read and the word returned may be inaccurate. The programming considerations for dual CPU operation are discussed later in this section. (This bit was always 0 in early revision controllers.)

Read Disc Address

DIC [f] ac, DKP

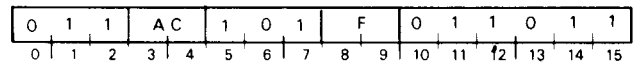

Places the contents of the controller's disc address register and sector counter in bits 0-15 of the specified AC. After the data transfer, sets the controller's Busy and Done flags according to the function specified by F. The format of the specified accumulator is as follows:

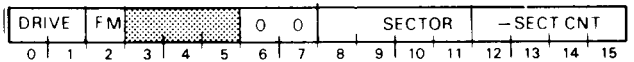

Bits	Name	Contents
0-1	Drive	Number (0-3) of the selected drive.
2	Format	When 1, Indicates that the controller is in FORMAT mode.
3-5	---	Reserved for future use.*
6-7	Surface	Surface number (0-3) of the selected head on the drive.
8-11	Sector	Number of the sector (0-13 ₈) immediately following the last sector read or written. If a read or write operation ends at the last sector (13 ₈) of a surface, this field contains the value 14 ₈ .
12-15	- Sector Count	Two's complement of the number of sectors remaining to be read or written.

*Bits 3-5 are the high-order bits for the head address field; they are ignored in all operations. If these bits are loaded with a value during a DOC instruction, that value will appear in the specified accumulator when a DIC instruction is issued. Upon End of Cylinder Error, the contents of these bits is incremented by 1.

Read Memory Address Register

DIB [f] ac, DKP

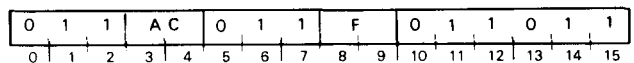

Places the contents of the controller's memory address register in bits 1-15 of the specified AC; sets bit 0 to 0. After the data transfer, sets the controller's Busy and Done flags according to the function specified by F. The format of the specified AC is shown below.

NOTE At the end of a write operation, the memory address register points to a memory location two greater than that of the most recent word written to disc.

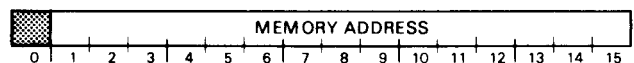

Bits	Name	Contents
0	---	Reserved for future use.
1-15	Memory Address	Location of the next word in memory to be used for a data channel transfer.

PROGRAMMING

Programming data transfers to or from 6045/50/51 disc cartridge subsystems proceeds in three phases: (1) selecting the drive, surface and sector; (2) positioning the heads over the correct cylinder; and (3) initiating the read or write operation. After issuing commands in any phase, check the controller's status register for errors before proceeding to the next phase.

The description below of these three programming phases assumes operation without errors. (Error conditions are discussed later in the text.) It also assumes three restrictions in the configuration of the disc cartridge subsystem: (1) that the subsystem contains a single disc drive; (2) that it connects to only one CPU and its controller in that CPU is configured accordingly; and (3) that the CPU is dedicated to it (i.e., the CPU's ION flag is set to 0). Certain additional considerations must be borne in mind when a subsystem contains more than one drive or when it operates in a dual-processor environment. (See end of section.)

The operations described below can easily be applied to interrupt-driven service routines.

Phase I: Select the Drive, Surface, Sector and Number of Sectors

Issue a SPECIFY DISC ADDRESS AND SECTOR COUNT instruction (DOC) to the controller with no device flag command. Use appropriate accumulator fields to select the drive (0-3₈) the surface (0-3₈) and the first sector to be read or written, (0-13₈) as well as the two's complement of the number of sectors to be transferred in the operation. (The subsystem can transfer, at most, 16₁₀ consecutive sectors in one operation.) Take care to ensure that the parameters specified in this initial selection do not exceed the capacity of the drive.

After selecting the drive unit, check its status to verify the unit is ready to perform an operation. Issue a READ STATUS instruction (DIA) with no flag command, and then examine the Ready flag (bit 9) and the Diskette flag (bit 5). If the Ready flag is 1 and the Diskette flag is 0, proceed to phase II. If the Ready flag is 0, do NOT issue any commands to that drive unit. If the Diskette flag is 1, follow instructions for 6030 diskette programming.

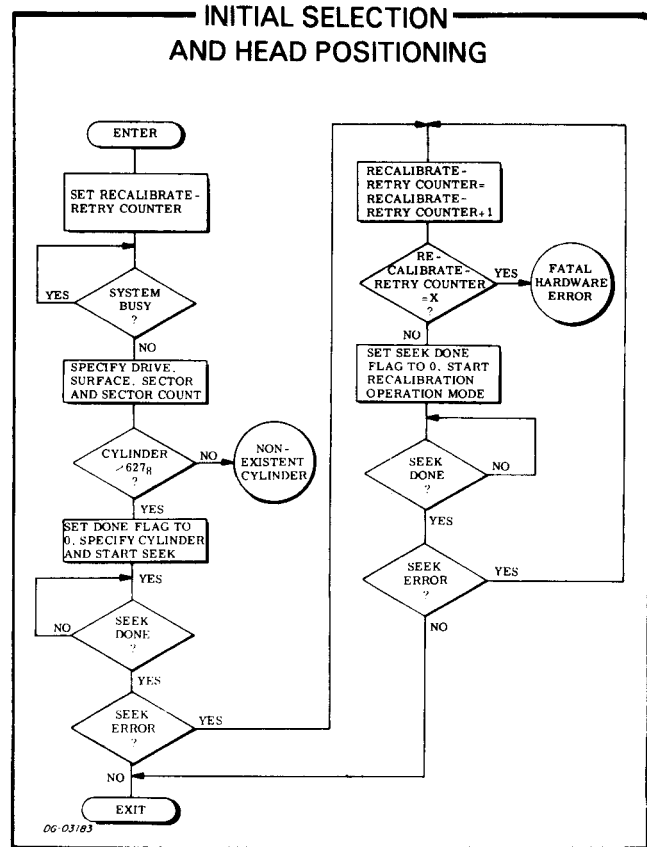

Phase II: Position the Heads

Move the heads to the desired cylinder using a SPECIFY COMMAND AND CYLINDER instruction (DOA) plus a P command. Use the appropriate accumulator bits to clear R/W Done and Seek Done on the selected drive and use the appropriate accumulator fields to specify both a cylinder address and the seek command.

The P flag command initiates the seek operation without affecting the controller's Busy flag. P, however, sets the Done flag to 0.

While the drive is seeking, the Unit Ready and Seek Done flags for the selected drive are 0; at the conclusion of the seek operation, the controller sets the Seek Done flag for the selected drive to 1 in the subsystem status register.

After the specified drive completes the seek operation, issue a READ STATUS instruction; check both the Unit Ready (bit 9) and the Error flags. If there are no errors, proceed to phase III.

Phase III: Read or Write

A read operation transfers blocks of data from a sector on disc to the computer's memory via the data channel; a write operation transfers blocks of data from the computer's memory to a sector on disc via the data channel. A block is 256 16-bit words. One to 16 blocks can be transferred in one read or write operation. Multiple block transfer operations read or write consecutive disc sectors from one disc cylinder. (The sector that follows sector 13₈ on a surface is sector 0 on the next surface.)

Read

Specify the starting address of the area in memory to receive the data transfer, using a LOAD MEMORY ADDRESS REGISTER instruction (DOB). Use the appropriate accumulator field to specify the 15-bit address of the memory location to receive the first word read from disc. The SPECIFY DISC ADDRESS AND SECTOR COUNT instruction (DOC) issued during phase I specified the disc surface to be read, the number of sectors to be read and the number of the starting sector.

Issue a read command using the SPECIFY COMMAND AND CYLINDER instruction (DOA) along with an s flag command. Use the appropriate accumulator bits to clear both the R/W flag and the Seek Done flag for the specified drive, and use the appropriate accumulator fields to specify both the read operation and a cylinder address. (The cylinder number must match that of the cylinder being read; it is used by the controller for address checking at the start of each 256-word sector transfer in the read operation.)

The s flag command sets the Busy flag to 1, and the Done flag to 0 and initiates the read operation.

At the start of the operation, the drive waits until the desired sector passes under the specified head; it reads the address field from that disc sector, and the controller performs an address check. The cylinder address read from the sector address field must match that posted in the SPECIFY COMMAND AND CYLINDER instruction, and the sector and surface numbers contained in the address field must match those contained in the disc address register. If the address check is successful, the drive continues the operation, reads the sequential data bits from the sector, and calculates a 16-bit checkword from the serial data.

The controller builds 16-bit words from the serial data and transfers them to the computer's memory via the data channel. Each time a word is transferred to memory, the controller automatically increments its memory address register by 1.

After the drive reads the 256 words from the sector, the controller increments its sector counter by 1. The drive then reads the 16-bit checkword at the end of

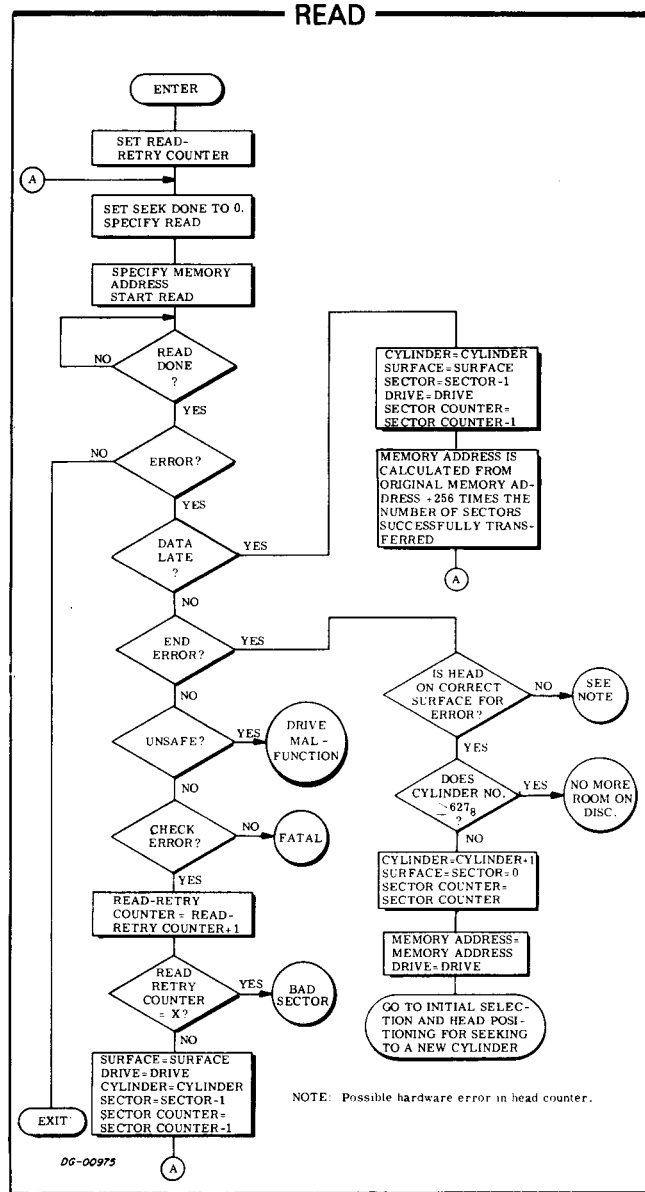

the sector and the controller verifies that it matches the checkword calculated while data was read from disc.

If the controller's sector counter does not overflow at the trailing edge of a sector, the drive reads the next sector; the process repeats until either the sector counter overflows or the last sector on a surface is read. When last sector on surfaces 0-2 is read, the controller automatically changes the surface and sector address in the disc address register to specify the first (0) sector on the next surface of the same cylinder, and the drive continues reading from that sector.

A read operation continues until the sector counter indicates, by overflowing, that the specified number of sectors has been read. Upon completing the read operation, the controller sets its Busy flag to 0 and its Done flag to 1, initiating a program interrupt request.

Write

Specify the starting address of the area in memory to be transferred by using a LOAD MEMORY ADDRESS REGISTER instruction (DOB). Use the appropriate accumulator field to specify the 15-bit address of the first word in memory that will be written to disc. The SPECIFY DISC ADDRESS AND SECTOR COUNT instruction (DOC) issued during phase I specified the disc surface to be written, the number of sectors to be written and the number of the starting sector.

Issue a write command using the SPECIFY COMMAND AND CYLINDER instruction (DOA) plus an S flag command. Use the appropriate accumulator bits to clear both the R/W flag and the Seek Done flag for the specified drive, and use the appropriate accumulator fields to specify both the write operation and a cylinder address. (The cylinder number must match that of the cylinder to be written; it is used by the controller for address checking at the start of each 256-word sector transfer in the write operation.)

The S flag command sets the Busy flag to 1 and the Done flag to 0 and initiates the write operation.

At the start of the operation, the drive waits until the desired sector passes under the specified head; it reads the address field from that disc sector, and the controller performs an address check. The cylinder address read from the sector address field must match that posted in the SPECIFY COMMAND AND CYLINDER instruction, and the sector and surface numbers contained in the address field must match those contained in the disc address register. If the address check is successful, the drive continues the operation and writes the sequential data bits to the sector.

The controller receives 16-bit data words from the data channel and transfers them serially to the drive unit while continually recalculating a 16-bit cyclic checkword from the serial data. Each time a word is transferred from memory, the controller automatically increments its memory address register by 1.

After the drive writes the 256 words from the sector, the controller increments its sector counter by 1 and adds the checkword to the data written to disc.

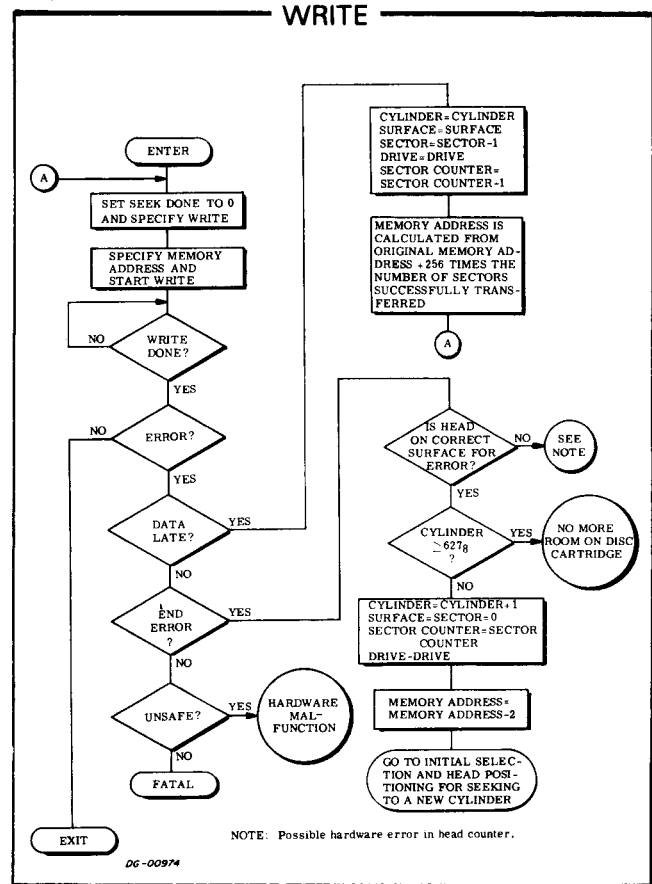

If the controller's sector counter does not overflow at the trailing edge of a sector, the drive writes the next sector; the process repeats until either the sector counter overflows or the last sector on a surface is written. When the last sector on surfaces 0, 1 or 2 is written, the controller automatically changes the surface and sector address in the disc address register to specify the first (0) sector on the next surface of the same cylinder, and the drive continues writing on that sector.

A write operation continues until the sector counter indicates, by overflowing, that the specified number of sectors has been written. Upon completing the write operation, the controller sets its Busy flag to 1 and its Done flag to 1, initiating a program interrupt request.

FORMATTING

All disc data surfaces must be formatted before a Data General disc cartridge subsystem will properly function. The format delineates an address field and a data field in each sector of every track of a surface. The address field of a sector is a coded header that precedes the data area of the sector and contains the sector's logical address. The purpose of the format is twofold: (1) it provides information for address checking by the subsystem (transparent to the programmer) before each data transfer; (2) it provides splice areas that separate the address field from the data field in a sector while giving read and write controls time to properly initialize and settle prior to a data transfer.

The format field contains a gap or splice area followed by twenty-four 16-bit words. The first 22 words, all containing zeros, and a 23rd word containing 000001₈, form a synchronization field. The 24th word is the address word containing the cylinder, sector and surface numbers.

Another splice field follows the format field, and it is followed, in turn, by a synchronization field of all zeros, a single sync bit (1), the 256-word data area, and its check word. Zeros fill the remainder of the sector.

If the status register repeatedly indicates an address error after many failures to read or write an area on the disc, the area in question (possibly one sector, or several adjacent sectors on one surface) may need reformatting.

Typically, disc cartridges obtained from Data General are completely formatted before they are shipped; cartridges obtained elsewhere must be formatted by the customer. Should the fixed platter in a disc unit be removed or replaced, it, too, requires reformatting.

Data General provides a stand-alone program that will format all the sectors and surfaces of a disc unit. The program can also format a single sector, several sectors, or one cylinder of the drive. The formatter program is available on paper tape (DGC no. 095-000300), and its operation is described in a companion program listing (DGC no. 096-000300).

Whenever any sector is reformatted, all the data in that sector is lost. Formatting is done independently of and before initializing a disc for use with a Data General operating system.

TIMING

The discs in the drive unit rotate at 2400rpm; a complete revolution requires 25ms. A register within the drive (transparent to the programmer) continually indicates to the controller the number of the sector presently passing under the heads. This feature allows the subsystem to carry out a read or write operation the first time the desired sector passes under the head.

The minimum sector access time is that required to read the address field at the start of a sector - 300us; the maximum access time is that needed for a full revolution plus the address field time - 25.3ms; the average sector access time is 12.7ms.

A sector passes under a head in 2.08ms; the *data portion* of that sector passes under the head in 1.638ms. A data channel request occurs every two words, approximately 12.8us (nominal). This corresponds to an average data transfer rate of 156,250wps. The controller can buffer two words for the data channel, which provides a maximum allowable data channel latency of 12.8us. If the data channel does not respond to a controller request within this time, both the Data Late flag and the Error flag are set to 1.

The time required to position the heads (seek time) depends on the number of cylinders the heads must cross to reach the destination cylinder, seek time is direction-independent. The minimum seek time is that for a single cylinder seek - 8ms; the maximum seek time is that needed to traverse all cylinders - 70ms.

The recalibrate operation moves the heads back to cylinder 0; but it progresses more slowly than a seek to protect the head moving mechanism and to reset its controls in an orderly manner. The maximum recalibrate time is approximately 200ms.

NOTE Issue no commands to the disc controller for at least 50us after the start of a seek or recalibrate operation.

ERROR CONDITIONS

During Initial Selection (Phase I)

Initial selection errors appear subsequently to recent disc read and write operations and are unrelated to commands issued in phases I or II.

Absence of Valid Status

If a single processor is used, the entire disc subsystem remains dedicated to one controller. In this case, the Valid flag may be set to 0 if: (1) the controller has been improperly configured for use with a single processor; (2) the controller can only operate with a single processor and, hence, its valid flag is always set to 0; (3) a hardware malfunction exists.

If dual processors are used, access to the disc subsystem is provided to one controller at a time, on a demand basis. (See subsection below on dual processor considerations.) In this case, a Valid flag set to 0 may mean that the status word returned is suspect (i.e., the controller did not have access to the subsystem while reading the status word). To ensure accuracy of the status word, issue a seek command (to any cylinder, any drive) wait at least 50us, reselect the desired drive and reread the Valid flag. Repeat this process until the Valid flag reads 1.

Unsafe Error

If the Unsafe flag is 1, the Unit Ready flag is 0. Issue an S, C, P, or IORST to set the Unsafe flag in the controller to 0; however, this action will usually not remove the drive unit's unsafe condition. (Momentarily toggling the LOAD/RUN switch on the drive control panel to LOAD and then back to RUN, or powering down the drive and then restarting it will usually clear the unsafe condition.)

If a drive's unsafe condition persists after the Unsafe flag is set to 0 in the controller, the flag will *not* return to 1 again until either (1) *another* unsafe drive unit is selected or (2) the original unsafe unit is first deselected (SPECIFY ... another drive) and then reselected.

During Head Positioning (Phase II)

If the program issues a SPECIFY COMMAND AND CYLINDER instruction (DOA) that initiates a seek operation to a non-existent cylinder (i.e., greater than 627₈), the seek operation immediately terminates, and both the Seek Error and the Seek Done flag are set to 1; then a program interrupt request is initiated. If any seek operation to a valid cylinder number results in a Seek Error, perform a reasonable number of seek retries.

Seek Retry

A seek retry is a recalibrate operation followed by another attempt to position the heads over the desired cylinder. The recalibrate operation is a hardware recovery sequence that moves the heads of the selected drive over cylinder 0 and resets the head positioning control in that drive.

To perform a seek retry, recalibrate the drive using a SPECIFY COMMAND AND CYLINDER instruction (DOA) plus a P flag command. Use the appropriate accumulator bits to clear both the Seek Done flag for the selected drive unit and the R/W Done flag; use the appropriate accumulator field to specify a recalibrate operation. The cylinder address field is ignored in a recalibrate operation.

The P flag command sets the Done flag to 0 and initiates the operation without affecting the controller's Busy flag. While the drive is recalibrating, the Unit Ready and the Seek Done flags for the specified drive are 0; at the conclusion of the operation, the controller sets the Seek Done flag for the appropriate drive and initiates a program interrupt request.

At the conclusion of the recalibrate operation, increment a seek retry counter (see flowchart on initial selection and head positioning) and try again to position the heads over the desired cylinder. If, after several attempts, the drive does not successfully position the heads over the desired cylinder, that drive or the subsystem may be faulty.

During Reading

If the program specifies a non-existent sector (i.e., greater than 13₈), the controller sets the contents of the sector register value to zero and increments the surface by 1. If, after incrementing, the resulting surface address is 1, 2 or 3, the read operation begins at the first sector of that surface. If the resulting surface address is 4 (a non-existent surface), an End of Cylinder Error is indicated.

End of Cylinder Error

An error can occur when the disc subsystem attempts to read past the last sector on surface 3. If the read operation does not terminate (i.e., if the sector counter does not overflow) after writing sector 13₈ on that surface, both the Error and the End of Cylinder Error flags are set to 1, and the operation terminates. The sector counter remains at its *incremented* value, the controller forces both the sector and the surface addresses to 0 and also increments by 1 the unused head address field (bits 3-5) of the controller's disc address register. (See READ DISC ADDRESS instruction.) The controller sets its Busy flag to 0 and its Done flag to 1 and initiates a program interrupt request.

Address Error

An address field preceding each sector on the drive identifies its surface, cylinder and sector position. Before the controller reads data from a specified sector, it performs an address check. If the controller reads an address from the address field that does not match that in the disc address register, the controller sets both the Error and the Address flags to 1, and the read operation terminates immediately. The controller sets the Busy flag to 0, the Done flag to 1, and initiates a program interrupt request.

After an address error, the sector counter and the sector address register retain the values they had when the error occurred. That is, the sector address register retains the number of the faulty sector and the sector counter contains the two's complement of the number of sectors left to read in the operation.

Repeated address errors from the same sector(s) on the disc cartridge may indicate damage to the magnetic media; or those sector(s) may need reformatting. (See subsection on formatting, above.)

Checkword Error

Each time the subsystem writes data to disc, it appends a 16-bit checkword to the 256-word data block. While the controller reads the data from a sector, it continually computes a checkword from the data stream from disc and compares it to the checkword written at the end of the data block on the disc. If the checkwords differ, the controller sets both the Error and the Checkword flags to 1, and the read operation terminates at the end of the sector, even if there are more sectors to read. The controller sets the Busy flag to 0 and the Done flag to 1 and initiates a program interrupt request. A Checkword error indicates that at least one data word read from the sector is erroneous.

After a Checkword error, the sector address register points to the sector following that in which the error occurred. The sector counter contains the two's

complement of the number of sectors, *not including the faulty sector*, that remain unread after the error.

Data Late Error

If the data channel does not respond in time to a data channel request, both the Error and the Data Late flags are set to 1. Reading of the current sector continues, but at the end of that sector, the read operation terminates. (The sector counter and the sector address register increment normally.) The controller sets the Busy flag to 0 and the Done flag to 1 and initiates a program interrupt. The Data Late flag indicates that at least one word from the last sector read was not correctly transferred to memory.

After a Data Late error, the sector address register points to the sector following that in which the error occurred. The sector counter contains the two's complement of the number of sectors, *not including the faulty sector*, that remain unread after the error.

During Writing

If the program specifies a non-existent sector (i.e., greater than 13₈), the controller sets the contents of the sector register to zero and increments the surface by 1. If, after incrementing, the resulting surface address is 1, 2 or 3, the write operation begins at the first sector of *that surface*. Otherwise, an End of Cylinder Error occurs.

End of Cylinder Error

An error can occur when the disc subsystem attempts to write past the last sector on surface 3. If the write operation does not terminate (i.e., if the sector counter does not overflow) after writing sector 13₈ on that surface, both the Error and the End of Cylinder Error flags are set to 1, and the operation terminates. The sector counter remains at its *incremented* value, the controller forces both the sector and the surface addresses to 0 and also increments by 1 the unused head address field (bits 3-5) of the controller's disc address register. (See READ DISC ADDRESS instruction.) The controller sets its Busy flag to 0 and its Done flag to 1 and initiates a program interrupt request.

Address Error

An address field preceding each sector on the disc unit contains its surface, cylinder and sector position. Before the controller writes data to a specified sector, it performs an address check. If the controller reads an address from this field that does not match that in the disc address register, the controller sets both the Error and the Address Error flags to 1, and the write operation terminates immediately. The controller sets the Busy flag to 0 and the Done flag to 1 and initiates a program interrupt request.

After an address error, the sector counter and the sector address register retain the values they had when the faulty sector came under the head. That is, the sector address register retains the number of the faulty sector and the sector counter contains the two's complement of the number of sectors left to write in the operation.

Repeated address errors from the same sector(s) on the disc cartridge may indicate damage to the magnetic media; or those sector(s) may need reformatting. (See subsection on formatting, above.)

Data Late Error

If the data channel does not respond in time to a data channel request, both the Error and the Data Late flags are set to 1. Writing into the current sector continues, but at the end of that sector, the operation terminates. The controller sets the Busy flag to 0 and the Done flag to 1 and initiates a program interrupt. The Data Late flag indicates that at least one word written into the last sector was not correctly transferred from memory.

After a Data Late error, the sector address register points to the sector following that in which the error occurred. The Sector Counter contains the two's complement of the number of sectors, *not including the faulty sector*, that remain unwritten after the error.

MULTIPLE DRIVES

In a multiple drive subsystem, any unit may initiate a seek or recalibrate operation while other units are executing head positioning commands. The subsystem can also overlap seek or recalibrate operations on several drives with a data transfer on a single drive - but all the commands to seek or recalibrate must precede the command to start reading or writing. Certain programming considerations must be borne in mind during each phase when performing multiple operations.

Phase I Considerations

Issue the SPECIFY DISC ADDRESS AND SECTOR COUNT instruction if no disc unit in the subsystem is performing a read or write operation. Deselecting a drive engaged in a data transfer will immediately terminate that transfer.

If commands to the subsystem are to be overlapped, only the accumulator field specifying unit number is significant, and the other fields may be set to zero. (The unneeded fields may not, however, specify parameters that exceed the capacity of the unit.)

Phase II Considerations

Initiate a head positioning operation on the unit selected in phase I, as described previously. Overlap it with a head positioning operation on a different unit as follows: branch immediately to phase I, specify and check status on the new unit, and then return to phase II to start the new operation. Repeat this sequence until all the overlapped positioning operations have been started.

Next, determine which drive is to perform the first data transfer. The decision may be dictated by priority. But when it is possible to initiate a transfer on the first available drive, to find it, keep examining the Seek Done flags by repeatedly issuing READ STATUS instructions.

After choosing a unit for the data transfer, issue a SPECIFY DISC ADDRESS AND SECTOR COUNT instruction (DOC) to reselect that unit and establish parameters for the transfer.

Check the selected unit's status by issuing a READ STATUS instruction (DIA). Check both the Unit Ready flag and the Error flag. If there are no errors, proceed to phase III.

NOTE *If a seek error occurs, perform one seek retry (described above); but, if possible, move on to initiate a transfer on another disc unit. Wait for a retry to finish only if the drive involved must perform the next data transfer.*

Phase III Considerations

Once a unit has been selected for a read or write operation at the end of phase II, begin the data transfer exactly as described earlier. Starting the read or write operation with an S flag control does not affect the values of the Seek Done flags. Do not issue a SPECIFY DISC ADDRESS instruction (DOC) to the subsystem until both the Done flag and the R/W Done flag (in the status register) are set to 1.

It is safe to issue a READ STATUS instruction any time to determine whether any seek operations overlapped in phase II have been completed. This may be useful in choosing the next unit for a transfer and for preparing that transfer.

After the transfer, issue a READ STATUS instruction. Once status has been read, either check for errors in the present transfer or, if possible, save the status word, reselect units and start the *next* transfer before checking the present one for errors.

DUAL PROCESSOR CONSIDERATIONS

The disc subsystem hardware imposes certain restrictions on the program when the subsystem operates in a dual processor (shared disc) environment. The dual access mechanism switches access to the entire subsystem from one controller to the other on a demand basis, in conjunction with timing and command protocols.

Each processor obtains subsystem control by issuing head positioning commands. Once established, this control may be maintained by issuing other head positioning commands prior to completion of a 3-second subsystem timeout. Completion of a read or write immediately terminates subsystem control. The other processor must wait for service until the processor in control has completed its task.

The description and flowcharts below describe non-interrupt driven procedures for operating a single-drive subsystem in a shared-disc environment. These procedures focus on maintaining the integrity of the subsystem only at the *hardware* level. The concepts can be extended to support interrupt drivers for multiple-drive subsystems.

A separate protocol is needed to maintain data integrity within the file structure. A simple file protocol, for example, might assign a number of blocks to one processor for unrestricted use (including writing) while assigning the remaining blocks to the other processor. In general, the protocol is implemented by means of some communication link between processors to allow conflict arbitration. Data General's Real Time Disc Operating System (RDOS) uses the facilities of the model 4240 interprocessor bus for resolving conflicts in the dual CPU environment.

Program a shared disc subsystem in three phases: (1) select the disc unit and specify parameters for the transfer; (2) position the heads over the desired cylinder and gain access to the subsystem; and (3) initiate the transfer.

Phase I, Initial Selection

Set up the subsystem control as described previously in the subsection on programming, phase I. Do not read status.

Phase II

Issue a SPECIFY COMMAND AND CYLINDER instruction (DOA) with a P appended to it as described previously. Wait at least 50 microseconds after issuing the seek command and then issue a READ STATUS instruction (DIA). Verify that the Valid Status flag (bit 6) is 1. The controller receives access to the subsystem for a maximum of 3 seconds after the Valid Status flag in its status register becomes 1. Continue reading status until both the Seek Done flag and the Unit Ready flag are 1. If the Error flag is 0, proceed to phase III.

If the Error flag is 1, then the seek may be retried several times. Since the processor reasserts control of the subsystem for 3 seconds each time a seek or recalibrate command is issued, the programmer should limit the number of retry operations to avoid locking out the other processor.*

Phase III

Initiate the data transfer as previously described. The processor unconditionally loses control of the subsystem at the end of a data transfer operation or 3 seconds after the last head positioning command, whichever comes first.

After a data transfer, the contents of the status register remain unchanged in the controller until the controller issues a SPECIFY DISC ADDRESS ... instruction (DOC) that alters the disc unit selection.

NOTE *The Valid Status flag returned in the status register at the conclusion of a data transfer will always be 0. If the program has not issued an initial selection command or a device flag command (S, C, P), the contents of the status register remain valid.*

If the data transfer is terminated by a timeout (3 seconds), restart the entire process beginning with phase I.

* Note that only head positioning commands assert control of the subsystem; no other commands will restart the 3-second timeout.

INITIAL SELECTION AND HEAD POSITIONING
(SHARED DISC)

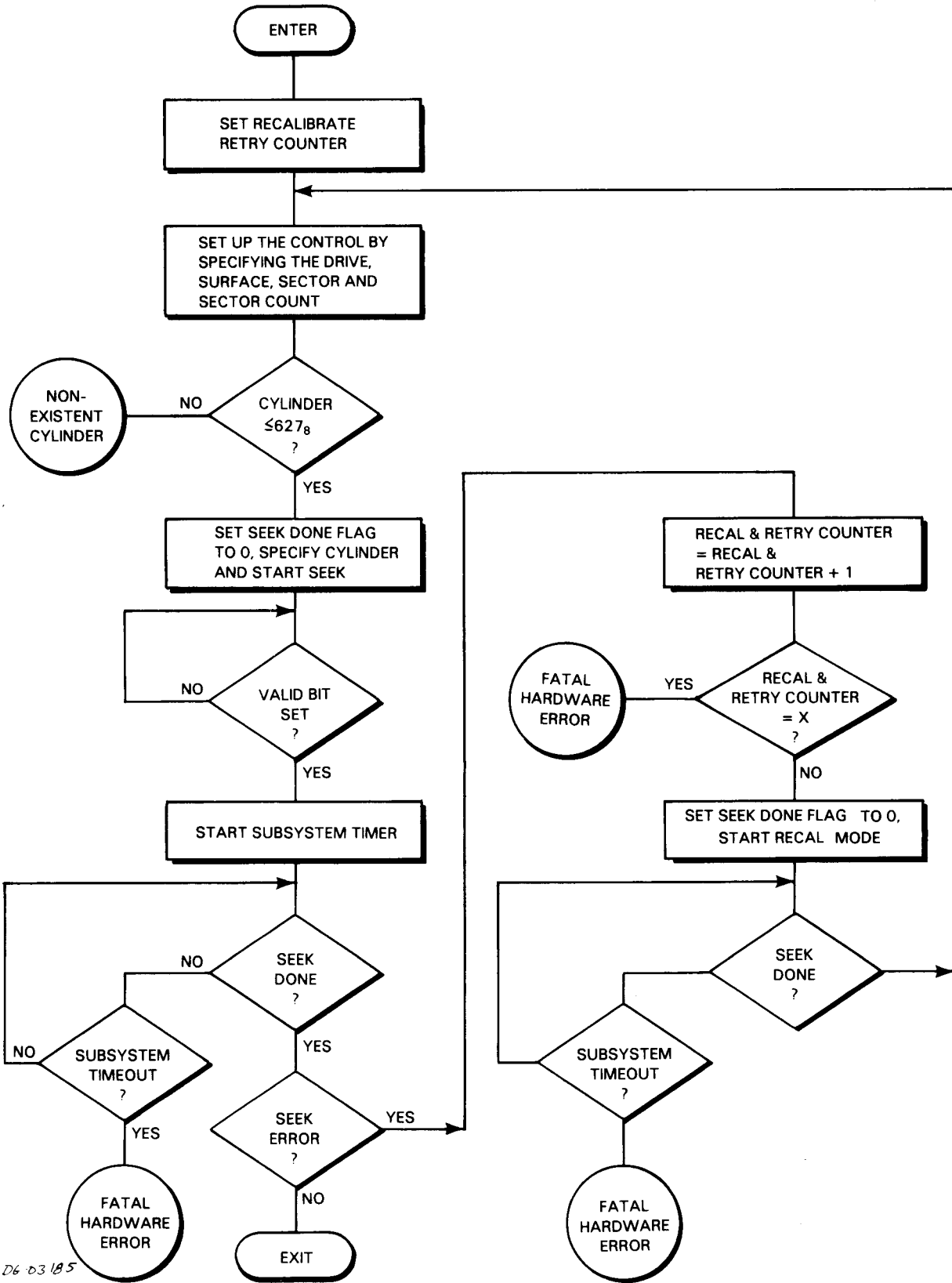

D6 D3 185

READ (SHARED DISC)

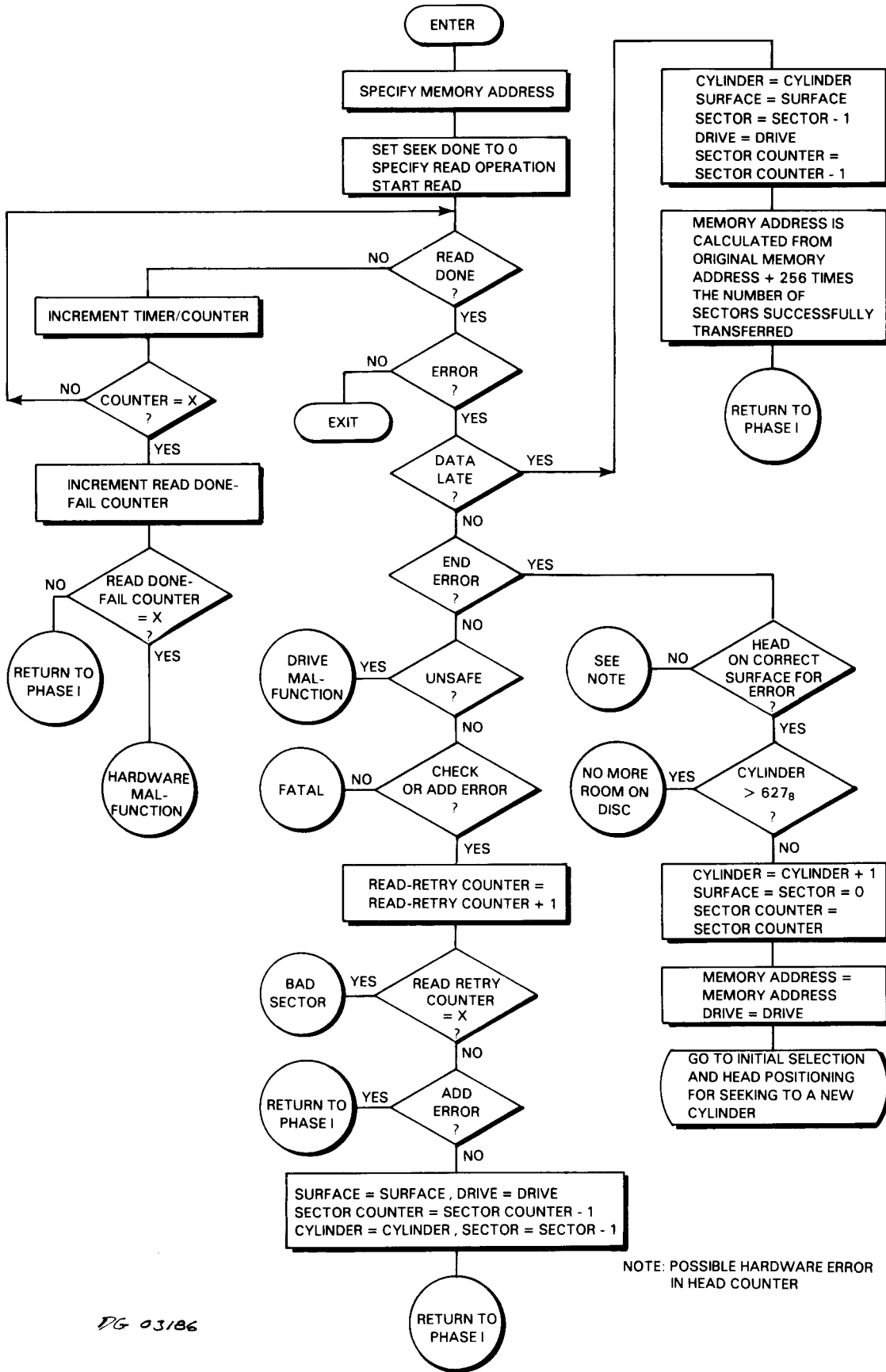

NOTE: POSSIBLE HARDWARE ERROR
IN HEAD COUNTER

DG 03186

WRITE (SHARED DISC)

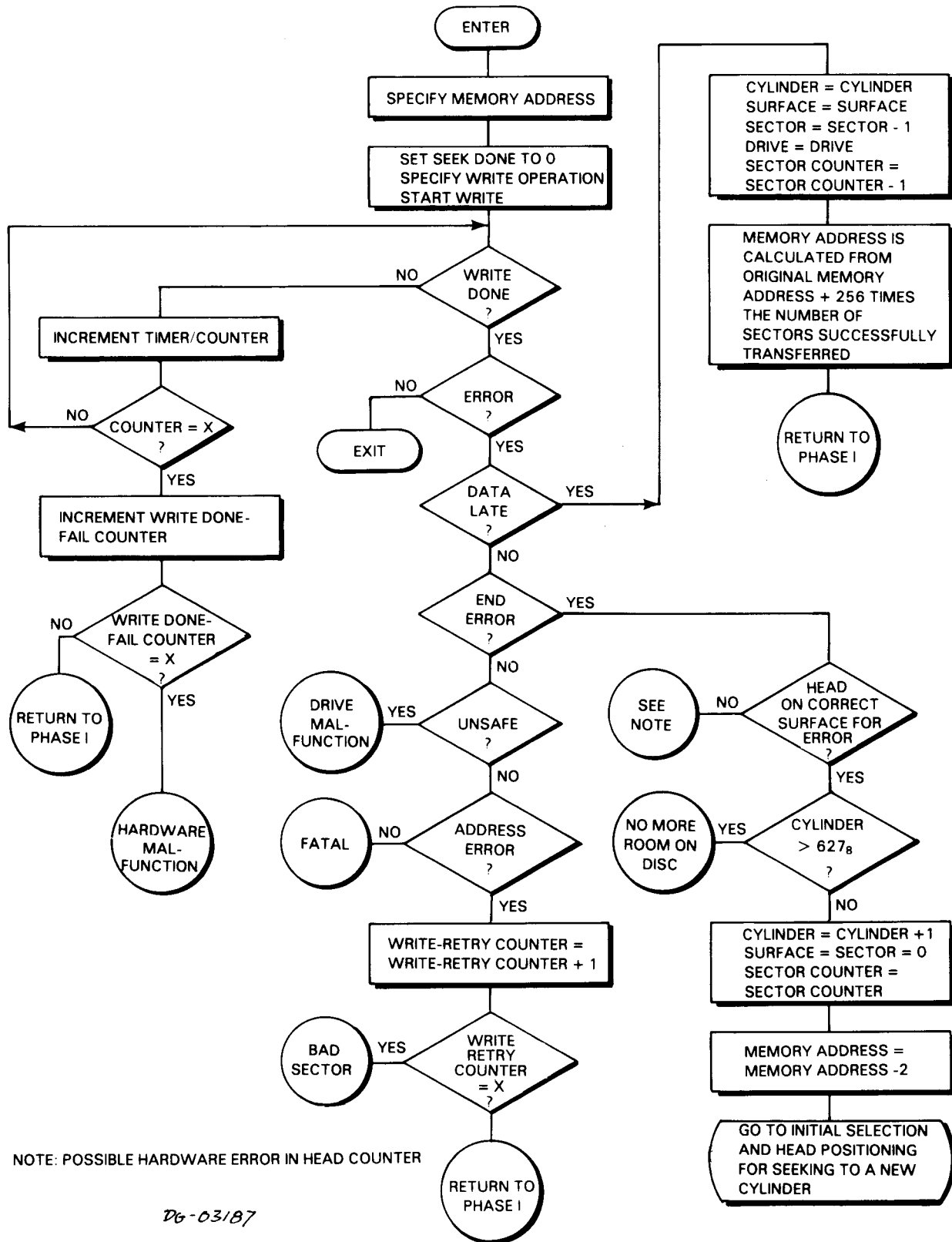

NOTE: POSSIBLE HARDWARE ERROR IN HEAD COUNTER

D6-03187

This page intentionally left blank.

6030 SERIES DISKETTE SUBSYSTEM

PROGRAMMING SUMMARY

Mnemonic (First Controller)	DKP	Sectors/Track	8
Device Code	33 ₈	Words/Sector	256
Mnemonic (Second Controller)	DKP1	Total Storage Capacity (Words)	157,696
Device Code	73 ₈	Max. Transfer Rate (wps)	15,625
Priority Mask Bit	7	Allowable Data Channel Latency (us)	128
Surfaces/Unit	1	Seek Time (max/min, ms)	770/20
Tracks/Surface	77	Sector Access Time (max/min, ms)	166/3

ACCUMULATOR FORMATS

**Specify Disc Address
and Sector Count**

(DOC)

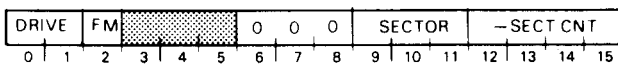

Read Disc Address

(DIC)

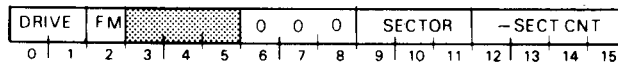

Specify Command and Track

(DOA)

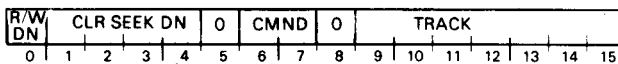

Commands

- 00 Read
- 01 Write
- 10 Seek
- 11 Recalibrate

Read Status

(DIA)

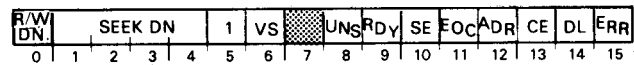

Load Memory Address Register

(DOB)

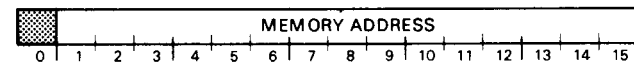

Read Memory Address Register

(DIB)

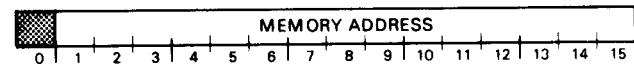

S, C and P FUNCTIONS

- f = S* Sets the Busy flag to 1, and the Done flag to 0; starts the operation specified in the command register.
- f = C* Sets the Busy flag and the Done flag to 0 and stops all data transfer operations.
- f = P* Sets the Done flag to 0 and starts the operation specified in the command register if that operation is a seek or a recalibrate.

INTRODUCTION

The 6030 diskette subsystem includes up to four moving head diskette drives and one or two controllers; 6030 diskette units may be intermixed with 4234 or 6045/50/51 disc cartridge units.* The subsystem controller occupies a single slot of the computer chassis and directs the activities of the disc drives. Control over the subsystem may be shared by two NOVA® or ECLIPSE® central processors if a subsystem controller is installed in each processor.

This section discusses the programming protocols for driving 6030 series diskette units in both single- and dual-processor environments. Similar protocols for the cartridge units are presented elsewhere in this manual.

A subsystem may contain four diskette units; the identity of each unit (unit number) is operator-selectable by means of a front panel thumbswitch. Each disc unit contains a single program-accessible surface. There are 77 tracks in a unit, numbered 0-114₈. Each track contains 8 sectors, numbered 0-7. Each sector contains an address header and a data field that stores 256 (400₈) 16-bit data words and a 16-bit checkword. The data storage capacity is 2,048 words per track or 157,696 words per diskette.

Data is transferred to and from the subsystem via the data channel at a maximum rate of 15,625 words per second. From one to eight consecutive sectors in one track can be transferred in one operation.

CONTROLLER REGISTERS

The disc drive controller contains four program-accessible registers: a 15-bit memory address register, a 16-bit status register, a 16-bit combined command and track select register, and a combined disc address register and sector counter. The memory address register is self-incrementing and contains the address of the next location whose contents are to be transferred to or from the disc subsystem via the data channel. The status register contains four Seek Done flags, a Read/Write (R/W) Command Done flag, a Unit Ready flag, a Valid Status flag, and six error flags. The

Seek Done flag and the R/W Done flag each initiate a program interrupt request when set to 1. The combined command and track select register contains the last command issued to the subsystem and the number of the desired track on the selected unit. The combined disc address register and sector counter contains the number of the next sector to be read or written and the two's complement of the number of sectors remaining to be read or written. The disc address and the sector counter portions of this register self-increment immediately after a sector is read or written.

INSTRUCTIONS

Six instructions program data channel transfers to and from the subsystem. Three of these instructions supply the controller with all the necessary information for any disc operation. The remaining instructions allow the program to determine, in detail, the current state of the subsystem.

The device flag commands control the disc controller's Busy and Done flags as follows:

- f = S** Sets the Busy flag to 1, the Done flag to 0, the Address Error, End of Cylinder, Checkword Error, Data Late, and Unsafe flags to 0, and initiates the operation specified by the contents of the command register.
- f = C** Sets the Busy flag, the Done flag, all Error flags, and all Seek Done flags to 0 and stops all data transfer operations; does not terminate a seek operation already in progress.
- f = P** Sets the Done flag and all Error flags to 0 and initiates the operation specified by the contents of the command register.

NOTE - The P flag command does not affect the controller's Busy flag. If the Busy flag is 0 and the program starts an operation with the P command, the controller does not initiate a program interrupt request at the conclusion of the operation unless it is a seek or recalibrate. The controller initiates an interrupt at the end of all seek or recalibrate operations.

* Certain early revision diskette units operate in dual CPU environments only when combined with 6045/50/51 cartridge drives. Also, since the 4234 series units do not support dual CPU operation, diskette units combined with the 4234 units are similarly restricted.

Instruction Coding Conventions

In the descriptions that follow, certain coding conventions are used so the assembler can recognize the instruction and translate it correctly into machine language. See Appendix E for these conventions.

Specify Command And Track

DOA [f] ac, DKP

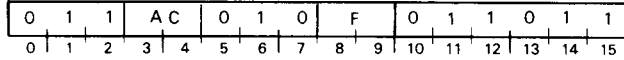

Loads bits 0-15 of the specified AC into the controller's combined command and track select register. After the data transfer, sets the controller's Busy and Done flags according to the function specified by F. The contents of the specified AC remain unchanged; the format of the accumulator is as follows:

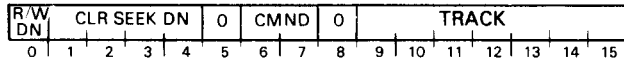

Bits	Name	Function
0	Clear R/W Done	Sets the status register's DC Done flag to 0; sets the following error flags to 0: Address Error, Checkword Error, End of Cylinder, and Unsafe.
1-4	Clear Seek Done (0-3)	Sets the Seek Done flags to 0 on drives 0-3, respectively.
5	---	Must be 0.
6-7	Command	Specifies the command for the selected drive as follows: 00 Read 01 Write 10 Seek 11 Recalibrate
8	---	Must be 0.
9-15	Track	Specifies the desired track (0-114 ₈) for a seek, read or write operation.

Specify Disc Address And Sector Count

DOC [f] ac, DKP

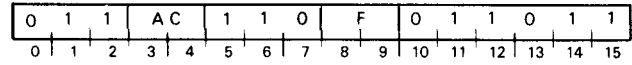

Loads bits 0-15 of the specified AC into the controller's disc address register and sector counter. After the data transfer, sets the controller's Busy and Done flags according to the function specified by F. The contents of the specified AC remain unchanged; the format of the accumulator is as follows:

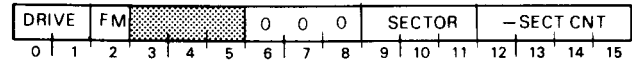

Bits	Name	Function
0-1	Drive	Selects drive 0-3 ₈
2	Format	If 1, places controller in FORMAT mode.
3-5	---	Reserved for future use.
6-8	---	Must be 0.
9-11	Sector	Selects the starting sector (0-7) for the start of a read or a write operation.
12-15	-Sector Count	Specifies the two's complement of the number of sectors to be read or written in one operation (maximum of 8 ₁₀).

Load Memory Address Register

DOB [f] ac, DKP

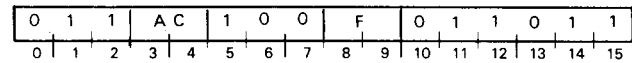

Loads Bits 1-15 of the specified AC into the controller's memory address register. After the data transfer, sets the controller's Busy and Done flags according to the function specified by F. The contents of the specified AC remain unchanged; the format of the accumulator is as follows:

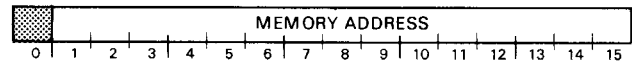

Bits	Name	Contents
0	---	Reserved for future use.
1-15	Memory Address	Location of the next word in memory to be used for a data channel transfer.

Read Status

DIA [f] ac, DKP

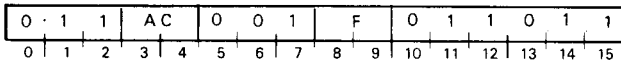

Places the contents of the controller's status register in bits 0-15 of the specified AC. After the data transfer, sets the controller's Busy and Done flags according to the function specified by F. The format of the specified accumulator is as follows:



Bits	Name	Meaning When 1
0	R/W Done	The subsystem has completed a read or a write operation.
1-4	Seek Done (0-3)	Drive 0-3, respectively, has completed a seek or recalibrate operation. <i>More than one of these bits can be set at any time.</i>
5	Diskette	Must be 1.
6	Valid Status	When the read status command was issued, the controller had control of the disc subsystem*
7	---	Reserved for future use.
8	Unsafe	The selected drive is in an unsafe condition. The Unsafe flag can be reset with an S, C, P, or IORST command, but this action will not remove the drive's unsafe condition. Try to remedy the unsafe condition by powering down the drive, and then restarting it.
9	Unit Ready	The selected drive is not performing any head movements and is ready to carry out a command (read, write, seek, or recalibrate)
10	Seek Error	The selected drive was not able to carry out the last seek or recalibrate operation issued.
11	End of Track	The last read or write operation attempted to continue beyond the last sector of a track.
12	Address Error	The address read from the address field at the beginning of a sector does not match the last address specified to the disc controller.
13	Checksum Error	The checksum read from the disc at the end of a sector does not match the checksum calculated by the controller during the sector transfer.
14	Data Late	The data channel failed to respond in time to a data channel request.
15	Error	One or more of the following bits in the status register is set to 1: 8, 10, 11, 12, 13, or 14.

* This bit is used in dual CPU - multiple drive environments. It allows the program to test the status of a drive unit without first issuing a dummy seek to guarantee its control of the shared subsystem. When 0, the bit indicates that the controller lost control of the subsystem before status was read and the word returned may be inaccurate. The programming considerations for dual CPU operation are discussed later in this section. (This bit was always 0 in early revision controllers.)

Read Disc Address

DIC [f] ac, DKP

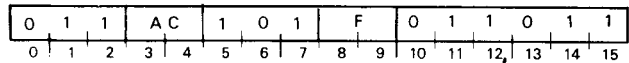

Places the contents of the controller's disc address register and sector counter in bits 0-15 of the specified AC. After the data transfer, sets the controller's Busy and Done flags according to the function specified by F. The format of the specified accumulator is as follows:

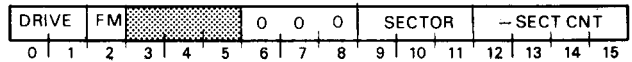

Bits	Name	Contents
0-1	Drive	Number (0-3) of the selected drive.
2	Format	When 1, Indicates that the controller is in FORMAT mode.
3-5	---	Reserved for future use.*
6-8	---	Must be 0.
9-11	Sector	Number of the sector (0-7) immediately following the last sector read or written. If a read or write operation ends at the last sector (7) of a surface, this field contains the value 0, and bit 8 will contain 1.
12-15	Sector Count	Two's complement of the number of sectors remaining to be read or written.

*Bits 3-5 are the high-order bits for the head address field; they are ignored in all operations. If these bits are loaded with a value during a DOC instruction, that value will appear in the specified accumulator when a DIC instruction is issued. Upon End of Track Error, the contents of these bits is incremented by 1.

Read Memory Address Register

DIB [f] ac, DKP

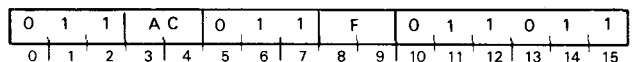

Places the contents of the controller's memory address register in bits 1-15 of the specified AC; sets bit 0 to 0. After the data transfer, sets the controller's Busy and Done flags according to the function specified by F. The format of the specified AC is shown below.

NOTE At the end of a write operation, the memory address register points to a memory location two greater than that of the most recent word written to disc.

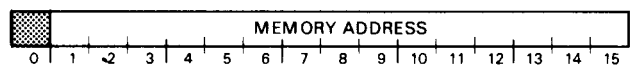

Bits	Name	Contents
0	---	Reserved for future use.
1-15	Memory Address	Location of the next word in memory to be used for a data channel transfer.

PROGRAMMING

Programming data transfers to or from a 6030 series diskette unit proceeds in three phases (1) selecting the drive and sector; (2) positioning the heads over the correct track; and (3) initiating the read or write operation. After issuing commands in any phase, check the controller's status register for errors before proceeding to the next phase.

The description below of these three programming phases assumes operation without errors. (Error conditions are discussed later in the text.) It also assumes three restrictions in the configuration of the diskette subsystem: (1) that the subsystem contains a single disc drive; (2) that it connects to only one CPU and its controller in that CPU is configured accordingly; and (3) that the CPU is dedicated to it (i.e., the CPU's ION flag is set to 0). Certain additional considerations must be borne in mind when a subsystem contains more than one drive or when it operates in a dual-processor environment. (See end of section.)

The operations described below can easily be applied to interrupt-driven service routines.

Phase I: Select the Drive, Sector, and Number of Sectors

Issue a SPECIFY DISC ADDRESS AND SECTOR COUNT instruction (DOC) to the controller with no device flag command. Use appropriate accumulator fields to select the drive (0-3₈) the first sector (0-7₈) to be read or written, and the two's complement of the number of sectors to be transferred in the operation. (The subsystem can transfer, at most, 8₁₀ consecutive sectors in one operation.) Take care to ensure that the parameters specified in this initial selection do not exceed the capacity of the drive.

After selecting the drive unit, check its status to verify that it is ready to perform an operation. Issue a READ STATUS instruction (DIA) with no flag command, and then examine the Ready flag (bit 9) and the Diskette flag (bit 5). If the Ready flag is 1 and the Diskette flag is 1, proceed to phase II. If the Ready flag is 0, do NOT issue any commands to that drive unit.

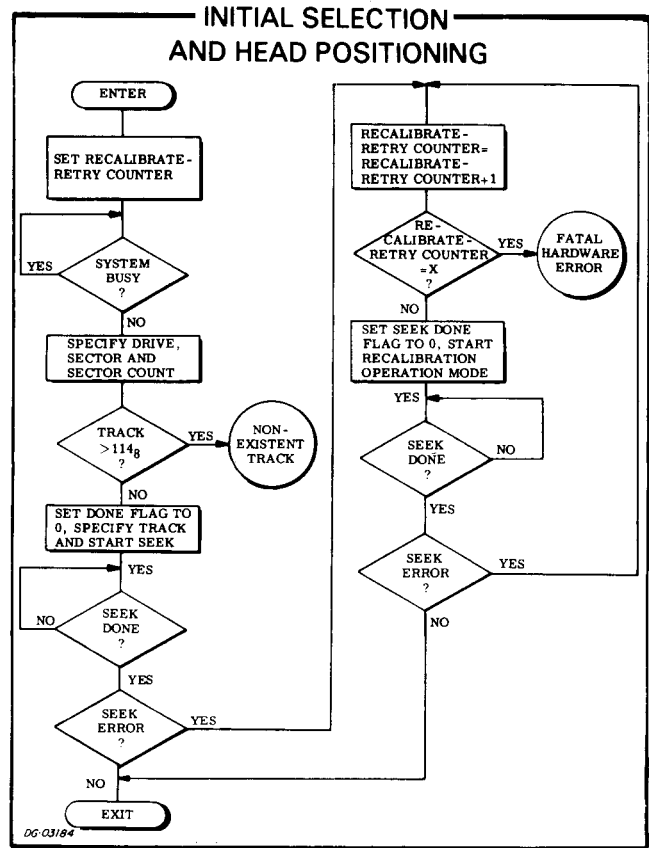

Phase II: Position the Heads

Move the heads to the desired track using a SPECIFY COMMAND AND TRACK instruction (DOA) plus a P command. Use the appropriate accumulator bits to clear R/W Done and Seek Done on the selected drive and use the appropriate accumulator fields to specify both a cylinder address and the seek command.

The P flag command initiates the seek operation without affecting the controller's Busy flag. P, however, sets the Done flag to 0.

While the drive is seeking, the Unit Ready and Seek Done flags for the selected drive are 0; at the conclusion of the seek operation, the controller sets the Seek Done flag for the selected drive to 1 in the subsystem status register.

After the specified drive completes the seek operation, issue a READ STATUS instruction; check both the Unit Ready (bit 9) and the Error flags. If there are no errors, proceed to phase III.

Phase III: Read or Write

A read operation transfers blocks of data from a sector on disc to the computer's memory via the data channel; a write operation transfers blocks of data from the computer's memory to a sector on disc via the data channel. A block is 256 16-bit words. One to eight blocks can be transferred in one read or write operation. Multiple block transfer operations read or write consecutive disc sectors from one disc track.

Read

Specify the starting address of the area in memory to receive the data transfer, using a LOAD MEMORY ADDRESS REGISTER instruction (DOB). Use the appropriate accumulator field to specify the 15-bit address of the memory location to receive the first word read from disc. The SPECIFY DISC ADDRESS AND SECTOR COUNT instruction (DOC) issued during phase I specified the number of sectors to be read and the number of the starting sector.

Issue a read command using the SPECIFY COMMAND AND TRACK instruction (DOA) along with an s flag command. Use the appropriate accumulator bits to clear both the R/W flag and the Seek Done flag for the specified drive, and use the appropriate accumulator fields to specify both the read operation and a track address. (The track number must match that of the sector being read; it is used by the controller for address checking at the start of each 256-word sector transfer in the read operation.)

The s flag command sets the Busy flag to 1, and the Done flag to 0 and initiates the read operation.

At the start of the operation, the drive waits until the desired sector passes under the specified head; it reads the address field from that disc sector, and the controller performs an address check. The track address read from the sector address field must match that posted in the SPECIFY COMMAND AND TRACK instruction, and the sector number contained in the address field must match the one in the disc address register. If the address check is successful, the drive continues the operation, reads the sequential data bits from the sector, and calculates a 16-bit checkword from the serial data.

The controller builds 16-bit words from the serial data and transfers them to the computer's memory via the data channel. Each time a word is transferred to memory, the controller automatically increments its memory address register by 1.

After the drive reads the 256 words from the sector, the controller increments its sector counter by 1. The

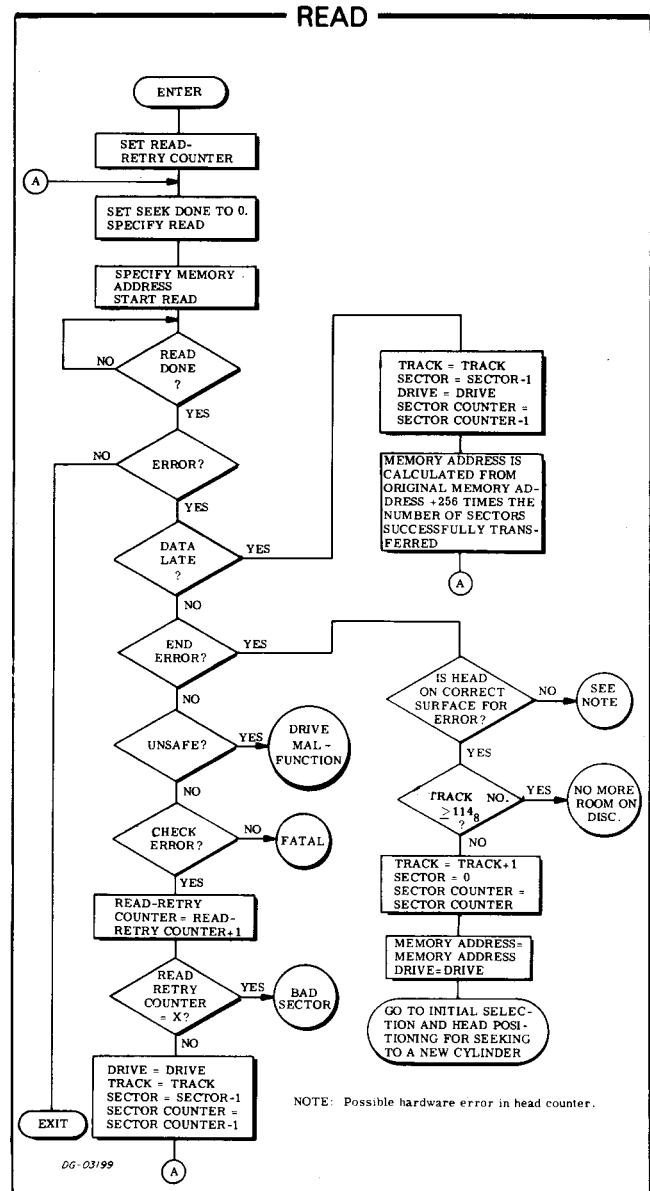

drive then reads the 16-bit checkword at the end of the sector and the controller verifies that it matches the checkword calculated while data was read from disc.

If the controller's sector counter does not overflow at the trailing edge of the sector, the drive reads the next sector; the process repeats until either the sector counter overflows or the last sector of a track is read.

A read operation continues until the sector counter indicates, by overflowing, that the specified number of sectors has been read. Upon completing the read operation, the controller sets its Busy flag to 0 and its Done flag to 1, initiating a program interrupt request.

Write

Specify the starting address of the area in memory to be transferred by using a LOAD MEMORY ADDRESS REGISTER instruction (DOB). Use the appropriate accumulator field to specify the 15-bit address of the first word in memory that will be written to disc. The SPECIFY DISC ADDRESS AND SECTOR COUNT instruction (DOC) issued during phase I specified the number of sectors to be written and the number of the starting sector.

Issue a write command using the SPECIFY COMMAND AND TRACK instruction (DOA) plus an s flag command. Use the appropriate accumulator bits to clear both the R/W flag and the Seek Done flag for the specified drive, and use the appropriate accumulator fields to specify both the write operation and the track address. (The track number must match that of the track to be written; it is used by the controller for address checking at the start of each 256-word sector transfer in the write operation.)

The s flag command sets the Busy flag to 1, and the Done flag to 0 and initiates the write operation.

At the start of the operation, the drive waits until the desired sector passes under the specified head; it reads the address field from that disc sector, and the controller performs an address check. The track address read from the sector address field must match that posted in the SPECIFY COMMAND AND TRACK instruction, and the sector number contained in the address field must match the one in the disc address register. If the address check is successful, the drive continues the operation and writes the sequential data bits to the sector.

The controller receives 16-bit data words from the data channel and transfers them serially to the drive unit while continually recalculating a 16-bit cyclic checkword from the serial data. Each time a word is transferred from memory, the controller automatically increments its memory address register by 1.

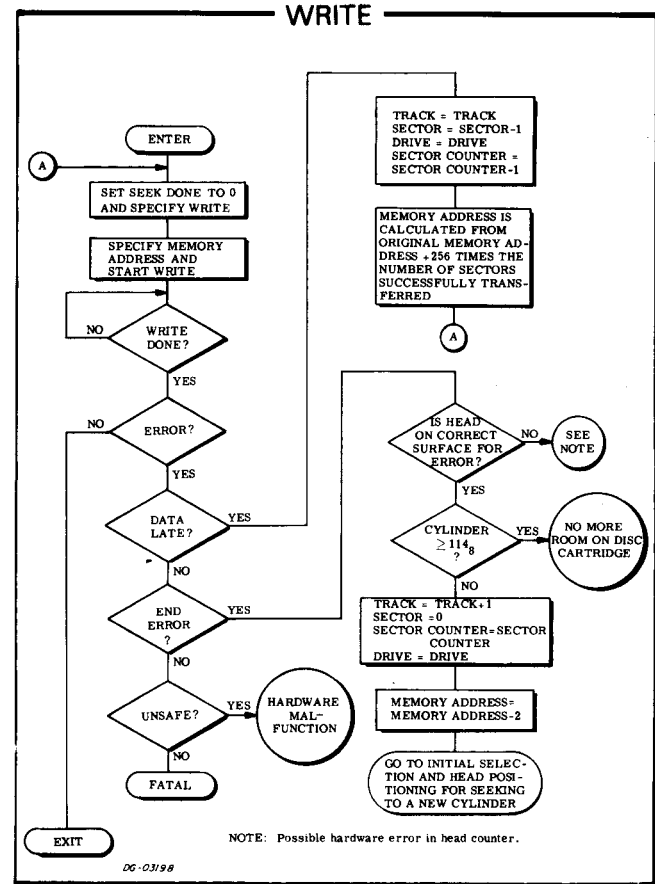

After the drive writes the 256 words from the sector, the controller increments its sector counter by 1 and adds the checkword to the data written to disc.

If the controller's sector counter does not overflow at the trailing edge of a sector, the drive writes the next sector; the process repeats until either the sector counter overflows or the last sector on a track is written.

A write operation continues until the sector counter indicates, by overflowing, that the specified number of sectors has been written. Upon completing the write operation, the controller sets its Busy flag to 0 and its Done flag to 1, initiating a program interrupt request.

FORMATTING

All diskette data surfaces must be formatted before a Data General disc cartridge subsystem will properly function. The format delineates an address field and a data field in each sector of every track. The address field of a sector is a coded header that precedes the data area of the sector and contains the sector's logical address. The purpose of the format is twofold: (1) it provides information for address checking by the subsystem (transparent to the programmer) before each data transfer; (2) it provides splice areas that separate the address field from the data field in a sector while giving read and write controls time to properly initialize and settle prior to a data transfer.

The format field contains a gap or splice area followed by twenty-four 16-bit words. The first 22 words, all containing zeros, and a 23rd word containing 000001₈, form a synchronization field. The 24th word is the address word containing the track and sector numbers.

Another splice field follows the format field, and it is followed, in turn, by a synchronization field of all zeros, a single sync bit (1), the 256-word data area, and its check word. Zeros fill the remainder of the sector.

If the status register repeatedly indicates an address error after many failures to read or write an area on the diskette, the area in question (possibly one sector, or several adjacent sectors) may need reformatting.

Typically, diskettes obtained from Data General are completely formatted before they are shipped; diskettes obtained elsewhere must be formatted by the customer.

Data General provides a stand-alone program that will format all the sectors of a diskette unit. The program can also format a single sector, several sectors, or one track of the drive. The formatter program is available on paper tape (*DGC no. 095-000300*), and its operation is described in a companion program listing (*DGC no. 096-000300*).

Whenever any sector is reformatted, all the data in that sector is lost. Formatting is done independently of and before initializing a disc for use with a Data General operating system.

TIMING

The discs in the drive unit rotate at 360rpm; a complete revolution requires 166ms. A register within the drive (transparent to the programmer) continually indicates to the controller the number of the sector presently passing under the heads. This feature allows the subsystem to carry out a read or write operation the first time the desired sector passes under the head.

The minimum sector access time is that required to read the address field at the start of a sector - 3ms (when the head is loaded); the maximum access time is that needed for a full revolution plus the address field time - 169ms; the average sector access time is 86ms.

A sector passes under a head in 20.8ms; the *data portion* of that sector passes under the head in 16.4ms. A data channel request occurs every two words, approximately 128us (nominal). This corresponds to an average data transfer rate of 15,625wps. The controller can buffer two words for the data channel, which provides a maximum allowable data channel latency of 128us. If the data channel does not respond to a controller request within this time, both the Data Late flag and the Error flag are set to 1.

The time required to position the heads (seek time) depends on the number of tracks the heads must cross to reach the destination track; seek time is direction-independent. The head positioner moves one track in 10ms and requires 10ms settle time after reaching destination. Therefore, the minimum seek time (that for a single track seek) is 20ms; the maximum seek time is that needed to traverse all tracks - 770ms.

The recalibrate operation progresses at the same rate as a seek, but usually it is used to recover after an error condition occurs, when the exact location of the head may not be known. The program should allow the full stroke seek time (770ms) for a recalibration.

NOTE *Issue no commands to the diskette controller for at least 50us after the start of a seek or recalibrate operation.*

ERROR CONDITIONS

During Initial Selection (Phase I)

Initial selection errors appear subsequent to recent diskette read and write operations, and are unrelated to commands issued in phases I or II.

Absence of Valid Status

If a single processor is used, the entire disc subsystem remains dedicated to one controller. In this case, the Valid flag may be set to 0 if: (1) the controller has been improperly configured for use with a single processor; (2) the controller can only operate with a single processor and, hence, its Valid flag is always set to 0; (3) a hardware malfunction exists.

If dual processors are used, access to the disc subsystem is provided to one controller at a time, on a demand basis. (See subsection below on dual processor considerations.) In this case, a Valid flag set to 0 may mean that the status word returned is suspect (i.e., the controller did not have access to the subsystem while reading the status word.). To ensure accuracy of the status word, issue a seek command (to any track, any drive) wait at least 50 μ s, reselect the desired drive and reread the Valid flag. Repeat this process until the Valid flag reads 1.

Unsafe Error

If the Unsafe flag is 1, the Unit Ready flag is 0. Issue an S, C, P, or IORST to set the Unsafe flag in the controller to 0; however, this action will usually not remove the drive unit's unsafe condition. (Opening and closing the loading door on the diskette unit will usually do so.)

If a drive's unsafe condition persists after the Unsafe flag is set to 0 in the controller, the flag will *not* return to 1 again until either (1) *another* unsafe drive unit is selected or (2) the original unsafe unit is first deselected (SPECIFY ... another drive) and then reselected.

During Head Positioning (Phase II)

If the program issues a SPECIFY COMMAND AND TRACK instruction (DOA) that initiates a seek operation to a non-existent track (i.e., greater than 114₈), the seek operation immediately terminates, and both the Seek Error and the Seek Done flags are set to 1; then a program interrupt request is initiated. If any seek operation to a valid track number results in a Seek Error, perform a reasonable number of seek retries.

Seek Retry

A seek retry is a recalibrate operation followed by another attempt to position the heads over the desired track. The recalibrate operation is a hardware recovery sequence that moves the heads of the selected drive over track 0 and resets the head positioning control in that drive.

To Perform a seek retry, recalibrate the drive using a SPECIFY COMMAND AND TRACK instruction (DOA) plus a P flag command. Use the appropriate accumulator bits to clear both the Seek Done flag for the selected drive unit and the R/W Done flag; use the appropriate accumulator field to specify a recalibrate operation. The track address field is ignored in a recalibrate operation.

The P flag command sets the Done flag to 0 and initiates the operation without affecting the controller's Busy flag. While the drive is recalibrating, the Unit Ready and the Seek Done flags for the specified drive are 0; at the conclusion of the operation, the controller sets the Seek Done flag for the appropriate drive and initiates a program interrupt request.

At the conclusion of the recalibrate operation, increment a seek retry counter (see flowchart on initial selection and head positioning) and try again to position the heads over the desired track. If, after several attempts, the drive does not successfully position the heads over the desired track, that drive or the subsystem may be faulty.

During Reading

If the program specifies a non-existent sector (i.e., greater than 7), the controller sets the contents of the sector register to zero and sets bit 7 in the disc address register to 1, indicating an End of Track Error.

End of Track Error

An error can occur when the disc subsystem attempts to read past the last sector (7) in a track. If the read operation does not terminate (i.e., the sector counter does not overflow after reading sector 7), both the Error and the End of Track Error flags are set to 1, and the read operation terminates. The sector counter remains at its *incremented* value; the controller forces the sector address to 0 and increments the contents of the unused head address field (bits 3-5) of the controller's disc address register by 1 (See READ DISC ADDRESS instruction). The controller sets its Busy flag to 0, and its Done flag to 1 and initiates a program interrupt request.

Address Error

An address field preceding each sector on a diskette identifies its track and sector position. Before the controller reads data from a specified sector, it performs an address check. If the controller reads an address from the address field that does not match that in the disc address register, the controller sets both the Error and the Address flags to 1, and the read operation terminates immediately. The controller sets the Busy flag to 0, and the Done flag to 1 and initiates a program interrupt request.

After an address error, the sector counter and the sector address register retain the values they had when the error occurred. That is, the sector address register retains the number of the faulty sector and the sector counter contains the two's complement of the number of sectors left to read in the operation.

Repeated address errors from the same sector(s) on diskette may indicate damage to the magnetic media; or those sector(s) may need reformatting (see subsection on formatting above).

Checkword Error

Each time the subsystem writes data to disc, it appends a 16-bit checkword to the 256-word data block. While the controller reads the data from a sector, it continually computes a checkword from the data stream from disc and compares it to the checkword written at the end of the data block on the disc. If the checkwords differ, the controller sets both the Error and the Checkword flags to 1, and the read operation terminates at the end of the sector, even if there are more sectors to read. The controller sets the Busy flag to 0 and the Done flag to 1 and initiates a program interrupt request. A Checkword error indicates that at least one data word read from the sector is erroneous.

After a Checkword error, the sector address register points to the sector following that in which the error occurred. The sector counter contains the two's complement of the number of sectors, *not including the faulty sector*, that remain unread after the error.

Data Late Error

If the data channel does not respond in time to a data channel request, both the Error and the Data Late flags are set to 1. Reading of the current sector continues, but at the end of that sector, the read

operation terminates. The sector counter and the sector address register increment normally. The controller sets the Busy flag to 0 and the Done flag to 1 and initiates a program interrupt. The Data Late flag indicates that at least one word from the last sector read was not correctly transferred to memory.

After a Data Late error, the sector address register points to the sector following that in which the error occurred. The sector counter contains the two's complement of the number of sectors, *not including the faulty sector*, that remain unread after the error.

During Writing

If the program specifies a non-existent sector (i.e., greater than 7), the controller sets the contents of the sector register to zero and increments the unused accumulator field (bits 6-7) in the disc address register, indicating an End of Track Error.

End of Track Error

An error can occur when the disc subsystem attempts to write past the last sector on a track. If the write operation does not terminate (i.e., if the sector counter does not overflow) after reading sector 7, both the Error and the End of Track Error flags are set to 1, and the operation terminates. The sector counter remains at its *incremented* value, the controller forces the sector address to 0 and also increments the contents of an unused bit field (bits 6-7) of the controller's disc address register. See READ DISC ADDRESS (DIC) instruction. The controller sets its Busy flag to 0 and its Done flag to 1 and initiates a program interrupt request.

Address Error

An address field preceding each sector on the disc unit contains its track and sector position. Before the controller writes data to a specified sector, it performs an address check. If the controller reads an address from this field that does not match that in the disc address register, the controller sets both the Error and the Address Error flags to 1, and the write operation terminates immediately. The controller sets the Busy flag to 0 and the Done flag to 1 and initiates a program interrupt request.

After an address error, the sector counter and the sector address register retain the values they had when the faulty sector came under the head. That is, the sector address register retains the number of the faulty sector and the sector counter contains the two's complement of the number of sectors left to write in the operation.

Repeated address errors from the same sector(s) on the diskette may indicate damage to the magnetic media; or those sector(s) may need reformatting (See subsection on formatting above).

Data Late Error

If the data channel does not respond in time to a data channel request, both the Error and the Data Late flags are set to 1. Writing into the present sector continues, but at the end of that sector, the operation terminates. The controller sets the Busy flag to 0 and the Done flag to 1 and initiates a program interrupt. The Data Late flag indicates that at least one word written into the last sector was not correctly transferred from memory.

After a Data Late error, the sector address register points to the sector following that in which the error occurred. The sector counter contains the two's complement of the number of sectors, *not including the faulty sector*, that remain unwritten after the error.

MULTIPLE DRIVES

In a multiple-drive subsystem, any unit may initiate a seek or recalibrate operation while other units are performing head positioning commands. The subsystem can also overlap seek or recalibrate operations on several drives with a data transfer on a single drive - but all the commands to seek or recalibrate must precede the command to start reading or writing. Certain programming considerations must be borne in mind during each phase when performing multiple operations.

Phase I Considerations

Issue the SPECIFY DISC ADDRESS AND SECTOR COUNT instruction if no disc unit in the subsystem is performing a read or write operation. Deselecting a drive engaged in a data transfer will immediately terminate that transfer.

If commands to the subsystem are to be overlapped, only the accumulator field specifying unit number is significant, and the other fields may be set to zero. (The unneeded fields may not, however, specify parameters that exceed the capacity of the unit.)

Phase II Considerations

Initiate a head positioning operation on the unit selected in phase I, as described previously. Overlap it with a head positioning operation on a different unit as follows: branch immediately to phase I, specify and check status on the new unit, and then return to phase II to start the new operation. Repeat this sequence until all the overlapped positioning operations have been started.

Next, determine which drive is to perform the first data transfer. The decision may be dictated by priority. But when it is possible to initiate a transfer on the first available drive, to find it, keep examining the Seek Done flags by repeatedly issuing READ STATUS instructions.

After choosing a unit for the data transfer, issue a SPECIFY DISC ADDRESS AND SECTOR COUNT instruction (DOC) to reselect that unit and establish parameters for the transfer.

Check the selected unit's status by issuing a READ STATUS instruction (DIA). Check both the Unit Ready flag and the Error flag. If there are no errors, proceed to Phase III.

NOTE *If a seek error occurs perform one seek retry (described above); but, if possible, move on to initiate a transfer on another disc unit. Wait for a retry to finish only if the drive involved must perform the next data transfer.*

Phase III Considerations

Once a unit has been selected for a read or write operation at the end of phase II, begin the data transfer exactly as described earlier. Starting the read or write operation with an S flag control does not affect the values of the Seek Done flags. Do not issue a SPECIFY DISC ADDRESS instruction (DOC) to the subsystem until both the Done flag and the R/W Done flag (in the status register) are set to 1.

It is safe to issue a READ STATUS instruction any time to determine whether any seek operations overlapped in phase II have been completed. This may be useful in choosing the next unit for a transfer and for preparing that transfer.

After the transfer, issue a READ STATUS instruction. Once status has been read, either check for errors in the present transfer or, if possible, save the status word, reselect units and start the next transfer before checking the present one for errors.

DUAL PROCESSOR CONSIDERATIONS

The disc subsystem hardware imposes certain restrictions on the program when the subsystem operates in a dual processor (shared disc) environment. The dual access mechanism switches access to the entire subsystem from one controller to the other on a demand basis, in conjunction with timing and command protocols.

Each processor obtains subsystem control by issuing head positioning commands. Once established, this control may be maintained by issuing other head positioning commands prior to completion of a 3-second subsystem timeout. Completion of a read or write immediately terminates subsystem control. The other processor must wait for service until the processor in control has completed its task.

The description and flowcharts below describe non-interrupt driven procedures for operating a single-drive subsystem in a shared-disc environment. These procedures focus on maintaining the integrity of the subsystem only at the *hardware* level. The concepts can be extended to support interrupt drivers for multiple-drive subsystems.

A separate protocol is needed to maintain data integrity within the file structure. A simple file protocol, for example, might assign a number of blocks to one processor for unrestricted use (including writing) while assigning the remaining blocks to the other processor. In general, the protocol is implemented by means of some communication link between processors to allow conflict arbitration. Data General's Real Time Disc Operating System (RDOS) uses the facilities of the model 4240 interprocessor bus for resolving conflicts in the dual CPU environment.

Program a shared disc subsystem in three phases: (1) select the disc unit and specify parameters for the transfer; (2) position the heads over the desired track and gain access to the subsystem; and (3) initiate the transfer.

Phase I, Initial Selection

Set up the subsystem control as described previously in the subsection on programming, phase I. Do not read status.

Phase II

Issue a SPECIFY COMMAND AND TRACK instruction (DOA) with a P appended to it as described previously. Wait at least 50 microseconds after issuing the seek command and then issue a READ STATUS instruction (DIA). Verify that the Valid Status flag (bit 6) is 1. The controller receives access to the subsystem for a maximum of 3 seconds after the Valid Status flag in its status register becomes 1. Continue reading status until both the Seek Done flag and the Unit Ready flag are 1. If the Error flag is 0, proceed to phase III.

If the Error flag is 1, then the seek may be retried several times. Since the processor reasserts control of the subsystem for 3 seconds each time a seek or recalibrate command is issued, the programmer should limit the number of retry operations to avoid locking out the other processor.*

Phase III

Initiate the data transfer as previously described. The processor unconditionally loses control of the subsystem at the end of a data transfer operation or 3 seconds after the last head positioning command, whichever comes first.

After a data transfer, the contents of the status register remain unchanged in the controller until the controller issues a SPECIFY DISC ADDRESS ... instruction (DOC) that alters the disc unit selection.

NOTE *The Valid Status flag returned in the status register at the conclusion of a data transfer will always be 0. If the program has not issued an initial selection command or a device flag command (S, C, P), the contents of the status register remain valid.*

If the data transfer is terminated by a timeout (3 seconds) restart the entire process beginning with phase I.

* Note that only head positioning commands assert control of the subsystem; no other commands will restart the 3-second timeout.

INITIAL SELECTION AND HEAD POSITIONING
(SHARED DISC)

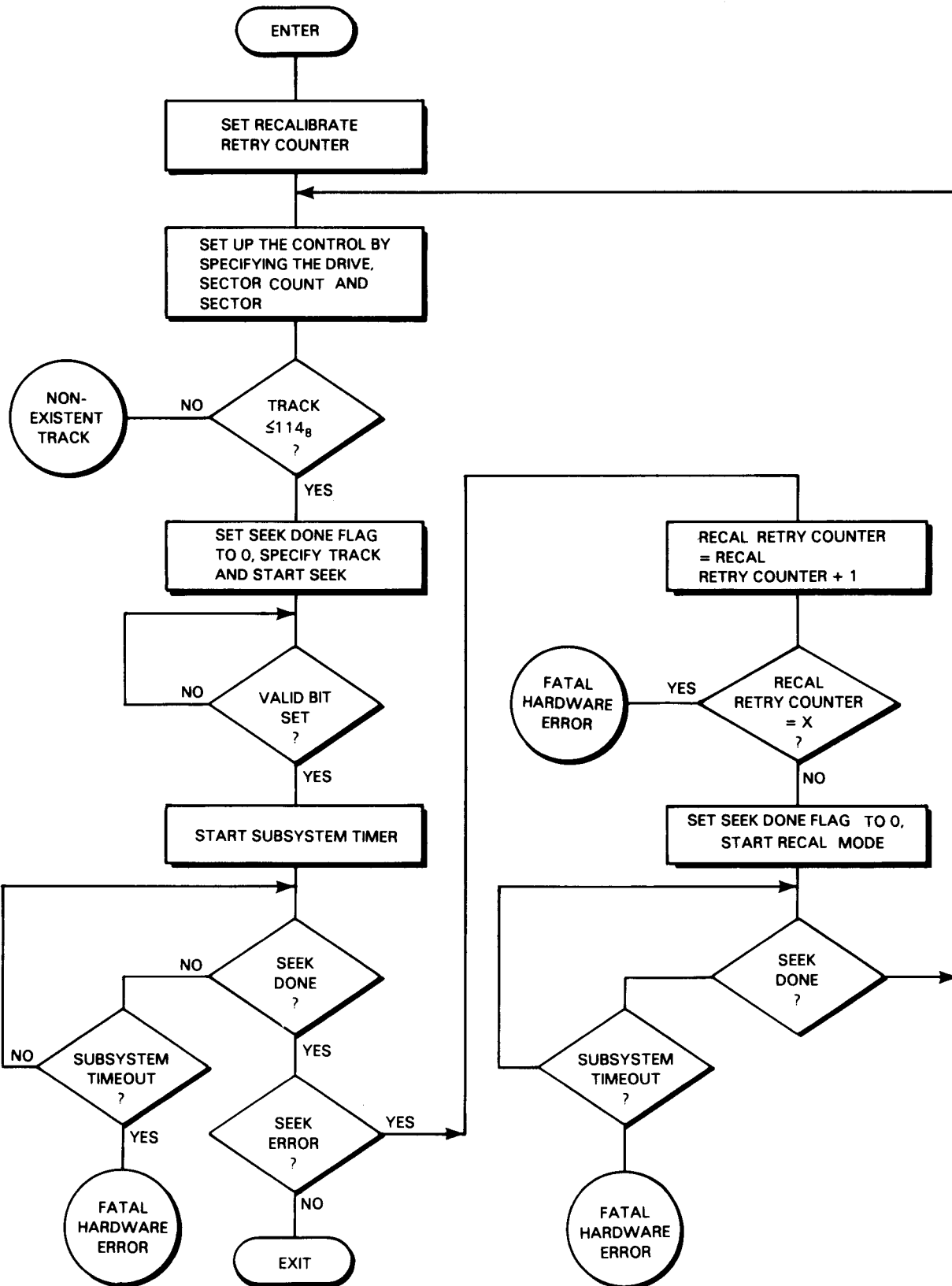

DG-03215

READ (SHARED DISC)

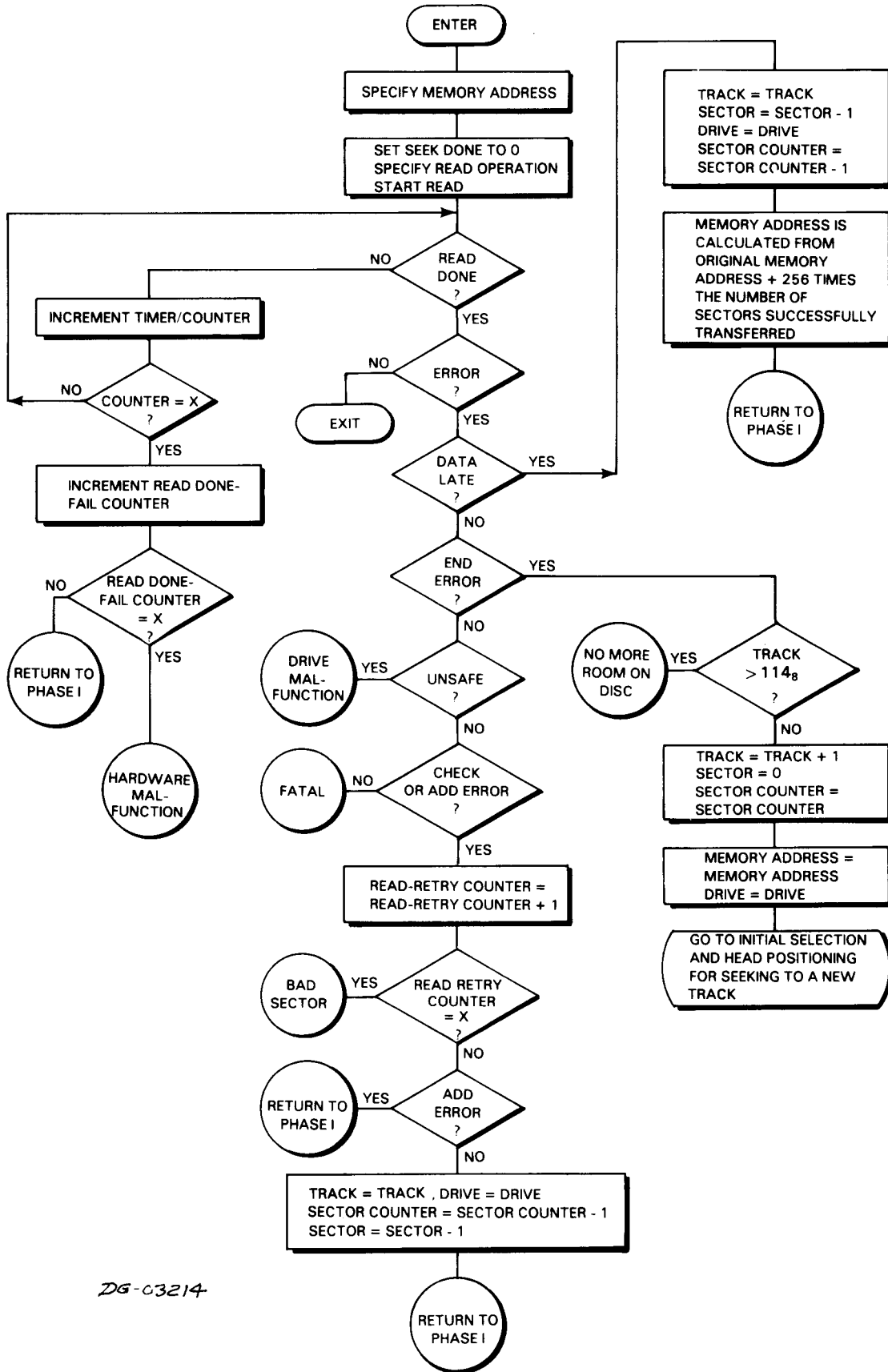

DG-C3214

WRITE (SHARED DISC)

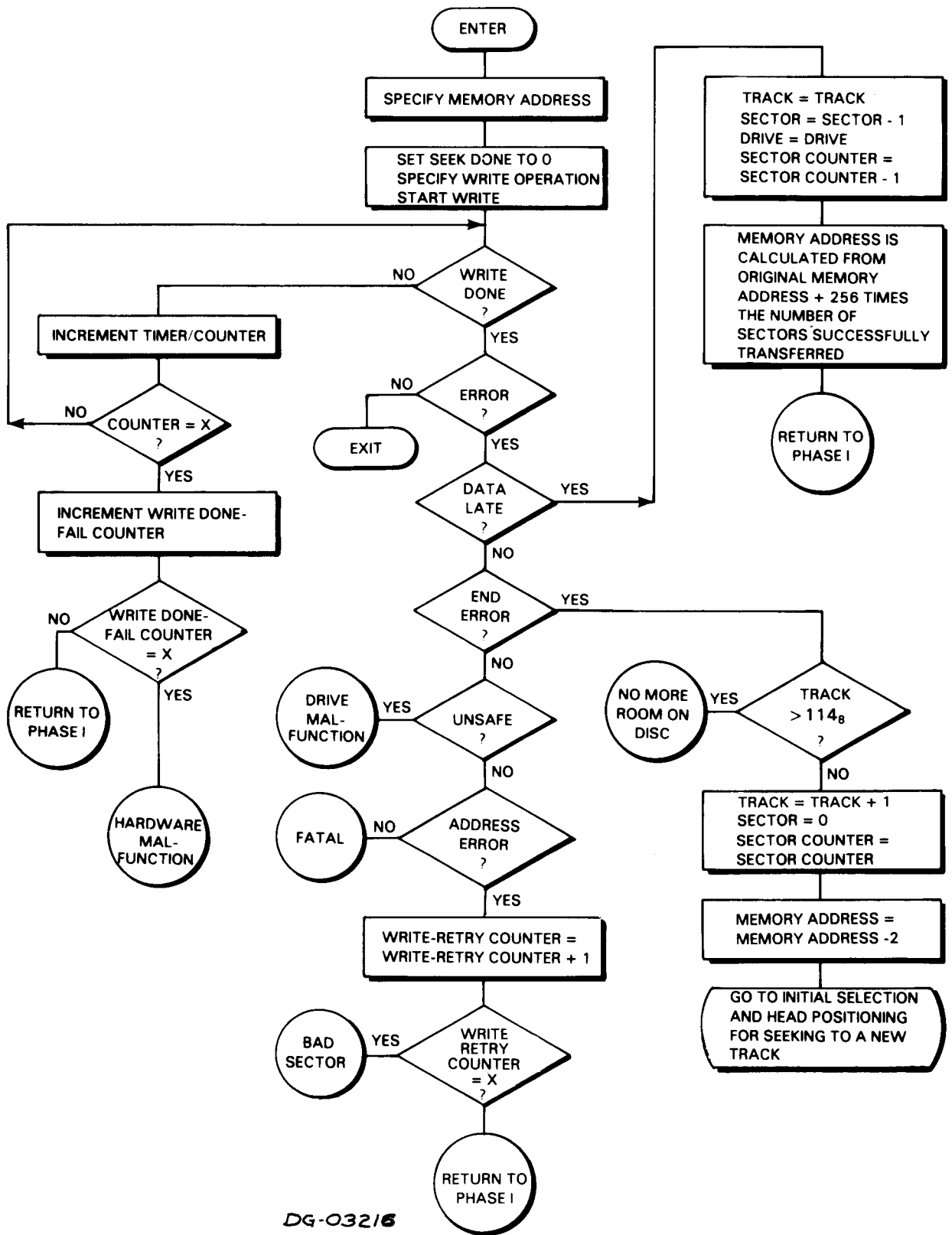

DG-03216

This page intentionally left blank.

4234 SERIES 10MB CARTRIDGE DISC SUBSYSTEM

PROGRAMMING SUMMARY

Mnemonic (First Controller)	DKP	Sectors/Track	12
Device Code	33 ₈	Words/Sector	256
Mnemonic (Second Controller)	DKP1	Total Storage Capacity (Words)	5,013,504
Device Code	73 ₈	Max. Transfer Rate (wps)	156,250
Priority Mask Bit	7	Allowable Data Channel Latency (us)	12.8
Surfaces/Unit	4*	Seek Time (max/min, ms)	70/8
Tracks/Surface	408	Sector Access Time (max/min, ms)	25/12

* Two non-removable surfaces

ACCUMULATOR FORMATS

**Specify Disc Address
and Sector Count**

(DOC)

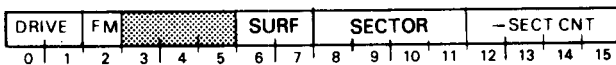

Read Disc Address

(DIC)

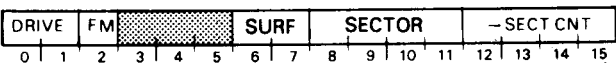

Specify Command and Cylinder

(DOA)

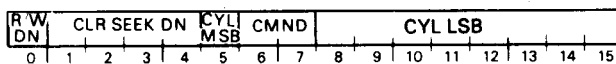

Commands

- 00 Read
- 01 Write
- 10 Seek
- 11 Recalibrate

Read Status

(DIA)



Load Memory Address Register

(DOB)

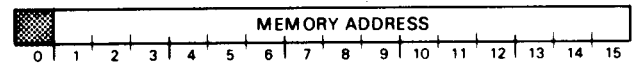

Read Memory Address Register

(DIB)

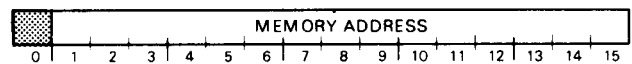

S, C and P FUNCTIONS

- f = S** Sets the Busy flag to 1, and the Done flag to 0; starts the operation specified in the command register.
- f = C** Sets the Busy flag and the Done flag to 0 and stops all data transfer operations.
- f = P** Sets the Done flag to 0 and starts the operation specified in the command register if that operation is a seek or a recalibrate.

INTRODUCTION

This disc subsystem includes a maximum of four moving head disc drives plus one or two controllers. The drives may be 4234 series* disc cartridge units, or 6030 series diskette units, intermixed in any combination. The subsystem controller occupies a single slot of the computer chassis and directs the activities of the disc drives. Subsystems that include 4234 series disc units operate under the control of a single NOVA or ECLIPSE central processor.

This section discusses the programming protocols for driving 4234 series disc cartridge units in single processor environments. Similar protocols for the 6030 series units are presented later in this manual.

Each disc unit contains four program-accessible surfaces. Surfaces 0 and 1 are on a platter in a removable disc cartridge; surfaces 2 and 3 are on a platter permanently located in the lower half of the drive unit. There are 408 cylinders in each unit, numbered 0-627₈. Each of the four tracks in a cylinder contains 12 sectors, numbered 0-13₈. Each sector contains an address header and a data field that stores 256 (400₈) 16-bit data words and a 16-bit checkword. The data storage capacity is 3072 words per track or 5,013,504 words per drive unit.

Data is transferred to and from the subsystem via the data channel at a maximum rate of 156,250 words per second. From 1 to 16 consecutive sectors in one cylinder (up to 4096 words) can be transferred in one operation.

CONTROLLER REGISTERS

The disc drive controller contains four program accessible registers: a 15-bit memory address register, a 16-bit status register, a 16-bit combined command and cylinder select register, and a combined disc address register and sector counter. The memory address register is self incrementing and contains the address of the next location whose contents are to be transferred to or from the disc subsystem via the data channel. The status register contains four Seek Done flags, a Read/Write (R/W) Command Done flag, a Unit

Ready flag, a Valid Status flag, and six Error flags. The Seek Done flag and the R/W Done flag each initiate a program interrupt request when set to 1. The combined command and cylinder select register contains the last command issued to the subsystem and the number of the desired cylinder on the selected unit. The combined disc address register and sector counter contains the number of the next surface and sector to be read or written and the two's complement of the number of sectors remaining to be read or written. The disc address and the sector counter portions of this register self-increment immediately after a sector is read or written.

INSTRUCTIONS

Six instructions program data channel transfers to and from the subsystem. Three of these instructions supply the controller with all the necessary information for any disc operation. The remaining instructions allow the program to determine, in detail, the current state of the subsystem.

The device flag commands control the disc controller's Busy and Done flags as follows:

- f = S** Sets the Busy flag to 1, the Done flag to 0, the Address Error, End of Cylinder, Checkword Error, Data Late, and Unsafe flags to 0, and initiates the operation specified by the contents of the command register.
- f = C** Sets the Busy flag, the Done flag, all Error flags, and all Seek Done flags to 0 and stops all data transfer operations; does not terminate a seek operation already in progress.
- f = P** Sets the Done flag and all Error flags to 0 and initiates the operation specified by the contents of the command register.

NOTE - The P flag command does not affect the controller's Busy flag. If the Busy flag is 0 and the program starts an operation with the P command, the controller does not initiate a program interrupt request at the conclusion of the operation unless it is a seek or recalibrate. The controller initiates an interrupt at the end of all seek or recalibrate operations.

* Although 4234 series disc drives are functionally identical and electrically similar to 6045/50/51 series units. DGC does not recommend intermixing these series in the same subsystem.

** 4234 series disc units cannot be shared between two CPU's.

Instruction Coding Conventions

In the descriptions that follow, certain coding conventions are used so the assembler can recognize the instruction and translate it correctly into machine language. See Appendix E for these conventions.

Specify Disc Address And Sector Count

DOC [*f*] *ac*, DKP

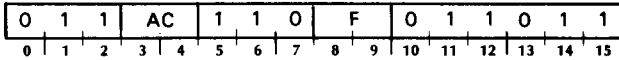

Loads bits 0-15 of the specified AC into the controller's disc address register and sector counter. After the data transfer, sets the controller's Busy and Done flags according to the function specified by F. The contents of the specified AC remain unchanged; the format of the accumulator is as follows:

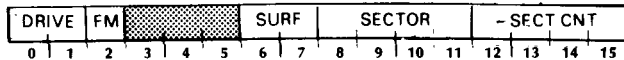

Bits	Name	Function
0-1	Drive	Selects drive 0-3 ₈
2	Format	If 1, places controller in FORMAT mode.
3-5	---	Reserved for future use.
6-7	Surface	Selects the surface (head) 0-3 ₈ for the start of a read or a write operation.
8-11	Sector	Selects the starting sector, 0-13 ₈ for the start of a read or a write operation.
12-15	Sector Count	Specifies the two's complement of the number of sectors to be read or written in one operation (maximum of 16 ₁₀).

Specify Command And Cylinder

DOA [*f*] *ac*, DKP

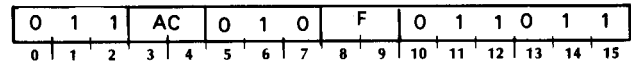

Loads bits 0-15 of the specified AC into the controller's combined command and cylinder select register. After the data transfer, sets the controller's Busy and Done flags according to the function specified by F. The contents of the specified AC remain unchanged; the format of the accumulator is as follows:

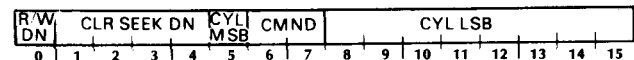

Bits	Name	Function
0	Clear R/W Done	Sets the status register's DC Done flag to 0; sets the following error flags to 0: Address Error, Checkword Error, End of Cylinder, and Unsafe.
1-4	Clear Seek Done (0-3)	Sets the Seek Done flags to 0 on drives 0-3, respectively.
5	Cylinder MSB	Most significant bit of cylinder address. Together with bits 8-15, specifies the desired cylinder.
6-7	Command	Specifies the command for the selected drive as follows: 00 Read 01 Write 10 Seek 11 Recalibrate
8-15	Cylinder LSB	Least significant bits of cylinder address. Together with bit 5, specifies the desired cylinder (0-627 ₈) for a seek, read or write operation.

Load Memory Address Register

DOB [*f*] *ac*, DKP

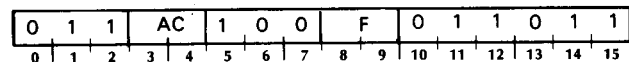

Loads bits 1-15 of the specified AC into the controller's memory address register. After the data transfer, set the controller's Busy and Done flags according to the function specified by F. The contents of the specified AC remain unchanged; the format of the accumulator is as follows:

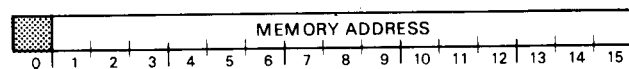

Bits	Name	Contents
0	---	Reserved for future use.
1-15	Memory Address	Location of the next word in memory to be used for a data channel transfer.

Read Status

DIA [f] ac, DKP

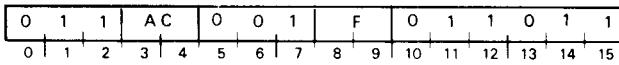

Places the contents of the controller's status register in bits 0-15 of the specified AC. After the data transfer, sets the controller's Busy and Done flags according to the function specified by F. The format of the specified accumulator is as follows:

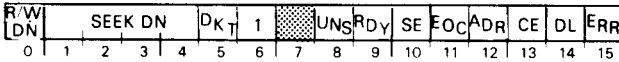

Bits	Name	Meaning When 1
0	R/W Done	The subsystem has completed a read or a write operation.
1-4	Seek Done (0-3)	Drive 0-3, respectively, has completed a seek or recalibrate operation. <i>More than one of these bits can be set at any time.</i>
5	Diskette	The selected unit is a 6030 series diskette.*
6	---	The selected unit is a diskette drive unit*
7	---	Reserved for future use.
8	Unsafe	The selected drive is in an unsafe condition. The Unsafe flag can be reset with an S, C, P, or IORST command, but this action will not remove the drive's unsafe condition. Try to remedy the unsafe condition by powering down the drive, and then restarting it.
9	Unit Ready	The selected drive is not performing any head movements and is ready to carry out a command (read, write, seek, or recalibrate)
10	Seek Error	The selected drive was not able to carry out the last seek or recalibrate operation issued.
11	End of Cylinder	The last read or write operation attempted to continue beyond the fourth surface in the disc drive unit.
12	Address Error	The address read from the address field at the beginning of a sector does not match the last address specified to the disc controller.
13	Checkword Error	The checkword read from the disc at the end of a sector does not match the checkword calculated by the controller during the sector transfer.
14	Data Late	The data channel failed to respond in time to a data channel request.
15	Error	One or more of the following bits in the status register is set to 1: 8, 10, 11, 12, 13, or 14.

* Consult programming information on 6030-series subsystem in this manual.

** In some early revision controllers, this bit was always 0.

Read Disc Address

DIC [f] ac, DKP

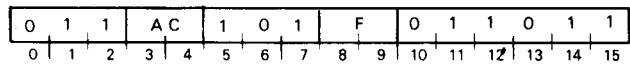

Places the contents of the controller's disc address register and sector counter in bits 0-15 of the specified AC. After the data transfer, sets the controller's Busy and Done flags according to the function specified by F. The format of the specified accumulator is as follows:

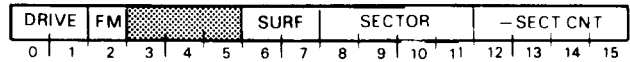

Bits	Name	Contents
0-1	Drive	Number (0-3) of the selected drive.
2	Format	When 1, Indicates that the controller is in FORMAT mode.
3-5	---	Reserved for future use.*
6-7	Surface	Surface number (0-3) of the selected head on the drive.
8-11	Sector	Number of the sector (0-13 ₈) immediately following the last sector read or written. If a read or write operations ends at the last sector (13 ₈) of a surface, this field contains the value 14 ₈ .
12-15	- Sector Count	Two's complement of the number of sectors remaining to be read or written.

*Bits 3-5 are the high-order bits for the head address field; they are ignored in all operations. If these bits are loaded with a value during a DOC instruction, that value will appear in the specified accumulator when a DIC instruction is issued. Upon End of Cylinder Error, the contents of these bits is incremented by 1.

Read Memory Address Register

DIB [f] ac, DKP

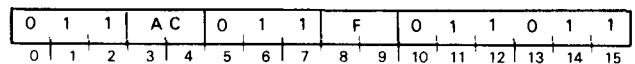

Places the contents of the controller's memory address register in bits 1-15 of the specified AC; sets bit 0 to 0. After the data transfer, sets the controller's Busy and Done flags according to the function specified by F. The format of the specified AC is shown below.

NOTE At the end of a write operation, the memory address register points to a memory location two greater than that of the most recent word written to disc.

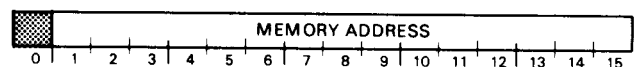

Bits	Name	Contents
0	---	Reserved for future use.
1-15	Memory Address	Location of the next word in memory to be used for a data channel transfer.

PROGRAMMING

Programming data transfers to or from a model 4234 disc cartridge subsystem proceeds in three phases: (1) selecting the drive, surface and sector; (2) positioning the heads over the correct cylinder; and (3) initiating the read or write operation. After issuing commands in any phase, check the controller's status register for errors before proceeding to the next phase.

The description below of these three programming phases assumes operation without errors. (Error conditions are discussed later in the text.) It also assumes two restrictions in the configuration of the disc cartridge subsystem: (1) that the subsystem contains a single disc drive; (2) that the CPU is dedicated to it (i.e., the CPU's ION flag is set to 0). Certain additional considerations must be borne in mind when a subsystem contains more than one drive. (See end of section.)

The operations described below can easily be applied to interrupt-driven service routines.

Phase I: Select the Drive, Surface, Sector and Number of Sectors

Issue a SPECIFY DISC ADDRESS AND SECTOR COUNT instruction (DOC) to the controller with no device flag command. Use appropriate accumulator fields to select the drive (0-3), the surface (0-3), the first sector to be read or written (0-13₉), and the two's complement of the number of sectors to be transferred in the operation. (The subsystem can transfer, at most, 16₁₀ consecutive sectors in one operation.) Take care to ensure that the parameters specified in this initial selection do not exceed the capacity of the drive.

After selecting the drive unit, check its status to verify that it is ready to perform an operation. Issue a READ STATUS instruction (DIA) with no flag command, and then examine the Ready flag (bit 9) and the Diskette flag (bit 5). If the Ready flag is 1 and the Diskette flag is 0, proceed to phase II. If the Ready flag is 0, do NOT issue any commands to that drive unit. If the the Diskette flag is 1, follow instructions for 6030 diskette programming.

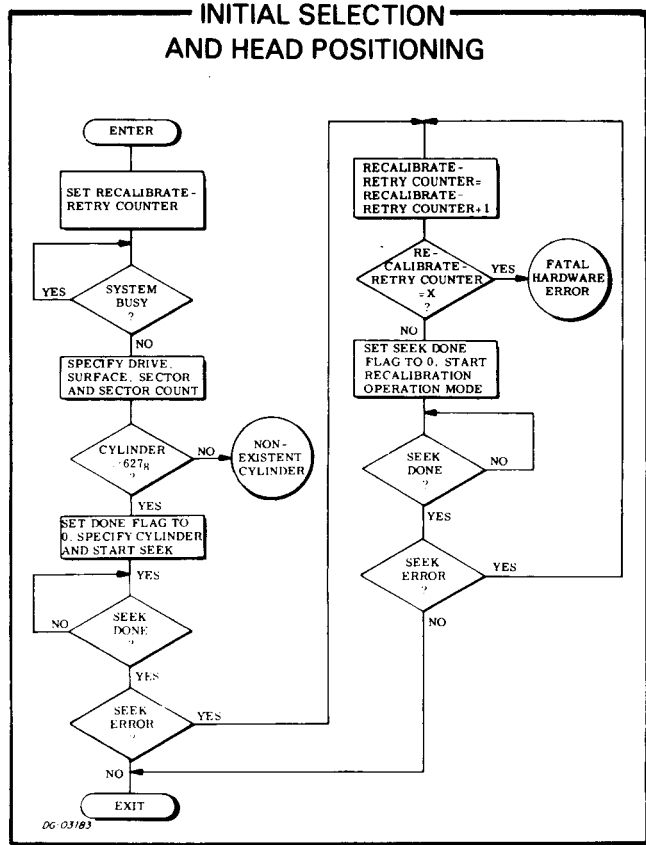

Phase II: Position the Heads

Move the heads to the desired cylinder using a SPECIFY COMMAND AND CYLINDER instruction (DOA) plus a P command. Use the appropriate accumulator bits to clear R/W Done and Seek Done on the selected drive and use the appropriate accumulator fields to specify both a cylinder address and the seek command.

The P flag command initiates the seek operation without affecting the controller's Busy flag. P, however, sets the Done flag to 0.

While the drive is seeking, the Unit Ready and Seek Done flags for the selected drive are 0; at the conclusion of the seek operation, the controller sets the Seek Done flag for the selected drive to 1 in the subsystem status register.

After the specified drive completes the seek operation, issue a READ STATUS instruction; check both the Unit Ready (bit 9) and the Error flags. If there are no errors, proceed to phase III.

Phase III: Read or Write

A read operation transfers blocks of data from a sector on disc to the computer's memory via the data channel; a write operation transfers blocks of data from the computer's memory to a sector on disc via the data channel. A block is 256 16-bit words. One to 16 blocks can be transferred in one read or write operation. Multiple block transfer operations read or write consecutive disc sectors from one disc cylinder (the sector that follows sector 13₈ on a surface is sector 0 on the next surface).

Read

Specify the starting address of the area in memory to receive the data transfer, using a LOAD MEMORY ADDRESS REGISTER instruction (DOB). Use the appropriate accumulator field to specify the 15-bit address of the memory location to receive the first word read from disc. The SPECIFY DISC ADDRESS AND SECTOR COUNT instruction (DOC) issued during phase I specified the disc surface to be read, the number of sectors to be read and the number of the starting sector.

Issue a read command using the SPECIFY COMMAND AND CYLINDER instruction (DOA) along with an s flag command. Use the appropriate accumulator bits to clear both the R/W flag and the Seek Done flag for the specified drive, and use the appropriate accumulator fields to specify both the read operation and a cylinder address. (The cylinder number must match that of the cylinder being read; it is used by the controller for address checking at the start of each 256-word sector transfer in the read operation.)

The s flag command sets the Busy flag to 1 and sets the Done flag to 0 and initiates the read operation.

At the start of the operation, the drive waits until the desired sector passes under the specified head; it reads the address field from that disc sector, and the controller performs an address check. The cylinder address read from the sector address field must match that posted in the SPECIFY COMMAND AND CYLINDER instruction, and the sector and surface numbers contained in the address field must match those contained in the disc address register. If the address check is successful, the drive continues the operation, reads the sequential data bits from the sector, and calculates a 16-bit checkword from the serial data.

The controller builds 16-bit words from the serial data and transfers them to the computer's memory via the data channel. Each time a word is transferred to memory, the controller automatically increments its memory address register by 1.

After the drive reads the 256 words from the sector, the controller increments its sector counter by 1. The drive then reads the 16-bit checkword at the end of

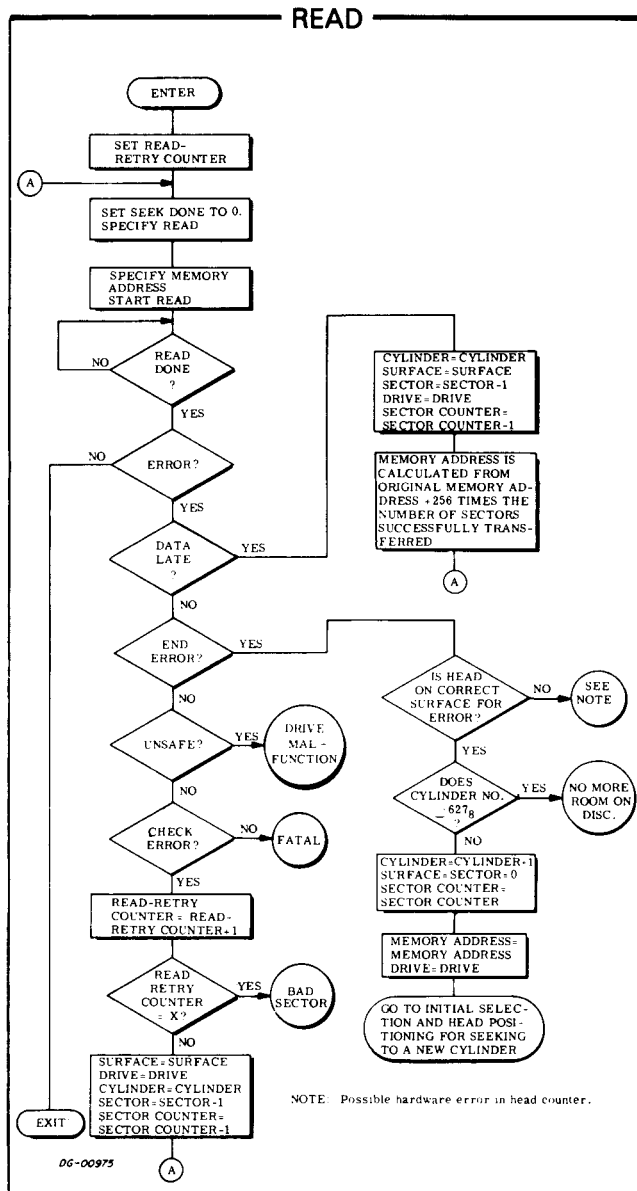

the sector and the controller verifies that it matches the checkword calculated while data was read from disc.

If the controller's sector counter does not overflow at the trailing edge of a sector, the drive reads the next sector; the process repeats until either the sector counter overflows or the last sector on a surface is read. When the last sector on surfaces 0-2 is read, the controller automatically changes the surface and sector address in the disc address register to specify the first (0) sector on the next surface of the same cylinder, and the drive continues reading from that sector.

A read operation continues until the sector counter indicates, by overflowing, that the specified number of sectors has been read. Upon completing the read operation, the controller sets its Busy flag to 0 and its Done flag to 1, initiating a program interrupt request.

Write

Specify the starting address of the area in memory to be transferred by using a LOAD MEMORY ADDRESS REGISTER instruction (DOB). Use the appropriate accumulator field to specify the 15-bit address of the first word in memory that will be written to disc. The SPECIFY DISC ADDRESS AND SECTOR COUNT instruction (DOC) issued during phase I specified the disc surface to be written, the number of sectors to be written and the number of the starting sector.

Issue a write command using the SPECIFY COMMAND AND CYLINDER instruction (DOA) plus an S flag command. Use the appropriate accumulator bits to clear both the R/W flag and the Seek Done flag for the specified drive, and use the appropriate accumulator fields to specify both the write operation and a cylinder address. (The cylinder number must match that of the cylinder to be written; it is used by the controller for address checking at the start of each 256-word sector transfer in the write operation.)

The S flag command sets the Busy flag to 1 and the Done flag to 0, and initiates the write operation.

At the start of the operation, the drive waits until the desired sector passes under the specified head; it reads the address field from that disc sector, and the controller performs an address check. The cylinder address read from the sector address field must match that posted in the SPECIFY COMMAND AND CYLINDER instruction, and the sector and surface numbers contained in the address field must match those contained in the disc address register. If the address check is successful, the drive continues the operation and writes the sequential data bits to the sector.

The controller receives 16-bit data words from the data channel and transfers them serially to the drive unit while continually recalculating a 16-bit cyclic checksum from the serial data. Each time a word is transferred from memory, the controller automatically increments its memory address register by 1.

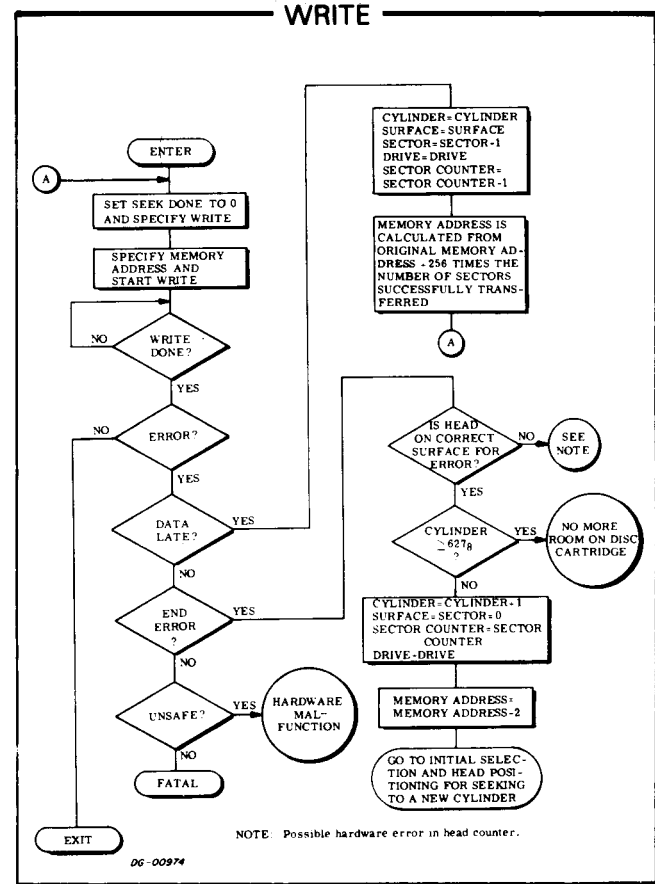

After the drive writes the 256 words from the sector, the controller increments its sector counter by 1 and adds the checksum to the data written to disc.

If the controller's sector counter does not overflow at the trailing edge of a sector, the drive writes the next sector; the process repeats until either the sector counter overflows or the last sector on a surface is written. When the last sector on surfaces 0, 1 or 2 is written, the controller automatically changes the surface and sector address in the disc address register to specify the first (0) sector on the next surface of the same cylinder, and the drive continues writing on that sector.

A write operation continues until the sector counter indicates, by overflowing, that the specified number of sectors has been written. Upon completing the write operation, the controller sets its Busy flag to 0 and its Done flag to 1, initiating a program interrupt request.

FORMATTING

All disc data surfaces must be formatted before a Data General disc cartridge subsystem will properly function. The format delineates an address field and a data field in each sector of every track of a surface. The address field of a sector is a coded header that precedes the data area of the sector and contains the sector's logical address. The purpose of the format is twofold: (1) it provides information for address checking by the subsystem (transparent to the programmer) before each data transfer; (2) it provides splice areas that separate the address field from the data field in a sector while giving read and write controls time to properly initialize and settle prior to a data transfer.

The format field contains a gap or splice area followed by twenty-four 16-bit words. The first 22 words, all containing zeros, and a 23rd word containing 000001₈, form a synchronization field. The 24th word is the address word containing the cylinder, sector and surface numbers.

Another splice field follows the format field, and it is followed, in turn, by a synchronization field of all zeros, a single sync bit (1), the 256-word data area, and its check word. Zeros fill the remainder of the sector.

If the status register repeatedly indicates an address error after many failures to read or write an area on the disc, the area in question (possibly one sector, or several adjacent sectors on one surface) may need reformatting.

Typically, disc cartridges obtained from Data General are completely formatted before they are shipped; cartridges obtained elsewhere must be formatted by the customer. Should the fixed platter in a disc unit be removed or replaced, it, too, requires reformatting.

Data General provides a stand-alone program that will format all the sectors and surfaces of a disc unit. The program can also format a single sector, several sectors, or one cylinder of the drive. The formatter program is available on paper tape (DGC No. 095-000300), and its operation is described in a companion program listing (DGC No. 096-000300).

Whenever any sector is reformatted, all the data in that sector is lost. Formatting is done independently of and before initializing a disc for use with a Data General operating system.

TIMING

The discs in the drive unit rotate at 2400rpm; a complete revolution requires 25ms. A register within the drive (transparent to the programmer) continually indicates to the controller the number of the sector presently passing under the heads. This feature allows the subsystem to carry out a read or write operation the first time the desired sector passes under the head.

The minimum sector access time is that required to read the address field at the start of a sector - 300 μ s; the maximum access time is that needed for a full revolution plus the address field time - 25.3ms; the average sector access time is 12.7ms.

A sector passes under a head in 2.08ms; the *data portion* of that sector passes under the head in 1.638ms. A data channel request occurs every two words, approximately 12.8 μ s (nominal). This corresponds to an average data transfer rate of 156,250wps. The controller can buffer two words for the data channel, which provides a maximum allowable data channel latency of 12.8 μ s. If the data channel does not respond to a controller request within this time, both the Data Late flag and the Error flag are set to 1.

The time required to position the heads (seek time) depends on the number of cylinders the heads must cross to reach the destination cylinder, seek time is direction-independent. The minimum seek time is that for a single cylinder seek - 8ms; the maximum seek time is that needed to traverse all cylinders - 70ms.

The recalibrate operation moves the heads back to cylinder 0; but it progresses more slowly than a seek to protect the head moving mechanism and to reset its controls in an orderly manner. The maximum recalibrate time is approximately 200ms.

NOTE Issue no commands to the disc controller for at least 50 μ s after the start of a seek or recalibrate operation.

ERROR CONDITIONS

During Initial Selection (Phase I)

Initial selection errors appear subsequently to recent disc read and write operations and are unrelated to commands issued in phases I or II.

Unsafe Error

If the Unsafe flag is 1, the Unit Ready flag is 0. Issue an **S**, **C**, **P**, or **IORST** to set the Unsafe flag in the controller to 0; however, this action will usually not remove the drive unit's unsafe condition. (Momentarily toggling the LOAD/RUN switch on the drive control panel to LOAD and then back to RUN, or powering down the drive and then restarting it will usually clear the unsafe condition.)

If a drive's unsafe condition persists after the Unsafe flag is set to 0 in the controller, the flag will *not* return to 1 again until either (1) *another* unsafe drive unit is selected or (2) the original unsafe unit is first deselected (SPECIFY ... another drive) and then reselected.

During Head Positioning (Phase II)

If the program issues a SPECIFY COMMAND AND CYLINDER instruction (DOA) that initiates a seek operation to a non-existent cylinder (i.e., greater than 627_8), the seek operation immediately terminates, and both the Seek Error and the Seek Done flag are set to 1; then a program interrupt request is initiated. If any seek operation to a valid cylinder number results in a Seek Error, perform a reasonable number of seek retries.

Seek Retry

A seek retry is a recalibrate operation followed by another attempt to position the heads over the desired cylinder. The recalibrate operation is a hardware recovery sequence that moves the heads of the selected drive over cylinder 0 and resets the head positioning control in that drive.

To perform a seek retry, recalibrate the drive using a SPECIFY COMMAND AND CYLINDER instruction (DOA) plus a **P** flag command. Use the appropriate accumulator bits to clear both the Seek Done flag for the selected drive unit and the R/W Done flag; use the appropriate accumulator field to specify a recalibrate operation. The cylinder address field is ignored in a recalibrate operation.

The **P** flag command sets the Done flag to 0 and initiates the operation without affecting the controller's Busy flag. While the drive is recalibrating, the Unit Ready and the Seek Done flags for the specified drive are 0; at the conclusion of the operation, the controller sets the Seek Done flag for the appropriate drive, and initiates a program interrupt request.

At the conclusion of the recalibrate operation, increment a seek retry counter (see flowchart on initial selection and head positioning) and try again to position the heads over the desired cylinder. If, after several attempts, the drive does not successfully position the heads over the desired cylinder, that drive or the subsystem may be faulty.

During Reading

If the program specifies a non-existent sector (i.e., greater than 13_8), the controller sets the contents of the sector register to zero and increments the surface by 1. If, after incrementing, the resulting surface address is 1, 2 or 3, the read operation begins at the first sector of *that surface*. If the resulting surface address is 4 (a non-existent surface), an End of Cylinder Error occurs.

End of Cylinder Error

An error can occur when the disc subsystem attempts to read past the last sector on surface 3. If the read operation does not terminate (i.e. the sector counter does not overflow after reading sector 13₈ on that surface), both the Error and the End of Cylinder Error flags are set to 1, and the read operation terminates. The sector counter remains at its *incremented* value, the controller forces both the sector and the surface addresses to 0 and also increments by 1 the unused head address field (bits 3-5) of the controller's disc address register. (See READ DISC ADDRESS instruction.) The controller sets its Busy flag to 0, its Done Flag to 1 and initiates a program interrupt request.

Address Error

An address field preceding each sector on the drive identifies its surface, cylinder and sector position. Before the controller reads data from a specified sector, it performs an address check. If the controller reads an address from the address field that does not match that in the disc address register, the controller sets both the Error and the Address flags to 1, and the read operation terminates immediately. The controller sets the Busy flag to 0, the Done flag to 1, and initiates a program interrupt request.

After an address error, the sector counter and the sector address register retain the values they had when the error occurred. That is, the sector address register retains the number of the faulty sector and the sector counter contains the two's complement of the number of sectors left to read in the operation.

Repeated address errors from the same sector(s) on the disc cartridge may indicate damage to the magnetic media; or those sector(s) may need reformatting. (See subsection on formatting, above.)

Checkword Error

Each time the subsystem writes data to disc, it appends a 16-bit checkword to the 256-word data block. While the controller reads the data from a sector, it continually computes a checkword from the data stream from disc and compares it to the checkword written at the end of the data block on the disc. If the checkwords differ, the controller sets both the Error and the Checkword flags to 1, and the read operation terminates at the end of the sector, even if there are more sectors to read. The controller sets the Busy flag to 0 and the Done flag to 1 and initiates a program interrupt request. A Checkword error indicates that at least one data word read from the sector is erroneous.

After a checkword error, the sector address register points to the sector following that in which the error occurred. The sector counter contains the two's

complement of the number of sectors, *not including the faulty sector*, that remain unread after the error.

Data Late Error

If the data channel does not respond in time to a data channel request, both the Error and the Data Late flags are set to 1. Reading of the current sector continues, but at the end of that sector, the read operation terminates. (The sector counter and the sector address register increment normally.) The controller sets the Busy flag to 0 and the Done flag to 1 and initiates a program interrupt. The Data Late flag indicates that at least one word from the last sector read was not correctly transferred to memory.

After a Data Late error, the sector address register points to the sector following that in which the error occurred. The sector counter contains the two's complement of the number of sectors, *not including the faulty sector*, that remain unread after the error.

During Writing

If the program specifies a non-existent sector (i.e., greater than 13₈), the controller sets the contents of the sector register to zero and increments the surface by 1. If, after incrementing, the resulting surface address is 1, 2 or 3, the write operation begins at the first sector *of that surface*. Otherwise, an End of Cylinder Error occurs.

End of Cylinder Error

An error can occur when the disc subsystem attempts to write past the last sector on surface 3. If the write operation does not terminate (i.e., if the sector counter does not overflow) after writing sector 13₈ on that surface, both the Error and the End of Cylinder Error flags are set to 1, and the operation terminates. The sector counter remains at its *incremented* value, the controller forces both the sector and the surface addresses to 0 and also increments by 1 the unused head address field (bits 3-5) of the controller's disc address register. (See READ DISC ADDRESS instruction.) The controller sets its Busy flag to 0 and its Done flag to 1 and initiates a program interrupt request.

Address Error

An address field preceding each sector on the disc unit contains its surface, cylinder and sector position. Before the controller writes data to a specified sector, it performs an address check. If the controller reads an address from this field that does not match that in the disc address register, the controller sets both the Error and the Address Error flags to 1, and the write operation terminates immediately. The controller sets the Busy flag to 0 and the Done flag to 1 and initiates a program interrupt request.

After an address error, the sector counter and the sector address register retain the values they had when the faulty sector came under the head. That is, the sector address register retains the number of the faulty sector and the sector counter contains the two's complement of the number of sectors left to write in the operation.

Repeated address errors from the same sector(s) on the disc cartridge may indicate damage to the magnetic media; or those sector(s) may need reformatting. (See subsection on formatting, above.)

Data Late Error

If the data channel does not respond in time to a data channel request, both the Error and the Data Late flags are set to 1. Writing into the current sector continues, but at the end of that sector, the operation terminates. The controller sets the Busy flag to 0 and the Done flag to 1 and initiates a program interrupt. The Data Late flag indicates that at least one word written into the last sector was not correctly transferred from memory.

After a Data Late error, the sector address register points to the sector following that in which the error occurred. The sector counter contains the two's complement of the number of sectors, *not including the faulty sector*, that remain unwritten after the error.

MULTIPLE DRIVES

In a multiple drive subsystem, any unit may initiate a seek or recalibrate operation while other units are executing head positioning commands. The subsystem can also overlap seek or recalibrate operations on several drives with a data transfer on a single drive - but all the commands to seek or recalibrate must precede the command to start reading or writing. Certain programming considerations must be borne in mind during each phase when performing multiple operations.

Phase I Considerations

Issue the SPECIFY DISC ADDRESS AND SECTOR COUNT instruction if no disc unit in the subsystem is performing a read or write operation. Deselecting a drive engaged in a data transfer will immediately terminate that transfer.

If commands to the subsystem are to be overlapped, only the accumulator field specifying unit number is significant, and the other fields may be set to zero. (The unneeded fields may not, however, specify parameters that exceed the capacity of the unit.)

Phase II Considerations

Initiate a head positioning operation on the unit selected in phase I, as described previously. Overlap it with a head positioning operation on a different unit as follows: branch immediately to phase I, specify and check status on the new unit, and then return to phase II to start the new operation. Repeat this sequence until all the overlapped positioning operations have been started.

Next, determine which drive is to perform the first data transfer. The decision may be dictated by priority. But when it is possible to initiate a transfer on the first available drive, to find it, keep examining the Seek Done flags by repeatedly issuing READ STATUS instructions.

After choosing a unit for the data transfer, issue a SPECIFY DISC ADDRESS AND SECTOR COUNT instruction (DOC) to reselect that unit and establish parameters for the transfer.

Check the selected unit's status by issuing a READ STATUS instruction (DIA). Check both the Unit Ready flag and the Error flag. If there are no errors, proceed to phase III.

NOTE *If a seek error occurs, perform one seek retry (described above); but, if possible, move on to initiate a transfer on another disc unit. Wait for a retry to finish only if the drive involved must perform the next data transfer.*

Phase III Considerations

Once a unit has been selected for a read or write operation at the end of phase II, begin the data transfer exactly as described earlier. Starting the read or write operation with an S flag control does not affect the values of the Seek Done flags. Do not issue a SPECIFY DISC ADDRESS instruction (DOC) to the subsystem until both the Done flag and the R/W Done flag (in the status register) are set to 1.

It is safe to issue a READ STATUS instruction any time to determine whether any seek operations overlapped in phase II have been completed. This may be useful in choosing the next unit for a transfer and for preparing that transfer.

After the transfer, issue a READ STATUS instruction. Once status has been read, either check for errors in the present transfer or, if possible, save the status word, reselect units and start the *next* transfer before checking the present one for errors.

This page intentionally left blank.

6060 SERIES DG/DISC STORAGE SUBSYSTEM

PROGRAMMING SUMMARY

Mnemonic	DSKP	Transfer Rate	806,400 bytes/sec
Device Code	27 (Alt. 67)	Dch Latency	20us
Priority Mask Bit	7	Extended addressing and map control	
Surfaces per Unit	19	NOVA 3 A/B Map Select	
Tracks per Surface		NOVA 3 64K Addressing	
Single Density	411	Seek Time	
Double Density	815	Min/Avg/Max	6ms/35ms/60ms
Sectors per Track	24	Sector Access Time	
Bytes per Sector	512	Avg/Max	8.3ms/16.7ms
Capacity per Drive			
Single Density	95,956,992 bytes		
Double Density	190,279,680 bytes		

ACCUMULATOR FORMATS

Specify Command and Drive (DOA)

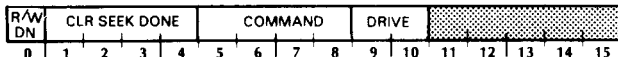

Specify Cylinder (DOC)

Context: The previous DOA specified a seek operation.

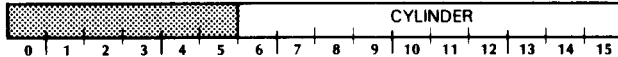

Specify Surface, Sector and Count (DOC)

Context: The previous DOA did not specify a seek operation.

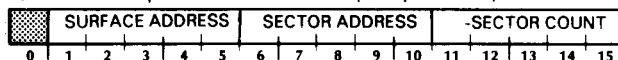

Read Surface, Sector and Count (DIC)

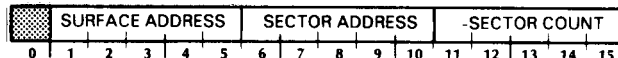

Specify Memory Address (DOB)

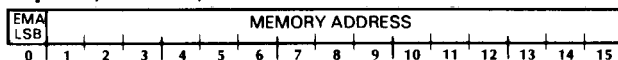

Read Memory Address (DIA)

Context: Alternate instruction mode 1

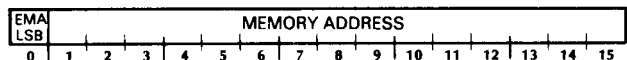

Read Drive Status (DIB)



Read Data Transfer Status (DIA)

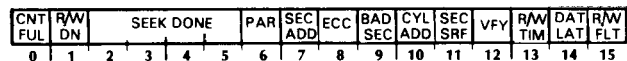

Read First ECC Word (DIA)

Context: Alternate instruction mode 2

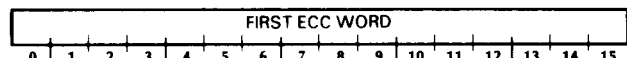

Read Second ECC Word (DIB)

Context: Alternate instruction mode 2

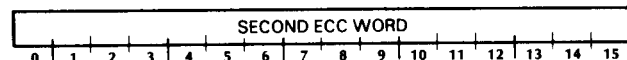

S, C AND P FUNCTIONS

- f = S Sets the Busy flag to 1; sets the Done flag to 0. Starts the following operations: READ, WRITE, FORMAT, READ BUFFERS, and VERIFY.
- f = C Sets the Busy flag and Done flag to 0 and stops all data transfer operations.
- f = P Starts the following operations; SEEK, RECALIBRATE, OFFSET, STOP, WRITE DISABLE, RELEASE, and TRESPASS. (Does not affect the Busy flag or Done flag.)

INTRODUCTION

This disc subsystem includes a maximum of four moving head disc drives plus an adapter and controller. (Dual processor access may be configured by adding a controller in the second processor.) The drives are free-standing and the subsystem may contain any mix of 6060 (single density) or 6061 (double density) disc storage units. The adapter is rack mounted and occupies seven inches of panel space. The controller occupies two slots in the computer chassis and directs the activities of the subsystem through the common adapter.

Each disc storage unit contains 19 (0-22₈) program-accessible surfaces on a removable disc pack. A single density unit contains 411 (0-632₈) cylinders, and a double density unit contains 815 (0-1456₈) cylinders. Each of the 19 tracks in a cylinder contains twenty-four (0-27₈) sectors. Each sector contains a 3-byte address header, a 512-byte data field and a 4-byte checkword. The data storage capacity is 12,288 bytes per track, 233,472 bytes per cylinder, and 95,956,992 bytes per single density drive or 190,279,680 bytes per double density drive.

Data is transferred two bytes (one 16-bit computer word) at a time via the data channel at a maximum rate of 403,400 words per second. From one to thirty two consecutive sectors (512 to 16,384 bytes) in one cylinder may be transferred in one operation. The controller contains a 16-bit address register and supports extended data channel addressing on NOVA 3 computers. A first in first out (FIFO) provides 8 words of buffering to improve immunity to data late conditions.

Data integrity is enhanced by a powerful error detecting and correcting mechanism which detects and helps correct most transcription errors. In addition, a bad sector flag is provided to prevent data transfers on sectors known to be faulty. Sectors are tested during a format operation and the bad sector bit is set in each sector which will not support error free data. Finally, two positioner offset commands may eliminate data errors caused by head misalignment, and a special verify command may be used to perform a read after write check.

Two independent channels connect the controller(s) to the selected drive(s); one transfers drive commands and the other transfers data. This feature supports overlapped seeks and data transfers in multi-drive subsystems to improve database access time. Each

channel can store a command and issue it when the selected drive becomes available. Drive operations may be initiated as quickly as the subsystem will accept them. (A busy drive does not prevent the command channel from transferring a new command to another drive.) Program interrupt requests are initiated when command execution is completed. Drive attention program interrupts are blocked when a data transfer is pending or in progress, to provide a single interrupt on a seek/transfer string.

In a dual processor environment, the adapter multiplexes access by two processors to a common set of drives via both the command and read/write channels. Processors may partition access to the drives by reserving selected drives for their own exclusive use. A processor may trespass on the partition in an emergency to capture a drive reserved by the other processor.

CONTROLLER REGISTERS

The controller contains a read/write Busy flag, and seven program accessible registers:

Register name	Number of bits
Command and drive address	6
Memory address	16
Cylinder address	10
Surface, sector and count	15
Error correction checkword	32
Drive status	15
Read/write status	16

The memory address register is self-incrementing and contains the address of the next memory location for data channel data transfer. The sector address and sector count registers increment half way through a sector data transfer, and the surface address register increments following a data transfer on sector 23 (27₈)

The status registers contain four drive attention flags, a read/write Done flag, a command channel busy flag, a valid status flag, 6 drive status flags and 18 error flags. The read/write Done flag (which is the same as the device Done flag) initiates a program interrupt request when it becomes 1. A drive attention flag initiates a program interrupt request when it becomes 1 if the read/write Busy flag (which is the same as the device busy flag) is 0 (indicating that a read/write operation is pending or in progress.)

INSTRUCTIONS

Eleven instructions program data channel data transfers to and from the subsystem. The four data out instructions supply the controller with all the necessary information for any disc operation. The remaining instructions allow the program to determine, in detail, the state of the subsystem.

The device flag commands operate on the controller as follows:

f = S Sets the Busy flag to 1; sets the Done flag to 0. Initializes the read/write channel (terminates any read/write operation in progress); clears all read/write error flags; clears trespassed flag. Disables drive attention interrupts. Starts read/write timeout. Transfers stored instruction from command channel to read/write channel and starts read/write operation (read, write, format, verify, or read buffers).

f = C Sets the Busy and Done flags to 0. Initializes read/write channel (terminates any read/write operation in progress); clears all read/write error flags; clears trespassed flag and drive attention flags; does not terminate any drive operation currently in progress.

f = P Starts the drive operation (seek, recalibrate, offset, stop, write disable, release, or trespass); does not affect the Busy flag or Done flag.

IORST Performs all operations listed under f=C and initiates a recalibrate operation on the lowest numbered ready drive if it is not reserved by the other processor. Clears the sector and surface address. Stored command defaults to READ.

NOTE Some of the following instructions can be executed properly only in a specific context. When this is so, the required context is indicated.

Specify Command and Drive

DOA [f] ac, DSKP

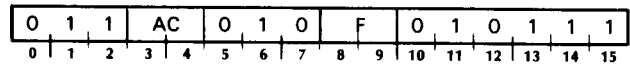

Loads bits 5-8 of the specified accumulator into the controller's command register and loads bits 9-10 of the specified accumulator into the controller's drive select register. Clears the done/attention flags selected by bits 0-4 of the specified accumulator. After the data transfer, sets the controller's Busy and Done flags and initiates operations according to the function specified by F. The contents of the specified accumulator remain unchanged; its format is as follows:

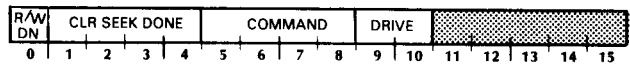

Bits	Name	Function
0	Clear R/W Done	Clears the status register's read/write Done flag. Clears all the read/write error flags except read/write timeout.
1-4	Clear Atten (0-3)	Clears the drive attention flags for drives 0-3 respectively.
5-8	Command	Specifies the command to be transmitted to the selected drive on the command or read/write channel as follows 0000 Read 0001 Recalibrate 0010 Seek 0011 Stop drive 0100 Offset forward 0101 Offset reverse 0110 Write disable 0111 Release 1000 Trespass 1001 Set alternate mode 1 1010 Set alternate mode 2 1011 No operation 1100 Verify 1101 Read buffers 1110 Write 1111 Format
9,10	Drive	Specifies the drive (0-3) to be selected on the command or read/write channel
11-15	---	Reserved for future use

Specify Cylinder

DOC [f] ac, DSKP

Context: The previous DOA specified a seek operation.

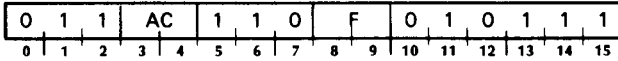

Loads bits 6-15 of the specified accumulator into the controller's cylinder address register. After the data transfer, sets the controller's Busy and Done flags and initiates operations according to the function specified by F. The contents of the specified accumulator remain unchanged; its format is as follows:

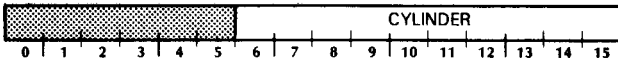

Bits	Name	Function
0-5	---	Reserved for future use
6-15	Cylinder	Specifies the desired cylinder for a seek operation

Specify Surface, Sector and Count

DOC [f] ac, DSKP

Context: The previous DOA did not specify a seek operation.

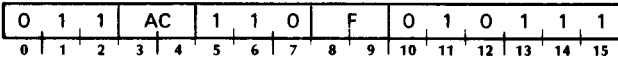

Loads bits 1-5 of the specified accumulator into the controller's surface address register, loads bits 6-10 of the specified accumulator into the controller's sector address register, and loads bits 11-15 of the specified accumulator into the controller's sector count register. After the data transfer, sets the controller's Busy and Done flags and initiates operations according to the function specified by F. The contents of the specified accumulator remain unchanged; its format is as follows:

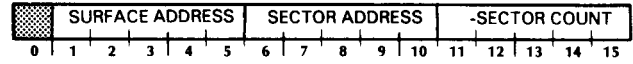

Bits	Name	Function
0	---	Reserved for future use
1-5	Surface	Selects the starting surface (head) (0 - 22 ₈) for a read, write, format or verify operation.
6-10	Sector	Selects the starting sector (0 - 27 ₈) for a read, write, format or verify operation.
11-15	-Sector count	Specifies the two's complement of the number of sectors to be transferred in one operation (maximum of 40 ₈ .)

Read Surface, Sector and Count

DIC [f] ac, DSKP

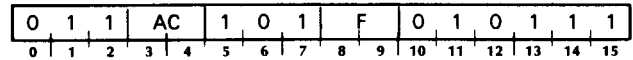

Places the contents of the controller's surface address register in bits 1-5 of the specified accumulator, places the contents of the controller's sector address register in bits 6-10 of the specified accumulator, and places the contents of the controller's sector count register in bits 11-15 of the specified accumulator. After the data transfer, sets the controller's Busy and Done flags and initiates operations according to the function specified by F. The format of the accumulator is as follows:

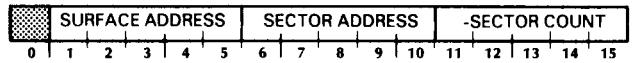

Bits	Name	Meaning when 1
0	---	Reserved for future use.
1-5	Surface	Indicates the current surface (0 - 22 ₈) for a read, write, format or verify operation
6-10	Sector	Indicates the sector (0 - 27 ₈) immediately following the last which was transferred.
11-15	-Sector count	Indicates the two's complement of the number of sectors remaining to be transferred.

Specify Memory Address

DOB [*ff*] *ac*, **DSKP**

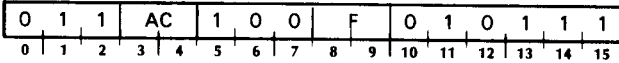

Loads bit 0 of the specified accumulator into the least significant bit (lsb) of the controller's extended memory address register, and loads bits 1-15 of the specified accumulator into the controller's memory address register. After the data transfer, sets the controller's Busy and Done flags and initiates operations according to the function specified by F. The contents of the specified accumulator remain unchanged; its format is as follows:

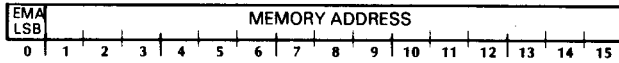

Bits	Name	Function
0	Extended memory address	Specifies the lsb of the extended memory address or the NOVA 3 data channel map selection.
1-15	Memory address	Specifies the starting address for data channel transfers

Read Memory Address

DIA [*ff*] *ac*, **DSKP**

Context: Alternate instruction mode 1

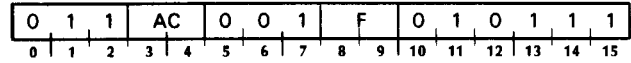

Places the contents of the lsb of the controller's extended memory address register in bit 0 of the specified accumulator, and places the contents of the controller's memory address register in bits 1-15 of the specified accumulator. After the data transfer, sets the controller's Busy and Done flags and initiates operations according to the function specified by F. The format of the accumulator is as follows:

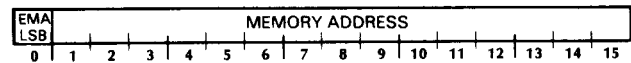

Bits	Name	Meaning when 1
0	Extended memory address	Indicates the lsb of the extended memory address or the NOVA 3 map selection.
1-15	Memory address	Indicates the location of the next word in memory for a data channel transfer.

Read Drive Status

DIB [f] ac, DSKP

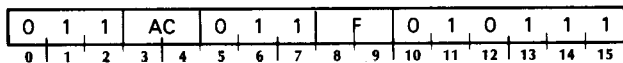

Places the drive status flags for the drive selected by the previous DOA in bits 0-6 and 8-15 of the specified accumulator; sets bit 7 to 0. After the data transfer, sets the controller's Busy and Done flags and initiates operations according to the function specified by F. The format of the accumulator is as follows:



Bits	Name	Meaning when 1
0	Invalid status	The command channel is busy and bits 5-6 and 8-15 should be ignored
1	Reserved	The drive is reserved by the other processor
2	Trespassed	One of the drives was trespassed upon by the other processor
3	Ready	The drive is ready to accept commands
4	Busy	The drive is busy executing a position command, or reporting an aborted seek or a trespass by the other processor
5	Offset	The positioner is offset forward or reverse
6	Write disable	The write circuits are disabled
7	---	Reserved for future use
8	Illegal address	The surface or cylinder capacity of the drive was exceeded.
9	Illegal command	The drive received an illegal read/write or position command
10	Power fault	The power supply malfunctioned
11	Pack unsafe	A condition occurred which imperiled the heads and pack.
12	Positioner fault	The head positioner malfunctioned
13	Clock fault	The servo clock malfunctioned
14	Write fault	The write or head select circuits malfunctioned
15	Drive fault	Any of the above faults (bits 8 - 14)

Read Data Transfer Status

DIA [f] ac, DSKP

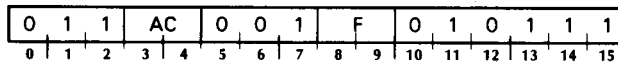

Places the contents of the controller's done flags and read/write status flags in bits 0-15 of the specified accumulator. After the data transfer, sets the controller's Busy and Done flags and initiates operations according to the function specified by F. The format of the accumulator is as follows:

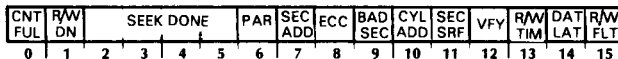

Bits	Name	Meaning when 1
0	Control full	The drive command initiated by the previous IOPULSE or IORESET has not yet been issued to the selected drive
1	R/W Done	The read/write operation initiated by the previous START has terminated. (This is the same as the device Done flag.)
2-5	Drive 0-3 Done	The respective drives have executed a positioner command, have rejected an illegal positioner command, have been trespassed upon, or have changed their ready status.
6	Parity	A parity error occurred on a data transfer between the controller and the adapter
7	Illegal sector	The sector address exceeded the capacity of the drive
8	ECC	A data error was detected by the error check circuits
9	Bad sector	A bad sector flag was detected during a sector header check
10	Cylinder error	A cylinder address error was detected during a sector header check
11	Surf/sect error	A surface or sector address error was detected during a sector header check
12	Verify error	A data error was detected during a verify operation
13	Read/write timeout	The read/write operation initiated by the previous START was not completed in 1 second.
14	Data late	The FIFO overflowed during a read or underflowed during a write
15	Read/write fault	Any of the above faults or a drive fault on the drive currently selected by the read/write channel

Read First ECC Word

DIA [*f*] *ac*, **DSKP**

Context: Alternate instruction mode 2

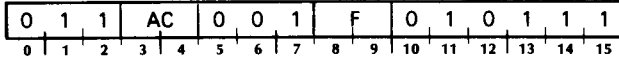

Places bits 0-15 of the controller's ECC remainder register in bits 0-15 of the specified accumulator. After the data transfer, sets the controller's Busy and Done flags and initiates operations according to the function specified by F. The format of the accumulator is as follows:

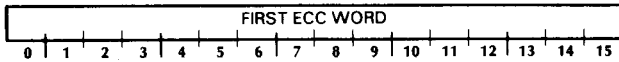

Bits	Name	Meaning when 1
0-15	$a_{31} - a_{16}$	Indicates the coefficients of the high order bits of the ECC remainder following a read operation

Read Second ECC Word

DIB [*f*] *ac*, **DSKP**

Context: Alternate instruction mode 2

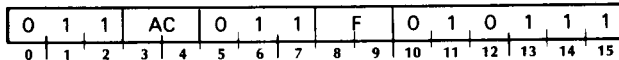

Places bits 16-31 of the controller's ECC remainder register in bits 0-15 of the specified accumulator. After the data transfer, sets the controller's Busy and Done flags and initiates operations according to the function specified by F. The format of the accumulator is as follows:

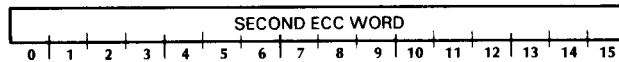

Bits	Name	Meaning when 1
0-15	$a_{15} - a_0$	Indicates the coefficients of the low order bits of the ECC remainder following a read operation.

PROGRAMMING DETAILS

To program data channel transfers for a DG/DISC storage subsystem, proceed in 5 steps :

Select a drive and specify a seek command

Specify a cylinder address and initiate the position operation

Select a drive and specify a read/write command

Specify a starting memory address, surface address, sector address and sector count and initiate the read/write operation

Release the drive following all required operations

Before issuing commands in phases I, III, and V, check the control full flag to avoid destroying a previously stored position command. Following phase IV check the read/write and drive status flags for error indications.

NOTE *The following discussion assumes a dual processor subsystem. In a single processor subsystem, ignore the release and trespass commands and also the trespassed flag, the drive reserved flag and the invalid status flag.*

Unless otherwise noted, do not follow an instruction with a device flag command (start, clear or iopulse).

Phase I: Select a Drive and Specify a Seek Command

Issue a *read data transfer status* instruction. (DIA) This automatically requests access to the command channel. Check that the control full flag is clear, indicating that any previously stored drive command has been transmitted to the adapter. Issue a *Specify command and drive* instruction (DOA) and specify a seek command. This automatically reserves the selected drive if it is not currently reserved by the other processor. Issue a *read drive status* instruction (DIB) and check that the invalid status flag is 0, indicating that the command channel is open and that the drive status indicators are therefore valid. Check that the drive is ready, and that it is not reserved by the other processor. Also check that no drive faults are present and that write operations are not disabled (if a write is to ensue). (If the drive is busy, the stored command feature waits for completion of the current operation before it issues the new command. The drive rejects all commands if it is not ready.)

Phase II: Position the Heads

Move the heads to the desired cylinder by issuing a *specify cylinder* instruction (DOC) plus a P device flag command. The P command initiates the seek operation by setting the control full flag; it does not affect the controller's Busy or Done flags. When the stored command is transmitted to the adapter, the control full flag is cleared (note that if the drive is reserved by the other processor, control full remains set and can be cleared only with a Clear flag command, an Ioreset or a Trespass command). If a read/write operation is to follow, proceed immediately to phase III without waiting for a drive attention interrupt request. Otherwise an interrupt request will follow if the drive command was a seek, recalibrate, offset forward, offset reverse, or stop. While the drive is seeking, its busy flag is set (its ready flag is unaffected.)

Phase III: Select a Drive and Specify a Read/Write Command

Check the device Busy flag to see that no data transfer operation is pending or in progress. Issue a *read data transfer status* instruction (DIA). This automatically requests access to the command channel. Check that the control full flag is clear, indicating that any previously stored drive command has been transmitted to the adapter. Issue a *specify command and drive* instruction (DOA) and specify a read/write command. This automatically reserves the drive if it is not currently reserved by the other processor. (This operation is redundant if the drive was reserved previously.) If the status of the reserved flag is not known, issue a *read drive status* instruction (DIB) and check that the selected drive is not currently reserved by the other processor.

Phase IV: Read or Write

Issue a *specify surface, sector and count* instruction (DOC) Be sure not to exceed the capacity of the drive. Then, issue a *specify memory address* instruction (DOB) plus an S device flag command. The S command initiates the read/write operation by setting the device Busy flag; it clears the read/write done flag (which is the same as the device done flag), starts the one second timer, and inhibits drive attention interrupts for the duration of the operation. When the

selected drive completes the previous seek operation and clears the associated seek busy flag, the controller transmits the stored read/write command to the adapter and the operation begins.

At the start of a read/write operation, the adapter waits until the starting sector passes under the specified head. It then reads the sector address field, checks the bad sector flag and verifies that the cylinder address matches that posted by the *specify cylinder* instruction which accompanied the previous seek command, and that the surface and sector address match those posted by the *specify surface, sector and count* instruction which accompanied the current read/write command.

If the address check is successful, the data transfer commences. The memory address register increments following every word transfer across the data channel. As the data transfer proceeds, the adapter accumulates a 32-bit ECC checkword. After each sector is read, the controller stores the final ECC checkword (which should equal zero) in the controller's ECC register.

The sector address and count increment half way through the data field transfer. If the sector address overflows, the surface address increments at the end of the sector transfer. If the sector count does not overflow, the next sector is transferred in the same manner. Data transfer continues until the sector count overflows, whereupon the operation terminates, the device Done flag sets and program interrupt request is generated.

Phase V: Release Drive

It may be desirable to release the reserved status of the drive after the last data transfer to allow access by the other processor. To do this, issue a *read data transfer status* instruction (DIA). This automatically requests access to the command channel. Check that the control full flag is clear, indicating that any previously stored drive command has been transmitted to the adapter. Issue a *specify command and drive* instruction (DOA) plus a P device flag command and specify a release command. The P command initiates the release operation by setting the control full flag; it does not affect the device Busy or Done flags. When the stored command is transmitted to the adapter, the control full flag is cleared.

DRIVE COMMAND INITIATION FLOWCHART

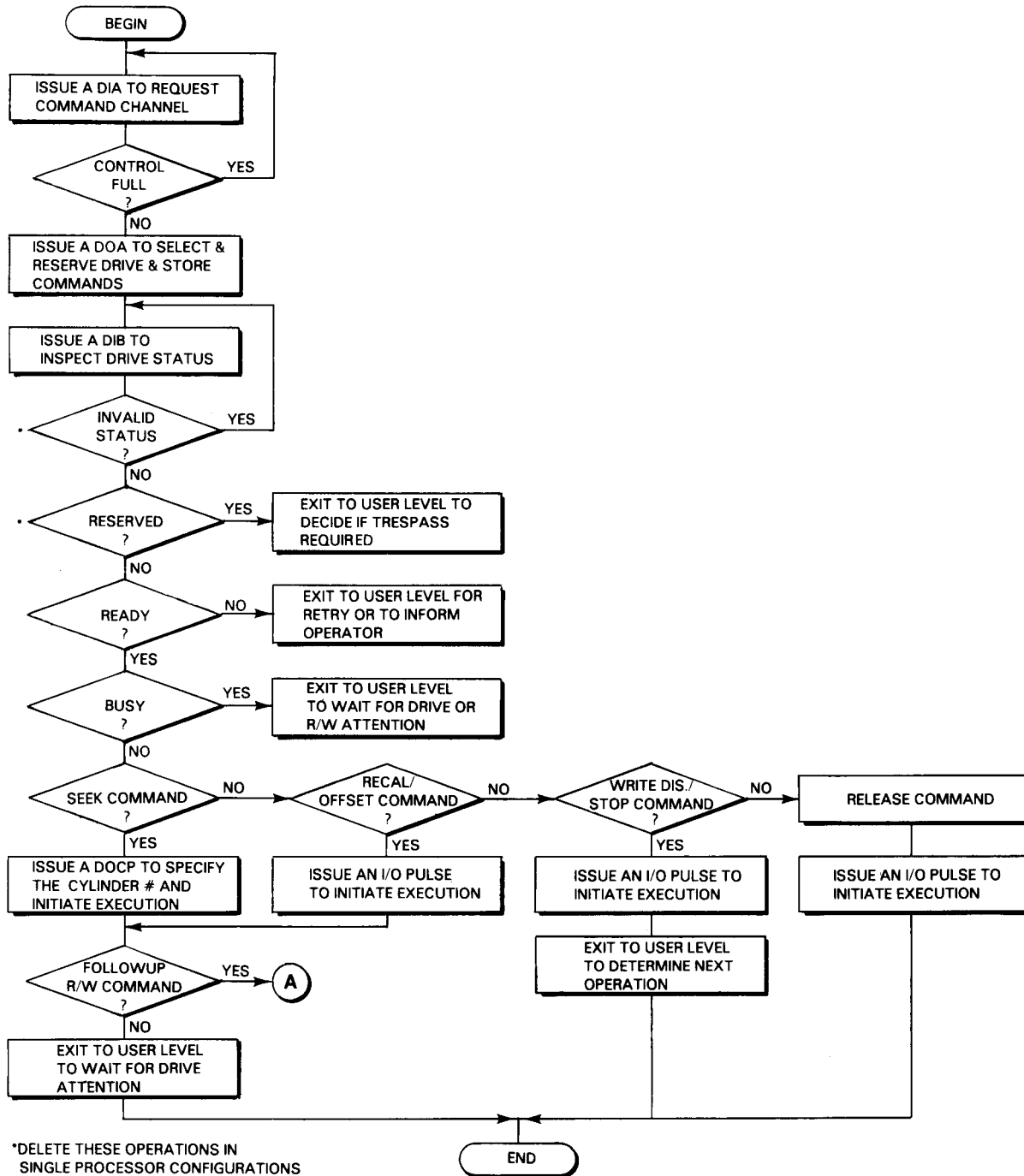

*DELETE THESE OPERATIONS IN SINGLE PROCESSOR CONFIGURATIONS

DG-03730

READ/WRITE COMMAND INITIATION FLOWCHART

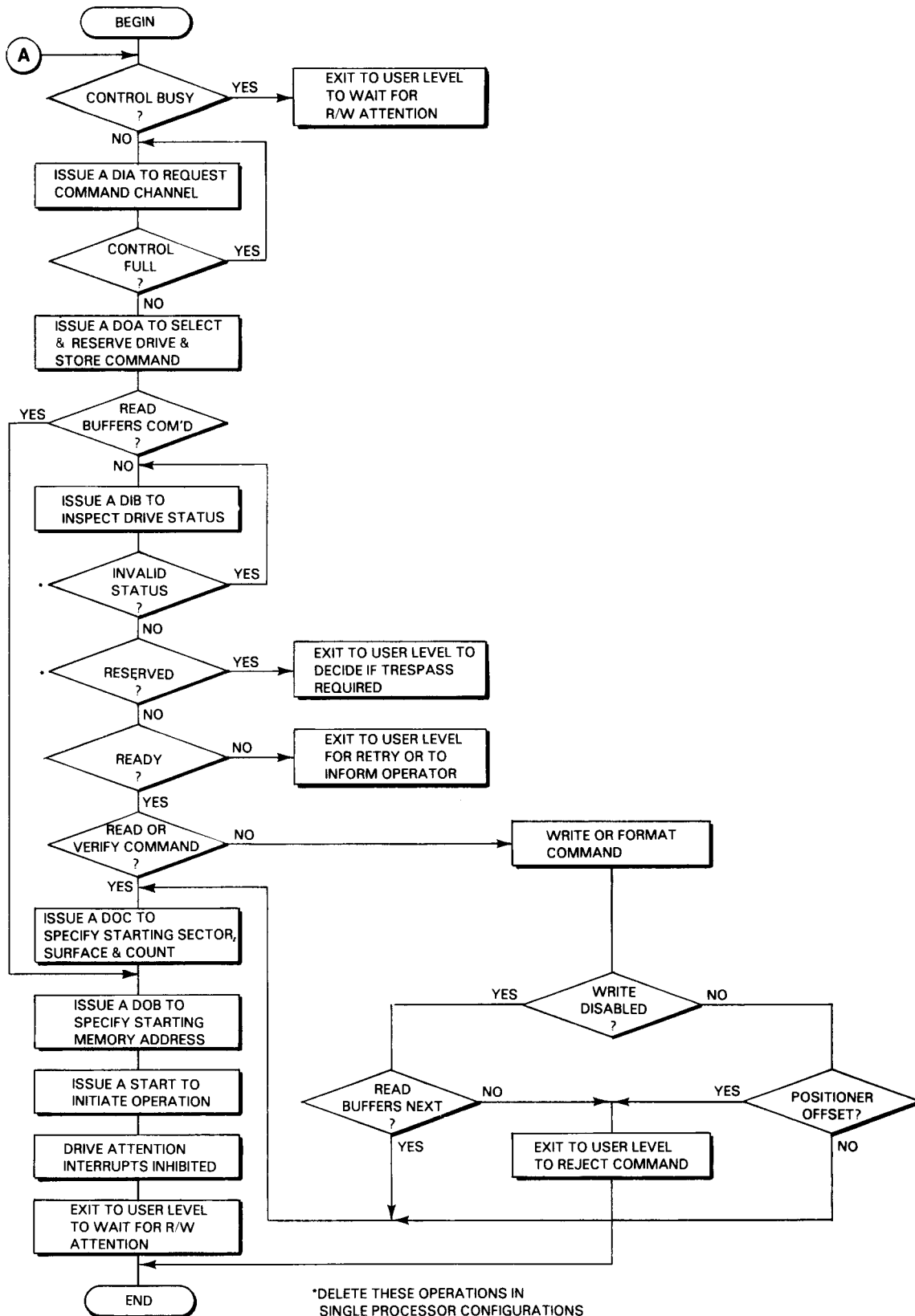

*DELETE THESE OPERATIONS IN SINGLE PROCESSOR CONFIGURATIONS

DG-03731

DRIVE INTERRUPT PROCESSING FLOWCHART

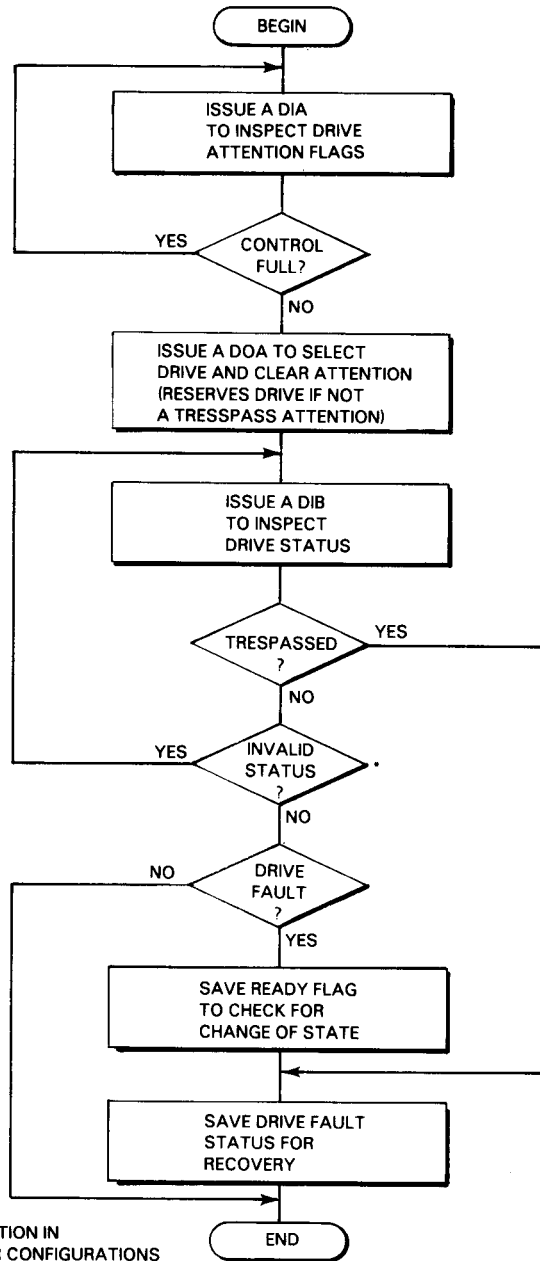

*DELETE THIS OPERATION IN SINGLE PROCESSOR CONFIGURATIONS

DG-03728

READ/WRITE INTERRUPT PROCESSING FLOWCHART

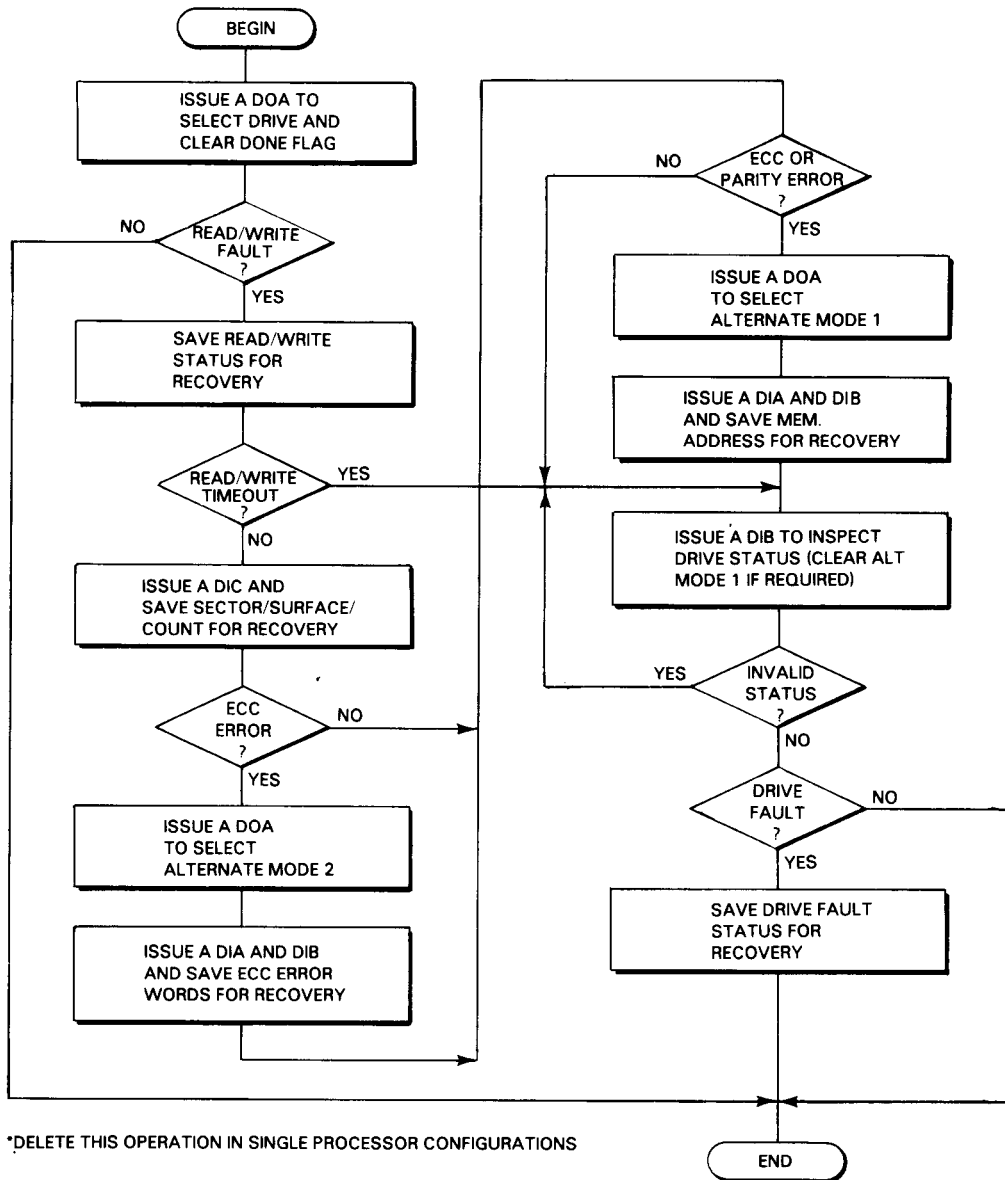

*DELETE THIS OPERATION IN SINGLE PROCESSOR CONFIGURATIONS

DG-03729

FORMATTING

Data General Corporation's disc storage subsystems require that the data surfaces be formatted before a subsystem will properly function. The format delineates an address field and a data field in each sector. The address field is a coded header that precedes the data field, and contains the sector's physical address. The data field provides space for 512 data bytes and 4 ECC bytes.

The purpose of the format is twofold: 1) it provides information for data integrity and address checking by the subsystem (transparent to the programmer) before each data transfer; 2) it provides splice areas that separate the address field from the data field in a sector while giving read and write controls time to properly initialize and settle prior to a data transfer.

A sector is formatted into four fields. The first splice field contains 27 bytes of zeros followed by a synchronization mark (0001). The address field contains 3 bytes of address information, including a bad sector flag. The second splice field contains 13 bytes of zeros followed by a synchronization mark (0001). The data field contains 512 data bytes and 4 ECC bytes.

If the data transfer status register repeatedly indicates an address error after many failures to read or write an area on the disc, the area in question (one sector, or several adjacent sectors on a surface) may need reformatting. The formatter program sets the bad sector flag on any sector that will not support error free data.

Typically, disc packs obtained from Data General Corporation are formatted before they are shipped; packs obtained elsewhere must be formatted by the customer.

Data General Corporation provides a stand-alone program that will format all the sectors of a disc pack. The program can also format a single sector. It is available on paper tape (*DGC no. 095-000471*) and with Data General's Diagnostic Tape (and Disc) Operating Systems; its operation is described in a companion program listing (*DGC no. 096-000471*).

Whenever any sector is reformatted, all the data in that sector is lost. Formatting is done independently of and before initialization of a disc for use with a Data General operating system.

TIMING

The discs in the drive unit rotate at a nominal 3600rpm; a complete revolution requires 16.667ms. A register in the selected drive continually indicates the number of the sector currently passing under the heads. This feature allows the subsystem to carry out a read or write operation the first time the desired sector passes under the selected head.

The minimum sector access time is 55 us. (the time required to read the address field at the start of a sector and start the data transfer). The maximum access time is therefore 16.772 ms. (55 us. plus the time for a full revolution). The average access time is 8.389ms.

A sector passes under a head in 0.695ms; the data portion of that sector (not including the ECC field) passes under the head in 0.636ms. A data channel request occurs for every word, approximately 2.48us (nominal). This corresponds to an average data transfer rate of 403,200wps. The controller can buffer 8 words for the data channel, which provides a maximum allowable data channel latency of 20us. If the data channel does not respond to a controller request within this time, both the data late flag and the read/write fault flag set and the data transfer operation immediately ends.

Data transfer operations are timed. If the subsystem does not complete a data transfer within 1 second after the initiating S flag command, the read/write timeout flag and the read/write fault flag set and the data transfer operation immediately ends.

The time required to position the heads (seek time) depends upon the number of cylinders the heads must cross to reach the destination cylinder, independent of the direction of movement. The minimum seek time is that for a single cylinder seek - 6ms. The maximum seek time to traverse all cylinders is 60ms. and the average seek time is 35ms. The time to set or clear a positioner offset is 3ms. The zero length seek time is 60us.

The recalibrate operation moves the heads back to cylinder 0 and selects surface 0; but it progresses more slowly than a seek to that cylinder. The maximum recalibrate time is 350ms.

In a dual processor system, a controller can retain access to the command channel for up to 50us. after the other controller has requested access. If that time period is exceeded, the command channel is automatically released, to allow access by the other controller. The controller transmits the command and clears the control full flag. The adapter then closes the command channel 4.8us after the P flag command is issued if the command channel was already open, and the drive was not already busy or reserved by the other processor. (The controller cannot transmit the command until all these conditions are met. If the drive is reserved by the other processor, control full remains set following an Iopulse or Ioreset.)

In a single processor system configuration, the command channel remains open following the initial access request (the invalid status flag is always 0), but the minimum time required for the control full flag to clear, following a P flag command remains 4.8us.

DETAILED COMMAND DESCRIPTIONS

Read

Reads up to 32 contiguous sectors into memory from the selected drive, starting at the specified surface and sector, and in the cylinder selected by the previous seek instruction. Data is read from the disc in blocks of 256 words per sector and is transferred to processor memory starting at the specified memory address. pa Before a sector data transfer commences, the adapter reads the address field and checks the bad sector flag and the surface, sector and cylinder address. The operation terminates if an error is detected.

The subsystem accumulates an ECC checkword during the sector data transfer. It divides the data field and the appended ECC field by a fixed generator polynomial and indicates an ECC error if the resulting checkword is non-zero.

If the sector address overflows during a multiple sector read, the operation continues on the first sector of the next surface. The transfer terminates when the sector count overflows or an error is detected.

Recalibrate

Moves the heads to cylinder 0 and selects surface 0.

Seek

Moves the heads to the specified cylinder.

Stop Disc

Unloads the heads and stops spindle rotation. (Only the operator can start the disc.)

Offset Forward

Offsets the positioner forward of the track centerline. This operation is cleared by the next seek command or by an offset reverse command or by a recalibrate operation. (The drive disallows write operations when the positioner is offset.)

Offset Reverse

Offsets the positioner reverse of the track centerline. This condition is cleared by the next seek command or by an offset forward command or by a recalibrate operation. (The drive disallows write operations when the positioner is offset.)

Write Disable

Disables write operations in the drive. (Only the operator can enable write operations.)

Release Drive

Clears the reserved status of a selected drive which this processor had reserved previously.

Trespass

Clears the reserved status of a selected drive reserved by the other processor and reserves it for this processor.

Set Alternate Mode 1

Changes the interpretation of DIA and DIB to read the current memory address. This mode is cleared when a new command or an IORST is issued.

Set Alternate Mode 2

Changes the interpretation of DIA and DIB to read the ECC remainder. This mode is cleared when a new command or an IORST is issued.

No Operation

Null command. (This command may be used to select a drive and read its status, or to clear alternate mode 1 or 2.)

Data Verify

Compares data written on the disc against its image in processor memory (read after write check). A data transfer proceeds as for a normal read command except that data words are not written to processor memory. Instead, data words are read from processor memory as the corresponding words are read from the disc and the converging data streams are compared in the controller. If an error is detected, the operation terminates at the end of the current sector.

Read Buffers

Reads the contents of the FIFO to facilitate diagnostic testing. Data is read from the FIFO as an eight word block and is transferred to processor memory starting at the specified memory address. The FIFO must first be filled by issuing a write command to a nonexistent or write disabled drive. This operation terminates in a read/write timeout.

Write

Writes up to 32 contiguous sectors from processor memory to the selected drive, starting at the specified surface and sector, and in the cylinder selected by the previous seek instruction. Data is transferred from processor memory starting at the specified memory address and is written to the disc in blocks of 256 words per sector.

Before a sector data transfer commences, the adapter reads the address field and checks the bad sector flag and the surface, sector and cylinder address. The operation terminates if an error is detected.

The subsystem accumulates an ECC checkword during the sector data transfer. It divides the data field by a fixed generator polynomial and appends the resulting ECC checkword to the data field.

If the sector address overflows during a multiple sector write, the operation continues on the first sector of the next surface. The transfer terminates when the sector count overflows or an error is detected.

Format

Formats up to 24 contiguous sectors on a selected surface.

FAULT FLAGS

The following table lists the faults detected by the disc storage subsystem, and is divided into two parts: errors detected by the drive are called drive faults and errors detected by the controller/adaptor are called read/write faults. The drive fault flag sets when any fault is indicated by the selected drive. A drive fault may cause the drive to lock out an operation, recalibrate the positioner or unload the heads.

The read/write fault flag sets when when any fault is indicated by the controller/adaptor, or when a drive fault is indicated by the drive currently selected on the read/write channel. This fault immediately terminates a read/write operation. Most faults can be cleared by issuing a new command, and a retry is generally recommended. Drive faults which result in an emergency retract are not recoverable. Data and sector address check errors might be recovered by offsetting the positioner.

Drive Faults

Illegal Address

One of the following:

The surface address received by the drive was greater than 18 (22_8).

The cylinder address received by the drive was greater than 410 (632_8) for a single density drive or 814 (1456_8) for a double density drive.

The command is rejected.

Illegal Command

One of the following:

The drive received a new seek or offset command while it was busy executing a previously commanded seek, offset, recalibrate or unload. The command is rejected.

The drive received a write command while the positioner was offset or write operations were disabled, or it received a new command or commenced positioner movement while reading or writing.

Dc Voltage Fault

The drive detected an undervoltage in its dc power supply.

Pack Unsafe

One of the following:

The door was opened while the spindle was energized.

The drive detected an undervoltage on the emergency retract power supply.

The drive detected a low blower pressure condition.

The drive detected a low spindle speed condition.

The drive failed to complete a brush cycle before the spindle speed exceeded 2400 rpm (this will occur if no pack is in place).

Positioner Fault

One of the following:

The positioner failed to follow the track selected by the previous seek or recalibrate command.

The positioner ran into a guard band during a seek or offset operation.

The drive failed to complete a load, seek or recalibrate operation in 750ms. Failure to complete a seek operation results in an automatic recalibrate operation. Failure to complete a load or recalibrate operation results in an automatic unload operation.

The drive failed to complete an unload operation in 750 msec.

The positioner velocity exceeded allowable limits.

The positioner moved away from the track centerline during a write operation.

Clock Fault

The servo clock lost phase lock with the servo disc. If the fault is severe, the positioner unloads and reloads the heads. If the clock is not subsequently recovered, a seek incomplete fault results and the heads unload.

Write Fault

One of the following:

Write current did not turn on when a write command was issued.

Write current did not turn off when a write command was rescinded.

No head or more than one head was selected for a write operation.

Read/Write Faults

Parity

A parity error occurred on command, data, or ECC transfer on the read/write channel between the adapter and controller.

Illegal Sector Address

The starting sector address received by the adapter was greater than 23 (27₈).

ECC

The ECC logic detected a data error during a read operation. (The final ECC remainder may be read to perform error correction.)

Bad Sector

The bad sector flag, written in the sector address header by the formatter and read prior to a sector data transfer, indicated that the sector could not support reliable data storage.

Cylinder Address

The cylinder address, written in the sector address header by the formatter and read prior to a data transfer, did not agree with the cylinder address specified during the previous seek operation. (The drive should be recalibrated.)

Sector or Surface Address

The sector or surface address, written in the sector address header by the formatter and read prior to a data transfer, did not agree with the currently specified surface or sector address.

Verify

Data read from the disc did not match data read from processor memory during a verify operation.

Read/Write Timeout

The subsystem did not complete a read/write operation and set read/write done within 1 second after the initiating S flag command.

Data Late

The data channel FIFO overflowed on a read data transfer or underflowed on a write data transfer.

ERROR CONDITIONS

During Initial Selection

If the pack unsafe flag or the dc voltage fault flag set, or the positioner fault flag sets due to an unload fault or overspeed fault, the heads unload, the spindle stops and the unit ready flag resets. These error conditions can only be cleared by switching the drive's power switch off and then on again. The spindle cannot be restarted until these faults are cleared.

During Head Positioning

If the program specifies an illegal position command, the command is rejected. If the program specifies an illegal cylinder address in conjunction with a seek command, the seek operation is rejected.

If a skip track fault, overtravel fault, seek incomplete fault or clock fault occur, the drive automatically initiates a recalibrate operation. If the clock fault is severe, the drive automatically unloads and reloads the heads. If a load (initial seek) or recalibrate incomplete fault occurs, the drive automatically initiates an unload operation.

During Data Transfer

If the program specifies an illegal surface or sector address or an illegal read/write command, the command is rejected and the data transfer operation terminates.

If the program specifies a sector count which causes the surface or cylinder address to exceed the capacity of the drive, the data transfer operation terminates at the start of the sector in which the overflow occurred.

If the subsystem detects a bad sector flag, or a surface, sector or cylinder select error, the data transfer operation terminates at the start of the sector in which the error occurred. (If a cylinder address error occurs, the drive should be recalibrated).

If the subsystem detects a parity or data late error, a write fault or an off track write, the data transfer operation terminates when the error occurs. If the error occurs more than half way through a sector data transfer, the sector count indicates the address of the next sector. (Note that it may be possible to eliminate ECC errors by using the positioner offset commands.)

If the subsystem detects an ECC or verify error, the data transfer operation terminates at the end of the sector in which the error occurred and the sector count indicates the address of the next sector.

If a drive fault occurs during the head positioning phase of a back to back seek/ data transfer operation, or if a drive or read/write fault occurs during a data transfer operation, the data transfer operation terminates when the fault is detected. Also, the specific fault flag(s), the read/write fault flag and the read/write attention flag set, the Busy flag resets and a program interrupt request is initiated.

DATA ERROR CORRECTION

The disc storage subsystem supports error detection and correction to help maintain data integrity. The ECC feature detects all error bursts contained within 21 contiguous bits in a sector, and supports software correction of all error bursts contained within 11 contiguous bits. A large class of additional errors may also be detected, but a small possibility exists that the correction algorithm will indicate erroneous corrections on error bursts that exceed 11 bits.

When the subsystem writes a sector, the ECC hardware divides the data field by a fixed generator polynomial and appends the resulting checkword to the data field.

When the subsystem reads a sector, the ECC hardware divides the data field plus the appended checkword by a factored version of the same generator polynomial. If a transcription error occurs, the resulting remainder is non-zero (except for a small class of errors which are undetectable due to the cyclic properties of the generator polynomial), and the controller's ECC error flag sets.

The processor may read the 4-byte ECC remainder via a *Read first ECC word* instruction (DIA, alternate mode 2) and a *Read second ECC word* instruction (DIB, alternate mode 2). A software error correction algorithm then manipulates the checkword to attempt to correct the erroneous data. (The algorithm may find some detected errors to be uncorrectable.)

The generator polynomial is:

$$(4005) (10000001) = 40050004005$$

or in terms of powers of x

$$(x^{11} + x^2 + 1) \cdot (x^{21} + 1) =$$

$$x^{32} + x^{23} + x^{21} + x^{11} + x^2 + 1 =$$

The following set of steps describe the method of error correction when using the ECC status words:

1. Get the first and second ECC words.
2. Check for error and its correctability.
3. Perform left rotate on P0 to find 11 bit error pattern.
4. Duplicate error pattern in P1 using XOR and SHIFT.
5. Compute bit displacement of 11 bit error burst.
6. Check that error burst falls within sector.
7. Compute correction.
8. Reconstruct word or words in error.

The flow charts and diagrams on the following pages illustrate the method described above.

METHOD FOR PERFORMING ERROR CORRECTION USING ECC ERROR WORDS

GET P0 & P1 CONTAINED IN ECC STATUS WORDS

DIA-2 (FIRST ECC WORD)

0	1	2	3	4	5	6	7	8	9	10	11	12	13	14	15
---	---	---	---	---	---	---	---	---	---	----	----	----	----	----	----

DIB-2 (SECOND ECC WORD)

16	17	18	19	20	21	22	23	24	25	26	27	28	29	30	31
----	----	----	----	----	----	----	----	----	----	----	----	----	----	----	----



CHECK FOR ERROR AND ITS CORRECTABILITY

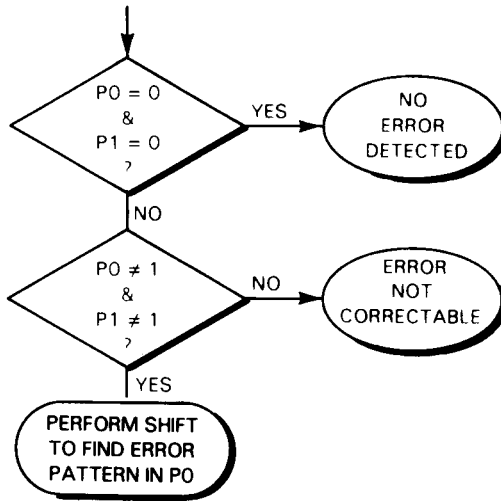

DG-03818

METHOD FOR PERFORMING ERROR CORRECTION USING ECC ERROR WORDS

TAKE P0
 SHIFT LEFT N TIMES $0 \leq N \leq 20$
 UNTIL $P0(0,9) = 0$ *

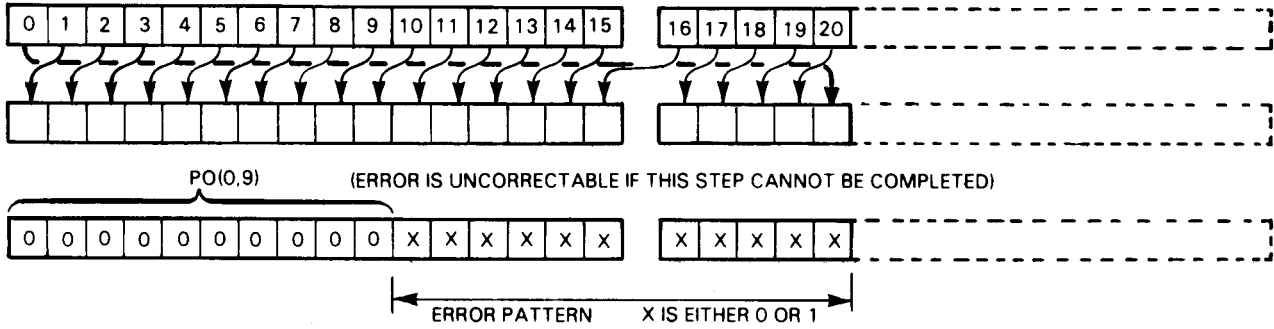

STORE N
 STORE ERROR PATTERN

TAKE P1
 PERFORM THE INDICATED SHIFT & XOR OPERATIONS M TIMES
 $0 \leq M \leq 2047$
 UNTIL P1 MATCHES ERROR PATTERN *

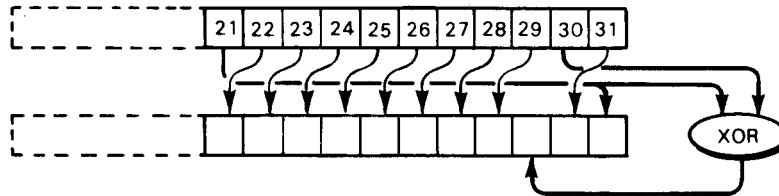

STORE M

DG-03818

* ERROR IS UNCORRECTABLE IF THIS STEP CANNOT BE COMPLETED

**METHOD FOR PERFORMING ERROR CORRECTION
USING ECC ERROR WORDS**

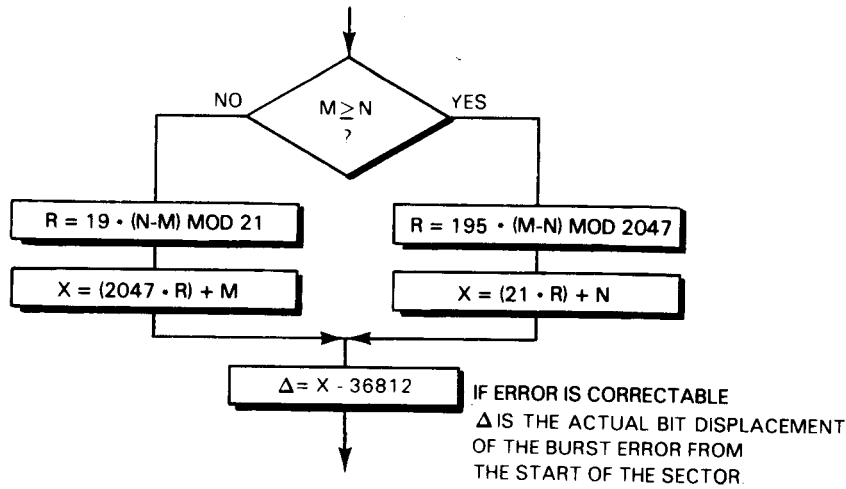

CHECK THAT ERROR FALLS WITH SECTOR

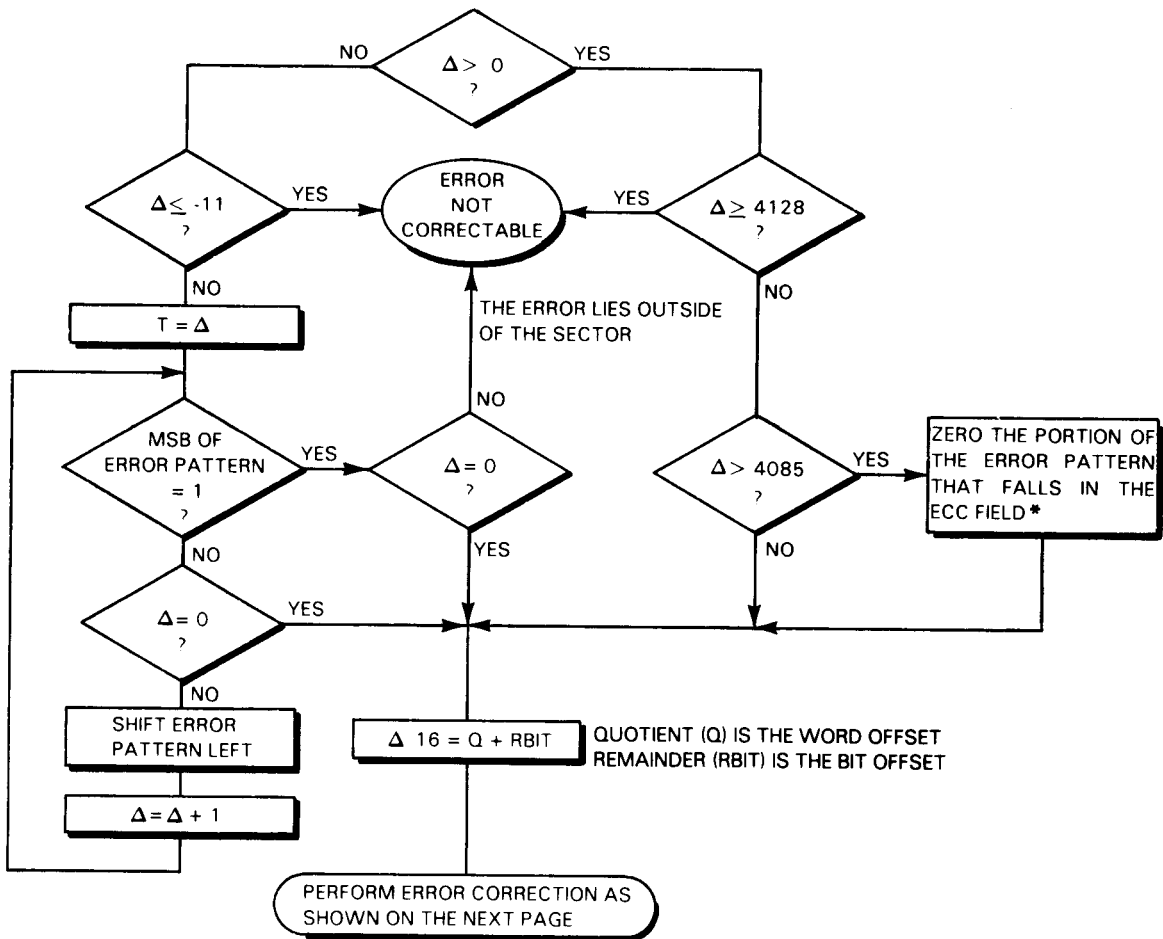

*THE ECC FIELD IS NOT STORED IN CORE, BUT IT IS PART OF THE FIELD THAT IS CORRECTABLE.

DG-03820

METHOD FOR PERFORMING ERROR CORRECTION USING ECC ERROR WORDS

COMPUTE THE CORRECTION AND RECONSTRUCT DATA IN CORE

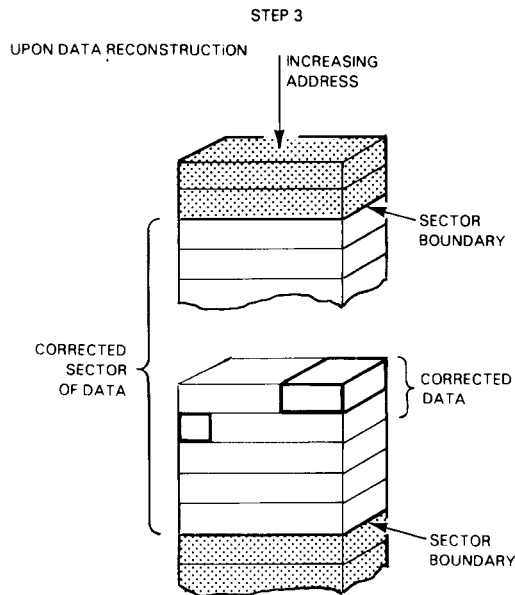
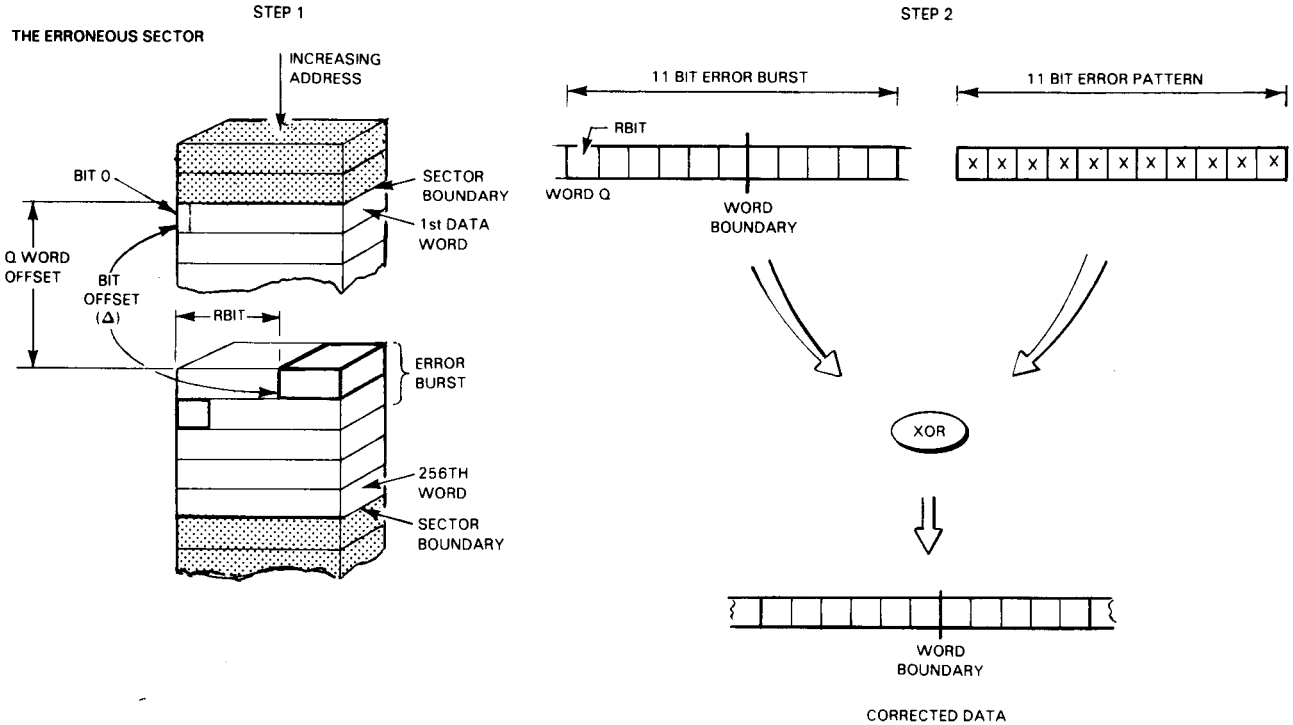

DG-03735

This page intentionally left blank.

6063/6065 SERIES FIXED HEAD DG/DISC SUBSYSTEM

PROGRAMMING SUMMARY

Mnemonic (First Controller)	DKB
Device Code	26
Mnemonic (Second Controller)	DKB1
Device Code	66
Priority Mask Bit	9
Surfaces/Unit	2
Tracks/Surface	64
Sectors/Track	32
Words/Sector	256
Total Storage Capacity (words)	1,048,576
Max. Transfer Rate (wps)	450,450
Allowable Data Channel Latency (us)	18
Sector Access Time (ms)	10.12

ACCUMULATOR FORMAT

Specify Queue Address (DOA)

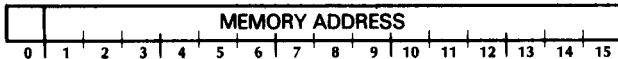

COMMAND FORMAT

Disk Address

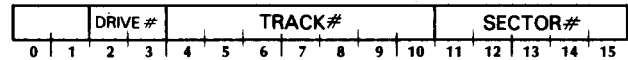

Command and Extended Address

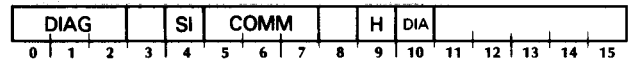

Command

- 000 Read
- 001 Write
- 010 Data Verify
- 011 Jump
- 100 Idle
- 101 WR Buffer
- 110 RD Buffer
- 111 Reserved for future use

Memory Address

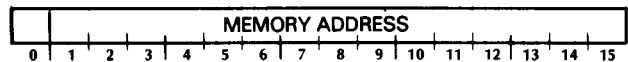

Status Word

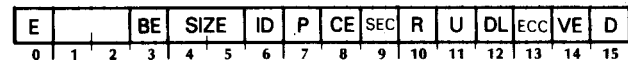

INTRODUCTION

This disc subsystem consists of from one to four fixed head disc drives and one or two controllers. The subsystem controller occupies two slots of the computer chassis and directs the activities of the disc drives. Control over the subsystem may be shared between two NOVA or ECLIPSE computers by installing a controller in each processor.

Subsystem operations are controlled by a command queue located in main memory. This queue consists of a series of five-word entries, each of which instructs the unit to perform a single operation. The program builds the queue, sends its address to the controller, and issues a Start command. The controller processes commands until a Halt function or error condition occurs.

Each full capacity disc unit contains 128 tracks, numbered 0-177₈. Each track contains 32 sectors, numbered 0-37₈. Each sector contains a data field that stores 512 bytes and a 32-bit error correction checkword. The data storage capacity is 16,384 bytes/track or 2,097,152 bytes/unit. A half capacity disc unit has 64 tracks (0-7₈) for a total of 1,048,576 bytes.

Data is transferred two bytes (one 16-bit computer word) at a time via the data channel at a maximum rate of 450,450 words per second. A first-in first-out (fifo) buffer provides 8 words of buffering between the subsystem and the computer. The controller contains a 16-bit memory address register, enabling it to use the extended data channel addressing on processors which support the use of bit 0 for alternate map selection.

A powerful error detecting and correcting facility is provided to improve data integrity. This facility detects transcription errors and supports software correction of most error bursts of 11 bits or less.

Memory address registers in the controller are 16 bits wide, permitting bit 0 to be used to select an alternate MAP on machines so equipped.

CONTROLLER REGISTERS

The controller contains seven registers. The table below summarizes their properties and functions.

CONTROLLER REGISTERS

NAME	SIZE (bits)	FUNCTION	ACCESS METHOD
Queue Address	16	Contains address of current word in command queue	Data channel or programmed I/O
Memory Address	16	Contains address of next word to transfer to/from disc	Data channel or programmed I/O
Status	16	Contains status and error bits	Data channel or programmed I/O
ECC	32	Contains checkword remainder after a transfer	programmed I/O only
Alternate Instruction	3	Selects alternate functions for I/O instructions	programmed I/O only
Disc Address	14	Contains address of current sector for data transfer	Data channel only
Command	16	Contains current command; also diagnostic bits	Data channel only

INSTRUCTIONS

For normal operation, the only instruction which is used to program the subsystem is that which loads the queue address register (DOA). All data transfers are controlled by the information in the queue itself. Six additional instructions allow the program to determine, in detail, the current state of the subsystem and to perform various diagnostic functions.

The device flag commands control the disc controller's Busy and Done flags as follows:

f = S Context: Follows a *Specify queue address* instruction.

Sets the Busy flag to 1, sets the Done flag to 0, sets all error flags, disc address, command, and alternate instruction select registers to 0, and initiates disc operation using the command entry at the address contained in the queue address register; terminates any operation already in progress.

f = S Context: Follows an IORST instruction.

Sets the Busy flag to 1, sets the Done flag to 0, sets all error flags, disc address, command, and alternate instruction select registers to 0, and initiates disc operation without using the command queue. Data is read from disc unit 0, track 0, sector 0, into memory beginning at location 0. Status is returned into location 0 following these transfers. The controller then sets its Busy flag to 0, sets its Done flag to 1, and initiates an interrupt request.

f = C Sets the Busy flag to 0, sets the Done flag to 0, sets all error flags, disc address, command, and alternate instruction select registers to 0, terminates any operation already in progress.

f = P Sets the the Done flag to 0, and sets the interrupt request flag to 0, does not affect any operation already in progress.

Instruction Coding Conventions

In the descriptions that follow, certain coding conventions are used so that the assembler can recognize the instruction and translate it correctly into machine language. See Appendix E for these conventions.

Specify Queue Address

DOA [*f*] *ac*, FHD

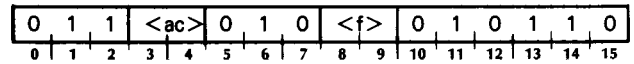

Loads bits 0-15 of the specified accumulator into the controller's queue address register. After the transfer, the controller sets its Busy flag and Done flag according to the function specified by F. The contents of the specified accumulator remain unchanged; its format is as follows.

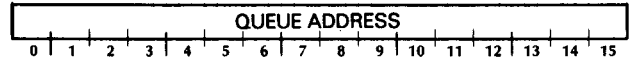

Bits	Name	Contents
0-15	Queue Address	The starting address of the first command queue entry in CPU memory.

Specify Memory Address

DOB [*f*] *ac*, FHD

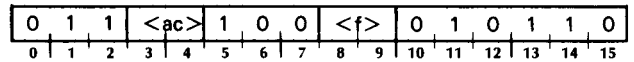

Loads the contents of the specified accumulator into the controller's memory address register. After the transfer the controller sets its Busy and Done Flags according to the function specified by F. The format of the accumulator is given below.

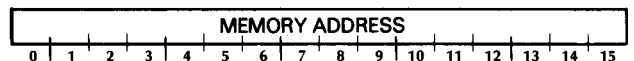

Bits	Name	Contents
0-15	Memory Address	The address of the next data word to be transferred.

Specify Alternate Instruction Type

DOC [f] ac, FHD

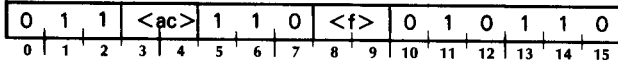

Loads the contents of bits 13-15 from the specified accumulator into the controller's alternate instruction register. After the transfer, the controller sets its Busy flag and Done flag according to the function specified by F. The contents of the specified accumulator remain unchanged; its format is as follows.

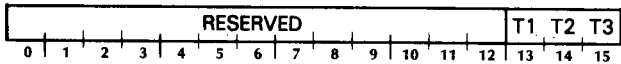

Bits	Name	Meaning when 1
0-12	---	Reserved for future use.
13	Type 3	Selects alternate instruction type 3.
14	Type 2	Selects alternate instruction type 2.
15	Type 1	Selects alternate instruction type 1.

NOTE Do not set more than one of the three bits (13, 14 and 15) to 1 in any single instruction; the results of coding more than one alternate instruction type are unspecified.

Read Memory Address

DIA [f] ac, FHD

Context: Alternate instruction type 1 specified.

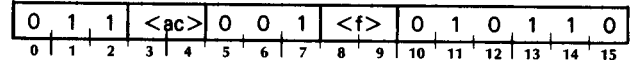

Places the contents of the memory address register in bits 0-15 of the specified accumulator, destroying the accumulator's previous contents. After the transfer, the controller sets its Busy flag and Done flag according to the function specified by F. The format of the specified accumulator is as follows.



Bits	Name	Contents
0-15	Memory Address	Contents of the memory address register.

Read First ECC Word

DIA [f] ac, FHD

Context: Alternate instruction type 2 selected.

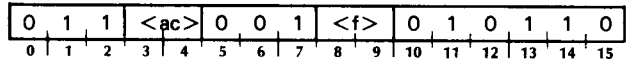

Places bits 0-15 of the ECC register in bits 0-15 of the specified accumulator, destroying the accumulator's previous contents. After the transfer, the controller sets its Busy flag and Done flag according to the function specified by F. The format of the specified accumulator is as follows.

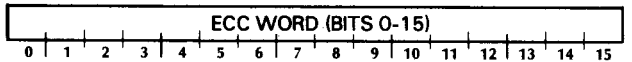

Bits	Name	Contents
0-15	1st ECC	Bits 0 - 15 of the ECC register.

Read Second ECC Word

DIB [f] ac, FHD

Context: Alternate instruction type 2 selected.

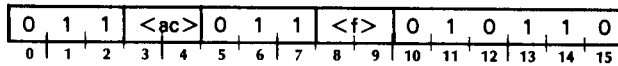

Places bits 16-31 of the ECC register in bits 0-15 of the specified accumulator, destroying the accumulator's previous contents. After the transfer, the controller sets its Busy flag and Done flag according to the function specified by F. The format of the specified accumulator is as follows.

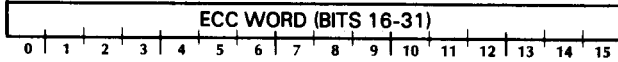

Bits	Name	Contents
0-15	2nd ECC	Bits 16 - 31 of the ECC register.

Read Queue Address Register

DIA [f] ac, FHD

Context: Alternate instruction type 3 selected.

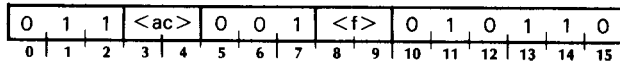

Places the contents of the queue address register in bits 0-15 of the specified accumulator, destroying its previous contents. After the transfer, the controller sets its Busy flag and Done flag according to the function specified by F. The format of the specified accumulator is as follows.

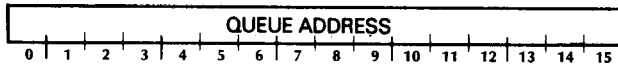

Bits	Name	Contents
0-15	Queue Address	Bits 0-15 of the queue address register.

Read Status

DIC [f] ac, FHD

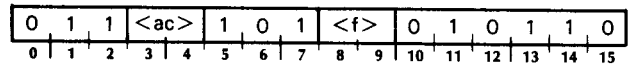

Places the contents of the controller status register in bits 0-15 of the specified accumulator. After the transfer, the controller sets its Busy flag and its Done flag according to the function specified by F. The accumulator format is the same as that for the status word returned in the command queue (described later).

NOTE The meaning of some flags in the status register changes for single and dual processor environments; also, the value returned for some flags may be invalid if status is read while the subsystem is executing a command. Refer to the section on "Status Checking" for details.

COMMAND QUEUE FORMAT

Each entry in the command queue is five words long. The first word contains the disk address to be used. The second word contains the command to be executed and several diagnostic bits. The third word contains the memory address to be used. The fourth word receives the subsystem's status word after completion of a Read, Write, Data Verify, or Idle operation. The fifth word is ignored by the controller, and is available for use by the programmer.

Disc Address (Word offset 0)

DRIVE		TRACK				SECTOR									
0	1	2	3	4	5	6	7	8	9	10	11	12	13	14	15
Bits	Name	Function													
0-1	---	Reserved for future use.													
2-3	Drive	Selects the drive unit to be used.													
4-10	Track	Selects the track number to be used in the data transfer.													
11-15	Sector	Selects the disc sector to be used in the data transfer.													

Command (Word offset 1)

CU		SI		COMMAND				HA		HE					
0	1	2	3	4	5	6	7	8	9	10	11	12	13	14	15
Bits	Name	Function													
0-1	Diag.	Reserved for diagnostic use.													
2	Clear Unsafe	When set to 1, clears disc unsafe errors.													
3	---	Reserved for future use.													
4	Soft Intr	When set to 1, causes an interrupt condition to occur at the end of the command without interrupting the queuing process.													
5-7	Command	Specifies the command for the selected drive as follows: 000 Read 001 Write 010 Data Verify 011 Jump 100 Idle 101 Write Buffer 110 Read Buffer 111 Reserved for future use.													
8	---	Reserved for future use.													
9	Halt	When set to 1, causes queuing to be stopped at the end of the command and an interrupt condition to occur.													
10	Halt on Error	When set to 1, causes queuing to be stopped at the end of the command and an interrupt condition to occur if any error condition occurs.													
11-15	---	Reserved for future use.													

Memory Address (Word offset 2)

MEMORY ADDRESS															
0	1	2	3	4	5	6	7	8	9	10	11	12	13	14	15
Bits	Name	Contents													
0	---	Reserved for future use.													
1-15	Memory Address	Logical address of the first memory location used in the command.													

Status (Word offset 3)

ERR		BUS		SIZE		ID	CTL	ERR	TMO	RDY	UNS	LAT	ECC	VER	CDN
0	1	2	3	4	5	6	7	8	9	10	11	12	13	14	15

Bits	Name	Meaning when 1													
0	Error	Bits 7,8,9,11,12,13, or 14 are 1 or bit 10 is 0.													
1-2	---	Reserved for future use.													
3	Bus Enable	In dual processor systems, the controller has access to the drive units. In single processor systems, always set to 1.													
4-5	Size	Specifies the capacity of the selected drive as follows: 00 No drive 01 1Mbyte 10 2Mbyte 11 Reserved for future use													
6	Idle Done	An idle function has been completed.													
7-8	Ctrl Error	The controller has detected an error along data paths internal to the controller.													
9	Sector Timeout	An extra sector pulse was detected or a sector pulse was missed.													
10	Ready	The disc is ready for a data transfer.													
11	Unsafe	A disc unit failure such as Power Not OK, or Speed Not OK. Disc Unsafe causes the Done flag to be set to 1 and requests an interrupt.													
12	Data Late	The data channel did not respond in time to service the disc.													
13	ECC	The ECC system detected an error.													
14	Verify	The data verify system detected an error.													
15	Command Done	A read, write, or data verify function has been completed.													

User Available Word (Word offset 4)

USER-DEFINABLE															
0	1	2	3	4	5	6	7	8	9	10	11	12	13	14	15

Available for use by the user; not used by the controller.

PROGRAMMING

Programming the subsystem for data transfers to or from the disc unit consists of building the command queue in memory and starting the controller at the beginning of the queue. The Jump command permits implementation of circular queues, linked lists, and other sophisticated control structures. The program should regularly check the status words returned by the subsystem to insure proper functioning.

After preparing the queue, start the subsystem by issuing a *Specify queue address* instruction (DOA) with an S command. The specified accumulator must contain the starting address of the queue. The S command sets the controller's Busy flag to 1 and its Done flag to 0. The controller retrieves, via the data channel, the first three words of the first command entry. It then decodes and executes the command specified.

After executing the command, the controller returns the status generated by the transfer into the fourth word of the queue entry if the command was a Read, Write, Verify, or idle. If the Halt flag in the command entry is set to 1 or another halt condition exists, the controller stops queueing, sets its Busy flag to 0, sets its Done flag to 1, and initiates an interrupt request. Otherwise, the controller proceeds to the next entry in the queue.

The accompanying flowchart demonstrates a method of programming the subsystem. This algorithm requires that the Halt on Error bit be set to 1 in all queue entries so that, in the event of an error, recovery can be attempted before the subsystem proceeds to another command. In the event of an unrecoverable error, the program signals its failure and resumes queueing with the next entry.

The flowchart shows a wait loop in which the program waits for the subsystem to set its Done flag. In most systems, an interrupt handler will be used instead of a loop so that the processor can do useful work while the controller is running.

Write

A Write function transfers a 256-word block of data from memory to a disc sector. The disc and memory addresses to be used are obtained from the queue entry as described above. The controller calculates an ECC checkword during the transfer of data. This 32-bit checkword is written onto the disc following the block of data. The controller then returns its status to the command queue, and proceeds to the next entry in the queue if the Halt and error flags are 0.

Read

A Read function transfers a 256-word block of data from a disc sector to memory. The disc and memory addresses to be used are obtained from the queue entry. The controller then reads the 32-bit ECC checkword from disc and verifies it with the checkword calculated while data was read from the disc. It stores the remaining 32-bit error correction code in the ECC register. Following these transfers, the controller returns its status word to the queue and proceeds to the next queue entry if the Halt and error flags are all 0.

Data Verify

A Data Verify function reads a block of data from a sector on disc and compares it, word by word, with a block of data from memory. The disc and memory addresses to be used are obtained from the queue entry. It sets the Verify Error flag if any word pair does not match. After the blocks of data are compared, the controller reads the 32-bit ECC checkword from disc and verifies it with the checkword calculated while data was read from the disc. The controller stores the remaining 32-bit error correction code in the ECC register. Following these transfers, the controller returns its status to the queue, and proceeds to the next queue entry if the Halt and error flags are all 0.

Jump

A Jump function reads a new queue address from the command entry. Normally the controller places the third word of the command entry in the memory address register. During a Jump operation, however, the controller places the third word in the queue address register. This causes the next command entry to be read from a new address. The controller proceeds to read the next command entry at the new queue address immediately following the transfer of the third word. This function does not transfer data or return status to the queue.

Idle

An Idle function reads a block of data from disc but does not transfer that data into memory. After the block of data is read, the controller reads the 32-bit ECC checkword from disc and verifies it with the checkword calculated while data was read from the disc. The controller transfers the remaining 32-bit error correction code into the ECC register. Then it returns the status generated by these transfers, and proceeds to the next queue entry if the Halt and error flags are all 0.

Read/Write Buffer

The Read Buffer and Write Buffer functions are primarily used to verify the proper functioning of the 8-word buffer. The Write Buffer function fills the 8-word buffer with data. The controller reads words from memory, via the data channel, until the buffer is full. The controller then requests an interrupt. No data is written onto disc; no status is returned; and queueing stops after a Write Buffer function. The Read Buffer function reads data from the 8-word buffer into memory, via the data channel, until the buffer is empty. No data is read from disc; status is not returned; and queueing stops after a Read Buffer function.

STATUS CHECKING

The recommended method of obtaining the subsystem status after a data transfer is to examine the fourth word of the queue entry. The status register may be examined directly by a Read Status (DIC) instruction; however the returned bits may not be valid. Status bits are undefined if an operation is in progress, or if, in a dual processor environment, the other processor has control of the subsystem. The table below summarizes the condition of the status word at various times.

STATUS CHECKING

CONTEXT		STATUS BITS															
		0	1	2	3	4	5	6	7	8	9	10	11	12	13	14	15
SINGLE PROCESSOR	After IORST or Clear	0	0	0	1	0	0	0	0	0	0	0	0	0	0	0	0
	After queueing	2	0	0	1	2	2	0	2	2	2	2	2	2	2	2	0
	During queueing	3	0	0	3	3	3	3	3	3	3	3	3	3	3	3	3
DUAL PROCESSOR	After IORST Or Clear	0	0	0	2	2	0	0	0	0	2	2	0	0	0	0	0
	After queueing	2	0	0	2	2	0	2	2	2	2	2	2	2	2	2	0
	During queueing	3	0	0	3	3	3	3	3	3	3	3	3	3	3	3	3
DUAL PROCESSOR (other processor selected)		3	0	0	3	3	3	3	3	3	3	3	3	3	3	3	3
SINGLE OR DUAL PROCESSOR (after interrupt following Write Buffer command)		2	0	0	1	2	2	0	2	2	2	2	2	2	0	0	0

KEY:
 0 = bit is 0.
 1 = bit is 1.
 2 = bit is valid status.
 3 = bit is invalid.

TIMING

The disc in the drive unit rotates at 2964 rpm; a complete revolution requires 20.24ms. The average access time is 10.12ms.

A register within the drive (transparent to the programmer) continually indicates to the controller the address of the sector presently passing under the heads. This feature allows the subsystem to carry out a command the first time the desired sector passes under the head.

A sector passes under a head in 633us; the data portion of that sector passes under the head in 568us. Data moves to or from the disc at a rate of 2.22us/word. This corresponds to an average transfer rate of 450,450 words/second.

The data channel interface, through which all data passes to or from memory, contains an 8-word buffer which allows a maximum data channel latency of 18us provided the transfer rate of 450,450 words/second is maintained. If the data channel is unable to service the subsystem within 18us, the Data Late and Error flags are set to 1.

The command interface's data channel, through which all command queue entries pass, has unlimited data channel latency. The controller waits until the command information is transferred. There is no Data Late flag associated with the command interface's data channel.

The subsystem can switch tracks and/or functions (i.e., read or write) between two consecutive sectors on the disc. The time between the end of a data transfer and the start of the next sector is sufficient, if the data channel does not receive any higher priority service requests, for as many as four Jump commands to be executed and the command entry read for the next sector.

ERROR CONDITIONS

During normal queuing operations, the error flags described below are returned in the status word, the fourth word of the command queue entry. These error conditions may affect queuing after the completion of the command.

Parity Error

A Parity Error can occur during the transfer of data bytes along data paths internal to the controller. This error sets the Parity Error and Error flags to 1. This error can occur only during a Write operation, and halts queuing only if the Halt on Error flag in the command register is set to 1.

ECC Error

An ECC Error can occur following the transfer of data from the disc to memory. If the ECC checkword generated while data was read from disc does not equal the checkword stored on the disc, the ECC Error and Error flags are set to 1. This error can occur during a Read, Idle, or Data Verify operation, and halts queuing only if the Halt on Error flag in the command register is set to 1.

Verify Error

A Verify Error can occur during the comparison of data words from memory with data words from disc. If a word from memory does not equal the corresponding word from the disc, the Verify Error and Error flags are set to 1. This error can occur only during a Data Verify operation, and halts queuing only if the Halt on Error flag in the command register is set to 1.

Data Late

A Data Late Error can occur during the transfer of data to or from memory. If the controller cannot empty its buffer, via the data channel, as fast as it is filled or, conversely, fill its buffer as fast as it is emptied, the Data Late Error and Error flags are set to 1. This error can occur during a Write, Read, or Data Verify operation, and halts queuing only if the Halt on Error flag in the command register is set to 1.

Sector Pulse Error

A Sector Pulse Error can occur at any time. If an extra sector pulse occurs or a sector pulse is missed, the Sector Pulse Error and Error flags are set to 1. This error halts queueing.

Disc Unsafe

Disc Unsafe can occur at any time. If the selected drive has an unsafe condition, the Disc Unsafe and Error flags are set to 1. This can be caused by a R/W Fault, Sector Fault, Clock Fault, Speed Fault, or Power Fault occurring in the selected drive. This error halts queueing.

Address/Data Error

An Address/Data Error can occur during the transfer of data bytes along data paths internal to the controller. This error sets the Address/Data Error and Error flags to 1. This error halts queueing.

NOTE *In a system with a half-capacity drive, the program could issue a command which references a non-existent track. No error condition is produced when this occurs; the results of the operation are unspecified. If necessary, the program can determine the capacity of the drive by checking the appropriate bits in the status word.*

DUAL PROCESSOR CONSIDERATIONS

Access to the subsystem is shared on a demand basis. However, only one controller at a time can execute data transfers. Each controller must stop processing its queue before the other CPU can access the subsystem. A *lockout* condition, in which one CPU retains control of the subsystem but does not transfer data, is prevented by a timer internal to the drive. The timer releases the subsystem if the CPU does not read or write data to the disc within 100 ms.

If one CPU starts a queue while the other CPU is in control of the subsystem, the controller will process any Jump commands at the start of the queue, since these do not require access to the disc drives. Upon encountering a queue entry which calls for a data transfer, the controller will wait until the other CPU releases the subsystem. No special action is required of the program in a dual processor environment.

DATA ERROR CORRECTION

The disc storage subsystem supports error detection and correction to help maintain data integrity. The ECC feature detects all error bursts contained within 21 contiguous bits in a sector, and supports software correction of all error bursts contained within 11 contiguous bits. A large class of additional errors may also be detected, but a small possibility exists that the correction algorithm will indicate erroneous corrections on error bursts that exceed 11 bits.

When the subsystem writes a sector, the ECC hardware divides the data field by a fixed generator polynomial and appends the resulting checkword to the data field.

When the subsystem reads a sector, the ECC hardware divides the data field plus the appended checkword by a factored version of the same generator polynomial. If a transcription error occurs, the resulting remainder is non-zero (except for a small class of errors which are undetectable due to the cyclic properties of the generator polynomial), and the controller's ECC error flag sets.

The processor may read the 4-byte ECC remainder via a *Read first ECC word* instruction (DIA, alternate mode 2) and a *Read second ECC word* instruction (DIB, alternate mode 2). A software error correction algorithm then manipulates the checkword to attempt to correct the erroneous data. (The algorithm may find some detected errors to be uncorrectable.)

The generator polynomial is:

$$(4005) (10000001) = 40050004005$$

or in terms of powers of x

$$(x^{11} + x^2 + 1) \cdot (x^{21} + 1) =$$

$$x^{32} + x^{23} + x^{21} + x^{11} + x^2 + 1 =$$

The following set of steps describe the method of error correction when using the ECC status words:

1. Get the first and second ECC words.
2. Check for error and its correctability.
3. Perform left rotate on P0 to find 11 bit error pattern.
4. Duplicate error pattern in P1 using XOR and SHIFT.
5. Compute bit displacement of 11 bit error burst.
6. Check that error burst falls within sector.
7. Compute correction.
8. Reconstruct word or words in error.

The flow charts and diagrams on the following pages illustrate the method described above.

METHOD FOR PERFORMING ERROR CORRECTION USING ECC ERROR WORDS

GET P0 & P1 CONTAINED IN ECC STATUS WORDS

DIA-2 (FIRST ECC WORD)

0	1	2	3	4	5	6	7	8	9	10	11	12	13	14	15
---	---	---	---	---	---	---	---	---	---	----	----	----	----	----	----

DIB-2 (SECOND ECC WORD)

16	17	18	19	20	21	22	23	24	25	26	27	28	29	30	31
----	----	----	----	----	----	----	----	----	----	----	----	----	----	----	----

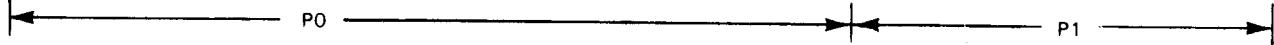

CHECK FOR ERROR AND ITS CORRECTABILITY

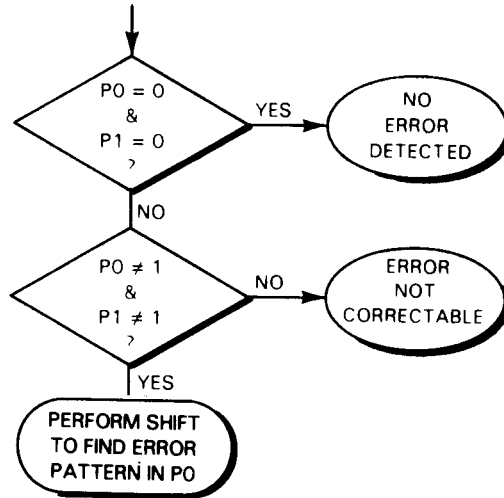

DG-03818

METHOD FOR PERFORMING ERROR CORRECTION USING ECC ERROR WORDS

TAKE P0
SHIFT LEFT N TIMES $0 \leq N \leq 20$
UNTIL P0(0,9) = 0 *

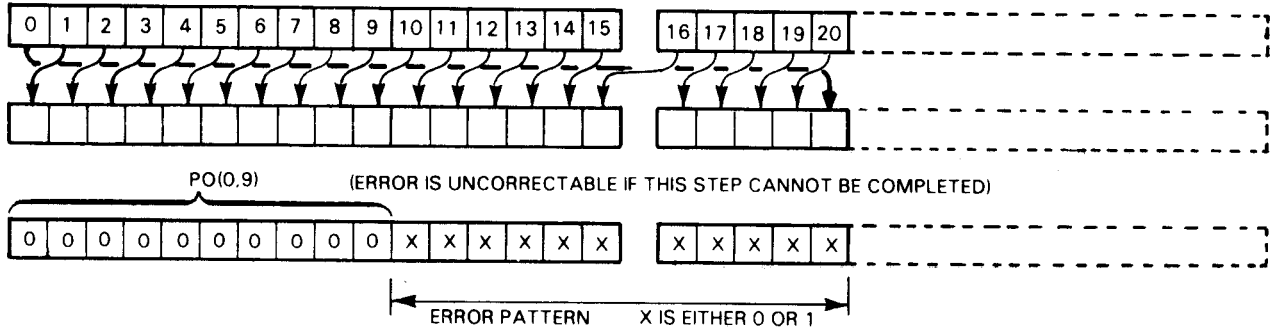

STORE N
STORE ERROR PATTERN

TAKE P1
PERFORM THE INDICATED SHIFT & XOR OPERATIONS M TIMES
 $0 \leq M \leq 2047$
UNTIL P1 MATCHES ERROR PATTERN *

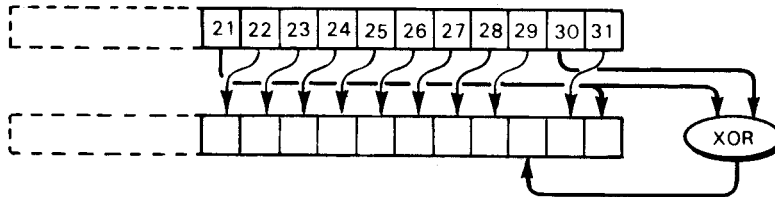

STORE M

DG-03818

* ERROR IS UNCORRECTABLE IF THIS STEP CANNOT BE COMPLETED

METHOD FOR PERFORMING ERROR CORRECTION USING ECC ERROR WORDS

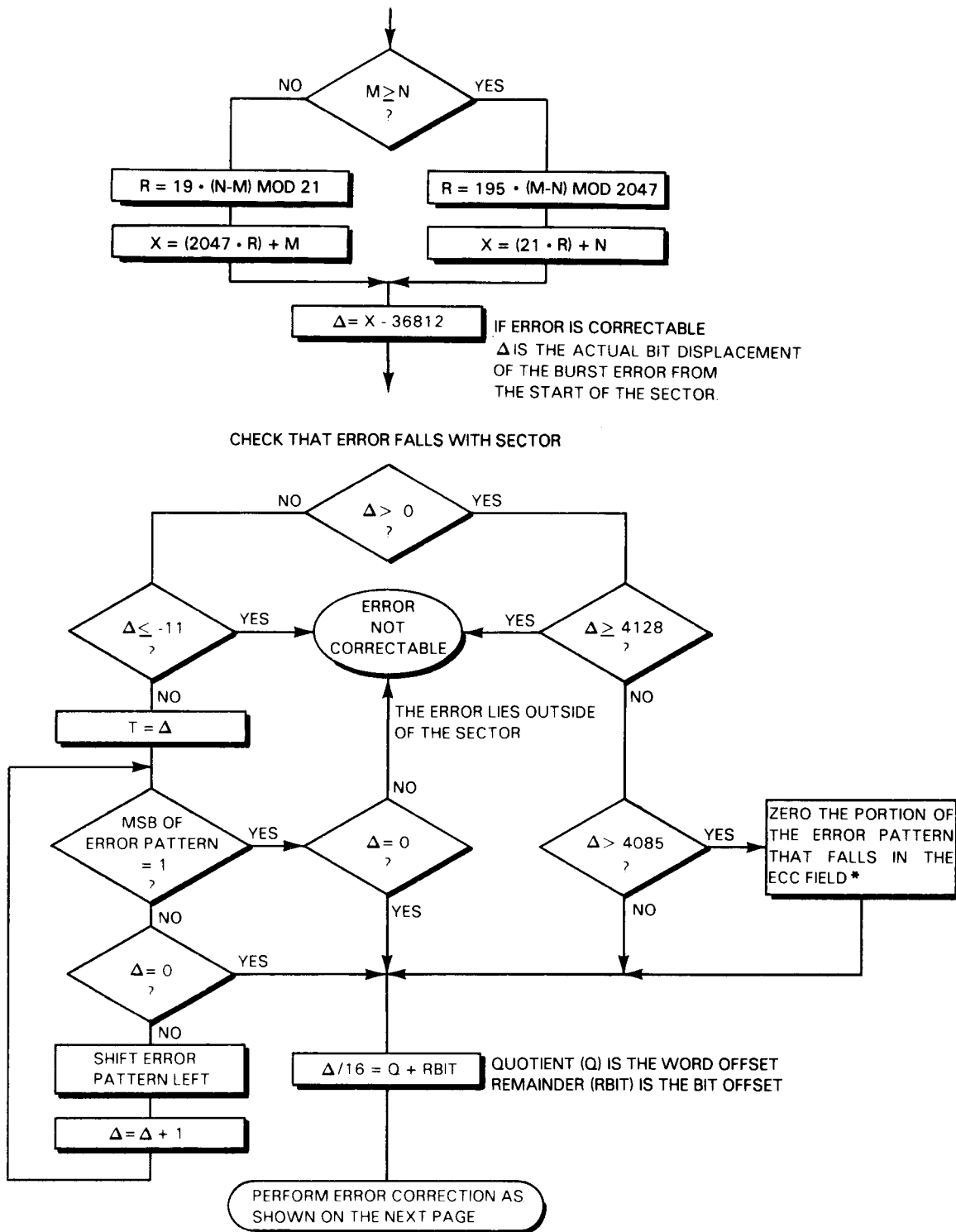

*THE ECC FIELD IS NOT STORED IN CORE, BUT IT IS PART OF THE FIELD THAT IS CORRECTABLE.

DG-03820

METHOD FOR PERFORMING ERROR CORRECTION USING ECC ERROR WORDS

COMPUTE THE CORRECTION AND RECONSTRUCT DATA IN CORE

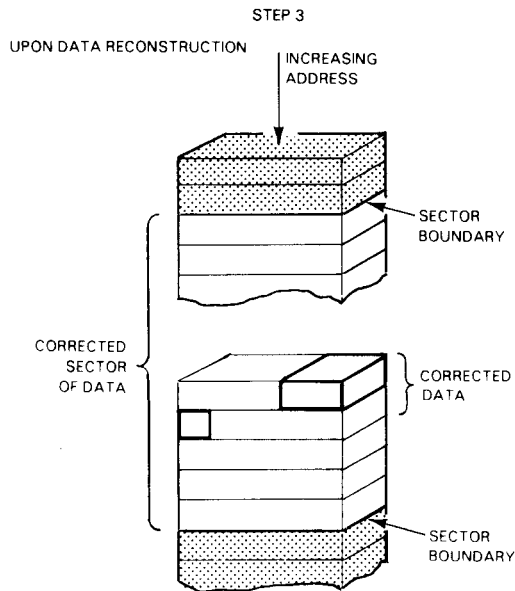
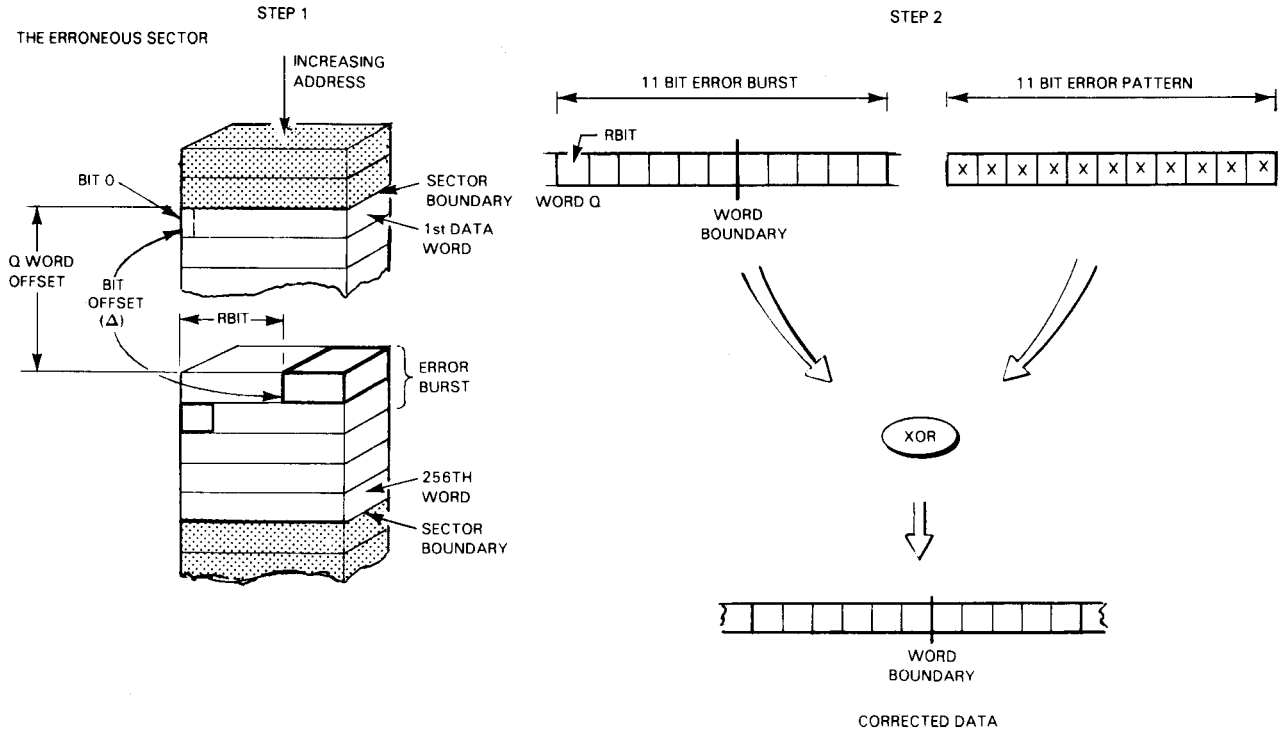

DG-03735

This page intentionally left blank.

SECTION VI

ANALOG / DIGITAL DIGITAL / ANALOG

- 4120 SERIES A/D CONVERSION SUBSYSTEM
- 4180 SERIES D/A CONVERSION SUBSYSTEM

This page intentionally left blank

INTRODUCTION TO DGC A/D AND D/A SUBSYSTEMS

The DGC Analog Data Conversion System provides a means for interfacing DGC computers to a wide range of analog devices. The Analog/Digital Conversion Subsystem, built around a 10- or 12-bit analog-to-digital (A/D) converter, serves the input function, converting external analog signals into digital data for the central processor. The output function is provided by the Digital/Analog Conversion Subsystem, which uses a 12-bit digital-to-analog (D/A) converter to translate digital data from the computer into analog signal voltages available to external devices.

ANALOG AND DIGITAL DATA

Analog Data

For the purposes of this chapter, analog data consists of voltages whose magnitudes represent, and are proportional to, numeric values. The subsystems may be configured to provide measurements in the following ranges: $\pm 2.5V$, $\pm 5V$, $\pm 10V$, 0 to 5V (A/D only), and 0 to 10V. The A/D and the D/A subsystems may have the same range, or their ranges may be chosen independently.

The total voltage span, either 5, 10, or 20 volts, is known as the "full scale range" (FSR). An analog range is called "unipolar" if it includes only non-negative voltages, "bipolar" if it encompasses both positive and negative voltages. The maximum value within a range is known as "plus full scale" (+FS). For a unipolar range, the minimum value is 0 volts. For a bipolar range, 0 volts is the mid-range value, and the minimum value is called "minus full scale" (-FS).

Digital Data

While analog values (voltages) are continuous over their range, digital data (binary numbers) are discrete--only certain values within the range can be represented. For an n -bit converter these values are the 2^n different n -bit binary integers. They are interpreted in the unipolar case as unsigned integers within the range 0 to $2^n - 1$, and in the bipolar case, with the most significant bit acting as the sign, as signed integers between -2^{n-1} and $2^{n-1} - 1$, inclusive, where two's complement form is used for the negative integers.

Analog/Digital Data Correspondence

In both cases these 2^n numbers define only $2^n - 1$ intervals, but the analog range is divided into 2^n discrete values, where the difference from one value to the next corresponds to a digital increment equal to the least significant bit (LSB). In this way the "analog LSB", i.e., the voltage increment corresponding to the digital LSB, equals $1/2^n$ of the analog full scale range (FSR), and the analog value represented by each bit position is an exact binary fraction of this full scale range.

The minimum digital value (0 for unipolar, -2^{n-1} for bipolar) corresponds to the minimum analog value (0 or -FS), but the maximum digital value ($2^n - 1$ or $2^{n-1} - 1$) actually represents an analog value one analog LSB less than the nominal full scale range. Just as the negative numbers outnumber the (non-zero) positives by one (since 0 is represented, as are the positive numbers, with a 0 sign bit), the actual analog range extends one LSB further in the negative direction than in the positive direction. Thus, the actual maximum analog value (+FS) is either $FSR - LSB$ (unipolar) or $1/2 FSR - LSB$ (bipolar).

For example, for a 12-bit converter with a ± 5 volt range, $FSR = 10$ volts, and $LSB = FSR/2^{12} = 10V/2^{12} = .0024$ volt. $-FS = -5.000$ volts, but $+FS = 5.000 - .0024 = 4.9976$ volts. (The term "full scale" (FS), without a sign prefacing it, usually means the nominal full 5 volts.)

Digital Representation of Analog Data

The digital values input or output by a converter consist of either ten or twelve bits of data. This number of bits is referred to as the "resolution" of the converter. When expressing a converter's n -bit digital value in a full 16-bit computer word, the n -bit field of data is right-justified--that is, the least significant data bit occupies the right-most position, bit 15. Ten-bit values take up bits 6 through 15; 12-bit values occupy bits 4 through 15. Note that this means that the same bit position in two converters with identical ranges but of different resolutions will not represent the same analog voltage level.

When transferring digital values from the computer to a D/A converter, only the rightmost twelve bits of the 16-bit computer word are of importance--the extra high-order bits are ignored and hence may have any value. When reading digital values into the computer from an A/D converter, the extra high-order bits are set by the converter subsystem to fill out the data word according to one of two conventions, one for unipolar ranges, the other for bipolar ones. No sign bit exists in the unipolar case; the extra high-order bits are set to 0. This allows the program to operate on unipolar inputs as if they were normal positive integers. In the bipolar case, the sign of the converter's digital value (the most significant bit in the n-bit field) is extended to the left. In other words, all of the extra high-order bits are set to 0 for a positive converter value and to 1 for a negative value. This convention allows the program to operate on bipolar values as if they were regular signed integers.

The four possible A/D converter data formats are:

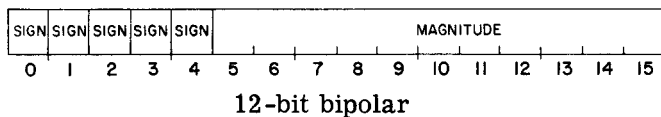
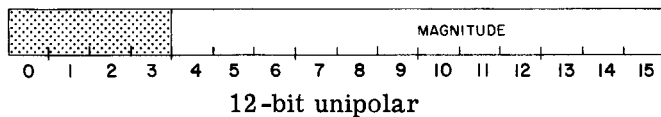
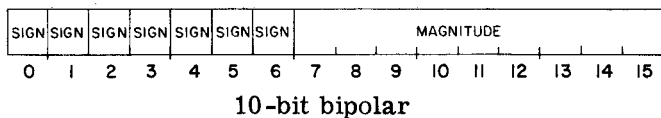
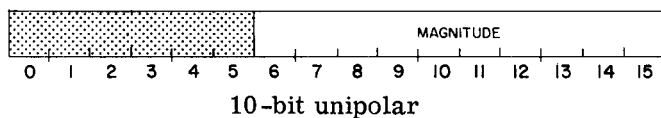

Although the digital values from the A/D converter will necessarily fall within the n-bit range of the converter, normal arithmetic operations on these values can be performed with valid results within the full 16-bit range of the computer. However, if it is desired to keep the results within the converter range (e.g., in order to convert them back to analog form via a D/A converter), care must be taken to check and provide for overflow and underflow out of the narrower range of the converter.

The following table shows the correspondence between analog and digital values for the 10-bit A/D converter and the 12-bit A/D and D/A converters with nominal ranges of 0 to V volts (unipolar) and ±V volts (bipolar). "+V" represents the nominal maximum positive voltages (FS); "-V" represents the minus full scale voltage for the bipolar case (-FS). Inputs to an A/D converter which exceed the range of the converter are clipped (truncated) as follows: any analog input value greater than +FS converts to the maximum digital value; any value less than the minimum analog value (0 or -FS) converts to the minimum digital value. The digital values are given as the octal equivalents of the 16-bit words received from the A/D converter; in D/A conversion the four most significant bits (bits 0 to 3) are ignored and may have any value.

Analog and Digital Data Correspondence

Converter Analog Voltage	12-bit A/D and D/A		10-bit A/D	
	unipolar	bipolar	unipolar	bipolar
≥ +V -LSB	007777	003777	001777	000777
+1/2V	004000	002000	001000	000400
+LSB	000001	000001	000001	000001
0	000000	000000	000000	000000
-LSB		177777		177777
-1/2V		176000		177400
-V +LSB		174001		177001
≤ -V		174000		177000

NOTE: V = FSR (unipolar)
= 1/2FSR (bipolar)

06-00656

DATA ACCURACY

In converting analog data to digital form, or vice versa, there exist two types of limitation on the accuracy of the conversion; hardware inaccuracies and the conversion process inaccuracies. The first derives from the limitations of the hardware and is severe in proportion to the tolerances and inaccuracies of the components in the system. The measurement of these errors is usually given in terms of "relative accuracy", which is defined as the ratio of the difference between a converter's output (V_{out}) and its given input (V_{in}) to the full scale range:

$$\text{Relative accuracy} = \frac{V_{out} - V_{in}}{FSR} \times 100\%$$

This definition of accuracy incorporates the fact that conversion accuracy is constant over the full scale range, not proportional to the value being measured. The accuracies of the A/D and D/A systems are given separately in their respective chapters.

The second limitation is due to the discrete nature of digital data. Because digital values exist only at certain points, at intervals of one LSB apart from each other, there is an inherent limitation on the accuracy of A/D conversion equal to $\pm 1/2$ LSB. In other words, for a given digital out-

put value, the actual analog input to the A/D converter can be anywhere within one half LSB of the analog value specified by the digital output. This "quantization error" must be added to all other analog errors when characterizing the accuracy of an A/D converter subsystem.

On the other hand, except for errors introduced into the D/A converter by actual circuit characteristics and signal noise, the analog output value corresponding to a particular digital input value is exact. However, in spite of appearances, the same $\pm 1/2$ LSB error is inherent in D/A conversion but does not appear in the converter; it occurs in the computer when the program rounds or truncates the digital quantities to n bits.

The table below gives the value (in millivolts) of the analog LSB associated with each converter offered with the Analog Data Conversion Subsystem. The inherent inaccuracy of each converter is then plus or minus one half of the value given.

Analog LSB's for Various Converters

Range Resolution	$\pm 2.5V$	$\pm 5V$	$\pm 10V$	0 to 5V	0 to 10V
10 bits	4.88mV	9.77mV	19.53mV	4.88mV	9.77mV
12 bits	1.22mV	2.44mV	4.88mV	1.22mV	2.44mV

06-00657

This page intentionally left blank

4120 SERIES ANALOG/DIGITAL CONVERSION SUBSYSTEM

SUMMARY

DEVICE MNEMONIC ADCV
 DEVICE CODE 218
 PRIORITY MASK BIT 8
 RESOLUTION 10 bits 12 bits
 CONVERSION TIME
 (MAXIMUM) 13.3 μ sec 36 μ sec
 MAXIMUM CONVERSION
 RATE (TYPICAL) 75kHz 28kHz
 SYSTEM ACCURACY
 w/o Prog. Gain $\pm .075\% \pm 1/2\text{LSB} \pm .025\% \pm 1/2\text{LSB}$
 w/ Prog. Gain $\pm .125\% \pm 1.2\text{LSB} \pm .075\% \pm 1/2\text{LSB}$
 APERTURE 40 \pm 5ns
 MAXIMUM ALLOWABLE DATA CHANNEL
 LATENCY (μ SEC) 13.3 @75kHz ... 36 @28kHz

ACCUMULATOR FORMATS

NOTES: [] Data Channel Option only.
 <> Programmable Gain Option only.

SELECT CHANNEL [AND LIMIT] DOA

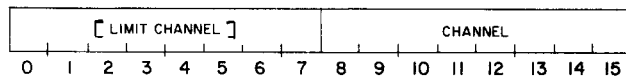

READ CHANNEL SELECT [AND LIMIT] .. DIA

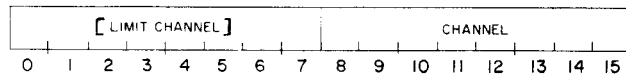

[LOAD MEMORY ADDRESS COUNTER] ... DOB

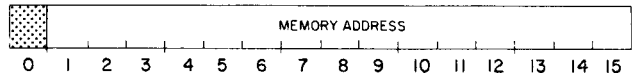

[READ MEMORY ADDRESS COUNTER] ... DIB

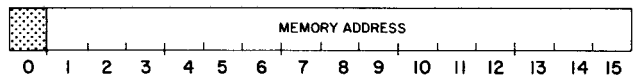

[LOAD WORD COUNT] AND
< SELECT GAIN > DOC

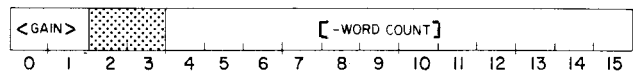

READ DATA DIC

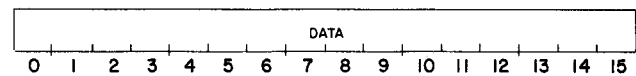

S, C AND P FUNCTIONS

- S Set Busy to 1, set Done to 0, and either trigger a single conversion or prime the clock.
- C Set Busy and Done to 0.
- P Set Busy to 1, set Done to 0, and trigger a sequence of conversions and data channel transfers or prime the clock.

CONFIGURATIONS

The Analog/Digital Conversion Subsystem enables any DGC computer to read digitized data from external analog measuring devices. Multiplexing of the analog inputs allows a single A/D converter to handle up to 32 analog channels. The subsystem is available with a resolution of either ten or twelve bits and an input range (which is hardware select-

able) of $\pm 2.5\text{V}$, $\pm 5\text{V}$, $\pm 10\text{V}$, 0 to 5V, or 0 to 10V. An internal clock, which can be used for synchronizing channel samplings, is standard equipment with all systems. Optional features are the Data Channel Option and the Programmable Gain Option. The Data Channel Option provides automatic sequential or repetitive channel sampling at the maximum possible rate. The digital results are sent automatically to memory via the data channel.

Programmable Gain Option

The Programmable Gain Option, available only on subsystems with an FSR of at least 10 volt, provides for a program-controlled variable gain (voltage multiplication factor) applied to the analog inputs. Gains of 1, 2, 4, and 8 are available and may be selected independently for each conversion or sequence of conversions. If the Data Channel Option is present, the same gain is used for the entire sequence of conversions. This option is useful in a situation where the various analog measuring devices in the system have characteristic ranges of different magnitudes. For example, if the input signals to the A/D converter from at least one device can range up to ± 10 volts, the subsystem must be configured with a ± 10 volt range to accommodate this device. A device whose signals remain within a ± 2.5 volt range would then normally use only one quarter of the total range, which would result in a loss of potential accuracy. However, with the Programmable Gain Option, the original ± 10 volt subsystem range may be kept for the first device by assigning it a gain of one, while an effective range of ± 2.5 volts may be selected for the second device by choosing a gain of

four. Signal voltages from the second device will be multiplied by four before they are converted to digital values. A signal of 2 volts from the second device will then be read as 8 volts and digitized as such. In this way the full ± 10 volt subsystem range will be utilized for both devices, thereby maximizing overall subsystem resolution. It is up to the programmer to remember that the digital values representing the analog signals from the second device are actually four times as large as they would be if the Programmable Gain Option were not in use.

The table below shows the effective ranges available with the Programmable Gain Option. This operation is available only on systems with a full scale range of at least 10 volts.

Sub-System Range \ Gain	1	2	4	8
$\pm 5V$	$\pm 5V$	$\pm 2.5V$	$\pm 1.25V$	$\pm .625V$
$\pm 10V$	$\pm 10V$	$\pm 5V$	$\pm 2.5V$	$\pm 1.25V$
0 to 10V	0 to 10V	0 to 5V	0 to 2.5V	0 to 1.25V

Effective input voltage ranges with Programmable Gain Option

06-00658

OPERATION

Modes of Operation

There are basically two modes of operation for the A/D Conversion Subsystem. The first allows a program to select a channel, trigger a conversion on that channel, and read the digital result when the conversion is done. This is called "single-conversion mode", since the program must separately initiate each conversion. The second mode allows a program to set up a sequence of conversions and let them proceed automatically, with the digital results being transferred directly to memory via the data channel. This is called "data channel mode" and is available to the program only if the Data Channel Option is present.

The data channel mode is a supplement to, not a replacement for, the operation of the basic subsystem. All of the capabilities of the single-conversion mode remain available to the user with the Data Channel Option. The instruction sets reflect this expansion of capabilities--several of the data channel mode instructions are expanded versions of single-conversion mode instructions. All of the single-conversion mode instructions can still be used, but because these instructions have additional effects when the Data Channel Option is present, special care must be taken when programming in this situation. For this reason, a brief section on single-conversion mode programming with the Data Channel Option present is included in this chapter, following the sections on the two basic modes of programming.

Conversion Sequence

After the program sets up the A/D subsystem as desired, it initiates a conversion by issuing a Start or Pulse command. This sets the Busy flag to 1, the Done flag to 0, and selects either single-conversion mode or data channel mode (S and P commands, respectively). The controller selects the channel specified by a Channel Select Register (previously set up by the program) by sending control signals to the multiplexor. If the system includes the Programmable Gain Option, the input voltage signal selected by the multiplexor is amplified by a factor equal to the selected gain before it enters the A/D converter. The controller then issues a "start conversion" command to the converter. When the conversion is done, the converter sends an end-of-conversion signal back to the controller, indicating that the digital output of the converter is now available to the computer. This digital result, residing in a data register internal to the A/D converter, remains unchanged until a new conversion is begun (or until power is turned off). It may be read repeatedly by the program if desired.

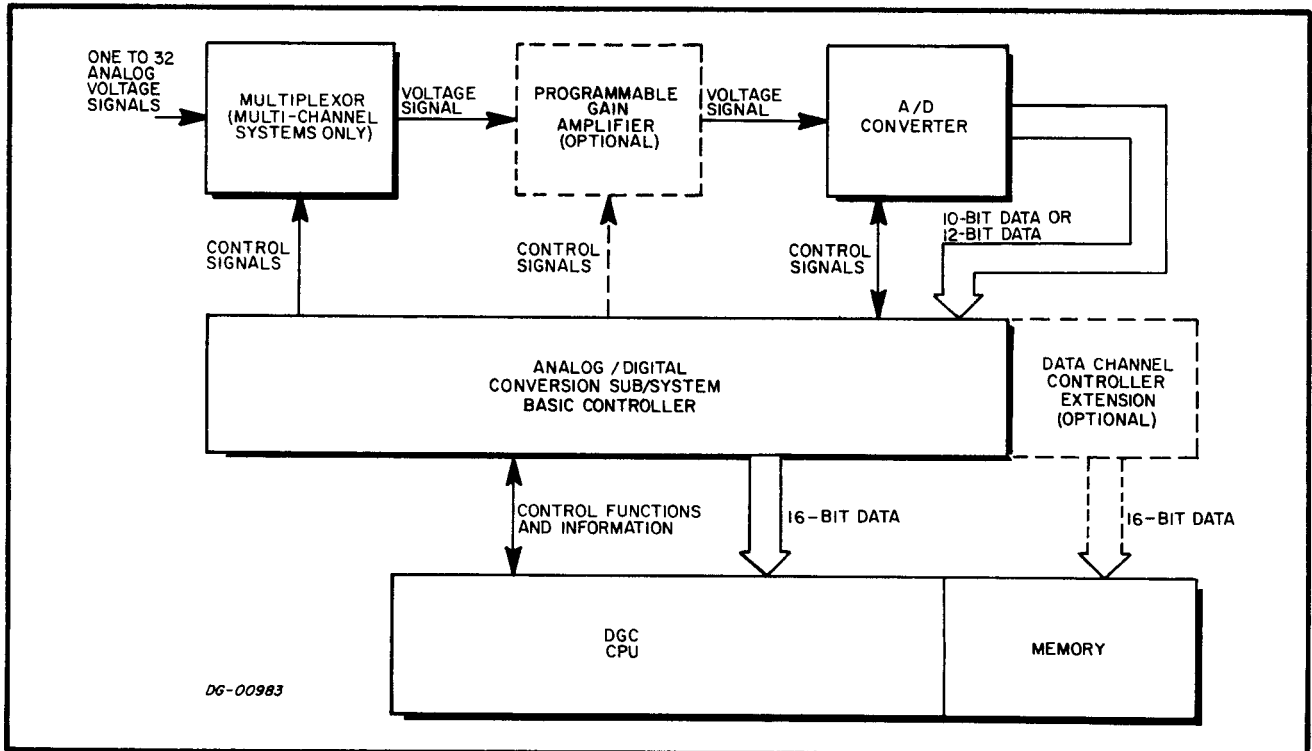

The effects of the end-of-conversion signal depend on the mode in which the system is operating. In the single-conversion mode, the end-of-conversion signal sets the Busy flag to 0, sets the Done flag to 1, and initiates a program interrupt request. If the data channel mode was selected, the end-of-conversion signal causes a data channel request to be made to the central processor in order to transfer the converter output data directly to memory. As soon as the data channel transfer is complete, the next conversion is begun automatically. When the entire sequence of conversions and data channel transfers has been completed, the Busy flag is set to 0, the Done flag is set to 1, and a program interrupt request is initiated.

The end-of-conversion signal normally has an additional effect in both operating modes--it increments the Channel Select Register in preparation for a conversion on the next sequential channel. This is necessary for automatic sequential channel sampling in the data channel mode and is useful in single-conversion mode when sampling channels sequentially. In some cases, however, it may be desirable not to increment to the next channel automatically. For example, an application may require that individual channels be sampled repeatedly, in either single-conversion or data channel mode. To accommodate these situations, the automatic channel increment feature can be disabled by adjusting the controller.

Synchronization to a Clock

Channel sampling may optionally be synchronized to a clock. A clock is included as standard equipment with all A/D subsystems. The period of this internal clock is mechanically adjustable within the range 10 to 100 microseconds. To provide clock periods outside of this range or a more accurate clock, the user may supply his own external clock.

When the subsystem is configured with either type of clock active, the Start and Pulse commands do not directly trigger a conversion--they prime the clock to do it. In other words, after the Busy flag is set to 1 by the Start or Pulse commands, the next occurring clock pulse will trigger the conversion.

A clock is used in either single-conversion or data channel mode to maintain a constant sampling rate for a sequence of conversions. The first conversion is triggered by the first clock pulse after the

Start or Pulse command, and hence may occur at any time up to the clock period. Succeeding conversions will be triggered at the clock frequency, provided that the Busy flag is 1 when each successive clock pulse occurs. In single-conversion mode, the program must issue another Start command (to set the Busy flag back to 1) before each clock period expires in order to maintain the sampling rate. In data channel mode, the Busy flag remains set to 1 until the entire sequence of conversions has been completed, so successive clock pulses will always trigger new conversions. (If, due to an overloaded data channel, the previous converter result has not yet been transferred to memory when the next clock pulse occurs, the previous result is lost and all following conversions in the sequence are invalid. No indication of this is given.)

NOTE At shipping time, the internal clock is disabled. Therefore, unless this clock is enabled or an external one is installed, the Start and Pulse commands will directly trigger conversions.

Power-Up Conditions

When power for the A/D subsystem is turned on, the state of all of the registers in the interface is indeterminate. All relevant registers must therefore be initialized by the program before the first valid conversion can be performed.

The first conversion performed after power-up will always produce a value of minus full scale (-FS); thereafter, conversions will yield correct results. The program can allow for this phenomenon by executing one dummy conversion after power-up. Since the result will be ignored, the program need not initialize any registers for this conversion. An NIOS instruction is therefore sufficient to start the conversion. The program must be sure to wait for this dummy conversion to finish before starting any other conversions.

Channel Numbering

The channels in the system are numbered consecutively from 0 up to one less than the total number of channels. For example, in a 16-channel system the first channel is channel 0 and the last one is channel 15 (channel 17_g).

INSTRUCTIONS: SINGLE-CONVERSION MODE

All of the six available I/O transfer instructions are used by the complete A/D subsystem. They can be grouped into two overlapping instruction sets, one for each basic operating mode. Single-conversion mode programming employs three of these instructions (four if the Programmable Gain Option is present). Five of the six instructions make up the data channel mode instruction set. When programming single conversions in a system which has the Data Channel Option, the expanded data channel mode versions of the three (or four) instructions used in single-conversion mode must be used.

The Busy and Done flags are set to 0 by the Clear command, by the I/O RESET instruction and by the Reset console switch. A Start command in any instruction sets the Busy flag to 1, sets the Done flag to 0, selects single-conversion mode, and triggers a conversion. A Pulse command sets the Busy flag to 1, sets the Done flag to 0, selects data channel mode, and triggers a sequence of conversions.

The single-conversion mode of operation is available on all systems, with or without the Data Channel Option. This section describes the instructions used in single-conversion mode for subsystems which do not include the option. The additional considerations which apply when the system includes data channel operation are given in a later section entitled "Programming: Single-Conversion Mode with Data Channel Option Present".

Basic Controller

The basic A/D subsystem controller contains a Channel Select Register, interrupt control logic, and an internal clock. With the Programmable Gain Option the controller also contains a Gain Select Register.

Channel Select Register

The 8-bit Channel Select Register specifies the channel on which the next conversion is to be performed. It is set up by the program through a SELECT CHANNEL instruction (DOA). It may be

read with a READ CHANNEL SELECT instruction (DIA). Unless the automatic channel increment feature is disabled, the Channel Select Register is incremented at the end of each conversion in preparation for a conversion on the next sequential channel.

In a multi-channel subsystem the multiplexor selects the correct channel according to control signals from the Channel Select Register. The subsystem capacity of 32 channels requires only five bits for actual channel selection. The low-order five bits of the Channel Select Register specify the channel; the high-order three bits are ignored at present and are reserved for future system expansion. In a single-channel subsystem there is no multiplexor, and though there still is a Channel Select Register (which can be loaded and read with the SELECT CHANNEL and READ CHANNEL SELECT instructions), it is not meaningful to the controller.

Interrupt Logic and Clock

The controller's interrupt control logic includes the usual Busy and Done flags. The Clear command sets both flags to 0. The Start command sets the Busy flag to 1 and the Done flag to 0. Start triggers a conversion directly if the internal clock is disabled and no external clock is installed. When either type of clock is enabled, the conversion is not triggered until the first clock pulse following the Start command. The end-of-conversion signal from the converter sets the Busy flag to 0, sets the Done flag to 1, and initiates an interrupt request.

Gain Select Register

The controller for a subsystem with the Programmable Gain Option also includes a 2-bit Gain Select Register, which is set up by the SELECT GAIN instruction (DOC). This instruction is used only when the Programmable Gain Option is present. Moreover, when the subsystem includes this option, this instruction must be used, since upon power-up, the Gain Select Register is in an indeterminate state. A SELECT GAIN instruction must be given after power-up and thereafter whenever a gain change is desired.

Instruction Set

SELECT CHANNEL

DOA <f> ac, ADCV

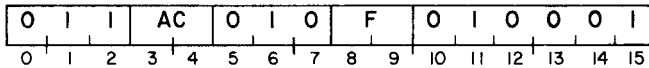

Bits 8-15 of the specified AC are loaded into the Channel Select Register. Bits 0-7 of the specified AC are ignored. After the data transfer, the controller's Busy and Done flags are set according to the function specified by F. The contents of the specified AC remain unchanged. The format of the specified AC is as follows:

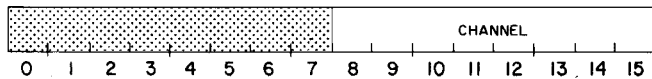

Bits	Name	Function
0-7	---	Reserved for the Data Channel Option.
8-15	Channel	Select channel 0-37 ₈ for the next conversion.

READ CHANNEL SELECT

DIA <f> ac, ADCV

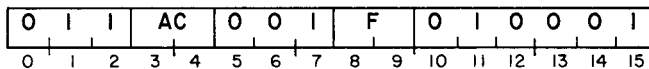

The contents of the Channel Select Register are placed in bits 8-15 of the specified AC. Bits 0-7 of the specified AC are set to 0. After the data transfer, the controller's Busy and Done flags are set according to the function specified by F. The format of the specified AC is as follows:

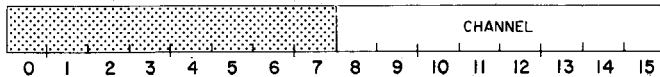

Bits	Name	Contents
0-7	---	Reserved for future use.
8-15	Channel	The next channel to be sampled--in other words, the channel on which the next S (or P) command will trigger a conversion. Unless the automatic channel increment feature is disabled, this channel number is one greater than the number of the channel last sampled.

SELECT GAIN

DOC <f> ac, ADCV

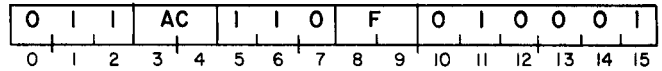

Bits 0 and 1 of the specified AC are loaded into the Gain Select Register. Bits 2-15 of the specified AC are ignored. After the data transfer, the controller's Busy and Done flags are set according to the function specified by F. The contents of the specified AC remain unchanged.

The SELECT GAIN instruction is used only when the PROGRAMMABLE Gain Option is present. (See Basic Controller section.) If this option is not included in the subsystem, the instruction is a functional "No-op". The format of the specified AC is as follows:

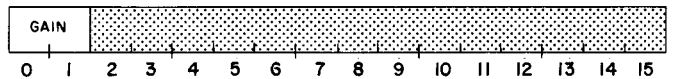

Bits	Name	Function
0-1	Gain	Select the gain as follows: 00 X1 01 X2 10 X4 11 X8
2-15	---	Reserved for Data Channel Option.

READ DATA

DIC <f> ac, ADCV

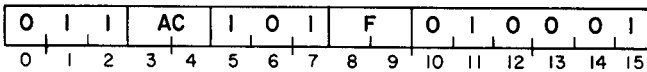

The n-bit output (n=10 or 12) from the A/D converter is placed in the rightmost n bits of the specified AC. If the A/D subsystem is unipolar, the remaining high-order AC bits are set to 0. If the system is bipolar, the remaining high-order AC bits are set to the value of the most significant bit of the converter output (i.e., the sign of the data is extended to the left). After the data transfer, the controller's Busy and Done flags are set according to the function specified by F. The format of the specified AC is as follows:

10-bit unipolar

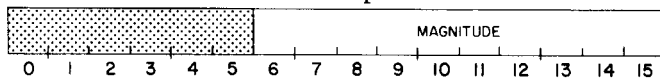

or

12-bit unipolar

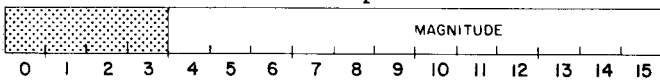

Bits	Name	Contents
0-5 or 0-3	---	Reserved for future use.
6-15 or 4-15	Magnitude	10- or 12-bit digital representation of the analog value which was converted.

10-bit bipolar

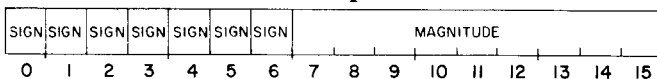

or

12-bit bipolar

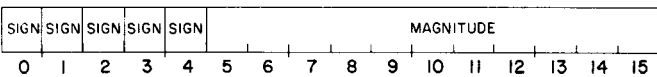

Bits	Name	Contents
0-6 or 0-4	Sign	Sign of the digital representation of the analog value; 0 is positive, 1 is negative.
7-15 or 5-15	Magnitude	9- or 11-bit digital representation of the analog value which was converted. If the sign bits are 1, this is the two's complement of the absolute magnitude of the value.

PROGRAMMING: SINGLE-CONVERSION MODE

The programming for a single-conversion can be divided conceptually into three stages, during which the actions performed by the program are as follows:

1. The controller is set up and the conversion is initiated.
2. The program waits until the conversion is done.
3. The converter data is read into the computer.

The programming for each stage is described more fully below.

Setting up the controller consists of selecting a channel and (optionally) selecting a gain. The SELECT CHANNEL (DOA) and SELECT GAIN (DOC) instructions may be given in either order, but they must both precede the Start command which triggers the conversion. The Start command may be given alone (NIOS), but it is usually appended to the last select instruction given. For consistency it is recommended that the SELECT GAIN instruction (DOC) be given first if it is given at all, followed by the SELECT CHANNEL instruction combined with the Start command (DOAS). (In a single-channel system a DOCS or an NIOS is sufficient.)

To read the converter data into an accumulator the program must give a READ DATA instruction (DIC). This instruction may appear any time after the program has determined that the conversion is done. The converter result accessed by the READ DATA instruction remains available until a new conversion is begun and may be read repeatedly if desired.

The procedures described above, with the following additional note, are sufficient for programming a single isolated conversion. When using interrupts, the Done flag must be set to 0 before exiting from the interrupt handling routine--otherwise, when interrupts are again enabled an unwanted interrupt will occur. The Done flag may be set to 0 by appending to the READ DATA instruction a Clear command (DICC).

To implement a series of conversions, the program should respond to each conversion completion by reading the data and initiating a new conversion. For a series of random channel samplings, the DIC instruction can be followed by a DOAS instruction or a DOC, DOAS sequence. For a series of sequential channel samplings, the program need only issue a Start command to initiate a conversion on the next channel (providing that the automatic channel increment feature is enabled). If the gain need not be switched, the Start command may be appended to the READ DATA instruction (DICS).

Example

The following sample subroutine executes a single-conversion to sample an analog input channel each time it is called. It is called with a JSR CNVRT instruction with the channel number in AC0 and the gain in AC1 (in bits 0 and 1). It returns to the instruction following the JSR CNVRT instruction with the converted data in AC0. The contents of AC3 are destroyed when the JSR is executed. The subroutine does not use interrupts; A/D subsystem interrupts must be disabled.

```
CNVRT: DOC    1, ADCV ;Select gain
        DOAS   0, ADCV ;Select channel and
                ; start conversion
        SKPDN  ADCV  ;Wait for end-of-
        JMP    .-1   ; conversion
        DIC    0, ADCV ;Read converted data
        JMP    0, 3   ;Return
```

INSTRUCTIONS: DATA CHANNEL MODE

The Data Channel Option, which consists of an extension to the basic A/D subsystem controller, adds data channel operation to the subsystem. This section describes the instructions used in the data channel mode. For programming single-conversions in a subsystem which has the Data Channel Option, see the following section.

Extended Controller

The extended A/D subsystem controller contains all of the components of the basic controller: the Channel Select Register, the interrupt control logic, and the internal clock. In addition, it contains a Limit Channel Register and the components necessary for data channel operation: a Memory Address Counter, a Word Count Register, and data channel control logic. As with the basic controller, if the subsystem includes the Programmable Gain Option, there is also a Gain Select Register.

Channel Selection Registers

In addition to the 8-bit Channel Select Register, the extended controller contains an 8-bit Limit Channel Register. After a conversion on the channel specified by the Limit Channel Register, the Channel Select Register is set to 0 instead of being incremented. This allows the program to treat the channels from 0 to the limit as a continuous cycle for sequential channel sampling purposes. The SELECT CHANNEL AND LIMIT instruction (DOA) sets up both the Channel Select Register and the Limit Channel Register. It is an extended form of the SELECT CHANNEL instruction used in single-conversion mode. Similarly, the READ CHANNEL SELECT AND LIMIT instruction (DIA), which reads these two registers, is an extended form of the READ CHANNEL SELECT instruction.

Normally, the end-of-conversion signal from the A/D converter increments the Channel Select Register, a comparison is made with the Limit Channel Register, and the Channel Select Register is set to 0 if its incremented contents specify a channel number above the limit. This automatic channel increment feature may be disabled, in which case the Channel Select Register is never incremented--it changes only when set by a SELECT CHANNEL AND LIMIT instruction.

NOTE In this case, however, if the Channel Select Register is set to a channel number greater than or equal to the channel number specified for the Limit Channel Register, the Channel Select Register will be set to 0 after the first conversion on the specified channel, and all subsequent samplings will be on channel 0.

In a multi-channel subsystem the multiplexor selects the correct channel according to control signals from the Channel Select Register. The low-order five bits are sufficient to specify any channel up to the subsystem maximum of 32 channels. The high-order three bits are ignored in actual channel selection and are reserved for future subsystem expansion; however, they are not ignored when the check against the Limit Channel Register is made to determine whether to set the Channel Select Register to 0. In a single-channel subsystem, there is no multiplexor, and though the controller still contains a Channel Select Register and a Limit Channel Register (which can be loaded and read with the SELECT CHANNEL AND LIMIT and READ CHANNEL SELECT AND LIMIT instructions), these registers are not meaningful to the controller.

Interrupt Logic and Clock

As in the basic controller, the interrupt control logic in the extended controller includes the usual Busy and Done flags. The Clear command sets both flags to 0. The Pulse command sets the Busy flag to 1 and the Done flag to 0. The Pulse command directly triggers a sequence of conversions if the internal clock is disabled and no external clock is installed. When either type of clock is enabled, the first conversion is not triggered until the first clock pulse following the Pulse command. Subsequent conversions are triggered on successive clock pulses.

Each end-of-conversion signal from the A/D converter initiates a data channel transfer request to send the converter output to memory. When the entire sequence of conversions has been completed, the Busy flag is set to 0, the Done flag is set to 1, and a program interrupt request is initiated.

Memory Address Counter

The 15-bit Memory Address Counter specifies the address in memory which is to receive, via the data channel, the digital result of the next A/D conversion. It is set up by a LOAD MEMORY ADDRESS COUNTER instruction (DOB) before a sequence of conversions and data channel transfers is begun. After each data channel transfer, the Memory Address Counter is incremented automatically so that successive converter results go into consecutive memory locations.

The Memory Address Counter may be read with a READ MEMORY ADDRESS COUNTER instruction (DIB). This instruction can be used after a complete sequence of conversions to determine the next available memory location--the Memory Address Counter always specifies an address one greater than the address into which the most recent converter data was placed. The instruction may be used at any time, even during a conversion, without disrupting subsystem operation.

Word Counter

The Word Counter is a 12-bit counter used to signal the end of a sequence of conversions in data channel mode. It specifies the two's complement of the number of conversions to be performed in sequence, from 1 up to a maximum of $2^{12} = 4096$ conversions. The Word Counter is automatically incremented along with the Memory Address Counter after each data channel transfer. When the

count reaches 0, the Busy flag is set to 0, the Done flag is set to 1, and a program interrupt request is initiated.

The Word Counter is set up by either a LOAD WORD COUNTER instruction or a LOAD WORD COUNTER AND SELECT GAIN instruction, depending upon whether or not the Programmable Gain Option is included in the subsystem. Both are forms of the DOC instruction.

Gain Select Register

The extended controller for a subsystem with the Programmable Gain Option also includes a 2-bit Gain Select Register, identical to that in the basic controller. Subsystems with this option in addition to the Data Channel Option use the same instruction (DOC) to load both the Gain Select Register and the Word Counter. The 2-bit gain and the 12-bit word count are both set up each time the LOAD WORD COUNTER AND SELECT GAIN instruction is used. The desired gain must therefore be coded into the accumulator for this instruction each time the instruction is given, even if it is desired that the gain remain the same. The selected gain is the same for all conversions in a sequence of conversions using the data channel.

SELECT CHANNEL AND LIMIT

DOA <f> ac, ADCV

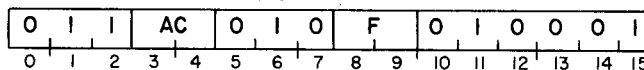

Bits 0-7 of the specified AC are loaded into the Limit Channel Register. Bits 8-15 of the specified AC are loaded into the Channel Select Register. After the data transfer, the controller's Busy and Done flags are set according to the function specified by F. The contents of the specified AC remain unchanged. The format of the specified AC is as follows:

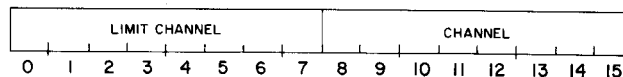

Bits	Name	Contents
0-7	Limit Channel	Maximum channel number for a series of conversions transferred via the data channel.
8-15	Channel	Starting channel for the series of conversions.

READ CHANNEL SELECT AND LIMIT

DIA <f> ac, ADCV

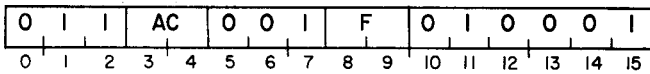

The contents of the Limit Channel Register are placed in bits 0-7 of the specified AC. The contents of the Channel Select Register are placed in bits 8-15 of the specified AC. After the data transfer, the controller's Busy and Done flags are set according to the function specified by F. The format of the specified AC is as follows:

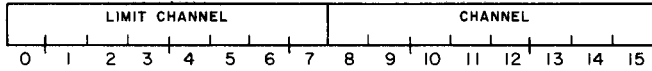

Bits	Name	Contents
0-7	Limit Channel	The Limit Channel Register specifies the highest-numbered channel which will be sampled. Following a sampling on the limit channel, the Channel Select Register will be set to 0 instead of being incremented.
8-15	Channel	The Channel Select Register always specifies the next channel to be sampled--in other words, the channel on which the next P (or S) command will trigger a conversion. Unless the automatic channel increment feature is hardware disabled, this channel number is either 0 or one greater than the number of the channel last sampled.

LOAD MEMORY ADDRESS COUNTER

DOB <f> ac, ADCV

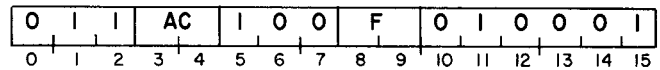

Bits 1-15 of the specified AC are loaded into the Memory Address Counter. Bit 0 of the specified AC is ignored. After the data transfer, the controller's Busy and Done flags are set according to the function specified by F. The contents of the specified AC remain unchanged. The format of the specified AC is as follows:

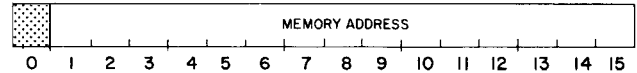

Bits	Name	Contents
0	---	Reserved for future use.
1-15	Memory Address	Location of the next word in memory to be used in a data channel transfer.

READ MEMORY ADDRESS COUNTER

DIB <f> ac, ADCV

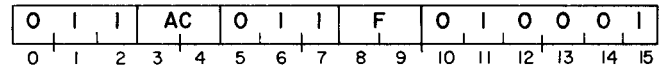

The contents of the Memory Address Counter are placed in bits 1-15 of the specified AC. Bit 0 of the specified AC is set to 0. After the data transfer, the controller's Busy and Done flags are set according to the function specified by F.

The Memory Address Counter always specifies the memory address which is to receive the next data word output by the A/D converter. After a sequence of conversions and data channel transfers has been completed, the Memory Address Counter contains an address one greater than the address into which the last data word was placed. The format of the specified AC is as follows:

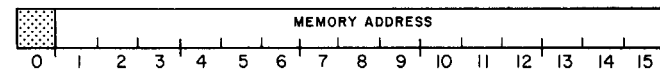

Bits	Name	Contents
0	---	Reserved for future use.
1-15	Memory Address	Location of the next word in memory to be used in a data channel transfer.

LOAD WORD COUNTER

DOC <f> ac, ADCV

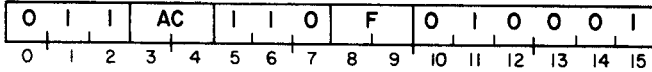

Bits 4-15 of the specified AC are loaded into the Word Counter. Bits 0-3 of the specified AC are ignored. After the data transfer, the controller's Busy and Done flags are set according to the function specified by F. The contents of the specified AC remain unchanged.

Bits 4-15 of the specified AC must contain the two's complement of the desired word count. The format of the specified AC is as follows:

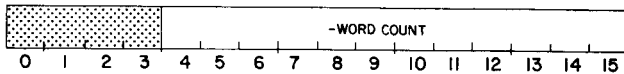

Bits	Name	Contents
0-3	---	Reserved for future use.
4-15	-Word Count	Two's complement of the number of conversions to be made and transferred.

NOTE The LOAD WORD COUNTER instruction is used only when the Programmable Gain Option is not present.

LOAD WORD COUNTER AND SELECT GAIN

DOC <f> ac, ADCV

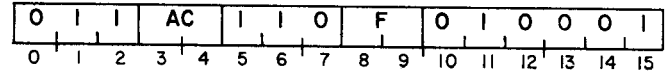

Bits 4-15 of the specified AC are loaded into the Word Counter. Bits 0 and 1 of the specified AC are loaded into the Gain Select Register. Bits 2 and 3 of the specified AC are ignored. After the data transfer, the controller's Busy and Done flags are set according to the function specified by F. The contents of the specified AC remain unchanged.

Bits 4-15 of the specified AC must contain the two's complement of the desired word count. The format of the specified AC is as follows:

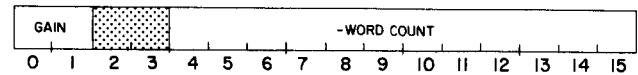

Bits	Name	Contents
0-1	Gain	Select the gain for the sequence of conversions as follows: 00 X1 01 X2 10 X4 11 X8
2-3	---	Reserved for future use.
4-15	-Word Count	Two's complement of the number of conversions to be made and transferred.

NOTE The LOAD WORD COUNTER AND SELECT GAIN instruction is used when the Programmable Gain Option is present.

Programming

The programming for data channel operation of the A/D subsystem comprises two stages:

1. The controller is set up and the sequence of conversions is initiated.
2. The program waits until the sequence of conversions is complete before accessing the converter results in memory.

No programming is necessary for reading the results into the computer, since the converter data is transferred automatically to memory via the data channel after each conversion. For this reason, the data channel mode provides rapid, automatic sequencing of conversions with minimal supervision from the program.

Setting up the extended controller consists of loading up to five registers, including the optional Gain Select Register. The three output instructions--SELECT CHANNEL AND LIMIT (DOA), LOAD MEMORY ADDRESS COUNTER (DOB), and either LOAD WORD COUNTER or LOAD WORD COUNTER AND SELECT GAIN (DOC)--accomplish this initialization. (In a single-channel subsystem the SELECT CHANNEL AND LIMIT instruction is unnecessary.) These instructions may be given in any order, but they must all precede the Pulse command. The Pulse command may be given alone (NIOP), but it is usually appended to the last select instruction given.

When all conversions in the sequence have been completed, the Done flag will be set to 1. At this point the results for the entire sequence of conversions are in memory and accessible to the program. The program can diagnose this condition in the usual ways, by testing the Done flag with an I/O SKIP instruction or by allowing a program interrupt to occur.

Initial word count values are loaded into the Word Counter from only the rightmost twelve bits of an accumulator. If the Programmable Gain Option is not present in the subsystem, accumulator bits 0-3 are ignored when the LOAD WORD COUNTER in-

struction (DOC) is given. The program may, therefore, load the accumulator with the normal 16-bit representation of the word count (between -1 and -4096) instead of the less convenient 12-bit representation. However, if the subsystem includes the Programmable Gain Option, bits 0 and 1 of the LOAD WORD COUNTER AND SELECT GAIN instruction (DOC) are used to select the gain. In this case the desired gain must be coded into accumulator bits 0 and 1 every time the word count is initialized.

Example

The following sample programming excerpt causes the extended controller to execute a sequence of conversions on channels 5 through 7 and on 0 through 2, in that order. The gain selected is two. The results are put into six locations in memory, beginning at BUFF. This code may be used with or without interrupts.

```
.
.
.
LDA 0,CHANS
DOA 0,ADCV ;Select channel and
           ; limit
LDA 0,ABUFF
DOB 0,ADCV ;Load Memory Ad-
           ; dress Counter
LDA 0,GWDCT
DOCP 0,ADCV ;Load word count and
            ; gain and trigger se-
            ; quence of conver-
            ; sions
.
.
.
CHANS: 3405 ;Limit channel of 7,
           ; channel select of 5
ABUFF: BUFF ;Target location
GWDCT: 47772 ;Gain of 2, word count
            ; of -6
BUFF: .BLK 6 ;6-word block for data
.
.
.
```

PROGRAMMING: SINGLE-CONVERSION MODE WITH DATA CHANNEL OPTION PRESENT

The programming of single-conversions in a subsystem that includes the Data Channel Option is a cross between the programming of the two basic modes. The methods are those of the single-conversion mode with the addition of the limit channel capability of the data channel mode. The instruction sequences are the same as in single-conversion mode, but since the extended controller is present, the data channel mode versions of some of these instructions must be employed.

In single-conversion mode the SELECT CHANNEL instruction (DOA) loads the Channel Select Register with the channel number contained in bits 8-15 of the specified accumulator; bits 0-7 of this AC are ignored and hence are usually programmed (by default) as zeroes. When the Data Channel Option is present, the same DOA instruction also sets up the Limit Channel Register, according to AC bits 0-7. If the program were to use the normal single-conversion mode channel select word, the Limit Channel Register would be set to 0. At the end of the conversion following the SELECT CHANNEL instruction, the Channel Select Register would be set to 0 instead of being incremented and automatic sequential channel selection would be disrupted. The normal sequential channel selection of single-conversion mode can be preserved by insuring that the Limit Channel Register always specifies a higher-numbered channel than the Channel Select Register does. The simplest way to do this is to set the Limit Channel Register to its maximum value, namely 255 (377₈), in which case sequences of single-conversions can be programmed just as if the Data Channel Option were not present.

By setting the Limit Channel Register to its maximum value, its limit channel function is effectively disabled. The program also has the option, however, of using this limit channel capability by setting the Limit Channel Register to some smaller value. In this case the channels from 0 to the limit are treated as a continuous cycle, just as in data channel mode. This capability would be useful if the program wanted to sample sequential channels cyclically, but not at regular intervals as in data channel mode.

A modified version of the single-conversion mode sample program CNVRT could be used to implement the sampling sequence described above. After setting up the gain (if necessary) and selecting the first channel and the limit channel, the following subroutine would be called (with a JSR NEXTC instruction) to trigger a conversion on the next se-

quential channel and return with the result in AC0. (A/D interrupts must be disabled, as before.)

```
NEXTC: NIOS   ADCV   ;Trigger next conver-
          ; sion
        SKPDN ADCV   ;Wait until done
        JMP   .-1
        DIC   0, ADCV ;Read data
        JMP   0, 3    ;Return
```

Except for the limit channel effects described above, single-conversion mode programming is the same for systems with and without the Data Channel Option.

TIMING CONSIDERATIONS

Maximum Conversion Time

Conversion time is defined as the time between the Start or Pulse command and the moment when either an interrupt or a data channel transfer is requested (in single-conversion mode and data channel mode, respectively). Maximum conversion time is the maximum amount of time that a conversion could require in an A/D subsystem of a given resolution. A given converter in a given controller will always take the same amount of time to perform its conversions. This actual conversion time depends on the given converter and controller hardware and is variable to a certain extent among different subsystems. For this reason maximum conversion times are specified for the A/D subsystem. These times are 13.3 μ sec for 10-bit subsystems and 36 μ sec for 12-bit subsystems. Subsystems of a given resolution are guaranteed to have their conversion times less than or equal to the maximum specified for that resolution.

Typical Maximum Conversion Rate

The maximum possible conversion rate is attained by a given subsystem when it is operating in data channel mode without a clock enabled. (If there are other peripherals also using the data channel, the A/D subsystem must be given the highest priority for this to be true.) The maximum conversion rate of a subsystem depends not only on the fixed conversion time, but also on the speed of the data channel in the computer being used. For this reason, typical maximum conversion rates are specified. For the 10-bit and 12-bit subsystems these typical maximum conversion rates are roughly 75,000 and 28,000 conversions per second, respectively.

Clock Settings

As described earlier, the period of the internal clock can be adjusted between 10 and 100 microseconds (yielding frequencies of between 10kHz and 100kHz), and an external clock may be installed for more accuracy or for periods outside this range. No matter what clock range is available, however, there is an operational lower limit on the clock period which is determined by the configuration of the given subsystem. The clock period must be greater than the conversion time, or else clock pulses will start new conversions before the current ones are finished, producing unpredictable results. In fact, the clock period must be enough greater than the conversion time to allow for either the maximum programmed I/O latency in single-conversion mode or the maximum data channel latency in data channel mode.

Additional Considerations

The program should be careful not to start a new conversion while one is still in progress, as this produces unpredictable results. More generally, during a conversion or sequence of conversions, the program should normally avoid giving any instructions which alter the states of any of the registers or flags in the controller.

The Clear command is normally used only to set the Done flag to 0 after an interrupt has occurred if another conversion is not to be started immediately. However, if it is necessary to idle the A/D subsystem while it is running, the Clear command can also be used for this purpose. It should be noted that, although the Clear command idles the subsystem controller, it does not abort a conversion already begun by the A/D converter. Once an actual conversion has been started, it will necessarily proceed to completion. Setting the Busy flag to 0 with the Clear command merely inhibits the initiation of either the interrupt request or the data channel transfer request which normally would have occurred when the conversion was completed. Thus, if a Clear command is given during a conversion, the subsystem is not really idle until the conversion has finished. For this reason, the pro-

gram should wait at least one conversion time after idling a running subsystem before attempting to start a new conversion or sequence of conversions.

In single-conversion mode the Clear command might be used to ignore the conversion in progress if the subsystem were then to remain idle for some time. However, there is little reason to use the Clear command when executing a single-conversion if it is desired to start a new conversion right away. Even after giving the Clear command, the program would have to wait for the conversion to finish before starting another. For this reason it is more efficient for the program to allow the end-of-conversion interrupt to occur, to ignore the conversion by not reading in the result, and to start the new conversion immediately.

When used in data channel mode the Clear command causes termination of the sequence of conversions being performed after the conversion in progress is completed. The result of this conversion will not be transferred to memory, and no further conversions of the sequence will be performed. (The results of all conversions completed prior to the Clear command will have been transferred properly to memory provided the data channel responded in time to each request.) The Word Counter will contain the negative of the number of conversions by which the sequence was shortened, and the Memory Address Counter will contain the address into which the result from the conversion in progress would have gone. Again, the program must allow enough time for the actual conversion in progress to finish before starting a new conversion or sequence of conversions.

In data channel mode, as in single-conversion mode, there is a more efficient way than the Clear command to terminate the current sequence of conversions when another is to be started right away. The program need only set the word count to -1 while the sequence of conversions is being executed. When the conversion in progress finishes, the result will be transferred to memory as usual. The Word Counter will be incremented up to 0, thereby terminating the sequence of conversions and requesting an interrupt. The program can then respond to the interrupt by starting a new conversion or sequence of conversions immediately.

4180 SERIES DIGITAL/ANALOG CONVERSION SUBSYSTEM

CONFIGURATIONS

The Digital/Analog Conversion subsystem provides any DGC computer with the capability of directly controlling external analog devices. The subsystem may be configured with either one or two analog output channels. The output voltage range may be mechanically selected independently for each channel from among the following ranges: $\pm 2.5V$, $\pm 5V$, $\pm 10V$, and 0 to 10V. (Note: Unipolar and bipolar ranges may not be mixed in the same subsystem.) The subsystem resolution is twelve bits, providing 4096 discrete analog values, regardless of the range or ranges chosen.

Scope Control Option

The Scope Control Option provides all necessary control functions for interfacing the computer to any typical storage or non-storage oscilloscope. Two output channels are required for this application--one to drive the horizontal input and one for the vertical input of the oscilloscope. The operation and programming of the Scope Control Option are fully described later in this chapter.

OPERATION

The subsystem controller contains a separate 12-bit data register and D/A converter for each output channel. Each D/A converter continuously converts the digital value stored in its corresponding data register to an analog output signal. Whenever the contents of a data register are changed by the program, the converter on that channel begins converting the new value immediately. It takes five microseconds before the new digital value is accurately represented by the analog output value. The output remains constant at the new analog value until the data register's contents are changed again.

The controller also contains a Channel Select Bit to specify the channel. The two channels are numbered 0 and 1, corresponding to the value of this bit. When digital data is sent to the controller for conversion, the Channel Select Bit determines which data register will receive the new value.

SUMMARY

DEVICE MNEMONIC DACV
 DEVICE CODE 23₈
 PRIORITY MASK BIT..... None
 RESOLUTION 12 bits
 SETTLING TIME TO 0.01%
 OF FINAL VALUE 5 μ sec
 ACCURACY $\pm 0.02\%$ of FSR

ACCUMULATOR FORMATS

SELECT CHANNEL DOB

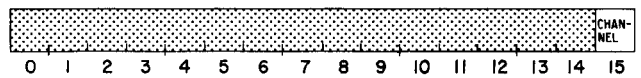

OUTPUT DATA AND CONVERT DOA

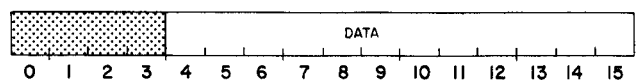

SCOPE CONTROL

SELECT SCOPE MODE DOC

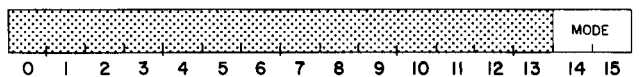

READ ERASE STATUS DIA

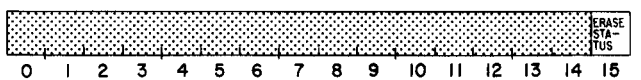

S, C AND P FUNCTIONS

(SCOPE CONTROL ONLY)

- S Z-axis control
- C No effect
- P Erase scope

When power is turned on for the subsystem, the data registers and the Channel Select Bit are in indeterminate states. The initial outputs of the D/A converters are hence undefined.

The Channel Select Bit is present even in a single-channel subsystem. To insure that this single-channel (channel 0) is operable, channel 0 must be explicitly selected (once) after each power-up.

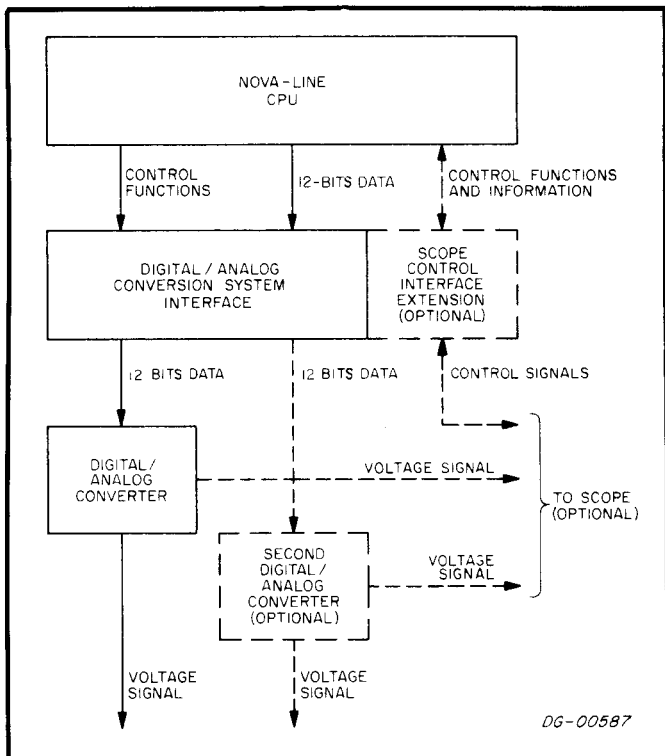

The D/A subsystem controller has no data channel or interrupt facilities. Interrupt facilities are not required since there is no need for the program to know when a conversion is complete. The program need not wait for the end of a conversion before proceeding with another, nor must it perform any specific action when a conversion is complete. Similarly, flag control commands are unnecessary--the D/A converters are always converting whatever values are contained in the data registers, and new values are converted automatically when they are placed in the registers. (The Start and Pulse commands are used by the Scope Control Option; the Clear command has no effect.)

INSTRUCTIONS: D/A

The basic D/A conversion subsystem (without the Scope Control Option) uses only two I/O instructions--one selects the channel and the other sends digital data to the controller. Interrupts and the flag control commands (Start, Clear, and Pulse) are not used by the basic controller.

SELECT CHANNEL

DOB <f> ac, DACV

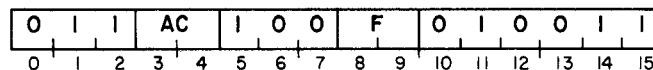

Bit 15 of the specified AC is loaded into the Channel Select Bit. Bits 0-14 of the specified AC are ignored. After the data transfer, the function specified by F is generated. The contents of the specified AC remain unchanged. The format of the specified AC is as follows:

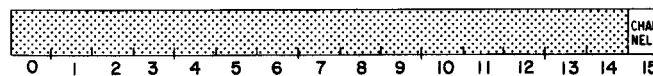

Bits	Name	Contents
0-14	---	Reserved for future use.
15	Channel	Select the channel 0 or 1.

OUTPUT DATA AND CONVERT

DOA <f> ac, DACV

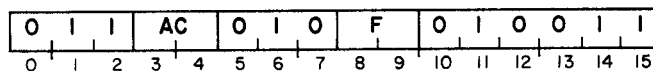

Bits 4-15 of the specified AC are loaded into the data register for the channel specified by the Channel Select Bit. Bits 0-3 of the specified AC are ignored. After the data transfer, the function specified by F is generated. The contents of the specified AC remain unchanged. The two allowable formats of the specified AC are as follows:

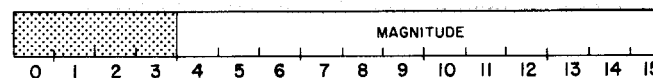

Unipolar systems

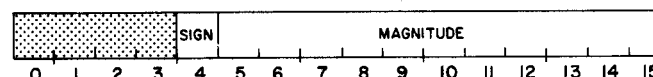

Bipolar systems

Bits	Name	Contents
0-3	---	Reserved for future use.
4 (bipolar)	Sign	Sign bit for magnitude 0 = positive, 1 = negative.
4-15 (unipolar) 5-15 (bipolar)	Magnitude	Digital value to be converted to an analog value.

PROGRAMMING: D/A

To generate a single-conversion, the program can give a SELECT CHANNEL instruction (DOB) followed by an OUTPUT DATA AND CONVERT instruction (DOA). If consecutive conversions are on the same channel, it is not necessary to reselect the channel. For a sequence of conversions on the same channel, the program need issue only one SELECT CHANNEL instruction followed by any number of OUTPUT DATA AND CONVERT instructions.

For a sequence of conversions on alternate channels, the program may simplify the channel selection by merely incrementing between conversions the accumulator used to specify the channel in the SELECT CHANNEL instruction. Only bit 15 of this accumulator participates in channel selection; the other bits are ignored. Of course, the accumulator's contents must not be destroyed between channel selections.

The fact that the high-order four bits of data words are ignored when the OUTPUT DATA AND CONVERT instruction is given simplifies both the initialization of negative data words in an assembly language program and the arithmetic operations on signed data during program execution. The program may set up and use normal signed as well as unsigned integers with correct results as long as the actual 12-bit range of the system is not exceeded. For unipolar systems the actual range is 0 to 4095 (0 to 7777₈); for bipolar systems it is -2048 to +2047 (174000₈ to 3777₈).

Timing and Accuracy Considerations

The contents of a data register are changed when an OUTPUT DATA AND CONVERT instruction is given. However, it takes a significant amount of time for the D/A converter to switch its analog output value accordingly. The value that the analog output ultimately attains, corresponding to the new digital value, is known as the "final value". This final value represents the new digital value to an accuracy of 0.02% of the full scale range.

After the conversion of a new digital value is begun, analog output value is indeterminate for up to five

microseconds. At the end of this 5 μ sec "settling time", the analog output value is guaranteed to be within 0.01% of the final value. Note that the converter output may be in error as much as 0.02% + 0.01% = 0.03% at this point. If no new digital data is introduced to the data register, the converter output will become accurate to within the specified 0.02% a short time later.

Despite the settling time described above, there is no harm in starting another conversion on a channel within five microseconds of the beginning of the last conversion on that channel. The converter is always converting the contents of its data register, so the aborted conversion is "forgotten" and the conversion of the new digital value is begun immediately.

Example

The following sample subroutine DASEQ performs a rapid sequence of D/A conversions. It is entered by executing a JSR DASEQ instruction in the calling program. AC1 contains the two's complement of the number of conversions to perform; AC2 contains the address of a block of data. Each word of data in the block is presumed to contain twelve bits of converter data in bits 3-14 and the desired channel number in bit 15 as follows:

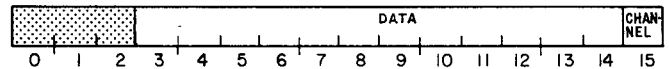

The subroutine fetches each data word in turn, selects the channel according to bit 15, right-justifies the 12-bit data, outputs the data to the selected channel, and increments the word count. When the count reaches 0, the subroutine returns to the instruction in the calling program following the JSR DASEQ instruction.

```
DASEQ: LDA 0,0,2 ;Fetch data to AC0
        DOB 0,DACV ;Select channel
        MOVR 0,0 ;Shift 12-bit data into
                ; place
        DOA 0,DACV ;Output data and convert
        INC 2,2 ;Point to next data word
        INC 1,1,SZR ;Increment word count
        JMP DASEQ ;Loop back
        JMP 0,3 ;Return
```

SCOPE CONTROL OPTION

The Scope Control Option provides for program control of any typical storage or non-storage oscilloscope. Capabilities include display screen operation, beam intensification control, storage scope erasing, and two additional signals that may be used as needed to control special aspects of a particular scope.

Operation

Display Screen Operation

Operating an oscilloscope as a display screen requires that the scope have an external horizontal input and that the D/A conversion system include two output channels. The two channels are connected to the horizontal and vertical inputs (X and Y axes) of the scope. Individual points are located on the screen by specifying their X and Y coordinates.

Since the digital range of each D/A channel encompasses $2^{12} = 4096$ different values, the scope screen appears to the program as a 4096 x 4096 dot matrix. This is generally more than enough points to enable the illusion of continuous lines on the screen. To specify a point the program supplies the two coordinates by setting up both output channels with the correct values. The usual convention is to connect channel 0 to the X input and channel 1 to the Y input, but this is by no means mandatory.

Intensification Control

The intensity of the scope beam (known as the "Z-axis" of the scope) can be controlled by a signal which is sent to the scope when the Start command is generated by the program. This intensity signal is a pulse, with a beginning, duration, and end. The characteristics of this Z-axis pulse can be adjusted mechanically to meet the requirements of the scope and the programming.

The duration of the Z-axis pulse, as well as the delay between the issuance of the Start command and the beginning of the pulse, can be adjusted within the range 1.4 to 6 microseconds. The amplitude of the Z-axis pulse is variable in several increments, and both ac and dc coupling are available.

The Z-axis pulse may be a "blinking" or "unblanking" pulse. A blinking pulse makes the beam disappear for the duration of the pulse, with normal intensity returning at the end of the pulse. An unblanking pulse turns up the intensity to a level adequate for viewing for the pulse's duration and returns the screen to its blank state when the pulse is terminated.

The scope may be operated without the Z-axis control, keeping the beam always at normal intensity. In this case, however, "ghost" lines appear when the beam is moved from one point to another since the beam sweeps across the screen. One purpose of the Z-axis control is to eliminate these lines. The blanking type of pulse can be used to turn off the beam temporarily while the beam's coordinates are being changed. When the unblanking type of pulse is used, on the other hand, the screen is kept blank except for short periods of intensification corresponding to the durations of the pulses. The unblanking type of pulse is more commonly used since the programming is simpler--the program merely intensifies the beam temporarily with a Start command to display each point.

NOTE When using either a blanking Z-axis pulse or no Z-axis control at all, be careful not to harm the scope screen by leaving the beam intensified for an extended period of time without changing the coordinates.

Erase Control

The stored image of a storage scope may be erased under program control by issuing a Pulse command. Erasing can also be accomplished by means of a manual switch on the scope's front panel. Erase time is typically in the range one-tenth to one-half second.

If the particular scope being used generates an "erase status" signal which is properly connected to the D/A subsystem, the program can determine whether the scope is presently being erased by giving a READ ERASE STATUS instruction (DIA).

Additional Control Signals

Two additional control signals are provided which may be used to select one of several scope operating modes under program control. These two signals are independent of each other, and each is two-valued. The two possible values for each can be thought of as binary 0 and 1 or as logical false and true. These signals act like flags in that they remain in one state until the program assigns them a different value. The SELECT SCOPE MODE instruction (DOC) sets the value of both of these signals at once.

The use, if any, of these control signals is determined by the requirements and features of the particular scope being used. In one typical usage with a storage scope, one of the signals selects storage versus non-storage mode while the other selects "write-through" mode when the scope is in storage mode. In write-through mode points are displayed on the scope without being stored, while the information already stored is not affected.

INSTRUCTIONS: SCOPE CONTROL

The Scope Control Option uses the two instructions described for the basic D/A subsystem, two additional instructions described below, and the Start and Pulse commands. As described previously, a Pulse command erases the stored image of a storage scope, and a Start command is used to control the beam intensity. The Clear command is not used (it has no effect on the D/A controller), and there are no interrupt or data channel facilities.

SELECT SCOPE MODE

DOC <f> ac, DACV

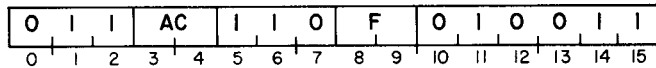

The scope mode is selected according to bits 14 and 15 of the specified AC. The effect of these bits depends on the scope and how it is interfaced to the D/A conversion subsystem. Bits 0-13 of the specified AC are ignored. After the mode selection, the function specified by F is performed. The contents of the specified AC remain unchanged. The format of the specified AC is as follows:

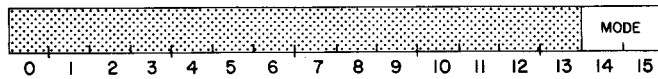

Bits	Name	Function
0-13	---	Reserved for future use.
14-15	Mode	Depends on the particular scope used and the manner in which it is interfaced to the controller.

READ ERASE STATUS

DIA <f> ac, DACV

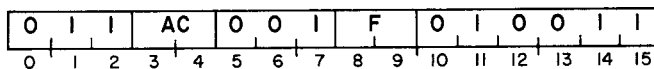

The scope erase status is read into bit 15 of the specified AC. Bits 0-14 of the specified AC are set to 0. After the data transfer, the function specified by F is performed. AC is formatted as follows:

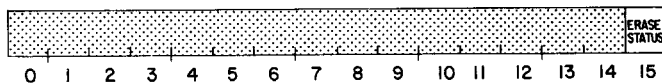

Bits	Name	Meaning if 1
0-14	---	Reserved for future use.
15	Erase Status	Scope is presently being erased.

PROGRAMMING: SCOPE CONTROL

To display a point on the scope screen, the program must supply the X and Y coordinates and then intensify the beam. To supply each coordinate, the program must give a SELECT CHANNEL instruction (DOB) to select the correct axis followed by an OUTPUT DATA AND CONVERT instruction (DOA) to specify the coordinate itself. The method for intensifying the beam depends on the type of Z-axis pulse for which the hardware is configured. For the unblanking Z-axis pulse, the program need only generate a single Start command by appending an "S" mnemonic modifier to the last I/O instruction which specifies the coordinates. The example program at the end of this chapter illustrates the use of the unblanking Z-axis pulse.

If the Z-axis pulse is a blanking pulse, it is generally used to blank the screen during the time it takes to switch the coordinates of the beam from one point to the next. In this case, three things are necessary:

1. The SELECT CHANNEL and OUTPUT DATA AND CONVERT instructions required to move the scope beam to the next point should follow each other in close succession;
2. The Start command should be included with each of these I/O instructions to keep the screen blank until all coordinate switching is done; and
3. The delay of the Z-axis pulse should be adjusted to its minimum value and the duration of the Z-axis pulse should be near its maximum value (at least $5\mu\text{sec}$).

For example, with the (blanking) Z-axis pulse delay set at $1.4\mu\text{sec}$ and the duration set at $5\mu\text{sec}$, the following code moves the scope beam from its current position to the point whose coordinates are stored at XCO and YCO, blanking the screen while the coordinates are being changed.

```
LDA 1,XCO ;AC1 holds X coordinate
SUB 0,0 ;Set AC0 to 0
DOBS 0,DACV ;Select X axis and blank
; screen
DOAS 1,DACV ;Set new X coordinate and
; continue blanking
INC 0,0 ;Set AC0 to 1
DOBS 0,DACV ;Select Y axis and continue
; blanking
LDA 1,YCO ;AC1 holds Y coordinate
DOAS 1,DACV ;Set new Y coordinate and
; continue blanking during
; settling time
```

Example

The following example program produces the image of a right isosceles triangle on a typical non-storage oscilloscope. The Z-axis pulse is assumed to be of the unblanking type. The resulting display appears as follows on the scope screen:

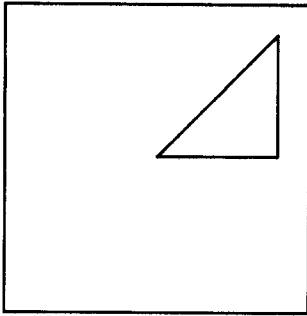

The program first initializes the accumulators. AC0 is used with the SELECT CHANNEL instructions to select the axes. AC1 holds, throughout the program, an incremental coordinate value (INCRE) which is added to or subtracted from the

coordinates of the current point to produce the coordinates of the next point. AC2 contains current coordinate data, either for the X axis (horizontal leg of the triangle), the Y axis (vertical leg), or both (hypotenuse). AC3 always contains a limiting coordinate value (LIMIT); comparisons between this value and the current coordinate value in AC2 enable the program to tell when it has reached the upper vertex at the end of the diagonal leg.

The main loop of the program, which is repeated indefinitely, comprises three smaller loops which "draw" the three sides of the triangle. The program starts at the origin and draws the hypotenuse at a 45° angle by setting the X and Y coordinates equal for each point. When the limiting value is reached, the program draws down the vertical side by outputting successively smaller Y coordinates without changing the X coordinate. When the Y coordinate becomes 0, the program displays the corner vertex and uses a similar procedure to draw the horizontal base. This time, when the X coordinate becomes 0, the program displays the origin (not displayed as part of any leg) and starts again on the hypotenuse.

```

;      PROGRAM TO DISPLAY AN ISOSCELES RIGHT TRIANGLE ON A
;      NON-STORAGE SCOPE

;      UNBLANKING Z-AXIS IS ASSUMED

SCOPE  = DACV

      .LOC      400

INIT:  SUBZL    0,0      ;AC0 HOLDS CHANNEL SELECT - INITIALLY 1
      LDA      1,INCR   ;AC1 HOLDS COORDINATE INCREMENT
      SUB      2,2      ;AC2 HOLDS COORDINATE DATA - INITIALLY 0
      LDA      3,LIMIT  ;AC3 HOLDS LIMIT COORDINATE FOR COMPARISON

DIAG:
LOOP1: INC      0,0      ;INCREMENT CHANNEL SELECT
AGAIN: ADD      1,2      ;INCREMENT COORDINATE DATA
      DOB      0,SCOPE  ;SELECT X AXIS
      DOA      2,SCOPE  ;SET X COORDINATE
      INC      0,0      ;INCREMENT CHANNEL SELECT
      DOB      0,SCOPE  ;SELECT Y AXIS
      DOAS     2,SCOPE  ;SET Y COORDINATE AND INTENSIFY BEAM
      SUBZ#    3,2,SNC  ;PAST LIMIT?
      JMP      LOOP1    ;NO, LOOP BACK
      STA      2,TEMP   ;YES, SAVE FINAL COORDINATE AND GO ON

VERT:
LOOP2: SUBZ     1,2,SNC  ;DECREMENT Y COORDINATE, SKIP IF INCR LE COORD
      JMP      HORIZ    ;Y COORDINATE IS 0 - REACHED X AXIS
      DOAS     2,SCOPE  ;SET NEW Y COORDINATE AND INTENSIFY BEAM
                        ;(Y AXIS IS ALREADY SELECTED)
      JMP      LOOP2    ;LOOP BACK

HORIZ: DOAS     2,SCOPE  ;DISPLAY CORNER VERTEX
      INC      0,0      ;INCREMENT CHANNEL SELECT
      DOB      0,SCOPE  ;SELECT X AXIS
      LDA      2,TEMP   ;RESTORE X COORDINATE
LOOP3: SUBZ     1,2,SNC  ;DECREMENT X COORDINATE, SKIP IF INCR LE COORD
      JMP      LAST     ;BOTH COORDINATES ARE 0
      DOAS     2,SCOPE  ;SET NEW X COORDINATE AND INTENSIFY BEAM
      JMP      LOOP3    ;LOOP BACK

LAST:  DOAS     2,SCOPE  ;DISPLAY ORIGIN
      JMP      AGAIN    ;REPEAT PROGRAM

INCR:  10
LIMIT: 2000
TEMP:  0

      .END      INIT

```

This page intentionally left blank.

APPENDICES

- I/O DEVICE CODES AND
DATA GENERAL MNEMONICS
- OCTAL AND HEXADECIMAL
CONVERSION
- ASCII - 128 CHARACTER CODES
EBCDIC CHARACTER CODES
- NOVA LINE COMPUTERS
INSTRUCTION EXECUTION TIMES
ECLIPSE COMPUTER
INSTRUCTION EXECUTION TIMES

This page intentionally left blank

APPENDIX A

I/O DEVICE CODES AND DATA GENERAL MNEMONICS

Device Code (Octal)	Mnemonic	Priority Mask Bit	Device
00	--	--	Power fail
01 ^o	WCS	--	Writeable control store
02 ^o	ERCC	--	Error checking and correction
03 ^o	MAP	--	Memory Allocation and Protection
01 ^o	MDV	--	Multiply/Divide
02 ^o	MMPU	--	Memory Management and Protection Unit
02* ^o	MAP0	--	Memory Allocation and Protection
03 ^o	MAP1	--	
04 ^o	MAP2	--	
05			
06	MCAT	12	Multiprocessor adapter transmitter
07	MCAR	12	Multiprocessor adapter receiver
10	TTI	14	Teletype input
11	TTO	15	Teletype output
12	PTR	11	Paper tape reader
13	PTP	13	Paper tape punch
14	RTC	13	Real time clock option
15	PLT	12	Incremental plotter
16	CDR	10	Card reader
17	LPT	12	Line printer
20	DSK	9	Fixed head disc
21	ADCV	8	A/D converter
22	MTA	10	Magnetic tape
23	DACV	--	D/A converter
24	DCM	0	Data communications multiplexor
25			
26			
27			
30	QTY	14	Asynchronous hardware multiplexor
31*	IBM1	13	IBM 360/370 interface
32	IBM2		
33	DKP	7	Moving head disc
34	CAS	10	Cassette tape
34*	MX1	11	Multiline asynchronous controller
35	MX2		
36	IPB	6	Interprocessor bus--half-duplex
37	IVT	6	IPB watchdog timer
40	DPI	8	IPB full-duplex input
41	DPO	8	IPB full-duplex output
40+	SCR	8	Synchronous communication receiver
41.	SCT	8	Synchronous communication transmitter

DG-01450

^o ECLIPSE computer only

^o NOVA line computers only

* code returned by INTA and used by VCT for ECLIPSE computer

+ may be set up with any unused even device code 40 or greater

· may be set up with any unused odd device code 41 or greater

APPENDIX A (Continued)

I/O DEVICE CODES AND DATA GENERAL MNEMONICS

Device Code (Octal)	Mnemonic	Priority Mask Bit	Device
42	DIO	7	Digital I/O
43	DIOT	6	Digital I/O timer
44	MXM	12	Modem control for multiline asynchronous controller
45			
46	MCAT1	12	Second multiprocessor transmitter
47	MCAR1	12	Second multiprocessor receiver
50	TTI1	14	Second teletype input
51	TTO1	15	Second teletype output
52	PTR1	11	Second paper tape reader
53	PTP1	13	Second paper tape punch
54	RTC1	13	Second real time clock option
55	PLT1	12	Second incremental plotter
56	CDR1	10	Second card reader
57	LPT1	12	Second line printer
60	DSK1	9	Second fixed head disc
61	ADCV1	8	A/D converter
62	MTA1	10	Second magnetic tape
63	DACV1	--	D/A converter
64* ^o	FPU1		
65 ^o	FPU2	5	Alternate location for floating point
66 ^o	FPU4		
67			
70	QTY1	14	Second asynchronous hardware multiplexor
70	SLA1	14	Second synchronous line adapter
71* } 72 }		13	Second IBM 360/370 interface
73	DKP1	7	Second moving head disc
74	CAS1	10	Second cassette tape
74* } 75 }		11	Second multiline asynchronous controller
74* ^o } 75 ^o }	FPU1 } FPU2 }	5	Floating point
76 ^o	FPU		
77	CPU	--	Central processor and console functions

DG-01450

*code returned by INTA and used by VCT for ECLIPSE computer

^oNOVA line computers only

APPENDIX B

OCTAL AND HEXADECIMAL CONVERSION

To convert a number from octal or hexadecimal to decimal, locate in each column of the appropriate table the decimal equivalent for the octal or hex digit in that position. Add the decimal equivalents to obtain the decimal number.

To convert a decimal number to octal or hexadecimal:

1. Locate the largest decimal value in the appropriate table that will fit into the decimal number to be converted;
2. note its octal or hex equivalent and column position;
3. find the decimal remainder.

Repeat the process on each remainder. When the remainder is 0, all digits will have been generated.

	8^5	8^4	8^3	8^2	8^1	8^0
0	0	0	0	0	0	0
1	32,768	4,096	512	64	8	1
2	65,536	8,192	1,024	128	16	2
3	98,304	12,288	1,536	192	24	3
4	131,072	16,384	2,048	256	32	4
5	163,840	20,480	2,560	320	40	5
6	196,608	24,576	3,072	384	48	6
7	229,376	28,672	3,584	448	56	7

	16^5	16^4	16^3	16^2	16^1	16^0
0	0	0	0	0	0	0
1	1,048,576	65,536	4,096	256	16	1
2	2,097,152	131,072	8,192	512	32	2
3	3,145,728	196,608	12,288	768	48	3
4	4,194,304	262,144	16,384	1,024	64	4
5	5,242,880	327,680	20,480	1,280	80	5
6	6,291,456	393,216	24,576	1,536	96	6
7	7,340,032	458,752	28,672	1,792	112	7
8	8,388,608	524,288	32,768	2,048	128	8
9	9,437,184	589,824	36,864	2,304	144	9
A	10,485,760	655,360	40,960	2,560	160	10
B	11,534,336	720,896	45,056	2,816	176	11
C	12,582,912	786,432	49,152	3,072	192	12
D	13,631,488	851,968	53,248	3,328	208	13
E	14,680,064	917,504	57,344	3,584	224	14
F	15,728,640	983,040	61,440	3,840	240	15

This page intentionally left blank.

APPENDIX C

ASCII - 128 CHARACTER CODES

Decimal	Hexa-decimal	7-Bit Octal	ASCII Graphic Or Control Characters	Explanation	To Produce On TTY Mod 33, 35	To Produce On TTY Mod 37	ASHCII Punched Card Code	8-Bit Octal
0	00	000	NUL	Null	P ^{°+}	Null*	12- 0-1-8-9	000
1	01	001	SOH	Start of Heading	A [°]	A [°]	12- 1-9	201
2	02	002	STX	Start of Text	B [°]	B [°]	12- 2-9	202
3	03	003	ETX	End of Text	C [°]	C [°]	12- 3-9	003
4	04	004	EOT	End of Transmission	D [°]	D [°]	7- 9	204
5	05	005	ENQ	Enquiry	E [°]	E [°]	0- 5-8-9	005
6	06	006	ACK	Acknowledge	F [°]	F [°]	0- 6-8-9	006
7	07	007	BEL	Bell	G [°]	G [°]	0- 7-8-9	207
8	08	010	BS	Back Space	H [°]	backspace*	11- 6-9	210
9	09	011	HT	Horizontal Tab	I [°]	tab	12- 5-9	011
10	0A	012	LF	Line Feed	line feed J [°]	new line*	0- 5-9	012
					line feed [°]			212
11	0B	013	VT	Vertical Tab	K [°]	K [°]	12- 3-8-9	213
12	0C	014	FF	Form Feed	L [°]	L [°]	12- 4-8-9	014
13	0D	015	CR	Carriage Return	return M [°]	return	12- 5-8-9	215
					return [°]			015
14	0E	016	SO	Shift Out	N [°]	N [°]	12- 6-8-9	216
15	0F	017	SI	Shift In	O [°]	O [°]	12- 7-8-9	017
16	10	020	DLE	Data Link Escape	P [°]	P [°]	12-11-1-8-9	220
17	11	021	DC1	Device Control 1	Q [°]	Q [°]	11- 1-9	021
18	12	022	DC2	Device Control 2	R [°]	R [°]	11- 2-9	022
19	13	023	DC3	Device Control 3	S [°]	S [°]	11- 3-9	223
20	14	024	DC4	Device Control 4	T [°]	T [°]	4- 8-9	024
21	15	025	NAK	Negative Acknowledge	U [°]	U [°]	5- 8-9	225
22	16	026	SYN	Synchronous Idle	V [°]	V [°]	2- 9	226
23	17	027	ETB	End of Transmission Block	W [°]	W [°]	0- 6-9	027
24	18	030	CAN	Cancel	X [°]	X [°]	11- 8-9	030
25	19	031	EM	End of Medium	Y [°]	Y [°]	11- 1-8-9	231
26	1A	032	SUB	Substitute	Z [°]	Z [°]	7- 8-9	232
27	1B	033	ESC	Escape	esc K ^{°+}	escape	0- 7-9	033
28	1C	034	FS	File Separator	L ^{°+}	\ [°]	11- 4-8-9	234
29	1D	035	GS	Group Separator	M ^{°+}] [°]	11- 5-8-9	035
30	1E	036	RS	Record Separator	N ^{°+}	^ [°]	11- 6-8-9	036
31	1F	037	US	Unit Separator	O ^{°+}	- [°]	11- 7-8-9	237
32	20	040	SP	Space	space	space	No Punches	240
33	21	041	!		1 ⁺	1 ⁺	12- 7-8	041
34	22	042	"		2 ⁺	2 ⁺	7- 8	042

D6-01016 (Sheet 1)

- ° Control
- + Shift
- * Repeat

APPENDIX C (Continued)

ASCII - 128 CHARACTER CODES

Decimal	Hexa- decimal	7-Bit Octal	ASCII Graphic Or Control Characters	Explanation	To Produce On TTY Mod 33, 35	To Produce On TTY Mod 37	ASHCII Punched Card Code	8-Bit Octal
35	23	043	#		3 ⁺	3 ⁺	3- 8	243
36	24	044	\$		4 ⁺	4 ⁺	11- 3-8	044
37	25	045	%		5 ⁺	5 ⁺	0- 4-8	245
38	26	046	&		6 ⁺	6 ⁺	12	246
39	27	047	'		7 ⁺	7 ⁺	5- 8	047
40	28	050	(8 ⁺	8 ⁺	12- 5-8	050
41	29	051)		9 ⁺	9 ⁺	11- 5-8	251
42	2A	052	*		: + [*]	: + [*]	11- 4-8	252
43	2B	053	+		; +	; +	12- 6-8	053
44	2C	054	,		,	,	0- 3-8	054
45	2D	055	-		-*	-*	11	055
46	2E	056	.		.*	.*	12- 3-8	056
47	2F	057	/		/	/	0- 1	257
48	30	060	0		0	0	0	060
49	31	061	1		1	1	1	261
50	32	062	2		2	2	2	262
51	33	063	3		3	3	3	063
52	34	064	4		4	4	4	264
53	35	065	5		5	5	5	065
54	36	066	6		6	6	6	066
55	37	067	7		7	7	7	267
56	38	070	8		8	8	8	270
57	39	071	9		9	9	9	071
58	3A	072	:		:	:*	2- 8	072
59	3B	073	;		;	;	11- 6-8	273
60	3C	074	<		, +	<	12- 4-8	074
61	3D	075	=		- +	=	6- 8	275
62	3E	076	>		. +	>	0- 6-8	276
63	3F	077	?		/ +	/	0- 7-8	077
64	40	100	@		P ⁺	@	4- 8	300
65	41	101	A		A	A ⁺	12- 1	101
66	42	102	B		B	B ⁺	12- 2	102
67	43	103	C		C	C ⁺	12- 3	303
68	44	104	D		D	D ⁺	12- 4	104
69	45	105	E		E	E ⁺	12- 5	305
70	46	106	F		F	F ⁺	12- 6	306
71	47	107	G		G	G ⁺	12- 7	107
72	48	110	H		H	H ⁺	12- 8	110
73	49	111	I		I	I ⁺	12- 9	311
74	4A	112	J		J	J ⁺	11- 1	312

DG-01016 (Sheet 2)

+ Shift
* Repeat

APPENDIX C (Continued)

ASCII - 128 CHARACTER CODES

Decimal	Hexa-decimal	7-Bit Octal	ASCII Graphic Or Control Characters	Explanation	To Produce On TTY Mod 33, 35	To Produce On TTY Mod 37	ASHCII Punched Card Code	8-Bit Octal
75	4B	113	K		K	K ⁺	11- 2	113
76	4C	114	L		L	L ⁺	11- 3	314
77	4D	115	M		M	M ⁺	11- 4	115
78	4E	116	N		N	N ⁺	11- 5	116
79	4F	117	O		O	O ⁺	11- 6	317
80	50	120	P		P	P ⁺	11- 7	120
81	51	121	Q		Q	Q ⁺	11- 8	321
82	52	122	R		R	R ⁺	11- 9	322
83	53	123	S		S	S ⁺	0- 2	123
84	54	124	T		T	T ⁺	0- 3	324
85	55	125	U		U	U ⁺	0- 4	125
86	56	126	V		V	V ⁺	0- 5	126
87	57	127	W		W	W ⁺	0- 6	327
88	58	130	X		X	X ⁺ *	0- 7	330
89	59	131	Y		Y	Y ⁺	0- 8	131
90	5A	132	Z		Z	Z ⁺	0- 9	132
91	5B	133	[K ⁺	[12- 2-8	333
92	5C	134	\		L ⁺	\	0- 2-8	134
93	5D	135]		M ⁺]	11- 2-8	335
94	5E	136	(^)		N ⁺	^	11- 7-8	336
95	5F	137	~ (-)		O ⁺	-*	0- 5-8	137
96	60	140	`			@ ⁺	1- 8	140
97	61	141	a			A	12- 0-1	341
98	62	142	b			B	12- 0-2	342
99	63	143	c			C	12- 0-3	143
100	64	144	d			D	12- 0-4	344
101	65	145	e			E	12- 0-5	145
102	66	146	f			F	12- 0-6	146
103	67	147	g			G	12- 0-7	347
104	68	150	h			H	12- 0-8	350
105	69	151	i			I	12- 0-9	151
106	6A	152	j			J	12-11-1	152
107	6B	153	k			K	12-11-2	353
108	6C	154	l			L	12-11-3	154
109	6D	155	m			M	12-11-4	355
110	6E	156	n			N	12-11-5	356
111	6F	157	o			O	12-11-6	157
112	70	160	p			P	12-11-7	360
113	71	161	q			Q	12-11-8	161
114	72	162	r			R	12-11-9	162

DG-01016 (Sheet 3)

+ Shift
* Repeat

APPENDIX C (Continued)

ASCII - 128 CHARACTER CODES

Decimal	Hexa- decimal	7-Bit Octal	ASCII Graphic Or Control Characters	Explanation	To Produce On TTY Mod 33, 35	To Produce On TTY Mod 37	ASHCII Punched Card Code	8-Bit Octal
115	73	163	s			S	11- 0-2	363
116	74	164	t			T	11- 0-3	164
117	75	165	u			U	11- 0-4	365
118	76	166	v			V	11- 0-5	366
119	77	167	w			W	11- 0-6	167
120	78	170	x			X*	11- 0-7	170
121	79	171	y			Y	11- 0-8	371
122	7A	172	z			Z	11- 0-9	372
123	7B	173	{			[+	12- 0	173
124	7C	174				\ +	12-11	374
125	7D	175	}]	11- 0	175
126	7E	176	~			^ +	11- 0-1	176
127	7F	177	DEL	Delete	rubout	delete*	12- 7-9	377

DG-01016 (Sheet 4)

- + Shift
- * Repeat

APPENDIX C (Continued)

EBCDIC CHARACTER CODES

Decimal	Hexadecimal	EBCDIC Graphic or Control Characters	Explanation	Punched Card Code
0	00	NUL	Null	12- 0-1-8-9
1	01	SOH	Start of Heading	12- 1-9
2	02	STX	Start of Text	12- 2-9
3	03	EXT	End of Text	12- 3-9
4	04	PF	Punch Off	12- 4-9
5	05	HT	Horizontal Tab	12- 5-9
6	06	LC	Lower Case	12- 6-9
7	07	DEL	Delete	12- 7-9
8	08			12- 8-9
9	09			12- 1-8-9
10	0A	SMM	Start of Manual Message	12- 2-8-9
11	0B	VT	Vertical Tab	12- 3-8-9
12	0C	FF	Form Feed	12- 4-8-9
13	0D	CR	Carriage Return	12- 5-8-9
14	0E	SO	Shift Out	12- 6-8-9
15	0F	SI	Shift In	12- 7-8-9
16	10	DLE	Data Link Escape	12-11-1-8-9
17	11	DC1	Device Control 1	11- 1-9
18	12	DC2	Device Control 2	11- 2-9
19	13	TM	Tape Mark	11- 3-9
20	14	RES	Restore	11- 4-9
21	15	NL	New Line	11- 5-9
22	16	BS	Back Space	11- 6-9
23	17	IL	Idle	11- 7-9
24	18	CAN	Cancel	11- 8-9
25	19	EM	End of Medium	11- 1-8-9
26	1A	CC	Cursor Control	11- 2-8-9
27	1B	CU1	Customer Use 1	11- 3-8-9
28	1C	IFS	Interchange File Separator	11- 4-8-9
29	1D	IGS	Interchange Group Separator	11- 5-8-9
30	1E	IRS	Interchange Record Separator	11- 6-8-9
31	1F	IUS	Interchange Unit Separator	11- 7-8-9
32	20	DS	Digit Select	11- 0-1-8-9
33	21	SOS	Start of Significance	0- 1-9
34	22	FS	Field Separator	0- 2-9
35	23			0- 3-9
36	24	BYP	Bypass	0- 4-9
37	25	LF	Line Feed	0- 5-9
38	26	ETB	End of Transmission Block	0- 6-9
39	27	ESC	Escape	0- 7-9
40	28			0- 8-9
41	29			0- 1-8-9
42	2A	SM	Set Mode	0- 2-8-9
43	2B	CU2	Customer Use 2	0- 3-8-9
44	2C			0- 4-8-9

APPENDIX C (Continued) EBCDIC CHARACTER CODES

Decimal	Hexadecimal	EBCDIC Graphic or Control Characters	Explanation	Punched Card Code
89	59			11- 1-8
90	5A	!		11- 2-8
91	5B	\$		11- 3-8
92	5C	*		11- 4-8
93	5D)		11- 5-8
94	5E			11- 6-8
95	5F	┘		11- 7-8
96	60	-		11
97	61	/		0- 1
98	62			11- 0-2-9
99	63			11- 0-3-9
100	64			11- 0-4-9
101	65			11- 0-5-9
102	66			11- 0-6-9
103	67			11- 0-7-9
104	68			11- 0-8-9
105	69			0- 1-8
106	6A	!		12-11
107	6B	.		0- 3-8
108	6C	%		0- 4-8
109	6D	-		0- 5-8
110	6E	>		0- 6-8
111	6F	?		0- 7-8
112	70			12-11-0
113	71			12-11-0-1-9
114	72			12-11-0-2-9
115	73			12-11-0-3-9
116	74			12-11-0-4-9
117	75			12-11-0-5-9
118	76			12-11-0-6-9
119	77			12-11-0-7-9
120	78			12-11-0-8-9
121	79			1- 8
122	7A	:		2- 8
123	7B	#		3- 8
124	7C	@		4- 8
125	7D	.		5- 8
126	7E	=		6- 8
127	7F	"		7- 8
128	80			12- 0-1-8
129	81	a		12- 0-1
130	82	b		12- 0-2
131	83	c		12- 0-3
132	84	d		12- 0-4

APPENDIX C (Continued)

EBCDIC CHARACTER CODES

Decimal	Hexadecimal	EBCDIC Graphic or Control Characters	Explanation	Punched Card Code
133	85	e		12- 0-5
134	86	f		12- 0-6
135	87	g		12- 0-7
136	88	h		12- 0-8
137	89	i		12- 0-9
138	8A			12- 0-2-8
139	8B			12- 0-3-8
140	8C			12- 0-4-8
141	8D			12- 0-5-8
142	8E			12- 0-6-8
143	8F			12- 0-7-8
144	90			12-11-1-8
145	91	j		12-11-1
146	92	k		12-11-2
147	93	l		12-11-3
148	94	m		12-11-4
149	95	n		12-11-5
150	96	o		12-11-6
151	97	p		12-11-7
152	98	q		12-11-8
153	99	r		12-11-9
154	9A			12-11-2-8
155	9B			12-11-3-8
156	9C			12-11-4-8
157	9D			12-11-5-8
158	9E			12-11-6-8
159	9F			12-11-7-8
160	A0			11- 0-1-8
161	A1	~		11- 0-1
162	A2	s		11- 0-2
163	A3	t		11- 0-3
164	A4	u		11- 0-4
165	A5	v		11- 0-5
166	A6	w		11- 0-6
167	A7	x		11- 0-7
168	A8	y		11- 0-8
169	A9	z		11- 0-9
170	AA			11- 0-2-8
171	AB			11- 0-3-8
172	AC			11- 0-4-8
173	AD			11- 0-5-8
174	AE			11- 0-6-8
175	AF			11- 0-7-8
176	B0			12-11-0-1-8
177	B1			12-11-0-1

APPENDIX C (Continued)

EBCDIC CHARACTER CODES

Decimal	Hexadecimal	EBCDIC Graphic or Control Characters	Explanation	Punched Card Code
45	2D	ENQ	Enquiry	0- 5-8-9
46	2E	ACK	Acknowledge	0- 6-8-9
47	2F	BEL	Bell	0- 7-8-9
48	30			12-11-0-1-8-9
49	31			1- 9
50	32	SYN	Synchronous Idle	2- 9
51	33			3- 9
52	34	PN	Punch On	4- 9
53	35	RS	Reader Stop	5- 9
54	36	UC	Upper Case	6- 9
55	37	EOT	End of Transmission	7- 9
56	38			8- 9
57	39			1- 8-9
58	3A			2- 8-9
59	3B	CU3	Customer Use 3	3- 8-9
60	3C	DC4	Device Control 4	4- 8-9
61	3D	NAK	Negative Acknowledge	5- 8-9
62	3E			6- 8-9
63	3F	SUB	Substitute	7- 8-9
64	40	SP	Space	no punches
65	41			12- 0-1-9
66	42			12- 0-2-9
67	43			12- 0-3-9
68	44			12- 0-4-9
69	45			12- 0-5-9
70	46			12- 0-6-9
71	47			12- 0-7-9
72	48			12- 0-8-9
73	49			12- 1-8
74	4A	¢		12- 2-8
75	4B	.		12- 3-8
76	4C	<		12- 4-8
77	4D	(12- 5-8
78	4E	+		12- 6-8
79	4F			12- 7-8
80	50	&		12
81	51			12-11-1-9
82	52			12-11-2-9
83	53			12-11-3-9
84	54			12-11-4-9
85	55			12-11-5-9
86	56			12-11-6-9
87	57			12-11-7-9
88	58			12-11-8-9

APPENDIX C (Continued)

EBCDIC CHARACTER CODES

Decimal	Hexadecimal	EBCDIC Graphic or Control Characters	Explanation	Punched Card Code
178	B2			12-11-0-2
179	B3			12-11-0-3
180	B4			12-11-0-4
181	B5			12-11-0-5
182	B6			12-11-0-6
183	B7			12-11-0-7
184	B8			12-11-0-8
185	B9			12-11-0-9
186	BA			12-11-0-2-8
187	BB			12-11-0-3-8
188	BC			12-11-0-4-8
189	BD			12-11-0-5-8
190	BE			12-11-0-6-8
191	BF			12-11-0-7-8
192	C0	}		12- 0
193	C1	A		12- 1
194	C2	B		12- 2
195	C3	C		12- 3
196	C4	D		12- 4
197	C5	E		12- 5
198	C6	F		12- 6
199	C7	G		12- 7
200	C8	H		12- 8
201	C9	I		12- 9
202	CA			12- 0-2-8-9
203	CB			12- 0-3-8-9
204	CC	J		12- 0-4-8-9
205	CD			12- 0-5-8-9
206	CE	T		12- 0-6-8-9
207	CF			12- 0-7-8-9
208	D0	}		11- 0
209	D1	J		11- 1
210	D2	K		11- 2
211	D3	L		11- 3
212	D4	M		11- 4
213	D5	N		11- 5
214	D6	O		11- 6
215	D7	P		11- 7
216	D8	Q		11- 8
217	D9	R		11- 9
218	DA			12-11-2-8-9
219	DB			12-11-3-8-9
220	DC			12-11-4-8-9
221	DD			12-11-5-8-9

APPENDIX C (Continued) EBCDIC CHARACTER CODES

Decimal	Hexadecimal	EBCDIC Graphic or Control Characters	Explanation	Punched Card Code
222	DE			12-11-6-8-9
223	DF			12-11-7-8-9
224	E0			0- 2-8
225	E1			11- 0-1-9
226	E2	S		0- 2
227	E3	T		0- 3
228	E4	U		0- 4
229	E5	V		0- 5
230	E6	W		0- 6
231	E7	X		0- 7
232	E8	Y		0- 8
233	E9	Z		0- 9
234	EA			11- 0-2-8-9
235	EB			11- 0-3-8-9
236	EC	␣		11- 0-4-8-9
237	ED			11- 0-5-8-9
238	EE			11- 0-6-8-9
239	EF			11- 0-7-8-9
240	F0	0		0
241	F1	1		1
242	F2	2		2
243	F3	3		3
244	F4	4		4
245	F5	5		5
246	F6	6		6
247	F7	7		7
248	F8	8		8
249	F9	9		9
250	FA	LVM		12-11-0-2-8-9
251	FB			12-11-0-3-8-9
252	FC			12-11-0-4-8-9
253	FD			12-11-0-5-8-9
254	FE			12-11-0-6-8-9
255	FF	EO		12-11-0-7-8-9

APPENDIX D

NOVA LINE COMPUTERS

INSTRUCTION EXECUTION TIMES

SUPERNOVA read-only time equals semiconductor time, except add 0.2 for LDA, STA, ISZ, and DSZ if reference is to core. NOVA times are for core; for read-only subtract 0.2 except subtract 0.4 for LDA, STA, ISZ, and DSZ if reference is to read-only memory. When two numbers are given, the one at the left of the slash is the time for an isolated transfer, the one at the right is the minimum time between consecutive transfers. All times are in microseconds.

	NOVA	SUPERNOVA		1200 SERIES	800,820 840	830	NOVA 2	
		SC	CORE				8K	16K
LDA	5.2	1.2	1.6	2.55	1.6	2.0	1.6	2.0
STA	5.5	1.2	1.6	2.55	1.6	2.0	1.6	2.0
ISZ, DSZ	5.2	1.4	1.8	3.15	1.8	2.2	1.7	2.1
JMP	5.6	0.6	0.8	1.35	0.8	1.0	0.8	1.0
JSR	3.5	1.2	1.4	1.35	0.8	1.0	1.1	1.2
COM, NEG, MOV, INC	5.6	0.3	0.8	1.35	0.8	1.0	0.8	1.0
ADC, SUB, ADD, AND	5.9	0.3	0.8	1.35	0.8	1.0	0.8	1.0
Each level of @, add	2.6	0.6	0.8	1.2	0.8	1.0	0.8	1.0
Each autoindex, add	0.0	0.2	0.2	0.6	0.2	0.2	0.5	0.5
Base register addr, add	0.3	0.0	0.0	0.0	0.0	0.0	0.0	0.0
If skip occurs, add	0.0	*	0.8	1.35	0.2	0.2	0.3	0.2
I/O input (except INTA)	4.4	2.8	2.9	2.55	2.2	2.4	1.4	1.5
INTA	4.4	3.6	3.7	2.55	2.2	2.4	1.4	1.5
I/O output	4.7	3.2	3.3	3.15	2.2	2.4	1.6	1.7
NIO	4.4	3.2	3.3	3.15	2.2	2.4	1.6	1.7
I/O skips	4.4	2.8	2.9	2.55	1.4	1.6	1.1	1.2
If skip occurs, add	0.0	0.0	0.0	0.0	0.2	0.2	0.3	0.2
For S, C, or P; add	0.0	0.0	0.0	0.0	0.6	0.6	0.3	0.3
MUL								
Average	11.1	3.7	3.8	3.75	8.8	9.0	6.1	6.2
Maximum	11.1	5.3	5.4	3.75	8.8	9.0	6.1	6.2
DIV								
Successful	11.9	6.8	6.9	4.05	8.8	9.0	6.4	6.5
Unsuccessful	11.9	1.5	1.6	2.55	1.6	2.0	6.4	6.5
P.I. CYCLE	5.2	1.8	2.2	3.0	1.6	2.0	2.2	2.5
INTERRUPT LATENCY								
With MUL/DIV	12.0	9.0	9.0	7.0	10.6	12.0	5.8	5.9
Without MUL/DIV	12.0	5.0	5.0	7.0	4.6	6.0	1.9	2.3
DATA CHANNEL								
Input	3.5	2.3	2.3	1.2	2.0	2.2	2.0	2.1
Output	4.4	2.8	2.8	1.2/1.8	2.0	2.2	2.1	2.2
Increment	4.4	2.8	2.8	1.8/2.4	2.2	2.4	2.2	2.3
Add to memory	5.3	2.8	2.8	----	----	N/A	---	---
Latency*								
With MUL/DIV	17.3	11.8	11.8	9.4	5.8	6.4	5.2	5.3
Without MUL/DIV	17.3	7.8	7.8	9.4	5.8	6.4	5.2	5.3
HIGH SPEED DATA CHANNEL								
Input	N/A	0.8	0.8	N/A	0.8	1.0	0.8	0.9/1.0
Output		0.8/1.0	0.8/1.0		0.8/1.0	1.0/1.2	1.2	1.3
Increment		1.0/1.2	1.0/1.2		1.0/1.2	1.2/1.4	1.3	1.4
Add to memory		1.0/1.2	1.0/1.2	----	----	N/A	---	---
Latency*								
With MUL/DIV		5.7	5.7		4.8	5.4	4.3	4.4
Without MUL/DIV		3.7	3.7		3.2	3.6	4.3	4.4

*If 2AC-multiple operation instruction is skipped, add 0.3; otherwise add 0.6.

+For highest priority peripheral on I/O bus.

06-01131

APPENDIX D (Continued)

ECLIPSE COMPUTER

INSTRUCTION EXECUTION TIMES

The following table gives minimum, maximum, and typical execution times for all instructions in the basic instruction set. These times assume

a system without the MAP feature operating with 4-way interleaved core memory. All times are in microseconds.

STANDARD INSTRUCTION SET	MINIMUM	MAXIMUM	TYPICAL	NOTES
ADD	0.6	0.6	0.6	1
ADD COMPLEMENT	0.6	0.6	0.6	1
ADD IMMEDIATE	0.6	0.6	0.6	
EXTENDED ADD IMMEDIATE	1.2	1.2	1.2	
AND	0.6	0.6	0.6	1
AND IMMEDIATE	1.2	1.2	1.2	
AND WITH COMPLEMENTED SOURCE	0.6	0.6	0.6	
BLOCK ADD AND MOVE	1.8+0.8N	1.8+1.2N	1.7 +1.0N	2
BLOCK MOVE	2.0+0.6N	1.4+1.2N	1.85+0.85N	2
COMPARE LIMITS	specified AC's not the same			
number within limits	1.8	2.2	1.9	
number less than L	2.0	2.4	2.1	
number greater than H	2.2	2.6	2.3	
	specified AC's the same			
number within limits	1.6	1.6	1.6	
number less than L	1.8	1.8	1.8	
number greater than H	1.6	1.6	1.6	
COMPLEMENT	0.6	0.6	0.6	1
COUNT BITS	1.0	10.6	1.0 +0.6N	3
DECIMAL ADD	0.6	0.6	0.6	
DECREMENT AND SKIP IF ZERO	1.4	1.6	1.5	4
EXTENDED DECREMENT AND SKIP IF ZERO	2.4	2.6	2.45	4
DECIMAL SUBTRACT	0.6	0.6	0.6	
DISPATCH				
number within limits	3.6	3.6	3.6	4, 11
number less than L	2.8	2.8	2.8	4
number greater than H	2.6	2.8	2.65	
DOUBLE HEX SHIFT LEFT	2.4	4.2		depends on shift count
DOUBLE HEX SHIFT RIGHT	2.4	4.2		depends on shift count
DOUBLE LOGICAL SHIFT	1.0	5.6		depends on shift count
ENTER WCS	depends on user instruction			
EXCHANGE ACCUMULATORS	0.8	0.8	0.8	
EXCLUSIVE OR	0.6	0.6	0.6	
EXCLUSIVE OR IMMEDIATE	1.2	1.2	1.2	
EXECUTE	0.8 + time for instruction to be executed			
EXTENDED OPERATION	4.8	5.8	5.05	5
HALVE	1.0	1.0	1.0	
HEX SHIFT LEFT	1.8	3.0		depends on shift count
HEX SHIFT RIGHT	1.8	3.0		depends on shift count
INCLUSIVE OR	0.6	0.6	0.6	
INCLUSIVE OR IMMEDIATE	1.2	1.2	1.2	
INCREMENT	0.6	0.6	0.6	1
INCREMENT AND SKIP IF ZERO	1.4	1.6	1.5	4
EXTENDED INCREMENT AND SKIP IF ZERO	2.4	2.6	2.45	4

APPENDIX D (Continued)

ECLIPSE COMPUTER

INSTRUCTION EXECUTION TIMES

STANDARD INSTRUCTION SET	MINIMUM	MAXIMUM	TYPICAL	NOTES
JUMP	0.6	0.8	0.65	4
EXTENDED JUMP	1.6	1.6	1.6	4
JUMP TO SUBROUTINE	0.6	0.8	0.65	4
EXTENDED JUMP TO SUBROUTINE	1.6	1.6	1.6	4
LOAD ACCUMULATOR	0.8	1.4	1.0	4
EXTENDED LOAD ACCUMULATOR	1.8	2.4	1.95	4
EXTENDED LOAD EFFECTIVE ADDRESS	1.6	1.6	1.6	4
LOAD BYTE	1.4	1.8	1.5	
LOAD MAP	2.4+0.6N	2.4+0.6N	2.3+0.6N	2
LOCATE AND RESET LEAD BIT	1.2	7.2	1.2+0.4N	3
LOCATE LEAD BIT	1.0	7.0	1.0+0.4N	3
LOGICAL SHIFT	1.0	3.8	depends on shift count	
MODIFY STACK POINTER	2.2	2.4	2.25	12
MOVE	0.6	0.6	0.6	1
NEGATE	0.6	0.6	0.6	1
POP BLOCK	4.0	4.8	4.2	7
POP MULTIPLE ACCUMULATORS	2.2+0.4N	3.0+0.4N	2.4+0.4N	7, 8
POP PC AND JUMP	2.4	3.2	2.6	7
PUSH JUMP	2.2	3.6	2.7	6, 13
PUSH MULTIPLE ACCUMULATORS	2.2+0.4N	3.0+0.4N	2.4+0.4N	5, 8
PUSH RETURN ADDRESS	2.6	3.2	2.8	5
RESTORE	6.0	8.0	6.85	
RETURN	4.4	5.0	4.55	7
SAVE	3.8	5.2	4.08	5
SET BIT TO ONE	2.4	2.8	2.45	6
SET BIT TO ZERO	2.4	2.8	2.45	6
SIGN EXTEND AND DIVIDE	2.2	9.8	9.5	
SIGNED DIVIDE	2.2	10.2	9.6	
SIGNED MULTIPLY	7.2	7.2	7.2	
SKIP IF ACS > ACD	1.0	1.0	1.0	
SKIP IF ACS ≥ ACD	1.0	1.0	1.0	
SKIP ON NON-ZERO BIT	2.2	2.6	2.3	6, 10
SKIP ON ZERO BIT	2.2	2.6	2.3	6, 10
SKIP ON ZERO BIT AND SET TO ONE	2.6	2.8	2.8	6
STORE ACCUMULATOR	0.8	1.4	1.0	4
EXTENDED STORE ACCUMULATOR	1.8	2.4	1.95	4
STORE BYTE	1.8	2.0	1.85	
SUBTRACT	0.6	0.6	0.6	1
SUBTRACT IMMEDIATE	0.6	0.6	0.6	
SYSTEM CALL	4.2	5.0	4.45	5, 6
UNSIGNED DIVIDE	1.6	8.2	8.2	
UNSIGNED MULTIPLY	7.2	7.2	7.2	

APPENDIX D (Continued)

ECLIPSE COMPUTER

INSTRUCTION EXECUTION TIMES

I/O INSTRUCTION SET	MINIMUM	MAXIMUM	TYPICAL	NOTES
DATA INPUT	2.2	2.2	2.2	9
DATA OUTPUT	2.6	2.6	2.6	9
I/O SKIP	0.8	0.8	0.8	10
NO I/O TRANSFER	1.2	1.2	1.2	9
VECTOR ON INTERRUPTING DEVICE CODE				
MODE A	2.6	2.8	2.65	
MODE B	8.6	9.6	8.85	5
MODE C	10.2	12.2	10.75	5
MODE D	15.0	18.0	16.5	5
MODE E	16.6	20.2	18.05	5
PROGRAM INTERRUPT CYCLE	1.4	1.8	1.5	4
DATA CHANNEL INPUT	0.8	0.8	0.8	
DATA CHANNEL OUTPUT	1.4	1.6	1.6	
DATA CHANNEL LATENCY ⁺	0.8	1.5	5.6	
<p>PROGRAM INTERRUPT LATENCY is the sum of the longest time that the program runs with the interrupt system disabled plus the time for the program interrupt cycle. The longest non-interruptable instruction is a Mode E VECTOR with a maximum time of 20.2 microseconds. Because this VECTOR also enables the interrupt system, an interrupt will not be honored until after the next instruction, unless the next instruction is interruptable (e.g., BLOCK ADD AND MOVE). Therefore, the time for the next longest instruction must be added. The next longest instruction is COUNT BITS WITH A worst case time of 10.6 microseconds. To this must be added the time for the program interrupt cycle of 1.8 microseconds. This yields an absolute worst case program interrupt latency of 32.6 microseconds. The interrupt latency for a specific application can be computed using the above method.</p>				

⁺ For highest priority peripheral on I/O bus.

APPENDIX D (Continued)

ECLIPSE COMPUTER

INSTRUCTION EXECUTION TIMES

	MINIMUM	MAXIMUM	TYPICAL
NOTES: 1. If skip occurs, add:	0.6	0.6	0.6
2. N is number of words moved. For each indirect reference in AC3, add:	0.8	0.8	0.8
For each indirect reference in AC2, add:	0.6	0.8	0.65
If N is less than 1, then time is:	1.2	1.2	1.2
3. N is the count added to ACD. For LOCATE AND RESET LEAD BIT, if the count is 16, the time is:	7.4	7.4	7.4
For LOCATE LEAD BIT, if the count is 16, the time is:	7.2	7.2	7.2
4. For each indirect reference, add:	0.6	0.8	0.65
For each indirect auto-index reference, add:	1.0	1.6	1.15
5. If stack overflows, add: In addition, see note 6.	3.2	3.8	3.45
6. For each indirect reference, add:	0.8	0.8	0.8
7. If stack underflows and underflow protection is disabled, add:	0.4	0.8	0.7
If stack underflows and underflow protection is enabled, add:	3.8	5.0	4.4
In addition, see note 6.			
8. N is number of words pushed or popped.			
9. S, C, and P functions require no extra time.			
10. If skip occurs, add:	0.4	0.4	0.4
11. For each indirect reference in the table address add:	0.6	0.6	0.6
12. If stack overflows add:	4.2	4.8	4.65
13. If stack overflows add:	4.0	4.6	4.25

APPENDIX D (Continued)

ECLIPSE COMPUTER

INSTRUCTION EXECUTION TIMES

FLOATING POINT INSTRUCTION EXECUTION TIMES

Because the CPU and the floating point feature operate in parallel, there are two distinct times to consider when dealing with the execution time of a floating point instruction. These are "FPU time" and "CPU time".

FPU time is the amount of time taken in the floating point unit actually performing the calculation.

CPU time is that amount of time that the CPU devotes to a floating point instruction. This time is divided into three parts: setup time, wait time, and finish time. Setup time is the time devoted to decoding the instruction and computing the effective address if required. Wait time is the time spent by the CPU waiting for the FPU to finish a previous operation and become idle. Finish time is the time devoted to transferring to the FPU all required operands and initiating the floating point operation. The following example illustrates these times.

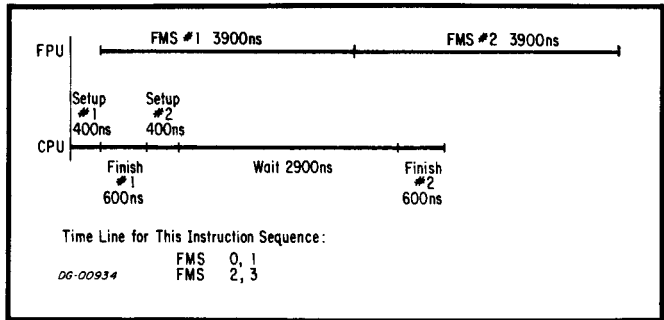

Wait time is given by the following equation:

$$\text{WAIT} = \text{FPU time for previous instruction} - (\text{finish time for previous instruction} + \text{total execution time for non-floating point instructions between the floating point instructions} + \text{setup time for this floating point instruction}).$$

If WAIT is less than 0, then a value of 0 should be used for WAIT.

APPENDIX D (Continued)

ECLIPSE COMPUTER

INSTRUCTION EXECUTION TIMES

INSTRUCTION	CPU		FPU	REMARKS
	SETUP	FINISH		
ADD SINGLE (FPAC)	0.4	0.6	1.5	Exponent over- or underflow
ADD DOUBLE (FPAC)				
SUBTRACT SINGLE (FPAC)				
SUBTRACT DOUBLE (FPAC)				
ADD SINGLE (MEMORY)	1.2	0.8	2.2	Exponent over- or underflow
SUBTRACT SINGLE (MEMORY)				
ADD DOUBLE (MEMORY)	1.2	1.4	2.8	Exponent over- or underflow
SUBTRACT DOUBLE (MEMORY)				
MULTIPLY SINGLE (FPAC)	0.4	0.6	3.9	
MULTIPLY DOUBLE (FPAC)	0.4	0.6	7.1	
MULTIPLY SINGLE (MEMORY)	1.2	0.8	4.6	Note 1
MULTIPLY DOUBLE (MEMORY)	1.2	1.4	8.4	Note 1
DIVIDE SINGLE (FPAC)	0.4	0.6	4.2	Divisor mantissa > dividend mantissa
			5.1	Divisor mantissa ≤ dividend mantissa
DIVIDE DOUBLE (FPAC)	0.4	0.6	7.4	Divisor mantissa > dividend mantissa
			8.3	Divisor mantissa ≤ dividend mantissa
DIVIDE SINGLE (MEMORY)	1.2	0.8	4.9	Divisor mantissa > dividend mantissa
			(Note 1)	5.8
DIVIDE DOUBLE (MEMORY)	1.2	1.4	8.7	Divisor mantissa > dividend mantissa
			(Note 1)	9.6
LOAD SINGLE	1.2	0.8	1.6	Note 1
LOAD DOUBLE	1.2	1.4	2.2	Note 1
STORE SINGLE	1.2	0.8	0.5	Notes 1, 2
STORE DOUBLE	1.2	1.2	0.5	Notes 1, 2
FLOAT FROM AC	0.4	0.6	1.9	Integer positive
			2.3	Integer negative
FLOAT FROM MEMORY	1.2	0.8	2.3	Integer positive
			(Note 1)	2.7
FIX TO AC	0.4	0.6	2.1	Integer positive
			(Note 2)	2.5
FIX TO MEMORY	1.2	0.8	2.3	Integer positive
			(Notes 1, 2)	2.7

APPENDIX D (Continued)

ECLIPSE COMPUTER

INSTRUCTION EXECUTION TIMES

INSTRUCTION	CPU		FPU	REMARKS
	SETUP	FINISH		
NEGATE	0.4	0.6	1.3	
ABSOLUTE VALUE	0.4	0.6	1.3	
READ HIGH WORD	0.4	0.6	0.4	Note 2
SCALE	0.6	0.6	1.7	
LOAD EXPONENT	0.6	0.6	1.6	
HALVE	0.8	0.6	1.8	
MOVE	0.4	0.6	1.0	
NORMALIZE	0.4	0.6	1.4	
COMPARE	0.4	0.6	0.9	
LOAD STATUS	1.6	0.8	0.7	Notes 1, 2
STORE STATUS	1.6	0.8	0.5	Notes 1, 2
PUSH FLOATING POINT STATE	1.4	7.0	7.0	
POP FLOATING POINT STATE	1.4	8.4	8.4	
TRAP ENABLE				
TRAP DISABLE	1.0	0.6	0.4	
CLEAR ERRORS				
SKIP TESTS	0.4	0.6	0.4	Note 3

- NOTES:
1. For setup time, add 0.4 for first indirect reference and 0.6 for each subsequent indirect reference. For finish time, add 0.2 for each indirect reference except for store instructions, add 0.0 for each indirect reference.
 2. FPU time can begin concurrently with the beginning of setup time, if the FPU is idle. Otherwise, FPU time begins as soon as the FPU finishes the previous instruction. Finish time cannot commence until the FPU has completed this instruction.
 3. If skip occurs, add 0.2 to finish time.

APPENDIX E

CODING AIDS

In this manual, instructions are coded according to the following format:

MNEMONIC *optional mnemonics* / **OPERAND STRING**

The mnemonic must be coded exactly as shown in the instruction description. Some instructions have optional mnemonics that may be appended to the main mnemonic if the option is desired. The operand string is made up of the operands for the given instruction.

Certain coding conventions are used so that the instruction can be recognized by the assembler and translated correctly into machine language. These conventions are as follows:

[], [] Square brackets indicate that the enclosed symbol is an optional operand or mnemonic. The operand enclosed in the brackets (e.g., *[skip]*) may be coded or not, depending on whether or not the associated option is desired.

BOLD Operands or mnemonics printed in boldface must be coded exactly as shown. For example, the mnemonic for the MOVE instruction is **MOV**

italic Operands or mnemonics printed in italics require a specific substitution. Replace the symbol with the number of a desired accumulator, address, or user-defined symbol that the assembler can recognize as a specific name, address, number, or mnemonic.

The following abbreviations are used throughout this manual:

AC Accumulator
F Flag Control Function

When describing the format of a word in an information transfer between an accumulator and an I/O device, the various fields and bits in the word are labeled with names descriptive of their functions. Bits in the word which are not used by the device are shaded; they are ignored on output and undefined on input.

This page intentionally left blank.

FOLD DOWN

FIRST

FOLD DOWN

NO POSTAGE STAMP NECESSARY IF MAILED IN THE UNITED STATES

BUSINESS REPLY MAIL

Postage will be paid by:

DataGeneral
Southboro, Massachusetts 01772

FIRST CLASS
PERMIT NO. 26
SOUTHBORO
MASS. 01772



ATTENTION: Engineering Publications

FOLD UP

SECOND

FOLD UP

STAPLE