

DIGITAL DESIGN

SYSTEMS ARCHITECTURE, INTEGRATION AND APPLICATIONS

MARCH 1985

■ THE WORKSTATION'S ROLE IN GATE ARRAY DESIGN, PART III

THE GEORGE E. FREEMAN LIBRARY
STATE TECHNICAL INSTITUTE AT MEMPHIS
5983 Macon Cove at Interstate 55
Memphis, Tennessee 38134

■ RISC MACHINES - AN ARCHITECTURE FOR THE FUTURE?

■ INTELLIGENT KEYBOARDS ENHANCE SYSTEMS INPUT

■ A/D CONVERTERS

■ Q/UNIBUS

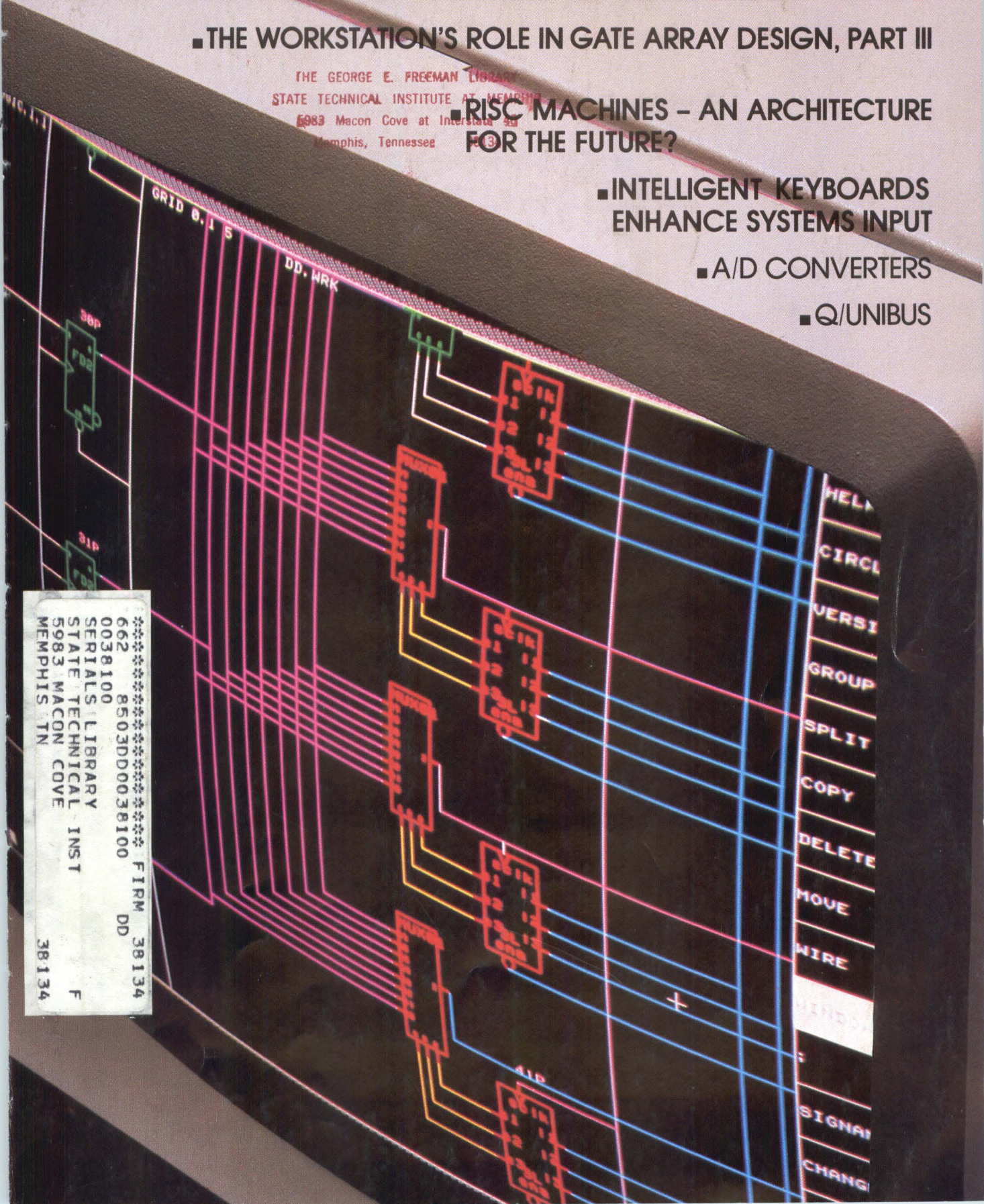

***** FIRM 38134
662 8503000038100 DD
0038100
SERIALS LIBRARY
STATE TECHNICAL INST
5983 MACON COVE
MEMPHIS TN
38134



Without Compromise.

The Modgraph GX-1000.

- | | |
|--|--|
| <input type="checkbox"/> 1024 x 780 Resolution | <input type="checkbox"/> 132 Column Text Display |
| <input type="checkbox"/> 4010/4014 Emulation | <input type="checkbox"/> VT100/VT52 Emulation |
| <input type="checkbox"/> 15 inch CRT | <input type="checkbox"/> \$2795 |

Circle 74 on Reader Inquiry Card

Modgraph

Modgraph, Inc., 56 Winthrop Street, Concord, MA 01742 (617) 371-2000

• 4010/4014 are trademarks of Tektronix, Inc. • VT100/VT52 are trademarks of Digital Equipment Corporation • The Screen image is courtesy of Computervision Corporation.

Now your computer can have 20/20 vision.

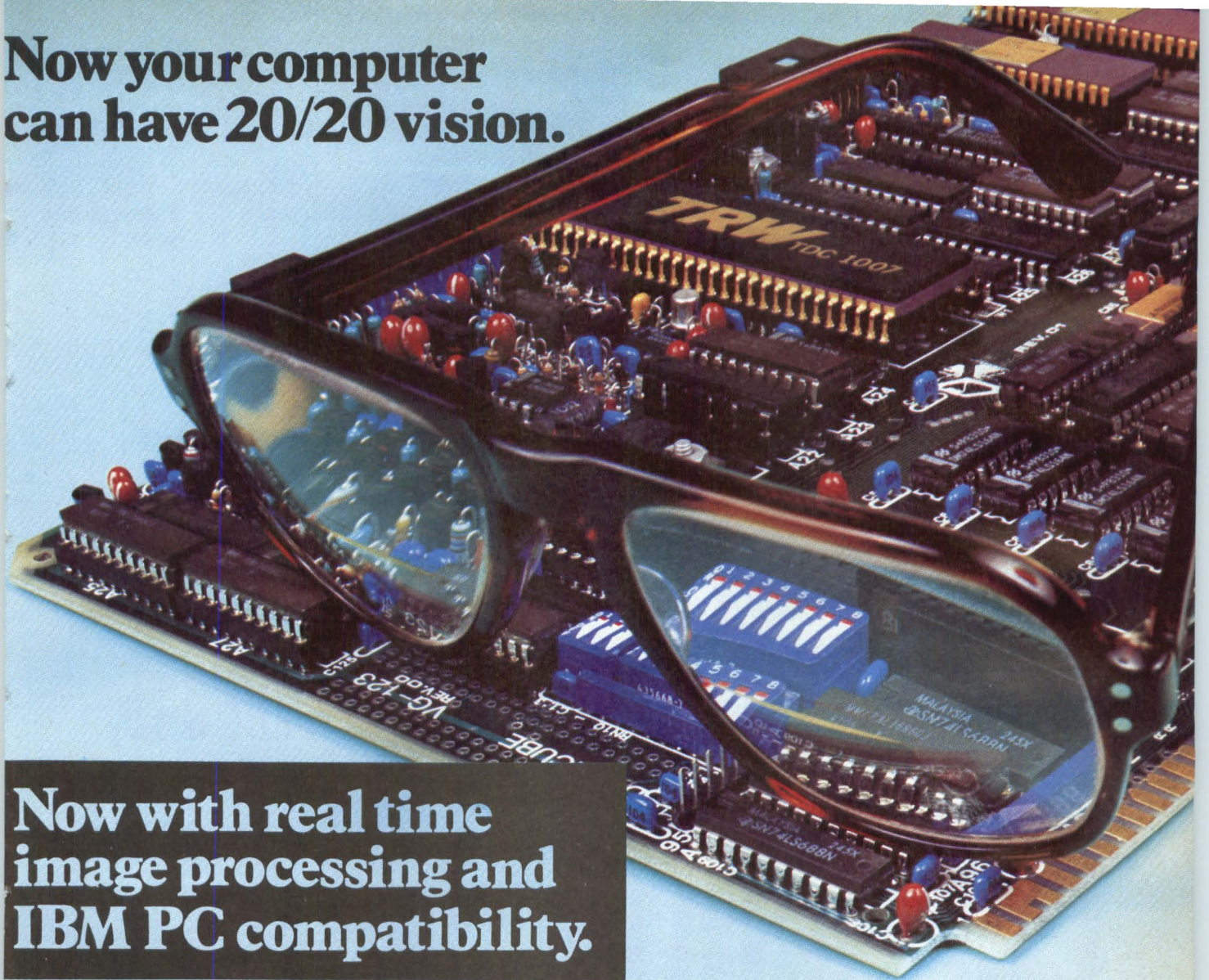

Now with real time image processing and IBM PC compatibility.



ROBOTICS

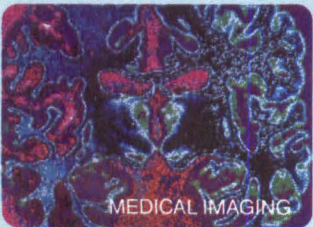

MEDICAL IMAGING



SURVEILLANCE

Datacube continues to be the single source leader in image processing and graphics for your Multibus, Q-Bus, and now IBM PC's. Solutions are available from single boards to fully integrated systems.

Resolutions range from 320H x 240V to 1400H x 1100V with pixel depths from 1 to 24 bits.

The new SP-123 offers advanced signal processing of high resolution black & white or full color images at the rate of 14 megapixels per second.

The new IVG-128 is a complete video acquisition and display module on a single IBM PC compatible card. It features input & output look up tables, an 8-bit digitizer, and RGB 8-bit outputs.

The new DC-1000 and DC-1500 systems are complete workstations capable of video acquisition and image processing.

Datacube products provide reliable vision and real time image processing for robotics, medical imaging, surveillance, inspection, teleconferencing, animation, etc. And at surprisingly low prices.

Call or write for our new Product Guide of Multibus, Q-Bus, and IBM PC compatible boards and systems. Datacube Incorporated, 4 Dearborn Road, Peabody, MA 01960, Telephone: (617) 535-6644. Western Sales Office: Telephone: (408) 737-9978.

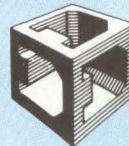

Datacube

Circle 4 on Reader Inquiry Card

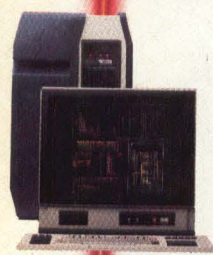

**IN AN AGE
OF STANDALONE
WORKSTATIONS,
IT ISN'T ENOUGH
FOR A WORKSTATION
TO STAND ALONE.**





It's a well-accepted dictum that the bigger the technical problem, the more compute power needed to solve it. A valid reason for engineers and scientists to demand their own standalone computers and the processing power that comes with them.

But experience tells us that the results of one person's efforts are inevitably meant to be shared with other people. A requirement that even the best standalone computers fail to meet.

One computer company has successfully solved this apparent dilemma. Apollo. Instead of simply building standalone computers, we've engineered DOMAIN[®] processing. A computing environment that adheres to our belief that both processing power and the ability to share that power are equally important in measuring a computer system's true value.

Thus DOMAIN combines dedicated 32-bit workstations in a computer system that lets users transparently share both information and resources across a high-speed local area network. Logically offering the advantages of both timesharing and dedicated computers without the drawbacks of either. Timesharing without a terminal case of limited power. Dedicated



Our workstations don't stand alone because you don't work alone.

workstations without isolation from co-workers and their data.

DOMAIN processing also delivers something else uncommon to standalone computers. A family of compatible workstations. They range from high performance color units for demanding applications such as solids modeling to monochromatic workstations for applications like software engineering.

Adding to DOMAIN's range and choice are more than 300 applications from the world's best software suppliers. Applications that cover electronic design, mechanical design, computer integrated manufacturing and much more. Letting you automate entire development processes rather than individual tasks.

While these facts no doubt attest to the efficacy of DOMAIN processing, it's also reassuring to know that the DOMAIN network even connects to other computer systems via industry standard protocols such as X.25 and ETHERNET.[®] Of course DOMAIN supports the UNIX[®] software environment as well.

A reminder that it's because our workstations don't stand alone, that we do stand alone.

Call (617) 256-6600 x4497. Or write Apollo, 330 Billerica Rd., Chelmsford, MA 01824, MS 17.



apollo

ETHERNET is a registered trademark of Xerox Corporation.
UNIX is a trademark of Bell Telephone Laboratories, Inc.
DOMAIN is a registered trademark of Apollo Computer Inc.



Circle 1 on Reader Inquiry Card

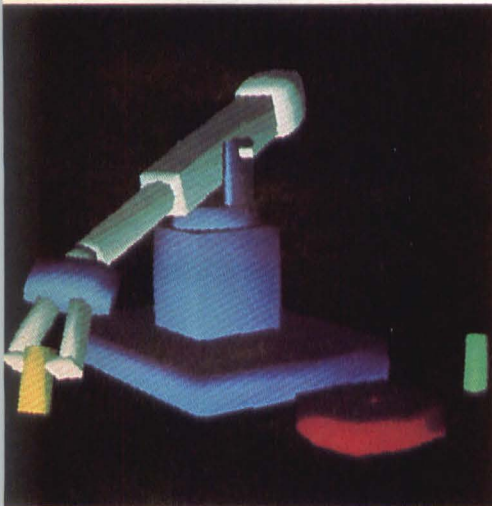

COURTESY RASTER TECHNOLOGIES

22 3D calculations for graphics

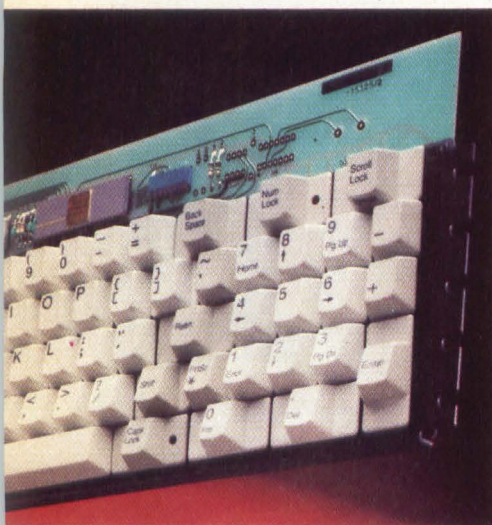

COURTESY ADVANCED INPUT DEVICES

64 Intelligent keyboard developments

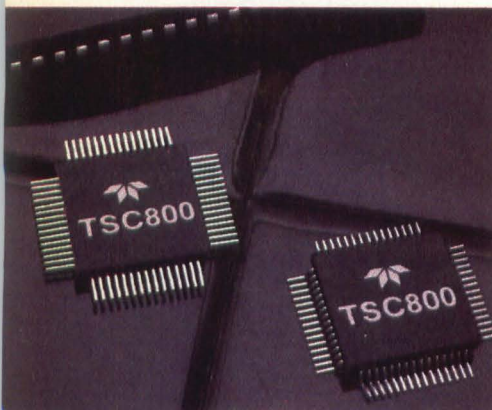

COURTESY TELEDYNE

74 A/Ds increase design options

DEPARTMENTS

- 22 **Graphics** / Graphics Processor Performs 3D Calculations
- 24 **CAD** / Graphics Workstations Compete For Top Performance
- 28 **Communications** / Low-Cost 1200 bps Modem Modules Interface Directly to UART, Phone Jack
- 31 **ICs** / Floating Point Chip Outperforms Competitors • 24x24 CMOS Multiplier — An Industry First
- 36 **Peripherals** / Micro Winchesters Slowly Penetrate Small System Designs • New Technologies Challenge Laser Printing
- 42 **Memory** / New Technique Secures System Access
- 46 **Systems** / Supercomputers At Supermini Prices • Supermini Series Ranges From Entry Level To 10-Processor System
- 100 **Applications Notebook** / Using the Signetics 8X41 In Bus Repeater And Bus Switching Applications
- | | | | |
|----|--------------------------|-----|-------------------------|
| 14 | Editor's Comment | 101 | Calendar |
| 16 | Update | 102 | New Products |
| 18 | Washington Report | 108 | New Literature |
| 80 | Product Index | 108 | Advertiser Index |
| 81 | Reader Service | | |

Published monthly thirteen times a year with two issues in November. Subscription rates for non-qualified subscribers (US and Canada) — \$40/yr; foreign — surface mail — \$50/yr; airmail — \$85/yr. Single copies — \$4. Copyright 1985 by Morgan-Grampian Publishing Company, 1050 Commonwealth Ave., Boston, MA 02215. Second class postage paid at Boston, MA and at additional mailing offices. POSTMASTER: Send address changes to Morgan-Grampian Publishing Company, Berkshire Common, Pittsfield, MA 01201 ISSN 0147-9245.

TABLE OF CONTENTS

52
Gate Array Design
Workstations for gate
array design: fact or
fallacy?

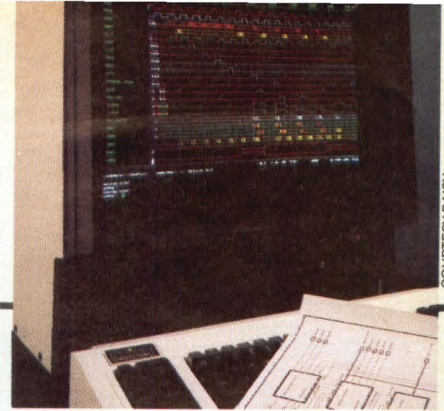

FEATURES

- 52** **Unlocking The Mysteries Of Gate Array Design, Part III**
by Ronald Collett
Having full control over the design cycle is the key factor in gate array design. Do workstations provide that added control?
- 64** **Keyboards Range From Single Components To Intelligent Input Subsystems**
by Julie Pingry
The data entry full array, full travel keyboard business can be divided into at least two distinct categories: simple, low-cost devices for integral use and high-end, reliable, intelligent peripheral products.
- 74** **High Resolution A/Ds Approach Performance Limits**
by Brita Meng
The need for higher resolution analog-to-digital converters — those with more than 12-bit outputs — is growing as the demand by systems architects for higher precision “real world” inputs increases.
- 87** **Systems Architect’s Guide To The Q/Unibus**
by Dave Wilson
Data communications products offer the system integrator a wide variety of options to choose from.
- 92** **RISC — A Risky New Architecture For The Future?**
by Gregory MacNicol
As the race for higher speed in computers continues, new alternatives are proposed promising better price/performance. One of these new architectures that is gaining momentum, press and venture capital is RISC — Reduced Instruction Set Computers.

ON THE COVER

Off-the-shelf chips, once the primary avenue for board design, are being replaced by the gate array. With the continuous growth in the semicustom IC market, the workstation promises to play an important role in the design of these chips. Numerous agreements between workstation and IC vendors lend credence to the trend. On the cover this month is Valid Logic's Scaldsystem I, which is currently being used by *Digital Design* to implement a CMOS array from LSI Logic. The display illustrates a portion of the schematic — a digital crosspoint switch. Photo courtesy Valid Logic.



DIGITAL'S NETWORKING. AN OPEN WINDOW TO DYNAMIC MARKET GROWTH.

If you want to significantly enhance your OEM product offerings and enable your products to fit in easily with your customers' distributed computing environments, consider the advantages of Digital Network Architecture.

No other company offers a wider range of efficient networking options tailored to OEM requirements. And no other company does so much to help you and your customers achieve the full benefits that networking can provide.

With Digital as your OEM supplier, you'll have the products you need to make local and wide area networking an essential part of your marketing plan. And that opens up an endless growth

path for you and your customers.

DIGITAL NETWORK ARCHITECTURE, YOUR WINDOW TO THE WORLD.

Digital Network Architecture (DNA) is the most comprehensive communications strategy yet developed, and currently implemented in proven, deliverable products. It supports several communications technologies. And it can accommodate future standards as they emerge because DNA is implemented in a layered structure consistent with the ISO Open Systems Interconnect model.

As an OEM, DNA gives you tremendous marketing and product opportunities. You can incor-

porate the best price performance components in your systems.

You can communicate with main-frame systems. You can match the technology to the job. And, most importantly, you can keep pace with your customers' distributed processing needs as they develop.

DECnet™ software lets you link Digital's systems in both local and wide area configurations. It supports high-speed local area network communications using Ethernet. And it provides gateways to allow Digital's computers to communicate with other vendors' systems over private lines or packet switched X.25 networks. This means you can tailor your products to fit in with your customers' current and future networks.

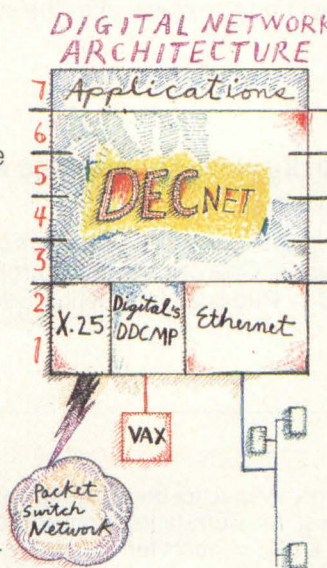



**BENEFITS FOR
YOUR USERS.
BENEFITS FOR YOU.**

The benefits you and your customers get by incorporating Digital's networking capabilities are virtually unlimited.

First of all, your systems can incorporate recognized industry standards. Such as Ethernet (IEEE 802.3 specification), X.25, and others.

In addition, our growing set of network-based products, including a distributed database system, allow your single systems to easily grow into networks. Your applications can access remote data and other resources transparently, with no extra development required.

This means that, with Digital, your systems are in an excellent position to be widely used in your customers' computing environments.

**ENGINEERED
FOR SUCCESS
IN MULTIVENDOR
ENVIRONMENTS.**

Your products need to communicate with equipment from

different vendors. Ethernet was designed with this fact in mind. Today, Ethernet-based networks are proliferating across all application segments – such as CAD/CAM, ATE, factory automation and medical applications.

Digital's networking systems allow Ethernet to be part of a single-source solution for your OEM installations. And DECnet gateways provide highly functional links to other non-Digital communications environments.

In short, DNA and Digital's products do the most to ensure that your systems will fit in with both new and existing networks.

**WE'LL BACK YOU
WITH TRAINING
AND SUPPORT.**

If you're already a Digital OEM, you know the advantages of Digital training and support. It's second to none in the industry.

We can give you the skills to configure, market, install and service local and wide area networks effectively. We'll help you make the most of our networking products in your systems.

Digital representatives are

available for pre-sales consultation and installation assistance. And our world-wide service organization can provide all the on-site network maintenance your customers require.

**BEST ENGINEERED
MEANS ENGINEERED
TO A PLAN.**

The communications systems implemented as part of Digital Network Architecture, like all Digital hardware and software products, are engineered to conform to an overall computing strategy. This means our systems are engineered to work together easily and expand economically.

Every system we make – from the Professional™ 300 Series workstations, to our MicroVAX I™ supermicro, to our high-end VAX™ computing systems – can cooperate using DECnet software. Only Digital provides you with a single, integrated computing strategy, from chips to 32-bit systems, and direct from desktop to data center.

For more information about how you can make networking

from Digital part of your product line, send in the coupon below or contact your Digital Sales Representative or a Digital Authorized Industrial Distributor. Or call 1-800-848-4400, ext. 139.

- Please send more information about Digital Network Architecture and DECnet.
- I'd like the whole story about OEM networking opportunities with Digital. Please have your representative call today.

Name _____

Title _____

Company _____

Address _____

City _____

State _____ Zip _____

Telephone _____ Ext. _____

Send to: Digital Equipment Corporation,
77 Reed Road, HL02-1/E10, Hudson, MA
01749.

**THE BEST ENGINEERED
COMPUTERS
IN THE WORLD.**

digital™

**HIGH
RELIABILITY
ACTIVE DELAY LINES**

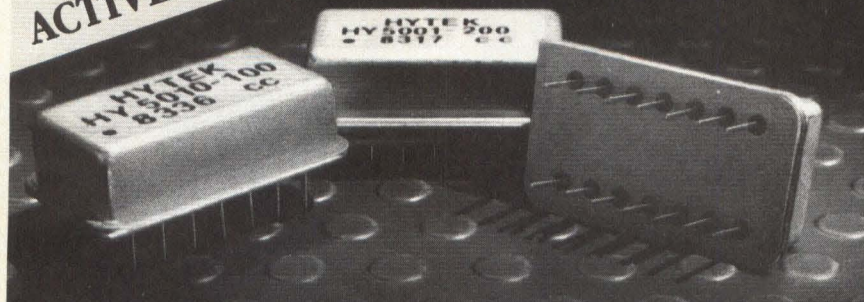

5 OR 10 TAP ACTIVE BUFFERED INPUTS AND OUTPUTS

- LOW PROFILE HERMETIC METAL 14 PIN DIP
 - HIGH RELIABILITY THICK FILM HYBRID CONSTRUCTION
 - IDEAL FOR HOSTILE ENVIRONMENTS/MILITARY GRADE COMPONENTS AVAILABLE
 - U.S. MANUFACTURED ON AUTOMATED ASSEMBLY AND TEST EQUIPMENT FOR REPEATABILITY
 - HIGH MTBF
 - COMPLETE STANDARD PRODUCT LINE AND CUSTOM DESIGNS AVAILABLE
- FOR MORE INFORMATION CONTACT...
JO-ANN RICCI (408) 395-2300 X265

HYTEK MICROSYSTEMS
980 UNIVERSITY AVENUE
LOS GATOS, CA 95030

Circle 2 on Reader Inquiry Card

Io Incorporated INTRODUCES 9 - TRACK TAPE INTERFACES

SCSI/9-TRACK

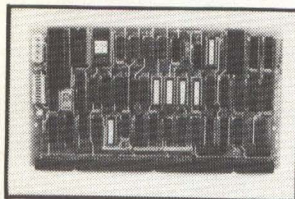

FEATURES

- Supports the standard SCSI command set for a non-direct access tape device
- Standard PERTEC compatible tape formatter connectors
- Parity generation and detection to tape formatter
- Flexible speed and density selection
- Selectable retries on read and write
- High speed-1M Byte/second burst throughput

402VME 9-TRACK

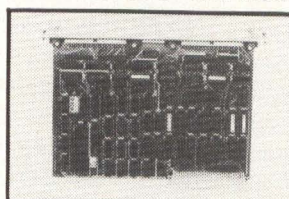

FEATURES

- Direct Memory Access Controller
- Interfaces to ANSI Standard 9-Track Tape Formatter
- Host Adaptor for SCSI/SASI Disk Controller
- Two RS-232 Serial Ports with Handshake
- Full Vectored Interrupt Support of All Devices
- Double-Height VME Eurocard size

FOR INFORMATION ON THESE AND OTHER VME PRODUCTS PLEASE
CONTACT THE FACTORY:

Io Incorporated
2430 N. HUACHUCA DR. TUCSON, ARIZONA 85745
(602) 792-0969

Circle 3 on Reader Inquiry Card

DIGITAL DESIGN

SYSTEMS ARCHITECTURE, INTEGRATION AND APPLICATIONS

Publisher	James R. DiFilippo
Editor in Chief	John Bond
Executive Editor	Dave Wilson
Managing Editor	Debra A. Lambert
Senior Editor/Directory Editor	Julie Pingry
Senior Technical Editor	Ronald E. Collett
West Coast Technical Editor (408) 356-0405	Gregory MacNicol
West Coast Technical Editor (408) 356-0405	Joe Aseo
Technical Editor	Brita Meng
Copy Editors	Sherri Mack Winnie Jenkins Rubino
New Products Editor	Terri Lamneck
International Electronics Editor	Ron Neale
Contributing Editor Peripherals	Bob Hirshon
Washington Correspondent	Anne Armstrong
Production Director	Paul Dadarria
Art Director	Maureen Bernardini
Advertising Production Manager	Martha Watjen
Graphics: Supervisor	William Manning Jr.
Sr. Technician	Don Schaaf
Jr. Technician	Paul Christo
Marketing Director	Charlotte King
Promotion Manager	Elaine Bull
Marketing Assistant	Jamie Rose
Research	Carolyn Wulfsberg, Peter Micheli
Circulation Director	Hugh J. Dowling
Circulation Supervisor	Maggie Hayes-Miville
Circulation Staff	Miriam Hlister, Betty Papa
Reader Service (413) 499-2550	Rose Wetherell
Direct Mail	Deborah Goldstein
Executive Administrator	Suzanne Levecque
General Administration	Karen Melanson Nancy Deveau Deanna Richardson Debra James Karen Bowman Sharon Lembo

President
Ronald W. Evans

Advertising Sales

Northeast: Terry L. Willins (617) 232-5470, 1050 Commonwealth Avenue, Boston, MA 02215

Middle Atlantic/Southeast: Sharon Greenberg (In PA) (215) 592-1895, (Outside PA) 800-223-7110, 703A South Street, Philadelphia, PA 19147

Midwest, South Central: Hank Bean, Rob Robinson (312) 794-1515, Edens East Office Center, 6200 N. Hiawatha, Suite 215, Chicago, IL 60646

Northwest: Carole Sacino, (408) 356-0405, 15951 Los Gatos Blvd., Suite 7, Los Gatos, CA 95030

Southwest: Mike Prewitt, (714) 851-8550, 2041 Business Center Dr., Suite 206, Irvine, CA 92715

National Postcard Sales: Jon Binder (617) 232-5470, 1050 Commonwealth Avenue, Boston, MA 02215

CITIZENS FOR BETTER READING.

OEMs and designers, Citizen™ is into LCD displays. Not just *any* LCDs—the most readable ones you've ever laid eyes on.

Thanks to higher contrast ratios. Wider viewing angles. Less shadowing. Faster response times. And just plain better readability.

The same people who give the world precision-engineered watches now give the world something just as reliable to watch.

Pick an application, we'll show you the right LCD.

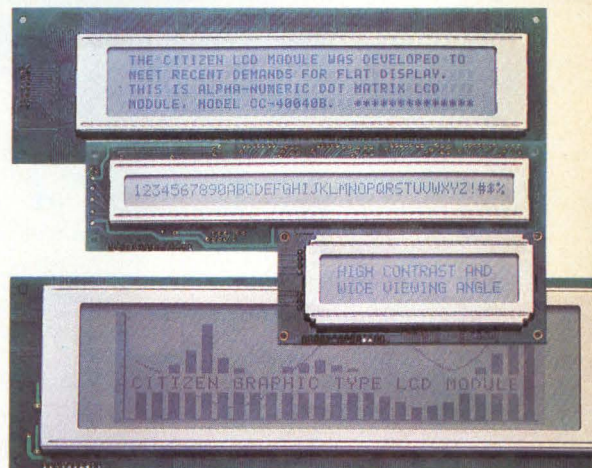

Invent an application, we'll customize the right LCD. And then back it up with a worldwide support and service network that's second to none.

The complete LCD line of alphanumeric and graphics displays—now from Citizen.

Read all about it. For details, a demo, or

information about our 3½" floppy disk drives and dot matrix printers, call 1-800-556-1234, Ext. 34. In California, 1-800-441-2345, Ext. 34. Or write Citizen America Corporation, 2425 Colorado Avenue, Santa Monica, CA 90404.

Character Display Modules		
Character Format	Module Size W x H x D (mm)	Viewing Area W x H (mm)
16 x 1	85 x 41 x 8.65	63.0 x 13.0
16 x 2	84 x 44 x 8.65	64.0 x 20.5
20 x 1	105 x 39 x 8.65	84.0 x 13.0
20 x 2	110 x 49 x 8.65	84.0 x 20.5
40 x 1	195 x 47 x 8.85	163.5 x 13.0
40 x 2	195 x 50 x 8.85	163.0 x 21.0

Graphic Display Modules		
Dot Format	Module Size W x H x D (mm)	Viewing Area W x H (mm)
240 x 64	263 x 84 x 9.00	210.0 x 54.0
480 x 64	267 x 80 x 10.40	228.0 x 46.0
480 x 128	279 x 110 x 10.30	228.0 x 74.0
480 x 200	270 x 124 x 12.60	203.0 x 88.0
640 x 128	280 x 88 x 11.10	230.0 x 53.0
640 x 200	290 x 118 x 11.10	230.0 x 76.0
640 x 200	270 x 230 x 12.60	230.0 x 174.0



Citizen and the Citizen logo are trademarks of Citizen Watch Co., Ltd.

Circle 33 on Reader Inquiry Card

TS-11 Users are seeing the difference.

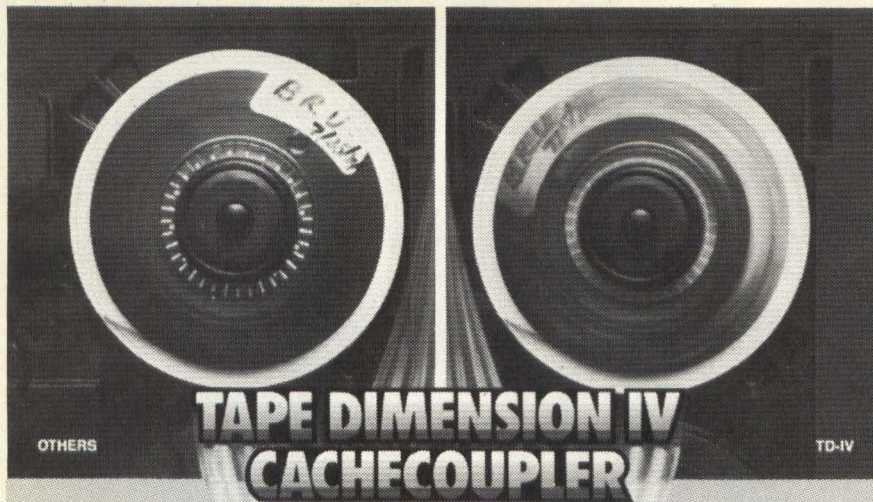

SAVES TIME & MONEY!

TOTAL ELAPSED TIME

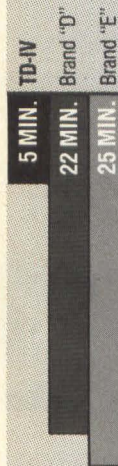

BRU WITHOUT VERIFY
First 2400' reel of tape.



In a series of tests, TD-IV outperformed Brand "E" and Brand "D" by as much as **600%**. With verify function enabled, TD-IV surpassed Brand "E" by 56.7% and Brand "D" by 49.2%.

TD-IV, the industry's first CacheCoupler, caches multiple records of any size between 1 and 64k bytes. It operates streaming and start/stop tape drives with speeds up to 200 ips with a maximum transfer rate of 1.5 MB. Even heavily loaded systems are *totally immune* to "Data Lates." Runs all DEC operating systems as well as Berkely Unix 4.2.

A new dimension in DEC Unibus TS-11 Emulation Tape Couplers, the TD-IV CacheCoupler maximizes state-of-the-art technology.

Call today for test details and complete catalog. WESTERN PERIPHERALS, div. of WESPERCORP, 14511 New Myford Road, Tustin, CA 92680, Telephone: (714) 730-6250 or outside Calif. 800-854-8737.



Circle 6 on Reader Inquiry Card

TOTAL ELAPSED TIME



BRU WITH VERIFY
First 2400' reel of tape.

**Using DEC's Backup Restore Utility (BRU) without verification.*

EDITORIAL AND SALES OFFICES
DIGITAL DESIGN, 1050 Commonwealth Avenue,
Boston, MA 02215, Telephone: (617) 232-5470

ME MORGAN-GRAMPIAN

CORPORATE HEADQUARTERS

Morgan-Grampian Publishing Company, 1050 Commonwealth Avenue, Boston, MA 02215, (617) 232-5470. Brian Rowbotham, Chairman; Ronald W. Evans, President; Charles Benz, Vice President.

EXPOSITIONS GROUP

Morgan-Grampian Expositions Group, 1050 Commonwealth Avenue, Boston, MA 02215 (617) 232-EXPO.

The following is a list of conferences produced by the Expositions Group:

ATE West	CADCON East
CADCON West	ATE Central
ATE Northwest	CADCON Central
ATE East	

In addition to DIGITAL DESIGN, Morgan-Grampian publishes the following in the United States: Circuits Manufacturing • Electronic Imaging • Electronics Test • Computer & Electronics Marketing
Morgan-Grampian also publishes the following in the United Kingdom: Electronic Engineering • Control & Instrumentation • Electronics Times • What's New in Electronics • What's New in Computing • Business Computing and Communications • Communications Systems Worldwide.

DIGITAL DESIGN serves the manufacturers of computer-related OEM products. This includes primary computer and systems manufacturers, systems integrators, components and peripheral manufacturers, integrating OEM's and commercial end users. These companies manufacture products used to control machinery, equipment and information in manufacturing, material processing, machine tools, packaging, health care, defense, data processing, communications, instrumentation, and scientific and business operations.

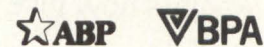

SUBSCRIPTION POLICY

DIGITAL DESIGN is circulated only to qualified research, development and design engineers and engineering managers primarily responsible for computer products and systems in OEM plants. To obtain a complimentary subscription, request (on company letterhead) a qualification card from Circulation Director. For change of address, attach old address label from recent issue to new company letterhead or note. Send this plus request for new qualification card to:

Circulation Department, **DIGITAL DESIGN**, Berkshire Common, Pittsfield, MA 01201

Subscription rates: non-qualified subscribers (US and Canada) — \$40/yr; foreign — surface mail — \$50; air mail — \$85. Single copies — \$4.

Authorization to photocopy items for internal or personal use, or the internal or personal use of specific clients, is granted by Morgan-Grampian Publishing Co. for libraries and other users registered with the Copyright Clearance Center (CCC) Transactional Reporting Service, provided that the base fee of \$2.00 per copy, plus \$.25 per page is paid directly to CCC, 21 Congress St., Salem, MA 01970. 0147-9245/84 \$2.00 + \$.25.

DIGITAL DESIGN solicits editorial material and articles from engineers and scientists. Contributors should submit duplicate manuscripts typed with two spaces between lines. All illustrations should be clear; components on all schematics and line drawings should be labeled. The editors assume no responsibility for the safety or return of any unsolicited manuscripts.

REPRINTS

DIGITAL DESIGN will reprint any article from past or present issues. Reprints are custom printed. Minimum order: 1,000 copies. Purchase order or letter of authorization required.

Allow one month from receipt of order for delivery, unless previously arranged and confirmed.

Advertisements alone can also be reprinted. Call (617) 232-5470, and ask for reprints.

Sell someone a Genicom 3000, and it may be some time before you hear from them again.

Genicom 3000 printer reliability can keep a customer happy for years.

From offices to factories across the country—hour after hour, day after day—Genicom 3000 printers have been proving their quality and reliability under even the toughest conditions for years.

The result has been a large number of very satisfied customers, which means a large number of satisfied OEM's. But durability is only part of the Genicom 3000 printer advantage.

The Genicom 3000 family of printers offers multi-model flexibility combined with single design simplicity to give OEM's real dollar savings with price/performance matching for every customer. Parts

commonality. Easier servicing. Single source supply. Plus you can select speeds from 180-500 cps draft/EDP, 45-100 cps NLQ, single or multi-

mode printing, automatic sheet feeders, document inserters, multi-color printing and graphics, plus more. There's such a diversity of models, features and options, you can choose just the right printer and you don't have to pay for things you don't need.

See how long you can keep your customers satisfied...with the long lasting, field proven printers that have earned the respect of OEM's nationwide—the Genicom 3000 family.

GENICOM
™
The New Printer Company.

Genicom Corporation, One General Electric Drive, Waynesboro, VA 22980 In Virginia, call 1-703-949-1170

For the solution to your printing needs call

TOLL FREE 1-800-437-7468

Circle 57 on Reader Inquiry Card



FORCE COMPUTERS

System 68000 VMEbus

Single board solutions for 16/32 bit "open systems" in industrial, business, and scientific environments

If your application requires advanced technology available in production quantities if quality, reliability, and price/performance ratio are the major criteria for supplier selection – then compare our product portfolio with other alternatives.

- Three CPU's for most applications from intelligent I/O controllers to multiuser/multitasking environments with powerful UNIX* or real time operating software PDOS* and up to 1M byte of on-board memory: CPU-1B, CPU-2, CPU-3.
- Two DRAM Boards: 512KB and 2MB; two SRAM Boards: 128KB and 512KB. RAM/ROM Board: 512KB (max.); DRAM-1, DRAM-2, SRAM-1/2, RR-1/S/E
- Mass memory interface boards with either direct control of up to seven drives (WFC-1) or intelligent VMEbus interface to SASibus with DMAC (SASI-1).
- Six-channel serial I/O board with Multi-Protocol-Communications-Controller (SIO-1).
- 32-channel parallel I/O boards either optically isolated (1000V) with DMAC (OPIO-1) or TTL-level with 64 mA drive capability signals (PIO-1).
- Intelligent high resolution graphics subsystem (master/slave) with resolution of 1024 x 1024 pixels and up to 12 bits of pixel depth. Powerful graphics operation through local 68000 MPU in parallel with 7220 graphics controller(s) GDC-1M/1S.
- Winchester/Floppy drive modules with up to 80M bytes: WFMOD-20/80.
- Auxiliaries: Backplanes, chassis, power supplies.
- A variety of Software Products, e. g.:
 - PDOS* – Real-Time, Multi-Tasking, with Basic interpreter, Pascal, Fortran 77, and C Compilers.
 - COHERENT* – UNIX* V.7 compatible with C Compiler, Pascal and Fortran 77 in preparation.
- UNIX* – System V, Multi-User, Multi-Tasking.
- In development: memory boards with byte parity and 32 bit addressing; dedicated LAN-Controller; high performance communication I/O.

Supported by a worldwide network of distributors and representatives, FORCE Computers is recognized by its customers (and competitors) as the leading supplier of 68000/VMEbus board products.

*PDOS is a trademark of Eyring Research, COHERENT is a trademark of Mark Williams Co., UNIX is a trademark of AT&T.

Consider, compare, and contact: FORCE COMPUTERS, INC.

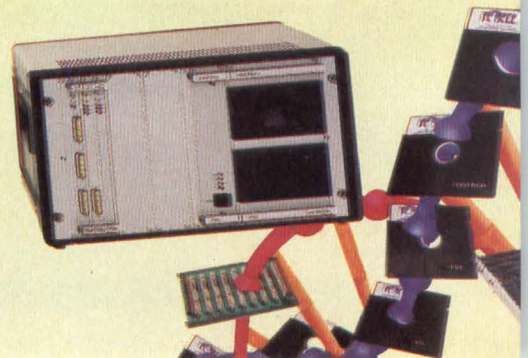



FORCE[®] COMPUTERS

FORCE COMPUTERS INC.
2041 Mission College Blvd.
Santa Clara, CA 95054
Phone (408) 988-8686
Tlx 172465
Telefax 408 980 93 31

FORCE COMPUTERS GmbH
Daimlerstraße 9
D-8012 Ottobrunn/München
Tel. (089) 609 20 33
Tlx 524 190 forc-d
Telefax (089) 609 77 93

Circle 58 on Reader Inquiry Card

Let's Get Drugs Out Of The Classroom Or How We Got To Be Number One

EDITOR'S COMMENT

Despite the headline I haven't, as yet, defected to the gonzo school of trade journalism espoused by certain West Coast practitioners. It is just that being new to this editor in chief business, I've been perusing the work of my associates on other magazines for tips on editorial writing. In this rather tedious process I've discovered that most editorials can be classified by the two broad categories represented in the headline.

"Let's get drugs, etc." refers to the editorial that sets up some straw man that no sane person could possibly support and proceeds to demolish it with righteousness. This exercise makes the editor feel good because he has come out foursquare against drugs in schools, for democratic principles or against wage slavery for engineers. Furthermore, he hasn't offended anyone except, perhaps, a few drug dealers who probably don't advertise anyway. Thus, "Let's get drugs, etc." is the perfect editorial for editors who wish to appear forceful but don't really want to gore anyone's favorite ox. Braver souls might try to get drugs out of Silicon Valley, and the especially foolhardy could make a big thing about drugs in the publisher's office. But most of us courageous editors are perfectly content to rail against the obvious. I am no braver than my counterparts on other magazines but I promise not to write this kind of editorial—simply because it's boring and obvious.

That other type of essay, "How we got to be, etc.," is an even more common disorder of editorial writers. Gentlemen and ladies of the pen who would normally squirm if forced to promote themselves too blatantly, nonetheless, exhibit no such false modesty about their marvelous editorial product. Thus, we are treated to delightful essays on awards the magazine has won, why it has the most pages, why it reaches the right people and serves them best, why it wins readership studies, and so on. On occasion such articles may help explain the magazine to the reader. Done too often, these editorials appear transparently self-serving. Worse than that, they bore the reader. So I won't do that unless, of course, I become so overwhelmed with self-congratulation that I just have to share it with the readers. But I'll try not to bend my self-imposed rule.

From time to time there are editorials in the trade press that address genuine issues of interest to engineers. These can be technical, political or professional. They are recognizable by their strength of conviction, even if the idea or causes they present are unpopular, wrong or just idiosyncratic. This is the kind of essay favored by most editors if they have sufficient time to think about such things. Of course, such editorials are harder to come up with than the formulaic approaches mentioned.



However, there is some danger, that in straining too hard for conviction, one may come across as merely quirky and cranky. A recent editorial in a competing magazine lambasted Lee Iacocca (my nomination for a Hero of Capitalism medal), Who's Who and the Japanese car of the editor's wife. Thus, an editorial writer, who I normally admire, fell into this trap, creating yet another subclass of editorial: "The paranoids are after me." Nonetheless, such aberrant editorial material is still more interesting than the usual pap most of us editors dish up because it springs from genuine conviction, no matter how weird.

A successful editorial describes or generates controversy and thus involves the readers. Editors know this even if they don't always practice it, or so it seems, because they often generate controversy in oblique ways. One such ploy is to support (or denounce) something that the IEEE has done. This will almost always result in a letter from Irwin Feerst who disagrees (or agrees) with the editorial. The editor can appear balanced in his judgement while Feerst puts in writing what the editor may really think. It's the best of both worlds. Controversy is generated but the editor continues to appear reasonable.

I don't know Feerst, but I have read many of his letters and agree with much of what he has to say. Nevertheless, baiting Irwin Feerst is an overworked editorial ploy that I promise not to indulge in—or have I already done so?

By now I have thoroughly painted myself into the corner for all future editorials: no straw men, blatant self-congratulation, paranoia or getting Irwin Feerst excited. I may never be able to write another editorial without violating my own guidelines. At the very least I will have to be clever in my transgressions. So, don't let me get away with anything. It keeps me straight.

John Bond, Editor In Chief

D.A.T.A. BOOKS® are like having 18 researchers at your fingertips...



but much easier to manage.

If you're an electronics engineer, chances are you've already heard about D.A.T.A. BOOKS. You may even be among the thousands of engineers who use one or more of our 25-plus publications daily.

Whatever information you need for your projects, D.A.T.A. BOOKS have it. Electrical specs... logic drawings... package design... device replacement... manufacturing sources... and more. D.A.T.A. BOOKS reference over 852,000 types of products from nearly 1,000 major manufacturers worldwide.

Our information is complete, accurate and up to date because we contact these manufacturers continually to get the technical data you need to complete your project faster and more efficiently. We know the information you require because

we've been in the business since 1956.

Inside D.A.T.A. BOOKS, you'll find easy to use standardized performance specifications, block drawings, alternate sources of supply, functional equivalence data, manufacturer locations and more.

You'll save time and money by contacting *only* those manufacturers you really need to for the best price and availability.

Your time is much too valuable to waste calling manufacturers and paging through out-of-date catalogs when you can have D.A.T.A. BOOKS do it for you!

Publications include — **Integrated Circuits:** Digital ICs, Linear ICs, Interface ICs, Memory ICs, IC Functional Equivalence Guide, Microprocessor ICs, Microcomputer Systems, Modules/Hybrids and Audio/Video

ICs. **Discrete Devices:** Transistors, Diodes and Thyristors. **Special Devices and Directories:** Optoelectronics, Power Semiconductors, Power Supplies, Microwave, Master Type Locator, Microprocessor Software and Applications Notes. **Discontinued Devices:** Digital and Audio/Video, Interface and Memory, Linear, Transistors, Diodes, Thyristors, Optoelectronics, Microwave and Type Locator.

Call or write us today. Or contact the D.A.T.A. BOOKS representative nearest you.

Toll-Free (800) 854-7030
Inside CA, call (800) 421-0159

D.A.T.A., INC.

P.O. Box 26875
9889 Willow Creek Road
San Diego, CA 92126

Circle 51 on Reader Inquiry Card

D.A.T.A. BOOKS Representative Listings: **EAST:** Motion Engineering, MA (617) 485-2144; Astrorep, NY (516) 422-2500, NJ (201) 826-8050; Motion Technology, DE/MD/DC/VA (800) 482-6318; Stegman Blaine, PA/WVA (513) 729-1969. **SOUTH:** Motion Technology, NC (800) 532-6849, TN/SC/GA/AL/FL (800) 482-6318; Blackburn Associates, TX/LA/AR/OK (214) 692-8885, TX (713) 463-1354. **MIDWEST:** Stegman Blaine, OH/KY (513) 890-7975, (216) 871-0520, (513) 729-1969; Enco Marketing, MI (313) 642-0203; JHS Associates, IL/IN/WI (312) 741-9070; J. F. Gleeson & Associates, IA/KS/MO/NE (913) 362-4422. **WEST:** System Sales of Arizona, Inc., AZ (602) 829-9338; SSA Inc. of New Mexico, NM (505) 881-8877; Dynatech, CO/UT (303) 773-2830; Applied Controls Northwest, WA (206) 775-2999, (509) 922-1762, OR (503) 257-7408; Leddy Associates, No. CA/NV/HI (415) 969-6313; Varigon Associates, So. CA (213) 322-1120, (714) 855-0233, (619) 576-0100. **CANADA:** Tech-Trek, (416) 674-1717, (604) 273-1800. **INTERNATIONAL:** (619) 578-7600 or TLX: 910530606.

Custom Chip Set To Implement Token-Passing Network

Gould AMI Semiconductors and Concord Data Systems are jointly developing a three-chip set that will implement the IEEE-802.4 standard. The chip set consists of a data chip with baseband or broadband modem interface, a direct memory access (DMA) interface and protocol controller chip linked via a private bus. The chips utilize a double-metal CMOS process implemented in VLSI to reduce part count and board space.



Hitachi Develops 32-Bit, 5 MIPS CMOS Microprocessor

Hitachi, Ltd. has developed a CMOS 32-bit microprocessor test chip with full 32-bit address and data structures. The test chip is fabricated in 1.3-micron CMOS, 2-layer metal process technology, contains over 300,000 transistors and executes at five million instructions per second.

Digital Research Software For NEC Microprocessors

Digital Research Japan is adapting CP/M, CP/M-86, Concurrent DOS and other system software for use on the initial microprocessors of NEC Corp.'s V-Series, the V20 and V30. NEC will provide the necessary microprocessor information for Digital Research Japan to complete the project by mid-1985.

Automation Control Graphic Systems

Industrial Data Terminals is providing high-end graphics terminals and systems to General Electric Co. for use with the GE series six programmable controller line. The graphic systems coupled with the controllers produce industrial control systems for factory automation. The system will be marketed by GE.



CMOS EPROM Technology

WaferScale Integration, Inc. (WSI) will supply Sharp Corp. with its proprietary 2-micron CMOS EPROM technology.

Sharp will use the patented technology to manufacture high density, high performance 64K and 256K CMOS EPROM products. In return, WSI will obtain product manufacturing capacity for the CMOS EPROM products marketed by WSI and an undisclosed sum of money in royalties. Sharp expects to reach full production of EPROM and products in the second half of 1985.

Ada Compiler Development

Sperry Corp. and Intermetrics Inc. are developing an Ada programming language processor for use with Sperry Series 1100 large scale computers. Intermetrics will develop the Sperry 1100 Ada Compiler System (1100 ACS) and expects it to be validated by the Ada Validation Facility of the US Department of Defense's Ada Joint Program Office.

Excelan Licenses Ethernet Front-End Processor

Excelan, Inc. has set up a licensing program for its Exos 200 Core Module Ethernet front-end processor. The generic hardware bus and software interface of the Core Module will enable computer builders to design networking into their new systems as well as allow simplified networking of their installed systems. Excelan provides design assistance, and the deliverables include CAD support circuit layout film, firmware object code and two prototype Exos 200 boards.

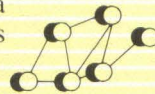

Intel Sells System 2000

Intel Corp. sold part of its Austin operation to SAS Institute Inc. The agreement gives SAS Institute design information, source code, product rights, and support responsibilities to Intel's System 2000 Data Base Management System, including System 2000, Quest, Plex, and Report Writer. Intel's iDIS Database Information System and the Fast 38xx semiconductor disk systems are not included in the agreement.

DOD Validates Alsys Ada Compiler

The first Ada compiler from Alsys, Inc. was validated under the new version of the US Department of Defense test series.

Effective January 1, 1984, the use of Ada was mandated by the DOD for mission critical applications. Alsys expects to offer the Ada compiler by April and produce four additional compilers by the end of 1985.

Brown Disc Expands Floppy Disk Activities

Under an agreement with Brown Disc Manufacturing, Rhone Poulenc, Inc. acquired 73.5% of Brown's total outstanding stock. The transaction includes the purchase of 2,150,000 new shares of common stock and the purchase of all Brown Disc securities currently held by Dysan Corp.



Tektronix Acquires CAE Systems

Tektronix, Inc. and CAE Systems, Inc. have agreed in principle to a corporate acquisition in which CAE Systems will become a wholly owned subsidiary of Tektronix. Under the terms of the proposed transaction, Tektronix will issue common stock valued at \$75 million to CAE's shareholders. The proposal is subject to a number of conditions, including the negotiation of a definitive agreement and formal approval by both companies.

React Purchases Zitel Memory Systems

Zitel Corp. is supplying high-speed semiconductor memory systems to React Corp. for use as a disk replacement product geared at improving the performance of Burroughs Corp. computer systems. Using the Zitel memory system in combination with a React proprietary interface, React intends to improve the speed and overall performance of Burroughs' systems.

Teknekron Affiliate Acquires Emulogic

A subsidiary of Teknekron Industries, ROI Consulting, has acquired Emulogic, Inc. and purchased most of its outstanding stock. Called Teknekron Emulogic, the company develops, manufactures, and markets universal microprocessor development systems, in-circuit emulators, and advanced software tools for the design engineer/software developer.

The first smart terminal under \$400.

THE NEW
**QVT
101™**

Block mode editing, multiple emulations, 16 host or user-programmable functions, a 14-inch screen, and more. All the editing power of the \$695 terminals, all for only \$395! Nothing is missing except the high price — you still get the industry's only one-year warranty. And its best reliability record.

No one else comes even close. Not Wyse. Not Esprit. Not TeleVideo. Only Qume can offer this unheard-of value, with smarter design, smarter sourcing, and greater resources behind us. For the best buy in VDT history, call (800) 223-2479. Qume Corporation, 2350 Qume Drive, San Jose, CA 95131. We'll be there.

Qume®
A Subsidiary of **ITT**

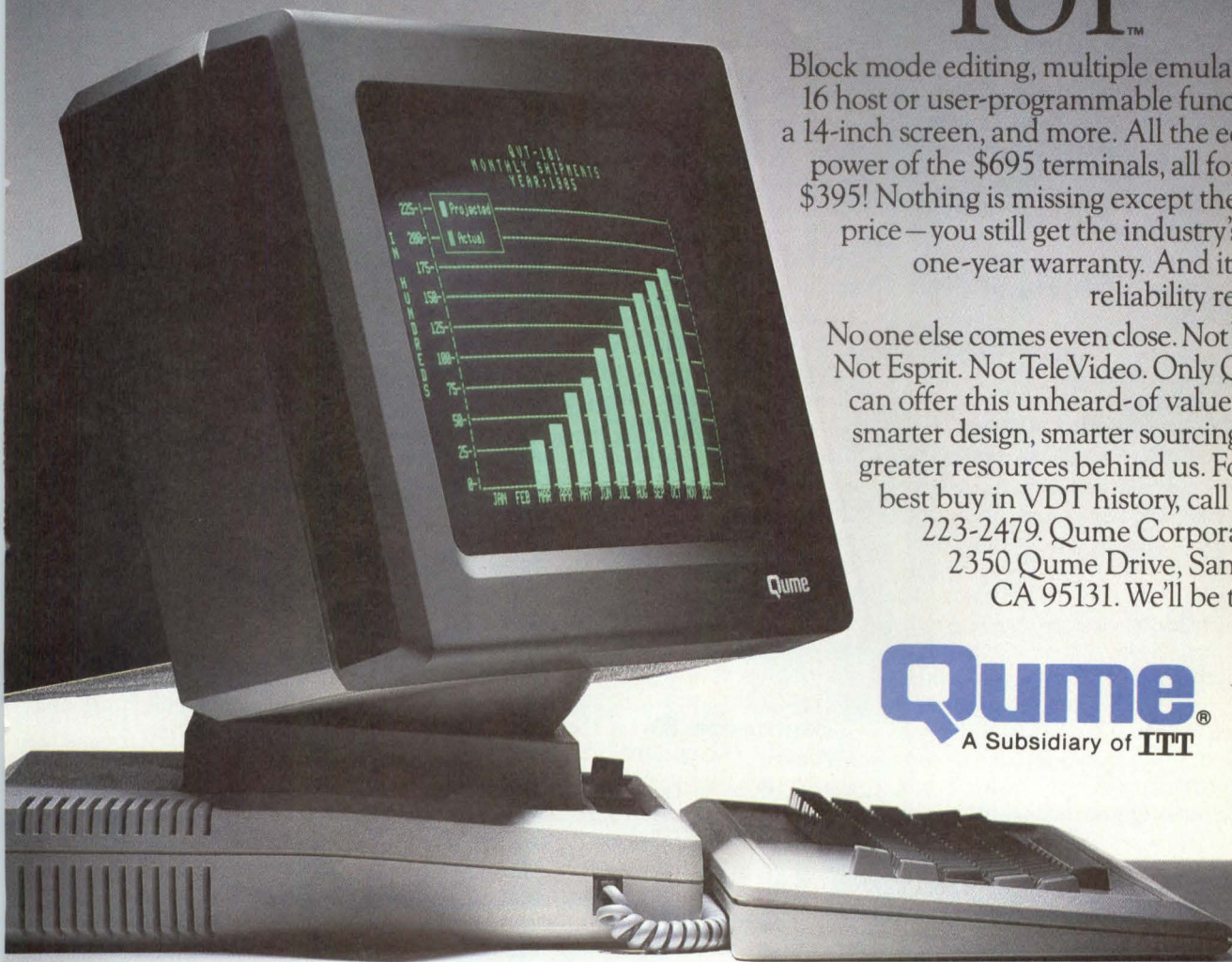

WASHINGTON REPORT

by Anne A. Armstrong

First IC Masks Registered With Copyright Office

A bright spot for semiconductor manufacturers faced with a depressed market was the passage of the Semiconductor Chip Protection Act at the end of the last session of Congress. Three companies marked the effective date of the new legislation by registering the masks used to manufacture individual chips with the Library of Congress' Copyright Office.

Intel Corp. was the first to formally apply for the 10-year protection when it registered its 256K EPROM chip model 27C256. Quickly following suit, Motorola registered its 68020 32-bit microprocessor, and Harris Corp. applied for protection for its 64K PROM.

The initial registrations were part of a ceremony held at the Copyright Office to celebrate the beginning of a new form of intellectual property protection. Carrying penalties of up to \$250,000 for infringement, the new copyright legislation may make possible the development of chips which were economically marginal before, said Congressional sponsors of the bills.

Foreign companies will also be able to register chip masks if their countries offer reciprocal protection to US products. Japan is reportedly considering some similar legislation.

Bell Expands Into Computers And Communications

The regional Bell operating companies have received approval from Judge Harold Greene, who is overseeing the break-up of the monopoly, to expand their businesses into some previously forbidden areas—such as computer sales and equipment leasing, service, overseas selling and real estate. Among the new endeavors which now have approval are the following:

- Bell Atlantic's entrance into computer equipment leasing through its purchase of Tri-Continental Leasing Corp. and into service through its acquisition of Sorbus.

- Nynex, Ameritech US West, and Pacific Telesis' entry into foreign markets to sell telecommunications equipment, computers and software or to set up cellular telephone operations.

- And with some limitations, US West and Pacific Telesis' move into real estate ventures.

Judge Greene's approval of 13 requests for a waiver of the conditions under which the regionals must operate gives the green light to a major expansion of the operating companies presence in the marketplace, according to industry observers.

Federal Electronics Market To Grow 6.75%

The Electronics Industries Association and the Aerospace Industries Association have completed an analysis of the expected spending by the federal government on electronic systems and products during the calendar year 1985. After adjusting for the differing government fiscal year, the associations estimate that in 1985 government spending on electronics will grow 6.75% to \$56.3 billion.

The bulk of that figure, of course, is Department of Defense spending, estimated to reach \$52.5 billion over the course of the year. EIA officials say in the past, their estimates of DOD spending have been accurate within 3%. Within DOD, the biggest categories of electronics spending are for missiles, the space program and electronic systems and communications.

Telecommunications is expected to be a big gainer this year—funding is up dramatically in both Air Force and Navy budgets. For DOD as a whole, EIA projects a \$3 billion increase in fiscal year 1985 and nearly that in fiscal 1986.

The civilian agencies will increase their spending for electronics only slightly—up from \$3.5 billion last year to \$3.8 billion this year. The biggest gainer on the civilian side will be NASA, whose funding increases \$.2 billion to \$2.4 billion.

Commerce Lifts Some Export Regulations

Early in the year, the Commerce Department continued its effort to get some kind of new export regulations established. Based on fall meetings of the CoCom group of western allies, Commerce removed controls from many low-end 8-bit microcomputers, but set stringent limitations on military microcomputers and on

minis comparable to the DEC VAX series.

Washington watchers of the long running feud between Commerce and the Department of Defense, over who is to establish and review the export of high tech equipment, believe the battle between the two cabinet departments is not over yet. Despite Commerce's action, new export legislation must still be moved through the Congress and many see DOD pressing its case on the Hill.

Regulations and restrictions changed so fast last fall that what was accurate when *Digital Design* went to press, could have completely changed by the time the issue reached readers. With that caveat, we can report that in mid-January Commerce lifted the need for export licenses from 8-bit microcomputers with processing data rates below 2 Mbits per second. Also, all restrictions have been removed from OEM equipment with embedded computers, providing the OEM product does not require any special export licenses and the embedded computer does not exceed established processing rates. In addition, floppy disks and most CRTs are now free to be exported without controls, unless they possess some special features.

Intel Wins Army Micro Contract

When the Navy and the Air Force decided to band together and select a single micro for both services, the Army chose not to participate. Instead, Army officials held a separate selection and bidding process. Officials have just announced they have awarded a contract, expected to be worth some \$66 million, to FMS Data Products Co. of McLean, VA for up to 8,500 Intel 86310 and 286310 microcomputers. The firm beat out 16 other manufacturers and distributors.

The contract is open ended—with indefinite quantity and delivery. All Army commands funnel their orders for micros through this one distributor. The pact runs through December 1989. The award marks the first large presence of Intel computers in the government. Zenith Data Systems won both large Navy/Air Force contracts.

Summagraphics

BIT PAD TWO

Feast your I/Os on this.

Unplug the old. Plug in the new. Bit Pad Two. The newest addition to Summagraphics' MM Series Data Tablets is format, function and plug compatible with Bit Pad One and Ten, and our other RS-232 UIO tablets. Summagrid, Supergrid and Microgrid.

Bit Pad Two offers the high reliability and low cost you'd expect of a product called Bit Pad. Plus electromagnetic technology to eliminate periodic biasing. And contemporary styling for today's ergonomic workstations.

Bit Pad Two is slim. Handsome. With a flat work surface for cursor steering or menu picking. And no metal edges or restrainers to scratch desks, catch spills, or collect dust. You have a choice of a 3 or 4 button cursor or one button stylus, which are interchangeable. Resolution (up to 1000 lines/inch), baud rate and sampling rate are switch selectable or programmable via the keyboard, along with remote request, software reset and self diagnostics.

Now you can move up to the latest in digitizer technology without special drivers or software rewrites. With Bit Pad Two. It's versatile. Programmable. Friendly. Built and backed by the company that knows how to deliver high quality. Summagraphics.

For information contact Summagraphics Corporation, 777 State Street Extension, P.O. Box 781, Fairfield, CT 06430. Telephone: (203) 384-1344. Telex 96-43-48. European Sales Office, Geneva, Switzerland. Telephone: 022-31-39-40.

Summagraphics[®]
CORPORATION

Draw on our experience.

FIND THE SHOP TO MAKE

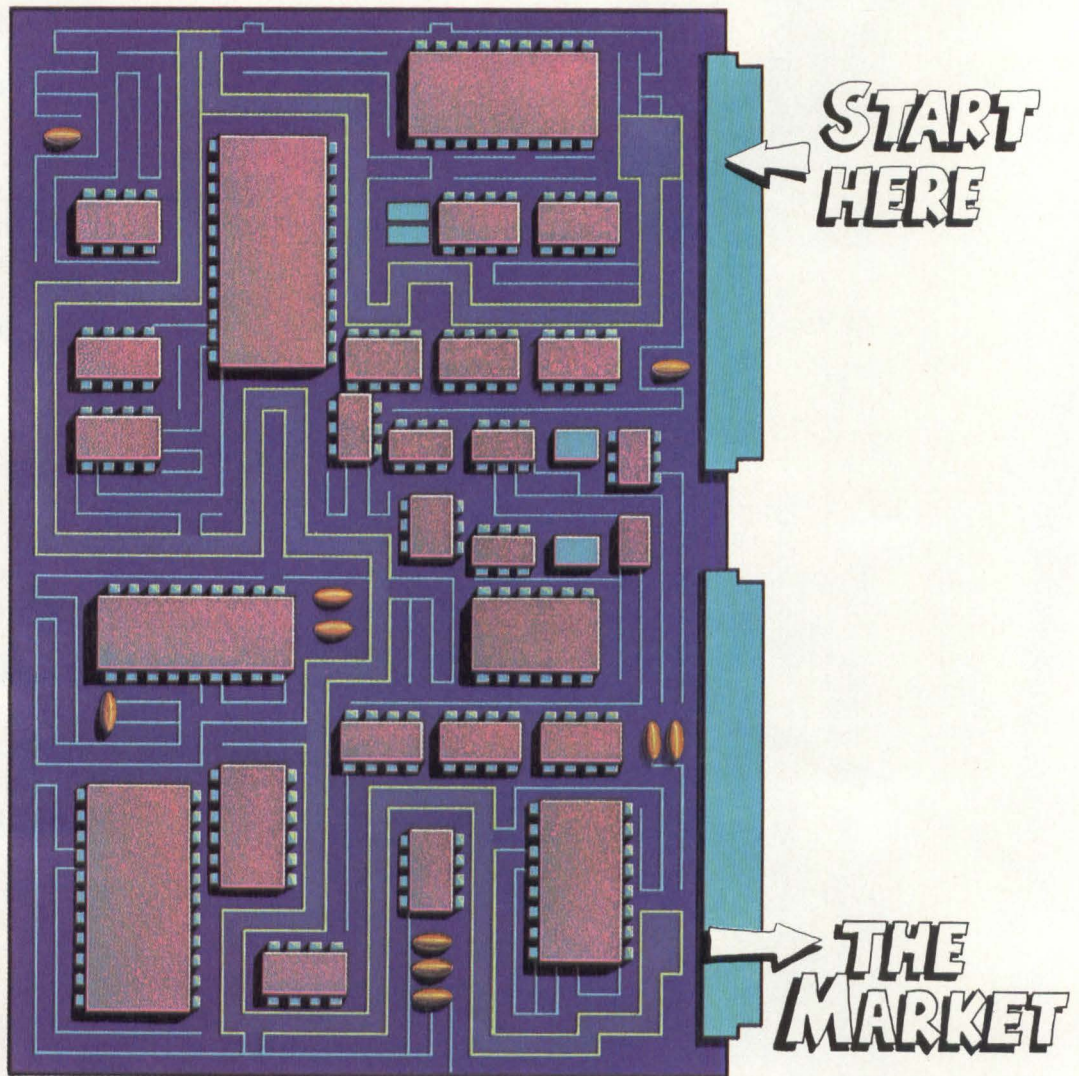

SHORTEST PATH MARKET.

Spend more time on your specific application. And get your product to market sooner with system and subsystem products from Mostek.

And because Mostek has a range of more than 100 predesigned bus boards and development software tools, we can serve almost any application you can create. Or we can design a custom board solution.

Take our high-performance 68000 family-based VMEbus boards and systems, for example. They're fast. And fast becoming the 16-bit industry standard. Then there's our VME Matrix 68K™, a multi-user UNIX™ system designed to meet and exceed the challenges of today's 16-bit applications. As well as serving as the base for tomorrow's 32-bit applications.

We're also one of the world's largest suppliers of 8-bit, Z80®-based, CP/M®-compatible STD BUS boards and systems. Like the I488 and ISIO, the newest members of our family of intelligent STD BUS boards, and a new STD BUS system, the Matrix 800™.

Mostek also produces a wide range of add-in/add-on memory boards for DEC®, Data General™ and Perkin-Elmer® computers. Fact is, most major manufacturers look to Mostek for innovative system solutions.

But it doesn't end there. Mostek also offers both custom and standard line SIPs and single in-line memory modules.

So whether your market is personal computers, large computer systems, large-scale memory processing or specialized applications, Mostek can get you there sooner.

For more information, contact Mostek Corp., 1215 W. Crosby Road, MS2205, Carrollton, TX 75006, 1-800-635-0200. In Europe, (32) 02/762.18.80. In Japan, 03/496-4221. In the Far East (Hong Kong), 5.681.157-9.

Matrix 68K and Matrix 800 are trademarks of Mostek Corporation.
UNIX is a trademark of Bell Laboratories.
Z80 is a registered trademark of Zilog, Inc.

CP/M is a registered trademark of Digital Research, Incorporated.
DEC is a registered trademark of Digital Equipment Corporation.
Data General is a trademark of Data General Corporation.
Perkin-Elmer is a registered trademark of Perkin-Elmer Corporation.



Graphics Processor Performs 3D Calculations

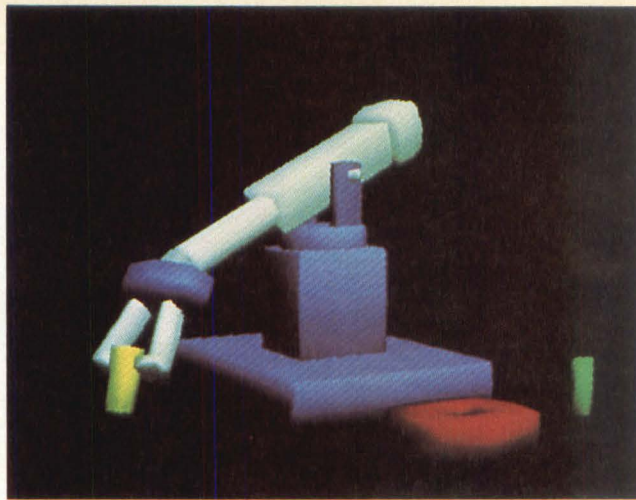
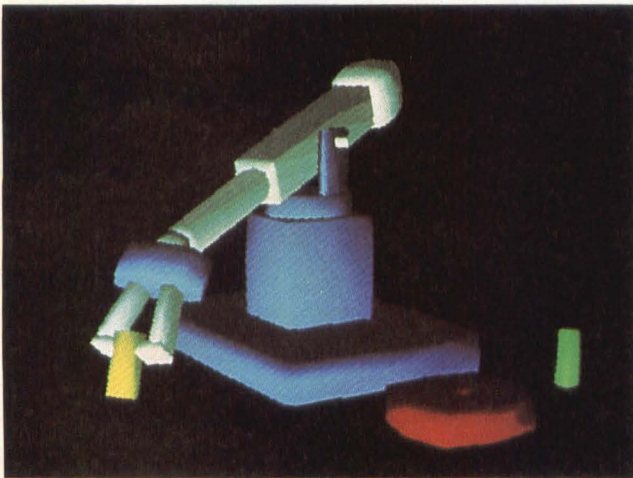

Figure 1: The Model One/380 from Raster Technologies allows the user to specify multiple local light sources and to define both specular and diffuse reflective surface properties for locally stored objects. (Left): Directional light source is coming from below the object from the left. Ambient lighting is present at a low level. (Right): Directional light source coming from above the object from the right. Ambient lighting has been increased to reduce the contrast between light and dark areas.

Raster Technologies has introduced a system, the Model One/380, that performs all the 3D calculations to create a rendered object. All rendering calculations are performed by the graphic display processor. Traditionally, the host had to render an image on each scanline, pixel by pixel. As a result of integrating the display process, local manipulation with realistic shading of complex objects can be displayed with near real-time rates. The Model One/380 software is compatible with the Model One series. The One/380 offers a high resolution of $1280 \times 1024 \times 24$ bits at 60 Hz, noninterlaced. Available as a deskside tower enclosure, it includes a keyboard, 19" monitor, tablet and mouse. A 4 Mbyte display list memory is optional.

The four major functions associated with 3D modeling are hidden surface removal, shading, light model calculations and 3D coordinate transformations. The One/380 executes these calculations through pipelining and a 32-bit floating-point processor. This allows the host to tessellate complex surfaces into complex patches, specifying color and light sources while the 380 performs the rest of the rendering pipeline. The standard 1 Mbyte local display list contains the graphics database. Up to eight local light sources can be specified. The diffuse and specular reflective properties for objects can also be specified. The light model consists of the base color, the surface charac-

teristics and the number and description of light sources, including ambient light. This is a step beyond local Gouraud shading which is also supported. The shading process may be speeded up for previewing using constant shading, so that polygons are drawn in a constant color.

An additional feature for shading during previewing is the ability to dither an 8-bit deep color. Few colors can create lines of intensity changes but dithering can soften these effects to about 12 bits. This feature is useful when 8 bits are used for color and 16 bits are used for the Z-buffer, in contrast to using the full 24 bit color depth capability of the One/380. After transformation and light modeling, a 16-bit Z-buffer performs hidden surface calculation. The process is further hastened by the ability of the coprocessor to disregard backfaces, if desired. The Z-dimension can extend to 65,535 units. The advantage to Z-buffering is that the surfaces do not have to be in any predetermined order, and incremental viewing of objects is possible. The alternative, scanline-based algorithms, creates objects in scanline order so the objects are seen after all calculations are finished.

Software features of the One/380 include the ability to set the refresh rate from 60 to 30 Hz interlaced. This is useful for using low-cost monitors and video hardcopy devices. The One/380 also includes a local debugger common to the Model One series. This allows single

stepping through programs, listing defined macros and returning to the program. Program development is further enhanced through the use of an online help facility. Multiple windows which can be placed anywhere on the screen are included. They can have selectable priority with nondestructive overlay.

The hardware of the One/380 is similar to the One/80 and uses the Z8000 as a central processor, 2901 bit-slice processor for graphics output and several gate arrays. The largest gate array has 8000 gates. Unique to the One/380 is the use of Weitek's floating point coprocessor chips to execute the 3D functions. Both the Weitek 1032 and the 1033 are used. The capability of the coprocessor reaches 10 Mflops. Housed in four boards, the standard One/380 consists of a graphics processor board, image memory board, floating processor board and the local display list memory board. Two more slots are available for additional memory.

The primary markets for the One/380 are CAD, geophysical applications such as seismic display, the automotive industry, simulation and modeling and aeronautical applications. Because of the ability of the One/380 to display wire frame objects in real time, render 3D objects with realistic shading and display objects with full 24 bit color depth, new applications will undoubtedly appear.

—MacNicol
Circle 235

ONLY EIKONIX[®]

DOES SO MUCH IN HIGH PERFORMANCE DIGITAL IMAGING CAMERAS.

EIKONIX[®] high-performance digital imaging cameras offer unique capabilities that clearly distinguish them from all others.

CCD or Photodiode Technology

Only EIKONIX offers a choice of high-resolution cameras employing either linear CCD (charge-coupled device) or photodiode technology. In fact, EIKONIX offers the highest-resolution CCD camera available anywhere, with up to 20 million pixels per image (4096 x 5200).

You can choose the economy and low-light capabilities of a CCD camera, or the greater dynamic range of a photodiode camera, *without sacrificing high resolution.*

Color or Monochrome

Only EIKONIX has a family of high-resolution cameras available for either monochrome (256 gray-scale levels) or color (a palette of 16 million colors) applications.

More User Control

Only EIKONIX cameras use a precision stepping-motor/lead-screw/ball-slide stage mechanism, which provides precise positioning of the array and eliminates one-dimensional



smearing. In addition, this mechanism allows asynchronous operation, so the user can control both scan speed and data collection rate. This eliminates the need for a separate "frame grabber" or dedicated processor, and frees the host computer for multi-tasking.

Buy Just What You Need

Only EIKONIX' broad product line lets OEMs and end users match needs precisely. Configurations range from bare-bones digital camera heads through complete image acquisition subsystems, including cameras, light sources, control electronics, imaging

software, and interfaces for many widely used computers (including most DEC and Multibus-based systems).

More Applications

Only EIKONIX offers the performance and flexibility to handle the broadest range of the most demanding applications, including mapping, engineering drawing digitizing, graphic arts, CAD/CAM input, office automation, X-ray storage and analysis, textile pattern design, geological imaging, communications, animation and microscopy.

EIKONIX Know-How

Only EIKONIX digital imaging products are backed by our 17 years of experience in matching advanced electro-optical technology to a widening world of applications.

To find out what we can do to support your digital imaging applications, contact EIKONIX, 23 Crosby Drive, Bedford, MA 01730, (617) 275-5070.

EIKONIX[®]
EIKONIX logo consisting of the word "EIKONIX" in a bold, sans-serif font, followed by a registered trademark symbol. Below the text are several horizontal lines of varying lengths, creating a stylized graphic element.

Circle 72 on Reader Inquiry Card

Graphics Workstations Compete For Top Performance

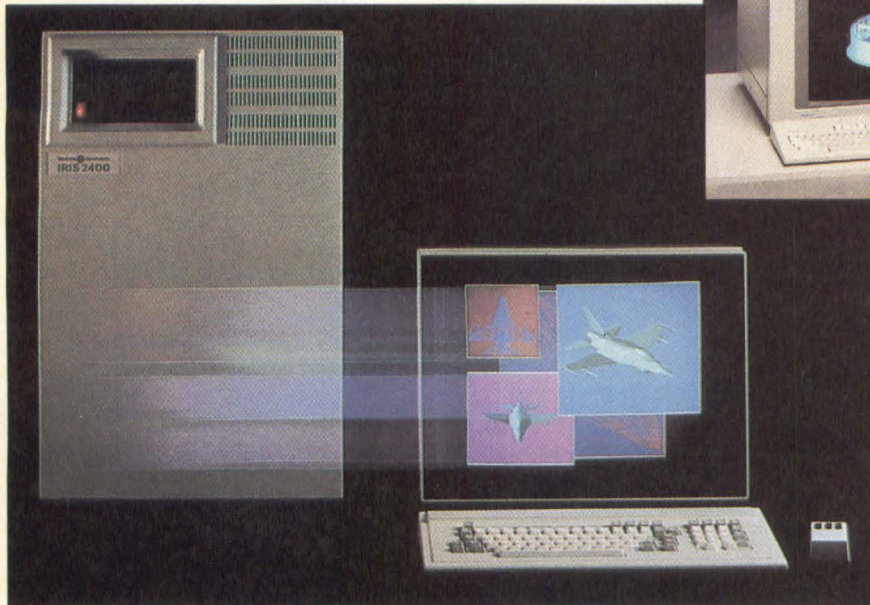

A new family of graphics workstations from Silicon Graphics (Mountain View, CA) may be the pacesetter for 1985. Designated the Iris Series 2000, this line of systems boasts 3D interactive graphics performance 100 times greater than its nearest competitor. The Iris family is composed of four workstations: models 2000, 2200, 2400 and 2500. All are 68010 based (10 MHz), run under UNIX, are equipped with an Ethernet interface (optional on the 2000) and use the XNS and TCP/IP protocol. According to Silicon Graphics, the systems' high performance is due to their multiplicity of full-custom ICs which enable a high level of parallelism.

The heart of the workstation's design rests in the Geometry Engine which consists of four 32-bit floating point ALUs and a microcoded control store. All Iris systems incorporate a pipelined array of 10 or 12 Geometry Engines with each engine responsible for one of three graphics operations (Figure 1). Four-by-four matrix transformations are performed by the first four Engines (e.g., rotation, translation and scaling). The next four to six clip the object in two or three dimensions; and the last two Engines perform a

perspective division and map the 3D coordinates to screen space.

Assisting the Geometry Engine, the Geometry Accelerator provides FIFO buffering and floating point conversion (Figure 2). Buffering is necessary because the CPU, Geometry Pipeline and frame buffer controller generate data at different rates. The Geometry Accelerator also converts the user's data to the Geometry Engine floating point format. After undergoing Geometry Engine processing, the data is converted back to the user's format. Silicon Graphics claims that executing this conversion in hardware results in a tenfold speed increase of light-source shading and hidden surface removal.

Transformed and clipped data leaving the pipeline is primarily a set of commands in absolute screen coordinates. With these coordinates, the raster subsystem updates the image memory and refreshes the display. The raster subsystem consists of three basic sections: the frame buffer controller, the update controller and the display controller. Bresenham coefficients for rendering lines and polygons are computed by the frame buffer controller which is a 16-bit 2903 bit-

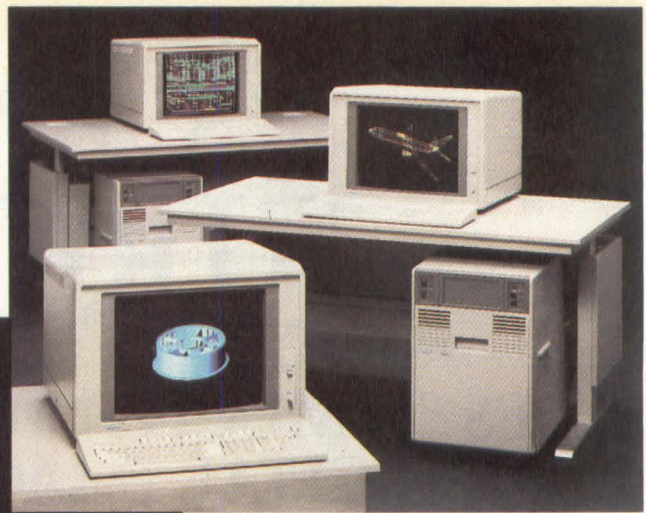

Above: The Tektronix 4125 color graphics workstation and the 4128 and 4129 3D graphics workstations feature a dynamically converged in-line display; 80286/80287 processor; up to 800K of display list RAM; 32 bit coordinates; up to 8-bit planes, and a highly interactive keyboard supporting a joystick and mouse.

Left: All four models of the Iris Series offer 1024 x 768 resolution, a 60 Hz noninterlaced display and a 16-bit Z-buffer.

slice processor with 4K of writable control store. Resulting images are placed in the frame buffer by the update controller which also does the scan conversion. The display controller refreshes the display using one of three display modes: single-buffer, double-buffer and red-green-blue (RGB). In single buffer mode, all bit-planes are divided into halves, and one half is viewed while the other is modified. When the modified frame is complete, the halves are exchanged and the new frame appears. In both instances, a color map specifies the red, green and blue intensity values.

Gouraud shading, depth cueing and 16-bit Z-buffer operation are other features of the Iris 2000. Depth cueing enhances 3D wireframe drawings by modulating the intensities of the lines and points that comprise the drawing. Consequently, images closer to the viewer are brighter than those further away. Depth cued vectors are drawn at a rate of 1.5 million to 3.0 million pixels per second. Another feature is an interactive 3D Window Manager that allows users to work on several designs simultaneously and run multiple 3D application programs.

Although response time has always



Our Smart-Frame™ will put you in touch.

Carroll Touch
a subsidiary of AMP Incorporated

In Touch with Technology

One of the easiest ways to interact with a computer is through a touch activated display. One that lets you merely point your finger at what you want your computer to do.

With touch, even the most complex application can become user friendly. And less susceptible to user error.

But the advantages of the highly reliable infrared touch input systems have been overshadowed by cost. Placing them out of the range of medium to low-cost turnkey systems manufacturers.

Which is the main reason Carroll Touch completely redesigned its line of touch input products.

We call it Smart-Frame™. Because it contains a powerful microprocessor built into the frame. And because it uses scanning infrared technology—a touch technology which is incredibly reliable, rugged, accurate, and fast. A technology Carroll Touch pioneered and refined.

As a result of the Smart-Frame design, Carroll Touch units contain 45 percent fewer components than before. Which means the cost to you is about 50 percent lower too.

We think that's pretty smart. And Carroll Touch did it just so you could get in touch. Today.

P.O. Box 1309
Round Rock, Texas 78680
512/244-3500, Telex 881906

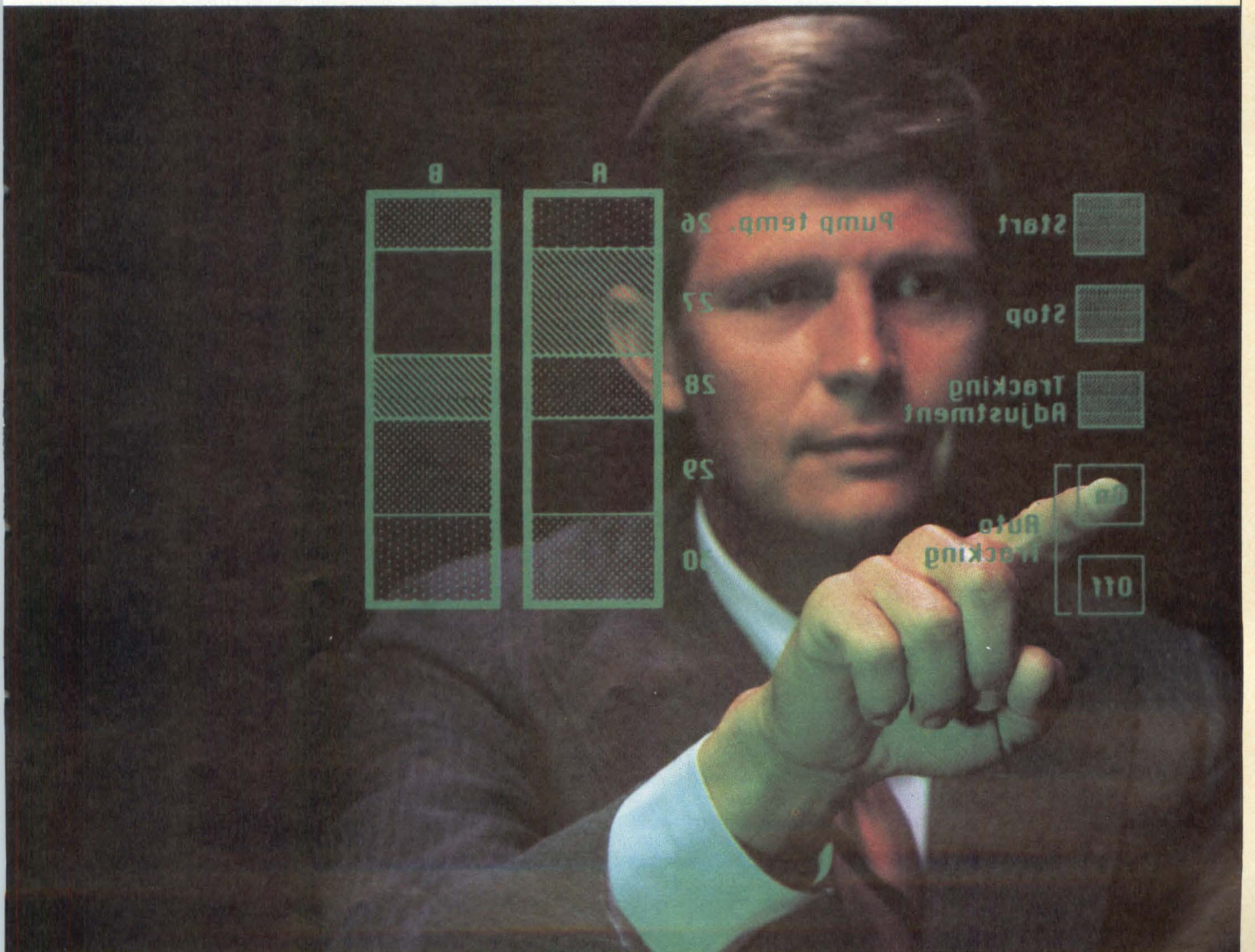

Circle 8 on Reader Inquiry Card

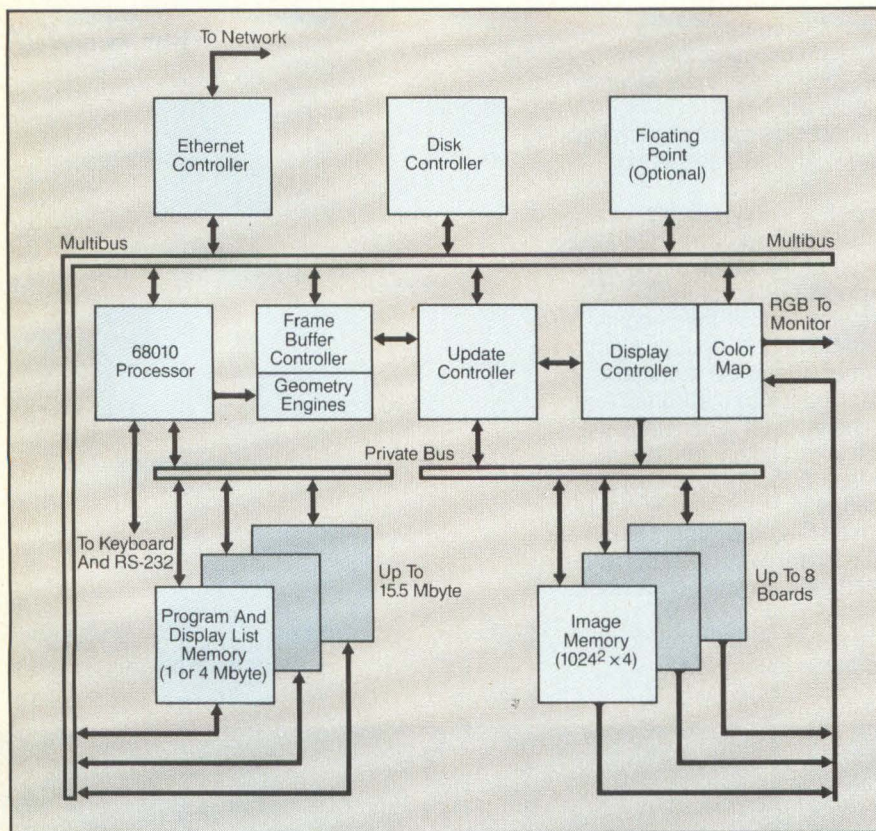

Figure 1: The Iris architecture is made up of three pipelined components: the central processing system, the Geometry Pipeline and the raster subsystem. The three sections communicate over the private bus while disk and network communication occurs over the system Multibus.

been recognized as a key parameter in workstation performance, IBM recently measured response time as a function of output productivity. The results of the study show that a one second decline in response time results in a quadrupling of hourly engineering output.

Silicon Graphics is not alone in the race for graphics supremacy. Tektronix (Beaverton, OR) is offering a major upgrade to their present line of graphics workstations. Intended for CAD applications in mechanical engineering, electrical engineering, cartography and analysis, the 4120 series of workstations is compatible with Tektronix's line of graphics products. Each of the three models — 4125, 4128 and 4129 — feature 2D, 3D wireframe and 3D solid shading capabilities respectively. The 80286/80287-based systems offer 1280x1024 pixel resolution for display on a 19" dynamically converged display at a refresh rate of 60 Hz, noninterlaced. A delta gun, utilizing autoconvergence, is available and each unit is upwardly compatible.

The 4125 basic workstation has firmware for segment editing, fast draw and panel fill, local zoom and pan, 2D image transformation and segment subroutine

Figure 2: The Geometry Pipeline comprises the Geometry Engine and Accelerator which are VLSI full-custom ICs. By using multiple Geometry Accelerators, the Iris manipulates geometric data, with clipping and perspective division, at an effective rate of 65,000 transformations per second.

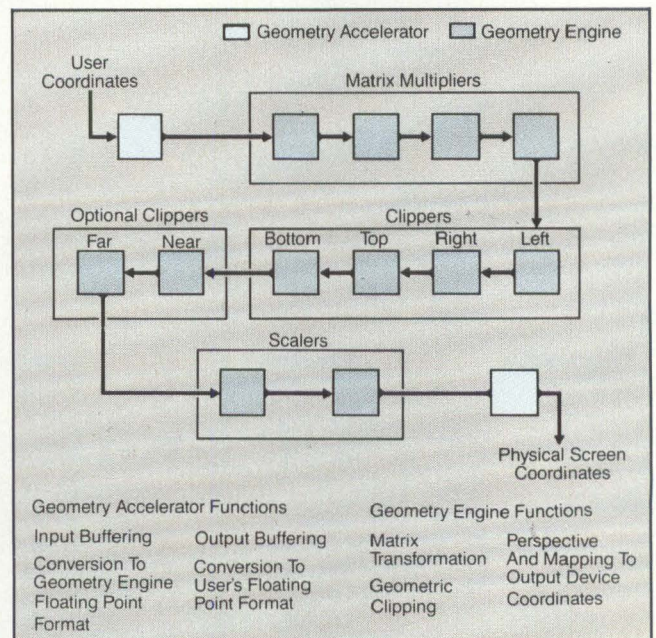

commands. This last feature is particularly useful for referencing a segment as part of another segment, such as using the function for local storage of repeated elements typical of integrated circuit design, schematic capture and mapping. This saves both memory and editing time. The 2D transformation capability allows drawing of 50,000 vectors per second at maximum resolution. A 4125 supports up to 64 scrollable windows on screen simultaneously and pop-up menus that can be saved and recalled from local memory. Coordinate space is 32 bits deep.

The 4125 hardware includes 288K of memory, expandable to 800K. Two-bit planes are standard, and it can be upgraded to eight. The keyboard has eight dedicated function keys, a numeric keypad and ports for a mouse and a joystick. A wireframe treadmill is optional.

Both 4128 and 4129 color graphics workstations are targeted for 3D applications, but also provide all the 2D capabilities of the 4125. They offer a 24-bit integer space for complex polygons where 2D and 3D information can be displayed simultaneously while executing local pan, zoom and rotation of 3D objects. Data types such as triangle lists, quadrilateral lists and quadrilateral meshes are supported for creating planar polygon definitions. Both units provide the ability to perform local 3D segment matrix transforms, in addition to parallel or perspective viewing through the use of a single

The 14-pen 51/52 MP:

We've just made the
best plotter
better!

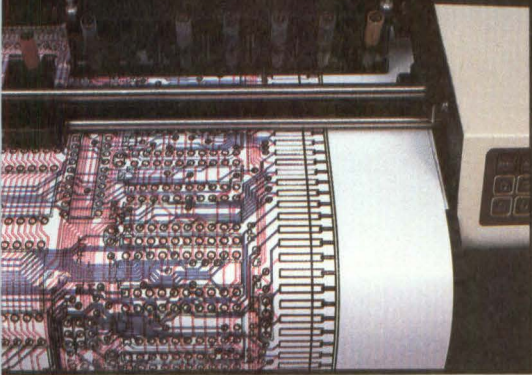
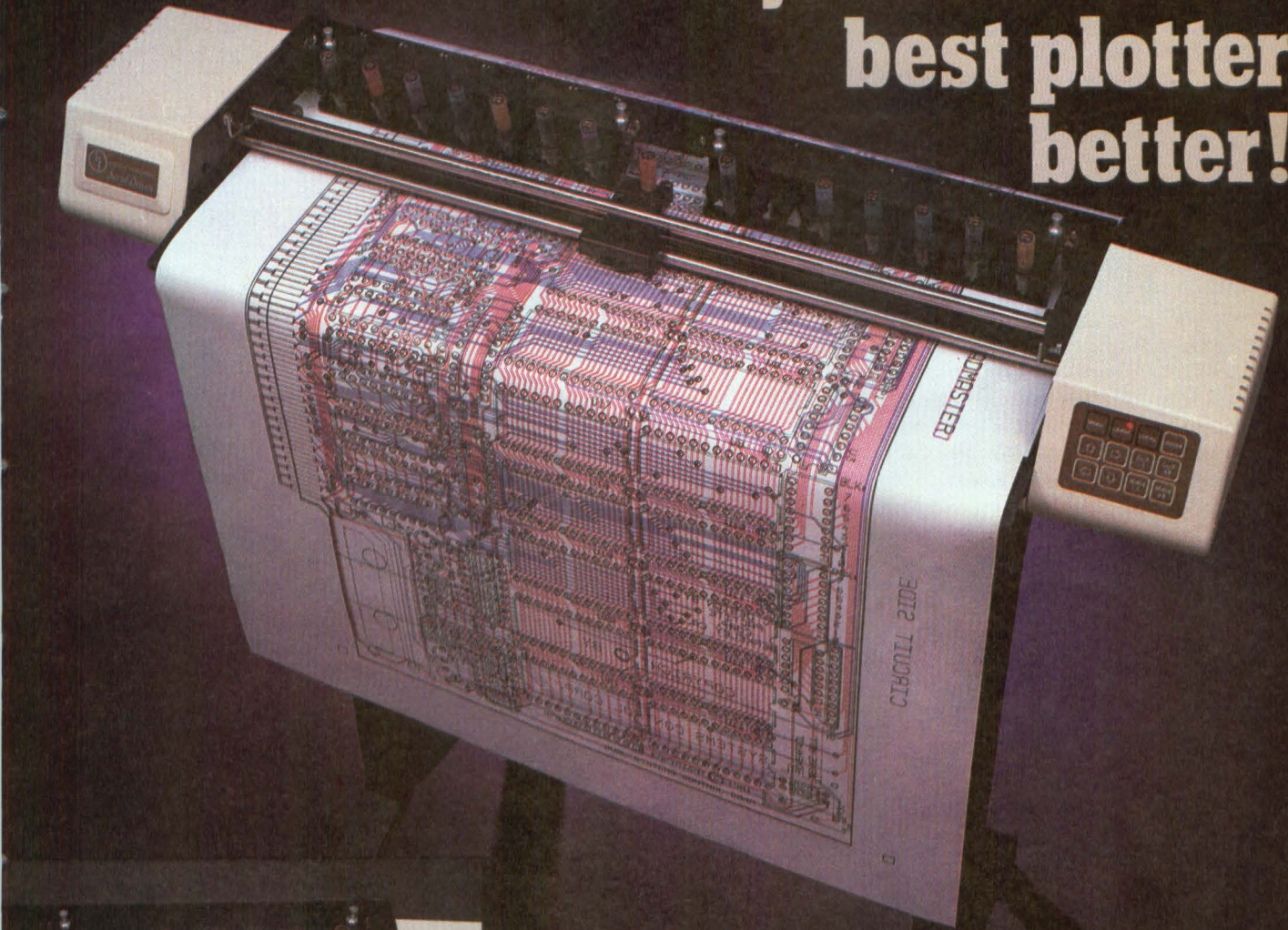

Unbelievable performance — and price . . . Go ahead! Investigate your options. You simply will not find a more capable multi-pen plotter on the market today. Priced at \$5,995.00*, Houston Instrument's DMP-51/52 MP combines top-of-the-line technical performance with sleek styling, quiet servo motors and our matchless DM/PL™ resident intelligence.

Holding up to 14 self-capping pens in a unique carriage assembly, the DMP-51/52 MP responds to any drafting-intensive demand. Whether your plots require multi-color capability or a variety of line widths, the DMP-51/52 MP quickly and efficiently meets the challenge. This multiple pen capability means your days of multi-stroking lines or

constantly changing pens are over — which allows you to dramatically reduce your drafting throughput time when creating C and D size plots.

Redefining state-of-the-art . . . The DMP-51/52 MP offers all the best features of Houston Instrument's phenomenally successful DMP-51/52 series. The multi-pen version features a maximum speed of up to 22 inches per second, a user-selectable acceleration rate of up to 4 Gs and a resolution of .001 inches. We've also added a constant velocity control to ensure uniform inking regardless of the angle of pen movement.

We're confident you'll be impressed with our newest plotter. Call us at 1-800-531-5205 (512-835-0900 for Texas residents) for the name of your nearest dealer or distributor, or write Houston Instrument, 8500 Cameron Road, Austin, Texas, 78753. In Europe, contact Houston Instrument, Belgium NV., Rochesterlaan 6, 8240 Gistel, Belgium. Tel.: 059-27-74-45. Tlx. 846-81399.

**houston
instrument**

* U.S. suggested retail price
DM/PL is a trademark of Houston Instrument

Circle 34 on Reader Inquiry Card

4P018

keystroke. Multiple views can be displayed and manipulated by the thumbwheels on the keyboard. Users can also control the depth clipping for front or back, eliminating unnecessary visual information.

One difference between the 4129 and the 4128 is the number of bit planes: four for the 4128 and eight for the 4129. Hidden line and surface removal is provided from the 4129's display list. The 4129 also includes enhancements for shading 3D surfaces. Shading can be either constant, cosine or Gouraud. Constant shading, where an object has the same color intensity across its surface, is useful for high speed display and previewing. Cosine shading provides a more realistic lighting effect with a local light source. Gouraud shading, the slowest method, provides the most realistic lighting where up to 16 local light sources may be used. Colors used to shade a surface are defined in a contiguous shade of indexes that represent a range of intensities. The illusion of a larger map equaling 1024 colors is allowed by 4x4 dithering. It also allows better smoothing and less "banding" to surfaces.

Harris' Computer Systems Division (Ft. Lauderdale, FL) has also jumped into the workstation arena with two UNIX-based systems: the HS-10 and HS-20. Both utilize a dual processor

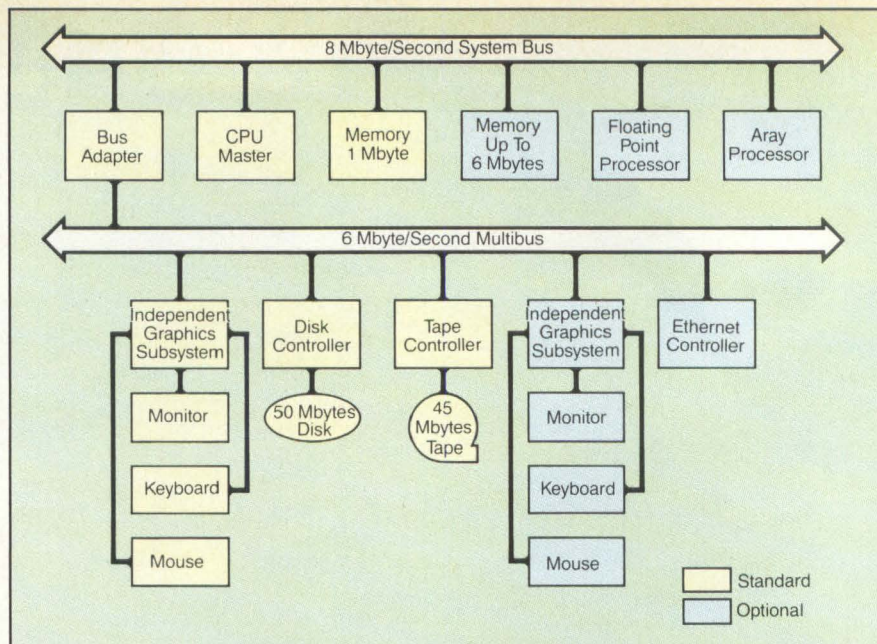

Figure 3: The architecture of Harris HS-10 and HS-20 workstations is built around the 68010 and 68000 processors. Graphics is handled by a third processor, a 68000, running at 12 MHz.

architecture (68000 and 68010) running at 10 MHz. A block diagram of the systems' configuration is shown in **Figure 3**. A dual bus architecture enables primary system modules to communicate via the 8 Mbyte per second system bus, while peripherals connect through a 6 Mbyte per second Multibus. Multitasking is aided through the use of 24 sets of 32-bit double precision registers. Moreover, performance can be raised by adding an

optional floating point processor which operates in parallel with the CPU. Similarly, an optional array processor can be directly tied onto the system bus to further increase speed. An Ethernet interface is also a standard feature.

—Collett, MacNicol

Tektronix **Circle 234**
Silicon Graphics **Circle 238**
Harris **Circle 239**

DEPARTMENTS/Communications

Low-Cost 1200 bps Modem Modules Interface Directly To UART, Phone Jack

Users are demanding expanded communications capability from systems; and integral modems for low-speed transmission serve that need in many products. Though ICs are available for modem signal processing, extensive auxiliary circuitry may be needed to provide even a 300 bps line. Modules are available from several sources that include more functions and eliminate most external circuitry. Two new Bell 212A products from Cermetek (Sunnyvale, CA)

ease interface and make costs of 1200 bps capability more attractive.

Cermetek introduced the CHI770 to be the first 212A-compatible (1200/300/110 bps) modem component that OEMs can purchase for under \$100. For large arrays of modems or security-sensitive applications, the newer CHI763 module's third port allows communications control and monitoring without disturbing the data. Both are complete modems to be mounted on a PC board.

The basic 1770 is 8" square (2.54"×3.74"×.75") and comprises auto dial/auto answer, tone or pulse dialing, auto-speed and auto-parity adjustment, and diagnostics in addition to the signal processing. With these components and FCC approval of the telephone line interface (DAA), communication can be a standard design feature by interfacing to a UART and a standard RJ11C telephone jack (**Figure 1**).

The larger 15" square CHI763 includes

Panasonic CRTs

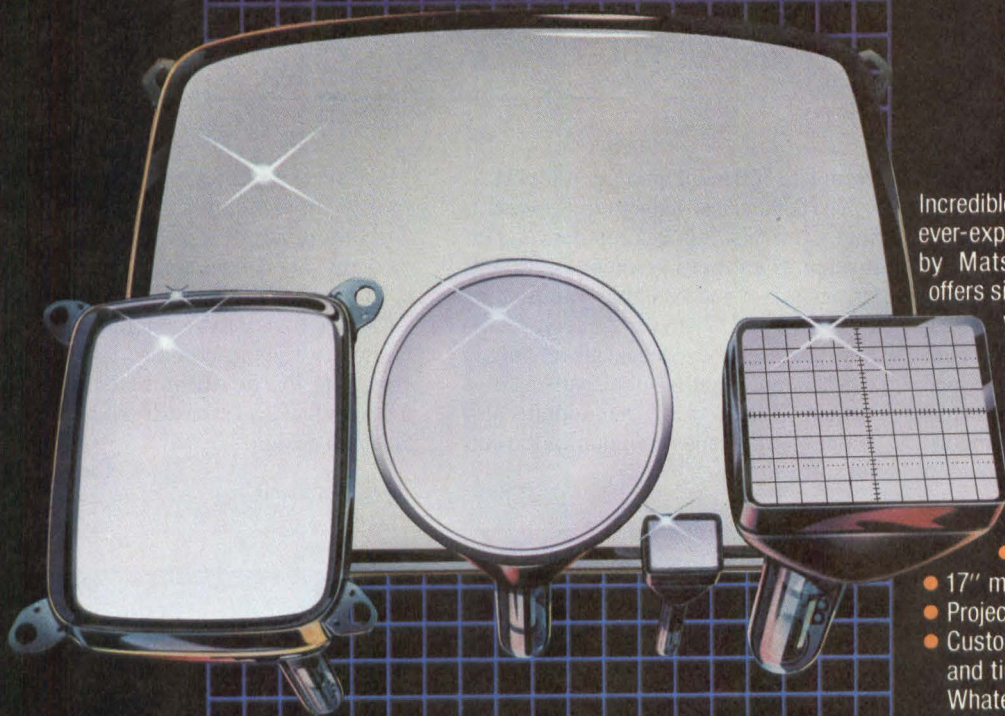

Incredible as it might seem, Panasonic's ever-expanding line of CRTs manufactured by Matsushita Electronics Corporation, offers sizes and variations so numerous,

we actually give you a thousand and one CRT alternatives. And then some.

Our options add up to suit your needs:

- Color and monochrome tubes, 1/2" to 40"
- In-line and delta guns
- 64KHz capability
- 17" mono page and 19" dual page readers
- Projection and instrumentation tubes
- Custom phosphor blends in 30 colors and tints

Whatever your product – from work stations to terminals to oscilloscopes – you can count on us. Because no one gives you more options when it comes to CRTs. No one.

For the complete picture, call or write: Panasonic Industrial Company, Computer Components Division, One Panasonic Way, Secaucus, NJ 07094. (201) 348-5278.

Panasonic Industrial Company

Circle 9 on Reader Inquiry Card

**A thousand
and one ways
to sharpen
your image.**

Panasonic

a third, parallel, port to connect to the host and an intelligent command interpreter, so the host can reconfigure connections to the modem or to an array of modems. Over the 8-bit parallel bus to the modem DTE, a host can scan several lines without separate UARTs and extra circuitry for each. In situations where security over telephone lines is in question, the host can disconnect the line and, after verifying the password, re-dial a call for transmission. Auditing, diagnostics and status reporting, features common on larger standalone modems, are also possible with this module.

Cermetek is not the only company offering 1200 bps modem modules. Rockwell (Newport Beach, CA) also has a 212A product; and TI (Dallas, TX) offers a 28-pin DIP for 1200 bps modem signal processing. Neither includes the DAA, which needs FCC approval. Several other IC manufacturers are expected to introduce 1200 bps products this year, but meantime companies like National Semiconductor (Santa Clara, CA) are introducing

Figure 1: An integral 212A modem requires only a UART and standard modular telephone jack in addition to the CH1770.

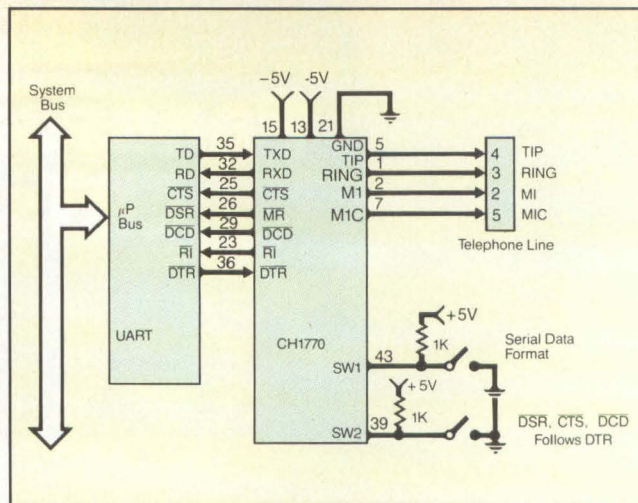

complete 300 baud modules with DAA.

The advantages of integrating modems into terminals, home computers and instruments are even greater as 1200 bps products become available. Eliminating a set of RS-232 drivers/receivers and hardware and the external power supply can be significant in such cost-sensitive systems. Firmware in the modules also lessens the demands communication puts on software.

Advances in LSI are allowing higher speeds, more features and lower prices with increasingly smaller footprint modems. Though the single-chip modem is ideal, integrating auto-dialing and DAA functions into a monolithic IC may be over a year in coming. Until then, complete PC board mounted modem modules will lead in ease of modem interface and design.

—Pingry
Circle 237

BEGONE, CURSED ALIAS

80 dB/octave attenuation. Time delay filters superior to Bessel. 1° phase match or better. Standard computer interfaces. Serial, parallel and GPIB.

We set these industry standards, and we keep extending the choice of Precision systems for HP, LP, TD, BP, BR and anti-alias filters. 2 channels to 64. Choice of cut-off frequencies, resolution, amplification and other features to match your needs precisely.

Read about them all in our summary catalog, **The Precision Conditioners**. Call 607-277-3550 or write.

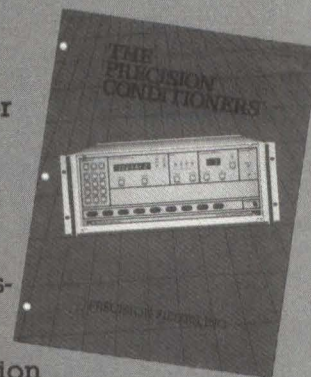

PRECISION FILTERS, INC.

240 Cherry Street, Ithaca, New York 14850

Floating Point Chip Outperforms Competitors

The MC68881 floating point coprocessor (FPCP) from Motorola calculates basic math functions twice as fast as any other single chip math processor. According to Motorola, a 16.67 MHz version of the MC68881 will perform an add or a subtract in 2.76 μ sec while a 12.5 MHz version of the chip will take 3.68 μ sec. This compares to 7.5 μ sec for National Semiconductor's 10 MHz NS32081 floating point processor. Intel's i80287 5 MHz chip requires 17 μ sec per add.

The long-awaited Motorola chip does floating point calculations in accordance with the latest draft of the IEEE floating point specification (P754 Draft 10.0). In addition, the MC68881 can perform transcendental and other functions. Such operations include trigonometric, exponential, hyperbolic and logarithmic functions as well as root values. All functions

are calculated in hardware to 80 bits of precision.

Although the FPCP is primarily intended to operate as a closely coupled coprocessor with the 32-bit MC68020, it can also operate as a memory-mapped peripheral with other 68000 family processors. Consequently, floating point functions can be added to the reduced bus MC68008, the 16/32-bit MC68000, the virtual memory 68010 and the expanded virtual MC68012.

In MC68020-based systems, MPU and FPCP communicate via the MPU's coprocessor interface with the 68020 passing instructions to the 68881. The coprocessor interface is transparent to programmers because coprocessor instructions are written as part of the main instruction stream. Since the coprocessor runs concurrently with the main processor, the instructions are executed in

the coprocessor while the CPU is free for other tasks. For present 68000 family processors, other than the 68020, instruction sequences must emulate the protocol of the coprocessor interface. However, future 68000 family processors will use the coprocessor interface.

The MC68881 includes a 67-bit arithmetic unit, a barrel shifter and eight 80-bit general-purpose registers. The 2-micron HCMOS process used for the chip permits 155,000 transistors on a chip measuring 270 \times 330 mils. Power dissipation of the 68-lead pin grid array is less than 1 W. Standard clock frequencies are 12.5 MHz and 16.67 MHz. Samples will be available this month for \$375 each. Limited quantity production is expected for July.

—Bond
Circle 233

BEGONE, OTHER PESKY PROBLEMS

From Precision Filters we grew to many Precision Conditioners. All multichannel. All programmable. All for the care and preservation of signals between transducer and A/D converter.

Instrumentation and filter amplifiers. Gain-ranging amplifiers and preamps. Multimode conditioners for strain, charge and voltage. Switching matrices. Frequency-band translators for super BP applications, as well as providing analog zoom for spectrum analysis, modal analysis and beam forming.

Read about them all in our summary catalog, *The Precision Conditioners*. Call 607-277-3550 or write.

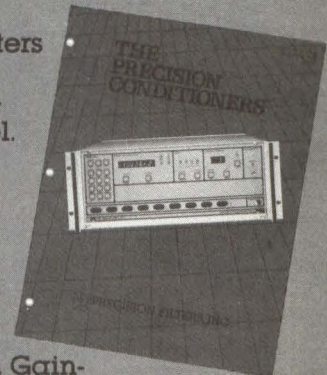

PRECISION FILTERS, INC.

240 Cherry Street, Ithaca, New York 14850

Circle 5 on Reader Inquiry Card

24×24 CMOS Multiplier — An Industry First

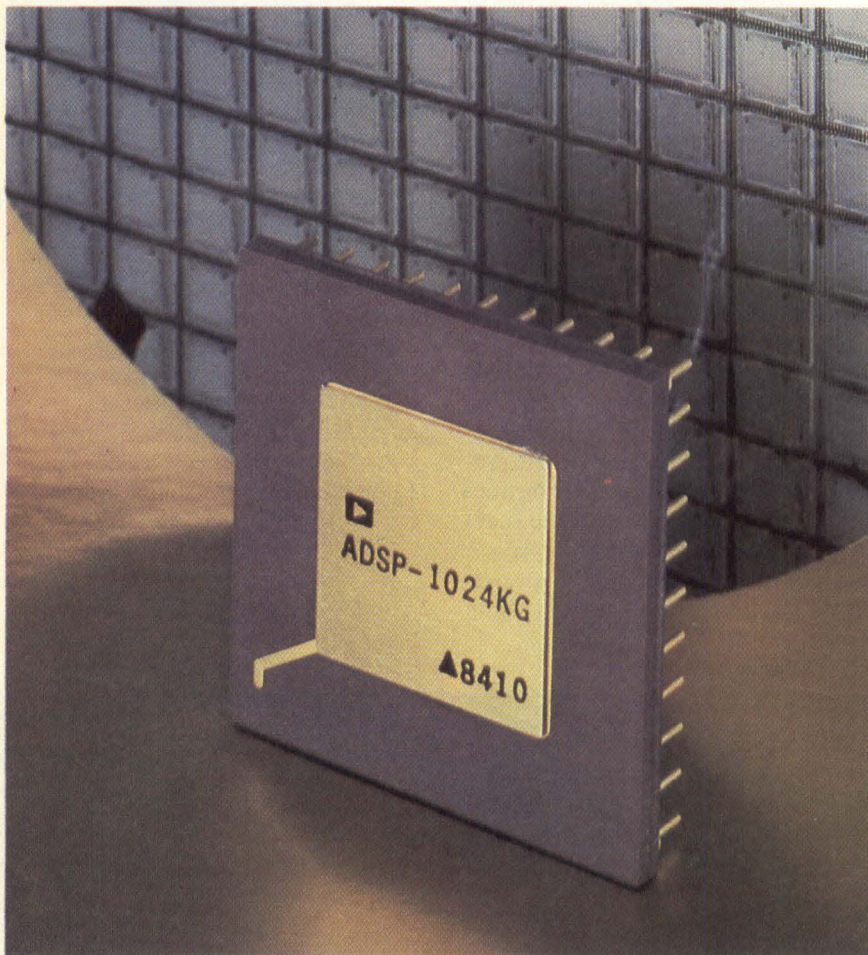

Analog Devices' (Norwood, MA) parallel array CMOS multiplier, the ADSP-1024, packaged in an 84-pin grid array, bridges the gap between resolution and cost. Processing operands at a 5-MHz rate, the 24-bit multiplier is specified (worst case) with multiplication time of 195 nsec (commercial grade) and power dissipation of 200 mW. It features two input ports and one output port. By multiplexing the Most Significant Product (MSP) and the Least Significant Product (LSP) through the output port in a single cycle, it achieves a full 48-bit product without sacrificing throughput.

Additional features on the ADSP-1024 include the ability to shift the output for format compatibility with the external system, status flags for normalized product and overflow and rounding capabilities on one of three different bits. Such

capabilities enable the device to be configured with external adders to perform 32-bit floating point multiplication with a 24-bit mantissa and an 8-bit exponent.

David Birkner, Vice President of Engineering at array processor manufacturer Computer Design & Applications Inc., believes the Analog Devices part may make its presence felt mainly in the development of floating point multipliers. Systems architects not wanting to implement single chip IEEE format floating point multipliers in their designs will be able to build floating point multipliers in other formats, such as DEC or IBM.

According to Louis Schirm IV, President of DSP Systems Corp., the ADSP-1024 offers impressive specs and a sensible design. The architecture of the multiplier is such that the device will be fairly easy to use since neither the MSP nor LSP are

multiplexed with the input ports. He predicts the 24-bit multiplier will be of definite use for systems architects working in specialized applications of digital signal processing (DSP) such as digital audio and seismic exploration and array processor development.

Designers of high accuracy DSP systems are often faced with the problem of choosing between lower resolution and more expensive multipliers. Unacceptable levels of digital noise, caused by either insufficient coefficient accuracy or the maintenance of too few bits, may require the systems architect to search for higher precision multipliers in order to perform digital filtering and fast Fourier transforms (FFTs).

Performing double-precision operations with several parallel 16-bit multipliers reduces the throughput of the device in addition to raising the cost. Although floating point multipliers provide greater dynamic range, they do so by increasing system complexity and cost. The latency period for such multipliers is longer, sometimes up to 900 nsec. In addition, some DSP applications may not require a full 32-bit floating point for precision. Analog Devices intends to give systems architects more design options by offering the 24×24-bit CMOS multiplier.

TRW's LSI Products Division (La Jolla, CA) made two attempts to manufacture a 24×24 bit multiplier. The first in 1978 resulted in a bipolar part which was slow, power hungry and difficult to implement. The chip did not proceed past the initial silicon stage.

In 1981 TRW announced another 24-bit multiplier; after preliminary sampling, the part was never manufactured. According to a TRW spokesperson, the MPY-24HJ was abandoned because there was a lack of interest among systems architects. Designers of the TRW bipolar part also had difficulty forcing the multiplier to desired power dissipation specs. Even with the achievement of the 24-bit multiplier at Analog Devices, TRW has no plans to resume development of a similar device within the current calendar year.

—Meng

Circle 232

STRONG STATEMENTS FROM PEOPLE WHO GIVE YOU...

STRAIGHTTALK

No claims. No boasts. Just straight facts and commitments from Jeffrey Liu, president of Microscience, on our growing family of half-height Winchester disk drives.

"By introducing the new HH-725 20 MB 5.25" and HH-312 10 MB 3.5" half-height Winchester disk drives to our product line, we now offer the proven quality and performance most OEMs need in volume today.

"Combined with our HH-612 10 MB 5.25" half-height disk drive, Microscience now provides a product family of superior quality and better performance than any other drives available.

"Time after time, we have proven that Microscience has the performance, quality, and price personal and portable computer manufacturers demand.

"The secret is the way we design and manufacture drives for you.

"Microscience disk drives have extremely low voltage requirements because small business and portable computers don't have the luxury of excess power or cooling capacity.

"We've used procedures and components that will be power misers, yet they still provide long-term performance and reliability.

"Our drives feature a thermally isolated stepper motor for precise head alignment and optimum seek performance. A proprietary linear actuator assembly was employed to ensure data reliability

and provide greater drive durability.

"A buffered seek mode and highly accurate proprietary micro-processor-controlled closed-loop servo positioning system keeps the head precisely on track. This maintains data integrity through a wide range of operating conditions regardless of thermal expansion, system hysteresis, or long-term wear.

"Microscience drives are not limited to functioning horizontally. Because of the growing use of portable computers and increasingly compact packaging, we designed our Winchester drives so you can use them in almost any position.

"While volume production is important, what you're really concerned about is the quality of product you use in your system or application. We have made a major commitment to

manufacturing and quality programs.

"Microscience test equipment and tooling have been carefully selected to meet our exacting standards.

"This ensures Microscience ships only zero defect half-height Winchester product that does not eat away at your profits... and your reputation.

"There's a lot more I could say about the Microscience half-height Winchester disk drive family. But what will convince you is using a Microscience drive in your application.

"For more straighttalk regarding your half-height Winchester needs, call or write us today."

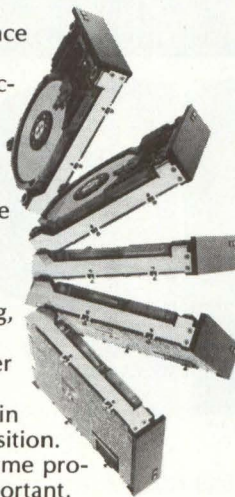

Jeffrey Z. Liu

President,
Microscience
International
Corporation

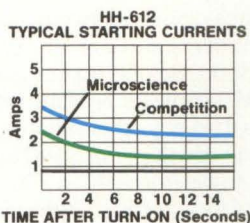

 **Microscience
International
Corporation**

575 E. Middlefield Road
Mountain View, CA 94043 (415) 961-2212

Area Sales Offices: Orlando, FL (305) 339-8283 • Boston, MA (617) 229-5823 • Mountain View, CA (415) 961-2212
International Sales Office: Munich, West Germany, Tel. 0894315669, TTX 5213442 Distributors: U.S. - Gulf Stream, Weatherford, North East Peripherals, Orion • International - Multitek, Canada • Pericomp, Australia • Dataguild, U.K. • Wide Trade Foundation Ltd., Hong Kong

Circle 32 on Reader Inquiry Card

CHOCK FULL OF CHIPS.



We've long been recognized for our tasty technology. But not many know us for our tempting selection.

Fact is, no one offers a more complete line of integrated circuits than Fujitsu: memories, microprocessors, microcontrollers, floppy disk controllers, LAN chip sets, codecs, flash converters, application specific ICs and more.

And while others make promises, we deliver. Now. In production quantities.

DRAMs. In MOS memories, we were the first to consistently ship production quantities of 16K, 64K and 256K DRAMs. With features that make your mouth water. Like our MB81256/MB81257 256K with both the smallest die size in the industry and the fastest address access time: 100 ns.

High-speed bipolar memories. We serve up PROMs in sizes from 256 to 64K bits. All made according to our unique DEAP™ recipe for high reliability.

ECL RAMs. Fully compatible with the industry-standard 10K and 100K series families. In densities from 1K bits at 7 ns to 16K bits at 15 ns. All available now. With a 16K at 10 ns version later this year.

Static RAMs. All the industry-standard high- and low-speed parts – from 35 ns to 150 ns address access times. In your choice of organizations and densities, from 4K to 64K bits.

EPROMs. We'll more than satisfy your appetite, from 64K to 256K. And 512K coming soon. In a choice of two flavors: CMOS and NMOS.

Microprocessors. We serve up a mouth-watering selection. Starting with our proprietary 4-bit microcontrollers offering the best value by function. And continuing with a complete line

of Intel-compatible (second source licensed) 8- and 16-bit microcontrollers, microprocessors and their peripherals.

Complemented by a choice of many Fujitsu-designed VLSI circuits. Including the industry's first Ethernet™ chip set, high-performance digital signal processor, disk and video/graphics controllers, and later this year – MBL80186 and MBL80286 microprocessors.

Gate Arrays. We supply more of the world's gate array requirements than any other manufacturer. With CMOS arrays in densities from 440 to 8000 gates. And bipolar arrays from 240 to 2000 gates. All supported by one of today's most sophisticated and prolific design systems, with well over 3000 designs already produced.

Packaging. Wrap it up any way you want. We offer the most comprehensive selection. From standard plastic DIP to LCC. PLCC to Cerdip. SIP to flat pack. And skinny DIP to high-pin-count grid arrays.

That's why, the next time you hunger for a part – any part – call Fujitsu first.

We'll satisfy your appetite.

**FUJITSU
MICROELECTRONICS, INC.**

Integrated Circuits Division
3320 Scott Boulevard
Santa Clara, CA 95054-3197
(408) 727-1700

Sales Offices: Atlanta 404/449-8539. Austin 512/343-0320. Boston 617/964-7080. Chicago 312/885-1500. Dallas 214/669-1616. Houston 713/784-7111. Minneapolis 612/454-0323. New York 516/361-6565. No. Calif. 408/866-5600. So. Calif. 714/720-9688. © 1985 Fujitsu Microelectronics, Inc. DEAP is trademark of Fujitsu. Ethernet is a trademark of Xerox.

Circle 11 on Reader Inquiry Card

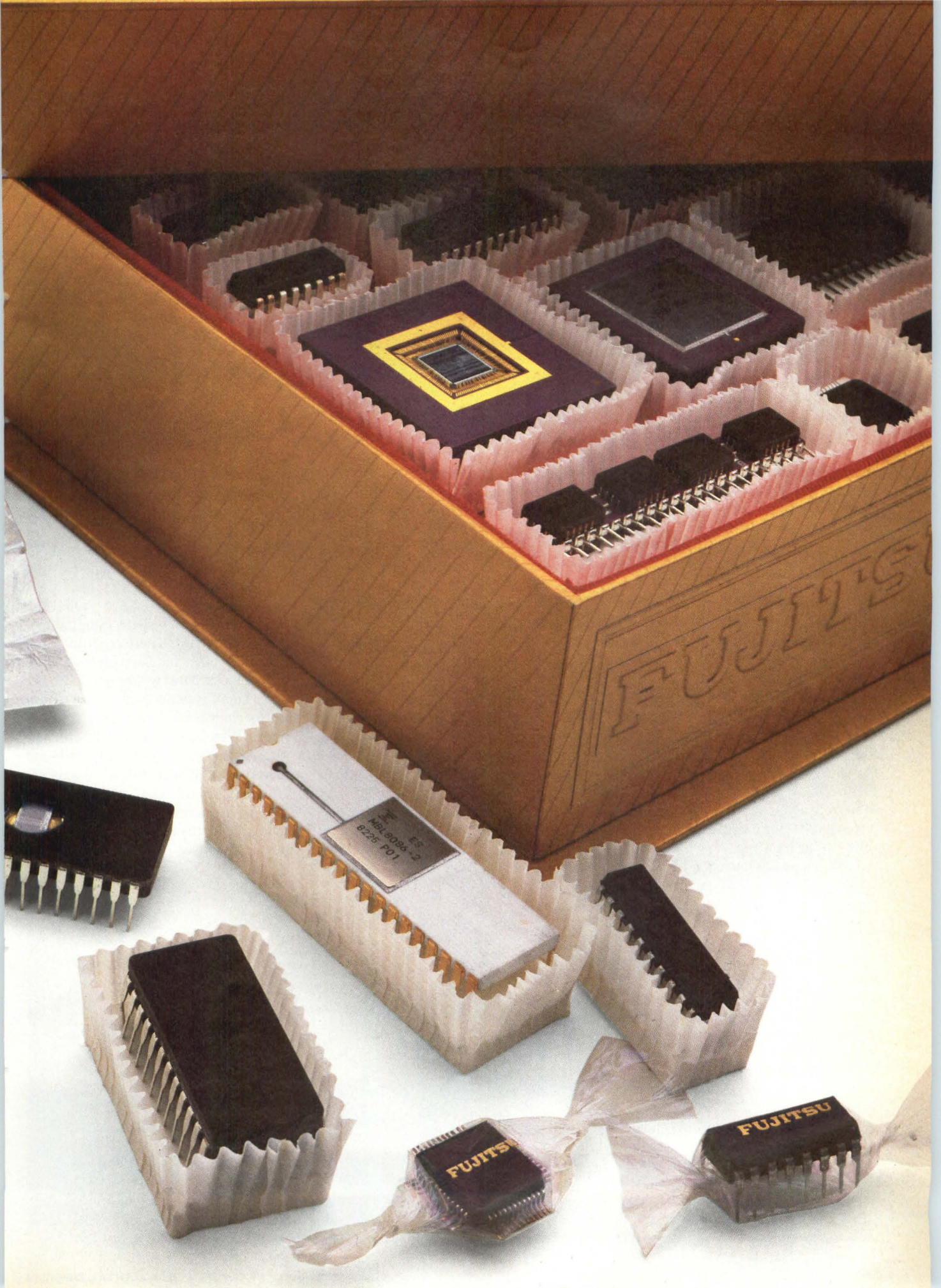

Micro Winchesters Slowly Penetrate Small System Designs

Disk drives have been getting smaller for years, and the generation of portable and desktop systems now being designed provide further impetus for this trend. Though most products using sub-4" micro Winchesters won't be announced for some time, at least two companies are manufacturing the small drives now.

Shipping 10 Mbyte drives for over a year now, Rodime (Boca Raton, FL) claims to have over 100,000 units in the field. They admit competition is finally heating up, but find it a potential benefit since integrating a micro Winchester is no longer the risk it was with a single source. Next into the field was Microcomputer Memories Inc. (Van Nuys, CA); both firms now have 20 Mbyte as well as lower capacity drives.

With predictions that 3½" drives will dominate in systems needing 30 Mbytes or less of storage, several companies have announced sub-4" products. Microscience International (Mountain View, CA), Seagate (Scotts Valley, CA), Newbury Data of the UK (with offices in Woburn, MA) and Hewlett-Packard (Palo Alto, CA) announced micro disk drives late in 1984. The products range from 5 to 20 Mbytes formatted; Newbury has introduced a 40 Mbyte unit to establish themselves at the high end.

Though costs to make 3½" drives are similar to those for 5¼" and prices may be higher now, several other advantages result from the size. In addition to space saving, smaller drives' lower mass improves shock and vibration isolation. Forces from 30G to 50G can be tolerated when the drives are not operating without destroying data; this allows them to be transported when already recorded. This feature may allow use of micro Winchesters as an exchangeable drive. Removing the mass storage from a system especially aids data security.

Smaller drives also consume and dissipate less power. These units require +5V or +12V at 0.3A to 0.8A (except the Newbury unit, which requires +12V at 2.0A) and dissipate only from 9W to 15W. Good thermal qualities are the result of less mass to spin coupled with the CMOS

Figure 1: Though systems with micro Winchesters will just be appearing this year, Rodime has been shipping 3½" rigid disk drives for over a year.

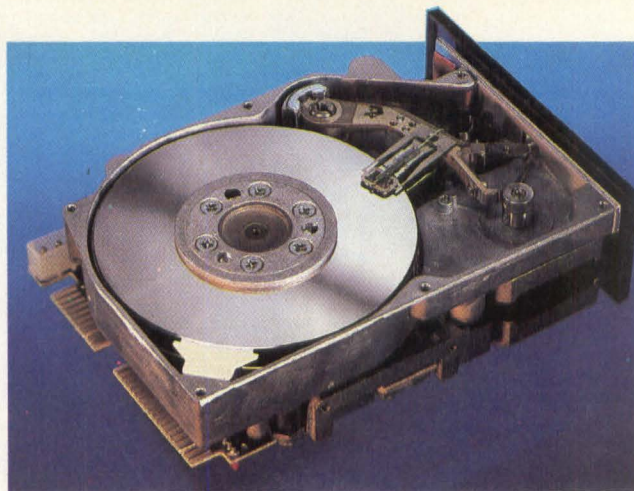

surface-mount electronics.

These heat characteristics permit high track and bit densities without over-extending recording technology. For extra insurance, many use a closed-loop servo for positioning. Even with the servo bits taking space, 3½" drives now pack an average of 10 Mbytes per platter or 5 Mbytes per surface, formatted. Metal disk media is used in most of the 10 and 20 Mbyte products for high density recording.

Although Winchesters can be internal to the system, adherence to the micro-floppy form factor could aid product design. In this area, SyQuest (Fremont, CA), making 3.9" fixed/removable drives since before the microfloppy 3½" standard was firm, falls short, as does Hewlett-Packard, whose drive is higher than the current standard 3½" form factor.

At the other extreme, Rodime and Microcomputer Memories offer frame mounts so the small drives will fit into a 5¼" space. This will not only allow the

drives a wider market, but permit shock mounting and isolation. Until enclosures and system mechanical specifications change, this will be an option for integrating drives into systems where weight, power consumption or heat are problems. Since these 3½" products use the standard ST-506/412 interface (HP drives use SCSI or IEEE-488), integration into existing designs is no problem.

The coming year or two should see announcements of systems using the 3½" drive as standard. There is a rumor that IBM and lesser industry giants will be among those. Most will be portables, but other small systems could benefit from the mechanical and thermal qualities of micro Winchesters. In single-user applications, a hard disk is still a high-end feature, and 10 or 20 Mbytes should accommodate most needs. As capacities of 5¼" drives increase, micro Winchesters may gain rapidly for relatively unsophisticated systems.

—Pingry

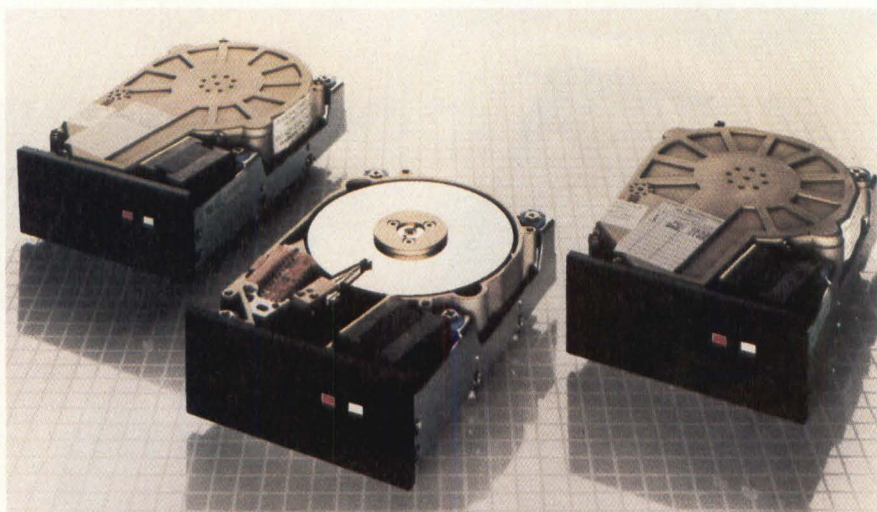

Figure 2: Microscience offers 10 and 20 Mbyte drives to the micro form factor.

INTRODUCING LARGE-DISK PERFORMANCE IN DRIVES HALF THE SIZE

MODEL 9715 FSD. With 160 Mbytes in a sealed module, you get the same capacity, speed and performance as the CDC™ Mini Module Drive (MMD) in a unit one-half the size.

MODEL 9710 RSD. With 80 Mbytes in removable data packs for unlimited storage. Has the same capacity, speed and performance as a CDC Storage Module Drive (SMD) in a unit one-half the size.

**FSD
NOW
ALSO AVAILABLE
340 AND 515
MEGABYTE
MODELS**

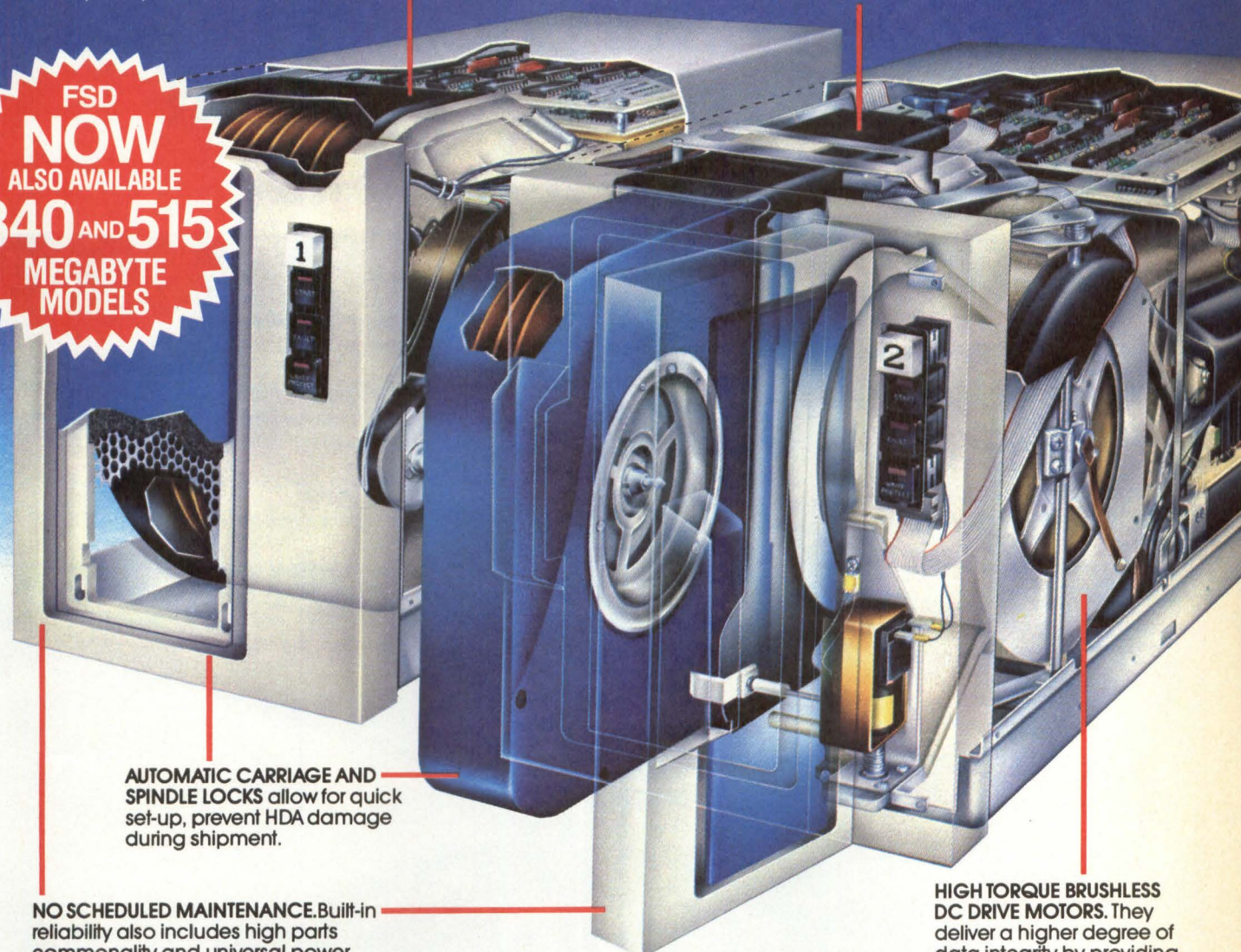

AUTOMATIC CARRIAGE AND SPINDLE LOCKS allow for quick set-up, prevent HDA damage during shipment.

NO SCHEDULED MAINTENANCE. Built-in reliability also includes high parts commonality and universal power supply (100-240V, 50/60 Hz) for easy installation worldwide.

BOTH MEET FCC, UL, CSA, VDE STANDARDS FOR A STAND-ALONE UNIT.

HIGH TORQUE BRUSHLESS DC DRIVE MOTORS. They deliver a higher degree of data integrity by providing rapid disk acceleration with minimum head drag. (Both models)

T H E F S D™ / R S D™ S E R I E S

Both 9710 and 9715 Drives use LSI circuitry for all read and write, fault, transmitter/receiver functions and a μ P for servo control, for full performance in half the space. For more data call your local Control Data OEM Sales Representative or write: OEM Product Sales, HQW08X, Control Data Corporation, P.O. Box 0, Minneapolis, MN 55440.



GD CONTROL DATA

Information Hot Line 1-800-828-8001
in Minnesota 612-921-4400, ext. 82

THE FPS 64-BIT FAMILY: CONSIDER WHY THE MOST ACCESSIBLE SUPERCOMPUTERS MAY BE THE FASTEST WAY TO DO YOUR JOB.

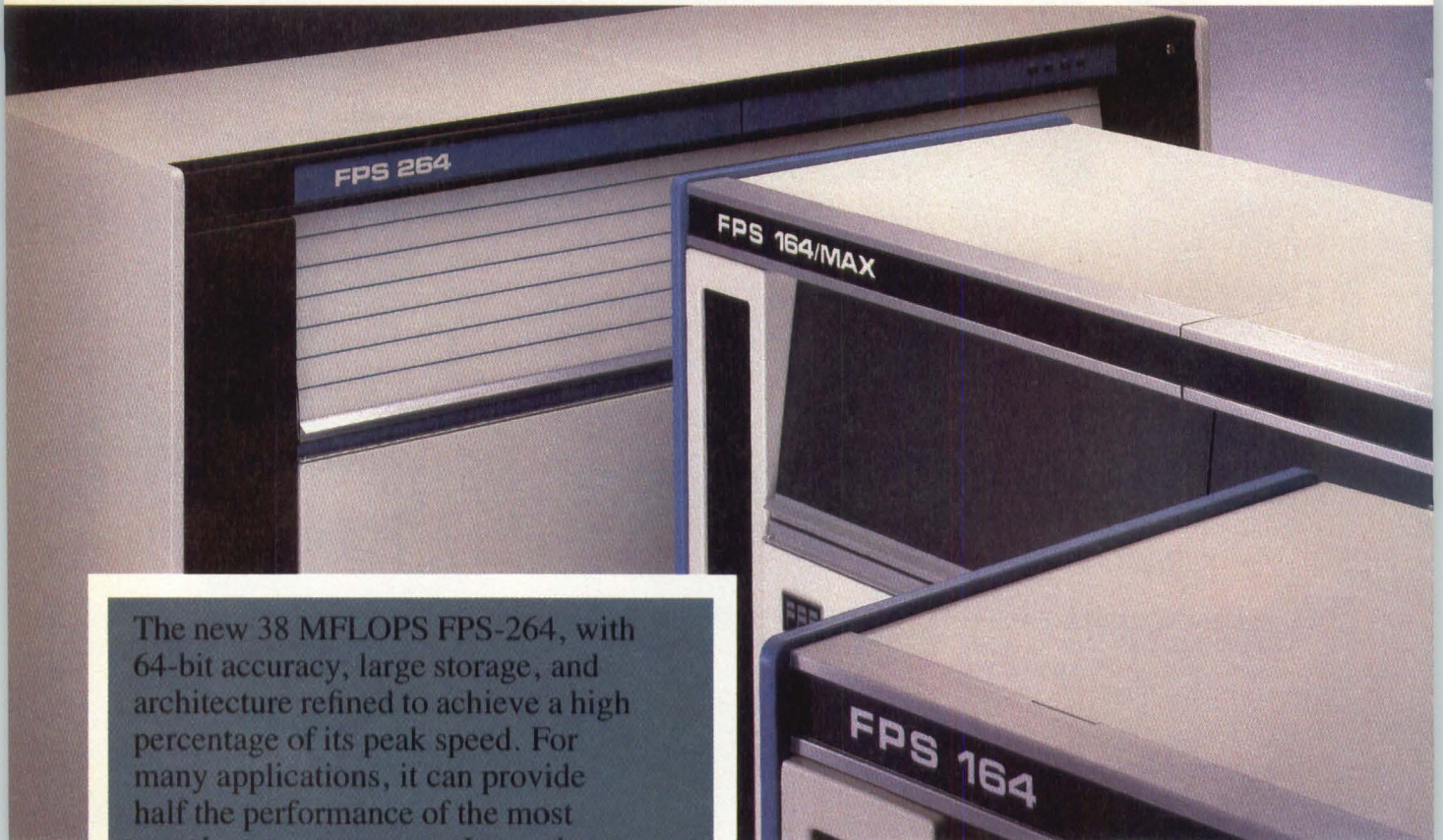

The new 38 MFLOPS FPS-264, with 64-bit accuracy, large storage, and architecture refined to achieve a high percentage of its peak speed. For many applications, it can provide half the performance of the most popular supercomputer. Its moderate price and exceptional support liberates supercomputing from the realm of major corporate investment and puts it within practical reach of departments and teams.

How fast can you get a supercomputer up and running is as important as how fast it runs. When you look beyond peak computing

speeds to the practical realities of compute-intensive analysis and simulation, odds are that nothing else can take your job from start to finish as fast as the FPS

64-bit supercomputer family. Here's why:

- 1. FPS protects and utilizes your existing software resources.** FPS offers you an exceptional, proven software tool set. If your investment in FORTRAN is typical, the FPS Compiler will alone be a compelling advantage.
- 2. More applications software than for any other comparable com-**

puter. Compare quantity and quality of compatible third party software packages—for structural analysis, circuit design, reservoir simulation, fluid flow analysis, chemistry and much more—and the FPS advantage widens.

- 3. The FPS 64-bit family makes supercomputing speeds affordable at the department level.** Even teams with remote access to Crays® and Cybers™ are



The FPS optimizing FORTRAN-77 Compiler lets you easily adapt code to FPS' pipelined architecture in a form that is nearly as efficient as hand-coded assembly language. With extensions for asynchronous I/O and for enhancing compatibility with other compilers, it is one of most comprehensive tools of its kind.

likely to find that the advantage of immediate, local access is well worth the sacrifice of standing in line for the "fastest" machines.

System prices start at \$300,000 (U.S.) for the 11 MFLOPS FPS-164. The new 38 MFLOPS FPS-264, starting at \$640,000,

achieves 4-5 times the speed of the FPS-164 on many applications programs. The multiple parallel processing units and peak 341 MFLOPS of the FPS 164/MAX can run many matrix computations faster than supercomputers, for less than one-tenth the price.

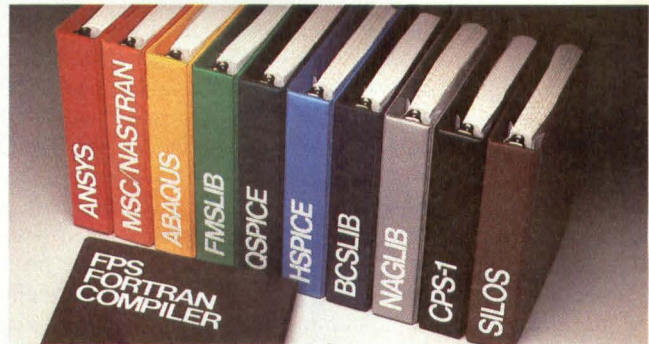

Family Specifications

	FPS-264	FPS-164/MAX	FPS-164
Peak speed, MFLOPS	38	33-341	11
Dynamic range	2.8 x 10 ⁻³⁰⁹ to 9.0 x 10 ⁺³⁰⁷	2.8 x 10 ⁻³⁰⁹ to 9.0 x 10 ⁺³⁰⁷	2.8 x 10 ⁻³⁰⁹ to 9.0 x 10 ⁺³⁰⁷
Logic format	64 bits	64 bits	64 bits
Main memory capacity	4.5 MWords	15 MWords	7.25 MWords
Maximum disk storage capacity	16 Gbytes	3 Gbytes	3 Gbytes
Precision	15 decimal digits	15 decimal digits	15 decimal digits
Vector registers	4 x 2K	124 x 2K (max.)	4 x 2K
Scalar registers	64	184 (max.)	64
Host interfaces	IBM, DEC	IBM, DEC, Sperry, Apollo	
Program Development Software	FORTRAN Compiler, Overlay Linker, Assembler, Object Librarian, Interactive Debugger.		

Family Performance Measures

	FPS-264	FPS-164/MAX	FPS-164
Peak MFLOPS	38	15 accelerators 341	1 accelerator 11
Peak MOPS	190	1705	165 55
Peak MIPS (Multi-instruction parcels)	19	5.5	5.5 5.5
Typical MFLOPS, LINPACK Benchmark	9.9	20.0	6.0 2.6
Whetstones (64-bit)	20,100	5800	5800 5800
1000x1000 matrix multiply, seconds	53	10	66 189
\$K/MFLOPS (system price/peak speed)	\$16.8K	\$2.5K	\$12.3K \$27.1K

4. The FPS family is expandable. Proven dependable. Well-supported. In other words, a safe, farsighted investment. You can upgrade your existing FPS computer, or evolve from one level of performance to another, with minimal disruption. And you can bank on a record of reliability that begins with exhaustive manufacturing testing and extends to our 21 field office service facilities worldwide.

Ask your local Floating Point sales representative to help you develop your own strategy for accessible supercomputing. Contact Floating Point Systems, Box 23489,

Portland, OR 97223.
Telex 360470
FLOATPOIN BEAV.
Sales offices worldwide.
Call collect (503) 627-9667.

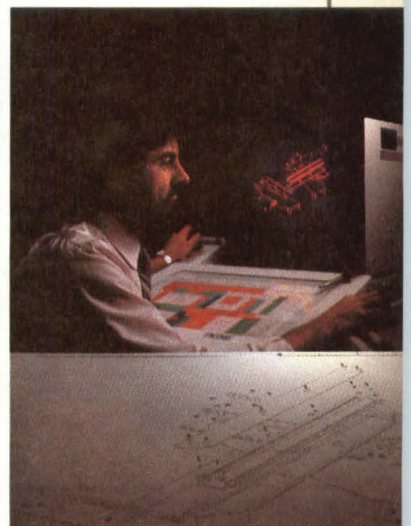

THE PROVEN POWER IN ACCESSIBLE HIGH-SPEED COMPUTATION.



New Technologies Challenge Laser Printing

With the increasing demand for high speed and high quality hard copy in the electronic data processing environment, nonimpact printing is becoming more popular. The high volume of copy printed in these settings requires sophisticated and reliable printers; 20,000 to 1,000,000 prints per month is typical. In this large volume area, three technologies currently dominate: electrophotography (laser xerographic), magnetography and ion deposition.

In the distributed data processing environment, typical print speed is 35 to 80 pages per minute; printer prices range from \$40,000 to \$100,000. In the centralized location, 80 or more prints per minute is average with prices starting at \$300,000.

The credibility of nonimpact printing has been enhanced by the commercial success of the laser technology, the first to reach maturity. Electrophotography, first developed for photocopiers, has since become a widely accepted and well-supported printing technology. The process involves a photoconductor drum that receives an electrical charge and is optically exposed to the image. Developed by a toner, the charged latent image is then transferred to the paper.

Electrophotography is unique because

it provides direct optical imaging and can print from an electronic video signal. This provides the capability for reproducing standard forms and makes it easier to design a system to operate in the local copy mode. Xerox Corp., (El Segundo, CA) one of the first companies to use the technology, is the major contender in this area. The Xerox 8700 laser xerographic printer produces 10,500 lines per minute and sells for approximately \$200,000. Their 9700 printer produces two pages per second (18,000 lines per minute) and is priced at \$392,000. These printers are the fastest in their league and, therefore, the most expensive.

The maturity of electrophotography has inhibited the commercial exploitation of magnetic printing, though developments in the technology show its potential to gain an edge in the marketplace. Magnetography is a relatively simple technique using a metal drum, rather than a photoconductor as in laser technology. The less complex drum offers a longer lifetime (10 million page) than a photoconductor. An additional advantage of magnetography is the virtually unlimited lifetime of the magnetic image. When the printing system is properly configured, the magnetic image will retain its quality throughout the toning and transfer pro-

cess, allowing many copies to be produced. Magnetic printing can also produce high quality pictorial images containing differing shades of gray.

Cynthia Peripheral's (Sunnyvale, CA) MP 6090 magnetic printer produces 6,000 lines per minute and is priced at \$60,000. It features fanfold, continuous form paper handling and uses a heat lamp fusing technique (as opposed to pressure roll fusing used in most laser systems) that reduces jam rates significantly. An easily replaceable imaging head offers a long lifetime; in a 500,000 to 1,000,000 volume range, the head should last the life of the machine. In most laser printers, when the optics or a laser fail, the entire machine will have to be replaced. Multiple imaging, a major strength in this technology, is available in electrophotographic printers but at some cost and complexity.

Introduced as an alternative to laser and magnetic printing, ion technology was brought to market and patented in 1980 by Delphax Corp. (Westwood, MA). The technology is geared toward large volume operations requiring 100,000 to 1.5 million copies. The unique feature of the ion deposition architecture is the ion print cartridge consisting of a multiplexed matrix of three electrodes which generate, control and focus charged

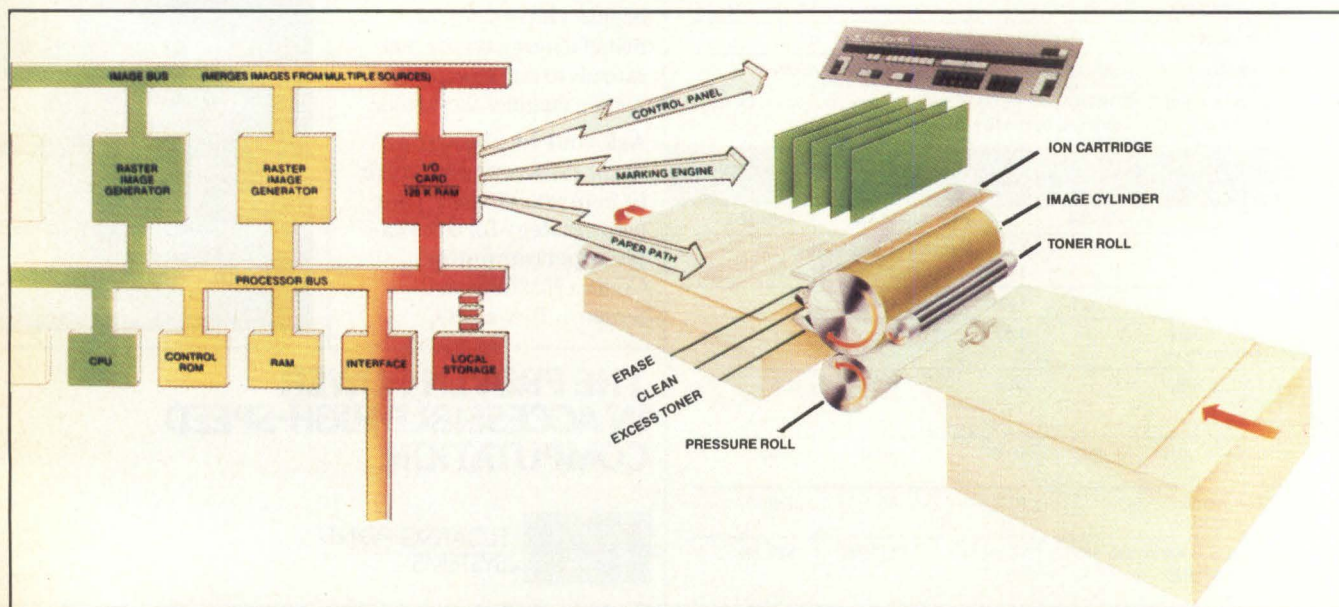

Delphax's S6000 ion deposition printer produces 60 pages per minute for large volume operations requiring 100,000 to 1.5 million copies per month.

CAD system integrators think our newest plotters were designed just for them.

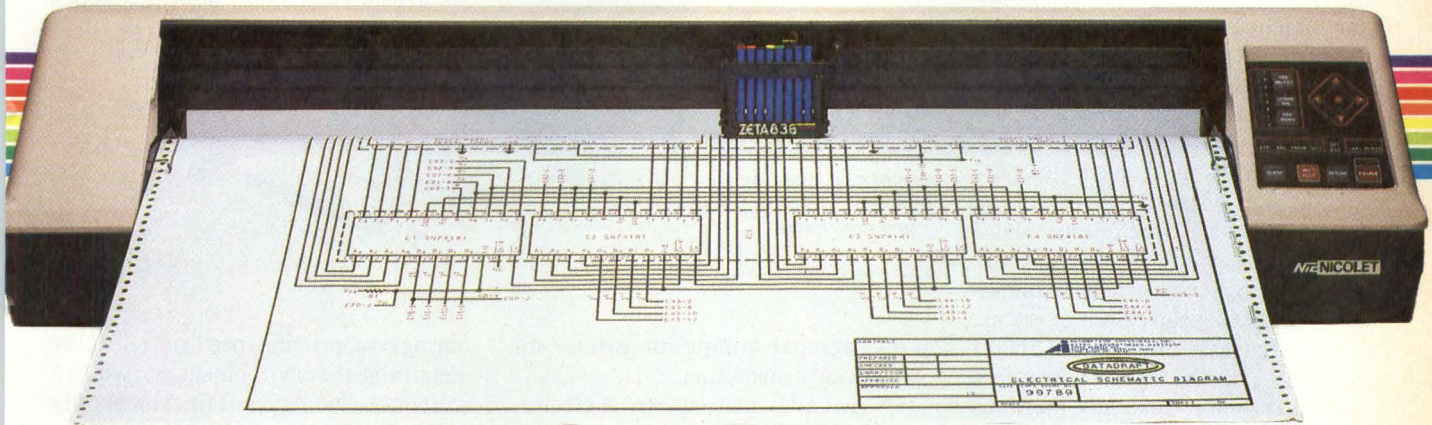

A price/performance breakthrough on intelligent pen plotters.

Take our newest, 8 pen 36" intelligent plotter, for example. We call it the ZETA 836 but you'll call it remarkable.

You'll be able to give your clients plotting speed of 25 ips, 2g acceleration and resolution of 0.001 inch. The ZETA 836 handles roll media for unattended operation. And the ZETA 836CS adds the flexibility of single sheet plotting. At a price several thousand below what you'd expect to pay.

Eight color, carriage-mounted pens eliminate time-consuming pen changes

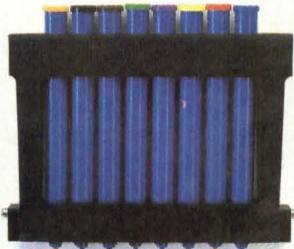

Incredibly, some plotters still grind to a dead stop to change pens.

Nicolet manufactures a complete line of high performance plotters ranging from compact, desktop models for personal computers up to 54" wide drum plotters with controller workstations.

Not ours. We've put all eight self-capping pens on the carriage. And this does amazing things for plotter throughput.

When you want to switch to liquid ink, simply snap in a four pen cartridge.

You'll have total user control over such variables as speed, pen pressure, acceleration and pen up/down delay times. Touch controls automatically adjust the ZETA 836 for perfect liquid ink plots.

Compatible with virtually all computer protocols.

We now offer an option to run these new plotters directly from the IBM 3274/3276 cluster controller via a simple coaxial connection.

And you can use any of our plotters on-line, off-line or remotely via RS 232C or IEEE-488 interfaces.

Save big on our new flexible pricing strategy.

We've created a new discount program that lets you mix quantities, keep your inventory lean, and still earn the best price breaks in the industry.

Choose from our family of plotters designed for the CAD system market - the ZETA 8 and the ZETA 887, 12" models, the ZETA 824 and the ZETA 824CS, 24.5" models or our newest ZETA 836 or ZETA 836CS 36" intelligent plotters.

Call (415) 372-7568. Nicolet Computer Graphics Division, 777 Arnold Drive, Martinez, CA 94553 TWX 910-481-5951

NTE Nicolet
Computer Graphics Division



Circle 15 on Reader Inquiry Card

particles. The process includes the cartridge, a toning system that develops the image and a pressure roller that transfers the image to the page. This method of transfixing requires less power and has the advantage of avoiding the warm-up times normally associated with thermal fusing systems. A notable consequence, however, is that pressure fixing can crush the fibers in the paper and produce a shiny surface on the page. In addition, the imaging process is simple and does not require numerous mechanisms to operate, as do laser systems.

Introduced in 1982, the Delphax 2460 print engine spurred the growth of this technology and precipitated the introduction of the S6000 page printing system. Printing 60 pages per minute, the S6000 is not as fast as the Xerox 8700, but offers a 25% cost savings. Currently, there are no other companies involved in ion technology because Delphax's patent position makes it very difficult for firms to explore this area of nonimpact printing. However, in December 1984, Delphax and Xerox announced a joint agreement to develop

Cynthia Peripheral's MP6090 magnetic printer uses fanfold paper and heat lamp fusing, printing 90 pages per minute.



a 60 page-per-minute ion printer for worldwide distribution.

C. A. Pesko analysts expect electrophotography to maintain its pre-eminent position in nonimpact technology. Ion deposition and magnetography are definitely decisive competitors in this field, but laser has the advantage of having been around for over 20 years. Unit manufac-

turing cost, printing speed and reliability determine the environment into which a certain technology will fit. More costly technologies appear in those areas where larger print volumes can justify the higher cost. However, speed and reliability determines whether the technology can compete in a high volume environment. —Lamneck

DEPARTMENTS/Memory

New Technique Secures System Access

In the past, several methods have been proposed to secure system access, each with its own relative drawbacks involving ease of use, cost and speed. The most common and least expensive method for system security is the software password. One reason for its popularity is the technique's inherent simplicity—a major benefit in systems involving many users. Unfortunately, it is relatively easy to break into, and that is its greatest drawback.

Securing data more cautiously was one of the driving forces behind the development of the Data Encryption Standard (DES) developed by the US Department of Commerce/National Bureau of Standards in 1977. The standard provides protection of computer data via encryption or cryptography. Basically, transmitted data is enciphered before trans-

mission and must be deciphered upon receipt to facilitate a secure communication channel.

The DES encrypts 64 bits of data at a time utilizing a 56-bit key. Although the algorithm is public knowledge, the code is considered unbreakable if the key is not known at the receiving end of a given transmission. The process of multiple encryption or decryption is a way to increase the size of the key to any desired length. For example, the sender may successively encipher, decipher and encipher a block of data using one key for the encipher operations and another for the decipher operation. The receiver would then have to decipher, encipher and decipher the data using the same pair of keys.

Another way to increase security with-

out reducing throughput is to perform the DES algorithm in reverse. Data or keys can be deciphered by the sender and then enciphered by the receiver to yield the original message. Several vendors currently offer products designed to work using the algorithm specified by the DES. These include the WD2001/2 from Western Digital Corp. (Irvine, CA), the MC6859 from Motorola (Austin, TX) and the 8294A from Intel Corp. (Santa Clara, CA).

Any cryptographic implementation using the DES can be broken into four fundamental timing sequences. First, the key is loaded into the device. Second, the data to be encrypted is loaded and the DES is executed. And, third, the result of the DES is unloaded from the device.

An alternative approach recently pro-

A practical guide to specifying dot matrix impact printers.

BEGIN AT THE END.

Dot matrix impact printers are very popular today for three simple reasons. They're rugged. They're reliable. And they're reasonably priced.

Still, specifying the right impact printer isn't easy. So we suggest you begin with a few questions targeted to the end-user.

For example, what form of hard copy would be needed? On cards or roll paper? And if paper, how many plies are needed?

And what about characters per line? And pre-printed forms? Is through-put speed or transaction time critical? How important is graphics capability?

TAKE A TEST DRIVE.

Dot matrix impact printers come in all shapes and sizes. But the biggest variable is speed.

In most impact printers, speed is affected by the shape and density of the characters—both of which can be changed. Another key factor is the method of moving paper through the printer.

By compressing the matrix, you can get more characters per line. By using stepper motors rather than solenoids, you can greatly improve paper speed.

As you can see, the possibilities are endless. So take a test drive first.

To assist you, Eaton Printer Products offers a development kit complete with expanded driver board and printer mechanism to help test & evaluate your complete prototype.

FACE-TO-FACE INTERFACE.

A prime factor in specifying a printer is the supplier's willingness to work one-on-one with you.

Rather than costly trial-and-error on your part, Eaton provides the necessary technical advice, either in person or in written form.

And Eaton offers you customized service for your customized design. Because there's nothing standard about your work.

FAST CHANGE CHANNELS.

There are two other important considerations in your design process: product changes and short lead times.

Eaton offers you a direct line to their engineering staff. So as problems, changes, or deadlines develop, your answers are a phone call away.

PROVEN VALUE.

Investigate the track record of both printer and manufacturer. For example, Eaton pioneered dot matrix impact printers . . . earning a reputation as a specialist in today's highly competitive market. And Eaton's 40 column dot matrix printer has a field-proven performance record that has set industry standards. It can be a solid complement to your design, too. It's a high performance printer. It's reliable. And it offers one practical feature that no other printer has . . . it's built in the U.S. and backed by Eaton worldwide.

**FOR HIGH PERFORMANCE
PRINTER TECHNOLOGY . . .
EATON IS THE ONLY SOURCE.**

NEWNEWNEW

NEWNEWNEW

*high speed
printing
from Eaton*

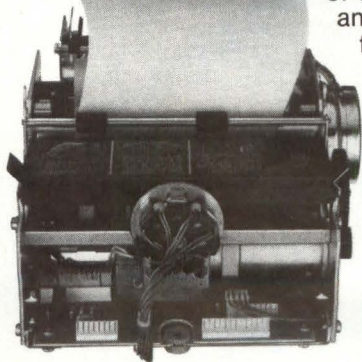

Eaton's new M-4 family of stepper motor printers feeds paper at a brisk 20 lines per second. With a printing speed of 3 lines per second bi-directionally. Plus, the printhead has a rated life of 100 million characters. The M-4 family includes journal printers, both single and split roll, with or without multi-line validation, and slip or document printers for single or multi-ply forms.

For M-4 custom applications, just contact Eaton Printer Products, Technical Research Park, Riverton, WY 82501. Phone: 307/856-4821.

EATON

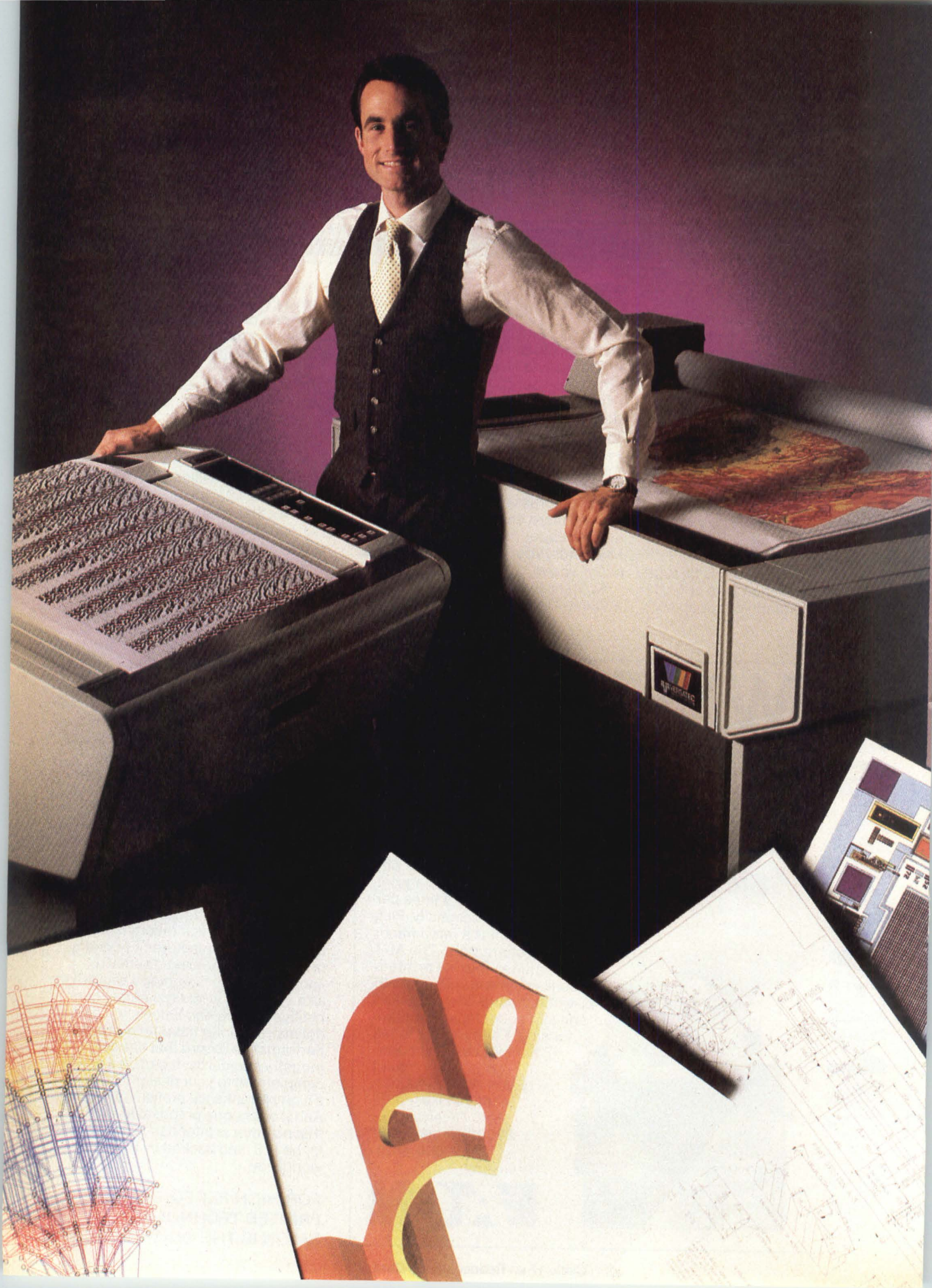

IT'S A VERSATEC.

Versatec invented electrostatic color and wide format plotting. Perhaps that's why we do it better than anyone else. So don't settle for just any plotter. Be sure it's a Versatec.

Our electrostatic color plotter, the world's first, lets you plot big, complex, full-color drawings, maps, and renderings, some impossible to produce with any other plotter, and do it in minutes. Create with eight line colors, 256 pre-defined area colors, and 256 user-definable colors. Use big formats—42 inches wide by up to 500 feet in length. And do it all faster than any pen plotter.

Or choose from the world's largest family of high resolution monochrome

plotters—our third generation 7000 series. Eight models offer widths of 22, 24, 36 and 44 inches, resolution of 200 and 400 points per inch, and more convenience features than other plotters.

Whether you choose color or monochrome, you'll get more support from Versatec. More systems help. More software support. More electrostatic technical and service specialists. And more selection in supplies.

For more information about our color and monochrome plotters, circle the readers' service number, see your CAD or geophysical system vendor, or call your nearby Versatec sales office. But whatever you do, be sure it's a Versatec.

VERSATEC
A XEROX COMPANY

2710 Walsh Avenue
Santa Clara, California 95051
Telephone: (408) 988-2800
TWX: 910-338-0243
Telex: 334421

Versatec is a trademark of Versatec, Inc.
Xerox is a trademark of Xerox Corporation.

Circle 43 on Reader Inquiry Card

See Us At NCGA

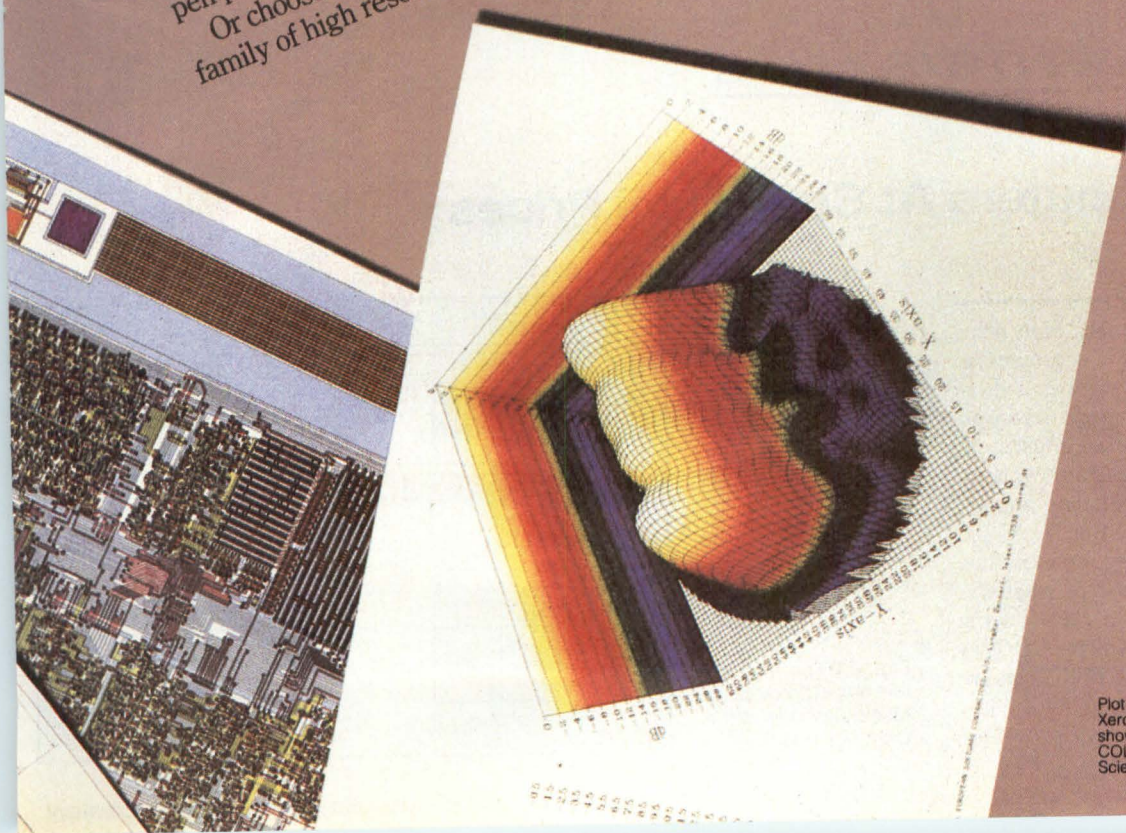

Plot data courtesy of Intergraph, Xerox, and NCA Software. Plot shown on color plotter via SPEED-COLOR™ courtesy of AMF Logic Sciences, Inc.

posed by Intel is to provide a data protection mechanism on-board an EPROM memory array. This device, the 27916, known as a KEPROM, is essentially a 27128 memory augmented by peripheral functions, such as random number generator, encryption circuitry, key, lock and control circuitry, that provide the authentication capabilities. Access to a locked 27916 is permitted through an initialization sequence called the authentication handshake. The handshake consists of a series of byte transfers between two KEPROMs. Initially, one 27916 internally generates a random number and passes it to the other device. Both KEPROMs internally encrypt this random number. The two resulting encrypted numbers are then compared within the 27916 now generating a random number. If this second comparison is favorable, both 27916s have been authenticated and their contents may be read by any system user.

All 27916 devices contain the same encryption circuitry which implements a proprietary logical combination of a random number and a KEY. The KEY, a designer-defined 64-bit number that has been programmed into a special portion of the device, is at the core of the authentication capability of the 27916. It is the key that prevents an unauthorized user

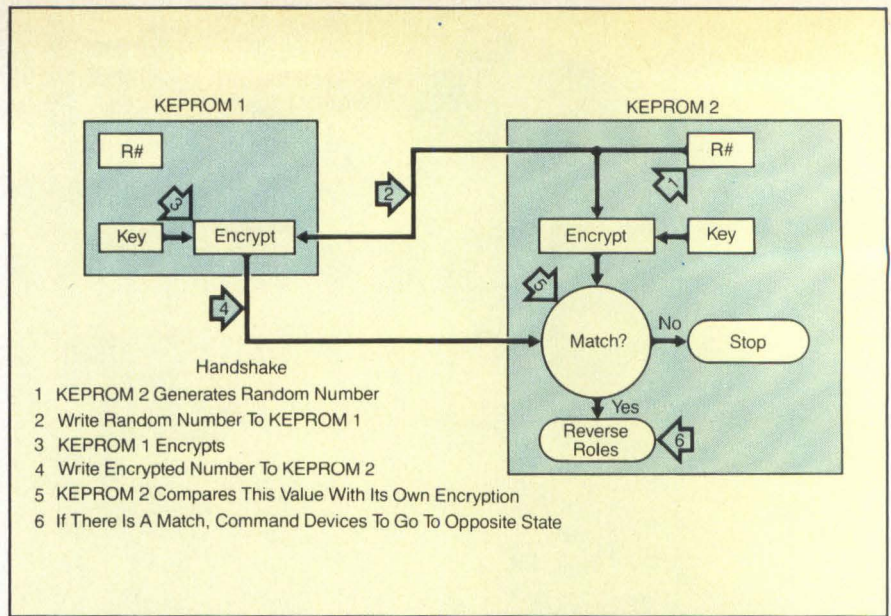

Figure 1: The authentication sequence between the two KEYPROMS.

from gaining access to the memory array. Consequently, for an authentication handshake to be successful, both 27916s involved in the handshake must contain the same key. Since the key is what the ultimate security of the software depends upon, it can never be read and is known only to the system designer or software designer.

In addition to system access security, the KEPROM is a safeguard against

firmware copying. For example, if a standard EPROM is substituted for a 27916, the second part of the handshake will prevent it from being used. Because Intel's KEPROM device can be plugged into the same sockets as a standard 128-Kbit EPROM, an OEM can protect its investment in proprietary system code by designing keyed-access EPROMs into the system.

— Wilson

DEPARTMENTS/Systems

Supercomputers At Supermini Prices

Traditionally, extremely high price tags have limited supercomputers to use in government laboratories, where they are used for very specialized purposes, such as fusion energy research, fluid dynamics studies and atmospheric science. In the past, many large computer manufacturers, including Burroughs and IBM, entered the supercomputer fray, only to withdraw because of what was viewed as a very small market, leaving Cray and Control Data Corp. (CDC) as the only large contenders. Both firms are still active in the market. Cray's latest model, the XMP/48 is a four processor

Figure 1: The architecture of the C1 computer resembles that of the Cray.

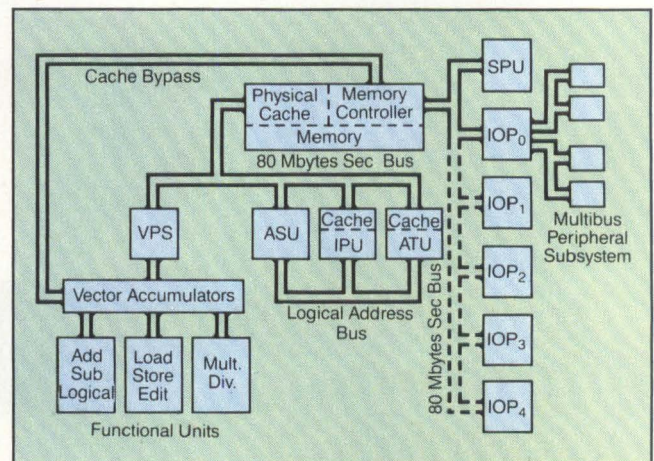



Introducing a family of plotters...
all fast, and all friendly.

Hewlett-Packard's plotters bring you ease of use...at a very affordable price. The HP 7580B, for A-D size plotting, is \$13,900.* The HP 7585B, for A-E size plotting, is \$16,900.* And the new HP 7586B, for roll-feed and single-sheet plotting, is \$21,900.*
*Domestic U.S. prices only

Hewlett-Packard drafting plotters... so easy to use, they almost run themselves

The plotters you don't
have to babysit.

Hewlett-Packard's high performance drafting plotters are designed to make your professional life a little easier. So you can concentrate on doing your job, not figuring out how to run your plotter.

With the HP family of plotters, plotting has never been easier:

- **Operating simplicity.** Just four buttons on the front panel run the entire plotter. And HP's joystick control moves the pen quickly and effortlessly.
- **Quick and easy paper loading.** Our no-fuss, no tape, loading methods make single-sheet paper loading as easy as rolling paper into a typewriter. And HP's streamlined, non-sprocketed roll media lets you load rolls in less than 60 seconds.
- **Compact and portable.** All HP drafting plotters can be moved easily from one area to another,

letting you share one plotter
among several users.

HP features let
you forget the details.

And our automatic features further simplify plotter operation:

- **Automatic paper size sensing** sets the correct margins for your paper automatically, so you'll never have to worry about "plotting off the paper."
- **Automatic pen capping** prevents your pens from drying out and skipping, because HP plotters *never* forget to cap your pens.
- **Automatic pen settings** always set the correct pen speed and force for the types of pens you're using—so you don't have to worry about these details.

HP designed-in quality
and reliability.

And Hewlett-Packard's designed-in quality and reliability means plotting performance you can rely on, job after job. So your

plotter will always be ready
when you are.

Hewlett-Packard.
Your best choice.

Hewlett-Packard drafting plotters bring you the plotting ease, performance and reliability that have made us leaders in the plotting industry. So when you make the decision to go with Hewlett-Packard, you know you've made the best choice.

If you'd like more information about our family of friendly drafting plotters, write to:

Hewlett-Packard,
Marketing
Communications,
16399 W. Bernardo Drive,
San Diego, CA 92127.
Or call Craig Schmidt at
(619) 487-4100.



 **HEWLETT
PACKARD**

version of the XMP with a peak performance rating from 250 MFLOPs to 1,000 MFLOPs at a price from five million to fourteen million dollars.

Future supercomputer development from CDC will be done by ETA Systems, a 1983 spinoff started by former CDC people. ETA plans to develop an eight-processor system that is compatible with the CDC Cyber 205 software and capable of 10,000 MFLOPs. Its price tag will be \$20 million. Three Japanese companies entered the supercomputer market during the past two years. Fujitsu delivered its first system in January 1984. Its single and dual-pipeline VP100 and VP200 offer performances ranging from 250 MFLOPs to 500 MFLOPs. Hitachi's S-810/10 and S-810/20 supercomputers are rated at 315 and 630 MFLOPs and were introduced in December 1983. NEC plans to deliver its SX-1 and SX-2 machines next year. These are rated at peak performances of 650 MFLOPs and 1,300 MFLOPs.

Over the past few months, several firms have introduced products intended to offer the performance of supercomputers at prices currently being paid for superminicomputers. A variety of architectural approaches have emerged in the marketplace. The first implements an architecture similar to Cray's. In effect, this is the approach taken by Convex Computer (Richardson, TX) in its C1 computer. Whereas conventional scalar processors must execute multiple instructions for each single data element, vector processors can execute one instruction for multiple element arrays, vectors and matrixes. The C1 integrates scalar and vector processing into a single processing system (Figure 1). Through this architectural design, both scalar and vector processors can function concurrently.

Two compilers are currently available with the system. A C compiler allows the C1 to use UNIX and applications written in C. In addition, a proprietary optimizing and vectorizing Fortran 77 compiler performs data flow analysis on interactive sequential procedures to produce a parallel executable code that utilizes the integrated vector processing capabilities of the Convex hardware. Initial installations have reported performance of about 10 to 20 times that of a VAX 11/780. Minimum prices for the system start at \$500,000.

Multiprocessor makers represent an-

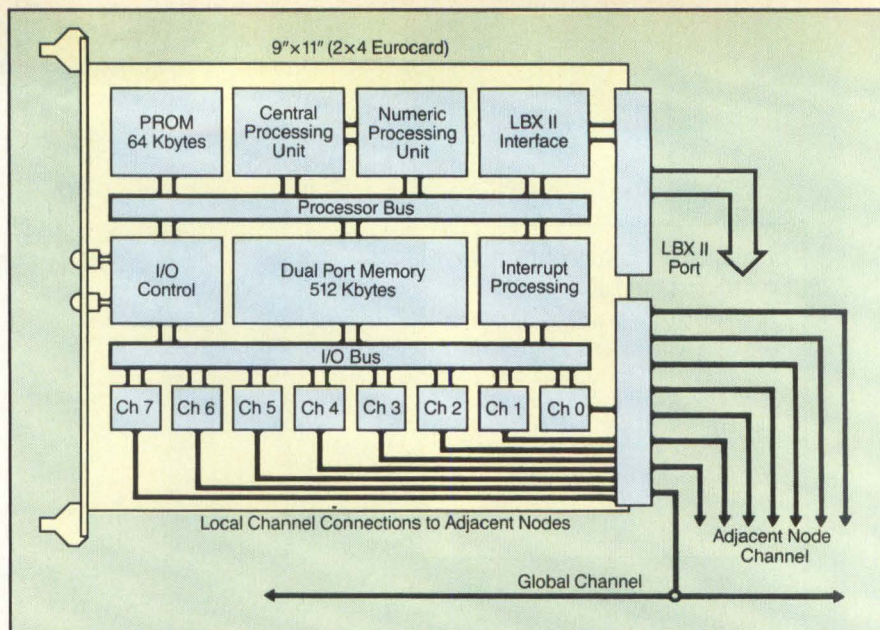

Figure 2: A single node on the Intel Cube.

other class of competitors in the scientific computer market. Denelcor's Heterogeneous Element Processor (HEP) is a modular system reportedly capable of 160 MIPS. The company expects to produce HEP machines with performance ranges up to 1,000 MIPS. Elxsi also manufactures a modular multiprocessor system, the System 6400. Each CPU consists of an ECL processor packaged on three boards. From one to ten processors can be included in the system providing calculation speeds ranging from 4 to 40 MIPS. System prices range from \$350,000 to \$5 million.

The third approach recently disclosed by Intel Corp. (Beaverton, OR) is based on the hypercube topology developed at Caltech. The basic iPSC system consists of 32 microcomputers connected to each other via multiple high speed communication channels. This group of processors is connected via a global communication channel to a local host processor called the cube manager which supports the programming environment and the system management. Each microcomputer or processing node is comprised of a 286 processor, a 287 floating point unit, 512 Kbytes of CMOS RAM and 64 Kbytes of ROM contained on a Eurocard printed circuit board (Figure 2). In addition each node contains seven point-to-point bidirectional communication channels and a single global channel. Each channel is controlled by a dedicated communications processor. These processors move messages between nodes via dedicated point-to-point communi-

cations channels, with integrated DMA to the associated nodes RAM.

The initial iPSC family contains three products, the iPSC/d5 with 32 nodes, the d6 with 64 and the d7 with 128. Each node runs under the iPSC Node Kernel, a message-based operating system that manages each node's resources. It provides the nodes with distributed processor communications, multiple process management and dispatching, and process debugging. The cube manager in the system is an Intel 286/310 microcomputer running under the Xenix operating system. It serves as a local host for the cube and supports local diagnostics. Intel claims that initial iPSC products will provide a performance range approximately 0.1 to 0.4 that of Cray 1.

It is important to note that compilers used to generate process code for the cube do not automatically find a way to run sequential programs concurrently. In fact, because efficient concurrent algorithms may be quite different from their sequential counterparts, the Caltech researchers regarded the translation as implausible. They attempted to formulate and express a computation explicitly in terms of a collection of communicating concurrent processes. This would place the Intel product firmly in the academic world. However, Intel is committed to work with these researchers and with third party vendors in developing application software that will accelerate commercial use of the iPSC systems in coming years.

—Wilson

WIDE WORD™

200 MB/second!

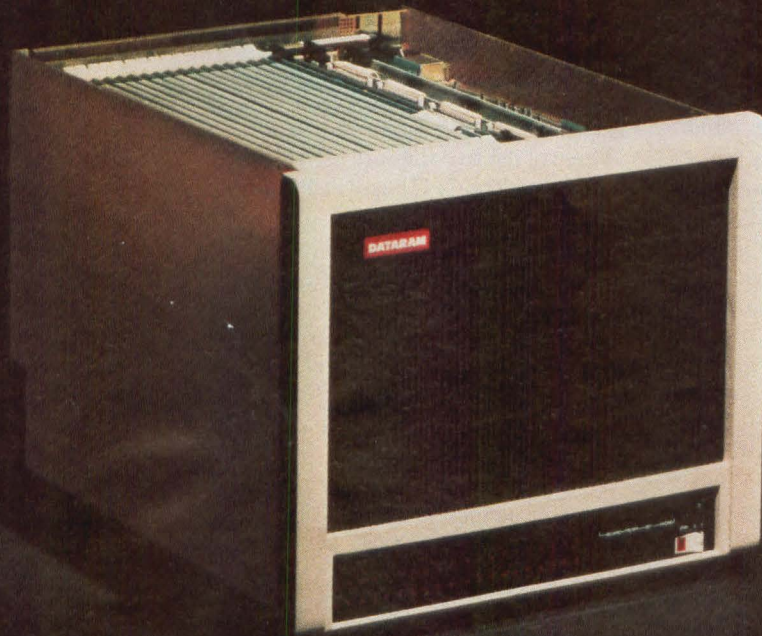

World's Fastest Bulk Memory System

It's true. Dataram's WIDE WORD memory system delivers an incredible data rate of 200 MB/sec! Achieved by utilizing 80 or 160 bits per word and four-way interleaving.

Much faster than even the fastest minicomputers can handle...but not too fast for your real-time applications, image processing, array processing or data acquisition needs.

Multi-port capability enables you to bring WIDE WORD speed to your host minicomputer. Simply connect one port to your high-speed input; the other to your mini.

Our library of dedicated interfaces allows you to run with Digital Equipment, Data General, Ampex, Control Data, CSPI, Honeywell, Intel (MULTIBUS), MODCOMP, Motorola (VERSAbus), Perkin-Elmer, ROLM, and SEL. And, possibly even more importantly, we can work with you to develop a custom WIDE WORD interface.

WIDE WORD. 128 MB of high-performance memory in a compact 15 3/4" system. Word lengths up to 160 bits. And, of course, a data rate of 200 MB/second.

Our new WIDE WORD brochure will tell you more. And you can have it at no charge by circling the Reader Response Number or calling us at (609) 799-0071.

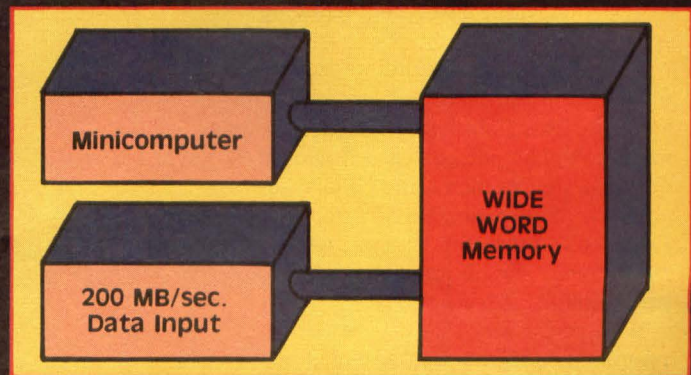

DATARAM

WIDE WORD is a trademark of Dataram Corporation. MULTIBUS is a registered trademark of Intel Corporation. VERSAbus is a trademark of Motorola, Inc.

Princeton Road □ Cranbury, NJ 08512 □ (609) 799-0071 □ TWX: 510-685-2542

Circle 16 on Reader Inquiry Card

Supermini Series Ranges From Entry Level To 10-Processor System

Innovations in architecture provide minicomputers with the speed and balance they need for complex, time-sensitive applications. Multiprocessing systems greatly improve computation speed. Additional processors for the new high-end 3260MPS system from Perkin-Elmer (Oceanport, NJ) speed not only number crunching, but also I/O. This modular parallel processing architecture is one that they plan to extend throughout the 32-bit product line.

Tightly coupled multiprocessing is not new to the PE 3200 series; earlier 3200MPS systems use up to nine APUs on the global memory bus. But the single CPU performs all I/O operations as well as executing the operating system and user tasks. So I/O bottlenecks may offset some of the computation speed advantage.

Processors for the new 3260MPS can be APUs or I/O processors (IOPs). All are connected by the 32-bit paths of the global memory bus (up to 64 Mbits/sec), and RTSM 8-bit parallel interprocessor links. For more than 10 processors or fault-tolerant standby, two systems can be cross-coupled and share memory.

IOPs are microcoded to support I/O operations and instruction sets, an auto-driver channel and task communications with the CPU. They also have 4K of cache, bus switches for CPU or IOP control of devices, a shared memory interface and 4K × 32 of RAM. In addition to peripheral operation, IOPs can be programmed for applications such as data compaction, limit testing and handling special devices.

Distributed logical I/O allows indexed file transfer to be offloaded from the CPU to APUs. This feature may increase file transfer throughput as much as five to ten times, as well as increasing CPU availability from an estimated 52% to 87%. PE's OS/32 operating system provides transparency of multiprocessing and I/O processing.

With processors that can be added, programmed and configured as desired, expansion and customization are eased. The base price for a 3262 (3260MPS with two memory banks) with one APU or IOP is \$185,000; each additional processor is \$42,000. These processor modules

are compatible with all 3200 systems, and APUs of installed systems can be upgraded to IOPs for \$11,000.

This high-end supermini was introduced with an entry-level machine in the series. Rounding out the low-cost end, the 16-user 3203 comes in a small desk-high enclosure. The 3203 fills the gap between microcomputers and superminis, while maintaining compatibility with larger PE systems.

Not only is the look of the 3203 comparable to supermicros (Figure 1), the \$10,292 quantity 100 (\$16,600 unit) price is competitive. Integral to the basic unit are ½ Mbyte of memory in single-in-line packages (SIPs), 51 Mbytes on a 5¼" disk, a 60 Mbyte streaming tape backup, one printer port and eight terminal ports.

Three of the five slots are used for the base system. The CPU board includes the memory (from ½ to 4 Mbytes) and floating point capability as well as the 334 Kbit/sec multiplexor bus and 1.5 Mbit/sec selector channel bus. A 68000-based controller has 8K loader storage, bootloader, clock and the parallel printer and RS-232 ports. The third card is for SCSI peripheral control; it is also 68000-based and has up to 128K of RAM.

To support the low-end products, PE has enhanced their Reliance PLUS soft-

ware. Its main thrusts are in transaction processing, database management, communications and query, update and report tools. 3200 communication allows SNA and other IBM modes as well as Ethernet and X.25 gateways. Up to 16 IBM PCs, IBM or PE terminals may be connected to the 3203.

The 3203's small footprint is pointing the way for superminis. Some peripheral manufacturers will be hard put to pack supermini capacity and performance in a 5¼" form factor. Peripheral makers will also feel pressure to support the SCSI bus as more large system firms move away from the old proprietary interfaces.

This product is an indication that microcomputer features of small size and standard interfaces are being designed into mid-range products. Multiprocessing may also become feasible for a broader range of products. Though initial innovations have been from start-up companies and in high-end products, parallel processing and other new architectures will become more important for all systems. With these products, Perkin-Elmer is not only broadening their 3200 line, but also indicating where some of the future trends may lie for minicomputers.

—Pingry
Circle 236

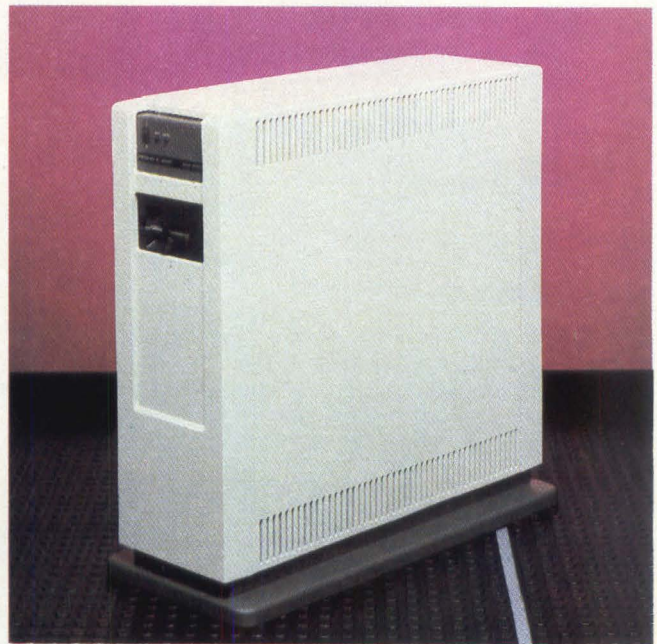
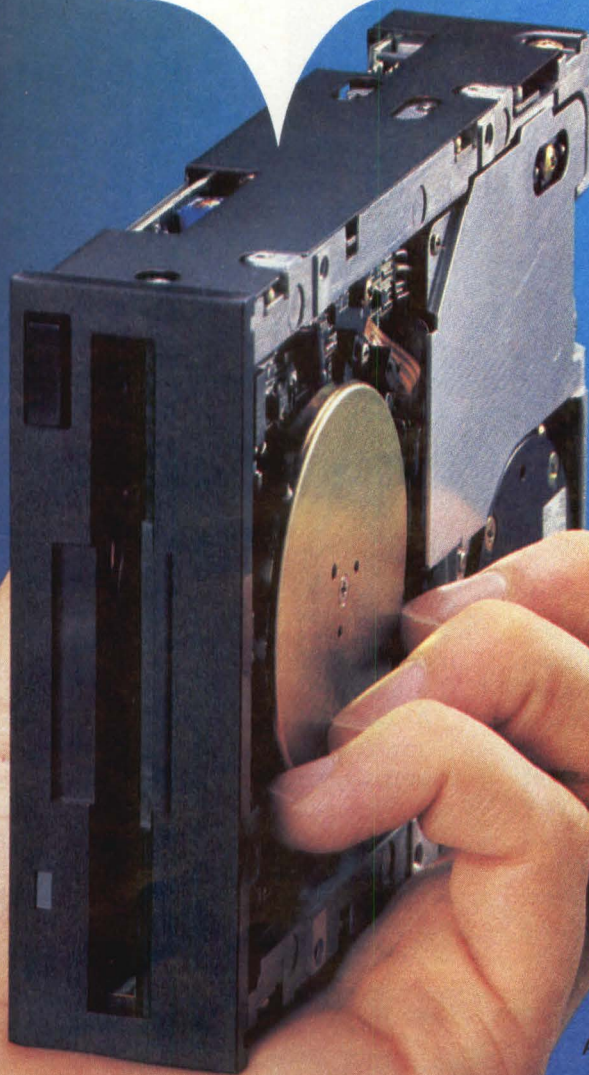

Figure 1: The entry-level 3203 is packaged in the free-standing desk-high enclosure made popular by supermicrocomputers.

Thinking 3½ inches? Think **Canon.**

THE NEW SMALL STANDARD.



Shown
Actual Size

Canon is known as the master of the ultraprecise miniature mechanism. And the smaller disk drives become, the more essential such mastery becomes.

The new Canon 3½-inch microfloppy disk drives are the new small standard size. 30mm high without the bezel. 105mm wide. Weight: 550 grams.

Available now in any quantity.

Our MD350 records 135 tracks per inch, with a track-to-track access time of 3ms and an unformatted capacity of 1 Mbyte. Yet our soft read error rate is only 10^{-9} bits, and our hard read error rate a mere 10^{-12} bits.

Three critical parts designed and manufactured by Canon contribute significantly to our drives' accuracy, and to their extraordinary reliability: the extremely durable brushless drive motor; the head assembly, which uses advanced video head technology; and the steel belt positioning system.

Other good reasons to use Canon's 3½-inch drives:

- Simple pushbutton operation (now industry standard, pioneered by Canon).
- Available without bezels, or with any color bezel.
- Compatible with 5¼-inch drives. Can be used in your present system without changing electronics.

Four models are available:

MD350: 135 TPI, double sided, double density, 1 Mbyte.

MD351: 135 TPI, single sided, double density, .5 Mbyte.

MD352: 67.5 TPI, double sided, double density, .5 Mbyte.

MD353: 67.5 TPI, single sided, double density, .25 Mbyte.

Canon

Call us for even more reasons why 3½-inch drives are Canon's corner. (516) 488-6700, Ext. 4958. Or write Canon U.S.A., Inc., Disk Drive Division, One Canon Plaza, Lake Success, NY 11042.

Circle 27 on Reader Inquiry Card

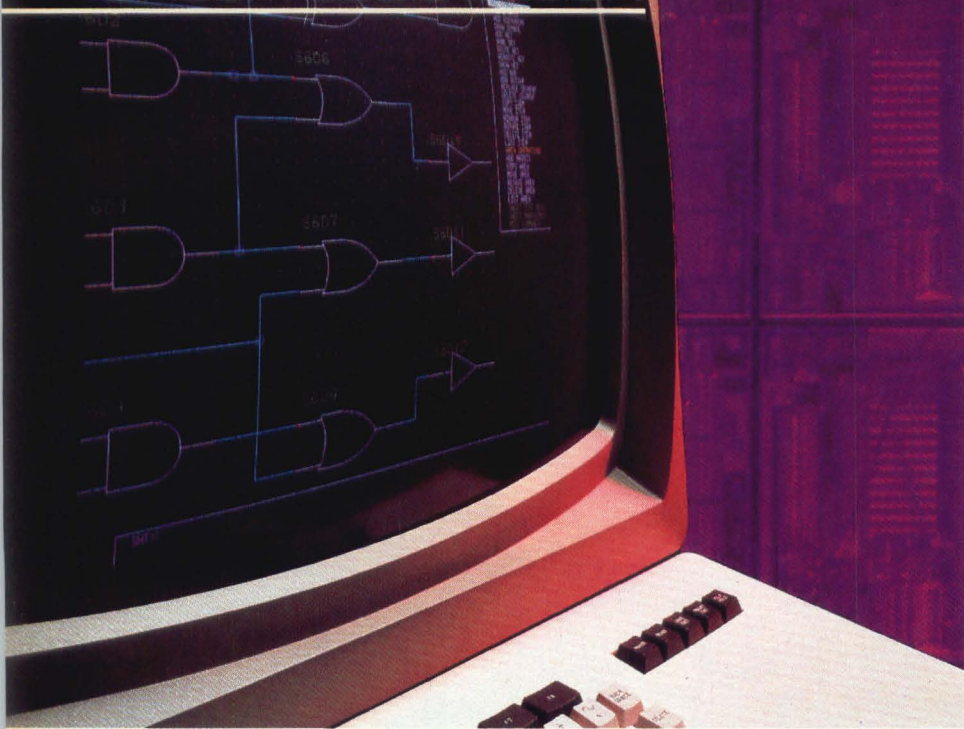

PHOTO COURTESY CALMA

With the gate array finding widespread use, new tools are required in the design process: is the workstation a viable solution?

Unlocking The Mysteries Of Gate Array Design, Part III

by Ronald Collett, Sr. Technical Editor

Having full control over the design cycle is the key factor in gate array design. In this report, the third in our series (Parts I and II appeared in January and February 1985), we examine whether or not workstations provide that added control.

Workstation vendors often paint a colorful picture depicting a turnkey CAD/CAE system as the ultimate tool providing the designer with full control over a design cycle's front end. While this is true in some situations, the workstation is clearly inadequate in others. Moreover, several viable alternatives do exist.

The first is for the customer to hand over his schematic and test vectors to the array vendor, allowing the vendor to perform the entire task. In this case, schematic capture, simulation and timing verification are among the vendor's responsibilities. Not only is this the most costly method, but the chance of a design oversight increases. Despite this drawback, many customers prefer to absolve themselves from the design implementation. A second alternative is to use the vendor's in-house CAD/CAE system where the customer performs all of the front-end stages of the design. In this situation, computer charges are a variable cost. Larger designs incur higher computer charges. A fourth option is to purchase a mainframe or a supermini computer along with third-party software. With this solution, how-

ever, CAD/CAE programs among third party suppliers are often incompatible with each other and the gate array vendor's cell library. A final alternative is to use a low cost personal workstation for schematic capture and perhaps small simulations.

Although a certain percentage of designs are completely implemented by the IC vendor, the clear trend is for the customer to assume responsibility for timing analysis, simulation and test vector generation. Thus, the issue is whether to use the IC vendor's CAD/CAE system, purchase a large host or buy a workstation. Each class of designs is accompanied by a particular set of variables which in turn reflect a unique CAD/CAE solution. Aside from finances, the technical issues influencing the decision include the following: (1) number of arrays to be designed in the future, (2) size of the arrays, (3) operating speed of the chips and (4) length of time allotted for the design.

Behind The Scenes Of Design Verification

Comprehensive timing analysis is the crucial element in a design cycle's front end. Because of its significance, LSI Logic (Milpitas, CA) developed a timing analysis program called the Design Verifier. Normally, when LSI Logic's CAD/CAE system is used for gate array design, the Verifier is incorporated into their software and overall design methodology. Recently,

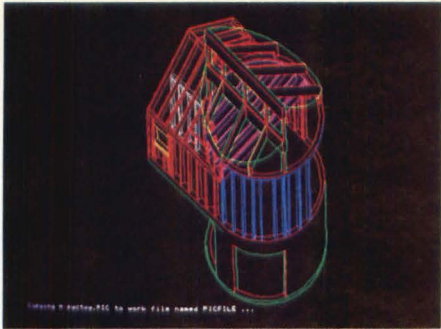

1. High Speed (MicroCAD Software)

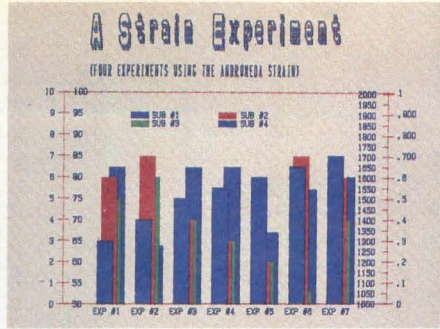

2. Dual Display Modes (Energraphics Software)

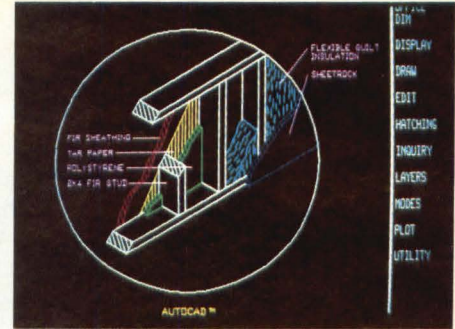

3. Simplified Processing (AutoCAD Software)

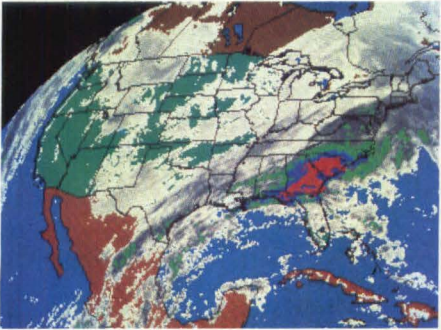

4. 9 Bit Planes (Courtesy WSI Inc., Bedford, MA)



5. 16.8M Color Shades (Courtesy Catherine Del Tito, Wave Graphics)

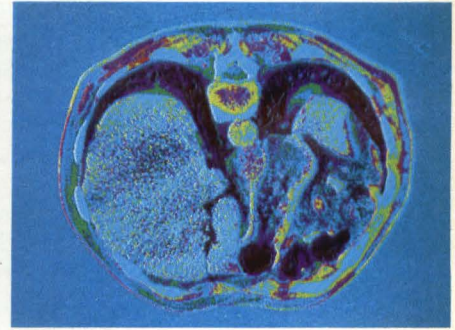

6. High Resolution (Courtesy University of North Carolina at Chapel Hill, Depts of Computer Science and Radiology)

Six reasons why professionals continue to choose Vectrix for quality IBM XT/PC graphics.

Even though IBM offers a color graphics card, professionals still choose Vectrix. It's not surprising. Especially once they've seen us in action. Professionals know that our VX/PC Board Set delivers the quality and performance they need for serious color graphics.

The VX/PC Board Set provides advanced features that help simplify sophisticated graphics design. Besides displaying 512 simultaneous colors from a palette of 16.8 million, the VX/PC supports an extensive library of on-board graphics macros for ease of programming and fast design, as well as full emulation of the IBM color card. And, an on-board 16-bit micro-

processor frees your computer to concentrate on other tasks.

But that's not all. Our 9 bit planes

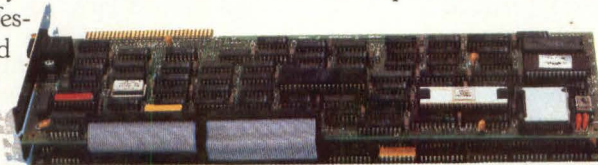

add an extra dimension of sharpness and clarity to your image that must really be seen to be appreciated. That's why it's not surprising to see Vectrix color cards in applications such as medical imaging, weather satellite data mapping, computer aided design and drafting, and graphics arts, to name a few.

What you will find most surprising, however, is the price. Our VX/PC Board Set was designed with the OEM in mind. So when comparing the performance of Vectrix with the competition, check the price too. You'll like what you see. For more information, contact Vectrix Corporation, 2606 Branchwood Drive, Greensboro, North Carolina 27408. Phone (919) 288-0520. Telex 574417.



Distributor inquiries welcome.

IBM XT, IBM AT, and IBM PC are trademarks of International Business Machines Corporation, White Plains, NY.
MicroCAD is a trademark of Imagimedia Technologies, Inc., San Francisco, CA.
AutoCAD is a trademark of AutoDesk, Inc., Sausalito, CA.
EnerGraphics is a trademark of Enertronics Research, Inc., St. Louis, MO.

Circle 22 on Reader Inquiry Card

however, LSI Logic ported the Verifier to workstations offered by Mentor, Daisy and Valid.

With the Design Verifier, the user gets the most accurate representation of the circuit's timing characteristics before layout. In short, fabrication process deviation and estimated wire lengths along with actual fanout are combined to yield a statistically-based delay model at each node in the circuit. In contrast, many gate array vendors that port their cell libraries to third party workstations incorporate fixed propagation delays into the library's models. In this fashion, a wide variation may exist between the CAE timing analysis and the circuit's actual performance. Design verification of high speed circuits demands fabrication process deviation, wirelengths and actual fanout be included in the delay model. There is only one drawback to the Design Verifier: a \$28,000 price tag. Since it is expensive, its cost can be justified only in high speed designs where fabrication process technology is pushed to the limit.

Like most other array vendors, LSI provides a low cost version of their cell library (approximately \$2,000), the so-called Software Databook. Unlike the Design Verifier, all propagation delays are fixed.

Workstation Advantages

Generally speaking, engineering workstations offer schematic capture, logic/circuit simulation, timing verification and documentation software. Although Valid Logic's (Mountain View, CA) Scaldsystem I was chosen to implement our design, *Digital Design* examined competitive products from Mentor Graphics (Beaverton, OR) and Daisy Systems (Mountain View, CA). Like Valid's system, both were viewed in the context of gate array design. All of these products allow the front-end design tasks to be completed with minimal reliance on the IC vendor. This reduces computer charges, which typically amount to about \$1.25/CPU-sec. A \$20,000 computer cost would not be unusual for an 2000-gate array.

An increasing number of firms are recognizing that graphical schematic capture is a vital element in the designer's tool box. In most instances, engineers given the opportunity to use a graphics editor find it difficult to retreat to traditional alphanumeric methods of schematic entry. Even more significant, graphical methods drastically reduce the number of wiring errors associated with conventional alphanumeric design entry. In designing our gate array, we found that a graphics editor together with a puck significantly facilitates design.

Comparing one schematic entry system to another requires focusing on exactly how many steps a particular operation requires. Look at the sequence necessary to move a chunk of circuitry from one point to another. Also note the procedure for connecting wires and check whether components can be easily flipped sideways and upside down. These are just a few of the basic features that a schematic capture tool should possess. Every drawing task that a draftsman could do by hand should be easily within the workstation's grasp.

Schematic checking eliminates drawing oversights. Once the schematic is entered and the "schematic checker" is invoked, the machine culls flagrant wiring and signal name errors. Typically, a design with a few thousand gates is completely checked in less than a minute.

Compilation of the circuit is the next step in the design cycle. Circuit elements are compiled into a format suitable for input

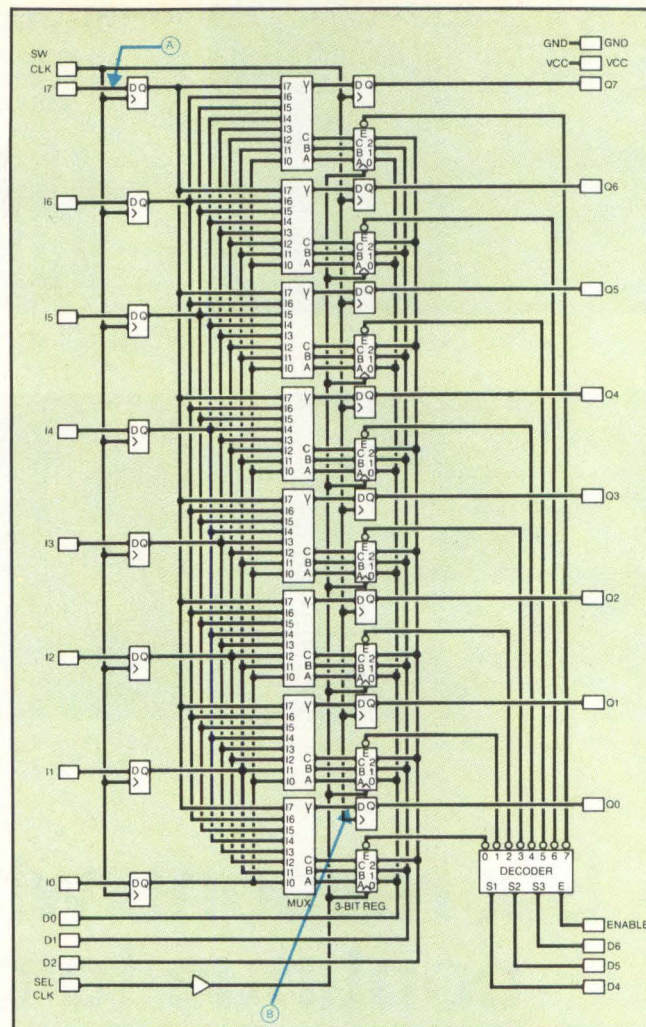

Figure 1: In this circuit, the critical path lies between points A and B where the propagation delay can be no longer than 43 nsec. The timing verifier would determine if the delay is longer than 43 nsec.

to the verification software. Depending on the size of the design, this process takes anywhere from a few minutes to several hours. When executed on an IC vendor's mainframe, compilation time is much shorter. Nonetheless, CPU costs are completely avoided in workstation-based designs. Once the circuit is compiled, electrical rule violations are flagged.

Simulation and timing verification consume the most time in the design cycle's front end. Consequently, when utilizing the IC vendor's CAD/CAE system, this stage dictates computer costs. However, hardware accelerators have added to the workstation's performance. Accelerators implement simulation algorithms in "hardware" and thus increase simulation execution speeds by several orders of magnitude. For complex large arrays, this is a must.

When simulating logic, timing considerations are usually not taken into account. Instead, the logic's functional operation is checked. After the circuit is logically correct, timing analysis is performed. Timing verification searches for race conditions, pulse-width violations and delay problems (Figure 1). Again, depending on the size of the circuit, the time per simulation or timing verification run ranges from a few seconds to several hours.



There's an Epsonomic answer to your OEM disk drive needs.

Our tough-tested family of floppy drives is part of it.

There's more to Epsonomics than product quality. Though our drives have achieved major OEM certification, while operating under extremes of temperature, shock and vibration.

There's more to Epsonomics than quality in quantity. Though our fully automated production line produces a 3.5" drive every 8 seconds.

There's more to Epsonomics than interchangeability. Though all our half-height drives, from 5.25" through 3.5" from 250 KB through 1.0 MB, are plug compatible with industry standard interfaces. And our new 1.6 MB, 5.25" half-height floppy is IBM PC/AT* compatible.

Epsonomics means commitment. To our customers and their needs, today and tomorrow. Like the investment required to automate that production line. And to develop new and even more advanced drive products soon to be announced.

Epsonomics is an attitude. A way of doing business to help you increase your gross profits. It's just-in-time delivery to cut your inventory costs. It's before-and-after-sale support. It's reliability to make your products more reliable. It's special credit arrangements to help you meet your commitments. Because we can only grow if you grow.

Epsonomics. It's a lot more than superior products. Find out how much more. Call or write today for more details.

EPSON[®]
OEM

EPSON AMERICA, INC.
OEM Products Division
Peripherals Group
23600 Telo Avenue, Torrance,
CA 90505 (213) 534-4500
TELEX: 664277



*The top lines for
your bottom line*

SW Region (714) 768-7046 • NW Region (408) 970-9977 • SE Region (404) 956-1934 • NE Region (617) 245-8007 • Central Region (815) 338-5810
© Registered trademark of the Epson Corporation. *Trademark of IBM Corporation.

Circle 41 on Reader Inquiry Card

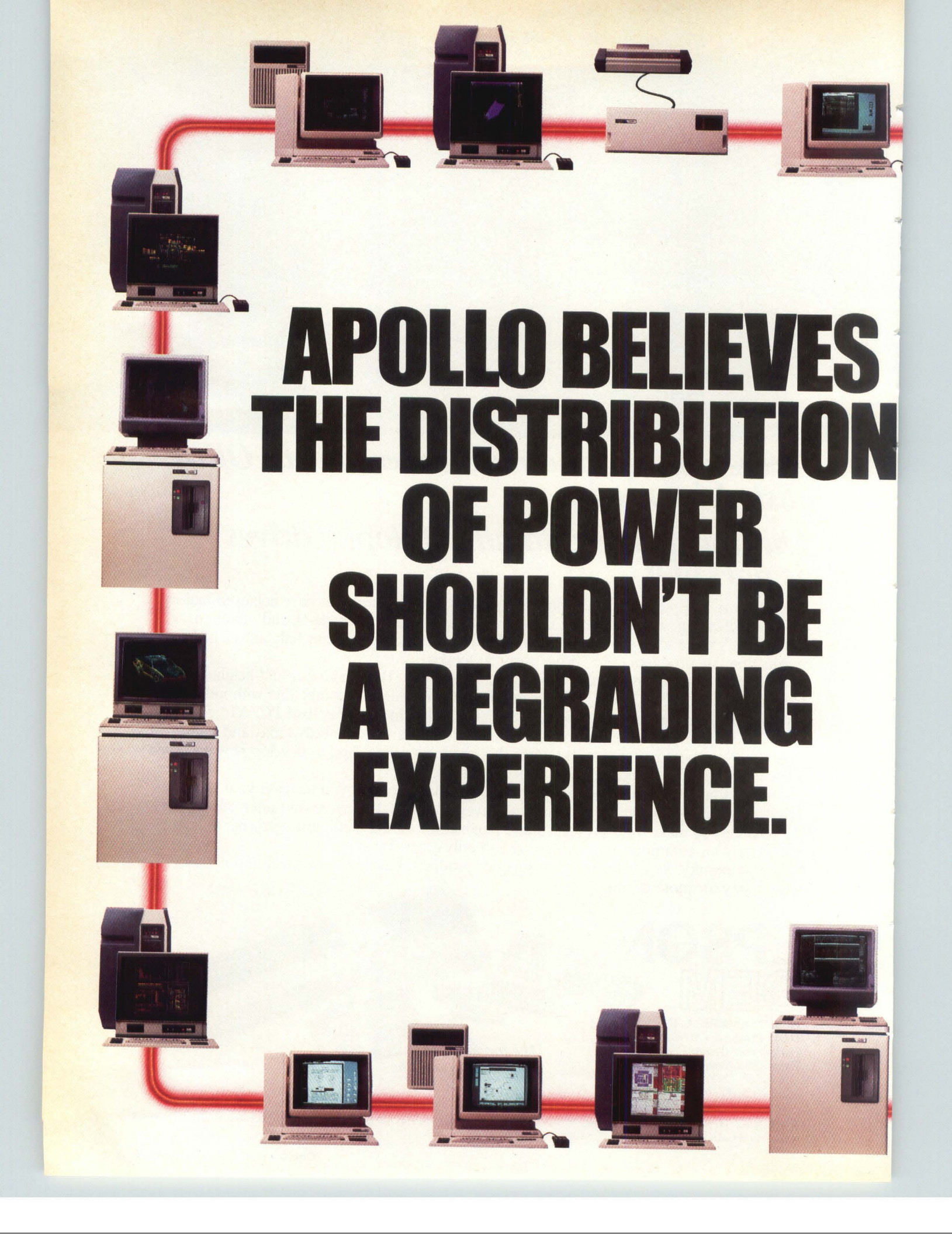
A network of vintage computers, including desktop monitors, towers, and printers, connected by a series of red lines. The computers are arranged in a grid-like pattern, with lines connecting them horizontally, vertically, and diagonally. The background is a light, textured yellow.

**APOLLO BELIEVES
THE DISTRIBUTION
OF POWER
SHOULDN'T BE
A DEGRADING
EXPERIENCE.**



That should begin to tell you what we think of timesharing on minicomputers and mainframes. An approach that has significant appeal when only a few people use a computer system. But a concept whose flaws become painfully apparent as soon as you try to distribute finite compute power to all the people who need it.

When you do, everyone has to sacrifice their share of that power. The result is system degradation. And the frustrations that come with slower processing, lack of adequate memory, and the additional time it takes to get work done.

There is, of course, an alternative. It's called DOMAIN[®] processing. And it's exactly what engineers, scientists, architects and other technical professionals have always clamored for. The computer industry's only known example of 32-bit dedicated workstations, each with the compute power of a mainframe, that let users transparently share both information and resources across a high-speed local area network.

Put another way, DOMAIN processing combines the best features of both timesharing and standalone computers, but none of their drawbacks. Sharing without sacrifice. Dedicated compute power without isolation from co-workers and their data.

With DOMAIN processing, every user

gets his or her own computer system connected to a network. Each workstation delivers large machine performance and functionality, substantial data storage, and effortless interaction with the system. And when you add additional workstations, you actually increase everyone's power. Rather than diminish it.

The DOMAIN family of compatible workstations offers a wide range of products. From high performance color workstations for demanding applications such as solids modeling and finite element analysis to low-cost monochromatic workstations for software development and technical documentation.

Of course the true worth of any computer system is its applicability. A measure by which Apollo excels. Today more than 300 of the finest application packages available run under DOMAIN. State-of-the-art programs that cover electronic design, mechanical design and engineering, computer integrated manufacturing and much more.

So if you're running out of power to distribute to your product developers, we suggest you contact Apollo. You'll find the experience enlightening.

Call (617) 256-6600 x4497. Or write Apollo, 330 Billerica Rd., Chelmsford, MA 01824 MS 17.



apollo

DOMAIN is a registered trademark of Apollo Computer Inc.



Circle 35 on Reader Inquiry Card

Workstation Disadvantages

Compared to a mainframe, workstations perform very slowly. Even if these systems could run as fast as a VAX 11/780, larger arrays demand mainframe-based CAD/CAE systems with execution speeds of 4-5 MIPS. Although hardware accelerators drastically reduce simulation run times, compiling times are still excessive. Thirty minutes to two hours is not unusual for a single compilation on a workstation. With a mainframe, however, the time shrinks to a few minutes.

Workstations purport to exist as single-user systems. Due to their high cost, however, sharing one unit among three to five designers is not uncommon. Prices for these machines range from \$70,000 to \$100,000, not including a hardware accelerator.

Hardware accelerators are designed to function as a network resource, allowing several users to simultaneously access the device. Therefore, only one accelerator is necessary for multiple workstations. Although this is some consolation, it is of nominal benefit. A comparison between the cost of a mainframe design environment and workstation configuration demonstrates the point. The cost of 25 workstations plus a hardware accelerator ranges from \$1.6 million to \$2 million. On the other hand, a design environment consisting of a VAX 8600, a low-end Zycad (St. Paul, MN) hardware accelerator, 25 PC-based schematic capture systems and LSI Logic's CAE software (LDS III) costs about \$1.6 million. Advantages of a VAX 8600 are execution speed, versatility and the number of users that can simultaneously access the system. For large design environments, the better bargain is the mainframe solution.

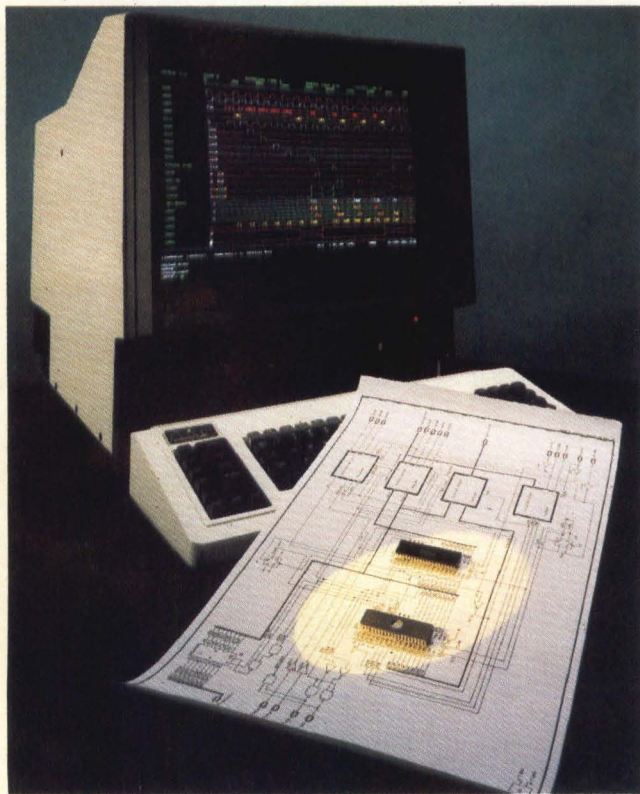

Figure 3: Daisy's Megalogician offers good execution speed with respect to compilation. As indicated, waveforms are displayed in a format similar to a logic analyzer and thus allows the designer to rapidly interpret the data.



Figure 2: Valid's Scaldsystem I is currently being used by *Digital Design* to implement a crosspoint switch on a CMOS gate array from LSI Logic. Valid's system excels in the graphics area. In addition, all software runs under both UNIX and DEC's VMS operating system.

One criticism of Zycad's machine is that it simply moves the simulation bottleneck from the execution stage to the compilation stage. More specifically, running a simulation on the accelerator requires that the logic be compiled into Zycad Intermediate Format (ZIF) first. Compilations have been known to require anywhere from a few minutes to many hours.

Like LSI Logic, Valid's CAE software runs on the VAX. Because of its graphics capabilities, many labs use Valid's Scaldsystem I primarily as a schematic capture tool. Running compilations and simulations on a mainframe is the only way to complete large array designs rapidly. Neither Daisy nor Mentor offer application software that runs under a common operating system such as UNIX or VMS. However, Daisy is currently porting their software to run under UNIX. The effort is expected to be completed in the next four months. Likewise, Apollo Computer plans to provide UNIX on their systems in the near future.

One complaint about mainframe computers is that they get bogged down during peak hours of operation and cannot adequately handle the workload. As a result, many claim the distributed processing power of a network of workstations yields greater productivity. Although this may be true to a certain extent, a mainframe executing 4-5 MIPS is not likely to be "brought to its knees" unless 25 to 30 users are simultaneously running memory intensive tasks such as logic simulation.

Realizing many systems manufacturers are not in a position to make a \$1 million-\$2 million investment in design tools, the issue remains whether to purchase a high-end workstation or buy computer time from the array vendor. Based on our gate array design experience, workstations do not provide the performance necessary to complete a large gate array in a timely manner; 1200 to 1500 gates would be pushing the limit of workstations from both Daisy and Valid. Mentor would be slightly higher since their workstation is based around a higher performance machine — the Apollo DN660. Excessive compilation and simulation times are the primary reasons for our criticism. Memory capacity is another significant workstation shortcoming in large designs. This is not to say that the job cannot be completed on a workstation, rather the rapid turn-around time found with gate arrays is lost to the workstation's slower execution rates.

Our newest design center for gate arrays.

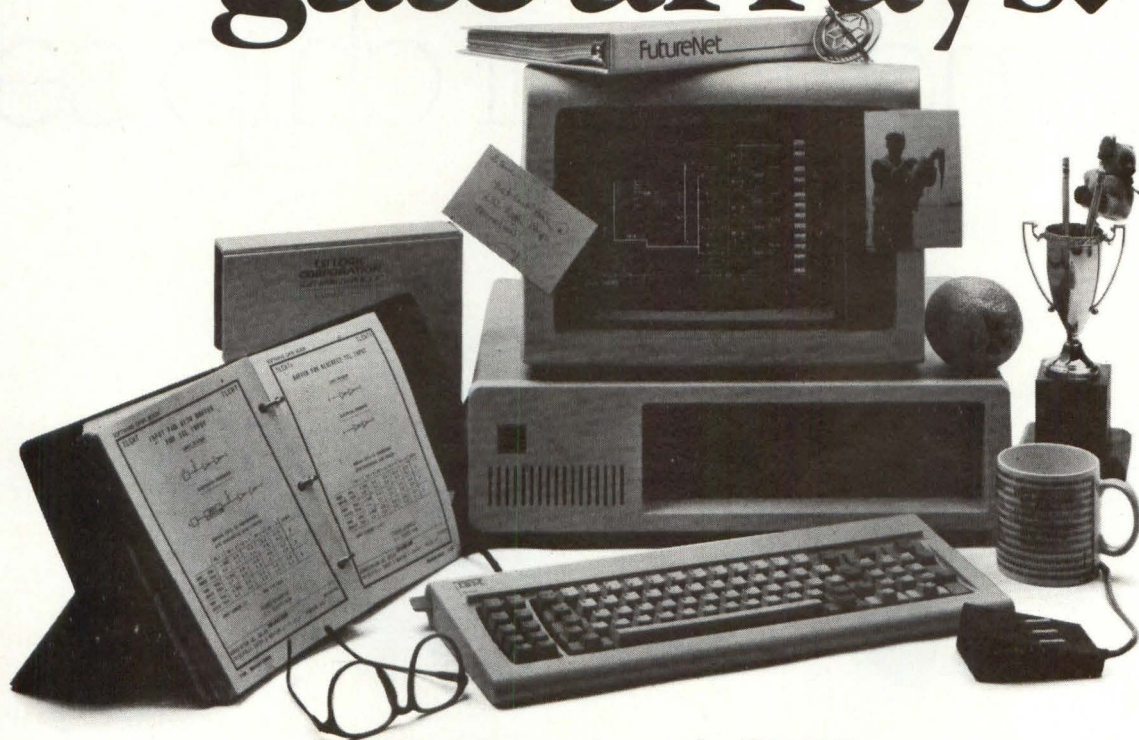

Yesterday it was just another IBM* PC.
Today it's a powerful workstation for gate array
design.

What happened? We did.

We're LSI Logic Corporation. Our LDS mainframe
design system has guided more than 600 gate array
designs from the drawing board to the assembly line.

With a 95% hit rate, first time out.

And now, with our Software Data Book™
macrocell library and the FutureNet DASH-1 Schematic
Designer,* you can create schematic designs on your
PC or XT.

Just see your local Wyle or Hamilton/Avnet
distributor. They stock the stuff to help you design great
gate arrays.

Without ever leaving your desk.

**LSI LOGIC
CORPORATION**

*IBM is a registered trademark of International Business Machines.

*FutureNet DASH-1 Schematic Designer is a registered trademark of FutureNet Corporation.

Weitek's new
8-megaflop, 64-bit
floating-point chip set

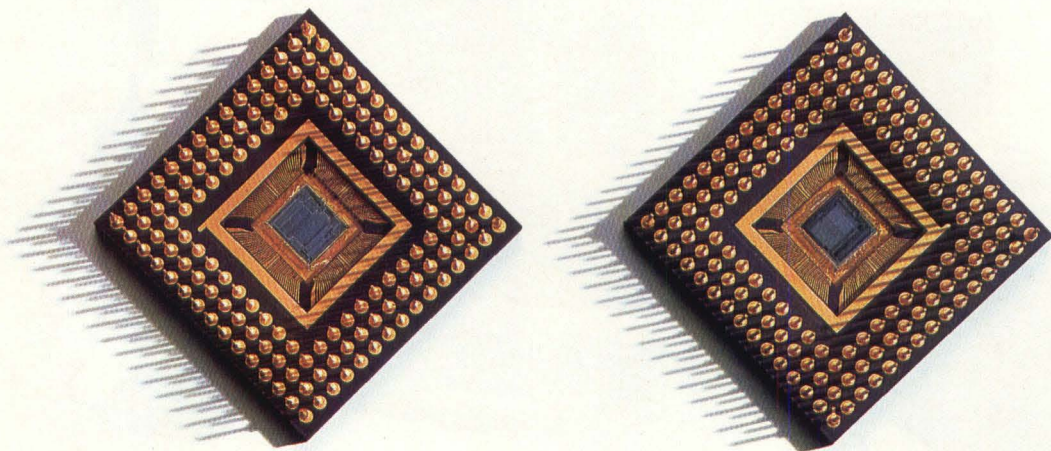

crunches numbers.

Not budgets.

Now you can afford to run 32- and 64-bit arithmetic operations, in either IEEE or DEC format, 50 times faster for an even lower cost.

The new WTL1064 multiplier and WTL1065 ALU perform double-precision add, subtract, multiply, absolute value, compare and floating-point/integer conversion, all on two low-power NMOS VLSI chips. They do the job of literally hundreds of expensive discrete circuits for as little as \$200 per megaflop, keeping your high-speed processors and coprocessors cool, compact and cost effective.

Your choice of flow-through or pipelined operation.

In coprocessor applications, the set operates in a flow-through mode to minimize latency. When speed is essential, however, as in array processing for scientific or engineering calculations, operations can be pipelined to achieve the maximum 8-megaflop bandwidth. A data transfer rate of 200 MBytes/sec maintains this high performance in nearly any bus configuration.

Easy adaptation to your host system.

The set interfaces directly with up to three buses of 16-, 32- or 64-bit widths. For even cleaner, easier system design, you can provide 32 x 32 intermediate storage with Weitek's WTL1066 Six-Port Register File. This companion part reduces the number of data ports entering the processor set, and lets you take advantage of its peak performance while using moderately priced external memory.

Leading-edge performance, proven technology.

Like our first-generation 32-bit chip set, the WTL1064/1065 is proof positive that intelligently applied algorithms can break performance barriers more effectively than experimental fabrication technologies. At Weitek, nearly all of our research is devoted to algorithm, architecture and circuit design, while our products are manufactured by proven processes to assure their reliability. So your engines not only run fast — they run long.

To learn more about how to reach peak performance without breaking the bank, call or write Weitek Corporation, 501 Mercury Drive, Sunnyvale, CA 94086, (408) 738-8400.



WE HAVE A WAY WITH NUMBERS

For smaller array projects, the workstation is a viable solution. However, if only a few small arrays are to be designed, the IC vendor's CAD/CAE system is probably the better solution because computer charges will remain low anyway. High-end workstations become cost effective when many small arrays are to be designed.

Comparing Daisy, Mentor And Valid

Approximate prices for workstations from Daisy, Mentor and Valid are as follows: Daisy's Logician is \$100,000, and the version of the Logician that includes the hardware accelerator (Megalogician) is \$125,000; Mentor's DN660-based workstation is \$90,000, with the hardware accelerator price set at an extra \$180,000; Valid's Scaldsystem I is priced at \$70,000 (\$130,000 for the four-user configuration) with the hardware accelerator priced at an additional \$38,500. Mentor's hardware accelerator, which is manufactured by Zycad, performs 500,000 evaluations per second; Valid's performs 500,000 evaluations per second; and Daisy's performs 100,000 evaluations per second. From a price performance standpoint, Valid is the better choice. Although when the Scaldsystem I supports four users, this load drastically slows the system.

Schematic capture and graphics capabilities of Daisy, Mentor and Valid were compared. Valid was the best, with Mentor running a close second. Valid's ease of use and limited number of steps per change or addition were the deciding factors. However, Valid's superiority is tainted if a design is entered "flat," because the time necessary to compile and simulate the drawing increases significantly. As noted in Part II (February 1985), exploiting the Scaldsystem I to the fullest requires the schematics be captured in a streamlined fashion. This method, which employs the "sizing" command, yields a drawing that is often difficult to decipher.

As indicated earlier, the ideal configuration employs the Scaldsystem I as a front end to a mainframe. Thus, schematics are entered in the traditional "flat" style with the compilation executed on the mainframe. If a larger computer is unavailable and a workstation is to be the sole source of computer power, Mentor's DN660 would be the more favorable alternative. Valid is reportedly revamping their compiler to increase compilation speeds by a factor of 10.

Unlike Daisy and Valid, Mentor's system automatically divides the display so there is an entire schematic in one window and a close-up of the area under construction in the other. With interwindow communication, the cursor is located at the same point on the schematic in both windows. Without this feature, the designer can easily lose track of which area of the schematic is under construction. Although this extra window consumes screen space, it is very useful for entering large complex circuits. Both Mentor and Valid permit "point and drag." This allows the user to pick up a component and drag it across the screen; rubberbanding is also standard on Mentor and Valid systems. These features are a tremendous benefit in schematic capture.

In comparing the compilation speeds between Daisy and Valid, we found Daisy to be faster if the design is entered "flat" on each system. Daisy does not require the user to "size" drawings to exploit their system's performance. Although we did not have an opportunity to measure the compilation speed of Mentor's DN660-based system, we assume it offers the highest performance of the three since it uses a full 32-bit processor.



Figure 4: Mentor's high-end workstation, based on the Apollo DN660, offers very good graphics and provides execution speeds just below that of a VAX 11/780. Like Daisy and Valid, Mentor offers a hardware accelerator that significantly speeds logic simulation.

Incremental compilation capability is a major advantage that both Daisy and Mentor have over Valid's Scaldsystem I. With this feature, designers make changes in schematics without completely recompiling the entire design. For instance, instead of rerunning a 35 minute compilation, the task is completed in less than five minutes. Sometimes, however, when a particular change affects several different portions of the circuit, incremental compilation is not possible. From a functional standpoint, timing verification and simulation capabilities were comparable among the three systems. However, waveform data is displayed most informatively on Daisy's workstation (Figure 3). Again, Mentor runs a very close second in this category.

(continued on p. 72)



Figure 5: Futurenet's Dash-1 and Dash-2 can be configured on the IBM PC XT or AT. In addition, these systems can be equipped with the Dash Cadat, a 32016 co-processor board with 1 Mbyte of RAM, providing designers with simulation and timing verification.

HOW TO DOUBLE YOUR CONTROL WITHOUT DOUBLING YOUR CONTROLLER.

If your plans for controlling disk and tape drives call for two boards and two CPU slots, you can now cut your plans in half.

And use the SPECTRA 25 LSI-11 emulating multifunction controller instead. You'll get all the control of separate disk and tape boards in just half the space. Half the slots. Half the spares. While using less power.

SPECTRA 25 is the smarter way to handle SMD/Winchester and 1/2-inch tape drives, and it's the first and only multifunction controller designed for DEC Q-BUS® computers.

Its block-mode data transfer capability can increase your throughput by up to 50%. And it performs Error Correction Code (ECC) independently of the operating system. All 32 bits worth.

SPECTRA 25 fully emulates DEC's RM02/5 and RM80 disk subsystems, and TS11 tape subsystem. It can run two SMD disk drives and four tape drives, in any combination. Plus an E²PROM lets you easily reconfigure while the controller is in your system.

But SPECTRA 25 puts something else in your system, too: proven reliability. Because you're working with half as many parts and pre-tested ICs.

You're also working with excellent documentation that's regularly updated. And the most comprehensive one year warranty in the industry. All backed by responsive nationwide service.



SPECTRA 25 is the multifunction controller that doubles your control. And your advantage on the competition.

Before you look at Emulex or Dilog, consider the SPECTRA 25 from Spectra Logic.

It could be all the controller you'll ever need. For further information on our expanding family of controllers for DEC Q-BUS and UNIBUS® computers, call or write us today.

	SPECTRA 15*/ SPECTRA 25	SPECTRA 111*/ SPECTRA 121	SPECTRA 12*/ SPECTRA 21
BUS	Q-BUS (Block-mode)	UNIBUS	UNIBUS
Disk Emulation	RM02/05, RM80, RP06 (2 drives)	RM02/05, RM80, RP06 (4 drives)	RK06/07 (4 drives)
Tape Emulation	TS11 (4 drives)	TS11 (4 drives)	TS11, TM11 (4, 8 drives)
Disk Transfer Rate (SMD)	2.0MB/sec	2.0MB/sec	2.0MB/sec
Configurable On-Line	Yes	Yes	No
*Single function disk controller			

Spectra Logic Corporation, 297 North Bernardo Avenue, Mountain View, CA 94043, (415) 964-2211, TWX 910-339-9566, TELEX 172524 SPL MNTV. International Sales Office: The Netherlands (31) 23 273744, TELEX 71080 SPECL.

SPECTRA LOGIC

A Cipher Data Products Company.

©1984 Spectra Logic Corporation

Circle 25 on Reader Inquiry Card

Keyboards Range From Simple Components To Intelligent Input Subsystems

by Julie Pingry, Senior Editor

Integrating the keyboard into a system poses choices of technology, intelligence and layout to system designers. Both keyswitch and electronics technology have advanced to allow data entry keyboards to be self-contained systems. European DIN standards for ergonomics that dictate detachability are further impetus for intelligent keyboards. With the microprocessors currently used, basic keyboard control and functions to control many elements of an input system are available.

At the other extreme, many computer-based systems are now low-cost commodity items. These applications require

a keyboard that is inexpensive and ready to integrate. Since the lifespan of personal computers and low-end terminals is short, many reliability features like non-contact switching, double-shot molded keycaps and life cycles up to 100 million keystrokes are more than the application demands.

So the data entry full array, full travel keyboard business can be divided into at least two distinct categories. Simple, low-cost devices for integral use and high-end, reliable, intelligent peripheral products both can use any of several technologies for switching. Important differences will be in customizing, delivery, marketing and support. Switch technol-

ogy will still be a choice, even after the vendor has been chosen.

Ergonomic standards have changed more than where the electronics are placed; the demand for a low profile package has opened the market. Many designs are calling for a new keyboard to meet standards or special requirements, and some firms are now looking beyond their long-standing supplier for comparison.

Technology Trends

Glass reed relay and electromechanical switching were mainstay keyboard technologies for many years. Over the past 10 years, other technologies have gained



Figure 1: A line of full-travel membrane keyboards is available from Oak Switch.

You choose from all the best technologies at

KEYBOARD HEADQUARTERS

DIN compatibility in the most advanced keyboard technologies.

Only from Cherry: Where we are ready today to meet 1985 ergonomic standards.

Only from Cherry: Where we make all the most cost-effective technologies for your application.

Only from Cherry: Your Keyboard Headquarters. Worldwide.

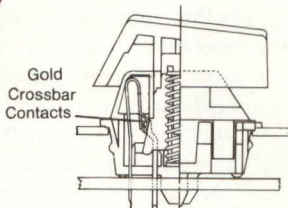
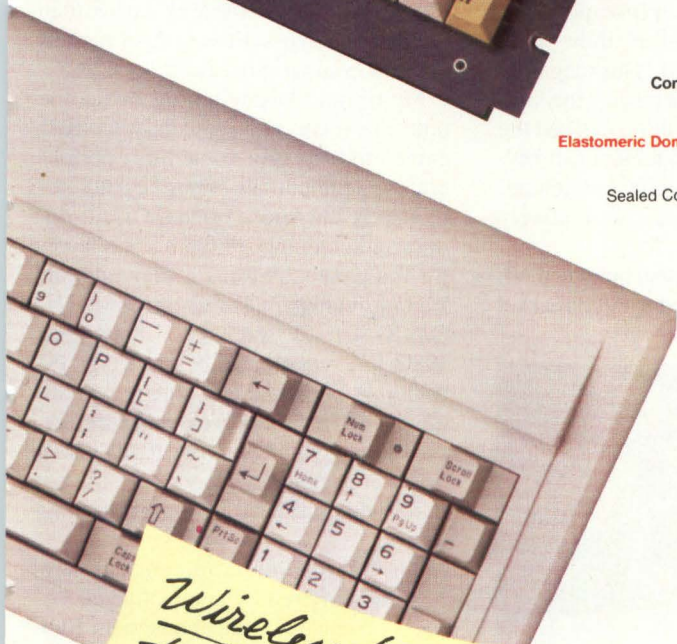
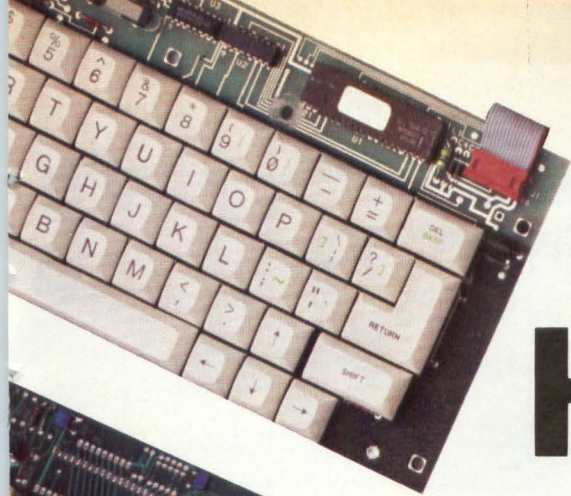

Full Travel Hard Contact

Gold crossbar contact configuration relied on in millions of applications worldwide. A first from Cherry more than a decade ago. Now proven and improved to meet the low-profile challenges of the 80's.

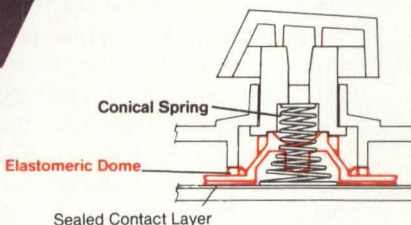

Full Travel Sealed Contact

NEW: A next generation keyboard that combines full travel with the quality and reliability of sealed silver contacts for long life, low cost. **Conical steel spring action** with linear feel... or **elastomeric action** with tactile feel.

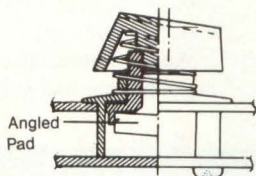

Full Travel Capacitive

Pad capacitive in a uniquely simple design requiring only five parts and a snap-in angled pad. Another keyboard technology alternative from Cherry... the folks with the *most* logical alternatives.

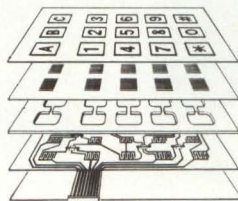

Flat Panel Membrane

Unlimited design options thanks to our state-of-the-art production techniques and in-house fabrication. Thin, lightweight, reliable, low cost. All this and sealed contacts, too!

SEND FOR COMPLETE DATA



KEYBOARD HEADQUARTERS

CHERRY ELECTRICAL PRODUCTS CORP.

3631 Sunset Avenue, Waukegan, IL 60087 • 1-312-578-3500

Wireless Keyboards too! Call me at 1-312-578-3522 Eric Olson

Circle 28 on Reader Inquiry Card

prominence; nevertheless, reed and mechanical keyboards are still available from several sources. In the mid-1970s, inherently reliable noncontact technologies had a surge in popularity. More recently, membrane and elastomer (or rubber) switches have gained market share. All these types of switches will be used for data entry keyboards throughout this decade. And though functionality, quality and supplier capability may be the major factors in choices, the technologies do differ and each has strong features.

Reed relay switching is still useful for very hostile environments. The sealed contact switches are impervious to oil, gas and humidity, and may be found in point-of-sale, machine tool and process control applications. Though not a volume production offering, Keytronics (Spokane, WA) and Maxi-Switch (Minneapolis, MN) supply reed relay boards. A major drawback to reed switching for data entry keyboards is that the switches are too tall to meet DIN standards for low-profile.

Electromechanical (often called mechanical) switching was not very reliable in its original form, partly because the physical contact points could wear and were not sealed from contaminants. Most mechanical keyboards are now specified for 20 million-50 million keystrokes; Hi-Tek's (Garden Grove, CA) IBM PC-compatible products are specified at 100 million cycles.

One design change that contributes to enhanced mechanical switch reliability is a move away from the single gold contact



Figure 3: Stackpole's KS-600E mechanical hard-contact keyboard meets DIN low-profile specifications and can easily be made in custom configurations.

for closure. One firm focusing on this field, Stackpole (Raleigh, NC), uses twin bifurcated contacts, for four contact points, rather than one. Hi-Tek similarly uses trifurcated contacts. Cherry (Waukegan, IL), another leader in mechanical keyboards, uses gold wire crosspoint switches, for extremely high pressure on a small contact area closing. Mechanical keyboard manufacture is relatively low cost; and since single keys can be made, customizing doesn't cost much.

In 1968, Micro Switch (Freeport, IL) introduced new levels of reliability with the Hall-effect keyboard. This magnetic switching technique eliminates the hard contact, and its introduction marked the beginning of electronic noncontact keyboard availability. Hall-effect switching, though highly reliable, is a relatively costly technology.

Another noncontact switching method, capacitance, has gained a large market

share since the mid- to late-1970s. Though electronic in the switch function, capacitive products are not as expensive to manufacture as Hall-effect. The wide use of these two contactless technologies increased the industry standard life cycle specifications to 100 million cycles. Capacitive keyboards are available from many firms, including Keytronics, General Instrument (El Paso, TX) and some whose product line began with other technologies. All noncontact keyboards have generally been more expensive than hard-contact types, though many models are now comparably priced.

Membrane keyswitching has come onto the scene fairly recently for data entry products. For some time, peripheral, instrument and other keypad for relatively low-speed use have used conductive screening on membrane layers for flat panels. A full-travel membrane keyboard (Figure 1) was introduced by Oak Switch (Crystal Lake, IL) in August 1980, just two months before IBM's PC with that keyboard technology was announced. The layers of a membrane keyboard may switch either by hard contact or by capacitance, depending on what material is screened onto the switching layers.

A similar layered approach to keyboards is offered by conductive elastomer or conductive rubber materials. Rubber may be used in a dome configuration for hard contact switching or screened for capacitance. Like membrane, rubber switching has primarily been used in minimal travel key panels. The costs are low, and with appropriate full-travel keys over the rubber layers as actuators, companies like Advanced Input Devices (AID) (Coeur D'Ilene, ID) and Maxi-Switch offer products for data entry. There have been some doubts about the



Figure 2: The PC-84D from Hi-Tek uses the Dvorak key layout, with often-used keys in convenient positions. Note that vowels are on the left side of the home row.

For the highest quality, most cost-effective low-profile keyboards...ask the leader in full travel membrane technology.

Ask OAK.

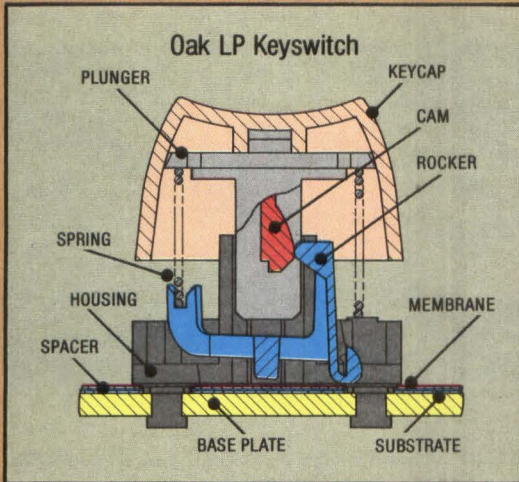

For engineering excellence...ask OAK

Introducing the low-profile, DIN compatible keyboard with the features you've been searching for — **Oak's Low-Profile FTM® Keyboard**. Designed especially for high speed data entry systems, where long life and operator comfort are paramount, Oak low-profile FTM keyboards feature a patented keyswitch design. Now, finally, you can specify the "feel" your customers want... from standard linear to fall-through tactile.



Tactile or Linear Feel available.

For design flexibility and savings...ask OAK

Simple design, coupled with advanced manufacturing, spells maximum design flexibility and savings for you. Oak keycaps are made of durable, light-weight, non-glare polyester and feature a comfortable cylindrical industry standard design. Sublimation printing provides for a wide variety of printing options — quadrant printing, multicolors, front legending, and custom legends — order whatever you need. And, there are a host of available options to fill most any special design requirement — LED indicators, EMI/RFI/ESD shielding, standard or custom encoding electronics, variable operating forces and more!

For proven technological leadership...ask OAK

Oak is the recognized leader in full travel membrane technology, a technology that provides proven performance features, benefits and cost savings not available with other keyboard designs • high reliability • long life of 50 million cycles • elimination of double-sided, plated-through hole printed circuit boards • environmental protection by design • light weight

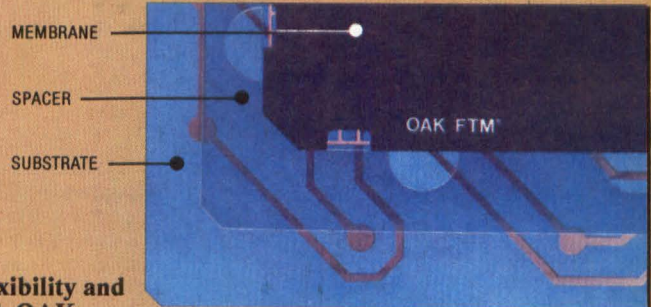

... just a few of the many features designed to help enhance the performance of your product.

For commitment to quality, service and value...ask OAK

Oak remains dedicated to staying in the forefront of keyboard technology. To providing a superior quality product, in the quantities you need, on time, at the right price. **To see how the new Low-Profile FTM Keyboard can go to work for you...ask OAK.**



OAK Switch Systems Inc.

P.O. Box 517 • Crystal Lake, Illinois 60014
Phone 815/459-5000 • TWX 910-634-3353
TELEX 72-2447

For Sales Circle 52 For Literature 62



wear tendencies of elastomer keyboards since switching actually deforms the rubber layer. However, AID specifies a minimum of 60 million keystrokes with their non-silicone rubber dome keyswitches.

Each switching technology has advantages, and the system design will determine which characteristics are most important. The quality of the finished product in feel, life specifications, delivery time and cost are the main factors to consider. These may be largely independent of the technology, but vary between suppliers.

The Low End

Since computers are no longer necessarily large, expensive machines and, more importantly, since technology advances occur very frequently, the useful life of many systems has dropped. The volumes for these micro systems are often very large and profit margins accordingly small. As systems drop in cost and high-volume applications like personal computers and terminals become more competitive, keyboard costs must be kept low.

Membrane and rubber keyboards do not need to be placed directly on a printed circuit board. For a detached DIN-standard keyboard, some of this advantage is lost. But many low-end systems still use integral keyboards. These keyboards can be "wired-only" or unencoded, with electronics for keyboard control included with the computer or terminal boards.

Portable computers may demand an integral keyboard. Another consideration with portable systems is low power consumption. Electromechanical keyboards, whether membrane or mechanical, drain little power when keys are not depressed. Since capacitance switches are scanned for data, they drain more power than desirable for battery-driven computers.

Many simple computer-based products are designed for relatively inexperienced users, or for infrequent use. Even poorly manufactured computers last as long as most companies and individuals want to keep a particular model. The common 100 million keystroke spec of Hall-effect and capacitance products is clearly more than needed for these systems, which might not even reach the 20 million-50 million keystrokes of many low-cost hard contact models.

Simple unencoded keyboards, commonly mechanical, membrane or rubber, are generally inexpensive. But costs to makers of mechanical keyboards using

A natural extension of the keyboard is control of other input devices in the enclosure or connected to it.

Figure 4: Trackball and keyboard are included in one enclosure in the programmable Wico Smartboard; it can be used either as a Dvorak or standard Qwerty device.



precious metal contacts such as gold can vary greatly with market forces. Rubber keyboards may also use these variable-price metals on the controlling PC board.

Many companies currently supply unencoded keyboards at low prices. But as in other commodity markets, Japanese and other far-East companies' labor force usually produce for much less than US laborers. Several Japanese companies have offices in the US: Alps is based in San Jose, CA, now; Panasonic's Electronic Components Division in Secaucus, NJ, handles their keyboard line; and Fujitsu America's keyboard operation is based in Lake Bluff, IL.

Though many US keyboard manufacturers are using automation and off-shore manufacturing, these Asian firms are difficult to compete with for simple mechanical products. Some US makers of rubber and membrane products have a lead on the Japanese in these inherently low-cost technologies. Despite the furor over the IBM PCjr chicklet keyboard, supplier AID is shipping large volumes of inexpensive rubber dome keyboards. Many other domestic firms are looking to value-adding and higher-end market segments for their livelihood.

Flexible Keyboards

Detached keyboards with other ergonomic and OEM design features are the

mainstay for most US manufacturers. For heavy-use systems, feel, layout, configurability and, above all, reliability, are critical. To compete in this market, firms must be able to customize keyboard appearance and electronics to customer specification and turn out consistent products in a reasonably short time.

Again, many technologies compete. As for reliability, noncontact is inherently good. To compete with Hall-effect and capacitance, keyboards using other types of switches are also specified at 100 million cycles. In membrane, the layers themselves have an almost unlimited life, and, as mentioned earlier, several approaches to mechanical contacts have improved their performance.

In harsh environments, reed relay has long been the standard. But the sealed membrane technology used for flat controls in many factories can also prevent contamination in a properly designed full-travel keyboard. In a capacitive membrane product, Micro Switch uses six layers; three are for venting so that external air pressure or temperature changes do not destabilize air pressure in the three switching layers of the sealed unit. Cherry uses membrane technology to provide a seal for silver hard contacts.

One of the main considerations for data entry devices is operator comfort, or ergonomics. European DIN standards sug-

We can't demonstrate here how good our new keyboard feels. But we can show you how it sounds.



That's how quiet our new Silent-Tactile keyboard is. Really. And when you combine this quiet operation with its good feel, positive tactile feedback, and good looks, you'll see why the new MICRO SWITCH Silent-Tactile keyboard is unmatched in the industry.

You'll also see why this new keyboard's good looks and quality feel help make your product more saleable.

It keeps the peace without losing its touch.

Our new low-profile Silent-Tactile keyboard gives you a unique combination of quiet operation and positive tactile feedback.

In increasingly noisy office environments, the quiet operation helps improve work atmosphere. And its smooth operation and tactile feedback cut down on errors while increasing satisfaction for the operator.

These new keyboards are designed to survive millions of operating keystrokes and still keep working. In capacitance or contact membrane versions, with the same consistent positive feedback.

The Silent-Tactile key-

board is available in enclosures to give you plug 'n' play capability. You also get human factors options that include key shapes, colors, legends, keyboard slope and layout to give you the design flexibility you need.

The response you need—and then some.

Over twenty years of keyboard experience has gone into the new Silent-Tactile keyboard design. This experience is combined with the expertise of our field and application engineers and expanded production facilities. So we can work with you to make sure you get the best keyboard for your application... in a standard or custom-tailored design.

Trying is believing.

Don't take our word for it. Sit down with a MICRO SWITCH Silent-Tactile keyboard and test it yourself. You'll see that it's as quiet, responsive and good-looking as we say. Maybe more so. A phone call is all it takes to arrange a demonstration. Simply call 815-235-6600. Or, write MICRO SWITCH, Freeport, IL 61032. Let us show you how good silence can feel.



Together, we can find the answers.

MICRO SWITCH
a Honeywell Division

Circle 36 on Reader Inquiry Card



Figure 5: This Keytronics subsystem with touch pad and keyboard also has ports for other input devices.

gest a home row height of 30mm or less from the desktop, with a profile angle at 15° or less. Except for reed-type switches, all switch technologies can be made to the low-profile size dictated.

In addition to height, ergonomic standards call for some form of feedback for the operator. Though tactile feel keyboards have long been available and gained popularity for a while, most full-time data entry operators find the make-point change in force tiring on the fingers. Most keyboard models are available with either linear or tactile feel. And if linear feel is wanted as well as some sort of feedback, an audible click may be used. The office environment may, however, benefit from an approach like Micro Switch's Silent-Tactile series.

Another feature that can promote accurate data entry at very high speeds is N-key rollover. This feature assures that when several keys (up to a set N or the total keys on the board) are depressed in more rapid succession than they can be processed, all are retained in memory in the sequence they were entered. This feature is standard on some noncontact keyboards, and it is an option on many products. Multikey rollover is sufficient for most uses and, with mechanical technologies, usually less expensive.

Optimum operator throughput requires a new layout of the keys. The standard Qwerty layout was developed when all typing was on mechanical devices. Before this standard, keyboards were laid out serially A-Z. Anyone who has used a mechanical typewriter has experienced key lock-ups if they type rapidly; strike two keys in succession and the first will tend not to be out of the way of the second as it comes up. The Qwerty arrangement helped avoid some key clashes by separating some keys and also slowing down typing speed.

Another arrangement, called Dvorak

after its designer, places the most commonly used keys in the easiest positions to reach (Figure 2). Studies show vast improvements in entry speed with the Dvorak keyboard, and some schools are teaching touch typing on them. But until the education process is further along, the Dvorak keyboard options from many of the leading manufacturers will be small-run production items.

Though most designs require a custom-manufactured keyboard, the IBM PC keyboard and the DEC VT 220 configuration have become popular semistandards for layout and look. Many systems can use one of these types of keyboard and get very good turnaround time and price from the supplier. Nevertheless, most designs will vary at least the color or placement of some keys.

A vendor's ability to meet specific design requirements is important. Though rubber and membrane keyboards are generally screened all at once with a new pattern needed for each different customer order, the technologies are generally inexpensive on large runs. Mechanical keyboards can be custom-configured easily, as illustrated in Stackpole's KS-600E (Figure 3), for which they have keys already made and simply cut a new metal plate for the placement of the keys. The model EKS from AID is a similar single-key approach with rubber domes.

Some keyboards can be configured for various applications with PROMs or EPROMs. Essential to using other input devices connected through the keyboard, PROM can also provide flexibility as to what function keys do, where functions will reside and type of rollover. Fast production turnaround can also be achieved when a standard physical keyboard is customized via PROM programming.

One of the most interesting ergonomic dictates from the DIN group is for de-

tachable keyboards. The standard was set for comfort and flexibility. Detaching the keyboard has several effects: information out of the keyboard must be converted from its parallel form out of the matrix into serial for transmission; and all electronics must be in the enclosure. In the past, many keyboard companies worried little about enclosures, let alone microprocessors. For the future, these detached keyboards may provide the basis for intelligent input subsystems.

Input Subsystems

The trend toward intelligent peripherals is nearly universal, and now that most keyboards are attached to the system via a serial connection, they must also have a microcontroller. Most keyboards use the Intel 8048/49/50/51 family or an equivalent or similar 8-bit part. These devices are not used to their fullest on only keyboard encoding/decoding, scanning and control.

A natural use for the processing power is to incorporate other input devices into the enclosure, or at least connect them through a port on the keyboard. The keyboard processor can then control several input devices, as well as minimizing the tangle of cords out the back of the system.

Though this is a new idea, several firms already have products with other devices included in the keyboard enclosure. Wico (Niles, IL), traditionally a manufacturer of controls for video games, has entered the keyboard market with their Smartboard keyboard with an integral trackball (Figure 4). The trackball quadrature output is translated into keystrokes through a Motorola 6802 processor.

Keytronics' 5153T (Figure 5) has an integral touch pad; the keyboard also has ports for connecting barcode scanners and voice input systems through it. Such a configuration, with one other type of input control included in the keyboard enclosure and ports for others, may become common.

In their PC AT, IBM has provided the bidirectional interface needed to connect more than one device through the keyboard. The new interface allows the computer to respond to the keyboard, for acknowledgement of a mode change, often signaled by an LED indicator on the keyboard. This is needed to switch from keyboard operation to another form of input, if both are controlled by one set of electronics.

Initially, the inclusion of multiple devices in the keyboard means only some

You can put a better keyboard in your enclosure without modifying the enclosure.

Stackpole's new KS-600E keyboard—featuring snap-in modular switches—gives you a low-cost encoded keyboard that will retrofit into your present enclosure without retooling.

The discrete snap-in modular switches assemble into a metal plate to give you any kind of main or ancillary array layout you need. The metal plate assures alignment of the switches, adds rigidity and aids in RFI/EMI suppression.

You don't have to tool up for a new enclosure or modify the present one. We'll do the retrofitting for you on the backplate, and all you do is drop it in and connect it up.

And we can provide our custom encoded scheme, or design to your proprietary encoded format. Plus we let you choose between tactile or linear feel—at no additional cost.

The ergonomically designed full travel switches have a total stroke of .140 (3.6 mm nominal), are rated at 50 million cycles, are wave solderable and field repairable. The switches contain Stackpole's patented twin bifurcated contacts, with four make-point redundancy, which assures you of switch closure. And today's sophisticated electronics make mechanical switch operation reliable and dependable...at lower cost.

Stackpole also gives you the option of purchasing our modular switches individually, or in sets of configured arrays for your in-house assembly.

We have a variety of key-cap styles. And we offer a major cost saving through our large legend library...tooled and in place...including the most popular international legends.

Our Application Engineers are ready to help, our domestic and off-shore facilities keep our prices attractive.

Call or write us today for complete information.



STACKPOLE

Stackpole Components Company
P.O. Box 14466, Raleigh, NC 27620
Telephone: 919/828-6201

changes in the interface electronics. For the inclusion of many input controls in a single subsystem, a more powerful processor may be needed. And for voice I/O, extensive electronics are needed. A variety of relatively low-cost processors can handle keyboard control as well as translation of other types of signals into keystrokes. This scheme allows the host of common application packages written for keyboard entry to use mice, touch pads, light pens and other devices with no drivers.

As many keyboard manufacturers point out, they cope with most of the elements that a computer manufacturer does now: processors, interface electronics, PC board assembly, enclosures and plastics. Some hint that they may pursue systems since keyboards are one of the elements that cannot be significantly reduced in size for portable systems. Still, that would mean competing with current customers.

For the present, count on the power of low-cost processors within the keyboard to control several input devices. Simplification of peripheral hardware and inter-

faces as well as software interfaces for input options may be eased by keyboard subsystems.

Human Interface

A variety of keyboards and suppliers compete in nearly every segment of the market. Technology, customization, feel, delivery speed and prices are relevant in the choice. In many cases, trust in the supplier, an affinity for a particular feel or layout or a desire to have extremely good lifecycle specification may outweigh other criteria.

Specific operating conditions of the system must be considered in choosing a keyboard. Harsh environments benefit from sealed keyswitches, reed or membrane. For inexperienced users, tactile feel may be desirable (although in general, desired key feel is highly individual). Mechanical contact products tend to be less expensive. If integral to the system, separate electronics, as with a membrane keyboard, may be easier to service.

Turn-around time is critical in having

designs completed within short market acceptance periods. Supplier ability to aid in design, to configure products and to vary the production run for a system are always important. The custom nature of the keyboard business has changed very little, even with the popularity of PC and VT 220 configurations.

To meet DIN standards, purchasing a keyboard will generally include the enclosure and electronics. Such peripheral products offer potential for a single-box input subsystem. And with graphics and other menu-driven software, mouse, touch pad or trackball input can increase efficiency. Should the market for data entry become sufficiently interested in productivity to push for education, even the Dvorak keyboard layout may take off. **DD**

How useful did you find this article? Please circle the appropriate number on the Reader Inquiry Card.

Very Useful604
 Useful605
 Somewhat Useful606

CIRCUIT/LOGIC DESIGN

(continued from p. 62)

The Low Cost Alternative

Valid, Mentor and Daisy each offer low-cost workstations that provide an excellent solution. Using the smaller workstation for schematic capture and then performing the design verification on the gate array vendor's CAD/CAE system is the most appropriate solution for the majority of gate array designs.

Prices for these machines are roughly \$20,000. In comparing the offerings from the three firms, Valid's Scaldsystem IV was the favored choice, with Daisy's Personal Logician (AT) running a close second. Both workstations offer the basic capabilities, other than computational horsepower, found in the Scaldsystem I and Logician, respectively. Futurenet (Canoga Park, CA) is another vendor offering a low cost system compatible with LSI Logic's cell library (Figure 5). In contrast, Mentor's Capture Station is only a schematic capture system. Although verification software can be added to the system, it is not part of the standard \$20,000 configuration.

Until the price of the larger systems comes down, or the performance increases, low-cost workstations are a better buy. Simply stated, the additional computational horsepower found in the higher priced systems is not worth the extra cost.

Where We Stand

Like most design projects, we ran into a few snags. The most significant difficulty was the incompatibility between Valid's simulator and LSI Logic's Design Verifier. The software per-

mits the use of statistical delay data (for wiring and fanout) to be incorporated into the design verification process. However, in order to utilize this data, Valid's simulator must be invoked. The Design Verifier requires a "delay" command be placed inside the simulator command file, but the simulator was unable to understand the command.

To rectify the problem, Valid recently tailored their simulator to meet the Design Verifier's requirements. This new version of the simulator (7.5) is just reaching beta-site testing. Unfortunately, this stumbling block consumed a large chunk of time. Since we are still in the process of designing our chip, update reports will be published periodically. **DD**

Acknowledgements

Digital Design expresses much appreciation for the support given by Valid Logic, LSI Logic and Datacube. Special thanks is extended to Gerry McCarthy, Applications and Marketing Engineer at Valid Logic; Steve Hummel, Applications Engineer at LSI Logic, and Jay Dunn, Vice President of Engineering at Datacube.

How useful did you find this article? Please circle the appropriate number on the Reader Inquiry Card.

Very Useful601
 Useful602
 Somewhat Useful603

OEMs... Is Your Input Strategy As Sound As Your CPU Strategy?



Computer users are demanding additional input devices from you. Key Tronic can help you meet the demand for these input devices, and minimize your development costs.

Key Tronic is integrating the most popular input devices into OEM keyboards. All processing is done in the keyboard and no additional system ports are required . . . using existing electronics saves money. Also, all input can be presented as a series

of key presses to assure compatibility with existing and future software.

Speech Recognition, Touch Pad, Mouse, Bar Code and Joy Disk are available to enhance your product with unique, value added benefits. Distinguish your product from the ordinary! Talk to your Key Tronic representative today.

A. Joy Disk — Four keys in one; rapid cursor control.

B. Touch Pad — Multi-purpose input device; programmable key pad, cursor control, drawing tablet.

C. Speech Recognition — Natural, language independent command entry. Hands free operation.

D. Mouse — Popular pointing and selecting tool.

E. Bar Code — Fast, accurate data capture.

“Feel the Key Tronic Touch”

key tronic
The *Responsive* Input Company

P.O. Box 14687 • Spokane, WA 99214 • USA
(509) 928-8000 • TWX 510-773-1885

High Resolution A/Ds Approach Performance Limits

by Brita Meng, Technical Editor

The integration of functions onto high resolution A/D converters increases design options, but component limitations may make higher resolutions more difficult to attain.

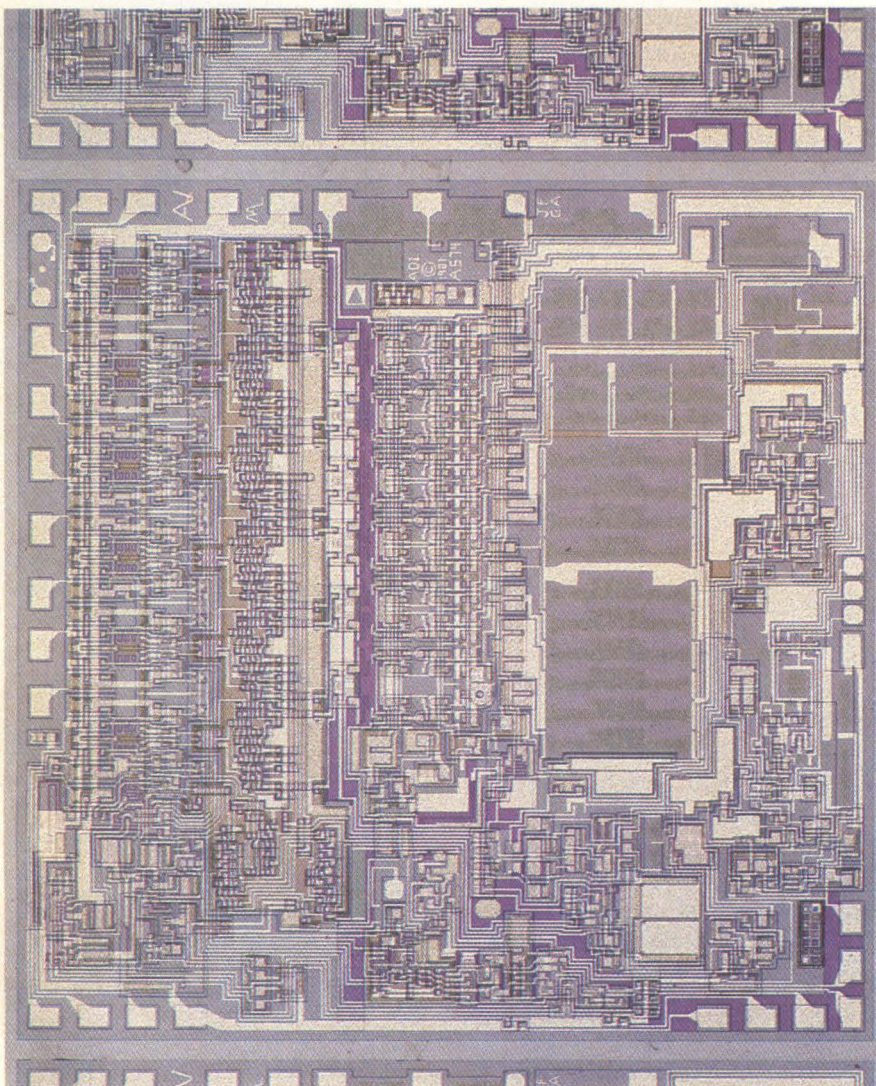

The need for higher resolution analog-to-digital converters—those with more than 12-bit outputs—is growing as the demand by systems architects for higher precision “real world” inputs increases. Applications such as telecommunications, industrial process control, digital audio, seismic exploration, robotics and instrumentation demand high resolution to obtain either high accuracy, better resolution or expanded dynamic range. In addition to higher resolution, integrated functions such as sample and hold circuits on the analog side and microprocessor interfaces on the digital portion of the A/D converter are also in demand by systems architects.

Several types of modular, hybrid and monolithic high resolution A/D converters exist, each with a distinct conversion technique having inherent advantages and disadvantages. Successive approximation, integrating and two-stage series parallel are among the most popular approaches.

The heart of the successive approximation A/D converter (**Figure 1**) is the digital-to-analog converter in a feedback loop with a comparator and a successive approximation register. The conversion algorithm consists of switching the bits of

Analog Devices' AD574, a microprocessor compatible 12-bit A/D converter, will appear in monolithic form in late 1985.

How Datel converts analog signals and design engineers at an amazing rate.

Design engineers responsible for the development of high-speed/high-accuracy data acquisition systems have, for many years, specified Datel conversion components.

But the incredible speed and exceptional accuracy aren't the only reasons Datel has attracted a loyal following among design engineers. Manufactured with state-of-the-art thin film hybrid technology and active laser trimming, Datel A/D Converters are also respected for their stability and reliability.

12 Bit, 2 μ sec

If you're looking for high speed, look at our ADC-810 hybrid, successive approximation A-D. It features $\pm 1/2$ LSB differential linearity and no missing codes over temperature; four pin programmable input voltage ranges; and an optional input buffer amplifier.

Datel's ADC-810 is most often used in automatic test instrumentation, guidance and control avionics and high-speed multiplexed data acquisition systems.

8 Bit, 700 nsec

For ultra-fast conversion, try our hybrid ADC-815. In addition to conversion rates up to 1.67 MHz, six programmable input voltage ranges are offered.

It's been designed for pattern recognition, telecommunication, fast servo, radar, instrumentation, automatic control and data acquisition applications.

One of the unique features of the ADC-815 is a logic input which switches the converter from unipolar to bipolar operation. Output coding is binary, offset binary, or two's complement.

12 Bit, 500 nsec

High accuracy and ultra high speed

are packaged together in our modular ADC-868. No external components are required. It features on-board gain and offset adjustments and internal analog and digital supply decoupling capacitors to simplify installation and calibration.

The ADC-868 is best suited for test and measurement systems, performing spectrum analysis, analyzing real time waveforms, industrial testing, radar digitizing and digital communications.

NOTE: For military and aerospace applications Datel's Hybrid ADCs can be subjected to rigorous screening procedures in accordance with MIL-STD-883, method 5008, Class B.

For your FREE Engineering Data Sheets call 617/339-9341 Extension 121, or write Mr. Bob Leonard, Applications Engineer, Datel, 11 Cabot Boulevard, Mansfield, MA 02048.

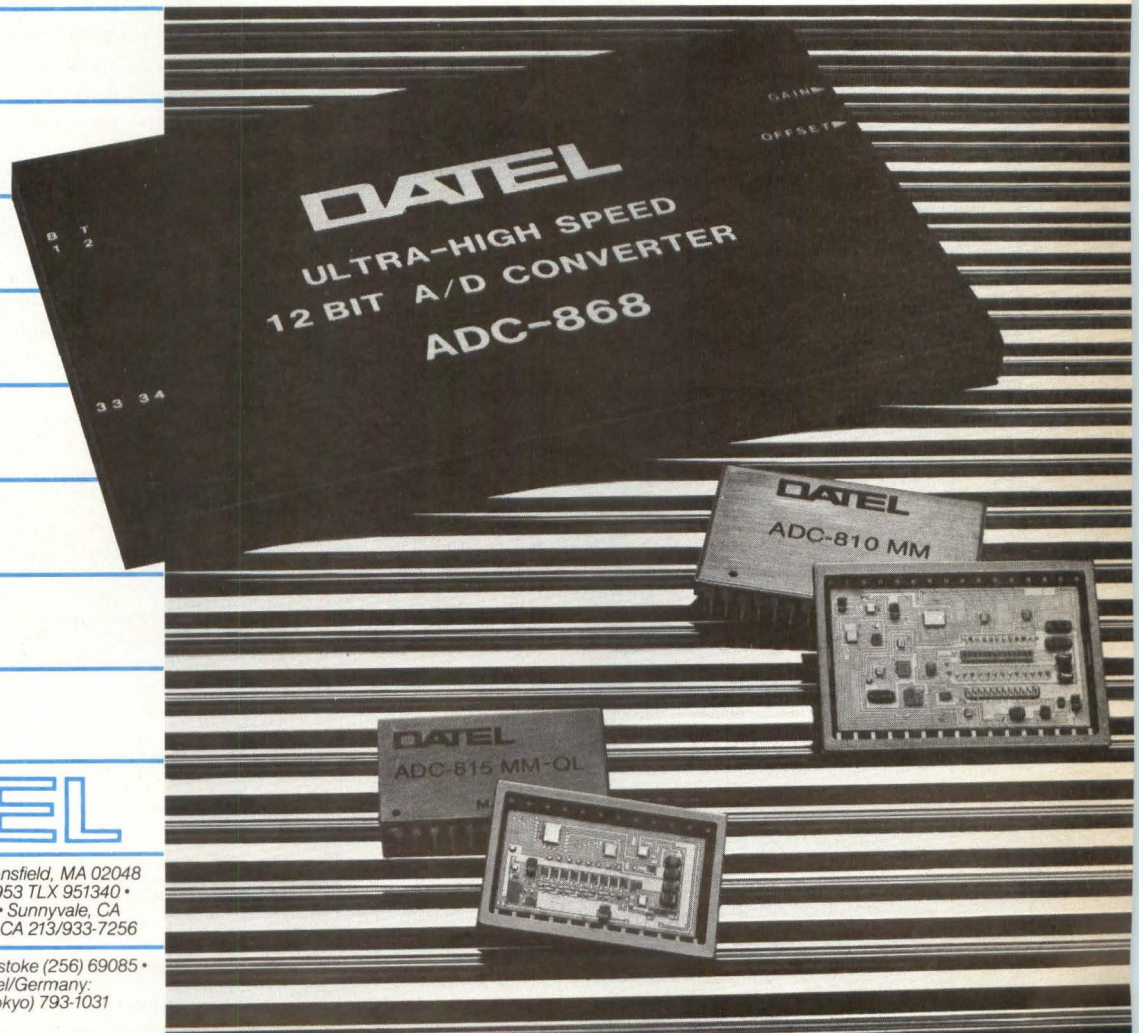

DATEL

USA: 11 Cabot Boulevard, Mansfield, MA 02048
617/339-9341 TWX 710-346-1953 TLX 951340 •
Santa Ana, CA 714/835-2751 • Sunnyvale, CA
408/733-2424 • Los Angeles, CA 213/933-7256

Overseas: Datel/UK: Basingstoke (256) 69085 •
Datel/France: 602-57-11 • Datel/Germany:
(89) 530741 • Datel/Japan: (Tokyo) 793-1031
(Osaka) 354-2025

Circle 24 on Reader Inquiry Card

the D/A converter, which are in digital form, and comparing those bits with the analog signal input. The bit in question is set to one. If the D/A converter output is less than the input, that bit is left at one; if the D/A converter output is greater than the reference, the bit is set to zero. The register then proceeds to the next bit. At the completion of the conversion, the output voltage of the D/A converter should match the A/D analog input voltage to within one-half least significant bit (LSB). Further differences between the two voltages make up the quantization error of the converter.

This comparison algorithm can begin either with the most significant bit (MSB) or the LSB. Forward conversion starts with the MSB at high and all other bits low; the initial state for backward conversion is MSB low and all other bits high. In either algorithm implementation, the output will be the same.

The primary advantage of the successive approximation A/D converter is its high conversion speed. Another is that every conversion takes the same amount of time, possibly simplifying system design and implementation of the converter.

Disadvantages of the successive approximation converter are its need for high precision D/A converters and comparators as well as a lack of noise immunity. For example, the design of a fast 20-bit successive approximation A/D converter necessitates the availability of D/A converters and comparators accurate to 20 bits or more in order for the A/D converter to be accurate to 20 bits. Sample and hold circuits may be necessary to freeze the input signal during the mea-

Hybrid Systems (Billerica, MA) offers a 16-bit successive approximation A/D converter providing full 0.0008% linearity at conversion times of 100 μ sec.

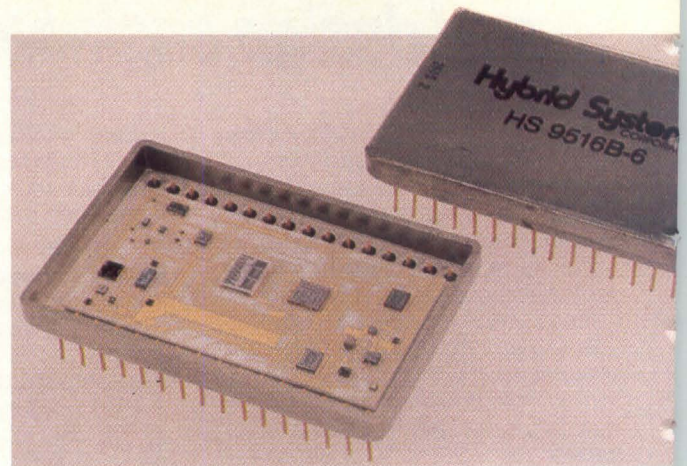

surement period since no averaging of that signal takes place. The slew rate of the input signal is, therefore, an important limitation of the accuracy of the successive approximation A/D converter.

In situations where high noise immunity and not high conversion speed is important, the integrating A/D converter (Figure 2) may be the ideal choice. Integrating converters operate by an indirect conversion method, and the output of such a converter represents the integral or average value of an input voltage over a fixed period of time. The dual-slope, or dual-ramp, configuration is the most popular integrating A/D converter; other variations exist, including the quad-slope converter which cancels offset and scale errors by two additional integration phases of digital subtraction.

Dual-slope conversion begins when the unknown input voltage is switched to the integrator input. Simultaneously, the counter initiates clock pulse counting up to overflow. At this point the control cir-

cuit switches the integrator to the negative reference voltage until the output returns to zero. Upon detection of the zero crossing by the comparator, the clock pulses stop. The counter output is then the converted digital signal which represents the ratio of the input voltage to the reference.

The accuracy of an integrating A/D converter is independent of the stability of the clock and integrating capacitor since each affects the up-slope and the down-ramp in equal proportions. Missing output codes will never exist since all outputs are generated by a clock and a counter. Counter resolution is the sole factor affecting differential nonlinearity.

The noise immunity of the integrating converter is due primarily to the rejection of unwanted high frequency noise by the input signal integration; changes in the signal that occur during the sampling period are also averaged by the integrating technique of conversion.

The disadvantage of this type of A/D converter is that integration is a slow con-

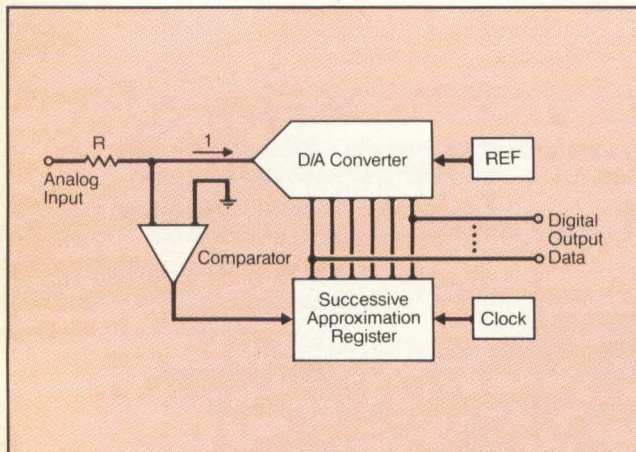

Figure 1: The successive approximation A/D converter is the most popular converter for moderate to high speed applications.

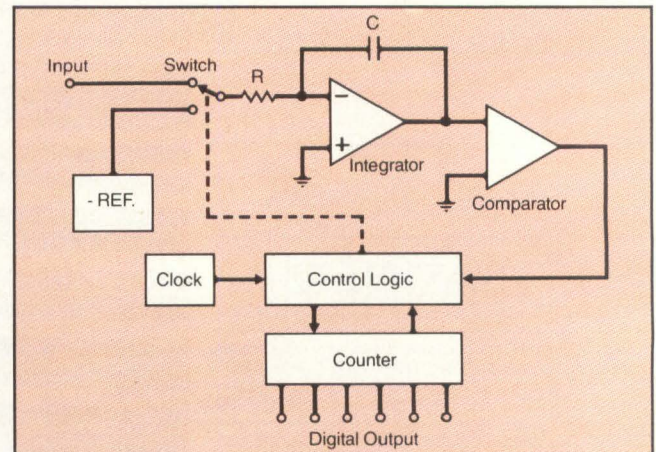

Figure 2: The dual slope A/D converter has excellent linearity characteristics and the ability to reject input noise.

Fingertip control

FLUKE 1722A INSTRUMENT CONTROLLER

Can make the difference
in your OEM system

Touch Here

The Fluke 1722A Instrument Controller

Of course, the biggest difference is 1722A touch-sensitivity. It will make your system truly user-friendly. And that sells systems!

But there's much more.

The 1722A Controller provides your customers with predictably controlled procedures. Even semi-skilled personnel can easily operate complex systems at the touch of a finger.

Designing the 1722A into your system is no problem. It's fully integrated and features a high-performance micro-computer, graphics display, 400K disk drive, complete software packages, plus RS-232-C and IEEE-488 I/O ports.

Most importantly, with the 1722A you



Panel or rack mountable, the 1722A fits right into your OEM system.

get Fluke support. You're working with a multinational corporation and worldwide service organization.

The 1722A Instrument Controller is available, on an OEM basis, in as few as

20-piece quantities for under \$6000. For further details, contact your local Fluke Sales Engineer or Representative. Or call us at **1-800-426-0361**.

Consider the 1722A in your next development. It will make your OEM system easier to build, to sell, to use, and to support. That's a big difference!

IN THE U.S. AND NON-
EUROPEAN COUNTRIES:
John Fluke Mfg. Co., Inc.
P.O. Box C9090, M/S 250C
Everett, WA 98206
206-356-5400, Tlx: 152662

IN EUROPE:
Fluke (Holland) B.V.
P.O. Box 5053, 5004 EB,
Tilburg, The Netherlands
(013) 673973, Tlx: 52237



version method, typically with 3 to 100 readings per second. In many applications, averaging the analog input signal over several milliseconds is unacceptable. Although a sample-hold circuit may be used to freeze the input, systems demanding short measurement windows usually require high speed conversions.

A two-stage series parallel A/D converter (Figure 3) operates on the principle of digitizing the quantization error between the D/A output and the analog signal input in successive approximation A/D converters. If the D/A converter has more accuracy than resolution, then the second digitization may extend the overall resolution of the A/D converter. In general, the development of the two-stage series parallel technique has helped to improve the speed, not the resolution of converters.

Such A/D converters make extensive use of parallel (flash) converters as the initial stage; the input must be digitized quickly, but with low resolution. The resulting digital output is passed to a low resolution, high accuracy D/A converter. The difference between the original analog input and the output from the D/A converter is as accurate as the D/A converter. That difference, or residue, is amplified and then digitized to extend the resolution of the converter.

Devices designed with this conversion technique are high speed, high resolution converters. However, the relatively expensive components—such as the flash converters—make the two-stage series parallel converter a tradeoff of speed for power, complexity and cost.

For many systems architects, conversion speed is vital. Some manufacturers, however, feel that the successive approximation conversion technique is beginning to reach its speed limit. Increasing the clock speeds to decrease the time intervals between trials may help. According to Bill Sheppard, Marketing Engineer at Analog Devices' Measurement and Control Division (Norwood, MA), customers would like to see 15- or 16-bit A/D converters with sampling speeds of around $5\mu\text{sec}$, currently beyond the limit of successive approximation converters. Two-stage series parallel A/D converters may become the best way to attain such speeds.

The achievement of A/D converters with resolutions over 16 bits is likewise a problem for converter designers. Chuck Sabolis, Manager of Strategic Planning at

Micro Networks (Worcester, MA) feels that most improvements in A/D converter design have been architectural in nature, not technical. Adjustments in the physical layouts of converters have helped to decrease interference between the analog and digital portion of the devices. The ability to laser trim thin film resistor ladders has solved the problem of resistor matching only up to a point.

For example, an 18-bit successive

modular and hybrid technologies have an advantage in the design of high resolution A/D converter design. In the past, data converters have been mostly discrete component devices, available in instrument cases and then modules. The modular design approach enables the combination of optimum components of all types.

For example, for very high levels of speed and precision, a high speed comparator may be combined with precision,

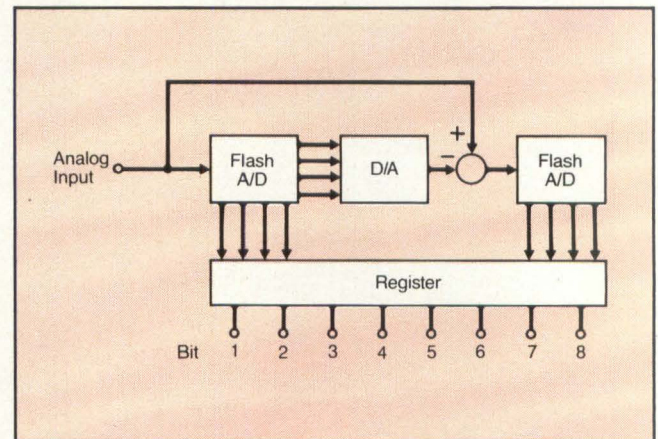

Figure 3: With high conversion speed in much demand by systems architects, the two-stage series parallel A/D converter is growing in popularity.

approximation A/D converter requires a D/A converter which cannot drift more than one-half LSB over time and the A/D converter's temperature range. If one-half LSB is approximately equal to 1.9 parts/million of full scale, resistor matching becomes almost an impossible task. Laser trimmed resistors, says Brian Conant, Marketing Manager, Data Products Division of Burr-Brown (Tucson, AZ), have helped to achieve converters of 14 bits; however, such trimming cannot be relied upon to maintain accuracy for 16 bits and beyond. Temperature stability is another problem.

One more potential stumbling block to the development of higher resolution A/D converters is comparator accuracy. An ideal comparator would have zero offset, infinite gain, infinite input impedance and a zero comparison time. Comparators for fast, high resolution A/D converters must have input noise levels significantly less than overdrive levels of one-half LSB. The same comparators must respond quickly to such overdrives. The greater the overdrive, the faster the response time. Obviously, high accuracy (high gain) and high speed are not parameters which are easily compatible.

Since the only devices which fit such requirements are of discrete design,

high speed current switches utilizing low temperature coefficient resistors and a reference. Whole data acquisition subsystems are available in high performance modules.

Although the design of hybrid converters is almost as flexible as that of modules, two limitations do exist. Not all of the semiconductor components needed for a high resolution hybrid A/D converter are readily available in monolithic form. To produce a feasible hybrid, the number of chips must be kept to a certain minimum.

Hybrid manufacturers cite the availability of low cost switches, monolithic successive approximation registers and laser trimmable thin film resistors as important developments in technology for reducing hybrid costs. Hybrid substrates are able to physically isolate the analog and the digital portions of the chip, reducing the transfer of analog and digital noise on the chip. A pretested, pre-trimmed package can be of great use to a systems architect.

Some manufacturers of hybrids, after adding microprocessor interfaces to the converters, are predicting the integration of memory chips or buffers in order to store Fast Fourier Transform values; an intelligent A/D converter with multi-

(continued on p. 91)

We have what it takes to get you to switch medium speed band printers:



Twice the reliability. And less money.

Now there's a Family of 400-900 LPM band printers with such overwhelming price/performance benefits, its worth your while to switch — even if you are satisfied with your present printer supplier.

Hitachi Koki's new UP-Series band printers are winning over OEMs because they deliver an honest 8,000 hours MTBF — more than twice the reliability of the industry standbys. Plus they offer all the features you'd like to expect: OCR scannable print quality, 55 dbA cabinets,

advanced diagnostics and low-maintenance modular design in both pedestal and cabinet configurations — all at a price that's worth the switch.

Call Nissei Sangyo America today. Find out why NSA and Hitachi Koki are winning supplier excellence awards from major OEMs. Why Hitachi Koki is one of the biggest printer manufacturers in the world. And why the UP series is worth the switch.



Distributor inquiries invited.

NSA

NISSEI SANGYO AMERICA, LTD.



HITACHI
Hitachi Koki Co., Ltd.

Boston: 40 Washington Street, Wellesley Hills, MA 02181, (617) 237-9643
San Francisco: 460 E. Middlefield Road, Mountain View, CA 94043, (415) 969-1100

Circle 42 on Reader Inquirv Card

EXPERIENCE THE PRESENT ...EXPLORE THE FUTURE



ATE NORTHWEST

San Mateo County Fair
& Exposition Center • April 16-18, 1985

See where ATE technology is today...
learn where it will be tomorrow.

CONFERENCE & EXHIBIT STRESS IMPACT OF COMPUTER AUTOMATION ON ATE.

Conference Program Combines Technology and Application in Technical Sessions, Application Sessions, Commercial Workshops, Forums, and Keynote Address. Limited attendance means discussion and individual attention to your testing problems.

CAD/ATE Interface

Strong emphasis will be given in the program to CAD/CAM/CAE and their impact on ATE. Companies committed to this merger of technologies will exhibit products and provide a preview of what's to come.

Focus on PCB & VLSI/LSI Testing

Conference Program and Product Exhibits will address the ATE needs of the regional industries of Northern California and the Northwest.

I'd like to know more about ATE Northwest

- Send free 12-page Conference
& Exhibit Preview
- Send information on exhibiting



Name _____
Title _____
Company _____
Address _____
City/State/Zip _____
Phone No. () _____

FOR IMMEDIATE INFORMATION CALL TOLL FREE 1-800-223-7126

Morgan-Grampian Expositions Group • 1050 Commonwealth Ave., Boston, MA 02215

THE VQ-11 SERIES...

GET THE Q-BUS SYSTEM PACKAGE THAT YOU WANT

CUSTOM OR STANDARD – ZOLTECH DELIVERS



BUY IT COMPLETE

- **CPU:** 11/23, 11/73, 68000, MicroVAX
- **MEMORY:** Up to 4 million bytes
- **MASS STORAGE:** Virtually any combination of removable and fixed devices including 5" and 8" floppies, Winchesters and tape. Capacities to 190mb. Emulations from TU58 to MSCP.
- **SERIAL I/O:** DL, DZ, DH, and DHV
- **SPECIAL PURPOSE:** Analog I/O, graphics, array processors, counter-timers...
- **SOFTWARE:** Single or multi-user, utility, development, and application.

**Your exact
configuration!**

BUILD IT YOURSELF

- **VQ-11/Model 30:** The **INTEGRATED** system chassis includes 8x4 Q-22 card cage, quad-output power supply, full control panel, superior cooling, mounting hardware and power wiring for mass storage devices and a rear I/O connector panel that is compatible with, but more flexible than, the DEC Micro/PDP-11. Rack-mount, "Tower," and desk-top enclosures are available.
- **VQ-11/Model 20:** The **CARD CAGE ONLY** chassis – based on the Model 30, but does not provide for internal mass storage.
- **VQ-11/Model 16:** **MASS STORAGE SUBSYSTEM** chassis – based on the Model 30, but does not provide for an internal card cage.
- **VQ-11/Model 11:** The **MINIMUM** system chassis – includes only the empty metal shell of the Model 30 and the AC power input components.

Just the components that you need!

Zoltech manufactures a variety of systems and other Q-Bus related components. The VQ-11 system packages are designed to maximize reliability and versatility while minimizing cost and lead time. **Call or write** today for a quote or for our catalog of system packages, boards, drives, software and accessories available for your Q-Bus needs.

DEC and Micro/PDP-11 are trademarks of the Digital Equipment Corporation



**Call or
write today**

**ZOLTECH
CORPORATION**

7023 Valjean Avenue, Van Nuys, California 91406 USA
(818) 780-1800

Telex 755451

Representative and dealer inquiries are invited.

Circle 60 on Reader Inquiry Card

Systems Architect's Guide To The Q/Unibus

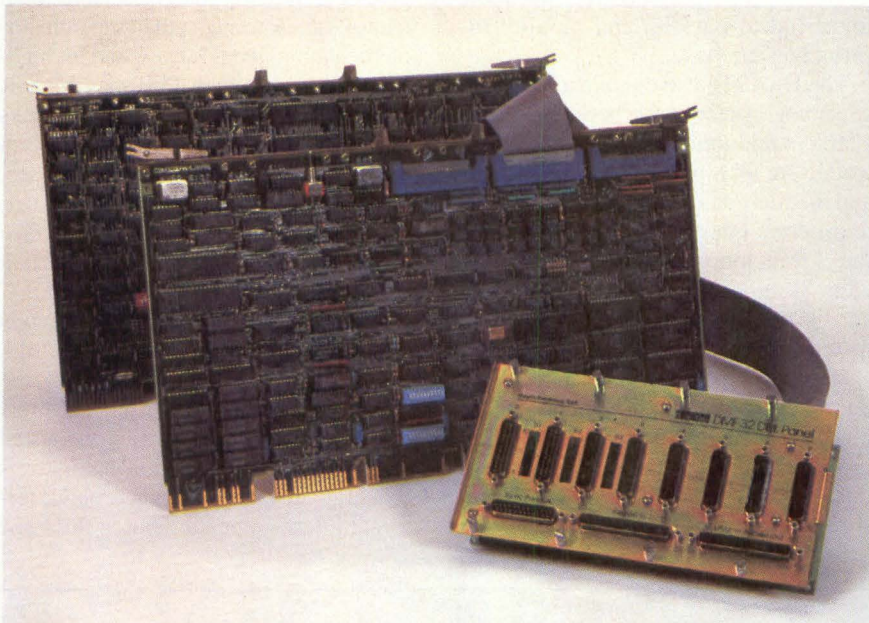

Digital Equipment Corp's DMF 32.

by Dave Wilson, Executive Editor

Offering enhancements or additional features not found on DEC products has always been the key to success in the DEC-compatible marketplace. However, in many cases, third party vendors cannot lead the technology but are restricted to a "wait-and-see" approach before building products. Often designing to meet the DEC specification is a difficult enough task, as is bringing other features to the OEM. Nowhere is this more evident than in the disk and tape arena (*Digital Design*, October 1984, p. 67). The Digital Storage Architecture (DSA) and the Mass Storage Control Protocol (MSCP) have taken many third party suppliers a great deal of time to work around. Inevitably, the larger suppliers (such as Emulex) were first to market with such products, but it has only been very recently that the

smaller houses have introduced products to conform to the architecture.

DEC's first product that brought the Digital Storage Architecture and the Mass Storage Control Protocol down to the Q-Bus was the RQDX-1, which received poor acceptance in the marketplace and left the door open for third party introductions. Recently, two new Q-Bus dual height controllers that claim to be compatible with the MSCP have been announced from Andromeda Systems (Canoga Park, CA) and Webster Computer Corp. (Sunnyvale, CA).

Whereas DEC's RQDX-1 controller permitted two RD51 or RD52 Winchester drives, one RX50 floppy drive, or both to be hooked to a Q-Bus system, the UDC11 from Andromeda can control up to four Winchesters, cartridge and floppy drives. Operating under the MSCP,

the UDC11 permits the use of ST506 interface disk drives of any manufacturer or capacity. Though the Webster card allows only one 5¼" drive to be connected to each controller, up to three controllers may coexist in one system. Undoubtedly, DEC is committed to supporting both the Q-Bus and the Unibus in the long term. The Q-Bus-based MicroVAX-1 and the new MicroVAX-2 are undoubtedly only stepping stones to placing the VAX architecture on the higher performance VBI bus (to be announced this year). New announcements continue to be made from both the systems and the OEM board division of DEC in support of the older bus structures.

Many of the leading vendors of disk and tape controller products also offer a wide range of communications multiplexers for both the Q-Bus and Unibus. Like the disk and tape arena, these products usually offer enhancements and additional capability to emulate a number of DEC products. Early DEC products were characterized by a limited number of asynchronous lines and by Programmed I/O. Later versions were able to automatically select one of two methods to transfer data from the host to multiple terminals. They include buffered Programmed Input/Output (PIO) and Direct Memory Access (DMA). PIO transfers are more efficient for short burst transmissions, but tie up the computer for longer data relays. By offering DMA transfers for longer relays, the controller is able to access main memory directly. The size of the FIFO buffers on early boards was also small. FIFO buffers are important when a large amount of data is being input during peak periods.

By implication, the larger the FIFO, the greater the amount of data that can be handled at one time and the greater the system throughput. The majority of vendors producing DEC-compatible controllers increased the size of the FIFO capacity as a standard or selectable feature.

Until now there have only been a few approaches to providing multiple terminal connections to a system. Each of these approaches has advantages and disadvantages. One approach is to provide 8 or 16 channels on-board that must plug directly into the CPU bus. This requires many board slots for a multiple terminal system and all terminals clustered around the CPU.

Typical of the early DEC offerings was the DZ11, an asynchronous multiplexer that provided an interface between a PDP-11 processor and eight asynchronous lines. Each module provided for eight asynchronous lines; but since each module interfaced to these channels with a 16-line passive distribution panel, 2 DZ11 modules could be used with one panel. Two versions of the DZ11 (EIA or 20 mA) consisted of different module and panel types, allowing the user to mix EIA and 20 mA by using multiple DZ11s.

For higher performance than the DZ11, DEC introduced the DH11 series. The unit included PIO for input operations but used DMA for output transmissions to reduce the load on the CPU. Although it was possible to do 16-bit word transfers, the multiplexer was not capable of processing these transfers, handling them one byte at a time. The DH11 slowed throughput operations by transferring each DMA word twice in order to process both bytes in the word.

As many as 16 DH11s may be placed on a single PDP-11 processor to create a total of 256 lines. **Figure 1** shows a typical system implementation. Since DEC does not offer a Q-Bus version of the DH11, several vendors jumped in to fill the gap that was open and many products are currently available to the OEM ranging from look-alikes to products with enhanced features.

The disadvantage of having to add several multiplexer boards into a single cabinet space was solved by an approach that allowed the board to interface to an active distribution panel. Emulex, for example, provides for its DH11-compatible controller to interface to a distribution panel that contains up to two eight-

Data communications products offer the systems integrator a wide variety of options to choose from.

channel line card adapters and an integral power supply (**Figure 2**). The line adapters provide the data and modem interface circuitry plus USARTs that allow for serial-to-parallel and parallel-to-serial conversions.

The USARTs also contain a baud rate generator. Data transfers between the line adapters and the communications controller are on a parallel character basis and the line adapters may be configured to different interface standards (such as the current loop). Channels can be added in 8- rather than 16-line increments, and the type of interface can be changed, mixed and matched as needed.

If more than 64 lines are needed, only one additional standalone board must be placed on the bus to handle a second group of 64 lines. The disadvantages of this approach are that it requires expensive active distribution panels and the

panels end up clustering into one or two adjoining cabinets.

Providing a multifunction board often gives the systems integrator additional features at a lower cost than separate implementations would. Designed for higher performance than DZ11s on VAX-11 series machines, DEC's DMF 32 breaks down into three major components: an 8-line asynchronous terminal interface, a synchronous port and a parallel port. The asynchronous terminal interface portion of the controller supports a feature unavailable on most other DEC multiplexers, automatic internal selection of buffered programmed I/O or DMA output of characters. Recognizing the value of this feature, some manufacturers chose to eliminate the synchronous and parallel ports and to provide multiplexers that emulate only the asynchronous terminal interface portion but at the same

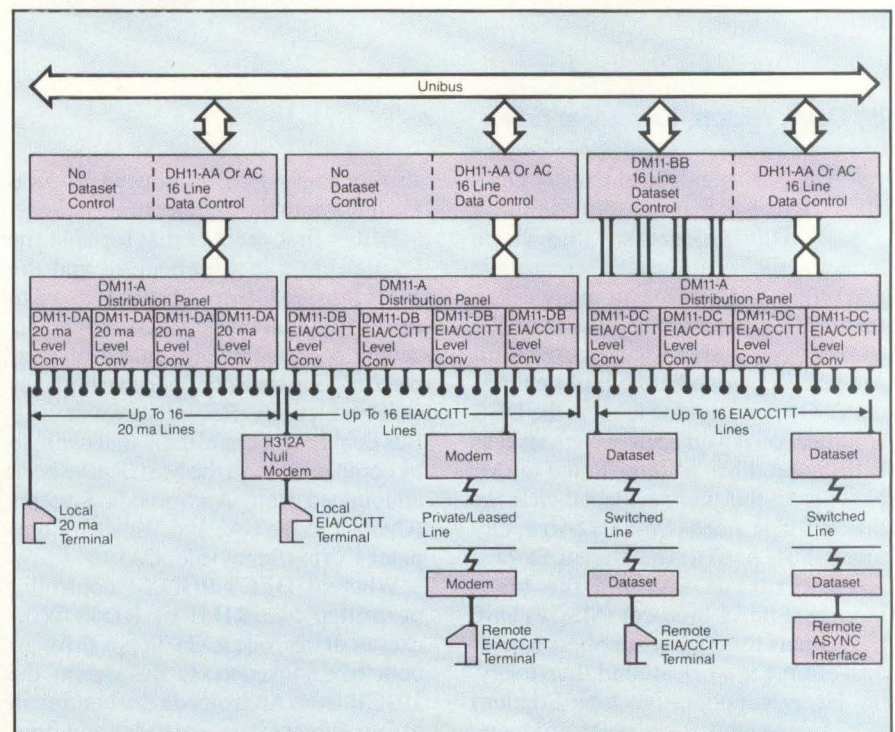
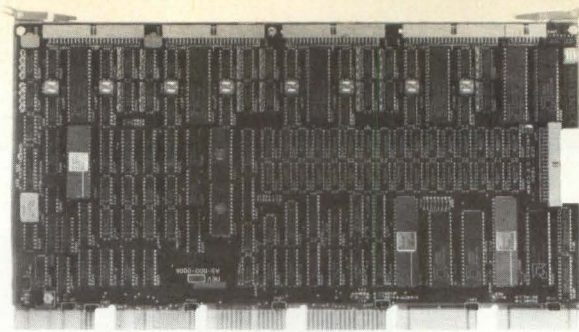
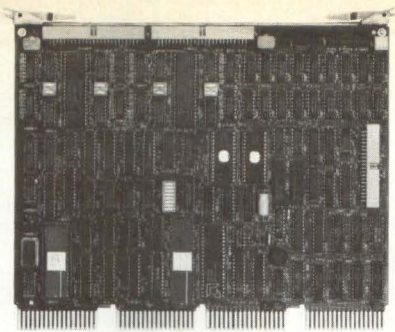

Figure 1: Typical system implementation using the DH11.



UNIBUS*



or Q-BUS

Simpact Solves Your DEC Communications Problem!

We started with DEC's MICRO/T-11 16-bit PDP-11 microprocessor so you can use your host's software development tools to write programs using the familiar PDP-11 instruction set.

Then we married the MICRO/T-11 to multiple Z8030 Serial Communications Controllers to create a family of front-end processors that can support nearly all serial protocols, standard or custom.

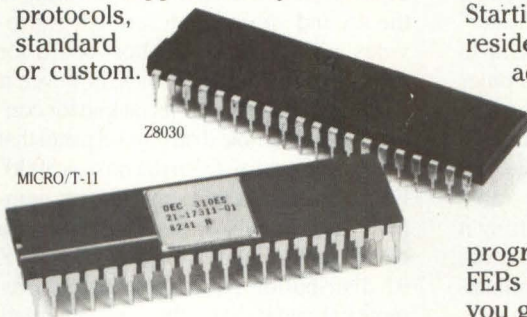

All ports on our FEPs are individually programmable for baud rates, synchronous and asynchronous protocols, RS-232C, RS-449 (RS-422, RS-423), MIL-188C and MIL-188-114.

We also built in 22-bit hardware memory management so you can download sophisticated application tasks and still have plenty of room for data storage.

Finally, we added firmware for boot loading, self-test diagnostics,

and program debugging. But the hardware is only half the story...

Powerful Package of Software Tools

Because we understand what it takes to develop and support a communications system, we created a software toolkit to make our family of FEPs easy to use. Starting with our proven, memory-resident Real-Time Executive, we added a sysgen program to develop down-loadable, run-time images. We also designed efficient drivers for RSX and VMS operating systems so host applications programs can easily talk to our FEPs with simple QIO calls. To help you get started with your project we provide complete software documentation and hands-on training classes.

Standard Protocol Software

We can also provide turnkey packages for Telenet certified X.25 LAPB protocol software (CCITT 1980, Levels 1, 2, and 3) and HDLC (LAPB) frame and link level software. More standard protocols are on the way.

For the UNIBUS Model ICP1600:

Eight fully programmable comm ports
256K RAM, DMA transfers to host
Single hex-height card
Up to eight ICP1600s per UNIBUS
\$4975. (single quantity)

For the Q-BUS Model ICP1622V:

Four fully programmable comm ports
128K dual ported RAM
Single quad-height card
Up to eight ICP1622s per Q-BUS
\$3000. (single quantity)

Port Expander, Model EXC1612:

Gives the ICP1600 or the ICP1622V
twelve additional programmable
RS-232C comm ports
Optional DMA capability for two ports
Single quad-height module for UNIBUS
or Q-BUS
\$2400. (single quantity)

Software Toolkit Model QX100:

For RSX or VMS operating systems
Includes Training Class
\$5000. (one time charge)

Let us solve your DEC communications problem. Call us today at (619) 565-1865.

simpact
COMPUTER SYSTEMS

Circle 31 on Reader Inquiry Card

Simpact Associates, Inc., 5520 Ruffin Road
San Diego, CA 92123

© 1984 Simpact Associates, Inc.

* DEC, UNIBUS, Q-BUS, PDP-11, MICRO/T-11, RSX and VMS are Trademarks of Digital Equipment Corporation.

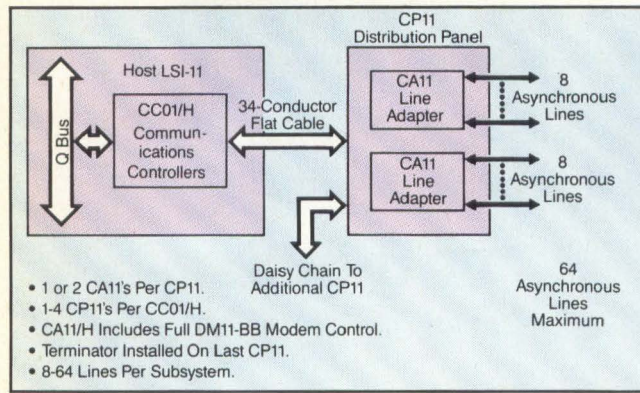

Figure 2: The Emulex DH11-compatible board interfaces to an active distribution panel.

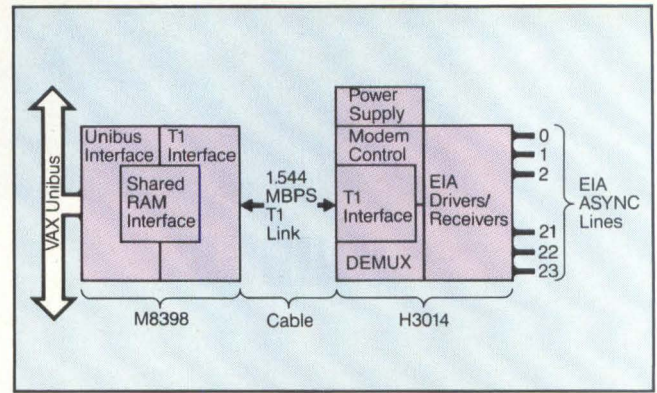

Figure 3: DEC's DMZ 32 consists of a Unibus Interface Module and a remote distribution panel.

time allowing for a large number of lines to be supported.

In their emulation of the DMF 32, MDB Systems chose to also provide a unique alternative to the conventional methods of interfacing to the host. The MDB approach for a multiterminal system is a single host board connected directly to the CPU bus that generates a 1000' bus which allows up to 16 separate attachment points for terminal clusters anywhere along its entire length supporting up to 128 terminals in total. Up to 32 terminals may be connected through a single card. This requires a single system slot to provide power and connector panel that can be mounted in the rear panel of the DEC Micro-11 or similar boxes. The system is comprised of a microprocessor board, one or more asynchronous channel boards and a connector panel for each channel board.

The microprocessor board plugs into the system bus and generates the Parallel Bus Interconnect (PBI) signals over a dual 34-pin cable that connects as many as 16 slave boards over 1000'. The slave board developed for the PBI controls 32 asynchronous channels. It can be plugged into a Q-Bus slot anywhere in a system and only requires power. A connector panel is for each CRT terminal and converts a flat ribbon cable from the 32 channel board to 32-DIN connectors.

Traditionally, users have been limited when it comes to satisfying both remote and local communications requirements for a single host minicomputer system. Traditional remote communications provided no means for the multiplexing of data. Each remote terminal line consequently required an attendant pair of

dedicated modems, its own distribution panel port and its own dial up or leased telephone line. The primary advantage of this method is that no changes to the resident software are required. However, the redundant hardware, cabling and line-usage costs of this method are unnecessarily severe for any application involving a number of terminals.

An alternative is to use master/slave data concentrators to eliminate redundant telephone lines and modem costs. Here, one data concentrator unit operates at each end of a transmission line. Working with a multiline controller, the "master" concentrator multiplexes data from up to 16 physical ports at the host computer site, sending it across a single line to the "slave" concentrator at the remote site. The slave is configured and instructed by the master and demultiplexes the transmitted data, dividing and transmitting it to a number of terminals. In this method, the relationship between parts (communications interfaces) and terminals is one-to-one. In addition to eliminating redundant line and modem costs, all communication protocol and any error correction procedures used between the concentrators are embedded in the controller, the concentrator firmware or both; no changes to the resident software are necessary.

Although this system does significantly reduce hardware requirements/costs, each channel still requires one distribution panel port at the computer interface. Adding port concentration at the computer site to the master/slave data concentration method allows the multiplexing/demultiplexing of up to 256 remote and local lines to be handled by a single con-

troller board. Multiplexed data from up to 16 channels passes through a single asynchronous RS-232-C port to a port concentrator. The port concentrator aids the controller in its multiplexing tasks and establishes and maintains the link with the remote concentrator and buffers data during peak loading periods.

The latest approach to providing a communications controller that can work in both a local or remote location has been announced by DEC in the form of the DMZ 32, a Unibus-based 24-line asynchronous multiplexer. It is similar to the second approach described. It provides a bit-sliced-based host board for connection into the CPU bus, however, it generates a high speed serial line for connection to a remote distribution panel that can be as far away from the host as 5000'. For VAX systems that support large numbers of terminals or VAX systems in a cluster environment, placing the DMZ 32 distribution panel in a common remote cabinet reduces the need of Unibus expander cabinets for each system.

The DMZ 32 system consists of two components: the Unibus Interface Module with shared RAM and T1 interface and the Remote Distribution Panel. The T1 interface controls all data going on and off the high speed (1.544 Mbit/sec) T1 trunk (Figure 3).

The second component of the DMZ 32 asynchronous multiplexer is the remote distribution panel. The active panel is responsible for coordinating all data transfers between any of the 24 asynchronous lines and the T1 trunk. The panel decodes the incoming T1 formatted serial data. In the reverse direction, it places outgoing asynchronous terminal

(continued from p. 78)

data and modem control signals into the T1 serial bit stream, using bipolar encoding techniques.

The disadvantage of this system is that it only supports one distribution panel, or with additional hardware, two. In actual practice, although the terminals can be remoted farther from the CPU, the terminals must all cluster around one or two distribution panels for the entire multiterminal system.

Unlike the disk and tape arena, implementing a solution to link a single mini to many different terminals presents the systems architect with a variety of alternatives, compounded by the fact that the location of the terminals are in a local or remote site or a mixture of the two.

The opportunities for third parties to provide alternatives to existing DEC products is assisted by the fact that to provide compatibility between its future generation and previous generation products, DEC has retained older bus structures such as the Q-Bus and Unibus, often increasing system performance by employing coprocessing techniques to off-loading bus traffic. The VAX line, for example, recently boosted by the announcement of the VAX 8600, retained the Unibus as a method of supporting I/O, gaining its speed improvement through the use of custom ECL. Likewise, the latest in the PDP-11 minicomputer family, the PDP-11/84, retains the use of the Unibus, but gains its speed over older models through the use of a private memory bus across the CD interconnect slots on the Unibus as well as through an 8 Kbyte direct-mapped cache.

Many of the vendors of Q-Bus products currently promote the fact that their boards will work with the LSI-11 range of machines as well as with the MicroVAX-1 product that DEC currently offers. In reality, however, the MicroVAX-1 as a Q-Bus-based machine runs under a different operating system (MicroVMS) than the LSI-11 line. Since MicroVMS has only been available since October 1984, it will take some time before third party vendors can produce products to meet the specifications. **DD**

How useful did you find this article? Please circle the appropriate number on the Reader Inquiry Card.

Very Useful 610
 Useful 611
 Somewhat Useful 612

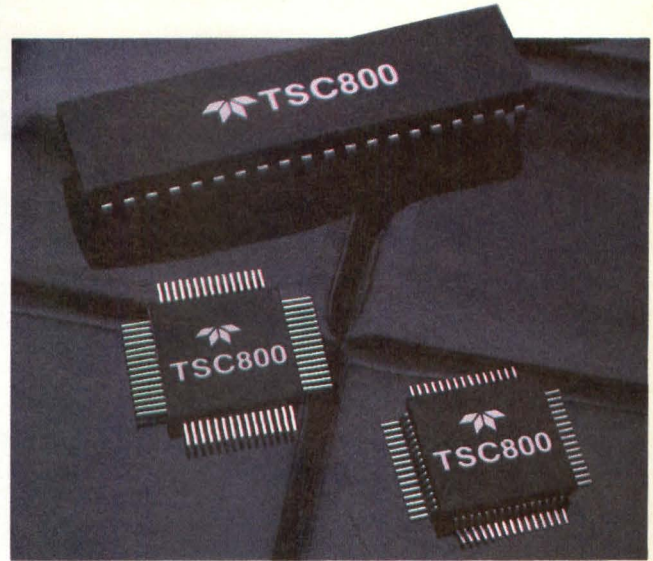

The TSC800 from Tele-dyne (Mountain View, CA) is a 15-bit plus sign integrating A/D converter designed for microprocessor interface.

pliers, accumulators and a dedicated microprocessor to perform digital signal processing calculations is possible. Designers are discussing on-chip EPROMs as a way to improve error correction techniques. Network protocols and communication processors, also on the digital portion of the A/D converter, may appear. Sample and hold circuits, presently available on the front end, may be joined by optional programmable gain amplifiers to increase dynamic range.

Monolithic A/D converters are generally a step behind modular and hybrid units in performance due to inherent design limitations. The prevention of noise interference between the digital and analog parts presents a greater challenge for designers of such devices. In addition, these converters usually require various external components for proper operation—although their lower prices may compensate for the added cost of additional components.

Single chip converters have been manufactured in both CMOS and bipolar technologies. In the past, bipolar components have proved to be better linear devices, whereas CMOS components were considered to be logic oriented. Better switches and input devices are being developed with the improvements in MOS technology and, as a result, CMOS has become a viable processing method for high resolution A/D converters, due to reasons other than low power dissipation.

Several manufacturers feel that a mixed technology may provide the ideal solution for monolithic converters by combining the best features of MOS and bipolar. Most important, bimos allows the wide analog voltage range required by

high resolution converters. Leakage currents are also low. Analog Devices has two separate divisions working on such manufacturing methods, the Semiconductor Division (Wilmington, MA) from a bipolar to CMOS direction and the Microsystems Division (Limerick, Ireland) from a CMOS to bipolar angle. Other companies are working on merging the two technologies as well.

Finally, the search for high resolution A/D converters of 18 bits and more continues. Modular and hybrid manufacturers seem to have the advantage in developing such devices; however, the physics of noise may affect their attempts as it already has seemed to affect monolithic manufacturers. Systems architects may find themselves having to make more serious choices between resolution and accuracy, especially since few 16-bit converters can offer full 16-bit linearity now. Differential linearity specs may become more controversial due to difficulties in testing high resolution A/D converters. If successive approximation, integrating and two-stage conversion methods are reaching limits, the time may have come when the only possible way to achieve accurate, higher resolution converters will be to invent a new sampling algorithm or a very innovative architectural approach. **DD**

How useful did you find this article? Please circle the appropriate number on the Reader Inquiry Card.

Very Useful 613
 Useful 614
 Somewhat Useful 615

A Risky New Architecture For The Future?

by Gregory MacNicol, West Coast Technical Editor

As the race for higher speed in computers continues, new alternatives are proposed promising better price/performance. One of these new architectures that is gaining momentum, press and venture capital is RISC — Reduced Instruction Set Computers.

The departure from conventional Complex Instruction Set Computers, or CISC, is based around several fundamental problems facing modern computer architects. High computational speed means higher cost. More importantly, a computer should be designed for greater efficiency in program generation through a supportive operating system and higher level languages. Computer architecture resolves the division of labor between hardware and software. Thus, microcomputer manufacturers provide a rich set of commands on chip that allow software designers to build operating systems, languages and hardware specific programs. An example is the iAPX 432 from Intel which was intended to directly support the Ada language. Enhancements added to CISC systems to increase performance have been floating point processors, array processors, memory management units, cache memory and multiple buses. The alternative to such complexity is to use RISC-based architectures.

The RISC concept is not new. Seymour Cray, of Cray Research, has been a leading proponent of reduced instruction sets for the last 20 years. Considered an academic path of computer science, RISC

remained in the research labs of universities and large corporations until recently. The most notable of the RISC researchers is David Patterson, who first coined the term, from the University of California at Berkeley.

What Is RISC?

The foundations of reduced instruction set computers are based on three primary attributes:

- The instruction set is minimized to execute only the most used instructions.
- Each instruction is executed in one machine cycle.
- Memory is accessed only by load/store instructions, where as all other instructions operate between registers.

RISC derives from the analysis of computer program execution. Tracing instructions in programs indicated that load, store, branch and integer add accounted for most of the execution time. In addition, accessing data in registers is much faster than accessing data in memory. This means that the more data that can be kept in registers, the faster a program will run. Part of RISC implementation, thus, includes large register files, overlapping register windows and a simple pipelined data path. Instructions also

have fixed length with a small variety of formats. The single cycle instructions allow a simplified architecture which, in turn, leads to streamlined organization. The overhead in each instruction can be reduced, allowing a shorter clock cycle time. Ultimately, all of this results in a smaller, much faster and less expensive computer.

There are several reasons why this architecture is becoming attractive, after being overlooked in the past. Microprocessors evolved from mainframes with operating systems written in assembly language. Attempting to facilitate operating system design with VLSI, chip designers offered functions that made software development easier. Now that higher level languages are being used to write operating systems, it is possible to use a small but effective instruction set in combination with an optimized compiler and omit the secondary process of assembly interpretation. Another major reason for RISC's current implementation is the present state of VLSI. Due to the small instruction set, the chip's die size and gate count is also smaller which provides a better cost/speed ratio. The alternative has previously been to use expensive ECL for cache memory. The small size not only allows better bus utilization for passing of operands, but also faster clock rate and execution speed due to fewer interchip paths.

The reduced instruction set is only a small aspect of RISC architecture. An important part of the concept is a truly optimized and integrated compiler. This supports the concept of shifting complexity from the hardware to software. Better

Multibus Microcomputer Systems *EASIER!* ~~Made Easy~~

OEMs get products to market faster with SMS microcomputer foundation systems, storage systems and Winchester controllers. These products already support popular operating systems such as iRMX*86/286, Xenix**, CP/M*** and others.

Whether you select 8086, 80286, 68000, Z8000 or another Multibus* single board computer you can choose the SMS product to fit your packaging needs.



The attractive floor standing SMS 8000 Model 40 microcomputer system provides from 10 to 280 Mb of 5-1/4" Winchester storage,

one or two 5-1/4" floppy disk drives, one 8" floppy, a 5-1/4" streaming tape and includes a Multibus backplane — all in a single 5-1/4" enclosure.

An integrated "System Foundation Module" contains all the peripheral control logic plus operator status, test and set up capability without taking any backplane space.

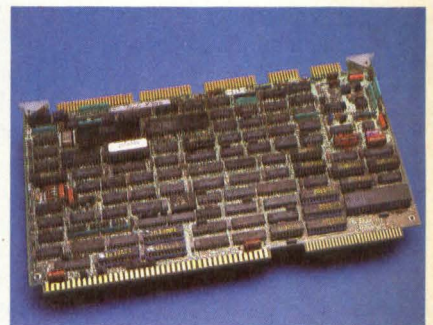

Table top or rack mount enclosures are also available for the Model 40.

If you have your own Multibus backplane, plug in the SMS 8000 Model 60 storage system. It occupies only 5-1/4" of rack space and comes in all the peripheral configurations of the Model 40.



For high volume or unique packaging requirements the FWD8001/FWD8006 single board controllers are INTEL*215 compatible and support 8" Winchester/floppy, 5-1/4" Winchester and 5-1/4" or 8" floppy disk drives.



SMS

Scientific Micro Systems, Inc.

339 N. Bernardo Avenue, Mountain View, CA 94043
(415) 964-5700 TWX: 910-379-6577

*Trademark of Intel Corporation
**Trademark of Microsoft Corporation
***Trademark of Digital Research, Inc.

SMS SALES OFFICES: Seattle, WA (206) 883-8303; Boston, MA (617) 246-2540; Atlanta, GA (404) 296-2029; Morton Grove, IL (312) 966-2711; Melrose Park, IL (312) 345-5320; Arlington, TX (817) 429-8527; Philadelphia, PA (215) 860-8626; Greensboro, NC (919) 292-8072; Laguna Hills, CA (714) 643-8046; Mountain View, CA (415) 964-5700.

Circle 26 on Reader Inquiry Card

The Reduced Instruction Set Computer architecture is touted as being a replacement for everything from microprocessors to VAXs. Are these claims valid?

algorithms are available for compilers optimizing the theory and use of register handling. The advantage of these compilers is that changes can be made in the future. RISC is based on a memory hierarchy from cache memory to registers to main memory. The organization of the architecture is critical for proper implementation.

The concept of the reduced instruction set was developed by several independent researchers. For example, at IBM, where work was done on the new IBM 370, it was realized that a sequence of load instructions is faster than a load-multiple instruction for fewer than four registers, which accounts for over 40% of these instructions in typical programs. Another example was at DEC where the INDEX instruction on the 11-780 was replaced with several low level instructions. The result was an increase in speed of 45%. If the compiler took advantage of the set of low level instructions, the program ran 60% faster. The lesson learned is that bigger instructions don't necessarily mean faster execution.

A serious attempt at a minicomputer RISC goes back to IBM's 801 project, 10 years ago. Trace tapes which followed the path and frequency of execution of computer instructions indicated that relatively simple instructions such as STORE,

LOAD, ADD and SUBtract were used more frequently than complex instructions. Several implementations of RISC have been researched at IBM and the research continues. Reports indicate that an in-house system works at 10 MIPS (million instructions per second), which compared to the 370/168's 2.4 MIPS, is quite impressive.

What IBM is facing is common to other major computer manufacturers. If they make a computer that is faster but not compatible with their present computers, languages and operating systems, it could affect the sales of their mainline systems. The ability of a computer manufacturer to stay in business does not depend on the speed of the computers but on upward compatibility, service, support and total functionality. It is no surprise that large computer manufacturers have not been tempted to build systems based on a technology that is not compatible with their present line.

The academic world has been the leading force in RISC. The result of the Berkeley RISC project, which David Patterson led after a leave of absence from DEC, was a 32-bit NMOS RISC chip. Patterson realized that building a computer like a VAX on a chip would include difficulties, such as a writable control store. So, he chose to depart from the current 16-bit approach of mimicking a PDP-11 to implement RISC architecture.

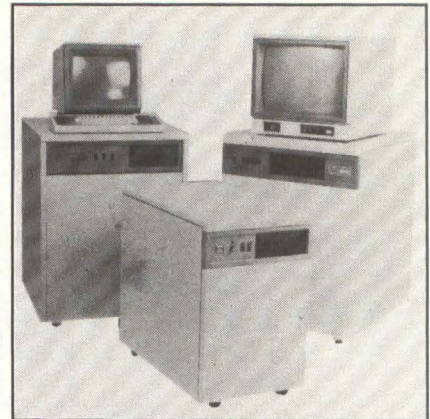

Figure 1: The Ridge 32S from Ridge Computers is a 32-bit, single-user workstation capable of executing up to 8 MIPS.

The result was a 39 opcode chip that can support 8-, 16-, and 32-bit data and 32-bit addresses. The NMOS chip uses 41,000 transistors, was fabricated using 1.5-micron geometry, and runs at a clock cycle of 330 nsec. Floating point arithmetic is intended to be calculated externally.

One problem often encountered in programs is the handling of temporary data from several origins. The Berkeley group solved this problem by using several sets of registers, called register windows, to ensure local variables are kept in registers until needed. This method of register switching is faster than placing the variables in memory and returning them back to the registers. Overlapping register windows further increase efficiency by automatically passing variables. Register design is essential to RISC architecture because RISC creates more procedure calls than CISC.

At Berkeley, there is a project that may potentially test the overall power of RISC. SOAR, Smalltalk on RISC, is a MOS chip under development sponsored by DARPA. (DARPA is also funding a LISP chip at TI.) Smalltalk-80 is an AI language with object-oriented storage man-

Table 1: UNIX C compile-time benchmarks.

Compiled Program		VAX 11/780 C Compiler					RISC C Compiler				
name	size (lines)	on VAX (secs)	on RISC		VAX RISC		on VAX (secs)	on RISC		VAX RISC	
			8MHz	12MHz	8	12		8MHz	12MHz	8	12
ld.c	1587	27.9	21.0	13.9	1.3	2.0	35.2	22.4	14.8	1.6	2.4
sort.c	873	17.4	13.2	8.7	1.3	2.0	20.0	13.2	8.7	1.5	2.3
puzzle.c	118	5.2	3.6	2.4	1.4	2.2	7.3	4.8	3.2	1.5	2.3
Total	2578	50.5	37.8	25.0	1.3	2.0	62.5	40.4	26.7	1.5	2.3

For 13 years some of the biggest names in the business have been bringing us their toughest power supply requirements.

Why? Because we work with them, beyond their specifications. Quickly. Effectively. Creatively.

How? By being highly sensitive to their needs. By working closely with them to develop the power supply that meets both their specifications and their system's requirements. By value-engineering our design before production to insure a cost-effective product. By carefully balancing materials and manpower to maintain flexibility.

PSI is committed to meeting International Safety requirements. We have developed a Safety Certification Package with all the data and specs needed to obtain approval from UL, CSA, and VDE, and other certifying organiza-

tions. And we are authorized to self-certify power supplies.

Whether your power supply requirements are simple or complex, bring them to us. Power Systems, Inc. Where powerful solutions are everyday achievements.

To find out why Power Systems, Inc. should be your power supply vendor, contact: Power Systems, Inc., 12 Tobey Road, Bloomfield, Connecticut 06002, Tel. (203) 243-0357, TWX 710-425-8778

Power Systems, Inc.

Circle 19 on Reader Inquiry Card

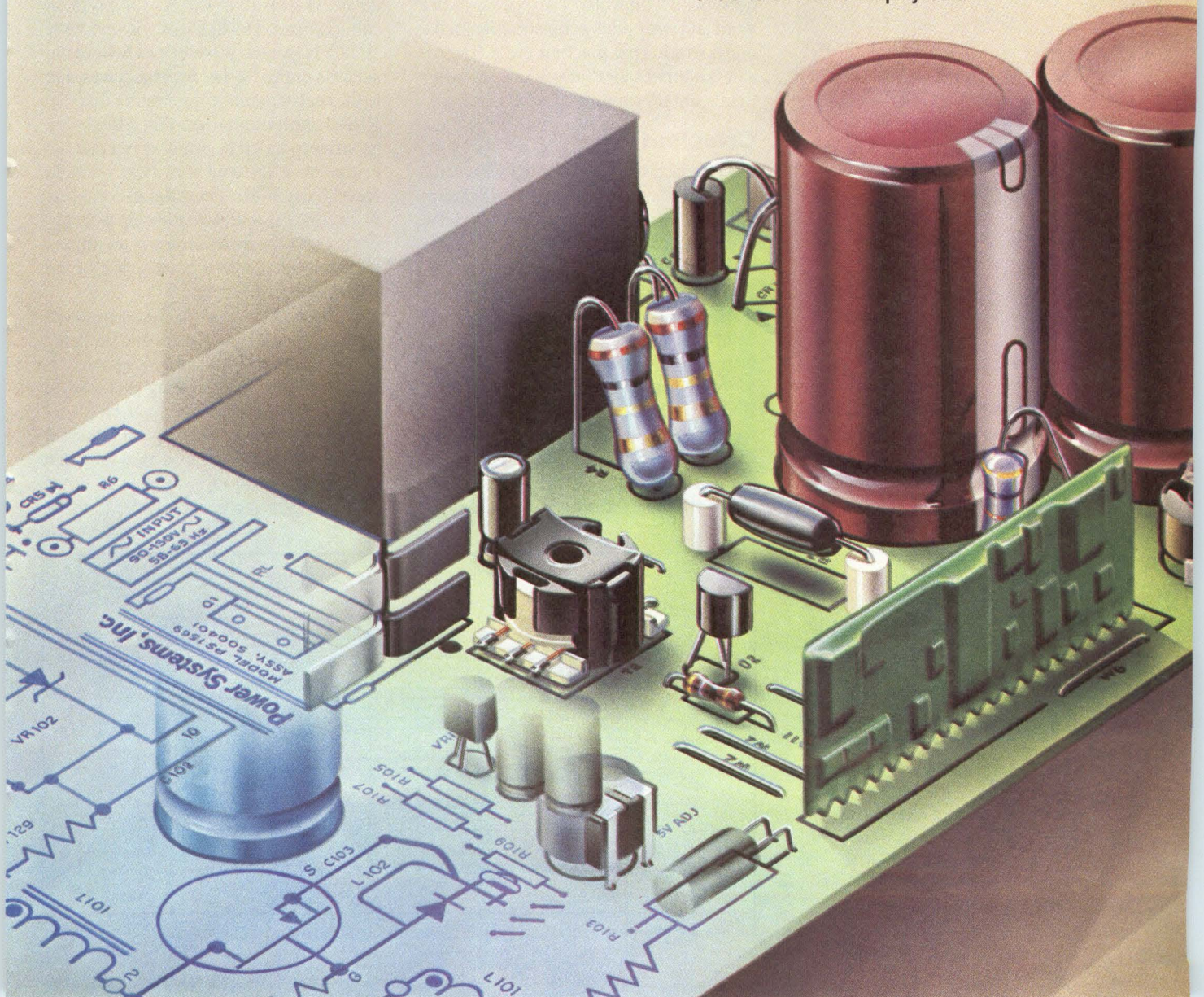

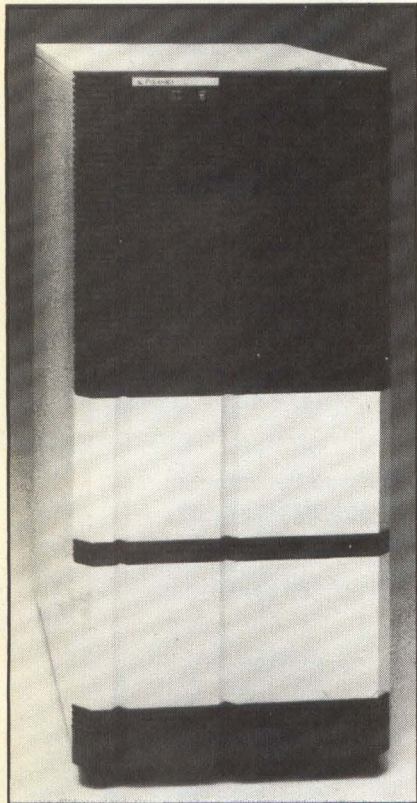

Figure 2: The Pyramid 90X is a 32-bit, virtual memory computer with memory from 1 to 80 Mbytes.

agement and operates like a stack-oriented virtual machine. The usefulness of Smalltalk is overshadowed by problems that make almost all implementations slow. Smalltalk has no type declarations, resulting in variables to be discovered during run time. There are more procedure calls than in other languages because of its object-oriented storage and high overhead. Despite Smalltalk's inherent difficulties, the prototype chip compares favorably with Xerox's Dorado, an ECL minicomputer. Results indicate that procedures such as call/return are about four times faster on the Dorado, eight times faster on a 68000 and 30 times faster on a VAX 11/780. Some of SOAR's speed is partially due to overlapping register windows, zero delay in initializing local variables and a cache that holds the results of destination addresses.

At Stanford University, the Center for Integrated Systems is also conducting RISC research. The primary difference is that Stanford has been implementing in software what the Berkeley group is exploring in VLSI. Led by John Hennessy,

Stanford has been designing an architecture called Microprocessor without Interlocked Pipe Stages (MIPS). The basic philosophy is the design of a compiler-driven instruction set that provides little or no decoding due to close correspondence with the microcode. Instead of using hardware on the chip for registers, MIPS uses sophisticated compiler theory for an ideal of zero idle time in the pipeline. Although the processor is pipelined, there is no pipeline interlock hardware because it will be implemented in software.

The MIPS compiler consists of several closely integrated parts. A pipeline organizer sets up the sequence of commands through instruction packing. An instruction scheduler and branch scheduler further optimize the process. The MIPS architecture can pack two instructions per 32-bit word. Two operands per word and two cycles per instruction make one operation per machine cycle. The result is a processor that is six times faster than a 68000 running at 8 MHz.

Criticism

Despite its great promises, RISC is criticized by microprocessor or CISC supporters. A group led by Robert Cowell at Carnegie-Mellon University is objectively evaluating both sides of the issue. The results are not clear and raise further questions. The problem is that no one has been able to prove whether multiple register sets or reduced instruction sets are more important for RISC performance. Both architectures use different compiler technologies, virtual memory techniques and operating system overheads, making comparison complicated. The object-oriented architecture which minimizes the

programming errors and multiprocessing features are not designed for rapid execution. The group is continuing its efforts, however, to evaluate more accurately the differences between the two architectures.

Another issue concerns the use of the register window scheme. The window register scheme is important to RISC because RISC designs create more procedure calls than CISC, which handles complex instructions as opcodes. The problem exists in the nesting of procedures. If the depth is large enough, an additional stack is created in memory. Depending on the frequency of register overflows and underflows, the physical registers may not be visible to the machine language programmer at any given time. The Berkeley group has developed a sophisticated scheme using overlapped register windows. The result is 2 μ secs for a typical call, compared to 20 μ secs with the VAX 11/780. However, some critics believe the success of the Berkeley project was due to the register architecture rather than the RISC implementation. The Berkeley group responded by pointing out that the critics have ignored a critical point in RISC design. The decrease in complexity in control logic area on a chip that supports complex instructions is an important factor that allows more space for the large number of registers.

An important feature found on most 32-bit computers, but not on the Berkeley RISC system, is virtual memory. An early attempt at incorporating this feature with a memory management chip that translated virtual memory to physical memory actually slowed performance 25%. One solution is the use of faster 256K RAMs or a cache similar to those

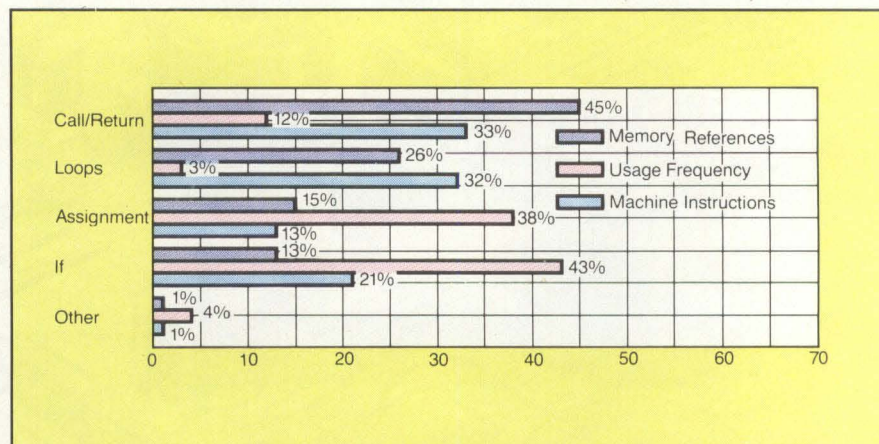

Figure 3: Statement usage in typical C programs on a traditional architecture.

PLUG US IN.

A built-in RS-232C serial interface board lets NCR standalone 40 column printers work with any system configuration.

Just write the proper software program and plug in the standard 25-pin female "D" connector. Without needing to reconfigure your present system. Printer control codes are fed over the RS-232C lines.

And even in the roughest work environment, NCR standalone receipt printers average only a single service call a year. But you can count on years of loyal service.

Other features you can count on include:

- 40 column lines.
- Print head life of 150 million characters.
- Cash drawer activation.

- Easy to configure; adapts to any environment.
- Easy to maintain; needs no routine lubrication.
- Extremely cost-effective; exceptional reliability reduces life cycle costs.
- Ideal for system flexibility; available in a variety of slip, receipt or journal printer configurations.

All NCR standalone printers were originally developed for NCR by NCR. Built in America, they meet our established quality standards of reliability. And are now available to you, backed by NCR service and support.

For more information on NCR's family of standalone printers, just send in the enclosed coupon.

**INNOVATIVE COMPUTER
TECHNOLOGY.
YOU CAN EXPECT IT
FROM NCR.**

NCR

Circle 37 on Reader Inquiry Card

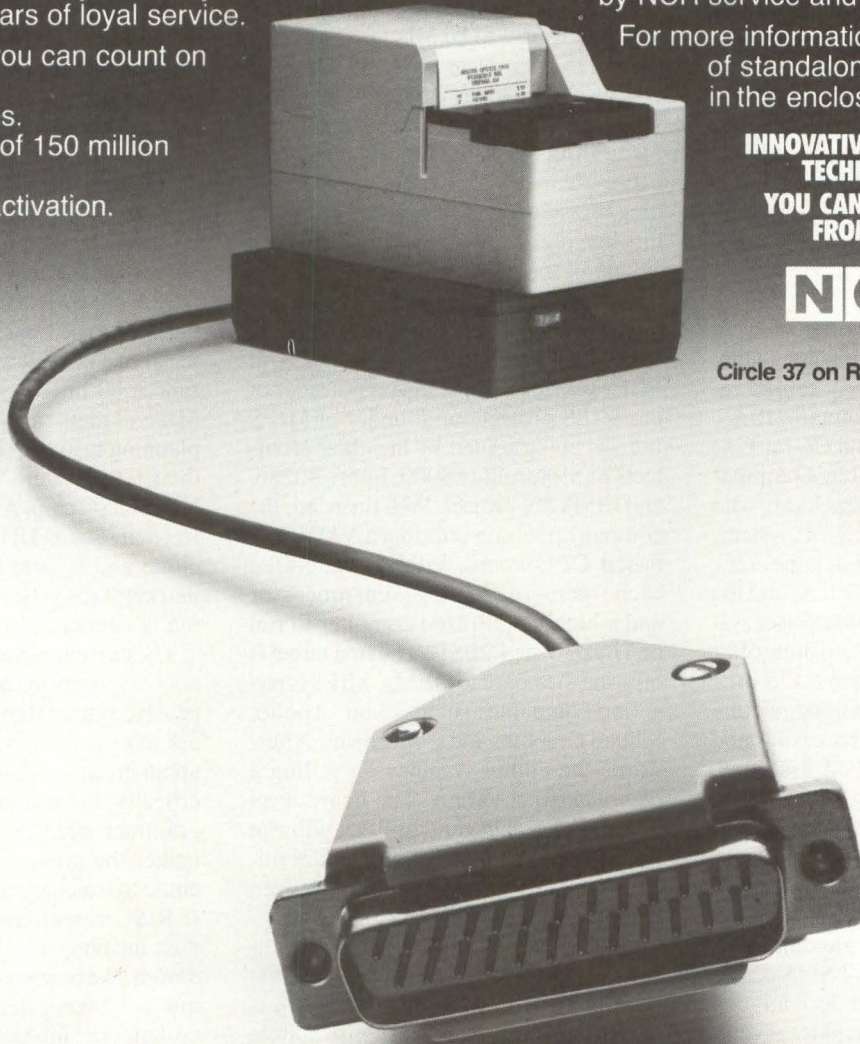

Yes, I'd like more information on NCR's family of standalone printers.

I prefer: ___ a sales call ___ a phone call

Our requirements are: ___ up to 49 printers/year ___ 50-500 printers/year ___ over 500 printers/year

NAME TITLE COMPANY ADDRESS

CITY STATE ZIP PHONE BEST TIME TO CALL

Please Mail To: Technology Marketing Division, NCR Corporation, Dayton, Ohio 45479 (513) 445-7443

found on VAX.

Benchmarks are truly unfair judges for new computers and languages. Although it is fair to say that RISC machines are faster than conventional computers, other qualities make the judging process more complicated. The Ridge, for example, is intended for only a few users, while the Pyramid is designed for a multiuser capacity of over a hundred. Additionally, one of the important components of a RISC-based computer is the compiler, which is a technology in itself. Regardless, several in-house and independent groups have made extensive evaluations using C programs, such as *Id.c*, *sort.c*, and *puzzel.c*. Solving complex linear equations in full precision indicates very positive results using RISC architecture. One group, Argonne National Laboratory, tested and published the performance times of over 150 computers with different compilers.

RISC Takers

There are several manufacturers who are developing RISC-based computers. Only two companies are presently selling reduced instruction set computers; Ridge and Pyramid. Ridge (Santa Clara, CA) was founded in May 1980 by computer designers, from Hewlett-Packard, who were already working on a RISC system. The Ridge 32 series includes the 32C, providing multiuser capabilities; and the 32S (Figure 1), a smaller single user system designed for OEMs. Both units offer 32-bit data and address paths, 125 nsec cycle time, four stage pipelining, virtual memory, floating point processing and high resolution bit-mapped graphics. Variations of the Berkeley RISC design were implemented to satisfy market needs. These include fast context switching supported by hardware to allow many I/O devices, users and processes. In addition, the Ridge 32 uses standard TTL instead of a single custom VLSI chip. The operating system is ROS, a derivative of UNIX V and 4.2BSD. It includes several capabilities not included in most UNIX implementations such as paged virtual memory, a high performance file system and a fast message-oriented interprocess communication system.

A unique quality of the Ridge 32 is the bit-mapped graphics support. A 19" color display has 1024x768 pixel resolution with eight planes, at a 33 Hz refresh rate. The controller board has its own 128K of

memory for graphics, which allows refreshing the display 60 frames per second, similar to the way memory is paged in and out from a disk. Additionally, ROS has a multiwindow, screen-oriented editor for efficient graphics interfacing.

The focus of Pyramid Technology (Mountain View, CA) differs from other RISC developments because they seek to match the needs of minicomputer users who want large multiuser capabilities with UNIX. As a result, neither Ridge nor Pyramid sees the other as a competitor. The Pyramid 90X (Figure 2) is a 32-bit, virtual memory computer with memory from 1 to 80 Mbytes. The CPU has a 125 nsec cycle time, fits on three boards and includes a 68000 for system support and diagnostics. Deviations were made from the RISC criteria, such as a two-cycle instruction time, but overlapping register sets and parameter passing through register windows is supported.

One of the more ambitious efforts to commercialize RISC took place in August with the incorporation of MIPS (Mountain View, CA) from the Stanford MIPS project. John Hennessy, leader of the MIPS project and founder of MIPS Inc., is being joined by the chief architects of Motorola's 68000, Intel's 80286, and IBM's 801 project. Well financed, the company plans on building a VME bus-based CPU board with an integrated cache memory, floating point processor and a highly optimized compiler to run on UNIX V or 4.2BSD. The first target is offering the board to OEMs. MIPS is targeting companies such as Sun, Apollo, Silicon Graphics and Convergent. Afterward, the company plans on selling a complete workstation. The board level product, due at the end of 1985, will run five to ten times faster than standard microprocessors because of the optimized compilers.

NCR (Dayton, OH) is the first company to offer a RISC-based board on the Multibus I. The NCR/32-796A board is a 32-bit wide system that must double buffer the input and output data for the 24-bit Multibus. The board is intended to be installed on an NCR 3200-based development system and can either act as a coprocessor or emulate a computationally intensive processor. The instruction cycle is 150 nsec which translates to executing 6.5 MIPS. NCR plans to make the board available for 32-bit buses.

The unannounced proprietary work

on RISC being done at several large companies will undoubtedly change the course of commercial RISC. IBM's 801 project may be announced, possibly, as a CAE system running on VM. According to rumors, IBM has two RISC projects, both called ROMP. One is probably an experiment because of its incompatibility with IBM's present line. The other project, being researched in Austin, TX, is said to be a part of IBM's effort to develop an advanced workstation. DEC is also involved with two projects. The first is thought to be a high-end ECL computer that performs at 10 MIPS. Forrest Baskett, from the Stanford RISC project, is leading the project at the company's Los Altos facility. A 2 MIPS system is the other project. It is aimed at the engineering workstation market and would have the ability to run some of the software of the VAX series, but would not be upwardly compatible. Hewlett-Packard's work continues, despite the fact that they dropped RISC years ago. They are believed to be working on two RISC projects, one of which is to replace the current 3000 line. It is to be a 64-bit, 5-6 MIPS computer. Hewlett-Packard is also planning to use a RISC-based system for their CAE system which will include a VLSI RISC chip. AT&T's new RISC project that runs on UNIX is called the C machine and is sure to change the RISC marketplace when the product is formally announced.

The current wave of RISC architecture not only promises faster, smaller, less expensive systems but also requires designers to consider more global questions about the process of programming. Specifically, the role of the computer, programmer and the human interface that makes the process of instructing a machine to execute complex chores easier. If RISC researchers are correct about their invoking a major trend in computer design, we may see profound changes in microcomputer design, VLSI, compiler design, operating systems and computers in general. **DD**

How useful did you find this article? Please circle the appropriate number on the Reader Inquiry Card.

Very Useful 607
 Useful 608
 Somewhat Useful 609

2nd Annual

Midwest Electronics Exposition

"It's all here—Components, Process and Production, Protective Packing, Purchasing and Management, Quality and Test."

May 8, 9, 1985

St. Paul Civic Center St. Paul Minnesota

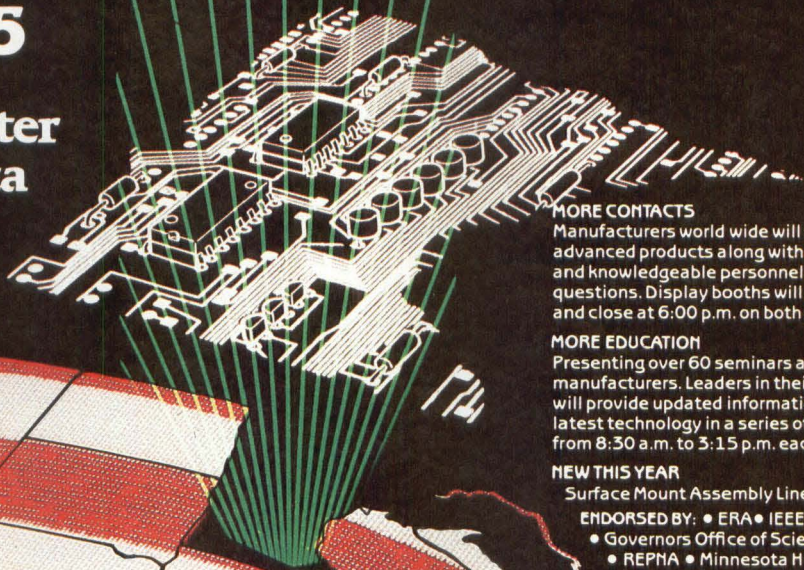

MORE CONTACTS

Manufacturers world wide will display their most advanced products along with current information and knowledgeable personnel to answer your questions. Display booths will open at 10:00 a.m. and close at 6:00 p.m. on both days.

MORE EDUCATION

Presenting over 60 seminars and 1000 manufacturers. Leaders in their respective fields will provide updated information regarding the very latest technology in a series of ongoing seminars from 8:30 a.m. to 3:15 p.m. each day.

NEW THIS YEAR

Surface Mount Assembly Line.

- ENDORSED BY: • ERA • IEEE • ISHM
- Governors Office of Science & Technology
- REPMA • Minnesota High Tech Council
- Women in Electronics

Sponsored by Circuits Manufacturing & Digital Design

ADVANCE REGISTRATION FORM MIDWEST ELECTRONICS EXPO - MAY 8, 9, 1985

PLEASE PRINT

NAME _____

COMPANY _____

ADDRESS _____

CITY _____ STATE _____ ZIP _____

PHONE () - - - - - MAIL STATION _____

- Check Principle Job Function
- Electrical/Electronic Engineering
 - Mechanical Product Engineering
 - Test Engineering
 - Production/Manufacturing Engineering
 - Engineering Services
 - Purchasing
 - Sales/Marketing
 - Manufacturer's Representative
 - Management
 - Student/Educator
 - Other

Please send me _____ additional registration forms for my co-workers.
Return form to: LST OF MINNEAPOLIS, INC. 7900 W. 78th Street
Suite # 105 Edina, MN 55435 Tel (612) 944 3639

PLEASE REGISTER ME FOR:

Plan A - Exhibits only _____

Plan B - One day technical sessions _____

Plan C - Two day technical sessions _____

Seminar Tracks - Please check track of interest*

- Process and Production (Automation, PCB Assembly, Soldering, Cleaning, Surface Mounted Devices, Electro Static Devices)
- Purchasing and Management

* Note: This is not a commitment to this track, but will help us in providing appropriate room space.

Enclosed is a check or money order # _____

Bill me: P.O. # _____ (payable next 30 days)

Visa or Master Card # _____

Expiration Date _____ Signature _____

registrations received by	_____
April 26, 1985 - no charge	_____
\$10.00 at the door	_____
\$20.00	_____
\$35.00 at the door	_____
\$50.00	_____
\$50.00 at the door	_____

- Semiconductor, Hybrid and Vacuum
- Basic Electronics
- Design and Components
- Protective Packaging
- Quality, Test and Environmental

DD385

Using The Signetics 8X41 In Bus Repeater And Bus Switching Applications

by L. A. Lehmann, DigiRad Corp., Palo Alto, CA and Mike Ashtiani, Applications Engineer, Bipolar LSI Division, Signetics Corp., Sunnyvale, CA

Information processing systems are increasingly being limited by the channel rates of the bus or buses that interconnect system components. High speed disk memories, image storage and processing, and multiprocessor systems are examples of computer environments which can overtax the conventional single bus, sequential operation structure.

Conventional single backplane bus structures, on which all machine cycles take place and for which the various masters compete, lack flexibility. The systems designer must design the backplane (and power supply) to accommodate a worst case population of boards. Exceeding these design parameters creates an awkward situation, typically requiring use of repeaters. The repeater itself is frequently a design problem since many bus signals are bidirectional. While signal regeneration and amplification are desirable, there may be no easy way to determine the direction of signal propagation for the control of repeater transceivers.

The Signetics 8X41 auto-directional bus transceiver contains eight channels of bidirectional receiver/drivers and, for each channel, a simple asynchronous state machine to control signal direction. No external direction controls are necessary, but there are provisions for disabling one or both driven directions. This feature allows a very simple, fast and ele-

gant bus switching architecture. (The part should not be enabled for driving into an established low level signal once the 8X41 has been disabled. An inherent race condition can cause the internal state machine to err in its determination of signal direction.) The 8X41 is fully TTL-compatible, with low (less than 100 μ A) input current and with open collector outputs capable of sinking 70 mA. Propagation delay is less than 30 nsec.

Perhaps the simplest use of the 8X41 is an uncontrolled bus repeater (Figure 1). This structure is applicable to a wide range of bus types. Figure 1b shows the termination details for one channel of the repeater. In practice, the length of the repeater cable is often limited by its RC charging time. The designer should be fully aware of allowable skew and additional propagation delay. Many modern buses are very tolerant of additional delays since they are asynchronous and perform a full control signal handshake with every data exchange.

Bus-switched applications include systems in which data transfers occur simultaneously and asynchronously on multiple buses. Simultaneous CPU and disk controller transfers, for example, result in high data transfer throughput. Typically, a master within one bus environment will occasionally wish to communicate with resources on another bus. At

these times, the buses are connected so that they are logical extensions of one another. After an interval, the buses are detached again so that they can continue independently.

Bus switching is an alternative for configurations in which the separate buses communicate by some slower form of networked I/O (i.e., by RS-232 or Ethernet). When data exchange rates are high, when the component systems are in close proximity (generally within the same rack or enclosure), and when a general purpose CPU in each component system would be an unnecessary hardware and software expense, bus switching is preferred.

The bus switching described here is also an alternative to another more popular form, in which multiple masters own local resources on their board and rarely request the off-board bus for transfers to a slave which is a joint resource. This form is adequate for many multiprocessing applications, but it is imperative that each master confine most of its accesses to on-board resources; otherwise, the system bus remains a bottleneck for data transfers.

Bus switchers can be subdivided into two broad categories: those in which a master must explicitly request connection or disconnection by writing to a control port (reminiscent of the way many

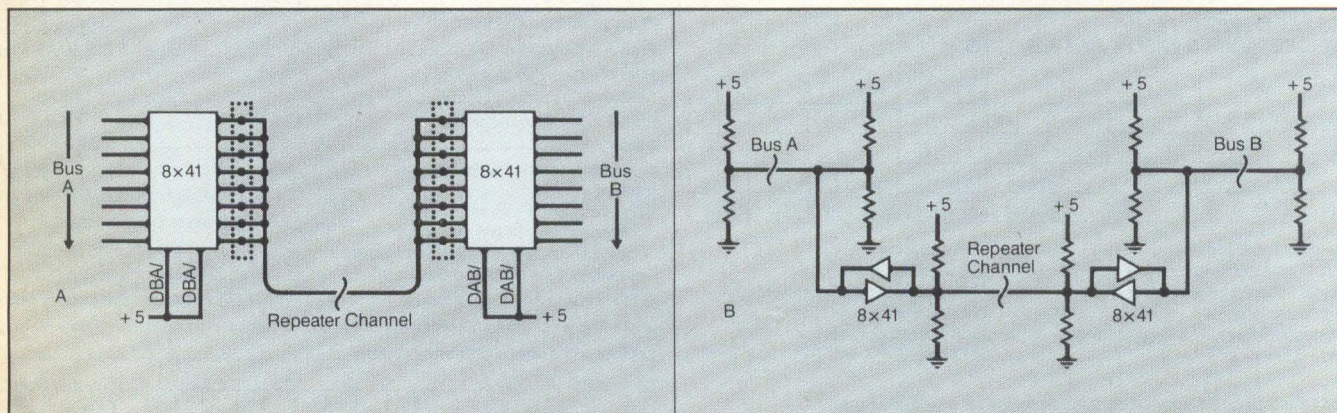

Figure 1: The 8X41, a: as an uncontrolled bus repeater; b: repeater terminations for a single channel.

CPUs maintain a memory mapping look-up table in external hardware to select from all existing physical memory), and those configurations which imply bus selection by the address of the data transfer operation.

System configuration and protocols for bus switching are very application dependent. However, the general concept is illustrated through the following example. Suppose an application calls for a fast image display station which is disk I/O intensive. A general purpose CPU is also required, but it has real-time processing commitments and must not be burdened by image transfers from disk. Program and data memory are too large to combine memory and CPU onto a single board.

In this system there are two masters that must communicate with off-board resources at high rates and without interference: the CPU must access program and data memory slaves, while the disk controller must transfer data at high rates to the display subsystem. At times, the CPU must have access to the disk. At

Figure 2: An example of bus switching using the 8X41.

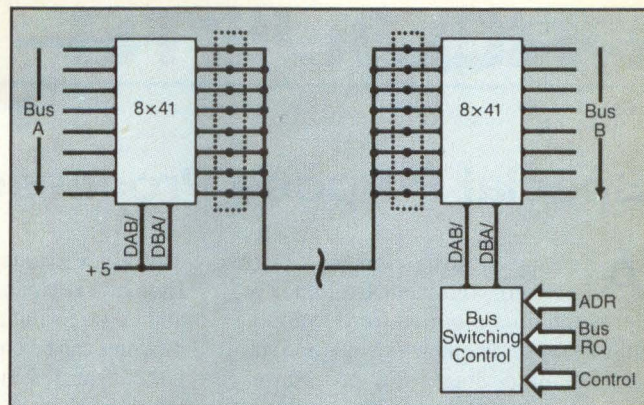

other times, the disk controller must have access to data memory so that it can read and write I/O parameter blocks (IOPBs).

A solution utilizing the 8X41 as a bus switcher is shown in Figure 2. The two buses are ordinarily connected through the 8X41, giving the CPU full access to the display subsystem and to the disk at bus speeds. When the CPU directs the disk controller to begin an operation, the disk controller requests mastership of its

local bus. A control circuit responds to that request from the controller. The disk controller places an address on the bus, defining the bus location of the addressed slave. If that address matches a slave in the display subsystem, the slave will record and the transfer will continue normally without burdening the CPU. If that address points to a slave within the CPU's bus, the 8X41 link is re-established.

Circle 230

CALENDAR

April 1-3

UNIX Seminar. Boston, MA. (Also in Atlanta, GA, April 17-19.) Contact: Center for Advanced Professional Education, 1820 E. Garry St., Suite 110, Santa Ana, CA 92705. (714) 261-0240.

April 2-4

Modern Integrated Circuit Technology. Santa Clara, CA. Contact: Technology Seminars Inc., PO Box 487, Lutherville, MD 21093. (301) 269-4102.

April 9-12

Implementing Local Area Networks. Philadelphia, PA. Contact: Integrated Computer Systems, PO Box 45405, Los Angeles, CA 90045. (213) 417-8888.

April 9-12

Programming In C: A Hands-On Workshop. Los Angeles, CA. Contact: Integrated Computer Systems, PO Box 45405, Los Angeles, CA 90045. (213) 417-8888.

April 9-12

Knowledge-Based Systems And Artificial Intelligence. Anaheim, CA. (Also in Palo Alto, CA, April 23-26.) Contact: Integrated Computer Systems, PO Box 45405, Los Angeles, CA 90045. (213) 417-8888.

April 10-11

Nepcon Southwest '85. Dallas, TX. Con-

tact: Ruann International, PO Box 1877, Des Plaines, IL 60018. (312) 296-2191.

April 10-12

Hands-On UNIX For Programmers. Bellevue, WA. Contact: Specialized Systems Consultants, PO Box 7, Northgate Station, Seattle, WA 98125-0007. (206) 367-8649.

April 14-18

Computer Graphics '85. Dallas, TX. Contact: National Computer Graphics Assoc., Suite 601, 8401 Arlington, VA 22031. (703) 698-9600.

April 16-18

ATE Silicon Valley '85. San Mateo, CA. Contact: Morgan-Grampain Expositions Group, 1050 Commonwealth Avenue, Boston, MA 02215. (617) 232-5470.

April 23-25

Electro '85. New York, NY. Contact: Electronic Conventions Management, 8110 Airport Blvd., Los Angeles, CA 90045. (213) 772-2965.

April 23-25

Mini/Micro Northeast '85. New York, NY. Contact: Electronic Conventions Management, 8110 Airport Blvd., Los Angeles, CA 90045. (213) 772-2965.

April 24-26

UNIX Systems Expo '85 Spring. San Francisco, CA. Contact: Computer Faire Inc., 181 Wells Ave., Newton, MA 02159. (617) 965-8350.

April 30-May 2

Modern Electronic Packaging. Philadelphia, PA. Contact: Technology Seminars Inc. PO Box 487, Lutherville, MD 21093. (301) 269-4102.

April 30-May 2

Artificial Intelligence Exhibition. Long Beach, CA. Contact: Tower Conference Management Co. 331 W. Wesley St., Wheaton, IL 60187. (312) 668-8100.

May 6-8

Seminar And Trade Show For Printed Circuit Board Fabricators. San Jose, CA. Contact: PMS Industries Inc., 1790 Hembree Rd., Alpharetta, GA 30201. (404) 475-1818.

May 6-9

Modern Data Communications. Washington, D.C. Contact: The George Washington University, Washington, D.C. 20052. (202) 676-6106.

May 6-9

Comdex/Spring. Atlanta, GA. Contact: The Interface Group Inc., 300 First Ave., Needham, MA. (617) 449-6600.

NEW PRODUCTS

Special Purpose Processor

As an upgrade to the company's Logic Evaluator, the Fault Evaluator reduces the time required for developing fully tested semiconductor chips and subsequent chip diagnostic procedures. Using a concurrent fault simulation algorithm, the Fault Evaluator can simulate 16,000 faults per pass, rather than one per pass, as with the Logic Evaluator. In the form of ZIF modeling elements 500,000 differences can be maintained in

each Fault Evaluator module. The Fault Evaluator is expandable up to 16 modules, and Logic Evaluator and Fault Evaluator modules can be combined in one cabinet. Other features include user controlled number of faults per pass, user select serial or concurrent algorithms, incremental loading of test vectors, initial release to handle unidirectional gates, RAM and ROM. **Zycad**, Arden Hills, MN
Circle 126

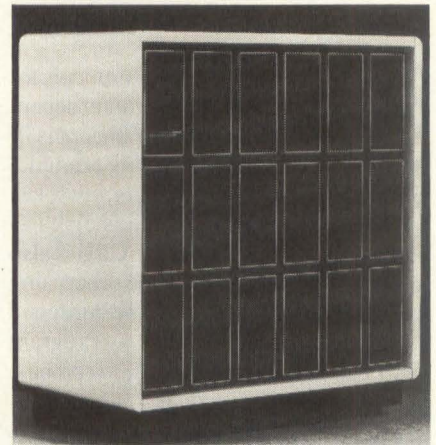

12 MIPS Coprocessor

When used with the firm's software languages, this coprocessor subsystem, the Maximizer, performs IEEE double and single precision math functions. Executing an average of 12 MIPS, the Maximizer contains a 48 MHz (master clock rate) bit-slice processor. With 16 Kbytes of data memory (50 nsec cycle time), 16 dual-port registers and 4096 48-bit words of downloadable microcode instructions, the Maximizer is microprogrammable using the 4 Kbytes of microcode RAM. Most instructions execute in 62.5 nsec, but up to 125 nsec are allowed for complex operations. To support the Maximizer, a microcode assembler software package — Model Maxasm — is available. The Maximizer is available now to run under the

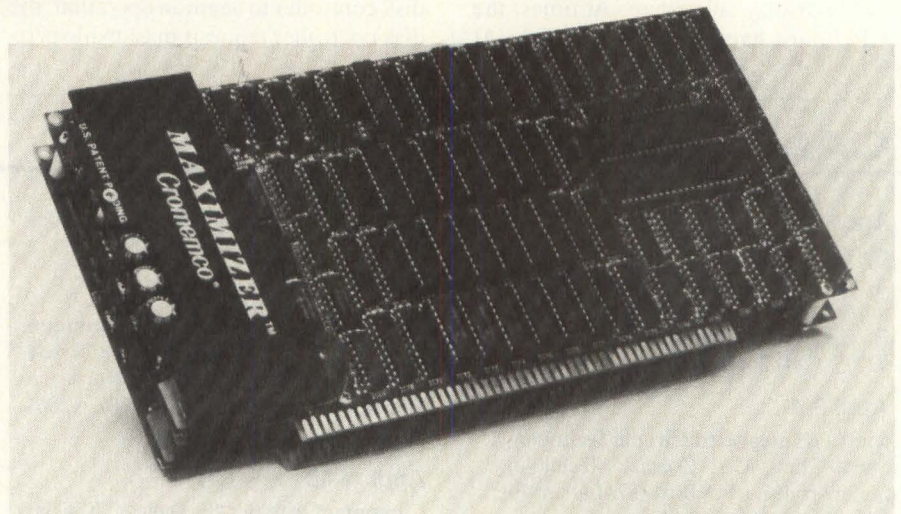

CROMIX operating system and will soon be available under UNIX. Price is

\$3,495. **Cromemco**, Mountain View, CA
Circle 127

300 Mbyte 5 1/4" Winchester Drive

Based on 14" drive design methods, MegaFile, a 5 1/4" Winchester disk drive, consists of a shell-like Head Disk Assembly (HDA) containing up to 12 read/write heads and seven platters, spindle with an integrated motor, absolute filter and a voice coil positioner. The MegaFile also features a dual servo system: one dedicated servo surface plus embedded servo on all surfaces. Twin

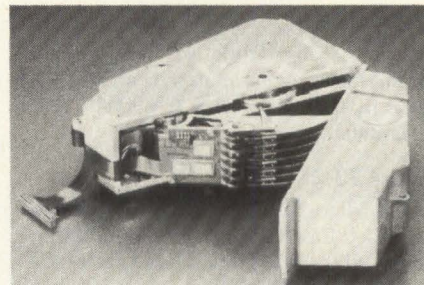

bearings on both top and bottom of the spindle and the positioner allow track density of 1207 tpi and recording density of 19077 bpi. With capacity up to 300 Mbytes per drive and a 25 msec average positioning time, the MegaFile has a 25000 hours HDA Mean Time Between Failure (MTBF). **Siemens**, West Lake Village, CA

Circle 128

NEED LOW POWER CUSTOM CMOS? CHECK OUT HOLT!

Custom CMOS Check List

- ✓ Micro power operation down to 10 μ A or less
- ✓ Supply voltage, 1.5 to 18 volts
- ✓ Analog, digital or both combined
- ✓ Gate arrays, standard cell or full custom
- ✓ 3 micron silicon gate or 5 micron metal gate
- ✓ Can take over design from concept, schematic or net list
- ✓ Over 8 years of experience with A/D, D/A, switch capacitor filters, telemetry, voltage conversion, display drivers, clocks and battery powered instruments
- ✓ Standard cell prototypes in 14 weeks or less
- ✓ Guaranteed development and production costs — up front — NO SURPRISES!

HOLT

Contact Mark Ellsberry for more information:
Holt Inc., 9351 Jeronimo Road, Irvine, CA 92718
(714) 859-8800, Telex 753307

Circle 45 on Reader Inquiry Card

HOLT INC.
INTEGRATED CIRCUITS
MAKING CMOS WORK FOR YOU.

COMPUTERS/SYSTEMS

Word Pattern Generator



The latest feature of the Step-2700 Development Station, this Word Pattern Generator may be used as a separate device or with other design tools of the Step-2700. The pattern width is provided in 16-bit increments. The system also offers a fully programmable sequencer and a symbolically-oriented assembler. Patterns may also be uploaded or downloaded onto any host computer via RS-232. Prices start at \$25,000. **Step Engineering**, Sunnyvale CA **Circle 173**

Multiplexer System

Allowing cluster controllers to be located at any position on two 1,000' composite links made up of a twisted pair cable, the Mux Master Multiplexer System features 8 or 16 line modules, both of which can support local async devices at 50 to 38,400 baud/second. The Mux Master single host board supports up to 8 Q-Bus or 16 Unibus cluster controllers at 1 Mbyte/second. The system is software compatible with VMS, RSX and RSTS. Available in a desk-top, wall-mount or floor-stand model, the Mux Master is priced at \$5,800. **Able Computer**, Irvine, CA **Circle 162**

Microprocessor Development System



Incorporating the Zax ICD-series in-circuit emulators and DEC's MicroVAX I, the ZAX/VAX, 32-bit universal microprocessor development system, provides 2 Mbytes of RAM, 31 Mbyte hard disk storage, 8-port RS-232 controller, disk controller and 400K floppy disk. Development software includes C, Pascal and PLM 86 language support, cross assemblers and the Zax interface (Zice). Zice features symbolic debugging capability, file control of the emulators, automatic journaling and help features. Price for the ZAX/VAX Development System is \$56,000. **Zax**, Irvine, CA **Circle 168**

11/73-Based System

The 11/73-based Micro/11 system, Micro/11-73, contains a 20.8 Mbyte Winchester subsystem and a dual

8" floppy, 1 Mbyte diskette subsystem. Supplied with dual size 256K or 512K RAM memory modules or a quad-size 1 Mbyte RAM module, the system is expandable to 4 Mbytes of memory. All memory boards feature full byte parity with CSR and block mode capability. A 250W switching power supply provides +5VDC, +12VDC and +24VDC to the backplane and disk subsystems. The backplane card guide accommodates eight quad-size modules and provides 22-bit addressing on all slots. Price is \$13,150-\$15,050. **MDB**, Orange, CA **Circle 172**

68000 Emulator

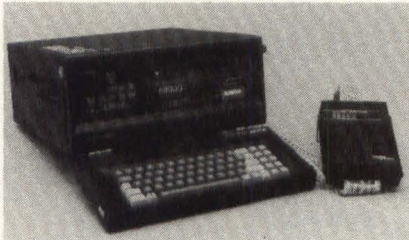

The SA700-68K emulator for the 68000 combines software development capability with a 68K mini-assembler, a real-time 10 MHz in-circuit emulator, CRT display, fold-down ASCII keyboard, 8" floppy disk drive and a built-in PROM programmer. It accepts executable object code and symbol files in Motorola's S-record format from development hosts such as the VAX running VMS or UNIX. A batch Debug command language in the SA700 allows the user to develop and execute debug routines on the emulator. **Sophia Computer Systems**, Santa Clara, CA **Circle 163**

Color Workstation

An addition to the CAE 2000 product line, the CAE 2000/550 color workstation is based on the Apollo Domain DN550. Operating as a standalone or as a node in a "Worksystem," the CAE 2000/550 uses a 32-bit 68010 processor and a dedicated bit-sliced graphics processor. The system is available with up to 3 Mbytes main memory and can support up to 24 concurrent processes, each with 16 Mbytes of virtual address space. CRT resolution is 1024 x 800, displaying eight colors simultaneously. All color features of the CAE 2000/550 are user-configurable. Price is \$62,800. **CAE Systems**, Sunnyvale, CA **Circle 166**

Multuser UNIX Workstation

Based on the 68000/68010, the Minibox multuser UNIX system offers a built-in C compiler, six Multibus card slots (five open for users), single or dual 5 1/4" floppy drives, 30 Mbyte to 280 Mbyte Winchester storage and an interactive streamer tape drive. The Minibox is built around the HK68 micro-computer featuring an 8 or 10 MHz CPU, quad-channel DMA, Winchester interface, streamer tape drive (or definable dip switches), 64 Kbytes EPROM, 512K to 1 Mbyte RAM, two iSBX expansion connectors, MMU (addresses 16 Mbytes of RAM), four serial I/O ports (expandable to 12) and three 16-bit counter timers plus two parallel I/O ports. **Heurikon**, Madison, WI **Circle 171**

32-Bit Processor Systems

An addition to the firm's family of 32-bit multi-processor systems, the 1200 Series of multi-processor systems contains up to four 12.5 MHz

68000 CPUs, 12 68000-based I/O controllers, 16 Mbytes of EDAC main memory and up to 88 async and sync serial communications ports. With up to 4 internal and 44 external disk drives, the 1200 provides up to 9 Gbytes of storage for up to 88 users. The system also features a 33.3 Mbyte/second I/O transfer rate, and like the earlier 1100 series, supports both the ARIX and RM/COS operating systems. Price is \$70,000-\$150,000. **Areté**, Mountain View, CA **Circle 165**

IBM PC-Compatible Multiuser Computer

An extension of this company's Personal Mini Family, the PM/4T and PM/16T multiuser computers are IBM PC compatible. The PM/4T 4-user version contains a 20 Mbyte formatted Winchester drive, a 4 tpi, PC-compatible floppy drive and an integrated 20 Mbyte streaming tape drive. The PM/16T incorporates a 20 Mbyte streaming tape drive, 512 Kbytes of RAM, a 44.5 Mbyte formatted Winchester drive and a 48 tpi, PC-compatible floppy drive. Price is \$5,995 (PM/4T) and \$9,995 (PM/16T with Infoshare/M and PM/Office Manager). **TeleVideo Systems**, San Jose, CA **Circle 170**

Logic Programmers



Combining menu-driven protocols, this multiuser prototyping tool (60A) programs devices inserted manually into a socket, while the 60H combines the capabilities of the 60A with a software and hardware interface to an automatic device handler. The handler automatically inserts devices into a socket and the 60H programs and tests them. No device codes are required and both models operate as standalone or remote-controlled programmers. Price is \$3,425 (60A) and \$4,425 (60H). **Data I/O**, Redmond, WA **Circle 161**

PERIPHERALS

Capacitance-Sensing Touch Screen

An addition to this firm's series of capacitance-sensing touch screens, the TK-1000D series has a touch response time under 50 msec. The unit consists of a monolithic glass sensor and circuit board that contains touch sensing circuitry and an RS-232-C interface. Standard screen types are flat, cylindrical curved and spherical. Standard sizes are 9", 12", 13", 15" and 19" diagonals. Price in quantities of 1,000 is \$450. **Interaction Systems**, Newtonville, MA **Circle 181**

LCD Modules

With an 80 column x 25 line format, the two new LCD modules, CG-6402000G and CG-6402001G,

have a 640 × 200 dot display. Effective display area of the CG-6402000G is 224 mm/8.8" wide × 70 mm/2.8" high, and the CG-6402001G is 224 mm/8.8" × 168 mm/6.6". Corresponding pixel size is 0.31 mm square and 0.31 mm × 0.79 mm rectangle. The modules require +5V and -12V DC. Price in quantities of 1,000 is \$200 (6402000G) and \$300 (6402001G). **C. Itoh**, Los Angeles, CA

Circle 182

Daisy Wheel Printer

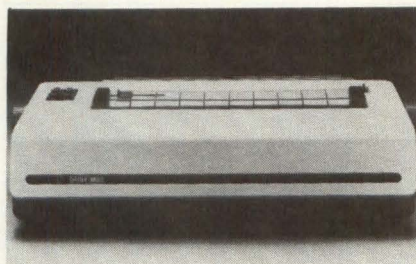

Compatible with most Diablo, Qume and NEC printers, the M20 daisy wheel printer prints 20 cps bidirectional. Horizontal formats include 10, 12, 15 pitch and proportional spacing, printing each line 15.7" wide on paper up to 16.5" wide. It also allows six, eight or twelve lines/inch. A separate motor drives the multistrike ribbon cartridge, creating longer ribbon life. In plotting, a resolution of 23,000 dots/square inch is used. **Daisy Systems Holland BV**, The Netherlands

Circle 187

Protocol Converter

By emulating an IBM 3278-2 display station, the PC-1000E microprocessor-based protocol converter can link ASCII terminals and PCs to the IBM 3270 network. Featuring multilevel password security, help screens, substitution of English commands for IBM functions, dial-up connection and default terminal type selection, the PC-1000E may be used in BSC, SNA/SDLC protocols or in channel-attached operations. Able to connect to a modem, the PC-1000E is accessible by any remote terminal or PC dialing in through switched or leased lines, or through a data switch. Price is \$995. **International Data Sciences**, Lincoln, RI

Circle 184

1/2" Streaming Magnetic Tape Drive



With a MTBF of 7,400 hours, the DMT 2000 1/2" streaming magnetic tape drive features automatic tape loading and self diagnostics. Reel sizes are 10 1/2", 8 1/2" or 7", and phase encoded, 9-track tape format is fully ANSI/IBM-compatible at 1600 bpi. The DMT 2000's drive mechanism reduces the amount of uneven roll on the tape-up reel and guarantees uniform tension during rewinding. With a dual tape speed of 100/25 ips, the unit also offers a switch-selectable interblock gap with four settings: 0.6", 1.2", 1.8", 2.4". **Anritsu**, Oakland, NJ

Circle 185

Enhanced Network Bridge

Designed to interconnect multiple Net/One communications systems in the same geographic location, the enhanced network bridge, Net/One Local Bridge, allows connection between frequency channels on broadband networks. The enhanced Net/One Local Bridge forwards information from network to network or channel to channel on a per-packet basis at rates of 1,000 packets/second. The new Local Bridge can also forward network management messages from network to network. Price is \$9,850. **Ungermann-Bass**, Santa Clara, CA

Circle 183

2400 BPS Modems

All five of these full-duplex auto-dialing modems, 2400PA, VA4224, VI2422S, 2400V and 2400PC, operate at 2400, 1200, and 0 to 300 bps, automatically selecting the appropriate speed. At 2400 bps, these modems comply with CCITT recommendation V.22 bis. Various features include automatic dialing, call-progress detection, security passwords, user diagnostics, public switched-telephone network support and two-wire leased line operation. Price ranges from \$925-\$995. **Racal-Vadic**, Milpitas, CA

Circle 179

Automated PCB Plotter

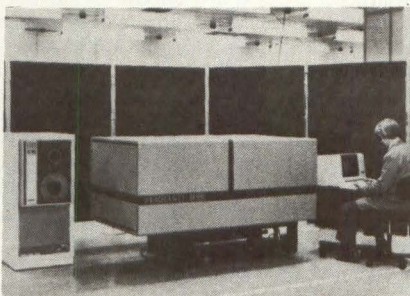

The EP530 precision photo plotter can be controlled and operated interactively with the VDT and keyboard. Users can also input via punched paper tape, magnetic tape and an on-line interface. Diagnostic routines are built into the microprocessor to increase availability of the plotting system. The unit features linear motors rather than gearbox drive systems and uses fiber optic light transmission to reduce weight. **Ferranti Infographics Division**, Huntington Beach, CA

Circle 174

7" Liquid Crystal Shutter

Providing contrast in high ambient light, this 7" liquid crystal shutter consists of a liquid crystal switch (pi-cell) set between two color polarizers and a neutral polarizer. Combined with a monochrome CRT, the Liquid Crystal Shutter transmits the green part of the light when a voltage is applied and the red part when the voltage is removed. Any combination of the two primary colors is accomplished by varying the CRT beam current. Available in a red/green/yellow color combination, the 7" liquid crystal shutter is offered with a 7" monochrome CRT with red/green phosphor. Single unit price is \$200. **Tektronix**, Beaverton, OR

Circle 175

5 1/4" Winchester Drives

The Miniscribe 6000 family of 5 1/4" full-height Winchester disk drives comprises four models: the 6085

with unformatted storage of 85.3 Mbytes, the 6074 with 74.7 Mbytes, the 6053 with 53.3 Mbytes and the 6032 with 32 Mbytes. With an average access time of 30 msec, all model 6000 drives have an ST412 track capacity of 10,416 bytes and 5.0 Mbit/second data transfer rate. Other features include a single printed circuit board, low power requirement and automatic actuator lock. **Miniscribe**, Longmont, CO

Circle 186

3D Digitizer



The GP-8-3DP sonic digitizer uses sound to determine the distance between a digitized point and four microphone sensors that are mounted on a plane. The host computer then converts these distances into Cartesian X, Y and Z coordinates. Users can adjust the active volume to up to 10' × 10' × 10' with a .01" resolution throughput. Choice of formats include ASCII or binary RS-232-C or parallel packed binary. Optional multiplexers that digitize up to 16 points in space sequentially are offered. Price is \$7,500. **Science Accessories**, Southport, CT

Circle 180

COMPONENTS

FIFO Buffer Unit

As an addition to the family of Z8000 and Z8500 peripheral products, the Z8060 FIFO buffer unit and FIO expander features bidirectional, async data transfer, 128-bit × 8-bit buffer memory and 3-state data outputs. With two-wire, interlock handshake protocol, the Z8060 operates in temperature ranges of 0°C to +70°C and -40°C to +85°C. Other operating characteristics include 6 MHz and 4 MHz clock frequencies, -0.3V to +7.0V max operating voltages, and a storage temperature of -65°C to +150°C. Price in quantities of 1,000 is \$15. **SGS Semiconductor**, Phoenix, AZ

Circle 134

Multiplexed Comparators

Allowing the user to program 256 different comparator threshold levels, the ADC0852 and ADC0854 CMOS analog comparators are powered from a single +5V supply and dissipate 30 mW. A choice of 2- or 4-input multiplexers is provided, with both single-ended and differential input capability programmable in either device. Total untrimmed error (accuracy) of ±1/2 lsb of reference includes comparator offset, threshold DAC nonlinearity and multiplexer errors. Packaged in an 8-pin mini DIP, price in 100s is \$2.65-\$2.85. **National Semiconductor**, Santa Clara, CA

Circle 133

Bipolar Op Amp

The HA-2541 wideband, unity gain stable, bipolar operational amplifier achieves a unity gain band-

NEW PRODUCTS

width of 40 MHz and a 300V/ μ sec slew rate. With an 80 nsec settling time, a 5 MHz power bandwidth and an output voltage swing of $\pm 10V$, the HA-2541 is pin compatible with the HA-2540, HA-5190 and LH-0032 wideband op amps. Price in quantities of 100 ranges from \$6 (DIP, commercial temperature range 0° to +75°C) to \$24 (TO-5 metal can package). **Harris**, Melbourne, FL **Circle 131**

Overvoltage Sensing Circuits

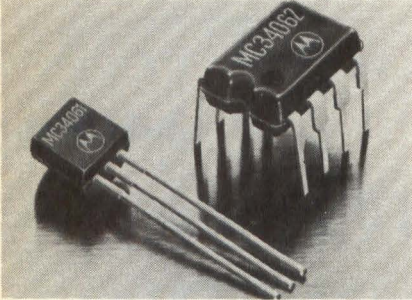

These two overvoltage sensing circuits (MC34061, MC34062) offer a choice of power supply overvoltage trip points ranging from 2.5V to 40V. The MC34061 three-terminal device includes a voltage reference of 2.5V bandgap type with tolerances of $\pm 1.0\%$ at room temperature and $\pm 2.0\%$ over temperature (a suffix device). The internal comparator provides 250 mV of hysteresis, and drain current is 1.5 mA over its power supply voltage range (3.0V to 40V) and temperature range. The MC34062 Pin Programmable overvoltage sensing circuit provides a six-resistor network which can program 120 different overvoltage trip points from 25V to 39V. **Motorola**, Phoenix, AZ **Circle 142**

μ P Compatible 16-Bit DACs

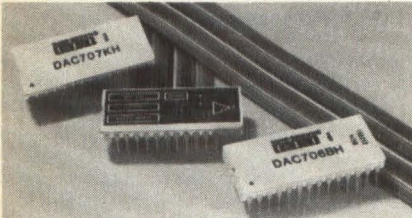

Designed to interface to a 16-bit μ processor bus, the DAC705, DAC706 and DAC707 are complete digital-to-analog converters. Each model features a maximum linearity error of $\pm 0.003\%$ of FSR and maximum differential linearity error (BH grade) of $\pm 0.006\%$ FSR. With a guaranteed monotonicity to 14 bits over the 0°C to +70°C (KH grade) and -25°C to +85°C (BH grade) temperature range, gain drift is ± 15 ppm/°C typical (RH), ± 25 ppm/°C (KH). All models operate from $\pm 12V$ and $\pm 15V$ supplies. Prices in 100s start at \$44. **Burr-Brown**, Tucson, AZ **Circle 137**

Dual 12-Bit DAC

Matching DAC ladder resistances to 3% (maximum), this dual 12-bit DAC (AD7549) occupies one-half to two-thirds of the area occupied by two separate DACs. Both DACs in the AD7549 have separate reference inputs and feedback resistors, are loaded from double-buffered latches and provide four-quadrant multiplication capability. Guaranteed monotonic over the full military temperature range, the AD7549's maximum gain error is restricted to

three and six lsb for K/B/T and J/A/S grades; relative accuracy is one-half and 1 lsb max for the same grades. Packaged in a 0.3" wide 20-pin DIP, the price is \$16.95 to \$80. **Analog Devices**, Norwood, MA **Circle 141**

Hermetic Color Dot Matrix Displays

Available in yellow (HDSP-088X) and two versions of high-efficiency red (HER) (low power—HDSP-078X and high brightness—HDSP-079X), this family of dot matrix displays operate as single digit, numeric, hexadecimal or overrange indicators. Featuring a hermetic seal, the displays are end-stackable and operate over a -55°C to +100°C range, offer TTL compatibility and are end-stackable. Price in quantities of 1 to 99 is \$64-\$72. **Hewlett-Packard**, Palo Alto, CA **Circle 140**

BOARDS

IBM PC/XT-Compatible Controllers

An expansion of the firm's data controller line, these two controllers (OMTI 5500, OMTI 5700) can attach up to two ST506/412 interface-compatible fixed and/or removable drives. The OMTI 5700 supports Winchester drives as well as a QIC-02 interface-compatible streaming tape drive and offers three bidirectional data paths. Using the Winchester cartridge as backup, the OMTI 5500 provides up to 10 Mbytes of backup on a single media volume. The OMTI 5700 provides up to 60 Mbytes of backup using the QIC-02 tape capabilities. Price is \$245 (5500) and \$365 (5700). **SMS**, Mountain View, CA **Circle 146**

VMEbus Serial And Parallel I/O Board

Fitting into a single slot in a card cage, this serial and parallel I/O module for a VMEbus system offers up to eight async serial communications channels, 24 parallel I/O lines and an on-board control latch. The 24 parallel I/O lines provide one Centronics-type printer port plus 12 bidirectionally buffered lines, or two printer ports. All parallel I/O is accommodated through the board's P2 connector. A 24-bit programmable counter/timer can be used to generate system interrupts, to perform real-time clock functions or to act as a watchdog timer. Price is \$1,130. **General Micro Systems**, Ontario, CA **Circle 145**

Front-End Communications Processor

Available in dual-ported RAM configurations of 64, 256 and 512 Kbytes, sharing a 64 Kbyte memory space with the IBM PC, the DCP-88/VM single-board front-end processor for the IBM PC family and compatibles can support up to four multi-protocol communications lines and parallel printer port. Memory is addressable on a bank-select basis from the host PC or directly from the DCP-88/VM processor. Price is \$695. **Emulex**, Costa Mesa, CA **Circle 144**

32-Bit Multibus Board

Featuring three members of the NCR/32 chip set, the NCR/32-796A 32-bit microprocessor on a

Multibus board includes a 32-bit ALU and 32-bit process or memory (PM) bus. The addressing range available is 4 Gbytes virtual and 16 Mbytes real memory. Operating with a 13.3 MHz clock, the board has 150 nsec access time and dual port main memory access via Multibus or iLBX. The NCR/32's external microprogrammability is supported with 16K words of RAM microcode instruction storage. A 128-word scratch pad memory for temporary data storage is also available. Price is \$895. **NCR**, Dayton, OH **Circle 160**

Add-In Memory Cards

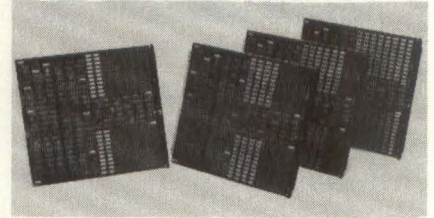

Compatible with the Prime 2250, 2550, 9650 and all older 50 Series CPUs, these memory cards use 256 Kbyte RAMs for capacities of 1024 to 4096 Kbytes. The 1 Mbyte E9-1 is functionally equivalent to Prime's E9 module including self-interleaving, wide word and error check and correction. The E9-2 features 2 Mbytes of RAM, E9-3, 3 Mbytes, and E9-4, 4 Mbytes. This new series of memory cards incorporates all of the additional features of the company's earlier Prime-compatible memories including on-line/off-line comfort switch. Prices are up to \$5,530. **EMC**, Natick, MA **Circle 152**

Auto Dial Card

Designed for 110 and 300 bps operation, the 103 Auto Dial Card features auto dial, auto answer, analog and digital test modes. All functions of this modem card assembly are controlled by serial data commands; and it is compatible with the Bell 103A and the CCITT V.21 standards for direct connection to the switched telephone network. The assembly is available with either the Novation or the Hayes-compatible command set. The 103 measures 3" x 4". **Novation**, Chatsworth, CA **Circle 151**

Multibus A/D Boards

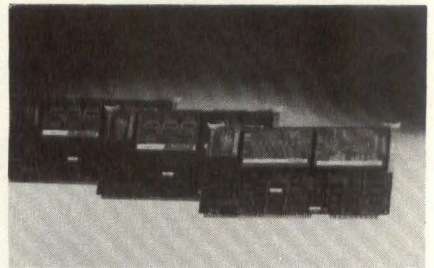

Consisting of three boards: DT772 for high level analog inputs, DT774 for low level analog inputs, and DT778 for simultaneous sample/hold analog input system, the DT772 Series of Multibus boards offers 8- and 16-bit data transfer rates and 24-bit addressing capabilities. Both the DT772 and DT774 provide up to 40,000 samples/second throughput rates with 12-bit resolution. The DT778 allows the user to take a snapshot of up to 12 single-ended analog input channels, freezing their values within a ± 5 nsec aperture uncertainty. Price is \$895-\$1,695. **Data Translation**, Marlboro, MA **Circle 157**

SOFTWARE

Design Automation Software

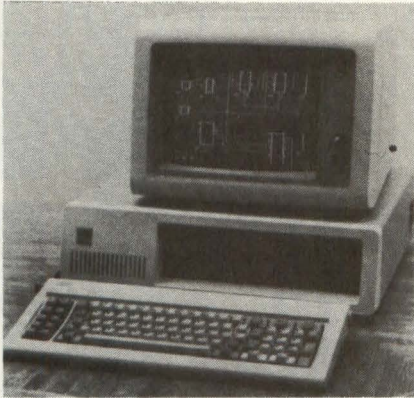

Tailored for the IBM PC/XT and compatibles, this schematic-capture software package, Dasoft 16S, comes with a component library, design and library editors, a graphics-oriented design entry routine, documentation programs and plotter drivers. Allowing users to build schematics on the CRT screen, Dasoft 16S displays and positions symbols as they are called up from the library. The system automatically checks for duplicate designators; title blocks are defined and revision blocks are optional.

Price is \$12,000. **Dasoft Design Systems**, Berkeley, CA **Circle 194**

Updated UNIX-Compatible Operating System

An enhanced version (Revision 5) of the UNOS operating system supports VMEbus, Versabus, runs larger disks and data files, supports ISO standard LANs and interconnects with IBM systems. This UNIX-compatible operating system runs on Charles River Data's Universe 68 and 2203 families of super-micros. Identical versions of UNOS Revision 5 run on the VMEbus-based Universe 6 computers. UNOS Revision 5 also supports Universe NET, the company's LAN as well as disk files up to 2 Gbytes. **Charles River Data Systems**, Framingham, MA **Circle 195**

CP/M For Macintosh

Resulting from a contract between Digital Research and I.Q. Software, the CP/M operating system is now available for the Macintosh Computer. Two programs that run on the Macintosh now are Wordstar and dBase II. Each CP/M package includes two volumes of documentation from Digital Research and I.Q. Software, six diskettes of programs including CP/M, C Language Compiler, Modem 7 compatible program, Macro Assembler, Terminal Emulation and Standard Printer Drives. Price is \$395. **I.Q. Software**, Ft. Worth, TX **Circle 192**

Graphics Support Software

Designed to run on the AT&T PC 6300 and compatibles equipped with the Video Display Adapter or the Image Capture Board, the Paint and Image Processing Software and Business Graphics Presentation Software provide continuous-tone graphics capabilities. The paint and Image Processing Software has functions for adjusting color, adding to or eliminating elements in a photo, combining photos, cropping as well as color manipulation, text overlay, merging of multiple images, drawing and layout. The Business Graphics Presentation Software generates two- and three-dimensional bar and pie charts and is compatible with the Paint and Image Processing Software. **AT&T**, Indianapolis, IN **Circle 199**

Fault Isolation Software

Enabling fault isolation in IBM PCs to the component level, the IBM PC Test modular software package is designed for Fluke's 9010A or 9005A Micro-System Trouble Shooters and Fluke's 8088 Interface POD. The package consists of five tape modules and a manual, allowing for guided fault isolation (GFI) or self-guided tests. Tapes one and two perform auto-tests and functional go/no-go IBM PC testing. The other three tapes contain GFI programs for the main board, disk controller and monochrome video board. Price is \$1,500. **Fluke**, Everett, WA **Circle 198**

Northeast

C3 Systems \$46k
 Digital signal \$43k
 LSI/VLSI design \$47k

We're your complete personnel service in the Northeast. All confidential, no resume needed & no fee.

Staffing, USA and International.

Engineerslog

Box 252 Latham, New York 12110

MICROCOMPUTERS AND INTERFACES

We have six single board computers, two video boards and interfaces for the IBM-PC and APPLE IIe computers. You can use our products for security systems, heat control, light control, automated slide show, traffic lights, irrigation systems, home computer systems, automated process control, and robot control just to name a few. OEM prices available. For catalog call or write to:

JOHN BELL ENGINEERING, INC.
 460 OXFORD WAY
 BELMONT, CA 94002
 (415) 592-8411

Circle 44 on Reader Inquiry Card

LITHIUM BATTERY HOLDERS IN 2 STYLES

COIN HOLDER BH906*

Fits all coin type cells up to 23mm x 3.2mm.

CYLINDER HOLDER BH2/3A*

Fits all standard type cells style 2/3A. (Dustcover available).

Memory Protection was Never Easier.

Now you can permanently solder MPD's new coin or horizontal battery holder right on your PC board. Standard 3 volt lithium cells for reliable memory back-up systems clip right in...

- Sturdy, high-temp UL94V-0 Valox® material
- Stainless steel nickel plated contacts
- Easy insertion and removal of batteries
- Efficient, economical
- Custom battery holders available on request.

*Patent Pending

For all the details, call or write today.

Memory Protection Devices Inc.

320 Broad Hollow Road, Farmingdale, NY 11735 • 516-454-0340

Circle 48 on Reader Inquiry Card

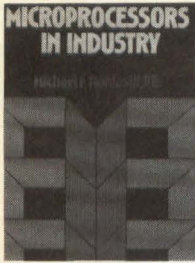

Microprocessors Book. This 544-page book from Van Nostrand Reinhold provides information on microcomputer system design and control theory for industrial applications of microprocessors. Microprocessors are discussed in relation to sensor systems, data acquisition, microcomputer products, and automatic control systems. Also explained are interfacing, programming, control system elements, and systems application and design.

Van Nostrand Reinhold **Circle 257**

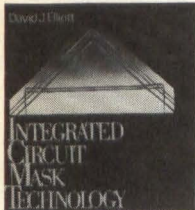

Integrated Circuit Mask Book. This 281-page book from McGraw-Hill covers aspects involved in making an integrated circuit mask, including substrate imaging, quality control, production techniques, etching, pattern design and measurement, mask quality glass and coatings for mask blanks. Included are illustrations, photos and line drawings.

McGraw-Hill **Circle 258**



Micro-Products Handbook. This 176-page book from Emulex Corp. provides information on its line of micro products, including host adapters, disk and tape controllers, micro subsystems, and the Persyst line of products for the IBM PC. An overview of each major product line is presented and includes background on the operational environment, as well as characteristics of the peripheral devices supported.

Emulex **Circle 250**

CAD/CAM Handbook. This 432-page book from McGraw-Hill contains contributed sections from 20 specialists on their areas of expertise in CAD/CAM technology. The book explores effective ways to evaluate and acquire CAD/CAM systems, and demonstrates how they are currently used. Described are the hardware and software involved as well as applications.

McGraw-Hill **Circle 254**

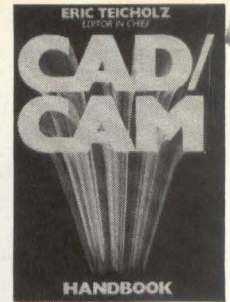

Surface Mount Technology Manual. This 112-page manual from Texas Instruments provides an overview of surface mount technology, including terminology, the connection process, testing and reliability consideration and current surface-mounted products. Also covered are the thermal characteristics of surface-mounted component (SMC) assemblies and techniques for combining SMCs and DIPs on the same board.

Texas Instruments **Circle 252**



Power Mosfets Applications Handbook. This 512-page technical reference book from Siliconix contains articles and application notes that will aid in the design of power Mosfet circuits. Provided are information and solutions to power Mosfet design problems. Subjects covered include power Mosfet structures, electrical characteristics, thermal design, SOA precautions, practical design considerations, and device testing and reliability.

Siliconix **Circle 251**



ADVERTISER INDEX

Apollo Computer	2,3,56,57	Force Computers	12,13	Oak Switch Systems	67
ATE Northwest	85	Fujitsu Microelectronics . . .	34,35	Panasonic	29
John Bell Engineering	107	Genicom	11	Power Systems	95
Canon	51	Hewlett-Packard	47	Precision Filters	30,31
Carroll Touch	25	Holt	103	Qume	17
Cherry Electrical Products . . .	65	Houston Instrument	27	Scientific Microsystems	93
Citizen America	9	Hytek Microsystems	8	Simpect	89
Control Data	37	Io Inc.	8	Spectra Logic	63
D.A.T.A. Books	15	Keytronics	73	Stackpole Components	71
Datacube	1	LSI Logic	59	Summagraphics	19
Dataram	49	Memory Protection Devices . .	107	Systech	C3
Datel	75	Microscience International . . .	33	Vectrix	53
Digital Equipment Corp.	6,7	Micro Switch	69	Versatec	44,45
Eaton	43	Midwest Electronics Exposition	99	Weitek	60,61
Eikonix	23	Modgraph	C2	Western Peripherals	10
Epson America	55	Mostek	20,21,C4	Zoltech	86
Floating Point	38,39	NCR	97		
John Fluke Manufacturing	77	Nicolet	41		
		Nissei Sangyo America	79		