

## INDUSTRIAL PROCESS CONTROL: THE ROLE OF COMPUTERS

The application of modern, automatic computer control techniques in industrial process control systems has been so limited -- indeed, so surprisingly restricted -- that it seems almost to disavow the tremendous advances made in the control art. These giant steps in the development and refinement of analog, digital and combined analog-digital control computers are all directed toward more productivity, better quality, and higher profits for industry in general. Yet, so few of these control improvements are in use, even in the newest plants, that just the general acceptance and wide use of what we know already about process control will take many years to achieve.

This apparent riddle is clearly and satisfyingly resolved in the accompanying reprint. The authors have called on their many years of practical experience in control engineering to bring into clear focus the technical and economic problems confronting the process industries in this area of automatic control. Their personal examination and evaluation of over 100 process plants, as well, has given them an insight to this problem that is both revealing and useful.

# MODERN PROCESS CONTROL

by

R. E. Finnigan, P. M. Uthe, A. E. Lee

---

REPRINTED FROM  
INTERNATIONAL  
**SCIENCE AND  
TECHNOLOGY**

A CONOVER-MAST PUBLICATION  
205 EAST 42 ST. NEW YORK 17, N. Y.

---

May 1963

# MODERN PROCESS CONTROL

**Weapon and space techniques of automatic control ought to be usable in industry now.**

**Here's an account of the barriers in their way—technical ones and economic ones.**

by R. E. Finnigan, P. M. Uthe, A. E. Lee

*IN BRIEF: The advanced state of the control art is belied by the narrowness of its applications in the process industry. Despite great advances in control techniques and equipment for aerospace and military systems, few of these improvements appear in even the newest plants. Not enough is known about the dynamics of most processes to develop the mathematical definitions from which integrated systems can be engineered to control all the process variables simultaneously. When they can, integrated controls, supervised by a computer, often produce vast improvements in throughput and product quality. But marrying computers to controls is still a costly experiment for most processors, for few are capable of engineering the total system; they tend to turn back this responsibility to instrumentation and control manufacturers. However, these suppliers, in turn, have to put more emphasis on hardware for the widest markets than on advanced techniques that require new sensors and actuators. Technological fall-out from aerospace controls is slowly increasing; by the late 1960's, its impact will be strongly felt.—E.H.*

■ **Question:** Is industry today using the available automatic control technology to improve productivity, quality, and profits to the fullest extent possible?

**Answer:** Surprisingly, no—its potentialities still are virtually untapped and it will require several decades to utilize everything we already know today.

We base this on more than a year of visiting 150 process plants and engineering organizations, examining them in the light of our many years of experience in control engineering. Two of us had long been involved with control as applied to aerospace and military systems where much of this new technology has been reduced to practice. The third has had many years of practice in industrial process control engineering.

We've analyzed the vexing technoeconomic factors in industry that hold back control ap-

plications to the fullest extent of the art, but the most advanced techniques of process control will ultimately produce an impressive payoff in quality, throughput, and safety.

We find that great technological breakthroughs are *not* needed, but the process industries, in particular, will have to make major changes in their approach to control. These changes will require new types of specialists, revisions to the philosophy of plant design and operation, and adoption of design and construction procedures.

One of the biggest deterrents to more rapid changes is that industrial plants are one-of-a-kind from a control systems standpoint. Not all of the controllable factors have been defined mathematically.

It is rare for equivalent processes to have numerically identical parameters from a control viewpoint. It turns out that even supposedly identical boilers for steam generating plants are often found to have different dynamic characteristics. One answer is that myriad variations in processes and process vessels make it difficult to justify the extensive research and engineering needed to produce identical processes from control systems of the type found in the aerospace industry.

By process industries we are referring to those industries that continuously or semi-continuously process gases, liquids, and solids. Typically these include chemical, food, steel, pulp and paper, and steam power plants. The process industries have control-system design objectives quite different from those of aerospace. Rather than maximizing performance while limiting size and weight and regarding cost as a secondary factor, industrial processors seek adequate performance at minimum cost. Usually, instrumentation involves off-the-shelf hardware to minimize design and startup time and permit the use of standardized application procedures.

Unfortunately, what's available off-the-shelf for aerospace control is not usually suitable for industrial environments. Industrial equipment must perform reliably far beyond the few critical minutes of a missile launching, to endure years of constant use exposed to

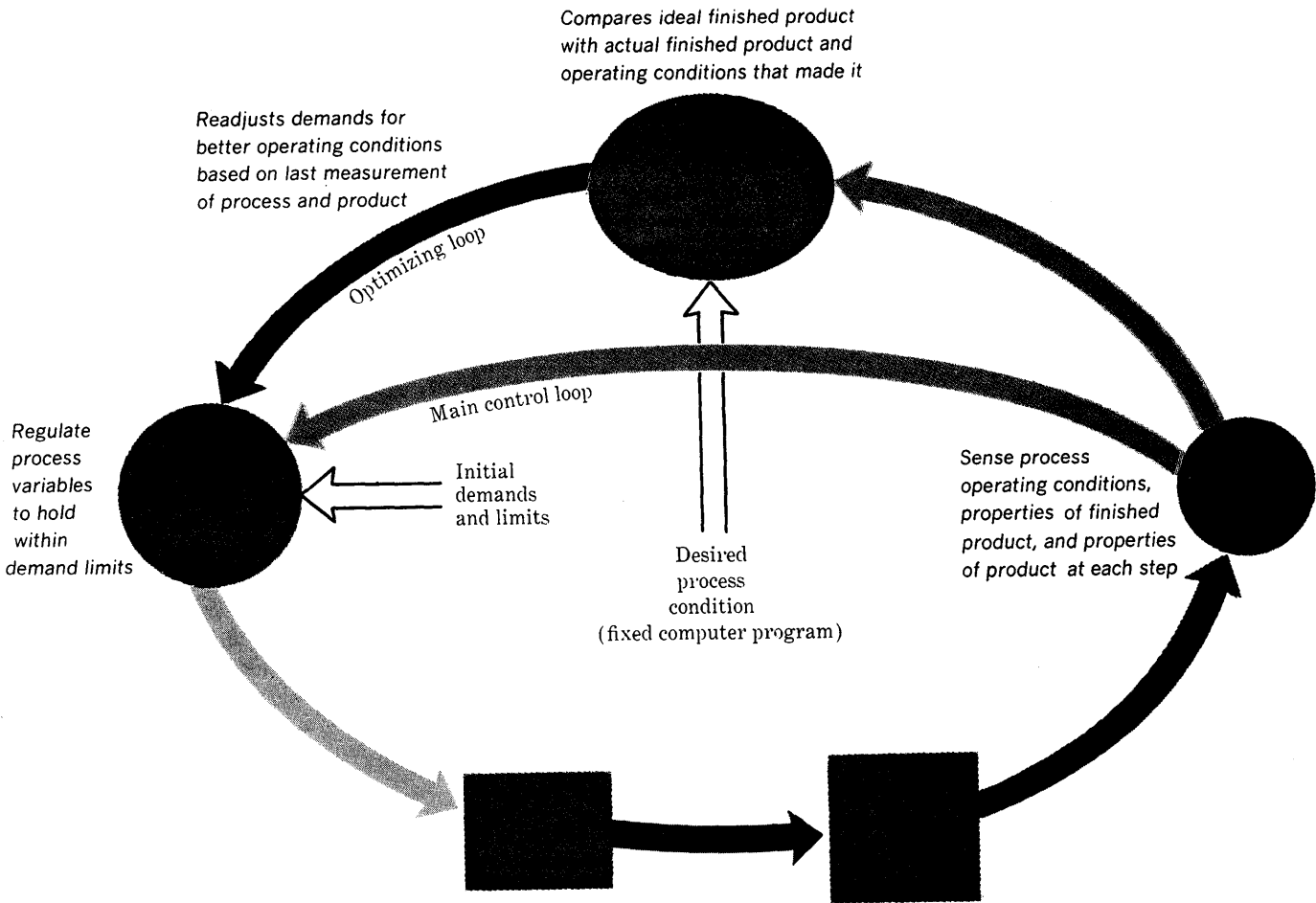

*Supervisory or optimizing control is one of the more advanced control techniques applied in aerospace systems and now being adapted to industrial processes. While each variable is conventionally regulated to hold certain values or setpoints, computer compares observed result with model of what's wanted, orders changes in setpoints during process, much like foreman at right in 18th century plate glass factory below.*

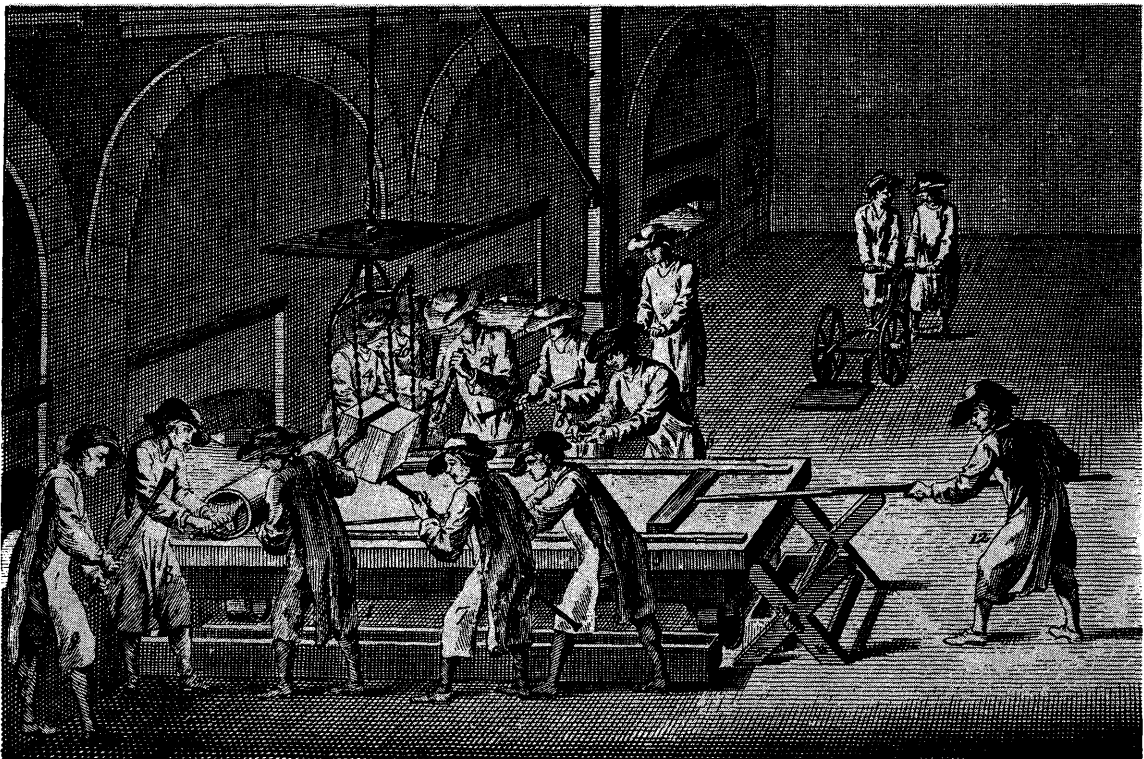

high temperatures and pressures, highly corrosive process fluids, and fatiguing vibration. Often the measurement devices must be protected from the very environment whose properties they are trying to measure, thus reducing dynamic response and accuracy.

No wonder, then, that our investigations frequently uncovered an air of suspicion and even disenchantment with newer control technology. "We're in business to make chemicals (or steel)," we heard, "not only to advance technology."

When significant cost savings or other major advantages of new controls are easily recognizable to the potential user, they're adopted with alacrity. One steel company, which has capitalized on advanced control system techniques, first increased production of steel strip within  $\pm 2$  mils-tolerance from 37% of total steel rolled to 85% by installing an analog multivariable control system and then, with digital computer control, achieved 94% useable product.

The electric utility industry, by use of modern integrated control systems, has safely enabled plant capacities to increase from 50 megawatts to 500 megawatts. This rapid advancement in steam-plant technology has caused the reduction in critical response times required of the control system and operators from several minutes to a few seconds. But these benefits of advanced control technology today still turn out to be more the exception than the rule.

### **Tuning the loops**

Then where do the process industries stand today in the use of control systems?

The majority of control systems in use today involve combinations of single-variable control loops. Each control loop is assembled, tuned, and operated independently of all other loops. But the various sub-loops may interact when many of them are combined to control a process. Control would be more effective if it could be integrated—if it could keep multiple variables from interacting in an uncontrolled way.

When you drive a car, you're the integrating control over speed and direction. A locomotive engineer doesn't control direction—the tracks do that—he only controls speed. He cannot optimize speed and direction simultaneously because each of these variables is independently controlled.

Typically, the data about each control loop is picked up by sensors in the process plant and transmitted to recorders, indicators, and controllers at a central location. Controllers measure the difference between actual and desired conditions of, say, temperature, pressure, or flow, and send signals to appropriate actuators back in the plant to correct these conditions. The plant operators have had lots of "seat-of-the-pants" experience and know

what demands and limits should be set on each loop to achieve the desired end-product from the plant.

The trouble comes when the specifications of the end-product are changed—a different grade of gasoline, another type of paper. It also comes when the plant is started and each loop must be brought up to a steady-state condition; the loops have different reaction times, and their interactions differ under various conditions. The fact is that too little is known even about the static conditions of a process when the variables are all being held to their desired set-points. Even less is known about what happens to all the variables under changing conditions.

Conventional single-variable control systems are actually a collection of compatible components adjusted for each variable by trial and error, rather than integrated systems that exercise unified control over all variables at once. Thus far, in the vast majority of cases, integrated control systems are used by the process industries only when processes are uncontrollable or unsafe under conventional control. Seldom have they been used simply to improve product quality, throughput, or cost of operation.

### **Advanced automatic techniques**

It is significant to note that literally hundreds of thousands of military and aerospace control systems have been built since the early 1940's using mathematical techniques for quantitative design and analysis of feedback control systems. Some of the mathematical disciplines for the solution of modern control problems are: vector analysis, numerical analysis, advanced algebra, differential and integral equations (linear and nonlinear), Laplace transform and Fourier analysis, complex variables, probability and statistics, information theory, and operations research.

Mathematical techniques are used to describe basic components, the interaction of components, and detailed operating characteristics of the process, as well as in the design and analysis of the control system itself. More important, the use of advanced mathematics permits the "optimization" of the control system strategy and hardware. As used in control theory, optimization is a relative term implying the "best possible" within real-world constraints and indeterminates.

We will not go into details of the classical methods of control systems analysis here, but merely note that these methods provide for quantitative synthesis and analysis of linear systems where the steady-state and transient behavior often serve as the design criteria. Almost without exception, military and aerospace systems have employed continuous (full time), dynamic (transient as well as steady-state) analog control of the process or weapon system. In analog control systems we usually

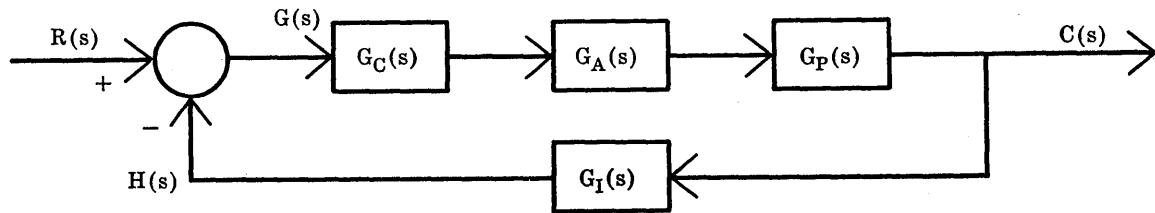
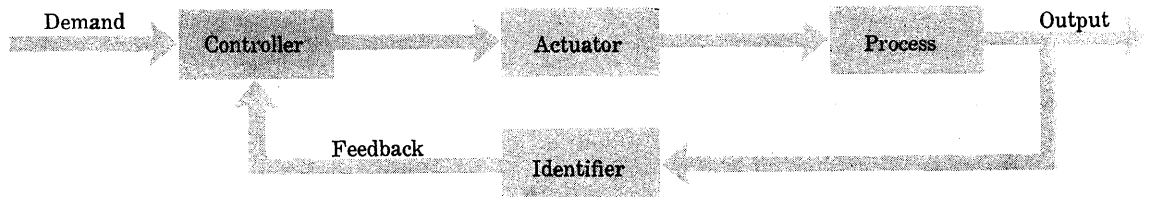

$$\frac{C}{R}(s) = \frac{G_C(s) G_A(s) G_P(s)}{1 + G_I(s) G_C(s) G_A(s) G_P(s)}$$

$$s = \sigma + j\omega$$

*Control systems that are essentially linear can be represented by transfer functions of each sensor, actuator, and controller. Desired ratio of over-all system output to its input is achieved by adjusting transfer function of controller.*

control an easily measurable and transmittable quantity—such as voltage, current or pressure—which is proportional to (or an analog of) the desired control variable. The variable is generally a physical quantity such as position, temperature, velocity, heading, etc.

In the last few years, a number of expressions have been coined to designate systems derived from even more advanced concepts. More common descriptors are “optimum,” “optimizing,” “adaptive,” “self-adaptive,” “self-adjusting,” “learning,” “self-organizing,” and “self-improving.” (See *LEARNING MACHINES*, Nov. 1962, p. 20.) Frequently, identical terms are used to designate different systems.

The type of advanced system that is getting the most attention today is supervisory or optimizing control. To understand how this works, you should recall that conventional controllers have certain demands set into them and operate to close the difference between real and desired values. These demands are based on experienced predictions of what the setpoints should be to achieve a desired result.

With supervisory control, the predicted setpoints of a number of controllers are automatically produced by a computer, based on a mathematical model of the process that should produce the ideal product. In the steel strip mill shown on pages 34-35, the operator tells a supervisory computer that a specific type of steel, so thick, must emerge from the rolling line at a given speed. The computer also gets information from sensors that measure temperature, thickness, and width of the slab to be rolled. From the specifications of the finished product and the information about the slab, the computer sets the initial demands—a model of control system conditions—into the multivariable controller that will maintain screwdown of the rollers, gage control, and

individual stand speeds.

When the first slab emerges from the end of the line as steel strip, the computer compares its finished specifications with the specifications for the ideal product. On the basis of calculated deviations from the ideal, the computer improves its model of the process.

#### **Electronic supervisors**

Computers are interwoven with the technology of modern control. They are used to analyze control systems, to design them, and to operate as part of them.

The multipurpose analog computer, an equation-solving device, can be used as a multivariable controller operating simultaneously on each process variable. Each computer component performs a single mathematical function such as addition, integration, multiplication, etc. A program for solving a simple differential equation is shown on page 32.

You'll find analog computers used as multivariable controllers for stable and optimized control of distillation columns or nuclear reactors. They are most easily and inexpensively applied to those processes which can be described by linear mathematical equations, though you also can get modular computing elements with nonlinear capabilities.

Computing time in an analog machine is independent of the number of control variables involved, but complex mathematical control functions require more computing equipment. Solution of partial differential equations or discrete iterative selection processes often proves so complicated that the number of computing components becomes prohibitively large for analog equipment.

When only a few variables are to be controlled, the analog computer (multivariable controller) is eminently suitable, usually cost-

ing about \$1000 per variable. Only when you get near 100 variables does a digital computer enter more serious economic consideration.

The modern process control digital computer is neither a glorified version of a business machine nor a scaled-down version of a scientific computer. It has been designed specifically for process control and more than 175 have been installed in the US alone—but few are actually being used to control a process. Most of the digital computers presently in operation are used for process monitoring, alarming, computing, and logging. While the analog computer shines in dynamic simulation and control, the digital computer excels in modeling, data reduction, scanning and comparing, accurate computing, and general data processing.

The “one sample at a time” operating mode of presently available digital computers is incompatible with the continuous and multivariable characteristic of the modern process. In practice, this basic incompatibility is often focused at the interface between computer and conventional analog measurement and control components. This interface is bridged by analog-to-digital converters and digital-to-analog converters which tend to be expensive and of lower accuracy than the computer.

As presently used in process control, the digital computer operates sequentially on each process variable. For this reason, computing time is dependent upon the number of variables and computer operations required.

If memory and input-output capacity are not fully committed, additional control functions can be incorporated without the addition of more computer equipment. Unfortunately, most computer purchasers underestimate equipment requirements.

Theoretically, the digital computer should be very valuable in supervising process startups and shutdowns, and it should ultimately see considerable use in industrial plants (such as steam-generating stations) for this purpose. Because of the great number of manual operations presently required in starting up complex processing, these plants will have to be redesigned for computer control before a digital computer can be employed effectively.

Digital control computers are designed to be more reliable than business or scientific machines. But few data have been published on control computer mean time between failures. About 40 days of failure-free operation are being realized now and at least one computer has operated on-line without failure for more than 240 days. It is standard practice to operate these computers with little or no preventive maintenance. Most control computers are self-checking and fail-safe; in the event of a failure, they usually turn control back to the conventional controllers.

Prices for digital control computers range upward from \$100,000. Today, typical installed cost is about \$300,000, but special control re-

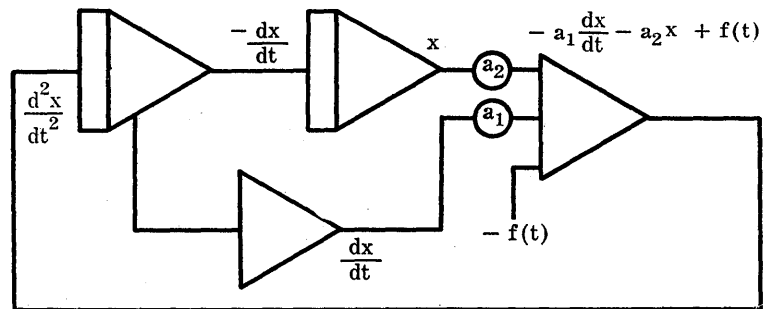
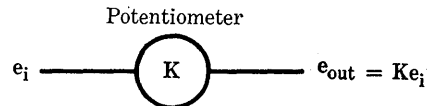
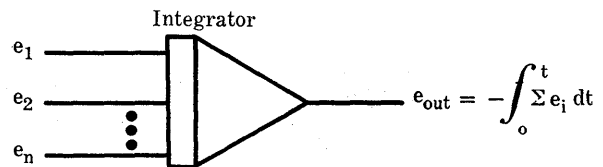
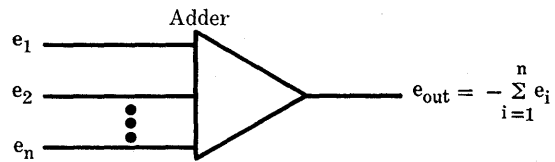

$$\frac{d^2x}{dt^2} = -a_1 \frac{dx}{dt} - a_2 x + f(t)$$

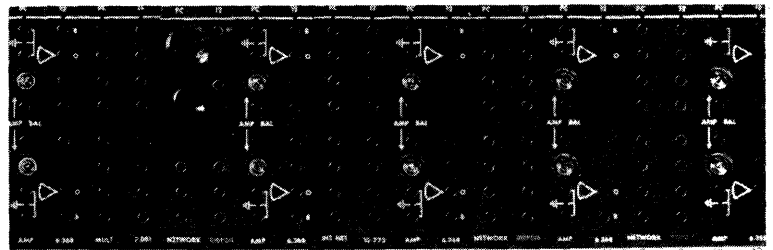

Analog computing components in diagram perform single mathematical functions, can be connected via patch panel below to solve equations.

quirements can easily double this. Furthermore, since a considerable amount of application engineering is required to implement a digital computer process control program, an equal investment for technical manpower also may be required. Normally, the equipment purchaser and supplier share these costs.

### Control systems engineering

It is common practice today to design and construct a modern process plant to satisfy an economic performance objective. After the plant has been built, months and even years are spent in manually adjusting the system to achieve better performance—usually increased throughput at some required quality level.

A more modern approach to process and con-

trol system design might enable this plant to be brought on line within a shorter time period, to operate with significantly greater economic benefit than otherwise is possible, and to undergo major improvement during its lifetime. Modern process and control system design focuses on the uniqueness of the process, while conventional design focuses on the capability of already available controls, instrumentation, and other process equipment. Though the conventional controller has been applied to a great number of processes, the modern multivariable control system cannot be readily applied to any process other than the one for which it was synthesized.

So broad is the scope of modern control systems engineering that no single individual can be sufficiently competent in all the technical and economic areas involved. The solution of a control system problem may involve process specialists, control and instrumentation engineers, economists, and applied mathematicians. Modern process control is truly multi-disciplinary with no one technical specialty being of overwhelming importance. Program direction is often assumed by the technical specialist who has the major problem; generally, it is better to assign program responsibility to an individual who grasps the fundamentals of each of the technologies involved.

Effectively applied, the technology of control systems requires considerable thought and analysis about process control objectives and designs before production hardware is procured. In fact, this is the reason technological manpower costs may exceed hardware costs.

If one starts from process definition, a manpower to equipment cost ratio of more than two to one is usually anticipated. A distillation column controlled by a multivariable controller (analog computer) may incorporate \$20,000 in instrumentation and controls, but may involve \$40,000 in technical manpower to design and apply it. Such a system has raised the return on investment for one petroleum company by 50% over previous designs.

#### **Stumbling blocks to modern control**

What, then, are the stumbling blocks which limit what can be accomplished by processors today and which determine the time constant of their advance to more modern control?

Although many of our industrial processes have been with us for years, the dynamic characteristics of the majority of them are still relatively undefined. Oddly enough, we know considerably more about the complicated dynamics of missiles and rocket engines and nuclear power plants.

Within the past several years, a handful of processors have formed sizable analysis groups to improve the control of existing processes and assist in the design of new ones. Several such groups move around a company examining the various processes and upgrad-

ing the control systems. Some groups use a mobile digital computer for on-line process analysis and data reduction. These specialists must have a familiarity with the processes, with the instrumentation used to analyze them, and with mathematical techniques of process analysis and modeling. They must be able to choose parameters based on these process models which will provide stable and accurate control. In the application phase, they must be familiar with modern techniques of control engineering and with all available types of hardware. Because the process industries have been slow to realize the importance of such analytical work, the type of specialists required are rare in industry today, and will continue to be until control systems engineering becomes a recognized discipline taught in the universities.

Throughout the process industries the most critical equipment need is for better sensors to provide both primary and secondary measurements. Primary measurements are those used for direct dynamic control of the process; secondary measurements are those used for monitoring, evaluation, safety, etc. To provide adequate dynamic control, primary measurements such as temperature, pressure, level, and flow must possess good accuracy, high stability, reasonably fast response, and extremely high reliability. Secondary measurements such as stream composition analysis (often with gas chromatographs), stack gas analysis, process efficiency measurements, etc., do not require the same order of reliability and speed of response as primary measurements but they do require high accuracy and stability.

The lack of accurate and reliable sensors is limiting our ability to control many of our present processes, and retards making such major improvements in the processes themselves as going from batch to continuous operation. This is particularly true where unusual fluids are being processed. For example, it is difficult to measure accurately the temperature of molten steel, the consistency of pulp for paper, the properties of processed food slurries, such as sugar or salt, or the yeast level during beer processing.

Many of these measurements presently have to be made in the laboratory because of the lack of sensors which can make such measurements "on-line" during the actual process. This frequently necessitates a batch operation to allow time for such measurements and to permit operator supervision of each batch. Continuous processes requiring accurate, on-line instrumentation, save money for the processor because they eliminate costly storage tanks and increase throughput.

In addition to not having sensors available to measure many process characteristics, those which we do have are often inadequate in terms of accuracy, speed of response, stability, and maintainability. Despite the recent in-



# A TOUR AROUND THE CONTROL LOOP OF THE WORLD'S MOST AUTOMATED STEEL PLANT...

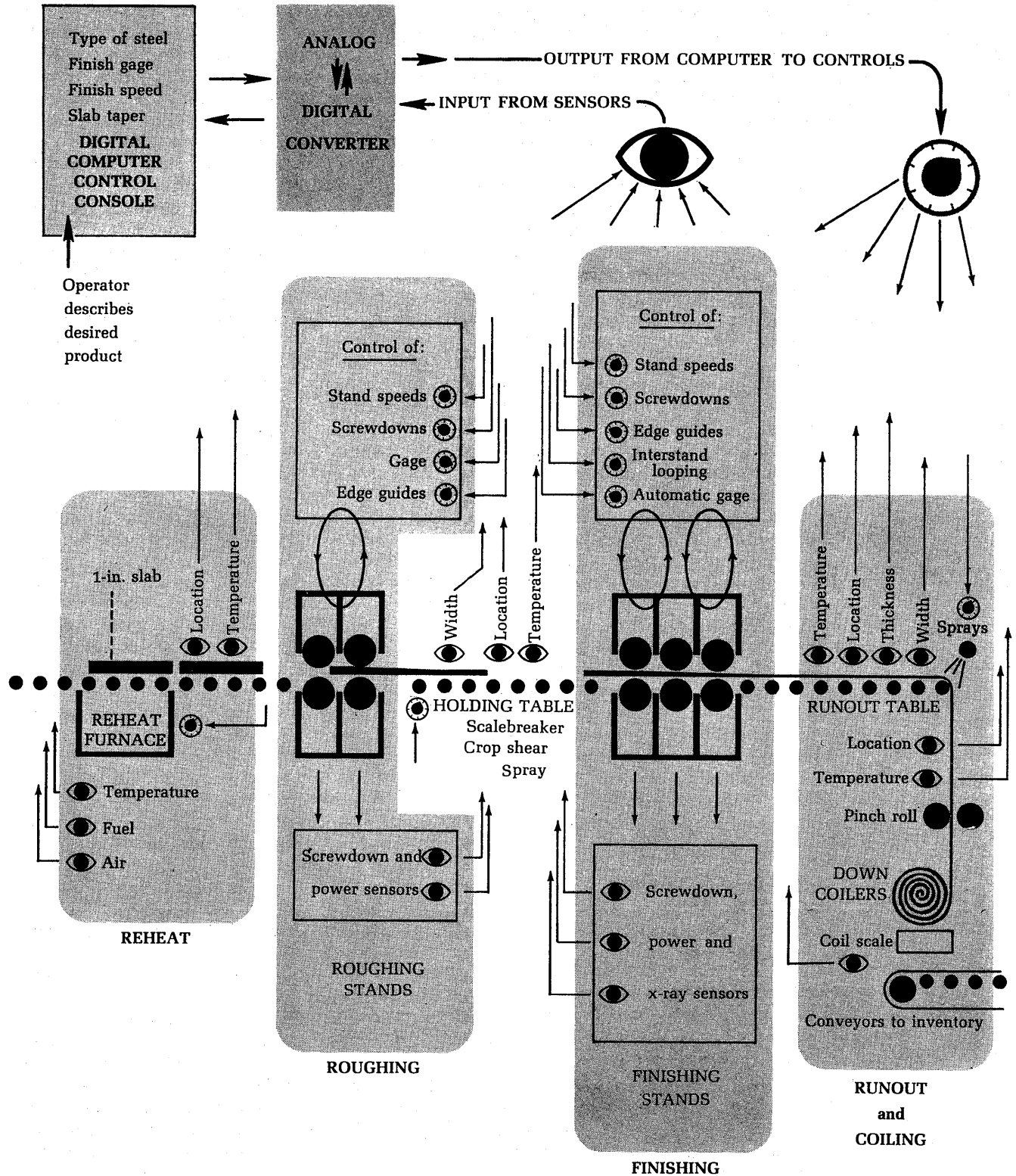

This month, new Spencer Works of Richard Thomas & Baldwin, Wales, England starts rolling steel under supervisory control of GE digital computer. Entire process was first simulated on an analog and digital computer in a US control engineering laboratory. Supervisory computer tracks each slab from time it enters reheat furnace. It has been programmed with customer specifications for desired product: grade of steel,

thickness, temperature as it is finished and coiled. Comparing these with mathematical model of process, the computer calculates how equipment in entire hot strip line must react at each stage of process and keeps changing set-points of multivariable analog control system. Steel mill near Detroit has been under similar computer control for 3 years, though total supervisory loop is shorter, doesn't include reheat furnace.

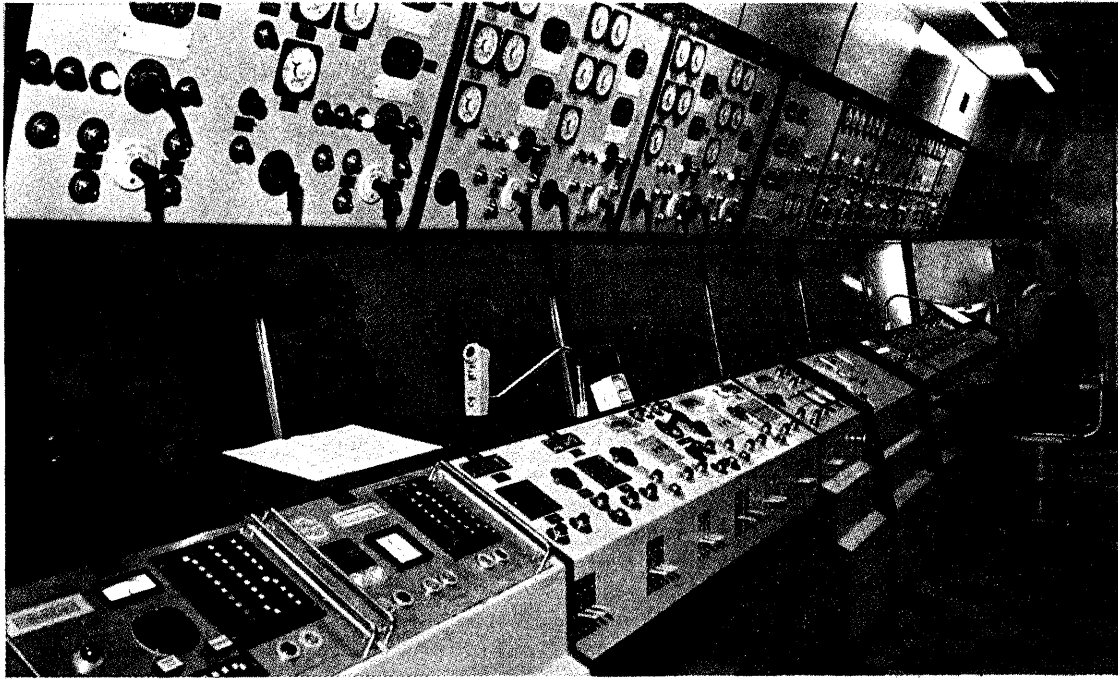

*Control pulpit of Welsh hot-strip steel mill overlooks rolling line longer than nine football fields. Digital computer (right) is located in another building where it predicts initial setpoints for multivariable analog controller, monitors data from sensors and recalculates new regulator setpoints as steel is rolled. In more simple, though still automatic, mode of control an operator in control room above would assign setpoints to multivariable controller. Under completely manual control, an operator would be assigned to each roughing or finishing stand along the process line.*

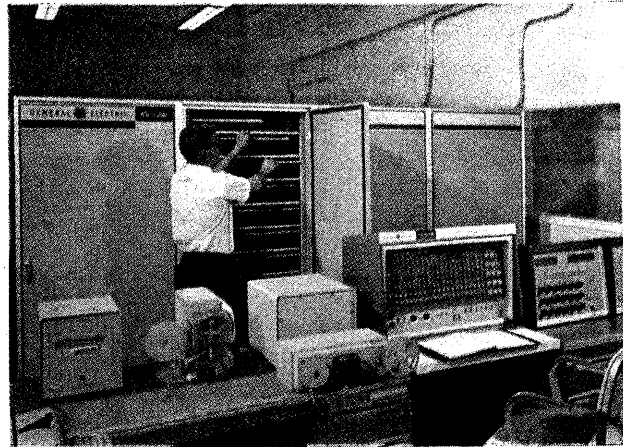

terest in electronic instruments, most of the instrumentation in the process industries today is pneumatic. Pressure is usually measured by conventional diaphragm or bellows-type transmitters. High accuracy, high-response strain-gage transducers, for example, have not yet come into common use for pressure measurement.

Temperature is still measured with bulb-type thermometers or large thermocouples insulated from the process in thermowells rather than by accurate and fast miniature thermocouples or resistance thermometers. These slow and often inaccurate sensors penalize industrial control systems, make even the most modern electronic controls less effective.

In considering the sheer variety of instruments required by the process industries and the severe environments in which they must work, it is not surprising that instrument companies find it economically infeasible to attempt to meet all the industry's needs. It would involve development of many special-

purpose instruments. The development costs are high and the market is usually narrow. So, the processor is forced to do without the needed instruments or develop them himself. The largest processors can maintain a staff of qualified instrument engineers, but, this certainly is not feasible for the typical company.

Many of the sorely needed sensors are presently available from our aerospace programs. But most of these have yet to be engineered to meet the daily punishment of severe environmental conditions in process plants. High cost and lack of assurance about long-term reliability have discouraged any great demand for them by the process industries.

Rather than pursue the limited market for special-purpose sensors, numerous manufacturers are producing and marketing sophisticated control systems including analog and digital control computers, employing, wherever possible, multipurpose equipment which can be used in many applications. There simply is not enough activity toward the de-

velopment of a measurement technology which provides for more quantitative design of the needed instruments and which makes better use of the considerable aerospace research and development. Until more processors recognize that there is a critical need in this area and are willing to invest their time and money accordingly, the performance of available control systems will be limited by capabilities of its measurement equipment.

### **Computer-process interface problems**

It is important to recognize that the marriage of the control computer to the industrial process is still an experiment. Rarely is a computer applied as a result of adequate systems engineering by the processors and their engineering firms. Usually it is superimposed on the process almost as an expensive afterthought rather than integrated into the process control system in the design and checkout phase. Often this results in the superposition of a sophisticated control computer on a Model-T control system.

A number of processors have already invested millions of dollars over 3 or 4 calendar years (in some cases more than 50 man-years of engineering time) in attempting to put a digital computer in control of a process. (The first computer-controlled hot strip mill took 18 months to shakedown.) When they have only limited success, the computer ends up as a fancy data logger and performance monitor. On the other hand, less sophisticated analog computers for on-line control of petroleum and chemical processes have been successfully put to work in less than 6 months, paying out their total investment in periods as short as two months out of savings in the cost of processing or from improvements in product quality.

What are the problems which complicate computer control? Can a processor determine in advance whether or not he should attempt computer control?

Initially, a major problem was the unreliability of the digital computer itself, which had a very low "meantime between failures." This has since been corrected by using all solid-state and magnetic components.

But marrying a digital computer to an analog process involves the mating of equipment that is somewhat incompatible. The digital computers currently in use are serial machines which operate on only one variable at a time; each variable must be in some digital form. Hence, digital computers need high-speed conversion equipment for both the input and output of process information. To keep track of what all the variables of the process are doing (as many as 2400 are monitored in some processes) the computer must sample these quantities at very high rates, rapidly operating on the information to determine required settings or to take necessary corrective actions. But process sensors produce a variety of low-level

inputs; sampling them at high rates and with a satisfactory signal-to-noise ratio has been a major problem in many applications.

Possibly the knottiest problems arise in the search for a completely new approach to process control. Before computers (B.C.) the processor solved most of his control problems by finding the proper instrumentation and control equipment or, in many cases, by bringing in an equipment manufacturer who tuned what hardware he had to the process. The user did not rely on new techniques to solve his control problems.

With more sophisticated hardware like digital control computers, the equipment itself can introduce many more problems than it solves. The user must learn to program the machine (or at least to write computer flow diagrams). He must understand his process and its present control systems so he can describe them to the computer. Programming the computer to control a process which is not thoroughly understood and whose dynamic behavior may vary from one day to the next with change in ambient temperature, humidity, etc., is a problem which can require many man-months of expensive engineering time. Also the user must design circuits which convert his present instrumentation signals to levels compatible with the computer, taking care to assure proper isolation between the two. In short, the user must learn to use systems engineering techniques in all phases of the computer implementation program.

But some users seem to feel it is advantageous to have the engineering firm or the equipment manufacturer marry the computer to his process; many a control computer sale has depended on providing this service free or at nominal cost. As with most everything else, the purchaser gets just what he pays for when buying control computers. Those who have obtained "free" software such as process control system studies, computer programming service, and application engineering service, very often end up with expensive control computer installations which cannot be economically or technically justified. In many cases, those same processors would have gained more if they had invested in training their engineering staff in more modern control techniques or in securing the services of special consultants.

No general, well-defined method of specifying a digital computer for process control has yet been derived. We think a possible approach might be to solicit equipment bids on the basis of a functional block diagram (an expanded computer flow chart) with information concerning required reliability, environmental resistivity, service guarantee, delivery dates, etc., included in the normal manner. This technique would force the purchaser (the processor) to think through his requirements in functional detail before committing him-

## INSTRUMENTATION AND CONTROL COSTS

	Basic Equipment +	Required Application Engineering
Conventional controls (per loop)	\$750-\$1250	\$450-\$1250
Stream analyzer or other special sensor	\$1000-\$65,000	\$2400-\$160,000
Integrated control (per loop, no digital computer)	\$1200-\$1500	\$2000-\$3000
Added costs for digital computer control	\$175,000-\$1,100,000	\$200,000-\$1,100,000

*Control components for advanced control systems need to be integrated by applications engineering more expensive than the hardware itself.*

self to a specific computer system. The computer manufacturer could more clearly determine what type of computers are needed and would no longer be forced to play the role of process engineer or even control systems engineer. The computer purchaser could easily protect his proprietary interests through use of functional flow chart specifications. The use of symbolic language could even prevent the computer supplier from knowing what the pertinent plant produces.

### **A crystal ball on control**

We think the immediate future of process control will parallel the immediate past. We foresee new techniques and new hardware emerging in an evolutionary way. There's too much inertia to be overcome for us to believe the heralds of a revolution in control.

We doubt that mathematical techniques of control system design and analysis will be generally accepted and used in the process industries until the 1970's. But managements of the more progressive processors will support experimentation with modern control techniques—especially control computers.

As attempts are made to improve process control, the system imbalance between sensors and actuators and the controllers will become increasingly obvious. High performance sensors and actuators will be adopted, even though they will cost more.

We believe that a major shift of electronic instrumentation will take place, spurred by the requirements for faster control system responses and compatibility with computers. As these advanced equipments become available, the analog computer, the advanced continuous sensor, and the high-performance control actuator will be engineered as a system to accomplish high stability of operation over a wide band of operating conditions. These integrated control systems will be highly reliable and will be self-checking.

The digital computer will be used for the supervision of the process primarily through the analog computer control system. This supervision will incorporate adaptive features and will intermittently test the process to determine a better operating point for greater

economic return. Product analyzers will probably feed directly to the digital computer while most other process feedback will be obtained from the analog control system. The computer will also collect and compile production and accounting data but will *not*, for many years to come, be supervised by a master computer at the corporate offices.

Plant operators and technicians will be closely coupled to the analog system while management will be concerned primarily with the digital computer, for it is here that profit and loss will be balanced. For plant managers this may involve some change in present thinking, for the digital computer will be used increasingly to optimize *profit* per day, not throughput per day.

This evolution in process control will be accompanied by other advances. Process plants will cost less to build because they will be designed for high reaction and flow rates with less intermediate storage capability and less intrinsic safety margin. The new hot-strip mills and high-capacity steam plants are indicators of what is to come. Typically, throughput is up 500% in the last ten years.

To reduce engineering costs and, in some instances, permit automatic, unattended operation, many processes will become "packaged." This is already happening in gas and sewage processing. Plant startup time and the time needed for first-level optimization will be much less than today. Many chemical plants today are started up within nine months of contract award. More operating manpower will be required (engineers and technicians) but fewer accountants and men to schedule production will be needed. Operators will be trained on simulators.

As all of this comes about, the process industries will cease to lag the technical state of the control art. Indeed, to gain greater increases in productivity, they will start pushing the state of the art in many other areas—metallurgy, reaction chemistry, and structural design.

*If you want to process more information about control systems, you'll find direct pipelines to additional data in the references on page 99.*

