

PB 135 384
AD 133 786

AFCRC-TR-57-367
ASTIA Document No. AD 133786

RECEIVED

~~File No.~~
38 File No.

Copy

Final Report Under
Contract No. AF 19 (604)-2041

"Development of an Acoustic
Delay Line for Digital
Storage"

The Research Reported in this
document has been sponsored by
the Air Force Cambridge Research
Center, Air Research and Develop-
ment Command

FERRANTI ELECTRIC, INC.

30 ROCKFELLER PLAZA

NEW YORK 20, N.Y.

Rec'd NOV 13 - 1962

TABLE OF CONTENTS

	SUBJECT	PAGE NUMBER
1	LIST OF SYMBOLS	1
2	ABSTRACT	3
3	INTRODUCTION	4
4	BASIC MAGNETOSTRICTIVE DELAY LINE	8
5	MAGNETOSTRICTION	9
6	TRANSDUCER DESIGN	11
7	PROPAGATION OF ACOUSTIC WAVES	17
8	CHOICE OF MATERIALS	20
8.1	TEMPERATURE COEFFICIENT OF DELAY	22
8.2	ATTENUATION	26
8.3	LINE SUPPORT MATERIAL	28
8.4	ACOUSTIC TERMINATION	29
9	MODE CONVERTING JUNCTION	30
10	PRACTICAL DESIGN	33
11	TESTING	34
12	CONCLUSION	35
13	APPENDIX: a) Figures 1 through 25 b) References c) Distribution List	

LIST OF SYMBOLS

- A = Cross Sectional Area of Tape: cm^2
- B = Flux Density: Gauss
- c_L = Longitudinal Phase Velocity of Sound in a Straight Wire: cm/sec .
- c_T = Torsional Phase Velocity of Sound in a Straight Wire: cm/sec
- E = Youngs Modulus of Elasticity: Dynes/cm^2
- f = Frequency Cycles/Second
- F = Force: Dynes
- H = Magnetic Field: Oersteds
- \dot{I} = Moment of Inertia per unit length: g-cm
- k = Radius of Gyration: cm
- k_c = Electro Mechanical Coupling Factor
- M = Bending Moment: Dyne-cm
- m = Mass per unit length: g/cm
- N = Number of Digits in a Store
- n = Number of Tapes on a Longitudinal-Torsional Mode Transformer
- R = Radius of Curvature of Wire: cm
- r = Radius of Wire: cm
- S = Cross Sectional Area: cm^2
- T = Temperature: Degrees Centigrade
- t = Time: Seconds
- τ = Time Delay : Seconds
- v_L = Phase Velocity of Longitudinal Stress Waves: cm/sec .
- v_T = Phase Velocity of Torsional Stress Waves: cm/sec .
- l = Length : cm
- Z = Impedance : cgs Units
- λ = Wavelength cm

- i = Current : Amperes
- Λ = Magnetostriction Stress Constant : Dynes/Gauss cm^2
- μ_i = Incremental Permeability
- μ_0 = Permeability of Free Space : Gauss/Oersted
- ρ = Density : g/cm^3
- ρ_R = Reflection Factor
- σ = Poisson's Ratio

2. ABSTRACT

This report describes investigations into an ultrasonic delay line using magnetostriction drivers, with the following results:

- a) Experimentation with materials and heat treating has shown the possibility of achieving temperature coefficients of delay of approximately ± 1 part per million per degree centigrade.
- b) Design criteria are discussed for
 1. Transducer
 2. Reduction of dispersion
 3. Line length
 4. Mode converting junction
- c) Quantitative figures are given for attenuation and dispersion.
- d) Practical construction techniques have been worked out for a finished line.
- e) The torsional mode has been shown practical for delays of 5 ms., at a storage capacity of 2500 bits.
- f) Lines capable of operating at 1 megacycle bit rate and 500 microsecond delay have been achieved.
- g) Techniques of measurement are described.
- h) A recirculating store has been designed and fabricated to demonstrate the operation of a delay line at a digit rate of 500 kc./sec.

3. INTRODUCTION

A system suitable for the storage of digital information can be made with any delay element which has a delay time equal to the length of pattern to be stored and which is sufficiently non-dispersive. Thus a pulse written into it at any one digit time must be distinguished unambiguously at the output, without interference from pulses written in at other times. A recirculating circuit can then standardise and retime the output pulses so that they can be written back at the input and thus stored indefinitely without loss.

In order to avoid expensive installations, it is desirable that the delay element be unaffected by environmental conditions such as temperature variation, vibration and stray magnetic fields. In addition it is essential that the delay element be cheap, of reasonable size and readily fabricated. The overall loss in the device should be low, and input and output impedances should be compatible with existing circuit techniques.

Ultrasonic delay lines have been in use as a digital storage element for some considerable time. In all cases the delay is achieved by utilizing the relatively low velocity of propagation of acoustic waves in a solid or liquid medium. The three most widely used media are:

- (1) Mercury
- (2) Quartz
- (3) Wire or tape

Mercury delay lines are cumbersome and suffer from a large temperature coefficient of delay (300×10^{-6} per degree C.)

Quartz lines are smaller than those using mercury, but precision grinding is necessary in their manufacture and they also suffer from a large temperature coefficient of delay (75×10^{-6} per degree C.)

Wire type delay lines offer several distinct advantages over the mercury and quartz types. They are more flexible with respect to packaging, are light

in weight, robust and cheap. In addition, by suitable choice of materials an extremely low temperature coefficient of delay may be realised, thereby eliminating the need for temperature control of the environment in which they are used.

This investigation has been restricted to the use of wire as the delay medium.

In addition to the delay medium, it is necessary to provide some method of converting from electrical to mechanical energy at the input in order to launch the acoustic waves in the delay medium, and at the output the acoustic waves must be reconverted to electrical energy. The two well known methods of making such a transducer depend upon either the piezo-electric phenomenon or the magnetostrictive phenomenon.

The piezo-electric effect relates to the fact that stress is suffered by certain types of crystal when subjected to an applied voltage. This type of transducer is difficult to manufacture because of the problem of attaching the small crystal to the delay medium. Large voltage signals are required at the input making them unsuitable for use with transistor circuitry. To offset this however, it is possible for a piezo-electric transducer to handle digit rates as high as 5 megacycles/sec.

The magnetostrictive effect refers to the change in linear dimensions of a material when subjected to a magnetic field. Magnetostrictive transducers are more flexible in design, easier to assemble and are much more rugged than the piezo-electric type. The upper limit of digit rate for these transducers is around 2 megacycles/sec. It is not necessary to use magnetostrictive material for the delay medium and thus each material can be chosen independently for optimum characteristics. The complete delay line is then formed by welding the line material to the magnetostrictive material.

Only magnetostrictive type transducers will be considered in this report, and these will launch and detect longitudinal stress waves in the material under the transducer.

The energy in the delay medium can be propagated as longitudinal, shear, or torsional waves. When longitudinal waves are used, the transverse dimensions of the delay material must be small compared to the wavelength in order to avoid dispersion due to intermode coupling from Poisson contraction effects. This necessitates the use of fine wire, which presents considerable handling difficulties.

When torsional waves are used there is no spurious coupling and no dispersion occurs in a medium of circular cross section for any diameter. It is difficult however, to launch and detect torsional waves at a diameter greater than the wavelength, and it is this that determines the maximum diameter for the delay material.

The rate of propagation of torsional waves is appreciably slower than for longitudinal waves in the same material. This results in a shorter length of wire for a given delay time when using torsional waves.

In order to accommodate a delay greater than about 100 microseconds in a practical size of package it is necessary to coil the delay material. The resulting curvature introduces phase dispersion for both longitudinal and torsional modes of propagation. In the case of longitudinal waves there is no method for avoiding this dispersion, whereas for torsional propagation the dispersion can be virtually eliminated by using material which is naturally straight.

These points clearly indicate that the torsional mode of propagation in the delay medium confers several advantages over other modes, and it has been adopted in this investigation.

It will be remembered however that the transducers launch longitudinal pulses in the magnetostrictive material. Thus some means of converting from longitudinal to torsional stress waves and vice versa is required. A simple yet efficient mode converter has been developed for this purpose.

Reflections from the ends of the delay line have been minimized by the choice of suitable termination materials and methods. In addition, the effects of line support material on pulse distortion has been investigated.

A more detailed treatment follows, as to the various phenomena investigated and their interrelationship in producing a practical digital storage element.

4. BASIC MAGNETOSTRICTIVE DELAY LINE (2)

The simplest form of a magnetostrictive line (Fig. 1a) consists of a piece of wire, made of a material exhibiting the magnetostrictive effect, threaded into 2 small coils spaced a distance l , (equivalent to a delay τ) apart. An external biasing magnet is provided for each transducer, supplying flux parallel to the longitudinal axis of the wire.

Application of a current pulse to one of these coils (the "drive" coil) results in the propagation of two equal longitudinal stress pulses travelling in opposite directions. One of these pulses travels down the line in the direction of the second or "receive" coil. The other pulse is absorbed by a soft rubbery termination. The traveling stress pulse moves with the velocity of sound in the solid and is detected upon passing under the second coil by means of the inverse magnetostrictive effect. A second termination prevents reflections from the other end of the line.

Further analysis has shown the desirability of making lines using the torsional mode (Fig. 1b). This involves generating the pulses longitudinally, letting them travel through tapes to a mode converting junction. Then (upon conversion to the torsional mode) torsional vibrations are permitted to travel along the wire line till they reach a second mode converting junction. From this point, upon being transformed back into longitudinal stress waves operation is similar to the receive portion of the line previously described. Actual torsional lines are packaged with the wire material formed into a spiral. The delay is given by:

$$\tau = (l_1 + l_2)/v_L + l_3/v_T \quad (4.1)$$

where l_1 & l_2 are the lengths of the metal tapes associated with the drive and receive transducers, v_L is the velocity of propagation in the longitudinal mode, l_3 is the length of the wire material and v_T is the velocity of propagation in the torsional mode.

5. MAGNETOSTRICTION (4)

The magnetostrictive effect occurs in ferromagnetic materials such as iron, nickel, cobalt and certain alloys. A magnetic field applied parallel to the axis of a rod of such material causes a change in its length. If a field $H = \frac{\pi}{2.5} iN/l$ Oersted is generated by a coil of length l and turns N , the flux density B within a piece of the line material inserted into the coil will be

$$B = \frac{\pi}{2.5} \mu iN/l \text{ Gauss}$$

The value of μ is a function of the core material, its treatment, the magnetic field and the temperature.

A strain $\delta l/l$ will be induced by the field H . A plot of the strain versus field strength and flux density is shown for Nickel and Permalloy in Figure 2a and 2b.

It is known that the sign of the strain is independent of the direction of the applied field. This would indicate that the strain is an even function of the magnetic field. Experiment has shown that the following relationship holds within the range of operation: $\delta l/l = cB_0^2$ (5.1)

where B_0 is the polarizing flux density and c is a material constant.

Differentiating the strain with respect to the flux density B_0 gives:

$$d(\delta l/l) = 2cB_0 dB \quad (5.2)$$

If we consider the incremental stress as a function of the incremental flux density dB_0 , for a clamped rod (assuming Hooke's law)

$$d(F/A) = 2cB_0 E dB_0 \quad (5.3)$$

Where $2cB_0 E = \Lambda$ the magnetostriction stress constant in dynes/gauss cm^2 .

Nickel contracts with increasing B , so its Λ is negative. Permalloy on the other hand, expands when magnetized, and therefore Λ is positive.

It can be shown that the induction of a polarizing flux in a magnetostrictive material lowers the value of Young's modulus:

$$E' = (1 - k_c^2) E \quad (5.4)$$

k_c is the electromechanical coupling factor:

$$k_c = 2cB_0 \sqrt{\mu_i \mu_o} E \quad (5.5)$$

The degree of coupling is thus dependent on the operating point on the magnetization curve of the core material. This point may be altered for given external conditions by annealing. In practice it is found that the nickel tapes used can be annealed to a satisfactory degree by heating the region to be placed under the transducer coils for approximately 30 seconds in air, at a temperature of about 700° C.

1292° F

6. TRANSDUCER DESIGN

Consider transmit and receive transducer coils of effective lengths l_1 and l_2 where l_1 is greater than or equal to l_2 .

Consider a current applied to the transmit transducer. The resulting current flow is shown in Fig. 3a. If the flux changes by a small amount $\delta \phi$ then by the magnetostrictive effect, a disturbance over the length l_1 results. Hence a stress wave of length l_1 is propagated. In time τ this will travel a distance $v\tau$ and if the flux continues to change for a similar time τ the resulting stress wave will be $l_1 + v\tau$. It is also apparent that the stress distribution is a function of $d\phi/dt$. The distribution of the stress along the line is shown in Fig. 3b. As the stress wave passes through the receive coil, the flux ϕ_2 produced by it, which is approximately proportional to stress, and integrated over the coil length is as shown in Fig. 3c.

The resulting output is proportional to $d\phi_2/dt$ and is shown in Fig. 3d. In practice l_2 is chosen such that an output, as shown in Fig. 3e is obtained. If a rectangular input current pulse of finite length is now applied to the transmit transducer then the resulting current flow is as shown in Fig. 3f and the output voltage as in Fig. 3g. By reducing the width of the input pulse, the two parts of the output can be combined. This is the output waveform usually required for digital storage. However a non return to zero type of pattern can be used and the output waveform which is shown in Fig. 3e utilized.

An improvement in efficiency, and a better utilisation of the available bandwidth may be achieved by combining consecutive "ones" as illustrated in Fig. 3i. The "resolution" or minimum digit spacing, which such a system will accommodate may be defined as the separation of the two positive lobes of the signal in Fig. 3i to ensure that two consecutive ones are combined without pattern sensitivity.

Consider the combinations of the positive and negative lobes in Fig. 3d by the choice of l_2 (as discussed in the previous section). For minimum separation of the two peaks in the resulting di-pulse, it is apparent that:

$$l_2' = l_2 (l_1/v + \tau) \quad (6.1)$$

This should equal $t/2$ where t = digit spacing

i.e. $l_2' (l_1/v + \tau) = t/2$

or $l_1/v + \tau = t$ (6.2)

and if $\tau = t/2$ (6.3)

$$l_1/v = t/2 \quad (6.4)$$

From 6.1 and 6.2

$$l_2' /v = t/2 \quad (6.5)$$

Also $\lambda = tv$

Therefore $l_1 = \lambda/2$ (6.6)

$$l_2' = \lambda/2 \quad (6.7)$$

Hence, each coil should be one half a wavelength long.

The length of the transmit transducer is defined from equation (6.4) $l_1/v = t/2$. The inductance of the receive transducer must be able to accommodate the minimum rise time associated with the output signal i.e. $t/2$. Hence, each transducer assembly can be similar. The object of the transmit transducer is to convert the induced magnetic energy into mechanical (acoustic) energy. Therefore good electromechanical coupling is desirable, (in practice efficiencies of 1% are achieved). A typical insertion loss for one transducer is 20 db.

Transducers have been made of varying l/d ratios, total number of turns etc. To ensure good coupling it is desirable that the coil must be wound as close as possible to the magnetostrictive material. The same argument can be applied to the receive transducer, only here the object is to convert the mechanical energy, which has been propagated, back into electrical energy. This demands that the magnetic flux links the whole winding and again a closely wound coil is desirable.

Once a satisfactory mechanical design of transducer has been achieved, it is possible to improve operation by tuning the electromechanical circuit by means of a capacitor shunted across the transducer coil. The value can be chosen to resonate with the coil at the frequency of operation. A shunt damping resistor may then be used, and chosen to provide critical damping.

Another cause of distortion is improper magnetic biasing of the tapes. For proper operation the stress pulses in each of the strips should be in exact anti-phase. This is accomplished, for small signal operation, by biasing to about 60% of saturation. Operation about this point produces stress pulses symmetrically about the biasing point thus permitting "push pull" operation of the tapes. In addition it is required that the transducer coils be the same time delay away from the junction. As the bit rate goes up the loss of resolution introduced by a given misalignment of the coils also goes up. Figures 4 & 24 illustrate the relationship of the coils to the line, and also show a typical transducer holder.

It is a well known fact that the physical length of a coil is not equal to its effective length. Some allowance must be made for the flux fringing at each end of the coil. This effect has been measured directly as follows. Two transducer coils, wound on Teflon tubing of outside diameter 0.047 inches, were threaded side by side onto a length of nickel strip. The coils could be moved together. One of the coils was connected to a 500 kc oscillator and the

voltage induced in the adjacent coil was measured. The amplitude of the induced voltage was taken as a measure of the end effects.

The effect measured was independent of coil length, but dependent on the inside and outside diameters of the coils. Fig. 5 shows a graph of induced voltage versus spacing for two coils of mean diameter 0.055 inches. It is apparent that at spacings of approximately the mean diameter, the induced voltage, and hence the fringing field is small compared to zero spacing. The conclusion is therefore, that the effective length of a coil is the physical length plus the sum of the two end effects (approximately a mean diameter). If we assume that the exact correction factor is constant, within some range of coil dimensions, we can write:

$$l_{\text{eff}} = l + KD' \quad (6.8)$$

where: D' = mean diameter
 K = correction factor
 l = actual length
 l_{eff} = effective length

We see therefore, that a reduction in coil length and mean diameter should improve the frequency response. It is also apparent that coils of various dimensions can produce the same frequency response.

It is evident from the above experiment that the measurement as performed, was dependent on the mutual inductance of the two coils used. If two coils with rectangular sections are spaced co-axially, then approximate values of mutual inductance are found as follows (6)

$$L_m = F' N^2 D'/2 \quad (6.9)$$

where N = number of turns on each coil
 D' = mean diameter of coil
 F' = correction factor

It has been found experimentally that the inductance of the coils changes by approximately 10% due to insertion of nickel tapes. For this reason the air core formula is used.

F^1 can be expressed approximately (for the region of operation) as an exponential function of the mean diameter and the distance between coils (r_2) as follows:

$$F^1 = 0.1e^{-4.6 r_2/r_1} \quad (6.10)$$

where $r_1^2 = r_2^2 + D^2$

when $r_2 \approx 0$ $L_m \approx 0.05N^2D^1$

when $r_2 \approx D/2$ $L_m \approx 0.05N^2D^{1-4.6 \times .45}$

from which it can be seen that the end effects can be conservatively approximated by assuming $D/2$ as the additional effective length per transducer coil end.

Consider a transducer 0.025 inches long and of I.D. = 0.047 inches, O.D. = 0.110 inches. This transducer injects a signal 1 microsecond in duration into nickel tapes. Using the criteria previously developed and assuming the velocity of propagation in nickel to be 5.28 microseconds per inch, the effective length desired in nickel is:

$$l_{\text{eff}} = 1/2 \times 1/5.28 \text{ inches/microsecond} \quad (6.11)$$

inserting above values into (6.8) gives

$$1/2(5.28) = .025 + K (0.047 + 0.110)/2$$

and $K = 0.95 \quad (6.12)$

It must be pointed out however, that the velocity of propagation used in the above computation is not exact, as annealing and magnetization affect the elastic modulus. Both tend to give a modulus that is lower than normal, therefore a lower velocity results. This means that the transducer would need a lower effective length in order to provide equivalent performance. In general these effects could cause a maximum change of 50% in the velocity of propagation.

In practice the change appears to be of the order of a few per cent.

As the transducer coils are made in a simple form, with no attempt to complete the magnetic circuit outside the wire, it is, of course natural to expect the end effects mentioned previously. In order to minimize this effect it is therefore desirable that the magnetic circuit of at least the transmitter coil should be completed by some material such as "Ferroxcube".

Fig. 7 shows a typical improvement in output wave shape when such "Ferroxcube III" cylindrical cheeks are used at each side of the transducer coils. (Sweep speed was one microsecond per division. Gain was adjusted to 20 millivolts per cm. Bandwidth of amplifier was 1.3 megacycles). The end effects may be altered further by varying the dimensions and the composition of the cheeks.

In addition to the distortion caused by end effects of the transducers, there is also the skin effect. If the skin depth in the wire material in the transducers is small compared with the thickness of the wire at the operating frequencies, the effective magnetisation in the wire lags 45° behind the applied field and is attenuated by an amount proportional to the square root of the frequency. Since a similar effect occurs at the receiver end also, the total effect is a 90° phase lag and attenuation proportional to frequency - an effect similar to that of an ordinary integration. This effect can be reduced by using flat tapes of reduced thickness. (In practice tapes are 0.005 inches thick and 0.020 inches wide). As annealing of the tapes increases the permeability of the material this effect is then worsened.

Fig. 8 shows the signal distortion caused by annealing of the tapes. Number 1 is of the untreated tape. Number 2 represents the effect of having the transmit tape annealed. Number 3 is of the receive annealed. Number 4 shows the result if both transmit and receive are annealed.

7. PROPAGATION OF ACOUSTIC WAVES (1) (5)

The velocity of propagation of longitudinal waves in straight wire is given by:

$$v_L = \sqrt{E/\rho} \quad (7.1)$$

The derivation of the equation ignores intermode coupling by means of Poisson contraction.

The velocity of propagation of torsional waves in straight wire is given by:

$$v_T = \sqrt{E_s/\rho} \quad (7.2)$$

where

$$E_s = E/2(1 + \sigma)$$

$$v_T/v_L = \sqrt{1/2(1 + \sigma)}$$

and since

$$\sigma \cong 0.3$$

$$v_T/v_L \cong 0.6 \quad (7.3)$$

Where the diameter of the wire is comparable to the sound wavelength, the phase velocity of longitudinal waves may be described by the following equation.

$$v_L \cong c_L (1 - 2\pi^2 \sigma^2 k^2 / \lambda^2) \quad (7.4)$$

Only by using thin wire can the phase distortion described by (7.4) be minimized. Since torsional strain in a circular wire is not accompanied by any other strain, a torsional pulse can be transmitted along a straight cylindrical bar without dispersion as long as the bar is perfectly elastic.

A typical wire material has a delay of approximately 5 microseconds per inch in the longitudinal mode and 9 microseconds per inch in the torsional mode. A 5 millisecond line would thus require 500 inches or approximately 40 feet of wire, if used torsionally and twice that if used longitudinally. In order to achieve large delays in a reasonable package it is found necessary to coil the wire into a spiral. If this is done another form of dispersion will be produced.

The phase velocity of longitudinal waves in a uniformly curved wire is given by

$$v_L = c_L (1 + \lambda^2 / 8\pi^2 R^2) \quad (7.5)$$

Dispersion due to this is serious in long delays and can be avoided only by increasing the radius of curvature.

The phase velocity of torsional waves for curved wire is given by:

$$v_T = c_T (1 + \lambda_T^2 (1 + \sigma) / 8\pi^2 R_n R) \quad (7.6)$$

Where R_n is the natural, and R the forced, radius of curvature.

In this case, making R_n large, (i.e. by using wire which is naturally straight, or which has been straightened after drawing,) will reduce phase distortion.

If R_n could be made infinite phase distortion would be zero regardless of R , the forced radius. R is chosen as the largest value compatible with good packaging and the smallest value compatible with the elastic properties of the wire.

Another form of dispersion is that due to parasitic transverse motion. When waves which are primarily longitudinal are propagated along a curved wire, they are accompanied by a parasitic transverse motion in the plane of curvature.

Similarly when torsional waves travel in a curved wire, the parasitic transverse motion is normal to the plane of curvature. The supports for the wire interfere

with this motion and produce dispersion. For a given input power the torsional mode shows less parasitic motion than the longitudinal mode.

In practice it is possible to approximate the conditions required for minimum phase distortion by straightening the wire after delivery from the manufacturer and prior to any heat treating that might be required. The Ni-Span C wire must be coiled into a maximum diameter of 40 inches to permit insertion into available furnaces. This places a practical upper limit on the natural radius of curvature of such wire, as heat treating produces a permanent set. For the case where the untreated wire will be used in a line R_n will of course be larger.

The principle in straightening wire is that the wire material be taken past its elastic limit in ever decreasing amplitudes. This is accomplished by passing the wire through a rotating, curved aluminum mandrel which introduces curvature into the wire, then introduces one opposite in direction, enabling the wire to be taken out co-linearly with the input.

Fig. 6 demonstrates the effect of permanently bending the wire. An extreme case is that of a one millisecond line permanently spiralled to a diameter of one inch. The picture demonstrates the dispersion produced when various frequencies arrive at different times, and with different amplitudes.

It has been shown however, that the wire may be constrained to a diameter of six inches and still provide satisfactory operation over a delay of one millisecond at a PRR of one megacycle.

8. CHOICE OF MATERIALS (3) (4) (5)

In general, the line material will introduce variables of the following nature.

- a) Variation in delay as a function of temperature for a given line configuration
- b) Variation in amplitude as a function of temperature
- c) Phase distortion introduced by visco elastic effects
- d) Variation in amplitude as a function of frequency
- e) Elastic limit of the material determines the radius of curvature to which one can form line without permanent deformation.

The following discussion on energy losses in solids is meant only as a general guide to thinking and experimentation, rather than as an explanation of specific phenomena.

Energy losses of a sound wave propagated through a solid may be attributed to several mechanisms:

- 1) Thermal effects
- 2) Relaxations
- 3) Scattering

The first mechanism is loss due to heat flow. This is caused by the alternate compressions or rarefactions caused by the sound wave traveling along the material. This effect is proportional to the square of the frequency. In addition to this is the loss due to intergrain heat flow. This is due to a thermoelastic relaxation loss arising as heat flow from grains that have received more compression or extension in the course of wave motion than do adjacent grains. This effect occurs below 100 kc.

Losses due to grain rotation occur because of the viscosity of the boundary layer between grains. This allows a relative rotation of grains, provided the relaxation time is comparable with the time of the applied force.

This relaxation time shows a shift as a function of temperature:

Losses due to scattering occur because of loss of energy from the main wave due to the scattering of sound when the sound wavelength is of the same order as the grain size. In the region of wavelength equal to 3 times grain size attenuation is proportional to grain size cubed, frequency to the fourth power and inversely proportional to the velocity to the fourth power. For shorter wavelengths the attenuation is less frequency dependent and for wavelengths less than the grain size the loss is independent of frequency.

It appears that most polycrystalline metals show a linear increase of overall attenuation versus frequency. In the ultrasonic range in general, damping is strongly increased by cold work and permanent strain, whereas, annealing produces a substantial reduction of the losses. Furthermore energy lost in the transmission of the ultrasonic wave depends on the degree of isotropy in the material.

The losses are particularly small in aluminum, magnesium and tungsten whose elastic constants differ only slightly in the different crystal directions. Lowest losses are encountered in single crystals and amorphous materials like fused quartz. The smaller the grain size of a polycrystalline material the higher the losses.

In ferromagnetic materials, acoustic losses can be shown to be related to the motion of walls or rotation of domains in metallic ferromagnetic materials which generate eddy currents. This effect has its peak at about one megacycle for polycrystalline nickel rod.

We know experimentally that attenuation in annealed nickel, used for the transmission tapes, is greater than in the untreated nickel.

results for longitudinal waves can be taken as a rough guide for expected results in torsional experiments. The Poisson ratio is generally a function of temperature, and therefore this must be known in addition to the temperature dependence of Young's modulus before one can predict the temperature coefficient of delay in the torsional mode. This discrepancy becomes of great importance when analyzing the region around 0 parts per million per degree centigrade.

The general procedure has been to make a torsional delay line of from 3 to 5 milliseconds delay, and measure the change in delay as a function of temperature from 0°C to 65°C.

Materials tested have fallen into 2 categories, either those whose modulus is a function of chemical composition, or those whose modulus is controllable by heat treating. An example of the first is "Isoelastic" manufactured by John Chattillon and Sons. An example of the second is "Ni-Span-C", manufactured by H. A. Wilson and Co. Work has centered around the Ni-Span-C, as it was found early in the experiments that the Isoelastic material attenuated the signal to an unsatisfactory extent.

Reference to Fig. 10 shows typical behaviour of the elastic modulus of an iron nickel alloy. The points at which the temperature coefficient of the modulus are zero are also points at which the coefficient changes rapidly with composition, and therefore cannot be used commercially, as the problem of alloy control to these tolerances is difficult. One way out of this problem is to utilize the region of 34% nickel content, at which point variation in composition will have the minimum effect on the temperature coefficient. In the Isoelastic type of alloy, chromium is added, to depress the high positive peak. The amount may be adjusted until the peak is in the region shown by the dotted line of Fig. 10. The mechanical property of these alloys can be increased only by cold working. Addition of another alloying element titanium, permits the entire system to be hardened by heat treating. The resulting alloy, Ni-Span-C, has increased age or precipitation hardening characteristics. A slight change of nickel and titanium

content also produces a change in the temperature coefficient of modulus. The final heat treatment adjusts the thermo-elastic coefficient to the desired value as well as increasing the strength.

It is believed that an intermetallic compound of titanium and nickel is formed (Ni_2Ti) and this phase is dissolved in the iron-nickel chromium matrix by raising the alloy to a solution annealing temperature of approximately 1750°F to 1950°F . The alloy is then rapidly cooled to room temperature (usually by water quenching) to retain the intermetallic compound in a super saturated condition. A subsequent age-hardening treatment is performed in the range of 1100°F during which the intermetallic compound is precipitated from the matrix to bring about marked change in physical properties.

The first step leaves the material in its softest, most ductile state. In this form cold work is performed to produce change in shape and other physical characteristics. Cold worked material responds to precipitation hardening treatment more rapidly than an unstrained alloy, so that time required for age hardening can be reduced. The first step is usually performed by the supplier of the wire material. The second step of the heat treatment, age hardening, is accomplished by bringing the material to the 1100°F - 1350°F range at any convenient rate, and then cooling at a convenient rate.

Figure 11 shows the relation between the age hardening temperature, the adjusted chromium plus titanium content, and the resulting thermoelastic coefficient. Adjusted chromium plus titanium content = $\text{Cr} + (\text{Ti} - 4\text{C})$ where C is the percentage carbon.

In general it is advisable to remove internal stresses resulting from cold working by suitable treatment prior to age hardening. Internal stresses accelerate age hardening. Varying internal stresses can produce varying degrees of age hardening and thus lead to slight variations after heat treating. A stress relieve anneal at 750°F , from one to four hours, can be used to minimize this condition.

The fabrication of 5 millisecond delay lines requires single pieces of Ni Span C wire about fifty feet in length. The wire material used (0.030") in diameter must be straightened (as dictated by the previous analysis of dispersion) prior to winding into the spiral shape used. Straightening takes place after the solution annealing and the cold work process required to reduce the wire to required diameter. Heat treating the wire material the second time, increases strength and hardness, gives the wire a permanent set. Thus, age hardening should ideally take place on the straightened wire, uncoiled. No furnaces are available with capacity greater than a 40" diameter. The permanent curvature introduced into the wire in this manner has to be accepted.

Thus we see that, although chemical composition puts outside limits on the performance of the wire material, there are variables that can be manipulated after the chemical composition is fixed.

The temperature coefficient can be controlled by

- a) Work hardening, which yields a coefficient varying from - 25 to + 10 PPM/^oC.
- b) Age hardening, which yields a coefficient from - 25 to + 25 PPM/^oC.

In general, the Ni-Span-C wire is heat treated after cold work, at that temperature which will give a zero thermoelastic coefficient for the given adjusted nickel - titanium content of that batch of wire (Fig. 11).

The following table illustrates typical results achieved:

% Cold Work	Heat Treatment	Temp Coeff
0	Standard	+ 2
60	Standard	+ 25
60	None	+ 1 to + 2 (Drift)
60	Low temp anneal	+ 4 to + 5

The most successful results to date have been achieved with a particular batch of Ni-Span-C wire. The 60% cold work figure given is that after the last solution anneal, as several passes and anneals are required to give the final

wire diameter. The wire is then straightened. In this condition the temperature coefficient of delay has been found to be from 1 to 1.5 ppm/°C. However, in performing repeated measurements on the wire, it was found that the coefficient varied with time at an elevated temperature. Upon submitting the wire to a stress relieve anneal, the coefficient of delay settled about a value of 4 to 5 ppm/°C. With a different batch of wire, repetition of the process produced a confirmation of the figure for temperature coefficient. It was found however that the dispersion for this particular batch was excessive, and anomalous.

Fig. 12 illustrates this fact. The low frequencies are seen to be arriving much later than the higher frequencies. It is felt that this was not due to dispersion introduced by any previously discussed mechanism, but that this might be interpreted as operation of the material as a Voigt Solid. Attempts will be made to correlate known variables in order to prevent this phenomenon from recurring.

In analyzing a particular line it is necessary to consider the percentage of total delay contributed by the nickel tapes that are used. As the temperature coefficient of delay is approximately 150 ppm/°C it can be seen that nickel tapes can be responsible for a large portion of the variation in time delay when operating near the region of zero ppm/°C. It is thus important to reduce to a minimum the length of nickel lying between transducer and tape junction.

8.2 ATTENUATION

The wire used as a delay medium should be made of a material which propagates the sound waves with small loss, and experiments have been carried out to obtain amplitude frequency responses of lines made of different materials. The technique used was to compare the amplitudes of a torsional pulse before and after transmission, and the ratio of these two measurements was plotted against frequency.

(See Fig. 13)

It has been demonstrated ⁽¹⁾ that the amplitude/frequency response for a nickel-iron-titanium alloy is substantially independent of the mode of transmission. The Q factor is defined at a frequency f as

$$Q = - f\tau\pi / \ln(A_f/A_0)$$

Where A_f/A_0 is the voltage loss at a frequency f and τ is the time delay. When the loss in the wire is a constant loss per cycle, (or the Q factor is independent of frequency) the amplitude frequency curves when placed on a log scale should be exponential.

The wire material is held under slight tension between two clamps. (Fig. 14) One end is damped for a distance of about four inches. The other end is clamped tightly enough between steel jaws, so that the reflected acoustic pulse will have the same amplitude and polarity as the incident wave. The mode converting junction has been welded to the wire prior to this, at a distance l from the clamped and undamped end and about four inches from the other end. Two transducers are mounted on the nickel tapes. One of them is the drive or signal injector. The other, closer to the junction is the receive transducer. With a length of line equivalent to 1 ms delay, a pulsed sine wave of frequency f was applied to the transmit transducer. The circuit of the pulse generator is shown in Fig. 15. The losses can be measured by comparing the amplitude of the direct signal to that of the indirect signal (that reflected from the clamped end at distance l.) These losses are made up of (a) Junction loss due to mismatch etc. (b) Line loss.

By varying f the effect of frequency is indicated. A graph of the ratio of direct to indirect signal was plotted against f on semi log paper. With l equal to three or four inches, a length involving negligible line loss, a similar test was carried out. The ratio of direct to reflected indicates the loss of the junction alone. By subtracting vertical ordinates a loss vs frequency graph results for the material.

Fig. 13 shows typical data for frequency response of the junction.

Fig. 16 shows typical results of such a test made at various frequencies. A is the direct signal B is the first reflection from the junction. C is the indirect signal (reflection) from clamped end. The signals following are the multiple reflections produced from previous signals.

The junction has been shown to impose a loss of resolution of 0.05 microseconds.

The attenuation and loss of resolution the line material introduces is obviously a function of the delay. Fig. 17 illustrates this for an input pulse of one microsecond. At a pulse repetition frequency of one megacycle/sec Ni-Span-C introduces a loss of resolution of 0.1 microsecond/millisecond of delay. Attenuation as a function of temperature is illustrated in Figure 18. This is for a completed line mounted in its supports, etc. In general, the signal ratio appears to be about 4 to 1 maximum over the range of temperatures from + 5°C to + 65°C for lines of up to 4 milliseconds delay.

Factors contributing to this variation are at present thought to be:

- (a) Attenuation due to wire material
- (b) Attenuation due to tape material
- (c) Value of magnetostrictive coefficient
- (d) Line support material
- (e) Dimensional changes in transducer

No investigation has, however, been carried beyond recording the overall variation mentioned above.

8.3 LINE SUPPORT MATERIAL

For lines which are subject to no external vibration it has been found that nylon knifedges are satisfactory means of support. Reflections are not noticeable. Noise is introduced however, when the line is moved.

Short (500 microsecond) lines are supported by means of expanded p.v.c.

tubing held in place about the wire by a modified comb structure Fig. 19.

Longer lines are supported by means of polyurethane foam strips. These have holes burned and slit through in such a manner that the wire can be inserted after the strips are cemented on the baseplate. A template is used to locate the strips accurately in order to facilitate the insertion of the wire material. (Fig. 20)

8.4 ACOUSTIC TERMINATION

The drive transducer emits a stress wave in two directions. For this application one wave has to be damped, as it would appear in the output as a spurious signal reflected from the tape end.

The attenuation in unannealed nickel appears to be negligible for the tape lengths used in the torsional lines. Thus, it is necessary to increase the attenuation of the unwanted pulse and its reflection from the tape end. The technique devised consists of bringing damping pads to bear against a few inches of the tape extending past the transducers. Each tape is sandwiched between sheets of damping material. On one side of the tape, the damping material consists of silicone rubber - on the other side, the material consists of a composite surface. The wave enters and is damped by a rubber sheet cut to about $2/3$ of the total damping length. This is then followed by a teflon sheet. The other tape is sandwiched in a symmetric manner. See Fig. 21.

The reason for "stepping" the materials is to provide a better acoustic match for entry of the pulse into the damping medium. The first material is followed by teflon, a material of better absorbing qualities, but one which causes spurious reflections if used on entry. The signal to noise ratio is independent of temperature over the range measured. The use of such pads will provide attenuation figures of between 25 and 45db. The size of the pad used is $2\ 1/2 \times 1/2$ inches. In carrying out many experiments in the laboratory it has been found convenient to use paper backed or mylar backed scotch tape for damping.

9. MODE CONVERTING JUNCTION

Torsional waves are launched and detected by means of the mode transformer shown in Fig. 4. The magnetostriction transducers launch longitudinal stress waves in the tape at equal distances from the wire, and these in turn cause torsional stress waves to be launched along the wire.

The condition for matching the tape to the wire is

$$A = \pi r^2 / 2n \sqrt{E_s/E} \quad (9.1)$$

In general two tapes are used. The diameter of the wire used for torsional waves 0.030" is such that the peripheral distance between welds is small compared with the wavelength of longitudinal waves. The theory from which the above equation was derived considers the tape to be joined to the wire by perfect hinges. In the real situation, if a weld is used, twisting of the wire tends to launch transverse waves back along the tape. When using thin tape, this effect is negligible. The junction between tape and wire is made by use of a condenser welder. Scrupulous care must be maintained that the surfaces to be joined are clean, properly aligned as to parallelism of tapes with respect to each other, and rectangularity with respect to the wire transmission medium. To this end a jig has been designed to hold tapes and wire in fixed relative positions during the welding operation. Using this jig a series of measurements have been made, to determine junction efficiency. The experimental technique is similar in physical arrangement to that used to make Q measurements, except that pairs of di-pulses were monitored rather than a burst of sine waves, and that the length l of the free end of the wire medium is only six inches. Also the ends are left free, but ground flat. See Fig. 22 for the physical set up.

In designing the junction, the dimensions have been chosen for the situation where one end of the wire is flush with one edge of the tapes. In making measurements of junction efficiency as a function of welding conditions, one expects a reflection from the junction, as there is a mismatch which has been introduced

the amplitudes of the drive pulses to the sum of the squares of all measured pulses that were seen to have gone through the junction. Figure 16 is a picture showing the drive pulse, reflection from junction, and successive multiple reflections.

Fig. 23 is a graph showing variation in efficiency as a function of weld voltage and pressure.

Practical results of the tests indicate an efficiency of 90% or better when welds are made under carefully controlled conditions.

10. PRACTICAL DESIGN

<u>PACKAGE</u>	<u>MEDIUM</u>	<u>LARGE</u>
Minimum Delay microsecs.	70	500
Maximum Delay microsecs.	500	5000
Maximum Digit Rate	1 mc/s	500 kc/s
Minimum Digit Rate	100 kc/s	100 kc/s
Maximum Storage Capacity (binary digits)	500	2500
Input	40 m A at 10 V	
Output into 5000 ohms	25 - 40 mv	5 - 25 mv
Size	6" x 7" x 5/16"	12" x 13" x 5/16"
Temperature Coefficient of Delay	positive, < 10 parts/million/ ^o C	
Temperature Coefficient of Amplitude	positive, function of line length.	
Working Temperature Range	15 - 70 ^o C	
Attenuation	30 db + 3 db/millisecond of delay	
Signal to Noise Ratio	greater than 20:1	
Delay Adjustment Range	± 2 microseconds	

11. TESTING

Although a good deal of information regarding the performance of a delay line may be obtained by observing the output voltage waveform due to a single digit input, the only really satisfactory test is one which uses the delay line as a digital storage element, making the store handle its full range of digital patterns. This has been done by using the delay line in a recirculating store loop to which is connected a 'half adder', so that the pattern in the delay line is changed by 'one' each delay time. Then due to the speed of addition in the first few digit places, the various digit patterns appear superposed, and the picture is characterised by the presence of half areas above the base line. The uniformity of these areas is a measure of the pattern sensitivity of the delay line and the signal to noise ratio.

Fig. 25 shows the output waveform from a 500 microsecond line operating at 500 kc/sec when connected to a store and adder.

With the delay line connected in a storage loop it is possible to investigate the effects of environmental conditions on the performance of the line.

Simple vibration tests have been conducted, and it was found that reliability was much improved by supporting the mode converting junction between foam polyurethane strips, fairly severe blows then being required before upsetting the contents of the store.

CONCLUSIONS

The results of this investigation have confirmed the fact that the wire type delay line with magnetostrictive driver is inherently capable of satisfying the demands put upon it as a delay element suitable for digital storage. A pulse written into it at any one digit time can be distinguished unambiguously at the output, without interference from pulses written into it at other times. The line can be used with a recirculating circuit to provide storage without loss for an indefinite period of time. The line can be made reasonably free from the effects of temperature variation, vibration and stray magnetic fields. It is cheap, small and can be easily fabricated. Input and output impedances are compatible with existing techniques.

It has become obvious during the course of the investigation that many questions have not been definitively answered.

The subjects are as follows:

1. Stability of characteristics with time
2. Reproducibility of temperature coefficients of delay and amplitude
3. Uniformity of wire material within a batch
4. Uniformity and or reproducibility of the wire straightening process
5. Bearing of chemical constituency on variation in Q of the wire material
6. Anomalous dispersion effects
7. Improvement of signal to noise ratio
8. Upper limit of delay and bit rate using present techniques
9. Improvement in signal amplitude
10. Minimum package size

USED ON

1- (a) LONGITUDINAL DELAY LINE

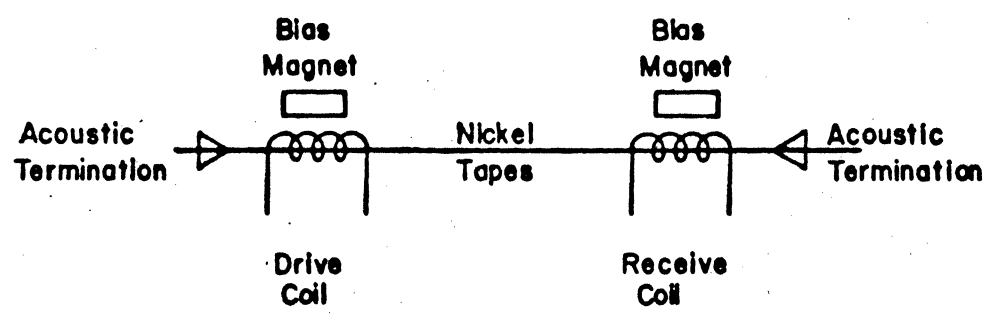

1- (b) TORSIONAL DELAY LINE

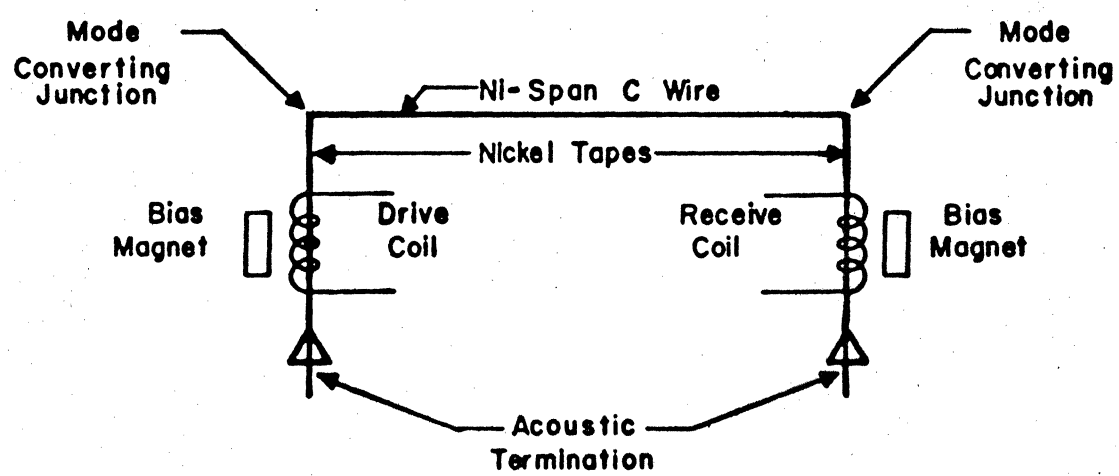
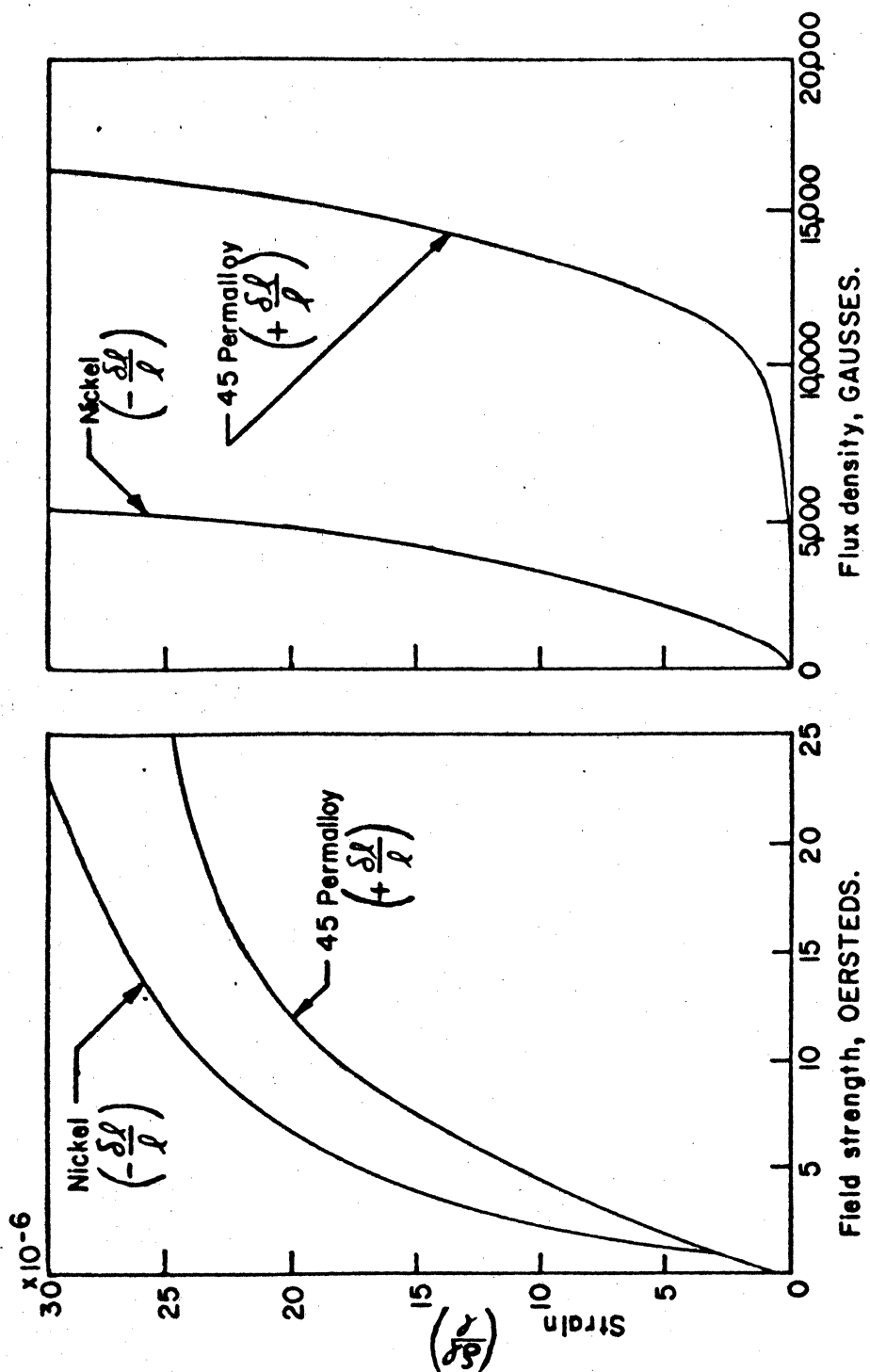

FIGURE - 1

NO. ALTERATIONS DATE BY	TITLE BLOCK DIAGRAM - DELAY LINE		
	TOLERANCE SHALL BE - FRACTIONAL $\pm 1/100$ DECIMAL $\pm .005$ EXCEPT WHERE SPECIFIED		SCALE \pm
	MATERIAL \pm	DRAWN R.C.	CHECKED L.G.
	FINISH \pm	DATE 11-25-57	APPD. L.G.
	FERRANTI ELECTRIC, INC. 30 ROCKEFELLER PLAZA NEW YORK CITY		DRAWING NO. A-204-6001



(B) Strain as a function of flux density.

(A) Strain as a function of field strength.

FIGURE-2

NO. ALTERATIONS DATE BY	TITLE MAGNETOSTRICTION OF NICKEL & PERMALLOY	
	TOLERANCE SHALL BE - FRACTIONAL $\pm 1/64$ DECIMAL $\pm .008$ EXCEPT WHERE SPECIFIED	SCALE $\text{---} H \text{---}$
	MATERIAL $\text{---} H \text{---}$	DRAWN RC. CHECKED L.G.
	FINISH $\text{---} H \text{---}$	DATE 11-25-57 APP'D L.G.
FERRANTI ELECTRIC, INC. 30 ROCKEFELLER PLAZA NEW YORK CITY		DRAWING NO. A-204-6002

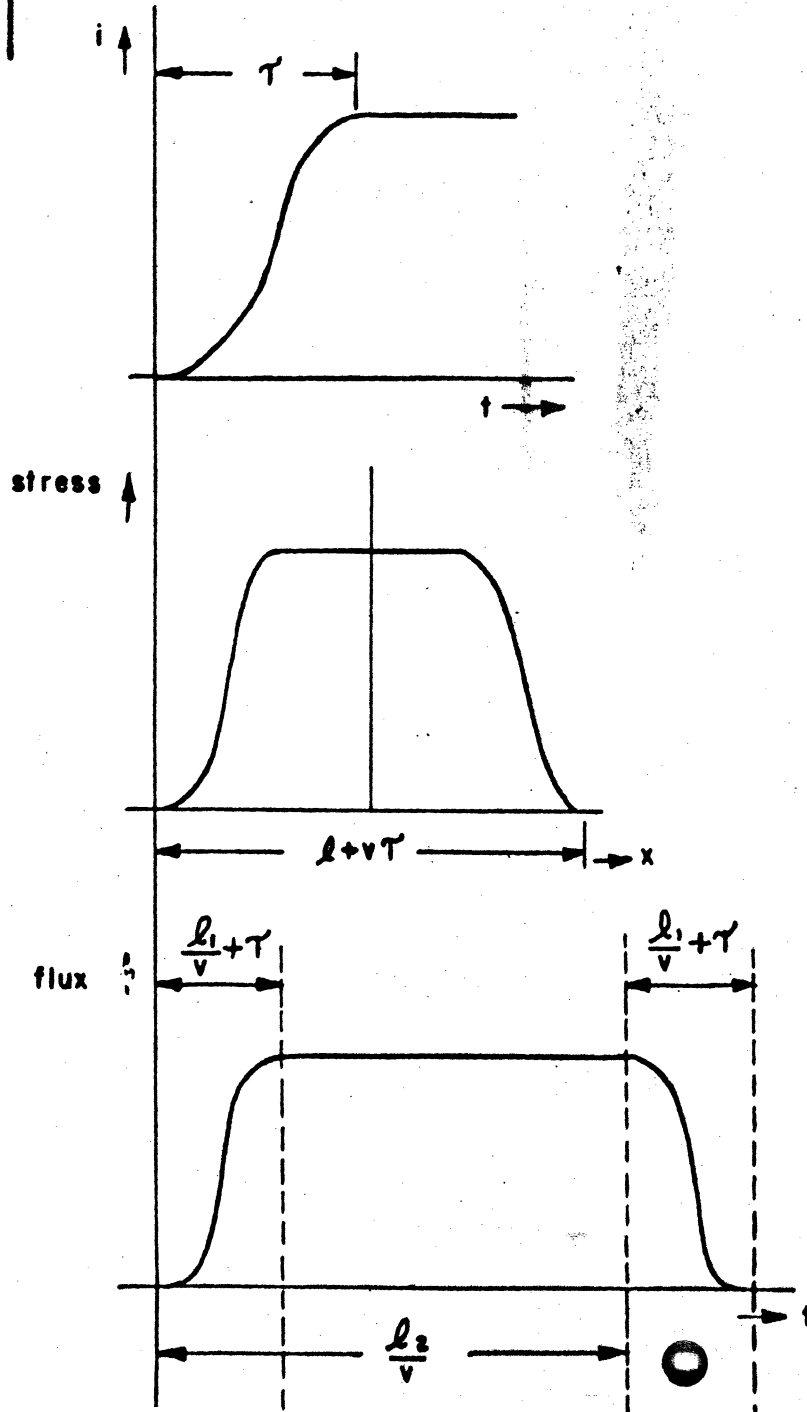

(a) Input current through drive coil resulting from applied step function.

(b) Distribution of stress along line at one instant of time due to (a).

(c) Variation of flux integrated over coil length l_2 as stress wave (b) passes through.

$l_2 = \frac{l_1}{v}$

USED ON

(e) Output voltage obtained by proper choice of β_2 .

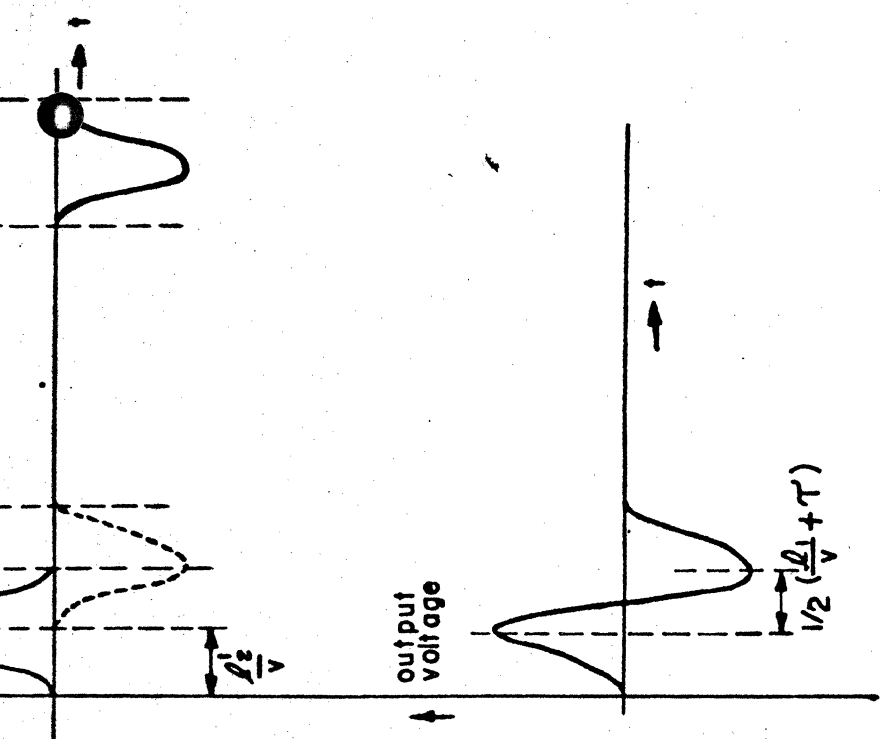
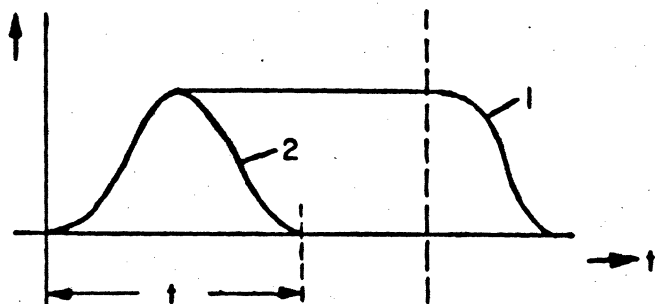
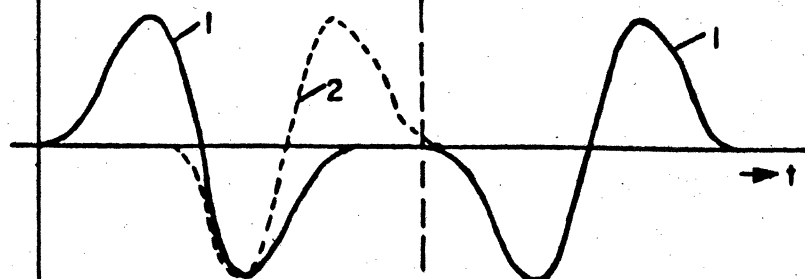

FIGURE - 3

TITLE GENERATION OF SIGNAL WAVEFORM		SCALE —H—	
TOLERANCE SHALL BE: FRACTIONAL $\pm 1/64$ DECIMAL $\pm .005$ EXCEPT WHERE SPECIFIED		DRAWN R.C.	CHECKED L.G.
MATERIAL —H—		DATE 11:25:57	APPD. L.G.
FINISH —H—		B-204-6003	
FERRANTI ELECTRIC, INC. 30 ROCKEFELLER PLAZA NEW YORK CITY			



(f) 1- Input current through drive coil resulting from square wave.
2- Narrow square wave.



(g) Output voltage due to (f).
1- Wide square wave.
2- Narrow square wave.

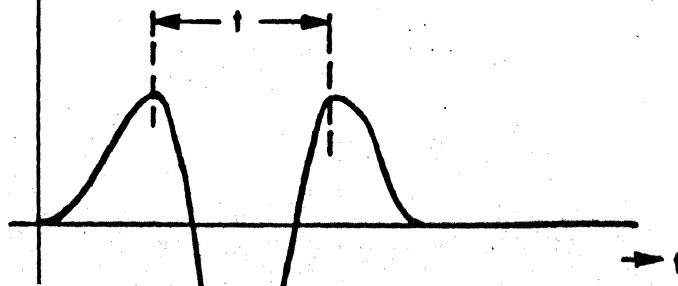

(h) Output voltage due to narrow square wave.

USED ON

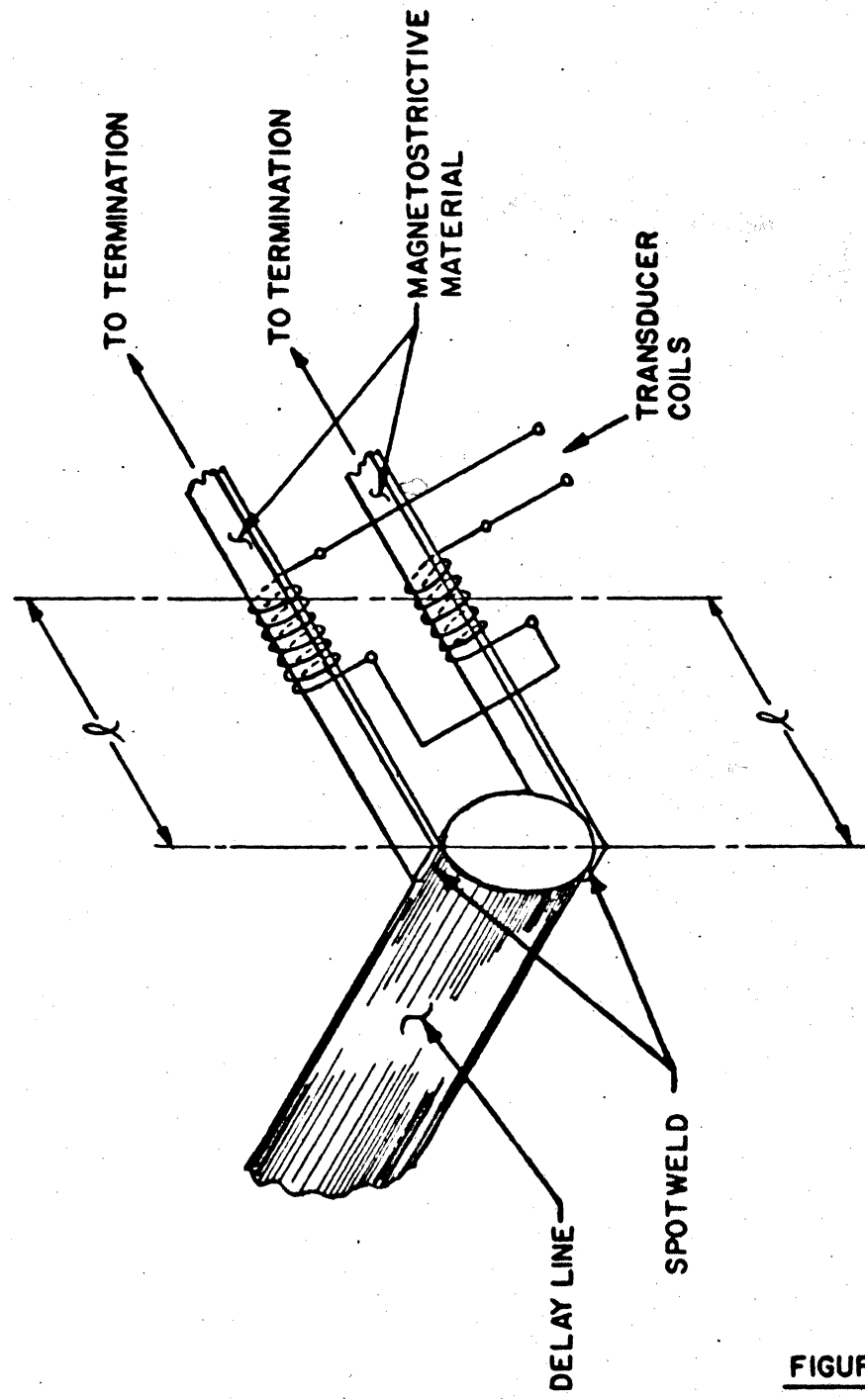

FIGURE-4

NO. ALTERATIONS DATE BY	TITLE TRANSducer, TAPES & MODE CONVERTER		
	TOLERANCE SHALL BE - FRACTIONAL $\pm 1/64$ DECIMAL $\pm .008$ EXCEPT WHERE SPECIFIED		SCALE —H—
	MATERIAL —H—	DRAWN R.C.	CHECKED L.G.
	FINISH —H—	DATE 112557	APP'D. L.G.
	FERRANTI ELECTRIC, INC. 30 ROCKEFELLER PLAZA NEW YORK CITY		DRAWING NO. A-204-6004

USED ON

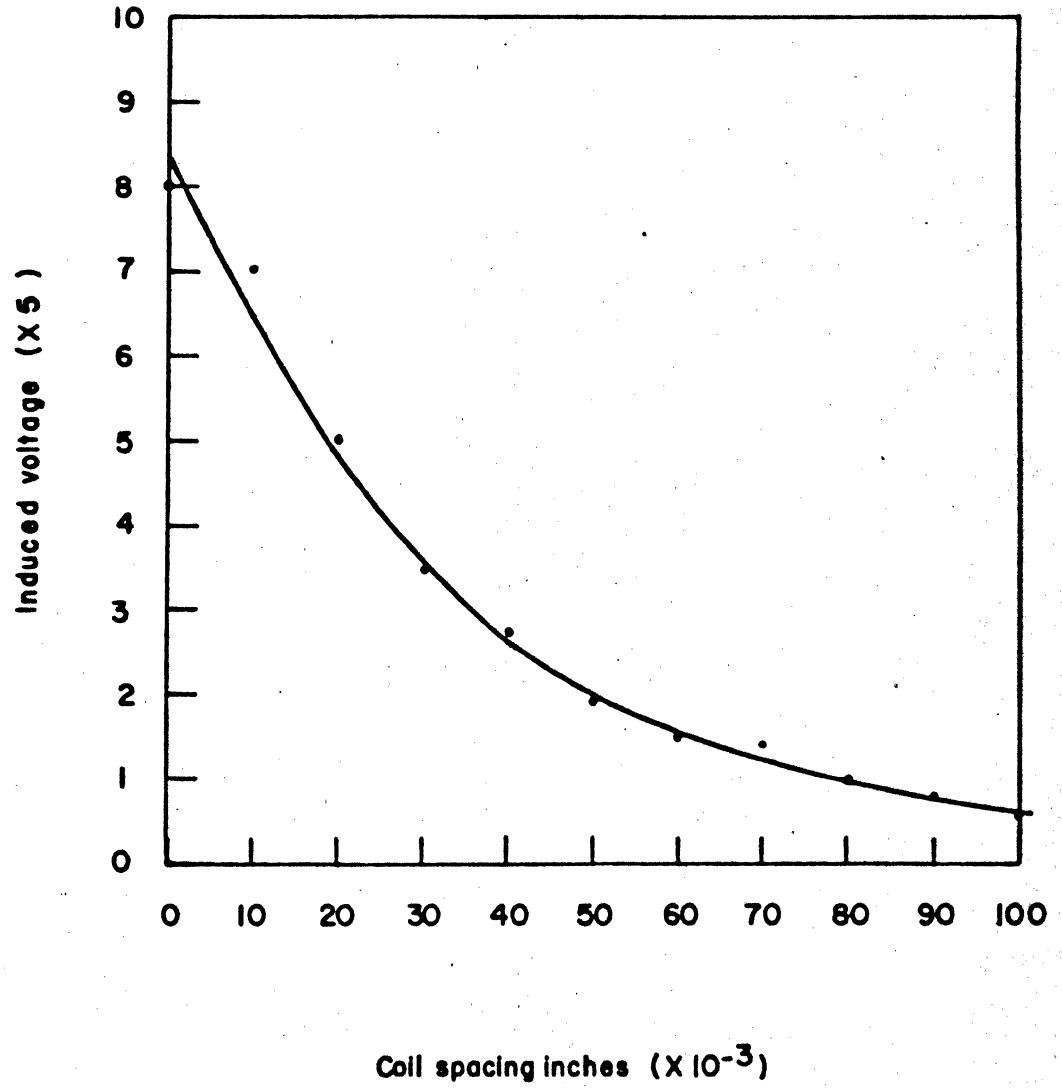
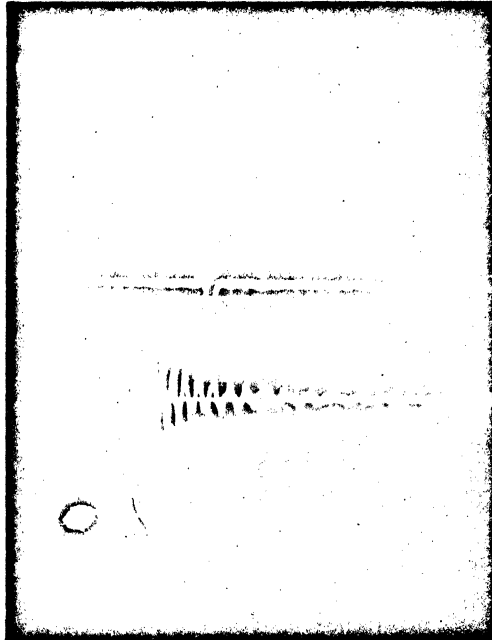

FIGURE-5

NO. ALTERATIONS DATE BY		TITLE TRANSDUCER END EFFECT	
		TOLERANCE SHALL BE - FRACTIONAL \pm 1/64 DECIMAL \pm .008 EXCEPT WHERE SPECIFIED	SCALE -H-
		MATERIAL -H-	DRAWN R.C. CHECKED L.G.
		FINISH -H-	DATE 11-25-57 APP'D L.G.
		FERRANTI ELECTRIC, INC. 30 ROCKEFELLER PLAZA NEW YORK CITY	DRAWING NO. A-204-6005

USED ON



Upper: One millisecond delay, straight wire.
Lower: One millisecond delay, one inch helix.

FIGURE - 6

NO ALTERATIONS DATE BY		TITLE DISTORTION DUE TO CURVATURE	
		TOLERANCE SHALL BE - FRACTIONAL $\pm 1/64$ DECIMAL $\pm .008$ EXCEPT WHERE SPECIFIED	SCALE <u>H</u>
		MATERIAL <u>H</u>	DRAWN <u>R.C.</u> CHECKED <u>L.G.</u>
		FINISH <u>H</u>	DATE <u>12-4-57</u> APPD. <u>L.G.</u>
		FERRANTI ELECTRIC, INC. 30 ROCKEFELLER PLAZA NEW YORK CITY	
		DRAWING NO. A-204-6006	

USED ON

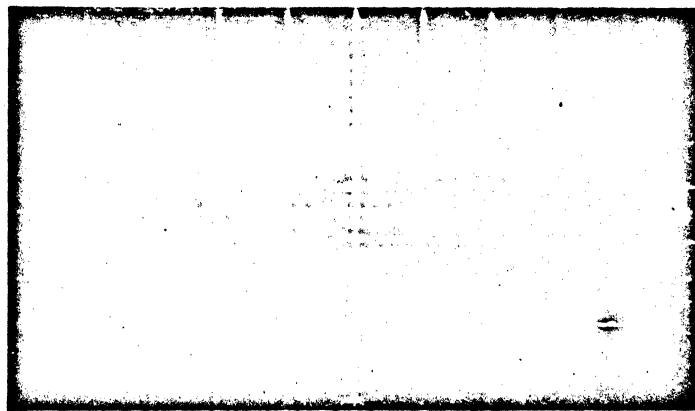

Upper: Without ferrite cheeks.
Lower: With ferrite cheeks.

H: One microsecond/cm.
V: 20 millivolts/cm.

FIGURE - 7

NO ALTERATIONS DATE BY	TITLE		EFFECT OF FERRITE CHEEKS	
	TOLERANCE SHALL BE - FRACTIONAL \pm 1/100 DECIMAL \pm .008 EXCEPT WHERE SPECIFIED		SCALE <u>H</u>	
	MATERIAL <u>H</u>		DRAWN R.C.	CHECKED <u>Z.G.</u>
	FINISH <u>H</u>		DATE <u>12-4-57</u>	APPD. <u>Z.G.</u>
	FERRANTI ELECTRIC, INC. 30 ROCKEFELLER PLAZA NEW YORK CITY		DRAWING NO. A-204-6007	

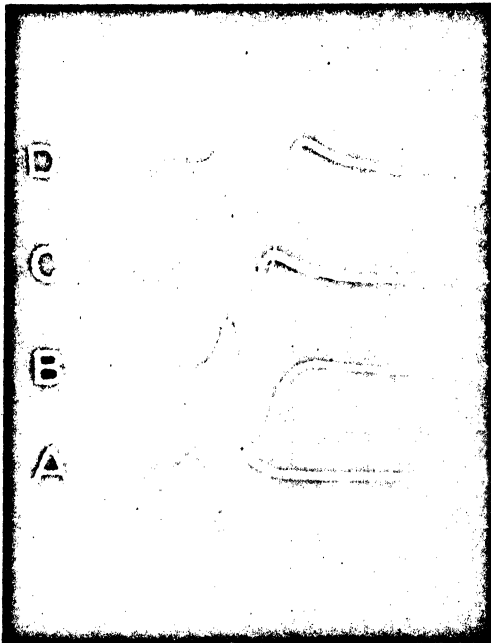

- A - Both tapes not annealed.
- B - Transmit tapes annealed.
- C - Receive tapes annealed.
- D - Both tapes annealed.

FIGURE - 8

NO. ALTERATIONS DATE BY		TITLE SIGNAL DISTORTION PRODUCED BY ANNEALING	
		TOLERANCE SHALL BE - FRACTIONAL $\pm 1/64$ DECIMAL $\pm .008$ EXCEPT WHERE SPECIFIED	SCALE H
		MATERIAL H	DRAWN R.C. CHECKED K.G.
		FINISH H	DATE 12-4-57 APP'D K.G.
		FERRANTI ELECTRIC, INC. 30 ROCKEFELLER PLAZA NEW YORK CITY	DRAWING NO. A-204-6008

USED ON

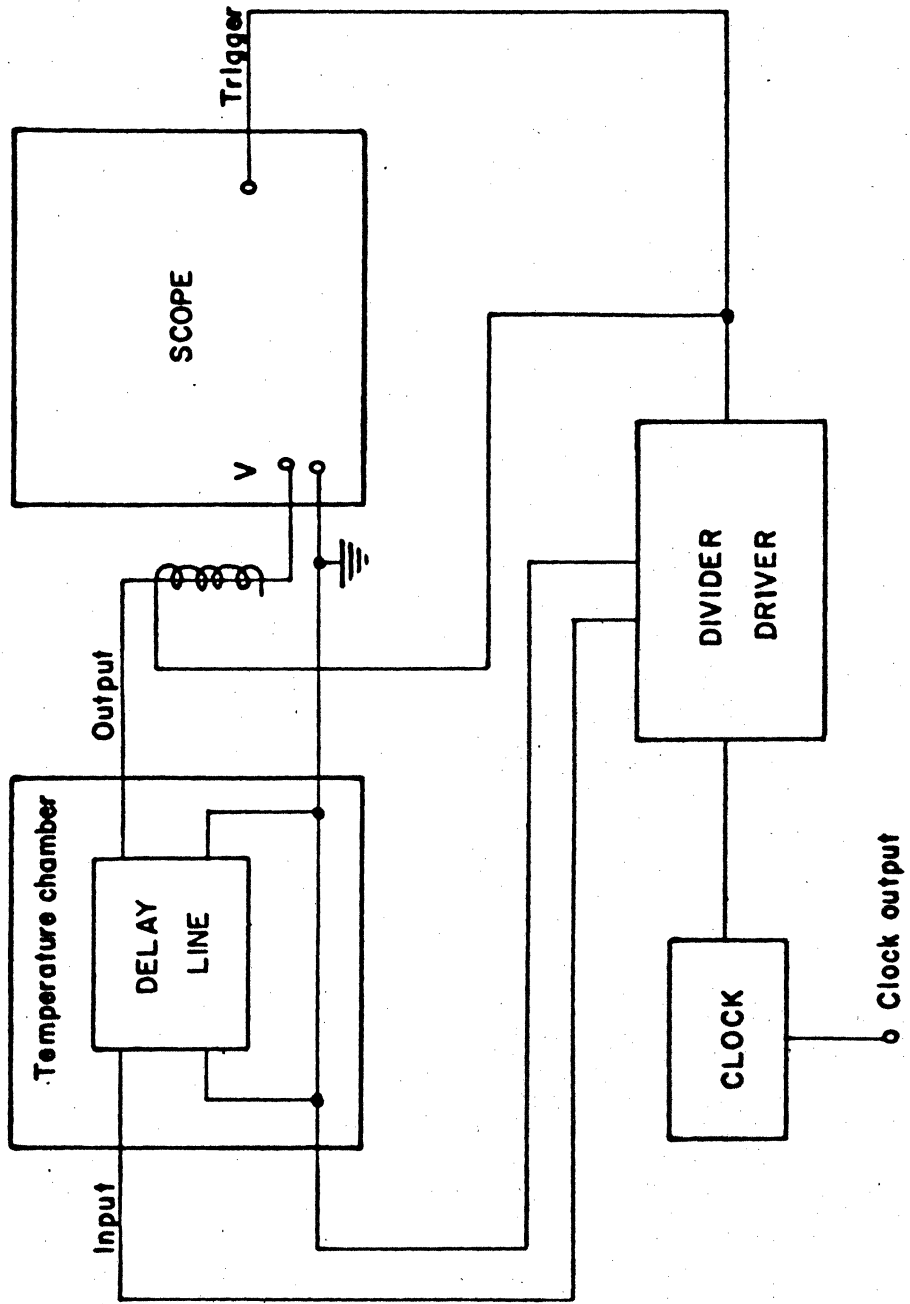

FIGURE - 9

NO. ALTERATIONS DATE BY	TITLE BLOCK DIAGRAM-MEASUREMENT OF TEMPERATURE COEFFICIENT OF DELAY.		
	TOLERANCE SHALL BE - FRACTIONAL $\pm 1/64$ DECIMAL $\pm .008$ EXCEPT WHERE SPECIFIED		SCALE <u>—H—</u>
	MATERIAL <u>—H—</u>	DRAWN <u>R.C.</u>	CHECKED <u>L.G.</u>
	FINISH <u>—H—</u>	DATE <u>11-29-57</u>	APPD <u>L.G.</u>
	FERRANTI ELECTRIC, INC. 80 ROCKEFELLER PLAZA NEW YORK CITY		DRAWING NO. A-204-6009

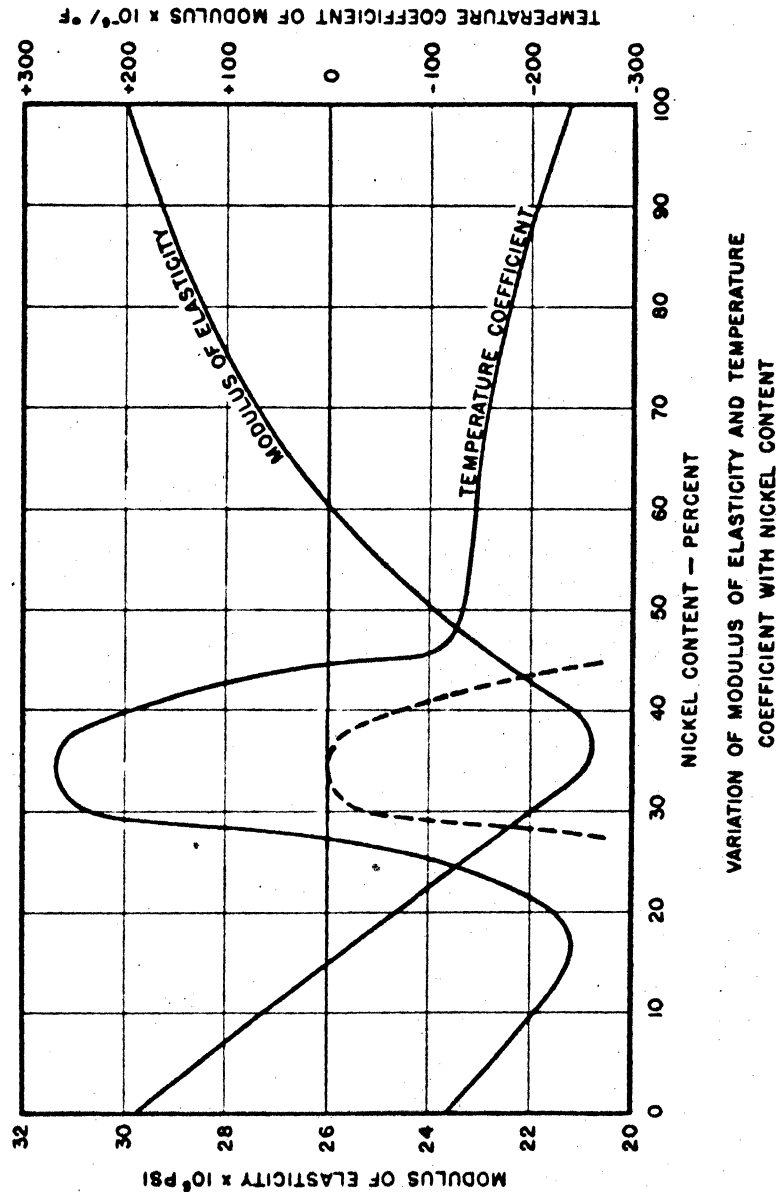
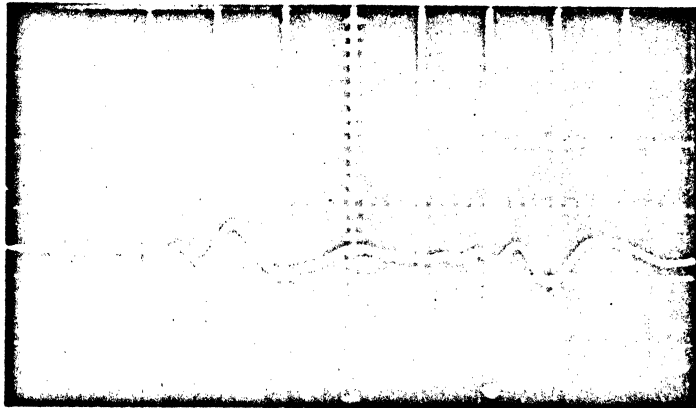

FIGURE-10

NO. ALTERATIONS	DATE BY	TITLE PROPERTIES OF IRON-NICKEL ALLOYS	
		TOLERANCE SHALL BE: FRACTIONAL $\pm 1/64$ DECIMAL $\pm .008$ EXCEPT WHERE SPECIFIED	SCALE H
		MATERIAL H	DRAWN R.C. CHECKED L.G.
		FINISH H	DATE 12-5-57 APPD. Z.G.
		FERRANTI ELECTRIC, INC. 80 ROCKEFELLER PLAZA NEW YORK CITY	DRAWING NO. A-204-6010

USED ON



Phase shift distortion introduced by material.

FIGURE-12

NO ALTERATIONS DATE BY		TITLE POSSIBLE OPERATION OF LINE AS VOIGT SOLID	
		TOLERANCE SHALL BE - FRACTIONAL $\pm 1/64$ DECIMAL $\pm .008$ EXCEPT WHERE SPECIFIED	SCALE —H—
		MATERIAL —H—	DRAWN R.C. CHECKED L.G.
		FINISH —H—	DWG NO 12-5-57 APPD L.G.
		FERRANTI ELECTRIC, INC. 30 ROCKEFELLER PLAZA NEW YORK CITY	
		DRAWING NO A-204-601	

USED ON

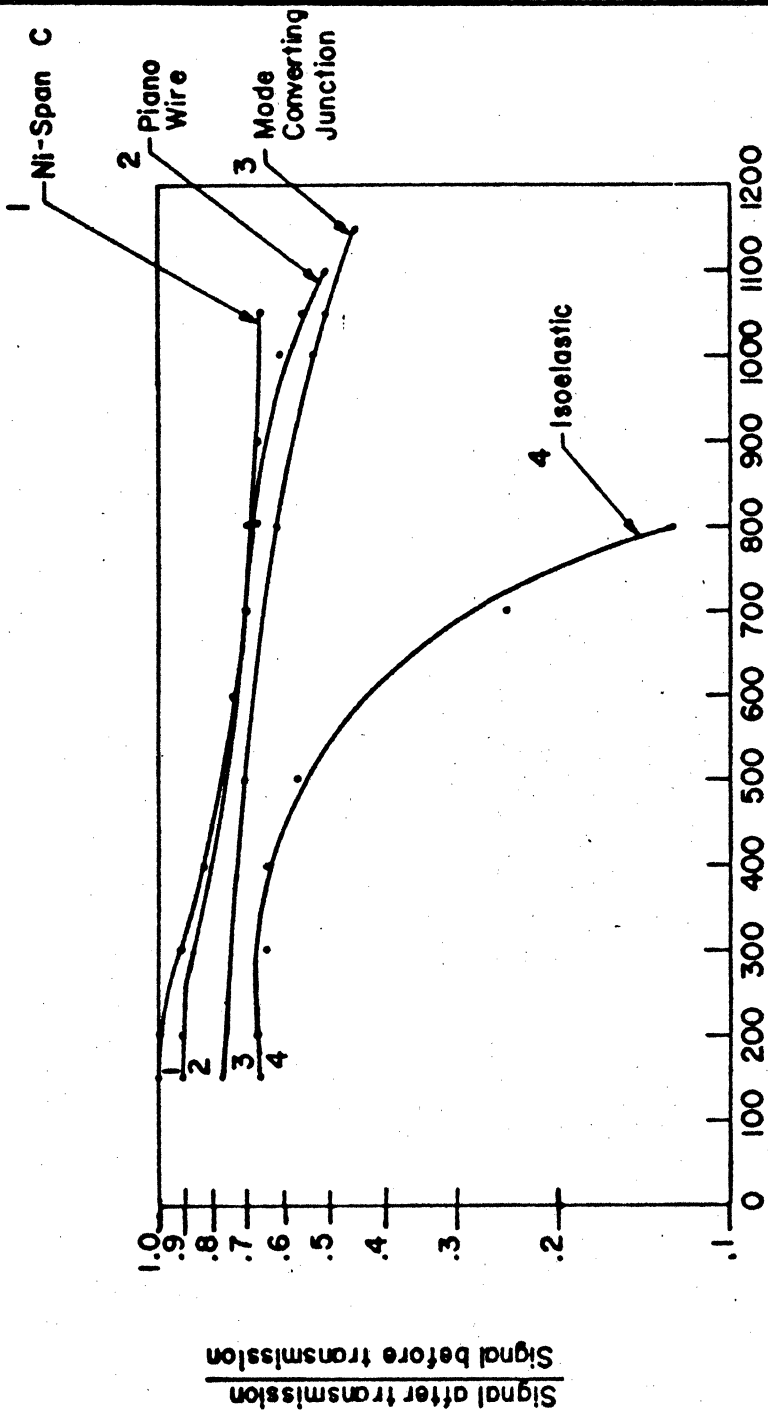

Frequency K.C.

FIGURE-13

NO. ALTERATIONS DATE BY	TITLE FREQUENCY RESPONSE, WIRE & JUNCTION		SCALE H	
	TOLERANCE SHALL BE: FRACTIONAL $\pm 1/16$ DECIMAL $\pm .008$ EXCEPT WHERE SPECIFIED		DRAWN R.C.	CHECKED Z.G.
	MATERIAL H		DATE 11-25-57	ASPD Z.G.
	FINISH H		DRAWING NO. A-204-6013	
FERRANTI ELECTRIC, INC. 30 ROCKEFELLER PLAZA NEW YORK CITY				

NO	ALTERATIONS	DATE	BY
TITLE			
N Q ⁿ TEST			
TOLERANCE SHALL BE: FRACTIONAL $\frac{1}{1000}$ DECIMAL $\pm .000$ EXCEPT WHERE SPECIFIED			
MATERIAL	FINISH	SCALE	DRAWN
H	H	H	R.C.
			CHECKED
			Z.P.C.
FERRANTI ELECTRIC, INC. 30 ROCKEFELLER PLAZA NEW YORK CITY		DRAWING NO. A-204-6014	

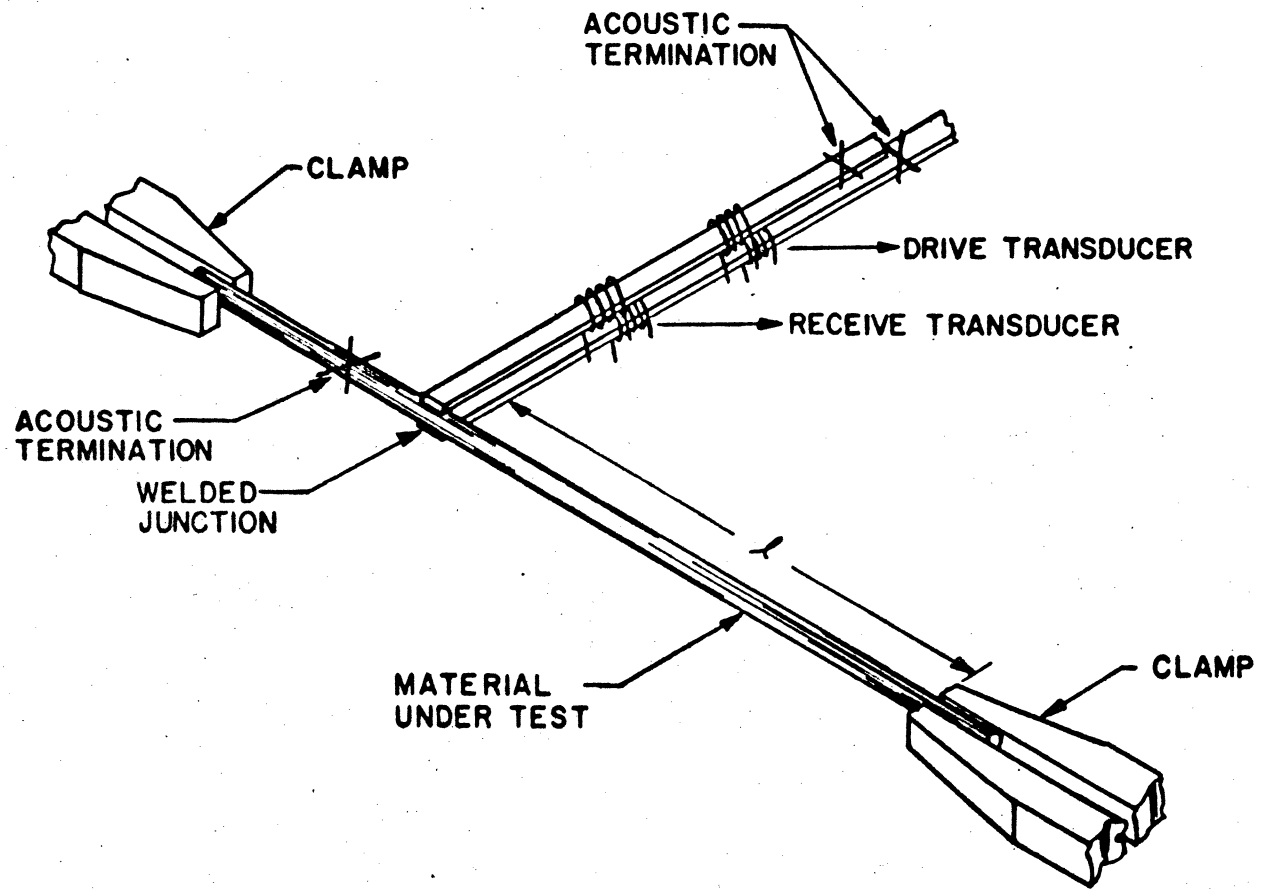
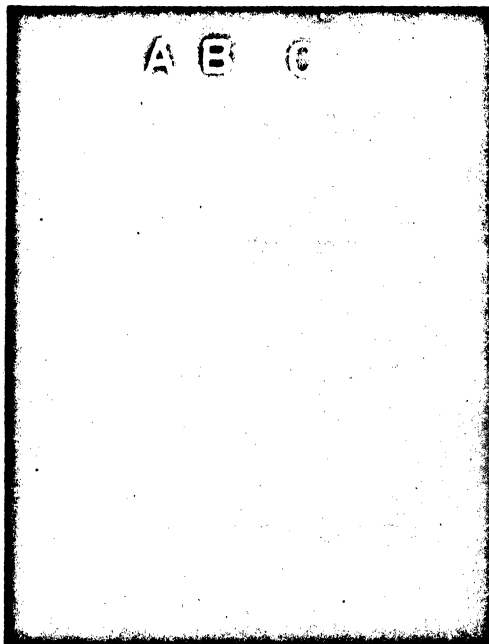

FIGURE-14

USED ON

USED ON



- A- Direct signal.
- B- Junction reflection
- C- Indirect (Reflection from wire end).

FIGURE-16

BY	TITLE SINE WAVE BURSTS FOR Q MEASUREMENT & JUNCTION RESPONSE		
	TOLERANCE SHALL BE - FRACTIONAL $\pm 1/64$ DECIMAL $\pm .008$ EXCEPT WHERE SPECIFIED		SCALE —H—
	MATERIAL —H—	DRAWN R.C.	CHECKED L.G.
	FINISH —H—	DATE 12-5-57	APP'D L.G.
NO ALTERATIONS	FERRANTI ELECTRIC, INC. 30 ROCKEFELLER PLAZA NEW YORK CITY		DRAWING NO. A-204-6016

USED ON

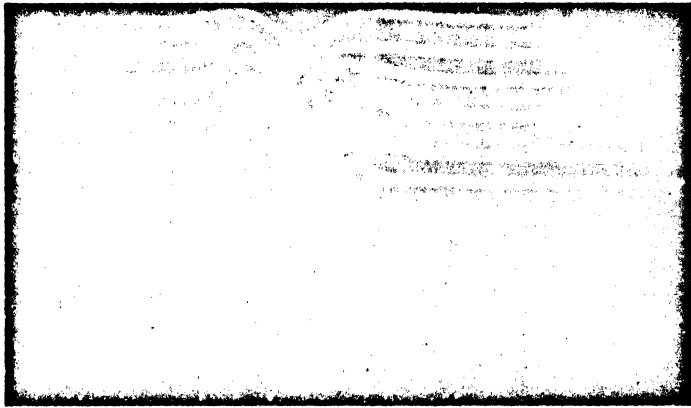

Attenuation & Reduction in Resolution as the delay is increased in 1 millisecond steps.

H: One microsecond/cm.
V: 20 millivolts/cm.

FIGURE - 17

NO ALTERATIONS DATE BY		TITLE DISTORTION PRODUCED BY INCREASED DELAY	
		TOLERANCE SHALL BE - FRACTIONAL $\frac{1}{16}$ DECIMAL $\pm .008$ EXCEPT WHERE SPECIFIED	SCALE 1:1
		MATERIAL —H—	DRAWN R.C. CHECKED L.G.
		FINISH —H—	DATE 12-4-57 APP'D L.G.
		FERRANTI ELECTRIC, INC. 30 ROCKEFELLER PLAZA NEW YORK CITY	DRAWING NO. A-204-6017

USED ON

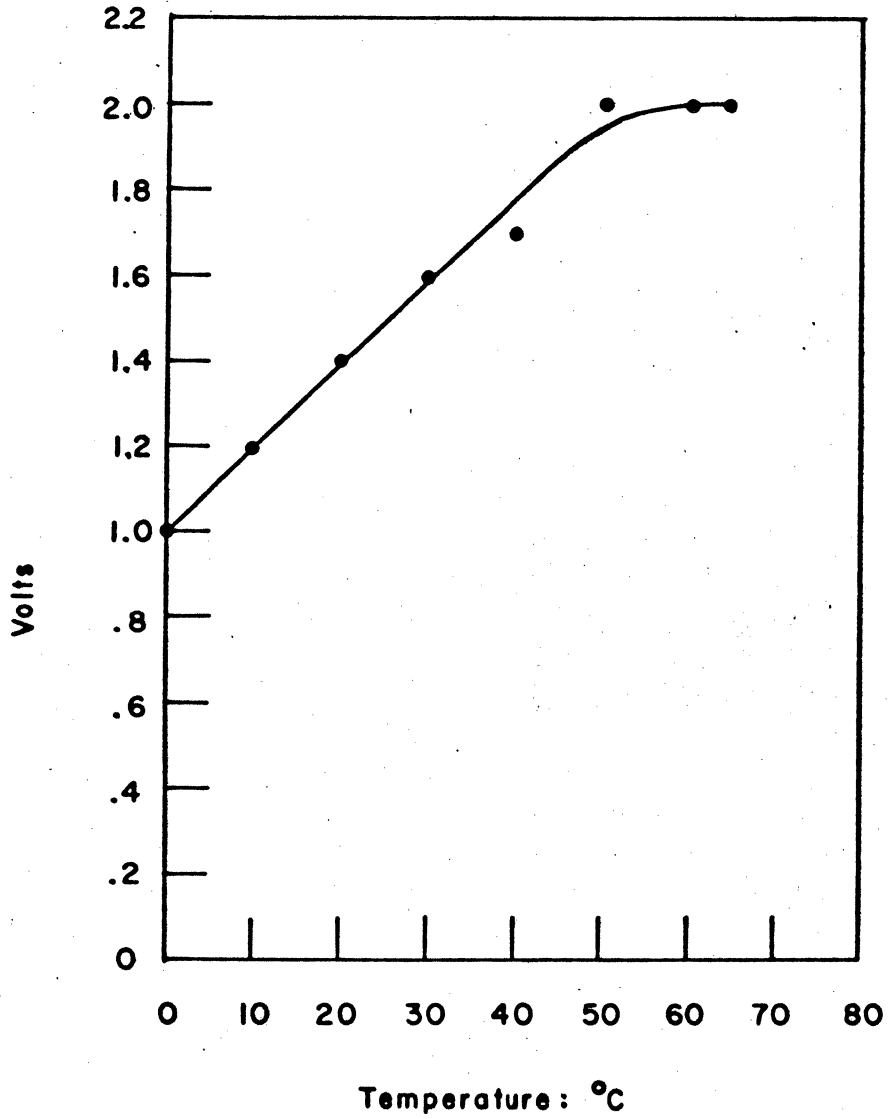

FIGURE-18

NO. ALTERATIONS	DATE BY	TITLE OUTPUT SIGNAL VS. TEMPERATURE	
		TOLERANCE SHALL BE FRACTIONAL $\pm 1/64$ DECIMAL $\pm .008$ EXCEPT WHERE SPECIFIED	SCALE H
		MATERIAL H	DRAWN R.C. CHECKED L.G.
		FINISH H	DATE 11-25-57 APPD. L.G.
		FERRANTI ELECTRIC, INC. 30 ROCKEFELLER PLAZA NEW YORK CITY	DRAWING NO. A-204-6018

USED ON

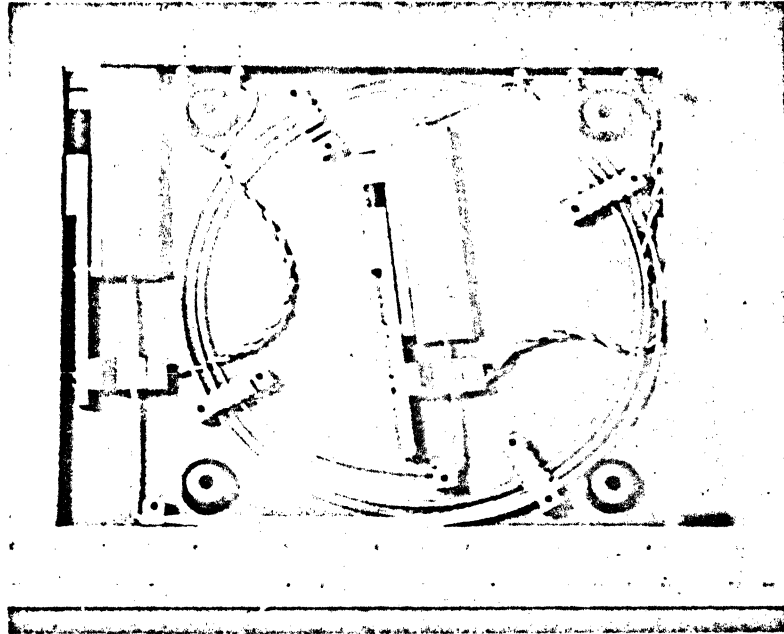

FIGURE-19

NO. ALTERATIONS DATE BY		TITLE 500 MICROSECOND DELAY LINE		
		TOLERANCE SHALL BE - FRACTIONAL $\frac{1}{1004}$ DECIMAL $\pm .009$ EXCEPT WHERE SPECIFIED	SCALE — H —	
		MATERIAL — H —	DRAWN R.C.	CHECKED L.G.
		FINISH — H —	DATE 12-5-57	APPD. L.G.
		FERRANTI ELECTRIC, INC. 30 ROCKEFELLER PLAZA NEW YORK CITY		DRAWING NO. A-204-6019

USED ON

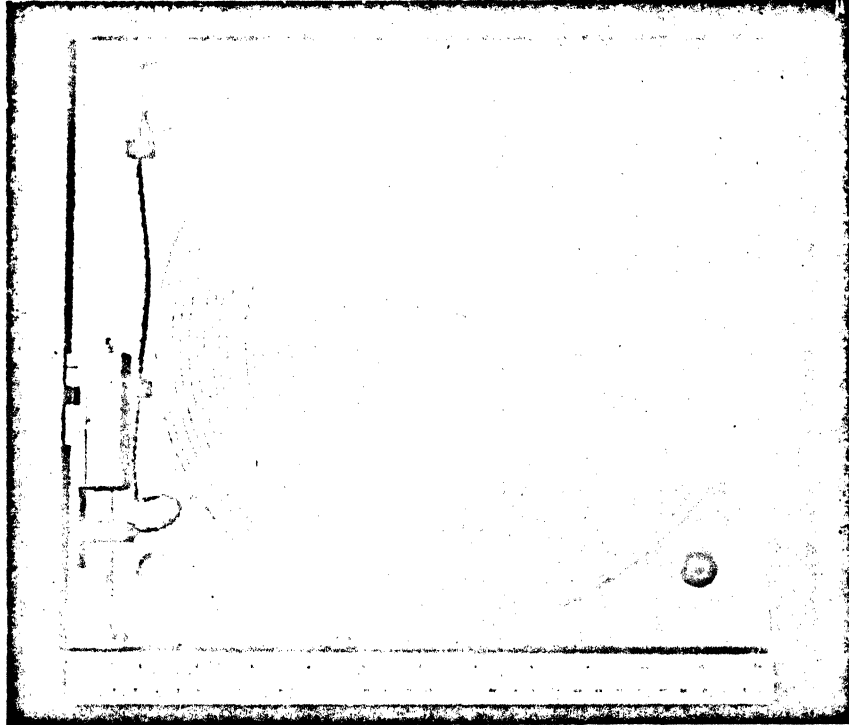

FIGURE-20

NO ALTERATIONS DATE BY		TITLE	4 MILLISECOND DELAY LINE	
		TOLERANCE SHALL BE - FRACTIONAL $\pm 1/64$ DECIMAL $\pm .005$ EXCEPT WHERE SPECIFIED	SCALE	— H —
		MATERIAL	— H —	DRAWN R.C. CHECKED L.G.
		FINISH	— H —	DATE 12-6-57 APPD. L.G.
		FERRANTI ELECTRIC, INC. 30 ROCKEFELLER PLAZA NEW YORK CITY	DRAWING NO. A-204-6020	

USED ON

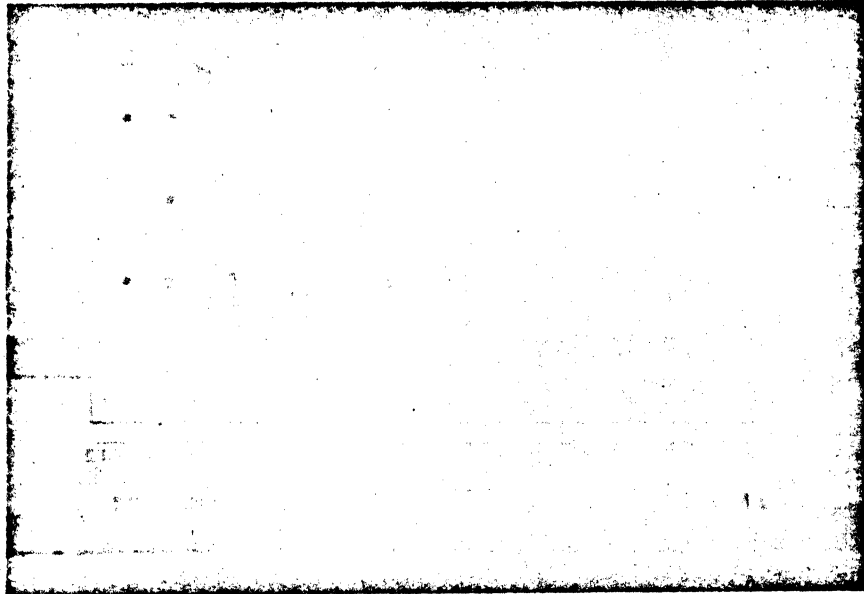

FIGURE-21

NO. ALTERATIONS DATE BY	TITLE	EXPLODED VIEW, ACOUSTIC TERMINATION	
	TOLERANCE SHALL BE: FRACTIONAL $\pm 1/64$ DECIMAL $\pm .008$ EXCEPT WHERE SPECIFIED	SCALE	H
	MATERIAL	H	DRAWN R.C. CHECKED L.G.
	FINISH	H	DATE 12-6-57 APP'D L.G.
	FERRANTI ELECTRIC, INC. 30 ROCKEFELLER PLAZA NEW YORK CITY		DRAWING NO. A-204-6021

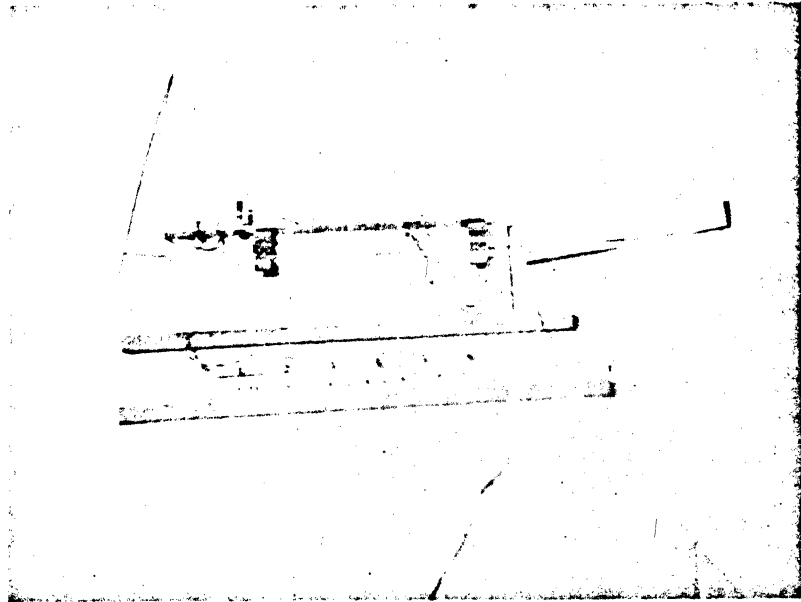

FIGURE-22

NO. ALTERATIONS DATE BY	TITLE			WELD TEST FIXTURE	
	TOLERANCE SHALL BE - FRACTIONAL $\pm 1/16$ - DECIMAL $\pm .008$ EXCEPT WHERE SPECIFIED			SCALE	
	MATERIAL			—H—	DRAWN
	FINISH			—H—	CHECKED
	FERRANTI ELECTRIC, INC. 30 ROCKEFELLER PLAZA NEW YORK CITY			DATE	APPRO. / DRAWING NO.
			RC.	L.G.	A-204-602
			12-6-57	L.G.	

USED ON

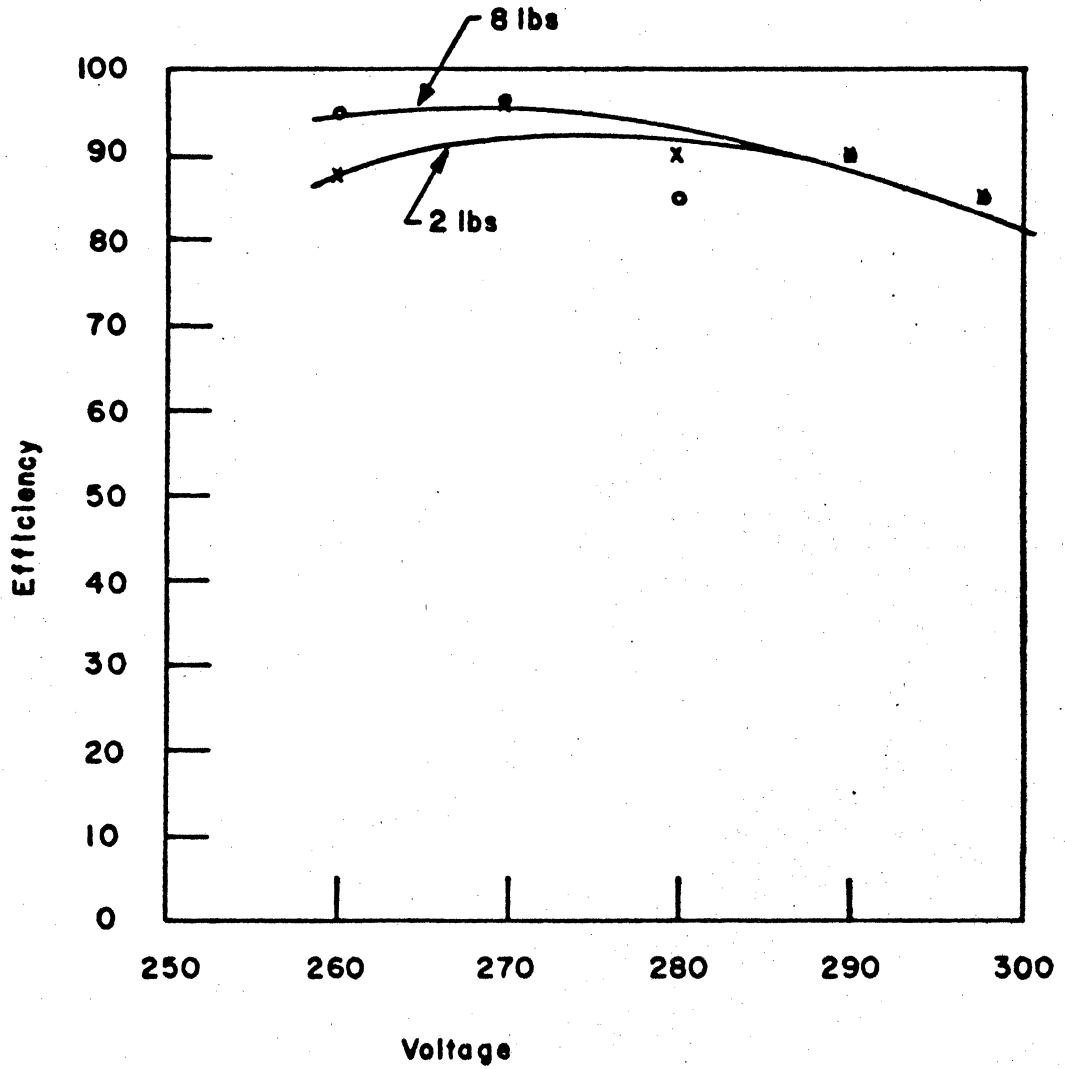

FIGURE-23

NO. ALTERATIONS DATE BY	TITLE WELD EFFICIENCY		
	TOLERANCES SHALL BE - FRACTIONAL $\pm 1/64$ DECIMAL $\pm .000$ EXCEPT WHERE SPECIFIED		SCALE —H—
	MATERIAL —H—	DRAWN R.C.	CHECKED L.G.
	FINISH —H—	DATE 12-6-57	APP'D. L.G.
FERRANTI ELECTRIC, INC. 80 ROCKEFELLER PLAZA NEW YORK CITY		DRAWING NO. A-204-6023	

USED ON



FIGURE-24

NO. ALTERATIONS DATE BY		TITLE TRANSDUCER BLOCK	
		TOLERANCE SHALL BE - FRACTIONAL $\pm 1/64$ DECIMAL $\pm .008$ EXCEPT WHERE SPECIFIED	SCALE H
		MATERIAL H	DRAWN R.C. CHECKED L.G.
		FINISH H	DATE 12-6-57 APD L.G.
		FERRANTI ELECTRIC, INC. 30 ROCKEFELLER PLAZA NEW YORK CITY	
		DRAWING NO. A-204-6024	

USED ON

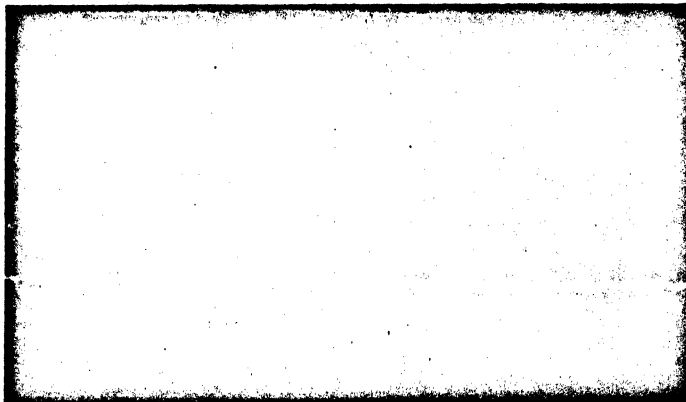

FIGURE - 25

NO ALTERATIONS DATE BY		TITLE TYPICAL DIGIT PATTERN FROM STORE & ADDER	
		TOLERANCE SHALL BE FRACTIONAL $\pm 1/64$ DECIMAL $\pm .005$ EXCEPT WHERE SPECIFIED	SCALE H
		MATERIAL H	DRAWN R.C. CHECKED L.G.
		FINISH H	DATE 12-5-57 APP'D L.G.
		FERRANTI ELECTRIC, INC. 30 ROCKEFELLER PLAZA NEW YORK CITY	DRAWING NO. A-204-6025

REFERENCES

- 1) Scarrott, G.G. & Naylor R.
Wire Type Acoustic Delay Lines For Digital Storage
Proc. I.E.E., Part B Supplement No. 3
Vol. 103 1956 pp. 497-508
- 2) Fairclough, J.W.
A Sonic Delay Line Storage Unit For A Digital Computer
Proc. I.E.E. Part B Supplement No. 3
Vol. 103 1956 pp. 491-496
- 3) American Institute of Physics Handbook
McGraw Hill 1957
Acoustic Properties of Solids pp. 3-74 to 3-78
- 4) Hueter T.F. & Bolt R.H.
Sonics Wiley 1955
- 5) Kolsky, H.
Stress Waves In Solids
Oxford 1953
- 6) Lee R.
Electronic Transformers & Circuits
Wiley 1947 pp. 194-196