

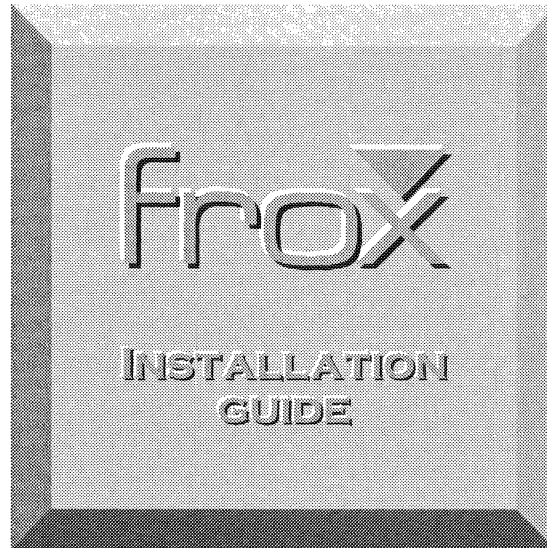



Frox, Inc., 323 Sinclair Frontage Road, Milpitas, CA 95035  
408 .957 .7420  
FAX 408 .946 .3657

Frox Technical Support may be contacted at 800 .525 .5257  
during the hours of 8:30AM to 5:00PM PST, Monday - Friday

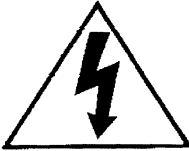

*Important Safeguards*

	<b>CAUTION</b> RISK OF ELECTRIC SHOCK DO NOT OPEN	
<p><b>CAUTION:</b> TO REDUCE THE RISK OF ELECTRIC SHOCK, DO NOT REMOVE COVER (OR BACK) NO USER-SERVICEABLE PARTS INSIDE REFER SERVICING TO QUALIFIED SERVICE PERSONNEL.</p>		



The lightning flash with arrowhead symbol, within an equilateral triangle, is intended to alert the user to the presence of uninsulated 'dangerous voltage' within the product's enclosure that may be of sufficient magnitude to constitute a risk of electric shock.



The exclamation point within an equilateral triangle is intended to alert the user to the presence of important operation and maintenance (servicing) instructions in the literature accompanying the appliance.



# IMPORTANT SAFEGUARDS

Thank you for selecting the FroxSystem home entertainment theater ensemble! We hope your entertainment experience is enriched by our state-of-the-art digital audio/video imaging and information management systems.

**Please READ THESE INSTRUCTIONS CAREFULLY concerning safe operation of your system, and retain this manual for future reference.**

Use this space to record your component(s) serial numbers for future reference:

Model Numbers	Serial Numbers	Model Numbers	Serial Numbers
_____	_____	_____	_____
_____	_____	_____	_____
_____	_____	_____	_____

**WARNING:**

TO PREVENT FIRE OR SHOCK HAZARD, DO NOT EXPOSE THIS APPLIANCE TO RAIN OR MOISTURE.

**CAUTION:**

TO PREVENT ELECTRIC SHOCK, DO NOT USE THIS POLARIZED OR THREE-WIRE GROUNDING PLUG WITH AN EXTENSION CORD, RECEPTACLE OR OTHER OUTLET UNLESS THE BLADES CAN BE FULLY INSERTED TO PREVENT BLADE EXPOSURE.

**NOTE TO CATV SYSTEM INSTALLER:**

THIS REMINDER IS PROVIDED TO CALL THE CATV SYSTEM INSTALLER'S ATTENTION TO ARTICLE 820-33 OF THE NEC THAT PROVIDES GUIDELINES FOR PROPER GROUNDING. IN PARTICULAR, THIS SPECIFIES THAT THE CABLE GROUND SHALL BE CONNECTED TO THE GROUNDING SYSTEM OF THE BUILDING AS CLOSE TO THE POINT OF CABLE ENTRY AS PRACTICAL.

*Important Safeguards*

**IMPORTANT SAFEGUARDS**

- (1) Read, Follow and Retain all Instructions and Warnings.**

Read and follow all the safety and operational instructions before using your FroxSystem, and retain these instructions for future reference. All warnings on the components and within the Owner's Manual should be carefully adhered to. Please review and follow all specific operation and usage instructions as outlined within this Owner's Manual.

- (2) Water and Moisture.**

To prevent fire or electrical shock, do not expose the Frox components to water or moisture. Do not set or use these components near water (for example, near a sink or wash tub, in a wet basement, etc.). Use extreme care with any liquids near any electronic components.

- (3) Cabinet Care and Cleaning.**

Always unplug your FroxSystem from the wall outlet before cleaning. Use only a damp cloth for cabinet cleaning; wipe dry. A mild detergent can be applied to a moistened cloth for heavier cleaning needs. Never use any petroleum-based liquid or aerosol cleaners.

- (4) Placement and Mounting.**

Never place the Frox components on an unstable stand, table, cart, bracket or the like. A cart or stand may fall, resulting in

serious injury to an adult or child and damage to the components. Use care when moving any component and cart combination, as uneven surfaces, quick starts and stops, even excessive force may cause the cart to overturn. Use only on a stand, table, or cart recommended by the cart manufacturer or Frox. Do not place heavy objects on top of the Frox components as damage may result. Finally, use care in mounting any of the system components; follow all specific installation instructions, heed all mounting safety warnings and only use recommended mounting accessories (where applicable).



- (5) Attachments.**

Attachments other than those recommended by Frox may cause hazards. Do not use any other attachments or devices to these components without the manufacturer's approval.

- (6) Ventilation.**

Your components are designed with optimum ventilation for reliable operation and protection from overheating. Maximum ventilation occurs when placed on hard, flat



*Important Safeguards*

surfaces. Special cabinet slots assisting in ventilation must never be blocked by placing the components on a bed, sofa, rug (and any other like materials) or other components. Never allow drapes, rugs or other coverings to block any of the component vents. Always establish proper component spacing when installing the Frox components into a bookshelf or component rack. Also, insure that the electronics are kept away from heat sources (radiators, heating ducts) that may cause damage to the system components.

(7) **Power Sources.**

The Frox components are intended to operate only from power sources listed on the marked label on the components. Consult your Frox dealer or your local power company if you are unsure of the specific type of power supplied to your home. For video products intended to operate from battery power, or from other sources, refer to the operating instructions.

(8) **Power Cords, Plugs and Grounding.**

Your components are equipped with a three-wire Grounding-type plug for your safety:

**Three-wire Grounding-type Plugs** - a plug with a third (grounding) pin. This plug will only fit into a grounding-type power outlet. This is a safety feature. If you are unable to insert the plug into the outlet, contact your electrician to replace your obsolete outlet. Do not defeat the safety purpose of the grounding-type plug.

To prevent the risk of fire or electric shock, never overload wall outlets and/or extension cords. **Frox recommends the use of a safety-fused, properly-grounded regulated power strip or recepticle for optimum component protection.**

Finally, protect your power supply cords. Always route power cords with care to minimize fire or shock hazards. Insure that power cords are never walked upon, crimped or pinched by any furniture placed upon or near them, component positioning against the wall, etc. Pay particular attention to cords at plugs, convenience recepticles and the point where they exit from the component(s).

(9) **Outside Antenna Systems - Safety and Grounding.**

Use extreme care when installing an outside antenna system. Never locate an outside antenna system near overhead power lines, overhead lights or any other powered circuits, particularly if the antenna could fall and come into contact with the power lines or circuits. When installing an outside antenna system, extreme care should be taken to keep from touching any power lines or circuits - contact with them might be fatal.

If you use an outside antenna or cable system, insure that the antenna or cable system is properly grounded to protect from unwanted voltage surges or built-up static charges. Section 810 of the National Electric Code, ANSI/NFPA No. 70 - 1984, provides information with respect to proper grounding of the mast and supporting structure, grounding of the lead-in wire to an antenna-discharge unit, size of

*Important Safeguards*

grounding conductors, location of antenna-discharge unit, connection to grounding electrodes, and requirements for the grounding electrode.

EXAMPLE OF ANTENNA GROUNDING ACCORDING TO NATIONAL ELECTRICAL CODE INSTRUCTIONS CONTAINED IN ARTICLE 810 - "RADIO AND TELEVISION EQUIPMENT"

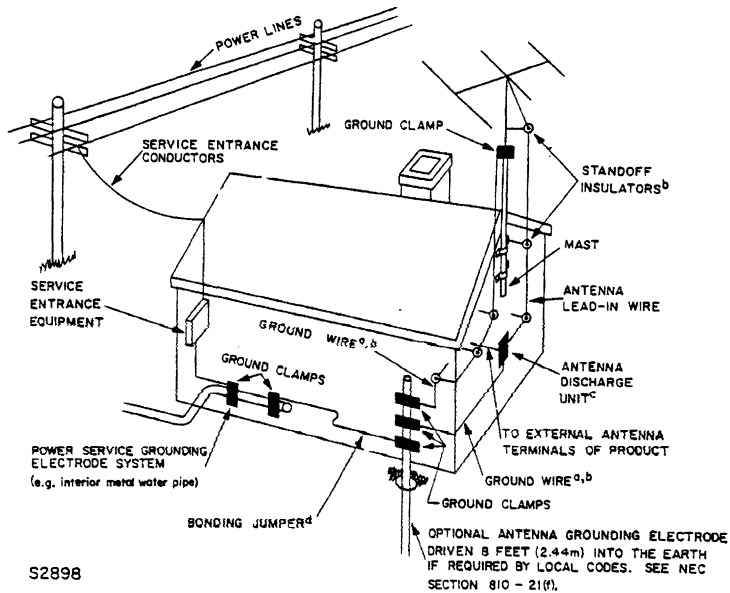

☐ (10) Lightning.

For added protection for your video components during a lightning storm, or when it is left unattended and unused for long periods of time, unplug the Frox processors from the wall outlet (**after powering down the system using the FroxWand's power off button**) and disconnect the antenna or cable system connected to it. This will prevent damage to the video product due to lightning and power-line surges.

☐ (11) Object and Liquid Entry.

Never push objects of any kind into any openings of the Frox component, as they may touch dangerous voltage points or short-out parts that could result in a fire or electric shock. Never spill liquid of any kind on the components.

☐ (12) Servicing.

Please refer all servicing to qualified personnel; contact your system installer or Frox at 800-525-5257 for specific service details should your system require attention. **Do not remove the component covers or attempt to service the units yourself** - there are no user-serviceable parts inside. Opening or removing the cabinet covers can expose you to dangerous voltage and electrical hazards.

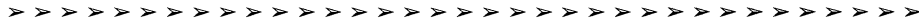

*Important Safeguards*

**(13) Damage Requiring Service.**

Immediately disconnect the components from the power source and contact your qualified service personnel should one of the following conditions occur:

- (a) Any liquid has spilled in/on the components
- (b) Any object has fallen into the components.
- (c) A heavy object has fallen onto the components
- (d) Any Frox component has been dropped and/or exhibits cabinet damage
- (e) Whenever the power cord and/or plug has been damaged
- (f) The products have been exposed to rain or other elements
- (g) If the product exhibits a distinct change in performance; this indicates a need for service

- (h) Your product does not appear to operate normally by following these operation instructions within the Owner's Manual. Adjust only those controls covered by the operating instructions, as improper adjustment of other controls may result in damage and will often require extensive work by a qualified technician to restore the product to its normal operation.

**(14) Replacement Parts.**

When replacement parts are required, be sure the service technician has used replacement parts specified by the manufacturer or have the same characteristics as the original part. Unauthorized substitutions may result in fire, electric shock or other hazards.

**(15) Safety Check.**

Upon completion of any service or repairs to this product, ask the service technician to perform safety checks to determine that the product is in proper operating condition.

*Important Safeguards*

(16) **Software Authorizations.**

CAUTION: Any changes or modifications to the operating software, design, recommendations and electronic component(s) not expressly authorized and approved by Frox, Inc. in writing will void the specific user's authority to operate the equipment. See your component warranty for further details.

(17) **FCC Class B Digital Device Compliance.**

NOTE: This equipment has been tested and found to comply with the limits for a Class B digital device, pursuant to Part 15 of the FCC Rules. These limits are designed to provide reasonable protection against harmful interference in a residential installation.

This equipment generates, uses and can radiate radio frequency energy and, if not installed and used in accordance with the instructions, may cause harmful interference to radio communications. However, there is no guarantee that interference will not occur in a particular installation. If this equipment does cause harmful interference to radio or television reception, which can be determined by turning the equipment off and on, the user is encouraged to try to correct the interference by one or more of the following measures:

 Reorient or relocate the receiving antenna.

 Increase the separation between the equipment and receiver.

 Connect the equipment into an outlet on a circuit different from that to which the receiver is connected.

 Consult an experienced radio/TV technician for help.





**Important Safeguards...2**

**Introduction**

- Purpose of the Manual...11
- Using the Manual...12

**Planning a Successful Installation...15**

- Environmental and Electrical Considerations...16

**Upgrading to V3.0 and Beyond**

- Frox CD Booting Utility...19

**Hardware Installation**

- Getting Started...25
- Connecting the Media Processor and the Video Preprocessor...29
- Monitor Connection...31
- TV Signals...37
- CD Players...41
- Time Base Correctors...43
- VCRs...45
- Laserdisc Players...49
- Speakers...51
- Miscellaneous Analog Audio Devices...55
- IR Emitters...57
- IR Repeaters...59
- Using X-10 Modules...61
- Multiroom Audio...62

**Software Installation**

- Getting Started...63
- Preferences...64
- Authorizations...67
- Locale, Date and Time...69
- TV Channels...71
- TV Signals...75
- VCRs...79
- Laserdisc Players...83
- CD Players...85
- Miscellaneous Analog Audio Devices...89
- Speakers...91
- Alternate Monitor...97

**Maintenance**

- Save Setup...101
- Restore Setup...102
- System Update...102
- CD Covers...102
- Convergence...104
- UI Shifting...105
- Statistics...106

**Troubleshooting...109**

**Appendices...113**

- Appendix A - General Electrostatic Procedures
- Appendix B - Sync Jumper
- Appendix C - DSP Audio Cards
- Appendix D - Learn Mode Scripts

*Acknowledgments***ACKNOWLEDGMENTS**

Frox, FroxSystem, FroxVision, FroxSound, FroxControl, FroxWand, FroxRoute, FroxZone, Active Pixel Control, Sonic Playground and Digital Straight Line are all trademarks of Frox, Inc. FroxCast is a servicemark of Frox, Inc. All rights reserved.

Portions of the FroxSystem products have been licensed from Adobe Systems Incorporated, Bradley Forthware and Raima Corporation.

The Frox Dolby™ Pro • Logic processing is manufactured under license from Dolby Laboratories Licensing Corporation. Additionally licensed under one or more of the following patents: U.S. numbers 3,632,886, 3,746,792 and 3,959,590; Canadian numbers 1,004,603, 1,037,877. “Dolby” and the double-D symbol are trademarks of Dolby Laboratories Licensing Corporation. All rights reserved.

The Frox Home THX® Audio System is manufactured under license from LucasArts Entertainment Company. THX is a registered trademark of LucasArts Entertainment Company. All rights reserved.



The FroxSystem Installation Manual is intended to be a simple navigation guide through a FroxSystem installation. Along the way, many useful facts and hints are provided that should reduce the chance of error. It is a good idea to read the entire installation manual as if it was a novel. As the FroxSystem is an integrated platform combining audio, video and sophisticated computer technologies, all installation topics are very much related and should be understood prior to attempting any installation.

- A numeric “checkbox” format has been used that allows the installer to mark off completed steps. Installation notes may be written directly on each page in the margins provided.



## How to Use This Manual

### USING THIS MANUAL

The FroxSystem Installation Manual is designed to walk an installer through the planning stages of an installation to the moment the system is ready for operation. The manual should be closely observed from beginning to the end. The "Hardware" chapter should **always** be completed before the "Software" chapter is initiated to avoid potential hazards.

A "Troubleshooting" section provides a quick reference for common installation problems; several appendices are included for miscellaneous hardware and software issues requiring more detailed explanations.

In the information packet shipped with each Media Processor and Video Preprocessor there are rear panel diagrams of each component. These are to be used during the "Hardware" installation chapters to notate what is connected to each port. This will be helpful later when going through the "Software" installation procedure. It is strongly recommended that these charts be completed and used when attempting a FroxSystem installation. Since the system integrates a multitude of products it is important to keep track of hardware connections. (The rear panel diagrams for both the Media Processor and Video Preprocessor are also located in the Preparation section of the "Hardware" installation chapter).

In this manual, several graphic and textual conventions are used to simplify the understanding of procedures and words. For example, button names are in all-caps as illustrated in the sentence - *To change the FroxWand speed, click on the FROX button to access the Frox "Go-To" menu and then*

*click on the PREFERENCES button...* In this sentence both "FROX" and "PREFERENCES" are button names. Note that the words "click on" refer to squeezing and releasing the activation triggers on the FroxWand.

Other important topics are indicated by the capitalization of the first letter in each word describing each respective screen, area or control panel. For example in the sentence - *If the VCR button does not appear on the Video Control Stripe then re-enter Installation and re-install the VCR.* In this sentence both "Video Control Stripe" and "Installation" conform to the defined rules.

In the "Software" Installation procedure various buttons provide functions that help an installer move through screens (or scroll through lists). Here are some button descriptions that are useful to know:

#### NEXT

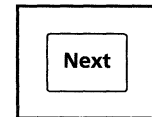

The NEXT button is found on the Installation Control Stripe. It is used to move forward in a particular area of Installation. For example, when installing Analog Audio/Video components, the NEXT button will scroll forward to relevant installation screens. Depending upon what the system already knows it may or may not access every installation screen in a particular area. For example, if no device is installed in *Video In 2*, a NEXT selection will scroll directly to *Aux In 1* instead of landing on each of the installation screens associated with *Video In 2*.

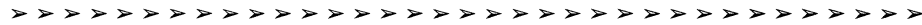

The NEXT button will not scroll from section to section. At the end of a particular installation section, a NEXT selection will not introduce any new screen. To get to a different installation section, select the appropriate new topic button from the Installation Control Stripe.

**PREV**

The PREV button is found on the Installation Control Stripe. It is used to scroll backward in a particular area of Installation. For example, when installing Analog Audio/Video components, the PREV button will move backward to relevant installation screens. Depending on what the system already knows it may or may not access every installation screen in a particular area. For example, if no device is installed in *Video In 2*, a PREV selection from the *Aux In 1* installation screen will scroll directly to *Video In 2* instead of landing on each of the installation screens associated with *Video In 2*.

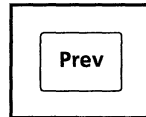

The PREV button will not scroll from section to section. At the beginning of a particular installation section, a PREV selection will not introduce any new screen. To get to a different installation section, select the appropriate button from the Installation Control Stripe.

**SCROLL BARS**

Scroll Bars can be found adjacent to lists that extend to another page of information. They are

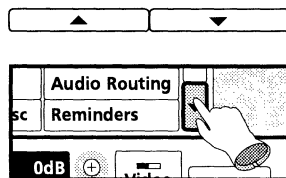

commonly found at the bottom of device lists and television channels lists. The Frox "Go-To" menu offers another example of Scroll Bars in the FroxSystem.

**DONE**

The DONE button is found on the Installation Control Stripe. It is used to exit the Installation procedure and save all changes to the installation configuration that were made. This procedure can take up to 30 seconds. While this is occurring the message "Completing Installation...One moment please" will notify you of the system's status. When the data is saved, the message "Installation completed successfully" will briefly be written to the screen, followed by the drawing of the Video Control Stripe with TV selected as the default.

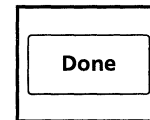

To save the installation configuration while working in Installation, select the SAVE SETUP option from the Maintenance area of Installation.

**CRITICAL INSTALLATION POINTS**

The hand icon is used throughout this installation manual to identify critical installation points in many chapters and sections. Make certain that these topics are read and understood before proceeding with the installation. An understanding of these warnings can make the difference between a successful installation and a problematic one.

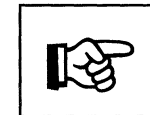



*Notes*



**INSTALLER'S NOTES**



**PLANNING A SUCCESSFUL INSTALLATION**

A successful FroxSystem installation involves adhering to standard industry practices for high quality electronic systems integration. Common sense and thoughtful planning will result in happy customers. Before beginning a FroxSystem installation, keep in mind the considerations in this chapter.

 Probably the most important fact to remember when installing a FroxSystem is that it is a computer. While it is cleverly packaged as an attractive audio/video processor, the core of the product is a very sophisticated computing system.

The FroxSystem is a computer designed to run 24 hours a day. Traditional personal computers are not, and generally they will not work reliably without special electrical accessories like uninterruptible power supplies (UPS) and surge protectors. Therefore, special attention must be made to the electrical conditions and physical environment of the home or office in which the FroxSystem will be installed.

Another thing about computers is that they are hopelessly logical. If you don't "tell them the truth" they have a funny way of letting you know about it (usually at a later date). Do not try to "fool" the FroxSystem into doing something it isn't intended to do. This important rule will save an installer from inevitable future headaches.

Preparation with a good knowledge base is an excellent starting place to enter a FroxSystem installation. Read the following items carefully.

**ENVIRONMENTAL AND ELECTRICAL CONSIDERATIONS**

**Safety First**

For your protection, observe the following safety precautions when setting up your equipment:

 Follow all warnings and instructions marked on the equipment.

 Insure that the voltage and frequency of your power source matches the voltage and frequency inscribed on the equipment's electrical rating labels.

 Never push objects of any kind through openings in the equipment. Dangerous voltages may be present. Conductive foreign objects could produce a short circuit that could cause fire, electric shock, damage to the equipment, or personal injury.

**Modifications to Equipment**

Do not make mechanical or electrical modifications to the equipment. Frox, Inc., is not responsible for the regulatory compliance of a modified Frox product.

**Placement of a FroxSystem**

To insure reliable operation of your FroxSystem and to protect it from overheating, ventilation points must not be blocked or covered. Several inches should be provided in front of and behind the Media Processor and Video



## *Environmental and Electrical Considerations*

Preprocessor, in order to insure proper air flow and cooling. A FroxSystem should never be placed near a radiator or heat register.

Never position the Media Processor's infrared (IR) sensor in line with direct sunlight, halogen lights, or fluorescent lights. The FroxWand infrared (IR) controller uses IR technology that makes the system sensitive to stray lighting at various frequencies. This can cause the FroxSystem to malfunction.

### **Power Cord Connection**

Frox products are designed to work with single-phase power systems having a neutral and a ground conductor. The FroxSystem uses a nominal input voltage of 115 VAC. To reduce the risk of electrical shock, do not plug Frox products into any other type of power system. Contact a qualified electrician if you are not sure what type of power is supplied to a building.

Not all power cords have the same current ratings. Common household extension cords do not have overload protection and are not meant for use with computer systems. Do not use household extension cords with a Frox product.

The FroxSystem is shipped with grounding type (three-wire) power cords. To reduce the risk of electric shock, always plug the cord into a grounded power outlet.

### **Stable Power Supply**

As listed on the rear of the Media Processor and the Video Preprocessor, the FroxSystem will operate with a continuous AC voltage in the range of 90 to 132 VAC. The key here is that the voltage should be continuous and not swing too far from its continuous level. Ideally, the FroxSystem should receive a continuous nominal input voltage of 115 VAC. Unfortunately many homes are not capable of delivering a continuous voltage; large spikes and dips in the voltage coming out of the wall are common. Voltage activity of this type can result in a host of problems with the FroxSystem, as all computers typically require a stable supply for reliable operation.

In addition to poor electrical wiring systems in homes and offices, some common occurrences are power outages or surges due to inclement weather and other factors. This also can cause problems for the FroxSystem. Therefore, it is strongly recommended that the FroxSystem be isolated from the voltage being supplied by the wall and protected from power surges.

The best solution- one that is recommended for every FroxSystem installation- is an uninterruptible power supply (UPS). These can be found at a wide range in price but can be purchased for several hundred dollars. A UPS will pay for itself over time. These devices will provide a continuous voltage to the FroxSystem, while protecting against sudden surges or dips in the wall voltage.





*Environmental and Electrical Considerations*

Accessories such as surge protectors and powerline conditioners (that protect the FroxSystem from spikes and other noise that can get in the AC line) are also excellent solutions.

**Ground Loops**

Often the various electrical power outlets in a home are not at the same ground potential. A remote video monitor, if plugged into a nearby outlet, is likely to have a slightly different voltage on its ground than that of the distant Media Processor. This small voltage differential will cause a noise current to flow through the shields of the video and audio cables that can cause interference to both picture and sound.

Noise interference from powerline ground loops will typically come and go, depending on operation of other electrical appliances in the building or neighborhood. Nearby “SCR” style light dimmers often produce significant amounts of powerline noise. As an installer, it is often difficult to properly test an installation due to the randomness of these occurrences. The best policy, therefore, is to always install both video, audio and power circuits according to standards that insure good performance. This is not always an easy task and can be the installer’s biggest technical challenge. The proper solution will depend on the particular situation.

A quick way to help determine if a ground loop is occurring is to power the remote monitor or audio device from an extension cord that is plugged directly into the same UPS as the Media Processor and Video Processor. This should eliminate most of the “loop” and the noise it generates.

Cable television companies often do not provide adequate grounding on the cable-drop into a home. Twenty volts of 60Hz hum (and more) is not unheard of. This pollution, traveling down the “outside” of the coaxial cable does not interfere with direct reception of the cable television signals. It can, however, get back into any audio or video output cable via the common shields and case grounds.

Some installers may prefer to add a DC-block coupling between the FroxSystem and the properly-grounded cable television drop. To be effective at preventing ground loops, such a block must provide a low frequency open circuit in both the shield and the center conductor. Such DC-blocks have been fashioned from back-to-back 75ohm to 300ohm transformers, for example.

**Overloading Circuits**

When installing any home entertainment system (including the FroxSystem) make certain that the AC current demands of the electrical components can be adequately supplied by the home or office building. Check the maximum current drain of each component and sum all of the current needs together to ascertain the maximum current drain of the system. Installations with large power amplifiers and video monitors can require large amounts of power. Never push an electrical circuit to its limit. Investigate the available current on a particular circuit ahead of time. Also check if large appliances (refrigerators or air conditioners) are sharing the circuit elsewhere in the home or office building.



*Environmental and Electrical  
Considerations*

If possible, give the Media Processor, Video Preprocessor and primary monitor its own circuit. This will reduce the chances of overloading the circuit to the point where it can affect the performance of the FroxSystem. Successful installations may even require having an electrician adding new circuits as needed.

#### **The FroxSystem's AC Switched Outlets**

There are two AC Switched Outlets on the rear of the Media Processor. These outlets switch ON and OFF whenever the FroxSystem is soft-powered ON and OFF from the FroxWand. Though these outlets are rated at 500 Watts, it is never a good idea to overload them with peripherals. Low-load applications, such as AC/DC current triggers for relays and power strips, are good ones for the AC Switched Outlets.

If devices are desired to turn ON and OFF along with the FroxSystem, it is strongly recommended that X-10 lamp and appliance modules be used for this purpose. Instructions on how to install these accessories can be found in the Hardware section "Using X-10 Modules."

Never plug the Video Preprocessor into the switched outlets on the back of the Media Processor. Both components should be on dedicated AC lines to the uninterruptible power supply (UPS) or AC power strip.

#### **System Unit Cover**

You must remove the cover of the Media Processor in order to add DSP cards, change PROMs, NVRAM or internal storage devices. Be sure to replace the cover before powering up your FroxSystem. Read Appendix A, "General Electrostatic Handling Rules," located at the rear of this manual before removing the cover of either the Media Processor or the Video Preprocessor.

#### **Environmental Ranges**

The acceptable environmental ranges are:

Temperature: Between 32 and 104 degrees Fahrenheit (0 and 40 degrees Celsius)

Humidity: Between 5% and 80% (relative noncondensing)

Altitude: Between 0 and 10,000 feet (0 and 3,048 meters)

Ventilation: Keep the installation area well ventilated or air-conditioned to avoid overheating.

Dust: Keep the installation area as dust-free as possible.



**SYSTEM SOFTWARE UPGRADES**

The FroxBoot Compact Disc Booting Utility allows installers/users to update the FroxSystem software by transferring data from a compact disc (CD) to the FroxSystem hard disk drive. Additionally, FroxBoot provides quick recovery from most hard disk failures and unrecoverable system crashes.

 FroxBoot requires that a CD player with a coaxial or fiberoptic digital output be connected to any of the eight digital inputs on the Media Processor. In the case of a 100-disc Frox (CDC-01) or NSM branded changer, the serial control cable must also be connected to the FroxCD serial port on the Media Processor in order for proper control and data transfer.

 CD album covers are not backed up by V3.0, but must, in the event of a crash or system software upgrade, be re-read from the CD Covers Tape.

 When installing V3.0 for the first time, it will be necessary to reinstall the entire system including preferences, CDs in collection, and devices, since FroxSystem software versions 2.0 and prior did not back this information up the way V3.0 does.

**CONVERTING FROM V2.0 TO V3.0**

 The V3.0 upgrade includes a set of PROMs and a FroxCD. The existing hard disk in the Media Processor need not be replaced in order to upgrade to V3.0. The V3.0 software will, when fully installed, make a backup copy of all the preferences, CDs in collection, TV schedules, and installation information on a “read-only” partition on the hard disk drive. In the event that the system experiences a fatal crash and must be restarted by reloading from the FroxCD, this saved information will be recovered, avoiding the inconvenience of reinstalling the entire system. The same custom information is saved upon upgrading to later releases of FroxSystem software.

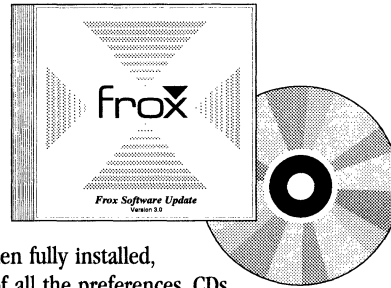

If a Media Processor is running any version of software V3.0 or later, you must have a set of PROMs installed that are labeled version 2.0 or later. The PROMs are located in the Media Processor on the motherboard near the fan. There are four PROMs which are socketed integrated circuits (ICs). Make sure that the power is OFF on the Media Processor and Video Preprocessor when inspecting or changing PROMs (or any other hardware inside either component).

*Upgrading to U3.0 and Beyond -  
From CD Booting  
Utility*

 Keep the grounded AC power cord connected to the Media Processor and Video Preprocessor while disconnecting the AC power from the external power strip. Power should not be restored until the PROM installation is complete and the cover has been returned to the Media Processor.

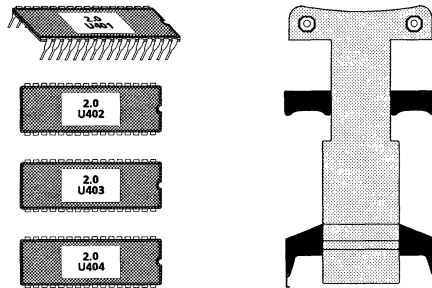

**TO INSTALL NEW PROMS**

- 1) Read Appendix A, entitled "General Electrostatic Procedures" found at the rear of this manual. Be sure to follow all of the rules outlined.
- 2) Turn off power to the Media Processor and Video Preprocessor.
- 3) Remove the three screws located along the top of the rear panel of the Media Processor, and slide the top cover out of its mounting, towards the back of the unit. The top cover has a very snug fit, so some exertion is normal to remove it.

4) Locate the four PROMs. If facing the front of the Media Processor the PROMs are in increasing numeric order from right to left. The rightmost PROM is the one closest to the fan. Also note that the dimple on the end of the PROM must face towards the front of the Media Processor.

5) Using the PROM puller, remove the PROMs. Grasp each PROM with the puller, and squeeze the handle until the PROM pops out of its socket. Then lift the puller away from the motherboard. As an aid to memory, lay the PROMs down on a flat surface in the same orientation that they came out.

6) Inspect the new PROMs to verify that the pins are not bent.

7) Install the new PROMs.

 It is critical that all pins fit inside the socket. It may be required to slightly align the pins on a flat surface so that they fit comfortably in their sockets. Place each PROM lightly in its socket at first; inspect it carefully so that all pins are seated properly, then press down on the whole surface of the PROM to seat it firmly.

8) Inspect your work. Do the PROMs increase in numeric order from right to left? Are the PROM dimples all facing the front of the Media Processor? Are all the pins in their sockets, and the chips seated firmly?

9) Restore the cover to the Media Processor. Return the three screws to the unit.



**LOADING THE V3.0 FROM THE FROXCD**

- 1) Turn on the power to the Media Processor and Video Preprocessor simultaneously. It is best if they are ganged together on a power distribution strip.
  
- 2) As soon as possible, but not more than 15 seconds after applying power, hold down the F1 button on the FroxWand and aim it at the front of the Media Processor. Continue to hold it down until at least five seconds after the Media Processor light has lit. At this point you will see the screen painted blue-grey, and the following words will appear briefly on the screen:

*FroxBoot (CD booting utility 2.0 PROM)*

If there is a software or hardware problem with the Media Processor hard disk, you will then see this text:

*The disk in your FroxSystem could not be read.  
Contact your Frox service center, or  
to use the FroxBoot CD booting utility,  
squeeze-click the FroxWand now.*

If the problem is only software, FroxBoot will fix it. If it is hardware, FroxBoot will tell you about this later.

If you have a Frox CD Changer, you will then see this screen:

*You have a Frox CD changer.  
Place the FroxBoot CD in slot 100 in the changer.  
Then use the FroxWand SEL up/down buttons to select the  
desired track.  
(Refer to FroxBoot instructions to determine which track  
you need.)  
Select the track, then squeeze-click the FroxWand.  
If you do not want to boot from your Frox CD changer,  
press the F2 button now to boot from any other CD  
player.*

If you do not have a Frox CD Changer, you will see:

*No Frox CD changer found.  
Insert the FroxCD in any CD player with digital output  
that is connected to the FroxSystem.  
(Refer to FroxBoot instructions to determine which track  
you need.)  
Select and play the desired track.*

*Upgrading to V3.0 and Beyond -  
Frox CD Booting  
Utility*

*If there is a Frox CD changer installed, and you want to use it to boot, check its connections, cycle its power, then restart the booting procedure.*

- 3) Follow the appropriate on-screen instructions for your CD player.

To determine the track you should use on the FroxCD refer to the chart below.

Track Numbers	Description
1, 3	Designed to bring your system up to limited functionality quickly. These tracks do not include the CD or movie databases. Loading time for these tracks is on the order of four to five minutes.
2, 4	Designed to bring your system up to full functionality. These tracks include all databases. Loading time for these tracks is on the order of 15 to 30 minutes.
5	Format boot. Select this track only to completely format a hard drive. Note: This process erases all information on the hard drive in preparation for initial data loads.

If the software is loading properly, two horizontal bars are drawn at the bottom of the screen. A red cursor zips along the top of each. When data is read from the CD, it is posted to the top visual display. When data is read into memory, or onto disk, it is posted to the bottom one. Each word of

FroxSystem code is written in a single pixel on the screen, and the pixels are drawn one after another. This is a visual reference for the process your FroxSystem is undertaking.

**LOADING V3.0 AND FUTURE SOFTWARE RELEASES ONTO A V3.0 HARD DISK**

There are two ways to load software "on top" of V3.0:

- 1) With the existing V3.0 FroxCD (or a future release of software) in the CD player, begin the procedure "Loading V3.0 from the FroxCD" from step 1.
- 2) With the existing V3.0 FroxCD (or a future release of software) in the CD player, go to the Maintenance screen in Installation. Click on the SYSTEM UPDATE button. Doing this will complete steps 1 and 2 from the "Loading V3.0 from the FroxCD" procedure above. Proceed from step 3.

**RECOVERING FROM FATAL CRASHES**

Recovery from fatal system crashes is simple with FroxBoot.

If the crash occurs in FroxSystem V2.0 or any prior release, follow the instructions from the beginning of the "Converting from V2.0 to V3.0" section above. Once again, it will be important to change the PROMs in the Media Processor if current PROMs are not installed.

If the crash occurs in FroxSystem V3.0 or any subsequent release, follow the procedure "Loading V3.0 from the FroxCD" described above.



**ERROR MESSAGES AND HOW TO RECOVER**

**Media Processor Hard Disk Hardware Failures**

If during FroxCD installation you see the screen:

*(MinBoot – CD booting utility 1.0 Beta)  
(Relabeling the disk...)  
ERROR WRITING DISK LABEL  
Call your Frox service center.*

This message means that FroxSystem software V3.0 could not write to your Media Processor disk. Most likely the hard disk drive is defective.

*ERROR WRITING TO DISK  
(The disk could not write fast enough.)  
Call your Frox service center.*

This message indicates that the Media Processor hard disk writes too slowly and can't keep up with the rate of data flowing off of the CD. This could occur if the disk encounters numerous soft errors while writing, or it could mean that the disk in the Media Processor is not a standard SCSI disk. Call your Frox service center.

**Media Processor Hard Disk Software Failures**

If during installation you see the screen:

*Critical information on the disk in your Media Processor could not be read.  
Contact your Frox service center.  
Or, to use the FroxBoot CD booting utility,  
squeeze-click the FroxWand now.*

This message indicates that some important components of software on the disk have been lost, and must be restored. It is unlikely to be a disk hardware problem. Proceed with FroxBoot.



*Upgrading to V3.0 and Beyond -  
Frox CD Booting  
Utility*

### Problems Reading The CD

If you see the screen:

*ERROR READING CD.*

*Problems could include:*

- ◆ *scratches on the FroxCD:  
try playing another track, or different disc.*
- ◆ *poor connection to player:  
check the wiring.*
- ◆ *player can't read the disc properly:  
try a different player.*

*Try the booting sequence again from the beginning.  
Click on the FroxWand to continue.*

A similar message to this might occur elsewhere in the booting sequence and substitutes the following for the last line:

*Try the booting sequence again from the beginning.  
Cycle the FroxSystem power, while holding down the F1  
button to continue.*

Scratches on the CD can render portions of it unreadable. This is why multiple copies of the data are distributed over the CD, allowing you to bypass problem areas. Use care when handling these discs, as they are sensitive to scratches or other surface imperfections.

Poor connections to the CD player can also result in problems reading the CD. Long fiberoptic cables can sometimes cause loss of data. With coaxial cables, grounding can be a problem. Check the connections for corrosion or try a different cable. Switch to an optical cable if available.

There is a possibility that some CD players experience problems reading FroxCDs. While there is no evidence to suggest that this is a common problem, if a CD player is having trouble transferring data, try a different player.





**HARDWARE INSTALLATION**

Getting started with hardware installation involves checking to see if all the component hardware and accessories are at hand, inserting batteries in the FroxWand and taking out the rear panel diagrams of the Media Processor and Video Preprocessor.

The FroxSystem ships with an accessory kit (model AAP-01) that includes all of the wiring accessories and documentation necessary to complete a FroxSystem installation. Familiarize yourself with all of the contents and be sure that everything is readily available.

**CHECK THE PACKAGE CONTENTS**

Check the contents of the Media Processor, Video Preprocessor, and AAP-01 (Frox Accessory Kit) boxes. The contents of each box should include the following:

**Media Processor box**

- 1) Media Processor
- 2) AC Power Cord
- 3) Packet containing installation and operation instructions, and a Media Processor back panel diagram card.

**Video Preprocessor box**

- 1) Video Preprocessor
- 2) AC Power Cord
- 3) Packet containing installation and operation instructions, and a Video Preprocessor back panel diagram card.

**AAP-01 Frox Accessory Kit**

- 1) FroxWand box:
  - a) FroxWand
  - b) 4 AAA alkaline batteries
- 2) 5 infrared (IR) mini emitters
- 3) 2 mini phono jack Y-adaptors
- 4) Universal DB-15 to 4BNC video cable
- 5) Owner's Manual
- 6) Installation Manual
- 7) Warranty Card
- 8) SCSI cable
- 9) 4 BNC female/female barrels

*Getting Started*

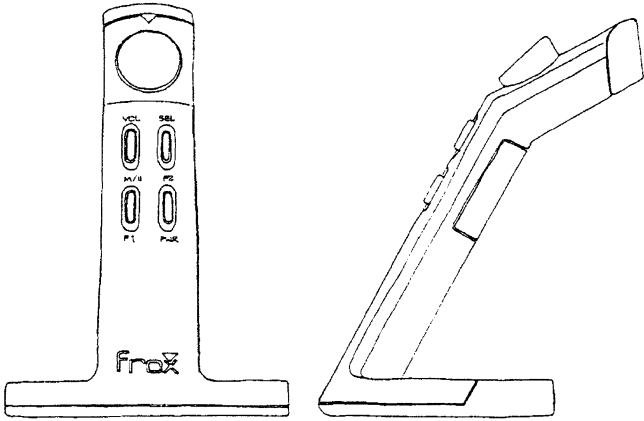

FroxWand (front and side view)

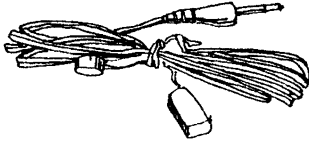

IR emitter

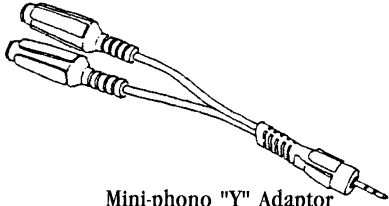

Mini-phono "Y" Adaptor

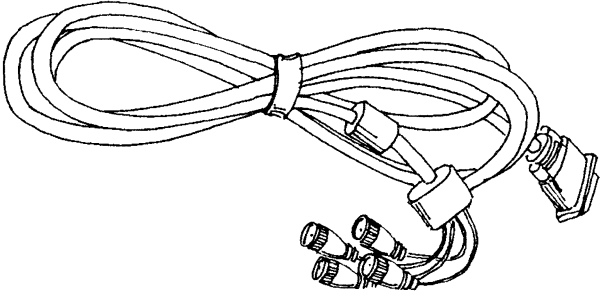

Unversal DB 15 to 4 BNC video connector

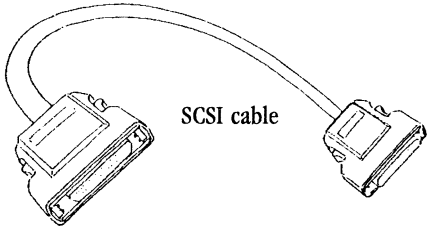

SCSI cable

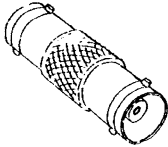

BNC female-to-female-connector

**INSERT BATTERIES INTO THE FROXWAND**

- 1) Remove the screw on the bottom of the base of the FroxWand
- 2) Remove the bottom plate of the FroxWand. This exposes two openings inside the shaft of the FroxWand. One is marked - (negative) and the other is marked + (positive).
- 3) Place two batteries with negative side up in the opening marked -.
- 4) Place 2 batteries with positive side up in the opening marked +.
- 5) Replace the plate, and secure it with a screw. Do not overtighten.

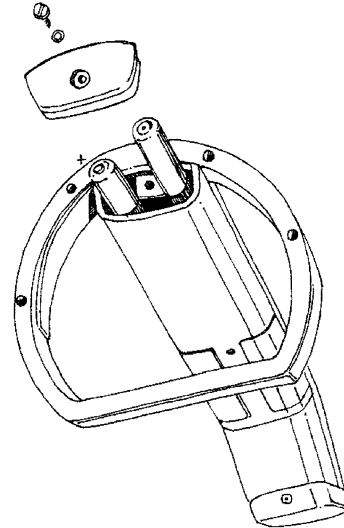

*Getting Started*

**LABELING THE REAR PANEL DIAGRAMS**

Now is the time to take out the rear panel diagrams of the Media Processor and Video Preprocessor that are included in each of the respective boxes. Use a pencil

when writing down which components are connected to each port. As stated on page one, these charts will be a useful tool when entering the "Software" Installation chapter as well as being an important document for future servicing issues.

**Media Processor**

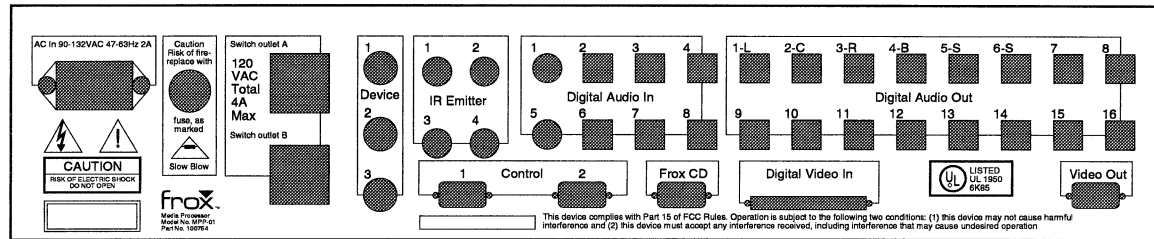

**Video Preprocessor**

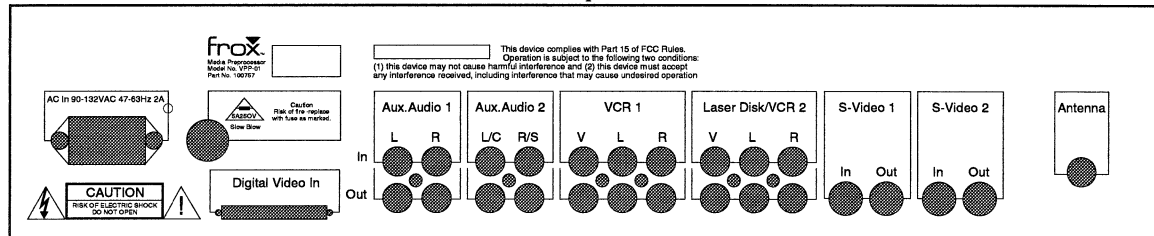





*Connect the Media Processor and Video Preprocessor*

**CONNECTING THE TWO FROX COMPONENTS**

The Media Processor is connected to the Video Preprocessor via a SCSI (small computer system interface) cable which has fifty pins and shielded wires. This is a special cable along which is passed digital video, digital audio and data.

 A bad connection of the SCSI cable on either end may result in erratic FroxSystem functionality. The same is true if any of the pins on the terminating ends are bent, missing or damaged in any way. Make sure the cable is in perfect condition prior to its connection.

 As discussed in the chapter "Planning A Successful Installation," the Media Processor and Video Preprocessor must be plugged into the same power strip, surge protector or uninterruptible power supply (UPS).

**CONNECTING THE MEDIA PROCESSOR WITH THE VIDEO PREPROCESSOR**

 1) Connect one end of the SCSI cable (provided in the AAP-01, Frox Accessory Kit) to the Media Processor *Digital Video In* port and the other end to the Video Preprocessor *Digital Video Out* port.

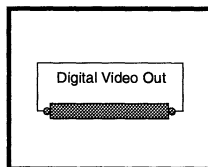
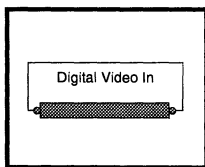

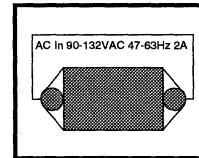

 2) Connect one end of the AC power cord provided with the Media Processor to the AC power port on the back of the Media Processor.

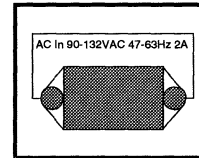

 3) Connect the other end in the same AC power strip or terminal, surge protector, or uninterruptible power supply (UPS) having the same electrical ground for both the Media Processor and Video Preprocessor.

 4) Connect one end of the AC power cord provided with the Video Preprocessor to the AC power port on the back of the Video Preprocessor.



 5) Connect the other end in the same AC power strip or terminal, surge protector, or uninterruptible power supply (UPS) having the same electrical ground as both the Media Processor and Video Preprocessor.



*Notes*



**INSTALLER'S NOTES:**



*Connecting Monitors*

**FROXSYSTEM MONITORS**

The FroxSystem supports two basic kinds of video display devices (VDDs): Datagrade Graphics Monitors and NTSC Monitors.

In most cases the primary monitor in the system will be of the datagrade variety. These monitors, also known as “computer grade” or “multisync” have a horizontal scanning frequency of 31.5kHz (twice that of a conventional television.) The purpose of this is to take advantage of the Frox digital video and line doubling capabilities, as well as the computer graphics resolution. The FroxSystem graphical user interface, as well as the entire video output, is optimized on a monitor capable of displaying such high resolution.

The FroxSystem also allows for a “regular television-type” monitor to be used as a VDD. These monitors have a horizontal scanning frequency of 15.75kHz and are not capable of displaying odd and even scan lines simultaneously. As a result, the FroxSystem video output will not be line doubled or have the full computer graphics resolution. Because these conditions may be suitable for a control monitor outside the main viewing room, Frox provides an “Alternate Monitor” feature that allows the Frox user interface to be overlaid on the *Laserdisc/VCR2* NTSC video output.

 When an alternate monitor is active, all devices installed in *Laserdisc/VCR2 In* will become inaccessible. Also, all PIP features and Video Dubbing activities are not available in the “alternate monitor” mode. Therefore, when using an alternate monitor be sure to install the audio/video device needed to be active under every circumstance in the *VCR1 In* port.

The alternate monitor feature sends video to a television through the S-video and/or composite *Laserdisc/VCR2* output. This feature can be installed to default “all-the-time” or it can be activated on-demand. The on-demand option will allow devices installed in *Laserdisc/VCR2 In* port to be accessible when the alternate monitor is turned OFF.

 When using S-video cables over long distances it is not recommended running over 30 feet without adding amplification to the line. This is typically accomplished by installing in an S-video distribution amplifier.

 Because it is impossible to know if the alternate monitor is the only video display device in the system, the alternate monitor is pre-installed as “always on.” If the alternate monitor is the only monitor in the system **NEVER** un-install it as a *Video Out 2* option in the “Software” installation section ANALOG AUDIO/VIDEO. Doing so will disable all video from the *Laserdisc/VCR2* output (which means that upon leaving INSTALLATION, no video will be present on the alternate monitor; hence, no FroxSystem operation will be possible).

The graphics quality of the S-video output will be superior to that of the composite video output. This is due to the fact that S-video signals are made up of separate luminance and chrominance signals that allow graphics-jitter and color bleeding to be more readily controlled.

The ON and OFF commands for an infrared-controlled television can be taught to the FroxSystem so that when the alternate monitor is engaged the FroxSystem can turn the television ON. When the television is not needed, it can be

*Connecting Monitors*

powered OFF. This is done by using the *Learn* mode (see Appendix D) found on the Alternate Monitor Installation Screen.

**MEDIA PROCESSOR RGB VIDEO OUTPUT SPECIFICATIONS**

**Video Output Connector**

The *Video Out* port on the Media Processor uses a HI-density type DB-15 VGA male connector. The RGB video output of the Media Processor is IBM VGA compatible and will drive such compatible monitors.

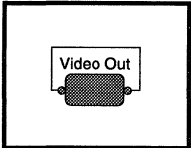

PIN	SIGNAL
1	Red
2	Green
3	Blue
4	-
5	-
6	Ground
7	Ground
8	Ground
9	-
10	Ground
11	Ground
12	-
13	Horizontal or Composite Sync
14	Vertical Sync
15	-
case	Ground

**Signal Timing**

Pixel Clock: 28.636363 MHz

Horizontal Frequency	31.469 kHz	
Horizontal Period	31.778 microsec	910 pixels
Horizontal Active Scan	26.260 microsec	752 pixels
Horizontal Blanking	5.517 microsec	158 pixels
Horizontal Front Porch	1.257 microsec	36 pixels
Horizontal Sync Period	1.886 microsec	54 pixels
Horizontal Back Porch	2.375 microsec	68 pixels

Vertical Frequency	59.940 Hz	
Vertical Period	16.667 msec	525 lines
Vertical Active Scan	15.094 msec	475 lines
Vertical Blanking	1.589 msec	50 lines
Vertical Front Porch	0.095 msec	3 lines
Vertical Sync Period	0.095 msec	3 lines
Vertical Back Porch	1.398 msec	44 lines

**Resolution**

Maximum 484 rows X 768 pixels  
 Minimum 475 rows X 722 pixels



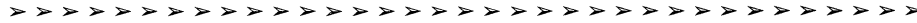

*Connecting Monitors*

**TEST PATTERNS AND MONITOR SETUP**

Traditional methods for converging monitors include adjusting for gray scale and color balance, using reference test

patterns and signals typically derived from test pattern generators or reference videotapes or laserdiscs. While this is fine for analog systems, it is *not the correct* way to optimize the FroxSystem.

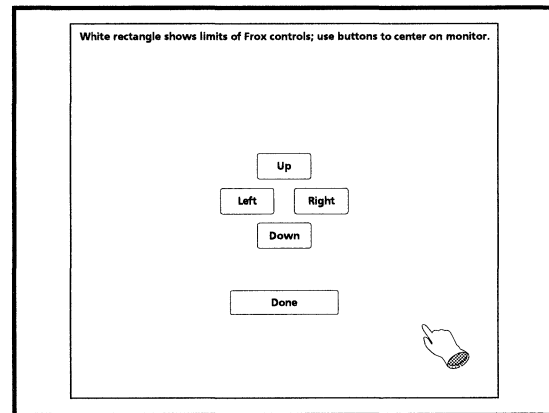
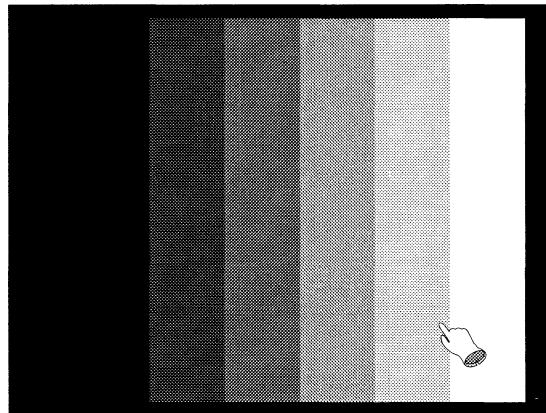
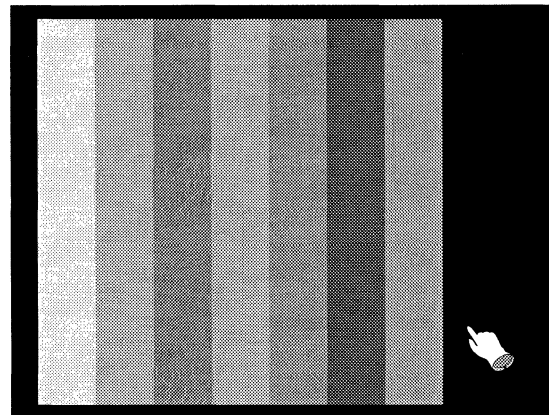
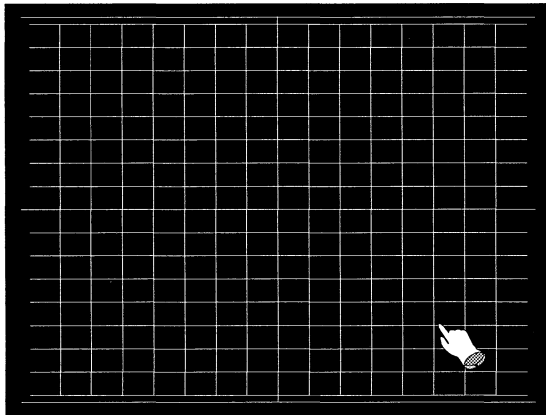

## Connecting Monitors

The source signal that is sent to a monitor in a FroxSystem configuration is generated by the Media Processor (from an area known as a video frame buffer). The video frame buffer combines one or more video sources that have been digitized, the Graphical User Interface (GUI), and the gloved hand (which is a combination of video and graphics). The video frame buffer, therefore, should be considered the reference source signal that is sent to any monitor.

Adjusting the monitor to any one of the video inputs is a mistake in a FroxSystem installation, even though the source may deliver an industry "reference" signal. The reason for this is that each of the three video channels in the FroxSystem are treated differently depending on whether they are television signals, videotape signals or laserdisc signals.

Because the video frame buffer is the reference for monitor setup, various Frox-generated test patterns have been provided in the Maintenance area of the FroxSystem (see the software section, "Maintenance" in this manual). Using the cross hatch, gray scale and color bar patterns provided, monitors can be optimized for the FroxSystem video output. If the convergence procedure on a given projection system allows greater convergence flexibility, use the projector's grids and graphics. All other patterns, however, should be Frox images.

### SYNCHRONIZATION ISSUES WITH DATAGRADE MONITORS

Datagrade monitors input analog video signals broken down into separate red, green, blue and synchronization (sync) components. The sync components are either handled as

separate horizontal and vertical sync elements or they are mixed together to run on a single wire in "composite" form. The FroxSystem can operate with monitors that have either separate or composite sync. The system is configured at the factory to drive a composite sync monitor, but this can be changed by moving a jumper on the motherboard of the Media Processor. This procedure is described in Appendix B of this manual. Check the service manual of your monitor to determine the type of sync it requires.

 When using more than a single datagrade monitor in a FroxSystem installation be certain that all the monitors have the same type of sync requirements. Do not try to mix separate and composite sync monitors in the same installation.

### INSTALLING A DATAGRADE MONITOR

- 1) Connect one end of the AC power cord provided with the monitor to the AC power port on the back of the monitor.
- 2) Connect the other end in the same AC power strip or terminal, surge protector, or uninterruptible power supply (UPS) having the same electrical ground as the Media Processor and Video Preprocessor.

 Do not plug the monitor or projector in the Frox switched outlets.

- 3) Connect the DB-15 to video cable (provided in the AAP-01 accessory kit) to the *Video Out* port of the Media Processor.

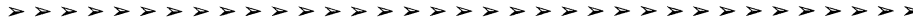

*Connecting Monitors*

 If a system is installed with 1 or more separate sync monitors, then a DB-15 to 5BNC video cable will be needed. Your 4 BNC video cable can be exchanged for the 5BNC cable by contacting the Frox Service Department.

- 4) Connect the BNC ends of the video cable to the BNC analog video inputs on the VDD. In the case of a composite sync monitor you will use the red, green and blue leads as well as the composite sync lead (which runs on the horizontal sync wire and is usually colored black). In the case of a separate sync monitor you will use the red, green and blue leads as well as both sync leads. The horizontal sync lead is usually black and the vertical sync lead is usually either white or yellow.

**EXTENDING THE CABLE LENGTHS**

It is possible that the VDD will be at a greater distance from the Media Processor than the provided cable allows. This will require that each of the red, green, blue and sync leads be extended using coaxial cable. Remember that when running video via coaxial cable on runs over 30 feet, the use of a video distribution amplifier may be necessary to achieve optimum picture quality. To extend the RGB video leads follow this procedure:

- 1) Add a BNC female/female barrel connector (provided in the AAP-01 accessory kit) to each of the red, green, blue and sync leads of the video cable routed from the Media Processor.
- 2) Connect shielded, 75 ohm coaxial cables (RG-59, RG-6) terminating with BNC ends to each of the BNC barrel connectors (installed in step 1).
- 3) Run the coaxial cables to the monitor and connect the BNC ends of each red, green, blue and sync coaxial cable to the BNC analog video inputs on the VDD.

 Labeling each coaxial cable with the words "red," "green," "blue," and "sync," on both terminating ends might be helpful at a later date if you ever have to go back and work with these cables.



*Connecting Monitors*

**INSTALLING AN NTSC MONITOR AS AN “ALTERNATE MONITOR”**

- 1) Plug the AC power cord from the NTSC monitor into the same AC power strip or terminal, surge protector, or uninterruptible power supply (UPS) having the same electrical ground as the Media Processor and Video Preprocessor.
- 2) Connect one end of a high-quality S-video or composite video cable to the appropriate *Laserdisc/VCR2* output of the Video Preprocessor.
- 3) Connect the other end of the cable to the desired S-video or composite video input on the NTSC monitor.

 Note that the S-video and composite video inputs on the Video Preprocessor are not located in the same physical location.

- 4) Turn on the monitor and make sure that the input selector is set to the position that corresponds to the cable used.



*Connecting TV Signals*

**RF INSTALLATION**

Television signals enter the system through RF connections on either the Video Preprocessor or VCRs. These signals may be directly wired to the RF inputs or go through cable decoders (also known as “descramblers”).

☞ When installing the RF (tuner) inputs on VCRs, or the RF input on the Video Preprocessor, be certain that RF signals are not looped through VCRs. If necessary, always split the cable or antenna path prior to entering any RF input.

☞ If cable decoders are being used when installing the RF (tuner) inputs on VCRs or the RF input on the Video Preprocessor, always dedicate a cable decoder to a single RF input. Never split the output from a cable decoder to more than one RF input. If decoding is necessary for more than one RF input, use additional cable decoders. A violation of this rule will cause unpredictable operation from the FroxSystem.

☞ If a cable decoder is being used on any RF input in the system and it is the type of cable decoder that has an A channel and a B channel, then you must do the software installation for the decoder before assigning TV channels. This will provide you with the correct virtual on-screen keyboard that includes the ability to assign an A or B to each channel.

☞ To insure optimum picture quality from the FroxSystem, be sure that a signal strength of at least 7dB is available at the Video Preprocessor RF input. Ideally, the

FroxSystem would like to see 10dB at the Video Preprocessor RF input. Passive RF signal splitters tend to attenuate the signal by at least 3dB and often more. RF amplifiers are not usually a good means of adding signal strength because they tend to amplify noise along with the signal. The best way to get the required signal strength is to call the local cable operator and have them perform the necessary adjustments at the installation site.

A sensible accessory for RF lines is a TV-IF (intermediate frequency) filter that blocks random noise from being passed such as the noise generated by fluorescent lighting.

**SOME THOUGHTS ABOUT ANTENNAS, CABLES, ETC.**

A typical Frox installation will require a little extra thought and preparation with respect to incoming television signals. There are many reasons for this; here are a few:

☞ Large screen displays tend to blatantly show even small reception defects (ghosts, snow, interference, etc.).

☞ The FroxSystem can use more than one tuner simultaneously. Preamps with signal splitters feeding VCRs and the Video Preprocessor are preferred over the customary coaxial switches and relays.

☞ Increased interference from the abundance of associated (or nearby) consumer equipment is possible without special care by the installer.

☞ Channel reception problems can arise when attempting to combine multiple sources, such as antennas, cable and satellite.

*Connecting TV Signals*

☞ A few users may require rotary antennas to achieve desired performance.

☞ Cable television customers with cable decoders may have special conflicts related to the type of service provided by different cable companies.

For some situations, larger types of cables may be desirable. Bigger cables can carry the signal farther without noticeable degradation, as a rule. It is sometimes harder to find suitable connectors and adapters for them. The smaller cables can fit in tight places, look neat and sometimes cost less. In some situations, their performance can be poor unless used for just a few feet. Cables smaller than RG-59U should never be used for distances greater than about 30 feet. Most consumer oriented S-video cables have 2 tiny coaxial cables inside a rubber jacket and must also be considered in the "short run" category.

Coaxial cables up to many inches in diameter are commercially available. These could carry the signals for miles, for example. For many reasons these sizes are not usually recommended even though they could be used successfully. For these applications it is more usual to combine the use of smaller cables with line amplifiers, line equalizers, distribution amplifiers and other commercially available video products. These installations must be carefully designed to obtain excellent performance. Such installations may be highly desirable and very compatible with ProxSystems.

Use top quality audio and video cables (gold plated connectors, etc.). These cables can vastly improve audio and video performance in properly wired installations. Cheap

connectors can appear to perform well when they are first used. However, their performance tends to drop rapidly with time. The normal wear and tear of occasional reconnection quickly distorts the shape of cheap connectors and tends to break some of the shielding wire. This, plus the rapid buildup of dirt and oxides with the cheaper metals, help make top quality cables the right choice.

Beyond this, there is a much more important reason for installers to use the best cables possible: it is regarding over-the-air reception. Unfortunately, most consumer video gear such as laserdisc players and VCRs have significant amounts of radio frequency interference emanating from each rear connector (along with the audio and video signals). Poor cables allow this high frequency interference to leak out along the cable.

The leaking interference usually finds its way back along the cable shielding to the Video Preprocessor, then up to the roof on the outside of the antenna coax. From there it is "received" along with the desired signal by the antenna. The interference then travels back down the coax as part of the signal "inside." Other wiring and sometimes pipes or ductwork in the wall can carry this interference to the antenna as well.

**INSTALLING A TELEVISION SIGNAL TO THE VIDEO PREPROCESSOR**

The RF (tuner) on the back of the Video Preprocessor is considered the main television input on the

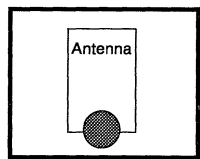



*Connecting TV Signals*

FroxSystem. The signals entering this port are accessed when selecting the TV button on the Video Control Stripe.

 When timer recordings are scheduled, the FroxSystem will not use the television signal entering the Video Preprocessor as the source of the recording, but it will use the signal entering the RF input on the VCR. If a cable decoder is required for viewing a particular channel, and that channel is desired for recording, insure that a decoder is in the path of the television signal that enters the RF input on the VCR. This may mean that a second or third cable decoder is necessary for a FroxSystem installation.

- 1) Using an “F” type connector, attach the cable carrying the TV signal to the Video Preprocessor *Antenna* port. If a cable decoder is used for this input, connect the cable carrying the TV signal to the RF input on the decoder first and then run a second cable from the RF output of the decoder to the *Antenna* port on the Video Preprocessor.

**INSTALLING A TELEVISION SIGNAL TO A VCR**

The RF (tuner) input on the back of a VCR is considered a secondary television input on the FroxSystem. The signals entering this port are viewed by selecting the VCR button on the Video Control Stripe and then accessing its TUNING button.

- 1) Using an “F” type connector, attach the cable carrying the TV signal to the RF input on the VCR. If a cable decoder is used for this input, connect the cable carrying the TV signal to the RF input on the decoder first and then run a second cable from the RF output of the decoder to the RF input on the VCR.
- 2) If necessary, repeat step 1 for additional VCRs.



**INSTALLER'S NOTES:**







*Connecting CD Players*

**CD PLAYER INTERCONNECT**

Connection of a compact disc (CD) player to the FroxSystem will vary based upon the type of player used. If the CD player is a Frox CD Changer (CDC-01) or an NSM-equivalent model, then use the section called *Installing a Frox CD Changer* (CDC-01). If the CD player has a digital output, then use the section called *Installing A Digital CD Player*. If the CD player has only analog outputs then refer to the section called *Installing An Analog CD Player*.

 CD players that do not have a digital output can be controlled via infrared (IR) by the FroxSystem, but because there is no subcode information available on the analog output of a CD player, all data-related FroxSystem features such as CD Identification and Elapsed Time Counter will not be possible.

 Only 1 FroxCD changer is allowed per installation.

 A maximum of 4 CD players (including analog CD players, digital CD players and FroxCD Changers) may be installed per FroxSystem installation.

**INSTALLING A FROX CD CHANGER (CDC-01)**

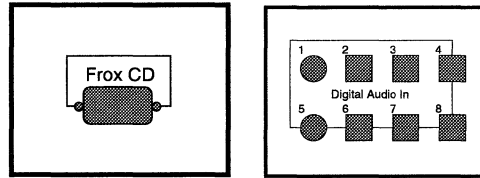

- 1) Connect one end of provided fiberoptic cable or coaxial cable to the corresponding digital output on the CDC-01.
- 2) Connect the other end of the fiberoptic cable to one of the Media Processor *Digital Audio In* ports. Ports 1 or 5 are used for coaxial cable. Ports 2, 3, 4, 6, 7, or 8 are used with fiberoptic cable.
- 3) Connect one end of the DB-9 serial cable provided with the CDC-01 changer to the serial port on the back of the Media Processor.
- 4) Connect the other end of the DB-9 serial cable to the *RS-232* port of the CDC-01.
- 5) Connect one end of the AC power cord provided with the CDC-01 to the AC power port on the back of the CDC-01.
- 6) Install the other end in the same AC power strip or terminal, surge protector, or uninterruptible power supply (UPS) providing the same electrical ground as the Media Processor and Video Preprocessor.

*Connecting CD Players*

 Do not plug the AC cord of the CDC-01 into any outlet that switches ON and OFF with the FroxSystem. The CDC-01 must receive constant current or it can negatively impact the functionality of the overall system.

**INSTALLING A DIGITAL CD PLAYER**

- 1) Connect one end of a high-quality coaxial or fiberoptic cable to the coaxial or digital output of the CD player.

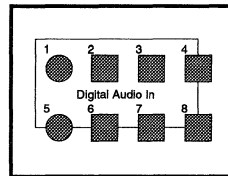

- 2) Connect the other end of the cable to a digital audio input on the Media Processor. If a coaxial wire is used, connect the wire to either the *Digital Audio In* ports 1 or 5. If a fiberoptic cable is used, connect the cable to the *Digital Audio In* ports 2, 3, 4, 6, 7, or 8.
- 3) Connect the manufacturer-supplied AC cord into an available AC outlet.

**INSTALLING AN ANALOG CD PLAYER**

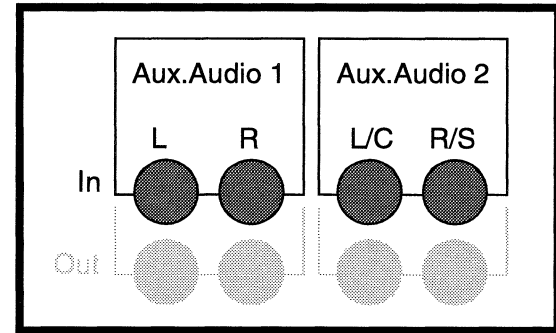

- 1) Connect one end of a high-quality stereo phono cable to the audio line outputs (left and right) of the CD player.
- 2) Connect the other end of the cable to the *Aux In 1* or *Aux In 2* audio inputs (left and right) on the Video Preprocessor.
- 3) Connect the manufacturer-provided AC cord into an available AC outlet.



### VIDEO TIME BASE CORRECTORS (TBC)

While not an installation requirement, digital time base correctors are highly recommended when using video sources that do not output standard video signals. The video device most commonly associated with unstable video output is the VCR. Any digital video system will have trouble with components that output poor synchronization (sync) signals. This includes broadcast studios, digital video editors and multimedia boards for personal computers.

With VCRs, when a field of video reaches the bottom and goes to the top of the next field, the heads switch, causing the horizontal sync pulses to jump. This jump, or shift, is an example of time base error and is very common. High grade VCRs may have the mechanical and electrical design to deal with such problems, but these are rare exceptions. Some inexpensive VCRs might actually perform better than a much higher priced model, depending upon quality.

 To achieve the best video performance when using a VCR with the FroxSystem, use a model that has a built-in digital time base corrector. These models typically cost more than the average VCR but will ultimately provide better signals to the FroxSystem.

The visual artifact that results from video sources with time base errors is a phenomenon often referred to as “flagging” or “tearing” - a bending of the video that can be seen at the top of the screen. In the case of wandering sync, the visible effect can be a “sawtooth” pattern distortion which occurs in the vertical direction over the entire picture.

Time base correctors range in price and features. Some have more than a single input and output. Some have S-video inputs and outputs as well as translation circuits that allow a composite video source to be processed and output as S-video images.

 The FroxSystem always prefers an S-video signal as a video input. The Video Preprocessor hardware is optimized for a video signal broken into separate luminance and chrominance components. Use the S-video inputs whenever possible.

 Some time base correctors have loud fans. Be careful when selecting a time base corrector that will be installed within a critical listening environment.



*Connecting Time Base  
Correctors*

**INSTALLING A TIME BASE CORRECTOR**

- 1) Connect one end of a high-quality video cable to the video output from the video source component.
- 2) Connect the other end of the cable to the desired input on the time base corrector.
- 3) Connect one end of a high-quality video cable to the corresponding video output on the time base corrector.
- 4) Connect the other end of the cable to the desired video input on the Video Preprocessor.

 For complete installation instructions for VCRs, laserdisc players and television signals refer to the appropriate device installation section in this manual.

- 5) Repeat steps one through five for any additional sources requiring a time base corrector.



Connecting VCRs

**VIDEO CASSETTE RECORDERS**

VCR audio and video signals enter and exit the FroxSystem via connections to the Video Preprocessor.

The FroxSystem always prefers an S-video signal as a video input. The Video Preprocessor hardware is optimized for a video signal broken into separate luminance and chrominance components. Use the S-video inputs whenever possible.

If an external time base corrector is not being used for the VCR it is highly recommended that the VCR have a built in digital time base corrector. This will insure the FroxSystem “sees” video with proper sync, eliminating any flagging artifacts commonly associated with poor sync sources (such as VCRs).

A video device such as a VCR or laserdisc player must be installed in *VCR 1* before *Laserdisc/VCR2* can be used.

When installing the RF (tuner) inputs on VCRs, or the RF input on the Video Preprocessor be certain that RF signals are not looped through VCRs. If necessary, always split the cable or antenna path prior to entering any RF input.

When installing the RF (tuner) inputs on VCRs or the RF input on the Video Preprocessor: if cable decoders are being used, always dedicate a cable decoder to a single RF input. Never split the output from a cable decoder to more than one RF input. If decoding is necessary for more than one RF input, use additional cable decoders. A violation of this rule will cause unpredictable operation from the FroxSystem.

If a cable decoder is being used on any RF input in the system and it is the type of cable decoder that has an A channel and a B channel, then you must perform the software installation for the cable decoder(s) before assigning TV channels. This will provide you with the correct virtual on-screen keyboard that includes the ability to assign an A or B to each channel.

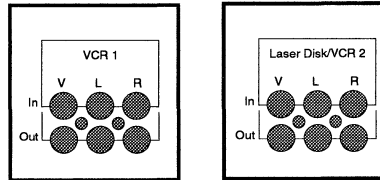

A sensible accessory for RF lines is a TV-IF (intermediate frequency) filter that blocks random noise from being passed (such as the noise generated by fluorescent lighting).

**INSTALLING VCR AUDIO**

- 1) Connect one end of a high-quality stereo phono cable to the audio line outputs (left and right) of the VCR.
- 2) Connect the other end of the cable to the *VCR1* or *Laserdisc/VCR2* audio inputs (left and right) on the Video Preprocessor.
- 3) Connect one end of a high-quality stereo phono cable to the desired audio line inputs (left and right) of the VCR.

*Connecting VCRs*

 Be sure to note which stereo audio input is being connected. Some VCRs have several choices of audio inputs and the proper audio input must be identified later during the software installation of the VCR.

- 4) Connect the other end of the cable to the corresponding *VCR1* or *Laserdisc/VCR2* audio outputs (left and right) on the Video Preprocessor.

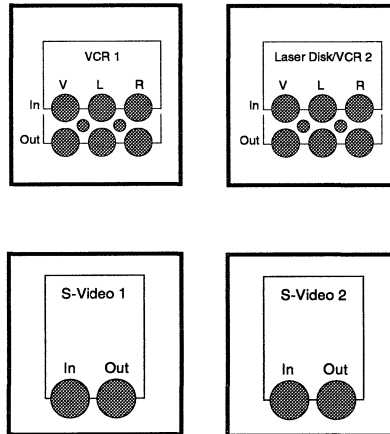

**INSTALLING VCR VIDEO**

- 1) Connect one end of a high-quality S-video or composite video cable to the desired video output of the VCR.
- 2) Connect the other end of the cable to the *VCR1* or *Laserdisc/VCR2* S-video or composite video input on the Video Preprocessor.

 Note that the S-video and composite video inputs on the Video Preprocessor are not located in the same physical location.

- 3) Connect one end of a high-quality S-video or composite video cable to the desired video input of the VCR.
- 4) Connect the other end of the cable to the corresponding *VCR1* or *Laserdisc/VCR2* video output on the Video Preprocessor.

 Note that the S-video and composite video outputs on the Video Preprocessor are not located in the same physical location.



*Connecting VCRs*

**INSTALLING A TELEVISION SIGNAL TO A VCR**

The RF (tuner) input on the back of a VCR is considered a secondary television input on the FroxSystem. The signals entering this port are viewed by selecting the VCR button on the Video Control Stripe and then accessing the TUNING button.

 When timer recording is scheduled, the FroxSystem will not route the television signal entering the Video Preprocessor as the source of recording, but it will use the signal entering the RF input on the VCR. If a cable decoder is required for viewing a particular channel, (and that channel is desired for recording), insure that a decoder is in the path of the television signal that enters the RF input on the VCR. This may mean that a second or third cable decoder is necessary for a proper FroxSystem installation.

- 1) Using an “F” type connector, attach the cable carrying the TV signal to the RF input on the VCR. If a cable decoder is used for this input, connect the cable carrying the TV signal to the RF input on the decoder first and then run a second cable from the RF output of the decoder to the RF input on the VCR.
  
- 2) If necessary, repeat step 1 for additional VCRs.



**INSTALLER'S NOTES:**







### INSTALLING LASERDISC PLAYERS

Laserdisc player *video* signals enter the FroxSystem via connections to the Video Preprocessor.

Laserdisc player *analog audio* signals enter the FroxSystem via connections to the Video Preprocessor.

Laserdisc player *digital audio* signals enter the FroxSystem via connections to the Media Processor.

 A video device such as a VCR or laserdisc player must be installed in *VCR1* before *Laserdisc/VCR2* can be used.

 All laserdiscs contain analog audio soundtracks. Not all laserdiscs, however, have a digital audio soundtrack. Therefore, it is important to connect both the analog and digital outputs of the laserdisc player to the FroxSystem.

 When a laserdisc player is installed and a digital audio input is assigned, a DIGITAL/ANALOG toggle button will appear on the Laserdisc Control Stripe. The default position of this button is DIGITAL. To change to analog audio, click on the DIGITAL button. (The button will be relabeled ANALOG). If a laserdisc is being played that does not have the digital audio track, no sound will be heard unless the DIGITAL button is toggled to the ANALOG position.

### INSTALLING LASERDISC PLAYER ANALOG AUDIO

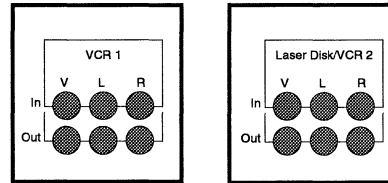

- 1) Connect one end of a high-quality stereo phono cable to the audio line outputs (left and right) of the laserdisc player.
- 2) Connect the other end of the cable to the *VCR1* or *Laserdisc/VCR2* audio inputs (left and right) on the Video Preprocessor.

*Connecting Laserdisc Players*

**INSTALLING LASERDISC PLAYER DIGITAL AUDIO**

- 1) Connect one end of a high-quality coaxial or fiberoptic cable to the coaxial or digital output of the laserdisc player.

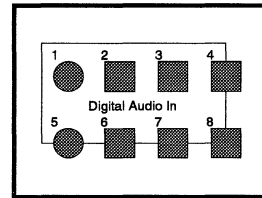

- 2) Connect the other end of the cable to a digital audio input on the Media Processor. If a coaxial wire is used, connect the cable to either the Digital Audio In ports 1 or 5. If a fiberoptic cable is used, connect the cable to the Digital Audio In ports 2, 3, 4, 6, 7, or 8.

**INSTALLING LASERDISC PLAYER VIDEO**

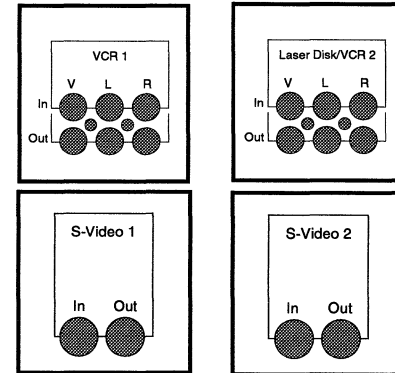

- 1) Connect one end of a high-quality S-video or composite video cable to desired video output of the laserdisc player.
- 2) Connect the other end of the cable to the *VCR1* or *Laserdisc/VCR2* S-video or composite video input on the Video Preprocessor.

Note that the S-video and composite video inputs on the Video Preprocessor are not located in the same physical location.

The FroxSystem always prefers an S-video signal as a video input. The Video Preprocessor hardware is optimized for a video signal broken into separate luminance and chrominance components. Use the S-video inputs whenever possible.



*Connecting Speakers*

**INSTALLING LOUDSPEAKERS**

Loudspeakers are installed into a FroxSystem three different ways. The *first* way is to take a digital, fiberoptic output of the Media Processor and route it to an outboard digital-to-analog converter (DAC). The analog output(s) of the DAC then get sent to analog amplifiers (and then passive speakers) or self-powered (active) analog speakers. The *second* method of connecting speakers to the FroxSystem is using one or more analog auxiliary audio output(s) from the Video Preprocessor and similarly connecting to analog amplifiers (and then passive speakers) or self-powered speakers. The *third* way to connect speakers to a FroxSystem is to use “digital,” self-powered speakers that receive a fiberoptic, digital signal as an input. These speakers may be

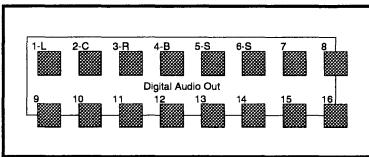

connected to any one of the 16 fiberoptic digital audio outputs on the Media Processor.

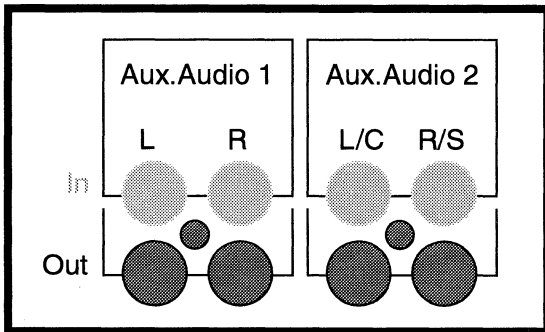

Speakers are assigned to rooms in the SPEAKERS section of the software INSTALLATION procedure found later in this manual. When accomplishing the hardware installation of speakers it is important to note the configuration on the supplied back-panel charts by mapping each speaker to a physical output port on either the Media Processor or the Video Preprocessor, (noting which audio channel the speaker is supposed to receive). This will be helpful later when completing the software installation of your speakers.

The fiberoptic, digital audio outputs on the Media Processor are designed to send digital audio up to a distance of 30 meters. If digital audio must be routed at greater distances, then the FroxRoute MusicPlates should be used. Contact the Frox Technical Support at 800-525-5257 to learn more about these devices.

The digital inputs and outputs of the FroxSystem conform to the AES/EBU standard for digital transmission.

The fiberoptic inputs and outputs of the FroxSystem use connectors that conform to the TOS-LINK standard commonly found on consumer digital audio products. Always use fiberoptic cables that have TOS-LINK terminators.

FroxSystem installations using six-channel, Home THX processing will require at least one external DAC. Every FroxSystem has four analog outputs for audio; A THX six-channel installation thus requires external D/A conversion for the remaining two channels. Additionally, multiroom systems using more than four channels of audio will also require external D/A converters for each pair of audio channels.

## Connecting Speakers

### FROXSYSTEM ASSIGNMENT OF AUDIO PAIRS

FroxSystem digital and analog audio outputs are assigned in pairs. These pairs are listed under *Associated Speakers* in the Speakers section of software Installation. There are 16 fiberoptic digital outputs on the Media Processor and two pair of analog auxiliary outputs on the Video Preprocessor. When using digital speakers that accept one of the two channels on the digital data stream, it is important to be aware of the sequence in which the channels exist. For example, when assigning *Left/Right/Sub* to a digital speaker, channel 1 will carry the left channel and channel 2 will carry the right channel. *Sub* simply means that the very same left and right channels will terminate at a subwoofer that sums the left and right channels together to derive an input. To set the proper channel designation on a Frox digital speaker, set DIP switch 3 (located on the back of each speaker) to either the "B" (channel 1) position or "A" (channel 2) position.

The rules remain the same when using analog outputs or D/A converters. If in the example above the *Left/Right/Sub* audio pair was assigned to the first (*Aux Out 1*) analog audio output pair, the left channel output would be port 1 (leftmost) and the right channel output would be port 2. Similarly, when assigning an audio pair to a digital output

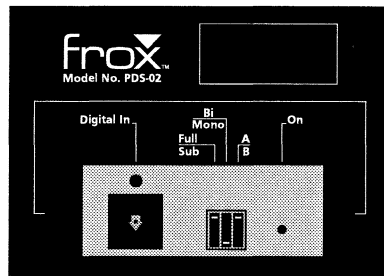

which then connects to a D/A converter, the D/A converter analog output labeled (left) would carry channel 1 and the output labeled (right) would carry channel 2.

### AUDIO AMPLIFIERS AND THE FROXSYSTEM

The FroxSystem allows the user to calibrate volume level for every audio channel as well as providing a master volume control. Because volume can be changed through the FroxSystem it is often misunderstood that the FroxSystem is a preamplifier. This is not true. The FroxSystem maximum output is a 16 bit representation of the input signal from the source. The volume scheme is a digital attenuation method that allows the user to reduce the volume from maximum source level to no sound at all, in single decibel decrements.

If the FroxSystem is to be used as a "virtual" preamplifier, then it is important that large enough power amplifiers are used to generate the desired sound pressure levels. Since the FroxSystem is certified as a Home THX controller/processor, its output levels meet the specifications set by Home THX and therefore will adequately drive a Home THX certified power amplifier.

It is also possible to use a preamplifier or integrated amplifier with the FroxSystem. When doing this remember that two volume controls will now be playing against each other. To achieve optimum performance from the FroxSystem, set the master system volume at 0 dB and then adjust the gain on the preamplifier or integrated amplifier to the desired setting for maximum volume. Then, only use the FroxSystem volume control for changing volume.



*Connecting Speakers*

**CONNECTING SPEAKERS USING DIGITAL-TO-ANALOG CONVERTERS**

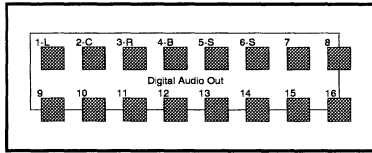

- 1) Connect a fiberoptic cable to one of the Media Processor *Digital Audio Out* ports.
- 2) Connect the other end of the cable to the fiberoptic input of a DAC.

 If using a Frox DAC (DAC-01) the fiberoptic input is *Input 2*. Make sure that the switch on the front face of the DAC-01 is set to *Input 2*.

- 3) Connect the analog audio left channel output of the DAC to an input on an audio amplifier. Remember that the left channel output represents the first channel of the audio channel-pair that will be assigned to a FroxSystem output during the software installation of speakers.
- 4) Wire the corresponding speaker outputs of the amplifier to a passive speaker.

- 5) Connect the analog audio right channel output of the DAC to an input on an audio amplifier. Remember that the right channel output represents the second channel of the audio channel-pair that will be assigned to a FroxSystem output during the software installation of speakers.
- 6) Wire the corresponding speaker outputs of the amplifier to a passive speaker.
- 7) Repeat steps 1-6 for all audio channels.

*Connecting Speakers*

**CONNECTING SPEAKERS USING AUXILIARY AUDIO OUTPUTS**

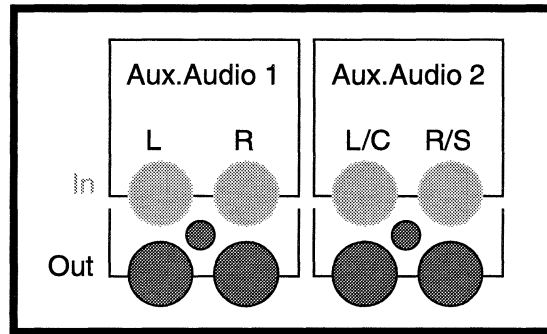

- 1) Connect the desired *Aux Audio* output of the Video Preprocessor to an input on an audio amplifier. Remember that the left channel output represents the first channel of the audio channel-pair that will be assigned to a FroxSystem output during the software installation of speakers.
- 2) Connect the corresponding speaker outputs of the amplifier to a passive speaker.
- 3) Repeat step one and two for as many audio channels as necessary.

**CONNECTING DIGITAL SPEAKERS**

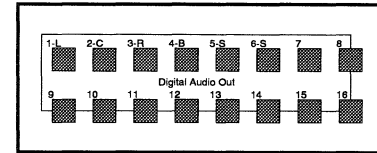

Digital speakers will be connected to the FroxSystem by using accessory fiberoptic cables that connect to both the speaker and the *Digital Audio Out* ports on the Media Processor. While the rear panel of the Media Processor contains markings for a recommended configuration, any of the 16 fiberoptic output can be configured to output any audio channel pair.

- 1) For a single audio channel, connect a fiberoptic cable to one of the Media Processor *Digital Audio Out* ports.
- 2) Connect the other end of the fiberoptic cable to a digital speaker.
- 3) By following the operation instructions provided by the speaker manufacturer, set the speaker to receive either the first or second channel in the channel pair.
- 4) Repeat steps one through three for as many audio channels as desired.

**OTHER ANALOG DEVICES**

Miscellaneous analog audio signals enter the FroxSystem via connection to the Video Preprocessor.

The FroxSystem software V3.0 supports the infrared (IR) control of the following audio devices: Compact disc players, VCRs, laserdisc players, and cable decoders. The audio from other analog audio devices such as cassette decks and AM/FM tuners can be routed through the Frox System audio path without the benefit of IR control.

There are two stereo pairs of analog audio inputs on the FroxSystem's Video Preprocessor:

- Aux In 1
- Aux In 2

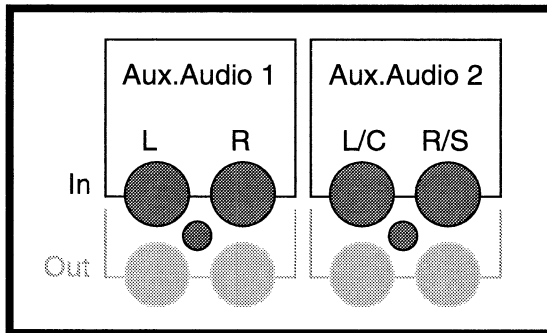

When a miscellaneous analog audio component is installed in *Aux In 1* or *Aux In 2*, an OTHER or OTHER2 (for the second device) button will appear in the routing panel as options to access this audio device.

Steps to connect the audio from a miscellaneous analog audio component:

- 1) Connect one end of a high-quality stereo phono cable to the audio line outputs (left and right) of the analog audio device.
- 2) Connect the other end of the cable to the *Aux In 1* or *Aux In 2* audio inputs (left and right) on the Video Preprocessor.



*Notes*



**INSTALLER'S NOTES:**





**IR EMITTERS**

The FroxSystem controls compact disc (CD) players, laserdisc players, VCRs and cable decoders by sending command codes via infrared (IR) light to each device's IR receiver. There are four *IR Emitter* output ports located on the back of the Media Processor to which IR Emitter Cables are attached.

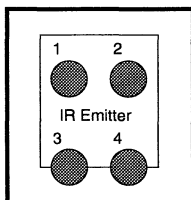

**RULES FOR ASSIGNING PORTS TO DEVICES**

As devices are installed in the FroxSystem, the software makes intelligent decisions about which *IR Emitter* ports will output command codes. This configuration is necessary for the following reason - if an installation contains two "similar components" from the same manufacturer (like two Sony CD players or two Mitsubishi VCRs, for example), and a PLAY command is issued from each of the four IR Emitter ports, both similar components will go into PLAY mode. Since control of a single device is desired in a system, the FroxSystem can be configured to be device-selective.

**Installations With two Similar Components**

If an installation has one or more instances of two similar components, the IR Emitter Cables must be installed using the following table (the like components must be connected to emitter ports that are *diagonal* from one to another):

SIMILAR COMPONENT	IR EMITTER PORT
Device A	1 or 3
Device B	2 or 4

**Installations With Three Similar Components**

If an installation has one or more cases of three similar components, the IR Emitter Cables must be installed using the following table:

SIMILAR COMPONENT	IR EMITTER PORT
Device A	3
Device B	2 or 4
Device C	1

**Installations With Four Similar Components**

If an installation has one or more cases of four similar components the IR Emitter Cables must be installed using these guidelines:

SIMILAR COMPONENT	IR EMITTER PORT
Device A	3
Device B	4
Device C	1
Device D	2

If there are no similar devices in an installation, any *IR Emitter* port may be used to send IR Commands to a device without operational penalty.



*Connecting IR  
Emitters*

#### CONTROLLING MORE THAN FOUR IR DEVICES

If there are more than four IR controllable devices in a FroxSystem installation, it will become necessary to extend the capabilities of the four *IR Emitter* ports on the Media Processor. This is done by using the mini phono "Y" adapters provided in the AAP-01 accessory kit. Simply plug the male end of the adapter into the desired *IR Emitter* port.

Remember that the extended *IR Emitter* ports conform to all the installation rules as defined previously in this section.

#### INSTALLING AN IR EMITTER CABLE

- 1) Connect the 1/8" male mini phono end of the IR Emitter Cable (provided in the AAP-01 Frox Accessory kit) to the desired *IR Emitter* port on the rear of the Media Processor.
- 2) Peel the tape from the plastic housing located on the other end of the cable. There will be a pinhole through which the IR signal is passed.
- 3) Position the pinhole side of the plastic housing directly over the IR receiver on the front face of the IR-controllable component device. Press firmly so the housings sticks securely to the device.



*Connecting IR Repeater*

**INSTALLING IR REPEATERS**

Infrared (IR) repeaters are devices that extend the IR/FroxWand control of the FroxSystem into rooms other than the main theater. A simplification of what an IR repeater is is to think of someone ripping out the IR sensor from the front of the Media Processor, connecting a long wire to it and placing it in another room.

IR repeaters attach to the Media Processor through the three *Device* ports located on the rear panel. This, coupled with the IR sensor on the front of the Media Processor, creates four different ways IR can independently be input to the FroxSystem. Because these are discrete IR inputs, they are commonly thought of as control zones.

(from connector face)

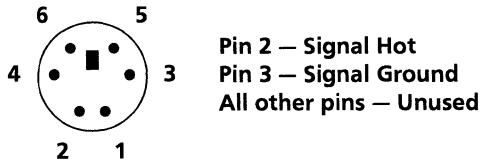

The FroxSystem can be controlled with the FroxWand from four discrete IR zones. The first zone is seen from the Media Processor's front panel sensor. The other zones correspond to the three numbered *Device* inputs on the Media Processor's rear panel. These inputs are compatible with most third-party IR repeaters. They can be

connected via the Frox FCI-001 interface cable available from Frox and Videolink. Alternatively, a cable can be made using a six-pin circular mini-DIN

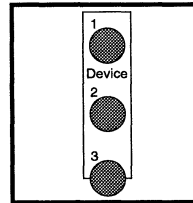

plug wired according to the diagram in this section.

The four IR inputs are directly related to the first four rooms listed in the Speaker installation section described later in this manual and as described below. Full functionality of the FroxWand in any zone is gained only if the IR repeater is connected to that zone's corresponding input.

ZONE	INPUT
Main Theater	Front Panel Sensor
Living Room	Device Port 1
Bedroom 1	Device Port 2
Bedroom 2	Device Port 3

In many installations, the main theater layout will not allow a line-of-sight path between the FroxWand and the Media Processor's front panel sensor, making it necessary to use an IR repeater. In this case, the installer must use one of the rooms other than the *Main Theater*, such as the *Living Room*, in which to install the main theater speakers. In the case of the *Living Room*, if an IR repeater is installed in *Device Port 1* then full FroxWand functionality will be

Connecting IR Repeaters

Under no circumstances should an IR emitter, or "flasher," be used to send IR commands to the Media Processor's front panel sensor.

GENERAL IR CONSIDERATIONS

Any IR controlled device can be "blinded" when the background level of IR energy exceeds the input level of its controller. This is often caused by sunshine or the output from a bright lamp falling directly on a sensor. In planning the positioning of IR sensors the installer must consider the lighting pattern and the path of sunshine movement in a room. Other sources of possible IR interference that should be considered when placing sensors include IR motion sensors, IR driven wireless headphones, very hot surfaces (i.e. wood stoves, fireplaces, radiant heaters, etc.) and other IR remote controls.

Another source of poor control performance can be noisy IR repeaters. The problem can be caused by noise being induced in the sensor cabling or by noisy pickups.

With the FroxSystem, symptoms of errant IR energy can range from poor FroxWand performance to system lockup and/or error recovery. Symptoms can occur even if the sensor being contaminated is not the one currently being used to input FroxWand commands (i.e. one located in another room/zone). The effects of noise and/or interference are additive with each additional sensor added to the system.

Many problems can be corrected by using line filters and/or sunlight filters, available from several IR repeater manufacturers, to eliminate excess noise. Or simply replace or reposition the remote sensor away from the source of interference.

INSTALLING AN IR REPEATER

- 1) Plug the six-pin mini circular DIN end of the FCI-001 interface cable into the desired Device port.
- Make certain that the connector is firmly planted in the port. This may require using a knife to cut back some of the plastic housing on the connector end. This will insure a proper connection.
- 2) Plug the 1/8" mini phono end of the FCI-001 interface cable into the output port on the IR repeater. If no port exists then isolate the signal and ground output leads from the IR repeater and connect them to the appropriate leads on the FCI-001 by either using a screw terminal block or by soldering the wires together.
- 3) Make sure the IR repeater receives the proper DC power supply as specified by the manufacturer.





*Using X-10 Modules*

**USING X-10 MODULES**

The FroxSystem uses X-10 AC powerline communication to toggle X-10 *lamp* and *appliance* modules ON and OFF. These modules are commonly available and useful when an installation calls for monitors, peripherals and miscellaneous electronics to be triggered ON and OFF when the FroxSystem is also soft-powered ON/OFF.

A toggle command of ON/OFF is automatically inserted on the AC line in the home for an X-10 address of HOUSE CODE A and UNIT CODE 1. Make certain that the lamp or appliance module(s) are set to this address.

 The X-10 modules may be plugged in anywhere in the home as long as the AC is on the same circuit that the Media Processor is on.

 Surge protectors (as well as other power conditioning and filtering accessories) are likely to filter the X-10 commands off the AC line, along with noise. Contact the manufacturer or supplier of these devices to determine if the X-10 commands can pass through.

Whether or not X-10 commands are issued is directly related to how speakers are assigned in the system. Speakers are assigned to rooms in the Software Installation section, "Speakers". Infrared (IR) zones are created by using IR repeaters that plug into the *Device* ports located on the back of the Media Processor (see the Hardware Installation section, "Connecting IR Repeaters" to review how the FroxSystem treats zones). X-10 commands will only be issued if the FroxWand power command is received from

the first room in which speakers are installed. For example, if the *Main Theater* is the first room in which speakers are installed, the FroxSystem will issue X-10 commands only when a power command is received from zone 0 (which is the IR sensor found on the front face of the Media Processor). While the system can be soft-powered ON and OFF from other zones, no X-10 commands will be issued.

If the Media Processor needs to be hidden in an installation, an IR repeater will be required for sending IR commands. This means that one of the *Device* ports must be used to replace the front sensor on the Media Processor. To insure that X-10 commands are issued in this case, make certain that the *Device* port used corresponds to the first room in which speakers are installed. If *Device* port 1 is used for an IR repeater and the *Living Room* is the first room in which speakers are installed, then a soft-power command from the FroxWand in the *Living Room* will issue X-10 commands along the AC power. If the *Living Room* is the main listening area, it can be renamed in a procedure defined in the Speakers section of Software.



*Multiroom Audio*

**FROXZONE MULTIROOM CONFIGURATIONS**

The FroxSystem can be utilized as a true multisource, multiroom audio routing platform, in addition to the system's primary home theater role.

Separate FroxZone hardware and software installation documentation is available from Frox. Contact the Technical Support department at 800-525-5257 and request the FroxZone Audio Routing Installation Guides.



*Software Installation*

**SOFTWARE INSTALLATION**

After completeing all Hardware inteconnections, the Software Installation steps can begin. Remember that the entire Hardware Installation must be finished prior to attempting the Software Installation.

To begin the Software Installation, turn on the FroxSystem by powering ON the AC power strip, surge protector or uninterruptible power supply (UPS) to which the Media Processor and Video Preprocessor are connected. Also, make sure that the primary monitor is turned ON along with any peripheral devices that will be used with the system.

When the system is powered up by turning the AC power ON, the system is considered to be “cold-booted” or “hard power-cycled.” The FroxSystem is a computer that operates 24 hours, every day (meaning that it should continuously receive AC power).

During daily usage of the system always “soft-power” OFF the components by hitting the power (PWR) button on the FroxWand. (This will also trigger the system to begin looking for FroxCast information.) When FroxSystem operation is desired again, simply “soft-power” the system ON by again hitting the PWR button on the FroxWand.

Hard power-cycling the FroxSystem can take up to 30 seconds before full functionality is available. During the course of a hard power-cycle, the front LED Frox triangle will first illuminate on the Video Preprocessor and

several seconds later the triangle will illuminate on the Media Processor. Moments after this the FroxSystem will present a gray “Copyright” screen. When the system is ready, it will present the Video Control Stripe, select TV as the source and tune the Frox television tuner to channel 2. If there is a TV signal available on this channel, a picture will appear at this time.

 The FroxSystem always remembers its last “state” when hard power-cycling. This means that if the system was soft-powered OFF before hard power-cycling (after the Video Control Stripe is drawn on the screen), the system will automatically soft-power OFF. This is important in homes where electric power outages are a common occurence. Once the system automatically soft-powers OFF, simply press the PWR button on the FroxWand to turn the system ON.

Since the Software Installation will require using the FroxWand, it is often helpful at this time to choose a comfortable FroxWand Speed and Sensitivity. This can be done by following the directions in the next section entitled "Preferences".

*Preferences*

**PREFERENCES**

To enter the user preferences area of the FroxSystem, click on the PREFERENCES button located on the Frox "Go-To" menu.

The preference area is used to customize various features in the FroxSystem. When installing a FroxSystem it is convenient to have a comfortable Wand Speed and Wand Sensitivity so that navigating through the installation screens is a simple task.

 Wand Sensitivity settings are adjustable; this allows the user to customize the infrared (IR) reception characteristics of the FroxSystem based on the environment in which the system is installed. If the FroxSystem is located in a room that receives a good amount of sunlight or other synthetic lighting, false command triggers can occur. (This includes some IR commands from other manufacturer's IR remote controls).

There are three Wand Sensitivity settings: Low, Mid, and High. The *Low* setting will attempt to block out stray light signals that do not fall within the specification for valid Frox

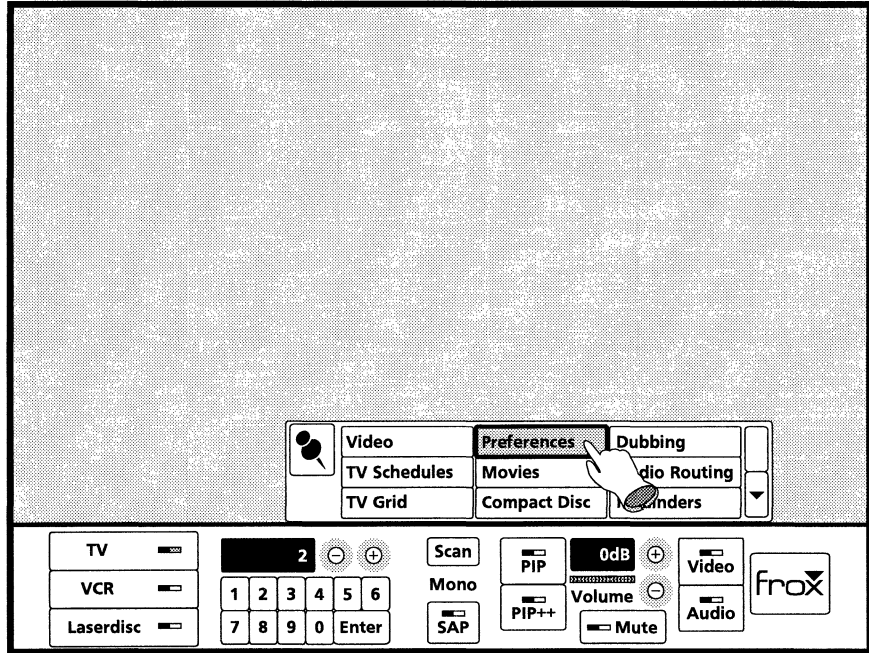
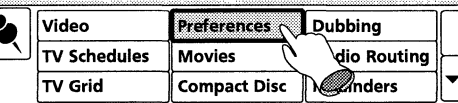

IR command signals. When using this setting be certain that the FroxWand has fully charged batteries: otherwise the wand response could "feel" sluggish. The *Mid* setting is a happy medium between Low and High, throwing away some stray light signals, but allowing some borderline signals to pass through. The *High* setting tries to interpret any signal looking like a Frox signal into a Frox command. This is a good setting for longer battery life, but only recommended when stray lighting conditions are at a minimum.





**TO SELECT A WAND SPEED**

- 1) Click on the WAND SPEED button.
- 2) Click on the SLOW, MID, or FAST button under *Speed*, as desired.

**TO SELECT A WAND SENSITIVITY**

- 1) Click on the WAND SPEED button.
- 2) Click on the LOW, MID, or HIGH button under *Sensitivity*, as desired.

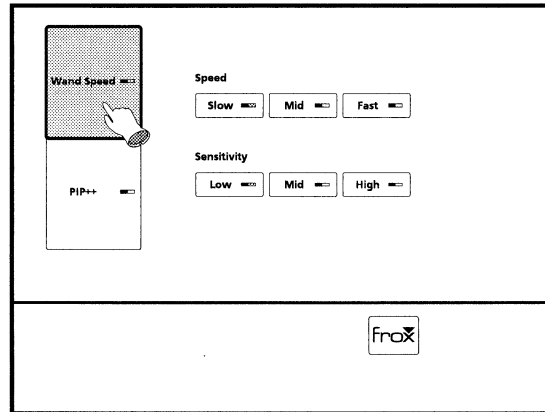

*Software Installation*

To begin the FroxSystem Software Installation procedure:

1) CLICK ON the FROX button.

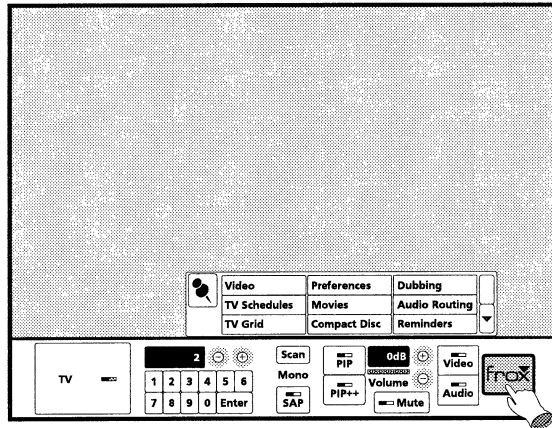

2) Scroll down to the second menu page.

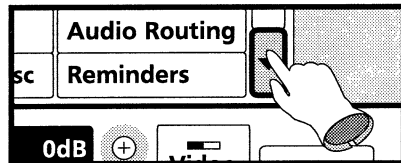

3) CLICK ON the INSTALLATION option.

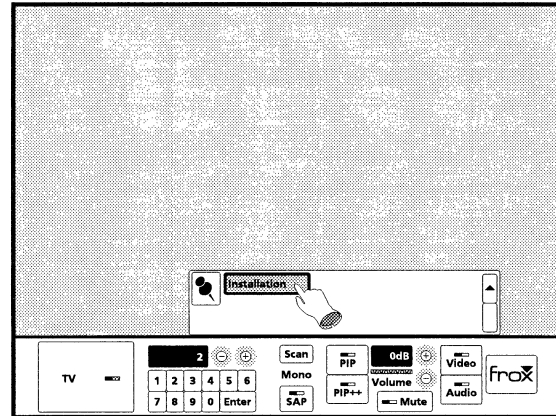



**AUTHORIZATIONS**

The Authorization Screen is the initial screen upon entering Installation.

To enter the authorization section of Installation, click on the AUTHORIZATION button located on the Installation Control Stripe.

From this screen it is possible to authorize features as well as configure an Installation Lockout Password (to keep the user from modifying your installation parameters).

The Authorization Screen is provided to authorize and enable many FroxSystem features. Some features in FroxSystem software V3.0 are pre-authorized and require no authorization code. These features are:

- Basic Databases
- Sonic Playground
- THX
- Frox CD Player
- FroxZone

Other features such as the FroxCast services may require an authorization code to enable the feature in the system.

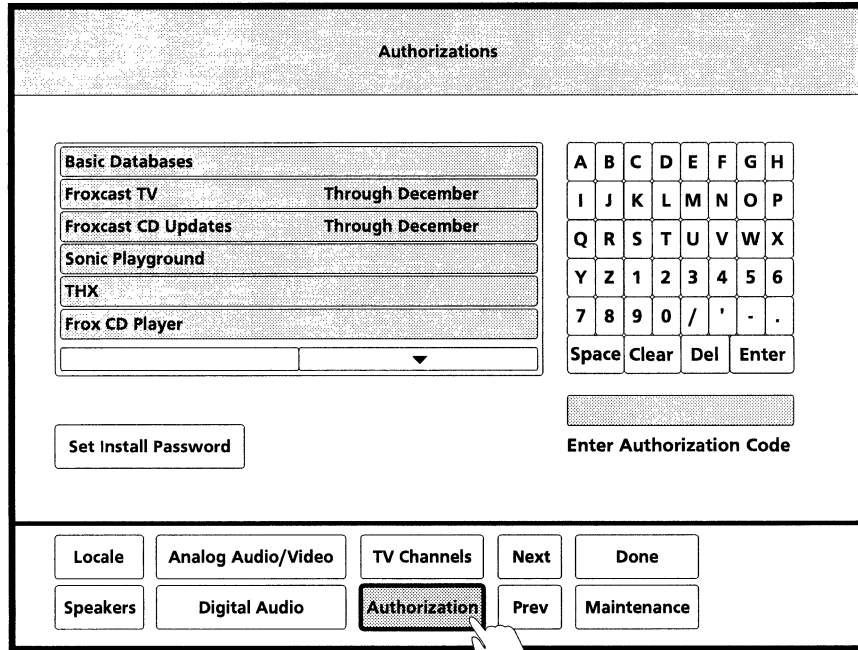

Authorization codes are 12 character “strings” derived from the serial number of the Media Processor. The serial number can be found on the back of the Media Processor as well as in the Statistics screen in the Maintenance area.

When entering codes it is helpful to know that some similar characters are treated as the same. The letter “O” is treated the same as the number “0.” The letter “I” is treated the same as the number “1.”

*Authorizations*

**ENTERING AN AUTHORIZATION CODE**

1) Using the FroxWand and the virtual, on-screen keyboard, enter the 12 character authorization code and click on the ENTER button. If the entry is valid, the 12 character authorization code will disappear from the entry box labeled *Enter Authorization Code*, and the newly authorized feature will be added to the scrolling menu at the top left of the screen. If the entry is not valid, the entry area will remain filled with the characters.

2) Repeat step 1 for additional features.

**SETTING AN INSTALLATION PASSWORD**

 Before setting an installation lockout password, it is a good idea to write down your password and store it in a safe place.

1) Click on the SET INSTALL PASSWORD button. Note that the entry box formerly labeled *Enter Authorization Code* has been re-labeled *Enter New Password*.

2) Using the FroxWand and the on-screen keyboard, enter a personal installation password and click on the ENTER button.

 Upon re-entering INSTALLATION the system will wait for the entry of this installation password. The data entry box will now read *Enter Install Password*. All installation areas except for Maintenance will be locked out unless the proper installation password is entered.

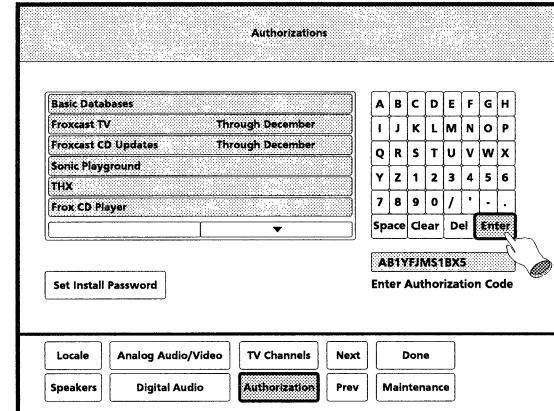

**CHANGING AN INSTALLATION PASSWORD**

1) Enter the current installation password in the data entry box labeled *Enter Install Password*.

2) Perform the steps above for "Setting An Installation Password".

**REMOVING AN INSTALLATION PASSWORD**

1) Enter the current installation password in the data entry box labeled *Enter Install Password*.

2) Click on the SET INSTALL PASSWORD button. Note that the entry box formerly labeled *Enter Authorization Code* has been re-labeled *Enter New Password*.

3) Click on the ENTER button.



*Locale, Date and Time*

**SETTING LOCALE, DATE & TIME**

To enter the locale in which your FroxSystem operates, click on the LOCALE button on the Installation Control Stripe.

The Locale installation section is used to designate a geographic area, set the proper date and time.

**DESIGNATING A GEOGRAPHIC AREA**

Where are you?

- 1) Click on the market area in the scroll menu that best describes *Your TV Market Area*.

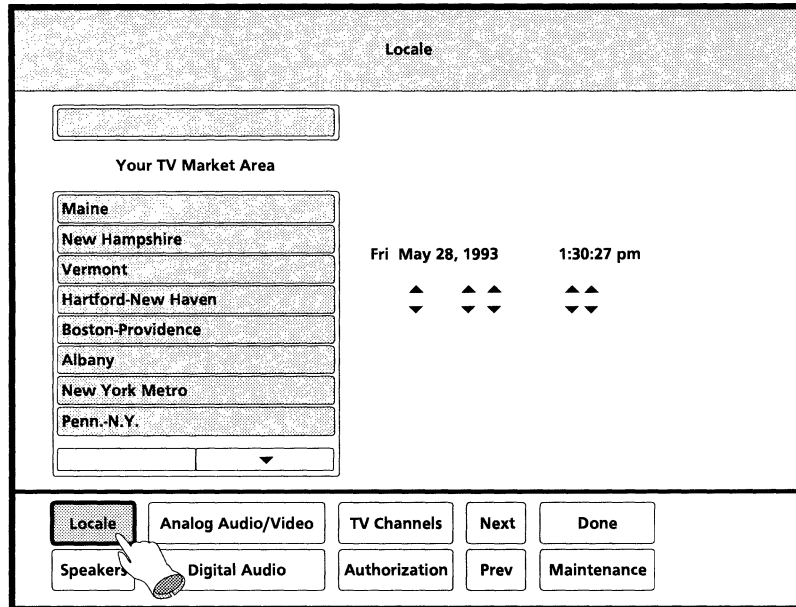

**SETTING THE PROPER DATE AND TIME**

- 1) Using the scrolling buttons under the date and time, adjust the day, month, hour, and minute to the current date and time.

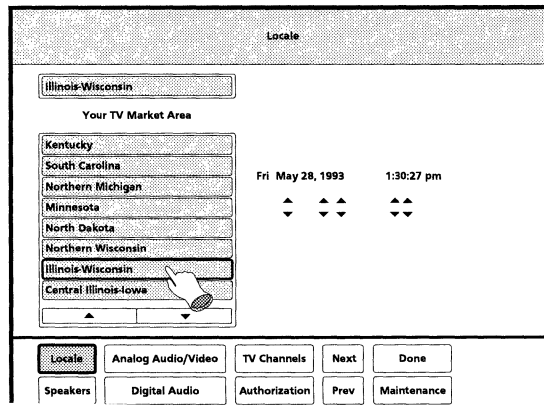



*Notes*



**INSTALLER'S NOTES**



**CONFIGURING TV CHANNELS**

To identify the television channels available to your FroxSystem, click on the TV CHANNELS button located on the Installation Control Stripe.

The TV Channels installation section is used to assign the proper FroxCast Data Channel, configure a cable modulation channel and assign channel numbers to local and national stations.

**Assign Channel Numbers to Stations**

Station	Channel Number
FROXCAST DATA CHANNEL	A 9
CABLE MODULATION CHANNEL	3
WBBM Chicago	A 3
WCGV Milwaukee	Unavailable
WCIU Chicago	B 26
WFLD Chicago	B 32
WGBO Chicago	A 66
WGN Chicago	A 9
	▼

0

1	2	3	4	5	6	7
8	9	0	A/B	Enter		

Unavailable

▲

17

VBI Line

▼

National

Local

Locale

Analog Audio/Video

TV Channels

Next

Done

Speakers

Digital Audio

Authorizatio

Prev

Maintenance

TV Channels

 If a cable decoder being installed is the type that has an A channel and a B channel, then you must perform the software installation for the cable decoder(s) prior to assigning TV channels. This will provide you with the correct virtual on-screen keyboard that includes the ability to assign an A or B to each channel.

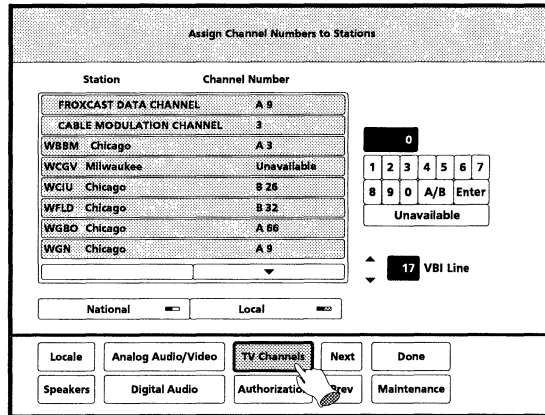

**SELECTING THE FROXCAST DATA CHANNEL**

- 1) Click on the FROXCAST DATA CHANNEL listing in the *Station* list
- 2) Determine which channel number is the FroxCast data carrier in your area. If you are unsure as to which FroxCast data carrier is available in your area, chose one from this chart. Please use a national

FroxCast Data Carrier	Region	VBI Line
WTBS	National	20
WGN	National	17
KTVU	Northern California	17
KMIR	Palm Springs	17

carrier whenever possible, and check to see that reception for your carrier station is better than any other alternatives.

- 3) Using the on-screen keypad and the FroxWand, enter the FroxCast Data Channel Number. If the channel number is only a single digit, then the ENTER button must also be selected.
- 4) Using the scroll buttons adjacent to the VBI Line meter, select the VBI Line number that matches your FroxCast data carrier. The VBI line number will range from 17 to 20 and is listed in the above chart.





**ASSIGNING A CABLE MODULATION CHANNEL  
(VERSION 3.0 AND LATER)**

Most cable decoders modulate an RF output to channel 3. In some cases, however, alternative channels are used such channels 2 or 4. The cable modulation channel has a factory default of 3, meaning that the Frox tuner internally changes to channel 3 when an external decoder is used. This value, however, can be changed from any value in the range of 1 - 99.

- 1) Click on the CABLE MODULATION CHANNEL listing under the *Station* listings.
- 2) Using the on-screen keypad and the FroxWand, enter the Cable Modulation Channel required to send RF audio and video to the RF input on the Video Preprocessor. If the channel number is only a single digit, then the ENTER button must be selected.

**ASSIGNING CHANNEL NUMBERS TO LOCAL AND NATIONAL STATIONS**

- 1) Click on the NATIONAL channels button below the stations list. (National is the default screen).
- 2) Click on one of the national stations in the list.
- 3) Using the on-screen keypad, select the channel number that properly identifies that station. If the channel number is only a single digit, then the ENTER button must also be hit.
- 4) Repeat steps 2 and 3 as needed to enter additional nation stations.
- 5) Click on the LOCAL channels button.
- 6) Click on one of the local stations in the list.
- 7) Using the on-screen keypad, select the channel number that properly identifies that station. If the channel number is only a single digit, then the ENTER button must be selected.
- 8) Repeat steps 6 and 7 as needed to enter additional local stations.



*Notes*



**INSTALLER'S NOTES**



**TV SIGNALS**

To enter the television signal installation section, click on the ANALOG AUDIO/VIDEO button located on the Installation Control Stripe.

Television signals enter the system through RF connections on either the Video Preprocessor or VCRs. These signals may be directly wired to the RF inputs or go through cable decoders also known as “descramblers”.

☞ When installing the RF (tuner) inputs on VCRs, or the RF input on the Video Preprocessor, be certain that RF signals are not looped through VCRs. If necessary, always split the cable or antenna path prior to entering any RF input.

☞ When installing the RF (tuner) inputs on VCRs (or the RF input on the Video Preprocessor) always dedicate a cable decoder to a single RF input. Never split the output from a cable decoder to more than one RF input. If decoding is necessary for more than one RF input, use additional cable decoders. A violation of this rule will cause unpredictable operation from the FroxSystem.

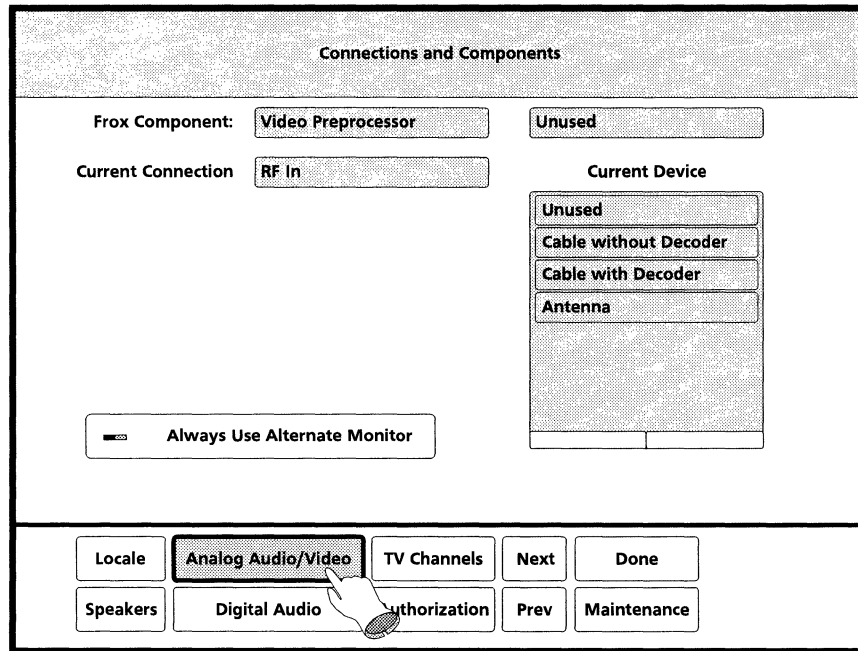

☞ The RF input on the Video Preprocessor must be installed before the RF input on any VCR.

☞ If a cable decoder is the type that has an A channel and a B channel, then you must perform the software installation for the cable decoder(s) prior to assigning TV channels. This will provide you with the correct on-screen keyboard that includes the ability to assign an A or B to each channel.

TV Channels

 To insure optimum picture quality from the FroxSystem, insure that a signal strength of at least 7dB is available at the Video Preprocessor's RF input. Ideally, the FroxSystem would like to see 10dB at the Video Preprocessor RF input. Passive RF signal splitters tend to attenuate the signal by at least 3dB and often more. RF amplifiers are usually not the best solutions to adding signal strength (because they tend to amplify noise along with the signal). The best way to improve required signal strength is to contact the local cable operator and have them make the necessary adjustments to their equipment.

**INSTALLING TV SIGNALS**

Instructions for installing TV signals to VCR RF inputs are described below (and is repeated under the section regarding VCRs):

- 1) Using the NEXT and PREV buttons on the Installation Control Stripe, scroll through the pages of installation screens to find the desired *Current Connection*. For the RF (tuner) input on the Video Preprocessor locate the *Current Connection* that reads *RF In*. (This is the initial installation screen for ANALOG AUDIO/VIDEO). This RF input is the main television signal pathway to the FroxSystem and will be accessed from the Video Control Stripe button labeled TV. For the RF inputs associated with any VCR, scroll to the VCR *Tuner In* screen for that VCR.

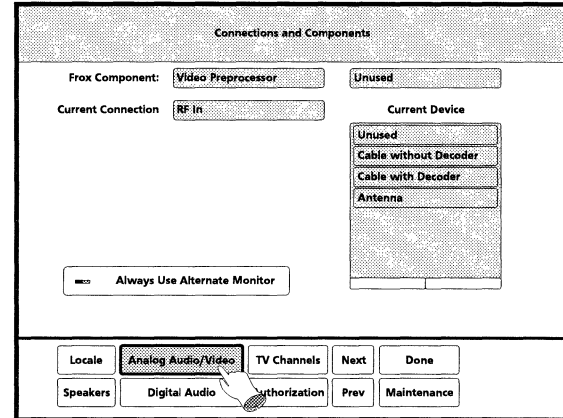



*Installing TV Signals*

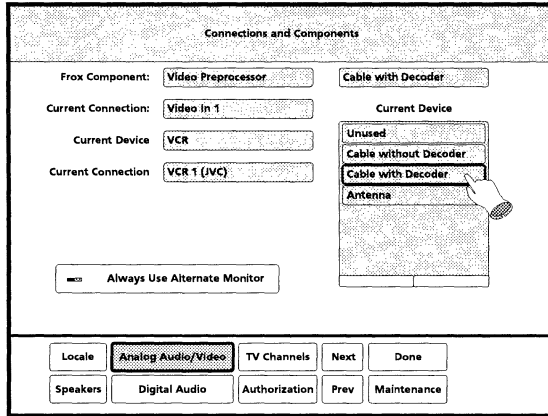

- 2) Click on the desired option in the *Current Device* menu for the Video Preprocessor RF input or the *VCR Tuner In* menu for any particular device.

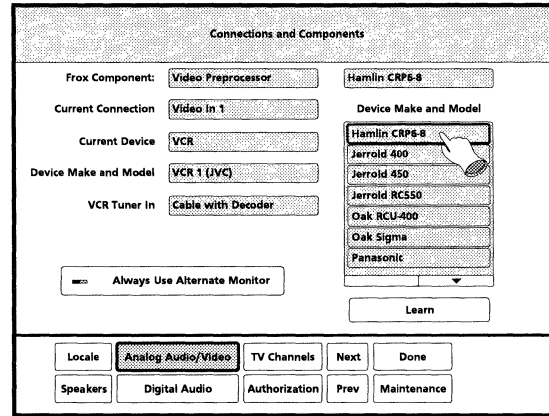

- 3) If a *Cable with Decoder* is selected, click on the appropriate *Device Make and Model* for the cable decoder in question. If the particular model number for a manufacturer is not available in the provided listing, try another model from the same manufacturer. It is quite probable that models from the same manufacturer use the same infrared (IR) codes. If later it is determined that this was not a suitable choice, then the device can be taught to the FroxSystem via the *Learn* mode (see Appendix D).



*Notes*





**INSTALLER'S NOTES**

**VCR INSTALLATION**

To enter the VCR installation section, click on the ANALOG AUDIO/VIDEO button located on the Installation Control Stripe.

 Frox recommends that all VCRs have a built in digital time base corrector (TBC) or an external TBC component. This will insure the FroxSystem “sees” video with proper sync and will eliminate any flagging artifacts commonly associated with poor sync sources (such as VCRs).

 A video device (such as a VCR or laserdisc player) must be installed in *Video In 1* before *Video In 2* can be used.

 When installing the RF (tuner) inputs on VCRs, or the RF input on the Video Preprocessor insure that RF signals are not looped through VCRs. If necessary, always split the cable or antenna path prior to entering any RF input.

 When installing the RF (tuner) inputs on VCRs, (or the RF input on the Video Preprocessor), always dedicate a cable decoder to a single RF input. Never split the output from a

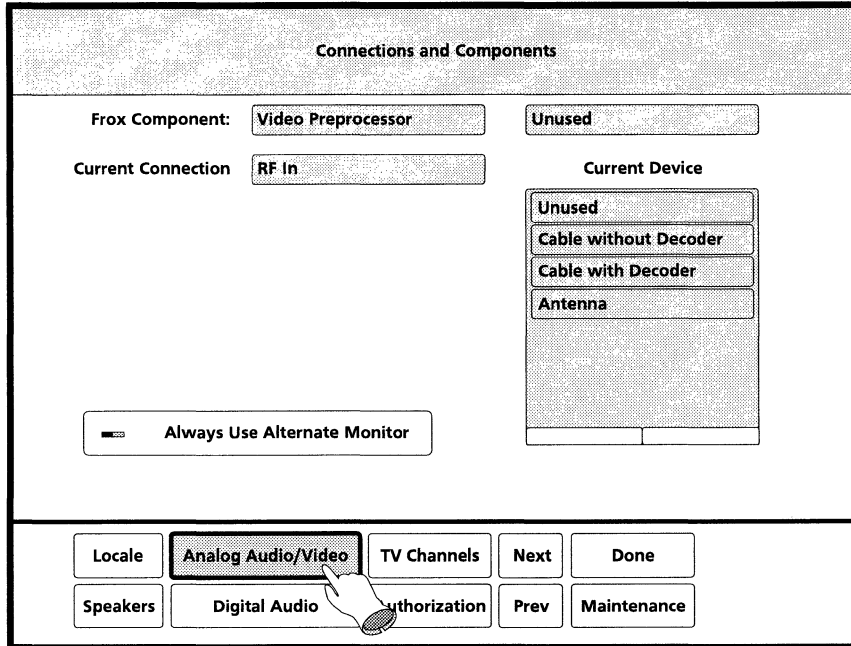

cable decoder to more than one RF input. If decoding is necessary for more than one RF input, use additional cable decoders. A violation of the rule will cause unpredictable operation from the system

*Installing a VCR*

**INSTALLING A VCR**

- 1) Using the NEXT and PREV buttons on the Installation Control Stripe, scroll through the list of installation screens to find the desired *Current Connection - Video In 1 or Video In 2*.

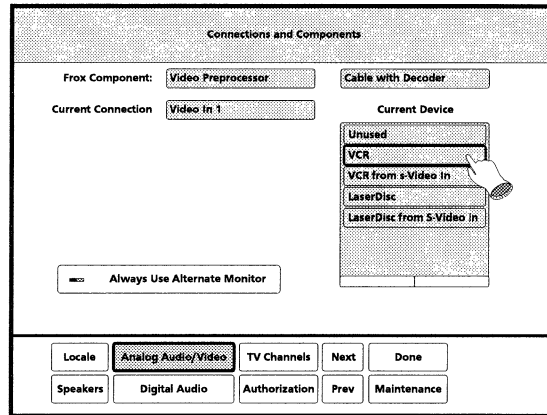

- 2) Click on the *Current Device* that best describes the video output of the playback VCR. If the video component is connected via composite cables, click on VCR, but if the video output is S-video click on *VCR from S-video In*.
- 3) From the list of devices, click on the *Device Make and Model* for the VCR in question. If the particular model number for a manufacturer is not listed, select another model from the same manufacturer. It is quite

probable that models from the same manufacturer use the same infrared (IR) codes. If there is no suitable choice, then the device can be taught to the FroxSystem in the *Learn* mode (see Appendix D).

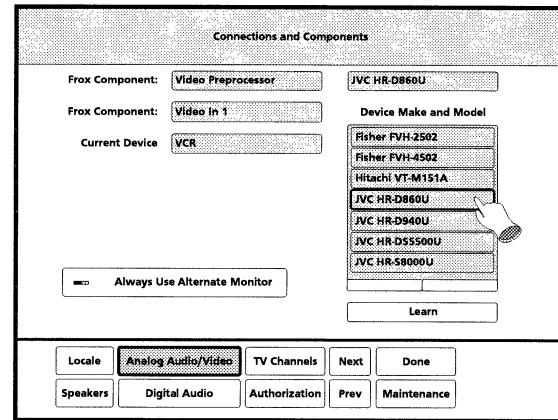

- 4) If an RF signal will be forwarded to the RF (tuner) input on the VCR, click on the appropriate option in the *VCR Tuner In* scrolling menu.



- 5) If a Cable with Decoder is selected, click on the appropriate *Device Make and Model* for the cable decoder in question. If the particular model

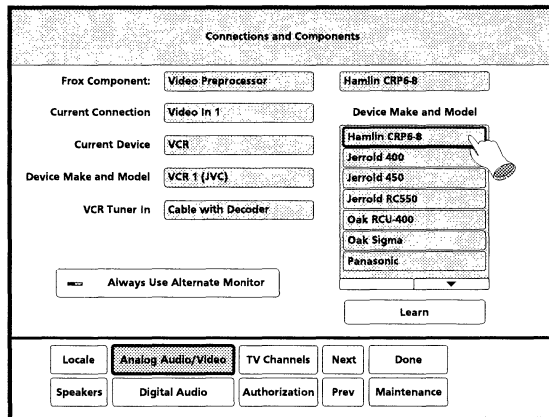
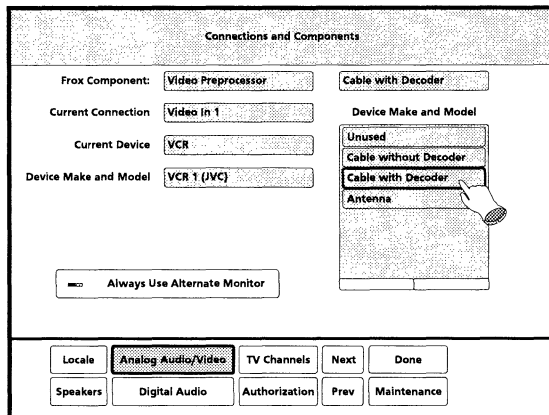

number for your decoder is not available in the provided listings, select another model from the same manufacturer. It is quite probable that models from the same manufacturer use the same infrared (IR) codes. If there is no suitable choice, then the device can be taught to the FroxSystem via the *Learn* mode (see Appendix D).

- 6) Using the NEXT and PREV buttons on the Installation Control Stripe, scroll through the pages of installation screens to locate the desired *Current Connection - Video Out 1 or Video Out 2*.
- 7) Click on the VCR option under Current Device.

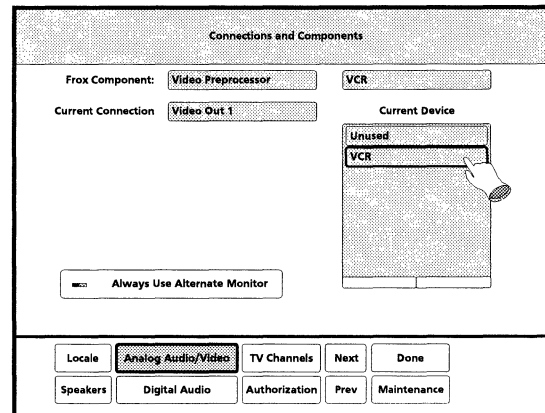

*Installing a VCR*

8) From the scrolling list of devices, click on the *Device Make and Model* for the VCR in question.

If the recording VCR is the same as the playback VCR you must select the option at or near the top of the list that reads *VCR n (Make)*, where *n* is the installation order of a previously installed VCR and *Make* is the manufacturer of the VCR. This will instruct the FroxSystem that the playback device is the same as the recording device. If any other listing is selected, the system will think that there are separate VCRs for playback and recording (also a valid configuration).

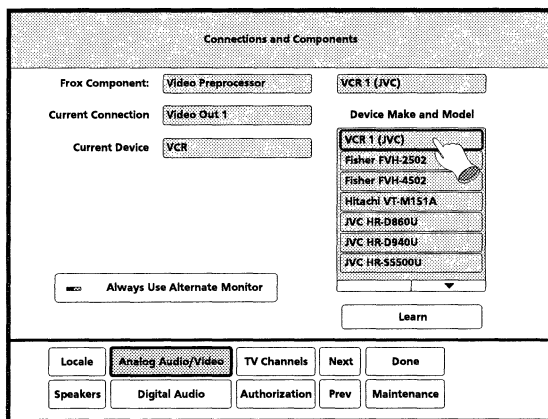

If the particular model number for a manufacturer is not available in the provided listing, select another model from the same manufacturer. It is quite probable that models from the same manufacturer use

the same infrared (IR) codes. If there is no suitable choice, then the device can be taught to the FroxSystem in the *Learn* mode (see Appendix D).

9) Should the VCR have more than one audio line input, it may be necessary to assign a *Dub Source Position*. This assignment tells the FroxSystem which audio line input to use when dubbing. The *Dub Source Position* is defined as the number of steps (inputs) past the RF input (tuner) on the VCR. This can be determined by counting the number of times the *Input* (or equivalent) key must be hit on the VCR remote to move from the RF input to the audio input desired for dubbing. The choices under *Dub Source Position* will be listed as *One past tuner*, *two past tuner*, etc. Click on the appropriate option at this time.

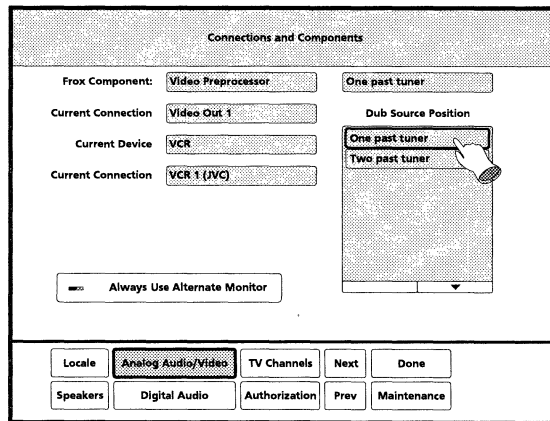



**LASERDISC INSTALLATION**

To enter the laserdisc (LD) player Installation section, click on the ANALOG AUDIO/VIDEO button located on the Installation Control Stripe.

 A video device (such as a VCR or laserdisc player) must be installed in *Video In 1* before *Video In 2* can be used.

**INSTALLING A LASERDISC PLAYER**

- 1) Using the NEXT and PREV buttons on the Installation Control Stripe, scroll through the pages of installation screens to locate the desired *Current Connection* - *Video In 1* or *Video In 2*.

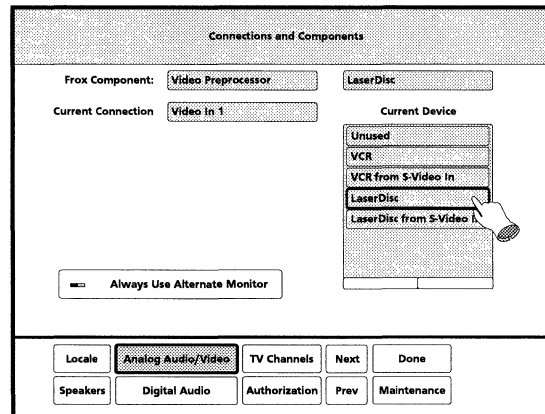
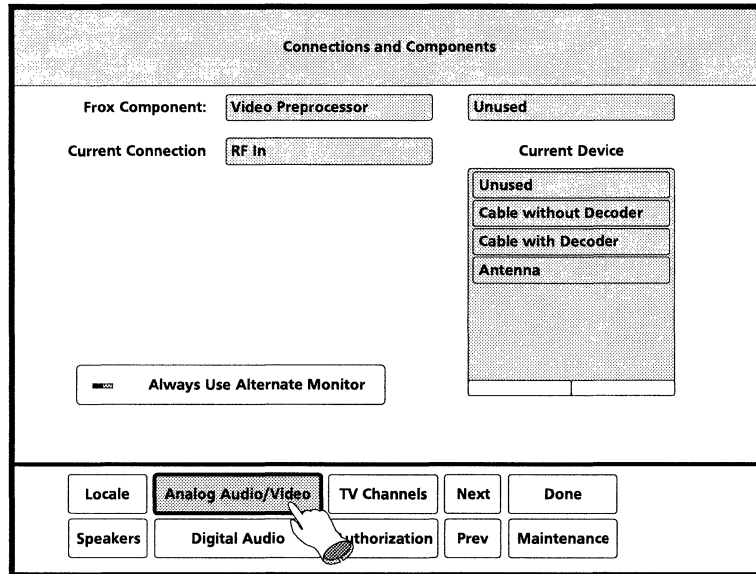

*Installing a Laserdisc Player*

- 2) Click on the *Current Device* that best describes the video output of the LD player. If the video output features composite video, click on *LaserDisc*; if the video output is from an S-video port click on *LaserDisc from S-video In*.
- 3) From the list of devices, click on the *Device Make*

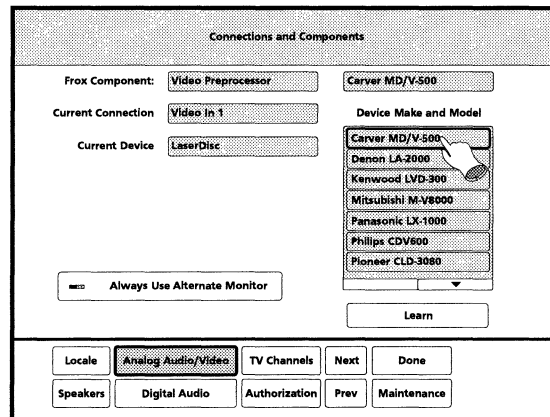

and *Model* for the LD player in question. If the particular model number for a manufacturer is not available in the provided listing, select another model from the same manufacturer. It is quite probable that models from the same manufacturer use the same infrared (IR) codes. If there is no suitable choice, then the device can be taught to the FroxSystem via the *Learn* mode (see Appendix D).

- 4) Click on the *Digital Audio Connection* to which the digital audio output of the LD player is connected (the analog input is automatically assumed to be associated with the video #1 or #2 inputs).

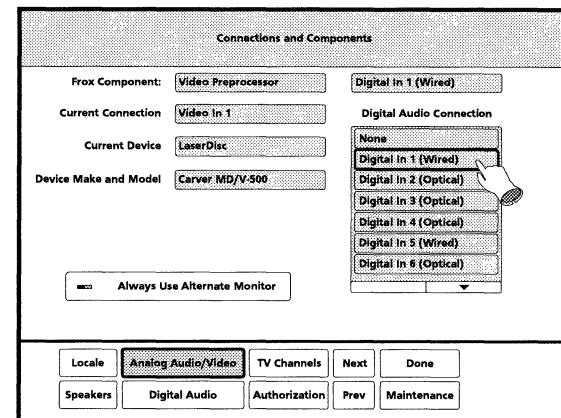

**CD PLAYER INSTALLATION**

There are two ways to configure compact disc (CD) players to the FroxSystem. First, determine whether or not the CD player has a digital output. If it has a digital output then follow the installation procedure for "Installing A Digital CD Player". If the player does not have a digital output, then follow the installation procedures for "Installing An Analog CD Player".

 CD players that do not offer a digital output can be controlled via infrared (IR) by the FroxSystem, but because there is no subcode information available on the analog output of a CD player, all data related FroxSystem features (such as CD Identification and Elapsed Time Counter) will not be available.

 Only one 100-Disc FroxCD changer (CDC-01) or equivalent NSM-model is allowed per installation.

 A maximum of four CD players (including analog CD players, digital CD players and FroxCD Changers) may be configured per FroxSystem installation.

**INSTALLING A DIGITAL CD PLAYER**

Click on the DIGITAL AUDIO button located on the Installation Control Stripe.

There are eight digital audio inputs on the FroxSystem's Media Processor. Two of these are wired (coaxial) and the remaining six are optical.

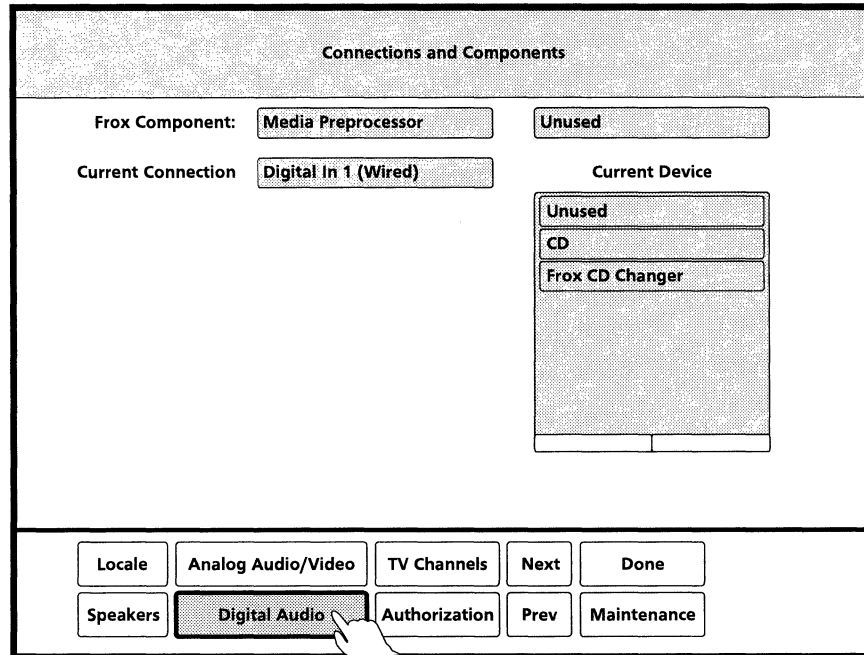

*Installing a Compact Disc Player*

Digital In 1 (Wired) Digital In 5 (Wired)  
 Digital In 2 (Optical) Digital In 6 (Optical)  
 Digital In 3 (Optical) Digital In 7 (Optical)  
 Digital In 4 (Optical) Digital In 8 (Optical)

The DIGITAL AUDIO installation menu sequences through each of the 8 digital inputs for device installation. Use the NEXT and PREV buttons on the Installation Control Stripe to scroll through inputs 1 - 8. For each input a compact disc player or Frox 100 CD Changer (CDC-01) is offered as an option.

 Some CD players (including combination CD/LD players with digital outputs) strip the subcode information from the digital data stream. Though these components can be used to play audio through the FroxSystem, they cannot be used with the identification and data control portions of the FroxSystem. Please check the operation manual, service manual or with the manufacturer of the CD player in question before proceeding with the installation to verify the integrity of the digital output.

- 1) Using the NEXT and PREV buttons, select the digital input desired. This is listed under *Current Connection*.
- 2) Select either CD or FroxCD Changer.

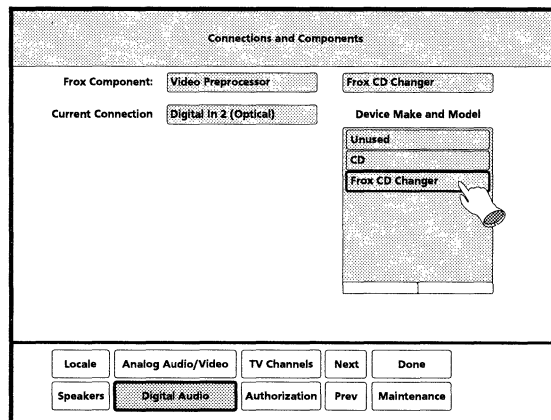
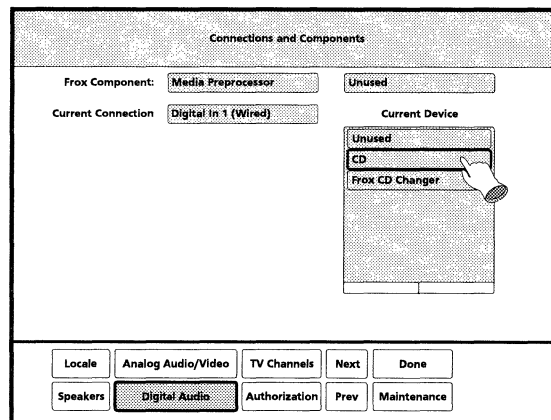

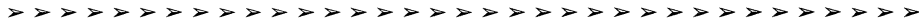

*Installing a Compact Disc Player*

- 3) Choose CD, then select the *Device Make and Model* that is connected to the *Current Device* option. If the particular model number for a manufacturer is not available in the list, select another model from the same manufacturer. It is quite probable that models from the same manufacturer use similar infrared (IR) codes. If there is no suitable choice, then the device can be taught to the FroxSystem via the *Learn* mode (see Appendix D).

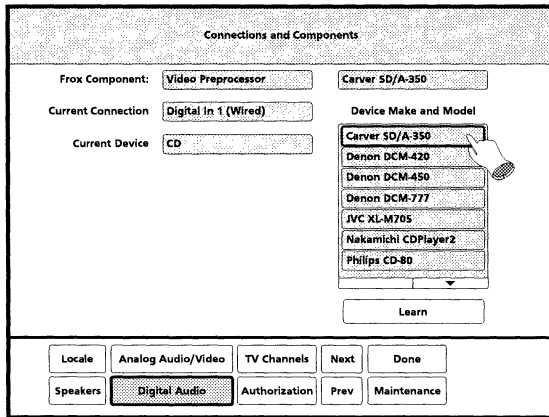

- 4) If additional digital CD players are to be installed, repeat steps 1 through 3.

**INSTALLING AN ANALOG CD PLAYER**

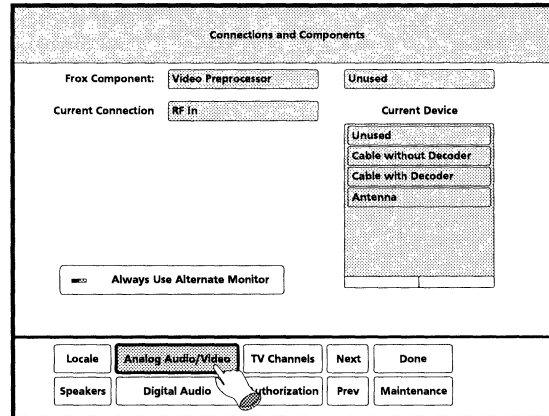

To install an analog CD player, click on the ANALOG AUDIO/VIDEO button located on the the Installation Control Stripe. There are two stereo pairs of analog audio inputs on the

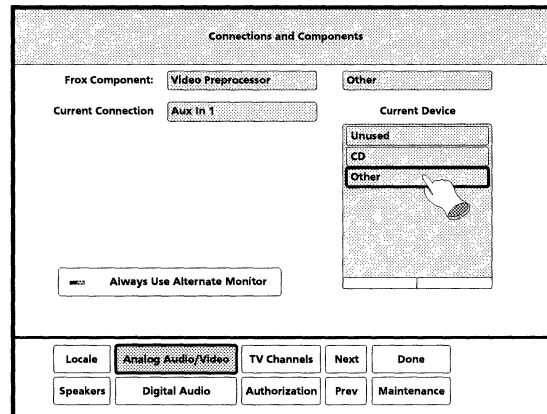

*Installing a Compact Disc Player*

FroxSystem's Video Preprocessor.

Aux In 1

Aux In 2

- 1) Using the NEXT and PREV buttons, scroll through the installation screens of ANALOG AUDIO/VIDEO until the *Current Connection* reads *Aux In 1* or *Aux In 2*.

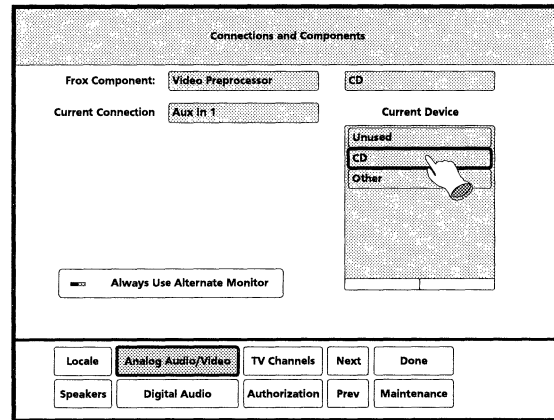

- 2) Click on the choice labeled CD .

- 3) Click on the desired *Device Make and Model* of your analog CD player. If the particular model number is not available in the device list, select another model from the same manufacturer. It is quite probable that models from the same manufacturer use similar infrared (IR) codes. If there is no suitable choice, then the device can be taught to the FroxSystem via the *Learn* mode (see Appendix D).

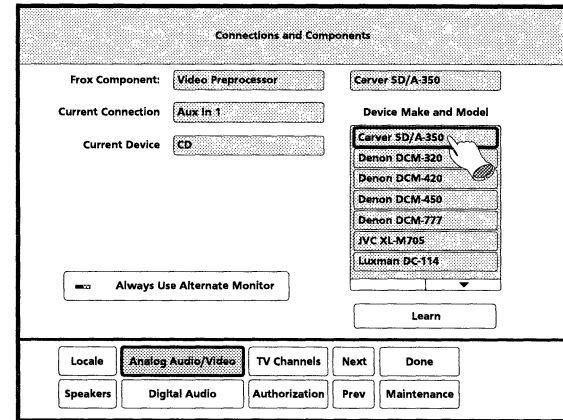

- 4) If additional analog CD players are left to be installed, repeat steps 1 through 3.



### MISCELLANEOUS ANALOG AUDIO COMPONENTS

To enter the miscellaneous analog audio device installation section, click on the ANALOG AUDIO/VIDEO button located on the Installation Control Stripe.

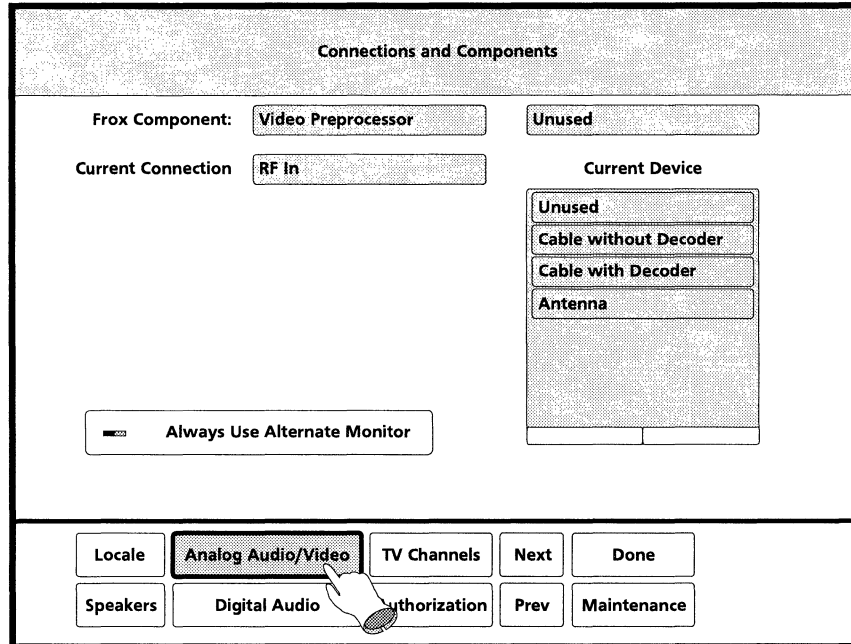

*Installing Miscellaneous  
Analog Audio  
Devices*

The FroxSystem software V3.0 supports the infrared (IR) control of the following devices: compact disc player, VCRs, laserdisc players, and cable decoders. The audio from other analog audio devices (such as cassette decks and AM/FM tuners) can be routed through the FroxSystem studio path without the benefit of IR control.

There are two stereo pairs of analog audio inputs on the FroxSystem's Video Preprocessor.

Aux In 1

Aux In 2

When a miscellaneous analog audio device is installed in *Aux In 1* or *Aux In 2* an OTHER or OTHER 2 button will appear as options in the Audio Routing Screen. A selection of these controls will route the corresponding audio device to the room of choice.

**INSTALLING A MISCELLANEOUS ANALOG AUDIO DEVICE**

- 1) Using the NEXT and PREV buttons, scroll through the installation screens of ANALOG AUDIO/VIDEO until the *Current Connection* reads *Aux In 1* or *Aux In 2* as desired.
- 2) Click on *Other*.

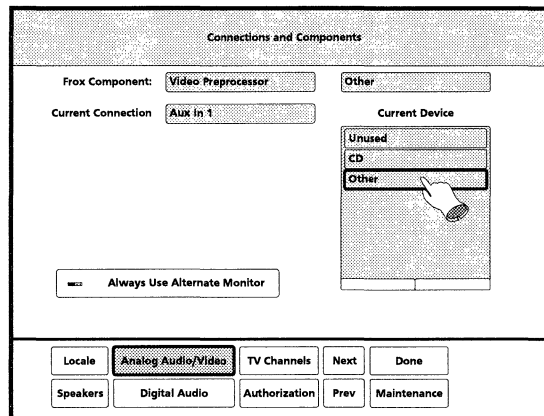

**GENERAL PROCEDURES**

To configure speakers to the FroxSystem, click on the **SPEAKERS** button located on the Installation Control Stripe.

There are 16 rooms available in which speakers can be installed (V3.0 or later releases); they are listed in a menu under *Select a Room*. The default room names are: *Main Theater, Living Room, Bedroom 1, Bedroom 2, Bedroom 3, Bedroom 4, Kitchen, Den, Family Room, Patio, Rec Room, Bathroom 1, Bathroom 2, Bathroom 3, Great Room, and Pool*. Room names can be changed by the installer (in a procedure discussed later in this section).

FroxSystem digital and analog audio outputs are assigned in pairs. These pairs are listed under *Associated Speakers*. There are 16 optical digital outputs on the Media Processor and two pair of analog auxiliary outputs on the Video

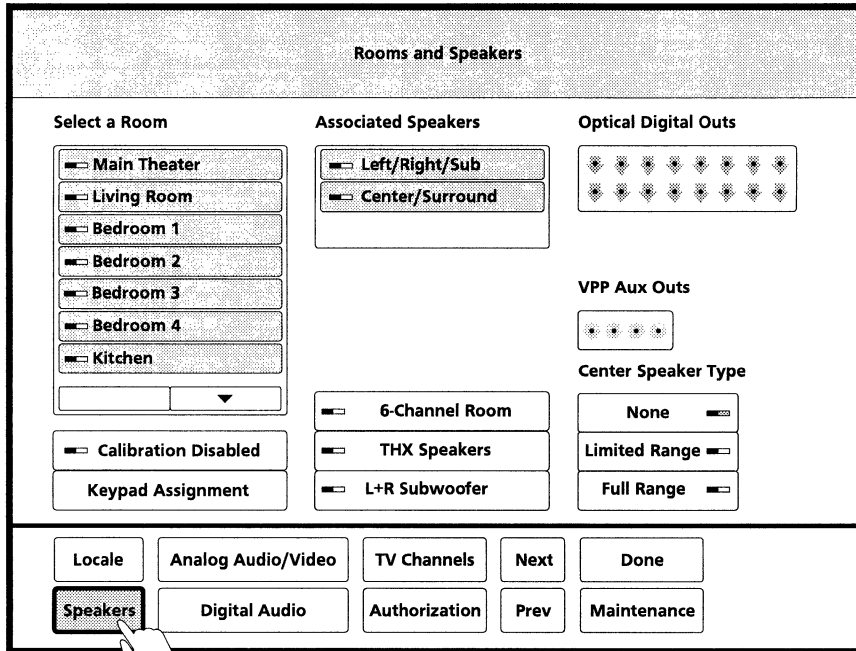

Preprocessor. When installing digital speakers that use one of the two channels on the digital data stream, it is important to be aware of the sequence in which the channels exist. For example, when assigning *Left/Right/Sub* to a digital speaker, channel 1 will carry the left channel and channel 2 will carry the right channel. *Sub* simply means that the very same left and right channels will

*Speaker Installation*

terminate at a subwoofer (one that sums the left and right channels together to derive an input). For example, to set the proper channel designation on a Frox digital speaker, set DIP switch #3 (located on the back of each speaker) to either the B (channel 1) position or A (channel 2) position.

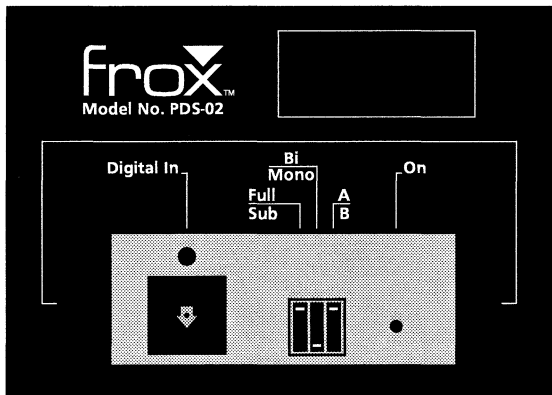

The rules remain the same when using analog outputs or D/A converters. If a *Left/Right/Sub* audio pair is assigned to the first (Aux Out 1) analog audio output pair, the left channel output would be 'port one' (furthest left) and the right channel output would be port two. Similarly, when assigning an audio pair to a digital output that connects to a D/A converter, the D/A converter output labeled 'left' would carry channel 1 and the output labeled 'right' would carry channel 2.

An interactive graphical representation of the FroxSystem analog and digital audio outputs is displayed on screen to simplify the installation process.

**INSTALLING A TWO-CHANNEL ROOM**

- 1) Click on the name of the room to be installed.
- 2) Click on *Left/Right/Sub*.

**Associated Speakers**

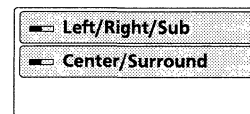

- 3) Click on as many unused (black-filled) digital and analog ports required to route *Left/Right* audio signals to desired speakers. When a port is assigned it will change to a red-filled state. Unavailable speaker ports are displayed as gray-filled (when the room associated with those ports is not the current room selected).
- 4) Click on the L+R SUBWOOFER button if a subwoofer is present.

**INSTALLING A FOUR-CHANNEL ROOM**

(Dolby Pro • Logic Surround and The Sonic Playground)

- 1) Click on the name of the room to be installed.
- 2) Click on *Left/Right/Sub*.

**Associated Speakers**

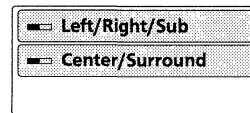



- 3) Click on as many unused (black-filled) digital and analog ports required to route *Left/Right* audio signals to desired speakers. When a port is assigned it will change to a red-filled state. Unavailable speaker ports are displayed as gray-filled (when the room associated with those ports is not the current room selected).

- 4) Click on *Center/Surround*

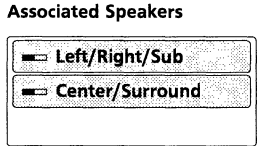

- 5) Click on as many unused (black-filled) digital and analog ports required to route *Center/Surround* audio signals to desired speakers. When a port is assigned it will change to a red-filled state. Unavailable speaker ports are displayed as gray-filled (when the room associated with those ports is not the current room selected).

- 6) Click on the appropriate *Center Speaker Type*. If any *Center/Surround* speakers have been installed, this will default to FULL RANGE. Otherwise it will be set to NONE. The LIMITED RANGE selection is for smaller speakers (such as those built into a television, incapable of handling a full range of audio frequencies).

- 7) Click on the L+R SUBWOOFER button if a subwoofer is present.

**INSTALLING A SIX-CHANNEL ROOM**  
(Home THX and The Sonic Playground)

- 1) Click on the name of the room to be installed
- 2) Click on the 6-CHANNEL ROOM button. Note that the list of speaker options under *Associated Speakers* will change to reflect the six discrete channels of Home THX.

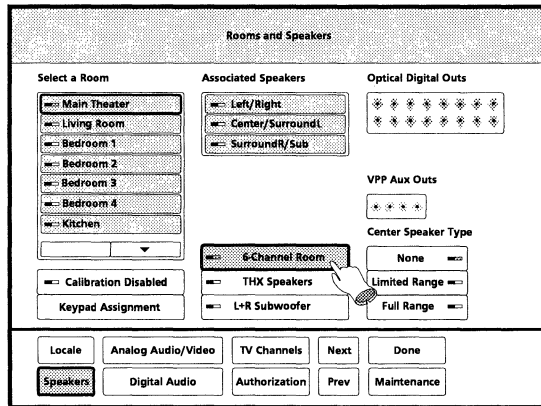

*Speaker Installation*

- 3) If the room is equipped with THX-certified speakers, then click on the THX SPEAKERS button. Note that the *Center Speaker Type* options, as well as the L+R SUBWOOFER button, will disappear (since these are no longer valid options).

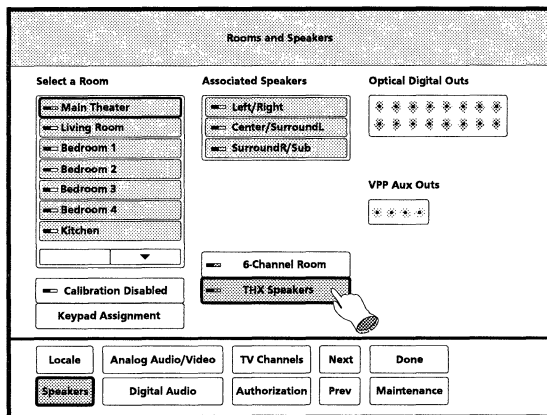

- 4) If the room does not have THX-certified speakers and does have a subwoofer that sums the left and right channels, click on the L+R SUBWOOFER button. If the room has no subwoofer, do not select the L+R SUBWOOFER BUTTON.

**Associated Speakers**

- 5) Click on *Left/Right*.

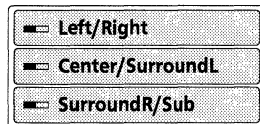

- 6) Click on as many unused (black-filled) digital and analog ports required to route *Left/Right* audio signals to desired

speakers. When a port is assigned it will change to a red-filled state. Unavailable speaker ports are displayed as gray-filled (when the room associated with those ports is not the current room selected). If the L+R SUBWOOFER button is selected, the entry in the *Associated Speakers* browser will read *Left/Right/Sub* instead of *Left/Right*. In this case click on the output ports connected to the subwoofer.

**Associated Speakers**

- 7) Click on *Center/SurroundL*.

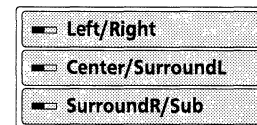

- 8) Click on as many unused (black-filled) digital and analog ports required to route *Center/SurroundL* audio signals to desired speakers. When a port is assigned it will change to a red-filled state. Unavailable speaker ports are displayed as gray-filled (when the room associated with those ports is not the current room selected).

**Associated Speakers**

- 9) Click on *SurroundR/Sub*

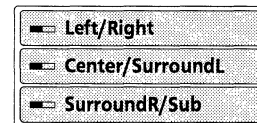

- 10) Click on as many unused (black-filled) digital and analog ports required to route *Surround R/Sub* audio signals to desired speakers. When a port is assigned it will change to a red-filled state. Unavailable speaker ports are displayed as gray-filled (when the room associated with those ports is not the current room selected). If the L+R SUBWOOFER button is selected,

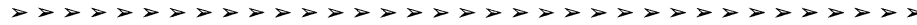

the entry in the *Associated Speakers* browser will read *SurroundR/None* (instead of *SurroundR/Sub*) and only the *SurroundR* port selections are provided.

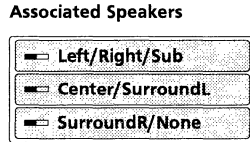

- 11) If the room does not have THX-certified speakers Click on the appropriate *Center Speaker Type*. If any *Center/Surround* speakers have been installed, this menu will default to FULL RANGE. Otherwise it will be set to NONE. The LIMITED RANGE selection is for small speakers (such as those built into a television, incapable of handling a full range of audio frequencies).

NOTE: To properly calibrate a six-channel Home THX room, refer to Lucasfilm LTD's document entitled "Home THX Audio System Installation & Operation Manual."

**SAFEGUARDING YOUR INSTALLATION**

On the Home THX Audio Processing Control Stripe, there is a button called CALIBRATION that presents a subpanel of detailed calibration controls. Once the room is calibrated for optimum sound it is advised that the installer lock this menu away from alteration by the user. This is accomplished in the same SPEAKERS installation panel. The net effect of this procedure is to remove the CALIBRATION button from the Home THX Audio Processing Control Stripe:

- 1) Click on the name of the room that has the six-channel installation.
- 2) Click on the CALIBRATION DISABLED button (the green tally light is turned ON).

**RENAMING ROOMS**

Any room can be renamed by typing the correct room name via a virtual keyboard. The procedure to change the name of a room is:

- 1) Click on the name of the room that you wish to change.
- 2) Click on the KEYPAD ASSIGNMENT button.
- 3) Click on the NAME THIS ZONE button.
- 4) Type in the characters using the on-screen keyboard and the FroxWand. When completed, click on the ENTER button.
- 5) To return to Speaker Installation area, click on the SPEAKERS button.



*Notes*





**INSTALLER'S NOTES**



**ALTERNATE MONITOR**

To configure an alternate monitor, click on the ANALOG AUDIO/VIDEO button located on the the Installation Control Stripe.

 The alternate monitor feature is a method for displaying the Frox Graphical User Interface (GUI) on a regular television via composite or S-video inputs (horizontal scanning frequency 15.75kHz), usually in a room outside the main theater. It is assumed that the main theater monitor is 'datagrade' or "multisync" (scanning at 31.5kHz). A monitor of this variety takes full advantage of the Frox line doubling capability and displays the Frox GUI with its proper graphics resolution.

 When an alternate monitor is active all devices installed in *Video In 2* will become inaccessible.

The alternate monitor feature forwards video to a television through the S-video and composite Video 2 outputs. This feature can be installed as a permanent method of system viewing or it can be activated on-demand. The on-demand

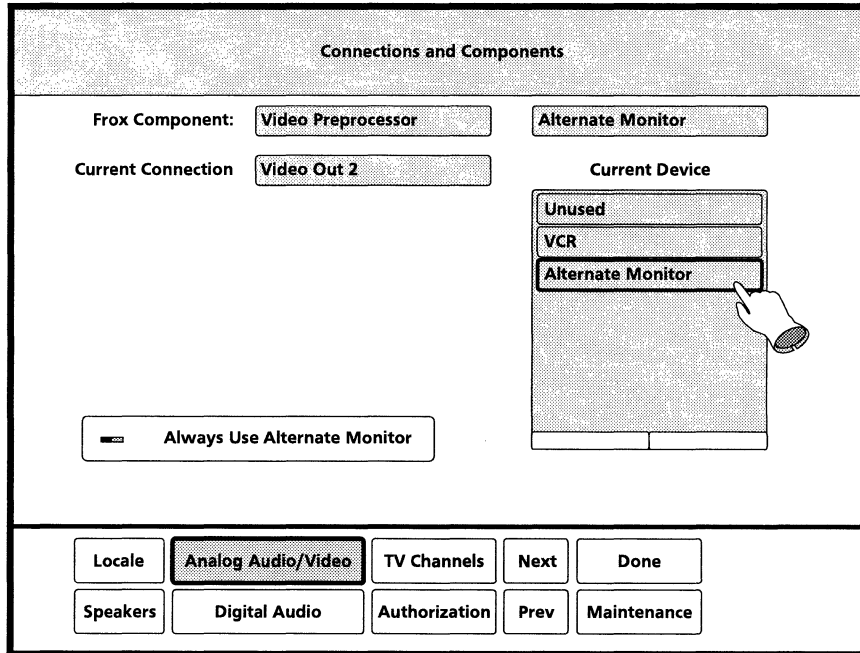

option will allow devices installed in *Video In 2* to be accessible when the alternate monitor is turned OFF.

 When using S-video cables, long distance runs are not recommended over 30 feet without adding amplification to the line. This is typically accomplished by adding an S-video distribution amplifier.

 Because it is impossible to know if the alternate monitor is the only monitor in the system, the alternate monitor is

*Alternate Monitor*

pre-installed as “always on.” If the alternate monitor is the only monitor in the system NEVER un-install it. Doing so will blank the video output when routed from the video 2 output. If this should occur, upon leaving INSTALLATION no video will be present on the alternate monitor (and hence no FroxSystem operation will be possible).

 The graphics quality of the S-video output will be superior to that of the composite video output.

 The FroxSystem always prefers an S-video signal as a video input. The Video Preprocessor hardware is optimized for a video signal broken into separate luminance and chrominance components. Use the S-video inputs whenever possible.

The ON and OFF commands for an infrared-controlled television can be taught to the FroxSystem, so that when the alternate monitor is engaged the FroxSystem can turn the television ON or OFF via the FroxWand's F2 control.

**INSTALLING THE ALTERNATE MONITOR FOR ON-DEMAND USE**

- 1) Using the NEXT and PREV buttons, scroll through the installation screens of ANALOG AUDIO/VIDEO until the *Current Connection* is *Video Out 2*.
- 2) Click on the ALWAYS USE ALTERNATE MONITOR button so that the green tally light goes OFF.

- 3) Check to see if the *Current Device* is set to *Alternate Monitor*.
- 4) If not, click on the *Alternate Monitor* option in the *Current Device* menu.
- 5) If the television is not required to be powered ON and OFF when the alternate monitor is activated, click on the *Generic TV* option under *Device Make and Model*.
- 6) If the television is to be powered ON and OFF when the alternate monitor is activated, use the *Learn* mode option (see Appendix D).

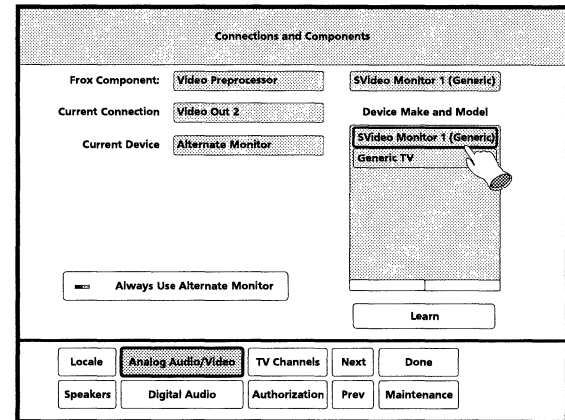



**INSTALLING THE ALTERNATE MONITOR FOR CONSTANT USAGE**

- 1) Using the NEXT and PREV buttons, scroll through the installation screens of ANALOG AUDIO/VIDEO until the *Current Connection* is *Video Out 2*.
- 2) Make sure that the ALWAYS USE ALTERNATE MONITOR button is ON (i.e. the green tally light is ON).
- 3) Check to see if the *Current Device* in *Video Out 2* is set to *Alternate Monitor*.
- 4) If the television is not required to be powered ON and OFF when the alternate monitor is activated, click on the *Generic TV* option under *Device Make and Model*.
- 5) If the television is required to be powered ON and OFF when the alternate monitor is activated, use the *Learn* mode option (see Appendix D) to teach these commands to the FroxSystem.

**UN-INSTALLING THE ALTERNATE MONITOR**

- 1) Using the NEXT and PREV buttons, scroll through the installation screens of ANALOG AUDIO/VIDEO until the *Current Connection* is *Video Out 2*.
- 2) Click on the *Unused* option under *Current Device*.



**INSTALLER'S NOTES**



**THE MAINTENANCE AREA**

To enter the system maintenance and update section of INSTALLATION, click on the MAINTENANCE button located on the Installation Control Stripe.

The Maintenance screen provides tasks for the installation, maintenance and updating of the FroxSystem. The tasks are:

- 1) Save Setup\*
- 2) Restore Setup\*
- 3) System Update\*
- 4) CD Covers
- 5) Converge
- 6) Statistics

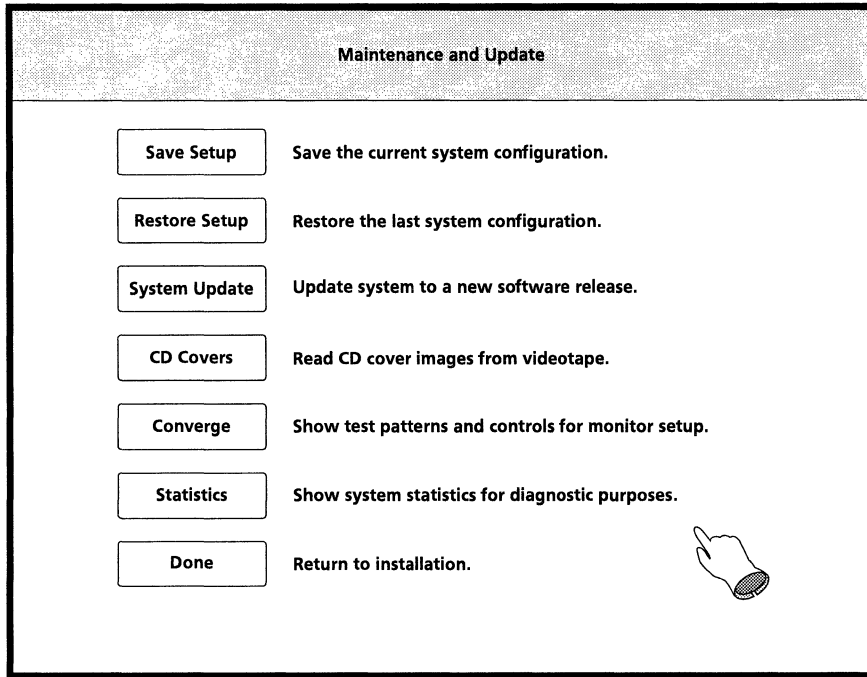

**SAVE SETUP (V3.0 Release)**

The Save Setup option writes the current system configuration to a "read-only" partition on the hard disk.

- 1) Click on the SAVE SETUP button. This will take several seconds and no FroxSystem operation will be available during this time.

\*These features are available in Version 3.0 or later releases.

**RESTORE SETUP (V3.0 Release)**

The Restore Setup option reads the previously saved system configuration from the "read-only" partition on the hard disk and restores the system to those settings.

- ❑ 1) Click on the RESTORE SETUP button. This can take from several seconds to several minutes. An informational pop-up will appear during the restoration and will disappear when this procedure is complete.

**SYSTEM UPDATE (V3.0 Release)**

The System Update option is used when upgrading the FroxSystem to new releases of software. It can also be used to install a clean version of the existing software release into the system.

- ❑ 1) Click on the SYSTEM UPDATE button.

☞ A FroxCD containing your current release of software (or any subsequent version of FroxSystem software) is now required. Without the FroxCD, execution of System Update will result in an inoperable system.

- ❑ 2) Click on the CONFIRM button to proceed with System Update (or the CANCEL button to return to the Maintenance screen). The System Update procedure will take up to 30 minutes.

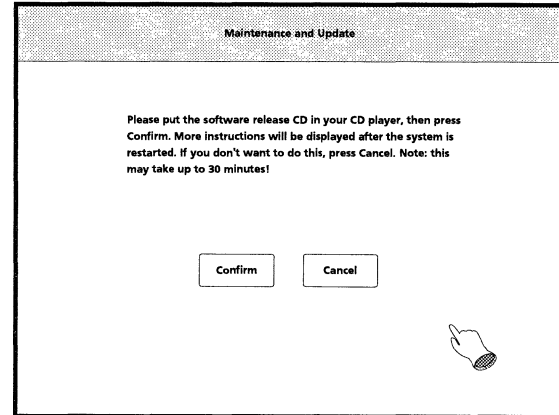

- ❑ 3) Refer to the chapter "Upgrading to V3.0 - FroxBoot - FroxCD Booting Utility" in this manual and proceed from step 3 under the subsection "Loading V3.0 From the FroxDC."

**CD COVERS**

The Frox V3.0 CD Covers Tape has over 10,000 CD cover images for a wide variety of compact discs.

☞ Before exercising the CD Covers routine, complete the CD Identification procedure found in Appendix C of this manual.



This procedure matches the CD's cover graphics for the discs that have been identified as "In Collection". If the graphic is available, it will appear every time the CD record is opened in the Compact Disc browser.

 Because the universe of compact discs is greater than 10,000, it can be expected that some CDs in one's personal collection may not yield a graphic from the CD Covers Tape. The best way to guarantee that all discs are in the Frox database is to send the CD collection to Frox (so that all discs can be entered and scanned).

 When attempting to load cover art from the CD Covers Tape insure that no VCR on-screen graphics are also presented. This will corrupt the data being read from the tape and will result in no graphics "captures".

 Because the videotape is transferring data to the Frox-System, it is vital that the tape is tracking properly in the VCR. At the beginning of the tape there are several seconds of black and white vertical bars that are used as a "header" to test the data quality of the transfer. If the system cannot properly read the tape follow these steps to correct this: First, turn off the "Automatic Digital Tracking" feature commonly found on VCRs (consult the VCR's user's manual). With the VCR now in a "Manual Tracking" mode adjust the tracking until the black and white header bars line up vertically and look as clean as possible. Then begin the loading procedure again. Another cause of bad tracking is when the tape is wound poorly on the reels. To correct this, fast forward the tape to its end and then rewind it to the beginning. This should align the tape to allow for better head-to-tape tracking.

- 1) Insert the CD Covers tape in a VCR connected to the FroxSystem.
- 2) Click on the CD COVERS button.
- 3) Insure that the tape is at its beginning, physically press the PLAY button on the VCR containing the CD Covers Tape.

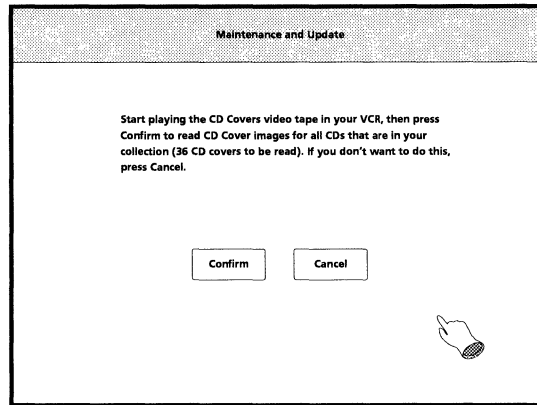

- 4) Click on the CONFIRM button to begin the loading process (or the CANCEL button to return to the Maintenance screen). During the loading process an on-screen counter will keep track of each cover graphic that is successfully captured. Additionally, the graphic itself will appear on-screen when it is located on the CD Covers Tape.

*Maintenance*

**CONVERGENCE**

Several calibration screens are available in the Converge subsection to aid in properly setting up a monitor for a FroxSystem.

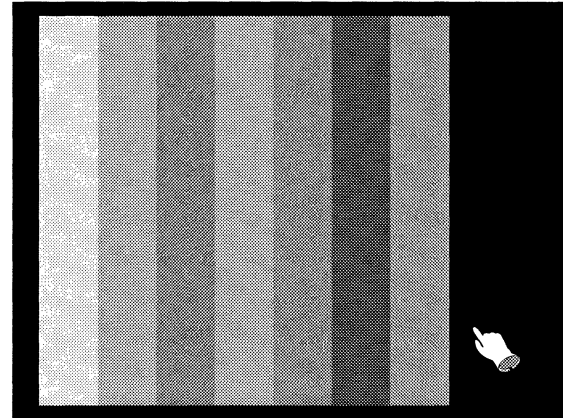
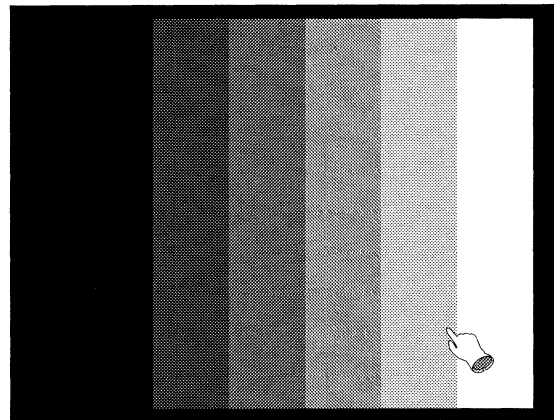
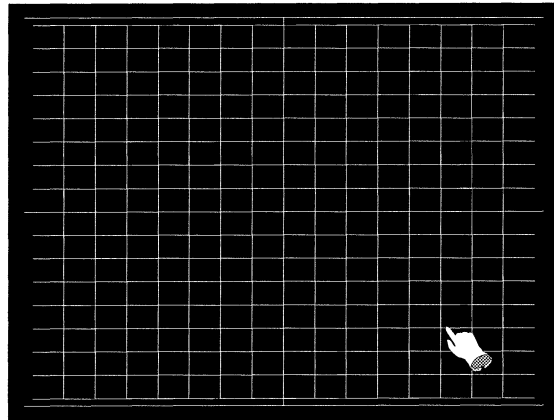

It is important that the Frox-provided patterns are used during monitor calibration (verses external patterns generated by a laserdisc or test pattern generator).

There are three test patterns provided for calibrating monitors. The Cross Hatch, Gray Scale and SMPTE Color Bar patterns are accessed as follows:

- 1) To view the Cross Hatch pattern, click on the CONVERGE button.
- 2) To make the Gray Scale pattern appear, click on the Cross Hatch Screen.
- 3) To view the SMPTE color bars, click on the Gray Scale Screen.





Due to excessive "over scanning" in many composite video monitors, Frox has provided a screen-shifting feature that allows the installer to shift the entire Graphical User Interface (GUI) to the left or right, up or down. Screen shifting is often required when using NTSC monitors for the alternate monitor feature.

 When using more than a single monitor in a system, insure that the screen positioning is at a happy medium for all monitors. Be aware that the user interface shifting will affect all monitors in the system.

**To move the User Interface:**

- 1) Click on the CONVERGE button.

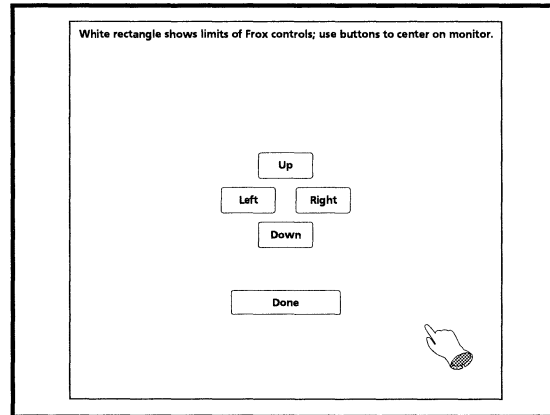

- 2) Continue to click on the test patterns until the screen-shift page is reached. This will be the screen following the SMPTE color bars.
- 3) When finished, click on the DONE button to return to the Maintenance Area.

## STATISTICS

The Statistics screen provides useful information about the FroxSystem configuration, hardware and software status, plus FroxCast transmission quality.

The *FroxCast Transmission Statistics* reveals the number of data packets that have been recently received by the FroxSystem. Two numbers appear and are separated by a colon. The first number is the total number of data packets that has been received by the system; the second is the number of "bad" packets received. Upon exiting this screen, both numbers will be reset to zero. The FroxCast Data Channel and VBI Line must be installed before any reception count is reflected on the Statistics screen.

To check for FroxCast reception, leave installation and soft-power-down the system for approximately 10 minutes. Turn the system on and return to the Statistics screen. The system should have received a small number of packets. If

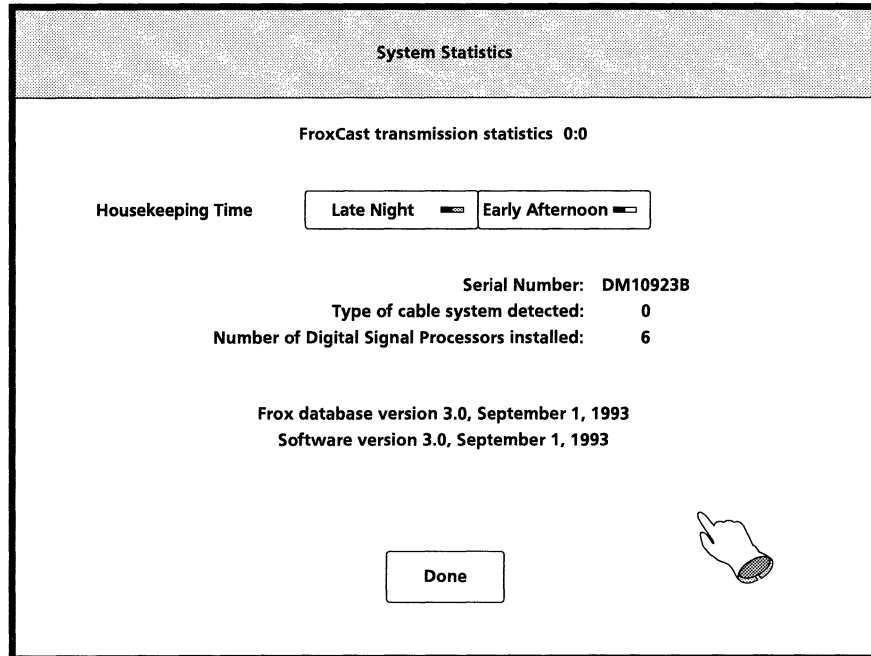

the *FroxCast Transmission Statistics* are still 0:0 then it is probable that this test either occurred during a FroxCast down time or there is an error in the installation. The absolute test of FroxCast transmission is to leave the system soft-powered-down for an entire evening. If the *FroxCast Transmission Statistics* still reads 0:0 in the morning then there is some other problem with the software or hardware installation.

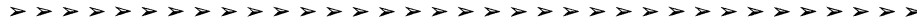

*Housekeeping Time* allows the installer/user to set a preferred time for the FroxSystem to perform the "House-cleaning" routine. This is an automated daily event where unnecessary data is purged from memory (such as yesterday's television schedules). During this procedure no other FroxSystem operation is possible. The Housekeeping event should be scheduled at a time when the system is likely not to be in use. The factory setting for Housekeeping is "Late Night" which translates to 3:00 A.M. An alternate time slot of "Early Afternoon", or 3:00 P.M. can be selected at any time by the installer/user.

**To set the *Housekeeping Time*:**

- 1) Click on the *Housekeeping Time* button (LATE NIGHT or EARLY AFTERNOON) as desired.

**OTHER STATISTICS INFORMATION:**

Every FroxSystem Media Processor has its own chassis *Serial Number*. This number is displayed on the screen and is important when generating authorization codes. This number is also labeled on the rear panel of the Media Processor.

If a cable system is installed a number will be listed next to *Type of cable system detected* to indicate whether the cable system is standard, HRC or IRC.

The *Number of Digital Signal Processors* installed is listed on the Statistics Screen. The MPP-02 ships with three DSP cards, which will display the number 6 (since there are two physical DSP integrated circuits on each DSP card).

The *Frox database version* is listed along with the date of that version.

The *FroxSystem Software version* is listed along with the date of the installed software version.



*Notes*



**INSTALLER'S NOTES**



Following are some potential problems that can occur when installing a FroxSystem. If the recommended solutions do not yield the desired results, contact the Frox Technical Support department at 1-800-525-5257 for additional assistance.

**VIDEO**

**Symptom:**

*The datagrade monitor displays nothing from the Media Processor's video output.*

**Possible causes:**

- The Media Processor is not receiving power.
- The connections from the datagrade monitor to the Media Processor are loose or otherwise interrupted.

**Symptom:**

*Signals from antenna, cable or satellite look "grainy."*

**Possible causes:**

- The RF (Antenna) input on the Video Preprocessor is not receiving the required 7-10dB of signal.
- The signal itself is noisy.
- There is a noisy video amplifier in the line.

**Symptom:**

*The color red turns to green (or green to blue) during some scenes.*

**Possible causes:**

- The color saturation level for that channel or source is too high. Reduce the value by accessing the Video Processing Control Stripe and reducing the SATURATION level.

**Symptom:**

*The video looks washed out even though the video processing parameters are pushed high.*

**Possible causes:**

- The monitor is not set up to work properly with the FroxSystem. Read the section "Connecting Monitors" in this manual and follow the setup procedures in detail.

**Symptom:**

*There are horizontal pink and green bars that appear on the screen..*

**Possible causes:**

- The FroxSystem initiates synchronization with all video sources. This means that all video sources must be started from the Frox Graphical User Interface (GUI). For example, when using a VCR, the PLAY button must be selected from the VCR Control Stripe to begin playback. If the PLAY button is used from the physical device and not initiated from the GUI, then the FroxSystem will not be able to synchronize to the video. This may result in horizontal pink and greens bars across the video image.

**Symptom:**

*When using an alternate monitor, parts of the graphical user interface can't be read (because they are off the screen).*

**Possible causes:**

- Use the Screen Shifting feature found in the MAINTENANCE area of Installation to center the user interface on the alternate monitor. This will correct for the overscan of the NTSC monitor.

 Troubleshooting

**AUDIO**
**Symptom:**

*There is no sound.*

**Possible causes:**

➤ The best way to check for sound is to select the TV button from the Video Control Stripe and increase the master volume. If no sound is heard, then recheck the speaker installation area of the system and retrace all component wiring.

**Symptom:**

*When playing certain laserdiscs, there is no sound.*

**Possible causes:**

➤ Not all laserdiscs have *digital* audio soundtracks, but all have *analog* audio soundtracks. If the system is installed properly both the digital and analog audio outputs of the laserdisc player will be configured into the FroxSystem. Then, on the Laserdisc Control Stripe an ANALOG/DIGITAL toggle button will be presented for the user to select the appropriate soundtrack. If ANALOG is the current state and no sound can be heard, then there is some other problem. Check the installation of the component and speakers.

**Symptom:**

*When attempting to route a new audio source to a room, or when selecting an audio processing option, an informational pop-up appears that says "Not enough DSPs."*

**Possible causes:**

➤ The FroxSystem ships with three DSP cards, which is enough processing power to sample convert a digital audio source and add Home THX, six-channel processing. If any audio processing tasks above this are required, then additional DSP cards must be purchased and installed.

➤ Insure that the DSP cards are securely fitted into the slots in the Media Processor.

➤ A defective DSP card.

**Symptom:**

*An audible hum is present in the audio whenever the monitor is connected to the system.*

**Possible causes:**

➤ Most likely a ground loop exists. Make certain that the monitor is at the same electrical ground as the Media Processor and Video Preprocessor. Review the discussion about ground loops in the chapter "Planning A Successful Installation."



**☐ SYSTEM AND DEVICE CONTROL**

**Symptom:**

*The FroxWand does not move the hand on screen.*

**Possible causes:**

- The batteries are dead or too low for the FroxWand to function properly.
- The FroxWand is broken.
- The IR receiver on the front of the Media Processor is blocked or broken.
- An IR repeater in use with the system is not properly connected.

**Symptom:**

*The system won't turn ON in the morning.*

**Possible causes:**

- The FroxSystem has experienced a software failure overnight and may not be able to self-recover. Hard power cycle the system. This should restore normal operating conditions.
- The FroxWand batteries may be low, thus not issuing the proper POWER ON command. Replace all batteries.

**Symptom:**

*The system turns ON and the Preferences screen automatically appears. When other menu options are selected the screens look like they are writing over one another but not fully disappearing.*

**Possible causes:**

- Check to see if the AC power of the Video Preprocessor is

plugged into the switched outlets of the Media Processor. If so, remove and reconnect the AC power directly to a source outlet.

- There may be a bad or missing connection between the Digital Video SCSI ports on the Media Processor and the Video Preprocessor. Check to see that the connections are securely made to both components.

**Symptom:**

*The system turns ON, the Copyright screen automatically appears and never goes away.*

**Possible causes:**

- This could indicate a hard disk failure due to either hardware or software. Hard power cycle the system and wait a few minutes to see if the condition persists.

**Symptom:**

*Control of one or more infrared (IR) devices is lost.*

**Possible causes:**

- Check the IR emitter connection to the devices. Be sure that the emitter is placed directly over the IR receiver on the device.
- Check the software configuration to see if the device is installed properly. Even if it is, try "re-installing" the device.

**Symptom:**

*An AC power 'brownout' has occurred; now the system is dead and will not power up.*

**Possible causes:**

- The main power supply in the Media Processor may be damaged. Contact Frox Technical Support at 1-800-525-5257.

**Troubleshooting** **FROXCAST****Symptom:**

*The system is not receiving TV schedules (a FroxCast service).*

**Possible causes:**

- Check to see if the FroxCast Data Channel is installed properly along with the VBI Line Number. Remember the FroxSystem will only receive FroxCast data when the system is soft-powered OFF.
- Is the system currently authorized to receive the data updates? Check the Authorizations screen to review the service expiration date.





**APPENDIX A:  
IMPORTANT ELECTROSTATIC DISCHARGE PROCEDURES**

The following guidelines should be observed to prevent electrostatic discharge (ESD) from damaging the sensitive electronic components contained inside the FroxSystem.

**PERSONNEL**

- All personnel handling electronic components should ground themselves by wearing wrist straps properly connected to an earth ground. Wrist straps must contact bare skin and not be worn over clothing.

**EQUIPMENT**

- Items that generate static charges (such as styrofoam cups, plastic, glass, wool, etc.) should be removed from the work area.
- All work areas should be conductive bench tops or covered by conductive mats properly connected to earth ground.
- The installer and the FroxSystem should be grounded to the same earth potential.

**HANDLING PROCEDURES**

- Some electronic components such as integrated circuits (ICs), DSP cards and hard disk drives will be shipped in an ESD-safe bag. Do not remove the item from an ESD-safe bag until you are ready for its installation.
- Removing the component from its package must be done while grounded. Personnel must wear wrist straps and make sure the area is free of common static generators.
- Electronic components shipped in ESD-safe bags should be stored or transported in conductive or shielded containers only.



*Sync Jumper*

**APPENDIX B:  
SYNC JUMPER**

 Before opening the top of either the Media Processor or Video Preprocessor be certain to follow the general electrostatic guidelines found in Appendix A.

The sync type of the FroxSystem is changed by moving a jumper on the motherboard of the Media Processor. When a FroxSystem is shipped from the factory the sync is set to output composite sync (see the section entitled "Connecting Monitors" in this manual for further descriptions of the different types of video sync). If one or more monitors is used that has separate horizontal and vertical sync, the sync jumper must be moved.

**CHANGING THE SYNC JUMPER**

- 1) Power OFF the AC power strip, uninterruptible power supply (UPS), or surge protector in which the Media Processor and Video Preprocessor are plugged.

- 2) Remove the three screws that hold down the lid of the Media Processor. These screws are found on the upper back of the unit's cover.

- 3) Slide the top cover out of its mounting, towards the back of the unit. The top cover has a very snug fit, so some exertion is normal to remove it.

 Attach the wrist strap to the chassis divider before proceeding.

- 4) With the rear of the Media Processor facing you, locate the jumper clip. The jumper clip is on the right edge of the board and 5" from the back of the unit (see illustration).

- 5) Move the jumper clip to the desired position. Connecting pins one and two will result in the configuration for separate horizontal and vertical sync. Connecting pins two and three will result in the configuration for composite sync.

- 6) Carefully replace the lid and re-install the three screws.



*Sync Jumper*

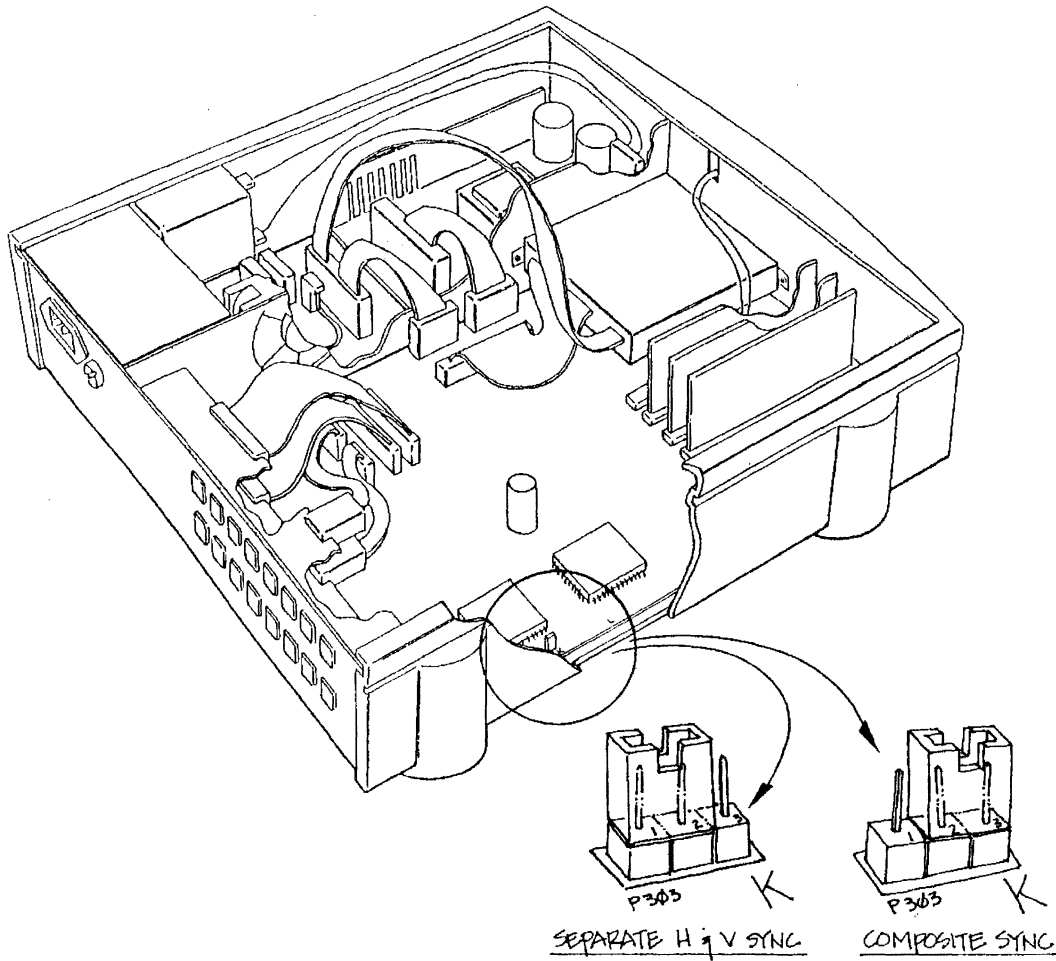

*DSP Card***APPENDIX C:  
DSP AUDIO CARD REMOVAL**

DSP cards are located in the Media Processor. There are eight slots that house these cards and there is no particular sequence or priority given to any of the slots.

 Before opening the top of either the Media Processor or Video Preprocessor be certain to follow the general electrostatic guidelines found in Appendix A.

**ADDING OR REPLACING DSP CARDS**

- 1) Power off the AC power strip, uninterruptible power supply (UPS), or surge protector in which the Media Processor and Video Preprocessor are plugged.
- 2) Remove the three screws that secure the lid of the Media Processor. These screws are found on the upper back of the unit's cover.
- 3) Slide the top cover out of its mounting, towards the back of the unit. The top cover has a very snug fit, so some exertion is normal to remove it.

 Attach the wrist strap to the chassis divider before proceeding.

- 4) If necessary, remove the defective DSP card.
- 5) Insert the new DSP card into the first available slot.
- 6) Carefully replace the lid and re-install the three screws.



**APPENDIX D:  
LEARN MODE**

A *Learn* mode is available for teaching the FroxSystem the infrared (IR) commands for devices that are not supplied in the device lists provided for each category of product. Cable decoders, VCRs, compact disc (CD) players, laserdisc players and the POWER functions for conventional televisions can be taught to the FroxSystem by selecting the LEARN button (located under the *Device Make and Model* menu for each of the respective device categories in INSTALLATION).

 Most, but not all IR remotes can be taught to the FroxSystem. Some IR systems use a carrier frequency higher than the Frox IR receiver can read. If the *Learn* mode is not possible with a particular IR remote call Frox Technical Support to discuss possible reasons and options.

 It is important that when in *Learn* mode, be sure the room lighting is either very dim or completely off. This will insure the proper IR commands are transmitted to the FroxSystem. Furthermore, both the FroxWand and the IR device remote control should be no further than one foot away from the Media Processor IR sensor. Be certain that all remotes are aimed directly at the Media Processor IR sensor.

 When entering IR commands from a remote control, do not hit the keys in rapid succession. This will allow the FroxSystem to properly isolate and receive each command.

**THE MEANING OF FROXWAND CLICKS**

During the course of a *Learn* script, the FroxWand will be used in various ways. The *first* way is to select a button as an option presented on a particular screen. The *second* application is to substitute a FroxWand click for any function that is not available on a remote control. The *third* meaning of a FroxWand click is to indicate the end of a sequence of keystrokes.

The text of the *Learn* script will prompt the installer in each of these cases.

**ACCESSING THE LEARN MODE**

- 1) On the *Device Make and Model* installation screen for each of the IR devices supported by the FroxSystem, a LEARN button is located under the scrolling list of devices. Click on the LEARN button to enter the *Learn* mode.

**LEARN MODE SCRIPTS**

The *Learn* mode asks many questions that, when properly answered, help the FroxSystem understand the state of a device during FroxSystem operation. In order to answer questions properly, it is helpful to physically work with the device to test functionality. (Having the unit's Operation Manual is helpful, as well).

The following *Learn* mode scripts should be reviewed as a preliminary step to entering the *Learn* mode. Answering all of the questions before attempting the *Learn* mode will help you effectively accomplish this task.

*Learn Mode***LASERDISC LEARN MODE SCRIPT**

When learning to control the laserdisc player (LD), the FroxSystem will ask you to perform a sequence of operations on the laserdisc remote control while you point it at the media processor's infrared sensor. Note that a **CLICK ON** instruction refers to squeezing the activation trigger on the FroxWand. Please turn off the light during the learning process. To continue, select the **PROCEED** button and **CLICK ON** the FroxWand.

Please type the device name. When finished, select the **PROCEED** button and **CLICK ON** the FroxWand.

Please **POWER ON**, **POWER OFF**, **POWER ON**, **POWER OFF** and **POWER ON**. In most cases, this will be the same key on the remote control. This is five keystrokes in all. If you cannot **POWER ON/POWER OFF** from the remote control, **CLICK ON** the FroxWand instead of that action.

Please press **PLAY**, **PAUSE**, **STOP**, **PLAY**, **PAUSE** and **STOP**. This is six keystrokes in all. Please press **STILL** instead of **PAUSE** if a **PAUSE** key does not exist. If any key (for example, **PAUSE**) does not exist, **CLICK ON** the FroxWand instead of that key.

When the disc is playing and the **PLAY** key is pressed, does the disc continue to play from the current position?

When the disc is paused and the **PLAY** key is pressed, does the disc resume playing from the current position?

Please press **FORWARD SCAN(>>)**, **BACKWARD SCAN(<<)**, **FORWARD SCAN(>>)** and **BACKWARD SCAN(<<)**. If any key (for example, **BACKWARD SCAN**) does not exist, **CLICK ON** the FroxWand instead of that key.

**FRAME** is sometimes called **STEP** or **STILL** on the remote control. Please press **FORWARD FRAME**, **BACKWARD FRAME**, **FORWARD FRAME**, and **BACKWARD FRAME**. This is four keystrokes in all. If any key (for example, **BACKWARD FRAME**) does not exist, **CLICK ON** the FroxWand instead of that key.

Does the LD player have a **MULTI-SPEED PLAY** key?

Please press **FORWARD MULTI-SPEED**, **BACKWARD MULTI-SPEED**, **FORWARD MULTI-SPEED** and **BACKWARD MULTI-SPEED**. If any key (for example, **BACKWARD MULTI-SPEED**) does not exist, **CLICK ON** the FroxWand instead of that key.

Please press **SPEED +**, **SPEED -**, **SPEED +** and **SPEED -**. If any key (for example, **SPEED -**) does not exist, **CLICK ON** the FroxWand instead of that key.

Please press **SIDE A**, **SIDE B**, **SIDE A**, and **SIDE B**. If any key (for example, **SIDE B**) does not exist, **CLICK ON** the FroxWand instead of that key.

**SKIP**, sometimes called **AUTOMATIC CHAPTER SEARCH**, moves to the beginning of a chapter; either the same, the preceding or the following chapter. Is there a **Chapter SKIP** key or **ACS** (Automatic Chapter Sensor) key on the remote control?



*Learn Mode*

Please press FORWARD SKIP(>>|), BACKWARD SKIP(|<<), FORWARD SKIP(>>|) and BACKWARD SKIP(|<<). Is there a NUMBER EXTENSION key (for example, 10+) on the remote control?

Please press numbers 0 - 10 sequentially and 0 - 10 sequentially once again. Please DO NOT press the number 10+ key instead of the number 10 key. If any key (for example, 10) does not exist, CLICK ON the FroxWand instead of that key.

Please press numbers 0 - 20 sequentially and 0 - 20 sequentially once again. Please DO NOT press the number 20+ key instead of the number 20 key. If any key (for example, 20) does not exist, CLICK ON the FroxWand instead of that key.

Please press numbers 0 - 9 sequentially, press ENTER, press 0 - 9 sequentially and press ENTER. If any key (for example, ENTER) does not exist, CLICK ON the FroxWand instead of that key.

Please press the NUMBER EXTENSION key (for example, 10+) twice.

When the disc is in STILL/PAUSE mode and the CHAPTER NUMBER key is pressed, does the LD start playing from a new chapter?

#### **CABLE DECODER LEARN MODE SCRIPT**

When learning to control the Cable Box, the FroxSystem will ask you to perform a sequence of operations on the Cable Box remote control while you point it at the media processor's infrared sensor. Note that a CLICK ON instruction refers to squeezing the activation trigger on the FroxWand. Please turn off the light during the learning process. To continue, select the PROCEED button and CLICK ON the FroxWand.

Please type the device name. When finished, select the PROCEED button and CLICK ON the FroxWand.

Can you execute a function other than POWER ON while the Cable Box is powered off?

Please press POWER OFF and then POWER OFF again. If there is no POWER OFF key, CLICK ON the FroxWand.

Please POWER ON, POWER OFF, POWER ON, POWER OFF and POWER ON. In most cases, this will be the same key on the remote control. This is five keystrokes in all. If you cannot POWER ON/POWER OFF from the remote control, CLICK ON the FroxWand instead of that action.

Is there an A/B switch key on the remote control?

Please press the A/B switch key twice.

Is there a NEXT CHANNEL key and PREVIOUS CHANNEL key on the remote control?

*Learn Mode*

Please press NEXT CHANNEL, PREVIOUS CHANNEL, NEXT CHANNEL and PREVIOUS CHANNEL.

Is there a NUMBER EXTENSION key (for example,10+) on the remote control?

Please press numbers 0 - 10 sequentially and 0 - 10 sequentially once again. Please DO NOT press the number 10+ key instead of the number 10 key. If any key (for example, 10) does not exist, CLICK ON the FroxWand instead of that key.

Please press numbers 0 - 20 sequentially and 0 - 20 sequentially once again. Please DO NOT press the number 20+ key instead of the number 20 key. If any key (for example, 20) does not exist, CLICK ON the FroxWand instead of that key.

Please press numbers 0 - 9 sequentially, press ENTER, press 0 - 9 sequentially and press ENTER. If any key (for example, ENTER) does not exist, CLICK ON the FroxWand instead of that key.

Please press the NUMBER EXTENSION key (for example, 10+) twice.

**ALTERNATE MONITOR LEARN SCRIPT**

To learn how to power on and off your S-VIDEO <ALTERNATE> TV Monitor, the FroxSystem will ask you to perform a sequence of operations on the TV remote control while you point it at the media processor's infrared sensor. Note that a CLICK ON instruction refers to squeezing the

activation trigger on the FroxWand. Please turn off the light during the learning process. To continue, select the PROCEED button and CLICK ON the FroxWand.

Please type the manufacturer's name and optionally, model number. When finished, select the PROCEED button and CLICK ON the FroxWand.

Please POWER ON, POWER OFF, POWER ON, POWER OFF and POWER ON. In most cases, this will be the same key on the remote control. This is five keystrokes in all. If you cannot POWER ON/POWER OFF from the remote control, CLICK ON the FroxWand instead of that action.

**COMPACT DISC LEARN SCRIPT**

When learning to control the compact disc player (CD), the FroxSystem will ask you to perform a sequence of operations on the CD remote control while you point it at the media processor's infrared sensor. Note that a CLICK ON instruction refers to squeezing the activation trigger on the FroxWand. Please turn off the light during the learning process. To continue, select the PROCEED button and CLICK ON the FroxWand.

Please type the device name. When finished, select the PROCEED button and CLICK ON the FroxWand.

Please POWER ON, POWER OFF, POWER ON, POWER OFF and POWER ON. In most cases, this will be the same key on the remote control. This is five keystrokes in all. If you cannot POWER ON/POWER OFF from the remote control, CLICK ON the FroxWand instead of that action.





*Learn Mode*

Please press PLAY, PAUSE, STOP, PLAY, PAUSE and STOP. This is six keystrokes in all. If any key (for example, PAUSE) does not exist, CLICK ON the FroxWand instead of that key.

When the disc is playing and the PLAY key is pressed, does the disc continue to play from the current position? When the disc is paused and the PLAY key is pressed, does the disc resume playing from the current position?

SCAN, sometimes called MANUAL SEARCH, is movement of the disc while in PLAY or PLAY/PAUSE mode, with the speed faster than the normal PLAY. Please press FORWARD SCAN(>>), BACKWARD SCAN(<<), FORWARD SCAN(>>) and BACKWARD SCAN(<<). This is four keystrokes in all. If any key (for example, BACKWARD SCAN) does not exist, CLICK ON the FroxWand instead of that key.

SKIP, sometimes called AUTOMATIC TRACK SEARCH, moves to the beginning of a track; either the same, the preceding or the following track. Is there a track SKIP key or AMS (Automatic Music Sensor) key on the remote control?

Please press FORWARD SKIP(>>|), BACKWARD SKIP(|<<), FORWARD SKIP(>>|) and BACKWARD SKIP(|<<). This is four keystrokes in all. If any key (for example, BACKWARD SKIP) does not exist, CLICK ON the FroxWand instead of that key.

Please select the number that describes the behavior of the CD player when the last track of a CD is playing and the NEXT TRACK key is pressed. 1: Stays on the last track. 2: Goes to track 1 of the same CD. 3: Goes to track 1 of the next CD.

Does the CD player hold more than one CD?

Does the CD player load a multi-CD magazine (for example, a six-disc cartridge)?

How many magazines (cartridges) can the CD player hold?

What is the maximum number of CDs that each magazine (cartridge) can hold?

How many CDs can the carousel CD player hold?

Is there a DIRECT-DISC key (for example, DISC 1, DISC 3) which will automatically load a selected disc?

Is there a PREFIX key (for example, a DISC SELECT key) that needs to be pressed before the DIRECT-DISC key?

Please press the PREFIX key twice.

Please sequentially press the DIRECT-DISC keys from CD1, CD2 ... to CDn. To indicate the end of the sequence, CLICK ON the FroxWand.

Please press the FORWARD DISC SKIP key twice. If there is no FORWARD DISC SKIP key, CLICK ON the FroxWand.

Please select the number that describes the behavior of the CD player when the STOP key is pressed. 1: Stays on the same disc and stops. 2: Goes to disc 1 and stops.

Please select the number that describes the behavior of the CD player when the end of a disc is playing. 1: Stays on the

*Learn Mode*

same disc and stops. 2: Stays on the same disc and starts to play at track 1. 3: Goes to disc 1 and stops. 4: Goes to next disc and starts to play.

Is there a NUMBER EXTENSION key (for example 10+) on the remote control?

Please press numbers 0 - 10 sequentially and 0 - 10 sequentially once again. Please DO NOT press the number 10+ key instead of the number 10 key. If any key (for example, 10) does not exist, CLICK ON the FroxWand instead of that key.

Please press numbers 0 - 20 sequentially and 0 - 20 sequentially once again. Please DO NOT press the number 20+ key instead of the number 20 key. If any key (for example, 20) does not exist, CLICK ON the FroxWand instead of that key.

Please press numbers 0 - 9 sequentially, press ENTER, press 0 - 9 sequentially and press ENTER. If any key (for example, ENTER) does not exist, CLICK ON the FroxWand instead of that key.

Please press the NUMBER EXTENSION key (for example, 10+) twice.

When the TRACK NUMBER key[s] is pressed, does the CD go directly to that track?

When the disc is paused and the TRACK NUMBER key is pressed, does the CD start playing from the new track? Does this CD Player have DIGITAL output?

**VCR LEARN SCRIPT:**

When learning to control the VCR, the FroxSystem will ask you to perform a sequence of operations on the VCR remote control while you point it at the media processor's infrared sensor. If you would like to test the behavior of the VCR player, please insert a tape in the VCR on which you can record. Note that a CLICK ON instruction refers to squeezing the activation trigger on the FroxWand. Please turn off the light during the learning process. To continue, select the PROCEED button and CLICK ON the FroxWand.

Please type the device name. When finished, select the PROCEED button and CLICK ON the FroxWand.

Please POWER ON, POWER OFF, POWER ON, POWER OFF and POWER ON. In most cases, this will be the same key on the remote control. This is five keystrokes in all. If you cannot POWER ON/POWER OFF from the remote control, CLICK ON the FroxWand instead of that action.

Please press PLAY, PAUSE, STOP, PLAY, PAUSE and STOP. This is six keystrokes in all. If any key (for example, PAUSE) does not exist, CLICK ON the FroxWand instead of that key.

When the tape is playing and the PLAY key is pressed, does the tape continue to play from the current position?

When the tape is paused and the PLAY key is pressed, does the tape resume playing from the current position?



*Learn Mode*

Please press FAST FORWARD (FF), REWIND, FAST FORWARD (FF) and REWIND. If any key (for example, REWIND) does not exist, CLICK ON the FroxWand instead of that key.

Is there an X2 SPEED key on the remote control?

Please press the X2 key twice. Make sure keystrokes are not in rapid succession.

SCAN, sometimes called SEARCH, is movement of the tape while in PLAY or PLAY/PAUSE mode, with the speed faster than the normal PLAY. Assume the VCR is in PLAY mode and then in PLAY/PAUSE mode. From both modes, can the VCR begin the SLOWEST FORWARD SCAN? For example, if SCAN must start from PLAY mode or if SCAN must start from PLAY/PAUSE mode, answer NO.

Assume the VCR is in the mode (PLAY or PLAY/PAUSE mode) which requires more keystrokes to begin the SLOWEST FORWARD SCAN. Please press the sequence of key[s] that make the VCR "READY" for FORWARD SCAN. For example, if FORWARD SCAN must start from PLAY mode, press the PLAY key. If FORWARD SCAN must start from PAUSE mode, press the PAUSE key. Other VCRs might require some other series of keystrokes. Please refer to the Operations Manual for assistance. To indicate the end of the sequence, CLICK ON the FroxWand.

Assuming the VCR is ready for FORWARD SCAN, please press the keystroke[s] to start the slowest FORWARD SCAN and step to the fastest. You may have to press the same key more than once. Please refer to the Operations Manual for assistance. To indicate the end of the sequence, CLICK ON the FroxWand.

Assume the VCR is in PLAY mode and then in PLAY/PAUSE mode. From both modes, can the VCR begin the SLOWEST BACKWARD SCAN? For example, if SCAN must start from PLAY mode or if SCAN must start from PLAY/PAUSE mode, answer NO.

Assume the VCR is in the mode (PLAY or PLAY/PAUSE mode) which requires more keystrokes to begin the SLOWEST BACKWARD SCAN. Please press the sequence of key[s] that make the VCR "READY" for BACKWARD SCAN. For example, if BACKWARD SCAN must start from PLAY mode, press the PLAY key. If BACKWARD SCAN must start from PAUSE mode, press the PAUSE key. Other VCRs might require some other series of keystrokes. Please refer to the Operations Manual for assistance. To indicate the end of the sequence, CLICK ON the FroxWand.

Assuming the VCR is ready for BACKWARD SCAN, please press the keystroke[s] to start the slowest BACKWARD SCAN and step to the fastest. You may have to press the same key more than once. Please refer to the Operations Manual for assistance. To indicate the end of the sequence, CLICK ON the FroxWand.

*Learn Mode*

Please press PAUSE, ADVANCE FRAME, PAUSE, ADVANCE FRAME and PAUSE. This is five keystrokes in all. If there is no ADVANCE FRAME key, CLICK ON the FroxWand .

Assume the VCR is in PLAY mode and then in PLAY/PAUSE mode. From both modes, can the VCR begin the FASTEST SLOW-MOTION PLAY? For example, if SLOW-MOTION PLAY must start from PLAY mode or if SLOW-MOTION PLAY must start from PLAY/PAUSE mode, answer NO.

Assume the VCR is in the mode (PLAY or PLAY/PAUSE mode) which requires more keystrokes to begin the FASTEST SLOW-MOTION PLAY. Please press the sequence of key[s] that make the VCR "READY" for SLOW-MOTION PLAY. For example, if SLOW-MOTION PLAY must start from PLAY mode, press the PLAY key. If SLOW-MOTION PLAY must start from PAUSE mode, press the PAUSE key. Other VCRs might require some other series of keystrokes. Please refer to the Operations Manual for assistance. To indicate the end of the sequence, CLICK ON the FroxWand.

Assuming the VCR is ready for SLOW-MOTION PLAY, please press the keystroke[s] to start the fastest SLOW-MOTION PLAY and step to the slowest. You may have to press the same key more than once. Please refer to the Operations Manual for assistance. To indicate the end of the sequence, CLICK ON the FroxWand.

Assuming the VCR is in slowest SLOW-MOTION PLAY, please press the keystroke[s] to step to the fastest. You may have to press the same key more than once. Please refer to the Operations Manual for assistance. To indicate the end of the sequence, CLICK ON the FroxWand.

Does this VCR support two or three recording speeds?

Please press the key that changes the RECORD SPEED (For example, SP/EP). Please press this key again. If no single RECORD SPEED key exists on the remote control, then RECORD SPEED must be set manually by the user (perhaps through a menu or with the controls on the VCR). CLICK ON the FroxWand to continue.

Please set the RECORD SPEED on the VCR to SP. When finished, select the PROCEED button and CLICK ON the FroxWand.

Please press STOP, RECORD, STOP, RECORD and STOP. This is five keystrokes in all. If any key (for example, RECORD) does not exist, CLICK ON the FroxWand instead of that key.

While playing a tape, does pressing the RECORD key start the VCR recording?

While in PLAY mode and in the PAUSE position, does the REC key take the VCR into a state other than PLAY/PAUSE?

While in PLAY mode and in the PAUSE position, does the RECORD key exit PAUSE mode?

While in RECORD mode and in the PAUSE position, does the PLAY key leave the RECORD mode while staying in the PAUSE position?

While in RECORD mode and in the PAUSE position, does the PLAY key leave PAUSE mode while staying in the RECORD mode?

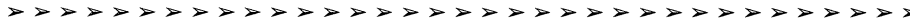

*Learn Mode*

While in RECORD mode and in the PAUSE position, does the PAUSE key leave PAUSE mode ?

While in RECORD mode and in the PAUSE position, does the RECORD key leave PAUSE mode ?

Is there a NEXT CHANNEL and PREVIOUS CHANNEL key on the remote control?

Please press NEXT CHANNEL, PREVIOUS CHANNEL, NEXT CHANNEL and PREVIOUS CHANNEL.

Is there a NUMBER EXTENSION key (for example 10+) on the remote control?

Please press numbers 0 - 10 sequentially and 0 - 10 sequentially once again. Please DO NOT press the number 10+ key instead of the number 10 key. If any key (for example, 10) does not exist, CLICK ON the FroxWand instead of that key.

Please press numbers 0 - 20 sequentially and 0 - 20 sequentially once again. Please DO NOT press the number 20+ key instead of the number 20 key. If any key (for example, 20) does not exist, CLICK ON the FroxWand instead of that key.

Please press numbers 0 - 9 sequentially, press ENTER, press 0 - 9 sequentially and press ENTER. If any key (for example, ENTER) does not exist, CLICK ON the FroxWand instead of that key.

Please press the NUMBER EXTENSION key (for example, 10+) twice.

How many input sources can this VCR select (eg: Tuner, Simulcast, Line1, Line2)?

Please press the key that changes the INPUT selection. Press this key again. If no single INPUT selection key exists on the remote control, then INPUT selection must be set manually by the user (perhaps through a menu or the controls on the VCR). CLICK ON the FroxWand to continue.

*Notes*

**INSTALLER'S NOTES**