



**HAYES STACK CHRONOGRAPH
OWNER'S MANUAL**

Hayes Microcomputer Products, Inc.

NOTICE

Hayes Microcomputer Products, Inc. reserves the right to make improvements in the product described in this manual at any time and without notice.

This manual is copyrighted and contains proprietary information. All rights are reserved. This document may not, in whole or part, be copied, photocopied, reproduced, translated, or reduced to any electronic medium or machine readable form without prior consent, in writing, from Hayes Microcomputer Products, Inc.

© 1981 by Hayes Microcomputer Products, Inc.
5835 Peachtree Corners East
Norcross, Georgia 30092
(404) 449-8791

TABLE OF CONTENTS

Chapter 1: Introduction	1-1
Chapter 2: Installation	2-1
Battery Backup System	2-1
RS-232C Connection	2-3
Power Connection	2-4
Chronograph Display	2-4
Write-protect Switch	2-5
Changing the Batteries	2-5
FCC-Supplied Information for Users	2-6
Chapter 3: Chronograph Commands	3-1
AT Attention Code	3-1
Carriage Return	3-1
Result Codes	3-1
Display Commands	3-2
Read Commands	3-3
Line Feed Option	3-4
Set Commands	3-5
Error Checking	3-7
Alarm Commands	3-7
Appendix A: Sample Programs	A-1
Appendix B: RS-232C Interface Connection Pin Assignments	A-5
Appendix C: Block Diagram	A-7
Appendix D: Specifications Summary	A-9
Appendix E: Jumper 1 Configuration	A-11
Appendix F: Oscillator Adjustment	A-12
Appendix G: Return For Repair Procedures	A-13
Two Year Warranty Card	



Chapter 1 INTRODUCTION

The Hayes Stack Chronograph is an RS-232C compatible calendar/clock for computers. The Chronograph is one of the Hayes Stack series of advanced microcomputer component systems that stack one atop the other.

Chronograph features include:

- Day, date and time reporting via RS-232C communication
- Large, easy-to-read display
- Computer alarm
- Write-protect switch
- 300 or 1200 baud operation
- Automatic baud rate detection
- Automatic parity sense detection
- Automatic word size detection
- Automatic leap year adjust
- Battery backup system

The Chronograph is controlled by a set of ASCII command sequences. These commands allow the user to set, read and display day, date and time data and to select various options. The time can be set in either 12- or 24-hour mode. Options include selection of separators for date and time and insertion of line feeds after carriage returns. Date and time are output in ANSI 3.30 and 3.43 compatible format.

Featuring quartz-crystal control, the Chronograph adds the dimension of precise timekeeping to your computer system. With the Chronograph and user-developed software, a computer can log programs and reports by date and time. Utilizing the computer alarm feature, the Chronograph can also provide your computer with information necessary to control lights, burglar alarms and sprinkler systems. Or, combining the Chronograph with the Hayes Stack auto-dial Smartmodem and your computer, you can develop programs to batch messages during the day and send them at night when telephone rates are lowest.

Chapter 2 INSTALLATION

In addition to this manual, the Hayes Stack Chronograph system consists of 3 parts (See Figure 1):

- Chronograph unit
- Power Pack
- 3 AA batteries (The battery tube is inside the unit.)

Remove each part from the packing and check to make certain the Chronograph system is complete and undamaged.

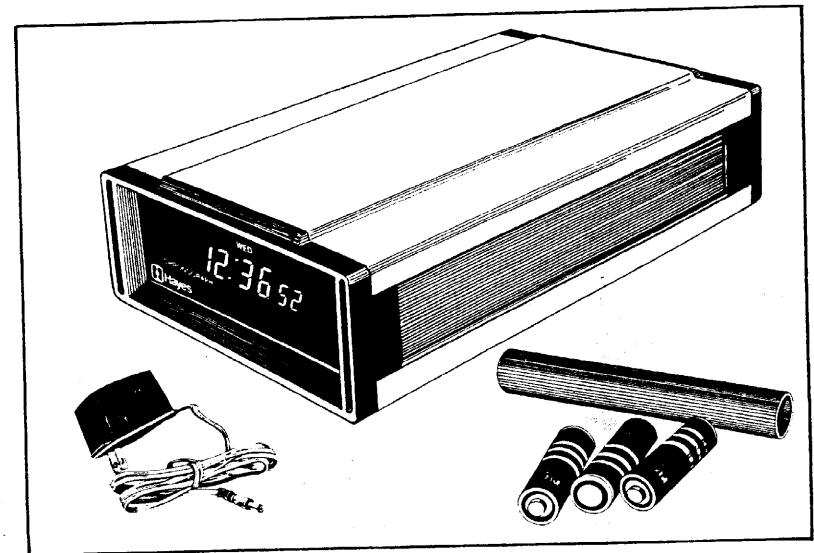

Figure 1
Chronograph System Parts

BATTERY BACKUP

When power is first applied to the Chronograph, meaningless symbols may appear on the Chronograph display. After the time and date are set, these symbols will disappear. Although the Chronograph will operate without the battery backup, it is recommended that the system be installed to maintain timekeeping in the event of a power failure.

The battery backup system maintains only data controlled by **S** or set commands, i.e. date, time and weekday. Other operational options are not maintained by the system and must be reentered after a loss of power.

The backup system does not power the Chronograph display. During a loss of power the display remains blank. When power returns, the correct time will be displayed by default.

The batteries for the backup power system of the Chronograph need to be installed on the printed circuit board. Always disconnect the RS-232C cable and power cable from the rear panel of the Chronograph before opening the unit.

Removing the End Cap

To install the batteries, you must first remove the end cap from the Chronograph. Firmly hold or support the unit and remove the end cap according to the following procedures. (Note that the end cap fits snugly.)

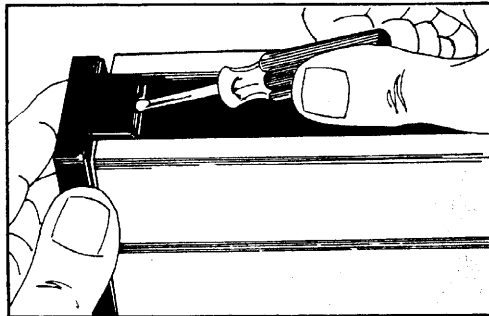

Figure 2a

Insert the tip of small tool in the notch as shown above. Twist slightly to release the end cap.

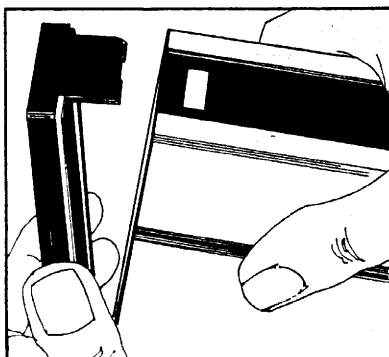

Figure 2b

Carefully remove the end cap from the Chronograph.

Removing the Printed Circuit Board

The printed circuit board is attached to the Chronograph case by two screws found on the bottom of the case. Turn the Chronograph over and remove the screws. Return the Chronograph to an upright position, grasp the board and carefully slide the board out of the case.

CAUTION: TWO ELEMENTS, THE HEAT SINK AND RESISTOR R-5, ON THE CHRONOGRAPH CIRCUIT BOARD ARE HOT. (SEE FIGURE 3.) AVOID CONTACT WITH THESE ELEMENTS WHEN INSTALLING OR CHANGING THE BATTERIES.

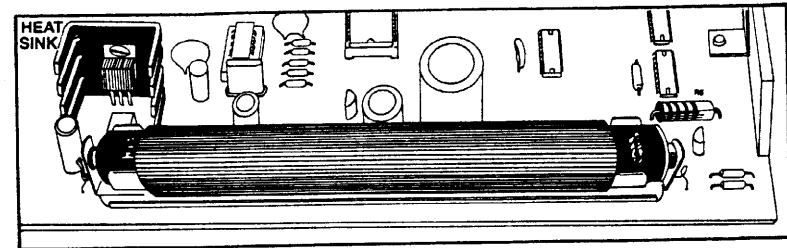

Figure 3
Chronograph Printed Circuit Board

INSTALLING THE BATTERIES

The batteries should be installed in the holder on the far left side of the printed circuit board (see Figure 3). Polarity indicators for each battery are printed on the board to the left of the battery holder. Cut and remove the tie-wrap holding the battery tube. Slide the three batteries in the protective tube and insert the positive (+) end in the appropriate clamp. Carefully push the negative end of the batteries into the remaining clamp. The fit will be snug. Being careful not to damage the display, slide the circuit board back into the case and replace the screws.

RS-232C CONNECTION

NOTE: No wiring changes are required if you are connecting your Chronograph to a terminal or to a computer that is wired as DTE (Data Terminal Equipment). If you are not certain how your equipment is wired, check the manual supplied by the manufacturer of the equipment or contact your computer dealer. If your computer is wired as DCE (Data Communications Equipment), you must first make the following adjustments:

1. Use only pins 2, 3 and 7 for the RS-232C interface.
2. Reverse pins 2 and 3 in the RS-232C connector.

Connecting the Chronograph to a computer requires an RS-232C serial port which operates at 300 or 1200 baud, and a standard RS-232C cable with male DB-25 connector to connect the computer and Chronograph RS-232C ports. In addition, your computer may need special software to access the RS-232C port. If your computer does not have this equipment, consult your computer reference manual or computer dealer to obtain the appropriate RS-232C equipment and software.

Install the RS-232C equipment and software according to the instructions provided in your computer reference manual or by your dealer.

To install the RS-232C cable, insert the DB-25 male connector into the DB-25 female connector located on the rear panel of the Chronograph. (See Figure 4.)

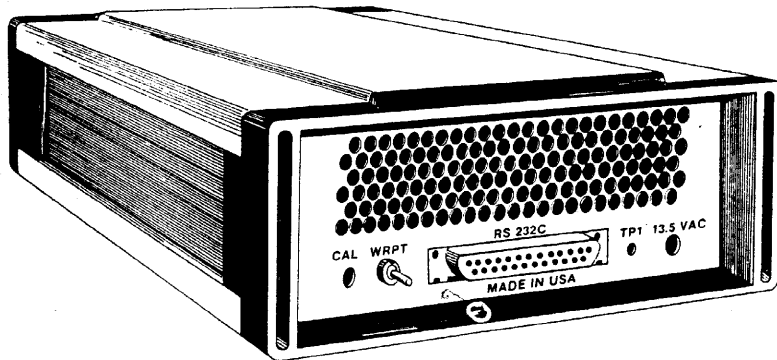

Figure 4
Chronograph Back Panel

POWER CONNECTION

Insert the power pack connector in the small jack located on the rear panel of the Chronograph and plug the transformer in an electrical outlet.

The Chronograph is now installed. Meaningless symbols may appear on the Chronograph and computer displays until the day, date and time are set. Refer to Chapter 3 of this manual for commands to set and use the Chronograph.

CHRONOGRAPH DISPLAY

The front panel of the Chronograph is a large, easy-to-read, six digit display for the time, date and weekday. The format of the Chronograph display includes one permanent separator, a colon, located after the second digit. (See Figure 5.) The colon appears in both date and time displays and cannot be changed or removed. The weekday is always visible across the top of the display.

The display may flicker slightly when the Chronograph is sending or receiving data.

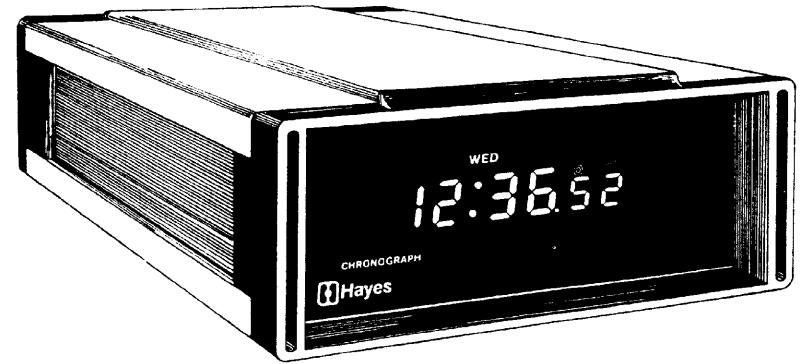

Figure 5
Chronograph Front Panel

In addition to calendar and time data, three indicators are located on the front panel: the alarm indicator, write-protect indicator and low-battery indicator. (See Figure 5.)

When the alarm is set, the alarm indicator on the front panel of the Chronograph is turned on. The indicator begins flashing when an alarm occurs and continues flashing until the alarm is cleared or reset. The alarm makes no sound. When the write-protect switch is in the UP position, the write-protect indicator is turned on. If for any reason, the batteries in the backup system weaken or are removed, the low-battery indicator will be turned on and the batteries should be replaced.

WRITE-PROTECT SWITCH

The write-protect switch is located on the rear panel of the Chronograph. When the switch is in the UP position, the S or set commands are disabled, and a decimal point is visible to the right of the fourth digit on the Chronograph display. This feature prevents accidental changing of the time, date and weekday. The remaining commands are not affected by the write-protect switch.

CHANGING THE BATTERIES

It is recommended that the batteries in the backup power system be replaced annually or at any time the low battery indicator is visible.

FCC SUPPLIED INFORMATION FOR USERS

Disconnect the RS-232C cable and power pack from the rear panel of the Chronograph. Follow the instructions at the beginning of this chapter for removing the end cap and printed circuit board. To remove the old batteries, grasp the battery pack at either end and carefully pull upwards. Remove the old batteries and follow the instructions at the beginning of this chapter for installing the fresh batteries and reassembling the Chronograph.

(Source of information: The Federal Communications Commission has established technical standards regarding radiation of radio frequency energy by computing devices. The Chronograph falls under rules of a Class B computing device and the following information must be supplied to the user in accordance with Paragraph 15.838 of the FCC standard Part 15, Subpart J.)

This equipment generates and uses radio frequency energy and if not installed and used properly, that is, in strict accordance with the manufacturer's instructions, may cause interference to radio and television reception. It has been type tested and found to comply with the limits for a Class B computing device in accordance with the specification Subpart J of Part 15 of the FCC rules, which are designed to provide reasonable protection against such interference in a residential installation. However, there is no guarantee that interference will not occur in a particular installation. If this equipment does cause interference to radio or television reception, which can be determined by turning the equipment on and off, the user is encouraged to try to correct the interference by one or more of the following measures:

- Reorient the receiving antenna.
- Relocate the computer with respect to the receiver.
- Move the computer away from the receiver.
- Plug the computer into a different outlet so that the computer and receiver are on different branch circuits.

If necessary, the user should consult the dealer or an experienced radio/television technician for additional suggestions. The user may find the following booklet prepared by the Federal Communications Commission helpful: "How to Identify and Resolve Radio-TV Interference Problems."

The booklet is available from the U.S. Government Printing Office, Washington DC 20402, Stock No. 004-000-00345-4.

NOTE: The specifications in Subpart J of Part 15 of the FCC Rules are the most stringent regulations for use of this device in all environments, e.g. home, office.

Chapter 3 CHRONOGRAPH COMMANDS

CHRONOGRAPH COMMANDS Hayes Stack Chronograph functions are controlled by a set of easy-to-use commands. These commands set the day, date and time, control the computer alarm feature, control the Chronograph display, allow the user to select time and date separators, and enable the line feed option.

This chapter provides an explanation of the Chronograph commands and some basic guidelines that must be followed in sending any commands to the Chronograph. It also defines the result codes which the Chronograph sends in response to user commands.

AT ATTENTION CODE All commands must begin with the characters **AT** which is an attention code. The baud rate, parity sense, and word size are determined from the **AT**. The remainder of the command sequence contains commands for the Chronograph. There are no provisions for erasing or deleting command characters once they have been entered.

CARRIAGE RETURN Commands must be terminated with a carriage return. When the Chronograph receives the carriage return, the command is executed and a result code or requested data is sent.

RESULT CODES The result codes are responses by the Chronograph to most user-entered commands. Once the command has been completed, the Chronograph sends a result code that appears on the screen of the computer or terminal. Result codes are followed by a carriage return and, if selected, a line feed character. No result code is generated after commands which read the time, date or weekday unless there is a syntax error. Valid read commands result in the requested information being output by the Chronograph.

Chronograph result codes and their meanings are listed below:

RESULT CODE	MEANING
0	No error
8	Syntax error
9	Write-protect error

A syntax error result code, or 8, indicates an invalid command has been entered. A write-protect error code, or 9, occurs if a command to set the time, date or weekday is entered while the write-protect switch is ON.

DISPLAY COMMANDS - "D"

The **D** commands cause the time or date to be shown on the Chronograph display. The Chronograph can be set to display 12- or 24-hour time. By default, the time is displayed after a loss of power. The weekday is always visible across the top of the display.

To display the time:

Enter: ATDT

Result: 0

Chronograph display:



To display the date:

Enter: ATDD

Result: 0

Chronograph display:



READ COMMANDS - "R"

With the **R** commands, the computer or terminal interrogates the Chronograph for the time, date or weekday. When the Chronograph receives the command, the data requested is output to the computer or terminal in an ASCII character string followed by a carriage return and, if selected, a line feed. Separators are inserted between elements of time and date data if the appropriate separator commands have been entered.

To read the time:

Enter: ATRT

Result: hhmmssA (12 hour mode, AM)

hhmmssP (12 hour mode, PM)

hhmmss (24 hour mode)

hh:mm:ss (24 hour mode, colons selected as separators)

To read the date:

Enter: ATRD

Result: yymmdd (no options)

yy/mm/dd (slashes selected as separator)

NOTE: yy=year; mm=month; dd=day

The weekday is represented by a single digit, 0-6 as shown in the chart below:

Monday	0
Tuesday	1
Wednesday	2
Thursday	3
Friday	4
Saturday	5
Sunday	6

EXAMPLE: To read the weekday:

Enter: ATRW

Result: 1 (Tuesday)

**LINE FEED
OPTION
COMMANDS
- "L"**

Some computers and most terminals require a line feed after each carriage return to avoid printing over and over on the same line. When the line feed option is set, the Chronograph provides a line feed after each line of output. The line feed option is not maintained by the battery backup and must be reentered after a loss of power.

To set the line feed option:

Enter: ATLS

Result: 0

To clear the line feed option set by the previous command:

Enter: ATLC

Result: 0

**SEPARATOR
COMMANDS
"V"**

The separator commands permit the user to specify characters used to separate hour, minute and second in time data and year, month and day in date data. The **V** commands affect the output of time and date information as a result of the "read" or **R** commands. Separators cannot be inserted on the Chronograph display. **V** commands are also used to remove separator options previously selected.

Time and date separator options are not maintained by the Chronograph's battery backup system and must be reentered after a loss of power.

To set the time separator:

Enter: ATVTx

Separators may be any ASCII character, except null or carriage return, that is compatible with the user's application.

EXAMPLE:

Enter: ATVT: (Select colon separators)

Result: 0

Enter: ATRT (Read time)

Result: 12:56:37



**SET
COMMANDS
- "S"**

A **VT** Command immediately followed by a carriage return, removes time separators previously selected.

EXAMPLE: To remove the time separator:

Enter: ATVT (carriage return)

Result: 0

To set the date separator:

Enter: ATVDx

Separators may be any ASCII character, except null or carriage return, that is compatible with the user's application.

EXAMPLE:

Enter: ATVD/ (Select slash separators)

Result: 0

Enter: ATRT (Read date)

Result: 81/03/13

A **VD** command, immediately followed by a carriage return, removes the date separator.

EXAMPLE: To remove the date separator:

Enter: ATVD (carriage return)

Result: 0

S commands set the time, date and weekday. 12- or 24-hour mode is selected when setting the time. To set the time in 12-hour mode, AM, enter the letter "A" after the time. To set 12-hour mode, PM, enter a "P" after the time. If neither an "A" or "P" follows the time, the time is set in 24-hour mode. The time is set to the nearest hour and minute. Seconds cannot be set with the **S** command.

The time is maintained by the Chronograph's battery back-up system in the mode set, e.g. 12-hour mode, AM; 12-hour mode, PM; 24-hour mode. To set the time in 12-hour mode. AM:

Enter: ATSThhmm00A

EXAMPLE:

Enter: ATST024500A

Result: 0

Enter: ATRT (Read time)

Result: 024500A (2:45 AM)

To set the time in 12-hour mode, PM:

Enter: ATSThhmm00P

EXAMPLE:

Enter: ATST024500P

Result: 0

Enter: ATRT (Read time)

Result: 024500P (2:45 PM)

To set the time in 24 hour mode:

Enter: ATSThhmm00

EXAMPLE:

Enter: ATST144500

Result: 0

Enter: ATRT (Read time)

Result: 144500 (14:45)

NOTE: hh=hours, mm=minutes, ss=seconds

The date is set in a year, month, day format.

To set the date:

Enter: ATSDyyymmdd



EXAMPLE:

Enter: ATSD810317

Result: 0

Enter: ATRD (Read date)

Result: 810317 (March 17, 1981)

NOTE: yy=year; mm=month; dd=day

The weekday is set by entering a single digit, 0-6, after the **SW** (set weekday) command. Each digit represents a day of the week: 0=Monday, 1=Tuesday, 2=Wednesday, 3=Thursday, 4=Friday, 5=Saturday, 6=Sunday.

EXAMPLE: To set the weekday:

Enter: ATSW3

Result: 0

Enter: ATRW (Read weekday)

Result: 3 (Thursday)

ERROR CHECKING

The Chronograph provides only a limited amount of error checking when setting the time, date and weekday. An error result code, 8, will be output if a non-numeric character is entered in a set command where a numeral is expected. However, the Chronograph does not check the validity of numeric data. For example, the Chronograph will permit the time to be set to 17:05AM or 10:78; the date can be set to 81/14/37; and the weekday can be set to 8. The user should verify the data used to set the time, date and weekday.

ALARM COMMANDS - "A"

The alarm feature of the Chronograph permits a computer operation to be triggered at a specific time without having to continuously request time information from the Chronograph. The alarm indicator on the front panel of the Chronograph is visible when an alarm has been set.

Three things happen when the alarm occurs: the alarm indicator on the front panel begins flashing; the character "A" is sent to the computer followed by a carriage return and, if selected, a line feed character; and the Ring Indicator line in the DB-25 connector is turned ON.

The alarm should always be set after the time has been set, and it must always be set in the same mode as the time e.g. 12-hour, 24-hour, or the alarm will not occur. The alarm can only be set to hours and minutes; seconds cannot be set. An alarm can be set to go off up to 23 hours and 59 minutes in advance. Once the alarm has occurred, the indicator will continue to flash and the ring indicator line will remain ON until the alarm is reset or an alarm-clear command is issued. The alarm will not go off again until the alarm has been reset.

If the alarm occurs off while the Chronograph is executing another command, the Ring Indicator Line will be turned ON and the alarm indicator will begin flashing but the character "A" will not be output until the command in progress has been completed.

The alarm feature is not maintained by the battery backup system and the appropriate commands must be reentered after a loss of power.

To set the alarm in 12-hour mode, AM:

Enter: ATASHhmmA

Result: 0

EXAMPLE:

Enter: ATAS0245A (set alarm 2:45 AM)

To set the alarm in 12-hour mode, PM:

Enter: ATASHhmmP

Result: 0

To set the alarm time in 24-hour mode:

Enter: ATASHhmm

Result: 0

NOTE: hh=hours; mm=minutes

To clear the alarm previously set:

Enter: ATAC

Result: 0

Appendix A SAMPLE PROGRAMS

The Chronograph is designed to be compatible with a variety of computers and it is not possible to include sample programs for every machine. Appendix A contains sample programs for the TRS-80* Model I and Model III computers, the Atari 800** computer and the Apple II† and Apple III† computers. These programs are intended as a starting point to help users develop programs for specific applications.

The samples listed are BASIC programs in which the computer obtains the date, time and weekday from the Chronograph and displays that information on the computer's monitor. Although the programs are written for different machines, each contains the same subroutine sequence and produces the same output. The output of each program is displayed in the following format.

EXAMPLE:

TIME IS 04:36:27A
TODAY IS FRIDAY, 8/03/13

The programs consist of four subroutines. Lines with numbers 1000-1999 contain an initialization subroutine. An input/output routine is listed in lines 2000-2999. The subroutine in lines 3000-3999 provides for the changing of the weekday code to the name of the weekday and the last subroutine, lines 4000-4999, displays the data on the computer's monitor.

TRS-80
MODEL I &
MODEL II

```
100 GOSUB 1000:REM INITIALIZE PROGRAM
110 OST$="ATVT":GOSUB 2000:REM SET TIME SEPARATOR
120 OST$="ATVD/":GOSUB 2000:REM SET DATE SEPARATOR
130 OST$="ATRT":GOSUB 2000:TIM$=IST$:REM READ TIME
140 OST$="ATRD":GOSUB 2000:DTE$=IST$:REM READ
    DATE
150 OST$="ATRW":GOSUB 2000:W=VAL(IST$):REM READ
    WEEKDAY
160 GOSUB 3000:REM CONVERT WEEKDAY CODE TO
    CHARACTERS
170 GOSUB 4000:REM OUTPUT TIME, WEEKDAY, AND DATE
    ON SCREEN
180 END
```

*Trademark of Tandy Corporation.

**Trademark of Atari, Inc.

†Trademark of Apple Computers, Inc.

Initialization Subroutine

```
1000 OUT 232,0:REM RESET RS-232 PORT
1010 OUT 233,85:REM SET BAUD RATE=300
1020 OUT 234,165:REM SET WORD SIZE, PARITY SENSE, AND
STOP BITS
1030 RETURN
```

Input/Output Subroutine

```
2000 FOR I=1 TO LEN(OST$)
2010 OUT 235,ASC(MID$(OST$, I,1))
2020 IF INP(234)<71 GOTO 2020:REM WAIT TIL UART BUFFER
EMPTY
2030 NEXT I
2040 OUT 235,13:REM OUTPUT CARRIAGE RETURN
2050 IST$="":REM CLEAR INPUT STRING
2060 IF INP(234)<128 THEN GOTO 2060:REM WAIT UNTIL
CHAR RECEIVED
2070 X=INP(235):REM READ CHARACTER FROM RS-232
PORT
2080 IF X=13 THEN RETURN:REM EXIT ROUTINE IF
CARRIAGE RETURN
2090 IST$=IST$+CHR$(X):REM APPEND CHARACTER TO
INPUT STRING
2100 GOTO 2060
```

Weekday Conversion Subroutine

```
3000 FOR LOOP=0 TO W
3010 READ DAY$
3020 NEXT LOOP
3030 RETURN
3040 DATA MONDAY, TUESDAY, WEDNESDAY
3050 DATA THURSDAY, FRIDAY, SATURDAY
3060 DATA SUNDAY
```

Display Data Subroutine

```
4000 PRINT "TIME IS ";TIM$
4010 PRINT "TODAY IS ";DAY$," ";DTE$
4020 RETURN
```

ATARI 800

```
100 GOSUB 1000:REM INITIALIZE PROGRAM
110 OST$="ATVT:":GOSUB 2000:REM SET TIME SEPARATOR
120 OST$="ATVD/":GOSUB 2000:REM SET DATE SEPARATOR
130 OST$="ATRT":GOSUB 2000:TIM$=IST$:REM READ TIME
140 OST$="ATRD":GOSUB 2000:DTE$=IST$:REM READ DATE
150 OST$="ATRW":GOSUB 2000:W=VAL(IST$):REM READ
WEEKDAY
160 GOSUB 3000:REM CONVERT WEEKDAY CODE TO
CHARACTERS
170 GOSUB 4000:REM OUTPUT TIME, WEEKDAY, AND DATE
ON SCREEN
180 END
```

Initialization Subroutine

```
1000 DIM OST$(10),IST$(10)
1010 DIM TIM$(10),DTE$(10),DAY$(10)
1020 XIO 36,#1,0,0,"R:":REM SET BAUD RATE=300
1030 OPEN #1,13,0,"R:":REM OPEN CHANNEL #1
1040 XIO 40,#1,0,0,"R:":REM START CONCURRENT I/O
1050 RETURN
```

Input/Output Subroutine

```
2000 PRINT #1;OST$:REM OUTPUT CLOCK COMMAND
2010 INPUT #1;IST$:REM GET INPUT FROM CLOCK
2020 RETURN
```

Weekday Conversion Subroutine

```
3000 FOR LOOP=0 TO W
3010 READ DAY$
3020 NEXT LOOP
3030 RETURN
3040 DATA MONDAY, TUESDAY, WEDNESDAY
3050 DATA THURSDAY, FRIDAY, SATURDAY
3060 DATA SUNDAY
```

Display Data Subroutine

```
4000 PRINT "TIME IS ";TIM$
4010 PRINT "TODAY IS ";DAY$," ";DTE$
4020 RETURN
```

APPLE III

```
100 GOSUB 1000:REM INITIALIZE PROGRAM
110 OST$="ATVT:":GOSUB 2000:REM SET TIME SEPARATOR
120 OST$="ATVD/":GOSUB 2000:REM SET DATE SEPARATOR
130 OST$="ATRT":GOSUB 2000:TIM$=IST$:REM READ TIME
140 OST$="ATRD":GOSUB 2000:DTE$=IST$:REM READ DATE
150 OST$="ATRW":GOSUB 2000:W=VAL(IST$):REM READ
WEEKDAY
160 GOSUB 3000:REM CONVERT WEEKDAY CODE TO
CHARACTERS
170 GOSUB 4000:REM OUTPUT TIME, WEEKDAY, AND DATE
ON SCREEN
180 END
```

Initialization Subroutine

```
1000 OPEN #1,"RS232":REM OPEN CHANNEL
1010 RETURN
```

Input/Output Subroutine

```
2000 PRINT #1;OST$:REM OUTPUT CLOCK COMMAND
2010 INPUT #1;IST$:REM GET INPUT FROM CLOCK
2020 RETURN
```

Weekday Conversion Subroutine

```
3000 FOR LOOP=0 TO W
3010 READ DAY$
3020 NEXT LOOP
3030 RETURN
3040 DATA MONDAY, TUESDAY, WEDNESDAY
3050 DATA THURSDAY, FRIDAY, SATURDAY
3060 DATA SUNDAY
```

Display Data Subroutine

```
4000 PRINT "TIME IS ";TIM$
4010 PRINT "TODAY IS ";DAY$ " ";DTE$
4020 RETURN
```

APPLE II

```
100 GOSUB 1000:REM INITIALIZE PROGRAM
110 OST$="ATVT/":GOSUB 2000:REM SET TIME SEPARATOR
120 OST$="ATVD/":GOSUB 2000:REM SET DATE SEPARATOR
130 OST$="ATRT":GOSUB 2000:TIM$=IST$: REM READ TIME
140 OST$="ATRD":GOSUB 2000:DTE$=IST$: REM READ DATE
150 OST$="ATRW":GOSUB 2000:W=VAL(IST$): REM READ WEEKDAY
160 GOSUB 3000: REM CONVERT WEEKDAY CODE TO CHARACTERS
170 GOSUB 4000:REM OUTPUT TIME, WEEKDAY, AND DATE ON SCREEN
180 END
```

Initialization Subroutine

```
1000 CS=7: REM COMMUNICATIONS CARD SLOT
1010 CR$=CHR$(13):REM CARRIAGE RETURN
1020 D$=CR$+CHR$(4)
1030 RETURN
```

Input/Output Subroutine

```
2000 IST$="":REM CLEAR INPUT STRING
2010 PRINT D$"PR#"CS:REM OUTPUT TO CLOCK ON
2020 PRINT OST$:REM OUTPUT COMMAND
2030 PRINT D$"PR #0":REM OUTPUT TO CLOCK OFF
2040 PRINT D$"IN#"CS:REM INPUT FROM CLOCK ON
2050 GET X$:REM GET ONE CHARACTER FROM CLOCK
2060 IF X$=CR$THEN 2090
2070 IST$=IST$+X$
2080 GTO 2050
2090 PRINT D$"IN#0":REM INPUT FROM CLOCK ON
2100 RETURN
```

Weekday Conversion Subroutine

```
3000 FOR LOOP=0 TO W
3010 READ DAY$
3020 NEXT LOOP
3030 RETURN
3040 DATA MONDAY, TUESDAY, WEDNESDAY
3050 DATA THURSDAY, FRIDAY, SATURDAY
3060 DATA SUNDAY
```

Display Data Subroutine

```
4000 PRINT "TIME IS ";TIM$
4010 PRINT "TODAY IS ";DAY$ " ";DTE$
4020 RETURN
```

Appendix B RS-232C CONNECTOR PIN ASSIGNMENTS

PIN NUMBER	CIRCUIT	FUNCTION	DESCRIPTION
1	AA	Protective Ground	Connected to the chassis and pin 7 (signal ground) by a mini jumper.
2	BA	Transmitted Data	Data transmitted by the host device and received by the Chronograph.
3	BB	Received Data	Data transmitted by the Chronograph and received by the host device.
5	CB	Clear to Send	Signal held at the ON EIA level by the Chronograph.
6	CC	Data Set Ready	Signal held at the ON EIA level by the Chronograph.
7	AB	Signal Ground	Return path for all data and control signals.
8	CF	Carrier Detect	Signal held at the ON EIA level by the Chronograph.
22	CE	Ring Indicator	Signal controlled by the Chronograph alarm function. Signal is switched to the ON EIA level when an alarm occurs.

Appendix C BLOCK DIAGRAM

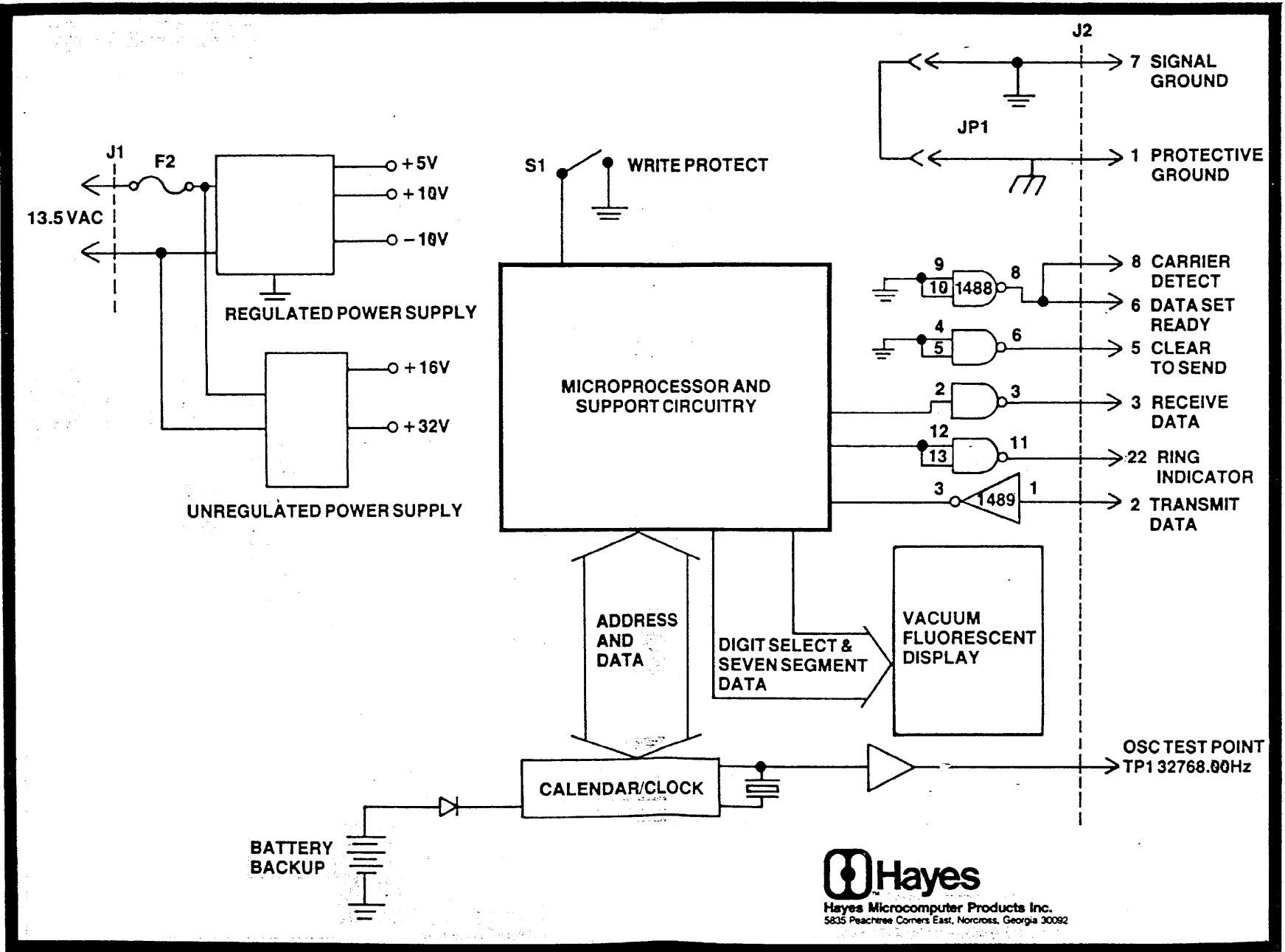

Hayes
 Hayes Microcomputer Products Inc.
 5835 Peachtree Corners East, Norcross, Georgia 30092

Appendix D SPECIFICATIONS SUMMARY

CLOCK MODES	Hours, minutes, seconds with 12- or 24-hour operation.
CALENDAR MODE	Year, month, day with automatic leap year adjust to year 2100.
DATA FORMAT	Serial, binary, asynchronous 7 data bits, odd, even or fixed parity, 1- or 2-stop bits; 8 data bits, odd, even, fixed or no parity, 1- or 2-stop bits.
COMMANDS	AC : Alarm clear AS : Alarm set DD : Display date DT : Display time LC : Line feed option clear LS : Line feed option set RD : Read date as YYMMDD RT : Read time as HHMMSS RW : Read weekday SD : Set date as YYMMDD ST : Set time as HHMMSS SW : Set weekday VD : Select date separator VT : Select time separator
	User may select any ASCII character except null or carriage return as a date or time separator.
	<i>NOTE: All Chronograph commands must be preceded by AT characters and terminated with a carriage return.</i>
RESULT CODES	0= No error; 8= Syntax error; 9= Write-protect error.
DISPLAY	Six digit vacuum-fluorescent display 3.9" x 1.3".
DATE/TIME REPORTING FORMAT	ANSI 3.30 and 3.43 compatible.
REAR PANEL	RS-232C connector, power jack, write-protect switch.
DATA RATE	300 or 1200 baud. Automatically detects baud rate, parity sense and word size.

INTERFACE RS-232C.

INTELLIGENCE General Instruments PIC1650A microprocessor.

REGISTRATION FCC-Registered Part 15.

POWER PACK U.L. listed 120VAC, 60Hz. 13.5VAC output.

SIZE 2.6" x 5.5" x 9.6".

BATTERY BACKUP 1 year.

BATTERIES REQUIRED 3 "AA" batteries.

FCC REGISTRATION NO. BFJ9D9 08 0100

Appendix E JUMPER 1 CONFIGURATION

Jumper 1 (JP1) is located on the Chronograph board between the DB-25 connector and the write-protect switch. The Chronograph is shipped with JP1 installed between pins 1 and 2 as shown in Figure 6a. If circuit AA (protective ground) is implemented in the RS-232C interface, JP1 should be installed between pins 2 and 3. (See Figure 6b.)

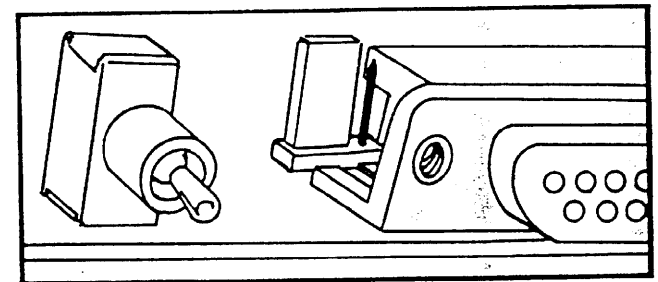

Figure 6a

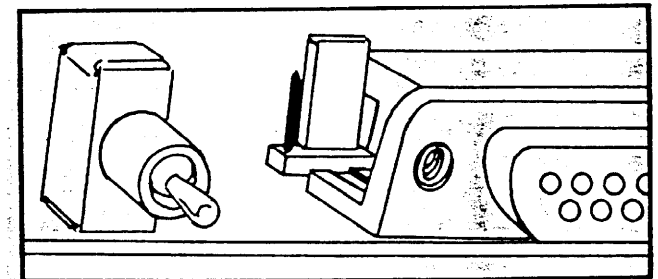

Figure 6b

Appendix F

OSCILLATOR ADJUSTMENT

Prior to shipment, the crystal oscillator in each Chronograph is precisely adjusted for accurate timekeeping. With time, however, component aging may lead to small changes in the frequency of the oscillator circuit. Users having the necessary equipment who wish to check or adjust the oscillator circuit should follow the procedure below.

1. Using a frequency counter with a minimum of 0.01Hz resolution, e.g. HP5315, monitor the frequency of the signal at TP1 on the rear panel of the Chronograph. (See Figure 3 in Chapter 2.) Pin 7 of the DB-25 connector should be used as a ground.
2. The frequency at TP1 should be 32768Kz. If a significant error is noted, i.e., $\pm 0.05\text{Hz}$, small adjustments may be made by inserting a non-metallic screwdriver in the CAL. opening in the rear panel of the Chronograph.