

# COMPUTER TECHNOLOGY

COMPUTER TECHNOLOGY DEPT  
PURDUE UNIVERSITY  
CALUMET CAMPUS  
HAMMOND, IN 46323

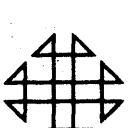
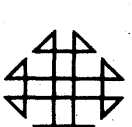
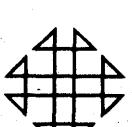
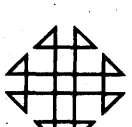
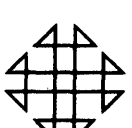
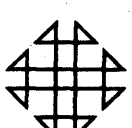
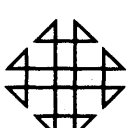
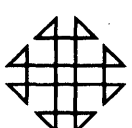
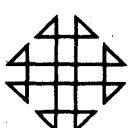
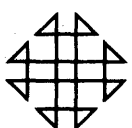
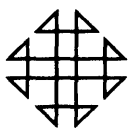
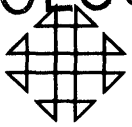
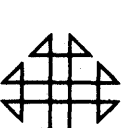
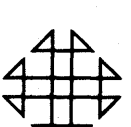
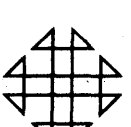
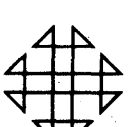
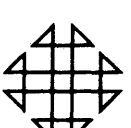
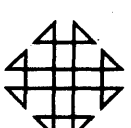
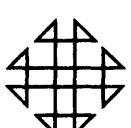
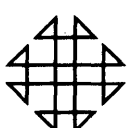
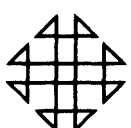
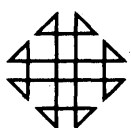
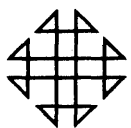
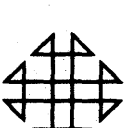
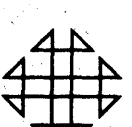
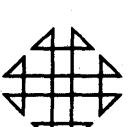
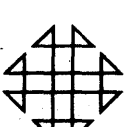
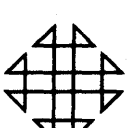
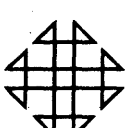
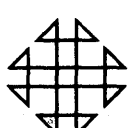
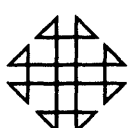
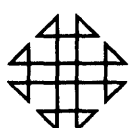
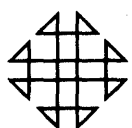
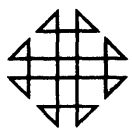
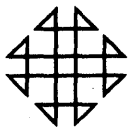
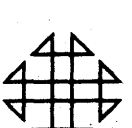
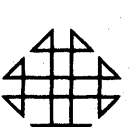
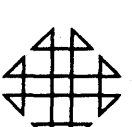
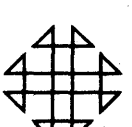
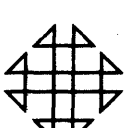
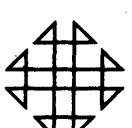
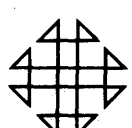
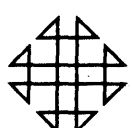
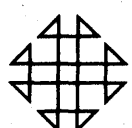
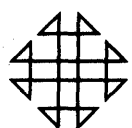
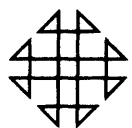
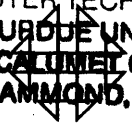
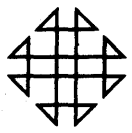
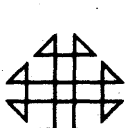
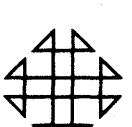
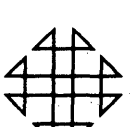
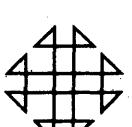
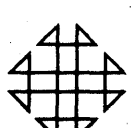
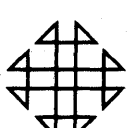
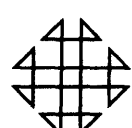
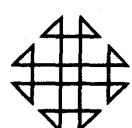
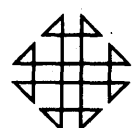
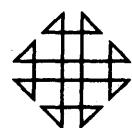
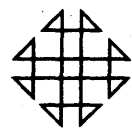
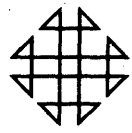
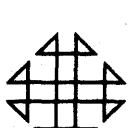
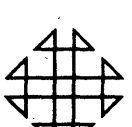
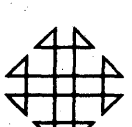
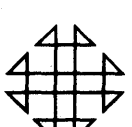
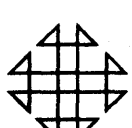
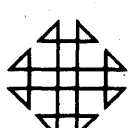
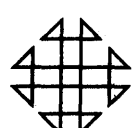
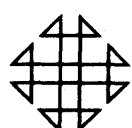
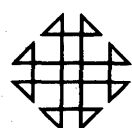
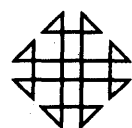
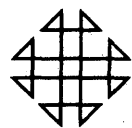
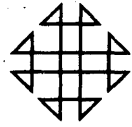
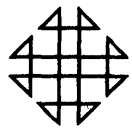
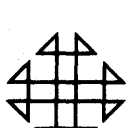
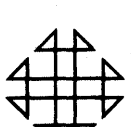
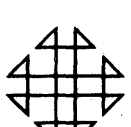
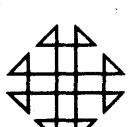
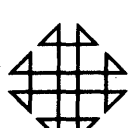
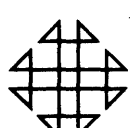
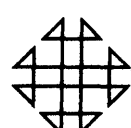
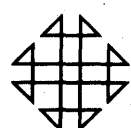
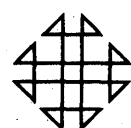
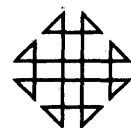
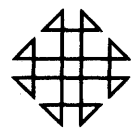
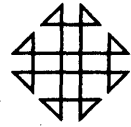
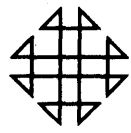
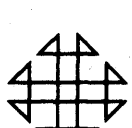
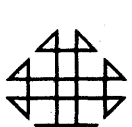
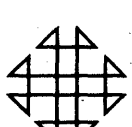
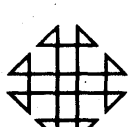
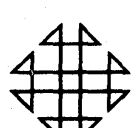
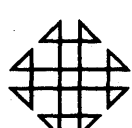
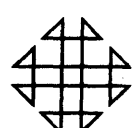
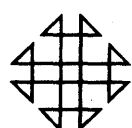
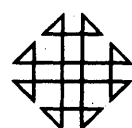
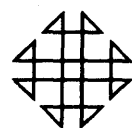
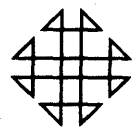
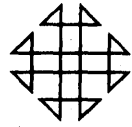
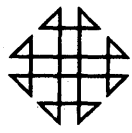
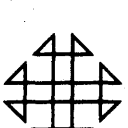
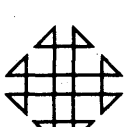
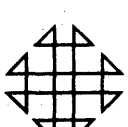
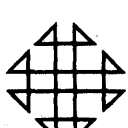
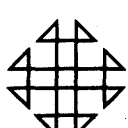
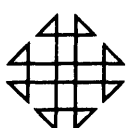
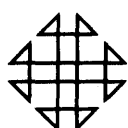
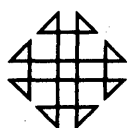
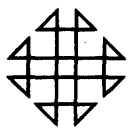
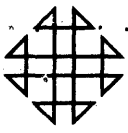

1620 GENERAL PROGRAM LIBRARY

THE GAME OF DICE ON THE 1620

11.0.025

DISCLAIMER

Although each program has been tested by its contributor, no warranty, express or implied, is made by the contributor or 1620 USERS Group, as to the accuracy and functioning of the program and related program material, nor shall the fact of distribution constitute any such warranty, and no responsibility is assumed by the contributor or 1620 USERS Group, in connection therewith.

1620 USERS GROUP PROGRAM REVIEW AND EVALUATION

Program No. \_\_\_\_\_

Date \_\_\_\_\_

Program Name: \_\_\_\_\_

1. Does the abstract adequately describe what the program is and what it does? Yes \_\_\_ No \_\_\_  
Comment \_\_\_\_\_
  
2. Does the program do what the abstract says? Yes \_\_\_ No \_\_\_  
Comment \_\_\_\_\_
  
3. Is the Description clear, understandable, and adequate? Yes \_\_\_ No \_\_\_  
Comment \_\_\_\_\_
  
4. Are the Operating Instructions understandable and in sufficient detail? Yes \_\_\_ No \_\_\_  
Comment \_\_\_\_\_  
Are the Sense Switch options adequately described (if applicable)? Yes \_\_\_ No \_\_\_  
Are the mnemonic labels identified or sufficiently understandable? Yes \_\_\_ No \_\_\_  
Comment \_\_\_\_\_
  
5. Does the source program compile satisfactorily (if applicable)? Yes \_\_\_ No \_\_\_  
Comment \_\_\_\_\_
  
6. Does the object program run satisfactorily? Yes \_\_\_ No \_\_\_  
Comment \_\_\_\_\_
  
7. Number of test cases run \_\_\_\_\_  
Are any restrictions as to data, size, range, etc. covered adequately in description? Yes \_\_\_ No \_\_\_  
Comment \_\_\_\_\_
  
8. Does the Program meet the minimal standards of the 1620 Users Group? Yes \_\_\_ No \_\_\_  
Comment \_\_\_\_\_
  
9. Please list any suggestions to improve the usefulness of the program. These will be passed on to the author for his consideration.  
Comment \_\_\_\_\_

Please return to:

Mr. Robert J. Robinson (PREP)  
Marquette University  
Computing Center  
1515 W. Wisconsin Avenue  
Milwaukee 3, Wisconsin

Your Name \_\_\_\_\_  
Company \_\_\_\_\_  
Address \_\_\_\_\_  
User Group Code \_\_\_\_\_

THE GAME OF DICE ON THE 1620

Author: Mr. Robert H. Fahnestock  
Centralia College  
2615 Howard Street  
Centralia, Washington

DECK KEY

1. Source Deck - 01010 through 13130  
in card columns 01 through 05
2. SPS Compressed Deck - 0000 through  
0094 in card columns 77 through 80
3. SPS Listing Decks - 0000 through 0576  
in card columns 77 through 80

1620 USERS Group Library

Program Abstract

Title (If subroutine state in Title) THE GAME OF DICE ON THE 1620

Subject Classification 11.0

Author; Organization: ROBERT H. FAHNESTOCK, CENTRALIA COLLEGE

Direct Inquires to:

Name ROBERT H. FAHNESTOCK Address 2615 HOWARD ST.  
CENTRALIA, WASHINGTON Phone 736-7127

Purpose/Description: THIS IS AN ENTERTAINMENT TYPE PROGRAM THAT SIMULATES A CRAP GAME USING TWO DICE.

Mathematical Method: \_\_\_\_\_

Restrictions, Range: \_\_\_\_\_

Storage Requirements: 4303 POSITIONS OF CORE INCLUDING THE ADD TABLES.

Equipment Specifications:

Memory 20K  40K  60K  K  Automatic Divide: Yes  No   
Indirect Addressing: Yes  No  Other Special Features Required N/A

Additional Remarks (Include at author's discretion: Language; Fixed/Float; Relocatability) (Optional: Running time; Approximate number of times run successfully; Programming Hours) TWO PASS SPS PROGRAM. ESTIMATED RUNNING TIMES: TYPE OUT OF INITIAL OPERATING INSTRUCTIONS THIRTY SECONDS. MAXIMUM TIMES DICE CAN BE ROLLED IN ONE MINUTE IS THIRTEEN. APPROXIMATE NUMBER OF TIMES THE PROGRAM HAS BEEN RUN SUCCESSFULLY PRIOR TO MAY 14, 1963 IS TWENTY.

1620 CRAP GAME TABLE OF CONTENTS

	PAGE
USERS SECTION	1
OPERATING INSTRUCTIONS	3
TEST DATA	4
GENERAL FLOW CHART	6
DETAIL BLOCK DIAGRAM	7
407 LISTING SOURCE PROGRAM	APPENDIX I
407 LISTING SPS LISTING DECK	APPENDIX II
407 LISTING COMPRESSED DECK	APPENDIX III
LABEL TABLE LISTING	APPENDIX IV
SAMPLE GAME TYPE CUT	APPENDIX V

## 1620 CRAP GAME

## USERS SECTION

THIS IS AN ENTERTAINMENT TYPE PROGRAM THAT SIMULATES A CRAP GAME USING TWO DICE. THE PROGRAM IS ENTERED INTO THE COMPUTER FROM CARDS. THE MACHINE THEN TYPES OUT THE PLAYING INSTRUCTIONS. THE PLAYER ENTERS HIS OR HER TWO, ONE DIGIT LUCKY NUMBERS FROM THE TYPEWRITER. BETS ARE PLACED BY TURNING ON ANY OF THE CONSOLE SWITCHES ONE THROUGH FOUR. IF CONSOLE SWITCH ONE IS ON, FIVE CENTS IS BET; IF CONSOLE SWITCH TWO IS ON, TEN CENTS IS BET; IF CONSOLE SWITCH THREE IS ON, TWENTY-FIVE CENTS IS BET; IF CONSOLE SWITCH FOUR IS ON, FIFTY CENTS IS BET; AND IF ALL FOUR CONSOLE SWITCHES ARE ON, NINETY CENTS IS BET.

ANY AMOUNT CAN BE BET ON EACH SERIES OF DICE ROLLS. PLAYERS CAN BE CHANGED AT ANYTIME BY TURNING ALL THE CONSOLE SWITCHES OFF AND PUSHING START. THIS INITIATES A MACHINE TYPE OUT, STATING WHETHER THE PLAYER IS AHEAD AND HOW MUCH, WHETHER THE MACHINE IS AHEAD AND HOW MUCH, OR IF BOTH ARE EVEN. ON EVERY TOSS OF THE DICE THE MACHINE TYPES OUT THE REPRESENTATIVE SYMBOLS FOR THE NUMBER OR NUMBERS ON EACH DICE. EVERY TIME THE PLAYER WINS, THE MACHINE TYPES OUT "YOU WIN" AND THE AMOUNT WON. EVERYTIME THE MACHINE WINS IT WILL TYPE OUT "CRAPS."



1620 CRAP GAME          USERS SECTION

IF A SEVEN OR A ELEVEN IS TOSSED ON THE FIRST  
ROLL, THE PLAYER WINS. IF A TWO, A THREE, OR A TWELVE  
IS TOSSED ON THE FIRST ROLL THE MACHINE WINS. IF ANY  
OTHER NUMBER IS TOSSED ON THE FIRST ROLL, DICE TOSsing  
SHOULD BE CONTINUED UNTIL THE POINT IS ROLLED (THE  
TOTAL OF THE DICE ON THE FIRST ROLL) OR A SEVEN IS  
ROLLED. IF A SEVEN IS ROLLED THE MACHINE WINS,  
OTHERWISE THE PLAYER WINS.

1620 CRAP GAME OPERATING INSTRUCTIONS

1. CLEAR THE CORE MEMORY TO ZEROS. \*
2. TURN CONSOLE SWITCHES OFF.
3. SET MARGINS ON THE TYPEWRITER TO THE RIGHT AND LEFT LIMITS OF THE PAPER.
4. NO TAB SETTINGS ARE REQUIRED.
5. DEPRESS RESET KEY.
6. PLACE THE PROGRAM IN THE READ HOPPER.
7. DEPRESS THE LOAD KEY.
8. WHEN THE READER NO FEED LIGHT COMES ON, DEPRESS THE READER START KEY.
9. DEPRESS START KEY ON CONSOLE.
10. FOLLOW INSTRUCTIONS THAT ARE TYPED OUT ON THE TYPEWRITER.

\* A SUGGESTED METHOD FOR CLEARING CORE MEMORY TO ZEROS IS:

1. DEPRESS THE RESET KEY.
2. DEPRESS THE INSERT KEY.
3. TYPE THE INSTRUCTION 26 00008 00009
4. DEPRESS THE RELEASE KEY.
5. DEPRESS THE START KEY.
6. AFTER ALL STORAGE POSITIONS HAVE BEEN CLEARED, DEPRESS THE INSTANT STOP KEY.

(APPROXIMATELY 0.8 SECONDS ARE REQUIRED TO CLEAR 20,000 CORE POSITIONS.)

Two digit lucky number 21, all switches on.

Number of tosses	Number on dice one	Number on dice two	Machine wins yes (x)	Human wins yes (x)
1	2	4		
2	3	2		
3	4	5		
4	5	3		
5	6	1	x	
6	2	4		
7	1	2		
8	4	6		
9	3	3		x
10	6	1		x
11	5	5		
12	3	2		
13	5	6		
14	1	4		
15	6	1	x	
16	4	5		
17	2	3		
18	4	3	x	
19	6	5		x
20	2	1	x	
21	5	4		
22	3	2		
23	1	6	x	
24	5	3		
25	3	1		
26	6	5		
27	1	2		
28	2	6		x
Totals			5	4

Dice total	Machine wins amount	Human wins amount	Machine ahead balance	Human ahead balance
6			-0-	-0-
5				
9				
8				
7	.90		.90	
6				
3				
10				
6		.90	-0-	-0-
7		.90		.90
10				
5				
11				
5				
7	.90		-0-	-0-
9				
5				
7	.90		.90	
11		.90	-0-	-0-
3	.90		.90	
9				
5				
7	.90		1.80	
8				
4				
11				
3				
8		.90	.90	
Totals			.90	

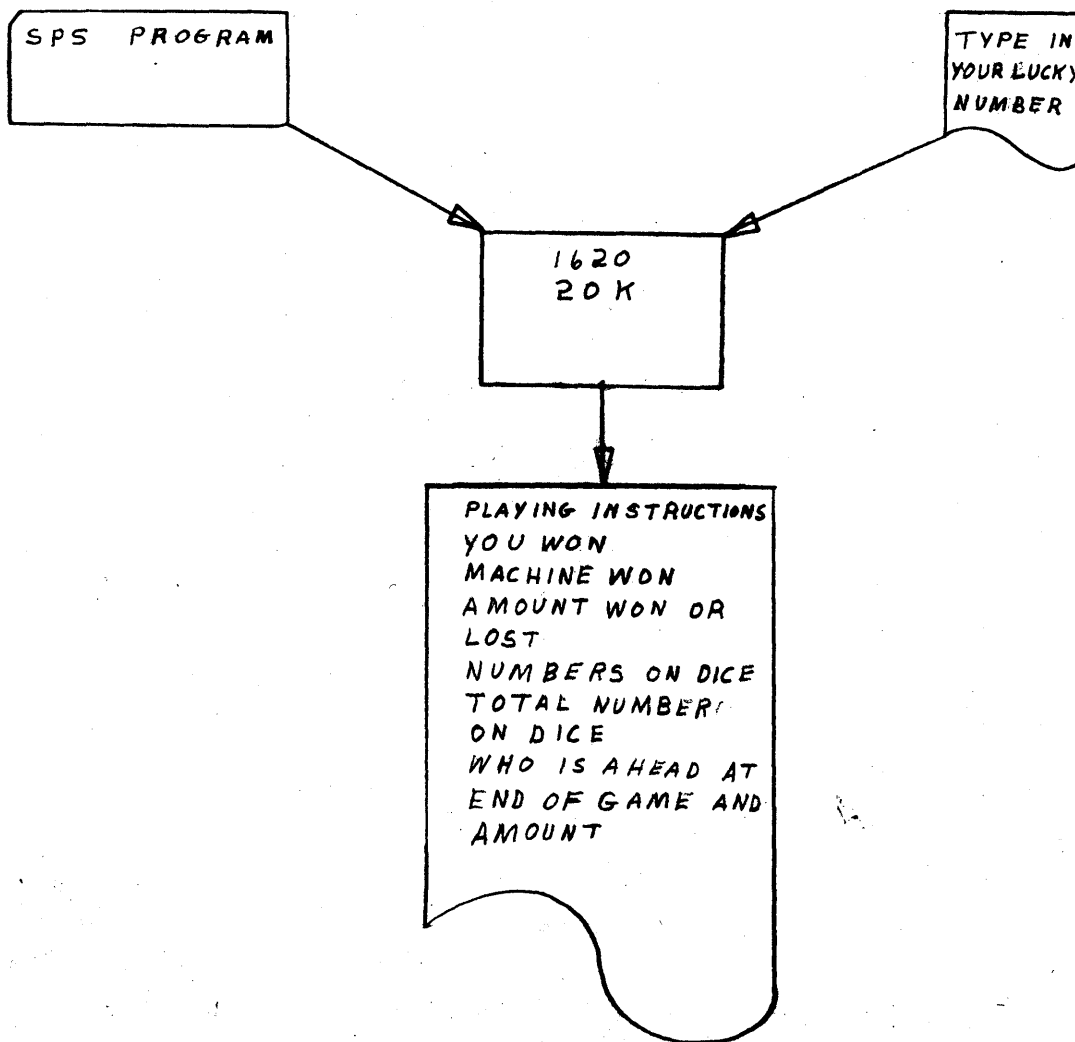

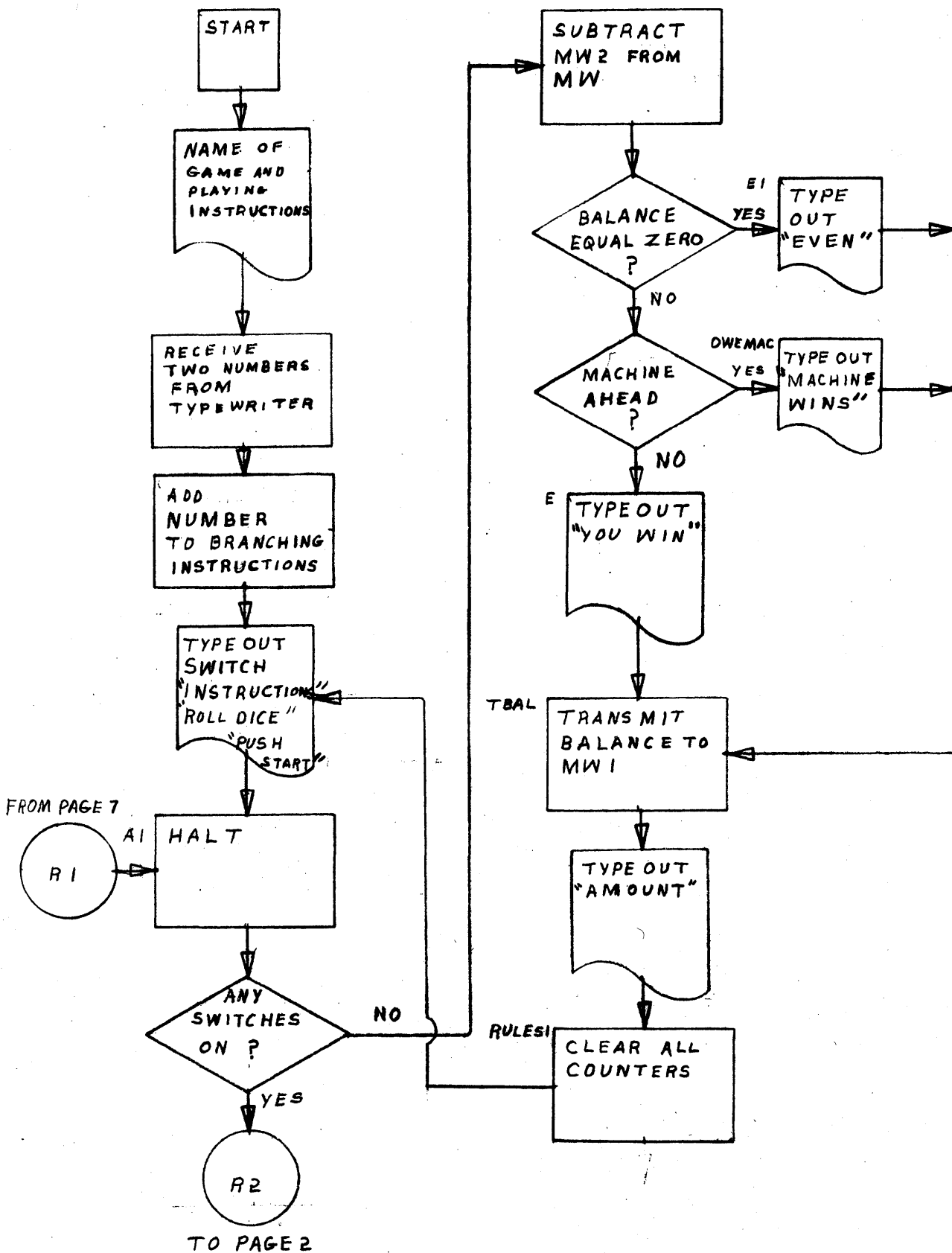

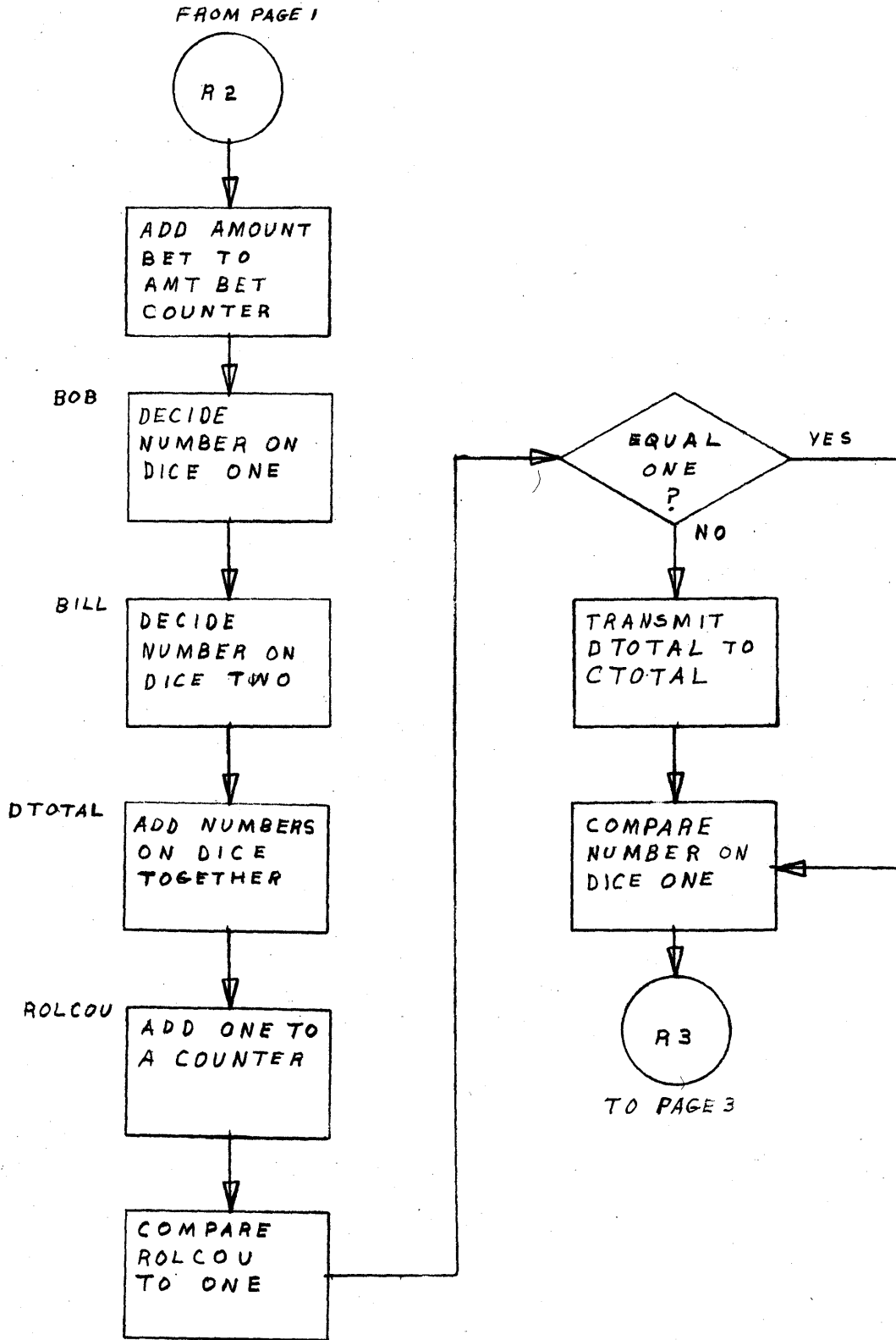

FROM PAGE 2

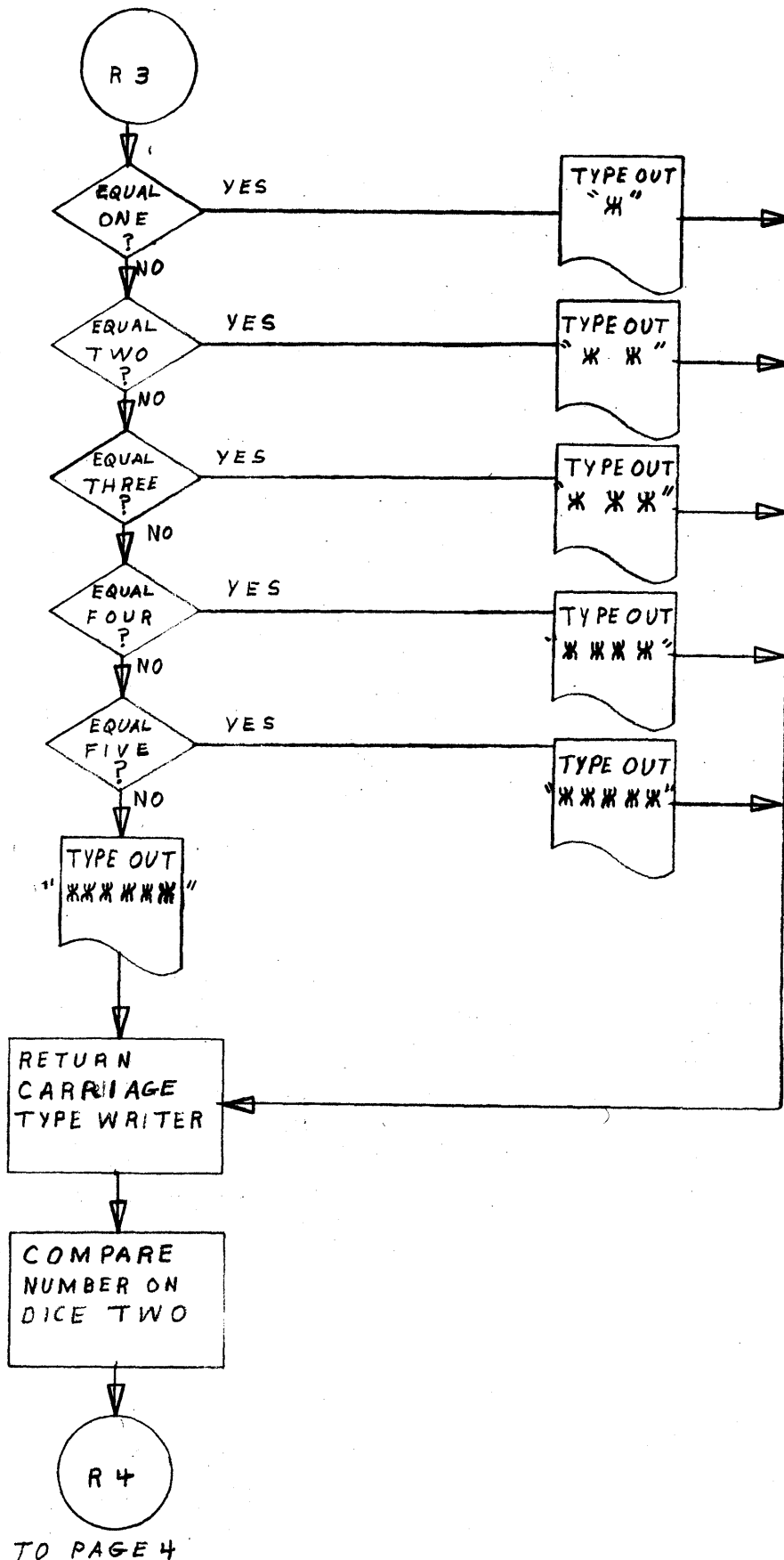

TO PAGE 4



FROM PAGE 3

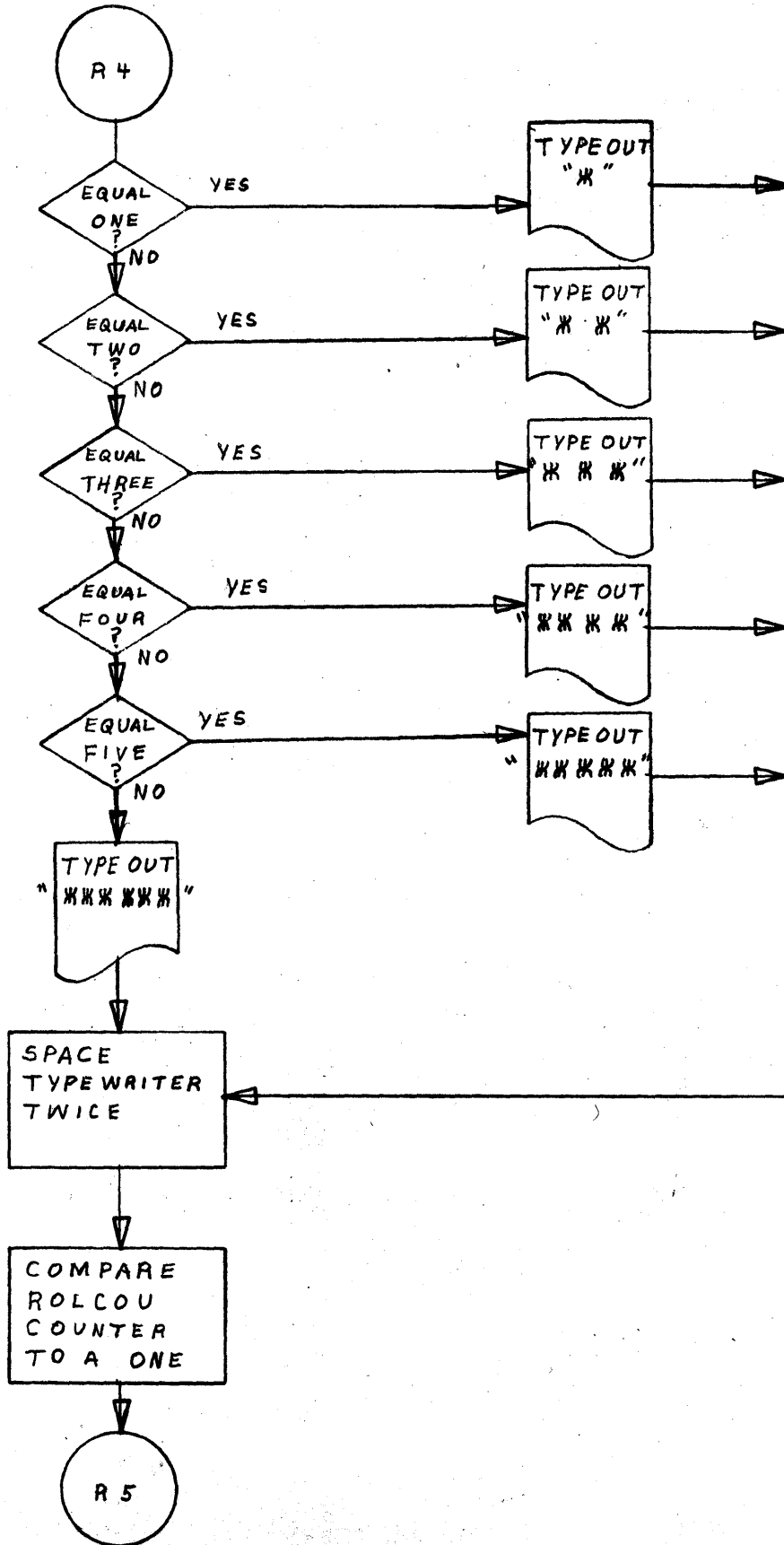

TO PAGE 5

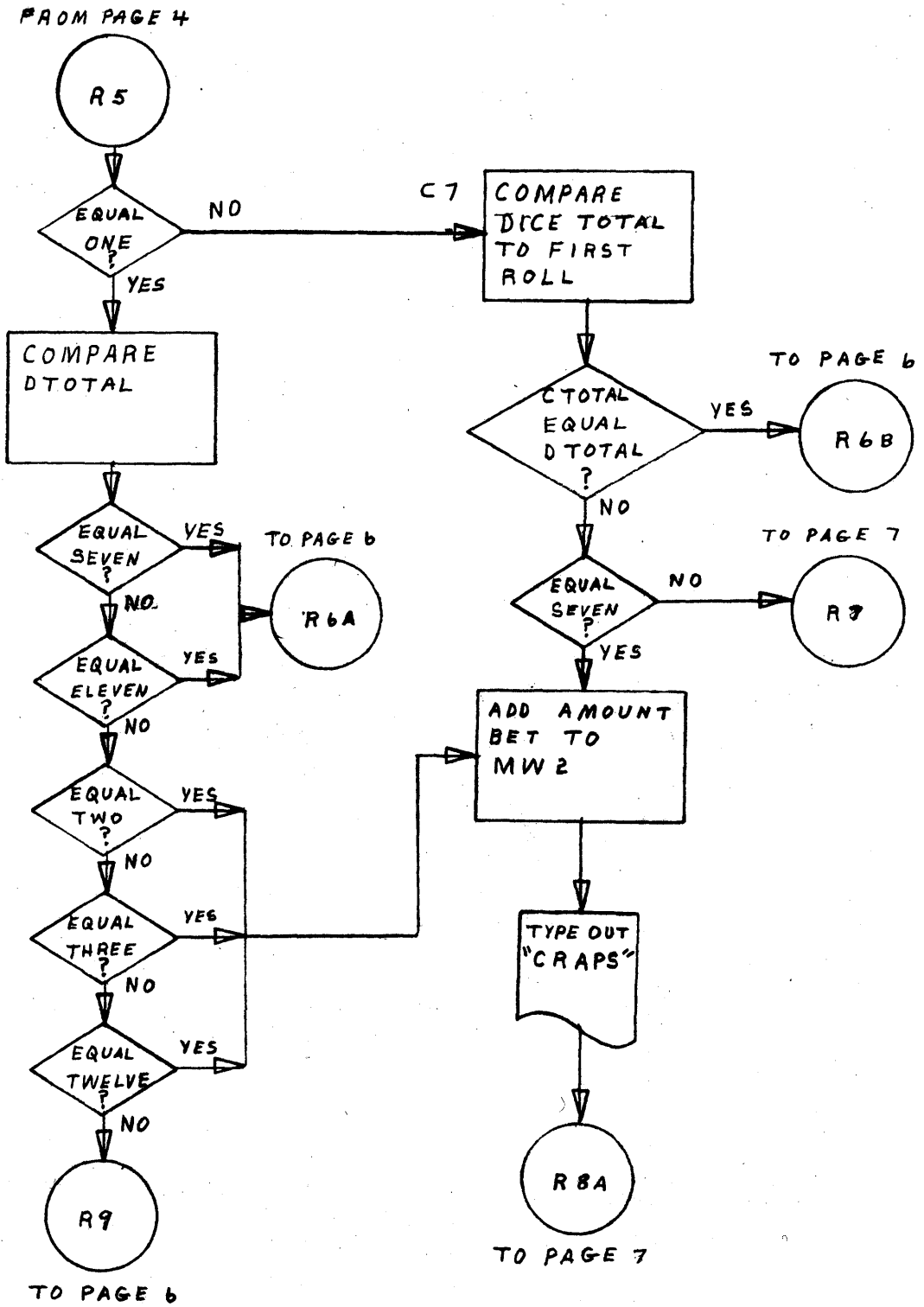

FROM PAGE 5

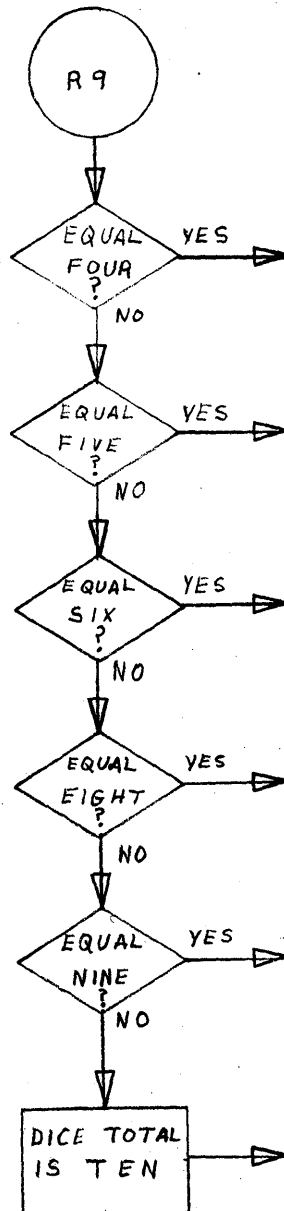

FROM PAGE 5

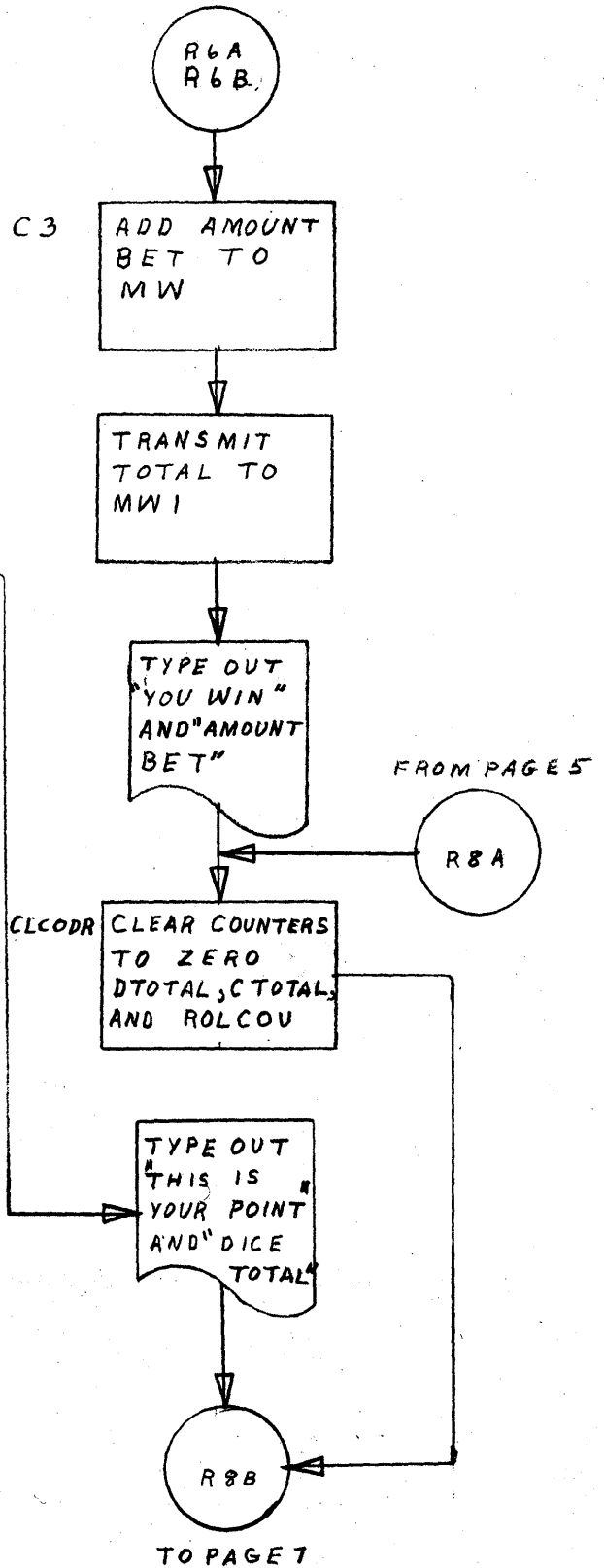

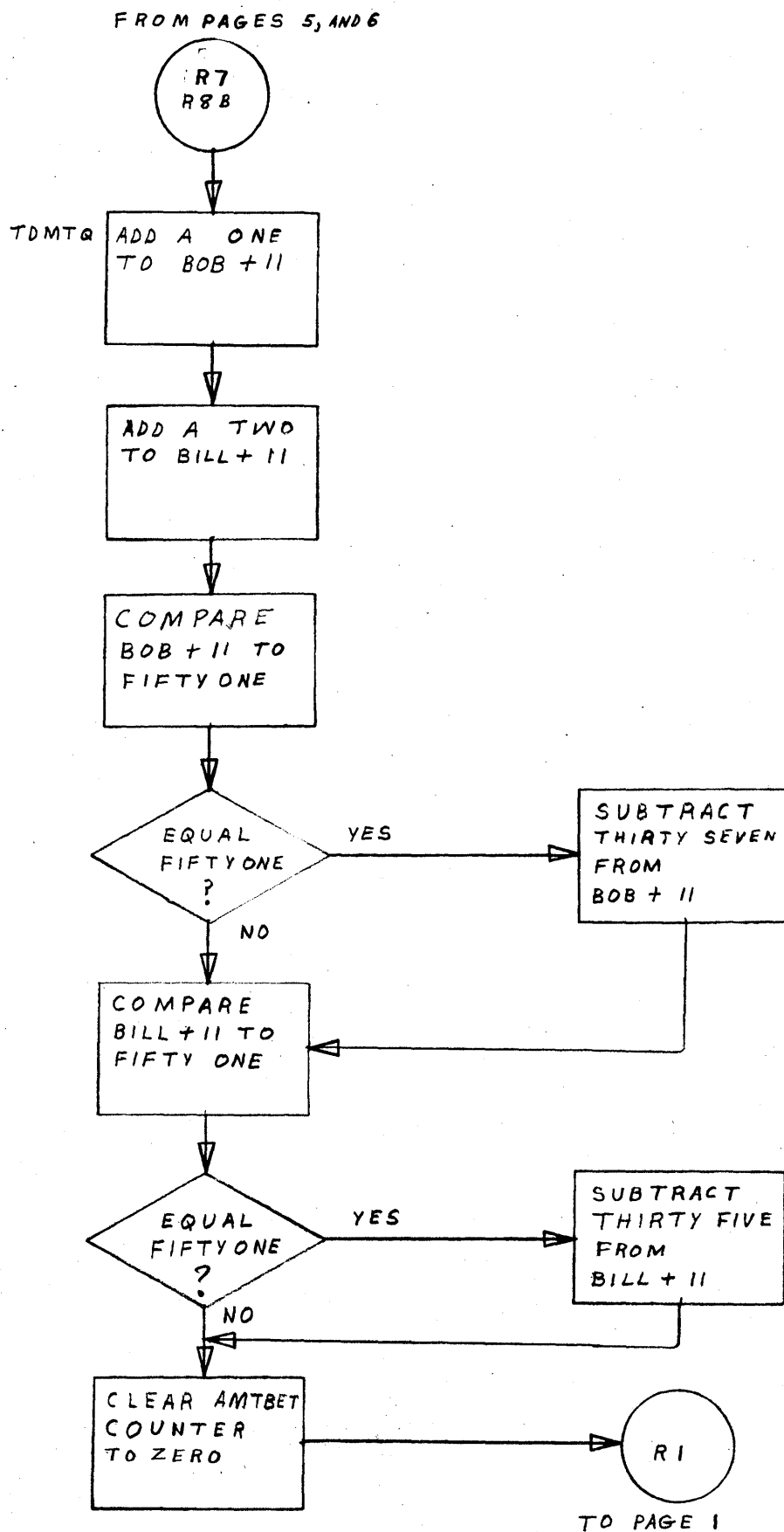

# APPENDIX I

## ROBERT FAHNESTOCK

### 407 MACHINE LISTING SOURCE PROGRAM

	01010	DORG402		
	01020	START RCTY		
	01030	WATYSTA1,,,	WELCOME	
	01040	RCTY		
	01050	WATYSTA2,,,	AT THIS TABLE	
	01060	RCTY		
	01070	WATYSTA3,,,	GREEN DICE	
	01080	RCTY		
	01081	RCTY		
	01090	WATYSTA5,,,	TO CHANGE PLAYERS	
	01100	RCTY		
	01110	WAT/PSTART,,,	PUSH START	
	01120	RCTY		
	01121	RCTY		
	01130	WATYTYPEND,,,	TYPE YOUR TWO DIGIT LUCKY NUMBER	
	01140	RCTY		
	01150	WATYTYPEN,,,	THEN HIT RELEASE + START	
	01160	RCTY		
	01161	RCTY		
	01170	RECNO RNTYNUMBIN-1,,,	RECEIVE A TWO DIGIT NUMBER	
	01180	RCTY		
	01190	TD ADD,NUMBIN,,,	TRANSMIT DIGIT TO ADDRESS ADJUST AREA	
	01200	TD ADD1,NUMBIN-1		
	02010	A BOB+11,ADD,,,	ADD FIELD TO BR INSTRUCTIONS	
	02020	A BILL+11,ADD1		
	02030	RULES RCTY		
	02031	RCTY		
	02040	WATYSTA6,,,	TO PLAY FOR NICKLES	
	02050	RCTY		
	02060	WATYSTA7,,,	TO PLAY FOR DIMES	
	02070	RCTY		
	02080	WATYSTA8,,,	TO PLAY FOR QUARTERS	
	02090	RCTY		
	02100	WATYSTA9,,,	TO PLAY FOR HALVES	
	02110	RCTY		
	02120	WATYBETS,,,	PLACE YOUR BETS	
	02130	RCTY		
	02140	WATYRODICE,,,	TO ROLL DICE PUSH START	
	02141	RCTY		
	02150A1	H		
	02160	BC1 A2,,,	BRANCH CONSOLE SWITCH ON	
	02170	BC2 A2		
	02180	BC3 A2		
	02190	BC4 A2		
	02200	S MW-1,MW2-1,,,		
	02201	RCTY		
	02202	RCTY		
	02210	CM MW-1,00000,,,	COMPARE AMOUNT TOTAL TO ZERO	
12	03010	BE E1,,,	IF ZERO TYPEOUT EVEN	
11	03020	BNF E,MW-1,,,	IF NEGATIVE BRANCH	
10	03030	WAT/OWEMAC,,,	TYPEOUT YOU LOST	
9	03040	TDBAL CF MW-1,		
8	03041	TD MW1+10,MW-1		
7	03050	TD MW1+8,MW-2		
6	03060	TD MW1+4,MW-3		
5	03070	TD MW1+2,MW-4		
4	03080	TD MW1,MW-5		
3	03090	CF MW1-1,,,	CLEAR FLAG	
2	03100	BD D1,MW1,,	BRANCH ON DIGIT TO TYPE AMOUNT	
1	03110	BD D2,MW1+2		

03120	HD D3,MW1+4	
03130	H D4	
03140	D1 WATYMW1	
03150	H RULES1	
03180D2	WATYMW1+2,,	TYPEOUT AMOUNT
03190	H RULES1	
03200D3	WATYMW1+4	
03210	H RULES1	
0320D4	WATYMW1+6	
04021RULES1SF	MW1-1,,	SET FLAG
04022	RCTY	
04023	RCTY	
04030	S MW-1,MW-1,,	CLEAR COUNTERS TO ZEROS
04040	S ROLCOU,ROLCOU	
04050	S MW2-1,MW2-1	
04060	S AMTBET,AMTBET	
04070	S AMTB-1,AMTB-1	
04080	TF MW1+10,MW3+10	
04090	H RULES	
04100E	WATYYOUWIN,,	TYPEOUT YOU WIN
04110	H TDBAL	
04120E1	WATYEVEN,,	TYPEOUT AT THE MOMENT YOU ARE EVEN
04130	H RULES1	
04140A2	HNC1B1,,	BRANCH CONSOLE SWITCH NOT ON
04150	AM ROBERT,5,10,	ADD AMOUNT BET TO A COUNTER
04160B1	HNC2B2	
04170	AM ROBERT,10,10	
04180B2	HNC3B3	
04190	AM ROBERT,25,10	
04200B3	HNC4B4	
04210	AM ROBERT,50,10	
04211B4	TF AMTBET,ROBERT	
04212	S ROBERT,ROBERT	
010BOB	TD DICE1,DA1,7,	DECIDE ON NUMBER ON DICE NUMBER ONE
05020BILL	TD DICE2,DA2,7,	DECIDE ON NUMBER ON DICE NUMBER TWO
05030	TF DTOTAL-1,DICE1	
05040	A DTOTAL-1,DICE2,,	FIND TOTAL BOTH DICE
05050	AM ROLCOU,1,10,	TOTAL NO OF TIMES DICE HAVE BEEN TOSSED
05060	CM ROLCOU,1,10,	COMPARE EQUAL, FIRST ROLL
05070	HNE RAY	
05080	TF CTOTAL-1,DTOTAL-1,,	TRANSMIT TOTAL DICE ROLL ONE TO A COUNT
5090RAY	RCTY	
*5091	RCTY	
05100	CM DICE1,1,10,	COMPARE NUMBER ON DICE NUMBER ONE
05110	BNE *+36	
05120	WATYNO1+1	
*5130	H C1	
05140	CM DICE1,2,10	
05150	BNE *+36	
05160	WATYNO2+1	
*5170	H C1	
05180	CM DICE1,3,10	
05190	BNE *+36	
*5200	WATYNO3+1	
5210	H C1	
05220	CM DICE1,4,10	
05230	BNE *+36	
06010	WATYNO4+1	
06020	H C1	
06030	CM DICE1,5,10	
06040	BNE *+36	
06050	WATYNO5+1	
06060	H C1	
06070	WATYNO6+1	
*6080C1	RCTY	
06090	CM DICE2,1,10,	COMPARE NUMBER ON DICE NUMBER TWO

	06100	BNE *+36	
	*6110	WATYN01+1	
	*6120	B C2	
	06130	CM DICE2,2,10	
	06140	BNE *+36	
	*6150	WATYN02+1	
	06160	B C2	
	06170	CM DICE2,3,20	
	06180	BNE *+36	
	06190	WATYN03+1	
	06200	B C2	
	07010	CM DICE2,4,10	
	07020	BNE *+36	
	07030	WATYN04+1	
	07040	B C2	
	07050	CM DICE2,5,10	
	07060	BNE *+36	
	*7070	WATYN05+1	
	07080	B C2	
	07090	WATYN06+1	
	7100C2	SPTY	
	7110	SPTY	
	07120	CM ROLCOU,1,10,	COMPARE COUNTER TO ROLL ONE
	7130	BNE C7	
	07140	CM DTOTAL-1,7,9,	COMPARE DICE TOTAL
	*7150	BE C3	
	07160	CM DTOTAL-1,11,9	
	07170	BE C3	
	07180	CM DTOTAL-1,2,9	
	*7190	BE C4	
	07200	CM DTOTAL-1,3,9	
	08010	BE C4	
	08020	CM DTOTAL-1,12,9	
	030	BE C4	
	08140	B C5	
	08150C3	A MW-1,AMTBET,,	ADD AMOUNT BET TO HUMAN TOTAL
	08160	TD MW1+10,MW-1	
	08170	TD MW1+8,MW-2	
	08180	TD MW1+4,MW-3	
	08190	TD MW1+2,MW-4	
	08200	TD MW1,MW-5	
	08210	TF AMTB-1,AMTBET,,	TRANSMIT AMOUNT BET TO TYPEOUT AREA
	08220	CF AMTB-2	
	09010	WATYOUW,,,	TYPEOUT YOU WIN
	09020	WNTYAMTB-2,,,	TYPEOUT AMOUNT BET
	09021CLCODRS	DTOTAL-1,DTOTAL-1	
	09022	S CTOTAL-1,CTOTAL-1	
	09023	S ROLCOU,ROLCOU	
	09030	RCTY	
	09040	B TDMTO	
	09050C4	A MW2-1,AMTBET,,	ADD AMOUNT BET TO MACHINE TOTAL
	09060	WATYCRAPS,,,	TYPEOUT CRAPS
	09061	B CLCODR	
	09080C5	WATYPOINT,,,	TYPEOUT THIS IS YOUR POINT
2	09090	BD C6,DTOTAL-2	
1	09110	WNTYDTOTAL-1,,,	TYPEOUT POINT ROLLED ONE DIGIT NUMBER
10	09120	B TDMTO	
9	09130C6	CF DTOTAL-2,,,	CLEAR FLAG
8	09131	WNTYDTOTAL-2,,,	TYPEOUT POINT ROLLED TWO DIGIT NUMBER
7	09132	RCTY	
6	09140	B TDMTO	
5	9141	RCTY	
4	09150C7	C CTOTAL-1,DTOTAL-1,,	SECOND ROLL EQUAL FIRST
3	*9160	BE C3	
2	09170	CM DTOTAL-1,7,9,	EQUAL SEVEN, MACHINE WINS
1	9180	BE C4	

6150

MICRO - 1600K ADDRESS RANGE, INC. (K.C. DIV.)

FORM 1313 12-27-58 X 11" - 3 LINES PER INCH

0919	TD	MTD	AM	HOB+11,1,,	DECIDE ON NEXT NUMBER FOR DICE ONE
0920			AM	HILL+11,2,,	DECIDE ON NEXT NUMBER FOR DICE TWO
1000			C	BOB+11,BETTY,,	BRANCHED PAST DICE AREA ONE YES OR NO
1002			BH	SJBBOB	
1003			CO	HILL+11,BETTY+5,,	BRANCHED PAST DICE AREA TWO YES OR NO
1004			BH	SUBILL	
1005			B	ATT	
1006			US	SUBBOHSM	HOB+11,37
1007			B	COBILL	
1008			US	SUBILLSM	HILL+11,35
1009			C	ATT	
1009			S	AMTBET,AMTRET	
10091			S	DTOTAL-1,DTOTAL-1	
1010			B	AI	
1101			STA1	DAC	49,WELCOME TO THE PALACE ROOM, WE FEATURE ALL TYPES@
1102			STA2	DAC	45,OF GAMING DEVICES. AT THIS TABLE WE USE THE@
1103			STA3	DAC	47,WORLD FAMOUS GREEN DICE FROM WASHINGTON STATE.@
1105			STA5	DAC	48,TO CHANGE PLAYERS TURN CONSOLE SWITCHES OFF AND@
1106			UP	STARTDAC	12,PUSH START.@
1107			UC	CRAPS	DAC 7,CRAPS.@
1108			STA6	DAC	40,TO PLAY FOR NICKLES, TURN ON SWITCH 1.@
1109			STA7	DAC	40,TO PLAY FOR DIMES, TURN ON SWITCH 2.@
1110			STA8	DAC	40,TO PLAY FOR QUARTERS, TURN ON SWITCH 3.@
1111			STA9	DAC	40,TO PLAY FOR HALVES, TURN ON SWITCH 4.@
1112			OEVEN	DAC	29,AT THE MOMENT, YOU ARE EVEN.@
1113			URO	DICEDAC	25,TO ROLL DICE PUSH START.@
1115			U	TYPENUDAC	41,TYPE YOUR TWO, ONE DIGIT LUCKY NUMBERS, @
1116			OWEMAC	DAC	14,YOU LOST \$ @
1117			YOUWIND	DAC	13,YOU WIN \$ @
1118			U	POINT	DAC 23,THIS IS YOUR POINT @
1119			U	TYPEN	DAC 27,THEN HIT RELEASE + START. @
1120			U	NUMB	INDC 3,012,
1121			U	BETS	DAC 18,PLACE YOUR BETS, @
1122			U	YOUW	DAC 14,YOU WIN \$ .@
010			ADD	DC	5,10
1202			ADD1	DC	5,10
12021			BETTY	DSA	CUBE1,CUBE2
1204			AMTBET	DC	2,0
1205			MW	DC	6,00000@
1206			U	CUBE1	DC 50,1234562143653516424625315361246452136542
1207			U	CUBE2	DC 50,6543215432164321653216542165431654323456
1210			DA1	DS	,CUBE1-49,
1211			DA2	DS	,CUBE2-49,
1212			U	DICF1	DC 2,0
1213			U	DICE2	DC 2,0
1214			U	TOTALDC	4,000@
1215			U	ROLC	COUDC 2,0
1216			U	TOTALDC	4,000@
1217			U	MW1	DAC 7,000.00@
1220			U	MW2	DC 6,00000@
1221			U	AMTB	DC 4,000@
1222			U	MW3	DAC 7,000.00@
1223			U	ROBERT	DC 2,00
1301			U	N1	DC 12,00001200000@
1302			U	N2	DC 20,0000120000000000120@
1303			U	N3	DC 24,00001200000012000000120@
1304			U	N4	DC 24,12001200000000001200120@
1305			U	N5	DC 20,1200120012001200120@
1306			U	N6	DC 24,12001200120012001200120@
1307			U	N01	DSS 12,N1-11
1308			U	N02	DSS 20,N2-19
1309			U	N03	DSS 24,N3-23
1310			U	N04	DSS 24,N4-23
1311			U	N05	DSS 20,N5-19
1312			U	N06	DSS 24,N6-23
1313			U		DENDSTART

PALACE COLUMNET STAMPS.



APPENDIX II

ROBERT FAHNESTOCK

407 MACHINE LISTING

SPS LISTING DECK

360007200500360020100500440001200276260005900274250001100000260000000269  
20000950026431000000020026001140027425000000011490001200000

	1010	BORG402		402				0000	00102	0003
	1020	START RCTY		402	34	00000	00102			0005
	1030	WATYSTA1,,,	WELCOME	414	39	02851	00100			0007
	1040	RCTY		426	34	00000	00102			0009
	1050	WATYSTA2,,,	AT THIS TABLE	438	39	02949	00100			0011
	1060	RCTY		450	34	00000	00102			0013
	1070	WATYSTA3,,,	GREEN DICE	462	39	03039	00100			0015
	1080	RCTY		474	34	00000	00102			0017
	1081	RCTY		486	34	00000	00102			0019
	01090	WATYSTA5,,,	TO CHANGE PLAYERS	498	39	03133	00100			0021
	1100	RCTY		510	34	00000	00102			0023
	1110	WATYPSTART,,,	PUSH START	522	39	03229	00100			0025
	1120	RCTY		534	34	00000	00102			0027
	1121	RCTY		546	34	00000	00102			0029
	01130	WATYTYPENU,,,	TYPE YOUR TWO DIGIT LUCKY NUMBER	558	39	03695	00100			0031
	1140	RCTY		570	34	00000	00102			0033
	01150	WATYTYPEN,,,	THEN HIT RELEASE + START	582	39	03877	00100			0035
	1160	RCTY		594	34	00000	00102			0037
	1161	RCTY		606	34	00000	00102			0039
	01170	RECNO RNTYNUMBIN-1,,,	RECEIVE A TWO DIGIT NUMBER	618	36	03931	00100			0041
	1180	RCTY		630	34	00000	00102			0043
	01190	TD ADD,NUMBIN,,,	TRANSMIT DIGIT TO ADDRESS ADJUST AREA	642	25	04002	03932			0045
	1200	TD ADD1,NUMBIN-1		654	25	04007	03931			0047
	02010	A BOB+11,ADD,,,	ADD FIELD TO BR INSTRUCTIONS	666	21	01517	04002			0049
	2020	A BILL+11,ADD1		678	21	01529	04007			0051
	2030	RULES RCTY		690	34	00000	00102			0053
	2031	RCTY		702	34	00000	00102			0055
	2040	WATYSTA6,,,	TO PLAY FOR NICKLES	714	39	03267	00100			0057
	2050	RCTY		726	34	00000	00102			0059
	2060	WATYSTA7,,,	TO PLAY FOR DIMES	738	39	03347	00100			0061
	2070	RCTY		750	34	00000	00102			0063
	2080	WATYSTA8,,,	TO PLAY FOR QUARTERS	762	39	03427	00100			0065
	2090	RCTY		774	34	00000	00102			0067
	2100	WATYSTA9,,,	TO PLAY FOR HALVES	786	39	03507	00100			0069
	2110	RCTY		798	34	00000	00102			0071
	2120	WATYBETS,,,	PLACE YOUR BETS	810	39	03935	00100			0073
	2130	RCTY		822	34	00000	00102			0075
	*2140	WATYRODICE,,,	TO ROLL DICE PUSH START	834	39	03645	00100			0077
	2141	RCTY		846	34	00000	00102			0079
	2150A1	H		858	48	00000	00000			0081
	02160	HC1 A2,,,	BRANCH CONSOLE SWITCH ON	870	46	01386	00100			0083
	2170	HC2 A2		882	46	01386	00200			0085
	2180	HC3 A2		894	46	01386	00300			0087
	2190	HC4 A2		906	46	01386	00400			0089
	2200	S MW-1,MW2-1,,		918	22	04024	04158			0091
	2201	RCTY		930	34	00000	00102			0093
	2202	RCTY		942	34	00000	00102			0095
	02210	CM MW-1,00000,,	COMPARE AMOUNT TOTAL TO ZERO	954	14	04024	00000			0097
	*3010	HE EI,,,	IF ZERO TYPEOUT EVEN	966	46	01362	01200			0099
1	3020	HNF E,MW-1,,	IF NEGATIVE BRANCH	978	44	01338	04024			0101
0	3030	WATYOWEMAC,,,	TYPEOUT YOU LOST	990	39	03777	00100			0103
9	3040	TDHAL CF MW-1,		1002	33	04024	00000			0105
8	3041	TD MW1+10,MW-1		1014	25	04151	04024			0107
7	3050	TD MW1+8,MW-2		1026	25	04149	04023			0109
6	3060	TD MW1+4,MW-3		1038	25	04145	04022			0111
5	3070	TD MW1+2,MW-4		1050	25	04143	04021			0113
4	3080	TD MW1,MW-5		1062	25	04141	04020			0115
3	3090	CF MW1-1,,,	CLEAR FLAG	1074	33	04140	00000			0117
2	03100	BD D1,MW1,,	BRANCH ON DIGIT TO TYPEOUT AMOUNT	1086	43	01134	04141			0119
1	3110	BD D2,MW1+2		1098	43	01130	04145			0121

6100

Model - Model Business Forms, Inc., Mac. Div.

FORM 313 12.27/58 X 11" X 11" 3 LINES PER INCH

21

	3130	H	D4			1122	49	01206	00000	0125
	3150D1		WATYMW1			1134	39	04141	00100	0127
	3170	H	RULES1			1146	49	01218	00000	0129
	3180D2		WATYMW1+2,,,	TYPEOUT AMOUNT		1158	39	04143	00100	0131
	3190	H	RULES1			1170	49	01218	00000	0133
	3200D3		WATYMW1+4			1182	39	04145	00100	0135
	4010	H	RULES1			1194	49	01218	00000	0137
	4020D4		WATYMW1+6			1206	39	04147	00100	0139
	402IRCLEISF		MW1-1,,,	SET FLAG		1218	32	04140	00000	0141
	4022		RCTY			1230	34	00000	00102	0143
	4023		RCTY			1242	34	00000	00102	0145
	*4030	S	MW-1,MW-1,,	CLEAR COUNTERS TO ZEROS		1254	22	04024	04024	0147
	4040	S	ROLCOU,ROLCOU			1266	22	04135	04135	0149
	4050	S	MW2-1,MW2-1			1278	22	04158	04158	0151
	4060	S	AMTBET,AMTBET			1290	22	04019	04019	0153
	4070	S	AMTB-1,AMTB-1			1302	22	04162	04162	0155
	4080	TF	MW1+10,MW3+10			1314	26	04151	04175	0157
	4090	H	RULES			1326	49	00690	00000	0159
	4100E		WATYYOUWIN,,,	TYPEOUT YOU WIN		1338	39	03805	00100	0161
	4110	H	TDBAL			1350	49	01002	00000	0163
	04120E1		WATYEVEN,,,	TYPEOUT AT THE MOMENT YOU ARE EVEN		1362	39	03587	00100	0165
	4130	H	RULES1			1374	49	01218	00000	0167
	04140A?		BNCIB1,,,	BRANCH CONSOLE SWITCH NOT ON		1386	47	01410	00100	0169
	04150	AM	ROBERT,5,10,	ADD AMOUNT BET TO A COUNTER		1398	11	04179	00005	0171
	4160B1		BNC2B2			1410	47	01434	00200	0173
	4170	AM	ROBERT,10,10			1422	11	04179	00000	0175
	4180B2		BNC3B3			1434	47	01458	00300	0177
	4190	AM	ROBERT,25,10			1446	11	04179	00005	0179
	4200B3		BNC4B4			1458	47	01482	00400	0181
	4210	AM	ROBERT,50,10			1470	11	04179	00000	0183
	4211B4	TF	AMTBET,ROBERT			1482	26	04019	04179	0185
	4212	S	ROBERT,ROBERT			1494	22	04179	04179	0187
	05010B0B	TD	DICE1,DA1,7,	DECIDE ON NUMBER ON DICE NUMBER ONE		1506	25	04127	04026	0189
	05020B1L	TD	DICE2,DA2,7,	DECIDE ON NUMBER ON DICE NUMBER TWO		1518	25	04129	04076	0191
	5030	TF	DTOTAL-1,DICE1			1530	26	04132	04127	0193
	*5040	A	DTOTAL-1,DICE2,,	FIND TOTAL BOTH DICE		1542	21	04132	04129	0195
	05050	AM	ROLCOU,1,10,	TOTAL NO OF TIMES DICE HAVE BEEN TOSSED		1554	11	04135	00001	0197
	05060	CM	ROLCOU,1,10,	COMPARE EQUAL, FIRST ROLL		1566	14	04135	00001	0199
	5070	BNE	RAY			1578	47	01602	01200	0201
	05080	TF	CTOTAL-1,DTOTAL-1,,	TRANSMIT TOTAL DICE ROLL ONE TO A COUNT		1590	26	04138	04132	0203
	5090RAY		RCTY			1602	34	00000	00102	0205
	5091		RCTY			1614	34	00000	00102	0207
	05100	CM	DICE1,1,10,	COMPARE NUMBER ON DICE NUMBER ONE		1626	14	04127	00001	0209
	5110	BNE	*+36			1638	47	01674	01200	0211
	5120		WATYNO1+1			1650	39	04181	00100	0213
	5130	H	C1			1662	49	01878	00000	0215
	5140	CM	DICE1,2,10			1674	14	04127	00002	0217
	5150	BNE	*+36			1686	47	01722	01200	0219
	5160		WATYNO2+1			1698	39	04193	00100	0221
	5170	H	C1			1710	49	01878	00000	0223
2	5180	CM	DICE1,3,10			1722	14	04127	00003	0225
1	5190	BNE	*+36			1734	47	01770	01200	0227
10	5200		WATYNO3+1			1746	39	04213	00100	0229
9	5210	H	C1			1758	49	01878	00000	0231
8	5220	CM	DICE1,4,10			1770	14	04127	00004	0233
7	5230	BNE	*+36			1782	47	01818	01200	0235
6	6010		WATYNO4+1			1794	39	04237	00100	0237
5	6020	H	C1			1806	49	01878	00000	0239
4	6030	CM	DICE1,5,10			1818	14	04127	00005	0241
3	6040	BNE	*+36			1830	47	01866	01200	0243
2	6050		WATYNO5+1			1842	39	04261	00100	0245
1	6060	H	C1			1854	49	01878	00000	0247

699

REGISTER - MOORE BUSINESS FORMS, INC., JAC. DIV.

FORM 1313 12 27 52" X 11" 3 LINES PER INCH

	6080C1	RCTY			1878	34	00000	00102	0251
	06090	CM DICE2,1,10,	COMPARE NUMBER ON DICE NUMBER TWO		1890	14	04129	00001	0253
	6100	HNE *+36			1902	47	01938	01200	0255
	6110	WATYNO1+1			1914	39	04181	00100	0257
	6120	H C2			1926	49	02142	00000	0259
	6130	CM DICE2,2,10			1938	14	04129	00002	0261
	6140	HNE *+36			1950	47	01986	01200	0263
	6150	WATYNO2+1			1962	39	04193	00100	0265
	6160	H C2			1974	49	02142	00000	0267
	6170	CM DICE2,3,20			1986	14	04129	00003	0269
	6180	HNE *+36			1998	47	02034	01200	0271
	6190	WATYNO3+1			2010	39	04213	00100	0273
	6200	H C2			2022	49	02142	00000	0275
	7010	CM DICE2,4,10			2034	14	04129	00004	0277
	7020	HNE *+36			2046	47	02082	01200	0279
	7030	WATYNO4+1			2058	39	04237	00100	0281
	7040	H C2			2070	49	02142	00000	0283
	7050	CM DICE2,5,10			2082	14	04129	00005	0285
	7060	HNE *+36			2094	47	02130	01200	0287
	7070	WATYNO5+1			2106	39	04261	00100	0289
	7080	H C2			2118	49	02142	00000	0291
	7090	WATYNO6+1			2130	39	04281	00100	0293
	7100C2	SPTY			2142	34	00000	00101	0295
	7110	SPTY			2154	34	00000	00101	0297
	07120	CM ROLCOU,1,10,	COMPARE COUNTER TO ROLL ONE		2166	14	04135	00001	0299
	7130	HNE C7			2178	47	02646	01200	0301
	7140	CM DTOTAL-1,7,9,	COMPARE DICE TOTAL		2190	14	04132	00007	0303
	7150	BE C3			2202	46	02322	01200	0305
	7160	CM DTOTAL-1,11,9			2214	14	04132	00011	0307
	7170	BE C3			2226	46	02322	01200	0309
	7180	CM DTOTAL-1,2,9			2238	14	04132	00002	0311
	7190	BE C4			2250	46	02502	01200	0313
	7200	CM DTOTAL-1,3,9			2262	14	04132	00003	0315
	8010	BE C4			2274	46	02502	01200	0317
	8020	CM DTOTAL-1,12,9			2286	14	04132	00012	0319
	8030	BE C4			2298	46	02502	01200	0321
	8140	H C5			2310	49	02538	00000	0323
	08150C3	A MW-1,AMTBET,,	ADD AMOUNT BET TO HUMAN TOTAL		2322	21	04024	04019	0325
	8160	TD MWI+10,MW-1			2334	25	04151	04024	0327
	8170	TD MWI+8,MW-2			2346	25	04149	04023	0329
	8180	TD MWI+4,MW-3			2358	25	04145	04022	0331
	8190	TD MWI+2,MW-4			2370	25	04143	04021	0333
	8200	TD MWI,MW-5			2382	25	04141	04020	0335
	08210	TF AMTB-1,AMTBET,,	TRANSMIT AMOUNT BET TO TYPEOUT AREA		2394	26	04162	04019	0337
	8220	CF AMTB-2			2406	33	04161	00000	0339
	9010	WATYYOUW,,,	TYPEOUT YOU WIN		2418	39	03971	00100	0341
	9020	WNTYAMTB-2,,,	TYPEOUT AMOUNT BET		2430	38	04161	00100	0343
	9021CLCODRS	DTOTAL-1,DTOTAL-1			2442	22	04132	04132	0345
	9022	S CTOTAL-1,CTOTAL-1			2454	22	04138	04138	0347
	9023	S ROLCOU,ROLCOU			2466	22	04135	04135	0349
	9030	RCTY			2478	34	00000	00102	0351
	9040	H TDMT0			2490	49	02694	00000	0353
	09050C4	A MW2-1,AMTBET,,	ADD AMOUNT BET TO MACHINE TOTAL		2502	21	04158	04019	0355
	9060	WATYCRAPS,,,	TYPEOUT CRAPS		2514	39	03253	00100	0357
	9061	B CLCODR			2526	49	02442	00000	0359
	9080C5	WATYPOINT,,,	TYPEOUT THIS IS YOUR POINT		2538	39	03831	00100	0361
	9090	BD C6,DTOTAL-2			2550	43	02588	04131	0363
	09110	WNTYDTOTAL-1,,,	TYPEOUT POINT ROLLED ONE DIGIT NUMBER		2562	38	04132	00100	0365
	9120	H TDMT0			2574	49	02694	00000	0367
	9130C6	CF DTOTAL-2,,,	CLEAR FLAG		2586	33	04131	00000	0369
	09131	WNTYDTOTAL-2,,,	TYPEOUT POINT ROLLED TWO DIGIT NUMBER		2598	38	04131	00100	0371
	9132	RCTY			2610	34	00000	00102	0373

also

MIDRND - WHAT BUSINESS FORMS, INC. - K.C. MO. 8

FORM 1313 12.27/58 "X 11" - 3 LINES PER INCH

2

1

10

9

8

7

6

5

4

3

2

1

	9141	RCTY			2634	34	00000	00102	0377	
	*9150C7	C	TOTAL-1,DTOTAL-1,,	SECOND ROLL EQUAL FIRST ROLL	2646	24	04138	04132	0379	
	9160	RE	C3		2658	46	02322	01200	0381	
	9170	CM	DTOTAL-1,7,9,	EQUAL SEVEN, MACHINE WINS	2670	14	04132	00007	0383	
	9180	RE	C4		2682	46	02502	01200	0385	
	09190	DTMIG	AM	BOB+11,1,,	DECIDE ON NEXT NUMBER FOR DICE ONE	2694	11	01517	00001	0387
	09200	AM	BILL+11,2,,	DECIDE ON NEXT NUMBER FOR DICE TWO	2706	11	01529	00002	0389	
	10010	C	BOB+11,BETTY,,	BRANCHED PAST DICE AREA ONE YES OR NO	2718	24	01517	04012	0391	
	10020	BH	SUBBOB		2730	46	02778	01100	0393	
	10030	COBILL	BILL+11,BETTY+5,,	BRANCHED PAST DICE AREA TWO YES OR NO	2742	24	01529	04017	0395	
	10040	BH	SUBBILL		2754	46	02802	01100	0397	
	10050	B	ATT		2766	49	02814	00000	0399	
	10060	SUBBOBSM	BOB+11,37		2778	12	01517	00037	0401	
	10070	B	COBILL		2790	49	02742	00000	0403	
	10080	SUBBILLSM	BILL+11,35		2802	12	01529	00035	0405	
	10090	ATT	S	AMTBT,AMTBT	2814	22	04019	04019	0407	
	10091	S	DTOTAL-1,DTOTAL-1		2826	22	04132	04132	0409	
	10100	B	A1		2838	49	00858	00000	0411	
	11010	STA1	DAC	49,WELCOME TO THE PALACE ROOM, WE FEATURE ALL TYPES@	2851		00049		0413	
	1101006455343565445006356006348450057415341434500595656Z						060285002900			
	11010054230066450046454163645945004153530063685745620Z						060290002948			
	11020	STA2	DAC	45,OF GAMING DEVICES. AT THIS TABLE WE USE THE@	2949		00045		0417	
	1102006460047415449554700444565494345620300004163006348Z						060294802998			
	11020496200634142534500664500646245006348450Z						060299803038			
	11030	STA3	DAC	47,WORLD FAMOUS GREEN DICE FROM WASHINGTON STATE.@	3039		00047		0421	
	1103006565953440046415456546200475945455500444943450046Z						060303803088			
	110305956540066416248495547635655006263416345030Z						060308803132			
	11050	STA5	DAC	48,TO CHANGE PLAYERS TURN CONSOLE SWITCHES OFF AND@	3133		00048		0425	
	1105003560043484155474500575341684559620063645955004356Z						060313203182			
	11050556256534500626649634348456200564646004155440Z						060318203228			
	11060	START	DAC	12,PUSH START.@	3229		00012		0429	
	11060N7646248006263415963030Z						060322803252			
	11070	CRAPS	DAC	7,CRAPS.@	3253		00007		0432	
	11070M359415762030Z						060325203266			
	11080	STA6	DAC	40,TO PLAY FOR NICKLES, TURN ON SWITCH 1.@	3267		00040		0435	
	1108003560057534168004656590055494352534562230000636459Z						060326603316			
	1108055005655006266496343480071030Z						060331603346			
	11090	STA7	DAC	40,TO PLAY FOR DIMES, TURN ON SWITCH 2.@	3347		00040		0439	
	110900356005753416800465659004449544562230000000636459Z						060334603396			
	1109055005655006266496343480072030Z						060339603426			
	11100	STA8	DAC	40,TO PLAY FOR QUARTERS, TURN ON SWITCH 3.@	3427		00040		0443	
	1110003560057534168004656590058644159634559622300636459Z						060342603476			
	1110055005655006266496343480073030Z						060347603506			
	11110	STA9	DAC	40,TO PLAY FOR HALVES, TURN ON SWITCH 4.@	3507		00040		0447	
	1111003560057534168004656590048415365456223000000636459Z						060350603556			
	1111055005655006266496343480074030Z						060355603586			
	11120	EVEN	DAC	29,AT THE MOMENT, YOU ARE EVEN.@	3587		00029		0451	
	11120M.630063484500545654455563230068566400415945004565Z						060358603636			
	111204555030Z						060363603644			
	11130	RODICE	DAC	25,TO ROLL DICE PUSH START.@	3645		00025		0455	
	111300356005956535300444943450057645248005263415963030Z						060364403694			
	11150	TYPEN	DAC	41,TYPE YOUR TWO, ONE DIGIT LUCKY NUMBERS, @	3695		00041		0458	
	1115003685745006856645900636656230056554500444947496300Z						060369403744			
	11150536443526800536454245596223000Z						060374403776			
	11160	WEMAC	DAC	14,YOU LOST \$ @	3777		00014		0462	
	111600856640053566263000130000Z						060377603804			
	11170	YOUWIND	DAC	13,YOU WIN \$ @	3805		00013		0465	
	11170085664006649550000130000Z						060380403830			
	11180	POINT	DAC	23,THIS IS YOUR POINT @	3831		00023		0468	
	1118003484962049620068566459005756495563000000000Z						060383003876			
	11190	TYPEN	DAC	27,THEN HIT RELEASE + START. @	3877		00027		0471	
	1119003484555004849630059455345416245001000626341596303Z						060387603926			

6150  
MISSED - WEDGE BUSINESS PAPER, INC., INC. DIV. 4

FORM 1313 12 27/58  
3 LINES PER INCH

12  
11  
10  
9  
8  
7  
6  
5  
4  
3  
2  
1

	11200NUMB INDC 3,012, 11200012Z	060393003933	3932	00003	0475
	11210BETS DAC 18,PLACE YOUR BETS, 11210N75341434500068566459004245636223000Z	060393403970	3935	00018	0478
	11220YOUW DAC 14,YOU WIN 5 11220085664006649550000130000030Z	060397003998	3971	00014	0481
	12010CADD DC 5,10 1201000010Z	060399804003	4002	00005	0484
	12020CADD1 DC 5,10 1202000010Z	060400304008	4007	00005	0487
	12021BETTY DSA CUBE1,CUBE2 12040AMTHETDC 2,0	060401804020	4012 4019	00005 00002	04025 0490 0493
	1204000Z 12050MW DC 6,00000@	060402004026	4025	00006	0496
	120500000Z 12060CUBE1 DC 50,1234562143653516424625315361246452136542	060402604076	4075	00050	0499
	12070CUBE2 DC 50,6543215432164321653216542165431654323456	060407604126	4125	00050	0502
	120700000000006543215432164321653216542165431654323456Z				
	12100D.1 DS ,CUBE1-49, 12110D.2 DS ,CUBE2-49, 12120DICE1 DC 2,0		4026 4076 4127	00000 00000 00002	0505 0507 0509
	1212000Z 12130DICE2 DC 2,0	060412604128	4129	00002	0512
	1213000Z 12140DTOTALDC 4,000@	060412804130	4133	00004	0515
	1214000Z 12150ROLCOU DC 2,0	060413004134	4135	00002	0518
	1215000Z 12160CTOTALDC 4,000@	060413404136	4139	00004	0521
	1216000Z 12170MW1 DAC 7,000,00@	060413604140	4141	00007	0524
	12170P070700370700Z 12200MW2 DC 6,00000@	060414004154	4159	00006	0527
	122000000Z 12210AMTH DC 4,000@	060415404160	4163	00004	0530
	1221000Z 12220MW3 DAC 7,000,00@	060416004164	4165	00007	0533
	12220P070700370700Z 12230ROBERTDC 2,0	060416404178	4179	00002	0536
	1223000Z 13010N1 DC 12,00001200000@	060417804180	4191	00012	0539
	130100001200000Z 13020N2 DC 20,000012000000000120@	060418004192	4211	00020	0542
	1302000012000000000120Z 13030N3 DC 24,00001200000012000000120@	060419204212	4235	00024	0545
	13030000120000001200000120Z 13040N4 DC 24,12001200000000001200120@	060421204236	4259	00024	0548
	13040J200120000000001200120Z 13050N5 DC 20,1200120012001200120@	060423604260	4279	00020	0551
	13050J200120012001200120Z 13060N6 DC 24,12001200120012001200120@	060426004280	4303	00024	0554
	13060J2001200120012001200120Z 13070N01 DSS 12,N1-11	060428004304	4180	00012	0557
	13080N02 DSS 20,N2-19		4192	00020	0559
	13090N03 DSS 24,N3-23		4212	00024	0561
	13100N04 DSS 24,N4-23		4236	00024	0563
	13110N05 DSS 20,N5-19		4260	00020	0565
	13120N06 DSS 24,N6-23		4280	00024	0567
	13130 DENDSTART		402		0569
	13130 L6000000500490000Z 360010000500360017200500360024400500360031600500360000000500	080009600115			

619

INTREP - MORE BUSINESS FORMS, INC. (R)

FORM 313 12 27/82 X 11 1/2 3 LINES PER INCH

102030400020406880003060902100408021610050015102006021814200Z  
704112820080614223009081726300000000050607080900121418151811242720242Z  
822363520353045403632484455324946536348465462754453620123456789123456Z  
7890234567890J34567890JK4567890JKL567890JKLM67890JKLMN7890JKLMNO890JKLMNZ  
M80000000000490040Z0P9CJKLMN0PQZ L1003880019M90000000000M90003600000

610

UNITED STATES GOVERNMENT

FORM 313 2 27/58 X 11 3 LINES PER INCH

1  
2  
3  
4  
5  
6  
7  
8  
9  
0  
-  
-

APPENDIX III

ROBERT FAHN ESTOCK

407 MACHINE LISTING  
COMPRESSE D DECK  
MACHINE LANGUAGE

36	00072	00500	36	00201	00500	44	00012	00276	26	00059	00274	25	00011	00000	
5	00095	00264	31	00000	00200	26	00114	00274	25	00000	00011	49	00012	00000	1
34	00000	00102	39	02851	00100	34	00000	00102	39	02949	00100	34	00000	00102	2
39	03039	00100	34	00000	00102	34	00000	00102	39	03133	00100	34	00000	00102	3
39	03229	00100	34	00000	00102	34	00000	00102	39	03695	00100	34	00000	00102	4
39	03877	00100	34	00000	00102	34	00000	00102	36	03931	00100	34	00000	00102	5
25	04002	03932	25	04007	03931	21	01517	04002	21	01529	04007	34	00000	00102	6
34	00000	00102	39	03267	00100	34	00000	00102	39	03347	00100	34	00000	00102	7
39	03427	00100	34	00000	00102	39	03507	00100	34	00000	00102	39	03935	00100	8
34	00000	00102	39	03645	00100	34	00000	00102	48	00000	00000	46	01386	00100	9
46	01386	00200	46	01386	00300	46	01386	00400	22	04024	04158	34	00000	00102	10
34	00000	00102	14	04024	00000	46	01362	01200	44	01338	04024	39	03777	00100	11
33	04024	00000	25	04151	04024	25	04149	04023	25	04145	04022	25	04143	04021	12
25	04141	04020	33	04140	00000	43	01134	04141	43	01158	04143	43	01182	04145	13
49	01206	00000	39	04141	00100	49	01218	00000	39	04143	00100	49	01218	00000	14
39	04145	00100	49	01218	00000	39	04147	00100	32	04140	00000	34	00000	00102	15
34	00000	00102	22	04024	04024	22	04135	04135	22	04158	04158	22	04019	04019	16
22	04162	04162	26	04151	04175	49	00690	00000	39	03805	00100	49	01002	00000	17
39	03587	00100	49	01218	00000	47	01410	00100	11	04179	00005	47	01434	00200	18
11	04179	00000	47	01458	00300	11	04179	00005	47	01482	00400	11	04179	00000	19
26	04019	04179	22	04179	04179	25	04127	04026	25	04129	04076	26	04132	04127	20
21	04132	04129	11	04135	00001	14	04135	00001	47	01602	01200	26	04138	04132	21
34	00000	00102	34	00000	00102	14	04127	00001	47	01674	01200	39	04181	00100	22
49	01878	00000	14	04127	00002	47	01722	01200	39	04193	00100	49	01878	00000	23
14	04127	00003	47	01770	01200	39	04213	00100	49	01878	00000	14	04127	00004	24
47	01818	01200	39	04237	00100	49	01878	00000	14	04127	00005	47	01866	01200	25
39	04261	00100	49	01878	00000	39	04281	00100	34	00000	00102	14	04129	00001	26
47	01938	01200	39	04181	00100	49	02142	00000	14	04129	00002	47	01986	01200	27
39	02033	00100	49	02142	00000	34	04129	00003	47	02034	01200	39	04213	00100	28
49	02142	00000	14	04129	00004	47	02082	01200	39	04237	00100	49	02142	00000	29

FORM 1313 12-27-58 X 11 3 LINES PER INCH

MILITARY - REPORT BUSINESS FORMS, INC., INC. DIV. 4

6159  
MULTIPLY - MORE BUSINESS FOR THE INC. - MC DIV. 4  
FORM 313 12 27/68 X 11" - 3 LINES PER INCH

14	04129	00005	47	02130	01200	39	04261	00100	49	02142	00000	39	04281	00100	30
34	000	00101	34	00000	00101	14	04135	00001	47	02646	01000	14	04132	00007	31
46	02322	01200	14	04132	00011	46	02322	01200	14	04132	00002	46	02502	01200	32
14	04132	00003	46	02502	01200	14	04132	00012	46	02502	01200	49	02538	00000	33
1	04024	04019	25	04151	04024	25	04149	04023	25	04145	04022	25	04143	04021	34
25	04141	04020	26	04162	04019	33	04161	00000	39	03971	00100	38	04161	00100	35
22	04132	04132	22	04138	04138	22	04135	04135	34	00000	00102	49	02694	00000	36
21	04158	04019	39	03253	00100	49	02442	00000	39	03831	00100	43	02586	04131	37
38	04132	00100	49	02694	00000	33	04131	00000	38	04131	00100	34	00000	00102	38
49	02694	00000	34	00000	00102	24	04138	04132	46	02322	01200	14	04132	00007	39
46	02502	01200	11	01517	00001	11	01529	00002	24	01517	04012	46	02778	01100	40
24	01529	04017	46	02802	01100	49	02814	00000	12	01517	00037	49	02742	00000	41
12	01529	00033	22	04019	04019	22	04132	04132	49	00858	00000	Z			42
06	45534	35654	45	00635	60063	48	45005	74153	41	43450	05956	56	Z		43
54	23006	64500	46	45416	36459	45	00415	35300	63	68574	56202				44
N6	46004	74154	49	55470	04445	65	49434	56203	00	00416	30063	48	Z		45
49	62006	34142	53	45006	64500	64	62450	06348	45	02					46
06	56595	34400	46	41545	66462	00	47594	54555	00	44494	34500	46	Z		47
59	56540	06641	62	48495	54763	56	55006	26341	63	45030	Z				48
03	56004	34841	55	47450	05753	41	68455	96200	63	64595	50043	56	Z		49
55	62565	34500	62	66496	34348	45	62005	64646	00	41554	40Z				50
N7	64624	80062	63	41596	3030Z										51
M3	59415	76203	0Z												52
03	56005	75341	68	00465	65900	55	49435	25345	62	23000	06364	59	Z		53
55	00565	50062	66	49634	34800	71	030Z								54
03	56005	75341	68	00465	65900	44	49544	56223	00	00000	06364	59	Z		55
55	00565	50062	66	49634	34800	72	030Z								56
03	56005	75341	68	00465	65900	58	64415	96345	59	62230	06364	59	Z		57
55	00565	50062	66	49634	34800	73	030Z								58
03	56005	75341	68	00465	65900	48	41536	54562	23	00000	06364	59	Z		59
55	00565	50062	66	49634	34800	74	030Z								60
MI	63006	34843	00	54565	44555	63	23006	85664	00	41594	50045	65	45550	30Z	61
03	56005	95653	53	00444	94345	00	57645	24800	62	63415	96303	0Z			62



03 68574 50068 56 64590 06366 56 23005 65545 00 44494 74963 00 Z	63
53 64435 26800 55 64544 24559 62 23000 Z	64
08 56640 05356 62 63000 01300 00 0Z	65
08 56640 06649 55 00001 30000 0Z	66
3 48496 20049 62 00685 66459 00 57564 95563 00 00000 00Z	67
03 48455 50048 49 63005 94553 45 41624 50010 00 62634 15963 03 000Z	68
I 2Z	69
N7 53414 34500 68 56645 90042 45 63622 3000Z	70
08 56640 06649 55 00001 30000 03 0Z	71
1000 010Z	72
4 07504 125Z	73
Z	74
12 34 56214 36535 16 42462 53153 61 24645 21365 42 Z	75
65 43 21543 21643 21 65321 65421 65 43165 43234 56 00000 00Z	76
Z	77
PO 70700 37070 0Z	78
Z	79
Z	80
PO 70700 37070 0Z	81
I 20000 0Z	82
120 00000 00 00120 Z	83
120 00000 12 00000 0120Z	84
J2 00120 00000 00 00120 0120Z	85
J2 00120 01200 12 00120 Z	86
J2 00120 01200 12 00120 0120Z	87
L6000 00 00500 49000 00 Z	88
36 00100 00500 36 00172 00500 36 00244 00500 36 00316 00500 36 00000 00500	89
10 20304 00020 40 60800 03060 90 21004 08021 61 00500 1510Z	90
70 41128 20080 61 42230 09081 72 63000 00000 00 50607 08090 01 21416 18151	91
82 23635 20353 04 54036 32484 45 53249 46536 04 84654 62754 45 36271 80123	92
78 90234 56789 0J 34567 890JK 45 67890 JKL56 78 90JKL M6789 0J KLMN7 890JK	93
M8 00 00000 49 00402 0P90J KL MNOPQ Z LI 00388 000 M9 00000 00000	94

FORM 1313 11-27-60 11" x 11" 3 LINES PER INCH

APPENDIX IV

LABEL TABLE LISTING

FORM 813  
 260000800009 260000800009S  
 SPS PROCESSOR FOR 1620/1710 CARD I/O SYSTEM, DATED 1/1/1962

END OF PASS I

END OF PASS II

00402	START	00618	RECNO	00690	RULES	00058	A1	01002
TDDAL								
01134	D1	01158	D2	01182	D3	01206	D4	01210
*RULES1								
01330	E	01362	E1	01386	A2	01410	B1	01434
32								
01450	D3	01482	D4	01506	BOB	01518	BILL	01602
RAY								
01070	C1	02142	C2	02322	C3	02442	*CLCDDR	02502
C4								
02530	C5	02586	C6	02646	C7	02694	TDMTQ	02742
*COBILL								
02770	*SUBBOR	02802	*SUBILL	02814	ATT	02851	STA1	02949
STA2								
03030	STA3	03133	STA5	03229	*PSTART	03253	CRAPS	03267
STA6								
03347	STA7	03427	STA8	03507	STA9	03507	EVEN	03645
*RODICE								
03095	*TYPENU	03777	*QWENAC	03805	*YOUWIN	03831	POINT	03877
TYPEN								
03932	*HUMBIN	03935	BETS	03971	YOUV	04002	ADD	04007
ADD1								
04012	BETTY	04019	*ANTBET	04025	NW	04075	CUBE1	04125
CUBE2								
04026	DA1	04076	DA2	04127	DICE1	04129	DICE2	04133
*DTOTAL								
04135	*RGLCOU	04139	*CTOTAL	04141	NW1	04159	NW2	04163
ANTB								
04165	NW3	04179	*ROBERT	04191	N1	04211	N2	04235
N3								
04250	N4	04279	N5	04303	N6	04180	N01	04192
N02								
04212	N03	04236	N04	04260	N05	04280	N06	

260000100002RS

Continuous Interleafed @ Moore Business Forms, Inc. e

260000800009RS

WELCOME TO THE PALACE ROOM, WE FEATURE ALL TYPES OF GAMING DEVICES. AT THIS TABLE WE USE THE WORLD FAMOUS GREEN DICE FROM WASHINGTON STATE.

APPENDIX V  
SAMPLE GAME  
TYPE OUT

TO CHANGE PLAYERS TURN CONSOLE SWITCHES OFF AND PUSH START.

TYPE YOUR TWO, ONE DIGIT LUCKY NUMBERS, THEN HIT RELEASE + START.

21

TO PLAY FOR NICKLES, TURN ON SWITCH 1.  
TO PLAY FOR DIMES, TURN ON SWITCH 2.  
TO PLAY FOR QUARTERS, TURN ON SWITCH 3.  
TO PLAY FOR HALVES, TURN ON SWITCH 4.  
PLACE YOUR BETS,  
TO ROLL DICE PUSH START.

⌘ ⌘      ⌘  
⌘ ⌘      ⌘ ⌘ THIS IS YOUR POINT      6

⌘ ⌘ ⌘  
⌘      ⌘

⌘ ⌘      ⌘ ⌘  
⌘ ⌘ ⌘ ⌘ ⌘

⌘ ⌘ ⌘ ⌘ ⌘  
⌘      ⌘ ⌘

⌘ ⌘ ⌘ ⌘ ⌘ ⌘  
⌘      CRAPS.

⌘      ⌘  
⌘ ⌘      ⌘ ⌘ THIS IS YOUR POINT      6

⌘  
⌘      ⌘

⌘ ⌘      ⌘ ⌘  
⌘ ⌘ ⌘ ⌘ ⌘ ⌘

⌘      ⌘ ⌘  
⌘      ⌘ ⌘ YOU WIN \$ .90

⌘ ⌘ ⌘ ⌘ ⌘ ⌘  
⌘      YOU WIN \$ .90

YOU WIN \$ .90

TO PLAY FOR NICKLES, TURN ON SWITCH 1.  
TO PLAY FOR DIMES, TURN ON SWITCH 2.  
TO PLAY FOR QUARTERS, TURN ON SWITCH 3.  
TO PLAY FOR HALVES, TURN ON SWITCH 4.  
PLACE YOUR BETS,

Continuus Interbay<sup>nd</sup> @ Moore Business Forms, Inc. e

FORM 013

TO ROLL DICE PUSH START.

511 11101

XXXXXXXXX  
XXXXXXXXX THIS IS YOUR POINT 10

XXX  
XX

XXXXXXXXX  
XXXXXXXXX

X  
XX XX

XXXXXXXXX  
X CRAPS.

Business Forms, Inc. ©

XXXXXX  
XXXXXXXXX THIS IS YOUR POINT 9

XX  
XX X

XXXXXX  
XX X CRAPS.

Continuous Inver

YOU LOST \$ 1.50

TO PLAY FOR NICKLES, TURN ON SWITCH 1.  
TO PLAY FOR DIMES, TURN ON SWITCH 2.  
TO PLAY FOR QUARTERS, TURN ON SWITCH 3.  
TO PLAY FOR HALVES, TURN ON SWITCH 4.  
PLACE YOUR BETS,  
TO ROLL DICE PUSH START.

XXXXXXXXX  
XXXXXXXXX YOU WIN \$ .50

XX  
X CRAPS.

AT THE MOMENT, YOU ARE EVEN.

TO PLAY FOR NICKLES, TURN ON SWITCH 1.  
TO PLAY FOR DIMES, TURN ON SWITCH 2.  
TO PLAY FOR QUARTERS, TURN ON SWITCH 3.  
TO PLAY FOR HALVES, TURN ON SWITCH 4.  
PLACE YOUR BETS,  
TO ROLL DICE PUSH START.

XXXXXXXXX  
XXXXX THIS IS YOUR POINT 9

Ж Ж Ж  
Ж Ж

Ж  
Ж Ж Ж Ж Ж Ж CRAPS.

Ж Ж Ж Ж Ж  
Ж Ж Ж THIS IS YOUR POINT 8

Ж Ж Ж  
Ж

Ж Ж Ж Ж Ж Ж  
Ж Ж Ж Ж Ж

Ж  
Ж Ж

Ж Ж Ж Ж Ж Ж  
Ж Ж Ж Ж Ж YOU WIN \$ .15

Ж Ж Ж Ж Ж  
Ж Ж Ж Ж Ж THIS IS YOUR POINT 8

Ж Ж Ж Ж Ж Ж  
Ж CRAPS.

Ж Ж Ж Ж Ж Ж  
Ж Ж Ж Ж Ж THIS IS YOUR POINT 9

Ж Ж Ж Ж Ж  
Ж Ж Ж

Ж Ж Ж Ж Ж Ж  
Ж Ж Ж Ж Ж

Ж  
Ж Ж Ж Ж

Ж Ж Ж  
Ж Ж

Ж Ж Ж Ж Ж Ж  
Ж Ж Ж Ж Ж

Ж Ж Ж Ж Ж  
Ж Ж Ж Ж Ж Ж

Ж Ж Ж Ж Ж Ж  
Ж Ж Ж Ж Ж YOU WIN \$ .05

AT THE MOMENT, YOU ARE EVEN.

TO PLAY FOR NICKLES, TURN ON SWITCH 1.  
TO PLAY FOR DIMES, TURN ON SWITCH 2.  
TO PLAY FOR QUARTERS, TURN ON SWITCH 3.  
TO PLAY FOR HALVES, TURN ON SWITCH 4.  
PLACE YOUR BETS,  
TO ROLL DICE PUSH START.

26

re Business Forms, Inc. e

Continuous Interle.

