

The IBM logo, consisting of the letters "IBM" in a bold, sans-serif font, is positioned inside a solid black square.

Systems Reference Library

**IBM System/360 Component Descriptions—
2841 Storage Control Unit
2302 Disk Storage, Models 3 and 4
2311 Disk Storage Drive
2321 Data Cell Drive, Model 1
7320 Drum Storage**

This publication contains reference information for the operation and programming of storage devices which attach to the IBM 2841 Storage Control Unit. These storage devices include the IBM 2311 Disk Storage Drive, the IBM 2302 Disk Storage, Models 3 and 4, the IBM 2321 Data Cell Drive, Model 1, and the IBM 7320 Drum Storage.



This publication (Form A26-5988-0) incorporates information from the following publications, which are made obsolete by this publication.

IBM 2841 Storage Control Unit (Form A24-3254)
IBM 2311 Disk Storage Drive (Form A26-5860)
IBM 2321 Data Cell Drive (Form A26-5851)
IBM 2302 Disk Storage Models 3 and 4 (Form A26-5861)

Copies of this and other IBM publications can be obtained through IBM Branch Offices. A form has been provided at the back of this publication for readers' comments. If the form has been detached, comments may be directed to :
IBM, Product Publications Department, San Jose, Calif. 95114

CONTENTS

	Page		Page
IBM 2841 STORAGE CONTROL UNIT	1	Record Overflow	27
Introduction	1	IBM 2311 DISK STORAGE	29
IBM 2841 Functions	1	Introduction	29
Data Character Format	1	Device Description	29
Data Characters	1	Data Storage	31
Data Checking	1	Operator Controls and Indicators	31
Data Character Transfer	2	Operating Procedures	32
Track Format	2	IBM 2302 DISK STORAGE, MODELS 3 AND 4	34
Index Marker	2	Introduction	34
Gaps	2	Device Description	34
Home Address	3	Data Storage	36
Track Descriptor Record (R0)	3	Indicators	36
Data Records (R ₁ - R _n)	5	IBM 2321 DATA CELL DRIVE	37
INPUT/OUTPUT OPERATIONS	7	Introduction	37
Instructions	7	Device Description	37
Start I/O	8	Data Storage	38
Halt I/O	8	Operator Controls and Indicators	39
Test I/O	8	Operating Procedures	40
Test Channel	8	IBM 7320 DRUM STORAGE	41
Channel Operations	9	Introduction	41
Channel Status Word	9	Device Description	41
Channel Address Word	11	Data Storage	41
Channel Command Word	11	APPENDIX A. 2841/2311 PROGRAMMING EXAMPLE	43
Program Status Word	12	APPENDIX B. HEXADECIMAL-DECIMAL CONVERSION	46
Channel Program Branching	12	APPENDIX C. COMMAND SUMMARY	51
Control Commands	12	APPENDIX D. TRACK ORIENTATION	52
Search Commands	17		
Search Identifier	18		
Read Commands	20		
Write Commands	22		
End-of-File	27		
Multiple Track Operation	27		
Two-Channel Switch	27		

INTRODUCTION

The IBM 2841 Storage Control Unit provides for the attachment of direct access storage devices to IBM System/360. These storage devices are:

- IBM 2311 Disk Storage Drive (standard feature)
- IBM 2302 Disk Storage, Models 3 and 4 (special feature)
- IBM 2321 Data Cell Drive (special feature)
- IBM 7320 Drum Storage (special feature)

A single 2841 Storage Control Unit provides for the attachment of any combination of the above storage devices up to a maximum of eight access mechanisms. With the 2841 Additional Storage special feature, up to eight access mechanisms may be added, bringing the total available access mechanisms to sixteen.

A versatile set of instructions ensures optimum data processing efficiency. Direct access to vast quantities of operating information enables the user to locate specific data records without sequential address searching. Voluminous master record files can be stored on-line, ready for immediate reference or updating.

Maintenance of master record files can be immediate and direct; the most current information can be entered into the proper area of the master record file as transactions occur. Complex accounting procedures can be simplified, because intermediate manual operations, necessary to maintain off-line record files, are eliminated.

IBM 2841 Functions

The 2841 performs the following functions:

- Interprets and executes commands from the channel attached to the central processing unit (CPU).
- Provides a path for data between the CPU and attached storage devices.
- Translates data appropriately as it is transferred between the storage devices and the CPU.
- Furnishes operation status information to the CPU.
- Performs checks to ensure accurate transfer of data.

DATA CHARACTER FORMAT

Data Characters

The basic unit of data within all components of the IBM System/360 is called a byte. A byte is eight bits in length. A single byte can represent one alphameric character, one 8-bit binary number, or two decimal digits. The eight bits of each byte can be arranged in any of 256 combinations.

Decimal Values of Byte Positions

128	64	32	16	8	4	2	1
0	1	2	3	4	5	6	7

A Byte Containing the Number 19

0	0	0	1	0	0	1	1
0	1	2	3	4	5	6	7

11250

A group of related bytes is called a field. A series of related fields is called a record. A series of similar records is known as a logical file. The length and organization of records and logical files is versatile and is based on the needs of the data processing application.

	First Record			Second Record	
Field Name:	Social Security Number	Name	Address	Social Security Number	Name
Bytes Required:	5*	30	30	5*	30

*Two Digits per Byte

Records and Fields within a File

11251

Data Checking

CPU (Central Processing Unit) — Parity

To ensure data accuracy, a parity bit is associated with each byte within the CPU. When the byte is formed, the parity bit is set to "zero" or "one" to maintain an odd number of "one"-bits within the byte. This is called odd parity.

Whenever data is accessed by the CPU, its parity is checked.

Storage Units — Cyclic Check

In 2841 controlled storage devices, data is stored and retrieved in Areas, which contain one or more fields. Storage capacity can be more efficiently used by associating check bits with each area, rather than with each byte.

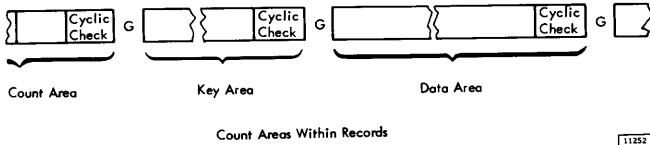

As data is transferred from the CPU to an attached storage device, the 2841 removes the parity bit from each byte. The 2841 then computes two Cyclic Check (cc) bytes which are added to the end of each Data Area. The two Cyclic Check bytes are arithmetically coded to represent the data in the associated area.

The Cyclic Check code detects the following types of errors:

1. All errors occurring within a 16-bit span.
2. All errors involving an odd number of bits over any span.
3. Errors involving an even number of bits over a span greater than 16-bits, except in certain cases.

During a transfer from a storage device, all areas read are inspected by the 2841. Cyclic Check bytes are recalculated for each area and compared with those retrieved from storage. An unequal comparison will set Data Check Error indicators.

As the 2841 transmits data to the CPU, Cyclic Check bytes are removed and parity bits are restored as needed to maintain odd parity.

Data Character Transfer

Information is transmitted between the CPU and 2841 Storage Control Unit one byte at a time. A ninth bit, the odd parity or check bit, is added as needed and is associated with each byte. Thus, nine bits are transferred simultaneously (in parallel) between these two units. This transfer method is called parallel-by-bit.

Information is transferred between attached storage devices and the 2841 one bit at a time (in serial). This transfer method is called serial-by-bit.

The 2841 converts data from serial-by-bit to parallel-by-bit or from parallel-by-bit to serial-by-bit to provide data movement between the CPU and the attached storage devices.

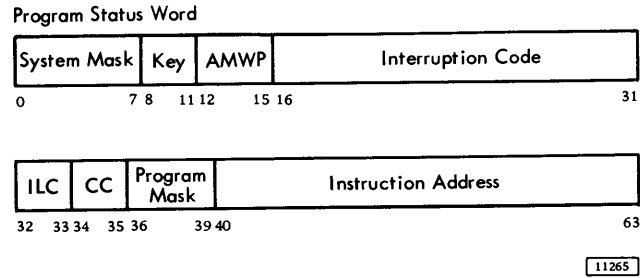

TRACK FORMAT

All direct access storage units associated with the 2841 use the same track format:

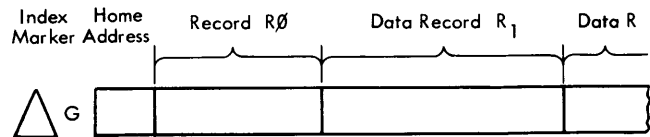

Track Format

11255

Index Marker

The Index Marker indicates the physical beginning of each track. There is one index marker per recording medium (disk pack, drum, strip). All tracks on a device are synchronized by the same index marker. No index indication appears on individual records.

Gaps (G)

Gaps (G) separate record areas on recording tracks. Gap lengths will vary depending on storage device, location within the record and the record length.

Home Address

The Home Address consists of seven bytes which define track condition and physical location within the storage device. There is one Home Address per track. Home Addresses are transferred from the CPU to the storage device only by a Write Home Address operation, and from the storage device to the CPU only by a Read Home Address operation. Writing Home Addresses is usually accomplished by utility programs.

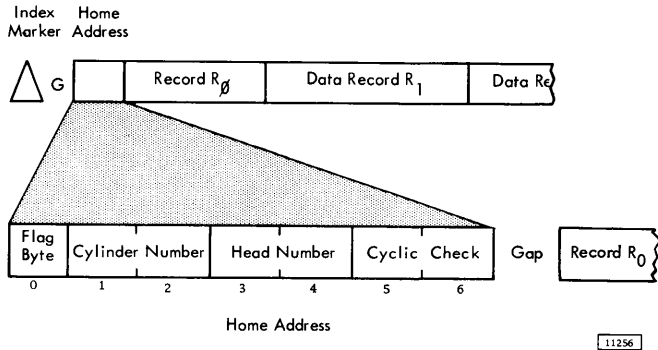

Flag

A flag (1 byte) indicates track condition. It is normally all zero bits when Home Addresses are first written. Bit significance is:

Bit	Function
0	Zero
1	Zero
2	Zero
3	Zero
4	Zero
5	Zero
6	Track Condition 0 indicates operative track 1 indicates defective track
7	Track Use 0 indicates primary track 1 indicates alternate track

Cylinder Number

The cylinder number (2 bytes) identifies the storage unit cylinder within which the data is stored.

Read/Write Head Number

The read/write head number (2 bytes) identifies a read/write head within the selected cylinder.

The combination of cylinder and read/write head numbers is used to locate a specific track.

A more detailed discussion of addressing schemes will be found in the descriptions of the various storage units.

Cyclic Check

A Cyclic Check is used for error detection as described in the section on Data Checking. Two bytes are required for this check.

Gap

This is a fixed gap generated by the 2841 to separate the Home Address from the next recorded area.

Track Descriptor Record (R0)

The first record following the home address on each data track is the Track Descriptor Record (Figure 1), or R0. Although it may be used to store data, R0 has been designed to enable entire tracks to be moved to alternate tracks if a portion of the recording surface becomes defective. This repositioning is independent of the file organization scheme in use.

Count Area

This 11-byte area describes the Data Area and Key Area which follow.

Flag. Byte 0 of the Count Area is generated by the 2841 as R0 is written. It is not sent from the CPU.

Bit	Function or Setting
0	Zero
1	Zero
2	Zero
3	Zero
4	Zero
5	Zero
6	Track Condition 0 indicates operative track 1 indicates defective track
7	Track Use 0 indicates primary track 1 indicates alternate track

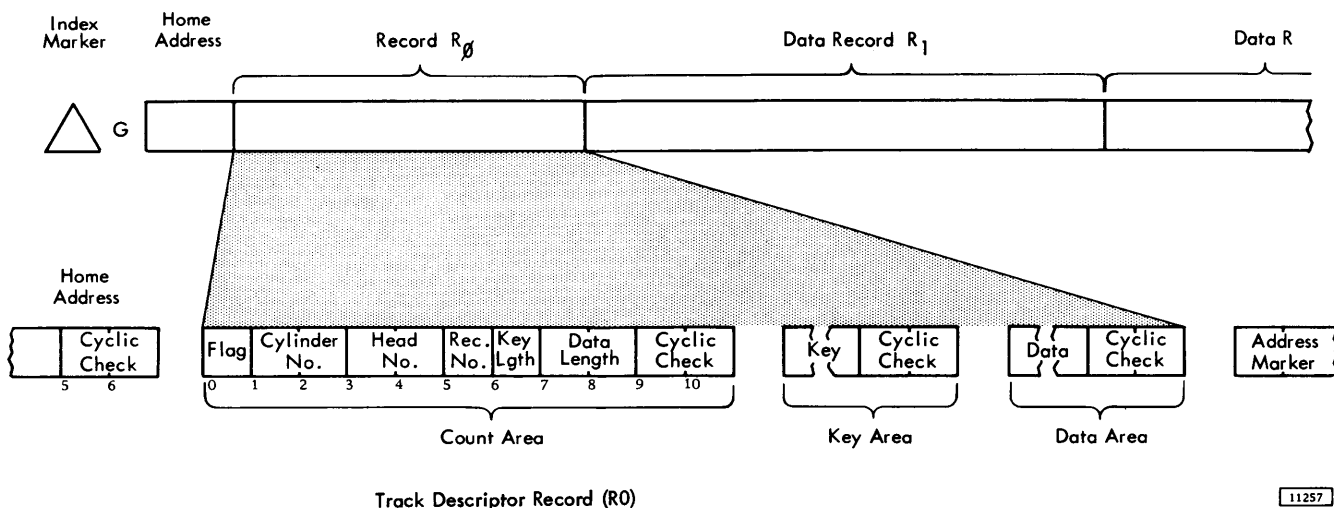

Figure 1. Track Descriptor Record

Bits 6 and 7 are transmitted to the flag bytes of all records on the track from the flag byte of the home address of that track.

Cylinder Number. Bytes 1 and 2 of R0 contain the cylinder number of the primary track on which this record was stored. If this record has been moved to an alternate track (because of track condition), the cylinder number of the primary track remains; and the cylinder number of the alternate track appears in Record 0 of the defective primary track.

Read/Write Head Number. In a primary track, bytes 3 and 4 always contain the read/write head number of the primary track on which this record was stored. If this record has been moved to an alternate track (because of track condition), the head number of the primary track remains. The head number of the alternate track appears in Record 0 of the defective primary track.

Record Number. Byte 5 designates the sequential number of the record on the track. For R0, the record number is zero.

Key Length. Byte 6 specifies the number of bytes in the Key Area of the record (excluding check bytes). If the record has no key, this byte is zero. This byte can indicate a Key Length from 0 to 255 bytes. Because of its intended special use with alternate track procedures, R0 will normally have no Key Area.

Data Length. Bytes 7 and 8 specify the number of bytes in the Data Area of the record (excluding check

bytes). Two bytes (16 bits) can indicate Data Length from 1 to 65,535 bytes.

Zero Data Length indicates the end of a logical file. The 2841 sends special indicators to the CPU when an End-of-File record is read or written.

Cyclic Check. Bytes 9 and 10 are used for error detection as discussed in the section on Data Checking.

Key Area

Although a Key Area can be written and used in R0 by the commands used by the 2841, this use is purely at the discretion of the programmer. Standard use of R0 by IBM Programming Systems does not include a Key Area.

A more detailed discussion of Key Area may be found in the section of this manual which describes Key Area within Data Records (R1 - Rn).

Data Area

The design and use of this area is normally prescribed by IBM Programming Systems. Because of this special use by the programming system, it is recommended that this area not be used for application data.

If the Data Length is zero, indicating End-of-File, the Data Area contains one byte of zeros in addition to the check bytes. No data is transferred to the channel when this record is read, but the End-of-File indicator is set.

Data Records ($R_1 - R_n$)

One or more data records may follow R_0 on a track. Count areas make each record self-formatting for maximum data organization flexibility and efficiency.

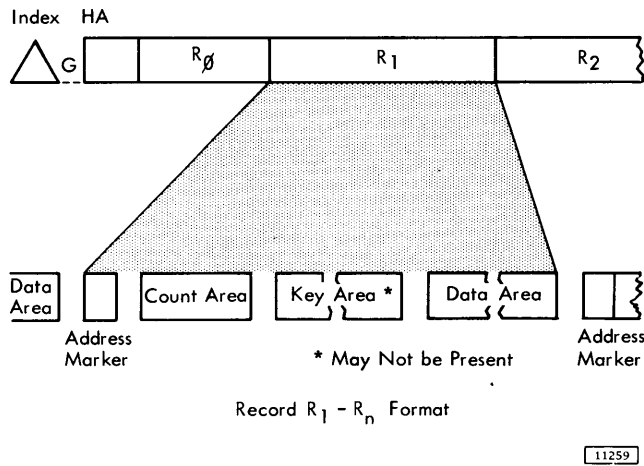

Address Marker

This 3-byte area indicates the beginning of each record after R_0 (Figure 2). Address markers are supplied by the 2841 as records are written. They are used by the 2841 to locate the beginning of a record for searching, writing, and reading operations.

Count Area

This 11-byte area describes the Key and Data Areas which follow it. Bytes 1 through 8 are created in the CPU by the program used to write the record.

Flag. Byte 0 of the Count Area is generated by the 2841 as each record is written. It is not sent from the CPU.

Bit	Function
0	0 for even-count records (R_0, R_2, R_4, R_6) 1 for odd-count records (R_1, R_3, R_5, \dots) Used by the 2841 to ensure that all address markers (and records) are present. The 2841 signals a missing Address Marker when two consecutive, identical bits are encountered (unless an Index Point intervenes). When a command which uses Address Markers is issued, a missing Address Marker is signalled if the Index Point is encountered twice without at least one intervening Address Marker. (The Search ID command does not indicate a missing address marker.)
1	Used with Record Overflow feature. 0 for all non-overflow records and for the last record of an overflow chain. 1 for each record except the last record of an overflow.

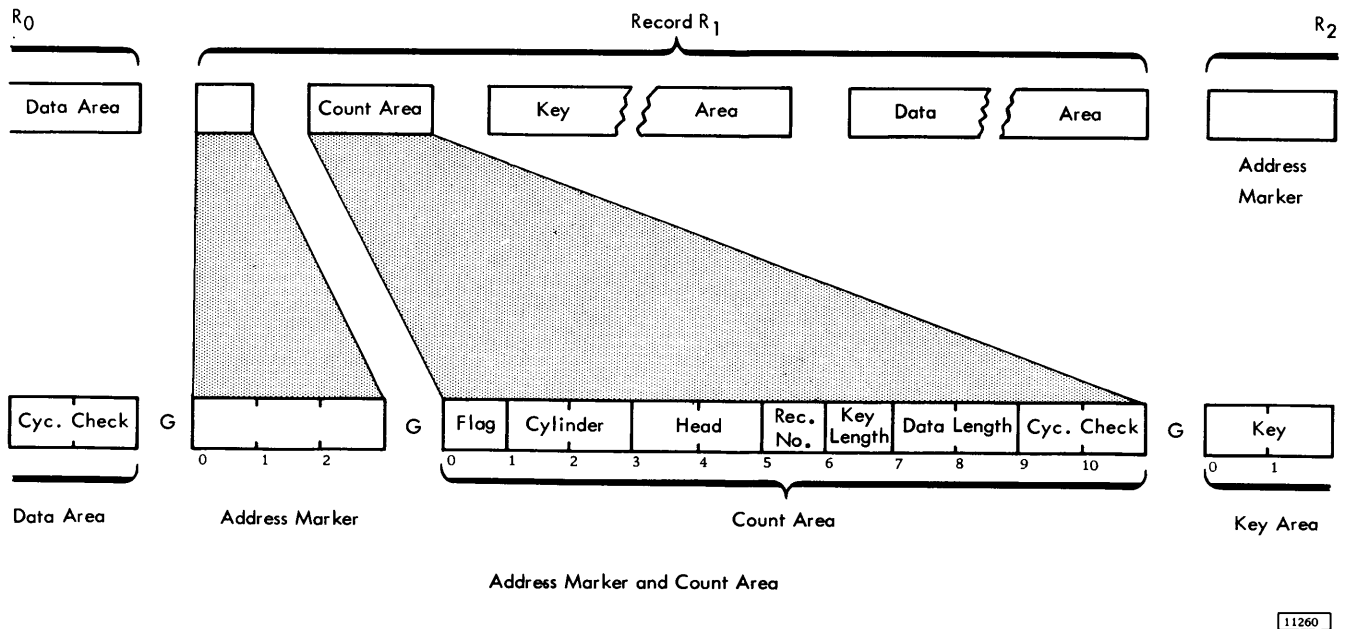

Figure 2. Address Marker and Count Area

Bit	Function	
2	Zero	
3	Zero	
4	Zero	
5	Zero	
Flag Byte	6	Track Condition 0 indicates operative track 1 indicates defective track
	7	Track Use 0 indicates primary track 1 indicates alternate track

Bits 6 and 7 are transmitted to the flag bytes of all records on the track from the flag byte of the Home Address of that track by the 2841.

Cylinder Number. Bytes 1 and 2 contain the cylinder number of the track on which the data is stored.

Read/Write Head Number. Bytes 3 and 4 contain the read/write head number of the track on which the data is stored.

Record Number. Byte 5 designates the sequential number of the record on the track.

Key Length. Byte 6 specifies the number of bytes in the Key Area of the record (excluding check bytes). If the record has no key, this byte is zero. This byte can indicate a Key Length from zero to 255 bytes.

Data Length. Bytes 7 and 8 specify the number of bytes in the Data Area of the record (excluding check bytes). Two bytes (16 bits) can indicate Data Length from 1 to 65,535 bytes. It should be noted that maximum data length is a function of the track capacity of the specific storage device. See the description of the Overflow Feature for records that exceed the track size.

Zero Data Length indicates the end of a logical file. Special indicators are sent to the CPU when an End-of-File record is read or written.

Cyclic Check. Bytes 9 and 10 are used for error detection as discussed in the section on Check Characters.

Key Area

The Key Area concept has been provided in storage units of the 2841 family to allow searching and data accessing during a single disk, drum, or strip revolution. The Key Area can contain identifying information about a record, such as serial number, social security number, or policy number. Special commands are provided to search Key Areas for this identifying information. When the desired record is found, a read or write instruction can be issued and the Data Area read or written during the same revolution.

Comparison (during searching) is accomplished within the 2841. Thus, use of Key Areas for searching allows searching and comparing of keys and movement of the desired Data Area to or from the CPU during a single disk, drum, or strip revolution.

Key Area length ranges from 1 to 255 bytes. Two Cyclic Check bytes are added to the Key Area by the 2841. If Key Length, in the Count Area, is zero, no Key Area will be written.

Data Area

This area contains the information identified by the Count and Key Areas. Data information is organized and arranged by the programmer.

Two Cyclic Check bytes are added to the Data Area by the 2841. If Data Length was zero, indicating End-of-File, the Data Area will contain one byte of zeros in addition to the check bytes, however no data is transferred to the channel when this record is read.

Input/Output (I/O) operations involve the transfer of information to or from CPU storage. Within this concept, disk and drum storage drives and data cell drives are considered I/O devices.

The CPU program initiates I/O operations with the Start I/O instruction. Bit positions 24-31 of this instruction identify the device. Start I/O causes the channel to fetch the Channel Address Word (CAW) from main storage location 72. The command address portion of the CAW designates the location in main storage from which the channel subsequently fetches the first Channel Command Word (CCW). The CCW specifies the command to be executed and the storage area to be used.

If the channel is not busy, the channel attempts to select the device by sending the address of the device to all attached control units. The control unit specified in the address responds to its selection and awaits further instructions. The command code is sent to the selected control unit; the control unit then responds with a device status byte to the CSW.

At this time, the start I/O is terminated. The results of the attempt to initiate the execution of the command are indicated by the condition code in the Program Status Word, and, under certain conditions, by status bytes in the Channel Status Word.

All data transfers from the channel to the 2841 are checked for parity. If a parity error is detected, a unit check signal is sent to the CSW by the 2841 and the command will not be executed.

An I/O operation may involve transfer of data to one storage area, designated by a single CCW. When data chaining is specified, data is transferred to a number of storage areas. In each case, a chain of CCWs is used, in which each CCW designates an area in main storage for a part of the operation. The program can be notified of the progress of chaining by specifying that the channel modify the Channel Status byte upon fetching a new CCW. When command chaining is specified, a series of commands is executed.

Termination of an I/O device operation normally is indicated by two CSW conditions: Channel End and Device End. The channel end condition indicates that the I/O device has received or provided all information associated with the operation and no longer needs channel facilities. The device end signal indicates that the I/O device has terminated execution of the operation. The device end condition can occur concurrently with the channel end condition or later. If

command chaining has been specified, the next CCW is fetched by the channel and the operation designated is commenced. Unusual conditions and errors terminate the execution of a command chain.

INSTRUCTIONS

All I/O instructions use the following format:

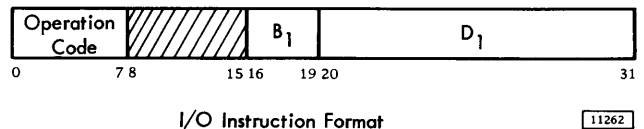

Fields in the instruction are allocated as follows:

Bit Position	Field Designation	Function
0-7	Operation (Op) Code	Designates the operation to be performed.
8-15	Not Used	
16-19	Base Address Register Location (B_1)	Designates the address of a general register in main storage. The register is 24 bits in length.
20-31	Displacement (D_1)	The sum obtained by the addition of the content of the register at B_1 and content of the D_1 field identifies the channel and device addressed by the instruction. The result has the format:

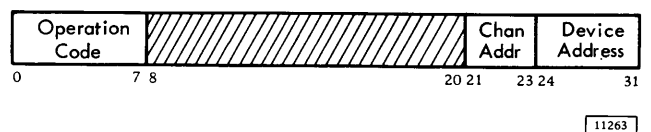

Bit Position	Field Designation	Function
0-7	Operation (Op) Code	Designates the operation to be performed.
8-20	Not Used	
21-23	Channel Address	000 - designates multiplexer channel. 001 - 110 - designates selector channel 1-6. 111 - invalid combination.
24	Shared Channel Indicator	1 indicates multiplex channel or sub-channel. On a selector channel, this bit is included in the control unit address.
25-27	Control Unit	0-7 control units per channel.
28-31	Access Mechanism	0-7. Bit 28 will be 1 only if additional access feature is installed (indicates mechanism 8-15).

Bit positions 24 to 31 of the I/O instruction specify a control unit and access mechanism.

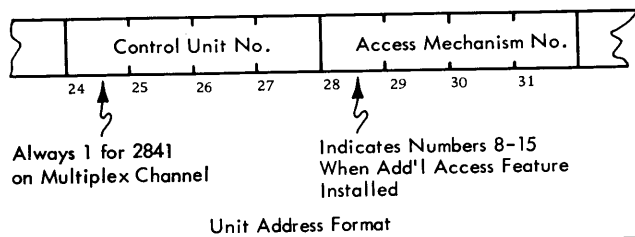

A control unit number is permanently assigned to each 2841 through internal wiring at the time the unit is installed.

A maximum of 16 access mechanisms can be addressed by each control unit. A standard 2841 can control eight mechanisms; eight more can be attached with the Additional Storage feature.

Start I/O

All I/O operations are initiated by a Start I/O instruction. If the channel facilities are free, Start I/O is accepted and the CPU continues its program. The channel independently selects the I/O device specified by the instruction.

The CAW at main storage location 72 contains the protection key for the sub-channel and the address of the first CCW. The CCW so designated specifies the operation to be performed, the main-storage

area to be used, and the action to be taken when the operation is completed.

If any of the several conditions exist, Start I/O will cause the status portion, bit positions 32-47, of the CSW at main storage location 64 to be replaced by a new set of status bits. The status bits pertain to the device addressed by the instruction. The contents of the other fields of the CSW are not changed.

Halt I/O

Halt I/O terminates a channel operation, and the 2841 is disconnected from the channel.

Test I/O

Test I/O sets the condition code in the Program Status Word to indicate the state of the addressed channel, sub-channel, and I/O device. The Channel Status Word is stored in location 64.

Test Channel

Test Channel sets the condition code in the Program Status Word to indicate the state of the channel addressed by the instruction. The condition code then indicates channel available, interruption condition in channel, channel working, or channel not operational. The execution of this command does not affect the 2841. Fields in the PSW are designated as follows:

PSW Bit Position	Field Designation	Function
0-7	System Mask	Associated with I/O channels and external signals. When a mask bit is one, the source can interrupt the CPU. When a mask bit is zero, the corresponding source cannot interrupt the CPU and interruptions remain pending.
8-11	Interrupt Key*	
12	ASCII (A)*	
13	Machine-Check Mask (M)*	
14	Wait State (W)*	
15	Problem State (P)*	
16-31	Interruption Code*	Identifies the cause of an I/O, program, supervisor call, or external interruption.
32-33	Instruction Length Code (ILC)*	
34-35	Condition Code (CC)*	
36-39	Program Mask*	
40-63	Instruction Address	

*Refer to IBM System/360 Principles of Operation, Form A22-6821.

CHANNEL OPERATION

The IBM 2841 Storage Control is attached to the CPU through a set of data paths called a channel (Figure 3). So that the CPU may control a wide variety of input/output devices with a minimum of programming differences, all control units are designed to respond to a standard set of commands from the channel. The control unit then translates these commands into specific operating orders for the particular input/output unit. This enables the CPU to oper-

ate all input/output devices uniformly with the set of basic instructions.

Channel Status Word (CSW)

The Channel Status Word informs the program of the status of an I/O device or the conditions under which an I/O operation has been terminated. The CSW is formed, or parts of it are replaced, during I/O interruptions and during execution of I/O instructions. The CSW is placed in main storage at

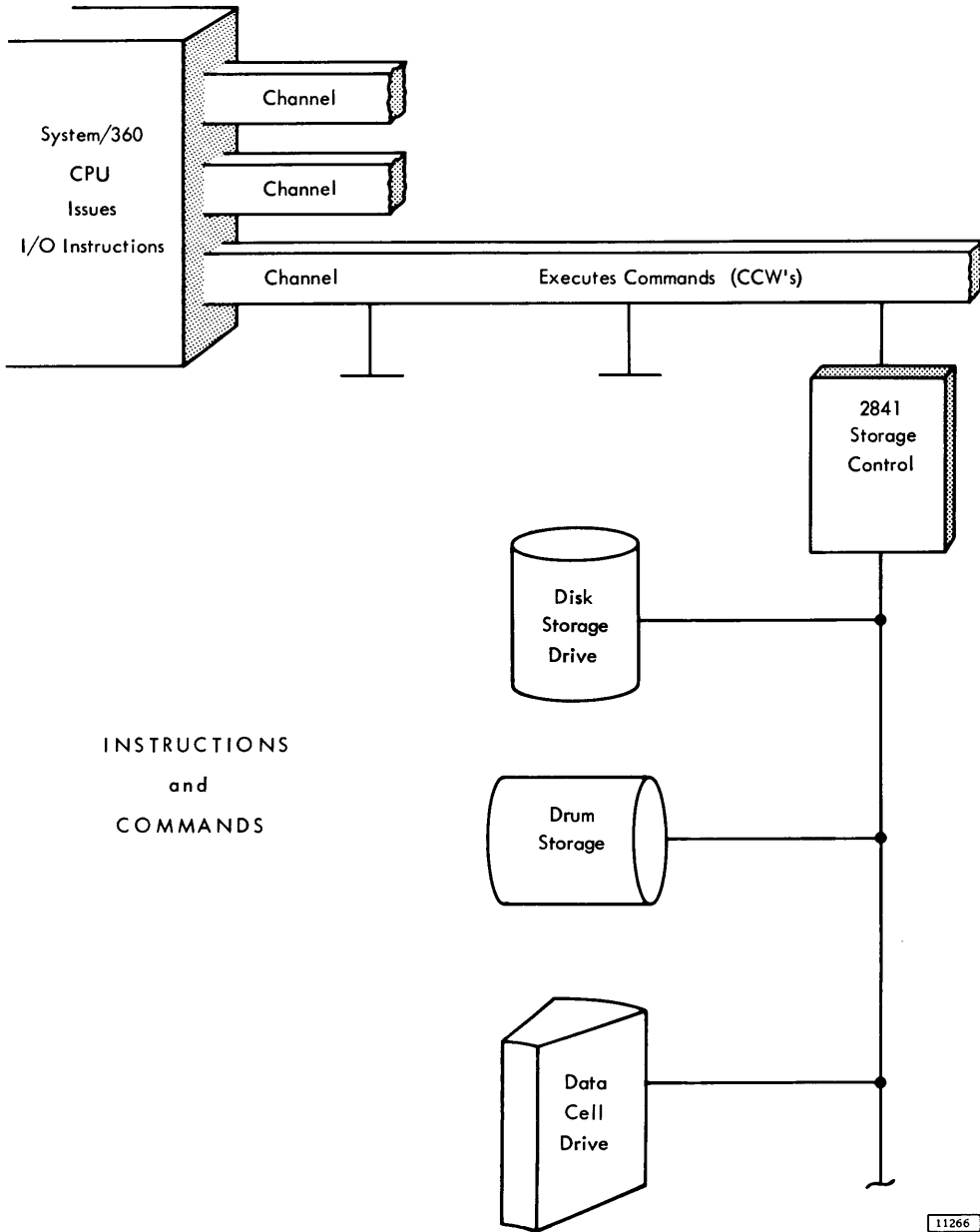
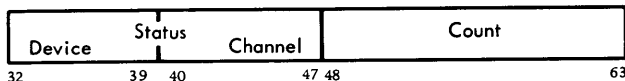
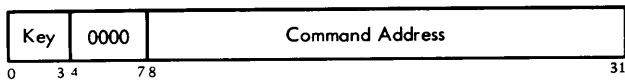

Figure 3. Instructions, Commands and Orders

location 64. It is available to the program at this location until the next I/O interruption occurs or until another I/O instruction generates a new CSW, whichever occurs first.

When the CSW is stored as a result of an I/O interruption, the I/O device is identified by the I/O address in the old PSW. The information placed in the CSW by an I/O instruction pertains to the device addressed by the instruction.

The CSW has the following format:



Channel Status Word

11267

Fields in the CSW are allocated for the following purposes:

CSW Bit Position	Field Designation	Function
0-3	Protection Key	Form the storage protection key used in the chain of operation.
4-7	Not Used	Always zero.
8-31	Command Address	Form an address eight positions higher than the address of the last CCW used.
32	Attention	Not Used.
33	Status Modifier	Set whenever a Search High, Search Equal, or a Search High or Equal command has been executed and the condition satisfied. The Status Modifier is also set whenever the 2841 is Busy. This bit, in conjunction with the Busy Bit, signifies Control Unit Busy.
34	Control Unit End	Set if a Control Unit Busy status has been generated previously and the busy condition has been terminated.

CSW Bit Position	Field Designation	Function																		
35	Busy	Indicates that the selected device is busy. It is set when a new command chain is initiated while the selected access mechanism is still in motion due to a previous Seek command. In conjunction with the Status Modifier bit, indicates the control unit is busy. It is set when a new command chain is initiated while the 2841 is causing a track to be erased following a Format Write command. See section on Two Channel Switch.																		
36	Channel End	Set at the end of each channel command.																		
37	Device End	Indicates that an access mechanism is free to be used.																		
38	Unit Check	Set whenever an unusual or error condition is detected in the 2841 or the selected file device. A Sense I/O Command may then be used to identify the condition.																		
39	Unit Exception	Indicates an End-of-File has been detected during a Read R0 CKD, Read KD, Read D, Write KD, or Write D operation. It results from a Data Length of zero being detected in the Count Area of a record. When this condition is detected, no data is transferred. If Key Length is not zero, the Key Area is transferred.																		
40-47	Channel Status	Indicate channel conditions as follows: <table border="1" style="margin-left: 20px;"> <thead> <tr> <th>Bit</th> <th>Designation</th> </tr> </thead> <tbody> <tr><td>40</td><td>Program-controlled interruption</td></tr> <tr><td>41</td><td>Incorrect length</td></tr> <tr><td>42</td><td>Program check</td></tr> <tr><td>43</td><td>Protection check</td></tr> <tr><td>44</td><td>Channel data check</td></tr> <tr><td>45</td><td>Channel control check</td></tr> <tr><td>46</td><td>Interface control check</td></tr> <tr><td>47</td><td>Chaining check</td></tr> </tbody> </table>	Bit	Designation	40	Program-controlled interruption	41	Incorrect length	42	Program check	43	Protection check	44	Channel data check	45	Channel control check	46	Interface control check	47	Chaining check
Bit	Designation																			
40	Program-controlled interruption																			
41	Incorrect length																			
42	Program check																			
43	Protection check																			
44	Channel data check																			
45	Channel control check																			
46	Interface control check																			
47	Chaining check																			
48-63	Count	Form the count of the last CCW used.																		

Channel Address Word (CAW)

Successful execution of start I/O causes the channel to fetch a channel address word from main storage location 72. The CAW specifies the location in main storage where the channel program begins.

The CAW has the following format:

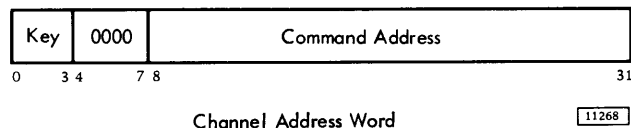

CAW fields are allocated for the following purposes:

CAW Bit Position	Field Designation	Function
0-3	Protection Key	Forms the Storage Protection key for all commands associated with Start I/O. This key is matched with a storage key whenever data is placed in storage.
4-7		Always Zero.
8-31	Command Address	Designates the location of the first CCW in main storage.

Channel Command Word (CCW)

The byte location specified by the CAW is the first of eight bytes of information (a double word) that the channel fetches from main storage. These 64 bits of information are called a Channel Command Word (CCW). The address of the leftmost position of the CCW must be divisible by four (in binary notation, the two low-order positions of the address are zero). One or more CCWs make up the channel program that directs channel operations.

The CCW specifies the command to be executed. For commands initiating I/O operations, it designates the storage area associated with the operation and the action to be taken when transfer to or from the area is completed. CCWs can be located anywhere in main storage and more than one can be associated with a Start I/O. The channel refers to a CCW in main storage only once. Once obtained, the pertinent information is retained in the channel.

The first CCW is fetched during the execution of Start I/O. Each additional CCW in the sequence is obtained when the operation has progressed to a point where the additional CCW is needed. Fetching of CCWs by the channel does not affect the contents of main storage.

Fields in the CCW are allocated for the following purposes:

CCW Bit Position	Field Designation	Function
0-7	Command Code	Specify the operation to be performed. The 4 high-order bits specify the function to be performed by the addressed I/O device; the 2 low-order bits specify the channel function.
8-31	Data Address	Specify the location of an 8-bit byte in main storage. This is the first location of the area designated by the CCW.
32	Chain Data (CD) Flag	When set to one, specifies chaining of data. It causes the storage area designated by the next CCW to be used with the current operation. The command code of the next CCW will be ignored. When bit 32 is zero, the current CCW is the last one for the operation.
33	Chain Command (C.C) Flag	When set to one, and when the CD flag is zero, specifies chaining of commands. It causes the operation specified by the command code in the next CCW to be initiated on normal completion of the current operation.
34	Suppress Incorrect Length Indicator (SILI)	Controls whether an incorrect length condition is to be indicated to the program. When this bit is set to one and the CD flag is zero in the last CCW used, the incorrect length indication is suppressed. When both the CC and the SILI flags are set to one, command chaining takes place regardless of the presence of an incorrect length indication. Absence of the SILI flag or the presence of the CD flag causes the program to be notified of the incorrect length condition when it occurs.
35	Skip (SKIP) Flag	When set to one, specifies suppression of a transfer of information to storage during a read, read-backward, or sense operation. When bit 35 is zero, normal transfer of data takes place.
36	Program-Control- Interruption (PCI) Flag	When set to one, causes the channel to generate an interruption condition upon fetching the CCW. When bit 36 is zero, normal operation takes place.

CCW Bit Position	Field Designation	Function
37-39	Transfer-in-Channel	Bit positions 37-39 of every CCW other than one specifying transfer in channel must contain zeros. Violation of this restriction generates the program-check condition. For additional information, see <u>Control Commands — Transfer-in-Channel</u> .
40-47		Not used.
48-63	Count	Specify the number of 8-bit byte locations in the storage area designated by the CCW.

Program Status Word (PSW)

A double word, the program status word (PSW) contains information required for proper program execution. In general, the PSW is used to control instruction sequencing and to hold and indicate the status of the system in relation to the program being executed. The active or controlling PSW is called the "current PSW." By storing the current PSW during an interruption, the status of the CPU can be preserved for subsequent inspection. By loading a new PSW or part of a PSW, the state of the CPU can be initialized or changed.

The PSW has the following format:

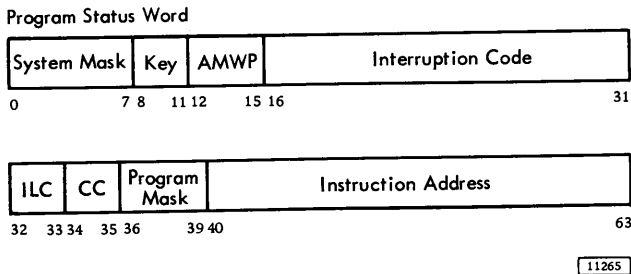

Channel Program Branching

Normally the next CCW in a chain is fetched from a core position eight bytes higher than the current CCW. This sequence can be modified in two ways:

1. If command chaining is specified in the current CCW and execution of the CCW results in a status modifier indication (without other unusual conditions detected), the channel will fetch the next CCW from a main storage location sixteen positions higher than the current CCW (one CCW is skipped). Since

all Search commands transmit a status modifier indication, this allows branching from a command chain when the search command condition has been satisfied.

2. The programmer can also modify the CCW chain sequence by using the Transfer-in-Channel (TIC) command. This command directs the channel to fetch the next CCW from an address specified within the TIC CCW. See Control Commands — Transfer-In-Channel for additional information.

These methods of modifying the sequence of a chain of CCWs provide branching capability in the channel program.

Control Commands

Control operations on I/O devices do not involve a transfer of data between a storage unit and the CPU. However, in certain Control operations, a few bytes or bits may be transferred between the CPU and 2841 to enable the operation to take place. These bytes are parity checked during transfer.

Eraser

This command is used to erase the end of a track after a track overflow has occurred. It has the same chaining requirements as a Write Count-Key-Data command. The execution of this command causes one's to be written from the end of the Data area of the record on which the preceding search was satisfied, or the record just written by Write CKD, to the end of the track. Channel End and Device End signals are generated when Index Point is reached. Both the channel and the control unit are busy during execution of this command.

Eraser Command Code		
Decimal	Hexadecimal	Binary
17	11	0001 0001

11269

No Operation (No-Op)

This command causes the addressed device to respond with Channel End and Device End. No information other than the command itself is transferred to the 2841. The addressed device takes no action.

Channel End and Device End are signalled simultaneously to the CSW.

No-Operation Command Code		
Decimal	Hexadecimal	Binary
03	03	0000011

11270

Release

Without the Two-Channel Switch feature, Release is interpreted by the 2841 as a No-Op command.

With the Two-Channel Switch feature, a 2841 is selected to a particular channel whenever that channel executes a command which uses the 2841. The 2841 remains selected to the channel until the channel issues a Release command to the control unit, or until the CPU is reset.

See special features, Two Channel Switch, for additional information.

Release Command Code		
Decimal	Hexadecimal	Binary
23	17	0001 0111

11271

Restore

This command causes the 2311 to seek to head zero and track zero. It causes Channel End to be generated immediately and Device End to be generated when the operation is complete.

This command causes the 2841 to perform a No-Op when the 2302 is selected.

This command causes the 2321 to restore the strip from the drum to the cell. It causes Channel End to be generated upon initiation of the operation by the Control Unit and Device End when the strip is fully restored. The Restore command operates exactly like a seek command except that no address is transferred to the 2841.

This command causes the 2841 to perform a No-Op command when the 7320 is selected.

All Restore commands work under the same File Protect Mask as Cylinder Seek.

Restore Command Code		
Decimal	Hexadecimal	Binary
19	13	0001 0011

11272

Seek

Three seek commands are associated with the 2841 Storage Control unit: Seek, Seek Cylinder, and Seek Head. After a Start I/O instruction has selected the proper channel, control unit, storage unit, and access mechanism, the Seek CCW transfers a 6-byte Seek Address from main storage to the 2841. The CCW count (positions 48-63) should specify a 6-byte count field. If the count is more than six, the 2841 operates on the first six bytes transferred and, if the CCW SILI (Suppress Incorrect Length Indicator) bit is zero, a Wrong Length Record is signalled to the CSW. If the CCW count is less than six, the CSW Unit Check bit is set, and a Sense I/O CCW may be used to identify the Seek Check and Command Reject. The six bytes specified must form a valid address. At the completion of a successful address transfer from main storage to the 2841, a Channel End indication is sent to the CSW. A Device End indicator is set in the CSW when the selected access mechanism has reached the addressed track.

A Seek command need not be preceded by any other CCW.

Seek commands operate in conjunction with the Set File Mask command.

The 6-byte seek address is arranged as follows:

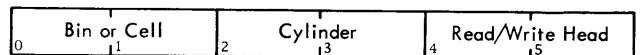

11274

Seek. All six seek address bytes referenced by the CCW are used to determine seek address.

Seek Cylinder. Only the four low-order bytes (bytes 2-5) referenced by the CCW are used to determine seek address. With the 2321, only bytes 4 and 5 are used.

Seek Head. Only the two low-order bytes (bytes 4 and 5) referenced by the CCW are used to determine seek address. With the 2321, only byte 5 is used.

Command	Seek Command Code		
	Decimal	Hexadecimal	Binary
Seek	07	07	00000111
Seek Cylinder	11	0B	00001011
Seek Head	27	1B	00011011

11276

Sense I/O

Four bytes of sense condition information are provided by the 2841 to identify the setting of the Unit Check bit in the CSW Status Byte. These Sense Bytes are transferred to the Channel by a Sense I/O command.

The Data Address portion of the CCW directs the bytes to a specific CPU storage location.

Sense I/O Command Code		
Decimal	Hexadecimal	Binary
04	04	0000 0100

11277

The significance of a "1" condition for each bit is:

Byte	Bit	Designation	Significance of "1"
0	0	Command Reject	Indicates that the 2841 has received an invalid operation code, an invalid sequence of commands, an invalid Seek Address*, or a file mask is violated on a write command. (See Set File Mask.)
0	1	Intervention Required	Indicates that the specified file is not physically attached to the system or, if physically attached to the system, it is not available for use because the file motor is not on, a cover interlock is open, etc.
0	2	Bus Out Parity Check	Indicates that the 2841 has detected a parity error during the transfer of a command or data from the channel to the 2841. A parity error detected during command transfer signals a Parity Check, not a Command Reject.
0	3	Equipment Check	Indicates that an unusual condition is detected in the control or storage unit. Conditions covered by this bit are defined by Sense Byte 2.
0	4	Data Check	Indicates that a data error has been detected in the information received by the 2841 from the storage unit.
0	5	Overrun	Indicates that a chained CCW was issued but that it was received too late to be properly executed; or that a byte was received during Reading or Writing; or that a byte was received too late (during a read or write operation) to be executed properly. When Writing, the remaining portion of the record area will be filled with valid zeros and the Overrun check will be generated. When Reading, the remaining portion of the record will continue to be read into the 2841 and the Overrun Check will be generated.
0	6	Track Condition Check	1 indicates Defective track
0	7	Seek Check	Indicates that the file has been unable to complete a Seek because: <ol style="list-style-type: none"> 1. Transferred Seek address is outside the valid address boundaries of the storage device. Unused seek address bytes must be a valid address for the device selected. Command Reject is also set. 2. Less than six seek address bytes were sent. Equipment failed which resulted in the access mechanism going to either the inner or outer stop. In this case Command Reject is not set.

*A track condition interrupt on an overflow record occurs during a write command.

Byte	Bit	Designation	Significance of "1"	Byte	Bit	Designation	Significance of "1"
1	0	Count Area Check	Indicates that a data error has been detected in a Count Area read from the storage device. Data Check (bit 4) in Byte 0 is also turned on. Error detection is the same as described for Data Check.	1	6	Missing Address Marker	When a Missing Address Marker is detected, this bit and bit 4 of Sense Byte zero (Data Check) will be turned on for all commands or chained commands except Search ID CCWs. The Search ID CCW may be used to pass over the Missing Address Marker so that the remaining data on the track can be retrieved. Missing Address Marker is set in conjunction with No Record Found if there is no data on the track.
1	1	Track Overrun	Indicates that writing has not been completed by the time the Index Point is detected. This type of error is created during a Write R0 or Write Count, Key, and Data operation.				
1	2	Cylinder End	Indicates that the CCW Command Chain has not been completed, and Cylinder End has been detected.	1	7	Overflow Incomplete	This bit is used with the Record Overflow special feature. It is set with other indicators to signal conditions as follows:
1	3	Invalid Sequence	Indicates that an attempt has been made to execute an invalid sequence of CCWs or that two Set File Mask commands appear in the same command chain. Valid command sequences are defined in the individual command descriptions. Command Reject (Byte 0 bit 0) is also set when an invalid sequence is detected.				Sets Overflow Incomplete and Other Indicator:
1	4	No Record Found	Indicates that while executing a chain of CCWs, the 2841 has detected two Index Points without completing an intervening command to read or write the Data Area, Read Home Address, or Read R0. It is also set in conjunction with Missing Address Marker if there is no data on the track. No Record Found is never set if the Multi-Track bit in the command (Bit 0) is on.				Overflow to a defective track (Byte 0, bit 6) Overflow from an alternate track (Byte 0, bit 6)
1	5	File Protected	Indicates that a Seek or Write CCW was issued contrary to the file mask. The Command Reject bit is also set by this condition, if the operation is a write operation.				Overflow to File Protected boundary (Byte 1, bit 5) Overflow to wrong track (Head number unequal) (Byte 0, bit 0)
1	6	Missing Address Marker	A missing Address Marker, which may indicate a missing record is detected during the execution of command or chain of commands which operates on successive Count Areas on a track. The condition detected is two successive records on a track with equal bit conditions in bit 0 of the Flag bytes, with no intervening Index Point. A missing Address Marker is also detected if two Index Points are passed with no intervening Address Marker record on the track.				File Protected (Byte 1, bit 5) Command Reject (Byte 0, bit 0) Set for write only. Seek Check (Byte 0, bit 7).

A Track Condition check is generated under the following conditions:

1. If an overflow record is being read, written, or searched which overflows to a defective track. The interrupt occurs after the last byte on the previous track has been operated on and before the first byte for the defective track is requested from or sent to the channel. In this case Overflow Complete is also set. Command Reject is also set if the operation was a write.
2. A Search HA, Read HA, or Read R0 causes a head switch to a defective track during a multiple track operation, when a Search operation other than Search HA is attempted. The interruption occurs prior to transfer of any data to or from the channel.

Write commands never set track condition checks.

Sense Bytes 2 and 3. These bytes are provided to assist the Customer Engineer when using diagnostic programs to locate equipment malfunctions.

Set File Mask (Figure 4)

A Set File Mask command causes one byte of data to be transferred from main storage to the 2841. At the completion of the transfer, a Channel End and Device End signal are sent to the CSW. The byte of data that is sent to the 2841 describes the Write and Seek functions that can be performed in the CCW chain. Set File Mask can be issued anywhere within a CCW chain. At the completion of the CCW chain, the File Mask is reset to all zeros.

If a Seek or Write command is issued which violates the File Mask, the command is not executed, and a Unit Check signal is generated in the CSW Status Byte. A subsequent Sense I/O command signals File Protect and Command Reject if the generation was a write. For a seek operation, File Protect is set; for a write operation, both File Protect and Command Reject are set.

A Set File Mask command can be issued only once within any given CCW chain. If an attempt is made to issue more than one Set File Mask command with a given CCW chain, a Unit Check signal is generated in the CSW Status Byte. A subsequent Sense I/O command indicates Command Reject and Invalid Sequence.

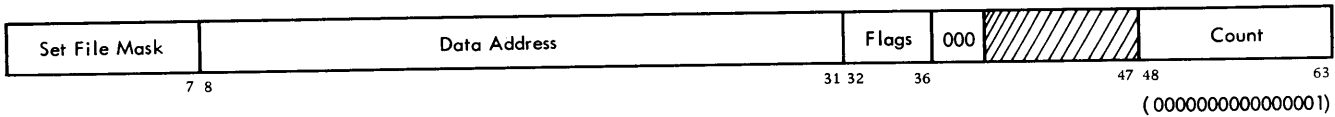

Specifies CPU Storage Location of the Mask Byte, At That Location is Found:

Decimal	Hexadecimal	Binary
31	1F	0001 1111

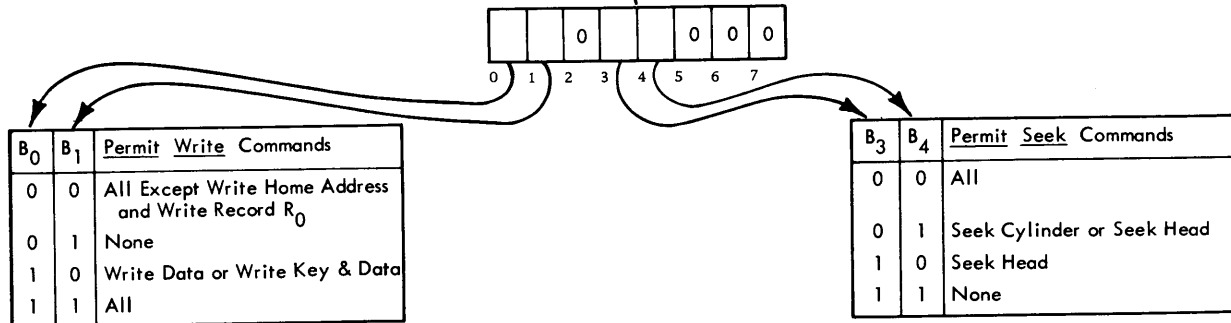

For the 2841 Storage Control, B₂, B₅, B₆, and B₇ of the mask must be zero. If these bits are not zero, the mask is considered to be invalid and a CSW Unit Check signal is generated. A subsequent Sense I/O command will indicate Command Reject.

11278

Figure 4. Set File Mask

Space Record

This command enables the 2841 to pass over the next record on a track. It allows the 2841 to retrieve subsequent records from a track when the Count Area of a preceding record is not readable.

The execution of the Space Record command causes the 2841 to search for the next Address Marker on the track. Upon detection of the Address Marker, Channel End and Device End signals are generated. Thus, the following CCW searches for the Address Marker following the one detected by the Space Record command.

When a Space Record command follows a Search HA or Read HA CCW, the search for an Address Marker is suspended and Channel End and Device End signals are generated immediately. The effect of this sequence is to cause Record R0 to be passed over.

The Space Record command does not detect a Missing Address Marker. However, if an Address Marker is missing, it is detected on all valid commands chained from the Space Record command except Search ID commands.

The Space Record command must be chained from either a Search or a Read command.

Space Record Command Code		
Decimal	Hexadecimal	Binary
15	0F	00001111

11279

Transfer In Channel (TIC)

The Transfer in Channel command provides chaining between CCWs not located in adjacent CPU storage locations. The next CCW is fetched from the location specified by the Data Address field of the TIC CCW.

TIC does not initiate any channel I/O operation and the I/O device is not signalled that this command is being executed.

TIC may not be the first CCW designated by a CAW. One TIC command may not transfer directly to a second TIC command.

When either of these errors is detected or when an invalid address is specified in Transfer in Channel, the program-check condition is generated. Detection of these errors during data chaining causes the operation of the I/O device to be terminated, whereas during command chaining they cause an interruption condition to be generated.

Bit positions 0-3 and 32-63 are ignored. Bits 29-31 must be zero to meet the boundary requirements for double words.

TIC Command Code		
Decimal	Hexadecimal	Binary
X8	X8	XXXX1000
Positions Marked "X" Are Ignored		

11280

Search Commands

On all Search operations, the Channel operates in the Write mode while the storage unit operates in the Read mode. The 2841 compares the information coming from CPU storage and the information coming from the storage unit.

If the search condition is satisfied, a status modifier indication is sent to the CSW and the channel fetches the next CCW in the command chain from a position sixteen positions higher than the current (Search) CCW. This allows modification of a command chain as a function of the data recorded on the direct access device.

On all Search commands, Command Code bit 0 determines whether this is to be a multiple track operation; that is, whether switching to the next read/write head in the cylinder is to occur when the Index Point is detected. If bit 0 is not set (0), head switching does not take place; if bit 0 is set (1), head switching does take place. If head switching has occurred, the next track will be used if the Search Command is repeated. This allows for sequential searching of an entire cylinder by repeating the Search Command once for each record to be searched.

The following command chain illustrates the procedure for reading a record identified by a key stored at location α in the CPU.

<u>Command Chain</u>	<u>Function</u>
Search Key α	Compare Key with Search Argument
TIC *-8	Transfer Back to Search
Read Data β	Read Data Area if Status Modifier was Returned from Search

The channel is busy during a search operation.

Search Home Address Equal (Search HA)

This command causes the 2841 to search for the Index Point, then compare four bytes of Home Address data (CCHH) coming from main storage with four bytes of Home Address data coming from the storage device. The Flag byte is not transferred or compared during this command.

If a logical comparison is equal, a Channel End, Device End, and Status Modifier signal is generated in the CSW status byte. If the logical comparison is unequal, then a Channel End and Device End are generated.

Search Home Address does not generate a No Record Found signal if the specified Home Address is not found.

If the CCW Count is greater than four bytes, the Search operation is completed when the 2841 count equals zero. The 2841 terminates the command with a Channel End and Device End. The Status Modifier is generated if the logical comparison was satisfied.

If the CCW Count is less than four bytes, the logical comparison between the data coming from CPU Storage and the data coming from the storage unit continues until the CCW Count reaches zero. At the time the 2841 count reaches zero, a Channel End and Device End are generated. A Status Modifier is generated if the search condition was satisfied on the short field.

If a Parity Check, Overrun, or Data Check is detected, Unit Check, Channel End, and Device End signals are generated in the CSW at the completion of the command.

A Search Home Address command does not have to be preceded by any other CCW in order to be executed.

Search Identifier (Search ID)

Search ID commands (Figure 5) cause a comparison to be made between five bytes of data from CPU storage and the five byte record identifier portion of a count area from the storage unit.

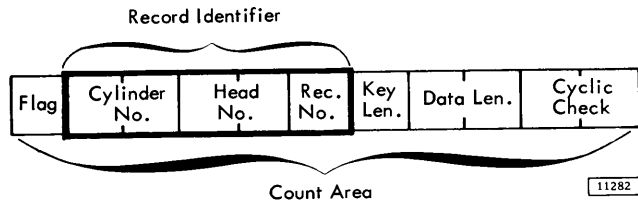

The ID to be searched is the ID of the record following the next Address Marker or Index point, in which case R0 is searched.

If the CCW count is greater than five bytes, the Search operation is completed when the 2841 count equals zero. The 2841 terminates the command with a Channel End and Device End. The Status Modifier is generated if the logical comparison was satisfied.

If the CCW count is less than five bytes, the logical comparison between the data coming from core storage and the data coming from the file continues until the CCW Count reaches zero. When the 2841 count reaches zero, a Channel End and Device End are generated. A Status Modifier is generated if the Search condition was satisfied on the short field.

If a Parity Check, Overrun, or Data Check is detected during a Search-ID operation, Unit Check, Channel End, and Device End signals are generated at the completion of the command.

A Search ID command does not have to be preceded by any other CCW in order to be executed.

If Command Code bit 0 (multiple track) is 0, the search is confined to one track and can be repeated until either the Search Condition is satisfied or until two Index Points are sensed; at which time Unit Check (No Record Found), Channel End, and Device End signals are generated.

If the multiple track bit is a 1, the search can be repeated until the Search Condition is satisfied or until the End-of-Cylinder is detected. At this time a Unit Check (End-of-Cylinder) signal is generated.

Search ID Equal. If a logical comparison on equal is encountered, Channel End, Device End, and Status Modifier signals are generated.

If the logical comparison is unequal, Channel End and Device End signals are generated.

Command	Search ID Command Code		
	Decimal	Hexadecimal	Binary
Search ID Equal	49	31	00110001
Search ID High	81	51	01010001
Search ID Equal or High	113	71	01110001

Command	Search ID Multiple Track Command Code		
	Decimal	Hexadecimal	Binary
Search ID Equal	177	B1	10110001
Search ID High	209	D1	11010001
Search ID Equal or High	241	F1	11110001

11283

Figure 5. Search Command Codes Missing (Error)

Search ID High. This command operates in a manner similar to that of the Search ID Equal command, except that the comparison is made for a high condition. The high condition indicates that the ID on the Storage Unit is higher than the ID in main storage. The comparison is made byte by byte.

Search ID Equal or High. This command operates in a manner similar to that of the Search ID Equal command except that the comparison is made for either an equal or high condition. The equal or high condition indicates that the ID on the storage device is equal to or higher than the ID in main storage.

Search Key

Execution of a Search Key command causes a comparison to be made between bytes of data from main storage and a Key from the storage device. The Key to be searched is the Key of the record following the next Address Marker. Search Key will pass over R0 unless chained from a Search ID that has searched the ID of R0.

If the CCW count is greater than the Key length, the Search operation is completed when the 2841 count equals zero. The 2841 terminates the command with a Channel End and Device End. The Status Modifier is generated if the logical comparison was satisfied.

If the CCW count is less than the Key length, the logical comparison between data from CPU storage and the data from the storage unit continues until the CCW count reaches zero. When the 2841 count reaches zero, a Channel End and Device End are generated. A Status Modifier is generated if the Search Condition was satisfied on the (short) field.

If a Parity Check, Overrun, or Data Check is detected during the Search-Key operation, Unit Check, Channel End, and Device End signals are generated at the completion of the command.

A Search-Key command does not have to be preceded by any other CCW in order to be executed.

If the multiple track bit is 0, the search can be confined to one track and can be repeated until either the search condition is satisfied or until two Index Points are sensed; at which time a Unit Check (No Record Found), Channel End, and Device End signals are generated. If the multiple track bit is 1, the search can be repeated until either the search condition is satisfied or until End-of-Cylinder is detected. If End-of-Cylinder is detected, an End-of-Cylinder indication is generated.

The Search Key command never returns a Status Modifier if the Key Length of the search record is zero.

Search Key Equal. If a logical comparison on equal is encountered, Channel End, Device End, and Status Modifier signals are generated. If the logical comparison is unequal or the Record has no Key area, then Channel End and Device End signals are generated.

Search Key High. This command operates in a manner similar to that of the Search-Key Equal command except that the comparison is made for a high condition. The high condition indicates that the key in the storage unit is higher than the key in CPU storage.

Search Key Equal or High. This command operates in a manner similar to that of the Search Key Equal command except that the comparison is made for either an equal or high condition. The equal or high condition indicates that the key in the storage unit is equal or higher than the key in CPU storage.

Command	Search Key Command Codes		
	Decimal	Hexadecimal	Binary
Search Key Equal	41	29	00101001
Search Key High	73	49	01001001
Search Key Equal or High	105	69	01101001

Command	Search Key Command Codes, Multiple Track		
	Decimal	Hexadecimal	Binary
Search Key Equal	169	A9	10101001
Search Key High	201	C9	11001001
Search Key Equal or High	233	E9	11101001

11284

Search Key and Data (File Scan Special Feature)

The File Scan feature provides an automatic rapid search for a specific set of conditions. The search is carried out over both Key and Data areas of a record. Prior to executing a File Scan operation, a "control mask" is set up in main storage. The mask consists of bytes of information on which a comparison is or is not to be made. The bytes on which a comparison is not to be made are filled with 1's prior to the search.

If an equal comparison is encountered, Channel End, Device End, and Status Modifier signals are generated. If the logical comparison is unequal, only Channel End and Device End signals are generated.

If the multiple track bit is off (0), the search can be confined to one track until the condition is satisfied or until two Index Points are sensed, at which time Unit Check (No Record Found), Channel End, and Device End signals are generated. If the multiple track bit is 1, the search can be repeated until the specified condition is met or until End-of-Cylinder is encountered, at which time an End-of-Cylinder signal is generated.

No more positions than the number specified by the CCW Count are compared. If the CCW Count is greater than Key Length plus Data Length, the Search operation is limited by the record Key and Data Lengths. A zero Key Length causes comparison of data only. If the channel count is less than the Data Length plus the Key Length, a truncated search is performed.

If a Parity Check, Overrun, or Data Check is detected during a Search Key and Data Operation, Unit Check, Channel End, and Device End signals are generated at the completion of the command.

Search Key and Data Equal. This command causes the 2841 to make a logical comparison on equal between the Key and Data information from the storage device with the mask information coming from main storage (Figure 6).

Search Key and Data High. This command operates in a manner similar to that of the Search Key and Data Equal command except that the comparison is made for a high condition. The high condition indicates that the storage device information is higher than the mask information in main storage.

Search Key and Data Equal or High. This command operates in a manner similar to that of the Search Key and Data Equal command except that the comparison is made for an equal or high condition. The equal or high condition indicates that the storage device information is equal to or higher than the mask information in main storage.

A File Scan function over an entire cylinder can be executed by the sequence of CCWs given below. This sequence assumes that a Set File Mask CCW was performed prior to the Scan sequence.

<u>Command</u>	<u>Remark</u>
1. Seek	Position Access
*2. SRCH IDEQ (Previous)	find record prior to beginning of scan area
3. TIC *-8	on Unequal Repeat Search
*4. Read Count α	Read Count of Record into α
*5. Search Key and Data EQ	Scan Key and Data
*6. TIC *-16	On Unequal, Repeat steps 4 & 5
7. Seek Head α	Reposition access (head select only)
**8. Search ID EQ α	Search for ID read in step 4
9. TIC *-8	On unequal repeat step 8
**10. Read Key and Data	Read Key and data
*Multiple Track Bit On	
**Multiple Track Bit Off	

Step 4 of the sequence causes the Count information coming from the storage device to be read into CPU storage. Key and data information from the storage device are compared with the mask information from main storage on step 5. The comparison is made based on the condition specified by the Search Key and Data CCW. When the specified condition is encountered, the program must re-orient to the beginning of the record with steps 8 and 9. Then the desired key and data is read in step 10.

At each detection of Index Point in step 5, the head address is incremented by one. As a result, step 4 is done on the next track if the previous record searched was the last one on a track.

Read Commands

On all Read commands the 2841 checks the validity of each area in a record as the area is transferred from the storage device.

If a Data Check or Overrun is detected, a Unit Check signal is generated upon completion of the command except when the error is in the Count Area. The command is terminated at the end of the Count Area. At the completion of the last check, the 2841 sends Channel End and Device End signals to the channel.

Search Key and Data Equal
 Search Key and Data High
 Search Key and Data Equal or High

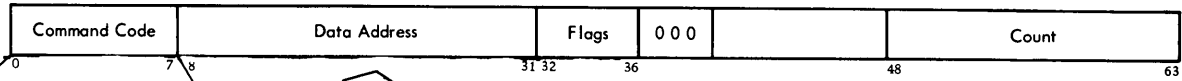

Specifies number of Bytes in CPU storage (including "Mask Bytes" to be used as Search Argument. If CCW count equals key length, command is effectively a "Search Key."

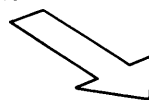

Command Code			
Command	Decimal	Hexadecimal	Binary
Search Key & Data Equal	45	2D	00101101
Search Key & Data High	77	4D	01001101
Search Key & Data Equal or High	109	6D	01101101

Command Code Multiple-Track			
Command	Decimal	Hexadecimal	Binary
Search Key & Data Equal	173	AD	10101101
Search Key & Data High	205	CD	11001101
Search Key & Data Equal or High	237	ED	11101101

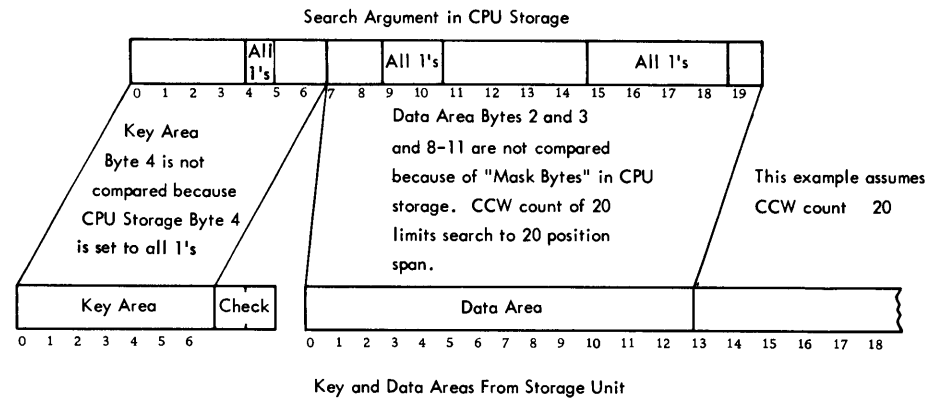

Figure 6. Search Key and Data

Read Home Address (Read HA)

This command causes the 2841 to search for the Index Point. Detection of the Index Point causes the five bytes of Home Address information to be transferred from the storage device to CPU storage. Exactly five bytes are transferred including the flag byte. If the channel count is less than five, only that number of bytes is transferred.

Chaining requirement: None

Read HA Command Code		
Decimal	Hexadecimal	Binary
26	1A	00011010

Read HA Command Code Multiple Track		
Decimal	Hexadecimal	Binary
154	9A	10011010

11286

Read Count

This command causes the eight bytes of the Count Area following the next Address Marker (AM) to be transferred from the storage device to main storage. The number of bytes of information to be read is always eight. If the channel count is less than eight, only that number of bytes is transferred.

Chaining requirement: None. The Count Area of R0 cannot be read by a Read Count command.

Read Count Command Code		
Decimal	Hexadecimal	Binary
18	12	00010010

Read Count Command Code, Multiple-Track		
Decimal	Hexadecimal	Binary
146	92	10010010

11287

Read Track Descriptor Record (Read R0)

This command causes the 2841 to search for Index Point. Detection of Index Point causes the 2841 to "count off" to Home Address and the following gap. When these Areas have been traversed, record R0 (Count, Key and Data) is transferred from the storage device to main storage.

Chaining Requirement: None. A Read R0 command chained from a Search HA or Read HA is

executed immediately and does not cause a search for Index Point.

Read R0 Command Code		
Decimal	Hexadecimal	Binary
22	16	00010110

Read R0 Command Code, Multiple-Track		
Decimal	Hexadecimal	Binary
150	96	10010110

11288

Read Data (Figure 7)

This command causes the Data Area of a record to be transferred from the storage device to main storage.

Read Key and Data

This command causes the Key and Data areas of a record to be transferred from the storage device to main storage. If Key Length is zero, this command operates like a Read Data command.

The record from which the Data or Key and Data is read is dependent upon the previous operation.

Read Count, Key, and Data (Figure 8)

This command causes the entire record (Count, Key, and Data) following the next AM to be transferred from the storage device to main storage. Record R0 is bypassed as it is not preceded by an address mark.

Chaining requirements: None.

Write Commands

Write commands cause data to be transferred from main storage to the storage device. During the transfer, the 2841 adds appropriate Cyclic Check bits to each area written. At the completion of the command, Channel End and Device End signals are sent to the channel.

Format Write Commands

The following are Format Write commands:

- Write Home Address
- Write R0
- Write Count, Key and Data

Read Data

Read Key and Data

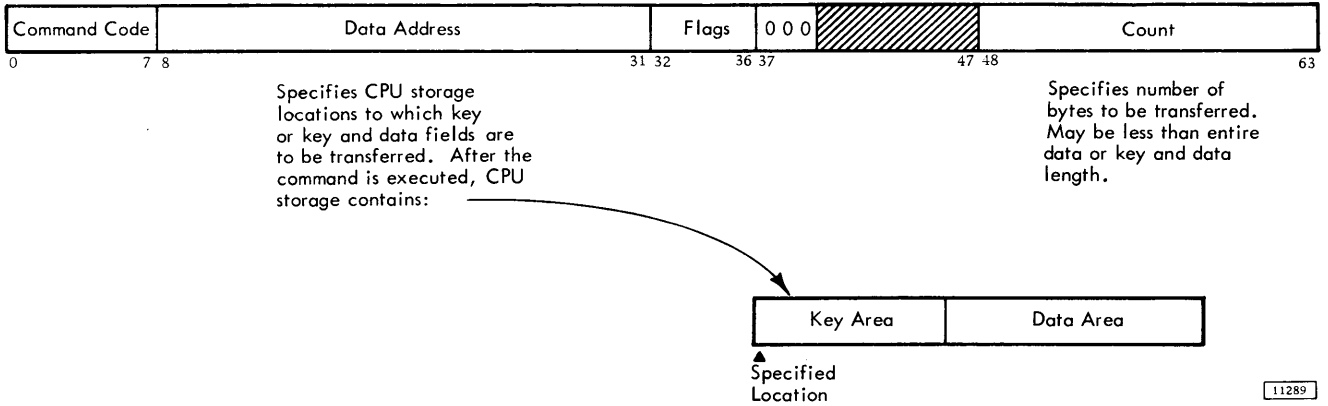

Figure 7. Read Data and Key and Data

Read Count, Key and Data

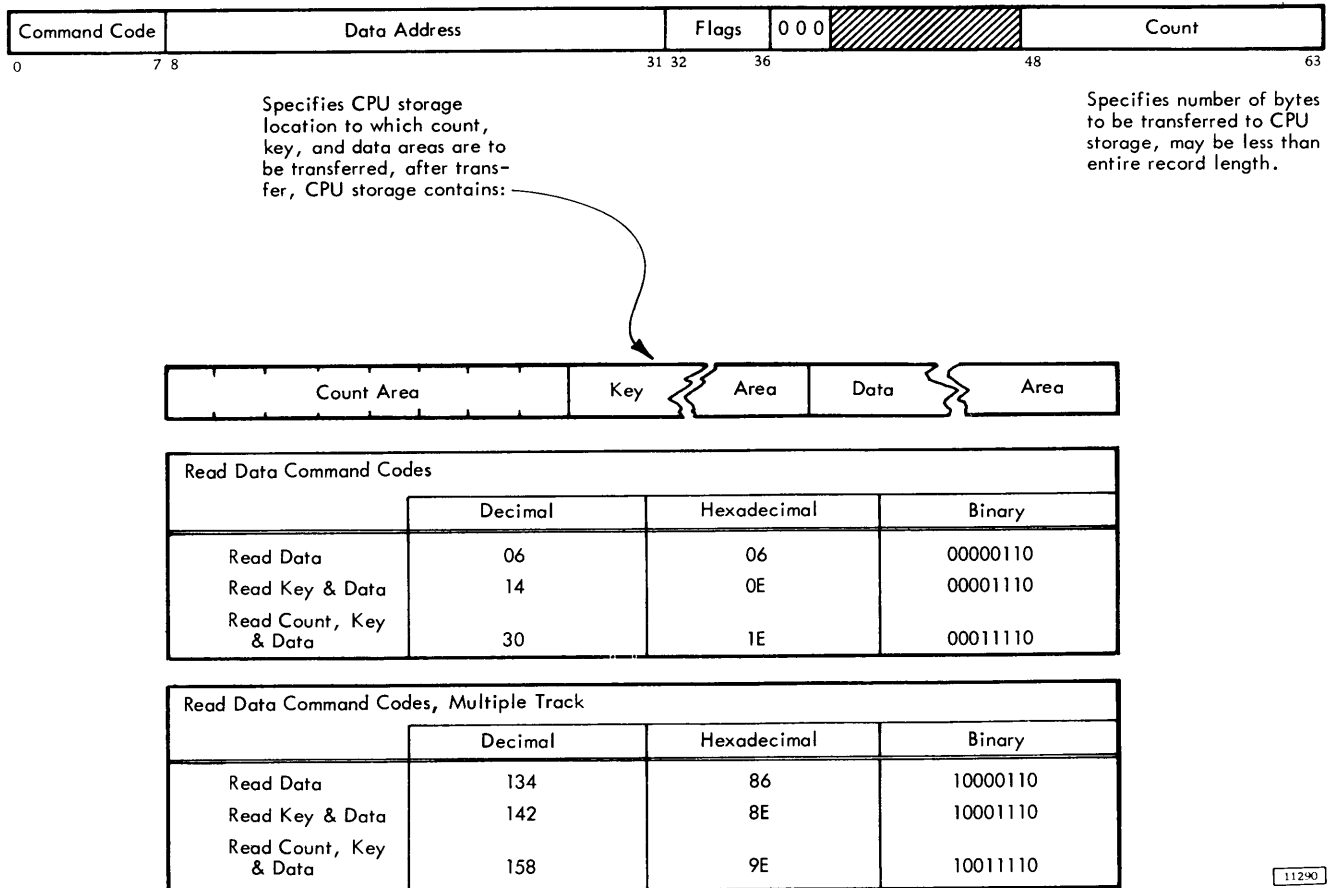

Figure 8. Read Count, Key, and Data

These commands are used to initialize tracks or records. A command chain which includes one or more Format Write commands must include an appropriate Set File Mask CCW preceding it.

After the last Format Write command in a chain has been completed, and Channel End and Device End signals generated, the 2841 causes the remaining portion of the track to be erased. If a new command chain is initiated before the end of the track is reached, a Control Unit Busy signal is generated in the CSW. At the end of the track, Control Unit End is signalled to the channel.

If a command other than a Format Write is chained from a Format Write command, the 2841 retains and executes it after the track has been erased and Index Point is detected.

Detection of a Parity Check on an Overrun during a Format Write operation causes a Unit Check to be signalled at the end of the operation. The 2841 writes valid zeros from the time the Overrun is detected to the end of the record. The Cyclic Check bits written in this case may not be valid.

Write Home Address (Write HA). This command causes the 2841 to search for the Index Point (Figure 9). When the Index Point is detected, the specified data is transferred from main storage to the storage device. The 2841 transfers five bytes of

data from the CPU, and adds two bytes of Code Check. At this point, Channel End and Device End signals are generated.

If the CCW Count is less than five, the 2841 records valid zeros until five bytes have been written. If the CCW Count is greater than five, the 2841 transfers only the first five bytes from CPU storage. A Write HA command is normally used to establish track identity within a storage device. Each track must be initialized with a Home Address before a data operation which involves that track can take place.

Chaining Requirements: Execution of this command is dependent upon a correct Set File Mask command preceding it in the same command chain.

Write Track Descriptor Record (Write R0). This command causes specified data to be transferred from main storage to the storage device (Figure 10).

The first eight bytes transferred from core make up the Count Area. The Flag byte is generated by the 2841. The remaining data is written in the Key and Data Areas as specified by Key Length and Data Length in the Count Area. The 2841 writes the correct Code Check at the end of each Area. Channel End and Device End signals are generated after the Code Check of the Data Area has been written.

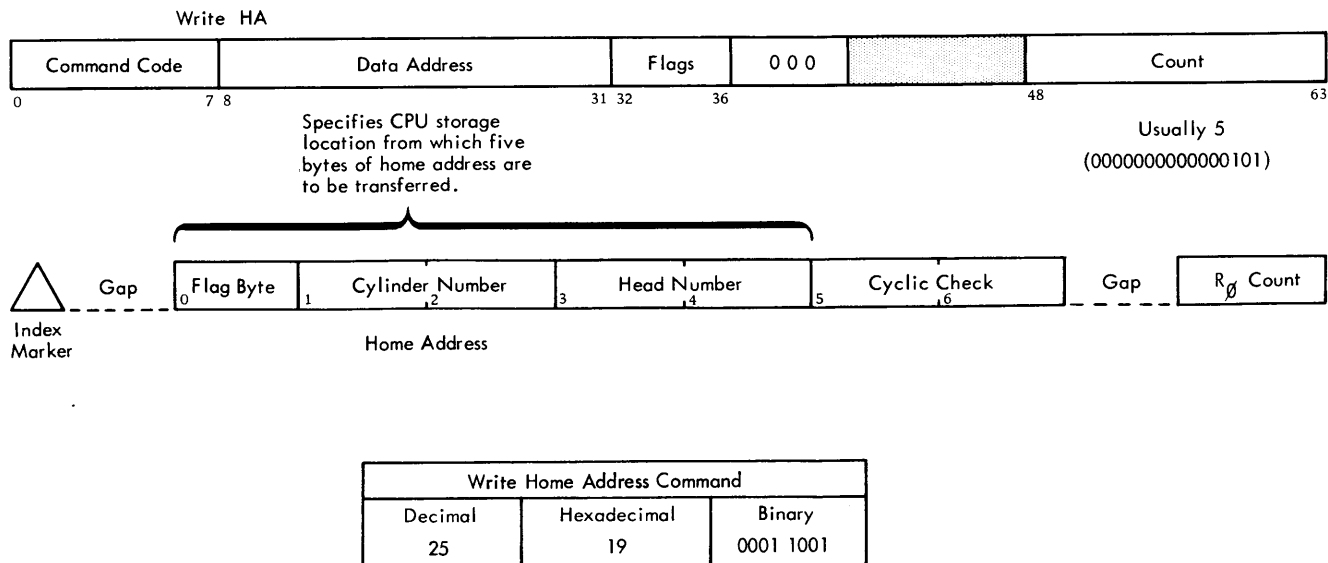

11291

Figure 9. Write HA

Write R₀

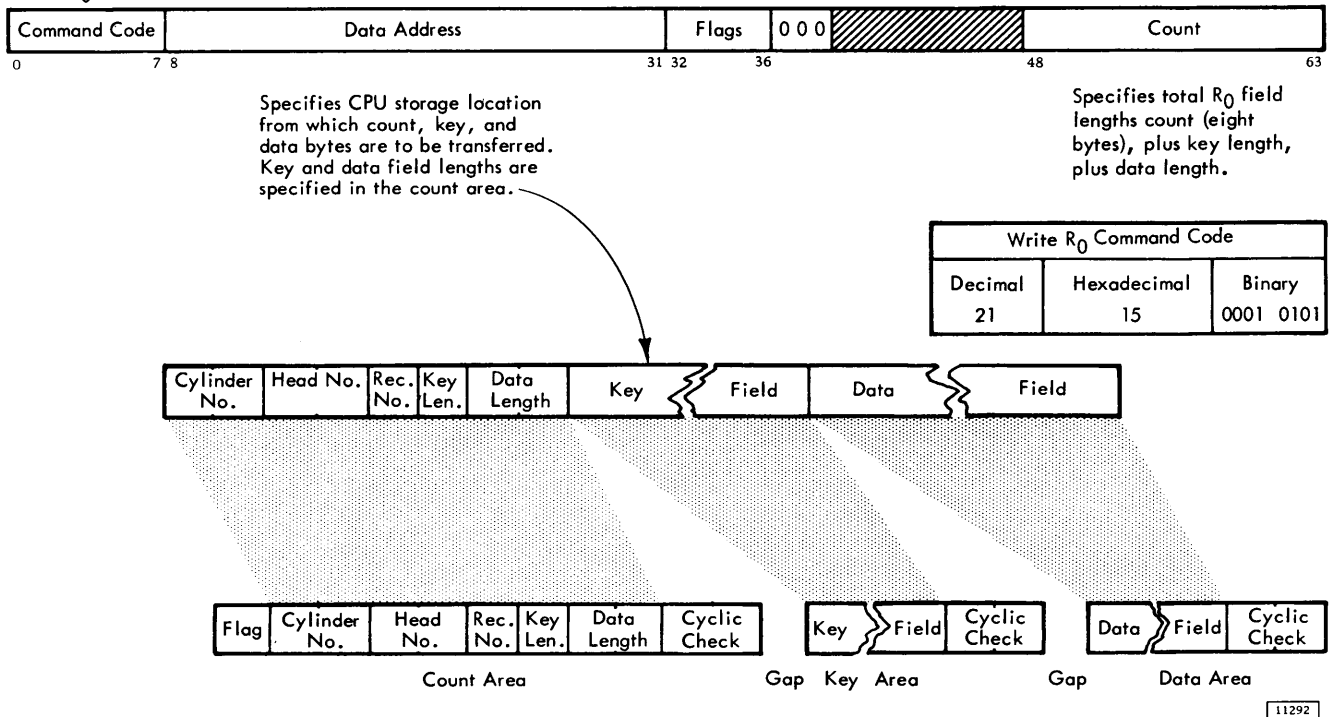

Figure 10. Write R₀

The CCW Count Field specifies the number of bytes to be transferred from main storage by the channel. This is eight (bytes) plus Key Length plus Data Length. If CCW Count is less than this, the 2841 writes valid zeros so that the Key and Data Areas conform to the lengths specified in the record Count Area.

Chaining Requirements: This command causes an Invalid Sequence signal to be generated, unless it is chained from a Search HA that was equal on all five bytes of the Home Address, or from a Write HA.

If the Write R₀ CCW is issued more than 60 microseconds after the preceding Search HA or Write HA, an Overrun signal is generated.

Write Count, Key, and Data (Figure 11). This command is the same as the Write R₀ except that the 2841 causes an Address Marker to be written on the track immediately before the Count.

This command causes an Invalid Sequence Signal to be generated unless it is chained from a Write R₀, another Write Count, Key and Data, or from a successful Search Equal ID or Search Equal Key command. This search must not be a truncated search, or one in which the CCW count is less than the length of the area. A Read Data or Read Key and Data CCW may be inserted between a Search CCW and Write Count, Key and Data CCW.

Write Special Count, Key, and Data (Figure 12).

This command functions like the Write command except that it causes a one-bit to be placed in bit-position one of the Flag byte when the 2841 generates and writes the Flag byte. It is used with the Record Overflow feature.

Data Write Commands

These commands are used for normal record updating. Detection of a Parity Check or Overrun causes a Unit Check to be generated at the completion of the command. A data check which occurs in record areas which must be passed over but not written, terminates the command before data is written.

Write Data. This command causes the specified data to be transmitted from CPU storage to the storage device. Writing continues as specified by the Data Length portion of the Count Area. At this point, the 2841 causes the Code Check to be written and then sets Channel End and Device End. If the CCW Count is less than the Data Length in the Count Area, the 2841 causes valid zeros to be written in the remaining portion of the Data Field.

Chaining Requirement: Write Data causes an Invalid Sequence to be generated if it is not chained

Write Count, Key and Data

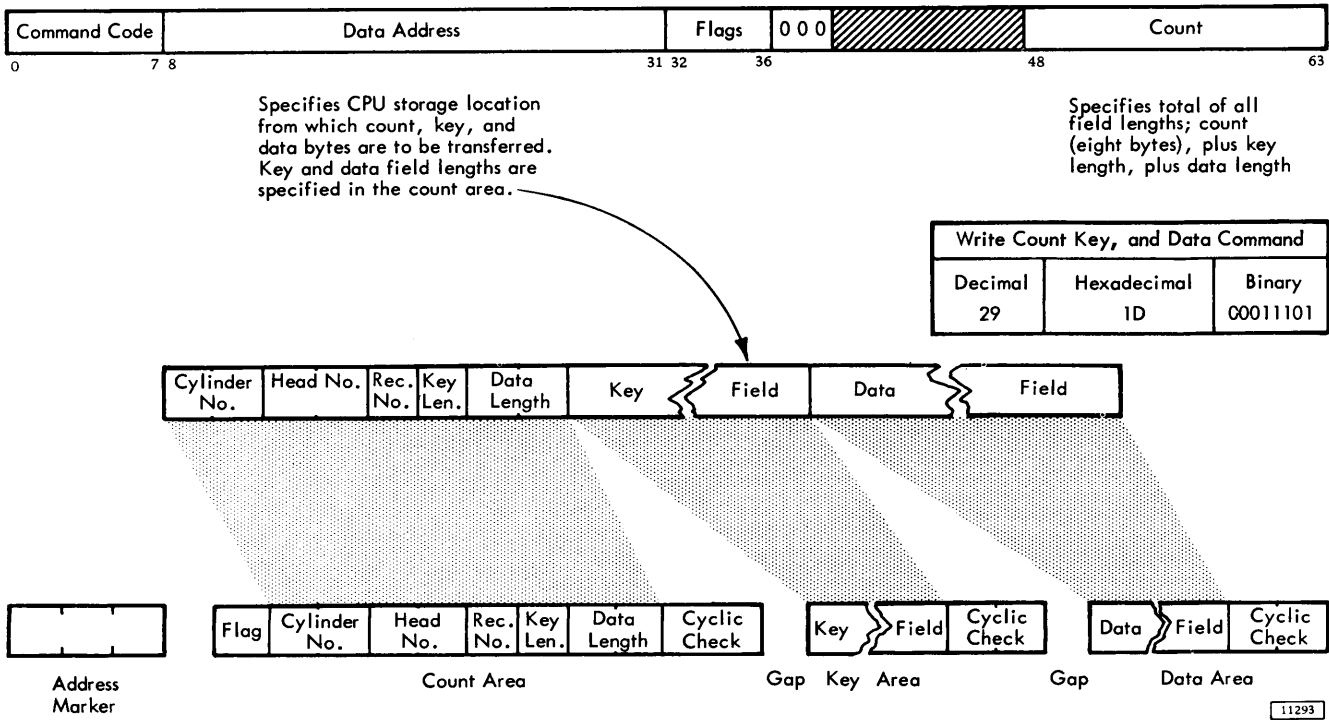

Figure 11. Write Count, Key and Data

Write Special Count, Key, and Data

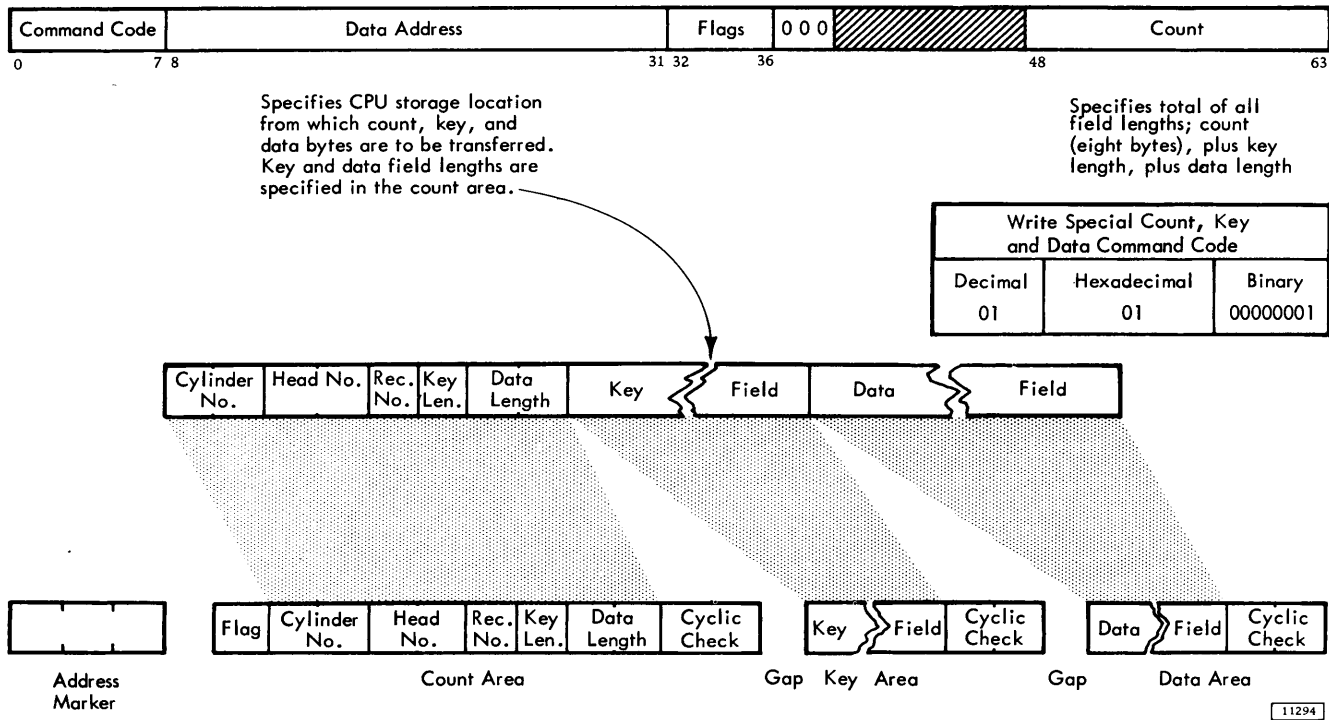
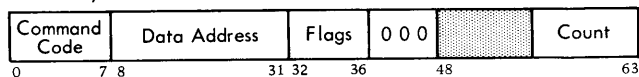

Figure 12. Write Special Count, Key, and Data

from a successful Search Equal ID or from a Search Equal Key command which was not truncated.

Write Key and Data. This command is the same as a Write Data command except that the Key Area is also written. If the Key Length Field of the Count Area is zero, the Write Key and Data command functions just like the Write Data command.

Write Data
Write Key and Data



Specifies CPU storage location from which data or key and data fields are to be transferred. The CCW count field specifies the number of bytes to be transferred.

Write Data Command Codes			
	Decimal	Hexadecimal	Binary
Write Data	05	05	00000101
Write Key & Data	13	0D	00001101

11295

An Invalid Sequence is generated if Write Key and Data is not chained from a successful Search Equal ID command, which was not truncated. Write commands are never truncated.

End of File

The end of a logical file is indicated by a record whose Count Area contains a Data Length of two bytes of zeros. This may be any record on a track.

This record is written by a Write Count, Key and Data CCW or a Write R0. The indicated zero Data Length causes the 2841 to record a Data Area of a single zero byte.

Formation of a Key Area in an end-of-file record depends on the indicated Key Length. If Key Length is not zero, the Key Area is transferred.

As a logical file is read or written, the Count Area of each record is examined. Detection of a zero Data Length causes Unit Exception to be signalled in the Channel Status Word at the completion

time of the read or write operation that is performed. No part of the Data Area is transferred.

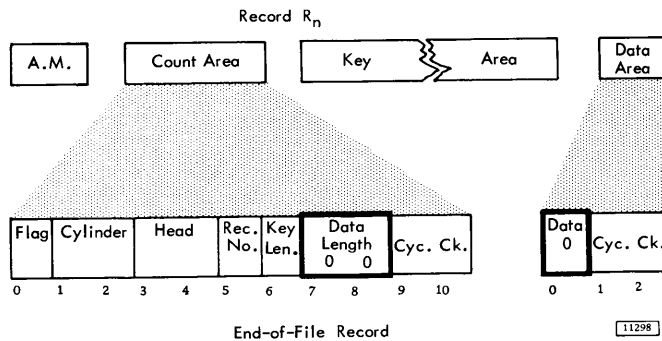

11298

Multiple Track (M-T) Operation

The 2841 has the ability to automatically select the next sequentially numbered head on an access mechanism under control of bit 0 (B0) of the Command Byte. Head switching does not take place at Index Point if B0 is a zero. Head switching takes place at Index Point if B0 is a 1.

The M-T bit is recognized on all Read and Search commands. Therefore, a certain amount of discretion should be used when making B0 a 1 bit. For example, if during a Search operation the M-T bit is a 1 and index is encountered before the search condition is satisfied, the head automatically switches to the next track. The operation continues until the End-of-Cylinder is detected. This condition can occur if the search was initiated beyond the point where the record was located on the track. On the other hand, by correctly utilizing the M-T bit, it is possible to search a complete cylinder of IDs or Keys.

Two-Channel Switch (Special Feature)

The Two-Channel Switch feature provides the ability for the 2841 Storage Control to be shared by two channels and also allows individual devices (access mechanisms) to be reserved for the exclusive use of either of the channels. The two channels may be attached to the same CPU or different CPUs. Channel switching and device reservation in the 2841 are performed under control of the system program.

Record Overflow (Special Feature)

The Record Overflow feature is provided to allow a logical record to overflow from one track to another. It is useful in achieving a greater data packing

efficiency and in formatting records which exceed the capacity of a track. The cylinder boundary is the limiting factor to the size of a record.

Formatting Overflow Records

A portion of an overflow record which is written on one track is called a record segment. Each record segment is processed as a normal record during Format Write operations. The Write Special Count, Key, and Data CCW is the command used for formatting all segments of an overflow record except the last segment. The last segment is written by the normal Write Count, Key, and Data CCW.

The Write Special CCW causes a bit to be written in Flag byte one in bit position one of the record segment being written. Otherwise, the Write Special CCW functions just like the normal Write command.

All overflow segments must be recorded as the first record following R0 on the overflow track.

Overflow segments are normally recorded without a Key Field, since only the Key Field of the first segment has significance. All overflow record segments, except the last one, are full track records.

Processing Overflow Records

The following CCWs operate on an overflow record as though it were a normal record if the Overflow Record feature is installed:

- Read Data
- Read Key and Data
- Read Count-Key and Data
- Write Data
- Write Key and Data

The 2841 detects that flag byte bit position one is a 1-bit. After completing the read or write operation on the first segment based on the count of the first segment, the 2841 searches for the Index Point. At Index Point, the next sequential Head is selected and the 2841 searches for the first Address Marker on the track. Then, under control of the Data Length in the Count Area, it processes

the Data Field of this record segment. This operation continues until the 2841 detects a record segment which contains a zero bit in flag byte bit position one. At the end of this record segment, the operation is terminated.

A CCW chain which starts operation on a record segment other than the first segment is processed as though it started on the first segment. This type of operation may make it desirable to repeat the Key Field in all record segments if the chain of CCWs is dependent on a Search Key Equal.

Search ID, Search Key, and Read Count CCWs operate on each record segment as though each were a normal record.

Unusual Conditions. In addition to the checks provided in normal processing of any record, certain conditions can occur which are unique to overflow records. The commands stop immediately on detecting the following conditions:

1. Overflow to a Defective Track
Overflow Incomplete and Track Condition Check sense bits will be set if an overflow occurs to a track which has been flagged as defective.
2. Overflow From an Alternate Track
Overflow Incomplete and Track Condition Check sense bits are set if an attempt is made to overflow from a track flagged as an alternate.
3. Overflow Violating a File Mask
Attempting to overflow by issuing a command in violation of a file mask sets Overflow Incomplete, File Protected, and Command Reject (write command only) sense bits.
4. Overflow to a Track with Incorrect Head Number
Overflow Incomplete and Seek Check sense bits are set if the Head number compare is unequal during an overflow. This condition occurs if the last Seek Address issued to the 2841 is not the address of the track with the overflow record and an overflow record is being read or written.

Introduction

The IBM System/360 is used in many applications which require that files of medium size be accessible to the central processor. These files may contain customer account balances, current inventory status, payroll information, computer operating programs, or other information, permanent or temporary, to which the central processor must refer to complete the specific application.

If all files need not be directly accessible (on line) to the central processor at all times, operating and equipment economies can be realized if the file can be separated from the file drive. As with magnetic tape, an unlimited volume of data can be stored away from the central processor (off-line). Appropriate data files can be placed on-line as required by the processing schedule.

It may also be desirable to be able to transfer data files from one file drive to another (possibly attached to a second central processor). This allows one system to process and update a data file, and another (possibly a smaller satellite system), to print reports or answer inquiries. This capability also enables a second system to complete a task if the primary system is not available because of other applications.

The IBM 2311 Disk Storage Drive, with IBM 1316 Disk Packs, offers processing features which answer the needs of many data processing applications:

Storage capacity:	Over 7.2 million bytes per disk pack
High speed accessibility:	85 milliseconds, average
Data file removability:	Disk pack change time: about one minute
Fast data transfer to the processor.	156,000 bytes per second
Multiple unit growth potential:	Up to eight 2311's 58 million bytes, on a single 2841 control unit

Compatibility between units:	1316's compatible between any 2311's used on IBM System/360
Large volume of data available at a single access:	Over 36,000 bytes per cylinder

Device Description

The IBM 2311 Disk Storage consists of two main components: the 2311 Disk Storage Drive and the 1316 Disk Pack.

Storage Medium (1316 Disk Pack)

Each disk pack consists of six 14-inch disks, mounted 1/2 inch apart on a central hub. Data is recorded on the inside ten disk surfaces. The two outer surfaces are covered by protective plates. The entire assembly of disks, hub, and protective plates is rotated at 2,400 revolutions per minute (25 ms per revolution). Each disk pack weighs about ten pounds.

The two-piece plastic cover is designed to protect disks against damage. A built-in handle on the top cover makes carrying easy and efficient. A self-locking device in the handle permits removal of the top cover only when the pack is mounted on the disk storage drive.

Access Mechanism

When the 1316 Disk Pack is mounted in the 2311 Disk Storage Drive, information is written on and read from the ten disk surfaces by magnetic read/write heads. These read/write heads are mounted in pairs between each two disks on a movable comb-like access mechanism. When in operation, the read/write heads float over the disk surfaces on a thin film of air.

Access Time

Cylinder-to-cylinder (horizontal) access time varies according to the number of cylinders traversed. Access time from a cylinder to an adjacent cylinder is 30 ms. Maximum access time (from cylinder 202 to cylinder 000) is 145 ms, and the average time for "random" accesses is approximately 85 ms (Figure 13).

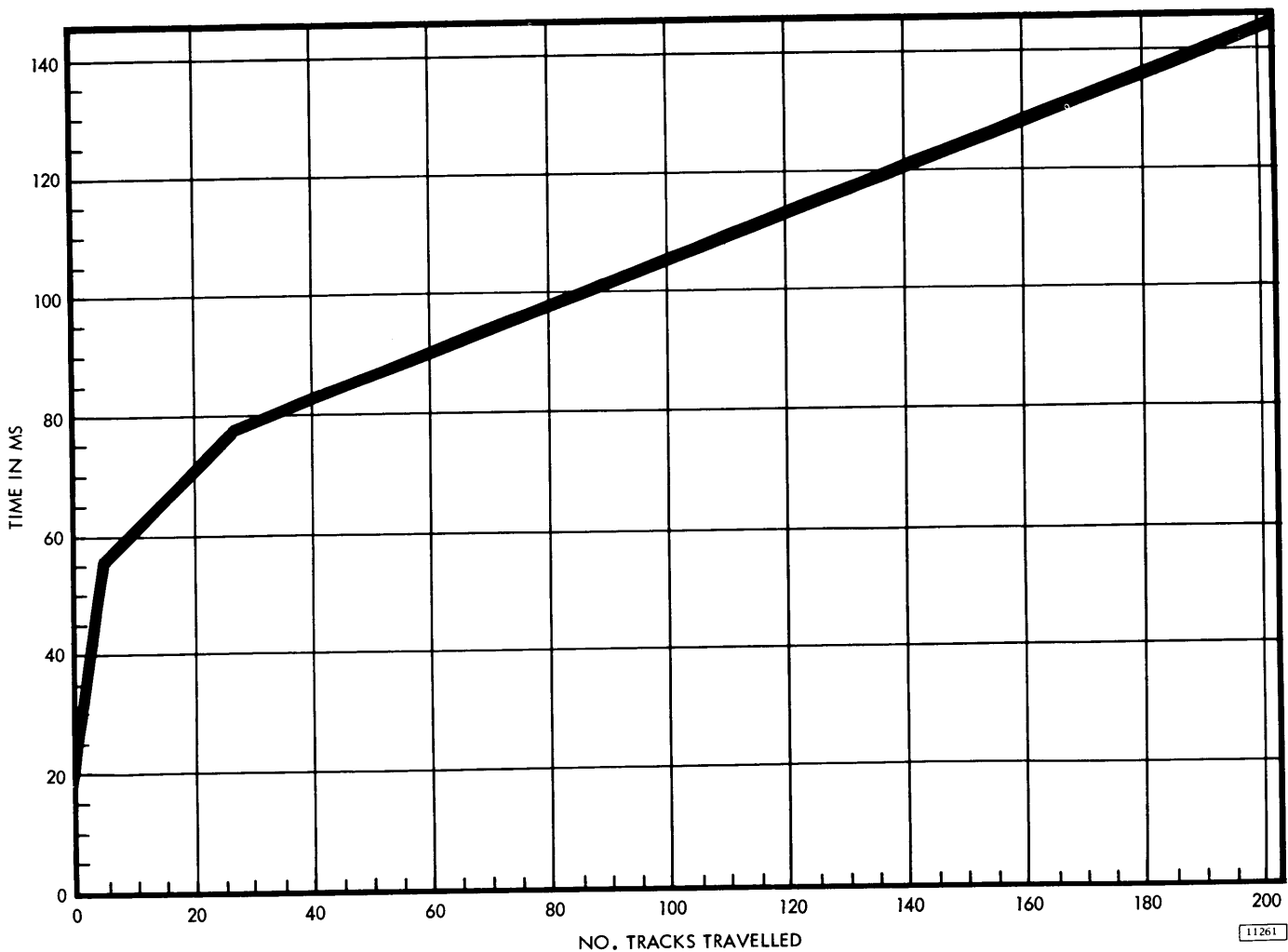
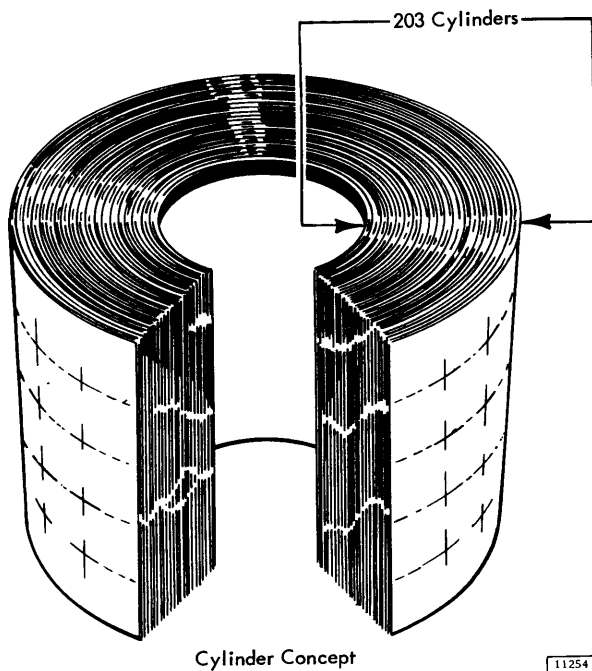

Figure 13. Access Times



11254

Once the access mechanism has reached a cylinder position, additional time is required for disk rotation to the desired record. At 2,400 revolutions per minute, rotation time is 25 ms, and one-half revolution (12.5 ms) is the average rotational delay.

Because the access mechanism includes one read/write head for each disk surface, no vertical access motion is required.

Figure 13 shows the approximate times for access mechanism movement in either direction, excluding rotational delay. This may be used as an aid in programming for the most efficient utilization of the storage unit.

Data Record Addressing

As the access mechanism is moved horizontally, it may be stopped at any of the 203 positions. This provides 203 data tracks on each surface. Since all ten read/write heads are moved by a single access mechanism, a cylinder of ten data tracks is available at each access mechanism position.

Data Storage

Format

Data is stored in the IBM 2311 Disk Storage Drive in the format defined by the IBM 2841 Storage Control Unit. This format is uniform for all storage devices attached to the 2841.

Capacity

If IBM Programming Systems are not used, the first record on each track (R0) may contain application data.

Based on 200 tracks, with all records used for application data, a single IBM 1316 Disk Pack can contain over 7.3 million bytes, or over 14.7 million packed decimal digits.

IBM Programming Systems reserve the use of the first record on each track (Record R0) to store various information about the track. This information is used by the Programming System, and no application data is included. Using this format, based on 200 tracks, each 1316 disk pack can contain over 7.2 million bytes, or over 14.4 million packed decimal digits (Figure 14). Record R1 is the first application data record, and if R1 is the only data record on the track, it may contain up to 3625 bytes of information.

With the high density recording techniques used in the 2311, minute contamination particles can affect data reading and writing and may cause loss of bits. Therefore, 203 tracks per disk surface are provided to ensure that the stated capacity, based on 200 tracks, is maintained for the life of the disk pack.

Because each data record has non-data components, like Count Area and Gaps, track capacity for data storage will vary with record design. As the number of separate records on a track increases, additional byte positions are used by gaps so that data capacity is reduced. The track capacity formulas (Figure 14) provide the means to determine total byte requirements for records of various sizes on a track.

Operator Controls and Indicators

Start/Stop Key. This key is lighted (on) when it is in the Start position.

With the 2311 properly connected in a processing system, press this key to the Start position to supply power to the disk drive motor and other 2311 components. When the disk drive motor has come to speed, and other components are ready for operation, the read/write heads are moved into position and the access mechanism performs an automatic seek cycle.

Pressing the Start/Stop key when it is in the Start position changes it to the Stop position. This action causes the access mechanism to retract from the disk

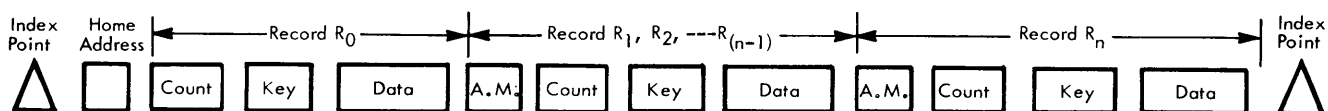

Storage Units	Track Capacity Basis in Bytes, When R ₀ is Used as Specified By IBM Programming Systems.	Basic Track Capacity When R ₀ is Used for Data	Bytes Required by Data Records			
			Data Records (except for last record)		Last Record	
			Without Key	With Key	Without Key	With Key
2311	3625	3694	$61 + 1.049 D_L$	$81 + 1.049 (K_L + D_L)$	D_L	$20 + (K_L + D_L)$

Record R ₀ used as specified by IBM Programming Systems. No application data; K _L = 0; D _L = 8	Number of Equal Length Records Per 2311 Track																			
	1	2	3	4	5	6	7	8	9	10	11	12	13	14	15	16	17	18	19	20
	Without Key	3625	1739	1130	829	650	531	446	383	334	294	262	235	212	193	176	161	148	137	127
With Key	3605	1719	1110	809	630	511	426	363	314	274	242	215	192	173	156	141	128	117	107	97

Figure 14. 2311 Capacity

11258

pack and removes power from the disk drive motor. Automatic braking stops disk pack rotation in a few seconds.

Select Lock Indicator. When on, this indicates a machine condition which requires Customer Engineering attention. This condition causes the disk storage drive to be disabled and stops the usage meter.

Enable/Disable Switch. When the CPU is in the stopped state, this switch enables or disables the communication of the storage drive with the CPU. It also enables or disables the equipment usage meter.

If the CPU is running when the switch setting is changed, the storage drive and usage meter operating status are not changed until the CPU is placed in the stopped state. (See also Select Lock Indicator.)

Operating Procedures

Disk Pack Handling

Each disk pack is protected in transit by special carton inserts and special protective material.

When received, examine the carton closely. If its condition is acceptable, remove the disk pack and store it. Keep the carton and inserts; you may need them later.

If the carton or its contents show any unusual shipping damage, do not use the disk pack. Retain the damaged carton and disk pack in its "as received" condition and notify your IBM Customer Engineer immediately.

Disk packs have been designed for ease of transport from location to location.

For best shipping results:

1. Be sure the pack is secure in its two-piece cover.
2. Use only the specially designed IBM shipping carton with its special protective padding properly inserted. If the original carton is worn or damaged, a new carton may be ordered from your local IBM office.

Handle a disk pack only with its cover on.

If the disk pack is accidentally dropped, or receives a sharp impact of any kind, call an IBM Customer Engineer before using it.

Disk Pack Labeling. For positive identification, small adhesive-backed labels can be placed on the disk pack center hub. Labels in this location can be read through the transparent disk pack cover.

The following operating procedures should be followed when labeling disk packs:

1. Use adhesive-backed labels which can be applied and removed easily.
2. Use a writing implement, like a pen or felt-tip marker, which does not produce loose residue. Do not use a lead pencil.
3. Write on the label before it is applied to the disk pack.
4. Place the label only on the center hub, not on the disk pack cover or top disk surface.
5. Use a new label if changes are necessary. Never use an eraser because microscopic eraser particles can damage disk surfaces and read/write heads.

Disk Pack Loading and Unloading. The following procedures should be followed for rapid, effective disk pack changing:

Loading.

1. Open the 2311 cover.
2. Remove the bottom disk pack cover by turning the bottom locking knob.
3. Place the 1316 disk pack (still contained in top cover) on the 2311 spindle.
4. Turn the top cover in direction of ON arrow until firm resistance is met.
5. Lift the top cover from the disk pack.
6. Close the 2311 cover.
7. Press the 2311 Start key.
8. Reassemble the top and bottom covers of the disk pack.
9. Store the covers in a clean cabinet or on a clean shelf.

CAUTION: Do not leave disk pack top cover inside Disk Drive.

Unloading.

1. Press the 2311 Stop key.
2. Wait for the disk pack to stop rotating.
3. Separate the top and bottom disk pack covers.
4. Open the 2311 cover.
5. Place the disk pack top cover over disk pack.
6. Turn the top cover in direction of OFF arrow at least two full turns.
7. Lift the top cover, now containing the disk pack, from the spindle.
8. Fasten the bottom cover to disk pack (firmly).
9. Close the 2311 cover.
10. Store the disk pack in a clean cabinet or on a clean shelf.

Disk Pack Storage. To assure maximum disk pack life and reliability:

1. Store the disk packs flat, not on edge.
2. Each pack should rest on a shelf, not on another disk pack.
3. Store in a clean, enclosed metal cabinet or a similar fire-resistant container; never

in direct sunlight.

4. Store disk packs in a machine-room atmosphere (60° to 90° F, 10% to 80% humidity).
5. If disk packs must be stored in a different environment, allow two hours for adjustment to machine room atmosphere before use.

Introduction

The IBM 2302 provides the using system with:

- High data storage capacity
- Fast, direct access to stored data
- High data transfer rate
- Flexible data organization

The IBM 2302 Disk Storage provides fast access to vast quantities of on-line, stored information. Random access to specific areas of information enables the user to locate any data record within a maximum of 180 milliseconds, without sequential address searching. Thus, voluminous master record files may be stored on-line ready for immediate reference or updating.

Maintenance of master record files is immediate and direct; the most current information available is entered into the proper area of the master record file as transactions occur. Complex accounting procedures can be simplified, because intermediate manual operations, necessary to maintain off-line record files, are eliminated.

Device Description

Storage Medium

Disk storage consists of thin metal disks uniformly coated with a magnetic recording medium. Data and control information are recorded as magnetized spots on the coated surfaces of the disks in concentric data tracks.

Access Mechanism

Horizontal positioning of the read/write heads is performed by a hydraulic access mechanism containing 46 data read/write heads. During a seek operation, the access mechanism positions the read/write heads at the program specified track location. No vertical movement is necessary because there is a head for each data surface. It is not necessary to perform an additional seek operation if the desired record is in the same vertical plane (cylinder) as the previous record; only electronic head selection is necessary.

Two access mechanisms are used to address the 500 data tracks on the disk surface. One access mechanism services the inner 250 data tracks, and the other access mechanism services the outer 250 data tracks (Figure 15).

The two access mechanisms of the 2302 are addressed as Access 0 for the outer 250 cylinders and Access 1 for the inner 250 cylinders.

The two access mechanisms on the 2302 operate independently and may be in motion simultaneously. Each mechanism is restricted to motion within its own zone of operation; accordingly, one access mechanism cannot read a track written by the other access mechanism.

Access Group. The access mechanism, together with the attached read/write heads, and the 250 tracks serviced by it, comprise an access group. Two access groups are provided with the 2302 Model 3, and four are provided with the 2302 Model 4.

Disk Storage Module. A stack of 25 magnetic disks (50 disk surfaces) together with the associated read/write heads and the horizontal positioning mechanisms comprise a disk storage module.

Model 3 and Model 4 Disk Storage Designation.

Model (3 or 4) designation refers to the number of disk storage modules provided. Model 3 disk storage contains one module of disk storage; Model 4 contains two modules of disk storage, one above the other.

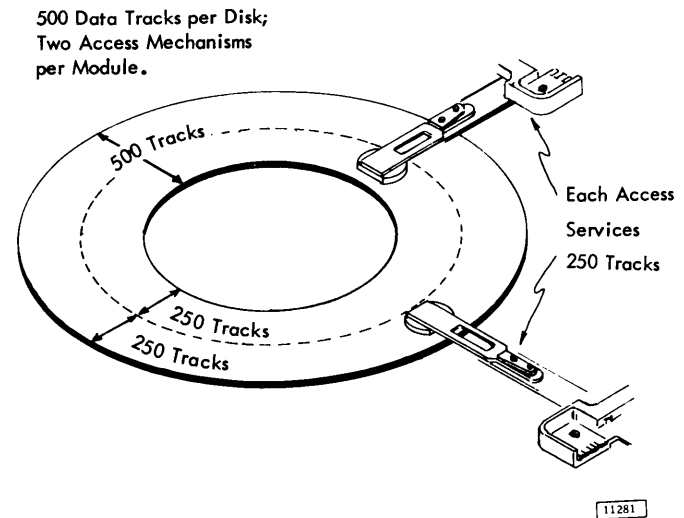

Figure 15. Access Mechanisms

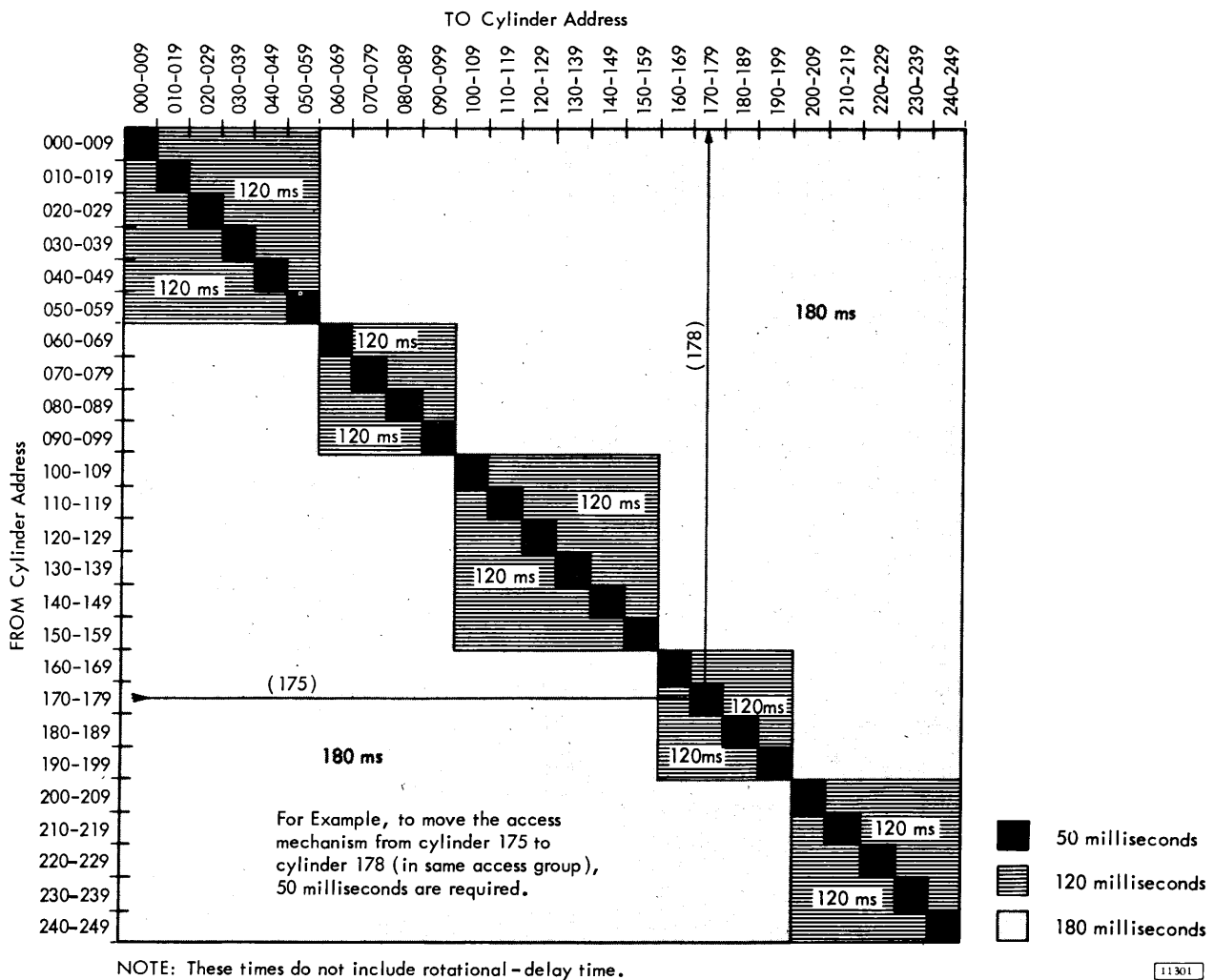

Figure 16. 2302 Disk Storage Access Time

Access Time

Access to one specific track on a given recording surface is accomplished by the lateral movement of the whole access mechanism from a current track location. The time required for this movement is called access motion time and is related to the lateral distance the arm moves. Figure 16 shows the time requirements for access motion time for the IBM 2302 Disk Storage.

In addition to access motion time, an additional timing factor known as rotational delay time is encountered. Rotational delay time is the time required for the disk to position the desired record at the selected read/write head. Maximum rotation at delay time is 34 milliseconds; average rotational delay time is 17 milliseconds.

The selection of the proper read/write head is performed simultaneously with access motion time. The read/write head selection time consists solely of electronic switching and is negligible.

Total data access time includes the summation of access motion time and rotational delay time. Average rotational delay time (17 milliseconds) is generally used in this calculation.

Data Record Addressing

The data tracks of the cylinders are numbered sequentially from bottom to top and from outermost cylinder to the innermost cylinder of each access group. Data track numbers begin with 0000 at the outermost cylinder of the lowest data disk surface, and continue up through this outermost cylinder to track number 0045.

Numbering continues with the lowest data track of the next inner cylinder, 0046 and proceeds upward within the cylinder. Continuing through each of the cylinders of the single access group in like manner, the last track is the top track of the innermost cylinder.

Data Storage

Format

The format of the data stored on the 2302 is determined by the 2841 Storage Control. It is identical for all storage devices which attach to the 2841.

Capacity

If IBM Programming Systems are not used, the first record on each track (R0) may contain application data. Based on the use of all record areas for application data, a single IBM 2302 Disk Storage Drive Model 3 can contain over 113 million bytes or 226 million packed decimal digits; the Model 4 can contain over 226 million bytes or 452 million packed decimal digits.

IBM Programming Systems reserve the use of the first record on each track (Record R0) to store various information about the track. This information is used by the programming system, and no application data is included. By using this format, each 2302 Disk Storage module can contain over

112 million bytes, or over 224 million packed decimal digits. Record R1 is the first application data record and if it is the only data record on the track, it may contain up to 4984 bytes of information.

With the high density recording techniques used in the 2302, surface defects or contamination can affect data reading and writing and require that alternate tracks be used. Therefore, rated capacity is 112.0 million bytes per module to ensure that the stated capacity is maintained.

Because each data record has non-data components, such as Count Area and Gaps, the track capacity for data storage will vary with record design. As the number of separate records on a track increases, additional byte positions are used by gaps so that data capacity is reduced. The track capacity formulas (Figure 17) provide the means to determine total byte requirements for records of various sizes on a track.

Indicators

File Ready

File Ready indicates that the 2302 has power on, is up to operating temperature, and is ready to accept or retrieve data, on demand of the 2841 Storage Control. This light is used to determine when the storage device is ready after power is turned on. The light remains on until power is dropped though temperature may fall below normal operating range.

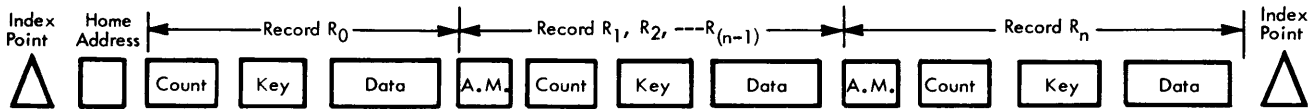

Storage Unit	Track Capacity Basis in Bytes, When R ₀ is Used as Specified By IBM Programming Systems.	Basic Track Capacity When R ₀ is Used for Data	Bytes Required By Data Records			
			Data Records (except for last record)		Last Record	
			Without Key	With Key	Without Key	With Key
2302	4984	5053	$61 + 1.049 D_L$	$81 + 1.049 (K_L + D_L)$	D_L	$20 + (K_L + D_L)$

Record R ₀ used as specified by IBM Programming Systems. No application data; K _L = 0; D _L = 8	Number of Equal Length Records Per 2302 Track																			
	1	2	3	4	5	6	7	8	9	10	11	12	13	14	15	16	17	18	19	20
	Without Key	4984	2402	1569	1157	912	749	632	546	478	424	380	343	312	285	263	243	224	208	195
With Key	4964	2383	1550	1138	892	729	613	526	459	405	361	324	293	266	244	224	205	189	176	163

11302

Figure 17. 2302 Capacity

Introduction

Many data processing applications include the maintenance of very large files of operating information. Direct access to a large file enables the central processor to answer inquiries about any item in the file. For processing economy, transactions may still be batched and sequenced. However, processing may be interrupted, an inquiry about another part of the file answered, and processing resumed on an "up-to-the-minute" basis. Thus, business decisions can be based on the most current data available, and applications not previously practical can be accomplished by data processing equipment.

The IBM 2321 Data Cell Drive includes processing capabilities which expand the sphere of data processing applications:

Large storage capacity:	Over 418 million bytes per 2321
Medium speed accessibility:	600 milliseconds <u>maximum</u> to any record
Data file removability:	Data Cell change time: about one minute
Fast data transfer to the central processor:	55,000 bytes per second
Multiple unit growth potential:	Up to eight 2321s per 2841
Compatibility between units:	Data Cells compatible between 2321s used with IBM System/360
Large volume of data available at single access:	198,000 bytes per strip

Device Description

The IBM 2321 is a random access storage unit capable of storing and retrieving data on individual magnetic strips.

From a circular array of 10 cells with 20 subcells each (Figure 18), a rotary positioning system positions a selected subcell of ten strips beneath an access station. At this station a selected strip is first withdrawn from the subcell, then rotated past a read/write head element for data transfer, and finally returned to its original location in the subcell.

Cell Drive

Data Cell positioning is initiated by a Seek instruction. The cell drive rotates the circular array of ten Data Cells to one of 200 discrete subcell positions. The array can rotate in either direction and always moves in the direction that requires least travel.

When the array has placed the subcell containing the addressed strip beneath the access station, a position check is made by a subcell position detector, which signals the 2841 Storage Control Unit that a subcell is within the range of the access station.

Access Station

The addressed strip is exposed by parting the adjacent strips with separation fingers. The strip is selected from a subcell of 10 and placed on a revolving drum. It is then rotated past the read/write head block for data transfer. When reading and/or writing is complete, the strip is returned to its original subcell location by a restore function. The read/write head block contains 20 magnetic elements. It can be positioned to any of five positions (cylinders), thus providing 100 recording tracks per strip. The head block position is specified by the address in the Seek instruction.

Access Time

Access time is defined as the length of time required to place a selected strip in a data transfer position. Average access time under varying conditions is listed in Figure 19.

Data Record Addressing

The physical location of an individual recording track is determined by considering the following areas:

- Data Cell Drive
- Data Cell
- Subcell
- Strip
- Cylinder
- Read/Write Head Element

When a record is addressed, the location of each of the areas just listed is compared against the new

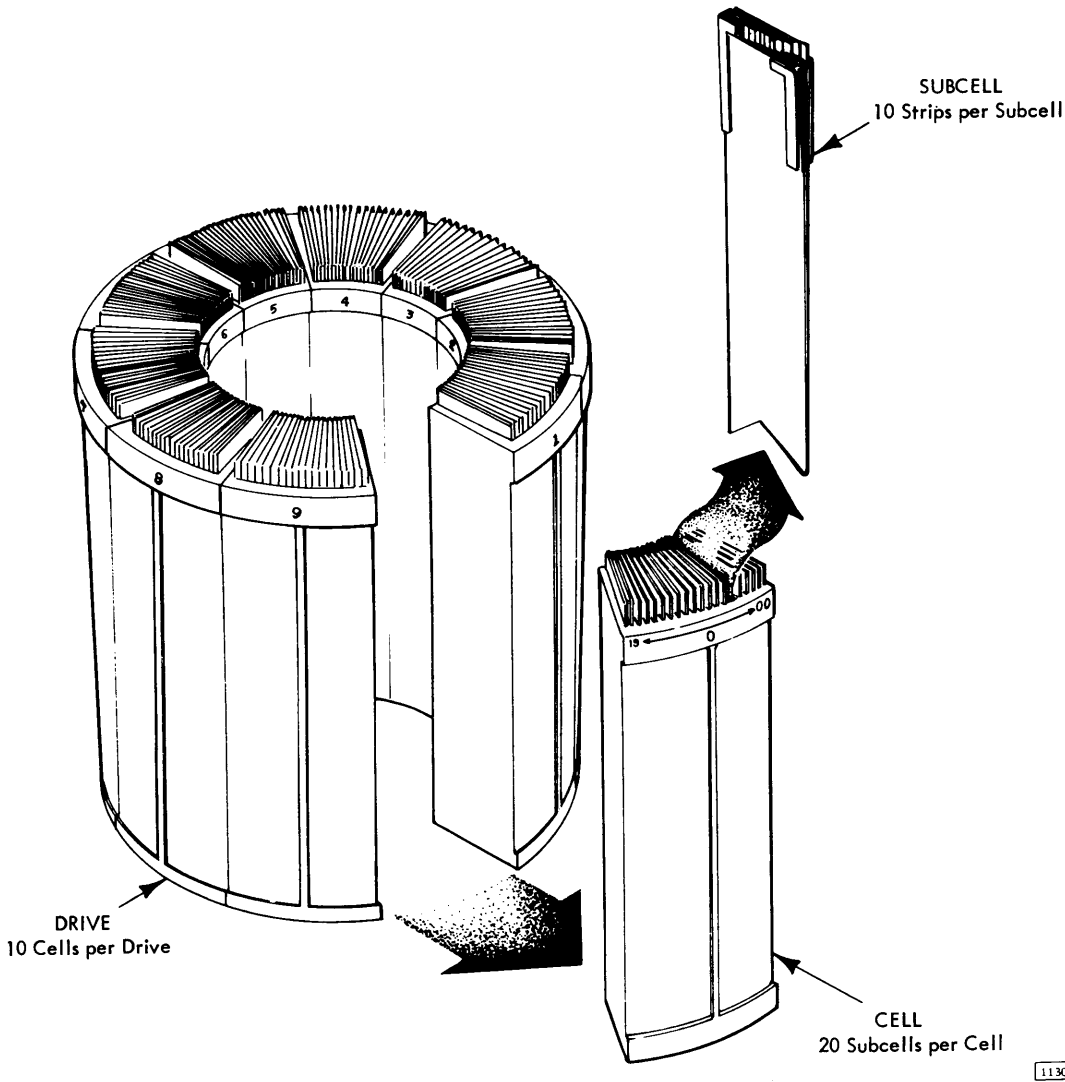

Figure 18. 2321 Drive, Cell, Subcell

Conditions	Time/Number of Subcell Moves			
	0 Subcell	1 Subcell	50 Subcell	100 Subcell
When only Read/Write element selection is required	100 μ sec			
When only Read/Write head Block motion is required	95 ms			
When No Strip is on the Drum	175 ms	250 ms	350 ms	400 ms
When a previously Addressed Strip is on the Drum	375 ms	450 ms	550 ms	600 ms

Figure 19. 2321 Access Time

address. From this comparison, the necessary electronic and electromechanical action required to place the addressed record in the data transfer position is determined.

When the new address is the same as the old address in a specific area, no access motion is required. For example, if the only difference between a new and old address is the selection of an adjacent track within the same cylinder position, the only action would be the electronic selection of the proper read/write head element, providing the strip was not restored in the interim.

Data Storage

Format

Data is stored in the IBM 2321 Data Cell Drive in the format defined by the IBM 2841 Storage

Control. This format is uniform for all devices attached to the 2841.

Capacity

If IBM Programming Systems are not used, the first record on each track (R0) may contain application data. Based on the use of all records on a track for application data, a single IBM 2321 Data Cell Drive can contain 418 million bytes or 836 million packed decimal digits.

IBM Programming Systems reserve the use of the first record of each track (Record R0) to store various information about the track. This information is used by the Programming System, and no application data is included. By using this format, each 2321 can contain over 400 million bytes, or over 800 million packed decimal digits (Figure 20). Record R1 is the first application data record, and if R1 is the only data record on the track, it may contain up to 2000 bytes of information.

Because each data record has non-data components, like Count Area and Gaps, track capacity for data storage will vary with record design. As the number of separate records on a track increases, additional byte positions are used by gaps so that data capacity is reduced. The track capacity formulas (Figure 20) provide the means to determine total byte requirements for records of various sizes on a track.

Operator Controls and Indicators

The operator's console on the Data Cell Drive contains indicator lights and manual controls. The indicator lights provide the machine operator with the following information.

Ac Power On. Indicates that primary ac power is applied to the IBM 2321.

Drive Operative. Indicates that the 2321 has all power on and no interlock conditions exist. Interlock conditions, such as an open entry door or an improperly mounted data or ballast cell, render the 2321 inoperative.

Drive Ready. Indicates that the 2321 is ready to perform normal programmed operations under control of the 2841.

Thermal. Indicates that a high temperature condition exists within the 2321.

Drive Select. Indicates that the storage control unit is communicating with the 2321.

The manual keys and switch enable the operator to control the following functions.

Restart. This key allows the restart of the 2321 in the event of certain inoperative conditions, such as a momentary interrupt in power.

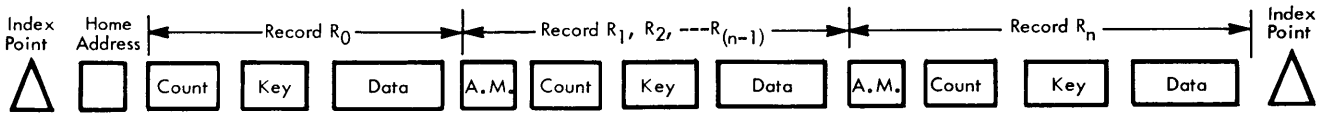

Storage Unit	Track Capacity Basis in Bytes, When R ₀ is Used as Specified By IBM Programming Systems.	Basic Track Capacity When R ₀ is Used for Data	Bytes Required By Data Records			
			Data Records (except for last record)		Last Record	
			Without Key	With Key	Without Key	With Key
2321	2000	2092	$84 + 1.049 D_L$	$100 + 1.049 (K_L + D_L)$	D_L	$16 + (K_L + D_L)$

Record R ₀ used as specified by IBM Programming Systems. No application data; K _L = 0; D _L = 8	Number of Equal Length Records Per 2321 Track																			
	1	2	3	4	5	6	7	8	9	10	11	12	13	14	15	16	17	18	19	20
	Without Key	2000	935	591	421	320	252	204	168	141	119	100	85	72	61	52	43	36	29	23
With Key	1984	919	575	406	304	237	189	153	125	103	84	70	57	46	37	28	20	14	8	

Figure 20. 2321 Capacity

11305

Reset. This key allows the 2321 indicators to be reset in the event of an improper status condition. This reset will not establish a Drive Operative status.

DC On. Indicates that all dc power within the 2321 is on.

Operating Procedures

Data Cell Replacement. To facilitate Data Cell replacement, four operator aids are provided.

1. **Entry door with interlock:** The entry door permits access to the Data Cell array. An interlocking switch is provided for operator safety. When the door is open, no machine controlled motion can occur.
2. **Data Cell location indicator:** The Data Cell location indicator identifies, by number, the Data Cell located in the replacement position. It also indicates the number of the Data Cell positioned under the access station.
3. **Manual by-pass valve:** The manual by-pass valve allows an operator to manually rotate the array to place any desired Data Cell in the replacement position. The valve is mechanically interlocked with the access station and is closed automatically with the closing of the entry door.
4. **Data Cell mount interlock:** An interlock switch is provided to prevent 2321 operation unless the switch is properly closed by either a Data Cell or a ballast cell.

The following procedure should be followed when replacing Data Cells.

1. Check the indicator lights for the following pattern:
 - Ac Power should be on.
 - Drive Operative should be on.
 - Drive Ready should be on.
 - Drive Select should be off.
2. Open the entry door. The Drive Ready indicator should extinguish.
3. Check the Data Cell location indicator to determine the physical position of the desired Data Cell.
4. Open the manual by-pass valve and rotate the array (in either direction) to place the desired Data Cell in the replacement position.
5. Place a Data Cell cover on the desired Data Cell. This action engages all mechanical and electrical interlocks and allows the Data Cell to be removed from the machine.

NOTE: New Data Cells, replacement Data Cells, or ballast cells must be inserted in place of removed cells. When the Data Cell cover is removed from a properly inserted cell, the mechanical and electrical interlocks are disconnected.

6. Close the entry door.
7. Check the indicator lights for the following pattern:
 - Ac Power on
 - Drive Operative on
 - Drive Ready on
 - Drive Select off

Introduction

The IBM 7320 Drum Storage provides on-line random access storage of 878 thousand bytes on a magnetic drum. Eight 7320s may be attached to each 2841 Storage Control Unit for a total on-line random access storage of 7 million bytes of 14 million packed decimal digits.

The drum is divided into 400 data tracks; each track has a read/write head and may contain up to 2,081 bytes of data. The maximum data transfer rate is 135 thousand bytes per second.

Device Description

The 7320 Drum Storage consists of a vertically mounted drum and its associated electronic circuitry. The drum, coated with a magnetic recording material, rotates at about 3,500 revolutions per minute. The surface of the drum is divided into tracks. These addressable tracks, extending around the periphery of the drum, are used for storing data as follows:

400	Standard Data Tracks
40	Alternate Data Tracks

The alternate tracks are provided to ensure that each recorded bit can be stored in a magnetically perfect medium. If a defect is encountered on a track, the entire track is disabled and one of the alternate tracks is substituted. This alternate track is given the address of the disabled track.

Each data track has its own read/write head, used for both recording and retrieving data. The data read/write heads are fixed in position on 20 vertical racks that surround the drum. Each rack contains 20 data read/write heads.

Access Time

Because of the assignment of an individual read/write head to each data track, data seek operations, with their associated access motion time delay, are eliminated.

Data Record Addressing

Arrangement of read/write heads on vertical racks permits organization of data to be stored in a "cylinder" of data. Cylinder operations with drum storage units allow up to 400 tracks to be written or read with a single drum storage order.

Data Storage

Format

Data is stored in the IBM 7320 Drum Storage in the format defined by the 2841 Storage Control. This format is uniform for all storage devices which attach to the 2841.

Capacity

If IBM Programming Systems are not used, the first record on each track may contain application data. Based on the use of all records on a track for application data, a single IBM 7320 Drum Storage Unit can contain over 873 thousand bytes or over 1.7 million packed decimal digits.

IBM Programming Systems reserve the use of the first record of each track (Record R0), to store various information about the track. This information is used by the Programming System, and no application data is included. By using this format, each 7320 can contain 830 thousand bytes, or 1.6 million packed decimal digits (Figure 21). Record R1 is the first application data record, and if R1 is the only data record on the track, it may contain up to 2075 bytes of information.

With the high density recording techniques used in the 7320, minute contamination particles can affect data reading and writing. Therefore, 40 alternate tracks are provided to ensure that the stated capacity, based on 400 tracks is maintained.

Because each data record has non-data components, like Count Area and Gaps, track capacity for data storage will vary with record design. As the number of separate records on a track increases, additional byte positions are used by gaps so that data capacity is reduced. The track capacity formulas (Figure 21) provide the means to determine total byte requirements for records of various sizes on a track.

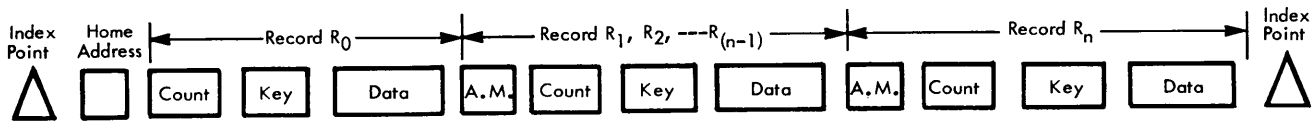

Storage Unit	Track Capacity Basis in Bytes, When R_0 is Used as Specified By IBM Programming Systems.	Basic Track Capacity When R_0 is Used for Data	Bytes Required By Data Records			
			Data Records (except for last record)		Last Record	
			Without Key	With Key	Without Key	With Key
7320	2075	2183	$100 + D_L$	$118 + (K_L + D_L)$	D_L	$18 + (K_L + D_L)$

Record R_0 used as specified by IBM Programming Systems. No application data; $K_L = 0$; $D_L = 8$	Number of Equal Length Records Per 7320 Track																			
	1	2	3	4	5	6	7	8	9	10	11	12	13	14	15	16	17	18	19	20
	Without Key	2075	987	625	443	335	262	210	171	141	117	97	81	67	55	45	35	27	20	14
With Key	2057	969	607	425	317	244	192	153	123	99	79	63	49	37	27	17	9			

11306

Figure 21. 7320 Capacity

APPENDIX A. 2841/2311 PROGRAMMING EXAMPLE

The following 2311 Programming example is included to illustrate the use of 2841 channel commands to perform operations on attached storage devices. The program was assembled and simulated with the 7090/7094 Support Package for System/360. The example is solely for the purpose of illustration, it does not necessarily reflect techniques in the use of Operating System/360 Programs.

Two separate operations are performed. The first is the writing of Home Addresses (HA) and Track Descriptor Records (RO) on all 2030 tracks of the 2311. Read Back Check of RO is performed in CPU storage. The second program writes three records on track number 37, reads them into a separate I/O area and searches for a fourth record which is not there.

The first routine is labeled HAROWT and uses the Channel command list WRDKHA. The three record read/write and fourth record search is performed with the CCW list WR3REC. A subroutine (EXCP) is used to start I/O. Not shown is an interrupt handling subroutine, a subroutine (BZSIO) that acts on condition codes 1, 2 and 3 and DUMP which dumps CPU storage (as a debugging aid) in case of errors or conditions not yet programmed. The system is in the supervisory mode and enabled for interrupts at all times unless EXCP has disabled or the interrupt subroutine is being used. EXCP sets a bit equal to one in DEVTAB to indicate that the device is being used, this bit is cleared by the interrupt subroutine when the device end bit appears in the channel status word.

* * * WRITE HOME ADDRESSES AND TRACK DESCRIPTOR RECORDS *					
000112	18 77	HAROWT	SR	R5,R5	SET CYLINDER REGISTER TO 0
000114	58 40 C 2CA		L	R2,C1	SET INCREMENT TO 1
000118	40 70 C 4F2	CYLP	STH	R5,BBCCHH+4	STORE CYLINDER NUMBER FOR SEEK
00011C	40 70 C 4FA		STH	R5,FCCHH+4	STORE CYLINDER NUMBER FOR WRITE
000120	40 70 C 4FE		STH	R5,ROCNT	STORE CYLINDER IN TRACK DES REC
000124	58 50 C 2D2		L	R3,C9	SET HEAD LOOP COMPARE TO 9
000128	18 66		SR	R4,R4	SET HEAD REGISTER TO 0
00012A	40 60 C 4F4	HDLP	STH	R4,BBCCHH+6	STORE HEAD NUMBER FOR SEEK
00012E	40 60 C 4FC		STH	R4,FCCHH+6	STORE HEAD NUMBER FOR WRITE
000132	40 60 C 500		STH	R4,ROCNT+2	STORE HEAD IN TRACK DES. REC.
000136	41 00 C 1AE		LA	SP,WRDKHA	WRITE HOME ADDRESS AND
00013A	58 10 C 2E6		L	PL,C1D1	TRACK DESCRIPTOR RECORD
00013E	45 E0 C 07A		BAL	R,EXCP	ON THIS TRACK
000142	91 01 C 3EF		TM	CH1DV1,1	WAIT FOR READ BACK COMPLETE
000146	47 10 C 040		BC	1,*-4	
00014A	05 17 C 51E C 4FE		CLC	ROCMPR(24),ROCNT	READ BACK CHECK
000150	47 70 C 076		BC	7,HAROER	
000154	87 64 C 028		BXLE	R4,R2,HDLP	INCREMENT HEAD AND RECYCLE
000158	58 50 C 2D6		L	R3,C202	SET CYLINDER LOOP COMPARE TO 202
00015C	87 74 C 016		BXLE	R5,R2,CYLP	INCREMENT CYLINDER AND RECYCLE
* * * WRITE THREE RECORDS ON CYLINDER 3, TRACK 7 * READ THEM BACK AND LOOK FOR A FOURTH (NOT THERE) *					
000160	41 00 C 1EE		LA	SP,WR3REC	
000164	58 10 C 2E6		L	PL,C1D1	
000168	45 E0 C 07A		BAL	R,EXCP	
00016C	91 01 C 3EF		TM	CH1DV1,1	
000170	47 10 C 06A		BC	1,*-4	
000174	45 E0 C 166		BAL	R,DUMP	
000178	45 E0 C 166	HAROER	BAL	R,DUMP	READ BACK CHECK FAILED
* * * START I/O SUBROUTINE *					
00017C	80 00 C 2C7	EXCP	SSM	DISABL	DISABLE SYSTEM FROM INTERRUPTS
000180	50 00 0 048		ST	SP,72(0,0)	SP CONTAINS CAW
000184	9C 00 1 000		SIO	0(PL)	PL CONTAINS DEVICE ADDRESS
000188	47 70 C 0AC		BC	7,BZSIO	TEST FOR UNUSUAL CONDITIONS
00018C	50 70 C 276	CONTIN	ST	R5,REGS	DEVICE STARTED.
000190	41 71 C 2EE		LA	R5,DEVTAB(PL)	SET BIT IN DEVICE TABLE
000194	92 01 7 00C		MVI	C(R5),1	
000198	58 70 C 276		L	R5,REGS	
00019C	8C 00 C 2C8		SSM	ENABLE	CALLER BAL R, EXCP AND
0001A0	07 FE		BCR	15,R	R CONTAINS RETURN TO CALLER
			EJECT		

11310

*
*
*
*
*
*

CHANNEL COMMAND WORD LISTS

WRITE HOME ADDRESSES AND DESCRIPTOR RECORDS

0002B0	1F	0003CB	4C00	0001	WRCKHA	CCW	31,HAMASK,X'40',1	SET FILE MASK
0002B8	07	0005F2	4C00	0006		CCW	07,BBCCHH+2,X'40',6	SEEK TRACK
0002C0	19	0005FB	4C00	0005		CCW	25,FCCHH+3,X'40',5	WRITE HOME ADDRESS
0002C8	15	000600	4C00	0018		CCW	21,ROCNT,X'40',24	WRITE TRACK DESCRIPTOR RECORD
0002D0	39	0005FC	4C00	0004		CCW	57,FCCHH+4,X'40',4	SEARCH HA EQUAL
0002D8	08	0002E8	0C00	0000		CCW	08,#+16,0,C	
0002E0	16	000620	0C00	0018		CCW	22,ROCMR,0,24	READ RO
0002E8	03	0002E8	0C00	0000		CCW	03,#+0,0	ERROR EXIT

*
*

WRITE AND READ BACK THREE RECORDS

0002F0	1F	0003CB	4C00	0001	WR3REC	CCW	31,HAMASK,64,1	SET FILE MASK
0002F8	07	00063A	4C00	0006		CCW	07,RECO-2,64,6	SEEK CYL 3 TRK 7
000300	39	00063C	4C00	0004		CCW	57,RECO,64,4	SEARCH HA
000308	08	000370	0C00	0000		CCW	08,NORCFD,0,0	
000310	31	00063C	4C00	0005		CCW	49,RECO,64,5	SEARCH RO EQUAL
000318	08	000370	0C00	0000		CCW	08,NORCFD,0,0	
000320	1D	000641	4C00	0418		CCW	29,REC1,64,1048	WRITE REC 1
000328	1D	000A59	4C00	0038		CCW	29,REC2,64,56	WRITE REC 2
000330	1D	000A91	4C00	0218		CCW	29,REC3,64,536	WRITE REC 3
000338	31	000641	4C00	0005		CCW	49,REC1,64,5	SEARCH R1 ID
000340	08	000338	0C00	0000		CCW	08,#+-8,0,0	TIC FOR SEARCH
000348	0E	000CAC	4C00	0410		CCW	14,REC1KD,64,1040	READ R1 KD
000350	1E	0010BC	4C00	0038		CCW	30,REC2CD,64,56	READ R2 CKD
000358	1E	0010F4	4C00	0218		CCW	30,REC3CD,64,536	READ R3 CKD
000360	31	00130C	4C00	0005		CCW	49,REC4,64,5	LOOK FOR R4
000368	08	000360	0C00	0000		CCW	08,#+-8,0,0	TIC FOR SEARCH
000370	03	000370	0C00	0000	NORCFD	CCW	03,#+0,0	RECORD NOT THERE EXIT

*
*
*
*

SAVE AREA FOR GENERAL REGISTERS

000378					REGS	DS	16F	
000388						DS	00	
							EJECT	

11311

		* *		CONSTANTS		
0003B8	0000000000	NICPSW	DC	XL5'0000000000'		
0003BD	0001FC		DC	AL3(INT)		
0003C0	FF0000C0	APSW	DC	X'FF000000'		
0003C4			DS	F		
0003C8	00	ECFFLG	DC	X'00'		
0003C9	00	DISABL	DC	X'00'		
0003CA	FF	ENABLE	DC	X'FF'		
0003CB	C0	HAMASK	DC	X'CC'		FILE MASK-ALL WRITES-ALL SEEKS
0003CC	00000001	C1	DC	F'1'		
0003D0	00000C04	C4	DC	F'4'		
0003D4	000000C9	C9	DC	F'9'		
0003D8	00C00CCA	C202	DC	F'202'		
0003DC	00000001	COD1	DC	F'1'		READER SYSINI
0003F0	00000002	COD2	DC	F'2'		PRINTER SYSQ1
0003E4	00000100	C100	DC	F'256'		TAPE IN/OUT SYSUT4
0003E8	00000101	C101	DC	F'257'		2311 SYSCK1
0003F0		DEVTAB	DS	64C		STATUS OF DEVICES
	0003F0		ORG	DEVTAB		ONE EQUALS BUSY
0003F0	0C	CH0DV0	DC	X'00'		ZERO EQUALS FREE.
0003F1	00	CHGDV1	DC	X'00'		
0003F2	00	CH0DV2	DC	X'00'		
	0004F0		ORG	DEVTAB+256		
0004F0	00	CH1CV0	DC	X'00'		
0004F1	00	CH1CV1	DC	X'00'		
0004F2	00	CH1CV2	DC	X'00'		
	0005F0		ORG	DEVTAB+512		
						* RECORD AREAS
0005F0	00000000	BBCCHH	DC	2F'0'		SEEK ADDRESS 00 BB CC HH
0005F4	00000000					
0005F8	00000000	FCCHH	DC	2F'0'		HOME ADDRESS 0C OF CC HH
0005FC	0C0000C0					
000600	0000000000CC0010	ROCNT	DC	XL8'10'		RO COUNT FIELD
000608	000000000000000000	RODATA	DC	XL16'0'		RO DATA FIELD
00C611	0000000000CC00					
0C0618	0000000C	HACMPR	DC	2F'0'		HA COMPARE 00 0X XX XX
00061C	00000000					
000620		ROCMPR	DS	6F		TRACK RO COMPARE AREA
000638	000000C0		DC	F'0'		
00C63C	00C300C700	RECO	DC	X'00030007C0'		RO ID
000641	000300C7011C0400	REC1	DC	X'00030007011004C0'		COUNT
000649			DS	CL16		KEY
00C659			DS	64CL16		DATA
000A59	00030007021C002C	REC2	DC	X'00030007C21C0020'		COUNT
000A61			DS	CL16		KEY
000A71			DS	2CL16		DATA
000A91	000300C7031C0200	REC3	DC	X'00030007031C0200'		COUNT
000A99	D9C5C3D6D9C440F340		DC	CL16'RECORD 3 KEYKEY'		KEY
000AA2	D2C5E8D2C5E84C					
000AA9			DS	32CL16		DATA
000CAC		REC1KD	DS	260F		BUFFER FOR READ BACK
0010BC		REC2CC	DS	14F		
0010F4		REC3CC	DS	134F		
00130C	0003000704	REC4	DC	X'0C030007C4'		RECORD NOT THERE YET

APPENDIX B. HEXADECIMAL-DECIMAL CONVERSION

The table in this appendix provides for direct conversion of decimal and hexadecimal numbers in these ranges:

Hexadecimal
000 to FFF Decimal
0000 to 4095

For numbers outside the range of the table, add the following values to the table figures:

Hexadecimal Decimal
1000 4096
2000 8192
3000 12288

<u>Hexadecimal</u>	<u>Decimal</u>
4000	16384
5000	20480
6000	24576
7000	28672
8000	32768
9000	36864
A000	40960
B000	45056
C000	49152
D000	53248
E000	57344
F000	61440

	0	1	2	3	4	5	6	7	8	9	A	B	C	D	E	F
00	0000	0001	0002	0003	0004	0005	0006	0007	0008	0009	0010	0011	0012	0013	0014	0015
01	0016	0017	0018	0019	0020	0021	0022	0023	0024	0025	0026	0027	0028	0029	0030	0031
02	0032	0033	0034	0035	0036	0037	0038	0039	0040	0041	0042	0043	0044	0045	0046	0047
03	0048	0049	0050	0051	0052	0053	0054	0055	0056	0057	0058	0059	0060	0061	0062	0063
04	0064	0065	0066	0067	0068	0069	0070	0071	0072	0073	0074	0075	0076	0077	0078	0079
05	0080	0081	0082	0083	0084	0085	0086	0087	0088	0089	0090	0091	0092	0093	0094	0095
06	0096	0097	0098	0099	0100	0101	0102	0103	0104	0105	0106	0107	0108	0109	0110	0111
07	0112	0113	0114	0115	0116	0117	0118	0119	0120	0121	0122	0123	0124	0125	0126	0127
08	0128	0129	0130	0131	0132	0133	0134	0135	0136	0137	0138	0139	0140	0141	0142	0143
09	0144	0145	0146	0147	0148	0149	0150	0151	0152	0153	0154	0155	0156	0157	0158	0159
0A	0160	0161	0162	0163	0164	0165	0166	0167	0168	0169	0170	0171	0172	0173	0174	0175
0B	0176	0177	0178	0179	0180	0181	0182	0183	0184	0185	0186	0187	0188	0189	0190	0191
0C	0192	0193	0194	0195	0196	0197	0198	0199	0200	0201	0202	0203	0204	0205	0206	0207
0D	0208	0209	0210	0211	0212	0213	0214	0215	0216	0217	0218	0219	0220	0221	0222	0223
0E	0224	0225	0226	0227	0228	0229	0230	0231	0232	0233	0234	0235	0236	0237	0238	0239
0F	0240	0241	0242	0243	0244	0245	0246	0247	0248	0249	0250	0251	0252	0253	0254	0255
10	0256	0257	0258	0259	0260	0261	0262	0263	0264	0265	0266	0267	0268	0269	0270	0271
11	0272	0273	0274	0275	0276	0277	0278	0279	0280	0281	0282	0283	0284	0285	0286	0287
12	0288	0289	0290	0291	0292	0293	0294	0295	0296	0297	0298	0299	0300	0301	0302	0303
13	0304	0305	0306	0307	0308	0309	0310	0311	0312	0313	0314	0315	0316	0317	0318	0319
14	0320	0321	0322	0323	0324	0325	0326	0327	0328	0329	0330	0331	0332	0333	0334	0335
15	0336	0337	0338	0339	0340	0341	0342	0343	0344	0345	0346	0347	0348	0349	0350	0351
16	0352	0353	0354	0355	0356	0357	0358	0359	0360	0361	0362	0363	0364	0365	0366	0367
17	0368	0369	0370	0371	0372	0373	0374	0375	0376	0377	0378	0379	0380	0381	0382	0383
18	0384	0385	0386	0387	0388	0389	0390	0391	0392	0393	0394	0395	0396	0397	0398	0399
19	0400	0401	0402	0403	0404	0405	0406	0407	0408	0409	0410	0411	0412	0413	0414	0415
1A	0416	0417	0418	0419	0420	0421	0422	0423	0424	0425	0426	0427	0428	0429	0430	0431
1B	0432	0433	0434	0435	0436	0437	0438	0439	0440	0441	0442	0443	0444	0445	0446	0447
1C	0448	0449	0450	0451	0452	0453	0454	0455	0456	0457	0458	0459	0460	0461	0462	0463
1D	0464	0465	0466	0467	0468	0469	0470	0471	0472	0473	0474	0475	0476	0477	0478	0479
1E	0480	0481	0482	0483	0484	0485	0486	0487	0488	0489	0490	0491	0492	0493	0494	0495
1F	0496	0497	0498	0499	0500	0501	0502	0503	0504	0505	0506	0507	0508	0509	0510	0511

11313

	0	1	2	3	4	5	6	7	8	9	A	B	C	D	E	F
20 -	0512	0513	0514	0515	0516	0517	0518	0519	0520	0521	0522	0523	0524	0525	0526	0527
21 -	0528	0529	0530	0531	0532	0533	0534	0535	0536	0537	0538	0539	0540	0541	0542	0543
22 -	0544	0545	0546	0547	0548	0549	0550	0551	0552	0553	0554	0555	0556	0557	0558	0559
23 -	0560	0561	0562	0563	0564	0565	0566	0567	0568	0569	0570	0571	0572	0573	0574	0575
24 -	0576	0577	0578	0579	0580	0581	0582	0583	0584	0585	0586	0587	0588	0589	0590	0591
25 -	0592	0593	0594	0595	0596	0597	0598	0599	0600	0601	0602	0603	0604	0605	0606	0607
26 -	0608	0609	0610	0611	0612	0613	0614	0615	0616	0617	0618	0619	0620	0621	0622	0623
27 -	0624	0625	0626	0627	0628	0629	0630	0631	0632	0633	0634	0635	0636	0637	0638	0639
28 -	0640	0641	0642	0643	0644	0645	0646	0647	0648	0649	0650	0651	0652	0653	0654	0655
29 -	0656	0657	0658	0659	0660	0661	0662	0663	0664	0665	0666	0667	0668	0669	0670	0671
2A -	0672	0673	0674	0675	0676	0677	0678	0679	0680	0681	0682	0683	0684	0685	0686	0687
2B -	0688	0689	0690	0691	0692	0693	0694	0695	0696	0697	0698	0699	0700	0701	0702	0703
2C -	0704	0705	0706	0707	0708	0709	0710	0711	0712	0713	0714	0715	0716	0717	0718	0719
2D -	0720	0721	0722	0723	0724	0725	0726	0727	0728	0729	0730	0731	0732	0733	0734	0735
2E -	0736	0737	0738	0739	0740	0741	0742	0743	0744	0745	0746	0747	0748	0749	0750	0751
2F -	0752	0753	0754	0755	0756	0757	0758	0759	0760	0761	0762	0763	0764	0765	0766	0767
30 -	0768	0769	0770	0771	0772	0773	0774	0775	0776	0777	0778	0779	0780	0781	0782	0783
31 -	0784	0785	0786	0787	0788	0789	0790	0791	0792	0793	0794	0795	0796	0797	0798	0799
32 -	0800	0801	0802	0803	0804	0805	0806	0807	0808	0809	0810	0811	0812	0813	0814	0815
33 -	0816	0817	0818	0819	0820	0821	0822	0823	0824	0825	0826	0827	0828	0829	0830	0831
34 -	0832	0833	0834	0835	0836	0837	0838	0839	0840	0841	0842	0843	0844	0845	0846	0847
35 -	0848	0849	0850	0851	0852	0853	0854	0855	0856	0857	0858	0859	0860	0861	0862	0863
36 -	0864	0865	0866	0867	0868	0869	0870	0871	0872	0873	0874	0875	0876	0877	0878	0879
37 -	0880	0881	0882	0883	0884	0885	0886	0887	0888	0889	0890	0891	0892	0893	0894	0895
38 -	0896	0897	0898	0899	0900	0901	0902	0903	0904	0905	0906	0907	0908	0909	0910	0911
39 -	0912	0913	0914	0915	0916	0917	0918	0919	0920	0921	0922	0923	0924	0925	0926	0927
3A -	0928	0929	0930	0931	0932	0933	0934	0935	0936	0937	0938	0939	0940	0941	0942	0943
3B -	0944	0945	0946	0947	0948	0949	0950	0951	0952	0953	0954	0955	0956	0957	0958	0959
3C -	0960	0961	0962	0963	0964	0965	0966	0967	0968	0969	0970	0971	0972	0973	0974	0975
3D -	0976	0977	0978	0979	0980	0981	0982	0983	0984	0985	0986	0987	0988	0989	0990	0991
3E -	0992	0993	0994	0995	0996	0997	0998	0999	1000	1001	1002	1003	1004	1005	1006	1007
3F -	1008	1009	1010	1011	1012	1013	1014	1015	1016	1017	1018	1019	1020	1021	1022	1023

	0	1	2	3	4	5	6	7	8	9	A	B	C	D	E	F
40 -	1024	1025	1026	1027	1028	1029	1030	1031	1032	1033	1034	1035	1036	1037	1038	1039
41 -	1040	1041	1042	1043	1044	1045	1046	1047	1048	1049	1050	1051	1052	1053	1054	1055
42 -	1056	1057	1058	1059	1060	1061	1062	1063	1064	1065	1066	1067	1068	1069	1070	1071
43 -	1072	1073	1074	1075	1076	1077	1078	1079	1080	1081	1082	1083	1084	1085	1086	1087
44 -	1088	1089	1090	1091	1092	1093	1094	1095	1096	1097	1098	1099	1100	1101	1102	1103
45 -	1104	1105	1106	1107	1108	1109	1110	1111	1112	1113	1114	1115	1116	1117	1118	1119
46 -	1120	1121	1122	1123	1124	1125	1126	1127	1128	1129	1130	1131	1132	1133	1134	1135
47 -	1136	1137	1138	1139	1140	1141	1142	1143	1144	1145	1146	1147	1148	1149	1150	1151
48 -	1152	1153	1154	1155	1156	1157	1158	1159	1160	1161	1162	1163	1164	1165	1166	1167
49 -	1168	1169	1170	1171	1172	1173	1174	1175	1176	1177	1178	1179	1180	1181	1182	1183
4A -	1184	1185	1186	1187	1188	1189	1190	1191	1192	1193	1194	1195	1196	1197	1198	1199
4B -	1200	1201	1202	1203	1204	1205	1206	1207	1208	1209	1210	1211	1212	1213	1214	1215
4C -	1216	1217	1218	1219	1220	1221	1222	1223	1224	1225	1226	1227	1228	1229	1230	1231
4D -	1232	1233	1234	1235	1236	1237	1238	1239	1240	1241	1242	1243	1244	1245	1246	1247
4E -	1248	1249	1250	1251	1252	1253	1254	1255	1256	1257	1258	1259	1260	1261	1262	1263
4F -	1264	1265	1266	1267	1268	1269	1270	1271	1272	1273	1274	1275	1276	1277	1278	1279
50 -	1280	1281	1282	1283	1284	1285	1286	1287	1288	1289	1290	1291	1292	1293	1294	1295
51 -	1296	1297	1298	1299	1300	1301	1302	1303	1304	1305	1306	1307	1308	1309	1310	1311
52 -	1312	1313	1314	1315	1316	1317	1318	1319	1320	1321	1322	1323	1324	1325	1326	1327
53 -	1328	1329	1330	1331	1332	1333	1334	1335	1336	1337	1338	1339	1340	1341	1342	1343
54 -	1344	1345	1346	1347	1348	1349	1350	1351	1352	1353	1354	1355	1356	1357	1358	1359
55 -	1360	1361	1362	1363	1364	1365	1366	1367	1368	1369	1370	1371	1372	1373	1374	1375
56 -	1376	1377	1378	1379	1380	1381	1382	1383	1384	1385	1386	1387	1388	1389	1390	1391
57 -	1392	1393	1394	1395	1396	1397	1398	1399	1400	1401	1402	1403	1404	1405	1406	1407
58 -	1408	1409	1410	1411	1412	1413	1414	1415	1416	1417	1418	1419	1420	1421	1422	1423
59 -	1424	1425	1426	1427	1428	1429	1430	1431	1432	1433	1434	1435	1436	1437	1438	1439
5A -	1440	1441	1442	1443	1444	1445	1446	1447	1448	1449	1450	1451	1452	1453	1454	1455
5B -	1456	1457	1458	1459	1460	1461	1462	1463	1464	1465	1466	1467	1468	1469	1470	1471
5C -	1472	1473	1474	1475	1476	1477	1478	1479	1480	1481	1482	1483	1484	1485	1486	1487
5D -	1488	1489	1490	1491	1492	1493	1494	1495	1496	1497	1498	1499	1500	1501	1502	1503
5E -	1504	1505	1506	1507	1508	1509	1510	1511	1512	1513	1514	1515	1516	1517	1518	1519
5F -	1520	1521	1522	1523	1524	1525	1526	1527	1528	1529	1530	1531	1532	1533	1534	1535

	0	1	2	3	4	5	6	7	8	9	A	B	C	D	E	F
60 -	1536	1537	1538	1539	1540	1541	1542	1543	1544	1545	1546	1547	1548	1549	1550	1551
61 -	1552	1553	1554	1555	1556	1557	1558	1559	1560	1561	1562	1563	1564	1565	1566	1567
62 -	1568	1569	1570	1571	1572	1573	1574	1575	1576	1577	1578	1579	1580	1581	1582	1583
63 -	1584	1585	1586	1587	1588	1589	1590	1591	1592	1593	1594	1595	1596	1597	1598	1599
64 -	1600	1601	1602	1603	1604	1605	1606	1607	1608	1609	1610	1611	1612	1613	1614	1615
65 -	1616	1617	1618	1619	1620	1621	1622	1623	1624	1625	1626	1627	1628	1629	1630	1631
66 -	1632	1633	1634	1635	1636	1637	1638	1639	1640	1641	1642	1643	1644	1645	1646	1647
67 -	1648	1649	1650	1651	1652	1653	1654	1655	1656	1657	1658	1659	1660	1661	1662	1663
68 -	1664	1665	1666	1667	1668	1669	1670	1671	1672	1673	1674	1675	1676	1677	1678	1679
69 -	1680	1681	1682	1683	1684	1685	1686	1687	1688	1689	1690	1691	1692	1693	1694	1695
6A -	1696	1697	1698	1699	1700	1701	1702	1703	1704	1705	1706	1707	1708	1709	1710	1711
6B -	1712	1713	1714	1715	1716	1717	1718	1719	1720	1721	1722	1723	1724	1725	1726	1727
6C -	1728	1729	1730	1731	1732	1733	1734	1735	1736	1737	1738	1739	1740	1741	1742	1743
6D -	1744	1745	1746	1747	1748	1749	1750	1751	1752	1753	1754	1755	1756	1757	1758	1759
6E -	1760	1761	1762	1763	1764	1765	1766	1767	1768	1769	1770	1771	1772	1773	1774	1775
6F -	1776	1777	1778	1779	1780	1781	1782	1783	1784	1785	1786	1787	1788	1789	1790	1791
70 -	1792	1793	1794	1795	1796	1797	1798	1799	1800	1801	1802	1803	1804	1805	1806	1807
71 -	1808	1809	1810	1811	1812	1813	1814	1815	1816	1817	1818	1819	1820	1821	1822	1823
72 -	1824	1825	1826	1827	1828	1829	1830	1831	1832	1833	1834	1835	1836	1837	1838	1839
73 -	1840	1841	1842	1843	1844	1845	1846	1847	1848	1849	1850	1851	1852	1853	1854	1855
74 -	1856	1857	1858	1859	1860	1861	1862	1863	1864	1865	1866	1867	1868	1869	1870	1871
75 -	1872	1873	1874	1875	1876	1877	1878	1879	1880	1881	1882	1883	1884	1885	1886	1887
76 -	1888	1889	1890	1891	1892	1893	1894	1895	1896	1897	1898	1899	1900	1901	1902	1903
77 -	1904	1905	1906	1907	1908	1909	1910	1911	1912	1913	1914	1915	1916	1917	1918	1919
78 -	1920	1921	1922	1923	1924	1925	1926	1927	1928	1929	1930	1931	1932	1933	1934	1935
79 -	1936	1937	1938	1939	1940	1941	1942	1943	1944	1945	1946	1947	1948	1949	1950	1951
7A -	1952	1953	1954	1955	1956	1957	1958	1959	1960	1961	1962	1963	1964	1965	1966	1967
7B -	1968	1969	1970	1971	1972	1973	1974	1975	1976	1977	1978	1979	1980	1981	1982	1983
7C -	1984	1985	1986	1987	1988	1989	1990	1991	1992	1993	1994	1995	1996	1997	1998	1999
7D -	2000	2001	2002	2003	2004	2005	2006	2007	2008	2009	2010	2011	2012	2013	2014	2015
7E -	2016	2017	2018	2019	2020	2021	2022	2023	2024	2025	2026	2027	2028	2029	2030	2031
7F -	2032	2033	2034	2035	2036	2037	2038	2039	2040	2041	2042	2043	2044	2045	2046	2047

	0	1	2	3	4	5	6	7	8	9	A	B	C	D	E	F
80 -	2048	2049	2050	2051	2052	2053	2054	2055	2056	2057	2058	2059	2060	2061	2062	2063
81 -	2064	2065	2066	2067	2068	2069	2070	2071	2072	2073	2074	2075	2076	2077	2078	2079
82 -	2080	2081	2082	2083	2084	2085	2086	2087	2088	2089	2090	2091	2092	2093	2094	2095
83 -	2096	2097	2098	2099	2100	2101	2102	2103	2104	2105	2106	2107	2108	2109	2110	2111
84 -	2112	2113	2114	2115	2116	2117	2118	2119	2120	2121	2122	2123	2124	2125	2126	2127
85 -	2128	2129	2130	2131	2132	2133	2134	2135	2136	2137	2138	2139	2140	2141	2142	2143
86 -	2144	2145	2146	2147	2148	2149	2150	2151	2152	2153	2154	2155	2156	2157	2158	2159
87 -	2160	2161	2162	2163	2164	2165	2166	2167	2168	2169	2170	2171	2172	2173	2174	2175
88 -	2176	2177	2178	2179	2180	2181	2182	2183	2184	2185	2186	2187	2188	2189	2190	2191
89 -	2192	2193	2194	2195	2196	2197	2198	2199	2200	2201	2202	2203	2204	2205	2206	2207
8A -	2208	2209	2210	2211	2212	2213	2214	2215	2216	2217	2218	2219	2220	2221	2222	2223
8B -	2224	2225	2226	2227	2228	2229	2230	2231	2232	2233	2234	2235	2236	2237	2238	2239
8C -	2240	2241	2242	2243	2244	2245	2246	2247	2248	2249	2250	2251	2252	2253	2254	2255
8D -	2256	2257	2258	2259	2260	2261	2262	2263	2264	2265	2266	2267	2268	2269	2270	2271
8E -	2272	2273	2274	2275	2276	2277	2278	2279	2280	2281	2282	2283	2284	2285	2286	2287
8F -	2288	2289	2290	2291	2292	2293	2294	2295	2296	2297	2298	2299	2300	2301	2302	2303
90 -	2304	2305	2306	2307	2308	2309	2310	2311	2312	2313	2314	2315	2316	2317	2318	2319
91 -	2320	2321	2322	2323	2324	2325	2326	2327	2328	2329	2330	2331	2332	2333	2334	2335
92 -	2336	2337	2338	2339	2340	2341	2342	2343	2344	2345	2346	2347	2348	2349	2350	2351
93 -	2352	2353	2354	2355	2356	2357	2358	2359	2360	2361	2362	2363	2364	2365	2366	2367
94 -	2368	2369	2370	2371	2372	2373	2374	2375	2376	2377	2378	2379	2380	2381	2382	2383
95 -	2384	2385	2386	2387	2388	2389	2390	2391	2392	2393	2394	2395	2396	2397	2398	2399
96 -	2400	2401	2402	2403	2404	2405	2406	2407	2408	2409	2410	2411	2412	2413	2414	2415
97 -	2416	2417	2418	2419	2420	2421	2422	2423	2424	2425	2426	2427	2428	2429	2430	2431
98 -	2432	2433	2434	2435	2436	2437	2438	2439	2440	2441	2442	2443	2444	2445	2446	2447
99 -	2448	2449	2450	2451	2452	2453	2454	2455	2456	2457	2458	2459	2460	2461	2462	2463
9A -	2464	2465	2466	2467	2468	2469	2470	2471	2472	2473	2474	2475	2476	2477	2478	2479
9B -	2480	2481	2482	2483	2484	2485	2486	2487	2488	2489	2490	2491	2492	2493	2494	2495
9C -	2496	2497	2498	2499	2500	2501	2502	2503	2504	2505	2506	2507	2508	2509	2510	2511
9D -	2512	2513	2514	2515	2516	2517	2518	2519	2520	2521	2522	2523	2524	2525	2526	2527
9E -	2528	2529	2530	2531	2532	2533	2534	2535	2536	2537	2538	2539	2540	2541	2542	2543
9F -	2544	2545	2546	2547	2548	2549	2550	2551	2552	2553	2554	2555	2556	2557	2558	2559

	0	1	2	3	4	5	6	7	8	9	A	B	C	D	E	F
A0 -	2560	2561	2562	2563	2564	2565	2566	2567	2568	2569	2570	2571	2572	2573	2574	2575
A1 -	2576	2577	2578	2579	2580	2581	2582	2583	2584	2585	2586	2587	2588	2589	2590	2591
A2 -	2592	2593	2594	2595	2596	2597	2598	2599	2600	2601	2602	2603	2604	2605	2606	2607
A3 -	2608	2609	2610	2611	2612	2613	2614	2615	2616	2617	2618	2619	2620	2621	2622	2623
A4 -	2624	2625	2626	2627	2628	2629	2630	2631	2632	2633	2634	2635	2636	2637	2638	2639
A5 -	2640	2641	2642	2643	2644	2645	2646	2647	2648	2649	2650	2651	2652	2653	2654	2655
A6 -	2656	2657	2658	2659	2660	2661	2662	2663	2664	2665	2666	2667	2668	2669	2670	2671
A7 -	2672	2673	2674	2675	2676	2677	2678	2679	2680	2681	2682	2683	2684	2685	2686	2687
A8 -	2688	2689	2690	2691	2692	2693	2694	2695	2696	2697	2698	2699	2700	2701	2702	2703
A9 -	2704	2705	2706	2707	2708	2709	2710	2711	2712	2713	2714	2715	2716	2717	2718	2719
AA -	2720	2721	2722	2723	2724	2725	2726	2727	2728	2729	2730	2731	2732	2733	2734	2735
AB -	2736	2737	2738	2739	2740	2741	2742	2743	2744	2745	2746	2747	2748	2749	2750	2751
AC -	2752	2753	2754	2755	2756	2757	2758	2759	2760	2761	2762	2763	2764	2765	2766	2767
AD -	2768	2769	2770	2771	2772	2773	2774	2775	2776	2777	2778	2779	2780	2781	2782	2783
AE -	2784	2785	2786	2787	2788	2789	2790	2791	2792	2793	2794	2795	2796	2797	2798	2799
AF -	2800	2801	2802	2803	2804	2805	2806	2807	2808	2809	2810	2811	2812	2813	2814	2815
B0 -	2816	2817	2818	2819	2820	2821	2822	2823	2824	2825	2826	2827	2828	2829	2830	2831
B1 -	2832	2833	2834	2835	2836	2837	2838	2839	2840	2841	2842	2843	2844	2845	2846	2847
B2 -	2848	2849	2850	2851	2852	2853	2854	2855	2856	2857	2858	2859	2860	2861	2862	2863
B3 -	2864	2865	2866	2867	2868	2869	2870	2871	2872	2873	2874	2875	2876	2877	2878	2879
B4 -	2880	2881	2882	2883	2884	2885	2886	2887	2888	2889	2890	2891	2892	2893	2894	2895
B5 -	2896	2897	2898	2899	2900	2901	2902	2903	2904	2905	2906	2907	2908	2909	2910	2911
B6 -	2912	2913	2914	2915	2916	2917	2918	2919	2920	2921	2922	2923	2924	2925	2926	2927
B7 -	2928	2929	2930	2931	2932	2933	2934	2935	2936	2937	2938	2939	2940	2941	2942	2943
B8 -	2944	2945	2946	2947	2948	2949	2950	2951	2952	2953	2954	2955	2956	2957	2958	2959
B9 -	2960	2961	2962	2963	2964	2965	2966	2967	2968	2969	2970	2971	2972	2973	2974	2975
BA -	2976	2977	2978	2979	2980	2981	2982	2983	2984	2985	2986	2987	2988	2989	2990	2991
BB -	2992	2993	2994	2995	2996	2997	2998	2999	3000	3001	3002	3003	3004	3005	3006	3007
BC -	3008	3009	3010	3011	3012	3013	3014	3015	3016	3017	3018	3019	3020	3021	3022	3023
BD -	3024	3025	3026	3027	3028	3029	3030	3031	3032	3033	3034	3035	3036	3037	3038	3039
BE -	3040	3041	3042	3043	3044	3045	3046	3047	3048	3049	3050	3051	3052	3053	3054	3055
BF -	3056	3057	3058	3059	3060	3061	3062	3063	3064	3065	3066	3067	3068	3069	3070	3071

	0	1	2	3	4	5	6	7	8	9	A	B	C	D	E	F
C0 -	3072	3073	3074	3075	3076	3077	3078	3079	3080	3081	3082	3083	3084	3085	3086	3087
C1 -	3088	3089	3090	3091	3092	3093	3094	3095	3096	3097	3098	3099	3100	3101	3102	3103
C2 -	3104	3105	3106	3107	3108	3109	3110	3111	3112	3113	3114	3115	3116	3117	3118	3119
C3 -	3120	3121	3122	3123	3124	3125	3126	3127	3128	3129	3130	3131	3132	3133	3134	3135
C4 -	3136	3137	3138	3139	3140	3141	3142	3143	3144	3145	3146	3147	3148	3149	3150	3151
C5 -	3152	3153	3154	3155	3156	3157	3158	3159	3160	3161	3162	3163	3164	3165	3166	3167
C6 -	3168	3169	3170	3171	3172	3173	3174	3175	3176	3177	3178	3179	3180	3181	3182	3183
C7 -	3184	3185	3186	3187	3188	3189	3190	3191	3192	3193	3194	3195	3196	3197	3198	3199
C8 -	3200	3201	3202	3203	3204	3205	3206	3207	3208	3209	3210	3211	3212	3213	3214	3215
C9 -	3216	3217	3218	3219	3220	3221	3222	3223	3224	3225	3226	3227	3228	3229	3230	3231
CA -	3232	3233	3234	3235	3236	3237	3238	3239	3240	3241	3242	3243	3244	3245	3246	3247
CB -	3248	3249	3250	3251	3252	3253	3254	3255	3256	3257	3258	3259	3260	3261	3262	3263
CC -	3264	3265	3266	3267	3268	3269	3270	3271	3272	3273	3274	3275	3276	3277	3278	3279
CD -	3280	3281	3282	3283	3284	3285	3286	3287	3288	3289	3290	3291	3292	3293	3294	3295
CE -	3296	3297	3298	3299	3300	3301	3302	3303	3304	3305	3306	3307	3308	3309	3310	3311
CF -	3312	3313	3314	3315	3316	3317	3318	3319	3320	3321	3322	3323	3324	3325	3326	3327
D0 -	3328	3329	3330	3331	3332	3333	3334	3335	3336	3337	3338	3339	3340	3341	3342	3343
D1 -	3344	3345	3346	3347	3348	3349	3350	3351	3352	3353	3354	3355	3356	3357	3358	3359
D2 -	3360	3361	3362	3363	3364	3365	3366	3367	3368	3369	3370	3371	3372	3373	3374	3375
D3 -	3376	3377	3378	3379	3380	3381	3382	3383	3384	3385	3386	3387	3388	3389	3390	3391
D4 -	3392	3393	3394	3395	3396	3397	3398	3399	3400	3401	3402	3403	3404	3405	3406	3407
D5 -	3408	3409	3410	3411	3412	3413	3414	3415	3416	3417	3418	3419	3420	3421	3422	3423
D6 -	3424	3425	3426	3427	3428	3429	3430	3431	3432	3433	3434	3435	3436	3437	3438	3439
D7 -	3440	3441	3442	3443	3444	3445	3446	3447	3448	3449	3450	3451	3452	3453	3454	3455
D8 -	3456	3457	3458	3459	3460	3461	3462	3463	3464	3465	3466	3467	3468	3469	3470	3471
D9 -	3472	3473	3474	3475	3476	3477	3478	3479	3480	3481	3482	3483	3484	3485	3486	3487
DA -	3488	3489	3490	3491	3492	3493	3494	3495	3496	3497	3498	3499	3500	3501	3502	3503
DB -	3504	3505	3506	3507	3508	3509	3510	3511	3512	3513	3514	3515	3516	3517	3518	3519
DC -	3520	3521	3522	3523	3524	3525	3526	3527	3528	3529	3530	3531	3532	3533	3534	3535
DD -	3536	3537	3538	3539	3540	3541	3542	3543	3544	3545	3546	3547	3548	3549	3550	3551
DE -	3552	3553	3554	3555	3556	3557	3558	3559	3560	3561	3562	3563	3564	3565	3566	3567
DF -	3568	3569	3570	3571	3572	3573	3574	3575	3576	3577	3578	3579	3580	3581	3582	3583

	0	1	2	3	4	5	6	7	8	9	A	B	C	D	E	F
E0	3584	3585	3586	3587	3583	3589	3590	3591	3592	3593	3594	3595	3596	3597	3598	3599
E1	3600	3601	3602	3603	3604	3605	3606	3607	3608	3609	3610	3611	3612	3613	3614	3615
E2	3616	3617	3618	3619	3620	3621	3622	3623	3624	3625	3626	3627	3628	3629	3630	3631
E3	3632	3633	3634	3635	3636	3637	3638	3639	3640	3641	3642	3643	3644	3645	3646	3647
E4	3648	3649	3650	3651	3652	3653	3654	3655	3656	3657	3658	3659	3660	3661	3662	3663
E5	3664	3665	3666	3667	3668	3669	3670	3671	3672	3673	3674	3675	3676	3677	3678	3679
E6	3680	3681	3682	3683	3684	3685	3686	3687	3688	3689	3690	3691	3692	3693	3694	3695
E7	3696	3697	3698	3699	3700	3701	3702	3703	3704	3705	3706	3707	3708	3709	3710	3711
E8	3712	3713	3714	3715	3716	3717	3718	3719	3720	3721	3722	3723	3724	3725	3726	3727
E9	3728	3729	3730	3731	3732	3733	3734	3735	3736	3737	3738	3739	3740	3741	3742	3743
EA	3744	3745	3746	3747	3748	3749	3750	3751	3752	3753	3754	3755	3756	3757	3758	3759
EB	3760	3761	3762	3763	3764	3765	3766	3767	3768	3769	3770	3771	3772	3773	3774	3775
EC	3776	3777	3778	3779	3780	3781	3782	3783	3784	3785	3786	3787	3788	3789	3790	3791
ED	3792	3793	3794	3795	3796	3797	3798	3799	3800	3801	3802	3803	3804	3805	3806	3807
EE	3808	3809	3810	3811	3812	3813	3814	3815	3816	3817	3818	3819	3820	3821	3822	3823
EF	3824	3825	3826	3827	3828	3829	3830	3831	3832	3833	3834	3835	3836	3837	3838	3839
F0	3840	3841	3842	3843	3844	3845	3846	3847	3848	3849	3850	3851	3852	3853	3854	3855
F1	3856	3857	3858	3859	3860	3861	3862	3863	3864	3865	3866	3867	3868	3869	3870	3871
F2	3872	3873	3874	3875	3876	3877	3878	3879	3880	3881	3882	3883	3884	3885	3886	3887
F3	3888	3889	3890	3891	3892	3893	3894	3895	3896	3897	3898	3899	3900	3901	3902	3903
F4	3904	3905	3906	3907	3908	3909	3910	3911	3912	3913	3914	3915	3916	3917	3918	3919
F5	3920	3921	3922	3923	3924	3925	3926	3927	3928	3929	3930	3931	3932	3933	3934	3935
F6	3936	3937	3938	3939	3940	3941	3942	3943	3944	3945	3946	3947	3948	3949	3950	3951
F7	3952	3953	3954	3955	3956	3957	3958	3959	3960	3961	3962	3963	3964	3965	3966	3967
F8	3968	3969	3970	3971	3972	3973	3974	3975	3976	3977	3978	3979	3980	3981	3982	3983
F9	3984	3985	3986	3987	3988	3989	3990	3991	3992	3993	3994	3995	3996	3997	3998	3999
FA	4000	4001	4002	4003	4004	4005	4006	4007	4008	4009	4010	4011	4012	4013	4014	4015
FB	4016	4017	4018	4019	4020	4021	4022	4023	4024	4025	4026	4027	4028	4029	4030	4031
FC	4032	4033	4034	4035	4036	4037	4038	4039	4040	4041	4042	4043	4044	4045	4046	4047
FD	4048	4049	4050	4051	4052	4053	4054	4055	4056	4057	4058	4059	4060	4061	4062	4063
FE	4064	4065	4066	4067	4068	4069	4070	4071	4072	4073	4074	4075	4076	4077	4078	4079
FF	4080	4081	4082	4083	4084	4085	4086	4087	4088	4089	4090	4091	4092	4093	4094	4095

11317

COMMAND		COMMAND CODE						DATA ADDRESS	COUNT
		Multiple Track Off			Multiple Track On (If Applicable)				
		Decimal	Hexadecimal	Binary	Decimal	Hexadecimal	Binary		
Control	No Op	03	03	0000 0011				X	X
	Release*	23	17	0001 0111				X	X
	Restore	19	13	0001 0011				X	X
	Seek	07	07	0000 0111					6
	Seek Cylinder	11	0B	0000 1011				CPU storage location of seek address	6
	Seek Head	27	1B	0001 1011					6
	Sense I/O	04	04	0000 0100				CPU storage location to which four sense bytes are sent	4
	Set File Mask	31	1F	0001 1111				CPU storage location of mask byte	1
	Space Record	15	0F	0000 1111				X	X
Transfer in Channel	X 8	X 8	XXXX 1000				CPU storage location of next CCW - (Must be divisible by 4)	X	
Search	Home Address Equal	57	39	0011 1001	1 8 5	B 9	1011 1001	CPU storage location of search argument	4 (usually)
	Identifier Equal	49	31	0011 0001	1 7 7	B 1	1011 0001		5 (usually)
	Identifier High	81	51	0101 0001	2 0 9	D 1	1101 0001		5 (usually)
	Identifier Equal or High	1 13	71	0111 0001	2 4 1	F 1	1111 0001		5 (usually)
	Key Equal	41	29	0010 1001	1 6 9	A 9	1010 1001		From 1 to 255
	Key High	73	49	0100 1001	2 0 1	C 9	1100 1001		From 1 to 255
	Key Equal or High	1 05	69	0110 1001	2 3 3	E 9	1110 1001		From 1 to 255
	Key and Data Equal*	45	2D	0010 1101	1 7 3	A D	1010 1101		Number of bytes (including mask bytes) in search argument
	Key and Data High*	77	4D	0100 1101	2 0 5	C D	1100 1101		
Key and Data Equal or High*	109	6D	0110 1101	2 3 7	E D	1110 1101			
Read	Home Address	26	1A	0001 1010	1 5 4	9 A	1001 1010	CPU storage location to which areas read will be transferred	5
	Count	18	12	0001 0010	1 4 6	9 2	1001 0010		8
	Record R0	22	16	0001 0110	1 5 0	9 6	1001 0110		Number of bytes to be transferred
	Data	06	06	0000 0110	1 3 4	8 6	1000 0110		Number of bytes to be transferred
	Key and Data	14	0E	0000 1110	1 4 2	8 E	1000 1110		Number of bytes to be transferred
	Count, Key and Data	30	1E	0001 1110	1 5 8	9 E	1001 1110		Number of bytes to be transferred
Write	Home Address	25	19	0001 1001				CPU storage location from which areas to be written will be transferred	5 (usually)
	Record R0	21	15	0001 0101					8+Key Length + Data Length of Record R0
	Count, Key and Data	29	1D	0001 1101					8+Key Length + Data Length
	Special Count, Key and Data*	01	01	0000 0001					8+Key Length + Data Length
	Data	05	05	0000 0101					Data Length
	Key and Data	13	0D	0000 1101					Key Length + Data Length

* Special Feature
X Not Significant

1131b

APPENDIX D. TRACK ORIENTATION

As there is no unique physical address associated with each record on a given track, the 2841 must have some means of locating these records. There are seven states of orientation with respect to a track in the 2841 that are used to accomplish this.

1. Index Point State - Gap between Index Point and Home Address.
2. Home Address State - Gap between Home Address and R0.
3. Count State - Gap between Count and Key Fields.
4. Key State - Gap between Key and Data Field.
5. Data State - Gap between Data Field and succeeding Address Mark or Index Point if this is the last record on the track.
6. Address Marker State - Gap between Address Mark and Count Field.
7. Reset Orientation State - None of the above.

The Reset Orientation State, while not associated with any specific area of a track does not necessarily imply that the 2841 has lost orientation. Any time a CCW chain is broken or a Control Command is performed, the 2841 is set

to this state. The next data command (i.e., read, write or search) further defines this state to one of the three sub-states below.

1. Reset Orientation to Index Point State (ROIP). Orientation state is set to Index Point State upon detection of the Index Point on the track.
2. Reset Orientation to Address Marker State (ROAM). Orientation is set to Address Marker State upon detection of any Address Marker.
3. Reset Orientation to Address Marker or Index Point State (ROAM or IP). Orientation is set to either Index Point State, upon detection of the Index Point, or to Address Marker State upon detection of any Address Marker, whichever occurs first.

Read, Write, Search and some Control commands in the 2841 have two types of prerequisites that must be satisfied to insure proper operation of the command. By considering command sequence restrictions and orientation requirements, all valid command sequences can be constructed and the result of their execution predetermined. The following table illustrates these two prerequisites and the resulting orientation state for all data commands:

Command	Command Prerequisite	Valid Orientation State at Beginning of Command	Orientation State at Completion of Command
Read CKD	None	ROAM	Data
Read KD	None	Count ROAM	Data
Read D	None	Count Key ROAM	Data
Write CKD (also Write Special CKD)	Search Equal Count or Key Write CKD Write R0	Count Key Data	Data
Write KD	Search Equal Count of Key	Count ROAM	Data
Write D	Search Equal Count or Key	Count Key	Data
Search ID	None	ROAM or IP	Count
Search Key	None	ROAM Count	Key
Search Home Address	None	ROIP	Home Address
Read R0	None	Home Address ROIP	Data
Write R0	Search Equal Home Address Write HA	Home Address	Data
Read HA	None	ROIP	Home Address
Write HA	None	ROIP	Home Address
Read IPL	None	ROAM	Data
Read Count	None	ROAM	Count
Control Space Record	Search (any) Read (any)	Count Key	Reset Orientation
Control Erase	Write CKD Write R0	Count Key Data	Reset Orientation
Control NOP	None	None	Reset Orientation

11319

- Is the material:
 - Yes
 - No

Easy to read?	<input type="checkbox"/>	<input type="checkbox"/>
Well organized?	<input type="checkbox"/>	<input type="checkbox"/>
Fully covered?	<input type="checkbox"/>	<input type="checkbox"/>
Clearly explained?	<input type="checkbox"/>	<input type="checkbox"/>
Well illustrated?	<input type="checkbox"/>	<input type="checkbox"/>

- How did you use this publication?
 - As an introduction to the subject
 - For additional knowledge of the subject
 - Studying machine operation
 - During an actual service call

- Which of the following terms best describes your job?

<i>Customer Personnel</i>		<i>IBM Personnel</i>		
Manager	<input type="checkbox"/>	Customer Engineer	<input type="checkbox"/>	Field Stock Personnel <input type="checkbox"/>
Systems Analyst	<input type="checkbox"/>	Instructor	<input type="checkbox"/>	Manufacturing Engineering <input type="checkbox"/>
Operator	<input type="checkbox"/>	Sales Representative	<input type="checkbox"/>	Manufacturing <input type="checkbox"/>
Programmer	<input type="checkbox"/>	Systems Engineer	<input type="checkbox"/>	Development Engineering <input type="checkbox"/>
Trainee	<input type="checkbox"/>	Trainee	<input type="checkbox"/>	Other _____
Other _____				

- How often do you use this publication?
 - Often
 - Occasionally
 - Seldom

- Comments:

Your comments help us produce better publications. Please include specific page references if appropriate. You may include your name and address if you wish.

STAPLE

STAPLE

OLD

FIRST CLASS
PERMIT NO. 2078
SAN JOSE, CALIF.

BUSINESS REPLY MAIL
NO POSTAGE STAMP NECESSARY IF MAILED IN U. S. A.

POSTAGE WILL BE PAID BY
IBM CORPORATION
MONTEREY & COTTLE RDS.
SAN JOSE, CALIFORNIA
95114

ATTN: PRODUCT PUBLICATIONS DEPT. 455

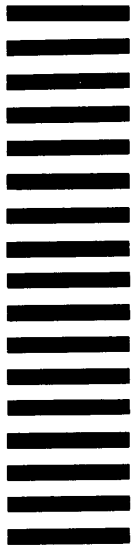

CUT ALONG LINE

OLD



**International Business Machines Corporation
Data Processing Division
112 East Post Road, White Plains, N. Y. 10601**