

3174 Establishment Controller

GA27-3874-04

**Models 21H, 21L, 21R, 22L, 22R,  
23R, and 24R User's Guide**

**Setting Up the 3174  
Making the 3174 Operational  
Solving Problems**

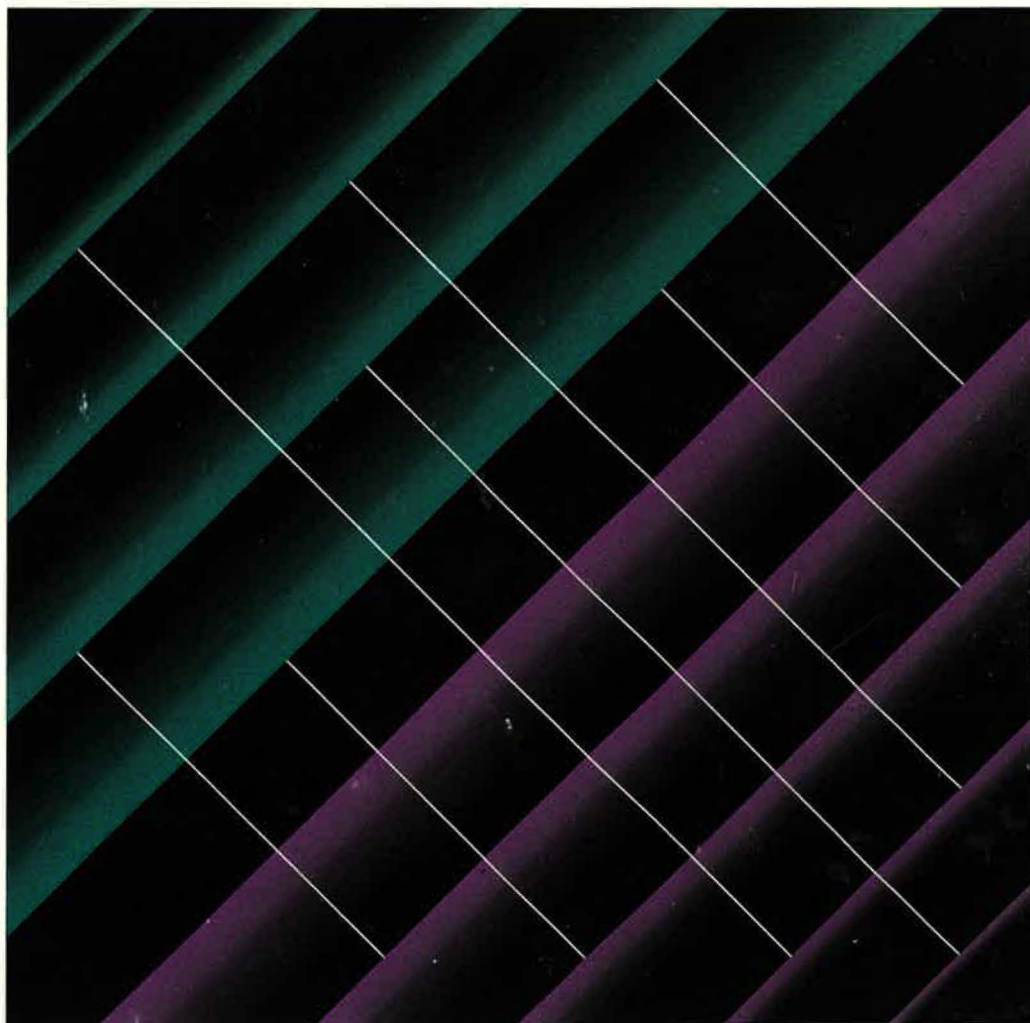



Cut or Fold  
Along Line

Reader's Comments  
GA27-3874-04

# TELL US WHAT YOU THINK!

We hope you find this publication useful, readable, and technically accurate, but only you can tell us!

Your comments and suggestions will help us improve our technical publications.

Please take a few minutes to let us know what you think by completing this form.

If you are in the U.S.A., you may mail this form postage free or FAX it to us at 1-800-253-3520. (Elsewhere, your local IBM branch office or representative will forward your comments or you may mail directly to the address below.)

Fold and Tape

Please do not staple

Fold and Tape



NO POSTAGE  
NECESSARY  
IF MAILED IN THE  
UNITED STATES

## BUSINESS REPLY MAIL

FIRST CLASS MAIL PERMIT NO. 40 ARMONK, NEW YORK

POSTAGE WILL BE PAID BY ADDRESSEE

Department E02  
Design & Information Development  
International Business Machines Corporation  
P O BOX 12195  
RESEARCH TRIANGLE PARK NC 27709-9990



Fold and Tape

Please do not staple

Fold and Tape

# FAX or MAIL 1-(800)-253-3520

Cut or Fold  
Along Line

GA27-3874-04

# TELL US

3174 Establishment Controller  
Models 21H, 21L, 21R, 22L, 22R, 23R, and 24R  
User's Guide Setting Up the 3174 Making the 3174  
Operational Solving Problems  
GA27-3874-04

Specific Problems and Comments:

---

---

---

---

---

---

	Strongly Agree	Agree	Neutral	Disagree	Strongly Disagree
Overall, I am satisfied with this publication.	<input type="checkbox"/>	<input type="checkbox"/>	<input type="checkbox"/>	<input type="checkbox"/>	<input type="checkbox"/>
The information in this publication is technically accurate.	<input type="checkbox"/>	<input type="checkbox"/>	<input type="checkbox"/>	<input type="checkbox"/>	<input type="checkbox"/>
The procedures in this publication are easy to follow.	<input type="checkbox"/>	<input type="checkbox"/>	<input type="checkbox"/>	<input type="checkbox"/>	<input type="checkbox"/>
This publication contains all the information I need.	<input type="checkbox"/>	<input type="checkbox"/>	<input type="checkbox"/>	<input type="checkbox"/>	<input type="checkbox"/>
Specific items of information are easy to find.	<input type="checkbox"/>	<input type="checkbox"/>	<input type="checkbox"/>	<input type="checkbox"/>	<input type="checkbox"/>
The figures and tables are easy to understand.	<input type="checkbox"/>	<input type="checkbox"/>	<input type="checkbox"/>	<input type="checkbox"/>	<input type="checkbox"/>
The examples are helpful and useful.	<input type="checkbox"/>	<input type="checkbox"/>	<input type="checkbox"/>	<input type="checkbox"/>	<input type="checkbox"/>
The layout and format are attractive and useful.	<input type="checkbox"/>	<input type="checkbox"/>	<input type="checkbox"/>	<input type="checkbox"/>	<input type="checkbox"/>

What do you like most about this publication? \_\_\_\_\_

How can this publication be improved? \_\_\_\_\_

What similar publications, if any, do you think are better than this publication? (IBM or other) \_\_\_\_\_

## For a Reply, Complete the Following—

Name \_\_\_\_\_ Company \_\_\_\_\_  
Occupation \_\_\_\_\_ Address \_\_\_\_\_  
Phone \_\_\_\_\_  
FAX \_\_\_\_\_

Thank you for your response. When you send information to IBM, you grant IBM the right to use or distribute the information without incurring any obligation to you. You of course retain the right to use the information in any way you choose.



FAX or MAIL 1-(800)-253-3520



3174 Establishment Controller

GA27-3874-04

**Models 21H, 21L, 21R, 22L, 22R,  
23R, and 24R User's Guide**

**Setting Up the 3174**

**Making the 3174 Operational**

**Solving Problems**

## 3174 Licensed Internal Code

Licensed Internal Code remains the property of IBM and is to be used only in accordance with the Agreement for Purchase of IBM Machines or the Agreement for Lease or Rental of IBM Machines, whichever Agreement is applicable.

In this document, the term **3174 microcode** refers to Licensed Internal Code.

### Note

Before using this information and the product it supports, be sure to read the general information under "Notices" on page ix.

## Fifth Edition (June 1994)

This edition applies to Configuration Support C Release 5.0 of the 3174 Establishment Controller and to all subsequent releases and modifications until otherwise indicated in new editions.

Order publications through your IBM representative or the IBM branch serving your locality. Publications are not stocked at the address given below.

Forms for readers' comments appear at the front and back of this publication. If the forms have been removed, address your comments to:

Department E02  
Design & Information Development  
IBM Corporation  
PO Box 12195  
RESEARCH TRIANGLE PARK NC 27709-9990  
USA

In the USA, you may also use our toll-free FAX number, 1-800-253-3520, to send us your comments.

When you send information to IBM, you grant IBM a nonexclusive right to use or distribute the information in any way it believes appropriate without incurring any obligation to you.

© Copyright International Business Machines Corporation 1990, 1994. All rights reserved.

Note to U.S. Government Users — Documentation related to restricted rights — Use, duplication or disclosure is subject to restrictions set forth in GSA ADP Schedule Contract with IBM Corp.

---

## Translated Safety Notices

U.S. English	You can find translated safety notices in the multilingual safety notice book, GA27-3824.
Belgian Dutch	De vertaalde veiligheidsinstructies vindt u in het meertalige boekje GA27-3824.
Brazilian Portuguese	Voce encontrará notas de segurança traduzidas no manual multilíngüe de notas de segurança, código GA27-3824.
Canadian French	Vous trouverez les consignes de sécurité en français dans le manuel multilingue GA27-3824.
Danish	Oversatte sikkerhedsbestemmelser kan findes i den flersprogede sikkerhedsbog, GA27-3824.
Finnish	Turvaohjeet ovat myös suomeksi monikielisessä julkaisussa, GA27-3824.
French	Vous trouverez les consignes de sécurité traduites dans la brochure multilingue <i>Safety Notice Book</i> , GA27-3824.
German	Übersetzte Sicherheitshinweise sind dem mehrsprachigen <i>Safety Notice Book</i> , GA27-3824, zu entnehmen.
Italian	Le informazioni di sicurezza tradotte si trovano nel manuale, GA27-3824.
Japanese	日本語の「安全に関するご案内」は各国語に翻訳された安全に関する記述を一冊にまとめた にありますのでご参照ください。 GA27-3824.
Korean	다국어 안전 정보 서적(GA27-3824)에서 번역된 안전 정보를 찾아 볼 수 있습니다.
Norwegian	Du finner oversatte sikkerhetsmeldinger i den flerspråklige sikkerhetsboken GA27-3824.
Portuguese	As informações de segurança traduzidas estão incluídas no manual de indicações de segurança GA27-3824 (multilíngüe).
Spanish	Puede hallar la información sobre seguridad traducida en el manual multilingüe correspondiente, GA27-3824.
Swedish	Svenska översättningar av de varningstexter som riktar sig till användaren finns i det flerspråkiga dokumentet med nummer GA27-3824.
Swiss French	Vous trouverez la traduction des instructions de sécurité dans le manuel des instructions de sécurité polyglotte, GA27-3824.
Swiss German	Sie finden die übersetzten Sicherheitsinformationen im mehrsprachigen Sicherheits-Informationen-Buch GA27-3824.
Swiss Italian	Lei trova gli informazioni di sicurezza tradotte nel <i>Safety Notice Book</i> plurilingue, GA27-3824.





# Contents

Translated Safety Notices	iii
<b>Notices</b>	<b>ix</b>
Trademarks	ix
Electronic Emission Notices	x
<b>Preface</b>	<b>xiii</b>
How This Manual Is Organized	xiii
Choosing the Right Book from the 3174 Library	xiv
Other Related Publications:	xvi
<b>Summary of Changes</b>	<b>xvii</b>
<b>Chapter 1. Introducing the 3174 Controller</b>	<b>1-1</b>
3174 Description	1-1
Model Descriptions	1-2
3174 Features	1-3
Identifying 3174 Hardware Group Numbers	1-5
Asynchronous Emulation Adapter (AEA) HG21, 22, or 23	1-5
Channel Adapter HG16	1-5
Communication Adapter HG11	1-5
Concurrent Communication Adapter (CCA) HG51 or 52	1-5
Enterprise Systems Connection (ESCON) Adapter HG17	1-6
Ethernet Adapter HG41	1-6
Fiber Optic Terminal Adapter (FTA) HG26 or 27	1-6
Integrated Services Digital Network (ISDN) Adapter HG36, 37, 38, or 39	1-6
Terminal Adapter (TA) HG26 or 27	1-6
Terminal Multiplexer Adapter (TMA) HG26 or 27	1-6
Telephone Twisted Pair Terminal Multiplexer Adapter	1-7
Token-Ring Adapter HG31	1-7
Operations	1-8
Diskettes or Fixed Disk	1-8
Status Codes	1-8
Tests	1-8
Panels, Switches, and Indicators	1-9
Power Panel Switch and Indicator	1-12
Operator Panel	1-12
Priority Switches (Models 21H and 21L only)	1-14
Problem Solving	1-14
<b>Chapter 2. Setting Up the 3174 Controller</b>	<b>2-1</b>
Setting Up 3174 Models 21H, 21L, 21R, 22L, 22R, 23R, and 24R	2-3
<b>Chapter 3. Determining 3270 Terminal Port Addresses</b>	<b>3-1</b>
For Terminals Directly Connected to the TA	3-1
For Terminals Indirectly Connected to the TA	3-1
Ports and Cables	3-2
Sample Configuration (Normal 3270 Connection)	3-2
TMA Worksheet 8A	3-3
3299 Worksheet 9C	3-4

Terminal Adapter to Terminal (Direct Connection) Worksheet 10 . . . . .	3-6
Sample Configuration (3270 Port Expansion Feature) . . . . .	3-7
TMA Worksheet 8E . . . . .	3-8
Sample Configuration (ASCII Terminals) . . . . .	3-9
AEA Worksheet 11A (AEA Number 1) . . . . .	3-10
<b>Chapter 4. Making the 3174 Controller Operational</b> . . . . .	<b>4-1</b>
Panel Layout . . . . .	4-1
How to IML the 3174 . . . . .	4-2
How to IML a Different Microcode Version from a Diskette . . . . .	4-3
Taking the 3174 Offline . . . . .	4-4
Taking Model 21H or 21L Offline . . . . .	4-4
Forcing Model 21H or 21L Offline . . . . .	4-4
Taking Model 22L Offline and Putting Model 22L Online . . . . .	4-5
<b>Chapter 5. 3174 Controller Problem Solving and Offline Testing</b> . . . . .	<b>5-1</b>
Problem Solving . . . . .	5-1
Offline Testing . . . . .	5-4
Testing the 3174 . . . . .	5-5
Testing the 3174 from a Diskette . . . . .	5-5
Testing the 3174 from a Fixed Disk . . . . .	5-6
Testing the Adapters . . . . .	5-7
Testing the Adapters from a Diskette . . . . .	5-8
Testing the Adapters from a Fixed Disk . . . . .	5-9
AEA Wrap Test . . . . .	5-10
CCA and Cable Test . . . . .	5-12
Communication Adapter and Cable Test . . . . .	5-14
ESCON Adapter Wrap Test . . . . .	5-16
Ethernet Adapter Wrap Test . . . . .	5-17
ISDN Adapter and Cable Wrap Test . . . . .	5-18
Token-Ring Adapter and Cable Test . . . . .	5-21
<b>Chapter 6. Relocating the 3174 Controller</b> . . . . .	<b>6-1</b>
<b>Appendix A. Diskettes and Diskette Drives</b> . . . . .	<b>A-1</b>
Types of 3174 Diskettes . . . . .	A-1
How to Handle Diskettes . . . . .	A-2
How to Insert Diskettes . . . . .	A-3
How to Ship, Receive, and Store Diskettes . . . . .	A-3
<b>Glossary of Terms and Abbreviations</b> . . . . .	<b>X-1</b>
<b>Index</b> . . . . .	<b>X-17</b>

# Figures

	1-1.	Front View of the 3174 Models 21H, 21L, 21R, 22L, 22R, 23R, and 24R	1-9
	1-2.	Rear View of the 3174 Model 21L	1-9
	1-3.	Rear View of the 3174 Model 21R	1-10
	1-4.	Rear View of the 3174 Model 21R with the 3270 Port Expansion Feature	1-10
	1-5.	Rear View of the 3174 Model 21R with the ISDN Adapter	1-10
	1-6.	Rear View of the 3174 Model 22L	1-11
	1-7.	Rear View of the 3174 Model 23R	1-11
	1-8.	Rear View of the 3174 Model 21L with Ethernet Adapter shown	1-11
	1-9.	3174 Power Panel	1-12
	1-10.	3174 Operator Panel	1-12
	2-1.	Items Shipped with the Controller	2-2
	2-2.	Front View of Models 21H, 21L, 21R, 22L, 22R, 23R, and 24R	2-3
	3-1.	Sample Layout	3-2
	3-2.	Sample TMA Worksheet 8A	3-3
	3-3.	Sample 3299 Worksheet 9C	3-4
	3-4.	Sample Terminal Adapter to Terminal Worksheet 10	3-6
	3-5.	Sample Layout for 3270 Port Expansion Feature Connection	3-7
	3-6.	Sample TMA Worksheet 8E	3-8
	3-7.	Sample ASCII Adapter Connection	3-9
	3-8.	Sample AEA Worksheet 11A	3-10
	4-1.	Panel Layout	4-1



---

## Notices

References in this publication to IBM products, programs, or services do not imply that IBM intends to make these available in all countries in which IBM operates. Any reference to an IBM product, program, or service is not intended to state or imply that only IBM's product, program, or service may be used. Any functionally equivalent product, program, or service that does not infringe any of IBM's intellectual property rights may be used instead of the IBM product, program, or service. Evaluation and verification of operation in conjunction with other products, except those expressly designated by IBM, are the user's responsibility.

IBM may have patents or pending patent applications covering subject matter in this document. The furnishing of this document does not give you any license to these patents. You can send license inquiries, in writing, to the IBM Director of Licensing, IBM Corporation, 208 Harbor Drive, Building 1, STAMFORD CT 06904 USA.

---

## Trademarks

The following terms, denoted by an asterisk (\*) in this publication, are trademarks of the IBM Corporation in the United States or other countries or both:

Advanced Peer-to-Peer Networking	IBM
APPN	NetView
Enterprise System/9000	S/390
Enterprise Systems Connection Architecture	System/370
ES/9000	System/38
ESCON	System/390

---

## Electronic Emission Notices

The following warning statements (required by country regulatory agencies) are applicable in the countries indicated.

### United States

**Note:** This equipment has been tested and found to comply with the limits for a Class A digital device, pursuant to Part 15 of the FCC Rules. These limits are designed to provide reasonable protection against harmful interference when the equipment is operated in a commercial environment. This equipment generates, uses, and can radiate radio frequency energy and, if not installed and used in accordance with the instruction manual, may cause harmful interference to radio communications. Operation of this equipment in a residential area is likely to cause harmful interference in which case the user will be required to correct the interference at his own expense. Properly shielded and grounded cables and connectors must be used in order to meet FCC emission limits. Proper cables are available from IBM authorized dealers. IBM is not responsible for any radio or television interference caused by using other than recommended cables or by unauthorized changes or modifications to this equipment. Unauthorized changes or modifications could void the user's authority to operate the equipment. This device complies with Part 15 of the FCC Rules. Operation is subject to the following two conditions: (1) this device may not cause harmful interference, and (2) this device must accept any interference received, including interference that may cause undesired operation.

### United Kingdom Safety Warning

**IBM Digital Interface Adapters:** The connector on the Digital Interface Adapter plugs into the feature slot of an IBM 3174 Establishment Controller (or IBM 3174 Generic Product) and does not provide sufficient isolation to satisfy the requirements of BS6301. Apparatus into which this adapter is plugged must have been approved to BS6301. If not, they must have been evaluated against British Telecom (Post Office) Technical Guides 2 or 26 and given permission to attach. Other usage invalidates any approval given to this adapter.

Apparatus with a port (or ports) intended for connection to other apparatus may cause hazardous conditions on the network. This is irrespective of whether the interconnection is made directly or indirectly, or whether or not the ports are marked in accordance with BS6301. Advice should be obtained from a competent engineer before any such connections are made.

This adapter must be installed only in a 3174 Establishment Controller (or IBM 3174 Generic Product) using adapters that do not use Mains voltage, or any other excessive voltage as defined in BS6301.

### **Canadian Department of Communications compliance statement**

This equipment does not exceed Class A limits per radio noise emissions for digital apparatus, set out in the Radio Interference Regulation of the Canadian Department of Communications. Operation in a residential area may cause unacceptable interference to radio and TV reception requiring the owner or operator to take whatever steps are necessary to correct the interference.

### **Avis de conformité aux normes du ministère des Communications du Canada**

Cet équipement ne dépasse pas les limites de Classe A d'émission de bruits radioélectriques pour les appareils numériques, telles que prescrites par le Règlement sur le brouillage radioélectrique établi par le ministère des Communications du Canada. L'exploitation faite en milieu résidentiel peut entraîner le brouillage des réceptions radio et télé, ce qui obligerait le propriétaire ou l'opérateur à prendre les dispositions nécessaires pour en éliminer les causes.

### **Japanese Voluntary Control Council for Interference compliance statement**

This equipment is Class 1 Equipment (information equipment to be used in commercial and industrial districts) which is in conformance with the standard set by Voluntary Control for Interference by Data Processing Equipment and Electronic Office Machines (VCCI) with an aim to prevent radio interference in commercial and industrial districts. This equipment could cause interference to radio and television receivers when used in and around residential districts. Please handle the equipment properly according to the instruction manual.





---

## Preface

This manual contains operator reference, setup and cabling, basic problem-solving, and relocation information for the IBM 3174 Establishment Controller Models 21H, 21L, 21R, 22L, 22R, 23R, and 24R.

Keep this manual with the controller so that the responsible people can refer to it when performing operating procedures or basic problem solving.

---

## How This Manual Is Organized

This manual contains the following chapters and appendix:

**Chapter 1:** Contains an introduction to the 3174 Establishment Controller.

**Chapter 2:** Describes how to set up a 3174 Establishment Controller and verify that it is operating correctly.

**Chapter 3:** Describes how to determine 3270 terminal port addresses. It also shows sample configurations of the 3174 Establishment Controller.

**Chapter 4:** Describes how to make the 3174 Establishment Controller operational.

**Chapter 5:** Describes how to correct some of the basic problems that might occur with the 3174 Establishment Controller and how to perform offline tests.

**Chapter 6:** Describes how to relocate the 3174 Establishment Controller.

**Appendix A:** Contains reference information about diskettes and diskette drives.

---

## Choosing the Right Book from the 3174 Library

The 3174 library contains information for installing, customizing, operating, maintaining, and programming the data stream for the 3174 controller. The list below shows the IBM manuals you need to perform these tasks.

### To Find Translations of Safety Notices:

*Safety Notices*, GA27-3824

### To Organize Library Materials:

Binders and Inserts, SBOF-0089

Binder, SX23-0331

Inserts, SX23-0332

### To Become Familiar with the 3174:

*Master Index*, GC30-3515

*3174 Introduction*, GA27-3850

### To Prepare Your Site for the 3174:

*Site Planning*, GA23-0213

*Physical Planning Template*, GX27-2999

### To Set Up and Operate the 3174:

*Models 1L, 1R, 2R, 3R, 11L, 11R, 12L, 12R, 13R, and 14R User's Guide*, GA23-0337

*Models 21H, 21L, 21R, 22L, 22R, 23R, and 24R User's Guide*, GA27-3874

*Models 51R, 52R, 53R, 61R, 62R, 63R, and 64R User's Guide*, GA23-0333

*Models 81R, 82R, 90R, 91R, and 92R User's Guide*, GA23-0313

### To Plan for and Customize the 3174:

#### Configuration Support A and S

*Planning Guide*, GA27-3844

*Utilities Guide*, GA27-3853

*Central Site Customizing User's Guide*, GA23-0342

*ASCII Functions Reference*, GA27-3872

#### Configuration Support B

*Planning Guide*, GA27-3862

*Model 90R Tokenway Planning*, GD21-0036

*Utilities Guide*, GA27-3863

*Central Site Customizing User's Guide*, GA27-3868

*ASCII Functions Reference*, GA27-3872

#### Configuration Support C

*3174 Planning Guide*, GA27-3918

*3174 Utilities Guide*, GA27-3920

*Central Site Customizing User's Guide*, GA27-3919

*ASCII Functions Reference*, GA27-3872

**To Perform Problem Determination:**

*Customer Problem Determination, GA23-0217*  
*Status Codes, GA27-3832*

**To Install Features or Convert Models on the 3174:**

*Fixed Disk Installation and Removal Instructions, GA27-3864*  
*Diskette Drive Installation and Removal Instructions, GA23-0263*  
*Device Control Adapters Installation and Removal Instructions, GA23-0265*  
*Model Conversion Instructions, GA23-0295*  
| *Token-Ring Network Feature and Ethernet Network Feature Installation and Removal Instructions,*  
| *GA23-0329*  
*Storage Expansion Feature Installation and Removal Instructions, GA23-0330*  
*Communication Adapter Installation and Removal Instructions, GA27-3830*  
*Asynchronous Emulation Adapter Installation and Removal Instructions, GA23-0341*  
*Concurrent Communication Adapter and Integrated Services Digital Network Adapter Installation and*  
*Removal Instructions, GA27-3851*  
| *Models 21H, 21L, 21R, 22L, 22R, 23R, and 24R Feature Installation and Removal Instructions,*  
| *GA27-3875*

**To Use the Asynchronous Emulation Adapter Feature:**

| *ASCII Functions Reference, GA27-3872*  
*Terminal User's Reference for Expanded Functions, GA23-0332*

**To Use the Multiple Logical Terminals Function:**

*Terminal User's Reference for Expanded Functions, GA23-0332*

**To Obtain Data Stream Programming and Reference Information:**

*Functional Description, GA23-0218*  
*Data Stream Programmer's Reference, GA23-0059*  
| *ASCII Functions Reference, GA27-3872*  
*3174 Reference Summary, GX27-3872*  
*3174 Character Set Reference, GA27-3831*  
*3270 X.25 Operation, GA23-0204*

**To Perform Maintenance (Service Personnel):**

| *Models 1L, 1R, 2R, 3R, 11L, 11R, 12L, 12R, 13R, and 14R Maintenance Information, SY27-2572*  
| *Models 21H, 21L, 21R, 22L, 22R, 23R, and 24R Maintenance Information, SY27-0323*  
| *Models 51R, 52R, 53R, 61R, 62R, 63R, and 64R Maintenance Information, SY27-2573*  
*Models 81R, 82R, 90R, 91R, and 92R Maintenance Information, SY27-2584*  
*CE Reference Summary, SX27-3873*  
*Status Codes, GA27-3832*

**To Install, Customize, and Service the 8250 Workstation Networking Module**

| *8250 Workstation Networking Module Installation and Customization Guide, GA27-4022*  
| *3174 Planning Guide - Configuration Support C, GA27-3918*  
| *3174 Utilities Guide - Configuration Support C, GA27-3920*  
| *8250 Workstation Networking Module Problem Determination and Service Guide, SY27-0342*

## Other Related Publications:

The following publications are available for the 3174. They are developed by the International Technical Support Center. The intended audience for these books are IBM System Engineers and Customer Network Planners.

*Installation Guidelines for IBM Token-Ring Network Products*, GG24-3291  
*IBM 3174 Establishment Controller Installation Guide*, GG24-3061  
*3174 Establishment Controller APPN Implementation Guide*, GG24-3702  
*APPN Architecture and Product Implementations Tutorial*, GG24-3669  
*NetView Distribution Manager Release 2 and 3174 Central Site Change Management Implementation Guide*, GG24-3424  
*IBM 3174 CECF Migration Issues*, GG24-3380.  
*3174 Workstation Peer Communication Support Program User's Guide*, available with the 3174-WPCSP, P/N 96X5677

The following books may also be useful when working with your 3174 or its attached network.

*Enterprise Systems Connection Fault Isolation*, SY22-9533  
*Cabling System Planning and Installation Guide*, AG27-3361  
*ESCON\* Cable Connector Cleaning Procedures*, SY27-2604  
*Token-Ring Network Problem Determination Guide*, SX27-3710  
*NetView Operations*, SC31-6019  
*3299 Terminal Multiplexer Product Information and Setup*, G520-4216  
*3299 Model 32 Planning for Optical Fiber Cable*, GA27-3902  
*Local Area Network Technical Reference*, SC30-3383  
*Token-Ring Network Architecture Reference*, SC30-3374  
*Local Area Network Administrator's Guide*, GA27-3748  
*Token-Ring Network Installation Guide*, GA27-3678  
*Token-Ring Network Bridge Program*,  
Version 1.1 available with P/N 83X8880  
Versions 2.0 and 2.1 available with P/N 16F0493  
Version 2.2 available with P/N 53F7724  
*TCP/IP Tutorial and Technical Overview*, GG24-3376  
*SNA – APPN Architecture Reference*, SC30-3422  
*SNA Formats*, GA27-3136

---

## Summary of Changes

This book has been revised to include the following changes and enhancements:

- | • Configuration Support A and S, Release 5
- | • Configuration Support C Release 4
- | • Configuration Support C Release 5
- | • Ethernet hardware support
- | • Addition of Models 21H, 22R, and 24R

Technical changes to the text are indicated by a vertical line to the left of the change.



---

## Chapter 1. Introducing the 3174 Controller

This chapter describes the IBM 3174 Establishment Controller models and features. Although the 3174 is available in other models, this manual describes Models 21H, 21L, 21R, 22L, 22R, 23R, and 24R only.

---

### 3174 Description

The IBM 3174 Establishment Controller (hereafter known as the 3174) is a multi-purpose establishment controller. Originally a 3270 display/prINTER control unit, its function has been increased to support many types of devices and connectivity.

The 3174 controller can:

- Act as a gateway to a token-ring or Ethernet network
- Attach as a member of a token-ring or Ethernet network
- Provide network-node-to-network-node communication over Token-Ring networks
- Provide a bridge to an IBM Token-Ring Network
- Provide pass-through support of downstream physical devices to a Systems Network Architecture (SNA) host through dial-in
- Communicate with multiple upstream hosts
- Support connection of ASCII devices
- Connect to the host by fiber optic cable instead of the traditional bus and tag cables

The 3174 links 3270 display stations and printers (in this manual, display stations and printers are referred to as *terminals*) to a central computer, or host. The 3270 terminals attach to the controller directly through the terminal adapter or indirectly through an internal Terminal Multiplexer Adapter (TMA) or an external terminal multiplexer (for example, an IBM 3299 Terminal Multiplexer). Models 21H, 21L, 21R, 22L, 22R, 23R, and 24R can support a maximum of either 32 or 64 terminals, depending on whether the 3270 Port Expansion Feature is installed.

The 3174 allows attachment of ASCII hosts or terminals through an optional feature called the Asynchronous Emulation Adapter (AEA). A maximum of 24 ASCII devices can be attached using the AEA. Each AEA adapter has eight ports, and up to three AEA adapters can be installed.

One 5-1/4 inch, high-capacity 2.4MB diskette drive is standard for all models. A second 2.4MB diskette drive or fixed disk is required if Configuration Support C is installed, if Distributed Function Terminals (such as a 3290 Information Panel) are used for downstream load, or if an AEA is installed.

## Introduction

One 20MB fixed disk drive is available. The microcode<sup>1</sup> on a Control, Control Extension, Utility, Downstream Load (DSL), or Request for Price Quotation (RPQ) diskette can be contained on the fixed disk.

2MB of storage is standard on Models 21H, 21L, 21R, 22L, 22R, 23R, and 24R. These models support a maximum of 4MB of storage. Optional storage expansion cards are available for expanding the controller's storage up to 4MB.

## Model Descriptions

**Model 21H:** Has an internal channel connector for attachment to an ES9000 model 120, 130, 150, and 170 processor.

**Model 21L:** Has a System/370\* Channel Adapter for local attachment to a host in an SNA or non-SNA environment.

**Model 21R:** Is designed for remote operations. It contains a Type 1 Communication Adapter that provides EIA 232D/CCITT V.24/V.28 or CCITT V.35 interfaces for SDLC, BSC, X.25, or frame-relay remote link attachment to a host.

**Model 22L:** Has an Enterprise Systems Connection (ESCON\*) Adapter for local attachment to a host in an SNA or non-SNA environment. The ESCON Adapter provides for fiber optic cabling from the host to the controller. It also has a Type 1 Communication Adapter using CCITT V.24/V.28 (EIA 232D) and CCITT V.35 electrical interfaces for remote communication to a host.

**Model 22R:** Is designed for remote operations. It contains a Type 2 Communication Adapter that provides a CCITT V.11 (X.21) interface for SDLC, X.25, or frame-relay remote link attachment to a host.

**Model 23R:** Is designed to connect to an IBM Token-Ring Network. It contains a Token-Ring Adapter and cable that enables the controller to operate on an IBM Token-Ring Network at either 16 Mbps or 4 Mbps. It also has a Type 1 Communication Adapter using CCITT V.24/V.28 (EIA 232D) and CCITT V.35 electrical interfaces for remote communication to a host.

**Model 24R:** Is designed to connect to an Ethernet network. It contains an Ethernet Adapter that enables the controller to operate on an Ethernet network. It also has a Type 1 Communication Adapter using CCITT V.24/V.28 (EIA 232D) and CCITT V.35 electrical interfaces for remote communication to a host.

---

<sup>1</sup> Microcode is classified as IBM Licensed Internal Code. See the "3174 Licensed Internal Code" notice at the beginning of this document for information.



## 3174 Features

Feature	3174 Models	Functions
Asynchronous Emulation Adapter (AEA)	All	<p>Allows ASCII terminals to communicate with ASCII hosts, emulate 3270 devices, and communicate with 3270 devices and hosts.</p> <p>Allows 3270 terminals attached to the 3174 to emulate ASCII terminals and communicate with ASCII hosts.</p> <p>You can have up to three AEAs, each supporting up to eight ASCII terminals or hosts. A terminal or host is attached directly or through a modem (switched or nonswitched).</p>
Communication Adapter	21R, 22L, 22R, 23R, 24R	<p>Provides remote communication capability using CCITT V.24/V.28 (EIA 232D) and CCITT V.35 electrical interfaces.</p> <p><b>Note:</b> The Communication Adapter is standard on the base machine.</p>
Concurrent Communication Adapter (CCA)	All	<p>Provides an alternate telecommunication path to a host. Up to two adapters can be installed. These adapters are available with a Type 1 (EIA 232D/CCITT V.35) or a Type 2 (X.21) interface.</p>
Ethernet Adapter	All	<p>Connects an Ethernet network to the 3174 and can serve as an Ethernet gateway controller for the Ethernet network.</p> <p><b>Note:</b> The Ethernet Adapter is standard on Model 24R.</p>
Fiber Optic Terminal Adapter (FTA)	All	<p>Attaches one 3299 Terminal Multiplexer Model 32 using fiber optic cable. Up to three FTAs can be installed on Models 21H, 21L, 21R, 22L, and 23R.</p>
Fixed Disk Drive	All	<p>One 20MB fixed disk drive can be installed. One fixed disk drive should be installed on the central site controller when using Central Site Change Management (CSCM). The fixed disk cannot be installed along with the optional second diskette drive.</p>
Integrated Services Digital network (ISDN) Adapter	21H, 21L, 21R, 22L, 22R	<p>Provides pass-through support for downstream devices to an SNA host through a dial-in ISDN connection. Up to four ISDN Adapters can be installed in Models 21H, 21L, 21R, and 22L.</p>
Second Diskette Drive	All	<p>Is normally used for DSL diskettes when downstream load terminals are attached to the controller. A second diskette drive (or a fixed disk) is required if an AEA is installed in the controller or for Configuration Support C.</p>
Storage Expansion Cards	All	<p>Are available in three types: 1MB, 2MB, and 4MB.</p>
Telephone Twisted-Pair Terminal Multiplexer Adapter	All	<p>Attaches thirty-two 3270 terminals. The TTP TMA connects to either TA coaxial cable. Two TTP TMAs can be installed if the Port Expansion feature is installed.</p>
Terminal Adapter (TA)	All	<p>Attaches up to four 3270-type terminals, Terminal Multiplexer Adapters (TMAs), or terminal multiplexers, such as an IBM 3299 Terminal Multiplexer.</p> <p>Two types of TAs are available on Models 21H, 21L, 21R, 22L, 22R, 23R, and 24R. The standard TA supports a maximum of 32 terminals attached through multiplexers (TMAs, 3299s, or equivalent). An optional TA supports an additional 32 terminals, for a total of 64.</p>
Terminal Multiplexer Adapter (TMA)	All	<p>Attaches eight 3270-type terminals. The TMA connects to the TA with coaxial cable. Up to four TMAs can be installed.</p>

## Introduction

Feature	3174 Models	Functions
16/4Mbps Token-Ring Adapter	All	Connects an IBM Token-Ring network to the 3174 and can serve as a Token-Ring gateway controller for the Token-Ring network.  <b>Note:</b> The 16/4Mbps Token-Ring Adapter is standard on Model 23R.

## Identifying 3174 Hardware Group Numbers

The controller model and features ordered determines which of the adapters is installed in the controller.

Identify each adapter in the controller by name and hardware group (HG) number. It is important that you can identify which HG number is assigned to a particular adapter to run online or offline tests. In addition, you may be asked to give the port number (PN) on the adapter. Use the following table and descriptions to determine the HG number.

Asynchronous Emulation Adapter (AEA)	HG = 21, 22, or 23
Channel Adapter	HG = 16
Communication Adapter	HG = 11
Concurrent Communication Adapter (CCA)	HG = 51 or 52
Fiber Optic Terminal Adapter (FTA)	HG = 26 or 27
Enterprise Systems Connection (ESCON) Adapter	HG = 17
Ethernet Adapter	HG = 41
Integrated Services Digital Network (ISDN) Adapter	HG = 36, 37, 38, or 39
Telephone Twisted-Pair TMA	HG = 26 or 27
Terminal Adapter (TA)	HG = 26 or 27
Terminal Multiplexer Adapter (TMA)	HG = 26 or 27
Token-Ring Adapter	HG = 31

### Asynchronous Emulation Adapter (AEA) HG21, 22, or 23

The AEA connects eight ASCII terminals and ASCII hosts (in any combination) to the controller. The communication connectors (ports) on this adapter attach to:

- ASCII terminals or hosts
- Nonswitched modems
- Switched modems

### Channel Adapter HG16

The channel adapter provides a primary communication link between the 3174 and host. This adapter is available only on Models 21H and 21L.

### Communication Adapter HG11

The Communication Adapter is used for remote connection with a modem using a CCITT V.24/V.28 (EIA 232D) or CCITT V.35 electrical interface.

### Concurrent Communication Adapter (CCA) HG51 or 52

The CCA provides a secondary communication link between the 3174 and hosts other than the primary communication link (channel adapter or communication adapter). A 25-pin D-shell connector on the adapter allows connection of the communication interface cable. There are two types of CCA. The Type 1 CCA provides CCITT V.24/V.28 (EIA 232D) and CCITT V.35 electrical interfaces to connect the controller to a modem or other signal converter. The Type 2 CCA provides a CCITT V.11 (X.21) electrical interface to connect the controller to an X.21 network or other signal converter that provides a compatible interface.

## Adapter Hardware Group Numbers

### Enterprise Systems Connection (ESCON) Adapter HG17

The ESCON Adapter provides a primary communication link between the 3174 and a host through a fiber optic cable. This adapter is available only on the Model 22L.

### Ethernet Adapter HG41

The Ethernet Adapter connects to the Ethernet LAN by interfacing with the MMIO bus and the FRU ID bus. The adapter supports one connection at a time using one of the following connectors:

- 10BASE2 BNC connector
- 10BASE5 15-pin D-SUB connector
- 10BASE-T RJ-45 connector

### Fiber Optic Terminal Adapter (FTA) HG26 or 27

The FTA attaches to the TA with a single coaxial cable and to a 3299 Terminal Multiplexer Model 32 with a fiber optic cable. The 3299 Model 32 supports 32 terminals when connected to ports 26-0 or 27-0. Otherwise, it supports only eight terminals.

The FTA is HG26 unless it is connected to port 27-0, in which case it is HG27.

### Integrated Services Digital Network (ISDN) Adapter HG36, 37, 38, or 39

The ISDN Adapter provides a pass-through gateway function from downstream devices to an SNA host through a dial-in ISDN connection. Up to four ISDN Adapters can be installed in Models 21H, 21L, 21R, and 22L, and each adapter provides four incoming ports. Each port supports two connections providing a maximum of 32 active concurrent connections.

### Terminal Adapter (TA) HG26 or 27

The TA is used to connect 3270-type terminals to the controller. The terminal connectors (ports) on this adapter accept the standard bayonet connector (BNC) or the dual-purpose connector (DPC).

Models 21H, 21L, 21R, 22L, 22R, 23R, and 24R have a TA in the base hardware that allows attachment of a maximum of thirty-two 3270-type terminals. Each of the ports on the TA provides a path to one terminal, one FTA, one TMA, or one 3299 Terminal Multiplexer. This adapter is HG26.

As an optional feature, the 3270 Port Expansion Feature the second TA, allows the attachment of up to thirty-two additional 3270-type terminals. The first three ports on this adapter are HG26, and the rightmost port is HG27.

### Terminal Multiplexer Adapter (TMA) HG26 or 27

The TMA provides up to eight additional ports for connecting 3270-type terminals to the TA. A maximum of four TMAs can be connected. The TMA is connected to the TA by a short coaxial cable.

The TMA is HG26 unless it is connected to port 27-0, in which case it is HG27.

### **Telephone Twisted Pair Terminal Multiplexer Adapter**

The Telephone Twisted Pair Terminal Multiplexer Adapter (TTP TMA) allows attachment of up to thirty-two 3270-type devices (displays and printers) to the controller through two 25-pair telephone twisted-pair cables, meeting IBM Cabling System (ICS) Type 3 specifications.

The TTP TMA attaches to port 0 of the TA (HG26). If the Port Expansion feature is installed, one TTP TMA attaches to port 26-0 of the TA (HG26) and a second TTP TMA can attach to port 27-0 of the TA (HG27). No other devices should be attached to the remaining TA ports. If the TTA TMA is attached to any of the remaining TA ports, it acts as an eight-port multiplexer, with only ports 0 through 7 on the TTP TMA active.

### **Token-Ring Adapter HG31**

The Token-Ring Adapter cable connects the 3174 to the multistation access unit by means of the Token-Ring Adapter cable. The adapter has one connector (port) and supports only one connection between the controller and the multistation access unit.

### Operations

Before performing the basic operating procedures, you should become familiar with the controller diskette and fixed disk features, status codes, and tests.

### Diskettes or Fixed Disk

The Control program microcode<sup>2</sup> can be on a diskette or fixed disk (if the fixed disk feature is installed). The Utilities, for example, customizing and diagnostics, can be on a diskette or a fixed disk.

The 3174, as it is shipped, is not an operational unit. You must customize it with your system configuration prior to its use. For information on customizing your controller locally, refer to *3174 Establishment Controller Planning Guide*. For information on customizing your controller from the central site, refer to *3174 Establishment Controller Central Site Customizing User's Guide*. You should work closely with your site planners and system coordinators when customizing your controller.

For more information on operations with diskettes, see Appendix A, "Diskettes and Diskette Drives."

### Status Codes

Operation of the 3174 depends on the use of status codes and their action plans. After you turn on the controller, it communicates with status codes prompting you for responses, informing you of the progress of an operation, or indicating that a problem exists. The *3174 Establishment Controller Status Codes*, which is shipped with every controller, explains the meaning of each status code.

### Tests

**Offline:** The offline tests are a part of the Utility microcode that is on the Utility diskette or the Utility microcode stored on an optional fixed disk. These tests are used to check particular features on the controller. Chapter 5, "3174 Controller Problem Solving and Offline Testing," describes how to perform offline tests.

**Online:** The Control diskette provided with the controller contains diagnostic routines called online tests. The online tests allow you to test the 3174 while performing normal daily operations. Online tests are described in *3174 Establishment Controller Customer Problem Determination*.

---

<sup>2</sup> Microcode is classified as IBM Licensed Internal Code. See the "3174 Licensed Internal Code" notice at the beginning of this document for more information.

Panels, Switches, and Indicators

Figure 1-1 shows a front view of the 3174 with the decorative panel removed. The front panel on the 3174 contains a power supply panel, an operator panel, diskette drive, optional diskette drive or fixed disk drive, and a diskette storage pocket. Figure 1-2 on page 1-9 through Figure 1-5 on page 1-10 show rear views of the 3174.

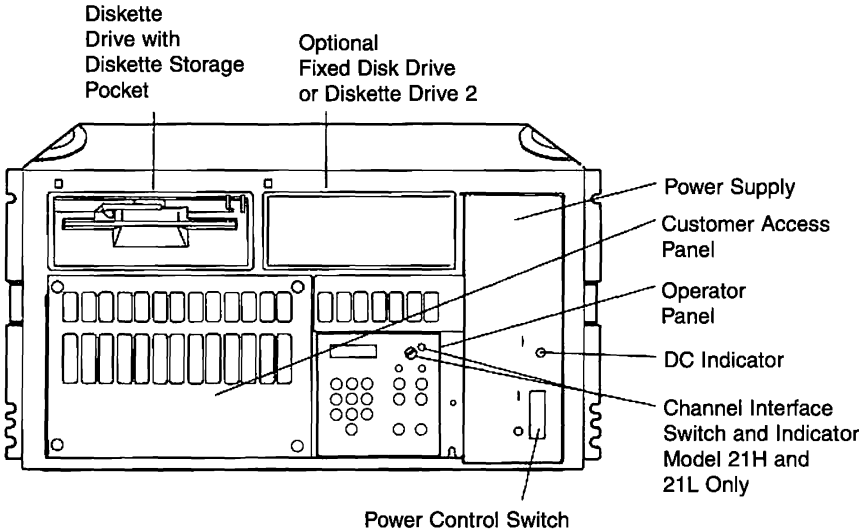

Figure 1-1. Front View of the 3174 Models 21H, 21L, 21R, 22L, 22R, 23R, and 24R

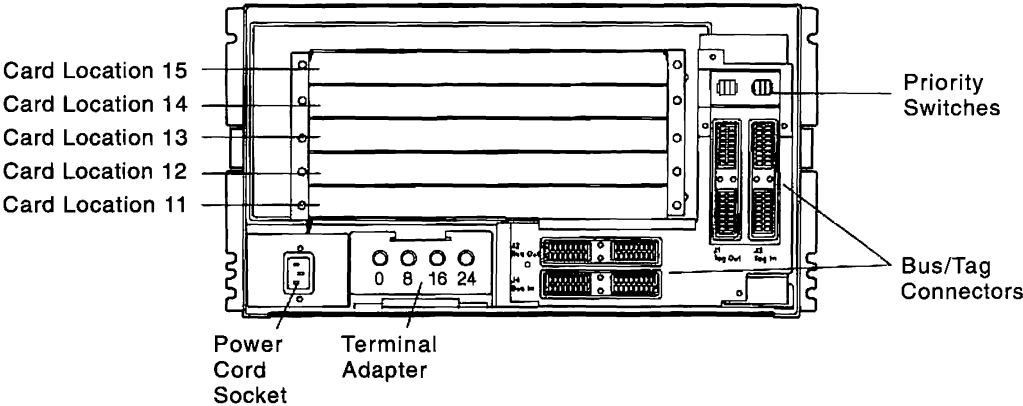

Figure 1-2. Rear View of the 3174 Model 21L

## Panels, Switches, and Indicators

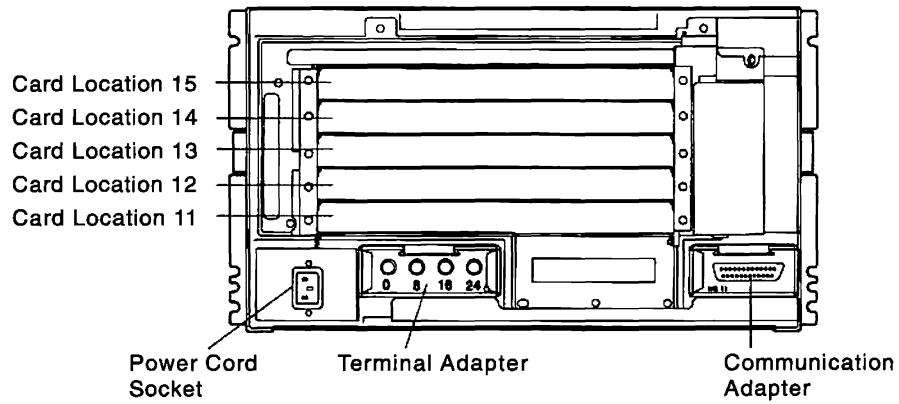

Figure 1-3. Rear View of the 3174 Model 21R

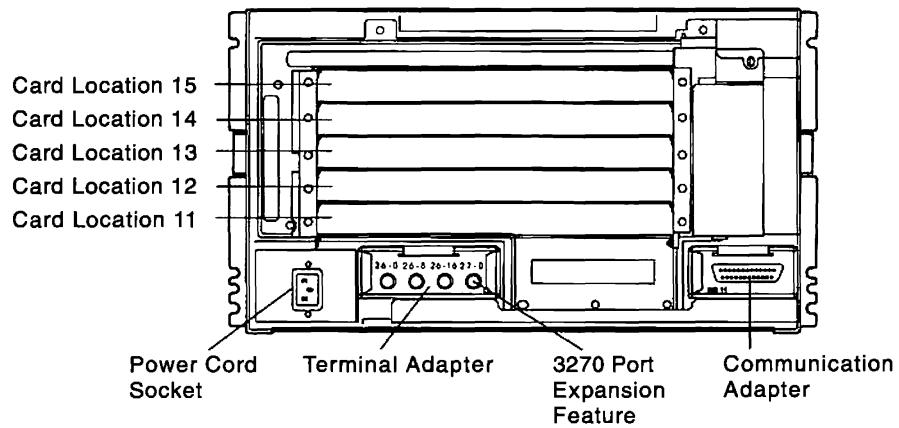

Figure 1-4. Rear View of the 3174 Model 21R with the 3270 Port Expansion Feature

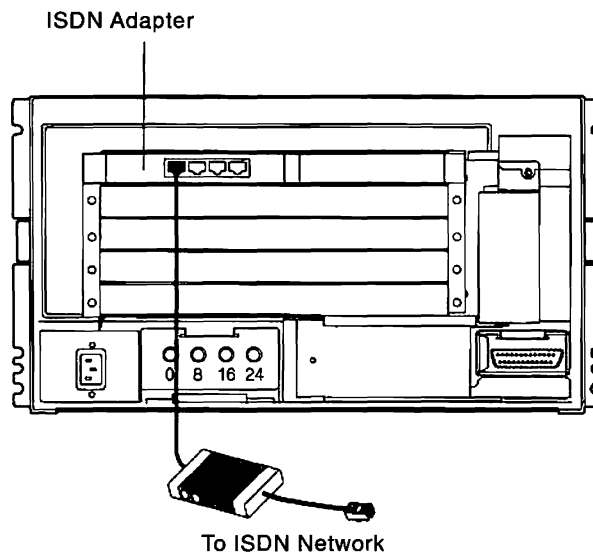

Figure 1-5. Rear View of the 3174 Model 21R with the ISDN Adapter



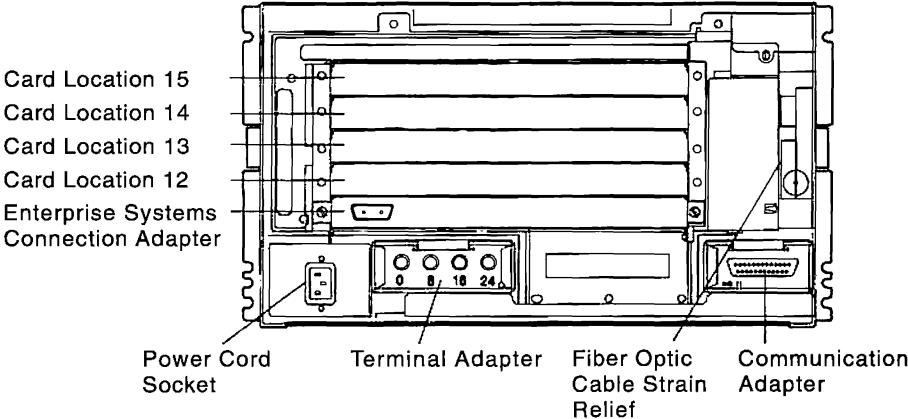

Figure 1-6. Rear View of the 3174 Model 22L

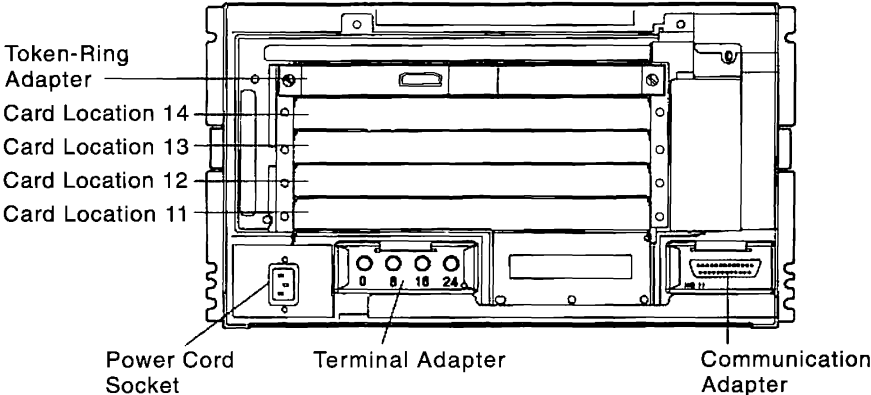

Figure 1-7. Rear View of the 3174 Model 23R

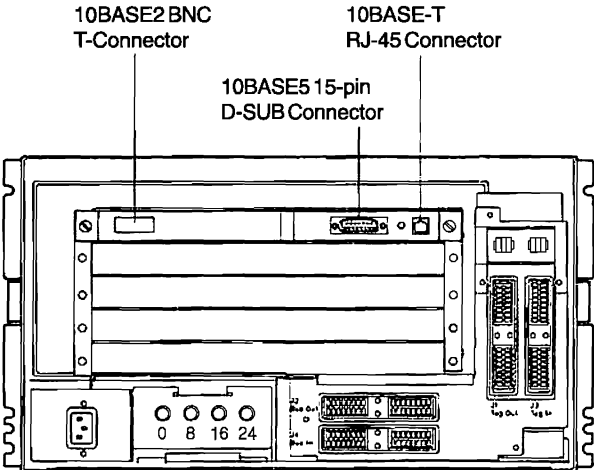

Figure 1-8. Rear View of the 3174 Model 21L with Ethernet Adapter shown

1

## Operator Panel

### Power Panel Switch and Indicator

Figure 1-9 shows the power panel for the 3174.

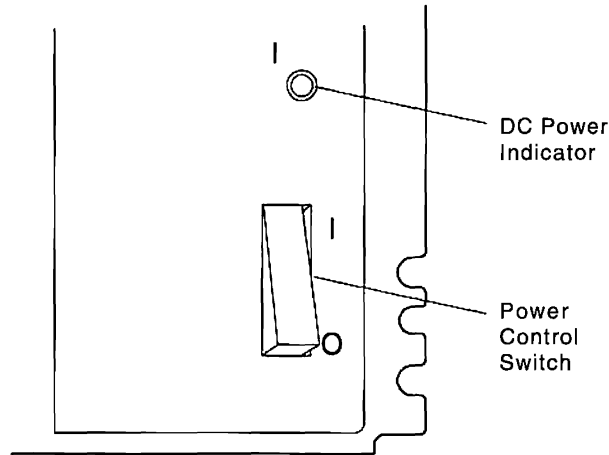

Figure 1-9. 3174 Power Panel

**DC Power:** The green DC Power indicator is lit when the 3174 is on and shows that the DC power supply voltages are at the correct levels.

**Power:** Turn on the 3174 by lifting the Power switch to I (on). An initial microcode load (IML) sequence starts when you turn on the 3174. Turn off the 3174 by pressing the Power switch to O (off).

## Operator Panel

Figure 1-10 shows the Operator panel for the 3174 Models 21H, 21L, 21R, 22L, 22R, 23R, and 24R.

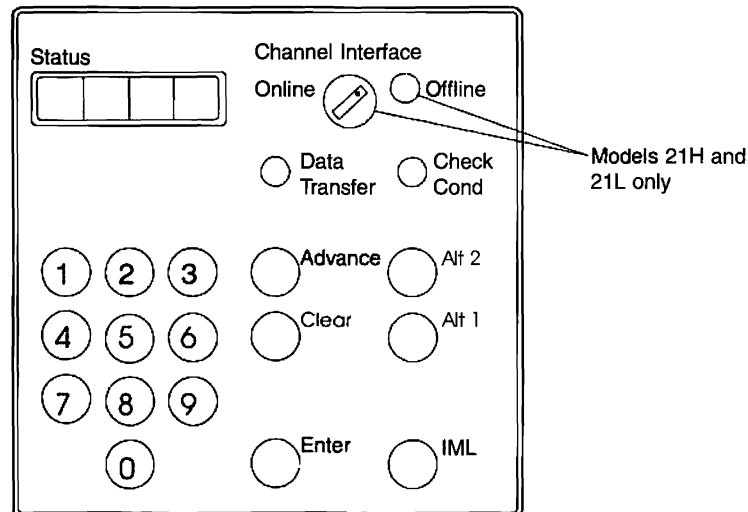

Figure 1-10. 3174 Operator Panel

The Operator panel is located behind the decorative panel on the front of the 3174. You can easily remove the decorative panel by holding it by the sides and pulling it toward you.

The functions of the indicators and controls for the operator panel are:

**Status:** The four Status indicators display numeric status codes or keypad input. Status codes are used by the 3174 to prompt you for responses, inform you of the progress of an operation, or indicate that a problem exists. Refer to *3174 Establishment Controller Status Codes*, for an explanation of status codes.

**Channel Interface:** This switch is present only on the Models 21H and 21L. When this switch is set to Offline and the Offline indicator is lit, the 3174 is logically disconnected from the host channel (offline). In this condition, you can turn off power to Models 21H and 21L or start an IML sequence. When the switch is set to Online and the Offline indicator is not lit, the 3174 is logically connected to the host channel and you cannot IML or switch off the 3174.

**Offline:** This indicator is present only on Models 21H and 21L, and is lit after the Channel Interface switch is turned to Offline. It indicates that the 3174 is logically disconnected from the host.

**Data Transfer:** The Data Transfer indicator is lit or blinking when the controller is transmitting data to the host or receiving data from the host.

**Check Cond:** The Check Cond indicator is lit when the controller has a hardware or microcode failure.

**Keypad:** Use the numeric keypad to type in numbers in response to controller prompts. Numbers appear in the Status display (from left to right) as you press the keys.

**Clear:** Press Clear to erase the characters in the Status display that were entered from the operator keypad.

**Advance:** Press the Advance pushbutton to allow more keypad input (as many as four digits at a time) or to display additional status code fields in the Status display.

**Alt 2:** Press the Alt 2 pushbutton in conjunction with either an IML or a power-on sequence to run diagnostics on the controller. Alt 2 IML is used at feature installation, or whenever hardware problem solving is required. Alt 2 IML selects only diskette drive 1 as the microcode loading device. The Utility diskette contains the offline testing microcode. A 2082 status code indicates that testing completed successfully.

**Alt 1:** Press the Alt 1 pushbutton in conjunction with either an IML or a power-on sequence to perform any of the following:

- Customer setup tests
- Customizing procedures
- Specific offline tests
- Loading alternate Control code

An Alt 1 IML (see “Testing the Adapters from a Diskette” on page 5-8 and “Testing the Adapters from a Fixed Disk” on page 5-9) causes a 40 prompt to appear in the Status display. You can then either press Enter to display a menu of procedures (Master Menu) at the 3270-type terminal connected to port 0, or make a keypad entry and press Enter to request one of the specified functions.

## Problem Solving

**Enter:** Press Enter to cause the function indicated in the Status display to be performed. Also use Enter when the controller is operating to display any status codes that might be present.

**IML:** Press the IML pushbutton to light all indicators on the operator panel and to display 8888 in the Status indicators. Release the IML pushbutton to run IML tests. If no errors are found, operational microcode is loaded into controller storage from a customized Control diskette or fixed disk. A normal IML is complete when 503, 505, 507, or 532 appears in the Status display. 3174 appears in the Status display when the host system brings the controller online. If a failure occurs during any portion of the IML sequence, a status code appears and remains in the Status display. The IML pushbutton is also used with the Alt 1 and Alt 2 pushbuttons.

### Priority Switches (Models 21H and 21L only)

The Priority switches are located near the channel connectors on the rear of the 3174. They are used by the service representative to set the order in which the devices attached to the channel are serviced by the host.

---

## Problem Solving

If you know the results of pertinent tests, your support groups can help you solve a problem.

The 3174 and the attached terminals are usually part of a larger network. To solve a problem, you must isolate the problem to a particular part of the network. The procedures in Chapter 5, "3174 Controller Problem Solving and Offline Testing," enable you to resolve common problems that can occur.

For example, many problems are the result of poor cable connections, so you might be asked to check cable or terminal connections to find the source of the problem.

If the basic problem solving in Chapter 5, "3174 Controller Problem Solving and Offline Testing," does not help to solve the problem, the *3174 Establishment Controller Customer Problem Determination* has more detailed procedures for correcting problems. You can contact your technical support group or help desk for assistance in using these procedures.

Gather all available information before you call for assistance about a problem.

---

## Chapter 2. Setting Up the 3174 Controller

The following items come with the 3174 as shown in Figure 2-1 on page 2-2. Items shown with gray shading are shipped with the 3174 only if that feature is installed.

- Control diskettes, Control Extension diskette, Utility diskettes, and if applicable, one or more DSL or RPQ diskettes
- Cable management hooks and retainers (if TMA adapters or AEA adapters are factory installed)
- Support rails for the equipment rack, if applicable
- One or more of the following cables, if applicable:
  - Communication cable, either EIA 232D or V.35 (for models with the Type 1 CCA or for Model 21R or 23R)
  - Communication cable, X.21 (for models with the Type 2 CCA)
  - ISDN Adapter cable
  - Token-Ring Adapter cable
- The following base publications:
  - *3174 Establishment Controller Customer Problem Determination Guide*
  - *3174 Establishment Controller Models 21H, 21L, 21R, 22L, 22R, 23R, and 24R Maintenance Information*
  - *3174 Establishment Controller Models 21H, 21L, 21R, 22L, 22R, 23R, and 24R User's Guide*
  - *3174 Establishment Controller Planning Guide*
  - *3174 Establishment Controller Status Codes*
  - *3174 Establishment Controller Utilities Guide*

## Setting Up the 3174 Controller

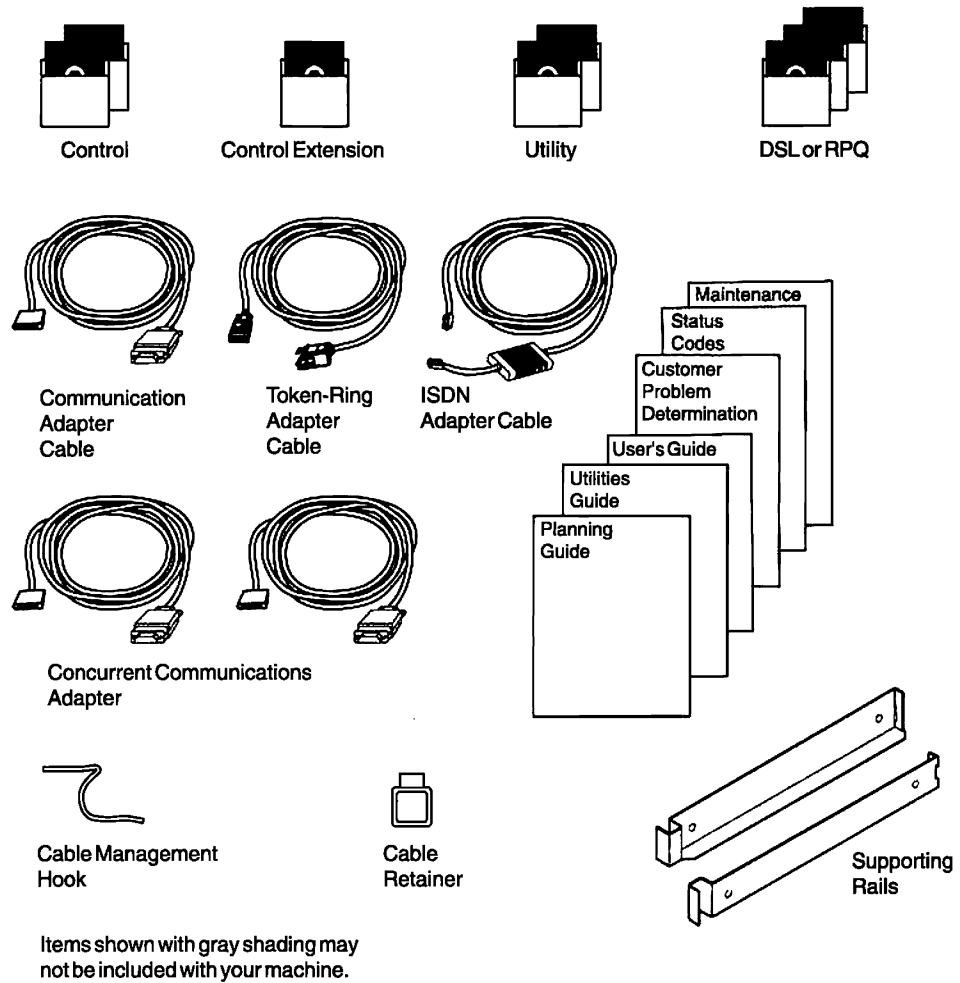

Figure 2-1. Items Shipped with the Controller

## Setting Up 3174 Models 21H, 21L, 21R, 22L, 22R, 23R, and 24R

Read through the setup instructions completely before performing the setup tasks. Then return to Step 1 and follow the instructions.

While performing the setup, you use diskettes. If you need information on the correct way to handle diskettes, see Appendix A, "Diskettes and Diskette Drives" on page A-1.

**Note:** Do not attempt to close the diskette drive lever unless the diskette is inserted.

**Warning:** Do not place electrical equipment on top or within 305 millimeters (12 inches) of the sides of the 3174. Placing equipment close to the 3174 can cause intermittent failures.

Figure 2-2 shows the front view of the Models 21H, 21L, 21R, 22L, 22R, 23R, and 24R with the decorative panel removed. Refer to the labeled items later in the setup instructions.

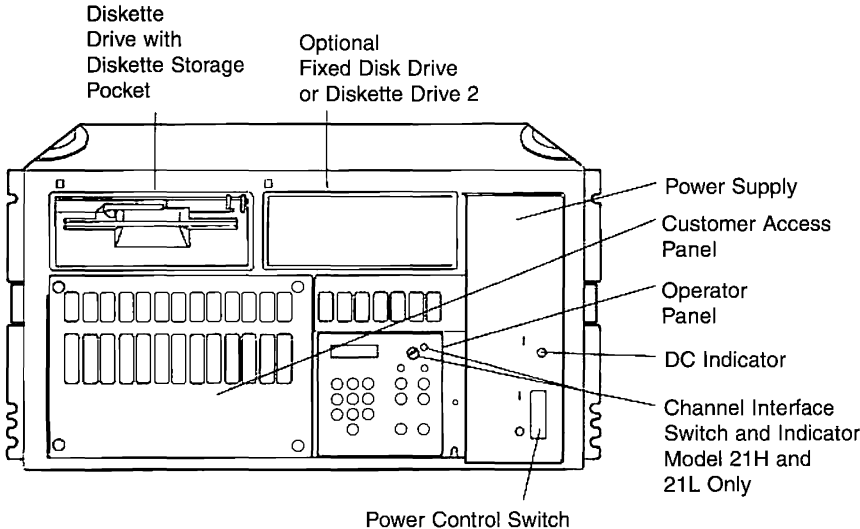

Figure 2-2. Front View of Models 21H, 21L, 21R, 22L, 22R, 23R, and 24R

- 1 Hold the decorative panel on each side. Pull the panel toward you and remove it from the front of the 3174 before installing the 3174 in the rack.

**CAUTION:**  
**This unit weighs over 18 kilograms (40 pounds). To avoid injury when lifting this unit, have someone assist you.** (For translations of this safety notice, see Safety Notice 12 in *3174 Safety Notices*, GA27-3824.)

**Note:** Use the handles located on the top of the 3174 for lifting. Only Underwriters Laboratory/Canadian Standards Association (UL/CSA) certified units are to be placed in the same rack with the 3174.

## Setting Up the 3174 Controller

- 2** Place the 3174 in the equipment rack.

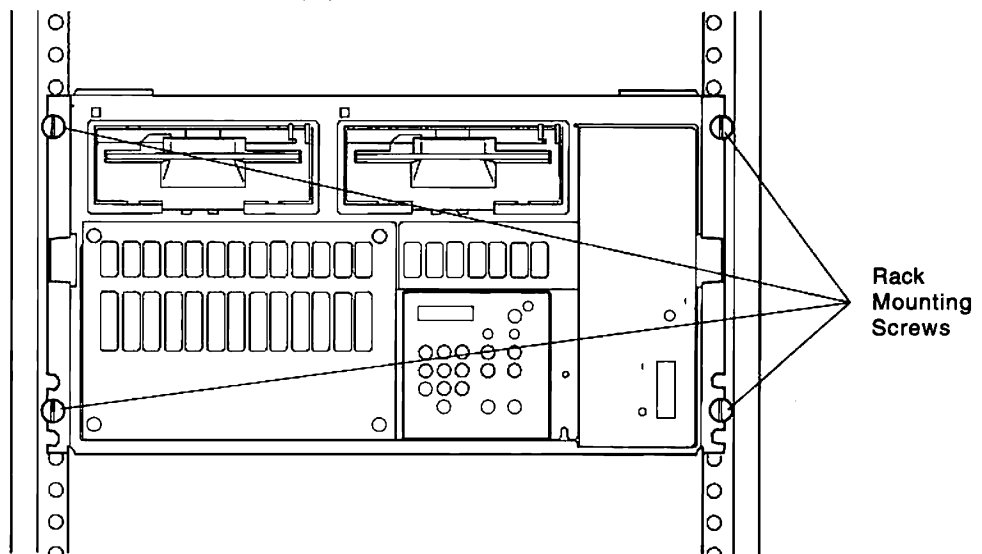

- 3** Tighten the rack mounting screws located in the front of the 3174 to keep the 3174 from slipping in the rack. They are not intended to support the 3174. The 3174 must sit on a shelf or on supporting rails that are secured at both ends.

- 4** Insert the cable management hooks with flexible retainers into the rear of the rack.

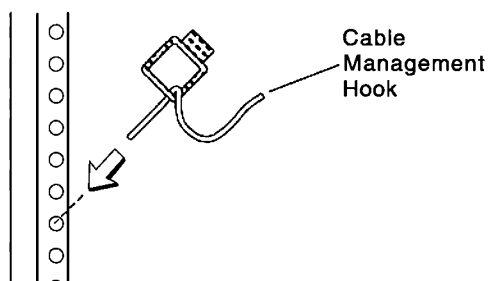

- 5** Set the Power switch to **O** (off).

- 6** Are you setting up a Model 21H or 21L?

**Yes** Set the Channel Interface switch to Offline.

**No** Continue with Step 7.

- 7** Are you setting up a Model 21R or 23R?

**Yes** Connect the Communication Adapter cable to the port labeled HG11 on the rear of the 3174.

**No** Continue with Step 8 on page 2-5.



**8** Does the 3174 have a Type 1 or Type 2 CCA (card type 926x)?

**Yes** Plug the adapter cable in the connector on the adapter card and tighten the thumbscrews.

**Note:** The card-type number referred to is the number printed on the front of the adapter card. The character x in the card type can be any digit.

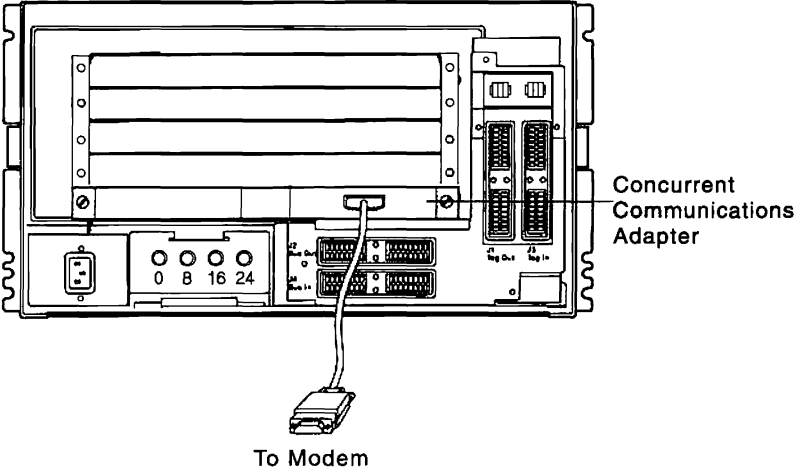

**No** Go to Step 10 on page 2-6.

**9** Set the TEST/OPER switches on the Communication Adapter cable and the CCA cable to TEST.

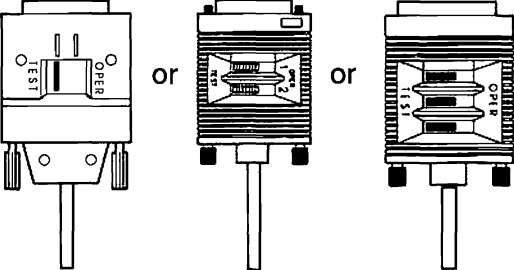

**10** Does the 3174 have the IBM Token-Ring Adapter (card type 935x)?

**Yes** Plug the Token-Ring Adapter cable (shipped with the 3174) into the connector on the adapter and tighten the thumbscrews. Do not connect the other end of the cable to the Token-Ring Network.

**Note:** The card-type number referred to is the number printed on the front of the adapter card. The character **x** in the card type can be any digit.

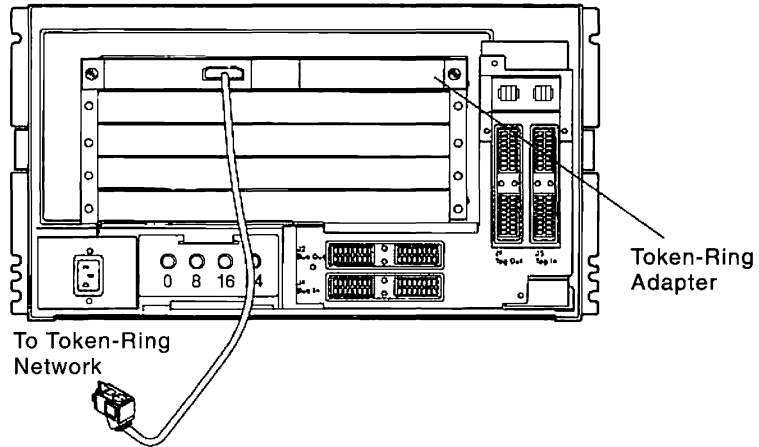

**No** Continue with Step 11.

**11** Does the 3174 have any ISDN Adapters (card type 9341)?

**Yes** Plug the long end of the ISDN Adapter cables (shipped with the 3174) into the connectors on the adapters.

**Note:** The card-type number referred to is the number printed on the front of the adapter card.

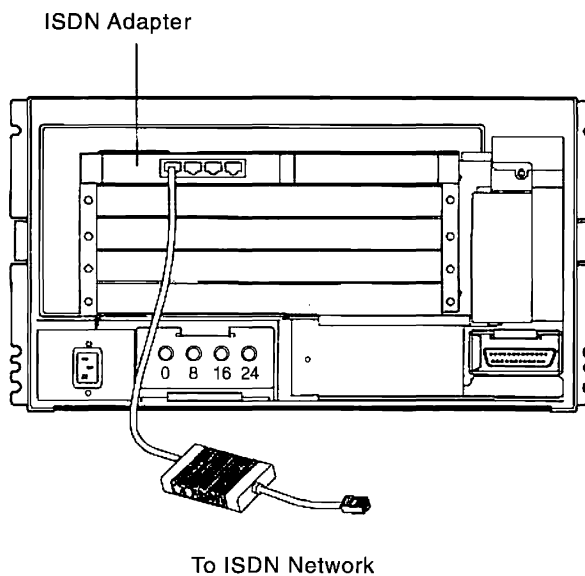

**No** Continue with Step 12 on page 2-7.

**12** Does the 3174 have a metallic, waterproof-type power plug?

**Yes CAUTION:**

**If your machine has a metallic, waterproof-type power plug, do not attempt to connect it. Instead, have a qualified electrician connect the plug.** (For translations of this safety notice, see Safety Notice 3 in *3174 Safety Notices*, GA27-3824.)

**No CAUTION:**

**The power plug must be connected to a properly wired and grounded receptacle. An improperly wired receptacle could place a hazardous voltage on accessible metal parts of machines.** (For translations of this safety notice, see Safety Notice 6 in *3174 Safety Notices*, GA27-3824.)

Plug the power cable into a *grounded* electrical outlet.

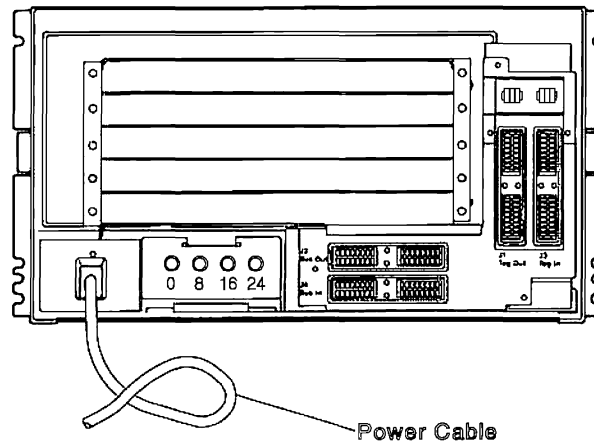

**13** Remove the Utility diskette from the envelope. Hold the diskette by the labeled end with the label facing up. Insert the diskette into drive 1 and close the lever. (If you have two diskette drives, drive 1 is the left drive.)

If you have two diskette drives, insert a DSL, Control, or RPQ diskette into drive 2 (the right drive) and close the lever.

**Note:** For a description of the diskettes, their function, their handling, and care, see Appendix A, "Diskettes and Diskette Drives."

**14** For the following steps, if the correct numbers do not appear in the Status display, refer to *3174 Establishment Controller Status Codes*.

Press and hold down the Alt 1 pushbutton, and press the Power switch to I (on).

**15** Continue holding down the Alt 1 pushbutton until 31 appears in the Status display, then release

Alt 1. 40 should appear in the Status display.

**16** Did 31 followed by 40 appear in the Status display?

**Yes** Type in **81** using the operator keypad.

Make sure that the correct numbers are in the display. If you type in a wrong number, press Clear and try again.

## Setting Up the 3174 Controller

**No** See Chapter 5, "3174 Controller Problem Solving and Offline Testing."

### **17** Press Enter.

Tests run and progress numbers appear in the Status display. The tests can take several minutes to run.

After the tests are successfully completed, 2081 appears and remains in the Status display. If 2081 does not appear in the Status display, refer to *3174 Establishment Controller Status Codes*.

### **18** Set the Power switch to **O** (off).

#### **CAUTION:**

**To avoid the possibility of electrical shock, disconnect all power plugs before connecting or disconnecting cables. Do not reconnect power plugs until connection or disconnection of the cables is completed.** (For translations of this safety notice, see Safety Notice 1 in *3174 Safety Notices, GA27-3824*.)

#### **DANGER**

**Do not connect or disconnect cables during periods of lightning activity.** (For translations of this safety notice, see Safety Notice 5 in *3174 Safety Notices, GA27-3824*.)

### **19** Place each diskette in its envelope and store the diskettes in the diskette storage pocket.

### **20** Are you setting up a Model 21H or 21L?

**Yes** Have a service representative attach the channel cables from the host computer to the 3174, then go to Step 33 on page 2-14.

**No** Continue with Step 21.

### **21** Are you setting up a Model 22L?

**Yes** Continue with Step 22 on page 2-9.

**No** Go to Step 33 on page 2-14.

- 22** Remove the shipping plug from the connector on the ESCON Adapter.  
(Save the shipping plug for use during relocation.)

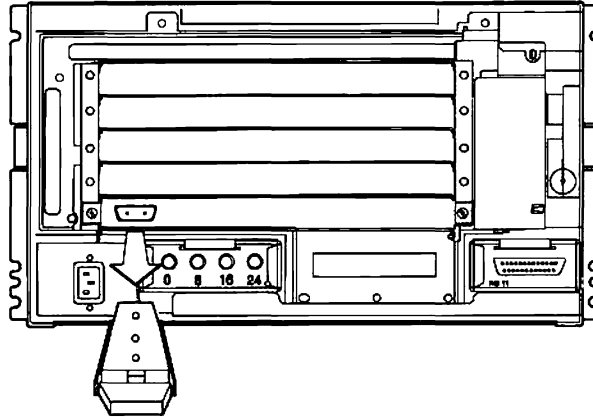

- 23** Remove the protective covers from the fiber optic duplex connector.

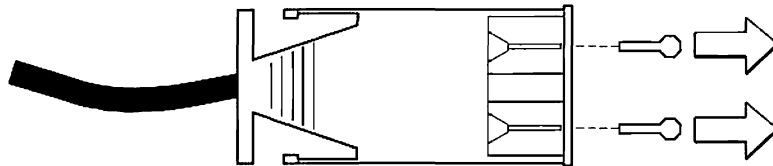

- 24** Clean the duplex connector with the IBM Fiber Optic Cleaning Kit (IBM P/N 5453521) before connecting it. Refer to *IBM Fiber Optic Cleaning Procedures*, SY27-2604, for instructions.

- 25** Connect the duplex connector to the ESCON Adapter. Be sure to align the duplex connector correctly. One side of the connector has bevels.

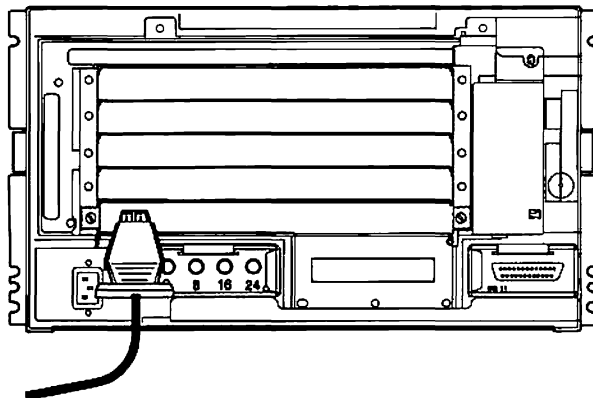

## Setting Up the 3174 Controller

### 26 Route the fiber optic cable through the strain relief attachments as follows:

- a. Slip the cable under the strain relief clip.
- b. Wrap it around the strain relief three times in a clockwise direction.
- c. Route the end leading away from the controller in the funnel-shaped groove on the base.
- d. Attach the cover over the funnel-shaped groove with the two thumbscrews provided.

When correctly routed through the strain relief attachments, the cable should look like this:

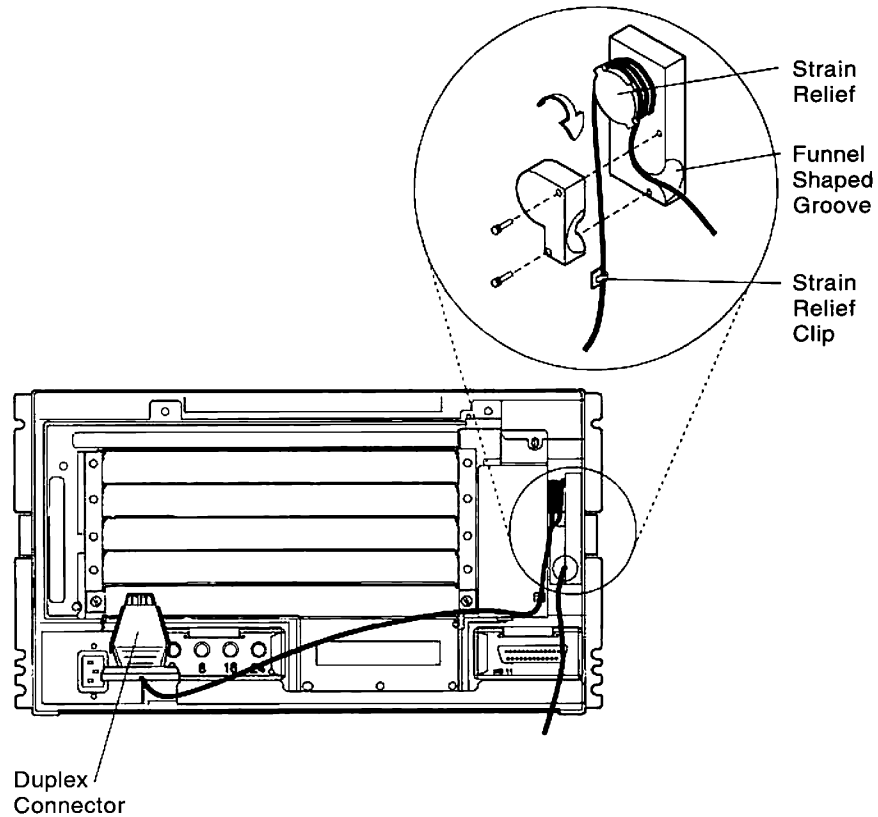

**27** Does the 3174 have a Terminal Adapter (TA) connector?

**Yes** Connect the Terminal Adapter connector to the 3174 or the terminal multiplexer by pushing the cable over the connector and turning it clockwise about one quarter of a turn to lock it securely into place.

To determine the addresses for port connectors, see Chapter 3, "Determining 3270 Terminal Port Addresses" on page 3-1.

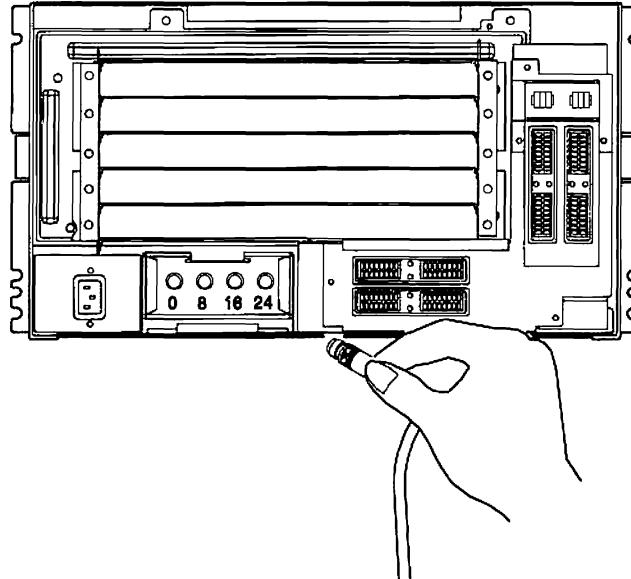

**No** Continue with Step 28.

**28** Does the 3174 have an Asynchronous Emulation Adapter cable?

**Yes** Connect a cable to an AEA port or ASCII terminal by inserting the cable into the connector and alternately turning the two thumbscrews clockwise until the connector sits evenly and the thumbscrews are tight.

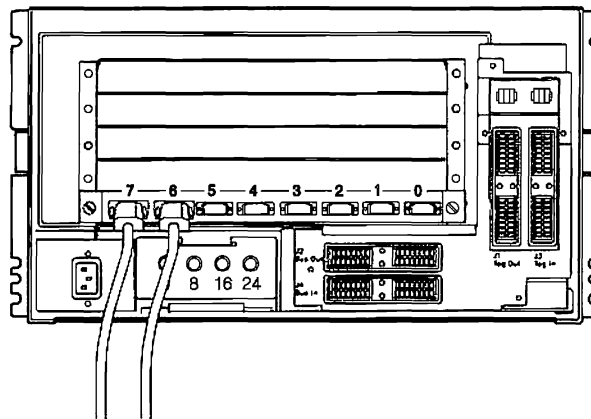

**No** Continue with Step 29 on page 2-12.

## Setting Up the 3174 Controller

**29** Does the 3174 have a Fiber Optic Terminal Adapter (FTA) Cable?

**Yes** To connect fiber optic cable to the FTA, do the following:

- a. Remove the shipping plugs from the ST connectors on the fiber optic cable.

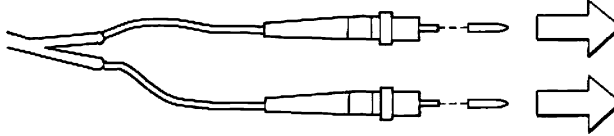

- b. Clean the fiber optic ST connectors with the Fiber Optic Cleaning Kit (IBM P/N 5453521) before installation. Refer to *IBM Fiber Optic Cleaning Procedures, SY27-2604*.

- c. Plug the ST connectors into the FTA.

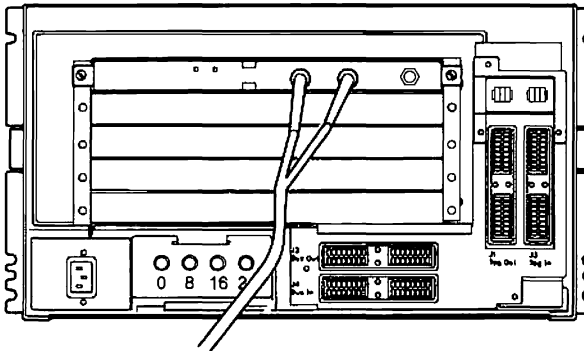

**No** Continue with Step 30.

**30** Does the 3174 have a Token-Ring cable?

**Yes** Connect the Token-Ring cable to the Token-Ring Network.

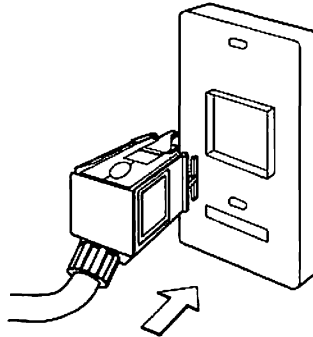

**No** Continue with Step 31 on page 2-13.



**31** Does the 3174 have any ISDN Adapters installed?

**Yes** Connect the other end of the adapter cables to the ISDN Network terminator (NT1) for each ISDN Adapter installed.

For Germany Only

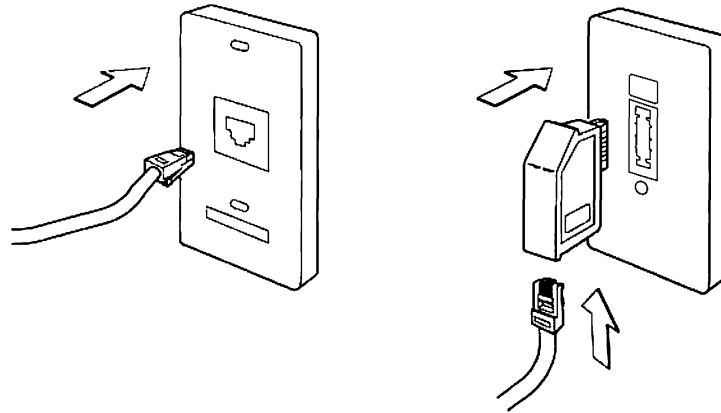

**No** Continue with Step 32.

**32** Does the 3174 have an Ethernet Adapter (card type 9344)?

**Yes** If you are using a 10BASE2 BNC connection, attach the T-connector for 10BASE2 BNC connections (shipped with the 3174) to the appropriate connector on the front of the adapter and tighten.

Plug the appropriate Ethernet cable (not shipped with the 3174) in the appropriate connector on the adapter and tighten.

Possible connectors include:

- 10BASE2 BNC connector
- 10BASE5 15-pin D-SUB connector
- 10BASE-T RJ-45 connector

**Note:** The 10BASE5 12-pin D-SUB connector is held in place with a sliding retainer clip. Slide the clip to the right to lock the connector in place.

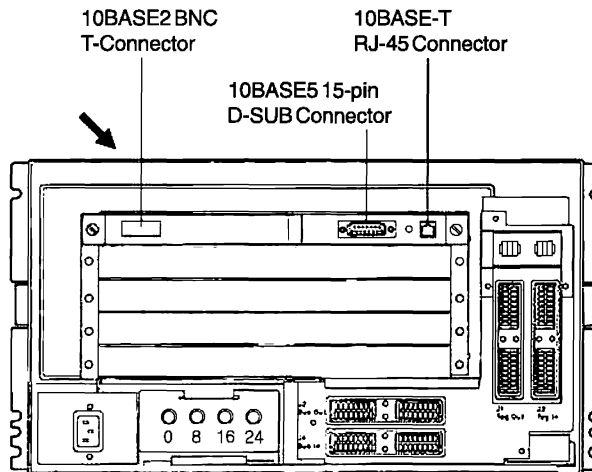

**No** Continue with Step 33 on page 2-14.

## Setting Up the 3174 Controller

**33** Install the decorative panel on the machine by aligning it with the sides and top of the 3174 and pressing it on the 3174.

**34** Route the cables to the sides of the rack and secure them in the cable management hooks with the flexible retainers.

**35** Initial setup and 3174 checkout are complete.

To make the 3174 operational, you must:

- a. Initialize the fixed disk, if present (refer to *3174 Establishment Controller Utilities Guide*).
- b. Plan the customization of the 3174 (refer to *3174 Establishment Planning Guide*).
- c. Customize the 3174 (refer to *3174 Establishment Controller Utilities Guide*).
- d. IML the 3174 (follow the instructions in Chapter 4, "Making the 3174 Controller Operational").

---

## Chapter 3. Determining 3270 Terminal Port Addresses

This chapter explains how to determine terminal and port addresses by following two steps.

- 1** Determine the configuration layout for the terminals. Assign an address to a terminal when cabling worksheets are filled out as part of site planning. Cabling worksheets are in *3174 Establishment Controller Site Planning*.
- 2** Determine which physical port on the 3174 gives you the address asked for on the cabling worksheet. For example, the worksheet has a 3278 addressed as 26-00. The 26 represents the HG number and is assigned to 3270-type terminals. The 00 represents the port address, which is always two digits beginning with 00. So in this case, this 3278 is connected to the first port (labeled only with a single 0). Terminals attached to the 3270 Port Expansion Feature are identified similarly except that the hardware group is 27.

---

### For Terminals Directly Connected to the TA

When the terminal is connected to the port on the Terminal Adapter, the terminal is *directly connected* to the Terminal Adapter.

The port number or terminal port address of the terminal is the same as the Terminal Adapter port number. For example, if the terminal is connected to TA port 16, its terminal port address is 26-16.

---

### For Terminals Indirectly Connected to the TA

When the terminal is connected to the port on TMA (card type 917x) or an external multiplexer, such as a 3299, the terminal is *indirectly* connected to the Terminal Adapter.

The port number or terminal port address of the terminal is determined by adding the number of the TA port to which the terminal multiplexer is connected to the number of the 3299 or TMA port to which the terminal is connected. For example:

Terminal Adapter Port	+	3299 or TMA Port	=	Terminal Port Address
26-00	+	3	=	26-03
26-16	+	5	=	26-21
27-00	+	9	=	27-09
27-00	+	28	=	27-28

## Ports and Cables

This section shows sample layouts for ports and cabling on Models 21H, 21L, 21R, 22L, 22R, 23R, and 24R. Examples are:

- Normal 3270 connection (Figure 3-1)
  - Attached to a TMA
  - Attached to a 3299 Model 32
  - Directly attached
- Connection to the 3270 Port Expansion Feature through a TMA (Figure 3-5 on page 3-7)
- ASCII terminal connection (Figure 3-7 on page 3-9).

Following each sample layout are examples of completed worksheets showing how the sample layout has been configured.

### Sample Configuration (Normal 3270 Connection)

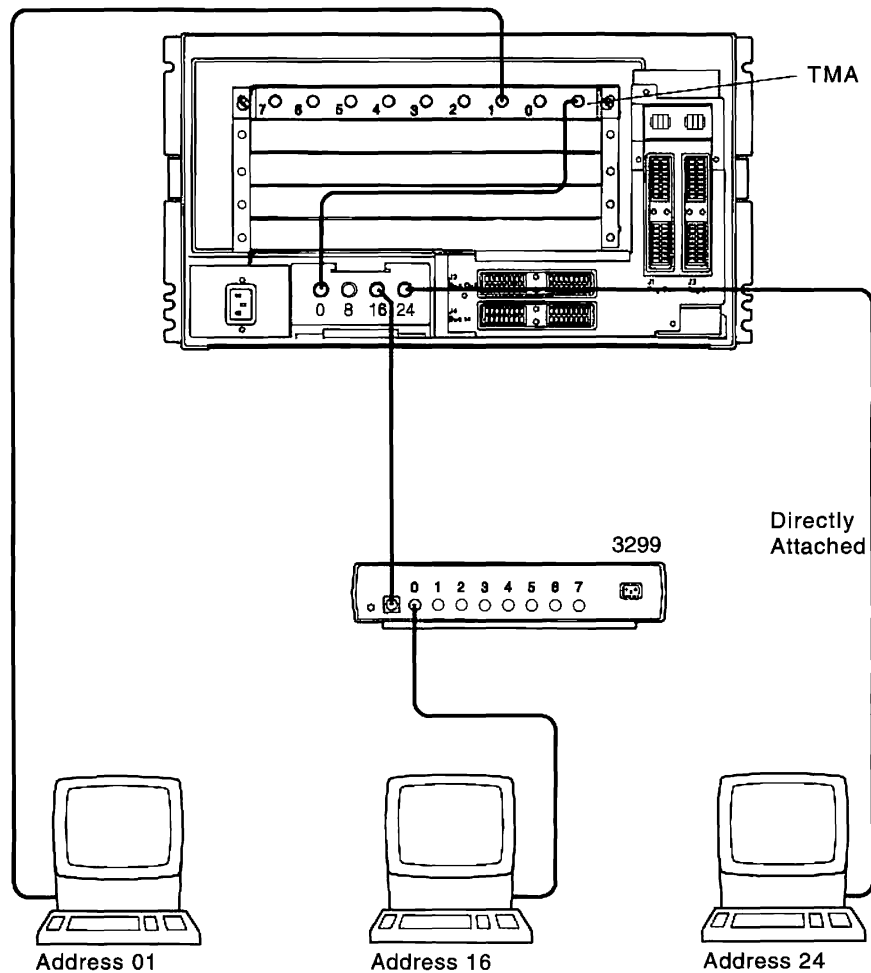

Figure 3-1. Sample Layout

The following pages show samples of completed 3174 cabling worksheets 8A, 9C, and 10 for indirect and direct connections.

**TMA Worksheet 8A**

**TMA Worksheet 8A (Terminal Port Address Range 00–07)**

- This worksheet identifies the cabling from terminal adapter connector 0 to a TMA and from the TMA to the terminals.
- Fill it out during site planning.
- Use it for cable installation.
- Modify it when cabling changes are made.
- Store it with the 3174 documentation for relocation and problem determination use.

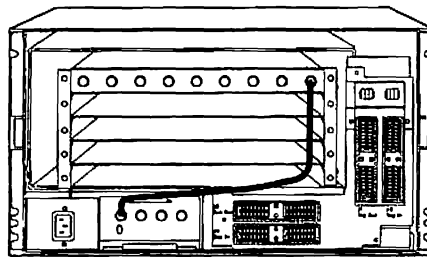

From the TMA to the terminals — Terminal Port Address Range 00-07

TMA Connector	Terminal Cable ID	Terminal Type	Terminal Location	Terminal Port Address
0	_____	_____	_____	26-00
1	27	3279	Shipping	26-01
2	_____	_____	_____	26-02
3	_____	_____	_____	26-03
4	_____	_____	_____	26-04
5	_____	_____	_____	26-05
6	_____	_____	_____	26-06
7	_____	_____	_____	26-07

Figure 3-2. Sample TMA Worksheet 8A

**3299 Worksheet 9C**

**3299 Worksheet 9C (Terminal Port Address Range 16–23)**

- This worksheet identifies the cabling from Terminal Adapter connector 16 to a 3299 Model 1, 2, 3, or 32, and from the 3299 to the terminals. It also identifies the cabling from Terminal Adapter connector 16 through a Fiber Optic Terminal Adapter to a 3299 Model 32, and from the 3299 to the terminals.
- Fill it out during site planning.
- Use it for cable installation.
- Modify it when cabling changes are made.
- Store it with the 3174 documentation for relocation and problem determination use.

From the Terminal Adapter to the 3299

Terminal Adapter Connector	3299 Cable ID	3299 Model	3299 Location	3299 ID or Number
16	<u>664-29</u>	<u>2</u>	<u>664-301</u>	<u>6</u>

From the 3299 to the terminals — Terminal Port Address Range 16-23

3299 Connector	Terminal Cable ID	Terminal Type	Terminal Location	Terminal Port Address
0	<u>29</u>	<u>3279</u>	<u>Quality Control</u>	26-16
1	_____	_____	_____	26-17
2	_____	_____	_____	26-18
3	_____	_____	_____	26-19
4	_____	_____	_____	26-20
5	_____	_____	_____	26-21
6	_____	_____	_____	26-22
7	_____	_____	_____	26-23

Figure 3-3 (Part 1 of 2). Sample 3299 Worksheet 9C

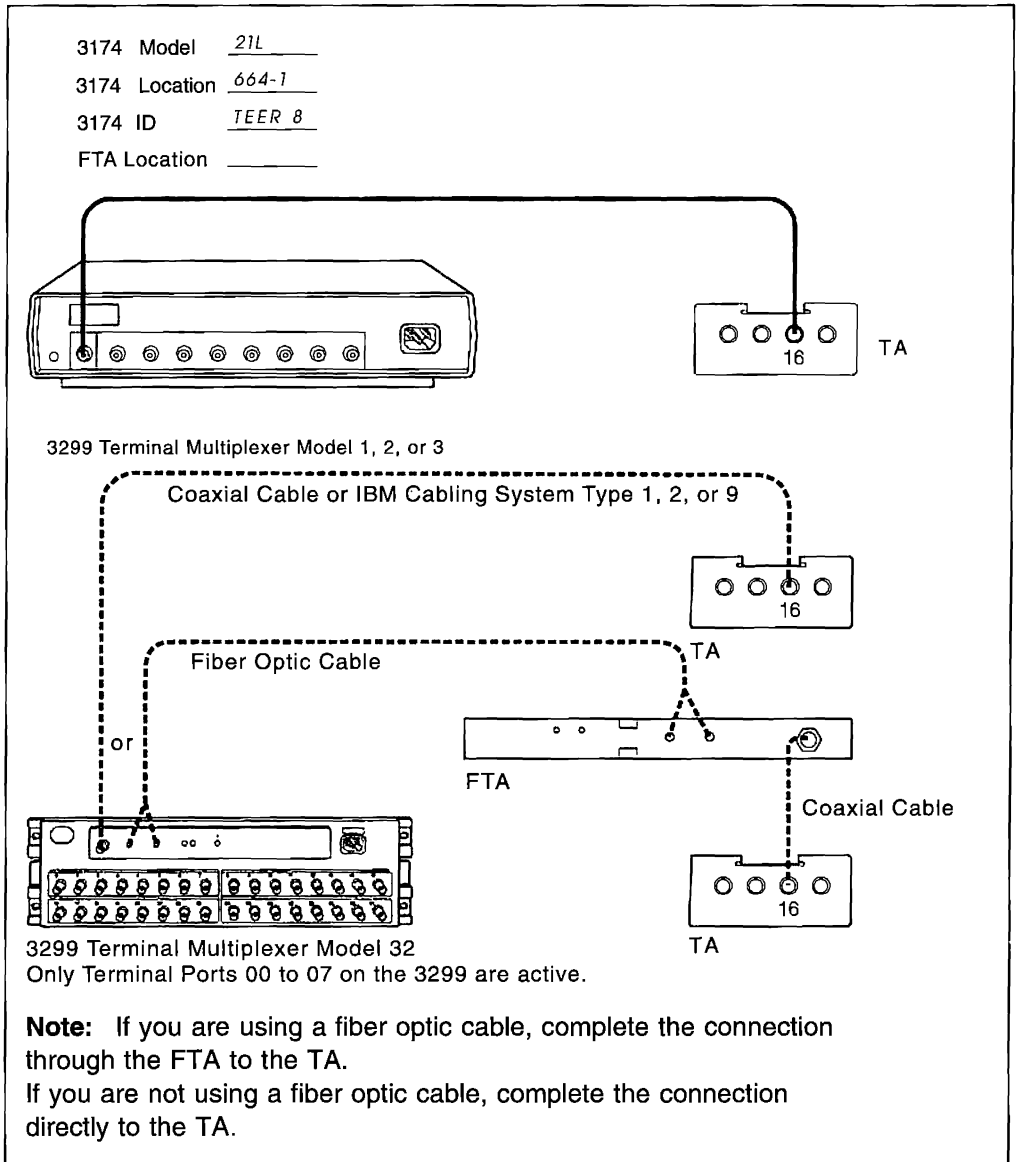
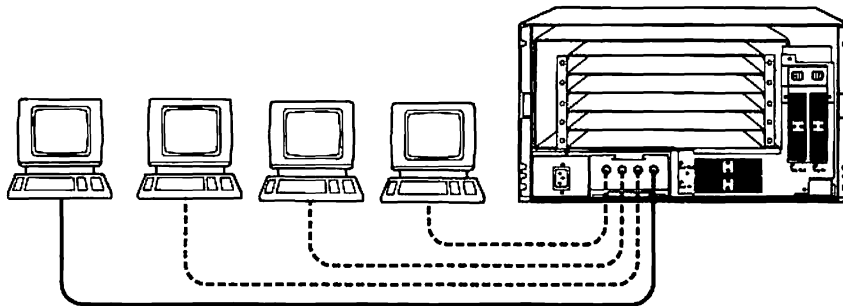

Figure 3-3 (Part 2 of 2). Sample 3299 Worksheet 9C

**Terminal Adapter to Terminal (Direct Connection) Worksheet 10**

**Terminal Adapter to Terminal (Direct Connection) Worksheet 10**

- This worksheet identifies the cabling from the four terminal adapter connectors directly to the terminals.
- Fill out this worksheet during site planning.
- Use it for cable installation.
- Modify it when cabling changes are made.
- Store it with the 3174 documentation for relocation and problem determination.



From the terminal adapter to the terminals

**Complete this table for a 3174 that does not have the 3270 Port Expansion Feature.**

Terminal Adapter Connector	Terminal Cable ID	Terminal Type	Terminal Location	Terminal Port Address
0	_____	_____	_____	26-00
8	_____	_____	_____	26-08
16	_____	_____	_____	26-16
24	<u>37</u>	<u>3279</u>	<u>Receiving</u>	26-24

**Complete this table for a 3174 with the 3270 Port Expansion Feature.**

Terminal Adapter Connector	Terminal Cable ID	Terminal Type	Terminal Location	Terminal Port Address
26-0	_____	_____	_____	26-00
26-8	_____	_____	_____	26-08
26-16	_____	_____	_____	26-16
27-0	_____	_____	_____	27-00

Figure 3-4. Sample Terminal Adapter to Terminal Worksheet 10



### Sample Configuration (3270 Port Expansion Feature)

Figure 3-5 shows a 3270 terminal attached to port 1 of a TMA connected to the 3270 Port Expansion Feature.

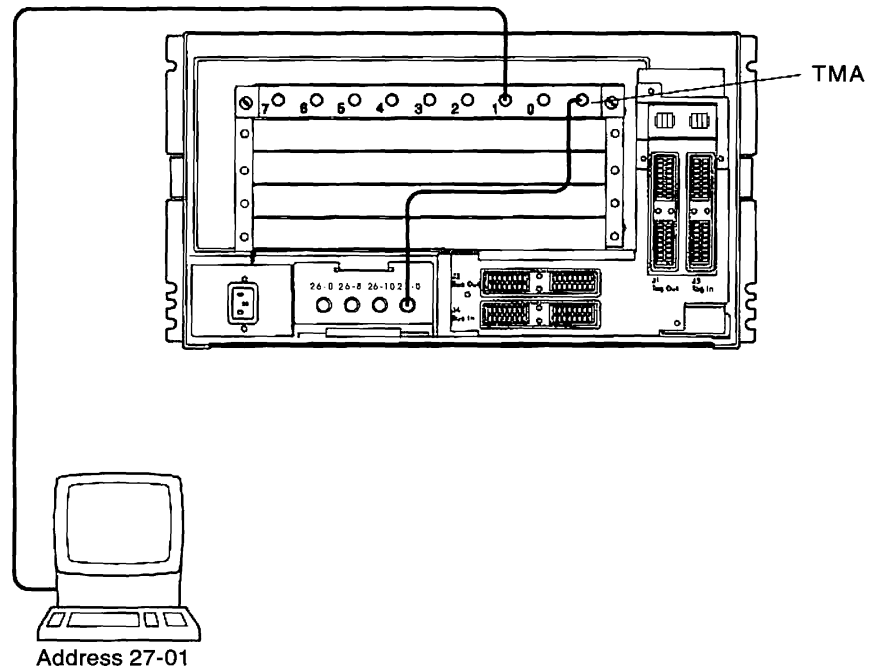

Figure 3-5. Sample Layout for 3270 Port Expansion Feature Connection

The following page shows a sample of a completed 3174 cabling worksheet 8E for indirect connection to the 3270 Port Expansion Feature.

**TMA Worksheet 8E**

**TMA Worksheet 8E (Terminal Port Address Range 27: 00–07)**

- This worksheet identifies the cabling from terminal adapter connector 27-0 (on a 3174 with the 3270 Port Expansion Feature) to a TMA and from the TMA to the terminals.
- Fill it out during site planning.
- Use it for cable installation.
- Modify it when cabling changes are made.
- Store it with the 3174 documentation for relocation and problem determination use.

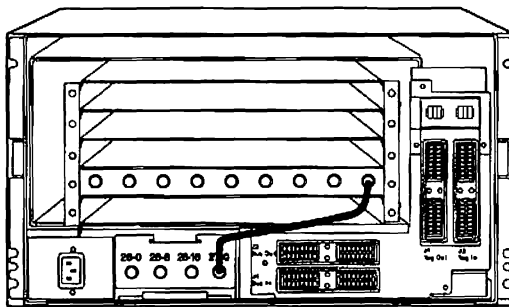

3174 with Port Expansion Feature

From the TMA to the terminals — Terminal Port Address Range 00-07

TMA Connector	Terminal Cable ID	Terminal Type	Terminal Location	Terminal Port Address
0				27-00
1	52	3279	Personnel	27-01
2				27-02
3				27-03
4				27-04
5				27-05
6				27-06
7				27-07

Figure 3-6. Sample TMA Worksheet 8E

### Sample Configuration (ASCII Terminals)

Figure 3-7 shows two possible connections to ASCII devices.

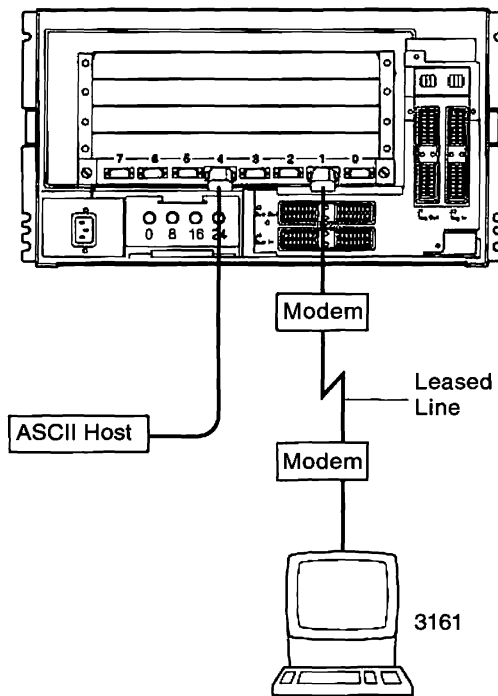

Figure 3-7. Sample ASCII Adapter Connection

The following pages show a sample of a completed AEA Worksheet 11A for ASCII connection.

**AEA Worksheet 11A (AEA Number 1)**

**AEA Worksheet 11A (AEA Number 1)**

- This worksheet identifies the cabling from AEA number 1 to the terminals or hosts. In Models 21H, 21L, and 21R it is recommended that the first AEA be installed in location 11. In Models 22L and 23R, it is recommended that the first AEA be installed in location 12.
- Fill it out during site planning.
- Use it for cable installation.
- Modify it when cabling changes are made.
- Store it with the 3174 documentation for relocation and problem determination use.

3174 Model 21L      3174 Location 656-1A      3174 ID 01F

AEA 1 Connector	Cable ID	Terminal/ Host Type	Terminal/ Host Location	Modem Type	Dial In Number	Dial Out Number	Terminal/ Host Port Address
0	_____	_____	_____	_____	_____	_____	21-00
1	<u>35</u>	<u>3161</u>	<u>Greenville</u>	<u>5842</u>	_____	_____	21-01
2	_____	_____	_____	_____	_____	_____	21-02
3	_____	_____	_____	_____	_____	_____	21-03
4	<u>27</u>	<u>Host</u>	<u>656-4A</u>	_____	_____	_____	21-04
5	_____	_____	_____	_____	_____	_____	21-05
6	_____	_____	_____	_____	_____	_____	21-06
7	_____	_____	_____	_____	_____	_____	21-07

Figure 3-8 (Part 1 of 2). Sample AEA Worksheet 11A

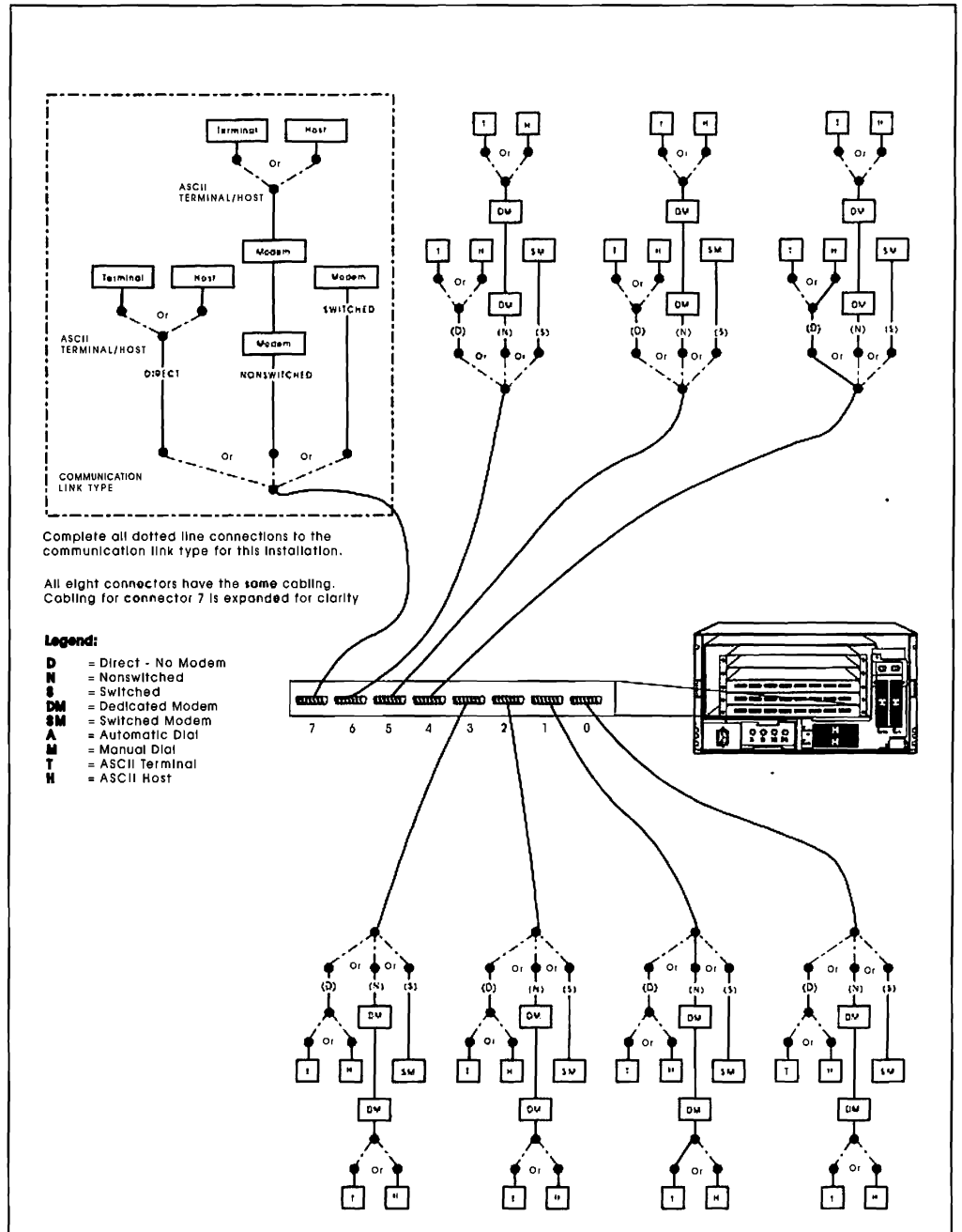

Figure 3-8 (Part 2 of 2). Sample AEA Worksheet 11A



## Chapter 4. Making the 3174 Controller Operational

The 3174 is operational when it is actively communicating with the host. You must have a customized Control diskette or fixed disk to make the 3174 operational. For instructions on customizing a diskette or fixed disk, refer to *3174 Establishment Controller Planning Guide*.

An IML sequence runs some basic 3174 tests. If these tests run without error, microcode is then loaded from the diskette or fixed disk.

You can start a normal IML in one of the following ways:

- By turning on the 3174 (also called a power-on IML)
- By pressing the IML pushbutton while the power is on (for Models 21H or 21L, the Offline indicator must be lit)
- By having the host site do a remote IML using NetView\* Distribution Manager

If you get unexpected results at any time, see Chapter 5, "3174 Controller Problem Solving and Offline Testing," or refer to *3174 Establishment Controller Customer Problem Determination*. If you receive a status code, refer to *3174 Establishment Controller Status Codes*.

### Panel Layout

Figure 4-1 shows the panel layout for 3174 Models 21H, 21L, 21R, 22L, 22R, 23R, and 24R. Review this layout before performing the procedures in this chapter.

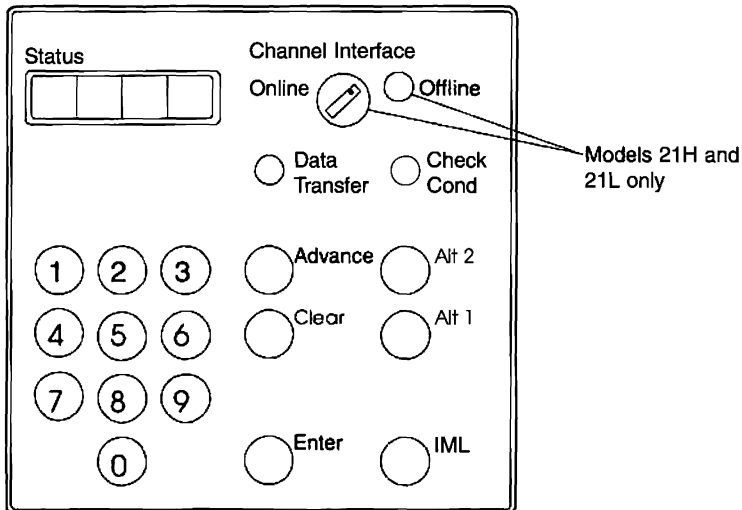

Figure 4-1. Panel Layout

Remove the decorative panel to access the operator panel, and replace it when finished.

### How to IML the 3174

To IML the 3174, follow the procedures in this section or in “How to IML a Different Microcode Version from a Diskette” on page 4-3.

If you are unfamiliar with the panel, switch, and indicator locations on the 3174, see Figure 4-1 on page 4-1 before you begin this procedure.

- 1** Determine how the microcode is loaded.  
**From a diskette** Continue with Step 2.  
**From a fixed disk** Go to Step 4.
- 2** Insert a properly customized Control diskette into diskette drive 1 and close the lever.
- 3** Do you have a properly merged Control Extension diskette or a DSL diskette?  
**Yes** Insert it into drive 2 and close the lever.  
**No** Continue with Step 4.
- 4** Does this 3174 have a Channel Interface switch on the operator panel?  
**Yes** Turn the Channel Interface switch to Offline.  
**No** Continue with Step 5.
- 5** Is the 3174 Power switch on?  
**Yes** Press the IML pushbutton.  
**No** Lift the Power switch to I (on).  

This starts a normal IML, and IML progress codes appear in the Status display. The IML takes several minutes and is complete when 503, 505, 507, or 532 appears in the Status display.
- 6** Does this 3174 have a Channel Interface switch?  
**Yes** Turn the Channel Interface switch to Online.  
**No** Continue with Step 7.
- 7** Does 503, 505, 507, or 532 appear in the Status display?  
**Yes** Notify the host operator to bring this 3174 online.  
**No** Continue with Step 8.
- 8** Does 3174 or 507 appear in the Status display?  
**Yes** The 3174 is operational.  
**No** Refer to *3174 Establishment Controller Status Codes*.



## How to IML a Different Microcode Version from a Diskette

Use this procedure if your microcode is resident on a fixed disk and you want to load a different version from a diskette.

If you are unfamiliar with the panel, switch, and indicator locations on the 3174, see Figure 4-1 on page 4-1 before you begin this procedure.

**1** Insert the Control diskette into diskette drive 1 and close the drive lever.

**2** Do you have a Control Extension diskette?

**Yes** Insert the Control Extension diskette into diskette drive 2.

**No** Continue with Step 3.

**3** Does this 3174 have a Channel Interface switch?

**Yes** Turn the Channel Interface switch to Offline.

**No** Continue with Step 4.

**4** Is the 3174 Power switch on?

**Yes** Continue with Step 5.

**No** Lift the Power switch to I (on).

**5** Complete the following steps:

- a. Press and hold down the Alt 1 pushbutton.
- b. Press and release the IML pushbutton.
- c. Release the Alt 1 pushbutton.

**6** When 40 is displayed in the Status display:

- a. Type in **0141**.
- b. Press Enter. The IML starts.

IML progress codes appear in the Status display. The IML takes several minutes and is complete when 503, 505, 507, or 532 appears in the Status display.

**7** Does this 3174 have a Channel Interface switch?

**Yes** Turn the Channel Interface switch to Online.

**No** Continue with Step 8.

**8** Does 503, 505, 507, or 532 appear in the Status display?

**Yes** Notify the host operator to bring this 3174 online.

**No** Continue with Step 9.

**9** Does 3174 or 507 appear in the Status display?

**Yes** The 3174 is operational.

**No** Refer to *3174 Establishment Controller Status Codes*.

---

### Taking the 3174 Offline

To take the 3174 offline, follow the steps listed for your particular 3174 model. The host operator must take the Models 21R and 23R offline.

If you are unfamiliar with the 3174 operator panel, see Figure 4-1 on page 4-1 before you begin.

### Taking Model 21H or 21L Offline

- 1** Ask the host operator to take the 3174 offline.
- 2** Switch the Channel Interface switch to Offline, and wait 10 seconds for the Offline indicator to light.
- 3** Is the Offline indicator lit?
  - Yes** The 3174 is now offline.
  - No** See “Forcing Model 21H or 21L Offline.”

### Forcing Model 21H or 21L Offline

Use this procedure if the Offline indicator did not light when you turned the Channel Interface switch to the Offline position.

- 1** Remove the decorative panel from the front of the 3174 by pulling it toward you. This allows you access to the operator panel and disk drives.
- 2** Complete these steps:
  - a. Press and hold down the Alt 1 pushbutton.
  - b. Press and release the IML pushbutton.
  - c. Release the Alt 1 pushbutton.
- 3** Is the Offline indicator lit?
  - Yes** The 3174 is now offline. Return to the step or procedure that brought you here.
  - No** Continue with Step 4.
- 4** Press the Power switch to **O** (off).
- 5** Wait 10 seconds and then switch the power on. This starts a normal IML sequence.
- 6** Is the Offline indicator lit?
  - Yes** The 3174 is now offline. Return to the step or procedure that brought you here.
  - No** Request help from your technical support person or help desk.

## Taking Model 22L Offline and Putting Model 22L Online

To take the 3174 offline, follow these steps:

- 1** Ask the host operator to take the 3174 offline.
- 2** Press Clear.
- 3** Type in **1700**.
- 4** Press Enter.

508 appears in the Status display to indicate the 3174 is offline.

To place the 3174 online, follow these steps:

- 1** Press Clear.
- 2** Type in **1701**.
- 3** Press Enter.

503 or 507 appears in the Status display to indicate the 3174 is online.



---

## Chapter 5. 3174 Controller Problem Solving and Offline Testing

This chapter explains basic problem solving and offline testing for the 3174 and its adapters.

---

### Problem Solving

To perform problem solving, you must find and correct basic problems such as loose connections, units with power off, cables and power cords not plugged in, and wrong diskettes.

You can refer to *3174 Establishment Controller Customer Problem Determination* or obtain help from your technical support group, depending on your knowledge and experience level with 3174 operations.

#### DANGER

**Do not work on the equipment during periods of lightning activity.**  
(For translations of this safety notice, see Safety Notice 4 in *3174 Safety Notices*, GA27-3824.)

Problem	Action
No power on the 3174.	<ul style="list-style-type: none"><li>• Ensure that the 3174 power switch is set to On.</li><li>• Reseat the power plug at both ends to ensure a good connection.</li><li>• Check the power outlet for proper voltage.</li><li>• If the 3174 power cord is connected to the rack power outlet, check power to the rack.</li><li>• If unable to resolve the problem, contact your support personnel.</li></ul>
Cannot correctly IML the 3174.	<ul style="list-style-type: none"><li>• Ensure that the diskette is inserted properly.</li><li>• Ensure that the diskette drive handle is closed.</li><li>• Check that the diskette is a Control/DSL diskette. Control/DSL diskette is defective. Try a backup diskette if available.</li><li>• Ensure that the fixed disk drive is customized correctly if fixed disk feature is installed.</li><li>• If unable to resolve the problem, contact your support personnel.</li></ul>

## Controller Problem Solving

<b>Problem</b>	<b>Action</b>
IML appears successful, but no terminals or hosts can communicate with the 3174.	<ul style="list-style-type: none"><li>• Ensure that the Channel Interface switch is set to Online (Model 21H or 21L only).</li><li>• Ensure that communication cable is connected and modem power on.</li><li>• Ensure that the ESCON channel cable is connected (Model 22L only).</li><li>• Check to see if diskette is marked as a Control/DSL diskette.</li><li>• If you have a backup copy of the Control/DSL diskette, try to IML from it.</li><li>• Have the host operator check to see if the 3174 is online at the host.</li><li>• Check the ISDN cable fuses, replacing them with IBM P/N 39F9181 or P/N 39F9153 (for Germany only).</li><li>• If unable to resolve the problem, contact your support personnel.</li></ul>
<b>Problem</b>	<b>Action</b>
One 3270-type terminal is failing.	<ul style="list-style-type: none"><li>• Check the cable connections to the terminal.</li><li>• Ensure that the security keylock is unlocked at the terminal.</li><li>• Try another multiplexer port or a new multiplexer, such as a 3299.</li><li>• Refer to <i>3174 Establishment Controller Customer Problem Determination</i>.</li><li>• Ensure that the 3174 is customized for this port.</li><li>• If unable to resolve the problem, contact your support personnel.</li></ul>
One ASCII terminal is failing.	<ul style="list-style-type: none"><li>• Check the cable connections to the terminal.</li><li>• Ensure that the security keylock is unlocked at the terminal.</li><li>• Refer to <i>3174 Establishment Controller Customer Problem Determination</i>.</li><li>• Check the modem power switch and power cord.</li><li>• Ensure that the outlet for the modem has power.</li><li>• Ensure that the 3174 is customized for this port.</li><li>• If unable to resolve the problem, contact your support personnel.</li></ul>

Problem	Action
ISDN-attached devices cannot communicate with the 3174.	<ul style="list-style-type: none"> <li>• Check the cable connections.</li> <li>• Ensure that the device is running the correct ISDN application.</li> <li>• Have the device operator dial-in on another number.</li> <li>• Check the ISDN Network terminator (NT1) power.</li> <li>• Ensure that the 3174 is configured for the ISDN Adapter.</li> <li>• Check the ISDN cable fuses, replacing them with IBM P/N 39F9181 or P/N 39F9153 (for Germany only).</li> <li>• If unable to resolve the problem, contact your support personnel.</li> </ul>
One host connection is failing.	<ul style="list-style-type: none"> <li>• Check the cable connections.</li> <li>• Check the modem power switch and power cord.</li> <li>• Ensure that the outlet for the modem has power.</li> <li>• Have the host operator ensure that the 3174 is online at the host.</li> <li>• Ensure that 3174 has been customized for this port.</li> <li>• If unable to resolve the problem, contact your support personnel.</li> </ul>
All terminals and hosts attached to this 3174 are failing.	<ul style="list-style-type: none"> <li>• Reconnect the power cable to the 3174 at both ends to ensure a good connection.</li> <li>• Check for proper voltage at the power outlet.</li> <li>• Ensure that you IML the 3174 with a customized Control/DSL diskette.</li> <li>• Control/DSL diskette is defective. Try using the backup Control/DSL diskette.</li> <li>• Have the host operator ensure that the 3174 is online at the host.</li> <li>• Ensure that the 3174 is customized correctly.</li> <li>• If unable to resolve the problem, contact your support personnel.</li> </ul>
Status code is displayed on operator panel.	Refer to <i>3174 Establishment Controller Status Codes</i> or contact your support personnel.
All other problems.	Refer to <i>3174 Establishment Controller Customer Problem Determination</i> or contact your support personnel.

---

### Offline Testing

You can perform offline tests on the 3174 and adapters by using an Alt 2 IML or an Alt 1 IML. Procedures are included for testing the 3174 and adapters from a diskette and from a fixed disk. Specific tests include the following:

- AEA
- CCA and cable
- Communication Adapter and cable
- ESCON Adapter
- Ethernet Adapter
- ISDN Adapter and cable
- Token-Ring Adapter and cable

The *3174 Establishment Controller Customer Problem Determination* contains more information on offline testing procedures.

The offline tests run from a Utility diskette or fixed disk and stop if they detect an error. To continue testing other areas of the 3174, type in 1 (from the operator keypad) and press Enter. This is called the *Continue* function.

If you want to stop testing or select another operation after an error, press Enter. This is called the *Free* function. The Free function resets the function in progress and 4001 appears in the Status display, indicating that the 3174 is ready for a new request.

To correct a keystroke mistake, press Clear and start over.



---

## Testing the 3174

You can use either of two procedures for testing the 3174. In the first procedure, you test the 3174 using the Alt 2 pushbutton with a Utility diskette in drive 1. In the second procedure, you test the 3174 using the Alt 1 pushbutton and the fixed disk. The test procedure you use depends upon where you store the Utility microcode.

- If you use a diskette, perform the steps in “Testing the 3174 from a Diskette.”
- If you use a fixed disk, perform the steps in “Testing the 3174 from a Fixed Disk” on page 5-6.

### Testing the 3174 from a Diskette

**Warning:** This procedure interrupts all 3174 operations. Notify other users if necessary.

Follow these steps to test the 3174 from a diskette:

- 1** Ask the host operator to take the 3174 offline.
- 2** Remove the decorative panel from the front of the 3174 by pulling it toward you. This allows you access to the operator panel and disk drives.
- 3** Are you testing a Model 21H or 21L?
  - Yes** Switch the Channel Interface switch to Offline and wait for the Offline indicator to light. If the Offline indicator does not come on, see “Forcing Model 21H or 21L Offline” on page 4-4 and then go to Step 5.
  - No** Continue with Step 4.
- 4** Are you testing a Model 22L?
  - Yes** Complete the following steps:
    - a. Press Clear.
    - b. Type in **1700**.
    - c. Press Enter.

The 3174 should go offline. Status code 508 should appear in the Status display.
  - No** Continue with Step 5.
- 5** Insert a Utility diskette into diskette drive 1 and close the lever.

## Testing the 3174

### 6 Complete the following steps:

- a. Press and hold down the Alt 1 pushbutton.
- b. Press and release the IML pushbutton.
- c. Release the Alt 1 pushbutton.

**Note:** If 40 does not appear in the Status display within five seconds, repeat this step.

### 7 When 40 appears in the Status display, type in **80** and press Enter.

### 8 When 4001 appears, you are ready for your test selection. Find the test you want to run in the list below, and go to the page indicated.

- To test the AEA, go to page 5-10.
- To test the CCA and cable, go to page 5-12.
- To test the Communication Adapter and cable, go to page 5-14.
- To test the ESCON Adapter, go to page 5-16.
- To test the Ethernet Adapter, go to page 5-17.
- To test the ISDN Adapter and cable, go to page 5-18.
- To test the Token-Ring Adapter and cable, go to page 5-21.

## Testing the 3174 from a Fixed Disk

**Warning:** This procedure interrupts all 3174 operations. Notify other users if necessary.

Follow these steps to test 3174 from a fixed disk:

### 1 Ask the host operator to take the 3174 offline.

### 2 Remove the decorative panel from the front of the 3174 by pulling it toward you. This allows you access to the operator panel and disk drives.

### 3 Are you testing a Model 21H or 21L?

**Yes** Switch the Channel Interface switch to Offline and wait for the Offline indicator to light. If the Offline indicator does not come on, see "Forcing Model 21H or 21L Offline" on page 4-4 and then go to Step 5 on page 5-7.

**No** Continue with Step 4.

### 4 Are you testing a Model 22L?

**Yes** At the operator panel:

- a. Press Clear.
- b. Type in **1700**.
- c. Press Enter.

The 3174 should go offline. Status code 508 should appear in the Status display.

**No** Continue with Step 5 on page 5-7.

**5** Complete the following steps:

- a. Press and hold down the Alt 1 pushbutton.
- b. Press and release the IML pushbutton.
- c. Release the Alt 1 pushbutton.

**Note:** If 40 does not appear in the Status display within five seconds, repeat this step.

**6** When 40 appears in the Status display, type in **0380**.

Press Enter.

**7** When 4001 appears, you are ready for your test selection. Find the test you want to run in the list below, and go to the page indicated.

- To test the AEA, go to page 5-10.
- To test the CCA and cable, go to page 5-12.
- To test the Communication Adapter and cable, go to page 5-14.
- To test the ESCON Adapter, go to page 5-16.
- To test the Ethernet Adapter, go to page 5-17.
- To test the ISDN Adapter and cable, go to page 5-18.
- To test the Token-Ring Adapter and cable, go to page 5-21.

---

## Testing the Adapters

You can use either of two procedures for running adapter tests. In the first procedure, you test the adapter from the Utility diskette. In the second procedure, you test the adapter from a fixed disk. The procedure you use depends upon where you store the Utility microcode.

- If you use a diskette, perform the steps in “Testing the Adapters from a Diskette” on page 5-8.
- If you use a fixed disk, perform the steps in “Testing the Adapters from a Fixed Disk” on page 5-9.

After you perform an Alt 1 IML, you may run the following offline tests:

- AEA wrap test
- CCA and cable test.
- Communication Adapter and cable test
- ESCON Adapter wrap test
- Ethernet Adapter wrap test
- ISDN Adapter and cable wrap test
- Token-Ring Adapter and cable test

## Testing the Adapters

### Testing the Adapters from a Diskette

**Warning:** This procedure interrupts all 3174 operations. Notify other users if necessary.

Follow these steps to test the adapters from a diskette:

- 1** Ask the host operator to take the 3174 offline.
- 2** Insert a Utility diskette into diskette drive 1 and close the lever.
- 3** Is this a Model 1L or 11L?
  - Yes** Set the Channel Interface switch to Offline and wait for the Offline indicator to light. Go to Step 5.
  - No** Continue with Step 4.
- 4** Is this a Model 12L?
  - Yes** Complete the following steps:
    - a. Press Clear.
    - b. Type in **1700**.
    - c. Press Enter.
    - d. Wait for 508 to appear in the Status display of the operator panel.
  - No** Continue with Step 5.
- 5** Complete the following steps:
  - a. Press and hold down the Alt 1 pushbutton.
  - b. Press and release the IML pushbutton.
  - c. Release the Alt 1 pushbutton.

**Note:** If 40 does not appear in the Status display within 5 seconds, perform this step again.
- 6** When 40 appears in the Status display, type in **80** and press Enter.
- 7** When 4001 appears, you are ready for your test selection. Find the test you want to run in the list below, and go to the page indicated.
  - To test the AEA, go to page 5-10.
  - To test the CCA and cable, go to page 5-12.
  - To test the Communication Adapter and cable, go to page 5-14.
  - To test the ESCON Adapter, go to page 5-16.
  - To test the Ethernet Adapter, go to page 5-17.
  - To test the ISDN Adapter and cable, go to page 5-18.
  - To test the Token-Ring Adapter and cable, go to page 5-21.

## Testing the Adapters from a Fixed Disk

**Warning:** This procedure interrupts all 3174 operations. Notify other users if necessary.

Follow these steps to test the adapters from a fixed disk:

- 1** Ask the host operator to take the 3174 offline.
- 2** Is this a Model 1L or 11L?
  - Yes** Set the Channel Interface switch to Offline and wait for the Offline indicator to light. Go to Step 4.
  - No** Continue with Step 3.
- 3** Is this a Model 12L?
  - Yes** Complete the following steps:
    - a. Press Clear.
    - b. Type in **1700**.
    - c. Press Enter.
    - d. Wait for 508 to appear in the Status display of the operator panel.
  - No** Continue with Step 4.
- 4** Complete the following steps:
  - a. Press and hold down the Alt 1 pushbutton.
  - b. Press and release the IML pushbutton.
  - c. Release the Alt 1 pushbutton.

**Note:** If 40 does not appear in the Status display within 5 seconds, perform this step again.
- 5** When 40 appears in the Status display, type in one of the following:
  - 0380** for fixed disk 1
  - 0480** for fixed disk 2
- 6** Press Enter.
- 7** When 4001 appears, you are ready for your test selection. Find the test you want to run in the list below, and go to the page indicated.
  - To test the AEA, go to page 5-10.
  - To test the CCA and cable, go to page 5-12.
  - To test the Communication Adapter and cable, go to page 5-14.
  - To test the ESCON Adapter, go to page 5-16.
  - To test the Ethernet adapter, go to page 5-17
  - To test the ISDN Adapter and cable, go to page 5-18.
  - To test the Token-Ring Adapter and cable, go to page 5-21.

## Testing the Adapters

### AEA Wrap Test DANGER

**Do not work on the equipment during periods of lightning activity.**  
(For translations of this safety notice, see Safety Notice 4 in *3174 Safety Notices*, GA27-3824.)

Follow these steps to test the AEA:

- 1** Does 4001 appear in the Status display?  
**Yes** Continue with Step 2.  
**No** Press Enter. If 4001 still does not appear, perform one of the following procedures:
  - “Testing the Adapters from a Diskette” on page 5-8
  - “Testing the Adapters from a Fixed Disk” on page 5-9.

When 4001 appears in the Status display, continue with Step 2.

- 2** Remove the cable from the AEA port that you want to test and plug the AEA wrap plug (P/N 39F6853) into the port from which you removed the cable.

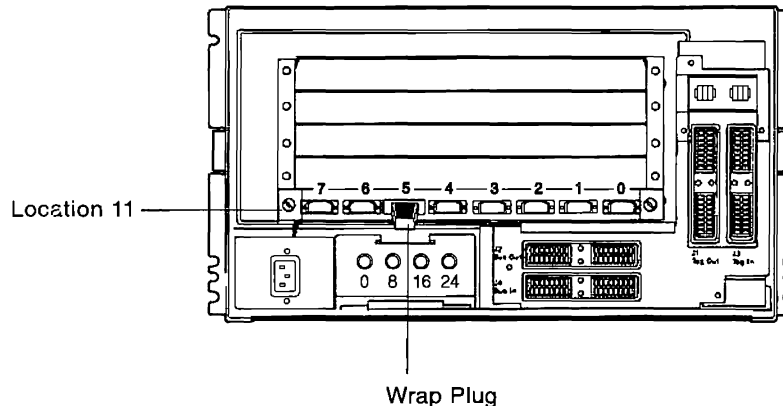

- 3** Type in **HG01**, where:
  - HG=21 specifies the first AEA in the lowest number card location
  - HG=22 specifies the second AEA in the second lowest number card location
  - HG=23 specifies the third AEA in the third lowest number card location.For more information on HG numbers, see “Identifying 3174 Hardware Group Numbers” on page 1-5 and “Asynchronous Emulation Adapter (AEA) HG21, 22, or 23” on page 1-5.
- 4** When 2101, 2201, or 2301 displays, press and release the Advance pushbutton.
- 5** Type in the two-digit port number (00 to 07) of the port you are testing and press Enter.

**6** When the test completes, a status code remains in the display. For status codes other than those shown, refer to *3174 Establishment Controller Status Codes*.

Status Code	Action
2021 or 2022 or 2023	The AEA is OK.. Continue with 7.
2921 or 2922 or 2923	<p>There is a problem with the AEA.</p> <ol style="list-style-type: none"> <li>1. Press the Advance pushbutton and record the additional data.</li> <li>2. Press the Advance pushbutton a second time and record the additional data.</li> <li>3. Press the Advance pushbutton a third time and record the additional data.</li> <li>4. Press the Advance pushbutton a fourth time and record the additional data. Request service for the 3174. Describe the problem and report the status codes and all additional data that you recorded.</li> </ol>
3060 or 3061	<p>There is a problem with the AEA.</p> <ol style="list-style-type: none"> <li>1. Press the Advance pushbutton and record the additional data.</li> <li>2. Press the Advance pushbutton a second time and record the additional data.</li> <li>3. Press the Advance pushbutton a third time and record the additional data. Request service for the 3174. Describe the problem and report the status codes and all additional data that you recorded.</li> </ol>

**7** Remove the AEA wrap plug and reconnect the cable. To make the 3174 operational, see Chapter 4, "Making the 3174 Controller Operational."

## Testing the Adapters

### CCA and Cable Test

#### DANGER

**Do not work on the equipment during periods of lightning activity.**  
(For translations of this safety notice, see Safety Notice 4 in *3174 Safety Notices*, GA27-3824.)

Follow these steps to test the CCA and cable:

**1** Does 4001 appear in the Status display?

**Yes** Continue with Step 2.

**No** Perform one of the following procedures:

- “Testing the Adapters from a Diskette” on page 5-8
- “Testing the Adapters from a Fixed Disk” on page 5-9.

When 4001 appears in the Status display, continue with Step 2.

**2** Disconnect the cable from the modem.

**3** Set the TEST/OPER switches on the CCA cable to TEST.

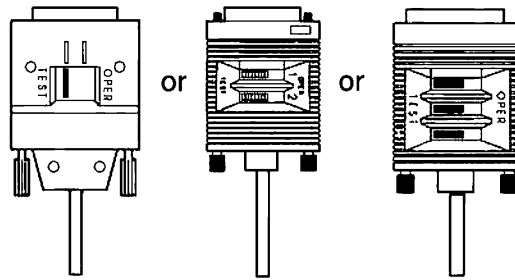

**4** Type in one of the following:

**5101** for the first CCA

**5201** for the second CCA

**5** Press Enter.



- 6** After the test of the CCA and cable is complete, a status code remains in the display. For status codes other than those shown, refer to *3174 Establishment Controller Status Codes*.

**Status**

---

<b>2051 or 2052</b>	<p>The CCA and cable are OK.</p> <ol style="list-style-type: none"> <li>1. Set the TEST/OPER switches on the CCA cable to OPER.</li> <li>2. Reconnect the cable to the modem.</li> <li>3. Install the decorative panel on the front of the 3174.</li> </ol> <p>Continue with Step 7.</p>
<b>2951 or 2952</b>	<p>The CCA or the cable is failing</p> <ol style="list-style-type: none"> <li>1. Press the Advance pushbutton and record the additional data.</li> <li>2. Press the Advance pushbutton a second time and record the additional data.</li> <li>3. Press the Advance pushbutton a third time and record the additional data.</li> <li>4. Press the Advance pushbutton a fourth time and record the additional data. Request service for the 3174. Describe the problem and report the status codes and all additional data that you recorded.</li> </ol>
<b>3030</b>	<p>The CCA or the cable is failing.</p> <ol style="list-style-type: none"> <li>1. Press the Advance pushbutton and record the additional data.</li> <li>2. Press the Advance pushbutton a second time and record the additional data.</li> <li>3. Press the Advance pushbutton a third time and record the additional data. Request service for the 3174. Describe the problem and report the status codes and all additional data that you recorded.</li> </ol>

- 7** To make the 3174 operational, see Chapter 4, "Making the 3174 Controller Operational."

## Testing the Adapters

### Communication Adapter and Cable Test

#### DANGER

**Do not work on the equipment during periods of lightning activity.**  
(For translations of this safety notice, see Safety Notice 4 in *3174 Safety Notices*, GA27-3824.)

Follow these steps to test the Communication Adapter and cable:

**1** Does 4001 appear in the Status display?

**Yes** Continue with Step 2.

**No** Perform one of the following procedures:

- “Testing the Adapters from a Diskette” on page 5-8
- “Testing the Adapters from a Fixed Disk” on page 5-9.

When 4001 appears in the Status display, continue with Step 2.

**2** Disconnect the cable from the modem.

**3** Set the TEST/OPER switches on the Communication Adapter cable to TEST.

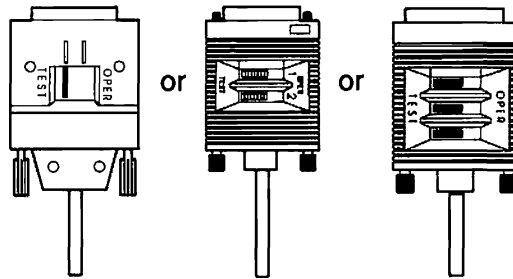

**4** With 4001 displayed in the Status display, type in **1101**.

**5** Press Enter.

**6** After the test of the Communication Adapter and cable is complete, a status code remains in the display. For status codes other than those shown, refer to *3174 Establishment Controller Status Codes*.

<b>Status Code</b>	<b>Action</b>
<b>2011</b>	<p>The Communication Adapter and cable are OK.</p> <ol style="list-style-type: none"> <li>1. Set the TEST/OPER switches on the communication cable to OPER.</li> <li>2. Reconnect the cable to the modem.</li> <li>3. Install the decorative panel on the front of the 3174.</li> </ol> <p>To make the 3174 operational, see Chapter 4, "Making the 3174 Controller Operational."</p>
<b>2911</b>	<p>There is a problem with the Communication Adapter or the cable.</p> <ol style="list-style-type: none"> <li>1. Press the Advance pushbutton and record the additional data.</li> <li>2. Press the Advance pushbutton a second time and record the additional data.</li> <li>3. Press the Advance pushbutton a third time and record the additional data.</li> <li>4. Press the Advance pushbutton a fourth time and record the additional data. Request service for the 3174. Describe the problem and report the status codes and all additional data that you recorded.</li> </ol>
<b>3030</b>	<p>There is a problem with the Communication Adapter or the cable.</p> <ol style="list-style-type: none"> <li>1. Press the Advance pushbutton and record the additional data.</li> <li>2. Press the Advance pushbutton a second time and record the additional data.</li> <li>3. Press the Advance pushbutton a third time and record the additional data. Request service for the 3174. Describe the problem and report the status codes and all additional data that you recorded.</li> </ol>

## Testing the Adapters

### ESCON Adapter Wrap Test

#### DANGER

**Do not work on the equipment during periods of lightning activity.**  
(For translations of this safety notice, see Safety Notice 4 in *3174 Safety Notices*, GA27-3824.)

Follow these steps to test the ESCON Adapter:

- 1** Does 4001 appear in the Status display?  
**Yes** Continue with Step 2.  
**No** Perform one of the following procedures:
  - “Testing the Adapters from a Diskette” on page 5-8
  - “Testing the Adapters from a Fixed Disk” on page 5-9.

When 4001 appears in the Status display, continue with Step 2.

- 2** Remove the fiber optic duplex connector from the ESCON Adapter. Remove the protective covers from the fiber optic wrap plug as shown and plug the wrap plug into the ESCON Adapter.

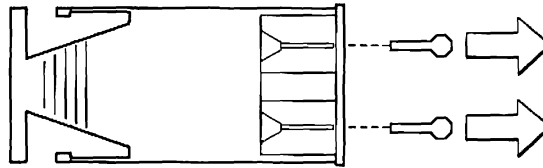

- 3** With 4001 displayed in the Status display, type in **1701**.
- 4** Press Enter.
- 5** When the test is complete, a status code remains in the display. For status codes other than those shown, refer to *3174 Establishment Controller Status Codes*.

Status Code	Action
<b>2017</b>	The ESCON Adapter is OK. <ol style="list-style-type: none"><li>1. Remove the fiber optic wrap plug from the adapter.</li><li>2. Clean the fiber optic duplex connector with the IBM Fiber Optic Cleaning Kit (IBM P/N 5453521) before connecting it. Refer to <i>IBM Fiber Optic Cleaning Procedures</i>, SY27-2604, for instructions.</li><li>3. Reconnect the fiber optic cable to the card connector.</li><li>4. Install the decorative panel on the front of the 3174.</li><li>5. Inform the host operator of a possible host cable problem.</li><li>6. Return the fiber optic wrap plug to its storage location.</li></ol> To make the 3174 operational, see Chapter 4, “Making the 3174 Controller Operational.”
<b>2917 or 3070</b>	The ESCON Adapter is failing. Request service for the 3174.

**Ethernet Adapter Wrap Test**

**DANGER**

**Do not work on the equipment during periods of lightning activity.**  
 (For translations of this safety notice, see Safety Notice 4 in *3174 Safety Notices, GA27-3824.*)

**Warning:** Disconnect the 3174 and install the appropriate wrap plug, or plugs from the Ethernet Network before you run the Adapter Wrap All (FN 01) test.

Follow these steps to test the Ethernet Adapter:

- 1** Load the test monitor.
- 2** Does 4001 appear in the Status display?
  - Yes** Continue with Step 3.
  - No** Perform one of the following procedures:
    - “Testing the Adapters from a Diskette” on page 5-8
    - “Testing the Adapters from a Fixed Disk” on page 5-9.

When 4001 appears in the Status display, continue with Step 3.

- 3** Type in **4101**.
- 4** Press Enter.
- 5** When the test is complete, a status code remains in the display. For information on status codes other than those shown, refer to *3174 Establishment Controller Status Codes*.

Status Code	Action
3081	The wrap test for the 10BASE2, 10BASE5, or 10BASE-T connection has failed. This could have been caused by a defective wrap plug or a defective Ethernet Adapter. Request service.

### ISDN Adapter and Cable Wrap Test

#### DANGER

**Do not work on the equipment during periods of lightning activity.**  
(For translations of this safety notice, see Safety Notice 4 in *3174 Safety Notices*, GA27-3824.)

Follow these steps to test either the ISDN Adapter and cable or the ISDN Adapter only:

**1** Does 4001 appear in the Status display?

**Yes** Continue with Step 2.

**No** Perform one of the following procedures:

- "Testing the Adapters from a Diskette" on page 5-8
- "Testing the Adapters from a Fixed Disk" on page 5-9.

When 4001 appears in the Status display, continue with Step 2.

**2** Do you want to test the ISDN cable and the ISDN Adapter?

**Yes** Connect the ISDN cable to the wrap coupler as follows:

- a. Unplug the ISDN cable from the ISDN Network terminator (NT1). Leave the other end of the cable attached to the connector on the ISDN Adapter.

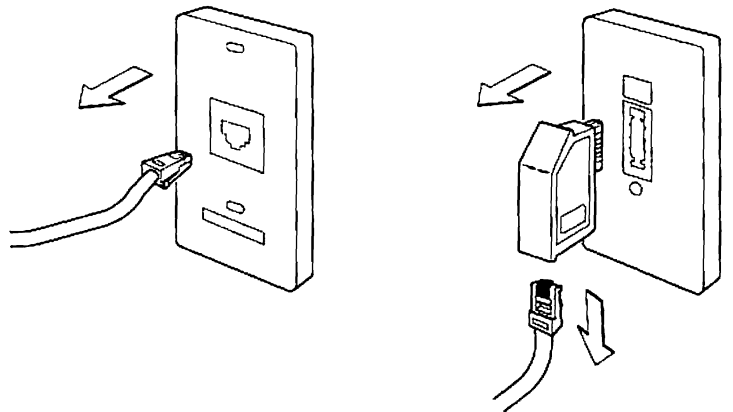

- b. Plug the free end of the ISDN cable into the wrap coupler. Be sure that the ISDN wrap plug is plugged into the other end of the coupler.

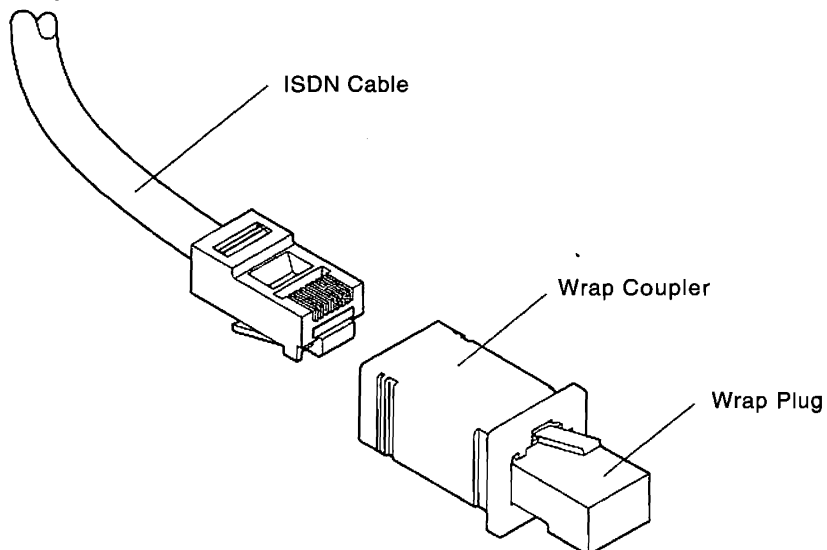

- c. When the ISDN cable, wrap coupler, and wrap plug are connected correctly, go to Step 4 on page 5-20.

**No** Continue with Step 3.

### 3 Connect the ISDN wrap plug to the ISDN Adapter as follows:

- a. Unplug the ISDN cable from the connector on the ISDN Adapter.
- b. Unplug the ISDN wrap plug from the wrap coupler.

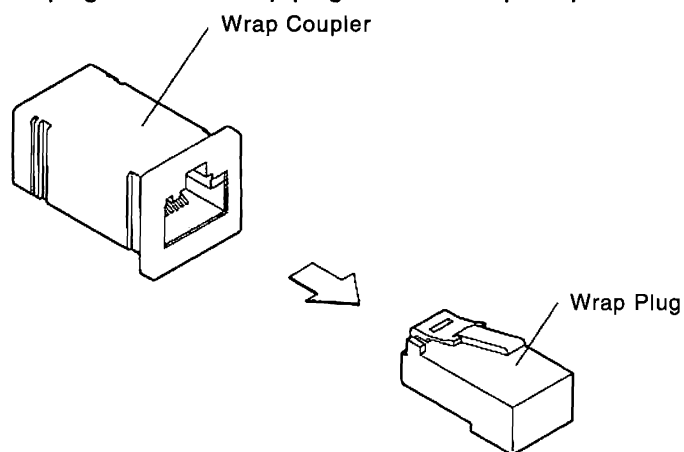

## Testing the Adapters

- c. Plug the ISDN wrap plug into the connector on the ISDN Adapter.

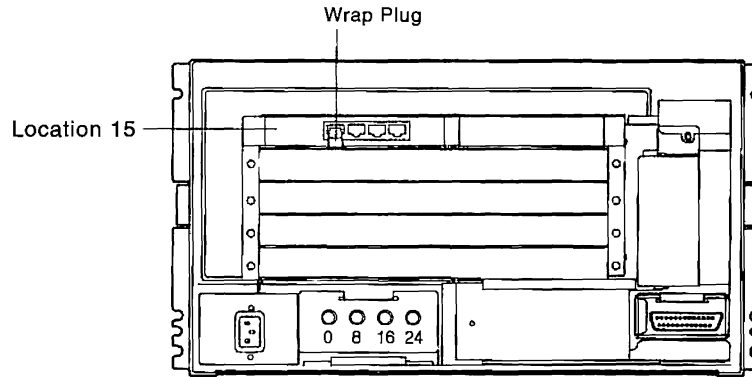

- 4** With 4001 displayed in the Status display, type in **HG03**, where:

HG=36 specifies the first ISDN Adapter from location 11  
HG=37 specifies the second ISDN Adapter from location 11  
HG=38 specifies the third ISDN Adapter from location 11  
HG=39 specifies the fourth ISDN Adapter from location 11

- 5** Press the Advance pushbutton.

- 6** Type in **PN**, where:

PN=00 for port 0  
PN=01 for port 1  
PN=02 for port 2  
PN=03 for port 3

- 7** Press Enter.

- 8** After the test of the ISDN Adapter and cable is complete, a status code remains in the display. For status codes other than those shown, refer to *3174 Establishment Controller Status Codes*.

### Status

<b>2036 or 2037 or 2038 or 2039</b>	The ISDN Adapter and cable are OK.  1. Disconnect the ISDN wrap plug or wrap coupler. 2. Reconnect the cable to the ISDN Network terminator (NT1). 3. Reconnect the cable to the adapter, if not connected. 4. Install the decorative panel on the front of the 3174.  To make the 3174 operational, see Chapter 4, "Making the 3174 Controller Operational."
<b>2936 or 2937 or 2938 or 2939</b>	The ISDN Adapter or the cable is failing.  1. Press the Advance pushbutton and record the additional data. 2. Press the Advance pushbutton a second time and record the additional data. 3. Press the Advance pushbutton a third time and record the additional data. 4. Press the Advance pushbutton a fourth time and record the additional data. Request service for the 3174. Describe the problem and report the status codes and all additional data that you recorded.



## Token-Ring Adapter and Cable Test

### DANGER

**Do not work on the equipment during periods of lightning activity.**  
(For translations of this safety notice, see Safety Notice 4 in *3174 Safety Notices*, GA27-3824.)

Follow these steps to test the Token-Ring Adapter and cable:

**1** Does 4001 appear in the Status display?

**Yes** Continue with Step 2.

**No** Perform one of the following procedures:

- “Testing the Adapters from a Diskette” on page 5-8
- “Testing the Adapters from a Fixed Disk” on page 5-9.

When 4001 appears in the Status display, continue with Step 2.

**2** Disconnect the Token-Ring Adapter cable from the wall connector, faceplate, or the multistation access unit.

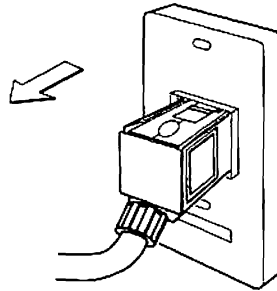

**3** Type in **3101**.

**4** Press Enter.

## Testing the Adapters

- 5** When the test of the Token-Ring Adapter and cable is complete, a status code remains in the display. For status codes other than those shown, refer to *3174 Establishment Controller Status Codes*.

<b>Status Code</b>	<b>Action</b>
<b>2031</b>	<p>The Token-Ring Adapter and cable are OK.</p> <ol style="list-style-type: none"><li>1. Reconnect the Token-Ring Adapter cable to the Token-Ring.</li><li>2. Install the decorative panel on the front of the 3174.</li></ol> <p>To make the 3174 operational, see Chapter 4, "Making the 3174 Controller Operational."</p>
<b>2931</b>	<p>The Token-Ring Adapter or cable is failing.</p> <ol style="list-style-type: none"><li>1. Press the Advance pushbutton and record the additional data.</li><li>2. Press the Advance pushbutton a second time and record the additional data.</li><li>3. Press the Advance pushbutton a third time and record the additional data.</li><li>4. Press the Advance pushbutton a fourth time and record the additional data. Request service for the 3174. Describe the problem and report the status codes and all additional data that you recorded.</li></ol>
<b>3050</b>	<p>Token-Ring Adapter or cable is failing.</p> <ol style="list-style-type: none"><li>1. Press the Advance pushbutton and record the additional data.</li><li>2. Press the Advance pushbutton a second time and record the additional data.</li><li>3. Press the Advance pushbutton a third time and record the additional data. Request service for the 3174. Describe the problem and report the status codes and all additional data that you recorded.</li></ol>

---

## Chapter 6. Relocating the 3174 Controller

When planning to relocate the controller, consider the following:

- Packing** Decide whether you need to pack the controller before moving it. The controller should be packed for shipping if it is being moved to another building. If you decide to pack the controller, call your IBM marketing representative and order a set of packing materials. Allow four weeks for delivery.
- Site Preparation** Use the procedures in *3174 Establishment Controller Site Planning* to prepare the new location for the controller.
- Scheduling** Relocate the controller during a time other than regular working hours or notify the users that computer service will be interrupted.
- If you are relocating a Model 21H or 21L, call IBM and arrange to have a service representative present for the relocation procedures. The service representative must be present to remove and reconnect the channel cables on Models 21H or 21L.
- If you have a metallic, waterproof-type power plug, schedule an electrician to disconnect it. See Step 10 on page 6-2.

Read through the relocating instructions completely before performing the relocating tasks. Then return to Step 1 and follow the instructions.

### DANGER

**Do not connect or disconnect cables during periods of lightning activity.** (For translations of this safety notice, see Safety Notice 5 in *3174 Safety Notices*, GA27-3824.)

- 1** Remove the decorative panel from the front of the 3174 by pulling it toward you. This allows you access to the operator panel and disk drives.
- 2** Ask the host operator to take the controller offline.
- 3** Are you relocating a Model 21H or 21L?
  - Yes** Switch the Channel Interface switch to Offline and wait for the Offline indicator to light. If the Offline indicator does not come on, see "Forcing Model 21H or 21L Offline" on page 4-4 and then continue with Step 4.
  - No** Continue with Step 4.
- 4** Does the 3174 have a fixed disk installed?
  - Yes** Continue with Step 6 on page 6-2.
  - No** Go to Step 10 on page 6-2.

## Relocating the 3174

- 5 Warning:** When relocating a 3174 with a fixed disk, the read/write heads can damage the recording surface on the fixed disk drive unless the heads are positioned over a *safe* area of the disk.

The Alt 2 IML procedure shown in Step 7 positions the read/write heads in a safe area of the recording surface.

Insert a Utility diskette (Release A4.0 or higher) into diskette drive 1 and close the lever.

- 6** Are there two diskette drives?

**Yes** Insert a DSL or Control diskette into diskette drive 2 and close the lever.

**No** Continue with Step 7.

- 7** Complete the following steps:

- a. Press and hold down the Alt 2 pushbutton.
- b. Press and release the IML pushbutton.
- c. Release the Alt 2 pushbutton.

The procedure runs for several minutes. 2082 should appear in the Status display.

- 8** Does 2082 appear in the Status display?

**Yes** The heads are positioned in a safe area. Continue with Step 9.

**No** Refer to *3174 Establishment Controller Status Codes*. Correct the problem and restart the relocation procedure.

- 9** Press the Power switch to the **O** (off) position.

- 10** Does the controller have a metallic, waterproof-type plug?

**Yes** **CAUTION:**

**If your machine has a metallic, waterproof-type power plug, do not attempt to disconnect it. Instead, have a qualified electrician disconnect the plug.** (For translations of this safety notice, see Safety Notice 2 in *3174 Safety Notices*, GA27-3824.)

**No** Unplug the power cable from the electric outlet.

**11** Does the controller have a Communication Adapter or CCAs?

**Yes** Disconnect the adapter cable from the modem.

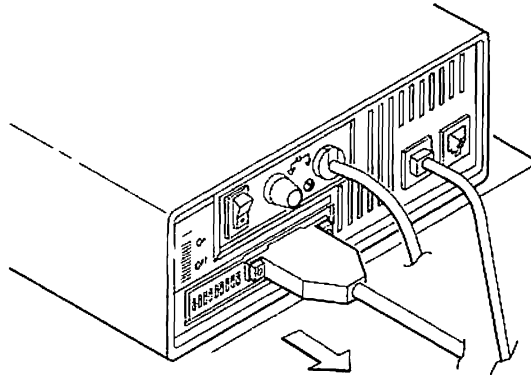

**No** Continue with Step 12.

**12** Does the controller have a Token-Ring Adapter?

**Yes** Disconnect the Token-Ring Adapter cable from the wall connector, faceplate, or multistation access unit.

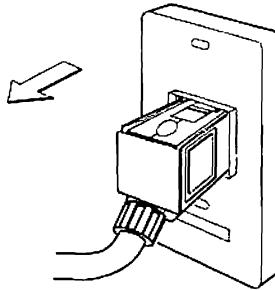

**No** Continue with Step 13.

**13** Does the controller have an AEA?

**Yes** Label any cables connected to the adapter ports and disconnect the cables.

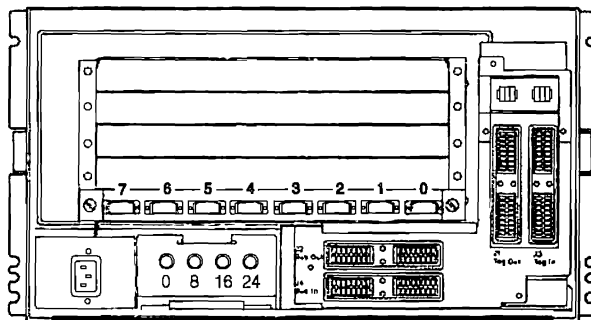

**No** Continue with Step 14 on page 6-4.

## Relocating the 3174

### 14 Does the controller have an ISDN Adapter?

**Yes** Label any cables connected to the ISDN Network terminator (NT1) and disconnect the cables.

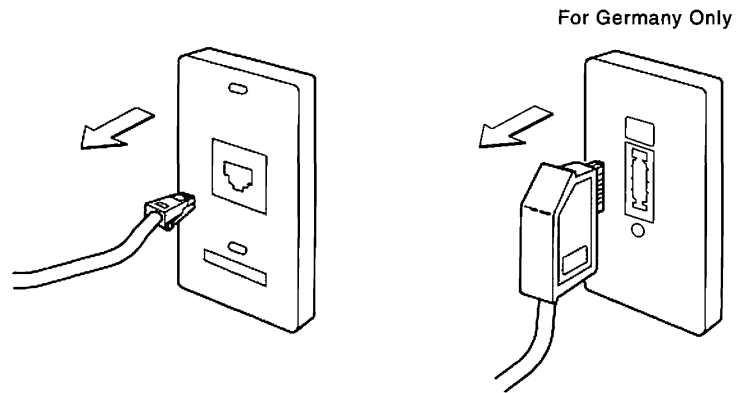

**No** Continue with Step 15.

### 15 Label each coaxial cable with its port number (labels are supplied by the customer).

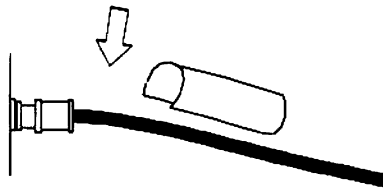

### 16 Disconnect all external coaxial cables from the controller by turning the cable connectors counterclockwise and carefully pulling them off.

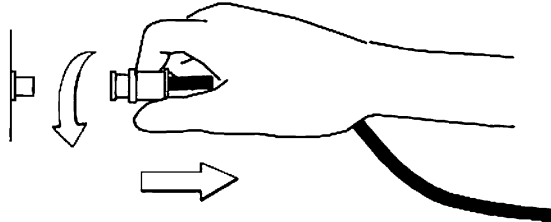

**17** Does the controller have an Ethernet Adapter?

**Yes** Disconnect the Ethernet Adapter cable from the adapter card.

**No** Continue with Step 18.

**18** Does the controller have an FTA?

**Yes** Label the left and right ST connectors and disconnect them from the FTA.

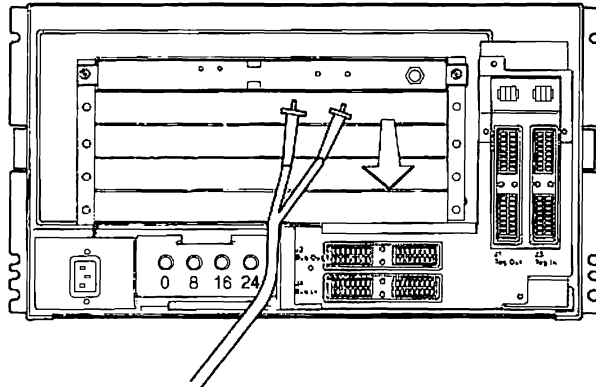

**No** Continue with Step 19.

**19** Replace the shipping plugs on the ST connectors.

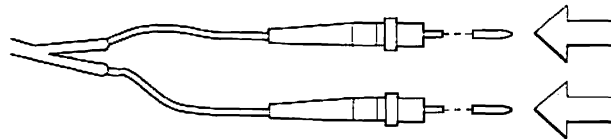

**20** Are you relocating a Model 21H or 21L?

**Yes** Have the service representative disconnect the host channel cables from the controller. Go to Step 26 on page 6-7.

**No** Continue with Step 21.

**21** Are you relocating a Model 22L?

**Yes** Continue with Step 22.

**No** Go to Step 26 on page 6-7.

**22** Disconnect the fiber optic duplex connector from the ESCON Adapter.

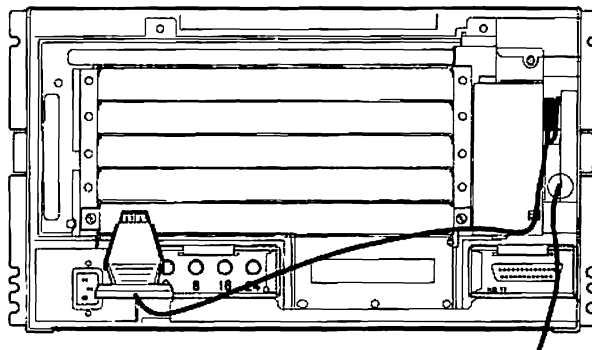

## Relocating the 3174

- 23** Replace the protective covers on the fiber optic duplex connector.

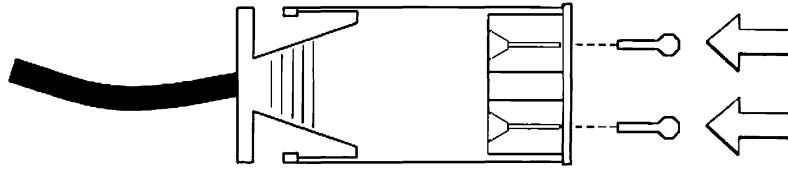

- 24** Remove the ESCON channel cable from the strain relief attachments.

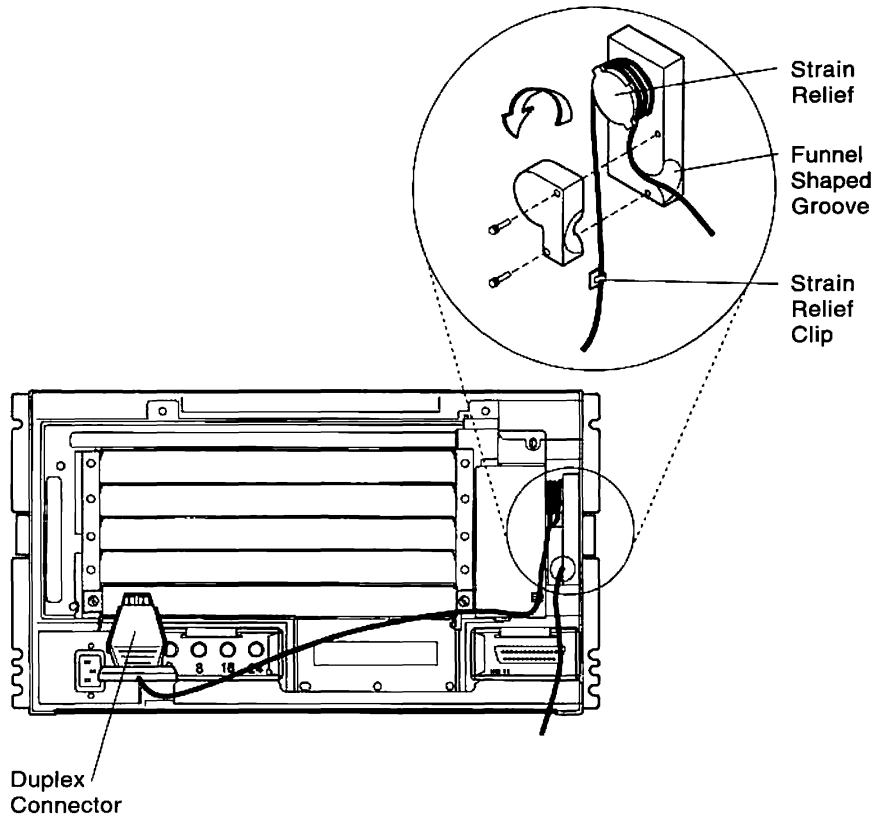

- 25** Plug the shipping plug into the ESCON Adapter.

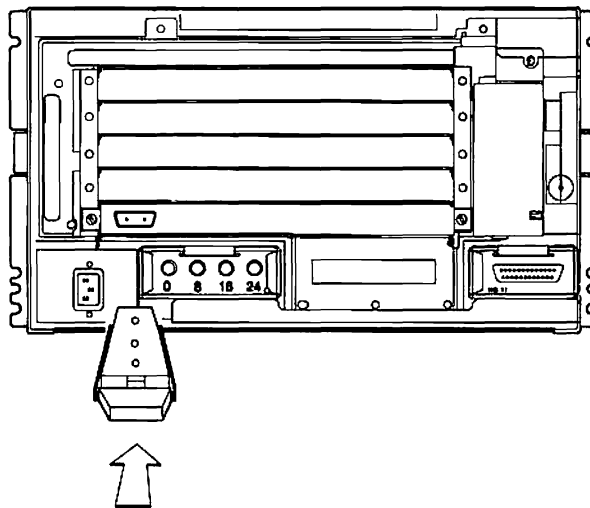



**26 CAUTION:**

**This unit weighs over 18 kilograms (40 pounds). To avoid injury when lifting this unit, have someone assist you.** (For translations of this safety notice, see Safety Notice 12 in *3174 Safety Notices*, GA27-3824.)

**Note:** Use the handles located in the top of the system for lifting. Remove the controller from the rack.

**27** Open the drive levers and remove the diskettes from the diskette drives.

**28** Insert each diskette into a diskette envelope and store in the diskette storage pocket. Do not close lever on diskette drive doors.

**29** Are you packing the controller?

**Yes** Follow the instructions that came with the packing materials and pack the controller for relocation.

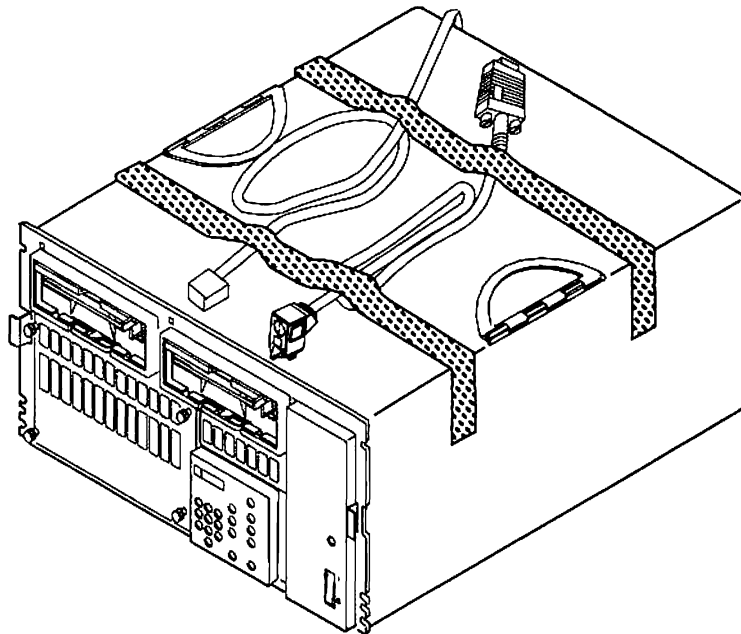

**No** Place the manuals, cables, and decorative panel on top of the controller and tape them in place.

**Note:** For the manuals and cables that were shipped with your controller, see Figure Figure 2-1 on page 2-2.

**30** Move the controller to its new location.

**31** Unpack the controller, if necessary.

**32** Perform the setup procedures in Chapter 2, "Setting Up the 3174 Controller."



---

## Appendix A. Diskettes and Diskette Drives

This appendix describes:

- Types of diskettes used with the 3174
- How to handle diskettes
- How to insert diskettes
- How to ship, receive, and store diskettes

---

### Types of 3174 Diskettes

A diskette is a thin, flexible magnetic disk permanently enclosed in a protective jacket.

**Warning:** Do not try to remove the flexible magnetic disk from its protective jacket.

The function of the diskette is to store information that the 3174 needs for operation. The types of diskettes used with the 3174 are described below:

**Control Diskette:** The Control diskette is used for the daily operation of the controller. It contains operational microcode and configuration information that are unique to your organization. For example, the Control diskette contains information that describes all the terminals attached to the controller.

**Control Extension Diskette:** The Control Extension diskette is used in conjunction with the Control diskette and contains microcode necessary to make the controller operational. All other DSL diskettes must be merged onto this diskette.

**Utility Diskette:** The Utility diskette contains the microcode necessary to run various controller utilities, including customizing and offline tests.

**Limited Function Utility (LFU) Diskette:** The LFU diskette contains microcode that supports these utilities: diagnostics, patch, copy files, and identify customizing keyboard.

**Downstream Load (DSL) Diskette:** The DSL diskette is used for display stations that require the controller to downstream load its operational microcode; for example, the 3290 Information Panel. The following 3174 features and functions also require DSL microcode, which is shipped on individual DSL diskettes:

- AEA
- 3174-Peer Communications
- Advanced Peer-to-Peer Networking (APPN).

These individual DSL diskettes must be merged onto the Control Extension diskette if you have Configuration Support C.

**Request for Price Quotation (RPQ) Diskette:** An RPQ diskette contains the changes or additions to the functional capabilities of the controller to fulfill your unique data processing requirements.

## How to Handle Diskettes

Follow the required diskette-handling procedures as shown here. Remember that a telephone is a source of a magnetic field.

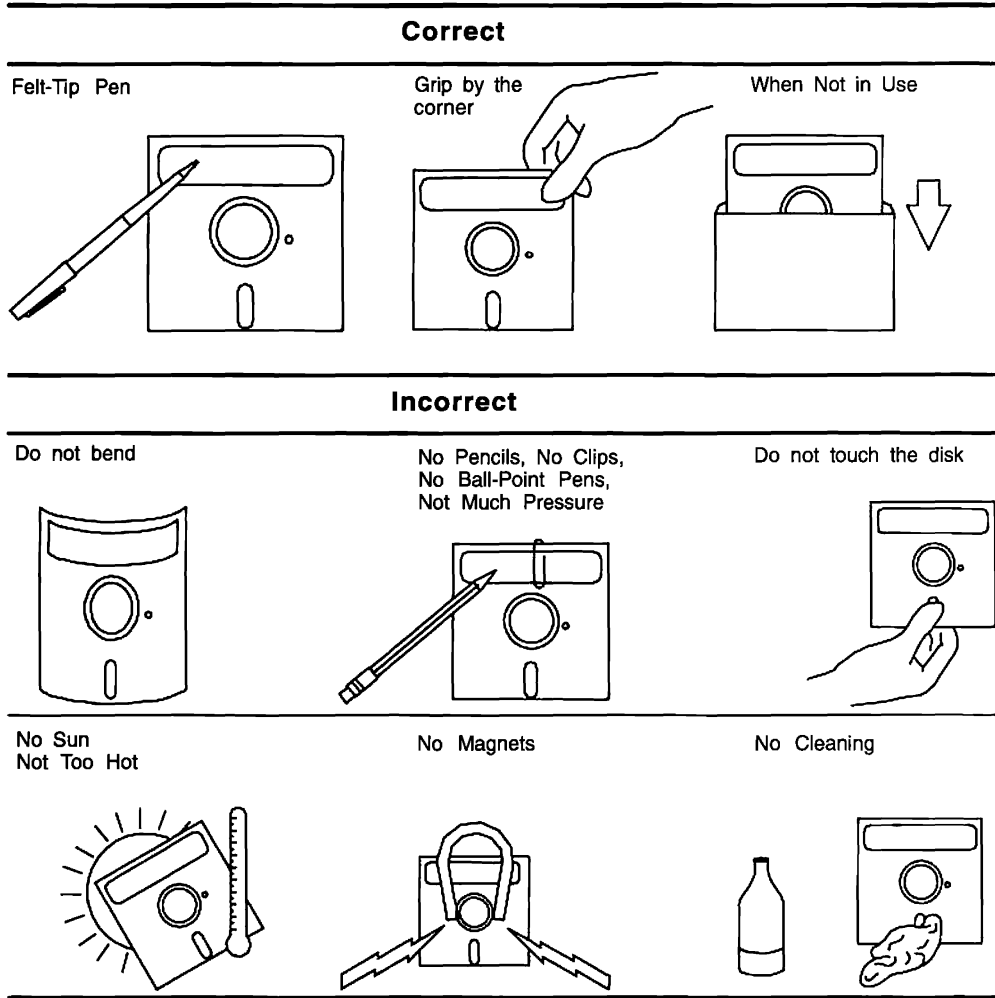

---

## How to Insert Diskettes

The control program microcode and utilities are contained on a 1.2MB or 2.4MB diskette (or fixed disk, if installed). A 2.4MB diskette drive can read either a 1.2MB or 2.4MB diskette. A 1.2MB diskette drive can read only a 1.2MB diskette.

A common problem in using diskettes is inserting the wrong diskette for a particular operation. It does not take long to learn how to handle and care for your diskettes, but it does take concentration at all times to use the correct diskette and avert the obvious problems. The proper way of inserting diskettes into diskette drives is shown below.

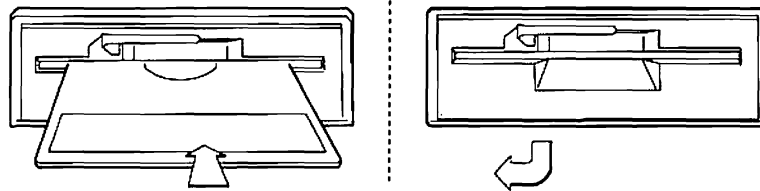

**Note:** Do not attempt to close the diskette drive lever unless the diskette is inserted.

---

## How to Ship, Receive, and Store Diskettes

Always ship diskettes inside the original shipping container. An ordinary envelope does not provide enough protection. Label the package:

**DO NOT EXPOSE TO EXCESSIVE HEAT (TEMPERATURES ABOVE 51.5 DEGREES C OR 125 DEGREES F) OR DIRECT SUNLIGHT.**

When you receive diskettes, check for damage to the shipping container or to the diskettes. Save the shipping container to store the diskettes for later shipment.

For long-term storage, place diskettes in their envelopes and store them in the following environment:

- Temperature: 10 to 51.5 degrees C (50 to 125 degrees F)
- Relative humidity: 8 to 80 percent.

Before you use a diskette that has been exposed to temperatures outside the recommended range, allow the diskette to adjust to room temperature for five minutes. The diskette can be removed from its shipping container while the temperature is adjusting, but should be kept in its envelope.



---

# Glossary of Terms and Abbreviations

This glossary defines terms and abbreviations used in this manual. It includes terms and definitions from the *IBM Dictionary of Computing* (New York; McGraw-Hill, Inc., 1994).

- The symbol (A) identifies definitions from the *American National Standard Dictionary for Information Systems*, ANSI X3.172-1990, copyright 1990 by the American National Standards Institute (ANSI). Copies can be purchased from the American National Standards Institute, 1430 Broadway, New York, New York 10018.
- The symbol (E) identifies definitions from the *ANSI/EIA Standard - 440A: Fiber Optic Terminology*, copyright 1989 by the Electronics Industries Association (EIA). Copies can be purchased from the Electronic Industries Association, 2001 Pennsylvania Avenue N.W., Washington, DC 20006.
- The symbol (I) identifies definitions from the *Information Technology Vocabulary*, developed by Subcommittee 1, Joint Technical Committee 1, of the International Organization for Standardization and the International Electrotechnical Commission (ISO/IEC JTC1/SC1).
- The symbol (T) identifies definitions from draft international standards, committee drafts, and working papers being developed by ISO/IEC JTC1/SC1.

The following cross-references are used in this glossary:

**Contrast with.** This refers to a term that has an opposed or substantively different meaning.

**See.** This refers the reader to multiple-word terms in which this term appears.

**See also.** This refers the reader to terms that have a related, but not synonymous, meaning.

**Synonym for.** This indicates that the term has the same meaning as a preferred term, which is defined in the glossary.

## A

**access unit.** A unit that allows multiple attaching devices access to a token-ring network at a central point such as a wiring closet or in an open work area.

**active.** (1) Able to communicate on the network. A token-ring network adapter is active if it is able to transmit and receive on the network. (2) Operational.

- (3) Pertaining to a node or device that is connected or is available for connection to another node or device.
- (4) Currently transmitting or receiving.

**adapter.** (1) A general term for a device that provides some transitional function between two or more devices. (2) In a local area network, within a communicating device, a circuit card with its associated software that enables the device to communicate over the network.

**address.** (1) In data communication, the IEEE-assigned unique code or the unique locally administered code assigned to each device or workstation connected to a network. (2) A character, group of characters, or a value that identifies a register, a particular part of storage, a data source, or a data sink. The value is represented by one or more characters. (T) (3) To refer to a device or an item of data by its address. (A) (4) The location in the storage of a computer where data is stored. (5) In word processing, the location, identified by the address code, of a specific section of the recording medium or storage. (T)

**Advanced Peer-to-Peer Networking (APPN).** An extension to SNA featuring (a) greater distributed network control that avoids critical hierarchical dependencies, thereby isolating the effects of single points of failure; (b) dynamic exchange of network topology information to foster ease of connection and reconfiguration, adaptive route selection, and simplified network definition; and (c) automated resource registration and directory lookup. APPN extends the LU 6.2 peer orientation for end-user services to network control; APPN also uses LU 6.2 protocols on its own control point sessions that provide the network control.

**Advanced Peer-to-Peer Networking (APPN) end node.** A type 2.1 end node that provides full SNA end-user services and supports sessions between its local control point (CP) and the CP in an adjacent network node, to dynamically register its resources with the adjacent CP (its network node server), to send and receive directory search requests, and to obtain management services; it can also attach to a subarea network as a peripheral node.

**Advanced Peer-to-Peer Networking (APPN) network.** A type 2.1 network having at least one APPN node.

**Advanced Peer-to-Peer Networking (APPN) network node.** A type 2.1 node that besides offering full SNA end-user services, provides intermediate routing services within a T2.1 network, and network services to its local LUs and attached T2.1 end nodes in its

domain; it can also attach to a subarea network as a peripheral node.

**AEA.** Asynchronous Emulation Adapter.

**AEA port.** A communication connector on the Asynchronous Emulation Adapter (AEA).

**Alt.** Alternate.

**alternate 1 initial microcode load (Alt 1 IML).** The initiating procedure for running specific adapter tests, starting customizing, or doing a normal IML.

**alternate 2 initial microcode load (Alt 2 IML).** The initiating procedure for running a general 3174 controller test.

**American National Standard Code for Information Interchange (ASCII).** The standard code, using a coded character set consisting of 7-bit coded characters (8 bits including parity check), used for information interchange among data processing systems, data communication systems, and associated equipment. The ASCII set consists of control characters and graphics characters. (A)

**analog.** Pertaining to data consisting of continuously variable physical quantities. (A) Contrast with *digital*.

**ANSI.** American National Standards Institute.

**APL.** A Programming Language.

**application.** (1) The use to which an information processing system is put, for example, a payroll application, an airline reservation application, or a network application. (2) A collection of software components used to perform specific types of work on a computer.

**APPN.** Advanced peer-to-peer networking.

**architecture.** A logical structure that encompasses operating principles including services, functions, and protocols. See *computer architecture*, *network architecture*, *Systems Application Architecture (SAA)*, *Systems Network Architecture (SNA)*.

**ASCII.** American National Standard Code for Information Interchange.

**asynchronous.** (1) Pertaining to two or more processes that do not depend upon the occurrence of a specific event such as a common timing signal. (T) (2) In Fiber Distributed Data Interface (FDDI) rings, a type of data traffic that does not need bounded access delay to the medium and guaranteed throughput.

**Asynchronous Emulation Adapter (AEA).** In the 3174, an adapter that enables an ASCII terminal to

communicate with a 3270 host using the 3270 data stream, an ASCII terminal to communicate with an ASCII host through the 3174, and a 3270 terminal to communicate with an ASCII host using data streams, such as the DEC VT100, DEC VT220, Data General D210, or IBM 3101 data streams.

**attach.** To make a device part of a network logically.

**attaching device.** Any device that is physically connected to a network and can communicate over the network.

## B

**backup copy.** A copy, usually of a program or of a library member, that is kept in case the original or the working copy is unintentionally altered or destroyed.

**backup diskette.** A diskette that contains information copied from another diskette. It is used in case the original information is unintentionally altered or destroyed.

**baseband.** (1) A frequency band that uses the complete bandwidth of a transmission medium. Contrast with *broadband* and *carrierband*. (2) A method of data transmission that encodes, modulates, and impresses information on the transmission medium without shifting or altering the frequency of the information signal.

**binary.** (1) Pertaining to a system of numbers to the base two; the binary digits are 0 and 1. (A) (2) Pertaining to a selection, choice, or condition that has two possible different values or states. (I) (A)

**binary synchronous communication (BSC).** A form of telecommunication line control that uses a standard set of transmission control characters and control character sequences, for binary synchronous transmission of binary-coded data between stations. Contrast with *synchronous data link control (SDLC)*.

**bit.** Either of the binary digits: a 0 or 1.

**bridge.** (1) An attaching device that connects two LAN segments to allow the transfer of information from one LAN segment to the other. A bridge may connect the LAN segments directly by network adapters and software in a single device, or may connect network adapters in two separate devices through software and use of a telecommunications link between the two adapters. (2) A functional unit that connects two LANs that use the same logical link control (LLC) procedures but may use the same or different medium access control (MAC) procedures. (T) Contrast with *gateway* and *router*.



**broadband.** A frequency band divisible into several narrower bands so that different kinds of transmissions such as voice, video, and data transmission can occur at the same time. Synonymous with *wideband*. See also *baseband*.

**BSC.** Binary synchronous communication.

**bus.** (1) In a processor, a physical facility on which data is transferred to all destinations, but from which only addressed destinations may read in accordance with appropriate conventions. (I) (2) A network configuration in which nodes are interconnected through a bidirectional transmission medium. (3) One or more conductors used for transmitting signals or power. (A)

## C

**cable loss (optical).** The loss in an optical cable equals the attenuation coefficient for the cabled fiber times the cable length.

**cable segment.** A section of cable between components or devices on a network. A segment may consist of a single patch cable, multiple patch cables connected together, or a combination of building cable and patch cables connected together. See *LAN segment*, *ring segment*.

**card.** In the 3174, a unit of electronic circuitry contained in a plastic casing (or cassette) and providing the controller with a specialized function, for example, a Terminal Adapter or an Encrypt/Decrypt Adapter.

**carrierband.** A frequency band in which the modulated signal is superimposed on a carrier signal (as differentiated from baseband), but only one channel is present on the medium (as differentiated from broadband). Contrast with *baseband* and *broadband*.

**CCA.** Concurrent Communication Adapter.

**CCITT.** International Telegraph and Telephone Consultative Committee.

**CECP.** Country extended code page.

**Central Site Change Management (CSCM).** A function of the 3174 Establishment Controller microcode that tracks the microcode for each controller in a network and, in conjunction with NetView DM, electronically distributes and retrieves microcode changes for each controller.

**Central Site Controller.** The controller that contains the central site library for all of the controllers in a network.

**central site customizing.** The process of tailoring the 3174 Licensed Internal Code for each controller in a network, at the central site.

**central site library.** One or more Library disks that contain customizing data and label information for the controllers in a network.

**channel.** (1) A functional unit, controlled by a host computer, that handles the transfer of data between processor storage and local peripheral equipment. (2) A path along which signals can be sent. (3) The portion of a storage medium that is accessible to a given reading or writing station. (4) In broadband transmission, a designation of a frequency band 6 MHz wide.

**channel-attached.** Pertaining to attachment of devices directly by data channels (I/O channels) to a computer. Synonym for *local-attached*. Contrast with *link-attached*.

**character set.** (1) A defined collection of characters. (2) A group of characters used for a specific reason, for example, the set of characters a printer can print. (3) The collection of graphic characters required to support a specific language.

**circuit.** (1) A logic device. (2) One or more conductors through which an electric current can flow.

**cluster.** A station that consists of a control unit (a cluster controller) and the terminals attached to it.

**CNM.** Communication network management.

**coaxial (coax) cable.** A cable consisting of one conductor, usually a small copper tube or wire, within and insulated from another conductor of a larger diameter, usually copper tubing or copper braid.

**COMM.** Communication.

**communication adapter.** (1) A circuit card with associated software that enables a processor, controller, or other device to be connected to a network. (2) See *EIA communication adapter, V.35 communication adapter*, and *X.21 communication adapter*.

**communication link.** Physical (hardware) link.

**communication network management (CNM).** The process of designing, installing, operating, and managing distribution of information and control among users of communication systems.

**component.** (1) Hardware or software that is part of a functional unit. (2) A functional part of an operating system, for example, the scheduler or supervisor. (3) See *terminal component* and *solid state component*.

**computer architecture.** The organizational structure of a computer system, including hardware and software. (A)

**Concurrent Communication Adapter (CCA).** In the 3174, a communication adapter that, along with the necessary microcode, provides terminals attached to the 3174 with the ability to concurrently access an additional 3270 host.

**configuration.** (1) The arrangement of a computer system or network as defined by the nature, number, and chief characteristics of its functional units. More specifically, the term may refer to a hardware configuration or a software configuration. (l) (A) (2) The devices and programs that make up a system, subsystem, or network. (3) See also *system configuration*.

**connect.** In a LAN, to physically join a cable from a station to an access unit or network connection point. Contrast with *attach*.

**connector.** A means of establishing electrical flow.

**Control (CTL) disk.** A customized diskette or fixed disk containing the microcode that describes a particular controller's attached terminals, and its method of attachment to the host.

**Control (CTL) diskette.** A customized diskette containing the microcode that describes a particular controller's attached terminals, and its method of attachment to the host.

**control character.** (1) A character whose occurrence in a particular context specifies a control function. (2) A character used to specify that a control unit is to perform a particular operation.

**controller.** A unit that controls input/output operations for one or more devices.

**control point (CP).** (1) A component of a node that manages resources of that node and optionally provides services to other nodes in the network. Examples are a system services control point (SSCP) in a type 5 node, a physical unit control point (PUCP) in a type 4 node, a network node control point (NNCP) in a type 2.1 (T2.1) network node, and an end node control point (ENCP) in a T 2.1 end node. An SSCP and an NNCP can provide services to other nodes. (2) A component of a T 2.1 node that manages the resources of that node. If the T2.1 node is an APPN node, the CP is capable of engaging in CP-CP sessions with other APPN nodes. If the T2.1 node is a network node, the CP also provides services to adjacent end nodes in the T2.1 network.

**control unit.** A general term for any device that provides common functions for other devices or mechanisms. Synonym for controller.

**control unit terminal (CUT).** A terminal that relies on the 3174 to interpret the data stream. Examples are the 3178, 3179, 3278 Model 2, and 3279 Model S2A.

**control unit terminal (CUT) mode.** A host-interactive mode that enables an IBM 3270 Personal Computer customized in this mode to run only one session emulating a 3178, 3179, 3278 Model 2, or 3279 Model S2A.

**conversion.** (1) In programming languages, the transformation between values that represent the same data item but belong to different data types. Information may be lost as a result of conversion because accuracy of data representation varies among different data types. (2) The process of changing from one method of data processing to another or from one data processing system to another. (3) The process of changing from one form of representation to another, for example, to change from decimal representation to binary representation.

**converter.** In an IBM Token-Ring Network, a device that converts electronic signals to light pulses or vice versa for use in an optical fiber subsystem.

**country extended code page (CECP).** A function of the 3174 microcode that provides a code page containing additional code points beyond those available with Table 5A code pages. CECP is supported by a universal character set, Character Set 697, which contains 190 characters.

**CSCM.** Central Site Change Management.

**CTL.** Control.

**customer replaceable unit (CRU).** An assembly or part that a customer can replace in its entirety when any of its components fail. Contrast with *field replaceable unit (FRU)*.

**customization.** Procedures that tailor the controller microcode to fit the various types of display stations and printers and the method of host attachment that a particular controller will handle.

**customizing keyboard.** A keyboard used to type in the customizing responses; this keyboard must be a Typewriter, Data Entry, APL (with APL off), or Text (with Text off) keyboard with a QWERTY layout. (On a QWERTY layout, the first six characters on the left side of the top row of alphabetic characters are Q, W, E, R, T, Y.)

**CUT.** Control unit terminal.

## D

**data.** (1) A representation of facts, concepts, or instructions in a formalized manner suitable for communication, interpretation, or processing by human or automatic means. (I) (A) (2) Any representations such as characters or analog quantities to which meaning is or might be assigned. (A)

**data communication.** (1) Transfer of information between functional units by means of data transmission according to a protocol. (T) (2) The transmission, reception, and validation of data. (A)

**data frame.** See *frame*.

**data link.** (1) Any physical link, such as a wire or a telephone circuit, that connects one or more remote terminals to a communication control unit, or connects one communication control unit with another. (2) The assembly of parts of two data terminal equipment (DTE) devices that are controlled by a link protocol, and the interconnecting data circuit, that enable data to be transferred from a data source to a data sink. (I) (3) In SNA, see also *link*.

**Note:** A telecommunication line is only the physical medium of transmission. A data link includes the physical medium of transmission, the protocol, and associated devices and programs; it is both physical and logical.

**data link control (DLC).** The process responsible for performing communication over a link using a specific data link control protocol, such as SDLC or token ring.

**data processing (DP).** The systematic performance of operations upon data; for example, handling, merging, sorting, and computing.

**data stream.** (1) All data transmitted through a data channel in a single read or write operation. (2) A continuous stream of data elements being transmitted, or intended for transmission, in character or binary-digit form, using a defined format. See also *data stream format*.

**data stream format.** In SNA, the format of the data elements (end-user data) in the request unit (RU). See also *3270 data stream* and *SNA character string (SCS)*.

**data terminal equipment (DTE).** (1) That part of a data station that serves as a data source, data receiver, or both. (I) (A) (2) Equipment that sends or receives data, or both.

**data transfer.** (1) The result of the transmission of data signals from any data source to a data receiver. (2) The movement, or copying, of data from one location and the storage of the data at another location.

**data transmission.** The conveying of data from one place for reception elsewhere by means of telecommunications. (I)

**dec.** Decimal.

**decrypt.** To convert encrypted data into clear data. Contrast with *encrypt*.

**DES.** Data Encryption Standard.

**destination.** Any point or location, such as a node, station, or particular terminal, to which information is to be sent.

**device.** (1) A mechanical, electrical, or electronic contrivance with a specific purpose. (2) An input/output unit such as a terminal, display, or printer. See also *attaching device*.

**diagnostics.** Modules or tests used by computer users and service personnel to diagnose hardware problems.

**dielectric.** Nonconductor of direct electric current.

**digital.** (1) Pertaining to data in the form of digits. (A) Contrast with *analog*. (2) Pertaining to data consisting of numerical values or discrete units.

**directory.** A database in an APPN node that lists names of resources (in particular, logical units) and records the CP name of the node where each resource is located.

**disk.** A direct-access data storage medium, which may be either flexible (diskette) or hard (fixed disk).

**diskette.** A flexible magnetic disk enclosed in a protective container.

**diskette drive.** The mechanism used to seek, read, and write data on diskettes.

**display field.** (1) An area in the display buffer that contains a set of characters that can be manipulated or operated upon as a unit. (2) A group of consecutive characters (in the buffer) that starts with an attribute character (defining the characteristics of the field) and contains one or more alphanumeric characters. The field continues to, but does not include, the next attribute character.

**display station.** An input/output device containing a display screen and an attached keyboard that allows a user to send information to or receive information from the system.

**distributed function terminal (DFT).** A programmable terminal that can perform operations previously performed by the control unit. These terminals can interpret the 3270 data stream themselves. Examples

are the IBM 3270 Personal Computer and the 3290 Information Panel.

**downstream.** (1) In the direction of data flow or toward the destination of transmission. (2) From the processor toward an attached unit or end user. (3) Contrast with *upstream*.

**downstream.** (1) On an IBM Token-Ring Network, the direction of data flow. (2) In the direction of data flow or toward the destination of transmission. Contrast with *upstream*.

**downstream load (DSL).** The capability of a distributed function terminal to receive its control program from the control unit to which it is attached. A disk containing the terminal's control program is loaded into the control unit.

**DPC.** Dual-purpose connector.

**DSL.** (1) Downstream load. (2) Data set label.

**DSR.** Data set ready.

**duplex.** Pertaining to communication in which data can be sent and received at the same time. Synonymous with *full duplex*. Contrast with *half-duplex*.

**duplex connector.** In an Enterprise Systems Connection environment, the component that terminates both jumper cables in one housing and provides physical keying for attachment to a duplex receptacle.

**duplex receptacle.** In an Enterprise Systems Connection environment, the fixed or stationary component that provides a keyed attachment method for a duplex connector.

## E

**EIA.** Electronic Industries Association.

**EIA communication adapter.** A communication adapter conforming to EIA standards that can combine and send information on two lines at speeds up to 19.2 kbps.

**EIA 232D.** An electrical interface defined by the Electronics Industries Association for establishing connections and controlling data flow between data terminal equipment and data communication equipment. The interface has been adapted to allow communication between DTEs.

**emulate.** To imitate one system with another, primarily by hardware, so that the imitating system accepts the same data, executes the same computer programs, and achieves the same results as the imitated computer system.

**emulation.** (1) The imitation of all or part of one computer system by another, primarily by hardware, so that the imitating system accepts the same data, executes the same programs, and achieves the same results as the imitated computer system. (I) (A) (2) The use of programming techniques and special machine features to permit a computing system to execute programs written for another system. (3) Imitation; for example, imitation of a computer or device. (4) See *terminal emulation*. (5) Contrast with *simulation*.

**encrypt.** To scramble data or convert it, before transmission, to a secret code that masks the meaning of the data to any unauthorized recipient. Contrast with *decrypt*.

**enterprise.** A business or organization that consists of two or more sites separated by a public right-of-way or a geographical distance. Contrast with *establishment*.

**Enterprise Systems Connection Adapter (ESCON Adapter).** In the 3174, this adapter allows the controller to communicate with an IBM S/390\* host through an Enterprise Systems Connection Channel using optical fiber cable.

**Enterprise Systems Connection environment.** The data processing environment in which units conform to the Enterprise Systems Connection (ESCON) Architecture and use optical fiber cables for information transfer between channels and control units.

**envelope.** (1) Information added to a frame or other message unit to allow it to be transmitted using a protocol other than the protocol in which the message unit originated. (2) To surround or enclose a message unit in information to allow the message unit to be transmitted using a protocol other than the protocol in which the message originated.

**equipment rack.** A metal stand for mounting network components, such as distribution panels and IBM 8228 Multistation Access Units. Synonymous with *rack*.

**ESCON.** Enterprise Systems Connection.

**establishment.** A user's premises that do not extend across public rights of way (for example, a single office building, warehouse, or campus). Contrast with *enterprise*.

**Ethernet network.** A 10-megabit baseband LAN that uses either the Ethernet Version 2 or IEEE 802.3 protocol in which messages are broadcast on a coaxial cable using a carrier sense multiple access/collision detection (CSMA/CD) transmission method.

**event.** (1) An occurrence or happening. (2) An occurrence of significance to a task; for example the

completion of an asynchronous operation, such as an input/output operation.

**execute.** To perform the actions specified by a program or a portion of a program. (T)

**exit.** To execute an instruction or statement within a portion of a program in order to terminate the execution of that portion. (T)

**Note:** Such portions of programs include loops, routines, subroutines, and modules.

## F

**faceplate.** A wall-mounted or surface-mounted plate for connecting data and voice connectors to a cabling system.

**fault.** An accidental condition that causes a functional unit to fail to perform its required function. (I) (A)

**FCC.** Federal Communications Commission.

**feature.** A part of an IBM product that may be ordered separately by the customer.

**Federal Communications Commission (FCC).** A board of commissioners appointed by the President under the Communications Act of 1934, having the power to regulate all interstate and foreign communications by wire and radio originating in the United States.

**fiber.** See *optical fiber*.

**Fiber Distributed Data Interface (FDDI).** A high-performance, general-purpose, multi-station network designed for efficient operation with a peak data transfer rate of 100 Mbps. It uses token-ring architecture with optical fiber as the transmission medium over distances of several kilometers.

**fiber optic cable.** See *optical cable*.

**fiber optics.** The branch of optical technology concerned with the transmission of radiant power through fibers made of transparent materials such as glass, fused silica, and plastic.

### Notes:

1. Telecommunication applications of fiber optics use optical fibers. Either a single discrete fiber or a nonspatially aligned fiber bundle may be used for each information channel. Such fibers are often called *optical fibers* to differentiate them from fibers used in noncommunication applications.
2. Various industrial and medical applications use (typically high-loss) flexible fiber bundles in which

individual fibers are spatially aligned, permitting optical relay of an image.

3. Some specialized industrial applications use rigid (fused) aligned fiber bundles for image transfer.

**Fiber Optic Terminal Adapter (FTA).** In the 3174, this adapter allows a 3299 Model 032 to be attached to the 3174 using optical fiber cable.

**field.** On a data medium or a storage medium, a specified area used for a particular category of data; for example, a group of character positions used to enter or display wage rates on a panel. (T) See also *display field*.

**field replaceable unit (FRU).** An assembly that is replaced in its entirety when any one of its components fails. In some cases a FRU may contain other FRUs; for example, a brush and a brush block that can be replaced individually or as a single unit. Contrast with *customer replaceable unit (CRU)*.

**file.** A named set of records stored or processed as a unit. (T)

**fixed disk.** A rigid magnetic disk used in a fixed disk drive. Synonymous with *hard disk*.

**fixed disk drive.** A disk storage device that reads and writes on rigid magnetic disks. Synonymous with *hard disk drive*.

**frame.** (1) The unit of transmission in some LANs, including the IBM Token-Ring Network and the IBM PC Network. It includes delimiters, control characters, information, and checking characters. On a token-ring network, a frame is created from a token when the token has data appended to it. On a token bus network (IBM PC Network), all frames including the token frame contain a preamble, start delimiter, control address, optional data and checking characters, end delimiter, and are followed by a minimum silence period. (2) A housing for machine elements. (3) In synchronous data link control (SDLC), the vehicle for every command, every response, and all information that is transmitted using SDLC procedures. Each frame begins and ends with a flag.

**frame relay.** (1) An interface standard describing the boundary between a user's equipment and a fast-packet network. In frame-relay systems, flawed frames are discarded; recovery comes end-to-end rather than hop-by-hop. (2) A technique derived from the integrated services digital network (ISDN) D channel standard. It assumes that connections are reliable and dispenses with the overhead of error detection and control within the network.

**frequency.** The rate of signal oscillation, expressed in hertz (cycles per second).

**from diskette.** The diskette that provides the data to be transferred.

**FRU.** Field-replaceable unit.

**FTA.** Fiber Optic Terminal Adapter.

**full-duplex.** Synonym for *duplex*.

**function.** (1) A specific purpose of an entity, or its characteristic action. (A) (2) In data communications, a machine action such as carriage return or line feed. (3) In NetView DM, a function is the specification of a transmission activity on a resource or group of resources. Functions are grouped into phases. In CSCM, resources are known as data objects.

**functional unit.** An entity of hardware, software, or both, capable of accomplishing a specified purpose. (I) (A)

## G

**gateway.** A device and its associated software that interconnect networks or systems of different architectures. The connection is usually made above the reference model network layer. For example, a gateway allows LANs access to System/370 host computers. Contrast with *bridge* and *router*.

**get.** In 3174 central site customizing, to select the type of data you want and store it in working copy.

**group.** (1) A set of related records that have the same value for a particular field in all records. (2) A collection of users who can share access authorities for protected resources. (3) A list of names that are known together by a single name.

## H

**half-duplex.** In data communication, pertaining to transmission in only one direction at a time. Contrast with *duplex*.

**hardware.** Physical equipment as opposed to programs, procedures, rules, and associated documentation. (I) (A)

**hexadecimal.** (1) Pertaining to a selection, choice, or condition that has 16 possible values or states. (2) Pertaining to a fixed-radix numeration system, with radix of 16. (3) Pertaining to a numbering system with base of 16; valid numbers use the digits 0 through 9 and characters A through F, where A represents 10 and F represents 15.

**host attachment.** A mode of SNA communication in which the processor acts as a secondary SNA device.

**host computer.** (1) In a computer network, a computer that provides end users with services such as computation and data bases and that usually performs network control functions. (2) The primary or controlling computer in a multiple-computer installation. (3) A computer used to prepare programs for use on another computer or on another data processing system; for example, a computer used to compile link edit, or test programs to be used on another system. (4) Synonym for *host processor*.

**host processor.** (1) A processor that controls all or part of a user application network. (2) In a network, the processing unit in which resides the access method for the network. (3) In an SNA network, the processing unit that contains a system services control point (SSCP). (4) A processing unit that executes the access method for attached communication controllers. (5) The processing unit required to create and maintain PSS. (6) Synonymous with *host computer*.

**host system.** (1) A data processing system used to prepare programs and operating environments for use on another computer or controller. (2) The data processing system to which a network is connected and with which the system can communicate. (3) The controlling or highest-level system in a data communication configuration; for example, a System/38 is the host system for the workstations connected to it.

## I

**IBM Cabling System.** A permanently installed wiring system that eliminates the need to rewire when terminals are moved from one location to another within an office complex. It allows transmission of data at very high speeds and is the foundation for installing a local area network.

**IML.** Initial microcode load.

**initialize.** In a LAN, to prepare the adapter (and adapter support code, if used) for use by an application program.

**initial microcode load (IML).** In the 3174, the action of loading the operational microcode.

**input/output (I/O).** (1) Pertaining to a device whose parts can perform an input process and an output process at the same time. (I) (2) Pertaining to a functional unit or channel involved in an input process, output process, or both, concurrently or not, and to the data involved in such a process.

**insert.** To make an attaching device an active part of a LAN.

**integrated services digital network (ISDN).** A digital end-to-end telecommunication network that supports multiple services including, but not limited to, voice and data.

**Note:** ISDNs are used in public and private network architectures.

**interface.** (1) A shared boundary between two functional units, defined by functional characteristics, common physical interconnection characteristics, signal characteristics, and other characteristics as appropriate. (I) (2) A shared boundary. An interface may be a hardware component to link two devices or a portion of storage or registers accessed by two or more computer programs. (A) (3) Hardware, software, or both, that links systems, programs, or devices.

**interference.** (1) The prevention of clear reception of broadcast signals. (2) The distorted portion of a received signal.

**International Organization for Standardization (ISO).** An organization of national standards bodies from various countries established to promote development of standards to facilitate international exchange of goods and services, and develop cooperation in intellectual, scientific, technological, and economic activity.

**ISDN.** Integrated Services Digital Network.

**ISO.** International Organization for Standardization.

## J

**jumper.** A connector between two pins on a network adapter that enables or disables an adapter option, feature, or parameter value.

## L

**LAN.** Local area network.

**LAN segment.** (1) Any portion of a LAN (for example, a single bus or ring) that can operate independently but is connected to other parts of the establishment network via bridges. (2) An entire ring or bus network without bridges. See *cable segment* and *ring segment*.

**large cluster.** In 3174, the specific models of the controller that support attachment of up to 64 IBM 3270 Terminals.

**layer.** (1) One of the seven levels of the Open Systems Interconnection reference model. (2) In open systems architecture, a collection of related functions that comprise one level of hierarchy of functions. Each layer specifies its own functions and assumes that lower level functions are provided. (3) In SNA, a grouping of

related functions that are logically separate from the functions of other layers. Implementation of the functions in one layer can be changed without affecting functions in other layers.

**LFU.** Limited Function Utility.

**LIC.** (1) Licensed Internal Code (2) Last in chain.

**Licensed Internal Code (LIC).** (1) Microcode that IBM does not sell as part of a machine but licenses to the customer, as designated in the Supplement to Agreement for Purchase of IBM Machines.

(2) Licensed Internal Code is implemented in a part of storage that is not addressable by user programs. It is used in a product to implement functions as an alternative to hard-wired circuitry. LIC is provided in accordance with the terms and conditions of the applicable written agreement between a customer and IBM. See also *microcode*.

**Limited Function Utility (LFU) diskette.** A diskette that contains the microcode to run only a limited number of utilities. These are: Diagnostics, Copy Files, Encrypt/Decrypt Master Key, Identify Customizing Keyboard, and Media Management. The Limited Function Utility diskette is used mainly in networks that are under central site control.

**link.** (1) The logical connection between nodes including the end-to-end link control procedures. (2) The combination of physical media, protocols, and programming that connects devices on a network. (3) In computer programming, the part of a program, in some cases a single instruction or an address, that passes control and parameters between separate portions of the computer program. (I) (A) (4) To interconnect items of data or portions of one or more computer programs. (5) In SNA, the combination of the link connection and link stations joining network nodes.

**link-attached.** Pertaining to the attachment of devices to a central computer through a communication control unit. Contrast with *channel-attached*. Deprecated term for *telecommunication-attached*.

**LLC.** Logical link control.

**lobe receptacle.** In the IBM Token-Ring Network, an outlet on an access unit for connecting a lobe.

**local.** Pertaining to a device accessed directly without use of a telecommunication line. Synonym for *channel-attached*. Contrast with *remote*.

**local area network (LAN).** A computer network located on a user's premises within a limited geographical area.

**Note:** Communication within a local area network is not subject to external regulations; however,

communication across the LAN boundary may be subject to some form of regulation. (T)

**locally administered address.** An adapter address that the user can assign to override the universally administered address. Contrast with *universally administered address*.

**location.** With reference to the 3174, a place within the 3174 chassis where a particular card or adapter is inserted.

**logical link control (LLC) sublayer.** One of two sublayers of the ISO Open Systems Interconnection data link layer (which corresponds to the SNA data link control layer), proposed for LANs by the IEEE Project 802 Committee on Local Area Networks and the European Computer Manufacturers Association (ECMA). It includes those functions unique to the particular link control procedures that are associated with the attached node and are independent of the medium; this allows different logical link protocols to coexist on the same network without interfering with each other. The LLC sublayer uses services provided by the medium access control (MAC) sublayer and provides services to the network layer.

**logical link control protocol (LLC protocol).** In a local area network, the protocol that governs the exchange of frames between data stations independently of how the transmission medium is shared. (T)

**loop.** A closed unidirectional signal path connecting input/output devices to a network.

## M

**MAC.** (1) Medium access control. (2) Message authentication code.

**main storage.** Program-addressable storage from which instructions and other data can be loaded directly into registers for subsequent processing.

**Mbps.** Megabits per second.

**medium.** A physical carrier of electrical or optical energy.

**medium access control (MAC) frame.** (1) In a ring network, an address resolution request frame that has the unique part of a destination address and an "all rings" address. A sender issues this request to determine the ring where the destination node is located and whether the node is active. (2) In a ring network, a response from an active destination node to the requesting source node that has its complete address and ring number.

**medium access control (MAC) protocol.** In a local area network, the part of the protocol that governs communication on the transmission medium without concern for the physical characteristics of the medium, but taking into account the topological aspects of the network, in order to enable the exchange of data between data stations. (T) See also *logical link control protocol*.

**memory.** Program-addressable storage from which instructions and other data can be loaded directly into registers for subsequent execution or processing. Synonymous with *main storage*.

**memory mapped I/O (MMIO).** In 3174, a method of accessing certain adapters as if an adapter was a memory location.

**merged.** In an IBM Token-Ring Network, pertaining to an IBM access control unit that has successfully joined the main ring path. Neither the ring in (RI) nor ring out (RO) data signal of the access control unit has been switched to the backup path.

**microcode.** (1) One or more microinstructions. (2) A code, representing the instructions of an instruction set, that is implemented in a part of storage that is not program-addressable. (3) To design, write, and also to test one or more microinstructions. (4) See also *microprogram*.

**Note:** The term microcode represents microinstructions used in a product as an alternative to hard-wired circuitry to implement functions of a processor or other system component. The term microprogram means a dynamic arrangement of one or more groups of microinstructions for execution to perform a certain function. (5) See also *licensed internal code (LIC)*.

**microprogram.** A sequence of microinstructions (T) that when executed performs a preplanned function.

**MMIO.** Memory mapped input/output.

**modem.** Modulator-demodulator.

**modem (modulator/demodulator).** A device that converts digital data from a computer to an analog signal that can be transmitted on a telecommunication line, and converts the analog signal received to data for the computer.

**monitor.** (1) A functional unit that observes and records selected activities for analysis within a data processing system. Possible uses are to show significant departures from the norm, or to determine levels of utilization of particular functional units. (I) (A) (2) Software or hardware that observes, supervises, controls, or verifies operations of a system. (A)



**multidrop (network).** A network configuration in which there are one or more intermediate nodes on the path between a central node and an endpoint node.

**multistation access unit.** In the IBM Token-Ring Network, a wiring concentrator that can connect up to eight lobes to a ring.

## N

**name.** An alphanumeric term that identifies a data set, statement, program, or cataloged procedure.

**NCCF.** Network Communications Control Facility.

**NetView.** A host-based IBM licensed program that provides communication network management (CNM) or communications and systems management (C&SM) services.

**network.** (1) A configuration of data processing devices and software connected for information interchange. (2) An arrangement of nodes and connecting branches. Connections are made between data stations. (T)

**network administrator.** A person who manages the use and maintenance of a network.

**network architecture.** The logical structure and operating principles of a computer network. (T) See also *systems network architecture (SNA)* and *Open Systems Interconnection (OSI) architecture*.

**Note:** The operating principles of a network include those of services, functions, and protocols.

**network layer.** (1) In the Open Systems Interconnection reference model, the layer that provides for the entities in the transport layer the means for routing and switching blocks of data through the network between the open systems in which those entities reside. (T) (2) The layer that provides services to establish a path between systems with a predictable quality of service. See *Open Systems Interconnection (OSI)*.

**network management.** The conceptual control element of a station that interfaces with all of the architectural layers of that station and is responsible for the resetting and setting of control parameters, obtaining reports of error conditions, and determining if the station should be connected to or disconnected from the network.

**network node (NN).** A node that can define the paths or routes, control route selection, and handle directory services for APPN.

**Network Problem Determination Application (NPDA).** An IBM licensed program that helps the user

identify network problems from a central control point using interactive display techniques.

**network wiring closet.** See *wiring closet*.

**NLDM.** Network Logical Data Manager.

**node.** (1) Any device, attached to a network, that transmits and/or receives data. (2) An endpoint of a link, or a junction common to two or more links in a network. (3) In a network, a point where one or more functional units interconnect transmission lines.

**noise.** (1) A disturbance that affects a signal and that can distort the information carried by the signal. (T) (2) Random variations of one or more characteristics of any entity, such as voltage, current, or data. (A) (3) Loosely, any disturbance tending to interfere with normal operation of a device or system. (A)

**NPDA.** Network Problem Determination Application.

**NUM.** Numeric.

## O

**office.** See *work area*.

**offline test.** In the 3174, a diagnostic test or data collection program that must be run when the 3174 and its connected terminals are not in normal operation.

**open.** (1) To make an adapter ready for use. (2) A break in an electrical circuit. (3) To make a file ready for use.

**Open Systems Interconnection (OSI).** (1) The interconnection of open systems in accordance with specific ISO standards. (T) (2) The use of standardized procedures to enable the interconnection of data processing systems.

**Note:** OSI architecture establishes a framework for coordinating the development of current and future standards for the interconnection of computer systems. Network functions are divided into seven layers. Each layer represents a group of related data processing and communication functions that can be carried out in a standard way to support different applications.

**Open Systems Interconnection (OSI) architecture.** Network architecture that adheres to a particular set of ISO standards that relates to Open Systems Interconnection. (T)

**Open Systems Interconnection (OSI) reference model.** A model that represents the hierarchical arrangement of the seven layers described by the Open Systems Interconnection architecture.

**operation.** (1) A defined action, namely, the act of obtaining a result from one or more operands in accordance with a rule that completely specifies the result for any permissible combination of operands. (A) (2) A program step undertaken or executed by a computer. (3) An action performed on one or more data items, such as adding, multiplying, comparing, or moving.

**optical cable.** A fiber, multiple fibers, or a fiber bundle in a structure built to meet optical, mechanical, and environmental specifications.

**optical fiber.** Any filament made of dielectric materials that guides light, regardless of its ability to send signals. (E) See also *fiber optics* and *optical waveguide*.

**optical fiber cable.** Synonym for *optical cable*.

**output device.** A device in a data processing system by which data can be received from the system. (I) (A) Synonymous with *output unit*.

**output unit.** Synonym for *output device*.

## P

**packet.** (1) In data communication, a sequence of binary digits, including data and control signals, that is transmitted and switched as a composite whole. (I) (2) Synonymous with *data frame*. Contrast with *frame*.

**page.** (1) The portion of a panel that is shown on a display surface at one time. (2) To move back and forth among the pages of a multiple-page panel. See also *scroll*. (3) In a virtual storage system, a fixed-length block that has a virtual address and is transferred as a unit between real storage and virtual storage.

**panel.** The complete set of formatted information that appears in a single display on a visual display unit.

**parity.** (1) A transmission error-checking scheme in which an extra bit is added to some unit of data, usually a byte, in order to make the total number of one bits even or odd. For the AEA feature, odd, even, mark, space, or no-parity coding is supported. No-parity means that no parity bit is sent or expected. Mark and space mean that the parity position is always set to one or zero, respectively, and that received parity is not checked. (2) The state of being either even-numbered or odd-numbered.

**parity (even).** A condition when the sum of all of the digits in an array of binary digits is even.

**parity (odd).** A condition when the sum of all of the digits in an array of binary digits is odd.

**parity check.** (1) A redundancy check by which a recalculated parity bit is compared to the pregiven parity bit. (T) (2) A check that tests whether the number of ones (or zeros) in an array of binary digits is odd or even. (A)

**path.** (1) In a network, any route between any two nodes. (T) (2) The route traversed by the information exchanged between two attaching devices in a network. (3) A command in IBM Personal Computer Disk Operating System (PC DOS) and IBM Operating System/2 (OS/2) that specifies directories to be searched for commands or batch files that are not found by a search of the current directory.

**personal computer (PC).** A desk-top, free-standing, or portable microcomputer that usually consists of a system unit, a display, a monitor, a keyboard, one or more diskette drives, internal fixed-disk storage, and an optional printer. PCs are designed primarily to give independent computing power to a single user and are inexpensively priced for purchase by individuals or small businesses. Examples include the various models of the IBM Personal Computers, and the IBM Personal System/2 computer.

**plug.** (1) A connector designed to insert into a receptacle or socket. (2) To insert a connector into a receptacle or socket.

**P/N.** Part number.

**port.** (1) An access point for data entry or exit. (2) A connector on a device to which cables for other devices such as display stations and printers are attached. Synonymous with *socket*.

**Port Expansion Feature.** In the 3174, an optional feature that allows up to 32 additional 3270 type terminals to be attached. This feature provides a new terminal adapter for specific large-cluster models of the 3174.

**post.** (1) To affix to a usual place. (2) To provide items such as return code at the end of a command or function. (3) To define an appendage routine. (4) To note the occurrence of an event.

**POST.** Power-On Self Test.

**Power-On Self Test (POST).** A series of diagnostic tests that are run automatically each time the computer's power is turned on.

**procedure.** A set of instructions that gives a service representative a step-by-step procedure for tracing a symptom to the cause of failure.

**processor.** In a computer, a functional unit that interprets and executes instructions. (I) (A)

**put.** In 3174 central site customizing, to store data from the working copy into a library member.

## R

**rack.** Synonym for *equipment rack*.

**radio frequency (RF).** Any frequency in the range within which radio waves may be transmitted, from about 10 KHz to about 300 000 MHz.

**receive.** To obtain and store information transmitted from a device.

**receptacle.** Electrically, a fitting equipped to receive a plug and used to complete a data connection or electrical path. See also *lobe receptacle*.

**rel.** Relative.

**remote.** Pertaining to a system, program, or device that is accessed through a telecommunication line.

**remove.** (1) To take an attaching device off a network. (2) To stop an adapter from participating in passing data on a network.

**request for price quotation (RPQ).** An alteration or addition to the functional capabilities that the controller provides.

**ring network.** A network configuration in which a series of attaching devices is connected by unidirectional transmission links to form a closed path. A ring of an IBM Token-Ring Network is referred to as a LAN segment or as a Token-Ring Network segment.

**ring segment.** A ring segment is any section of a ring that can be isolated (by unplugging connectors) from the rest of the ring. A segment can consist of a single lobe, the cable between access units, or a combination of cables, lobes, and/or access units. See *cable segment* and *LAN segment*.

**ring topology.** A logically circular, unidirectional transmission path without defined ends. Control can be distributed or centralized.

**ring topology.** A logically circular, unidirectional transmission path without defined ends. Control can be distributed or centralized.

**route.** An ordered sequence of nodes and transmission groups (TGs) that represent a path from an origin node to a destination node traversed by the traffic exchanged between them.

**router.** An attaching device that connects two LAN segments, which use similar or different architectures,

at the reference model network layer. Contrast with *bridge* and *gateway*.

**RPQ.** Request for price quotation.

## S

**SAA.** Systems Application Architecture.

**scroll.** To move a display image vertically or horizontally to display data that cannot be observed within the boundaries of the display screen.

**SCS.** SNA character string.

**SDLC.** Synchronous Data Link Control.

**segment.** A section of cable between components or devices on the network. A segment may consist of a single patch cable, multiple patch cables connected, or a combination of building cable and patch cables connected. See *cable segment*, *LAN segment*, and *ring segment*.

**signal.** (1) A time-dependent value attached to a physical phenomenon for conveying data. (2) A variation of a physical quantity, used to convey data.

**simulation.** (1) The representation of selected characteristics of the behavior of one physical or abstract system by another system. In a digital computer system, simulation is done by software; for example, (a) the representation of physical phenomena by means of operations performed by a computer system, and (b) the representation of operations of a computer system by those of another computer system. (2) Contrast with *emulation*.

**SNA.** Systems Network Architecture.

**SNA character string (SCS).** A character string composed of EBCDIC controls, optionally intermixed with end-user data, that is carried within a request/response unit.

**socket.** Synonym for *port (2)*.

**solid state component.** A component whose operation depends on control of electric or magnetic phenomena in solids, for example, a transistor, crystal diode, or ferrite core.

**star.** A wiring arrangement in which an individual cable runs from each work area to a concentration point.

**station.** (1) An input or output point of a system that uses telecommunication facilities; for example, one or more systems, computers, terminals, devices, and associated programs at a particular location that can send or receive data over a telecommunication line.

(2) A location in a device at which an operation is performed, for example, a read station. (3) In SNA, a link station.

**storage.** A unit into which recorded text can be entered, in which it can be retained and processed, and from which it can be retrieved. See also *memory*.

**SUB.** Substitute.

**switch.** On an adapter, a mechanism used to select a value for, enable, or disable a configurable option or feature.

**synchronous.** (1) Pertaining to two or more processes that depend on the occurrences of a specific event such as common timing signal. (I) (A)  
(2) Occurring with a regular or predictable timing relationship.

**synchronous data link control (SDLC).** A discipline conforming to subsets of the Advanced Data Communication Control Procedures (ADCCP) of the American National Standards Institute (ANSI) and High-level Data Link Control (HDLC) of the International Organization for Standardization, for managing synchronous, code-transparent, serial-by-bit information transfer over a link connection. Transmission exchanges may be duplex or half-duplex over switched or nonswitched links. The configuration of the link connection may be point-to-point, multipoint, or loop. (I)

**synonym.** A code point that is supported only by a device that contains an extended attribute buffer (EAB). For devices without an EAB, synonyms are translated to hyphens.

**system.** In data processing, a collection of people, machines, and methods organized to accomplish a set of specific functions. (I) (A)

**system configuration.** A process that specifies the devices and programs that form a particular data processing system.

**Systems Application Architecture (SAA).** An architecture developed by IBM that consists of a set of selected software interfaces, conventions, and protocols, and that serves as a common framework for application development, portability, and use across different IBM hardware systems.

**Systems Network Architecture (SNA).** The description of the logical structure, formats, protocols, and operational sequences for transmitting information units through, and controlling the configuration and operation of, networks.

**Note:** The layered structure of SNA allows the ultimate origins and destinations of information, that is, the end users, to be independent of and unaffected by the

specific SNA network services and facilities used for information exchange.

## T

**telecommunication-attached.** Pertaining to the attachment of devices by teleprocessing lines to a host processor. Synonym for *remote*. Contrast with *channel-attached*.

**telecommunication line.** (1) Any physical medium, such as a wire, that is used to transmit data.  
*Note:* A telecommunication line is the physical medium. A data link includes the physical medium of transmission, the protocol, and associated devices and programs; it is both physical and logical. (2) The portion of a data circuit external to data-circuit terminating equipment (DCE) that connects the DCE to a data-switching exchange (DSE), that connects a DCE to one or more other DCEs, or that connects a DSE to another DSE. (T)

**telecommunication network.** In a telecommunication system, the combination of all terminals and other telecommunication devices and the lines that connect them.

**telephone twisted pair.** One or more twisted pairs of copper wire in the unshielded voice-grade cable commonly used to connect a telephone to its wall jack. Also referred to as "unshielded twisted pair" (UTP).

**telephone twisted pair terminal multiplexer adapter (TTP TMA).** In the 3174, a feature that allows attachment of up to thirty-two 3270-type devices (displays and printers) to the controller through two 25-pair telephone twisted-pair cables, meeting IBM Cabling System (ICS) Type 3 specifications.

**terminal.** In data communication, a device, usually equipped with a keyboard and display device, capable of sending and receiving information.

**terminal adapter (TA).** In the 3174, an adapter that provides control for a maximum of 32 terminals per adapter. The maximum number of terminals that can be connected depends on the model of the 3174.

**terminal component.** A separately addressable part of a terminal that performs an input or output function, such as the display component of a keyboard-display device or a printer component of a keyboard-printer device.

**terminal emulation.** The capability of a microcomputer, personal computer, 3270 CUT mode display station, 3270 printer, ASCII display station, or ASCII printer to operate as if it were a particular type of terminal linked to a processing unit and to access data.

**terminal multiplexer.** A device, such as the 3299 Terminal Multiplexer, for interleaving the signals for many devices onto a single cable.

**terminal multiplexer adapter (TMA).** In the 3174, this adapter is connected to the 3174 terminal adapter (TA) and provides control for a maximum of eight terminals.

**terminal port.** (1) In a network, the functional unit of a node through which data can enter or leave the network. (2) The part of a processor that is dedicated to a single data channel for the purpose of receiving data from or transferring data to one or more external or remote devices.

**terminator.** A 75-ohm, resistive connector used on the end of a cable or an unused tap to minimize cable reflections.

**throughput.** (1) A measure of the amount of work performed by a computer system over a given period of time, for example, number of jobs per day. (I) (A) (2) A measure of the amount of information transmitted over a network in a given period of time. For example, a network's data transfer rate is usually measured in bits per second.

**TMA.** Terminal Multiplexer Adapter.

**token.** A sequence of bits passed from one device to another on the token-ring network that signifies permission to transmit over the network. It consists of a starting delimiter, an access control field, and an end delimiter. The access control field contains a bit that indicates to a receiving device that the token is ready to accept information. If a device has data to send along the network, it appends the data to the token. When data is appended, the token then becomes a frame. See *frame*.

**token-passing.** In a token-ring network, the process by which a node captures a token; inserts a message, addresses, and control information; changes the bit pattern of the token to the bit pattern of a frame; transmits the frame; removes the frame from the ring when it has made a complete circuit; generates another token; and transmits the token on the ring where it can be captured by the next node that is ready to transmit.

**token ring.** A network with a ring topology that passes tokens from one attaching device (node) to another. A node that is ready to send can capture a token and insert data for transmission.

**token-ring network.** (1) A ring network that allows unidirectional data transmission between data stations by a token-passing procedure over one transmission medium so that the transmitted data returns to and is removed by the transmitting station. (T) The IBM Token-Ring Network is a baseband LAN with a

star-wired ring topology that passes tokens from network adapter to network adapter. (2) A network that uses a ring topology, in which tokens are passed in a sequence from node to node. A node that is ready to send can capture the token and insert data for transmission. (3) A group of interconnected token rings.

**topology.** The physical or logical arrangement of nodes in a computer network. Examples include ring topology and bus topology.

**transmission medium.** (1) A physical carrier of electrical energy or electromagnetic radiation. (2) The physical medium that conveys data between data stations; for example, twisted-pair wire, optical fiber, coaxial cable. (T)

**transmit.** To send information from one place for reception elsewhere.

**transparent.** (1) Pertaining to operations or data that are of no significance to the user. (2) In data transmission, pertaining to information not recognized by the receiving program or device as transmission control characters.

**TTP TMA.** Telephone Twisted-Pair Terminal Multiplexer Adapter.

**twisted pair.** A transmission medium that consists of two insulated conductors twisted together to reduce noise. (T)

**type.** In the 3174, the identifying number of a card. For example, 9150 is a type number of the terminal adapter in the 3174.

**type 1 communication adapter.** In the 3174, the adapter that provides EIA 232D/CCITT V.24 or CCITT V.35 interfaces for SDLC, BSC, X.25, or frame-relay remote link attachment. The user selects the appropriate interface.

**type 2 communication adapter.** In the 3174, the adapter that provides CCITT V.11 (X.21) interface for SDLC, X.25, or frame-relay remote link attachment. The user selects the interface.

## U

**U.S.** United States.

**universally administered address.** The address permanently encoded in an adapter at the time of manufacture. All universally administered addresses are unique. Contrast with *locally administered address*.

**upstream.** (1) In the direction opposite to data flow or toward the source of transmission. (2) Toward the

processor from an attached unit or end user.  
(3) Contrast with *downstream*.

**Utility (UTL) diskette.** In the 3174, a diskette that contains the microcode necessary to run various utilities, for example, to copy portions of a diskette for a backup diskette.

## V

**V.35 communication adapter.** A communication adapter that can combine and send information on one line at speeds up to 64 kbps, and conforms to the CCITT V.35 standard.

**version.** A separate IBM-licensed program, based on an existing IBM-licensed program, that usually has significant new code or new function.

## W

**wideband.** Synonym for *broadband*.

**wiring closet.** A room that contains one or more distribution panels and equipment racks that are used to interconnect cables. Sometimes called a *network wiring closet* to distinguish it from a telephone wiring closet.

**wiring concentrator.** A unit that allows multiple attaching devices access to the ring at a central point such as a wiring closet or in an open work area. A star-wired ring consists of one or more concentrators connected together to form a ring. See also *access unit*.

**work area.** An area in which terminal devices (such as displays, keyboards, and printers) are located. Access units may also be located in work areas.

**workstation.** (1) An I/O device that allows either transmission of data or the reception of data (or both) from a host system, as needed to perform a job: for example, a display station or printer. (2) A configuration of I/O equipment at which an operator works. (T) (3) A terminal or microcomputer, usually one connected to a mainframe or network, at which a user can perform tasks.

**Workstation Networking Module (WNM).** In the 8250 and 8260, a module that provides 3174 Establishment Controller 3270 connectivity and type 1 communication functions.

**wrap test.** A test that checks attachment or control unit circuitry without checking the mechanism itself by returning the output of the mechanism as input. For example, when unrecoverable communication adapter or machine errors occur, a wrap test can transmit a specific character pattern to or through the modem in a loop and then compare the character pattern received with the pattern transmitted.

**write.** To make a permanent or transient recording of data in a storage device or on a data medium.

## X

**X.21.** In data communication, a recommendation of the International Telegraph and Telephone Consultative Committee (CCITT) that defines the interface between data terminal equipment and public data networks for digital leases and circuit switched synchronous services.

**X.21 communication adapter.** A communication adapter that can combine and send information on one line at speeds up to 64 kbps, and that conforms to CCITT X.21 standards.

**X.25.** In data communication, a recommendation of the CCITT that defines the interface between data terminal equipment and packet switching networks.

**3270 data stream.** (1) The commands, control codes, orders, attributes, and data or structured fields for 3270 devices, that are transmitted inbound to an application program or outbound to a terminal. (2) Data being transferred from or to an allocated primary or tertiary device, or to the host system, as a continuous stream of data and 3270 Information Display System control elements in character form.

**3270 Port Expansion Feature.** In the 3174, an optional terminal adapter and the required microcode that allows the 3174 to support an additional 32 terminals. This adapter is available only on large cluster models of the 3174.

---

# Index

## Numerics

- 3174
  - See also* general description, 3174
  - See also* setting up controller
  - cabling worksheets 3-3
  - features 1-1, 1-3
  - making operational 4-1
  - model descriptions 1-1
  - online, placing 4-1
  - panels, switches and indicators 1-9
  - problem solving 5-1
  - relocating 6-1
  - relocating the 3174 6-1
  - setting up 2-1
- 3270
  - gateway feature, Token-Ring network 1-4
- 3290 information panel 1-1
- 3299 Terminal Multiplexer
  - attachment of terminals via 1-1
  - cabling worksheet 8A 3-3
  - cabling worksheet 8E 3-8
  - functions and features 1-3

## A

- adapter hardware group numbers
  - See* hardware group (HG) numbers
- adapter test, Token-Ring 5-21
- adapters
  - AEA/ASCII connection, worksheet 11A 3-10
  - asynchronous emulation 1-3, 1-5
  - communication 1-3, 1-5
  - concurrent communication 1-3, 1-5
  - Ethernet 1-3
  - fiber optic terminal 1-3, 1-6
  - ISDN 1-3, 1-6
  - terminal 1-3, 1-6
  - terminal multiplexer 1-3, 1-6
  - Token-Ring 1-4, 1-7
- addresses
  - See* terminal port addresses
- Advance
  - Advance pushbutton 1-13
  - function 1-13
- AEA
  - See* Asynchronous Emulation Adapter
- Alt 1
  - adapter testing procedure 5-4
    - from diskette 5-8
    - from fixed disk 5-9
  - IML 1-13

- Alt 1 (*continued*)
  - pushbutton 1-13
  - setting up 2-7
  - testing procedure, IML 5-4
    - from diskette 5-5, 5-8
    - from fixed disk 5-6
- Alt 2
  - IML 1-13
  - pushbutton 1-13
  - testing procedure, IML 5-4
    - from fixed disk 5-9
- Asynchronous Emulation Adapter
  - attachment of ASCII hosts or terminals through 1-1
  - cabling for 2-11
  - cabling worksheet 11A 3-10
  - diskettes A-1
  - functions and features 1-3
  - wrap test 5-10

## B

- basic controller test 5-4
  - See also* Alt 2

## C

- cable
  - figure, ports and cables 3-2
  - tests
    - Communication Adapter 5-14
    - Ethernet Adapter 5-17
    - ISDN Adapter 5-18
    - Token-Ring Adapter 5-21
  - worksheets 3-3
    - 10, terminal direct-connect cabling 3-6
    - 11A, AEA (ASCII connection) cabling 3-10
    - 8A, TMA cabling 3-3
    - 8E, TMA cabling from the 3270 Port Expansion Feature 3-8
    - 9C, 3299 cabling 3-4
- cabling system
  - Asynchronous Emulation Adapter 2-11
  - Communication Adapter and cable test 5-14
  - Concurrent Communication Adapter and cable test 5-12
  - Ethernet Adapter and cable test 5-17
  - Fiber Optic Terminal Adapter 2-12
  - figure, ports and cables 3-2
  - ISDN Adapter and cable test 5-18
  - Terminal Adapter connectors 2-11
- cards, storage expansion 1-3

- CAUTION notices, customer setup of unit 2-7
- Channel Adapter (HG16) 1-5
- channel interface switch 1-13
- channel priority switches 1-14
- check condition indicator 1-13
- Clear pushbutton 1-13
- codes, status
  - Advance pushbutton 1-13
  - reference to 1-8
- Communication Adapter (EIA/V.35), Type 1
  - See Type 1 Communication Adapter (EIA/V.35)
- Communication Adapter (X.21), Type 2
  - See Type 2 Communication Adapter (X.21)
- Communication Adapter and cable test 5-14
- Concurrent Communication Adapter and cable test 5-12
- connection
  - modem 1-3
  - sample configuration 3-2
    - 3270 Port Expansion Feature, with 3-7
    - ASCII terminals 3-9
- connectors, Terminal Adapter 2-11
- continue function 5-4
- Control diskette 2-7, A-1
  - See also diskettes
- Control Extension diskette A-1
  - See also diskettes
- control program microcode 1-8
- controller
  - See also 3174
  - customizing utilities 1-8
  - models and features, 3174 1-1
  - operation verification, set up 2-1
  - relocating 6-1
- cover, front decorative panel removal 1-12
- Customer Problem Determination Guide 1-8
- customer setup instructions
  - See setting up controller
- customizing 1-8
  - utilities 1-8

## D

- data transfer indicator 1-13
- DC power indicator 1-12
- decorative panel removal 1-12
- description, 3174
  - See general description, 3174
- descriptions, 3174 model 1-1
- diagnostics 1-8, 1-13
  - See also problem solving
- different microcode load, how to 4-3
- different microcode version 4-3
- directly connected address 3-1
- directly connected terminals 3-1

- diskettes
  - AEA A-1, A-3
  - Alt 1 IML testing procedure from 5-5
  - Control 2-7, A-1
  - Control Extension diskette A-1
  - description of A-1
  - Downstream Load A-1
  - drive A-1
  - drives 1-1
  - handling A-2
  - introduction to A-3
  - Limited Function Utility A-1
  - operations with 1-8, A-3
  - RPQ A-1
  - second diskette drive 1-3
  - shipping A-3
  - storage of A-3
  - Utility 1-13, 2-7, A-1
- display stations
  - See terminal
- Downstream Load (DSL) diskette A-1
- Downstream Load terminals 1-1, 1-3
- drive, diskette
  - See diskettes
- drive(s), fixed (hard) disk
  - See fixed disk

## E

- EIA communication cable and connector 5-14
- EIA concurrent communication cable and connector 5-12
- EIA V.35
  - See Type 1 Communication Adapter (EIA/V.35)
- Enter pushbutton 1-14
- Enterprise Systems Connection (ESCON) Adapter (HG17) 1-6
- ESCON Adapter wrap test 5-16
- establishment controller models, 3174 1-1
- Ethernet Adapter
  - 3174 connection to Ethernet network 1-3
  - cable relocation 6-5
  - description 1-6
  - hardware group number 1-6
  - wrap test 5-17
- Ethernet Adapter wrap test 5-17
- expansion cards, storage 1-3

## F

- features, 3174 1-3
- Fiber Optic Terminal Adapter (HG26 or 27) 1-3, 1-6
  - cable connection 2-12
- fixed disk 1-1, 1-3
  - Alt 1 IML testing procedure from 5-6
  - operations with 1-8



- forcing the Model 21H offline 4-4
- forcing the Model 21L offline 4-4
- free function 5-4
- front decorative panel removal 1-12
- front view 1-9
  - panels 1-9

## G

- gateway feature, Token-Ring network 1-4
- general description, 3174
  - 3174 diskettes A-1
  - features 1-3
  - hardware group numbers 1-5
  - making operational 4-1
  - models and features 1-1
  - overview, 3174 1-1
  - relocating the 3174 6-1
  - sample configuration diagram 3-2
    - 3270 Port Expansion Feature, with 3-7
    - ASCII terminals 3-9
- group numbers, 3174 adapter hardware
  - See hardware group (HG) numbers

## H

- handling diskettes A-2
- hard disk
  - See fixed disk
- hardware group (HG) numbers
  - 3174 adapter 1-5
  - Asynchronous Emulation Adapter (HG21, 22, or 23) 1-5
  - Channel Adapter (HG16) 1-5
  - Communication Adapter (HG11) 1-5
  - Concurrent Communication Adapter (HG51 or 52) 1-5
  - Enterprise Systems Connection Adapter (HG17) 1-6
  - Ethernet Adapter 1-6
  - Fiber Optic Terminal Adapter (HG26 or 27) 1-6
  - ISDN Adapter (HG36, 37, 38 or 39) 1-6
  - Terminal Adapter (HG26 or 27) 1-6
  - Terminal Multiplexer Adapter (HG26 or 27) 1-6
  - Token-Ring Adapter (HG31) 1-7
- HG numbers
  - See hardware group (HG) numbers

## I

- IML
  - 3174 testing procedure, Alt 1 5-4
    - from diskette 5-5
    - from fixed disk 5-6
  - 3174 testing procedure, Alt 2 5-4
  - 3174, how to 4-2, 4-3
    - with power off 4-2

- IML (*continued*)
  - adapter testing procedure 5-4
    - from diskette 5-8
    - from fixed disk 5-9
  - Alt 1 1-13
  - Alt 2 1-13
  - normal 4-1
  - procedure 4-1
  - pushbutton 1-14
  - re-IML 4-1
  - sequence for 1-12
- indicators 1-9, 1-12
  - check condition 1-13
  - data transfer 1-13
  - DC power 1-12
  - offline 1-13, 4-4
  - status 1-13
- indirectly connected address 3-1
- information panel, 3290 1-1
- initial microcode load
  - See IML
- installation 2-1
  - See also setting up controller
  - feature installation 1-13
- instructions, relocation 6-1
- instructions, set up
  - See setting up controller
- ISDN Adapter
  - description 1-3
  - hardware group number 1-6
  - problem determination 5-3, 5-18—5-20
- ISDN Adapter and cable test 5-18
- ISDN Network terminator (NT1) 5-18
- items shipped 2-1

## K

- keypad, numeric 1-13

## L

- Limited Function Utility (LFU) diskette A-1

## M

- master menu 1-13
- microcode
  - control program 1-8
  - on hard (fixed) disk 1-1
- microcode, how to load different 4-3
- model descriptions 1-2
- modem 1-3
- moving, instructions for
  - See relocating controller

## N

NetView Distribution Manager 4-1  
  remote IML 4-1  
normal IML 4-1  
NT1 5-18  
numbers, 3174 adapter hardware group  
  See hardware group (HG) numbers  
numeric keypad 1-13

## O

offline mode  
  forcing Model 21H offline 4-4  
  indicator 4-4  
  problem solving 5-1  
  problem solving and testing 4-4  
  taking Model 22L offline 4-5  
  taking offline 4-4  
  tests 5-4  
online, 3174 placing 4-1  
operations  
  making the 3174 operational 4-1  
  with diskettes or fixed disks 1-8, A-3  
operator panel 1-12

## P

panel, operator 1-12  
panels 1-9  
port addresses  
  See terminal port addresses  
port number (PN) 1-5  
power 1-12  
  indicator 1-12  
  DC 1-12  
  on/off 1-12, 4-4  
  panel 1-12  
  switches 1-12  
printers  
  See terminal  
priority switches 1-14  
problem determination  
  See problem solving  
Problem Determination Guide, Customer 1-8  
problem solving 1-14, 5-1  
  See also diagnostics  
  AEA wrap test 5-10  
  Alt 1 IML testing procedure 5-4  
    from diskette 5-5  
    from fixed disk 5-6  
  Alt 2 IML 1-13  
  Alt 2 IML testing procedure 5-4  
  Communication Adapter and cable test 5-14  
  Concurrent Communication Adapter and cable  
  test 5-12  
  continue function 5-4

problem solving (*continued*)  
  ESCON Adapter wrap test 5-16  
  Ethernet Adapter and cable test 5-17  
  free function 5-4  
  ISDN Adapter and cable test 5-18  
  offline tests 5-4  
  Token-Ring Adapter test 5-21  
pushbutton  
  Advance 1-13  
  Alt 1 1-13  
  Alt 2 1-13  
  Clear 1-13  
  Enter 1-14  
  IML 1-14  
putting Model 22L online 4-5

## R

re-IML 4-1  
rear view 1-9  
  panels 1-9  
relocating controller 6-1  
  instructions 6-1  
  packing 6-1  
  scheduling 6-1  
  site preparation 6-1  
  Token-Ring cable 6-3  
remote IML 4-1  
removal, decorative panel 1-12  
RPQ diskettes A-1

## S

setting up controller  
  CAUTION notices 2-7  
  Control diskette 2-7  
  instructions 2-1  
  list of shipped items 2-1  
  relocating the 3174 6-1  
  steps in sequence 2-3  
  Utility diskette 2-7  
shipping diskettes A-3  
site planning  
  relocation 6-1  
site preparation  
  See site planning  
status codes  
  Advance pushbutton 1-13  
  reference to 1-8  
status indicator 1-13  
storage devices and media  
  AEA A-1  
  Control A-1  
  Control Extension diskette A-1  
  description of A-1  
  diskette drive, standard 1-1

storage devices and media (*continued*)

- Downstream Load A-1
- fixed disk drive 1-1, 1-3
- handling A-2
- Limited Function Utility A-1
- operations with A-3
- RPQ A-1
- second diskette drive 1-3
- shipping A-3
- storage of A-3
- Utility A-1
- storage expansion cards 1-3
- switches 1-9
  - channel interface 1-13
  - on/off 4-4
  - power 1-12
  - test/oper 2-5, 5-12, 5-14
- switches, priority 1-14

## T

- taking Model 21L offline 4-4
- taking Model 22L offline 4-5
- terminal
  - adapter 1-3
  - definition 1-1
  - Downstream Load 1-1, 1-3
- Terminal Adapter connectors 2-11
- terminal direct-connect cabling worksheet 10 3-6
- Terminal Multiplexer Adapter
  - attachment of terminals via 1-1
  - cabling worksheet 8A 3-3
  - cabling worksheet 8E 3-8
  - functions and features 1-3
- Terminal Multiplexer Adapter (HG26 or 27) 1-6
- terminal port addresses 3-1
  - directly connected 3-1
  - indirectly connected 3-1
- terminals directly connected 3-1
- test/oper switch 2-5, 5-12, 5-14
- tests
  - Alt 1 adapter 5-4
    - from diskette 5-8
    - from fixed disk 5-9
  - Alt 1 IML 5-4
    - from diskette 5-5
    - from fixed disk 5-6
  - Alt 2 IML 5-4
  - Communication Adapter and cable 5-14
  - Concurrent Communication Adapter and cable 5-12
  - Ethernet Adapter and cable 5-17
  - ISDN Adapter and cable 5-18
  - offline 1-8, 5-4
  - online 1-8
  - Token-Ring Adapter 5-21
  - wrap, Asynchronous Emulation Adapter 5-10

tests (*continued*)

- wrap, ESCON Adapter 5-16
- TMA
  - See Terminal Multiplexer Adapter
- Token-Ring network
  - adapter 1-7
  - adapter test 5-21
  - cable relocation 6-3
  - gateway feature 1-4
- troubleshooting
  - See problem solving
- turning controller on or off 1-12
- Type 1 Communication Adapter (EIA/V.35)
  - CCA cable and connector 5-12
  - communication cable and connector 5-14
- Type 2 Communication Adapter (X.21)
  - CCA cable and connector 5-12
  - communication cable and connector 5-14

## U

- utilities
  - customizing 1-8
- Utility diskette 1-13, 2-7, A-1
  - See also diskettes

## V

- V.35
  - See Type 1 Communication Adapter (EIA/V.35)
- views, panels 1-9

## W

- worksheets 3-3
  - 10, terminal direct-connect cabling 3-6
  - 11A, AEA (ASCII connection) cabling 3-10
  - 8A, TMA cabling 3-3
  - 8E, TMA cabling from the 3270 Port Expansion Feature 3-8
  - 9C, 3299 cabling 3-4
- wrap test
  - Asynchronous Emulation Adapter 5-10
  - ESCON Adapter 5-16
  - Ethernet Adapter 5-17

## X

- X.21
  - See Type 2 Communication Adapter (X.21)
- X.25
  - See Type 1 Communication Adapter (EIA/V.35)



Cut or Fold  
Along Line

Reader's Comments  
GA27-3874-04

# TELL US WHAT YOU THINK!

We hope you find this publication useful, readable, and technically accurate, but only you can tell us!

Your comments and suggestions will help us improve our technical publications.

Please take a few minutes to let us know what you think by completing this form.

If you are in the U.S.A., you may mail this form postage free or FAX it to us at 1-800-253-3520. (Elsewhere, your local IBM branch office or representative will forward your comments or you may mail directly to the address below.)

Fold and Tape

Please do not staple

Fold and Tape



NO POSTAGE  
NECESSARY  
IF MAILED IN THE  
UNITED STATES

## BUSINESS REPLY MAIL

FIRST CLASS MAIL PERMIT NO. 40 ARMONK, NEW YORK

POSTAGE WILL BE PAID BY ADDRESSEE

Department E02  
Design & Information Development  
International Business Machines Corporation  
P O BOX 12195  
RESEARCH TRIANGLE PARK NC 27709-9990

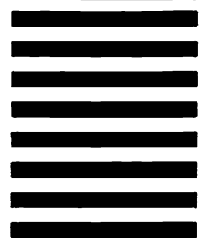

Fold and Tape

Please do not staple

Fold and Tape

# FAX or MAIL 1-(800)-253-3520

Cut or Fold  
Along Line

GA27-3874-04

# TELL US

3174 Establishment Controller  
Models 21H, 21L, 21R, 22L, 22R, 23R, and 24R  
User's Guide Setting Up the 3174 Making the 3174  
Operational Solving Problems  
GA27-3874-04

Specific Problems and Comments:

---

---

---

---

---

---

	Strongly Agree	Agree	Neutral	Disagree	Strongly Disagree
Overall, I am satisfied with this publication.	<input type="checkbox"/>	<input type="checkbox"/>	<input type="checkbox"/>	<input type="checkbox"/>	<input type="checkbox"/>
The information in this publication is technically accurate.	<input type="checkbox"/>	<input type="checkbox"/>	<input type="checkbox"/>	<input type="checkbox"/>	<input type="checkbox"/>
The procedures in this publication are easy to follow.	<input type="checkbox"/>	<input type="checkbox"/>	<input type="checkbox"/>	<input type="checkbox"/>	<input type="checkbox"/>
This publication contains all the information I need.	<input type="checkbox"/>	<input type="checkbox"/>	<input type="checkbox"/>	<input type="checkbox"/>	<input type="checkbox"/>
Specific items of information are easy to find.	<input type="checkbox"/>	<input type="checkbox"/>	<input type="checkbox"/>	<input type="checkbox"/>	<input type="checkbox"/>
The figures and tables are easy to understand.	<input type="checkbox"/>	<input type="checkbox"/>	<input type="checkbox"/>	<input type="checkbox"/>	<input type="checkbox"/>
The examples are helpful and useful.	<input type="checkbox"/>	<input type="checkbox"/>	<input type="checkbox"/>	<input type="checkbox"/>	<input type="checkbox"/>
The layout and format are attractive and useful.	<input type="checkbox"/>	<input type="checkbox"/>	<input type="checkbox"/>	<input type="checkbox"/>	<input type="checkbox"/>

What do you like most about this publication? \_\_\_\_\_

How can this publication be improved? \_\_\_\_\_

What similar publications, if any, do you think are better than this publication? (IBM or other) \_\_\_\_\_

## For a Reply, Complete the Following—

Name \_\_\_\_\_ Company \_\_\_\_\_  
Occupation \_\_\_\_\_ Address \_\_\_\_\_  
Phone \_\_\_\_\_  
FAX \_\_\_\_\_

Thank you for your response. When you send information to IBM, you grant IBM the right to use or distribute the information without incurring any obligation to you. You of course retain the right to use the information in any way you choose.



FAX or MAIL 1-(800)-253-3520

Cut or Fold  
Along Line

Reader's Comments  
GA27-3874-04

# TELL US WHAT YOU THINK!

We hope you find this publication useful, readable, and technically accurate, but only you can tell us!

Your comments and suggestions will help us improve our technical publications.

Please take a few minutes to let us know what you think by completing this form.

If you are in the U.S.A., you may mail this form postage free or FAX it to us at 1-800-253-3520. (Elsewhere, your local IBM branch office or representative will forward your comments or you may mail directly to the address below.)

Fold and Tape

Please do not staple

Fold and Tape



NO POSTAGE  
NECESSARY  
IF MAILED IN THE  
UNITED STATES

## BUSINESS REPLY MAIL

FIRST CLASS MAIL PERMIT NO. 40 ARMONK, NEW YORK

POSTAGE WILL BE PAID BY ADDRESSEE

Department E02  
Design & Information Development  
International Business Machines Corporation  
P O BOX 12195  
RESEARCH TRIANGLE PARK NC 27709-9990

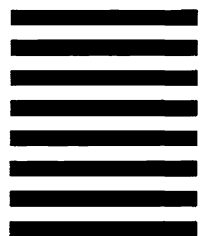

Fold and Tape

Please do not staple

Fold and Tape

# FAX or MAIL 1-(800)-253-3520

Cut or Fold  
Along Line

GA27-3874-04

# TELL US

3174 Establishment Controller  
Models 21H, 21L, 21R, 22L, 22R, 23R, and 24R  
User's Guide Setting Up the 3174 Making the 3174  
Operational Solving Problems  
GA27-3874-04

Specific Problems and Comments:

---

---

---

---

---

---

	Strongly Agree	Agree	Neutral	Disagree	Strongly Disagree
Overall, I am satisfied with this publication.	<input type="checkbox"/>	<input type="checkbox"/>	<input type="checkbox"/>	<input type="checkbox"/>	<input type="checkbox"/>
The information in this publication is technically accurate.	<input type="checkbox"/>	<input type="checkbox"/>	<input type="checkbox"/>	<input type="checkbox"/>	<input type="checkbox"/>
The procedures in this publication are easy to follow.	<input type="checkbox"/>	<input type="checkbox"/>	<input type="checkbox"/>	<input type="checkbox"/>	<input type="checkbox"/>
This publication contains all the information I need.	<input type="checkbox"/>	<input type="checkbox"/>	<input type="checkbox"/>	<input type="checkbox"/>	<input type="checkbox"/>
Specific items of information are easy to find.	<input type="checkbox"/>	<input type="checkbox"/>	<input type="checkbox"/>	<input type="checkbox"/>	<input type="checkbox"/>
The figures and tables are easy to understand.	<input type="checkbox"/>	<input type="checkbox"/>	<input type="checkbox"/>	<input type="checkbox"/>	<input type="checkbox"/>
The examples are helpful and useful.	<input type="checkbox"/>	<input type="checkbox"/>	<input type="checkbox"/>	<input type="checkbox"/>	<input type="checkbox"/>
The layout and format are attractive and useful.	<input type="checkbox"/>	<input type="checkbox"/>	<input type="checkbox"/>	<input type="checkbox"/>	<input type="checkbox"/>

What do you like most about this publication? \_\_\_\_\_

How can this publication be improved? \_\_\_\_\_

What similar publications, if any, do you think are better than this publication? (IBM or other) \_\_\_\_\_

## For a Reply, Complete the Following—

Name \_\_\_\_\_ Company \_\_\_\_\_  
Occupation \_\_\_\_\_ Address \_\_\_\_\_  
Phone \_\_\_\_\_  
FAX \_\_\_\_\_

Thank you for your response. When you send information to IBM, you grant IBM the right to use or distribute the information without incurring any obligation to you. You of course retain the right to use the information in any way you choose.



**FAX or MAIL 1-(800)-253-3520**



# TELL US WHAT YOU THINK!

We hope you find this publication useful, readable, and technically accurate, but only you can tell us!

Your comments and suggestions will help us improve our technical publications.

Please take a few minutes to let us know what you think by completing this form.

If you are in the U.S.A., you may mail this form postage free or FAX it to us at 1-800-253-3520. (Elsewhere, your local IBM branch office or representative will forward your comments or you may mail directly to the address below.)

Fold and Tape

Please do not staple

Fold and Tape



NO POSTAGE  
NECESSARY  
IF MAILED IN THE  
UNITED STATES

## BUSINESS REPLY MAIL

FIRST CLASS MAIL PERMIT NO. 40 ARMONK, NEW YORK

POSTAGE WILL BE PAID BY ADDRESSEE

Department E02  
Design & Information Development  
International Business Machines Corporation  
P O BOX 12195  
RESEARCH TRIANGLE PARK NC 27709-9990

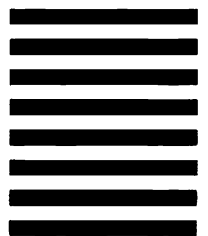

Fold and Tape

Please do not staple

Fold and Tape

# FAX or MAIL 1-(800)-253-3520

Cut or Fold  
Along Line

Cut or Fold  
Along Line

# TELL US

Specific Problems and Comments:

3174 Establishment Controller  
Models 21H, 21L, 21R, 22L, 22R, 23R, and 24R  
User's Guide Setting Up the 3174 Making the 3174  
Operational Solving Problems  
GA27-3874-04

---

---

---

---

---

---

	Strongly Agree	Agree	Neutral	Disagree	Strongly Disagree
Overall, I am satisfied with this publication.	<input type="checkbox"/>	<input type="checkbox"/>	<input type="checkbox"/>	<input type="checkbox"/>	<input type="checkbox"/>
The information in this publication is technically accurate.	<input type="checkbox"/>	<input type="checkbox"/>	<input type="checkbox"/>	<input type="checkbox"/>	<input type="checkbox"/>
The procedures in this publication are easy to follow.	<input type="checkbox"/>	<input type="checkbox"/>	<input type="checkbox"/>	<input type="checkbox"/>	<input type="checkbox"/>
This publication contains all the information I need.	<input type="checkbox"/>	<input type="checkbox"/>	<input type="checkbox"/>	<input type="checkbox"/>	<input type="checkbox"/>
Specific items of information are easy to find.	<input type="checkbox"/>	<input type="checkbox"/>	<input type="checkbox"/>	<input type="checkbox"/>	<input type="checkbox"/>
The figures and tables are easy to understand.	<input type="checkbox"/>	<input type="checkbox"/>	<input type="checkbox"/>	<input type="checkbox"/>	<input type="checkbox"/>
The examples are helpful and useful.	<input type="checkbox"/>	<input type="checkbox"/>	<input type="checkbox"/>	<input type="checkbox"/>	<input type="checkbox"/>
The layout and format are attractive and useful.	<input type="checkbox"/>	<input type="checkbox"/>	<input type="checkbox"/>	<input type="checkbox"/>	<input type="checkbox"/>

What do you like most about this publication? \_\_\_\_\_

How can this publication be improved? \_\_\_\_\_

What similar publications, if any, do you think are better than this publication? (IBM or other) \_\_\_\_\_

## For a Reply, Complete the Following—

Name \_\_\_\_\_ Company \_\_\_\_\_  
Occupation \_\_\_\_\_ Address \_\_\_\_\_  
Phone \_\_\_\_\_  
FAX \_\_\_\_\_

Thank you for your response. When you send information to IBM, you grant IBM the right to use or distribute the information without incurring any obligation to you. You of course retain the right to use the information in any way you choose.



FAX or MAIL 1-(800)-253-3520





Part Number: 39F9540  
File Number: 36/38/370/4300/8100/3174-09



Printed in the United States of America  
on recycled paper containing 10%  
recovered post-consumer fiber



GA27-3874-04

