

GA27-2827-4
File No. S360/S370/S3-09

Systems

**IBM 3270
Information Display System
3274 Control Unit
Planning, Setup, and
Customizing Guide**

IBM

GA27-2827-4
File No. S360/S370/S3-09

Systems

**IBM 3270
Information Display System
3274 Control Unit
Planning, Setup, and
Customizing Guide**

IBM

Fifth Edition (November 1978)

This manual obsoletes *IBM 3270 Information Display System Planning and Setup Guide*, GA27-2827-3. This manual revises the 3274 Control Unit planning, setup, and customizing information formerly in GA27-2827-3. It also includes planning and setup information for the 3278 Display Station, 3287 Printer, and 3289 Line Printer. Planning and setup information for the 3276 Control Unit Display Station has been revised and is now in a separate manual *IBM 3270 Information Display System, IBM 3276 Control Unit Display Station Planning and Setup Guide*, GA18-2041.

This publication is for planning only. Changes are periodically made to the information herein. Before using this publication in connection with the operation of IBM systems or equipment, consult your IBM sales representative, or the latest *IBM System/360 Bibliography*, GC20-0360, or the *IBM System/370 Bibliography*, GC20-0001, for the editions that are applicable and current.

Requests for the latest copies of IBM publications should be made to your IBM representative or to the IBM Branch Office serving your locality.

Some of the devices, options, and features listed in this publication may not be available in every locale. Consult your local IBM marketing representative for information about product availability.

A form has been provided at the back of this publication for readers' comments. Address additional comments to IBM Corporation, Department 63T, Neighborhood Road, Kingston, New York 12401. IBM may use or distribute any of the information you supply in any way it believes appropriate without incurring any obligations whatever. You may, of course, continue to use the information you supply.

**Summary of Amendments (November 30, 1978)
to GA27-2827-3 by Revision GA27-2827-4**

This edition contains the following significant changes from the previous edition:

1. The manual has been reorganized (see "Preface"). The sequence numbers are grouped by 3274 model.
2. Information about the 3276 Control Unit Display Station has been removed. This information can now be found in a separate manual (see "Preface").
3. The following sequence numbers are added to the customizing process; each requires a 1-digit (0 or 1) response:
 - 134 – APL Keyboard (Models 1A, 1C, and 1D)
 - 135 – Text Keyboard (Models 1A, 1C, and 1D)
 - 141 – Magnetic Slot Reader
 - 143 – Host-Loadable Printer Authorization Matrix
 - 145 – 3289 Text Print Control
 - 147 – Local Copy Function (Models 1C and 1D)
 - 211 – SCS Support (Models 1A and 1C)
 - 213 – Between Bracket Printer Sharing (Models 1A and 1C)
 - 343 – DDSA feature (Model 1C)
 - 352 – Encrypt/Decrypt feature (Model 1C)
4. The term "Documentation Level", entered as the last two digits in response to sequence number 001 (Keyboard Validation), has been renamed "Validation Number".
5. Appendix C has been added to describe the use of the printer authorization matrix. This appendix also includes an example of how to prepare a Printer Authorization Matrix Form.

Preface

This guide is written for customers, planners, and IBM representatives who may be responsible for:

- Planning the installation and customizing of the IBM 3274 Control Unit Models 1A, 1B, and 1D
- Planning the installation, setup, and customizing of the IBM 3274 Control Unit Model 1C
- Planning the installation and set of the IBM 3278 Display Station, 3287 Printer, and 3289 Line Printer

This guide is organized as follows:

Chapter 1, "Planning and Setup," provides planning and setup information for:

IBM 3274 Control Unit

IBM 3278 Control Unit Display Station

IBM 3287 Printer

IBM 3289 Line Printer

Chapter 2, "Introduction to Customizing," describes how and by whom the 3274 customizing procedure is performed.

Chapter 3, "Preparing to Customize," describes the sequence numbers used in the 3274 customizing procedure. The sequence numbers are grouped by 3274 model number.

Chapter 4, "Initial Customizing Procedure," describes how to perform the initial customizing of the 3274.

Chapter 5, "Modification Procedure," describes how a 3274 configuration can be modified without performing the entire customizing procedure.

Chapter 6, "Backup System Diskette Generation Procedure," describes how to generate a backup (duplicate) system diskette.

Chapter 7, "Update-Diskette Installation Procedure," describes how to install an update-diskette in your 3274.

Appendix A, "Planning Checklist," provides a suggested checklist to help you plan your installation.

Appendix B, "3274 Device Cables," provides cable attachment information, and also channel attachment information for the 3274 Models 1A, 1B, and 1D.

Appendix C describes the use of the Printer Authorization Matrix.

For detailed information about the functions and features of the above 3270 Information Display System units, see the latest editions of:

An introduction to the IBM 3270 Information Display System, GA27-2739

IBM 3270 Information Display System: Component Description, GA27-2749

IBM 3270 Information Display System: Installation Manual – Physical Planning, GA27-2787

IBM 3270 Information Display System: Configurator, GA27-2849

IBM 3274 Control Unit Operator's Guide, GA23-0023

IBM 3278 Display Station Operator's Guide, GA27-2890

IBM Cryptographic Subsystem Concepts and Facilities, GC22-9063

An Introduction to the IBM Data Analysis – APL feature, GA27-2788

See Figures P-1 through P-5 for other manuals that may help you plan your installation.

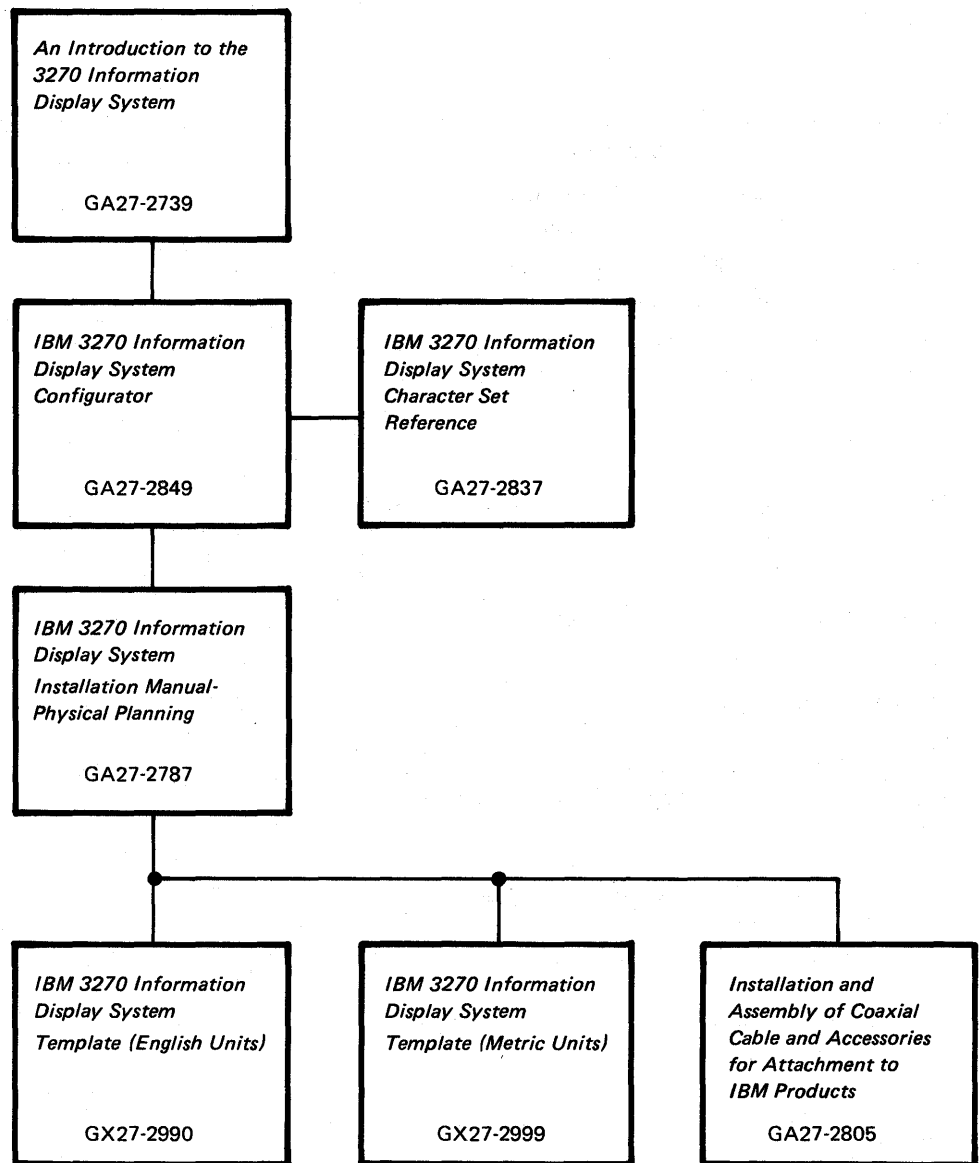
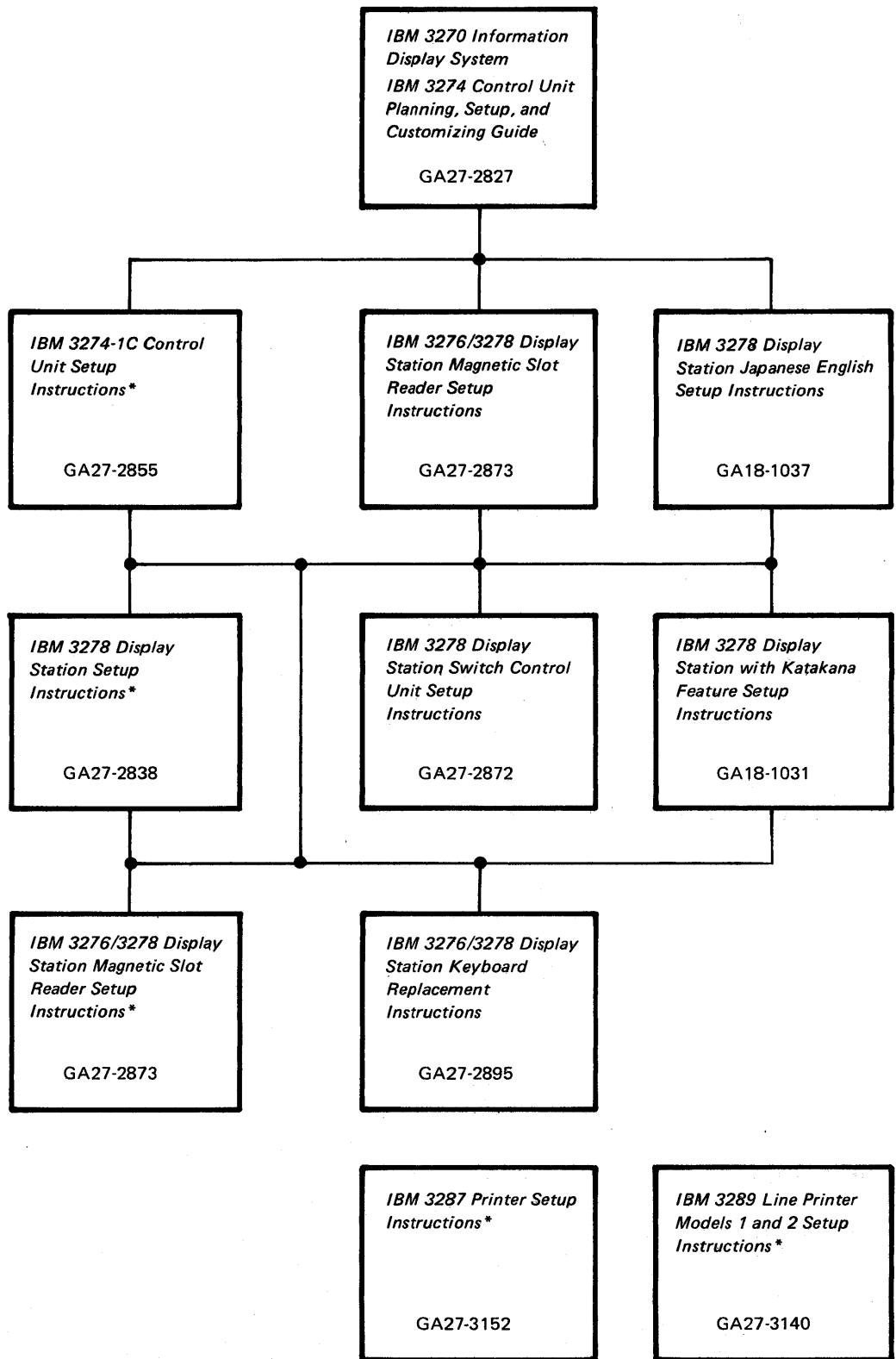

Figure P-1. General Information and Installation Manuals



**Will be delivered with the indicated machine.*

Figure P-2. Customer Setup Manuals

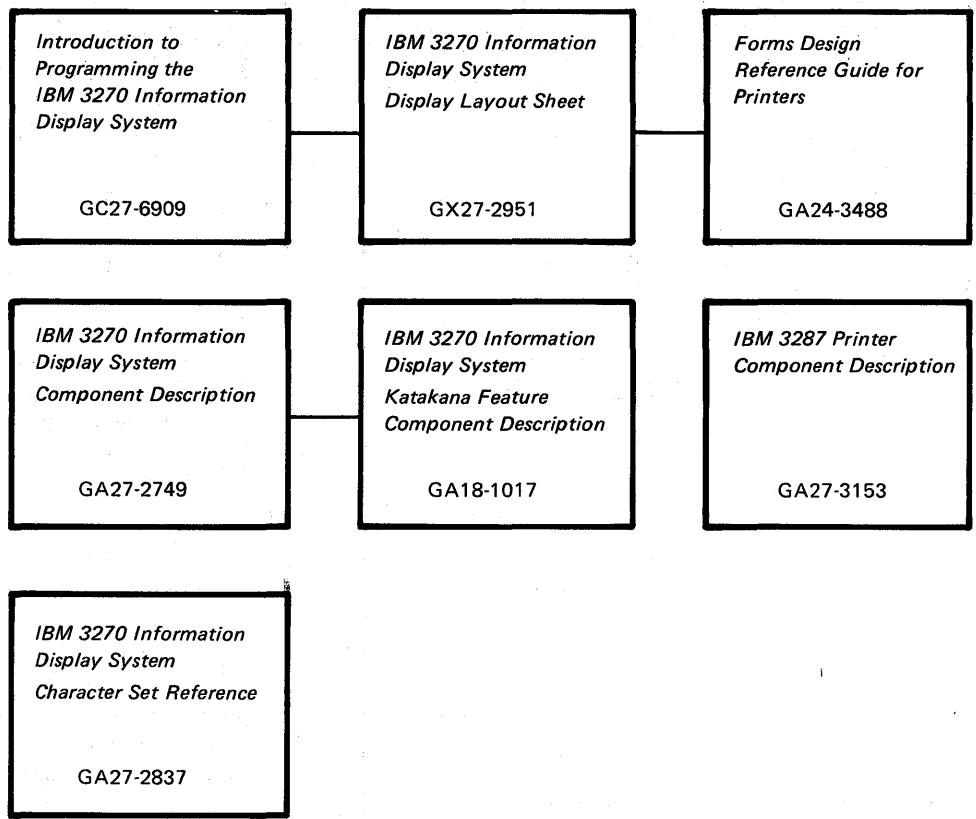

Figure P-3. Programming Manuals

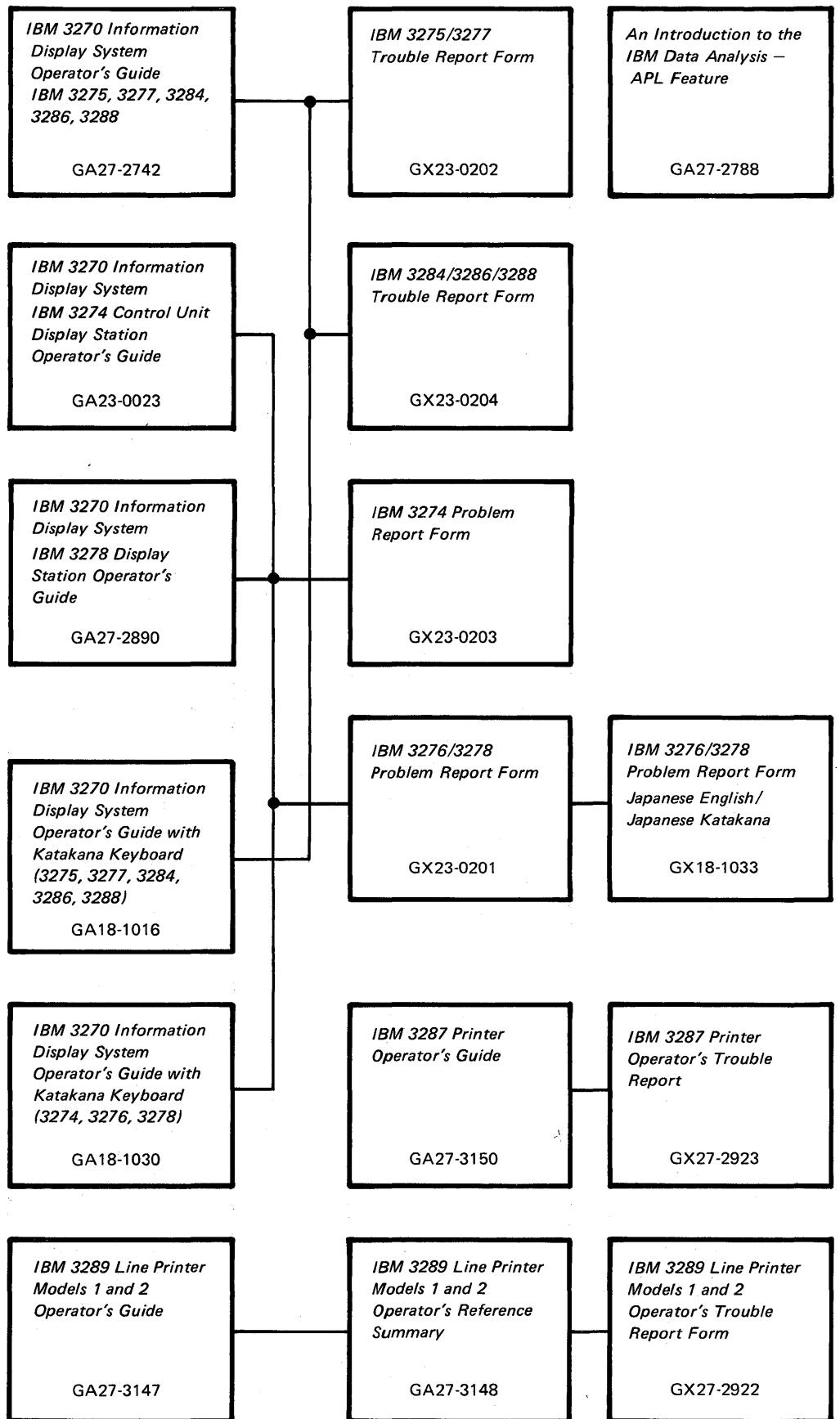
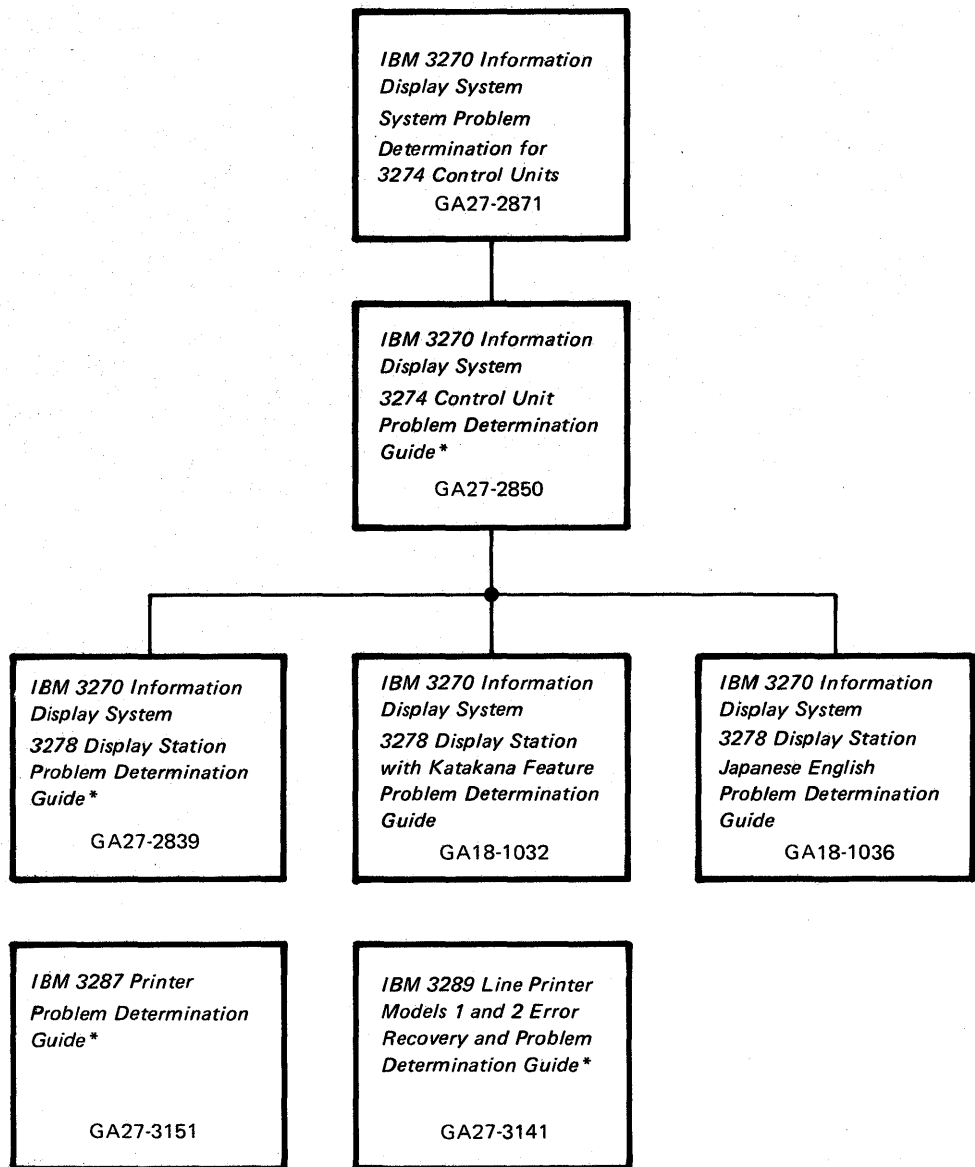

Figure P-4. Operator's Manuals



** Will be delivered with the indicated machine.*

Figure P-5. Problem Determination Manuals

Contents

Chapter 1. Planning and Setup	1-1
Introduction	1-1
3274 Cluster Unit Descriptions	1-1
Configuration Planning	1-2
System Planning	1-2
Site Preparation	1-2
Communication Services (3274-1C)	1-3
Local Channel Attachment (3274-1A, 1B, and 1D)	1-3
Programming Support	1-4
Encrypt/Decrypt Feature (3274 Model 1C Only)	1-4
Pre-Delivery Planning	1-5
3274-1A/1B/1D to Local Channel Cables	1-5
3274-1C Communication Cable	1-5
3274-1C System Grounding	1-5
3274 Device Cables	1-5
3274 Cluster Network Address Labels	1-6
3274 Customizing	1-6
Setup Procedures	1-7
3274-1C Setup Procedures	1-8
3278 Setup Procedures	1-8
3287 and 3289 Setup Procedures	1-8
Replacing a 3271 or a 3272 with a 3274	1-8
Problem Determination Procedures	1-9
Relocation/Removal	1-10
Progress Review	1-10
IBM Americas/Far East and IBM Europe/Middle East/Africa	1-10
Supplemental Information	1-10
Safety	1-10
Security	1-11
Personnel Training	1-11
Supplies	1-11
Voice Communication between 3274 Cluster Operators and Host System Operators	1-11
Reference Manuals	1-11
Chapter 2. Introduction to Customizing	2-1
Chapter 3. Preparing to Customize	3-1
3274 Model 1A Customizing	3-3
001 Keyboard Validation	3-3
011 Patch Request	3-3
021 Printer Authorization Matrix	3-3
022 Printer Authorization Matrix Specification	3-3
031 RPQ Diskettes Required	3-4
111 Number of Category B Terminals	3-4
112 Number of Category A Terminals	3-5
113 Extended Function Store	3-5
121 Keyboard/Character Set Language	3-6
131 Typewriter Keyboard	3-6
132 Data Entry Keyboard	3-6
133 Data Entry Keypunch Layout Keyboard	3-6
134 APL Keyboard	3-7
135 Test Keyboard	3-7
141 Magnetic Slot Reader	3-7
143 Host-Loadable Printer Authorization Matrix	3-7
145 3289 Text Print Control	3-7
147 3-7	
151 3274 Model Designation	3-7
201 Control Unit Address	3-7
211 SCS Support	3-7
213 Between Bracket Printer Sharing	3-7
301 3-7	
302 3-7	
310 through 352	3-7
900 Entry Acceptance	
901 Printer Authorization Matrix Acceptance	3-8
999 Modify Procedure	3-8
3274 Models 1B and 1D	3-9
001 Keyboard Validation	3-9
011 Patch Request	3-9
021 Printer Authorization Matrix	3-9
022 Printer Authorization Matrix Specification	3-9
031 RPQ Diskettes Required	3-10
111 Number of Category B Terminals	3-10
112 Number of Category A Terminals	3-12
113 Extended Function Store	3-12
121 Keyboard/Character Set Language	3-12
131 Typewriter Keyboard	3-12
132 Data Entry Keyboard	3-12
133 Data Entry Keypunch Layout Keyboard	3-12
134 APL Keyboard (Model 1D Only)	3-12
135 Test Keyboard (Model 1D Only)	3-12
141 Magnetic Slot Reader	3-12
143 Host-Loadable Printer Authorization Matrix	3-13
145 3289 Text Print Control	3-13
147 Local Copy Function (Model 1D Only)	3-14
151 3274 Model Designation	3-14
201 through 252	3-14
900 Entry Acceptance	3-14
901 Printer Authorization Matrix Acceptance	3-14
999 Modify Procedure	3-14
3274 Model 1C	3-15
001 Keyboard Validation	3-15
011 Patch Request	3-15
021 Printer Authorization Matrix	3-15
022 Printer Authorization Matrix Specification	3-15
031 RPQ Diskettes Required	3-16
111 Number of Category B Terminals	3-16
112 Number of Category A Terminals	3-17
113 Extended Function Store	3-17
121 Keyboard/Character Set Language	3-18
131 Typewriter Keyboard	3-18
132 Data Entry Keyboard	3-18
133 Data Entry Keypunch Layout Keyboard	3-19
134 APL Keyboard	3-19
135 Test Keyboard	3-19
141 Magnetic Slot Reader	3-19
143 Host-Loadable Printer Authorization Matrix	3-19
145 3289 Text Print Control	3-19
147 Local Copy Function (BSC Only)	3-19
151 3274 Model Designation	3-19
201 3-19	
211 SCS Support (SDLC Only)	3-19
213 Between Bracket Printer Sharing	3-19
301 Control Unit Number (BSC Only)	3-19
302 SDLC Control Unit Address	3-20
310 Modem Connection	3-20
311 Modem Wrap	3-20
313 NRZI (SDLC) or NRZ Encoding	3-21
314 Multipoint or Point-to-Point Network	3-21
317 Nonswitched or Switched-Network Backup	3-21
318 Normal or Half-Speed Transmission	3-21
321 EBCDIC or ASCII Character Set	3-21
331 BSC or SDLC Protocol	3-22
342 RTS (Request to Send) Control (2-wire or 4-wire)	3-22
343 DDSA (Dataphone** Digital Service Adapter)	3-22

**Trademark of American Telephone and Telegraph Co.

351	HPCA (SDLC Only) or CCA Adapter	3-22
352	Encrypt/Decrypt	3-22
900	Entry Acceptance	3-22
901	Printer Authorization Matrix Acceptance	3-22
999	Modify Procedure	3-22
Chapter 4. Initial Customizing Procedure 4-1		
	Initial Customizing Procedure Form	4-3
	Printer Authorization Matrix Form	4-15
Chapter 5. Modification Procedure 5-1		
	Modification Procedure Form	5-3
	Printer Authorization Matrix Form	5-15
Chapter 6. Backup System Diskette Generation Procedure 6-1		
	Backup System Diskette Form	6-3
Chapter 7. Update-Diskette Installation 7-1		
	Update-Diskette Installation Procedure for IBM 3274 Control Unit	7-3

Appendix A. Planning Checklist A-1

Appendix B. 3274 Device Cables B-1

Instructions for Completing the 3274 Device Cable Attachment Form	B-2
3274 Device Cable Attachment Procedure	B-3
3274 Device Cable Attachment Form	B-5
Channel Attachment Information Form (3274-1A, 1B, and 1D)	B-7

Appendix C. Printer Authorization Matrix C-1

The 3274 Printer Authorization Matrix	C-1
Defining the Printer Authorization Matrix During Customizing	C-3

Abbreviations Abbreviations-1

Figures

Figure P-1.	General Information and Installation Manuals	ii
Figure P-2.	Customer Setup Manuals	iii
Figure P-3.	Programming Manuals	iv
Figure P-4.	Operator's Manuals	v
Figure P-5.	Problem Determination Manuals	vi
Figure 2-1.	Configuration Information Needed	2-3
Figure 3-1.	3274 Model 1A Category A and B Terminal Quantity Relationships	3-5
Figure 3-2.	3274 Model 1A Keyboard/Character Set Languages	3-6
Figure 3-3.	3274 Models 1B and 1D Category A and B Terminal Quantity Relationships	3-11
Figure 3-4.	3274 Models 1B and 1D Keyboard/Character Set Languages	3-13
Figure 3-5.	3274 Model 1C Category A and B Terminal Quantity Relationships	3-17
Figure 3-6.	3274 Model 1C Keyboard/Character Set Languages	3-18
Figure 3-7.	BSC Polling Address/Control Unit Number Conversion Chart	3-20
Figure 4-1.	Valid Key Positions during Customizing	4-7
Figure 4-2.	Valid Key Positions during Customizing when Using Japanese Katakana and Japanese English Keyboards	4-8
Figure 4-3.	Inserting a Diskette into the 3274	4-9
Figure 4-4.	Operator Codes during Customizing	4-10
Figure 4-5.	Steady 8421 Indicator Codes during Customizing	4-11
Figure 4-6.	Flashing 8421 Indicator Codes during Customizing	4-12
Figure 4-7.	8421 Indicator Codes during IML that Result from an Incorrect Customizing Procedure	4-13
Figure 5-1.	Valid Key Positions during the Modification Procedure	5-7
Figure 5-2.	Valid Key Positions during the Modification Procedure When Using Japanese Katakana and Japanese English Keyboards	5-8
Figure 5-3.	Inserting a Diskette into the 3274	5-9
Figure 5-4.	Operator Codes during the Modification Procedure	5-10
Figure 5-5.	Steady 8421 Indicator Codes during the Modification Procedure	5-11
Figure 5-6.	Flashing 8421 Indicator Codes during the Modification Procedure	5-12
Figure 5-7.	8421 Indicator Codes during IML that Result from an Incorrect Modification Procedure	5-13
Figure 6-1.	Valid Key Positions during Backup System Diskette Generation	6-6
Figure 6-2.	Valid Key Positions during Backup System Diskette Generation When Using Japanese Katakana and Japanese English Keyboards	6-7
Figure 6-3.	Inserting a Diskette into the 3274	6-8
Figure 6-4.	Operator Codes during Backup System Diskette Generation	6-9
Figure 6-5.	Steady 8421 Indicator Codes during Backup System Diskette Generation	6-10
Figure 6-6.	Flashing 8421 Indicator Codes during Backup System Diskette Generation	6-11
Figure 6-7.	8421 Indicator Codes during IML that Result from an Incorrect Backup System Diskette Generation	6-12
Figure C-1.	Example of a Printer Authorization Matrix	C-3
Figure C-2.	Example of a Completed Printer Authorization Matrix Form	C-4
Figure C-3.	Printer Authorization Matrix Worksheet Example	C-5
Figure C-4.	Sample Printer Authorization Matrix Worksheet	C-6

Chapter 1. Planning and Setup

Introduction

This planning and setup guide will help you plan the installation of the IBM 3274 Control Unit Models 1A, 1B, and 1D and/or the setup of the following 3270 Information Display System units:

IBM 3274 Control Unit Model 1C

IBM 3278 Display Station

IBM 3287 Printer

IBM 3289 Line Printer

These units have convenient customer access areas to which your personnel can attach the cluster cables and the keyboard and feature cables.

The 3274 (all models), 3278, 3287, and 3289 units are delivered with unpacking instructions attached to an outside surface of the shipping carton. In addition to the unpacking instructions, the 3274-1C, 3278, 3287, and 3289 units have setup instructions inside the shipping carton. The unpacking instructions and the setup instructions are step-by-step procedures that describe the unpacking and setup tasks for the unit. The 3274 must also be customized for the unique cluster configuration.

Chapters 2, 3, and 4 provide the information needed to prepare for, and to customize, all models of the 3274. Included is a suggested form to use when customizing the 3274. Chapter 2 also describes the procedure for installing update diskettes sent to you from time to time by IBM. Chapter 5 provides the information and procedure to modify a system diskette. Chapter 6 provides the information and procedure to generate a backup (duplicate) system diskette. Chapter 7 provides the information needed and the procedure for installing an updated diskette package.

Using the planning information in this guide will help you to insure that your personnel can (1) unpack, position, set up, customize (3274), and check out the 3274-1C, 3278, 3287, and 3289 units, and (2) unpack, position, attach the device cables (coaxial cables that connect the 3274 to the attached units) to, and customize the 3274-1A, 1B, and 1D without the help of IBM service representatives (an IBM service representative will install the 3274-1A, 1B, and 1D). As a result, you will be able to use your new display/printer cluster at an early date. If, later, you choose to improve the work flow by relocating these units within the site, your personnel should be able to accomplish the relocation (the help of an IBM service representative is needed to relocate a 3274-1A, 1B, or 1D).

3274 Cluster Unit Descriptions

The 3274 cluster consists of an IBM 3274 Control Unit with attached display stations and/or printers.

For detailed information about the functions and features of the 3274 and the units that can be attached to the 3274, see the latest editions of:

An Introduction to the IBM 3270 Information Display System, GA27-2739

IBM 3270 Information Display System: Component Description, GA27-2749

IBM 3270 Information Display System Character Set Reference, GA27-2837

Configuration Planning

To plan the configuration of the 3274 and the attached units, use the appropriate (U.S., Americas/Far East, or Europe/Middle East/Africa) Configuration Tables in *IBM 3270 Information Display System: Configurator*, GA27-2849. These tables will help you determine which feature codes are needed to:

- Connect the:
 - a. 3274-1A, 1B, or 1D to a host system through a local channel.
 - b. 3274-1C to a host system through communication facilities.
- Provide the required quantity of 3274 terminal adapters.
- Provide feature compatibility among the individual units.

The tables also indicate necessary features, optional features, prerequisite features, and features that cannot coexist.

System Planning

The following tasks should be planned so that they can be accomplished in a timely manner:

- Site preparation for the 3274 clusters
- Communication facilities preparation for 3274-1C
- Host system channel preparation for 3274-1A, 1B, and 1D
- Programming support preparation
- 3274 pre-delivery planning activities

It may be useful to designate to a person in your organization the responsibility of ensuring that all these tasks are planned. The Planning Checklist in Appendix A of this guide contains the events, in a suggested sequence, that should be planned in order to install a 3274-1A, 1B, or 1D and/or set up a 3274-1C and the attached units for the first time; it, therefore, contains more detail than is required for adding to or replacing an existing display/printer system. In either case, each event should be carefully considered so that installing the 3274-1A, 1B, or 1D and/or setting up the 3274-1C and the attached units is problem-free.

Site Preparation

The specifications for all physical requirements of the 3274, 3278, 3287, and 3289 units are given in *IBM 3270 Information Display System: Installation Manual – Physical Planning*, GA27-2787.

This guide will help you provide compatibility between these units and the following:

- Work space considerations
- Electrical requirements
- Cable requirements and installation
- Power cord plug requirements
- Environmental requirements

Communication Services (3274-1C)

Arrangements need to be made for the installation of the communication facilities between the 3274-1C and the host communication unit/adaptor. There must be compatibility between the 3274-1C, the modems, the communication line, and the communication unit/adaptor; for example, line speed, duplex or half-duplex facilities, and NRZ (non-return to zero) or NRZI (non-return to zero inverted).

Compatibility among these components is a major consideration in new installations. To reduce delays caused by incompatibility, it is recommended that you request assistance from your communications representative and from your IBM representative to determine whether the 3274-1C, modems, communication line, and communication unit/adaptor are compatible. In addition, schedules should be established to ensure that the modems, communication line, and communication unit/adaptor are installed and tested before delivery of the 3274-1C and the attached units.

Local Channel Attachment (3274-1A, 1B, and 1D)

A plan needs to be established for the changes that are required to your host system selector, multiplexer, or block multiplexer channel configuration; considerations should include device priorities, device data rates, device addresses, I/O interface cable lengths, and changes to the sequence and control (power sequencing and emergency power off) cables.

The Channel Attachment Information Form in Appendix B should be completed before the 3274 is delivered. This information will be required by the IBM service representative at the time of installation. The following information will assist you in completing the form. For further information, see the *IBM System/370 Installation Manual – Physical Planning*, GC22-7004. The 3274-1A, 1B, and 1D may be attached to a byte multiplexer, block multiplexer, or selector channel. In most cases the choice of channel attachment depends on system considerations such as channel utilization rather than 3274 operation.

Selector or Block Multiplexer Channel (Non-Byte Mode Operation): If you choose to attach the 3274-1A, 1B, or 1D to a block multiplexer or selector channel, the following options should be selected:

1. Select the 100Kb data rate (Model 1A only).
2. Select burst mode for Model 1A. No selection is required for Models 1B and 1D.
3. Select the priority that will produce the greatest channel efficiency with other attached devices. Factory wiring of high priority is recommended.

The 3274-1A, 1B, and 1D are designed to operate with disconnect command chaining (DCC). Therefore, they will provide greater channel efficiency on a block multiplexer channel than on a selector channel.

Byte Multiplexer Channel (Byte Mode Operation): If you choose to attach the 3274-1A, 1B, or 1D to a byte multiplexer channel, the following considerations and selections should be made:

1. a. Select byte mode for Model 1A.
b. Select burst mode for Models 1B and 1D only if the 3274 is the only device on the channel. In all other cases select byte mode.
2. Select a priority that is below all overrunable devices on the channel. This can be accomplished by channel cabling between devices and/or the channel priority options.

3. On the Model 1A, select the data rate that will produce maximum channel utilization with other devices attached to the same channel. There is no data rate selection option on the Models 1B and 1D.

When choosing a control unit address for the 3274-1A any one of the 256 possible addresses may be used. The 3274-1B and 1D are very similar to the 3272. The hexadecimal address of the control unit must be a multiple of hex 10 (hex 00, hex 10, hex 20, etc.). If more than 16 devices are attached, the control unit address must be a multiple of hex 20 (hex 00, hex 20, hex 40, etc.).

The 3274-1B and 1D also require an address range. Calculate the number of contiguous addresses as follows:

$$8 \times \text{Number of Type A Terminal Adapters} + 4 \times \text{Number of Type B Terminal Adapters}$$

For example, a control unit address of hex 20 with 2 Type A Terminal Adapters and 3 Type B Terminal Adapters would be $16 + 12 = 28$. Therefore, 28 is the number of contiguous addresses. The 3274-1B and 1D will then respond to addresses hex 20 through hex 3B.

Programming Support

It is important to plan for proper programming support at the host system. The 3274 clusters can be added to most 3270 display/prINTER systems with minimal impact on the existing programs. In certain cases, however, host system definition (SYSGEN) parameters will have to be changed to accommodate attachment of a 3274 cluster. Information concerning programming requirements is included in the following publications:

An Introduction to the IBM 3270 Information Display System, GA27-2739

Introduction to Programming the IBM 3270, GC27-6999

IBM 3270 Information Display System: Component Description, GA27-2749

In addition, it is recommended that for 3274 clusters you enhance your system availability and serviceability by installing the Online Test Executive Program (OLTEP) at the host system. Contact your IBM representative for information about OLTEP.

Encrypt/Decrypt Feature (3274 Model 1C Only)

It is the customer's responsibility to install a copy of the secondary logical unit (LU) key (the terminal master key) in the 3274 Control Unit Model 1C equipped with the Encrypt/Decrypt feature (3680). This should be done by someone in a position of trust, such as a security officer. Once the terminal master key has been installed in the 3274, the 3274 generates a verification pattern based on the terminal master key. A master-key verification procedure can be performed by any operator without compromising the security of the Encrypt/Decrypt feature. A mercury battery, IBM Part 1743456, is installed in the 3274 to sustain the terminal master key when the 3274 power is off. Replacing this battery, or its equivalent, is also a customer responsibility. Procedures to install and verify the terminal master key, and to replace the mercury battery, are described in *IBM 3274 Control Unit Operator's Guide, GA23-0023*.

Refer also to *IBM Cryptographic Subsystem Concepts and Facilities, GA22-9063*, for background information, and to *IBM 3270 Information Display System Component Description, GA27-2749*, for programming information.

Pre-Delivery Planning

The 3274-1A, 1B, and 1D are installed by an IBM service representative. The 3274-1C, on the other hand, is set up by your personnel. To prevent delays and help ensure a smoother installation/setup, it is recommended that a designated person in your organization:

1. Compile the installation-dependent information described in this section
2. Distribute the installation-dependent information to the appropriate personnel or the IBM service representative
3. Coordinate the activities of your personnel and/or the IBM service representative

3274-1A/1B/1D to Local Channel Cables

The I/O interface and power sequencing cables between a 3274-1A, 1B, or 1D and a local channel will be installed and connected by IBM. However, these cables must be ordered by cable order unless you are replacing a 3272 with a 3274, in which case, the same cables can be used.

3274-1C Communication Cable

The communication cable that connects the 3274-1C to the modem or channel service unit is delivered with the 3274-1C. The standard cable length is 6.1 metres (20 feet); optional cable lengths of 3.0 metres (10 feet), 9.1 metres (30 feet), and 12.2 metres (40 feet) may be specified. This cable is connected to the 3274-1C by the setup personnel. Instructions for connecting the communication cable to the 3274-1C are provided by the 3274 Setup Instructions delivered with the 3274-1C. Connection to the modem or channel service unit should be discussed with your supplier.

3274-1C System Grounding

Frame ground (EIA RS232 or CCITT V.28 pin 1) and signal ground (EIA RS232 or CCITT V.28 pin 7) should be connected together at one point only. This can be either in the 3274-1C or in the modem or channel service unit. If possible, it is recommended that this connection be made in the modem or channel service unit.

In Europe/Middle East/Africa countries the majority of modems do not have this connection made. For this reason connection has been made within the 3274-1C at the plant of manufacture.

Note: If you are replacing a 3271 or 3275 with a 3274-1C, the modem should already have signal ground and frame ground connected together. However, this should be verified with your communications supplier.

Fan-Out Feature: This feature permits two or more control units to be connected to a single modem. If the model has this capability, it is imperative that the signal ground and frame ground wires be connected together in the modem.

3274 Device Cables

The device cables are the coaxial cables that connect the 3274 to its attached display stations and printers. These cables should be procured and installed before the delivery of the 3274 and the units which will be attached to the 3274. Your personnel (or contractor) will connect these cables to the 3274 and the attached units.

Note: If you are replacing a 3271 or a 3272 with a 3274, you can use the existing device cables between the 3271/3272 and the attached units. However, the 3271 or 3272 device cables must be connected/disconnected by an IBM service representative, because the 3271 and 3272 and the attached units do not have customer access areas. Before the IBM service representative disconnects these cables, it is recommended that you have the cables marked as described below.

To reduce delays associated with connecting these cables to the 3274, it is recommended that each cable be marked at both ends to identify:

- The 3274 connector panel type (Category A panels or Category B panels) and the 3274 port (0 to 31) to which it is to be connected
- The unit type to be attached

For additional information concerning device cables, refer to *IBM 3270 Information Display System: Installation Manual – Physical Planning*, GA27-2787.

A 3274 Device Cable Attachment form is provided in Appendix B of this guide to help simplify marking and connecting the cables. Instructions for completing all portions of the form except Network Addresses and using the form are also included in Appendix B. A form should be completed for each 3274 cluster you order. Copies of the completed form should be given to the personnel who will install and mark the cables and the personnel who will connect the cables to the 3274. In addition, a copy of the form should be stored in the pocket inside the 3274 customer access door for future reference.

3274 Cluster Network Address Labels

Hexadecimal address labels (IBM Part 1743290) are delivered with the 3274. (They will be found, together with a Problem Report Form and Configuration Data card, in the pocket inside the 3274 customer access door.) After each cluster unit is set up, the labels that specify the unit's network address should be attached to the unit's address label holder (if present).

It is recommended that a designated person in your organization (1) obtain the cluster network addresses from the system programmer, (2) enter the addresses in the Network Address column of the 3274 Device Cable Attachment form in Appendix B, and (3) distribute the network addresses information to the person who will attach the address labels.

For information concerning SNA network addresses, refer to *Systems Network Architecture General Information: Network Addresses*, GA27-3102; for information concerning BSC network addresses, refer to *IBM 3270 Information Display System: Component Description*, GA27-2749.

3274 Customizing

Once installation of a 3274-1A, 1B, or 1D Control Unit by your IBM service representative (or your own setup of a 3274-1C) is completed and device cables have been connected, you are ready to configure your system of displays and printers.

The 3274 controls the operations of all the terminals attached to it. Information stored on a diskette (mounted inside the 3274) enables the control unit to perform its terminal control functions. This *system* diskette, shipped with the 3274, contains microcode to direct control unit functions and performs diagnostic routines to test the 3274 prior to system operation. Before this diskette can perform any useful function in your system however, you must *customize* the diskette by writing certain information on it specifically for your configuration. Briefly, customizing is performed by keying in system parameters at an attached 3278 Display Station. As a result of this procedure, a unique configuration table is written on the system diskette. In daily operations the operator inserts this customized system diskette in the 3274 and presses the on/off switch to on, or, if this switch is already on, presses the IML button. This action causes the 3274 to execute the diagnostic routines stored on the system diskette. Upon successful completion of these tests, the 3274 is loaded with the configuration data that was stored on the system diskette by the customizing procedure. System operation can now begin.

There are various occasions when it will be necessary to customize your system diskette(s). They are as follows:

- When you initially customize your system diskette (as described above).
- When you wish to duplicate your system diskette. (This new diskette is referred to as a *backup* diskette.)
- When you wish to generate a second system diskette to be used for a different purpose. For example, you may choose to have one system diskette to operate in BSC mode and another to operate in SDLC/SNA mode.
- When you need to recustomize your system diskette because you have changed your configuration.

Detailed procedures for performing these tasks are provided in Chapters 2 through 6.

In general, the person who customizes the system diskette uses a *language* diskette and a *feature* diskette in conjunction with the customizing procedure. The language diskette is used to customize the system diskette for languages other than English (U.S.) and Canada/French (both are EBCDIC), and the ASCII (U.S.)* character set. The feature diskette is used to customize the system diskette for all other cluster parameters. The detailed customizing procedures explain when to insert the required diskettes and direct the person customizing the 3274 to enter the configuration information into the 3274 through a 3278 Display Station attached to port A0 of the 3274.

To simplify the customizing task, it is recommended that the planner compile the configuration information and supply it to the person responsible for performing the customizing procedure. Included in Chapter 3 are descriptions of the parameters to be entered and instructions for completing the Initial Customizing Procedure Form (Chapter 4). A form should be completed for each 3274 ordered prior to delivery of the unit. In addition, configuration information should be copied on the Configuration Data card (shipped with the 3274) and stored in the 3274. (A pocket, located on the inside of the 3274's customer access door, is a convenient place to store this card.)

Setup Procedures

Each 3274-1C, 3278, 3287, and 3289 unit is delivered with its own:

- Unpacking instructions attached to an outside surface of the shipping carton
- Setup instructions
- Problem Determination Guide (PDG)

Note: *Retain the package marked for the IBM service representative.*

Before each unit is unpacked and placed in its prepared location, the personnel who will unpack and place the units should read the unpacking instructions.

After the unit is unpacked and put in place, the setup personnel should perform the step-by-step procedures in the setup instructions. If the setup personnel encounter difficulties during the checkout portion of the setup instructions, they should use the procedures in the Problem Determination Guide to find the problem. The problem determination procedures should be performed before the service representative is called.

*The ASCII character set is available in the U.S. only.

The following information on setup procedures is included for planning purposes only and to give you a general idea of what is involved. It is *not* intended to replace the setup instructions delivered with the individual units.

It is recommended that the setup instructions be obtained and read before the units are delivered. These instructions may be ordered as Forms GA27-2855 (3274-1C), GA27-2838 (3278), GA27-3152 (3287), and GA27-3140 (3289).

The 3274 1A, 1B, and 1D are installed by an IBM service representative, because special skills and tools are needed to install these units. The IBM service representative will install the 3274-1A, 1B, or 1D after your personnel have unpacked and placed the unit. After the IBM service representative completes the 3274-1A, 1B, or 1D installation, your personnel will be able to connect the device cables and customize the 3274-1A, 1B, or 1D.

3274-1C Setup Procedures

After the 3274-1C is unpacked and placed in its prepared location, the 3274-1C setup involves:

- Connecting the communication cable to the 3274-1C.
- Plugging in the power cord and switching on the 3274 power.
- Inserting the diskettes.

Note: 3274-1C customizing and device cable attachment are not 3274-1C setup procedures; customizing and device cable attachment are performed after the 3274-1C setup is completed.

3278 Setup Procedures

After the 3278 is unpacked and placed in its prepared location, the 3278 setup involves:

- Connecting the keyboard cable to the 3278.
- Connecting the device cable(s) (coaxial cable from the control unit) to the 3278 or to the Switch Control Unit feature.
- Connecting the magnetic slot reader (if present) to the 3278.
- Plugging in the power cord and switching on the 3278 power.
- Performing the 3278 checkout procedures.

3287 and 3289 Setup Procedures

After the 3287 or 3289 is unpacked and placed in its prepared location, the setup involves:

- Plugging in the power cord and switching power on.
- Performing the 3287 or 3289 checkout procedures.
- Connecting the device cable (coaxial cable from the control unit) to the 3287 or 3289.

Replacing a 3271 or a 3272 with a 3274

When a 3272 is replaced by the 3274-1A, 1B, or 1D the existing 3272 local channel attachment and device (coaxial cables between the 3272 and its attached units) cables can be used with the 3274-1A, 1B, or 1D. However, if the existing 3277/3284/3286/3288 units are to be attached to the 3274, the device addresses of these units have to be changed. For information concerning device addresses for the 3274 cluster, refer to *IBM 3270 Component Description*, GA27-2749.

The 250V watertight plug used on the 3272 is not compatible with the 3274-1A, 1B, or 1D watertight plug. Therefore, when a 3272 is replaced by a 3274-1A, 1B, or 1D, the power receptacle must be changed prior to installation of the 3274. See *IBM Information Display System: Installation Manual – Physical Planning*, GA27-2787 for the type required.

When a 3271 is replaced by a 3274-1C, the existing 3271 device cables and modem can be used with the 3274-1C. However, the device addresses of the existing 3277/3284/3286/3288 units and the communication cable that connects the 3271 to its modem cannot be used with the 3274-1C. A new communication cable is delivered with the 3274-1C. The standard cable length is 6.1 metres (20 feet); optional cable lengths of 3.0 metres (10 feet), 9.1 metres (30 feet), and 12.2 metres (40 feet) may be specified.

If the existing 3271 or 3272 device cables are to be used with the 3274, it is recommended that the cables be marked as described under “3274 Device Cables.”

Notes:

1. The 3277 keyboards and operator ID card readers cannot be used with the 3278.
2. The 3274, when operating in BSC mode, functions as a 3271 Control Unit, but is not compatible with the 3275 Display Station. See IBM 3270 Information Display Station Component Description, GA27-2749, for an explanation of the differences.

When a 3271 or a 3272 is replaced by a 3274, the following should be considered:

- The 3274 can control up to sixteen 3277s/3284s/3286s/3288s. Therefore, more than one 3274 is required to replace a 3271 or 3272 that has more than 16 of these units attached.
- The 3274 needs a 3278 attached to port A0. Therefore, a 3278 must be added to the existing units.

Note: All the 3271 or 3272 cluster cables must be connected/disconnected by an IBM service representative, because the 3271 or 3272 and the attached units do not have customer access areas.

Problem Determination Procedures

The problem determination procedures will help you perform problem determination with minimal reliance on the host system. These procedures use tests contained in the 3274, 3278, 3287, and 3289 units. See Figure P-4, “Problem Determination Manuals” in the Preface.

The procedures enable you to determine whether a problem is being caused by a cluster unit, a system unit or function outside the 3274 cluster, or an operator error. You will also be able to determine whether:

- Operation in a degraded mode is possible.
- Useful work can be done until the problem is corrected.
- The repair action can be scheduled for deferred maintenance.

If you require the help of an IBM service representative, the error message and error condition information should be recorded on a problem report form for the failing unit before the service representative is called. This information will help the service representative resolve the problem as soon as possible.

Relocation/Removal

To ensure proper handling and/or shipping of the 3274 and the attached 3278s/3287s/3289s when the units are removed or relocated to a different room, building, or mailing address, it is recommended that you call your local IBM branch office. Your IBM representative will supply you with the necessary information and can order the required materials.

Note: The help of an IBM service representative is required to relocate a 3274-1A, 1B, or 1D.

Progress Review

To ensure a smooth installation of the 3274-1A, 1B, or 1D and/or setup of the 3274-1C and its attached units, it is recommended that approximately two months before delivery of the units you and the IBM representative review (1) the progress (or the schedule associated with the changes) at the host system site, (2) the communication network and modems, (3) the physical changes needed at the cluster site, and (4) the progress of the pre-delivery planning tasks. At the same time, you and the IBM representative can review the cluster configuration to determine whether the feature mix is adequate.

It is also recommended that about two weeks before delivery of the units a designated person in your organization and the setup personnel review the setup instructions with the IBM representative.

IBM Americas/Far East and IBM Europe/Middle East/Africa

The pre-delivery/setup responsibilities and procedures for the 3274-1C, the 3278, the 3287, and the 3289 are the same for U.S. installation and for countries served by IBM A/FE and IBM E/ME/A.

If you need IBM publications in languages other than English, ask your IBM representative. The IBM representative can provide information concerning the availability of translated IBM publications.

Supplemental Information

Safety

The 3270 units are listed by the Underwriters' Laboratory. Exposed hazardous voltages are not present at the designated customer access areas of the 3274, 3278, 3287, and 3289 units.

DANGER

Your personnel should be warned not to go beyond the customer access areas, because there are hazardous voltages within the areas designated for trained personnel only.

Electrical grounding of the 3274 and all the attached units is essential for safety. Be sure that all the facility power receptacles are properly grounded and will accept a grounding type plug (3-prong or equivalent). If you have any questions about the grounding of power receptacles, contact an electrician. For information about power

cord plugs, power receptacles, and other safety considerations, refer to *IBM 3270 Information Display System: Installation Manual – Physical Planning*, GA27-2787.

Security

If the 3274 and the attached units have access to proprietary records or personnel records, it is recommended that you implement appropriate safeguards for the security of the information and the units. IBM makes available some basic functions, but you should decide which ones to use. In addition to safeguards that you may develop, the Security Keylock and Magnetic Reader Control features, and the Magnetic Slot Reader accessory may be ordered for 3278s. Also available with the 3274-1C is an Encrypt/Decrypt feature that enhances data security in an SNA-communications environment.

Personnel Training

If you intend to provide formal training for your operators, you can use the following operator's guides as texts:

- *IBM 3274 Control Unit Operator's Guide*, GA23-0023
- *IBM 3278 Display Station Operator's Guide*, GA27-2890
- *IBM 3287 Printer Operator's Guide*, GA27-3150
- *IBM 3289 Line Printer Models 1 and 2 Operator's Guide*, GA27-3147

The operator's guides describe the basic capabilities of the 3270 units. It is recommended that you use this information to prepare operating procedures for your unique operations. Problem determination guides for the 3274, 3278, 3287, and 3289 are available to assist operators in determining when an error has been made or when the equipment is not performing properly.

Supplies

The following supplies may be required, depending upon the types of terminals, devices, and features installed.

- Ribbon: Black, IBM Part 1136653 or a customer-selected equivalent, used by the 3287-1 and 2.
- Ribbon: Black, IBM Part 1136634 or a customer-selected equivalent, used by the 3289-1.
- Ribbon: Black, IBM Part 1136670 or a customer-selected equivalent, used by the 3289-2.
- Paper: Single-part continuous or multipart (six-part maximum) for the 3287s and 3289s. See *Forms Design Reference Guide for Printers*, GA24-3488.
- Spare magnetic stripe cards.
- Hexadecimal address labels: IBM Part 1743290.
- Mercury Battery: IBM Part 1743456.

Voice Communication between 3274 Cluster Operators and Host System Operators

It is recommended that a telephone be available at each location to allow the 3274 cluster operators to talk with the host system operators. This will assist the operators in performing the problem determination procedures as well as the daily work.

Reference Manuals

See the Preface for a list of publications that may help you to plan the installing of your equipment.

Chapter 2. Introduction to Customizing

The 3274 Control Unit allows the user to specify the configuration under which the 3274 operates. Specification of the 3274 configuration is done by the "customizing procedure." This chapter describes how and by whom the customizing procedure is performed.

Customizing a 3274 Control Unit usually involves a planner and an operator or someone responsible for the actual customizing operation. The planner identifies and compiles the configuration information needed for each 3274 and gives it to the operator, who, following a prompting sequence at a 3278 Display Station (with keyboard) attached to the 3274, enters the information. The operator is prompted by a series of sequence numbers which are displayed in the form of three digits; the responses are usually 1- or 2-digit entries. The 3278 that is used for this operation must be attached to port A0 of the 3274; it should be near the 3274 during the customizing operation and be clearly identified for the operator.

Using Figure 2-1 as a guide, and with the sequence number descriptions in Chapter 3, the planner prepares a list of the responses to be entered. The operator, following the list, enters each response on the 3278 keyboard as each sequence number is displayed. If the entry is acceptable, the display changes to the next sequence number. If the entry is not acceptable, a 1- or 2-digit operator code (Figure 5-4) is displayed at the top center of the screen to identify the problem. At the end of the series of sequence numbers, the 3278 displays all the responses entered to permit verification and correction of the entries.

To prepare for customizing, it is recommended that the planner:

1. Use Chapter 3 as a guide to determine what configuration information is needed for each 3274 model. Figure 2-1 and the sequence number descriptions identify the information sources.
2. Using Figure 2-1 as a guide and the sequence number descriptions in Chapter 3, compile the needed information for each 3274.

Note: The sequence number descriptions contained in Chapter 3 are grouped as follows:

3274 Model 1A

3274 Models 1B and 1D

3274 Model 1C

3. Identify each diskette. A label in the upper right corner of the diskette identifies the diskette type by name, IBM part number, and validation number. The IBM part numbers are:

Feature diskette 5718400

System diskette 5718420

Language diskette 5718440

In addition, you may wish to write some unique designation of your own on the label. For example, you could specifically identify it as to configuration, 3274 Control Unit in which it is to be customized and used, etc.

4. Enter the following information on the Initial Customizing Procedure Form in Chapter 4:
 - a. The type of keyboard (typewriter or data entry) to be used by the operator.
Note: If using a 76- or 88-key Japanese English or Japanese Katakana keyboard, specify the number of keys and keyboard type.
 - b. In step 1, the identification of each diskette to be used.
 - c. In step 7, enter the response to sequence number 031. This is the number (0-3) of RPQ diskettes to be used.
 - d. In step 8, use as a guide the information in Chapter 3 that applies to the model to be customized and enter the responses to be keyed in by the operator.
5. If the printer authorization matrix is to be defined, or if changes are to be made to the existing matrix, fill out the Printer Authorization Matrix Form at the end of Chapter 4.
6. The following should be given to the operator who will customize the 3274:
 - a. Completed Initial Customizing Procedure Form
 - b. Completed Printer Authorization Matrix Form (if required)
 - c. Copy of the "Operators Codes" chart (Figure 4-4)
 - d. Copies of the "8421 Indicator Codes" charts (Figures 4-5, 4-6, and 4-7)
 - e. Copy of the appropriate keyboard layout showing valid keys (Figures 4-1 and 4-2)
 - f. Feature and system diskettes, and language diskette (if applicable)
 - g. RPQ diskette(s) (if applicable)

It may be convenient for the planner at the central or host system location to prepare the Initial Customizing Procedure Forms for several 3274s at other locations and to forward the forms to each location.

Sequence Number	Function	3274-				Notes	Response	
		1A	1B	1C	1D		Definition	Enter
001	Keyboard validation	X	X	X	X	1	—	—
011	Patch request	X	X	X	X	1	—	—
021	Printer authorization matrix	X	X	X	X	3	0=No 1=Yes	
022	Printer authorization matrix specification	X	X	X	X	1	See text	—
031	RPQ diskettes required	X	X	X	X	2	0=Not required 1=One diskette required 2=Two diskettes required 3=Three diskettes required	
111	Number of Category B terminals	X	X	X	X	2	See text	
112	Number of Category A terminals	X	X	X	X	2	See text	
113	Extended function store	X		X	X	2	See text	
121	Keyboard/character set language	X	X	X	X	2	See Figure 3-2	
131	Typewriter keyboard	X	X	X	X	2	0=None 1=Yes	
132	Data entry keyboard	X	X	X	X	2	0=None 1=Yes	
133	Data entry keypunch-layout keyboard	X	X	X	X	2	0=None 1=Yes	
134	APL keyboard	X		X	X	2	0=No 1=Yes	
135	Text keyboard	X		X	X	2	0=No 1=Yes	
141	Magnetic slot reader	X	X	X	X	2	A=No B=Yes	
143	Host-loadable printer authorization matrix	X	X	X	X	3	0=No 1=Yes	
145	3289 Text print control	X	X	X	X	3	0=No 1=Yes	
147	Local copy function			X	X	3, 5	0=No 1=Yes	
151	3274 model designation	X	X	X	X	2	A, B, C, D Model	
201	Control unit address	X				3	See text	
211	SCS support	X		X		2	0=No 1=Yes	
213	Between bracket printer sharing	X		X		3	0=No 1=Yes	
301	Control unit number (BSC only)			X		3	See text	
302	SDLC control unit address			X		3	See text	
310	Modem connection			X		2	0=Other 1=CCITT 108.1	
311	Modem wrap			X		2	0=Not possible 1=Possible	
313	NRZI encoding (SDLC only) or NRZ			X		2, 4	0=NRZ 1=NRZI	
314	Multipoint or point-to-point network			X		2, 4	0=Multipoint 1=Point-to-point	

Figure 2-1 (Part 1 of 2). Configuration Information Needed

Sequence Number	Function	3274-				Notes	Response	
		1A	1B	1C	1D		Definition	Enter
317	Nonswitched or switched network			X		2, 4	0=Nonswitched 1=SNBU	
318	Normal or half-speed transmission			X		2, 4	0=Normal 1=Half	
321	ASCII or EBCDIC character set			X		2	0=EBCDIC 1=ASCII	
331	BSC or SDLC protocol			X		2, 4	0=BSC 1=SDLC	
342	RTS (Request-to-send) control (2-wire or 4-wire)			X		2, 4	See text	
343	DDSA			X		2	0=No 1=Yes	
351	HPCA adapter (SDLC only) or CCA			X		2	0=CCA 1=HPCA	
352	Encrypt/decrypt			X		2	0=No 1=Yes	
900	Entry acceptance	X	X	X	X	1	—	—
901	Printer authorization matrix acceptance	X	X	X	X	1	—	—
999	Modify procedure	X	X	X	X	1	—	—

Notes: X in the model column indicates needed information; blank indicates not applicable.

1. Information is already identified on the Initial Customizing Procedures Form.
2. Obtain information from equipment orders placed with IBM, with the common carrier, and (if necessary) with the modem manufacturer.
3. Obtain information from the system programmer.
4. This parameter must be compatible with the host system communications controller and/or the modem.
5. Model 1C BSC only.

Figure 2-1 (Part 2 of 2). Configuration Information Needed

Chapter 3. Preparing to Customize

This chapter supplies the necessary information to permit the planner to fill in the Initial Customizing Procedure Form in Chapter 4. Chapter 3 is divided into three groups, according to model number. The first group contains information for customizing the 3274 Model 1A; the second for customizing the 3274 Models 1B and 1D; and the third for customizing the 3274 Model 1C. Select the group that applies to the model to be customized and fill in the replies in step 8 of the Initial Customizing Procedure Form in Chapter 4. The sequence numbers are listed here and on the form in numerical order, however they may not be displayed on the 3278 screen in numerical order. Although all sequence numbers are listed in each group, only those required for the model being customized are explained. All others instruct the planner to fill in a zero response on the Initial Customizing Procedure Form. This is necessary because all sequence numbers will be displayed to the operator after the responses are keyed in. The sequence numbers that are not applicable to the model being customized will be filled in with zeros on the 3278 screen.

3274 Model 1A Customizing

Use the following descriptions in conjunction with the Initial Customizing Procedure Form in Chapter 4 to customize a 3274 Model 1A.

001 Keyboard Validation

The response required for this sequence number is already entered on the form in step 4; it verifies that the keyboard at the 3278 is operating properly. Note that the last two digits (digits following the space) in the response to sequence number 001 identify the Validation Number that must be used in the customizing procedure. This number must be the same as the Validation Number on the feature and system diskette labels.

Note: If a data entry keypunch layout keyboard is used, the New Line key is pressed when ENTER is specified. Also, the PF10 key is pressed when RESET is required; the PF8 key is pressed when New Line is required. See Figures 4-1 and 4-2 for valid key positions and the differences just noted. Be sure to specify the keyboard type on the Initial Customizing Procedure Form.

011 Patch Request

The response required for this sequence number is already entered on the form in step 5. The service representative may use this sequence number to make a diskette patch request.

021 Printer Authorization Matrix

Enter a 0 in step 6 on the Initial Customizing Procedure Form if any of the following conditions apply:

- The printer authorization matrix is to be entered only by a host application program (a 1 must be specified in sequence number 143).
- All printers are to be used in system mode and local copy operations are not desired.
- No printers are to be attached to the system.

Enter a 1 if a matrix is to be defined, thereby causing sequence number 022 to be displayed. This matrix will be established for each 3274 IML, regardless of the response to sequence number 143.

022 Printer Authorization Matrix Specification

The printer authorization matrix is defined in sequence number 022 by use of the following parameters:

AA M XXXX YYYY YYYY

These parameters are entered by the operator who performs the customizing procedure. The Printer Authorization Matrix Form contains spaces for entering the parameters. These parameters correlate to the displayed entry as follows:

AA=Printer port address (01-31)

M=Printer mode

0=System

1=Local

2=Shared

XXXX=Printer class assignments

Composed of a 4-digit hexadecimal value, this field is bit-encoded and specifies which class(es) the printer will operate in.

YYYY YYYY=Source Device List

Composed of two 4-digit hexadecimal values, this field is bit-encoded and specifies which display(s) may be copied by the printer.

Refer to Appendix C for detailed information concerning the printer authorization matrix parameters.

Fill in the appropriate spaces on the Printer Authorization Matrix Form with a definition for each printer in your configuration, and attach it to the Initial Customizing Procedures Form to give to the operator who will perform the customizing procedure. The definitions may be entered in any sequence. Also, definitions do not have to be entered successively; for example, you may enter definitions in groups 1, 2, and 3 of the form, skip groups 4 and 5, and continue at group 6.

Once a printer authorization matrix has been defined, sequence number 021 is no longer displayed when a customized 3274 Control Unit is being updated. Instead, the defined matrix is displayed. If the entire matrix is deleted, sequence number 021 will again be displayed during each updating procedure until a new matrix is defined. Any time the initial customizing procedure is performed, the sequence number 021 is displayed and the printer authorization matrix must be redefined if it is still required.

031 RPQ Diskettes Required

Enter the number of RPQ diskettes required (1-3) in step 7 of the Initial Customizing Procedures Form. Enter a 0 if none are required.

111 Number of Category B Terminals

Enter a 2-digit number (00 to 16) specifying the number of Category B terminals that it is possible to attach to your 3274. (The actual number you have attached at any given time may be fewer than this number.)

Notes:

1. *A 2-digit number must be entered. If necessary, use a leading zero. For example, to specify 8, enter 08.*
2. *Category A terminals:*
 - 3278-1, -2, -3, -4
 - 3287-1, -2 with 3274/3276 attachment (#8331)
 - 3289-1, -2*Category B terminals:*
 - 3277-1, -2
 - 3284-1, -2
 - 3286-1, -2
 - 3287-1, -2 with 3271/3272 attachment (#8330)
 - 3288-2
- 3a. *Specify the number of Category A terminals in multiples of 8 (maximum of 32) and the number of Category B terminals in multiples of 4 (maximum of 26), unless the sum of the two categories exceeds 32.*
- 3b. *If the sum of the two categories exceeds 32:*
 - *For Category B terminals, specify the actual number of Category B terminals (sequence number 111).*
 - *For Category A terminals, specify the difference between 32 and the number of Category B terminals (sequence number 112).*

Example: 13 Category B terminals and 17 Category A terminals would be specified as 13 and 19, respectively. Figure 3-3 shows the relationship and the ways to specify the various Category A and B terminal quantities.

		Number of Category A Terminals																																Adapter Type	
Quantity		Base								A1								A2								A3									
		1	2	3	4	5	6	7	8	9	10	11	12	13	14	15	16	17	18	19	20	21	22	23	24	25	26	27	28	29	30	31	32		
0		Specify: A08 and B00								Specify: A16 and B00								Specify: A24 and B00								Specify: A32 and B00									
Number of Category B Terminals	B1	1																									Specify: 32-B=A								B0=31*
		2	Specify: A08 and B04								Specify: A16 and B04								Specify: A24 and B04																B0=30*
		3																									Specify: 32-B=A								B0=29*
		4	B0=08*								B0=16*								B0=24*																B0=28*
		5																									Specify: 32-B=A								B0=27*
	B2	6	Specify: A08 and B08								Specify: A16 and B08								Specify: A24 and B08																B0=26*
		7																									Specify: 32-B=A								B0=25*
		8	B0=08*								B0=16*								B0=24*																B0=24*
		9																									Specify: 32-B=A								B0=23*
	B3	10	Specify: A08 and B12								Specify: A16 and B12								Specify: 32-B=A								Not Permitted								
		11																									Specify: 32-B=A								
		12	B0=08*								B0=16*								B0=20*																
		13																									Specify: 32-B=A								
	B4	14	Specify: A08 and B16								Specify: A16 and B16								B0=18*																
		15																	B0=17*																
		16	B0=08*								B0=16*								B0=17*																
		Adapter Type																																	

*The host-recognized port addresses are sequential with the first Category A port (port A0) always being address 0 (with the exception of SNA, which is always 02). The first Category B port (port B0) is always the next sequential address after the last Category A port.

Figure 3-1. 3274 Model 1A Category A and B Terminal Quantity Relationships

112 Number of Category A Terminals

Enter a 2-digit number (08 to 32) specifying the number of Category A terminals that it is possible to attach to your 3274. (The actual number you have attached at any given time may be fewer than this number.)

113 Extended Function Store

Enter one of the following to specify whether any, and which, Extended Function Store feature is installed:

- 0000 = No Extended Function Store is installed.
- 3622 = Extended Function Store feature type C1 (#3622) is installed.
- 5000 = Extended Function Store feature type C1 (#3622) and C3 (#3625) is installed.
- 7000 = Extended Function Store feature type C1 (#3622) and D1 (#3627) is installed.
- 9000 = Extended Function Store feature type C1 (#3622), C3 (#3625), and D1 (#3627) is installed.

121 Keyboard/Character Set Language

Enter a 2-digit number (01 to 27) from Figure 3-2 specifying the keyboard/character set language being used. A 2-digit number must be entered. If necessary, use a leading zero. For example, to specify 8, enter 08.

Sequence Number 121 Response	Language Name	Specify Feature Codes	
		Keyboard	Character Set
01	English (U.S.)	2956*	2756* or 9082**
02	ASCII (U.S.)	4624** or 4628**	9084*
03	Austria/Germany	2957	2757
04	Belgium	2971	2771
05	Brazil	2975	2775
06	Canada/French	2977	2777
07	Denmark	2965	2762
08	Denmark (alternate)	2965	2742
09	Finland	2963	2763
10	Finland (alternate)	2963	2743
11	France (QWERTY)	2970	2770
12	France (AZERTY)	2964	2770
13	Austria/Germany (alternate)	2957	2748
14	International	2950	2750
15	Italy	2968	2768
16	Japan/English	2955	2755
17	Japan/Katakana	2973	2773
18	Portugal	2959	2749
19	Spain	2960	2760
20	Spain (alternate)	2960	2740
21	Spanish-speaking	2969	2769
22	English (U.K.)	2958	2758
23	Norway	2966	2762
24	Sweden	2967	2763
25	EBCDIC (W.T.)	2951	2756
26	Norway (alternate)	2966	2742
27	Sweden (alternate)	2967	2743

Notes:

1. Further keyboard/character set information can be found in the IBM 3270 Information Display System: *Character Set Reference, GA27-2837*.
2. All keyboards and character sets are EBCDIC except ASCII (U.S.).
 - * This feature code applies to World Trade orders only. U.S. customers with U.S. English keyboards enter response 01.
 - ** Available on U.S. orders only.

Figure 3-2. 3274 Model 1A Keyboard/Character Set Languages

131 Typewriter Keyboard

Enter a 0 if none of the attached 3278s have a typewriter keyboard (#2715, 2727, 4621, 4624, 4627, 4628) or a 1 if any do.

132 Data Entry Keyboard

Enter a 0 if none of the attached 3278s have a data entry keyboard (#2716, 4622) or a 1 if any do.

133 Data Entry Keypunch Layout Keyboard

Enter a 0 if none of the attached 3278s have a data entry keypunch layout keyboard (#4623) or a 1 if any do.

134 APL Keyboard

Enter a 0 if none of the attached 3278s have an APL Keyboard feature (#4626) or a 1 if any do.

Note: If neither an APL nor a text keyboard is attached to any 3278 but you wish to display or print APL and/or text characters, enter a 1.

135 Text Keyboard

Enter a 0 if none of the attached 3278s have a Text Keyboard feature (#4629) or a 1 if any do.

141 Magnetic Slot Reader

Enter an A if none of the attached 3278s have a magnetic slot reader or a B if any do.

143 Host-Loadable Printer Authorization Matrix

Enter a 0 if a printer authorization matrix is not to be loaded from the host or a 1 if it is.

This matrix is defined by a user-written application program. When run, a host-loaded matrix will override any other printer authorization matrix. (See also sequence number 021.)

145 3289 Text Print Control

Enter a 0 if a 3289 Line Printer without a Text Print chain is being used or a 1 if it is.

147

Enter 0 for this sequence number in step 8 on the customizing form.

151 3274 Model Designation

Enter an A to specify the 3274 Model 1A.

201 Control Unit Address

Enter the 2-character hexadecimal control unit address; this information can be obtained from the system programmer at the host system location. The host system recognizes this address as the input/output address.

211 SCS Support

Enter a 0 if the SNA character string (SCS) feature (9660) is not installed on any attached printer, or a 1 if it is.

213 Between Bracket Printer Sharing

Enter a 0 if Between Bracket Printer sharing is not allowed or a 1 if it is.

301

Enter 00 for this sequence number in step 8 on the customizing form.

302

Enter 00 for this sequence number in step 8 on the customizing form.

310 through 352

For sequence numbers 310 through 352, fill in each of the appropriate boxes in step 8 of the Initial Customizing Procedure Form with a 0.

900 Entry Acceptance

Sequence number 900, which appears as part of the sequence number 999 display, prompts the operator to enter a 1 if, after the entries are verified, all the responses are entered correctly. If incorrect responses are detected by the 3274, the 1 is automatically

changed back to a 0 by the 3274, an operator code is displayed for the incorrect information, and incorrect entries are intensified.

901 *Printer Authorization Matrix Acceptance*

Sequence number 901, which appears as part of sequence number 022 (printer authorization matrix display), prompts the operator to enter a 1 if, after the entries are verified, all the responses are entered correctly. If unacceptable responses are detected by the 3274, the 1 is automatically changed back to a 0 by the 3274 and invalid entries are intensified.

999 *Modify Procedure*

Sequence number 999 displays all the responses entered during the customizing operation, permitting the operator to review the entries and to make any corrections needed. The Initial Customizing Procedure Form instructs the operator how to reply to this sequence number.

3274 Models 1B and 1D

Use the following descriptions in conjunction with the Initial Customizing Procedure Form in Chapter 4 to customize 3274 Models 1B and 1D.

001 Keyboard Validation

The response required for this sequence number is already entered on the form in step 4; it verifies that the keyboard at the 3278 is operating properly. Note that the last two digits (digits following the space) in the response to sequence number 001 identify the Validation Number that must be used in the customizing procedure. This number must be the same as the Validation Number on the feature and system diskette labels.

Note: If a data entry keypunch layout keyboard is used, the New Line key is pressed when ENTER is specified. Also, the PF10 key is pressed when RESET is required; the PF8 key is pressed when New Line is required. See Figures 4-1 and 4-2 for valid key positions and the differences just noted. Be sure to specify the keyboard type on the Initial Customizing Procedure Form.

011 Patch Request

The response required for this sequence number is already entered on the form in step 5. The service representative may use this sequence number to make a diskette patch request.

021 Printer Authorization Matrix

Enter a 0 in step 6 on the Initial Customizing Procedure Form if any of the following conditions apply:

- The printer authorization matrix is to be entered only by a host application program (a 1 must be specified in sequence number 143).
- All printers are to be used in system mode and local copy operations are not desired.
- No printers are to be attached to the system.

Enter a 1 if a matrix is to be defined, thereby causing sequence number 022 to be displayed. This matrix will be established for each 3274 IML, regardless of response to sequence number 143.

022 Printer Authorization Matrix Specification

The printer authorization matrix is defined in sequence number 022 by use of the following parameters:

AA M XXXX YYYY YYYY

These parameters are entered by the operator who performs the customizing procedure. The Printer Authorization Matrix Form contains spaces for entering the parameters. These parameters correlate to the displayed entry as follows:

AA=Printer port address (01-31)

M=Printer mode

0=System

1=Local

2=Shared

XXXX=Printer class assignments

Composed of a 4-digit hexadecimal value, this field is bit-encoded and specifies which class(es) the printer will operate in.

YYYY YYYY=Source Device List

Composed of two 4-digit hexadecimal values, this field is bit-encoded and specifies which display(s) may be copied by the printer.

Refer to Appendix C for detailed information concerning the printer authorization matrix parameters.

Fill in the appropriate spaces on the Printer Authorization Matrix Form with a definition for each printer in your configuration, and attach it to the Initial Customizing Procedure Form to give to the operator who will perform the customizing procedure. The definitions may be entered in any sequence. Also, definitions do not have to be entered successively; for example, you may enter definitions in groups 1, 2, and 3 of the form, skip groups 4 and 5, and continue at group 6.

Once a printer authorization matrix has been defined, sequence number 021 is no longer displayed when a customized 3274 Control Unit is being updated. Instead, the defined matrix is displayed. If the entire matrix is deleted, sequence number 021 will again be displayed during each updating procedure until a new matrix is defined. Any time the initial customizing procedure is performed, the sequence number 021 is displayed and the printer authorization matrix must be redefined if it is still required.

031 RPQ Diskettes Required

Enter the number of RPQ diskettes required (1-3) in step 7 of the Initial Customizing Procedures Form. Enter a 0 if none are required.

111 Number of Category B Terminals

Enter a 2-digit number (00 to 16) specifying the number of Category B terminals that it is possible to attach to your 3274. (The actual number you have attached at any given time may be fewer than this number.)

Notes:

1. *A 2-digit number must be entered. If necessary, use a leading zero. For example, to specify 8, enter 08.*
2. *Category A terminals:*
 - 3278-1, -2, -3, -4*
 - 3287-1, -2 with 3274/3276 attachment (#8331)*
 - 3289-1, -2**Category B terminals:*
 - 3277-1, -2*
 - 3284-1, -2*
 - 3286-1, -2*
 - 3287-1, -2 with 3271/3272 attachment (#8330)*
 - 3288-2*
- 3a. *Specify the number of Category A terminals in multiples of 8 (maximum of 32) and the number of Category B terminals in multiples of 4 (maximum of 26), unless the sum of the two categories exceeds 32.*

3b. If the sum of the two categories exceeds 32:

- For Category B terminals, specify the actual number of Category B terminals (sequence number 111).
- For Category A terminals, specify the difference between 32 and the number of Category B terminals (sequence number 112).

Example: 13 Category B terminals and 17 Category A terminals would be specified as 13 and 19, respectively. Figure 3-3 shows the relationship and the ways to specify the various Category A and B terminal quantities.

4. The 3274-1B is a multaddress unit which is wired during installation for a limited address range. If this limited address range and the specified number of Category A and B terminals do not match, the 3274 will not be able to complete a normal startup sequence.

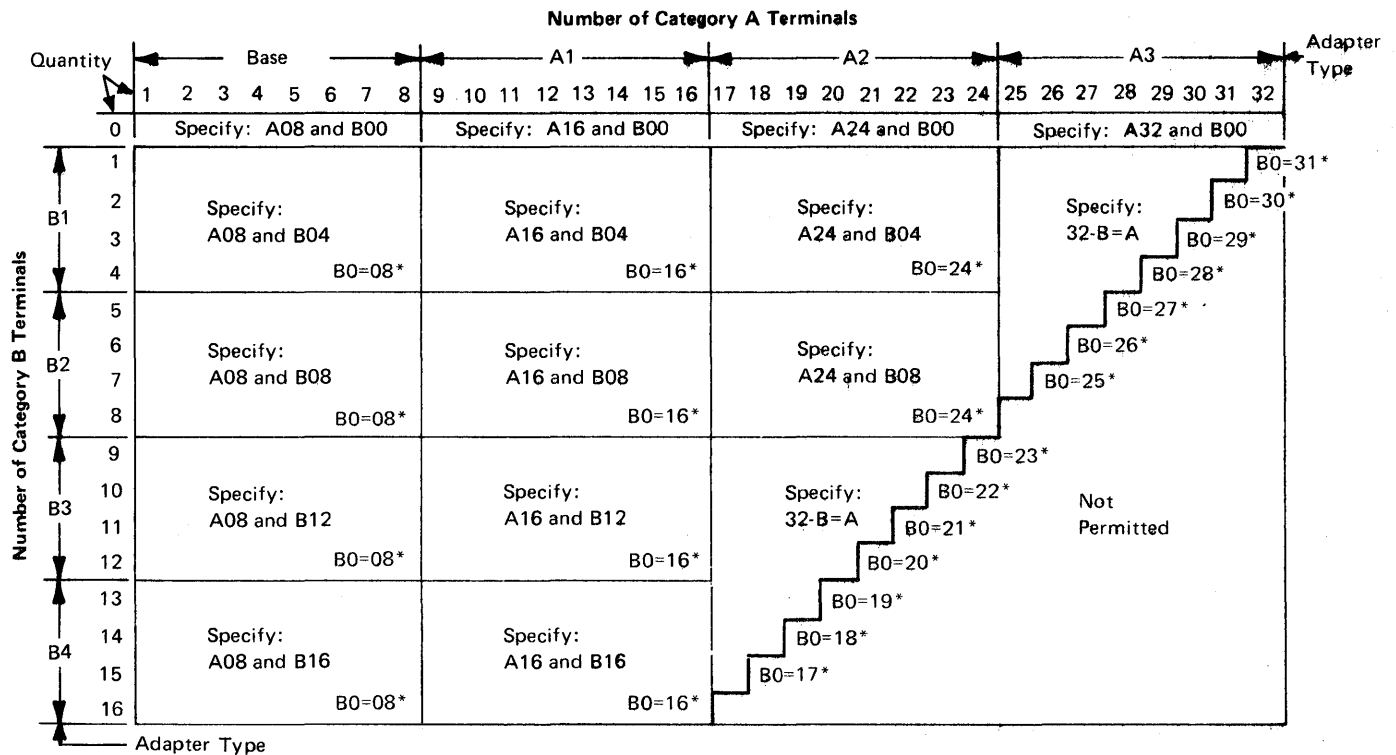

*The host-recognized port addresses are sequential with the first Category A port (port A0) always being address 0 (with the exception of SNA, which is always 02). The first Category B port (port B0) is always the next sequential address after the last Category A port.

Figure 3-3. 3274 Models 1B and 1D Category A and B Terminal Quantity Relationships

112 Number of Category A Terminals

Enter a 2-digit number (08 to 32) specifying the number of Category A terminals that it is possible to attach to your 3274. (The actual number you have attached at any given time may be fewer than this number.)

113 Extended Function Store

For Model 1B: Enter A for this sequence number in step 8 on the customizing form.

For Model 1D: Enter one of the following to specify whether any, and which, Extended Function Store feature is installed:

0000 = No Extended Function Store is installed.

3622 = Extended Function Store feature type C1 (#3622) is installed.

5000 = Extended Function Store feature type C1 (#3622) and C3 (#3625) is installed.

7000 = Extended Function Store feature type C1 (#3622) and D1 (#3627) is installed.

9000 = Extended Function Store feature type C1 (#3622), C3 (#3625), and D1 (#3627) is installed.

121 Keyboard/Character Set Language

Enter a 2-digit number (01 to 27) from Figure 3-4 specifying the keyboard/character set language being used. A 2-digit number must be entered. If necessary, use a leading zero. For example, to specify 8, enter 08.

131 Typewriter Keyboard

Enter a 0 if none of the attached 3278s have a typewriter keyboard (#2715, 2717, 4621, 4624, 4627, 4628) or a 1 if any do.

132 Data Entry Keyboard

Enter a 0 if none of the attached 3278s have a data entry keyboard (#2716, 4622) or a 1 if any do.

133 Data Entry Keypunch Layout Keyboard

Enter a 0 if none of the attached 3278s have a data entry keypunch layout keyboard (4623) or a 1 if any do.

134 APL Keyboard (Model 1D Only)

Enter a 0 if none of the attached 3278s have an APL Keyboard feature (#4626) or a 1 if any do.

Note: If neither an APL nor a text keyboard is attached to any 3278 but you wish to display or print APL and/or text characters, enter a 1.

135 Text Keyboard (Model 1D Only)

Enter a 0 if none of the attached 3278s have a Text Keyboard feature (#4629) or a 1 if any do.

141 Magnetic Slot Reader

Enter an A if none of the attached 3278s have a magnetic slot reader or a B if any do.

Sequence Number 121 Response	Language Name	Specify Feature Codes	
		Keyboard	Character Set
01	English (U.S.)	2956*	2756* or 9082**
02	ASCII (U.S.)	4624** or 4628**	9084*
03	Austria/Germany	2957	2757
04	Belgium	2971	2771
05	Brazil	2975	2775
06	Canada/French	2977	2777
07	Denmark	2965	2762
08	Denmark (alternate)	2965	2742
09	Finland	2963	2763
10	Finland (alternate)	2963	2743
11	France (QWERTY)	2970	2770
12	France (AZERTY)	2964	2770
13	Austria/Germany (alternate)	2957	2748
14	International	2950	2750
15	Italy	2968	2768
16	Japan/English	2955	2755
17	Japan/Katakana	2973	2773
18	Portugal	2959	2749
19	Spain	2960	2760
20	Spain (alternate)	2960	2740
21	Spanish-speaking	2969	2769
22	English (U.K.)	2958	2758
23	Norway	2966	2762
24	Sweden	2967	2763
25	EBCDIC (W.T.)	2951	2756
26	Norway (alternate)	2966	2742
27	Sweden (alternate)	2967	2743

Notes:

1. Further keyboard/character set information can be found in the IBM 3270 Information Display System: *Character Set Reference, GA27-2837*.
2. All keyboards and character sets are EBCDIC except ASCII (U.S.).

* This feature code applies to World Trade orders only. U.S. customers with U.S. English keyboards enter response 01.

** Available on U.S. orders only.

Figure 3-4. 3274 Models 1B and 1D Keyboard/Character Set Languages

143 Host-Loadable Printer Authorization Matrix

Enter a 0 if a printer authorization matrix is not to be loaded from the host or a 1 if it is.

This matrix is defined by a user-written application program. When run, a host-loaded matrix will override any other printer authorization matrix. (See also sequence number 021.)

145 3289 Text Print Control

Enter a 0 if a 3289 Line Printer without a Text Print chain is being used or a 1 if it is.

147 Local Copy Function (Model 1D Only)

Enter a 0 if the local copy function is not being used or a 1 if it is.

Note: If a 0 is entered, local copy by means of the print key and the host Copy command are nullified.

151 3274 Model Designation

Enter a B or D to specify the 3274 model:

B = 3274-1B

D = 3274-1D

201 through 352

For sequence numbers 201 through 352, fill in the appropriate boxes in step 8 of the Initial Customizing Procedure Form with the following entries:

201 Enter 00.

211 Enter 0.

301 Enter 00.

302 Enter 00.

310 – 352 Enter 0 in each box.

900 Entry Acceptance

Sequence number 900, which appears as part of the sequence number 999 display, prompts the operator to enter a 1 if, after the entries are verified, all the responses are entered correctly. If incorrect responses are detected by the 3274, the 1 is automatically changed back to a 0 by the 3274, an operator code is displayed for the incorrect information, and incorrect entries are intensified.

901 Printer Authorization Matrix Acceptance

Sequence number 901, which appears as part of sequence number 022 (printer authorization matrix display), prompts the operator to enter a 1 if, after the entries are verified, all the responses are entered correctly. If unacceptable responses are detected by the 3274, the 1 is automatically changed back to a 0 by the 3274 and invalid entries are intensified.

999 Modify Procedure

Sequence number 999 displays all the responses entered during the customizing operation, permitting the operator to review the entries and to make any corrections needed. The Initial Customizing Procedure Form instructs the operator how to reply to this sequence number.

3274 Model 1C

Use the following descriptions in conjunction with the Initial Customizing Procedure Form in Chapter 4 to customize a 3274 Model 1C.

001 Keyboard Validation

The response required for this sequence number is already entered on the form in step 4; it verifies that the keyboard at the 3278 is operating properly. Note that the last two digits (digits following the space) in the response to sequence number 001 identify the Validation Number that must be used in the customizing procedure. This number must be the same as the Validation Number on the feature and system diskette labels.

Note: If a data entry keypunch layout keyboard is used, the New Line key is pressed when ENTER is specified. Also, the PF10 key is pressed when RESET is required; the PF8 key is pressed when New Line is required. See Figures 4-1 and 4-2 for valid key positions and the differences just noted. Be sure to specify the keyboard type on the Initial Customizing Procedure Form.

011 Patch Request

The response required for this sequence number is already entered on the form in step 5. The service representative may use this sequence number to make a diskette patch request.

021 Printer Authorization Matrix

Enter a 0 in step 6 on the Initial Customizing Procedure Form if any of the following conditions apply:

- The printer authorization matrix is to be entered only by a host application program (a 1 must be specified in sequence number 143).
- All printers are to be used in system mode and local copy operations are not desired.
- No printers are to be attached to the system.

Enter a 1 if a matrix is to be defined, thereby causing sequence number 022 to be displayed. This matrix will be established for each 3274 IML, regardless of the response to sequence number 143.

022 Printer Authorization Matrix Specification

The printer authorization matrix is defined in sequence number 022 by use of the following parameters:

AA M XXXX YYYY YYYY

These parameters are entered by the operator who performs the customizing procedure. The Printer Authorization Matrix Form contains spaces for entering the parameters. These parameters correlate to the displayed entry as follows:

AA=Printer port address (01-31)

M=Printer mode

0=System

1=Local

2=Shared

XXXX=Printer class assignments

Composed of a 4-digit hexadecimal value, this field is bit-encoded and specifies which class(es) the printer will operate in.

YYYY YYYY=Source Device List

Composed of two 4-digit hexadecimal values, this field is bit-encoded and specifies which display(s) may be copied by the printer.

Refer to Appendix C for detailed information concerning the printer authorization matrix parameters.

Fill in the appropriate spaces on the Printer Authorization Matrix Form with a definition for each printer in your configuration, and attach it to the Initial Customizing Procedures Form to give to the operator who will perform the customizing procedure. The definitions may be entered in any sequence. Also, definitions do not have to be entered successively; for example, you may enter definitions in groups 1, 2, and 3 of the form, skip groups 4 and 5, and continue at group 6.

Once a printer authorization matrix has been defined, sequence number 021 is no longer displayed when a customized 3274 Control Unit is being updated. Instead, the defined matrix is displayed. If the entire matrix is deleted, sequence number 021 will again be displayed during each updating procedure until a new matrix is defined. Any time the initial customizing procedure is performed, the sequence number 021 is displayed and the printer authorization matrix must be redefined if it is still required.

031 RPQ Diskettes Required

Enter the number of RPQ diskettes required (1-3) in step 7 of the Initial Customizing Procedures Form. Enter a 0 if none are required.

111 Number of Category B Terminals

Enter a 2-digit number (00 to 16) specifying the number of Category B terminals that it is possible to attach to your 3274. (The actual number you have attached at any given time may be fewer than this number.)

Notes:

1. A 2-digit number must be entered. If necessary, use a leading zero. For example, to specify 8, enter 08.

2. Category A terminals:

3278-1, -2, -3, -4

3287-1, -2 with 3274/3276 attachment (#8331)

3289-1, -2

Category B terminals:

3277-1, -2

3284-1, -2

3286-1, -2

3287-1, -2 with 3271/3272 attachment (#8330)

3288 -2

3a. Specify the number of Category A terminals in multiples of 8 (maximum of 32) and the number of Category B terminals in multiples of 4 (maximum of 26), unless the sum of the two categories exceeds 32.

3b. If the sum of the two categories exceeds 32:

- For Category B terminals, specify the actual number of Category B terminals (sequence number 111).
- For Category A terminals, specify the difference between 32 and the number of Category B terminals (sequence number 112).

Example: 13 Category B terminals and 17 Category A terminals would be specified as 13 and 19, respectively. Figure 3-3 shows the relationship and the ways to specify the various Category A and B terminal quantities.

Quantity	Number of Category A Terminals																																Adapter Type	
	Base								A1								A2								A3									
	1	2	3	4	5	6	7	8	9	10	11	12	13	14	15	16	17	18	19	20	21	22	23	24	25	26	27	28	29	30	31	32		
0	Specify: A08 and B00								Specify: A16 and B00								Specify: A24 and B00								Specify: A32 and B00									
Number of Category B Terminals	1																									Specify: 32-B=A								B0=31*
	2	Specify: A08 and B04								Specify: A16 and B04								Specify: A24 and B04																B0=30*
	3																																	B0=29*
	4	B0=08*								B0=16*								B0=24*																B0=28*
	5																																	B0=27*
	6	Specify: A08 and B08								Specify: A16 and B08								Specify: A24 and B08																B0=26*
	7																																	B0=25*
	8	B0=08*								B0=16*								B0=24*																
	9																																	B0=23*
	10	Specify: A08 and B12								Specify: A16 and B12								Specify: 32-B=A								Not Permitted								
	11																																	B0=22*
	12	B0=08*								B0=16*																								B0=21*
	13																																	B0=20*
	14	Specify: A08 and B16								Specify: A16 and B16																								B0=19*
	15																																	B0=18*
	16	B0=08*								B0=16*																								B0=17*
Adapter Type																																		

*The host-recognized port addresses are sequential with the first Category A port (port A0) always being address 0 (with the exception of SNA, which is always 02). The first Category B port (port B0) is always the next sequential address after the last Category A port.

Figure 3-5. 3274 Model 1C Category A and B Terminal Quantity Relationships

112 Number of Category A Terminals

Enter a 2-digit number (08 to 32) specifying the number of Category A terminals that it is possible to attach to your 3274. (The actual number you have attached at any given time may be fewer than this number.)

113 Extended Function Store

Enter one of the following to specify whether any, and which, Extended Function Store feature is installed:

- 0000 = No Extended Function Store is installed.
- 3622 = Extended Function Store feature type C1 (#3622) is installed.
- 5000 = Extended Function Store feature type C1 (#3622) and C3 (#3625) is installed.
- 7000 = Extended Function Store feature type C1 (#3622) and D1 (#3627) is installed.
- 9000 = Extended Function Store feature type C1 (#3622), C3 (#3625), and D1 (#3627) is installed.

121 Keyboard/Character Set Language

Enter a 2-digit number (01 to 27) from Figure 3-6 specifying the keyboard/character set language being used. A 2-digit number must be entered. If necessary, use a leading zero. For example, to specify 8, enter 08.

Sequence Number 121 Response	Language Name	Specify Feature Codes	
		Keyboard	Character Set
01	English (U.S.)	2956*	2756* or 9082**
02	ASCII (U.S.)	4624** or 4628**	9084*
03	Austria/Germany	2957	2757
04	Belgium	2971	2771
05	Brazil	2975	2775
06	Canada/French	2977	2777
07	Denmark	2965	2762
08	Denmark (alternate)	2965	2742
09	Finland	2963	2763
10	Finland (alternate)	2963	2743
11	France (QWERTY)	2970	2770
12	France (AZERTY)	2964	2770
13	Austria/Germany (alternate)	2957	2748
14	International	2950	2750
15	Italy	2968	2768
16	Japan/English	2955	2755
17	Japan/Katakana	2973	2773
18	Portugal	2959	2749
19	Spain	2960	2760
20	Spain (alternate)	2960	2740
21	Spanish-speaking	2969	2769
22	English (U.K.)	2958	2758
23	Norway	2966	2762
24	Sweden	2967	2763
25	EBCDIC (W.T.)	2951	2756
26	Norway (alternate)	2966	2742
27	Sweden (alternate)	2967	2743

Notes:

- Further keyboard/character set information can be found in the IBM 3270 Information Display System: *Character Set Reference, GA27-2837*.
- All keyboards and character sets are EBCDIC except ASCII (U.S.).
 - * This feature code applies to World Trade orders only. U.S. customers with U.S. English keyboards enter response 01.
 - ** Available on U.S. orders only.

Figure 3-6. 3274 Model 1C Keyboard/Character Set Languages

131 Typewriter Keyboard

Enter a 0 if none of the attached 3278s have a typewriter keyboard (#2715, 2717, 4621, 4624, 4627, 4628) or a 1 if any do.

132 Data Entry Keyboard

Enter a 0 if none of the attached 3278s have a data entry keyboard (#2716, 4622) or a 1 if any do.

133 Data Entry Keypunch Layout Keyboard

Enter a 0 if none of the attached 3278s have a data entry keypunch layout keyboard (#4623) or a 1 if any do.

134 APL Keyboard

Enter a 0 if none of the attached 3278s have an APL Keyboard feature (#4626) or a 1 if any do.

Note: *If neither an APL nor a text keyboard is attached to any 3278 but you wish to display or print APL and/or text characters, enter a 1.*

135 Text Keyboard

Enter a 0 if none of the attached 3278s have a Text Keyboard feature (#4629) or a 1 if any do.

141 Magnetic Slot Reader

Enter an A if none of the attached 3278s have a magnetic slot reader or a B if any do.

143 Host-Loadable Printer Authorization Matrix

Enter a 0 if a printer authorization matrix is not to be loaded from the host or a 1 if it is.

This matrix is defined by a user-written application program. When run, a host-loaded matrix will override any other printer authorization matrix. (See also sequence number 021.)

145 3289 Text Print Control

Enter a 0 if a 3289 Line Printer without a Text Print Chain is being used or a 1 if it is.

147 Local Copy Function (BSC Only)

Enter a 0 if the local copy function is not being used or a 1 if it is.

Note: *If a 0 is entered, local copy by means of the print key and the host Copy command are nullified.*

151 3274 Model Designation

Enter a C to specify the 3274 Model 1C.

201

Enter 00 for this sequence number in step 8 on the customizing form.

211 SCS Support (SDLC Only)

Enter a 0 if the SNA character string (SCS) feature (#9660) is not installed on any attached printer, or a 1 if it is.

213 Between Bracket Printer Sharing

Enter a 0 if Between Bracket Printer Sharing is not allowed or a 1 if it is.

301 Control Unit Number (BSC Only)

Enter the 2-digit decimal control unit number. Obtain the polling address (in hexadecimal) for this control unit from the system programmer at the host system site. Use Figure 3-7 to convert this address to the decimal control unit number.

Note: *Because it is standard practice to send the address twice, the system programmer may give you a "double address", for example, 4040. You would use only the first two digits, that is, 40.*

BSC Hexadecimal Polling Address		Control Unit Number (Sequence Number 301 Response)
EBCDIC	ASCII	
40	20	00
C1	41	01
C2	42	02
C3	43	03
C4	44	04
C5	45	05
C6	46	06
C7	47	07
C8	48	08
C9	49	09
4A	5B	10
4B	2E	11
4C	3C	12
4D	28	13
4E	2B	14
4F	21	15
50	26	16
D1	4A	17
D2	4B	18
D3	4C	19
D4	4D	20
D5	4E	21
D6	4F	22
D7	50	23
D8	51	24
D9	52	25
5A	5D	26
5B	24	27
5C	2A	28
5D	29	29
5E	3B	30
5F	5E	31

Example: If the EBCDIC hexadecimal BSC polling address is 4E, the value to be entered is 14. If the ASCII hexadecimal BSC polling address is 4E, the value to be entered is 21.

Figure 3-7. BSC Polling Address/Control Unit Number Conversion Chart

302 SDLC Control Unit Address

Enter the 2-character hexadecimal SDLC control unit address; this information can be obtained from the system programmer at the host system location. The host system, if using NCP, specifies this address in the 3704/3705 PU macro.

310 Modem Connection

Enter a 0 if the 3274 is operating in Canada or in the U.S. For World Trade countries, enter a 0 if the 3274 is operating in RTS/CTS (Request to Send/Clear to Send) mode. Enter a 1 if the 3274 is connected to a CCITT 108.1 (CDSTL).

311 Modem Wrap

Enter a 0 if the modem is not capable of a DTE-initiated automatic wrap test or a 1 if the modem is. (In this case, the DTE is the 3274 Control Unit. The wrap test is initiated by the CX Test (DTE) control signal option via pin 18 from the 3274 Control Unit.)

If an IBM 3872, 3874, or 3875 modem is used, enter a 1 if the CX Test (DTE) control signal option was activated at the time of modem installation.

Wrap Feature: Determine whether the modem permits data to be wrapped under control of the 3274 Control Unit or whether the modem has a switch to control the wrap function. If the modem has the wrap capability and wrapping can be controlled from the 3274 Control Unit, it is recommended that this method be used.

If you are unable to determine that your modem has the wrap option activated, enter a 0. However, note that this may require you to recustomize at a later date if you determine later that the modem does have the wrap option activated and you wish to use the wrap capability.

313 NRZI (SDLC Only) or NRZ Encoding

Enter a 0 if NRZ (non-return to zero) encoding is used or a 1 if NRZI (non-return to zero inverted) encoding is used.*

314 Multipoint or Point-to-Point Network

Enter a 0 if the 3274 is part of a multipoint network or a 1 if it is part of a point-to-point network.*

317 Nonswitched or Switched-Network Backup

Enter a 0 if the modem does not have switched-network backup (SNBU) capability. If the modem does have SNBU, enter a 0 to cause the modem to operate in nonswitched mode or a 1 to cause the modem to operate in switched mode.*

If the modem does have this capability, determine whether this capability can be controlled externally by the 3274 or at the modem. It is recommended that this capability be controlled by the 3274.

Notes:

1. *In the U.S. and Canada a switched network attachment requires the use of a protective device. This must be ordered from an OEM communication equipment supplier and installed separately.*
2. *To have the capability to operate in either nonswitched or switched network backup mode, two system diskettes may be generated (as described in Chapter 6), one for each type of operation. To change modes, select the other system diskette and perform IML procedures. Ensure that diskettes are appropriately labeled.*

318 Normal or Half-Speed Transmission

Enter a 0 if the modem does not have half-speed transmission capability or if full-speed transmission capability is desired. Enter a 1 if half-speed transmission operation is desired.

If the modem has half-speed transmission capability, determine whether this capability can be controlled externally by the 3274 or by a switch on the modem. If the capability can be controlled by a switch on the modem, it is recommended that a 0 be entered and that the switch be used.*

Note: *To have the capability to operate in either full-speed or half-speed mode, two system diskettes may be generated (as described in Chapter 6), one for full-speed operation and one for half-speed operation. To switch modes, select the other system diskette and perform IML procedures. Ensure that diskettes are appropriately labeled.*

321 EBCDIC or ASCII Character Set

Enter a 0 if the EBCDIC character set is used or a 1 if the ASCII character set is used (available in the U.S. only).

*This parameter must be compatible with the host system communications controller and/or the modem.

331 BSC or SDLC Protocol

Enter a 0 if the BSC protocol is used or a 1 if the SDLC protocol is used.*

342 RTS (Request to Send) Control (2-wire or 4-wire)

SDLC:

2-wire: Enter a 0.

4-wire: Enter a 1.

BSC:

2-wire: Enter a 0.

4-wire: If your modems use the New SYNC feature, enter a 0. If you desire RTS from selection to end of transmission (EOT), enter a 1. (Be aware that entering a 1 may cause communications errors. If in doubt, enter a 0.)

Note: Entering a 1 here and also in response to sequence number 314 will provide permanent RTS.

343 DDSA (Dataphone Digital Service Adapter)**

Enter a 0 if the DDSA feature (#5650 for point-to-point or #5651 for multipoint operation) is not installed or a 1 if it is.

351 HPCA (SDLC Only) or CCA Adapter

Enter a 0 if the CCA Adapter feature (#6302) is installed or a 1 if the HPCA Adapter feature (#6303) is installed.

352 Encrypt/Decrypt

Enter a 0 if the Encrypt/Decrypt feature (#3680) is not installed or a 1 if it is.

900 Entry Acceptance

Sequence number 900, which appears as part of the sequence number 999 display, prompts the operator to enter a 1 if, after the entries are verified, all the responses are entered correctly. If incorrect responses are detected by the 3274, the 1 is automatically changed back to a 0 by the 3274, an operator code is displayed for the incorrect information, and incorrect entries are intensified.

901 Printer Authorization Matrix Acceptance

Sequence number 901, which appears as part of sequence number 022 (printer authorization matrix display) prompts the operator to enter a 1 if, after the entries are verified, all the responses are entered correctly. If unacceptable responses are detected by the 3274, the 1 is automatically changed back to a 0 by the 3274 and invalid entries are intensified.

999 Modify Procedure

Sequence number 999 displays all the responses entered during the customizing operation, permitting the operator to review the entries and to make any corrections needed. The Initial Customizing Procedure Form instructs the operator how to reply to this sequence number.

* This parameter must be compatible with the host system communications controller and/or the modem.

** Trademark of American Telephone and Telegraph Co.

Chapter 4. Initial Customizing Procedure

This chapter contains a recommended Initial Customizing Procedure Form. This form should be used the first time the 3274 Control Unit is customized. Once the 3274 is successfully customized, if changes are required or desired, the Modification Procedure Form (Chapter 5) should be used.

When initial customizing is complete, the information on the Initial Customizing Procedure Form should be copied onto the Configuration Data card supplied with the 3274. The card should be stored in the pocket on the inside of the 3274 operator access door for future reference.

The following information should be entered by the planner on the Initial Customizing Procedure Form:

1. The type of keyboard (typewriter or data entry) to be used by the operator.

Note: *If using a 76- or 88-key Japanese English or Japanese Katakana keyboard, specify the number of keys and keyboard type.*

2. In step 1, the identification of each diskette to be used.
3. In step 7, enter the response to sequence number 031 (number of RPQ diskettes to be used). If you have no RPQ diskettes, the response is 0.
4. In step 8, use as a guide the section in Chapter 3 that applies to the model being customized, enter the responses to be entered by the operator.

In addition to the form, this chapter also contains:

- Keyboard diagrams showing the valid key positions for customizing (Figures 4-1 and 4-2).
- A diagram showing how to properly insert a diskette into the 3274 Control Unit (Figure 4-3).
- A chart giving the meanings of and recommended actions for the operator codes that may appear on the 3278 Display Station during the customizing procedure (Figure 4-4).
- Charts giving the meanings of and recommended actions for the 8421 indicator codes that appear on the 3274 control panel during the customizing procedure (Figures 4-5 and 4-6).
- A chart giving the meanings of and recommended actions for the 8421 indicator codes that could appear on the 3274 control panel during IML because of improper customizing (Figure 4-7).
- A Printer Authorization Matrix Form to be used with sequence number 022 in Chapter 3.

All of the information listed above and the completed Initial Customizing Procedure Form should be given to the operator who is to perform the customizing procedure at the 3278 Display Station.

Initial Customizing Procedure Form

Review this entire form before starting the customizing procedure. Unit operating procedures are described in the 3270 Information Display System: Operator's Guide, GA27-2890.

These procedures configure the 3274 Control Unit. If you do not get the expected result in any step, start over at step 1. If you have the same problem a second time, check with your supervisor, or follow your local procedures.

There are four indicators, labeled 8421, on the 3274 control panel. The meanings of the 8421 indicator codes are shown in Figures 4-5 and 4-6. If an error occurs during this procedure, the 8421 indicator codes may aid in locating the cause. Within this form, an On indicator is called a 1, an Off indicator a 0 (zero).

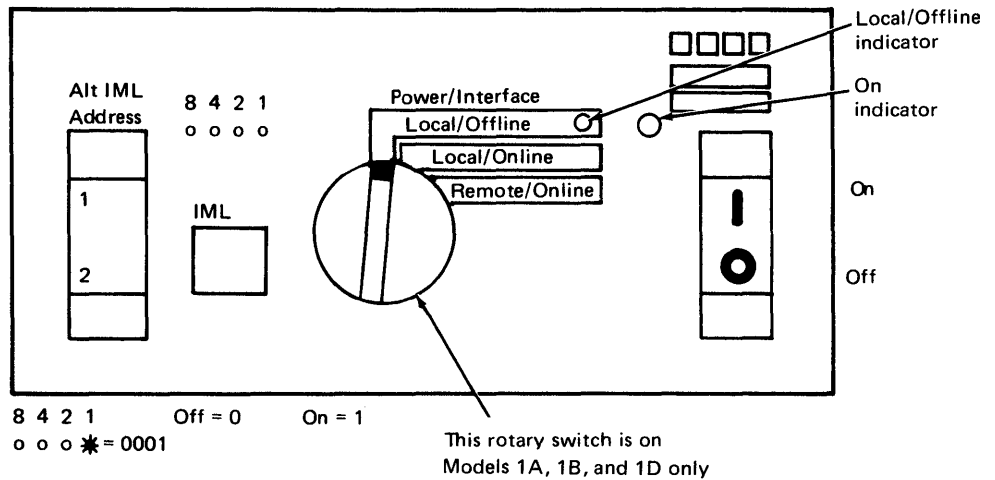

Type of 3278 keyboard to be used: _____

Note: See Figure 4-1 or 4-2 before continuing.

1. Obtain the:

- | | | |
|-----------------------------------|----------------------------------|---|
| System diskette | _____ | } These diskettes were delivered with the 3274. |
| Feature diskette | _____ | |
| Language diskette (if applicable) | _____ | |
| RPQ diskette(s) (if applicable) | 1. _____
2. _____
3. _____ | |

2. Ensure that the 3274 Control Unit and the 3278 Display Station have power switched on. The 3278 must have a keyboard and must be attached to port A0 of the 3274.

Note: When customizing a 3274-1A, 1B, or 1D, do not set the on/off switch to the off position unless the rotary switch on the control panel is in the Local/Offline position and the Local/Offline indicator is lit.

3. Insert the feature diskette (Figure 4-3), and press the IML pushbutton momentarily. After 1 minute or less, the 8421 indicator code should be 0001.

4. Look for a 3-digit sequence number in the upper-left corner of the 3278 screen. The first one is 001. Beneath the sequence number are Xs that are replaced by keying in the response to sequence number 001 (below). If the entered response is acceptable, a new sequence number will be displayed. If the response is unacceptable, an operator code will be displayed at the upper, center portion of the screen. See Figure 4-4 for the meaning of the displayed code.

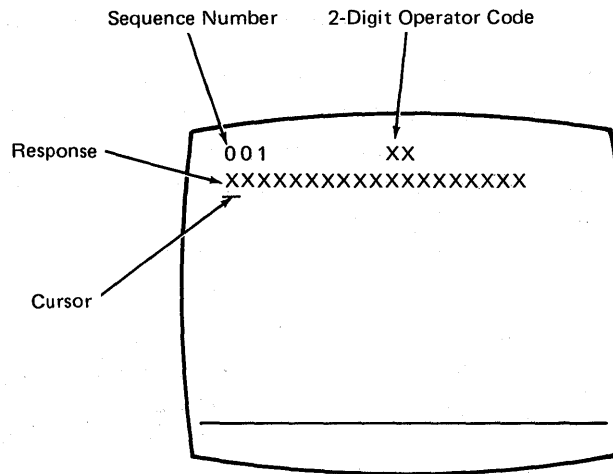

Note: If a 76- or 88-key Japanese English or Japanese Katakana keyboard is used, press the key circled in Figure 4-2 before proceeding. The keyboard will be locked for about 10 seconds. When the keyboard unlocks, continue.

Key in the following characters in response to sequence number 001:

1234567890ABCDEF (03)

Press ENTER.

↑ Spacebar ← This number must match the Validation Number on the feature and system diskette labels.

Note: Use only the cursor move keys to reposition the cursor during this procedure.

5. Key in a 0 (zero) in response to sequence number 011. Press ENTER.
6. Key in a 1 in response to sequence number 021 if a Printer Authorization Matrix Form has been given to you. Follow the instructions on the Printer Authorization Matrix form. Otherwise, key in a 0 (zero). Press ENTER.
7. Key in the number of RPO diskettes being used in response to sequence number 031, and press ENTER.
(0-3)

8. Look for new sequence numbers (they may not be in numerical order nor will all be displayed), and enter the response indicated for each from the following listing. (Note that the listing is shown left-to-right, top-to-bottom to match a display to be shown later in step 9.) Press ENTER after keying in each response.

111 -	<input type="text"/>	<input type="text"/>	112 -	<input type="text"/>	<input type="text"/>	113 -	<input type="text"/>				
121 -	<input type="text"/>	<input type="text"/>	131 -	<input type="text"/>			132 -	<input type="text"/>	133 -	<input type="text"/>	
134 -	<input type="text"/>		135 -	<input type="text"/>							
141 -	<input type="text"/>		143 -	<input type="text"/>			145 -	<input type="text"/>	147 -	<input type="text"/>	
151 -	<input type="text"/>		201 -	<input type="text"/>	<input type="text"/>			211 -	<input type="text"/>	213 -	<input type="text"/>
301 -	<input type="text"/>	<input type="text"/>	302 -	<input type="text"/>	<input type="text"/>			310 -	<input type="text"/>	311 -	<input type="text"/>
313 -	<input type="text"/>		314 -	<input type="text"/>			317 -	<input type="text"/>	318 -	<input type="text"/>	
321 -	<input type="text"/>		331 -	<input type="text"/>			342 -	<input type="text"/>	343 -	<input type="text"/>	
351 -	<input type="text"/>		352 -	<input type="text"/>							
			900 -	0							

Note: Use leading zeros to have a 1-digit response fill a 2-digit box.

9. After the last response is entered, sequence number 999 is displayed with the responses entered during step 8. Verify the entries with the listing in step 8. Zeros will be displayed with any sequence number for which you did not enter a response. Entries may be corrected by moving the cursor to the entry to be changed and entering the correct response. Do not try to change the sequence number itself.

10. When all the entries are correct, move the cursor to the zero after sequence number 900, change it to a 1, and press ENTER. If all the entries are acceptable, the screen will be cleared. Go to step 11. If any entry is unacceptable, the entry to sequence number 900 is changed back to 0 (zero) and the unacceptable value is intensified. The operator code at the upper, center portion of the screen refers to the greatest sequence number with its response intensified. Repeat step 9 and this step. If there are still unacceptable entries, notify your supervisor.

11. After 2 minutes or less, the 8421 indicator code on the 3274 Control Unit should be flashing 1100, 1011, or 1101:

1100 — Replace the feature diskette with the RPO diskette. *Do not press IML.* (If you do press IML, go back to step 3.) After the RPO diskette is inserted, the code will change to 0111 within 30 seconds. If additional RPO diskettes are required, the indicator code will again flash 1100. Repeat the procedure for each additional RPO diskette. *At no time should you press IML.* When the RPO diskette procedure is completed, the indicator code should be flashing 1110. Reinsert the feature diskette. *Do not press IML.* After 2 minutes or less, the 8421 indicator code will flash 1011 or 1101.

1011 — Replace the feature diskette with the system diskette. *Do not press IML.* (If you do press IML, go back to step 3.) After 20 minutes or less, the indicator code will change to 111. If errors occur during this 20-minute period, a flashing 8421 indicator code will appear. Figures 4-5 and 4-6 may aid in locating the cause. Customizing is now completed and an IML of the 3274 Control Unit may be initiated.

1101 — Replace the feature diskette with the language diskette. *Do not press IML.* After 30 seconds or less, the indicator code will change to 0111 and then to flashing 1011 in 1 minute or less. When the indicator code is flashing 1011, replace the language diskette with the system diskette. *Do not press IML.* After 20 minutes or less, the indicator code will change to 1111. If errors occur during this 20-minute period, a flashing 8421 indicator code will appear. Figures 4-5 and 4-6 may aid in locating the cause. Customizing is now completed and an IML of the 3274 Control Unit may be initiated.

12. During IML, errors may occur because of improper customizing. The 8421 indicator codes caused by these errors are shown in Figure 4-7.

If, after IML is initiated, the X  symbol appears with no communication reminders in the 3278 Display Station's operator information area for more than 1 minute, contact your host system operator to ensure that the 3274 Control Unit is being polled.

13. It is suggested that you copy the configuration information from this form on the Configuration Data card supplied with the 3274 Control Unit. Store the card in the pocket on the inside of the 3274 operator access door for future reference.

Note: During customizing, only certain key positions are valid.
Only those key positions shown below are to be used.

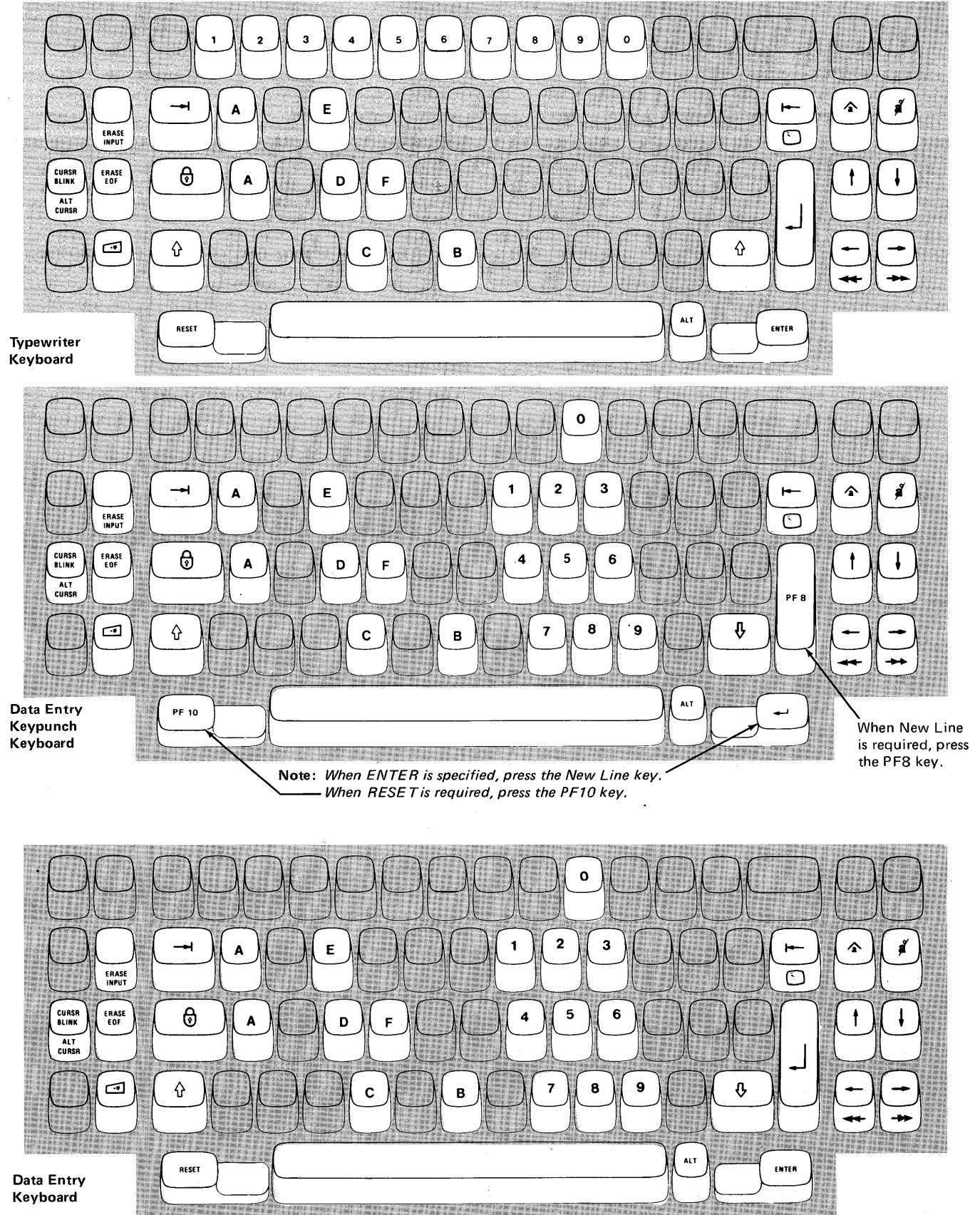

Typewriter Keyboard

Data Entry Keypunch Keyboard

Data Entry Keyboard

Figure 4-1. Valid Key Positions during Customizing

Note: These drawings show the valid keys for both the 76- and 88-key keyboards. The PF keys located on the right side of the 88-key keyboards are not shown and are not valid during this procedure.

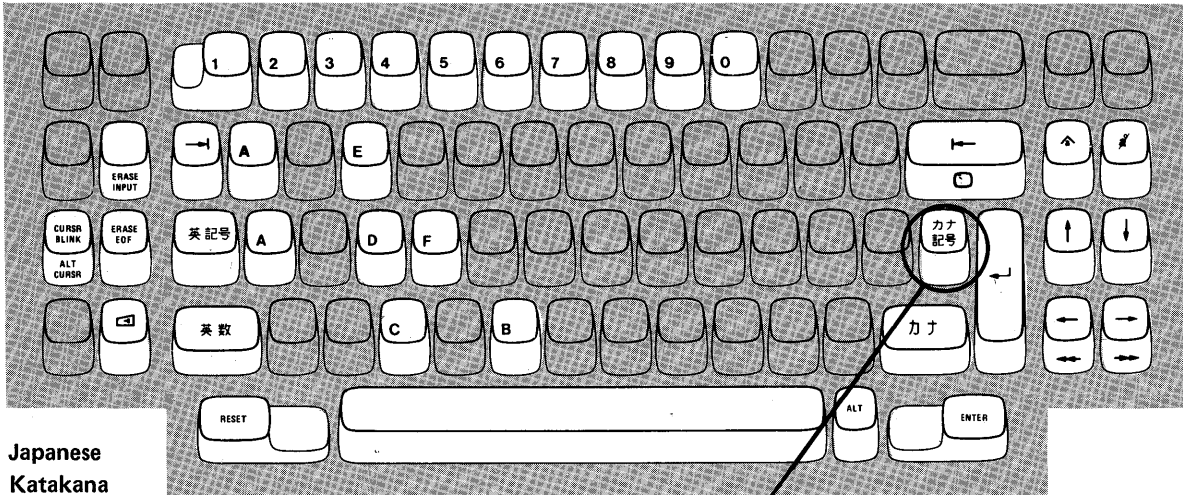

**Japanese
Katakana
Typewriter
Keyboard**

Press this key when sequence number 001 appears in upper left corner of 3278 screen.

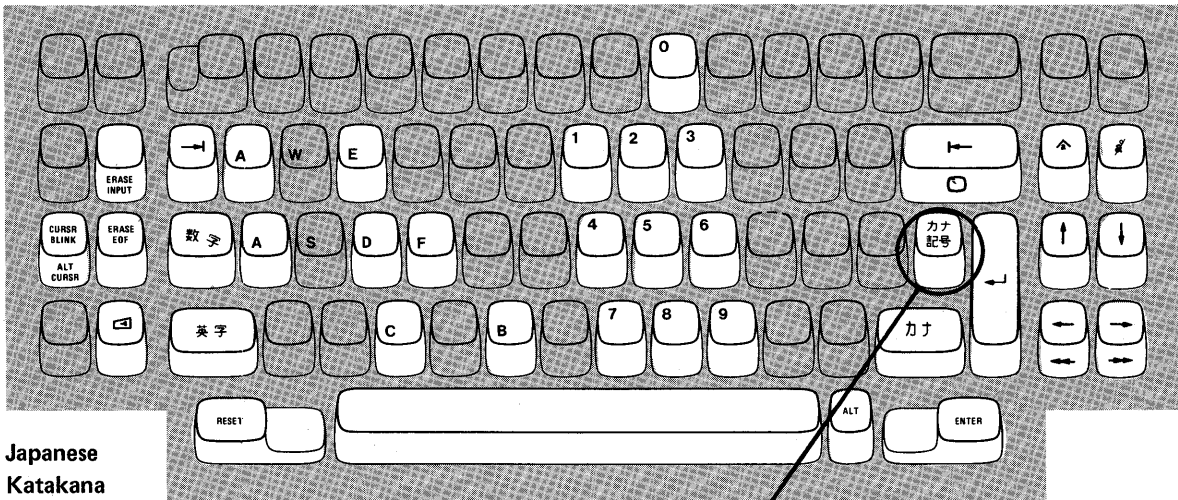

**Japanese
Katakana
Data Entry
Keyboard**

Press this key when sequence number 001 appears in upper left corner of 3278 screen.

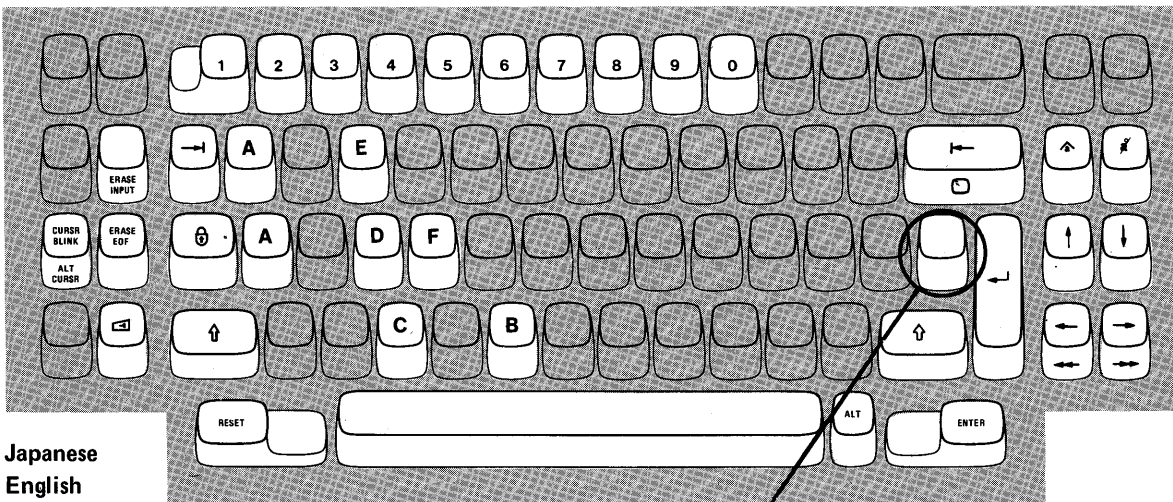

**Japanese
English
Typewriter
Keyboard**

Press this key when sequence number 001 appears in upper left corner of 3270 screen.

Figure 4-2. Valid Key Positions during Customizing When Using Japanese Katakana and Japanese English Keyboards

3274 Diskette Insertion Procedure

1. Open the diskette enclosure door by pressing the latch to the right.

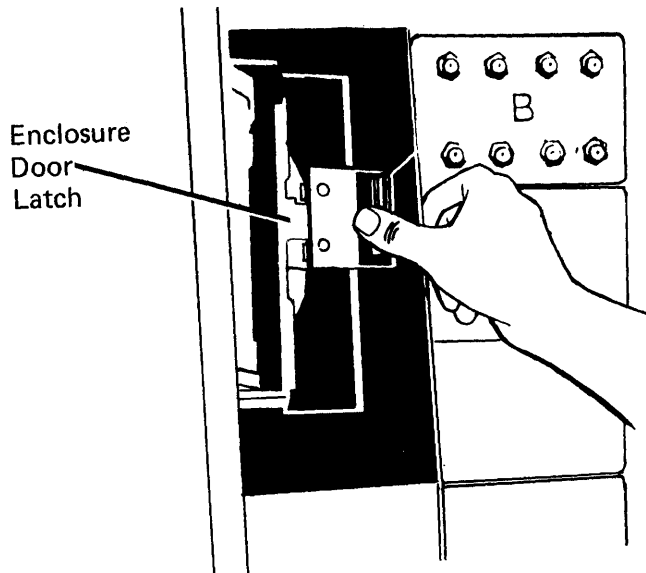

3. Close the diskette reader enclosure door by pushing the door to the left until it latches (clicks).

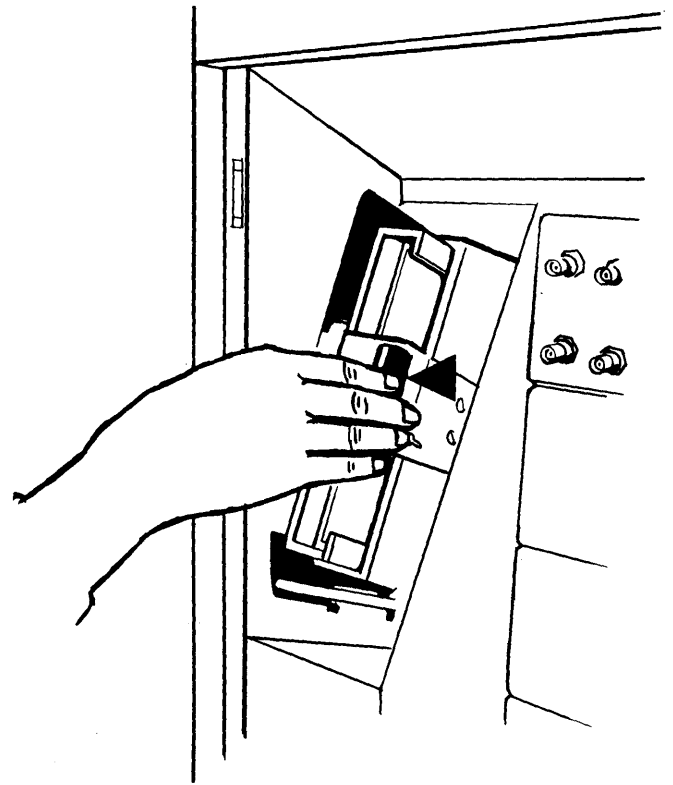

2. Remove the diskette to be used with the 3274 from its gray protective envelope, and insert it squarely into the enclosure. Note diskette label position is to the right.

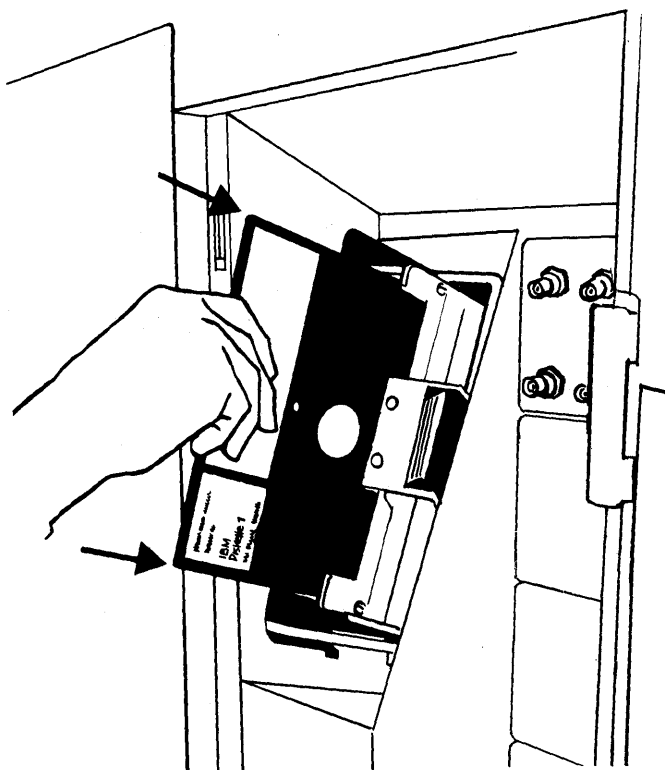

4. Close the customer access door.

Figure 4-3. Inserting a Diskette into the 3274

Code	Meaning	Action
01	One or more of the first 10 characters is incorrect.	Enter the correct response.
02	One or more of the 11th to 17th characters, including the space, is incorrect.	Enter the correct response.
03	(1) One of the last two characters you entered in response to sequence number 001 is incorrect, or, (2) the diskette release level is not the same as the documentation level.	(1) Enter the correct response. (2) Restart after matching diskette and documentation levels.
11	You entered an invalid response (too many characters, value too high or too low, wrong character, etc.).	Enter the correct response.
12	You entered a character other than A, B, C, or 1D in response to sequence number 151.	Enter the correct response.
13	Your response has too few characters.	Enter the correct response.
14	The numerical sum of the responses you entered for sequence numbers 111 and 112 is greater than 32.	Enter the correct response.
21*	You made an unacceptable change during the modify sequence (number 999).	Recheck the entries and correct them.
22*	(1) Your response to sequence number 321 is 1, but 121 is not 02 and/or 131 is not 1, or (2) 321 is 0 and 121 is 02.	(1) Verify and enter the correct response. (2) Verify and enter the correct response.
23*	One or more of your responses are not compatible with the response to sequence number 331.	Verify and enter the correct response.
24*	(1) All of your responses to sequence numbers 131, 132, and 133 are 0s (at least one response must be a 1), or, (2) Your response to sequence number 113 was 3622 but the extended function store feature is not installed in the 3274.	(1) Verify and enter the correct response(s). (2) Verify and enter the correct response.
25*	(1) If this is response to sequence number 133, you specified Katakana in 121 and Data Entry Key-punch keyboard in 133. (There is no Data Entry Key-punch keyboard for Katakana.) (2) If this is response to sequence number 113, the 3274 has insufficient storage.	(1) Verify and enter the correct response. (2) Notify your supervisor.
26*	Insufficient storage in the 3274.	Notify your supervisor.
99	Your entries are acceptable, but the entry for sequence number 900 or 901 has not been changed to a 1.	Change 900 or 901 entry to a 1.

* If any entry is unacceptable, the entry for sequence number 900 is changed back to 0 (zero) and the unacceptable value is intensified.

Figure 4-4. Operator Codes during Customizing

Steady Code	Diskette Mounted	Meaning	Action
0001	Feature	Customizing being performed	None.
0010	Any (indication lasts for 3 minutes or more)	Diskette improperly inserted or an internal 3274 error	Insert diskette properly and retry.
0011	Feature	Customizing being performed	None.
0100	Feature	Patch, printer authorization matrix, or RPQ being performed	None.
0101	Feature	Configuration being performed	None.
0110	Feature	Modification being performed	None.
0111	Feature, language, or RPQ	Normal 3274 operation	None.
1000	System (customizing in process)	Normal 3274 operation	None.
1001	Any	Internal 3274 error	Retry. Notify supervisor if error recurs.
1010	Any	Internal 3274 error	Retry. Notify supervisor if error recurs.
1101	Any (customizing procedure in progress)	1. IML button pressed while changing diskette, or, 2. A bad or uncustomized system diskette is being used	1. Recustomize. Do not press IML button unless instructed to do so. 2. Insert a good customized system diskette.
1111	System (IML not performed)	Customizing is complete	IML can be performed.

Figure 4-5. Steady 8421 Indicator Codes during Customizing

Flashing Code	Diskette Mounted	Meaning	Action
0000 1011	Any	System diskette request	Insert system diskette.
0000 1100	Any	RPO diskette request	Insert RPO diskette.
0000 1101	Any	Language diskette request	Insert language diskette.
0000 1110	Any	Feature diskette request	Insert feature diskette.
0100 0010	System	Configuration on system diskette being used for update-diskette procedure is not compatible with this 3274	Use a system diskette with a compatible configuration.
1000 0001	System	Uncustomized system diskette being used during update procedure	Use customized system diskette.
1001 0110	Any	Wrong level diskette being used	Use correct level diskette.
1111 0011	Feature	On/Off switch or TEST key pressed instead of ENTER	Retry. Notify supervisor if error recurs.
1111 0100	Feature or System	Internal 3274 error	Retry. Notify supervisor if error recurs.
1111 0101	System	Internal 3274 error	Retry. Notify supervisor if error recurs.
	Feature	On/Off switch or TEST key on the 3278 pressed instead of ENTER	
1111 0110	RPO	Incompatible RPOs	Notify supervisor.
	Feature	Internal 3274 error	
1111 0111	System	Internal 3274 error	Notify supervisor.
1111 1000	System	Internal 3274 error	Notify supervisor.
1111 1001	System	Internal 3274 error	Notify supervisor.
1111 1010	Any	Internal 3274 error	Notify supervisor.
1111 1011	System	Internal 3274 error	Notify supervisor.
1111 1100	Any	Diskette drive error or a bad diskette	Retry. Notify supervisor if error recurs.
1111 1101	System or feature	Diskette drive error or a bad diskette	Retry. Notify supervisor if error recurs.
1111 1110	Any	Internal 3274 error	Retry. Notify supervisor if error recurs.

Figure 4-6. Flashing 8421 Indicator Codes during Customizing

Steady Code	Flashing Code	Diskette Mounted	Meaning	Action
—	0000 0101	System	Internal 3274 error or wrong response to sequence number 113 during customizing procedure	Check response to sequence number 113 and retry. Notify supervisor if error recurs.
—	0000 0110	System	Internal 3274 error or wrong response to sequence numbers 111, 112, or 351 during customizing procedure	Check response to sequence numbers 111, 112, and 351 and retry. Notify supervisor if error recurs.
—	0000 0111	System	Internal 3274 error or wrong response to sequence number 311 during customizing procedure	Check response to sequence number 311 and retry. Notify supervisor if error recurs.
—	0000 1000	System	Internal 3274 error or wrong response to sequence number 111 during customizing procedure	Check response to sequence number 111 and retry. Notify supervisor if error recurs.
1101	—	System	Uncustomized system diskette	Insert customized system diskette.

Figure 4-7. 8421 Indicator Codes during IML That Result from an Incorrect Customizing Procedure

Printer Authorization Matrix Form

Enter the characters (below) supplied by the planner in the appropriate groups on your display screen. If a group already is displayed as AA M XXXX YYYY YYYY, your entry will overwrite these characters. When you have completed all your entries, move the cursor to the zero after sequence number 901 at the bottom of the screen, change it to a 1, and press ENTER. Any entry that is not valid will be intensified at this time and the 1 you entered will change back to a 0 (zero). Correct the invalid entry, and return to 901. Again, change the zero to a 1, and press ENTER. When all entries are valid, the printer authorization matrix display will be replaced by the next customizing sequence number. (If, at any time during this procedure, you wish to return to the original matrix, change the 0 (zero) after the 901 to A and press ENTER.) Return to your original instructions.

To delete an entry, move the cursor (with cursor-move keys) to the leftmost position of the entry (the Printer Port Address) and press the spacebar twice. The entire matrix, or as many entries as desired, can be deleted in this manner. After all changes have been made, press ENTER. All deleted entries will be displayed as AA M XXXX YYYY YYYY. When the matrix is satisfactorily defined, move the cursor to the zero after sequence number 901, change it to a 1, and press ENTER.

	Printer Port Address		Printer Mode	Printer Class Assignment				Source Device List						
	A	A	M	X	X	X	X	Y	Y	Y	Y	Y	Y	Y
1)	-	-	-	-	-	-	-	-	-	-	-	-	-	-
2)	-	-	-	-	-	-	-	-	-	-	-	-	-	-
3)	-	-	-	-	-	-	-	-	-	-	-	-	-	-
4)	-	-	-	-	-	-	-	-	-	-	-	-	-	-
5)	-	-	-	-	-	-	-	-	-	-	-	-	-	-
6)	-	-	-	-	-	-	-	-	-	-	-	-	-	-
7)	-	-	-	-	-	-	-	-	-	-	-	-	-	-
8)	-	-	-	-	-	-	-	-	-	-	-	-	-	-
9)	-	-	-	-	-	-	-	-	-	-	-	-	-	-
10)	-	-	-	-	-	-	-	-	-	-	-	-	-	-
11)	-	-	-	-	-	-	-	-	-	-	-	-	-	-
12)	-	-	-	-	-	-	-	-	-	-	-	-	-	-
13)	-	-	-	-	-	-	-	-	-	-	-	-	-	-
14)	-	-	-	-	-	-	-	-	-	-	-	-	-	-
15)	-	-	-	-	-	-	-	-	-	-	-	-	-	-
16)	-	-	-	-	-	-	-	-	-	-	-	-	-	-

	Printer Port Address		Printer Mode	Printer Class Assignment				Source Device List							
	A	A	M	X	X	X	X	Y	Y	Y	Y	Y	Y	Y	Y
17)	-	-	-	-	-	-	-	-	-	-	-	-	-	-	-
18)	-	-	-	-	-	-	-	-	-	-	-	-	-	-	-
19)	-	-	-	-	-	-	-	-	-	-	-	-	-	-	-
20)	-	-	-	-	-	-	-	-	-	-	-	-	-	-	-
21)	-	-	-	-	-	-	-	-	-	-	-	-	-	-	-
22)	-	-	-	-	-	-	-	-	-	-	-	-	-	-	-
23)	-	-	-	-	-	-	-	-	-	-	-	-	-	-	-
24)	-	-	-	-	-	-	-	-	-	-	-	-	-	-	-
25)	-	-	-	-	-	-	-	-	-	-	-	-	-	-	-
26)	-	-	-	-	-	-	-	-	-	-	-	-	-	-	-
27)	-	-	-	-	-	-	-	-	-	-	-	-	-	-	-
28)	-	-	-	-	-	-	-	-	-	-	-	-	-	-	-
29)	-	-	-	-	-	-	-	-	-	-	-	-	-	-	-
30)	-	-	-	-	-	-	-	-	-	-	-	-	-	-	-
31)	-	-	-	-	-	-	-	-	-	-	-	-	-	-	-

Chapter 5. Modification Procedure

The modification procedure is used to modify an existing 3274 configuration without performing the entire customizing procedure. The recommended Modification Procedure Form contained in this chapter should be used only after the 3274 Control Unit has been initially customized per the Initial Customizing Procedure Form in Chapter 4. The Modification Procedure Form is used to change an existing 3274 configuration. After changes are made, be sure that the changes are recorded on the Configuration Data card stored in the pocket inside the 3274 customer access door.

The following information should be entered by the planner on the Modification Procedure Form:

1. The type of keyboard (typewriter or data entry) to be used by the operator.

Note: *If using a 76- or 88-key Japanese English or Japanese Katakana keyboard, specify the number of keys and keyboard type.*

2. In step 1, the identification of each diskette to be used.
3. In step 7, enter the response to sequence number 031 (number of RPQ diskettes to be used).

In addition to the form, this chapter also contains:

- Keyboard diagrams showing the valid key positions for modification (Figures 5-1 and 5-2).
- A diagram showing how to insert diskettes into the 3274 Control Unit (Figure 5-3).
- A chart giving the meanings of and recommended actions for the operator codes that may appear on the 3278 Display Station during the modification procedure (Figure 5-4).
- Charts giving the meanings of and recommended actions for the 8421 indicator codes that appear on the 3274 control panel during the modification procedure (Figures 5-5 and 5-6).
- A chart giving the meanings of and recommended actions for the 8421 indicator codes that could appear on the 3274 control panel during IML due to improper modification.
- A Printer Authorization Matrix Form to be used with sequence number 022 (Printer Authorization Matrix Specification).

All of the information listed above and the filled-in Modification Procedure Form should be given to the operator who is to perform the modification procedure at the 3278 Display Station.

Modification Procedure Form

Review this entire form before starting the procedure. Unit operating procedures are described in the *3270 Information Display System: Operator's Guide*, GA27-2890.

This procedure modifies an existing 3274 Control Unit configuration. *If you do not get the expected result in any step, start over at step 1. If you have the same problem a second time, check with your supervisor, or follow your local procedures.*

There are four indicators, labeled 8421, on the 3274 control panel. The meanings of the 8421 indicator codes are shown in Figures 5-5 and 5-6. If an error occurs during this procedure, the 8421 indicator codes may aid in locating the cause. Within this form, an On indicator is called a 1, an Off indicator a 0 (zero).

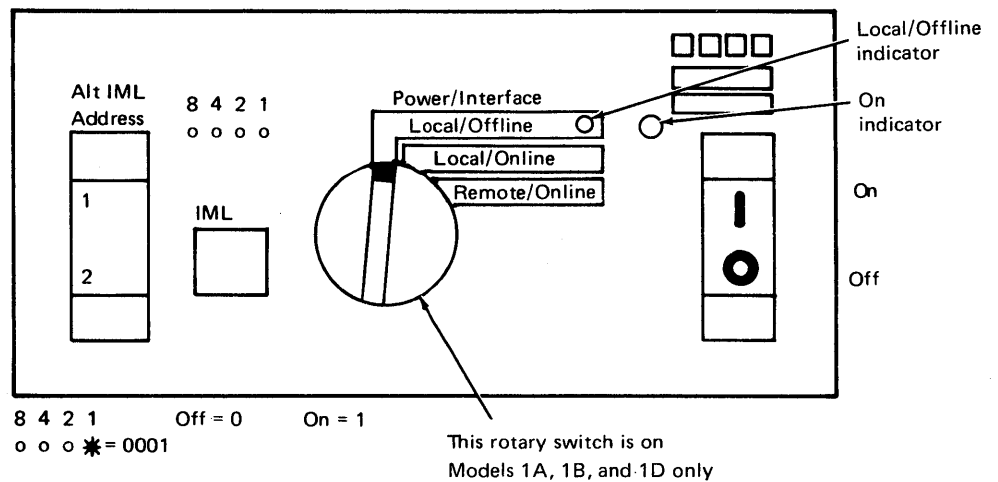

Type of 3278 keyboard to be used: _____

Note: See Figure 5-1 or 5-2 before continuing.

1. Obtain the:
 - Feature diskette _____
 - Customized system diskette _____
 - Language diskette (if applicable) _____
 - RPQ diskette(s) (if applicable) 1. _____
 - 2. _____
 - 3. _____

2. Ensure that the 3274 Control Unit and the 3278 Display Station have power switched on. The 3278 must have a keyboard and must be attached to port A0 of the 3274.

Note: When customizing a 3274-1A, 1B, or 1D, do not set the on/off switch to the off position unless the rotary switch on the control panel is in the Local/Offline position and the Local/Offline indicator is lit.

3. Insert the feature diskette (see Figure 5-3) and, holding the Alt IML Address switch in position 1, press and release the IML button; then release the Alt IML Address switch. After 2 minutes or less, the 8421 indicator code will be a flashing 1011.
4. Insert the customized system diskette. After 1 minute or less, the 8421 indicator code will be a flashing 1110.
5. Insert the feature diskette again. After 1 minute or less, the 8421 indicator codes will be a steady 0001.
6. Look for a 3-digit sequence number in the upper-left corner of the 3278 screen. The first one is 001. Beneath the sequence number are Xs that are replaced by keying in the response to sequence number 001 (below). If the entered response is acceptable, a new sequence number will be displayed. If the response is unacceptable, an operator code will be displayed at the upper, center portion of the screen. See Figure 5-4 for the meaning of the displayed code.

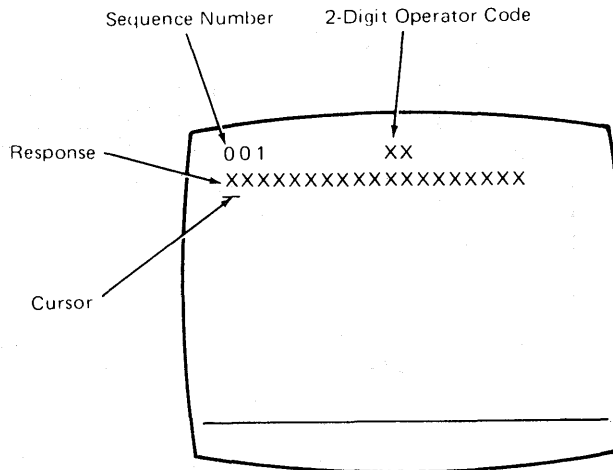

Note: If a 76- or 88-key Japanese English or Japanese Katakana keyboard is used, press the key circled in Figure 5-2 before proceeding. The keyboard will be locked for about 10 seconds. When the keyboard unlocks, continue.

Key in the following characters in response to sequence number 001:

1234567890ABCDEF (03) ← This number must match the Validation Number on the feature and system diskette labels.

Press ENTER. ↑ Spacebar

Note: Use only the cursor move keys to reposition the cursor during this procedure.

7. Key in a 0 (zero) in response to sequence number 011. Press ENTER.
8. At this time, either sequence number 021 is displayed (meaning that no printer authorization matrix has been defined) or the defined matrix is displayed.

If sequence number 021 is displayed and if you have not been given a Printer Authorization Matrix Form, key in a 0 (zero) and press ENTER. If you have been given the Printer Authorization Matrix Form, key in a 1 and press ENTER, then follow the instructions on the form. If the printer authorization matrix is displayed and you are to make changes to the matrix, make the changes. Move the cursor to the entry for 901 (located at the bottom of the screen), change it to a 1, and press ENTER. If you have no changes, simply move the cursor to the entry for 901, change it to a 1, and press ENTER.

9. Key in the number of RPQ diskettes $\frac{\quad}{(0-3)}$ being used in response to sequence number 031, and press ENTER.
10. The entire set of sequence numbers should now be displayed on the display screen. Change the responses to the sequence numbers as required. After all changes have been made, move the cursor to the entry for sequence number 900, change it to a 1, and press ENTER. Go to step 11.

If any entry is unacceptable, the entry for sequence number 900 is changed back to a 0 (zero) and the unacceptable response is intensified. The operator code at the upper, center portion of the display refers to the greatest sequence number with its response intensified. The meanings of the operator codes are shown in Figure 5-4. Check all responses that were changed and correct any errors. Again, move the cursor to the entry for 900, change it to a 1, and press ENTER. If errors recur, notify your supervisor.

11. After 2 minutes or less, the 8421 indicator code on the 3274 Control Unit should be flashing 1100, 1011, or 1101:

1100 — Replace the feature diskette with the RPQ diskette. *Do not press IML.* (If you do press IML, go back to step 3.) After the RPQ diskette is inserted, the code will change to 0111 within 30 seconds. If additional RPQ diskettes are required, the indicator code will again flash 1100. Repeat the procedure for each additional RPQ diskette. *At no time should you press IML.* When the RPQ diskette procedure is completed, the indicator code should be flashing 1110. Reinsert the feature diskette. *Do not press IML.* After 2 minutes or less, the 8421 indicator code will flash 1011 or 1101.

1011 — Replace the feature diskette with the system diskette. *Do not press IML.* After 20 minutes or less, the indicator code will change to 1111. If errors occur during this 20-minute period, a flashing 8421 indicator code will appear. Figures 5-5 and 5-6 may aid in locating the cause. Recustomizing of the system diskette is completed.

1101 .— Replace the feature diskette with the language diskette. *Do not press IML.* After 30 seconds or less, the indicator code will change to 0111 and then to flashing 1011 in 1 minute or less. When the indicator code is flashing 1011, replace the language diskette with the system diskette. *Do not press IML.* After 20 minutes or less, the indicator code will change to 1111. If errors occur during this 20-minute period, a flashing 8421 indicator code will appear. Figures 5-5 and 5-6 may aid in locating the cause.

The modification procedure is completed and an IML of the 3274 Control Unit may be initiated. Record the changes made during this procedure on the Configuration Data card stored in the pocket inside the 3274 customer access door. During IML, errors may occur because of improper modification. The 8421 indicator codes caused by these errors are shown in Figure 5-7.

Note: During the modification procedure, only certain key positions are valid.
Only those key positions shown below are to be used.

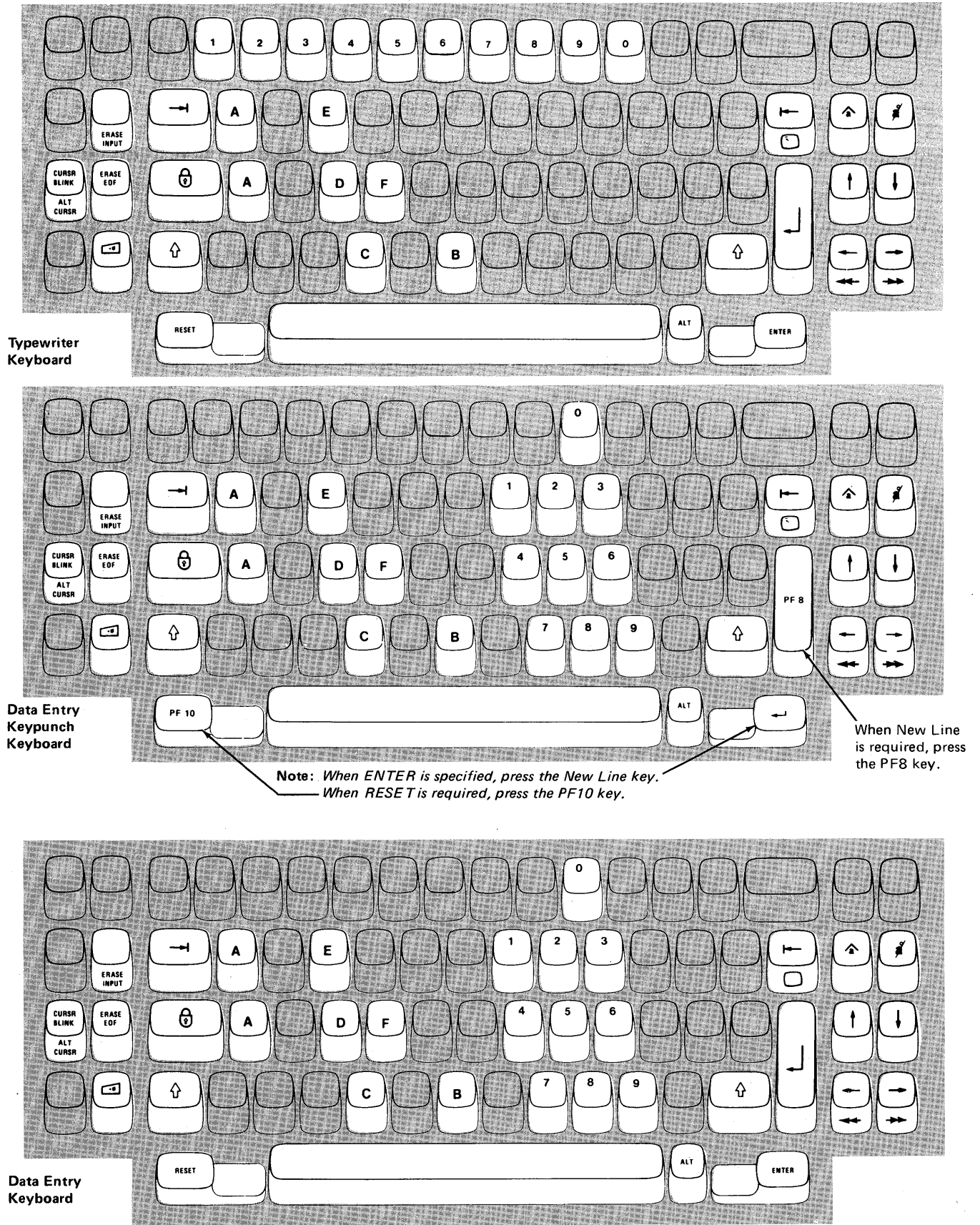
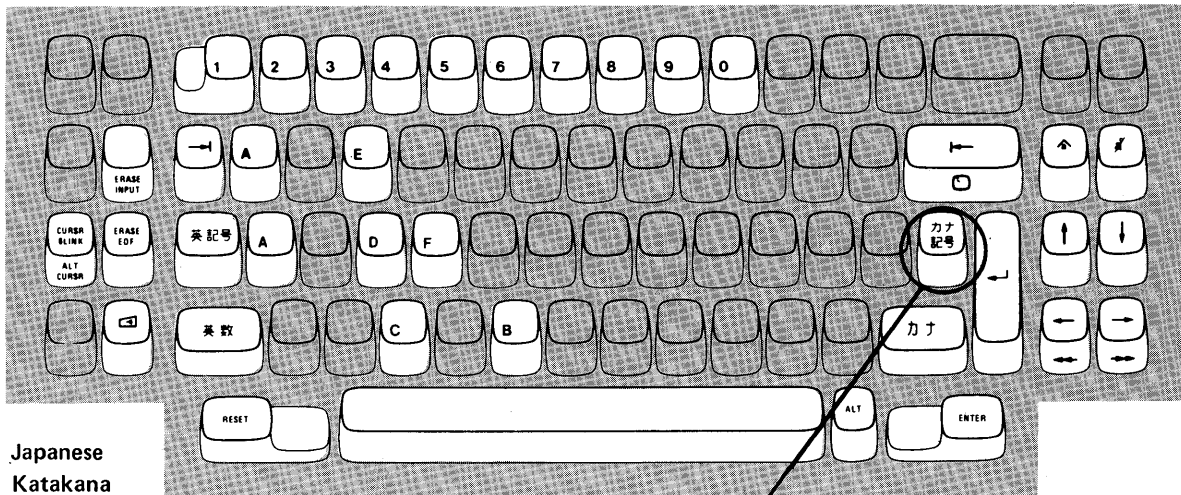

Figure 5-1. Valid Key Positions during the Modification Procedure

Note: These drawings show the valid keys for both the 76- and 88-key keyboards. The PF keys located on the right side of the 88-key keyboards are not shown and are not valid during this procedure.



Japanese
Katakana
Typewriter
Keyboard

Press this key when sequence number 001 appears in upper left corner of 3278 screen.

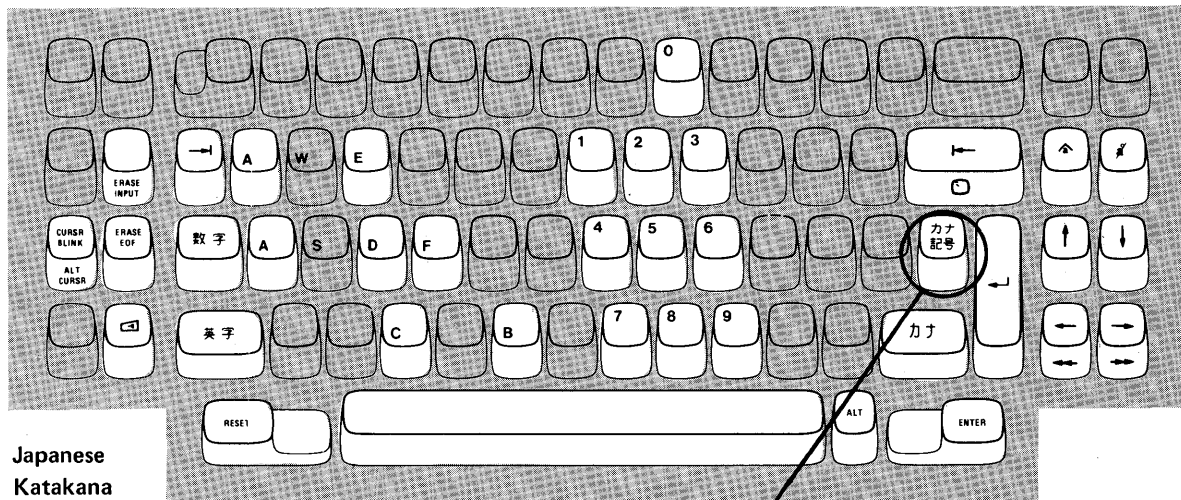

Japanese
Katakana
Data Entry
Keyboard

Press this key when sequence number 001 appears in upper left corner of 3278 screen.

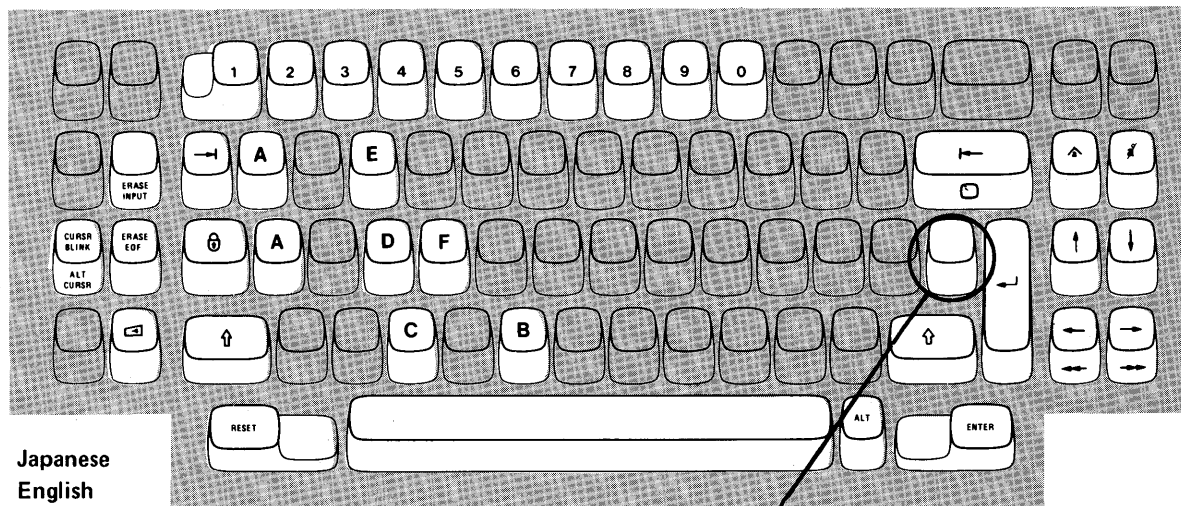

Japanese
English
Typewriter
Keyboard

Press this key when sequence number 001 appears in upper left corner of 3270 screen.

Figure 5-2. Valid Key Positions during the Modification Procedure When Using Japanese Katakana and Japanese English Keyboards

3274 Diskette Insertion Procedures

1. Open the diskette enclosure door by pressing the latch to the right.

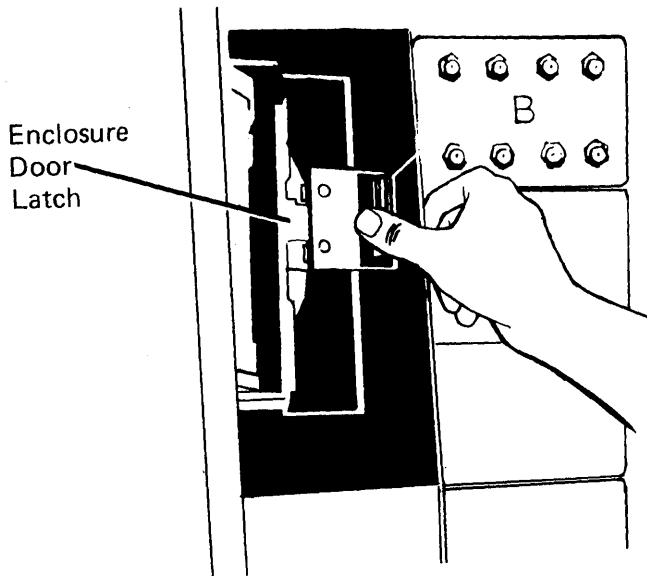

3. Close the diskette reader enclosure door by pushing the door to the left until it latches (clicks).

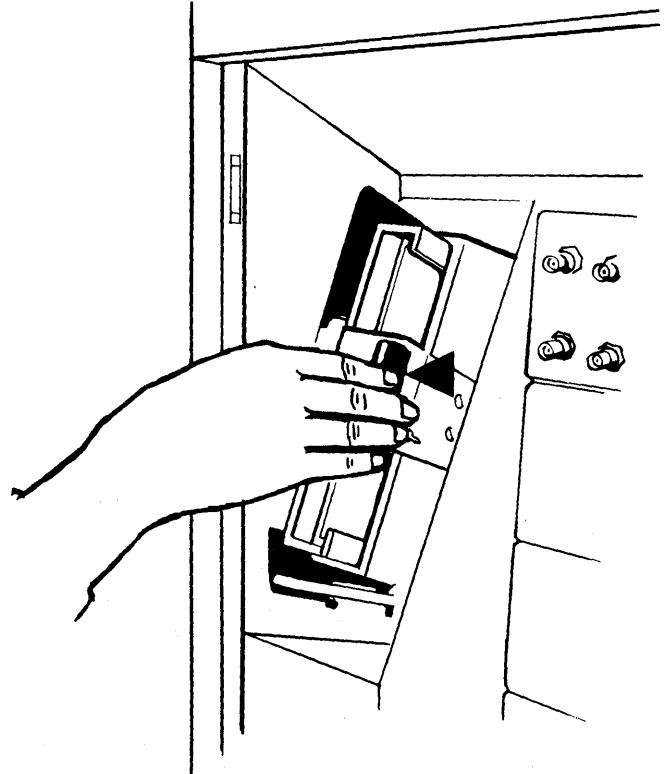

2. Remove the diskette to be used with the 3274 from its gray protective envelope, and insert it squarely into the enclosure. Note diskette label position is to the right.

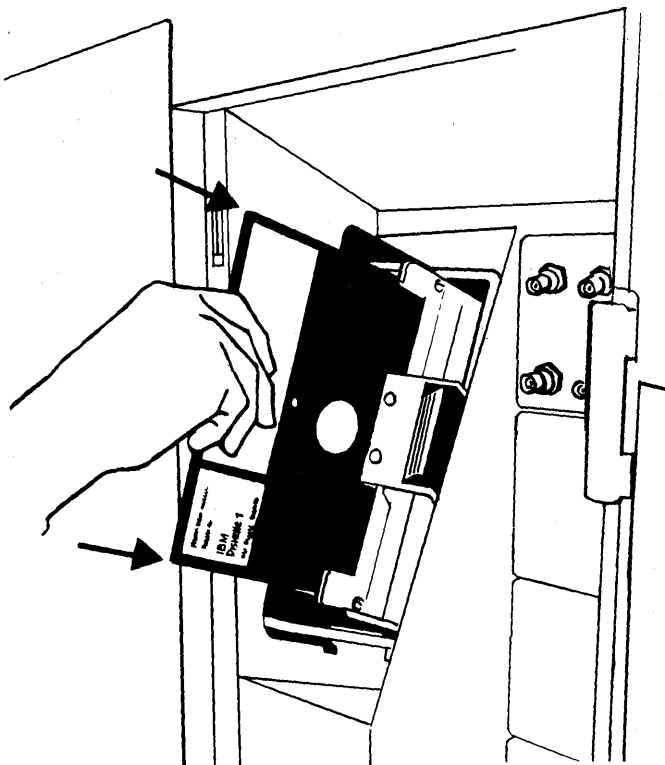

4. Close the customer access door.

Figure 5-3. Inserting a Diskette into the 3274

Code	Meaning	Action
01	One or more of the first 10 characters is incorrect.	Enter the correct response.
02	One or more of the 11th to 17th characters, including the space, is incorrect.	Enter the correct response.
03	(1) One of the last two characters you entered in response to sequence number 001 is incorrect, or, (2) the diskette release level is not the same as the documentation level.	(1) Enter the correct response. (2) Restart after matching diskette and documentation levels.
11	You entered an invalid response (too many characters, value too high or too low, wrong character, etc.).	Enter the correct response.
12	You entered a character other than A, B, C, or 1D in response to sequence number 151.	Enter the correct response.
13	Your response has too few characters.	Enter the correct response.
14	The numerical sum of the responses you entered for sequence numbers 111 and 112 is greater than 32.	Enter the correct response.
21*	You made an unacceptable change during the modify sequence (number 999).	Recheck the entries and correct them.
22*	(1) Your response to sequence number 321 is 1, but 121 is not 02 and/or 131 is not 1, or (2) 321 is 0 and 121 is 02.	(1) Verify and enter the correct response. (2) Verify and enter the correct response.
23*	One or more of your responses are not compatible with the response to sequence number 331.	Verify and enter the correct response.
24*	(1) All of your responses to sequence numbers 131, 132, and 133 are 0s (at least one response must be a 1), or, (2) Your response to sequence number 113 was 3622 but the extended function store feature is not installed in the 3274.	(1) Verify and enter the correct response(s). (2) Verify and enter the correct response.
25*	(1) If this is response to sequence number 133, you specified Katakana in 121 and Data Entry Keypunch keyboard in 133. (There is no Data Entry Keypunch keyboard for Katakana.) (2) If this is response to sequence number 113, the 3274 has insufficient storage.	(1) Verify and enter the correct response. (2) Notify your supervisor.
26*	Insufficient storage in the 3274.	Notify your supervisor.
99	Your entries are acceptable, but the entry for sequence number 900 or 901 has not been changed to a 1.	Change 900 or 901 entry to a 1.

* If any entry is unacceptable, the entry for sequence number 900 is changed back to 0 (zero) and the unacceptable value is intensified.

Figure 5-4. Operator Codes during the Modification Procedure

Steady Code	Diskette Mounted	Meaning	Action
0001	Feature	Customizing being performed	None.
0010	Any (indication lasts for 3 minutes or more)	Diskette improperly inserted or an internal 3274 error	Insert diskette properly and retry.
0011	Feature	Customizing being performed	None.
0100	Feature	Patch, printer authorization matrix, or RPQ being performed	None.
0101	Feature	Configuration being performed	None.
0110	Feature	Modification being performed	None.
0111	Feature, language, or RPQ	Normal 3274 operation	None.
1000	System (customizing in process)	Normal 3274 operation	None.
1001	Any	Internal 3274 error	Retry. Notify supervisor if error recurs.
1010	Any	Internal 3274 error	Retry. Notify supervisor if error recurs.
1101	Any (customizing procedure in progress)	1. IML button pressed while changing diskette, or, 2. A bad or uncustomized system diskette is being used	1. Recustomize. Do not press IML button unless instructed to do so. 2. Insert a good customized system diskette.
1111	System (IML not performed)	Customizing is complete	IML can be performed.

Figure 5-5. Steady 8421 Indicator Codes during the Modification Procedure

Flashing Code	Diskette Mounted	Meaning	Action
0000 1011	Any	System diskette request	Insert system diskette.
0000 1100	Any	RPO diskette request	Insert RPO diskette.
0000 1101	Any	Language diskette request	Insert language diskette.
0000 1110	Any	Feature diskette request	Insert feature diskette.
0100 0010	System	Configuration on system diskette being used for update-diskette procedure is not compatible with this 3274	Use a system diskette with a compatible configuration.
1000 0001	System	Uncustomized system diskette being used during update procedure	Use customized system diskette.
1001 0110	Any	Wrong level diskette being used	Use correct level diskette.
1111 0011	Feature	On/Off switch or TEST key pressed instead of ENTER	Retry. Notify supervisor if error recurs.
1111 0100	Feature or System	Internal 3274 error	Retry. Notify supervisor if error recurs.
1111 0101	System	Internal 3274 error	Retry. Notify supervisor if error recurs.
	Feature	On/Off switch or TEST key on the 3278 pressed instead of ENTER	
1111 0110	RPO	Incompatible RPOs	Notify supervisor.
	Feature	Internal 3274 error	
1111 0111	System	Internal 3274 error	Notify supervisor.
1111 1000	System	Internal 3274 error	Notify supervisor.
1111 1001	System	Internal 3274 error	Notify supervisor.
1111 1010	Any	Internal 3274 error	Notify supervisor.
1111 1011	System	Internal 3274 error	Notify supervisor.
1111 1100	Any	Diskette drive error or a bad diskette	Retry. Notify supervisor if error recurs.
1111 1101	System or feature	Diskette drive error or a bad diskette	Retry. Notify supervisor if error recurs.
1111 1110	Any	Internal 3274 error	Retry. Notify supervisor if error recurs.

Figure 5-6. Flashing 8421 Indicator Codes during the Modification Procedure

Steady Code	Flashing Code	Diskette Mounted	Meaning	Action
—	0000 0101	System	Internal 3274 error or wrong response to sequence number 113 during customizing procedure	Check response to sequence number 113 and retry. Notify supervisor if error recurs.
—	0000 0110	System	Internal 3274 error or wrong response to sequence numbers 111, 112, or 351 during customizing procedure	Check response to sequence numbers 111, 112, and 351 and retry. Notify supervisor if error recurs.
—	0000 0111	System	Internal 3274 error or wrong response to sequence number 311 during customizing procedure	Check response to sequence number 311 and retry. Notify supervisor if error recurs.
—	0000 1000	System	Internal 3274 error or wrong response to sequence number 111 during customizing procedure	Check response to sequence number 111 and retry. Notify supervisor if error recurs.
1101	—	System	Uncustomized system diskette	Insert customized system diskette.

Figure 5-7. 8421 Indicator Codes during IML That Result from an Incorrect Modification Procedure

Printer Authorization Matrix Form

Enter the characters (below) supplied by the planner in the appropriate groups on your display screen. If a group already is displayed as AA M XXXX YYYY YYYY, your entry will overwrite these characters. When you have completed all your entries, move the cursor to the zero after sequence number 901 at the bottom of the screen, change it to a 1, and press ENTER. Any entry that is not valid will be intensified at this time and the 1 you entered will change back to a 0 (zero). Correct the invalid entry, and return to 901. Again, change the zero to a 1 and press ENTER. When all entries are valid, the printer authorization matrix display will be replaced by the next customizing sequence number. (If, at any time during this procedure, you wish to return to the original matrix, change the 0 (zero) after the 901 to A, and press ENTER.) Return to your original instructions.

To delete an entry, move the cursor (with cursor-move keys) to the leftmost position of the entry (the Printer Port Address) and press the spacebar twice. The entire matrix, or as many entries as desired, can be deleted in this manner. After all changes have been made, press ENTER. All deleted entries will be displayed as AA M XXXX YYYY YYYY. When the matrix is satisfactorily defined, move the cursor to the zero after sequence number 901, change it to a 1, and press ENTER.

	Printer Port Address		Printer Mode	Printer Class Assignment				Source Device List							
	A	A	M	X	X	X	X	Y	Y	Y	Y	Y	Y	Y	Y
1)	-	-	-	-	-	-	-	-	-	-	-	-	-	-	-
2)	-	-	-	-	-	-	-	-	-	-	-	-	-	-	-
3)	-	-	-	-	-	-	-	-	-	-	-	-	-	-	-
4)	-	-	-	-	-	-	-	-	-	-	-	-	-	-	-
5)	-	-	-	-	-	-	-	-	-	-	-	-	-	-	-
6)	-	-	-	-	-	-	-	-	-	-	-	-	-	-	-
7)	-	-	-	-	-	-	-	-	-	-	-	-	-	-	-
8)	-	-	-	-	-	-	-	-	-	-	-	-	-	-	-
9)	-	-	-	-	-	-	-	-	-	-	-	-	-	-	-
10)	-	-	-	-	-	-	-	-	-	-	-	-	-	-	-
11)	-	-	-	-	-	-	-	-	-	-	-	-	-	-	-
12)	-	-	-	-	-	-	-	-	-	-	-	-	-	-	-
13)	-	-	-	-	-	-	-	-	-	-	-	-	-	-	-
14)	-	-	-	-	-	-	-	-	-	-	-	-	-	-	-
15)	-	-	-	-	-	-	-	-	-	-	-	-	-	-	-
16)	-	-	-	-	-	-	-	-	-	-	-	-	-	-	-

	Printer Port Address		Printer Mode	Printer Class Assignment				Source Device List						
	A	A	M	X	X	X	X	Y	Y	Y	Y	Y	Y	Y
17)	-	-	-	-	-	-	-	-	-	-	-	-	-	-
18)	-	-	-	-	-	-	-	-	-	-	-	-	-	-
19)	-	-	-	-	-	-	-	-	-	-	-	-	-	-
20)	-	-	-	-	-	-	-	-	-	-	-	-	-	-
21)	-	-	-	-	-	-	-	-	-	-	-	-	-	-
22)	-	-	-	-	-	-	-	-	-	-	-	-	-	-
23)	-	-	-	-	-	-	-	-	-	-	-	-	-	-
24)	-	-	-	-	-	-	-	-	-	-	-	-	-	-
25)	-	-	-	-	-	-	-	-	-	-	-	-	-	-
26)	-	-	-	-	-	-	-	-	-	-	-	-	-	-
27)	-	-	-	-	-	-	-	-	-	-	-	-	-	-
28)	-	-	-	-	-	-	-	-	-	-	-	-	-	-
29)	-	-	-	-	-	-	-	-	-	-	-	-	-	-
30)	-	-	-	-	-	-	-	-	-	-	-	-	-	-
31)	-	-	-	-	-	-	-	-	-	-	-	-	-	-

Chapter 6. Backup System Diskette Generation Procedure

Each 3274 Control Unit is shipped with two uncustomized system diskettes. One is customized, using the initial customizing procedure in Chapter 4, and used as the primary system diskette. The second may be used as a duplicate of, or backup for, the primary system diskette. A backup system diskette is generated by performing the procedure on the recommended Backup System Diskette Form contained in this chapter.

The following information should be entered by the planner on the Backup System Diskette Form:

1. The type of keyboard (typewriter or data entry) to be used by the operator.
Note: *If using a 76- or 88-key Japanese English or Japanese Katakana keyboard, specify the number of keys and keyboard type.*
2. In step 1, the identification of each diskette to be used .
3. In step 7, enter the response to sequence number 031 (number of RPQ diskettes to be used).

In addition to the form, this chapter also contains:

- Keyboard diagrams showing the valid key positions for backup diskette generation (Figures 6-1 and 6-2).
- A diagram showing how to insert diskettes into the 3274 Control Unit (Figure 6-3).
- A chart giving the meanings of and recommended actions for the operator codes that may appear on the 3278 Display Station during backup diskette generation (Figure 6-4).
- Charts giving the meanings of and recommended actions for the 8421 indicator codes that appear on the 3274 control panel during the customizing procedure (Figures 6-5 and 6-6).
- A chart giving the meanings of and recommended actions for the 8421 indicator codes that could appear on the 3274 control panel during IML due to improper backup diskette generation.

All of the information listed above and the filled-in Backup System Diskette Form should be given to the operator who is to perform this backup diskette generation at the 3278 Display Station.

Backup System Diskette Form

Review this entire form before starting the procedure to create a backup system diskette. Unit operating procedures are described in the 3270 Information Display System: Operator's Guide, GA27-2890.

These procedures duplicate the existing system diskette. *If you do not get the expected result in any step, start over at step 1. If you have the same problem a second time, check with your supervisor, or follow your local procedures.*

There are four indicators, labeled 8421, on the 3274 control panel. The meanings of the 8421 indicator codes are shown in Figures 6-5 and 6-6. If an error occurs during this procedure, the 8421 indicator codes may aid in locating the cause. Within this form, an On indicator is called a 1, an Off indicator a 0 (zero).

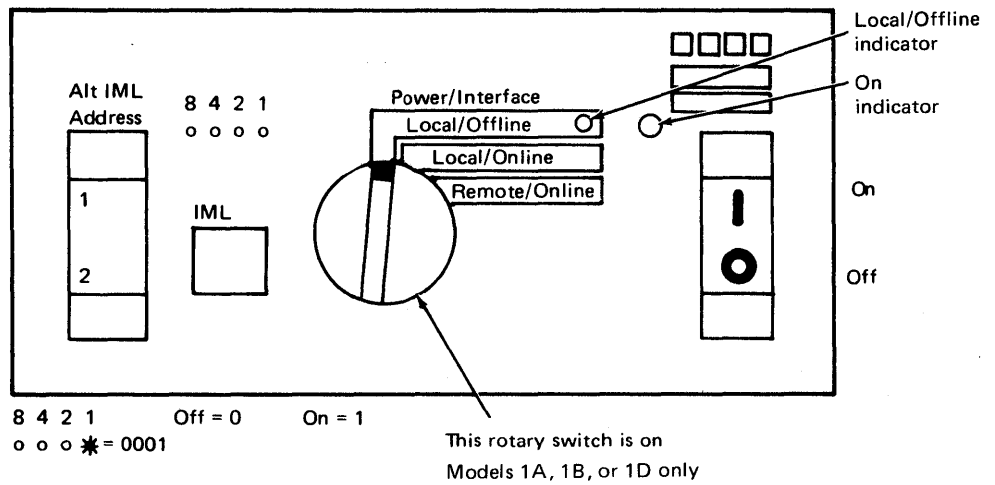

Type of 3278 keyboard to be used: _____

Note: See Figure 6-1 or 6-2 before continuing.

1. Obtain the:
 - Feature diskette _____
 - Customized system diskette (diskette to be duplicated) _____
 - Backup system diskette (diskette to be customized) _____
 - Language diskette (if applicable) _____
 - RPQ diskette(s) (if applicable)
 - 1. _____
 - 2. _____
 - 3. _____

2. Ensure that the 3274 Control Unit and the 3278 Display Station have power switched on. The 3278 must have a keyboard and must be attached to port A0 of the 3274.

Note: When customizing a 3274-1A, 1B, or 1C, do not set the on/off switch to the off position unless the rotary switch on the control panel is in the Local/Offline position and the Local/Offline indicator is lit.

3. Insert the feature diskette (see Figure 6-3) and, holding the Alt IML Address switch in position 1, press and release the IML button; then release the Alt IML Address switch. After 2 minutes or less, the 8421 indicator code will be a flashing 1011.
4. Insert the customized system diskette. After 1 minute or less, the 8421 indicator code will be a flashing 1110.
5. Insert the feature diskette again. After 1 minute or less, the 8421 indicator codes will be a steady 0001.
6. Look for a 3-digit sequence number in the upper-left corner of the 3278 screen. The first one is 001. Beneath the sequence number are Xs that are replaced by keying in the response to sequence number 001 (below). If the entered response is acceptable, a new sequence number will be displayed. If the response is unacceptable, an operator code will be displayed at the upper, center portion of the screen. See Figure 6-4 for the meaning of the displayed code.

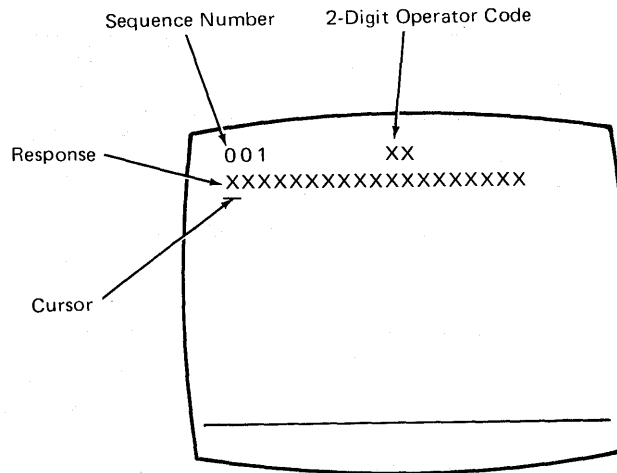

Note: If a 76- or 88-key Japanese English or Japanese Katakana keyboard is used, press the key circled in Figure 6-2 before proceeding. The keyboard will be locked for about 10 seconds. When the keyboard unlocks, continue.

Key in the following characters in response to sequence number 001:

1234567890ABCDEF (03) ← This number must match the Validation Number on the feature and system diskette labels.

Press ENTER. ↑ Spacebar

Note: Use only the cursor move keys to reposition the cursor during this procedure.

7. Key in a 0 (zero) in response to sequence number 011. Press ENTER.

8. At this time, either sequence number 021 is displayed (meaning that no printer authorization matrix has been defined) or the defined matrix is displayed.

If sequence number 021 is displayed, key in a 0 (zero). Press ENTER. If the matrix is displayed, move the cursor to the zero after sequence number 901 and change it to a 1. Press ENTER.

9. Key in the number of RPO diskettes $\frac{\quad}{(0-3)}$ being used in response to sequence number 031, and press ENTER.
10. The entire set of sequence numbers should now be displayed on the screen. Move the cursor to the zero after sequence number 900, and change it to a 1. Press ENTER.
11. After 2 minutes or less, the 8421 indicator code on the 3274 Control Unit should be flashing 1100, 1011, or 1101:
 - 1100 — Replace the feature diskette with the RPO diskette. *Do not press IML.* (If you do press IML, go back to step 3.) After the RPO diskette is inserted, the code will change to 0111 within 30 seconds. If additional RPO diskettes are required, the indicator code will again flash 1100. Repeat the procedure for each additional RPO diskette. *At no time should you press IML.* When the RPO diskette procedure is completed, the indicator code should be flashing 1110. Reinsert the feature diskette. *Do not press IML.* After 2 minutes or less, the 8421 indicator code will flash 1011 or 1101.
 - 1011 — Replace the feature diskette with the backup system diskette. *Do not press IML.* After 20 minutes or less, the indicator code will change to 1111. If errors occur during this 20-minute period, a flashing 8421 indicator code will appear. Figures 6-5 and 6-6 may aid in locating the cause. The backup diskette generation procedure is completed.
 - 1101— Replace the feature diskette with the language diskette. *Do not press IML.* After 30 seconds or less, the indicator code will change to 0111 and then to flashing 1011. When the indicator code is flashing 1011 in 1 minute or less, replace the language diskette with the backup system diskette. *Do not press IML.* After 20 minutes or less, the indicator code will change to 1111. If errors occur during this 20-minute period, a flashing 8421 indicator code will appear. Figures 6-5 and 6-6 may aid in locating the cause. The backup system diskette procedure is completed.

The newly created backup system diskette may now be used as well as the existing customized system diskette. The backup system diskette may now be used to initiate an IML of the 3274 Control Unit. During IML, errors may occur because of improper backup diskette creation. The 8421 indicator codes caused by these errors are shown in Figure 6-7.

Note: During backup system diskette generation, only certain key positions are valid. Only those key positions shown below are to be used.

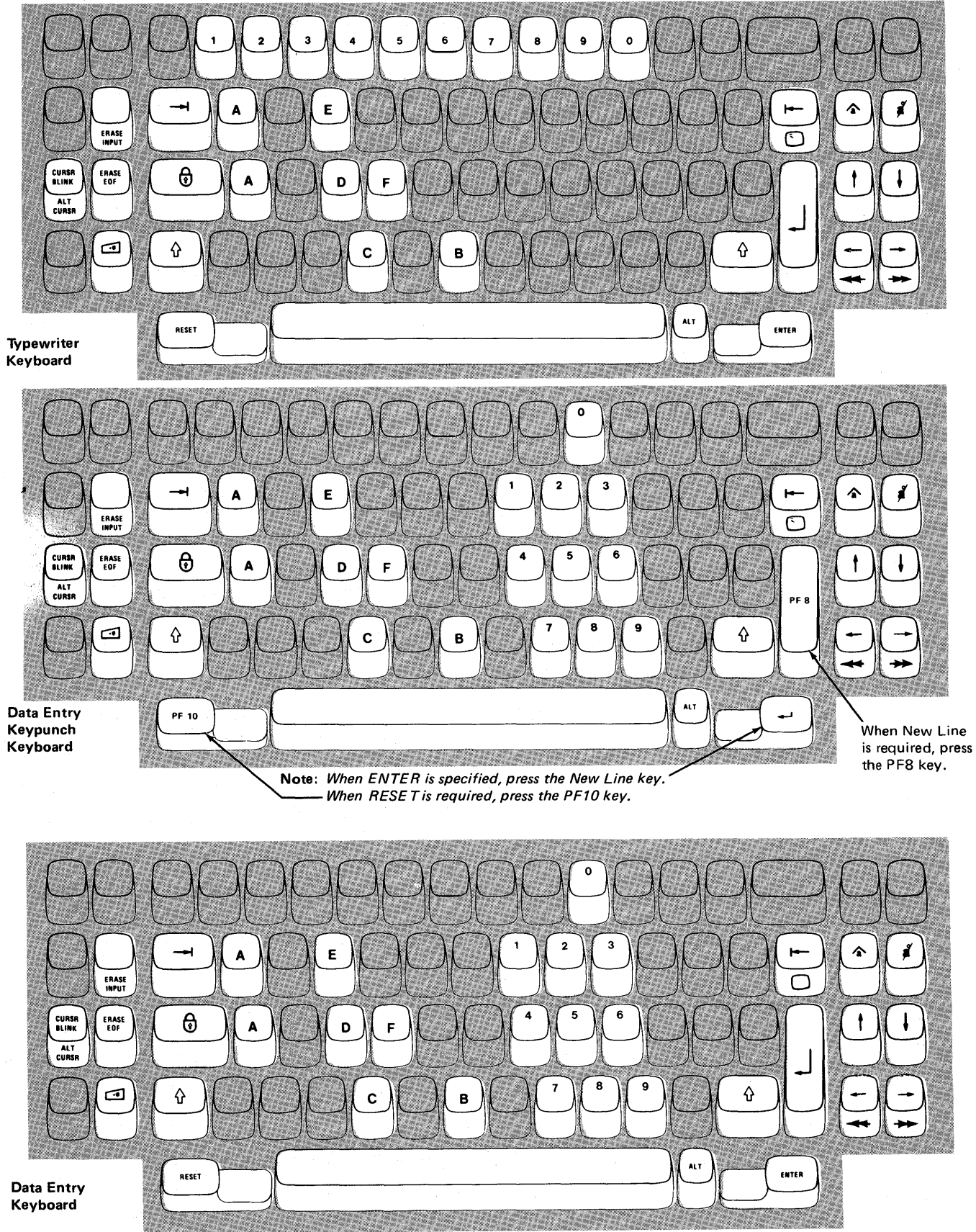
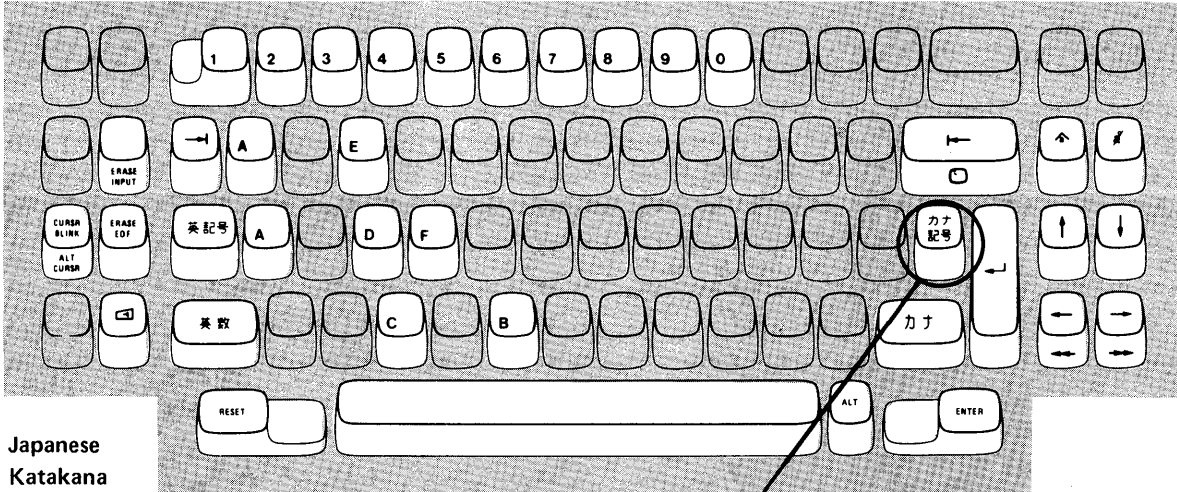

Figure 6-1. Valid Key Positions during Backup System Diskette Generation

Note: These drawings show the valid keys for both the 76- and 88-key keyboards. The PF keys located on the right side of the 88-key keyboards are not shown and are not valid during this procedure.



Japanese
Katakana
Typewriter
Keyboard

Press this key when sequence number 001 appears in upper left corner of 3278 screen.

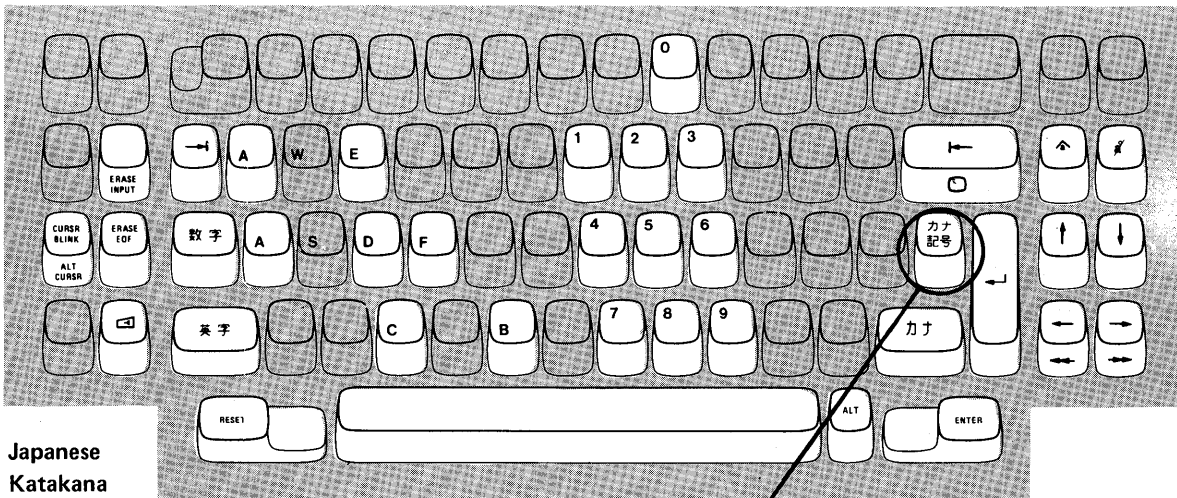

Japanese
Katakana
Data Entry
Keyboard

Press this key when sequence number 001 appears in upper left corner of 3278 screen.

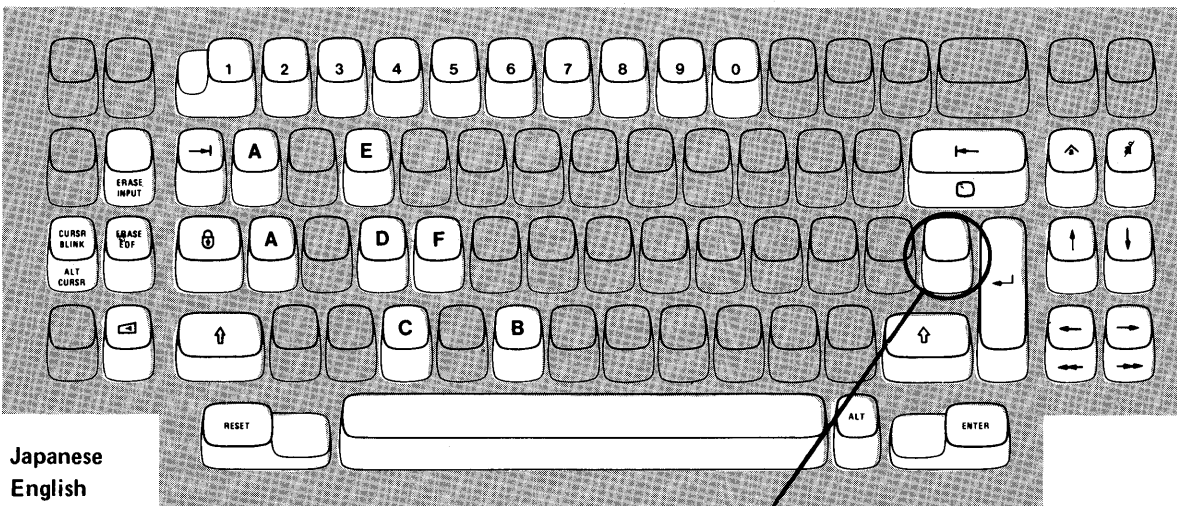

Japanese
English
Typewriter
Keyboard

Press this key when sequence number 001 appears in upper left corner of 3270 screen.

Figure 6-2. Valid Key Positions during Backup System Diskette Generation When Using Japanese Katakana and Japanese English Keyboards

3274 Diskette Insertion Procedures

1. Open the diskette enclosure door by pressing the latch to the right.

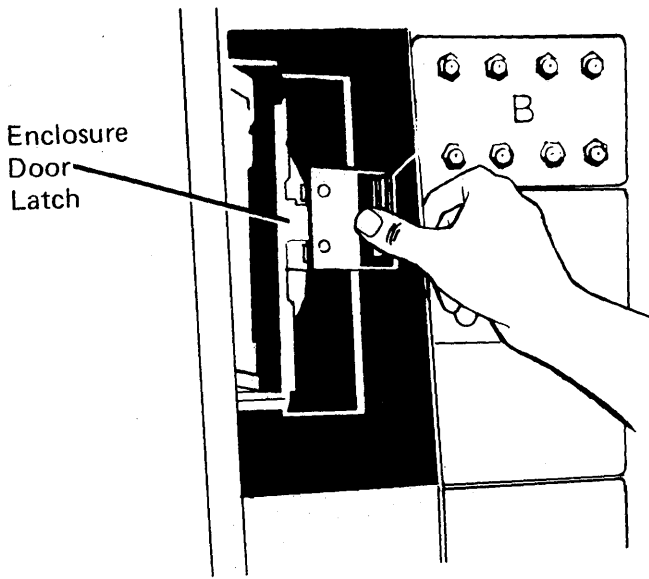

3. Close the diskette reader enclosure door by pushing the door to the left until it latches (clicks).

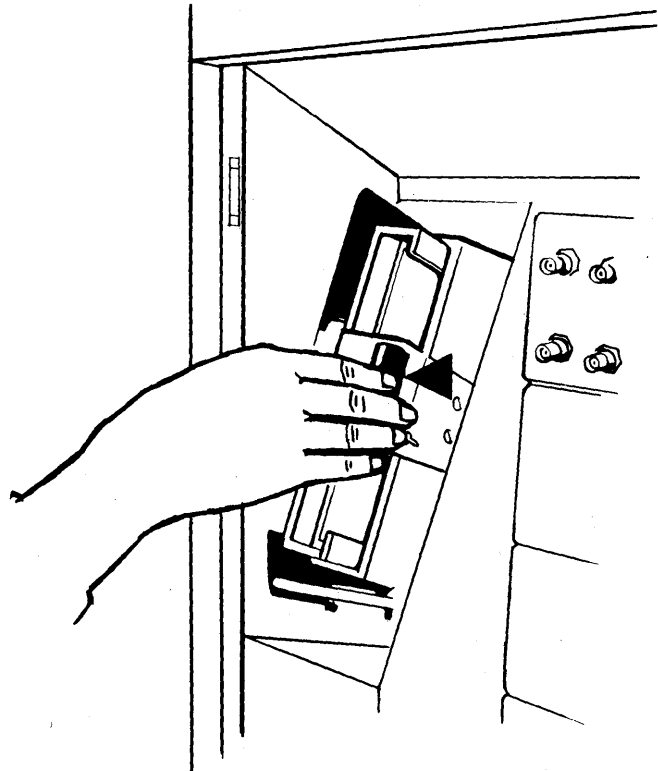

2. Remove the diskette to be used with the 3274 from its gray protective envelope, and insert it squarely into the enclosure. Note diskette label position is to the right.

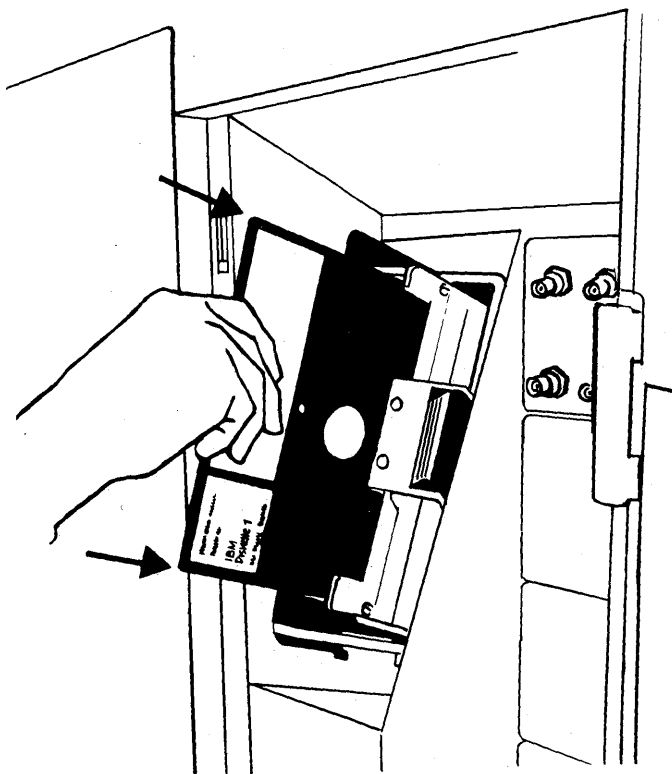

4. Close the customer access door.

Figure 6-3. Inserting a Diskette into the 3274

Code	Meaning	Action
01	One or more of the first 10 characters is incorrect.	Enter the correct response.
02	One or more of the 11th to 17th characters, including the space, is incorrect.	Enter the correct response.
03	(1) One of the last two characters you entered in response to sequence number 001 is incorrect, or, (2) the diskette release level is not the same as the documentation level.	(1) Enter the correct response. (2) Restart after matching diskette and documentation levels.
11	You entered an invalid response (too many characters, value too high or too low, wrong character, etc.).	Enter the correct response.
12	You entered a character other than A, B, C, or D in response to sequence number 151.	Enter the correct response.
13	Your response has too few characters.	Enter the correct response.
14	The numerical sum of the responses you entered for sequence numbers 111 and 112 is greater than 32.	Enter the correct response.
21*	You made an unacceptable change during the modify sequence (number 999).	Recheck the entries and correct them.
22*	(1) Your response to sequence number 321 is 1, but 121 is not 02 and/or 131 is not 1, or (2) 321 is 0 and 121 is 02.	(1) Verify and enter the correct response. (2) Verify and enter the correct response.
23*	One or more of your responses are not compatible with the response to sequence number 331.	Verify and enter the correct response.
24*	(1) All of your responses to sequence numbers 131, 132, and 133 are 0s (at least one response must be a 1), or, (2) Your response to sequence number 113 was 3622 but the extended function store feature is not installed in the 3274.	(1) Verify and enter the correct response(s). (2) Verify and enter the correct response.
25*	(1) If this is response to sequence number 133, you specified Katakana in 121 and Data Entry Key-punch keyboard in 133. (There is no Data Entry Key-punch keyboard for Katakana.) (2) If this is response to sequence number 113, the 3274 has insufficient storage.	(1) Verify and enter the correct response. (2) Notify your supervisor.
26*	Insufficient storage in the 3274.	Notify your supervisor.
99	Your entries are acceptable, but the entry for sequence number 900 or 901 has not been changed to a 1.	Change 900 or 901 entry to a 1.

* If any entry is unacceptable, the entry for sequence number 900 is changed back to 0 (zero) and the unacceptable value is intensified.

Figure 6-4. Operator Codes during Backup System Diskette Generation

Steady Code	Diskette Mounted	Meaning	Action
0001	Feature	Customizing being performed	None.
0010	Any (indication lasts for 3 minutes or more)	Diskette improperly inserted or an internal 3274 error	Insert diskette properly and retry.
0011	Feature	Customizing being performed	None.
0100	Feature	Patch, printer authorization matrix, or RPQ being performed	None.
0101	Feature	Configuration being performed	None.
0110	Feature	Modification being performed	None.
0111	Feature, language, or RPQ	Normal 3274 operation	None.
1000	System (customizing in process)	Normal 3274 operation	None.
1001	Any	Internal 3274 error	Retry. Notify supervisor if error recurs.
1010	Any	Internal 3274 error	Retry. Notify supervisor if error recurs.
1101	Any (customizing procedure in progress)	1. IML button pressed while changing diskette, or, 2. A bad or uncustomized system diskette is being used	1. Recustomize. Do not press IML button unless instructed to do so. 2. Insert a good customized system diskette.
1111	System (IML not performed)	Customizing is complete	IML can be performed.

Figure 6-5. Steady 8421 Indicator Codes during Backup System Diskette Generation

Flashing Code	Diskette Mounted	Meaning	Action
0000 1011	Any	System diskette request	Insert system diskette.
0000 1100	Any	RPO diskette request	Insert RPO diskette.
0000 1101	Any	Language diskette request	Insert language diskette.
0000 1110	Any	Feature diskette request	Insert feature diskette.
0100 0010	System	Configuration on system diskette being used for update-diskette procedure is not compatible with this 3274	Use a system diskette with a compatible configuration.
1000 0001	System	Uncustomized system diskette being used during update procedure	Use customized system diskette.
1001 0110	Any	Wrong level diskette being used	Use correct level diskette.
1111 0011	Feature	On/Off switch or TEST key pressed instead of ENTER	Retry. Notify supervisor if error recurs.
1111 0100	Feature or System	Internal 3274 error	Retry. Notify supervisor if error recurs.
1111 0101	System	Internal 3274 error	Retry. Notify supervisor if error recurs.
	Feature	On/Off switch or TEST key on the 3278 pressed instead of ENTER	
1111 0110	RPO	Incompatible RPOs	Notify supervisor.
	Feature	Internal 3274 error	
1111 0111	System	Internal 3274 error	Notify supervisor.
1111 1000	System	Internal 3274 error	Notify supervisor.
1111 1001	System	Internal 3274 error	Notify supervisor.
1111 1010	Any	Internal 3274 error	Notify supervisor.
1111 1011	System	Internal 3274 error	Notify supervisor.
1111 1100	Any	Diskette drive error or a bad diskette	Retry. Notify supervisor if error recurs.
1111 1101	System or feature	Diskette drive error or a bad diskette	Retry. Notify supervisor if error recurs.
1111 1110	Any	Internal 3274 error	Retry. Notify supervisor if error recurs.

Figure 6-6. Flashing 8421 Indicator Codes during Backup System Diskette Generation

Steady Code	Flashing Code	Diskette Mounted	Meaning	Action
—	0000 0101	System	Internal 3274 error or wrong response to sequence number 113 during customizing procedure	Check response to sequence number 113 and retry. Notify supervisor if error recurs.
—	0000 0110	System	Internal 3274 error or wrong response to sequence numbers 111, 112, or 351 during customizing procedure	Check response to sequence numbers 111, 112, and 351 and retry. Notify supervisor if error recurs.
—	0000 0111	System	Internal 3274 error or wrong response to sequence number 311 during customizing procedure	Check response to sequence number 311 and retry. Notify supervisor if error recurs.
—	0000 1000	System	Internal 3274 error or wrong response to sequence number 111 during customizing procedure	Check response to sequence number 111 and retry. Notify supervisor if error recurs.
1101	—	System	Uncustomized system diskette	Insert customized system diskette.

Figure 6-7. 8421 Indicator Codes during IML That Result from an Incorrect Backup System Diskette Generation

Chapter 7. Update-Diskette Installation

From time to time you will receive an update-diskette package from IBM. These update packages are for use only with previously customized 3274 Control Units and should not be used prior to initial customizing. It is recommended that each update-diskette package be installed on the 3274 Control Unit as soon as possible after receipt of the package.

Each update-diskette package will include a copy of the installation procedure to be followed when installing the package on your control unit. A copy of this procedure is shown on the following pages.

Update-Diskette Installation Procedure For IBM 3274 Control Unit

This update-diskette package and installation procedure is for use by the person responsible for customizing the IBM 3274 Control Unit. This procedure requires a knowledge of and access to the latest level of the *IBM Information Display System, IBM 3274 Control Unit Planning, Setup, and Customizing Guide, GA27-2827*. The procedure should take less than one hour to perform.

Procedure:

Note: *If you encounter difficulties while following this procedure, either revert to the old level system and inform your supervisor, or follow your local procedures.*

1. Obtain the following:
 - a. Existing (old-level) system diskette, language diskette (if applicable), and RPQ diskettes (if applicable).

Note: *If an RPQ diskette is provided in the update-diskette package substitute it for the old-level RPQ diskette.*
 - b. Enclosed (update-level) feature diskette.
 - c. Enclosed (update-level) system diskette.

Note: *Do not install the update-level diskettes if the release level number on the old-level system diskette is higher than the release level number on the update-level system diskette.*

2. Ensure that the 3274 has power on.

Note: *On locally-attached 3274s (Models 1A, 1B, and 1D), the rotary switch on the operator panel must be in the Local/Offline position and the Local/Offline indicator must be lit.*

3. Insert the update-level feature diskette and, while holding the ALT IML Address switch in position 2, press and release the IML button, then release the ALT IML Address switch.
4. After 2 minutes or less, the 8421 indicator code will flash 1011.
5. Replace the update-level feature diskette with the old-level system diskette and wait for approximately 20 seconds for the 8421 indicator code to flash 1110.
6. Replace the old-level system diskette with the update-level feature diskette.

7. Using the following 8421 indicator code descriptions, take the action indicated as the codes appear on the 3274:

Note: *After a diskette is inserted, wait 2 minutes for the machine to complete its operation before interpreting the 8421 indicator code.*

8421 Indicator Code

Steady	Flashing	Meaning/Action
	1011-0000	Insert the update-level system diskette.
	1100-0000	Insert the RPQ diskette. (This will occur multiple times if multiple RPQs are to be applied.)
	1101-0000	Insert the language diskette.
	1110-0000	Insert the update-level feature diskette.
	1000-0001	The system diskette is not customized. Use the proper level, customized diskette. Retry from step 2.
	1001-0110	Wrong level diskette. Insert the diskette normally used in daily operation. Retry from step 2.
0010		The diskette was improperly inserted. Retry from step 2 with diskette inserted properly.
1010		This diskette may be faulty. Retry from step 2 with backup diskette, if available.
1111		The customizing process is complete. Normal startup (IML) can be done.

Note: *Indicator codes other than those shown above indicate a possible malfunction. Retry the operation once, starting with step 2. If the same error recurs, refer to the IBM 3270 Information Display System, IBM 3274 Control Unit Planning, Setup, and Customizing Guide, GA27-2827. If progress cannot be made, record the 8421 indicator code, reinstall the old-level system diskette to continue your operation, and call IBM.*

Appendix A. Planning Checklist

This planning checklist is provided as a sample plan; the plan may have to be modified to accommodate your unique system/cluster configuration.

Weeks Before Delivery	Schedule Date	Responsibility		✓	Event
		Customer	IBM		
16		X			Designate a person in your organization who will be responsible for all phases of the cluster installation.
		X	X		Review this planning guide with the person designated above.
		X			Decide who will install (1) the device cables between the 3274/3276 and the attached units and (2) the power receptacles, wiring, etc. (your maintenance personnel or a contractor).
		X	X		Determine the schedule dates with the IBM representative. Fill in the dates on this form and give a copy to the IBM representative.
		X			Identify and schedule data communication needs. Identify the source for communication line (contact telephone company). Order modems as required.
14		X			Lay out the floor plan. Show locations of modems and cluster units.
		X			Order supplies (refer to "Supplies" list).
		X	X		Review the overall installation plan with IBM representative.
		X			Place order for device cables (coaxial cables between 3274/3276 and attached units) from IBM or a contractor, or order the materials to make the cables yourself. Refer to <i>Assembly of Coaxial Cables and Accessories for Attachment to IBM Products</i> , GA27-2805.
12		X			Determine whether changes are required to the existing programs (system control program, network control program, program products, and application programs. (Refer to <i>Introduction to Programming the IBM 3270</i> , GC27-6999, and the <i>3270 Component Description</i> , GA27-2749.) If so, schedule the required changes.
		X			Determine whether changes are required to the existing data processing units (host system computer, 2701, 2703, 3704, and 3705). If so, schedule the required changes.

Weeks Before Delivery	Schedule Date	Responsibility		✓	Event
		Customer	IBM		
		X			Arrange for the installation of (1) the device cables between the 3274 and the attached units and (2) the power receptacles, wiring, etc.
		X			Define a training program for employees.
		X			Order the required 3274, 3278, 3287, and 3289 manuals.
10	_____	X			Review the progress of the data communication plan. Identify and resolve any schedule conflicts.
9	_____	X	X		Review the cluster configuration to make sure the configuration meets your requirements. Make any necessary changes to your order.
8	_____	X	X		Review the installation plan to define any exposure to schedule.
		X	X		Confirm the arrival of package containing cluster cables.
		X			Start installing and labeling cluster cables and power receptacles.
6	_____	X			Start employee training.
			X		IBM representative checks progress of site preparation.
4	_____	X			Receive supplies (magnetic stripe cards, forms, etc.).
		X			Complete the installation of cables and power receptacles.
2	_____	X			Complete the checkout of the cables and power: continuity and polarity tests of cluster cables, power receptacles, and safety considerations.
		X			Complete the required changes to the existing programs and data processing units.
		X			Complete the site preparation.
		X			Install communication facilities (telephone line and modems).
		X			Make sure all the necessary information is available for the setup personnel (switch settings, configuration information, customizing form, etc.).
		X			Review setup instructions with the setup personnel.

Weeks Before Delivery	Schedule Date	Responsibility		✓	Event
		Customer	IBM		
Arrival of Units		X			Move the units to locations. Unpack per unpacking instructions.
		X			Read the setup instructions.
		X			Complete setup of the 3274-1C or 3276, 3278s, 3287s, and 3289s using the setup instructions included in the shipping cartons.
			X		Install the 3274-1A/1B/1D.
		X			Complete the 3274 customizing.

Appendix B. 3274 Device Cables

In order to assign the device cables to the correct 3274 ports, you should be aware of the following:

- Two categories of units can attach to the 3274:
 1. Category A – 3278s, 3287s with a 3274 attachment feature, and 3289s.
 2. Category B – 3277s, 3284, 3286s, 3287s with a 3271/3272 attachment feature, and 3288s.

Category A units must attach to a 3274 Type A Terminal Adapter; Category B units must attach to a 3274 Type B Terminal Adapter.

- The basic 3274 is capable of attaching eight Category A units. Type A Terminal Adapters and Type B Terminal Adapters can be ordered in various combinations to provide a maximum cluster of (a) 32 Category A units or (b) 32 Category A and Category B units, of which a maximum of 16 can be Category B units. For detailed information concerning 3274 terminal adapter feature combinations, refer to *IBM 3270 Information Display System: Configurator*, GA27-2849.
- Depending upon the configuration of the 3274 and its attached units, a maximum of five device cable connector panels can be installed on the 3274 (see page B-3). Each panel used to attach Category A units contains eight ports for attachment of device cables; each panel used to attach Category B units contains either four or eight active ports. Therefore, a maximum of 40 ports can be present. However, only 32 of the possible 40 ports may be used.
- There are two types of 3274 device cable connector panels:
 1. Black panels, labeled “A,” which are used to attach device cables from units that attach to a Type A Terminal Adapter.
 2. White panels, labeled “B,” which are used to attach device cables from units that attach to a Type B Terminal Adapter.
- The lowermost panel (and also the second and third lower panels, if present) are *always* black, labeled “A,” have ports numbered 0 through 23 (A0 – A23), and are used to attach only Category A units.
- The fourth panel from the bottom (if present) has a dual function. It can be used to attach either Category A units or Category B units. This panel can be used for one or the other category of machines, *but not both categories*. When this panel is used to attach Category A units, the panel is black, labeled “A,” and has ports numbered 24 through 31 (A24 – A31); when this panel is used to attach Category B units, the panel is white, labeled “B,” and has ports numbered 8 through 15 (B8 – B15).
- The fifth (uppermost, if present) panel is *always* white, labeled “B,” has ports numbered 0 through 7 (B0 – B7), and is used to attach only Category B units.
- Port A0 must always be assigned to a 3278 with a keyboard.

***Instructions for completing the 3274 Device Cable
Attachment Form***

1. Determine how many units are in each of the following two categories:
 - A 3278s, 3287s with a 3274 attachment feature, and 3289s
 - B 3277s, 3284s, 3286s, 3287s with a 3271/3272 attachment feature, and 3288s
2. Assign a 3278 with a keyboard to port A0 and fill in the unit location (office/column number) and telephone number portions of the table. It is recommended that this 3278 be as close as possible to the 3274, because this 3278 will be used for 3274 customization and problem determination.
3. Assign the remaining Category A units to the ports numbered A1 through A31 sequentially (bottom of table to top). Fill in the table with the required information for each unit. If any of the ports numbered A24 through A31 are used, cross out the B port number(s) to the right of the A port number(s) used.
4. If there are no Category B units in the configuration, go to step 6.
5. Assign the Category B units to the ports numbered B0 through B15 starting at port B0 and progressing sequentially (top of table to bottom). Fill in the required information in the table for each unit. If any of the ports numbered B8 through B15 are used, cross out the A port number(s) to the left of the B port number(s) used.
6. Cross out all port entries in the table that are unused.
7. Enter the 3274 location information (office/column number) into the 3274 location entry above the table.

It is recommended that copies of the completed form be given to the personnel who will install and mark the cables and to the personnel who will connect the cables to the 3274. In addition, a copy of the form should be stored in the pocket inside the 3274 customer access door.

3274 Device Cable Attachment Procedure

- 1 DO Open the customer access door.
- 2 DO Unlatch the device cable retention clamp by lifting up on the left side of the clamp and rotating it toward the front of the 3274.

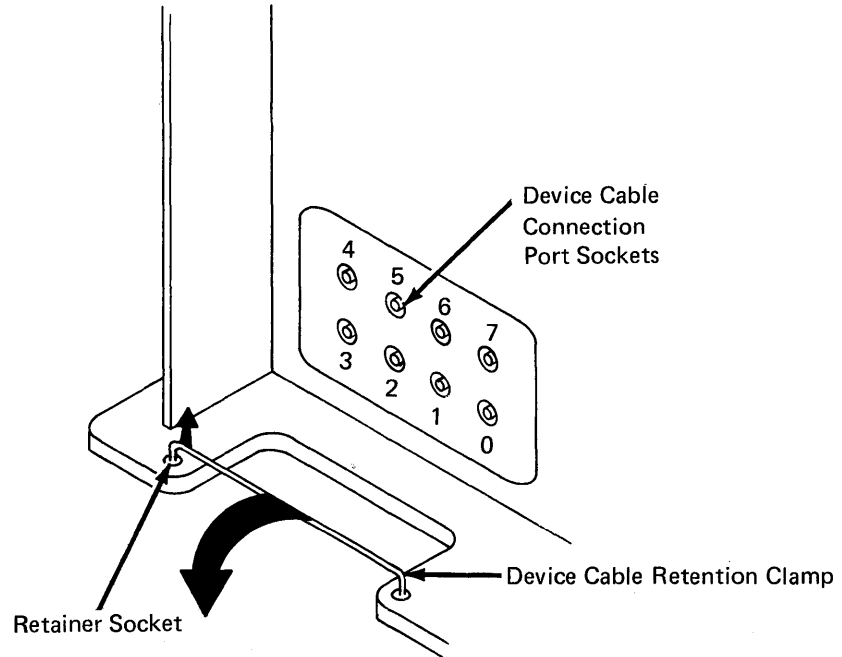

- 3 DO Use the 3274 Device Cable Attachment Form on the back of this page to connect the device cables to their corresponding ports on the device cable panel(s).
- DO Use a push-and-twist clockwise motion to connect and lock the device cables to the port sockets.

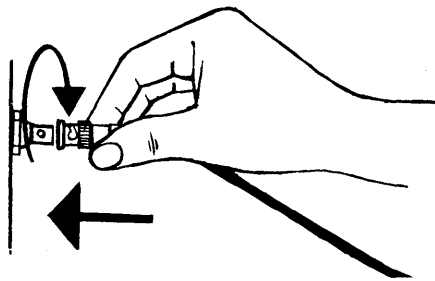

CAUTION: Do not connect or disconnect device cables during an electrical storm.

- 4 DO Rotate the device cable retention clamp toward the rear of the 3274 (clockwise), and latch the clamp in place by inserting the loose end firmly in the retainer socket. Be sure all the device cables are behind the retention clamp.
- 5 DO Close the customer access door.

3274 Device Cable Attachment Form

DO Use this form to connect the device cables to the 3274 ports.

1. Connect the device cables identified for the A panel and port numbers (A0, A1, A2, and so on) to the corresponding ports on the black connector panels. Connect the cables in numeric order from the bottom of the table to the top.
2. Connect the device cables identified for the B panel and port numbers (B0, B1, B2, and so on) to the corresponding ports on the white connector panels. Connect the cables, starting with the largest (used) port number in the B portion of the table, in reverse numeric order (B15, B14, B13, and so on) from the bottom of the table to the top.

3274 Panel and Port Number	Network Address	Cable Identification	Unit Type	Unit Location	Telephone Nearest the Unit
B0					
B1					
B2					
B3					
B4					
B5					
B6					
B7					
A31 or B8					
A30 or B9					
A29 or B10					
A28 or B11					
A27 or B12					
A26 or B13					
A25 or B14					
A24 or B15					
A23					
A22					
A21					
A20					
A19					
A18					
A17					
A16					
A15					
A14					
A13					
A12					
A11					
A10					
A9					
A8					
A7					
A6					
A5					
A4					
A3					
A2					
A1					
A0			3278		

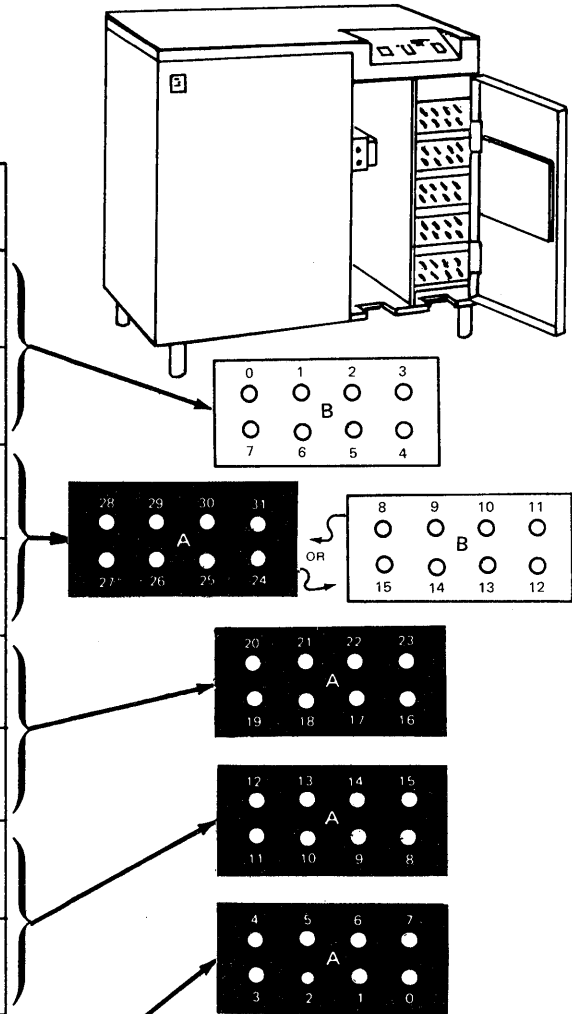

Appendix C. Printer Authorization Matrix

The 3274 Printer Authorization Matrix

The 3274 printer authorization matrix defines the operating characteristics of the printers attached to the control unit. In this regard, the matrix serves a three-fold purpose:

- Establish Printer Mode. A printer may be reserved for exclusive use of either the host or the local copy function. A third mode allows a sharing between these two functions.
- Assign Print “Classes.” A print “Class” is a way of grouping printers for use by local copy. A local copy request directed to a “class” is then serviced by one of the printers assigned to that group.
- Define Source Device Lists. The source device list specifies which displays may use any given printer for local copy. Note that all displays for a printer must be attached to the same adapter type as the printer. For example, a Category A printer can have only Category A displays in its source device list.

Printer Modes. A printer may be in one of three modes, specified in the printer authorization matrix as local, system, or shared mode. Each printer on the 3274 defaults to system mode until a matrix is loaded. Printers that are specified as being in shared or local mode then become available for local copy use.

Local Mode. A printer in local mode may be used for local copy functions regardless of host attachment or communications protocol. This means that displays within the cluster may contend for use of printers but the host may not. The printer is not available for direct print operations from the host.

A local copy operation involves the transfer of data from the display buffer to the printer buffer and the subsequent printing of that data. A local copy may be initiated by an operator using the Print key on a 3278 attached to a 3274 or by the host when the display is operating in SNA/SDLC.

System Mode. A printer in system mode is entirely under host (system) control. This is the default mode each printer assumes when no matrix has been defined. The printer cannot be used for operator-initiated local copy requests. The printer is likewise not available for host-initiated copy operations when using SNA/SDLC. However, when operating with BSC discipline, the printer may honor a BSC Copy command when it is in system mode. The BSC Copy command, directed to the “to” device, specifies the “from” device as a command parameter and does not use the printer authorization matrix.

Shared Mode. In shared mode, both host-directed printing operations and local copy operations are permitted on the same printer. When in system mode, the printer is protected from local copies; in local mode, the printer is protected from host-initiated operations. However, when in shared mode, the subsystem does not guarantee this type of integrity. The user must assume the responsibility for integrity of his printed data by “installation rules” and proper programming practices when using a printer in shared mode.

In SNA/SDLC, a printer in shared mode attached to the 3274 may be used for local copy only when it is not in session with a primary logical unit (PLU) in the host.

The printer authorization matrix is required to perform local copy operations. If the matrix is not loaded, the default condition for the cluster is that all printers are in system mode, and local copy operations are not possible except with the BSC Copy command.

Printer Class Structure. The printer authorization matrix permits the assignment of a printer to a class. By selecting a class containing multiple printers, improved copy throughput can be obtained. The definition of a class of printers is made by the customer, and may be based on type, character subset, type of forms mounted, location, etc. For example, in a particular installation class, "72" may have been defined as referring to all printers with yellow paper. Thus, an operator may select an authorized printer on the basis of this characteristic rather than by address.

The printer authorization matrix allows a maximum of 16 printer classes to be defined in each subsystem. A display operator may select a printer by class by using the IDENT key (ALT key pressed) and keying in a number ranging from 70 through 85 corresponding with one of 16 classes. In any configuration, a single printer may be in one or several classes, or not in a class. Several printers may be members of a single class.

Source Device Lists. Each printer may be restricted as to which displays it may accept local copies from. Any given printer may be permitted to process copies from some, all, or none of the displays on the control unit. When a local copy is directed to a print class, the printer selected will be one that is authorized to accept copies from the requesting display. Not all printers assigned to a particular class may be authorized for the same subset of display terminals.

Matrix Structure. The 3274 printer authorization matrix defines how display stations (source devices) may use printers (destination devices) attached to the same control unit, for the purpose of accepting a local copy request.

The printer authorization matrix is structured as a two-dimensional array with each printer in the cluster represented by a printer port address with the following format:

Printer Port Address	Mode	Class	Source Device List
----------------------	------	-------	--------------------

The printer port address is the first field of the descriptor. A decimal address from 01 to 31 for the 3274 allows printers to be attached to any port on the control unit, except port 0. Addresses are sequential by adapter.

Mode defines the printer to be in system, local, or shared mode, where:

- 0 = System
- 1 = Local
- 2 = Shared

Class permits the grouping of printers into classes. This field is bit-coded, one bit for each 16 classes, so that a single printer may be in more than one class. Valid classes are designated 70 through 85 inclusive. Coding a 1 under the appropriate class permits the printer to accept copies from display stations selected by that class.

Source Device List is a bit-coded field that specifies which displays (D) are authorized and configured to use the printer (P) associated with this device descriptor. Each bit position is associated with a port number on the cluster. Coding a 1 under a given display station port address permits the printer to service copy requests from that display station.

Consider an example in which ports 0 through 11 of a 3274 Control Unit have terminals attached as follows:

Port Number	0	1	2	3	4	5	6	7	8	9	10	11
Terminal	D	D	P	P	D	D	P	P	D	D	D	D

Printer Authorization Matrix Form

Enter the characters (below) supplied by the planner in the appropriate groups on your display screen. If a group already is displayed as AA M XXXX YYYY YYYY, your entry will overwrite these characters. When you have completed all your entries, move the cursor to the zero after sequence number 901 at the bottom of the screen, change it to a 1, and press ENTER. Any entry that is not valid will be intensified at this time and the 1 you entered will change back to a 0 (zero). Correct the invalid entry, and return to 901. Again, change the zero to a 1, and press ENTER. When all entries are valid, the printer authorization matrix display will be replaced by the next customizing sequence number. (If, at any time during this procedure, you wish to return to the original matrix, change the 0 (zero) after the 901 to A and press ENTER.) Return to your original instructions.

To delete an entry, move the cursor (with cursor-move keys) to the leftmost position of the entry (the Printer Port Address) and press the spacebar twice. The entire matrix, or as many entries as desired, can be deleted in this manner. After all changes have been made, press ENTER. All deleted entries will be displayed as AA M XXXX YYYY YYYY. When the matrix is satisfactorily defined, move the cursor to the zero after sequence number 901, change it to a 1, and press ENTER.

	Printer Port Address		Printer Mode	Printer Class Assignment				Source Device List								
	A	A	M	X	X	X	X	Y	Y	Y	Y	Y	Y	Y	Y	
Sequence A	1)	0	2	1	0	0	0	0	0	0	0	0	0	0	0	0
	2)	0	3	2	4	0	0	0	4	0	0	0	0	0	0	0
	3)	0	6	1	4	0	0	0	4	0	0	0	0	0	0	0
	4)	0	7	0	0	0	0	0	0	0	0	0	0	0	0	0
	5)	-	-	-	-	-	-	-	-	-	-	-	-	-	-	-
	6)	-	-	-	-	-	-	-	-	-	-	-	-	-	-	-
	7)	-	-	-	-	-	-	-	-	-	-	-	-	-	-	-
Sequence B	8)	0	3	2	4	0	0	0	4	0	0	0	0	0	0	0
	9)	-	-	-	-	-	-	-	-	-	-	-	-	-	-	-
	10)	0	6	1	4	0	0	0	4	0	0	0	0	0	0	0
	11)	-	-	-	-	-	-	-	-	-	-	-	-	-	-	-
	12)	-	-	-	-	-	-	-	-	-	-	-	-	-	-	-
	13)	0	7	0	0	0	0	0	0	0	0	0	0	0	0	0
	14)	0	2	1	0	0	0	0	0	0	0	0	0	0	0	0
	15)	-	-	-	-	-	-	-	-	-	-	-	-	-	-	-
	16)	-	-	-	-	-	-	-	-	-	-	-	-	-	-	-

Figure C-2. Example of a Completed Printer Authorization Matrix Form

Printer Port Address	Mode	Class				Source Device List											
		X	X	X	X	Y	Y	Y	Y	Y	Y	Y	Y	Y			
Class Number		70 71 72 73	74 75 76 77	78 79 80 81	82 83 84 85	0 1 2 3	4 5 6 7	8 9 10 11	12 13 14 15	16 17 18 19	20 21 22 23	24 25 26 27	28 29 30 31				
A A	M	X	X	X	X	Y	Y	Y	Y	Y	Y	Y	Y				
02	1	0	0	0	0	8	0	0	0	0	0	0	0				
		0000	0000	0000	0000	1000	0000	0000	0000	0000	0000	0000	0000				
03	2	4	0	0	0	4	8	0	0	0	0	0	0				
		0100	0000	0000	0000	0100	1000	0000	0000	0000	0000	0000	0000				
06	1	4	0	0	0	4	8	C	0	0	0	0	0				
		0100	0000	0000	0000	0100	1000	1100	0000	0000	0000	0000	0000				
07	0	0	0	0	0	0	0	0	0	0	0	0	0				
		0000	0000	0000	0000	0000	0000	0000	0000	0000	0000	0000	0000				
--	-	-	-	-	-	-	-	-	-	-	-	-	-				

Port Number
Hex Notation
Binary Value

Figure C-3. Printer Authorization Matrix Worksheet Example

Printer Port Address	Mode	Class				Source Device List											
		X 70 71 72 73	X 74 75 76 77	X 78 79 80 81	X 82 83 84 85	Y 0 1 2 3	Y 4 5 6 7	Y 8 9 10 11	Y 12 13 14 15	Y 16 17 18 19	Y 20 21 22 23	Y 24 25 26 27	Y 28 29 30 31				
--	-	-	-	-	-	-	-	-	-	-	-	-	-	-			
--	-	-	-	-	-	-	-	-	-	-	-	-	-	-			
--	-	-	-	-	-	-	-	-	-	-	-	-	-	-			
--	-	-	-	-	-	-	-	-	-	-	-	-	-	-			
--	-	-	-	-	-	-	-	-	-	-	-	-	-	-			
--	-	-	-	-	-	-	-	-	-	-	-	-	-	-			
--	-	-	-	-	-	-	-	-	-	-	-	-	-	-			
--	-	-	-	-	-	-	-	-	-	-	-	-	-	-			
--	-	-	-	-	-	-	-	-	-	-	-	-	-	-			

Enter this row on the Printer Authorization Matrix Form

Figure C-4. Sample Printer Authorization Matrix Worksheet

The X and Y entries are completed in two steps. In step 1, the binary values of X and Y are entered on the worksheet for the class and the source device list, respectively. In step 2, the binary values are converted to hexadecimal notation. The hexadecimal notations are later transferred to the Printer Authorization Matrix Form.

To continue with Figure C-1, no class (70 through 85) is defined for the printer attached to port 02, so XXXX = hex 0000. The source device list in Figure C-1 indicates (by an "1") that the display terminal attached to port 0 can copy to this printer. Therefore, a 1 is entered in the 0 column of the first Y (Figure C-3). No other displays can copy to this printer so 0s (zeros) are entered in all remaining columns under the Ys. The binary 1000 under the first Y on the worksheet is converted to hex 8. Because all other X and Y entries are binary 0s, all remaining hex entries are 0s.

Abbreviations

A/FE	Americas/Far East	Kb	kilobyte
ALT	alternate	NCP	Network Control Program
APL	a programming language	NRZ	non-return to zero
ASCII	American National Standard Code for Information Interchange	NRZI	non-return to zero inverted
BSC	binary synchronous communication	OEM	original equipment manufacturer
CCA	common communication adapter	OLTEP	online test executive program
CCITT	Consultative Committee on International Telephone and Telegraph	PF	program function
CDSTL	connect data set to line	PU	physical unit
CTS	clear to send	RPQ	request for price quotation
DCC	disconnect command chaining	RTS	request to send
DDSA	Dataphone* Digital Service Adapter	SCS	SNA character string
DTE	data terminal equipment	SDLC	synchronous data link control
EBCDIC	extended binary-coded decimal interchange code	SNA	systems network architecture
EIA	Electronic Industries Association	SNBU	switched network backup
E/ME/A	Europe/Middle East/Asia	SYSGEN	system generation
HPCA	high performance communications adapter	U.S.	United States
IML	initial microprogram load		
I/O	input/output		

*Trademark of American Telephone and Telegraph Co.

IBM 3270 Information Display System
3274 Control Unit Planning,
Setup, and Customizing Guide

READER'S
COMMENT
FORM

Order No. GA27-2827-4

This manual is part of a library that serves as a reference source for systems analysts, programmers, and operators of IBM systems. This form may be used to communicate your views about this publication. They will be sent to the author's department for whatever review and action, if any, is deemed appropriate. Comments may be written in your own language; use of English is not required.

IBM may use or distribute any of the information you supply in any way it believes appropriate without incurring any obligation whatever. You may, of course, continue to use the information you supply.

Note: Copies of IBM publications are not stocked at the location to which this form is addressed. Please direct any requests for copies of publications, or for assistance in using your IBM system, to your IBM representative or to the IBM branch office serving your locality.

How did you use this publication?

- | | | | |
|--------------------------|-------------------------------------|--------------------------|------------------------|
| <input type="checkbox"/> | As an introduction | <input type="checkbox"/> | As a text (student) |
| <input type="checkbox"/> | As a reference manual | <input type="checkbox"/> | As a text (instructor) |
| <input type="checkbox"/> | For another purpose (explain) _____ | | |

Is there anything you especially like or dislike about the organization, presentation, or writing in this manual? Helpful comments include general usefulness of the book; possible additions, deletions, and clarifications; specific errors and omissions.

Page Number:

Comment:

What is your occupation? _____

Newsletter number of latest Technical Newsletter (if any) concerning this publication: _____

If you wish a reply, give your name and address:

IBM branch office serving you

Thank you for your cooperation. No postage stamp necessary if mailed in the U.S.A. (Elsewhere, an IBM office or representative will be happy to forward your comments or you may mail directly to the address in the Edition Notice on the back of the title page.)

Note: Staples can cause problems with automated mail sorting equipment.
Please use pressure sensitive or other gummed tape to seal this form.

Reader's Comment Form

Fold

Fold



NO POSTAGE
NECESSARY
IF MAILED
IN THE
UNITED STATES

BUSINESS REPLY MAIL
FIRST CLASS PERMIT NO. 40 ARMONK, N.Y.

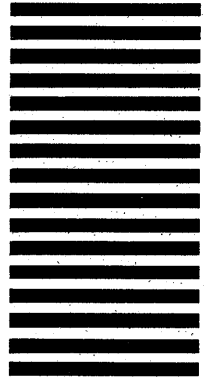

POSTAGE WILL BE PAID BY ADDRESSEE:

**International Business Machines Corporation
Department 63T
Neighborhood Road
Kingston, New York 12401**

Fold

Fold



**International Business Machines Corporation
Data Processing Division
1133 Westchester Avenue, White Plains, N.Y. 10604**

**IBM World Trade Americas/Far East Corporation
Town of Mount Pleasant, Route 9, North Tarrytown, N.Y., U.S.A. 10591**

**IBM World Trade Europe/Middle East/Africa Corporation
360 Hamilton Avenue, White Plains, N.Y., U.S.A. 10601**

IBM 32/U IUS 32/4 Control Unit Planning, Setup, and Customizing Guide (File No. S36U/S3/U/S3-U9) Printed in U.S.A. GA2/-282/-4
Cut or Fold Along Line

IBM 3270 Information Display System
3274 Control Unit Planning,
Setup, and Customizing Guide

READER'S
COMMENT
FORM

Order No. GA27-2827-4

This manual is part of a library that serves as a reference source for systems analysts, programmers, and operators of IBM systems. This form may be used to communicate your views about this publication. They will be sent to the author's department for whatever review and action, if any, is deemed appropriate. Comments may be written in your own language; use of English is not required.

IBM may use or distribute any of the information you supply in any way it believes appropriate without incurring any obligation whatever. You may, of course, continue to use the information you supply.

Note: Copies of IBM publications are not stocked at the location to which this form is addressed. Please direct any requests for copies of publications, or for assistance in using your IBM system, to your IBM representative or to the IBM branch office serving your locality.

How did you use this publication?

- | | | | |
|--------------------------|-------------------------------------|--------------------------|------------------------|
| <input type="checkbox"/> | As an introduction | <input type="checkbox"/> | As a text (student) |
| <input type="checkbox"/> | As a reference manual | <input type="checkbox"/> | As a text (instructor) |
| <input type="checkbox"/> | For another purpose (explain) _____ | | |

Is there anything you especially like or dislike about the organization, presentation, or writing in this manual? Helpful comments include general usefulness of the book; possible additions, deletions, and clarifications; specific errors and omissions.

Page Number:

Comment:

What is your occupation? _____

Newsletter number of latest Technical Newsletter (if any) concerning this publication: _____

If you wish a reply, give your name and address:

IBM branch office serving you

Thank you for your cooperation. No postage stamp necessary if mailed in the U.S.A. (Elsewhere, an IBM office or representative will be happy to forward your comments or you may mail directly to the address in the Edition Notice on the back of the title page.)

Note: Staples can cause problems with automated mail sorting equipment. Please use pressure sensitive or other gummed tape to seal this form.

Reader's Comment Form

Fold

Fold



NO POSTAGE
NECESSARY
IF MAILED
IN THE
UNITED STATES

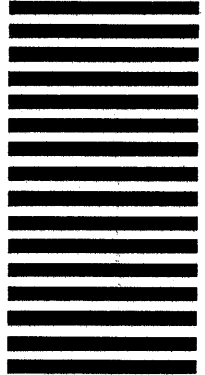

BUSINESS REPLY MAIL
FIRST CLASS PERMIT NO. 40 ARMONK, N.Y.

POSTAGE WILL BE PAID BY ADDRESSEE:

**International Business Machines Corporation
Department 63T
Neighborhood Road
Kingston, New York 12401**

Fold

Fold



**International Business Machines Corporation
Data Processing Division
1133 Westchester Avenue, White Plains, N.Y. 10604**

**IBM World Trade Americas/Far East Corporation
Town of Mount Pleasant, Route 9, North Tarrytown, N.Y., U.S.A. 10591**

**IBM World Trade Europe/Middle East/Africa Corporation
360 Hamilton Avenue, White Plains, N.Y., U.S.A. 10601**

Cut or Fold Along Line
IBM 3270 IDS 3274 Control Unit Planning, Setup, and Customizing Guide (File No. S360/S370/S3-09) Printed in U.S.A. GA27-2827-4

IBM 3270 Information Display System
3274 Control Unit Planning,
Setup, and Customizing Guide

READER'S
COMMENT
FORM

Order No. GA27-2827-4

This manual is part of a library that serves as a reference source for systems analysts, programmers, and operators of IBM systems. This form may be used to communicate your views about this publication. They will be sent to the author's department for whatever review and action, if any, is deemed appropriate. Comments may be written in your own language; use of English is not required.

IBM may use or distribute any of the information you supply in any way it believes appropriate without incurring any obligation whatever. You may, of course, continue to use the information you supply.

Note: Copies of IBM publications are not stocked at the location to which this form is addressed. Please direct any requests for copies of publications, or for assistance in using your IBM system, to your IBM representative or to the IBM branch office serving your locality.

How did you use this publication?

- | | | | |
|--------------------------|-------------------------------------|--------------------------|------------------------|
| <input type="checkbox"/> | As an introduction | <input type="checkbox"/> | As a text (student) |
| <input type="checkbox"/> | As a reference manual | <input type="checkbox"/> | As a text (instructor) |
| <input type="checkbox"/> | For another purpose (explain) _____ | | |

Is there anything you especially like or dislike about the organization, presentation, or writing in this manual? Helpful comments include general usefulness of the book; possible additions, deletions, and clarifications; specific errors and omissions.

Page Number:

Comment:

What is your occupation? _____

Newsletter number of latest Technical Newsletter (if any) concerning this publication: _____

If you wish a reply, give your name and address:

IBM branch office serving you

Thank you for your cooperation. No postage stamp necessary if mailed in the U.S.A. (Elsewhere, an IBM office or representative will be happy to forward your comments or you may mail directly to the address in the Edition Notice on the back of the title page.)

Note: Staples can cause problems with automated mail sorting equipment.
Please use pressure sensitive or other gummed tape to seal this form.

Reader's Comment Form

Fold

Fold



NO POSTAGE
NECESSARY
IF MAILED
IN THE
UNITED STATES

BUSINESS REPLY MAIL
FIRST CLASS PERMIT NO. 40 ARMONK, N.Y.

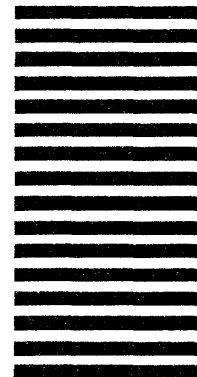

POSTAGE WILL BE PAID BY ADDRESSEE:

**International Business Machines Corporation
Department 63T
Neighborhood Road
Kingston, New York 12401**

Fold

Fold



**International Business Machines Corporation
Data Processing Division
1133 Westchester Avenue, White Plains, N.Y. 10604**

**IBM World Trade Americas/Far East Corporation
Town of Mount Pleasant, Route 9, North Tarrytown, N.Y., U.S.A. 10591**

**IBM World Trade Europe/Middle East/Africa Corporation
360 Hamilton Avenue, White Plains, N.Y., U.S.A. 10601**

Cut or Fold Along Line

IBM 3270 IDS 3274 Control Unit Planning, Setup, and Customizing Guide (File No. S360/S370/S3-09) Printed in U.S.A. GA27-2827-4

IBM 3270 Information Display System
3274 Control Unit Planning,
Setup, and Customizing Guide

READER'S
COMMENT
FORM

Order No. GA27-2827-4

This manual is part of a library that serves as a reference source for systems analysts, programmers, and operators of IBM systems. This form may be used to communicate your views about this publication. They will be sent to the author's department for whatever review and action, if any, is deemed appropriate. Comments may be written in your own language; use of English is not required.

IBM may use or distribute any of the information you supply in any way it believes appropriate without incurring any obligation whatever. You may, of course, continue to use the information you supply.

Note: Copies of IBM publications are not stocked at the location to which this form is addressed. Please direct any requests for copies of publications, or for assistance in using your IBM system, to your IBM representative or to the IBM branch office serving your locality.

How did you use this publication?

- | | | | |
|--------------------------|-------------------------------------|--------------------------|------------------------|
| <input type="checkbox"/> | As an introduction | <input type="checkbox"/> | As a text (student) |
| <input type="checkbox"/> | As a reference manual | <input type="checkbox"/> | As a text (instructor) |
| <input type="checkbox"/> | For another purpose (explain) _____ | | |

Is there anything you especially like or dislike about the organization, presentation, or writing in this manual? Helpful comments include general usefulness of the book; possible additions, deletions, and clarifications; specific errors and omissions.

Page Number:

Comment:

What is your occupation? _____

Newsletter number of latest Technical Newsletter (if any) concerning this publication: _____

If you wish a reply, give your name and address:

IBM branch office serving you

Thank you for your cooperation. No postage stamp necessary if mailed in the U.S.A. (Elsewhere, an IBM office or representative will be happy to forward your comments or you may mail directly to the address in the Edition Notice on the back of the title page.)

Note: Staples can cause problems with automated mail sorting equipment.
Please use pressure sensitive or other gummed tape to seal this form.

Reader's Comment Form

Fold

Fold



NO POSTAGE
NECESSARY
IF MAILED
IN THE
UNITED STATES

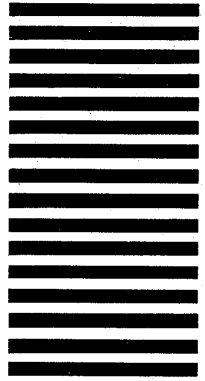

BUSINESS REPLY MAIL
FIRST CLASS PERMIT NO. 40 ARMONK, N.Y.

POSTAGE WILL BE PAID BY ADDRESSEE:

**International Business Machines Corporation
Department 63T
Neighborhood Road
Kingston, New York 12401**

Fold

Fold



**International Business Machines Corporation
Data Processing Division
1133 Westchester Avenue, White Plains, N.Y. 10604**

**IBM World Trade Americas/Far East Corporation
Town of Mount Pleasant, Route 9, North Tarrytown, N.Y., U.S.A. 10591**

**IBM World Trade Europe/Middle East/Africa Corporation
360 Hamilton Avenue, White Plains, N.Y., U.S.A. 10601**

Cut or Fold Along Line
IBM 3270 IDS 3274 Control Unit Planning, Setup, and Customizing Guide (File No. S360/S370/S3-09) Printed in U.S.A. GA27-2827-4



International Business Machines Corporation
Data Processing Division

1133 Westchester Avenue, White Plains, N.Y. 10604

IBM World Trade Americas/Far East Corporation
Town of Mount Pleasant, Route 9, North Tarrytown, N.Y., U.S.A. 10591

IBM World Trade Europe/Middle East/Africa Corporation
360 Hamilton Avenue, White Plains, N.Y., U.S.A. 10601