

## **Systems**

### **IBM 3505 Card Reader and IBM 3525 Card Punch Subsystem**

This reference publication describes the IBM 3505 Card Reader with its self-contained control unit and the IBM 3525 Card Punch, which can be attached to the 3505 control unit. The manual describes the operation of the subject devices operating as a subsystem to the IBM System/370. The manual is designed for those having a basic knowledge of programming and computer operations. The manual covers such subjects as device timings, throughput rates, features, commands, suggested error recovery procedures, and other programming and operating information.

For additional information, refer to the Bibliography of the system to which the subsystem is attached.

# **IBM**

**Second Edition (March 1971)**

**This is a reprint of GA21-9124-0 incorporating changes released in Technical Newsletter GN21-0130 (dated March 8, 1971).**

Changes are periodically being made to the information in this manual; before using this manual in connection with the operation of IBM systems, consult the latest SRL newsletter for the system you are using for the editions that are applicable and current.

Requests for copies of IBM publications should be made to your IBM representative or to the IBM branch office serving your locality.

A form for reader's comments is provided at the back of this publication. If the form has been removed, comments may be addressed to IBM Corporation, Product Publications, Department 245, Rochester, Minnesota 55901.

® Copyright International Business Machines Corporation 1971

## About This Manual

**Function:** Provide reference material about

- IBM 3505 Card Reader
- IBM 3525 Card Punch

**Audience:** Experienced IBM System/370

- Programmers (assembler language)
- Systems Analysts
- Operators

**Subject:** The manual contains information relating to

- Instructions and commands used to control the units and to communicate with the system
- Error indications, conditions, and recovery procedures
- Hardware description
- Operator controls and procedures
- Application hints

**Prerequisite Knowledge:** The reader must be familiar with the operation of the system to which the card I/O device is to be attached. Programmers should also be thoroughly familiar with system interface characteristics.

# Contents

ABOUT THIS MANUAL . . . . .	iii	OPERATOR CONTROLS AND STATUS INDICATIONS . . . . .	22
INTRODUCTION . . . . .	1	IBM 3505 Operator's Panel . . . . .	22
Attachment to System . . . . .	1	IBM 3525 Operator's Panel . . . . .	23
Billable-Time Metering . . . . .	2	3505/3525 Status Lights . . . . .	24
Data Representation . . . . .	2	3505/3525 Control Keys . . . . .	25
Card Sensing . . . . .	2	3505 Stacker Control . . . . .	27
Error Recovery Procedures . . . . .	2	3505 Stop Indications and Restart Procedures . . . . .	28
IBM 3505 CARD READER . . . . .	3	3525 Stop Indications and Restart Procedures . . . . .	34
3505 General Characteristics . . . . .	3	Log-Out Indications (Numbers) . . . . .	40
3505 Standard Features . . . . .	4		
3000-Card Capacity File Feed . . . . .	4		
Vacuum-Assisted Feed and Hopper Retry Capability . . . . .	4		
Recovery-Oriented Operator Panel . . . . .	5		
Alternate Stacking into Two 1750-Card Stackers . . . . .	5		
Optical Hole-Sense Reading . . . . .	5		
Reread Capability . . . . .	6		
Card Image . . . . .	6		
3505 Special Features . . . . .	7		
Special Feature Adapter . . . . .	7		
Selective Stacker (Stacker 2) . . . . .	7	PROGRAMMING CONSIDERATIONS . . . . .	42
Read Column Eliminate . . . . .	7	Commands . . . . .	42
Optical Mark Read . . . . .	8	Sense . . . . .	42
3525 Punch Adapter . . . . .	9	Test I/O . . . . .	43
3525 Read Punch Adapter . . . . .	10	Control No-Op . . . . .	44
3525 Two-Line Print Control . . . . .	10	Feed and Select Stacker . . . . .	45
3525 Multiline Print Control . . . . .	10.1	Read Only . . . . .	46
IBM 3525 CARD PUNCH . . . . .	11	Diagnostic Read . . . . .	47
3525 General Characteristics . . . . .	11	Read, Feed, and Select Stacker . . . . .	48
3525 Card Punch Standard Features . . . . .	12	Write, Feed, and Select Stacker . . . . .	50
1200-Card Capacity Hopper and Multi-Tooth Clutch . . . . .	12	Write RCE (Read Column Eliminate) Format . . . . .	52
Recovery-Oriented Operator Panel . . . . .	13	Write OMR (Optical Mark Read) Format . . . . .	54
Program-Controlled Selectable Stackers . . . . .	13	Print Line . . . . .	55
Dedicated Error Pocket and Punch Retry . . . . .	13	Command Programming Examples . . . . .	56
Data Security Safeguards . . . . .	14	Reading & Punching (3525) . . . . .	56
Punch Buffer . . . . .	14	Read Column Eliminate Programming Example . . . . .	57
IBM 3525 Card Punch Special Features . . . . .	15	Optical Mark Read Programming Example . . . . .	58
Card Read . . . . .	15	Reading, Then Printing (3525) . . . . .	59
Multiline Card Print . . . . .	15	Punching, Then Printing (3525) . . . . .	59.1
Two-Line Card Print . . . . .	16	Reading, Punching, & Printing (3525) . . . . .	59.2
OPERATIONAL CHARACTERISTICS . . . . .	17	Other Instructions and Resets . . . . .	60
3505 Initial Run-In . . . . .	17	Halt I/O . . . . .	60
Operator Action . . . . .	17	Stop . . . . .	60
Subsystem Action . . . . .	17	Selective Reset . . . . .	60
System Action . . . . .	18	System Reset . . . . .	60
3525 Initial Run-In . . . . .	19	Channel Checks . . . . .	61
Operator Action . . . . .	19	Status Byte . . . . .	62
Subsystem Action . . . . .	19	Status Byte Format . . . . .	62
System Action . . . . .	20	Valid Status Combinations and Status Timings . . . . .	65
3525 Card Movement After Initial Run-In . . . . .	21	Sense Bytes . . . . .	66
		Sense Byte 0 . . . . .	67
		Sense Byte 1 . . . . .	68

SUBSYSTEM TIMING CONSIDERATIONS . . . . .	70
Operating Rates . . . . .	70
Performance Analysis . . . . .	70
3505 Timings for Source Program Using Read Only, and Feed and Select Stacker Commands . . . . .	71
3505 Timings for Source Program Using Only Read, Feed, and Select Stacker Commands . . . . .	72
3525 Timings for Source Program Using Only Write, Feed, and Select Stacker Commands . . . . .	73
3525 Timings for Source Program Using Only Read Only, and Write, Feed, and Select Stacker Commands .	74
3525 Timings for Source Program Using Only Read Only, and Feed and Select Stacker Commands . . . . .	75
3525 Timings for Source Program Using Only Read, Feed, and Select Stacker Commands . . . . .	76
3505 Card Throughput . . . . .	77
3525 Card Throughput . . . . .	78
3525 Card Throughput While Printing With the Multiline Card Print Feature . . . . .	79

APPENDIX A. SUBSYSTEM CARD SPECIFICATIONS AND RECOMMENDATIONS . . . . .	80
Special Feature Cards . . . . .	80
Carbon-Back Cards . . . . .	81

APPENDIX B. OPTICAL MARK READ SPECIFICA- TIONS . . . . .	82
OMR Card Specifications . . . . .	82
Reflectance Measurements . . . . .	83
Card Stock . . . . .	83
Recommended Marking Constraints . . . . .	83
OMR Columns . . . . .	84
OMR Fields . . . . .	84
Location of OMR data . . . . .	84
Transfer of OMR Card Data to the System . . . . .	84
Marks and Erasures . . . . .	85
Marking Recommendations . . . . .	85

APPENDIX C. SEQUENCE OF CHECKING INDICATORS . . . . .	86
--	----

APPENDIX D. PERMANENT ERROR DIAGNOSTIC DATA . . . . .	87
--	----

APPENDIX E. PRINT FEATURE CHARACTER SET AND CHAIN ARRANGEMENT . . . . .	88
--	----

INDEX . . . . .	89
-----------------	----



**IBM 3525 CARD PUNCH ATTACHED TO IBM 3505 CARD READER**

Data processing systems are designed to keep user programming effort to a minimum. To achieve this, input and output units are attached to a processing unit through a standard I/O interface (such as a channel) via some controlling device (such as a control unit). The controlling device accepts basic commands (read, punch, sense, select, etc.) and automatically performs the functions necessary for I/O operation, control, and response to the command. In effect, there are two systems at work in such situations: the main data processing system and another special function I/O system consisting of the controlling device and its attached I/O devices. This latter system can be viewed as a subsystem to the main system.

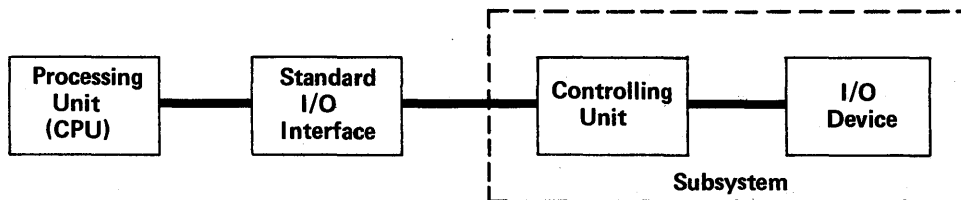

The machines described in this manual constitute such a subsystem, which is available in the following configurations:

- IBM 3505 Card Reader Model B1 or B2 with an internal control unit.
- IBM 3505 Card Reader Model B1 or B2 with an internal control unit and an attached IBM 3525 Card Punch Model P1, P2, or P3.

Both the reader and punch can be equipped with special features that expand the function range of the subsystem.

In the 3505/3525 subsystem, the controlling device is the control unit. This control unit is fully buffered, and has its own processing unit and resident programs for error detection and recovery assistance. The control unit also stores a log of the last 14 to 28 errors in the subsystem; the customer engineer uses this log for maintenance procedures. Because the subsystem is buffered, channel overrun cannot occur and card data can be transferred to and from the subsystem in burst mode. Minimization of error-procedure decisions and reduced device selection and connect time allow the main system more time for other data processing.

## Attachment to System

The subsystem can be attached to any channel of the IBM System/370 in any priority.

## Billable-Time Metering

Each I/O unit has a meter that records billable time while the system is in operation and the I/O unit is online and operational. The meter runs if:

1. There is at least one card in the unit's feed path, and
2. The unit has accepted a functional command (read, write, etc.) since a card run-in condition last occurred, and
3. The system's processing unit billable time meter is running.

## Data Representation

Reading: (Applies to both the IBM 3505 and the IBM 3525 with a card read feature.) Either EBCDIC (data mode 1) or card image (data mode 2) can be read under program control. Data read in EBCDIC is checked for validity according to the rule: "Any combination of punches in a single column is valid if it contains no more than one punch in rows 1 through 7."

Punching: Either EBCDIC or card image under program control.

Printing: EBCDIC code using either an EBCDIC character set or an ASCII character set.

## Card Sensing

The subsystem reads cards optically as the cards move past the read station during card feed cycles. On the 3505, data is read serially by column, starting at column 1 of the card. On a 3525 with the read feature, data is read parallel by row, 12-row first.

*Note:* Cards with holes punched in columns minus 1, 0, 81, and 82 are read without error-indication. The data punched in these columns is not sensed, so it is not sent to the system. Cards must not contain punches in both column -1 and column 0. Cards with column 1 corner cuts must not have punches in column 0.

## Error Recovery Procedures

The amount of program error recovery support required for the 3505 and 3525 is less than that required for such I/O devices as the IBM 2540, because many functions that were performed by the program support now are performed by the subsystem. Examples of these functions are automatic feed retry and automatic punch retry. If the subsystem control unit cannot correct a failure itself, it identifies not only the error, but the specific recovery action to be taken by the program error recovery procedure, the operator, or both. When a device error (unit check in the command status word) occurs, the subsystem presents four sense bytes to the recovery program, instead of one byte, as is presented for the 2540 and similar devices. The sense data is designed such that the error recovery requirement is device independent for the 3505 and 3525.



## IBM 3505 CARD READER

### 3505 GENERAL CHARACTERISTICS

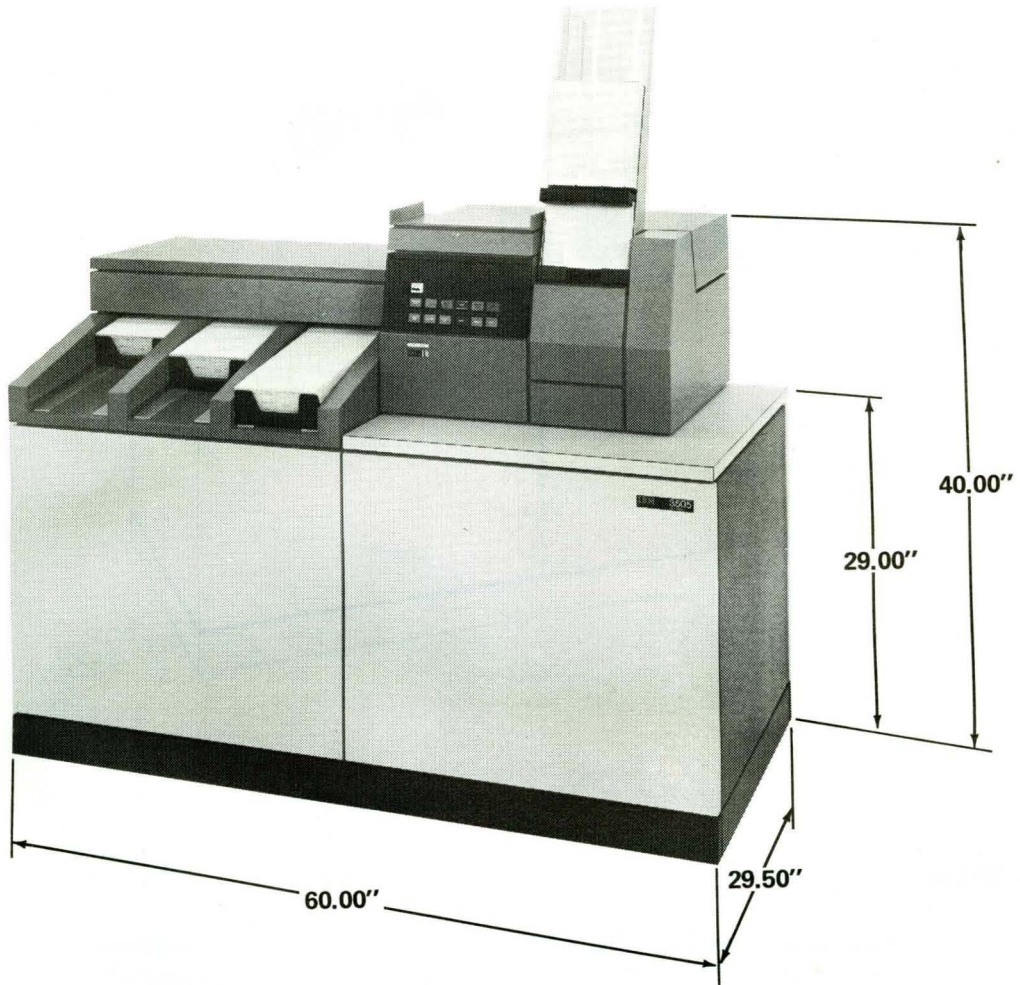

The basic machine color is gray. You can select one of these accent colors:

- Gray
- Blue
- Red
- Yellow
- White

## 3505 STANDARD FEATURES

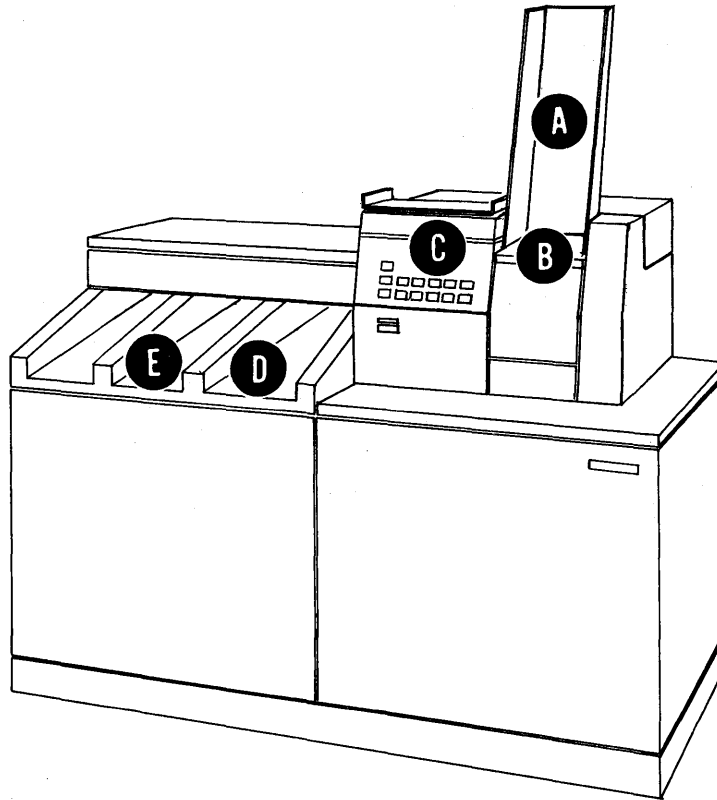

### **A** 3000-Card Capacity File Feed

This large-capacity file feed supplies cards to the hopper on a demand basis, allowing a large supply of cards to be in position for feeding. Misfeeds caused by excess card weight are eliminated by this feature.

### **B** Vacuum-Assisted Feed and Hopper Retry Capability

Cards feed automatically from the file feed into the hopper. At the hopper, friction feed rolls and an assisting vacuum feed mechanism work together to feed documents into the card path as required for document reading and initial run in. If a card fails to feed from the hopper on the first try, the reader tries to feed documents during three successive hopper cycles before the control unit signals an error condition (hopper misfeed). All except damaged cards will feed successfully during the first feed cycle. Retry prevents unwanted misfeeds with damaged cards and resulting lost time.

## **C** Recovery-Oriented Operator Panel

All normal stops and most error stops can be handled by looking at the indicators and lights on the operator panel. The indicators either show the precise action to be performed or direct the operator to the procedure. Operating keys and switches are situated in the same general area for ease of control.

If you need more explicit directions (for example, when more than one action is to be taken), refer to the "3505 Stop Indications and Restart Procedures" in this manual or to the instructions in the error recovery procedure box (a drawer located near the operator panel).

## **D E** Alternate Stacking into Two 1750-Card Stackers

Stacker 1 consists of two stacking mechanisms—the left half and the right half—called stacker 1 left and stacker 1 right, respectively. An active stacker is the half into which cards entering stacker 1 are currently being placed. The active half is indicated to the operator by its associated light being on. Whenever an active half of stacker 1 becomes full, one of the following events occurs:

1. If the other half has not been readied, the 3505 stops with a stacker full indication. The stacker light that is on during this stop indicates the half of stacker 1 that was filled last. For example, if both halves of stacker 1 are full and the 3505 is displaying a full stacker indication, examine the stacker lights. The light that is on indicates the last half filled. To maintain correct file sequence, you should empty the inactive side of stacker 1, then the active side.
2. If the other half has been readied, the 3505 control unit makes that half active and places cards selected into stacker 1 into the now active half.

By emptying and readying the inactive half of stacker 1 (by turning a stacker readied switch toward the half you are readying) before the active half fills, the operator can prevent 3505 stops caused by stacker 1 full conditions. That is, the operator can empty the inactive stacker and set the switch toward the half just emptied. Then, as soon as the active half becomes full, the 3505 will activate the empty half.

When power is applied to a 3505, stacker 1 right **D** is the initially-active stacker. If stacker 1 left **E** is readied before stacker 1 right fills, alternate stacking into stacker 1 left occurs. However, if the stacker readied switch (see "Stacker 1 Controls") is pointing toward stacker 1 right when the right half becomes full, the 3505 stops with a full stacker indication. If cards are removed from both halves of stacker 1 during any stop other than a power off stop, then cards enter the half that was active when the stop occurred.

## ● Optical Hole-Sense Reading

Photo transistors, which sense light passing through holes in the cards as the cards pass the read station are used to read data from the cards. This optical method of reading is fast, efficient, and comparatively trouble-free.



## **3505 SPECIAL FEATURES**

### ● **Special Feature Adapter**

Description: This feature consists of circuitry and logic needed for the operation of all other 3505 and 3525 special features and the 3525 adapter.

Operation: This feature operates entirely under subsystem control, so the operator and programmer need not be concerned with its operation.

Prerequisites: None.

Limitations: None.

### ● **Selective Stacker (Stacker 2)**

Description: This feature adds a program-selectable 1750-card capacity third pocket and a stacker wait station to the 3505.

Operation: With this feature installed, cards leaving the read station can be stopped at the post-read station until the subsystem executes another command that causes a card feed cycle. During the next card feed cycle, the card at the stacker wait station is directed into either (1) stacker 1 (stacker 1 left or stacker 1 right) or (2) stacker 2, under program control.

Prerequisite: Special feature adapter.

Limitations: None.

### ● **Read Column Eliminate**

Description: Under program control, this feature suppresses the reading of data from specified card columns; it also suppresses normal validity checks and read checks on those columns. The specified columns can, therefore, contain invalid codes and open-punched scores without resulting error indications. During read operations in read column eliminate formatted mode (usually called RCE mode), the subsystem transmits blanks, instead of the data from the specified columns, to the system. (See "Programming Notes" for "Write RCE Format".)

**Operation:** The format for read column eliminate mode operations must be established before a card to be read in the formatted mode moves through the read station because the format control is applied to the columns as the columns are sensed and their data is moved into the read buffer. To establish the format, the source program must issue a write RCE (read column eliminate) command, which transfers up to 80 formatting bytes from CPU storage into 80 associated control bit positions in the read buffer. For each column that is to be eliminated (that is, is to be moved into CPU storage as a blank), the format must contain either a digit (0 through 9) or a letter (A through Z). These are called RCE characters. Each column read as punched must be left blank in the format.

*Example:*

Characters in format moved from CPU storage:	<del>1</del> <del>2</del> <del>3</del> <del>4</del> <del>5</del> 35
Characters in associated card columns:	XXXXXXXXXX
Characters that will go to the CPU:	X <del>1</del> XXXXXX <del>5</del>

Transferring the format data to the reader places the reader in format mode. Thereafter, all data is read into storage in format mode until the mode is reset to unformatted mode (see "Write RCE Format Command").

**Note:** During a job that is to perform formatted mode reading, the first card must not be a card to be read in formatted mode. It can, however, contain the format to be used, and this format can be read into CPU storage for later use with the write RCE format command.

**Prerequisite:** Special feature adapter.

**Limitation:** Both the read column eliminate feature and the optical mark read feature can be installed on the same 3505, but only one can operate at a time in a program.

## ● Optical Mark Read

**Description:** This feature gives the card reader the ability to read handwritten pencilled marks and machine-printed, non-reflective-ink marks from cards. (See "Appendix B" for requirements.) Marks can be placed no closer than every other column of the card—that is, one blank column must separate any marked column from any other mark column or punched column on the card (see Appendix). A mark read card can contain from one to forty mark read positions interspersed with punched columns in any combination that allows at least one blank column between each mark column and its adjacent punch column. Bad and marginal marking results in a substitute character being sent as data (see "Write OMR Format Command").

**Operation:** A beam of light aimed at each mark position reflects into a photoelectric cell. When the mark position is in place to be read, the reader samples the output of the photocell. The photocell senses any significant reduction in light reflected from the card as being a mark in that mark position. Reflective printing and marking is allowed anywhere on the card. Non-reflective printing and marking should be used only as shown in Appendix B.

OMR data is checked for validity in the same manner as punched data: in EBCDIC, only one mark is allowed per column in rows 1 through 7; in card image mode, any combination of marks in a column is allowed.

The format for optical mark read cards must be established before an OMR card moves through the read station because the format control is applied to the columns as they are sensed and their data is moved to the read buffer. To establish the format, the source program must issue a write OMR format command. This command transfers up to 80 formatting bytes from CPU storage into 80 associated control bit positions in the read buffer. For each card column that is to contain OMR marks, the format must contain either a digit (0 through 9) or a letter (A through Z). These are called OMR-column characters. In the format, blanks must be used for all columns that will not contain OMR marks.

During read operations, when data from OMR cards is moving from the read buffer to CPU storage, the first blank after each OMR column is ignored by the subsystem; that is, the first blank is not sent to the CPU.

*Example (X = mark read columns; Z = punch columns):*

Characters in format moved from CPU storage:	1 <del>0</del> 1 <del>0</del> 1 <del>0</del> 1 <del>0</del> 1 <del>0</del> 1 <del>0</del>
Characters in associated card columns:	X <del>0</del> X <del>0</del> X <del>0</del> X <del>0</del> ZZ
Characters that will go to CPU:	XXX <del>0</del> ZZ

(See programming notes for "Write OMR format command.")

*Note:* During a job that is to contain OMR card reading, the first card must not be a card to be read in OMR formatted mode. It can, however, contain the format to be used, and this format can be read into CPU storage for later use with the write OMR format command.

**Prerequisite:** Special feature adapter.

**Limitation:** Both the optical mark read feature and the read column eliminate feature can be installed on the same 3505, but only one can operate at a time.

## ● 3525 Punch Adapter

**Description:** This adapter permits the IBM 3525 Card Punch to be attached to the control unit housed in the 3505.

**Operation:** The 3505 and 3525 are logically independent; that is, they have separate addresses, sense bytes, and status bytes. Only one channel position is required.

**Prerequisite:** The 3505 must be equipped with a special feature adapter.

**Limitation:** Cannot be installed on a 3505 equipped with the 3525 read punch adapter special feature. However, field conversion of these two adapters is allowed.

## ● 3525 Read Punch Adapter

**Description:** This adapter permits an IBM 3525 with an installed card read feature to be attached to the control unit housed in the 3505.

**Operation:** The 3505 and 3525 are logically independent; that is, they have separate addresses, sense bytes, and status bytes. Only one channel position is required.

**Prerequisites:** The 3505 must be equipped with a special feature adapter.

**Limitation:** Cannot be installed on a 3505 equipped with the 3525 Punch Adapter special feature. However, field conversion of these two adapters is allowed.

## ● 3525 Two-Line Print Control

**Description:** This feature has an adapter, special microprogram, and print buffer that allow the control unit housed in the 3505 to control printing, with print overlap, by the two-line print feature installed on the IBM 3525 Card Punch.

**Operation:** With this adapter installed, the two-line print feature is logically independent of all 3505 functions. It uses the 3525 address, status bytes, and sense bytes, but has its own microprogram and print buffer. (For print control adapter operation, see "Print Line Command".)

**Prerequisite Features:** 3525 Punch Adapter or 3525 Read Punch Adapter.

**Limitations:** The two-line print control feature and multiline print control feature are mutually exclusive. However, field conversion of the two features is allowed.



## ● 3525 Multiline Print Control

**Description:** This feature has an adapter, special microprogram, and print buffer that allow the control unit housed in the 3505 to control printing, with print overlap, on the multiline print feature installed on the IBM 3525 Card Punch.

**Operation:** With this feature installed, the multiline print feature on the 3525 is logically independent of all 3505 functions. It uses the 3525 address, status bytes, and sense bytes, but has its own microprogram and print buffer. (For print feature operation, see "Print Line Command".)

**Prerequisite:** 3525 punch adapter or 3525 read punch adapter.

**Limitations:** The multiline print control feature and two-line print control feature are mutually exclusive. However, field conversion of the two features is allowed.



## IBM 3525 CARD PUNCH

### 3525 GENERAL CHARACTERISTICS

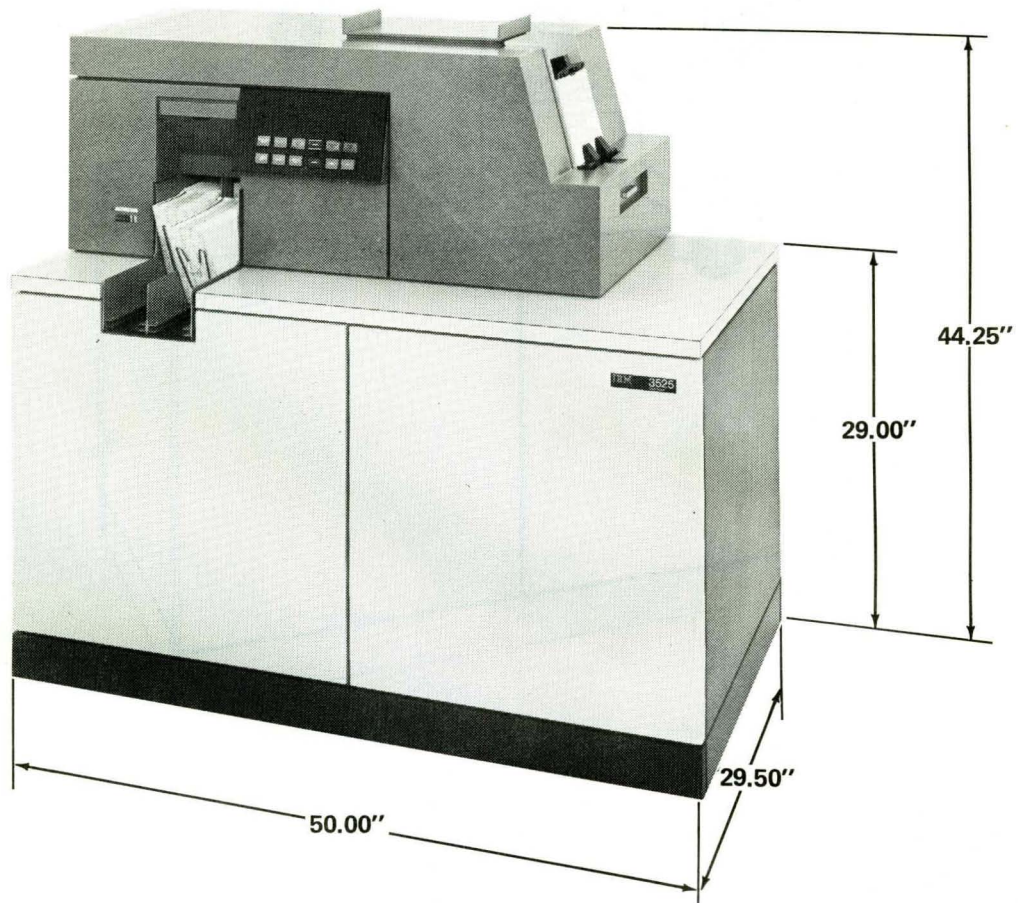

The basic machine color is gray. You can select one of these accent colors:

- Gray
- Blue
- Red
- Yellow
- White

## 3525 CARD PUNCH STANDARD FEATURES

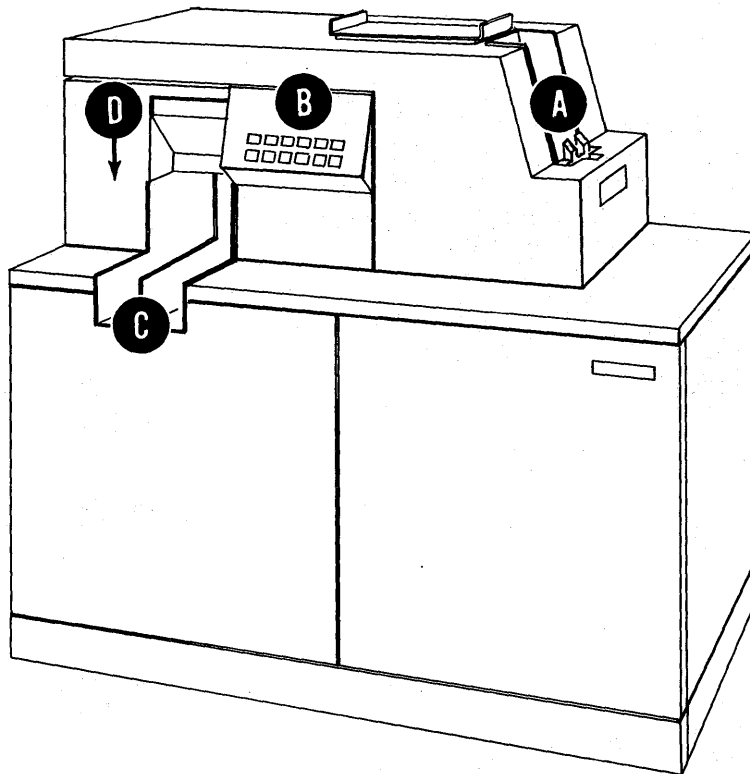

### **A** 1200-Card Capacity Hopper and Multi-Tooth Clutch

The 3525 card hopper, which holds up to 1200 cards, feeds cards under clutch control. The clutch has four teeth. These allow card cycles to start with a maximum delay of one fourth of a machine cycle.

The hopper is equipped with a card weight. This weight must be used whenever there are less than 3 inches of cards in the hopper. If the card weight is not used, cards will be damaged by the picker knives.

**B****Recovery-Oriented Operator Panel**

All normal stops and most error stops can be handled by looking at the indicators and lights on the operator panel. The indicators either show the precise action to be performed or direct the operator to the procedure. Operating keys are located in the same general area for ease of control.

If you need more explicit directions (for example, when more than one action is to be taken), refer to the "3525 Stop Indications and Restart Procedures" in this manual or to the instructions in the error recovery procedure box (a drawer located near the operator panel).

**C****Program-Controlled Selectable Stackers**

The two stackers are designated stacker 1 (on right) and stacker 2 (on the left). Each stacker holds about 1200 cards and has a full stacker switch which stops the punch and turns on the operator call light when that stacker becomes full.

If the card has been punched without a punch error, cards enter stackers 1 and 2 under program control. Stacker 2 must be selected by a command containing a feed and select stacker operation. Cards enter stacker 1 if they are not selected into stacker 2.

**D****Dedicated Error Pocket and Punch Retry**

A third stacker (stacker 3, or reject stacker), at the end of the transport under the machine top cover, holds up to 200 cards rejected by the 3525 because of detected punching errors. As soon as each row is punched, the subsystem compares the punch data against the data actually punched.

If any column in the card is punched incorrectly, the subsystem action is a function of the commands preceding the punch command experiencing the error:

1. If no 3525 read command has been accepted since the last successful punch command and prior to the punch command experiencing the error, the subsystem performs a punch retry sequence. The punch retry sequence directs the original error card to the third stacker, performs a first punch retry, directs the card punched to the third stacker, and performs a second retry, which is the data card for the customer. Normal operation continues after the second retry.

*Notes:* The card punched by the first retry is directed to the third stacker so that the customer engineer may compare the error card and a good copy (first retry card) in his repair activity.

The punch retry discussion above assumes no errors on the first or second retry. If a punch error occurs on the first retry, the 3525 stops with the original error card in stacker 3, and the first retry card at the post punch wait station. A permanent error is posted to the program and the Permanent Error and NPRO indicators are lit on the operation panel of the 3525. If a punch error occurs on the second retry, the second retry card assumes the role of an original error card, and punch retry continues in the same manner as discussed above.

2. If read commands have been issued since the last successful punch command and prior to the unsuccessful punch command, the punch retry function is suppressed. The 3525 will post a permanent error to the program and the Permanent Error and NPRO indicators will be lit on the operator panel. The error card will be in the post punch wait station.

Recommendation: For those applications that punch additional data into prepunched cards, the 3525 should be equipped with the card read feature and the program should issue a read command before each punch command. This will suppress punch retry and the unintentional punching of data into the wrong card.

### ● Data Security Safeguards

The stacker 3 indicator comes on any time a card enters the reject stacker, and stays on until the start key is next pressed. If the job is a data security job, the third stacker should be emptied during the next machine stop that occurs, and the card or cards from the stacker should be disposed of as directed by the user.

When punching into prepunched cards, the punch command should be preceded by a read command to suppress punch retry. If punch retry is not suppressed and if a punch error occurs, the prior card punch data is punched into the following cards by the punch retry sequence.

### ● Punch Buffer

The subsystem has a buffer that accepts all 80 columns of data and stores them until the next data is sent to the buffer by the system. This makes the punch a time-independent device; that is, punch overrun cannot occur.

# IBM 3525 CARD PUNCH SPECIAL FEATURES

## ● Card Read

**Description:** This feature provides the punch with an optical-punched hole sensing station ahead of the punch station. The feature allows the 3525 to execute 3505 read programs compatibly. See "End of File" lamp description.

**Operation:** As each card moves past the read station, light passes through holes in the rows of the card. Phototransistors sense the light shining through the holes as data bits. The exact bit pattern from the card is stored in the card read feature buffer. This data is then available for transfer to the system by a read command. The next card passing the read station reads new data into the buffer. This destroys the data previously stored in the buffer.

**Prerequisite:** 3525 Read Punch Adapter on the 3505.

**Limitation:** None.

## ● Multiline Card Print

**Description:** Provides the punch with a print station between the post-punch station and the stackers, and an interchangeable 64-character set. The customer can select the character set to be installed. (See appendix for character sets available.) Printing occurs on any or all of 25 lines on each card under source program control.

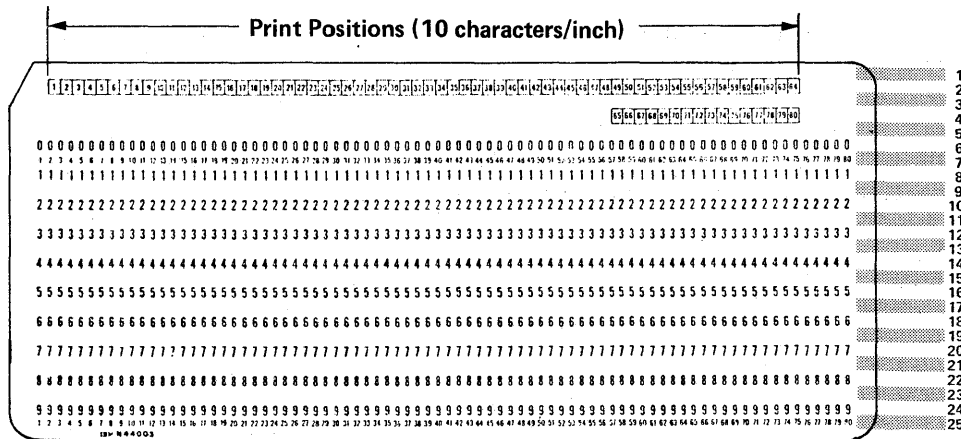

The last two lines of data to be printed are printed in an overlap mode — that is, these lines are printed during the next card feed cycle. Each print line is 64 characters long, with ten characters to the inch horizontal spacing. Maximum throughput when printing (in cards per minute) depends upon the machine model, the average number of lines being printed, and the location of the printed lines.

**Operation:** Cards leaving the 3525 punch station always stop at the post-punch station. If these cards are to be printed, the source program must issue the print commands required to print every line of the card before issuing a command that causes a card feed cycle to occur. Each line requires a separate print line command, which specifies the line on which printing is to occur. The last two lines on a card are printed during the next card feed cycle caused by a command. (These two lines are said to be printed in "overlap" mode.) When printing, the 3525 increments the card to the line specified by the print line command, then printing occurs.

**Prerequisite:** 3525 Multiline Print Control Adapter on the 3505. Also, the customer must specify the desired character set.

**Limitation:** The multiline print control adapter cannot be installed on a 3525 that is equipped with the two-line print control adapter. However, field conversion is allowed.

## ● Two-Line Card Print

**Description:** This feature is similar to the multiline card print feature. However, this feature allows printing on lines 1 and 3 only (between the top edge of the card and punch row 12 for line 1, and between punch rows 12 and 11 for line 3). When printing with the two-line card print feature installed, maximum throughput depends upon the machine model. For example:

Number of Lines	Throughput in Cards per Minute		
	<i>Model P1</i>	<i>Model P2</i>	<i>Model P3</i>
1	100	200	300
2	100	200	300

**Operation:** The operation described for the multiline card print feature applies to the two-line card print feature operations.

**Prerequisite:** 3525 Two-Line Print Control Adapter on the 3505. Also, the customer must specify the character set to be installed.

**Limitation:** The two-line card print feature cannot be installed on a 3525 that is equipped with the multiline card print feature. However, field conversion is available.



## OPERATIONAL CHARACTERISTICS

### 3505 INITIAL RUN-IN

#### Operator Action

1. Determine that the reader power is on.
2. Place cards to be read in the file feed.
  - Face down.
  - 9-edge first.
3. Press the start key.

#### Subsystem Action

- **Reader Without The Selective Stacker:** The reader takes two card feed cycles. During the first card cycle, card 1 feeds from the hopper into the pre-read station. During the second cycle, the first card moves from the pre-read station, past the read station, into stacker 1 while the second card moves from the hopper into the pre-read station. As card 1 moves past the read station, the reader senses the data from the card and stores it in the read buffer. At the end of the second feed cycle, the subsystem becomes ready and sets device end.

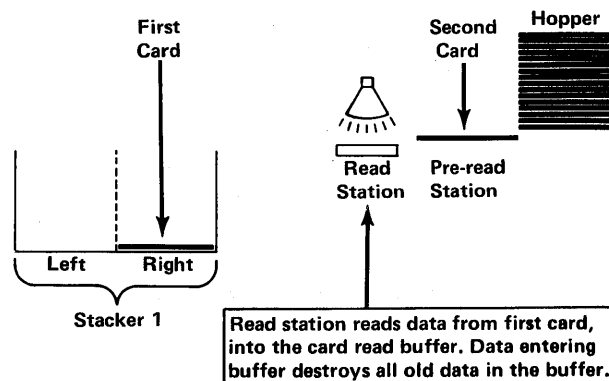

- **Reader Equipped With A Selective Stacker:** Reader takes two card feed cycles. During the first card cycle, card 1 feeds from the hopper into the pre-read station. During the second cycle, the first card moves from the pre-read station, past the read station, into the post-read station while the second card moves from the hopper into the pre-read station. As card 1 moves past the read station, the reader senses the data from the card and stores it in the read buffer. (The card at the post-read station remains there until the next card feed cycle occurs.) At the end of the second card feed cycle, the subsystem becomes ready and issues device end.

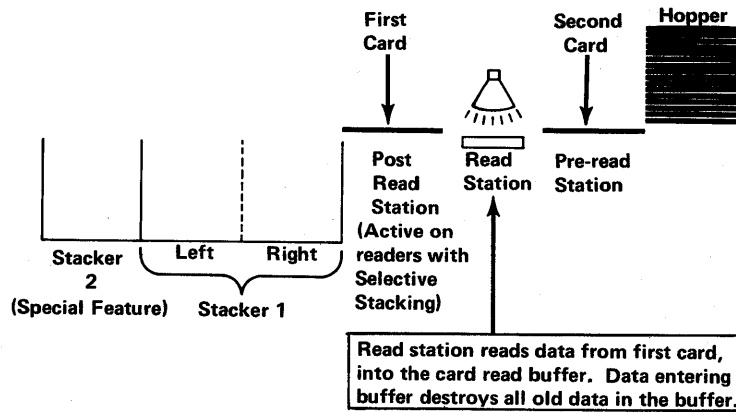

### System Action

The source program can now issue one of the following macros: GET or READ, EXCP, CNTRL.

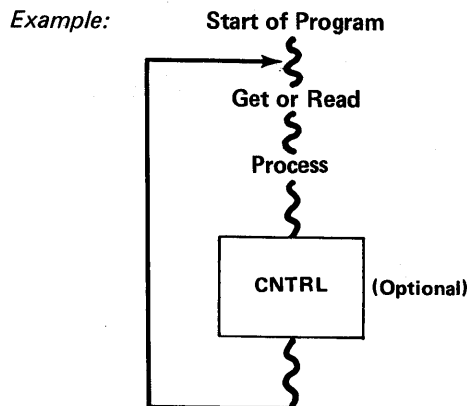

## 3525 INITIAL RUN-IN

### Operator Action

1. Determine that power on light is on.
2. Determine that the offline indicator is off.
3. Place cards in the hopper.
  - Face down
  - 12-edge first
4. Press the start key.

### Subsystem Action

Punch takes two card feed cycles. During the first card cycle, the first card feeds from the hopper into the pre-read station. (Notice that this moves the card only partially out of the hopper.) During the second cycle, the first card moves from the pre-read station past the read station into the pre-punch station. If the 3525 is equipped with the card read feature, the read head senses all holes prepunched in the first card and stores the data (including blanks for any unpunched columns) in the read feature buffer as the card passes the read station. At the end of the second feed cycle, the subsystem becomes ready and sets device end.

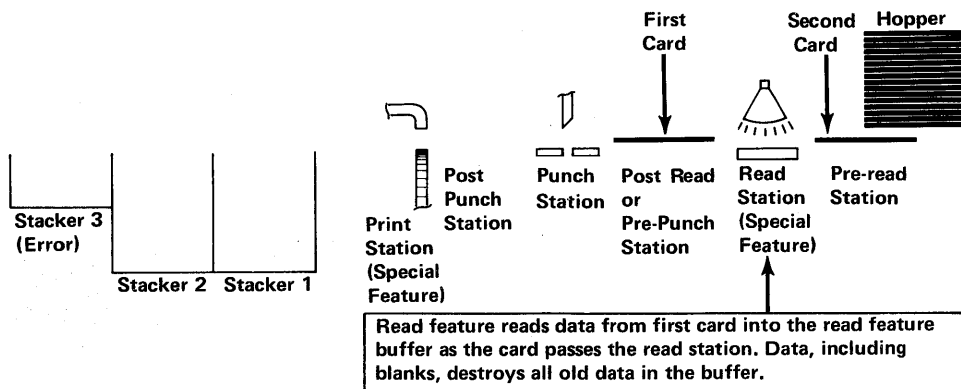

*Card Location At End of Run-In*

## System Action

The source program can now issue one of the following macros: PUT or WRITE, EXCP, CNTRL for output operations. For reading operations using the card read feature, programming is the same as described for the 3505 (except that the device address is the address assigned to the 3525).

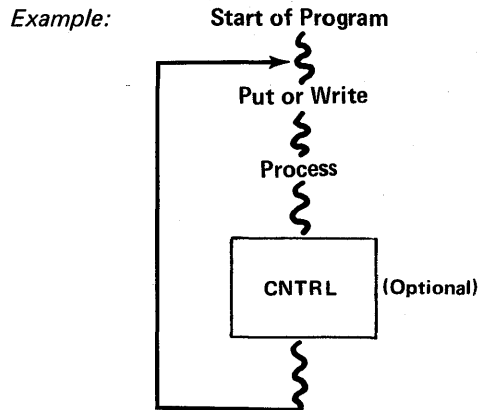

As the program issues instructions that result in card feed cycles, each card in the transport moves forward one station. For example, during the first card feed cycle after initial run-in, the first card moves from the pre-punch station, past the punch station, and into the post punch station; the second card moves from the pre-read station, past the read station, into the pre-punch station; and another card (third card) feeds from the hopper into the pre-read station.

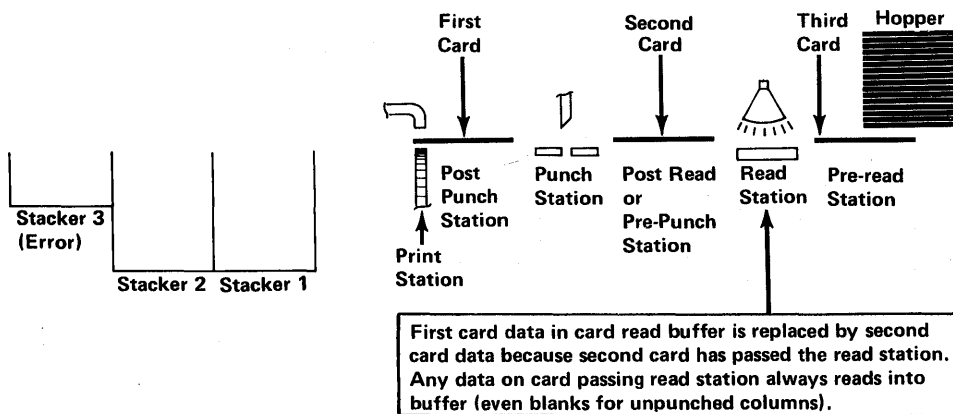

*Card Locations At End of Card Run-In Plus 1 Card Feed Cycle*

## 3525 CARD MOVEMENT AFTER INITIAL RUN-IN

When a 3525 with a multiline print feature installed executes a print line command that requires a previously buffered line of data to be printed, the card at the post-punch station moves into position for printing of the buffered data on the line specified by the command for that buffered data. All other cards in the transport remain motionless. See "Print Line Command" for further discussion of printing operation.

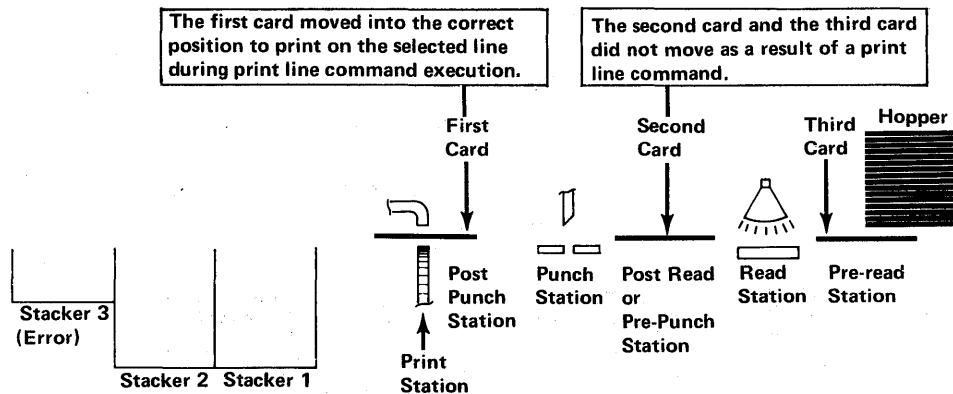

*Position of Cards after Print Instruction Specifying Print Line Position 12*

During the second card feed cycle after the card run-in and during each subsequent card feed cycle: (1) the card at the post-punch station advances into the selected stacker, (2) the card at the pre-punch station advances into the post-punch station, (3) the card at the pre-read station advances into the pre-punch station, and (4) a card feeds from the hopper into the pre-read station. Also during this card feed cycle, any lines of print data buffered for the card at the print station are printed and then the card will be ejected to the selected stacker.

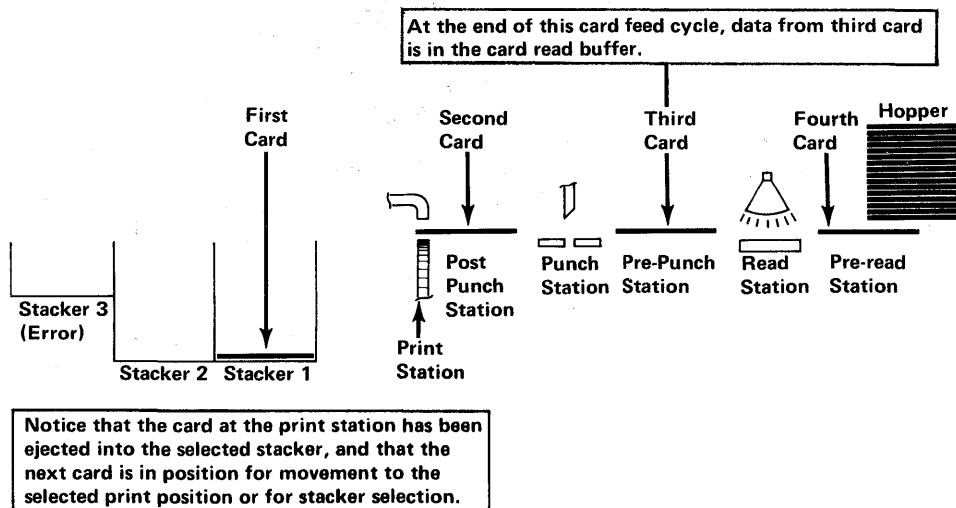

*Card Locations at End of Card Run-In Plus 2 Card Cycles*

# OPERATOR CONTROLS AND STATUS INDICATIONS

## IBM 3505 OPERATOR'S PANEL

The operator uses these controls and indicators to place the card reader online and keep it operational.

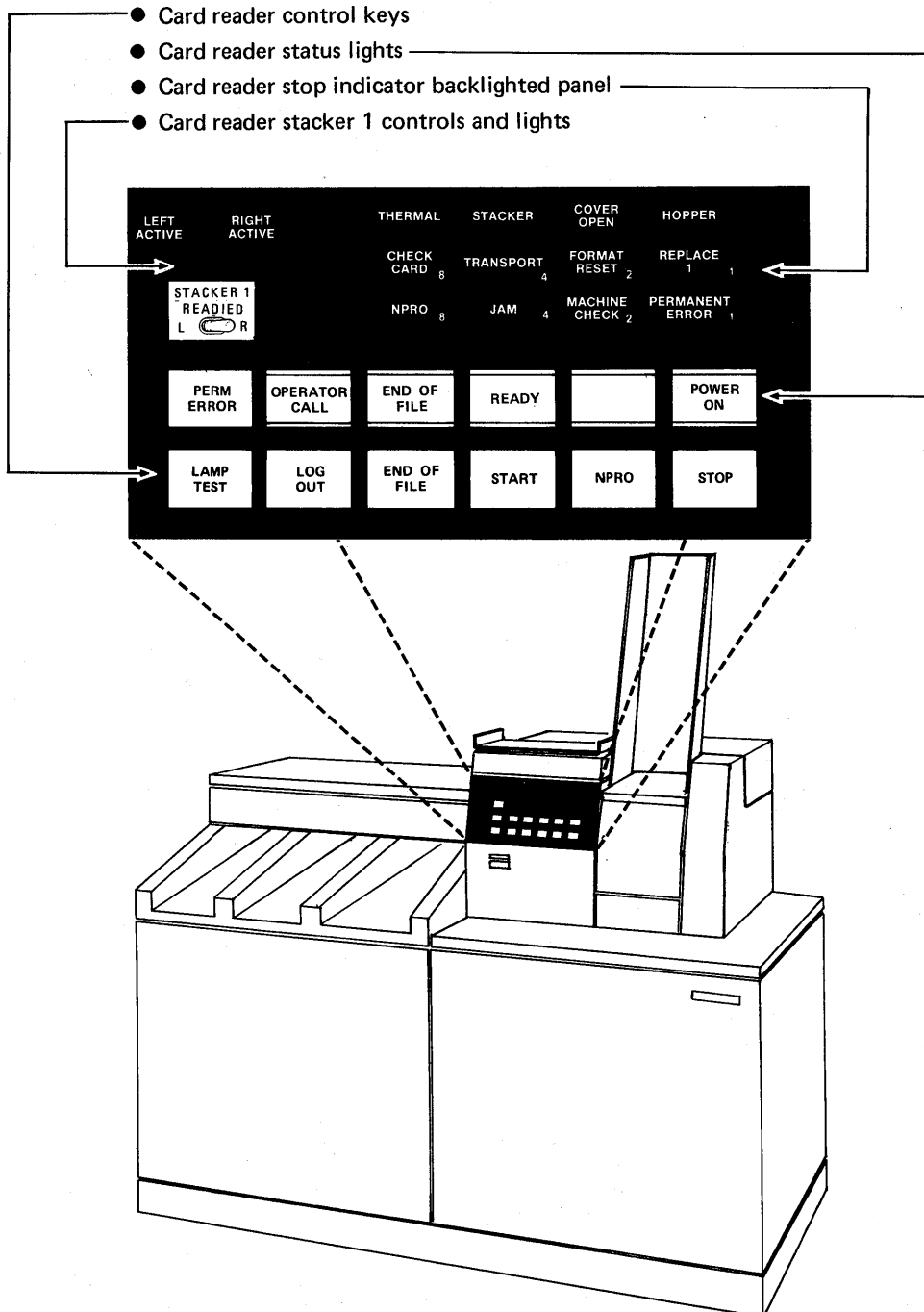

## IBM 3525 OPERATOR'S PANEL

The operator uses these controls and indicators to place the card punch online and keep it operational.

- Card punch status lights
- Card punch control keys
- Card punch stop indicator backlighted panel

Notice that the keys and lights on the punch are identical to those shown on the reader.

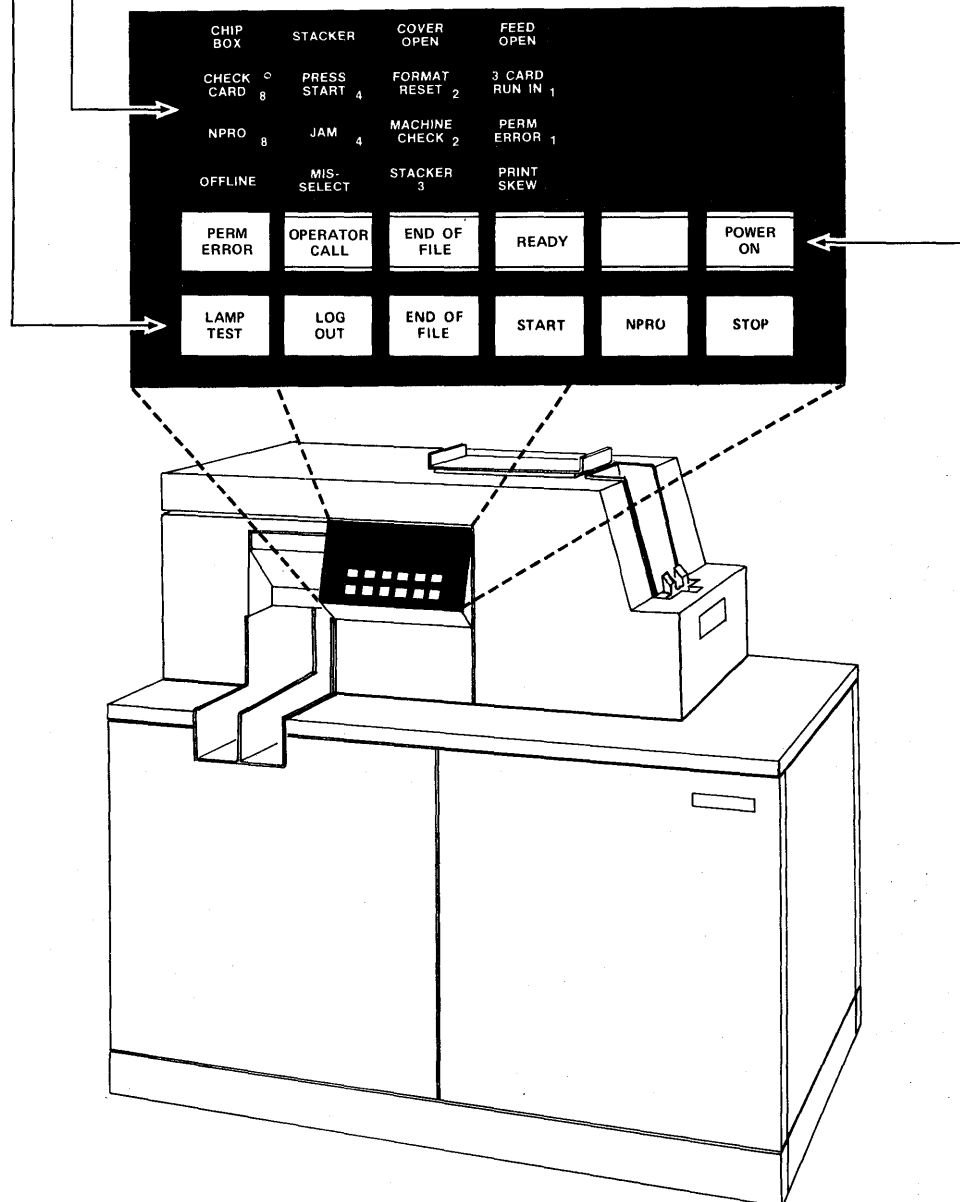

# 3505/3525 STATUS LIGHTS

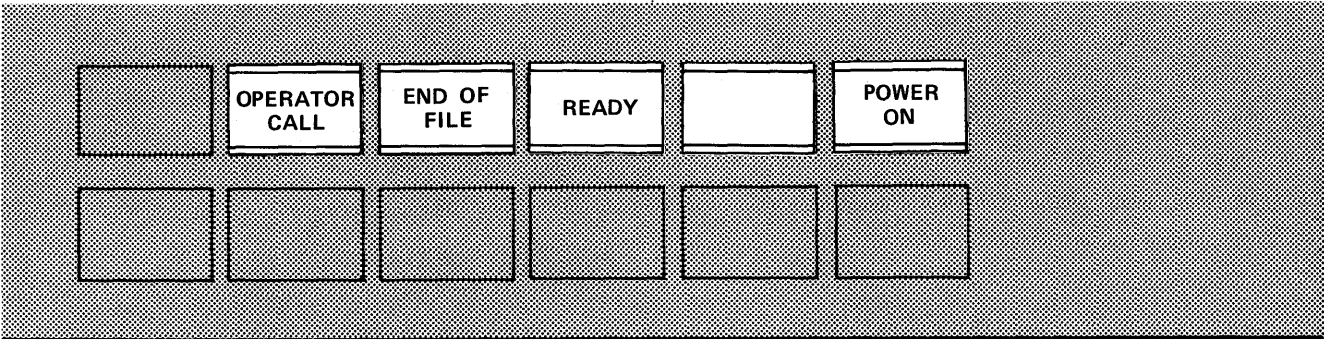

LIGHT

FUNCTION

OPERATOR  
CALL

*Indicates* that the device requires operator attention.

Examine the backlighted panel to determine the condition causing the stop and the restart action needed.

END OF  
FILE

*Indicates* that the end-of-file key has been pressed.

**3505 Turns Off:**

With channel acceptance of unit exception status or by pressing of the stop key. The last card is stacked.

**3525 Turns Off:**

1. With nonread command sequence.
2. By pressing the stop key.
3. With stacking of the last card after unit exception status has been accepted by the interface. When unit exception status is given, the last card is located at the post punch station and the 3525 is ready. See operating system I/O programming documentation for information about how to move this last card to a stacker.

*Note:* This light applies only to the reader and to those 3525s with the read feature.

READY

*Indicates* that the device is ready to execute commands from the system.

POWER  
ON

*Indicates* that power is being supplied to the device.



## 3505/3525 CONTROL KEYS

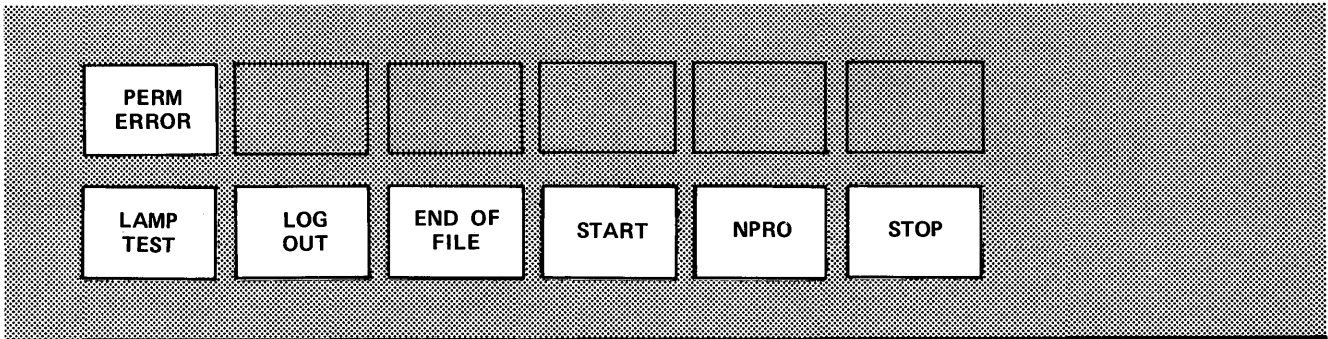

### KEY

### FUNCTION

**PERM ERROR**

This key is provided for the operator to post a permanent error to the system when he cannot correct or continue after an error condition at the 3505 or 3525. Unless the source program has a permanent error recovery routine, the job will terminate. Therefore, this key can be used for job termination at the device.

Pressing this key when the unit is not ready causes these alternate functions:

1. Sets bit 7, sense byte 0; causes a permanent error to be posted to the source program at initial selection of the first command after the device is ready; and immediately turns on the permanent error indicator.
2. Pressing this key again turns off all the indicators and bits set by the previous pressing of the key if the device has not been made ready between the first and second key pressings.

**LAMP TEST**

Turns on all control panel lights and indicators. Any indicator not turned on has a burned out lamp.

**LOG OUT**

Displays sense byte 2 as two rows of indicators that indicate the reason for the last machine error. On the 3505, the center row and lower row of indicators display the error cause. On the 3525, the center two rows of indicators display the error cause. The log out key should be pressed and the resultant indicators noted if the customer intends to call the Customer Engineer because of the error.

**END OF FILE**

Press this key when the last cards in the job are placed in the hopper or file feed. The last card will then be processed under program control. In the 3505, this card may be processed into the appropriate stacker. In the 3525, the last card will remain in the post punch station and may be stacked by program control or cleared with the NPRO key. See I/O programming documentation for information about how to move this card to a stacker. (Key does not apply for 3525 without card read feature.)

**START**

Turns on the motor and runs cards into the machine and/or establishes a ready condition. During error procedures, pressing this key resets the stop indicators and error circuits if the condition causing the error indication has been corrected.

KEY	FUNCTION
<p data-bbox="261 289 345 321">NPRO</p>	<p data-bbox="526 241 1453 363">Pressing this key down on the 3525 while the cards in the hopper are lifted from the throat by hand or on the 3505 while cards are held off the bottom of the hopper because the jogger is open runs all the cards out of the machine transport into stacker 1 without processing them. On the 3505, cards are run into the active half of stacker 1.</p> <p data-bbox="526 401 1453 489"><i>CAUTION:</i> On the 3525 cards must be kept out of the throat area until the machine feed mechanism stops operating. Placing cards on the hopper bed while the machine is cycling can damage cards and can cause unwanted feed cycles to occur.</p> <p data-bbox="526 527 1453 716"><i>To recover cards for reprocessing during non-process run out (NPRO) operations:</i> If there is no card in the active stacker, or if there are not enough cards in the active stacker to perform the NPRO procedure, recover the necessary additional cards from the inactive stacker. For example, if there is only 1 card in the active stacker and the procedure calls for the replacement of two cards from stacker 1, remove the second card from the back of the inactive stacker.</p>
<p data-bbox="266 779 341 810">STOP</p>	<p data-bbox="526 774 1453 835">Stops the device at the end of the card cycle in progress when the key was pressed. This key also resets end-of-file circuits.</p>

## 3505 STACKER CONTROL

The right active and left active lights indicate stacker 1 activity. The light that is on indicates that its stacker is receiving cards directed to stacker 1.

*To empty stacker 1, always remove cards from the inactive stacker first—that is, remove cards from the right stacker if the left active light is on, and from the left stacker if the right active light is on. After emptying the inactive stacker, the active stacker can be emptied if the reader is not ready.*

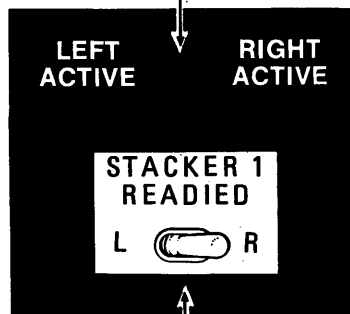

The readied toggle switch, which is set by the operator, indicates that a stacker is ready to receive cards after the active stacker becomes full.

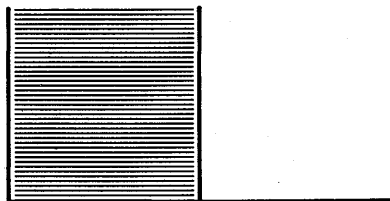

**ALTERNATE STACKING DOES NOT OCCUR**

If switch is turned toward stacker being filled, the reader stops, indicating a full stacker, when the active stacker becomes full.

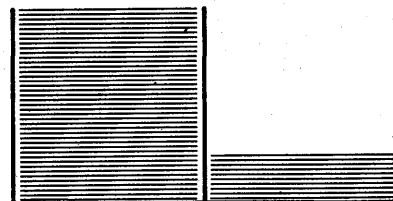





**ALTERNATE STACKING OCCURS**

If switch is turned toward a stacker that is not full, cards automatically enter that stacker when the stacker being filled becomes full.

## 3505 STOP INDICATIONS AND RESTART PROCEDURES

THERMAL	STACKER	COVER OPEN	HOPPER
CHECK CARD 8	TRANSPORT 4	FORMAT RESET 2	REPLACE 1
NPRO 8	JAM 4	MACHINE CHECK 2	PERMANENT ERROR 1

INDICATION DISPLAYED	RECOVERY PROCEDURE
	<p>Except for end-of-file conditions:</p> <ol style="list-style-type: none"> <li>1. Fill the hopper and close the joggler.</li> <li>2. Press the start key.</li> </ol> <p>For end-of-file:</p> <ol style="list-style-type: none"> <li>1. Press the end of file key.</li> <li>2. Press the start key.</li> </ol> <p><i>Note:</i> The permanent error key is operative during this stop.</p>
	<ol style="list-style-type: none"> <li>1. Empty the full stacker or set stacker 1 switch to point to empty stacker.</li> <li>2. Press the start key.</li> </ol> <p><i>Note:</i> The permanent error key is operative during this stop.</p>
	<ol style="list-style-type: none"> <li>1. Close all covers.</li> <li>2. Check last card in stacker area to see that it was completely stacked.</li> <li>3. Press the start key.</li> </ol> <p><i>Note:</i> The permanent error key is operative during this stop.</p>
	<p>The read lamp has overheated.</p> <ol style="list-style-type: none"> <li>1. NPRO (Open the joggler and press the NPRO key.)</li> <li>2. Place last 2 cards entering stacker 1 ahead of cards in hopper. Close the joggler.</li> <li>3. Press the start key. If the read lamp has cooled enough, the thermal light will turn off.</li> <li>4. If the thermal light remains on, allow the lamp to cool for a while, then press the start key again. Repeat this step until the light remains off.</li> <li>5. Press the start key.</li> <li>6. If the thermal condition is persistent, call a Customer Engineer.</li> </ol> <p><i>Note:</i> The permanent error key is operative during this stop.</p>

**INDICATION DISPLAYED****RESTART PROCEDURE**

FORMAT  
RESET

Indicates that an optical mark read or read column eliminate format has been reset by an unformatted read only command or by an unformatted read, feed, and stacker select command. If this error occurs within a job, and if the operator has no other information from the programmer, he should press the permanent error key and make the device ready. If this error occurs within a job, and the programmer has provided operator instructions, the operator should follow these instructions. If this error occurs at job initiation, the operator should NPRO, load the last two cards entering stacker 1 back under the cards in the hopper, and press the start key.

HOPPER

JAM

1. Remove cards from hopper, repair or replace any damaged cards, and place the removed cards ahead of the cards in the file feed.
2. Press the start key.

*Note:* The permanent error key is operative during this stop.

TRANSPORT

JAM

PERMANENT  
ERROR

This is a device permanent error.

1. Press the log out key and record the log number displayed on the backlighted panel.
2. Perform the error recovery specified by the source program for this type of error.
3. Call your customer engineer to report the problem, giving him the log number during the call.

STACKER

JAM

1. Remove card jam from the stacker area.
2. Place these cards in correct stacker or stackers, preserving card sequence.
3. Press the start key.

*Note:* Data integrity is preserved. The subsystem cannot ensure card sequence for cards involved in the jam. The permanent error key is operative during this stop.

CHECK  
CARD

NPRO

1. NPRO. (Open the joggler and press the NPRO key.)
2. Remove the last two cards that entered stacker 1. The first card stacked is in error: check this card for more than one punch in row positions 1 through 7 in each column, and for poor punch registration. (If necessary, replace the card with a card punched correctly offline.) Place the two cards ahead of the deck in the hopper. Close the joggler.
3. Press the start key.

*Note:* The permanent error key is operative during this stop.

**INDICATION DISPLAYED****RECOVERY PROCEDURE**

CHECK  
CARD  
NPRO

REPLACE  
1

**Cards in hopper:**

1. Remove the cards from the hopper and examine the bottom card for anything that may have caused the misfeed (a burred edge, for example). Reproduce this card, if necessary, then place the appropriate card on the bottom of the deck removed from the hopper.
2. NPRO (Open the joggler and press the NPRO key.)
3. Place the card that entered stacker 1 at the front of the deck from the hopper.
4. Put the deck back into the hopper and close the joggler.
5. Press the start key.

**No cards in hopper:**

1. NPRO (Open the joggler and press the NPRO key.)
2. Remove the last card that entered stacker 1. Check this card for more than one punch in row positions 1 through 7 in each column and for poor punch registration. (If necessary, replace the card with a card punched correctly offline.) Place the card back in the hopper and close the joggler.
3. Press the end of file and start keys.

*Note:* The permanent error key is operative during this stop.

**Recovery is likely.**

1. NPRO (Open the joggler and press the NPRO key.)
2. Place the last 2 cards entering stacker 1 in front of the cards in the hopper, then close the joggler.
3. Press the start key.

*Note:* The permanent error key is operative during this stop.

Recovery is possible. If desired, perform the procedure specified for the NPRO indication two or three times.

Perform the NPRO indication procedure, or if that procedure fails repeatedly:

1. Press the log out key and write down the two rows of indicators that show on the backlighted panel. See Log Out key discussion for location.
2. Call your customer engineer and report the problem. Give him the indications you recorded from the backlighted panel.

*Note:* The permanent error key is operative during this stop.

NPRO

NPRO

MACHINE  
CHECK

**INDICATION DISPLAYED****RECOVERY PROCEDURE**

CHECK  
CARD    TRANSPORT  
  
JAM

1. Remove two cards from the transport.
2. Check the cards for damaged edges.
3. Repair or reproduce any damaged cards.
4. Place cards (or their replacements) removed from the transport ahead of the cards in the hopper in correct sequence.
5. Press the start key.

*Note:* The permanent error key is active during this stop.

JAM    MACHINE    PERMANENT  
CHECK    ERROR

Consider this a permanent error condition and perform the procedure specified by the source program. During this procedure the NPRO key should be pressed with the joggler open to run cards out of the unit.

NPRO                      PERMANENT  
ERROR

This is a device permanent error — command reject.

1. Perform the error recovery specified by the source program for this type of error.

TRANSPORT  
  
JAM

There is a jam or misfeed in the transport. Two cards must be placed back in the hopper.

- Machine without selective stacker:
  1. Examine the transport for a jam at the pre-read or read station, or for two cards at the pre-read station.
  2. If you only recovered one card from the transport, remove the top card from the active stacker (the stacker indicated by the indicator panel). Place this card in front of the card removed from the transport.
  3. Place all cards under the deck in the hopper.
  4. Press the start key.
- Machine with selective stacker:
  1. Examine the transport, from the start of the pre-read station to the end of the post-read station, for cards.
  2. Place the last 2 cards fed (that is, the two cards closest to the hopper) back into the hopper and close the joggler.
  3. Place any remaining cards in their appropriate stackers.
  4. Press the start key.

*Note:* The permanent error key is operative during this stop.



**INDICATION DISPLAYED****RECOVERY PROCEDURE**

TRANSPORT  
JAM  
REPLACE  
1

There is a jam or misfeed in the transport. One card must be placed back in the hopper.

- Machine without selective stacker:
  1. Examine the transport for a jam at the read station or for a card in the pre-read station.
  2. If you did not remove a card there, remove the top card from the active stacker.
  3. Place the removed card in the hopper and close the jogger.
  4. Press the start key and the end-of-file key.
- Machine with selective stacker:
  1. Examine the transport for a jam at the read station or for a card in the pre-read station.
  2. If you did not remove a card there, examine the post-read station. Remove the card, if any.
  3. Place the removed card in the hopper and close the jogger.
  4. Press the start key and the end-of-file key.

NPRO  
REPLACE  
1

Recovery is likely.

1. NPRO. (Open the jogger and press the NPRO key.)
2. Place the last card that entered the active side of stacker 1 back into the hopper, then close the jogger.
3. Press the start key and the end-of-file key.

*Note:* The permanent error key is operative during this stop.

NPRO  
MACHINE  
CHECK  
REPLACE  
1

Recovery is possible. If desired, perform the procedure specified for the NPRO and REPLACE 1 indication two or three times.

If you do not perform the specified indication recovery procedure, or if that procedure fails repeatedly:

1. Press the log out key and write down the two rows of indicators shown on the backlighted panel. See log out key discussion for location.
2. Call your customer engineer and report the problem. Give him the indications you recorded from the backlighted panel.

*Note:* The permanent error key is operative during this stop.

CHECK  
CARD  
TRANSPORT  
JAM  
REPLACE  
1

1. Locate and remove the card from the transport.
2. Check the card for damaged edges.
3. Repair or reproduce the card, if necessary.
4. Place the card in the hopper.
5. Press the start key and end of file key.

*Note:* The permanent error key is operative during this stop.





## 3525 STOP INDICATIONS AND RESTART PROCEDURES

CHIP BOX	STACKER	COVER OPEN	FEED OPEN
CHECK CARD 8	PRESS START 4	FORMAT RESET 2	3 CARD RUN IN 1
NPRO 8	JAM 4	MACHINE CHECK 2	PERM ERROR 1
OFFLINE	MIS-SELECT	STACKER 3	PRINT SKEW

### INDICATION DISPLAYED

CHIP BOX

### RECOVERY PROCEDURE

1. Remove and empty the chip box.
2. Place the chip box back into the machine.

*Note:* After the chip box light comes on, the punch continues to operate for a reasonable period of time if the box is in the machine and properly positioned. However, when the chip box becomes too full to permit machine operation, the operator call light will come on and the punch will stop.

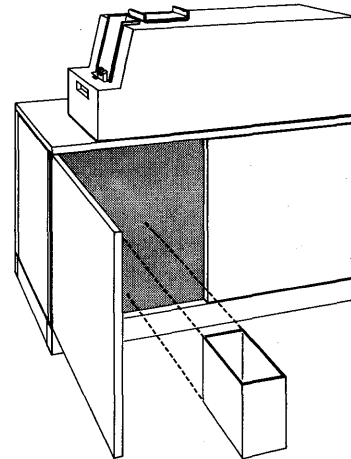

*Note:* The permanent error key is operative during this stop.

STACKER

1. Empty the full stacker.
2. Press the start key.

*Note:* If the stacker light is on and neither stacker 1 nor stacker 2 is full, check for the reject stacker being full.

*Note:* The permanent error key is operative during this stop.

---

**INDICATION DISPLAYED****RECOVERY PROCEDURE**

---



1. Close any cover that is open.
2. Press the start key.

*Note:* The permanent error key is operative during this stop.



1. Close and latch the feed mechanisms.
2. Press the start key.

*Note:* The permanent error key is operative during this stop.



1. Remove cards from the card transport area manually, keeping the cards in their correct sequence.
2. Repair or reproduce any damaged cards.
3. Place these cards in their correct place with those removed from the transport area.
4.
  - If the jam occurred during a run-in operation:
    - a. Place the cards in the hopper.
    - b. Press the start key.
  - If the jam occurred during an NPRO operation:
    - a. Place the cards in their appropriate stackers.
    - b. Continue performing the procedure under progress when the jam occurred.

*Note:* The permanent error key is operative during this stop.



Indicates that the 3525 is disconnected from the system functionally.

To place the 3525 online:

1. Open the 3505 front cover.
2. Set the ONLINE/OFFLINE switch to its ONLINE setting.



1. Remove cards from stacker manually, keeping cards in correct sequence.
2. Repair or reproduce any damaged cards offline, then reassemble them in correct sequence with the undamaged cards; place all these cards in the stacker(s).
3. Press the start key.

*Note:* The permanent error key is operative during this stop.

**INDICATION DISPLAYED****RECOVERY PROCEDURE**

1. Remove cards from the transport manually, keeping them in sequence.
2. Repair or reproduce any damaged cards offline; reassemble cards in correct sequence and place them with undamaged cards.
3. Place last three cards below the cards in the hopper.
4. Place remaining cards in correct stacker or stackers.
5. Press the start key.

*Note:* The permanent error key is operative during this stop.



1. Manually remove all cards from the card transport.
2. Perform the procedure specified by the source program.

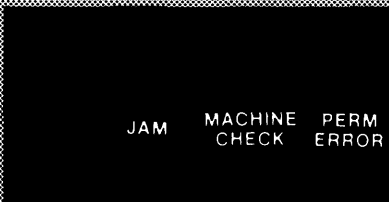

1. Manually remove all cards from the card transport.
2. Perform the procedure specified by the source program.

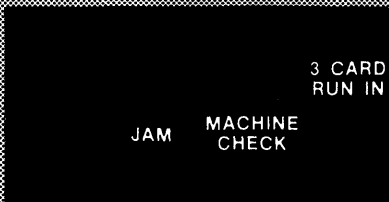

1. Remove all cards from the transport manually, keeping them in sequence.
2. Repair or reproduce any damaged cards offline, then put them, in correct sequence, with the undamaged cards.
3. Place all cards removed at the bottom of the deck in the hopper.
4. Place the remainder of the cards in the correct stacker(s).
5. Press the start key.

*Note:* The permanent error key is operative during this stop. This is the only time that more than three cards can be returned to the hopper.



1. Empty stacker 1.
2. NPRO (While holding cards in hopper away from bottom of hopper, run cards out of transport by holding the NPRO key down.)
3. Remove all other cards from stacker 1 and place them in their correct stacker or stackers, if possible. If you cannot determine the correct stackers for these cards, put them aside for later manual distribution.
4. Press the start key.

*Note:* The permanent error key is operative during this stop.

**INDICATION DISPLAYED****RECOVERY PROCEDURE**

CHECK  
CARD  
NPRO

1. Press the stop key: the 3-card run-in light will come on.
2. Empty stacker 1.
3. NPRO (While holding cards in hopper away from bottom of hopper, run cards out of transport by holding the NPRO key down.)
4. Remove and examine the cards that ran into stacker 1. Repair, or replace with a manually-reproduced card, any damaged cards.
5. Place all these run-out cards under the deck in the hopper, maintaining correct card sequence.
6. Press the start key.

*Note:* The permanent error key is operative during this stop.

NPRO

PERM  
ERROR

1. Perform the procedure specified by the source program. During this procedure, the cards in the transport must be run out by pressing the NPRO key.

PRESS  
START

MACHINE  
CHECK

1. Press the start key.

*Note:* The permanent error key is operative during this stop.

FORMAT  
RESET

Indicates that a read column eliminate format has been reset by an unformatted read only command or by an unformatted read, feed, and stacker select command. If this error occurs within a job, and if he has no other information from the programmer, the operator should press the permanent error key and make the device ready. If this error occurs within a job, and the programmer has provided operator instructions, the operator should follow these instructions. If this error occurs at job initiation, the operator during this stop should NPRO (lift the cards off the bottom of the hopper and press the NPRO key) load the last two cards entering stacker 1 back under the cards in the hopper, and press the start key.

*Note:* The permanent error key is operative during this stop.

PERM  
ERROR

If this indicator is lighted and you did not press the permanent error key deliberately, press the permanent error key to turn the light off. This will ensure that a permanent error indication posted for the last job, (or one resulting from an unintended depression of the permanent error key) will not be associated with the present job.

## INDICATION DISPLAYED

## RECOVERY PROCEDURE



1. Remove the cards from the hopper and examine the throat area.
  - a. If partially-fed card is stuck in the throat, remove it, repair or replace it, and put it on the bottom of the stack removed from the hopper.
  - b. Remove any dust or pieces of paper from the throat area.
2. Empty stacker 1.
3. NPRO (Press the NPRO key.)
4. Place cards that entered stacker 1 in the hopper.
5. Place cards removed from hopper back into the hopper.
6. Press the start key.

**Note:** During NPRO, three cards should enter stacker 1 unless one card was stuck in the throat; if card was stuck in throat, two cards should enter stacker 1.

**Note:** The permanent error key is operative during this stop.

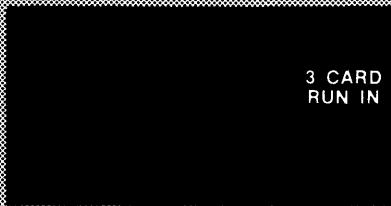

This indicator may have been left on from an error in a previous job. To reset the indication when initiating a new job:

1. Press the permanent error key twice.



The stacker 3 indicator can be on either alone or in combination with other indications. It comes on when a card enters the reject stacker and remains on until the start key is pressed.

If the job being processed is a data security job—that is, if it is important for the cards or the information they contain to be kept under security—the reject stacker (stacker 3) must be emptied, as part of the restart procedure before the start key is pressed, and at the end of the job. Non-security error cards should be collected for the customer engineer's examination.

To remove cards from stacker 3:

1. Press the cover release **A**, open the top cover, **B**, then the front cover, **C**.
2. Remove cards from stacker 3 (inside the machine).
3. Close the front cover, then the top cover.
4. Press the start key.

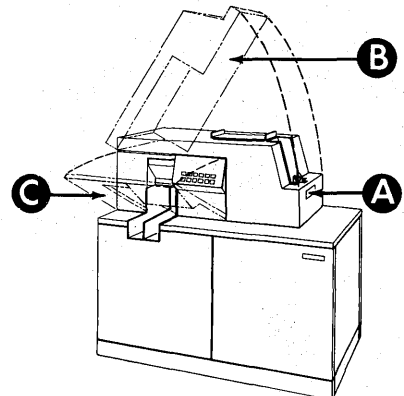

---

**INDICATION DISPLAYED****RECOVERY PROCEDURE**

---



MIS-  
SELECT

A punch error occurred and the error card failed to enter stacker 3.

1. Examine the last cards to enter stackers 1 and 2 for a card containing a punch error. Place this card in stacker 3.
2. Press the start key.

*Note:* The permanent error key is operative during this stop.



MIS-     STACKER  
SELECT     3

1. Examine stacker 3 for error-free data cards misselected into the stacker.
2. Place these cards in stacker 1 or stacker 2, as appropriate.
3. Press the start key.

*Note:* The permanent error key is operative during this stop.



PRINT  
SKEW

1. Inspect the last 2 cards in each stacker for skewed printing. If necessary, manually reproduce and print the cards, or place them aside for later reproduction.
2. Replace these cards in their correct stackers.
3. Press the start key.

*Note:* The permanent error key is operative during this stop.

## LOG-OUT INDICATIONS (NUMBERS)

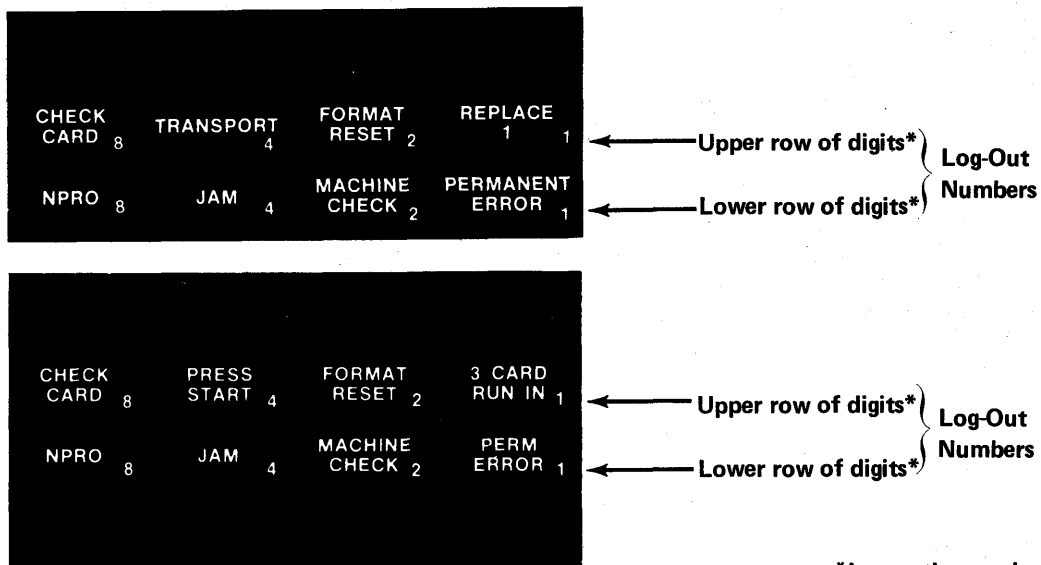

The back-lighted panel serves two functions. Normally, the panel displays indications that show the operator what procedure to follow to recovery from an error. (These indications have been discussed earlier in this manual.) When a permanent error occurs that requires machine repair, the recovery procedure directs the operator to press the log-out key. This causes the panel to display a different set of indications, which are called log-out numbers. (The words displayed on a log-out indication are meaningless and should be ignored.) When the operator calls to report the problem, he should tell the customer engineer what digits are displayed in the upper row, then what digits are displayed in the lower row. If no digits are shown in a row, the operator should report that the row is blank.

### EXAMPLE:

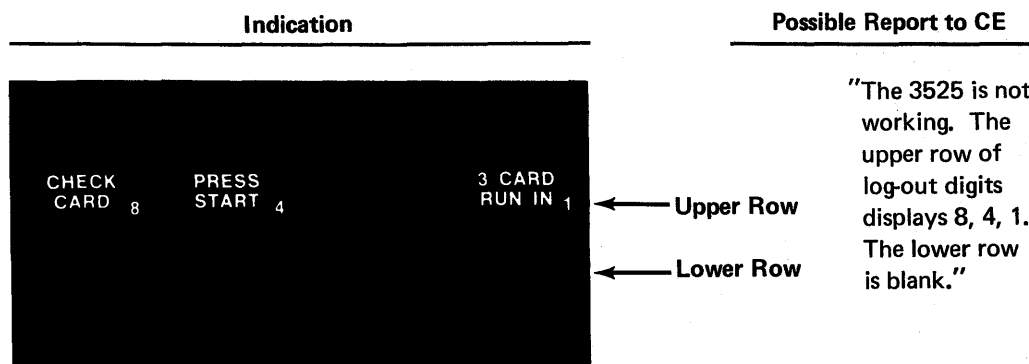





# PROGRAMMING CONSIDERATIONS

## COMMANDS

### ▶ Sense

#### Command Code

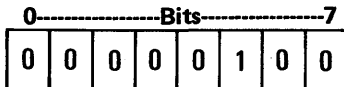

#### Operation Performed

Sense bytes 0, 1, 2, and 3 transfer to the system.

#### Channel End

After last sense byte has been accepted by the system or when an interface stop occurs.

#### Device End

Same as channel end.

#### Card Motion

None.

**▶ Test I/O**

**Command Code**

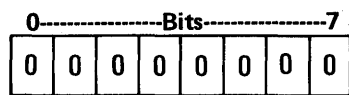

**Operation Performed**

Status byte transfers to the system.

**Channel End**

Not applicable.

**Device End**

Not applicable.

**Card Motion**

None.

**▶ Control No-Op**

**Command Code**

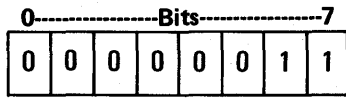

**Operation Performed**

None.

**Channel End**

At initial selection.

**Device End**

At initial selection.

**Card Motion**

None.

**Programming Note**

Unit check will be presented to the channel if the device is not operational because of an intervention required condition.



## Feed and Select Stacker

### Command Code

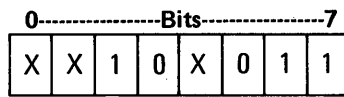

**Format Bit:**  
 0 = Reset format to off, load buffer in unformatted mode  
 1 = Load buffer in formatted mode

**Stacker Selection Bits:**  
 00 = Select card at post read station into stacker 1  
 01 = Select card at post read station into stacker 2  
 10 = Select card at post read station into stacker 2  
 11 = Command rejected (invalid combination)

### Operation Performed

A feed cycle occurs. As the card from the pre-read station passes the read station, data from that card enters the card image buffer, destroying old data in buffer.

### Channel End

At initial selection.

### Device End

When buffer is full.

### Card Motion

All cards in the transport advance one station. If the device is equipped with selective stackers, the card at the post-read station enters the selected stacker. Otherwise, the card moved from the pre-read station enters stacker 1.

### Programming Note

This command is valid for the 3525 if one or more of the following features are installed in the 3525:

1. Card read.
2. Two-line card print.
3. Multiline card print.

**Read Only**

**Command Code**

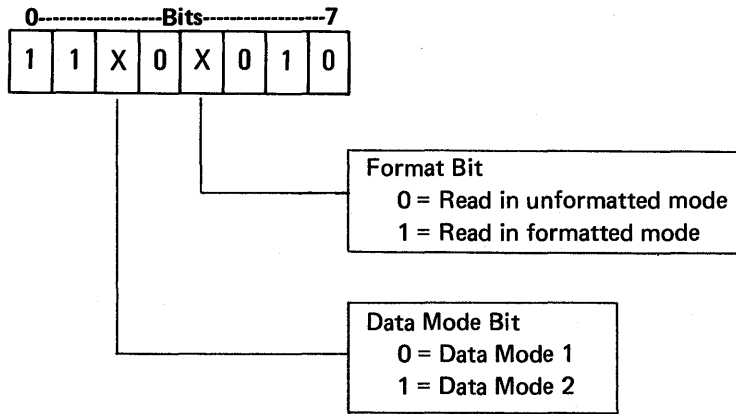

**Operation Performed**

Contents of read buffer transfer to the CPU.

**Channel End**

At end of data transfer.

**Device End**

At end of data transfer.

**Card Motion**

None.

**Programming Note:**

A unit exception presented to a read command causes a normal RCE and OMR format reset. This is not a valid command to the 3525 if the 3525 is not equipped with the card read feature.

## Diagnostic Read

### Command Code

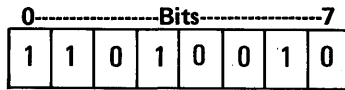

### Operation Performed

Subsystem sends the contents of subsystem main storage to the CPU.

### Channel End

At end of data transfer.

### Device End

At end of data transfer.

### Card Motion

None.

### Programming Notes:

This command is used for customer engineering diagnostics.

## ► Read, Feed, and Select Stacker

### Command Code

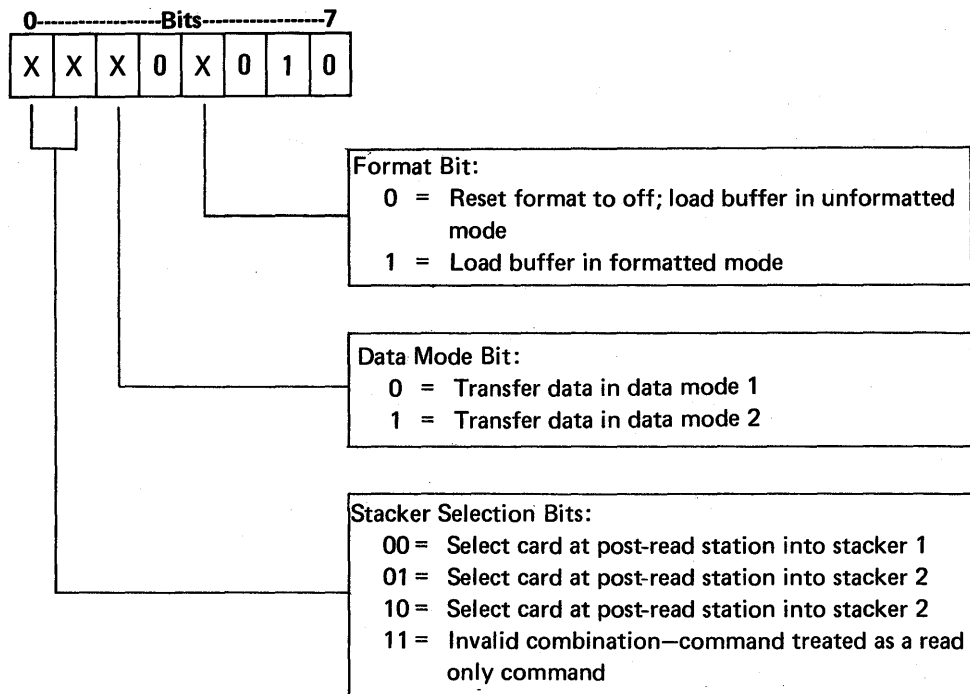

### Operation Performed

This command causes two distinct, non-overlapped operations: a read operation, then a feed operation. That is, the subsystem sends the contents of the card image buffer to the system in the format mode effective during the last card feed cycle. Then:

- If there is no unit check status at the end of data transfer a card feed cycle occurs. As the card at the preread station passes the read station, data from that card enters the card image buffer, destroying old data in the buffer.
- If there is a unit check status at the end of data transfer, or if the subsystem has recognized an interface disconnect sequence, the feed portion of the instruction is aborted.

Note that this characteristic makes recovery from read errors considerably easier because the command in error may be reissued since no card motion occurred.

### Channel End

At the end of data transfer.



**Device End**

At buffer full, if unit check did not occur at end of data transfer to the system.

Along with channel end and unit check at end of data transfer if a unit check status occurred during the read portion of the instruction.

**Card Motion**

All cards in the transport advance one station. If the device is equipped with selective stackers, the stacker select bits apply to the card in the post-read station (see "Operational Characteristics").

**Programming Note**

Whenever the subsystem presents unit exception to a read command it also resets the format (RCE or OMR format) off. This command is valid for the 3525 if it is equipped with a card read feature. Otherwise, the command is command rejected if issued to a 3525.



## Write, Feed, and Select Stacker

### Command Code

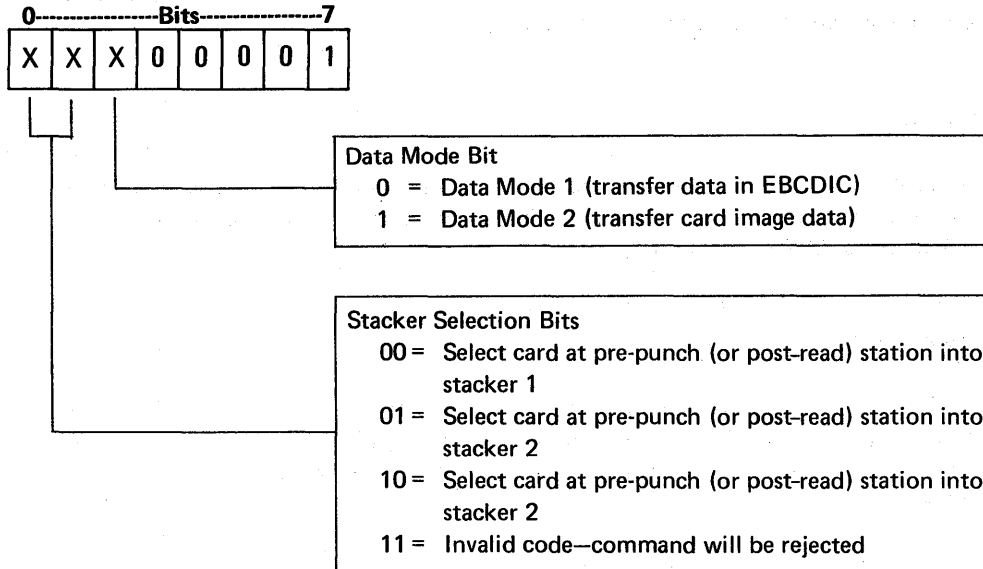

### Operation Performed

This instruction causes two operations: transfer of data from system storage to the punch buffer, then, if data was successfully transferred, the punching of that data into the card that was at the pre-punch station.

### Data Transfer Operation

The system sends data to the subsystem until the punch buffer is full or until data transfer is stopped by a stop sequence, interface disconnect, selective reset, or system reset.

The buffer can be filled by:

- 80 bytes of data in data mode 1
- 160 bytes of data in data mode 2

If the system does not send enough data to fill the buffer (short CCW count—that is, channel command word count), the subsystem fills the remaining unfilled positions with blanks (hexadecimal 40 in EBCDIC or hexadecimal 0000 in card image) for each remaining column.

### **Feed and Punch Operation**

When the system accepts channel end, the punch feeds a card from the hopper and moves each card in the transport forward one station. As the card at the prepunch station passes the punch unit, the 3525 punches the data stored in the punch buffer into that card.

The stacker selection bits in this instruction apply to the card that was at the pre-punch station at the start of the command, rather than to the card entering the stacker as a result of this card feed cycle. Selection data is stored to be used during the next card feed cycle, when the card just punched will be stacked.

### **Card Motion**

All cards in the transport advance one station, and the card at the post punch station enters the selected stacker.

### **Programming Note**

This command is invalid for a 3505 and is command rejected.

### **Punch Checking**

See "Dedicated Error Pocket and Punch Retry" discussion.

### **Channel End**

After buffer full.

### **Device End**

At the end of the card feed cycle if there were no errors, at the end of the card cycle during which unit check was indicated (if a punch error occurred), or with channel end if a data transfer error occurred.

## Write RCE (Read Column Eliminate) Format

### Command Code

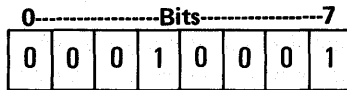

### Operation Performed

Transfers read column eliminate format from system storage to the read column eliminate circuits of the read card image buffer for the selected device.

Format bytes 1 through 80 are associated directly with the transfer of data from columns 1 through 80 of the card. Format control byte 1 is associated with card column 1, byte 5 with column 5, etc.

If fewer than 80 format bytes are transferred to the device from the system, the subsystem supplies the control circuits for the remaining card columns with blanks as their format bytes.

### Channel End

At the end of data transfer or when a channel-initiated stop occurs.

### Device End

When format control data has been entered in the circuits for all 80 card columns.

### Card Motion

None.

## Programming Notes

The RCE format must be established before a card that is to be formatted passes the read station. Therefore, the first card in any write RCE job must be either a blank card or a format card.

Although the RCE feature and the OMR (optical mark read) feature can both be installed, the two features cannot be used at the same time in a program.

The format data stored in the system should contain either a digit (0 through 9) or a letter (A through Z) in each column that is *not* to be read from the card. Positions representing columns to be read from the card should contain blanks (X '40'). Because the subsystem automatically fills remaining control positions with blanks, causing the associated card columns to be read in a normal fashion, the program can stop sending format data after sending the format character for the last column to be eliminated from the card. In this case the program should specify a short CCW count, causing an early channel end. Issuing this instruction places the reader in formatted mode. The specified columns will be transferred to the system as blanks until the reader is removed from the formatted mode. The next feed and select stacker, read only, or read, feed, and select stacker instruction issued that does not specify formatted mode removes the reader from the formatted mode of operation. Also, a unit exception status presented to a read command causes a normal format reset.

The subsystem sends these codes to the system in place of the eliminated columns:

In data mode 1—X'40'

In data mode 2—X'0000'

If a formatted read only, read feed select stacker or feed and select stacker command is issued to an unformatted device, the command is command rejected.

If an unformatted read only or read feed and select stacker command is issued to a device in a formatted mode, an Abnormal Format Reset error results and the format is reset in the device.

This command is valid for a 3505 only if the subsystem has the read column eliminate special feature; otherwise, the command is rejected.

This command is valid for a 3525 only if the 3525 has an installed card read feature.

See operating systems I/O programming documentation for support of this feature.

## Write OMR (Optical Mark Read) Format

### Command Code

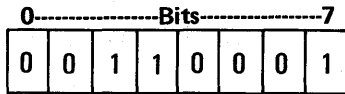

### Operation Performed

Same as for write RCE format instruction.

### Channel End

At end of data transfer or when a channel-initiated stop occurs.

### Device End

When format control data has been entered in the circuits for all 80 card columns.

### Card Motion

None.

### Programming Notes

The OMR format must be established before the card that is to be formatted passes the read station. Therefore, the first card in any write OMR format job must be either a blank card or a format card.

Although the OMR feature and the RCE (read column eliminate) feature can both be installed, the two features cannot be used at the same time in a program.

The format data stored in the system should contain either a digit (0 through 9) or a letter (A through Z) for each card column that is to contain OMR data. All other format bytes would contain blanks (X'40'). Because the subsystem automatically fills unloaded control positions with blanks, causing the associated card positions to be read as regular punched-hole columns, the program can stop sending format data after sending the format character for the last column to be read as an OMR column. In this case, the program should specify a short CCW count with the write OMR format command, causing an early channel end.

Issuing a write OMR format command places the reader in OMR format mode. The next feed and select stacker, read only, or read feed and select stacker command that does not specify the formatted mode of operation removes the reader from the formatted mode. Also, when unit exception status is presented to a read command, a normal format reset occurs.

The following rules apply to data transfer to the system during OMR mode operations:

1. When the subsystem detects a marginal mark, a weak mark, or a poor erasure in a column, the subsystem sends an X'3F' code in data mode 1, or two X'3F' codes in data mode 2 instead of the data from that column. This condition is not unit-checked; it is the responsibility of the source program to check for these occurrences. As an aid in checking the data received for accuracy, the source program can examine channel byte 80 in data mode 1 or channel byte 160 in data mode 2 for an X'3F' (not sent on short record) code, which indicates that one or more marginal marks, a weak mark, or a poor erasure was detected somewhere in the card.
2. The first blank column immediately after each OMR column is not transferred to the system. All other columns are transferred to the system. For example, assume that columns 2, 4, 6, and 9 are OMR columns, that column 11 is the first column of a hole data field, and that column 11 contains a blank.

X = OMR column  
b = blank column

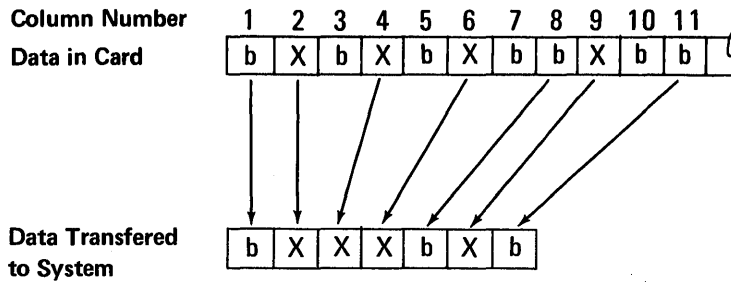

For additional information about formatting OMR data, see the Appendix.

If a formatted read only, read feed select stacker, or feed select stacker command is issued to an unformatted device, the command is command rejected.

If an unformatted read only or read feed select stacker command is issued to a device that is operating in the formatted mode, an abnormal format reset error results and the format is reset in the device.

This command is invalid for a 3525 and will be command rejected.

This command is valid for a 3505 equipped with optical mark read.

## Print Line

### Command Code

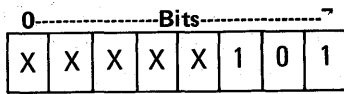

#### Line Position Bits

These five binary bits specify the line position on which data moved by this instruction will be printed.

#### Example:

00011 = Line position 3

11001 = Line position 25

### Operation Performed

The system sends up to 64 characters (including blanks) to the subsystem print buffer. If the system sends fewer than 64 characters, the subsystem fills the remaining unfilled higher numbered print buffer positions with blanks.

On a 3525 with the two line card print feature, the data for each print line command executed (up to a maximum of two) is buffered, then printed during the next card feed cycle caused by a command.

On a 3525 with the multiline card print feature, the data for the first and second print line commands executed are buffered and no printing occurs. When the third print line command is executed, its data is buffered and the first line of buffered print data is printed. When the fourth print line command is executed, its data is buffered and the second line of buffered print data is printed. This process continues through the balance of the print line commands in the sequence. Any lines buffered at completion of the print line command sequence are printed during the next card feed cycle caused by a command.

### Channel End

After the print buffer has been filled with all 64 characters, or after an interface disconnect occurs.

### Device End

With channel end if a data error occurred during transfer of data from the system to print storage or if an interface disconnect occurred.

With channel end (1) on a 3525 equipped with two line print (2) for each of the first two print line commands on a 3525 equipped with multiline print.

On a 3525 equipped with multiline print, after printing when a print line command causes a line buffered two commands previously, to be printed.



## Programming Note

These conditions cause the print line command to be rejected:

A line position other than 1 or 3 is specified for a 3525 equipped with a two line card print feature.

The command specifies a line position equal to or less than that specified for the last print line command executed for this card.

A line position greater than 25 has been specified.

The 3525 is not equipped with either card print feature.

If a print error occurs, the subsystem sets the equipment check and permanent error sense bits, and returns unit check status along with device end after the line has been printed. The subsystem stops and displays the appropriate error indications on the 3525 operators backlighted panel. Notice that print errors occur while a line is being printed, and are indicated after the line has been printed. *Therefore, characters written into the print buffer during the print command sequence can be printed incorrectly during the next card feed cycle.* It is the responsibility of the source program to resolve such errors.

The following table shows the overlapped printing action as a function of the number of print line commands issued between commands which cause card motion.

Number of Print Line Commands Issued	Number of Lines That Will Print in Overlap
2 or more	2
1	1
None	None

Print line commands may be chained or not, as desired.

## Card Motion

The 3525 uses a stepping motor to move cards through the print station and allows them to stop in position to print data in the lines specified by the print line command. Each print line that is *not* printed in the overlapped mode causes the card being printed, *and no other card* in the 3525, to move. Lines being printed in the overlapped mode are printed as the card moves through the print station during a regular card feed cycle. The cards enter the stacker as a result of a feed cycle—never as a result of printing.

## COMMAND PROGRAMMING EXAMPLES

### Reading & Punching (3525)

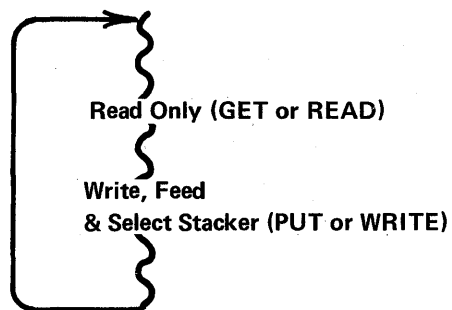

**Punching into Prepunched Cards:** This file type (that is, sequence of commands) should be used whenever you are punching data into prepunched cards, because the read-punch command sequence causes the subsystem to suppress the punch retry function for punching errors. If the punch retry function were not suppressed, and if a punch error were to occur, the subsystem would automatically try to punch data correctly into the following two cards.

# Read Column Eliminate Programming Example

## Format (Initialization Step)

In IBM operating systems, this function is automatically performed by OPEN if the user has specified RCE mode in his file definition.

Read Only in Unformatted Mode

Write Read Column Eliminate Format

Feed and Select Stacker in Formatted Mode

(This command feeds the first data card and stores its data in the read buffer per the format established by Write RCE command.)

## Data Processing

Read Only (Formatted)  
(GET, READ)

Feed & Select  
Stackers (Formatted)  
(CNTRL)

Read, Feed, & Select  
Stackers (Formatted)  
(GET, READ)

OR

## Completion

In IBM operating systems, this function is automatically performed by CLOSE if the user has specified RCE mode in his file definition.

If end of file (unit exception), no reset action is required.

If no end of file, issue a Feed and Select Stacker command in the unformatted mode. This resets the device for the next job.

STOP

# Optical Mark Read Programming Example

## Format (Initialization Step)

In IBM operating systems, this function is automatically performed by OPEN if the user has specified OMR mode in his file definition.

Read Only in Unformatted Mode

Write Optical Mark Read Format

Feed and Select Stacker in Formatted Mode  
(This command feeds the first data card and stores its data in the read buffer per the format established by the write OMR format command.)

## Data Processing

Read Only  
(Formatted)  
(GET, READ)

Feed & Select  
Stackers  
(Formatted)  
(CNTRL)

Read, Feed, &  
Select Stackers  
(Formatted)  
(GET, READ)

## Completion

In IBM operating systems, this function is automatically performed by CLOSE if the user has specified OMR mode in his file definition.

If no end of file, issue a feed and select stacker command in the unformatted mode. This resets the device for the next job.

STOP

## Reading, Then Printing (3525)

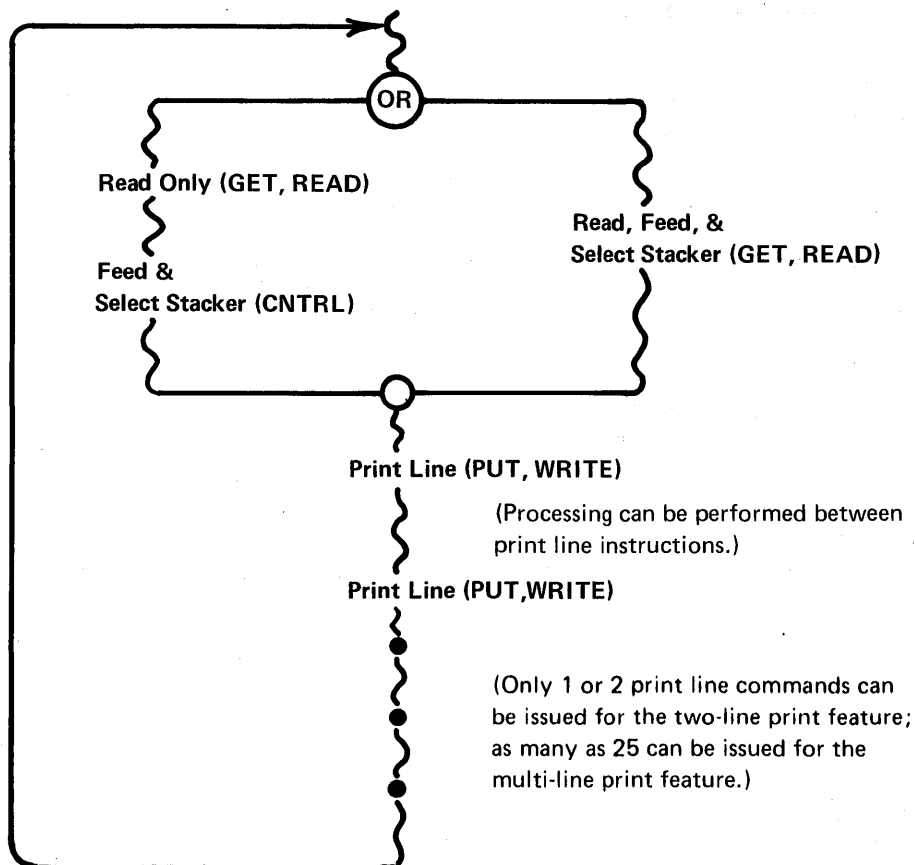

If preselection of the card is possible, then the read, feed, and select stacker command is suggested for this application. If the card is to be stacker-selected by means of data read from the card, the program should issue a read only command, process the data, then issue a feed and select stacker command specifying the appropriate stacker.

Print commands are to be issued in ascending line number sequence until commands have been issued for all lines to be printed.

## Punching, Then Printing (3525)

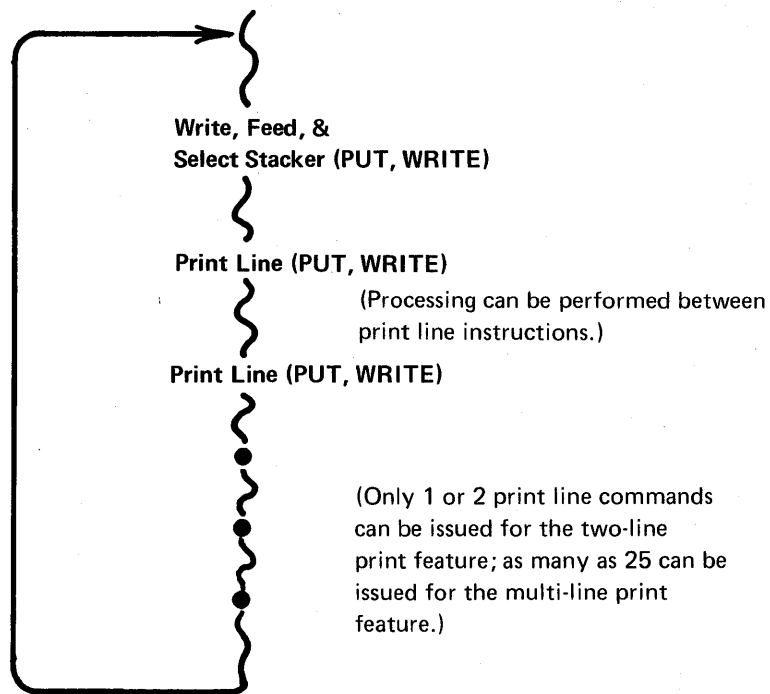

This file type (sequence of commands) should be used for punching and printing on blank cards because the command sequence allows the automatic subsystem punch retry function to occur in case of punching errors.

Print commands are issued in ascending line number sequence until commands have been issued for all lines to be printed.

If the data punched on the card is to be printed, the print data must be supplied from the CPU. See IBM OS or DOS support documentation for information about IBM support supplied.

## Reading, Punching, & Printing (3525)

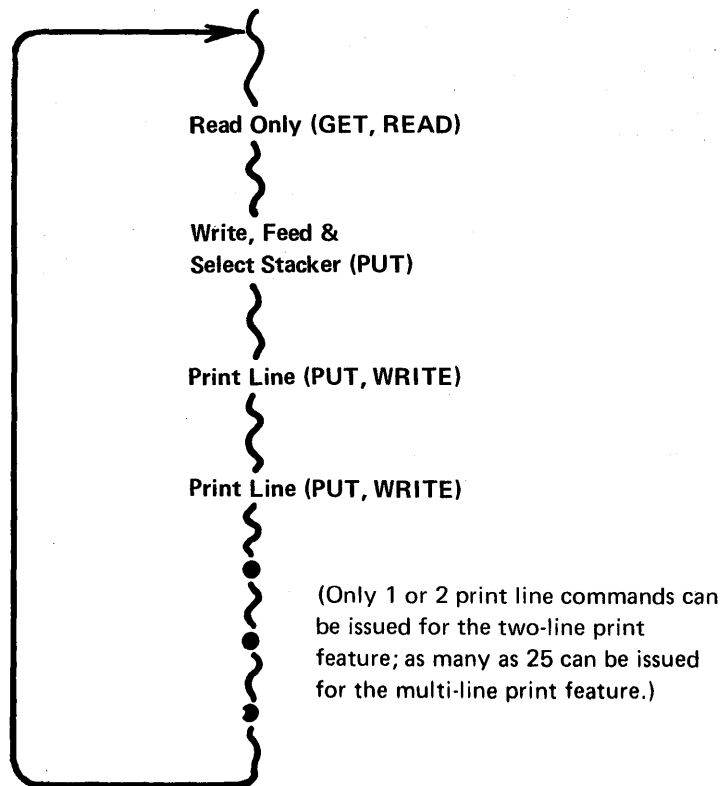

**Punching and Printing On Card That Is Being Read:** This file type (sequence of commands) should be used whenever prepunched cards are to be punched and printed: the read-punch command sequence causes the subsystem to suppress the punch retry function for mispunched cards. If the punch retry function were not suppressed, and if a punching error were to occur, the subsystem would try to repunch the data correctly into the following two cards.

Print commands are issued in ascending line number sequence until commands have been issued for all lines to be printed.

## OTHER INSTRUCTIONS AND RESETS

### Halt I/O

The device does not send its address in response to the interface disconnect. The response, in terms of device status, is a function of the occurrence of the interface disconnect relative to the command execution. Interface disconnect does not reset status, sense, or data information. Neither does it generate any status or sense information. If a Unit Check is present in the device it will be presented at the proper time. If interface disconnect is given when the device is not busy, no status is generated and the device remains not busy. If Halt I/O is issued before normal Channel End, Channel End and Device End are sent and any Feed associated with the command is aborted. If Halt I/O is issued between Channel End and Device End, the device responds Busy until Device End is generated by the device and accepted by the channel.

### Stop

Stop is interpreted as "command out" as a response to "service in." The device always interprets Stop as a signal to suppress any further data transfer and the device responds with Channel End and any other status which is appropriate at Channel End. If Device End is not sent with Channel End, the device remains busy until Device End is available, presented to, and accepted by the channel.

### Selective Reset

If selective reset is given between Initial Selection and Channel End all commands, status, and sense information are reset and any feed associated with the command is aborted. The data associated with cards in the transport is maintained as well as any error detected as those cards were loading their respective buffer positions. Therefore, when execution is resumed no operator assistance at the device is required in terms of media repositioning.

If selective reset is given between Channel End and Device End, it has no effect because the device is in mechanical motion and continues in motion until the normal stopping point. The device is busy until Device End is accepted. Any data errors detected are stored for presentation at Channel End of the next Read command.

If selective reset is given between Device End and Initial Selection, it has no effect.

### System Reset

System Reset operates the same as selective reset, above. There are, however, special considerations. The system reset initiated by the system power-on reset turns off the device Ready and End-of-File lights, while the system reset which is initiated by the System Reset key does not affect the device Ready and End-of-File lights, nor does it reset the OMR and RCE format mode.



## Channel Checks

Recovery from channel errors (channel control check, interface control check, and channel data check) is as follows:

If selective reset or interface disconnect was given between Initial Selection and Channel End, reissue the command to the device.

If selective reset or interface disconnect was given between Channel End and Device End, issue the next command to the device.

If selective reset or interface disconnect was given between Device End and Initial Selection, issue the next command to the device.

The use of the stop sequence for termination is only retrievable if the command normally returns a simultaneous Channel End and Device End. Otherwise, operator intervention is required to recover after a stop sequence.

The above recoveries assume no errors within the subsystem. If there are errors within the subsystem, use the appropriate ERP to recover the device.

## STATUS BYTE

The status is presented to the interface under the following conditions.

1. During the initial selection sequence after the interface sends a command byte.
2. After an operation ends because of an I/O interrupt, such as channel end after data transfer or device end after the completion of the mechanical portion of the operation.
3. During an I/O interrupt operation initiated by the control unit when the device goes from not-ready to ready (device end is generated).
4. During initial selection for a Test I/O instruction.
5. To present any previously stacked status.

A status condition is reset when accepted by the interface, except that:

1. Unit-check (bit 6) is not reset until the I/O device has been restored to ready after an intervention-required condition.
2. Busy (bit 3) is not reset until device-end status is accepted by the interface.

### Status Byte Format

Only bits 3 to 7 of the status byte are used. The contents of the status byte, except bit 6, are reset by a service-out response to status in, a system reset, selective reset, or a power-on reset.

#### Bits 0, 1, and 2

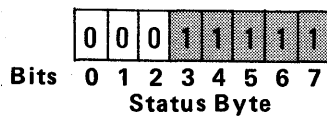

These bits are not used; they must be set to 0.

### Bits 3 Busy (Hexadecimal 10)

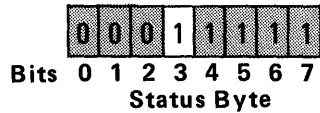

Busy status is presented to the interface when the I/O device is executing a previous command or the subsystem has an outstanding device-end condition in the status byte. Busy status is presented only at initial selection. Once the command has been accepted by the subsystem, busy status is presented to any following command until the outstanding device end has been accepted by the interface. Status conditions, if any, accompany the busy indication. Busy is not presented to a Test I/O command if channel end or device end is part of the status. After device end is accepted, the I/O device becomes not busy. Busy is presented with a not ready to ready Device End at Initial Selection for commands other than Test I/O.

### Bit 4 Channel End (Hexadecimal 08)

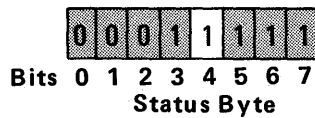

Channel-end status is presented to the interface after completing a data transfer to or from the subsystem. Channel end is also presented when a control command is accepted by the subsystem. Channel end is not set if the command is rejected during the initial selection sequence.

### Bit 5 Device End (Hexadecimal 04)

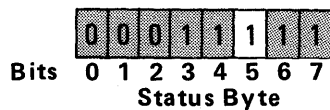

Device-end status is presented to the interface when a previous command has been completed. The subsystem can accept another command after the status is accepted by the interface. Device end is also generated by a change from not-ready to ready. Device end is not set if the command is rejected during the initial selection sequence.

**Bit 6 Unit Check (Hexadecimal 02)**

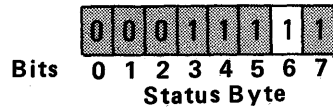

Unit-check status indicates that the I/O device requires program or operator intervention. A sense command should be given, and the sense data analyzed, to determine the cause and appropriate recovery procedure (*see* "Sense Bytes"). The unit-check status bit can be presented at initial selection or along with channel-end and/or device-end status. If unit check is set by intervention required, it is not reset until the I/O device is restored to the ready condition.

**Bit 7 Unit Exception (Hexadecimal 01)**

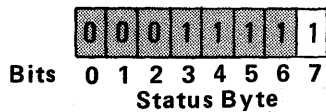

Indicates an end of file condition and (reader only) that the card has been stacked or (read feature only) that the card has entered the post-punch station. Unit exception is returned at initial selection for the first read command after the last card has been used. Unit exception turns RCE and OMR formats off.

# VALID STATUS COMBINATIONS AND STATUS TIMINGS

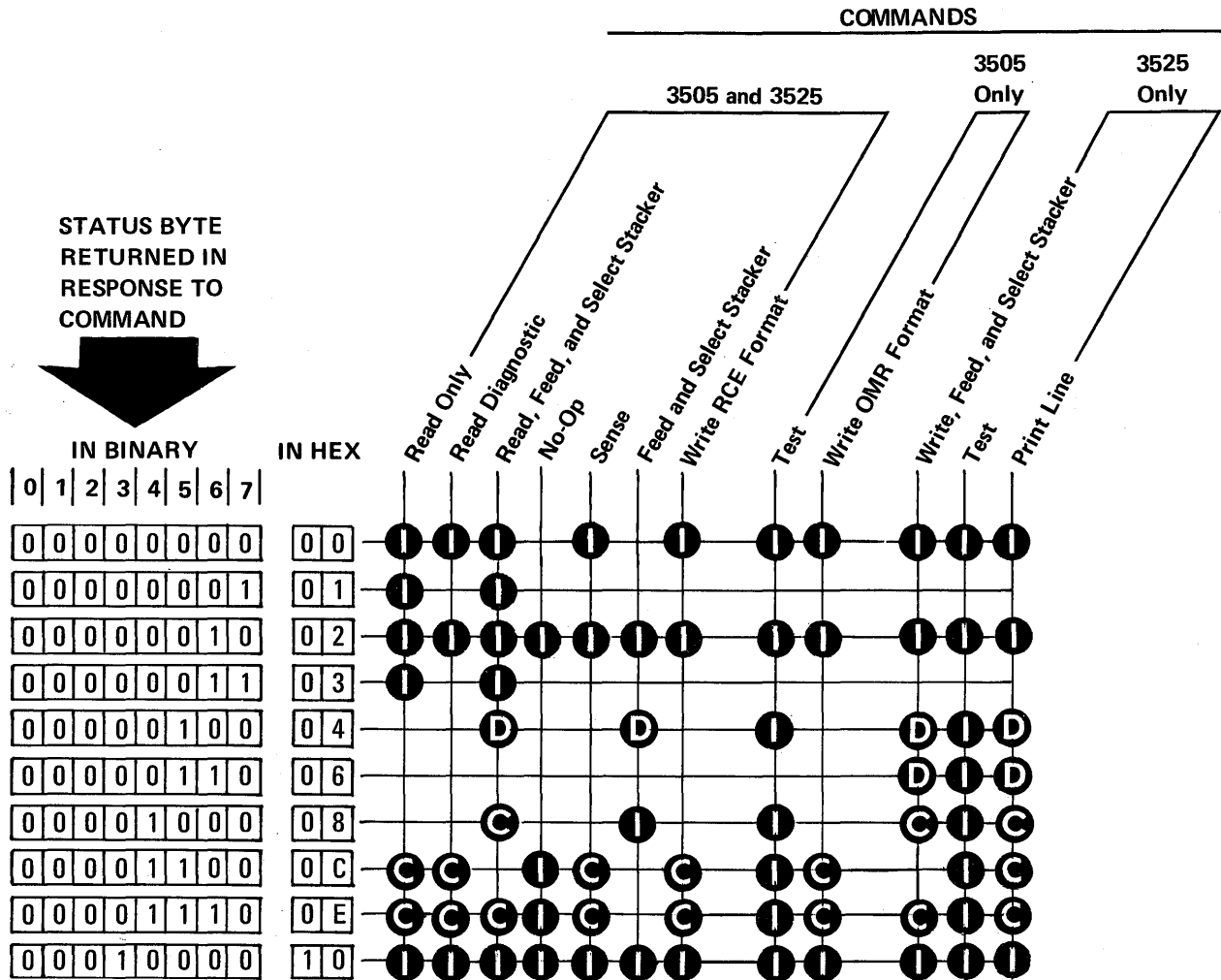

**Legend:**

- I** — Status returned at initial selection.
- C** — Status returned at channel end.
- D** — Status returned at device end.

**NOTE:** Status bit combinations not shown are invalid.

## SENSE BYTES

Sense bytes are transmitted from the subsystem to the CPU in response to a sense command initiated by the system. They provide the program with detailed subsystem status information that indicates why a unit check occurred. The same information transmitted to the system is stored by the subsystem to build a log of the last 14 to 28 subsystem errors that occurred.

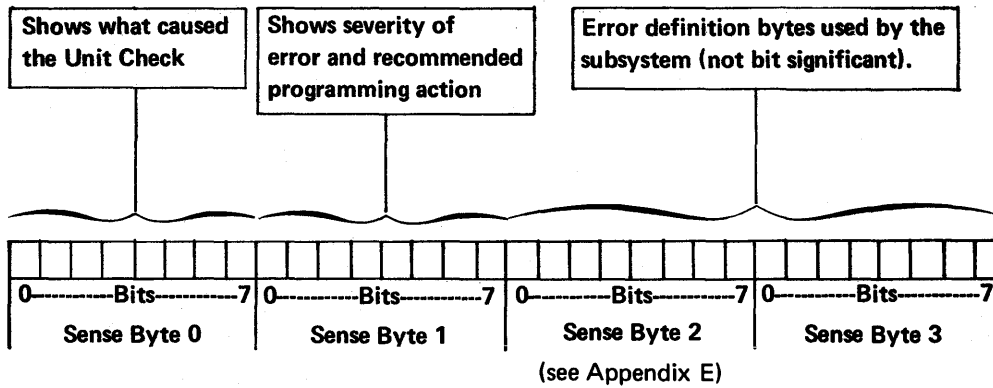

SENSE BYTE	BIT	UNIT CHECK TIMING	INDICATION	CAUSED BY	ERROR RECOVERY PROCEDURE	OPERATOR ACTION REQUIRED
0	0	Initial Selection	Command Reject	<ol style="list-style-type: none"> <li>1. Program issued an invalid command to the I/O (read Backward, etc)</li> <li>2. Program issued a command for an uninstalled feature</li> <li>3. The command is contingently invalid, see the command description for the contingencies</li> </ol>	<ol style="list-style-type: none"> <li>1. Post permanent error condition.</li> <li>2. Correct the program.</li> </ol>	Permanent error procedure stipulated by the source program run book for that application.
0	1	Initial Selection	Intervention Required	<ol style="list-style-type: none"> <li>1. Misfeed or jam in card path</li> <li>2. Normal stops (hopper empty, stacker full, covers open, stop key depression)</li> </ol>	Per byte 1, bit 3 or byte 1, bit 0.	As defined by recovery indicators on the machine.
0	2	Initial Selection or Channel End	Bus Out Check	Incorrect parity on bus out line during initial selection or data transfer during any write operation.	Per byte 1, bit 1	Permanent error procedure indicated by the user run book for the application being run.
0	3	Channel End or Device End	Equipment Check	Hardware error.	Per byte 1, bits 0, 1, or 3	As defined by recovery indicators on the machine.
0	4	Channel End	Data Check	Invalid EBCDIC character code while reading in data mode 1.	Per byte 1, bit 3	As defined by recovery indicators on the machine.
0	5		Not Used			
0	6	Initial Selection of Unformatted Rd and SS or Rd, Fd, and SS command when device is in OMR or RCE formatted mode.	Abnormal Format reset	1. Programming error.	Per byte 1, bit 3	Correct the program. 1. Press permanent error key.
				2. Programmed abnormal format reset.	Per byte 1, bit 3	Program planned on this stop. Perform the error procedure stipulated in run book for abnormal format reset indication.
				3. Job terminated without program resetting mode to unformatted.	Per byte 1, bit 3	Correct program for previous job. 1. NPRO device. 2. Replace 2 cards run out in bottom of hopper. 3. Press the start key.
0	7	Initial Selection	Permanent Error	Operator pressing the permanent error key to bypass an error.	Post permanent error to program	Perform the error procedure stipulated in the run book for permanent error key depression.

## **Sense Byte 1**

### **Bit 0—Permanent Error**

**Occurs With:**

Sense Byte 0, Bits 0, 1, and 3

**Recommended Program Action:** Post permanent error condition and perform appropriate routine to dispose of the condition.

### **Bit 1—Automatic System-Programmed Retry**

**Occurs With:**

Sense Byte 0, Bit 2

Sense Byte 0, Bit 3

**Recommended Program Action:** Retry failing CCW once. If successful, continue normal program execution; if unsuccessful, post a permanent error condition and perform appropriate routine to dispose of the condition.

### **Bit 2—Motion Malfunction**

**Occurs With:**

Sense Byte 0, Bit 1

**Recommended Program Action:** None. This bit is not used by the recovery program.

### **Bit 3—Retry After Intervention Required Complete**

**Occurs With:**

Sense Byte 0, Bit 1

Sense Byte 0, Bit 3

Sense Byte 0, Bit 4

Sense Byte 0, Bit 6

**Recommended Program Action:** Reissue the failing CCW after a normal not-ready to ready device end occurs.



**Explanation:** This sense bit is the only sense bit associated with the permanent error key and the sense bit that indicates that the permanent error key has been pressed (sense byte 0, bit 7). When byte 1, bit 3 comes on, the operator can elect to:

1. Perform the intervention indicated by the device backlighted panel. The program, upon sensing the not-ready to ready device end, should reissue the failing CCW. Upon receiving the reissued CCW, the device will continue normal processing.
2. Press the permanent error key and ready the device. The program upon sensing the not-ready to ready device end, should reissue the failing CCW. When the system reissues the CCW in this case, the subsystem responds with unit check at initial selection and sets bit 7 of sense byte 0. The source program should consider the reissued CCW to be the failing CCW and the error to be permanent.

**Note:** If the permanent error key is pressed when sense byte 1, bit 3 is not present, the key has no effect.

**Bits 4 through 7 – Not Used**

## **SUBSYSTEM TIMING CONSIDERATIONS**

### **OPERATING RATES**

The throughput rate for each IBM 3505 and 3525 (operating at maximum rated capacity) is:

#### **3505**

Model B1—800 cards per minute (75ms/cycle)  
Model B2—1200 cards per minute (50ms/cycle)

#### **3525**

Model P1—100 cards per minute (600ms/cycle)  
Model P2—200 cards per minute (300ms/cycle)  
Model P3—300 cards per minute (200ms/cycle)

### **PERFORMANCE ANALYSIS**

The critical parameters in achieving throughput on the 3505 and 3525 are the relative timings between the status presentation points on commands that cause card motion.

In the following timings, rated throughput is achieved by consistently meeting the criteria presented in the charts for the commands being used in the program.

**3505 Timings for Source Program Using Read Only,  
and Feed and Select Stacker Commands**

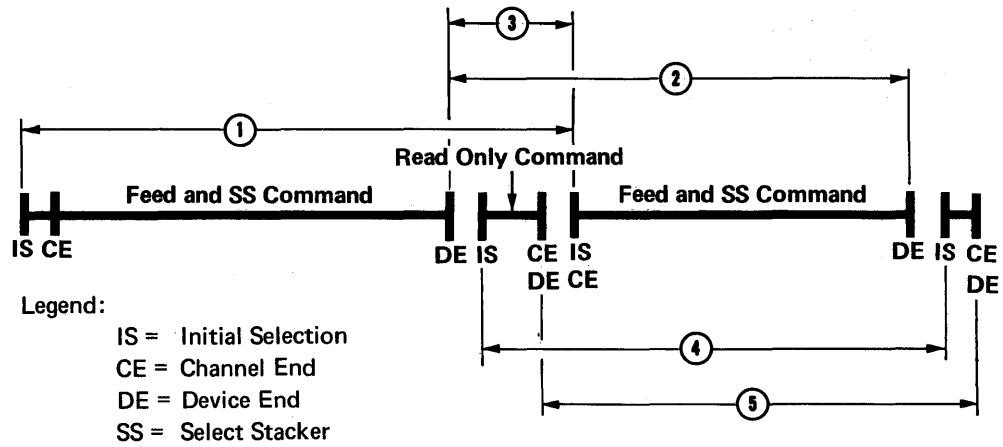

**Feed and Select Stacker Commands**

	Model B1	Model B2
① Initial Selection to Initial Selection	75ms	50ms
② Device End to Device End	75ms	50ms
③ Device End of Feed Stacker Select to Initial Selection of next Feed, Stack Select Command	9ms	6ms

**Read Only Commands**

④ Initial Selection to Initial Selection	75ms	50ms
⑤ Channel End to Channel End	75ms	50ms

**Note:** Time between Initial Selection and Channel End of a Read Only command is a function of the time required for a complete data transfer.

**3505 Timings for Source Program Using Only  
Read, Feed, and Select Stacker Commands**

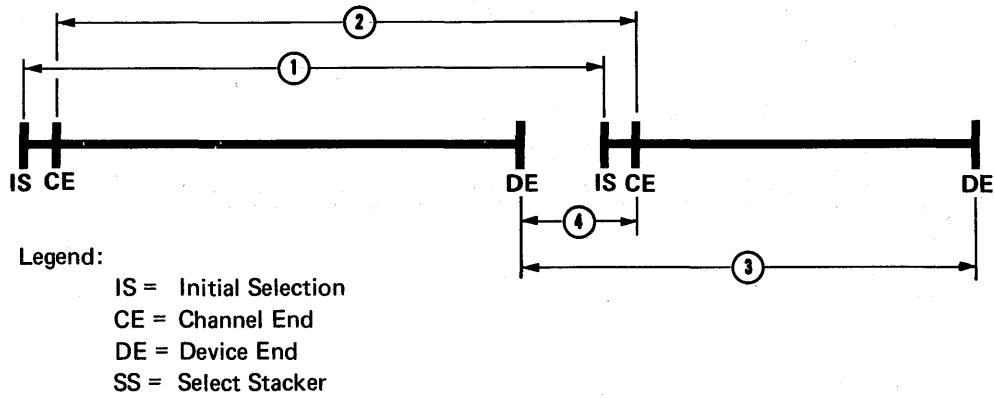

	Model B1	Model B2
① Initial Selection to Initial Selection	75ms	50ms
② Channel End to Channel End	75ms	50ms
③ Device End to Device End	75ms	50ms
④ Device End to Channel End of next command	9ms	6ms

*Note:* Time between Initial Selection and Channel End of a Read, Feed, Stack-Select command is a function of the time required for a complete data transfer.

**3525 Timings for Source Program Using Only Write, Feed, and Select Stacker Commands**

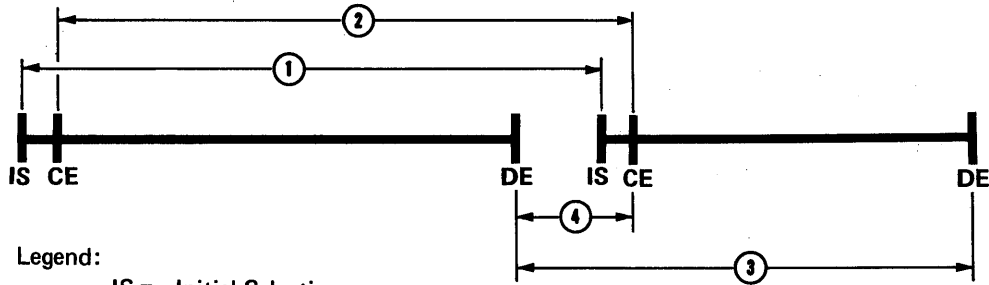

Legend:  
 IS = Initial Selection  
 CE = Channel End  
 DE = Device End  
 SS = Select Stacker

	P1	P2	P3
① Initial Selection to Initial Selection	600ms	300ms	200ms
② Channel End to Channel End	600ms	300ms	200ms
③ Device End to Device End	600ms	300ms	200ms
④ Device End to Channel End of next Command	67.5ms	33.75ms	22.5ms
Device Speed (NOMINAL)	100cpm	200cpm	300cpm

*Note:* The time between initial selection and channel end of a Write, Feed, Select Stacker command is a function of the time required for a complete data transfer.

**3525 Timings for Source Program Using Only Read Only, and Write, Feed, and Select Stacker Commands**

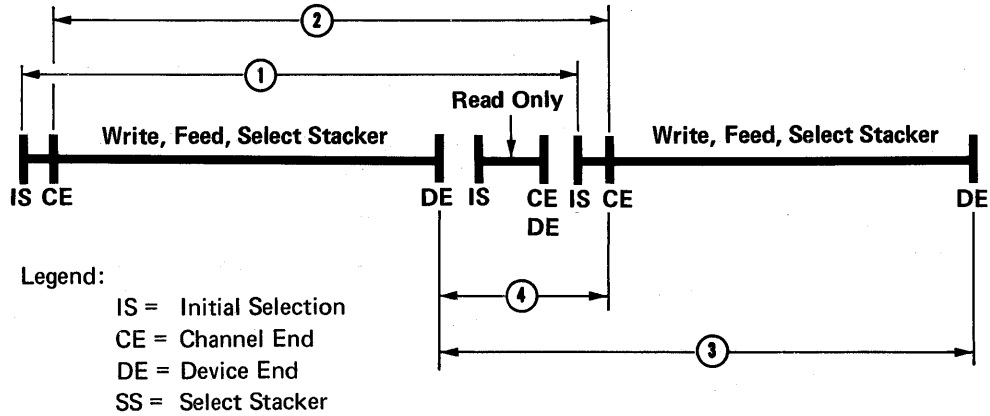

	P1	P2	P3
① Initial Selection to Initial Selection	600ms	300ms	200ms
② Channel End to Channel End	600ms	300ms	200ms
③ Device End to Device End	600ms	300ms	200ms
④ Device End from one Write, Feed, Select Stacker to Channel End of next Write, Feed, Select Stacker	67.5ms	33.75ms	22.5ms

**Note:** The time between Initial Selection and Channel End of a Read Only or a Write, Feed, Select Stacker command is a function of the time required for a complete data transfer.

**3525 Timings for Source Program Using Only  
Read Only, and Feed and Select Stacker Commands**

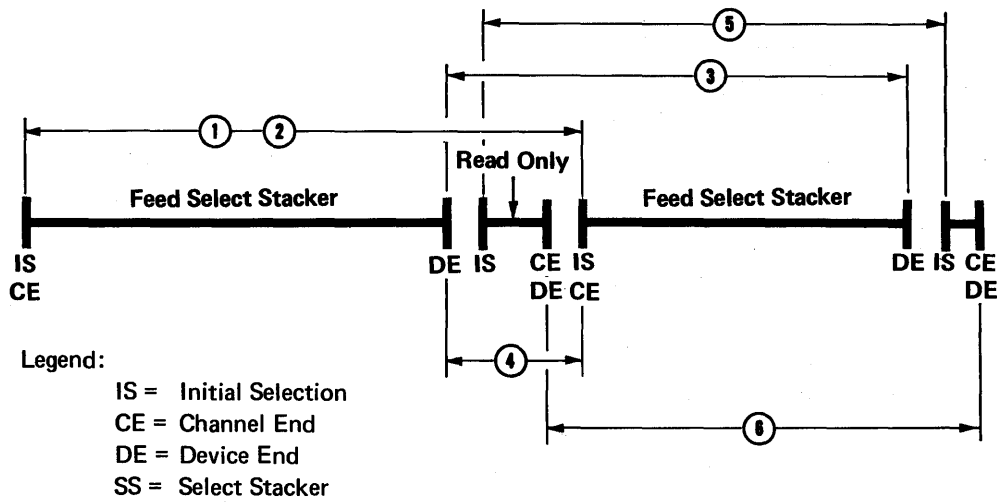

**Feed, Select Stacker Commands**

	P1	P2	P3
① Initial Selection to Initial Selection	600ms	300ms	200ms
② Channel End to Channel End	600ms	300ms	200ms
③ Device End to Device End	600ms	300ms	200ms
④ Device End of one Feed, Select Stacker to Channel End of next Feed, Select Stacker	67.5ms	33.75ms	22.5ms

**Read Only Commands**

⑤ Initial Selection to Initial Selection	600ms	300ms	200ms
⑥ Channel End to Channel End	600ms	300ms	200ms

*Note:* The time between Initial Selection and Channel End of a Read Only command is a function of the time required for a complete data transfer.

**3525 Timings for Source Program Using Only Read, Feed, and Select Stacker Commands**

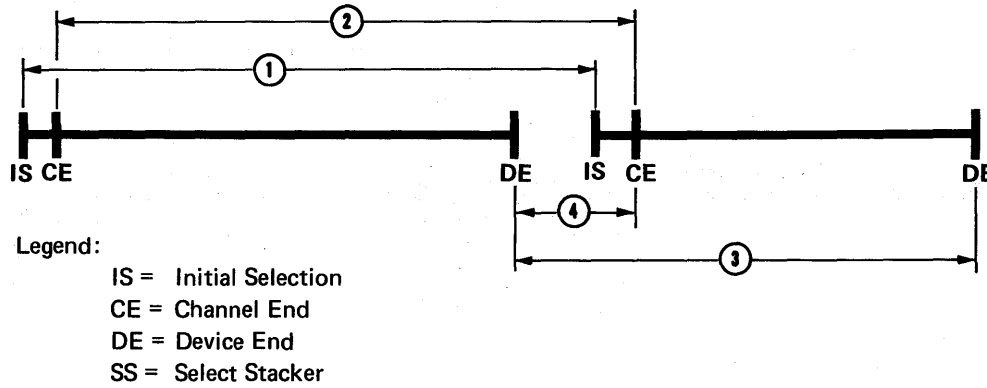

	P1	P2	P3
① Initial Selection to Initial Selection	600ms	300ms	200ms
② Channel End to Channel End	600ms	300ms	200ms
③ Device End to Device End	600ms	300ms	200ms
④ Device End to Channel End of next Command	67.5ms	33.75ms	22.5ms

*Note:* The time between Initial Selection and Channel End of a Read, Feed, Select Stacker command is a function of the time required for a complete data transfer.



### 3505 Card Throughput

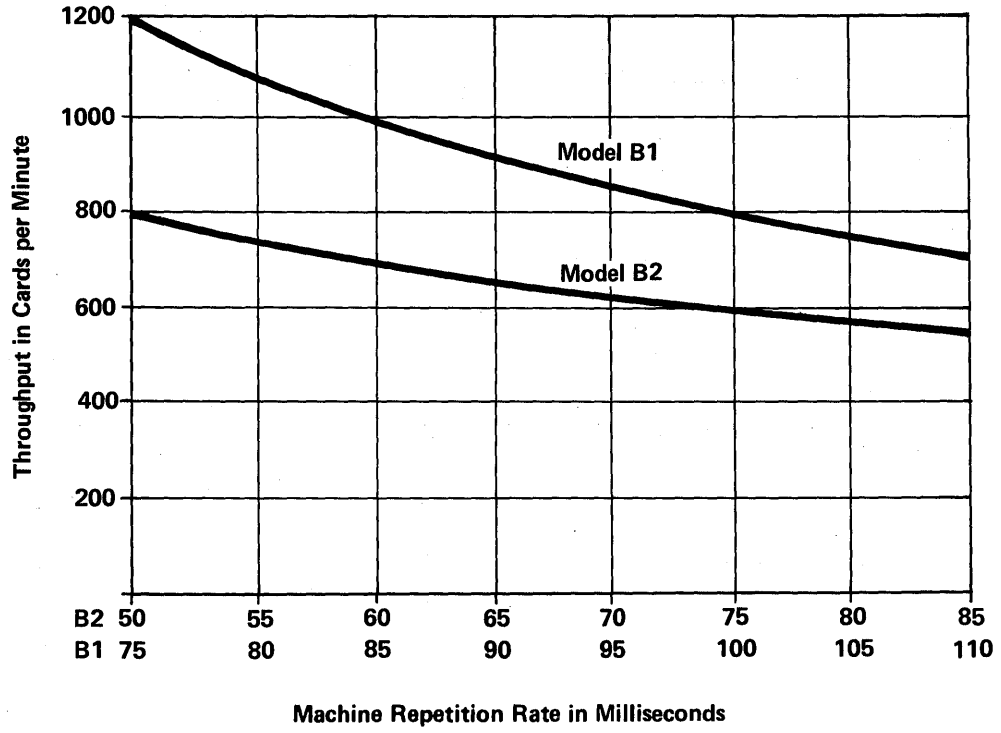

### 3525 Card Throughput

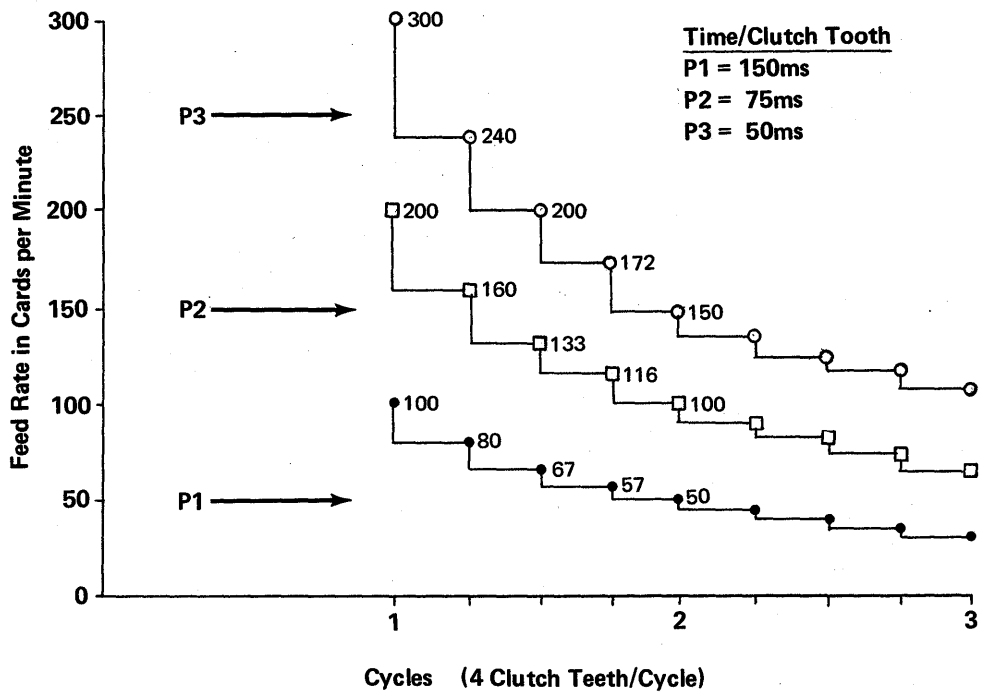

The throughput will decrease per above chart if compute time allowable is exceeded.

### 3525 Card Throughput While Printing With the Multiline Card Print Feature

The following table shows typical rates.

Number of Lines Printed	Line Positions	Cards Per Minute		
		P1	P2	P3
1	1	100	200	300
2	1, 3	100	200	240
3	11, 12, 13	67	133	150
4	11, 12, 13, 14	67	114	120
6	11, 12, 13, 14, 15, 16	57	89	92
10	11 through 20	44	62	63
25	All	24	29	29

## APPENDIX A. SUBSYSTEM CARD SPECIFICATIONS AND RECOMMENDATIONS

Card Stock: Regular, edge coated, and heavy duty.

Special Punching: Cards with the following special punching can be used:

- Verify notch (column 1 and column 80).
- Columns 81 and 82 punching.
- Punching in columns minus 1 or 0 (cards with column 1 corner cuts must not have punches in column 0).
- IBM Port-A-Punch® cards.

### SPECIAL FEATURE CARDS

Generally, special feature cards require careful handling and should be stored and used in areas with favorable temperature and humidity.

The following features have been approved for use in this subsystem.

Corner Cuts	Internal Scores (Before Separation)	External Scores		
		Column 1 End	Column 80 End	12 and 9 Edge
Any corner:	M-4 M-5 OM-2 (see Note 1)	M-3 M-4 M-5	M-3 M-4 M-5	CF-1/9A
C-1	OM-3 (see Note 1)	M-6	M-6	
C-2	ID-1	M-7	M-7	
C-3	ID-2	M-11	M-11	
C-5	ID-3	OM-2	OM-2	
	S-1	OM-3 (see Note 3)	CF-4	
	S-2 (see Note 2)	CF-4	CF-11	
		CF-11		
<p>Note 1: Either reading must be terminated before the column that contains the score is read out of the buffer (that is, data transfer must be stopped by a short CCW count for a read instruction) or reading of the scored column and each adjacent column must be suppressed by means of the program-controlled read column eliminate feature.</p> <p>Note 2: Cards may be used before they have been folded. If they are properly flattened, cards may be used after they have been folded.</p> <p>Note 3: OM-3 is not approved on column-80 end of card for 3505 and 3525.</p>				

All other special feature cards may result in unsatisfactory performance and should be tested in an actual application prior to being used or ordered in large quantities.



*Special feature cards, and information about cards and card design, are available from your IBM Information Records Division representative.*

## **CARBON-BACK CARDS**

Cards with carbon backs and those containing other substances that may transfer to the feed rolls or to other cards can cause feed problems and OMR reading problems, if contamination occurs. Whenever you use such cards, periodically examine the face of OMR cards that have passed through the device, to make certain that blemishes do not appear on your OMR fields and thereby increase your OMR error rate. Also examine feed rolls periodically to detect any build-up of carbon or other contamination on the feed rollers. Such contamination can result in misfeeds or in blemishes on OMR cards run later.

If you process carbon-backed documents, try to use documents with high-quality carbon to avoid transfer to other cards.

# APPENDIX B. OPTICAL MARK READ SPECIFICATIONS

## OMR CARD SPECIFICATIONS

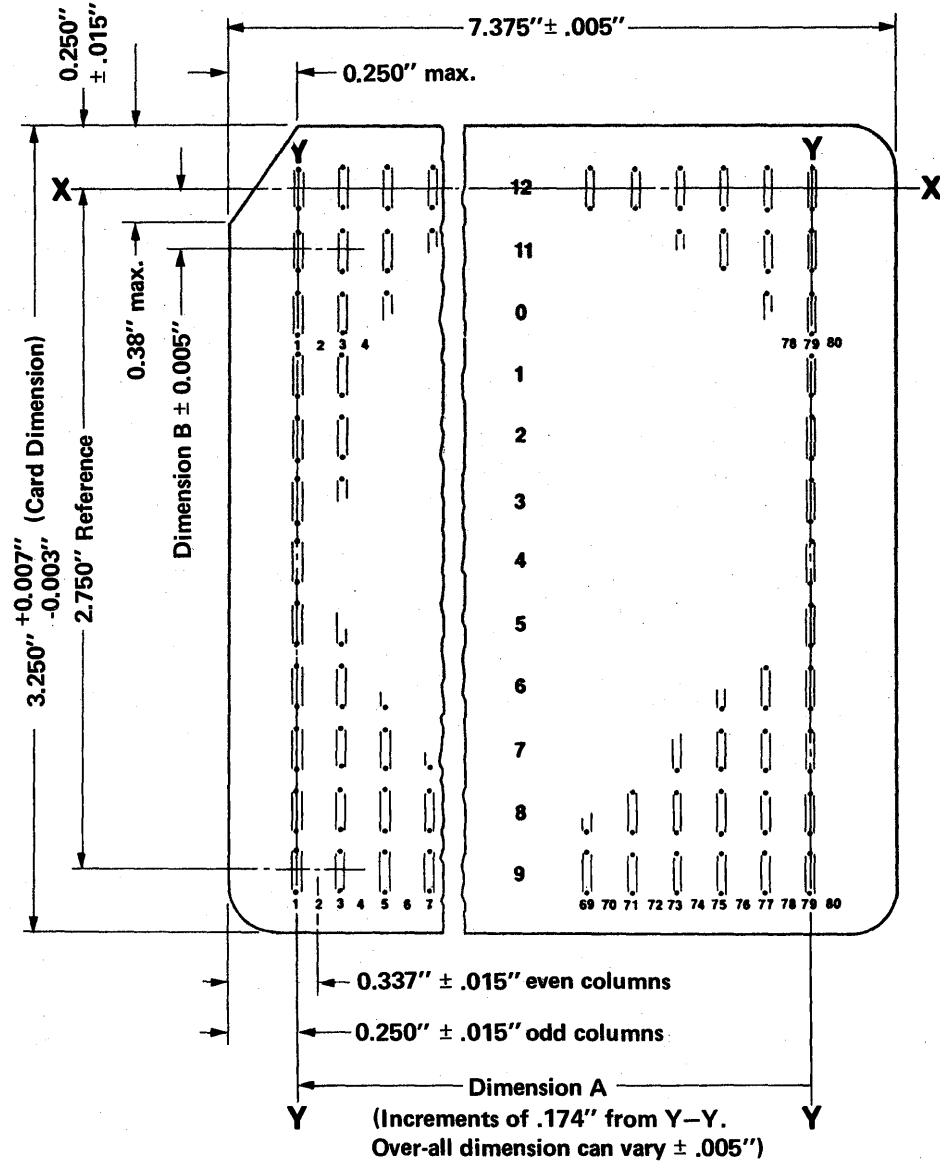

**Legend:**

- Y-Y = centerline through card column 1 and 79 on standard tabulating card.
- X-X = centerline through row 12 on standard tabulating card.
- Dimension A = distance between horizontal center of marking position or punch position and line Y-Y.
- Dimension B = distance between vertical center of marking position or punch position and line X-X. This dimension increases in increments of 0.250" (distance from center of marking positions).
- ⏏ = outline of marking position.

**Note:**

Information not to be read by the 3505 and mark constraints must be printed in reflective ink.

## Reflectance Measurements

Reflectance measurements specified herein have been measured by a Kidder Press Company, Inc. Model 081 Optical Character Tester, infrared section, with a 0.0125 inch diameter aperture and with the tester calibrated using magnesium oxide as 100 percent. *Average reflectance* means the average of three readings on this test instrument at three separate locations on the card, mark, or erasure.

## Card Stock

Any card acceptable for use as input to the 3505 can be used for an optical mark card with these provisions:

1. The average reflectance of the card stock must not fall below 80 percent.
2. Blemishes and printing in the marking field of the card must reflect at least 85 percent of the average reflectance of that particular card. (Therefore, a card whose average reflectance is 90 percent may not have a blemish or printing that indicates less than  $0.85 \times 0.90$ , or 76.5 percent.)
3. The card must not contain any non-reflective printing or handwriting anywhere to the left of column 1 except in a vertical band  $1/32$  of an inch wide along the left edge of the card.

*Note:* White and natural cards manufactured to card industry standards are almost always satisfactory. Printing should be done on one side only.

## Recommended Marking Constraints

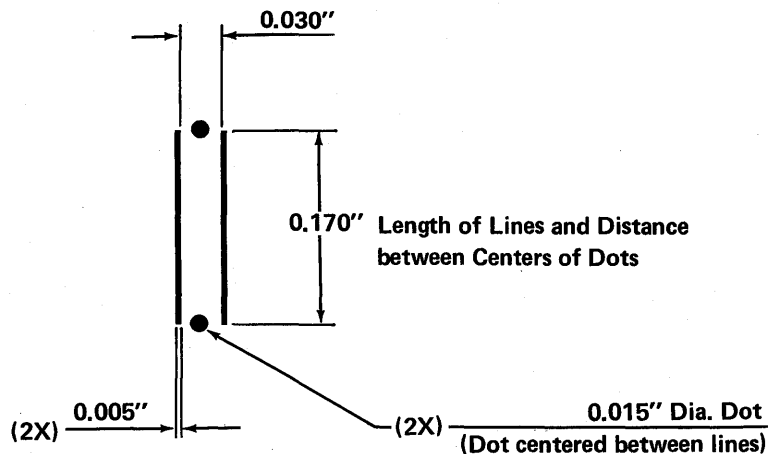

*Note:* Dots and vertical lines must be printed in reflective ink.

Reflectance must not be below 0.85 (85%) of the average background reflectance. This constraint identifies the area in which a mark must be confined. This area has an optimum width of  $0.030'' \pm 0.005''$  and must facilitate a mark from 0.155'' to 0.240'' in length.

Constraints may be printed in either odd or even columns.

## OMR Columns

An OMR column is a vertical arrangement of twelve mark positions. (These correspond to the twelve punch positions in a column of a punched card.) An OMR column must not contain punching and must not contain non-reflective writing, printing, or blemishes. (For example, there cannot be any handwriting in any mark read column.)

*Note:* Columns minus 1, 0, 81, and 82 cannot be used for OMR columns.

## OMR Fields

An OMR field consists of one or more OMR columns with a blank column between each OMR column and adjacent OMR column, punched column, or non-reflective marking, printing, or blemishes. To prevent non-reflective printing and writing being recognized by the reader as uncertainties or unintended marks, there can be no non-reflective printing or handwriting;

1. Within the OMR field (except the actual OMR marks in OMR columns).
2. Above and below the OMR columns and adjacent columns.
3. For one column width to the right of column 80, when column 80 is an OMR column.
4. Anywhere between the leftmost OMR column in the field and a vertical band 0.060 inch wide along the left edge of the card if the first OMR column in the field is either card column 1 or card column 2.
5. There must be no handwriting prior to column 1.

## Location of OMR Data

1. There must be at least one blank column between OMR columns.
2. There must be at least one blank column between an OMR column and a punched hole column.
3. There must be at least two blank columns between even column OMR fields and odd column OMR fields.
4. An OMR field may begin in any column (1-80) of the card subject to the rules above.

## Transfer of OMR Card Data to the System

1. If column  $n$  is not an OMR column, the data from column  $n+1$  is the next contiguous byte in EBCDIC (bytes in card image).
2. If column  $n$  is an OMR column, the data from column  $n+2$  is the next contiguous byte in EBCDIC (bytes in card image).
3. The contents of column 1 is always the first data transferred to the system.



## **Marks and Erasures**

A mark must be a vertical single stroke line using a #2 pencil or equivalent marking material.

The minimum dimensions are: width, .015" (0,38mm) within constraints; length, .155" (3,94mm) centered within constraints.

The maximum dimensions are: width, .041" (1,04mm) with .015" (0,38mm) minimum of mark width within constraint over full length of mark; length, .240" (6,1mm) centered within constraint.

The mark must have an average reflectance that is less than or equal to 35% of the reflectance of that portion of the card immediately adjacent to the mark. Single stroke marks with a #2 pencil will meet this specification.

An erasure must have an average reflectance that is greater than or equal to 80% of the reflectance of that portion of the card immediately adjacent to the erasure.

## **Marking Recommendations**

Marks made with a number 1 or IBM ELECTROGRAPHIC® pencil are not recommended because these marks are hard to erase. Residual left on a card might be read as a mark.

Pencil marks should be made with a firm stroke without excessive pressure. Marks cut into the card stock are difficult to erase.

Erasures must be made carefully and completely to meet the 80% reflectance requirement.

Document cleanliness is important. Extraneous ink spots, pencil marks, and smudges can be recognized either as valid marks or rejects.

## APPENDIX C. SEQUENCE OF CHECKING INDICATORS

<i>Priority</i>	<i>Sense Byte</i>	<i>Bit</i>	<i>Condition</i>
1			Channel Control Check
2			Interface Control Check
3			Channel Data Check
4			Status Bits 0, 1 & 2 (Not Used)
5			Unit Check
6	0	5	Unused
7	0	7	Permanent Error
8	0	3	Equipment Check (Note 1)
9	0	6	Abnormal Format Reset (Note 1)
10	0	1	Intervention Required (Note 1)
11	0	2	Bus Out Check at Initial Selection (Notes 1 and 2)
12	0	2	Bus Out Check at Channel End (Notes 1 and 2)
13	0	4	Data Check (Note 1)
14	0	0	Command Reject (Note 1)
15			Chaining Check
16			Program Check
17			Protection Check
18			Unit Exception
19			Incorrect Length

**Note 1:** The sequence of checking the bits in Sense Byte 1 are as follows:

1.	Sense Byte 1, bits 4-7	Unused
2.	Sense Byte 1, bit 0	Permanent Error
3.	Sense Byte 1, bit 3	Retry After Intervention Complete
4.	Sense Byte 1, bit 1	Automatic Retry

**Note 2:** Bus out check at initial selection and bus out check at channel end may be combined.

## APPENDIX D. PERMANENT ERROR DIAGNOSTIC DATA

ERROR COUNT (LOG OUT) NUM- BER IN BITS (Sense Byte 2)	DEVICE	CHANNEL SENSE INDICATOR		INDICATION DISPLAYED ON OPERATOR'S PANEL	ERROR DEFINITION
		BYTE	BIT		
0111 000X	3505	0 1	1 0,2	Jam, Permanent Error, & Transport	Hopper Feed Without Command
0000 0001	3505	0 1	1 0,2	Jam, Permanent Error, & Machine Check	Machine Emitter Check
0000 0110	3525	0 1	1 0,2,3	Jam, Machine Check, Permanent Error	Extra Clutch Cycle
0000 1000	3525	0 1	1 0,2,3	Jam, Machine Check, Permanent Error	Extra Clutch Cycle during Clutch Retry
0001 0000	3525	0 1	1 0,2,3	Machine Check, Jam, Permanent Error	Clutch Failed To Pick
1101 XXXX	3525	0 1	3 0	NPRO, Permanent Error	Punch Emitter Check
110X 1XXX	3525	0 1	3 0	NPRO, Permanent Error	Punch Check Scan Overrun
110X X1XX	3525	0 1	3 0	NPRO, Permanent Error	Punch Scan Overrun
110X XX1X	3525	0 1	3 0	NPRO, Permanent Error	Punch Exit Skew
110X XXX1	3525	0 1	3 0	NPRO, Permanent Error	Punch Check
111X XXX1	3525	0 1	1 0,2,3	Jam, Machine Check, Permanent Error	Emitter Check at Feed Count Time
111X XX1X	3525	0 1	1 0,2,3		Emitter Check at Home
1111 XXXX	3525	0 1	1 0,2,3		CU Bus In Parity Check
111X 1XXX	3525	0 1	1 0,2,3		CU Bus Out Parity Check
111X X1XX	3525	0 1	1 0,2,3		3525 Parity Check
1110 0000	3525	0 1	1 0,2,3		Drive Motor Malfunction
0000 1100	3525	0 1	1 0,2,3		Extra Home Emitter Between Feeds
0000 0010	3525	0 1	1 0,2,3		Home Emitter Failed to Start
0000 0100	3525	0 1	1 0,2,3		Feed Emitter Failed to Start
0111 XXXX	3525	0 1	1 0	NPRO, Permanent Error	Print Sync Check
011X 1XXX	3525	0 1	3 0		Stepper Check
011X X1XX	3525	0 1	3 0		Hammer On Check
011X XX1X	3525	0 1	3 0		Hammer Off Check
011X XXX1	3525	0 1	3 0		Hammer Address Parity Check
0010 0010	3525	0 1	3 0	If printing: NPRO, Permanent error; If not printing: No error	Prestacker Card Skew

X indicates don't care bits.

CHAIN POS	CHAR	CHARACTER DESCRIPTION	EBCDIC* CODE	CHAIN POS	CHAR	CHARACTER DESCRIPTION	EBCDIC* CODE
0		Space	01000000	32	-	Minus Sign ,Hyphen	01100000
1	A	A	11000001	33	/	Slash	01100001
2	B	B	11000010	34	S	S	11100010
3	C	C	11000011	35	T	T	11100011
4	D	D	11000100	36	U	U	11100100
5	E	E	11000101	37	V	V	11100101
6	F	F	11000110	38	W	W	11100110
7	G	G	11000111	39	X	X	11100111
8	H	H	11001000	40	Y	Y	11101000
9	I	I	11001001	41	Z	Z	11101001
10	¢ (I) **	Cent Sign (Left Brkt)	01001010	42	(\) **	Not Used (Reverse Slant)	01101010
11	.	Period , Decimal Point	01001011	43	,	Comma	01101011
12	<	Less Than Sign	01001100	44	%	Percent Sign	01101100
13	(	Lt Parenthesis	01001101	45	_	Underscore	01101101
14	+	Plus Sign	01001110	46	>	Greater Than Sign	01101110
15		Logical OR	01001111	47	?	Question Mark	01101111
16	&	Ampersand	01010000	48	0	Zero	11110000
17	J	J	11010001	49	1	Number One	11110001
18	K	K	11010010	50	2	Two	11110010
19	L	L	11010011	51	3	Three	11110011
20	M	M	11010100	52	4	Four	11110100
21	N	N	11010101	53	5	Five	11110101
22	O	O	11010110	54	6	Six	11110110
23	P	P	11010111	55	7	Seven	11110111
24	Q	Q	11011000	56	8	Eight	11111000
25	R	R	11011001	57	9	Nine	11111001
26	! (I) **	Excl Point (Rt Brkt)	01011010	58	:	Colon	01111010
27	\$	Dollar Sign	01011011	59	#	Number Sign	01111011
28	*	Asterisk	01011100	60	@	At Sign	01111100
29	)	Rt Parenthesis	01011101	61	'	Prime, Apostrophe	01111101
30	;	Semi-Colon	01011110	62	=	Equal Sign	01111110
31	⌋	Logical Not	01011111	63	"	Quotation Marks	01111111

\* Print Code is last 6 bits of EBCDIC Code.

\*\* Represents characters printed if ASCII chain cartridge is installed in the 3525.  
This does not mean that the attachment/CU will handle ASCII code.

- A** alternate stacking 5
  - analysis, performance 70
- B** billable-time metering 2
- C** capacity, 3505 file feed, 3000-card 4
  - carbon-back cards 81
  - card
    - image 6
    - movement after initial run-in, 3525 21
    - path 19
    - punch special features, 3525 15
    - punch standard features, 3525 12
    - read, 3525 special feature 15
    - reader, IBM 3505 3
    - sensing 2
    - specifications, OMR card 82
    - stackers, alternate stacking 5
    - stock 83
    - throughput while printing with multiline print feature, 3525 79
    - throughput, 3505 77
    - throughput, 3525 78
  - cards
    - carbon-back 81
    - special feature 80
  - chain arrangement and print feature character set 88
  - character set and chain arrangement, print feature 88
  - characteristics, 3505 general 3
  - checking indicators sequence 86
  - column binary 6
  - columns, OMR 84
  - command programming examples 56
    - optical mark read 58
    - punching, then printing (3525) 59.1
    - read column eliminate 57
    - reading, punching, & printing (3525) 59.2
    - reading, then printing (3525) 59
  - commands
    - control no-op 44
    - diagnostic read 47
    - feed only and select stacker 45
    - print line 55.1
    - read only 46
    - sense 42
    - test I/O 43
    - write OMR (optical mark read) format 54
    - write RCE (read column eliminate) format 52
    - write, feed, and select stacker 50
  - control keys
    - end of file 25
    - lamp test 25
    - log out 25
    - NPRO 26
    - perm error 25
    - start 25
    - stop 26
    - 3505/3525 25
  - control no-op command 44
  - controls and status indications 22
  - corner cuts 80
- D** data
  - mode 2 6
  - representation 2
  - security safeguards 14
  - dedicated error pocket and punch retry 13
  - diagnostic
    - data, permanent error 87
    - read command 47
- E** erasures and marks 85
  - error posting 13
  - error recovery procedures 2
- F** feature cards, special 80
  - features, 3505 standard 4
  - feed and select stacker command 45
  - feed, vacuum-assisted 4
  - fields, OMR 84
  - formatting OMR data 9
  - formatting RCE data 8
- G** general characteristics, 3505 3
- H** hopper retry capability, vacuum-assisted feed 4
  - hopper, 1200-card capacity hopper and multi-tooth clutch 12
- I** IBM 3505 card reader 3
  - IBM 3505 operator's panel 22
  - IBM 3525 card punch 11
  - IBM 3525 card punch special features 15
  - IBM 3525 operator's panel 23
  - image, card 6
  - indications, status and operator controls 22
  - initial run-in
    - 3505 17
    - 3525 19
  - instructions and resets
    - channel checks 61
    - halt I/O 60
    - other 60
    - selective reset 60
    - stop 60
    - system reset 60
  - introduction 1
- L** lines, print 15
  - location of OMR data 84
- M** marking
  - constraints, recommended 83
  - recommendations 85
  - marks and erasures 85
  - measurements, reflectance 83
  - metering, billable-time 2
  - multi-tooth clutch and 1200-card capacity hopper 12
  - multiline card print, 3525 15

**O** OMR  
 card specifications 82  
 columns 84  
 data location 84  
 fields 84  
 operational characteristics 17  
 operator controls and status indications 22  
 operator panel  
 recovery, oriented 5  
 3505 22  
 3525 23  
 optical  
 hole-sensing reading 5  
 mark read specifications 82  
 mark read, 3505 feature 8  
 other instructions and resets 60

**P** performance analysis 70  
 permanent error  
 diagnostic data 87  
 posting 13  
 position of cards  
 3505 17, 18  
 3525 20, 21  
 posting permanent error 13  
 print  
 feature character set and chain arrangement 88  
 line command 55.1  
 lines 15  
 positions 15  
 procedures, error recovery 2  
 program-controlled selectable stackers, 3525 13  
 programming considerations 42  
 programming examples  
 optical mark read 58  
 punching, then printing (3525) 59.1  
 read column eliminate 57  
 reading, punching, & printing (3525) 59.2  
 reading, then printing (3525) 59  
 progressive stacking into two 1750-card stackers 5  
 punch buffer 14  
 punch retry and dedicated error pocket, 3525 13  
 punch retry suppression 14

**R** read column eliminate, 3505 feature 7  
 read, feed, and select stacker command 48  
 read only command 46  
 reading, optical hole-sense 5  
 recommendations, marking 85  
 recommended marking constraints 83  
 recovery procedures, error 2  
 recovery-oriented operator panel 5  
 recovery-oriented operator panel, 3525 13  
 reflectance measurements 83  
 reject stacker, 3525 (stacker 3) 13  
 representation, data 2  
 reread capability 6  
 restart procedures and stop indications  
 3505 28  
 3525 34  
 retry, feed 4

**S** safeguards, data security, 3525 14  
 selectable stackers, program-controlled, 3525 13  
 selective stacker (stacker 2), 3505 feature 7  
 sense byte  
 0 67  
 1 68  
 sense bytes 66  
 sense command 42  
 sensing, card 2  
 sequence of checking indicators 86  
 spacing, print 15  
 special features (3505)  
 cards 80  
 multiline print control, 3525 10.1  
 optical mark read 8  
 punch adapter, 3525 9  
 read column eliminate 7  
 read punch adapter, 3525 10  
 selective stacker (stacker 2) 7  
 special feature adapter 7  
 two-line print control, 3525 10  
 special features (3525)  
 card-read 15  
 multiline card print 15  
 two-line card print 16  
 specifications  
 OMR card 82  
 optical mark read 82  
 subsystem card 80  
 stacker control, 3505 27  
 standard features  
 3505 4  
 3525 12  
 status byte 62  
 bits 0, 1, and 2 62  
 bit 3 – busy 63  
 bit 4 – channel end 63  
 bit 5 – device end 63  
 bit 6 – unit check 64  
 bit 7 – unit exception 64  
 format 62  
 status  
 combinations and status timings, valid 65  
 indications and operator controls 22  
 status lights  
 end of file 24  
 operator call 24  
 power on 24  
 ready 24  
 3505/3525 24  
 status timings and valid status combinations 65  
 stop indications and restart procedures, 3505 28  
 check card and NPRO 29  
 check card, replace 1, and NPRO 30  
 check card, transport, and jam 31  
 check card, transport, replace 1, and jam 32  
 format reset 29  
 hopper 28  
 hopper, jam 29  
 jam, machine check, and permanent error 31  
 machine check and NPRO 30  
 NPRO 30  
 NPRO and machine check 30

- permanent error and NPRO 31
- replace 1 and NPRO 32
- replace 1, NPRO, and machine check 32
- stacker 28
- stacker and jam 29
- thermal 28
- transport and jam 31
- transport, jam, and permanent error 29
- transport replace 1, and jam 32
- stop indications and restart procedures, 3525 34
  - check card and NPRO 37
  - chip box 34
  - cover open 25
  - feed open 35
  - format reset 37
  - jam 35
  - jam, machine check, and permanent error 36
  - mis-select and stacker 3 39
  - NPRO and machine check 36
  - NPRO and permanent error 37
  - offline 35
  - permanent error 37
  - permanent error and jam 36
  - press start and jam 35
  - press start and machine check 37
  - print skew 39
  - stacker 34
  - stacker 3 38
  - 3 card run-in and jam 36
  - 3 card run-in 38
  - 3 card run-in and NPRO 38
  - 3 card run-in, jam, and machine check 36
- stops, machine 13
- subsystem
  - card specifications and recommendations 80
  - timing considerations 70
- suppressing punch retry 14

**T** test I/O 43

- throughput
  - while printing with multiline print feature, 3525 79
  - 3505 77
  - 3525 78
- timing considerations, subsystem 70
- timings (3505)
  - read only, feed and select stacker commands 71
  - read, feed, and select stacker commands 72
- timings (3525)
  - read only, and feed and select stacker commands 75
  - read, feed, and select stacker commands 76
  - read, write, feed, and select stacker commands 74
  - write, feed, and select stacker commands 73
- transport, card 19
- two-line card print, 3525 special feature 16

**V** vacuum-assisted feed and hopper retry capability 4

- valid status combinations and status timings 65

**W** write commands

- OMR format 54
- RCE format 52
- write, feed, and select stacker 59.2

- 1200-card capacity hopper and multi-tooth clutch 12
- 1750-card stackers, progressive stacking 5
- 3000-card capacity file feed 4
- 3505

- card throughput 77
- general characteristics 3
- initial run-in 17
- operator's panel 22
- special features 7
  - optical mark read 8
  - read column eliminate 7
  - selective stacker (stacker 2) 7
  - special feature adapter 7
  - 3525 multiline print control 10,1
  - 3525 punch adapter 9
  - 3525 read punch adapter 10
  - 3525 two-line print control 10
- stacker control 27
- standard features 4
- stop indications and restart procedures (see stop indications 3505)
- timings, read only, feed and select stacker commands 71
- timings, read, feed, and select stacker commands 72
- 3505/3525 control keys 25
- 3505/3525 status lights 24
- 3525
  - general characteristics 11
  - card movement after initial run-in 21
  - card punch standard features 12
  - card throughput 78
  - card throughput while printing with multiline print feature 79
  - dedicated error pocket and punch retry 13
  - initial run-in 19
  - multiline card print special feature 15
  - multiline print control, 3525 feature 10,1
  - operator's panel 23
  - program-controlled selectable stackers 13
  - punch adapter, 3505 feature 9
  - punch buffer 14
  - punch retry and dedicated error pocket 13
  - read punch adapter, 3505 feature 10
  - recovery-oriented operator panel 13
  - special feature
    - card read 15
    - multiline card print 15
    - two-line card print 16
  - stop indications and restart procedures (see stop indications, 3525) 34
  - timings
    - read only, and feed and select stacker commands 75
    - read, feed, and select stacker commands 76
    - read, write, feed, and select stacker commands 74
    - write, feed, and select stacker commands 73
  - two-line print control, 3505 feature 10

## READER'S COMMENT FORM

GA21-9124-1

IBM 3505 Card Reader and  
IBM 3525 Card Punch  
Subsystem

### YOUR COMMENTS, PLEASE. . .

Your comments concerning this publication will help us produce better publications for your use. Each reply will be carefully reviewed by the persons responsible for writing and publishing this material. All comments and suggestions become the property of IBM.

*Note:* Please direct any requests for copies of publications, or for assistance in using your IBM system, to your IBM representative or to the IBM branch office serving your locality.



Cut Along Line

Fold

Fold

FIRST CLASS  
PERMIT NO. 387  
ROCHESTER, MINN.

**BUSINESS REPLY MAIL**  
NO POSTAGE STAMP NECESSARY IF MAILED IN THE UNITED STATES

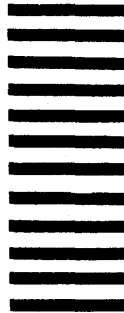

POSTAGE WILL BE PAID BY . . .

IBM Corporation  
General Systems Division  
Development Laboratory  
Rochester, Minnesota 55901

Attention: Product Publications, Dept. 245

Fold

Fold

IBM 3505 and 3825 Subsystem Printed in U.S.A. GA21-9124-1



International Business Machines Corporation  
Data Processing Division  
112 East Post Road, White Plains, N.Y. 10601  
[USA Only]

IBM World Trade Corporation  
821 United Nations Plaza, New York, New York 10017  
[International]