

IBM

A Programmer's Introduction
to IBM System/360
Assembler Language

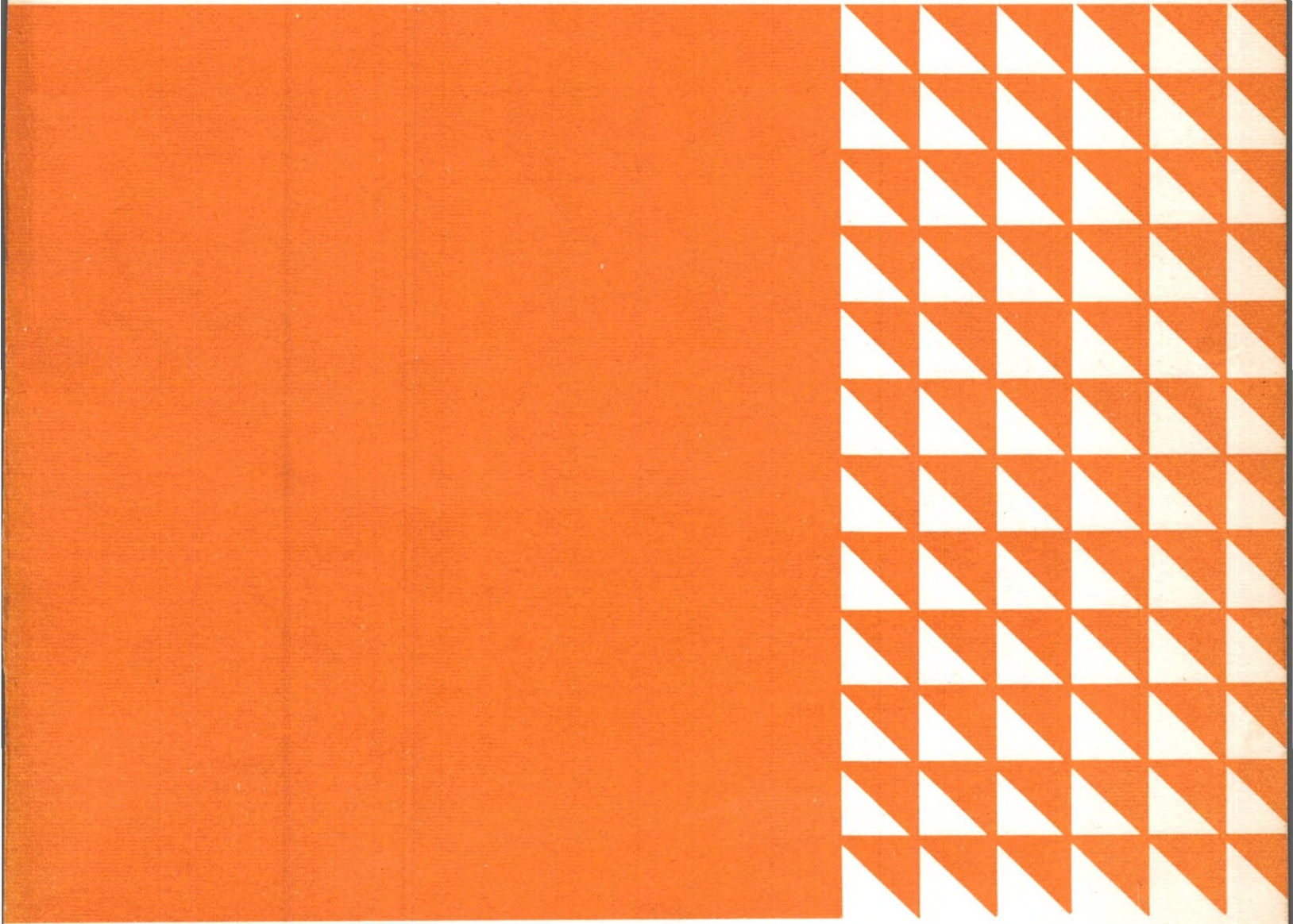

Student Text





A Programmer's Introduction
to IBM System/360
Assembler Language

Student Text

MAJOR REVISION (July 1969)

This edition, C20-1646-5, is a major revision and obsoletes all preceding editions of C20-1646, previously titled *A Programmer's Introduction to the IBM System/360 Architecture, Instructions, and Assembler Language*. The text and program examples have been revised throughout to bring them up to date and in line with current programming conventions. In addition, significant new material appears in Chapters 1, 2, 6, 7, 8, and 9. Chapter 2 contains selected material from the original chapters on System/360 architecture, automatic interrupts, and number systems. Useful reference material is given in the Appendix, and an index is included.

Requests for copies of IBM publications and forms should be made to the IBM branch office serving your locality.

A form for readers' comments is provided at the back of this publication. If the form has been removed, comments may be addressed to IBM Corporation, DPD Education Development, Education Center, Endicott, New York 13760.

This student text is an introduction to System/360 assembler language coding. It provides many examples of short programs shown in assembled form. Some elementary programming techniques and the specific instructions illustrated in the programs are discussed in simple, relatively nontechnical terms. Much of the text is based on information in *IBM System/360 Principles of Operation* (A22-6821). This includes a brief review of relevant System/360 concepts and descriptions of selected assembler language instructions for arithmetic, logical, and branching operations. Standard (fixed-point), decimal, and floating-point arithmetic are discussed. The book also includes an elementary introduction to assembler language and the assembler program, and chapters on base register addressing and on program linkages and relocation. The coding of many other common programming techniques, such as the use of branches, loops, and counters, is shown. The use of macro instructions is demonstrated, but not covered in detail. Program flowcharting and input/output operations are beyond the scope of the book.

The publication is a sampler rather than a comprehensive textbook. It is intended for supplementary reading for the student in a regular course of study on System/360 assembler language coding, and for the novice programmer. In general, the reader will find that the program examples are quite simple at the beginning of each chapter, or major subject division, and become progressively more complex. If the going seems difficult, it is suggested that he simply skip to the next subject and come back later.

The student should have access to two IBM System/360 System Reference Library (SRL) manuals for reference purposes: the *Principles of Operation* and the assembler specification manual for one of the System/360 operating systems. (All publications and their form numbers are listed at the end of the Preface.) He should also be familiar with fundamental concepts of data processing and the basic operating principles of System/360. Two IBM programmed instruction (P.I.) courses, or their equivalent, are prerequisite to a full understanding of this student text:

Computing System Fundamentals and *Introduction to System/360*. The student who is not enrolled in a comprehensive programming course will find the P.I. book *Fundamentals of Programming* a valuable guide to problem analysis and program flowcharting.

The text and programs of this book have been revised throughout, mainly to reflect changes in programming conventions attributable to the development of System/360 operating systems. Chapter 1 is new, and several sections in other chapters have been entirely rewritten. The sample programs have been reassembled under the widely used Disk Operating System (DOS). As far as possible, usages limited to DOS have been avoided, and the programs and text in general are applicable to System/360 models 25, 30, 40, 50, 65, and 75, under any of the operating systems.

IBM publications that may be useful to the student are:

IBM System/360 Principles of Operation (SRL manual A22-6821)

IBM System/360 Reference Data (card X20-1703)

IBM System/360 System Summary (SRL manual A22-6810)

Number Systems (Student Text C20-1618)

Introduction to IBM System/360 Architecture (Student Text C20-1667)

Introduction to System/360 (P.I. Course R29-0256 through -0259)

Computing System Fundamentals (P.I. Course R29-0241 through -0249)

Fundamentals of Programming (P. I. Course R29-0019)

System/360 Assembler Language Coding (P. I. Course R29-0231 through -0235)

The form numbers of the assembler specification manuals for the various System/360 programming systems are:

Basic Programming Support (Tape System)—C24-3355

Basic Operating System—C24-3361

Tape Operating System } C24-3414

Disk Operating System } C24-3414

Operating System—C28-6514

Contents

Chapter 1: Introduction	1	An Example	52
What Is Assembler Language?	1	More than One Base Register	54
Machine Language	1	Separate Base Registers for Instructions and Data	56
Assembler Language	1	Questions and Exercises	58
Why Learn Assembler Language?	4		
The Assembler Program	5	Chapter 5: Decimal Arithmetic	60
The System Environment	5	Addition and Subtraction in Decimal	61
Functions of the Assembler	5	Decimal Multiplication	63
Final Processing	6	Decimal Division	64
Use of the Coding Form	7	Shifting of Decimal Fields	66
An Assembler Language Program	9	Shifting to the Right	66
Writing the Program	9	Shifting to the Left	67
The Assembly Listing	10	Decimal Division with Shifting	68
Error Analysis by the Assembler	12	Format and Base Conversions	69
Modifying an Assembler Language Program	15	Decimal Comparison: Overtime Pay	71
		The Social Security Problem in Decimal	72
Chapter 2: System/360 Review	17	The "Indian" Problem	73
Main Storage	17	Questions and Exercises	74
Bytes and Data Field Lengths	17		
Addressing	18	Chapter 6: Logical Operations on Characters and Bits	75
Positioning on Integral Boundaries	18	Alphameric Comparison: An Address Sort	76
Central Processing Unit	19	Logical Tests	78
General and Floating-Point Registers	19	The Wallpaper Problem	78
Arithmetic and Logical Unit	19	Setting Bits On and Off	79
Program Execution	23	A Self-Checking Number Routine	80
Sequential Instruction Execution	23	A Final Example	82
Branching	23	Questions and Exercises	84
Instruction Format	23		
Generation of Main Storage Addresses	24	Chapter 7: Edit, Translate, and Execute Instructions	85
Interruptions and the Program Status Word	25	The Edit Instruction	86
Hexadecimal Numbers	26	The Edit and Mark Instruction	91
Hexadecimal Code	26	The Translate Instruction	92
Hexadecimal Number System	26	How it Works	92
		An Example	93
Chapter 3: Fixed-Point Arithmetic	29	The Translate and Text Instruction and the Execute	
Addition and Subtraction	29	Instruction	97
Multiplication	32	An Assembler Application of Translate and Test and	
Multiplication and Division with Decimal Points	34	Execute	100
Shifting and Data Manipulation	37	Processing Variable-Length Blocked Records	102
Branches and Decision Codes	39	Questions and Exercises	105
The Condition Code	39		
A Sorting Procedure	39	Chapter 8: Subroutine Linkages and Program	
Further Decisions: The Social Security Problem	42	Relocation	107
Simple Loops: Finding a Sum	45	Subroutine Linkages	108
Case Study: Averaging a List of Temperatures	48	Standard Linkage Registers	111
Questions and Exercises	50	Program Relocation	115
		The Linkage Editor	115
Chapter 4: Programming with Base Registers and the		The CALL and PDUMP Macros	116
USING Instruction	51	Reading a Dump	117
The USING Instruction	51		

Communication between Separate Programs	120	Appendix	139
Questions and Exercises	124	System/360 Machine Instructions	139
Chapter 9: Floating-Point Arithmetic	125	Condition Code Settings	140
Floating-Point Numbers	126	Extended Mnemonic Codes	140
Floating-Point Instructions	130	EBCDIC Chart	140
Questions and Exercises	134	System/360 Assembler Instructions	142
		Types of Assembler Language Constants	142
Answers to Questions and Exercises	135	Index	143

FIGURES

Assembly Listings of Programs

1-2	PROGA	The program in Figure 1-1	3
1-5	PROGC	The program rewritten with deliberate errors	12
1-7	PROGB	The same program modified to store the binary contents of register 6	15
3-2	STOCK	The program in Figure 3-1	30
3-5	GROSS	A program to perform binary (fixed-point) multiplication	32
3-9	INTA	A program involving binary multiplication and division with the result rounded off	34
3-10	INTB	A different version of the program of Figure 3-9, using a scale modifier for constants	35
3-11	SHIFTA	A program to separate three quantities stored in one fullword	37
3-12	SHIFTB	Modified version of the program of Figure 3-11, making it operate correctly with negative quantities	38
3-15	SORT	A program to carry out the sorting procedure charted in Figure 3-14	41
3-18	FICA1	A program based on the flowchart in Figure 3-17	43
3-19	FICA2	A much better version of the program to calculate Social Security tax	44
3-20	SUMA	First version of a program to form the sum of 20 numbers	45
3-21	SUMB	Second version of program to form the sum of 20 numbers	46
3-22	SUMC	Third and shortest version of program to form the sum of 20 numbers, using the BXLE instruction	47
3-23	AVGTEMP	A program to compute average monthly temperature, which takes into account the possibility of omitted readings	48
4-1	PROGE	A program to show how the assembler calculates and supplies addresses of all storage operands	52
4-3	PROGF	An incomplete program with an Origin (ORG) assembler instruction to simulate a length of over 4096 bytes, thus requiring two base registers	54
4-4	LOOPA	Program with separate base registers for processing and data, showing how a base register can be used to provide indexing for loop control	56
5-3	STOCK1	The decimal arithmetic program in Figure 5-2	61
5-5	INTC	A program that performs decimal multiplication; step-by-step results to be expected during execution are shown in the comments field	63
5-6	AVG	Assembled program showing decimal division and "shifting"; step-by-step results to be expected during execution are included in the comments field	68
5-7	CONVERT	Assembled program showing various instructions for changing the format of data; contents of registers 5 and 6 to be expected during execution are given in the comments field	69
5-8	OTPAY	Assembled program that computes a man's gross pay, including any overtime pay, in decimal arithmetic; results expected during execution are shown in the comments field	71
5-9	FICA3	Assembled program to calculate Social Security tax in decimal arithmetic; results expected during execution are shown in the comments field	72
5-10	INDIAN	Assembled program to compute compound interest, with counting in binary and calculations in decimal arithmetic	73
6-1	SORTABC	A program to sort three 13-character items into ascending sequence on keys in the middle of each item	76

6-3	ACCTNO	A self-checking account number routine that recalculates a check-digit and verifies it	80
6-6	FORMAT	A program that checks a decimal field at NUMBER for validity and converts a composite field at COMB into separate binary and packed decimal quantities	83
7-14	SORTABC2	A program to sort three fields named A, B, and C into ascending sequence on file-character keys in each field	95
7-16	MAILLIST	A program to print names and addresses	98
7-18	ASSMBLR	A program to break down the operands of an assembler language instruction into its constituent parts, using TRT and EX	101
7-19	VARBLK	A program to prepare for printing a series of variable-length blocked records, each consisting of four fields	103
8-1	LINK1	Listing of a single program that consists of a main, or calling, routine and a subroutine	108
8-3	LINK2	The program of Figure 8-1 modified to give the subroutine a choice between two return points	109
8-5	LINK3	A program with a subroutine that averages a series of numbers	112
8-7	LINK4	A slightly different version of the program in Figure 8-5, modified by use of two macro instructions, CALL and PDUMP	116
8-11	MAIN1	The same main program assembled separately; the EXTRN assembler instruction and the Load macro have been added	120
8-12	SUBR	The same subroutine assembled separately; the START and ENTRY assembler instructions and the PDUMP macro have been added	121
9-7	SHORTFP	Assembly listing of a program to perform simple computations in short floating-point arithmetic	131
9-9	LONGFP	Assembly listing of the same program as in Figure 9-7, modified to perform all computations in long floating-point arithmetic	133

Other Figures Useful for Reference

1-1	An assembler language program as prepared by the programmer	2,7
1-3	Assembly of a problem program, PROGA	5
1-6	Assembly listing of diagnostic error messages for the program in Figure 1-5	13
2-1	Sample data formats	17
2-2	Integral boundaries for halfwords, words, and doublewords	18
2-3	Functions of the central processing unit	19
2-4	General and floating-point registers	19
2-5	Fixed-point number formats	20
2-6	Packed decimal number format	20
2-7	Zoned decimal number format	21
2-8	Short and long floating-point number formats	21
2-9	Fixed- and variable-length logical information	21
2-10	Machine instruction formats	24
3-14	Program flowchart of a method of sorting three numbers into descending sequence	40
3-17	Program flowchart of a procedure for computing Social Security tax	42
4-2	Symbol cross-reference table constructed and listed by the assembler	53
5-1	Formats of packed and zoned decimal numbers	60
6-4	Alphabetic input for COMB that can be viewed as two numbers: 12345678 and binary 11001010	82
6-5	A flowchart of the steps required to solve the problem	82
7-1	Results of Editing source data in left-hand column	86
7-2	Editing results with an asterisk as the fill character	87
7-3	Editing results with blank fill and the insertion of commas	87
7-4	Editing results with blank fill and the insertion of comma and decimal point	87
7-5	Editing results with blank fill, comma and decimal point insertion, and significance starter	88
7-6	Editing results with blank fill, comma and decimal point insertion, significance starter, and CR symbol for negative numbers	89
7-7	Same with asterisk fill	89
7-8	Editing results showing the blanking of zero fields by the use of two additional instructions	89
7-9	Same with zero fields filled with asterisks	89

7-10	Examples of multiple edits	90
7-11	Examples of the application of the Edit and Mark instruction to get a floating currency symbol	91
7-12	Baudot teletypewriter code	92
7-13	Table for translation of Baudot code to EBCDIC	93
8-8	Hex dump of registers and storage produced by execution of the PDUMP macro in the program in Figure 8-7	117
8-9	Hex dump of the program (Figure 8-7) loaded at 3000	118
8-10	Hex dump of the program (Figure 8-7) loaded at 4000	118
8-13	First dump produced by the subroutine in Figure 8-12, SUBR	122
8-14	Second dump produced by the subroutine in Figure 8-12, SUBR	122
8-15	Dump produced by the main program in Figure 8-11, MAIN1	122
9-1	Assembly listing of decimal integers specified as short floating-point constants	127
9-2	A listing of the same examples as in Figure 9-1, showing them in the comments field in a form that is easy to read	128
9-3	The same values shown as negative numbers	128
9-4	Some fractional and mixed decimal numbers expressed as short floating-point constants	129
9-5	Some long floating-point constants	129
9-6	Some decimal values with exponents expressed as floating-point constants	129

TABLES

2-1	Extended Binary Coded Decimal Interchange Code (EBCDIC) for Graphic Characters	22
2-2	Hexadecimal Code	26
2-3	Hexadecimal and Decimal Integer Conversion Table	27
3-1	Masks for testing various states of the condition code	39
7-1	Summary of Editing Functions	88
8-1	DOS Linkage Registers	111
9-1	Equivalent Values of the Characteristics of Some Floating-Point Numbers	127
9-2	Instruction Set for the System/360 Floating-Point Feature	130



WHAT IS ASSEMBLER LANGUAGE?

Machine Language

A computer is a willing servant. It will invariably and reliably do exactly what it is told to do, as long as it is told in its own language. This is true of any computer. Let's take a quick look at the language that System/360—the machine itself—understands.

If an IBM System/360 computer is given the instruction 1B67, it will subtract whatever amount is in register 7 from the amount in register 6. When the operation is finished, the contents of register 7 will be the same as they were originally, but the contents of register 6 will be the difference between the two original quantities. The code 1B signifies to the computer (1) just what operation it is to perform, (2) what format it can expect the two quantities to be in, and (3) whether they are in registers or in main storage. Specifically, 1B indicates that the computer is to subtract two 32-bit binary numbers, both of which are in registers. The two quantities to be operated on are called *operands*. The one that is written first is called the first operand and in this case is in register 6. The second operand is in register 7.

The instruction 1B67 is in *machine language*. It is a representation in the hexadecimal number system (base of 16) of the actual binary arrangement in the computer. The computer responds to it in a particular way because its circuitry has been designed to do so whenever it senses this combination of signals.

Let's take another example of a machine language instruction, say 5A20B02A. The *operation code* 5A causes the computer to add two 32-bit binary numbers (the first in a register and the second in main storage) and to place the result in the first operand location. In this case, the first operand is in register 2, and the second operand is in main storage, beginning at the location designated by 0B02A.

Not many years ago all programs were written in machine language. The most valuable tool the programmer had was an eraser. He was concerned with an enormous amount of clerical detail. He had to remember dozens of numerical codes for the computer operations and try not to make a mistake when using them. He had to keep track of the storage space he used for instructions, data, and work areas, and actually calculate any addresses he needed to refer to in his program. Revising a program (a very frequent occurrence then, as it is now), often meant changing every address that followed the revisions. All this detail meant many errors and much time spent on checking, calculating, keeping tables, and other clerical tasks.

Assembler Language

The realization that the computer itself was better suited than man for doing this type of clerical work led to the development of assembler languages (each computer has its own assembler language). In System/360 assembler language, every operation code is written in alphabetic letters that are easy to remember, called mnemonics, and the addresses of locations in storage can be given symbolic names like PAY, HOURS, and RATE by the programmer. The machine language instruction 1B67 would be written in assembler language as SR 6,7 (SR for Subtract Register). The instruction 5A20B02A might be A 2,CON (A for Add), with another instruction to define CON as a certain value. We do not have to say where it is—the computer will take care of that. An assembler language program as prepared by a programmer is shown in Figure 1-1. The operations to be performed start in column 10, the operands in column 16.

As we said at the beginning, however, the computer cannot understand any language except its own machine language. Therefore, a *program* that translates our symbolic program into machine language or *object code* is needed. Such a program, actually a component part of an IBM System/360 operating system, is brought from the system "library" into a separate area in main storage when needed, and it does the job. This program is called an *assembler*. Besides translating the problem program statements into machine language, it calculates storage locations for all instructions, keeps track of any symbols like CON that are used, and performs a number of other necessary functions. The program written by the programmer is not executed during the assembly process; it will be executed later, after further processing. Figure 1-2 shows the listing produced by the assembler for our sample program.

Machine Instructions

All the columns to the left of the statement number (STMT) column are in machine language. The LOC, ADDR1, and ADDR2 columns have to do with address arithmetic handled by the assembler, and will be discussed later. The heart of our program has been translated into the code headed OBJECT CODE. The circled area at the left contains the code for every *executable* instruction in the entire program. What we mean by an executable instruction is one that, when the problem program is run, will tell the computer to perform an actual operation in the machine itself. Each of the executable instructions has a corresponding System/360 machine operation code; these operation codes

PROGRAM		PUNCHING INSTRUCTIONS		GRAPHIC		PAGE OF	
PROGA							
PROGRAMMER		DATE		PUNCH		CARD ELECTRO NUMBER	
J. J. JONES							
STATEMENT							
Name	Operation	Operand	Comments	Identification-Sequence			
	TITLE	'ILLUSTRATIVE PROGRAM'					
PROGA	START	256					
BEGIN	BALR	11,0					
	USING	*,11					
	L	2,DATA	LOAD REGISTER 2				
	A	2,CON	ADD 10				
	SLA	2,1	THIS HAS EFFECT OF MULTIPLYING BY 2				
	S	2,DATA+4	NOTE RELATIVE ADDRESSING				
	ST	2,RESULT					
	L	6,BIN1					
	A	6,BIN2					
	CVD	6,DEC	CONVERT TO DECIMAL				
	EOJ		END OF JOB				
DATA	DC	F'25'					
	DC	F'15'					
CON	DC	F'10'					
RESULT	DS	F					
BIN1	DC	F'12'					
BIN2	DC	F'78'					
DEC	DS	D					
	END	BEGIN					

Figure 1-1. An assembler language program as prepared by the programmer

are represented by the first two characters (the first two hexadecimal numbers, really) in the circled object code. In the example, the executable instructions include one of the branching instructions (BALR, op code 05), Load (L, op code 58), Add (A, op code 5A), one of the Shift Left instructions (SLA, op code 8B), Subtract (S, op code 5B), Store (ST, op code 50), and so on. In assembler language, the executable instructions are called *machine instructions*.

Not counting floating-point arithmetic instructions, System/360 assembler language has about 100 different machine instructions. It is fairly easy to recognize and remember all of the mnemonics for them—certainly easier than remembering the machine language operation codes. Some other examples are C for Compare, CVD for Convert to Decimal, SH for Subtract Halfword, STH for Store Halfword, M for Multiply, and BC for Branch on Condition. A full list of System/360 machine instructions appears in the Appendix; floating-point instructions are given in the chapter on that subject. Each machine instruction and what it does is described in complete detail in the IBM Systems Reference Library (SRL) manual *IBM System/360 Principles of Operation* (A22-6821). Many will be described in this book in nontechnical language, but not in complete detail.

Assembler Instructions

What about the TITLE, START, and USING instructions that have not generated any object code in the assembly

listing in Figure 1-2? The mnemonic TITLE does not even show up at all (it was in the source program), but we see that the assembly listing has the heading ILLUSTRATIVE PROGRAM. TITLE is an instruction to the assembler that tells it to print a heading or title at the top of each page in the listing. Similarly, START and USING are instructions to the assembler; these concern the addressing plan it is to follow. Although they will affect the way in which the assembler assigns addresses, they will have no direct function in the execution of the problem program. In contrast to machine instructions, they are called *assembler instructions*. They may be defined as instructions to the assembler program itself.

Skipping the EOJ for the moment, we see the mnemonics DC (Define Constant) and DS (Define Storage). These two instructions are also assembler instructions. DC's generate object code for the values they define, but no operation codes. DS's actually reserve storage space of a specific size, but they too do not generate operation codes. In other words, DC's cause the assembler to create object code for actual values and DS's reserve actual storage spaces, but they do not themselves give rise to any action during program execution. Instead, they are used for either information or space by other instructions in the program. If we look again at the assembly listing, we see that DATA, CON, RESULT, etc., are operands of some of the executable instructions.

Assembler-instruction mnemonics, which are also listed

ILLUSTRATIVE PROGRAM		Machine instructions in machine language				Machine instructions in assembler language	
LOC	OBJECT CODE	ADDR1	ADDR2	STMT	SOURCE STATEMENT		
000100				2	PROGA	START 256	
000100	05B0			3	BEGIN	BALR 11,0	
000102				4		USING *,11	
000102	5820 B022		00124	5		L 2,DATA	LOAD REGISTER 2
000106	5A20 B02A		0012C	6		A 2,CON	ADD 10
00010A	8820 0001		00001	7		SLA 2,1	THIS HAS EFFECT OF MULTIPLYING BY 2
00010E	5820 B026		00128	8		S 2,DATA+4	NOTE RELATIVE ADDRESSING
000112	5020 B02E		00130	9		ST 2,RESULT	
000116	5860 B032		00134	10		L 6,BIN1	
00011A	5A60 B036		00138	11		A 6,BIN2	
00011E	4E60 B03E		00140	12		CVD 6,DEC	CONVERT TO DECIMAL
				13		EOJ	END OF JOB
				14**	360N-CI-453	EOJ	CHANGE LEVEL 3-0
000122	0A0E			15+		SVC 14	
000124	00000019			16	DATA	DC F'25'	
000128	0000000F			17		DC F'15'	
00012C	0000000A			18	CON	DC F'10'	
000130				19	RESULT	DS F	
000134	0000000C			20	BIN1	DC F'12'	
000138	0000004E			21	BIN2	DC F'78'	
000140				22	DEC	DS D	
000100				23	END	BEGIN	

Figure 1-2. Assembly listing of the program in Figure 1-1. The executable instructions (see text) are circled in both assembler language and the machine language translation.

in the Appendix, generally suggest their purpose. USING indicates a particular register to be used by the assembler for keeping track of storage addresses, EJECT tells the assembler to start a new page in the program listing, and END to terminate the assembly program. Assembler instructions and the functions of the assembler program are described fully in each of the SRL assembler language manuals for the various IBM operating or programming support systems (see Preface for list). It should be explained that variations of the System/360 assembler program are available for different operating systems and sizes of computers. Basically, they all work similarly, but some are more flexible and versatile than others. Many differences do exist, however, in the input/output (I/O) programming for different systems. Largely for this reason, the subject of I/O will not be covered in this book.

Macro Instructions

In an entirely different category, System/360 assembler language includes another type of instruction, called a *macro instruction* or macro. If a programmer writes a series of instructions for a routine that will be needed again and again during the program, he does not have to code the entire sequence each time. He can make up his own code name to represent the sequence, and, by using his code word in a single statement whenever it is needed, he can cause the sequence of instructions to be assembled and inserted. Incorporated in the system library, the sequence can also be used in entirely separate programs and by all programmers associated with a computer installation simply by writing one statement in the source program. The mnemonics used for macro instructions are often unique to an installation. Some macros are prepared and supplied by IBM;

they have mnemonics like EOJ, READ, WRITE, OPEN, CLOSE, WAIT, WAITF, DTFCD, DTFIS, etc. The mnemonics for both the user-prepared and the IBM-supplied macros constitute an extension to System/360 assembler language.

The macros supplied by IBM are mainly for procedures that affect other components of the IBM operating system, like the supervisor and the input/output control system, and they ensure accuracy and consistency in maintaining the interrelations within the operating system. The EOJ (End of Job) in the program example is a supervisor macro instruction. It generates just two statements, which are indicated in the listing by plus signs. The first is simply for identification, and the second is the executable Supervisor Call instruction (SVC, op code 0A).

Most I/O routines are long and complicated, and for any particular device and operating system are programmed in exactly the same way in program after program. Most of the macros supplied by IBM are for these I/O routines. Some of the Disk Operating System (DOS) macro instructions we shall use in this book, besides EOJ, are CALL, SAVE, RETURN, and PDUMP. The book does not cover the preparation of new macros, but shows, in the chapter on subroutines, another method for reusing a sequence of instructions. However, the programmer can save much time and effort by using the macros that are already available in his system library. Their use will also ensure accuracy and standardization of frequently repeated procedures.

Summary

To summarize, these are the three kinds of instructions used in System/360 assembler language, and what each does:

1. A *machine instruction* specifies an actual operation

to be performed by the computer when the object program is executed. The operation may be arithmetic, or the comparison, movement, or conversion of data, or performing a branch. The instruction generates executable object code.

2. *An assembler instruction* specifies an instruction to the assembler program itself and is effective only at assembly time. It does not generate executable object code.

3. *A macro instruction* specifies a sequence of machine and assembler instructions to perform a frequently needed routine. The machine instructions generate executable object code.

Why Learn Assembler Language?

The most important single thing to realize about assembler language is that it enables the programmer to use all System/360 machine functions as if he were coding in System/360 machine language. Of all the programming languages, it is closest to machine language in form and content. The high-level languages such as FORTRAN, COBOL, and PL/I are problem-oriented rather than machine-oriented. Their languages are much like English or mathematical notation. Depending on what is involved, one statement in these languages may be compiled into a series of two or eight or fifty machine language instructions. The problem-oriented languages have the advantage of letting the programmer concentrate on what he wants to accomplish and not on how it is to be done by the computer, and they may save considerable time in programming, program modification, and program testing. Choice of a programming language in any given situation usually involves weighing the cost of

programming time against the cost of machine time. A complex mathematical problem that can be run in a few minutes and will be run only once is a very different situation from a program that runs for several hours and will be repeated every week.

Here we can appreciate one of the important advantages of assembler language over the high-level languages: its efficient use, in the hands of a skillful programmer, of computer storage and time. High-level languages produce generalized routines so that a wide range of data processing needs can be met with a minimum of programming effort. A routine can be written in assembler language exactly to fit some particular data processing need, thus saving storage space and execution time.

As we shall see in the course of this book, there are often many ways of accomplishing the same data processing results. Sometimes the overall programming requirements of a computer installation strain its capacity. If the particular problem arises of either not enough main storage space or not enough processing time, the problem may be solved by assembler language. In such a situation, its flexibility permits the programmer to choose those programming techniques that will provide just the kind of economy needed—time or space.

A knowledge of assembler language has some important benefits for a programmer working in a high-level language. It can be helpful to him in analyzing and debugging programs. It also enables him to include certain assembler language routines in his program to meet special systems or other requirements.

THE ASSEMBLER PROGRAM

The System Environment

As a first step in the assembly process, the handwritten problem program has to be put into a form that can be read by the computer system. Punched cards are frequently used; they are convenient and easy to substitute in case of error. The program is punched by a keypunch operator, each line on a separate card. The original program and these cards are called the *source program*, or the cards may be called the *source deck*. The assembler program is loaded into main storage and executed, using the source deck as input.

It is important to realize that the basic function of the assembler is to translate the source program. It does not execute the program. The final output of the assembler program is called the *object program*. It contains the machine language equivalent of the source program, and is put on cards, tape, or disk by a system output device. It is this object program that will later be subjected to further processing and will itself be executed. The assembler output also includes several listings to aid the programmer, which are produced by a line printer. Figure 1-3 shows the assembly process in outline.

Before going into detail about the functions of the assembler, it may be helpful to look at the overall system environment into which a programmer-written problem program goes. As we already know, the assembler program is a component of the IBM operating system. It functions under the control of another, very important component, the control program. (To avoid confusion in terminology, perhaps it should be mentioned that the control program is often referred to as the control system. The supervisor is one element of the control program, and the most powerful. The job control program is another element.)

The System/360 control program is, in effect, a traffic director. It supervises the movement of data, the assignment of all the devices attached to the system, and the scheduling of jobs. Working under a set of priorities for various kinds of situations, it handles the flow of operations in the central processing unit (CPU), with the aim of keeping it constantly busy and the entire system at its most productive level. The control program sees to it that needed IBM processing programs, like the assembler program and the linkage editor program, are brought from the system library and loaded into main storage at the right time. These two kinds of programs combined—that is, the control program and the processing programs—make up what is called the *IBM operating system* (or, for smaller installations, the *IBM programming support system*). With an operating system at work, the programmer is relieved of practically all concern about having on hand for either processing or execution of his problem program the system resources available at his installation.

Functions of the Assembler

During execution of the assembler program, the assembler scans the source program statements a number of times. Its first activities are to process any macro instructions it finds, and to store the complete sequences of individual instructions generated by the macros. They are then standing by, ready to be inserted into the assembled problem program at the points indicated by the programmer. Afterwards, the assembler proceeds to translate the one-for-one assembler language statements into machine instructions.

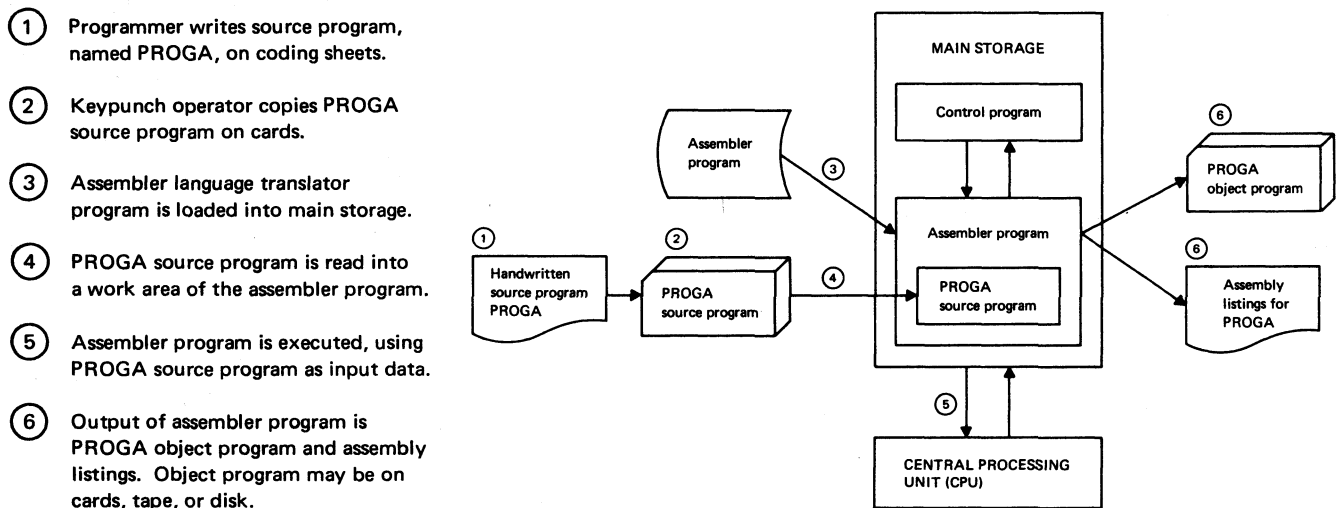

Figure 1-3. Assembly of a problem program, PROGA. Note that PROGA is not executed during the assembly process.

Briefly, here is how the assembler works. It reads source statements as input data, checking for errors and flagging them for further processing. At first, it translates the parts of the input (such as operation codes) that do not need further analysis or calculation. Meanwhile, it constructs a table of all the symbols used, in which it collects, as it goes along, such information as each symbol's length, its value or location, and the statements in which it is referred to. From this table and other analyses of the source statements, the assembler can then assign relative storage addresses to all instructions, constants, and storage areas. It uses a location counter for this purpose (see LOC column in Figure 1-2). It does all the clerical work involved in maintaining the base register addressing scheme of System/360 computers. During its operations, the assembler continues to note errors and to resolve any it can.

As shown in Figure 1-3, there are two kinds of output from the assembler program. The primary output is the object program in machine language; included with it is certain information tabulated by the assembler, which is needed for relocating the program to an actual main storage location and for establishing links with separate programs. (This information will later be passed on to the linkage editor for the next step in the processing.) The other output from the assembler is a series of printed listings that are valuable to the programmer for documentation and analysis of his program:

1. The listing of the program (samples of these will be shown throughout this book) includes the original source program statements side by side with the object program instructions created from them. Most programmers work from this assembly listing as soon as it is available, hardly ever referring to their coding sheets again.

2. Probably next in interest to the programmer is the diagnostics listing, which cites each statement in which an error condition is encountered and includes a message describing the type of error.

3. The cross-reference listing shows the symbol table compiled by the assembler.

4. The external symbol dictionary (ESD) describes any references in the problem program needed for establishing links with separate programs. It is possible for the programmer to combine his program with others, or to use portions of separate programs, or to make certain portions of his program available to other programs. The ESD is part of the tabular information passed on to the linkage editor.

It always contains at least the name of the problem program, its total length, and its starting address on the assembler's location counter.

5. The relocation dictionary (RLD) describes the address constants that will be affected by program relocation. This list is also passed on to the linkage editor.

We have now reached the end of the assembly process. What happens next? Our object program is in relocatable form, but it will not be executable until it has been processed by the linkage editor.

Final Processing

The *linkage editor* program is another component of the IBM operating system. Its functions, which will not be described fully here, can provide great flexibility and economy in the use of main storage. The linkage editor also makes it possible for a long and complicated program to be divided into separate sections, which can be programmed, assembled, and debugged by different programmers, and then linked together to be executed. The linkage editor is loaded into main storage and operates as a separate program under control of the control program, just as the assembler did. Input to the linkage editor may be a single assembled program or many separate programs. The linkage editor works on one after the other, building up composite dictionaries of ESD and RLD data to resolve all references between individual programs and to set up necessary linkages. It also searches the system library and retrieves any programs referred to. It relocates the individual programs as necessary in relation to each other, assigns the entire group to a specific area of main storage, and modifies all necessary address constants to the relocated values of their symbols.

After completion of the link-editing, our problem program can be loaded into main storage and executed under supervision of the control program. Unless specified otherwise, each machine instruction is executed in sequence, one after the other. If there is separate input data, it can be brought in by I/O instructions in the program. Output—the results of program execution—also requires I/O instructions.

The scope of this book does not go beyond the assembly process. For a clear understanding of the detailed program examples, however, it is essential for the reader to be able to visualize at just what stage in the entire process each action occurs. For this reason, the complete process from programmer-written program to its final execution has been outlined in this section.

USE OF THE CODING FORM

Assembler language programs are usually written on special coding forms like the one in Figure 1-1, which will be repeated here for convenience. Space is provided at the top for program identification and instructions to keypunch operators, but none of this information is punched into cards.

The body of the form is completely keypunched in corresponding columns of 80-column cards. Use of the Identification-Sequence field (columns 73 - 80) is optional and has no effect in the assembled program. Program identification and statement sequence numbers can be written in part or all of the field. They are helpful for keeping the source cards in order and will also appear on the assembly listing. Indeed, the programmer can use an assembler instruction (ISEQ) to request the assembler to check the input sequence of these numbers.

The statement field is for our program instructions and comments, which are normally limited to columns 1 - 71. Each statement can be continued on one or more lines, depending upon which assembler program is used. A statement consists of:

1. A name entry (sometimes)
2. An operation entry (always)
3. An operand entry (usually)
4. Any comment we wish to make

It isn't necessary to use the spacing shown on the form, since

the assembler permits nearly complete freedom of format. However, lining up entries as shown makes it simpler to read a program, and following the form permits the programmer to painlessly observe the few essential rules required by the assembler.

Some of these rules are as follows. (1) The entries must be in proper sequence. (2) If a name is used, it must begin in column 1. (3) The entries must be separated by at least one space, because a space (except in a comment or in certain terms enclosed in single quotes) is the signal to the assembler that it has reached the end of an entry. (4) Spaces must not appear within an entry, except as noted. (5) A statement must not extend beyond the statement boundaries, normally columns 1 - 71.

We have been using that word "normally" because the programmer can override the specific column designations by an ICTL (Input Format Control) assembler instruction, which can specify entirely different begin, end, and continuation columns. A statement is normally continued on a new line in column 16, with some character (often an X) inserted in column 72 of the preceding line. Since the normal spacing is generally the most convenient and is easiest for a keypunch operator to follow, we shall use the spacing indicated on the form throughout this book.

The purpose of using a name in a statement is to be able to refer to it elsewhere. It is a symbol of eight characters or

Name	Operation	Operand	STATEMENT	Comments	Identification-Sequence
IBM IBM System/360 Assembler Coding Form X28-6509					
PROGRAM PROGA		DATE		PUNCHING INSTRUCTIONS	PAGE OF
PROGRAMMER J. J. JONES				GRAPHIC PUNCH	CARD ELECTRO NUMBER
PROGA	TITLE	'ILLUSTRATIVE PROGRAM'			
BEGIN	START	256			
	BALR	11,0			
	USING	*2,11			
	L	2,DATA	LOAD REGISTER 2		
	A	2,CON	ADD 10		
	SLA	2,1	THIS HAS EFFECT OF MULTIPLYING BY 2		
	S	2,DATA+4	NOTE RELATIVE ADDRESSING		
	ST	2,RESULT			
	L	6,BIN1			
	A	6,BIN2			
	CVD	6,DEC	CONVERT TO DECIMAL		
	EQJ		END OF JOB		
DATA	DC	F'25'			
	DC	F'15'			
CON	DC	F'10'			
RESULT	DS	F			
BIN1	DC	F'12'			
BIN2	DC	F'78'			
DEC	DS	D			
	END	BEGIN			

Figure 1-1. An assembler language program as prepared by the programmer

less, created by the programmer. It may identify a program, a location in storage, a specific value, or a point in the program to which the programmer may plan to branch. As we know, the assembler compiles a symbol table, keeping track of where each name is defined and where each reference to it appears. These references occur when the name is used as an operand in an instruction.

Each instruction must include an operation entry, which may be a machine, assembler, or macro mnemonic. They are limited to five characters in length (some systems allow longer macro mnemonics) and begin in column 10 of the form.

Operand entries are always required for machine instructions and usually for assembler instructions. They begin in column 16 and may be as long as necessary, up to the maximum statement size the assembler can handle. An operand entry is the coding that identifies and describes the data to be acted upon by the instruction. All operands in a statement must be separated from each other by commas, without blank spaces.

Comments may be used freely, at the programmer's

discretion, to document the purpose of coding or the approach used in the programming. These notes can be helpful during debugging and other phases of program checkout and also during later maintenance of a program. They have no effect in the assembled program, but are only printed in the assembly listing. If a programmer wishes to include extensive notes in the printed record, he can use entire lines just for comments by inserting an asterisk in column 1 of each line. A comment that is part of an instruction statement may begin anywhere beyond the operand entry, provided there is at least one blank space after the operand. Most programmers like to line up all comments in some convenient column for easier reading.

A word of caution may be in order about leaving "illegal" blanks in operand entries. If, in our sample program, we were to write:

```
L 2, DATA LOAD REGISTER 2
```

the assembler, on finding a blank after the comma, would interpret DATA as the first word of the comment and give us an error message MISSING OPERAND.

AN ASSEMBLER LANGUAGE PROGRAM

Writing the Program

Let's look at some of the actual instructions in the program in Figure 1-1. This program does not have any particular task to accomplish; it merely demonstrates the use of some serviceable assembler language instructions. In later chapters, each program example will be prefaced by a clear statement of the problem to be solved, which is good practice, but for now let's just get started.

The TITLE assembler instruction in the first line will cause a heading to be printed on every page of the assembly listing. The heading will be ILLUSTRATIVE PROGRAM, which is written within single quotes as the operand entry.

The START instruction specifies to the assembler what the initial value of the location counter for this program should be. Although zero is the usual practice, we specify decimal 256, which is the equivalent of hexadecimal 100. The assembler assumes in most cases that any numeral we use in an operand is a decimal number, unless specified otherwise. We are also using the START statement to give our program a name, PROGA, which is another good programming practice.

The next two instructions are important ones that will appear in every program. To understand their effect, we had better look at these two statements in the order in which they will actually take effect. During assembly, the USING statement will tell the assembler: (1) that it should use register 11 for address calculations and (2) that the address of the next machine instruction, which is L 2,DATA, will be in register 11 when PROGA is finally executed. To fulfill this promise, the Branch and Link (BALR) will, when PROGA is

executed, actually put the address of the L 2,DATA instruction into register 11. The BALR and USING combination is generally the most efficient way of setting up a register for use as a base register in the System/360 addressing scheme. This subject will be discussed in detail in a separate chapter.

So much for the preliminaries. The body of the program starts with the L 2,DATA instruction. L is the mnemonic for the machine instruction Load, which in this case will place in register 2 the contents of a location in storage that has the symbolic address DATA. Looking down the coding sheet, we see that DATA is in the name field of a DC assembler instruction that defines a constant value of 25, occupying four bytes. The name DATA refers to the address of the first byte; the length is implied by the F, for fullword.

The A 2,CON is a similar type of instruction. It adds to register 2 the contents (that is, the constant value 10) of a fullword that has its first byte at the symbolic location CON.

The next instruction (SLA 2,1) is quite different. SLA stands for the algebraic Shift Left Single. The contents of register 2 are to be shifted left one binary place. There is no symbolic address in this case; the second operand simply indicates the extent of the shift.

The Subtract instruction that comes next (S 2,DATA+4) includes an example of *relative addressing*: the address is given relative to another address. This address is specified as four bytes beyond DATA. Looking at the constant area of the program, we see that four bytes (one fullword) beyond DATA there is indeed another fullword constant, the number 15.

The Store instruction (ST 2,RESULT) specifies that the contents of register 2 are to be placed in a storage area with the symbolic address RESULT. Looking below again, we see RESULT in the name field of a DS for a fullword area. As a machine operation, Store has one somewhat unusual feature. In most System/360 machine instructions, the result of an operation replaces the first operand. In Store, however, the result is stored in the second operand location. The same is also true of CVD, which we shall come to shortly.

The following two statements, the Load and the Add, present no new assembler language concepts. They will form a sum in register 6, in the same way as before.

The Convert to Decimal (CVD) converts the contents of register 6, which are binary, to a decimal number, and stores the result in the eight-byte area beginning at DEC. The operation of the machine instruction CVD requires that this location be a doubleword, aligned on a doubleword boundary. More on this later.

The next instruction, EOJ, is a macro instruction that will, after PROGA has been executed, return control to the supervisor, so that the computer can immediately go on

PROGRAM		PROGA	
PROGRAMMER		J. J. JONES	
DATE			
Name	Operation	Operand	STATEMENT
	TITLE	'ILLUSTRATIVE PROGRAM'	
PROGA	START	256	
BEGIN	BALR	11,0	
	USING	*2,11	
	L	2,DATA	LOAD REG
	A	2,CON	ADD 10
	SLA	2,1	THIS HAS
	S	2,DATA+4	NOTE REL
	ST	2,RESULT	
	L	6,BIN1	
	A	6,BIN2	
	CVD	6,DEC	CONVERT
	EOJ		END OF JO
DATA	DC	F'25'	
	DC	F'15'	
CON	DC	F'10'	
RESULT	DS	F	
BIN1	DC	F'12'	
BIN2	DC	F'78'	
DEC	DS	D	
	END	BEGIN	

with other jobs. EOJ is the last executable (or machine) instruction in our program example.

The DC's and DS's follow the executable part of the program in a group, as is customary. These assembler instructions were discussed earlier in this chapter. Define Storage (DS) is used to define and reserve an area of storage, which may be used during execution of the program for work areas or for storing a varying value. Define Constant (DC) allows us to introduce specific data into a program (a constant simply means an unchanging value).

Each DC and DS must have a *type specification* that designates the particular data format in which it is to be entered into internal machine storage. Some of the data formats are the eight-bit character code (type C), the four-bit hexadecimal code (type X), zoned decimal numbers (type Z), packed decimal numbers (type P), and fixed-point binary numbers (type F or H). A more complete list appears in the Appendix and in the assembler language specification manuals listed in the Preface. In the program at hand and in Chapter 3, where we shall be studying System/360 fixed-point binary operations, however, all the constants are type F or H (the F is for fullword, H for halfword, implying length as well as giving the type).

Fixed-point operations work on fixed-length operands and in most systems require that they be located in storage on halfword, fullword, or doubleword boundaries. In other words, the addresses must be multiples of 2, 4, or 8. When F or H is used to signify the length of a DC or DS (D for doubleword may also be used in a DS), the assembler will perform the necessary alignment, skipping a few bytes if necessary. In our program all the F-type constants and areas will be on four-byte boundaries. The DS at DEC will reserve an eight-byte space, aligned on a doubleword boundary. If the programmer modifies these terms, for example, by specifying 2F instead of D, the assembler will not perform

alignment, and it becomes the programmer's responsibility.

The END assembler instruction specifies that nothing further follows, and it terminates the assembly process. The END instruction must always be the last statement in a source program.

The Assembly Listing

Let's inspect the assembly listing, repeated here as Figure 1-4, to see how the assembler handled things. We see that, except for the TITLE statement, the original source program has been reproduced without change on the righthand side of the listing. The object code created from the source instructions is listed under that heading. The location counter setting of each statement is shown in the leftmost column. The address of the second operand in each instruction is under the heading ADDR2. (All first operands here happen to be in registers.) All entries to the left of the statement number column are in the hexadecimal number system, which is the alphabet, so to speak, of System/360 machine language.

The assembler instructions TITLE, START, USING, and END did not produce any object code, and, as we can see from an inspection of the location counter readings, do not use any space in the object program. The location shown on each of these lines is simply the current setting of the location counter, which, after assembly of each instruction that will use storage space, was updated to show the next available byte.

The START 256 sets the assembler's location counter to hexadecimal 000100, or 100. The object code that is actually at location 100 (in bytes 100 and 101) and will be at the equivalent location in core storage is 05B0, the machine language translation of the BALR instruction. Hex 05 is the BALR operation code, B is register 11 (B is the

ILLUSTRATIVE PROGRAM						
LOC	OBJECT CODE	ADDR1	ADDR2	STMT	SOURCE	STATEMENT
000100				2	PROGA	START 256
000100	05B0			3	BEGIN	BALR 11,0
000102				4		USING *,11
000102	5820 B022		00124	5	L	2,DATA LOAD REGISTER 2
000106	5A20 B02A		0012C	6	A	2,CON ADD 10
00010A	8B20 0001		00001	7	SLA	2,1 THIS HAS EFFECT OF MULTIPLYING BY 2
00010E	5820 B026		00128	8	S	2,DATA+4 NOTE RELATIVE ADDRESSING
000112	5020 B02E		00130	9	ST	2,RESULT
000116	5860 B032		00134	10	L	6,BIN1
00011A	5A60 B036		00138	11	A	6,BIN2
00011E	4E60 B03E		00140	12	CVD	6,DEC CONVERT TO DECIMAL
				13	EOJ	END OF JOB
				14+*	360N-CL-453	EOJ CHANGE LEVEL 3-0
000122	0A0E			15+	SVC	14
000124	00000019			16	DATA	DC F'25'
000128	0000000F			17		DC F'15'
00012C	0000000A			18	CON	DC F'10'
000130				19	RESULT	DS F
000134	0000000C			20	BIN1	DC F'12'
000138	0000004E			21	BIN2	DC F'78'
000140				22	DEC	DS D
000100				23	END	BEGIN

Figure 1-4. Assembly listing of the program in Figure 1-1

hex equivalent of 11), and 0 is register zero (which means, in effect, *no* register and *no* branching). This instruction is in the RR (register-to-register) machine format, which has a length of two bytes and looks like this in storage (contents are shown here in hex rather than binary):

Op Code		Reg ₁	Reg ₂
0	5	B	0
0	7 8	11 12	15

The subscripts 1 and 2 refer, both here and in other instruction formats, to the first and second operands. In the RR format both operands are in registers.

After the BALR was assembled, the location counter read 102, which was the next available byte, and stayed that way until additional object code was generated. USING did not generate object code, so 102 was the setting when the L 2,DATA was assembled. The asterisk in the USING means the *current*, updated location counter setting, which at that point was 102.

The next instruction, Load, is the first that will actually process program data. It is an RX (register-and-indexed-storage) instruction, which has a machine format of four bytes. It occupies bytes 102 to 105:

Op Code	Reg ₁	Index ₂	Base ₂	Displacement ₂			
5	8	2	0	B	0	2	2
0	7 8	11 12	15 16	19 20	31		

In this format, the first operand is in a register, the second in main storage. Reading the assembled bytes from left to right, we have the op code 58 for Load and register 2 for the register to be loaded, and the remaining code gives the address of the second operand. Zero means there is no index register, B (hex for 11) is the base register, and 022 is the displacement in bytes. The effective address, formed by the assembler, is the sum of the contents of the base register (102), the contents of the index register (0 or no register), and the displacement (022). These add up to hexadecimal 124. Looking down to the assembled location of DATA, we see that it is 124, as it should be.

The Add instruction that follows is also in the RX format, and again no index register is used. The base register contents of 102 (258₁₀) plus the displacement of 02A (42₁₀) gives a sum of 12C (300₁₀), which is the location of CON.

(The subscript 10 is used to indicate a number in the decimal system. A subscript of 16 is used for hexadecimal, and 2 for binary.)

SLA is in the RS (register-and-storage) machine instruction format, also four bytes in length, and it is in bytes 10A, 10B, 10C, and 10D.

Op Code	Reg ₁	Reg ₃	Base ₂	Displacement ₂			
8	B	2	0	0	0	0	1
0	7 8	11 12	15 16	19 20	31		

The op code is 8B and the first operand is in register 2. The next four bits are never used in a shift operation, the next four could be used for a base register for the second operand but are not in this case, and the final 001 merely indicates a shift of one binary place. No provision is made for using an index register in this format. As we shall see later, some RS instructions, like Branch on Index High (BXH) and Store Multiple (STM), have a third operand.

The next five instructions are all in the RX format and offer no new concepts. The reader may wish to brush up on hexadecimal numbers and check that the displacements have been computed correctly, taking into account the relative address in the Subtract. We can see even in this simple example how much of the clerical burden the assembler takes over by automatically assigning base registers and calculating displacements.

The assembled entries for the DC's are simply the requested constants, in hexadecimal. We note that the DS entered nothing, but simply reserved space. A study of the address for the doubleword constant at DEC shows that boundary alignment was performed. The fullword constant BIN2 was placed at 138. Counting in hexadecimal, BIN2 occupies four bytes: 138, 139, 13A, and 13B. Although 13C was available for DEC, it is not on a doubleword boundary, nor is 13D, 13E, or 13F. So the assembler skipped these four bytes and assigned DEC to 140.

The END assembler instruction terminates the assembly of the program. The operand indicates the point to which we wish control to be transferred when the program is loaded. In this case, it is to our first instruction in the object program, named BEGIN, where actual execution of the program is to begin. Note that the location counter shows the value 100 at the END statement.

ERROR ANALYSIS BY THE ASSEMBLER

Certain kinds of programming errors can be detected rather simply by the assembler. In fact, some errors make it impossible for the assembler to generate an instruction and complete the assembly. The assembler carries out the assembly as completely as possible, regardless of the number of errors, even if the first error detected makes it impossible for the object program to be executed. The idea is that, if there are more errors, the programmer needs to know about all of them, not just the first one the assembler encounters.

Figure 1-5 is the assembly listing of a program written deliberately with a number of errors in it, to demonstrate what the assembler can do and how it announces its findings. The first announcement is made on the program listing itself, where every statement with a discernible error is followed by a line prominently reading

*** ERROR ***

When the programmer is warned of the existence of an error, he can often see rather quickly what is wrong. Looking over the listing in Figure 1-5, he would probably notice at once that the comma between operands in statement 9 is omitted, and that statement 19 is, from his point of view (but not the assembler's), a bundle of typographical keypunching errors.

Some errors may not be so obvious. To help the programmer analyze them, the assembler prints a separate listing of diagnostic messages. This is part of the output

from the assembler program, which was described earlier in this chapter. The diagnostics listing for our program example is shown in Figure 1-6. The assembler always gives a summary message, shown at the bottom, of the total number of statements in error. If no errors are found, the happy message NO STATEMENTS FLAGGED IN THIS ASSEMBLY is printed at the end of the symbol cross-reference table, and no diagnostic listing is printed.

Let's see what the assembler has to tell us about statement 6. The message is on the first line of the diagnostics listing: UNDEFINED OPERATION CODE.

We check the mnemonic for Shift Left Single and find of course that we should have written SLA instead of SLS. The assembler program cannot assume SLA was meant; we might have meant SL, SLR, SLL, or any other valid operation code. Since it cannot tell what was intended, it flags the statement and does not assemble the object code or even assign space to the instruction.

The diagnostic message for statement 7 is UNDEFINED SYMBOL. The undefined symbol is DATA4. This is accepted as a valid symbol, since it follows all the rules governing the writing of symbols. That is, it begins with a letter, uses only letters and numbers, does not contain special characters or blanks, and isn't more than eight characters. Looking at the symbols or names listed in the source statements, we see we have defined DATA and remember that we intended DATA+4 as the address of the

LOC	OBJECT CODE	ADDR1	ADDR2	STMT	SOURCE STATEMENT
000100				1	PROGC START 256
000100	05B0			2	BEGIN BALR 11,0
000102				3	USING *,11
000102	5820 B01E		00120	4	L 2,DATA
000106	5A20 B026		00128	5	A 2,CON
				6	SLS 2,1
	*** ERROR ***				
00010A	0000 0000		00000	7	S 2,DATA4
	*** ERROR ***				
00010E	5020 B02A		0012C	8	ST 2,RESULT
000112	0000 0000		00000	9	L 6BIN1
	*** ERROR ***				
000116	5A60 B02E		00130	10	A 6,BIN2
00011A	0000 0000		00000	11	CVD 6,BIN1
	*** ERROR ***				
				12	EOJ
				13**	360N-CL-453 EOJ CHANGE LEVEL 3-0
				14+	SVC 14
00011E	0A0E			15	DATA DC F'25'
000120	00000019			16	DC F'9876543210'
000124	4CB016EA				
	*** ERROR ***				
000128	0000000A			17	CON DC F'10'
00012C				18	RESULT DS
	*** ERROR ***				
00012C	0000 0000		00000	19	IN1 C '12'
	*** ERROR ***				
000130	0000004E			20	BIN2 DC F'78'
000138				21	DEC DS D
000140	00000019			22	DATA DC F'25'
	*** ERROR ***				
000100				23	END BEGIN

Figure 1-5. Assembly listing of the program rewritten with deliberate errors

DIAGNOSTICS

STMT	ERROR CODE	MESSAGE
6	IJQ088	UNDEFINED OPERATION CODE
7	IJQ024	UNDEFINED SYMBOL
9	IJQ039	INVALID DELIMITER
9	IJQ039	INVALID DELIMITER
11	IJQ024	UNDEFINED SYMBOL
16	IJQ017	DATA ITEM TOO LARGE
18	IJQ031	UNKNOWN TYPE
18	IJQ009	MISSING OPERAND
19	IJQ039	INVALID DELIMITER
19	IJQ018	INVALID SYMBOL
22	IJQ023	PREVIOUSLY DEFINED NAME

8 STATEMENTS FLAGGED IN THIS ASSEMBLY

Figure 1-6. Assembly listing of diagnostic error messages for the program in Figure 1-5

next constant. To the assembler there is no relationship at all between DATA4 and DATA; they are simply different symbols. But if we write DATA+4, the assembler program will recognize the plus sign as a special character that, among other things, delimits the symbol DATA. Confronted with DATA4, the assembler does not assemble the object code. This time, however, the valid mnemonic S indicates that this instruction will be in RX format. So the assembler assigns four bytes to the instruction.

In statement 9, the Load instruction, we already know that our error was the omission of the comma in 6,BIN1. This made the assembler give two identical diagnostic messages: INVALID DELIMITER. From the mnemonic L, the assembler anticipates an RX format, the L to be followed by a register number, a comma, and a storage operand. Finding a B instead of a comma probably led to the first message. What about the second message? What does it mean?

Here the error code in the second column of the diagnostic listing may help. The meaning of each message is given in expanded form in a table of error codes in the assembler manuals. (The letters IJQ here simply stand for a particular assembler program, the Disk Operating System D assembler.) If we were to look up IJQ039 in the table, we would find that it means "any syntax error". About a dozen possibilities are listed. An invalid delimiter is the usual error in assembler language syntax, hence the wording of the message. Some other possibilities are (1) an unpaired parenthesis, (2) an embedded blank, (3) a missing delimiter, (4) a missing operand, and (5) a symbol beginning with other than an alphabetic character. Well, the first two obviously don't apply to 6BIN1, and it would be difficult and unrewarding to make a choice among the others, especially considering the compounded error in the symbol in statement 19. What the two messages signify is that there is no reliable evidence of what was intended or just which specification was really violated. The programmer is amply

warned that an error exists. It is his job to make his intentions known.

UNDEFINED SYMBOL appears again for statement 11. From the programmer's viewpoint, a reverse situation exists from the one in statement 7. This time the instruction statement is as it should be, but the DC defining the symbol shows IN1 instead of BIN1. There is no indication that these are related in any way or that one is not correct.

Statement 16 elicits the message DATA ITEM TOO LARGE. This is perfectly clear. The decimal value 9,876,543,210 cannot be contained in a 32-bit binary full-word, and the hexadecimal value shown as four bytes has evidently been truncated.

Statement 18 was awarded two error messages: UNKNOWN TYPE when the assembler program found no type designation, and MISSING OPERAND when it scanned further on. Jumping ahead for a moment, we find that statement 22 has the message PREVIOUSLY DEFINED NAME, and we see that DATA has already been given in statement 15.

In statement 19 the first letter of each entry is omitted. The messages are INVALID DELIMITER, which may mean almost any error of syntax, and INVALID SYMBOL, which apparently applies to the name IN1. What's the matter with IN1? It begins with a letter and violates no rules we know of. It should be perfectly acceptable to the assembler. We are the only ones who know it is misspelled. Also, when the message UNKNOWN TYPE is available, why single out the operand with its missing F as a syntax error? Four bytes of zeros have been generated. Why did the assembler assign a specific length? Also, apparently no fault was found with the mnemonic C. How is that? The point is precisely that C is a valid operation code. So the assembler, being given this definite "fact" (the most important single fact in any instruction), performs its syntax scan and other operations as if it were dealing with a Compare. The mnemonic C indicates that the instruction is in the RX format requiring

four bytes, that the first operand must be a number between 0 and 15 followed by a comma, and that the second operand may be a symbol. But the operand field of this Compare instruction contains simply the characters "12". *This* then is the "symbol" the second message refers to. Indeed, both messages evidently apply to the operand field. To the assembler program nothing is wrong with the name or the operation code mnemonic.

For such reasons as these, the diagnostic messages given by the assembler may often seem quite inaccurate from the programmer's point of view. In many cases, the assembler simply does not have enough clues to pin down the precise error, and the messages should not be taken literally. The assembler program was designed to be as helpful as it can be, and the messages are an effort to help the programmer diagnose the trouble. Usually the error flag on the program

listing is enough. The programmer will be interested in the message itself only when he cannot identify the mistake.

This review of how the assembler analyzes programming errors should also make it clear that many errors are beyond the power of the assembler even to recognize. When we incorrectly write DATA4 for DATA+4, the assembler can detect it, but not if DATA4 itself is a legitimate symbol. If we write SLL for SLA, the assembler will assume that SLL is what we mean; both are valid operation codes with the same format. The ability of the assembler to detect and analyze errors can be very helpful to the programmer. However, the message NO STATEMENTS FLAGGED IN THIS ASSEMBLY cannot be taken to mean that a program has no errors or that it will necessarily produce the right answers when it is executed.

MODIFYING AN ASSEMBLER LANGUAGE PROGRAM

After a program has been written, assembled, and completely debugged, it frequently happens that some change must be made later. Many types of revisions are simple to make in an assembler language program. But let us see what happens to the locations of instructions and data when even a minor change is made. We shall base the example on the correct version of the program, as it appeared assembled in Figure 1-4.

Let us suppose that for some unspecified reason it is necessary to store the sum of BIN1 and BIN2 in binary before converting it to decimal. We must insert an instruction:

```
ST 6,BINANS
```

just before the CVD.

This is a rather simple sort of change and one that is representative of the kind of modification made with routine frequency on many programs. Yet it can have the effect of

changing almost every effective address in the program! The insertion of the four-byte instruction "pushes down" the storage spaces for the DC's and DS's, requiring a change in the displacements of all the instructions that refer to the constants.

Figure 1-7 is the assembly listing of the modified program. Scanning down the assembled instructions, we see that the displacements have been computed to reflect the change in locations. Continuing the comparison, however, we see that ADDR2 and the displacement in the Convert to Decimal instruction are the same as in the earlier version. Has there been a mistake?

The answer is the boundary alignment of the doubleword constants. In the earlier version, it was necessary to skip four bytes to provide an address for DEC that was on a doubleword boundary. The inserted instruction, in effect, filled that skipped space. The reassembly therefore left the assembled address for DEC unchanged.

LOC	OBJECT CODE	ADDR1	ADDR2	STMT	SOURCE	STATEMENT
000100				1	PROGB	START 256
000100	05B0			2	BEGIN	BALR 11,0
000102				3		USING *,11
000102	5820 B026		00128	4	L	2,DATA LOAD REGISTER 2
000106	5A20 B02E		00130	5	A	2,CON ADD 10
00010A	8B20 0001		00001	6	SLA	2,1 THIS HAS EFFECT OF MULTIPLYING BY 2
00010E	5B20 B02A		0012C	7	S	2,DATA+4 NOTE RELATIVE ADDRESSING
000112	5020 B032		00134	8	ST	2,RESULT
000116	5860 B036		00138	9	L	6,BIN1
00011A	5A60 B03A		0013C	10	A	6,BIN2
00011E	5060 B046		00148	11	ST	6,BINANS
000122	4E60 B03E		00140	12	CVD	6,DEC
				13	EOJ	END OF JOB
				14**	360N-CL-453	EOJ CHANGE LEVEL 3-0
000126	0A0E			15+	SVC	14
000128	00000019			16	DATA	DC F'25'
00012C	0000000F			17	DC	F'15'
000130	0000000A			18	CON	DC F'10'
000134				19	RESULT	DS F
000138	0000000C			20	BIN1	DC F'12'
00013C	0000004E			21	BIN2	DC F'78'
000140				22	DEC	DS D
000148				23	BINANS	DS F
000100				24	END	BEGIN

Figure 1-7. Assembly listing of the same program modified to store the binary contents of register 6



Chapter 2: System/360 Review

The reader may find it helpful at this point to review some basic facts about System/360 that are directly relevant to assembler language programming. These are stated as briefly as possible in this chapter and will serve mainly as a reminder. A student who is familiar with the material may skip any or all of the sections without loss. A student who needs more than a reminder is urged to go back to the textbook or course materials he originally studied for an introduction to System/360.

The basic structure of a System/360 consists of main

storage, a central processing unit (CPU), the selector and multiplexor channels, and the input/output (I/O) devices attached to the channels through control units. For basic information that applies to the material in this book, we are concerned principally with the CPU and main storage. In this chapter, discussion will essentially be limited to these machine units and their basic operating principles.

Since a knowledge of hexadecimal numbers is necessary in assembler language programming, these will also be explained.

MAIN STORAGE

Main storage is also called core or processor storage to distinguish it from storage on tape, disk, or other auxiliary devices. It is closely involved in the operation of the CPU, although it may be either physically integrated with it or constructed as a stand-alone unit. Capacity may be from 8,192 bytes to several million bytes, depending on the system model. Protection features are available that make it possible to protect the contents of main storage from access or alteration.

In general, instructions and data are stored along with each other in whatever order they are presented to the machine. Particular areas of storage may be used over and over again by a succession of programs or groups of programs being executed. Each group overlays, or replaces, the instructions and data of the one preceding. The programmer must therefore specify blanks or zeros where he needs them; he can never assume he is writing on a clean slate. During execution of his program, he can obtain a printout or "dump" of an area of storage at any point in the program by use of suitable instructions.

Bytes and Data Field Lengths

The system transmits information between main storage and the CPU in units of eight bits, or a multiple of eight bits at a time. Each eight-bit unit of information is called a *byte*, the basic building block of all formats. A ninth bit, the parity or check bit, is transmitted with each byte and carries odd parity on the byte. The parity bit cannot be affected by the program; its only purpose is to cause an interruption when a parity error is detected. References in this book to the size of data fields and registers exclude the mention of the associated parity bits.

Bytes may be handled separately or grouped together in fields. A *halfword* is a group of two consecutive bytes and is the basic building block of instructions. A *word* is a group of four consecutive bytes; a *doubleword* is a field consisting of two words (Figure 2-1). The location of any field or group of bytes is specified by the address of its leftmost byte.

Byte

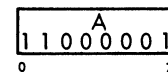

Halfword

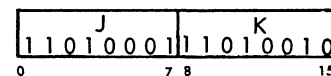

Word

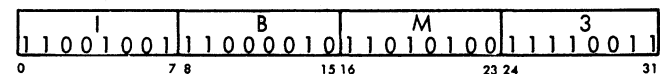

Figure 2-1. Sample data formats

The length of fields is either implied by the operation to be performed or stated explicitly as part of the instruction. When the length is implied, the information is said to have a fixed length, which can be either one, two, four, or eight bytes.

When the length of a field is not implied by the operation code, but is stated explicitly, the information is said to have variable field length. This length can be varied in one-byte increments.

Within any program format or any fixed-length operand format, the bits making up the format are consecutively numbered from left to right starting with the number 0.

This general information on data formats and field lengths will be supplemented later by further details. Lengths and the specific form of the *contents* of the fields are discussed in the section on the arithmetic and logical unit, under the headings for logical operations and the specific types of arithmetic.

Addressing

Byte locations in storage are consecutively numbered starting with 0; each number is considered the address of that byte. A group of bytes in storage is addressed by the leftmost byte of the group. The number of bytes in the group is either implied or explicitly defined by the operation. The addressing arrangement uses a 24-bit binary address to accommodate a maximum of 16,777,216 byte addresses. This set of main-storage addresses includes some locations reserved for the supervisor and other special purposes. How storage addresses are generated is described in the section on program execution.

The available storage is normally contiguously addressable, starting at address 0. An addressing exception is recognized when any part of an operand is located beyond the maximum available capacity of an installation. Except for a few instructions, the addressing exception is recognized only when the data are actually used and not when the operation is completed before using the data. The addressing exception causes a program interruption.

Positioning on Integral Boundaries

Fixed-length fields, such as halfwords and doublewords,

must be located in main storage on an *integral boundary* for that unit of information. A boundary is called integral for a unit of information when its storage address is a multiple of the length of the unit in bytes. For example, words (four bytes) must be located in storage so that their address is a multiple of the number 4. A halfword (two bytes) must have an address that is a multiple of the number 2, and doublewords (eight bytes) must have an address that is a multiple of the number 8.

For greatest efficiency in storage addressing, address arithmetic is done exclusively in binary. In binary, integral boundaries for halfwords, words, and doublewords can be specified only by the binary addresses in which one, two, or three of the low-order bits, respectively, are zero (Figure 2-2). For example, the integral boundary for a word is a binary address in which the two low-order positions are zero.

Variable-length fields are not limited to integral boundaries, and may start on any byte location.

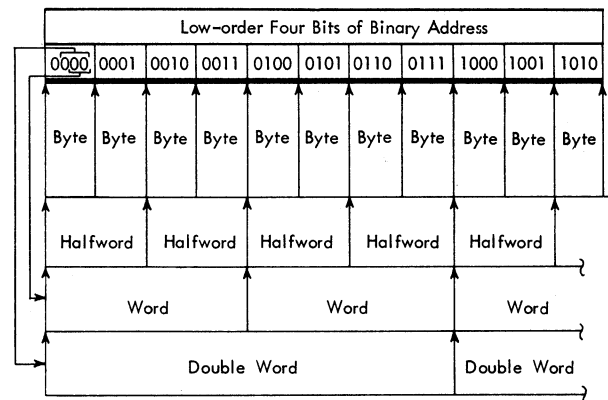

Figure 2-2. Integral boundaries for halfwords, words, and doublewords

CENTRAL PROCESSING UNIT

The central processing unit (Figure 2-3) contains the facilities for addressing main storage, for fetching or storing information, for arithmetic and logical processing of data, for sequencing instructions in the desired order, and for initiating the communication between storage and external devices.

The system control section provides the normal CPU control that guides the CPU through the functions necessary to execute the instructions. The programmer-trainee will probably be glad to know that the result of executing a valid instruction is the same for each model of System/360.

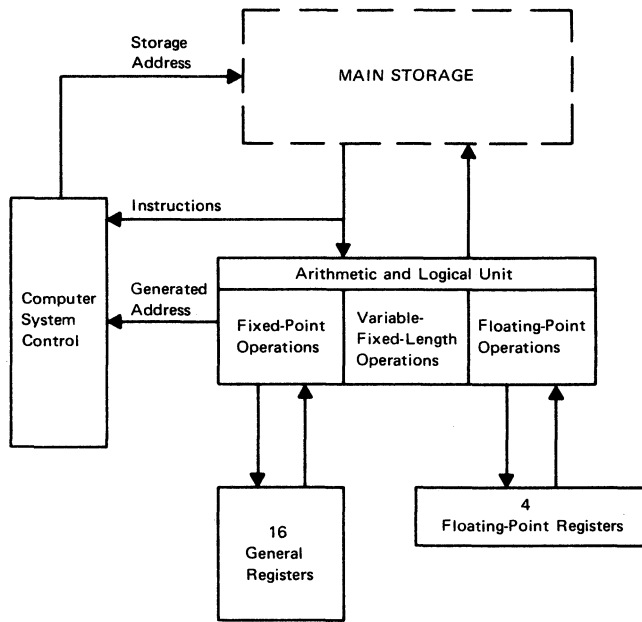

Figure 2-3. Functions of the central processing unit

General and Floating-Point Registers

The CPU provides 16 *general registers* for fixed-point operands and four *floating-point registers* for floating-point operands. Physically, these registers may be in special circuitry, in a local storage unit, or in a separate area of main storage. In each case, the address and functions of these registers are identical.

The CPU can address information in 16 general registers. The general registers can be used as index registers, in address arithmetic and indexing, and as accumulators in fixed-point arithmetic and logical operations. The registers have a capacity of one word (32 bits). The general registers are identified by numbers 0–15 and are specified by a four-bit R field in an instruction (Figure 2-4). Some instructions provide for addressing multiple general registers by having several R fields.

For some operations, two adjacent general registers are coupled together, providing a two-word capacity. In these operations, the addressed register contains the high-order

operand bits and must have an even address, and the implied register, containing the low-order operand bits, has the next higher address.

R Field	Reg No.	General Registers	Floating-Point Registers
0000	0	←32 Bits→	←64 Bits→
0001	1	←32 Bits→	
0010	2	←32 Bits→	←64 Bits→
0011	3	←32 Bits→	
0100	4	←32 Bits→	←64 Bits→
0101	5	←32 Bits→	
0110	6	←32 Bits→	←64 Bits→
0111	7	←32 Bits→	
1000	8	←32 Bits→	
1001	9	←32 Bits→	
1010	10	←32 Bits→	
1011	11	←32 Bits→	
1100	12	←32 Bits→	
1101	13	←32 Bits→	
1110	14	←32 Bits→	
1111	15	←32 Bits→	

Figure 2-4. General and floating-point registers

Four floating-point registers are available for floating-point operations. They are identified by the numbers 0, 2, 4, and 6 (Figure 2-4). These floating-point registers are two words (64 bits) in length and can contain either a short (one word) or a long (two words) floating-point operand. A short operand occupies the high-order bits of a floating-point register. The low-order portion of the register is ignored and remains unchanged in short-precision arithmetic. The instruction operation code determines which type of register (general or floating-point) is to be used in an operation, and if floating-point whether short or long precision.

Arithmetic and Logical Unit

The arithmetic and logical unit can process binary integers and floating-point fractions of fixed length, decimal integers of variable length, and logical information of either fixed or variable length.

Arithmetic and logical operations performed by the CPU fall into four classes: fixed-point arithmetic, decimal arithmetic, floating-point arithmetic, and logical operations. These classes differ in the data formats used, the registers involved, the operations provided, and the way the field length is stated. Data formats are discussed under each of the headings in this section. General information on field lengths was given in the section on main storage.

Fixed-Point Arithmetic

The basic arithmetic operand is the 32-bit fixed-point binary number. Sixteen-bit halfword operands may be specified in most operations for improved performance or storage utilization (see Figure 2-5). To preserve precision, some products and all dividends are 64 bits long. A

fixed-point number is a signed value, recorded as a binary integer. It is called fixed point because the programmer determines the fixed positioning of the binary point.

In both halfword (16 bits) and word (32 bits) lengths, the first bit position (0) holds the sign of the number. The remaining bit positions (1–15 for halfwords and 1–31 for fullwords) are used to designate the value of the number.

Positive fixed-point numbers are represented in true binary form with a zero sign bit. Negative fixed-point numbers are represented in two's complement notation with a one bit in the sign position. In all cases, the bits between the sign bit and the leftmost significant bit of the integer are the same as the sign bit (i.e. all zeros for positive numbers, all ones for negative numbers). The filled-in examples in Figure 2-5 show the equivalent of decimal +62 and -62 in fixed-point halfwords.

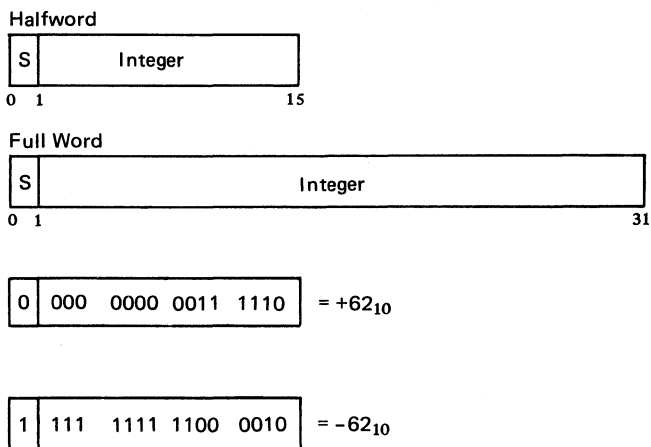

Figure 2-5. Fixed-point number formats. In the example the negative number is in two's complement notation

Because the 32-bit word size readily accommodates a 24-bit address, fixed-point arithmetic can be used both for integer operand arithmetic and for address arithmetic. This combined usage provides economy and permits the entire fixed-point instruction set and several logical operations to be used in address computation. Thus, multiplication, shifting, and logical manipulation of address components are possible.

Additions, subtractions, multiplications, divisions, and comparisons are performed upon one operand in a register and another operand either in a register or from storage. Multiple-precision operation is made convenient by the two's-complement notation and by recognition of the carry from one word to another. A word in one register or a double word in a pair of adjacent registers may be shifted left or right. A pair of conversion instructions—Convert to Binary and Convert to Decimal—provides transition between decimal and binary number bases without the use of tables. Multiple-register loading and storing instructions facilitate subroutine switching.

Decimal Arithmetic

Decimal arithmetic lends itself to data processing procedures that require few computational steps between the source input and the documented output. This type of processing is frequently found in commercial applications. Because of the limited number of arithmetic operations performed on each item of data, conversion from decimal to binary and back to decimal is not justified, and the use of registers for intermediate results yields no advantage over storage-to-storage processing. Hence, decimal arithmetic is provided, and both operands and results are located in storage. Decimal arithmetic includes addition, subtraction, multiplication, division, and comparison.

Decimal numbers are treated as signed integers with a variable-field-length format from one to 16 bytes long. Negative numbers are carried in true form.

The decimal digits 0–9 are represented in the four-bit binary-coded-decimal (BCD) form by 0000–1001, respectively, as follows.

Digit	Binary Code	Digit	Binary Code
0	0000	5	0101
1	0001	6	0110
2	0010	7	0111
3	0011	8	1000
4	0100	9	1001

The codes 1010–1111 are not valid as digits and are reserved for sign codes. The sign codes generated in decimal arithmetic depend upon the character set code used. When the extended binary coded decimal interchange code (EBCDIC) is used, the codes are 1100 for a plus sign and 1001 for a minus. (When the USASCII set, expanded to eight bits, is preferred, the sign codes are 1010 and 1011. The choice between the two code sets is determined by a mode bit.)

Decimal operands and results are represented by four-bit BCD digits packed two to a byte (see Figure 2-6). They appear in fields of variable length and are accompanied by a sign in the rightmost four bits of the low-order byte. Operand fields may be located on any byte boundary, and may have length up to 31 digits and sign (16 bytes). Operands participating in an operation may have different lengths. Packing of digits within a byte and use of variable-length fields within storage results in efficient use of storage, in

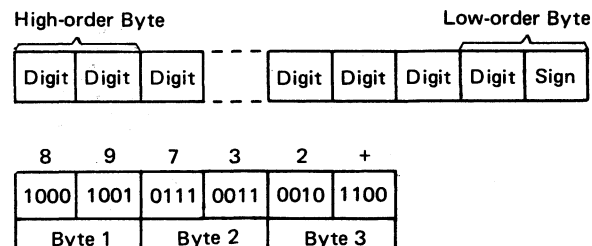

Figure 2-6. Packed decimal number format. The three-byte example shows decimal value +89,732

increased arithmetic performance, and in an improved rate of data transmission between storage and files.

Decimal numbers may also appear in a zoned format in the regular EBCDIC eight-bit alphanumeric character format (Figure 2-7). This representation is required for I/O devices that are character-set sensitive. A zoned format number carries its sign in the leftmost four bits of the low-order byte. The zoned format is not used in decimal arithmetic operations. Instructions are provided for packing and unpacking decimal numbers so that they may be changed from the zoned to the packed format and vice versa.

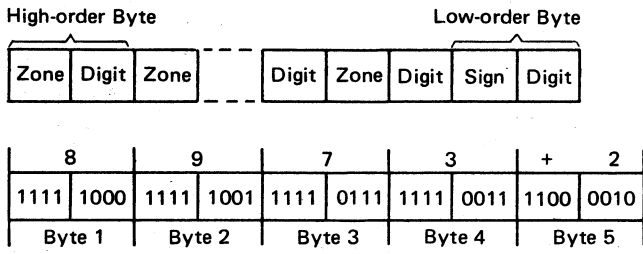

Figure 2-7. Zoned decimal number format. The decimal number +89,732 requires five bytes

Floating-Point Arithmetic

Floating-point numbers occur in either of two fixed-length formats—short or long. These formats differ only in the length of the fractions (Figure 2-8). They are described in detail in the chapter on floating-point arithmetic.

Floating-point operands are either 32 or 64 bits long. The short length permits a maximum number of operands to be placed in storage and gives the shortest execution times. The long length, used when higher precision is desired, more than doubles the number of digits in each operand.

Four 64-bit floating-point registers are provided. Arithmetic operations are performed with one operand in a register and another either in a register or from storage. The result, developed in a register, is generally of the same length as the operands. The availability of several floating-point registers eliminates much storing and loading of intermediate results.

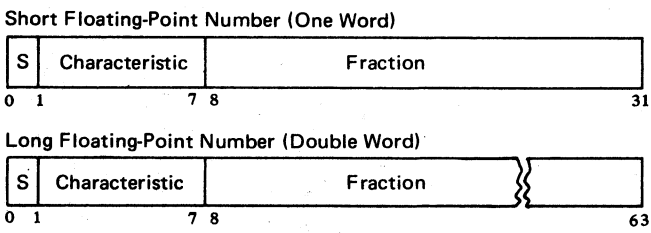

Figure 2-8. Short and long floating-point number formats

Logical Operations and the EBCDIC Character Set

Logical information is handled as fixed- or variable-length data. It is subject to such operations as comparison, translation, editing, bit testing, and bit setting.

When used as a fixed-length operand, logical information can consist of either one, four, or eight bytes and is processed in the general registers (Figure 2-9).

A large portion of logical information consists of alphabetic or numeric character codes, called *alphanumeric data*, and is used for communication with character-set sensitive I/O devices. This information has the variable-field-length format and can consist of up to 256 bytes (Figure 2-9). It is processed storage to storage, left to right, an eight-bit byte at a time.

The CPU can handle any eight-bit character set, although certain restrictions are assumed in the decimal arithmetic and editing operations. However, all character-set sensitive I/O equipment will assume either the extended binary coded decimal interchange code (EBCDIC) or the USA Standard Code for Information Interchange (USASCII) extended to eight bits. Use of EBCDIC is assumed throughout this book.

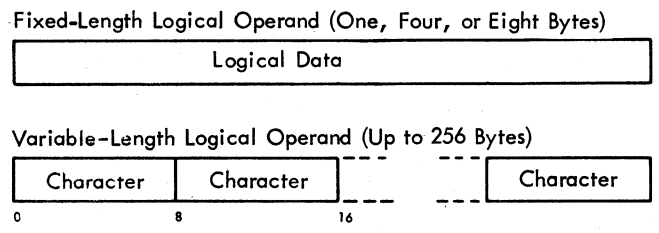

Figure 2-9. Fixed- and variable-length logical information

EBCDIC does not have a printed symbol, or graphic, defined for all 256 eight-bit codes. When it is desirable to represent all possible bit patterns, a hexadecimal representation may be used instead of the preferred eight-bit code. The hexadecimal representation uses one graphic for a four-bit code, and therefore, two graphics for an eight-bit byte. The graphics 0–9 are used for codes 0000–1001; the graphics A–F are used for codes 1010–1111. EBCDIC eight-bit code for characters that can be represented by well-known symbols is shown in Table 2-1. The hexadecimal equivalents and punched card code are also shown. For other symbols, System/360 control characters, and unassigned codes, see the complete 256-position EBCDIC chart in the Appendix. It may be observed from the table that the EBCDIC collating sequence for alphanumeric characters, from lower to higher binary values, is (1) special characters, (2) lower case letters, (3) capital letters, and (4) digits, with each group in its usual order.

Table 2-1. Extended Binary Coded Decimal Interchange Code (EBCDIC) for Graphic Characters

Graphic character	EBCDIC 8-bit code		Hex equivalent	Punched card code	Graphic character	EBCDIC 8-bit code		Hex equivalent	Punched card code
	Bit Positions					Bit Positions			
	0123	4567				0123	4567		
blank	0100	0000	40	no punches	u	1010	0100	A4	11-0-4
¢	0100	1010	4A	12-8-2	v	1010	0101	A5	11-0-5
.	0100	1011	4B	12-8-3	w	1010	0110	A6	11-0-6
(0100	1101	4D	12-8-5	x	1010	0111	A7	11-0-7
+	0100	1110	4E	12-8-6	y	1010	1000	A8	11-0-8
&	0101	0000	50	12	z	1010	1001	A9	11-0-9
!	0101	1010	5A	11-8-2	A	1100	0001	C1	12-1
\$	0101	1011	5B	11-8-3	B	1100	0010	C2	12-2
*	0101	1100	5C	11-8-4	C	1100	0011	C3	12-3
)	0101	1101	5D	11-8-5	D	1100	0100	C4	12-4
;	0101	1110	5E	11-8-6	E	1100	0101	C5	12-5
-	0110	0000	60	11	F	1100	0110	C6	12-6
,	0110	1011	6B	0-8-3	G	1100	0111	C7	12-7
%	0110	1100	6C	0-8-4	H	1100	1000	C8	12-8
?	0110	1111	6F	0-8-7	I	1100	1001	C9	12-9
:	0111	1010	7A	8-2	J	1101	0001	D1	11-1
#	0111	1011	7B	8-3	K	1101	0010	D2	11-2
@	0111	1100	7C	8-4	L	1101	0011	D3	11-3
'	0111	1101	7D	8-5	M	1101	0100	D4	11-4
=	0111	1110	7E	8-6	N	1101	0101	D5	11-5
”	0111	1111	7F	8-7	O	1101	0110	D6	11-6
a	1000	0001	81	12-0-1	P	1101	0111	D7	11-7
b	1000	0010	82	12-0-2	Q	1101	1000	D8	11-8
c	1000	0011	83	12-0-3	R	1101	1001	D9	11-9
d	1000	0100	84	12-0-4	S	1110	0010	E2	0-2
e	1000	0101	85	12-0-5	T	1110	0011	E3	0-3
f	1000	0110	86	12-0-6	U	1110	0100	E4	0-4
g	1000	0111	87	12-0-7	V	1110	0101	E5	0-5
h	1000	1000	88	12-0-8	W	1110	0110	E6	0-6
i	1000	1001	89	12-0-9	X	1110	0111	E7	0-7
j	1001	0001	91	12-11-1	Y	1110	1000	E8	0-8
k	1001	0010	92	12-11-2	Z	1110	1001	E9	0-9
l	1001	0011	93	12-11-3	0	1111	0000	F0	0
m	1001	0100	94	12-11-4	1	1111	0001	F1	1
n	1001	0101	95	12-11-5	2	1111	0010	F2	2
o	1001	0110	96	12-11-6	3	1111	0011	F3	3
p	1001	0111	97	12-11-7	4	1111	0100	F4	4
q	1001	1000	98	12-11-8	5	1111	0101	F5	5
r	1001	1001	99	12-11-9	6	1111	0110	F6	6
s	1010	0010	A2	11-0-2	7	1111	0111	F7	7
t	1010	0011	A3	11-0-3	8	1111	1000	F8	8
					9	1111	1001	F9	9

PROGRAM EXECUTION

Interplay of equipment and program is an essential consideration in System/360. The system is designed to operate with a control program that coordinates and executes all I/O instructions, handles exceptional conditions, and supervises scheduling and execution of multiple programs. System/360 provides for efficient switching from one program to another, as well as for the relocation of programs in storage. To the problem programmer, the control program and the equipment are indistinguishable.

The CPU program consists of instructions, index words, and control words that specify the operations to be performed. Some of its functions will be discussed here. The format of the machine instructions is basic to an understanding of how the CPU executes them and how it forms addresses of operands in main storage. A doubleword called the program status word (PSW) contains detailed information required by the CPU for proper program execution: the instruction address, the condition code setting, etc. It is stored at a fixed location. If a problem program aborts and the contents of storage are printed out, the PSW can be inspected by the programmer. He will find much information to help him analyze the trouble, including a code that identifies the cause of the interruption.

The interruption system permits the CPU to respond automatically to conditions arising outside of the system, in I/O units, or in the CPU itself. Interruption switches the CPU from one program to another by changing not only the instruction address but all essential machine-status information.

Programs are checked for correctness of instructions and data as the instructions are executed. (The types of errors involved are not detectable during assembly.) This policing action distinguishes and identifies program errors and machine errors. Thus, program errors cannot cause machine checks: each of these types of error causes a different type of interruption.

Sequential Instruction Execution

Normally, the operation of the CPU is controlled by instructions taken in sequence. An instruction is fetched from a location specified by the instruction address in the current PSW. The instruction address is then increased by the number of bytes in the instruction fetched to address the next instruction in sequence. The instruction is then executed and the same steps are repeated using the new value of the instruction address.

A change from sequential operation may be caused by branching, interruptions, etc.

Branching

The normal sequential execution of instructions is changed when reference is made to a subroutine, when a two-way choice is encountered, or when a segment of coding, such as

a loop, is to be repeated. All these tasks can be accomplished with branching instructions. Provision is made for subroutine linkage, permitting not only the introduction of a new instruction address but also the preservation of the return address and associated information.

Decision-making is generally and symmetrically provided by the Branch on Condition instruction. This instruction inspects a two-bit *condition code* in the PSW, that reflects the result of a majority of the arithmetic, logical, and I/O operations. Each of these operations can set the code in any one of four ways, and the conditional branch can specify any of these four settings, or any combination of them, as the criterion for branching.

Loop control can be performed by the conditional branch when it tests the outcome of address arithmetic and counting operations. For some particularly frequent combinations of arithmetic and tests, the instructions Branch on Count and Branch on Index are provided. These branches, being specialized, provide increased performance for these tasks.

Instruction Format

The length of an instruction format can be one, two, or three halfwords. It is related to the number of storage addresses necessary to specify the location of all operands in the operation. Operands may be located in registers or in main storage, or may be a part of an instruction. An instruction consisting of only one halfword causes no reference to main storage. A two-halfword instruction provides one storage-address specification; a three-halfword instruction provides two storage-address specifications. All instructions must be located in storage on integral boundaries for halfwords. Figure 2-10 shows the five basic instruction formats, called RR, RX, RS, SI, and SS.

These format codes express, in general terms, the operation to be performed. RR denotes a register-to-register operation; RX, a register-and-indexed-storage operation; RS, a register-and-storage operation; SI, a storage and immediate-operand operation; and SS, a storage-to-storage operation. An immediate operand is one contained within the instruction.

For purposes of describing the execution of instructions in the SRL manual *IBM System/360 Principles of Operation* (A22-6821), operands are designated as first and second operands and, in the case of branch-on-index instructions, third operands. These names refer to the manner in which the operands participate. The operand to which a field in an instruction format applies is generally denoted by the number following the code name of the field, for example, R₁, B₁, L₂, D₂.

In each format, the first instruction halfword consists of two parts. The first byte contains the operation code. The length and format of an instruction are specified by the

first two bits of the operation code:

Bit Positions (0-1)	Instruction Length	Instruction Format
00	One halfword	RR
01	Two halfwords	RX
10	Two halfwords	RS or SI
11	Three halfwords	SS

The second byte is used either as two 4-bit fields or as a single 8-bit field. As shown in Figure 2-10, this byte can contain the following information:

- Four-bit operand register specification (R_1 , R_2 , or R_3)
- Four-bit index register specification (X_2)
- Four-bit operand length specification (L_1 or L_2)
- Eight-bit operand length specification (L)
- Eight-bit byte of immediate data (I_2)

In some instructions a four-bit field or the whole second byte of the first halfword is ignored. In the Branch on Condition instruction, which may be used in either the RR or RX format, the first four bits of the second byte are used as a 4-bit mask field (M_1 in the following diagram). This mask tests the four settings of the condition code and is used to determine whether a branch will or will not be made.

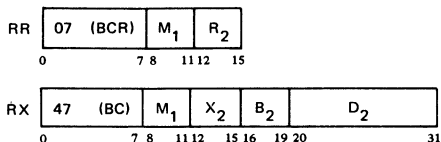

In all instructions, the second and third halfwords always have the same format: four-bit base register designation (B_1 or B_2), followed by a 12-bit displacement (D_1 or D_2).

Generation of Main Storage Addresses

To permit the ready relocation of program segments and to provide for the flexible specifications of input, output, and working areas, all instructions referring to main storage have been given the capacity of employing a full address.

The address used to refer to main storage is generated from the following numbers, all binary:

Base Address (B) is a 24-bit number contained in a general register specified by the program in the B field of the instruction. (One way to insert a base address into a register is to specify a BALR operation at the beginning of a program. The BALR operation does just that, getting the address of the next sequential instruction from the current program status word, no matter where the program may have been relocated.) The B field is included in every address specification. The base address can be used as a means of relocation of programs and data. It provides for addressing the entire main storage. The base address may also be used for indexing purposes.

Index (X) is a 24-bit binary number contained in a general register specified by the program in the X field of

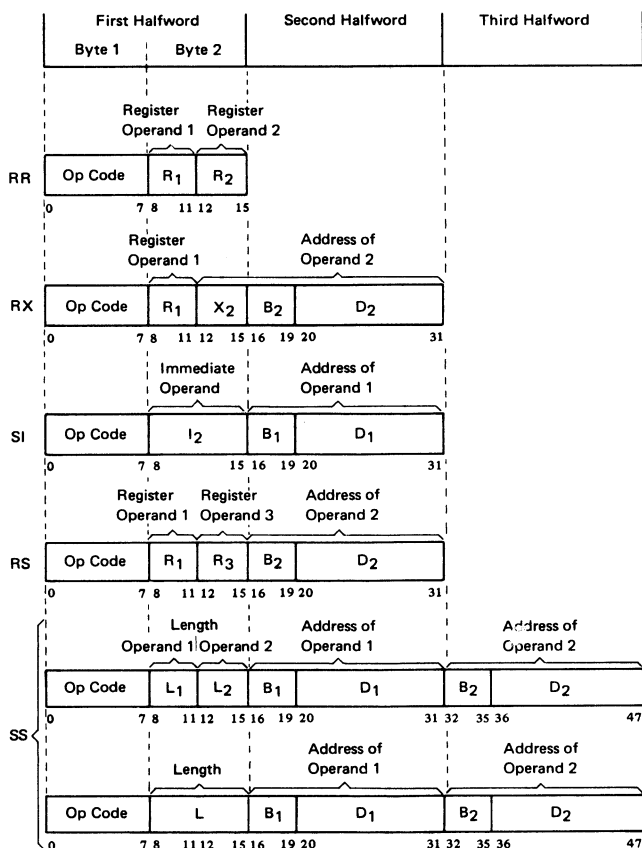

Figure 2-10. Machine instruction formats

the instruction. It is included only in the address specified by the RX instruction format; or it may simply be omitted in an RX instruction. The RX format instructions permit double indexing.

Displacement (D) is a 12-bit binary number contained in the instruction format. It is included in every address computation. The displacement provides for relative addressing up to 4095 bytes beyond the base address, which is the limit that can be expressed by 12 binary bits. In Chapter 1 we saw how the displacements were calculated by the assembler from symbolic addresses written by the programmer.

We also saw that the three binary numbers are added together to form the actual address. This sum is a 24-bit number, which can be represented by six hexadecimal digits.

The program may have zeros in the base address, index, or displacement fields. A zero is used to indicate the absence of the corresponding address component. A base or index of zero implies that a zero quantity is to be used in forming the address, regardless of the contents of general register 0. Initialization, modification, and testing of base addresses and indexes can be carried out by fixed-point instructions, or by Branch and Link, Branch on Count, or Branch on Index instructions.

Interruptions and the Program Status Word

To make maximum use of a modern data processing system, some automatic procedure must be made available to alert the system to an exceptional condition, the end of an I/O operation, program errors, machine errors, etc., and send the system to the appropriate routine following the detection of such an event. The system must have, in effect, the ability to pause to answer the telephone and then to resume the interrupted work. This automatic procedure is called an interruption system.

It makes possible the operation of a system in a non-stop environment and greatly aids the efficient use of I/O equipment. The desire to make the interruption procedure as short and simple as possible means that the method of switching between the interrupted program and the program that services the interruption must be quite efficient. It operates as follows:

The complete status of the System/360 is held in eight bytes of information. This status information, which consists of the instruction address, condition code, storage protection key, etc., is saved when an interruption occurs, and is restored when the interruption has been serviced.

As soon as the interruption occurs, all the status information, together with an identification of the cause of the interruption, is combined into a doubleword called the program status word (PSW).

The PSW is stored at a fixed location, the address of which depends on the type of interruption. The system then automatically fetches a new PSW from a different fixed location, the address of which is also dependent on the type of interruption. Each class of interruption has two fixed locations in main storage: one to receive the old PSW when the interruption occurs, and the other to supply the new PSW that governs the servicing of that class of interruption.

After the interruption has been serviced, a single instruction uses the stored PSW to reset the processing unit to the status it had before the interruption.

Types of Interruptions

The interruption system separates interruptions into five classes:

Supervisor Call interruptions are caused when the processing program issues an instruction to turn over control to the supervisor in the control program. The exact reason for the call is shown in the old PSW.

External interruptions are caused by either an external device requiring attention or by the system timer going past zero.

Machine Check interruptions are caused by the machine-checking circuits detecting a machine error.

I/O interruptions are caused by an I/O unit ending an operation or otherwise needing attention. Identification of

the device and channel causing the interruption is stored in the old PSW; in addition, the status of the device and channel is stored in a fixed location.

Program interruptions are caused by various kinds of programming errors or unusual conditions resulting from improper specification or use of instructions or data. The exact type of error is shown in an interruption code in the PSW.

Finding the Source of a Program Interruption

When a program interruption occurs, provision is always made to locate the instruction that was being interpreted and to identify the exact type of error involved, so that the programmer can make the necessary corrections. For this information he must go to the PSW in a printout of storage contents.

Fifteen interruption codes are used for the different types of program interruptions, as follows.

Interruption Code	Program Interruption Cause
1 00000001	Operation
2 00000010	Privileged operation
3 00000011	Execute
4 00000100	Protection
5 00000101	Addressing
6 00000110	Specification
7 00000111	Data
8 00001000	Fixed-point overflow
9 00001001	Fixed-point divide
10 00001010	Decimal overflow
11 00001011	Decimal divide
12 00001100	Exponent overflow
13 00001101	Exponent underflow
14 00001110	Significance
15 00001111	Floating-point divide

To take an example, one of the conditions that causes a "data exception" to be recognized is an incorrect sign or digit code in an operand used in decimal arithmetic. In this case, the operation would be terminated, and all, part, or none of the arithmetic result would be stored. Since the result is unpredictable, it should not be used for further computation. The interruption code, binary 0000 0111, or hexadecimal 07, for a data exception would be recorded in bit positions 24–31 of the *program* old PSW (always at main storage location 40₁₀).

The location of the instruction that was being interpreted when the interrupt occurred can also be determined from an inspection of the old PSW. The instruction address, which is found in bit positions 40–63 of the PSW, is for the instruction *to be executed next*. To locate the preceding instruction, all that is needed is to subtract its length in bytes. This instruction length can be found in bit positions 32 and 33 of the PSW, recorded there in binary as 1, 2, or 3 halfwords.

HEXADECIMAL NUMBERS

Hexadecimal Code

Hexadecimal numbers have been mentioned a number of times. In Chapter 1 we used them to represent machine language instructions, and we saw that the assembler listed object code, location counter settings, and addresses in hexadecimal numbers. In System/360 hexadecimal code is a shorthand method of representing the internal binary zeros and ones, one hex digit for each four binary bits.

Hex numbers are a convenient way for the assembler language programmer to specify masks in testing and branching operations, and to specify hexadecimal constants (type X). Principally, he uses hexadecimal code to locate and interpret the contents of storage, which may be printed out when a program must be analyzed and debugged. In a later chapter, we shall see some "dumps" of storage and attempt to locate information in them.

Converting from binary to hex, or from hex to binary, is simple. There are only 16 hex symbols, and their value is based on the numerical value of four bits. We recall that four bits in the binary number system can express all values from zero to 15_{10} . We also recall that the position of each bit determines its value:

Binary	Decimal
0001	1
0010	2
0100	4
1000	8

Some people find it easier to remember these binary positional values this way:

8	4	2	1
---	---	---	---

If we try the four bit values in various combinations, we find that we can rather quickly discover how to count from zero to the equivalent of decimal 15 in sequence. In order to be able to represent these 16 values by a single symbol, the letters A, B, C, D, E, and F are used for 10, 11, 12, 13, 14, and 15, respectively. The numbers 0-9 stand for themselves. The entire four bit code is shown in Table 2-2.

Table 2-2. Hexadecimal Code

Binary	Hexadecimal	Decimal	Binary	Hexadecimal	Decimal
0000	0	0	1000	8	8
0001	1	1	1001	9	9
0010	2	2	1010	A	10
0011	3	3	1011	B	11
0100	4	4	1100	C	12
0101	5	5	1101	D	13
0110	6	6	1110	E	14
0111	7	7	1111	F	15

All kinds of information, data, instructions, etc., in System/360 can be represented in hexadecimal code, two

graphic hex symbols per byte. The same hex coding system is used regardless of the code in which the information is recorded internally. The internal information may be EBCDIC characters, zoned decimal numbers, signed binary numbers, the eight-bit code used for System/360 operation codes, or any of the other codes and formats in use. All are coded in some form of binary coding, and, since the eight-bit byte is the basic unit of System/360, they can readily be taken four bits at a time.

Let's look at some examples. Each "box" represents a byte. Binary bits are shown in groups of four for convenience.

1. EBCDIC characters

Characters	I	B	M	3
Internal form	1100 1001	1100 0010	1101 0100	1111 0011
Hex code	C 9	C 2	D 4	F 3

2. Zoned decimal number

Decimal	8	9	7	3	+	2
Internal form	1111 1000	1111 1001	1111 0111	1111 0011	1100 0010	
Hex code	F 8	F 9	F 7	F 3	C 2	

3. Packed decimal number

Decimal	8	9	7	3	2	+
Internal form	1000 1001	0111 0011	0010 1100			
Hex code	8 9	7 3	2 C			

4. Signed binary number

(This fixed-point fullword is equivalent to decimal +89,732)

Internal form	0000 0000	0000 0001	0101 1110	1000 0100
Hex code	0 0	0 1	5 E	8 4

The reader may wonder how, when he sees a hexadecimal printout of storage contents, he will be able to interpret the different formats correctly. This is not a problem, but does require care. The programmer can refer to the assembly listing of the program. By tracing the assembler addresses, he can calculate just where in main storage each instruction or data item is. In some cases, the format will have been specified explicitly. In others, he must know which format is implied by use of particular instructions or types of data.

Hexadecimal Number System

Turning back to the examples, we notice that internally the characters and decimal numbers are, generally speaking, coded separately in either four- or eight-bit binary codes. The binary number in example 4, however, is recorded internally in its actual value as an integer in a number system with a base of 2. The 0's and 1's are the only digits in this number system. Similarly, the hexadecimal equivalent 15E84 is an integer in a valid number system with a base

of 16. Considering the binary and hex numbers in this example in their entirety, they have exactly the same total value. Each hex digit also equals the value of the four bits it represents. We see from this that hex numbers can be used in two different ways: (1) simply as a four-bit code into which each internal half-byte is translated, and (2) both as a four-bit code and as a valid number system with a base related in a definite way to the base of the binary number system.

In the familiar decimal number system, the base is 10, and there are ten digits, 0–9. In the decimal number 234, we know that the 2, because of its position, equals 2×100 , or 200; the 3 equals 3×10 , or 30; and the 4 equals 4×1 , or 4. The three values are in effect added together. We may represent the place value of each digit in a whole number (not a fractional or mixed number) in this way:

Power of base 10	10^4	10^3	10^2	10^1	10^0
Value	10,000	1000	100	10	1

In the same way, the binary number system has a base of 2 and has two digits, 0 and 1. Its place values are:

Power of base 2	2^8	2^7	2^6	2^5	2^4	2^3	2^2	2^1	2^0
Value in decimal	256	128	64	32	16	8	4	2	1

The hexadecimal number system has a base of 16 and has 16 digits, 0–9 and A–F. Its place values are:

Power of base 16	16^4	16^3	16^2	16^1	16^0
Value in decimal	65,536	4096	256	16	1

We may notice that there is a relationship between binary and hexadecimal place values. Beyond the zeroth power (this always equals 1), hex place values are exactly four times greater than binary. This becomes clear when we compare them up to $2^{12} = 16^3$:

Power of base 2	2^{12}	2^{11}	2^{10}	2^9	2^8	2^7	2^6	2^5	2^4	2^3	2^2	2^1	2^0
Power of base 16	16^3				16^2				16^1				16^0
Value in decimal	4096	2048	1024	512	256	128	64	32	16	8	4	2	1

It is this relationship that makes one hex digit equal arithmetically to four binary bits, two hex digits equal to two groups of four bits each, etc. All hex and binary digits must of course be kept in correct place order.

Now we are ready to figure out some actual hexadecimal values. Hex numbers are especially useful for calculating main storage addresses and displacements. A storage address, we may remember, is a 24-bit true binary number internally, always represented externally by the machine as six hexadecimal digits.

We shall use Table 2-3 for converting hex numbers to decimal, and decimal to hex. It is for integers only. The table shows eight places, each place being the position of a hex digit, starting from the right.

The table shows the equivalent decimal value of each hexadecimal digit in each hex position from 1 to 8. To convert a hex number to decimal, it is necessary only to find the value of each hex digit in the column corresponding to its position, and to add them together. To convert $D34_{16}$ to decimal, we start in column 3 because this is a three-digit number. We find (1) $D00_{16} = 3328_{10}$ in column 3, (2) $30_{16} = 48_{10}$ in column 2, and (3) $4_{16} = 4_{10}$ in column 1; then (4) summing the decimal values, we get

$$\begin{array}{r} 3328 \\ 48 \\ 4 \\ \hline 3380_{10} = D34_{16} \end{array}$$

To convert the five-digit number $B60A6_{16}$ to decimal, we follow the same procedure, beginning in column 5:

Hex	Decimal
B0000	= 720 896
6000	= 24 576
000	= 0
A0	= 160
6	= 6
<u>B60A6</u>	<u>745 638</u>

Using the same table to convert a decimal number to hexadecimal requires a rather different procedure. Let's

Table 2-3. Hexadecimal and Decimal Integer Conversion Table

HALF WORD															
BYTE				BYTE				BYTE				BYTE			
BITS 0123		BITS 4567		BITS 0123		BITS 4567		BITS 0123		BITS 4567		BITS 0123		BITS 4567	
Hex	Decimal	Hex	Decimal	Hex	Decimal	Hex	Decimal	Hex	Decimal	Hex	Decimal	Hex	Decimal	Hex	Decimal
0	0	0	0	0	0	0	0	0	0	0	0	0	0	0	0
1	268,435,456	1	16,777,216	1	1,048,576	1	65,536	1	4,096	1	256	1	16	1	1
2	536,870,912	2	33,554,432	2	2,097,152	2	131,072	2	8,192	2	512	2	32	2	2
3	805,306,368	3	50,331,648	3	3,145,728	3	196,608	3	12,288	3	768	3	48	3	3
4	1,073,741,824	4	67,108,864	4	4,194,304	4	262,144	4	16,384	4	1,024	4	64	4	4
5	1,342,177,280	5	83,886,080	5	5,242,880	5	327,680	5	20,480	5	1,280	5	80	5	5
6	1,610,612,736	6	100,663,296	6	6,291,456	6	393,216	6	24,576	6	1,536	6	96	6	6
7	1,879,048,192	7	117,440,512	7	7,340,032	7	458,752	7	28,672	7	1,792	7	112	7	7
8	2,147,483,648	8	134,217,728	8	8,388,608	8	524,288	8	32,768	8	2,048	8	128	8	8
9	2,415,919,104	9	150,994,944	9	9,437,184	9	589,824	9	36,864	9	2,304	9	144	9	9
A	2,684,354,560	A	167,772,160	A	10,485,760	A	655,360	A	40,960	A	2,560	A	160	A	10
B	2,952,790,016	B	184,549,376	B	11,534,336	B	720,896	B	45,056	B	2,816	B	176	B	11
C	3,221,225,472	C	201,326,592	C	12,582,912	C	786,432	C	49,152	C	3,072	C	192	C	12
D	3,489,660,928	D	218,103,808	D	13,631,488	D	851,968	D	53,248	D	3,328	D	208	D	13
E	3,758,096,384	E	234,881,024	E	14,680,064	E	917,504	E	57,344	E	3,584	E	224	E	14
F	4,026,531,840	F	251,658,240	F	15,728,640	F	983,040	F	61,440	F	3,840	F	240	F	15
8		7		6		5		4		3		2		1	

X20-8047

take 3380_{10} as an example. We look for the highest decimal value in the table that will fit into 3380. The closest is 3328_{10} in column 3, equal to the D. We make a note that this corresponds to $D00_{16}$ and subtract, as shown below. The closest value below the remainder (52_{10}) is 48_{10} in column 2, and we note it is equal to 30_{16} . Subtracting again, we look for the best fit into the remainder of 4_{10} , and find 4_{10} in column 1, equal to 4_{16} . Adding the hex values, we get the result $3380 = D34$, which we know from our first conversion example is correct. (The best way to check the result of a conversion is to reconvert. Any lost zeros are likely to be found in the process.)

<u>Decimal</u>	<u>Hex</u>
<u>3380</u>	
<u>3328</u>	= D00
52	
<u>48</u>	= 30
4	
	= 4
	D34

Without looking back, let's convert $745,638_{10}$ to hexadecimal:

<u>Decimal</u>	<u>Hex</u>
745 638	
<u>720 896</u>	= B0000
24 742	
<u>24 576</u>	= 6000
166	
<u>160</u>	= A0
6	
	= 6
	B60A6

The easiest way to find the decimal value of a long binary number is to convert it to hex, and from hex to decimal. Similarly, to find the binary value of a decimal number, the decimal number should be converted to hex, and from hex to binary. To get the binary equivalent of $745,638_{10}$, we would convert it to hex as in the last example and merely substitute the four-bit code for each hex digit in the result:

0 B 6 0 A 6
 0000 1011 0110 0000 1010 0110

It is entirely feasible to perform all kinds of arithmetic calculations in hexadecimal arithmetic. The rules are the same as in decimal arithmetic. Most programmers prefer to

convert hexadecimal values to decimal, however, do their calculations in decimal, and then convert back to hex. This can be done easily and quickly with the use of a conversion table.

On the other hand, computer personnel often find it useful to be able to do simple addition in hexadecimal. Until they become proficient, they can simply count on their fingers. The rules for carrying are the same as in decimal addition. In decimal, the highest digit value is 9. When 1 is added to 9, the result is 0 and a carry of 1. Or, as we usually see it:

9	99	999
<u>+1</u>	<u>+1</u>	<u>+1</u>
10	100	1000

In hex, when 1 is added to the highest digit F, the result is also 0 and a carry of 1:

F	FF	FFF
<u>+1</u>	<u>+1</u>	<u>+1</u>
10 (= 16_{10})	100 (= 256_{10})	1000 (= 4096_{10})

The following list of equivalent values may help to crystallize the concepts of hexadecimal notation. Hex numbers that end in zero are always multiples of 16. To avoid confusion hex numbers like 10, 11, 12, etc., should be read as "one zero, one one, one two," and not as "ten, eleven, twelve."

Dec.	Hex	Dec.	Hex	Dec.	Hex	Dec.	Hex
1	1	22	16	43	2B	80	50
2	2	23	17	44	2C	81	51
3	3	24	18	45	2D	:	:
4	4	25	19	46	2E	:	:
5	5	26	1A	47	2F	:	:
6	6	27	1B	48	30	94	5E
7	7	28	1C	49	31	95	5F
8	8	29	1D	50	32	96	60
9	9	30	1E	51	33	97	61
10	A	31	1F	52	34	98	62
11	B	32	20	:	:	99	63
12	C	33	21	:	:	100	64
13	D	34	22	:	:	:	:
14	E	35	23	62	3E	:	:
15	F	36	24	63	3F	:	:
16	10	37	25	64	40	240	F0
17	11	38	26	65	41	:	:
18	12	39	27	:	:	:	:
19	13	40	28	:	:	254	FE
20	14	41	29	78	4E	255	FF
21	15	42	2A	79	4F	256	100

Chapter 3: Fixed-Point Arithmetic

This chapter introduces and discusses some of the fixed-point operations of the standard instruction set in the System/360. These include the arithmetic and shifting instructions as the central topic, with important consideration also of certain logical operations (comparison, branching), and loop methods.

Fixed-point instructions perform binary arithmetic on fixed-length data of either a fullword or a halfword. The use of registers for arithmetic and other operations is thus

most convenient. As might be expected, the fixed-point instruction set uses only these three instruction formats: RR, RX, and RS.

In the course of presenting the instructions and considering programming methods used with the System/360, we shall review the basic ideas of the machine organization and operation.

The presentation will be almost entirely through the medium of eight examples and a final extended case study.

ADDITION AND SUBTRACTION

For a first example we shall consider a simple inventory calculation. We begin the calculation with an on-hand quantity, a receipt quantity, and an issue quantity. We are required to compute the new on-hand, according to the formula:

$$\text{new on-hand} = \text{old on-hand} + \text{receipts} - \text{issues}$$

Using fairly obvious symbols for the four quantities, this becomes:

$$\text{NEWOH} = \text{OLDOH} + \text{RECPT} - \text{ISSUE}$$

A program to carry out this calculation is shown in Figure 3-1. We shall be concentrating on the four actual processing instructions, but at the outset we shall display all programs in logically complete form.

The assembler instruction PRINT NOGEN is used simply to suppress printing of statements generated by macro instructions such as the EOJ macro. These statements and their storage locations and displacements will still be part of the object program; they will be omitted only from the printed listing.

The next three lines of coding are rather standard preliminaries; instructions of this character will appear at the beginning of all but highly specialized programs. To review briefly, the START establishes a reference point for the assembly: the assembly listing (shown later) will assume that the first byte is to be loaded into 256 as shown. The BALR (Branch and Link Register) and the USING, as written here, together direct that register 11 shall be used as a base register wherever one is needed, and inform the assembler that the base register at execution time will contain the location of the first byte after the USING.

PROGRAM		STOCK					
PROGRAMMER		J. J. JONES					
1	Name	8	10	14	16	20	Operand
							25
			PRINT		NOGEN		
STOCK			START		256		
BEGIN			BALR		11,0		
			USING		*11		
			L		3,OLDOH		
			A		3,RECPT		
			S		3,ISSUE		
			ST		3,NEWOH		
			EOJ				
OLDOH			DC		F'9'		
RECPT			DC		F'4'		
ISSUE			DC		F'6'		
NEWOH			DS		F		
			END		BEGIN		

Figure 3-1. A program, written in assembler language, to perform a simple computation in binary arithmetic

Now we reach the first processing instruction, where we wish to concentrate our attention.

The Load instruction is classified as an RX format instruction, which implies a number of facts about it:

1. The instruction itself takes up four bytes of storage.
2. The fields within the instruction are, from left to right: the operation code (eight bits), the number of the register to be loaded from storage (four bits), the number of the register used as an index register (four bits), the

number of the register used as a base register (four bits), and the displacement (twelve bits).

3. The instruction involves a transfer of information between storage and a general register.

4. The effective address of a byte in storage is formed by adding the contents of the base register, the contents of the index register, and the displacement. If register zero is specified for an index register or a base register, a zero value is used in the address computation, rather than whatever register zero may contain.

The operation of the Load instruction is straightforward: obtain a fullword (four bytes) from storage at the effective address specified, and place the word in the general register indicated. The effective address must refer to a fullword boundary, which means that the address must be a multiple of 4.

Let us consider the complete line of coding for the Load instruction to see what each part does.

The letter L is the mnemonic operation code for Load; this is converted by the assembler into the actual machine operation code for Load, 58. The 3 is the number of the general register we wish loaded with a word from storage. OLDOH is the symbolic address of the word in storage to be copied into general register 3. By writing the address in this fashion, we have indicated that the assembler should supply the base register and the displacement, and that we do not wish indexing.

The assembly listing for this program is shown in Figure 3-2. Looking at the machine instruction assembled from this symbolic instruction, and remembering that all numbers are shown in hexadecimal, we see that the operation code is 58, the general register is 3, the index register is zero, the base register is B (= 11₁₀), and the displacement is 012₁₆. Since the base register contains 102, the effective address is 114, which is shown in the assembly listing under ADDR2 as the address of the second operand and which we see is the location of OLDOH.

The Add instruction is also of the RX format. The operation is to add the fullword at the storage address specified, to the general register named. In our case, we

have, of course, named the same general register as in the Load instruction, since the intent is to add OLDOH and RECPT together. Looking at the assembled instruction, we see that things have been handled much as they were with the Load. Base register 11 has been assigned, there is no index register, and the displacement has been computed to give the effective address of the storage location associated with RECPT (118).

After the execution of this instruction, register 3 will contain the sum of the storage quantities identified in our program by OLDOH and RECPT.

The Subtract instruction (S) in the next line subtracts the quantity identified by the symbol ISSUE from the quantity now standing in register 3. The format and general operation of the instruction are very similar to Add.

Now we have the desired result in register 3. The problem statement required the result to be placed in another location in storage, that is identified by the symbol NEWOH. Placing the contents of a general register in storage is the function of the Store instruction (operation code ST). The general register contents are unchanged by the operation. The format is again RX, so address formation is as before.

This completes the actions required by the problem statement, but we must now indicate what we want done next. The System/360 forces a program organization that keeps the machine in operation as much of the time as possible. What we have shown here is an End of Job macro instruction, which is used in the Disk Operating System environment. As we saw in the preceding chapter, the EOJ macro generates a Supervisor Call instruction, SVC 14. The use of this instruction assumes that there is in storage, at the time of execution of this program, a control program that runs the machine between jobs. We here indicate to the supervisor that this program has no further need for the machine.

The program in Figure 3-2 does not include any instructions for reading in data from an input device such as a card reader or magnetic tape unit, or for printing out or punching out the results of our calculations. Input and

LOC	OBJECT CODE	ADDR1	ADDR2	STMT	SOURCE	STATEMENT
				1		PRINT NOGEN
000100				2	STOCK	START 256
000100	0580			3	BEGIN	BALR 11,0
000102				4		USING *,11
000102	5830 B012		00114	5	L	3,OLDOH
000106	5A30 B016		00118	6	A	3,RECPT
00010A	5830 B01A		0011C	7	S	3,ISSUE
00010E	5030 B01E		00120	8	ST	3,NEWOH
				9		EOJ
000114	00000009			12	OLDOH	DC F'9'
000118	00000004			13	RECPT	DC F'4'
00011C	00000006			14	ISSUE	DC F'6'
000120				15	NEWOH	DS F
000100				16	END	BEGIN

Figure 3-2. The assembly listing of the program in Figure 3-1

output instructions vary considerably in different systems, depending upon the operating (or programming support) system in use and the particular pieces of input/output equipment available at an installation.

In normal commercial practice, a computer program would be used, not for calculations on just one set of data, but on large series of data that require similar treatment. An example would be a program to calculate weekly pay for several hundred employees of a company, and the data would include the hours worked, pay rate, withholding amounts, etc., for each of them. In our program examples, our principal interest lies in how the assembler language instructions work, and so we will generally use only one set of specific values for the purpose of illustrating what happens in each step.

We have simply entered the illustrative values for the input data with DC instructions, and reserved space for the output with a DS. The F's in the DC's and the DS specify fullwords of four bytes. The Load, Add, Subtract, and Store instructions all operate on fullwords. As we shall see in later examples, there are corresponding halfword instructions.

The END instruction informs the assembler that the termination of the program has been reached and specifies in this case that the first instruction to be executed after the program is loaded is the one with the name BEGIN, that is, the BALR instruction.

By using either a suitable assembler language routine or macro instruction, it is possible to get a "dump" of the contents of the registers and selected areas of storage, and get our data and results out of the machine. Such a routine produced the numbers, converted to decimal, that are shown in Figure 3-3. The four items, in sequence, are OLDOH, RECPT, ISSUE, and NEWOH.

It might be interesting to run this program again with a value of, say, 16 for ISSUE. We know that negative fixed-point numbers are represented in two's complement form. Our output routine will make a conversion to true

```
0000009+ 0000004+ 0000006+ 0000007+
```

Figure 3-3. Output of the program of Figure 3-2. The four numbers are OLDOH, RECPT, ISSUE, and NEWOH, in that order.

numbers and sign, as shown in the first line of Figure 3-4. In the second line, the same numbers are shown in hexadecimal as they normally appear in a dump.

We see that the first three numbers, which are positive, have zeros before the significant digits. The last number, which is negative, has 1's to the left of the significant digit (hexadecimal F equals binary 1111). If we were to write out this hexadecimal number, FFFFFFFD, in the binary form actually in storage, we would have thirty 1's followed by 01. Recalling how two's complement numbers are formed, we see that the complement of this number is binary 11, which equals decimal 3. Checking with the given data and the formula, we see that this is the correct answer, and, of course, the decimal value was printed out as a minus 3.

Naturally, if a negative result were actually obtained in an inventory control program, it would indicate some kind of trouble, probably bad data; it is not possible to issue more than there are on hand plus what was received. A realistic program would include a test for the possibility of a negative result and the corrective action to be taken.

```
0000009+ 0000004+ 0000016+ 0000003-
00000009 00000004 00000010 FFFFFFFD
```

Figure 3-4. Output of the same program with a value for ISSUE that causes NEWOH to be negative. Values are shown in decimal in the first line, hexadecimal in the second; the value for NEWOH is in complement form.

MULTIPLICATION

For a simple example of fixed-point multiplication in the System/360, consider the following problem. We are to multiply an ISSUE quantity by a PRICE to get TOTAL. We shall assume that PRICE is an integer, expressed in pennies. The product will therefore also be in pennies. For instance, an ISSUE of 5 and a PRICE of 25 would give a TOTAL of 125.

The program to do this multiplication is shown in Figure 3-5. The first four lines are the same as before. The Load places the multiplicand in general register 5. The Multiply (M) forms the product of what is in 5 and what is in the full word identified by PRICE, and places the result, which could of course be much longer than either of the factors, in registers 4 and 5 combined. It is required that the general register named in the Multiply be even numbered; if it is not, a specification exception and an interrupt occur. The multiplicand must always be in the odd-numbered register of an even-odd pair, such as 4 and 5 here. The multiplicand in the odd register, and whatever may have been in the even register, are both destroyed by the operation of the Multiply.

After the product has been formed, we store it in TOTAL on the assumption that the result does not exceed the length of one register. The validity of such an assumption, of course, is the responsibility of the programmer; if in fact the product extended over into register 4, there would be no automatic signal of the fact that the result in TOTAL is not the complete product. If a product extending into the even register could be a legitimate outcome, we would naturally have to arrange to store both parts of the product.

Let us try this program with several sets of sample factors in order to see precisely how the operation works. Figure 3-6 shows the values of ISSUE, PRICE, TOTAL, and the contents of register 4 and 5 after the completion of the program. These were obtained by a dump routine and converted to decimal. We see that the product of 7 and 23 is indeed 161, as we might expect. This number is shown as the contents of register 5, while register 4 is zero; the

ISSUE	PRICE	TOTAL
000007+	000023+	0000161+
REG 4	REG 5	
000000+	0000161+	

Figure 3-6. Output of the program of Figure 3-5

product was not long enough to extend into 4.

In Figure 3-7 the numbers are the same except that the 7 is negative. (This makes no sense in terms of the problem, of course.) We see that TOTAL and register 5 are negative, as expected, but what has happened to register 4? The answer is that the product is a full 64 bits long; a negative number has 1's to the left of the leftmost significant digits. Register 4 properly contained all 1's which, considered as part of the 64-bit product, are merely sign bits. But printed as a separate number (which is pointless, in reality), a word of all 1's represents -1 as shown. A printout not reproduced here substantiates what we have said: register 4 printed in hexadecimal form appears as eight F's.

ISSUE	PRICE	TOTAL
000007-	000023+	0000161-
REG 4	REG 5	
0000001-	0000161-	

Figure 3-7. Output of the program with a negative value for ISSUE

In Figure 3-8 we see an example of what can happen when the numbers entering the machine do not conform to the assumptions made in setting up the program (that is, the product would never extend into register 4). With both factors being 87654, the product, in decimal, should be 7,683,223,716. This is too long to fit into register 5, so we would expect TOTAL to contain only the equivalent of the part of the product that appeared there. But we would hardly have expected it to be negative! What happened?

LOC	OBJECT CODE	ADDR1	ADDR2	STMT	SOURCE	STATEMENT
				1		PRINT NOGEN
000100				2	GROSS	START 256
000100	05B0			3	BEGIN	BALR 11,0
000102				4		USING *,11
000102	5850 B00E		00110	5	L	5,ISSUE
000106	5C40 B012		00114	6	M	4,PRICE
00010A	5050 B016		00118	7	ST	5,TOTAL
				8		EOJ
000110	00000007			11	ISSUE	DC F'7'
000114	00000017			12	PRICE	DC F'23'
000118				13	TOTAL	DS F
000100				14	END	BEGIN

Figure 3-5. Assembly listing of a program to perform binary (fixed-point) multiplication

The answer becomes apparent if we look at the product as a hexadecimal number and note the part of it that would appear in register 5. The complete product is 1C9F4B0A4, that is, nine hexadecimal digits — a register can hold eight. So the 1, preceded by seven hexadecimal zeros, would be the contents of register 4, as shown. The part in register 5 begins with the hexadecimal digit C, which is 1100 in binary. This means that the leftmost bit is 1, which, when C9F4B0A4 is taken as a number by itself, indicates a negative number that is in two's-complement notation! Thus, in converting to decimal for Figure 3-8, System/360 performed as it was designed to do, re-complemented (to hexadecimal 360B4F5C), and came up with the decimal equivalent of that amount.

This recitation of troubles is not meant to suggest any difficulty in using the System/360. Any programmer

appreciates the necessity of knowing a good deal about his data and for testing it for validity if he is not sure of it. The purpose in showing these slightly surprising results is simply to clarify how the machine operates, especially since many programmers will not have had previous contact with complement representation of negative numbers.

ISSUE	PRICE	TOTAL
0087654+	0087654+	906710876-
REG 4	REG 5	
0000001+	906710876-	

Figure 3-8. Output of the program with values for ISSUE and PRICE that lead to a TOTAL too large to fit in a fullword

MULTIPLICATION AND DIVISION WITH DECIMAL POINTS

The next example involves a little further practice with multiplication, an application of the Divide instruction, and a rather basic question of decimal point handling in binary.

The task is to increase a principal amount named PRINC by an interest rate of 3%. The principal is stored in pennies as in the previous example; for instance, 24.89 would be stored simply as the integer 2489. Later program segments would have to insert any "graphic" decimal point that might be desired for printing; at this point we make a mental note of the true situation, while pretending for programming purposes at the moment that the unit of currency is the penny.

One possible program is shown in Figure 3-9. (There are other ways, as we shall see.) After the usual preliminaries we load the principal into an odd-numbered register preparatory to multiplying. The interest rate is shown as 103, which should be read as 1.03. This is a shortcut: instead of multiplying the principal by 0.03 and adding the product to the principal, we multiply the principal by 1.03. The result is the same either way; our way saves an addition.

The absence of the decimal point is another matter. We are saying here that instead of multiplying by 1.03, we will multiply by 103; the product will be 100 times too large as a result. It will be necessary in a subsequent step to divide by 100 to correct for this. The reason for this is that there is a question of how to represent a decimal fraction in binary form. The question can be answered, as we shall see, leading to a different program. For now, let us take what seems at first to be the easy way out and stay with integers.

Using the sample principal mentioned above, 24.89, the product after multiplication is 256367. We shall assume that the product in all cases is short enough to be held in register 5 alone.

We now wish to round off. We think of the product as \$25.6367; the desired rounded value is \$25.64. Remem-

bering that the computer knows nothing of our behind-the-scenes understanding about decimal points, all we have to do to round off is to add 50 to the integer product. We will think of the 50 as \$0.0050, but to the computer it is 50.

Having done this, we need finally to divide by 100 to correct for using 103 in place of 1.03. This requires the Divide instruction, which as we might expect is a close relative to the Multiply instruction. The dividend must be in an even-odd pair of registers as a 64-bit number. This requirement is already met by the way the Multiply leaves the product in an even-odd pair (the machine was designed to make it simple to follow a Multiply with a Divide). The remainder is placed in the even register and the quotient in the odd. Our quotient will be 2564 (we read: \$25.64) and the remainder will be 17 (we don't care about this). The quotient can now be stored back in the location for PRINC, as required in the problem statement.

The question will occur to many: why was it necessary to divide? Why not simply shift two places right to drop the right two digits? The answer is, of course, that we could do precisely that in decimal, but this is binary. Shifting one place to the right in decimal divides the number by 10; shifting one place to the right in binary divides the number by 2. There is no number of binary shifts that divides a number by a factor of decimal 100. Six places divides it by 64, and seven places by 128. With this way of approaching the problem, we have no choice but to divide.

It should be kept clearly in mind that in all examples so far we have explicitly stated that all quantities were to be viewed for programming purposes as integers, whatever we on the outside might understand by the digits. This was by agreement, not necessity. We can work with binary numbers that are taken to have "binary points" elsewhere than at the extreme right. Let us, for instance, attempt to express the factor 1.03 as a binary number.

LOC	OBJECT CODE	ADDR1	ADDR2	STMT	SOURCE	STATEMENT
				1		PRINT NOGEN
000100				2	INTA	START 256
000100	05B0			3	BEGIN	BALR 11,0
000102				4		USING *,11
000102	5850 B016		00118	5	L	5,PRINC
000106	5C40 B01A		0011C	6	M	4,INT
00010A	5A50 B01E		00120	7	A	5,C50
00010E	5D40 B022		00124	8	D	4,C100
000112	5050 B016		00118	9	ST	5,PRINC
				10		EOJ
000118	000009B9			13	PRINC	DC F'2489'
00011C	00000067			14	INT	DC F'103'
000120	00000032			15	C50	DC F'50'
000124	00000064			16	C100	DC F'100'
000100				17		END BEGIN

Figure 3-9. Assembly listing of a program involving binary multiplication and division with the result rounded off

It may be recalled from a study of the conversion rules that there will be in general no *exact* binary equivalent for a decimal fraction. If we try 1.03 we get an infinitely repeating binary fraction. The first twelve bits are

1.00000111101

The binary point is, of course, *understood* (by us).

If we enter such a number as the constant (which we shall see how to do in a moment), we can multiply by it. The machine cares nothing for our understood binary points, and carries out the multiplication. We must then take into account the understood binary point in the product, according to a literal translation of familiar rules: the binary point in the product will have as many places to the right as the sum of the number of places to the right of the binary points in the multiplier and in the multiplicand. If the constant has eleven places to the right, as written above, and the principal is still understood to be an integer (zero places), then the product will have eleven places to the right.

Let us turn to Figure 3-10 to see how this much of the revised program looks.

The Load is the same as before, as is the Multiply. The constant used for multiplication is different, however. Down at INT we see that the DC is

FS11'1.03'

The F stands for fullword, as before. The S stands for Scale factor and is the number of binary places that are to be reserved for the fractional part of the constant. We have indicated eleven places as the number of bits to the right of the binary point in the factor as we write it before.

The Add to round off is the same as before, but once again the constant is different. What we have after the multiplication this time is not an integer but a binary fraction. To the left of the assumed binary point we have a whole number of pennies; to the right a fractional part of a penny. This time, to round off we need a constant that is 0.5 cent expressed in the same form as the fractional part

of our product. The Scale factor method shown gives this. (In fact, the constant consists of a 1 followed by ten zeros.)

After rounding off we are left with eleven superfluous bits at the right end of the product. These can be shifted off the end of the register with a suitable shift instruction. "Suitable" in this case means that the shift should be to the right, it should involve a single register, and it should be an algebraic shift so that if the number were negative, proper sign bits would be shifted into the register. The instruction is called Shift Right Single (SRA), in which we specify the register first and then the number of positions of shift desired. Bits shifted off the right end of the register are lost. After the shift we are ready to store the result.

The point of doing all this is that we have replaced a Divide with a Shift, and the latter is considerably faster than the former. In some applications the difference in time could be significant.

If we print the result, we get a surprise: the answer is 2563 (\$25.63); rounding seems not to have taken place. The trouble is that the binary "equivalent" of the decimal number 1.03 was not *exactly* equivalent. To prove the point, let us ask for 15 binary places in the fractional part of the constant created for 1.03. We change the rounding constant likewise, and make the shift 15 places. This time, the printout shows 2564 (\$25.64) as before.

The moral of this story is that decimal fractions do not usually have exact binary equivalents. Computations that are required to be exact to the penny should be done in integer form, as in the first version of the program. (Even though a larger number of bits led to a correct answer this time, it would not always do so, particularly for larger principal amounts.)

This means, in most situations, that it would be most unwise to go the further possible step of representing penny amounts as binary fractions. Unless approximate results are acceptable, which they sometimes are, of course, the use of anything but integer arithmetic leads to problems more severe than they are worth.

LOC	OBJECT CODE	ADDR1	ADDR2	STMT	SOURCE	STATEMENT
				1		PRINT NOGEN
000100				2	INTB	START 256
000100	05B0			3	BEGIN	BALR 11,0
000102				4		USING *,11
000102	5850 B016		00118	5	L	5,PRINC
000106	5C40 B01A		0011C	6	M	4,INT
00010A	5A50 B01E		00120	7	A	5,HALF
00010E	8A50 000B		0000B	8	SRA	5,11
000112	5050 B016		00118	9	ST	5,PRINC
				10		EOJ
000118	000009B9			13	PRINC	DC F'2489'
00011C	0000083D			14	INT	DC FS11'1.03'
000120	00000400			15	HALF	DC FS11'0.5'
000100				16	END	BEGIN

Figure 3-10. A different version of the program of Figure 3-9, using a scale modifier for constants

Some readers may be wondering whether binary arithmetic is worth the trouble. The answer is yes, of course. Many applications of binary arithmetic raise none of the questions suggested here and do not involve the possible complications with complement form either. For the straightforward cases, it is barely necessary to know anything about the binary and complement matters. We present examples like these to warn the unwary and to lay a

foundation of understanding for those with problems where the advantages of binary arithmetic are worth the care that must be exercised in using it. It is true that many applications will suggest staying with decimal arithmetic, for users having the decimal instruction set, but even then there will be more than a few occasions where binary operations are the only ones that make sense from a standpoint of time.

SHIFTING AND DATA MANIPULATION

Having introduced the shifting operation briefly in the previous example, let us now turn to an application that will involve considerably more shifting.

We begin with a fullword, supplied by some other program, in which three data items are stored in binary form:

Bits	Item name
0 - 11	A
12 - 23	B
24 - 31	C

We are required to separate the three data items and store each in a separate halfword storage location, with names for the latter as shown. All three numbers are positive.

The program shown in Figure 3-11 is a more or less straightforward matter of shifting and storing, but a few notes are necessary to make clear what is happening at certain points.

The numbers in the Comments field are sample contents of registers 6 and 7 as they would appear during execution of the program if the original word were hexadecimal 78ABCDEF. These sample values, of course, were entered when the source program was punched; it is quite impossible for the object program to print anything on the assembly listing.

We begin by loading the fullword into an even-numbered general register. This permits us to continue with a double-length shift that moves bits from the named even-numbered register into the adjacent odd-numbered register, which we think of as being to the right. This is what "double" means in Shift Right Double Logical (SRDL). The "logical" refers to the handling of sign bits and means that zeros are entered at the left of register 6. This is in contrast to the "algebraic" shifts, in which the bits entered at the left are

made to be the same as the original "sign bit", that is, the original leftmost bit. Here, we were guaranteed in the problem statement that all three numbers are positive, so we can ignore any question of what the leftmost bit in each item might be. Whether it is zero or one, the number represented is positive.

The SRDL moves the rightmost eight bits into register 7; from there we move them to the right-hand end of the same register, using a single-length logical shift that does not affect register 6. What were originally the rightmost eight bits of the fullword are now properly positioned in register 7 to be stored in a halfword location with the Store Halfword (STH) instruction. The action here is to store the rightmost 16 bits of the register named, in the two bytes identified by the effective address. The register is not disturbed by the operation of the instruction. This is an RX format instruction; it could be indexed if we had occasion to do so.

Now we again shift the two registers together to get the twelve-bit B item into register 7. From there we move it on over to the right-hand end of 7 and store it. A further shift of what was originally the leftmost twelve bits is not needed, since they are now in the right-hand end of 6, from whence they may be stored.

Actually, the restriction to positive numbers is not too difficult to remove. It would have to be agreed that the leftmost bit of each item was its sign bit, that is, that in generating the fullword each negative item was in complement form and of such length as to fit in the item size allotted. With this assumption, the program of Figure 3-12 properly expands the sign bits of the items and stores any negative items in halfwords in complement form. The "expansion" of the sign bit is one of the functions of an algebraic shift, as noted above. The program must also be

LOC	OBJECT CODE	ADDR1	ADDR2	STMT	SOURCE	STATEMENT
				1		PRINT NOGEN
00010J				2	SHIFTA	START 256
000100	05B0			3	BEGIN	BALR 11,0
000102				4		USING *,11
000102	5860 B022		00124	5	L	6, FWORD 78ABCDEF 00000000
000106	8C60 0008		00008	6	SRDL	6,8 0078ABCD EF000000
00010A	8870 0018		00018	7	SRL	7,24 0078ABCD 000000EF
00010E	4070 B02A		0012C	8	STH	7,C 0078ABCD 000000EF
000112	8C60 000C		0000C	9	SRDL	6,12 0000078A BCD00000
000116	8870 0014		00014	10	SRL	7,20 0000078A 00000BCD
00011A	4070 B028		0012A	11	STH	7,B 0000078A 00000BCD
00011E	4060 B026		00128	12	STH	6,A 0000078A 00000BCD
				13		EOJ
000124				16	FWORD	DS F
000128				17	A	DS H
00012A				18	B	DS H
00012C				19	C	DS H
000100				20		END BEGIN

Figure 3-11. Assembly listing of a program to separate three quantities stored in one fullword

LOC	OBJECT CODE	ADDR1	ADDR2	STMT	SOURCE	STATEMENT
				1		PRINT NOGEN
000100				2	SHIFTB	START 256
000100	05B0			3	BEGIN	BALR 11,0
000102				4		USING *,11
000102	5860 B02A		0012C	5	L	6,FWORD 78ABCDEF 00000000
000106	8C60 0008		00008	6	SRDL	6,8 0078ABCD EF000000
00010A	8A70 0018		00018	7	SRA	7,24 0078ABCD FFFFFFFEF
00010E	4070 B032		00134	8	STH	7,C 0078ABCD FFFFFFFEF
000112	8C60 000C		0000C	9	SRDL	6,12 0000078A BCDFFFFFF
000116	8A70 0014		00014	10	SRA	7,20 0000078A FFFFFFFBCD
00011A	4070 B030		00132	11	STH	7,B 0000078A FFFFFFFBCD
00011E	8C60 000C		0000C	12	SRDL	6,12 00000000 78AFFFFFF
000122	8A70 0014		00014	13	SRA	7,20 00000000 0000078A
000126	4070 B02E		00130	14	STH	7,A 00000000 0000078A
				15		EOJ
00012C				18	FWORD	DS F
000130				19	A	DS H
000132				20	B	DS H
000134				21	C	DS H
000100				22		END BEGIN

Figure 3-12. Modified version of the program of Figure 3-11, making it operate correctly with negative quantities

changed to expand the sign of item A. The final two shifts are added to do this. Actually, it could be done more efficiently and these extra steps avoided simply by changing the SRDL in statements 6 and 9 to the algebraic SRDA.

Figure 3-13 shows the output of the two programs for the sample input word of 78ABCDEF. The three parts of the combined word, in hexadecimal, were therefore 78A, BCD, and EF. In the first line of Figure 3-13 we see that these have been put into halfwords by the first program as 078A, 0BCD and 00EF, that is, as three positive numbers. In the second line we see that the second program, on the

other hand, interpreted the second and third numbers as negative because their leftmost bits were 1's. The three output halfwords are 078A, FBCD, and FFEF, showing that the sign bits of the numbers were properly expanded.

PROG SHIFTA	078A	0BCD	00EF
PROG SHIFTB	078A	FBCD	FFEF

Figure 3-13. Output of the two programs executed with hexadecimal 78ABCDEF for the fullword

BRANCHES AND DECISION CODES

The Condition Code

Decisions and branching are important parts of data processing, and the programming methods by which these operations are carried out are important aspects of the programming task. The facilities offered by the System/360 are particularly powerful and flexible. The basic action is the setting of the *condition code* by any of a large number of instructions and the subsequent testing of the condition code by a Branch on Condition instruction.

Many arithmetic, shift, and logical instructions have as a part of their action the setting of the condition code to indicate something about the result of the instruction's execution. For instance, after an Add instruction, the condition code indicates whether the sum was zero, positive, negative, or too large for the register. After a Compare instruction the condition code indicates whether the first operand was greater than, equal to, or less than the second operand. The meaning of each of the different states or values of the condition code is specified in the description of each instruction that affects the code. These descriptions may be found in the *System/360 Principles of Operation*, which also contains a complete tabulation of the instructions involved and the meaning of the condition codes.

The condition code occupies two bits (in the control program area of storage). Two bits can, of course, be set in just four ways: 00, 01, 10, and 11; and these four binary settings are equal to decimal values 0, 1, 2, and 3, respectively.

At any time after the condition code has been set by the action of an instruction, it may be tested by using a Branch on Condition (BC) instruction. In this instruction, which is in the RX format, the four bits that in other instructions designate a general register are here used for a *mask* that designates in which states of the condition code we wish a certain branch to occur.

The leftmost bit of the mask checks for a condition code of zero, the next bit for code 1, the next for code 2, and the rightmost for code 3. If the condition code is equal to any of the values selected by the mask bit(s), the Branch is taken. The correspondences between condition codes and mask are summarized in Table 3-1.

Note that the mask bits correspond from left to right with the four condition codes. Another way, perhaps easier to remember, of summarizing this correspondence is as follows:

Condition code	0	1	2	3
Mask used to test code	8	4	2	1

A BC instruction with a decimal mask of 12 (8+4) specifies

that a branch is to be made if the condition code is 0 or 1, and is not to be made if the condition code is 2 or 3. A mask of 7 (4+2+1) will cause a branch only if the condition code is 1, 2, or 3.

A decimal mask value of zero makes the instruction test for no condition codes; it thus becomes a no-operation instruction. A mask of 15 tests for *any* condition code; it is thus an unconditional branch.

Table 3-1. Masks for testing various states of the condition code

Mask bits	Decimal value	Condition codes tested
0000	0	None
0001	1	3
0010	2	2
0011	3	2 or 3
0100	4	1
0101	5	1 or 3
0110	6	1 or 2
0111	7	1, 2, or 3
1000	8	0
1001	9	0 or 3
1010	10	0 or 2
1011	11	0, 2, or 3
1100	12	0 or 1
1101	13	0, 1, or 3
1110	14	0, 1, or 2
1111	15	0, 1, 2, or 3

A Sorting Procedure

To see how some of these ideas are applied, consider a simple example. We are given three fullword data items named A, B, and C. They may be positive or negative. We are required to change any negative values to positive, and then to rearrange the three values in storage to make the number in A the largest, the number in B the next largest, and the number in C the smallest of the three. Figure 3-14 expresses the logic of the method that will be used here to perform the sort; other ways are possible.

We first make all three numbers positive. A comparison is then made between A and B; if A is the smaller, we interchange the two values. Now we know that the value in A is the larger of the two, whether it originally was or not. A similar process compares A and C and interchanges if A is smaller. Having done this, we know that what is in A is the largest of the three. A final comparison of the numbers now

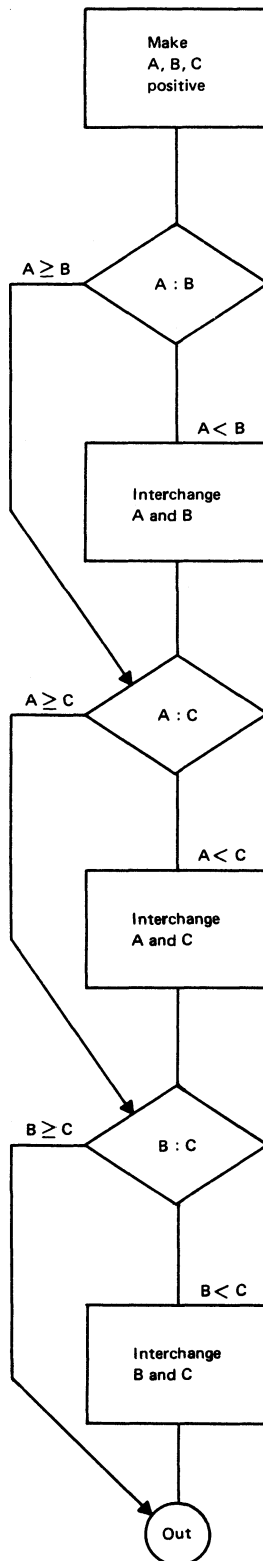

Figure 3-14. Program flowchart of a method of sorting three numbers into descending sequence. Any negative numbers are changed to positive before sorting.

in B and C, and an interchange if necessary, gets the "middle" number in B and the smallest in C.

The program of Figure 3-15 involves some instructions that we have not used before. The Load Multiple (LM) instruction begins loading fullwords from the specified storage location. The first word goes into the first-named register. Successive fullwords go into higher-numbered registers until the second-named register has been loaded. In the program, the result of the LM instruction will be to place A in 2, B in 3, and C in 4.

Now three Load Positive Register (LPR) instructions change any negative numbers to positive, leaving any positive numbers unchanged. This is an RR format instruction, meaning that both of its operands are registers. Here both operands are the same register, as will frequently be the case. The action is to take the value from a register, complement it if it is negative, and place the result back in the same register. If it were necessary, two different registers could of course be used.

Next comes a Compare Register (CR) instruction, which is also in the RR format. This instruction does not change the contents of either register, but simply sets the condition code to zero if the two operands are the same, to 1 if the first operand is low, and to 2 if the first operand is high. (The comparison is algebraic, meaning that signs are taken into account according to the rules of algebra, by which any positive number is greater than any negative number. We know that our numbers are by now all positive, so this feature does not concern us.)

Next comes the Branch on Condition instruction, with a mask of 10 (decimal) and a branch address of COMP2. The mask of 10, checking with the table above, tests for condition code zero or 2. Following a Compare-type instruction, these mean, respectively, that the first operand is equal to or greater than the second operand. If the condition code is either of these, we branch; otherwise the next instruction in sequence is taken. The effect is: if the number in register 2 is already equal to or greater than the number in register 3, we skip down to the second comparison, because A and B are already in correct sequence.

The interchange, if it is necessary, is performed by moving the contents of register 2 to register 6, moving 3 to 2, and finally moving 6 to 3. These transfers are made with the Load Register (LR) instruction.

The remaining instructions repeat these operations twice for the other comparisons. Finally, there is a Store Multiple (STM) instruction to place the rearranged items back in the original three locations, as required by the problem statement.

Figure 3-16 shows before-and-after values of A, B, and C for six possible original orderings of the three values. Each pair of lines is one set. These are hexadecimal numbers; the original value of A in the last set is -3.

LOC	OBJECT CODE	ADDR1	ADDR2	STMT	SOURCE STATEMENT	
				1	PRINT NOGEN	
000100				2	SORT START 256	
000100	0580			3	BEGIN BALR 11,0	
000102				4	USING *,11	
000102	9824 B036		00138	5	LM 2,4,A	LOAD REGISTERS WITH 3 NUMBERS
000106	1022			6	LPR 2,2	MAKE NUMBERS POSITIVE
000108	1033			7	LPR 3,3	
00010A	1044			8	LPR 4,4	
00010C	1923			9	CR 2,3	COMPARE A AND B
00010E	47A0 B016		00118	10	BC 10,COMP2	
000112	1862			11	LR 6,2	INTERCHANGE IF NECESSARY
000114	1823			12	LR 2,3	
000116	1836			13	LR 3,6	
000118	1924			14	COMP2 CR 2,4	COMPARE A AND C
00011A	47A0 B022		00124	15	BC 10,COMP3	
00011E	1862			16	LR 6,2	INTERCHANGE IF NECESSARY
000120	1824			17	LR 2,4	
000122	1846			18	LR 4,6	
000124	1934			19	COMP3 CR 3,4	COMPARE B AND C
000126	47A0 B02E		00130	20	BC 10,OUT	
00012A	1863			21	LR 6,3	INTERCHANGE IF NECESSARY
00012C	1834			22	LR 3,4	
00012E	1846			23	LR 4,6	
000130	9024 B036		00138	24	OUT STM 2,4,A	STORE SORTED VALUES
				25	EOJ	
000136	0000					
000138	00000001			28	A DC F'1'	
00013C	00000002			29	B DC F'2'	
000140	00000003			30	C DC F'3'	
000100				31	END BEGIN	

Figure 3-15. Assembly listing of a program to carry out the sorting procedure charted in Figure 3-14

INPUT1	00000001	00000002	00000003
OUTPUT1	00000003	00000002	00000001
INPUT2	00000001	00000003	00000002
OUTPUT2	00000003	00000002	00000001
INPUT3	00000002	00000001	00000003
OUTPUT3	00000003	00000002	00000001
INPUT4	00000003	00000002	00000001
OUTPUT4	00000003	00000002	00000001
INPUT5	00000003	00000001	00000002
OUTPUT5	00000003	00000002	00000001
INPUT6	FFFFFFFD	00000002	00000001
OUTPUT6	00000003	00000002	00000001

Figure 3-16. Six sets of sample input and output for the program of Figure 3-15

**FURTHER DECISIONS:
THE SOCIAL SECURITY PROBLEM**

In this application, which is presumably familiar to many readers, we combine two decisions with some arithmetic processing.

We are given a man's earnings for a week (EARN), his previous ("old") year-to-date earnings (OLDYTD), and his previous year-to-date Social Security tax (OLDFICA). We are to compute his Social Security tax for this week (TAX); his new year-to-date earnings (NEWYTD) and new Social Security tax (NEWFICA). Assume the Social Security tax is computed as 4.4% of earnings (with certain exclusions such as sick pay, which we shall ignore) up to an annual limit on taxable income of \$7800. The program must decide whether the employee has yet earned \$7800 this year; if so, he is exempt from further Social Security tax. Actually, the situation is slightly more complex than that: if the man has not yet earned \$7800 before this week's pay but, counting this week's pay, goes over \$7800, only the portion of this week's pay that takes him up to the \$7800 limit is taxable.

The flowchart of Figure 3-17 expresses the logic we have just described. Figure 3-18 translates this logic into a program illustrating in the process that there are many ways to implement a flowchart.

We begin by loading the previous year-to-date into a register, and from there immediately load it into another register, in order to have it both places. This method saves a little time over loading twice from storage. We add this week's earnings, giving the new year-to-date, which is stored. Once this is done, we no longer need the same information in register 6, so this register is free for any other processing we will need to do. Now we compare the *old* year-to-date with \$7800. The Branch on Condition that follows asks whether the condition code is 1, that is, whether the first operand is low. This can be read: branch if the old year-to-date was less than \$7800. If the branch is not taken, the old year-to-date was already over \$7800, so there is no tax to pay. We clear register 7, where the tax is developed if there is any, by subtracting it from itself – the fastest and simplest way to clear a register to zero. The Branch on Condition with a mask of 15 is an unconditional branch down to the final instructions where the tax is stored and the Social Security updated.

If the branch is taken, there is a tax to be paid, but we still need to know whether this week took the man over the top. Accordingly, at the instruction labeled YES, we compare the new year-to-date with \$7800. The Branch on Condition with a mask of 2 asks whether the first operand – the new year-to-date – was greater than \$7800. If so, it is necessary to compute the tax on just that part of this week's pay that takes the total up to \$7800. At OVER78, accordingly, we load register 7 with \$7800 and subtract the previous year-to-date; the difference is just the amount that is taxable. If the branch was not taken, the full week's

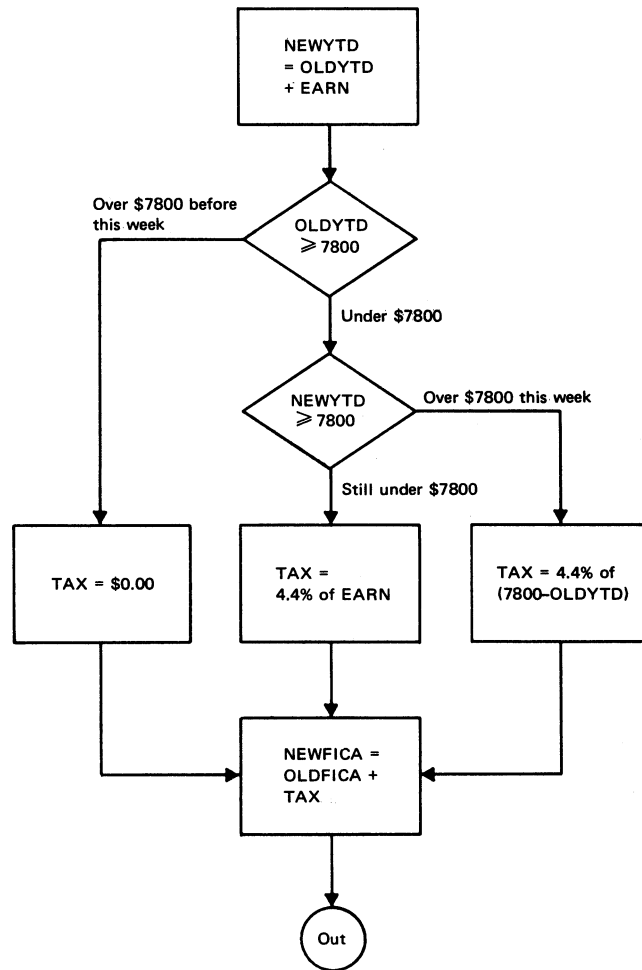

Figure 3-17. Program flowchart of a procedure for computing Social Security tax

earnings are taxable, and they are therefore loaded into register 7 and we branch unconditionally to MULT.

At that location is an instruction to multiply whatever is in register 7 – either the full week's pay or some part of it – by 4.4%. This constant is entered as the integer 44. We must think of this number as 0.044, however, remembering that it is a fraction. The constant for rounding, HALF, is therefore 500, and we remove all the excess decimals by dividing by 1000. At this point the tax is in register 7 ready to be stored by the instruction at STORE. This same Store instruction is the one to which we branched if there was no tax to pay, having cleared register 7. A final Add and Store update the year-to-date Social Security.

This program fulfills the requirements of the problem statement and does the processing described by the flowchart – but it is quite unacceptable. The problem is something not mentioned in the problem statement. Let us see what the trouble is by looking at an example.

Suppose we have a man who earns \$164.00 per week. Multiplying by 0.044 and rounding to the nearest cent, we get a Social Security tax of \$7.22. In 47 weeks of working at this rate, the man will accumulate year-to-date earnings of \$7708.00 and a year-to-date Social Security tax of \$339.34. Now in the next week his full earnings are not taxable, but only the part that takes him up to \$7800, or \$92.00; the tax on this amount is \$4.05. Adding \$4.05 to his previous year-to-date Social Security, we get \$343.39, which is more than 4.4% of the \$7800 maximum.

The difficulty is in the computation of the tax on one week's earnings. Before rounding, the product of \$164.00 and 0.044 is \$7.21600. When we round this to \$7.22 we add nearly half a cent. For each of the 47 weeks we are adding nearly half a cent.

This would be inaccurate. Social Security tax is seldom computed the way we have shown.

Fortunately, correcting the trouble is not only fairly easy, but leads to a shorter program. The general approach is to compute 4.4% of the new year-to-date earnings, then compute the tax by subtracting from this the previous year-to-date Social Security. The effects of the rounding error are thus balanced from week to week, and we are never more than half a cent off in the accumulated total.

Consider the example given above. The first week of

the year, we get \$7.22 as the tax. The second week, we begin by computing 0.044 times \$328.00, the new year-to-date gross; this gives us \$14.43 as the new year-to-date Social Security, which we store. This week's tax is \$14.43 minus the previous year-to-date Social Security of \$7.22, or \$7.21. In other words, where last week we were a fraction of a cent high, now we are a fraction of a cent low; the two tend to cancel each other. The offset may not always be equal; however, we can never be more than half a cent off.

The test for reaching the maximum taxable amount is now made in terms of the tax instead of the earnings. We compute the Social Security on the new year-to-date earnings, then ask whether the result is greater than \$343.20. If so, the result is replaced by \$343.20 and the tax is computed as before, by subtracting the previous year-to-date Social Security. If that was already \$343.20, that is, if the maximum had already been reached, then the tax computed by this method is zero, as it should be. If this week's pay goes over the taxable limit, the tax is the difference between the maximum tax and the amount already paid, which is correct.

The program shown in Figure 3-19 should not be too difficult to follow after the description of the process that has just been given. The program is eight instructions

LOC	OBJECT CODE	ADDR1	ADDR2	STMT	SOURCE	STATEMENT
				1		PRINT NOGEN
000100				2	FICA1	START 256
000100	05B0			3	BEGIN	BALR 11,0
000102				4		USING *,11
000102	5860 B052		00154	5		L 6,OLDYTD
000106	1856			6		LR 5,6
000108	5A60 B04E		00150	7		A 6,EARN
00010C	5060 B056		00158	8		ST 6,NEWYTD
000110	5950 B066		00168	9		C 5,C7800
000114	4740 B01C		0011E	10		BC 4,YES
000118	1B77			11		SR 7,7
00011A	47F0 B040		00142	12		BC 15,STORE
00011E	5960 B066		00168	13	YES	C 6,C7800
000122	4720 B02C		0012E	14		BC 2,OVER78
000126	5870 B04E		00150	15		L 7,EARN
00012A	47F0 B034		00136	16		BC 15,MULT
00012E	5870 B066		00168	17	OVER78	L 7,C7800
000132	5B70 B052		00154	18		S 7,OLDYTD
000136	5C60 B06A		0016C	19	MULT	M 6,C44
00013A	5A70 B06E		00170	20		A 7,HALF
00013E	5D60 B072		00174	21		D 6,CHUN
000142	5070 B062		00164	22	STORE	ST 7,TAX
000146	5A70 B05A		0015C	23		A 7,OLDFICA
00014A	5070 B05E		00160	24		ST 7,NEWFICA
				25		EOJ
000150	00004010			28	EARN	DC F'16400'
000154	000BBF00			29	OLDYTD	DC F'770000'
000158				30	NEWYTD	DS F
00015C	00008408			31	OLDFICA	DC F'33800'
000160				32	NEWFICA	DS F
000164				33	TAX	DS F
000168	000BE6E0			34	C7800	DC F'780000'
00016C	0000002C			35	C44	DC F'44'
000170	000001F4			36	HALF	DC F'500'
000174	000003E8			37	CHUN	DC F'1000'
000100				38	END	BEGIN

Figure 3-18. Assembly listing of a program based on the flowchart in Figure 3-17

shorter and considerably less complex. Both versions have been tested with a variety of data; both give "correct" results in that they do what we expect, although of course the results are not identical.

The only new instruction used in this program is BL UNDER, which means Branch on Low to the address UNDER. BL is an *extended mnemonic code*; it is translated by the assembler to the Branch on Condition operation code (47) with a decimal mask of 4. Other extended

mnemonics used after Compare instructions are BH (Branch on High) for BC 2, BE (Branch on Equal) for BC 8, BNH (Branch on Not High) for BC 13, and so on. Additional extended mnemonics can be used after arithmetic operations and Test under Mask instructions. They are supplied with most System/360 assemblers and are a great convenience in writing and checking conditional branching instructions, since they specify the conditions. A full list is given in the Appendix.

LOC	OBJECT CODE	ADDR1	ADDR2	STMT	SOURCE	STATEMENT
				1		PRINT NOGEN
000100				2	FICA2	START 256
000100	05B0			3	BEGIN	BALR 11,0
000102				4		USING *,11
000102	5850 B036		00138	5	L	5,OLDYTD
000106	5A50 B032		00134	6	A	5,EARN
00010A	5050 B03A		0013C	7	ST	5,NEWYTD
00010E	5C40 B04A		0014C	8	M	4,C44
000112	5A50 B04E		00150	9	A	5,HALF
000116	5D40 B052		00154	10	D	4,CHUN
00011A	5950 B056		00158	11	C	5,MAX
00011E	4740 B024		00126	12	BL	UNDER
000122	5850 B056		00158	13	L	5,MAX
000126	5050 B042		00144	14	UNDER	ST 5,NEWFICA
00012A	5850 B03E		00140	15	S	5,OLDFICA
00012E	5050 B046		00148	16	STORE	ST 5,TAX
				17		EOJ
000134	00004010			20	EARN	DC F'16400'
000138	0008BF00			21	OLDYTD	DC F'770000'
00013C				22	NEWYTD	DS F
000140	00008408			23	OLDFICA	DC F'33800'
000144				24	NEWFICA	DS F
000148				25	TAX	DS F
00014C	0000002C			26	C44	DC F'44'
000150	000001F4			27	HALF	DC F'500'
000154	000003E8			28	CHUN	DC F'1000'
000158	00008610			29	MAX	DC F'34320'
000100				30	END	BEGIN

Figure 3-19. Assembly listing of a much better version of the program to calculate Social Security tax

SIMPLE LOOPS: FINDING A SUM

A frequent programming requirement is to perform some operation on a set of values arranged in some systematic way in storage. We shall examine some of the coding methods available for such operations in the System/360, in terms of a very simple example.

For our illustrative problem, suppose that there are 20 fullwords in consecutive fullword locations starting with the one identified by the symbol TABLE. We are required to form the sum of the 20 numbers and place it in SUM.

We shall consider the three different ways of doing this. All three involve the use of an index register to modify the effective address in an instruction. The contents of the index register are changed between repetitions of the loop.

The first version of the program is shown in Figure 3-20. We shall use register 8 to accumulate the sum and register 11 as the index register. We want register 8 cleared to zero so that the sum will be correct; as it happens, we want the index register cleared to zero also. Both operations are done with Subtract Register instructions.

Now comes the instruction that does the actual computing. We add to register 8 the contents of some fullword in storage. The first time through the loop we want to add the word at TABLE. The instruction specifies that the contents of index register 11 should be used in computing the effective address — but we just made those contents zero, so the effective address is that of the word at TABLE. The first

time through the loop, this instruction therefore adds the word at TABLE to register 8, which was cleared to zero.

The next time through the loop, we want the fullword at TABLE+4 added to register 8. This can be accomplished by adding 4 to the index register. In this version of the program, we do so with an Add instruction.

Now we are at the point in the program where a test for completion must be made. The last of the 20 words is located at TABLE+76. We are modifying before testing, however. At the point where the loop has just been executed with TABLE+76 for an effective address, we will now have 80 in the index register. That is, therefore, the correct constant to use in testing for completion. We do so with a Compare, then Branch on Condition with a mask that asks for a branch if the index was less than 80. We could use the extended mnemonic code BL and write the branch instruction as BL LOOP; the object program would be the same.

The branch will be executed 19 times, giving 20 executions of the Add at LOOP. After that, the branch is not executed, we store the total at SUM, and the program is completed.

The reader will no doubt have recalled the customary names for the parts of a loop. The part at the beginning that gets the loop started is the *initialization* section; here, it consists of the first two instructions. The part that does the

LOC	OBJECT CODE	ADDR1	ADDR2	STMT	SOURCE STATEMENT
				1	PRINT NOGEN
000100				2	SUMA START 256
000100	0530			3	BEGIN BALR 3,0
000102				4	USING *,3
000102	1888			5	SR 8,8
000104	1888			6	SR 11,11
000106	5A8B 301A	0011C		7	LOOP A 8, TABLE(11)
00010A	5AB0 306E	00170		8	A 11,C4
00010E	5980 3072	00174		9	C 11,C80
000112	4740 3004	00106		10	BC 4, LOOP
000116	5080 306A	0016C		11	ST 8,SUM
				12	EOJ
00011C	00000001		15	TABLE	DC F'1'
000120	00000002		16		DC F'2'
000124	00000003		17		DC F'3'
000128	00000004		18		DC F'4'
00012C	00000005		19		DC F'5'
000130	00000006		20		DC F'6'
000134	00000007		21		DC F'7'
000138	00000008		22		DC F'8'
00013C	00000009		23		DC F'9'
000140	0000000A		24		DC F'10'
000144	0000000B		25		DC F'11'
000148	0000000C		26		DC F'12'
00014C	0000000D		27		DC F'13'
000150	0000000E		28		DC F'14'
000154	0000000F		29		DC F'15'
000158	00000010		30		DC F'16'
00015C	00000011		31		DC F'17'
000160	00000012		32		DC F'18'
000164	00000013		33		DC F'19'
000168	00000014		34		DC F'20'
00016C			35	SUM	DS F
000170	00000004		36	C4	DC F'4'
000174	00000050		37	C80	DC F'80'
000100			38	END	BEGIN

Figure 3-20. First version of a program to form the sum of 20 numbers

actual work of the loop is called the *compute* part, and here consists of the Add at LOOP. The *modification* section changes something between repetitions; here, it is the modification of the index contents by the Add. The *testing* section determines whether the action of the loop has been completed, and consists here of the Compare and the Branch on Condition. The sequence of the last three sections is not always as in this example. And as we shall see in the third version, the modification and testing can often be combined into one instruction.

The second version shortens the repeated section of the loop by one instruction. Normally, we do not worry too much about trying to get the last microsecond out of programs, but in heavily repeated parts it is worth some effort.

The method will require us to go "backward" through the table, which in this particular example is permissible; sometimes, of course, it would not be. As shown in Figure 3-21 we again clear register 8. This time, however, instead of loading the index register (11) with zero, we use a new instruction, Load Address, to put 76 in it. The Load Address (LA) simply puts the address part of the instruction itself in the designated register; there is no reference to storage whatsoever. In this case, 76 is actually the displacement and there is no base or index register. If we wanted to state this specifically, the statement could be written LA 11,76(0,0).

Now when we execute the indexed Add instruction at LOOP, the effective address is TABLE+76. Following this, we subtract 4 from the index register. As it happens, the

execution of a Subtract sets the condition code. A condition code of zero indicates that the result was zero, 1 indicates a negative result, and 2 a positive result. (A code of 3 indicates an overflow — a result too large to hold in the register. If the program is correct an overflow cannot occur here, so the possibility does not concern us.) We want to branch back to LOOP as long as the result of the subtraction is either positive or zero, so the mask on the Branch on Condition is 10: 8 picks condition code zero and 2 picks up code 2.

The Store is as before.

Where in the first version there were four instructions in the repeated portion of the loop, here there are three. The final version reduces this number to the minimum, two. The technique is to use the Branch on Index Low or Equal instruction (BXLE), which is a combination of an Add, a comparison, and a conditional branch.

Let us assume we have three registers set up as follows: Register 9 will be the index; it initially contains zero. Register 10 will contain the amount by which the index is to be incremented each time around the loop, 4. Register 11 will contain the limit value, the value of the index which is not to be exceeded, 76. If we have the instruction:

BXLE 9,10,LOOP

the action will be as follows: The contents of register 10 (4) are added to register 9, which is the index and initially contains zero. If the sum is less than or equal to the

LOC	OBJECT CODE	ADDR1	ADDR2	STMT	SOURCE	STATEMENT
				1	PRINT	NOGEN
000100				2	SUMB	START 256
000100	0530			3	BEGIN	BALR 3,0
000102				4	USING	*,3
000102	1B88			5	SR	8,8
000104	41B0 004C		0004C	6	LA	11,76
000108	5A8B 301A		0011C	7	LOOP	A 8,TABLE(11)
00010C	5B80 306E		00170	8	S	11,C4
000110	47A0 3006		00108	9	BC	10,LOOP
000114	5080 306A		0016C	10	ST	8,SUM
				11	EOJ	
00011A	0000					
00011C	00000001			14	TABLE	DC F'1'
000120	00000002			15		DC F'2'
000124	00000003			16		DC F'3'
000128	00000004			17		DC F'4'
00012C	00000005			18		DC F'5'
000130	00000006			19		DC F'6'
000134	00000007			20		DC F'7'
000138	00000008			21		DC F'8'
00013C	00000009			22		DC F'9'
000140	0000000A			23		DC F'10'
000144	0000000B			24		DC F'11'
000148	0000000C			25		DC F'12'
00014C	0000000D			26		DC F'13'
000150	0000000E			27		DC F'14'
000154	0000000F			28		DC F'15'
000158	00000010			29		DC F'16'
00015C	00000011			30		DC F'17'
000160	00000012			31		DC F'18'
000164	00000013			32		DC F'19'
000168	00000014			33		DC F'20'
00016C				34	SUM	DS F
000170	00000004			35	C4	DC F'4'
000100				36	END	BEGIN

Figure 3-21. Second version of program to form the sum of 20 numbers

contents of register 11, the limit, the branch to LOOP is taken; otherwise the next instruction in sequence is taken.

The instruction is written in assembler language in the general form:

BXLE R1,R3,D2(B2)

Three factors, each of which must be located in a register, are required by the BXLE instruction. An index must be in the register specified by R1. An increment must be in the register specified by R3. A limit value must also be in a register but the register is not explicitly specified in the instruction. The BXLE instruction will first add the increment to the index. It will then compare the resultant index against the limit. If the index is less than or equal to the limit, a branch is taken to the location specified by D2(B2); otherwise the next instruction in sequence is taken. The register containing the limit value is always odd-numbered and is chosen in the following way:

1. If the register specified by R3 is an even-numbered register, the limit value is assumed to be in the next higher-numbered register. If we have the instruction:

BXLE 9,10,LOOP

the limit value is in register 11, the next higher-numbered register.

2. If the register specified by R3 is an odd-numbered register, a third register is not used. In this case the BXLE instruction assumes that R3 specifies the register to be used

for both the increment and the limit. If we have the instruction:

BXLE 6,7,LOOP

register 7 will be used by BXLE as the source of the increment and the limit.

We shall see in later chapters how it can be useful to have the second and third registers the same. For now we shall use R3 operands that are even-numbered.

At first glance this instruction seems more complicated than it is. Let us turn to an example to see how it works. Figure 3-22 is the final version of our summing loop.

We begin the program by loading the three registers that will be used by the BXLE instruction (registers 9, 10, and 11), with the desired initial contents. We then proceed to the Add instruction at LOOP, which is the same as in the previous two versions. Next comes the BXLE, which operates as described.

The operation of the BXLE instruction is most easily remembered if we think in terms of three registers representing the index, the increment, and the limit, in that order.

For a situation where it is desired to work backwards, in which case the increment would be negative, the Branch on Index High (BXH) instruction is available.

The BXLE and BXH instructions are very powerful and very flexible. They will find heavy use in many practical applications, and are well worth the investment of effort necessary to understand them fully.

LOC	OBJECT CODE	ADDR1	ADDR2	STMT	SOURCE	STATEMENT
				1		PRINT NOGEN
000100				2	SUMC	START 256
000100	0530			3	BEGIN	BALR 3,0
000102				4		USING *,3
000102	1B88			5	SR	8,8
000104	1B99			6	SR	9,9
000106	41A0 0004	00004		7	LA	10,4
00010A	41B0 004C	0004C		8	LA	11,76
00010E	5A89 301A	0011C		9	LOOP	A 8,TABLE(9)
000112	879A 300C	0010E		10	BXLE	9,10,LOOP
000116	5080 306A	0016C		11	ST	8,SUM
				12		EOJ
00011C	00000001			15	TABLE	DC F'1'
000120	00000002			16		DC F'2'
000124	00000003			17		DC F'3'
000128	00000004			18		DC F'4'
00012C	00000005			19		DC F'5'
000130	00000006			20		DC F'6'
000134	00000007			21		DC F'7'
000138	00000008			22		DC F'8'
00013C	00000009			23		DC F'9'
000140	0000000A			24		DC F'10'
000144	0000000B			25		DC F'11'
000148	0000000C			26		DC F'12'
00014C	0000000D			27		DC F'13'
000150	0000000E			28		DC F'14'
000154	0000000F			29		DC F'15'
000158	00000010			30		DC F'16'
00015C	00000011			31		DC F'17'
000160	00000012			32		DC F'18'
000164	00000013			33		DC F'19'
000168	00000014			34		DC F'20'
00016C				35	SUM	DS F
000100				36	END	BEGIN

Figure 3-22. Third and shortest version of program to form the sum of 20 numbers, using the BXLE instruction

**CASE STUDY:
AVERAGING A LIST OF TEMPERATURES**

In an attempt to draw together some of the things that have been discussed in this chapter, we shall now consider a final problem that involves several different concepts.

Suppose we have in storage a group of halfwords giving the temperature, to the nearest degree, on each of the days of a month. There may be 28, 29, 30, or 31 of them; the number is given by a halfword named DAYS. The table of temperatures begins at TEMP and continues for a total of 31 halfwords; if there are fewer than 31 days in the month at hand, the last entries of the table are to be ignored. It is possible that the temperature reading may be missing for some days; a missed reading is indicated in storage by a halfword of all 1's. We are to form the average of the temperatures for the month, using only as many good readings as are found. If the entire table should happen to contain bad readings, a halfword of all 1's should be stored to indicate that the average was not computed. In any case, we are to store in NGOOD the number of good readings found. The average should be rounded off to the nearest degree.

The program shown in Figure 3-23 uses the halfword

variations of a number of instructions that should be quite familiar in their fullword forms.

Before analyzing the operation of the program, it may be helpful to summarize the functions of the registers used, which will often be a valuable thing for the programmer to do.

Register	Usage
3	Base register
4	Index register
5	Word of 1's
6	Left half of dividend
7	Sum of temperatures—right half of dividend
8	Count of nonzero temperatures
10	Increment for BXLE
11	Limit for BXLE

The initialization consists of setting up the contents of the seven registers used by the program. The first one to be set to zero (6) is cleared by a Subtract Register, the others by Load Registers from 6. The Load Halfword to get the

LOC	OBJECT CODE	ADDR1	ADDR2	STMT	SOURCE STATEMENT
				1	PRINT NOGEN
000100				2	AVGTEMP START 256
000100	0530			3	BEGIN BALR 3,0
000102				4	USING *,3
000102	4850 3094		00196	5	LH 5,ONES
000106	1866			6	SR 6,6
000108	1876			7	LR 7,6
00010A	1886			8	LR 8,6
00010C	41A0 0002		CCC02	9	LA 10,2
000110	4880 3096		00198	10	LH 11,DAYS
000114	4880 3092		00194	11	SH 11,ONE
000118	8880 0001		00C01	12	SLA 11,1
00011C	1846			13	LR 4,6
00011E	4954 3054		00156	14	LOOP CH 5,TEMP(4)
000122	4780 302C		0012E	15	BE ZERO EXTENDED MNEMONIC FOR BC 8
000126	4A74 3054		00156	16	AH 7,TEMP(4)
00012A	4A80 3092		00194	17	AH 8,CNE
00012E	874A 301C		0011E	18	ZERO BXLE 4,10,LOOP
000132	4080 309A		0019C	19	STH 8,NGOOD
000136	1288			20	LTR 8,8
000138	4770 3040		00142	21	BNZ NOT EXTENDED MNEMONIC FOR BC 7
00013C	4050 3098		0019A	22	STH 5,AVER STORE ONES IF NO GOOD DATA
				23	EOJ STOP
000142	8B70 0001		00C01	26	NOT SLA 7,1 TO GET EXTRA BINARY PLACE IN QUOTIENT
000146	1D68			27	DR 6,8 DIVIDE REGISTER
000148	4A70 3092		00194	28	AH 7,ONE ROUND OFF
00014C	8A70 0001		00C01	29	SRA 7,1 DROP THE EXTRA BIT
000150	4070 3098		0019A	30	STH 7,AVER FINAL RESULT
				31	EOJ END OF JOB
000156	0001			34	TEMP DC H'1'
000158	0002			35	DC H'2'
00015A	0003			36	DC H'3'
00015C	0004			37	DC H'4'
00018C	001C			60	DC H'28'
00018E	001D			61	DC H'29'
000190	001E			62	DC H'30'
000192	001F			63	DC H'31'
000194	0001			64	ONE DC H'1'
000196	FFFF			65	ONES DC X'FFFF'
000198				66	DAYS DS H
00019A				67	AVER DS H
00019C				68	NGOOD DS H
000100				69	END BEGIN

Figure 3-23. A program to compute average monthly temperature, which takes into account the possibility of omitted readings

number of days into register 11 automatically expands the halfword into a fullword, which would mean that the sign bit of a negative number would be filled out. With correct data, the word here cannot be negative, of course. The number of days is to be used to terminate the summing loop that adds up the temperatures. The loop should be *executed* as many times as the number of days; it should be *repeated* (after the first time) one less time than the number of days. We accordingly subtract 1 from register 11 after loading it.

Since the table of data consists of halfwords, the index register will have to be incremented by 2 between loop repetitions, and the proper limit value is two less than double the number of days. We can double a number quite simply by shifting left one place in a binary machine. (If the table had consisted of fullwords, requiring an increment of 4, a left shift of two places would multiply the number of days by 4.)

In the working part of the loop we first check to see whether the particular temperature is valid, by comparing with the word of all 1's that had been set up in register 5. The Compare Halfword expands the halfword from storage to a fullword by propagating the sign bit. This is necessary to us, since the load halfword that put the word of all 1's in register 5 did the same thing. We next branch on equal to the instruction at ZERO, which would happen if the reading was bad. If it was good, the branch is not taken; we add in the temperature, add one to the count of good readings, and then reach the BXLE.

The BXLE increments the index register (4) by 2 (which is in 10) and checks whether the index is now the same as what we put in 11. If the index is low or equal, meaning that the list has not been exhausted, we branch back to LOOP to go around again.

When the loop is finished, we reach the Store Halfword after the BXLE. Here we store the count of good readings at NGOOD; this conceivably could be zero. Next we check whether it was zero, using the Load and Test Register instruction (LTR). With the two register designations being the same, as they are here, the effect of this instruction is to set the condition code according to the sign and magnitude of the count in register 8. The Branch on Condition instruction then asks whether the count was either positive or negative and branches if so. If it was neither of these it must have been zero, in which case we store the word of all 1's for the average in AVER, and stop.

If there was at least one good reading, we are ready now to compute the average. In order to be able to round off to the nearest degree, it is necessary to arrange the division so that the quotient has one binary place in it; this can be done by shifting the dividend to the left one place before dividing. The division is done this time with the Divide Register instruction, since the desired divisor (the count) is already in a register. Following the Divide Register we add 1 to the rightmost bit position of the quotient register to round off. Having done so, we shift the quotient back to the right to get rid of the extra bit and store the result.

QUESTIONS AND EXERCISES

1. The L, A, S, and ST instructions all operate on a (fullword, halfword).
2. The first operand of an instruction *usually* specifies the operand that (sends, receives) information.
3. In a ST instruction the first operand specifies the operand that (sends, receives). Does the ST instruction, in this respect, follow the general rule, or is it an exception to the general rule?
4. Is the instruction M 7,QTY a legitimate instruction? If not, why not?
5. The D instruction specifies _____ as the first operand, and the _____ as the second operand. After completion of the divide operation, where is the quotient located? Where is the remainder located?
6. Assume that a fullword area of storage (reserved by a DS), to be addressed as XANDY, contains two positive items as below:

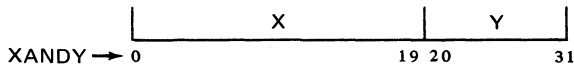

- Write the program to store X in a fullword area in storage called X, and Y in a halfword area in storage called Y.
7. The instruction BC 5,ROUT3 would branch to ROUT3 if the:
 - a. Condition code is 5.
 - b. Condition code is 1, 2, or 3.
 - c. Condition code is 1 or 3.
 8. Write an instruction to branch unconditionally to an instruction called NEWONE.
 9. There are four fullwords named X1, X2, X3, and X4 sequentially located in storage. Write one instruction that loads these four fullwords into registers 2, 3, 4, and 5 respectively.
 10. Write an instruction that clears register 5 to zero.
 11. Consider the instruction named LOOP in Figure 3-20. How will the effective address of TABLE(11) be formed?
 12. Write a single instruction that adds the contents of register 6 to register 5, tests to see if the sum now in register 5 is equal to or less than the contents of register 7, and then branches to an instruction called NEWONE if the answer is yes.

Chapter 4: Programming with Base Registers and the USING Instruction

A major programming feature of System/360 is the use of base registers for addressing main storage. One advantage is that compatibility is maintained between the small system with its short addresses and the large system with its longer addresses. The same instruction size and format accommodates both. Also, through appropriate use of base registers it is possible to relocate assembled programs almost at will. Great flexibility in program organization is thus achieved, since storage locations can be reassigned as dictated by the needs of the particular "mixture" of programs or program segments.

Base registers are thus deeply involved in programming and in program execution. However, as we shall see, it is

possible to delegate to the assembler almost all the clerical work of keeping track of base registers and computing displacements. With a full understanding of these techniques, the programmer is able to leave the housekeeping to the assembler where appropriate, and to employ more sophisticated methods where needed.

In this chapter we shall see how the automatic techniques are called into operation and how the assembler implements them, and we will explore a few slightly more advanced techniques. As in so many other aspects of programming, particular emphasis must be placed on the question of when various actions occur: during assembly, linkage editing, or program execution.

THE USING INSTRUCTION

Automatic computation of the addresses of all operands in main storage requires the programmer to supply two items of information to the assembler and one to the object program.

With the USING instruction, the programmer tells the assembler:

1. Which general registers may be used as base registers
2. What each one will contain at the time the object program is executed

With this information the assembler can do its work of designating base registers and computing displacements.

It still remains to place in the base registers the values we have promised the assembler will be there. This can in principle be done in many ways, but the most common is to use the Branch and Link Register instruction (BALR). The general format of this instruction is:

BALR R1,R2

R1 receives the address of the next byte after the BALR; R2 supplies a branch address unless it is zero, in which case

the next instruction in sequence is taken as usual. For our purposes here, the second operand (R2) is always zero. For instance, in the illustrative program we shall be considering shortly, we have an instruction:

BALR 11,0

This places in register 11 the address of the next byte after the BALR, and there is no branch. Register 11 was arbitrarily chosen as the base register for this program. It is used as a base register for most of the programs in this text. In actual practice, the choice of a base register cannot be a completely arbitrary one. As mentioned earlier, most installations find it necessary to establish rather rigid conventions for register usage. In addition, the various operating systems for System/360 make use of certain general registers for supervisor routines, linkages between separate programs, and other purposes. Under most operating systems, registers 2 through 11 are freely available to the programmer and should be used to avoid any complication.

AN EXAMPLE

These ideas may be made more concrete by considering an example. Figure 4-1 is an assembly listing of a program the processing details of which do not concern us.

The START instruction specifies that the assembled first byte of the program is location $256_{10} = 100_{16}$. We see that the BALR instruction has in fact been placed at 100. (All numbers in the object program area of the assembly listing — on the left-hand side — are hexadecimal.) The BALR instruction specifies that general purpose register 11 is to be loaded with the address of the next machine instruction. This, of course, is done at execution time by the machine. The USING instruction, which is an assembler instruction and takes no space in the object program, informs the assembler that general purpose register 11 is available for use as a base register and will contain the address of the next machine instruction, as signified by the asterisk. The BALR is a two-byte instruction so the next instruction, the Load, is placed at 102. This number, shown in the location counter column in the USING statement, indicates what the assembler assumed would be the contents of base register 11.

Let us look at the Load instruction to see how the assembler handled it. Reading from left to right the operation code is 58, the register loaded with a word from storage is number 2, no index register is specified, the base register is $B_{16} = 11_{10}$, and the displacement is 022_{16} . With base register 11 containing 102 and with a displacement of 22, we get an actual address of 124_{16} , as listed under ADDR2. Looking down the listing we see that 124 is in fact the address corresponding to the symbol DATA, as it should be.

The Add instruction is similar. With base register 11 again automatically designated, we have a base address of

102 and a displacement of 2A for an effective address of 12C, which is the address of the symbol TEN.

The Shift Left Algebraic instruction is a little different. All shift instructions have the RS format, with the index portion unused, but they still must specify a base register. Even though the effective "address" is never used for a storage reference, it is possible to make effective use of a variable number or positions of shift by varying the contents of the base register. In this program, however, such is not the case and we need a base register designation of zero. We see that this was done. The effective address is therefore just the displacement of 1. The remainder of the program presents no new base register concepts.

As always, it is most important to distinguish between what is done at assembly time and what is done at execution time. The assembler, in the example at hand, has filled in base register numbers where needed and has computed displacements. These base register numbers and displacements become part of the actual instructions, as listed down the left side of the assembly listing. In carrying out the assembly operations, the assembler had to know what base register we wished to use and what we planned to put in it; this information we provided with the USING.

The assembler cannot load the base register for the execution of our program, since that can be done only when the program is executed. We therefore provided the BALR instruction, which, at execution time, places the address of the next instruction into the specified register. The remainder of the program can now be carried out, with effective addresses being developed as intended.

The assembler program is actually processed in several separate phases. One of its functions is to determine the length and location of each instruction, area, and constant.

LOC	OBJECT CODE	ADDR1	ADDR2	STMT	SOURCE	STATEMENT
				1		PRINT NOGEN
000100				2	PROGE	START 256
000100	05B0			3	BEGIN	BALR 11,0
000102				4		USING *,11
000102	5820 B022		00124	5	L	2,DATA
000106	5A20 B02A		0012C	6	A	2,TEN
00010A	8B20 0001		00001	7	SLA	2,1
00010E	5820 B026		00128	8	S	2,DATA+4
000112	5020 B02E		00130	9	ST	2,RESULT
000116	5860 B032		00134	10	L	6,BIN1
00011A	5A60 B036		00138	11	A	6,BIN2
00011E	4E60 B03E		00140	12	CVD	6,DEC
				13		EOJ
000124	00000019		16 DATA	16	DC	F'25'
000128	0000000F			17	DC	F'15'
00012C	0000000A			18	TEN	DC F'10'
000130				19	RESULT	DS F
000134	0000000C			20	BIN1	DC F'12'
000138	0000004E			21	BIN2	DC F'78'
000140				22	DEC	DS D
000100				23	END	BEGIN

Figure 4-1. Listing of a program to show how the assembler calculates and supplies addresses of all storage operands. The processing performed is not intended to be realistic.

While doing this, the assembler constructs a symbol table. As shown in Figure 4-2, this lists for each symbol used in the program: its length in bytes, either its value or location (VALUE), the number of the statement in which it is defined (DEFN), and all statements in which it is referenced. With the length and location of each instruction and the base register information provided by the programmer in the USING instruction, the assembler is able, in a later phase, to calculate the base register and displacement and to list these and the actual assembled addresses of all operands as they appear in Figure 4-1.

In our program, we said with the START instruction that the first byte of the program should be assembled at location $256_{10} = 100_{16}$. Everything said so far has assumed that the program will actually be loaded at 100_{16} . This is not so. In the first place, this location is within the low area of main storage that is occupied by the supervisor and other parts of the control program, and could not be used for program execution. Parenthetically, it should be explained that START 256 is not a standard programming practice. We have chosen it for the examples in the first few chapters of this book to cause our assemblies to begin at some positive value, simply for illustrative purposes. The usual practice is to specify a zero START, which greatly simplifies the programmer's chore of calculating addresses, a necessity when debugging a program.

The second reason that our program will not be loaded at location 100_{16} is that, regardless of the location we give in the START statement, our assembled object program is in relocatable form and it is not executable until processed by the *linkage editor*. The linkage editor is an IBM service program that is part of the operating or programming support system.

The linkage editor assigns the actual starting address in main storage for each object program in a job input stream, and edits these into executable programs. It uses information supplied by the assembler regarding the length of

the program, its name (given in the START statement, PROGE in this case), the assembled locations of any relocatable address constants, and other details necessary to perform the relocation.

When the program is in executable form, all statements, constants, reserved storage spaces, etc., remain in the same relative positions as in the assembly listing. Nothing needs to be changed to make the object program operate correctly from the new location or, at a later time, from still another location. All that is involved is the relocation factor.

Suppose the linkage editor assigns location 3200_{16} as the starting address. When the program has been loaded, it begins with execution of the BALR instruction. Now, what is the address of the next instruction after the BALR? The answer is 3202. This value goes into register 11 and becomes the base address. The displacements in the assembled instructions have not changed, of course. The effective address in the Load instruction is now $3202 + 22 = 3224$. With the new starting location, 3224 is exactly where DATA appears. All other addresses are correctly computed as well, including the "address" in the Shift, which is completely unchanged since no base register is used.

It is also possible for the programmer by use of a control card to tell the linkage editor which starting location to assign. A complete relocation of the program after assembly is thus a simple matter. In more complex program structures, the linkage editor has more work to do than this example might suggest, but it is nevertheless feasible to execute programs from whatever storage locations may be convenient and available under any particular set of circumstances.

As we have noted, this simplicity of program relocation was one of the reasons for providing base registers in System/360.

The techniques of program relocation and the functions of the linkage editor will be discussed in more detail in the chapter on subroutines and program relocation.

CROSS-REFERENCE				
SYMBOL	LEN	VALUE	DEFN	
BEGIN	00002	000100	00003	0023
BIN1	00004	000134	00020	0010
BIN2	00004	000138	00021	0011
DATA	00004	000124	00016	0005 0008
DEC	00008	000140	00022	0012
PROGE	00001	000100	00002	
RESULT	00004	000130	00019	0009
TEN	00004	00012C	00018	0006

NO STATEMENTS FLAGGED IN THIS ASSEMBLY

Figure 4-2. Symbol cross-reference table constructed and listed by the assembler for the assembly in Figure 4-1

MORE THAN ONE BASE REGISTER

The displacement in an instruction is limited to a positive number in the range $0-4095_{10} = 0-FFF_{16}$, since this is the limit that can be expressed in an unsigned 12-bit number. This means that an effective address cannot be less than the base address or more than 4095 greater, when an index register is not being used. If a program must reference a range of addresses greater than 4095, the easiest and most common approach in routine programming is to use more than one base register.

It should be noted, however, that it takes a rather large program segment to exhaust the range of displacements using one base register. With average length instructions, it takes a full pad of coding paper to use up 4096 bytes: It will usually be desirable to break a program this large into smaller segments anyway, so it will probably be extremely rare in practice to need more than one base register because of program length. Long sections of storage for data or results are another matter. Frequently it may be advantageous to assign one base register to the program and another to data. This is done in the last example in this chapter.

For now, to establish some basic ideas, let us make up a program that does use more than 4096 bytes for combined data and program. We shall not actually write an illustrative program that large, but we can simulate the effect of such a size by using the ORG assembler instruction to advance the location counter.

The partial program shown in Figure 4-3 was designed with the sole purpose of illustrating base register ideas; the "processing" is not intended to be meaningful. After the usual START, we have a BALR to load base register 11 with the address of the next instruction. The USING instruction is slightly different this time. Instead of using an asterisk to denote the address of the first byte of the

following instruction, we give that instruction a symbolic name (HERE) and use the symbol. This gives exactly the same effect with respect to register 11, and permits us to refer to the contents of 11 in terms of a symbol, which we shall need for loading register 9. (The choice of register 9 was arbitrary.)

In loading the second base register, we cannot use a BALR; we want register 9 to contain not the address of the next instruction, but 4096 more than whatever went into 11. To accomplish this we use an address constant, named BASE in this case, which is written with the address $HERE+4096$. We see that the constant BASE has been assembled as we instructed: hexadecimal 1102 is 1000 greater than the value of the symbol HERE, and $1000_{16} = 4096_{10}$.

Base register 9 will thus be loaded with 1102_{16} at execution time. This information is given to the assembler with a USING that has the address $HERE+4096$.

It is worthwhile noting which base register was used in the Load instruction that loaded base register 9: we see that the base register is 11 (which contains 102) and there is a displacement of A (+10 decimal). The effective address is thus 10C, which we see is indeed the address of the constant BASE. It is important to realize that at the time register 9 is being loaded, the only base register available is 11; the effective address of the instruction that loads 9 therefore cannot be more than 4096 greater than the contents of 11. Thus the address constant BASE cannot be at the end of the entire program, which would be more than 4096 bytes away. We have chosen to place it at almost the beginning and branch around it. Other placements are possible, so long as they do not cause the assembler to try to use a displacement in the Load instruction at HERE that is negative or greater than 4095.

LOC	OBJECT CODE	ADDR1	ADDR2	STMT	SOURCE	STATEMENT
000100				1	PROGF	START 256
000100	05B0			2	BEGIN	BALR 11,0
000102				3		USING HERE,11
000102	5890 800A		0010C	4	HERE	L 9,BASE
001102				5		USING HERE+4096,9
000106	47F0 800E		00110	6		BC 15,FIRST
00010A	0000					
00010C	00001102			7	BASE	DC A(HERE+4096)
000110	5820 8FFE		01100	8	FIRST	L 2,DATA
000114	5A20 900E		01110	9		A 2,TEN
000118	47F0 9002		01104	10		BC 15,SECOND
001100				11		ORG **4068
001100	0000007B			12	DATA	DC F'123'
001104	5830 8FFE		01100	13	SECOND	L 3,DATA
001108	5A30 900E		01110	14		A 3,TEN
00110C	47F0 800E		00110	15		BC 15,FIRST
001110	0000000A			16	TEN	DC F'10'
000100				17	END	BEGIN

Figure 4-3. Listing of an incomplete program with an Origin (ORG) assembler instruction to simulate a length of over 4096 bytes, thus requiring two base registers

As an example of an attempt to use a negative displacement, suppose we were to put the address constant BASE at the very beginning of the program, between the START and the BALR: then the displacement in the Load would need to be -6, which is impossible.

Following the constant BASE, we have two instructions that are meant to suggest the processing steps of the program, and then a branch to an instruction near the end. For the sake of illustration, we want the program to look as though it is more than 4096 bytes long. This we can simulate by an ORG that, in this case, advances the location counter by 4068. This arbitrary-appearing number was chosen to put DATA at the end of a 4096-byte segment controlled by base register 11, which means that the following instructions and data are referenced by base register 9.

Let us now investigate how the assembler assigned base registers and computed displacements.

The next instruction is a Branch on Condition with a mask of 15, which indicates a branch on any condition, or an unconditional branch. This branch to FIRST involves a location under the control of base register 11; if base register 9 were specified, the displacement would have to be

negative. The Load at FIRST refers to DATA. The base is 11, with a large displacement of $FFE_{16} = 4094_{10}$. The Add refers to a location that is more than 4096 bytes away from the beginning of the program, so base register 11 cannot be used. We see that 9 has been indicated, with a displacement of $E_{16} = 14_{10}$. The following Branch on Condition references a storage location 2 greater than what was placed in register 9, so register 9 is the base and the displacement is 002.

Down at SECOND, the base registers and displacements for getting DATA and TEN are exactly as they were before; these matters are unaffected by the location of the instructions. The assembled Branch on Condition to FIRST is precisely the same as the assembled Branch on Condition that appeared earlier just before BASE.

The essential concept is that the assembler assigns whatever base register is necessary to get a displacement less than 4096. If the program has been written so that two or more base registers have contents that satisfy this rule, the assembler chooses the one that leads to the smallest displacement. Later we shall see an instance in which this rule for choosing base registers is important.

SEPARATE BASE REGISTERS FOR INSTRUCTIONS AND DATA

We have suggested that it will be rare for a program segment to be so long as to require more than one base register. On the other hand, it may be fairly common to want separate base registers for instructions and data, even though the instructions take far fewer than 4096 bytes. How this can happen is illustrated in the following problem.

Suppose we have six records in storage, each record consisting of 80 characters. The six records are in consecutive storage locations; the first of the 480 bytes has the symbolic address DATA. Within each record there are eight fields of ten characters each, named FIELD1, FIELD2, etc. Each field is in packed decimal format. We are required to add FIELD1 and FIELD2 and place the result in FIELD3. The other five fields are not used in this program. This processing is to be done for each of the six records, using a loop.

Now the question is, how do we attack the loop? The arithmetic will use decimal instructions, which have the SS format and do not provide for use of an index register. We *could* write instructions to modify the displacement of every instruction that refers to the records, but this is very poor form if there is a better way available.

The solution proposed here is to modify the base register contents to pick up the records in succession, which means that between loop repetitions we will add 80 to the base register. But now we have a new problem. If only one base register is used, how do we modify its contents and still get a correct base for Branch instructions and for references to program constants? The simplest answer is probably

obvious: use two base registers, the second of which refers *only* to the data processed by the loop.

A program is shown in Figure 4-4. The loading of base registers is much as it was in Figure 4-3, except that this time register 8 is loaded with the address corresponding to DATA, rather than with 4096 more than what register 11 contained. As a matter of fact, it turns out that register 11 contains 102_{16} , and register 8 contains $12C_{16}$. This will mean that the first byte of the area named DATA could be obtained by adding a displacement of $2A$ to register 11, or by adding a displacement of zero to register 8. As we noted, the assembler picks the way that gives the smaller displacement. It is essential for us to be able to depend on this fact.

We see also that in this program the address constant for loading register 8 has been placed at the end of the instructions rather than in the instruction stream. This is permissible as long as we are sure that it is not more than 4096 bytes away from the beginning of the program, which it obviously is not.

It is assumed, for the purposes of this illustration of base register ideas, that the data is provided by another program segment and will be used later by still another program. We therefore provide space for the data with DS instructions that allot space for the required number of characters but do not assemble constants to be entered. The DS for DATA, in fact, does even less than that: it provides a reference point for the symbol, but does not even reserve space since a zero is written for the duplication factor. Thus

LOC	OBJECT	CODE	ADDR1	ADDR2	STMT	SOURCE	STATEMENT	
					1		PRINT NOGEN	
000100					2	LOOPA	START 256	
000100	05B0				3	BEGIN	BALR 11,0	
000102					4		USING *,11	
000102	5880	B01E		00120	5	LOOP1	L 8,BASE	
00012C					6		USING DATA,8	
000106	D209	8014	8000	00140	0012C	7	LOOP2	MVC FIELD3,FIELD1
00010C	FA99	8014	800A	00140	00136	8		AP FIELD3,FIELD2
000112	5A80	B022		00124	9		A 8,EIGHTY	
000116	5980	B026		00128	10		C 8,TEST	
00011A	4770	B004		00106	11		BNE LOOP2	
					12		EOJ	
000120	0000012C				15	BASE	DC A(DATA)	
000124	00000050				16	EIGHTY	DC F'80'	
000128	0000030C				17	TEST	DC A(DATA+480)	
00012C					18	DATA	DS OF	
00012C					19	FIELD1	DS CL10	
000136					20	FIELD2	DS CL10	
000140					21	FIELD3	DS CL10	
00014A					22	FIELD4	DS CL10	
000154					23	FIELD5	DS CL10	
00015E					24	FIELD6	DS CL10	
000168					25	FIELD7	DS CL10	
000172					26	FIELD8	DS CL10	
00017C					27		DS 5CL80	
000100					28	END	BEGIN	

Figure 4-4. Program with separate base registers for processing and data, showing how a base register can be used to provide indexing for loop control

DATA and FIELD1 both refer to the same byte. The point of this approach is to have DATA for a name for the entire 480-character storage area, and still use names for the fields within the first record. An alternative approach would be to use DATA as the name of the first field, DATA + 10 for the second, DATA + 20 for the third, etc., but the loss of meaningful names would be a disadvantage. Another alternative would be to omit the entry for DATA and use FIELD1 wherever DATA appears earlier. This would also be a little less meaningful, perhaps. The final DS reserves 400 bytes of storage for the remaining five records.

The Move Characters instruction at LOOP2 moves the first field to the third field location. Reading across the assembled instruction, which we note is in the SS format, we see: the actual operation code is D2, the length code is 09, the base register for the first operand is 8, the displacement for the first operand is 014, the base register for the second operand is also 8, and the displacement for the second operand is zero. The length code of 9 is correct for a field of length 10; the assembler picked up the implied length from the DS entry for FIELD3, and subtracted 1 from the length to get the length code. Checking the address calculations, we see that a base address of 12C plus a displacement of 014 give an effective address of 140, which is correct for FIELD3. A base address of 12C and a displacement of zero give the address of FIELD1.

The Add Decimal instruction that follows does the required addition. This instruction has two length codes, both 9 in this case, for two fields of length 10. The displacement of 00A, together with the base address of 12C, correctly lead to 136, the address of FIELD2. The addressing of FIELD3 is as before.

Now we are ready to add 80 to the base register associated with DATA and go back to process more records if more remain. We add 80 to base register 8 and then compare with an address constant to test for completion of the loop. What should the test constant be? Since we modify before testing, and since there are 480 characters in the six records, we should stop repeating if at this point the base register contains a number 480 greater than what it was to start. It was originally the equivalent of the symbol DATA, so the test value ought to be DATA + 480, as shown. The Branch on Not Equal here is the extended mnemonic for BC 7. If the branch is not executed, we are finished and the next instruction ends the job.

If the program were written to use only one base

register, we would be in trouble with the address of the Branch instruction. The assembler would assume a certain value for the base register and compute a displacement accordingly. After modifying the base register contents, we would no longer have the desired branch address.

It is of course true that we are modifying the contents of base register 8 also, but we have carefully arranged that it is not used as a base for anything besides DATA. No confusion is caused, therefore, because we have "cheated" by changing the contents of a base register from what we promised the assembler would be there. What we told the assembler will lead correctly to the first record processed; by the time the contents are actually changed during execution, the assembler will no longer be on the scene to know that anything happened.

In practice it would normally be necessary to process many blocks of six records, not just one. In that case we would have to get register 8 back to its starting value. This is done simply by re-executing the Load instruction at LOOP1.

If a program like this were to be executed, it is perhaps obvious that something would have to be done during loading to take care of the address constants at BASE and TEST. It would clearly not be enough for the linkage editor just to assign the initial program loading location. This matter is properly handled by an automatic flagging of all address constants in the relocation dictionary produced by the assembler, and by suitable modifications performed by the linkage editor.

In order to illustrate one last facet, suppose that there were some compelling reason to place additional instructions *after* DATA. This could be done by a Branch to them. Suppose that within these additional instructions there were Branches to locations within the new group. What would the base register situation be? With the size of program and data shown, either base register 11 or 8 could supply a displacement of acceptable size; the assembler could pick the one leading to the smaller displacement, register 8. But the contents of 8 change as the loop is executed; how can we tell the assembler that 11 is wanted, not 8?

The answer is the DROP instruction, in which we would say DROP 8 at the beginning of the new group of instructions. This says to the assembler that general purpose register 8 may no longer be used as a base register. The only one left is then 11, so it is the one used, as desired.

QUESTIONS AND EXERCISES

Consider the following programs. Note that some of the program statements have been omitted from the listings. The locations assigned to each instruction, constant, and area are listed in hexadecimal, as in all program listings. The locations are such that you should have no difficulty with hexadecimal arithmetic. Questions 1 to 4 refer to Figure 4-5.

1. In the program in Figure 4-5,
 - a. What instruction informs the assembler that register 11 is to be used as a base register, and tells the assembler what value it must assume to be in that base register?
 - b. What instruction causes register 11 to be loaded with the base address at execution time?
2. In the spaces provided in the diagram,
 - a. Write the value the assembler assumes to be in base register 11.
 - b. Using the symbol table and answer 2a, write the base register and displacement appearing in the object instruction for each encircled operand.
3. Using the specified base register and displacement, write (in the spaces provided) the effective address developed during assembly for each encircled operand.

4. Assume that the program, when loaded for execution, is located starting at 3200_{16} instead of 200_{16} . In the spaces provided, list:

- a. The locations into which each instruction, area, and constant (that is, each statement) is loaded.
 - b. The value placed in register 11 at execution time.
 - c. The effective address computed at execution time for each encircled operand.
5. Consider the program in Figure 4-6. In the spaces provided, list:
- a. The symbol table prepared by the assembler (symbol and location only).
 - b. The contents of base registers 9, 10, and 11 assumed by the assembler.
 - c. The base register and displacement for each encircled operand.
 - d. The values actually placed in registers 9, 10, and 11 at execution time, assuming the program is loaded at 1000_{16} .
 - e. The location of each statement at execution time.
 - f. The effective address computed at execution time for each encircled operand.

			During assembly			During execution with program loaded at 3200_{16}		VALUE LOADED IN BASE REGISTER 11
PROGG	START		LOCATION OF STATEMENT	Base Reg.	Displacement	Address	LOCATION OF STATEMENT	
BEGIN	BALR	11,0	000200					
	USING	*,11	Assumed				Actual	
	L	2,DATA	000202					
	A	2,TEN	000206					
	:	:	:					
	S	2,DATA+4	000234					
	ST	2,RESULT	000238					
	:	:	:					
	L	6,BIN1	000252					
	:	:	:					
DATA	DC	F'25'	000304					
	DC	F'15'	000308					
	:	:	:					
TEN	DC	F'10'	000324					
RESULT	DS	F	000328					
	:	:	:					
BIN1	DC	F'12'	000344					
	:	:	:					
	END	BEGIN						

SYMBOL	LENGTH	VALUE
BEGIN	02	000200
BIN1	04	000344
DATA	04	000304
RESULT	04	000328
TEN	04	000324

*Base and displacement remain the same as during assembly.

Figure 4-5. Program for questions 1 to 4

	During assembly			During execution with program loaded at 100016		REGISTER	VALUE LOADED INTO BASE REGISTERS		
	LOCATION OF STATEMENT	STORAGE OPERAND	Base Reg.	Displacement	Address		LOCATION OF STATEMENT	ADDRESS OF STORAGE OPERAND*	During assembly (assumed)
PROGH	START	0							
BEGIN	BALR	11,0	000000						
	USING	FIRST,11							
FIRST	BC	15,SKIP	000002						
DATA	DC	F'3472'	000008						
	:	:	:						
BASE1	DC	A(FIRST+4096)	000024						
BASE2	DC	A(FIRST+8192)	000028						
	:	:	:						
SKIP	L	10, <u>BASE1</u>	000104						
	USING	FIRST+4096,10							
	L	9, <u>BASE2</u>	000108						
	USING	FIRST+8192,9							
	:	:	:						
	BC	15, <u>CKB</u>	001504						
	:	:	:						
LOOP	A	4, <u>DATA</u>	001898						
	:	:	:						
LOOPB	S	5, DATA	002204						
	:	:	:						
	BC	8, <u>LOOP</u>	002508						
	:	:	:						
CKB	BC	8, <u>LOOPB</u>	002904						
	END	BEGIN							

REGISTER	During assembly (assumed)	During execution (actual)
11		
10		
9		

SYMBOL	VALUE
_____	_____
_____	_____
_____	_____
_____	_____
_____	_____
_____	_____
_____	_____
_____	_____
_____	_____

*Base and displacement remain the same as during assembly.

Figure 4-6. Program for question 5

Chapter 5: Decimal Arithmetic

The decimal instruction set is an optional feature of System/360, but one that most users elect. Besides making it possible to do arithmetic in the more familiar decimal system, the decimal instruction set includes instructions for editing data, that is, preparing data for printing by the insertion of characters such as commas, periods, and dollar signs. The decimal instruction set permits operations on variable length data since the operations are performed in storage areas rather than in registers. It includes the following instructions:

- Add Decimal
- Compare Decimal
- Divide Decimal
- Edit
- Edit and Mark
- Multiply Decimal
- Subtract Decimal
- Zero and Add

The student will find a detailed description of the basic operation of these instructions in the *System/360 Principles of Operation*. This chapter will provide examples of their use in various problem situations and will attempt to show how the programmer can make them a working part of his strategy.

Data operated upon by instructions in the decimal set must be in one of two forms, *packed* or *zoned*, depending on the instruction. As a generalization, we can say that the packed format is required for arithmetic and the zoned for input/output. The two formats are shown in Figure 5-1.

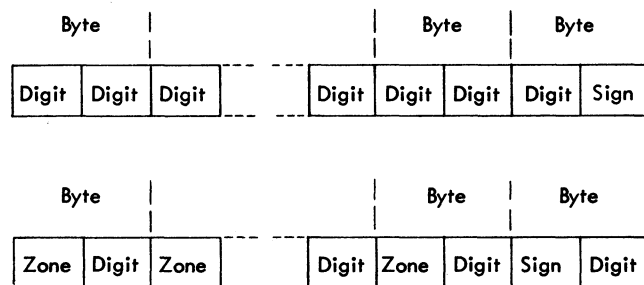

Figure 5-1. Formats of packed and zoned decimal numbers

In the packed format, two decimal digits are placed in each byte except the rightmost of the field, which contains a digit and the sign of the entire number. Digits and sign occupy four bits each. The decimal digits 0–9 have the binary codes 0000–1001. The codes 1010–1111 are not valid as digits. In the sign position, the code combinations

1010, 1100, 1110, and 1111 are taken to mean plus, and 1011 and 1101 are recognized as minus. When a sign is generated as a part of an arithmetic result, a plus is 1100 and a minus is 1101. As mentioned before, all reference to binary codes in this book is to System/360 EBCDIC unless another is specified.

In the zoned format the rightmost four bits of a byte are called the numeric portion of the byte and contain a digit. The leftmost four bits are called the zone and contain either a zone code or, in the case of the rightmost byte, the sign of the number. The codes for signs are treated as described for the packed format. The code for all zones is 1111.

Decimal instructions have precise requirements that operands be in packed or zoned format. The Pack and Unpack instructions, standard instructions of the system, are available for converting from one form to another. The Move with Offset instruction, another of the standard instructions, is often used for shifting factors used or developed in decimal arithmetic operations. Instructions for converting from binary to packed and from packed to binary are also part of the standard instruction set. We shall see examples of all of these operations later.

Decimal instructions use the SS (Storage-to-Storage) format. The machine format is:

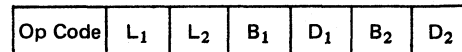

In assembler format, as written in the source program, the sequence of an SS instruction is:

Op code D₁(L₁,B₁),D₂(L₂,B₂)

There are two addresses, both of course referring to core storage. Each address is formed from a base register contents and a displacement. The address *always* refers to the *leftmost* byte of an operand.

For each operand there is a separate length in most cases. In the *machine instruction*, the length code may vary between 0000 and 1111, or zero and 15. These correspond to lengths of one to 16. In other words, the actual length is one greater than what appears in the length code of the object program. In assembler language programming, lengths will quite often be implicit in the data definitions, but when we do write an explicit length, it is the *actual* length. The generation of the proper code in the machine instruction (one less than whatever we write) is the function of the assembler.

With these preliminaries in mind, let us turn to an example.

ADDITION AND SUBTRACTION IN DECIMAL

Let us take the first example used in the chapter on fixed-point arithmetic and write it with decimal arithmetic. The application is an inventory updating. We were given an old on-hand (OLDOH), a number received (RECPT), and a number issued (ISSUE); we were to compute the new on-hand (NEWOH). For this program we shall assume that all data entries are already in packed format and are four bytes long. Four bytes can contain, in packed format, seven decimal digits and the sign.

In Figure 5-2 let us look first at the data definitions. The DC instructions for OLDOH, RECPT, and ISSUE and the DS for NEWOH all have operands that start with PL4. The P stands for packed format, and the L4 for a length of 4. Lengths are always in bytes, never digits. This is our first contact with a length modifier in a DC instruction. Here, we are specifying that the constants *must* be four bytes long. If we had omitted the length, the constant generated by the assembler would have been as long as needed to hold the data value we wrote, in this case one byte. (Length modifiers are permitted for other types of data, too.)

Looking at the assembly listing in Figure 5-3, we see that the DC entries have resulted in four-byte constants. In each case, with the data shown, there are six zeros, followed by a digit, followed by a hexadecimal C (binary 1100), which signifies a plus sign in EBCDIC.

Turning back to the instructions of the program, we see the familiar PRINT, START, BALR, and USING instructions. Note that the START instruction specifies zero. This is the usual programming practice at most computer installations, and we will follow it in this book from now on. The START instruction simply tells the assembler where to begin the program during assembly. The linkage editor will assign the actual starting address later, that is, the address in core storage at which the program will be located during execution.

The first processing instruction is a new one, Move Characters (MVC). This is an SS format instruction of a slightly different sort: it moves from storage to storage, but

PROGRAM		STOCK1	
PROGRAMMER		J. J. JONES	
Name	Operation	Operand	
	PRINT	NOGEN	
STOCK1	START	0	
BEGIN	BALR	11,0	
	USING	*,11	
	MVC	NEWOH,OLDOH	
	AP	NEWOH,RECPT	
	SP	NEWOH,ISSUE	
	EQT		
OLDOH	DC	PL4'9'	
RECPT	DC	PL4'4'	
ISSUE	DC	PL4'6'	
NEWOH	DS	PL4	
	END	BEGIN	

Figure 5-2. An assembler language program to perform a simple calculation in arithmetic, using the System/360 decimal instruction set

there is only one length, because the "sending" and "receiving" fields must be of the same length. That length may be from one to 256 bytes. Looking at the assembled instruction, we see that a length code of 3 has been supplied by the assembler; this is the correct code for a length of four bytes. The length of the operands was *implied* by the data definitions. It is also possible, and frequently necessary, to write *explicit* lengths to override what the assembler would infer.

The generation of an address from the base register contents and the displacement is as before: for instance, for OLDOH the base register contains 002, the displacement is 014; the sum of these is 016 which we see is the address for OLDOH.

LOC	OBJECT CODE	ADDR1	ADDR2	STMT	SOURCE STATEMENT
				1	PRINT NOGEN
000000				2	STOCK1 START 0
000000	0580			3	BEGIN BALR 11,0
000002				4	USING *,11
000002	D203 B020 B014 00022 00016			5	MVC NEWOH,OLDOH
000008	FA33 B020 B018 00022 0001A			6	AP NEWOH,RECPT
00000E	FB33 B020 B01C 00022 0001E			7	SP NEWOH,ISSUE
				8	EQT
000016	0000009C			11	OLDOH DC PL4'9'
00001A	0000004C			12	RECPT DC PL4'4'
00001E	0000006C			13	ISSUE DC PL4'6'
000022				14	NEWOH DS PL4
000000				15	END BEGIN

Figure 5-3. Assembly listing of the decimal arithmetic program in Figure 5-2

The purpose of the Move Characters instruction is to get the old on-hand quantity into a location where we can perform arithmetic without disturbing the original quantity. The decimal instructions make no use of the general registers (except, of course, to specify the base), so we must provide storage locations for all data. We do not wish to destroy the old on-hand, so we must arrange for the arithmetic results to go somewhere else. In this case, the obvious place is NEWOH, where we want the eventual result anyway. In other problems, as we shall see, it is often necessary to provide temporary working storage.

The Add Decimal (AP, for Add Packed) instruction adds the quantity received to the old on-hand, which by now is in NEWOH. Note that the result of an arithmetic operation is always stored in the *first* operand location. The two fields in an Add Decimal instruction need not be the same length, since there are two length codes in the instruction. Here,

they are the same, as it happens. The Subtract Decimal (SP) instruction deducts the quantity issued.

There is no need for something equivalent to a Store instruction; every instruction already involves two storage addresses, one of which receives the result.

The output in Figure 5-4 shows that the result has been correctly computed.

0000009C	0000004C	0000006C	0000007C
----------	----------	----------	----------

Figure 5-4. Output of the program of Figure 5-3, showing OLDOH, RECPT, ISSUE, AND NEWOH, in that order

DECIMAL MULTIPLICATION

For a simple example of decimal multiplication, let us write a program for the computation of a new principal amount.

We are given a principal (PRINC), here taken to be four bytes, and an interest factor (INT), two bytes; we are to compute the new principal amount after adding in the year's interest. The interest rate of 3% is expressed as the factor 1.03, so that a single multiplication does the whole job. A program is shown in Figure 5-5.

The Multiply Decimal (MP) instruction takes the second operand to be the multiplier; the first operand initially contains the multiplicand, and at the end of the operation contains the product. However, we cannot begin with a multiply instruction specifying PRINC as the multiplicand, as we might be inclined, because extra space is required. The first operand is required to have at least as many high-order zeros as the size of the multiplier field. We need, therefore, to move the principal to a working storage area having extra positions at the left. These extra positions must be cleared to zero before the multiplication starts.

The Zero and Add (ZAP) does just what we need. The effect of the instruction is to clear the first operand (PROD, in this case) to zero, then add the second operand (PRINC) to it. PROD is two bytes longer than PRINC; these extra four digit positions will be cleared to zeros before PRINC is added in. This provides the zeros needed to satisfy the multiplication rule.

Now we multiply. With the sample data shown, the result in PROD will be 00000256367C, as shown in the comments field. We were regarding 2489 as meaning \$24.89, and 103 as meaning 1.03, so there are four places to the right of the understood decimal point in the product, which we therefore regard as 0000025.6367+. We would now like to round this off to \$25.64. This can be done in a number of ways. Here we simply add a constant (ROUND) properly set up to add a 5 into the second place from the

right. The second operand in an Add Decimal instruction is permitted to be shorter than the first (which holds the result). When this is done, any carries that occur are properly propagated.

We are now ready to discard the two digits at the right end of the product. But this is not quite as simple as just not moving them to PRINC, because if we did that, PRINC would not be a legal operand in any subsequent arithmetic operation, since it would not have a sign. Before moving the result back to PRINC, therefore, we must move the sign from where it is to the byte just to the left. This we can do with a Move Numeric (MVN) instruction, which transmits only the numeric portions of the bytes. The instruction says: Take the numeric portion of the byte at PROD+5 (which is the rightmost byte of the PROD, and contains the sign) and move it to the byte at PROD+4 (which is the byte to the left and will be the rightmost byte of PRINC after the next instruction); the field to be moved is one byte long. The length for this instruction cannot be left to the assembler; the implied length here would be 6 (the length of PROD), which would destroy the result. The Move Numeric instruction has only one length code, so we need give only one explicit length.

Finally, we are ready to move the result to the field where it is required to be at the end of the program, PRINC. Remember that PROD is six bytes long. The leftmost byte contains two zeros, we assume, and the maximum size of the result is taken to be seven digits. The validity of such an assumption as always, is the responsibility of the programmer. The rightmost byte of PROD contains a digit and sign that we now wish to drop. To drop the leftmost byte, we write the address as PROD+1. To drop the rightmost, we need a length of 4, which happens to be the implied length of PRINC, so no explicit length is necessary.

LOC	OBJECT CODE	ADDR1	ADDR2	STMT	SOURCE STATEMENT	
				1	PRINT NOGEN	
000000				2	INTC START 0	
000000	05B0			3	BEGIN BALR 11,0	
000002				4	USING *,11	
				5	*	
				6	*	NUMBERS BELOW SHOW CONTENTS
				7	*	OF PROD AFTER INSTR IS EXECUTED
				8	*	C IS PLUS SIGN IN PACKED FORMAT
000002	F853 B026 B020 00028 00022			9	ZAP PROD,PRINC	00 00 00 02 48 9C
000008	FC51 B026 B024 00028 00026			10	MP PROD,INT	00 00 02 56 36 7C
00000E	FA51 B026 B02C 00028 0002E			11	AP PROD,ROUND	00 00 02 56 41 7C
000014	D100 B02A B028 0002C 0002D			12	MVN PROD+4(1),PROD+5	00 00 02 56 4C 7C
				13	*	
00001A	D203 B020 B027 00022 00029			14	MVC PRINC,PROD+1	CONTENTS OF PRINC WILL BE
				15	*	00 02 56 4C
				16	EOJ	
000022	0002489C			19	PRINC DC PL4' 2489'	
000026	103C			20	INT DC PL2' 103'	
000028				21	PROD DS PL6	
00002E	050C			22	ROUND DC PL2' 50'	
000000				23	END BEGIN	

Figure 5-5. Listing of a program that performs decimal multiplication. Step-by-step results to be expected during execution are shown in the comments field.

DECIMAL DIVISION

Some of the operations in working with the decimal instruction set are different enough from similar operations in other machines that it may be well to pause and consider them in somewhat more detail than we have devoted to other topics. Division is one such operation; Move instructions, used as the equivalent of shifting and considered later in the section on shifting of decimal fields, is another.

The Divide Decimal (DP) instruction is in the SS format. The first operand is the dividend (the number divided into), the second the divisor (the number divided by). After the operation is completed, the first operand field holds the quotient (at the left) and the remainder (at the right). The remainder is the same length as the divisor. Let us see how this description works out in an example.

Suppose we begin with the symbolic locations DIVID and DIVIS as follows:

```
DIVIDbefore 0 0 0 0 0 4 2 4 6 +
DIVIS      0 3 1 +
```

We have indicated DIVID as a "before" value, because after the division the same field will contain both the quotient and the remainder. All operands are in packed format, as with other decimal arithmetic operations. After executing the instruction:

DP DIVID,DIVIS

the contents of DIVIS would be unchanged; the contents of DIVID would be:

```
DIVIDafter 0 0 1 3 6 + 0 3 0 +
```

This means that 4246 divided by 31 in this way gives a quotient of 136 and a remainder of 30. The divisor was two bytes, so the remainder is two bytes. The quotient takes up the remaining space in the first operand field.

The question of the lengths of the various fields can be answered with a useful rule:

Number of bytes in dividend = number of bytes
in divisor + number of bytes in quotient

It is perhaps most common to know the number of bytes in the divisor and the number desired in the quotient, the question being how much space to allow in the dividend in order to get the specified size of the quotient. If two of the three lengths are known, the formula can be used to get the length of the third.

Note that the formula is stated in terms of the number of bytes, not the number of digits. The reason is that the first operand field contains only one sign at the beginning, when it is the dividend, but two afterward, when it contains both quotient and remainder. This change would invalidate

a rule stated in terms of digits.

A very similar rule gives the relationship among decimal points. If we agree that by "decimal places" we mean the number of digits to the right of an assumed decimal point, the rule is:

Number of places in dividend = number of places
in divisor + number of places in quotient

In the example given above, we assume that all quantities are integers, that is, they have no decimal places. The rule still holds, although in its most elementary form:

$$0 = 0 + 0$$

Let us see what the result would be if we were to arrange the dividend of the example so that it has one decimal place:

```
DIVIDbefore 0 0 0 0 4 2 4 6 0 +
```

In other words, we now view the dividend as 4246.0. The result is:

```
DIVIDafter 0 1 3 6 9 + 0 2 1 +
```

The rule says that the quotient should have one decimal place: the dividend has one and the divisor has zero. The quotient must therefore be interpreted as meaning 136.9. (And if anything has to be done with the remainder, it should be taken as meaning 2.1.)

Suppose the dividend were shifted one more place to the left:

```
DIVIDbefore 0 0 0 4 2 4 6 0 0 +
DIVIDafter 1 3 6 9 6 + 0 2 4 +
```

This result should be read as 136.96.

What would happen if we tried to set up the dividend with yet one more shift to the left? There is room in the dividend — but there is no more space in the quotient field. This constitutes a divide exception, which occurs whenever the quotient is too large to fit in the field available to it. An interrupt occurs.

It is possible to check for the possibility of a divide exception, given sample numbers. To do this, the leftmost digit position of the divisor is aligned with the second digit position from the left of the dividend. When the divisor, so aligned, is less than or equal to the dividend, a divide exception will occur. Take the situation suggested:

```
DIVIDbefore 0 0 4 2 4 6 0 0 0 +
DIVIS      0 3 1 +
```

This is the alignment described by the rule. As aligned, the divisor is smaller. We saw before that there would not be enough room for the quotient.

This question does depend on the particular numbers involved, of course. Suppose the quantities were aligned the same way but that the dividend were 2246 instead of 4246:

DIVID _{before}	0	0	2	2	4	6	0	0	0	+
DIVIS		0	3	1	+					

This is entirely acceptable.

To be completely confident that a divide exception cannot occur, we have to know the maximum possible size of the dividend and the minimum possible size of the divisor, or we must know the maximum size of the quotient.

Further examples of decimal division will be given after we have studied shifting, which is often needed to arrange the dividend so as to give the necessary number of decimal places.

SHIFTING OF DECIMAL FIELDS

Shifting *as such* is not provided in System/360 decimal operations. As in other variable-field-length computers, the equivalent of shifting is performed by appropriate combinations of data movement instructions.

The matter is made somewhat more complex by the factor of packed formats, with two digits per byte and with the special status of the sign position. This is a small price to pay for the increased storage economy of the two-digits-per-byte arrangement.

It is also necessary to exercise caution when overlapping fields are to be manipulated, in order to be sure that no data is destroyed. This is another occasion where it is absolutely essential to remember that *all* operands are addressed by the leftmost byte.

Shifting to the Right

Let us begin with the simplest type of shift: a decimal right shift of an even number of places. Suppose that we have a five-byte, nine-digit number in SOURCE; we are to move it to a five-byte field named DEST with the last two digits dropped and two zeros at the left. We can do this two ways: with or without disturbing the original contents of SOURCE. Let us do it first without disturbing them.

Suppose that the two fields originally contain:

SOURCE					DEST			
12	34	56	78	9S	55	55	55	55

The S stands for a plus or minus sign, whichever it might be. The instructions for accomplishing the shift could be as follows, where we have also shown the contents of the two fields after the execution of each instruction:

	SOURCE	DEST
MVC		
DEST+1(4),SOURCE	12 34 56 78 9S	55 12 34 56 78
MVN		
DEST+4(1),SOURCE+4	23 34 56 78 9S	55 12 34 56 7S
MVC		
DEST(1),ZERO	12 34 56 78 9S	00 12 34 56 7S

In the first Move Characters instruction, an explicit length of 4 is stated; this length applies to both fields. With the first operand address being DEST+1, the four bytes of the destination are the rightmost four. The second operand is given simply as SOURCE, so the four bytes there are the leftmost. The last two digits (one byte) have been dropped.

But the sign has been dropped too, in the process. We accordingly use a Move Numeric instruction to attach it to the shifted number. This must be done with an explicit length of one, to avoid disturbing any of the digits of DEST. Both addresses must be written with the "+4" to pick out the proper single character. Finally, we move one byte of a constant named ZERO (not shown), which contains zeros, to the first byte of DEST. This clears to zero whatever may have been there before.

If the contents of SOURCE are no longer needed in their original form, the following sequence is a bit shorter.

	SOURCE	DEST
MVN		
SOURCE+3(1),SOURCE+4	12 34 56 7S 9S	55 55 55 55 5S
ZAP		
DEST,SOURCE(4)	12 34 56 7S 9S	00 12 34 56 7S

The Move Numeric moves the sign to the byte which will contain the sign in the eventual result. The Zero and Add picks up four bytes of SOURCE and adds them to DEST after clearing DEST to zeros. The Zero and Add has two length codes. For DEST we use the implied length of 5; for SOURCE it is necessary to give an explicit length in order to drop the last two digits.

Finally, suppose that for some reason it is necessary to leave the shifted result in SOURCE, without resorting to the expedient of simply moving the sign and appending zeros at the left.

	SOURCE
MVN SOURCE+3(1),SOURCE+4	12 34 56 7S 9S
ZAP SOURCE,SOURCE(4)	00 12 34 56 7S

The sign movement is as before. In the Zero and Add, the second operand is given as SOURCE(4), which means a four-byte field the leftmost byte of which has the address SOURCE; this is just 12 34 56 7S. The first operand is simply SOURCE, with its implied length of 5, which means the whole field.

It is important to know that this type of overlap is permitted when the first operand field is at least as long as the second operand, but not when it is too short to contain all significant digits of the second operand. A little study shows that a violation of this rule would result in destroying bytes of the second operand before they have been moved.

Let us now turn to a slightly more complex shift, one that involves an odd number of places. This requires the use of a special instruction designed for the purpose, the Move with Offset. The action of this instruction can be described as follows. The sign of the first operand is not disturbed; the second operand is placed to the left and adjacent to the four low-order bits (the sign bits) of the first operand. Any unused high-order digit positions in the first operand are filled with zeros.

Looking at an example, take the fields described in the previous illustration, but suppose that the shift must be three positions instead of two.

	SOURCE	DEST
MVO		
DEST,SOURCE(3)	12 34 56 78 9S	00 01 23 45 6S
MVN		
DEST+4(1),SOURCE+4	12 34 56 78 9S	00 01 23 45 6S

In the Move with Offset, the second operand is given as SOURCE(3), which picks up a three-byte field starting at

the left, namely, the bytes containing 12 34 56. The first operand is DEST, with its implied length of 5. The digits 12 34 56 are moved to DEST with an offset of four bits, or one digit, leaving 00 01 23 45 65 in DEST; the right-most 5 is the one that was there to begin with. A final Move Numeric attaches the source sign to the destination field.

If the shift is required to leave the result in SOURCE, only one instruction is needed, since the Move with Offset instruction has no effect on the sign of the first operand, and the left end of the receiving field is filled with zeros.

```

                SOURCE
MVO SOURCE,SOURCE(3)  00 01 23 45 6S

```

The overlapping fields here cause no trouble, since again the movement is to the right of the original contents. (Actually, overlap of any type is *permitted*; it is the programmer's responsibility to make sure that the result is meaningful.)

Shifting to the Left

A shift to the left presents slightly different problems. This time suppose that we have a source field of three bytes and a destination of five.

```

Before          SOURCE          DEST
                12 34 5S      99 99 99 99 99

```

Let us take our problem, to move the number at SOURCE to DEST, with four zeros to the right at DEST, and with DEST left ready to do arithmetic. An acceptable sequence of instructions is shown below.

```

                SOURCE          DEST
MVC DEST(3),SOURCE  12 34 5S      12 34 5S 99 99
MVC DEST+3(2),ZEROS 12 34 5S      12 34 5S 00 00
MVN DEST+4(1),DEST+2 12 34 5S      12 34 5S 00 0S
MVN DEST+2(1),ZEROS 12 34 5S      12 34 50 00 0S

```

The first Move Characters needs an explicit length on DEST; otherwise, the length would, improperly for our problem, be interpreted from DEST as 5. The last two bytes of DEST are unaffected by the first Move; a second clears them. A Move Numeric transfers the sign, and a second Move Numeric clears the now extraneous sign that went with the source data on the first Move Characters.

Another way to clear the extraneous sign is available, using the And Immediate instruction. "Anding" two quantities gives a result that has a one bit wherever *both* operands had 1's, and a zero elsewhere. For instance, if we "And" 1100 and 1010, the result is 1000; only in the first bit position did both operands have ones. In the And Immediate instruction (NI), both operands are exactly eight bits long. One of them is given by the byte specified by the address; the other is contained in the instruction itself (which is the reason for the term "immediate"). The result replaces the byte specified in storage.

In the example at hand, we wish to leave the first four bits of the byte at DEST+2 just as they were; this can be done by placing ones in the corresponding positions in the part of the instruction that will be "And-ed". (This is usually called the mask.) We wish to make the right four bits of DEST+2 zero, whatever they were before; this can be done by placing zeros in that part of the mask. The mask, in short, should be 11110000, expressed in binary. To write the instruction, we can either convert this to its decimal equivalent 240, or, better, write it in hexadecimal, X'F0'. In other words, we can replace the last instruction with either of the following:

```

NI  DEST+2,240
NI  DEST+2,X'F0'

```

Finally, consider a shift to the left of an odd number of places. For an example, take the data of the preceding illustration, but suppose there are to be three zeros at the right instead of four.

```

                SOURCE          DEST
Before          12 34 5S      99 99 99 99 99
MVC DEST(3),SOURCE 12 34 5S      12 34 5S 99 99
MVC DEST+3(2),ZEROS 12 34 5S      12 34 5S 00 00
MVN DEST+4(1),DEST+1 12 34 5S      12 34 5S 00 0S
NI  DEST+2,X'F0'    12 34 5S      12 34 50 00 0S
MVO DEST(4),DEST(3) 12 34 5S      01 23 45 00 0S

```

The first four instructions are just the same as in the previous example, except that the And Immediate is substituted for the Move Numeric. The final instruction now is a Move with Offset that shifts one digit position to the right.

DECIMAL DIVISION WITH SHIFTING

We are now prepared to approach a realistic problem in decimal division.

Suppose that in a four-byte field named SUM we have the total of the number of hours worked by all the employees in a factory, given to tenths of an hour. In NUMBER we have the number of employees included in the sum; this is a two-byte number. We are to calculate the average workweek, to tenths of an hour, rounded, and place it in a two-byte location named AVERAG.

We begin the analysis of the problem knowing that the dividend (SUM) has one decimal place to start, and the divisor (NUMBER) has none. If we set up the division this way, we would get a quotient having one place; this would not permit rounding. Evidently we shall have to allow extra places to the right. One more would be sufficient, but this would involve a shift of an odd number of places; it would be simpler for us and faster in the machine to make a shift of two places and simply ignore the extra digit. The dividend therefore should be set up like this:

XX XX XX X0 0+

The X's stand for any digits.

Now we turn to the rule stating that the number of bytes in the dividend is equal to the number of bytes in the divisor plus the number of bytes in the quotient. We know that we have two bytes in the divisor as it stands. The quotient need be only three: there can be no more than two digits before the decimal point, there will be three after the decimal point, and there will be a sign. (There will be

three decimal places in the quotient because there are three in the dividend and none in the divisor.) The dividend evidently should be five bytes. As it happens — which will by no means always be the case — that is just how long it will be as the result of the shifting we decided upon.

With this much background, let us now look at the program shown in Figure 5-6. We assume that it is permissible to destroy the original contents of SUM; if this were not so, it would be a matter of one extra instruction to move the contents of SUM to a working storage location.

Notice in the list of constants at the end of the program that a one-byte constant named PAD has been established just after, and therefore to the right of, SUM. Now, instead of actually moving the contents of SUM in order to accomplish a shift, we simply extend the field by one byte. This is the function of the first two instructions. We have assumed, reasonably enough, that the sum is always positive, so a plus sign is moved with the first Move Characters, and the original sign is simply erased with the And Immediate.

The Divide Decimal might seem to carry the possibility of a divide exception. We must fall back on a knowledge of the data, which is the eventual foundation of any intelligent programming. We simply observe that the average hours worked would not be as great as 100 hours — and anything less can be contained in the space provided.

Rounding is accomplished by adding 5 in the proper position. We move the sign to where it is needed, and finally transfer the result to the specified location in storage.

LOC	OBJECT CODE	ADDR1	ADDR2	STMT	SOURCE STATEMENT	
				1	PRINT NOGEN	
000000				2	AVG	START 0
000000	05B0			3	BEGIN	BALR 11,0
000002				4		USING *,11
				5	*	
				6	*	
				7	*	
				8	MVC	SUM+4(1),ZERO
000002	D200 B028 B02F	0002A	00031			01 93 64 8C 0C
000008	94F0 B027	00029		9	NI	SUM+3,X'FO'
00000C	FD41 B024 B029	00026	00028	10	DP	SUM(5),NUMBER
000012	FA21 B024 B02D	00026	0002F	11	AP	SUM(3),ROUND
000018	D100 B025 B026	00027	00028	12	MVN	SUM+1(1),SUM+2
00001E	D201 B028 B024	0002D	00026	13	MVC	AVERAG,SUM
				14	EOJ	
000026	0193648C			17	SUM	DC PL4'0193648'
00002A				18	PAD	DS PL1
00002B	487C			19	NUMBER	DC PL2'487'
00002D				20	AVERAG	DS PL2
00002F	050C			21	ROUND	DC PL2'50'
000031	0C			22	ZERO	DC PL1'0'
000000				23	END	BEGIN

Figure 5-6. Assembled program showing decimal division and "shifting". Step-by-step results to be expected during execution are included in the comments field.

FORMAT AND BASE CONVERSIONS

It is often necessary to convert from zoned to packed format and vice versa, and also to convert from binary to decimal and vice versa. In this section, we shall examine a program that has been constructed as an exercise in manipulating the form of data. For practice purposes, some new instructions are introduced for these maneuvers, which might be accomplished more simply in a realistic situation.

We are given a fullword named REG, in binary format. Actual data for the three-byte field named PREM is read in directly from an input card on which the sign is in the high-order position, instead of the low-order. That is, a positive number was punched with a 12 zone over the leftmost digit, and a minus number was punched with an 11 zone over the leftmost digit. We are required to place the sum of REG and PREM in ANS, as a decimal number in the normal zoned format, that is, with the sign in the zone of the low-order byte. The zone bits that result in a byte in storage from a 12 zone on the card, are the zone bits required for a plus sign in the EBCDIC zoned format in storage. An 11 zone likewise is translated into the correct zone bits for a minus sign. Our problem, then, is simply to move the zone bits of the high-order byte to the zone bits of the low-order byte.

In the program of Figure 5-7 we have shown at the right of the first half-dozen instructions the contents of the last eight bit positions of registers 5 and 6, to aid in understanding how the instructions operate on sample data consisting of the three bytes:

1101 0011 1111 0111 1111 1001

With the card column assignments we have described, this is the EBCDIC representation of -379.

The program begins with a new instruction: Insert Character (IC). This is an RX format instruction that gets one character (byte) from the specified storage location and places it in the rightmost byte position of the register named. The other bit positions of the register are not disturbed. We do not know what might be in them, but it will not matter, as it happens, since the following instruction clears them. This is an And to erase the numeric bits of the high-order character of our sample data.

Next we perform the similar operations on the low-order byte, using register 6, except that this time we erase the zone bits.

Now we have in register 6 the numeric bits of the low-order byte, and in register 5 the zone bits that are to be attached to that byte. They can be combined with an Or Register (OR) instruction. "Or-ing" two operands is a bit-by-bit operation that results in a 1 wherever *either* operand had a 1, and zero where both had zero. The result of this instruction is to combine the two groups of bits, leaving the result in register 5. This now is the byte that we want in the low-order position, so we use a Store Character instruction (STC) to place it there.

Insert Character and Store Character do not require the character to be on any sort of integral boundary. They are the only indexable instructions for which this is true. The various decimal instructions do not require boundary alignment either, of course, but they are not indexable. The two

LOC	OBJECT CODE	ADDR1	ADDR2	STMT	SOURCE	STATEMENT		
000000				1		PRINT NOGEN		
000000	0580			2	CONVERT	START 0		
000002				3	BEGIN	BALR 11,0		
				4		USING *,11		
				5	*			
				6	*			LAST BYTE (BITS 24 TO 31) OF REGS 5
				7	*			AND 6 AFTER EXECUTION OF EACH INSTR
				8	*			IS SHOWN BELOW
				9	*			
000002	4350 B03A		0003C	10	IC	5,PREM	1101 0011	REG 5
000006	5450 B032		00034	11	N	5,MASK1	1101 0000	REG 6
00000A	4360 B03C		0003E	12	IC	6,PREM+2	1101 0000	1111 1001
00000E	5460 B036		00038	13	N	6,MASK2	1101 0000	0000 1001
000012	1656			14	OR	5,6	1101 1001	0000 1001
000014	4250 B03C		0003E	15	STC	5,PREM+2	1101 1001	0000 1001
000018	F212 B03D B03A 0003F	0003C	0003C	16	PACK	WORK,PREM		
00001E	5860 B042		00044	17	L	6,REG		
000022	4E60 B046		00048	18	CVD	6,DOUBLE		
000026	FA71 B046 B03D 00048 0003F	00048	0003F	19	AP	DOUBLE,WORK		
00002C	F357 B04E B046 00050 00048	00050	00048	20	UNPK	ANS,DOUBLE		
				21		EQJ		
000034				24		DS OF		
000034	000000F0			25	MASK1	DC X'000000F0'		
000038	0000000F			26	MASK2	DC X'0000000F'		
00003C				27	PREM	DS ZL3		
00003F				28	WORK	DS PL2		
000044				29	REG	DS F		
000048				30	DOUBLE	DS D		
000050				31	ANS	DS ZL6		
000000				32	END	BEGIN		

Figure 5-7. Assembled program showing various instructions for changing the format of data. Contents of registers 5 and 6 to be expected during execution are given in the comments field.

And (N) instructions, however, *do* require their operands to be on fullword boundaries. This is the purpose of the DS OF before the DC's for the masks.

At this point we have merely got the sign where it is expected to be in the zoned format of a decimal number. Now we must convert from zoned to packed format, which is the function of the PACK instruction. The second operand names a field in zoned format; the first names the field where the packed format should be stored. Both fields carry length codes. Here, we are able to leave the lengths implied: three bytes for PREM and two for WORK (two bytes allow space enough for three digits and sign in packed format). The PACK instruction ignores all zones except the rightmost, which is taken to carry the sign. Therefore we can leave the zone of the high-order byte as it was without disturbing the operation.

With the PREM amount finally in packed format, we are almost ready to do the addition — but not quite, because the REG amount is still in binary. The next instruction, accordingly, is a Load followed by a Convert to Decimal (CVD). Convert to Decimal takes the binary number in the specified register and converts it to packed format decimal in the location given, which must be aligned on a double-word boundary.

At last it is possible to do the addition, which is done in decimal. A final instruction, Unpack (UNPK), converts back from packed to zoned, as required in the problem statement. This will leave the final answer with the sign in the zone bits of the low-order byte, which was stated to be the desired position for whatever processing might follow. If it were necessary to get the result into the same format as PREM originally was, we could of course do so.

DECIMAL COMPARISON: OVERTIME PAY

Logical tests and decisions are as necessary in decimal operations as elsewhere. System/360 provides a Compare Decimal instruction, and the condition code is set as a result of this and three decimal arithmetic instructions.

For an example we take the familiar calculation of gross pay, with time-and-a-half for hours over 40. We have a RATE, given in dollars and cents, and an HOURS, to tenths of an hour. We are to place the total wages in GROSS.

There are several ways to approach the overtime computation. We choose here to begin by figuring the pay at the straight-time rate, on the full amount in HOURS. We then inspect the hours worked, and if it was not over 40 the job is finished. If there was overtime, we multiply the hours over 40 by the pay rate, and multiply this product by one-half to get the premium, which is then added to the previous figure. Several other ways to arrange the sequence of decisions and multiplications are obviously possible. This one probably minimizes the computation time if most employees do not work overtime; if most did work overtime, a different sequence might be a little better.

The program in Figure 5-8 begins with a three-instruction sequence to set up the multiplicand in a work area, multiply, and round. The Move with Offset instruction drops one digit in the move; this is the extra digit that was rounded off. The Move with Offset instruction does not transmit the sign; we have shown GROSS as a DC to get a plus sign there from the outset. Since the pay can never properly be negative, the plus sign will simply remain there throughout the operation of the program.

The Compare Decimal (CP) instruction is not greatly different in concept from Compare instructions we have seen previously. The two operands are compared algebraically; the condition code is set depending on the relative sizes of the two; neither operand is changed. The mask of 12 on the Branch on Condition will cause a branch if the contents of HOURS are less than or equal to FORTY, in which case there is no overtime to compute, and we simply branch out to whatever follows.

If the man did work more than 40 hours, we compute his pay on the amount over 40, then multiply by 5, which we view as having a decimal point, that is, as being one-half. This is done because we have already computed the straight-time pay on the amount over 40; now we need only to compute the extra premium. After the multiplication by 5 we round off, using a different rounding constant this time because the multiplication by 0.5 has added another decimal place. (It is necessary to check that WORK is long enough to satisfy the rule about at least as many zeros as the size of the multiplier. Assuming that no employee could make \$1000 in one week, the rule is satisfied.)

After a Move Numerics to move the sign, we can add the rounded amount to GROSS to get the total pay. In the Add Decimal, note the length of 3 to drop the last byte, which after rounding is extraneous. We now reach the termination of the program, the same point to which we transferred if there was no overtime. In other words, both paths would lead, in a real program, to the same continuation point.

LOC	OBJECT CODE	ADDR1	ADDR2	STMT	SOURCE	STATEMENT	
				1		PRINT NOGEN	
000000				2	OTPAY	START 0	
000000	05B0			3	BEGIN	BALR 11,0	
000002				4		USING *,11	
				5	*		
				6	*		NUMBERS BELOW SHOW CONTENTS OF
				7	*		FIRST OPERAND (WORK OR GROSS)
				8	*		AFTER INSTRUCTION IS EXECUTED
000002	F831 B056 B050	00058	00052	9	ZAP	WORK,HOURS	00 00 44 6C
000008	FC31 B056 B04E	00058	00050	10	MP	WORK,RATE	00 78 05 0C
00000E	FA30 B056 B05A	00058	0005C	11	AP	WORK,FIVE	00 78 05 5C
000014	F132 B052 B056	00054	00058	12	MVD	GROSS,WORK(3)	00 07 80 5C
00001A	F911 B050 B05D	00052	0005F	13	CP	HOURS,FORTY	
000020	47C0 B04C		0004E	14	BC	12,OUT	
000024	F831 B056 B050	00058	00052	15	ZAP	WORK,HOURS	00 00 44 6C
00002A	F831 B056 B05D	00058	0005E	16	SP	WORK,FORTY	00 00 04 6C
000030	FC31 B056 B04E	00058	00050	17	MP	WORK,RATE	00 08 05 0C
000036	FC30 B056 B05A	00058	0005C	18	MP	WORK,FIVE	00 40 25 0C
00003C	FA31 B056 B05B	00058	0005D	19	AP	WORK,FIFTY	00 40 30 0C
000042	D100 B058 B059	0005A	0005B	20	MVN	WORK+2(1),WORK+3	00 40 3C 0C
000048	FA32 B052 B056	00054	00058	21	AP	GROSS,WORK(3)	00 08 20 8C
				22	OUT	EOJ	
000050	175C			25	RATE	DC	PL2' 1.75'
000052	446C			26	HOURS	DC	PL2' 44.6'
000054	0000000C			27	GROSS	DC	PL4' 0'
000058				28	WORK	DS	PL4
00005C	5C			29	FIVE	DC	PL1' 5'
00005D	050C			30	FIFTY	DC	PL2' 50'
00005F	400C			31	FORTY	DC	PL2' 40.0'
000000				32	END	BEGIN	

Figure 5-8. Assembled program that computes a man's gross pay, including any overtime pay, in decimal arithmetic. Results expected during execution are shown in the comments field.

THE SOCIAL SECURITY PROBLEM IN DECIMAL

For a little further practice in applying decimal operations, we may rewrite the Social Security calculation of Figure 3-19 in the chapter on fixed-point operations. The logic of the decimal program shown in Figure 5-9 is the same as that of the earlier one. No new instructions are introduced, so a few notes should be all that is required to explain the program.

We begin by moving the old year-to-date to the new year-to-date location. The purpose is simply to get one of the two operands in the following addition where we want the result to be. Following is a Zero and Add to get the new year-to-date into working location where we can continue the processing without disturbing the NEWYTD location. From here on, the right side of Figure 5-9 shows the contents of the WORK field for sample data as shown in the DC instructions.

In the Multiply Decimal instruction that computes the Social Security tax on the new year-to-date figure, we use a constant for the 4.4% that has been set up with an extra zero at the right. This was done to put the product in a position where a Move with Offset would not be necessary. As it has been done, after rounding and moving the sign, we can carry out all following operations on the Social Security amount on the second, third and fourth bytes of WORK. Since the implied length from the DS is 6, an explicit length must be given. The explicit length specifications in the two Move Characters (statements 17 and 19) are unnecessary, however, because NEWFICA and TAX are defined as 3 bytes, and the assembler already has that information.

Except for the points discussed here, the operations closely parallel the program in the earlier version.

LOC	OBJECT CODE	ADDR1	ADDR2	STMT	SOURCE	STATEMENT
				1		PRINT NOGEN
000000				2	FICA3	START 0
000000	0580			3	BEGIN	BALR 11,0
000002				4		USING *,11
000002	D203 B04F B048	00051	0004D	5	MVC	NEWYTD,OLDYTD
000008	FA32 B04F B048	00051	0004A	6	AP	NEWYTD,EARN
				7	*	
				8	*	
				9	*	
				10	ZAP	WORK,NEWYTD
00000E	F853 B064 B04F	00066	00051			00 00 07 86 40 0C
000014	FC51 B064 B05F	00066	00061	11	MP	WORK,C44
00001A	FA52 B064 B061	00066	00063	12	AP	WORK,HALF
000020	D100 B067 B069	00069	00068	13	MVN	WORK+3(1),WORK+5
000026	F932 B064 B05C	00066	0005E	14	CP	WORK(4),MAX
00002C	4740 B034		00036	15	BC	4,UNDER
000030	D202 B065 B05C	00067	0005E	16	MVC	WORK+1(3),MAX
000036	D202 B056 B065	00058	00067	17	UNDER	MVC NEWFICA(3),WORK+1
00003C	FB22 B065 B053	00067	00055	18	SP	WORK+1(3),OLDFICA
000042	D202 B059 B065	00058	00067	19	MVC	TAX(3),WORK+1
				20	EOJ	
00004A	16400C			23	EARN	DC PL3'16400'
00004D	0770000C			24	OLDYTD	DC PL4'770000'
000051				25	NEWYTD	DS PL4
000055	33800C			26	OLDFICA	DC PL3'33800'
000058				27	NEWFICA	DS PL3
00005B				28	TAX	DS PL3
00005E	34320C			29	MAX	DC PL3'34320'
000061	440C			30	C44	DC PL2'440'
000063	05000C			31	HALF	DC PL3'5000'
000066				32	WORK	DS PL6
000000				33	END	BEGIN

CONTENTS OF WORK AFTER EXECUTION
OF EACH INSTR ARE SHOWN BELOW

Figure 5-9. Assembled program to calculate Social Security tax in decimal arithmetic. Results expected during execution are shown in the comments field.

THE "INDIAN" PROBLEM

A certain programming exercise has been done by so many generations of IBM students that it is a classic. We present it here, worked out with the calculation in decimal and the counting in binary.

The Indians sold Manhattan Island in 1627 for \$24. If the Indians had banked their \$24 in 1627, what would their bank balance be in 1965 at a 3% interest rate compounded annually?

To make the problem a little more interesting, let us assume that the principal, \$24, the interest rate factor, 1.03, and the number of years, 338, are all initially in zoned format. The program of Figure 5-10 accordingly begins with three PACK instructions to get from zoned to packed format.

The general scheme of the program will be to multiply the principal by 1.03 as many times as there are years. In other words, we shall go around a loop repeatedly, each time performing a multiplication and subtracting 1 from a count. When the count has been reduced to zero, the computation of the balance is completed. This counting down from 338 to zero could, of course, be done in decimal, testing for zero with a Compare Decimal instruction. It is better programming practice, however, to remove time-consuming operations from the repeated part of the loop wherever possible. Doing the repeated combination of an Add Decimal, a Compare Decimal, and a Branch on Condition is much more time-consuming than another approach that is available to us. This other way is to convert the years to binary once, before entering the loop, then use a Branch on Count (BCT) in the loop, a single instruction that will subtract 1, test, and conditionally branch.

The fourth instruction of the program is therefore a Convert to Binary (CVB) instruction, which in our program

takes the doubleword at YEARSP and converts to a binary number in register 4. The Convert to Binary instruction requires an *aligned* doubleword operand, which is why the DS for YEARSP was set up as it was instead of with a CL8.

The repeated part of the loop starts with a Multiply Decimal that should by now be moderately familiar. PRINCP was set up to be long enough to hold the size of number that previous runnings of the program have shown will be necessary. The programmer facing this problem completely fresh would have to make some preliminary calculations as to the possible size.

Now comes a familiar sequence of decimal instructions to round, move the sign, and shift right two digits (one byte). One might be tempted to replace the Move Characters and Zero and Add instructions with a single one of the sort:

```
MVC PRINCP+1(6),PRINCP
```

thinking that a right-to-left operation would permit this sort of overlap. A check of the *Principles of Operation* manual, however, discloses that Move Characters works from left to right! The instruction suggested would therefore propagate the leftmost character through the entire field! This can be quite useful on occasion, and is permitted, but it is hardly what we want here. Overlapping fields must be treated with caution.

The Branch on Count subtracts 1 from register 4; if the result is not zero, a branch occurs. If the result is zero, the next instruction in sequence is taken. The loop will be carried out 338 times, as required.

A final Unpack instruction puts the result into a location named BALANCE in zoned format. The answer obtained by execution of our program is \$523,998.22. Carrying the calculations out to more decimal places would of course give a more precise result.

LOC	OBJECT CODE	ADDR1	ADDR2	STMT	SOURCE	STATEMENT
				1		PRINT NOGEN
000000				2	INDIAN	START 0
000000	05B0			3	BEGIN	BALR 11,0
000002				4		USING *,11
000002	F263 B04A	B040	0004C	00042	5	PACK PRINCP,PRINCPZ
000008	F212 B051	B044	00053	00046	6	PACK INTP,INTZ
00000E	F272 B056	B047	00058	00049	7	PACK YEARSP,YEARZ
000014	4F40 B056			00058	8	CVB 4,YEARSP
000018	FC61 B04A	B051	0004C	00053	9	LOOP MP PRINCP,INTP
00001E	FA61 B04A	B05E	0004C	00060	10	AP PRINCP,ROUND
000024	D100 B04F	B050	00051	00052	11	MVN PRINCP+5(1),PRINCP+6
00002A	D205 B060	B04A	00062	0004C	12	MVC TEMP,PRINCP
000030	F865 B04A	B060	0004C	00062	13	ZAP PRINCP,TEMP
000036	4640 B016			00018	14	BCT 4,LOOP
00003A	F386 B066	B04A	00068	0004C	15	UNPK BALANCE,PRINCP
				16		EOJ
000042	F2F4F0C0			19	PRINCPZ	DC ZL4'24.00'
000046	F1F0C3			20	INTZ	DC ZL3'1.03'
000049	F3F3C8			21	YEARZ	DC ZL3'338'
00004C				22	PRINCP	DS PL7
000053				23	INTP	DS PL2
000058				24	YEARSP	DS D
000060	050C			25	ROUND	DC PL2'50'
000062				26	TEMP	DS PL6
000068				27	BALANCE	DS ZL9
000000				28	END	BEGIN
						MOVE SIGN
						DROP LOW-ORDER BYTE
						SUBTRACT 1 FROM REG 4

Figure 5-10. Assembled program to compute compound interest (the "Indian" problem), with counting in binary and calculations in decimal arithmetic

QUESTIONS AND EXERCISES

1a. Write the assembler instruction to define a packed decimal constant of 3 to be named CON3 and to occupy 5 bytes of storage.

b. Show how this constant appears on the assembly listing.

2. A length code in an instruction is called *implied* if it is supplied by the _____ on the basis of _____. An explicit length code is supplied by the _____.

3. An explicit length code is (equal to, one more than, one less than) the actual number of bytes to be dealt with.

4. The length code in the object instruction is (equal to, one more than, one less than) the actual number of bytes to be dealt with.

5a. In an MP instruction, the first operand specifies the location of a storage area containing _____.

b. Where is the product at the end of the multiplication?

6. If there were two successive DC statements of:

```
PRINC DC    PL4'2489'
INT    DC    PL2'103'
```

and PRINC were assigned a location of 158:

a. Byte by byte, what would be in the storage locations assigned to these constants?

b. To what storage location would the operand INT-2 refer?

7. A DP instruction specifies in its first operand the location of the _____, and in its second operand the location of the _____. Where will the quotient and remainder be after the completion of a DP instruction?

8. Assume two fields:

```
SOURCE containing 66 55 44 33 22 11
DEST    containing 11 22 33 44 55 66 (S = sign)
```

Show the contents of SOURCE and DEST after the execution of the instructions below. In each case, assume that before execution the contents of SOURCE and DEST are as shown above.

a. MVC DEST+2(3),SOURCE

b. MVN DEST+3(1),DEST+5

c. MVO DEST,SOURCE+2(2)

9. Assume the same fields (SOURCE and DEST) as given in question 8.

Would the instruction ZAP DEST,SOURCE be a legitimate one? If not, why not?

10. Assume a 5-byte field called FACTOR, which contains 12 34 56 78 9S (S = sign).

a. Write the instruction or instructions to store the leftmost 8 digits (12345678) and the sign in a 6-byte field called RESULT.

b. Write the instruction or instructions to store the leftmost 7 digits and the sign in RESULT.

11a. The NI (And Immediate) instruction is a _____ format instruction.

b. Write the NI instruction(s) that will change the contents of a field named HOLD from 11 22 33 44 6S to 00 22 33 44 6S.

c. 11 22 33 44 6S to 11 22 33 04 6S.

12. What is the difference between the And Immediate and Or Immediate instructions?

13. Decimal arithmetic can be performed only on (zoned decimal, packed decimal) fields.

14. What instruction converts information from zoned decimal to packed decimal form?

15. What instruction converts information from packed decimal to zoned decimal form?

16. Write DC's to store the number 578 as:

a. A fixed-point number.

b. A 3-byte zoned decimal number.

c. A 2-byte packed decimal number.

17. Write a DC to store the hexadecimal equivalent of 75_{10} .

18. Write an instruction that will place a byte named OLD in the rightmost byte position of register 6 without disturbing the remaining positions of register 6.

19. Write an instruction that will store the contents of the rightmost byte position of register 6 in a storage byte named OLD.

20. Consider the following excerpts from an assembly listing. Mask is located at 136.

```
N    6,MASK
```

```
 .
```

```
 .
```

```
 .
```

```
MASK DC X'0000000F'
```

a. Will the N 6,MASK instruction be successfully executed? If not, why not?

b. If not, what statement or statements could be inserted to correct the condition?

c. How could the DC itself be rewritten to correct the situation?

Chapter 6: Logical Operations on Characters and Bits

So far we have been dealing mainly with the arithmetic operations of System/360. Now we turn to an area of particular fascination to the programmer, one that opens up a nearly unlimited range of flexibility and inventiveness in the performance of his task. The logical operations of System/360 provide means for the testing and manipulation of data in a *logical* sense, rather than arithmetic or algebraic. Among these special assembler language instructions are: the Logical Compares, Test under Mask, some new Move instructions, the Logical Shifts, Insert Character, Store Character, and the highly versatile Ands, Ors, and Exclusive Ors. One or more forms of each of these instructions, which are part of the System/360 standard instruction set, will be demonstrated in examples in this chapter. Other logical instructions—the standard Translate and the decimal feature Edit instructions—have such highly specialized functions that they will be the subject of a separate chapter.

The most important thing for us to realize about the logical instructions is that (except for the Edit instructions) they treat all data as unsigned binary quantities, that is, all bits are treated alike and no distinction is made between sign and numeric bits. Remember the data format for a System/360 fixed-point number, with its sign in the first bit? And for a zoned or packed decimal number, with its sign in the first four or last four bits of the final byte? Well, the logical instructions are non-algebraic, and they treat all data as unstructured logical quantities, not as numbers. Fixed-length data such as a word in a register is regarded this way:

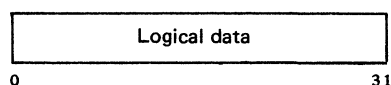

Variable-length data in storage is looked at this way:

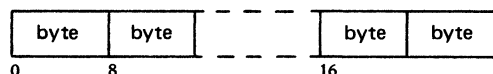

In practice, the operands are generally characters or groups of bits.

Since the logical operations do not recognize any signs as such, it is incumbent upon the programmer to know when and where they are in his data. He can use signed numeric data with whatever logical instructions may fill his needs as

long as he knows that any data examined will be regarded strictly as a binary quantity. Some of the instructions do not even examine data. The Move Numerics operation, for example, which was designed as a convenient way of moving just the numeric portions of zoned decimal numbers, will move any group or groups of four bits that are in the right location just as cheerfully as it moves valid numerics.

The programmer will find it important to differentiate carefully between the action of the fixed-point Compare and Shift instructions, which are algebraic, and the Logical Compare and Shift instructions, which of course are not. An L in the mnemonics of these logical instructions is a convenience.

In logical operations, processing is performed bit by bit from left to right, whereas arithmetic processing is generally from right to left. Processing may be done either in storage or in general registers. Some of the instructions may be used in a choice of four different formats: RR, RX, SI, or SS. Operands may be four bits, a byte, a word, a doubleword, or as many as 256 bytes for variable-length data in storage. The programmer may select a single bit for attention. The "Immediate" instructions (in the SI format) provide a streamlined method of introducing one byte of immediate data in the instruction statement itself. The action of most of the logical instructions sets the condition code and thus provides a basis for decision-making and branching.

Since the logical operations are covered in detail in the *System/360 Principles of Operation*, these introductory remarks are limited to generalizations, which give only a hint of their range and flexibility. The student is urged to consult the *Principles of Operation* for precise descriptions of their action, for useful programming suggestions, and for examples of their use. He will find it rewarding reading.

The program example in the first section of this chapter demonstrates a method for sorting three items into ascending sequence. The next two sections will show examples of testing combinations of bits with a mask and of setting specified bits on and off. Another program example uses a self-checking number routine to illustrate logical operations on a sequence of characters. A final example demonstrates a series of bit and byte manipulations on input data fields.

ALPHAMERIC COMPARISON: AN ADDRESS SORT

A frequent requirement in commercial data processing is the comparison of two alphameric quantities, such as names or account numbers, for relative "magnitude". Sometimes this is done to establish correspondence between records in two files, both of which are in ascending sequence on the name or account number, which is called the key. Another common application is in arranging a group of records into ascending or descending sequence on keys contained in the records. Let us consider this problem, which is usually called *sorting*, although *sequencing* might in some ways be a preferable term.

The problem will be to arrange three "records" of 13 characters each into ascending sequence on a five-character key contained in the middle five positions of the record. The rearranged records are to be moved to three new record areas named SMALL, MEDIUM, and LARGE.

The basic operation in the program will be an alphameric comparison of two five-character keys to determine relative magnitude. This will be done with a Compare Logical Character instruction (CLC). The word "logical" in the name means that in comparing two characters, all possible bit combinations are valid, and the comparison is made purely on binary values. In a table of EBCDIC character codes, we can see that, according to such a scheme, all letters will be "smaller" than all digits; if punctuation characters occur, they rank smaller than either letters or

digits. If we were working with the USASCII code, we would find, on the other hand, that the positions of letters and digits are just the opposite.

For our purposes here, we are not too concerned about the intricacies of where the various characters are ranked by the machine's *collating sequence*; all we really need to know is that names will be correctly alphabetized and that digits are *consistently* ranked somewhere.

The Compare Logical Character instruction is in the SS format and operates on variable-length fields. There is one length code, which applies to both operands. The comparison is from left to right, and continues either until two characters are found that are not the same, or until the end of the fields is reached. As soon as two characters are found to be different, there is no need to continue the comparison. If we are comparing SMITH and SMYTH, we know that SMITH is "smaller" as soon as the I and Y are compared, regardless of what characters follow.

With this much preliminary, let us consider the program in Figure 6-1. Perhaps we should begin by looking at the storage allocation. We see DS entries for A, B, and C, the three original records; these are 13 characters each. Next come three entries that define the addresses of A, B, and C, as ADDRA, ADDR B, and ADDR C, respectively. When we write ADDRA as the operand in a Load, what we get in the register is not A, but its address. Finally, there are DS's for

LOC	OBJECT CODE	ADDR1	ADDR2	STMT	SOURCE	STATEMENT
				1		PRINT NOGEN
000000				2	SORTABC	START 0
000000	05B0			3	BEGIN	BALR 11,0
000002				4		USING *,11
000002	9824 B072		00074	5	LM	2,4,ADDRA LOAD REGISTERS WITH ADDRESSES
000006	D504 2004 3004 00004 00004			6	CLC	4(5,2),4(3) COMPARE A WITH B
00000C	47C0 B014		00016	7	BC	12,X BRANCH IF A ALREADY LESS OR EQUAL
000010	1862			8	LR	6,2 IF NOT EXCHANGE ADDRESSES OF A AND B
000012	1823			9	LR	2,3
000014	1836			10	LR	3,6
000016	D504 2004 4004 00004 00004			11	X CLC	4(5,2),4(4) COMPARE A WITH C
00001C	47C0 B024		00026	12	BC	12,Y BRANCH IF A ALREADY LESS OR EQUAL
000020	1862			13	LR	6,2 IF NOT EXCHANGE ADDRESSES OF A AND C
000022	1824			14	LR	2,4
000024	1846			15	LR	4,6
000026	D504 3004 4004 00004 00004			16	Y CLC	4(5,3),4(4) COMPARE B WITH C
00002C	47C0 B034		00036	17	BC	12,MOVE BRANCH IF B ALREADY LESS OR EQUAL
000030	1863			18	LR	6,3 IF NOT EXCHANGE ADDRESSES OF B AND C
000032	1834			19	LR	3,4
000034	1846			20	LR	4,6
000036	D20C B07E 2000 00080 00000			21	MOVE MVC	SMALL,0(2) ADDRESS OF SMALLEST IS NOW IN REG 2
00003C	D20C B08B 3000 0008D 00000			22	MVC	MEDIUM,0(3) ADDRESS OF MEDIUM IS NOW IN REG 3
000042	D20C B09B 4000 0009A 00000			23	MVC	LARGE,0(4) ADDRESS OF LARGEST IS NOW IN REG 4
				24	EOJ	PROGRAM TERMINATION
00004A				27	A DS	CL13
000057				28	B DS	CL13
000064				29	C DS	CL13
000071	000000					
000074	0000004A			30	ADDRA DC	A(A)
000078	00000057			31	ADDRB DC	A(B)
00007C	00000064			32	ADDRC DC	A(C)
000080				33	SMALL DS	CL13
00008D				34	MEDIUM DS	CL13
00009A				35	LARGE DS	CL13
000000				36	END	BEGIN

Figure 6-1. A program to sort three 13-character items into ascending sequence on keys in the middle of each item. The three items are in A, B, and C, and when sorted will be placed in SMALL, MEDIUM, and LARGE.

SMALL, MEDIUM, and LARGE, where the results are to go.

The processing begins by loading the addresses of A, B, and C into registers 2, 3, and 4, respectively, with a Load Multiple. Now we begin a sequence of comparisons and (if necessary) interchanges that will put the three quantities into ascending sequence. We first compare A and B. If A is already equal to or smaller than B, we do nothing; but, if A is larger, we interchange the addresses of A and B. Let us see how this works.

The Compare Logical Character (CLC) instruction following the Load Multiple is written with explicit base registers and explicit lengths. The general format of the instruction is

CLC D1(L1,B1),D2(B2)

As we have written the instruction here, the displacement for operand 1 is 4, the length of both operands is 5, the base register for the first operand is 2, the displacement for the second operand is 4, and the base register for the second operand is 3. Exactly what character positions do these addresses refer to? Remember that base register 2 contains the address of A. This base, plus a displacement of 4, gives the address of the fifth character. Since we said that the key was to be the middle five characters of each record, what we have here is the address of the leftmost character of the key of record A. The length of the key is given explicitly as 5. Operand 2, likewise, gives the address of the key of record B.

The Branch on Condition asks whether the first operand (the key of A) was less than or equal to the second operand (the key of B). If so, there is a branch down to the next comparison, at X, since A and B are already in correct

If the Branch is not taken, we reach the interchange of A and B. Now, an actual interchange of two 13-character records is a somewhat time-consuming operation; and, of course, this example is only symbolic of real applications, where the records to be sorted might be hundreds of characters long. It is much faster to interchange the *addresses* of A and B than to interchange the records themselves; the addresses are only four characters instead of 13, and, as written here, they are in registers rather than in storage. Three Load Register instructions, which are executed very rapidly, carry out the interchange.

Now, when we continue to the comparison at X, what is the address situation? We know that we want to compare whichever of A and B was the smaller with C. Accordingly, we write addresses using base registers 2 and 4. We cannot say whether 2 contains the address of A or B; but, whichever it is, it is the address of the smaller of the two. That is all we need to know. After this comparison and (possible) interchange, we are guaranteed that base register 2 contains the address of the smallest of the three numbers.

A final comparison using whatever addresses are by now in registers 3 and 4 gives us the address of the "middle" number in 3 and the address of the largest of the three in 4.

Now, at MOVE, we are able to write three instructions that perform the rearrangement. In the first Move Characters, we pick up the smallest, using whatever is in base register 2. The displacement this time is zero; we want the entire 13 characters. The length can be left implicit this time; it will be implied from SMALL, which is 13 characters long.

With the program loaded at 2000₁₆, Figure 6-2 shows the contents of registers 2, 3, and 4 at four points during execution of the program: at the beginning, at X, at Y, and at MOVE. The three actual data items used for A, B, and C, in order, were 1111CCCC1111, 2222BBBB2222, and 3333AAAA3333. In other words, the items were in reverse order according to their keys.

In practical applications there are usually far too many records to be sorted internally for the keys of all of them to be held in base registers. On the other hand, the records are ordinarily so long that it is a saving in time to work with addresses held in storage rather than with the records themselves. The basic concept suggested here can readily be generalized.

AFTER EXECUTION OF	REG 2	REG 3	REG 4
STATEMENT 5	0000204A	00002057	00002064
STATEMENT 10	00002057	0000204A	00002064
STATEMENT 15	00002064	0000204A	00002057
STATEMENT 20	00002064	00002057	0000204A

Figure 6-2. The contents of registers 2, 3, and 4 at four points during execution of the program in Figure 6-1, loaded at 2000

LOGICAL TESTS

The Wallpaper Problem

Problems sometimes arise in which it is necessary to work with combinations of logical tests, where each test is of the yes-or-no variety. Such situations are often most conveniently attacked as logical operations on sets of binary variables. If the data can be suitably arranged, the tests can sometimes be made very simply with the Test under Mask (TM) instruction.

Consider the following problem. A wallpaper manufacturer classifies his products according to the colors each style contains. There are only four colors: red, blue, green, and orange. For each style there is a group of four bits at the right-hand side of a character named PATTRN. These bits represent, from left to right, the four colors, in the order named. For each bit position, a 1 means that the style contains the color, and a zero means that it does not. For instance, 0001 means a style with orange only; 1010 describes a pattern with red and green, but no blue or orange.

We wish to see how to set up instructions to answer questions of the following sort:

Does this pattern have *either* red or green, or both?

Does this pattern have red, or green, or orange, or any two of these, but not all three?

Does this pattern have both red and orange, whether or not it has blue and/or green?

Does this pattern have neither green nor orange?

Does this pattern have red but *not* orange?

Let us consider these questions in order.

Red, or green, or both. Looking at the four color-bits, we are interested in the first and third. If we let X stand for a bit that we want to be a 1, and D for a bit about which we don't care, the required pattern is XDXD.

The Test under Mask instruction can handle this situation with just two instructions:

```
TM PATTRN,X'0A'  
BC 5,YES
```

In the Test under Mask instruction, the 0A is the mask, written here in hexadecimal. Writing it out as a binary number, we have 00001010. The two 1's here pick out the two bits in the character at PATTRN that are to be tested. The resulting condition codes have meanings as follows: a code of zero means that all the selected bits were zero; a code of 1 means that the selected bits were mixed zeros and 1's; a condition code of 3 means that the selected bits were all 1's. (A condition code of 2 is not possible with this instruction.) The question to be answered was: Does this pattern contain either red, or green, or both? We have selected the two bits that describe the presence or absence of red and green. If the two bits selected were a mixture of zeros and 1's we have just one of the two colors in the pattern. If the two bits selected were both 1's, the pattern

contains both colors. Either situation answers the question affirmatively. We accordingly write a Branch on Condition instruction that tests for the presence of condition codes 1 or 3. (Remember that 8, 4, 2, and 1 in the R1 field of a BC correspond to condition codes of 0, 1, 2, and 3, respectively. Branch on Condition with an R1 field of 5, therefore, tests for a condition code of either 1 or 3.) At YES, we assume there would be instructions to do whatever action depended on an affirmative answer to the question.

Red, green or orange, but not all three. Here we need a mask that tests bits according to this scheme: XDXX. The necessary mask is 00001011, which is 0B in hexadecimal. The condition code that describes the wallpaper design specified is 1: mixed zeros and 1's. We want at least one 1, and two would do, but we must have at least one zero among the bits tested because the pattern must not have all three colors. The required instructions are:

```
TM PATTRN,X'0B'  
BC 4,YES
```

The conditional branch could equally well have been written as the extended mnemonic used after Test under Mask instructions, BM YES (BM means Branch if Mixed).

Both red and orange. This one is fairly simple. We pick out bits according to XDDX, and then ask whether they are all (both) 1's. The instructions are:

```
TM PATTRN,X'09'  
BC 1,YES (or BO YES)
```

Neither green nor orange. This is not very difficult, either. The bits are shown by DDXX, and we want to know whether they are all (both) zero. The instructions are:

```
TM PATTRN,X'03'  
BC 8,YES (or BZ YES)
```

Red but not orange. This is a different problem that cannot be done with a single Test under Mask. We turn to the logical instructions And, and Exclusive Or. The bits in question are shown as X's in XDDX. We want the leftmost X to be a 1, and the rightmost to be a zero.

We begin by moving PATTRN to WORK, where we may destroy its original value. An And Immediate instruction with an immediate portion of 09 (in binary: 00001001) erases all bits except the ones we want. In the two positions of interest, if there was a 1 before, there still is, and if there was a zero, there still is. All other bit positions are guaranteed to be zero. If the pattern is to pass the test, there must now be exactly one 1 in WORK, and it must be in this position: 0000X000. Whether this is so could be determined with a comparison or two Test under Mask instructions. But let us continue with the logical operations.

Exclusive Or is a logical operation; like And and Or, it is

a bit-by-bit operation. In each bit position, the result is 1 if the two operands had exactly one 1 in that position; the result bit is zero if both operand bits were zero or if both were 1. Suppose we write an Exclusive Or Immediate in which the immediate portion is 00001000; the 1 here is in the position for red. The result after the Exclusive Or Immediate will be zero in this position if there had been a 1, and vice versa.

In other words, if the result really were 00001000 after the And Immediate, there would be *all* zeros after the Exclusive Or Immediate. If, on the other hand, there were a zero in the position for red, there would now be a 1. And if there were a 1 in the position for orange, there would still be a 1 there. In short, a zero result corresponds to an answer of "yes, there is red but no orange". As it happens, the various logical operations used here all set the condition code; and, in the case of the Exclusive Or, a condition code of zero means that the result was zero. The program can thus be:

```
MVC  WORK,PATTRN
NI   WORK,X'09'
XI   WORK,X'08'
BC   8,YES (or BZ YES)
```

Test under Mask is a most useful instruction where it applies, and its usefulness is by no means limited to color-blind wallpaper manufacturers. It is useful partly because it is selective, testing only the bits specified by the mask, and partly because it gives a three-way description of the selected bits: all zero, mixed, or all 1's. It does have the drawback, however, that only one character can be tested at a time.

If it were necessary to extend the application to cover, say, 20 different yes-no descriptions, the Test under Mask instruction could not be used, except in combinations that would get rather involved. In such a situation, we would turn instead to the RX forms of the logical instructions. After moving the pattern to a register, which can hold a 32-bit pattern, we would use an And to "select" the bits of interest. The operand of the And instruction would be a fullword in storage that has 1's where there are bits of interest in the pattern.

What we do next depends on our answers to certain questions.

Question: Were *any* of the selected bits 1's?

Action: We need only test the condition code, which tells whether the result was all zeros or had at least one 1.

Question: Were certain of the selected bits 1, with the others being zero?

Action: We execute an Exclusive Or to change to zero the bits that should be 1's, then ask whether the result is all zero.

Working with larger groups of bits is thus seen not to be a great deal more difficult than working with a single character.

Setting Bits On and Off

A problem related to the one we have been considering is to set a specified bit of a character or a word to be zero or 1, or perhaps to reverse them from whatever they are. This might be necessary, for instance, if we were writing a program to develop the wallpaper codes that we tested in the preceding section.

Bearing in mind that fullword operands represent only a minor amount of additional programming effort, let us see how to carry out these operand operations on one-character operands.

To set a specified bit to 1, an Or Immediate is sufficient. Suppose that we are still working with a character named PATTRN, which now uses all eight bits, and that we want 1, 3, 6, and 7 to be "on" (1). We are not interested in the status of bits 0, 2, 4, and 5. In other words, we want the pattern to be D1D1DD11, where the D's stand for "don't care" or "leave them whatever they were". This action is precisely what will result from an Or Immediate in which the immediate part is 01010011 (53 hexadecimal). The Or results in a 1 in any bit position in which either operand, or both, had a 1. (The case of both having 1 is not excluded, as in the Exclusive Or. The ordinary Or is sometimes called the "inclusive" Or to distinguish between the two.)

The instruction could be

```
OI  PATTRN,X'53'
```

If the required action is to set the same four bit-positions to zero, regardless of their previous values, and leave the others as they were, we would use an And Immediate with zeros where we want zeros and 1's where we want the previous contents undisturbed. The necessary immediate portion is 10101100 (AC in hexadecimal). The instruction is therefore

```
NI  PATTRN,X'AC'
```

The And places a 1 in bit positions in which *both* operand bits were 1, and zero elsewhere. Wherever we put zeros in the immediate portion, therefore, there will be zeros in the result, as required. Wherever we placed 1's there will be a 1 if there was before, or a zero if there was a zero before. This is exactly what we need.

Sometimes it is necessary to change a bit to 1 if it was zero, and to zero if it was 1. This is called *complementing* a bit. If we place 1's in the immediate portion wherever we want this complementing action, the Exclusive Or Immediate does precisely what is needed. Other bit positions will be unchanged. Assuming we are still working with bits 1, 3, 6, and 7, the instruction is

```
XI  PATTRN,X'53'
```

A SELF-CHECKING NUMBER ROUTINE

It is fairly common practice in business to devise account numbers for things like credit cards so that the number is self-checking. This means that one of the digits is assigned to provide a certain amount of protection against fraud and clerical errors. This digit is assigned by some fixed sequence of operations on the other digits.

We shall work in this section with a ten-digit account number, the last (rightmost) of which is a check digit. This digit is computed when the number is assigned. It consists of the last digit of the sum found by adding together the second, fourth, sixth, and eighth digits, together with three times the sum of the first, third, fifth, seventh, and ninth digits. For instance, if a nine-digit account number is 123456789, the check digit is the last digit of the sum

$$(2 + 4 + 6 + 8) + 3(1 + 3 + 5 + 7 + 9) = 95$$

The last digit is five, so the complete account number would be 1234567895.

There is a certain protection against fraud here; unless the person attempting the fraud knows the system, there is only one chance in ten that an invented account number will be a valid one.

More important, perhaps, there is considerable protection against clerical error. If any one digit is miscopied, the erroneous account number will not pass the check. Furthermore, most transpositions of two adjacent digits will cause

the check to fail. For instance, the check digit for 132456789 would be

$$(3 + 4 + 6 + 8) + 3(1 + 2 + 5 + 7 + 9) = 93$$

The computed check digit of 3 is obviously not the same as the one in the number, so the account number is rejected as invalid.

We wish now to study a program that will determine whether an account number that has been entered into the computer is valid. We begin the program with a nine-digit account number in ACCT, in zoned format. Immediately following ACCT is a one-digit check digit named CHECK, also in zoned format.

In the program in Figure 6-3 we begin by loading register 3 with a 1. This will be used to determine whether a digit should be multiplied by 3 or not, as we shall see below. Register 4 is loaded with a 9; this is an index register, used to get the digits in order from right to left. A Move Character puts a signed zero in SUM where the sum of the digits will be developed. A Subtract Register clears register 5 to zero.

At LOOP we begin the processing of digits. With index register 4 containing 9, the effective address the first time through the loop will be ACCT+8, which is the address of the rightmost digit. The index is reduced by one each time around the loop by the Branch on Count Instruction, so we pick up the digits one at a time, from right to left, as stated.

LOC	OBJECT CODE	ADDR1	ADDR2	STMT	SOURCE STATEMENT
				1	PRINT NOGEN
000000				2	ACCTNO START 0
000000	0580			3	BEGIN BALR 11,0
000002				4	USING *,11
000002	4130 0001		00001	5	LA 3,1 REG 3 WILL HAVE SIGN REVERSED IN LOOP
000006	4140 0009		00009	6	LA 4,9 COUNTER FOR 9 DIGITS IN NUMBER
00000A	D201 B064	B066	00066	7	MVC SUM,ZERO SUM OF DIGITS KEPT IN SUM
000010	1B55			8	SR 5,5 CLEAR REG 5
000012	4354 B059		0005B	9	LOOP IC 5,ACCT-1(4) PICK UP 1 DIGIT OF INDEXED NUMBER
000016	8950 0004		00004	10	SLL 5,4 SHIFT LEFT 4 BITS
00001A	5650 B06A		0006C	11	O 5,PLUS ATTACH A PACKED PLUS SIGN
00001E	4250 B068		0006A	12	STC 5,DIGIT STORE IN TEMPORARY LOCATION
000022	FA10 B064	B068	00066	13	AP SUM,DIGIT ADD TO SUM OF DIGITS
000028	1333			14	LCR 3,3 REVERSE SIGN OF REG 3
00002A	4720 B038		0003A	15	BC 2,EVEN SKIP NEXT 2 INSTR ON PLUS ODD TIMES THRU
00002E	FA10 B064	B068	00066	16	AP SUM,DIGIT IF NOT SKIPPED ADD DIGIT TO SUM
000034	FA10 B064	B068	00066	17	AP SUM,DIGIT SAME. HAS EFFECT OF MULTIPLYING BY 3
00003A	4640 B010		00012	18	EVEN BCT 4,LOOP BRANCH BACK IF NOT ALL DIGITS PROCESSED
00003E	4350 B063		00065	19	IC 5,ACCT+9 PUT CHECK DIGIT IN REG 5
000042	8950 0004		00004	20	SLL 5,4 SHIFT LEFT 4 BITS
000046	5650 B06A		0006C	21	O 5,PLUS ATTACH SIGN TO PUT IN SAME FORMAT AS SUM
00004A	4250 B064		00066	22	STC 5,SUM PUT ONE BYTE IN LEFT BYTE OF SUM
00004E	D500 B064	B065	00066	23	CLC SUM(1),SUM+1 IS THIS BYTE SAME AS CHECK DIGIT
000054	4770 B058		0005A	24	BNE ERROR BRANCH TO ERROR ROUTINE IF NOT EQUAL
				25	OUT PROGRAM WOULD NORMALLY CONTINUE HERE
				28	ERROR EOJ
				31	ACCT DS CL9
00005C				32	CHECK DS CL1
000065				33	SUM DS CL2
000068	000C			34	ZERO DC PL2'0'
00006A				35	DIGIT DS CL1
00006C				36	OF DS OF
00006E	0000000C			37	PLUS DC XL4'0C'
000070				38	END BEGIN

Figure 6-3. A self-checking account number routine that recalculates a check-digit and verifies it

The digit inserted in register 5 is shifted left four bits. This puts the numeric part of the digit, which was in zoned format, into the leftmost four bits of an eight-bit byte at the right end of the register, and brings in four zeros at the right. Or-ing with PLUS puts a plus sign into the rightmost four bits (note that the machine code generated by this DC is 0000000C), and we have a one-digit byte in correct packed format for use with an Add Decimal. We therefore put the assembled digit into a working storage location at DIGIT and add it to SUM.

Now comes the question of whether or not this is a digit that is to be multiplied by 3. The rule requiring digits to be so multiplied can be stated thus: the first digit is multiplied by 3; after that, every other digit is so multiplied. In other words, we need some technique for getting a branch *every other* time through the loop. The method shown here is to reverse the sign of the contents of register 3 every time, then to ask whether the result is positive. The first time through we change a +1 to -1; the answer is "no, the result is not positive". The second time through we change a -1 to +1, and the answer is "yes, the result is positive". The third time through the +1 gets changed back to -1, and the answer is no. In short, every other time we ask whether the result of reversing the sign of register 3 is positive, the answer will be yes. We accordingly Branch on Condition to EVEN if register 3 is positive. This means that for digits in even positions 2, 4, 6, and 8, the two additional Add Decimal instructions will be skipped. These, if they are

executed, have the effect of adding in a digit three times instead of once, which is equivalent to multiplying and somewhat faster.

At EVEN we Branch on Count back to LOOP if, after reducing the contents of 4 by one, the result is not zero. The loop will therefore be executed the last time around with 1 in register 4, so the last digit picked up is at ACCT, as it should be.

Once all nine digits have been added to sum, we are ready to see whether the last digit of SUM is the same as CHECK. But it isn't quite that simple; the digit at CHECK is still in zoned format. We accordingly go through the steps necessary to convert it to packed format, storing it for comparison in the left byte of SUM, which we no longer need. A Compare Logical Character with an explicit length of one now determines whether the check digit that came with the account number, which is now in SUM, is the same as the computed check digit, which is now in SUM+1. We have ended the error path as well as the normal path with an End of Job macro instruction. In a real situation additional steps would be included to enable investigation of an invalid account number, and both paths would branch back to LOOP to continue with the next account number in the input stream.

There are, of course, many other techniques for computing check digits which give greater protection or make the check digit operations simpler.

A FINAL EXAMPLE

We are given two numbers, NUMBER and COMB. NUMBER is a seven-digit quantity in zoned format. We are to test each of the seven numeric portions separately in order to be certain that each represents a digit, that is, that the value of the numeric portion is less than ten. If each character contains a valid digit, we go on to the next test; if any one contains numeric bits not valid for a digit, we shall simply go to an End of Job. After completing this test, we are to check the zone bits of the rightmost byte of NUMBER to be sure that it contains a sign. The other zone positions are of no interest. As before, if there is an error condition, we go to an EOJ.

Next, we start with an eight-byte composite field named COMB. We shall assume for the purposes here that the numeric portions of each byte all represent valid digits; if this were questionable, they could be checked. The zones of the eight bytes contain either plus or minus signs. A plus sign is to be taken as meaning 1 and a minus sign as meaning zero; we are to assemble a one-byte quantity that contains a binary number formed from the signs. For instance, Figure 6-4 shows a card field that could have produced the data in COMB. If this field were viewed as an alphabetic quantity in normal IBM card code, it would be ABLMEOGQ. We want to view it, instead, as being a positive number 12345678 together with a binary number (contained in the zone punching area) of 11001010. The 1's and zeros here correspond to the zones: +- -+ -+ -. We are to separate the two items contained in COMB, placing the number in NUMERC as a packed decimal number and the zones in CODES as a one-byte binary number.

A flowchart showing the logic of this problem is shown in Figure 6-5 and the program in Figure 6-6 does the processing required. We start by placing a 7 in register 10, for use as an index. Register 9 is cleared. The instructions

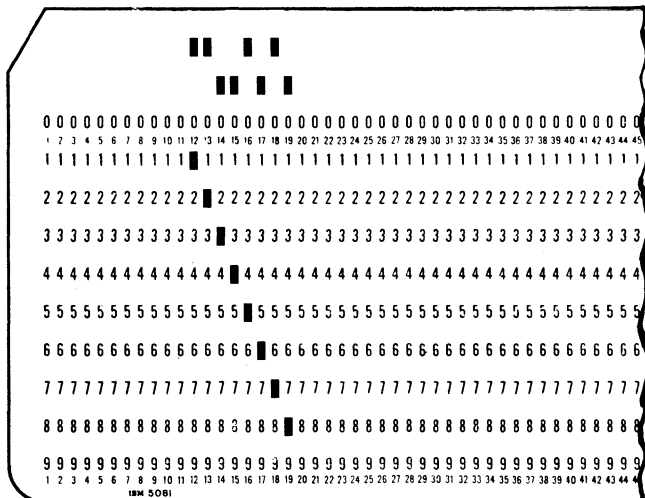

Figure 6-4. Alphabetic input for COMB that can be viewed as two numbers: 12345678 and binary 11001010

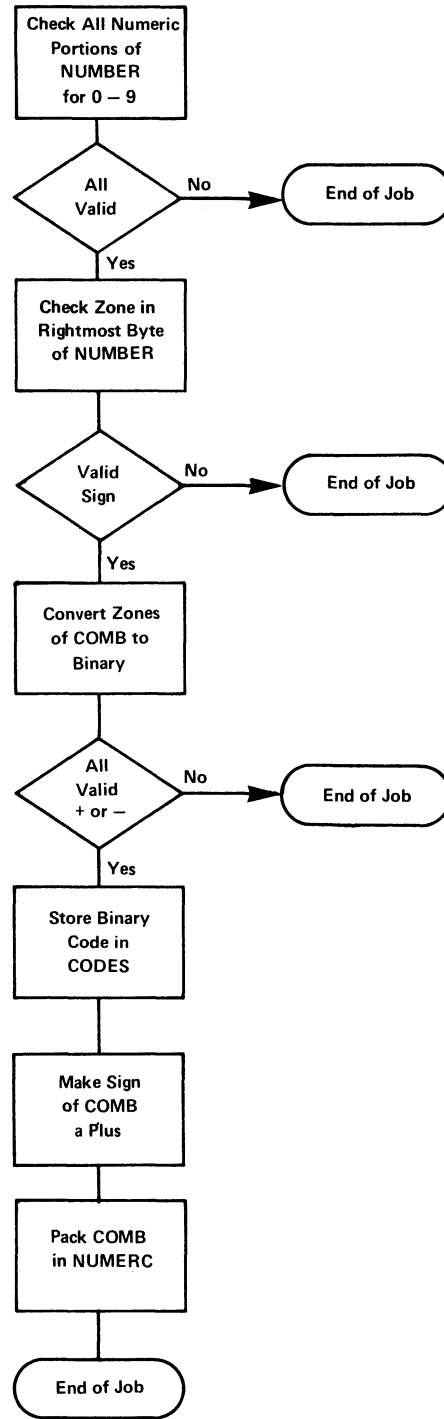

Figure 6-5. A flowchart of the steps required to solve the problem

from LOOP to OK pick up the digits in turn, strip off the zone bits with a suitable And, and compare the numeric portions with 10.

The instruction after OK picks up the rightmost byte of NUMBER; this should have either a plus sign or a minus sign. Another And, but with a different mask, strips off the numeric portion and the rightmost bit of the sign; we do not care whether the sign is plus or minus, a distinction

which is made in the rightmost bit of the sign. A comparison then establishes whether the left three bits of the sign are 110, which they should be for an EBCDIC sign.

At OK2 we are ready to go to work on the combined digits and zones at COMB. In preparation for what follows, we clear registers 8, 9, and 10. At LOOP2 there is a shift — before anything has been placed in the register shifted. The idea is that we want to shift the contents of this register seven times for eight bits. One way to accomplish this is to place the shift instruction so that it has no net effect the first time around.

The Insert Character is indexed with register 10, which initially contains zero. We will therefore pick up the digits from left to right this time. For each digit we use an And to drop the numeric bits, then test against constants so as to determine whether the sign is plus or minus. If it is neither, we get out; there should be one or the other. If the sign is plus, we branch to YES, where a 1 is added into register 9 — the one that we shifted at the beginning of the loop.

Whether the sign is plus or minus, we now reach NO, where we add 1 to the index register and branch back to LOOP2 if the contents are less than eight.

Now, when we branch back, we again shift the contents of register 9 one position to the left. This means that each time we again reach the beginning of this loop, whatever has been assembled in register 9 so far is shifted left one place, thereby making room for another bit at the rightmost position of the register. Thus, when we finally get out of the loop and arrive at the Store Character, the last byte of register 9 will contain a 1 in positions corresponding to plus signs in COMB, and zeros in positions corresponding to minus signs. The byte stored at CODES is just what the problem statement required.

An And Immediate now erases the zone positions of the rightmost byte of COMB, and an Or Immediate places a plus sign there. The Pack instruction does not check zones, except in the rightmost byte, so we can proceed to it immediately, with no concern for the other zone positions.

LOC	OBJECT CODE	ADDR1	ADDR2	STMT	SOURCE STATEMENT
				1	PRINT NOGEN
000000				2	FORMAT START 0
000000	0580			3	BEGIN BALR 11,0
000002				4	USING *,11
000002	41A0 0007		00007	5	LA 10,7 REG 10 IS USED AS AN INDEX
000006	1899			6	SR 9,9 CLEAR REG 9
000008	439A B075		00077	7	LOOP IC 9,NUMBER-1(10) INSERT 1 DIGIT IN REG 9--INDEXED
00000C	5490 B08E		00090	8	N 9,MASK1 STRIP OFF SIGN
000010	5990 B0A2		000A4	9	C 9,TEN IS NUMBER LESS THAN 10
000014	4740 B018		0001A	10	BL OK BRANCH AROUND EOJ IF OK
				11	EOJ NOT A DIGIT
00001A	46A0 B006		00008	14	OK BCT 10,LOOP REDUCE CONTENTS OF REG 10 BY 1 & BRANCH
00001E	4380 B07C		0007E	15	IC 8,NUMBER+6 IF HERE, ALL DIGITS CHECKED OK
000022	5480 B092		00094	16	N 8,MASK2 STRIP OFF LAST DIGIT & FINAL SIGN BIT
000026	5980 B09A		0009C	17	C 8,PLUS COMPARE 3 REMAINING BITS WITH SIGN
00002A	4780 B02E		00030	18	BE OK2 BRANCH IF OK
				19	EOJ NOT AN EBCDIC SIGN
000030	1888			22	OK2 SR 8,8 CLEAR REG 8
000032	1898			23	LR 9,8 CLEAR REG 9 BY LOADING FROM REG 8
000034	18A8			24	LR 10,8 CLEAR REG 10 BY LOADING FROM REG 8
000036	8B90 0001		00001	25	LOOP2 SLA 9,1 SHIFT REG 9 LEFT 1 BIT
00003A	438A B07D		0007F	26	IC 8,COMB(10) INSERT 1 BYTE IN REG 8--INDEXED
00003E	5480 B096		00098	27	N 8,MASK3 STRIP OFF DIGIT PART
000042	5980 B09A		0009C	28	C 8,PLUS COMPARE WITH CODING FOR PLUS
000046	4780 B052		00054	29	BE YES BRANCH IF PLUS
00004A	5980 B09E		000A0	30	C 8,MINUS COMPARE WITH CODING FOR MINUS
00004E	4780 B056		00058	31	BE NO BRANCH IF MINUS
				32	EOJ NEITHER PLUS NOR MINUS
000054	5A90 B0A6		000A8	35	YES A 9,ONE IF PLUS ADD 1 TO CONTENTS OF REG 9
000058	5AA0 B0A6		000A8	36	NO A 10,ONE ADD 1 TO REG 10 FOR LOOP TEST
00005C	59A0 B0AA		000AC	37	C 10,TEST COMPARE
000060	4770 B034		00036	38	BNE LOOP2 BRANCH BACK IF NOT FINISHED
000064	4290 B085		00087	39	STC 9,CODES STORE LAST BYTE OF REG 9
000068	940F B084		00086	40	NI COMB+7,X'0F' STRIP OFF OLD ZONE
00006C	96C0 B084		00086	41	OI COMB+7,X'CO' ATTACH ZONED PLUS SIGN
000070	F247 B086 B07D	00088	0007F	42	PACK NUMERC,COMB CONVERT TO PACKED FORMAT
				43	EOJ PROGRAM TERMINATION
000078				46	NUMBER DS CL7
00007F				47	COMB DS CL8
000087				48	CODES DS CL1
000088				49	NUMERC DS CL5
000090				50	DS OF
000090	0000000F			51	MASK1 DC X'0000000F'
000094	000000E0			52	MASK2 DC X'000000E0'
000098	000000F0			53	MASK3 DC X'000000F0'
00009C	000000C0			54	PLUS DC X'000000C0'
0000A0	000000D0			55	MINUS DC X'000000D0'
0000A4	0000000A			56	TEN DC F'10'
0000A8	00000001			57	ONE DC F'1'
0000AC	00000008			58	TEST DC F'8'
000000				59	END BEGIN

Figure 6-6. A program that checks a decimal field at NUMBER for validity and converts a composite field at COMB into separate binary and packed decimal quantities. The flowchart in Figure 6-5 was used as a guide for the programming

QUESTIONS AND EXERCISES

- The byte at location KEY in main storage contains four program switches in bit positions 4–7. Each of these bit positions may be 1 (on) or 0 (off). Write an instruction that will reverse the setting of the program switches and leave bits 0-3 unchanged.
- In the following byte, located at ADDR in main storage, a 1 in a particular position shows the presence of a characteristic and a zero its absence. Write instructions that will branch to ANIMAL for owners of dogs or cats or both, and proceed sequentially for all others.

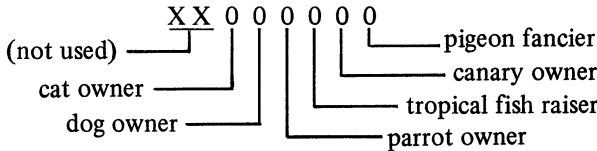

- Using the preceding, write instructions to branch to LIST2 for owners of fish but not canaries, or canaries but not fish.
- Suppose location SUM contains 05432+ in packed decimal format, and suppose that general register 2 initially contains zero. Show what register 2 will contain (in hexadecimal or binary) after:
 - IC 2, SUM
 - IC 2, SUM+2
 - IC 2, SUM+1
- At most, the TM (Test Under Mask) instruction can test _____ bit(s) or _____ byte(s) with one instruction.
- At most, the CLC (Compare Logical Character) instruction can compare _____ bit(s) or _____ byte(s) with one instruction.
- The CLC instruction will successfully compare two operands in only one of the following forms. Which is it?
 - Packed decimal numbers
 - Alphameric characters
 - Zoned decimal numbers
- In the CLC instruction, comparison proceeds from left to right, byte by byte, but ceases before the end of the operand is reached, as soon as one of the following is encountered (select one):
 - The EBCDIC sign code
 - A special character
 - An inequality
 - An improper zone code
- Neglecting leading zeros, give in decimal the contents of general register 5 after execution of each of the following:
 - LA 5,5

- LA 5,2
- LA 5,3(0,1)
- LA 5, FIELD

FIELD DS F

- Write instructions to determine whether or not the byte at main storage location FIELD contains a 5 (0000 0101 in binary).
- In the following hypothetical program, the rows of dots represent straightforward instruction sequences of any reasonable length, whose nature need not concern us.

```

        LA      2,10
LOOP   . . . . .
        . . . . .
INST   BC      0,ADDR
        OI      INST+1,X'F0'
        . . . . .
        ADDR   . . . . .
        . . . . .
        BCT    2,LOOP
    
```

Which part of the BC instruction is addressed by the relative address INST+1?

- Bearing in mind that in question 11 the hexadecimal immediate data X'F0' is simply a convenient way of specifying binary 11110000 (or decimal 240), can you say that the OI (Or Immediate) instruction:
 - Will be executed once and only once?
 - Causes certain instructions within the BCT loop to be skipped on all but the first execution of the loop?
 - Alters the bit structure of a mask field?
 - Does all of the above?

- Assume that the overall loop of the following sequence will be executed a number of times. What will be the effect of the XI (Exclusive Or) instruction?

```

LOOP   . . . . .
        XI      INST+1,X'F0'
INST   BC      0,ADDR
        . . . . .
ADDR   . . . . .
        BCT    5,LOOP
    
```

- Suppose that general register 5 contains a number of which only the high-order (leftmost) byte is of interest. Write a logical instruction to zero the three low-order bytes, together with any instructions necessary to define masks, load other registers, etc., as required.

Chapter 7: Edit, Translate, and Execute Instructions

This chapter will be devoted to several highly specialized and useful instructions that are part of the assembler language. They call into play some new concepts, and their functions and machine actions are different in many ways from any of the instructions we have encountered so far. Since they may be regarded as irregular verbs, so to speak, of System/360 Assembler Language, we will subject each of them to careful scrutiny.

The Execute (EX) instruction is a special type of branching instruction that causes one other instruction in main storage to be executed out of sequence without actually branching to its location. Since Execute can also modify the remote instruction before it is executed, it offers considerable economy in the number of instructions needed to achieve certain results.

The other instructions covered in this chapter are Edit, Edit and Mark, Translate, and Translate and Test. These are part of the System/360 logical operations discussed in the preceding chapter. We begin with a detailed demonstration of how the Edit, and the almost identical Edit and Mark, instructions work. These two instructions are invaluable aids to any programmer concerned with decimal arithmetic. Translate can be used for code conversion or to provide a control function. The description of the Translate instruction is necessary for an understanding of the Translate and Test (TRT), which follows it. Detailed program examples are included, with special emphasis on the use of the powerful combination of TRT and EX in various applications. The programmer will find many additional applications for the techniques demonstrated in this chapter.

THE EDIT INSTRUCTION

The Edit instruction is one of the most powerful in the repertoire of the System/360. It is used in the preparation of printed reports to give them a high degree of legibility and therefore greater usefulness. It makes it possible, as we shall see, to suppress nonsignificant zeros, insert commas and decimal points, insert minus signs or credit symbols, and specify where suppression of leading zeros should stop for small numbers. All of these actions are done by the machine in *one* left-to-right pass. The condition code can be used to blank all-zero fields with two simple instructions. A variation of the instruction, Edit and Mark, makes possible the easy insertion of floating currency symbols.

We shall study the application and results of this highly flexible instruction by applying it to successively more complex situations.

We begin with a simple requirement to suppress leading zeros; no punctuation is to be inserted. We have a field to be edited, called DATA. It is four bytes long, and the decimal data is in packed format. The packed format for data to be edited is a requirement of the Edit (ED) instruction, which is a decimal instruction. As we saw in an earlier chapter, data used in decimal arithmetic operations is always in packed format. If we happened to have source data in some other form, we would have to pack it before editing.

The data to be edited is named as the second operand of the Edit. The first operand must name a field containing a "pattern" of characters that controls the editing; after execution of the instruction, the location specified by the first operand contains the edited result. (The original pattern is destroyed by the editing process.) The pattern is in zoned format, as is the result; the Edit instruction causes the conversion of the data to be edited from packed to zoned format, since zoned format is what is needed for most output operations.

We said that in our example the data field to be edited was four bytes long, that is, seven decimal digits and sign, which we shall assume to be plus. The pattern must accordingly be at least eight bytes long: seven for the digits and one at the left to designate the "fill character". The fill character is of our choosing, but is usually a blank. This is the character that is substituted for nonsignificant zeros.

The leftmost character of the pattern in our case will be the character blank (hexadecimal 40 in System/360 EBCDIC coding). The other seven characters will contain hexadecimal 20, a control character called a digit selector, which is used to indicate to the Edit instruction that a digit from the source data may go into the corresponding position.

Let us see how all this works out in our example. Suppose we set up an eight-byte working storage field named WORK into which we move the pattern (located in an area called PATTRN). Then we will perform our edit using WORK and DATA as the two operands. The two

instructions necessary to do the job are:

```
MVC  WORK,PATTRN
ED   WORK,DATA
```

After execution of the two instructions, WORK contains our edited result. PATTRN still contains the original pattern and can transmit that original pattern to WORK for the editing of any new value in DATA. At PATTRN there should be the following characters, written here in hexadecimal:

```
40 20 20 20 20 20 20 20
```

or as they would appear in an actual program, defined as a hexadecimal constant:

```
PATTRN DC X'40202020202020'
```

In EBCDIC, 40 is the hexadecimal code for a blank and 20 for the digit selector control character. Hex is used to specify control characters, since there are no written or printed symbols to represent them. In this section, all patterns are shown exactly as they would appear in constants, except of course that the spaces would be closed up.

In our example, suppose that at DATA there is

```
00 01 00 0+
```

The edited result would be

```
b b b b 1 0 0 0
```

where the b's stand for blanks. All zeros to the left of the first nonzero digit have been replaced by blanks; but zeros to the *right* of the first nonzero digit have been moved to WORK without change. This is the desired action. Figure 7-1 shows a series of values for DATA and the resultant edited results in WORK, using the pattern stated. Note that the high-order position of WORK contains the fill character, a blank. The values of DATA are packed decimal; the edited results are changed during execution of the Edit instruction to zoned decimal format.

BDDDDDD	
40 20 20 20 20 20 20 20	
1234567	1234567
0120406	120406
0012345	12345
0001000	1000
0000123	123
0000012	12
0000001	1
0000000	

Figure 7-1. Results of Editing source data in left-hand column. Two lines at top give editing pattern in symbolic form (B represents a blank, D a digit selector) and in hexadecimal coding.

The fill character that we supply as the leftmost character of the pattern may be any character that we wish. It is fairly common practice to print dollar amounts with asterisks to the left of the first significant digit in order to protect against fraudulent alteration. This is usually called asterisk protection.

To do this, we need only change the leftmost character of the pattern of the previous example. The hexadecimal code for an asterisk is 5C; hence the new pattern is

```
5C 20 20 20 20 20 20 20
```

Figure 7-2 shows the edited results for the same DATA values that we used in Figure 7-1.

```
*DDDDDDD
5C 20 20 20 20 20 20 20

1234567 *1234567
0120406 **120406
0012345 ***12345
0001000 ****1000
0000123 *****123
0000012 *****12
0000001 *****1
0000000 *****
```

Figure 7-2. Editing results with an asterisk as the fill character

Any characters in the pattern other than the digit selector and two other control characters that we shall study later are called message characters. They are *not* replaced by digits from the data. Instead, they are either replaced by the fill character (if a significant digit has not been encountered yet), or left as they are (if a significant digit has been found). Suppose, for instance, that we set up a PATTRN as follows:

```
40 20 6B 20 20 20 6B 20 20 20
```

The 6B is hexadecimal coding for a comma, and it is a message character. The edited result will contain commas in the two positions shown, unless they are to the left of the first nonzero digit, in which case they are suppressed. Figure 7-3 shows the results for the same data values.

```
BD,DDD,DDD
40 20 6B 20 20 20 6B 20 20 20

1234567 1,234,567
0120406 120,406
0012345 12,345
0001000 1,000
0000123 123
0000012 12
0000001 1
0000000
```

Figure 7-3. Editing results with blank fill and the insertion of commas

The message characters inserted are, naturally, not limited to commas. A frequent application is to insert a decimal point as well as commas. Let us assume that the data values we have been using are now to be interpreted as dollars-and-cents amounts. We need to arrange for a comma to set off the thousands of dollars, and a decimal point to designate cents. The characters in PATTRN, where 6B is a comma and 4B is a decimal point, should be as follows:

```
40 20 20 6B 20 20 20 4B 20 20
```

The edited results this time are in Figure 7-4.

We see here something that would normally not be desired: amounts under one dollar have been edited with the decimal point suppressed. We would ordinarily prefer to have the decimal point. This can be done by placing a significance starter in the pattern. This control character, which has the hexadecimal code 21, is either replaced by a digit from the data or replaced by the fill character, just as a digit selector is. The difference is that the operation proceeds *as though* a significant digit had been found in the position occupied by the significance starter. In other words, succeeding characters to the right will not be suppressed. (An exception to this generalization may occur when we want to print sign indicators, a subject that will be explored later.)

```
BDD,DDD.DD
40 20 20 6B 20 20 20 4B 20 20

1234567 12,345.67
0120406 1,204.06
0012345 123.45
0001000 10.00
0000123 1.23
0000012 12
0000001 1
0000000
```

Figure 7-4. Editing results with blank fill and the insertion of comma and decimal point

The pattern for this action, assuming we still want the comma and decimal point as before, should be

```
40 20 20 6B 20 20 21 4B 20 20
```

The effect is this: if nothing but zeros has been found by the time we reach the significance starter (hex 21) in a left-to-right scan, the significance starter will turn on the significance indicator. This indicator will cause succeeding characters to be treated as though a nonzero digit had been found. The result is that the decimal point will always be left in the result, as will zeros to the right of the decimal point. The edited results this time are shown in Figure 7-5.

One useful point to remember is that the total number of digit selectors plus significance starters in the pattern must equal the number of digits in the field to be edited. Note that this is the case in all our examples.

BDD, DDS, DD									
40	20	20	6B	20	20	21	4B	20	20
1234567	12,345.67								
0120406	1,204.06								
0012345	123.45								
0001000	10.00								
0000123	1.23								
0000012	.12								
0000001	.01								
0000000	.00								

Figure 7-5. Editing results with blank fill, comma and decimal point insertion, and significance starter. In the symbolic pattern, S stands for significance starter.

We can begin to get a little idea of how the machine does its work on this instruction by noting that the significance indicator is initially in the off state before the scan begins. Scanning proceeds source digit by source digit. The significance indicator stays off until a nonzero data digit is found, or until the significance starter is encountered; either event causes the indicator to be turned on.

Source digits 1-9 always replace a digit selector or significance starter, but whether a zero source digit will do so depends upon the state of the significance indicator. If the significance indicator is on, then we know that either a significant digit was found at some previous character position, or a significance starter has been encountered; in either case, a zero from the source data is inserted. If the significance indicator is off, we know that no significant digit has been found so far during the scan; therefore, the fill character appears in the result, rather than a zero from the data.

It may be useful to refer to Table 7-1, which includes a summary of how the state of the significance indicator affects the editing operation under all conditions of consequence that you may encounter. The table also shows how the significance indicator itself is affected.

In the table, the four columns at the left list all the significant combinations of the four conditions that can be encountered in the execution of the editing operation. The two columns at the right under Results show the action taken for each case - that is, the type of character placed in the result field and the new setting of the significance indicator. Use of the field separator will be discussed in a later paragraph.

We have so far ignored the sign portion of the source data, which (in the packed decimal format required for the Edit instruction) is in the four low-order bits of the rightmost byte. These bits are examined each time the Edit instruction is executed. If the sign is plus, the significance indicator will then be turned off, as shown in the table; if the sign is minus, the significance indicator will be left on. The information will not appear in the result, however, if there are no further pattern characters to be scanned. As a matter of fact, if any of the source fields in the examples above had been negative, the results shown would have been exactly the same.

Suppose, however, that pattern characters remain after the sign position has been examined. The action of the significance indicator in controlling the instruction continues just as before, although the setting of the significance indicator was accomplished by a different condition. There are, of course, no more digits to move. Hence we will not want to place digit selectors in the pattern in this position,

Table 7-1. Summary of Editing Functions

CONDITIONS				RESULTS	
Pattern Character	Previous State of Significance Indicator	Source Digit	Low-Order Source Digit is a Plus Sign	Result Character	State of Significance Indicator at End of Digit Examination
Digit selector	off	0	*	fill character	off
	off	1-9	no	source digit	on
	off	1-9	yes	source digit	off
	on	0-9	no	source digit	on
	on	0-9	yes	source digit	off
Significance starter	off	0	no	fill character	on
	off	0	yes	fill character	off
	off	1-9	no	source digit	on
	off	1-9	yes	source digit	off
	on	0-9	no	source digit	on
Field separator	*	**	**	source digit	off
Message character	off	**	**	fill character	off
	on	**	**	message character	on

*No effect on result character and new state of significance indicator.
 **Not applicable because source digit is not examined.

but, rather, sign indicators, such as a minus sign or CR for credit. The action taken with the characters in the pattern is the same now as it was before: they remain unchanged if the significance indicator is on, but are replaced by the fill character if the significance indicator is off.

Let us set up a suitable pattern for the example data. Let us print the letters CR for negative numbers, with one blank between the rightmost digit and the C. In hexadecimal, CR is C3 D9, so the pattern becomes

```
40 20 20 6B 20 20 21 4B 20 20 40 C3 D9
```

Figure 7-6 shows the results for sample data values as before, together with two negative values.

```
BDD,DDS.DDBCR
40 20 20 6B 20 20 21 4B 20 20 40 C3 D9

1234567 12,345.67
0120406 1,204.06
0012345 123.45
0001000 10.00
0000123 1.23
0000012 .12
0000001 .01
0000000 .00
-0098765 987.65 CR
-0000000 .00 CR
```

Figure 7-6. Editing results with blank fill, comma and decimal point insertion, significance starter, and CR symbol for negative numbers

If we use an asterisk now as the fill character, positive quantities will have three asterisks following the cents, as shown in Figure 7-7. This may or may not be desired. There are other ways to handle the signs, as we shall see next.

We have seen above that an amount of zero prints in the general form .00 when a significance starter is used. It may in some cases be desirable to make such an amount print as all blanks or all asterisks. This is very easily done by making use of the way the condition code is set by execution of the Edit instruction:

<i>Code</i>	<i>Instruction</i>
0	Result field is zero
1	Result field is less than zero
2	Result field is greater than zero

This means that after completion of the Edit we can make a simple Branch on Condition test of the condition code and move blanks or asterisks to the result field if it is zero. The movement is particularly simple because the fill character is still there in the field and an overlapped Move Characters instruction can be used as follows:

```
BC 6,SKIP
MVC WORK+1(12),WORK
SKIP
```

```
*DD,DDS.DDBCR
5C 20 20 6B 20 20 21 4B 20 20 40 C3 D9

1234567 *12,345.67***
0120406 **1,204.06***
0012345 *****123.45***
0001000 *****10.00***
0000123 *****1.23***
0000012 *****.12***
0000001 *****.01***
0000000 *****.00***
-0098765 ****987.65 CR
-0000000 *****.00 CR
```

Figure 7-7. Same with asterisk fill

The explicit length of 12 is based on the most recent pattern, which has a total of 13 characters. The MVC, as written, picks up the leftmost character and moves it to the leftmost-plus-one position. It then picks up the leftmost-plus-one character and moves it to the leftmost-plus-two position, etc., effect propagating the leftmost character through the field. This is precisely what we want if the fill character is the one to be substituted.

Figure 7-8 shows our familiar data values with zero fields blanked, and Figure 7-9 shows them with zero fields filled with asterisks. Only the fill character differs in the two programs that would produce the results shown in Figures 7-8 and 7-9; the Edit, the Branch on Condition, and the Move Characters are the same in both cases.

```
BDD,DDS.DDBCR
40 20 20 6B 20 20 21 4B 20 20 40 C3 D9

1234567 12,345.67
0120406 1,204.06
0012345 123.45
0001000 10.00
0000123 1.23
0000012 .12
0000001 .01
0000000
-0098765 987.65 CR
-0000000
```

Figure 7-8. Editing results showing the blanking of zero fields by the use of two additional instructions

```
*DD,DDS.DDBCR
5C 20 20 6B 20 20 21 4B 20 20 40 C3 D9

1234567 *12,345.67***
0120406 **1,204.06***
0012345 *****123.45***
0001000 *****10.00***
0000123 *****1.23***
0000012 *****.12***
0000001 *****.01***
0000000 *****
-0098765 ****987.65 CR
-0000000 *****
```

Figure 7-9. Same with zero fields filled with asterisks

The condition code can also be used to distinguish between positive and negative numbers when it is necessary to present the sign in some manner that is not possible by using the automatic features of the Edit. We might, for instance, wish to test the condition code and use the results of the test to place a plus sign *or* minus sign to the left of the edited result.

The Edit instruction can be used to edit several fields with one instruction. Doing so uses a final control character, the field separator (hexadecimal 22). This character is replaced in the pattern by the fill character, and causes the significance indicator to be set to the off state. The characters following, both in the pattern and in the source data, are handled as described for a single field. In other words, it is possible to set up a pattern to edit a whole series of quantities, even an entire line, with one instruction. The packed source fields must, of course, be contiguous in storage, but this is often no inconvenience. One limitation is that the condition code, upon completion of such an instruction, gives information only about the last field encountered after a field separator.

Let us consider the example shown in Figure 7-10. Suppose that at DATA we have a sequence of three fields. The leftmost of the fields has four bytes, the next has three, and the rightmost has five bytes. The first is to be printed with commas separating groups of three digits. The values are always positive and, therefore, no sign control is desired. Zero values will be blank since we shall not use a significance starter.

The second field is to be printed with three digits to the right of the decimal point, with a significance starter to force amounts less than 1 to be printed with a zero before the decimal point. Positive quantities are to be printed without a sign, and negative quantities are to be printed with a minus sign immediately to the right of the number.

The third number is a dollar amount that could be as great as \$9,999,999.99. Commas and decimal point are needed just as shown. Amounts less than \$1 are to be

printed with the decimal point as the leftmost character. Zero amounts are to be blanked. Signs are not to be printed.

There is to be at least one blank between the first and second edited result, and at least three between the second and third.

Let us write out the necessary pattern in shorthand form, with b standing for a blank, d for digit selector, f for field separator, s for significance starter, and other characters for themselves:

```
bd,ddd,ddd,ddd,ddd,ddd,ddd,ddd,ddd,ddd,ddd,ddd,ddd,ddd
```

The required blank between the first and second edited result will be placed there by the replacement of the field separator with the fill character. The significance starter in the part of the pattern corresponding to the second field will give the required handling of quantities less than 1. The extra two blanks between the second and third results are provided by the blanks in the part of the pattern corresponding to the third data item. (These are not treated as new fill characters; only the leftmost character in the entire pattern is so regarded.) Notice that the total of digit selectors plus significance starters is equal to the number of digits in each field to be edited.

Instructions to do the required actions are as follows:

```
MVC WORK,PATTRN
ED   WORK,DATA
BC   6,SKIP
MVC  WORK+30(3),WORK+18
```

SKIP

The choice of addresses in the final MVC that blanks a zero field is somewhat arbitrary. We reason that if the entire field is zero, the first three positions of it are surely blank by now; hence a three-character MVC from there to the last three positions of the field will be correct.

Figure 7-10 shows initial source data values and edited results. The packed source fields must be adjacent as shown; we address the leftmost character.

1234567C12345C123456789C	1,234,567	12.345	1,234,567.89
0123456C01234C012345678C	123,456	1.234	123,456.78
0010009C00123C001000000C	10,009	0.123	10,000.00
0004502C98007D000001210C	4,502	98.007-	12.10
0000800C00012C000000006C	800	0.012	.06
0000001C00001D000000001C	1	0.001-	.01
0000000C00000C000000000C		0.000	

Figure 7-10. Examples of multiple edits. On each line the first field is a combination of three items; all three were edited with one Edit, giving the three results shown to the right. The editing pattern is shown in the text.

THE EDIT AND MARK INSTRUCTION

The Edit and Mark instruction (EDMK) makes possible the insertion of floating currency symbols. By this we mean the placement in the edited result of a dollar sign (or pound sterling symbol) in the character position immediately to the left of the first significant digit. This serves as protection against alteration, since it leaves no blank spaces. It is a somewhat more attractive way to provide protection than the asterisk fill.

The operation of the instruction is precisely the same as the Edit instruction, with one additional action. The execution of the Edit and Mark places in register 1 the address of the first significant digit. The currency symbol is needed one position to the left of the first significant digit. Consequently, we subtract one from the contents of register 1 after the execution of the Edit and Mark and place a dollar sign in that position.

There is one complication: if significance is forced by a significance starter in the pattern, nothing is done with register 1. Before going into the Edit and Mark, therefore, we place in register 1 the address of the significance starter plus one. Then, if nothing happens to register 1, we still get the dollar sign in the desired position by using the procedure described above.

Let us suppose that we are again working with a four-byte source data field, which we are to edit with a comma, a decimal point, and CR for negative numbers. Accordingly, the pattern (in shorthand form) should be

bdd,dds.ddbCR

The significance starter here is six positions to the right of the leftmost character of the pattern. The complete program to give the required editing and the floating dollar sign is as follows:

```
MVC  WORK,PATTRN
LA   1,WORK+7
EDMK WORK,DATA
BCTR 1,0
MVI  0(1),C'$'
```

The Load Address instruction as written places in register 1 the address of the position one beyond the significance starter. If significance is forced, this address remains in register 1, but otherwise the address of the first significant digit is placed in register 1 as part of the execution of the Edit and Mark. The Branch on Count Register instruction with a second operand of zero reduces the first operand register contents by 1 and does not branch. There are, of course, other ways to subtract 1 from the contents of register 1, but this is the easiest and fastest. In the Move Immediate instruction we write an explicit displacement of zero and an explicit base register number of 1. The net effect is to move one byte of immediate data, a dollar sign, to the address specified by the base in register 1. This is the desired action.

Figure 7-11 shows the effect on sample data values. Zero fields could be blanked by methods we have already discussed.

BDD,DDS.DDBCR	
40	20 20 6B 20 20 21 4B 20 20 40 C3 D9
1234567	\$12,345.67
0120406	\$1,204.06
0012345	\$123.45
0001000	\$10.00
0000123	\$1.23
0000012	\$.12
0000001	\$.01
0000000	\$.00
-0098765	\$987.65 CR
-0000000	\$.00 CR

Figure 7-11. Examples of the application of the Edit and Mark instruction to get a floating currency symbol

THE TRANSLATE INSTRUCTION

How It Works

Another powerful programming feature of System/360 is the ability, through the Translate instruction, to convert very rapidly from one coding system of eight or fewer bits to another coding system. Using a conversion table, we can convert a string of characters from one form to another at speeds that compare favorably with that of decimal addition.

Suppose that we have an input stream in which the data is in proper arrangement for processing, but is in Baudot teletypewriter code. Before System/360 can process the input, it must be converted to EBCDIC. The Baudot code is a five-bit code with shifting, which makes it the equivalent of a six-bit code. For simplicity, we will omit control characters, punctuation marks, and fractions; for our purposes, they are "invalid". As shown in Figure 7-12, our transmission receiving equipment adds two zero bits at the beginning of each character, which do not change its binary value, and converts the code signals into the equivalent binary bit patterns shown in the illustration, so that our input stream is in the necessary eight-bit bytes. It remains for us to translate this stream into the corresponding EBCDIC characters by programming.

The Translate instruction (TR) is in the SS format with two storage operands. The first operand names the leftmost byte of a field to be translated; this field may be from one to 256 bytes in length. In programming parlance, it is called the *argument*. The second operand names the start of a list, or table, that contains the characters of the code into which we wish to make the translation. The table may be 256 bytes in length or it may be shorter. It is called the *function*.

Our first step before using the Translate instruction is to construct a table like the one in Figure 7-13. Note that it is 64 bytes in length, which is the maximum length of a six-bit

code ($2^6 = 64$), and provides us with one byte for every binary value that we might receive. We give our table a name, TABLE, so that we will be able to refer to its symbolic storage address regardless of where it is. To create the table, a DC statement like the following might be used. In this case, we are arbitrarily filling the unused bytes with FF's.

```
TABLE DC X'FFE3FFD640C8D5D4FFD3D9C7C9D7C3E5C5E9
.....F2FFFFFF7F1FFFF'
```

Then, assuming each record is a maximum of 80 bytes in length, we set up a storage area for the Baudot data that is to be translated:

```
RECORD DS CL80
```

After moving the first input item to RECORD, the only processing instruction that is necessary to convert it to EBCDIC characters is:

```
TR RECORD, TABLE
```

The operation of this instruction is byte by byte, from left to right, until the end of the first operand field. Like the other logical instructions we have studied, TR treats all data as unstructured logical data, that is, as unsigned binary quantities. Say the first byte of RECORD is 0000 1010 (hex 0A), which is R in Baudot code. The machine action will be to go to the address TABLE+0A (that is, the byte at 0A within the table) and to replace the 0A in RECORD by the bit pattern it finds in that byte of the table. This is hex D9 or 1101 1001, which is R in EBCDIC. If the next Baudot byte is 0010 1100 (hex 2C) for the numeral 8, it will be replaced by the contents of the byte at TABLE+2C: hex F8 or 1111 1000, which is 8 in EBCDIC. If the next Baudot byte is either hex 04 or 24, a space, it will be replaced by hex 40, the EBCDIC blank, which we placed in

BIT POSITIONS 0, 1, 2, 3	HEX VALUE → ↓	BIT POSITIONS 4, 5, 6, 7															
		0000	0001	0010	0011	0100	0101	0110	0111	1000	1001	1010	1011	1100	1101	1110	1111
		0	1	2	3	4	5	6	7	8	9	A	B	C	D	E	F
0000	0		T		O	sp	H	N	M		L	R	G	I	P	C	V
0001	1	E	Z	D	B	S	Y	F	X	A	W	J		U	Q	K	
0010	2		5		9	sp						4		8	0		
0011	3	3					6				2			7	1		

Figure 7-12. Baudot teletypewriter code. This is a five-bit code that, with shifting, has the capacity of six bits, or 64 characters. Control characters, punctuation marks, and fractions have been omitted.

Symbolic address of this byte is TABLE This is TABLE+07

Address*	00	01	02	03	04	05	06	07	08	09	0A	0B	0C	0D	0E	0F
Contents†		E3 T		D6 0	40 sp	C8 H	D5 N	D4 M		D3 L	D9 R	C7 G	C9 I	D7 P	C3 C	E5 V
Address	10	11	12	13	14	15	16	17	18	19	1A	1B	1C	1D	1E	1F
Contents	C5 E	E9 Z	C4 D	C2 B	E2 S	E8 Y	C6 F	E7 X	C1 A	E6 W	D1 J		E4 U	D8 Q	D2 K	
Address	20	21	22	23	24	25	26	27	28	29	2A	2B	2C	2D	2E	2F
Contents		F5 5		F9 9	40 sp						F4 4		F8 8	F0 0		
Address	30	31	32	33	34	35	36	37	38	39	3A	3B	3C	3D	3E	3F
Contents	F3 3					F6 6				F2 2			F7 7	F1 1		
<p>*Location of function byte within table, given in hex. †Contents of function byte. The actual bit configuration is shown in hex at upper left; character at lower right is EBCDIC character represented by that bit pattern.</p>																

Figure 7-13. Table for translation of Baudot code to EBCDIC. Unused bytes may be filled with FF's to test for invalid characters.

the bytes at both TABLE+04 and TABLE+24.

There are some important things to note about our translate table:

1. It contains the characters of the code into which we are translating, the function bytes.
2. It is in order, not by the binary sequence of the characters it contains, but by the binary sequence of the characters of the code from which we are translating, the argument bytes.
3. It is 64 bytes long, the length we determined was equal to the maximum number of bit combinations we might have to deal with in the Baudot code.

If we were confronted by the reverse situation and needed to translate from EBCDIC to Baudot code, using the same letters, numbers, and blanks as before, we would have to construct a 256-byte table in order to have the required indexing or referencing capacity to 256 different addresses. (EBCDIC is an eight-bit code, and $2^8 = 256$.) The table would contain the 38 characters of interest to us, but the contents of these function bytes would now have to be in the Baudot code bit configuration, and they would be in order by the sequence of the EBCDIC characters, which are now the argument bytes.

We have not so far mentioned the unused function bytes of our table in Figure 7-13. We could store blanks or zeros as constants, but a better procedure is available to us, especially when a code without validity checks, like the Baudot, is transmitted. If we fill the spaces with a single unused character, such as hex FF (1111 1111), all invalid codes received would be translated to FF. After translation of each record, it would then be very simple to scan it for

invalid characters by using a Compare Logical Immediate instruction.

The Translate instruction may be used to convert any characters of no more than eight bits to any other characters, not necessarily from one standard code to another. It may be used to perform a control function, as in the program example in which we shall see the instruction at work. At first glance, this program may seem to be rather complicated, but it is simply a variation on an example of a sorting technique that we discussed earlier.

An Example

In the example we shall use the Translate instruction to accomplish a reversal of letters and digits in the collating sequence. When we compare a letter and a digit in normal EBCDIC coding the letter will always show as "smaller" than the digit. We shall assume that, for some special reason, it is necessary to arrange things so that letters sort as "larger".

It should be realized that we need to reverse the ordering of letters and digits *as complete groups*. It is therefore not possible simply to reverse the paths taken on the comparisons in the program. Consider an example. With EBCDIC coding and the Compare Logical Character instruction, this is the binary sequence, and the machine's normal collating sequence, of the following five items:

```
ADAMS
JONES
SMITH
12345
56789
```

We want to modify the sorted order to:

```
12345
56789
ADAMS
JONES
SMITH
```

If we were simply to reverse the paths taken after the comparison, the sorted order would be:

```
56789
12345
SMITH
JONES
ADAMS
```

We shall see how, using the Translate instruction, we can rearrange the letters and digits so that digits sort ahead of letters, while retaining normal numerical and alphabetical order. The translated characters will be used *only* for the sorting operation; we are not required to translate the characters into anything that would be otherwise meaningful.

The only thing we need to do in setting up the table, therefore, is to replace digits with something smaller than what we replace letters with. There are, of course, a great many ways to do this. In the program of Figure 7-14 we have chosen a scheme for its simplicity. The digits 0-9 are replaced by hexadecimal 01-10, A-I are replaced by 11-19, J-R by 21-29, and S-Z by 32-39. These replacements satisfy the one basic requirement, that digits sort earlier than letters. The scheme also preserves the ordering of the letters within the alphabet. The *particular* choices for the letters are not critical, but they will seem reasonable to someone familiar with punched cards.

The program begins with an unfamiliar operand in the PRINT instruction, the assembler instruction that controls the content of the assembly listing. The operand DATA has the effect of causing constants to be printed out in full in the listing. If DATA is omitted or NODATA is specified, only the leftmost eight bytes of any constant will be printed, no matter how large it may be. In actual programming, it is generally considered good practice to include PRINT DATA routinely—and also to let generated macro statements appear in full (by the use of GEN or the omission of NOGEN in the PRINT statement). Then the programmer will always have a complete listing for program checking and debugging. A full explanation of the PRINT instruction may be found in the assembler language reference manual.

We are assuming, for the purposes of this program, that the input stream contains nothing but letters and digits. There are only 36 of these. The other 220 positions of the table have been filled with blanks (represented by 40 in EBCDIC), which is not quite representative of what we might do in practice. In an actual application, if our data

had already been run and verified and we really knew that nothing else could appear, we would use relative addressing with a minus factor to reference the table, and would not store the blanks at the beginning of the table. If, as is more likely, we were concerned about the possibility of erroneous data, we might use the full 256-byte table to check validity.

The task is to sort into the stated sequence three records of 13 characters each, using as the sort key the middle five characters of each record. In other words, the sorted records, which are named A, B, and C, are to be in sequence on their middle five characters after the execution of the program.

In the program of Figure 7-14 we begin by moving the keys to locations in which they can be translated; we do not want to destroy the actual records. The working storage areas have been named KEYA, etc. We shall see shortly why these need to be 13 characters. The three Translate instructions make the conversions of coding on the keys that we have described in detail above. The original records are not disturbed.

Now we load three general registers with the addresses of A, B, and C, that is with (A)A, (A)B, and (A)C. It is these addresses that will be moved during the bulk of the sorting, not the records themselves. The Compare Logical that comes next must be studied carefully. The instruction says that the first operand begins 43 bytes after the address contained in register 2 and that the first operand is five bytes long. Register 2 at this point contains the *address* of A because of the Load Multiple just before this instruction. Looking at the data layout, we see that 43 bytes past the beginning of A is the beginning of the translated *key* of A. Similarly, the second operand refers to the key of B. (Only one length is required on this instruction.) We are thus asking for a comparison between the translated key of A and the translated key of B. If the key of A is already equal to or smaller than the key of B, we Branch on Not High down to X where the next comparison is made. If the key of A is larger than the key of B, we proceed in sequence to the three instructions that interchange the contents of registers 2 and 3. This means that when we arrive at X, register 2 contains the address of the smaller of the keys of A and B, whether or not there was an interchange.

In the addressing scheme described in the preceding paragraph, it is essential that there be a fixed relationship between the address of an item and the address of its translated key. In other words, the translated key of A in KEYA has to be the same distance beyond A as the translated key of B in KEYB is beyond B, and similarly with KEYC and C, so that the same displacement of 43 can be used for all three items. (This, in turn, is why KEYA, KEYB, and KEYC were made 13 characters long even though the keys are only five.) This addressing scheme is necessary because on the second and third comparisons, we will not know which keys are being compared—A, B, or C.

LOC	OBJECT CODE	ADDR1	ADDR2	STMT	SOURCE	STATEMENT
000000				1	PRINT	DATA,NOGEN
000000				2	SORTABC2	START 0
000000	05B0			3	BEGIN	BALR 11,0
000002				4	USING	*,11
000002	D204	B097	B070	00099	00072	5 MVC KEYA+4(5),A+4 MOVE KEYS TO POSITION FOR TRANSLATE
000008	D204	B0A4	B07D	000A6	0007F	6 MVC KEYB+4(5),B+4
00000E	D204	B0B1	B08A	000B3	0008C	7 MVC KEYC+4(5),C+4
000014	DC04	B097	B0ED	00099	000EF	8 TR KEYA+4(5),TABLE TRANSLATE KEYS TO CHANGE COLLATE SEQ
00001A	DC04	B0A4	B0ED	000A6	000EF	9 TR KEYB+4(5),TABLE
000020	DC04	B0B1	B0ED	000B3	000EF	10 TR KEYC+4(5),TABLE
000026	9824	B0BA			0008C	11 LM 2,4,ADDRA PUT ADDRESSES IN REGS 2, 3, 4
00002A	D504	202B	302B	0002B	0002B	12 CLC 43(5,2),43(3) CMPARE KEYA WITH KEYB
000030	47D0	B038		0003A		13 BNH X BRANCH IF ALREADY IN SEQUENCE
000034	1862					14 LR 6,2 INTERCHANGE
000036	1823					15 LR 2,3
000038	1836					16 LR 3,6
00003A	D504	202B	402B	0002B	0002B	17 X CLC 43(5,2),43(4) COMPARE SMALLER OF A AND B WITH KEYC
000040	47D0	B048		0004A		18 BNH Y BRANCH IF ALREADY IN SEQUENCE
000044	1862					19 LR 6,2 INTERCHANGE
000046	1824					20 LR 2,4
000048	1846					21 LR 4,6
00004A	D504	302B	402B	0002B	0002B	22 Y CLC 43(5,3),43(4) COMPARE TWO LARGER KEYS
000050	47D0	B058		0005A		23 BNH MOVE BRANCH IF ALREADY IN SEQUENCE
000054	1863					24 LR 6,3 INTERCHANGE
000056	1834					25 LR 3,4
000058	1846					26 LR 4,6
00005A	D20C	B0C6	2000	000C8	00000	27 MOVE MVC SMALL,0(2) MOVE USING ADDRESSES IN REGISTERS
000060	D20C	B0D3	3000	000D5	00000	28 MVC MEDIUM,0(3)
000066	D20C	B0E0	4000	000E2	00000	29 MVC LARGE,0(4)
				30	EOJ	
00006E				33	A DS CL13	
00007B				34	B DS CL13	
000088				35	C DS CL13	
000095				36	KEYA DS CL13	
0000A2				37	KEYB DS CL13	
0000AF				38	KEYC DS CL13	
0000BC	0000006E			39	ADDRA DC A(A)	
0000C0	0000007B			40	ADDRB DC A(B)	
0000C4	00000088			41	ADDRC DC A(C)	
0000C8				42	SMALL DS CL13	
0000D5				43	MEDIUM DS CL13	
0000E2				44	LARGE DS CL13	
0000EF	4040404040404040			45	TABLE DC CL193' '	
0000F7	4040404040404040					
0000FF	4040404040404040					
000107	4040404040404040					
00010F	4040404040404040					
000117	4040404040404040					
00011F	4040404040404040					
000127	4040404040404040					
00012F	4040404040404040					
000137	4040404040404040					
00013F	4040404040404040					
000147	4040404040404040					
00014F	4040404040404040					
000157	4040404040404040					
00015F	4040404040404040					
000167	4040404040404040					
00016F	4040404040404040					
000177	4040404040404040					
00017F	4040404040404040					
000187	4040404040404040					
00018F	4040404040404040					
000197	4040404040404040					
00019F	4040404040404040					
0001A7	4040404040404040					
0001AF	40					
0001B0	1112131415161718			46	DC	X'111213141516171819'
0001B8	19					
0001B9	4040404040404040			47	DC	CL7' '
0001C0	2122232425262728			48	DC	X'212223242526272829'
0001C8	29					
0001C9	4040404040404040			49	DC	CL8' '
0001D1	3233343536373839			50	DC	X'3233343536373839'
0001D9	4040404040404040			51	DC	CL6' '
0001DF	0102030405060708			52	DC	X'01020304050607080910'
0001E7	0910					
0001E9	4040404040404040			53	DC	CL6' '
000000				54	END	BEGIN

Figure 7-14. A program to sort three fields named A, B, and C into ascending sequence on file-character keys in each field. The Translate instruction is used to make digits sort ahead of letters.

We now carry out the same actions using the addresses in registers 2 and 4, thus comparing the smaller of KEYA and KEYB with KEYC. The two addresses are interchanged if necessary, to make the address in register 2 that of the smaller. After this sequence of instructions, therefore, we can be positive that register 2 contains the address of the smallest of the translated keys. The same set of actions on registers 3 and 4 gets them in proper sequence.

Now we know that whatever rearrangements may or may not have been carried out, register 2 contains the address of the smallest of the keys, register 3 the address of the middle-sized, and register 4 the address of the largest. We can therefore proceed to the three instructions that place the proper three records in SMALL, MEDIUM, and LARGE. For instance, the first of these instructions, the one at MOVE, says to move 13 characters from the address given in register 2, whatever it may be, to SMALL. The other two instructions do the same with registers 3 and 4.

Figure 7-15 shows the contents of registers 2, 3, and 4 at four points during the execution of the program: at the

beginning, at X, at Y, and at MOVE. The three actual data items, in order, were:

```
1111SMITH1111
2222ADAMS2222
3333567893333
```

In other words, the original items were in reverse order to the sequencing pattern we wanted.

AFTER EXECUTION OF	REG 2	REG 3	REG 4
STATEMENT 11	0000206E	0000207B	00002088
STATEMENT 16	0000207B	0000206E	00002088
STATEMENT 21	00002088	0000206E	0000207B
STATEMENT 26	00002088	0000207B	0000206E

Figure 7-15. The contents of registers 2, 3, and 4 during execution of the program in Figure 7-14, loaded at 2000

THE TRANSLATE AND TEST INSTRUCTION AND THE EXECUTE INSTRUCTION

The Translate and Test instruction (TRT) adds great power to the processing capability of System/360. It is related to the Translate instruction and has the same format, but is very different in operation. It is used to scan a data field for characters with a special meaning. Since it merits our close attention, we shall study it in the three remaining programs in this chapter.

As with Translate, we work with a table as the second operand that is accessed exactly the same way. That is, a first operand argument byte addresses a particular entry in the table by an address computation. Once again the table must be in order by the binary sequence of the code of the source material, which in this and the following sections will be standard EBCDIC input. This time, however, we must put zeros in the table to indicate characters without any special meaning and some nonzero value for each character with a special meaning.

In further contrast to the Translate instruction, there is no change in the argument bytes as a result of the TRT operation, despite the "translate" in its name. Instead, the argument bytes are merely inspected, byte by byte, from left to right. If the first argument byte references a function byte that is zero, the next argument byte is inspected, and so forth. If all the function bytes that are referenced are zero, the condition code is set to zero and the operation is complete. However, if a nonzero function byte is referenced, the contents of that byte are placed by the machine in register 2 and the address of the *argument* byte is placed in register 1. The condition code is set to 1 or 2, and the operation is terminated. A condition code of 1 indicates that there are more function bytes to inspect, a condition code of 2 that the nonzero function byte is at the end of the field. The programmer may then make use of the information in the registers and in the condition code.

This means that we can inspect a complete stream of argument bytes, looking for whatever interests us: error characters, end-of-message codes, blanks and commas that separate parts of a line, or whatever. The following problem shows one way to use the instruction.

We are given the starting address of a string of characters of unknown length. The string contains an unknown number of names and addresses. Each name is of unknown length; each address component is of unknown length; there may be from one to four lines of address; we do not know how many names and addresses there are. All we do know is that after each "line" of information there is a dollar sign (\$), after the last line of an address there are two dollar signs (\$\$), and at the end of the entire string there is a dollar sign followed by an asterisk (\$*). We are required to set up each name and address in four lines named LINE1, LINE2, LINE3, and LINE4. Any unused lines must be blanked. When an address has been assembled in this

manner, it is to be printed, after which we return to set up and print the next address.

The table required for this application must be 256 bytes in length in order to reference the complete range of EBCDIC binary values. It will consist of 254 zeros, with entries only in positions 5B (91) and 5C (92), corresponding to dollar sign and asterisk respectively. For the dollar sign we have chosen to enter 01 and for asterisk 02. These choices are highly arbitrary; as we shall see, any other two numbers would be just as good. All we need to know about the input stream is where the dollar signs and asterisks appear; we care nothing about any other characters.

The program in Figure 7-16 begins by placing in register 3 the address of the first character of the input stream that we shall break into names and addresses. On the assumption that there is only one such stream to process, this instruction is never repeated in this program. The next instruction is returned to each time another name and address is to be processed. It places a 4 in register 9 to be used as a guard against incorrect input streams; if ever a name and address would seem to require more than the four lines we have allotted, the program will stop. The next Load Address places in register 10 the address of the first line of the output. The next two instructions are overlapping Move Characters that clear to blanks the output areas. With assumed line lengths of 120 characters, this makes 480 bytes to clear. Since the maximum length in a Move Characters is 256 bytes, two instructions are needed, each clearing two lines. The first MVC instruction clears to blanks the first two lines and the first position of the third line. The second MVC instruction uses the blank now in the first position of the third line to blank the remaining positions of the third line and all of the fourth line.

Now we come to the Translate and Test. The first operand starts at the address in register 3, which we set up with the starting address of the input stream; it is stated to be a maximum of 120 characters in length. The second operand address names the table. If the input stream is correct, a dollar sign will be found within 120 characters. If, because of an error, there is no end-of-line dollar sign, we will have a condition code of zero at the completion of the execution of the instruction. A Branch on Zero, accordingly, takes us to an error exit (this could also be written as BC 8,ERROR).

In the normal case of finding a dollar sign to indicate the end of the first line, what do we have in the registers? Register 1 contains the address of the dollar sign that stopped the Translate and Test. We wish to do a little arithmetic on this address without destroying it, so we move it to register 4. Now we subtract from the address of the dollar sign the address of the first character of the line. The difference is the length of the line, in bytes. We are about

LOC	OBJECT CODE	ADDR1	ADDR2	STMT	SOURCE STATEMENT
				1	PRINT DATA,NOGEN
0C0000				2	MAILLIST START 0
0C0000	0580			3	BEGIN BALR 11,0
0C0002				4	USING *,11
0C0002	1B22			5	SR 2,2
0C0004	4130 B23D		CC23F	6	LA 3,NAME
0C0008	4190 0C04		0C004	7	AGAIN LA 9,4
0C000C	41A0 B05D		0C005F	8	LA 10,LINE1
0C0010	C2F0 B05D B05C 0005F		0C005E	9	MVC LINE1(241),BLANK
0C0016	D2EE B14E B14D 00150		0C014F	10	MVC LINE3+1(239),LINE3
0C001C	DD77 3000 B30A 00000		0C030C	11	LOOP TRT 0(120,3),TABLE
0C0022	4780 B054		0C0056	12	BZ ERROR
0C0026	1841			13	LR 4,1
0C0028	1B13			14	SR 1,3
0C002A	5B10 B302		CC304	15	S 1,CNE
0C002E	4740 B044		0C0046	16	BM OUT
0C0032	4410 B056		0C0058	17	EX 1,MVCINS
0C0036	4130 4C01		0C001	18	LA 3,1(0,4)
0C003A	41AA 0078		0C0078	19	LA 10,120(10)
0C003E	4690 B01A		0C001C	20	BCT 9,LOOP
0C0042	47F0 B054		0C0056	21	B ERROR
0C0046	0700			22	OUT NCPR 0
				23	*
				24	*
				25	*
0C0048	4130 4001		0C001	26	LA 3,1(0,4)
0C004C	5920 B306		0C308	27	C 2,ENDCCN
0C0050	4770 B006		0C008	28	BNE AGAIN
				29	EQJ
				32	ERROR EQJ
0C0058	D200 AC00 3000 00000		0C000	35	MVCINS MVC 0(0,10),0(3)
0C005E	40			36	BLANK DC CL1' '
0C005F				37	LINE1 DS CL120
0C0067				38	LINE2 DS CL120
0C014F				39	LINE3 DS CL120
0C01C7				40	LINE4 DS CL120
				41	NAME DC C'SMITH\$DETROIT\$\$J. C. JACKSON\$1234 MAIN STREET\$CHICAGO,X ILLINOIS\$\$F. C. R. ANDERSON\$553 MAPLE PLACE APARTMENT '
0C023F	E2D4C9E3C85BC4C5				
0C0247	E3D9D6C9E35858D1				
0C024F	4B40C34840D1C1C3				
0C0257	D2E2D6D55BF1F2F3				
0C025F	F440D4C1C9D540E2				
0C0267	E3D9C5C5E358C3C8				
0C026F	C9C3C1C7D66B40C9				
0C0277	D3D3C9D5D6C9E25B				
0C027F	58C64B40C34840D9				
0C0287	4B40C1D5C4C5D9E2				
0C028F	D6C55BF5F5F340D4				
0C0297	C1D7D3C540D7D3C1				
0C029F	C3C540C1D7C1D9E3				
0C02A7	D4C5D5E340				
				42	DC C'5C\$WHITE PLAINS, NEW YORK\$\$D. ADAMS AND FAMILY\$505 X GRATHSON\$APT. 31\$READING, PENN.\$**
0C02AC	F5C35BE6C8C9E3C5				
0C02B4	40D7D3C1C9D5E26B				
0C02BC	40D5C5E640E8D6D9				
0C02C4	D25B58C44E40C44B				
0C02CC	40C1C4C1D4E240C1				
0C02D4	D5C440C6C1D4C9D3				
0C02DC	E858F5F0F540C7D9				
0C02E4	C1E3C8E2D6C558C1				
0C02EC	D7E34B40F3F158D9				
0C02F4	C5C1C4C9D5C76B40				
0C02FC	D7C5D5C54B585C				
0C0303	00				
0C0304	000C0001			43	ONE DC F'1'
0C0308	00000C02			44	ENDCCN DC F'2'
0C030C	00000C0000000000			45	TABLE DC 91X'00'
0C0314	000C00C000000000				
0C031C	000000C000000000				
0C0324	0000000000000000				
0C032C	0000000000000000				
0C0334	000000C000C00000				
0C033C	000000C000C00000				
0C0344	0000000000000000				
0C034C	000000C000000000				
0C0354	000C00C00C000000				
0C035C	000000C000000000				
0C0364	000000				
0C0367	0102			46	DC X'0102'
0C0369	000000C000000000			47	DC 163X'00'
0C0371	000000C00C000000				
0C0379	000C00C000000000				
0C0381	0000000000C00C00				
0C03F9	000000C000000000				
0C0401	000000C000000000				
0C0409	000000				
0C0000				48	END BEGIN

Figure 7-16. A program to print names and addresses. The input stream contains an unknown number of names and addresses, each name and address contains a variable number of lines, and each line is of variable length.

ready to execute a Move Characters instruction in which we will use this computed address; but in the instruction itself the length *code* is always one less than the actual length. So we now subtract 1 from the difference residing in register 1.

What would it mean if this difference were now negative? We shall see, in further analysis of the program, that it would indicate the double dollar sign that denotes the end of a name and address. We therefore Branch on Minus (or BC 4) to OUT, where we would normally process the completed name and address.

Let us review the status of things. We have in register 3 the starting address of a group of characters that should be moved; in register 10 we have the address to which they should be moved; in register 1 we have the correct length code for a Move Characters instruction. We need either to place that length code in an instruction – or do something equivalent. “Something equivalent” is precisely what the Execute (EX) instruction provides. We say

EX 1,MVCINS

This means to execute the instruction at the second operand address named (MVCINS), after Or-ing together the last eight bits of register 1 and the length code portion of MVCINS. Looking down at MVCINS we see that a Move Characters instruction has been set up to do all the things just outlined as necessary, with the exception of the length. The instruction set up at MVCINS says to move a group of bytes starting at the address given in register 3 to another location given by the address in register 10. Both displacements are zero, because the base addresses are exactly what are wanted. The length code is zero in the instruction; the actual length is supplied by the last eight bits of register 1. One line of the complete name and address is thus moved to a printing position.

The Execute instruction is a very serviceable tool in the hands of a resourceful programmer, especially when it is used in a loop that deals with varying conditions. It is an unusual branching instruction that causes one instruction anywhere in a program to be executed out of sequence. Then, unless the remote instruction itself happens to be a successful branch, the program continues with the next instruction after the Execute. As we have seen, Execute can actually modify the remote instruction before execution. It can specify length codes, immediate data, register operands, or whatever information goes into the second byte in the format of the remote instruction. It does this by Or-ing with the last eight bits of a register, which the programmer may use to store information, do arithmetic, or whatever. We will see further examples of the Execute instruction in the next two programs.

We are now about ready to go back for another look at the input stream. To do that, register 3 must contain the address of the next valid data character in the stream. Register 4 contains almost what we need; it has the address of the dollar sign just prior to the next valid character. We

accordingly use a Load Address instruction to get the desired address into register 3. The instruction operates as follows. The displacement of one is added to the contents of the base register to get an effective address. (If an index register had been specified, its contents would also have been added in.) This address is then placed in register 3, with no actual reference to storage. It would have been legitimate to place the sum back in register 4, if that had been desired. Load Address provides a fast and simple way to add a small positive amount to a register.

In the next Load Address instruction we see register 10 being incremented by 120 by use of the method just described. The purpose is to set up the next line as the destination the next time around the loop. Finally we Branch on Count back to inspect the input stream again. If this would mean trying for a fifth line, the branch is not taken and we reach the error exit.

At OUT, which we reach on discovering either two dollar signs in sequence or a dollar sign followed by an asterisk, we would normally include a series of instructions to print the output. Since input/output operations are outside the scope of this book, we simply indicate by a No-Operation instruction that this action would occur here in the program. NOPR is an extended mnemonic for Branch on Condition with a mask of zero, which never causes a branch to occur.

Following the output operations we are ready to go back for another name and address, unless this was the last one in the stream. Whether that was the case can be determined by looking at the function byte in register 2 to see whether it is that produced by a dollar sign or by an asterisk, that is, a 1 or a 2 respectively. A comparison with ENDCON, which contains a 2 in proper form for a comparison with a fullword register, makes the determination. If the function byte is not that produced from an asterisk, we Branch on Not Equal back to AGAIN to repeat the whole process. Otherwise we reach the normal exit from the program.

Figure 7-17 shows successive groups of output, based on the input stream assembled with the program.

```
SMITH
DETROIT

J. C. JACKSON
1234 MAIN STREET
CHICAGO, ILLINOIS

F. C. R. ANDERSON
553 MAPLE PLACE APARTMENT 5C
WHITE PLAINS, NEW YORK

D. D. ADAMS AND FAMILY
505 GRATHSON
APT. 31
READING, PENN.
```

Figure 7-17. Four names and addresses produced by the program in Figure 7-16

AN ASSEMBLER APPLICATION OF TRANSLATE AND TEST AND EXECUTE

Another example of the powerful combination provided by the Translate and Test instruction with the Execute instruction is provided by a simplified version of part of the work an assembler must do.

We are given an input stream consisting of one type of operand field in an assembler language program. The field that we shall process will always consist of two operands: the first will be a general register, the second a symbolic address of not more than six letters. Relative addressing with either an increment or a decrement may or may not be included in the second operand. Accordingly, our field will start with one or two decimal digits, a comma, and from one to six letters. After the final letter there will be either: (1) a blank, or (2) a plus or a minus sign followed by from one to four decimal digits and a blank.

We are required to place the register number in REG as a binary number, to place the symbol in SYMBOL, and to place in INCDEC the increment or decrement as a properly signed binary number.

We are, of course, defining away a great deal of the actual work of an assembler program, which must sort out many different kinds of instructions and operands, and errors too.

The task of the Translate and Test Instruction this time will be to detect the "delimiters" that separate one part of the operand field from another. The delimiters in the job as we have defined it are the comma, the plus sign or the minus sign, and the blank. These set off register from symbol, symbol from increment or decrement, and mark the end of the address. We will need a translate table with entries in the positions corresponding to these four delimiters.

The input stream begins at symbolic location COL16, a name chosen to suggest where the operand field might begin on a card, although we realize that, in the System/360 assembler language, it is not *required* to begin there.

The program of Figure 7-18 begins by clearing to blanks the location set up for the symbol. This must be done because we do not know whether the symbols we shall find will always have six characters; therefore, any previous contents of SYMBOL must be erased. A similar consideration applies to INCDEC. There may or may not be an increment or decrement, hence we are required to place zero there. It seems to be a little easier to clear INCDEC at the beginning and then to leave it zero, if nothing is placed there, rather than to clear it later if necessary. REG need not be cleared; we will always place something there.

This time we construct the function table by entering a constant of 256 bytes of zeros in storage, and use the Move Immediate instruction to insert arbitrary values in the EBCDIC positions corresponding to the four delimiters. To find the correct positions, we need only read off the

hexadecimal values from an EBCDIC chart. For the delimiters, a value of 1 is used for a blank, 2 for a comma, 3 for a plus sign, and 4 for a minus sign. When the program is executed, these values will be moved into position in place of zeros in TABLE, which will then be in storage, and of course the values will be in the specified bytes before execution of the TRT instructions.

Following a procedure somewhat similar to that used in the name and address program of the preceding section, we now place in register 3 the address of the leftmost character of the stream. A Translate and Test will stop after two or three characters, depending on whether the register number has one or two digits. We now compute in register 4 the proper length code, either zero or 1, and use an Execute to carry out a Pack instruction that is stored at PCKINS. This remote Pack takes its first operand from the address given in register 3, its length from register 4, and places the result in WORK. The latter was set up as a doubleword, so we may now do a Convert to Binary, placing the result in register 5 from whence we store it in REG. The first required action is complete.

We are now ready to get the symbol, after some preliminaries. When we have found the delimiter after the symbol (a blank, a plus, or a minus), it will be necessary to compute the length of the symbol. In order to be able to do this later, we need now to put in register 3 the address of the first character of the symbol. This can be done with a Load Address instruction using register 1 as a base and a displacement of 1. The same scheme (base register 1 and displacement of 1) gives the correct starting address for the Translate and Test instruction also.

Once again, after completing the Translate and Test, we compute the length of the symbol and use an Execute, this time to move the symbol from its position in the input stream to SYMBOL. When this has been done, we inspect the delimiter. If it is a blank, signified by a function byte of 1 in the TABLE, we are finished because there is no increment or decrement.

If it is not a blank, then it must be either a plus or a minus, always assuming for this example that there are no errors. If it is a plus, we place a 2 in register 6; otherwise a zero. The purpose of this will become clear in a moment.

At NEXT we once again place the address of the next character in the stream in 3, this time to be able to compute the length of the increment or decrement. The next six instructions are much as they were before, resulting in the value of the increment or decrement being placed in register 5 in binary. It will be positive; the sign was not included.

Now we come to an Execute instruction used in a rather different way for a rather different purpose. We have specified register zero for the Or-ing, which means that the executed instruction is not modified. Then we have indexed

the address of the instruction to be modified. We will therefore execute either the instruction at MININS, if register 6 contains a zero, or the instruction two bytes later, if register 6 contains 2. The net effect is to do nothing to register 5 if the sign is plus, and to make register 5 negative if the sign is minus.

Having done this, we store the contents of register 5 at

INCDEC and our assigned task is completed; we have placed various parts of the operand in separate locations where they can be separately addressed. In the real world of an assembler, many more operations would have to be performed on this operand. Our small task of separating the various parts of the operand would facilitate these further operations.

LOC	OBJECT CODE	ADDR1	ADDR2	STMT	SOURCE	STATEMENT
				1		PRINT DATA,NOGEN
000000				2	ASSMBLR	START 0
000000	05B0			3	BEGIN	BALR 11,0
000002				4		USING *,11
000002	D205 B0A0 B0B6 000A2 000B8			5	MVC	SYMBOL,BLANK CLEAR LOCATION FOR SYMBOL
000008	1B22			6	SR	2,2 CLEAR REGISTER 2
00000A	5020 B0AA		000AC	7	ST	2,INCDEC CLEAR SPACE FOR INCREMENT OR DECR
00000E	9201 B10E	00110		8	MVI	TABLE+X'40',X'01' INSERT NONZERO VALUES IN TABLE
000012	9203 B11C	0011E		9	MVI	TABLE+X'4E',X'03'
000016	9204 B12E	00130		10	MVI	TABLE+X'60',X'04'
00001A	9202 B139	00138		11	MVI	TABLE+X'68',X'02'
00001E	5830 B0BE		000C0	12	L	3,ACOL16 PUT STARTING ADDRESS IN REG 3
000022	DD0E B1CE B0CE 001D0 000D0			13	TRT	COL16,TABLE LOOK FOR FIRST DELIMITER
000028	1841			14	LR	4,1 COMPUTE LENGTH CODE OF REG NUMBER
00002A	1B43			15	SR	4,3
00002C	5840 B0C2		000C4	16	S	4,ONE
000030	4440 B090		00092	17	EX	4,PCKINS PACK REG NUMBER AND PLACE IN WORK
000034	4F50 B0AE		000B0	18	CVB	5,WORK CONVERT TO BINARY AND PUT IN REG 5
000038	5050 B0A6		000A8	19	ST	5,REG STORE REG NUMBER IN BINARY
00003C	4131 0001		00001	20	LA	3,1(1) SET UP FOR NEXT TRT
000040	DD06 1001 B0CE 00001 000D0			21	TRT	1(7,1),TABLE LOOK FOR NEXT DELIMITER
000046	1841			22	LR	4,1 COMPUTE LENGTH OF SYMBOL
000048	1B43			23	SR	4,3
00004A	5840 B0C2		000C4	24	S	4,ONE
00004E	4440 B096		00098	25	EX	4,MVCINS PLACE RESULT IN SYMBOL
000052	5920 B0C2		000C4	26	C	2,ONE WAS DELIMITER A BLANK
000056	4780 B08E		00090	27	BE	OUT BRANCH IF SO
00005A	5920 B0CA		000CC	28	C	2,THREE WAS DELIMITER A PLUS SIGN
00005E	4780 B068		0006A	29	BE	PLS BRANCH IF SO
000062	4160 0000		00000	30	LA	6,0 SET UP FOR LATER REMOTE INSTRUCTION
000066	47F0 B06C		0006E	31	B	NEXT
00006A	4160 0002		00002	32	PLS	LA 6,2 SET UP FOR LATER REMOTE INSTRUCTION
00006E	4131 0001		00001	33	NEXT	LA 3,1(1) SET UP FOR NEXT TRT
000072	DD04 1001 B0CE 00001 000D0			34	TRT	1(5,1),TABLE LOOK FOR NEXT DELIMITER
000078	1841			35	LR	4,1 COMPUTE LENGTH OF INCDEC
00007A	1B43			36	SR	4,3
00007C	5840 B0C2		000C4	37	S	4,ONE
000080	4440 B090		00092	38	EX	4,PCKINS THIS IS INCREMENT OR DECREMENT
000084	4F50 B0AE		000B0	39	CVB	5,WORK CONVERT TO BINARY AND PUT IN REG 5
000088	4406 B09C		0009E	40	EX	0,MININS(6) COMPLEMENT IF SIGN WAS MINUS
00008C	5050 B0AA		000AC	41	ST	5,INCDEC STORE RESULT
				42	OUT	EQJ PROGRAM TERMINATION
000092	F270 B0AE 3000 000B0 00000			45	PCKINS	PACK WORK,0(0,3) EXECUTE INSTR ADDS LENGTH FROM REG 4
000098	D200 B0A0 3000 000A2 00000			46	MVCINS	MVC SYMBOL(0),0(3) DITTO
00009E	1155			47	MININS	LNR 5,5
0000A0	1055			48	LPR	5,5
0000A2				49	SYMBOL	DS CL6
0000A8				50	REG	DS F
0000AC				51	INCDEC	DS F
0000B0				52	WRK	DS D
0000B8	404040404040			53	BLANK	DC CL6' '
0000BE	0000					
0000C0	000001D0			54	ACOL16	DC A(COL16)
0000C4	00000001			55	ONE	DC F'1'
0000C8	00000002			56	TWO	DC F'2'
0000CC	00000003			57	THREE	DC F'3'
0000D0	0000000000000000			58	TABLE	DC 256X'00'
0000D8	0000000000000000					
0000E0	0000000000000000					
0000E8	0000000000000000					
0000F0	0000000000000000					
0001B8	0000000000000000					
0001C0	0000000000000000					
0001C8	0000000000000000					
0001D0	F1F16BC1C2C3C4C5			59	COL16	DC C'11,ABCDEF+1234 '
0001D8	C64EF1F2F3F440					
000000				60	END	BEGIN

Figure 7-18. A program to break down the operands of an assembler language instruction into its constituent parts, using TRT and EX

PROCESSING VARIABLE-LENGTH BLOCKED RECORDS

The following illustrative program applies techniques that are highly useful in certain commercial applications, and that the features of System/360 make particularly easy to accomplish. The task is the processing of blocked tape records (that is, many logical records in one physical block) with a variable number of records per block and with variable-length records. We shall take a record layout, furthermore, that places certain fixed-length items after the variable-length portion of the record.

Each record in a block to be processed by the program of this example will contain four fields, with characteristics as follows:

<i>Field</i>	<i>Length</i>	<i>Type</i>
DESC	variable, at most 60 characters	alphameric
ACCT	7 characters	alphameric
QOH	4 bytes	binary
DOLL	4 bytes	binary

The first field is a variable-length description of a stock item; it is alphameric and at most 60 characters. The next field is an account number, of exactly seven alphameric characters. The third field is four bytes long. It is a binary number giving the quantity on hand. The fourth and last field is also a four-byte binary number giving the year-to-date sales of the stock item to the nearest dollar. However long the description may be, its final character is always an equal sign to serve as a sentinel marking the end of the variable-length portion of the record. There is an unknown number of records. Immediately following the last record is another equal sign, which is the last character in the block.

We are required to process such a block, which we assume has already been read into core storage. We are to set up a line for printing that contains the account number, the quantity on hand, the sales, and the description, in that order. The numeric quantities are to be in zoned format. After printing a line for each record in the block, we are to print the total dollar sales from all records on a separate line.

The program is shown in Figure 7-19. After the usual preliminaries we clear register 4 and store the resulting zero in TOTAL in order to be sure that the accumulator for total sales is zeroed. Register 7 is next loaded with the address of the first character of the block; register 7 will always contain the address of the first character of the *next* record as the loop is repeated. The MVI instruction inserts a one in the equal sign position of our translate table. This will occur during execution, of course.

In the body of the loop we first blank out the space assigned to the description because, in general, it will be possible for a long description to be followed by a short one; without a prior blanking, the end of the previous line would still be there. The MVC instruction used here will blank out the DESC area for its entire 60-byte implied

length *provided* that the first operand DESC in storage is one byte to the right of the second operand BLANK. Checking statements 50 and 51 of the assembly listing, we see that this is so.

The Translate and Test instruction references a table in which the only nonzero entry corresponds to an equal sign. The effective address of the first operand in the Translate and Test is just the contents of register 7 because the explicit displacement is zero. The length of 60 sets a limit on the search for an equal sign. If no equal sign is found within 60 bytes, the condition code will be zero; a Branch on Condition transfers to an error routine if this happens.

We now are ready to move the description from its place in the block to the space from which it will be printed. This can be done readily enough once we have available the length code of the description. Register 1 after the Translate and Test contains the address of the equal sign. Subtracting from this address the address of the first byte of the description gives the length of the description in bytes; one less than this number is the length code of the description. With this number in register 3, we can Execute a remote Move Characters instruction that moves the description from the block storage area to a location from which it can be printed.

Just before doing so, however, we have a Branch on Minus instruction to detect a negative number after the computation of the length code of the description; this would happen only if the first character of the "description" were an equal sign, which would signal the end of the block.

Getting the account number from the block area to the printing location is an easy matter. We know that the account number begins one byte beyond the address of the equal sign, which is contained in register 1. The effective address of the account number is therefore just register 1 as a base with a 1 for displacement. The address of the quantity on hand is just eight bytes beyond the address in register 1. Here we must be careful of word boundaries. The quantity on hand was said to be a four-byte binary number, but, because of the variable length of the description, it may not be aligned on a word boundary in the block storage area. We therefore use a Move Characters instruction to move it to a temporary storage area that is definitely aligned on a word boundary. TEMP1 is on a word boundary because the DS says so.

Now this binary quantity can be loaded into a register and converted to decimal in a doubleword. From here it is unpacked to the location from which it will be printed, named QOH.

The same sequence of operations gets the year-to-date sales into DOLL. Because the sales are still in register 4 in binary, they can be added to the total for the block.

LOC	OBJECT CODE	ADDR1	ADDR2	STMT	SOURCE STATEMENT
				1	PRINT DATA,NOGEN
000000				2	VARBLK START 0
000000	0580			3	BEGIN BALR 11,0
000002				4	USING *,11
000002	1844			5	SR 4,4
000004	5040	BOEE	000F0	6	ST 4,TOTAL CLEAR REGISTER 4 TO ZEROS
000008	5870	B07A	0007C	7	L 7,AFIRST PUT ZEROS IN TOTAL
00000C	1811			8	SR 1,1 PUT ADDRESS OF 1ST RECORD IN REG 7
00000E	9201	B1E6	001E8	9	MVI TABLE+X*7E',X'01' CLEAR REGISTER 1
000012	D238	B0A3	B0A2 000A5	10	AGAIN MVC DESC,BLANK PUT 1 IN EQ SIGN POSITION OF TABLE
000018	DD3B	7000	B168 00000	11	TRT 0(60,7),TABLE START OF RECORD LOOP
00001E	4780	B070	00072	12	BC 8,ERROR LOOK FOR SENTINEL
000022	1831			13	LR 3,1 NO DELIMITER FOUND IN 60 CHARACTERS
000024	1837			14	SR 3,7 COMPUTE LENGTH CODE OF DESCRIPTION
000026	5B30	B07E	00080	15	S 3,ONE
00002A	4740	B06E	00070	16	BM OUT
00002E	4430	B072	00074	17	EX 3,MVCINS
000032	D206	B082	1001 00084	18	MVC ACCT,1(1) MOVE DESCRIPTION FOR PRINTING
000038	D203	B0E2	1008 000E4	19	MVC TEMP1,8(1) MOVE ACCOUNT NUMBER
00003E	5840	B0E2	000E4	20	L 4,TEMP1 MOVE QOH TO TEMPORARY STORAGE AREA
000042	4E40	B0E6	000E8	21	CVD 4,TEMP2 QOH TO REGISTER FOR PROCESSING
000046	F377	B08C	B0E6 0008E	22	UNPK QOH,TEMP2 UNPACK AND MOVE FOR PRINTING
00004C	D203	B0E2	100C 000E4	23	MVC TEMP1,12(1) SAME PROCESSING FOR DOLLARS
000052	5840	B0E2	000E4	24	L 4,TEMP1
000056	4E40	B0E6	000E8	25	CVD 4,TEMP2
00005A	F377	B097	B0E6 00099	26	UNPK DOLL,TEMP2
000060	5A40	BOEE	000F0	27	A 4,TOTAL
000064	5040	BOEE	000F0	28	ST 4,TOTAL ADD DOLLARS TO TOTAL
000068	4171	0010	00010	29	LA 7,16(1) PUT ADDRESS OF NEXT RECORD IN REG 7
				30	*
				31	*
				32	*
				33	*
00006C	47F0	B010	00012	34	B AGAIN GO BACK FOR NEXT RECORD
				35	OUT EDJ NORMAL END OF JOB
				38	ERROR EDJ ERROR TERMINATION
000074	D200	B0A3	7000 000A5	41	MVCINS MVC DESC(0),0(7) EXECUTE INSTR ADDS LENGTH FROM REG 3
00007A	0000				
00007C	000000F4			42	AFIRST DC A(RECORD)
000080	00000001			43	ONE DC F'1'
000084				44	ACCT DS CL7
000088	404040			45	DC CL3' '
00008E				46	QOH DS CL8
000096	404040			47	DC CL3' '
000099				48	DOLL DS CL8
0000A1	404040			49	DC CL3' '
0000A4	40			50	BLANK DC C' '
0000A5				51	DESC DS CL60
0000E4				52	TEMP1 DS F
0000E8				53	TEMP2 DS D
0000F0				54	TOTAL DS F
0000F4	C2C5E5C5D36B40C2			55	RECORD DC C'BEVEL, BLUE, 6 INCH='
0000FC	D3E4C56B40F640C9				
000104	D5C3C87E				
000108	F1F2F3C1C2C3F4			56	DC C'123ABC4'
00010F	000001CA			57	DC FL4'458'
000113	000015CA			58	DC FL4'5578'
000117	C1D5C7D3C56B40D9			59	DC C'ANGLE, RED, 8 INCH FORGED='
00011F	C5C46B40F840C9D5				
000127	C3C840C6D6D9C7C5				
00012F	C47E				
000131	F2F3F4E7E8E9F7			60	DC C'234XYZ7'
000138	00001F40			61	DC FL4'8000'
00013C	000125C0			62	DC FL4'75200'
000140	C6D3C1D5C7C56B40			63	DC C'FLANGE, 2 INCH, MAGNESIUM='
000148	F240C9D5C3C86B40				
000150	D4C1C7D5C5E2C9E4				
000158	D47E				
00015A	F7F5F3C7C8D1F8			64	DC C'753GHJ8'
000161	0000000C			65	DC FL4'12'
000165	00001EB0			66	DC FL4'7856'
000169	7E			67	DC C'='
00016A	0000000000000000			68	TABLE DC 256X'00'
000172	0000000000000000				
00017A	0000000000000000				
000182	0000000000000000				
00018A	00000C0000000000				
000242	0000000000000000				
00024A	0000000000000000				
000252	0000000000000000				
00025A	0000000000000000				
000262	0000000000000000				
000000				69	END BEGIN

Figure 7-19. A program to prepare for printing a series of variable-length blocked records, each consisting of four fields. Total dollar sales are computed at the same time.

This completes the actions needed to make our first line of information ready for printing, and we would normally include a printer output routine at this point. There may still be another record in the block, so we branch back to `AGAIN` to see whether there is. During execution, the program will continue to go through the loop each time there is another record. After the final record, the equal sign delimiter that follows it will produce a result of `-1` for the length-code computation, and this will cause the program to branch (on the Branch on Minus instruction) to our `EOJ` macro at `OUT`.

The sample block that appears at `RECORD` involves a little bit of trickery. One of the essential aspects of the assignment is that the binary fields appear in the block not aligned on word boundaries. In real life such a block would have been set up by a previous program. Here, in attempting to set it up with `DC` entries, we run into the automatic boundary alignment that is normally performed on fullwords. This action can be overridden, however, by specifying a length modifier. A length of 4 is, of course, the same as the implied length of a fullword; the whole purpose is to prevent boundary alignment.

QUESTIONS AND EXERCISES

For questions 1–6, show the contents of WORK after the execution of ED WORK,SOURCE. The characters in WORK have the following meanings:

Character	Meaning	Hexadecimal Equivalent
B	Blank	40
S	Significance starter	21
D	Digit selector	20
,	Comma	6B
.	Decimal	4B
C	C C3	C3
R	R D9	D9
*	*	5C
F	Field separator	22

1. WORK BDDDDDDD
SOURCE 0001540+
2. WORK BDDDDDDDCR
SOURCE 0005721+
3. WORK BDD,DDS.DDBCR
SOURCE 000001-
4. WORK BDDD,DDCR
SOURCE 00000+
5. WORK BSD,DDD.DDCR
SOURCE 0000010+
6. WORK BDD,DDS.DDCRFDD,DDS.DDBCR
SOURCE 0010143-0000107-

7a. Write a DC named PATRN to set up the editing pattern for a 9-digit amount to be printed as follows:

BX,XXX,XXX.XXBBB (for a positive amount)
BX,XXX,XXX.XXBBCR (for a negative amount)

Insignificant zeros should print as blanks. However, amounts less than one dollar must be punctuated with a decimal point.

b. If SOURCE contains 009250001—and we execute ED PATRN,SOURCE, what would PATRN then contain?

c. What would PATRN contain if EDMK instead of ED were the operation?

8. PATRN DC X'4020206B2020214B202040C3D9'
EDMK PATRN,SOURCE

Assume SOURCE contains 0123456-. Choose the address

that would be in bits 8–31 of general register 1 after execution of the EDMK instruction:

- a. PATRN
- b. PATRN+1
- c. PATRN+2
- d. PATRN+3

9. Does the ED instruction affect general register 1?
10. What would be in location AREA as a result of the following operations?

```
AREA DC X'00020103'
TABLE DC C'ABCD'
TR AREA,TABLE
```

- a. ABCD
- b. DBCA
- c. DCBA
- d. ADBC
- e. ACBD

11. What would be in general registers 1 and 2 as a result of the following operations:

```
AREA DC X'00010203'
TABLE DC X'00000100'
TRT AREA,TABLE
```

- a. Address of AREA+3 and X'03' respectively
- b. Address of TABLE+2 and X'01' respectively
- c. Address of TABLE+3 and X'04' respectively
- d. Address of AREA+2 and X'01' respectively

12. Assume the following sequence:

```
CON1 DC F'10'
WORK DC CL16'1234567899123456'
AREA DS CL20
L 2,CON1
MVI AREA,C'0'
MVC AREA+1(19),AREA
EX 2,MOVE
B ROU2
MOVE MVC AREA(0),WORK
```

What will AREA contain after the instruction B ROU2 is executed?

13. What would AREA contain if the EX instruction were EX 0,MOVE?

Chapter 8: Subroutine Linkages and Program Relocation

Subroutines are an important element in programming. Storage space is conserved when a subroutine at one storage location is branched to from many points in a main section instead of being inserted each time it is needed. Programming, compilation, and debugging time are conserved when an existing subroutine can be incorporated into a new program.

A subroutine is a set of instructions that performs a particular function. It may be used in more than one program or more than once within a single program. Subroutines have been used in scientific programming for many years. Common subroutines used are the sine, cosine, and square root functions. Subroutines have now become equally important in commercial programming. In many cases, a main program may be little more than a sequence of branches to subroutines, some of which may be used many times, some only once. When a long and involved program is to be written, it is frequently divided into a number of separate subroutines to be written by different programmers. After the general plan is determined, each part may be relatively simple to program, and a considerable saving of time can be achieved. Each section can be assembled and debugged independently.

Subroutines may be classified as either "open" or "closed". An open subroutine is included each time it is

required in the main program. The open subroutine is not normally branched to but is inserted into the main program and as such has little or no difficulty communicating with the main program. The closed subroutine, which is the kind we shall investigate in this chapter, is included once in a program and in storage no matter how many times it is branched to. Since the subroutine may be entered from many points in the main program, communication of data to the subroutine and of results back to the main program can be a problem unless standards are set.

In this chapter we shall be concerned primarily with the standards that have already been established for subroutine communication. By demonstrating the techniques in actual program examples, we shall answer questions like:

How does the subroutine know where to return in the main program?

How does the main program pass data to the subroutine?

How does the subroutine pass results back to the main program?

How can one program reference areas in another program that the assembler does not know about?

Much of the above is accomplished through register addressing. For the rest we will look to functions of the assembler and the linkage editor.

SUBROUTINE LINKAGES

The basic idea of a subroutine is to put it in storage at one place, then branch to it whenever its function is needed. If we are using a square root subroutine, for instance, we put it in one section of storage available for use as needed. Then, at any point in the main program that we need to take a square root, we branch to the square root subroutine, compute the square root, and branch back to the point in the main program where we left off.

This raises two questions: How does the subroutine know where to return when its work is finished? How does the main program provide the subroutine with information on the location of the number to be processed and where the result is to be left?

The question of where to return is answered by a *linkage* that places in a register the address of the next instruction after the one that branches to the subroutine. In System/360 we do this with the Branch and Link Register (BALR) instruction that we have seen so frequently for loading a base register. But now we specify a second operand other than zero, so that it really is a branch. The technique is to place in a register, usually 15, the address of the first instruction of the subroutine. Then, if we have chosen register 14 to hold the link, we write the instruction BALR 14,15. When executed, this instruction places in register 14 the address of the next byte after the BALR, and causes a branch to the address in register 15. At the end of the subroutine it is merely necessary to specify an unconditional branch to the address in register 14. This is done with a Branch Register Unconditional (extended mnemonic BR).

We can make these ideas much more clear by considering

an example. It is not our purpose now to explore new ideas in information processing, so we chose an unrealistically simple job for the subroutine to do: to double a number by shifting it left one place. Communicating data and the location of results between the main routine and the subroutine is handled easily by placing the number to be doubled in a register, in this case register 3, before the branch to the subroutine, and leaving the doubled result in register 3 on the return to the main program. Figure 8-1 is a listing of a single program consisting of a main, or calling, routine and a subroutine.

The START, BALR, and USING instructions in Figure 8-1 are still necessary; they are unchanged by the fact that a subroutine will be used. Next comes the first processing instruction of the main routine, to load register 3 with a number that is to be doubled by the subroutine. Register 15 is then loaded with the address of the subroutine, using an address constant, in preparation for branching to the subroutine with the BALR.

Address constants, a subject we have not so far encountered, provide a means of communicating between separate parts of a program or between separately assembled programs. We could have used other means in this single assembly, but since address constants will appear throughout the rest of this chapter, they are well worth some study. An address constant (adcon for short) is a storage address that is translated into a constant. Unlike other types of DC's, it is enclosed in parentheses. We are particularly interested here in two types of address constants: A and V.

An A-type address constant may be absolute (its value does not change upon program relocation) or it may be

LOC	OBJECT CODE	ADDR1	ACDR2	STMT	SOURCE STATEMENT
				1	PRINT NOGEN
000000				2	LINK1 START 0
000000	0580			3	BEGIN BALR 11,0
000002				4	USING *,11
000002	5830 B022	00024		5	L 3,FIRST FIRST NUMBER TO BE DOUBLED
000006	58F0 B01E	00020		6	L 15,ADSR1 SUBROUTINE ADDRESS
00000A	05EF			7	BALR 14,15 LINKAGE RETURN ADDRESS GOES INTO 14
00000C	5030 B02A	0002C		8	ST 3,ANS1 RETURN POINT FROM SUBROUTINE
000010	5830 B026	00028		9	L 3,SECOND SECOND NUMBER TO BE DOUBLED
000014	58F0 B01E	00020		10	L 15,ADSR1 SUBROUTINE ADDRESS AGAIN
000018	05EF			11	BALR 14,15 LINKAGE
00001A	5030 B02E	00030		12	ST 3,ANS2 STORE SECOND RESULT
				13	EOJ END OF JOB
000020	00000034			16	ADSR1 DC A(SR1) SUBROUTINE ADDRESS
000024	00000001			17	FIRST DC F'1'
000028	00000004			18	SECOND DC F'4'
00002C				19	ANS1 DS F
000030				20	ANS2 DS F
				21	*
				22	* THIS IS THE END OF THE MAIN PROGRAM
				23	* THE SUBROUTINE MAY USE ITS OWN BASE REGISTER
				24	* WHICH MUST BE LOADED AND IDENTIFIED
				25	*
000034	05A0			26	SR1 BALR 10,0
000036				27	USING *,10
000036	8B30 0001	00001		28	SLA 3,1 THIS IS THE ONLY PROCESSING INSTRUCTION
00003A	07FE			29	BR 14 UNCONDITIONAL BRANCH TO MAIN ROUTINE
000000				30	END BEGIN

Figure 8-1. Listing of a single program that consists of a main, or calling, routine and a subroutine. Standard linkage registers are used.

relocatable. The storage address is calculated by the assembler and is stored in binary integer form. If no length is specified, it is stored as a fullword, aligned to a fullword boundary. We note that in statement 16 the object code for the DC named ADSR1 is 00000034. The operand is A(SR1); the A stands for address and the SR1 in parentheses is the same as the label of the first machine instruction in the subroutine, which is at location 000034.

A V-type address constant, which we shall see later, is similar to the A-type, but it *must* be relocatable. It is used to reserve storage for the address of a symbol that is defined in a program or program segment *external* to the program it appears in. During assembly the V-type constant is given a zero value, and it is placed in the assembler's external symbol dictionary, to be resolved later by the linkage editor.

The BALR as written in statement 11 takes its branch address from register 15 and places in register 14 the address of the next instruction. The Branch and Link (BAL) instruction can sometimes be used instead of BALR, thereby avoiding the loading of a register before branching. The restriction is that the address of the subroutine must be within the range of addresses of the current program base register. This will not always be true, and will never be true for separately assembled routines, as we shall discuss later. BALR is probably a good habit even when not strictly needed.

We have now branched to the subroutine, which in this highly simplified example consists of just one processing instruction. The contents of register 3 are shifted left one

place, which doubles the number, and the processing is finished. We are now ready to return to the instruction following the BALR in the main routine. This address is precisely what is in register 14 now, so an unconditional branch to the address specified in register 14 is the correct return. The BR instruction is unconditional.

On returning to the main routine, we store the doubled number at ANS1 and proceed to load another number into register 3 for doubling by the subroutine. We again go through the operations of loading register 15 with the address of the subroutine and linking to it. Although it is true that register 15 still has the address of the subroutine in it from the last time, we prefer, even in this example, to load it again as a matter of good programming habit.

Figure 8-2 shows the values of FIRST, SECOND, ANS1, and ANS2, in that order, after the execution of the program in Figure 8-1.

```
00000001 00000004 00000002 00000008
```

Figure 8-2. Values of FIRST, SECOND, ANS1, and ANS2, respectively, after execution of program in Figure 8-1

In Figure 8-3 we add a feature to the program. Shifting a number left can, of course, result in loss of a bit from large numbers. Let us arrange things so that such a loss would be signaled back to the main routine as an error. Our method of signaling may be as follows. If such a loss of information occurs, the subroutine would return to the instruction after

LOC	OBJECT CODE	ADDR1	ADDR2	STMT	SOURCE	STATEMENT
				1		PRINT NOGEN
0C0000				2	LINK2	START 0
000000	05B0			3	BEGIN	BALR 11,0
000002				4		USING *,11
000002	5830 B02E		CC030	5	L	3,FIRST FIRST NUMBER TO BE DOUBLED
0C0006	58F0 B02A		CC02C	6	L	15,ADSR1 SUBROUTINE ADDRESS
0C000A	05EF			7	BALR	14,15 LINKAGE-RETURN ADDRESS
00000C	47F0 B026		00028	8	B	ERROR ERROR RETURN
000010	5030 B036		CC038	9	ST	3,ANS1 RETURN POINT FROM SUBROUTINE
000014	5830 B032		CC034	10	L	3,SECOND SECOND NUMBER TO BE DOUBLED
000018	58F0 B02A		0002C	11	L	15,ADSR1 SUBROUTINE ADDRESS AGAIN
00001C	05EF			12	BALR	14,15 LINKAGE
0C001F	47F0 B026		CC028	13	B	ERRCR ERROR RETURN
000022	5030 B03A		CC03C	14	ST	3,ANS2 STORE SECOND RESULT
				15	EOJ	PROGRAM TERMINATION
				18	ERROR	EOJ ERROR PROGRAM TERMINATION
00002A	0000					
00002C	00000040			21	ADSR1	DC A(SR1)
000030	00000010			22	FIRST	DC F'16'
0C0034	7FFFFFFF			23	SECOND	DC X'7FFFFFFF'
0C0038				24	ANS1	DS F
0C003C				25	ANS2	DS F
				26	*	
				27	*	THIS IS THE END OF THE MAIN PROGRAM
				28	*	THE SUBROUTINE MAY USE ITS OWN BASE REGISTER
				29	*	WHICH MUST BE LOADED AND IDENTIFIED
				30	*	
000040	05A0			31	SR1	BALR 10,0
0C0042				32		USING *,10
000042	8830 0C01		CC001	33	SLA	3,1 THIS IS THE ONLY PROCESSING INSTRUCTION
000046	4710 E000		CC000	34	BC	0(0,14) GO TO ERROR RETURN
0C004A	47F0 E004		CC004	35	B	4(0,14) UNCONDITIONAL BRANCH TO MAIN PROGRAM
0C0000				36	END	BEGIN

Figure 8-3. The program of Figure 8-1 modified to give the subroutine a choice between two return points

the BALR; if there is no loss of information, the subroutine would return to an instruction that is four bytes after the BALR. In other words, the instruction after the BALR would be executed only in the error condition, and it would be called the *error return*. The *normal return* would branch back beyond this point.

We shall insert in the program, following each BALR to the subroutine, a branch to a routine labeled ERROR to discontinue the program if the error arises. (In practical applications, of course, we would take some corrective action rather than give up completely.) The choice of whether to go back to the error return or the normal return will be made by the subroutine. Figure 8-3 shows the modifications required. After shifting left, we execute a Branch on Overflow (BO) instruction that tests the condition code set by the Shift Left Single (SLA) instruction. If we have overflowed, the branch is taken and the error return is

reached. If we have not overflowed, we go back to the normal return, which is four bytes beyond the address in register 14. This is done with a Branch Unconditional instruction (extended mnemonic B) that uses register 14 for a base register and has a displacement of 4.

Figure 8-4 shows the information at the end of execution of the program, with the values for FIRST, SECOND, and ANS1. A doubled value for SECOND has not been stored, since the error return was taken and the instruction (ST 3, ANS2) was never reached.

00000010	7FFFFFFF	00000020
----------	----------	----------

Figure 8-4. Values of FIRST, SECOND, and ANS1, respectively, after execution of the program in Figure 8-3. ANS2 was not stored because the error return was taken during the doubling of SECOND.

STANDARD LINKAGE REGISTERS

So far we have seen a typical subroutine linkage in action, with a variation that allows a choice between two return points. Communication of data and results between the main program and the subroutine was made easily because the programmer knew which registers were used for what purpose in both. Supposing they had been written by different programmers?

To ease the problem of assuring proper communications between program segments, which often are written by different programmers, standard register assignments and techniques have been defined in each of the IBM operating or programming support systems. (They are similar, but not identical, in all System/360 operating systems.) Standard register assignments in the Disk Operating System (DOS) are shown in Table 8-1. The items in this chart will be explained in the following pages of text, as their use is discussed. These registers are used for the purposes shown, both by programmers and by the DOS macros. The DOS macros for subroutine linking are CALL, SAVE, and RETURN.

Table 8-1. DOS Linkage Registers

Register Number	Register Function	Contents
0	Parameter register	Parameters to be passed to the subroutine.
1	Parameter register or Parameter list register	Parameters to be passed to the subroutine. Address of a parameter list to be passed to either the control program or a user's subroutine.
13	Save area register	Address of the register save area to be used by the subroutine.
14	Return register	Address of the location in the main program to which control should be returned after execution of the subroutine.
15	Entry point register	Address of the entry point in the subroutine.

Let us examine the standard linkage registers. We have been using register 14 for the return register and register 15 for the entry point register. Data may be passed to a subroutine using registers 0 and 1. However, a more common practice is to use register 1 to hold the address of a *parameter list*, because we usually have more data than will fit in two registers. (The expression "parameter list" merely signifies a list of numbers of any desired value.) The parameter list may consist of either data or the addresses of data. Addresses are used more often so that data of varying lengths can be handled easily. One common technique is to write the data and/or data addresses in the instruction

stream immediately following the BALR. This is a point from which the subroutine can readily obtain them.

Figure 8-5 illustrates the use of most of these techniques and includes a subroutine that averages a series of numbers. The main program stores two series of numbers as lists in consecutive fullword locations. The average of each list is to be calculated and stored, so the subroutine will be used twice and each time will return to different points in the main program. To simplify the averaging routine, each list begins with the total number of entries in the list. Each list is identified by its starting address. This address is to be communicated to the subroutine, along with the address at which the subroutine is to store the average.

There are several possible ways to give the necessary information to the subroutine. We chose one that is representative, using BALR and A-type address constants:

```
BALR 1,15      Link to subroutine
DC   A(LIST1)  Address of first parameter list
DC   A(AVER1)  Address of second parameter list
```

The address of the first word of the list and the address at which the average should be stored will immediately follow the BALR that branches to the subroutine. The subroutine will be required to pick up the information it needs from this parameter list. It can find it because it will have the address of the first word after the BALR in register 1, loaded there by the BALR. Of course, prior to this we had to load the address of our subroutine entry point into register 15. This was done by use of the Load Address (LA) instruction. In addition the return address was loaded into register 14. The return address must be carefully calculated to assure that the proper return point is stored. This address is the current value of the assembler's location counter at the *start* of this instruction plus the length of the LA (4 bytes) plus the length of the BALR (2 bytes) plus the length of the two address constants (8 bytes). This could also have been accomplished by labeling the return point and using that in a Load Address instruction. In any case, after we branch to the subroutine, register 1 contains the address of the first DC in the parameter list.

What about register 13, and what is a "save area"? Usually the subroutine will need to use the same registers that are used in the main program, but for different purposes. The main program may use the registers for base addresses, index addresses, intermediate results, or other data vital to the main program. To keep this data from being destroyed by the subroutine it has become conventional to store the contents of these registers in an area called a save area and defined by the main program. This area is 18 words in length in most System/360 systems and its address is stored in register 13 prior to branching to the subroutine. It is aligned on a doubleword boundary. In a standard save area, word 1 is used only by PL/I. Words 2 and 3 are used to trace subroutines that are branched to by

LOC	OBJECT CODE	ADDR1	ADDR2	STMT	SOURCE STATEMENT
				1	PRINT NOGEN
000000				2	LINK3 START 0
000000 0580				3	BEGIN BALR 11,0
000002				4	USING *,11
000002 4100 B086		CC088		5	LA 13,SAVEAREA ADDRESS OF SAVEAREA
000006				6	CNOP 2,4 CONDITIONAL NO-OP FOR ALIGNMENT
000006 41F0 B0CE		00000		7	LA 15,AVER BRANCH ADDRESS
00000A 41E0 B016		CC018		8	LA 14,*+14 RETURN ADDRESS
00000F 051F				9	BALR 1,15 LINK TO SUBROUTINE
000010 0000004C				10	DC A(LIST1) ADDRESS OF FIRST PARAMETER LIST
000014 0000007C				11	DC A(AVER1) ADDRESS OF RESULT
000018 5860 B03E		CC040		12	L 6,A OTHER PROCESSING
00001C 5A60 B042		CC044		13	A 6,B X
000020 5060 B046		CC048		14	ST 6,C X
000024 41C0 B086		CC088		15	LA 13,SAVEAREA ADDRESS OF SAVEAREA
000028 0700				16	CNOP 2,4 CONDITIONAL NO-OP FOR ALIGNMENT
00002A 41F0 B0CE		00000		17	LA 15,AVER RETURN ADDRESS
00002E 41E0 B03A		CC03C		18	LA 14,*+14 LINK TO SUBROUTINE
000032 051F				19	BALR 1,15 LINK TO SUBROUTINE
000034 00000060				20	DC A(LIST2) ADDRESS OF SECOND PARAMETER LIST
000038 00000080				21	DC A(AVER2) ADDRESS OF RESULT
				22	EQJ PROGRAM TERMINATION
00003E 0000					
000040 00000038			25 A	DC F'56'	
000044 0000004D			26 B	DC F'77'	
000048			27 C	DS F	
00004C 00000004			28 LIST1	DC F'4'	NUMBER OF ENTRIES IN LIST 1
000050 0000000A			29	DC F'10'	
000054 0000000C			30	DC F'12'	
000058 00000013			31	DC F'19'	
00005C 0000000F			32	DC F'15'	
000060 00000006			33 LIST2	DC F'6'	NUMBER OF ENTRIES IN LIST 2
000064 0000000B			34	DC F'11'	
000068 00000002			35	DC F'2'	
00006C 00000004			36	DC F'4'	
000070 FFFFFFFD			37	DC F'-3'	
000074 00000005			38	DC F'5'	
000078 FFFFFFFF			39	DC F'-1'	
00007C			40 AVER1	DS F	
000080			41 AVER2	DS F	
000088			42 SAVEAREA	DS 9D	
			43 *		
			44 *	THE END OF THE MAIN PROGRAM	
			45 *		
0000C4 0590			46 AVER	SAVE (14,12)	SAVE REGISTERS
0000D6			49	BALR 9,0	
0000D6 5851 0000		00000	50	USING *,9	
0000DA 4160 0004		00004	51	L 5,0(1)	STARTING ADDRESS
0000DE 5845 0000		CC000	52	LA 6,4	INCREMENT
0000E2 1874			53	L 4,0(5)	NUMBER OF ENTRIES
0000E4 8870 0002		CC002	54	LR 7,4	NUMBER OF ENTRIES
0000E8 1A75			55	SLA 7,2	FOUR TIMES NUMBER OF ENTRIES
0000EA 5870 903A		00110	56	AR 7,5	LIMIT
0000EE 1822			57	S 7,=F'1'	REDUCE BY 1 SO LOOP WILL NOT REPEAT
0000F0 1833			58	SR 2,2	CLEAR TO ZERO
0000F2 5A35 0004		CC004	59	SR 3,3	CLEAR TO ZERO
0000F6 8756 901C		CC0F2	60 LOOP	A 3,4(5)	ADD A VALUE FROM THE LIST
0000FA 1D24			61	BXLE 5,6,LCOP	
0000FC 5851 0004		00004	62	DR 2,4	DIVIDE BY NUMBER OF TERMS
000100 5035 0000		00000	63	L 5,4(1)	PICK UP ADDRESS OF RESULT
			64	ST 3,0(5)	STORE RESULT
			65	RETURN (14,12)	RETURN TO THE MAIN PROGRAM
000000			69	END BEGIN	
000110 00000001			70	=F'1'	

Figure 8-5. A program with a subroutine that averages a series of numbers. The subroutine will be used twice and will store the results at AVER1 and AVER2.

subroutines. Word 2 is the save area address of a preceding routine. Word 3 is the save area address of a succeeding routine. Words 4–18 are the contents of registers 14–12, respectively—that is, all the general registers except register 13.

Note that early in the main program after the usual preliminaries, we load register 13 with the address of the save area. Then follows the CNOP (which we will discuss later on), and the loading of the entry point and return addresses. In the subroutine we begin by saving the contents

of the registers in the save area. This is accomplished through the use of the SAVE macro in DOS, or by regular assembler language Store instructions in systems where this macro is not available. Register 14 is specified as the first register to be stored, and all additional registers are stored simply by specifying the last register to be stored. Thus the registers are stored in the order 14, 15, then 0 through 12. The instruction generated by the SAVE macro is STM 14, 12, 12(13). Therefore the registers are stored in the save area (its address is designated by the contents of register 13)

starting at a point that is twelve bytes past the beginning of the area (we recall that the first three words of the save area are reserved for other data). Now the subroutine can use the registers for its own purposes and, when its processing is finished, can restore the registers to their status when the subroutine was entered. This entire procedure is normal practice; it can almost never be assumed that any registers are available to the subroutine unless their contents are first saved.

Let's proceed with the work performed by the subroutine. Statement 51 gets the address of LIST1 by a Load instruction in which the effective address is simply the contents of register 1. After execution of this LOAD, the address in register 1 (00004C) is placed in register 5 for subsequent use. Stepping through the list will be done with a Branch on Index Low or Equal instruction (BXLE), so we proceed to set up the other parameters required. Register 6 is accordingly loaded with a 4, the increment between locations that must be added on each repetition of the loop. With register 6 containing the increment, register 7 must contain the final address, that is, the starting address plus four times the number of entries.

We load register 4 with the number of entries, which is the first fullword in each list. It is to be left in register 4 for computing the average later. For purposes of controlling the loop, we move it to register 7, shift left two places (in effect multiplying by four), and add the starting address. Since the BXLE will repeat the loop on an equal, we must now reduce the value in register 7 by 1, using the literal term =F'1' to introduce the value one. After clearing registers 2 and 3, we are ready to go into the loop.

A literal term in assembler language is a way of introducing data into a program in a machine instruction, and is (in that one sense only) like immediate data in an SI instruction. It is simply a constant preceded by an equal sign. It represents data rather than a reference to data. It can be used to enter a number for calculation, an address constant, or words or phrases for printing out a message. Unlike immediate data, a literal term is not assembled into the instruction in which it appears. The assembler generates the values of all literals in a program, collects them, and stores them in a "pool," usually at the end of the program. Their addresses, rather than their values, are assembled into the instructions in which they are used, and so literals are considered relocatable.

The Add instruction at LOOP uses as its address the contents of register 5, which is the index register for the loop. The address in register 5 is adjusted by 4 so that we will address the first number to be averaged rather than the number of entries. Between loop repetitions, register 5 is incremented by the contents of register 6, which we set at 4. Each time register 5 is lower than, or equal to, register 7 on comparison, we will branch back to LOOP. The looping stops when all entries in the list have been added to register 3.

To compute the average, which is simply a matter of dividing the contents of registers 2 and 3 (the sum of all the numbers in the list) by the contents of register 4 (the number of entries in the list), a Divide Register instruction (DR) is used. The quotient is the average, which is in register 3. We are now ready to store the average; where does it go? The answer is to be found by looking at the fullword address that is four bytes beyond the address specified by the contents of register 1; the address of the average is placed in register 5 by the Load. A Store instruction using this address now completes the work of the subroutine. By use of the RETURN macro, we restore the registers that had been saved and branch back to the main routine.

The RETURN macro is coded identically to the SAVE macro, that is, the operands are the starting and ending registers to be restored, RETURN 14,12. It restores the saved data to the specified registers and returns to the main program via the return address in register 14. The coding generated by the RETURN macro is a Load Multiple (LM) instruction and an unconditional branch.

Back in the main routine, we do some simple processing using register 6. We can use the same registers as we used in the subroutine because the SAVE and RETURN macros allow each section of programming to view the registers as their own.

We then wish to average another list, LIST2. At statement 15, note that we must again place the address of the save area in register 13 because we must enter the subroutine again. The execution of the subroutine follows the same lines as before, although this time it operates on different data and places the result in a different place.

The CNOP assembler instruction, which we have not discussed so far, appears twice in the main program during the preparations for each branch to the subroutine. The function of the CNOP (Conditional No-Operation) is to make sure that the two address constants appear in storage immediately after the BALR.

If the instruction before the BALR ended on a fullword boundary, the BALR (a two-byte instruction) would then occupy the first two bytes of the next word. The assembler, automatically aligning on a fullword boundary an A-type constant for which no length is specified, would skip two bytes before locating the constant. Then, when the BALR is executed, register 1 would contain the address of the byte following the BALR instruction, but this address would not be correct for the parameter list.

Before reaching the BALR we write the instruction CNOP 2,4. If the assembler's location counter is already set to a value that is two bytes greater than a fullword boundary, the CNOP is ignored, as is the case in statement 6. If not, as is the case in statement 16, the assembler inserts a Branch on Condition (BC) instruction with a mask of zero, which never causes a branch and therefore is equivalent to a "No-Operation". It occupies two bytes and thus causes the para-

meter list to be located immediately following the BALR.

The CNOP in statement 6 has no effect; we see that the location counter is already located as described by the CNOP (that is, it is in the second half of a fullword—000006). Therefore, no instruction is generated for the CNOP. Note that the DC will be on a fullword boundary without skipping any space between the BALR and the address constant.

The CNOP in statement 16 resulted in the creation of a No-Operation instruction because the assembler's location counter is at 000028, which is not two bytes beyond a fullword. If this had not been done, the assembler would have placed the BALR at 000030 and the A-type constant at 000034, thereby leaving a two-byte gap. The next byte after the BALR (000032) would go into register 1. The subroutine's ensuing attempt to call for a fullword from

000032 would have caused a specification exception and a program interruption.

The CNOP could be used before or after the two LA instructions that load the return and entry point addresses into registers 14 and 15. We have used the CNOP ahead of the two LA instructions in this program.

Figure 8-6 shows the two lists of numbers followed by the average of each, as computed by the program in Figure 8-5.

10	12	19	15			14
11	2	4	-3	5	-1	3

Figure 8-6. The data and results of the program in Figure 8-6. The last number in each line is the average.

PROGRAM RELOCATION

In an operating system environment, a program must be processed by the linkage editor program before it can be executed. During the process it is usually relocated, that is, assigned a starting location in main storage other than the locations assigned during assembly. Most programs are run more than once. A standard subroutine may be stored in a part of the system library in relocatable form and be used very frequently. A different core location may be assigned each time. We know that the storage location indicated by the START assembler instruction is tentative. The locations calculated by the assembler merely establish the relative storage locations of data and instructions within a program. Most programs are assembled relative to zero, but are never executed there because of restrictions on the use of lower core. System/360 was designed to run under a control program, and, under operating conditions, part of the control program is always resident in the low region of main storage for handling interruptions, error recovery routines, etc. In many systems this occupies several thousand bytes. Problem programs must be executed beyond this area.

Relocation is necessary for a number of other reasons not of direct interest to the programmer. These are (1) the overall storage requirements of other programs that are to go into core at the same time and (2) various operating considerations dependent upon the type of installation, operating system environment, etc.

The Linkage Editor

When the capabilities of the linkage editor are added to program relocatability, great programming efficiency can be achieved by dividing a large program into separate sections for coding. Each section can be written by a different programmer and compiled and checked out separately. It is even possible to code some of the subroutines in a different programming language. Each part of the programming operation is greatly simplified. Time is saved by having several people work independently and simultaneously on the program. When all the routines have been compiled, they are in relocatable form and can be link edited in any sequence. The linkage editor will assign storage locations and match up all address references between the routines, so that the entire program can be executed correctly as one program. If it should be necessary to correct a routine, only that one routine would have to be reassembled or recompiled and then link edited again with the other routines. This facility also makes it relatively simple to maintain a large program that may have to be updated from time to time.

The output of the assembler (or any language translator) is called an object module. It may consist of a single program or many. We should perhaps use the more exact term *control section*. A control section is the smallest separately relocatable unit of a program. It is an entity declared as such by

the programmer by use of the START statement or another assembler instruction called CSECT. A program may consist of one control section or many control sections.

In an operating system environment, an object module has two major characteristics:

(1) It is relocatable. This means that all address constants are in a form that can be modified to compensate for a change in the starting location.

(2) It is not executable.

The object module may call for other object modules assembled at other times and stored in the system library in relocatable form. Programmers frequently indicate standard I/O or other object modules to be included as subroutines in a new program. This is perfectly feasible. The linkage editor, which is a service program, will find all required modules, process one after the other, and combine them into a single, executable *load module* (or *program phase*, as it is called in some systems).

In Chapter 1 we described the output of the assembler program. The major items of input to the linkage editor program are the object code (or *text*), the external symbol dictionary (ESD), and the relocation dictionary (RLD). (Linkage editor control cards are also included, but will not be covered in this book.)

The text consists of the actual instructions and data fields of one or more control sections in the module. The dictionaries contain the information necessary for the linkage editor to resolve references between different modules.

For each control section in an assembly, the ESD contains its length in bytes, assembled address, and any name given in the START or CSECT statement. Also included is information about any V-type address constants, external references (a linkage symbol used in this control section but defined in another), and entry points (a linkage symbol defined in this control section but used in another).

The relocation dictionary contains all address constants that appear in an assembly. RLD information includes (1) the control section in which the adcon is used as an operand, (2) the control section in which it is defined, (3) whether it is a V-type or other type, (4) how long it is, and (5) the assembled address where it is stored.

The linkage editor, working under control of the job control program, builds up composite dictionaries of the ESD and RLD data found in the object modules. It resolves all linkages between different control sections as if they had been assembled as one object module. It relocates each control section as necessary and assigns the entire load module (or program phase) to a contiguous area of main storage. It adds the relocation factor to the location given by the assembler's location counter at the start of each assembly. It modifies all relocatable address constants to contain the relocated value of their symbols. (Except for adcons, no address values within the instructions and data fields are

changed during link editing. These remain in base and displacement form, as we shall see shortly in the dumps of the next program.) The load module is constructed by building the text in the form in which it will actually be loaded into core; it is then executable and nonrelocatable.

The CALL and PDUMP Macros

Perhaps it would help to clarify just what happens during program relocation if we could see our program in main storage while it is being executed. We can do nearly that by getting a "dump" of storage during execution. In this section we shall see how a program appears, first relocated to one area of storage and then to another. We shall use a program almost identical to the last one, a main program assembled with a subroutine.

In the last program, Figure 8-5, statements 6 through 11 and 16 through 21 were necessary to link to the subroutine, communicate data both ways, and get back to the right point in the main program. We had to be very careful about boundary alignment and using the correct standard linkage registers for the right functions. In DOS all of this can be taken care of very simply by use of the CALL macro, which generates instructions similar to the six statements in the last program. In the program in Figure 8-7 CALL appears in statements 7 and 18.

The CALL macro instruction was designed primarily for use with separately assembled programs to pass control from one program to a specified entry point in another. It works equally well within a single assembly, however, because the assembler and linkage editor carry out their functions just

LOC	OBJECT CODE	ACDR1	ACDR2	STMT	SOURCE STATEMENT	
				1	PRINT NOGEN	
				2	ENTRY AVER	
0C0000				3	LINK4 START 0	
0C0000	05B0			4	BEGIN BALR 11,0	
0C0002				5	USING *,11	
0C0002	41D0 B08E		0C090	6	LA 13,SAVEAREA	ADDRESS OF SAVEAREA
				7	CALL AVER,(LIST1,AVER1)	LINK TO SUBROUTINE
000018	5860 B046		0C048	14	L 6,A	OTHER PROCESSING
00001C	5A60 B04A		0C04C	15	A 6,B	X
0C0020	5060 B04E		0C050	16	ST 6,C	X
000024	41D0 B08E		0C090	17	LA 13,SAVEAREA	ADDRESS OF SAVEAREA
				18	CALL AVER,(LIST2,AVER2)	LINK TO SUBROUTINE
				25	PDUMP BEGIN,BEGIN+X*200*	DUMP ROUTINE
				30	EOJ	PROGRAM TERMINATION
000048	00000038			33	A DC F*56*	
0C004C	00000040			34	B DC F*77*	
000050				35	C DC F	
0C0054	00000004			36	LIST1 DC F*4*	NUMBER OF ENTRIES IN LIST 1
000058	0000000A			37	DC F*10*	
0C005C	0000000C			38	DC F*12*	
000060	00000013			39	DC F*19*	
0C0064	0000000F			40	DC F*15*	
0C0068	00000006			41	LIST2 DC F*6*	NUMBER OF ENTRIES IN LIST 2
0C006C	00000008			42	DC F*11*	
0C0070	00000002			43	DC F*2*	
0C0074	00000004			44	DC F*4*	
000078	FFFFFFFFD			45	DC F*-3*	
0C007C	00000005			46	DC F*5*	
0C0080	FFFFFFFFF			47	DC F*-1*	
0C0084				48	AVER1 DS F	
0C0088				49	AVER2 DS F	
0C0090				50	SAVEAREA DS 9D	
				51	*	
				52	* THE END OF THE MAIN PROGRAM	
				53	*	
				54	AVER SAVE (14,12)	SAVE REGISTERS
0000CC	0590			57	BALR 9,0	
0C00DE				58	USING *,9	
0000DE	5851 0000		0C000	59	L 5,0(1)	STARTING ADDRESS
0C00E2	4160 0004		0C004	60	LA 6,4	INCREMENT
0000E6	5845 0000		0C000	61	L 4,0(5)	NUMBER OF ENTRIES
0C00EA	1874			62	LR 7,4	NUMBER OF ENTRIES
0000EC	8B70 0002		0C002	63	SLA 7,2	4(NUMBER OF ENTRIES)
0000F0	1A75			64	AR 7,5	LIMIT
0C00F2	5870 904E		0012C	65	S 7,=F*1*	REDUCE BY 1 SO LOOP WILL NOT REPEAT
0000F6	1B22			66	SR 2,2	CLEAR TO ZERO
0000F8	1B33			67	SR 3,3	CLEAR TO ZERO
0000FA	5A35 0004		0C004	68	LOOP A 3,4(5)	ADD A VALUE FROM THE LIST
0000FE	8756 901C		0C004	69	BXLE 5,6,LCOP	
0C0102	1C24		0C004	70	DR 2,4	DIVIDE BY NUMBER OF TERMS
000104	5851 0004		0C004	71	L 5,4(1)	PICK UP ADDRESS OF RESULT
000108	5035 0000		0C000	72	ST 3,0(5)	STORE RESULT
				73	RETURN (14,12)	RETURN TO THE MAIN PROGRAM
0C0000				77	END BEGIN	
0C0118	5B5BC2C7C4E4D4D7			78	=CL8*\$\$BPDUMP*	
0C0120	000000C00000200			79	=A(BEGIN,BEGIN+X*200*)	
0C0128	00000000			80	=V(AVER)	
00012C	00000001			81	=F*1*	

Figure 8-7. A slightly different version of the program in Figure 8-5, modified by use of two macro instructions, CALL and PDUMP

the same. As our program example is organized, the macro requires (1) the symbolic address of the entry point (AVER) as operand, which generates a V-type address constant, and (2) the separate ENTRY AVER statement. Since this is not a typical example of the ENTRY assembler instruction, it would be preferable to wait for the next program example before discussing it. The addresses of the parameter lists also appear in the operand field of the CALL macro, in parentheses, and will be in register 1 (the parameter list register) when the called subroutine is entered.

The first three literals that appear at the end of the assembly appeared in the instructions generated by the PDUMP and CALL macros. As it was written, the CALL generates a V-type address constant rather than the A-type. We note that zeros and not the address of AVER are assembled in statement 80. This address will be supplied later by the linkage editor.

Our plan for the program shown assembled in Figure 8-7 is to have it link edited, and, using linkage editor control cards, have it loaded and executed first at storage location 3000₁₆, and then at 4000₁₆. Re-assembly is not necessary. The linkage editor can override these cards, but will accept the instructions if they do not create a problem. Normally the programmer is not involved in the question of where a program is to be loaded. The storage area from which a program executes is properly an operational, not a programming, decision.

The DOS PDUMP macro causes the system, during program execution, to print out a hexadecimal dump of all the registers and any particular area of storage we are interested in. Such a dump is often used for program checkout, and learning to read one is a worthwhile exercise. We decide we want to see the state of affairs in storage at just the point when all calculations have been executed and the results stored, so we insert the PDUMP just before the EOJ. It will be reached just once, after the second execution of the subroutine.

The programmer must supply two address expressions in the operand field of the PDUMP to show the beginning and end of the storage area wanted. One or both of the addresses may be given in registers, but, since we want a dump from two different core locations, we use symbolic

addresses. BEGIN will give us the beginning of the program, and BEGIN+200 is more than enough space to take us through to the end, as we know from the previous assembly of a similar program. Execution of the PDUMP macro will make no difference in execution of the program; processing will continue with the next sequential instruction. (Some other types of dumps result in termination of the program.)

Reading a Dump

Figure 8-8 shows the entire dump that was printed out (this is done by a line printer) during the first execution of the program in Figure 8-7. After assembly the program was link edited, loaded at 3000, and executed almost to the end. The point at which we see the dump is immediately after execution of the PDUMP macro. The EOJ macro instruction has not yet been reached.

A hexadecimal format is used because it represents the binary contents exactly. The contents of all the registers are shown at the top of the printout. General registers 0-7 are in the first line, and 8-15 in the second, a fullword each. The doubleword floating-point registers 0, 2, 4, and 6 are in the third line.

Next comes the hex dump of main storage. The six-digit column at the left shows the storage location of the first byte in each line. There are 20₁₆ (or 32₁₀) bytes to a line, divided into fullwords. Locating an address is simplified by the wide space in the center of each line; the next byte after this space is simply hex 10 beyond the location in the lefthand column. For example, in the line that begins at 003020, the B0 in the fifth fullword is at location 003030. The last two bytes in this line are at 00303E and 00303F. The entire storage area shown is from 003000 to 0031FF, since the boundaries given in the PDUMP macro were BEGIN and BEGIN+X'200'. Printing of repeated lines of zeros at the end is suppressed.

At the extreme right, any alphameric characters in a line are also represented in characters. In many cases this is very helpful in interpreting the hexadecimal material and speeds up analysis of a dump. It is not particularly useful in our program, however, so the characters will be omitted to let us get a closer look at the hex. The reader may wish to arm

GR 0-7	00003120	00003118	0C00FFFF	00002800	CC00FF84	FFFFFF7C	00000085	00002798		
GR 8-F	00004142	0A0407F1	0C002810	40003002	CC003698	0C003090	0000303C	000030D8		
FP REG	4431F800	8F5C28F5	4431F800	8F5C28F5	4752F1E8	6828F5C1	D200D000	B0000000		
003000	05B041D0	B08E58F0	812641E0	8016051F	CC003054	00003084	58608046	5A60804A0.....-...-..
003020	5060804E	41D0808E	070C58F0	812641E0	BC3A051F	00003068	0C003088	4110B116	E.....0.....
003040	4100B11E	0A020A0E	0C00C038	00000040	CC000085	00000C04	0000000A	0000000C
003060	00C00013	0000000F	000C0006	00CC0C0B	CC00C002	0C000004	FFFFFFFD	00000005
003080	FFFFFFF7	0C00000E	000C0003	00000C00	CC00C000	00000000	00000000	0000303C
0030A0	000030D8	00003000	60003034	0000FFFF	CC002800	0000FF84	FFFFFF7C	00000085	..Q.....2.....
0030C0	00002798	00004142	0A0407F1	00002810	4C003002	00003698	90EC000C	059058511.....
0030E0	00004160	00045845	0C001874	8B700002	1A755870	904E1822	1B335A35	00048756\$.....
003100	901C1D24	58510004	50350000	98ECD00C	07FE000C	0C000000	585BC2D7	C4E4D4D7E.....\$BPDUMP
003120	00003000	00003200	000030D8	00000C01	0C00C000	00000000	0C000000	00000000Q.....
003140	00000000	--SAME--							
0031E0	00000000	00000000	00000000	00000000	0C000000	00000000	00000000	00000000

Figure 8-8. Hex dump of registers and storage produced by execution of the PDUMP macro in the program in Figure 8-7. At right, EBCDIC characters are represented by characters.

himself with the card *IBM System/360 Reference Data* (see Preface), which is helpful for reading a dump.

Figures 8-9 and 8-10 show the dumps with the program loaded first at 3000 and then at 4000. Key areas have been labelled to help the reader tie the dump listing to the assembly listing. In Figure 8-9 at location 3000 is 05B0, which is the object code for BALR 11,0. Next is 41D0 B08E, which is for the instruction LA 13,SAVEAREA (see assembly listing). Next is the first CALL. Next is 5860 B046 for the instruction L 6,A. In this way, the entire program was

entered into storage and the registers, instruction by instruction and DC by DC, just as it appears in the object code. This dump was printed after execution, however, and therefore the storage areas and registers affected by the instructions have been altered in accordance with the operations they specified.

Let's see what happened when execution of this program began. The linkage editor supplied the starting address 3000, and the program was loaded starting there. BALR was executed; it put the current address from the PSW (by now

	BALR 11,0	AVER1 & AVER2		BASE ADDRESS	ADDRESS OF SAVE AREA	RETURN ADDRESS	ADDRESS OF SUBROUTINE
GR 0-7	00003120	00003118 0000FFFF	00002800	CCCCFF84	FFFFFF7C	00000085	00002798
GR 8-F	00004142	0A0407F1 00002810	40003002	CCCC3698	00003090	0000303C	00003008
FP REG	4431F800	8F5C28F5 4431F800	8F5C28F5	4752F1E8	6828F5C1	D200D000	B0000000
							1ST CALL
003000	05B041D0	B08E58F0 B12641E0	B016051F	0CC03054	00003084	5860B046	5A60B04A
003020	5060B04E	41D0B08E 070C58F0	B12641E0	BC3A051F	00003068	00003088	4110B116
003040	4100B11E	0A020A0E 0CCCC038	0000004D	CC000085	00000004	0000000A	0000000C
003060	00C00013	0000000F 00000006	0000000B	CC000002	00000004	FFFFFFFD	00000005
003080	FFFFFFFF	0000000E 00000003	00000000	CCCC0000	00000000	00000000	0000303C
0030A0	000030D8	00003000 60003034	0000FFFF	CCC02800	0000FF84	FFFFFF7C	00000085
0030C0	00002798	00004142 0A0407F1	00002810	4CC03002	00003698	90ECD00C	05905851
0030E0	00004160	00045845 00001874	8B700002	1A755870	904E1B22	1B335A35	00048756
003100	901C1D24	58510004 50350000	98ECD00C	07FE0000	00000000	585BC2D7	C4E4D4D7
003120	00003000	00003200 000030D8	0000CC01	0C000000	00000000	00000000	00000000
003140	00000000	--SAME--					
0031E0	00000000	00000000 00000000	00000000	0C000000	00000000	00000000	00000000
	2 ADCONS = A(BEGIN) = A(BEGIN + X'200')	ADCON = V(AVER)	LIST2	START OF SAVE AREA	LIST1	START OF SUBROUTINE - THIS IS LOCATION 30D8	

Figure 8-9. Hex dump of the program (Figure 8-7) loaded at 3000

	BALR 11,0	AVER1 & AVER2		BASE ADDRESS	ADDRESS OF SAVE AREA	RETURN ADDRESS	ADDRESS OF SUBROUTINE
GR 0-7	00004120	00004118 0000FFFF	00002800	0000FF84	FFFFFF7C	00000085	00002798
GR 8-F	00004142	0A0407F1 00002810	40004002	00003698	00004090	0000403C	00004008
FP REG	3F28F5C2	8F5C28F5 3F28F5C2	8F5C28F5	49D78C88	30B47ADD	D200D000	B0000000
							1ST CALL
004000	05B041D0	B08E58F0 B12641E0	B016051F	00004054	00004084	5860B046	5A60B04A
004020	5060B04E	41D0B08E 070058F0	B12641E0	B03A051F	00004068	00004088	4110B116
004040	4100B11E	0A020A0E 00000038	0000004D	00000085	00000004	0000000A	0000000C
004060	00000013	0000000F 00000006	0000000B	00000002	00000004	FFFFFFFD	00000005
004080	FFFFFFFF	0000000E 00000003	00000000	00000000	00000000	00000000	0000403C
0040A0	000040D8	00004000 60004034	0000FFFF	00002800	0000FF84	FFFFFF7C	00000085
0040C0	00002798	00004142 0A0407F1	00002810	40004002	00003698	90ECD00C	05905851
0040E0	00004160	00045845 00001874	8B700002	1A755870	904E1B22	1B335A35	00048756
004100	901C1D24	58510004 50350000	98ECD00C	07FE0000	00000000	585BC2D7	C4E4D4D7
004120	00004000	00004200 000040D8	00000001	00000000	00000000	00000000	00000000
004140	00000000	--SAME--					
0041E0	00000000	00000000 00000000	00000000	00000000	00000000	00000000	00000000
	2 ADCONS = A(BEGIN) = A(BEGIN + X'200')	ADCON = V(AVER)	LIST2	START OF SAVE AREA	LIST1	START OF SUBROUTINE - THIS IS LOCATION 40D8	

Figure 8-10. Hex dump of the program (Figure 8-7) loaded at 4000

updated to the next available byte, 3002) into register 11 for use as a base address. We see that 3002 is still in register 11. (System/360 uses the rightmost 24 bits of a register for its addressing scheme and ignores the leftmost byte. The 40 here has no effect.)

Next the LA (41D0 B08E) puts the address of SAVEAREA into register 13. This address in the instruction is in the form of a base register and displacement. Will it be correct now that the program has been relocated? The address is arrived at by adding 003002 (the contents of base register 11) and 08E (the displacement) = 003090. The assembly shows 000090 for SAVEAREA, and we shall see that this is where the SAVE macro stores the contents of the registers.

Skipping the CALL, the next instruction (5860B046) loads the value of A into register 6. It looks for A in location $003002 + 046 = 003048$. In the assembly, at 000048, we have a DC named A for a fullword of decimal value 56 (this is hex 38), and that is the value at location 003048 in the dump. Continuing in the same fashion with the next instruction (5A60B04A), we see that B (77_{10} or $4D_{16}$) is added to A in register 6. The total in register 6, which is not affected by any later instruction, is 85. This is the hex equivalent of decimal 133, and it is correct. The next instruction (5060B04E) does indeed store the total of 85 in C, location $003002 + 04E = 003050$, where a fullword was reserved by a DS.

In this way it is entirely possible to follow the workings of a program. Registers that are not used in a program may have values left over from previous runs—the floating-point registers here, for example. The contents of any register or

storage area that is used during a program will be the result of the *last* processing in it before execution of the PDUMP.

To check on the matter of maintaining linkages when a program is relocated, let's look at registers 11 (the base register), 14 (the standard return register), and 15 (the standard entry point register) in both dumps. These are different by the amount 1000, the difference between a relocation factor of 3000 and one of 4000. We also note that, beginning at word 4 in the save area (this program does not use words 1, 2, and 3), we have the contents of registers 14, 15, and 0 through 12 as they were in each case when the SAVE was executed. The code and data produced by the CALL macro can be checked fairly closely by going back to the assembly of the program in Figure 8-5. In this program the CALL generated a V-type address constant for the address of the subroutine, and it was assembled as 000000. The linkage editor supplied the values 30D8 and 40D8 from calculations on ESD and RLD data (although, as we know, a V-type adcon is not really necessary in a single assembly). The PDUMP generated two A-type adcons, and the linkage editor supplied their new values simply by adding the relocation factor (3000 and 4000 in these examples) to the assembled values.

We may also see, from a comparison of the instructions and data constants in both dumps, that the linkage editor does not change any assembled object code except for relocatable address constants. To find a storage address, the CPU simply uses a base-plus-displacement calculation. No matter where in main storage a program is loaded, the relative locations of elements within the program always remain the same.

COMMUNICATION BETWEEN SEPARATE PROGRAMS

The preceding examples have shown how it is possible for a program to keep track of addresses within itself during program relocation. We now turn to the important related question: how do two programs that are assembled separately keep track of addresses in each other, even if they are both relocated by different amounts?

Let us investigate this question in terms of the program in Figures 8-5 and 8-7. This time we shall assemble the main program and the subroutine separately. This method allows subroutines, written and tested separately, to be used in any program. Out of the two assemblies we shall get two object programs which we wish to be able to load at the same time, relocating them by different amounts, and have everything work just as it did before. Once again, we shall use AVER as the entry point into the subroutine, but this time the assembler will have no way of knowing its assembled location. In the single assembly in Figure 8-5, when we wanted to load the address of AVER into register 15, the assembler simply calculated a base-plus-displacement address. If we were to take the main program part of Figure 8-5 and assemble it, AVER would be an undefined symbol, and the assembly could not be completed.

We seem to need some way to say to the assembler: "AVER is a symbol that is *used* in this program but *defined* elsewhere. Whenever you find the symbol AVER, which will be only in address constants, assemble zeros and mark the location as one that will be supplied during the link editing of the object program".

This is precisely what the assembler instruction EXTRN does. We place the EXTRN at the beginning of the program, identify AVER in the operand field, and leave the name field blank. This will cause the action outlined above. The symbol AVER will then be treated, not as an undefined symbol, but as an external symbol defined outside this program.

Figure 8-11 is the assembly listing of the main program. It includes the CALL macro instruction the same as before. An assembler TITLE instruction has been used in order to get identification (in this case, MAIN) into the object deck in columns 73-76, thus distinguishing this object deck from others. Just before the START is the EXTRN. Nothing is printed on the program listing to describe the action of the EXTRN. What it does is to cause an external reference to be listed in the assembler's external symbol

MAIN CALLING PROGRAM FOR SEPARATE ASSEMBLY AND RELOCATION						
LOC	OBJECT CODE	ADDR1	ADDR2	STMT	SOURCE	STATEMENT
				2		PRINT NOGEN
				3		EXTRN AVER
000000				4	MAIN1	START 0
0C0000	05B0			5	BEGIN	BALR 11,0
0C0002				6		USING *,11
000002	41D0	B096	00098	7	LA	13,SAVEAREA ADDRESS OF SAVEAREA
				8	LCAD	SUBR
				14	CALL	AVER,(LIST1,AVER1) LINK TO SUBROUTINE
000020	5860	B04E	00050	21	L	6,A OTHER PROCESSING
000024	5A60	B052	0C054	22	A	6,B X
000028	5060	B056	0C058	23	ST	6,C X
0C002C	41D0	B096	00098	24	LA	13,SAVEAREA ADDRESS OF SAVEAREA
				25	CALL	AVER,(LIST2,AVER2) LINK TO SUBROUTINE
				32	PDUMP	BEGIN,BEGIN+X*200' DUMP ROUTINE
				37	EGJ	PROGRAM TERMINATION
000050	00000038			40	A	DC F*56'
000054	0000004D			41	B	DC F*77'
0C0058				42	C	DS F
00005C	00000004			43	LIST1	DC F*4' NUMBER OF ENTRIES IN LIST 1
000060	0000000A			44		DC F*10'
0C0064	0000000C			45		DC F*12'
0C0068	00000013			46		DC F*19'
00006C	0000000F			47		DC F*15'
0C0070	00000006			48	LIST2	DC F*6' NUMBER OF ENTRIES IN LIST 2
0C0074	0000000B			49		DC F*11'
0C0078	00000002			50		DC F*2'
0C007C	00000004			51		DC F*4'
0C0080	FFFFFFFF			52		DC F*-3'
0C0084	00000005			53		DC F*5'
0C0088	FFFFFFFF			54		DC F*-1'
0C008C				55	AVER1	DS F
000090				56	AVER2	DS F
000098				57	SAVEAREA	DS 9D
				58	*	
				59	*	THE END OF THE MAIN PROGRAM
				60	*	
0C0000				61	END	BEGIN
0000E0	E2E4C2C940404040			62		=CL8'SUBR'
0C00EB	5B5BC2C7C4E4D4D7			63		=CL8'\$\$BPDUMP'
0C00F0	000C00CC0CC0200			64		=A(BEGIN,BEGIN+X*200')
0C00F8	000000C0			65		=V(AVER)

Figure 8-11. The same main program assembled separately. The EXTRN assembler instruction and the LOAD macro have been added.

dictionary. When the linkage editor encounters the named symbol in another control section, it will resolve the ESD item. It happens that the V-type address constant =V(AVER) generated by the CALL macro is also entered in the ESD (and the relocation dictionary), so we have some duplication of effort here. Normally, we would be likely, with an EXTRN statement, to set up the linkage through use of an A-type address constant.

The subroutine (Figure 8-12) has been assembled separately with its own START statement. What about AVER, which is defined here by being used as the name of a statement? Does the symbol have to be identified in any way? The answer is yes, it does. If the subroutine had been assembled just as it was in Figure 8-7, there would be nothing to indicate to the assembler (and later to the linkage editor) that there was anything special about AVER. But there is something special: this symbol is used in the link editing process to supply information missing in the main program. The assembler cannot know this without explicit notification, because we are not assembling the two programs at the same time. What is used is the ENTRY assembler instruction, which says that the symbol given in the operand field is used by some other program, but is defined in this one. AVER also appears in the program in Figure 8-12 as the name of a statement, as required.

If AVER were the name of the program (that is, if it were given in either a START or CSECT statement), it would be listed in the ESD without further ado, and the ENTRY statement would not be necessary. However, we have chosen to name the subroutine SUBR. It is important, for linkage purposes, for the subroutine to have a name. The assembler can process an ENTRY statement that con-

tains a symbol defined in an unnamed control section, but the (DOS) linkage editor cannot process the resulting deck.

Except for the LOAD macro in the main program and another PDUMP in the subroutine, the balance of the two programs in Figures 8-11 and 8-12 is the same as before. The subroutine, we recall, is to be entered twice. The LOAD macro was used to bring in the separate subroutine load module (or program phase), although this might have been done by other means.

After completion of the assemblies, the two programs were link edited, and the main program was loaded at 3000 and the subroutine at 4000. Execution produced three dump printouts (Figures 8-13, 8-14, and 8-15). These are shown in the order in which they were executed. Figure 8-13 shows a printout of the contents of the registers and the storage area of interest produced by the PDUMP during the first execution of the subroutine, Figure 8-14 during the second execution. Figure 8-15 was produced by execution of the PDUMP in the main program. Various locations in the dumps are identified to help the reader follow the sequence of operations in the registers and main storage, as described below. A careful study of the dumps will help to make clear exactly how communication between programs is maintained and how control is returned to the correct points, even with separate assembly and relocation by different factors. This capacity is not limited to just two programs or control sections. A subroutine may link to another subroutine, which may link to another, etc. Also, one control section can refer to many external symbols and have many entry points from other programs.

The sequence of events, in brief, during execution of the programs in Figures 8-11 and 8-12 was as follows. We can

SUBROUTINE FOR SEPARATE ASSEMBLY AND RELOCATION						
LOC	OBJECT CODE	ADDR1	ADDR2	STMT	SOURCE STATEMENT	
				2	PRINT NGEN	
				3	ENTRY AVER	
000000				4	SUBR START 0	
				5	AVER SAVE (14,12)	SAVE REGISTERS
000004	0590			8	BALR 9,0	
000006				9	USING *,9	
000006	5851 0000	00C00		10	L 5,0(1)	STARTING ADDRESS
00000A	4160 0004	00C04		11	LA 6,4	INCREMENT
00000E	5845 0000	00C00		12	L 4,0(5)	NUMBER OF ENTRIES
000012	1874			13	LR 7,4	NUMBER OF ENTRIES
000014	8870 0002	00C02		14	SLA 7,2	4(NUMBER OF ENTRIES)
000018	1A75			15	AR 7,5	LIMIT
00001A	5B70 9052	00C58		16	S 7,=F'1'	REDUCE BY 1 SO LOOP WILL NOT REPEAT
00001E	1B22			17	SR 2,2	CLEAR TO ZERO
000020	1B33			18	SR 3,3	CLEAR TO ZERO
000022	5A35 0004	00C04		19	A 3,4(5)	ADD A VALUE FROM THE LIST
000026	8756 901C	00C22		20	BXLE 5,6,LCOP	
00002A	1C24			21	DR 2,4	DIVIDE BY NUMBER OF TERMS
00002C	5851 0004	00C04		22	L 5,4(1)	PICK UP ADDRESS OF RESULT
000030	5035 0000	00C00		23	ST 3,0(5)	STORE RESULT
				24	PDUMP AVER,AVER+X'100'	
				29	RETURN (14,12)	RETURN TO THE MAIN PROGRAM
000000				33	END AVER	
000048	5B5BC2C7C4E4D4D7			34	=CL8*\$\$BPDPUMP*	
000050	0000000000000100			35	=A(AVER,AVER+X'100')	
000058	00000001			36	=F'1'	

Figure 8-12. The same subroutine assembled separately. The START and ENTRY assembler instructions and the PDUMP macro have been added.

	SUBR BASE ADDRESS		MAIN1 BASE ADDRESS		ADDRESS LIST1	INCREMENT OF AVER1	INCREMENT FOR LOOP	END OF LOOP	
GR 0-7	00004050	00004048	CCCC0000	00000C0E	0CC00004	0000308C	00000004	00003068	
GR 8-F	00004142	40004006	00002810	40003C02	0CC03698	00003098	00003020	00004000	
FP REG	4431F800	8F5C28F5	4431F800	8F5C28F5	4752F1E8	6828F5C1	D200D000	B0000000	RETURN ADDRESS
004000	90ECD00C	05905851	00004160	00045845	C0001874	8B700002	1A755870	90521822	
004020	1B335A35	00048756	901C1D24	5851CC04	50350C00	41109042	4100904A	0A0298EC	
004040	D00C07FE	00000000	585BC2D7	C4E4D4D7	C0C04000	00004100	00000001	00000000	
004060	00000000	--SAME--							
0040E0	00000000	0C000000	00000C00	00000000	0C000000	00000000	00000000	00000000	
	SAVE MACRO	BALR 9,0	START OF LITERAL POOL	ST 3,0(5)	START OF PDUMP MACRO				

Figure 8-13. First dump produced by the subroutine in Figure 8-12, SUBR

	SUBR BASE ADDRESS		MAIN1 BASE ADDRESS		ADDRESS LIST2	INCREMENT OF AVER2	INCREMENT FOR LOOP	END OF LOOP	
GR 0-7	00004050	00004048	CCCC00C0	00000003	0CC00006	00003090	00000004	00003087	
GR 8-F	00004142	60004006	00002810	40003002	0CC03698	00003098	00003044	00004000	
FP REG	4431F800	8F5C28F5	4431F800	8F5C28F5	4752F1E8	6828F5C1	D200D000	B0000000	RETURN ADDRESS
004000	90ECD00C	05905851	00004160	00045845	C0001874	8B700002	1A755870	90521822	
004020	1B335A35	00048756	901C1D24	58510C04	50350C00	41109042	4100904A	0A0298EC	
004040	D00C07FE	00000000	585BC2D7	C4E4D4D7	C0C04000	00004100	00000001	00000000	
004060	00000000	--SAME--							
0040E0	00000000	00000000	00000C00	00000C00	0C0C0000	00000000	00000000	00000000	

Figure 8-14. Second dump produced by the subroutine in Figure 8-12, SUBR

	LOAD MACRO	BASE ADDRESS	ADDRESS OF SAVE AREA	RETURN ADDRESS	ADDRESS OF SUBROUTINE	
GR 0-7	000030F0	000030E8	0000FFFF	00002800	CCC0FF84	FFFFFF7C
GR 8-F	00004142	0A0407F1	00002810	40003002	C0003698	00003098
FP REG	4431F800	8F5C28F5	4431F800	8F5C28F5	4752F1E8	6828F5C1
003000	058041D0	80964110	80DE1B00	0A0458F0	B0F641E0	801E051F
003020	5860B04E	5A60B052	5060B056	41D0B096	070058F0	80F641E0
003040	00003090	4110B0E6	4100B0EE	0A020A0E	CC000038	0000004D
003060	0000000A	0000000C	00000013	0000000F	00000006	00000008
003080	FFFFFFFFD	C0000005	FFFFFFFF	0000000E	00000003	00000000
0030A0	00000000	00003044	00004000	00000000	6C00303C	0000FFFF
0030C0	FFFFFFF7C	00000085	00002798	00004142	CA0407F1	00002810
0030E0	E2E4C2D9	40404040	585BC2D7	C4E4D4D7	0CC03000	00003200
003100	00000000	--SAME--				
0031E0	00000000	00000000	00000C00	00000C00	0C000000	00000000
	PDUMP	AVER1	EOJ	START OF 2 ND CALL	AVER2	START OF SAVE AREA

Figure 8-15. Dump produced by the main program in Figure 8-11, MAIN1

follow these events fairly clearly in the dumps, remembering that each dump is produced at just one particular point during processing.

1. The calling program MAIN1 began with execution of the BALR 11,0 that is at 3000, then LA, then the LOAD macro.

2. The LOAD caused the subroutine load module to be entered into core beginning at 4000, and control to be returned to MAIN1.

3. Next, in MAIN1, execution of the CALL macro (see Figure 8-5 for the actions included) branched to and turned control over to the called program SUBR. It also informed SUBR where to find the parameter list and where to place the final result. We note that the last two fullwords in the CALL macro, as shown in the dump in Figure 8-15, are the addresses of LIST1 and AVER1.

4. SUBR was executed once, beginning with the SAVE macro at 4000, which stored the existing contents of all the general registers in the save area beginning at location 3098. Every instruction in SUBR was executed in turn, including repetitions of the loop, through the PDUMP macro. The reader may wish here to go back to the discussion about the subroutine in Figure 8-5 for a detailed review of the processing included.

5. The dump in Figure 8-13 was produced at this point. We note that the averaging calculations in SUBR used registers 2, 3, 4, 5, 6, and 7, and that its base address was in register 9. All this is reflected in the contents of these registers in Figure 8-13.

6. The final instruction in SUBR, the RETURN macro, restored the original contents of the registers from the save area and returned control to MAIN1 at location 3020 (L 6,A in statement 14).

7. MAIN1 then did its processing in register 6, and stored the result (85) at C (the fullword at 3058). It again

loaded the save area address in register 13 and executed the second CALL.

8. Beginning at the same location as before (4000), SUBR was executed again in its entirety. The contents of the registers were stored, the registers used, and the contents restored in the same way; and then control was returned to MAIN1. The dump in Figure 8-14 was produced before the registers were restored.

9. This time control was returned to MAIN1 at location 3044, where the PDUMP macro was immediately executed, producing Figure 8-15. Next came the EOJ at location 304E, and, with the Supervisor Call instruction (OAOE), control went back to the control program.

The remaining coding in the dump in Figure 8-15 is not executable, but consists of the constants and storage areas we set up in the original program and also those generated by the various macros. We note that the last item (at 30F8) is a value of 4000 for =V(AVER), the address constant for AVER. This was assembled as 00000000. The value was supplied by the linkage editor.

Two observations can be made from this review of the programs' execution. The first is that program linkage is closely related to the specification of base registers for each program. Throughout execution, the base-plus-displacement addressing system continues to work efficiently on the basis of the values originally assigned by the assembler. Second, communication between programs is easily maintained as long as the data and addresses needed by each is in a known location. When routines are written by different programmers and assembled separately, communication is simplified by use of standard linkage registers for specific functions. Although details differ in certain respects, the necessary linkages can be established similarly in all the operating systems by use of either regular assembler language instructions or macro instructions.

QUESTIONS AND EXERCISES

- 1a. What functions does BALR 14,15 perform?
- b. What functions does BAL 14,SUB perform?
- c. What instruction is used to return to the main program after either a. or b. above?

2. Match register numbers with their conventional usage.

REGISTER

- | | |
|----|--------------------------------|
| 1 | a. return address |
| 13 | b. address of subroutine entry |
| 14 | c. save area address |
| 15 | d. address of parameter list |
3. List 5 operations that are performed by the CALL macro.
 4. The CNOP updates the value in the instruction counter during the first phase of the assembly process. If the counter is now at a value of 000402, what will it be after

each of the following:

- | | | |
|----|------|-----|
| a. | CNOP | 0,8 |
| b. | CNOP | 0,4 |
| c. | CNOP | 4,8 |
| d. | CNOP | 6,8 |
| e. | CNOP | 2,8 |
| f. | CNOP | 2,4 |
- 5a. What is generated by a SAVE (14,12)?
 - b. What is generated by a RETURN (14,12)?
 - 6a. When a program is branching to an instruction not defined within the confines of that program, what instruction is needed?
 - b. When a program is to be branched to from another program, what may be used to identify the label of the instruction to be executed first?

Chapter 9: Floating-Point Arithmetic

With the growing use of mathematical and statistical methods to solve business and industrial problems, floating-point arithmetic, long the province of scientists and engineers, is being used more and more by commercial programmers. Although FORTRAN and PL/I are far more efficient for the programmer who wants to solve a complex mathematical problem, floating-point arithmetic can simplify programming in assembler language when the values used in a computation cover a very wide range or are unpredictable. This is so because, in floating-point operations, the machine automatically keeps track of the decimal or binary point and the alignment of intermediate arithmetic results. The programmer need not expend the time and effort required to do this in involved decimal or binary calculations.

Floating-point arithmetic may also save considerable storage space when the values used are either very small or very large. A value up to approximately 7×10^{75} can be expressed in just four bytes. That number is equivalent to 7 followed by 75 zeros. Represented in packed decimal, it would use up over 30 bytes of storage. Since all floating-point numbers are exactly either four or eight bytes in length (at the option of the programmer), he reaps some additional benefits. He does not need to estimate the maximum possible sizes of his data, intermediate results, and

final results for purposes of reserving sufficient space. Also, he does not run the risk of losing high-order digits from a register. He can, in fact, perform most calculations almost as directly as he would by hand.

The System/360 floating-point feature performs the same arithmetic calculations as decimal and binary instructions: addition, subtraction, multiplication, and division. There are also similar instructions for comparing, loading, and storing. Just one different kind of instruction is included: the Halve instruction, which has the effect of dividing by two. The entire floating-point instruction set, although it may appear long and complicated (the list is presented later in this chapter), consists only of variations of these basic operations. These variations permit the programmer to choose between (1) long-precision and short-precision numbers, (2) normalized and unnormalized addition or subtraction, and (3) register-to-register and storage-to-register operations.

This brief chapter describes how floating-point numbers are represented in System/360, shows a few examples of floating-point instructions, and explains the new terms used in the preceding paragraph. It is a simplified introduction to the subject for the non-mathematician who may have some curiosity about floating-point operations or who may anticipate using the floating-point feature.

FLOATING-POINT NUMBERS

Floating-point numbers are expressed in a form similar to that commonly used for scientific notation, which is a concise means of expressing very large or very small numbers. For example, the mean distance from the earth to the sun is roughly 93,000,000 miles. In scientific notation, we would give this number as $9.3 \cdot 10^7$. This expression consists of two factors, the significant digits multiplied by a power of 10. The exponent 7 indicates that the base 10 is to be multiplied by itself seven times, and this will give the entire number the proper magnitude. The number base need not be 10, but it is the most common and the easiest for us to understand. The base might be 2 or 8 or 9 or 12 or whatever. In fact, in System/360 it is 16. Let's look at a couple of other examples of scientific notation in base 10. A light year, which is a common term for expressing large distances, represents a distance of 5,880,000,000,000 (or $5.88 \cdot 10^{12}$) miles. A unit that may be used for measuring the wavelength of light is 0.00000001 (or $0.1 \cdot 10^{-7}$) centimeters.

A number in this form of notation is generally, but not always, expressed with one integer to the left of the decimal point. Sometimes it is more convenient to place it elsewhere, either to make some numerical relationship clearer or to simplify computation. In such a case, the exponent is simply increased or decreased by the same number as the number of places the decimal point is moved. The following shows equivalent values for our three examples.

$$93,000,000 = 9.3 \cdot 10^7 = 93.0 \cdot 10^6 = \underline{.93 \cdot 10^8} = .093 \cdot 10^9$$

$$5,880,000,000,000 = 5.88 \cdot 10^{12} = 5880.0 \cdot 10^9 \\ = \underline{.588 \cdot 10^{13}} = .00588 \cdot 10^{15}$$

$$0.00000001 = \underline{.1 \cdot 10^{-7}} = 1.0 \cdot 10^{-8} = .01 \cdot 10^{-6} \\ = .000001 \cdot 10^{-2}$$

In System/360 a floating-point number, written as a decimal number by the programmer, is converted internally by the machine to a form very much like the underscored examples. In these, the part of each value to the left of the multiplication sign is a fractional quantity, without any whole numbers before the decimal point. Note that the first digit after the decimal point is a nonzero digit. A number in this form is known as a *normalized* number. The final example in each group of examples shows the form of an *unnormalized* number, in which the fraction has one or more high-order zeros.

Floating-point numbers are fixed in length, either a fullword (32 bits) for short precision or a doubleword (64 bits)

for long precision. The format of a short floating-point number is as follows:

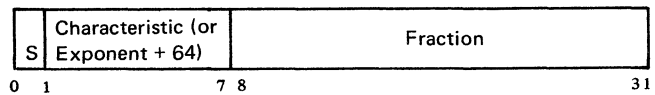

This format allows 24 bits for the fraction. A long floating-point number has the same arrangement, except that the fraction is 56 bits in length:

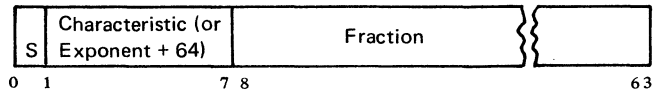

A value may be expressed in either short or long form; the short form will give greater speed and use less space, the long will give greater precision.

In either format, the first bit is the sign of the fraction, 0 for plus, 1 for minus, and indicates whether the entire number is positive or negative. The next seven bits are used for the exponent, which in System/360 is called the characteristic by analogy with logarithms. The characteristic also includes a sign (but in an indirect way that will be explained shortly), giving us a plus exponent for large values (over 1) and a minus for small values (below 1). For example, $16^1 = 16$ and $16^{-1} = 1/16$. Similarly, $-16^{+1} = -16$ and $-16^{-1} = -1/16$. The characteristic is a power of 16, of course, not 10, and is a 7-bit binary number with a range of values from 0 to 127_{10} . The fraction is expressed in *hexadecimal digits*, 6 digits for short precision and 14 for long, and in a normalized number its value is between 1/16 and 1. The fraction 1/16 is 0.1 in hexadecimal, with a bit pattern of 0001. Note that normalization applies to hexadecimal digits, not bits, and that the three high-order bits may be zero. The decimal point does not appear in storage, but is understood.

The method devised for indicating the sign of the characteristic in System/360 floating-point numbers is to use what is called excess-64 notation. This avoids the complications of a second sign. As we mentioned, seven bits can represent a range of values from 0 to 127. If 64_{10} is always added to the actual exponent, a range from -64 through +63 can be represented without further indication of a sign. In this scheme, a characteristic of 65 is equivalent to an exponent of +1, 66 to +2, and so on up to 127, which is equivalent to +63. In the low range, a characteristic of 63 is equivalent to an exponent of -1, 62 to -2, and zero to -64. Table 9-1 is given to help in understanding the actual value of some frequently used characteristics.

Table 9-1. Equivalent Values of the Characteristics of Some Floating-Point Numbers

Characteristic Dec.	Hex	Actual power of 16	Decimal value of characteristic
68	44	+4	65,536.0
67	43	+3	4,096.0
66	42	+2	256.0
65	41	+1	16.0
64	40	0	1.0
63	3F	-1	0.0625 (or 1/16)
62	3E	-2	0.00390625 (or 1/256)
61	3D	-3	0.000244140625
60	3C	-4	0.0000152587890625

Although the programmer does need to understand the internal form of floating-point numbers, he will never have to do the calculations to break down a value into its hexadecimal exponent and fraction. The machine does that with the greatest of ease. To enter a value into storage in an instruction, the programmer need only define a constant, giving the value in decimal (with or without a decimal point) and specifying its type as E for a short floating-point number or D for a long number. Here are some examples:

```
DC E'138.25'
DC E'138'
DC E'.00138'
DC E'9.3E+7'
DC D'9.3E+7'
```

The last two show how the expression $9.3 \cdot 10^7$ is specified as a constant. The E inside the quotation marks simply indicates an exponent.

Figures 9-1 through 9-6, which follow, show various assembly listings of DC entries of floating-point numbers.

000148	41100000	DC	E'1'
00014C	41200000	DC	E'2'
000150	41300000	DC	E'3'
000154	41900000	DC	E'9'
000158	41A00000	DC	E'10'
00015C	41B00000	DC	E'11'
000160	41F00000	DC	E'15'
000164	42100000	DC	E'16'
000168	42110000	DC	E'17'
00016C	421F0000	DC	E'31'
000170	42200000	DC	E'32'
000174	42210000	DC	E'33'
000178	42FF0000	DC	E'255'
00017C	43100000	DC	E'256'
000180	43101000	DC	E'257'
000184	43FFF000	DC	E'4095'
000188	44100000	DC	E'4096'
00018C	44100100	DC	E'4097'

Figure 9-1. Assembly listing of decimal integers specified as short floating-point constants

Each constant is specified by a decimal number, which we see may be an integer, a fraction, or a mixed number. A decimal point may be placed before, within, or after the number, or it may be omitted. A number without a decimal point is assumed by the machine to be an integer. The number may be signed or unsigned, and a number without a sign is assumed to be positive.

The assembled object code for the floating-point numbers appears at the left in the listings (see Figure 9-1). This is a hexadecimal representation of the actual storage contents. The first two digits represent the sign plus the characteristic. The remaining digits represent the fraction. The decimal point is understood and does not appear in storage. The same numbers are shown in the comments column in Figure 9-2 in a form that is easy to read. A plus or minus sign is printed, depending upon whether the first bit is a zero or a one. The two digits following the sign give the characteristic, the first digit representing the value of the first three bits of the seven-bit characteristic. A decimal point (actually a hexadecimal point) is printed preceding the fraction.

In these figures some of the decimal values specified are integers between 1 and 15. We see that they are represented in floating-point numbers by the corresponding hexadecimal digit in the fraction, with a characteristic of 41. To take the 9 as an example, +41.900000 should be considered as

$$16^1 \cdot \frac{9}{16}$$

Decimal 16 becomes +42.100000, which we consider as

$$16^2 \cdot \frac{1}{16}$$

Decimal 32 becomes +42.200000, or

$$16^2 \cdot \frac{2}{16}$$

The same constants are specified in Figure 9-3 as negative values. Looking at the actual storage values in the object code column, we see that the first digit in these cases is C. This represents the total of the first four bits of our floating-point numbers. In other words, the value of the sign bit (decimal 8) is added to the value of the first three bits of the characteristic. This is of no consequence when the sign is plus and is a zero bit. When it is negative, however, we get binary 1100 0001 (or hexadecimal C1, equal to decimal 12 and 1) for a sign and characteristic of -41. There is still another interesting fact to observe in these representations of negative floating-point numbers. Note that the values are all in true notation, and not in two's complement form as in other types of System/360 arithmetic.

In Figure 9-4 we have some decimal numbers that are fractional and mixed numbers, not integers. Decimal 0.5, for instance, becomes hexadecimal +40.800000, which we consider as

$$16^0 \cdot \frac{8}{16}$$

The decimal number 1.5 becomes +41.180000, or

$$16^1 \cdot \frac{24}{16^2}$$

It is interesting to note that the simple decimal number 0.1 is transformed into a nonterminating hexadecimal fraction; there is no exact hexadecimal representation for decimal 0.1. On the other hand, complex-looking decimal fractions that happen to be negative powers of 16 are transformed into particularly simple hexadecimal numbers, as $0.00390625 = +3F.100000$.

Figure 9-5 shows a few long floating-point numbers. The scheme is the same, the only difference being the presence of eight additional hexadecimal digits, which make the fraction a total of 14 digits. This permits more accurate representation of numbers that do not have an exact hexadecimal representation and naturally permits much greater precision when arithmetic is performed.

Figure 9-6 shows some examples of short and long floating-point numbers specified by decimal numbers with exponents. The decimal numbers are all in the form of our examples of scientific notation at the beginning of this

000190	41100000	DC	E'1'	+41.100000
000194	41200000	DC	E'2'	+41.200000
000198	41300000	DC	E'3'	+41.300000
00019C	41900000	DC	E'9'	+41.900000
0001A0	41A00000	DC	E'10'	+41.A00000
0001A4	41B00000	DC	E'11'	+41.B00000
0001A8	41F00000	DC	E'15'	+41.F00000
0001AC	42100000	DC	E'16'	+42.100000
0001B0	42110000	DC	E'17'	+42.110000
0001B4	421F0000	DC	E'31'	+42.1F0000
0001B8	42200000	DC	E'32'	+42.200000
0001BC	42210000	DC	E'33'	+42.210000
0001C0	42FF0000	DC	E'255'	+42.FF0000
0001C4	43100000	DC	E'256'	+43.100000
0001C8	43101000	DC	E'257'	+43.101000
0001CC	43FFF000	DC	E'4095'	+43.FFF000
0001D0	44100000	DC	E'4096'	+44.100000
0001D4	44100100	DC	E'4097'	+44.100100

Figure 9-2. A listing of the same examples as in Figure 9-1, showing them in the comments field in a form that is easy to read

000220	C1100000	DC	E'-1'	-41.100000
000224	C1200000	DC	E'-2'	-41.200000
000228	C1300000	DC	E'-3'	-41.300000
00022C	C1900000	DC	E'-9'	-41.900000
000230	C1A00000	DC	E'-10'	-41.A00000
000234	C1B00000	DC	E'-11'	-41.B00000
000238	C1F00000	DC	E'-15'	-41.F00000
00023C	C2100000	DC	E'-16'	-42.100000
000240	C2110000	DC	E'-17'	-42.110000
000244	C21F0000	DC	E'-31'	-42.1F0000
000248	C2200000	DC	E'-32'	-42.200000
00024C	C2210000	DC	E'-33'	-42.210000
000250	C2FF0000	DC	E'-255'	-42.FF0000
000254	C3100000	DC	E'-256'	-43.100000
000258	C3101000	DC	E'-257'	-43.101000
00025C	C3FFF000	DC	E'-4095'	-43.FFF000
000260	C4100000	DC	E'-4096'	-44.100000
000264	C4100100	DC	E'-4097'	-44.100100

Figure 9-3. The same values shown as negative numbers

section. In $E'12.78E+8'$ the decimal value is $12.78 \cdot 10^8$, which we see becomes +48.4C2CBC in hexadecimal. In $D'-0.00057E-5'$ the decimal value is $-0.00057 \cdot 10^{-5}$. This like all the examples we have seen, is converted to a floating-point number in normalized form, that is, with no high-order zeros in the fraction. The fraction is always normalized unless the programmer specifies a decimal number with a scale factor. (Since scaling has not been discussed in this book and is not needed for our elementary compu-

tations, it is suggested that a student interested in the subject refer to his assembler specification manual.)

In reviewing the hexadecimal values given by the assembler, we notice that in all the illustrations there are some fractions in which the first digit is 1. Hexadecimal 1, of course, is equivalent to binary 0001. It is important to realize that normalization refers to hexadecimal digits rather than to bits, and a normalized fraction may have as many as three leading zero bits.

000268	40800000	DC	E'0.5'	+40.800000
00026C	41180000	DC	E'1.5'	+41.180000
000270	41140000	DC	E'1.25'	+41.140000
000274	41120000	DC	E'1.125'	+41.120000
000278	41110000	DC	E'1.0625'	+41.110000
00027C	411C0000	DC	E'1.75'	+41.1C0000
000280	411E0000	DC	E'1.875'	+41.1E0000
000284	411F0000	DC	E'1.9375'	+41.1F0000
000288	4019999A	DC	E'0.1'	+40.19999A
00028C	3F28F5C3	DC	E'0.01'	+3F.28F5C3
000290	3E418937	DC	E'0.001'	+3E.418937
000294	3D68DB8C	DC	E'0.0001'	+3D.68DB8C
000298	3CA7C5AC	DC	E'0.00001'	+3C.A7C5AC
00029C	4111999A	DC	E'1.1'	+41.11999A
0002A0	40400000	DC	E'0.25'	+40.400000
0002A4	40100000	DC	E'0.0625'	+40.100000
0002A8	3F100000	DC	E'0.00390625'	+3F.100000

Figure 9-4. Some fractional and mixed decimal numbers expressed as short floating-point constants

0002B8	4110000000000000	DC	D'1'	+41.10000000000000
0002C0	4120000000000000	DC	D'2'	+41.20000000000000
0002C8	4210000000000000	DC	D'16'	+42.10000000000000
0002D0	4980000000000000	DC	D'34359738368'	+49.80000000000000
0002D8	4BB3A73CE5B59000	DC	D'12345678912345'	+4B.B3A73CE5B59000
0002E0	4080000000000000	DC	D'0.5'	+40.80000000000000
0002E8	401999999999999A	DC	D'0.1'	+40.1999999999999A
0002F0	411199999999999A	DC	D'1.1'	+41.1199999999999A
0002F8	C11A86BD134658D5	DC	D'-1.65789516'	-41.1A86BD134658D5
000300	3E10000000000000	DC	D'0.000244140625'	+3E.10000000000000

Figure 9-5. Some long floating-point constants

000308	484C2CBC	DC	E'12.78E+8'	+48.4C2CBC
00030C	5156BC76	DC	E'1E+20'	+51.56BC76
000310	B819256E	DC	E'-22.87035E-12'	-38.19256E
000314	EABF9572	DC	E'-2.8E+50'	-6A.BF9572
000318	7A25179157C93EC7	DC	D'0.1E+70'	+7A.25179157C93EC7
000320	173BDCF495A9703E	DC	D'0.1E-49'	+17.3BDCF495A9703E
000328	D0891087B9F3A6EC	DC	D'-9.87654321555E+18'	-50.891087B9F3A6EC
000330	BA187B375E0424FA	DC	D'-0.00057E-5'	-3A.187B375E0424FA
000338	401F9ADD3739635F	DC	D'12345.6789E-5'	+40.1F9ADD3739635F

Figure 9-6. Some decimal values with exponents expressed as floating-point constants

FLOATING-POINT INSTRUCTIONS

Four special registers, used only by the floating-point instructions, are part of the System/360 floating-point feature. They are 64 bits in length and are numbered 0, 2, 4, and 6. All 64 bits are used for long-precision operands and results, and only 32 bits for short-precision (except for the product in Multiply). Use of registers for floating-point arithmetic avoids the many operations that would otherwise be necessary for storing and loading results and operands. All floating-point operations are register-to-register (RR) or storage-to-register (RX), and most of the instructions are available with a choice of either format.

All floating-point instructions are also available with a choice between the use of long or short numbers. In addition, the programmer may select an Add or Subtract instruction in the execution of which the intermediate and final results are normalized or are not normalized. All these choices mean a long list of instructions in the floating-point instruction set (as we see in Table 9-2, there are eight separate Add instructions), but the basic functions are simply to Add, Subtract, Multiply, Divide, Halve, Compare, Store, and Load. The Load instructions also provide the programmer with the ability to control the signs of operands. Note that the mnemonics of instructions for long precision are distinguished by the letter D, and for short precision by the letter E. In Add Unnormalized and Subtract Unnormalized, these change to W and U.

Perhaps the best way to get an idea of how the instructions actually operate is to study an example. Figure 9-7 is an assembly listing of a program to evaluate the following formula, using short precision throughout.

$$Y = \left(\frac{A + \frac{B - C}{2}}{3.17 - 2D} \right)^2$$

The first processing instruction is Load Short (LE), which places the value of D in floating-point register 2. The fact that the 2 in this instruction refers to a floating-point register, rather than to a general purpose register, is implied in the operation code; floating-point is understood by the assembler when it encounters the code LE. This short operation will load the left half of the double-length register, leaving the low-order half unchanged. Any previous value in the low-order 32 bits, will ordinarily have no significant effect on later operations.

The second instruction multiplies the contents of floating-point register 2, which we just loaded, by the constant 2 in floating-point form. The result is left in the same register, destroying the previous contents. No other register is involved, in contrast to fixed-point multiplication. The lower half of the floating-point register is involved, however, because the entire register is used for the result of a Multiply operation. In short precision, the fraction of the product has 14 hexadecimal digits, of which at least two are always zero.

Table 9-2. Instruction Set for the System/360 Floating-Point Feature

Name	Mnemonic	Format
Load (Long)	LDR	RR
Load (Long)	LD	RX
Load (Short)	LER	RR
Load (Short)	LE	RX
*Load and Test (Long)	LTDR	RR
*Load and Test (Short)	LTER	RR
*Load Complement (Long)	LCDR	RR
*Load Complement (Short)	LCER	RR
*Load Positive (Long)	LPDR	RR
*Load Positive (Short)	LPER	RR
*Load Negative (Long)	LNDR	RR
*Load Negative (Short)	LNER	RR
*Add Normalized (Long)	ADR	RR
*Add Normalized (Long)	AD	RX
*Add Normalized (Short)	AER	RR
*Add Normalized (Short)	AE	RX
*Add Unnormalized (Long)	AWR	RR
*Add Unnormalized (Long)	AW	RX
*Add Unnormalized (Short)	AUR	RR
*Add Unnormalized (Short)	AU	RX
*Subtract Normalized (Long)	SDR	RR
*Subtract Normalized (Long)	SD	RX
*Subtract Normalized (Short)	SER	RR
*Subtract Normalized (Short)	SE	RX
*Subtract Unnormalized (Long)	SWR	RR
*Subtract Unnormalized (Long)	SW	RX
*Subtract Unnormalized (Short)	SUR	RR
*Subtract Unnormalized (Short)	SU	RX
*Compare (Long)	CDR	RR
*Compare (Long)	CD	RX
*Compare (Short)	CER	RR
*Compare (Short)	CE	RX
Halve (Long)	HDR	RR
Halve (Short)	HER	RR
Multiply (Long)	MDR	RR
Multiply (Long)	MD	RX
Multiply (Short)	MER	RR
Multiply (Short)	ME	RX
Divide (Long)	DDR	RR
Divide (Long)	DD	RX
Divide (Short)	DER	RR
Divide (Short)	DE	RX
Store (Long)	STD	RX
Store (Short)	STE	RX

*Operation sets condition code.

LOC	OBJECT CODE	ADDR1	ADDR2	STMT	SOURCE	STATEMENT
				1		PRINT NOGEN
000000				2	SHORTFP	START 0
000000	05B0			3	BEGIN	BALR 11,0
000002				4		USING *,11
000002	7820 B032		00034	5	LE	2,D LOAD FLOATING POINT REGISTER 2 WITH D
000006	7C20 B036		00038	6	ME	2,FTWO MULTIPLY D IN REGISTER 2 BY 2
00000A	3322			7	LCGR	2,2 REVERSE SIGN OF PRODUCT
00000C	7A20 B03A		0003C	8	AE	2,CON1 ADD CONSTANT 3.17
000010	7840 B02A		0002C	9	LE	4,B LOAD FLOATING POINT REGISTER 4 WITH B
000014	7840 B02E		00030	10	SE	4,C SUBTRACT C
000018	3444			11	HER	4,4 USE HALVE INSTRUCTION TO DIVIDE BY 2
00001A	7A40 B026		00028	12	AE	4,A ADD A
00001E	3D42			13	DER	4,2 DIVIDE NUMERATOR BY DENOMINATOR
000020	3C44			14	MER	4,4 SQUARE THE QUOTIENT
000022	7040 B03E		00040	15	STE	4,Y STORE THE FINAL RESULT
				16	EOJ	
000028				19	DS	OF
000028	41123456			20	A DC	E'1.1377772805'
00002C	43356800			21	B DC	E'854.50'
000030	43252600			22	C DC	E'594.3750'
000034	3E2D3EFD			23	D DC	E'.904E-4'
000038	41200000			24	FTWO DC	E'2'
00003C	41328852			25	CON1 DC	E'3.17'
000040				26	Y DS	F
000000				27	END	BEGIN

Figure 9-7. Assembly listing of a program to perform simple computations in short floating-point arithmetic

In the execution of a Multiply instruction, the machine normalizes both operands, if the fractions have leading zeros, before any arithmetic is performed. This is done by shifting the fraction left until the leftmost hexadecimal digit is a nonzero digit and reducing the characteristic by the number of shifts required. When this is done before the arithmetic process (as it is in both Multiply and Divide), the action is called *prenormalization*. With both operands prenormalized, the product will either be normalized already or have at most one leading zero. In the latter case, the product fraction is shifted left one hexadecimal position to *postnormalize* it, and the product characteristic is reduced by one.

In floating-point multiplication, the arithmetic process is very simple and follows the familiar rules for exponents. It consists of adding the characteristics and multiplying the fractions. To illustrate the procedure, let's consider a simple problem in base 10: to multiply 12,300 by 60. Expressed with decimal exponents, this is $(.123 \cdot 10^5) \cdot (.6 \cdot 10^2)$. Multiplying the fractions, we get $.123 \cdot .6 = .0738$. Adding the exponents, we get $10^{5+2} = 10^7$. Together, they give $.0738 \cdot 10^7 = 738,000$. In System/360, of course, the machine also has to subtract 64 from the characteristic of an intermediate product because, with both operands in the excess-64 notation, adding the characteristics gets the extra 64 into the product twice instead of once.

For those who wish to follow the arithmetic in the program example, the details are given in Figure 9-8. Each line shows the contents of the two registers used for computation after the execution of each of the floating-point instructions. The operation codes are given in the left-hand column. The program used for this output specified the addition of a point in printing the hexadecimal register contents. The decimal equivalents are in the usual form for floating-point numbers and show the true value of the

exponents. The decimal numbers are not all exact equivalents, because exact equivalents of fractional quantities often do not exist in base 10 and base 16. Inspection will show that these discrepancies are small for most practical purposes; they can be made much smaller by the use of long precision, as will be seen later.

We noted before that the product fraction of a short-precision Multiply is 14 hexadecimal digits in length, including some trailing zeros. Normally, after the ME operation in Figure 9-8, we would expect to find at least some nonzero digits in the low-order half of register 2. In this case, however, the two fractions that are multiplied yield only six significant digits ($.2D3EFD \times .200000 = .5A7DFA\ 000000$), so the low-order half of the register contains eight zeros. The more usual situation can be seen in register 4 after execution of the MER instruction.

The next instruction in our program, the Load Complement (RR), reverses the sign of the product as written here. (The instruction can also be used with two different register numbers.) It would of course be acceptable programming practice to have stored the constant 2 as a negative number.

Now we add the constant 3.17, using an Add Normalized instruction. Floating-point addition starts with a comparison of the two operand characteristics; if they are the same, addition of the fractions takes place immediately. Otherwise, the fractional part of the number with the smaller characteristic is shifted right, as many places as the difference in characteristics, until they agree. When this is done, the decimal points (hexadecimal points, really) are "lined up", as addition requires. The fractions are then added. The larger of the two characteristics becomes the "provisional" characteristic of the sum; we say provisional because it may have to be adjusted for a possible overflow carry in the fraction or for postnormalization.

If the addition caused overflow of the fraction, the

result fraction is now shifted right one place and the characteristic accordingly increased by 1. On the other hand, the addition might have resulted in a sum with leading zeros, which would happen if the operands were of about the same size but of opposite sign, and the characteristic would be decreased in the process of normalization.

If these actions cause the characteristic to go below or above the range of zero to 127, *exponent underflow* or *overflow* is signaled, and normally a program interruption occurs. If addition or subtraction results in an all-zero fraction, the loss of significance is complete, which may in some cases destroy the validity of all results of the computation. If this happens without the problem originator's knowledge, he may place confidence in results that are in fact meaningless. For this reason, System/360 provides a warning in the form of a *significance exception*, and a program interruption occurs, enabling the programmer to cope with the situation in a subroutine. For certain types of data, the programmer may wish to prevent an interruption, and he can do so in case of an exponent underflow or a significance exception. In case of exponent overflow, however, the interrupt action cannot be overridden.

With the values that have been entered in our sample program, there will be no loss of significance or other exceptions. To review what has been covered in the program so far, we have evaluated the denominator within the parentheses. We leave the result in floating-point register 2 and turn now to an evaluation of the numerator.

In loading B and subtracting C, instructions are used that are now familiar. Floating-point subtraction is just like addition, with the sign of the second operand reversed before adding the fractions. Since both addition and subtraction are completely algebraic, and since either one can involve any of the four combinations of signs of the operands, they are truly very similar.

The division by 2 is handled in a rather different way from what one might expect and illustrates an interesting member of the floating-point instruction set. The Halve instruction (HER) divides the second operand by 2 and places the result in the first operand; both registers are the

same here, as they so often are in using the RR-format instructions. What actually happens is that the fraction part is shifted right by one *binary* place, which is equivalent to dividing by 2. If the consequence of this is an intermediate result with all zeros in the first four bits of the fraction, the final result is postnormalized.

The next instruction is another Add Normalized, the details of which we discussed before. So far, however, we have not mentioned a feature of System/360 floating-point operations that is designed to increase the significance of final results. It is called the guard digit. As we know, the fractions in final results have six hexadecimal digits in short precision, and 14 in long precision. Intermediate results may have one additional significant low-order digit in the Add, Subtract, Compare, Halve, and Multiply operations, which participates in postnormalization of final results. This extra digit materializes when right-shifting into the guard digit position occurs during the operations named, as in Adding, for example, when the two operands are lined up with each other. When final results are subsequently shifted left in the process of postnormalization, the guard digit is simply included in the move.

At this point in our problem, we have the numerator in floating-point register 4 and the denominator in register 2. A Divide (RR, Short) places the quotient in register 4. Floating-point division works as follows. Both operands are prenormalized. Division of the fractions yields the quotient fraction. The characteristic of the denominator (or divisor) is subtracted from that of the numerator (or dividend), and then 64_{10} is added to get the characteristic back into excess-64 form. The arithmetic process here is similar, but opposite, to the Multiply instruction. In short-precision Divide, the low-order half of the registers is ignored, and the fraction of the result is six digits in length. Division of two normalized six-digit fractions will always yield either six or seven digits, never more or less. Postnormalization is never necessary, but the quotient fraction may need to be shifted right by one position and the characteristic increased correspondingly by 1.

Our program now requires us to square the result of the

OP	FLOATING POINT REGISTER 2		FLOATING POINT REGISTER 4	
	CONTENTS IN HEX	DEC EQUIVALENT	CONTENTS IN HEX	DEC EQUIVALENT
LE	3E.2D3EFD 00000000	+ .6903999E-03	00.000000 00000000	+ .0000000E+00
ME	3E.5A7DFA 00000000	+ .1380800E-02	00.000000 00000000	+ .0000000E+00
LCER	BE.5A7DFA 00000000	- .1380800E-02	00.000000 00000000	+ .0000000E+00
AE	41.32B2AA 00000000	+ .3168619E+01	00.000000 00000000	+ .0000000E+00
LE	41.32B2AA 00000000	+ .3168619E+01	43.356800 00000000	+ .8545000E+03
SE	41.32B2AA 00000000	+ .3168619E+01	43.104200 00000000	+ .2601250E+03
HER	41.32B2AA 00000000	+ .3168619E+01	42.821000 00000000	+ .1300625E+03
AE	41.32B2AA 00000000	+ .3168619E+01	42.833345 00000000	+ .1312003E+03
DER	41.32B2AA 00000000	+ .3168619E+01	42.2967F8 00000000	+ .4140613E+02
MER	41.32B2AA 00000000	+ .3168619E+01	43.68277A 98040000	+ .1714467430129645E+04
STE	41.32B2AA 00000000	+ .3168619E+01	43.68277A 98040000	+ .1714467430129646E+04

Figure 9-8. The contents of floating-point registers 2 and 4 after execution of each of the short-precision instructions in the program in Figure 9-7

division, which is standing in register 4. A Multiply (RR, Short), in which the quantity in register 4 is specified for both operands, does the job. Finally, a Store puts the result in the fullword storage location Y.

Figure 9-9 shows a listing of the same program, with identical decimal values, rewritten to do all processing in long precision. Step-by-step changes in the contents of the

registers may be seen in Figure 9-10. Here the full capacity of the registers is used in each operation, and the increase in precision of the arithmetic results can readily be seen. Except for the length of operands and results and the fact that in short precision the low-order halves of the registers are generally ignored, there is no difference in the execution of the instructions for long and short precision.

LOC	OBJECT CODE	ADDR1	ADDR2	STMT	SOURCE STATEMENT
				1	PRINT NOGEN
000000				2	LONGFP START 0
000000	05B0			3	BEGIN BALR 11,0
000002				4	USING *,11
000002	6820 B03E		00040	5	LD 2,D LOAD FLOATING POINT REGISTER 2 WITH D
000006	6C20 B046		00048	6	MD 2,FTWO MULTIPLY D IN REGISTER 2 BY 2
00000A	2322			7	LCDR 2,2 REVERSE SIGN OF PRODUCT
00000C	6A20 B04E		00050	8	AD 2,CON1 ADD CONSTANT 3.17
000010	6840 B02E		00030	9	LD 4,B LOAD FLOATING POINT REGISTER 4 WITH B
000014	6840 B036		00038	10	SD 4,C SUBTRACT C
000018	2444			11	HDR 4,4 USE HALVE INSTRUCTION TO DIVIDE BY 2
00001A	6A40 B026		00028	12	AD 4,A ADD A
00001E	2D42			13	DDR 4,2 DIVIDE NUMERATOR BY DENOMINATOR
000020	2C44			14	MDR 4,4 SQUARE THE QUOTIENT
000022	6040 B056		00058	15	STD 4,Y STORE THE FINAL RESULT
				16	EOJ
000028				19	DS 0D
000028	41123455F31E1180			20	A DC D'1.1377772805'
000030	4335680000000000			21	B DC D'854.50'
000038	4325260000000000			22	C DC D'594.3750'
000040	3E2D3EFD68D10972			23	D DC D'6.904E-4'
000048	4120000000000000			24	FTWO DC D'2'
000050	41328851EB851EB8			25	CON1 DC D'3.17'
000058				26	Y DS D
000000				27	END BEGIN

Figure 9-9. Assembly listing of the same program as in Figure 9-7, modified to perform all computations in long floating-point arithmetic

OP	FLOATING POINT REGISTER 2		FLOATING POINT REGISTER 4	
	CONTENTS IN HEX	DEC EQUIVALENT	CONTENTS IN HEX	DEC EQUIVALENT
LD	3E.2D3EFD 68D10972	+.690399999999997E-03	00.000000 00000000	+.000000000000000E+00
MD	3E.5A7DFA D7A212E4	+.138079999999998E-02	00.000000 00000000	+.000000000000000E+00
LCDR	8E.5A7DFA D7A212E4	-.138079999999998E-02	00.000000 00000000	+.000000000000000E+00
AD	41.3282AA 0BD7A496	+.316861919999997E+01	00.000000 00000000	+.000000000000000E+00
LD	41.3282AA 0BD7A496	+.316861919999997E+01	43.356800 00000000	+.854500000000000E+03
SD	41.3282AA 0BD7A496	+.316861919999997E+01	43.104200 00000000	+.260125000000000E+03
HDR	41.3282AA 0BD7A496	+.316861919999997E+01	42.821000 00000000	+.130062500000000E+03
AD	41.3282AA 0BD7A496	+.316861919999997E+01	42.833345 5F31E118	+.1312002772804998E+03
DDR	41.3282AA 0BD7A496	+.316861919999997E+01	42.2967F8 86170C3C	+.4140613592207608E+03
MDR	41.3282AA 0BD7A496	+.316861919999997E+01	43.6B277D 4E08C861	+.1714468091997438E+04
STD	41.3282AA 0BD7A496	+.316861919999997E+01	43.6B277D 4E08C861	+.1714468091997438E+04

Figure 9-10. The contents of floating-point registers 2 and 4 after execution of each of the long-precision instructions in the program in Figure 9-9

QUESTIONS AND EXERCISES

1. Write the DC instructions for the following short floating-point numbers:

3.14159265
 -2.78
 38754×10^6
 .00000278
 $-.000236 \times 10^{-7}$

2. Write the DC instructions for the following long floating-point numbers:

3.141592653589793
 -2.78
 -0.003×10^{-3}
 3.8×10^{30}
 0.000000008

3. Show the hexadecimal form that the following DC entries will generate in storage. (Note that 16777216 equals 16^6 and that $.59604644 \times 10^{-7}$ equals 16^{-7} .)

DC E'32'
 DC D'32'
 DC E'16777216'
 DC E'.59604644E-7'
 DC E'-.59604644E-7'
 DC E'-16777216'

4. After execution of each of the following sets of instructions, what will be in the registers used?

a. LE 2,A
 AE 2,B
 HER 4,2

given $A = 41789ABC$ and $B = 41876544$ in hexadecimal short floating-point.

b. What would be the results of the same instructions if $A = 41200000$ and $B = 44600044$?

c. LE 6,A
 SR 6,6
 :

A DC E'15'

d. L 3,A
 A 3,B
 :

A DC E'1.0'

B DC X'01000000'

5. Write a program segment to calculate the value of X in short floating-point arithmetic and put it into storage:

$$X = \frac{A - (B \times C)}{A + (B \times C)}$$

Answers to Questions and Exercises

Chapter 3: Fixed-Point Arithmetic

1. Fullword
2. Receives
3. Sends
Exception
4. No. The first operand must specify an even-numbered register for an even-odd pair.
5. An even-numbered register of an even-odd pair that contains the dividend

Divisor

The quotient is in the odd-numbered register.

The remainder is in the even-numbered register.

6.

START	256
BEGIN BALR	11,0
USING	*,11
L	2,XANDY
SRDL	2,12
SRL	3,20
ST	2,X
STH	3,Y

(Continued in next column)

	EOJ	
XANDY	DS	F
X	DS	F
Y	DS	H
	END	BEGIN

7. (c) Condition code is 1 or 3.
8. BC 15,NEWONE
The extended mnemonic equivalent is B NEWONE.
9. LM 2,5,X1
10. SR 5,5
11. It will be the sum of the contents of register 3 (the base register), register 11 (the index register), and the displacement.
12. BXLE 5,6,NEWONE

Chapter 4: Programming with Base Registers and the USING Instruction

- 1a. USING *,11
- b. BALR 11,0
- 2, 3, and 4. See illustration below.
5. See illustration on next page.

PROGG	STATEMENT	OPERAND	During assembly			During execution with program loaded at 3200 ₁₆		VALUE LOADED IN BASE REGISTER 11
			LOCATION OF STATEMENT	Base Reg.	Displacement	Address	LOCATION OF STATEMENT	
START	512							
BEGIN	BALR	11,0	000200			003200		
USING	*,11		Assumed 000202			Actual 003202		
L	2(DATA)		000202	B	102	000304	003304	
A	2(TEN)		000206	B	122	000324	003324	
⋮			⋮					
S	2(DATA+4)		000234	B	106	000308	003234	003308
ST	2(RESULT)		000238	B	126	000328	003238	003328
⋮			⋮					
L	6(BIN1)		000252	B	142	000344	003252	003344
⋮			⋮					
DATA	DC	F'25'	000304				003304	
	DC	F'15'	000308				003308	
⋮			⋮					
TEN	DC	F'10'	000324				003324	
RESULT	DS	F	000328				003328	
⋮			⋮					
BIN1	DC	F'12'	000344				003344	
⋮			⋮					
END	BEGIN							

SYMBOL	LENGTH	VALUE
BEGIN	02	000200
BIN1	04	000344
DATA	04	000304
RESULT	04	000328
TEN	04	000324

*Base and displacement remain the same as during assembly.

		During assembly			During execution with program loaded at 100016	
		LOCATION OF STATEMENT	STORAGE OPERAND		LOCATION OF STATEMENT	ADDRESS OF STORAGE OPERAND*
			Base Reg.	Displacement		
PROGH	START	0				
BEGIN	BALR	11,0			000000	001000
	USING	FIRST,11				
FIRST	BC	15,SKIP			000002	001002
DATA	DC	F'3472'			000008	001008
	:	:			:	
BASE1	DC	A(FIRST+4096)			000024	001024
BASE2	DC	A(FIRST+8192)			000028	001028
	:	:			:	
SKIP	L	10, <u>BASE1</u>	B	022	000024	001104 001024
	USING	FIRST+4096,10				
	L	9, <u>BASE2</u>	B	026	000028	001108 001028
	USING	FIRST+8192,9				
	:	:			:	
	BC	15, <u>CK8</u>	9	902	002904	002504 003904
	:	:			:	
LOOP	A	4, <u>DATA</u>	B	006	000008	002898 001008
	:	:			:	
LOOPB	S	5,DATA				003204
	:	:			:	
	BC	8, <u>LOOP</u>	A	896	001898	003508 002898
	:	:			:	
CK8	BC	8, <u>LOOPB</u>	9	202	002204	003904 003204
	END	BEGIN				

REGISTER	VALUE LOADED INTO BASE REGISTERS	
	During assembly (assumed)	During execution (actual)
11	000002	001002
10	001002	002002
9	002002	003002

SYMBOL	VALUE
BASE 1	000024
BASE 2	000028
BEGIN	000000
CK8	002904
DATA	000008
FIRST	000002
LOOP	001898
LOOPB	002204
SKIP	001104

*Base and displacement remain the same as during assembly.

Answers to questions 5

Chapter 5: Decimal Arithmetic

- 1a. CON3 DC PL5'3'
- b. 000000003C
- 2. Assembler
Data definitions
Programmer
- 3. Equal to
- 4. One less than
- 5a. The multiplicand in the low-order positions and zeros in the high-order positions
- b. In the storage area specified by the first operand
- 6a. 00 02 48 9C 10 3C
158 159 15A 15B 15C 15D
- b. 15A
- 7. Storage area containing the dividend
Divisor
The quotient will be in the left portion of the dividend area, and the remainder in the right portion.
- 8a. SOURCE 66 55 44 33 22 11
DEST 11 22 66 55 44 6S

- b. SOURCE 66 55 44 33 22 11
DEST 11 22 33 4S 55 6S
- c. SOURCE 66 55 44 33 22 11
DEST 00 00 00 04 43 3S
- 9. No. The ZAP instruction, as all the decimal arithmetic instructions and the decimal compare instructions, requires a legitimate sign in the low-order byte of the "sending" field.
- 10a. MVN RESULT+5(1),FACTOR+4
MVO RESULT,FACTOR(4)
- b. MVN FACTOR+3(1),FACTOR+4
ZAP RESULT,FACTOR(4)
- 11a. SI
- b. NI HOLD,X'00'
- c. NI HOLD+3,X'0F'
- 12. In both cases, each bit position of the referenced storage operand is analyzed against the corresponding bit position of the immediate portion of the instruction. The storage byte referenced by the first operand, after execution will be:
 - a. For the And Immediate instruction, a 1 in each bit

position in which both operands had 1s, and zeros elsewhere.

b. For the Or Immediate instruction a 1 in the bit positions in which either or both operands had a 1, and a zero where both operands had zeros.

13. Packed decimal

14. PACK

15. UNPK (Unpack)

16a. DC F'578' or DC H'578'

b. DC ZL3'578'

c. DC PL2'578'

17. There are at least four ways to write the DC statement. Keep in mind that 4B is the hexadecimal equivalent of 75₁₀.

a. DC F'75' would generate the 4-byte constant: 00 00 00 4B.

b. DC H'75' would generate the 2-byte constant: 00 4B.

c. DC X'4B' would generate the 1-byte constant: 4B.

The advantage of methods a and b over method c is that the programmer does not have to convert from decimal to hexadecimal. A disadvantage is that more space is used than is perhaps necessary.

d. The statement DC FL1'75' would remove this disadvantage since the characters L1 specify that the length (L) of the constant is to be 1 byte. Thus a 1-byte field of 4B would be generated. A point to remember is that when a length is stated for an F-type constant no boundary alignment is performed by the assembler.

18. IC 6,OLD

19. STC 6,OLD

20a. No. MASK is not located on a fullword boundary. The N instruction requires the operand in storage to be on a fullword boundary.

b. The statement DS OF could be inserted immediately before the DC defining MASK.

c. DC F'15'

Chapter 6: Logical Operations on Characters and Bits

1. XI KEY,15 (immediate data in decimal)
 XI KEY,X'0F' (immediate data in hexadecimal)
 XI KEY,B'00001111' (immediate data in binary)
2. TM ADDR,X'30'
 BC 5,ANIMAL
3. TM ADDR,X'06'
 BC 4,LIST2

There are many acceptable ways of performing tests such as 2 and 3. The TM instruction, where it can be used, has the advantages of leaving storage unchanged and obviating the need for registers or work areas.

4a. 05

b. 2C (the final C is the code for a plus sign)

c. 43

5. 8 bits, 1 byte

6. 2048 bits, 256 bytes

7. (b) Alphanumeric characters. Despite their plausibility, a and c are not correct in the general case because of possible difficulty with sign codes.

8. (c) An inequality. All codes are valid.

9. (a) 5, (b) 2, (c) 3 plus the contents of general register 1, (d) the computed effective address for FIELD, *not* the word stored at that address

10. Among the many ways to solve this are the following:

CLC FIELD(1),FIVE

BC 6,NOT5

FIVE DC X'05'

or:

CLI FIELD,X'05'

BC 6,NOT5

or:

TM FIELD,X'05'

BC 12,NOT5

TM FIELD,X'FA'

BC 5,NOT5

11. The second byte of the BC instruction, containing the mask M1 and index X2 fields.

12. (d) The OI instruction changes the BC 0 instruction, which never branches, to a BC 15 instruction, which branches unconditionally. Hence, after the first time around, the sequence between the BC and symbolic address ADDR is always skipped.

13. The instruction sequence between the BC instruction and the address ADDR will be alternately executed and skipped.

14. N 5,MASK

MASK DC X'FF000000'

Chapter 7: Edit, Translate, and Execute Instructions

1. BBBB1540
2. BBBB5721BB
3. BBBB01BCR
4. BBBB01BB
5. BB0,000,10BB
6. BBBB101,43CRBBBBB1,07BCR
- 7a. PATRN DC X'40206B2020206B2020214B202040C3D9'
- b. BBBB92,500,01BCR
- c. BBBB92,500,01BCR
8. (c) PATRN+2
9. No
10. (e) ACBD
11. (d) Address of AREA+2 and X'01' respectively

12. 12345678991000000000

Area is first set to zeros by the MVI and MVC instructions. The EX instruction first causes the low-order 8 bits of register 2 (0A) to be Or'd with the 8-bit length code portion (00) of the Move instruction. The result of the Or'ing is a length code of 0A (10 in decimal). Since the object instruction length code is always one less than the number of bytes to be affected, the Move instruction will cause 11 bytes to be moved.

13. 10000000000000000000

Chapter 8: Subroutine Linkages and Program Relocation

1a. The return address is entered in Register 14, and an unconditional branch is made to the address in Register 15.

b. The return address is entered in Register 14, and an unconditional branch is made to the location designated by SUB.

c. BR 14

2. 1 d

13 c

14 a

15 b

3a. Assures alignment of address constants by use of a CNOP.

b. Places the address of subroutine in Register 15

c. Places the address of return in Register 14

d. Sets up parameter list address by use of a BALR 1,15

e. Defines as many address constants as there are in parameter list.

4a. 000 408

b. 000 404

c. 000 404

d. 000 406

e. 000 402

f. 000 402

5a. STM 14,12,12(13)

b. LM 14,12,12(13)

BR 14

6a. EXTRN assembler instruction

b. ENTRY assembler instruction

Chapter 9: Floating-Point Arithmetic

1. DC E'3.14159265'
 DC E'-2.78'
 DC E'38754E+6'
 (DC E'3.8754E+10' is another possibility)

DC E'0.278E-5'
 DC E'-2.36E-11'

2. DC D'3.141592653589793'

DC D'-2.78'

DC D'-3E-6'

DC D'3.8E+30'

DC D'8E-9'

3. 42200000

4220000000000000

47100000

3A100000

BA100000

C7100000

4a. Floating-point register 2: 42100000 XXXXXXXXX

Floating-point register 4: 41800000 XXXXXXXXX

b. Floating-point register 2: 44600244 XXXXXXXXX

Floating-point register 4: 44300122 XXXXXXXXX

c. Floating-point register 6: 41F00000 XXXXXXXXX

General register 6: 00000000

d. General register 3: 42100000

5.

.

.

.

LE 2,B B in Reg. 2

ME 2,C B x C in Reg. 2

LCER 4,2 -(B x C) in Reg. 4

AE 2,A A+(B x C) in Reg. 2

AE 4,A A-(B x C) in Reg. 4

DER 4,2 A-(B x C) ÷ A+(B x C)

STE 4,X Store final result

.

.

.

A DS F

B DS F

C DS F

X DS F

SYSTEM/360 MACHINE INSTRUCTIONS

STANDARD INSTRUCTION SET

NAME	MNEMONIC	TYPE	CODE	OPERANDS (Assembler Format)
* Add	AR	RR	1A	R1, R2
* Add	A	RX	5A	R1, D2 (X2, B2)
* Add Halfword	AH	RX	4A	R1, D2 (X2, B2)
* Add Logical	ALR	RR	1E	R1, R2
* Add Logical	AL	RX	5E	R1, D2 (X2, B2)
* AND	NR	RR	14	R1, R2
* AND	N	RX	54	R1, D2 (X2, B2)
* AND	NI	SI	94	D1 (B1), I2
* AND	NC	SS	D4	D1 (L, B1), D2 (B2)
Branch and Link	BALR	RR	05	R1, R2
Branch and Link	BAL	RX	45	R1, D2 (X2, B2)
Branch on Condition	BCR	RR	07	M1, R2
Branch on Condition	BC	RX	47	M1, D2 (X2, B2)
Branch on Count	BCTR	RR	06	R1, R2
Branch on Count	BCT	RX	46	R1, D2 (X2, B2)
Branch on Index High	BXH	RS	86	R1, R3, D2 (B2)
Branch on Index Low or Equal	BXLE	RS	87	R1, R3, D2 (B2)
* Compare	CR	RR	19	R1, R2
* Compare	C	RX	59	R1, D2 (X2, B2)
* Compare Halfword	CH	RX	49	R1, D2 (X2, B2)
* Compare Logical	CLR	RR	15	R1, R2
* Compare Logical	CL	RX	55	R1, D2 (X2, B2)
* Compare Logical	CLC	SS	D5	D1 (L, B1), D2 (B2)
* Compare Logical	CLI	SI	95	D1 (B1), I2
Convert to Binary	CVB	RX	4F	R1, D2 (X2, B2)
Convert to Decimal	CVD	RX	4E	R1, D2 (X2, B2)
Diagnose	SI	SI	83	
Divide	DR	RR	1D	R1, R2
Divide	D	RX	5D	R1, D2 (X2, B2)
* Exclusive OR	XR	RR	17	R1, R2
* Exclusive OR	X	RX	57	R1, D2 (X2, B2)
* Exclusive OR	XI	SI	97	D1 (B1), I2
* Exclusive OR	XC	SS	D7	D1 (L, B1), D2 (B2)
Execute	EX	RX	44	R1, D2 (X2, B2)
* Halt I/O	HIO	SI	9E	D1 (B1)
Insert Character	IC	RX	43	R1, D2 (X2, B2)
Load	LR	RR	18	R1, R2
Load	L	RX	58	R1, D2 (X2, B2)
Load Address	LA	RX	41	R1, D2 (X2, B2)
* Load and Test	LTR	RR	12	R1, R2
* Load Complement	LCR	RR	13	R1, R2
Load Halfword	LH	RX	48	R1, D2 (X2, B2)
Load Multiple	LM	RS	98	R1, R3, D2 (B2)
* Load Negative	LNR	RR	11	R1, R2
* Load Positive	LPR	RR	10	R1, R2
† Load PSW	LPSW	SI	82	D1 (B1)
Move	MVI	SI	92	D1 (B1), I2
Move	MVC	SS	D2	D1 (L, B1), D2 (B2)
Move Numerics	MVN	SS	D1	D1 (L, B1), D2 (B2)
Move with Offset	MVO	SS	F1	D1 (L1, B1), D2 (L2, B2)
Move Zones	MVZ	SS	D3	D1 (L, B1), D2 (B2)
Multiply	MR	RR	1C	R1, R2
Multiply	M	RX	5C	R1, D2 (X2, B2)
Multiply Halfword	MH	RX	4C	R1, D2 (X2, B2)
* OR	OR	RR	16	R1, R2
* OR	O	RX	56	R1, D2 (X2, B2)
* OR	OI	SI	96	D1 (B1), I2
* OR	OC	SS	D6	D1 (L, B1), D2 (B2)
Pack	PACK	SS	F2	D1 (L1, B1), D2 (L2, B2)
† Set Program Mask	SPM	RR	04	R1
Set System Mask	SSM	SI	80	D1 (B1)
* Shift Left Double	SLDA	RS	8F	R1, D2 (B2)
* Shift Left Single	SLA	RS	8B	R1, D2 (B2)
Shift Left Double Logical	SLDL	RS	8D	R1, D2 (B2)
Shift Left Single Logical	SLL	RS	89	R1, D2 (B2)
* Shift Right Double	SRDA	RS	8E	R1, D2 (B2)
* Shift Right Single	SRA	RS	8A	R1, D2 (B2)
Shift Right Double Logical	SRDL	RS	8C	R1, D2 (B2)
Shift Right Single Logical	SRL	RS	88	R1, D2 (B2)
* Start I/O	SIO	SI	9C	D1 (B1)
Store	ST	RX	50	R1, D2 (X2, B2)
Store Character	STC	RX	42	R1, D2 (X2, B2)
Store Halfword	STH	RX	40	R1, D2 (X2, B2)
Store Multiple	STM	RS	90	R1, R3, D2 (B2)
* Subtract	SR	RR	1B	R1, R2
* Subtract	S	RX	5B	R1, D2 (X2, B2)

* Condition code is set

† New condition code is loaded

NAME	MNEMONIC	TYPE	CODE	OPERANDS (Assembler Format)
* Subtract Halfword	SH	RX	4B	R1, D2 (X2, B2)
* Subtract Logical	SLR	RR	1F	R1, R2
* Subtract Logical	SL	RX	5F	R1, D2 (X2, B2)
Supervisor Call	SVC	RR	0A	1
* Test and Set	TS	SI	93	D1 (B1)
* Test Channel	TCH	SI	9F	D1 (B1)
* Test I/O	TIO	SI	9D	D1 (B1)
* Test Under Mask	TM	SI	91	D1 (B1), I2
Translate	TR	SS	DC	D1 (L, B1), D2 (B2)
* Translate and Test	TRT	SS	DD	D1 (L, B1), D2 (B2)
Unpack	UNPK	SS	F3	D1 (L1, B1), D2 (L2, B2)

DECIMAL FEATURE INSTRUCTIONS

* Add Decimal	AP	SS	FA	D1 (L1, B1), D2 (L2, B2)
* Compare Decimal	CP	SS	F9	D1 (L1, B1), D2 (L2, B2)
Divide Decimal	DP	SS	FD	D1 (L1, B1), D2 (L2, B2)
* Edit	ED	SS	DE	D1 (L, B1), D2 (B2)
* Edit and Mark	EDMK	SS	DF	D1 (L, B1), D2 (B2)
* Multiply Decimal	MP	SS	FC	D1 (L1, B1), D2 (L2, B2)
* Subtract Decimal	SP	SS	FB	D1 (L1, B1), D2 (L2, B2)
* Zero and Add	ZAP	SS	F8	D1 (L1, B1), D2 (L2, B2)

DIRECT CONTROL FEATURE INSTRUCTIONS

Read Direct	RDD	SI	85	D1 (B1), I2
Write Direct	WRD	SI	84	D1 (B1), I2

PROTECTION FEATURE INSTRUCTIONS

Insert Storage Key	ISK	RR	09	R1, R2
Set Storage Key	SSK	RR	08	R1, R2

Floating-point feature instructions are listed in Chapter 9.

MACHINE FORMAT

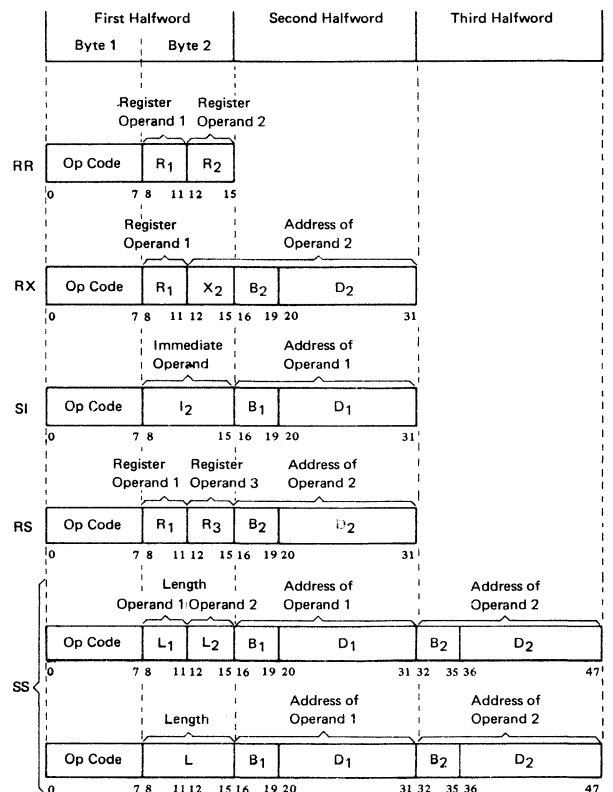

CONDITION CODE SETTINGS

Code State	0	1	2	3
Mask Bit Position	8	4	2	1
<i>Fixed-Point Arithmetic</i>				
Add H/F	zero	< zero	> zero	overflow
Add Logical	zero	not zero	zero	not zero
	no carry	no carry	carry	carry
Compare H/F (A:B)	equal	A low	A high	--
Load and Test	zero	< zero	> zero	carry
Load Complement	zero	< zero	> zero	overflow
Load Negative	zero	< zero	--	--
Load Positive	zero	--	> zero	overflow
Shift Left Double	zero	< zero	> zero	overflow
Shift Left Single	zero	< zero	> zero	overflow
Shift Right Double	zero	< zero	> zero	--
Shift Right Single	zero	< zero	> zero	--
Subtract H/F	zero	< zero	> zero	overflow
Subtract Logical	--	not zero	zero	not zero
		no carry	carry	carry
<i>Decimal Arithmetic</i>				
Add Decimal	zero	< zero	> zero	overflow
Compare Decimal (A:B)	equal	A low	A high	--
Subtract Decimal	zero	< zero	> zero	overflow
Zero and Add	zero	< zero	> zero	overflow
<i>Logical Operations</i>				
And	zero	not zero	--	--
Compare Logical (A:B)	equal	A low	A high	--
Edit	zero	< zero	> zero	--
Edit and Mark	zero	< zero	> zero	--
Exclusive Or	zero	not zero	--	--
Or	zero	not zero	--	--
Test Under Mask	zero	mixed	--	one(s)
Translate and Test	zero	incomplete	complete	--

EXTENDED MNEMONIC CODES FOR THE BRANCH ON CONDITION INSTRUCTION

Assembler Code	Meaning	Machine Instruction Generated
B	D2(X2,B2) Branch Unconditional	BC 15,D2(X2,B2)
BR	R2 Branch Unconditional (RR format)	BCR 15,R2
NOP	D2(X2,B2) No Operation	BC 0,D2(X2,B2)
NOPR	R2 No Operation (RR format)	BCR 0,R2
<i>Used after compare instructions (A:B)</i>		
BH	D2(X2,B2) Branch on High	BC 2,D2(X2,B2)
BL	D2(X2,B2) Branch on Low	BC 4,D2(X2,B2)
BE	D2(X2,B2) Branch on Equal	BC 8,D2(X2,B2)
BNH	D2(X2,B2) Branch on Not High	BC 13,D2(X2,B2)
BNL	D2(X2,B2) Branch on Not Low	BC 11,D2(X2,B2)
BNE	D2(X2,B2) Branch on Not Equal	BC 7,D2(X2,B2)
<i>Used after arithmetic instructions</i>		
BO	D2(X2,B2) Branch on Overflow	BC 1,D2(X2,B2)
BP	D2(X2,B2) Branch on Plus	BC 2,D2(X2,B2)
BM	D2(X2,B2) Branch on Minus	BC 4,D2(X2,B2)
BZ	D2(X2,B2) Branch on Zero	BC 8,D2(X2,B2)
BNP	D2(X2,B2) Branch on Not Plus	BC 13,D2(X2,B2)
BNM	D2(X2,B2) Branch on Not Minus	BC 11,D2(X2,B2)
BNZ	D2(X2,B2) Branch on Not Zero	BC 7,D2(X2,B2)
<i>Used after Test under Mask instructions</i>		
BO	D2(X2,B2) Branch if Ones	BC 1,D2(X2,B2)
BM	D2(X2,B2) Branch if Mixed	BC 4,D2(X2,B2)
BZ	D2(X2,B2) Branch if Zeros	BC 8,D2(X2,B2)
BNO	D2(X2,B2) Branch if Not Ones	BC 14,D2(X2,B2)

EBCDIC CHART

The 256-position chart at the right, outlined by the heavy black lines, shows the graphic characters and control character representations for the Extended Binary-Coded Decimal Interchange Code (EBCDIC). The bit-position numbers, bit patterns, hexadecimal representations and card hole patterns for these and other possible EBCDIC characters are also shown.

To find the card hole patterns for most characters, partition the chart into four blocks as follows:

1	3
2	4

- Block 1: Zone punches at top of table; digit punches at left
- Block 2: Zone punches at bottom of table; digit punches at left
- Block 3: Zone punches at top of table; digit punches at right
- Block 4: Zone punches at bottom of table; digit punches at right

Fifteen positions, indicated by circled numbers, are exceptions to the above arrangement. The card hole patterns for these positions are given below the chart.

Following are some examples of the use of the EBCDIC chart:

Character	Type	Bit Pattern	Hex	Hole Pattern	
				Zone Punches	Digit Punches
PF	Control Character	00 00 0100	04	12 - 9	4
%	Special Graphic	01 10 1100	6C	0 - 8	4
R	Upper Case	11 01 1001	D9	11 - 9	
a	Lower Case	10 00 0001	81	12 - 0	1
	Control Character, function not yet assigned	00 11 0000	30	12 - 11 - 0 - 9	8 - 1

Bit Positions
01 23 4567

EBCDIC CHART

		00				01				10				11				Bit Positions 0,1	
		00	01	10	11	00	01	10	11	00	01	10	11	00	01	10	11	Bit Positions 2,3	
Bit Positions 4, 5, 6, 7		Second Hexadecimal Digit																First Hexadecimal Digit	
Digit Punches		0	1	2	3	4	5	6	7	8	9	A	B	C	D	E	F		
		12				12	12		12	12		12	12					Zone Punches	
			11				11	11	11		11	11	11		11			Digit Punches	
				0		0		0	0	0		0	0			0			
		9	9	9	9	9	9	9	9										
0000	0	8-1	① NUL	② DLE	③ DS	④	⑤ SP	⑥ &	⑦ -	⑧					⑨	⑩	⑪	⑫ 0	8-1
0001	1	1	SOH	DC1	SOS				⑬ /		a	i		A	J	⑭	1	1	
0010	2	2	STX	DC2	FS	SYN					b	k	s	B	K	S	2	2	
0011	3	3	ETX	TM							c	l	t	C	L	T	3	3	
0100	4	4	PF	RES	BYP	PN					d	m	u	D	M	U	4	4	
0101	5	5	HT	NL	LF	RS					e	n	v	E	N	V	5	5	
0110	6	6	LC	BS	ETB	UC					f	o	w	F	O	W	6	6	
0111	7	7	DEL	IL	ESC	EOT					g	p	x	G	P	X	7	7	
1000	8	8		CAN							h	q	y	H	Q	Y	8	8	
1001	9	8-1		EM							i	r	z	I	R	Z	9	9	
1010	A	8-2	SMM	CC	SM		¢	!	⑮ :									8-2	
1011	B	8-3	VT	CU1	CU2	CU3	.	\$,	#								8-3	
1100	C	8-4	FF	IFS		DC4	<	*	%	@								8-4	
1101	D	8-5	CR	IGS	ENQ	NAK	()	_	'								8-5	
1110	E	8-6	SO	IRS	ACK		+	;	>	=								8-6	
1111	F	8-7	SI	IUS	BEL	SUB	!	~	?	"								8-7	
			12				12				12	12		12	12		12		
				11				11				11	11	11		11	11	11	
					0				0			0	0	0		0	0	0	
			9	9	9	9									9	9	9	9	

Card Hole Patterns (exceptions to punches shown in chart)

① 12-0-9-8-1	⑤ No Punches	⑨ 12-0	⑬ 0-1
② 12-11-9-8-1	⑥ 12	⑩ 11-0	⑭ 11-0-9-1
③ 11-0-9-8-1	⑦ 11	⑪ 0-8-2	⑮ 12-11
④ 12-11-0-9-8-1	⑧ 12-11-0	⑫ 0	

Control Character Representations

ACK	Acknowledge	EOT	End of Transmission
BEL	Bell	ESC	Escape
BS	Backspace	ETB	End of Transmission Block
BYP	Bypass	ETX	End of Text
CAN	Cancel	FF	Form Feed
CC	Cursor Control	FS	Field Separator
CR	Carriage Return	HT	Horizontal Tab
CU1	Customer Use 1	IFS	Interchange File Separator
CU2	Customer Use 2	IGS	Interchange Group Separator
CU3	Customer Use 3	IL	Idle
DC1	Device Control 1	IRS	Interchange Record Separator
DC2	Device Control 2	IUS	Interchange Unit Separator
DC4	Device Control 4	LC	Lower Case
DEL	Delete	LF	Line Feed
DLE	Data Link Escape	NAK	Negative Acknowledge
DS	Digit Select	NL	New Line
EM	End of Medium	NUL	Null
ENQ	Enquiry		

Special Graphic Characters

¢	Cent Sign	-	Minus Sign, Hyphen
.	Period, Decimal Point	/	Slash
<	Less-than Sign	,	Comma
(Left Parenthesis	%	Percent
+	Plus Sign	_	Underscore
	Logical OR	>	Greater-than Sign
&	Ampersand	?	Question Mark
!	Exclamation Point	:	Colon
\$	Dollar Sign	#	Number Sign
*	Asterisk	@	At Sign
)	Right Parenthesis	'	Prime, Apostrophe
;	Semicolon	=	Equal Sign
⌋	Logical NOT	"	Quotation Mark

SYSTEM/360 ASSEMBLER INSTRUCTIONS

Following is a representative list of assembler instructions, grouped according to use. The mnemonics used for conditional assembly and macro definition are included simply to clarify classification of assembler instructions as a whole. Information on these two subjects is given in the System/360 Assembler Language manuals (see Preface). The meaning of the extended mnemonics for the Branch on Condition machine instructions, and the machine code generated by each, appear elsewhere in this Appendix.

MNEMONIC MEANING

For symbol definition

EQU Equate Symbol

For data definition

DC Define Constant
DS Define Storage
CCW Define Channel Command Word

For program sectioning and linking

START Start Assembly
CSECT Identify Control Section
DSECT Identify Dummy Section
ENTRY Identify Entry-point Symbol
EXTRN Identify External Symbol
COM Identify Blank Common Control Section

For base register assignment

USING Use Base Address Register
DROP Drop Base Address Register

For control of printed listings

TITLE Identify Assembly Output
EJECT Start New Page
SPACE Space Listing
PRINT Print Optional Data

For program control

ICTL Input Format Control
ISEQ Input Sequence Checking
ORG Set Location Counter
LORG Begin Literal Pool
CNOP Conditional No Operation
COPY Copy Predefined Source Coding
END End Assembly
PUNCH Punch a Card
REPRO Reproduce Following Card

For macro definition

MACRO
MNOTE
MEXIT
MEND

MNEMONIC

For conditional assembly

GBLA
GBLB
GBLC
LCLA
LCLB
LCLC
SETA
SETB
SETC
AIF
AGO

Extended mnemonics for the BC and BCR machine instructions

B
BR
NOP
NOPR
BH
BL
BE
BNH
BNL
BNE
BO
BP
BM
BZ
BNP
BNM
BNZ
BNO

TYPES OF ASSEMBLER LANGUAGE CONSTANTS

Code	Type	Machine Format
C	Character	8-bit code for each character
X	Hexadecimal	4-bit code for each hexadecimal digit
B	Binary	Binary
F	Fixed-point	Signed, fixed-point binary; normally a fullword
H	Fixed-point	Signed, fixed-point binary; normally a halfword
E	Floating-point	Short floating-point; normally a fullword
D	Floating-point	Long floating-point; normally a doubleword
P	Decimal	Packed decimal
Z	Decimal	Zoned decimal
A	Address	Value of address; normally a fullword
Y	Address	Value of address; normally a halfword
S	Address	Base register and displacement value; a halfword
V	Address	Space reserved for external symbol addresses; each address normally a fullword

In this index, assembler and macro instructions are identified as such. Machine instructions are listed by name in capital letters.

- Adcon (*see* address constant)
- ADD (A) 9,11,30,42-44,113
 - Incrementing an indexed address 45,47
- ADD DECIMAL (AP) 57,62,71,73,81
- ADD HALFWORD (AH) 48
- ADD NORMALIZED (AD) 133
- ADD NORMALIZED (AE) 131
- Address arithmetic
 - Use of binary for 18,20
- Address calculations by assembler 6,10,11,55,57
- Address changes in program modification 15
- Address constant
 - A-type 108,111,113,119
 - in examples 76,94,101,103,108,112,116
 - to load base register 54,56
 - Modification by linkage editor 57,115,119,123
 - for subroutine linkage 108
 - to test completion of loop 57
 - V-type 109,115,117,119
- Address, effective 30,52
- Addressing byte locations 18
- Addressing main storage 9,18,19,24,30,51
- Addressing registers 19
- Address specification
 - Use of zero in 10,11,24,30
- Alignment, boundary (*see* boundary alignment)
- AND (N) 69,70,79,83
- AND (immediate) (NI) 67,68,78,79,83
- Argument 92,93,97
- Arithmetic and logical unit 19
- Arithmetic instructions, effect on condition code 140
- Assembler coding form 7
- Assembler instruction
 - In assembler language 2,4
 - List of 142
- Assembler instructions mentioned in text
 - CNOP (conditional no operation) 113,114
 - CSECT (identify control section) 115
 - DC (define constant) 2,10,11,31,127
 - DROP (drop base address register) 57
 - DS (define storage) 2,10,11,31,56,61,70
 - ENTRY (identify entry-point symbol) 121
 - EJECT (start new page) 3
 - END (end assembly) 10,11,31
 - EXTRN (identify external symbol) 120
 - ICTL (input format control) 7
 - ISEQ (input sequence checking) 7
 - ORG (set location counter) 54,55
 - PRINT (print optional data) 29,94
 - START (start assembly) 9,61,115
 - TITLE (identify assembly output) 2,9,120
 - USING (use base address register) 3,9,10,51-57
- Assembler language
 - Basic concepts 9,10
 - Comparison with high-level languages 4
 - Description 1-4
 - Types of instructions 3,4
- Assembler program 1,5,6,52,53
- "Assembler" program example 100,101
- Asterisk in a comment, use of 8
- Asterisk in an instruction, use of 11
- Averaging problem 48,49,68
- Base address 24,51,118,123
- Base register 9,11,24,51-57,123
 - Use of zero 30
- Base register range restriction 109
- Base registers, use of multiple 54-57
 - Base address chosen by assembler 56
- Baudot teletypewriter code 92
- Binary arithmetic (*see* fixed-point operations)
- Binary-coded decimal (BCD) data format 20
- Binary-decimal number conversion 28
- Binary fractions 35
- Bit 17
- Bit manipulation 82,83
- Bits, setting on and off 79
- Blanking storage area 100,102
- Boundary alignment 10,15,18,102
 - Of DC's and DS's 10
 - Of machine instructions 23
 - Use of CNOP instruction 113,114
 - Use of DS zero duplication factor 70
- Branch if Zeros (BZ) extended mnemonic 99
- BRANCH AND LINK (BAL) 109
- BRANCH AND LINK (BALR) 9,10,24,51,52,108,109,111
- Branching 23,39
- BRANCH ON CONDITION (BC) 40,42-44,71,78,79,81
 - 102
 - After COMPARE 45,76
- BRANCH ON CONDITION (BC, BCR)
 - with EDIT 89
 - Extended mnemonic code 44,78,79,83,140
 - No-Operation (NOP, NOPR) 39,140
 - Test of condition code 39
 - Uses 23,24

BRANCH ON COUNT (BCT) 23,73,80,83,99
 BRANCH ON COUNT (BCTR) 23,91
 Branch on Equal (BE) extended mnemonic 49
 BRANCH ON INDEX HIGH (BXH) 23,47
 BRANCH ON INDEX LOW OR EQUAL (BXLE) 23,
 46-49,113
 Branch on Low (BL) extended mnemonic 44
 Branch on Minus (BM) extended mnemonic 99,102
 Branch on Not Equal (BNE) extended mnemonic 99
 Branch on Not High (BNH) extended mnemonic 94
 Branch on Overflow (BO) extended mnemonic 110
 Branch Unconditional (B) extended mnemonic 98,101
 110,113
 Branch Unconditional (BR) extended mnemonic 108
 Branch, unconditional 39,42
 Branching alternate times through loop 81
 Branching by use of Execute instruction 99
 Byte 17,18

 CALL macro instruction 116,117,120,123
 Calling program 108
 Capacity of main storage 17
 Capacity of registers 19
 Central processing unit (CPU) 19
 Character codes 21
 Characteristic in floating-point number 126,127
 Character testing and manipulation 80,82,83
 Check bit 17
 Check digit, use of 80
 Clearing storage area to blanks 100,102
 CNOP assembler instruction 113,114
 Code conversion by use of TR 92,93
 Coding form, use of 7
 Collating sequence, EBCDIC 21,76
 Collating sequence, changing normal 93,94
 Comma and decimal point insertion 86-88
 Comments, use of 8
 COMPARE (C) 42-44,45,83
 COMPARE (CR) 40
 COMPARE DECIMAL (CP) 71
 COMPARE HALFWORD (CH) 49
 Compare instructions, logical contrasted to arithmetic
 76
 COMPARE LOGICAL (character) (CLC) 76,77,81,93,94
 COMPARE LOGICAL (immediate) (CLI) 93
 Comparison of alphanumeric characters 76,77
 Complementing bits 79
 Composite number problem 82,83
 Condition code 23,39
 after COMPARE 40
 in EDIT 89
 List of instructions that affect 130,139
 Masks for testing 39
 Summary of result settings 140
 after TEST UNDER MASK 78
 in TRT 97

 Constant, address (*see* address constant)
 Constants, assembling of
 Effect of PRINT DATA on 94
 Constants, types of 9,127,142
 Control characters in EDIT 86-90
 Control program 5,30,115,123
 Control section 115
 Conversion
 Binary-hexadecimal-decimal numbers 26-28
 Character codes 92,93
 Zoned-packed formats 69,70,81
 CONVERT TO BINARY (CVB) 73,100
 CONVERT TO DECIMAL (CVD) 9,70,102
 Core storage (*see* main storage)
 Counter, location 6,9,10,54,115
 CPU (central processing unit) operations 19
 Cross-reference table 6,8,52
 CSECT assembler instruction 115
 Currency symbols, floating 91

 Data constants (*see* DC assembler instruction)
 Data exception 25
 Data format 17,20-22,60,75,126
 (*See also* individual types of data)
 Data introduced in instructions 75,113
 DC assembler instruction 2,10,11,31,127
 Types of constants 142
 Decimal-binary number conversion 28
 Decimal data format 20,21,60
 Decimal data manipulation 82,83
 Decimal digits, clearing excess 63,71
 Decimal feature instruction set 60,139
 Decimal-hexadecimal number conversion 27,28
 Decimal operations 20,21,60-73
 Addition and subtraction 61-62
 Comparison 71,72
 Division 64,68
 Effect on condition code 140
 Format conversions 69,70
 Multiplication 63
 Providing storage locations for data 62
 Requirement for packed format 21,60
 "Shifting" 66-68
 Decimal places, rule for number of 64,68
 Decimal point and comma insertion 86-88
 Decimal point in binary numbers 34,35
 Decimal point in floating-point arithmetic 125,127
 Decimal signs, clearing excess 67
 Decision-making 23,39,42-44
 Delimiters, scan of data fields for 97,100
 Diagnostic messages 6,12-14
 Dictionaries 6,115 (*see also* ESD and RLD)
 Digit selector 86-90
 Disk Operating System (DOS) macros 111
 Displacement 11,24,51-57
 Assignment of smallest 56

Restrictions in size and sign 54,55
 DIVIDE (D) 34,42-44
 DIVIDE (DDR) 133
 DIVIDE DECIMAL (DP) 64,68
 Before and after results of operation 64
 DIVIDE (DER) 132
 DIVIDE (DR) 49,113
 Dollar amounts, editing of 87-91
 Dollar sign, insertion of floating 91
 DOS (Disk Operating System) macros 111
 Doubleword 10,17,18
 Doubling a binary number by shifting 49
 DROP assembler instruction 57
 DS assembler instruction 2,10,11,31
 Length modifier in 61
 Zero duplication factor in 56,70
 Dumps, "reading" 117-119,121-123

 EBCDIC character set 21,11
 Collating sequence 21
 Complete 256-position chart 140,141
 EDIT AND MARK (EDMK) 85,86,91
 Use of register 1 91
 EDIT (ED) 85-90
 Editing
 Conditions and results, summary of 88
 Dollar amounts 87-91
 Multiple fields 90
 Pattern, rule for length 87
 EJECT assembler instruction 3
 END assembler instruction 10,11,31
 Entries on coding form, rules for 7,8
 ENTRY assembler instruction 121
 Entry point 121
 Entry point register 111
 EOJ (End of Job) macro instruction 3,9,30
 Error analysis by assembler 12-14
 Error code 13
 Error detection by CPU 23
 Error detection by use of TRT 97
 Error messages 12-14
 Error return 110
 ESD (external symbol dictionary) 6,109,115,119,121
 Even, odd registers
 in BXLE 46,47
 in fixed-point multiplication 32
 Exception 25,32,114,132
 Excess-64 notation 126
 EXCLUSIVE OR (immediate) (XI) 79
 EXCLUSIVE OR (XR) 78
 EXCLUSIVE OR (XR, X, XI, XC) 78
 Executable instructions 1,3
 EXECUTE (EX) 85,99,100,102
 Explicit length specification 60,61,77
 Exponent 126,127,131
 Exponent overflow and underflow 132

 Extended binary coded decimal interchange code
 (See EBCDIC character set)
 Extended mnemonic code 44,78,79,83,140,142
 External interruption 25
 External references 115
 External symbol 120,121
 External symbol dictionary (ESD) 6,109,115,119,121
 EXTRN assembler instruction 120

 F (fullword) 31
 Field length 17
 Characters 21
 Fixed-length (fixed-point numbers) 20
 Variable length (decimal numbers) 20
 Field separator 90
 Fill character 86-90
 Fixed-length data, alignment of 10,18
 Fixed-point operations 19,20,29-50
 Addition 30
 Decimal point in 34,35
 Division 34,35
 Effect on condition code 140
 Multiplication 32,33,34,35
 Number format 20,82
 Subtraction 30
 Floating currency symbols 91
 Floating-point operations 21,125-133
 Advantages of using 125
 Constants 127-129
 Instruction set 130
 Number format 126-129
 Registers 19,21,130
 Flowchart, program 40,42,82
 Format
 Machine instruction 10,11,23,24,139 (*see also* RR,
 RX, SI, RS, SS)
 Data 17,20-22,60,75,126 (*see also* specific data
 formats)
 Fraction in floating-point number 126,127,130
 Fullword 10,17,18,20,31
 Function bytes 93,97
 Function table 92-94,97,100

 General registers (*see* registers, general)
 Graphic characters 21,22,141
 Guard digit 132

 Halfword 10,17,18,20
 Halfword operands, machine instructions using 48
 HALVE (HDR) 133
 HALVE (HER) 132
 Hexadecimal code 10,11,21
 For EBCDIC characters 22,86-93,141
 Four-bit binary code 26
 Interpreting in storage printout 26,117-119,121-123
 Uses of 26,27

- Hexadecimal-decimal number conversion 27,28
- Hexadecimal dump of storage area 117
- Hexadecimal numbers 26-28,33

- ICTL assembler instruction 7
- Immediate operand 23,24,75,78,79
- Implicit length 60,61,77
- Indexed addressing 45,46
- Index, limit value of 46,47,49
- Index register 24,45,46,49,80,83
- Index register zero 11
- “Indian” problem 73
- Initialization of program 48
- INSERT CHARACTER (IC) 69,80,83
- Instruction address 23
 - Next sequential in PSW 25
 - Length code in PSW 25
- Instruction execution out of sequence 99
- Instruction format 10,11,23,24,139
 - (See also RR, RX, SI, RS, and SS)
- Instruction sets, System/360
 - Decimal feature 60,139
 - Floating-point feature 130
 - Standard 29,139
- Integral boundaries 18
- Interchanging addresses instead of records 77
- Interchanging contents of registers 40,76,94
- Interest problem
 - In decimal arithmetic 63
 - In fixed-point arithmetic 34,35
 - Using both decimal and binary 73
- Interruption, program 25
- Interruptions, types of 25
- Interruption system 23,25
- Invalid delimiter 13
- Invalid symbol 13
- Inventory problem
 - In decimal arithmetic 61
 - In fixed-point arithmetic 29
- I/O devices, requirement for zoned decimal format 21,60
- I/O interruption 25
- I/O operations
 - Use of DC’s and DS’s as substitute 31
- ISEQ assembler instruction 7

- Keys, sorting on 76,77,93-96

- Leading zeros, suppression of 86-88
- Left “shifting” in decimal operations 67
- Length code in machine instructions 60,61
- Length modifier in DC 61
- Limit value of index 46,47,49
- Linkage editor 6,53,109,115-118,121,123
- Linkage registers 111
- Linkage subroutine 107-124

- Listings produced by assembler 6
- Literal 113,117
- LOAD ADDRESS (LA) 46,47,48,80,91,97,100,111
- LOAD AND TEST (LTR) 49
- LOAD COMPLEMENT (LCDR) 133
- LOAD COMPLEMENT (LCER) 131
- LOAD HALFWORD (LH) 48
- LOAD (L) 9,11,29,30,42-44,70,113
- LOAD (LD) 133
- LOAD (LE) 130
- Load location, program 53,117
- LOAD (LR) 40,42,43,48
- LOAD macro instruction 121,123
- Load module 115,116
- LOAD MULTIPLE (LM) 40,77
- LOAD POSITIVE (LPR) 40
- Location counter 6,9,10,54,115
- Logical instructions, using RX forms of 79
- Logical operations 21
- Logical operations 75-104
 - Effect on condition code 140
 - Summary of 75
- Long precision 130,133
- Loop control 23
- Looping with an index 45-49,80,83,113
- Loop, parts of 45
- Loop reiteration by loading of base address 57
- Loops, counting in 73,80,81

- Machine check interruption 25
- Machine instruction format 10,11,23,24,139
 - (See also RR, RX, SI, RS, SS)
- Machine instructions
 - In assembler language 1,4
 - (See name of individual instruction)
- Machine instructions, list of 130,139
- Machine language 1
- Machine operations, basic concepts of 9,10
- Macro instructions 3,4
 - Effect of PRINT instruction on listing 29,94
 - (See individual mnemonics)
- Macros for subroutine linkage, DOS 111
- Main storage 17,18
 - Addressing 24
 - Use of in decimal arithmetic 20
- Main storage area, contents of, printed out 117,118,122
- Mask
 - Use of hexadecimal code 26,69
 - Use in testing 24
- Mask field in machine instructions 24
- Message characters 87-90
- Mnemonics 1,2,3
 - Machine instructions, list of 139
 - Assembler instructions, list of 142
- Mnemonic code, extended 44,78,79,83,140,142
- MOVE (characters) (MVC) 57,61,66,68,73,77,86,90,94

Propagating character through field, use for 89,97,102
MOVE (immediate) (MVI) 100
Move instructions, use for "shifting" decimal fields 66,67
MOVE NUMERICS (MVN) 63,66,71,73,75
MOVE WITH OFFSET (MVO) 60,66,67,71
MULTIPLY DECIMAL (MP) 63,73
MULTIPLY (M) 32-35,42-44
MULTIPLY (MD) 133
MULTIPLY (MDR) 133
MULTIPLY (ME) 130,131
MULTIPLY (MER) 133

Name of program

In CSECT statement 115

In START statement 9,115

Naming fields in a storage area 57

Negative fixed-point numbers 20,31,38

Negative floating-point numbers 128

No-Operation (NOP) extended mnemonic 113,114

No-Operation (NOPR) extended mnemonic 39,99,140

Normalization 131

Normalized number 126,129

Notation, scientific 126

Number base 27,126

Number of places in decimal division 64,68

Numerical place values in base 2, 10, and 16 27

Object code 1,5,10,115

Object deck 120

Object module 115

Object program 5,10

Operand 1,8,20,21,23

Operating system 5

Operation code 1,23,24

ORG assembler instruction 54,55

OR (immediate) (OI) 79,83

OR (O) 69,81

Overflow in floating-point fraction 131,132

Overlapping fields in decimal operations 66,67,73

Overtime pay problem 71

PACK (PACK) 60,70,73,83,100

Packed decimal numbers 20,60,61,69,70,81

Parameter list 111,117

Parity bit 17

Pattern field in EDIT 86,87

PDUMP macro instruction 117,121

Pool, literal 113

Postnormalization 131,132

Prenormalization 131,132

PRINT assembler instruction 29,94

Printout of storage area contents 117,118,122

Program checkout, use of dump for 117

Program execution 6,23-25,118-119,121-123

Use of main storage in 17

Program interruption 25

Program listing 6

Programming errors 12-14

Programming support system 5

Program phase 115

Program status word (PSW) 23-25

Propagating character through field 89,97,102

PSW (program status word) 23-25

Punch card patterns for EBCDIC code 22,140,141

Recomplement 33

Records, processing fixed-length 45

Records, processing fixed-length blocked 56,57

Register contents shown in printout 117-119,121-123

Registers, floating-point 19,130

Registers, general 19,20

Available to programmer 51

Clearing to zero 42,45

Functions in a program summarized 48

Saving contents of 111,112

Specification 24

Standard assignments 111

Registers, general, use of

with BXLE instruction 46,47

in fixed-point multiplication 46,47

by operating system 51

in shifting operations 37

for subroutine linkages 108,111

Registers 1 and 2, use of, by TRT 97

Register zero 10,11

Register 1, use of, by EDMK 91

Relative addressing 9

Relocatability 115

Relocation dictionary (RLD) 6,115,119

Relocation factor 53,115

Relocation, program 24,53,115-119

RETURN macro instruction 113,123

Return point, subroutine 108,110,111

Return register 111

Right "shifting" in decimal operations 66

RLD (relocation dictionary) 6,115,119

Rounding errors, accumulated 43

Rounding off 34,35,42,43,49

In decimal arithmetic 63,68,71

RR instruction format 11,23,24

RS instruction format 11,23,24

RX instruction format 11,23,24,29

Save area 111,112,123

SAVE macro instruction 112,113

Scale factor

For binary constant 35

Scanning data fields for delimiters 97,100

Scientific notation 126

Sequential instruction execution 23

Setting bits on and off 79

Shifting, fixed-point 34,37,38,113

Shifting, logical contrasted to algebraic 37,38
 "Shifting" of decimal fields 66,67
 SHIFT LEFT SINGLE (algebraic) (SLA) 9,11,49,52,83,110
 SHIFT LEFT SINGLE LOGICAL (SLL) 80
 SHIFT RIGHT DOUBLE (algebraic) (SRDA) 38
 SHIFT RIGHT DOUBLE LOGICAL (SRDL) 37,38
 SHIFT RIGHT SINGLE (algebraic) (SRA) 35,38
 SHIFT RIGHT SINGLE LOGICAL (SRL) 37,38
 Short precision 130
 Sign bits
 In algebraic shifting 35
 In fixed-point numbers 20,32
 In logical shifting 37
 Propagation in halfword instructions 49
 Sign control in EDIT 88
 Significance exception 132
 Significance indicator 87-90
 Significance starter 87-91
 Sign of numbers
 EBCDIC 20
 Fixed-point 20
 Floating-point 126,128
 SI instruction format 23,24,139
 Social security tax problem
 In decimal arithmetic 72,73
 In fixed-point arithmetic 42-44
 Sorting problem 39-41,76,77,93-96
 Source deck 5
 Source of program interruption, locating 25
 Source program 5
 Specification exception 32,114
 SS instruction format 23,24,56,60-73,139
 Standard instruction set 29,139
 Standard linkage registers 111
 START assembler instruction 9,52,53,115
 Use of zero in 61
 Status, program (in PSW) 25
 Storage addressing 18,24
 Storage, main 17,18,20
 STORE CHARACTER (STC) 69,80,83
 STORE HALFWORD (STH) 37
 STORE MULTIPLE (STM) 40,112
 STORE (ST) 9,30,43,44,113
 STORE (STD) 133
 STORE (STE) 133
 Subroutine 107-123
 Assembled separately 120-122
 Entry point 111
 Program design 107
 Register availability for 113
 Relocatable 115
 SUBTRACT DECIMAL (SP) 62
 SUBTRACT HALFWORD (SH) 49
 SUBTRACT NORMALIZED (SD) 133
 SUBTRACT NORMALIZED (SE) 132
 SUBTRACT (S) 9,30
 Decrementing an indexed address 46
 SUBTRACT (SR) 42,43,45,48,80,113
 Supervisor 5
 SUPERVISOR CALL (SVC) 30,123
 Interruption 25
 Suppression of leading zeros 86-88
 Symbol (cross-reference) table 6,8,52
 Symbolic address 9,24,30
 Syntax error 13

 Table, function 92-94,97,100
 Table of decimal-hexadecimal values 28
 Table requirements for Translate instruction 92,94
 Table requirements for TRT instruction 97,100
 Table, use of MVI to insert values in 100,102
 Teletypewriter code, Baudot 92
 Testing bit combinations 78,79
 Testing characters 82,83
 Testing, terminating loop by 45
 Testing the condition code 23,32
 Tests
 Of address arithmetic 23
 Of counting 24
 With masks 24
 TEST UNDER MASK (TM) 78,79
 TITLE assembler instruction 2,9,120
 TRANSLATE AND TEST (TR) 85,97-104
 Starting address for 100
 Use to determine data length 102
 Translate table 92-94
 TRANSLATE (TR) 85,92-94
 TRT table 97,100
 Two's-complement notation 31,33
 Type specification of constants 10,86,127,142

 Undefined symbol 12,13
 Unnormalized number 126
 UNPACK (UNPK) 60,70,73,102
 USASCII code 20,76
 USING assembler instruction 3,9,10,51-57

 Valid data, checking for 44,93
 Variable-length data, use by SS-format instructions 60
 Variable length of decimal data 20

 Wallpaper problem 78,79
 Work areas in storage
 Setting up in decimal operations 63,71

 ZERO AND ADD (ZAP) 63,66,73
 Zeros, suppression of leading 86-88
 Zone and sign tests 82,83
 Zoned decimal numbers 21,60
 Conversion to packed 69,70,81

READER'S COMMENT FORM

A Programmer's Introduction
to IBM System/360 Assembler Language

C20-1646-5

Please comment on the usefulness and readability of this publication, suggest additions and deletions, and list specific errors and omissions (give page numbers). All comments and suggestions become the property of IBM. If you wish a reply, be sure to include your name and address.

COMMENTS

—
fold

—
fold

—
fold

—
fold

- Thank you for your cooperation. No postage necessary if mailed in the U.S.A.
FOLD ON TWO LINES, STAPLE AND MAIL.

YOUR COMMENTS PLEASE...

Your comments on the other side of this form will help us improve future editions of this publication. Each reply will be carefully reviewed by the persons responsible for writing and publishing this material.

Please note that requests for copies of publications and for assistance in utilizing your IBM system should be directed to your IBM representative or the IBM branch office serving your locality.

fold

fold

FIRST CLASS
PERMIT NO. 10
ENDICOTT, N. Y.

BUSINESS REPLY MAIL
NO POSTAGE NECESSARY IF MAILED IN THE UNITED STATES

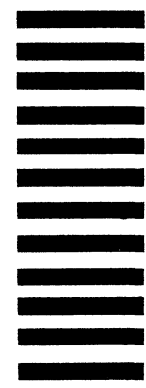

POSTAGE WILL BE PAID BY ...

IBM Corporation
1701 North Street
Endicott, N. Y. 13760

Attention: DP Education Development, Dept. 617

fold

fold



International Business Machines Corporation
Data Processing Division
112 East Post Road, White Plains, N.Y. 10601
[USA Only]

IBM World Trade Corporation
821 United Nations Plaza, New York, New York 10017
[International]

Printed in U.S.A. C20-1646-5

READER'S COMMENT FORM

A Programmer's Introduction
to IBM System/360 Assembler Language

C20-1646-5

Please comment on the usefulness and readability of this publication, suggest additions and deletions, and list specific errors and omissions (give page numbers). All comments and suggestions become the property of IBM. If you wish a reply, be sure to include your name and address.

COMMENTS

—
fold

—
fold

—
fold

—
fold

- Thank you for your cooperation. No postage necessary if mailed in the U.S.A.
FOLD ON TWO LINES, STAPLE AND MAIL.

YOUR COMMENTS PLEASE...

Your comments on the other side of this form will help us improve future editions of this publication. Each reply will be carefully reviewed by the persons responsible for writing and publishing this material.

Please note that requests for copies of publications and for assistance in utilizing your IBM system should be directed to your IBM representative or the IBM branch office serving your locality.

fold

fold

FIRST CLASS
PERMIT NO. 10
ENDICOTT, N. Y.

BUSINESS REPLY MAIL
NO POSTAGE NECESSARY IF MAILED IN THE UNITED STATES



POSTAGE WILL BE PAID BY . . .

IBM Corporation
1701 North Street
Endicott, N. Y. 13760

Attention: DP Education Development, Dept. 617

fold

fold

Printed in U.S.A. C20-1646-5



International Business Machines Corporation
Data Processing Division
112 East Post Road, White Plains, N.Y. 10601
[USA Only]

IBM World Trade Corporation
821 United Nations Plaza, New York, New York 10017
[International]



International Business Machines Corporation
Data Processing Division
112 East Post Road, White Plains, New York 10601
(USA only)

IBM World Trade Corporation
821 United Nations Plaza, New York, N. Y. 10017
(International)

C20-1646-5