IBM

**Large
Systems
Technical
Support**

**Technical
Bulletin**

**3720 Model 1/2 Installation
Planning Guide**

**C. L. Brinkman
N. W. Gates
H. J. Leyton
J. J. Lucas**

**National Technical Support
Washington Systems Center**

**GG66-0268-00
February 1987**

3720 Model 1/2 Installation Planning Guide

C. L. Brinkman
N. W. Gates
H. J. Leyton
J. J. Lucas

The information contained in this document has not been submitted to any formal IBM test and is distributed on an "as is" basis **without any warranty either expressed or implied**. The use of this information or the implementation of any of these techniques is a customer responsibility and depends on the customer's ability to evaluate and integrate them into the customer's operational environment. While each item may have been reviewed by IBM for accuracy in a specific situation, there is no guarantee that the same or similar results will be obtained elsewhere. Customers attempting to adapt these techniques to their own environments do so at their own risk.

In this document, any references made to an IBM licensed program are not intended to state or imply that only IBM's licensed program may be used; any functionally equivalent program may be used instead.

It is possible that this material may contain reference to, or information about, IBM products (machines and programs), programming, or services that are not announced in your country. Such references or information must not be construed to mean that IBM intends to announce such IBM products, programming, or services in your country.

Permission is hereby granted to reproduce the foil masters included in this bulletin in the form of transparencies.

Publications are not stocked at the address given below; requests for IBM publications should be made to your IBM representative or to the IBM branch office serving your locality.

A form for reader's comments is provided at the back of this publication. If the form has been removed, comments may be addressed to: IBM Corporation, Washington Systems Center, 18100 Frederick Pike, Gaithersburg, MD 20879

IBM may use or distribute any of the information you supply in any way it believes appropriate without incurring any obligation whatever. You may, of course, continue to use the information you supply.

Preface

This document contains presentations covering various IBM 3720 installation planning subjects and an accompanying script to aid in documenting the screens listed in the table of contents. Many of the sections are identical to the 3720 Installation Planning Seminar, G3663, conducted on September 29, October 6, and October 24, 1986 by the Washington Systems Center.

The material can be used either as a complete class module or sectionalized as the user requires it. All the screens are contained in a PC-AT, hi-density diskette orderable as a technical news letter (TNL) GNL28-0013 to this document. (Copies of the screens are also included in this document.) The diskette contains the Storyteller execution module with the following eight stories provided:

- OV.SH - Overview story
- PP.SH - Physical Planning story
- SO.SH - Software story
- OP.SH - Operations story
- PD.SH - Problem Determination story
- PF.SH - Performance story
- MI.SH - Migration story
- SE.SH - Service story

Each section identified in the table of contents corresponds to one of the stories listed above; each screen of the the story is also listed in the table of contents and documents the diskette files themselves.

The information presented in this manual is based on experiences gained by the Washington System Center (WSC) from the installation of a 3720 Model 1 at the WSC and from the 3720 Early Support Program.

Table of Contents

SECTION 1 - OVERVIEW	1
SCREEN OV01 Overview Section	1
SCREEN OV02 Overview Agenda	1
SCREEN OV03 Overview Agenda	1
SCREEN OV04 3720 Objectives	1
SCREEN OV05 3720 Model 1	1
SCREEN OV06 3720 Model 1 Software	2
SCREEN OV07 3720 Model 2	2
SCREEN OV08 3720 Model 2 Software	2
SCREEN OV09 3721 Models 1 and 2	2
SCREEN OV10 3721 Models 1 and 2 Software	2
SCREEN OV11 3720 Model 11	3
SCREEN OV12 3720 Model 11 Software	3
SCREEN OV13 3720 Model 12	3
SCREEN OV14 3720 Model 12 Software	3
SCREEN OV15 3720 Architecture	3
SCREEN OV16 3720 Architecture	3
SCREEN OV17 3720 Architecture	4
SCREEN OV18 Control Subsystem	4
SCREEN OV19 Transmission Subsystem-3720 M1 & M2	4
SCREEN OV20 Transmission Subsystem-3721 Model 1	4
SCREEN OV21 Transmission Subsystem-3721 Model 2	4
SCREEN OV22 Transmission Subsystem	4
SCREEN OV23 Transmission Subsystem	5
SCREEN OV24 Transmission Subsystem	5
SCREEN OV25 Transmission Subsystem	5
SCREEN OV26 MOSS Subsystem	5
SCREEN OV27 MOSS Subsystem	5
SCREEN OV28 MOSS Subsystem	6
SCREEN OV29 MOSS Subsystem	6
SCREEN OV30 Customer Environment	6
SCREEN OV31 3720 Model 1 Installation	6
SCREEN OV32 3720 Model 2 Installation	6
SCREEN OV33 3721 Model 1 and 2 Installation	6
SCREEN OV34 Service Concept	6
SECTION 2 - PHYSICAL PLANNING	8
SCREEN PP00 Title - Physical Planning	8
SCREEN PP01 Physical Planning Overview	8
SCREEN PP02 3720 Model 1	8
SCREEN PP03 3720 Model 1 Essential Information	8
SCREEN PP04 3720 Model 1 Control Panel	9
SCREEN PP05 3720 Model 1 Control Panel	9
SCREEN PP06 3720 Model 1 Control Panel	9
SCREEN PP07 3720 Model 1 Control Panel	10
SCREEN PP08 3720 Model 2	10
SCREEN PP09 3720 Model 2 Essential Information	10
SCREEN PP10 3720 Model 2 Control Panel	10
SCREEN PP11 3720 Model 2 Control Panel	11

SCREEN PP12	3720 Model 2 Control Panel	11
SCREEN PP13	3721 Model 1/ Model 2	11
SCREEN PP14	3721 Essential Information	11
SCREEN PP15	3720/37X5 Comparison	11
SCREEN PP16	3720/37x5 Comparison Assumptions	11
SCREEN PP17	3720 Model 1/2 Addressing	11
SCREEN PP18	3721 Model 1 Addressing	12
SCREEN PP19	3721 Model 2 Addressing	12
SCREEN PP20	Customer Setup Responsibilities	12
SCREEN PP21	Customer Setup Responsibilities	12
SCREEN PP22	Customer System Integration Responsibilities	12
SCREEN PP23	Customer System Integration Responsibilities	12
SCREEN PP24	Operator Console Support	13
SCREEN PP25	MOSS Console/RSF Attachment	13
SCREEN PP26, PP27	Cables	13
SECTION 3 - SOFTWARE SUPPORT		14
SCREEN SO00	Title	14
SCREEN SO01	Software Support Overview	14
SCREEN SO02	MVS Control Programs	14
SCREEN SO03	MVS Control Program	14
SCREEN SO04	MVS Control Program	14
SCREEN SO05	MVS Alert Suport	14
SCREEN SO06	VSE Control Program	15
SCREEN SO07	VSE Control Program	15
SCREEN SO08	VSE Alert Support	15
SCREEN SO09	VM Control Program	15
SCREEN SO10	VM Control Program	15
SCREEN SO11	VM Alert Support	15
SCREEN SO12	SSP V3R2	16
SCREEN SO13	NCP Generation	16
SECTION 4 - OPERATIONS		17
SCREEN OP01	Operations Section	17
SCREEN OP02	Operations Agenda	17
SCREEN OP03	Unchanged Host Functions	17
SCREEN OP04	Changed Host Functions	17
SCREEN OP05	Changed Host Functions	18
SCREEN OP06	New MOSS Functions	18
SCREEN OP07	MOSS Logo Screen	18
SCREEN OP08	3720 Authorization Screen	18
SCREEN OP09	Main Menu Screen - Passwords	19
SCREEN OP10	Password Management	19
SCREEN OP11	Passwords Function	19
SCREEN OP12	Passwords Function	19
SCREEN OP13	Passwords Function	20
SCREEN OP14	Passwords Function	20
SCREEN OP15	Passwords Function	20
SCREEN OP16	Password Management	20
SCREEN OP17	Passwords Function	20
SCREEN OP18	Passwords Function	20
SCREEN OP19	Password Management	20
SCREEN OP20	Passwords Function	20
SCREEN OP21	Passwords Function	21
SCREEN OP22	Passwords Function	21
SCREEN OP23	Passwords Function	21
SCREEN OP24	Configuration Data File	21
SCREEN OP25	Main Menu Screen - Configuration Data File	21
SCREEN OP26	Configuration Data File	21
SCREEN OP27	Configuration Data File	21
SCREEN OP28	Configuration Data File	22

SCREEN OP29	Configuration Data File	22
SCREEN OP30	Configuration Data File	22
SCREEN OP31	Configuration Data File	22
SCREEN OP32	Configuration Data File	22
SCREEN OP33	Configuration Data File	23
SCREEN OP34	Configuration Data File	23
SCREEN OP35	Configuration Data File	23
SCREEN OP36	Configuration Data File	23
SCREEN OP37	Configuration Data File	23
SCREEN OP38	Line Description File	23
SCREEN OP39	Main Menu Screen - Line Description File	24
SCREEN OP40	Line Description File	24
SCREEN OP41	Line Description File	24
SCREEN OP42	Line Description File	24
SCREEN OP43	Panel Function	24
SCREEN OP44	Main Menu Screen - Panel Function	24
SCREEN OP45	Panel Function	25
SCREEN OP46	Panel Function	25
SCREEN OP47	Panel Function	25
SCREEN OP48	Panel Function	25
SCREEN OP49	Panel Function	25
SCREEN OP50	Panel Function	25
SCREEN OP51	Disk Function	25
SCREEN OP52	Main Menu Screen - Disk Function	26
SCREEN OP53	Disk Function	26
SCREEN OP54	Disk Function	26
SCREEN OP55	Microcode Fixes	26
SCREEN OP56	Main Menu Screen - Microcode Fixes	26
SCREEN OP57	Microcode Fixes	26
SCREEN OP58	Machine Level Table	26
SCREEN OP59	Main Menu Screen - Machine Level Table	26
SCREEN OP60	Machine Level Table	27
SCREEN OP61	Line Threshold	27
SCREEN OP62	Main Menu Screen - Line Threshold	27
SCREEN OP63	Line Threshold	27
SCREEN OP64	Line Threshold	27
SCREEN OP65	Line Threshold	27
SCREEN OP66	Line Threshold	27
SCREEN OP67	Other New MOSS Functions	27
SECTION 5 - PROBLEM DETERMINATION		28
SCREEN PD01	Title - Problem Determination	28
SCREEN PD02	Differences from the 3725	28
SCREEN PD03	Wrap Test	28
SCREEN PD04	AutoBER Analysis	28
SCREEN PD05	MOSS Alarm Display	28
SCREEN PD06	MOSS Alarm Detail Display	29
SCREEN PD07	Alert Flow	29
SCREEN PD08	VTAM or NCCF (No Generic Alert)	29
SCREEN PD09	VTAM or NCCF (Generic Alert)	29
SCREEN PD10	NPDA V3	29
SCREEN PD11	NPDA V3 Cont'd (selection 3)	30
SCREEN PD11	NPDA V3 Cont'd (selection 2)	30
SCREEN PD11	NPDA V3 Cont'd (selection 1)	30
SCREEN PD14	Netview (selection 2)	30
SCREEN PD15	Conclusions	30
SECTION 6 - PERFORMANCE		31
SCREEN PF01	Title - Performance	31
SCREEN PF02	Performance Overview	31
SCREEN PF03	System Configuration	31

SCREEN PF04	3720 Hardware Configuration	31
SCREEN PF05	3720 Software	31
SCREEN PF06	Remote 3720 Scenario: NPM Results	31
SCREEN PF07	Remote 3720 Scenario: CF3725 Results	32
SCREEN PF08	Local Scenario: 3720	32
SCREEN PF09	Local Scenario: 3725	32
SCREEN PF10	Conclusions	32
SECTION 7 - MIGRATION		33
SCREEN MI00	Title - Migration	33
SCREEN MI01	Overview	33
SCREEN MI02	Hardware	33
SCREEN MI03	Hardware	33
SCREEN MI04	Software	34
SCREEN MI05	Software	34
SCREEN MI06	Software	34
SCREEN MI07	Hints and Tips	35
SCREEN MI08	Hints and Tips	35
SCREEN MI09	Hints and Tips	35
3720 Publications		36
SECTION 8 - SERVICE		37
SCREEN SE00	Title - Service	37
SCREEN SE01	Service Overview	37
SCREEN SE02	Remote Service Facility	37
SCREEN SE03	Hardware Support Center Access	37
SCREEN SE04,SE05	Hardware Service Cycle	37
SCREEN SE06	Software	37
Microcode Distribution Plan		38

Section 1 - Overview

SCREEN OV01 Overview Section

This manual consists of eight sections. The first section, the Overview, is designed to give the reader general knowledge of the 3720. Much greater detail of the various aspects of the 3720 are found in the subsequent sections--Physical Planning, Software Support, Operations, Problem Determination, Performance, Migration, and Service.

SCREEN OV02 Overview Agenda

The various models and hardware features are described first, along with the software products that support the different models and features. The Architecture section explains the different 3720 subsystems, the Control Subsystem, the Transmission Subsystem, and the Maintenance and Operator Subsystem.

SCREEN OV03 Overview Agenda

The customer environment section explains new packaging which allows customer setup, installation, reconfiguration, and relocation of some 3720 components. Customer versus IBM installation responsibilities are covered along with the 3720 service concept.

SCREEN OV04 3720 Objectives

The 3720, architecturally and operationally quite similar to the 3725, is specifically intended to extend the 3725 product line. It is ideally suited for customers with low end networks or a need for remote concentration. Customers who have a low end or small network, but may have a need to attach more lines than an Integrated Communication Adapter (ICA) can handle may find the 3720 a much better solution than a 3725 or 3705. Customers who have a large network may find that the 3720, with its remote operation and concentration capabilities, can improve their network design and lessen line costs.

SCREEN OV05 3720 Model 1

The 3720 Model 1 is a channel attached model with the capability of attaching to up to four host channels. One channel adapter is standard on the 3720-1, with another channel adapter and one or two two processor switches as options. The 3720-1 is quite compact, standing just 39 inches tall, 26 inches wide, and 26 inches long. A maximum of 28 lines can be attached--the number of active lines depends on line speed, protocol, and how much of the 3720 capacity they consume. One megabyte of storage is standard on the 3720-1 and another megabyte is an optional feature.

SCREEN OV06 3720 Model 1 Software

The 3720 Model 1 is supported by ACF/NCP Version 4 Release 1 in MVS and VSE environments and/or by ACF/NCP Version 4 Release 2 in MVS and VM environments. A new program product, the ACF/NCP Version 4 Subset, announced in conjunction with the 3720, is available for a significantly lower price than the full function NCP. The Subset contains no SNA Network Interconnection (SNI) code and supports up to 28 lines (in other words, supports a 3720 Model 1 or Model 2 without an expansion frame). The 3720 Model 1 is also supported by EP Release 3 in MVS and VSE environments and/or by EP Release 4 in MVS or VM environments. ACF/SSP Version 3 Release 2 is required to do the control program generation, load, and dump of the 3720 and also provides other utility programs.

Other controller resident software that can run in the 3720 is covered in the software section of this manual.

SCREEN OV07 3720 Model 2

The 3720 Model 2 has been specifically designed for remote operation and can be attached by communication facility to another 3720, a 3725, a 3705, an Integrated Communication Adapter (ICA) of a 4331/4361, or other type of communication controller. It has no channel adapter capability, and is smaller than the 3720 Model 1, standing only 24 1/2 inches tall. In all other ways, it is identical to the 3720 Model 1, with attachment capability of up to 28 lines, one megabyte of storage as standard, and another megabyte of storage as an optional feature.

SCREEN OV08 3720 Model 2 Software

The 3720 Model 2 is supported by the same NCP software as the Model 1--ACF/NCP Version 4 Release 1 in MVS and VSE environments, ACF/NCP Version 4 Release 2 in MVS and VM environments and/or the ACF/NCP Version 4 Subset. EP is not supported on the Model 2. ACF/SSP Version 3 Release 2 is required to generate, load, and dump the 3720 and to provide other utilities.

Other controller resident software that can run in the 3720 is covered in the software section of this manual.

SCREEN OV09 3721 Models 1 and 2

The 3721 Model 1 or the 3721 Model 2 are also referred to as an expansion frame, in that either allows more lines and scanning capacity to be added to a 3720 Model 1 or 3720 Model 2. The 3721 is installed on top of either a 3720 Model 1 or Model 2 and adds 15 inches to the height of the box. A 3720 Model 1 with an expansion frame (3721) stands 54 inches tall, while a 3720 Model 2 with an expansion frame stands 39 1/2 inches tall. The 3721 Model 1 adds one additional scanner and attachment capability of up to 32 lines to a 3720. (The actual number of active lines depends on line speed, protocol, and scanner capacity consumed). The 3721 Model 2 adds two additional scanners and attachment capability of up to 32 lines to a 3720.

SCREEN OV10 3721 Models 1 and 2 Software

There is no additional software required to support the 3721. The 3720 contains the central control unit and storage necessary for the execution of the software. The 3721 provides additional line and scanning capacity only. Note that the NCP Subset, in that it only supports up to 28 lines in one communication scanner, does not support the 3721.

SCREEN OV11 3720 Model 11

The 3720 Model 11 has the same channel adapter, two processor switch, and storage capabilities and options as does the 3720 Model 1. The Model 11 contains a Token-Ring Multiplexor, part of the hardware necessary for attaching token-rings. With the 3720 Model 11, a customer can optionally order one or two Token-Ring Interface Couplers (TICs) each of which provides attachment to a Token-Ring. Another option is to use two TICs to provide two attachments to one token-ring. The 3720 Model 11 also provides the capability of attaching up to 16 lines.

SCREEN OV12 3720 Model 11 Software

The 3720 Model 11 is supported by ACF/NCP Version 4 Release 2, the ACF/NCP Version 4 Subset, and/or EP Release 4. These software products are supported in MVS and VM environments only. ACF/SSP Version 3 Release 2 is also required for generation, loading, dumping, and utility functions.

See the software section of this manual for more information on the 3720 software.

SCREEN OV13 3720 Model 12

The 3720 Model 12 is specifically designed for remote operation for environments requiring token-ring attachment capability. The 3720 Model 12 contains the same Token-Ring Multiplexor, two optional Token-Ring Interface Couplers, and attachment capability of up to 16 lines as the 3720 Model 11. The 3720 Model 12, like the 3720 Model 2, has no channel adapters or two-processor switches, contains one megabyte of storage with an optional additional megabyte of storage, and attaches via communication facility to another 3720, 3725, 3705, ICA, or other type of communication controller.

SCREEN OV14 3720 Model 12 Software

The 3720 Model 12 is supported in MVS and VM environments only by either ACF/NCP Version 4 Release 2 or the ACF/NCP Version 4 Subset. ACF/SSP Versions 3 Release 2 is required for generation, loading, dumping, and other 3720 utilities.

See the software section of this manual for more information on the 3720 software.

SCREEN OV15 3720 Architecture

The next section describes the architecture of the various 3720/3721 models.

SCREEN OV16 3720 Architecture

Each base 3720 unit, a model 1, 2, 11, or 12, consists of several different components: a Central Control Unit (CCU), storage, a hard disk, an operator panel, MOSS microcode, 3 console ports, and a communication scanner. Other components are only available on certain models or are optional. The locally attached models, Model 1 and Model 11, each have at least one Channel Adapter (CA), and optionally another CA and one or two Two-Processor Switches (TPS). The token-ring attachment models, Model 11 and Model 12, contain a Token-Ring Multiplexor (TRM). One or two Token-Ring Interface Couplers (TICs) are optional. Up to seven Line Interface Couplers (LICs) are optional for attaching lines to the communication scanner of a 3720 Model 1 or 2, and up to four LICs are optional on the Model 11 or 12.

The 3721 Model 1 contains a communication scanner. The 3721 Model 2 contains two communication scanners. Up to eight LICs are optional for attaching lines to either the 3721 Model 1 or Model 2.

SCREEN OV17 3720 Architecture

The 3720 Models are made up of three subsystems, a Maintenance and Operator Subsystem (MOSS), a Control Subsystem, and a Transmission Subsystem. In the locally attached 3720's, the Control Subsystem consists of the Central Control Unit, Storage, and Channel Adapter(s), while in the remotely attached models, the Control Subsystem does not contain Channel Adapter(s). The 3721 Models are made up of only a Transmission Subsystem.

SCREEN OV18 Control Subsystem

These diagrams illustrate the Control Subsystem of the 3720 Model 1 (processor or CCU, one megabyte of storage, one channel adapter), and the Control Subsystem of the 3720 Model 2 (CCU and one megabyte of storage). Pictured above the diagram of the 3720 Model 1 are the optional features (an additional megabyte of storage, a TPS for CA1, an additional CA, and a TPS for CA2). Shown above the diagram of the 3720 Model 2 is the optional feature of one additional megabyte of storage.

SCREEN OV19 Transmission Subsystem-3720 M1 & M2

The Transmission Subsystem of the 3720 Model 1 or Model 2 consists of one communication scanner (called CS1) and allows attachment of up to seven LICs. Several different types of LICs are available. Some LIC types allow attachment of one line while other types allow attachment of up to four lines. The maximum line attachment capability, then, of a 3720 Model 1 or 2 is 28 lines.

SCREEN OV20 Transmission Subsystem-3721 Model 1

The 3721 Model 1 consists of one communication scanner (called CS3) and allows attachment of up to eight LICs. Depending on LIC type, each LIC can attach up to four lines. The maximum line attachment capability of the 3721 Model 1 is 32 lines.

SCREEN OV21 Transmission Subsystem-3721 Model 2

The 3721 Model 2 consists of two communication scanners (called CS3 and CS4). To each scanner can be attached between one and four LICs. While the maximum line attachment capability of the 3721 Model 2 is the same as the 3721 Model 1 (32 lines), the Model 2 has greater scanning capacity and can therefore attach more high speed lines than the Model 1.

SCREEN OV22 Transmission Subsystem

The transmission subsystem uses the same microcode as does the 3725, but the 3720 has some hardware improvements. Internal clock cards, which were optional on the 3725, are standard on the 3720. On the 3720 the internal clock speeds are all set via software or MOSS and can be selected on a per line basis. (With the 3725, some clock speeds require jumper cable setting by IBM

service personnel and the speed selected pertains to the entire LIC). The 3720 also has an improved transfer rate between the scanner and the Central Control Unit.

SCREEN OV23 Transmission Subsystem

A new type of LIC wrap test is available with the 3720 which does not require a plug to be placed on LIC port before testing. The LIC wrap test is accessible both to the customer running the 3720 in normal operational mode and to IBM service personnel running the 3720 in maintenance mode. (The 3725 LIC wrap test is only available when running in maintenance mode.) The Problem Determination section of this manual discusses the LIC wrap test in more detail.

The line cables which attach the LIC ports to communication facilities have snap on cable connections, making them easier to install. Each line attaching to the Transmission Subsystem has a weight indicative of how much scanning capacity it consumes. A more complete discussion of scanner capacity and LIC plugging is contained in the Migration section of this manual (MI03).

SCREEN OV24 Transmission Subsystem

With the 3720, a weight is assigned to each line which accounts for how much of the scanner capacity it uses. On the 3725, the weight is assigned on a per LIC basis and depends on the heaviest weight line on the LIC. With this change to weight per line rather than per LIC, more lines could potentially be attached to a scanner on a 3720 than to a scanner on a 3725.

To figure out how many lines can attach to a 3720 scanner, one must add the line weights together and the total must be 100 or less. If the total is greater than 100, another scanner is required. The line weight is assigned based on line speed and protocol.

The chart shows an example of line weights for the LIC types 2, 3, and 4B (these LICs attach only one line). For example, an SDLC full duplex line running at 256000 bps has a weight of 100, or in other words, uses the entire scanner capacity. A 56000 bps full duplex line has a weight of 21.4 while a BSC (half-duplex) line at 56000 bps has a weight of 13.1. N/S on the chart means a non-supported line type.

SCREEN OV25 Transmission Subsystem

This chart shows some of the line weights for line types that attach to LIC types 1 or 4A (these LICs attach up to four lines per LIC). The 3720 Configuration Guide contains a complete chart of line weights for all supported line types.

SCREEN OV26 MOSS Subsystem

The Maintenance and Operation Subsystem (MOSS) contains several improvements. An Error Checking and Correction (ECC) procedure corrects single bit errors and detects double bit errors during read operations. The 3720 contains a hard disk which improves the speed at which MOSS operations can be performed. There is also a diskette drive, using standard 5 1/4 inch hi-density diskettes, which is used for hard disk backup and microcode distribution.

SCREEN OV27 MOSS Subsystem

The operator interacts with the 3720 MOSS Subsystem through the use of a console. All 3720 Models provide three ports for console attachment. Two of these ports are for customer use. One of the ports can be used for a locally attached customer console. The second port can be used for attachment to a modem and switched communication facility for a remotely attached customer

console. The third port is used to attach a modem and switched communication facility for the Remote Support Facility (RSF). RSF allows IBM service personnel at a remote site access to the 3720.

SCREEN OV28 MOSS Subsystem

A local MOSS console is not mandatory for maintenance unless RSF is not used. The remote MOSS console is designed specifically for unattended operations in that functions performed via the 3720 panel can also be performed from the MOSS console. Access to the 3720 from the local console, remote console, or RSF is controlled by use of passwords.

SCREEN OV29 MOSS Subsystem

Two other new 3720 microcode features are automatic scanner re-IML and automatic BER (Box Event Record) analysis. Both of these features are discussed in the problem determination section of this manual.

SCREEN OV30 Customer Environment

This section explains IBM and customer responsibilities in the 3720 installation process, and gives an overview of the 3720 service facilities.

SCREEN OV31 3720 Model 1 Installation

The initial installation of a 3720 Model 1 or 11 is performed by IBM service personnel. The customer setup responsibilities are: installing the LICs and TICs, attaching line cables, setting up the local and/or remote console and interfaces, and setting up the RSF interface.

SCREEN OV32 3720 Model 2 Installation

The 3720 Model 2 and 12 are customer setup machines. The customer performs the initial setup, LIC and TIC installation, attachment of line cables, local and/or remote console and interface setup, and RSF interface setup.

SCREEN OV33 3721 Model 1 and 2 Installation

The 3721 Models 1 and 2 are customer setup machines. The customer performs the initial setup, LIC installation, and attachment of line cables.

SCREEN OV34 Service Concept

There are several facilities available to diagnose and repair 3720 problems. There are error indications and diagnostic tests available to the customer via the MOSS console (local or remote). In addition, maintenance functions are available to IBM service personnel via the MOSS console. Host software (VTAM, NPDA, NETVIEW) contains facilities for displaying and diagnosing error conditions. RSF provides IBM service personnel at the IBM RETAIN Center access to the 3720 if needed. The RSF link also provides a means of sending microcode fixes, an advantage over the previous method of using diskettes. However, diskette distribution is also available with the 3720.

The 3720 diagnosis and service facilities are explained in greater detail in subsequent sections of this manual.

Section 2 - Physical Planning

SCREEN PP00 Title - Physical Planning

SCREEN PP01 Physical Planning Overview

This section is designed to cover various aspects of the 3720 necessary to ensure a successful installation. The physical layout of each 3720 model is described; the structure of the control panel is reviewed for the Models 1 and 2; a comparison of the 3720 to different 3705 and 3725 models is made; the addressing structure is discussed; the customer responsibilities for setup and system integration are reviewed; operator console support is discussed as are modem requirements for the MOSS console and RSF; Finally, channel cable, LIC cable, and MOSS/RSF cable requirements are presented.

SCREEN PP02 3720 Model 1

Access to the 3720 Model 1 is from swinging doors at the rear and at the front. The side panels are fixed and do not require any clearances, consequently, 3720 controllers can be placed side by side.

This screen depicts the various components visible from the rear of the 3720. The upper and lower sections correspond to the two boards which make up the 3720 Model 1. The lower board is the channel adapter board which contains the standard channel adapter and optional second channel adapter and two processor switches. Associated with this board is a switching module power supply. The upper board is called the base board and contains the remaining components. Also associated with this board is a separate switching module power supply. The customer accessible components are the LIC cassette modules which plug into the LIC cards, and the console ports used for attaching operator consoles and the IBM Remote Service Facility modem. The 3720 Model 1 has seven slots, or LIC positions, that can contain LIC cassette modules. The LIC types 1, 2, 3, 4A, and 4B can all be used. The 3720 Configuration Guide describes maximum LIC attachments that can be supported depending on line speed and line protocol.

Three adapter interfaces are available for operator consoles and service support. These ports are dedicated to these functions and should not be confused with the LIC ports. MOSS consoles can be remotely located and attached via a 212A asynchronous modem connected to the link console interface. The MOSS console can be directly connected via a 3720 provided cable to the direct attachment interface. The remote service port (RSF) allows dial access to the 3720 from a remote IBM service location and a 212A modem (synchronous mode) is attached to the RSF port to provide this access.

SCREEN PP03 3720 Model 1 Essential Information

The 3720 Model 1 can be ordered for either 208/240V or 110/120V. The default voltage that is provided is 208/240V; the default power plug shipped is a non-locking, non-moisture proof plug. Specify Feature codes are available for obtaining locking plugs or moisture proof plugs providing voltage and power plug facilities suitable for all requirements.

SCREEN PP04 3720 Model 1 Control Panel

This discussion spans the next four screens. The diskette drive used for microcode installation and microcode engineering change (EC) installation, and the hard disk which contains the microcode and other resident MOSS files, are located behind the front panel of the 3720. The most noticeable feature of the front panel is a cutout providing access to the 3720 control panel. Various lights and switches are contained therein:

Hex Display LED - This display can contain a three digit alphanumeric code which indicates 3720 initialization phases, power error codes when the power check light is on, IPL and IML error code, and codes indicating correct operational status. These codes are documented in the 3720 Operators Guide, Problem Determination Guide and the Maintenance Information Reference manual, Part 2. When the 3720 is operating normally with a hex display status of '000' the hex display will power off after about 10 minutes. This extends the life of the display and conserves power usage. Any change in status will be immediately displayed.

MOSS Inop - ON when MOSS is inoperative; normally during some part of the IML/IPL phase.

Remote Console Active - ON when either the remote console or RSF is active. At this same time a message is displayed on the local MOSS console, if there is one, which says 'Terminal Disconnected' and is a second indication of remote console activity.

Power Check - ON, the 3720 has power problems; use HEX display for codes.

Channel Adapter Disabled - ON indicates which channel adapter interfaces are disabled. The lights reflect manual switch actions or actions resulting from commands issued by the MOSS panel alteration function.

Power On/OFF - Local power on/off switch. If the 3720 is located in the same machine room as 3725 be careful, this switch looks like the 3725 EPO (Emergency Power Off) switch.

SCREEN PP05 3720 Model 1 Control Panel

Panel/Console Switch - When set to PANEL, it allows use of control panel functions from the control panel; when set to CONSOLE it allows use of SPECIFIC control panel functions from the local or remote operator console.

Channel Adapter Interface Switch - DISABLE position disables the channel adapter interfaces; ENABLE allows the channel adapter interface to be enabled at IPL time.

General Reset Switch - completely resets the 3720.

Remote Console Disconnect Request Switch - the action of this switch depends on the setting of the PANEL/CONSOLE switch: If the latter is set to PANEL toggling this switch results in the remote console being disconnected. If the PANEL/CONSOLE switch is set to CONSOLE then the action of this switch results in a message inviting the remote console operator to log off.

Function Start Switch - Starts the operation selected by the Function Select switch discussed on the next screen.

SCREEN PP06 3720 Model 1 Control Panel

Function Select Switch - there are eight functions that can be selected using this switch

Normal - this is for normal initialization and loading of the 3720.

MOSS IML - used to IML MOSS only. If no control program is present in the 3720 the ending status will be MOSS ALONE. If a control program is present the ending status will be MOSS ON-LINE.

MOSS Dump - used to dump the MOSS microcode to the disk from the 3720 MOSS memory.

Maintenance - to load MOSS microcode and enter service mode.

Console Link Test - used to run a wrap test to the end of the console cable; a wrap plug is required on the console cable. See the 3720 Problem Determination Guide for the procedure.

Microcode Change - used when installing ECs from the control panel. See the 3720 Service Guide for further information.

Set Up Test - used when performing the 3720 Model 1 setup and test.

Diskette mode - allows the 3720 to be IPL'ed from the diskette instead of the disk if the disk is unusable. Note when the 3720 is IPL'ed in this fashion MOSS is not operational. See the 3720 Service Guide for further information.

SCREEN PP07 3720 Model 1 Control Panel

The Power Control Switch provides three settings:

Host - the 3720 power state is controlled by the host CPU power on/off cycle.

Local - the 3720 power state is controlled by the 3720 power on/off switch.

Network - the 3720 is powered on via the 3720 power on/off switch; the 3720 is powered off via the Remote Power Off command set from a VTAM host in the network.

Auto power on - means that if the power drops the 3720 will automatically power on and initialize itself to the load point ('FF4').

SCREEN PP08 3720 Model 2

The Model 2 is very similar to the Model 1 without the channel adapter board and corresponding power supply. The LIC capacities are identical, as are the operator console attachments. However, since the basic frame of the Model 2 is smaller than the Model 1, the Model 2 cannot be upgraded to a Model 1.

SCREEN PP09 3720 Model 2 Essential Information

The default voltage of the Model 2 is 110/120V. However, full flexibility exists with respect to the voltage and power plugs available. It can be ordered with 208/240 V and the default non-locking plug can be replaced by a locking or moisture-proof plug, if needed.

SCREEN PP10 3720 Model 2 Control Panel

The control panel lamps differ from the Model 1 in the following respects:

Remote Power Off lamp - ON indicates receipt of a remote power off command.

Power Check Lamp 1 - ON indicate over- or under-voltage.

Power Check Lamp 2 - ON indicates over-current.

Power Check Lamp 3 - ON indicates a blower problem or linear regulator power supply card problem.

SCREEN PP11 3720 Model 2 Control Panel

The control panel switches differs from the Model 1 in the following respects:

Remote Power Off Switch - causes a remote power off command from the host to be accepted (ENABLE) or rejected (DISABLE) by the 3720.

SCREEN PP12 3720 Model 2 Control Panel

The function select switches are the same as the Model 1.

SCREEN PP13 3721 Model 1| Model 2

The 3721 Expansion Frame is installed on top of either 3720 model and is fixed in place with four cam locks. Several cables are run from the 3721 to the 3720 including a power distribution cable. The 3721 has eight LIC positions and can accommodate up to eight LIC cassettes. The difference in the 3721 Model types is how many communication scanners a 3721 contains. The Model 1 has one scanner, the Model 2, two scanners. Note that the Model 1 cannot be upgraded to a Model 2, and vice versa.

SCREEN PP14 3721 Essential Information

Note that the 3721 takes its power from the 3720 Model 1 or 2 base frame.

SCREEN PP15 3720|37X5 Comparison

The IBM 3705 and 3725 configurator aids were used to establish the configurations described here. The 3720-1, 3725-1,-2 and 3705-ii all have channel adapters, the 3720-2 has none. The 3705-80 allows a maximum of 16 lines. The assumptions used to derive the data represented in this table are defined in the next screen, PP16. The basic conclusions are that the 3720 has a much lower operational power consumption, significantly less energy is required to cool it, and the floor loading is much reduced from the 3725 or 3705 models.

SCREEN PP16 3720|37x5 Comparison Assumptions

The environment chosen was 1 channel adapter and 28 lines wherever possible. Note that the 3720-2 is remote only, no channel adapters; the 3705-80 can offer a maximum of 16 lines.

SCREEN PP17 3720 Model 1|2 Addressing

The 3720 base frame has seven LIC positions and can accommodate a maximum of 28 lines, depending on line speed and protocol. The line number range is from 000 to 027. The base frame has one scanner and two internal clock cards (ICC) as standard. The clocks are used to provide clocking for DTE devices and non-clocked DCE. The base internal clocking for DTE is established for synchronous protocol by modifying the 3720 Configuration Data File using the Programmable

Line Speed function. For asynchronous protocol this is done via software at the control program generation time (ACF/SSP). When changing the line speed LIC plugging rules and line weight calculations must be reviewed to ensure that scanner restrictions are not encountered. These topics are discussed in the 3720 Configuration Guide and also can be validated using the IBM configurator aid. The text of screen MI03 also includes a LIC weight and scanner capacity discussion.

SCREEN PP18 3721 Model 1 Addressing

The 3721 expansion frame has eight LIC positions and can accommodate a maximum of 32 lines, depending on line speed and protocol. The line number range is from 032 to 063. The expansion frame has one scanner and two internal clock cards, as standard components. The scanner is CSP3 on the MOSS screens.

SCREEN PP19 3721 Model 2 Addressing

The 3721 expansion frame has eight LIC positions and can accommodate a maximum of 32 lines, depending on line speed and protocol. The line number range is from 032 to 063. The expansion frame has two scanners, and two internal clock cards, as standard components. The scanners are identified as CSP3 CSP4 on the MOSS screens.

SCREEN PP20 Customer Setup Responsibilities

The 3720 Model 1 base frame is installed and checked out by IBM. Channel adapter additions and two processor switch installations are also performed by IBM, as is the memory upgrade to both the 3720 Model 1 and Model 2, and model conversion from 3720 Models 1/2 to Models 11/12. Customer setup responsibilities include unpacking the 3720 Model 2, connecting it to power, running the 3720 Model 2 checkout procedures, installing the operator console and console cables to both 3720 Models 1 and 2, installing all LIC cables in both the base and expansion frames and installing the 3721 expansion frame and performing the requisite checkout procedures.

SCREEN PP21 Customer Setup Responsibilities

Any LIC reconfiguration, i.e., addition or deletion is the customer's responsibility for all 3720 and 3721 frames, as is the relocation of the 3720 Model 2 and all 3721 expansion frames.

SCREEN PP22 Customer System Integration Responsibilities

System integration includes attaching the MOSS operator consoles and cables, the RSF modem, customizing the password file, updating the configuration data file to reflect the current configuration, and, optionally, updating the line description file (LDF). The CDF upgrade is required in order to assign clocking speeds to DTE's for which the 3720 is providing the clocking and for 3720 diagnostics to run correctly.

SCREEN PP23 Customer System Integration Responsibilities

The link IPL ports table must be updated to allow link loading to take place, the RSF installation must be verified operational with IBM, and all the files just created should be backed up on

diskettes. The backup procedure requires two diskettes for the base frame and takes approximately 2 minutes per diskette. The backup for the expansion frame need only be done before relocation of the expansion frame. The diskettes used are the PC-AT, 1.2mb, high density 80TPI ones. A diskette format utility function is available using the 3720 disk function (DF) MOSS command.

SCREEN PP24 Operator Console Support

The basic requirements for a 3720 MOSS console are the following:

- IBM 3101 block mode emulation capability
- RS232c, PRTS (permanent request to send)
- 2400bps for local attach, 1200bps, remote attachment
- EVEN parity, DC3(x'19') turnaround character
- 2 stop bits, 7 bit word length
- 100ms response delay, 500ms break signal

The following terminals have been tested as MOSS consoles:

- IBM 3161, 3163, 3164 Models 11 and 12.
- IBM 3101 Model 23.
- IBM PC using 3101 Emulation Program.

SCREEN PP25 MOSS Console/RSF Attachment

Operator consoles can either be directly attached or modem attached to the respective 3720 operator console adapter ports. Direct attachment of the MOSS console is accomplished using a 3720 provided cable group. A separate 3720 cable group is available for attachment of the modem to the remote console adapter port. The modem required for remote console attachment should be a 212A compatible asynchronous modem at 1200bps. Remote service is provided via a 212A compatible synchronous modem. The 3720 RSF cable group is the same as the one used for the remote console attachment. The 3720 modem interface descriptions can be found in the 3720 Original Equipment Manufacturers Information (OEMI) publication. The detail description of the three console cable groups are found in the 3720 Maintenance Information Reference publication.

The 5841 modem can be used for both the remote console and RSF modem applications.

SCREEN PP26, PP27 Cables

One power cable is provided per 3720/3721 configuration with the 3721 obtaining its power from the 3720 base frame power distribution module. The channel adapter cables are standard 370 bus and tag cables like those used with the 3725, or 3705. LIC cables are unique for the 3720. 3705 line set cables or 3725 cannot be used with the 3720 because the LIC interface attachment is new to the 3720. A 25 pin D shell is used to attach the LIC cable to LIC cassette. The 3720 DCE or DTE interfaces are that same depending on cable group, i.e., RS232C, V.35, etc.

Section 3 - Software Support

SCREEN S000 Title

SCREEN S001 Software Support Overview

This section reviews the software products necessary to install a 3720 in MVS, VM or VSE environment. The software products discussed are the 3720 control programs: NCP, EP, NTO, NPSI, NRF, NSI and X.25 Extended Interconnection PRPQ; the CNM products, Netview and NPDA; the 3720 generic alert message provided for specific VTAM releases and the SSP V3R2 required to generate, load, and dump an NCP or EP.

SCREEN S002 MVS Control Programs

The levels of MVS that can be used install a 3720 are MVS SP V1 and MVS SP V2. Three NCP products are available to support the 3720. They all require ACF/SSP V3R2 level for 3720 control program generation, load and dump. The first product discussed is NCP V4R1 with PTFs to the base code to provide device support for the 3720. Absence of these PTFs will result in an NCP ABEND at load time of x'090D'. The corresponding additional controller products that are supported are shown here.

SCREEN S003 MVS Control Program

The second NCP product which supports the 3720 is NCP V4R2. The corresponding additional controller products are shown here.

SCREEN S004 MVS Control Program

The third NCP product which supports the 3720 is identified here. The corresponding additional controller products are shown here. The subset product supports up to 28 lines in the base frame of the 3720 only, supports 0, 1, or 2 channel adapters, and does not support SNI.

SCREEN S005 MVS Alert Suport

3720 alert support is provided by VTAM or Netview Release 1.0. The VTAM support is via a generic message that indicates a user action code and supporting qualifier data and must be referenced in the 3720 Problem Determination Guide. This support is provided by specific MVS VTAM levels either incorporated into the product, such as with ACF/VTAM V3R1.1, or via a program temporary fix (PTF) for VTAM V3R1.0 and VTAM V2R2. For MVS releases where no PTFs exist, such as VTAM V2R1, no alert message, generic or otherwise, will be displayed at the VTAM operators console.

Netview offers full alert support for each of the alerts presented by the 3720.

If NPDA V3 is installed the user action code and qualifier data is available on the NPDA detail event screen and must be looked up in the 3720 Problem Determination Guide similar to the generic alert received at the VTAM operators console.

SCREEN S006 VSE Control Program

The 3720 control program generation, load and dump is supported by SSP V3R2 on VSE/AF or VSE/SP V2R1. Two NCP products are supported under VSE. The first is the NCP V4R1 with PTFs to the base code to provide device support for the 3720. Absence of these PTFs will result in an NCP ABEND at load time of x'090D'. The corresponding additional controller products are shown here.

SCREEN S007 VSE Control Program

The second NCP product which supports the 3720 is identified here. The subset product supports up to 28 lines in the base frame of the 3720 only, supports 0, 1, or 2 channel adapters, and does not support SNI. The corresponding additional controller products for the subset are shown here.

For VSE systems with 3720s that are loaded by MVS or VM using MVS/VM subset or NCP V4R2 the VSE VTAM V2R1 or V3R1 can activate the controller, but not load or dump it.

SCREEN S008 VSE Alert Support

VSE 3720 alert support is provided by VTAM or NPDA V3R2. The VTAM support is via a generic message that indicates a user action code and supporting qualifier data and must be referenced in the 3720 Problem Determination Guide. This support is provided by specific VSE VTAM levels via a program temporary fix (PTF) for VTAM V2R1 and VTAM V3R1.

Full 3720 alert support is provided via NPDA V3R2 and a corresponding PTF.

SCREEN S009 VM Control Program

The 3720 control program generation, load and dump is supported by SSP V3R2 on VM/SP Release 4 and HPO R4.2. Two NCP products are supported under VM. The first is the NCP V4R2. The corresponding additional controller products are shown here.

SCREEN S010 VM Control Program

The second NCP product which supports the 3720 is identified here. The subset product supports up to 28 lines in the base frame of the 3720 only, supports 0, 1, or 2 channel adapters, and does not support SNI. The corresponding additional controller products for the subset are shown here.

SCREEN S011 VM Alert Support

3720 alert support is provided by VTAM or Netview Release 1.0. The VTAM support is via a generic message that indicates a user action code and supporting qualifier data and must be referenced in the 3720 Problem Determination Guide. This support is provided by VM/VTAM V3R1.1.

Netview offers full alert support for each of the alerts presented by the 3720.

SCREEN S012 SSP V3R2

SSP V3R2 is required for 3720 control program generation, load and dump. It also supports various releases of NCP for the 3720, 3725 and 3705, as well as supporting the Emulation Program usage in standalone environments or partitioned emulation mode with the NCP.

SCREEN S013 NCP Generation

The major change to the NCP deck is that MODEL = 3720 must be specified in the BUILD macro.

Section 4 - Operations

SCREEN OP01 Operations Section

This section deals with how to operate the 3720. The material will be easier to understand if the reader has some familiarity with the 3725, which can be obtained by reading the "3725 Installation Guide" (GG22-9340).

This section does not cover the operational aspects of the 3720 that are exactly the same as the 3725. However, there are many new or changed operational aspects so that even the reader who is unfamiliar with the 3725 should have a good idea of how to operate the 3720 at the completion of this section.

SCREEN OP02 Operations Agenda

Operations is covered in three parts. Parts one and two deal with what is unchanged and what is changed from a host viewpoint when a 3720 is installed. Unchanged or changed means as compared to having a 3725 installed.

The third part is the bulk of the operations section and deals with the new MOSS functions.

SCREEN OP03 Unchanged Host Functions

From a host viewpoint, there are several functions that are exactly the same as those for the 3725. The load or dump process for either channel attached 3720s or link attached 3720s is exactly the same as it is for the 3725. The SSP function (the generation process and the utilities for the 3720) is unchanged. Also the trace facility is exactly the same as it is for the 3725.

SCREEN OP04 Changed Host Functions

What differs between a 3720 and 3725 from a host standpoint are the various types of ALERT messages that may be received from a 3720. To support the 3720, VTAM has a new Generic Message containing a User Action Code and up to 3 Qualifier Data Fields. The explanation of the codes and data fields can be found in the VTAM Messages Manual or in the 3720 Problem Determination Guide. The new generic message support is in VTAM V3R1.1 and is also available via PTF for VTAM V3R1.0 for MVS/370, MVS/XA, or VSE, for VTAM V2R2 for MVS/370, and for VTAM V2R1 for VSE.

Please note that there are other version/release levels of VTAM that may be used in conjunction with a 3720, but that these levels will not provide any 3720 ALERT support.

SCREEN OP05 Changed Host Functions

Full 3720 ALERT support is available in NETVIEW or, for VSE customers, in NPDA V3R2 with a PTF. Full 3720 ALERT support means that these products will provide descriptive messages of the 3720 problem as opposed to the VTAM generic message which provides a code which must be looked up in a manual.

For those customers who do not have NETVIEW or NPDA V3R2 for VSE, NPDA V3 provides 3720 ALERT support in the form of messages containing a User Action Code and up to 3 Qualifier Data Fields.

The next section of this manual, Problem Determination, contains examples of these different types of ALERT messages and illustrates how the full ALERT support provides more problem determination assistance than the other types of ALERT messages do.

SCREEN OP06 New MOSS Functions

3720 MOSS functions that are new or changed in contrast with 3725 MOSS functions are Password Management, Configuration Data File, Line Description File, Panel Function, Disk Function, Microcode Fixes, Machine Level Table, and Link Threshold.

Each of these functions is covered in detail and the layouts of the various MOSS screens are included. These functions can be performed from either a local or remote MOSS console. Aside from the initial connection to the 3720, there is no difference in screen appearance or procedures between the local or remote MOSS console.

There are two other new MOSS functions, Auto-BER Analysis and Wrap Test, which are discussed in the Problem Determination section rather than in this section.

SCREEN OP07 MOSS Logo Screen

The examples of MOSS screens used in this manual are actual reproductions of the MOSS screens from a 3720 installed at the Washington Systems Center. On the Storyboard diskette, we have used color to highlight the subject being discussed. This color will not actually be seen on the 3720 console. Use of a 3164 as an operator console does produce some color differentiation (what the operator keys in is in red, for example), but the colors used on this diskette are a function of Storyboard, not the 3720.

This is the IBM logo screen that appears on the MOSS console once MOSS has been IML'ed and the initial connection to the 3720 has been made. From a local MOSS console this logo screen appears once the 3101 Model 23 equivalent terminal is cabled to the 3720, powered on and MOSS is IML'ed. From a remote MOSS console, the connection is made via a switched communication facility.

SCREEN OP08 3720 Authorization Screen

Once the SEND key (ENTER key on some terminal types) is pressed from the logo screen, this screen is displayed which asks the operator to enter his/her password. Also displayed is a count of unsuccessful attempts to logon to the local console, to the remote console, and to the 3720 using the maintenance password. "Unsuccessful attempts" represent number of errors made in entering the password and can assist the operator in determining if unauthorized attempts have been made to access the 3720. The ability to reset these counters is covered later in this section.

SCREEN OP09 Main Menu Screen - Passwords

Once the operator has entered the correct password, the 3720 main menu is displayed. From this menu the operator can select the desired function by typing the function's abbreviation in the System Input Area (SIA). In order to select the Passwords Function, the operator must locate Passwords on the menu and enter its abbreviation, P, in the SIA, and press SEND (ENTER).

The first three lines of any of the MOSS screens are called the Machine Status Area (MSA) and display numerous pieces of information about the 3720. Line 1 actually contains 6 fields in which information may be displayed. In this example only 4 of the fields contain information. PROCESS means the CCU (Central Control Unit) is in normal processing mode. STOP-CCU-CHK means the system will stop on a CCU check. MOSS-ONLINE means that MOSS is connected to a control program running in the 3720. MOSS could also be OFFLINE (a control program is operational in the 3720 but MOSS is not connected to it), or MOSS could be ALONE (MOSS is operational and there is no running or operational control program in the 3720). The field "X71:0A0800" displays the contents of the CCU X'71' output register.

Line 2 also contains 6 fields, however only 3 of the fields contain information in this example. RUN means the CCU is executing instructions or transferring data. BYP-IOC-CHK means the system will not stop on an IOC check. The field "X72:07A600" displays the contents of the CCU X'72' output register. The third line of the MSA contains three fields all of which are blank in this example. The MSA is explained in detail in the 3720 Extended Services manual.

Line 4 of the screen displays the Customer Identification, a field that the customer can change (discussed in OP22 and OP23), the 3720 model type, and the serial number.

The System Input Area is used to type in selections from the menu. T or OFF (as shown in the next line down) can also be entered in the System Input Area. Other options, selectable by PF key are displayed on the line beneath the System Input Area. Some of the MOSS screens, shown later in this section, also have more options, selectable by PF key, which are displayed in the lower area of the screen.

SCREEN OP10 Password Management

Passwords are used to control access to different functions that can be performed from the MOSS console. Use of the management password allows the operator to display and/or update the passwords themselves and to do other password management related functions. Use of the local password allows the operator to sign on to the local MOSS console while use of the remote customer password permits the operator to sign on to the remote MOSS console. The maintenance password can be used to sign on to the remote MOSS console in maintenance mode and is also used by the IBM hardware support center to sign on to the 3720 using the Remote Service Facility (RSF).

SCREEN OP11 Passwords Function

After the Passwords function is selected from the main menu, the passwords screen is displayed asking the operator to enter the management password. In this example, the operator has entered the management password, ISOLA, which will allow selection of any of the functions listed on the bottom three lines.

SCREEN OP12 Passwords Function

Updating of the management, local, remote customer, or remote maintenance password is all done in a similar fashion. For example, to update the remote customer password, the operator must type a "3" after "select option = >" and press SEND (ENTER). Updating the other passwords is done exactly the same except that numbers 1, 2, or 4 are selected.

SCREEN OP13 Passwords Function

The next screen that is displayed asks the operator to enter a new password which must be made up of alphanumeric characters and be between 5 and 8 characters long. If the operator decides not to change the password, he/she can quit by pressing PF6. Changing the local, management, or maintenance passwords is done in the same way.

SCREEN OP14 Passwords Function

An operator who knows the management password can also display the setting of all the passwords by entering "5" after "select option = = >".

SCREEN OP15 Passwords Function

The passwords display screen shows the setting of the four passwords. The passwords can be set to the same thing or set differently except that the remote maintenance password must be a different value than the remote customer password. The display screen also shows the status of the remote maintenance password. Status is discussed in OP16.

SCREEN OP16 Password Management

The remote maintenance password can be temporarily or permanently activated or deactivated by the operator. Temporary activation of the remote maintenance password allows it to be used one time before it becomes invalid. Permanent activation allows the password to be used indefinitely, and the operator can also invalidate the remote maintenance password by deactivating it.

SCREEN OP17 Passwords Function

To temporarily or permanently activate the maintenance password, or to deactivate it, the operator must enter numbers 6, 7, or 8 from the passwords menu.

SCREEN OP18 Passwords Function

In this example, the operator has entered a 7 to request permanent activation of the maintenance password and has received the message "REMOTE MAINTENANCE PASSWORD HAS BEEN PERMANENTLY ACTIVATED". Temporary activation or deactivation is performed in the same manner.

SCREEN OP19 Password Management

The final two password management functions which can be performed are displaying or resetting the logon attempt counters, and changing the customer identification field.

SCREEN OP20 Passwords Function

To display or reset the logon attempt counters, the operator enters "9" in the "SELECT OPTION = = >" area of the Passwords menu and presses SEND (ENTER).

SCREEN OP21 Passwords Function

This screen displays how many times someone has attempted to logon to the local console, to the remote console using the remote customer password, and to RSF or the remote console using the maintenance password. If the operator wishes to set the counters an "R" must be entered next to "ENTER 'R' TO RESET THE COUNTERS == >". To leave this screen without resetting the counters, the operator presses PF6.

SCREEN OP22 Passwords Function

There is a customer identification field, located on the fourth line of the MOSS screens, which can be used to display a name selected by the customer. In this example, the Customer Identification is set to WSC HASL 3720 (Washington Systems Center High Availability Systems Lab 3720). The Customer Identification could be very useful to an installation that has several 3720's controlled by the same operators for it gives them an immediate point of reference in case they should forget which 3720 they are operating. The Customer Identification can be changed by entering a 10 next to "SELECT OPTION == >" on the Passwords menu.

SCREEN OP23 Passwords Function

A new customer identification up to 16 characters long can be entered in the area next to "ENTER CUSTOMER IDENTIFICATION (1 TO 16 CHARACTERS) == >", or PF6 can be pressed to exit without changing the ID.

SCREEN OP24 Configuration Data File

The next function to be discussed is the Configuration Data File (CDF) option. The operator can use the CDF to display the hardware configuration of the 3720 and also to set the line speeds for internally clocked synchronous lines. The speeds which can be set for internal clocking are 2400, 4800, 19200, 38400, 55655, 245750, and RPQ. Internally clocked speeds between 50 and 1200 for synchronous lines and between 50 and 19200 for asynchronous lines are set via the software generation (in EP or in NCP). The default for internally clocked line speeds is 9600bps. Once the speed is changed using the CDF function the scanner must be IMLed for the speed to take effect. Speed can be set for each line on the 3720 rather than for each LIC, as is done on the 3725.

SCREEN OP25 Main Menu Screen - Configuration Data File

To select the Configuration Data File option, the operator enters CDF in the System Input Area.

SCREEN OP26 Configuration Data File

The CDF function allows either an upgrade option, discussed later, or a display option. To display, the operator enters "2" next to "SELECT CDF OPTION (1,2) == >".

SCREEN OP27 Configuration Data File

The display option screen allows the operator to select the display of the Basic Frame (3720), the Expansion Frame (3721), the Programmable Line Speeds, or to display all three by selecting option

number 1. If a 3721 is not installed, the Expansion Frame option is not displayed. The operator selects the display of the 3720 configuration by entering "2" next to "SELECT ONE DISPLAY OPTION (1 TO 4) = = >".

SCREEN OP28 Configuration Data File

In response to selecting the display of the Basic Frame, the configuration of the seven possible LICs and the two possible channel adapters is shown.

In the center area of the screen is shown LIC positions 1 through 7. Directly underneath each LIC number is displayed the type of LIC installed. In the case of the Washington Systems Center 3720, there is a LIC type 3 installed in LIC position 1 and LIC type 1's installed in LIC positions 2, 3, and 4. There are no LICs installed in positions 5, 6, and 7.

In the lower area of the screen, the installed cables are shown next to the port addresses. LIC position 1, PORT1 is Line Address 0 and contains an installed cable designated as "5", meaning a direct attach (DTE) cable. Since LIC position 1 contains a LIC type 3 (a one port LIC), PORT2, PORT3, and PORT4 have no cable installed (indicated by 0 in the ID column). The LIC type 1 allows up to 4 line cables to be attached. In this example, LIC positions 2, 3, and 4 in Ports 1 through 4 all have DTE cables installed (Line Addresses 4 through 15). Since LIC positions 5, 6, and 7 are empty, the cable IDs are displayed as 0s.

The display of the Basic Frame will also show the configuration of the channel adapters and addresses, located in the area on the right of the screen. In this example, there are two channel adapters installed (CA1 and CA2) and each has a two-processor switch (TPS). The Native Subchannel Address (NSC) associated with the A side of CA1 is 1A and with the B side of CA1 is 1B. The low Emulation Subchannel Address (ESC) is 00 and the high ESC is 00. The addresses associated with the channel adapters are not automatically "read" during a CDF upgrade, but, rather, are entered manually as part of the 3720 installation process by the customer engineer.

SCREEN OP29 Configuration Data File

To display the configuration of the 3721 (expansion frame), the operator enters "3" in the area next to "SELECT ONE DISPLAY OPTION (1 TO 4) = = >".

SCREEN OP30 Configuration Data File

The 3721 installed at the Washington Systems Center is a model 2 (containing two scanners). There are LIC type 1s installed in positions 1, 2, 3, 6, 7, and 8 with DTE cables in all four ports of each LIC (Line Addresses 32-43 and 52-63). LIC position 4 contains a LIC type 3 with a DCE cable (Cable ID is "4") installed, and LIC position 5 contains a LIC type 3 with a DTE cable installed. Line Addresses 45-47 and 49-51 are not available because of the LIC type 3 and are marked as Cable ID 0 because no cables are installed.

SCREEN OP31 Configuration Data File

To choose the display of the programmable line speeds, the operator selects option 4.

SCREEN OP32 Configuration Data File

The operator is asked to enter the address of the line he/she would like displayed. In this example, the line address entered is "00".

SCREEN OP33 Configuration Data File

The center area of the screen shows that the line at address 00 is currently set to an internal clocking speed of 55855 and is a LIC type3. When the screen is first displayed the bottom area does not appear. Rather, PF keys are displayed that allow displaying of the previous (PF7) or next (PF8) line address, returning to the CDF option screen (PF6), or changing the internal clocking speed of the displayed line (PF4).

After the operator presses PF4, a section is added in the lower area which allows the operator to choose a new internal clocking speed. In this example, in order to change the current speed, 55855, to 19200, the operator enters "3" next to "ENTER A DIGIT (0 TO 7) TO UPDATE CURRENT SPEED = = >"

SCREEN OP34 Configuration Data File

Part of the Configuration Data File function is an upgrade. An upgrade must be performed after the 3720 hardware has been changed (LICs or lines installed or removed, for example), in order for the 3720 microcode to accurately reflect the actual 3720 configuration.

SCREEN OP35 Configuration Data File

In this example, the operator has chosen the CDF option from the main menu, or has "QUIT" (PF6) from a CDF function discussed earlier, and now has entered "1" to perform a CDF upgrade.

SCREEN OP36 Configuration Data File

If there is a running control program in the 3720, the CDF upgrade is not allowed as is shown by the message at the bottom of the screen "MOSS IS NOT ALONE : CDF UPGRADE NOT ALLOWED". The 3720 must be IMLed before the CDF upgrade can be done.

Note: it is possible to do a CDF upgrade with a running control program if MOSS is in maintenance mode. Refer to the 3720 maintenance manuals for more information.

SCREEN OP37 Configuration Data File

If MOSS is alone, once the operator selects upgrade from the CDF option menu, the CDF upgrade starts immediately. The messages "CDF UPGRADE STARTED", "CCU INFORMATION FETCHED", "CHANNEL ADAPTER INFORMATION FETCHED", "SCANNER INFORMATION FETCHED", and "CDF UPGRADE COMPLETED" are displayed successively as they occur.

SCREEN OP38 Line Description File

The Line Description File is an optional file, generated by the user, which can be used to document descriptions of a line such as symbolic name, line address, protocol, and speed. The LDF function can also be used to compute the line weight.

SCREEN OP39 Main Menu Screen - Line Description File

In this example, the operator has selected the Line Description File Option from the main menu.

SCREEN OP40 Line Description File

After LDF is selected, a screen full of information about the 3720's lines is displayed, starting with address 00. Information such as symbolic name, protocol, speed, and line weight are displayed. The operator can request more information about a particular line by keying its number next to "ENTER ADDRESS (0-27 AMD 32-63) OF LINE TO BE DISPLAYED = = >". PF8 can also be used to page forward to display the next screen's worth of lines. In this example, to change information about the line at address 00, the operator must key in the address and press PF5 for UPDATE.

SCREEN OP41 Line Description File

A detailed Line Description Screen is presented as a result of keying in a line address and pressing PF5 on the LDF screen. Information such as symbolic name, scanner number, whether the line is in the basic frame (BASB) or expansion frame (EXB), protocol, speed, and LIC type is displayed.

To change the displayed information, the operator can key in a new line name, choose numbers 0-4 to specify various protocols, and/or key in a line speed. In this example, the operator is changing the protocol from SDLC FDX to SDLC HDX by choosing option 2. To record the changes in the Line Description File, the operator must press SEND (or Enter, depending on terminal type). PF4 can be used to go to display mode, PF7 can be used to page backward (to Line 63 in this case), or PF8 can be used to page forward to the next installed line (Line 4 in this example).

SCREEN OP42 Line Description File

After the operator records the changes, the screen displayed is the main LDF screen. Line 0 is now displayed as SDLC HDX protocol with a new line weight, 13.1, as opposed to SDLC FDX as it was originally.

SCREEN OP43 Panel Function

The panel function can be used from either a local or remote MOSS console to display information from the control panel. The control panel, located on the 3720, is discussed in the Physical Planning section of this manual. Information such as the Hex LED display code, the function select or power control switch settings, installed channel adapters, channel adapter lights, and channel adapter switch settings can be displayed at the MOSS console.

SCREEN OP44 Main Menu Screen - Panel Function

To select Panel Functions, the operator must enter "PAF" from the 3720 main menu.

SCREEN OP45 Panel Function

In this example, 000 is the code in the hex LED display, the function select switch is set to normal, the power control switch is set to local, the installed CAs are 1 (meaning CA1), 2 (meaning a TPS on CA1), 3 (meaning CA2), and 4 (meaning a TPS on CA2). The A side of CA1 and CA2 are enabled the the B side of both is disabled (CA state reflects the state of the lamps on the control panel). Desired state reflects the way the channel adapter switches are set.

SCREEN OP46 Panel Function

Some of the panel functions (general IML, MOSS IML, channel adapter enabling or disabling) can be performed from either a local or remote MOSS console instead of the panel if the switch labeled "PANEL/CONSOLE" on the 3720 is in the "CONSOLE" position.

SCREEN OP47 Panel Function

If the "PANEL/CONSOLE" switch is in the "CONSOLE" position, the operator can press BREAK and a new area labeled "SELECT A PANEL FUNCTION(IPL, IML, CA) = = >" will be displayed in the lower area of the Panel Functions screen. In this example, the operator selects "CA" to change the settings of the channel adapters.

SCREEN OP48 Panel Function

A new area is displayed showing the Installed CAs and the CA State (Enabled, Disabled, Disabled, Disabled). The operator can enable or disable any of these by replacing the *'s with E's or D's. In this example, to disable CA1 (it is currently enabled), the operator keys a "D" under CA1 and presses SEND.

SCREEN OP49 Panel Function

The message "YOUR REQUEST TO UPDATE CA STATE IS TRANSMITTED : CA1 DISABLED" is displayed after the operator has requested that CA1 be disabled. PF5 can be pressed to refresh the screen periodically.

SCREEN OP50 Panel Function

Once CA1 becomes disabled, the information in the lower area of the screen disappears, and the area labeled "INSTALLED CA:" reflects the new status of the channel adapters. In order to perform another panel function, the operator must press BREAK.

SCREEN OP51 Disk Function

The Disk Function can be used to install Engineering Changes onto the 3720 microcode, to backup the hard disk files on diskette, to restore the hard disk from diskette(s), and to format diskettes for use with the 3720.

SCREEN OP52 Main Menu Screen - Disk Function

To select Disk Functions, the operator keys "DF" in the SIA of the main menu and presses SEND.

SCREEN OP53 Disk Function

Disk Functions cannot be performed when MOSS is ONLINE. If MOSS is ONLINE when this function is selected the message "DISK FUNCTIONS CANNOT BE PERFORMED WHEN MOSS IS ONLINE" is displayed at the bottom of the screen.

SCREEN OP54 Disk Function

IF MOSS is OFFLINE or if MOSS is ALONE, the Disk Functions screen is displayed. The operator can select any of the five options by keying a number from 1 to 5 in the area labeled "SELECT ONE OF THE FOLLOWING FUNCTIONS = = >". Option 5 allows the disk arm to be secured in case the 3720 is being moved.

SCREEN OP55 Microcode Fixes

The Microcode Fixes function is used to apply microcode fixes, to restore the microcode back to the level it was before the latest application of microcode fixes, to display a history table of fixes, to display fixes applied in the past (these "old" fixes can no longer be de-installed), and to display "new" fixes (these are the ones that have not yet been applied or the ones that have just been applied and can be de-installed through the restore option).

SCREEN OP56 Main Menu Screen - Microcode Fixes

To select the Microcode Fixes function, the operator keys "MCF" in the SIA of the main menu and presses SEND.

SCREEN OP57 Microcode Fixes

In the case of the Washington Systems Center 3720, there were no existing microcode fixes at the time this manual was written, so the MCF file was empty.

SCREEN OP58 Machine Level Table

The Machine Level Table function allows the operator to display information concerning the control program loaded in the 3720, the EC level of the microcode, and name and date of the last applied microcode fix.

SCREEN OP59 Main Menu Screen - Machine Level Table

To select the Machine Level Table function, the operator keys "MLT" in the SIA of the main menu and presses SEND.

SCREEN OP60 Machine Level Table

The Machine Level Table screen shows that the control program in the 3720 is an NCP named N20L14 and that it is a Version 4 Release 2 NCP. The EC level of the 3720 is A39184 and the last applied microcode fix is M184A000. The date is all zeros because no microcode fixes have yet been installed on the Washington System Center 3720 using the MCF function.

SCREEN OP61 Line Threshold

The Line Threshold function allows the operator to change the number which determines when the 3720 will send an ALARM concerning line error conditions to the host. The threshold is set as a number which denotes how many Box Error Records are created for a physical line problem before an ALARM is created and sent to the host. The default for this threshold is 4.

SCREEN OP62 Main Menu Screen - Line Threshold

To select the Line Threshold function, the operator enters "LTH" in the SIA of the 3720 main menu and presses SEND.

SCREEN OP63 Line Threshold

The resulting screen displays the threshold set for each LIC. The LICs are grouped in columns under the scanner to which they apply. The PF5 key is used to change the threshold.

SCREEN OP64 Line Threshold

After the operator requests the update function by pressing PF5 from the Line Threshold function screen, the operator is asked to enter a line number. In this example, to change the threshold for the line at address 0, the operator keys "00" next to the area labeled "ENTER LINE ADDRESS = = >" and presses SEND.

SCREEN OP65 Line Threshold

The resulting display shows the value the threshold is currently set to and allows the operator to key a new value in the area labeled "ENTER NEW VALUE = = >". Any value entered lower than the default, 4, will automatically become a 1.

SCREEN OP66 Line Threshold

After the operator has entered a new threshold value, the Line Threshold function screen is again displayed, reflecting the new threshold value. (In this example, LIC 1 on Scanner 1, which was previously set at 4, is now set at 8).

SCREEN OP67 Other New MOSS Functions

There are two other new MOSS functions, Wrap Test and Auto-Ber Analysis which are covered in the Problem Determination section of this manual rather than here in the Operations section.

Section 5 - Problem Determination

SCREEN PD01 Title - Problem Determination

This section describes problem determination with the 3720. The section is written presuming a basic knowledge of the 3725. 3725 problem determination includes: control program dumps, traces, wrap tests and MOSS Box Event Records (BERs). This information can be obtained from the 3725 Operations Training tape that is available as an SRA technical update course, number 34539, or by reading the 3725 "Problem Determination and Extended Services" manual, GA33-0014. 3720 PD includes the above and several more areas to be discussed in the following material.

SCREEN PD02 Differences from the 3725

Problem determination for the 3720 differs from problem determination on the 3725 in three areas.

The first is an additional MOSS wrap capability at the line port level.

Box Event Records (BER) are recorded by MOSS whenever an abnormal event occurs within the 3720. The second capability is an AutoBER Analysis program running under the MOSS micro-processor that executes any time a Box Event Record is recorded by MOSS. The output of this program may be a reference code. This reference code is used to more easily and quickly isolate the failing component.

The third area that will be discussed is the "system alert" flow that takes place when an alarm occurs on the 3720. An alarm is a BER on the 372X that is considered serious by MOSS.

SCREEN PD03 Wrap Test

Customer access to the 'tailgate wrap' is new for the 3720. It is accessed via MOSS by entering 'WT'. A more appropriate name could have been a 'port wrap' since what it wraps is the particular port that you specify to MOSS.

SCREEN PD04 AutoBER Analysis

MOSS is a microprocessor based subsystem of the 3720. Abnormal occurrences within the 3720 are recorded by MOSS in the Box Events Records file. For every event that occurs, the AutoBER Analysis program analyzes the BER record and can generate a reference code which NSD will use to quickly identify failing Field Replaceable Units (FRUs).

SCREEN PD05 MOSS Alarm Display

The example that will be used in the PD section is a scanner failure. An enhancement to the 3720 MOSS is automatic scanner re-IML following a scanner failure. When the scanner fails six Box

Event Records (BERs) are recorded by MOSS. Of these six BERs two are considered serious by MOSS and are made into alarms.

In the example the two alarms have BER numbers of 467 and 471. These can be displayed by keying 'EV' in the MOSS options screen. 467 says the scanner is re-IML'ing and 471 says the re-IML is successful. (We will use these same alarms, numbers 16 and 18, when discussing the system alert flow).

SCREEN PD06 MOSS Alarm Detail Display

The alarm detail display contains the AutoBER reference code. Notice alarm 18 generates a reference code of BX132000. This code can be interpreted via the 3720 Maintenance Information Procedures manual. Alarm 16 is an example of an alarm that does not generate a reference code. These alarms are translated into alerts and transferred to the owning VTAMs by NCP. This is what will be discussed in the next section labeled 'alert flow'. (If the 3720 is running EP, MOSS will be the only source for information on a 3720 problem.)

SCREEN PD07 Alert Flow

The flow of alerts generated via the 3720 is similar to the flow of alerts generated by the 3725. If an alarm occurs on the 3720 it is translated into alert format and transferred to the owning VTAMs. If Netview or NPDA are active the alert is passed to one of these network management products. If they are not active the alert is kept by VTAM. If the 'generic alert' PTF is applied to VTAM then the alert is displayed by VTAM. If the 'generic alert' is not applied to VTAM, then the alert is not displayed by VTAM. We will show examples of all the above options. Alarms 16 and 8, used in the previous section, will be transformed into alerts 16 and 18 and transferred to VTAM.

SCREEN PD08 VTAM or NCCF (No Generic Alert)

This is what VTAM displays for a scanner failure if the generic PTF is not applied. There is no information on a scanner failure. The VTAM information (IST prefix) only relates to a failure of resources, such as lines and clusters, attached to the failing scanner. From these messages it would be difficult to conclude that a scanner has failed. The messages in the small print are displayed on the NCCF console if NPDA is active.

SCREEN PD09 VTAM or NCCF (Generic Alert)

The generic alert PTF displays a specific VTAM message for all 3720 alerts received by VTAM. Only the qualifiers of the message differ by alert type. The first highlighted message has a User Action Code (UAC) of 16. This message corresponds to alert 16 (which was transformed from alarm 16 in the 3720). The message can be translated with the 3720 PD guide or using the VTAM messages and codes manual. The qualifiers (Q1, Q2) show the scanner number and the particular line addresses affected by the scanner outage. The next highlighted message has a UAC of 18. This corresponds to alert 18. The qualifiers include Q3 which contains the AutoBER Analysis reference code, BX132000 (remember, this was also in alarm 18 in MOSS on the 3720), but to get the interpretation of this message requires access to the 3720 PD manual. A simple English description "scanner re-IML is successful" is not contained in the message.

SCREEN PD10 NPDA V3

With NPDA V3R2 the following information is displayed: selection #3 corresponds to alert 16, selection #2 corresponds to alert 18, and selection #1 is sent by NCP which detects a scanner outage. Both alert messages indicate a problem with the scanner without having to refer to a manual.

The TEMP 12 indicates a temporary error with hex '12' corresponding to alert 18. The INTV 10 indicates intervention with hex '10' corresponding to alert 16. Lets look at the 'event detail' screen for each selection for more information.

SCREEN PD11 NPDA V3 Cont'd (selection 3)

This 'event detail' screen is the information on alert 16. This screen indicates a scanner failure. The scanner number is 4 and line addresses 48-63 are affected by the failure. 'Event type' 4 implies operator intervention. 'General' says it is a hardware problem. 'Specific' says the hardware problem is the scanner. 'Action' of 10 corresponds to alert 16. And 'block id' of 04E is unique to the 3720.

But nowhere on this screen does it say that "scanner re-IML is in progress" as is indicated when the alarm is displayed in MOSS.

SCREEN PD11 NPDA V3 Cont'd (selection 2)

This 'event detail' screen is the information on alert 18. The only additional information is the AutoBER reference code in qualifier 3 which is BX132000. This alert indicated the scanner re-IML is successful but the screen does not display this information.

SCREEN PD11 NPDA V3 Cont'd (selection 1)

This 'event detail' screen is the information on NCP's detection of the scanner failure.

SCREEN PD14 Netview (selection 2)

This 'event detail' screen is Netview's information corresponding to alert 18. This screen does indicate that the scanner re-IML is successful, just as MOSS did. There is no requirement to refer to a manual to interpret the message or screen.

SCREEN PD15 Conclusions

The AutoBER reference code should improve problem resolution in the 3720.

Host support will require reference to a manual to interpret the messages unless Netview is installed. The manuals that could be referenced are: the 3720 Problem Determination Guide, the NPDA Reference Guide, or the VTAM Messages and Codes.

Section 6 - Performance

SCREEN PF01 Title - Performance

This section is based on work done in the Washington Systems Center.

SCREEN PF02 Performance Overview

There are five areas to become familiar with, in order to understand the performance results. We will look at the total system as well as details on the hardware and software. Once we have reviewed the configuration then we will discuss performance results for remote and local 3720s. Included in the local case is a comparison of the 3720 vs. 3725 performance using NPM as the measurement tool.

SCREEN PF03 System Configuration

TPNS is used in simplex mode to function test the 3720 using System 'U' only. System 'U' and 'V' are used in duplex mode with TPNS to stress test the 3720. The real terminals attached to the 3720 are not dedicated to the configuration. Using this configuration TPNS can drive the 3720 as a local, not using the INN links to SA12, or as a remote by disabling the channel adapter to SA01, and passing the traffic to SA12 via the INN links.

SCREEN PF04 3720 Hardware Configuration

All scanners are configured with 1 LIC3 and 3 LIC1's. This allows the line speeds of 19.2kb and 9.6 kb to be used interchangeably with no hardware configuration impact. We reconfigured to three LIC1s per scanner when we exceeded the scanning capacity by switching from 9.6kb to 19.2kb (the only symptom that we noticed was when activating resources the PU's stayed in PAPU2 status). Since the 3720 has customer installable LICs the reconfiguration is easy, but be aware of the line weight sums and scanner plugging restrictions also discussed in the migration topic of this document.

SCREEN PF05 3720 Software

VTAM V3R1 includes the 'generic alert' PTF. We used NCP V4R1 with PTF's UR14023 and UR14024. The CNM products and NPM 1.2 required no additional maintenance.

SCREEN PF06 Remote 3720 Scenario: NPM Results

TPNS in system 'V' simulated 1200 terminals on 24 BNN lines at 2 PUs/line and 25 LUs/PU. Transactions from this system drove a CICS echo application on system 'U'. The TPNS message size was a nice round 117 bytes in both directions. The resulting line utilizations obtained from

NPM were: 22-27% for 9.6kb BNN lines, 5-10% for the 19.2kb BNN lines, and 70% for the INN line. The remote 3720 utilization was 73%. This was taken over NPM intervals of 3 minutes.

SCREEN PF07 Remote 3720 Scenario: CF3725 Results

The results of the previous run using TPNS were put into CF3725. If the IBM configurator is to be accurate it should produce similar results since the message sizes and rates are fairly well controlled. For the configurator we used 117 bytes for the message size and simulated the same number of lines at the same speeds as the TPNS runs. The resulting line utilizations were: 24% for the 9.6kb lines, 12% for the 19.2kb lines, and 58% for the 56kb INN line. These line utilizations are approximately what the line utilizations were during the TPNS tests. The resulting 3720 utilization as approximated by CF3725 was 70.9%. This says the IBM aid is in the same range as the NPM measurements.

SCREEN PF08 Local Scenario: 3720

In the local scenario the configurations were changed to most easily match the hardware for the existing 3725. Consequently, 16 9.6kb BNN lines were used. These lines simulated 800 terminals at 2 PU's/line and 25 LU's/PU. Transactions from these lines drove the same CICS echo program with the same message size of 117 bytes. NPM measured the BNN lines at 60-70% utilization. The 3720 utilization during this test was 69%. NPM measured this utilization over 3 minute intervals.

SCREEN PF09 Local Scenario: 3725

For the 3725 we used the same number of resources and size of messages. During the measured time NPM indicated BNN line utilizations of 58-66% for the 16-9.6kb lines. And NPM measured the 3725 utilization at 23%.

SCREEN PF10 Conclusions

The performance tests show the same workloads running on the 3720 and the 3725 result in a box utilization of the 3720 being about three times that of the 3725. TPNS has a response time analysis report that indicated no perceptible difference between the 3720 and the 3725. Data gathered, as well, from NPM and TPNS indicated CF3725 to be in the same range for predictive analysis. The CF3725 results were also verified by several customers in a test (controlled) environment.

Section 7 - Migration

SCREEN MI00 Title - Migration

SCREEN MI01 Overview

The migration topic is divided into four sections. Three sections are contained on the diskette and discussed below. They are hardware migration considerations, software migration considerations and hints and tips. The fourth topic, publications, is a list of publications included at the end of this section.

The 3720 concepts are very similar to the current 3725 and, indeed, some components are identical or enhanced. When migrating from the 3705 to the 3720, a document that might be of additional use is the 3725 Installation Guide, GG22-9340-01.

SCREEN MI02 Hardware

From a hardware standpoint the 3720 does not introduce any new compatibility restrictions. It is compatible with the 3725 and 3705 in an SNA network. If there are 3725's in the network remember that the LIC cables are different and cannot be interchanged between 3725 and 3720.

Operating consoles require some consideration. The various consoles which can be used must be configurable for local or remote use via either micro-switch settings, such as the IBM 3101 Model 23; via software, such as an IBM Personal computer using the 3101 Emulation Program; via microcode, such as the IBM 3161, 3163 or 3164 ASCII Display station.

Contention must be managed since there are three console ports: one for the local console, one for the remote, and one for the remote service facility. Since only one console can be active at any time, the access must be coordinated. If the local console is logged on and the remote calls a message is displayed, 'remote console calling'. If the remote is logged on a message is displayed, 'local console calling', if certain switches are activated on the 3720 panel (see the Physical Planning discussion). The remote console can be disconnected from the 3720 panel (see the Physical Planning discussion), while the local console is disconnected automatically after fifteen minutes of inactivity if a remote console calls.

Modems are required for both the remote console port and the remote service facility and, consequently, planning must occur to provide for them. The IBM 5841 can be used for both applications. A final point is that if the 3720 is located with 3725s, the consoles are different and operator should become familiar with both types of consoles and the MOSS screens.

SCREEN MI03 Hardware

When migrating to the 3720, MOSS functions must be used to install the controller such as the Password function, CDF function, panel functions, and IPL ports for remote loading of the 3720.

When reconfiguring the 3720 or 3721 care must be taken not to exceed the line weight capacity of the scanners. This is very easy to do: simply change line speeds for direct attached lines using the Programmable line speed option of the CDF function, increase line speeds of externally clocked lines, or add more LICs. The CF3725 configurator should be used to validate configuration changes, ie, line speed changes and LIC movements. The MOSS Line Description Function (LDF) calculates line weights and simple addition can tell you if you have exceeded a scanner capacity. The other tool that can be used to indicate scanner over commitment are the following two formulae:

$$\text{1a) } \frac{\text{Total Scanner Capacity}}{\text{\# of last LIC position used on the scanner}} = \frac{\text{Total LIC Capacity}}{\text{Capacity}}$$

$$\text{b) } \frac{\text{Total LIC Capacity}}{\text{\# ports per LIC}} = \frac{\text{Maximum Line Speed}}{\text{For LIC}}$$

Total Scanner Capacity: 307,200 bps

- 2) A scanner has a maximum capacity equal to a total line weight sum of 100. The line weight is the percentage of the scanner capacity consumed per line.

Scanner and LIC rules are discussed in the 3720 Configuration Guide, GA33-0063-1, Chapter 4 which has tables showing maximum contiguous LIC positions based on maximum line speed. Note that empty LICs (no cables attached) also count towards the maximum # of occupied LIC positions.

With respect to backup considerations the 3720 may require different NCP versions than the 3705 or 3725 and it also has different line capacities. So planning must take place to use it in a backup situation.

SCREEN MI04 Software

The operating system definition for the 3720 is the same as a 3725: MVS and VSE allow it to be defined as a 3705 with either a type 1 or type 2 channel adapter; VM allows it to be defined as a 3725.

Since the 3720 can run NCP, EP or PEP various access methods can communicate with the 3720. They are listed here. Additionally, as already stated in the Software discussion, specific releases of VTAM support the mapping of the 3720 Alerts into a generic alert presented to the VTAM operators console.

SCREEN MI05 Software

Specific NCP products can be used to support the 3720 and SSP V3R2 is required to generate the control program, load and dump it. The NCP for the 3720 is different from the 3725; a 3725 load module cannot be used on the 3720.

SCREEN MI06 Software

When migrating to the 3720 full alert support is provided via Netview for the MVS and VM environments, and NPDA V3R2 with a specific PTF in the VSE environment. NPDA for MVS and VM provides the same data as the generic VTAM message, namely, a user action code and qualifier

data which requires referencing a the 3720 Problem Determination publication for a complete explanation. Also use of the Network Performance Manager requires a PTF for 3720 device support.

SCREEN MI07 Hints and Tips

3720 setup training and operator training is available through SRA Direct-Education, at telephone 800-SRA-1277 in three video tape formats, VHS, BETA, or the U-MATIC.

Microcode updates can be handled differently on the 3720 with the customer having greater control including the option of applying specific microcode fixes. The microcode distribution plan is included in the Service section.

Password management must be planned when migrating to the 3720 since local, remote, service and maintenance passwords are available and used.

To provide access to the 3720 using the remote MOSS capability 212A equivalent modems are required at 1200bps, using asynchronous ASCII protocol. A complete description of the requirement is stated in the 3720 System Integration publication.

To provide access to the 3720 using the remote service facility 212A equivalent modems are required at 1200bps, using synchronous protocol. A complete description of the requirement is stated in the 3720 System Integration publication.

SCREEN MI08 Hints and Tips

In an MVS/XA environment using VTAM V3R1.0 a performance PTF, UZ81453, allows the the RU size of each record sent during a load or dump of a 3720 or 3725 to be changed from 512 bytes to a maximum of 2048 bytes significantly reducing the time for the load and dump operations. For MVS and VM, in VTAM V3R1.1 this is implemented via a constant in the constant module, ISTRACON, and is documented in the VTAM Customization publication.

Miscellaneous installation related information is contained in a 3720 installation file on INFORMATION/SYSTEM in the Q file and can be located quickly using the keywords "3720 QBUCKET". This file is updated as new information becomes available and should be viewed periodically for any changes.

SCREEN MI09 Hints and Tips

The timings are basically self explanatory and show that the 3720 is about 1 minute faster to reach a load point than the 3725.

3720 Publications

Below is a complete list of the "KIT" numbers and document numbers for the 3720. Ordering should be by form number only if the "KIT" number is not available.

3720 DOCUMENTATION

3720 KIT NUMBER -----	3720 FORM NO -----	DOCUMENT NAME -----
SK2T-0271	SY33-2050	MAINT. INFO. PROCEDURE
SK2T-0272	SY33-2058 SY33-2040	MAINT. INFO. SUMMARY MAINT. INFO. REFERENCE
SK2T-0273	SY33-2039	SERVICE GUIDE
SK2T-0274	SY33-2053 S135-2009	3720-1 INSTALL PARTS CATALOG
SK2T-0275	S135-2009	PARTS CATALOG
GK2T-0276	GA33-0064 GA33-0067	CUSTOMER SETUP SYSTEM INTEGRATION
GK2T-0277	GA33-0065 GA33-0086	OPERATORS GUIDE PROBLEM DET. GUIDE
SK2T-0278	GA33-0066	EXTENDED SERVICES
N/A	GA33-0060	INTRODUCTION
N/A	GA33-0063	CONFIGURATION GUIDE
N/A	GA33-0061	PLAN & SITE PREP.
N/A	GA33-0068	O E M INFORMATION
N/A	GA33-0013	PRINCIPLES OF OPER.
N/A	SY33-2042	DIAGNOSIS DESCRIPTION
N/A	D99-3720A	CHANNEL ADAPTER OLTS

Section 8 - Service

This section covers the service offerings available for the 3720 controller.

SCREEN SE00 Title - Service

SCREEN SE01 Service Overview

New for the 3720 is the remote support facility similar in concept to that which has been available with the 4300 and 308X/3090 CPU products. With it customer access to the IBM 3720 Hardware Support Center will occur whereas now only the IBM customer engineer typically deals with this center. When using the remote support facility the service cycle is altered from the cycle currently being used for the 3725.

SCREEN SE02 Remote Service Facility

The remote support function is implemented in the 3720 via specific MOSS microcode and its basic functions are described on this screen. Corresponding functions are invoked by a hardware support center representative using a remote terminal connected via a network to CPUs in either Boulder, Colorado or Tampa, Florida.

SCREEN SE03 Hardware Support Center Access

The purpose of the 3720 hardware support center is to respond to problems calls it receives. Calls are returned, action plans developed and carried out either by the hardware support center and/or a local CE. If needed, development is easily accesible to the hardware support center for difficult problems that may require their assistance.

SCREEN SE04,SE05 Harware Service Cycle

The service cycle is initiated by the customer placing a call using the current IBM 800 service number. The call will then be dispatched to the 3720 hardware support center, and a callback placed. After discussing the problem the appropriate action is taken using whatever tools are needed to resolve the problem, such as the RSF facility if desired, on-site CE, RETAIN, development, etc.

SCREEN SE06 Software

There is no change in the way software problems are handled for the NCP, EP and any other controller programs used on the 3720.

Microcode Distribution Plan

The distribution of microcode for the 3720 is broken into 5 separate categories. These categories are:

1. Distribution of diagnostic Engineering Changes (EC)
2. Distribution of normal Engineering Changes (EC)
3. Distribution of microcode fixes (MCF) via RSF
4. Distribution of microcode fixes (MCF) via floppy diskette
5. Distribution of temporary patches

Distribution of Diagnostic Engineering Changes (EC)

All microcode ECs for the purpose of upgrading diagnostic features are considered to be mandatory. The responsibility for installing these ECs belongs to the CE located in the NSD branch office supporting the 3720. This type of EC is handled in the same manner as current ECs for the 3725.

Distribution of Normal Engineering Changes (EC)

All microcode ECs for updating the functional portion of the 3720 microcode will be considered mandatory for the first year. During this time the responsibility for EC updates will be the same as for diagnostic ECs (ie. it will belong to the CE). At the end of the first year, or once the microcode has reached a stable level (this will be determined by the number of MCFs generated per month) the responsibility for installing ECs will be given to the customer. All microcode ECs will be distributed via floppy diskette. This will require some minimal amount of training for the customer personnel at the physical 3720 location. This should include how to open the front cover, how to remove and insert diskettes into the floppy diskette reader, and customer procedures for filing and storing backup diskettes. The actual commands for the installation can be performed from the host site.

Distribution of Microcode Fixes (MCF) via RSF

Distribution of MCFs to the 3720 can be performed by the Hardware Support Center (HSC) providing that the customer has elected to use the Remote Support Facility (RSF). The HSC will electronically send MCFs to a customer over the RSF link to correct a problem they suspect to be in the microcode area, or to bring a 3720 up to the most current MCF level for that particular EC level to better assist the customer in resolving an unknown error. This type of support will be done on a box by box basis and only during the process of resolving problems with the 3720. The HSC will provide the customer with the MCF they suspect will fix the error along with all required pre-req MCFs, and if the customer desires, all other MCFs needed to bring the microcode up to the most current level for that EC. The customer may elect to have the HSC install and apply these fixes at that time, or they may decide to apply the MCFs themselves at a later time.

Distribution of Microcode Fixes (MCF) via Floppy Diskette

If a customer elects not to install RSF support in the 3720 location, the means of obtaining MCFs is via floppy diskette. The HSC will put the customer in contact with the Customer Order Facility (COF) when it has been determined that an MCF is needed. COF will send the customer a new copy of the entire 3720 microcode which will be at the highest current level. COF will have the ability to ship the diskette for next day delivery. It will be the customer's responsibility to install the new diskette. This install will be equivalent to the installation of a new EC level for the 3720. All MCFs needed to update other 3720s in a customer's network for preventive means will be obtained using this method regardless of the availability of RSF.

Distribution of Temporary Patches

Temporary patches will be the responsibility of the Product Engineering group. This group will have the option of creating a temporary patch (similar to a software local bypass), and applying it via RSF if available, or by floppy diskette using next day delivery. All patches will be transformed into an official MCF; at that time it will become the responsibility of the customer to obtain that fix and any pre-reqs, and apply it via one of the methods described above. The option of having the CE key in the microcode bypass still exists as it does for the 3725 today. This would be dependant on the severity of the problem as well as the complexity and amount of code needed to be input.

3720

0V01

Communication Controller

OVERVIEW

AGENDA

3720

- hardware
- software

Architecture

- control subsystem
- transmission subsystem
- maintenance & operator subsystem (MOSS)

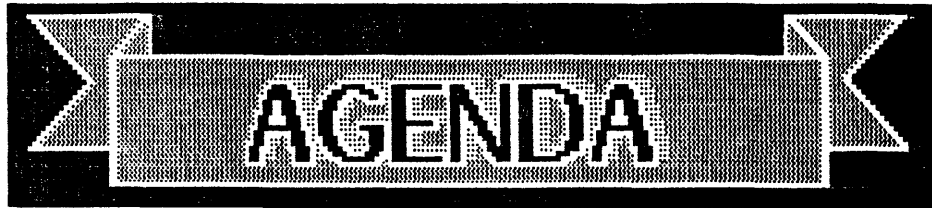
A black banner with a white border and a white background. The word "AGENDA" is written in a bold, white, sans-serif font in the center. The banner has a slight 3D effect with a shadow on the right side.

AGENDA

Customer Environment

- packaging & power
- installation & reconfiguration
- service

3720

EXTENDS

3725 product line

Designed Specifically for

LOW END NETWORKS

REMOTE CONCENTRATION

3720 Model 1

0U05

channel-attached

* HARDWARE

- up to 2 channel adapters (CAs)

* two-processor switch (TPS) option

- up to 28 lines
- up to 2 megabytes

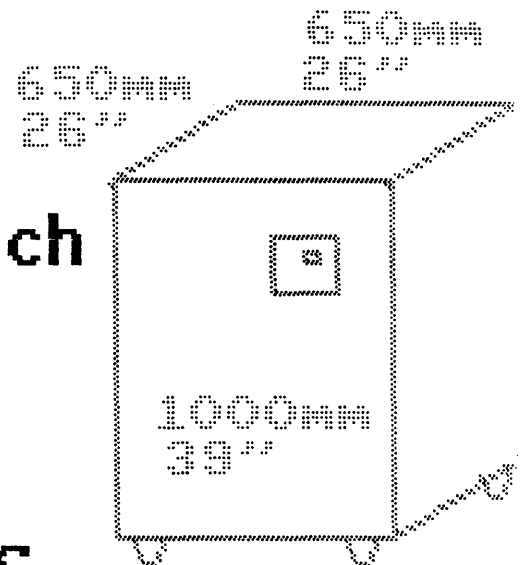

3720 Model 1

0U06

channel-attached

* SOFTWARE

○ NCP

V4R1 (MVS, VSE)

V4R2 (MVS, VM)

○ NCP V4 Subset

(MVS, VSE, VM)

○ EP R3 (MVS, VSE)

R4 (MVS, VM)

○ SSP V3R2 (MVS, USE, VM)

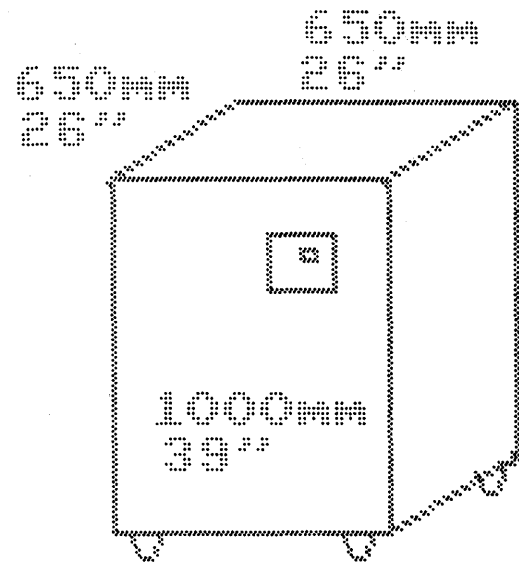

3720 Model 2

link-attached

0U07

* HARDWARE

- up to 28 lines
- up to 2 megabytes

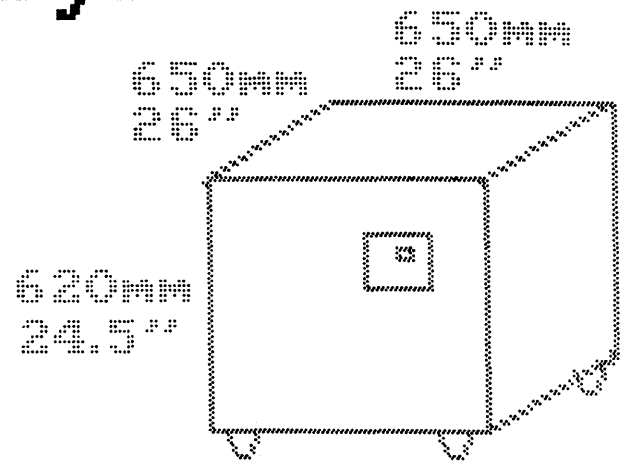

3720 Model 2

link-attached

0008

* SOFTWARE

- NCP
 - V4R1 (MVS, VSE)
 - V4R2 (MVS, VM)
- NCP V4 Subset (MVS, VSE, VM)
- SSP V3R2 (MVS, VSE, VM)

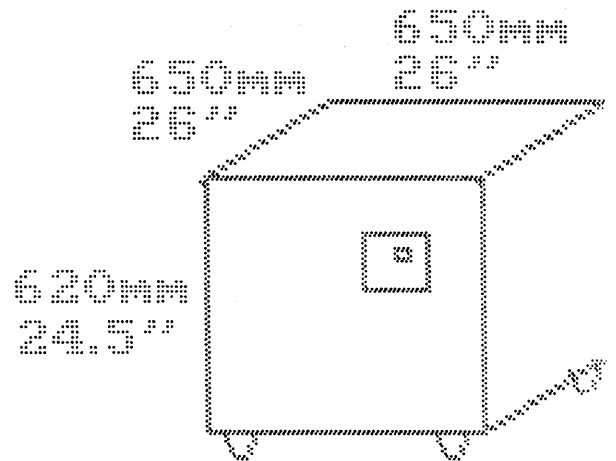

3721 Model 1 & 2

0U03

expansion frame

* HARDWARE

- o up to 32 lines
- o up to 2 scanners

Model 1

one scanner

Model 2

two scanners

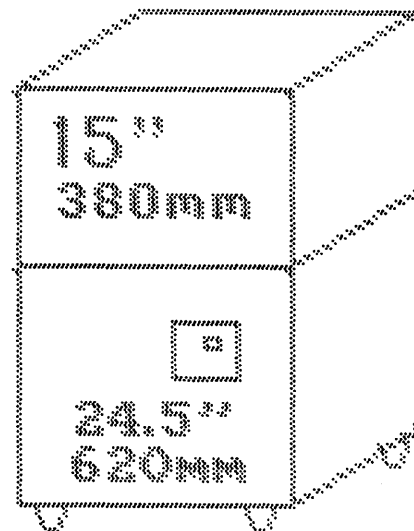

3270 Model 2

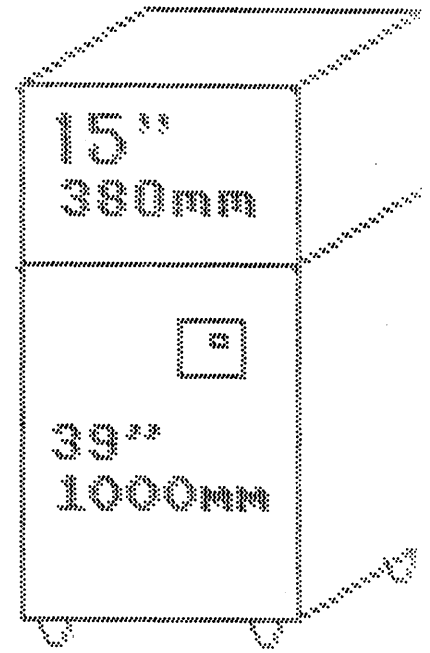

3270 Model 1

3721 Model 1 & 2

0010

expansion frame

* SOFTWARE

○ NONE
REQUIRED

* software
executes in
base frame

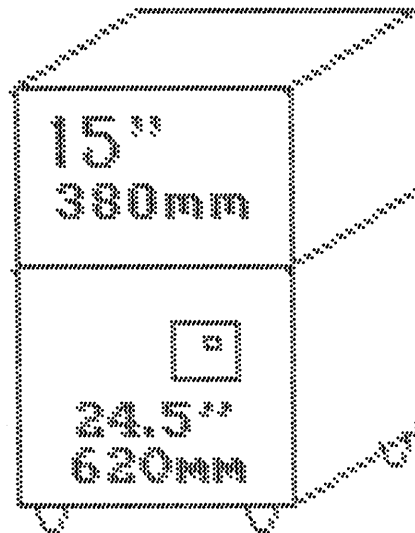

3270 Model 2

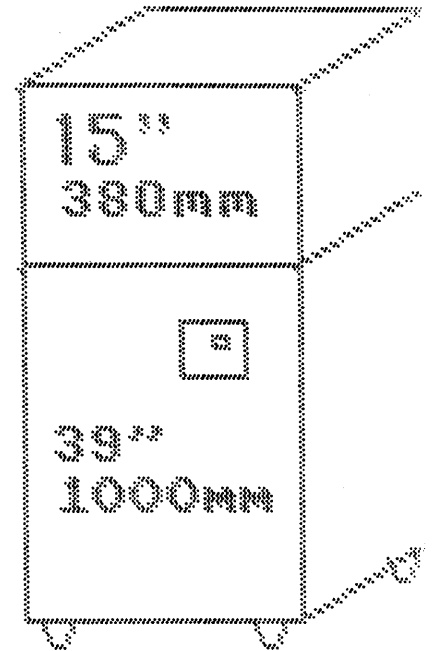

3270 Model

token-ring attachment

*** HARDWARE**

- o up to 2 token-ring interface couplers (TICs)
- o up to 16 lines
- o up to 2 channel adapters
 - * TPS option
- o up to 2 megabytes

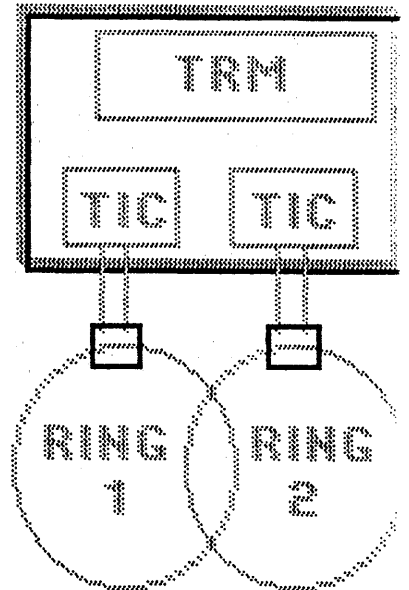

3720 Model 11

0U12

token-ring attachment

*** SOFTWARE**

- NCP V4R2
 - NCP V4 SUBSET
 - EP R4
 - SSP V3R2
- MVS, VM ONLY

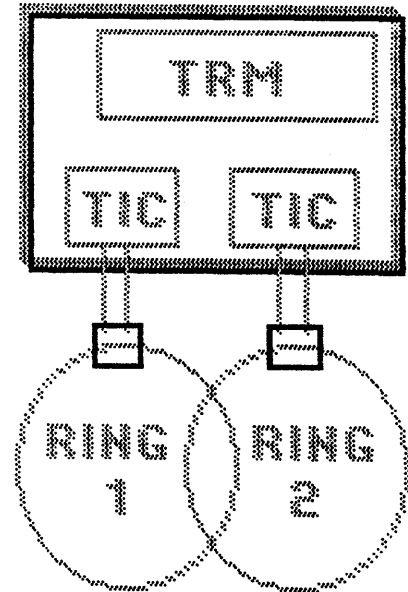

3720 Model 12

0U13

token-ring attachment

* **HARDWARE**

- up to 2 token-ring interface couplers (TICs)
- up to 16 lines
- up to 2 megabytes

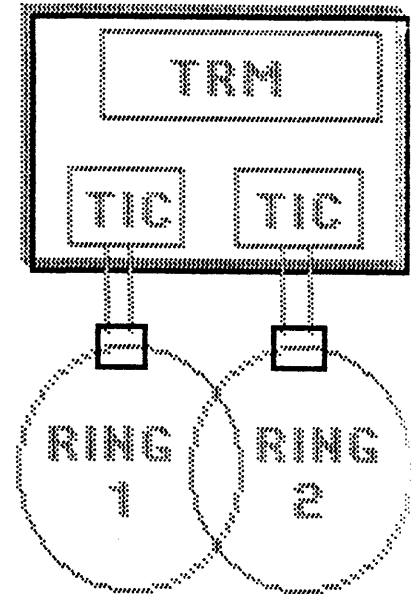

3720 Model 12

0014

token-ring attachment

* **SOFTWARE**

- o NCP V4R2
 - o NCP V4 SUBSET
 - o SSP V3R2
- MVS, VM ONLY

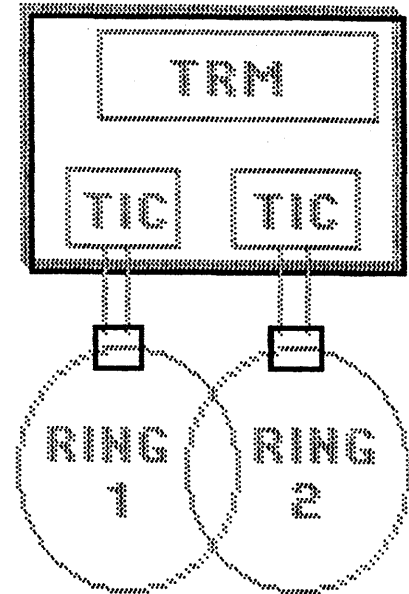

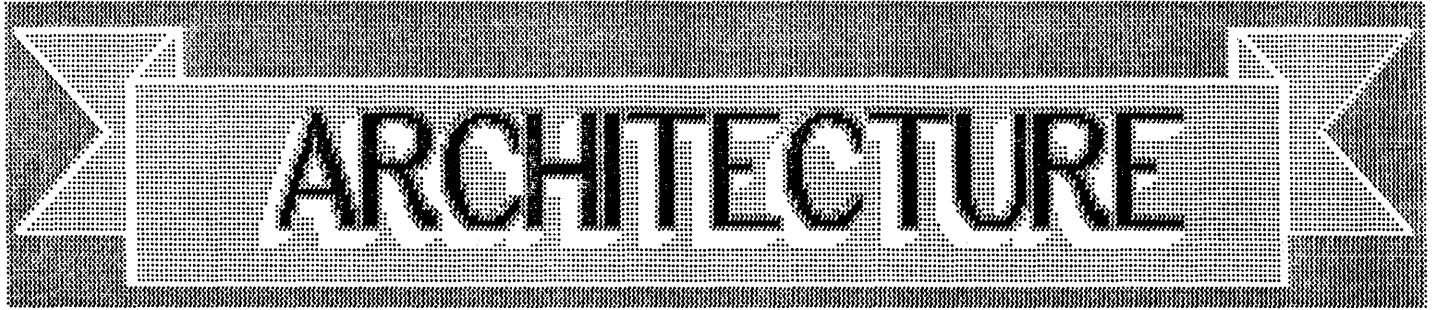

ARCHITECTURE

ARCHITECTURE

OU16

3720 MODEL 1, 2, 11, 12

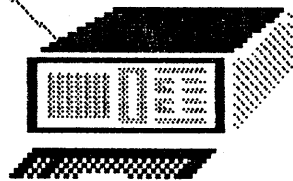
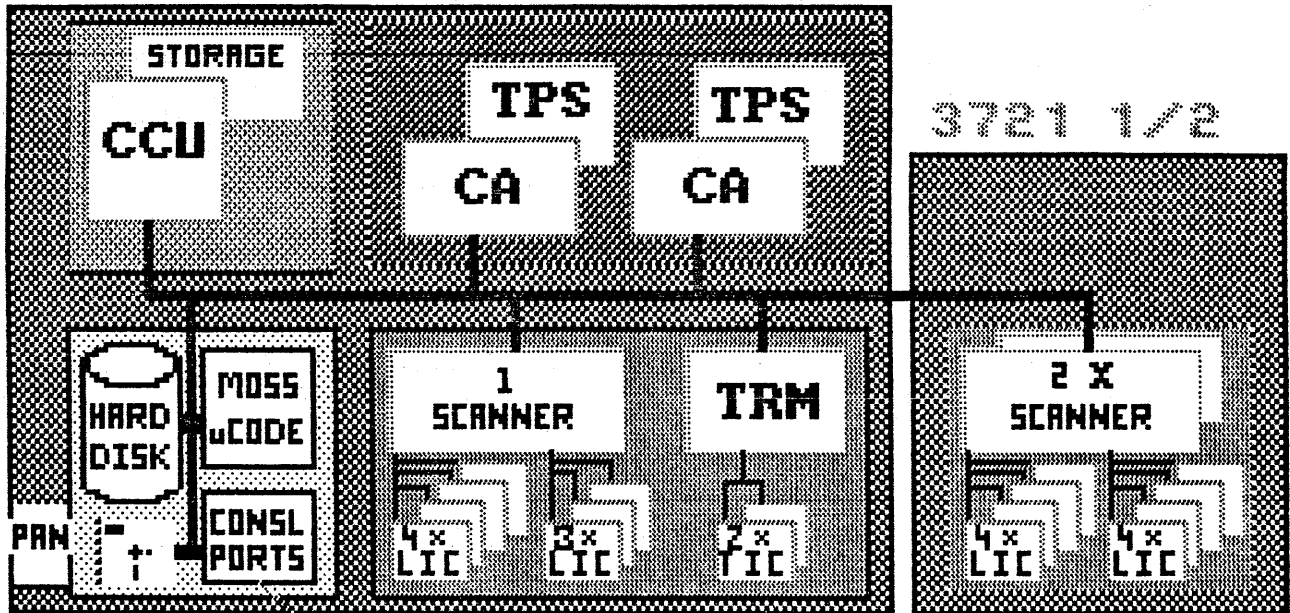

Console: Local
Remote
RSF

ARCHITECTURE

OU17

3720 Model 1

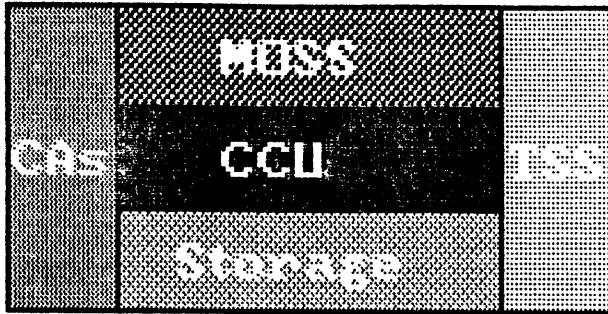

3721 Model 1/2

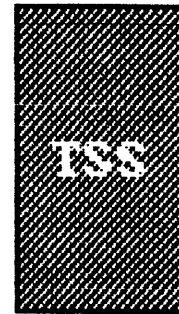

3720 Model 2

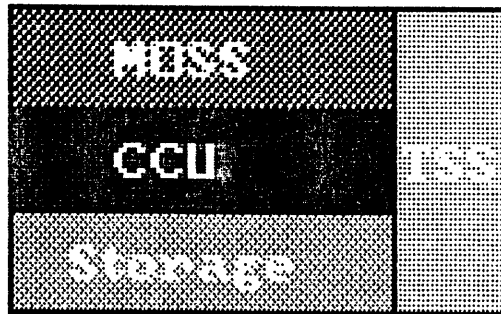

3721 Model 1/2

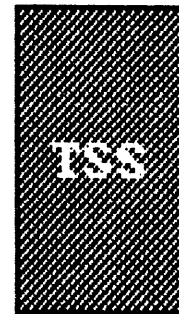

Control Subsystem

OU18

- o processor
- o storage
- o channel adapter

optional features

TPS1 (CA1)

CA2

TPS2 (CA2)

1 MB

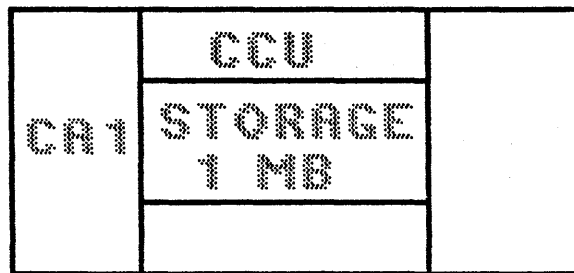

3720 Model 1 base

1 MB

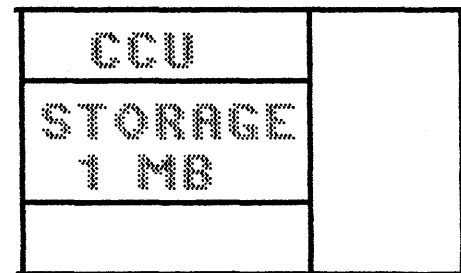

3720 Model 2 base

Transmission Subsystem

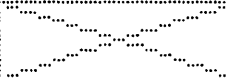
COMMUNICATION SCANNER CS1	
	7 LIC
	6 LIC
	5 LIC
	4 LIC
	3 LIC
	2 LIC
	1 LIC

3720 Model 1 & 2
(base frame)

Transmission Subsystem

COMMUNICATION SCANNER CS3	8 LIC
	7 LIC
	6 LIC
	5 LIC
	4 LIC
	3 LIC
	2 LIC
	1 LIC

3721 Model 1

(expansion frame)

Transmission Subsystem

COMMUNICATION SCANNER CS4	8 LIC
	7 LIC
	6 LIC
	5 LIC
COMMUNICATION SCANNER CS3	4 LIC
	3 LIC
	2 LIC
	1 LIC

3721 Model 2

(expansion frame)

Transmission Subsystem

0U22



uses 3725 microcode

HARDWARE IMPROVEMENTS

- internal clock cards
 - always installed
 - speed initialized via MOSS
 - speed selection per line
- improved transfer rate between CCU & scanner

Transmission Subsystem

OU23

- o electronic LIC wrap at cable interface
 - enables testing without human physical intervention
 - accessible in operational or diagnostic mode
- o snap on cable connections
 - cannot re-use 3725/3705 cable
 - connectors available from OEM
- o line weights

Transmission Subsystem

0024

- o line weights not LIC weights
- o total scanning capacity per scanner = 100
- o line weights depend on speeds & protocols

LIC 2, 3, 4B

SPEED (kbps)	SDLC (DX)	BSC
256	100	N/S
128	50	N/S
56	21.4	13.1

Transmission Subsystem

0V25

- o line weights not LIC weights
- o total scanning capacity
per scanner = 100

LIC 1, 4A

SPEED (kbps)	SDLC (DX)	BSC	S/S
19.2	12.5	6.2	50
14.4	9.4	4.7	37.5
9.6	6.2	3.1	25
4.8	3.1	1.6	12.5
2.4	1.6	0.8	6.2
1.2	0.8	0.4	3.1

MOSS Subsystem

OU26

HARDWARE IMPROVEMENTS

- ECC on memory
- hard disk
 - functions immediately available
 - extra storage
- standard 5 1/4" diskette
 - hard disk backup
 - microcode portability

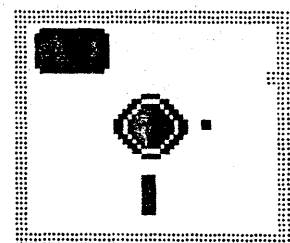

MOSS Subsystem

OU27

- three console ports
 - customer access via remote and/or local console
 - IBM access via Remote Support Facility (RSF)

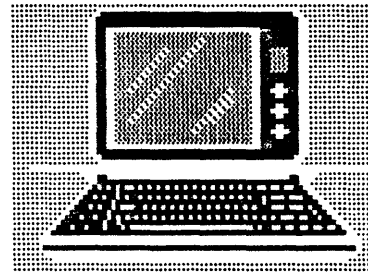
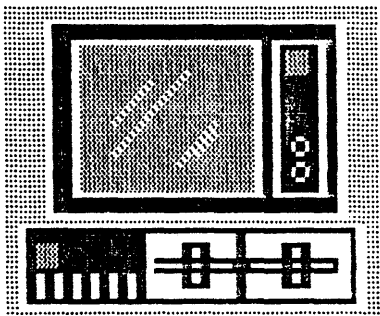

- panel interface

MOSS Subsystem

0U28

MOSS microcode capitalizes on 3725

HARDWARE IMPROVEMENTS

- MOSS local console not mandatory *

- support unattended operations via remote access to operator panel
- access protected via passwords

*** EXCEPT if RSF not used**

MOSS Subsystem

OU29

HARDWARE IMPROVEMENTS

- MOSS microcode improves availability
 - reduces down time due to automatic scanner re-IML for transient errors
 - automatic Box Event Record (BER) analysis:
error reference code & alert



CUSTOMER



ENVIRONMENT

Installation

- 3720 Model 1
 - initial installation by IBM CE
 - customer setup (CSU)
 - * line interface couplers (LICs)
 - * MOSS console interface(s)
local and/or remote
 - * Remote Support Facility (RSF)
interface

Installation

0U32

◦ 3720 Model 2

- customer setup (CSU)
 - * initial installation
 - * line interface couplers (LICs)
 - * MOSS console interface(s)
remote and/or local
 - * Remote Support Facility (RSF)
interface

Installation

- 3721 Model 1 & 2
 - customer setup (CSU)
 - * initial installation
 - * line interface couplers (LICs)

Service Concept

0034

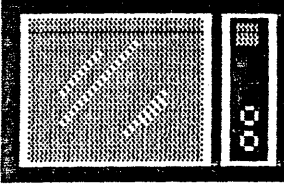

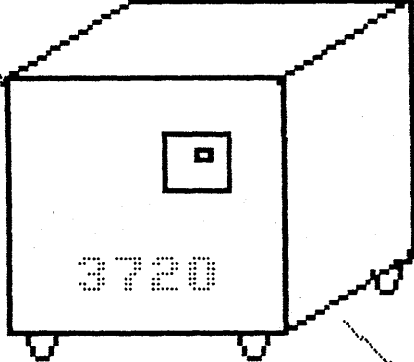

**CUSTOMER
REMOTE
CONSOLE**

**+
VTAM
NPDA**

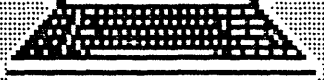

**IBM
Remote
Support Facility**

**IBM
RETAIN
Center**

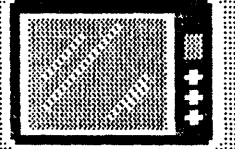

3720 Installation Planning

- o Overview
- o **Physical Planning**
- o Software
- o Operations
- o Problem Determination
- o Performance
- o Migration
- o Service

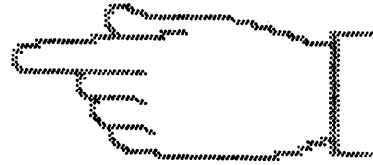

PP00

3720 Physical Planning

- o Physical Layout/Control Panel
- o 37X5 Comparison
- o Addressing
- o Setup and Integration
- o Operator Console Support
- o Cables

PP01

3720 Physical Planning

3720 Model 1

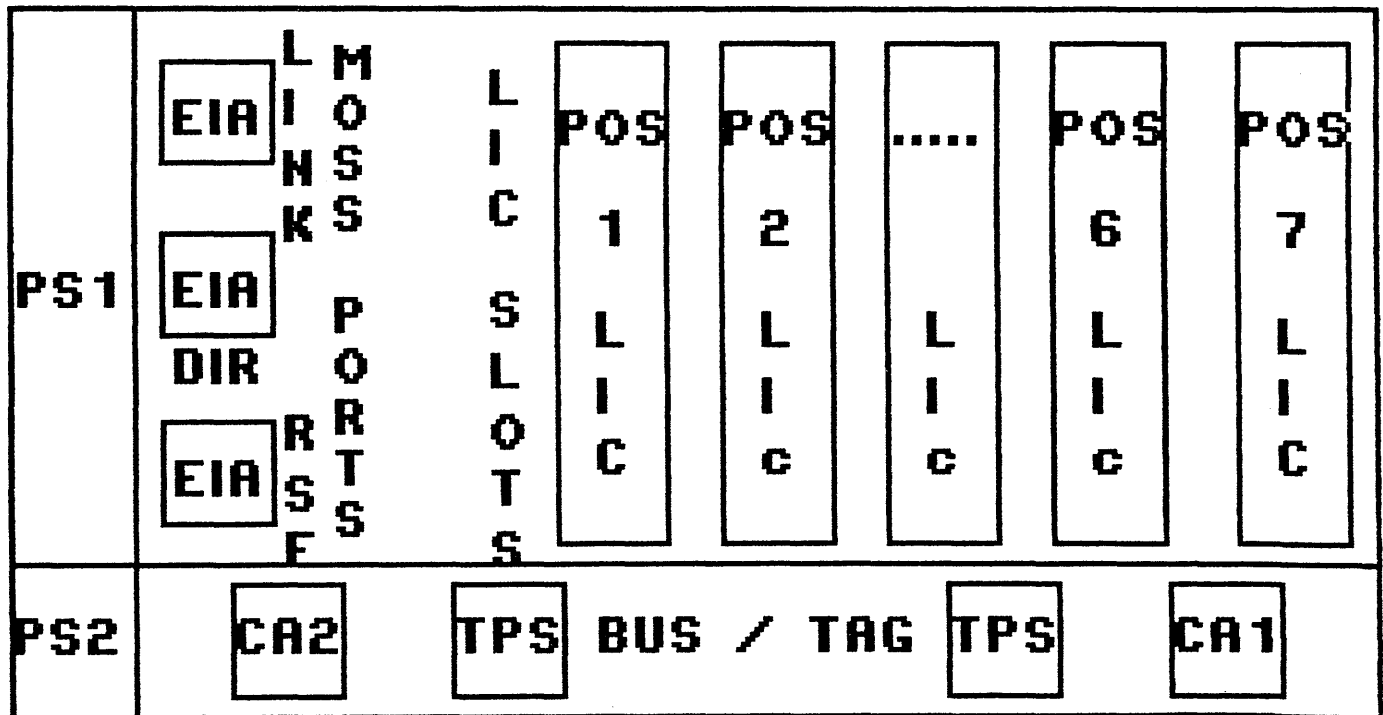

PP02

3720 Physical Planning

3720 Model 1

o Essential Information

Size (in.)			Weight (lb)	Clearance
Front	Rear	Height		
26	26	39	342	29.5" 29.5"
Rated Power (kva)			Default Voltage	Heat Output
1 Frame	2 Frame			
.8	1.2		208/240V	1754 btu/h

PP03

3720 Physical Planning

3720 Model 1 Control Panel

Hex
Display

Host
Inop

Remote
Console
Active

Power
On

Power
Check

TA TB 2A 2B

CA Disabled

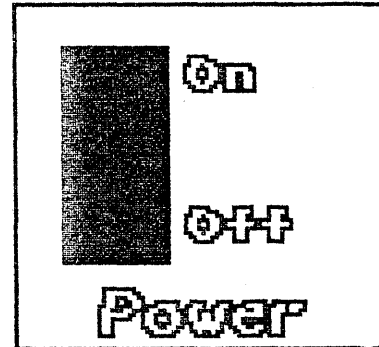

PP04

3720 Physical Planning

3720 Model 1 Control Panel

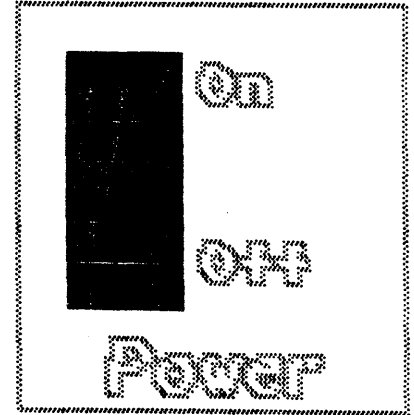
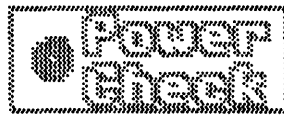
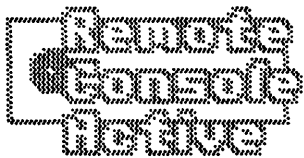

GA Disabled

PP04

3720 Physical Planning

3720 Model 1 Control Panel

**General
Reset**

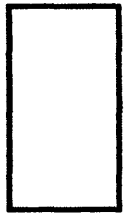

**Rem. Cnsl
Dis. Req**



**Function
Start**



Channel Adapter Interface

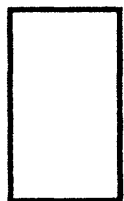

Panel

Console



PP05

3720 Physical Planning

3720 Model 1 Control Panel

Function Select Switch

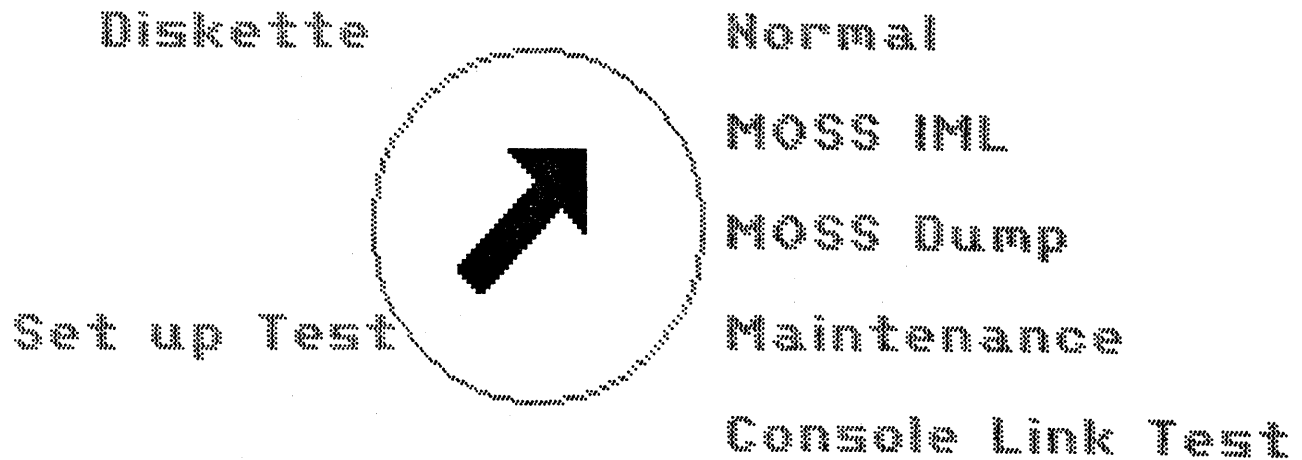

PP06

3720 Physical Planning

3720 Model 1 Control Panel

Power Control

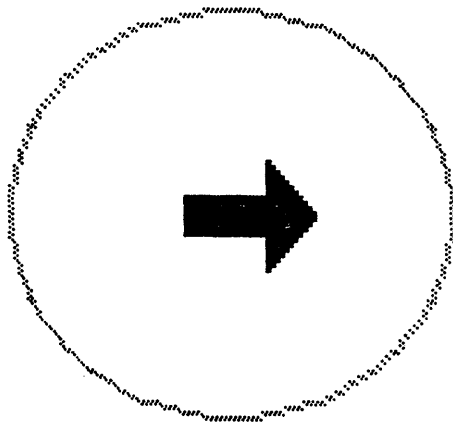

Host with
Auto Power
On

Local

Network with
Auto Power
On

PP07

3720 Physical Planning

3720 Model 2

PS1	EIA	L I O N S	M S S	L I C	POS 1	POS 2	POS 6	POS 7
	EIA DIR	K S	P O R T S	S L O T S	L I C	L I C	L I C	L I C	L I C
	EIA	R T S	F S						

PP08

3720 Physical Planning

3720 Model 2

o Essential Information

Size (in.)			Weight (lb)	Clearance
-----			-----	-----
Front Rear Height				
26	26	24.5	234	29.5" 29.5"
Rated Power (kva)			Default	Heat
-----			Voltage	Output
1 Frame	2 Frame		-----	-----
.6	1.0		120V	1436 btu/h PPU9

3720 Physical Planning

3720 Model 2 Control Panel

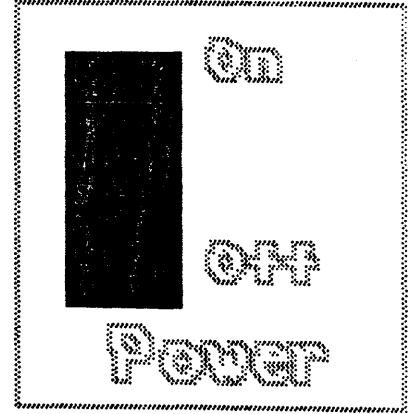
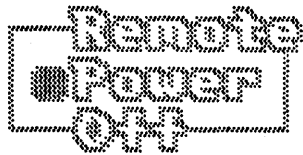
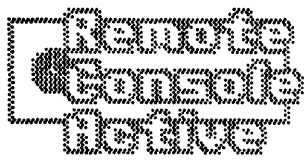

3720 Physical Planning

3720 Model 2 Control Panel

**General
Reset**

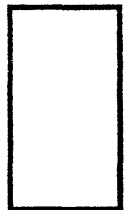

**Rem. Cnsl
Dis. Req**



**Function
Start**



**Remote
Power
Off**



Panel

Console



Enable

Disable

PP11

3720 Physical Planning

3720 Model 2 Control Panel

Function Select Switch

Diskette

Normal

MOSS IML

MOSS Dump

Maintenance

Console Link Test

Set up Test

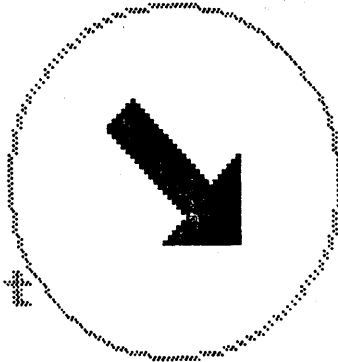

PP12

3720 Physical Planning

3721 Model 1 / Model 2

PS1	L	POS	POS	POS	POS	POS
	I	1	2		6	7	8
	C	L	L	L	L	L	L
	S	I	I	I	I	I	I
L							
O							
T							
S							

3720 Physical Planning

3721 Model 1 / Model 2

o Essential Information

<u>Size (in.)</u>			<u>Weight (lb)</u>	<u>Clearance</u>	
<u>Front</u>	<u>Rear</u>	<u>Height</u>			
26	26	15	132	29.5"	29.5"
<u>Rated Power (kva)</u>			<u>Default Voltage</u>	<u>Heat Output</u>	
<u>1 Frame</u>	<u>2 Frame</u>				
N/A	N/A		N/A	845 (Model 1)	1043 (Model 2)

pp14

3720 Physical Planning

3720 / 37X5 Comparison

Model	BTU/H	Rated/Real KVA	Weight
3720-1	1754	1.2 / .76	342 lb.
3720-2	1436	.8 / .76	234 lb.
3725-1	6484	1.9 / 1.9	880 lb.
3725-2	6484	1.9 / 1.9	880 lb.
3705-2	11228	5.29 / 3.29	1920 lb.
3705-80	6400	2.5 / 1.88	1010 lb.

3720 Physical Planning

3720 / 37X5 Comparison

o The Following Assumptions Apply:

- Configuration: 1 Channel Adapter, 28 lines, 3705-80 has only 16 lines
- KVA Real totals are arithmetic, not vector sum.
- Total heat values are derived from total system power, not unit heat
- Source of data: IBM aids CF3705 and CF3725.

PP16

3720 Physical Planning

3720 / 3721 Addressing Structure

3720 Model 1 Or 2

CSP 1

LIC #1

.....

LIC #7

000	001	024	025
002	003	026	027

PP17

3720 Physical Planning

3720 / 3721 Addressing Structure

3721 Model 1

CSP3

LIC # 1

LIC # 5

LIC # 8

032	033	048	049	060	061
034	035	050	051	062	063

PP18

3720 Physical Planning

3720 / 3721 Addressing Structure

3721 Model 2

CSP3

CSP4

LIC # 1

LIC # 5

LIC # 8

032	033	048	049	060	061
034	035	050	051	062	063

PP19

3720 Physical Planning

Setup and Integration

o Customer Setup Responsibilities

- PERFORM INITIAL SETUP OF MODEL 2

UNPACK - CONNECT TO POWER
RUN 3720 CHECKOUT PROCEDURES

- For 3720 MODEL 1/MODEL 2/3721

INSTALL CONSOLE and CABLES
INSTALL LIC CABLES
ATTACH 3721 TO 3720
RUN 3721 CHECKOUT PROCEDURES

PP20

3720 Physical Planning

Setup and Integration

o Customer Setup Responsibilities

- PERFORM COMMUNICATIONS FEATURE CHANGES FOR ALL 3720/3721 MODELS**
- PERFORM RELOCATION FOR 3720 MODEL 2 AND 3721**

PP21

3720 Physical Planning

Setup and Integration

o Customer System Integration

Responsibilities

- ATTACH MOSS CONSOLES
AND MODEMS TO 3720
- UPDATE PASSWORDS
- UPDATE CONFIGURATION
DATA FILE
- UPDATE LINE DESCRIPTION FILE

PP22

3720 Physical Planning

Setup and Integration

o Customer System Integration

Responsibilities

- UPDATE LINK IPL PORTS TABLE
- VERIFY RSF OPERATION
- BACKUP CUSTOMIZED DATA
ON DISKETTES

PP23

3720 Physical Planning

Operator Console Support

- o Operator (MOSS) Console
 - IBM 3101 in Block Mode
 - IBM PC Using The 3101 Emulation Program
 - IBM 3161,3163,3164 in 3101 Emulation Mode
 - 3101 Block Mode Compatible Terminal

PP24

3720 Physical Planning

Operator Console Support

- o Operator (MOSS) Console Attachment
 - Local Via Cable Attachment
 - Remote Via 212A Compatible Asynchronous Modem
- o Remote Service Attachment
 - RSF Via 212A Compatible Synchronous Modem

PP25

3720 Physical Planning Cables

- o One Power Cable/Configuration
- o Standard 370 Cables
- o New Console Cables

LOCAL ATTACHMENT (MAX 492FT)
REMOTE ATTACHMENT (MAX 115FT)
RSF ATTACHMENT (MAX 115FT)

3720 Physical Planning Cables

o New Line Interface Coupler (LIC) Cables

LIC1

DTE ATTACHMENT (MAX 492FT)

DCE ATTACHMENT (MAX 328FT)

LIC3

DTE ATTACHMENT (MAX 492FT)

DCE ATTACHMENT (MAX 115FT)

PP27

3720 Installation Planning

- o Overview
- o Physical Planning
- o **Software**
- o Operations
- o Problem Determination
- o Performance
- o Migration
- o Service

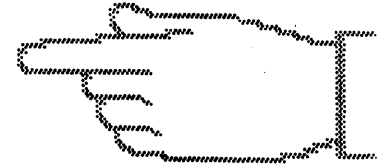

5000

3720 SOFTWARE SUPPORT

- o MVS NCP and ALERT Support
- o VSE NCP and ALERT Support
- o VM NCP and ALERT Support
- o SSP Version 3 Release 2

S001

3720 SOFTWARE SUPPORT

MVS

- o ACF/NCP V4R1 + PTFs UR14024
UR14033
- o EP/3725 Release 3
- o NPSI Release 4.2
- o NTO Release 3
- o NSI Release 4
- o NRF Release 2

S002

3720 SOFTWARE SUPPORT

MVS

- o ACF/NCP V4R2
 - o EP/3725 Release 4
 - o NPSI Release 4.3
 - o NTO Release 4
 - o NRF Release 3
 - o XI Release 1

5003

3720 SOFTWARE SUPPORT

MVS

- o ACF/NCP V4 Subset
 - o EP/3725 Release 4
 - o NPSI Release 4.3
 - o NTO Release 4
 - o NRF Release 3
 - o XI Release 1

S004

3720 SOFTWARE SUPPORT

MVS

3720 Alert Support

- o ACF/VTAM Generic Message
 - o VTAM V3R1.1
 - o VTAM V3R1.0 + APAR 0Z97428
+ APAR 0Z97429
 - o VTAM V2R2 + APAR 0Z9743C
 - o Netview Release 1.0
- Full Alert Support S005

3720 SOFTWARE SUPPORT

VSE

- o ACF/NCP V4R1 + UR15019
UR15591
- o EP/3725 Release 3
- o NPSI Release 4.2
- o NTO Release 3
- o NSI Release 4

S006

3720 SOFTWARE SUPPORT

VSE

- o ACF/NCP V4 Subset
 - o EP/3725 Release 3
 - o NPSI Release 4.2
 - o NTO Release 3
 - o NSI Release 4

S007

3720 SOFTWARE SUPPORT VSE

3720 Alert Support

- o ACF/VTAM Generic Message

- o VTAM V3R1.0 + APAR DY35733

- o VTAM V2R1.0 + APAR DY35734

- o NPDA V3R2 + PTF UD90142

Full Alert Support

S008

3720 SOFTWARE SUPPORT

VM

- o ACF/NCP V4R2
 - o EP/3725 Release 4
 - o NPSI Release 4.3
 - o NTO Release 4

S009

3720 SOFTWARE SUPPORT

VM

- o ACF/NCP V4 Subset
 - o EP/3725 Release 4
 - o NPSI Release 4.3
 - o NTO Release 4

5010

3720 SOFTWARE SUPPORT VM

3720 Alert Support

- o ACF/VTAM Generic Message

- o VTAM V3R 1.1

- o Netview Release 1.0

- Full Alert Support

S011

3720 SOFTWARE SUPPORT

SSP Version 3 Release 2

- o Required For 3720
- o Supports NCP V4R2, V4R1
- o Supports V4 Subset
- o Supports NCP V3 (3705,3725)
- o Supports EP R1, R2, R3,and R4
- o ACF/TAP Line Trace Enhanced

S012

3720 SOFTWARE SUPPORT

Sample NCP Parameters

NCP BUILD Parameter

MODEL = 3720

Note:

**For additional information see the
NCP/SSP Migration, SC30-3252-1,
or NCP/SSP Resource Definition
Reference, SC30-3254-1.**

S013

AGENDA

- OVERVIEW
- PHYSICAL PLANNING
- SOFTWARE SUPPORT
- ➔ OPERATIONS
- PROBLEM DETERMINATION
- PERFORMANCE
- MIGRATION
- SERVICE

AGENDA

3720 OPERATIONS

- UNCHANGED host functions
- CHANGED host functions
- NEW MOSS functions

OP0

3720 OPERATIONS

- UNCHANGED host functions
- load/dump process for:
 - channel-attached 3720
 - link-attached 3720
- file transfer
- SSP function
- trace facility

DP03

3720 OPERATIONS

- **CHANGED** host functions
- **VTAM** generic message
contains: user action code &
up to 3 qualified data fields
- specific **VTAM** releases do
NOT provide **ALERT** message

OP04

3720 OPERATIONS

- CHANGED host functions
- full 3720 ALERT support:
NetView
VSE only: NPDA V3R2 + PTI
- NPDA V3 provides:
user action code &
up to 3 qualified data fields

3720 OPERATIONS

- NEW MOSS functions available
- password management (P)
- configuration data file (CDF)
- line description file (LDF)
- panel function (PAF)
- disk function (DF)
- microcode fixes (MCF)
- machine level table (MLT)
- link threshold (LTH)

OFO

```
IIIIIII  BBBBBBBBBBBBBB  MMMMM  MMMMM
IIIIIII  BBBBBBBBBBBBBB  MMMMMMM  MMMMMMM
  III    BBB     BBB  MMMMM  MMMMM
  III    BBBBBBBBBB  MMMMMMM  MMMMMMM
  III    BBBBBBBBBB  MMM  MMMMMMM  MMM
  III    BBB     BBB  MMM  MMMMM  MMM
IIIIIII  BBBBBBBBBBBBBB  MMMMM  MMM  MMMMM
IIIIIII  BBBBBBBBBBBBBB  MMMMM  M  MMMMM
```

3720 MICROCODE (C) COPYRIGHT IBM CORP. 1986

PRESS SEND TO CONTINUE

OP07

CUSTOMER ID: WSC HASL 3720

3720-1

SERIAL NUMBER: 0010007

ENTER PASSWORD =====> ISOLA

01 UNSUCCESSFUL ATTEMPTS FOR LOCAL LOGGING
01 UNSUCCESSFUL ATTEMPTS FOR REMOTE LOGGING
03 UNAUTHORISED ATTEMPTS FOR MAINTENANCE LOGGING

OP08

PROCESS STOP--CCU--CHK M055--ONLINE
RUN BYP--IOC--CHK

X71:0A0800
X72:07A600

CUSTOMER ID: W5C HASL 3720

3720-1

SERIAL NUMBER: 0010007

SYSTEM INPUT AREA (SIA) ==> P

T: TERMINATE OFF: LOGOFF PF1: MOVE TO SIA PF2: CCU FNCTN PF3: ALARM

CONFIG DATA FILE.: CDF	LINE DESCR FILE.: LDF	MACHINE LVL TABLE: MLT
CONTROL PRGM PROC: C	LINE INTERF DPLY.: LID	MICROCODE FIXES...: MCF
DISK FUNCTIONS...: DF	LINE THRESHOLD...: LTH	PANEL FUNCTIONS...: PAF
EVENT LOG DISPLAY: E	LINK IPL PORTS...: LKP	PASSWORDS...: P
IML M055...: IML	LINK TEST...: LT	PORT SWAP FILE...: P5
IML ONE SCANNER...: IS	LOAD LK TEST REQ.: LOQ	WRAP TEST...: WT
IPL 3720...: IPL	LOAD LK TEST RESP: LOS	

OP09

PASSWORD MANAGEMENT (P)

- passwords control access to functions:
 - management
 - local
 - remote customer
 - remote maintenance
- update/display capability

OP10

PROCESS STOP-CCU-CHK MOSS-ONLINE
RUN BYP-IOC-CHK

X71:0A0800
X72:07A600

CUSTOMER ID: WSC HASL 3720
FUNCTION ON SCREEN: PASSWORDS

3720-1

SERIAL NUMBER: 0010007

SYSTEM INPUT AREA (SIA) ==>

T: TERMINATE OFF: LOGOFF PF1: MOVE TO SIA PF2: CCU FNCTN PF3: ALARM

- ENTER MANAGEMENT PASSWORD ==> ISOLA

AVAILABLE FUNCTIONS:

UPDATE/DISPLAY/ACTIVATION/DEACTIVATION OF PASSWORDS

DISPLAY/RESET LOGON ATTEMPT COUNTERS

UPDATE OF CUSTOMER IDENTIFICATION

OP11

PROCESS STOP-CCU-CHK MOSS-ONLINE
RUN BYP-IOC-CHK

X71:0A0800
X72:07A600

CUSTOMER ID: WSC HASL 3720 3720-1 SERIAL NUMBER: 0010007
FUNCTION ON SCREEN: PASSWORDS

SYSTEM INPUT AREA (SIA) ==>

T: TERMINATE OFF: LOGOFF PF1: MOVE TO SIA PF2: CCU FNCTN PF3: ALARM

-- SELECT OPTION ==> 3

- 1 = UPDATE MANAGEMENT PASSWORD
- 2 = UPDATE LOCAL PASSWORD
- 3 = UPDATE REMOTE CUSTOMER PASSWORD
- 4 = UPDATE REMOTE MAINTENANCE PASSWORD
- 5 = DISPLAY PASSWORDS
- 6 = TEMPORARY ACTIVATION OF REMOTE MAINTENANCE PASSWORD
- 7 = PERMANENT ACTIVATION OF REMOTE MAINTENANCE PASSWORD
- 8 = DEACTIVATION OF REMOTE MAINTENANCE PASSWORD
- 9 = DISPLAY/RESET LOGON ATTEMPT COUNTERS
- 10 = UPDATE CUSTOMER IDENTIFICATION

OP12

PROCESS STOP-CCU-CHK MOSS-ONLINE
RUN BYP-IOC-CHK

X71:0A0800
X72:07A600

CUSTOMER ID: WSC HASL 3720
FUNCTION ON SCREEN: PASSWORDS

3720-1

SERIAL NUMBER: 0010007

SYSTEM INPUT AREA (SIA) ==>

T: TERMINATE OFF: LOGOFF PF1: MOVE TO SIA PF2: CCU FNCTN PF3: ALARM

-- ENTER NEW REMOTE CUSTOMER PASSWORD ==>
(5 TO 8 ALPHANUMERIC CHARACTERS)

PF6: QUIT

OP19

PROCESS STOP--CCU--CHK MOSS--ONLINE
RUN BYP--IOC--CHK

X71:0A0800
X72:07A600

CUSTOMER ID: WSC HASL 3720
FUNCTION ON SCREEN: PASSWORDS

3720-1

SERIAL NUMBER: 0010007

SYSTEM INPUT AREA (SIA) ==>

T: TERMINATE OFF: LOGOFF PF1: MOVE TO SIA PF2: CCU FNCTN PF3: ALARM
PASSWORDS ARE :

MANAGEMENT PASSWORD = ISOLA

LOCAL PASSWORD = ISOLA

REMOTE CUSTOMER PASSWORD = ISOLA

REMOTE MAINTENANCE PASSWORD = IBMISOLA

REMOTE MAINTENANCE PASSWORD STATUS = P
(P=PERMANENT T=TEMPORARY D=DEACTIVATED)

PF6: QUIT

OP14

PROCESS STOP-CCU-CHK MOSS-ONLINE
RUN BYP-IOC-CHK

X71:0A0800
X72:07A600

CUSTOMER ID: WSC HASL 3720
FUNCTION ON SCREEN: PASSWORDS

3720-1

SERIAL NUMBER: 0010007

SYSTEM INPUT AREA (SIA) ==>

T: TERMINATE OFF: LOGOFF PF1: MOVE TO SIA PF2: CCU FNCTN PF3: ALARM
PASSWORDS ARE :

MANAGEMENT PASSWORD = ISOLA
LOCAL PASSWORD = ISOLA
REMOTE CUSTOMER PASSWORD = ISOLA
REMOTE MAINTENANCE PASSWORD = IBMISOLA
REMOTE MAINTENANCE PASSWORD STATUS = P
(P=PERMANENT T=TEMPORARY D=DEACTIVATED)

PF6: QUIT

OP15

PASSWORD MANAGEMENT (P)

- temporary or permanent activation of maintenance password
- deactivation of maintenance password

PROCESS STOP-CCU-CHK MOSS-ONLINE
RUN BYP-IOC-CHK

X71:0A0800
X72:07A600

CUSTOMER ID: WSC HASL 3720
FUNCTION ON SCREEN: PASSWORDS

3720-1

SERIAL NUMBER: 0010007

SYSTEM INPUT AREA (SIA) ==>

T: TERMINATE OFF: LOGOFF PF1: MOVE TO SIA PF2: CCU FNCTN PF3: ALARM
- SELECT OPTION ==>

- 1 = UPDATE MANAGEMENT PASSWORD
- 2 = UPDATE LOCAL PASSWORD
- 3 = UPDATE REMOTE CUSTOMER PASSWORD
- 4 = UPDATE REMOTE MAINTENANCE PASSWORD
- 5 = DISPLAY PASSWORDS
- 6 = TEMPORARY ACTIVATION OF REMOTE MAINTENANCE PASSWORD
- 7 = PERMANENT ACTIVATION OF REMOTE MAINTENANCE PASSWORD
- 8 = DEACTIVATION OF REMOTE MAINTENANCE PASSWORD
- 9 = DISPLAY/RESET LOGON ATTEMPT COUNTERS
- 10 = UPDATE CUSTOMER IDENTIFICATION

OP17

PROCESS STOP-CCU-CHK MO55-ONLINE
RUN BYP-IOC-CHK

X71:0A0800
X72:07A600

CUSTOMER ID: WSC HASL 3720
FUNCTION ON SCREEN: PASSWORDS

3720-1

SERIAL NUMBER: 0010007

SYSTEM INPUT AREA (SIA) ==>

T: TERMINATE OFF: LOGOFF PF1: MOVE TO SIA PF2: CCU FNCTN PF3: ALARM
- SELECT OPTION ==> 7

- 1 = UPDATE MANAGEMENT PASSWORD
- 2 = UPDATE LOCAL PASSWORD
- 3 = UPDATE REMOTE CUSTOMER PASSWORD
- 4 = UPDATE REMOTE MAINTENANCE PASSWORD
- 5 = DISPLAY PASSWORDS
- 6 = TEMPORARY ACTIVATION OF REMOTE MAINTENANCE PASSWORD
- 7 = PERMANENT ACTIVATION OF REMOTE MAINTENANCE PASSWORD
- 8 = DEACTIVATION OF REMOTE MAINTENANCE PASSWORD
- 9 = DISPLAY/RESET LOGON ATTEMPT COUNTERS
- 10 = UPDATE CUSTOMER IDENTIFICATION

REMOTE MAINTENANCE PASSWORD HAS BEEN PERMANENTLY ACTIVATED

OP18

PASSWORD MANAGEMENT (P)

- display/reset logon attempt counters
- update customer ID field

OP19

PROCESS STOP-CCU-CHK MOSS-ONLINE
RUN BYP-IOC-CHK

X71:0A0800
X72:07A600

CUSTOMER ID: WSC HASL 3720

3720-1

SERIAL NUMBER: 0010007

FUNCTION ON SCREEN: PASSWORDS

SYSTEM INPUT AREA (SIA) ==>

T: TERMINATE OFF: LOGOFF PF1: MOVE TO SIA PF2: CCU FNCTN PF9: ALARM

-- SELECT OPTION ==> 9

- 1 = UPDATE MANAGEMENT PASSWORD
- 2 = UPDATE LOCAL PASSWORD
- 3 = UPDATE REMOTE CUSTOMER PASSWORD
- = UPDATE REMOTE MAINTENANCE PASSWORD
- 5 = DISPLAY PASSWORDS
- 6 = TEMPORARY ACTIVATION OF REMOTE MAINTENANCE PASSWORD
- 7 = PERMANENT ACTIVATION OF REMOTE MAINTENANCE PASSWORD
- 8 = DEACTIVATION OF REMOTE MAINTENANCE PASSWORD
- 9 = DISPLAY/RESET LOGON ATTEMPT COUNTERS
- 10 = UPDATE CUSTOMER IDENTIFICATION

OP20

PROCESS STOP-CCU-CHK MO55-ONLINE
RUN BYP-IOC-CHK

X71:0A0800
X72:07A600

CUSTOMER ID: W5C HASL 3720
FUNCTION ON SCREEN: PASSWORDS

3720-1

SERIAL NUMBER: 0010007

SYSTEM INPUT AREA (SIA) ==>

T: TERMINATE OFF: LOGOFF PF1: MOVE TO SIA PF2: CCU FNCTN PF3: ALARM

05 UNSUCCESSFUL ATTEMPTS FOR LOCAL LOGGING
09 UNSUCCESSFUL ATTEMPTS FOR REMOTE LOGGING
09 UNAUTHORISED ATTEMPTS FOR MAINTENANCE LOGGING

-- ENTER 'R' TO RESET THE COUNTERS ==>

PF6: QUIT

OP21

PROCESS STOP-CCU-CHK MOSS-ONLINE
RUN BYP-IOC-CHK

X71:0A0800
X72:07A600

CUSTOMER ID: WSC HASL 3720
FUNCTION ON SCREEN: PASSWORDS

3720-1

SERIAL NUMBER: 0010007

SYSTEM INPUT AREA (SIA) ==>

T: TERMINATE OFF: LOGOFF PF1: MOVE TO SIA PF2: CCU FNCTN PF3: ALARM
- SELECT OPTION ==> 10

- 1 = UPDATE MANAGEMENT PASSWORD
- 2 = UPDATE LOCAL PASSWORD
- 3 = UPDATE REMOTE CUSTOMER PASSWORD
- 4 = UPDATE REMOTE MAINTENANCE PASSWORD
- 5 = DISPLAY PASSWORDS
- 6 = TEMPORARY ACTIVATION OF REMOTE MAINTENANCE PASSWORD
- 7 = PERMANENT ACTIVATION OF REMOTE MAINTENANCE PASSWORD
- 8 = DEACTIVATION OF REMOTE MAINTENANCE PASSWORD
- 9 = DISPLAY/RESET LOGON ATTEMPT COUNTERS
- 10 = UPDATE CUSTOMER IDENTIFICATION

OP22

PROCESS STOP-CCU-CHK MO55-ONLINE
RUN BYP-IOC-CHK

X71:0A0800
X72:07A600

CUSTOMER ID: WSC HASL 3720
FUNCTION ON SCREEN: PASSWORDS

3720-1

SERIAL NUMBER: 0010007

SYSTEM INPUT AREA (SIA) ==>

T: TERMINATE OFF: LOGOFF PF1: MOVE TO SIA PF2: CCU FNCTN PF3: ALARM

-- ENTER CUSTOMER IDENTIFICATION (1 TO 16 CHARACTERS) ==>

PF6: QUIT

OP23

Configuration Data File (CDF)

- display CDF
- programmable line speed
 - set ICC clocking: direct attach lines
 - default: 9600 bps
 - other speeds: 2400, 4800, 19200
38400, 55655, 245750
- * requires scanner re-IML

OP24

PROCESS STOP-CCU-CHK MO55-ONLINE
RUN BYP-IOC-CHK

X71:0A0800
X72:07A600

CUSTOMER ID: W5C HASL 3720

3720-1

SERIAL NUMBER: 0010007

SYSTEM INPUT AREA (SIA) ==> CDF

T: TERMINATE OFF: LOGOFF PF1: MOVE TO SIA PF2: CCU FNCTN PF3: ALARM

CONFIG DATA FILE.: CDF	LINE DESCR FILE..: LDF	MACHINE LVL TABLE: MLT
CONTROL PRGM PROC: C	LINE INTERF DPLY.: LID	MICROCODE FIXES...: MCF
DISK FUNCTIONS...: DF	LINE THRESHOLD...: LTH	PANEL FUNCTIONS...: PAF
EVENT LOG DISPLAY: E	LINK IPL PORTS...: LKP	PASSWORDS.....: P
IML MO55.....: IML	LINK TEST.....: LT	PORT SWAP FILE...: PS
IML ONE SCANNER...: IS	LOAD LK TEST REQ.: LOQ	WRAP TEST.....: WT
IPL 3720.....: IPL	LOAD LK TEST RESP: LOS	

OP25

PROCESS STOP-CCU-CHK MOSS-ONLINE
RUN BYP-IOC-CHK

X71:0A0800
X72:07A600

CUSTOMER ID: WSC HASL 3720
FUNCTION ON SCREEN: CONFIG DATA FILE

3720-1

SERIAL NUMBER: 0010007

SYSTEM INPUT AREA (SIA) ==>

T: TERMINATE OFF: LOGOFF PF1: MOVE TO SIA PF2: CCU FNCTN PF3: ALARM

-- SELECT CDF OPTION (1, 2)

==> 2

1 = UPGRADE

2 = DISPLAY

OP26

PROCESS STOP-CCU-CHK MOSS-ONLINE
RUN BYP-IOC-CHK

X71:0A0800
X72:07A600

CUSTOMER ID: WSC HASL 3720
FUNCTION ON SCREEN: CONFIG DATA FILE

3720-1

SERIAL NUMBER: 0010007

SYSTEM INPUT AREA (SIA) ==>

T: TERMINATE OFF: LOGOFF PF1: MOVE TO SIA PF2: CCU FNCTN PF3: ALARM
CDF - DISPLAY OPTION

- SELECT ONE DISPLAY OPTION (1 TO 4) ==> 2

- 1 = ALL (2 TO 4)
- 2 = BASIC FRAME
- 3 = EXPANSION FRAME
- 4 = PROGRAMMABLE LINE SPEED

PF6:QUIT

OP27

PROCESS STOP-CCU-CHK MO55-ONLINE
RUN BYP-IOC-CHK

X71:0A0800
X72:07A600

CUSTOMER ID: WSC HASL 3720
FUNCTION ON SCREEN: CONFIG DATA FILE

3720-1

SERIAL NUMBER: 0010007

SYSTEM INPUT AREA (SIA) ==>

T: TERMINATE OFF: LOGOFF PF1: MOVE TO SIA PF2: CCU FNCTN PF3: ALARM
LIC POS: 1 2 3 4 5 6 7 CHANNEL ADAPTERS
LIC TYPE: 03 01 01 01 00 00 00 Y/N TPS NSC ESC

LINE ADDRESS (A) AND CABLE ID INFO (I)

	A		I		A		I		A		I		A		I		CA1	Y	A	B	L	C
PORT1:	0	5	4	5	8	5	12	5	16	0	20	0	24	0	CA2	Y	2A	2B	00	0	0	
PORT2:	1	0	5	5	9	5	13	5	17	0	21	0	25	0								
PORT3:	2	0	6	5	10	5	14	5	18	0	22	0	26	0								
PORT4:	3	0	7	5	11	5	15	5	19	0	23	0	27	0								

PF6: QUIT

OP28

PROCESS STOP-CCU-CHK MOSS-ONLINE
RUN BYP-IOC-CHK

X71:0A0800
X72:07A600

CUSTOMER ID: WSC HASL 3720
FUNCTION ON SCREEN: CONFIG DATA FILE

3720-1

SERIAL NUMBER: 0010007

SYSTEM INPUT AREA (SIA) ==>

T: TERMINATE OFF: LOGOFF PF1: MOVE TO SIA PF2: CCU FNCTN PF3: ALARM
CDF - DISPLAY OPTION

- SELECT ONE DISPLAY OPTION (1 TO 4) ==> 3

- 1 = ALL (2 TO 4)
- 2 = BASIC FRAME
- 3 = EXPANSION FRAME
- 4 = PROGRAMMABLE LINE SPEED

PF6:QUIT

OP29

PROCESS STOP-CCU-CHK MOSS-ONLINE
RUN BYP-IOC-CHK

X71:0A0800
X72:07A600

CUSTOMER ID: WSC HASL 3720
FUNCTION ON SCREEN: CONFIG DATA FILE

3720-1

SERIAL NUMBER: 0010007

SYSTEM INPUT AREA (SIA) ==>

T: TERMINATE OFF: LOGOFF PF1: MOVE TO SIA PF2: CCU FNCTN PF3: ALARM
LIC POS: 1 2 3 4 5 6 7 8
LIC TYPE: 01 01 01 03 03 01 01 01

LINE ADDRESS (A) AND CABLE ID INFO (I)

	A	I	A	I	A	I	A	I	A	I	A	I	A	I	A	I
PORT1:	32	5	36	5	40	5	44	4	48	5	52	5	56	5	60	5
PORT2:	33	5	37	5	41	5	45	0	49	0	53	5	57	5	61	5
PORT3:	34	5	38	5	42	5	46	0	50	0	54	5	58	5	62	5
PORT4:	35	5	39	5	43	5	47	0	51	0	55	5	59	5	63	5

PF6:QUIT

OP30

PROCESS STOP-CCU-CHK M055-ONLINE
RUN BYP-I0C-CHK

X71:0A0800
X72:07A600

CUSTOMER ID: WSC HASL 3720
FUNCTION ON SCREEN: CONFIG DATA FILE

3720-1

SERIAL NUMBER: 0010007

SYSTEM INPUT AREA (SIA) ==>

T: TERMINATE OFF: LOGOFF PF1: MOVE TO SIA PF2: CCU FNCTN PF3: ALARM
CDF - DISPLAY OPTION

- SELECT ONE DISPLAY OPTION (1 TO 4) ==> 4

- 1 = ALL (2 TO 4)
- 2 = BASIC FRAME
- 3 = EXPANSION FRAME
- 4 = PROGRAMMABLE LINE SPEED

PF6:QUIT

OP31

PROCESS STOP--CCU--CHK MOSS--ONLINE
RUN BYP--IOC--CHK

X71:0A0800
X72:07A600

CUSTOMER ID: WSC HASL 3720
FUNCTION ON SCREEN: CONFIG DATA FILE

3720-1

SERIAL NUMBER: 0010007

SYSTEM INPUT AREA (SIA) ==>

T: TERMINATE OFF: LOGOFF PF1: MOVE TO SIA PF2: CCU FNCTN PF3: ALARM
PROGRAMMABLE LINE SPEED FUNCTION

-- ENTER A LINE ADDRESS (0 TO 27 AND 32 TO 63) ==> 00

PF6:QUIT

OP32

PROCESS STOP-CCU-CHK MO55-ONLINE
RUN BYP-IOC-CHK

X71:0A0800
X72:07A600

CUSTOMER ID: W5C HASL 3720
FUNCTION ON SCREEN: CONFIG DATA FILE

3720-1

SERIAL NUMBER: 0010007

SYSTEM INPUT AREA (SIA) ==>

T: TERMINATE OFF: LOGOFF PF1: MOVE TO SIA PF2: CCU FNCTN PF9: ALARM
PROGRAMMABLE LINE SPEED FUNCTION - UPDATE

LINE ADDRESS = 0
CURRENT SPEED = 55855
LIC TYPE = LIC3

- ENTER A DIGIT (0 TO 7) TO UPDATE CURRENT SPEED ==> 3

0 = 2400	4 = 38400
1 = 4800	5 = 55855
2 = 9600	6 = 245760
3 = 19200	7 = RPQ

PF6:QUIT

OP33

Configuration Data File (CDF)

- upgrade function:
alter 3720 hardware
configuration

PROCESS STOP-CCU-CHK MOSS-ONLINE
RUN BYP-IOC-CHK

X71:0A0800
X72:07A600

CUSTOMER ID: WSC HASL 3720
FUNCTION ON SCREEN: CONFIG DATA FILE

3720-1

SERIAL NUMBER: 0010007

SYSTEM INPUT AREA (SIA) ==>

T: TERMINATE OFF: LOGOFF PF1: MOVE TO SIA PF2: CCU FNCTN PF3: ALARM

-- SELECT CDF OPTION (1, 2)

==> 1

1 = UPGRADE

2 = DISPLAY

OP35

PROCESS STOP-CCU-CHK MOSS-ONLINE
RUN BYP-IOC-CHK

X71:0A0800
X72:07A600

CUSTOMER ID: WSC HASL 3720
FUNCTION ON SCREEN: CONFIG DATA FILE

3720-1

SERIAL NUMBER: 0010007

SYSTEM INPUT AREA (SIA) ==> PRESS SEND TO DISPLAY FUNCTION MENU
T: TERMINATE OFF: LOGOFF PF1: MOVE TO SIA PF2: CCU FNCTN PF3: ALARM

MOSS IS NOT ALONE

: CDF UPGRADE NOT ALLOWED

OP36

MOSS--ALONE

CUSTOMER ID: W5C HASL 3720

3720-1

SERIAL NUMBER: 0010007

FUNCTION ON SCREEN: CONFIG DATA FILE

SYSTEM INPUT AREA (SIA) ==>

PRESS SEND TO DISPLAY FUNCTION MENU

T: TERMINATE OFF: LOGOFF PF1: MOVE TO SIA PF2: CCU FNCTN PF3: ALARM

CDF UPGRADE STARTED

CCU INFORMATION FETCHED

CHANNEL ADAPTER INFORMATION FETCHED

SCANNER INFORMATION FETCHED

CDF UPGRADE COMPLETED

OP37

Line Description File (LDF)

- optional, user-generated file associates line parameters:

symbolic name

line address

line protocol

line speed

- computes line weight

OP38

PROCESS STOP-CCU-CHK MOSS-ONLINE
RUN BYP-IOC-CHK

X71:0A0800
X72:07A600

CUSTOMER ID: WSC HASL 3720 3720-1 SERIAL NUMBER: 0010007

SYSTEM INPUT AREA (SIA) ==> LDF

T: TERMINATE OFF: LOGOFF PF1: MOVE TO SIA PF2: CCU FNCTN PF9: ALARM

CONFIG DATA FILE.: CDF	LINE DESCR FILE.: LDF	MACHINE LVL TABLE: MLT
CONTROL PRGM PROC: C	LINE INTERF DPLY.: LID	MICROCODE FIXES.: MCF
DISK FUNCTIONS...: DF	LINE THRESHOLD...: LTH	PANEL FUNCTIONS...: PAF
EVENT LOG DISPLAY: E	LINK IPL PORTS...: LKP	PASSWORDS.....: P
IML MOSS.....: IML	LINK TEST.....: LT	PORT SWAP FILE...: PS
IML ONE SCANNER...: IS	LOAD LK TEST REQ.: LOQ	WRAP TEST.....: WT
IPL 3720.....: IPL	LOAD LK TEST RESP: LOS	

OP39

PROCESS STOP-CCU-CHK MO55-ONLINE
RUN BYP-IOC-CHK

X71:0A0800
X72:07A600

CUSTOMER ID: WSC HASL 3720
FUNCTION ON SCREEN: LINE DESCR FILE

3720-1

SERIAL NUMBER: 0010007

SYSTEM INPUT AREA (SIA) ==>

T: TERMINATE OFF: LOGOFF PF1: MOVE TO SIA PF2: CCU FNCTN PF3: ALARM

ADDRESS	NAME	PROTOCOL	SPEED(BPS)	WEIGHT
0	L1000	SDLC FDX	56000	21.4
1 TO 3		NOT INSTALLED		
4	L1004	SDLC HDX	9600	3.1
5	L1005	SDLC HDX	9600	3.1
6	L1006	SDLC HDX	9600	3.1
7	L1007	SDLC HDX	9600	3.1
8	L1008	SDLC HDX	9600	3.1
9	L1009	SDLC HDX	9600	3.1
10	L1010	SDLC HDX	9600	3.1
11	L1011	SDLC HDX	9600	3.1
12	L1012	SDLC HDX	9600	3.1

- ENTER ADDRESS (0-27 AND 32-63) OF LINE TO BE DISPLAYED ==> 0

PF5:UPDATE

PF8:FORWAR

OP40

PROCESS STOP-CCU-CHK MOSS-ONLINE
RUN BYP-IOC-CHK

X71:0A0800
X72:07A600

CUSTOMER ID: WSC HASL 3720
FUNCTION ON SCREEN: LINE DESCR FILE

3720-1

SERIAL NUMBER: 0010007

SYSTEM INPUT AREA (SIA) ==>

T: TERMINATE OFF: LOGOFF PF1: MOVE TO SIA PF2: CCU FNCTN PF3: ALARM
LINE 0 NAME: L1000 SCANNER: 1 BASB LIC POS : 1
PROTOCOL: SDLC FDX SPEED: 56000 BPS LIC TYPE: 3

- ENTER LINE NAME ==> L1000

- SELECT A LINE PROTOCOL ==> 2

0 = UNDEFINED

1 = B5C EBCDIC

2 = SDLC HDX

3 = B5C ASCII

4 = SDLC FDX

- ENTER A LINE SPEED ==> 56000 (0 TO 256000 BPS)

- PRESS SEND TO TRANSMIT DATA

PF4:DISPLAY PF7:LINE 63 PF8:LINE 4

OP41

PROCESS STOP-CCU-CHK M055-ONLINE
RUN BYP-IOC-CHK

X71:0A0800
X72:07A600

CUSTOMER ID: WSC HASL 3720
FUNCTION ON SCREEN: LINE DESCR FILE

3720-1

SERIAL NUMBER: 0010007

SYSTEM INPUT AREA (SIA) ==>

T: TERMINATE OFF: LOGOFF PF1: MOVE TO SIA PF2: CCU FNCTN PF3: ALARM

ADDRESS	NAME	PROTOCOL	SPEED(BPS)	WEIGHT
0	L1000	SDLC HDX	56000	13.1
1 TO 3		NOT INSTALLED		
4	L1004	SDLC HDX	9600	3.1
5	L1005	SDLC HDX	9600	3.1
6	L1006	SDLC HDX	9600	3.1
7	L1007	SDLC HDX	9600	3.1
8	L1008	SDLC HDX	9600	3.1
9	L1009	SDLC HDX	9600	3.1
10	L1010	SDLC HDX	9600	3.1
11	L1011	SDLC HDX	9600	3.1
12	L1012	SDLC HDX	9600	3.1

- ENTER ADDRESS (0-27 AND 32-63) OF LINE TO BE DISPLAYED ==>

PF5: UPDATE

PF8: FORWARD

OP42

Panel Function (PAF)

- local or remote console
- display control panel

information:

hex LED display codes

function select switch setting

power control switch setting

installed channel adapters

channel adapter lights

channel adapter switch settings

OP43

PROCESS STOP--CCU--CHK MO55--ONLINE
RUN BYP--IOC--CHK

X71:0A0800
X72:07A600

CUSTOMER.ID: WSC HASL 3720

3720-1

SERIAL NUMBER: 0010007

SYSTEM INPUT AREA (SIA) ==> PAF

T: TERMINATE OFF: LOGOFF PF1: MOVE TO SIA PF2: CCU FNCTN PF3: ALARM

CONFIG DATA FILE.: CDF	LINE DESCR FILE.: LDF	MACHINE LVL TABLE: MLT
CONTROL PRGM PROC: C	LINE INTERF DPLY.: LID	MICROCODE FIXES.: MCF
DISK FUNCTIONS...: DF	LINE THRESHOLD...: LTH	PANEL FUNCTIONS...: PAF
EVENT LOG DISPLAY: E	LINK IPL PORTS...: LKP	PASSWORDS.....: P
IML MO55.....: IML	LINK TEST.....: LT	PORT SWAP FILE...: P5
IML ONE SCANNER...: IS	LOAD LK TEST REQ.: LOQ	WRAP TEST.....: WT
IPL 3720.....: IPL	LOAD LK TEST RESP: LOS	

OP44

PROCESS STOP-CCU-CHK MO55-ONLINE
RUN BYP-IOC-CHK

X71:0A0800
X72:07A600

CUSTOMER ID: WSC HASL 3720
FUNCTION ON SCREEN: PANEL FUNCTIONS

3720-1

SERIAL NUMBER: 0010007

SYSTEM INPUT AREA (SIA) ==>

T: TERMINATE OFF: LOGOFF PF1: MOVE TO SIA PF2: CCU FNCTN PF3: ALARM

INFORMATION FROM THE CONTROL PANEL

HEX DISPLAY: 000
FUNCTION SELECT SWITCH: NORMAL
POWER CONTROL SWITCH: LOCAL

INSTALLED CA: 1 2 3 4
CA STATE: E D E D
REQUESTED CA STATE: E D E D
E=ENABLED
D=DISABLED

- TO HAVE ACCESS TO THE PANEL FUNCTIONS:
 1. GO TO THE CONTROL PANEL
 2. SET PANEL/CONSOLE SWITCH TO CONSOLE
- OR
- PRESS BREAK TO STOP REFRESH

OP45

Panel Function (PAF)

- local or remote console
- perform control panel

functions:

general IML

MOSS IML with reset

enable/disable channel adapters

OP46

PROCESS STOP-CCU-CHK MOSS-ONLINE
RUN BYP-IOC-CHK

X71:0A0800
X72:07A600

CUSTOMER ID: WSC HASL 3720
FUNCTION ON SCREEN: PANEL FUNCTIONS

3720-1

SERIAL NUMBER: 0010007

SYSTEM INPUT AREA (SIA) ==>

T: TERMINATE OFF: LOGOFF PF1: MOVE TO SIA PF2: CCU FNCTN PF3: ALARM

INFORMATION FROM THE CONTROL PANEL

HEX DISPLAY: 000
FUNCTION SELECT SWITCH: NORMAL
POWER CONTROL SWITCH: LOCAL

INSTALLED CA: 1 2 3 4
CA STATE: E D D D
REQUESTED CA STATE: E D D D
E=ENABLED
D=DISABLED

- SELECT A PANEL FUNCTION(IPL, IML, CA) ==> CA
IPL = GENERAL IPL
IML = MOSS IML WITH RESET
CA = ENABLE OR DISABLE A CHANNEL ADAPTER

PF5 : START REFRESH

OP47

PROCESS STOP-CCU-CHK MO55-ONLINE
RUN BYP-IOC-CHK

X71:0A0800
X72:07A600

CUSTOMER ID: WSC HASL 3720
FUNCTION ON SCREEN: PANEL FUNCTIONS

3720-1

SERIAL NUMBER: 0010007

SYSTEM INPUT AREA (SIA) ==>

T: TERMINATE OFF: LOGOFF PF1: MOVE TO SIA PF2: CCU FNCTN PF3: ALARM

INFORMATION FROM THE CONTROL PANEL

HEX DISPLAY: 000
FUNCTION SELECT SWITCH: NORMAL
POWER CONTROL SWITCH: LOCAL

INSTALLED CA: 1 2 3 4
CA STATE: E D D D
REQUESTED CA STATE: E D D D
E=ENABLED
D=DISABLED

CHANNEL ADAPTER STATE UPDATE:

INSTALLED CA 1 2 3 4
CA STATE E D D D
D * * *

- REPLACE ASTERISK (*) BY E OR D TO UPDATE ==>

PF5 : START REFRESH

OP48

PROCESS STOP--CCU--CHK MOSS--ONLINE
RUN BYP--IOC--CHK

X71:0A0800
X72:07A600

CUSTOMER ID: WSC HASL 3720 3720-1 SERIAL NUMBER: 0010007
FUNCTION ON SCREEN: PANEL FUNCTIONS

SYSTEM INPUT AREA (SIA) ==>

T: TERMINATE OFF: LOGOFF PF1: MOVE TO SIA PF2: CCU FNCTN PF3: ALARM

INFORMATION FROM THE CONTROL PANEL

HEX DISPLAY: 000
FUNCTION SELECT SWITCH: NORMAL
POWER CONTROL SWITCH: LOCAL

INSTALLED CA: 1 2 3 4
CA STATE: E D D D
REQUESTED CA STATE: E D D D
E=ENABLED
D=DISABLED

CHANNEL ADAPTER STATE UPDATE:

INSTALLED CA 1 2 3 4
CA STATE E D D D
D * * *

- REPLACE ASTERISK (*) BY E OR D TO UPDATE ==>
YOUR REQUEST TO UPDATE CA STATE IS TRANSMITTED:

CA1 DISABLED

PF5 : START REFRESH

PROCESS STOP--CCU--CHK MO55--ONLINE
RUN BYP--IOC--CHK

X71:0A0800
X72:07A600

CUSTOMER ID: WSC HASL 3720
FUNCTION ON SCREEN: PANEL FUNCTIONS

3720-1

SERIAL NUMBER: 0010007

SYSTEM INPUT AREA (SIA) ==>

T: TERMINATE OFF: LOGOFF PF1: MOVE TO SIA PF2: CCU FNCTN PF3: ALARM

INFORMATION FROM THE CONTROL PANEL

HEX DISPLAY: 000
FUNCTION SELECT SWITCH: NORMAL
POWER CONTROL SWITCH: LOCAL

INSTALLED CA: 1 2 3 4
CA STATE: D D D D
REQUESTED CA STATE: D D D D
E=ENABLED
D=DISABLED

- PRESS BREAK TO SELECT A PANEL FUNCTION AND STOP REFRESH

OP50

Disk Function (DF)

- install microcode Engineering Changes (ECs)
- save disk files onto diskettes
- restore disk from diskettes
- format diskettes for 3720 use

OP51

PROCESS STOP-CCU-CHK MO55-ONLINE
RUN BYP-IOC-CHK

X71:0A0800
X72:07A600

CUSTOMER ID: W5C HASL 3720

3720-1

SERIAL NUMBER: 0010007

SYSTEM INPUT AREA (SIA) =====> DF

T: TERMINATE OFF: LOGOFF PF1: MOVE TO SIA PF2: CCU FNCTN PF8: ALARM

CONFIG DATA FILE.: CDF	LINE DESCR FILE.: LDF	MACHINE LVL TABLE: MLT
CONTROL PRGM PROC: C	LINE INTERF DPLY.: LID	MICROCODE FIXES.: MCF
DISK FUNCTIONS...: DF	LINE THRESHOLD...: LTH	PANEL FUNCTIONS...: PAF
EVENT LOG DISPLAY: E	LINK IPL PORTS...: LKP	PASSWORDS.....: P
IML MO55.....: IML	LINK TEST.....: LT	PORT SWAP FILE...: PS
IML ONE SCANNER...: IS	LOAD LK TEST REQ.: LOQ	WRAP TEST.....: WT
IPL 3720.....: IPL	LOAD LK TEST RESP: LOS	

OP52

PROCESS : STOP-CCU-CHK MOSS-ONLINE
RUN BYP-IOC-CHK

X71:0A0800
X72:07A600

CUSTOMER ID: WSC HASL 3720 3720-1 SERIAL NUMBER: 0010007
FUNCTION ON SCREEN: DISK FUNCTIONS

SYSTEM INPUT AREA (SIA) ==>
T: TERMINATE OFF: LOGOFF PF1: MOVE TO SIA PF2: CCU FNCTN PF3: ALARM

DISK FUNCTIONS CANNOT BE PERFORMED WHEN MOSS IS ONLINE

OP53

Microcode Fixes (MCF)

used to:

- apply new microcode fixes
- restore last applied microcode fixes
- display MCF history table
- display "old" MCFs from earlier upgrade
- display new MCFs - applied or not

OP55

PROCESS STOP-CCU-CHK MOSS-OFFLINE
RUN BYP-IOC-CHK

X71:0A0800
X72:07A600

CUSTOMER ID: WSC HASL 3720

3720-1

SERIAL NUMBER: 0010007

SYSTEM INPUT AREA (SIA) ==> MCF

T: TERMINATE OFF: LOGOFF PF1: MOVE TO SIA PF2: CCU FNCTN PF3: ALARM

CONFIG DATA FILE.: CDF	LINE DESCR FILE.: LDF	MACHINE LVL TABLE: MLT
CONTROL PRGM PROC: C	LINE INTERF DPLY.: LID	MICROCODE FIXES.: MCF
DISK FUNCTIONS...: DF	LINE THRESHOLD...: LTH	PANEL FUNCTIONS...: PAF
EVENT LOG DISPLAY: E	LINK IPL PORTS...: LKP	PASSWORDS.....: P
IML MOSS.....: IML	LINK TEST.....: LT	PORT SWAP FILE...: PS
IML ONE SCANNER...: IS	LOAD LK TEST REQ.: LOQ	WRAP TEST.....: WT
IPL 3720.....: IPL	LOAD LK TEST RESP: LOS	

OP56

PROCESS STOP-CCU-CHK MO55-OFFLINE
RUN BYP-IOC-CHK

X71:0A0800
X72:07A600

CUSTOMER ID: WSC HASL 3720
FUNCTION ON SCREEN: MICROCODE FIXES

3720-1

SERIAL NUMBER: 0010007

SYSTEM INPUT AREA (SIA) ==> PRESS SEND TO DISPLAY FUNCTION MENU
T: TERMINATE OFF: LOGOFF PF1: MOVE TO SIA PF2: CCU FNCTN PF3: ALARM

MCF FILE IS EMPTY

OP57

Machine Level Table (MLT)

display microcode &

control program information :

● control program version loaded:

EP, NCP

● control program load name

● control program version

● EC level of microcode

● last applied microcode fix & date

OP58

PROCESS STOP-CCU-CHK MOSS-ONLINE
RUN BYP-IOC-CHK

X71:0A0800
X72:07A600

CUSTOMER ID: WSC HASL 3720

3720-1

SERIAL NUMBER: 0010007

SYSTEM INPUT AREA (SIA) ==> MLT

T: TERMINATE OFF: LOGOFF PF1: MOVE TO SIA PF2: CCU FNCTN PF3: ALARM

CONFIG DATA FILE.: CDF	LINE DESCR FILE...: LDF	MACHINE LVL TABLE: MLT
CONTROL PRGM PROC: C	LINE INTERF DPLY.: LID	MICROCODE FIXES...: MCF
DISK FUNCTIONS...: DF	LINE THRESHOLD...: LTH	PANEL FUNCTIONS...: PAF
EVENT LOG DISPLAY: E	LINK IPL PORTS...: LKP	PASSWORDS.....: P
IML MOSS.....: IML	LINK TEST.....: LT	PORT SWAP FILE...: PS
IML ONE SCANNER...: IS	LOAD LK TEST REQ.: LOQ	WRAP TEST.....: WT
IPL 3720.....: IPL	LOAD LK TEST RESP: LOS	

OP59

PROCESS STOP-CCU-CHK MOSS-ONLINE
RUN BYP-IQC-CHK

X71:0A0800
X72:07A600

CUSTOMER ID: WSC HASL 3720
FUNCTION ON SCREEN: MACHINE LVL TABLE

3720-1

SERIAL NUMBER: 0010007

SYSTEM INPUT AREA (SIA) ==> PRESS SEND TO DISPLAY FUNCTION MENU
T: TERMINATE OFF: LOGOFF PF1: MOVE TO SIA PF2: CCU FNCTN PF3: ALARM

CONTROL PROGRAM : NCP N20L14 VER4REL2

EC LEVEL : A39184

LAST APPLIED MCF : M184A000 ON 00/00/00

OP60

Line Threshold (LTH)

- changes level at which 3720 ALARM is created
- applies to physical line problem **ONLY**
- ratio of BERs to ALARM (default 4)

PROCESS STOP-CCU-CHK MO55-ONLINE
RUN BYP-IOC-CHK

X71:0A0800
X72:07A600

CUSTOMER ID: WSC HASL 3720

3720-1

SERIAL NUMBER: 0010007

SYSTEM INPUT AREA (SIA) ==> LTH

T: TERMINATE OFF: LOGOFF PF1: MOVE TO SIA PF2: CCU FNCTN PF9: ALARM

CONFIG DATA FILE.: CDF	LINE DESCR FILE.: LDF	MACHINE LVL TABLE: MLT
CONTROL PRGM PROC: C	LINE INTERF DPLY.: LID	MICROCODE FIXES.: MCF
DISK FUNCTIONS...: DF	LINE THRESHOLD...: LTH	PANEL FUNCTIONS...: PAF
EVENT LOG DISPLAY: E	LINK IPL PORTS...: LKP	PASSWORDS.....: P
IML MO55.....: IML	LINK TEST.....: LT	PORT SWAP FILE...: PS
IML ONE SCANNER..: IS	LOAD LK TEST REQ.: LOQ	WRAP TEST.....: WT
IPL 3720.....: IPL	LOAD LK TEST RESP: LOS	

OP62

PROCESS STOP--CCU--CHK MO55--ONLINE
RUN BYP--IOC--CHK

X71:0A0800
X72:07A600

CUSTOMER ID: W5C HASL 3720
FUNCTION ON SCREEN: LINE THRESHOLD

3720-1

SERIAL NUMBER: 0010007

SYSTEM INPUT AREA (SIA) ==>

T: TERMINATE OFF: LOGOFF PF1: MOVE TO SIA PF2: CCU FNCTN PF3: ALARM

THRESHOLD DISPLAY

LIC POSITION	* SCANNER 1	* SCANNER 3	* SCANNER 4
LIC 1	4	4	0
LIC 2	4	4	0
LIC 3	4	4	0
LIC 4	4	4	0
LIC 5	4	0	4
LIC 6	4	0	4
LIC 7	4	0	4
LIC 8	0	0	4

PF5: THRESHOLD UPDATE

OP63

PROCESS STOP-CCU-CHK MO55-ONLINE
RUN BYP-IOC-CHK

X71:0A0800
X72:07A600

CUSTOMER ID: WSC HASL 3720
FUNCTION ON SCREEN: LINE THRESHOLD

3720-1

SERIAL NUMBER: 0010007

SYSTEM INPUT AREA (SIA) ==>

T: TERMINATE OFF: LOGOFF PF1: MOVE TO SIA PF2: CCU FNCTN PF3: ALARM

THRESHOLD UPDATE

ENTER LINE ADDRESS (0-27 32-63) ==> 00

PF5: THRESHOLD DISPLAY

OP64

PROCESS STOP-CCU-CHK MO55-ONLINE
RUN BYP-IOC-CHK

X71:0A0800
X72:07A600

CUSTOMER ID: WSC HASL 3720
FUNCTION ON SCREEN: LINE THRESHOLD

3720-1

SERIAL NUMBER: 0010007

SYSTEM INPUT AREA (SIA) ==>

T: TERMINATE OFF: LOGOFF PF1: MOVE TO SIA PF2: CCU FNCTN PF3: ALARM

THRESHOLD UPDATE

ENTER LINE ADDRESS (0-27 32-63) ==> 00

CURRENT THRESHOLD: 4

ENTER NEW VALUE ==> 8

WARNING: ANY VALUE LOWER THAN DEFAULT (4) WILL BE FORCED TO "1"

PF5: THRESHOLD DISPLAY

OP65

PROCESS STOP-CCU-CHK MO55-ONLINE
RUN BYP-IOC-CHK

X71:0A0800
X72:07A600

CUSTOMER ID: WSC HASL 3720
FUNCTION ON SCREEN: LINE THRESHOLD

3720-1

SERIAL NUMBER: 0010007

SYSTEM INPUT AREA (SIA) ==>

T: TERMINATE OFF: LOGOFF PF1: MOVE TO SIA PF2: CCU FNCTN PF3: ALARM

THRESHOLD DISPLAY

LIC POSITION	* SCANNER 1	* SCANNER 3	* SCANNER 4
LIC 1	8	4	0
LIC 2	4	4	0
LIC 3	4	4	0
LIC 4	4	4	0
LIC 5	4	0	4
LIC 6	4	0	4
LIC 7	4	0	4
LIC 8	0	0	4

PF5: THRESHOLD UPDATE

3720 OPERATIONS

new MOSS function available:

- wrap test (WT)
- auto-BER analysis
- password management (P)
- configuration data file (CDF)
- line description file (LDF)
- panel function (PAF)
- disk function (DF)
- microcode fixes (MCF)
- machine level table (MLT)
- link threshold (LTH)

DP67

3720 Installation Planning

- o Overview
- o Physical Planning
- o Software
- o Operations
- o **Problem Determination**
- o Performance
- o Migration
- o Service

PD01

3720 Problem Determination

Differences from 3725

- o Additional MOSS Wrap Capability
- o MOSS AutoBER Analysis
- o System Alert Flow
(including VTAM Generic Alert)

PD02

3720 Problem Determination

Wrap Test (WT)

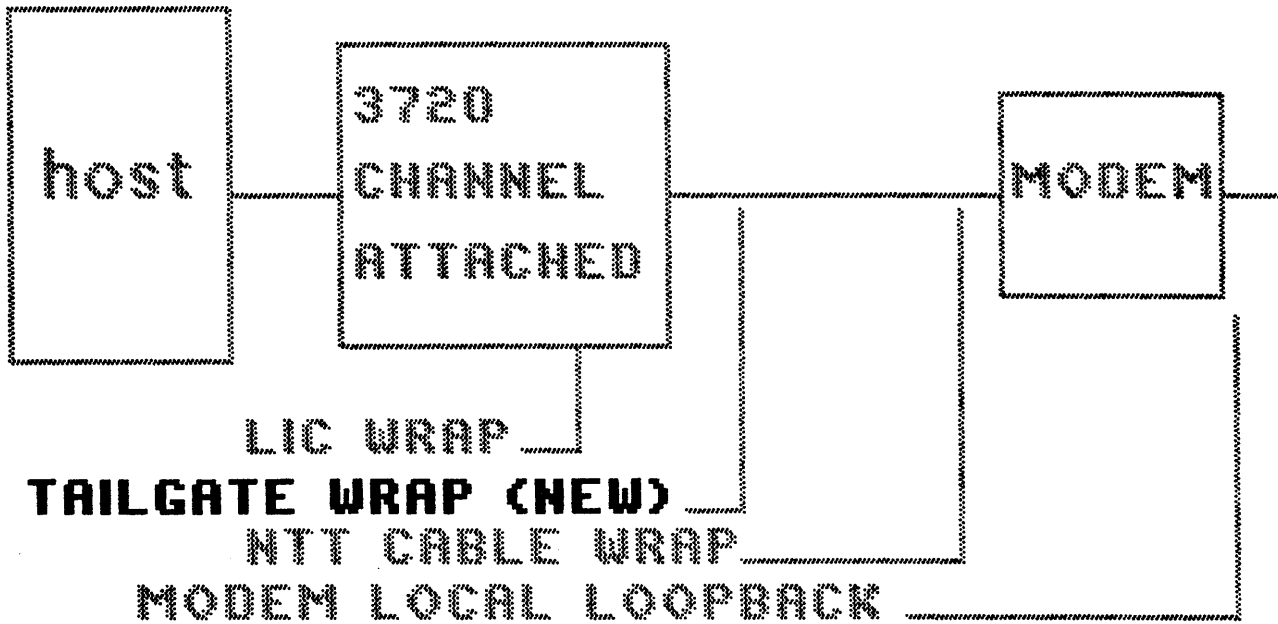

PD03

3720 Problem Determination

AutoBER Analysis

- o **WHAT: MOSS Program That Automatically Generates Reference Code For Some BERs**
- o **PURPOSE: NSD Uses Reference Code To Identify FRU's To Be Replaced Or Action To Be Taken**

PD04

3720 Problem Determination AutoBER Example (Scanner Failure)

MOSS ALARM DISPLAY

o 471 9/04 10:18 ALARM 18:SCANNER

04(LINES48-63) RE-IML SUCCESSFUL

o 467 9/04 10:18 ALARM 16:SCANNER

04(LINES48-63) RE-IML IN PROGRESS

PD05

3720 Problem Determination AutoBER Example (Scanner Failure)

MOSS ALARM DETAIL DISPLAY

o 471 9/04 10:18 ALARM 18:SCANNER

04(LINES48-63) RE-IML SUCCESSFUL **BX13200**

BX13200 => B-AUTOBER REFERENCE CODE
X-TYPE X BER
132-1ST FRU NUMBER
000-2ND FRU NUMBER
(INTERPRETATION IN MIP MANUAL)

PD06

3720 Problem Determination

Alert Flow

- o VTAM or NCCF (no NPDA)
- o NPDA V3 (MVS)
- o NETVIEW

PD07

3720 Problem Determination

Alert Flow Example (Scanner Failure)

VTAM or NCCF (w/o Generic Alert)

IST259I INOP RECEIVED FOR L1062 CODE=02
IST619I ID=L1062 FAILED - RECOVERY IN PROGRE
IST129I UNRECOVERABLE OR FORCED ERROR ON
NODE L1062 - VARY INACT SCHEDULED

NPD#INJ001 9/04 10:18 PERM ALERT RECEIVED

NPD#FROM THE FOLLOWING RESOURCE: COMIC ISOLANC

IST105I C1062A NODE NOW INACTIVE
IST105I L1062 NODE NOW INACTIVE

PD08

3720 Problem Determination

Alert Flow Example (Scanner Failure)

VTAM or NCCF (Generic Alert)

oIST772I UAC=16 Q1=4 Q2=48/63 (MVS)

o5H72I UAC=16 Q1=4 Q2=48/63 (USE)

oIST772I UAC=16 Q1=4 Q2=48/63 Q3=BX132000

o5H72I UAC=16 Q1=4 Q2=48/63 Q3=BX132000

(3720 ALARMS; PAGE 6-6 OF 3720 PD GUIDE)

PD09

3720 Problem Determination

Alert Flow Example (Scanner Failure)

NPDA V3

MOST RECENT EVENTS

- (1) 9/4 10:18 SCANNER CHECK:COMMUNICATION
CONTROLLER PERM 48
- (2) 9/4 10:18 (HARDWARE/MICROCODE;SCANNER:
TEMP 12
- (3) 9/4 10:18 (HARDWARE/MICROCODE;SCANNER:
INTV 10

PD 10

3720 Problem Determination

Alert Flow Example (Scanner Failure)

NPDA V3 Cont'd (selection 3)

EVENT DETAIL

DESCRIPTION,PROBABLE CAUSE:(HARDWARE/
MICROCODE/SCANNER) QUALIFIERS: 1)4 2)48/63
EVENT TYPE-04 GENERAL-01 SPECIFIC-11
ACTION-10 BLOCK ID-04E

3720 Problem Determination

Alert Flow Example (Scanner Failure)

NPDA V3 Cont'd (selection 2)

EVENT DETAIL

DESCRIPTION,PROBABLE CAUSE:(HARDWARE/
MICROCODE/SCANNER) QUALIFIERS: 1)4 2)48/63
3)BX132000

EVENT TYPE-02 GENERAL-01 SPECIFIC-11
ACTION-12 BLOCK ID-04E

PD12

3720 Problem Determination

Alert Flow Example (Scanner Failure)

NPDA V3 Cont'd (selection 1)

EVENT DETAIL FOR SDLC LINE

OPERATION-RUN-INITIATES NORMAL SEND/RECEIVE
THE SDLC LINK ERROR WHILE SENDING TEXT I-FOUR
PROBABLE CAUSE-HARDWARE FAILURE
ERROR DESCRIPTION-**SCANNER CHECK**-INDICATES
LEVEL 1 SCANNER CHECK OCCURRED

... RECMS HEX CODE ...

PD13

3720 Problem Determination

Alert Flow Example (Scanner Failure)

Netview (selection 2)

EVENT DETAIL

DESCRIPTION,PROBABLE CAUSE: HARDWARE ERROR
SCANNER RE-IML SUCCESSFUL

QUALIFIERS: 1)4 2)48/63 3)BX132000

EVENT TYPE-04 GENERAL-01 SPECIFIC-11
ACTION-12 BLOCK ID-04E

PD14

3720 Problem Determination

Conclusions

- o AutoBER Analysis Used To Quickly Identify Action Taken
- o Host Support Without Netview, Manuals Required To Interpret Messages

3720 Installation Planning

- o Overview
- o Physical Planning
- o Software
- o Operations
- o Problem Determination
- o Performance**
- o Migration
- o Service

PF01

3720 Performance

- o System Configuration
- o 3720 Hardware Configuration
- o 3720 Software Configuration
- o Remote 3720 Scenario
- o Local 3720 Scenario

PF02

3720 Performance

System Configuration

4001 4001

4001 4001

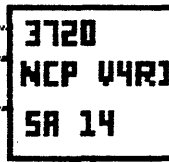
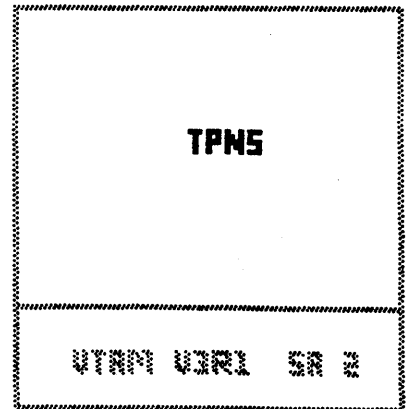
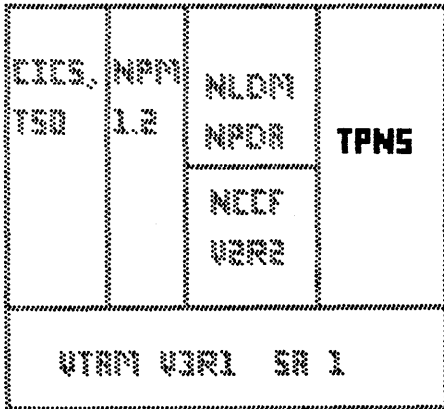

3-3000 1000

34-3000 1000

NTD, 3E705, 3708

PF03

3720 Performance

3720 HARDWARE CONFIGURATION

3720

CON/TPE	CON/TPE
DIR/DIR-U	DIR/DIR-U
CONSOLES:	
LOCAL, REMOTE, RSF	NEG
CSP 1	
1 LIC3	000 INN
3 LIC1 DIR - DIR	TANS

3721

CSP 2	
1 LIC3	000 INN
3 LIC1 DIR - DIR	TANS
CSP 3	
1 LIC3	000 INN
3 LIC1 DIR - DIR	TANS

PF04

3720 Performance

3720 SOFTWARE

VER 1.2

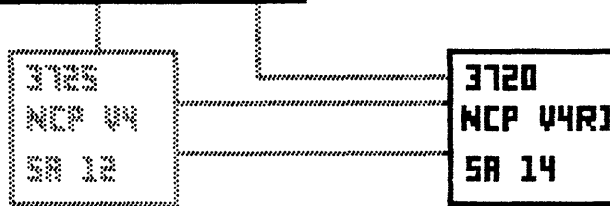
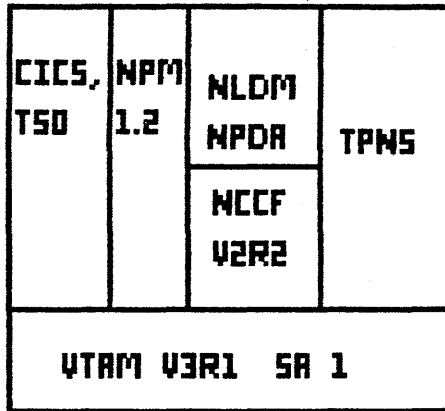

PF05

3720 Performance

REMOTE 3720 SCENARIO: NPM RESULTS

MODEL "V"

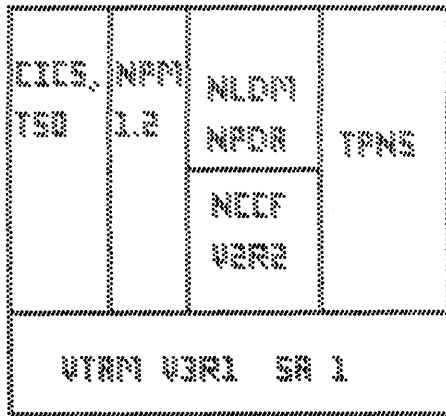

MODEL "V"

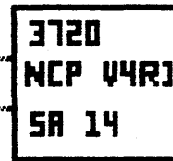
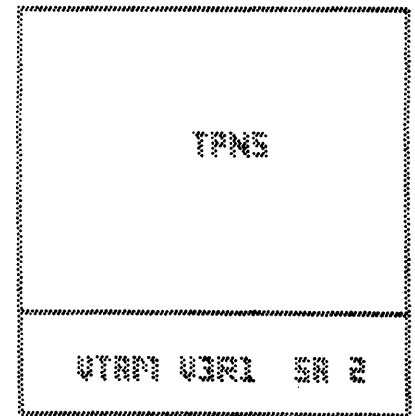

1 - 10.0KB
0 - 10.0KB
000

10 - 10.0KB
0 - 10.0KB
000

PF06

3720 Performance

REMOTE 3720 SCENARIO: CF3725

3720 "A"

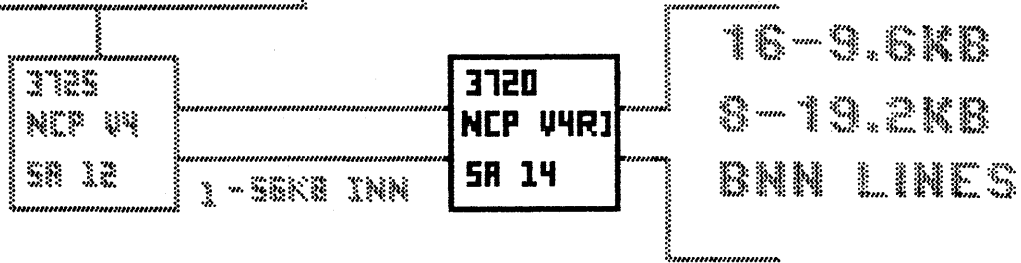
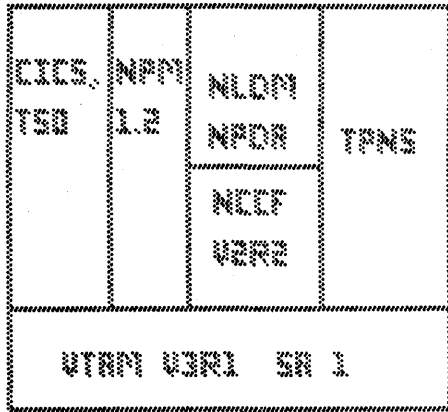

PF07

3720 Performance LOCAL SCENARIO: 3720

TEST #1

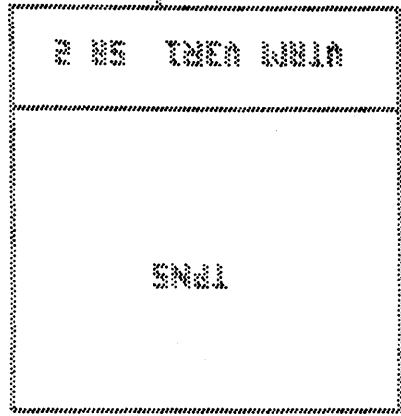

TEST #2

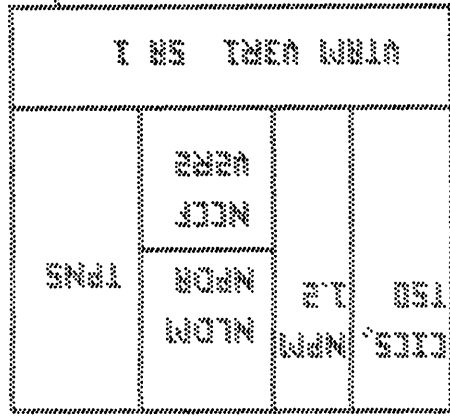
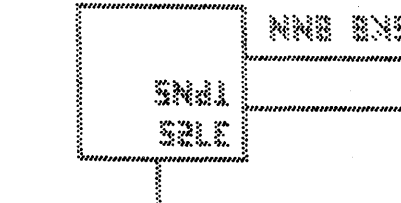

TEST #3



10 - 1000 MHz

PL08

3720 Performance

LOCAL SCENARIO: 3725

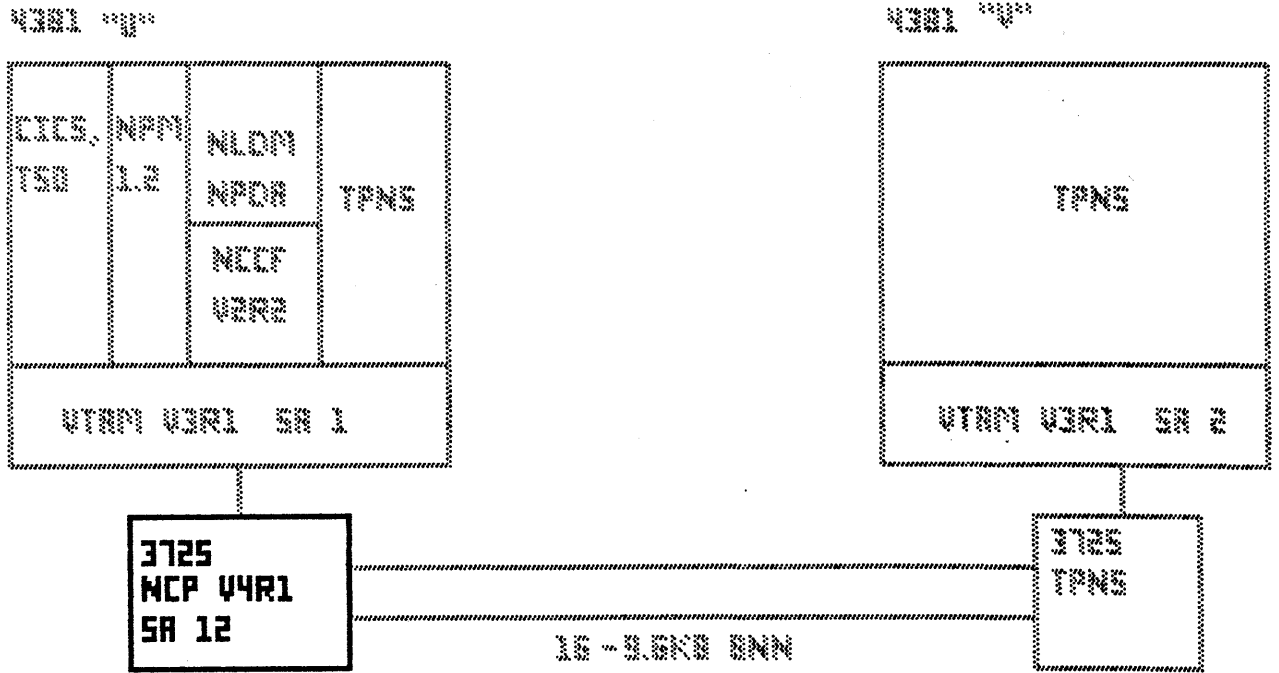

PF09

3720 Performance

Conclusions

- o For Same Workload 3720 Utilization
3 Times 3725 Utilization
- o No Impact On Response Time
- o CF372x Accurate For This Scenario

3720 Installation Planning

- o Overview
- o Physical Planning
- o Software
- o Operations
- o Problem Determination
- o Performance
- o **Migration**
- o Service



M100

3720 Migration

- o Hardware
- o Software
- o Hints and Tips
- o Publications

MI01

3720 Migration

Hardware

- o Can Coexist With 3725/3705
- o Line Cables Differ From 3725
- o Operating Consoles

Configuration

Contention

Modems

Coexistence With 3725 Console

MI02

3720 Migration

Hardware

- o MOSS Functions
 - Password, CDF,
 - IPL Ports, Panel Functions
- o Reconfiguration
 - Direct Attached Links
 - LIC Plugging
 - Scanner Overcommittment**
- o Backup Must Be Planned
 - NCP Versions/3720 Capacity

M103

3720 Migration

Software

- o Operating Systems
MVS, VM, VSE Definition
Same as For 3725
- o Access Methods
VTAM V2, V3
TCAM V2R4 As Data Host Or EP
BTAM/SP, BTAM/ES, RTAM
Maintenance Required For
ALERTS (VTAM Only)

MI04

3720 Migration

Software

- o 3720 Control Program
NCP V4 R1, R2, Subset
EP/3725 R3, R4
NCP Different From 3725
(Block ID)

- o SSP V3R2 - REQUIRED

MI05

3720 Migration

Software

- o CNM Products
 - o Formatted Alerts Support Via Netview For MVS/VM
 - NPDA V3R2 + PTF For VSE
- o NPDA V3 Provides Action Code/Qualifier Data On Event Detail Screen
- o NPM R2 + APAR 0Z95078

MI06

3720 Migration

Hints and Tips

- o Operator Training
- o Microcode Updates
- o Password Management
- o Remote Console Support
5841/212A Equivalent
- o Remote Support Facility
5841/212A Equivalent

MI07

3720 Migration

Hints and Tips

- o Remotes

**MVS VTAM Performance PTF For
Improved Load Dump Time**

**Implemented In Vtam V3.1.1 Via
ISTRACON Constant Module Entry**

- o 3720 Installation File

INFO Keyword: "3720 QBUCKET"

MI08

3720 Migration

Hints and Tips

o Timings

Switch Setting Utam Command	Ending LED	3720 TIME	3725 TIME
Power on IPL	FF4	2m10s	3m07s
General Reset	FF4	2m10s	
Function Start	FF4	1m18s	
MOSS IML	FEF	49s	
U NET,..Load=Yes	000	47s	
From 3720 FF4 State			

MI09

3720 Installation Planning

- o Overview
- o Physical Planning
- o Software
- o Operations
- o Problem Determination
- o Performance
- o Migration
- o **Service**



3720 Service Offering

- o Remote Support Facility
- o Hardware Support Center
- o Service Cycle
- o Software

SE01

3720 Service Offering

Remote Support Facility (RSF)

- o Interfaces To MOSS**
- o Remote Diagnostics/Tests**
- o Hardware/Microcode Status**
- o Microcode Application**
- o Access Protected Via Password**

SE02

3720 Service Offering

Hardware Support Center Access

- o Operates In Callback Mode
- o Develop Action Plan
- o Access To Local CE
For On-site Assistance
- o Access To Development

SE03

3720 Service Offering

Hardware Service Cycle

- o Call is Placed Using IBM 800 Service Number
- o IBM Dispatches Call To Hardware Support Center
- o 3720 Specialist Calls Customer
- o (If RSF Is Not Installed, Or At Customer Request) A CE Is Dispatched On-Site

SE04

3720 Service Offering

Hardware Service Cycle

- o Specialist Searches RETAIN
- o Specialist Dials 3720 Via RSF
- o If Needed, CE Is Dispatched With Parts

SE05

3720 Service Offering Software

o Business As Usual

SE06

READER'S COMMENT FORM

Title: 3720 Model 1/2 Installation Planning Guide
Washington Systems Center
Technical Bulletin GG66-0268-00

You may use this form to communicate your comments about this publication, its organization, or subject matter, with the understanding that IBM may use or distribute whatever information you supply in any way it believes appropriate without incurring any obligation to you.

Please state your occupation: _____

Comments:

Please mail to: C. L. Brinkman
IBM Corporation
Washington Systems Center
18100 Frederick Pike
Gaithersburg, MD 20879

Reader's Comment Form

Cut or Fold Along Line

Fold and tape

Please Do Not Staple

Fold and tape



NO POSTAGE
NECESSARY
IF MAILED
IN THE
UNITED STATES

BUSINESS REPLY MAIL
FIRST CLASS PERMIT NO. 40 ARMONK, N.Y.

POSTAGE WILL BE PAID BY ADDRESSEE:

C. L. Brinkman
IBM Corporation
Large Systems Technical Support
18100 Frederick Pike
Gaithersburg, MD 20879



Fold and tape

Please Do Not Staple

Fold and tape



GG66-0268-00

3720 Model 1/2 Installation
Planning Guide

Printed in U.S.A.

GG66-0268-00



GG66-0268-0

