



IBM 3270
Personal Computer

1

Using the Hardware

3270 Personal Computer Books You Can Order

If you are:

- Responsible for helping work station users solve problems with their 3270 Personal Computers
- Responsible for calling IBM to obtain service for the 3270 Personal Computers
- Doing your own problem diagnosis
- Customizing the 3270 PC Control Program for yourself or others

And you have not already received these manuals:

- *IBM 3270 PC Hardware Problem Determination, GA23-0233*
- *IBM 3270 PC Control Program Reference, GA23-0232*

You can order a copy of these manuals by contacting your IBM representative or the IBM branch office that serves your locality.



IBM 3270
Personal Computer

1

Using the Hardware

Federal Communications Commission (FCC) Statement

Warning: This equipment generates, uses, and can radiate radio frequency energy and if not installed and used in accordance with the instruction manual, may cause interference to radio communications. It has been tested and found to comply with the limits for a Class A computing device pursuant to Subpart J of Part 15 of FCC Rules, which are designed to provide reasonable protection against such interference when operated in a commercial environment. Operation of this equipment in a residential area is likely to cause interference in which case the user at his own expense will be required to take whatever measures may be required to correct the interference.

IBM Statement

The FCC statement is required for those machines that are used in the United States.

CAUTION

This product is equipped with a grounded line cord designed to avoid electrical shock. To insure electrical safety, you MUST supply and use properly grounded power receptacles.

Second Edition (July 1985)

This edition describes the IBM 3270 Personal Computer hardware.

References in this publication to IBM products, programs, or services do not imply that IBM intends to make them available in all countries in which IBM operates. Any reference to an IBM program product in this publication is not intended to state or imply that only IBM's program product may be used. Any functionally equivalent program may be used instead.

Publications are not stocked at the address given below. Requests for this or other IBM publications should be made directly to the IBM branch office serving your locality.

A form for readers' comments is provided at the back of this publication. If the form has been removed, address comments to IBM Corporation, Department 52Q, Neighborhood Road, Kingston, N.Y. 12401. IBM may use or distribute whatever information you supply in any way it believes appropriate without incurring any obligation to you.

About This Book

This book is your guide to using the 3270 Personal Computer. You may have just received a large carton containing a 3270 Personal Computer, or you may have just sat down in front of one. You may be a manager or an executive. You may be a secretary. You may be a programmer. This may be the first time you used a computer or it may be the first time you used a computer like the 3270 PC. You may be setting it up for someone else. You are about to become a work station user, and this book is for you.

How to Use This Book

This book is for the hardware. You should have received this book, a 3270 PC Inventory Record card, a 3270 PC Components Record card, and a 3270 PC Adapter Locations Record card, a Diagnostic diskette, and a binder to hold everything.

This book is designed to work with the books that come with the 3270 PC Control Program.

- If you are using Release 1.22 or an older of the control program, you will have a booklet for the Online Tutorial and the Control Program User's Guide and Reference in their own binders.
- If you are using a newer release of the control program, you will probably have a package containing Book 2 - Setting Up and Learning the Control Program, Book 3 - Using the Control Program, the Online

Tutorial diskette, two 3270 PC Control Program diskettes, and the 3270 PC Reference Summary. This package is designed to fit into binder that came with Book 1.

You can use either set of books with this book.

If you ordered the Control Program with your 3270 Personal Computer, the books will be packed with your work station. If you did not order the Control Program with the hardware, you will receive the books when you order the control program.

What to Do Next

You may not have to read all of this book. Here is a quick “road map” to help you decide how to use Book 1 and when to go to the other books.

- **Chapter 1. What Is the 3270 Personal Computer**

If you have already used a 3270 Personal Computer, you can probably skip this chapter.

If you want to know what your 3270 Personal Computer is and can do for you, you might like to read Chapter 1.

- **Chapter 2. Setting Up and Checking Your 3270 Personal Computer**

If someone has already unpacked your work station and set everything up for you, you can skip this chapter. You might want to read Chapter 3 to make sure that you know where everything is and how it works.

If you are going to unpack or set up the units yourself, read this chapter.

- **Chapter 3. Operating Your 3270 Personal Computer**

If you did not set up your own 3270 Personal Computer and want to learn how to operate its controls, read this chapter.

- **Chapter 4. Moving Your IBM 3270 PC to a New Location**

If you have to move your work station a short distance to a new office or ship it a long distance to another city or to a repair center, read this chapter.

- **Chapter 5. Locating Problems with Your 3270 Units**

If you have problems while you are setting up or using the units or using your work station, read this chapter.

Control Program Books 2

- If your work station is already set up, you do not need to read this book now. You can go directly to books that came with the release of the control program you are going to use, either:

Book 2 - Setting Up and Learning the Control Program and begin with Chapter 1.

Or.

Control Program Users's Guide and Reference. and begin with Appendix A, Customization, to setup your control program.

These books will explain how to set it up and use the control program.

Contents

Chapter 1. What Is the 3270 Personal Computer	1-1
How Does the 3270 PC Work?	1-3
What Can the 3270 PC Do for Me?	1-5
What Should I Do Next?	1-6
Chapter 2. Setting Up and Checking Your 3270 Personal Computer	2-1
Step 1. Unpacking the Units and Getting Organized	2-3
Step 2. Setting Up the Units	2-11
Step 3. Plugging in the Units and Arranging Them	2-29
Step 4. Checking Out the 3270 PC with the Power-On Self Test	2-37
Step 5. Option Instructions	2-47
Chapter 3. Operating Your 3270 Personal Computer	3-1
Operating the System Unit	3-3
Operating the Diskette Drive	3-4
Operating the Fixed Disk	3-8
Operating the Monochrome Display	3-9
Operating the Color Display	3-11
Operating the Keyboard	3-14
Operating Optional Units	3-15
Chapter 4. Moving Your IBM 3270 PC to a New Location	4-1
Chapter 5. Locating Problems with Your 3270 PC Units	5-1
Step 1. Check Your Cable and Power Cord Connections	5-3

Step 2. Run the Power On Self-Test (POST)	5-5
Step 3. Find Your Problem in the POST Error Chart	5-11
Step 4. Do the External Device Check	5-15
Step 5. Do the Display Check	5-17
Step 6. Do the Expansion Unit Check	5-25
Step 7. Do the Keyboard Check	5-27
Index	X-1

Chapter 1. What Is the 3270 Personal Computer

Congratulations, you are now a user of an IBM 3270 Personal Computer. Its nickname is the 3270 PC.

This chapter introduces you to:

- What the 3270 Personal Computer is
- How it works
- What it can do for you

You are probably wondering just what is this 3270 PC anyway? The 3270 PC work station looks like this:

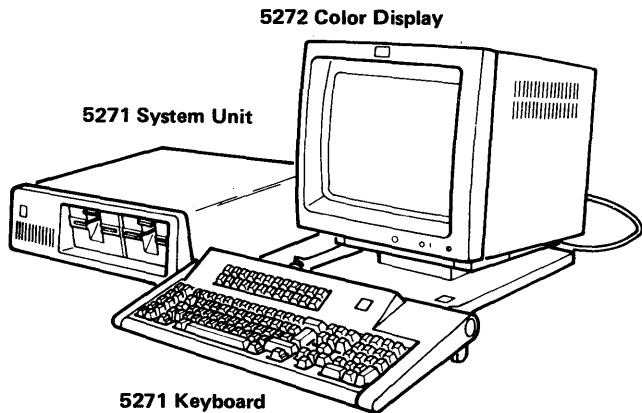

This is one model. Yours may look slightly different. The basic work station has a system unit, a display and a keyboard.

The system unit contains the processor and the diskette or fixed disk drives. It has connections to the other units and the host computers. The processor runs the software that controls the work station. The diskette and fixed disk drives store information.

The display may be color or monochrome (one color). It shows you what the processor is doing and let's you see what you are doing.

You use the keyboard to tell the control program what you want it to do and to type in the information you want stored or processed.

You can add an optional printer to the basic work station. And there are some other options that you can add to make your basic work station do more or run faster. The 3270 PC is a member of the IBM Personal Computer family. And, like all the other members of the family, it is designed to help you do your work. What makes this Personal Computer different? It is designed to bring together in one terminal an IBM Personal Computer and access to one or more IBM 370 host computers. Using the IBM 3270 PC Control Program, you can work with four host computers and more than one Personal Computer application program at the same time. The 3270 PC puts the convenience and flexibility of the IBM Personal Computer and the enormous processing and communications power of IBM System/370 host computers under your fingertips.

How Does the 3270 PC Work?

The 3270 PC does it with windows. It brings all of your computing power together and shows it to you through "windows". Windows are areas of the display screen that give you access to your host computers and your personal computer programs. Let's assume that your 3270 PC is connected to two host computers - a VM/370 and an MVS/TSO host. Let's also assume that you have one Personal Computer session. You would have three windows on your screen. Each window lets you set up a working session. If the 3270 PC were a traditional computer terminal, you could have only one working session at a time, and you would have to switch between the sessions like this:

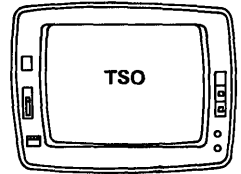
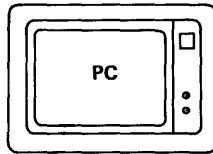
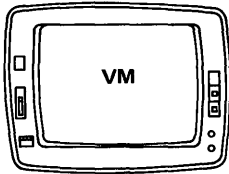

The 3270 PC lets you see all three sessions at the same time, like this:

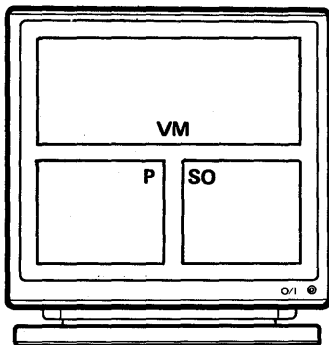

In the illustration, you probably noticed that you can't see all of the information in each window. That's correct, but you can choose the window you want to look into and enlarge it to fill the entire screen. So it now looks like this:

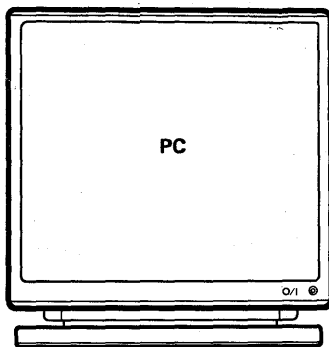

Remember, the sessions in the other windows are still running. When you are finished with one session, you can shrink it back to its original size and look into another window.

The 3270 PC does even more. It lets you move information from window to window. You can copy anything that appears in one window into another. If you have the necessary program on your host computer, you can copy complete files from your 3270 PC and move them to a host computer and back again. The 3270 PC also gives you one or two extra windows, if you want them, in which to write notes. They are like note pads on your screen. You can copy from or into them, too.

Are you wondering who controls how and where the windows appear on your screen? You do! You can set them up any way you want, and you can change them any time you want. There are other things that your 3270 PC can do. You will learn about them later.

What Can the 3270 PC Do for Me?

The best way to explain what the 3270 PC can do for you is with an example. Let's assume that you are an insurance agent using a 3270 PC. Your system is connected to an IBM host computer that gives you rates and statistical data. Your system is connected to another host computer that keeps customer information. You have an IBM PC application that helps you do financial analysis.

With the 3270 PC you can be connected to both hosts at the same time and have your PC application running. You will have a window for each work session. You can also have a window for a note pad. Since you have all of your work sessions available at the same time, you can move information between a host computer and a personal computer session.

The important thing to remember about the 3270 PC is that it is a tool to help you do your work.

What Should I Do Next?

You are now ready to take the next step.

If you are going to set up your units, go to Chapter 2 of this book.

If your units are already set up, go to either:

- Chapter 1 in *Book 2 - Setting Up and Learning the Control Program*.

Or,

- Appendix A in the *Control Program User's Guide and Reference*.

Chapter 2. Setting Up and Checking Your 3270 Personal Computer

Here is a brief summary of the steps in Chapter 2:

- Unpacking the units and getting organized (page 2-3)
- Setting up the units (page 2-11)
- Plugging in the units and arranging them (page 2-29)
- Turning on the 3270 PC and Watching the Power-On Self Test (page 2-37)
- Installing any optional devices or cards (page 2-47).

1. The first part of the document discusses the importance of maintaining accurate records of all transactions. This is essential for ensuring the integrity of the financial statements and for providing a clear audit trail. The records should be kept up-to-date and should be easily accessible to all relevant parties.

2. The second part of the document outlines the procedures for handling any discrepancies or errors that may arise. It is important to identify the source of the error as soon as possible and to take appropriate corrective action. This may involve adjusting the records and notifying the relevant parties of the changes.

3. The third part of the document discusses the role of the auditor in verifying the accuracy of the records. The auditor should conduct a thorough review of the records and should be satisfied that they are complete and accurate. Any findings should be reported to the relevant parties and should be used to improve the internal controls.

4. The fourth part of the document provides a summary of the key points discussed above. It emphasizes the importance of maintaining accurate records and of following the procedures for handling any discrepancies or errors. It also highlights the role of the auditor in verifying the accuracy of the records.

5. The final part of the document contains a list of references and a list of appendices. The references provide further information on the topics discussed in the document. The appendices contain additional information that is relevant to the document.

Step 1. Unpacking the Units and Getting Organized

Here are some hints to help you unpack and get organized before you begin setting up.

Unpacking the Rest of the Book Carton

If you have not unpacked the rest of the books, do that now.

What to Do with the 3270 PC Control Program Books

If you ordered Release 1.22 or if you have an older release of the control program, you should have these two books:

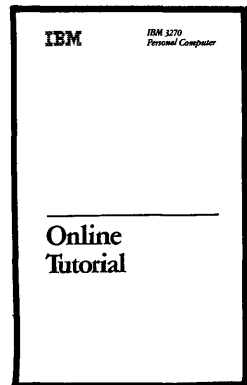
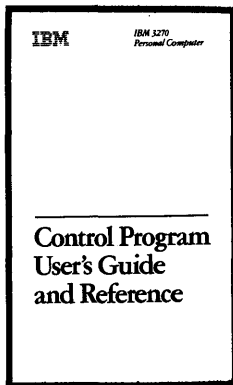

Keep them handy you will need them later.

If you ordered a newer release of the 3270 PC Control Program, you should have a package that looks like this:

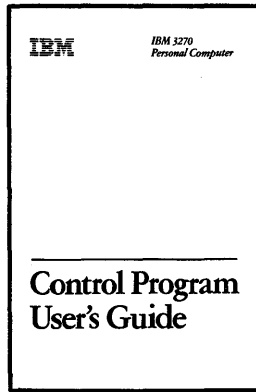

This package contains:

- Book 2 - Setting Up and Learning the Control Program
- Book 3 - Using the Control Program
- Three diskettes in a holder
- 3270 PC Control Program Summary Card

If you have this package, put the diskette holder in the back of this binder and insert the two manuals between Book 1 and the cards in the back of the binder.

Putting away the Maintenance Information Manual

Put the Maintenance Information manual in a safe place. You do not need to use this manual. It is for the service person. Have it available if you ever need to call for service.

Putting Away the BASIC Manual

For now, put the BASIC manual in a safe place. If you are going to write programs in BASIC, you will need this manual later.

Filing Away the BASIC Supplement

A small booklet that supplements the BASIC manual is packaged with this book. It looks like this:

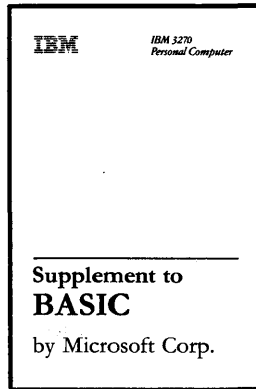

Insert this booklet in the BASIC manual. If you are going to use the BASIC manual, use the explanation of the 3270 PC keyboard in this booklet instead of the information in the BASIC manual.

Keep Your Disk Operating System (DOS) Manual Handy

If you have a Disk Operating System manual, it looks like this:

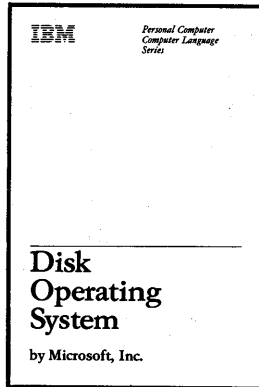

Keep it handy. You will need it later.

Do You Have Any Personal Computer Programs?

You may, if you ordered them, have Personal Computer Programs in the book box. For now, put them in a safe place also. You will need them after you have set up your 3270 PC and are ready to begin your work.

Clear Enough Space on Your Desk

Be sure that you have enough clear desk space. If you have a system unit, display, and printer, you will need about half the space on a normal (2 1/2' x 5') desk top. You will also need some extra room to move the units around while you are setting them up.

Unpacking the Rest of the Boxes

Be Careful - It's Heavy

The 3270 PC comes in one large carton.

CAUTION

Do not attempt to lift or move this large carton by yourself unless you have mechanical help.

You should, however, be able to lift all of the boxes in the carton by yourself. If you cannot lift them easily, ask someone to help you.

Dealing with the Packing Material

You will notice that there are lots of boxes and packing material. Find an out-of-the-way place to put the packing materials as you unpack the units. If you don't, you will quickly become swamped in all the clutter.

Be sure that you check the packing material as you unpack. There are small items included with the units in the boxes. Keep track of these small items. It is easy to loose them or discard them with the packing material.

Save the packing material until you have finished setting up your system, and you are sure it is working correctly. If something is wrong, you may have to repack the unit to be sent out for repair.

Unpacking the Boxes

If you have not unpacked the rest of the boxes, do that now.

Filing Away Option Instructions for Optional Units

You may also notice, as you unpack, that there may be a number of small booklets. These booklets look like this:

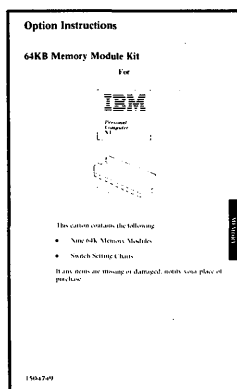
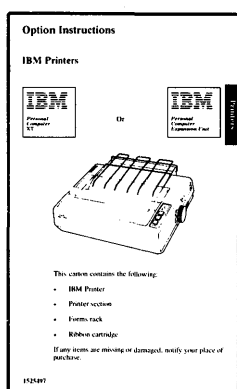
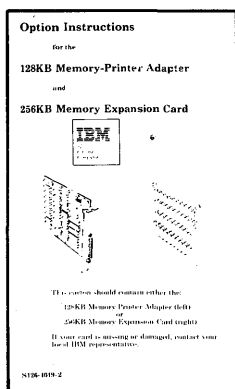

They come with some of the optional units or parts that you have or that have already been installed for you at the factory. You will need these instructions to install or set up the units or to use them properly.

So, take a few minutes, and file these booklets away in "Step 5. Option Instructions" in this chapter. Remember that they are there when you want to use your optional units.

Keeping a Record of Your System

There are three charts in the back of this binder. They will help you keep a written record of your 3270 PC. The charts are:

- 3270 PC Inventory Record - which units you ordered
- 3270 PC Components Record - what's installed in your system unit
- 3270 PC Adapter Locations Record - where the adapter cards are located in your system and expansion units

Take a few minutes now, before you go on, to fill out these cards. It is very important to keep an up-to-date record of your work station. You should know what is installed in your 3270 PC. An accurate record helps you keep track of where things are. It also helps the person who may have to service your work station.

What to Do If Something Is Broken or Missing

Your company probably has instructions that tell you how to handle computer problems. If so, follow those instructions, and report the problem. If you don't have specific instructions, contact your supervisor or the person who is supposed to help you with computer problems.

Be sure you know who to call. It will save you time in getting help.

You are now ready to go to "Step 2. Setting Up the Units."

(

(

Step 2. Setting Up the Units

This step shows you how to set up the units that make up the 3270 Personal Computer. The units are the:

- System unit
- Display
- Keyboard

This section has one description for setting up system units, and one for the keyboard. Following that are separate descriptions for setting up each type of display. Use the description for the display you have, and ignore the others.

Handle the Units With Care

As you begin working with your 3270 PC, you should handle the units as you would handle any sensitive electronic equipment. Remember:

- Don't bump or drop them.
- Don't spill anything on them.

Tools You May Need

You may need certain tools to set up or install some units.

- If you have a monochrome display, you will need a small, flat-bladed screwdriver to attach the display cable.
- If you are going to install adapter cards inside the system unit, you will need a

medium-sized, flat-bladed screwdriver to remove the cover.

- If you are going to set up or attach optional units (a printer, for example), you should have a flat-bladed and a Phillips screwdriver.

You are now ready to begin setting up your 3270 PC. Go to the next section, "Setting Up Your System Unit."

Setting Up Your System Unit

1. Place the system unit and power cord on your desk.

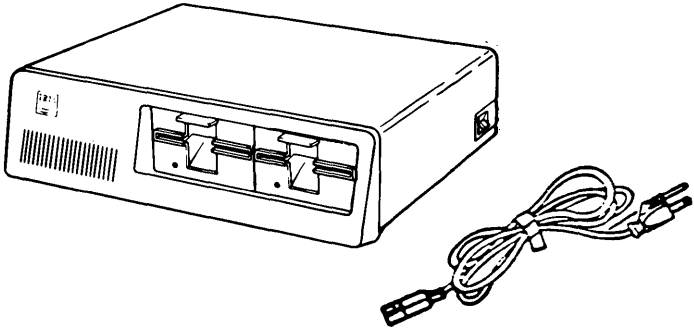

Your system unit may look like one of these:

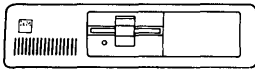

Model 2

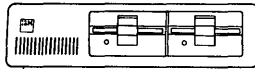

Model 4

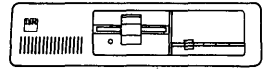

Model 6

-
2. Raise the load levers on the diskette drives.

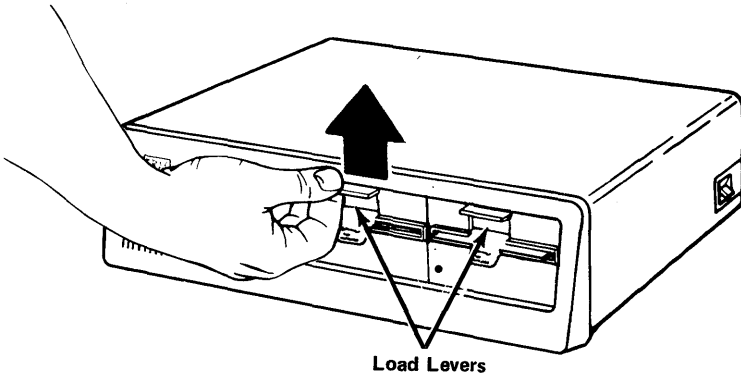

CAUTION

Always leave the levers up when the diskette drive is empty.

3. Remove the cardboard protectors.

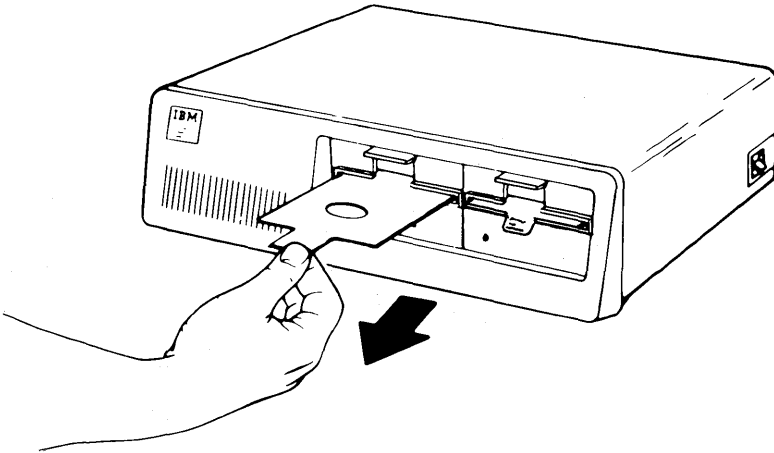

Store the cardboard in the diskette holder in the back of this binder. You will need to put it back into the diskette drives if you move the system unit.

4. Make sure you remove the cardboard from all the diskette drives in your system unit.
5. Turn the ON/OFF (I/O) switch to OFF.

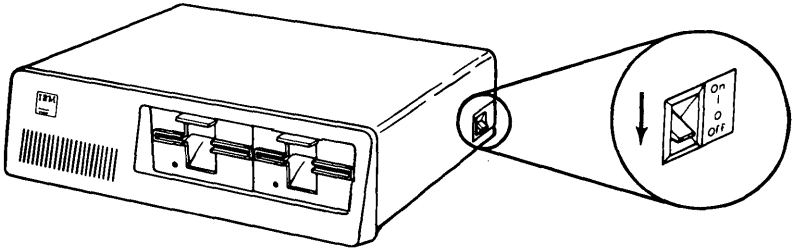

6. Plug the power cord into the back of the system unit.

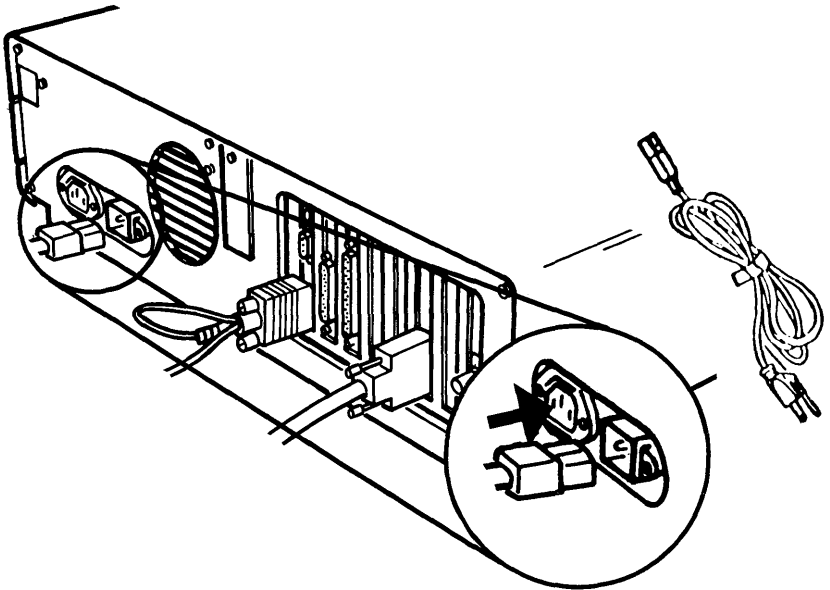

Do not plug the power cord into a wall outlet until you are told to do so later.

**Continue with the next section, “Setting Up
Your Keyboard.”**

Setting Up Your Keyboard

1. Place the keyboard on your desk. Get the keyboard adapter cable.

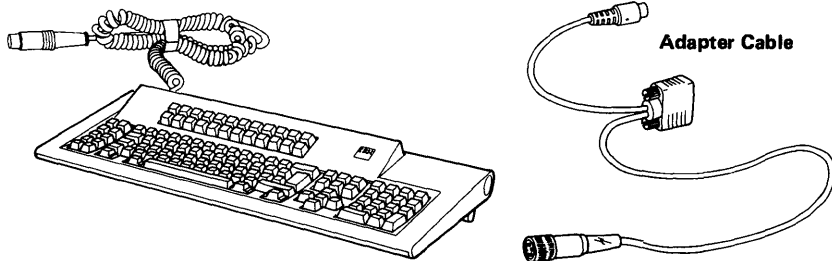

-
2. Connect the round plug on the black end of the keyboard adapter cable to the round connector on the back of the system unit.

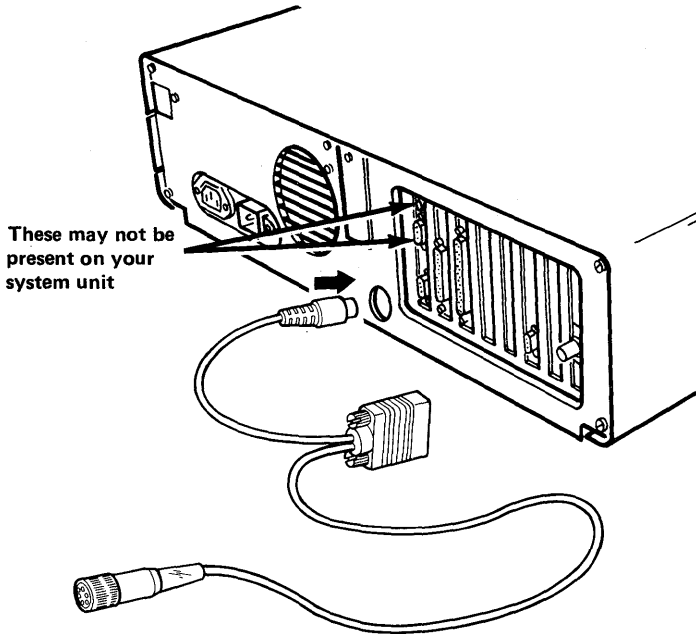

-
3. Connect the square plug on the keyboard adapter cable to the lower connector in slot 8 on the back of the system unit, and tighten the screws. Slot 8 is the leftmost slot.

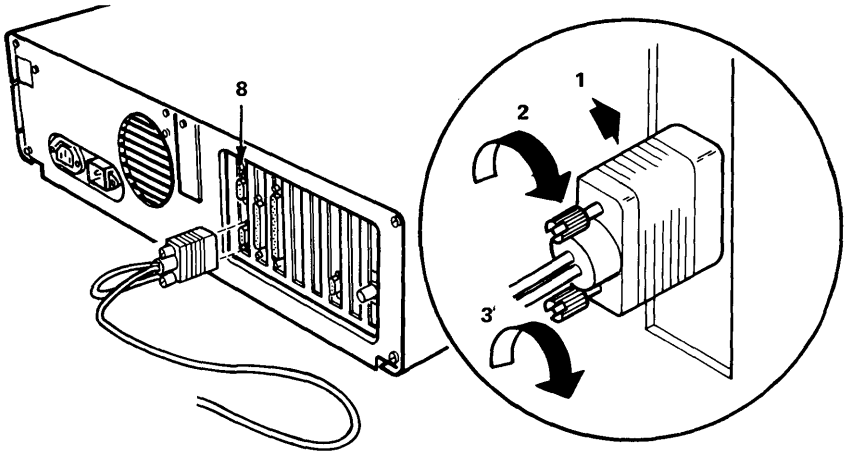

4. If there is a plastic cap on the keyboard cable connector, remove it.

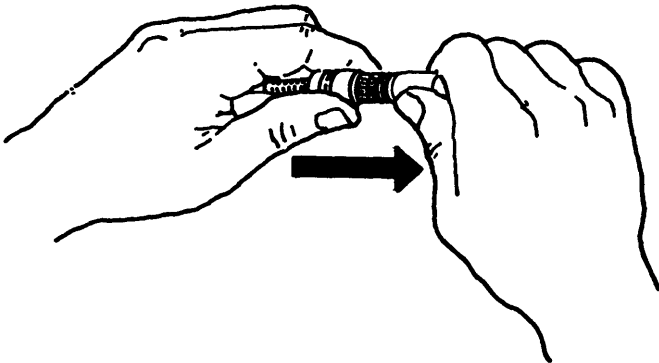

-
5. Connect the round plug on the light gray end of the keyboard adapter cable to the end of the keyboard cable.

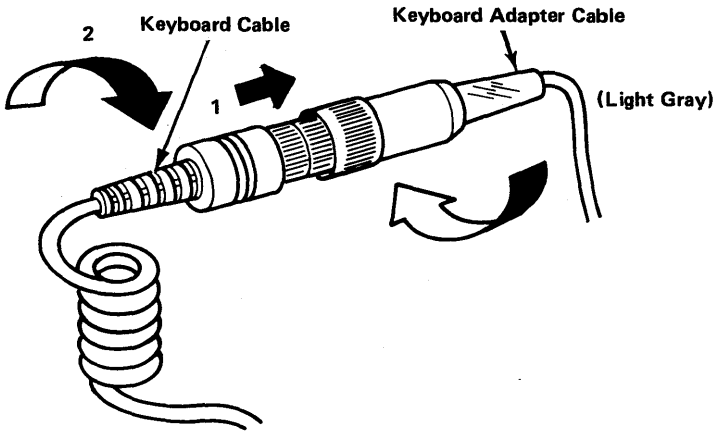

If you have a color display, continue with the next section, "Setting Up a Color Display." If you have a monochrome display, skip the next section and continue with the section "Setting Up a Monochrome Display" on page 2-27.

Setting Up a Color Display

1. Place the display on your desk. Get the base and the power cord.

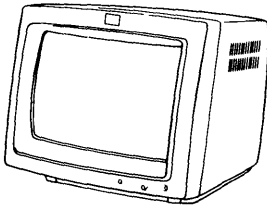

Color Display

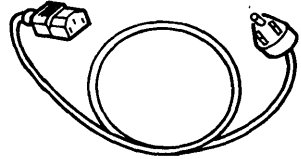

Power Cord

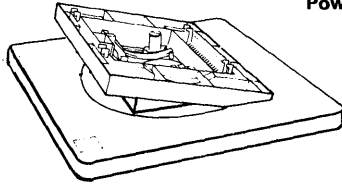

Adjustable Base

2. Tip the display onto its back.

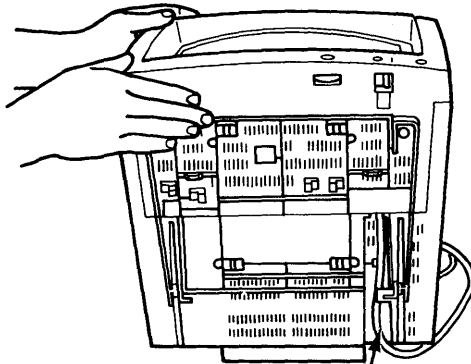

Display Signal Cable

Make sure that the display cable lies flat in the channel on the bottom of the display.

3. Position the base as shown.

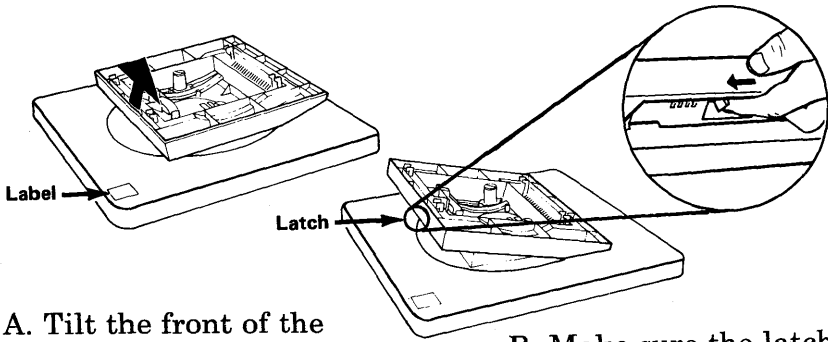

A. Tilt the front of the base upward to expose the latch.

B. Make sure the latch is moved all the way to the left.

4. Position the base so the label faces the O/I switch

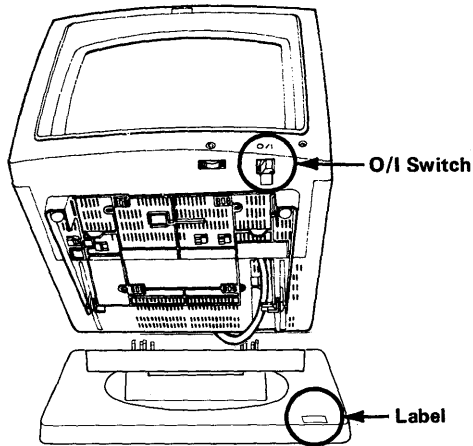

-
5. Attach the base to the bottom of the display by inserting the 4 pairs of L-shaped tabs on the base into the 4 pairs slots on the bottom of the display.

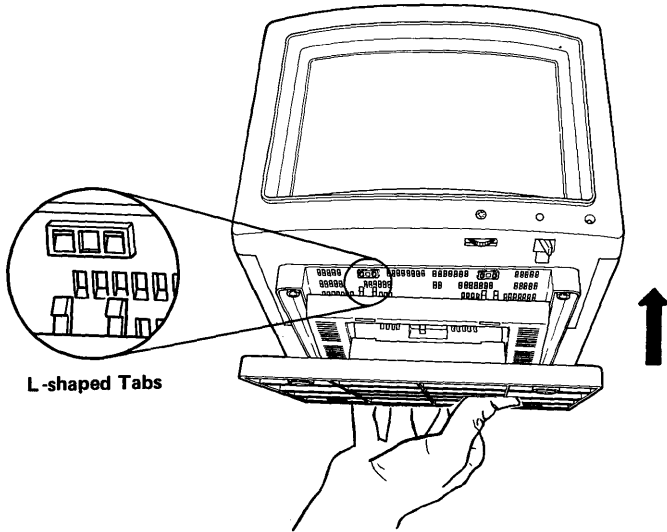

6. Pull upward on base to lock the base into position.

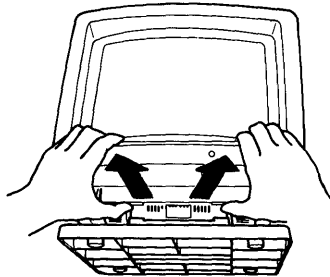

7. Carefully turn the display upright on its base.

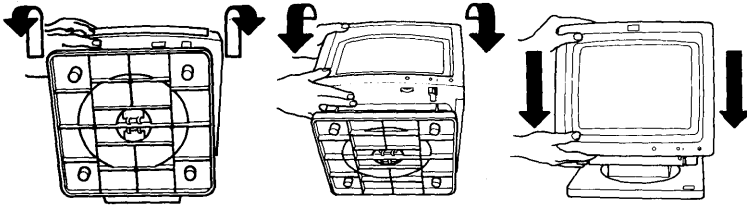

8. Turn the O/I switch to OFF.

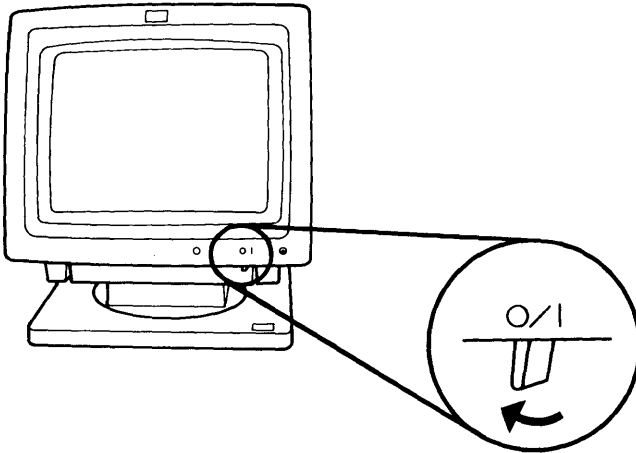

-
9. Plug the power cord into the back of the display.

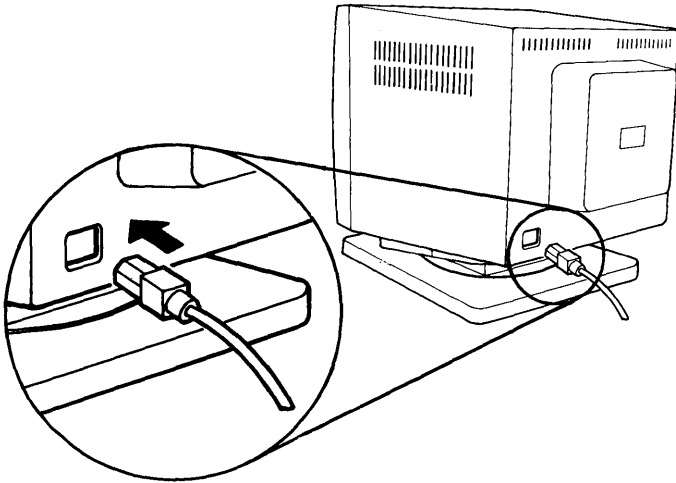

Do not plug the power cord into a wall outlet until you are told to do so later.

-
10. Attach the display cable to the connector in slot 3 on the back of the system unit, and tighten the screws.

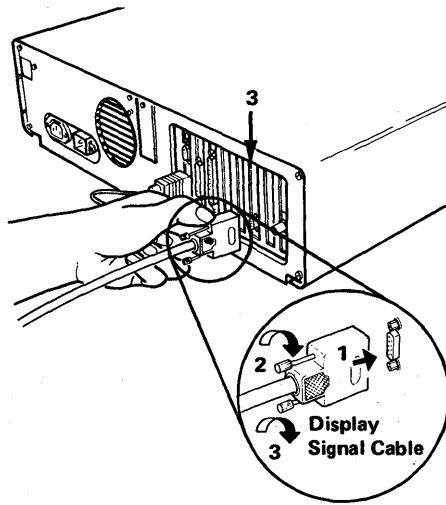

The display cable is attached to the back of the display.

Continue with “Step 3. Plugging in the Units and Arranging Them” on page 2-29.

Setting Up a Monochrome Display

1. Place the display on your desk.

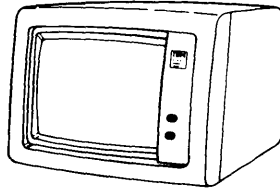

Monochrome Display

2. Connect the display cable to the connector in slot 3 on the back of the system unit, and tighten the screws. Slot 3 is the third slot from the right.

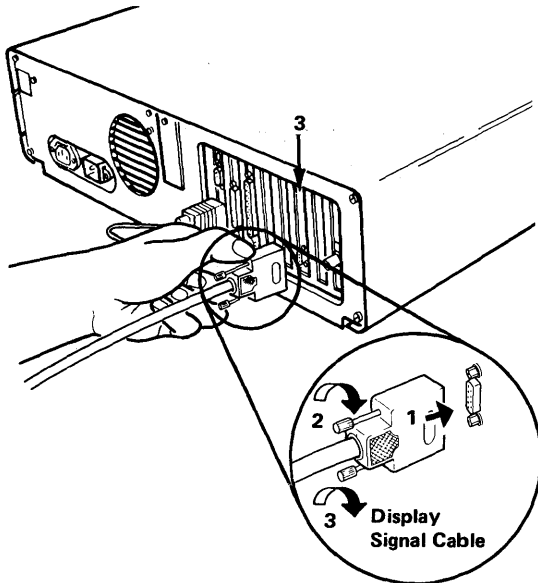

-
3. Plug the power cord into the back of the system unit.

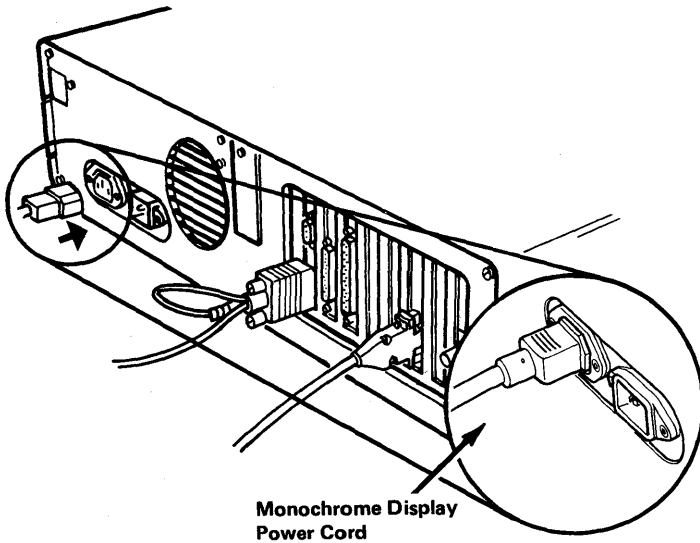

Continue with "Step 3. Plugging in the Units and Arranging Them" on page 2-29.

Step 3. Plugging in the Units and Arranging Them

This step tells you how to plug in your units and suggests ways to arrange them on your desk.

Plugging in the Units

1. Make sure that the system unit is turned off.

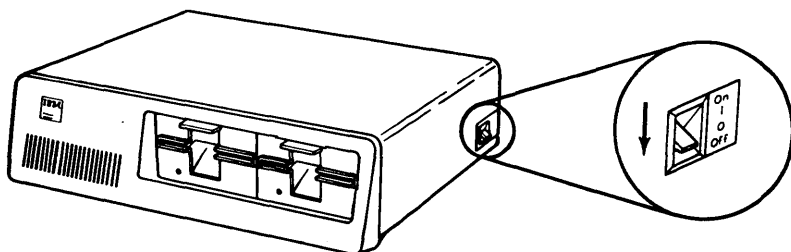

2. **CAUTION**

Use a properly grounded outlet to avoid electrical shock.

If you have a color display, plug the display into a properly grounded wall outlet.

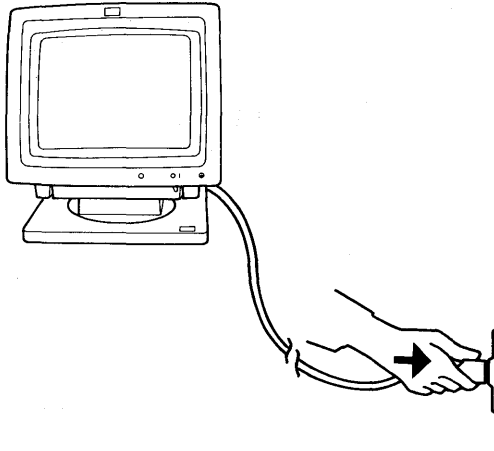

-
3. **CAUTION**
Do not make this connection during an electrical storm.

Attach the coaxial cable from your hosts' 3274 Control Unit to slot 1 on the back of your system unit. Slot 1 is the rightmost slot.

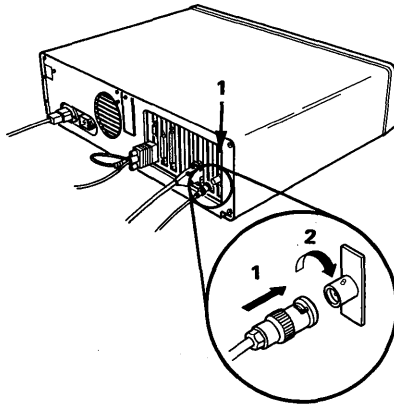

4. **CAUTION**
Use a properly grounded outlet to avoid electrical shock.

Plug the system unit into a grounded wall outlet.

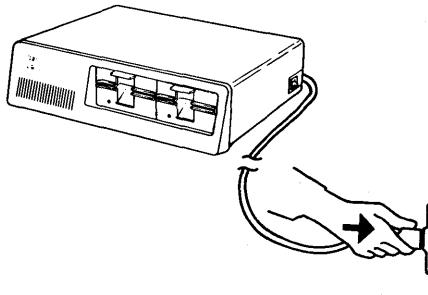

-
5. If you have any other units that have their own power cords, plug them into properly grounded outlets.

Continue with the next section, “Arranging the Units on Your Desk.”

Arranging the Units on Your Desk

After you have plugged in all the units, you can arrange them like this:

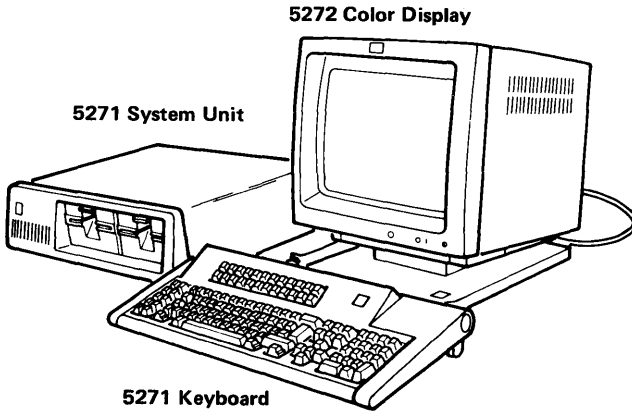

Or this:

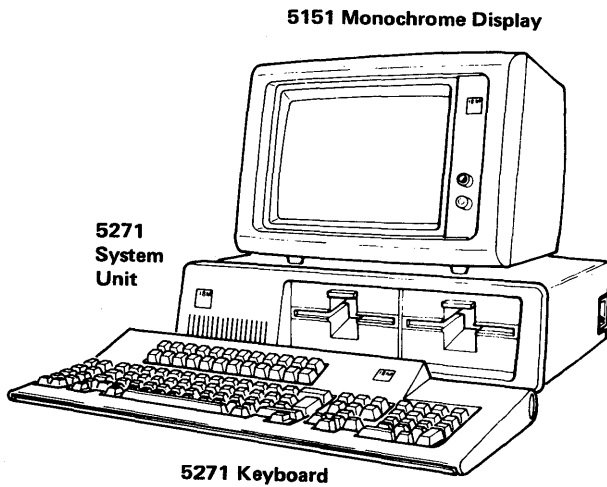

You should try to arrange the units so that the top of the display is at eye-level. If the units are too heavy, have someone else help you move them.

Adjusting the Height of the Keyboard

1. Press in the buttons on the side of the keyboard.

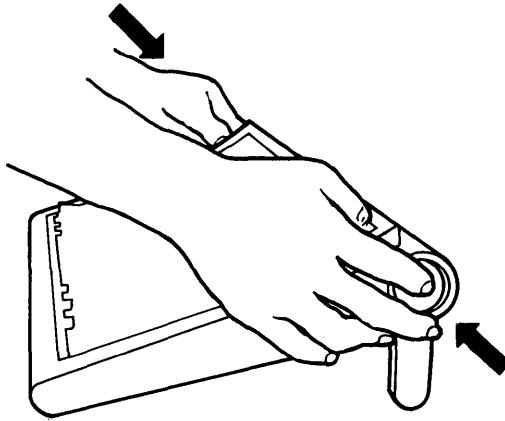

The legs should drop down.

-
2. If the long legs are too high, push the long legs back into the bottom of the keyboard.

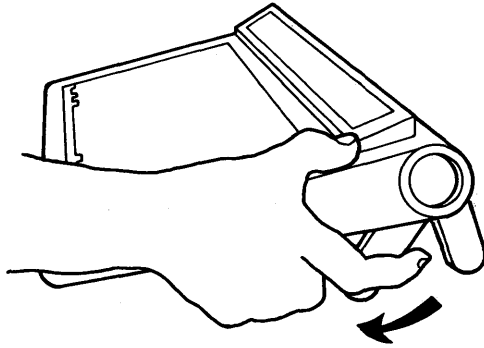

We recommend the short legs.

3. If the short legs are also too high, push them back also.

What to Do Next

You should now have all your units set up, connected to each other, plugged in, and arranged comfortably on your desk. You are ready to test your system. Go on to “Step 4, Checking Out the 3270 PC with the Power-On Self Test.”

Step 4. Checking Out the 3270 PC with the Power-On Self Test

This step tells you how to turn on the 3270 PC and what to look for when it tests itself.

Don't Turn on Your System Unit Yet

Wait until you have read the next section that describes the Power-On Self Test or POST, for short.

What to Expect

Every time you turn on your 3270 PC, it tests itself. You should know what to look for while the tests are running.

Three things will happen:

1. The memory in your system unit is tested. As it is tested, the amount of memory that was checked and is working appears in the upper left corner of your screen.



xxx KB OK

Note: This number (shown by xxx) changes by units of 16 as you watch, until all of the available storage in your system has been checked. When the number stops

changing, the last number that appears should be the total amount of memory in your 3270 PC including the amount on optional memory cards that may have been installed. For example, if you have not added memory, this number is 256 for the Model 2, 384 for Models 4 and 6. You can check the total on the screen with the amount of memory you wrote on the IBM 3270 Component Record card in the back of this manual.

2. You will hear one short "beep".

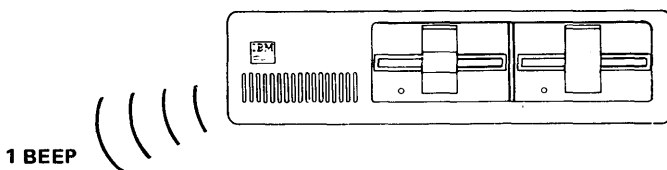

You may also hear the diskette drive hum and see the red "in use" lights flicker on and off.

-
3. The diagnostic program will be loaded into memory, and you will hear a second short beep.

Your screen should look like this:

```
The IBM 3270 Personal Computer
DIAGNOSTICS
Version x.xx Copyright IBM Corp. 19xx

SELECT AN OPTION

0 - RUN DIAGNOSTIC ROUTINES
1 - FORMAT DISKETTE
2 - COPY DISKETTE
3 - PREPARE SYSTEM FOR RELOCATION
9 - EXIT TO SYSTEM DISKETTE

ENTER THE ACTION DESIRED
? _
```

Notice the short line that looks like an underscore () after the question mark. It is called a cursor. The cursor must be on the screen in the location shown in the illustration.

Turning on the 3270 PC

You are now ready to turn on your 3270 PC:

1. Get the Diagnostic Diskette from the back of this binder.

When you handle any diskettes, always:

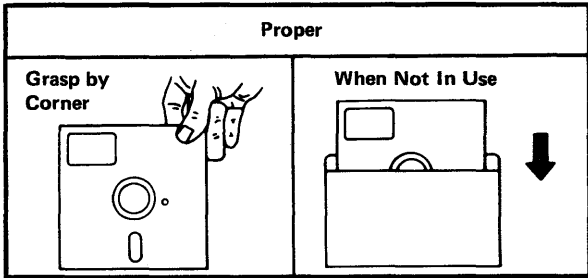

Never:

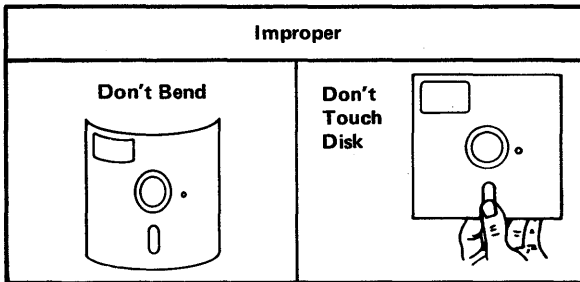

-
2. If you have a color display, turn it on.

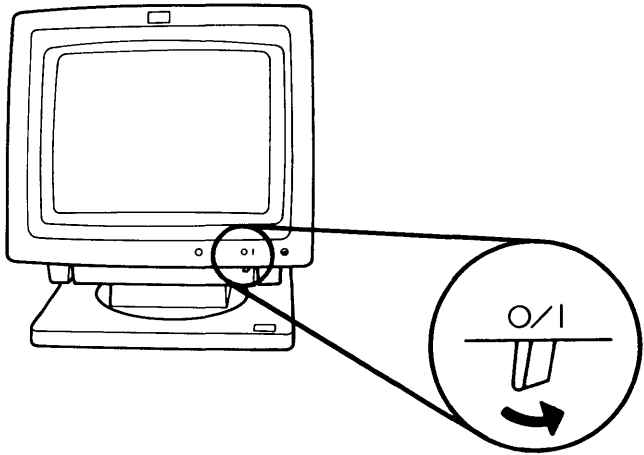

3. If you have a monochrome or color display, turn the brightness control clockwise as far as it will go.

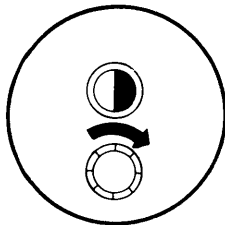

Monochrome

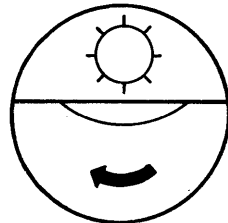

Color

4. If you have the expansion unit or any other optional units attached, turn them on.

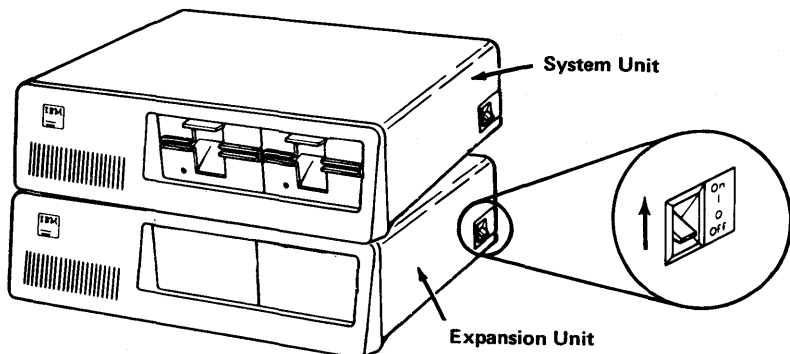

Note: If you are turning on the system unit for the first time, you should not have any other options attached.

5. Make sure that the load lever on diskette drive A is up, and insert the Diagnostic Diskette.

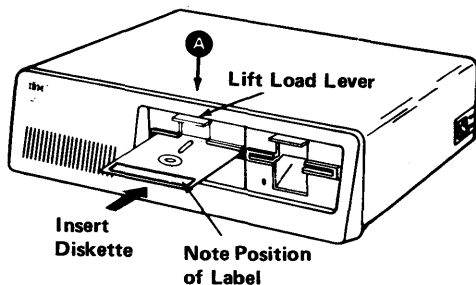

-
6. Push down the load lever.

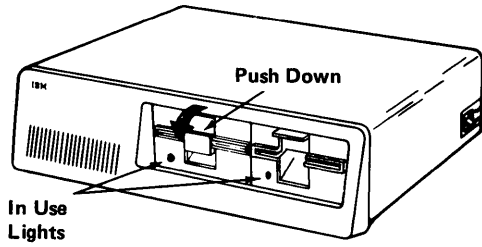

7. Turn on the system unit.

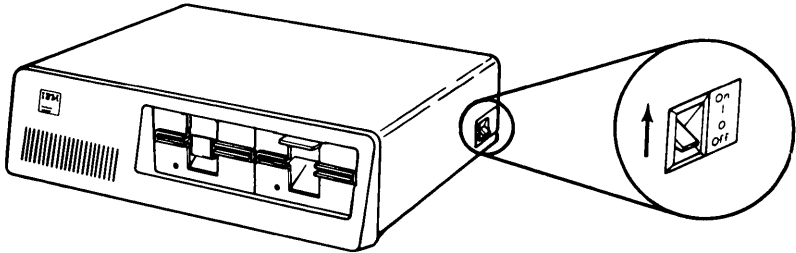

8. Wait approximately 2 minutes for the POST to finish.

If you missed the POST the first time, turn off your system unit and turn it on again.

Did the POST Run Correctly?

Did you see and hear:

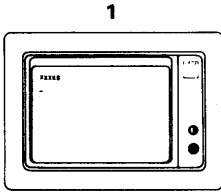

Memory Test

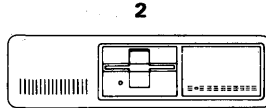

One Short Beep

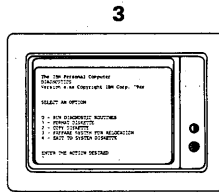

**IBM Personal Computer
Diagnostics Panel and
One Short Beep**

If you did:

1. Remove the Diagnostic diskette from drive A.
2. Put it back in the plastic holder in the back of this binder
3. You are ready to go on.
 - If you have optional units to install, continue with "Step 5. Option Instructions" on page 2-47.
 - If you do not and you want to familiarize yourself with the operation of the 3270

PC units, skip Step 5 and go to Chapter 3, "Operating Your 3270 Personal Computer" on page 3-1.

- If you are going to use the 3270 PC Control Program, go to either:

Chapter 1 in *Book 2 - Setting Up and Learning the Control Program*.

Or,

Appendix A in the *Control Program Users's Guide and Reference*

If the POST did not run correctly, read on.

What to Do If the POST Does Not Run Correctly

Go to Chapter 5, "Locating Problems with Your 3270 PC Units" on page 5-1 and follow the instructions to locate the unit with the problem and to report it or have the unit serviced.

Step 5. Option Instructions

You may have options to install on your 3270 PC. Many of these options come with Option Instructions booklets. We have included places in this step for these option booklets:

- Adapter cards
- Expansion units
- Input devices
- Memory expansion cards
- Printers
- Any other options

The option booklets look like this:

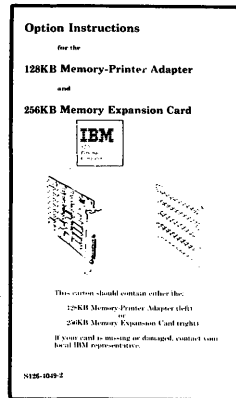
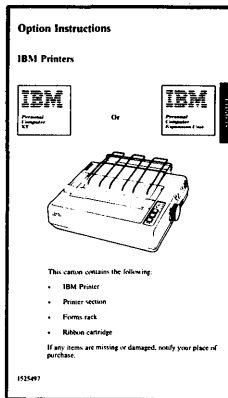
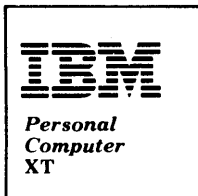
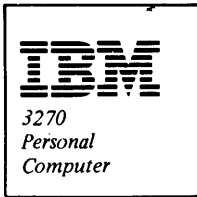

Filing the Option Booklets

If you have not already filed your option booklets here, do that now. Be sure to put them behind the correct instruction pages that follow. As you add new options in the future, be sure to place the new option booklets behind the correct instruction pages, also. You may also have booklets for options that were installed in your system unit at the factory; keep them.

Always Read the Instruction Pages First

Before you use any of the booklets to install or set up any of the options, read the notes (for example, about handling cards and switch settings) on the instruction pages first.

When you are using your system with options added, always check the insert booklets in this step or the separate manuals first for information you may need about an option. Be sure that you refer to them for solving any problems that you may have with the options.

What to Do after You Have Installed All Your Options

After you have installed or set up all the options that you have,

1. Update the charts in the back of this manual.
2. Go back to “Step 4. Checking Out the 3270 PC with the Power-On Self Test” on page 2-37, and rerun the POST.

Installing the Options

You are now ready to install or set up your options. Go to the the instruction pages for the options that you are going to install and read them first. Then go to the booklets for the options.

Adapters

This section is reserved for Option Instructions for the:

- All Points Addressable Adapter
- Asynchronous Communications Adapter
- Programmed Symbols Adapter
- Any other adapters

Filing Instructions

Place the booklets for the *Personal Computer XT* or the *3270 Personal Computer* behind the next page.

Handling Adapter Cards

Static electricity can damage adapter cards. This is the same kind of static electricity that makes a spark when you touch a doorknob after walking on a carpet. The cards that are sensitive come wrapped in a special plastic bag. Before you remove the card from its bag:

1. Hold the card (still wrapped in the bag) in one hand, and with your other hand hold the metal portion of a screwdriver or other metal object.

-
2. Touch the screwdriver or metal object to an **unpainted** metal part of your system unit (for example, the screws on the back).

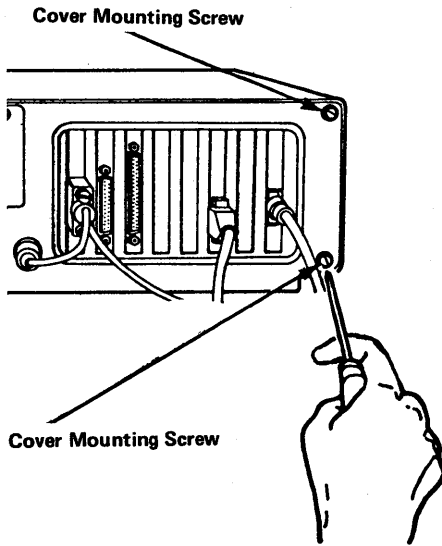

When you do this, you equalize the static charge on the card, on you, and on the system unit. You will prevent an accidental static discharge that can damage the sensitive circuits on the card.

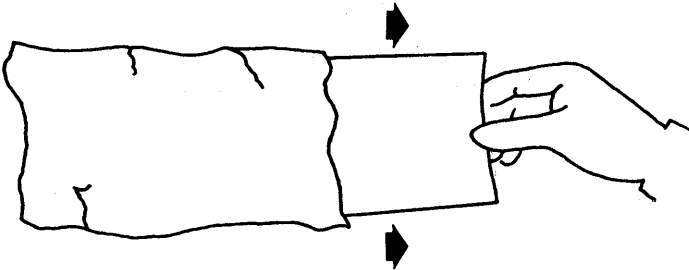

-
3. Carefully remove the adapter from its bag.

Be sure to handle circuit boards by the edges only and do not touch the component pins or solder joints.

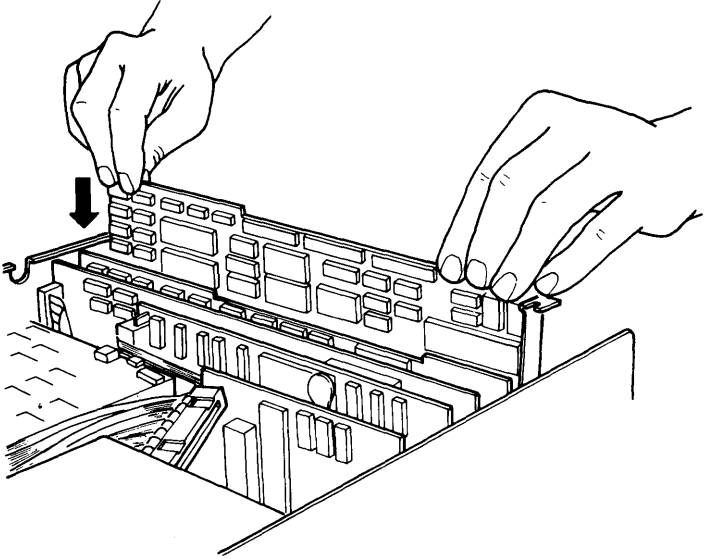

4. Hold the card by its top edge or corners when you insert it into the system unit or the expansion unit.
5. Now, go to the Option Instruction booklet, and follow the instructions there.



Expansion Unit

This section is reserved for Option Instructions for the:

- 5161 Expansion Unit Model 1 (for Models 2 and 4)
- 5161 Expansion Unit Model 2 (for Model 6)

Filing Instructions

For the 5161 Expansion Unit Model 1, place only the Option Instruction booklet for the *Personal Computer* behind this page. Discard the metal brackets, the plug-in module, and all the other pages that came with this unit.

For the 5161 Expansion Unit Model 2, place only the Option Instruction booklet for the *Personal Computer XT* behind this page. Discard all the other pages that came with this unit.

Which Adapters Can You Install in the Expansion Unit?

In either of these booklets, ignore the lists of adapter cards that can be installed in the expansion units. Instead, use the Adapter Locations card in the back of this binder for a list of adapter cards that can be installed in the expansion units.

Extender Card Switch Settings

In the option booklets, ignore any instructions to set switches on the Extender Card. Instead, set the switches on the card to match the amount of memory in the system unit. This table shows the correct switch settings:

For a System with a Total Memory of:	Set the Extender Card Switches to: 1 2 3 4
256K	1 0 1 1
320K	1 0 1 0
384K	1 0 0 1
448K	1 0 0 0
512K	0 1 1 1
576K	0 1 1 0
640K	0 1 0 1

Now, go to the Option Instruction booklet and follow the instructions there.

Memory Expansion Cards and Modules

This section is reserved for Option Instructions for the:

- 128KB Memory-Printer Adapter
- 256KB Memory Expansion Card
- 64/256KB Memory Expansion Card
- 64KB Memory Module Kit

Filing Instructions

Place the booklets for the *Personal Computer XT* or the *3270 Personal Computer* behind the page after next.

Handling Memory Expansion Cards

Static electricity can damage memory cards and modules. This is the same kind of static electricity that make a spark when you touch a doorknob after walking on a carpet. The cards that are sensitive, come wrapped in a plastic bag. Before you remove the adapter card from its bag:

1. Hold the card (still wrapped in the bag) in one hand and with your other hand hold the metal portion of a screwdriver or other metal object.

-
2. Touch the screwdriver or metal object to an **unpainted** metal part of your system unit (for example, the screws on the rear of the system unit).

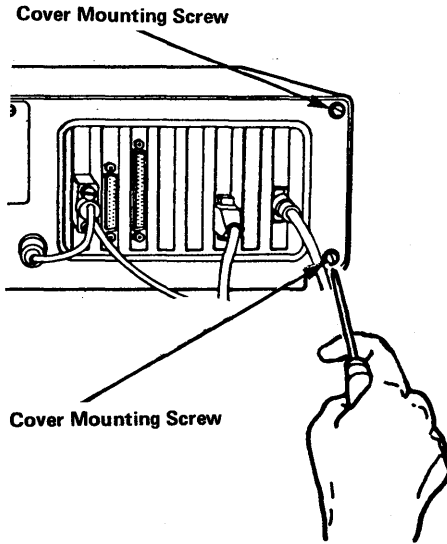

When you do this, you equalize the static charge on the card, on you, and on the system unit. You prevent an accidental static discharge that can damage the sensitive circuits on the card.

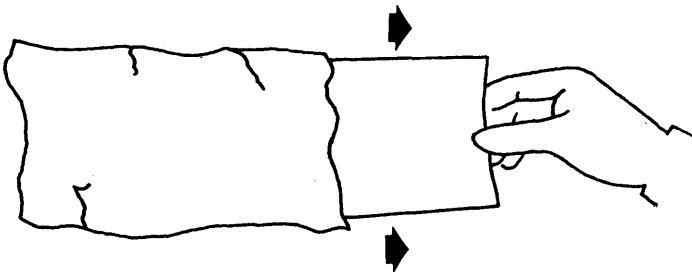

-
3. Carefully remove the option from its bag.

Be sure to handle circuit boards by the edges only and do not touch the component pins or solder joints. Handle memory modules by their narrow end and not by their pins.

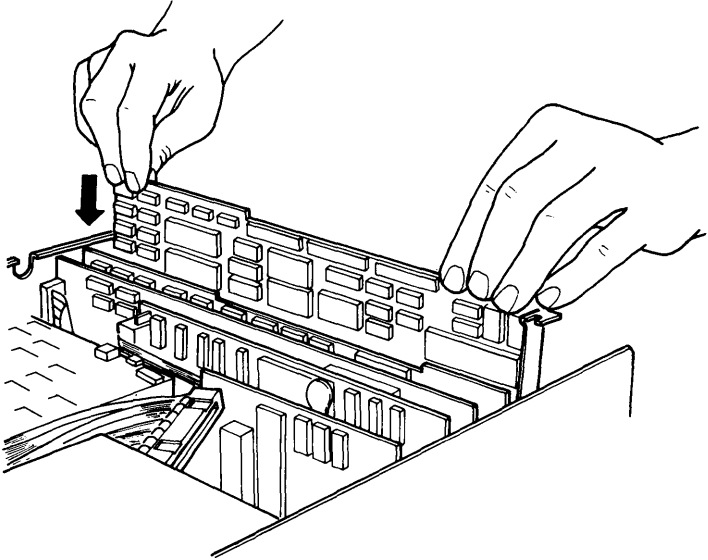

4. Hold the card by its top edge or corner when you insert the card into the system unit.

Setting Switches for the Memory Cards

In any of these booklets, ignore any instructions for setting switches on your system board. These switch settings for your 3270 PC are set correctly by IBM. You must set the switch on the memory card to match the settings in this table:

If You Add:	By Installing These Memory Cards:	Set the Switches on the Cards to: 1 2 3 4 5 6 7 8
64KB*	64/256KB Option with 64KB installed	1 0 1 1 1 0 0 0
128KB*	64/256KB Option with 128KB installed	1 0 1 1 0 1 0 0
	128KB Memory-Printer Adapter	0 1 0 1
192KB*	64/256KB Option with 192KB installed	1 0 1 1 0 0 1 0
	128KB Memory-Printer Adapter +	0 1 0 1
	64/256KB Option with 64KB installed	1 0 0 1 1 0 0 0
256KB*	64/256KB Option with 256KB installed	1 0 1 1 0 0 0 1
	128KB Memory-Printer Adapter +	0 1 0 1
	64/256KB Adapter with 128KB installed	1 0 0 1 0 1 0 0
320KB*	128KB Memory-Printer Adapter +	0 1 0 1
	64/256KB Option with 192KB installed	1 0 0 1 0 0 1 0
	64/256KB Option with 256KB installed +	1 0 1 1 0 0 0 1
	64/256KB Option with 64KB installed	0 1 1 1 1 0 0 0

If You Add:	By Installing These Memory Cards:	Set the Switches on the Cards to: 1 2 3 4 5 6 7 8
384KB*	128KB Memory-Printer Adapter + 256KB Expansion Card	1 0 0 1
	128KB Memory-Printer Adapter + 64/256KB Option with 256KB installed	0 1 0 1 1 0 0 1 0 0 0 1
	64/256KB Option with 256KB installed + 64/256KB Option with 128KB installed	1 0 1 1 0 0 0 1 0 1 1 1 0 1 0 0

*If you have an expansion unit, remember to reset the switches on the extender card in the system unit to match the new total memory. The new total = the amount of memory you are adding + 256KB. See the section on the expansion unit for the correct switch settings.

Now, go to the Option Instruction booklets, and follow the instructions there.



Printers

This section is reserved for Option Instructions for the:

- 3852 Color Printer
- 5201 Quietwriter
- 5216 Wheelprinter
- 5218 Printer and 5218 Printer Sharing Device
- 5152-2 Personal Computer Graphics Printer
- 5182 Personal Computer Color Printer
- Any other printers

Filing Instructions

If your printer has Option Installation and Operating Instruction booklets, place the booklets for the *Personal Computer XT* or the *3270 Personal Computer* behind this page.

Disregard any instructions in the booklets to replace pages in this manual.

Attaching Your Printer Cable to the System Unit

1. After you have set up your printer, attach the printer cable to the connector in slot 7. Slot 7 is the second slot from the left.

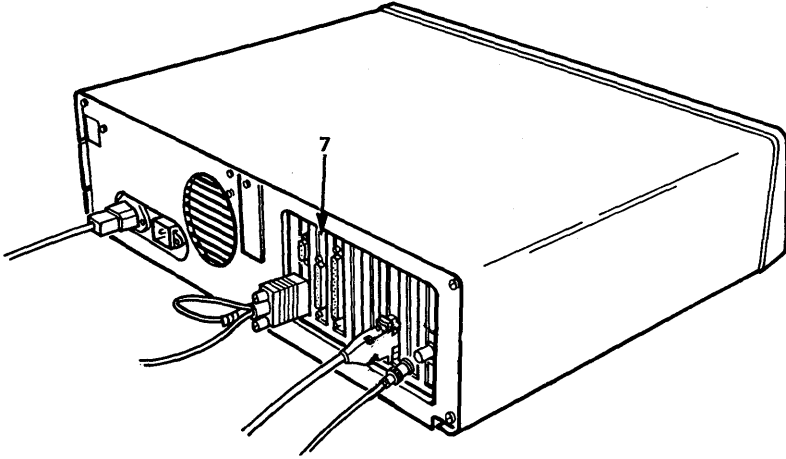

Now, go to the Option Instruction booklet, and follow the instructions there.

Any Other Options

This section is reserved for the Option Instructions for:

- IBM Personal Computer Keylock
- IBM Personal Computer Printer Stand
- Any other optional accessories

Filing Instructions

Place the booklets for the *Personal Computer XT* or the *3270 Personal Computer* behind this page.

Now, go the Option Instruction booklets, and follow the instructions there.

10/10/10

1

Chapter 3. Operating Your 3270 Personal Computer

This chapter shows you how to operate these units:

- System unit
- Diskette drive
- Fixed disk
- Display
- Keyboard

Note: Instructions on operating any optional units that you have are described in the booklets that came with the units. These booklets should be inserted in "Step 5. Option Instructions" on page 2-47.

Operating the System Unit

The basic controls for the system unit (Models 2, 4, and 6) are:

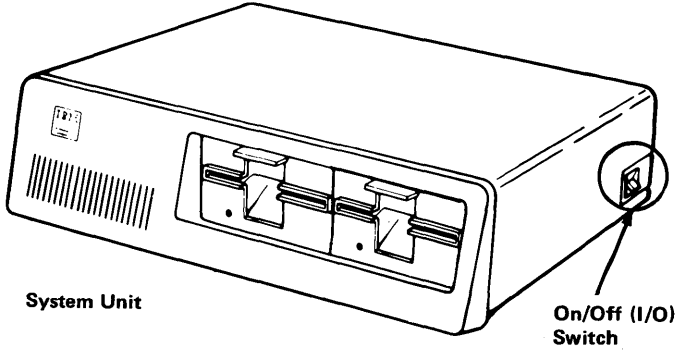

This is a Model 4.

- You can turn the system unit on and off:

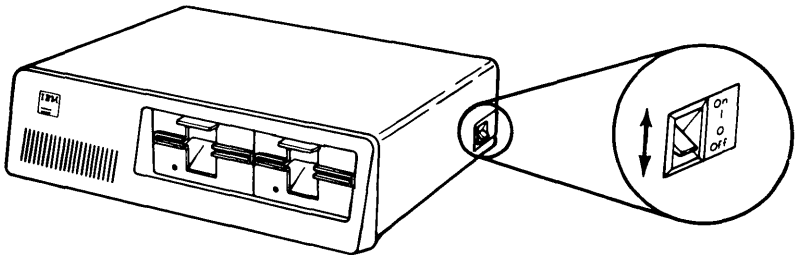

This is a model 4.

Operating the Diskette Drive

The basic controls for the diskette drive (Models 2, 4, and 6) are:

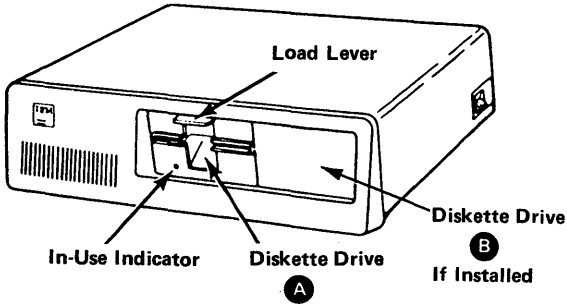

This is a Model 2.

- You can insert a diskette:

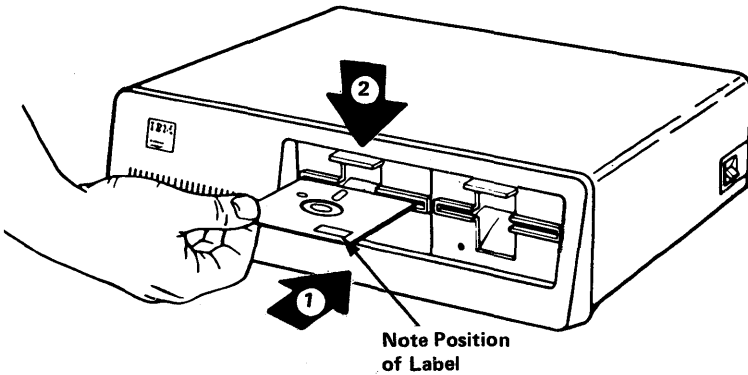

-
- You can remove a diskette:

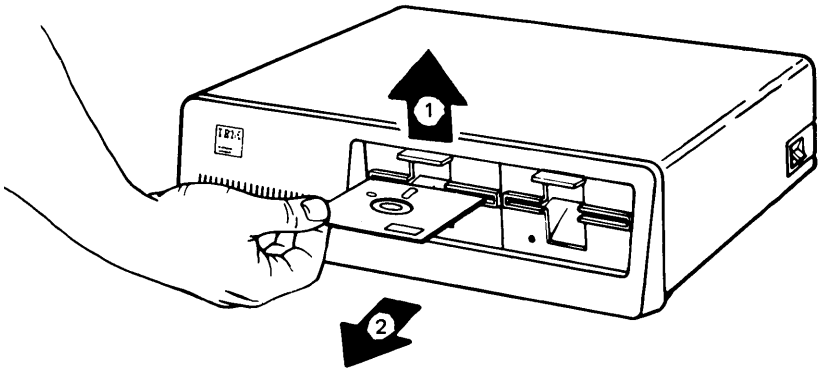

CAUTION

Always leave the lever up when the diskette drive is empty. Leaving the lever down when the drive is empty can damage the drive. Do not leave a diskette in the drive when the system unit is turned off.

Handling Diskettes

Be careful when you handle diskettes.

Always:

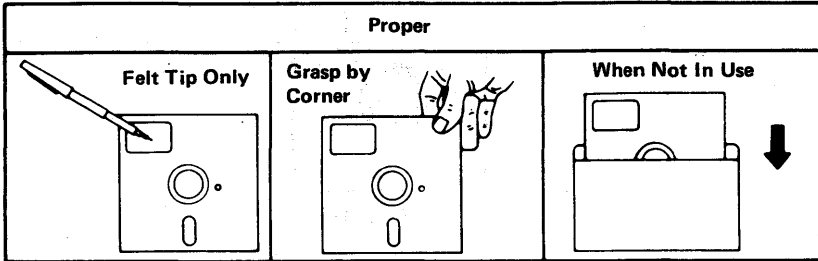

Never:

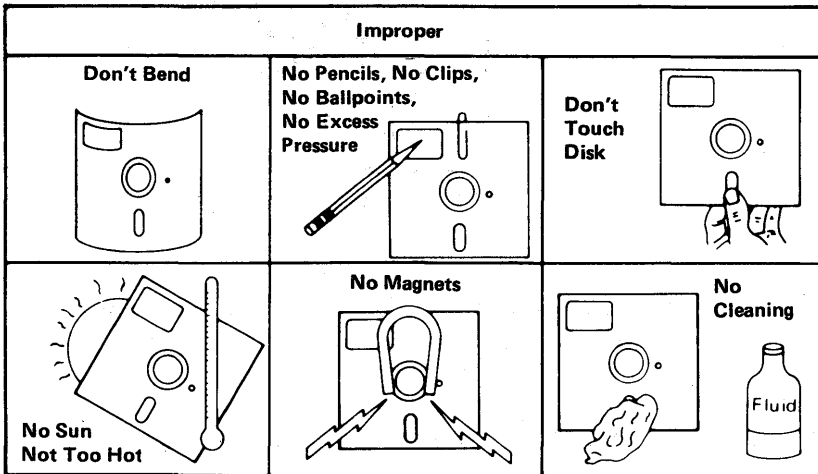

Writing on Diskettes

You cannot write onto diskettes that don't have a notch in the side.

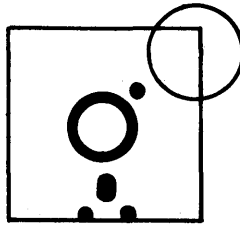

Write-Protected

You can write onto diskettes that have a notch.

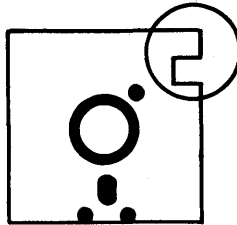

Non-Write-Protected

You can protect a diskette with a notch by placing a tab over the notch. Tabs are usually included in boxes of diskettes.

Formatting Diskettes

New diskettes must be formatted before you can write onto them. See the `FORMAT` command in the *Disk Operating System* manual, for instructions on formatting blank diskettes.

Operating the Fixed Disk

The fixed disk has no controls. You only see the in-use light.

Model 6:

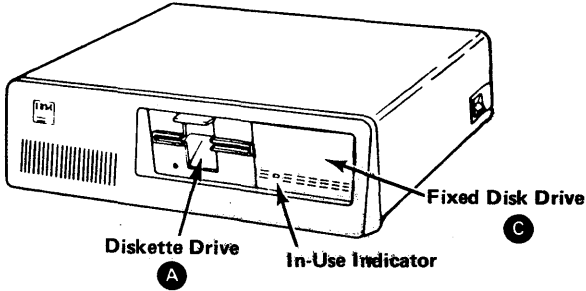

Preparing a New Fixed Disk

If your system unit is new, the fixed disk must be prepared before it can be used to store data. Do not prepare your fixed disk unless you are sure that it must be. Ask your supervisor or the person you call when you need assistance.

Operating the Monochrome Display

The basic controls for the monochrome display are:

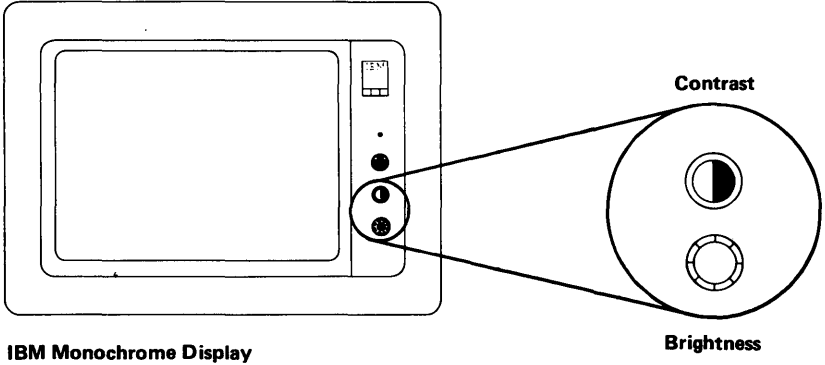

- You can adjust the brightness so that it is comfortable to look at.

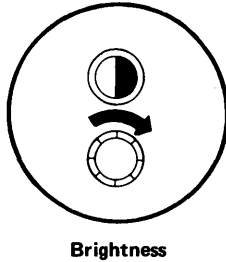

Clockwise is brighter.

-
- You can adjust the contrast.

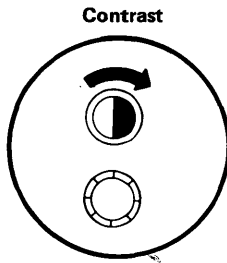

Clockwise is more contrast.

Operating the Color Display

The basic controls for the color display are:

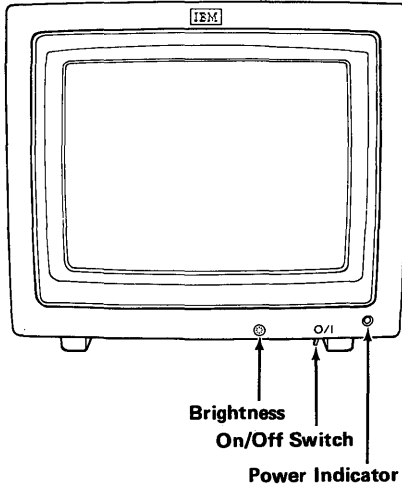

- You can turn it on and off:

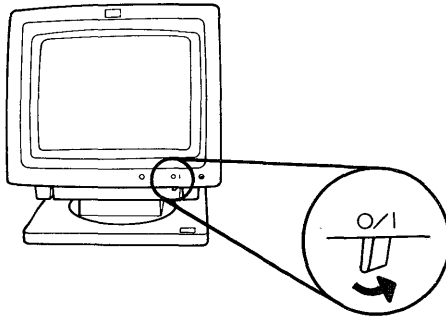

-
- You can adjust the brightness so that it comfortable to look at.

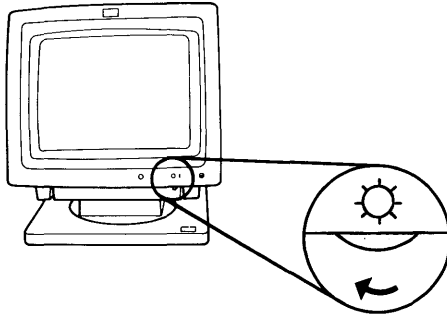

Clockwise is brighter.

- You can swivel the display right and left:

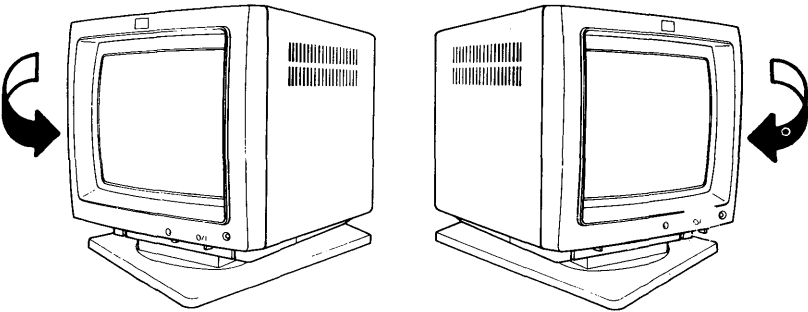

-
- You can tilt the display up and down:

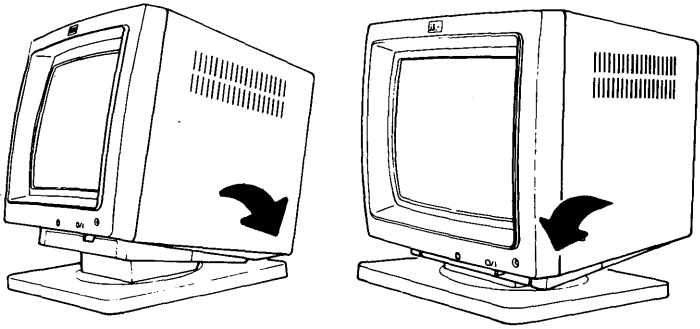

Operating the Keyboard

The keys on the keyboard are divided into 5 areas. They are:

Program Function Keys

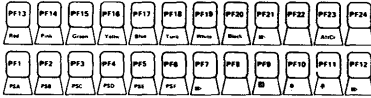

Numeric Keypad

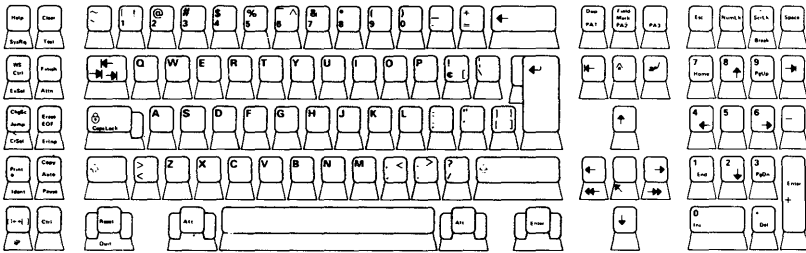

Left Control Keys

Typewriter Keyboard

Right Control Keys

The keys operate with a control program.

- If you are using the 3270 PC Control Program, the keyboard is explained in either:
 - Chapter 3 and Appendix B of *Book 3 - Using the Control Program*
 - Or,
 - Chapter 4 of the *Control Program User's Guide and Reference*.
- If you are using only the Disk Operating System without the 3270 PC Control Program, or if you will be using BASIC or BASICA, the keyboard is explained in the Supplement Booklet for BASIC that came with this manual.

-
- If you will be using some other control program, you must read its user's manual for instructions on using the keyboard.

Operating Optional Units

Use the option booklets or user's manuals that came with the optional units to learn how to operate them. The option booklets should be inserted in "Step 5. Option Instructions" on page 2-47.

What to Do Next

If you are setting up and using the IBM 3270 PC Control Program, go to either:

- Chapter 1 in *Book 2 - Setting Up and Learning the Control Program*.
- Or,
- Appendix A in the *Control Program User's Guide and Reference*

If you have Book 2, you should have inserted it behind Book 1 in this binder.

If you are using only DOS, go to the manual *Disk Operating System*.

If you are using BASIC or BASICA, go to the manual *BASIC by Microsoft*, for instructions.

If you are using another control program, go to its user's manual for instructions on what to next.

Chapter 4. Moving Your IBM 3270 PC to a New Location

This chapter explains how to prepare your 3270 PC units before you move them a short distance to a new location, ship them a long distance, or return them to a service center for repair.

Getting Started

- If you are moving your whole work station, go to the section, “Preparing Your System Unit or Expansion Unit” on page 4-2 and read all the remaining sections in this step.
- If you are shipping only one of your units (the system unit or display, for example), go to the section that describes how to prepare or remove that unit and then read the last section, “Final Steps” on page 4-14.
- If you are just removing a unit, go to sections “Removing Your Keyboard” on page 4-7, and “Removing Your Display” on page 4-9, or “Removing Your Printer” on page 4-13 as needed.

Note: If you have to ship one or all of your work station components, you should ship them in their original cartons. If the original cartons are not available, contact your supervisor or the person who handles computer problems to order replacement cartons.

Preparing Your System Unit or Expansion Unit

This section explains how to prepare your system unit (or expansion unit, if attached) for moving or shipping.

Do you have a fixed disk drive installed?

Yes

No

Go to "Preparing your Diskette Drives" on page 4-5

Preparing your Fixed Disk

Warning: Normal shipping and handling can result in a permanent loss of data on the fixed disk drive. It is recommended that all files be backed up onto diskettes .

To protect against a possible loss of data, follow the steps below.

1. Use the IBM Personal Computer DOS BACKUP command to copy the data from your fixed disk onto diskettes.

For Instructions on how to use this command, see your *IBM Personal Computer DOS 2.0* manual (or a version of DOS with a higher number).

2. After you back up your fixed disk data, return to this manual and continue with the next step.

-
3. Now that you have backed up your fixed disk, you are ready to prepare the fixed disk for the move:
 4. Get the Diagnostics diskette from the back of this manual.
 5. Insert it into drive A and push the load lever down.
 6. If your display has an On/Off (I/O) switch, set the switch to On (I).
 7. If you have an expansion unit, turn it on.
 8. Turn on the system unit.

The following panel should appear on your screen.

```
The IBM 3270 Personal Computer
DIAGNOSTICS
Version x.xx Copyright INM Corp. 19xx
```

```
SELECT AN OPTION
```

```
0 - RUN DIAGNOSTIC ROUTINES
1 - FORMAT DISKETTE
2 - COPY DISKETTE
3 - PREPARE SYSTEM FOR RELOCATION
4 - EXIT TO SYSTEM DISKETTE
```

```
ENTER THE ACTION DESIRED
```

```
?_
```

9. Press 3, then Enter to select PREPARE SYSTEM FOR RELOCATION. This step moves the disk head over the highest available cylinder.

10. The following message should appear.

```
The IBM 3270 Personal Computer
DIAGNOSTICS
Version x.xx Copyright IBM Corp. 19xx
```

```
SELECT AN OPTION
```

```
0 - RUN DIAGNOSTIC ROUTINES
1 - FORMAT DISKETTE
2 - COPY DISKETTE
3 - PREPARE SYSTEM FOR RELOCATION
9 - EXIT TO SYSTEM DISKETTE
```

```
ENTER THE ACTION DESIRED
```

```
73_
```

```
FIXED DISK(S) READY FOR SHIPPING
```

11. Remove the Diagnostic Diskette from the diskette drive and return it to the back of this binder.
12. Set the On/Off (I/O) switches for all work station components to Off (O).
13. Continue with the next section, "Preparing Your Diskette Drives" on page 4-5.

Preparing Your Diskette Drives

1. Make sure all the On/Off (I/O) switches for your work station units are turned off.
2. Unplug all the work station units from the electrical outlets.
3. Insert the shipping cardboards that came with your system unit into the diskette drives.

The cardboard is used to protect the drive magnetic heads during shipping. You should have stored these cardboard protectors in the back of this manual.

Note: If you do not have shipping cardboard, DO NOT ship the system with the load levers down; this can cause diskette drive head damage.

4. If you have the shipping cardboard in place, push the load levers down and put a strip of masking tape (or equivalent tape) over the lever to hold it in place.

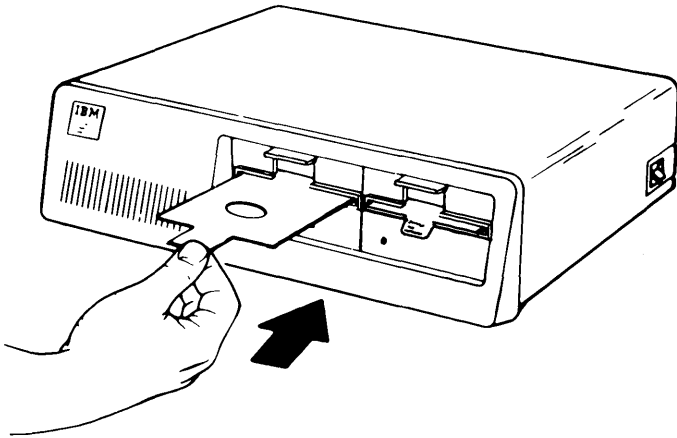

-
5. If you are moving or shipping your entire work station, continue with the next section “Removing Your Keyboard” on page 4-7.

Removing Your Keyboard

This section explains how to remove your:

- **IBM 3270 Personal Computer Keyboard (5271)**

- **Keyboard Adapter Cable**

1. Make sure all the On/Off (I/O) switches for your work station units are turned off.
2. Turn the metal sleeve of the keyboard cable counterclockwise until the cable is loose.
3. Disconnect the keyboard cable from the keyboard adapter cable.

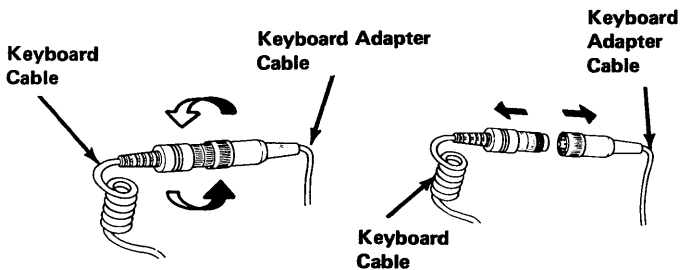

-
4. Loosen and remove the keyboard adapter cable from the system unit.

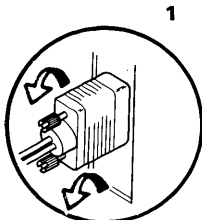
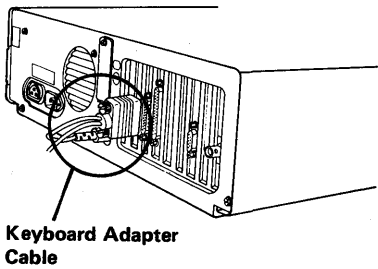

Loosen

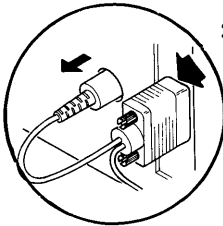

Remove

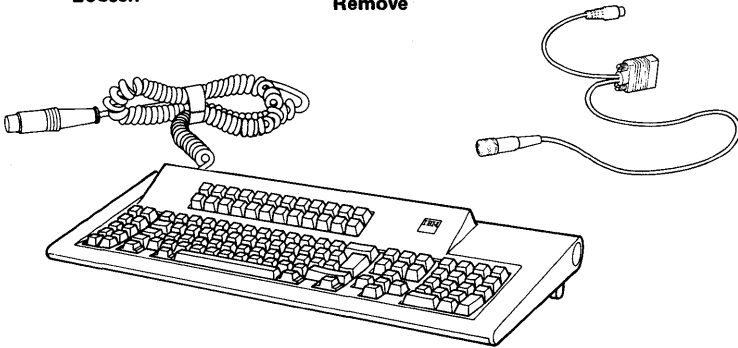

5. Tape the keyboard cable and the keyboard adapter cable to the keyboard to prevent damage to the connectors.
6. If you are moving or shipping your entire work station, continue with the next section "Removing Your Display" on page 4-9.

Removing Your Display

This section explains how to remove your:

- **IBM Monochrome Display (5151)**
 - **IBM 3270 Personal Computer Color Display (5272)**
1. Make sure all the On/Off (I/O) switches for your work station units are turned off (O) (including your display, if it has a switch).
 2. Unplug the power cord for the display from the wall outlet or the outlet on the back of the system unit.

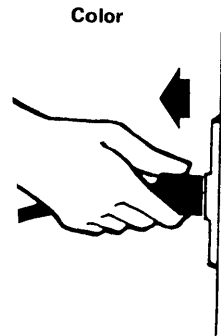
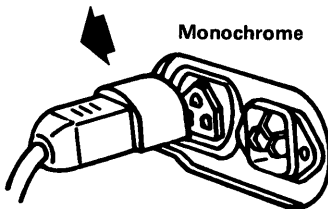

-
3. Remove the display signal cable from the back of the system unit.

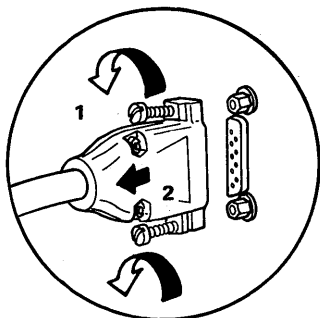

Monochrome

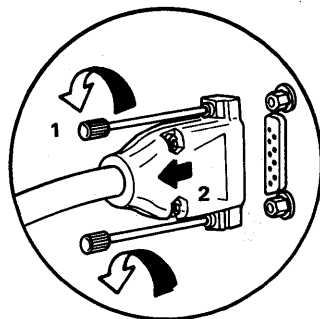

Color

4. If you have the monochrome display, go to step 9 on page 4-12. If you have a color display, continue with the next step.
5. Hold the display carefully and tip it gently onto its back as shown below.

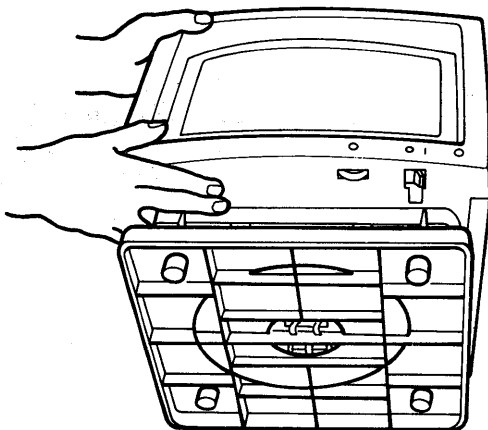

-
6. Tilt the front edge of the adjustable base outward to expose the latch.

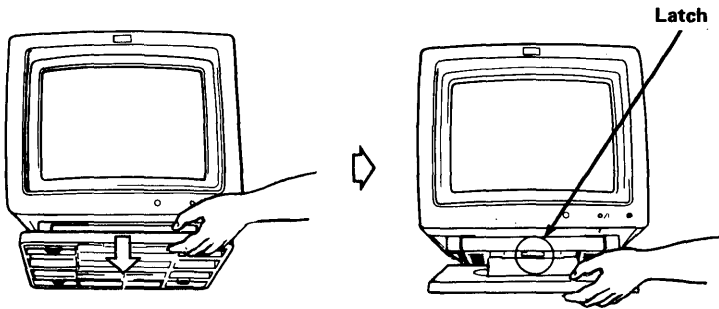

7. Push and hold the latch to the right to disengage the base from the display bottom.

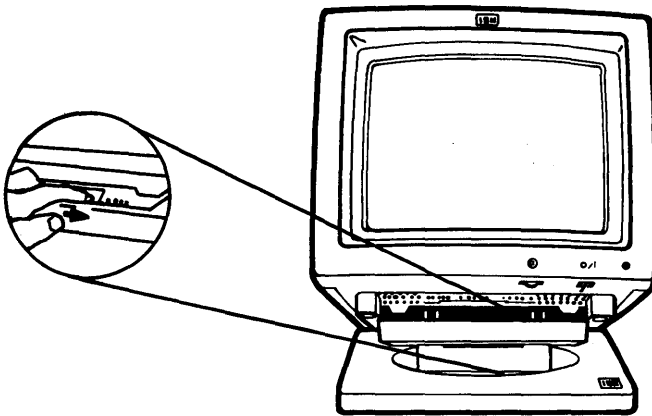

-
8. After you have removed the base, tip the display back to the upright position.

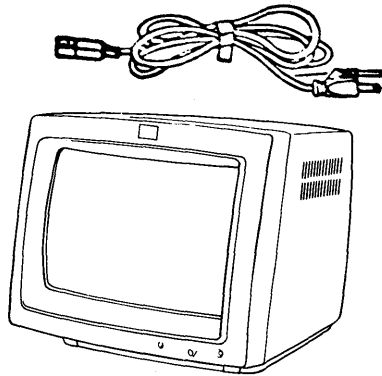

9. Coil the power cord and display cable and tape them to the display to prevent damage to the connectors.
10. If you are moving or shipping your entire work station, continue with the next section "Removing Your Printer" on page 4-13.

Removing Your Printer

Refer to the option instructions that were shipped with your printer for any special instructions on removing your printer.

You should have inserted the Options Booklets for your printer in “Step 5. Option Instructions” on page 2-47.

Make sure that you remove the printer cable from the system unit or expansion unit. The printer cable is attached to the connector in slot 7 on the system unit.

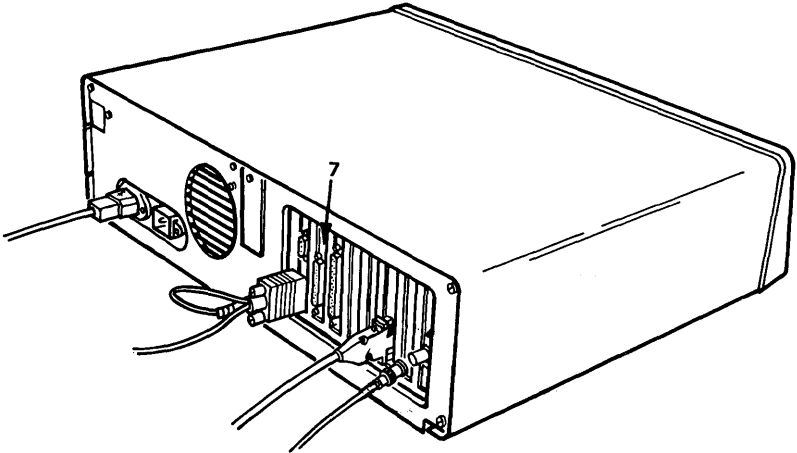

If you are moving or shipping your entire work station, continue with the next section “Final Steps” on page 4-14.

Final Steps

1. **CAUTION**

Do not connect or disconnect a coaxial cable during an electrical storm.

Remove the coaxial cable from the system unit.

2. Remove all remaining cables attached to the system unit, and coil and tape these cables to the system unit.
3. If you have an expansion unit, remove all remaining cables attached to it, and coil and tape these cables to the expansion unit.
4. Follow the instructions below, for a short- or long-distance move.

Short-Distance Move

For a short-distance move, you do not have to pack the units in cartons.

By **short-distance**, we mean any distance that does not involve trucking, for example, moving from one office or floor to another.

We recommend that each unit be moved separately.

Long-Distance Move

For a long-distance move, you must pack the units in secure cartons.

If you have saved the cartons and packing material that your IBM 3270 Personal Computer was shipped in, use them to pack your units.

Refer to the packing instructions that were shipped with your unit.

If you have not saved your original cartons, contact your IBM representative for information on ordering replacement cartons.

Setting Up the Units at the New Location

When your IBM 3270 Personal Computer arrives at its new location, carefully unpack it.

For setting up and cabling, refer to the instructions in Steps 2 through 5 of this chapter.

If you have moved the 3270 PC to another country, and if the electrical voltage in the new country is different than the voltage shown on the label on the back of your system unit, **do not plug it in!** First, contact your IBM representative.

Chapter 5. Locating Problems with Your 3270 PC Units

This chapter tells you what to do if:

- The POST fails to run correctly, or
- If you have been directed here from your Control Program book.

Since symptoms that appear on one unit may be caused by problems with another unit, you should always begin these instructions with “Step 1. Check Your Cable and Power Cord Connections” on page 5-3, and follow them step by step. They will help you locate the unit that has the problem so you can report the problem it accurately and obtain service promptly.

If you are told, in this chapter, to have a unit serviced, follow your company’s procedures to report the problem or to have the unit fixed.

Step 1. Check Your Cable and Power Cord Connections

1. Set all work station On/Off (I/O) switches, and any other attached devices, to Off (O).
2. Disconnect all non-IBM devices.
3. Unplug the system unit from the electrical outlet.
4. Plug a working lamp or small appliance into the outlet to make sure it has electrical power.
5. **CAUTION**

Do not do this next step during an electrical storm.

Make sure the all the cable connections between your units are secure and that the connector pins are not loose or damaged.

System Unit Cables

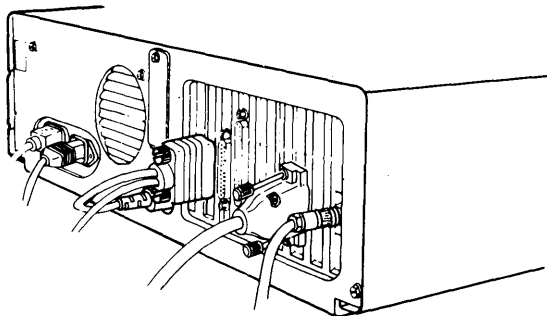

6. CAUTION

This product is equipped with a power cord and plug that is grounded for your safety. To avoid a possible electrical shock, do not alter this plug or plug it into an ungrounded wall outlet.

Plug the system unit power cord back into the wall outlet.

Continue with “Step 2. Run the Power-On Self Test.”

Step 2. Run the Power On Self-Test (POST)

1. If your display has an On/Off (I/O) switch turn it On (I).
2. If your display has a contrast or brightness control, make sure they are turned clockwise as far as they turn (full intensity).
3. Make sure the On/Off (I/O) switch for the system unit (and expansion unit, if attached) is Off (O).

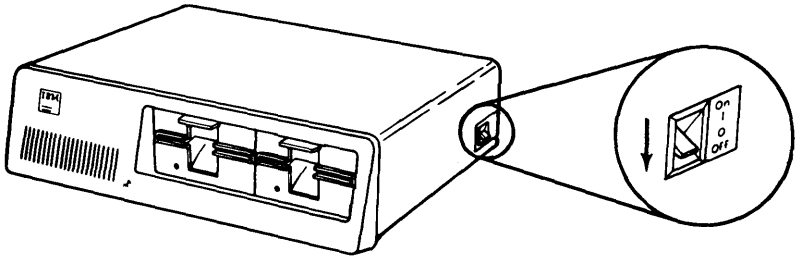

4. If there is a diskette in drive A, remove it.
5. Get the Diagnostic diskette from the back of this binder.
6. Insert the Diagnostic diskette in drive A.
7. Push down the lever on drive A.
8. If you have an expansion unit attached, turn it On (I).

If you do not turn on the expansion unit first, you will get an error message.

9. Turn the system unit On (I).

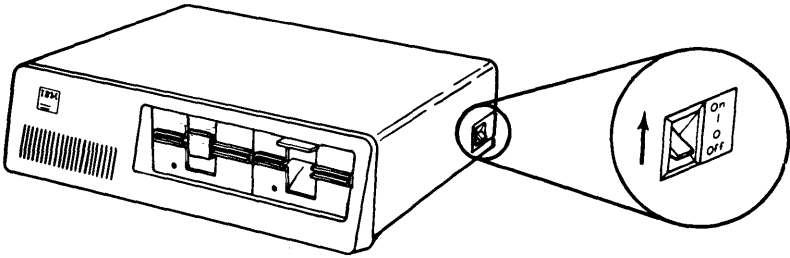

10. Watch and listen carefully for the three POST responses.

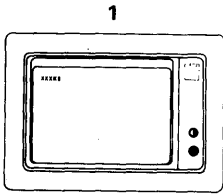

Memory Test

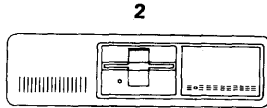

One Short Beep

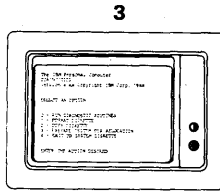

**IBM Personal Computer
Diagnostics Panel and
One Short Beep**

11. Watch the memory test.



The amount of memory (shown by the *xxx*) that has been checked and is working appears in the upper corner of your screen. A cursor will appear under the first digit of the number. If you have not added memory, this number is 256 for the Model 2 and 384 for Models 4 and 6. If you have added memory, you can check the total on the screen with the amount of memory you wrote on the IBM 3270 Component Record card in the back of this manual.

12. If the memory test did not run correctly make a note of what is on the screen and the position of the cursor.
13. Wait at least 90 seconds, and listen for one short beep.

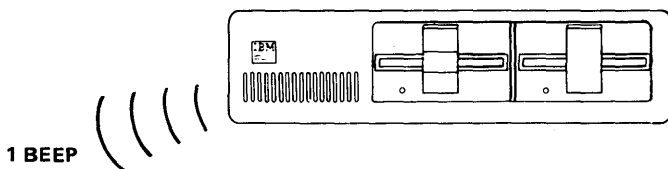

You may also hear the diskette drive hum and see the "in-use" lights flicker on and off. After a pause, you will hear a second short beep when the diagnostic program is loaded.

14. If you did not hear the beeps, separated by a pause, make a note of what you heard or that you did not hear anything.

15. Wait for this panel to appear on your screen:

The IBM 3270 Personal Computer
DIAGNOSTICS
Version x.xx Copyright IBM Corp. 19xx

SELECT AN OPTION

0 - RUN DIAGNOSTIC ROUTINES
1 - FORMAT DISKETTE
2 - COPY DISKETTE
3 - PREPARE SYSTEM FOR RELOCATION
9 - EXIT TO SYSTEM DISKETTE

ENTER THE ACTION DESIRED
? _

16. If this panel does not appear make a note of what did appear.

17. **Now** answer the following questions, and follow the instructions for the answers you give.

Did all three responses (above) occur correctly?

No Yes

Do you suspect you have a problem with your keyboard?

Yes No

There does not appear to be anything wrong with your system.

- If the Diagnostic diskette did not encounter the same problem, your system diskette or your fixed disk may have a problem. Try a new system diskette or call your supervisor or the person who handles computer problems. You can also refer to the *IBM 3270 PC Hardware Problem Determination manual, GA23-0233*.
- If you continue to have a problem that does not show up during the POST, call your supervisor or the person who handles computer problems, or refer to the *IBM 3270 PC Hardware Problem Determination manual, GA23-0233*.
- If you were directed here by the problem determination procedures for the control program, go back to your control program book, and follow the procedures there for reporting a software problem. ●

Note: The IBM 3270 PC Hardware Problem Determination manual did not come with your work station. You can order a copy from your IBM representative.

Go to Step 7, Keyboard Check on page 5-27.

Did you just add an option to your system unit?

No Yes

|
Make sure that you installed the option correctly.

If you find that you did not install the option correctly, correct the problem.

Rerun the POST.

If the POST does not run correctly, remove the option, and rerun the POST again. If the POST still does not run correctly, your system unit has a problem. Report the problem or have the unit serviced to fix the problem. ●

If the POST runs correctly, the option has a problem. Report the problem or have the option serviced to fix the problem. ●

1. Be sure that you made a note of your screen and audio responses.

If you missed the responses, rerun the POST.

2. Go to the POST Error Chart on page 5-11.

Step 3. Find Your Problem in the POST Error Chart

Start with symptom number one in the chart. Look at the screen and audio responses. If they do not match what you saw and heard during the POST, look at the rest of the symptoms in order until you find the symptom that you saw and heard. When you have found your symptom, follow the instructions in the last column.

POST Error Chart

Symptom	If Your Screen Looks Like This:	And You Heard:	Then Do This:
1	Blank or an incorrect display	No beep	Go to "Step 4. Do the External Device Check" on page 5-15.
2	Amount of memory is missing or wrong. The screen is not blank.	Correct audio response ¹	The system unit or the keyboard adapter cable has a problem. Report the problem or have them serviced to fix the problem.
3	One of the following: <ul style="list-style-type: none">● Correct display, but no cursor● Cursor only²● Cursor in the wrong position● Cursor in reverse video	1 beep or correct audio response ¹	The system unit ² or the keyboard adapter cable has a problem. Report the problem or have them serviced to fix the problem.

Chart continues on next page.

¹ A *correct audio response* is one beep, a pause, and then a second beep when the diagnostic program is loaded.

² A non-system diskette or a faulty diskette in your diskette drive could be the cause of the problem. Remove all diskettes from the drives and rerun the POST.

Symptom	If Your Screen Looks Like This:	And You Heard:	Then Do This:
4	Blank screen or an incorrect display (including TV-type problems).	Correct audio response ¹ or 4 beeps	Go to "Step 5, Do the Display Check" on page 5-17
5	0302 ERROR (RESUME = "F1" KEY)	2 beeps	The keyboard or its adapter cable has a problem. Report the problem or have them serviced to fix the problem.
6	1701 ERROR (RESUME = "F1" KEY)	2 beeps	If you have a fixed disk in your system unit, the system unit has a problem. Report the problem or have the unit serviced to fix the problem. If you have a fixed disk in your expansion unit, the expansion unit or its cable has a problem. Report the problem or have them serviced to fix the problem.
7	1801 ERROR (RESUME = "F1" KEY)	2 beeps	Make sure that you turned on the expansion unit before the you turned on the system unit, and make sure that the cables are securely attached. If you did, the expansion unit or its cable has a problem. Report the problem or have them serviced to fix the problem. If the expansion unit is not causing the problem, the system unit or the keyboard adapter cable has a problem. Report the problem or have them serviced to fix the problem.
8	28xx ERROR Or: 32xx ERROR (RESUME = "F1" KEY) ³	Any number of beeps	The system unit or the keyboard adapter cable has a problem. Report the problem or have them serviced to fix the problem.

Chart continues on next page.

³ xx can be any number.

Symptom	If Your Screen Looks Like This:	And You Heard:	Then Do This:
9	Any other number followed by: (RESUME = "F1" KEY)	Any number of beeps	The system unit or the keyboard adapter cable has a problem. Report the problem or have them serviced to fix the problem.
10	All other incorrect ⁴ screen responses or anything on the screen.	Any number of beeps other than a correct audio response ¹ or 4 beeps	If you have an expansion unit, go to "Step 6, Do the Expansion Unit Check" on page 5-25. If you do not have an expansion unit, the system unit ⁴ or the keyboard adapter cable has a problem. Report the problem or have them serviced to fix the problem.

⁴ An audio response of 1 long and 2 short beeps with a correct screen can be caused by switches on the system board that are incorrectly set. The correct switch settings are: 1 = 0, 2 = 0 for math coprocessor or 1 for no coprocessor, 3 = 0, 4 = 0, 5 = 1, 6 = 1, 7 = 0 for two diskette drives or 1 for one diskette drive, 8 = 1.

Step 4. Do the External Device Check

Do not do this step unless you were told to by Symptom 1 in the POST Error Chart.

1. Turn the system unit Off (O).
2. **CAUTION**
DO NOT disconnect a coaxial cable during an electrical storm.

Remove all cables attached to the system unit except the display or monitor cable and system unit power cord.

-
3. Turn the system unit On (I) and wait 13 to 90 seconds for any beeps. Ignore all error messages and anything else on the screen.

Was there any audio response?

Yes

No

The system unit has a problem. Report the problem or have the unit serviced to fix the problem. ●

Beginning with the keyboard adapter cable (and the keyboard), reconnect the disconnected cables one by one as follows:

1. Turn the system unit Off (O).
2. Reconnect any one of the disconnected cables.
3. Turn the system unit On (I).
4. Listen for any beeps.
5. When there is no beep, the device you connected last has a problem. Report the problem or have the device serviced to fix the problem. ●

Step 5. Do the Display Check

Do not do this step unless you were told to by Symptom 4 in the POST Error Chart.

This check is for the:

- IBM 5272 Color Display
- IBM 5151 Monochrome Display

Do this check only if your screen is blank, unreadable, unstable, incorrect, or matches one of the symptoms shown below:

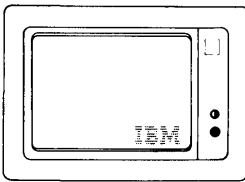

Too Dim

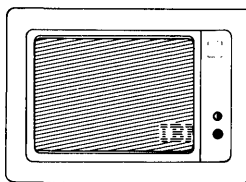

Too Wide

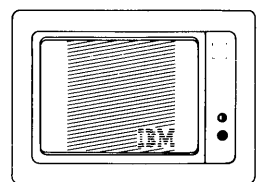

Too Narrow

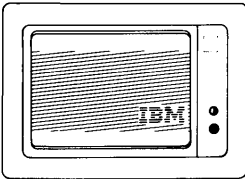

Too Short

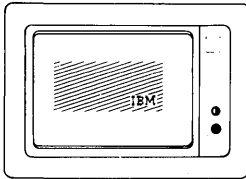

Shrunk

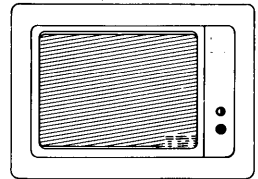

**Changes Size When
Brightness Control
Turned**

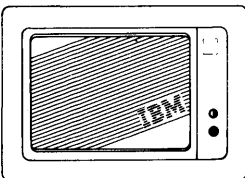

Tilted

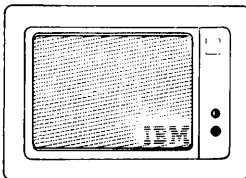

Out of Focus

Do you have a color display?

No

Yes

Is the Power indicator light on?

Yes

No

1. Check the On/Off (I/O) switch on you display. Make sure it is On (I).
2. Check the wall outlet by plugging in a working lamp.

Was there a problem with any of the above?

Yes

No

The display or its power cord has a problem. Report the problem or have them serviced to fix the problem. ●

Correct the problem, and go back to your normal work. ●

1. Get the Diagnostics diskette from the back of this manual.
2. Turn the system unit (and expansion unit, if attached) Off (O).

3. Raise the load lever on disk drive A, insert the Diagnostics diskette into drive A.

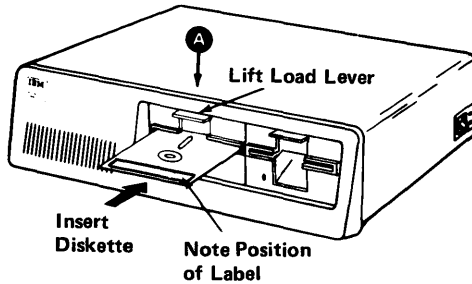

4. Push down the load lever.

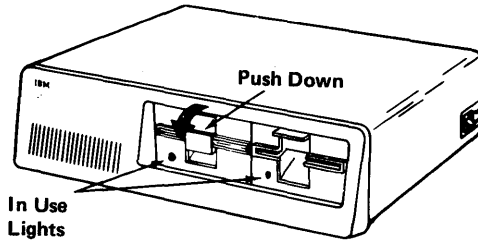

5. If you have an expansion unit attached, turn it On (|).
6. Turn the system unit On (|).

-
7. Wait approximately 1 to 2 minutes and listen for a long pause and one beep followed by a shorter pause and another beep.

Did you get the two beeps as described above?

Yes

No

|
Remove the diskette and make sure that:

- a. It is the Diagnostics diskette.
- b. You inserted it correctly.

Was there a problem with either *a* or *b*?

Yes

No

|
The system unit has a problem. Report the problem or have the unit serviced to fix the problem. ●

|
Correct the problem and start over with step 1 on page 5-18.

Do the following steps in the sequence listed.
Listen for the beep each time you press the Enter
key.

1. Press 0, then Enter. You should hear one beep after approximately 30 seconds.
2. Press Y, then Enter. You should hear one beep after approximately 1 second.
3. Press 0, then Enter. You should hear one beep after approximately 1 second.
4. Press 3, then 2, then Enter. You should hear one beep after approximately 60 seconds.

Were you able to complete the preceding steps with the correct responses?

Yes No

|
|
| The system unit has a
| problem. Report the
| problem or have the
| unit serviced to fix
| the problem. ●

Was your original POST symptom a blank screen?

No Yes

|
|
| **Is your screen blank now?**

| Yes No

| |
| | The system unit has a
| | problem. Report the
| | problem or have the
| | unit serviced to fix
| | the problem. ●

|
|
| The problem is most likely the display. You should
| confirm this by running this test again with a
| display that you know is working. If the problem
| does not occur with the other display, your original
| display has a problem; report the problem or have
| the display serviced to fix the problem. If the
| problem persists, your system unit has a problem;
| report the problem or have your system unit serviced.
| (If you do not have another working display, report
| your display, or have it serviced.) ●

Is your screen unreadable because of incorrect characters?

Yes No

|
The problem is most likely the display. You should confirm this by running this test again with a display that you know is working. If the problem does not occur with the other display, your original display has a problem; report a problem with the display, or have it serviced to fix the problem. If the problem persists, your system unit has a problem; report a problem with the system unit, or have it serviced. (If you do not have another working display, report your display, or have it it serviced.) ●

The system unit has a problem. Report the problem or have the unit serviced to fix the problem. ●

Step 6. Do the Expansion Unit Check

Do not do this check unless you were told to by Symptom 9 in the POST Error Chart.

Follow this procedure only if you have an expansion unit and your screen response was a blank screen (or it displayed other than the normal screen) and your audio response was any response other than one or four beeps.

1. Turn the system unit and expansion unit Off (O).
2. Disconnect the expansion unit cable at the system unit end.
3. Turn the system unit On (I) and watch and listen for the POST responses.
4. Continue with the next question on page 5-26.

If your screen and audio responses were other than those discussed above, go to the POST Error Chart on Page 5-11.

Did you receive the same error as the first time?

Yes

No

|
|
The expansion unit or its cable has a problem. Report the problem or have them serviced to fix the problem. ●

|
The system unit has a problem. Report the problem or have the unit serviced to fix the problem. ●

Step 7. Do the Keyboard Check

Follow this procedure only if you suspect that you have a problem with your keyboard.

Are any keys on your keyboard working?

Yes No

|

|
The system unit or the keyboard
adapter cable has a problem.
Report the problem or have them
serviced to fix the problem. ●

Repeat what you were doing when you noticed the problem. If you still have the same problem; the keyboard or the keyboard adapter cable has a problem. Report the problem or have them serviced to fix the problem. ●

Index

A

- A drive 3-4
- adapter cards
 - handling adapter cards 2-51
 - installation 2-51
 - installed in an expansion unit 2-55
- Adapter Locations card 2-9
- Adjusting height of keyboard 2-35
- arranging the hardware 2-33

B

- B drive 3-4
- BASIC 3-15
- BASIC Manual filing 2-4
- Books 2 and 3 filing 2-3
- broken hardware
 - in shipping carton 2-9

C

- C drive 3-8
- caution notices
 - attaching coaxial cable during an electrical storm 2-31
 - do not lift shipping carton 2-7
 - leave diskette drive levers open 2-14
 - preparing fixed disk for a move 4-2
 - using a grounded outlet 2-30, 2-31
 - voltage check after a move 4-15

- checking out the hardware after set up 2-37
- coaxial cable caution 2-31
- color display operating 3-11
 - preparing to move 4-9
 - setting up 2-21
- Components Record card 2-9

D

- desk space 2-6
- Disk Operating System (DOS) 3-15
- diskette drive levers caution 2-14
- diskette drives
 - drive A 3-4
 - drive B 3-4
 - operating 3-4
 - preparing to move 4-5
 - setting up 2-14
- diskettes
 - formatting 3-7
 - handling 3-6
 - operating the fixed disk drive 3-8
 - writing on 3-7
- display
 - placing at eye-level 2-34
- displays
 - operating the color display 3-11
 - operating the monochrome display 3-9
 - preparing to move 4-9
 - setting up the color display 2-21
 - setting up the monochrome display 2-27
- DOS (Disk Operating System) 3-15
- DOS Manual 2-6
- drive A 3-4
- drive B 3-4
- drive C 3-8

E

- expansion unit
 - adapter cards that can be installed 2-55
 - extender card switch settings 2-56
 - set up 2-55
- extender card for expansion unit switch settings 2-56

F

- filig
 - BASIC Manual 2-4
 - Books 2 and 3 2-3
 - Maintenance Information 2-4
 - Option Instructions 2-8, 2-48
- fixed disk
 - preparing to move 4-2
- fixed disk drive drive C 3-8
 - operating 3-8
 - preparing the fixed disk 3-8
- formatting diskette 3-7

G

- grounded outlet caution 2-30, 2-31

H

- handling adapter cards 2-51
- handling diskettes 3-6
- handling instruction for hardware 2-11
- handling memory cards 2-57
- hardware
 - arranging on your disk 2-33
 - checking out after ser up 2-37
 - formatting diskettes 3-7

- handling diskettes 3-6
- handling instructions 2-11
- installing options 2-47
- locating problems with 5-1
- moving the hardware 4-1
- operating the color display 3-11
- operating the diskette drive 3-4
- operating the keyboard 3-14
- operating the monochrome display 3-9
- operating the optional units 3-15
- operating the system unit 3-3
- operating, general instructions 3-1
- preparing the fixed disk 3-8
- preparing to move the diskette drives 4-5
- preparing to move the display 4-9
- preparing to move the expansion unit 4-2
- preparing to move the fixed disk 4-2
- preparing to move the keyboard 4-7
- preparing to move the printer 4-13
- preparing to move the system unit 4-2
- setting up 2-11
- setting up after a move 4-15
- writing on diskettes 3-7
- hardware overview 1-1
- hardware problems
 - with shipped items 2-9
- hardware problems locating 5-1
- height adjustment for keyboard 2-35

I

- installing options 2-47
- introduction 1-1
- inventory Record card 2-9

K

- keeping records 2-9
- keyboard
 - adjusting height 2-35
 - operating 3-14
 - preparing to move 4-7
 - setting up 2-17

L

- lifting caution 2-7
- locating problems 5-1
- long distance move 4-14

M

- Maintenance Information
 - filing 2-4
- memory cards
 - handling memory cards 2-57
 - installation 2-57
 - switch settings 2-60
- monochrome display
 - operating 3-9
 - preparing to move 4-9
 - setting up 2-27
- moving instructions
 - diskette drives 4-5
 - displays 4-9
 - fixed disk 4-2
 - general instructions 4-1
 - keyboard 4-7
 - long distance move 4-14
 - printers 4-13
 - short distance move 4-14
 - system unit 4-2

O

- operating instructions
 - color display 3-11
 - diskette drive 3-4
 - fixed disk drive 3-8
 - general 3-1
 - keyboard 3-14
 - monochrome display 3-9
 - options 3-15
 - system unit 3-3
- Option Instructions
 - filing 2-8, 2-48
- options
 - adapter card installation 2-51
 - expansion unit set up 2-55
 - general instructions 2-47
 - memory card installation 2-57
 - operating instructions 3-15
 - other options set up 2-65
 - printer set up 2-63
- other options set up 2-65

P

- packing material 2-7
- personal computer programs 2-6
- plugging in the units 2-29
- POST
 - POST during checkout 2-37
 - Power-On Self Test during check out 2-37
 - what to expect during check out 2-37
 - Power-On Self Test
 - what to expect during check out 2-37
 - preparing the fixed disk 3-8
 - printer set up 2-63
 - printers
 - preparing to move 4-13
 - problems, locating 5-1

S

- setting up
 - color display 2-21
 - keyboard 2-17
 - monochrome display 2-27
 - options 2-47
 - system unit 2-13
- setting up after a move 4-15
- setting up the hardware 2-11
 - color display 2-21
 - expansion unit set up 2-55
 - keyboard 2-17
 - memory card installation 2-57
 - monochrome display 2-27
 - other options 2-65
 - plugging in the units 2-49
 - printers 2-63
 - system unit 2-13
 - tools needed 2-11
- short distance move 4-14
- software overview 1-1
- switch settings
 - for expansion unit extender cards 2-56
 - for memory cards 2-60
- system unit
 - operating 3-3
 - preparing to move 4-2
 - setting up 2-13

T

- tools needed for set up 2-11

U

- unpacking 2-3
- using BASIC 3-14
- using DOS (Disk Operating System) 3-14
- using the Disk Operating System (DOS) 3-14
- using the 3270 PC Control Program 3-14

W

- writing on diskettes 3-7

Numerics

- 3270 PC Control Program 3-14

User's Comment Form

Book 1, Using the Hardware

Form No. GA23-0249-1

Your comments assist us in improving our products. IBM may use and distribute whatever information you supply in any way it believes appropriate without incurring any obligation to you. You may, of course, continue to use the information you supply.

Comments:

If you wish a reply, provide your name and address in this space.

Name _____

Address _____

City _____ State _____

Zip Code _____ Telephone No. _____

GA23-0249-1

Fold and Tape

Please Do Not Staple

Fold and Tape



NO POSTAGE
NECESSARY
IF MAILED
IN THE
UNITED STATES

BUSINESS REPLY MAIL
FIRST CLASS PERMIT NO. 40 ARMONK, N.Y.

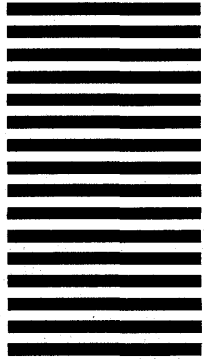

POSTAGE WILL BE PAID BY ADDRESSEE:

**International Business Machines Corporation
Department 52Q
Neighborhood Road
Kingston, New York 12401**

User's Comment Form

Book 1, Using the Hardware

Form No. GA23-0249-1

Your comments assist us in improving our products. IBM may use and distribute whatever information you supply in any way it believes appropriate without incurring any obligation to you. You may, of course, continue to use the information you supply.

Comments:

If you wish a reply, provide your name and address in this space.

Name _____
Address _____
City _____ State _____
Zip Code _____ Telephone No. _____

GA23-0249-1

Fold and Tape

Please Do Not Staple

Fold and Tape



NO POSTAGE
NECESSARY
IF MAILED
IN THE
UNITED STATES

BUSINESS REPLY MAIL
FIRST CLASS PERMIT NO. 40 ARMONK, N.Y.

POSTAGE WILL BE PAID BY ADDRESSEE:

**International Business Machines Corporation
Department 52Q
Neighborhood Road
Kingston, New York 12401**





International Business Machines Corporation

**Neighborhood Road
Kingston, New York 12401**