

IBM PC 3270 Emulation Program
Entry Level Version 1.21

User's Guide

Communications Family

The IBM logo, consisting of the letters 'IBM' in a stylized, horizontally striped font.

75X0576

IBM PC 3270 Emulation Program
Entry Level Version 1.21

User's Guide

Communications Family



Fourth Edition (December 1987)

This product could include technical inaccuracies or typographical errors. Changes are periodically made to the information herein; these changes will be incorporated in new editions of the publication.

It is possible that this material may contain references to, or information about, IBM products (machines and programs), programming, or services that are not announced in your country. Such references or information must not be construed to mean that IBM intends to announce such IBM products, programming or services in your country.

Products and publications are not stocked at the address below. Requests for copies of this product and for technical information about the system should be made to your authorized IBM Personal Computer dealer or local IBM representative.

A Reader's Comment Form is provided at the back of this publication. If the form has been removed, address comments to IBM Corporation, Department 95H, 11400 Burnet Road, Austin, Texas 78758. IBM may use or distribute whatever information you supply in any way it believes appropriate without incurring any obligation to you.

Printed in the United States of America. All rights reserved.

© Copyright International Business Machines Corporation 1986, 1987

**IBM PC 3270 Emulation Program
Entry Level, Version 1.21
License Program Information**

**STATEMENT OF LIMITED WARRANTY
(MEDIA AND PROGRAM)**

International Business Machines Corporation (IBM) grants the following limited warranty for this IBM Licensed Program (Program) if this copy of the Program is delivered by IBM, an IBM Authorized Dealer for this Program, or any other IBM approved supplier for this Program to a user. (Such a user is referred to herein as "original user.") A "user" shall mean a Customer who acquired possession of and is licensed to use this copy of the Program for its own use or for use within its own business enterprise and not for remarketing. Any unused portion of the Warranty Period may be conveyed to another user.

a. MEDIA

The Warranty Period for the media on which the Program is recorded is for three months from the date of its delivery to the original user as evidenced by a receipt.

IBM warrants that this media will be free from defects in material and workmanship under normal use during the Warranty Period. If notified during the Warranty Period that the media contains such defects, IBM will replace such media. If IBM is unable to deliver replacement media, you may terminate your license and your money will be refunded upon return of all your copies of the Program.

b. PROGRAM

The Warranty Period for this Program is for three months from the date of its delivery to the original user as evidenced by a receipt.

IBM warrants that this Program, if unaltered, will conform to its Program Specifications during the Warranty Period when such Program is properly used on a machine for which it was designed. If notified during the Warranty Period that the Program contains defects such that it does not conform to its Program Specifications, IBM will 1) attempt to make the Program operate as warranted a) if prior to the Service Expiration Date, by providing a correction, or b) if after the Service Expiration Date, by providing any existing corrections, or 2) replace the Program with a functionally equivalent Program, as determined by IBM. In the event that IBM does not provide such a remedy, you may terminate your license and your money will be refunded upon return of all your copies of the Program.

IBM does not warrant that any other defects in the Program will be corrected or that the operation of the Program will be uninterrupted.

This limited warranty will apply only if the Program is licensed and located in the United States or Puerto Rico.

THIS WARRANTY IS IN LIEU OF ALL OTHER WARRANTIES, EXPRESS OR IMPLIED, INCLUDING, BUT NOT LIMITED TO, THE IMPLIED WARRANTIES OF MERCHANTABILITY AND FITNESS FOR A PARTICULAR PURPOSE.

Some states do not allow the exclusion of implied warranties, so the above exclusion may not apply to you. This limited warranty gives you specific legal rights, and you may also have other rights which vary from state to state.

Following the end of the Warranty Period, Program Services may be available. The License Information contains details on such availability.

If you have a question as to where you may obtain warranty service, see the Statement of Service in the License Information for this Program.

License Information

IBM PC 3270 Emulation Program, Entry Level, Version 1.21, 75X1085.

Program Specifications

IBM PC 3270 Emulation Program, Entry Level, Version 1.21, provides user commands to perform the following user function:

- Installation of this product for the US will perform as specified in the User's Guide
- Support for Enhanced Connectivity Facilities is included in this product as specified in the User's Guide
- The SEND/RECEIVE functions of File Transfer will perform as specified in the User's Guide
- The Keyboard Redefinition Program will allow the user to remap the host session keyboard as specified in the User's Guide
- The Color Selection Program will allow the user to remap the host session screen colors as specified in the User's Guide
- The Patch Service Utility will allow the install and remove patches for this program as specified in the User's Guide.

Specified Operating Environment

Machine Requirements

The minimum configuration required to operate the IBM 3270 Emulation Program, Entry Level, Version 1.2 consists of:

- An IBM Personal Computer (5150), IBM Personal Computer XT (5160), IBM Personal Computer XT Model 286 (5162), or IBM Personal Computer AT (5170), with a keyboard and:
 - 128K bytes of main storage, of which approximately 107K bytes is available for concurrent operation of DOS and application programs in base operation. An additional 12K and application space is required for EEHLLAPI, and an additional 21K and requester space is required for Enhanced Connectivity Facilities.
 - An IBM Personal Computer 3278/79 Emulation Adapter
 - One dual-sided diskette drive and associated adapter.
 - An IBM 5151 Monochrome Display or IBM 5153 Color Display. The IBM 5153 Color Display and Color Graphics Adapter are required to emulate the 3279 Color Display Station Model 2A or S2A.

- IBM Personal System/2 Model 30 with a keyboard and:
 - 128K bytes of main storage, of which approximately 107K bytes is available for concurrent operation of DOS and application programs in base operation. An additional 12K is required for EEHLLAPI, and additional 21K (256K bytes of memory total) is required for Enhanced Connectivity Facilities.
 - An IBM Personal Computer 3278/79 Emulation Adapter
 - One dual-sided diskette drive and associated adapter
 - One of the following displays and associated adapter:
 - IBM Personal System/2 Monochrome Display Model 8503
 - IBM Personal System/2 Color Display Model 8512
 - IBM Personal System/2 Color Display Model 8513.
- For attachment to IBM Personal System/2 Models 50, 60, and 80, the following are supported:
 - 128K bytes of main storage, of which approximately 107K bytes is available for concurrent operation of DOS and application programs in base operation. An additional 12K is required for EEHLLAPI, and an additional 21K (256K bytes of memory total) is required for Enhanced Connectivity Facilities.
 - An IBM 3270 Connection Adapter
 - One dual-sided diskette drive and associated adapter
 - One of the following displays and associated adapter:
 - IBM Personal System/2 Monochrome Display Model 8503
 - IBM Personal System/2 Color Display Model 8512
 - IBM Personal System/2 Color Display Model 8513
 - IBM Personal System/2 Color Display Model 8514.
- A customer-supplied coaxial cable or either IBM Cabling System media or telephone twisted pair media. Use with telephone twisted pair media also requires that the ROLM 3270 Coax-to-Twisted Pair Adapter (3270-CTPA) be used with the IBM 3270 Connection or the IBM 3278/3279 Emulation Adapter for attachment to the IBM 3174 Subsystem Control Unit or 3274 Sybsystem Control Unit.
- Use of file transfer or IBM Enhanced Connectivity Facilities when attached to the IBM 3174 Subsystem Control Unit requires that the control unit be customized with the File Transfer Aid selected. For details refer to the *IBM 3174 Subsystem Control Unit Customizing Guide*, GA23-0214.
- Attachment to the 4701 Finance Communication Controller requires the Device Cluster Adapter (#3101). File transfer is not supported with the IBM 4701 Finance Communication Controller.
- Attachment to 43XX systems requires the Display/Printer Integrated Communications Adapter. Attachment to the 4361 can also be via the Workstation Adapter.

- In regard to the control unit, the adapter can be attached to any of the following:
 - IBM 3274 Control Unit configured for an IBM 3278 Model 2 Display Station or 3279 Model 2A Color Display Station with a 3278 Keyboard. (The keyboard must match country code loaded with DOS.)
 - IBM 4321/4331 Display/Printer Adapter with the specify code number 9843 installed
 - IBM 4361 Display/Printer Adapter
 - IBM 4701 Finance Communication Controller, using feature number 3101
 - IBM 3174 Control Unit, all models.

A coaxial cable connecting the Personal Computer to the control unit is required.

Program Requirements

This program is designed to operate with the following:

- IBM Personal Computer Disk Operating System (DOS) Versions 3.2 or 3.3 for the IBM Personal Computer or Personal Computer XT
- Versions 3.2 and 3.3 for the IBM Personal Computer XT Model 286
- Versions 3.1 through 3.3 for the IBM Personal Computer AT
- Version 3.3 for the IBM Personal System/2 Models 30, 50, 60, and 80
- For Enhanced Connectivity Facilities, VM/SP Release 5 installed at the host, with or without HPO installed at the host.

Note: Complementary support of Control Unit Terminal (CUT) Mode on IBM System/370 to IBM Personal Computer Enhanced Connectivity Facilities is provided by PTFs on VM/SP Release 5 and TSO/E Release 3. The PTF number is identified at general availability of IBM 3270 Emulation Program, Entry Level, Version 1.2.

The licensed programs required to be installed on the IBM 43XX or 30XX host computer for file transfer are:

- For MVS/TSO-IBM 3270 PC File Transfer Program, Release 1
- For VM/SP-IBM 3270 PC File Transfer Program, Release 1
- For CICS/VS (MVS and VSE)-IBM CICS/VM 3270 PC File Transfer Program, Release 1.

Licensed Program Materials Availability

This licensed program is available without source licensed program materials. It is available in object code.

Additional Information

None.

Type/Duration of Program Services

Central Service, including the IBM Support Center, is available until September 26, 1988. See the Statement of Service section for details.

Statement of Service

Program service is available only through registered service coordinators. Program users must contact their service coordinator to obtain this service.

IBM defines service coordinator as the customer-designated representative registered to interface with IBM for defect support of designated IBM licensed programs.

Customers of IBM North-Central or South-West Marketing Divisions should contact their IBM Marketing Representative to obtain information on how to qualify for registered service coordinators.

Authorized IBM Advanced Product Dealers are the registered service coordinator for retail customers.

Service Coordinator Responsibilities

The service coordinator's responsibilities include, but are not limited to:

- Problem determination
- Problem source identification
- Submitting APAR data
- Applying preventive and corrective service
- Performing activities recommended by IBM support organizations.

Corrective Service

IBM Central Service will respond to a defect in the unaltered portion of a supported release of the licensed program by issuing: defect correction documentation, corrected code or notice of availability of corrected code, a restriction, or a bypass.

For customers of IBM North-Central or South-West Marketing Divisions, the IBM Support Center will provide the customer's service coordinator with telephone assistance in problem determination, problem source identification, and problem resolution. The service coordinator may call the IBM Support Center at any time and will receive a call back within eight (8) business hours. The IBM Support Center will contact the service coordinator's location Monday through Friday, 8:00 a.m. - 5:00 p.m. local customer time.

For retail customers, requests for program service should be made through your authorized IBM Advanced Product Dealer.

Preventive service may be provided on a cumulative basis through updates to the licensed program. Updates may be distributed to designated service coordinators on diskettes, either on request or by general distribution, as determined by IBM.

When an update is available, one copy of the program and its supporting documentation will be provided to the service coordinator location. The service coordinator location is responsible for making and distributing copies to the work stations with the IBM PC 3270 Emulation Program, Entry Level, installed, not to exceed the total copies licensed to the customer.

Outside of the United States or Puerto Rico, contact your local IBM representative or your authorized IBM supplier for information on warranty services.

Any other documentation with respect to this licensed program, including any such documentation referenced herein, is provided for information purposes only and does not extend or modify the material contained in the License Information.

Preface

This manual explains how to use your IBM Personal Computer or IBM Personal Computer XT or AT with the IBM Personal Computer 3278/79 Emulation Adapter or the IBM 3270 Connection and the IBM PC 3270 Emulation Program, Entry Level, to simulate many of the functions of an IBM 3278 and 3279 typewriter keyboard (U.S. English) and the IBM 3278 Model 2 Display Station or the IBM 3279 Model 2A Color Display Station.

Terminology Used

Throughout this manual, the terms “PC” and “Personal Computer” are used interchangeably when referring to the following:

- IBM Personal Computer
- IBM Personal Computer XT
- IBM Personal Computer AT
- IBM Personal System/2™.

The term “emulation adapter” refers to the IBM Personal Computer 3278/79 Emulation Adapter and the IBM 3270 Connection.

The term “IBM Enhanced Connectivity Facilities” refers to the IBM System/370 to IBM

™ IBM Personal System/2 is a trademark of the International Business Machines Corporation.

Personal Computer Enhanced Connectivity Facilities.

The term “entry emulator” refers to Version 1.21 of the IBM PC 3270 Emulation Program, Entry Level.

The entry emulator allows you to:

- Integrate your IBM Personal Computer into your existing host computer network to give you dual session capability
- Use your IBM Personal Computer as a single work station.

The term “DOS” refers to the IBM Disk Operating System program, Versions 3.2 and 3.3 for the IBM Personal Computer or Personal Computer XT, Version 3.2 and 3.3 for the Personal Computer XT Model 286, Versions 3.2 and 3.3 for the IBM Personal Computer AT, and Version 3.3 for the IBM Personal System/2 Models 25, 30, 50, 60, and 80.

Who Should Use This Manual

This manual is for anyone using an IBM Personal Computer who wants to have dual session capability.

You should have a general knowledge of the IBM Personal Computer Disk Operating System and be familiar with your host VM/CMS or MVS/TSO computer system.

Organization of This Manual

This manual contains the following chapters and appendixes:

Chapter 1. Introduction acquaints you with the entry emulator and adapter, and reviews the capability requirements.

Chapter 2. Installing the Entry Emulator Program provides instructions for making a working copy of the entry emulator program.

Chapter 3. Starting the Entry Emulator describes ways to start the entry emulator.

Chapter 4. Using IBM Enhanced Connectivity Facilities describes how to install and load IBM Enhanced Connectivity Facilities with the entry emulator and provides a brief introduction of how you can use it.

Chapter 5. Using the Keyboard describes how the entry emulator redefines the keyboard to emulate an IBM 3278 Keyboard (U.S. English) and explains the key combinations used to switch between the host session and Personal Computer session.

Chapter 6. Printing tells you how to print information displayed on your screen to a printer attached to either your Personal Computer or an IBM 3274 Control Unit.

Chapter 7. Transferring a File tells you how to transfer files between the IBM Personal Computer and either VM/CMS or MVS/TSO.

Chapter 8. Using the Utilities describes how to personalize your host session keyboard, reassign the colors of your host session screen, and use the patch service utility.

Chapter 9. Some Problem-Solving Tools helps you determine if a problem is hardware related, software related, or caused by operator error.

Appendix A. Messages explains the messages that can appear on your screen.

Appendix B. Operator Information Area in a Host Computer Session contains a chart of 3278 status indicators to help you understand the symbols that appear in the Operator Information Area of your screen.

Appendix C. File Transfer ASCII to EBCDIC Translation shows the translations between ASCII and EBCDIC during file transfer.

Appendix D. Bibliography lists manuals from the IBM Personal Computer library and the IBM 3270 library to help you understand your system.

Appendix E. Glossary defines words, acronyms, terms, and phrases used in this publication.

Appendix F. National Language Support explains how to translate your system diskette.

Appendix G. Setting Up an AUTOEXEC.BAT File explains how to setup an AUTOEXEC.BAT file for a diskette system and a fixed disk system.

Appendix H. EEHLLAPI Compatibility describes compatibility considerations when using the entry emulator and other software products.

Appendix I. Creating a Patch File describes creating a patch file for a diskette system and a fixed disk system. This appendix also contains some tips on using the EDLIN editor.

Additional Material in This Manual

In addition to the material described above, this manual contains:

- Three keyboard templates that show the location of host keyboard functions on the Personal Computer keyboard.
- A reference card listing command formats and keyboard features.

Related Publications

For a list of related publications, refer to Appendix D, “Bibliography.”

Contents

Chapter 1. Introduction	1-1
Getting Started with the Entry Emulator	1-2
Minimum Requirements	1-3
Compatibility	1-3
Using the Entry Emulator with the Host System	1-4
Chapter 2. Installing the Entry Emulator Program	2-1
Introduction	2-2
Installing the Entry Emulator on a Diskette System	2-2
Installing the Entry Emulator on a Fixed Disk	2-3
Chapter 3. Starting the Entry Emulator	3-1
Introduction	3-2
The AUTOEXEC.BAT File	3-2
Starting a Dual Session with a PC3270 AUTOEXEC.BAT File	3-3
Setting Up the AUTOEXEC.BAT File	3-3
Starting the Entry Emulator	3-4
Starting a Dual Session Without a PC3270 AUTOEXEC.BAT File	3-6
Code Page Support	3-8
Start Options	3-8
Chapter 4. Using IBM Enhanced Connectivity Facilities	4-1
Introduction	4-2
Introduction to IBM Enhanced Connectivity Facilities	4-2
IBM Enhanced Connectivity Facilities Characteristics	4-4
Starting the Entry Emulator	4-5

The AUTOEXEC.BAT File	4-6
Starting a Dual Session with a PC3270	
AUTOEXEC.BAT File	4-6
Setting Up the AUTOEXEC.BAT File	4-6
Starting the Entry Emulator and	
EESRPI	4-7
Starting a Dual Session Without a	
PC3270 AUTOEXEC.BAT File	4-9
Starting the Host Router	4-12
Starting the Requester	4-13
Stopping IBM Enhanced	
Connectivity Facilities	4-13
Chapter 5. Using the Keyboard	5-1
Introduction	5-2
Key Combinations	5-3
Switch Screens (Alt + Esc)	5-3
Suspend (Alt + S)	5-4
Resume (Alt + R)	5-4
System Reset (Ctrl + Alt + Del) ...	5-4
Quit (Alt + 5)	5-5
Personal Computer Update Screens	5-6
IBM PC Keys with 3278 Typewriter Key	
Functions	5-7
Summary of 3278 Functions	5-10
Keys Used for the 3274 Entry Assist	
Functions	5-16
Chapter 6. Printing	6-1
Introduction	6-2
Personal Computer Session	6-2
Personal Computer and Host Computer	
Sessions	6-2
Host Computer Session	6-4
Chapter 7. Transferring a File	7-1
Introduction	7-2
The SEND Command	7-3
General Information	7-3
SENDing to VM/CMS	7-4
SENDing to MVS/TSO	7-5
The RECEIVE Command	7-7

General Information	7-7
RECEIVEing from VM/CMS	7-8
RECEIVEing from MVS/TSO	7-10
Command Syntax and Examples	7-11
Command Format Notation	7-11
SEND Command Format	7-12
RECEIVE Command Format	7-28
Chapter 8. Using the Utilities	8-1
Introduction	8-2
The Keyboard Redefinition Program ...	8-2
Before You Begin	8-3
Starting the Keyboard Redefinition Program	8-4
Keyboard Panels	8-6
Ending the Program	8-24
Other Capabilities	8-26
The Color Selection Program	8-27
Starting the Color Selection Program	8-27
Redefining Your Host Color Scheme	8-28
Ending the Program	8-31
Activating Your Color Selections ..	8-32
Deactivating Your Color Selections	8-32
Other Capabilities	8-33
The Patch Service Utility	8-33
Describing the Patch Format	8-34
Creating a Patch File	8-35
Installing a Patch	8-36
Listing the Current System Level and Currently Installed APARs	8-38
Removing a Patch	8-39
Chapter 9. Some Problem-Solving Tools	9-1
General Information	9-2
How to Read Problem Determination Tables	9-3
System Startup	9-4
File Transfer	9-5
PC Application	9-6
PC Printer	9-7
Keyboard	9-8

Appendix A. Messages	A-1
Installation Messages	A-2
File Transfer Messages	A-4
Keyboard Redefinition Messages	A-14
Color Selection Messages	A-17
Patch Installation Messages (PATnn) .	A-19
SRPI Messages	A-26
Appendix B. OIA in Host Computer	
Mode	B-1
Status Indicators	B-2
Operator Information Area	B-3
Status Indicators Reference Tables	B-4
Readiness and System Connection	
Messages	B-5
Do Not Enter Messages	B-6
Reminder Messages	B-8
Shifts and Mode Messages	B-9
Printer Status Messages	B-10
Appendix C. File Transfer ASCII to	
EBCDIC Translation	C-1
File Transfer Translation	C-1
ASCII to EBCDIC Translation	
(Code Page 437 Only)	C-3
EBCDIC to ASCII Translation	
(Code Page 437 Only)	C-5
Appendix D. Bibliography	D-1
IBM Personal Computer Publications	D-1
IBM Personal Computer XT	
Publications	D-1
IBM Personal Computer AT	
Publications	D-2
IBM Personal Computer 3278/79	
Emulation Adapter Publications ..	D-2
IBM 3270 Information Display System	
Publications	D-2
IBM 3274 Control Unit Publications	D-3
IBM 3174 Control Unit Publications	D-3

IBM 3270 Display Station	
Publications	D-4
VM CMS Publications	D-4
MVS TSO (TSO) Publications	D-4
Appendix E. Glossary	E-1
Appendix F. National Language Support	F-1
File Transfer	F-1
Character Set and Keyboard Differences	F-2
Answers to Control Unit Customization	
Question #121	F-8
EEHLLAPI Send Key Notes	F-10
Appendix G. Setting Up an	
AUTOEXEC.BAT File	G-1
Setting Up an AUTOEXEC.BAT File for	
a Diskette System	G-1
Setting Up an AUTOEXEC.BAT File for	
a Fixed Disk System	G-2
Modifying an Existing	
AUTOEXEC.BAT File	G-2
Appendix H. Entry Emulator	
Compatibility	H-1
Hardware Requirements	H-1
Control Unit	H-4
Software Requirements	H-5
Hardware Compatibility	H-6
General Limitations	H-6
Network Compatibility Option	
Limitations	H-6
Using the Entry Emulator with	
Applications	H-7
VDI 1.1 Compatibility Limitations	H-8
IBM Voice/Phone Assistant, Voice	
Communications Option Limitations	H-8
TopView 1.XX Compatibility	
Limitations	H-9
Using the Entry Emulator with a	
Personal Computer Network	H-10
Image Support Facility 2 Limitations	H-11

PC Program Limitations	H-11
Performance Considerations	H-13
Appendix I. Creating a Patch File	I-1
Creating a Patch File on a Diskette	
System	I-1
Creating a Patch File on a Fixed Disk	
System	I-3
Tips for Using EDLIN	I-5
Index	X-1

Chapter 1. Introduction

Getting Started with the Entry Emulator 1-2
Minimum Requirements 1-3
Compatibility 1-3
 Using the Entry Emulator with the
 Host System 1-4

Getting Started with the Entry Emulator

The IBM PC 3270 Emulation Program, Entry Level, when used with an emulation adapter, allows your IBM Personal Computer to simulate many of the functions of the 3278 and 3279 typewriter keyboard (U.S. English) and one of the following:

- IBM 3278 Model 2 Display Station
- IBM 3279 Model 2A or S2A Color Display Station, on which the adapter and the entry emulator support the following four base colors: white, red, blue, and green.

Note: Your host session colors can be redefined using the Color Redefinition Program. For more information, refer to "The Color Selection Program" on page 8-27.

With the entry emulator and adapter, you have dual session capability. You can use your IBM Personal Computer as:

- A personal computer with your own application programs and your own data storage
- A terminal attached to a host computer, using application programs under its supervision as well as data storage it provides.

Data can be transferred between your Personal Computer and a host computer when the entry emulator is used with the IBM host-supported File Transfer Program. For more information about file transfer, refer to Chapter 7.

Data can be transferred between your Personal Computer and a host computer when the entry emulator is used with the IBM host-supported IBM Enhanced Connectivity Facilities. For more information about Enhanced Connectivity Facilities, refer to Chapter 4.

Minimum Requirements

For information on the minimum requirements for using the IBM PC 3270 Emulation Program, Entry Level, see Appendix H, "Entry Emulator Compatibility."

Note: For the latest information on available hardware and software that can be used with this entry emulator program, see your authorized IBM Personal Computer dealer or local IBM representative.

Compatibility

For more information on using the entry emulator and other software products, see Appendix H, "Entry Emulator Compatibility."

Using the Entry Emulator with the Host System

The IBM PC 3270 Emulation Program, Entry Level, does not affect the normal operation of the host system, with one exception. If there are tasks running in the host session, you must not stop the entry emulator until you terminate the task. In other words, always terminate the tasks running in the host session before pressing the Alt + 5 keys to quit the entry emulator.

Chapter 2. Installing the Entry Emulator Program

Introduction 2-2
Installing the Entry Emulator on a
Diskette System 2-2
Installing the Entry Emulator on a Fixed
Disk 2-3

Notes:

- 1. If you are using an international keyboard, refer to Appendix F.*
- 2. If you are installing the Entry Emulator on a Personal Computer AT to a target disk or diskette drive for all countries except US, then the Entry Emulator on the target disk or diskette drive will be configured to run with an AT keyboard.*

Introduction

This chapter describes how to make a working copy of the 3270 Entry Emulation Program, Entry Level, on a diskette or fixed disk. Before you begin, make copies of your original Entry Emulator diskettes. If you have a fixed disk, you can use the DOS **copy** or **diskcopy** command. Store the originals in a safe place.

Installing the Entry Emulator on a Diskette System

To create a working copy of the Entry Emulator diskette, do the following:

1. Format a **blank diskette** using the DOS format command. Type the following:

```
format b:/S
```

Insert the blank diskette in drive B when prompted and press Enter.

The S parameter will copy the DOS files needed to make this a system (initialization) diskette onto the diskette.

2. Insert the Entry Emulator diskette in drive A.
3. Make A the default drive:

Type A:

Press Enter.

4. Refer to Figure 2-1 on page 2-5 for the Country Code of the language in which you want Entry Emulator to display.

5. Type the following:

```
install a: b: xx
```

where xx is the Country Code for the language you have selected. Press Enter, and follow the prompts that appear.

When the message, "Configuration Complete", appears, the installation is complete. Remove the Entry Emulator diskette from the diskette drive and put it in a safe place.

You are now ready to start Entry Emulator. Continue with Chapter 3.

Installing the Entry Emulator on a Fixed Disk

Note: If your fixed disk is new, you will have to prepare it before you can continue with this procedure. See the FDISK and FORMAT commands in your DOS manual.

To install a working copy of the Entry Emulator on your fixed disk:

1. Insert the Entry Emulator diskette into drive A.
2. Make drive A your default drive:

Type A:

Press Enter.

3. Refer to Figure 2-1 on page 2-5 for the Country Code of the language in which you want Entry Emulator to display.
4. Type the following:

```
install a: c: xx
```

where xx is the Country Code of the language you have selected. Press Enter, and follow the prompts that appear.

When the message, "Configuration Complete", appears, the installation is complete.

5. Remove the Entry Emulator diskette from the diskette drive and put it in a safe place.

Country	Country Code
Belgium	BE
Belgium (with RPQ7L0577)	BI
Canada, French (with RPQ7L0624)	CF
Denmark	DK
France	FB
France (alternate)	FR
Germany	GR
Italy	IT
Latin America (with RPQ7L0626)	LA
Norway	NO
Portugal	PO
Switzerland, French (with RPQ7L0811)	SF
Switzerland, German (with RPQ7L0811)	SG
Spain	SO
Spain (with RPQ7L0626)	SP
Sweden	SV
Finland	SU
United Kingdom	UK
United States	US

Figure 2-1. Country Codes for Installation

Go to Chapter 3 to start the Entry Emulator program.

Notes

Chapter 3. Starting the Entry Emulator

- Introduction 3-2
 - The AUTOEXEC.BAT File 3-2
- Starting a Dual Session with a PC3270
 - AUTOEXEC.BAT File 3-3
 - Setting Up the AUTOEXEC.BAT File 3-3
 - Starting the Entry Emulator 3-4
- Starting a Dual Session Without a PC3270 AUTOEXEC.BAT File 3-6
 - Code Page Support 3-8
- Start Options 3-8

Introduction

After you have made a working copy of the entry emulator (PC3270) onto a diskette or fixed disk, you are ready to start entry emulation. You then will be ready to use a dual host and personal computer session. You can start the entry emulator with or without an AUTOEXEC.BAT file.

Note: If you want to start the entry emulator with IBM Enhanced Connectivity Facilities, see Chapter 4, "Using IBM Enhanced Connectivity Facilities."

The AUTOEXEC.BAT File

When you power on your system unit or perform a system reset, DOS is automatically loaded and started. DOS then looks for a file called AUTOEXEC.BAT on the default drive. If DOS finds this file, any commands in the file will be executed. (Refer to the IBM Personal Computer *Disk Operating System* manual for more information on the AUTOEXEC.BAT file.)

- To start the entry emulator using an AUTOEXEC.BAT file, go to the next section.
- To start the entry emulator without using an AUTOEXEC.BAT file, skip the following section and go to "Starting a Dual Session Without a PC3270 AUTOEXEC.BAT File" on page 3-6.

Starting a Dual Session with a PC3270 AUTOEXEC.BAT File

Setting Up the AUTOEXEC.BAT File

Before you start the entry emulator, you must set up the AUTOEXEC.BAT file.

- If you have a diskette system, rename the IBM-supplied file **autoexec.p78** to **autoexec.bat**.

If you are unfamiliar with the DOS **RENAME** command, refer to Appendix G, which outlines the steps required to rename the IBM-supplied **AUTOEXEC.p78** file.

- If you have a fixed disk system, add the command, **pc3270** to an existing **AUTOEXEC.BAT** file using a personal computer editor program such as **EDLIN**.

If you are unfamiliar with **EDLIN** or the procedures for editing a file, refer to Appendix G, which outlines the steps required to create an **AUTOEXEC.BAT** file or modify an existing **AUTOEXEC.BAT** file.

*Note: Some functions specified in your original **AUTOEXEC.BAT** file may conflict with the way the entry emulator operates. Review "Compatibility" on page 1-3 for a list of functions to avoid.*

After you have renamed the IBM-supplied file to **AUTOEXEC.BAT** or added the command **pc3270** to an existing **AUTOEXEC.BAT** file, you are

ready to load the entry emulator into PC memory and operate the PC in a dual session.

Starting the Entry Emulator

1. If you are using a diskette, insert your PC3270 diskette into drive A and close the drive door.

If you are using a fixed disk, leave the drive A door open.

2. Switch **on** your PC, if you have not already done so. If the system unit is already **on**, press and hold Ctrl and Alt; then press Del, thus performing a system reset. Release all three keys.
3. DOS asks for today's date; enter the date.
4. DOS asks for the time; enter the time.

The entry emulator logo appears:

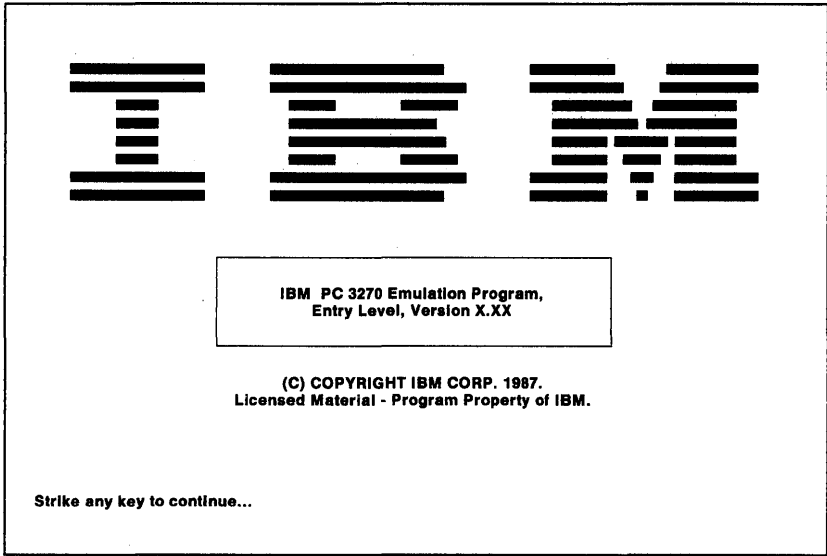

5. Press any key to continue.
6. When the execution of the AUTOEXEC.BAT file is complete, press and hold Alt; then press Esc. Release both keys.

If your host computer provides a logo, it appears on the screen now. Anytime a screen generated by your host computer appears on the display, you are in the “Host Computer Session” and keyboard functions change. Pressing Alt + Esc again returns your display to the PC screen and your keyboard to the PC functions.

Once it is established, the host session remains active until you turn off the system unit, do a system reset, or reload the entry emulator. Performing any one of these actions stops the current host session.

Continue with “Code Page Support” on page 3-8.

Starting a Dual Session Without a PC3270 AUTOEXEC.BAT File

This section describes how to load the entry emulator without using an AUTOEXEC.BAT file.

The following procedure starts a dual computer session. This allows you to operate your PC as a host computer or as a PC.

1. Insert a DOS diskette that does not contain an AUTOEXEC.BAT file into drive A.

Note: If you have a fixed disk without an AUTOEXEC.BAT file on drive C, you do not have to use your DOS diskette. You can load DOS from drive C.

2. Switch **on** your PC, if you have not already done so. If the System Unit is already **on**, press and hold Ctrl and Alt; then press Del, thus performing a system reset. Release all three keys.
3. DOS asks for today's date; enter the date.
4. DOS asks for the time; enter the time.

Because you are not using an AUTOEXEC.BAT file, you must tell DOS where it can find the entry emulator.

5. If the entry emulator is on a fixed disk, type **c:** or the correct path if in a subdirectory.
6. If the entry emulator is on your system diskette, type **a:** if on drive A, or **b:** if on drive B.
7. Press Enter (↵).

8. Type **pc3270 r**.
9. Press Enter (↵). The entry emulator logo appears:

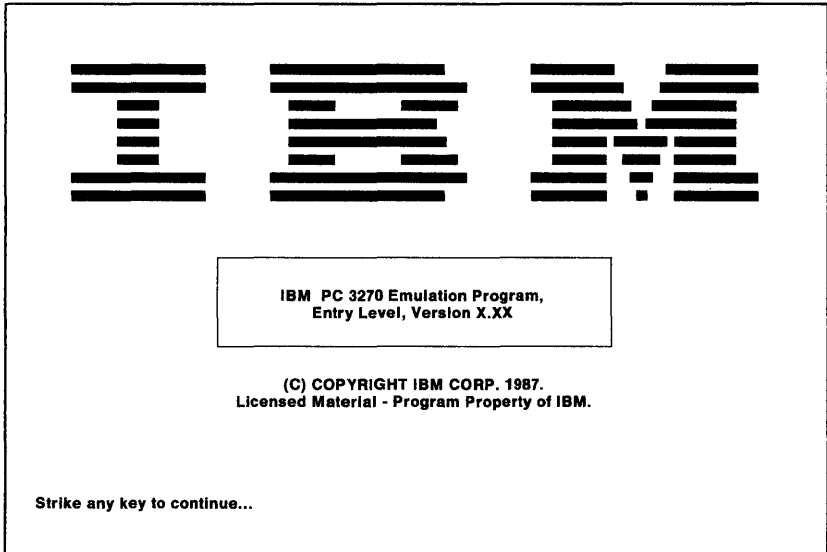

10. Press any key to continue.
11. When the DOS prompt appears, press and hold Alt; then press Esc. Release both keys.

If your host computer provides a logo, it appears on the screen now. Anytime a screen generated by your host computer appears on your display, you are in the "Host Computer Session" and the keyboard functions change. Pressing Alt + Esc again returns your display to the PC screen and your keyboard to the PC functions.

Once the host session is established, it remains active until you turn off the system unit, do a system reset, or reload the entry emulator.

Performing any one of these actions stops the current host session.

Code Page Support

When the entry emulator is started, it overlays its own display translate table with a code page table that corresponds to the current system code page installed on DOS. The entry emulator does not validate whether the DOS system code page is allowed for that country. Installing a system code page on DOS that is not supported for that country may cause unpredictable results when starting the entry emulator.

Start Options

There are three options available when starting the entry emulator. Options are identified by a single character that can be typed in when you start the entry emulation. You can also add options to your AUTOEXEC.BAT file.

The options are:

- n** Do not display the IBM logo. The emulation is started and the DOS prompt is displayed.
- r** Start with the PC session in resume mode. This is identical to pressing the Alt + R combination while in the host session. See “Resume (Alt + R)” on page 5-4. It allows the PC session to execute while the host session is active. Depending on how your PC programs write to the screen, you may find this

option distracting. See “Personal Computer Update Screens” on page 5-6.

- e **Load IBM Enhanced Connectivity Facilities support.** You must specify this option if you intend to use the IBM Enhanced Connectivity Facilities.

The options can be used singly or in combinations. They can be in any order. Some examples of these options are:

- **Starting the entry emulator without the IBM logo display.**

`pc3270 n`

- **Starting the entry emulator without the IBM logo display and with the PC session in resume mode.**

`pc3270 n r`

Notes

Chapter 4. Using IBM Enhanced Connectivity Facilities

Introduction	4-2
Introduction to IBM Enhanced Connectivity Facilities	4-2
IBM Enhanced Connectivity Facilities Characteristics	4-4
Starting the Entry Emulator	4-5
The AUTOEXEC.BAT File	4-6
Starting a Dual Session with a PC3270 AUTOEXEC.BAT File	4-6
Setting Up the AUTOEXEC.BAT File	4-6
Starting the Entry Emulator and EESRPI	4-7
Starting a Dual Session Without a PC3270 AUTOEXEC.BAT File	4-9
Starting the Host Router	4-12
Starting the Requester	4-13
Stopping IBM Enhanced Connectivity Facilities	4-13

Introduction

This chapter describes how to start the programs necessary for using the IBM Enhanced Connectivity Facilities.

This chapter also provides a brief introduction to IBM Enhanced Connectivity Facilities. Also see the *Introduction to IBM System/370 to IBM Personal Computer Enhanced Connectivity Facilities* for a more detailed description.

See Appendix A of this manual for messages that occur when IBM Enhanced Connectivity Facilities is active.

Introduction to IBM Enhanced Connectivity Facilities

IBM Enhanced Connectivity Facilities consists of software designed to connect personal computers and host computers so that many host services and resources become available to personal computer users and application programs.

Host resources that personal computer users would like to access include data bases containing frequently updated information, host files, fast printers, direct access storage space for storing and sharing vast amounts of information, and communications facilities that link users and data.

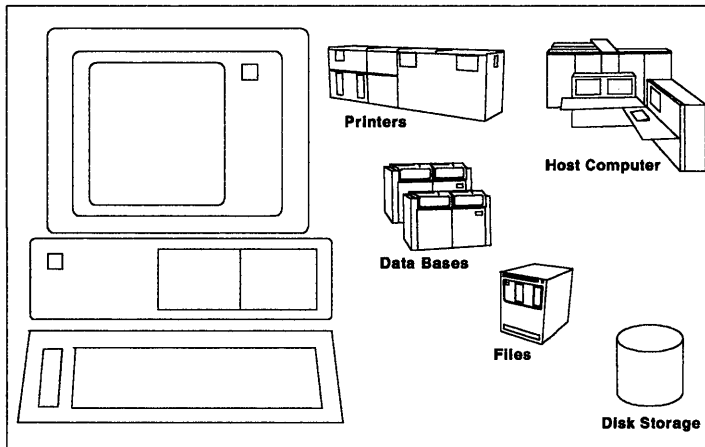

Access to selected MVS/XA and VM/SP host services is provided by host programs called *servers* and personal computer programs called *requesters*. This terminology comes from the fact that the personal computer or application program “requests a service” and the host computer “serves the request.” Access to each service is provided by a paired server and requester, referred to as a *server-requester* (or *servers-requesters*, for more than one pair).

The IBM Enhanced Connectivity Facilities includes a *server-requester programming interface*, which you can use to develop your own servers and requesters if you desire. The Server-Requester Programming Interface (SRPI) makes it easier for you to develop servers and requesters, because programmers do not need detailed knowledge of communication protocols. The interface is the same in all supported communication environments.

If you have installed the IBM servers and requesters, you can extend your personal computer application programs to access host resources without developing your own servers and requesters.

IBM Enhanced Connectivity Facilities Characteristics

Figure 4-1 on page 4-5 identifies the basic characteristics of IBM Enhanced Connectivity Facilities. IBM Enhanced Connectivity Facilities has the following characteristics:

- A consistent interface for application programs in a personal computer to request services, data, or both from a host. The personal computer application program making the request is referred to as the *requester*.
- A consistent interface for programs in a host to reply to requests for services, data, or both from personal computers. The host application program that services the request is referred to as the *server*.
- A consistent interface for handling communications between requesters and servers. The function provided by 3270 Emulation and hosts is referred to as a *router*. The routers provide a new Server-Requester Programming Interface (SRPI);, which supplies a request interface for requesters or a reply interface for servers. This interface isolates requesters and servers from the underlying communication environment.

Writing to the SRPI enables applications to be used in a number of communication environments. The SRPI provides a

consistent interface for programs in personal computers to obtain services, data, or both from host systems.

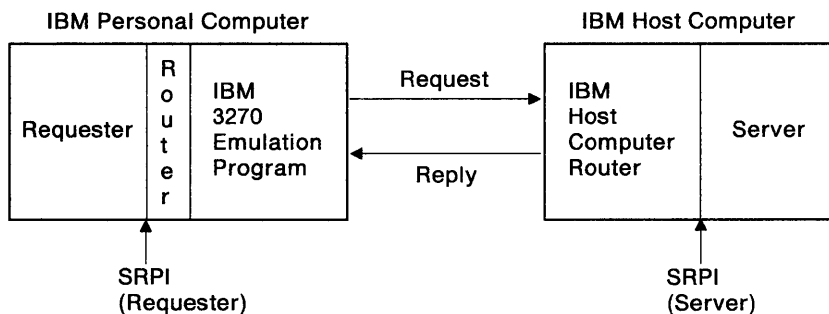

Figure 4-1. Characteristics of IBM Enhanced Connectivity Facilities.

Notes:

- 1. The IBM Enhanced Connectivity Facilities cannot be used under TopView.*
- 2. The file transfer SEND and RECEIVE commands cannot be used when a host router is active.*

Starting the Entry Emulator

After you have made a working copy of entry emulator (PC3270) onto diskette or fixed disk, you are ready to start the PC 3270 Emulation Program. You then will be ready to use a dual host and personal computer session. You can start the entry emulator with or without an AUTOEXEC.BAT file.

The AUTOEXEC.BAT File

When you power on your system unit or perform a system reset, DOS is automatically loaded. DOS then looks for a file called AUTOEXEC.BAT on the default drive. If DOS finds this file, any commands in the file will be executed. (Refer to the IBM Personal Computer *Disk Operating System* manual for more information on the AUTOEXEC.BAT file.)

- To start the entry emulator with IBM Enhanced Connectivity Facilities Facilities using an AUTOEXEC.BAT file, go to the next section.
- To start the entry emulator with IBM Enhanced Connectivity Facilities Facilities without using an AUTOEXEC.BAT file, skip the following section and go to “Starting a Dual Session Without a PC3270 AUTOEXEC.BAT File” on page 4-9.

Starting a Dual Session with a PC3270 AUTOEXEC.BAT File

Setting Up the AUTOEXEC.BAT File

Before you start the entry emulator, you must set up the AUTOEXEC.BAT file. Choose one of the following options.

- If you have a diskette system, rename the IBM-supplied file `autoexec.ecf` to `autoexec.bat`.

If you are unfamiliar with the DOS RENAME command, refer to Appendix G, which outlines the steps required to rename the IBM-supplied AUTOEXEC.ecf file.

- If you have a fixed disk system, add the commands **pc3270 e** and **eesrpi** to an existing AUTOEXEC.BAT file using a personal computer editor program such as EDLIN.

If you are unfamiliar with EDLIN or the procedure for editing a file, refer to appendix G, which outlines the steps required to create an AUTOEXEC.BAT file or to modify an existing AUTOEXEC.BAT file.

Note: Some functions specified in your original AUTOEXEC.BAT file may conflict with the way the entry emulator operates. Review “Compatibility” on page 1-3 and Appendix H for the functions to avoid.

After you have renamed the IBM-supplied file to AUTOEXEC.BAT or added the above commands to an existing AUTOEXEC.BAT file, you are ready to load the entry emulator into PC memory and operate the PC in a dual session.

Starting the Entry Emulator and EESRPI

1. If you are using a diskette, insert your PC3270 diskette into drive A and close the drive door.

If you are using a fixed disk, leave the drive A door open.

2. Switch **on** your PC, if you have not already done so. If the system unit is already **on**, press and hold Ctrl and Alt; then press Del, thus performing a system reset. Release all three keys.
3. DOS asks for today's date; enter the date.
4. DOS asks for the time; enter the time.
5. The AUTOEXEC.BAT file executes next.

The entry emulator logo appears:

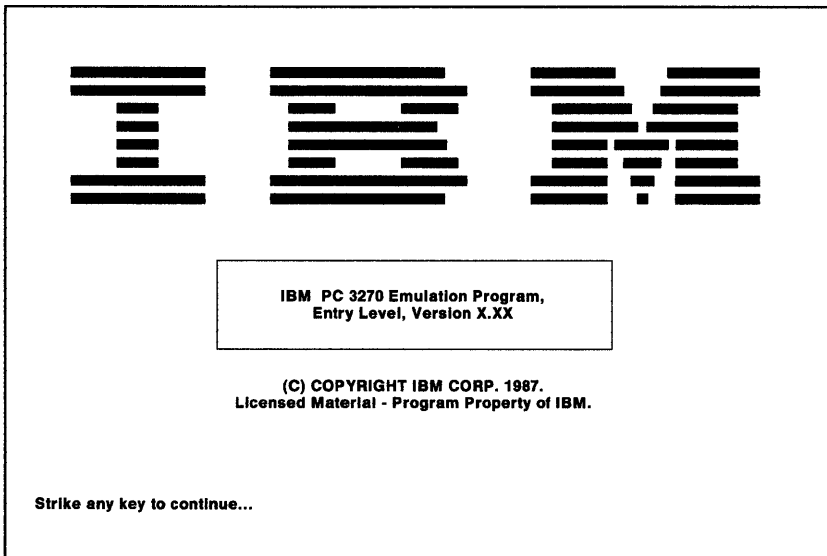

6. Press any key to continue. The Entry Emulator Server-Requester Programming Interface (EESRPI) starts automatically.
7. When execution of the AUTOEXEC.BAT file is complete, press and hold Alt; then press Esc. Release both keys.

If your host computer provides a logo, it appears on the screen now. Anytime a screen generated by your host computer appears on the display, you are in the “Host Computer Session” and keyboard functions change. Pressing Alt + Esc again returns your display to the PC screen and your keyboard to the PC functions.

Once it is established, the host session remains active until you turn off the system unit, do a system reset, or restart the entry emulator. Performing any one of these actions stops the current host session.

Continue with “Starting the Requester” on page 4-13.

Starting a Dual Session Without a PC3270 AUTOEXEC.BAT File

This section describes how to start the entry emulator without using an AUTOEXEC.BAT file.

The following procedure starts a dual computer session. This allows you to operate your PC as a host computer or as a PC.

1. Insert a DOS diskette that does not contain an AUTOEXEC.BAT file into drive A.

Note: If you have a fixed disk without an AUTOEXEC.BAT file on drive C, you do not have to use your DOS diskette. You can load DOS from drive C.

2. Switch **on** your PC, if you have not already done so. If the system unit is already **on**, press and hold Ctrl and Alt; then press Del,

thus performing a system reset. Release all three keys.

3. DOS asks for today's date; enter the date.
4. DOS asks for the time; enter the time.
5. Because you are not using an AUTOEXEC.BAT file, you must tell DOS where it can find the entry emulator. Choose one of the following:

- Type **c**: if the entry emulator is on your fixed disk.

OR

- Type **a**: if the entry emulator is on your system diskette in the **a** drive

OR

- Type **b**: if the entry emulator is on your diskette in the **b** drive.

6. Press Enter (↵).
7. Type **pc3270 e**.
8. Press Enter (↵). The entry emulator logo appears:



IBM PC 3270 Emulation Program,
Entry Level, Version X.XX

(C) COPYRIGHT IBM CORP. 1987.
Licensed Material - Program Property of IBM.

Strike any key to continue...

9. Press any key to continue.
10. When the DOS prompt appears, type `eesrpi`
11. Press Enter (↵).
12. When the DOS prompt appears, press and hold Alt; then press Esc. Release both keys.

If your host computer provides a logo, it appears on the screen now. Anytime a screen generated by your host computer appears on your display, you are in the "Host Computer Session" and the keyboard functions change. Pressing Alt + Esc again returns your display to the PC screen and your keyboard to the PC functions.

Once the host session is established, it remains active until you turn off the system unit, do a system reset, or restart the entry emulator. Performing any one of these actions stops the current host session.

Starting the Host Router

To use IBM Enhanced Connectivity Facilities, you must start a host router. If necessary, press and hold Alt; then press Esc to return to the host session. Log on to your system following your installation logon procedures. To start the host router for VM, type **CMSSERV (CUT** and press Enter (↵). To start the host router for TSO, type **MVSSERV** and press Enter (↵).

Following are additional parameters for MVSSERV:

- NOTRACE** Specify **NOTRACE** or leave blank to run **MVSSERV** without sending messages to a trace data set on the host. Use this parameter for production work. When testing requesters and servers, use **TRACE** or, preferably, **IOTRACE** to obtain complete diagnostic information about the **MVSSERV** session.
- TRACE** Specify **TRACE** to record all terminal messages as well as most diagnostic messages in a trace data set. The **TRACE** parameter requires a pre-allocated trace data set in which to store the messages.
- IOTRACE** Specify **IOTRACE** to record all terminal messages in a trace data set on the host. In addition to the messages recorded with the **TRACE** parameter, the **IOTRACE** parameter records data sent between the host and the IBM PC, and information about the data flow.

When the host router is started, a logo should appear. This logo will remain on your screen while you are in the host session and the host router is still active. Press and hold Alt; then press Esc again to return to the PC functions. Your host router is now active.

Starting the Requester

To use IBM Enhanced Connectivity Facilities, you must also start a requester.

Note: The requester does not come with your PC 3270 Emulation Program. It is available separately.

If necessary, press and hold Alt; then press Esc to return to the PC functions. To start the requester, follow the directions supplied with the one you have chosen.

Stopping IBM Enhanced Connectivity Facilities

To stop IBM Enhanced Connectivity Facilities while the host session is active, switch to the host session, if necessary, and press the PF3 key. This stops the host router, allowing standard VM or TSO requests. (The host router does not stop instantly.) You may also need to stop your requester to perform PC functions. Follow the directions associated with your chosen requester.

If, after stopping IBM Enhanced Connectivity Facilities, you wish to resume ECF activities, restart the host router. For information on this

procedure, see “Starting the Host Router” on page 4-12.

If you press the PF3 key while your PC requester is busy, you may have to terminate and restart the entry emulator and EESRPI, and the PC router.

Chapter 5. Using the Keyboard

Introduction	5-2
Key Combinations	5-3
Switch Screens (Alt + Esc)	5-3
Suspend (Alt + S)	5-4
Resume (Alt + R)	5-4
System Reset (Ctrl + Alt + Del) ...	5-4
Quit (Alt + 5)	5-5
Personal Computer Update Screens	5-6
IBM PC Keys with 3278 Typewriter Key	
Functions	5-7
Summary of 3278 Functions	5-10
Keys Used for the 3274 Entry Assist	
Functions	5-16

Introduction

Using the entry emulator, you can work with either a PC session or a host session. The session you are working with is displayed on your screen. The keyboard functions also fit the session. When you are working in the PC session, the keyboard acts as a PC keyboard. When you are in the host session, the entry emulator redefines some of the keys to act as a 3278 or 3279 keyboard.

While you are working with one session, the other can continue executing. The entry emulator uses a device called “update screens” to let you know how the session you are not working with has progressed.

While in the host session, you may be able to use the entry assist functions if they are available with your host.

This chapter describes:

- Key combinations, including:
 - The combination of keys you use to switch between sessions
 - The combinations of keys you use to either suspend or resume operation of a PC session while you are working with a host session
 - The combination of keys you use to either reset or exit the entry emulator.
- Update screens, including how the entry emulator presents update screens to you and how you can use them.
- How to use the PC keyboard when you are working with a host session.

Key Combinations

Switch Screens (Alt + Esc)

The Switch Screen (SWSC) function is used to switch alternately between the PC session and the host computer session. If you are using the host computer session, SWSC places your PC in the PC session. If you are using the PC session, SWSC places your PC in the host computer session.

If you are using a single display and you try to switch from the PC session to the host session when your display is currently in a graphics mode unsupported by the entry emulator, you will hear a 'beep' and the switch will not take place. This is done to protect you from a unpredictable screen image that you would receive when you switched back to the PC session again. You will need to exit the unsupported mode before switching to the host session. If you are using two displays, the switch will be allowed.

Note: If you have suspended a PC operation using the Ctrl + Num Lock key combination, press any character key to continue the PC operation before using the Switch Screen function.

Suspend (Alt + S)

This key combination suspends PC operations when the host session is active. This is the normal (default) condition when the entry emulator is first loaded, and remains in effect until the Resume function is used. Suspend can only be entered from the host computer session.

Resume (Alt + R)

The Resume function resets the suspended PC application and allows the PC application to be performed concurrently with an active host session. Resume can be entered only from the host computer session. When entered from the host session, any suspended PC operations are resumed.

System Reset (Ctrl + Alt + Del)

The System Reset function results in the equivalent of a “reboot.” PC storage is cleared and the PC is restarted. The host computer session is ended. This key combination is active only from the PC session.

Quit (Alt + 5)

The Quit function (Alt + numeric 5) allows you to exit the entry emulator and return storage to DOS. The host computer session is ended, and the entry emulator must be reloaded before you can start another dual session. This function is active only from the host session.

Note: Numeric 5 is the 5 located on the numeric keypad on the right side of your keyboard.

Warning: If you exit the entry emulator program with the Quit function, you will also exit EEHLLAPI and EESRPI. To use EEHLLAPI and EESRPI after you exit the entry emulator program with the Quit function, you must reload the entry emulator, EEHLLAPI and EESRPI.

Personal Computer Update Screens

Most PC routines use the Basic Input Output System (BIOS) to write to the screen. When the BIOS is used, the host computer screen is stored and the PC update screen is displayed. This only applies if you are in the host session.

Note: A PC routine that performs a direct memory write to the screen does not display an update screen. PC messages appear superimposed on the host computer screen. You retain the information from your host computer session, but lose the update screen. If PC messages appear superimposed on the host computer screen, you can suspend the PC session by using the Alt + S key combination.

A PC update screen does not indicate a session change. The update screen is only a message sent by the PC to inform you of its progress. When the update screen appears, you have the following options:

- Continue typing. The host computer screen returns with all characters entered from the keyboard displayed.
- Press any key. The host computer screen returns.

Note: Any keys you press will be entered in the host computer session.

- Press Alt + Esc. Exits the host computer session and allows you to respond to a PC update screen.

IBM PC Keys with 3278 Typewriter Key Functions

The entry emulator redefines the IBM Personal Computer keyboard in the host computer session to incorporate the functions of the IBM 3278 or 3279 typewriter keyboard (U.S. English). For more information about redefining the keyboard, refer to Chapter 8, "Using the Utilities."

There are three types of keyboards that can be redefined:

- The Personal Computer and Personal Computer XT keyboard
- The Personal Computer AT keyboard
- The Enhanced Personal Computer keyboard.

Remove from the back of this manual the keyboard aid that corresponds to your keyboard, and place it on your keyboard for reference. The color-coded aid shows the functions of your PC keyboard in your host computer session.

The key button on the template is divided into four areas: the top, middle, bottom, and base. On the keys, different functions are associated with different areas. For example, the F10 key on the PC keyboard has these four functions:

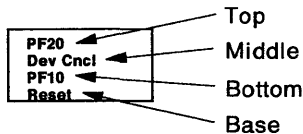

The location of each function designates how that key is used to obtain the desired function:

- Functions printed at the top (and in red on your keyboard aid) are obtained by pressing **Shift** and the key. For example:

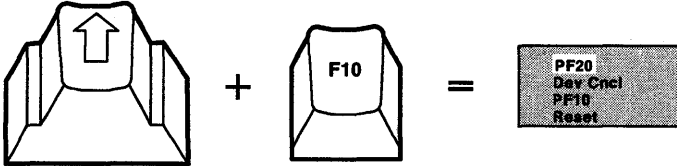

- Functions printed in the middle (and in blue on your keyboard aid) are obtained by pressing **Ctrl** and the key. For example:

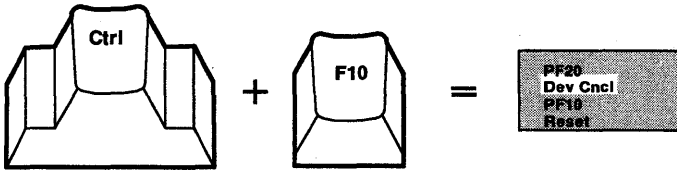

- Functions printed at the bottom are **unassisted** by any other key. For example:



-
- Functions printed on the base (and in green on your keyboard aid) are obtained by pressing **Alt** and the key. For example:

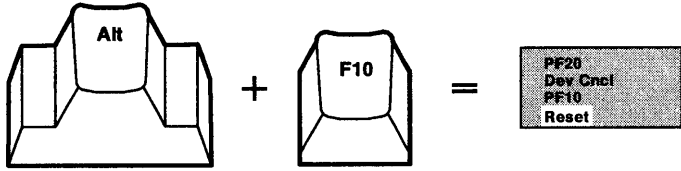

Summary of 3278 Functions

The following summary of 3278 functions (Figure 5-1) helps you identify the PC keys that emulate 3278 keyboard functions in a host computer session. For complete information, see *IBM 3270 Information Display System: 3278 Display Operator's Guide*.

- The first column of Figure 5-1 names the 3278 typewriter key function.
- The second column describes the keys you press to get the function if you have an IBM PC, PC XT, or PC AT keyboard.
- The third column describes the keys you press to get the function if you have an IBM Enhanced PC keyboard.
- The fourth column summarizes the function.

Notes:

1. *When reading this summary, you may run across the term "use duplicate keys, not numeric keys." This term refers to the Enhanced PC keyboard only. It simply means to use the cursor control keys that are grouped together on the right side of the typewriter key area of your keyboard. These keys are different from the numeric cursor control keys, which have numbers printed on them.*
2. *The PC Caps Lock key works slightly differently than the 3278 Shiftlock key. Only alphabetic characters can be locked in uppercase with Caps Lock, regardless of which session you are using. Any other character requires the assistance of the Shift key. If you press the Shift key while in Caps Lock, the Alphabetic keys have their unassisted or lowercase functions.*















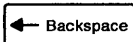









3278 Function	PC, PC XT, and AT Keys	Enhanced PC Keyboard Keys	What They Do
ATTN	 + 		Gets the program's attention only when B is displayed in the OIA. If you press this key when A is displayed in the OIA, the unavailable function (X-f) symbol appears in the OIA.
BACKSPACE			Moves the cursor one character to the left.
CLEAR	 + 		Erases the display and signals the host system that a clear action occurred.
CR SEL	 + 	 + 	Cursor Select chooses fields for processing. Cursor must be in a field that your application has designated for cursor selection.
DELETE 			Deletes the character occupying the position underlined by the cursor. It erases the character without leaving a blank. All characters in the field to the right of that position are then shifted left one position.
DEV CNCL	 +  OR  + 	 + 	Used to recover from a Do Not Enter condition caused by a Print key operation.
DUP	 + 	 + 	Displays an asterisk (*), and the cursor advances to the first character location of the next input field. DUP then enables you to quickly fill in information that is the same for every document, such as the date.
ENTER			This is the enter key when you are in the host computer mode. You can also use this key with the assistance of the other three keys: Shift, Alt, and Ctrl.

Figure 5-1 (Part 1 of 5). Summary of 3278 Functions







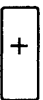
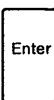

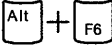

3278 Function	PC, PC XT, and AT Keys	Enhanced PC Keyboard Keys	What They Do
ENTER		 <i>Note: Use the Ctrl key on the right.</i>	<p>For your convenience, this is another Enter key when you are in host computer mode.</p> <p><i>Note: This ENTER function is not available with Shift, Alt, or Ctrl.</i></p>
ERASE EOF		 <i>Note: Use duplicate keys, not numeric keys.</i>	<p>Erases the input field from the cursor to the end of the field. The cursor does not move.</p>
ERASE INPUT	 OR 	 <i>Note: Use duplicate keys, not numeric keys.</i>	<p>Erases all input fields and moves the cursor to the first input character position on the screen.</p>
FIELD MARK		 <i>Note: Use duplicate keys, not numeric keys.</i>	<p>Displays a semicolon. This key is used when operating with an unformatted display to indicate the end of a field to the program.</p>
HOME			<p>Moves the cursor to the first character of the first input field on your screen.</p>
INDENT	 OR 		<p>Signals that the next two numbers will be the selected printer ID code. The ID code is displayed in the OIA. This key is also used to display the new ID when your printer assignment is changed.</p>
INSERT CHARACTER			<p>Inserts a character or characters into the middle of an input field without changing the characters already displayed there. Press RESET or the INSERT key again to end Insert Mode.</p>

Figure 5-1 (Part 2 of 5). Summary of 3278 Functions

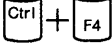
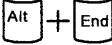
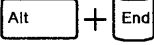
3278 Function	PC, PC XT, and AT Keys	Enhanced PC Keyboard Keys	What They Do
PA1			Program Access key that provides a means of signaling the program or communicating with it.
PA2			Program Access key that provides a means of signaling the program or communicating with it.
PRINT			Print key. Sends data from the display station to the 3274 printer.
RESET			Used to recover from Do Not Enter (X) conditions. This key restores the keyboard and turns off the Do Not Enter symbol for all Do Not Enter conditions except: <ul style="list-style-type: none"> • Printer Busy • Printer Very Busy • Printer Not Working • Wait This key also ends an Insert Mode condition.

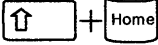
Figure 5-1 (Part 3 of 5). Summary of 3278 Functions

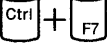
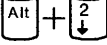
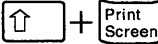





3278 Function	PC, PC XT, and AT Keys	Enhanced PC Keyboard Keys	What They Do
SYS REQ	(PC or PC XT only)  OR  OR  (AT only)		When A is displayed in the OIA, this key sends a unique signal to the host system to tell the program that your display station may be failing. When B is displayed in the OIA, this key: <ol style="list-style-type: none"> 1. Causes your display Screen to be cleared. 2. Switches your display station between host applications and host control programs.
TAB BACK			Moves the cursor back to the first character in an input field. <ul style="list-style-type: none"> • If the cursor is in a protected field, the cursor moves back to the first position of the previous input field. • If the cursor is already at the first character of an input field, the cursor moves to the first character of the previous input field.
TAB FORWARD		 or 	Moves the cursor forward to the right to the first character location of the next input field. If the screen is not formatted, it moves the cursor to the first location on line 1.

Figure 5-1 (Part 4 of 5). Summary of 3278 Functions

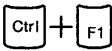
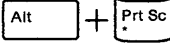

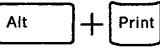
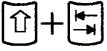
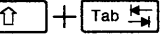







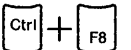
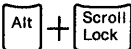
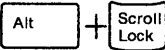

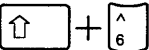



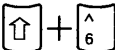

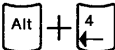
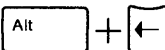

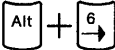
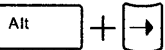

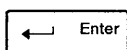









3278 Function	PC, PC XT, and AT Keys	Enhanced PC Keyboard Keys	What They Do
TEST	 OR 		Runs special problem determination functions.
¢			Displays the character ¢.
		 	Displays the character .
¬			Displays the character ¬.
		 <i>Note: Use duplicate keys, not numeric keys.</i>	Moves the cursor two characters to the left for each key stroke.
		 <i>Note: Use duplicate keys, not numeric keys.</i>	Moves the cursor two characters to the right for each key stroke.
			New line key used to move the cursor one line to the first unprotected character of the next line.
PF1—PF10	 — 	 — 	Program Function keys.
PF11	 + 		Program Function key.
PF12	 + 		Program Function key.
PF13 — PF20	 +  — 	 +  — 	Program function keys.
PF21 — PF24	Not applicable	 +  — 	Program function keys.

Figure 5-1 (Part 5 of 5). Summary of 3278 Functions

Keys Used for the 3274 Entry Assist Functions

Some host sessions may have entry assist functions for the IBM 3274 Control Unit. If your host does, the DOC * symbol will appear in the Operator Information Area at the bottom of your screen when you press:

- Ctrl + F5 on a PC, PC XT, or PC AT keyboard.
- Alt + F1 on an Enhanced Personal Computer keyboard.

If your installation supports this, your host has:

- On-demand scale line for establishing margins and tab stops
- Screen margins
- Tabbing
- Audible end-of-line signal
- Word wrap (automatic new line)
- Typematic forward and reverse cursor movement by word (the cursor moves to the beginning of either the previous word or the next word)
- Word delete
- Typematic character delete
- Typematic error-correcting backspace when in insert mode
- On-demand cursor position indicator display.

The following summary of the 3274 entry assist functions (Figure 5-2) will help you identify PC key combinations that emulate the 3274 entry assist function keys when in a host computer session. For complete information, see *IBM 3270 Information Display System: Entry Assist IBM 3274 Control Unit*.





3278 Function	PC, PC XT, and AT Keys	Enhanced PC Keyboard Keys	What They Do
DOC ON/OFF	 <p>Ctrl + F5 OR Alt + Home</p>		Press these keys to begin using the Entry Assist Mode functions. Press these keys again to cancel this function.
WORD WRAP	 <p>Ctrl + F9 OR Alt + F9</p>		Press these keys to automatically move the last word on a row to the next row if the word would otherwise overrun the right margin. This happens only if the entire next row from the left margin to the right margin contains nulls or spaces.
CHANGE FORMAT			Press these keys while in Entry Assist Mode with the keyboard in lowercase shift. You are now in Change Format mode and can change the current settings for the margins, tabs, and bell. Press these keys again to cancel this function.
CURSOR POSITION			Press these keys while in Entry Assist Mode to see the current position of the cursor displayed in the OIA.
WORD DELETE		 <p><i>Note: Use duplicate keys, not numeric keys.</i></p>	Press these keys while in Entry Assist Mode to delete the remainder of the word beginning with the character at the cursor position.

Figure 5-2 (Part 1 of 2). 3274 Entry Assist Functions

3278 Function	PC, PC XT, and AT Keys	Enhanced PC Keyboard Keys	What They Do
NEXT WORD		 <i>Note: Use duplicate keys, not numeric keys.</i>	Press these keys while in Entry Assist Mode to move the cursor to the first character of the next word.
PREVIOUS WORD		 <i>Note: Use duplicate keys, not numeric keys.</i>	Press these keys while in Entry Assist Mode to move the cursor to the first character of the current word.

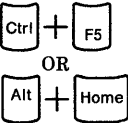
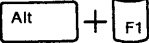
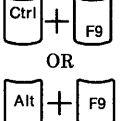
Figure 5-2 (Part 2 of 2). 3274 Entry Assist Functions

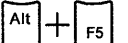
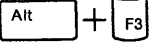
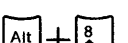
Notes

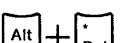
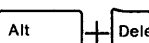
Chapter 6. Printing

Introduction	6-2
Personal Computer Session	6-2
Personal Computer and Host Computer Sessions	6-2
Host Computer Session	6-4

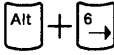
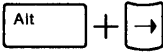
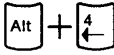
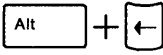
Introduction

You can print information several ways, depending on what session you are working in and where you want your information to print.

Personal Computer Session

Use the regular print function keys on your Personal Computer keyboard to start and end the print function. (Ctrl + Prt Sc for Personal Computer, Personal Computer XT, or Personal Computer AT; Print for Enhanced Personal Computer.)

Personal Computer and Host Computer Sessions

You can print information, one screen at a time, or one line at a time, on the Personal Computer printer. This function can be initiated from the PC or host computer session.

1. For the Personal Computer, Personal Computer XT, and Personal Computer AT keyboards:

To print one screen at a time:

- Press and hold the Shift key.
- Press your print key (Prt Sc).
- Release both keys.

To print one line at a time:

- Press and hold the Control key (Ctrl).
- Press your print key (Prt Sc).
- Release both keys.

2. For the PC Enhanced Personal Computer keyboard:

To print one screen at a time:

- Press the Print key.

To print one line at a time:

- Press and hold the Control key (Ctrl).
- Press the Print key.
- Release both keys.

In the Personal Computer session, the contents of the screen are printed on your Personal Computer printer. In the host computer session, lines 1–24 of the screen are printed.

Host Computer Session

You can print one screen at a time on your 3274 Control Unit printer. This function can be initiated only from your host computer session, as follows:

1. Press and hold Alt.
2. Press F7.
3. Release both keys.

The information displayed on the screen is printed on your 3274 Control Unit printer.

Note: You can also print from the host session by using the print facilities your host provides.

Chapter 7. Transferring a File

Introduction	7-2
The SEND Command	7-3
General Information	7-3
SENDing to VM/CMS	7-4
SENDing to MVS/TSO	7-5
The RECEIVE Command	7-7
General Information	7-7
RECEIVEing from VM/CMS	7-8
RECEIVEing from MVS/TSO	7-10
Command Syntax and Examples	7-11
Command Format Notation	7-11
SEND Command Format	7-12
RECEIVE Command Format	7-28

Introduction

File transfer allows you to use the SEND and RECEIVE commands to transfer files between your Personal Computer and the host computer, if your host supports VM/CMS (CMS) or MVS/TSO (TSO). You must have the IBM host-supported File Transfer Program for your system installed at your host site.

The SEND command, which is invoked during a PC session, sends a copy of a file from your PC session to your host session.

PC Session* = = = SEND = = > *Host Session

The RECEIVE command, which is also invoked from a PC session, transfers a copy of a file from your host session to your PC session.

PC Session* < = = RECEIVE = = = *Host Session

Note: Your Personal Computer must always be in Personal Computer DOS command mode to send files to the host or receive files from the host. That is, the SEND or RECEIVE command must be typed after a DOS prompt is displayed. The host must be in CMS or TSO mode and ready to accept commands.

In CMS, the transferred file resides on the CMS minidisk specified in the command. In TSO, the transferred file resides in the data set specified in the command.

The SEND Command

General Information

The SEND command is invoked from the PC session and sends copies of files from the PC to the host session.

If your SEND.COM file is on your PC3270 diskette, that diskette must be in a diskette drive.

Warning: File transfer uses both the PC session and the host session. Because the entire system is dedicated to file transfer, neither session can be used until file transfer is complete.

You must not use the keyboard while file transfer is running, except in response to displayed messages or instructions in this manual. Attempts to enter data during file transfer, except in response to messages or instructions in this manual, may cause file transfer to fail.

We recommend using a temporary filename when replacing an existing file.

The SEND command varies slightly, depending upon the type of host session you are using.

Note: You cannot use the SEND command when IBM Enhanced Connectivity Facilities is active.

SENDing to VM/CMS

To send a file from your PC to your VM/CMS host session:

1. Check that your PC is in PC DOS command mode, and your host system is in CMS command mode.
2. Switch to the host session. (Press and hold Alt; then press Esc.)
3. **IMPORTANT:** You must turn off unsolicited CMS messages (which will interrupt the transfer process unless you respond to them) by doing the following:

- Enter the command

```
set msg off
```

on the command line of your CMS session before you begin file transfer. Enter the command

```
set msg on
```

to turn your messages back on when the file transfer process has ended.

- Or, if you plan to transfer files often, create a CMS EXEC that disables messages before starting file transfer and reenables them after completion. The EXEC must be named IND\$FILE and could contain the following CMS statements:

```
&CONTROL OFF
CP SET MSG OFF
CP SET SMSG OFF
CP SET WNG OFF
IND$FILE &1 &2 &3 &4 &5 &6 &7 &8 &9 &10 &11 &12
CP SET MSG ON
CP SET SMSG ON
CP SET WNG ON
```

In this EXEC, messages are left enabled after file transfer is completed.

4. Switch to the PC session. (Press and hold Alt; then press Esc.)
5. Enter the SEND command. For example, you might enter the following command (typed on one line):

```
send pcfiler.txt cmsfile script a  
(ascii crlf)
```

If you are sending a text file, you must include the **ascii crlf** options.

(See "SEND Command Format" on page 7-12 for format examples, parameters, and options.)

After you enter the SEND command for VM/CMS, the entry emulator will send you a message telling you when file transfer is complete, along with the number of bytes transferred.

6. Switch back to the host session. (Press and hold Alt; then press Esc.)

The entry emulator will clear the host session screen after file transfer is complete.

SENDing to MVS/TSO

To send a file from your PC to your MVS/TSO host session:

1. Check that your PC is in PC DOS command mode, and your host system is in TSO command mode.
2. Switch to the host session. (Press and hold Alt; then press Esc.)

-
3. **IMPORTANT:** You must turn off unsolicited messages (which will interrupt the transfer process unless you respond to them) by doing the following:

- Enter the command

```
profile nointercom
```

on the command line of your TSO session before you begin file transfer. Enter the command

```
profile intercom
```

to turn your messages back on when the file transfer process has ended.

4. Switch to the PC session. (Press and hold Alt; then press Esc.)
5. Enter the SEND command.

For example, you might enter the following command:

```
send pcfiler.txt tsodet.script ascii crlf
```

If you are sending a text file, you must include the **ascii crlf** options.

(See “SEND Command Format” on page 7-12 for format examples, parameters, and options.)

After you enter the SEND command, the entry emulator will send you a message telling you when file transfer is complete, along with the number of bytes transferred.

6. Switch back to the host session. (Press and hold Alt; then press Esc.)

The entry emulator will clear the host session screen after file transfer is complete.

The RECEIVE Command

General Information

The RECEIVE command, which is invoked in the PC session, transfers copies of files from your host system to your PC session.

If your RECEIVE.COM file is on your PC3270 diskette, that diskette must be in a diskette drive.

Warning: File transfer uses both the PC session and the host session. Because the entire system is dedicated to file transfer, neither session can be used until file transfer is complete.

You must not use the keyboard while file transfer is running, except in response to displayed messages or instructions in this manual. Attempts to enter data during file transfer, except in response to messages or instructions in this manual, may cause file transfer to fail.

We recommend using a temporary filename when replacing an existing file.

The RECEIVE command varies slightly, depending upon the type of host session you are using.

Note: You cannot use the RECEIVE command when IBM Enhanced Connectivity Facilities is active.

RECEIVEing from VM/CMS

To receive a file from your VM/CMS host session at your PC:

1. Check that your host is in CMS command mode, and your PC is in PC DOS command mode.
2. Switch to the host session. (Press and hold Alt; then press Esc.)
3. **IMPORTANT:** You must turn off unsolicited CMS messages (which will interrupt the file transfer process unless you respond to them) by doing the following:

- Enter the command

```
set msg off
```

on the command line of your CMS session before you start file transfer.

Enter the command

```
set msg on
```

to turn your messages back on when the file transfer process has ended.

- Or, if you plan to transfer files often, create a CMS EXEC that disables messages before starting file transfer and reenables them after completion. The EXEC must be named IND\$FILE and could look like this:

```
&CONTROL OFF
CP SET MSG OFF
CP SET SMSG OFF
CP SET WNG OFF
IND$FILE &1 &2 &3 &4 &5 &6 &7 &8 &9 &10 &11 &12
CP SET MSG ON
CP SET SMSG ON
CP SET WNG ON
```

In this EXEC, messages are left enabled after file transfer is completed.

4. Switch to the PC session. (Press and hold Alt; then press Esc.)
5. Enter the RECEIVE command for VM/CMS.

For example, you might enter the following command (typed on one line):

```
receive pcfile.txt cmsfile script a
(ascii crlf)
```

If you are receiving a text file, you must include the **ascii crlf** options.

(See “RECEIVE Command Format” on page 7-28 for format examples, parameters, and options.)

The entry emulator will send you a message telling you when file transfer is complete, along with the number of bytes transferred.

6. Switch back to the host session. (Press and hold Alt; then press Esc.)

The entry emulator will clear the host session screen after file transfer is complete.

RECEIVEing from MVS/TSO

To receive a file from your MVS/TSO host session at your PC:

1. Check that your host is in TSO command mode, and your PC is in PC DOS command mode.
2. Switch to the host session. (Press and hold Alt; then press Esc.)
3. **IMPORTANT:** You must turn off unsolicited messages (which will interrupt the transfer process unless you respond to them) by doing the following:

- Enter the command

```
profile nointercom
```

on the command line of your TSO session before you begin file transfer. Enter the command

```
profile intercom
```

to turn your messages back on when the file transfer process has ended.

4. Switch to the PC session. (Press and hold Alt; then press Esc.)
5. Enter the RECEIVE command for MVS/TSO.

For example, you might enter the following command (typed on one line):

```
receive pfile.txt tsodset.script  
ascii crlf
```

If you are receiving a text file, you must include the **ascii crlf** options.

(See “RECEIVE Command Format” on page 7-28 for format examples, parameters, and options.)

The entry emulator will send you a message telling you when file transfer is complete, along with the number of bytes transferred.

6. Switch back to the host session.
(Press and hold Alt; then press Esc.)

The entry emulator will clear the host session screen after file transfer is complete.

Command Syntax and Examples

Command Format Notation

Throughout this chapter, the following notation is used to show how the **SEND** and **RECEIVE** commands are formatted:

- *Capital Letters* indicate a *keyword* parameter. You must type the word exactly as it is shown, in any combination of uppercase and lowercase letters.
- *Italic Letters* indicate a replaced word parameter. The italic word represents the *kind* of information, rather than the exact information, that must be supplied. The actual entry replaces the italic description. You must type the correct entry in any combination of uppercase and lowercase letters.

-
- *Brackets*, [], indicate an optional parameter. If you want to include optional information, you do not type the brackets, only the information inside the brackets.
 - *Bars*, |, indicate a choice of parameters. If a group of options is shown and the individual options are separated by bars, you must choose one of the options in the group. If none of these options is chosen, the default value is used. You do not type the bar.
 - *Commas, Colons, and Parentheses* must be entered as shown. When they appear within brackets, they are optional and are used only if the accompanying option is used.

SEND Command Format

The SEND command varies slightly, depending upon the type of host session you are using.

VM/CMS

If your host system is VM/CMS, use the following format for the SEND command.

```
[d:]SEND [d:][path]filename[.ext] fn ft [fm] [(options)]
```

Notes:

1. *Do not type spaces between the drive specifier, path, filename, and extension.*
2. *Do not use SEND keywords, such as ASCII, CRLF, or P850 as filename or filetype.*

See Figure 7-1 on page 7-13 for format definitions.

MVS/TSO

If your host system is MVS/TSO, use the following format for the SEND command (typed on one line).

```
[d:]SEND [d:][path]filename[.ext] data set name [(member name)]  
[/password][options]
```

Notes:

1. Do not type spaces between the drive specifier, path, filename, and extension.
2. Do not use SEND keywords, such as ASCII, CRLF, or P850 as filename, data set name, or member name.

See Figure 7-1 for format definitions.

Command/ Parameter/ Option	Definition	Notes
d:	The PC drive specifier. When placed before the word SEND, <i>d:</i> is the drive where the SEND.COM file resides. This parameter is required before the SEND command only if the default drive is not the drive where the SEND.COM file resides. If you omit this parameter, DOS uses the default drive.	
SEND	The required command name that transfers a file from the PC to the host computer.	
d:	The PC drive specifier used to indicate the drive where the PC file to be transferred resides. If you omit this parameter, DOS uses the default drive. (Refer to the IBM PC <i>Disk Operating System</i> manual for further information.)	

Figure 7-1 (Part 1 of 7). SEND Command Format Definitions

Command/ Parameter/ Option	Definition	Notes
path	List of directory names that define the location of the file to be sent to the host. (Refer to the IBM PC <i>Disk Operating System</i> manual for further information.)	Make sure you surround the path with two backslashes, or DOS will not recognize the entire command.
filename	Name of the PC file to be sent to the host. The filename can be from 1 to 8 characters and may be followed by a filename extension. (Refer to the IBM PC <i>Disk Operating System</i> manual for further information.)	
.ext	The PC file extension. It is required if the name of the file being sent has an extension. (Refer to the IBM PC <i>Disk Operating System</i> manual for further information.) An extension starts with a period, has 1 to 3 characters, and follows immediately after the filename. For example: 82PRICES .AUG where .AUG is the extension.	
fn	CMS file name. Can be from 1 to 8 characters.	Valid for VM/CMS only.
ft	CMS file type.	Valid for VM/CMS only.
fm	CMS file mode. If omitted, the default is A1.	Valid for VM/CMS only.
data set name	TSO data set name. You may type quotes around the combined data set name and the member name to show that the userid is not prefixed. (Refer to the IBM <i>OS/VS2 Command Language Reference</i> for further information.)	Valid for MVS/TSO only.
(member name)	Name of one of the members in the directory of a partitioned data set. The data set must exist on the host.	Valid for MVS/TSO only.

Figure 7-1 (Part 2 of 7). SEND Command Format Definitions

Command/ Parameter/ Option	Definition	Notes
/password	Required if password protection has been specified for your TSO data set.	Valid for MVS/TSO only.
Options*		
APPEND	Allows you to attach a PC file to the end of a host file. The APPEND parameter overrides any specified values for LRECL and RECFM.	If APPEND is not specified when the filename is the same as an existing CMS file, the PC file being transferred replaces the existing host file.
ASCII	Specifies that the file stored on the PC storage medium in ASCII form is to be converted to EBCDIC during the transfer to the host. Usually, alphanumeric data is encoded in ASCII on the PC and EBCDIC on the host computer. You should specify the ASCII parameter when sending ASCII files to the host if you want to display the file in a readable form when it is on the host. For further information, see Appendix C, "File Transfer ASCII to EBCDIC Translation."	
*Parentheses () are required around options for VM/CMS.		

Figure 7-1 (Part 3 of 7). SEND Command Format Definitions

Command/ Parameter/ Option	Definition	Notes
CRLF	<p>Specifies that carriage return/line feed characters present in the file should be recognized and deleted before being stored on the host storage medium. Usually, alphanumeric data on the PC contains CRLF characters at the end of each line. If CRLF characters are contained in your file, you should specify the CRLF parameter when sending alphanumeric files to the host. This allows you to read the file when it is on the host.</p>	
LRECL n	<p>Specifies the logical record length of the host file, where <i>n</i> is the number of characters in each record. If LRECL is omitted, the default value is 80 for new files. If you are replacing a file, the default characteristics are those of the existing file. If you are appending, LRECL is ignored. When working with variable-length records, <i>n</i> is the maximum size the host accepts.</p> <p>If, however, you don't send a record of the maximum size, the LRECL becomes whatever is the longest record actually sent.</p>	
BLKSIZE (n)	<p>The block size of the host data set where <i>n</i> is the length in bytes of a data block.</p> <ul style="list-style-type: none"> ● If BLKSIZE is omitted, the default is LRECL for new files. ● If you are appending or replacing a file, BLKSIZE is ignored. 	TSO only.

Figure 7-1 (Part 4 of 7). SEND Command Format Definitions

Command/ Parameter/ Option	Definition	Notes
RECFM (F V U)	<p>Specifies the record format and characteristics of the host file. RECFM is followed by an F, V, or U (TSO only). F specifies that the file contains fixed-length records. Fixed-length records are padded on the host with trailing space characters if the PC has sent a record shorter than the specified length. V specifies that the file contains variable-length records. U specifies that the data set contains undefined-length records.</p> <p>If you use the APPEND option, RECFM is ignored. If RECFM is not specified for new files, the default is F when CRLF is not specified. When CRLF is specified, the default is V. If RECFM is not specified for existing files, the default is the RECFM of the existing file.</p> <p>If consecutive sets of carriage return/line feed characters are sent to the host with no data between the sets, the host program operator creates a one-character record consisting of a space character for each occurrence for variable-length records; or the host program creates a record of specified length consisting of space characters for fixed-length records.</p>	U is for TSO only.

Figure 7-1 (Part 5 of 7). SEND Command Format Definitions

Command/ Parameter/ Option	Definition	Notes
SPACE (q[,i]) [AVBLOCK (value)] [TRACKS] [CYLINDERS] where: q = quantity i = increment	Amount of space to be allocated for a new data set. <ul style="list-style-type: none"> ● If SPACE is used, you may use one of the three options to specify the units used for quantity and increment: <ul style="list-style-type: none"> - AVBLOCK(value) - TRACKS - CYLINDERS ● If none of these options is specified, the system defaults to the value of BLKSIZE. 	TSO only
P850**	Specifies that the file stored on the PC should be converted from code page 850 ASCII to EBCDIC. This option is for users who do not have code page 850 loaded in their PC. If you have code page 850 loaded and specify the ASCII option alone, the code page 850 translation occurs automatically.	
P437**	Specifies that the file stored on the PC should be converted from code page 437 ASCII to EBCDIC. This option is for users who do not have code page 437 loaded in their PC. If you have code page 437 and specify the ASCII option alone, code page 437 translation occurs automatically.	
P860**	Specifies that the file stored on the PC should be converted from code page 860 ASCII to EBCDIC. This option is valid only if PO (Portugal) was chosen at installation.	

Figure 7-1 (Part 6 of 7). SEND Command Format Definitions

Command/ Parameter/ Option	Definition	Notes
P863**	Specifies that the file stored on the PC should be converted from code page 863 ASCII to EBCDIC. This option is valid only if CF (Canadian French) was chosen at installation.	
P865**	Specifies that the file stored on the PC should be converted from code page 865 ASCII to EBCDIC. This option is valid only if DK (Denmark) or NO (Norway) was chosen at installation.	
**Only one of these options can be specified at a time.		

Figure 7-1 (Part 7 of 7). SEND Command Format Definitions

Code Pages

Figure 7-2 describes the code pages supported for each country.

Country Code	Supported Code Pages
BE	437, 850
BI	437, 850
CF	437, 850, 863
DK	437, 850, 865
FR	437, 850
FB	437, 850
GR	437, 850
IT	437, 850
LA	437, 850
NO	437, 850, 865
PO	437, 850, 860
SP	437, 850
SO	437, 850
SV	437, 850
SU	437, 850
SF	437, 850
SG	437, 850
UK	437, 850
US	437, 850

Figure 7-2. Supported Code Pages

Warning: If you configure DOS for a language that does not match your entry emulator language, the results of an ASCII translation will be unpredictable.

Examples of SEND Command for VM/CMS

The following examples are variations of the SEND command for VM/CMS.

Note: Each of the following commands must be typed all on one line.

- **Sending a PC file from your default drive and adding it as a new file on your CMS A-disk.**

```
send pcfiler.txt cmsfile script a1  
  (ascii crlf lrecl 132 recfm v
```

This command sends a file named PCFILE.TXT from your default drive to your VM host. It creates a new SCRIPT file named CMSFILE on your A-disk. The records in the file may vary in length up to a maximum of 132 characters.

- **Sending a PC file from your default drive to replace a file on your CMS A-disk.**

```
send pcfiler.txt cmsfile script a1  
  (ascii crlf
```

This command sends a PC file named PCFILE.TXT from your default drive to your CMS A-disk. You do not need to name the PC drive if it is the default drive. The file replaces a SCRIPT file named CMSFILE. The new CMSFILE will have the same record length and format as the old CMSFILE.

If you do not have a file called CMSFILE SCRIPT on your A-disk, PCFILE is added to your A-disk as a new file called CMSFILE

SCRIPT. The records in the file may vary in length up to a maximum of 80 characters.

- **Sending a PC file from a drive other than your default to replace a file on your CMS B-disk.**

```
send a:pcfile.txt cmsfile script b1
      (ascii crlf)
```

This command sends a PC file named PCFILE.TXT from a diskette in drive A to your CMS B-disk. It replaces a SCRIPT file named CMSFILE.

If you do not have a file called CMSFILE SCRIPT on your B-disk, PCFILE will be added to your B-disk as a new file called CMSFILE SCRIPT. The records in the file may vary in length up to a maximum of 80 characters.

- **Sending a file from your fixed disk and adding it to the end of a file on your CMS A-disk.**

```
send c:pcfile.txt cmsfile script a1
      (ascii crlf append)
```

This command sends a PC file named PCFILE.TXT from your fixed disk to your VM host. It adds the file to the end of a SCRIPT file named CMSFILE on your CMS A-disk.

- **Sending a file from a subdirectory on your fixed disk to your CMS A-disk.**

```
send c:\subdir1\ pcfile.txt cmsfile
      script a1 (ascii crlf)
```

This command sends a file named PCFILE.TXT from a subdirectory named SUBDIR1 on your fixed disk to your VM host. It replaces a SCRIPT file, named CMSFILE, on your CMS A-disk.

- **Sending a binary file from your fixed disk to your CMS A-disk.**

```
send c:pcfile.com cmsfile combin a1
```

This command sends a file named PCFILE.COM from your fixed disk to your VM host. No translation takes place. This is the way to copy a binary file such as a COM or EXE file.

- **Sending a file from your fixed disk to your CMS A-disk with alternate code page translation.**

```
send c:pcfile.txt cmsfile script a1  
      (ascii crlf P850)
```

This command sends a file named PCFILE.TXT from your fixed disk to your CMS A-disk. The file will be translated from ASCII to EBCDIC using code page P850 and will be named CMSFILE SCRIPT A1.

Additional Information

If you need additional information about CMS or DOS, refer to the following manuals:

- *VM/370 CMS User's Guide*
- *IBM Virtual Machine Facility/370: CMS Command and Macro Reference*

-
- IBM Personal Computer *Disk Operating System*

Examples of SEND Command for MVS/TSO

The following examples are variations of the SEND command for TSO.

- **Sending a file from your default drive to replace a file on your TSO host.**

```
send pcfiler.txt tsodset.script
ascii crlf
```

This command sends a file named PCFILE.TXT from your default drive fixed disk to your TSO host. It replaces a data set named TSODSET.SCRIPT on your TSO volume.

- **Sending a file from a drive other than the default to your TSO host.**

```
send a:pcfiler.txt tsodset.script
ascii crlf
```

This command sends a file named PCFILE.TXT from a diskette in drive A to your TSO host. It replaces a data set named TSODSET.SCRIPT on your TSO volume.

- **Sending a file from your default drive to your TSO host and adding it to the end of a TSO data set.**

```
send a:pcfiler.txt tsodset.script ascii
crlf append
```

This command sends a file named PCFILE.TXT from a diskette in drive A to your TSO host. It adds it to the end of a data

set named TSODSET.SCRIPT on your TSO volume.

- **Sending a file to your TSO host and adding it to the end of a TSO data set that has a password.**

```
send a:pcfile.txt tsodset.script/brillig3
      ascii crlf append
```

This command sends a file named PCFILE.TXT from a diskette in drive A to your TSO host. It adds it to the end of a data set named TSODSET.SCRIPT on your TSO volume. This data set has a password of BRILLIG3.

- **Sending a file from a subdirectory on your fixed disk to a partitioned data set on your TSO host.**

```
send c:\subdir1\ pcfile.txt
      tsodset.script(member1) ascii crlf
```

This command sends a file named PCFILE.TXT from a subdirectory named SUBDIR1 on your fixed disk to your TSO host. It replaces a member named MEMBER1 in a partitioned data set named PCFILE.SCRIPT on your TSO volume.

-
- **Sending a file to a partitioned data set that has a password.**

```
send a:pcfile.txt tsodset.script  
      (member2)/slithy11 ascii crlf append
```

This command sends a file named PCFILE.TXT from a diskette in drive A to your TSO host. It adds it as a member named MEMBER2 to a partitioned data set named TSODSET.SCRIPT on your TSO volume. This data set has a password of SLITHY11.

- **Sending a file from your default drive and adding it as a new data set on your TSO volume.**

```
send pcfile.txt tsodset.script/vorpal34  
      ascii crlf lrecl(132) blksize(132)  
      recfm(v) space(20,10) tracks
```

This command sends a file named PCFILE.TXT from your default drive to your TSO host. It adds it as a new data set named TSODSET.SCRIPT on your TSO volume. A password of VORPAL34 is assigned to it. The records in the data set may vary in length up to a maximum of 132 characters. The data blocks are the same length as the records. Twenty tracks are set aside for this data set. If more tracks are needed, they will be added in groups of 10.

- **Sending a binary file from your fixed disk to your TSO host.**

```
send c:pcfile.com tsodset.bin
```

This command sends a file named PCFILE.COM from your fixed disk to your TSO host. The host file is named TSODSET.BIN. No translation takes place. This is the way to transfer a binary file such as a COM or EXE file.

-
- **Sending a file from your fixed disk to your TSO host with alternate code page translation.**

```
send c:pcfile.lst tsodset.script ascii  
      crlf P850
```

This command sends a file named PCFILE.LST from your fixed disk to your TSO host. The file will be translated from ASCII to EBCDIC using code page 850 and will be named TSODSET.SCRIPT.

Additional Information

If you need additional information about TSO or DOS, refer to these books:

- *IBM OS/VS2 TSO Terminal User's Guide*
- *IBM OS/VS2 TSO Command Language Reference*
- *IBM Personal Computer Disk Operating System*

RECEIVE Command Format

The RECEIVE command varies slightly, depending upon the type of host session you are using.

VM/CMS

To transfer files from VM/CMS to your PC, use the following format.

```
[d:]RECEIVE [d:][path]filename[.ext] fn ft [fm] [(options)]
```

Notes:

- 1. Do not type spaces between the drive specifier, path, filename, and extension.*
- 2. Do not use RECEIVE keywords, such as ASCII, CRLF, or P850 as filename or filetype.*

See Figure 7-3 on page 7-29 for format definitions.

MVS/TSO

To transfer files from MVS/TSO to your PC, use the following format (typed on one line).

```
[d:]RECEIVE [d:][path]filename[.ext] data set name [(member name)]  
[/password][options]
```

Notes:

1. Do not type spaces between the drive specifier, path, filename, and extension.
2. Do not use *RECEIVE* keywords, such as *ASCII*, *CRLF*, or *P850* as filename, data set name, or member name.

See Figure 7-3 for format definitions.

Command/ Parameter/ Option	Definition	Notes
d:	The PC drive specifier. When placed before the word <i>RECEIVE</i> , <i>d:</i> is the drive where the <i>RECEIVE.COM</i> file resides. This parameter is required before the <i>RECEIVE</i> command only if the default drive is not the drive where the <i>RECEIVE.COM</i> file resides. If you omit this parameter, DOS uses the default drive.	
RECEIVE	The required command name that transfers a file from the host computer to the PC.	
d:	The PC drive specifier used to indicate the drive that receives the file being transferred from the host computer. If you omit this parameter, DOS uses the default drive. (Refer to the <i>IBM PC Disk Operating System</i> manual.)	

Figure 7-3 (Part 1 of 4). RECEIVE Command Format Definitions

Command/ Parameter/ Option	Definition	Notes
path	List of directory names that specifies the directory where the transferred file is to be placed. (Refer to the <i>IBM PC Disk Operating System</i> manual for further information.)	Make sure that path is surrounded by backslashes, or DOS will not recognize the entire command.
filename	Name of the PC file given to the file received by the PC. The filename can be from 1 to 8 characters and may be followed by a filename extension. The filename with its extension may or may not already exist. (Refer to the <i>IBM PC Disk Operating System</i> manual for further information.)	
.ext	<p>The PC file extension. Required only if you want the file from the host to be stored under a filename with an extension. (Refer to the <i>IBM PC Disk Operating System</i> manual for further information.)</p> <p>An extension starts with a period, has 1 to 3 characters, and follows immediately after the filename. For example:</p> <p>82PRICES.AUG</p> <p>where .AUG is the extension.</p>	
fn	CMS file name. The filename can be from 1 to 8 characters.	Valid for VM/CMS only.
ft	CMS file type.	Valid for VM/CMS only.
fm	CMS file mode. If omitted, the default is A1.	Valid for VM/CMS only.
data set name	TSO data set name. You may type quotes around the combined data set name and the member name to show that the userid is not prefixed. (Refer to the <i>IBM OS/VS2 Command Language Reference</i> for further information.)	Valid for MVS/TSO only.

Figure 7-3 (Part 2 of 4). RECEIVE Command Format Definitions

Command/ Parameter/ Option	Definition	Notes
(member name)	Name of one of the members in the directory of a partitioned data set. The data set must exist on the host.	Valid for MVS/TSO only.
/password	Required if password protection has been specified for your TSO data set.	Valid for MVS/TSO only.
Options*		
APPEND	Allows you to attach a host file to the end of a PC file.	If APPEND is not specified when the filename is the same as an existing PC file, the file being transferred replaces the existing PC file.
ASCII	Specifies that the file stored on the host computer storage medium in EBCDIC form is to be converted to ASCII during the transfer to the PC. Usually, alphanumeric data is encoded in ASCII on the PC and in EBCDIC on the host computer.	The file should be stored on the PC storage medium in ASCII form if you want to display the file on the PC. (For further information, see Appendix C, "File Transfer ASCII to EBCDIC Translation.")
CRLF	Specifies that trailing spaces should be deleted and carriage return/line feed characters should be inserted as the last two characters of each line when a file is stored on the PC storage medium. This allows you to read the file when it is on the PC.	
P850**	Specifies that the file from the host should be converted from EBCDIC to code page 850 ASCII. This option is for users who do not have code page 850 loaded in their PC. If you have code page 850 loaded and specify the ASCII option only, the code page 850 translation occurs automatically.	

Figure 7-3 (Part 3 of 4). RECEIVE Command Format Definitions

Command/ Parameter/ Option	Definition	Notes
P437**	Specifies that the file from the host should be converted from code page 437 ASCII to EBCDIC. This option is for users who do not have code page 437 loaded in their PC. If you have code page 437 loaded and specify the ASCII option only, the code page 437 translation occurs automatically.	
P860**	Specifies that the file from the host should be converted from EBCDIC to code page 860 ASCII. This option is valid only if PO (Portugal) was chosen at installation.	
P863**	Specifies that the file from the host should be converted from EBCDIC to code page 863 ASCII. This option is valid only if CF (Canadian French) was chosen at installation.	
P865**	Specifies that the file from the host should be converted from EBCDIC to code page 865 ASCII. This option is valid only if DK (Denmark) or NO (Norway) was chosen at installation.	
<p>*Parentheses () are required around options unless for VM/CMS. **Only one of these options can be specified at a time.</p>		

Figure 7-3 (Part 4 of 4). RECEIVE Command Format Definitions

Examples of RECEIVE Command for VM/CMS

The following examples are variations of the RECEIVE command for VM/CMS.

Note: Each of the following commands must be typed all on one line.

- **Receiving a file from your CMS A-disk at your default drive for a PC session.**

```
receive pcfiler.txt cmsfile script al  
      (ascii crlf)
```

This command transfers a SCRIPT file named CMSFILE from your CMS A-disk to your PC session. It adds the file to your default drive (diskette or fixed disk) with the name PCFILE.TXT.

- **Receiving a file from your CMS B-disk and replacing a file on a drive other than your default.**

```
receive a:pcfiler.txt cmsfile script bl  
      (ascii crlf)
```

This command transfers a SCRIPT file named CMSFILE from your CMS B-disk to a drive other than the default for your PC session. It replaces a file named PCFILE.TXT on a diskette in drive A.

- **Receiving a file from your CMS A-disk and adding it to the end of a file on your fixed disk.**

```
receive c:pcfiler.txt cmsfile script al  
      (ascii crlf append)
```

This command transfers a SCRIPT file named CMSFILE from your CMS A-disk to your PC

session. It adds it to the end of a file named PCFILE.TXT on your fixed disk.

- **Receiving a file from your CMS A-disk and placing it in a subdirectory on your default drive.**

```
receive \subdir1\ pcfile.txt cmsfile
      script al (ascii crlf
```

This command transfers a SCRIPT file named CMSFILE from your CMS A-disk to your default drive. It replaces a file named PCFILE.TXT in a subdirectory named SUBDIR1.

Additional Information

If you need additional information about VM/CMS or DOS, refer to these books:

- *VM/370 CMS User's Guide*
- *IBM Virtual Machine Facility/370: CMS Command and Macro Reference*
- *IBM Personal Computer Disk Operating System.*

Examples of RECEIVE Command for MVS/TSO

The following examples are variations of the RECEIVE command for TSO.

- **Receiving a data set from a TSO host to the default drive for your PC session.**

```
receive pcfile.txt tsodset.script
      ascii crlf
```

This command transfers a data set named `TSODSET.SCRIPT` from your TSO volume to your PC session. It adds it to the default drive with the name `PCFILE.TXT`.

- **Receiving a data set from a TSO host to a drive other than that of your default drive.**

```
receive a:pcfile.txt tsodset.script
      ascii crlf
```

This command transfers a data set named `TSODSET.SCRIPT` from your TSO volume. It replaces a file named `PCFILE.TXT` on a diskette in drive A.

- **Receiving a data set from a TSO host and adding it to a PC file.**

```
receive a:pcfile.txt tsodset.script
      ascii crlf append
```

This command transfers a data set named `TSODSET.SCRIPT` from your TSO volume. It adds it to the end of a file named `PCFILE.TXT` on the diskette in drive A.

- **Receiving a data set from a TSO host and placing it in a subdirectory on your fixed disk.**

```
receive c:\subdir1\ pcfile.txt tsodset.
      script ascii crlf
```

This command transfers a data set `TSODSET.SCRIPT` from your TSO volume. It replaces a file named `PCFILE.TXT` in a subdirectory named `SUBDIR1` on your fixed disk.

- **Receiving a data set that has a password from a TSO host to your default drive.**

```
receive a:pcfile.txt tsodset.  
    script/brillig3 ascii crlf append
```

This command transfers a data set named TSOSET.SCRIPT from your TSO volume. The data set has the password BRILLIG3. The data set is added to the end of a file named PCFILE.TXT on your A-disk.

- **Receiving a member of a partitioned data set from a TSO host at your PC session.**

```
receive c:\subdir1\ pcfile.txt g:tsodset.  
    script(member1) ascii crlf
```

This command transfers a member named MEMBER1 from a partitioned data set named TSOSET.SCRIPT. The member is placed on your fixed disk in a subdirectory named SUBDIR1. It replaces a file named PCFILE.TXT.

- **Receiving a member of a partitioned data set that has a password to your PC session.**

```
receive a:pcfile.txt tsodset.  
    script(member2)/slithy11 ascii crlf  
    append
```

This command transfers a member named MEMBER2 from a partitioned data set named TSOSET.SCRIPT from your TSO volume. The data set has a password of SLITHY11. The member is added to a file named PCFILE.TXT on the diskette in diskette drive A.

Additional Information

If you need additional information about the TSO and DOS parameters, refer to these books:

- *IBM OS/VS2 TSO Terminal User's Guide*
- *IBM OS/VS2 TSO Command Language Reference*
- *IBM Personal Computer Disk Operating System*

Notes

Chapter 8. Using the Utilities

Introduction	8-2
The Keyboard Redefinition Program ...	8-2
Before You Begin	8-3
Starting the Keyboard Redefinition Program	8-4
Keyboard Panels	8-6
Ending the Program	8-24
Other Capabilities	8-26
The Color Selection Program	8-27
Starting the Color Selection Program	8-27
Redefining Your Host Color Scheme	8-28
Ending the Program	8-31
Activating Your Color Selections ..	8-32
Deactivating Your Color Selections	8-32
Other Capabilities	8-33
The Patch Service Utility	8-33
Describing the Patch Format	8-34
Creating a Patch File	8-35
Installing a Patch	8-36
Listing the Current System Level and Currently Installed APARs	8-38
Removing a Patch	8-39

Introduction

The entry emulator lets you redefine the keyboard functions and colors of your host session, and provides a patch utility to install software changes.

If you want to redefine your host session keyboard functions, continue with “The Keyboard Redefinition Program,” below.

If you want to modify the color scheme of your host session, refer to “The Color Selection Program” on page 8-27.

If you want to install a patch, refer to “The Patch Service Utility” on page 8-33.

The Keyboard Redefinition Program

The keyboard redefinition program allows you to design your own keyboard layout for your host session by using a program in your Personal Computer session. This program enables you to:

- Configure the host session keyboard definitions for the IBM Personal Computer, the IBM Personal Computer XT, the IBM Personal Computer AT, and the IBM Enhanced Personal Computer keyboard
- Swap, copy, or delete any of the keyboard functions and remap them in almost any position on your host keyboard

-
- Recover functions that have been deleted from your keyboard
 - Save multiple keyboard definitions.

The following sections describe in detail how to use the keyboard redefinition program.

Before You Begin

The keyboard redefinition program recognizes two types of keyboard definitions: default and current.

- The *default* definition is the keyboard arrangement IBM has specified.
- The *current* definition is the keyboard arrangement you have most recently either:
 - Written onto a disk with the keyboard redefinition program, or
 - Designated, by renaming or copying (refer to “Other Capabilities” on page 8-26), the current definition.

Each time you use this program, you must specify which keyboard definition you want the program to use.

Note: If your keyboard has never been redefined, your default and current definitions are the same.

Starting the Keyboard Redefinition Program

The entry emulator does not have to be active to use the Keyboard Redefinition program. However, if you have previously started the entry emulator, the PC session must be active. If necessary, press and hold the Alt key; then press Esc to switch to the PC session.

If the entry emulator was installed on a diskette, insert the diskette in drive A and make drive A the default by typing **a:**. If installed on a fixed disk, make that disk the default drive by typing its identifying character and a colon (for example, **c:**). If the entry emulator was installed in a subdirectory, make that subdirectory the default subdirectory using the DOS CHDIR (Change Directory) command. Refer to the IBM Personal Computer *Disk Operating System* manual for further information about this command.

1. Remove the keyboard aids from this binder and compare the pictured keyboards to your own or look at the label on your keyboard to determine your keyboard type. There are three types of keyboards:
 - The Personal Computer or Personal Computer XT keyboard
 - The Personal Computer AT keyboard
 - The Enhanced Personal Computer keyboard.
2. At the DOS prompt, type:
`ryokey`
3. Press Enter (↵).

4. The screen displays:

```
PANEL 1                KEYBOARD SELECTION
Make one selection for each category (Keyboard, Layout).
Move cursor under desired option, and press F2 to select.

Keyboard      Personal Computer
              Personal Computer XT
              Personal Computer AT
              Enhanced Personal Computer

Layout        Current
              IBM Default

F2=Select          PgDn=Next Panel          End=Exit
```

The preset options appear in reverse video.

To select, position the cursor on your choice and press F2.

5. After you have selected your Keyboard and Layout, press PgDn to go to the next screen.
6. An image of a typewriter keyboard, corresponding to the options you selected in Panel 1, appears on your screen. This is the first keyboard panel.

Keyboard Panels

The keyboard panels allow you to change your keyboard layout. For each change to the keyboard, you use the panel(s) to indicate the following:

- The mode of the change
- The type of change operation
- The source key and target key involved in the change.

For each type of keyboard, there are two keyboard panels, each displaying different keyboard areas.

- **Personal Computer or Personal Computer XT Keyboard**

If you selected either the Personal Computer or Personal Computer XT keyboard option on panel 1, your first keyboard panel looks like this:

Panel 2.1		HOST KEY DEFINITION															
SWSC	! 1	@ 2	# 3	\$ 4	% 5	- 6	& 7	* 8	(9) 0	- +	BKSP	BKSP	BKSP			
<-	Q q	W w	E e	R r	S s	T t	Y y	U u	I i	O o	P p	[]	←	→	↔	
CTRL	A a	S s	D d	F f	G g	H h	J j	K k	L l	:	"	~					
CTRL		SPND									:	"	~				
SHFT	\	Z z	X x	C c	V v	B b	N n	M m	<	>	/	SHFT	SHFT	PrSc	SHFT	ENTR	
SHFT												SHFT	SHFT	SREQ			
ALT						SPCE									CPLK		
ALT						SPCE									CPLK		
ALT						SPCE									CPLK		
SWAP	COPY	DELETE	RETRIEVE								FULL	SINGLE					
F2-Select							PgDn=Next Panel							End=Exit Panel			

Press the PgDn key to move to the second keyboard panel. It looks like this:

Panel 2.2		HOST KEY DEFINITION			
PF11	PF12	NMLK	DUP	FDMK	SREQ
PF1	PF2	NMLK	NMLK	TEST	
ATTN	CLR	SWSC			
PF13	PF14	7	8	9	PrSc
PF3	PF4	HOME	↑	PA1	ENTR
CSEL	DCNL	DOC	CPOS		
PF15	PF16	4	5	6	-
PF5	PF6	←		→	PA2
CFMT	EREF	←←	QUIT	→→	
PF17	PF18	1	2	3	ENTR
PF7	PF8	ERIP	IDEN		ENTR
PRT					ENTR
PF19	PF20	0			
PF9	PF10	INS		DEL	
WRAP	RSET			WDDL	

SWAP COPY DELETE RETRIEVE FULL SINGLE
 F2=Select PgDn=Prev Panel End=Exit Panel

You can return to the first keyboard panel by pressing PgDn again.

- **Enhanced Personal Computer Keyboard**

If you selected the Enhanced Personal Computer keyboard option on panel 1, your first keyboard panel looks like this:

Panel 2.1		HOST KEY DEFINITION															
~	!	•	#	\$	%	@	&	*	()	-	+	BKSP	BKSP	BKSP		
←	Q	W	E	R	T	Y	U	I	O	P	{	}					
→	q	w	e	r	t	y	u	i	o	p	{	}					
CPLK	A	S	D	F	G	H	J	K	L	:	"	'	↑	↑	↑		
CPLK	a	s	d	f	g	h	j	k	l	:	"	'	↑	↑	↑		
SHFT		Z	X	C	V	B	N	M	<	>	?	/	SHFT	SHFT	SHFT		
SHFT		z	x	c	v	b	n	m	<	>	?	/	SHFT	SHFT	SHFT		
CTRL		ALT											ALT				
CTRL		ALT											ALT				
CTRL		ALT											ALT				

SWAP COPY DELETE RETRIEVE FULL SINGLE
 F2=Select PgDn=Next Panel End=Exit Panel

Press the PgDn key to move to the second keyboard panel. It looks like this:

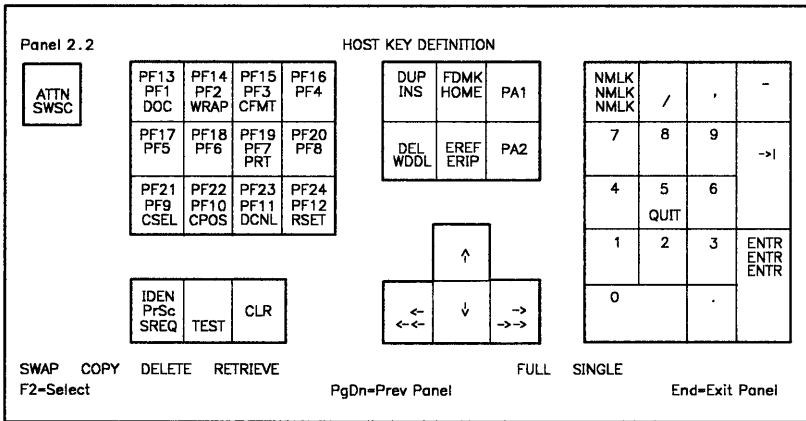

You can return to the first keyboard panel by pressing PgDn again.

Key Shift States

Most keys on the keyboard panels have three different shift states. Most keys function not only when pressed alone, but also when pressed in combination with the Shift, Alt, or Ctrl keys. For each key on the keyboard panels:

- The function obtained by pressing the Shift + the key is pictured at the top of the key diagram
- The function obtained by pressing the key alone is pictured in the middle of the key diagram
- The function obtained by pressing the Alt + the key is pictured at the base of the key diagram.

*Note: Functions obtained by pressing
Ctrl + a key cannot be redefined.*

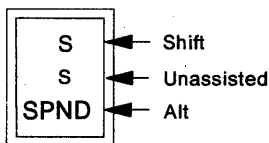

Modes

Each time you perform a keyboard change, you choose whether that change will affect all or only one of the functions on the key(s) involved. The number of functions affected is determined by the **mode** that is active:

FULL Causes the change to affect all of the functions of a key. **FULL** is the default mode. In **FULL** mode, you identify each key involved by placing the cursor on any position on the key and pressing F2.

SINGLE Causes the change to affect only one function of the key. In **SINGLE** mode, you identify the function involved by positioning the cursor on that function and pressing F2.

Change Operations: SWAP, COPY, DELETE, RETRIEVE

The keyboard panels provide four types of operations you can use to change your keyboard:

- SWAP
 - COPY
 - DELETE
 - RETRIEVE
-
- If you want to switch the position of one key function with another, use the SWAP operation.
 - If you want to make a key function available at more than one location on your keyboard, use the COPY operation.
 - If you want to erase a key function from a key, use the DELETE operation.
 - If you want to recover a key function that was deleted or erased from your keyboard, use the RETRIEVE operation.

Only one change operation can be active at a time; the active operation appears in reverse video. It remains active until you select a different one or perform an operation that returns you to SWAP, the default setting.

Note: You may not perform a change operation that affects the SWSC (Switch Screen) function, which allows you to switch between your host and PC session.

SWAP

SWAP allows you to exchange the positions of one key (the source) with another (the target).

To perform a SWAP operation:

1. Position your cursor on SWAP at the bottom of your screen.

2. Press F2.

You have selected the SWAP operation. SWAP appears in reverse video.

3. If you want to exchange all the key functions of a key with all those of another, position your cursor on FULL.

If you want to exchange only one key function on a key with one on another, position your cursor on SINGLE.

4. Press F2.

Your selected mode appears in reverse video.

5. Go to the keyboard panel that displays the first key you want to exchange. Press PgDn to get to the other keyboard panel if necessary.

6. Position your cursor on one of the keys or key functions you want to exchange. This is your source.

7. Press F2.

You have selected the first key in your SWAP operation. Your source appears in reverse video. The message:

```
RYOKEY06 Swap pending...
```

appears on your screen.

Note: If you accidentally select the wrong key or key function, position your cursor on that function again and press F2. The “Swap pending...” message is erased, and you can select another source.

8. If necessary, switch to the other keyboard panel by pressing PgDn.
9. Position your cursor on the other key or key function you want to exchange.
10. Press F2.
11. The SWAP is complete. You can perform another SWAP operation, select another change operation and mode, or end the program.

SWAP Example 1:

Suppose you use colons more often than semi-colons. You might like to exchange these two functions so you won't have to press Shift to type a colon. SWAP allows you to exchange the positions of these two functions.

1. Select the change operation. SWAP is active by default and appears in reverse video. (If you had to make SWAP active, you would place the cursor on SWAP and press F2.)
2. Select the mode. The SWAP operation you are performing involves rearranging two key functions on one key. To move individual functions, SINGLE must be active. Position the cursor on SINGLE, and press F2. SINGLE appears in reverse video.
3. Display the keyboard panel with the keyboard area that contains the colon/semi-colon key. (If your screen displays the other keyboard area, you can switch by pressing PgDn.)

When you use PgDn, the selections you have already made remain active.)

4. Now select the source function. Place the cursor on the colon and press F2. The colon appears in reverse video.
5. Select the target in the same way. Place the cursor on the semi-colon and press F2.
6. The two keys are swapped and the screen displays the change.

SWAP Example 2:

Suppose you want to move all the functions of the PF1 key to the position of the Tab key, and move the Tab key functions to the position of the PF1 key.

1. Select the change operation. If SWAP already appears in reverse video, you do not have to reactivate it. (If SWAP is not active, position the cursor on SWAP; press F2.)
2. Select the mode. Because you want to exchange all of the positions of the PF1 key with all of the corresponding positions of the Tab key, you need FULL mode. Unless FULL already appears in reverse video, position the cursor on FULL; press F2. FULL appears in reverse video.

3. Select the source and target keys involved.

To select PF1, position the cursor on any function of the PF1 key; press F2. The PF1 key appears in reverse video. Now go to the keyboard area where Tab appears by pressing PgDn. The other keyboard panel appears. Position the cursor on the other key involved, the Tab key, and press F2. The change is displayed.

COPY

COPY allows you to copy the function(s) of a key (the source) to another position on the keyboard (the target).

To perform a COPY operation:

1. Position your cursor on COPY at the bottom of your screen.

2. Press F2.

You have selected the COPY operation. COPY appears in reverse video.

3. If you want to copy all the key functions of a key onto another, position your cursor on FULL.

If you want to copy only one key function onto another, position your cursor on SINGLE.

4. Press F2.

Your selected mode appears in reverse video.

5. Go to the keyboard panel that displays the key function or functions you want to copy. Press PgDn to get to the other keyboard panel if necessary.

6. Position your cursor on the key or key function you want to copy. This is your source.

7. Press F2.

You have selected the first key in your COPY operation. Your source appears in reverse video. The message:

RYOKEY07 Copy pending...

appears on your screen.

Note: If you accidentally select the wrong key or key function, leave your cursor on that function and press F2. The "Copy pending..." message is erased, and you can select another source.

8. If necessary, switch to the other keyboard panel by pressing PgDn.

9. Position your cursor on the area you want to copy to. This is your target. If there is already a key function on your target, that function will be erased when the copy is complete.

Note: To recover functions that have been deleted or erased, refer to "RETRIEVE" on page 8-21.

10. Press F2.

11. The COPY is complete. You can perform another COPY operation, select another change operation and mode, or end the program.

COPY Example:

Suppose you want the Clear function to be available at its current position and also at the position of the Esc Key. This requires a COPY operation.

1. Select the COPY operation. Position the cursor on COPY and press F2. COPY appears in reverse video.
2. Select the mode. Because you are copying only one function from the Clear key, you need SINGLE mode. If SINGLE does not already appear in reverse video, position the cursor on SINGLE and press F2.
3. When you use the COPY function, the first key you select is the source key. It will be copied. For this example, you must first display the keyboard panel containing the Clear function. Press the PgDn key to move to the next keyboard panel.
4. Select the key function you want to copy. Place the cursor on Clear and press F2. The Clear function appears in reverse video.
5. Select the target position, the key area where you want the function to be copied. In this example, you must first switch to the keyboard area that displays the Esc key. Press PgDn. Then position the cursor on the Esc key and press F2. The change appears on the screen.

DELETE

DELETE lets you erase a key or key function from the keyboard.

To perform a DELETE operation:

1. Position your cursor on DELETE at the bottom of your screen.
2. Press F2.

DELETE appears in reverse video.

3. If you want to erase all the key functions of a key, position your cursor on FULL.

If you want to erase only one key function of a key, position your cursor on SINGLE.

4. Press F2.

Your selected mode appears in reverse video.

5. Go to the keyboard panel that displays the key function or functions you want to erase. Press PgDn to get to the other keyboard panel if necessary.
6. Position your cursor on the key function or functions you want to erase.
7. Press F2.
8. The DELETE operation is complete. You can perform another DELETE operation, select another change operation and mode, or end the program.

Note: To recover functions that have been deleted or erased, refer to "RETRIEVE" on page 8-21.

DELETE Example:

Suppose you want to remove the Attn function from your keyboard.

1. Select the change operation. Position the cursor on DELETE and press F2. DELETE appears in reverse video.
2. Select the mode. Because you are deleting only one function on a key, you need SINGLE mode. Position the cursor on SINGLE; press F2. SINGLE appears in reverse video.
3. Go to the keyboard panel that displays the Attn key. If necessary, press PgDn to move to the other keyboard area.
4. Select the key function. Place the cursor on the Attn function and press F2. Attn is deleted from that position of the keyboard.

Note: To return to the previous keyboard panel without selecting a key, press the End key.

4. Press F2.

The keyboard panel you were at when you selected RETRIEVE appears. The message:

```
RYOKEY08 Retrieve pending...
```

appears on your screen.

5. If necessary, switch to the other keyboard panel by pressing PgDn.
6. Position your cursor on the area you want to copy the key function to. This is your target. If a key function is already in your target area, that function will be overwritten by the new key function.
7. Press F2.
8. The RETRIEVE operation is complete. You can perform another RETRIEVE operation, select another change operation and mode, or end the program.

RETRIEVE Example:

Suppose you copied the Clear function onto the position of the lowercase letter z. Now you want to restore z to your keyboard. Retrieve allows you to do so.

1. Select the change operation. Position the cursor on RETRIEVE and press F2.
2. Your screen leaves the keyboard panel and displays the RETRIEVE table panel.

-
3. Position the cursor on the letter, symbol, or function you want to reassign to your keyboard. For this example, lowercase z is your source. Place the cursor on lowercase letter z and press F2. It is selected and your screen returns to the previous keyboard panel.
 4. Display the keyboard area to which you want to restore the letter z. If necessary, press PgDn to switch keyboard areas.
 5. Position the cursor on your target. Press F2. The change appears on your display.

Ending the Program

Note: Before you end the program, print your screen on your PC printer to make a reference of your redefined host keyboard layout.

When you have finished making changes, press the End key.

If the entry emulator is loaded in your system, this screen appears:

Panel 4	EXIT PANEL
Place cursor under desired option and press F2 to select.	
1. QUIT	- Exit program without saving changes
2. FILE	- Save changes to disk and exit program
3. MORE CHANGES	- Return to Panel 2.1
4. TEMPORARY SAVE	- Save all changes temporarily
F2=Select	

*Note: If your entry emulator is **not** loaded in your system, a similar panel will appear without the TEMPORARY SAVE option. You cannot save your changes temporarily unless you load the entry emulator and start over.*

You are shown four options on the exit panel:

1. QUIT

Quit allows you to exit the keyboard redefinition utility. If you want to discard

the changes you have made, position your cursor on 1 and press F2. If you saved your changes temporarily by selecting 4, they will still be active when you switch to your host session.

2. FILE

Note: Before selecting the FILE option, insert the PC3270 diskette you created.

If you want to make the layout you defined become the new host keyboard definition and overwrite the existing definition, position your cursor on 2 and press F2. If the entry emulator is currently loaded and you want your keyboard definition to take effect immediately, select TEMPORARY SAVE before FILE. Otherwise, the definition takes effect the next time the entry emulator is loaded.

3. MORE CHANGES

If you want to return to the keyboard panel after performing a TEMPORARY SAVE, position your cursor on 3 and press F2.

4. TEMPORARY SAVE

If you want to use the layout you defined temporarily, position your cursor on 4 and press F2. The new layout takes effect as soon as you switch to your host session; however, it will not overwrite the current definition file. When you reload the entry emulator, you will lose the keyboard definition you temporarily created.

Switch back to your PC session and select 2 (FILE) on the exit panel if you want to save this keyboard definition permanently.

Other Capabilities

Saving and Restoring Multiple Keyboard Definitions

By creating multiple keyboard definitions, you can retain several keyboard layouts, each designed to perform different tasks. To use multiple definitions:

- You must **save** the PC3270.KEY file by renaming it XXXXX.KEY with the **rename** command.
- You must **restore** the XXXXX.KEY file to PC3270.KEY, by using the **rename** command, when you want it to become the current definition again.

Note: Your current definition is always named PC3270.KEY.

XXXXX can be any valid DOS filename.

Deactivating Your Current Definition

To deactivate your current layout and reactivate your default definition:

1. Rename your PC3270.KEY file to XXXXX.KEY with the **rename** command.
2. If the entry emulator is active, enter the word RYOKEY. Select **IBM default** and **TEMPORARY SAVE**.
3. If the entry emulator is not active, it will automatically use your default definition when it is next loaded.

The Color Selection Program

The color selection program allows you to design your own color scheme for your host session. You redefine your host session screen colors by using the color selection program, which permits you to:

- Change your host session foreground color.
- Change your host session background colors.

The following sections detail how to use the color selection program.

Starting the Color Selection Program

The entry emulator does not have to be active to use the color selection program. However, if you have previously started the entry emulator, the PC session must be active. If necessary, press and hold the Alt key; then press Esc to switch to the PC session.

If the entry emulator was installed on a diskette, insert the diskette in drive A and make drive A the default by typing **a:**. If installed on a fixed disk, make the fixed disk the default drive by typing its identifying character and a colon (for example, **c:**). If the entry emulator was installed in a subdirectory, make that subdirectory the default subdirectory using the DOS CHDIR (Change Directory) command. Refer to the IBM Personal Computer *Disk Operating System* manual for further information about this command.

When the DOS prompt appears:

1. Type:
color
2. Press Enter (↵).

The color selection screen appears.

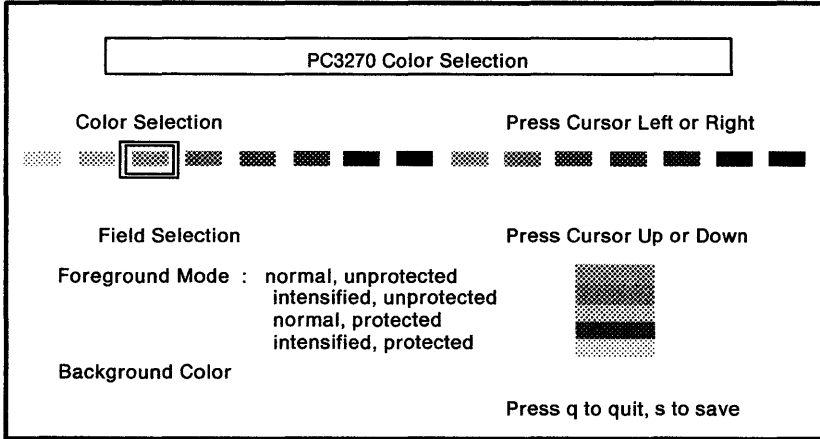

Redefining Your Host Color Scheme

You can redefine your host session color scheme in two steps:

1. Select the fields you want to change the colors of, and the colors you want to reassign to them.
2. End the program.

Your new color selection is activated.

Making Your Field and Color Selections

1. Selecting Your Field

Press and release either the Cursor Up or Cursor Down keys to select the first field you want to assign a new color to. The field you select appears in reverse video, and the color selection indicator moves to the color of that field.

Note: For more information about fields, refer to "Field Selection" on page 8-30.

2. Selecting Your Color

Press and release either the Cursor Left or Cursor Right keys to move the color selection indicator () left or right. The color the surrounds is the selected color.

Notice that the color to the right of the active field corresponds with the active color. When you move the left or right, the color corresponding to the active field changes.

Note: Your foreground and background colors cannot be the same, and you may only select one of the first eight colors of the Color Selection Area as a background.

If PC3270 is loaded, you can see your color selection on the host screen. Hold down Alt and press Esc to switch to the host screen.

3. When you are satisfied with the color you have chosen for the first field, you have two options:

- If you want to assign another color to another field, repeat steps 1 and 2.
- If you are satisfied with your color selections, continue with “Ending the Program” on page 8-31.

Field Selection

In the Field Selection area you can assign new colors to the foreground and background.

Foreground Color and Modes

Foreground color is the color of all the text that appears on your screen. You may have up to four different foreground colors corresponding to the four different types of

foreground modes. Each mode is defined by its intensity and protected state. The modes are:

- Normal, unprotected: N/U data is nonintensified text that you can modify (type over) without receiving an error message. Most information you enter is N/U. The standard N/U color is blue.
- Intensified, unprotected: I/U data is highlighted text you can modify without receiving an error message. The standard I/U color is red.
- Normal, protected: N/P data is nonintensified text you cannot modify. The standard N/P color is blue.

-
- Intensified, protected: I/P data is highlighted text you cannot modify. The standard I/P color is white.

Each default host session color is displayed to the right of its corresponding field.

Background Color

Background color is the color that appears behind and around your text. The standard background color is black. You may select a background color from the first eight colors of the color selection area.

The default host session background color is displayed to the right of the background option.

Ending the Program

- If you want to save the changes you made:
 1. Type the letter **s**. The color selection screen disappears, and you see the message:

```
COLOR05 Color selections saved in file PC3270.COL
```

When the file has been saved, the DOS prompt appears.

Your new color selection will be automatically activated by the entry emulator when you end the program.

- To leave the color selection program without saving your changes:
 1. Type the letter **q**.

The color selection screen disappears, and you see the DOS prompt.

Note: Your new color selection will be automatically activated for this session only.

Activating Your Color Selections

If your entry emulator is loaded, your new color selection will activate automatically when you end the color selection program.

If your entry emulator is not loaded, load the diskette with the PC3270.COL file and entry emulator, if necessary. Start the entry emulator as described in Chapter 3, “Starting the Entry Emulator” or Chapter 4, “Using IBM Enhanced Connectivity Facilities.”

Deactivating Your Color Selections

To deactivate your color definition and return to the default definition:

1. Rename your PC3270.COL to XXXXX.COL.
Type:

```
rename pc3270.col xxxxx.col
```

Note: XXXXX can be any valid DOS filename.

2. Follow the procedure in “Activating Your Color Selections.” When the entry emulator is loaded, it looks for the PC3270.COL file you just renamed. Because it isn’t found, the default colors are used.

Other Capabilities

Saving and Restoring Multiple Color Definitions

By saving multiple color definitions, you can retain several color schemes at the same time. To create multiple definitions:

- You must **save** the color definition you want by renaming it XXXXX.COL with the DOS **rename** command.
- You must **restore** the XXXXX.COL file to PC3270.COL by using the DOS **rename** command when you want it to become the current color definition again.

Note: Your current color definition is always named PC3270.COL.

The Patch Service Utility

The Patch Service utility is for anyone who is responsible for installing software changes. The Patch Service is a program that runs on DOS. To **invoke this program in the pc session**, enter the command INDPATCH and then follow the prompts on your screen. When you are instructed to press Enter in the procedures and prompts, you can use the Enter key (↵), in the Typewriter Key area. The program provides installation or removal of permanent changes, called **patches** or **fixes**, to the code and data. It also provides historical tracking and is limited to 100 entry emulator patches per release. A problem that the Patch Service utility resolves is

identified as an *Authorized Program Analysis Report (APAR)*.

This section describes how to:

1. Interpret the information you will put in a patch file
2. Create a patch file
3. Install a patch
4. List the current system level
5. List currently installed APARs
6. Remove a patch.

Appendix A contains error messages.

Describing the Patch Format

If you are unfamiliar with EDLIN or the procedure for editing a file, refer to Appendix I, "Creating a Patch File," which outlines the steps required to create a patch file or to modify an existing patch file.

Let's assume there is a problem within the entry emulator. When IBM sends you the patch to solve your problem, it will be in a written format like this example:

```
PRE LEVEL = 0012
PRE APAR = IR20001
ZAP PC3270.COM (OFF=01C4, VER=10CD, REP=4242)
```

This is the data that you must enter in a patch file. Note that all patches should start with a PRE LEVEL line and end with a ZAP line. When you create the patch filetype, type the data exactly as shown.

Creating a Patch File

Before you install the patches to your system diskette, you will need to create a **patch file** for each patch. For a single diskette system, insert your existing system diskette to be patched in drive A and create all patch files on that diskette. For a fixed disk system, create the patch file on the fixed disk. You can create a patch file anywhere. For actual installation, it must be on the same diskette or disk and subdirectory on which you install the entry emulator. Use the EDLIN EDITOR or any equivalent editor that creates an ASCII character file to create a patch file when you are in a PC session. To do this:

1. Create a new file, using the APAR number for the file name, with the editor that is on your system. Do not use a DOS file extension.

Note: The APAR number is supplied with the patch.

2. Enter the written information you received from IBM.

For example, if you received the following patch, you would use the editor to type the three lines exactly as supplied by IBM. You must press the Enter key (↵) after each line of information you enter. Your file should look like this:

```
PRE LEVEL = 0012
PRE APAR = IR20001
ZAP PC3270.COM (OFF=01C4, VER=10CD, REP=4242)
```

3. Save your file in accordance with your editing procedures.

So far you have done the following:

-
1. Received the patch in written form.
 2. Created a file in a PC session with each APAR number as the file name for each patch.
 3. Entered the information for each patch into each file.

Remember that a patch file contains one patch. If you have three patches to install, you will have to create three patch files, each with its own unique APAR number for the file name.

Now you are ready to install a patch.

Installing a Patch

Your patch file must be on the same diskette or disk on which you installed the entry emulator. If you installed the entry emulator in a subdirectory, the patch file must also be in the same subdirectory.

The entry emulator does not have to be active to use the patch program. However, if you have previously started the entry emulator, the PC session must be active. If necessary, press and hold the Alt key; then press Esc to switch to the PC session.

If the entry emulator was installed on a diskette, insert the diskette in drive A and make drive A the default by typing **a:**. If installed on a fixed disk, make that disk the default drive by typing its identifying character and a colon (for example, **c:**). If the entry emulator was installed in a subdirectory, make that subdirectory the default subdirectory using the DOS CHDIR (Change Directory) command. Refer to the IBM Personal Computer *Disk Operating System* manual for further information about this command.

When the DOS prompt appears:

1. Type
 indpatch
2. Press Enter (↵).

-
3. The following prompt appears:

<I>NSTALL, <R>EMOVE, OR <L>EVEL :

First you are going to install a patch:

- a. Type

I

- b. Press Enter (↵).

4. The next prompt appears:

TYPE APAR NUMBER OF PATCH AND
PRESS ENTER (↵),
OR PRESS ENTER (↵) TO QUIT

Type the seven character APAR number (for example, IR00055) and press Enter (↵). This is also the file name that contains the patch.

5. The ZAP data line associated with that APAR number appears on your display screen:

ZAP PC3270 (OFF=01C4, VER=10CD,
REP=4242) Verify is correct

6. A final prompt indicates that the patch has been installed:

PAT26 PATCHES INSTALLED

Listing the Current System Level and Currently Installed APARs

You can look at your APAR History List to see the current system level and the currently installed APARs. To do this:

1. Type
indpatch
2. Press Enter (↵).
3. The following prompt appears:
`<I>NSTALL, <R>EMOVE, or <L>EVEL :`
 - a. Type
L
 - b. Press Enter (↵).
4. An APAR History List, a listing of currently installed APARs on your system, appears on your screen. Notice also the current system level. Your screen should look something like this:

```
APAR History  
System Level =00XXX
```

```
APAR    APAR    APAR    APAR    APAR    APAR    APAR  
IR20001 IR20002 IR20003 IR20004 IR20005 IR20006 IR20007  
IR20008 IR20009 IR20010 IR20011 IR20012 IR20013 IR20014
```

```
A>
```

Removing a Patch

When you remove a patch, it is removed from the entry emulator. The patch file is not deleted. The patch file must be on the same diskette or disk as the entry emulator. If you installed the entry emulator in a subdirectory, the patch file must be in the same subdirectory.

If the entry emulator is in a subdirectory, make that subdirectory active with the DOS CHDIR (Change Directory) command. Refer to the IBM Personal Computer *Disk Operating System* manual for further information about this command.

If you have to remove more than one patch, we suggest you remove your patches in the opposite order you installed them.

Perhaps you need to remove the following two APARs:

- IR20002
- IR20004

First remove APAR IR20004. At the DOS prompt:

1. Type

```
indpatch
```

2. Press Enter (↵).

3. The following prompt appears:

```
<I>NSTALL, <R>EMOVE, OR <L>EVEL :
```

4. Type

R

5. Press Enter (↵).

6. The next prompt appears:

```
TYPE APAR NUMBER OF PATCH AND  
PRESS ENTER (↵),  
OR PRESS ENTER (↵) TO QUIT
```

Type the seven-character APAR number and press Enter (↵). This is also the file name that contains the patch.

7. The ZAP data line associated with that APAR number appears on your display screen:

```
ZAP PC3270.COM (OFF=01C4, VER=10CD21C3,  
REP=42424242) Verify is correct
```

8. A final prompt indicates that the patch has been removed:

```
PAT27 PATCHES REMOVED
```

To remove APAR IR20002, follow steps 1 through 8 again.

Chapter 9. Some Problem-Solving Tools

General Information	9-2
How to Read Problem Determination	
Tables	9-3
System Startup	9-4
File Transfer	9-5
PC Application	9-6
PC Printer	9-7
Keyboard	9-8

General Information

The problem determination tables in this chapter help you determine if a problem is hardware-related, software-related, or caused by operator error.

We assume you are familiar with the problem determination tools available for your host system. The tables included here do not attempt to be host-specific or all-inclusive.

Be sure your host computer is available and the coaxial cable is connected.

Refer to the IBM Personal Computer *Guide to Operations* for hardware-related problems.

See Appendix A of this manual for messages that occur during file transfer, keyboard redefinition, color selection, patch utility, and when using IBM Enhanced Connectivity Facilities.

See Appendix B of this manual for messages appearing in the operator information area of your screen in the host computer session.

How to Read Problem Determination Tables

Choose the section of this chapter that best describes the problem you are experiencing.

- If you are unable to start your system properly, refer to “System Startup” on page 9-4.
- If you are having difficulty transferring files from host to PC or PC to host, begin with “File Transfer” on page 9-5.
- If you are having trouble running your PC software, go to “PC Application” on page 9-6.
- If the printer attached to your PC is not working correctly, refer to “PC Printer” on page 9-7.
- If your keyboard does not function properly, go to “Keyboard” on page 9-8.

System Startup

This table helps you determine why your system is not starting properly.

Question	Yes	No
1. Did the power-on self-test (POST) run correctly and without any error messages the last time you turned your system on?	Continue with question 2.	Refer to the IBM Personal Computer <i>Guide to Operations</i> .
2. The entry emulator must be the last resident program loaded by DOS when the PC is turned on or you perform a system reset. Have you loaded any programs other than DOS and the entry emulator?	Restart your PC. Load the entry emulator immediately after loading DOS. Continue with question 3.	Continue with question 3.
3. Do you have the entry emulator loaded?	Contact your Service Coordinator.	Continue with question 4.
4. Load the entry emulator. Did it load successfully?	Contact your Service Coordinator.	Continue with question 5.
5. Load your DOS diskette. Did DOS load successfully?	Continue with question 6.	Refer to the IBM Personal Computer <i>Guide to Operations</i> .
6. Insert the PC3270 entry emulator diskette that you received with this manual into drive A. Type: pc3270 and press Enter (↵). Did the program load successfully?	Refer to Chapters 2 and 3. There is a problem with the diskette you created or the files copied onto your fixed disk.	Contact the point of purchase of your entry emulator.

File Transfer

Before you use this table to determine your transfer problem, make sure your PC is in PC DOS command mode and that the host computer is in either CMS or TSO mode and ready to receive commands.

Question	Yes	No
1. Is the failure the result of the host being inoperative?	Try the operation when the host is available.	Continue with question 2.
2. Was the file transfer command typed into the PC after a DOS prompt was displayed?	Continue with question 3.	Retry entering the command from PC DOS command mode.
3. Does a problem exist with the transferred file, even though file transfer was completed without an error message?	<p>Check for the following:</p> <ul style="list-style-type: none">• An error in source data set or incorrect options specified (ASCII or CRLF).• An unrequested APPEND (default is REPLACE).• An error displayed in the host session not generated by file transfer. Press and hold Alt; then press Esc to view host screen. <p><i>Note: If the host is TSO, there are potential problems with user catalogs.</i></p>	Continue with question 4.

Question	Yes	No
4. Did file transfer stop and display an error message?	See Appendix A for further information.	Continue with question 5.
5. Did file transfer stop without messages?	Continue with question 6.	Contact your Service Coordinator.
6. Switch to your host computer session. Are any messages or status information displayed?	Correct the condition and retry.	Contact your Service Coordinator.

PC Application

This table helps you determine the cause of a software application problem when the entry emulator is loaded.

Question	Yes	No
1. Load DOS without the PC3270 entry emulator. Does the PC application work with DOS alone?	Continue with question 2.	The problem is with the PC application. Report the problem to the point of purchase.
2. When the PC3270 entry emulator is loaded, does the application observe the restrictions imposed on applications by the entry emulator? <i>Note: Some applications cannot be used with the entry emulator. See "Compatibility" in Chapter 1 for further information.</i>	Contact your Service Coordinator.	The application cannot be run concurrently with the entry emulator.

PC Printer

This table helps you determine why the printer attached to your PC is not working correctly.

Question	Yes	No
1. Is your printer powered on, attached, online, and loaded with paper?	Continue with question 2.	Go to question 3.
2. Did you receive a message indicating that the printer is not ready?	Continue with question 3.	Go to question 4.
3. Ready the printer and retry. <i>Note: If the printer is powered off, not attached, off-line, or there is no paper, an error condition will occur.</i> Is the printer operating correctly?	Resume normal operations.	Refer to the IBM Personal Computer <i>Guide to Operations</i> .
4. Press and hold the Shift key and then press your print key. Did the printer print the information from the screen correctly? <i>Note: If you have an Enhanced PC keyboard, you should press the Print Key.</i>	Resume normal operations.	Refer to the IBM Personal Computer <i>Guide to Operations</i> .

Keyboard

Use this table if your keyboard does not function properly.

Note: If your keyboard has been redefined using the Keyboard Redefinition utility, your host keyboard layout may not match the layout of the keyboard aids. Refer to "Deactivating Your Current Definition" on page 8-26 for information about activating the default keyboard definition.

Question	Yes	No
1. Can you switch sessions (hold down the Alt key and press the Esc key)? <i>Note: Make sure your PC session is not paused (Ctrl + Num Lock).</i>	Go to question 4.	Continue with question 2.
2. Restart your system and load the entry emulator. Can you switch sessions?	Resume normal operations.	Continue with question 3.
3. Restart your system and load DOS. Try entering characters. Do the correct characters appear on your screen?	Contact your Service Coordinator.	Refer to the IBM Personal Computer Guide to Operations.
4. Do characters appear in the right case?	Go to question 6.	Continue with question 5.
5. Press and release the Caps Lock key. Do characters appear in the right case?	Resume normal operation.	Refer to the IBM Personal Computer Guide to Operations.
6. Do numbers appear when you try to move the cursor?	Continue with question 7.	Resume normal operation.
7. Press and release the Num Lock key. Do numbers appear when you try to move the cursor?	Refer to the IBM Personal Computer Guide to Operations.	Resume normal operation.
8. Do numbers appear when you try to type a symbol?	Continue with question 9.	Contact your Service Coordinator.

Question	Yes	No
<p data-bbox="125 175 457 267">9. Be sure to use the shift key when typing the symbols above numbers even when the Caps Lock is active.</p> <p data-bbox="175 284 457 332">Are you using the Shift key to obtain symbols?</p>	<p data-bbox="508 175 686 267">Refer to the IBM Personal Computer <i>Guide to Operations</i>.</p>	<p data-bbox="732 175 888 219">Resume normal operation.</p>

Notes

Appendix A. Messages

Installation Messages	A-2
File Transfer Messages	A-4
Keyboard Redefinition Messages	A-14
Color Selection Messages	A-17
Patch Installation Messages (PATnn)	A-19
SRPI Messages	A-26

Installation Messages

INDIN01 **Cannot find XX. Your country code is probably wrong.**

Explanation: The country code that you entered on your Install request is not valid.

User Response: Refer to Figure 2-1 on page 2-5 for correct country codes. Reenter the Install command with the correct code.

INDIN02 **Source drive, destination drive, and country code required.**

Explanation: You entered an Install request without specifying any drives or a country code.

User Response: Refer to “Installing the Entry Emulator on a Diskette System” on page 2-2 or “Installing the Entry Emulator on a Fixed Disk” on page 2-3 for the correct format of the Install command. Enter the command as directed.

INDIN03 **Destination drive and country code required.**

Explanation: You entered an Install request without specifying the destination drive or country code.

User Response: Refer to “Installing the Entry Emulator on a Diskette System” on page 2-2 or “Installing the Entry Emulator on a Fixed Disk” on page 2-3 for the correct format of the Install command. Enter the command as directed.

INDIN04 **Source drive and destination drive must be different.**

Explanation: You entered an Install request with identical source and destination drives. They must be different.

User Response: Refer to “Installing the Entry

Emulator on a Diskette System” on page 2-2 or “Installing the Entry Emulator on a Fixed Disk” on page 2-3 for the correct format of the Install command. Enter the command as directed.

INDIN05

Country code required.

Explanation: You entered an Install request without specifying a country code.

User Response: Refer to “Installing the Entry Emulator on a Diskette System” on page 2-2 or “Installing the Entry Emulator on a Fixed Disk” on page 2-3 for the correct format of the Install command. Refer to Figure 2-1 on page 2-5 for the country codes. Select a country code and enter the command as directed.

INDIN06

Cannot find file:

X:YYYYYYY.ZZZ

Explanation: You probably used backup diskettes to install the PC3270 Emulation Program and the diskettes are not complete.

User Response: Use the original PC3270 Emulation Program diskette to install and reback up on diskettes formatted without /S.

File Transfer Messages

TRANS01 File transfer command being processed

Explanation: This message appears when the file transfer command is entered and processing by the system has begun.

User Response: None.

**TRANS02 Number of bytes of file transferred so far:
 = = > XXXX**

Explanation: This is a progress message that tells you how many bytes of the PC file have been transferred to or from the host. The number is updated in increments of 4096 bytes. When the PC file size is not exactly divisible by 4096, the last update is less than 4096 and is followed by a completion message.

If the PC disk file being transferred is less than 4096 bytes, there is just one progress message for exactly the number of bytes in the file.

User Response: None.

TRANS03 File transfer complete

Explanation: The file transfer operation has been completed successfully. There is now a file either at the host or PC whose name and characteristics are those you specified in the SEND or RECEIVE command.

User Response: None.

TRANS04 File transfer complete with records segmented

Explanation: The file transfer operation has been completed. Any record greater than the set logical record length (LRECL) is divided into multiple records.

User Response: None.

TRANS05 Personal Computer filespec incorrect: file transfer canceled

Explanation: You have made an error in the Personal Computer DOS filespec, for example, diskette drive, path, filename, or extension.

User Response: Compare the Personal Computer DOS filespec in the file transfer command, which is still visible on the screen, with your manual to make sure that it conforms to the Personal Computer DOS requirements for a filespec.

If the filespec is correct, it is possible that the specified PC file does not exist on the PC disk. You should enter the DOS directory command, **DIR**, to check the PC filename and extension.

TRANS06 Command incomplete: file transfer canceled

Explanation: You did not enter any parameters after **SEND** or **RECEIVE**.

User Response: Read your manual on requirements for the **SEND** or **RECEIVE** commands and retry.

TRANS07 Cannot link to host: file transfer canceled

Explanation: This message indicates a program error.

User Response: If you see this message, file transfer is not working properly. Contact your Service Coordinator.

TRANS08**Command transmit error: file transfer canceled**

Explanation: This message occurs when there is a program error or if a key that produces an invalid code is pressed (for example, one that cannot be transmitted to the host).

User Response: Retry file transfer after carefully reading the instructions in this manual. Check the status of the host; there may be some information on the host session indicating the problem. If the message reappears when file transfer is retried, contact your Service Coordinator.

TRANS09**Error reading file from damaged Personal Computer disk: file transfer canceled**

Explanation: This message indicates that the PC diskette is probably damaged. The message also appears when you try to SEND a zero-length PC file.

User Response: Check the file length, using the DOS DIR command. If the file length is non-zero, replace the recording medium.

TRANS10**Host has not responded within timeout period: Refer to the user's guide for more information**

Explanation: The host has not responded to the file transfer within approximately one-half minute.

User Response: Use the SWSC (Alt + Esc) key to look at the host screen.

If X SYSTEM or X CLOCK appears in the host Operator Information Area, wait for it to clear. This indicates that the system is working slowly. Switch back to the PC screen to continue file transfer.

If the host is HOLDING, see the "User Response" for TRANS11.

If you want to stop file transfer after several timeout messages:

- Press **Ctrl+Break**.
- Switch to the host screen.
- Press **Reset** to clear the **Operator Information Area**.
- Press **F2**, possibly several times, until the host becomes ready.
- Press **Enter**.
- Switch back to the **PC screen** (Press and hold **Alt**; then press **Esc**). File transfer should be canceled.

TRANS11 Lost contact with host: file transfer canceled

Explanation: The host is inactive.

User Response: Use the **SWSC** (Press and hold **Alt**; then press **Esc**) key to look at the host screen.

If the host is not ready (there may be a message), press **Clear**, possibly several times. If the host becomes ready, press **Enter** and switch back to the **PC screen** using the **SWSC** (Press and hold **Alt**; then press **Esc**) key. File transfer should continue.

If file transfer does not continue, switch to the host screen and press **F2**, possibly several times, until the host becomes ready. Then press **Enter** and switch back to the **PC screen** using the **SWSC** (Press and hold **Alt**; then press **Esc**) key. File transfer should be canceled.

If file transfer is not canceled, cancel both the host and **PC sessions** and retry.

-
- TRANS12** **Error writing to damaged or full Personal Computer disk: file transfer canceled**
- Explanation:** This message indicates a damaged or full disk.
- User Response:** If the disk is damaged, replace the recording medium. If the disk is full, erase unwanted files or replace the recording medium.
- TRANS13** **Error writing file to host: file transfer canceled**
- Explanation:** The file transfer has been canceled either by you or the program because of an error in SEND.
- User Response:** See "User Response" for TRANS11.
- TRANS14** **Error reading file from host: file transfer canceled**
- Explanation:** The file transfer has been canceled either by you or the program because of error in RECEIVE.
- User Response:** See "User Response" for TRANS11.
- TRANS15** **Required host storage unavailable: file transfer canceled**
- Explanation:** You need more storage available on your host.
- User Response:** Contact your local host system support representative.
- TRANS16** **Incorrect request code: file transfer canceled**
- Explanation:** You have entered an incorrect command.
- User Response:** Correct the command and retry.

-
- TRANS17 (TSO version) Missing or incorrect TSO data set name: file transfer canceled**
- Explanation:** TSO data set name is missing or is not a sequential or partitioned data set.
- User Response:** Correct the TSO data set name in the command and retry.
- TRANS17 (CMS version) Missing or incorrect CMS file name: file transfer canceled**
- Explanation:** CMS file name is missing or incorrectly specified.
- User Response:** Correct the CMS file name in the command and retry.
- TRANS18 Incorrect option specified: file transfer canceled**
- Explanation:** You specified an invalid option.
- User Response:** Correct the command to specify an acceptable option and retry.
- TRANS19 Error while reading or writing to host disk: file transfer canceled**
- Explanation:** There is not enough space available for data on the host.
- User Response:** Look at the host session message for indications and correct the problem.
- TRANS21 Not enough Personal Computer memory available: file transfer canceled**
- Explanation:** Your system does not have enough memory to transfer a file.
- User Response:** Get additional memory.

-
- TRANS26 Unrecoverable system error: file transfer canceled**
- Explanation:** This message indicates a program error.
- User Response:** Contact your Service Coordinator.
- TRANS27 Communication sequence with host disrupted: file transfer canceled**
- Explanation:** This message is displayed when you press Ctrl + Break, or when a program error has occurred.
- User Response:** If it is a program error, contact your Service Coordinator.
- TRANS28 Invalid option XXXXXXXXX: file transfer canceled**
- Explanation:** XXXXXXXXX is replaced with the invalid option. The error is one of the following:
- The option is not recognized
 - More than one mutually exclusive option was entered
 - A code page translation option was entered while running in DOS 3.2.
- User Response:** Correct the option in the command and retry.
- TRANS29 Invalid option XXXXXXXXX with RECEIVE: file transfer canceled**
- Explanation:** XXXXXXXXX is replaced with the invalid option. The option is not valid with RECEIVE, but can be used with SEND.
- User Response:** Remove the option from the command and retry.

**TRANS30 Invalid option XXXXXXXXX with APPEND:
file transfer canceled**

Explanation: XXXXXXXXX is replaced with the invalid option. The option is not valid with APPEND.

User Response: Remove the option from the command and retry.

**TRANS31 Invalid option XXXXXXXXX without SPACE:
file transfer canceled**

Explanation: XXXXXXXXX is replaced with the invalid option. The option can only be used if SPACE is also specified.

User Response: Remove the option from the command and retry.

**TRANS32 Invalid option XXXXXXXXX with PDS: file
transfer canceled**

Explanation: XXXXXXXXX is replaced with the invalid option. The option is invalid with a host partitioned data set.

User Response: Remove the option from the command and retry.

**TRANS33 Only one of TRACKS, CYLINDERS,
AVBLOCK allowed: file transfer canceled**

Explanation: SPACE can be specified in units of either TRACKS, CYLINDERS, or AVBLOCK. Only one of these parameters can be used.

User Response: Remove the unwanted option from the command and retry.

TRANS34 CMS file not found: file transfer canceled

Explanation: An existing CMS file must be specified for RECEIVE.

User Response: Correct the CMS file specification in the command and retry.

TRANS35 CMS disk is Read-Only: file transfer canceled

Explanation: The CMS file mode specified for SEND must allow Write access.

User Response: Correct the CMS file specification in the command and retry.

TRANS36 CMS disk is not accessed: file transfer canceled

Explanation: The CMS file mode is not in the CMS disk search order.

User Response: Access the required disk in CMS or correct the CMS file specification in the command. Retry the command.

TRANS37 CMS disk is full: file transfer canceled

Explanation: Either the CMS disk is full, the maximum number of files (3400) on the minidisk has been reached, or the maximum number of data blocks (16060) per file has been reached.

User Response: Use another disk with enough space, or remove unwanted files from the specified disk. If the PC file is very large (more than 1 megabyte), consider dividing it into several pieces. Retry the command.

TRANS38 PC 3270 not loaded: file transfer canceled

Explanation: You tried to SEND or RECEIVE without loading the PC3270 entry emulation program.

User Response: Load the entry emulator, establish your Host session, and try again.

TRANS85 Incorrect system code page: file transfer canceled.

Explanation: The code page in your system is not allowed for file transfers, or you specified a code page not supported by your country.

User Response: Load the correct code page for the system or specify a supported code page option (see Figure 7-2 on page 7-20) and try again.

TRANS98 PC program error code XX XXXXXXXXX: file transfer canceled

Explanation: This message indicates a program error.

User Response: Contact your Service Coordinator.

TRANS99 Host program error code XX XXXXXXXXX: file transfer canceled

Explanation: This message indicates a program error.

User Response: Contact your Service Coordinator.

Keyboard Redefinition Messages

RYOKEY01 Failed to write PC3270.KEY.

Explanation: An error occurred trying to write the file PC3270.KEY to the diskette.

User Response: Check that the correct diskette is in the correct drive, that it is not write-protected, and that the drive door is closed. If the problem persists, contact your Service Coordinator.

RYOKEY02 Failed to read XXXXXXXXX.XXX

Explanation: An error occurred trying to read the file XXXXXXXXX.XXX from the diskette.

User Response: Check that the correct diskette is in the correct drive and that the drive door is closed. Rerun the utility. If the problem persists, contact your Service Coordinator.

RYOKEY03 Failed to find XXXXXXXXX.XXX

Explanation: The file XXXXXXXXX.XXX was not found on the diskette.

User Response: Copy the missing file from your backup diskette or run the install procedure if you do not have a backup diskette.

RYOKEY04 System error

Explanation: An error has occurred.

User Response: Run the program again. If this message appears again, copy the files from your backup diskette onto a blank diskette. Rerun the program. See your service coordinator if the problem is not corrected.

RYOKEY05 SWSC cannot be selected

Explanation: The Switch Screen location cannot be changed.

User Response: To change the other two functions on the key, select Single mode.

RYOKEY06 Swap pending...

Explanation: You have selected a source key for the SWAP operation.

User Response: Select a target key. To cancel the SWAP operation, reselect the source key.

RYOKEY07 Copy pending...

Explanation: You have selected a source key for the COPY operation.

User Response: Select a target key. To cancel the COPY operation, reselect the source key.

RYOKEY08 Retrieve pending...

Explanation: You have selected a source key for the RETRIEVE operation.

User Response: Select a target key. To cancel the RETRIEVE operation, press the end key and select the More Changes option on the Exit Panel.

RYOKEY09 Writing file PC3270.KEY

Explanation: You selected the File option on the Exit Panel. The file containing your new keyboard definition is being written.

User Response: None.

RYOKEY10 Changes written to storage

Explanation: You selected the Temporary Save option on the Exit Panel. The keyboard definition you've created has been written to storage. Your host session will now be using that definition until you restart the entry emulator.

User Response: Switch to your host session and try your changes. To save these changes permanently, return to the PC session, and select the File option on the Exit Panel.

Color Selection Messages

COLOR01 **Warning - Background/Foreground colors are the same**

Explanation: Background and foreground colors are the same. Your color selections cannot be saved until one color is changed.

User Response: Press either the Cursor Left or Cursor Right key to select another color.

COLOR02 **Invalid Background selection. Reselect**

Explanation: Only the eight colors on the left side of the Color Selection Area can be selected for Background.

User Response: Press either the Cursor Left or Cursor Right key to select one of the eight colors on the left as a Background color.

COLOR03 **Cannot save - Background/Foreground colors are the same**

Explanation: Background and foreground colors are the same. Your color selections cannot be saved until one color is changed.

User Response: Press either the Cursor Left or Cursor Right key to select another color.

COLOR04 **Cannot save - invalid Background color**

Explanation: Only the eight colors on the left side of the Color Selection Area can be selected for Background.

User Response: Press either the Cursor Left or Cursor Right key to select one of the eight colors on the left as a Background color.

COLOR05 Color selections saved in file PC3270.COL

Explanation: Your color selections have been saved in the file PC3270.COL.

User Response: None. Your color selections will be used immediately if the entry emulator is active.

COLOR06 COLORMSG.DAT not found

Explanation: The file COLORMSG.DAT was not found on the diskette.

User Response: Copy the missing file from your backup diskette or run the install procedure if you do not have a backup diskette.

Patch Installation Messages (PATnn)

There may be times when DOS messages appear, in addition to Patch messages, while you are using the Patch facility. If this happens, refer to your IBM Personal Computer *Disk Operating System* manual for explanations.

PAT01 Empty patch file

Explanation: Data was not found in the patch file specified.

User Response: Add the Patch information to the failing patch file.

PAT02 Zap data not specified

Explanation: Zap data was not found in the patch file specified.

User Response: Add the zap information to the failing patch file. Make sure you press the Enter key after every entry in the patch file. See "Creating a Patch File" on page 7-37 for further information.

PAT03 Prerequisite system level not specified

Explanation: The first entry in the patch file is a required system level, and none was found.

User Response: Add the system level as the first entry in the failing patch file.

PAT04 Current - system level = (XXXX) But patch prerequisite is - system level = (YYYY)

Explanation: The first entry in the patch file specified a prerequisite APAR level of (YYYY), but the system is currently at a system level of (XXXX).

User Response: Either upgrade the system level to (YYYY) or correct the patch file, whichever caused the failure.

PAT05 Requested APAR (IRXXXXX) already installed

Explanation: The APAR number specified is already installed on the system.

User Response: Verify that you typed in the correct APAR number. If you typed an incorrect APAR number, correct and retry.

PAT06 Requested APAR (IRXXXXX) not installed

Explanation: The APAR number specified is not currently installed on the system when the user is attempting to remove a APAR.

User Response: Determine whether:

- The APAR was removed previously or
- An incorrect APAR number was specified.

PAT07 Prerequisite APAR (IRXXXXX) not installed

Explanation: The APAR number specified a prerequisite APAR of *IRXXXXX*, but that APAR is not currently installed on the system.

User Response: Verify that the prerequisite APAR entry in the patch file is correct. Then install the required prerequisite APAR and retry the operation.

PAT08 INDQPCH.DAT history file not found on this diskette

Explanation: Either:

- The diskette you are attempting to patch is not an entry emulator program diskette or
- The INDQPCH.DAT history file has been deleted or is not on the diskette, the disk, or the subdirectory the patch is in.

User Response:

- Place the entry emulator diskette in the default drive or
- If the history file INDQPCH has been deleted from the diskette, use the most current backup of your system diskette and install any fixes required to bring the system up to the current level.

PAT09 Maximum APARs installed

Explanation: The system allows a maximum of 100 APARs to be installed for a given refresh level.

User Response: Upgrade your system to the most current refresh level.

PAT10 Patch file for APAR (IRXXXXX) not found

Explanation: The APAR number was not found.

User Response: This error can be caused by either:

- Entering an incorrect APAR number or
- Failing to specify the diskette drive identifier if the APAR file is on a diskette drive other than the current default drive or
- The patch file is not on the diskette.

PAT11 OFFset invalid or missing

Explanation: The *OFF*= keyword in the zap data of the patch file was either missing or misspelled.

User Response: Correct the zap line and retry the operation.

PAT12

VERify invalid or missing

Explanation: The *VER*= keyword in the zap data of the patch file was either missing or misspelled.

User Response: Correct the zap line and retry the operation.

PAT13

REPlace invalid or missing

Explanation: The *REP*= keyword in the zap line of the patch file was either missing or misspelled.

User Response: Correct the zap line and retry the operation.

PAT14

Invalid hex offset data

Explanation: The offset data in the zap line either contained nonhexadecimal data or was missing.

User Response: Correct the zap data and retry the operation.

PAT15

Invalid hex verify data

Explanation: The verify data in the zap line either contained nonhexadecimal data or was missing.

User Response: Correct the zap data and retry the operation.

PAT16

Invalid hex replace data

Explanation: The replace data in the zap line either contained nonhexadecimal data or was missing. You may see "Verify is correct" before getting this message. This indicates that only the replace data is incorrect.

User Response: Correct the zap data and retry the operation.

PAT17**Comma or parenthesis missing**

Explanation: A required delimiter is missing from the displayed zap line. You must have left and right parentheses and two commas in the zap line.

User Response: Correct the zap data and retry the operation.

PAT20

**PATCH = ZAP lmod
(OFF = hhhh, VER = hhhh, REP = hhhh)
module not found**

Explanation: The module specified in the zap data was not found during patch data verification.

User Response:

- If the zap data is incorrect, correct the data and retry the operation.
- If the data is correct, determine why the module was not found. There may be:
 - An incorrect diskette drive specifier, or
 - A deleted module. If a module has been deleted, use a backup copy and retry the operation.

PAT21

**PATCH = ZAP lmod
(OFF = hhhh, VER = hhhh, REP = hhhh)
mismatch
MODULE = MOD = hh**

Explanation: The verify data specified in the zap data line does not match the verify data in the module.

User Response:

- If the zap data is incorrect, correct the data and retry the operation.
- If the data is correct, record all data related to the problem. Include both:
 - A screen print
 - A copy of the diskette and report the program to IBM.

PAT22

**PATCH =ZAP lmod
(OFF = hhhh, VER = hhhh, REP = hhhh)
mismatch
MODULE = MOD = hh**

Explanation: The verify data specified in the zap data line does not match the verify information in the module when you are removing patches.

User Response: The zap data file for this patch has been changed since the APAR was installed. Correct the data file and retry the operation.

PAT23

Prerequisite APAR invalid or not specified

Explanation: Either the keyword PRE or APAR is misspelled or missing on one of the APAR prerequisite entries.

User Response: Correct the keyword data and retry the operation.

PAT24

Error in zap data – patches not installed

Explanation: An error in the zap data was encountered. Preceding error messages identified the type of error. This message always appears with another message.

User Response: Correct the problem identified by all preceding messages and retry.

PAT25

Error in zap data – patches not removed

Explanation: An error in the zap data was encountered. A preceding error message identified the type of error. This message always appears with another message.

User Response: Correct the problem identified by all preceding messages and retry.

PAT26

Patches installed

Explanation: The patch was installed, and the history file INDQPCH.DAT was updated.

User Response: None.

PAT27

Patches removed

Explanation: The patch was removed, and the history file INDQPCH.DAT was updated.

User Response: None.

SRPI Messages

SRPI902 **SRPI cannot be used with TopView.**

Explanation: You have attempted to load EESRPI with TopView loaded.

User Response: Exit TopView, then restart EESRPI.

SRPI903 **An interface problem exists between EESRPI and PC3270. Restart PC3270 with the ECF option. Then restart SRPI.**

Explanation: A PC software error has occurred.

User Response: Remove PC3270 from memory, then restart PC3270 with the E option. Then restart SRPI. If this message continues to occur, contact an IBM support representative.

SRPI904 **PC3270 was not loaded with the ECF option. Restart PC3270 with the ECF option. Then restart SRPI.**

Explanation: You did not specify the E option when starting PC3270.

User Response: Remove PC3270 from memory. Restart PC3270 with the E option. Then restart EESRPI.

SRPI905 **PC3270 is not loaded. Load PC3270 with the ECF option. Then restart SRPI.**

Explanation: You have attempted to start EESRPI without first starting PC3270.

User Response: Start PC3270 with the E option. Then start EESRPI.

SRPI906

EESRPI is already loaded.

Explanation: You have attempted to start EESRPI when EESRPI is already started.

User Response: To restart EESRPI, you must first remove PC3270 from memory. Then start PC3270 with the E option. Then start EESRPI. If you do not wish to restart EESRPI, no further action is necessary.

Notes

Appendix B. OIA in Host Computer Mode

Status Indicators	B-2
Operator Information Area	B-3
Status Indicators Reference Tables	B-4
Readiness and System Connection Messages	B-5
Do Not Enter Messages	B-6
Reminder Messages	B-8
Shifts and Mode Messages	B-9
Printer Status Messages	B-10

Status Indicators

In a host computer session, the bottom line of your screen becomes the **Operator Information Area (OIA)**, which shows operating and status messages. The messages are displayed as groups of symbols, words, and numbers, such as:

- X meaning Do Not Enter
- [] meaning time is required
- O representing a printer

The symbols, words, and numbers are combined to make messages. The messages are read from left to right. For example:

X [] meaning Do Not Enter because time is needed for the host system to perform a function.

X O-Ø meaning Do Not Enter because the printer you are using (system printer) is not operating properly.

Operator Information Area

The operating and status messages are grouped into five categories. The messages are displayed in five different sections of the operator information area, as shown here:

Operator Information Area Layout

Readiness and System Connection	Do Not Enter (Input Inhibited)	Reminders	Shifts and Modes	Printer Status
---------------------------------	--------------------------------	-----------	------------------	----------------

Status Indicators Reference Tables

The status indicators shown in the following tables only appear while you are using host computer mode. The tables list the status indicators you may see in the operator information area.

- The first column shows the message as it would appear on your screen while you are using the host computer mode.
- The second column is a brief description of the message that, when applicable, tells you what you should do when you see the message on your screen.
- The third column shows the message as it would appear on an IBM 3278 Display Station.

Remember, messages are composed of groups of symbols that you read from left to right.

For further information on 3278 status indicators, refer to *IBM 3270 Information Display System, 3278 Display Station Operator's Guide*.

Readiness and System Connection Messages

What You See on Your Screen	What This Means	How it Appears on the 3278 Display Station
4	Ready The 3274 Control Unit is ready (working).	4
S	Ready The 3174 Control Unit is ready (working).	S
<u>A</u> or <u>B</u>	Online The control unit is connected to the host system under rules A or B.	<u>A</u> or <u>B</u>
■	My Job Your display station is working with your job (application).	■
♀	System Operator Your display station is connected to the system operator (control program).	♀
?	Unowned Your display station is connected to the host system, but is not connected to your application program or the control program.	?
TEST	Test Your display station is in test mode.	TEST
4700	Ready The 4701 Control Unit is ready (working).	4700

What You See on Your Screen	What This Means	How it Appears on the 3278 Display Station
<p>X - X - - nn</p> <p>X - X - - nnn</p>	<p>Communication Check</p> <p>There is a problem with the communication line between the control unit and the host system. The error number nn or nnn, defines the type of Communication Check. Press RESET to restore your keyboard and continue. If the problem persists, refer to the problem determination section of your <i>Guide to Operations</i>.</p>	<p>X - - nn</p>
<p>X PROG nn</p> <p>X PROG 4nn</p>	<p>Program Check</p> <p>The control unit detected a programming error in the data it received from the host system. The error number, nn or 4nn, defines the type of Program Check. Press RESET to restore your keyboard and continue. If the problem persists, refer to the problem determination section of your <i>Guide to Operations</i>.</p>	<p>X PROG nn</p> <p>X PROG 4nn</p>
<p>X O-O []</p>	<p>Printer Busy</p> <p>The printer connected to your display is busy. If O-O is displayed on the right, the printer is busy with your work. Wait for the print operation to finish or press DEV CNCL to cancel a pending print operation.</p>	<p>X O-O O</p>
<p>X O-O [] []</p>	<p>Printer Very Busy</p> <p>This message is the same as Printer Busy except more time is anticipated before your operation is accepted.</p>	<p>X O-O O O</p>
<p>X O-Ø</p>	<p>Printer Not Working</p> <p>The printer you are attached to is not operating properly. Press DEV CNCL. Then select another printer.</p>	<p>X O-Ø</p>
<p>X - S</p>	<p>Minus Symbol</p> <p>The symbol key you pressed is not available. Press RESET.</p>	<p>X - S</p>
<p>X Ø 2 % %</p>	<p>Wrong Configuration</p> <p>Your keyboard is not configured for that selection.</p>	<p>X Ø 2 % %</p>





Reminder Messages

What You See on Your Screen	What This Means	How it Appears on the 3278 Display Station
<p>-X 7 - 00</p> <p>-X 7 - 000</p>	<p>Communication Error Reminder</p> <p>The communication link connecting your control unit to the host system is producing errors.</p>	<p>7 00</p> <p>or</p> <p>X 7 000</p>

Shifts and Mode Messages

What You See on Your Screen	What This Means	How it Appears on the 3278 Display Station
^	Insert Mode Your display station is in Insert Mode. To turn off Insert Mode, press RESET.	^
↑	Shift Mode Your display station is in Shift Mode.	↑
DOC↓	Document Mode Your display station is in Document Mode. To turn off document mode, press DOC ON/OFF.	DOC↓

Printer Status Messages

What You See on Your Screen	What This Means	How it Appears on the 3278 Display Station
0-0 _ _	Assign Printer When you are changing the Printer ID/Printer Class, the two numbers you type are displayed in the underlined locations of the message.	
0-0 nn	Printer Assignment You are authorized to use the printer with ID 'nn'.	
0-@ nn	Printer Printing The printer with ID 'nn' is printing your work.	
0-Ø nn	Printer Failure The printer with ID 'nn' stopped while printing your work. Press DEV CNCL (Device Cancel) to remove this indicator.	
0-0 ??	What Printer Your printer assignment has changed. Press Ident to display the new printer ID.	

Appendix C. File Transfer ASCII to EBCDIC Translation

File Transfer Translation

When transferring a file between the Personal Computer and host, we recommend using the ASCII option to translate the file for processing. (See Chapter 7, "Transferring a File" for more information.) Alphanumeric data is usually encoded in ASCII on the Personal Computer and EBCDIC on the host.

The tables on the following pages show the translations between ASCII and EBCDIC that occur during file transfer.

1. ASCII to EBCDIC translation is *always* the reverse of EBCDIC to ASCII. In other words, if you translate any character from EBCDIC to ASCII (as in RECEIVE) then back to EBCDIC (SEND), there is no overall change.
2. The following characters are equivalent in EBCDIC and ASCII; they are typed using the same key, but are displayed differently.

EBCDIC	┐	¢	
ASCII	^	[]

-
3. Apart from the exceptions in item 2, EBCDIC characters that may be typed directly in a host session (either alone or with the Shift key) are equivalent to the same ASCII characters as typed in a Personal Computer session. The host and Personal Computer sessions use the same key and display the same character.

Characters that cannot be entered directly are transferred according to the following tables. The EBCDIC and ASCII displays are not equivalent.

ASCII to EBCDIC Translation (Code Page 437 Only)

	0	1	2	3	4	5	6	7
0	00	01	02	03	37	2D	2E	2F
1	10	11	12	13	3C	3D	32	26
2	40	5A	7F	7B	5B	6C	50	7D
3	F0	F1	F2	F3	F4	F5	F6	F7
4	7C	C1	C2	C3	C4	C5	C6	C7
5	D7	D8	D9	E2	E3	E4	E5	E6
6	79	81	82	83	84	85	86	87
7	97	98	99	A2	A3	A4	A5	A6
8	20	21	22	23	24	15	06	17
9	30	31	1A	33	34	35	36	08
A	41	42	43	44	45	46	47	48
B	58	59	62	63	64	65	66	67
C	76	77	78	80	8A	8B	8C	8D
D	9F	A0	AA	AB	AC	AD	AE	AF
E	B8	B9	BA	BB	BC	BD	BE	BF
F	DC	DD	DE	DF	EA	EB	EC	ED

ASCII to EBCDIC Translation (Cont)

	8	9	A	B	C	D	E	F
0	16	05	25	0B	0C	0D	0E	0F
1	18	19	3F	27	1C	1D	1E	1F
2	4D	5D	5C	4E	6B	60	4B	61
3	F8	F9	7A	5E	4C	7E	6E	6F
4	C8	C9	D1	D2	D3	D4	D5	D6
5	E7	E8	E9	4A	E0	4F	5F	6D
6	88	89	91	92	93	94	95	96
7	A7	A8	A9	C0	6A	D0	A1	07
8	28	29	2A	2B	2C	09	0A	1B
9	38	39	3A	3B	04	14	3E	E1
A	49	51	52	53	54	55	56	57
B	68	69	70	71	72	73	74	75
C	8E	8F	90	9A	9B	9C	9D	9E
D	B0	B1	B2	B3	B4	B5	B6	B7
E	CA	CB	CC	CD	CE	CF	DA	DB
F	EE	EF	FA	FB	FC	FD	FE	FF

EBCDIC to ASCII Translation (Code Page 437 Only)

	0	1	2	3	4	5	6	7
0	00	01	02	03	9C	09	86	7F
1	10	11	12	13	9D	85	08	87
2	80	81	82	83	84	0A	17	1B
3	90	91	16	93	94	95	96	04
4	20	A0	A1	A2	A3	A4	A5	A6
5	26	A9	AA	AB	AC	AD	AE	AF
6	2D	2F	B2	B3	B4	B5	B6	B7
7	BA	BB	BC	BD	BE	BF	C0	C1
8	C3	61	62	63	64	65	66	67
9	CA	6A	6B	6C	6D	6E	6F	70
A	D1	7E	73	74	75	76	77	78
B	D8	D9	DA	DB	DC	DD	DE	DF
C	7B	41	42	43	44	45	46	47
D	7D	4A	4B	4C	4D	4E	4F	50
E	5C	9F	53	54	55	56	57	58
F	30	31	32	33	34	35	36	37

EBCDIC to ASCII Translation (Code Page 437 Only)

	8	9	A	B	C	D	E	F
0	97	8D	8E	0B	0C	0D	0E	0F
1	18	19	92	8F	1C	1D	1E	1F
2	88	89	8A	8B	8C	05	06	07
3	98	99	9A	9B	14	15	9E	1A
4	A7	A8	5B	2E	3C	28	2B	5D
5	B0	B1	21	24	2A	29	3B	5E
6	B8	B9	7C	2C	25	5F	3E	3F
7	C2	60	3A	23	40	27	3D	22
8	68	69	C4	C5	C6	C7	C8	C9
9	71	72	CB	CC	CD	CE	CF	D0
A	79	7A	D2	D3	D4	D5	D6	D7
B	E0	E1	E2	E3	E4	E5	E6	E7
C	48	49	E8	E9	EA	EB	EC	ED
D	51	52	EE	EF	F0	F1	F2	F3
E	59	5A	F4	F5	F6	F7	F8	F9
F	38	39	FA	FB	FC	FD	FE	FF

Appendix D. Bibliography

Note: See your IBM representative or IBM Personal Computer dealer to order any of the following publications.

IBM Personal Computer Publications

BASIC

Disk Operating System

Introduction to IBM System/370 to IBM Personal Computer Enhanced Connectivity Facilities

Guide to Operations

Hardware Maintenance and Service

MACRO Assembler

Technical Reference

TopView User's Guide

IBM Programmer's Guide to the Server-Requester Programming Interface for the IBM Personal Computer and the IBM 3270 PC

IBM Personal Computer XT Publications

Guide to Operations

Hardware Maintenance and Service

Technical Reference

IBM Personal Computer AT Publications

Guide to Operations

Installation and Setup

Disk Operating System

Technical Reference

Hardware Maintenance and Service

IBM Personal Computer 3278/79 Emulation Adapter Publications

Hardware Maintenance and Service

Guide to Operations (This publication cannot be ordered separately; it is included with the IBM Personal Computer 3278/79 Emulation Adapter card.)

Technical Reference

IBM 3270 Information Display System Publications

3270 Feature Description

Entry Assist User's Guide, 3270 Control Unit

Introduction

3270 Installation Manual—Physical Planning

Physical Planning Template (English)

Physical Planning Template (Metric)

IBM 3274 Control Unit Publications

Configuration Data Card (Configuration D)

Operator's Reference and 3274/3270 Problem Determination Guide

Model 41C Setup Instructions

3274 Customization Guide

Description and Programmer's Guide

Site Planning and Preparation Guide for 3274 Models 41A, 41C, 41D, and 61C

Planning, Setup, and Customizing Guide: Configuration Support A, B, C, and T

IBM 3174 Control Unit Publications

IBM 3174 Customization Guide

IBM 3174 User's Guide

IBM 3174 Help Desk

IBM 3174 Functional Description

IBM 3174 Site Planning Guide

IBM 3270 Display Station Publications

Operator's Guide

Problem Determination Guide

VM CMS Publications

CMS Command and Macro Reference

User's Guide

*IBM Programmer's Guide to the Server-Requester Programming
Interface for VM/System Product*

MVS TSO (TSO) Publications

OS/VS2 TSO Command Language Reference

OS/VS2 TSO Terminal User's Guide

*IBM TSO Extensions Programmer's Guide to the Server-Requester
Programming Interface for MVS/Extended Architecture*

Appendix E. Glossary

This glossary contains words, acronyms, terms, and phrases used in this manual. Most of these terms and acronyms are used in the 3270 publications library.

adapter. An attachment that modifies a mechanism to operate in a particular way. When used with a Personal Computer it is often called an *adapter card*.

American Standard Code for Information Interchange (ASCII). A standard code used for exchanging information among data processing systems and associated equipment.

APAR. Authorized program analysis report.

ASCII. American Standard Code for Information Interchange.

Authorized program analysis report (APAR). A report of a problem caused by a suspected defect in a current unaltered release of a program.

background. The area of your screen behind and around the text.

backup. Duplicating data from a diskette or fixed disk to another diskette or fixed disk, to ensure availability of data if the original is lost or damaged; this is also a DOS command (see the *Disk Operating System* manual).

Basic Input/Output System (BIOS). Basic input/output system for the Personal Computer.

BIOS. Basic Input/Output System.

byte. A character of information. Eight bits.

change operations. Four functions in the keyboard panels: SWAP, COPY, DELETE, and RETRIEVE. Change operations

allow you to alter the arrangement of key functions on the display of a keyboard definition.

CMS router. A program running under VM/SP that uses the Server-Requester Programming Interface (SRPI) to route requests from the PC to the corresponding server on the host. The CMS router is part of the CMSSERV command processor in VM/SP Release 5.

CMSSERV. (1) A program that provides the Server-Requester Programming Interface (SRPI) and a service request manager on an IBM System/370 using VM/CMS. (2) The implementation of IBM Enhanced Connectivity Facilities on a VM/SP system with CMS installed.

color selection program. A program that allows you to redefine the background and foreground colors of your host session.

control unit. A device that controls input/output operations of one or more devices.

COPY. A change operation in the keyboard redefinition program that allows you to duplicate a key or key function.

current keyboard definition. An arrangement of key functions on the Personal Computer keyboard in the host session. If available, the entry emulator program loads the current keyboard definition and makes it the layout effective in the host session.

data. All information entered into or used by a computer.

data set. A collection of data records. Data sets are stored either in the host computer's or on Personal Computer's storage medium. Data sets are also called files.

default. A value or option that is assumed when none has been specified.

default keyboard definition. An arrangement of key functions on the Personal Computer keyboard in the host session that incorporates the 3278/79 Typewriter key functions. The default keyboard definition is in effect when you switch to your host session, unless a current definition is present.

DELETE. A change operation in the keyboard redefinition program that allows you to delete a key or key function.

directory. A table of identifiers and references to the corresponding items of data. For example, the directory for a diskette contains the names of files on the diskette (identifiers), along with information that tells DOS where to find the file on the diskette.

diskette. A Personal Computer storage device consisting of a flexible magnetic disk inside a protective plastic jacket.

diskette drive. A device that uses diskettes for storage and retrieval of data.

display. An output device used for the visual display of data.

disk operating system (DOS). A disk-resident operating system.

Do Not Enter. A symbol (X) in the operator information area of the display surface that indicates that data should not be entered now.

DOS. Disk operating system.

dual computer session. Personal computer session and host computer session

EBCDIC. Extended Binary Coded Decimal Interchange Code.

emulate. To simulate one system with another, so that the simulating computer system accepts the same data, executes the same programs, and achieves the same results.

Enhanced Connectivity Facilities. The strategy for sharing services and resources in a heterogeneous network.

Entry Emulator Server-Requester Programming Interface (EESRPI). The entry emulator implementation of the SRPI.

execute. To perform an instruction or a computer program.

Extended Binary Coded Decimal Interchange Code (EBCDIC). A coded character set consisting of 8-bit coded

characters. The standard code used by the IBM System 370 computers.

F key. Function key.

file. A collection of data records. This data can be programs, text, or computational information. Files are stored either in the host computer or on Personal Computer diskettes or fixed disk. Files are also called data sets.

file transfer. The function that allows you to send and receive files between a Personal Computer and a host.

fixed disk. One of two types of storage in the Personal Computer. This storage device is housed in either the System Unit or expansion unit of a Personal Computer. A fixed disk is composed of rigid material with a magnetic coating, and is used for mass storage and retrieval of data.

foreground. The text on your screen.

FULL. A mode in the keyboard redefinition program that causes a key change operation to affect all of the functions on each key involved in the change.

function key. A key that passes a signal to a program to call for a particular operation to be performed.

hardware. The physical equipment used in data processing, as opposed to programs, procedures, and associated documentation. (Contrast with software.)

host computer. A large central computer which provides services such as computation, data base access, special programs, or programming languages.

intensified. Print used for emphasis, also describes full grain mode in the color utility.

“in use” light. The light on the diskette or disk drive that comes on when the drive is active.

K-byte. Kilobyte. 1024 characters. See “byte.”

key function. A single function associated with a Personal Computer key. Four key functions are potentially available on each key.

keyboard definition. An arrangement of the key functions, including 3278 emulated functions, on the Personal Computer keyboard for host session computing.

keyboard panel. A display of one of the keyboard areas of the Personal Computer keyboard in the keyboard redefinition program. This menu allows you to make changes to a host session keyboard definition.

Keyboard redefinition program. A program that allows you to redefine the arrangement of the key functions on a Personal Computer keyboard in your host session.

keyword. One of the predefined words of a programming language; a reserved word.

kilobyte. 1024 characters.

load. In programming, to enter data into storage or working registers.

logging on. The procedure by which you are linked to a multiple-user host computer system; the procedure requires a user identification (userid) and a password.

merge. To combine the items from two or more diskettes onto one diskette.

mode. In keyboard redefinition, refers to a state (FULL or SINGLE) that determines whether all or only one of the four possible functions on each key is involved in a key-change operation.

MVS router. A program running under TSO/E that uses the Entry Emulator Server-Requester Programming Interface (EESRPI) to route requests from the PC to the corresponding server on the host. The MVS router is part of the MVSSERV command processor in TSO/E Release 3.

MVSSERV. (1) A program that provides the Server-Requester Programming Interface (SRPI) and a service request manager on an IBM System/370 using the TSO/E (time-sharing option) on

MVS/XA. (2) A command processor in TSO/E Release 3. It initializes, terminates, and provides recovery for an IBM Enhanced Connectivity Facilities session between a PC and a host system. It also establishes communication and routes requests from the PC user to the corresponding server on the host.

operator information area (OIA). In the 3270 Information Display System, the area near the bottom of your display area where you receive information about the status of your terminal or system.

PA key. Program access key.

parameter. A name in a procedure that is used to refer to an argument passed to that procedure.

PC router. A program that is part of the IBM PC 3270 Emulation Program, Entry Level, Version 1.2 that uses the Server-Requester Programming Interface (SRPI) to route requests from the IBM PC requesters to the corresponding router on the host.

Personal Computer printer. The desktop printer attached exclusively to your Personal Computer.

PF key. Program function key.

PgDn. In keyboard redefinition, allows you to switch between the displays of different keyboard areas.

program access (PA) key. On a display device keyboard, a key that produces a call to a program that performs display operations.

program function (PF) key. A key that passes a signal to a program to call for a particular operation to be performed.

protected. Sections of your screen where you cannot type without getting an error message.

Quit key. (Press and hold Alt; then press numeric 5) A key that allows you to quit the entry emulator program and return storage to DOS.

RECEIVE. One of the two commands involved in file transfer. When you receive a file, a copy of the file is transferred from the host to the Personal Computer.

record. A collection of related information, treated as a unit.

reply. The answer to a service request that came from the server.

request. The requirement for service that came from the requester.

Request for price quotation. A customer request for a price quotation on alterations or additions to the functional capabilities of a computing system, hardware product, or device.

requester. The program that relays a request to another computer through the Entry Emulator Server-Requester Programming Interface (EESRPI). Contrast with server.

RETRIEVE. A change operation in the keyboard redefinition program that allows you to recover symbols or characters that were previously removed from a keyboard definition.

reverse video. An exchange of the color of a displayed character with its background color.

router. The router provides a new Server-Requester Programming Interface (SRPI): a request interface for requesters, or a reply interface for servers. See also CMS router, MVS router, PC router, Server-Requester Programming Interface (SRPI).

RPQ. Request for price quotation.

screen. The surface of your display or monitor.

SEND. One of the two commands involved in file transfer. When you send a file, a copy of the file is transferred from your Personal Computer to the host.

server. The program that responds to a request from another computer through the Entry Emulator Server-Requester Programming Interface (EESRPI). Contrast with requester.

Server-Requester Programming Interface (SRPI). (1) A protocol between requesters and servers in an IBM Enhanced Connectivity Facilities network. (2) An application programming interface used by requester and server programs to communicate with the PC or host routers.

SINGLE. A mode in the keyboard redefinition program that causes a key change operation to affect only one of the functions on each key involved in the change.

software. Programs that pertain to the operation of a computer system. (Contrast with hardware.)

SWAP. A change operation in the keyboard redefinition program that allows you to exchange the positions of two keys or key functions.

system reset. Within the Personal Computer session, this is the function that produces a result similar to a Power On. It is accomplished by pressing and holding these three keys in succession: Ctrl, Alt, and Del.

unprotected. Sections of your screen where you can type without getting an error message.

3274 Control Unit printer. The printer attached to the host computer by a 3274 Control Unit.

zap. A line in a patch file that defines the following:

- A file to be patched
- The offset of the data to be changed (OFF=)
- The data expected at that location (VER=)
- The replacement data (REP=).

Appendix F. National Language Support

The National Language Support provided in this release will allow you to configure your PC 3270 Emulation Program and EEHLLAPI to support different language keyboards. The support for a language assumes that you have the IBM Personal Computer keyboard specific to your language and a configuration of the control unit specific to your language.

File Transfer

When the ASCII option is specified, the SEND and RECEIVE file transfer modules will convert IBM Personal Computer characters to Host characters and vice versa. Only those characters which can be entered on the 3278 keyboard for your language will be converted. Where there is no exact equivalent, an approximation has been used.

Character Set and Keyboard Differences

The table below shows the differences between the PC and 3278 keyboards.

Country	PC Key	Host Character	Notes
Belgium	¨ diaeresis	displayed as ●	5
	alt ù (u grave)	' acute	2,3,4
	alt μ (micro)	` grave	2,3
	alt = (equal)	~ tilde	2,3,4
	alt & (ampersand)	‡ broken verticle	4
	alt ç (c cedilla)	{ left brace	4
	alt à (a grave)	} right brace	4
	@ at	@ at	4
	§ section	§ section	4
	° degree	° degree	4
	£ pound	£ pound	4
	\ reverse slope	\ reverse slope	4
	μ micro	not used	
	^ caret	not used	
	² superscript 2	not used	
³ superscript 3	not used		

Country	PC Key	Host Character	Notes
Canadien	or	not used	
French	\ reverse slope	not used	
	± plus/minus	not used	
	£ pound	not used	
	¢ cent	not used	
	∫ int currency	not used	
	¬ not	not used	
	broken vertical line	not used	
	² superscript	not used	
	³ superscript	not used	
	1/4 one quarter	not used	
	1/2 one half	not used	
	3/4 three quarters	not used	
	§ section	not used	
	¶ paragraph	not used	
	[left square bracket	not used	
] right square bracket	not used	
	~ tilde	not used	
	{ left brace	not used	
	} right brace	not used	
	' left angle quotes	not used	
	` right angle quotes	not used	
	° degree	not used	
	μ micro	not used	
	= double underscore	not used	
	È E accent	not used	
	– superscore	not used	
	Denmark	alt < (less than)	\ reverse slope
umlaut accent	ü u umlaut		
' acute accent	not used		
§ section	not used		
1/2 one half	not used		
£ pound	not used		
\$ dollar	not used		
@ at	not used		
{ left brace	not used		
} right brace	not used		
[left square bracket	not used		
] right square bracket	not used		
~ tilde	not used		

Country	PC Key	Host Character	Notes
Latin America	`` diaeresis alt 1 alt 3 alt 6 alt ñ (N tilde) alt ; # hash ° degree ~ tilde	displayed as ● or .. Middle dot ¬ not { left brace } right brace not used not used not used	5 2 2,6,9 2 2,9 2,9 not used not used not used
Norway	£ pound \$ dollar alt < (less than) umlaut accent ' acute accent § section or @ at { left brace } right brace [left square bracket] right square bracket ~ tilde	# int currency \ reverse slope ü u umlaut not used not used not used not used not used not used not used not used	9 9 2,9 8 8 8 8 8 8 8 8
Portugal	» right angle quotes ª ordinal indicator masculine º ordinal indicator feminine ^ caret ~ tilde or \ reverse slope @ at # hash £ pound § section { left brace } right brace « left angle quotes	^ caret O O tilde o o tilde A A tilde a a tilde not used not used not used not used not used not used not used not used	

Country	PC Key	Host Character	Notes
Spain	¨ diaeresis	displayed as ●	5
	alt 1	or	2
	alt 3	.. Middle dot	2,6,9
	alt 6	¬ not	2
	alt ñ (N tilde)	{ left brace	2,9
	alt ;	} right brace	2,9
	\$ dollar	Pts pesetas	7
	# hash	not used	
	' acute accent	not used	7
	^ caret	not used	7
	¡ open exclamation	not used	7
	¿ opening question	not used	7
	ç C cedilla	not used	7
	ç c cedilla	not used	7
	! exclamation	not used	7
	<u>a</u>	not used	7
	<u>o</u>	not used	7
Sweden, Finland	£ pound	§ section	9
	\$ dollar	int currency	9
	umlaut accent	ü u umlaut	
	' acute accent	è e acute	
	` grave accent	Ë E acute	
	or	not used	
	@ at	not used	
	{ left brace	not used	
	} right brace	not used	
	[left square bracket	not used	
] right square bracket	not used	
	~ tilde	not used	
	¹ / ₂ half	not used	8
	£ pound	not used	8
	\$ dollar	not used	
# hash	not used		
\ reverse slope	not used		

Country	PC Key	Host Character	Notes
Switzerland, French & German	¨ diaeresis	displayed as •	5
UK	^ caret [left square bracket] right square bracket ~ tilde	¬ not \ grave or overbar	9 9 9 1

Notes

1. The UK overbar is displayed as ~
2. The Alt key must be pressed together with the character.
3. Accent dead keys.
4. Only when using the Belgian 3274 RPQ 7L0577.
5. The diaeresis character is displayed as •
6. Only when using the Spanish 3274 RPQ 7L0626.
7. Not when using the Spanish 3274 RPQ 7L0626.
8. Only when using the Enhanced Keyboard.
9. Not when using the Enhanced Keyboard.
10. Only when using the French Enhanced Keyboard.
11. Only when using the Alternate French Enhanced Keyboard.

Answers to Control Unit Customization Question #121

The table below shows, for each country, the correct response to the Control Unit Customization Question #121.

Country	NLS Code	Answer
Belgium	BE	04
Belgium (with RPQ7L0577)	BI	04 (config. C) 31 (config. D)
Canada, French (with RPQ7L0624)	CF	29
Denmark	DK	07
France	FB	30
France	FR	30
Germany	GR	03
Italy	IT	15
Latin America (with RPQ7L0626)	LA	19 (config. B, C) 32 (config. D)
Norway	NO	23
Portugal	PO	28
Switzerland, French (with RPQ7L0811)	SF	32
Switzerland, German (with RPQ7L0811)	SG	31
Spain	SO	19
Spain (with RPQ7L0626)	SP	19 (config. B, C) 32 (config. D)

Country	NLS Code	Answer
Sweden	SV	24
Finland	SU	24
United Kingdom	UK	22
United States	US	01

Notes:

- 1. You must have a PC keyboard and Control Unit specific to your language.*
- 2. For more information, see the IBM 3274 Control Unit Customization Guide Configuration Support D (GA23-0065-3) or the IBM 3174 Control Unit Subsystem Control Unit Customizing Guide (GA23-0214).*

EEHLLAPI Send Key Notes

The following list describes the ASCII codes to use with the EEHLLAPI Send Key function to send certain characters in a given language to the host session. These codes are used if host characters are not represented on the PC keyboard or if a conflict exists between the two character sets.

Country	ASCII Decimal	Code Hex	Character	Code Page
Belgium (BE)	249	F9	diaeresis	437
Belgium with RPQ (BI)	181	B5	A acute	437
	182	B6	A circumflex	
	183	B7	A grave	
	198	C6	a tilde	
	199	C7	A tilde	
	210	D2	E circumflex	
	211	D3	E diaeresis	
	212	D4	E grave	
	214	D6	I acute	
	215	D7	I circumflex	
	216	D8	I diaeresis	
	222	DE	I grave	
	224	E0	O acute	
	226	E2	O circumflex	
	227	E3	O grave	
	228	E4	o tilde	
	229	E5	O tilde	
233	E9	U acute		
234	EA	U circumflex		
235	EB	U grave		
239	EF	acute		
249	F9	diaeresis		
France (FR)	249	F9	diaeresis	437
Latin America with RPQ (LA)	181	B5	A acute	437
	183	B7	A grave	
	212	D4	E grave	
	214	D6	I acute	
	216	D8	I diaeresis	
	221	DD	solid vertical bar	
	224	E0	O acute	
	227	E3	O grave	
	233	E9	U acute	
	239	EF	acute	
	249	F9	diaeresis	
Switzerland, French with RPQ (SF)	221	DD	solid vertical bar	437
	239	EF	acute	
	249	F9	diaeresis	

Country	ASCII Decimal	Code Hex	Character	Code Page
Switzerland, German with RPQ (SG)	221 239 249	DD EF F9	solid vertical bar acute diaeresis	437
Spain (SO)	221 249	DD F9	solid vertical bar diaeresis	437
	185	B9	pts pesetas	850
Spain with RPQ (SP)	181 183 212 214 216 221 224 227 233 239 249	B5 B7 D4 D6 D8 DD E0 E3 E9 EF F9	A acute A grave E grave I acute I diaeresis solid vertical bar O acute O grave U acute acute diaeresis	437
Finland (SU)	207	CF	international currency symbol	437
Sweden (SV)	207	CF	international currency symbol	437
United Kingdom, English (UK)	221 238	DD EE	solid vertical bar overline	437
United States, English (US)	221	DD	solid vertical bar	437

Notes

Appendix G. Setting Up an AUTOEXEC.BAT File

This appendix explains how to set up an AUTOEXEC.BAT file to start the entry emulator automatically for a diskette system and a fixed disk system.

Setting Up an AUTOEXEC.BAT File for a Diskette System

1. Start DOS from drive A if you have not already done so.
2. When the DOS A > prompt appears, remove your DOS diskette from drive A and insert your working copy of the entry emulator diskette in drive A.
3. At the DOS prompt, type the following:

```
rename autoexec.p78 autoexec.bat
```

Note: To start entry emulator with IBM Enhanced Connectivity Facilities (see Chapter 4), type:

```
rename autoexec.ecf autoexec.bat
```

4. Press Enter (↵)

The entry emulator starts automatically whenever you start your system with the entry emulator diskette in drive A.

Setting Up an AUTOEXEC.BAT File for a Fixed Disk System

To set up an AUTOEXEC.BAT file to start the entry emulator automatically for a fixed disk system, you must first determine whether you already have an AUTOEXEC.BAT file in your root directory.

To determine whether you already have an AUTOEXEC.BAT file, type the following at the DOS C > prompt:

```
dir autoexec.bat
```

If no file is found, continue with this section to set up an AUTOEXEC.BAT file. If a file is found, skip to "Modifying an Existing AUTOEXEC.BAT File."

1. At the DOS C > prompt, type the following:

```
rename autoexec.p78 autoexec.bat
```

Note: To start entry emulator with IBM Enhanced Connectivity Facilities (see Chapter 4), type:

```
rename autoexec.ecf autoexec.bat
```

2. Press Enter (↵).

The entry emulator starts automatically whenever you start your system or press CTRL, ALT, and DEL simultaneously.

Modifying an Existing AUTOEXEC.BAT File

If you have a fixed disk system that already has an AUTOEXEC.BAT file, complete the following steps to modify the file:

1. At the DOS C > prompt, type the following:

```
edlin autoexec.bat
```

-
2. Press Enter (↵).

When EDLIN is ready, the following message appears on your screen:

```
End of input file
*
```

3. To insert new commands after the first line of the EDLIN file, type:

```
1i
```

Note: The 1 refers to the number one, not the letter L.

4. Press Enter (↵).

5. When the EDLIN prompt * appears, type:

```
pc3270 r
```

Note: To start entry emulator with IBM Enhanced Connectivity Facilities (see Chapter 4), type:

```
pc3270 e r
```

6. Press Enter (↵).

*Note: To use IBM Enhanced Connectivity Facilities, you must also add the command **eesrpi** to your AUTOEXEC.BAT file by typing:*

```
eesrpi
```

Press Enter (↵).

7. Hold down Ctrl and press Scroll Lock. Release both keys.

8. When the EDLIN prompt * appears again, type:

e

9. Press Enter (↵).

The entry emulator starts automatically whenever you start your system from drive C.

Appendix H. Entry Emulator Compatibility

This appendix describes the operating environment required by the entry emulator and compatibility considerations for using the entry emulator and other software products.

Note: For the latest information on available hardware and software that can be used with this entry emulator program, see your authorized IBM Personal Computer dealer or local IBM representative.

Hardware Requirements

The minimum configuration required to operate the IBM PC 3270 Emulation Program, Entry Level consists of:

- An IBM Personal Computer (5150), IBM Personal Computer XT™ (5160), IBM Personal Computer XT™ Model 286 (5162), or IBM Personal Computer AT® (5170), with a keyboard and:
 - 128K bytes of main storage, of which approximately 107K bytes is available for concurrent operation of DOS and application programs in base operation. An additional 12K and application space is required for EEHLLAPI, and an additional 21K and requester space is required for Enhanced Connectivity Facilities.
 - An IBM Personal Computer 3278/79 Emulation Adapter

-
- One dual-sided diskette drive and associated adapter.
 - An IBM 5151 Monochrome Display or IBM 5153 Color Display. The IBM 5153 Color Display and Color Graphics Adapter are required to emulate the 3279 Color Display Station Model 2A or S2A.
 - IBM Personal System/2 Model 25 or Model 30 with a keyboard and:
 - 128K bytes of main storage, of which approximately 107K bytes is available for concurrent operation of DOS and application programs in base operation. An additional 12K is required for EEHLLAPI, and an additional 21K (256K bytes of memory total) is required for Enhanced Connectivity Facilities.
 - An IBM Personal Computer 3278/79 Emulation Adapter
 - One dual-sided diskette drive and associated adapter
 - The Model 25 includes a display and adapter. For the Model 30, use one of the following displays and associated adapter:
 - IBM Personal System/2 Monochrome Display Model 8503
 - IBM Personal System/2 Color Display Model 8512
 - IBM Personal System/2 Color Display Model 8513.
 - For attachment to IBM Personal System/2 Models 50, 60, and 80, the following are supported:
 - 128K bytes of main storage, of which approximately 107K bytes is available for concurrent operation of DOS and application programs in base operation. An additional 12K is required for EEHLLAPI, and an additional

21K (256K bytes of memory total) is required for Enhanced Connectivity Facilities.

- An IBM 3270 Connection Adapter
- One dual-sided diskette drive and associated adapter
- One of the following displays and associated adapter:
 - IBM Personal System/2 Monochrome Display Model 8503
 - IBM Personal System/2 Color Display Model 8512
 - IBM Personal System/2 Color Display Model 8513
 - IBM Personal System/2 Color Display Model 8514.
- A customer-supplied coaxial cable or either IBM Cabling System media or telephone twisted pair media. Use with telephone twisted pair media also requires that the ROLM 3270 Coax-to-Twisted Pair Adapter (3270-CTPA) be used with the IBM 3270 Connection or the IBM 3278/3279 Emulation Adapter for attachment to the IBM 3174 Subsystem Control Unit or 3274 Subsystem Control Unit.
- Use of file transfer or IBM Enhanced Connectivity Facilities when attached to the IBM 3174 Subsystem Control Unit requires that the control unit be customized with the File Transfer Aid selected. For details refer to the *IBM 3174 Subsystem Control Unit Customizing Guide*, GA23-0214.
- Attachment to the 4701 Finance Communication Controller requires the Device Cluster Adapter (#3101). File transfer is not supported with the IBM 4701 Finance Communication Controller.
- Attachment to 43XX systems requires the Display/Printer Integrated Communications Adapter. Attachment to the 4361 can also be via the Workstation Adapter.

Control Unit

The adapter can be attached to any of the following:

- IBM 3274 Control Unit configured for an IBM 3278 Model 2 Display Station or 3279 Model 2A Color Display Station with a 3278 Keyboard. (The keyboard must match country code loaded with DOS.)
- IBM 4321/4331 Display/Printer Adapter with the specify code number 9843 installed
- IBM 4361 Display/Printer Adapter
- IBM 4701 Finance Communication Controller, using feature number 3101
- IBM 3174 Control Unit, all models.

A coaxial cable connecting the Personal Computer to the control unit is required.

Software Requirements

The following are required:

- IBM Personal Computer Disk Operating System (DOS) Versions 3.2 or 3.3 for the IBM Personal Computer or Personal Computer XT
- Versions 3.2 and 3.3 for the IBM Personal Computer XT Model 286
- Versions 3.1 through 3.3 for the IBM Personal Computer AT
- Version 3.3 for the IBM Personal System/2 Models 25, 30, 50, 60, and 80
- For Enhanced Connectivity Facilities, VM/SP Release 5 installed at the host, with or without HPO installed at the host, or see footnote ¹
- For Enhanced Connectivity Facilities, TSO/E Release 3 installed at the host, or see footnote ¹.

¹ Complementary support of Control Unit Terminal (CUT) Mode on IBM System/370 to IBM Personal Computer Enhanced Connectivity Facilities is provided by PTF UV90227 (APAR VM28510) on VM/SP Release 5 (with or without HPO), and by PTF UY90083 on TSO/E Release 3.

The licensed programs required to be installed on the IBM 43XX or 30XX host computer for file transfer are:

- For MVS/TSO-IBM 3270 PC File Transfer Program, Release 1
- For VM/SP-IBM 3270 PC File Transfer Program, Release 1
- For CICS/VS (MVS and VSE)-IBM CICS/VS 3270 PC File Transfer Program, Release 1.

Hardware Compatibility

The IBM PC 3270 Emulation Program, Entry Level is data stream compatible with 3270 base data stream alphanumeric application environments that support the IBM 3278 Model 2 or the IBM 3279 Model 2A or S2A, with certain restrictions. No programming changes are required unless necessary functions are not available.

A mouse device cannot be used concurrently with the IBM 3270 Emulator Program, Entry Level.

General Limitations

This section describes general limitations to the use of the IBM 3270 Emulator Program, Entry Level.

Network Compatibility Option Limitations

The following restrictions must be observed when operating the IBM PC 3270 Emulation Program, Entry Level and PC Local Area Network Program 1.2 concurrently:

-
- The IBM PC Local Area Network Program 1.2 must be loaded before the IBM PC 3270 Emulation Program, Entry Level is loaded.
 - The IBM PC 3270 Emulation Program, Entry Level must be run in Resume (Alt + R) mode.
 - When a message notification occurs, any keystroke returns the system to the host screen.
 - A mouse device cannot be used concurrently with the IBM 3270 Emulation Program, Entry Level.
 - The IBM PC 3270 Emulation Program, Entry Level runs concurrently with these configurations of the IBM PC Local Area Network Program 1.2:
 - Redirector
 - Receiver
 - Messenger
 - Server.

Using the Entry Emulator with Applications

Many IBM software products run concurrently with the entry emulator on the IBM Personal Computer. Contact your marketing representative for specific details.

Applications may operate concurrently with the entry emulator if they do not:

- Overlay the DOS or BIOS area of storage
- Use interrupt vectors hex 7A or 7F
- Use adapter I/O port, hex 2D0 through hex 2DF
- Program the 8259 interrupt controller
- Use cassette interrupt hex 15 with function call in the AH register of hex FF

-
- Disable interrupts, fail to issue an end-of-interrupt (IRET) on a hardware interrupt level, or mask selected interrupt levels for more than 100 milliseconds
 - Use the Alt + Esc key combination
 - Write directly to the video buffer.

Note: Applications that write directly to the video buffer must be run in a suspended mode.

VDI 1.1 Compatibility Limitations

When using the PC 3270 entry emulator, do not run VDI graphics within a PC session that is in resume mode. You must suspend (run in Suspend (Alt+S) mode) the PC session to use VDI. VDI writes directly to the screen and will overwrite the whole screen.

IBM Voice/Phone Assistant, Voice Communications Option Limitations

The Voice Communication Option asynchronous communications function set is not supported concurrently with a 3270 emulation session.

When the Listen or Record function of the IBM Voice/Phone Assistant is used, intermittent messages may be written to the host screen. To avoid these messages, the user may choose to run the IBM PC 3270 Emulation Program, Entry Level in Suspend (Alt+S) mode.

TopView 1.XX Compatibility Limitations

The IBM PC 3270 Emulation Program, Entry Level, can be run as a TopView task.

Notes:

1. *You cannot run EEHLLAPI as a TopView task.*
2. *You cannot run IBM Enhanced Connectivity Facilities as a TopView task.*
3. *You cannot use a mouse device when running the IBM PC 3270 Emulation Program, Entry Level concurrently with the TopView Program.*
4. *You cannot use TopView while the IBM PC 3270 Emulation Program, Entry Level is operating in IBM Enhanced Connectivity Facilities mode.*

In the TopView environment, the emulator operates only in the host session. Under TopView, therefore, the following PC 3270 entry emulator functions are inactive:

- Suspend (Alt + S)
- Resume (Alt + R)
- Switch Screen (Alt + Esc)
- Quit (Alt + 5).

Note: TopView must be loaded before the PC 3270 entry emulator. Programs that interface with the host session should be started as TopView tasks. For more information about loading the PC 3270 entry emulator under TopView, refer to the TopView User's Guide.

File Transfer Under TopView

The entry emulator and programs that plan to use the file transfer capability must have a Program Information File (PIF) created. A PIF identifies these programs as needing a shared program. The shared program name required in the creation of the PIF is PC3270SH.COM.

PIFs for the entry emulator and for SEND and RECEIVE are provided on the distribution diskette.

Note: For more information about creating a PIF, refer to the TopView User's Guide.

Using the Entry Emulator with a Personal Computer Network

The IBM PC 3270 Emulation Program, Entry Level, can be set up to run within a network of IBM Personal Computers. When you set up the entry emulator to run on a network, you should consider the following:

- Always load the network applications **before** loading the entry emulator. For example, if the applications are loaded from an AUTOEXEC.BAT file, the commands to load the network applications should precede the command to load the entry emulator.
- Always run the entry emulator in resume mode. That is, the PC session must be running **actively** in the background, as opposed to being suspended.

Note: The default is the suspend mode, so you have to specifically place the PC session in resume mode by using one of the following:

- *The double-key press of Alt + R when in host mode*
- *The R option when starting PC 3270 (for example, PC3270 R).*

-
- If messages come in through the network for the PC session while you are in the host session, the screen switches to the PC session to display the messages. To return to the host session, press a single key (any one). If you forget and use the Alt + Esc keys, the first keypress switches the session momentarily to the host, while the immediately following concurrent keypress effectively switches the session back to the PC. In this case, you may not perceive that the sessions have switched. Simply press the Alt + Esc keys again to return to the host session.
 - If the PC is acting as a *server* in the network, do not quit (that is, use the double-key press of Alt + 5) the entry emulator before pausing all the shared devices.

Note: A server is a PC that is defined with a high functional level. Other PCs in the network can share the devices attached to a server (for example, a printer).

Image Support Facility 2 Limitations

The *hot key* function is not allowed when an application program is displaying the image on the IBM Personal System/2 Models 50, 60 and 80.

PC Program Limitations

Many, but not all, PC programs operate concurrently with the IBM PC 3270 Emulation Program, Entry Level. The following is a list of major program actions that preclude coexistence:

- Overlaying the DOS or basic input/output system area of storage.
- Using interrupt vectors hex 50 through hex 57, and interrupt vectors hex 7A or hex 7F.

-
- Using adapter input/output port hex 2D0 through hex 2DF.
 - Programming the 8259 interrupt controller.
 - Using cassette interrupt hex 15.
 - Disabling interrupts, failing to issue an end-of-interrupt (IRET) on a hardware interrupt level, or masking selected interrupt levels for more than 100 ms.
 - Using Alt and Esc key combination.
 - Checking the display mode. When a user hot keys from the PC session to the host session, IBM PC 3270 Emulation Program, Entry Level checks the display mode. If the mode is 11 or greater, or any advanced function of an installed IBM Personal System/2 Display Adapter (4050) is invoked, a beep is issued and the user remains in the PC session.

The following 3270 features and functions are not supported by the IBM PC 3270 Emulation Program, Entry Level when used with an emulation adapter.

- Security keylock
- Magnetic reader control and accessories
- Display of screens larger than 1,920 characters
- Monocase switch
- Selector light pen
- Video output
- Katakana (language)
- APL/Text character set
- Keyboards other than the 75-key ASCII typewriter keyboard (U.S. English)
- RPQs
- Extended data stream and associated keys:
 - Programmed symbols
 - Extended highlighting
 - Seven colors.
- Structured field and attribute processing
- Attachment to port 0 of a 3174 or 3274
- Alternate cursor
- Keyboard click key
- Cursor blink option

-
- 3270 diagnostic reset dump
 - Explicit partitions
 - Graphics escape
 - Numeric lock
 - 3274 response time monitor for this terminal.

The following RPQs for the 3274 Control Unit are not allowed when a Personal Computer using the IBM Personal Computer 3278/3279 Emulation Adapter is attached:

8K0809	8K1013	8K1162	8X0003
8K0931	8K1056	8K1163	8X0004
8K0949	8K1057	8K1169	8X0008
8K0988	8K1134	8K1193	8X0009
8K1011	8K1159	8K1202	8X0011
8K1012	8K1160	8K1281	
		8K1311	

Performance Considerations

File transfer applications may alter the performance of other devices attached to the same 3174 Subsystem Control Unit or 3274 Subsystem Control Unit.

Use of file transfer when attached to the IBM 3174 Subsystem Control Unit requires that the control unit be customized with the file transfer aid selected. For details refer to the *IBM 3174 Subsystem Control Unit Customizing Guide*, GA23-0214.

Notes

Appendix I. Creating a Patch File

This appendix explains how to create a patch file on both a diskette system and a fixed disk system. It also contains some tips on using EDLIN.

Creating a Patch File on a Diskette System

1. Insert your DOS diskette in drive A.
2. Insert your PC3270 diskette in Drive B.

Note: If your system has only one diskette drive, you may continue with this procedure. Simply insert the blank diskette when prompted for drive B.

3. At the DOS A > prompt, type the following:

```
edlin b:IRXXXXXX
```

where IRXXXXXX is the actual APAR number for the patch you are creating. Look at the written patch you received to determine this number.

4. Press Enter (↵)
5. When EDLIN is ready, the following message appears on your screen:

```
New file  
*
```

6. To begin typing the first line in the patch file, type the following command:

i

7. Press Enter (↵)
8. The following prompt will appear:

1*

Note: The 1 refers to the number one, not the letter L.

9. Next to the * prompt, type the first line of the written patch. When you have typed the entire line, press Enter (↵).

The following prompt will appear:

2*

10. Next to the prompt, type the second line of the written patch. When you have typed the entire line, press Enter (↵).
11. Continue this procedure until you have entered all the lines from the written patch. Be sure to copy each line exactly as it is written.
12. When you have finished entering all the patch lines, hold down the Ctrl key and press Scroll Lock. The following prompt should appear:

*

13. You now are ready to save your patch file. Type the following command:

e

14. Press Enter (↵)
15. The DOS A> should appear on your screen.
16. Follow the instructions in the section "Installing a Patch" on page 8-36 to install the patch file you have created.

Creating a Patch File on a Fixed Disk System

1. At the DOS C > prompt, type the following:

```
edlin b:IRXXXXX
```

where IRXXXXX is the actual APAR number for the patch you are creating. Look at the written patch you received to determine this number.

2. Press Enter (↵)
3. When EDLIN is ready, the following message appears on your screen:

```
New file  
*
```

4. To begin typing the first line in the patch file, type the following command:

```
i
```

5. Press Enter (↵)
6. The following prompt will appear:

```
1*
```

Note: The 1 refers to the number one, not the letter L.

7. Next to the * prompt, type the first line of the written patch. When you have typed the entire line, press Enter (↵).

The following prompt will appear:

```
2*
```

8. Next to the prompt, type the second line of the written patch. When you have typed the entire line, press Enter (↵).

-
9. Continue this procedure until you have entered all the lines from the written patch. Be sure to copy each line exactly as it is written.
 10. When you have finished entering all the patch lines, hold down the Ctrl key and press Scroll Lock. The following prompt should appear:
*
11. You now are ready to save your patch file. Type the following command:
e
12. Press Enter (↵)
 13. The DOS A > should appear on your screen.
 14. Follow the instructions in the section "Installing a Patch" on page 8-36 to install the patch file you have created.

Tips for Using EDLIN

Following are a few helpful tips for using EDLIN. For additional information on using EDLIN, refer to the section "The EDLIN Commands" in your DOS reference manual.

To retype a line, hold down the Ctrl key and press scroll lock. Next to the EDLIN * prompt, type the number of the line you wish to retype. The line number will appear with the EDLIN * prompt. Retype the line with corrections.

To add lines at the end of the file, hold down the Ctrl key and press scroll lock. Type the following command next to the EDLIN * prompt:

a

The line number for the next line will appear with the EDLIN * prompt. Continue entering lines using the procedures outlined above for your system.

Notes

Index

A

Alt + Esc (switch screens) 5-3
Alt + numeric 5 (quit) 5-5
Alt + R (resume) 5-4
Alt + S (suspend) 5-4
Alt key 5-9
American Standard Code for
Information Interchange
(ASCII) C-1
APAR
 prerequisite APAR 8-34
 problem report
 See APAR
ASCII (American Standard Code
for Information
Interchange) C-1
ASCII to EBCDIC
translation C-3

B

backup diskettes, making
bibliography D-1

C

change operations
COPY 8-16, 8-18
DELETE 8-19, 8-20
general information 8-11
RETRIEVE 8-22
 RETRIEVE table 8-21

SWAP 8-12, 8-13, 8-14
CMS (see VM/CMS) 7-4, 7-8
color
 selection
 redefining 8-28
colors
 background color 8-30, 8-31
 fields 8-29
 foreground modes 8-30
 selection
 deactivating 8-32
 ending 8-31
 intensity 8-30
 messages A-17
 protected state 8-30
 restrictions 8-29
 starting 8-27
command format for file
 transfer 7-11
control unit printer:printing from
 host session 6-4
control unit requirements H-4
COPY 8-16
create a patch file
 how to 8-33
creating patch file
 for a hardfile 8-35, 8-36
 for multi-diskette drives 8-35,
 8-36
 for single diskette drive 8-35,
 8-36
Ctrl + Alt + Del (system
reset) 5-4
Ctrl key 5-8
current keyboard definition 8-3
current system level
 listing 8-33
currently installed APARs
 current listing
 how to 8-33

D

- deactivating
 - color definition, current 8-32
 - keyboard definition, current 8-26
- default keyboard definition 8-3
- definition of terms E-1
- DELETE 8-19
- discarding color changes 8-31
- Disk Operating System (see DOS) x
- display station
 - 3278, model 2 1-2
 - 3279, model S2A 1-2
 - 3279, model 2A 1-2
- do - not - enter B-6
- dual session
 - host 1-2
 - personal computer 1-2
 - starting
 - using enhanced connectivity 4-6
 - with enhanced connectivity facilities 4-9
 - with PC3270
 - AUTOEXEC.BAT file 3-3, 4-6
 - without PC3270
 - AUTOEXEC.BAT file 3-6, 4-9

E

- EBCDIC (Extended Binary Coded Decimal Code) C-1
- EBCDIC to ASCII translation C-5
- ecf
 - See enhanced connectivity facilities
- EDLIN tips I-5
- ending color selection program
 - discarding changes 8-31
 - saving changes 8-31

- ending keyboard redefinition program
 - entry emulator loaded 8-24
 - entry emulator not loaded 8-24
 - file 8-25
 - more changes 8-25
 - quit 8-24
 - temporary save 8-25
- enhanced connectivity facilities
 - description 4-2
 - restarting EESRPI 4-13
 - SEND and RECEIVE 4-5
 - starting 4-5
 - starting the host router 4-12
 - starting the requester 4-13
 - starting with an AUTOEXEC.BAT file 4-6
 - starting without an AUTOEXEC.BAT file 4-9
 - stopping ECF 4-13
 - with MVS 4-2
 - with Topview 4-5
 - with VM 4-2
 - with 3270 emulation 4-2
- enhanced personal computer keyboard 5-7, 8-4
- entry assist
 - host session
 - keys used 5-16
- entry assist function
 - keys used 5-16
- entry emulator
 - applications H-7
 - compatibility 1-3, H-1
 - hardware H-6
 - TopView limitations H-9
 - VDI 1.1 limitations H-8
 - control unit H-4
 - general limitations H-6
 - hardware compatibility H-6
 - hardware requirements H-1
 - IBM Voice/Phone Assistant option limitations H-8
 - Image Support Facility 2 H-11
 - limitations
 - IBM Voice/Phone Assistant option H-8
 - network compatibility option limitations H-6

TopView
 compatibility H-9
 using the Entry Emulator
 with applications H-7
 VDI 1.1 compatibility H-8
 Voice Communication
 option H-8
network compatibility option
 limitations H-6
PC Program H-11
performance
 considerations H-13
requirements
 hardware H-1
 software H-5
software requirements H-5
TopView compatibility
 limitations H-9
 using with a Personal
 Computer Network H-10
 using with applications H-7
 VDI 1.1 compatibility
 limitations H-8
 Voice Communications option
 limitations H-8
Entry Emulator Server-Requester
 Programming Interface
 (EESRPI)
 description 4-4
 messages A-26
 restarting 4-13
examples
 COPY 8-18
 DELETE 8-20
 MVS/TSO
 RECEIVE 7-34
 SEND 7-24
 RETRIEVE 8-22
 SWAP 1 8-13
 SWAP 2 8-14
 VM/CMS
 RECEIVE 7-33
 SEND 7-21
Extended Binary Coded Decimal
 Code (EBCDIC) C-1

F

file (keyboard redefinition
 program) 8-25
file transfer
 command format 7-11
 messages A-4
 MVS/TSO
 SEND 7-5
 MVS/TSO RECEIVE
 examples 7-34
 MVS/TSO SEND
 examples 7-24
 problem determination 9-5
 RECEIVE command
 CAUTION 7-7
 definition of command,
 parameters, and
 options 7-29
 general information 7-7
 SEND command
 CAUTION 7-3
 definition of command,
 parameters, and
 options 7-13
 general information 7-3
 MVS/TSO format 7-13
 VM/CMS format 7-12
stopping unsolicited
 messages 7-4, 7-8
translation
 ASCII to EBCDIC C-1
 EBCDIC to ASCII C-1
VM/CMS
 RECEIVE 7-8
 SEND 7-4
 stopping unsolicited
 messages 7-4, 7-8
VM/CMS RECEIVE
 examples 7-33
VM/CMS SEND
 examples 7-21
file transfer under TopView H-10
format
 patch
 pre APAR 8-34
 pre level 8-34
 ZAP 8-34

format of file transfer
 commands 7-11
format of MVS/TSO
 RECEIVE 7-29
 RECEIVE command
 MVS/TSO format 7-29
format of MVS/TSO SEND
 SEND, MVS/TSO format
format of VM/CMS
 RECEIVE 7-28
 RECEIVE command
 VM/CMS format 7-28
format of VM/CMS SEND 7-12
FULL mode 8-10

G

general information ix
 problem determination 9-2
general limitations H-6
glossary E-1

H

hardware compatibility H-6
hardware requirements H-1
host programs
 servers 4-3
host router 4-12
host session
 entry assist
 keys used 5-16
 exiting the entry
 emulator 5-5
 key functions, typewriter 5-7
 printing
 to control unit printer 6-4
 to PC printer 6-2
 printing from,
 quit (Alt + numeric 5) 5-5
 redefining color scheme 8-28
 redefining keyboard 8-2
 resuming personal computer
 session 5-4
 screen printing 6-2

suspending personal computer
 session 5-4
switching to personal
 computer session 5-3
typewriter key functions 5-7
3278 keys in, 5-10

I

IBM Voice/Phone Assistant
IBM Voice/Phone Assistant
 option limitations H-8
 refid voiceph.using with Entry
 Emulator H-8
Image Support Facility 2
 using with Entry
 Emulator H-11
Image Support Facility 2
 Limitations H-11
INDPATCH command 8-33
installation
 messages A-2
installed APARs
 APAR
 definition 8-33
 current listings 8-33
installing a patch
 how to 8-33
 removing a patch
Installing the Entry Emulator on
 Fixed Disk
intensity 8-30

K

key combinations
 Alt + Esc (switch
 screens) 5-3
 Alt + numeric 5 (quit) 5-5
 Alt + R (resume) 5-4
 Alt + S (suspend) 5-4
 Ctrl + Alt + Del (system
 reset) 5-4
 quit (Alt + numeric 5) 5-5
 resume (Alt + R) 5-4
 suspend (Alt + S) 5-4

switch screens (Alt +
Esc) 5-3
system reset (Ctrl + Alt +
Del) 5-4
keyboard
 definitions
 deactivating 8-26
 default 8-3
 problem determination 9-8
 types 5-7
 enhanced personal
 computer keyboard 8-4
 personal computer AT
 keyboard 8-4
 personal computer
 keyboard 8-4
 personal computer XT
 keyboard 8-4
keyboard definition
 current 8-3
keyboard redefinition
 program 8-2

L

layout
 keyboard redefinition program
 current keyboard 8-5
 default keyboard 8-5
 operator information
 area B-3
limitations for the network
 compatibility option H-6
line by line printing from
 personal computer session 6-2
list of publications D-1

M

messages
 color selection A-17
 file transfer A-4
 installation A-2
 keyboard redefinition A-14
 operator information area, in
 do-not-enter B-6

mode B-9
 printer status B-10
 readiness B-5
 reminder B-8
 shift B-9
 status, printer B-10
 system connection B-5
 patch installation A-19
 SRPI A-26
mode
 full 8-10
 single 8-10
mode messages B-9
more changes (keyboard
 redefinition program) 8-25
MVS/TSO
 file transfer
 SEND 7-5
 RECEIVE 7-10
 RECEIVE command
 format 7-29
 parameters and
 options 7-29
 SEND command
 format 7-13
 parameters and
 options 7-13
 stopping unsolicited
 messages 7-5, 7-10

N

network compatibility option
 limitations H-6

O

OIA (see operator information
 area) B-2
operation requirements
 control unit H-4
operator information area
 layout of, B-3
 status indicator
 mode messages B-9
 shift messages B-9

- status indicators
 - do - not - enter messages B-6
 - printer status messages B-10
 - readiness messages B-5
 - reminder messages B-8
 - system connection messages B-5
- status indicators in, B-2, B-4
- organization of manual xi

P

- patch
 - installation messages A-19
- patch file
 - create
 - for a hardfile 8-35
 - for multi-diskette drives 8-35
 - for single diskette drive 8-35
 - how to 8-33
 - installing 8-36
 - or single diskette drive
 - for a hardfile 8-36
 - for multi-diskette drives 8-36
- patch format
 - defining
 - pre APAR 8-34
 - pre level 8-34
 - ZAP 8-34
- patch installation messages A-19
- patches
 - definition 8-33
 - installing a patch
 - how to 8-33
 - removing a patch
 - APAR 8-33
 - create a patch file 8-33
 - how to 8-33
 - list currently installed APARs 8-33
 - list the current system level 8-33
 - permanent changes 8-33
- PC program

- using with Entry Emulator H-11
- PC Program Limitations H-11
- PC 3270 Emulation Program, Entry Level, short name for x PC3270 AUTOEXEC.BAT files
 - starting dual session
 - with, 3-3, 4-6
 - starting dual session without, 3-6, 4-9
 - with enhanced connectivity 4-6
- performance considerations H-13
- personal computer
 - printer
 - problem
 - determination 9-7
 - problem determination 9-6
 - requester 4-3
 - personal computer AT
 - keyboard 5-7, 8-4
 - personal computer keyboard 5-7, 8-4
 - personal computer network
 - using with Entry Emulator H-10
 - personal computer session
 - printing from,
 - line by line 6-2
 - rebooting 5-4
 - resumed from host session 5-4
 - screen printing 6-2
 - screens, update 5-6
 - suspended from host session 5-4
 - switching to host session 5-3
 - system reset (Ctrl + Alt + Del) 5-4
 - update screens 5-6
- personal computer XT
 - keyboard 5-7, 8-4
- preparing the entry emulator diskette
 - preparing working copy of entry emulator 2-2
 - copying diskettes 2-2
- prerequisite APAR
 - definition 8-34
- printer status messages B-10
- printing

- host session
 - screen 6-2
 - to 3274 control unit
 - printer 6-4
- keyboard reference 8-24
- line by line 6-2
- messages, printer status B-10
- personal computer printer
 - problem
 - determination 9-7
- personal computer session
 - line by line 6-2
 - screen 6-2
- printer status messages B-10
- screen 6-2
 - host session 6-2
 - personal computer session 6-2
- problem determination
 - file transfer 9-5
 - general information 9-2
 - keyboard 9-8
 - personal computer 9-6
 - personal computer printer 9-7
 - system startup 9-4
- protected state 8-30

Q

- quit (Alt + numeric 5) 5-5
- quit (keyboard redefinition program) 8-24

R

- readiness messages B-5
- reboot (system reset) 5-4
- RECEIVE (file transfer)
 - general information 7-7
 - MVS/TSO 7-10
 - command format 7-29

- examples 7-34
- parameters and options 7-29
- VM/CMS 7-8
 - command format 7-28
 - examples 7-33
 - parameters and options 7-29
- redefining host color scheme 8-28
- redefinition, keyboard
 - change operations 8-11
 - COPY 8-16
 - DELETE 8-19
 - RETRIEVE 8-21
 - SWAP 8-12
 - current definition 8-3
 - deactivating current definition 8-26
 - default definition 8-3
 - determining keyboard type 8-4
 - ending the program 8-24
 - file 8-25
 - more changes 8-25
 - quit 8-24
 - temporary save 8-25
 - keyboard panels 8-6
 - keyboard type,
 - determining 8-4
 - messages A-14
 - modes 8-10
 - reference of redefined keys 8-24
 - shift states 8-9
 - starting 8-4
- reminder messages B-8
- requester 4-3, 4-4, 4-13
- restarting EESRPI 4-13
- restrictions, color selection 8-29
- resume (Alt + R) 5-4
- RETRIEVE 8-21
- RETRIEVE table 8-21
- router 4-4

S

- saving color changes 8-31
- screen printing
 - host, from 6-2
 - personal computer, from 6-2
- screens, update 5-6
- SEND (file transfer)
 - general information
 - MVS/TSO 7-5
 - command format 7-13
 - examples 7-24
 - parameters and options 7-13
 - VM/CMS 7-4
 - command format 7-12
 - examples 7-21
 - parameters and options 7-13
- server 4-3, 4-4
- Shift key 5-8
- shift messages B-9
- shift states
 - Alt + key
 - general 5-9
 - keyboard redefinition 8-9
 - Ctrl + key
 - general 5-8
 - keyboard redefinition 8-9
 - keyboard redefinition
 - importance 8-9
 - Shift + key
 - general 5-8
 - keyboard redefinition 8-9
- single mode 8-10
- software requirements H-5
- starting color selection
 - program 8-27
- starting dual session
 - with enhanced connectivity 4-6
 - with PC3270 AUTOEXEC.BAT file 3-3, 4-6
 - without PC3270 AUTOEXEC.BAT file 3-6, 4-9
- starting the host router 4-12
- starting the keyboard redefinition program 8-4

- starting the requester 4-13
- status indicators
 - do-not-enter B-6
 - mode B-9
 - operator information area, in B-4
 - printer B-10
 - readiness B-5
 - reference chart B-4
 - reminder B-8
 - shift B-9
 - system connection B-5
- stopping ECF 4-13
- summary of 3278 functions 5-10
 - emulating 3278 keyboard
- suspend (Alt + S) 5-4
- SWAP 8-12
- switching screens and sessions (Alt + Esc) 5-3
- system connection messages B-5
- system level
 - current listing
 - how to 8-33
- system reset (Ctrl + Alt + Del) 5-4
- system startup problem
 - determination 9-4

T

- temporary save (keyboard redefinition) 8-25
- tips
 - EDLIN I-5
- TopView
 - file transfer with, H-10
 - using with Entry Emulator H-9
- TopView Compatibility
 - Limitations H-9
- translation
 - ASCII to EBCDIC C-3
 - ASCII/EBCDIC C-1
 - EBCDIC to ASCII C-5
- TSO (see MVS/TSO) 7-5, 7-10
- typewriter key functions:
 - emulating 3278 keyboard 5-7

U

update screens 5-6
Using the Entry Emulator with a
 Personal Computer
 Network H-10
Using the Entry Emulator with
 Applications H-7

V

VDI 1.1 Compatibility
 Limitations H-8
 using with Entry Emulator
VM/CMS
 file transfer
 RECEIVE 7-8
 SEND 7-4
 stopping unsolicited
 messages 7-4, 7-8
 RECEIVE command
 format 7-28

 parameters and
 options 7-29
 SEND command
 format 7-12
 parameters and
 options 7-13
 Voice Communications option
 Voice Communications option
 limitations H-8
 refid voicecm.using with Entry
 Emulator H-8

Numerics

3274 control unit printer
 printing from host session 6-4
3278 display station
 model 2 1-2
3278 functions in host
 session 5-7
3278/79 Emulation Adapter, short
 name for ix
3279 color display station
 model S2A 1-2
 model 2A 1-2

© IBM Corp. 1987
All rights reserved.

International Business
Machines Corporation
P.O. Box 1328-W
Boca Raton,
Florida 33429-1328

Printed in the
United States of America

75X0576

IBM
®