

IBM

*Personal Computer
Hardware Reference
Library*

**IBM RT PC
Problem Determination Guide**

SA23-2604-0
P/N 22F9828

)

)

)



*Personal Computer
Hardware Reference
Library*

IBM RT PC Problem Determination Guide

Third Edition (June 1988)

This is a major revision of and obsoletes the second edition of *IBM RT PC Problem Determination Guide*.

This edition applies to all subsequent releases until otherwise indicated in new editions or technical newsletters. Changes are made periodically to the information herein; these changes will be incorporated in new editions of this publication.

References in this publication to IBM products, programs, or services do not imply that IBM intends to make these available in all countries in which IBM operates. Any reference to an IBM licensed program in this publication is not intended to state or imply that only IBM's licensed program may be used. Any functionally equivalent program may be used instead.

International Business Machines Corporation provides this manual "as is," without warranty of any kind, either express or implied, including, but not limited to, the implied warranties of merchantability and fitness for a particular purpose. IBM may make improvements and/or changes in the product(s) and/or the program(s) described in this manual at any time.

Products are not stocked at the address given below. Requests for copies of this product and for technical information about the system should be made to your authorized RT PC dealer.

A reader's comment form is provided at the back of this publication. If the form has been removed, address comments to IBM Corporation, Department 997, 11400 Burnet Road, Austin, Texas 78758. IBM may use or distribute whatever information you supply in any way it believes appropriate without incurring any obligation to you.

IBM is a registered trademark of International Business Machines Corporation.

RT PC is a registered trademark of International Business Machines Corporation.

© Copyright International Business Machines Corporation 1985, 1988

Safety

CAUTION

Before removing any cover or disconnecting any signal cable, set the power switches on the system unit and all attached devices to Off; then unplug all external power cables from the outlets.

This manual contains "DANGER" notices on pages A-12, A-14, A-16, and A-18. The following pages contain translations of this DANGER notice.

Safety Translations

DANISH

ADVARSEL

ADVARSEL

Der skal være slukket for afbryderkontakterne på systemenheden og alle tilsluttede enheder (Off), før eventuelle dæksler fjernes, eller signalkabler afmonteres. Dernæst tages alle ledninger ud af stikkontakterne.

Page A-12, A-14, A-16, A-18

IBM RT PC Udskiftning og erstatning af batterier - FARE. Fare for brand, eksplosion og forbranding. Batteriet må ikke genoplades, skilles ad, udsættes for temperaturer over 100 grader; der må ikke loddes direkte på elementet, elementet må ikke forbrændes eller komme i forbindelse med vand.

Hold batteriet væk fra børn. Må kun udskiftes med IBM reservedel nr. 6299201 eller et batteri, der anbefales af Underwriters Laboratories, Inc. til brug i IBM 6151, og som er klassificeret derfra. Brug af et andet batteri kan medføre brand eller eksplosionsfare.

Waarschuwing

Schakel de systeemeenheid en alle randapparatuur uit en haal de netspanningsstekkers van de systeemeenheid en van alle randapparatuur uit de stopcontacten, voordat u een kap opent of een signaalkabel loshaalt.

Page A-12, A-14, A-16 and A-18

“Verwijdering en vervanging van IBM RT PC - batterijen - LET OP! Gevaar voor brand, ontploffing en ernstige brandwonden. Laad de batterijen niet opnieuw op, haal ze niet uit elkaar, verhit ze niet boven 100°r.C, verbrand ze niet, stel de inhoud van de batterij niet bloot aan water en soldeer niets aan de batterijcel vast.

Houd de batterijen uit de buurt van kinderen. Gebruik bij vervanging IBM-batterijen bestelnummer 6299201 of batterijen die speciaal voor gebruik met de IBM 6151 zijn goedgekeurd door de Underwriters Laboratoires Inc. en waarop dat ook staat aangegeven. Als u andere batterijen gebruikt loopt u het risico dat er brand ontstaat of dat zich een ontploffing voordoet”

Huomio

Ennen minkään yhteyskaapelin tai kannen irroittamista, katkaise virta systeemyksiköstä ja kaikista siihen liitetystä laitteista; irroita sitten kaikki verkkojohdot pistorasioistaan.

Sivut A-12, A-14, A-16 ja A-18

IBM RT PC:n pariston poisto ja vaihto - VAARA

Tulipalon, räjähdysten ja vakavien palovammojen vaara. Älä lataa paristoa uudelleen, pura sitä, kuumenna sitä lämpötilaan yli 100°deg. C, juota paristoa kiinni, hävitä sitä polttamalla tai anna sen kastua. Pidä paristo poissa lasten ulottuvilta. Vaihda käytetyn pariston tilalle vain paristo, jonka IBM-tilausnumero on 6299201 tai joka on hyväksytty käytettäväksi IBM 6151 -koneen kanssa. Muunlaisten paristojen käyttö saattaa aiheuttaa tulipalon tai räjähdysten vaaran.

Attention!

Avant de retirer le carter de protection ou de débrancher les câbles de signalisation:

- Mettre en position hors tension tous les interrupteurs de l'unité et des périphériques.
- Débrancher tous les cordons d'alimentation de leur prise murale.

Page A-12, A-14, A-16, A-18

Retrait et remplacement de la pile de l'IBM RT PC - DANGER - Tenir hors de portée des enfants.

Ne pas recharger, démonter ou souder. Ne pas exposer la pile à une température excédant 100 C. Ne pas la mettre au feu ni à l'eau.

Risques d'incendie, d'explosion ou de brûlure grave.

N'utiliser sur l'IBM RT PC que les piles IBM Nr. 6299201 ou celles dont la classification "pour IBM 6151" est clairement spécifiée par des laboratoires agréés.

L'utilisation de toute autre pile présente un risque d'incendie ou d'explosion.

Achtung

Vor dem Entfernen von Verkleidungen oder dem Trennen von Signalkabeln Netzschalter der Systemeinheit und aller angeschlossenen Geräte ausschalten. Dann alle Netzkabel aus den Netzsteckdosen ziehen.

Sieten A-12, A-14, A-16 und A-18

Ausbau und Einbau der Batterie beim IBM RT PC - Gefahr.

Feuer-, Explosions- und Verbrennungsgefahr. Zelle nicht laden, zerrlegen, ueber 100 Grad C erhitzen, keine Loetstelle direkt an der Zelle anbringen, Zelle nicht verbrennen oder den Inhalt mit Wasser in Beruehrung bringen.

Kindersicher aufbewahren. Als Ersatz ausschliesslich IBM Original-Batterien verwenden. Bei Verwendung anderer Batterien besteht Feuer- und Explosionsgefahr.

Attenzione

Prima di togliere qualsiasi coperchio o scollegare qualsiasi cavo di segnale, spegnere gli interruttori di alimentazione dell'unità di sistema e di tutti i dispositivi collegati; scollegare poi dalle prese di corrente tutti i cavi di alimentazione esterni.

Rimozione e sostituzione della batteria del PC RT IBM - PERICOLO.

Rischio di gravi ustioni, esplosione ed incendio. Non caricare, disassemblare o riscaldare ad una temperatura superiore ai 100 gradi, non effettuare saldature direttamente sull'elemento, incenerire o metterne il contenuto a diretto contatto con l'acqua. Tenere lontano dalla portata dei bambini. Usare un ricambio IBM (numero parte 6299201), oppure una batteria specificatamente consigliata dalla Underwriters Laboratories, Inc. per il 6151 IBM e verificare che tale classificazione sia espressamente indicata. L'utilizzo di una qualsiasi altra batteria può rappresentare un rischio di incendio o esplosione.

注意：

カバーを取り外したり、信号ケーブルを切り離したりする場合には、必ずシステム装置の電源スイッチとすべての接続装置の電源スイッチをオフにしてから、すべての外部電源ケーブルをコンセントから抜いてください。

危険注意

火災、爆発、および重いやけどの危険があります。バッテリーを再充電する、分解する、 100°C 以上に熱する、バッテリー内容物を水にさらす等のことは決して行なわないでください。子供は近づけないでください。IBM部品番号6299201か、あるいは、Underwriters Laboratories, Inc. によって、IBM6150用に使用されると明確に指定され、そのような指定がなされているバッテリーのみと交換するようにしてください。他のバッテリーを使用方法と、火災や爆発の危険があります。

Advarsel

Før du tar av dekselet eller trekker ut signalkabler, må du slå av nettbryterne på systemenheten og alle tilkoblede enheter (AV, Off eller O) og trekke ut alle nettkablene fra stikkontaktene.

Side A-12, A-14, A-16 og A-18: "Bytte av batterier - FARE. På grunn av brann- og eksplosjonsfare må batteriene ikke lades opp, tas fra hverandre, brennes eller utsettes for sterk varme. Oppbevar batteriene utilgjengelig for barn. Bruk bare IBMs batterier med delnummer 6299201. Bruk av feil type batteri kan forårsake brann eller eksplosjon."

Cuidado

Antes de remover qualquer tampa ou de desligar qualquer cabo de sinal coloque os interruptores de corrente eléctrica da unidade do sistema e de todos os dispositivos a ela ligados na posição de desligado (off) e desligue das tomadas todos os cabos externos de corrente eléctrica.

Páginas A-12, A-14, A-16 e A-18

PERIGO - Ao retirar e substituir a bateria IBM RT PC pode haver perigo de incêndio explosão e queimaduras graves. Não recarregue, desmonte, aqueça a mais de 100 graus - C, solde directamente à célula, incinere ou deite o conteúdo na água. Mantenha afastada das crianças. Substitua apenas por uma bateria IBM P/N 6299201 ou por uma bateria especificamente designada pelos Underwriters Laboratories, Inc. para ser usada com o IBM 6151.

A utilização de outro tipo de bateria pode representar risco de fogo ou explosão.

SPANISH

PELIGRO

Precaucion

Antes de quitar cualquier cubierta o desconectar cualquier cable de se al, coloque los interruptores de alimentaci n en la unidad del sistema y en todos los dispositivos conectados en posici n de APAGADO; desenchufe entonces todos los cables externos de alimentaci n de las tomas de corriente.

PELIGRO

Riesgo de fuego, explosi n y quemaduras graves. No recargue, ni desmonte, ni exponga a temperaturas superiores a 100  C, ni suelde directamente en la bater a, ni queme, ni ponga en contacto con el agua el contenido de la bater a. Mant ngala fuera del alcance de los ni os. Sustit yala  nicamente por la pieza IBM N 6299201 o por una bater a espec ficamente clasificada por Underwriters Laboratoires, Inc. para utilizarse en el IBM 6150 y que est  marcada indicando dicha clasificaci n. La utilizaci n de otra bater a puede presentar riesgo de fuego o de explosi n.

Varning

Innan du tar bort någon kåpa eller lossar någon signalkabel måste du slå från strömbrytarna på systemenheten och alla anslutna enheter samt lossa alla nätkablar från sina uttag.

VARNING - Läs detta först

Den engelskspråkiga dokumentationen till denna utrustning innehåller varningstexter riktade till användaren. Innebörden av dessa texter är följande:

About This Book

Purpose

This book is used to do problem determination on your IBM RT Personal Computer®. When you suspect there is a problem with the hardware this book should be used to find the failing device.

If a device or adapter has recently been installed, go to Section 9, "Checking out the Installation," in the *IBM RT PC Options Installation* to verify that the installation is correct before using this book.

Audience

The audience for this book is anyone having hardware problems with the IBM RT PC.

How to Use This Book

Section 1, "Beginning Problem Determination," is the entry point for the problem determination procedures. This section guides you to the correct section and step needed to find the failing area of your system.

Section 2, "Hardware Problems," contains the steps needed to find hardware problems. You are directed to this section by Section 1.

RT Personal Computer and RT PC are registered trademarks of International Business Machines Corporation.

RT is a trademark of International Business Machines Corporation.

Section 3, "Utilities," contains descriptions of the utilities and tools provided on the IBM RT PC. Diagnostic Diskettes.

Appendix A. "Locations and Examples," provides drawings showing the locations of various display controls. Comparison drawings for use in display diagnostics are also shown.

Appendix B. "Problem Summary Form," consists of multiple copies of the Problem Summary Form. Use this form to record any information that can be used to diagnose system problems.

A Reader's Comment Form and Book Evaluation Form are provided at the back of this book. Use the Reader's Comment Form at any time to give IBM information that may improve the book. After you become familiar with the book, use the Book Evaluation Form to give IBM specific feedback about the book.

Related Publications

- *IBM RT PC User Setup Guide* provides instructions for setting up and connecting devices to the system units. This book also gives procedures for testing the setup. (Packaged with *IBM RT PC Options Installation*)
- *IBM RT PC Options Installation* provides instructions for installing optional adapters in IBM 6151 and IBM 6150 and installing fixed-disk and diskette drives in IBM 6150. (Packaged with *IBM RT PC User Setup Guide*)

Ordering Additional Copies of This Book

To order additional copies of this publication use either of the following sources:

- To order from your IBM representative, use Order Number SBOF-1825.
- To order from your IBM dealer, use Part Number 22F9800.

A binder, tabs, wrap-plug bag, and diagnostic diskettes are included with the order.

)

)

)

Contents

| | |
|---|------------|
| Section 1. Beginning Problem Determination | 1-1 |
| About This Section | 1-3 |
| Section 2. Hardware Problems | 2-1 |
| About This Section | 2-5 |
| Section 3. Utilities | 3-1 |
| About This Section | 3-3 |
| Loading the Utilities | 3-4 |
| Show Installed Options Utility | 3-9 |
| Show and Change Diagnostic Test List Utility | 3-10 |
| Fixed-Disk Utilities | 3-11 |
| Communication Utilities | 3-12 |
| Diagnostic Diskette Copy Utility | 3-13 |
| IBM 9332 Utilities | 3-14 |
| Appendix A. Locations and Examples | A-1 |
| Diagnostic Function Keys | A-2 |
| Types of Displays | A-3 |
| Display Test Patterns | A-5 |
| Battery Removal and Replacement | A-11 |
| Appendix B. Problem Summary Form | B-1 |
| Glossary | X-1 |

Section 1. Beginning Problem Determination

CONTENTS

| | |
|-------------------------------|-----|
| About This Section | 1-3 |
| Step 1. Symptom Index | 14 |
| Step 2. System Inactive | 1-6 |

About This Section

This section is the entry point for errors and problems with the system. The section contains steps for determining if the failure is caused by hardware.

Read the steps carefully and answer the questions as they appear. Some steps will refer you to another section of the guide. Unless instructed otherwise, always return to the step from which you were referred.

If a device or adapter has recently been installed, go to Section 9, "Checking out the Option Installation," in the *IBM RT PC Options Installation* to verify that the installation is correct. If the device or adapter still fails, use this manual or the maintenance information provided with the device.

Continue to the next page to begin the problem determination procedures.

Step 1. Symptom Index

The symptom index is a list of system problems (described in terms of their symptoms) and the action for determining their cause.

1. Find the failure or symptom that most closely resembles your system failure.
2. Follow the instructions in the Action column.
3. Follow the instructions given in the steps to complete the problem determination procedures.

| Symptom | Action |
|---|---|
| Obvious machine damage (noise, odor, smoke, heat, broken keys, broken covers, or similar failures) | Go to "Step 1. Obvious Damage" on page 2-6. |
| System will not turn on | Go to "Step 2. Diagnostics" on page 2-9. |
| You were sent here by the operating system problem determination guide. | Go to "Step 2. Diagnostics" on page 2-9. |
| <i>XX</i> remains displayed in two-digit display at power on (<i>XX</i> any digits). The <i>XX</i> does not blink. | Go to "Step 2. Diagnostics" on page 2-9. |
| A <i>cX</i> message or a blinking <i>XX</i> is displayed in the two-digit display during normal operation. | Use the operating system problem determination procedures. |
| Have to reset timer each time system is turned on. | Replace the battery. Go to "Battery Removal and Replacement" on page A-11 for removal/replacement procedures. |
| A message is displayed for the failure. | Follow the message procedures and actions listed in the appropriate message manual. If you cannot find the message, go to "Step 2. Diagnostics" on page 2-9. |
| You were sent here by a message. | If the message indicates a hardware problem, go to "Step 2. Diagnostics" on page 2-9. If the message indicates a software problem, use the operating system problem determination procedures. |
| Incorrect system operation with no message (incorrect output or unexplained system actions). | Go to "Step 2. Diagnostics" on page 2-9. |
| System is on but appears inactive (loop, no keyboard response). | Go to "Step 2. System Inactive" on page 1-6. |
| The problem is with the 5085 or a device attached to the 5085. | Go to the problem determination guide for the 5085. |

Step 2. System Inactive

If the system is on, but appears inactive and will not respond to the keyboard:

1. Turn off the system.
2. Wait about 1 minute.
3. Turn on the system.
4. After power-on self-test (POST) has completed, sign on the system.

CAN YOU USE YOUR SYSTEM NOW?

YES Continue with your normal operations.

NO Go to "Step 2. Diagnostics" on page 2-9.

Section 2. Hardware Problems

CONTENTS

| | |
|--|------|
| About This Section | 2-5 |
| Step 1. Obvious Damage | 2-6 |
| Step 2. Diagnostics | 2-9 |
| Step 3. Loading Diagnostics | 2-11 |
| Step 4. Operating Instructions | 2-13 |
| Step 5. Function Selection | 2-14 |
| Step 6. Diagnostic Selection | 2-15 |
| Step 7. Test Option | 2-16 |
| Step 8. Test Option | 2-17 |
| Step 9. Diagnostic Test List | 2-18 |
| Step 10. Updating the Test List | 2-19 |
| Step 11. Diagnostic Selection | 2-20 |
| Step 12. Test Method Selection | 2-21 |
| Step 13. Completing the Tests | 2-22 |
| Step 14. Completing the Tests | 2-23 |
| Step 15. Additional Problems | 2-24 |
| Step 16. Keyboard Lights, Beeper, or Two-Digit Display Failure | 2-25 |
| Step 20. Two-Digit Display | 2-26 |
| Step 21. Two-Digit Display | 2-27 |
| Step 22. Two-Digit Display | 2-28 |
| Step 23. Two-Digit Display | 2-29 |
| Step 24. Two-Digit Display | 2-30 |
| Step 25. Two-Digit Display | 2-31 |
| Step 30. Keylock | 2-36 |
| Step 31. Keylock | 2-37 |
| Step 40. Diskette | 2-38 |
| Step 41. Diskette | 2-39 |
| Step 50. Power | 2-40 |
| Step 51. Power | 2-41 |
| Step 52. Power | 2-42 |
| Step 60. Keyboard | 2-43 |
| Step 70. Diskette | 2-44 |
| Step 71. Diskette | 2-45 |
| Step 72. Diskette | 2-46 |
| Step 73. Diskette | 2-47 |
| Step 74. Diskette | 2-48 |
| Step 80. Blinking Two-Digit Display | 2-49 |
| Step 81. Blinking Two-Digit Display | 2-50 |
| Step 82. Blinking Two-Digit Display | 2-51 |
| Step 100. Display Types | 2-52 |

| | | |
|-----------|---|------|
| Step 101. | Display Types | 2-53 |
| Step 110. | IBM 5151 Personal Computer Display | 2-54 |
| Step 111. | IBM 5151 Personal Computer Display | 2-55 |
| Step 112. | IBM 5151 Personal Computer Display | 2-56 |
| Step 113. | IBM 5151 Personal Computer Display | 2-57 |
| Step 114. | IBM 5151 Personal Computer Display | 2-58 |
| Step 115. | IBM 5151 Personal Computer Display | 2-59 |
| Step 120. | IBM 5154 Personal Computer Enhanced Color Display | 2-60 |
| Step 121. | IBM 5154 Personal Computer Enhanced Color Display | 2-61 |
| Step 122. | IBM 5154 Personal Computer Enhanced Color Display | 2-62 |
| Step 123. | IBM 5154 Personal Computer Enhanced Color Display | 2-63 |
| Step 124. | IBM 5154 Personal Computer Enhanced Color Display | 2-64 |
| Step 125. | IBM 5154 Personal Computer Enhanced Color Display | 2-65 |
| Step 126. | IBM 5154 Personal Computer Enhanced Color Display | 2-66 |
| Step 127. | IBM 5154 Personal Computer Enhanced Color Display | 2-67 |
| Step 130. | IBM 6153 Advanced Monochrome Graphics Display | 2-68 |
| Step 131. | IBM 6153 Advanced Monochrome Graphics Display | 2-69 |
| Step 132. | IBM 6153 Advanced Monochrome Graphics Display | 2-70 |
| Step 133. | IBM 6153 Advanced Monochrome Graphics Display | 2-71 |
| Step 134. | IBM 6153 Advanced Monochrome Graphics Display | 2-72 |
| Step 135. | IBM 6153 Advanced Monochrome Graphics Display | 2-73 |
| Step 136. | IBM 6153 Advanced Monochrome Graphics Display | 2-74 |
| Step 137. | IBM 6153 Advanced Monochrome Graphics Display | 2-75 |
| Step 140. | IBM 6154 Advanced Color Graphics Display | 2-76 |
| Step 141. | IBM 6154 Advanced Color Graphics Display | 2-77 |
| Step 142. | IBM 6154 Advanced Color Graphics Display | 2-78 |
| Step 143. | IBM 6154 Advanced Color Graphics Display | 2-79 |
| Step 144. | IBM 6154 Advanced Color Graphics Display | 2-80 |
| Step 145. | IBM 6154 Advanced Color Graphics Display | 2-81 |
| Step 146. | IBM 6154 Advanced Color Graphics Display | 2-82 |
| Step 147. | IBM 6154 Advanced Color Graphics Display | 2-83 |
| Step 148. | IBM 6154 Advanced Color Graphics Display | 2-84 |
| Step 150. | IBM 6155 Extended Monochrome Graphics Display | 2-85 |
| Step 151. | IBM 6155 Extended Monochrome Graphics Display | 2-86 |
| Step 152. | IBM 6155 Extended Monochrome Graphics Display | 2-87 |
| Step 153. | IBM 6155 Extended Monochrome Graphics Display | 2-88 |
| Step 154. | IBM 6155 Extended Monochrome Graphics Display | 2-89 |
| Step 155. | IBM 6155 Extended Monochrome Graphics Display | 2-90 |
| Step 156. | IBM 6155 Extended Monochrome Graphics Display | 2-91 |
| Step 157. | IBM 6155 Extended Monochrome Graphics Display | 2-92 |
| Step 158. | IBM 6155 Extended Monochrome Graphics Display | 2-93 |
| Step 160. | IBM 5081 Graphics Display | 2-94 |

| | | |
|-----------|-----------------------------|-------|
| Step 161. | IBM 5081 Graphics Display | 2-95 |
| Step 162. | IBM 5081 Graphics Display | 2-96 |
| Step 163. | IBM 5081 Graphics Display | 2-97 |
| Step 164. | IBM 5081 Graphics Display | 2-98 |
| Step 165. | IBM 5081 Graphics Display | 2-99 |
| Step 166. | IBM 5081 Graphics Display | 2-100 |
| Step 167. | IBM 5081 Graphics Display | 2-101 |
| Step 168. | IBM 5081 Graphics Display | 2-102 |
| Step 169. | IBM 5081 Graphics Display | 2-103 |
| Step 200. | System Attached to 5085 | 2-104 |
| Step 201. | System Not Attached to 5085 | 2-105 |
| Step 202. | Power On at 5085 | 2-106 |
| Step 203. | Keyboard Connection | 2-107 |
| Step 204. | Y Cable Connection | 2-108 |

About This Section

This section provides you with steps for finding the failing hardware in your system. To successfully use this section, you must first use Section 1, "Beginning Problem Determination," to find the area most likely to cause the problem.

Before starting the procedures, make sure no other users are using the system.

Step 1. Obvious Damage

1. Check to be sure no programs are running and that the operating system is properly shutdown.
2. Turn off the system unit power.

Note: For minor problems, such as a broken mouse, it is not necessary to turn off the system unit power.

3. Get a copy of the Problem Summary Form from Appendix B of this manual. (Sample shown below.)

Appendix B. Problem Summary Form

Please complete the following information before calling IBM for service.
Save the complete form for your service representative.

1. Describe the problem:

2. Write all messages related to the problem here:

3. Write the two-digit display number here:

4. Write the Service Request Number here:

Appendix B. Problem Summary Form B-1

AIZAF058

CONTINUE to next page.

4. Find the problem area in the following list.
5. Write the Service Request Number (SRN) for the damaged device on item 4 of the Problem Summary Form.
6. Have the device serviced or refer to the service information for that device.

| Problem Area | Service Request (SRN) Number or Action |
|---|---|
| System Unit | 16-991 |
| Beeper | 16-100-780 |
| Two-Digit Display and Control Panel | 16-630 |
| Power Cable | 16-A50 |
| High Capacity Diskette Drive in location A | 16-64A |
| High Capacity Diskette Drive in location B | 16-64B |
| Dual Sided Diskette Drive in location B | 16-66B |
| Mouse | 86-790 |
| Keyboard | 36-780 |
| Keyboard LEDs | 16-780 |
| IBM 5151 Personal Computer Display | 26-540 |
| IBM 5154 Personal Computer Enhanced Color Display | 26-580 |
| IBM 6153 Advanced Monochrome Graphics Display | 26-600 |
| IBM 6154 Advanced Color Graphics Display | 26-590 |
| IBM 6155 Extended Monochrome Graphics Display | 26-620 |

| Problem Area | Service Request (SRN) Number or Action |
|---|---|
| IBM 6156 Portable Disk Drive module | Refer to documentation for that unit. |
| IBM 6156 Portable Disk Drive Model 001 | Refer to documentation for that unit. |
| IBM 6156 Portable Disk Drive Model 003 | Refer to documentation for that unit. |
| RT PC 6192 Expansion Unit | Refer to documentation for that unit. |
| IBM RT PC Streaming Tape Drive | 46-810 |
| IBM 5080 Dials Feature | B6-7A0 |
| Lighted Program Function Keyboard Feature | C6-7B0 |
| IBM 5083 Model 1 Tablet | A6-8C0 |
| IBM 5083 Model 11 Tablet | A6-7E0 |
| IBM 5083 Model 12 Tablet | A6-800 |
| IBM 5083 Model 1 Tablet Stylus | A6-8A0 |
| IBM 5083 Model 11 and 12 Tablet Stylus | A6-7C0 |
| IBM 5083 Model 1 Tablet Cursor | A6-8B0 |
| IBM 5083 Model 11 and 12 Tablet Cursor | A6-7D0 |
| Printer | Refer to the printer documentation. |
| Plotter | Refer to the plotter documentation. |
| Other attached terminals | Refer to the terminal documentation. |

Step 2. Diagnostics

Diagnostic Diskette Handling Procedures

The IBM RT PC Diagnostic Diskettes contain the diagnostic programs used to check out and test the system. Diagnostics 1 (DIAG-1) is the first diskette used. After the diagnostics are loaded, the system may prompt for another diskette to be inserted into a diskette drive.

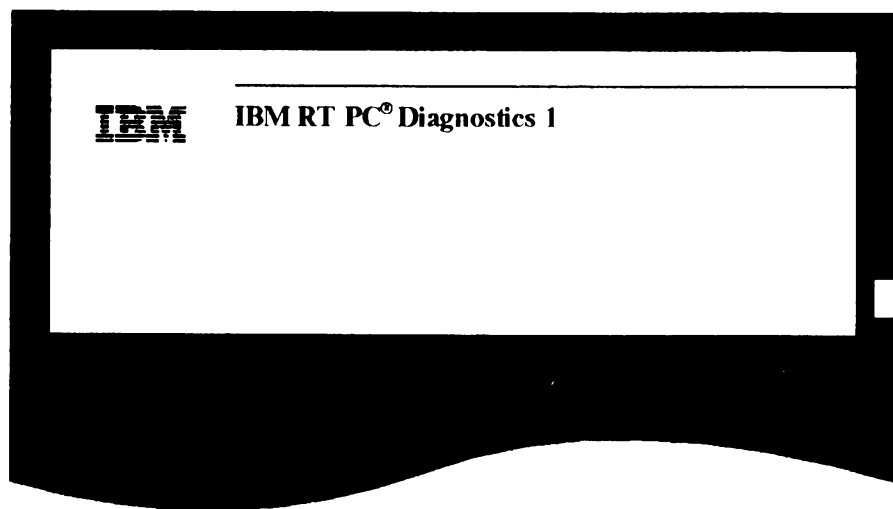

A1ZAF001

CONTINUE to next page.

Before the diagnostics are loaded:

1. Check that the system and display power cables are plugged in.
2. Check that the keylock is unlocked.
3. Check that the display Brightness Control is turned up enough to see the screen. See Appendix A for locations.

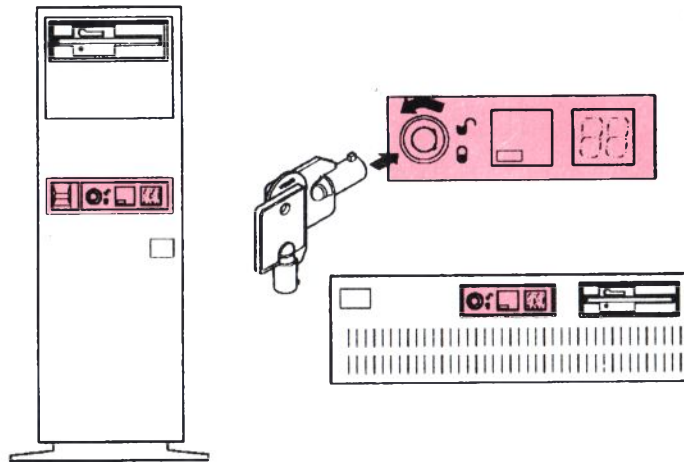

AIZAF002

DID THE ABOVE CHECKS FIND THE PROBLEM?

YES STOP, you have completed these procedures.

NO CONTINUE to next page.

Step 3. Loading Diagnostics

1. Get the diagnostic diskettes from the back of this manual.
2. Remove the write-protect tab, if one is present, from the diskettes.
3. Check to be sure no programs are running and that the operating system is properly shut down.
4. If an IBM 5085 is attached, turn off the 5085 power.
5. Turn off the system unit and wait for about 1 minute.
6. If an IBM 5085 is attached, turn the 5085 power on. Be sure the 5085 system diskette is in the 5085 diskette drive.
7. If an RT PC 6192 Expansion Unit is attached, turn on the 6192 power.
8. If an IBM 6156 Portable Disk Drive is attached, insert all the Portable Disk Drive modules you want to test and turn on the enclosure power.

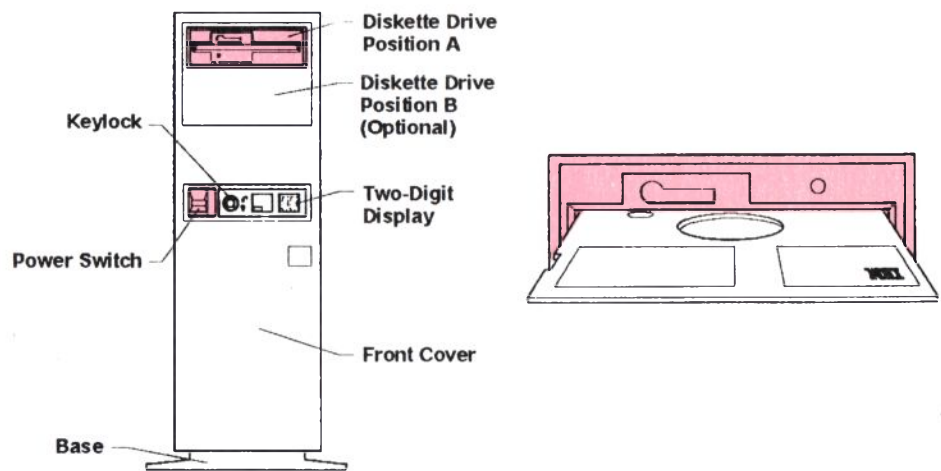

AIZAF003

CONTINUE to next page.

-
9. Turn on the system unit and immediately insert **DIAG-1** into the diskette drive in location A and close the drive.

Notes:

- a. Do not operate or move any device, unless instructed to do so, while diagnostics are running.
 - b. The IBM Logo screen may display for a short time while the diagnostics are loading and checking the system configuration.
10. Wait about 4 minutes or until the **DIAGNOSTIC OPERATING INSTRUCTIONS** screen appears.

Note: The system may appear inactive during this time.

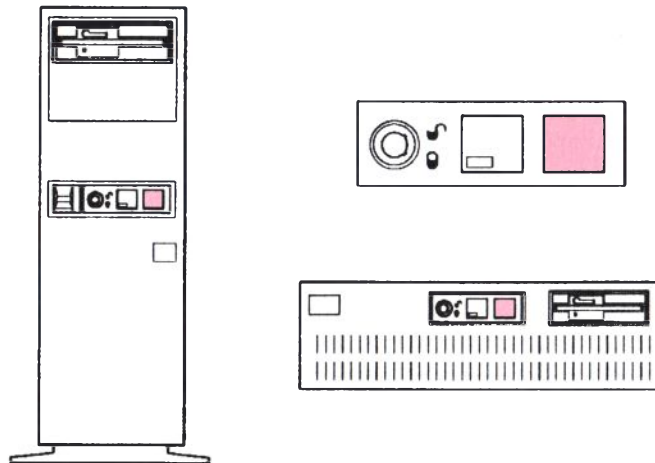

A1ZAF004

IS THE TWO-DIGIT DISPLAY BLANK (no numbers or letters displayed)?

YES CONTINUE to next page.

NO Go to "Step 20. Two-Digit Display" on page 2-26.

Step 4. Operating Instructions

Once the diagnostics are loaded, the DIAGNOSTIC OPERATING INSTRUCTIONS screen is displayed. "Diagnostic Function Keys" on page A-2 provides a description of the diagnostic function keys.

Notes:

1. If the display is blank, check the display's Brightness and Contrast controls and, if present, the power switch.
2. If your system is connected to a 5085, the keyboard belongs to the 5081 Display at power on. If you have not switched the keyboard to your display, press and hold the **Alt** key, then press the **Sw Keybd** key.

The Sw Keybd status light on the keyboard should now indicate PC mode. For more information on the 5085 see *IBM 5080/RT PC Graphics System Operation*.

DIAGNOSTIC OPERATING INSTRUCTIONS

This diskette contains diagnostics and utilities for your system. You should use these procedures whenever you are having problems with your system which have not been corrected by any software application procedures available.

In general, the procedures will run automatically. However, sometimes you will be required to select options, tell the system when to continue, and do simple tasks and exchange diskettes.

IS THE "DIAGNOSTIC OPERATING INSTRUCTIONS" SCREEN DISPLAYED WITHOUT ANY OBVIOUS DISPLAY PROBLEMS?

YES Read the screen and press **Enter**. **CONTINUE** to the next page.

NO Go to "Step 50. Power" on page 2-40.

Step 5. Function Selection

After the DIAGNOSTIC OPERATING INSTRUCTIONS screen, the FUNCTION SELECTION menu is displayed.

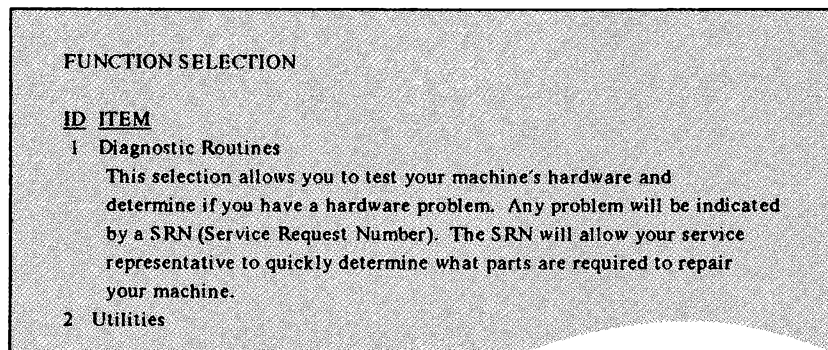

IS THE "FUNCTION SELECTION" MENU DISPLAYED?

YES Press **Enter**. CONTINUE to the next page.

NO Go to "Step 60. Keyboard" on page 2-43.

Step 6. Diagnostic Selection

If all options were found, the DIAGNOSTIC SELECTION menu is displayed.

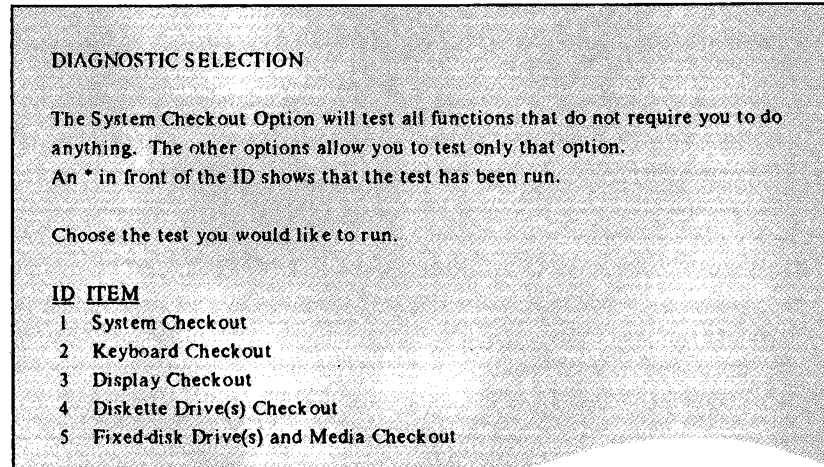

IS THE "DIAGNOSTIC SELECTION" MENU DISPLAYED?

YES Go to "Step 11. Diagnostic Selection" on page 2-20.

NO CONTINUE to next page.

Step 7. Test Option

The TEST OPTION menu is displayed when an option that was previously recognized by the system is not found during Power-On Self-Test (POST). The option that was not found is listed in the TEST OPTION menu.

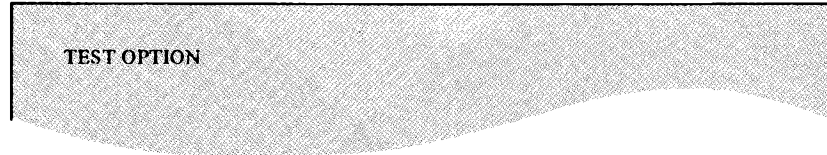

IS THE "TEST OPTION" MENU DISPLAYED?

- YES** CONTINUE to next page.
- NO** Go to "Step 9. Diagnostic Test List" on page 2-18.

Step 8. Test Option



TEST OPTION

HAS THE OPTION LISTED ON THE “TEST OPTION” MENU BEEN EITHER REMOVED FROM THE SYSTEM, MOVED TO ANOTHER LOCATION, OR TURNED OFF?

YES Choose ID 2. If the TEST OPTION menu is displayed again, repeat this step.

CONTINUE to next page.

NO Choose ID 1. If the TEST OPTION menu is displayed again, repeat this step.

Report the problem if the THERE IS A HARDWARE PROBLEM IN YOUR MACHINE screen is displayed.

Step 9. Diagnostic Test List

If a new option is found or no fixed disks are found in the system unit, the DIAGNOSTIC TEST LIST menu is displayed.



DIAGNOSTIC TEST LIST

IS THE “DIAGNOSTIC TEST LIST” MENU DISPLAYED?

YES CONTINUE to next page.

NO Go to “Step 11. Diagnostic Selection” on page 2-20.

Step 10. Updating the Test List

Before you can run the diagnostics, you must update the DIAGNOSTIC TEST LIST.

1. Read and follow the instructions as they appear on the screen.
2. If a list of options is displayed, compare your screen with the list of options for your system. See *User Setup Guide* for a list of adapters and devices installed.
3. If the THERE IS A HARDWARE PROBLEM IN YOUR MACHINE screen is displayed, report the problem. Otherwise, CONTINUE to the next page when the DIAGNOSTIC SELECTION menu is displayed.

CONTINUE to next page.

Step 11. Diagnostic Selection

The DIAGNOSTIC SELECTION menu is displayed after you select Diagnostic Routines or after you update the DIAGNOSTIC TEST LIST.

1. Read the menu items on the display carefully. The menu items displayed may differ from the example below.
2. Choose the test you would like to run. If you are not sure what is causing the problem, test each device starting with System Checkout.
3. Press **Enter**.

Notes:

1. If the keyboard will not respond, report Service Request Number (SRN) **16-986** and have the keyboard and system unit serviced.
2. If the option you wish to test is not listed, check to see if there is any supplemental information available. Use the supplemental information to test the option.

DIAGNOSTIC SELECTION

The System Checkout Option will test all functions that do not require you to do anything. The other options allow you to test only that option.
An * in front of the ID shows that the test has been run.

Choose the test you would like to run.

ID ITEM

| | |
|---|----------------------------|
| 1 | System Checkout |
| 2 | Keyboard Checkout |
| 3 | Display Checkout |
| 4 | Diskette Drive(s) Checkout |

CONTINUE to next page.

Step 12. Test Method Selection

The next menu displayed is the TEST METHOD SELECTION menu.

1. Read the item descriptions carefully.
2. Press **Enter** to run the test one time or type **2** to run the test multiple times.
3. Follow the instructions as they appear on the display to test the chosen device.

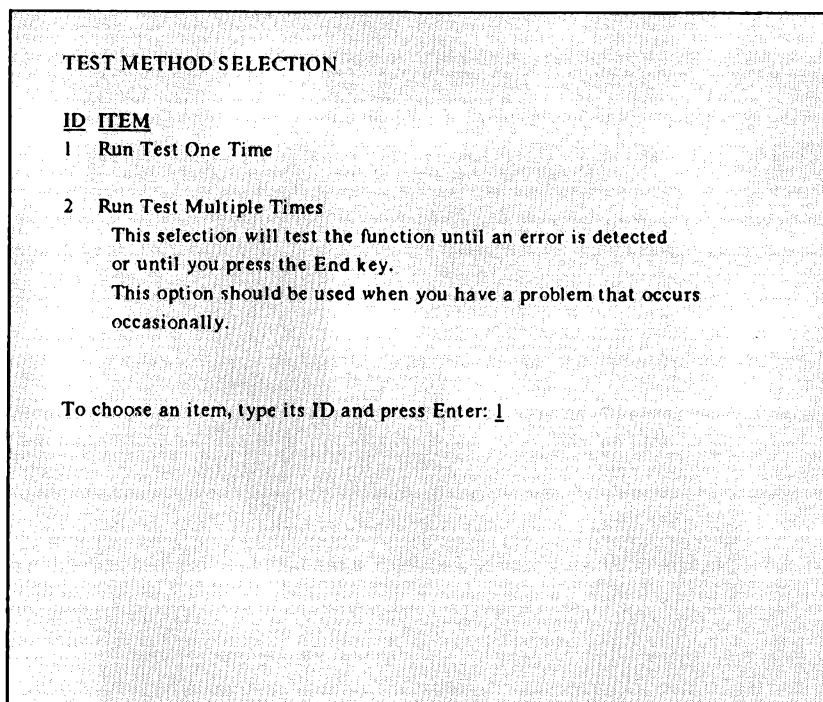

CONTINUE to next page.

Step 13. Completing the Tests

When the test completes, you will see either the TESTING COMPLETE or THERE IS A HARDWARE PROBLEM IN YOUR MACHINE screen. If no problem was found, the TESTING COMPLETE screen is displayed.

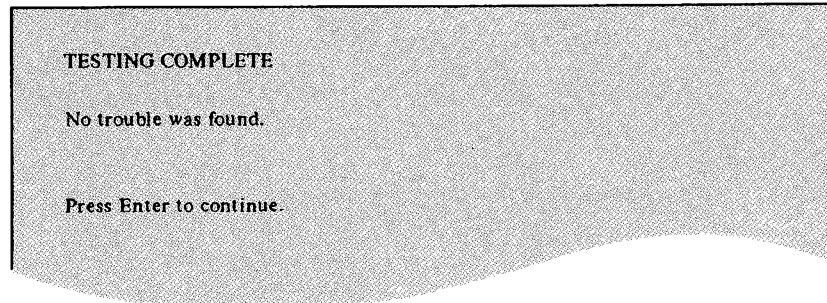

IS THE "TESTING COMPLETE" SCREEN DISPLAYED?

YES No trouble was found. STOP, you have completed the tests for this device. If other devices need to be checked, press **Enter** and choose another device.

If you are finished testing devices, remove the diagnostic diskette and return the diskettes to the back of this book. Go to "Step 15. Additional Problems" on page 2-24.

NO CONTINUE to next page.

Step 14. Completing the Tests

The diagnostics have found a problem with the system.

Note: If a screen similar to the one below does not display or an unexpected error occurs (such as something is displayed in the two-digit display, the system hangs or loops, the keyboard does not respond, you cannot end a test, or a Diagnostic Error message is displayed), report Service Request Number (SRN) **16-986**.

1. Get a Problem Summary Form from Appendix B of this manual.
2. Write the Service Request Number displayed on your screen on item 4 of the form.
3. Read the screen for additional information.

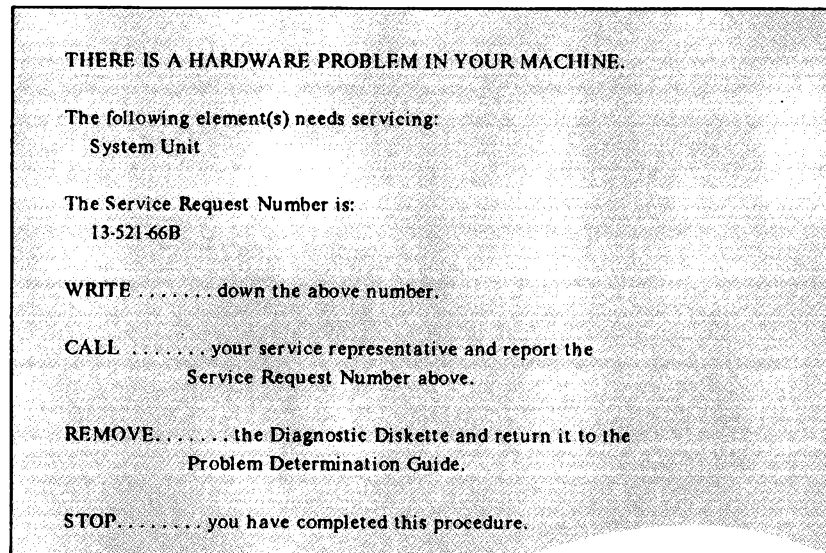

STOP. You have completed the tests.

Step 15. Additional Problems

The problem may be one of the following:

- Status lights on the keyboard do not work.

Note: The lights can be checked by turning on the system unit and watching the lights during the Power-On Self-Test (POST).

- Beeper does not beep or beeps continuously.

Note: The beeper can be checked by turning on the system unit and listening for the beeper during the POST.

- Two-digit display fails to display correctly.

Note: The two-digit display can be checked by turning on the system unit and checking that **88** is displayed in the two-digit display.

DO YOU HAVE ONE OF THESE PROBLEMS?

YES CONTINUE to next page.

NO STOP, you have completed these procedures.

If the application still fails, refer to the operating system problem determination guide for further information.

Step 16. Keyboard Lights, Beeper, or Two-Digit Display Failure

1. Get a Problem Summary Form from Appendix B of this manual.
2. Find the failing component in the following table.
3. Write the Service Request Number (SRN) for the failing component on item 4 of the form.
4. Have the failing device serviced.

| Failing Component | SRN | Device to be Serviced |
|-------------------|------------|-----------------------|
| Keyboard Lights | 36-780 | Keyboard |
| Beeper | 36-780-100 | Keyboard |
| Two-Digit Display | 16-630-84A | System Unit |

STOP. You have found the problem.

Step 20. Two-Digit Display

Look at the two-digit display.

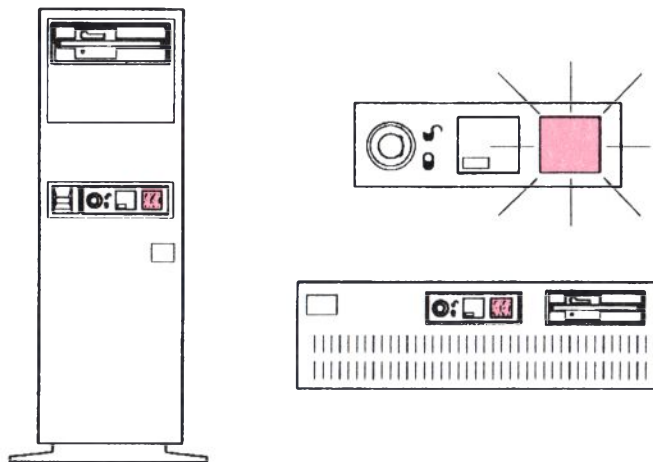

AIZAF005

IS THE TWO-DIGIT DISPLAY BLINKING?

- YES** Go to "Step 80. Blinking Two-Digit Display" on page 2-49.
- NO** CONTINUE to next page.

Step 21. Two-Digit Display

Compare the number in the two-digit display with the numbers in the table below.

| Two-Digit Display Number | Go To Step |
|--------------------------|--|
| 22 | Go to "Step 40. Diskette" on page 2-38. |
| 81 | Go to "Step 200. System Attached to 5085" on page 2-104. |
| 94 | Go to "Step 101. Display Types" on page 2-53. |
| 99 | Go to "Step 30. Keylock" on page 2-36. |

IS THE NUMBER IN THE TABLE?

YES Go to the step indicated in the table.

NO CONTINUE to next page.

Step 22. Two-Digit Display

DIAGNOSTIC OPERATING INSTRUCTIONS

This diskette contains diagnostics and utilities for your system. You should use these procedures whenever you are having problems with your system which have not been corrected by any software application procedures available.

In general, the procedures will run automatically. However, sometimes you will be required to select options, tell the system when to continue, and do simple tasks and exchange diskettes.

Several keys are used to control the procedures:

- The Enter key continues the procedure or performs an action.

IS THE "DIAGNOSTIC OPERATING INSTRUCTIONS" SCREEN DISPLAYED?

YES CONTINUE to next page.

NO Go to "Step 24. Two-Digit Display" on page 2-30.

Step 23. Two-Digit Display

1. Get a Problem Summary Form from Appendix B of this manual.
2. Write the Service Request Number **16-630-84A-100** on item 4 of the form.
3. Have the system unit serviced.

Appendix B. Problem Summary Form

Please complete the following information before calling IBM for service.
Save the complete form for your service representative.

1. Describe the problem:

2. Write all messages related to the problem here:

3. Write the two-digit display number here:

4. Write the Service Request Number here:

16-630-84A-100

16-630-84A-100

Appendix B. Problem Summary Form B-1

AIZAF006

STOP. You have found the problem.

Step 24. Two-Digit Display

1. Get a Problem Summary Form from Appendix B of this manual.
2. Write the number shown on the two-digit display on item 3 of the form.

Appendix B. Problem Summary Form

Please complete the following information before calling IBM for service.
Save the complete form for your service representative.

1. Describe the problem:

2. Write all messages related to the problem here:

3. Write the two-digit display number here:

0 5

4. Write the Service Request Number here:

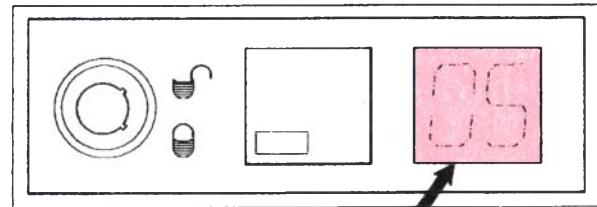

0 5

EXAMPLE

Appendix B. Problem Summary Form B-1

AIZAF007

CONTINUE to next page.

Step 25. Two-Digit Display

The tables on pages 2-31 through 2-35 list the numbers you may see in the two-digit display.

1. From the table below, find the number you wrote on item 3 of the Problem Summary Form.
2. Write the Service Request Number for the failing device on item 4 of the Problem Summary Form.
3. Have the device serviced.

EXAMPLE

Appendix B. Problem Summary Form

Please complete the following information before calling IBM for service. Save the complete form for your service representative.

1. Describe the problem:

2. Write all messages related to the problem here:

3. Write the two-digit display number here:

 0 5

4. Write the Service Request Number here:

11-981-F6C-84A-

| Two-Digit Display | Service Request Number or Problem | Unit to be Serviced or Problem Solution |
|-------------------|-----------------------------------|---|
| 00 | 11-100-84A-490 | System Unit |
| 01 | 11-84A | System Unit |
| 02 | 11-100-19B | System Unit |
| 03 | 11-F6C-84A | System Unit |
| 04 | 11-84A-100 | System Unit |
| 05 | 11-981-F6C-84A | System Unit |
| 07 | 11-100-84A | System Unit |
| 08 | 11-84A-100 | System Unit |

AIZAF008

STOP. You have found the problem.

Note that u is displayed in the upper half of the two-digit display.

| Two-Digit Display | Service Request Number or Problem | Unit to be Serviced or Problem Solution |
|--------------------------|--|--|
| 00 | 11-100-84A-490 | System Unit |
| 01 | 11-84A | System Unit |
| 02 | 11-100-19B | System Unit |
| 03 | 11-F6C-84A | System Unit |
| 04 | 11-84A-100 | System Unit |
| 05 | 11-981-F6C-84A | System Unit |
| 07 | 11-100-84A | System Unit |
| 08 | 11-84A-100 | System Unit |
| 09 | 11-100-780 | System Unit and Keyboard |
| 0c | 11-100-8EA-490 | System Unit |
| 0u | 11-100-18A-490 | System Unit |
| 10 | 11-100-84A | System Unit |
| 11 | 11-100 | System Unit |
| 12 | 11-100 | System Unit |
| 14 | 11-F80 | System Unit |
| 1c | 11-8EA | System Unit |
| 1u | 11-18A | System Unit |
| 22 | 11-F80-64A | System Unit |
| 23 | 11-984-F80-100 | System Unit |
| 25 | Software problem during soft IPL. | Power off to clear problem. |
| 27 | 11-F6C | System Unit |
| 30 | 12-490 | System Unit |
| 31 | 12-410 | System Unit |
| 32 | 12-430 | System Unit |
| 33 | 12-450 | System Unit |

| Two-Digit Display | Service Request Number or Problem | Unit to be Serviced or Problem Solution |
|--------------------------|--|--|
| 34 | 12-470 | System Unit |
| 35 | 12-FBC-F80 | System Unit |
| 36 | 12-8EA | System Unit |
| 37 | 12-FBE-F80-A20 | System Unit |
| 39 | 11-100-F80 | System Unit |
| 3c | 11-F6C-8EA | System Unit |
| 3u | 11-18A | System Unit |
| 40 | 12-F80-100 | System Unit |
| 41 | 12-4CB | System Unit |
| 43 | 12-200-240 | System Unit |
| 44 | 12-19B | System Unit |
| 45 | 12-490 | System Unit |
| 46 | 12-340 | System Unit |
| 47 | 12-1DC | System Unit |
| 48 | 12-1DD | System Unit |
| 49 | 12-3C0 | System Unit or IBM 6192 |
| 4c | 11-8EA-100 | System Unit |
| 4u | 11-18A-100 | System Unit |
| 50 | 12-310 | System Unit |
| 51 | 12-230 | System Unit or IBM 6192 |
| 52 | 12-5B0 | System Unit |
| 53 | 12-350 | System Unit or IBM 6192 |
| 54 | 12-230 | System Unit or IBM 6192 |
| 55 | 12-350 | System Unit or IBM 6192 |
| 56 | 12-390 | System Unit or IBM 6192 |
| 57 | 12-390 | System Unit or IBM 6192 |
| 58 | 12-320 | System Unit |
| 59 | 12-3A0 | System Unit |

| Two-Digit Display | Service Request Number or Problem | Unit to be Serviced or Problem Solution |
|--------------------------|--|--|
| 5c | 11-981-F6C-8EA | System Unit |
| 5u | 11-18A | System Unit |
| 60 | 12-280 | System Unit |
| 61 | 12-380 | System Unit |
| 62 | 12-400 | System Unit |
| 65 | 12-4A0 | System Unit |
| 66 | 12-4B0 | System Unit |
| 67 | 12-1CB | System Unit |
| 68 | 12-8EA | System Unit |
| 69 | 12-8EA | System Unit |
| 71 | 12-15C | System Unit |
| 72 | 12-12C | System Unit |
| 73 | 12-16C | System Unit |
| 74 | 12-1EC | System Unit |
| 76 | 12-12D | System Unit |
| 77 | 12-15D | System Unit |
| 78 | 12-16D | System Unit |
| 79 | 12-1ED | System Unit |
| 7c | 12-100-8EA | System Unit |
| 7u | 12-100-18A | System Unit |
| 80 | 12-100 | System Unit |
| 81 | 32-780 | Keyboard |
| 82 | 12-100 | System Unit |
| 84 | 12-210 | System Unit |
| 85 | 12-800 | System Unit |
| 86 | 12-300 | System Unit |
| 87 | 12-3B0 | System Unit or IBM 6192 |
| 88 | 11-F4A-100 | System Unit |

| Two-Digit Display | Service Request Number or Problem | Unit to be Serviced or Problem Solution |
|--------------------------|--|--|
| 89 | 12-F4A-100 | System Unit |
| 8c | 11-8EA-100 | System Unit |
| 8u | 11-18A-100 | System Unit |
| 90 | 12-850 | System Unit |
| 93 ¹ | 12-64A-F80 | System Unit |
| 95 | 12-FB0-F80 | System Unit |
| 9c | 12-3D0 | System Unit or IBM 6192 |
| c6 | 16-986 | System Unit |
| cc | E2-5D0 | Portable Disk Drive Enclosure |
| cu | E2-650 | Portable Disk Drive Enclosure |
| uc | 12-2E0 | System Unit |
| uu | 72-2F0 | IBM 6192 |
| Any Other Number | 16-84A-630-100 | System Unit |

¹ Check for a write-protect tab on the diskette.

Step 30. Keylock

If the keylock has not been unlocked, 99 is displayed in the two-digit display.

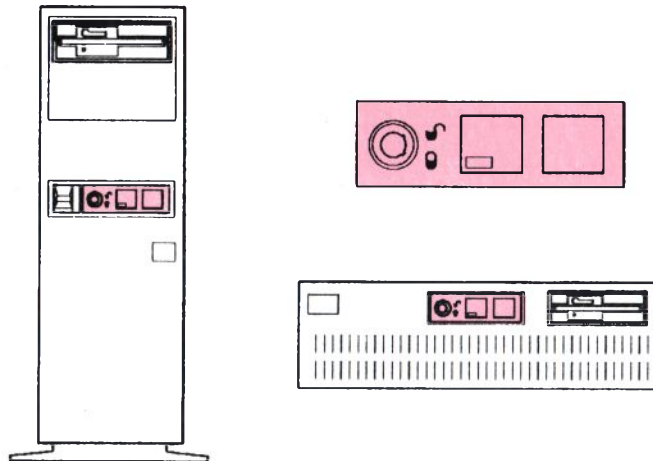

AIZAF004

IS THE KEYLOCK UNLOCKED?

- YES** CONTINUE to next page.
- NO** Unlock the keylock and go to "Step 3. Loading Diagnostics" on page 2-11 and try the procedures again.

Step 31. Keylock

1. Get a Problem Summary Form from Appendix B of this manual.
2. Write the Service Request Number **16-630-100** on item 4 of the form.
3. Have the system unit serviced.

Appendix B. Problem Summary Form

Please complete the following information before calling IBM for service.
Save the complete form for your service representative.

1. Describe the problem:

2. Write all messages related to the problem here:

3. Write the two-digit display number here:

4. Write the Service Request Number here:

16-630-100 - - - -

16-630-100 - - - -

Appendix B. Problem Summary Form B-1

AIZAF009

STOP. You have found the problem.

Step 40. Diskette

The diagnostic diskette may not be correctly inserted in the drive.

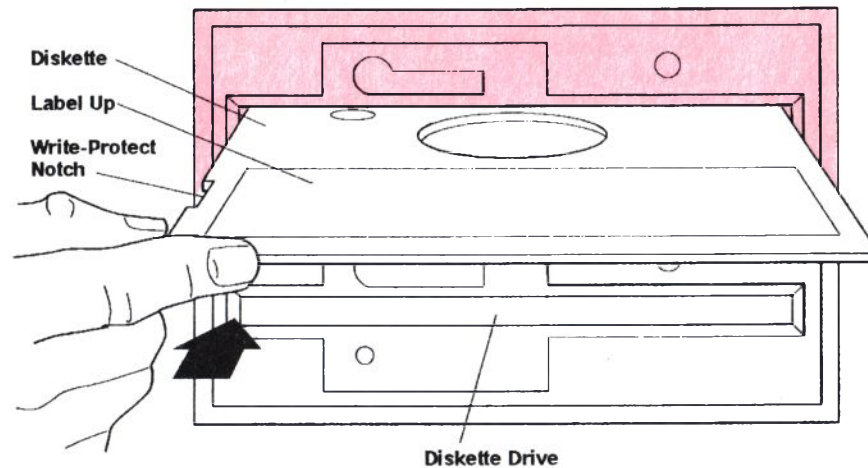

AS06A013

IS THE DISKETTE INSERTED PROPERLY?

- YES** CONTINUE to next page.
- NO** Go to "Step 3. Loading Diagnostics" on page 2-11 and try the procedures again.

Step 41. Diskette

1. Get a Problem Summary Form from Appendix B of this manual.
2. Write the Service Request Number **16-F80-64A** on item 4 of the form.
3. Have the system unit serviced.

Appendix B. Problem Summary Form

Please complete the following information before calling IBM for service.
Save the complete form for your service representative.

1. Describe the problem:

2. Write all messages related to the problem here:

3. Write the two-digit display number here:

4. Write the Service Request Number here:

16-F80-64A - - - -

16-F80-64A - - - -

Appendix B. Problem Summary Form B-1

AIZAF010

STOP. You have found the problem.

Step 50. Power

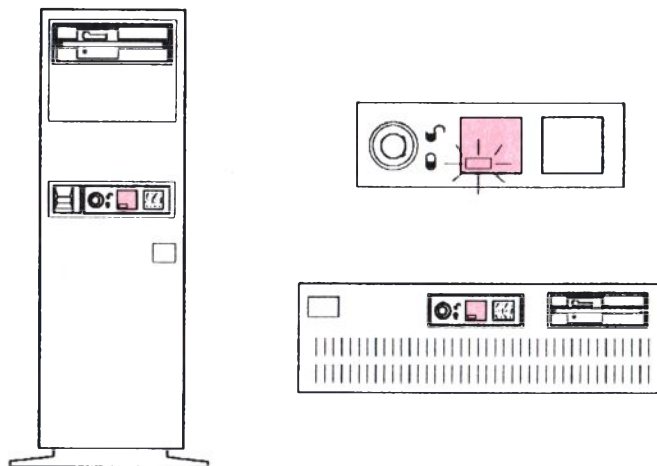

A1ZAF011

IS THE POWER-ON INDICATOR LIGHTED?

- YES** Go to "Step 70. Diskette" on page 2-44.
- NO** CONTINUE to next page.

Step 51. Power

Check that the system is plugged into the wall outlet and power is available at that outlet. You can use a lamp to test the outlet.

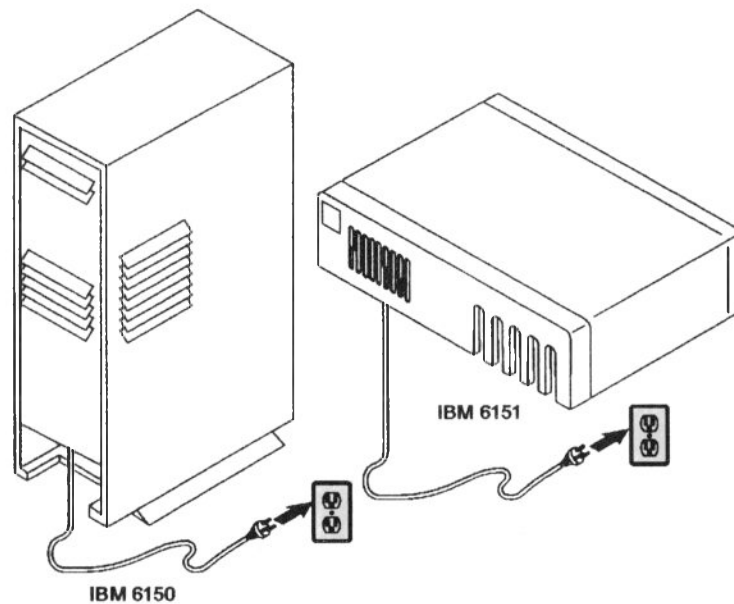

A1ZAF012

IS THE POWER-ON INDICATOR LIGHTED?

- YES** STOP. You have found the problem.
- NO** CONTINUE to next page.

Step 52. Power

1. Get a Problem Summary Form from Appendix B of this manual.
2. Write the Service Request Number **16-880** on item 4 of the form.
3. Have the system unit serviced.

Appendix B. Problem Summary Form

Please complete the following information before calling IBM for service.
Save the complete form for your service representative.

1. Describe the problem:

2. Write all messages related to the problem here:

3. Write the two-digit display number here:

4. Write the Service Request Number here:

16-880- - - -

16-880- - - -

Appendix B. Problem Summary Form B-1

AIZAF013

STOP. You have found the problem.

Step 60. Keyboard

1. Get a Problem Summary Form from Appendix B of this manual.
2. Write the Service Request Number **36-780** on item 4 of the form.
3. Have the keyboard serviced.

Appendix B. Problem Summary Form

Please complete the following information before calling IBM for service.
Save the complete form for your service representative.

1. Describe the problem:

2. Write all messages related to the problem here:

3. Write the two-digit display number here:

4. Write the Service Request Number here:

36-780 - - - - -

36-780 - - - - -

Appendix B. Problem Summary Form B-1

AIZAF014

STOP. You have found the problem.

Step 70. Diskette

Look at the upper left corner of the display.



IS "DCP" DISPLAYED?

- YES** CONTINUE to next page.
- NO** Go to "Step 72. Diskette" on page 2-46.

Step 71. Diskette

1. Get a Problem Summary Form from Appendix B of this manual.
2. Write the Service Request Number **16-64A-F80** on item 4 of this form.
3. Have the system unit serviced.

Appendix B. Problem Summary Form

Please complete the following information before calling IBM for service.
Save the complete form for your service representative.

1. Describe the problem:

2. Write all messages related to the problem here:

3. Write the two-digit display number here:

4. Write the Service Request Number here:

16-64A-F80 - - - - -

16-64A-F80 - - - - -

Appendix B. Problem Summary Form B-1

AIZAF015

STOP. You have found the problem.

Step 72. Diskette

It is possible that the diagnostic programs could not load from the diskette drive. If the program was unable to load from the diskette, the system may have loaded from the fixed disk.

**IS THE SCREEN ON YOUR DISPLAY YOUR USUAL
OPERATING SYSTEM SIGN-ON SCREEN?**

YES CONTINUE to next page.

NO Go to "Step 100. Display Types" on page 2-52.

Step 73. Diskette

Check that the diagnostic diskette is inserted correctly in the diskette drive.

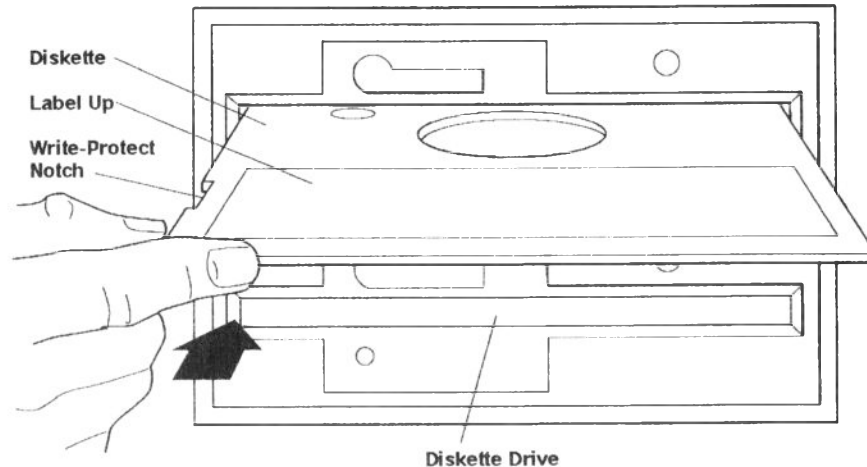

AS06A013

IS THE DISKETTE INSERTED CORRECTLY?

YES CONTINUE to next page.

NO Go to "Step 3. Loading Diagnostics" on page 2-11, and try the procedures again.

Step 74. Diskette

1. Get a Problem Summary Form from Appendix B of this manual.
2. Write the Service Request Number 16-64A-F80 on item 4 of the form.
3. Have the system unit serviced.

Appendix B. Problem Summary Form

Please complete the following information before calling IBM for service.
Save the complete form for your service representative.

1. Describe the problem:

2. Write all messages related to the problem here:

3. Write the two-digit display number here:

4. Write the Service Request Number here:

16-64A-F80- - - - -

16-64A-F80- - - - -

Appendix B. Problem Summary Form B-1

AIZAF016

STOP. You have found the problem.

Step 80. Blinking Two-Digit Display

1. Look at the two-digit display.
2. Compare the blinking number in the two-digit display with the numbers in the table below.

| Two-Digit Display Number | Go to Step |
|--------------------------|---|
| 02 | Go to "Step 81. Blinking Two-Digit Display" on page 2-50. |
| 30 | Go to "Step 81. Blinking Two-Digit Display" on page 2-50. |
| 99 | Go to "Step 82. Blinking Two-Digit Display" on page 2-51. |

IS THE BLINKING NUMBER LISTED IN THE TABLE?

- YES** Go to the step indicated in the table.
- NO** Report Service Request Number (SRN) 16-986.
 Have the system unit serviced.

Step 81. Blinking Two-Digit Display

The diagnostic diskette may be damaged. Try a new diagnostic diskette. If you continue to have problems:

1. Get a Problem Summary Form from Appendix B of this manual.
2. Write the Service Request Number **16-64A-F80** on item 4.
3. Have the system unit serviced.

Appendix B. Problem Summary Form

Please complete the following information before calling IBM for service.
Save the complete form for your service representative.

1. Describe the problem:

2. Write all messages related to the problem here:

3. Write the two-digit display number here:

4. Write the Service Request Number here:

16-64A-F80 - - - - -

16-64A-F80 - - - - -

Appendix B. Problem Summary Form B-1

AIZAF015

STOP. You have found the problem.

Step 82. Blinking Two-Digit Display

1. Get a Problem Summary Form from Appendix B of this manual.
2. Write the Service Request Number **16-986** on item 4 of the form.
3. Have the system unit serviced.

Appendix B. Problem Summary Form

Please complete the following information before calling IBM for service.
Save the complete form for your service representative.

1. Describe the problem:

2. Write all messages related to the problem here:

3. Write the two-digit display number here:

4. Write the Service Request Number here:

16-986 - - - - -

16-986 - - - - -

Appendix B. Problem Summary Form B-1

AIZAF017

STOP. You have found the problem.

Step 100. Display Types

1. Look at your display.
2. Compare the display type with the displays in the table below.

Note: See Appendix A, "Locations and Examples," for examples of the displays.

| Display Type | Go to Step |
|---|---|
| IBM 5151 Personal Computer Display | Go to "Step 110. IBM 5151 Personal Computer Display" on page 2-54. |
| IBM 5154 Personal Computer Enhanced Color Display | Go to "Step 120. IBM 5154 Personal Computer Enhanced Color Display" on page 2-60. |
| IBM 6153 Advanced Monochrome Graphics Display | Go to "Step 130. IBM 6153 Advanced Monochrome Graphics Display" on page 2-68. |
| IBM 6154 Advanced Color Graphics Display | Go to "Step 140. IBM 6154 Advanced Color Graphics Display" on page 2-76. |
| IBM 6155 Extended Monochrome Graphics Display | Go to "Step 150. IBM 6155 Extended Monochrome Graphics Display" on page 2-85. |
| IBM 5081 Graphics Display | Go to "Step 160. IBM 5081 Graphics Display" on page 2-94. |

IS YOUR DISPLAY TYPE LISTED IN THIS TABLE?

- YES** Go to step indicated in the table.
- NO** The display is not supported in this manual.

Step 101. Display Types

1. Look at your display.
2. Compare the display type with the displays in the table below.

Note: If you are not sure which display you are using, see Appendix A, "Locations and Examples" for examples of the displays.

| Display Type | Service Request Number |
|---|------------------------|
| IBM 5151 Personal Computer Display | 16-490-410 |
| IBM 5154 Personal Computer Enhanced Color Display | 16-410 |
| IBM 6153 Advanced Monochrome Graphics Display | 16-430 |
| IBM 6154 Advanced Color Graphics Display | 16-450 |
| IBM 6155 Extended Monochrome Graphics Display | 16-470 |
| IBM 5081 Graphics Display | 16-4A0-4B0 |

IS YOUR DISPLAY TYPE LISTED IN THIS TABLE?

YES Report the Service Request Number (SRN) for your display. Have the system unit serviced.

STOP, you have completed these procedures.

NO Follow the instructions that came with your display. If those instructions include loading the display program, go to "Step 4. Operating Instructions" on page 2-13 and continue.

Step 110. IBM 5151 Personal Computer Display

Turn the Brightness and Contrast controls on the display fully clockwise.

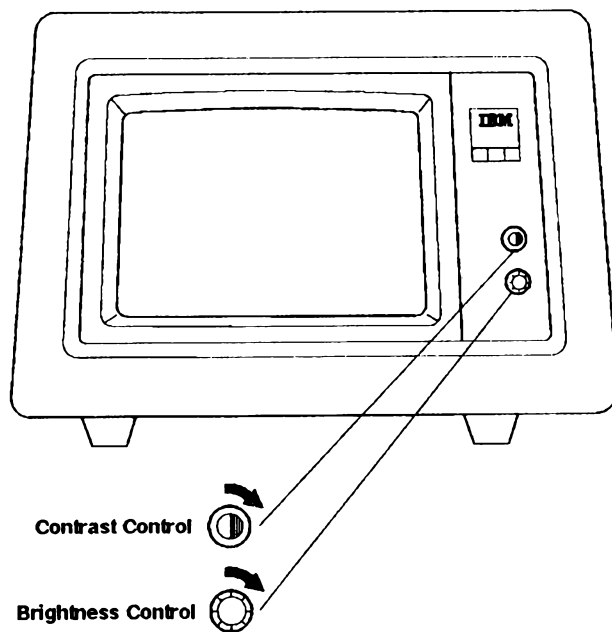

A1ZAF022

DOES THE SCREEN HAVE A LIGHTED BACKGROUND?

- YES** Go to "Step 112. IBM 5151 Personal Computer Display" on page 2-56.
- NO** CONTINUE to next page.

Step 111. IBM 5151 Personal Computer Display

Check that both the display power cable and signal cable are plugged into the system securely.

See *User Setup Guide*, for cover removal.

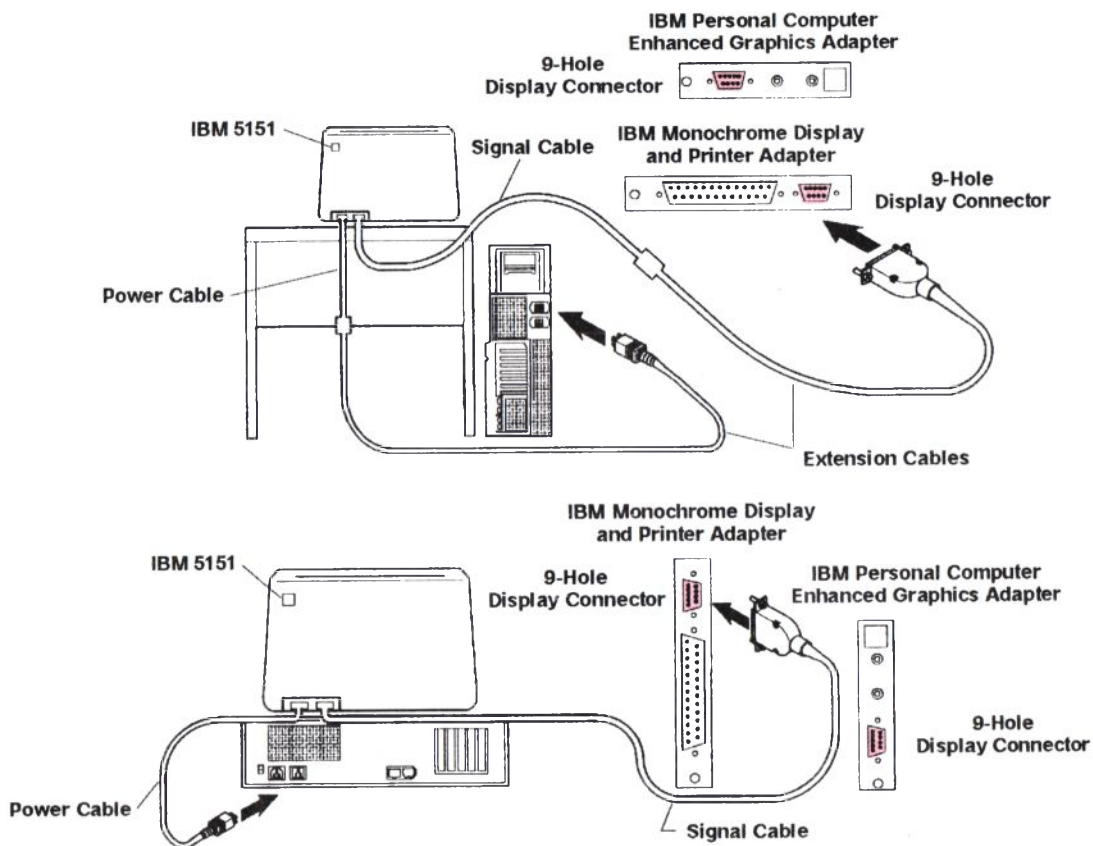

AIZAF018

ARE THE CABLES SECURELY PLUGGED IN?

- YES** Go to "Step 115. IBM 5151 Personal Computer Display" on page 2-59.
- NO** STOP. You have found the problem.

Step 112. IBM 5151 Personal Computer Display

Try to set the brightness and contrast to the desired level.

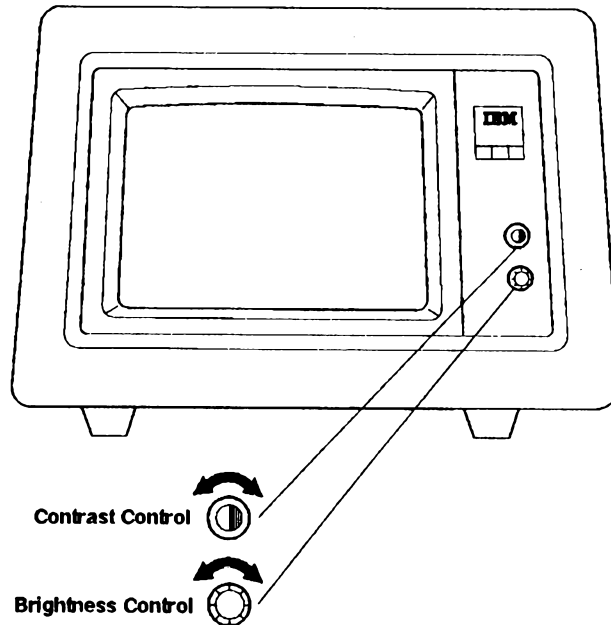

AS06A047

IS THERE A PROBLEM WITH THE BRIGHTNESS OR CONTRAST?

- YES** Go to "Step 115. IBM 5151 Personal Computer Display" on page 2-59.
- NO** CONTINUE to next page.

Step 113. IBM 5151 Personal Computer Display

Compare your display screen with those shown below.

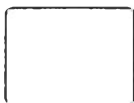

Too Dim



Too Wide



Too Narrow



Too Short



Too Small

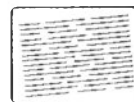

Tilted



**Changes Size When
Brightness Control
Turned**



Out of Focus



Rolling

AJZB214

DOES YOUR DISPLAY SCREEN RESEMBLE ANY OF THESE?

- YES** Go to "Step 115. IBM 5151 Personal Computer Display" on page 2-59.
- NO** CONTINUE to next page.

Step 114. IBM 5151 Personal Computer Display

1. Get a Problem Summary Form from Appendix B of this manual.
2. Write the Service Request Number **16-490-540** on item 4 of the form.
3. Have the system unit and display serviced.

Appendix B. Problem Summary Form

Please complete the following information before calling IBM for service.
Save the complete form for your service representative.

1. Describe the problem:

2. Write all messages related to the problem here:

3. Write the two-digit display number here:

4. Write the Service Request Number here:

16-490-540 - - - - -

16-490-540 - - - - -

Appendix B. Problem Summary Form B-1

AIZAF019

STOP. You have found the problem.

Step 115. IBM 5151 Personal Computer Display

1. Get a Problem Summary Form from Appendix B of this manual.
2. Write the Service Request Number **26-540-490** on item 4 of this form.
3. Have the display and system unit serviced.

Appendix B. Problem Summary Form

Please complete the following information before calling IBM for service.
Save the complete form for your service representative.

1. Describe the problem:

2. Write all messages related to the problem here:

3. Write the two-digit display number here:

4. Write the Service Request Number here:

26-540-490 - - - - -

26-540-490 - - - - -

Appendix B. Problem Summary Form B-1

AIZAF020

STOP. You have found the problem.

Step 120. IBM 5154 Personal Computer Enhanced Color Display

Check that the display Power control switch is in the on (clockwise) position.

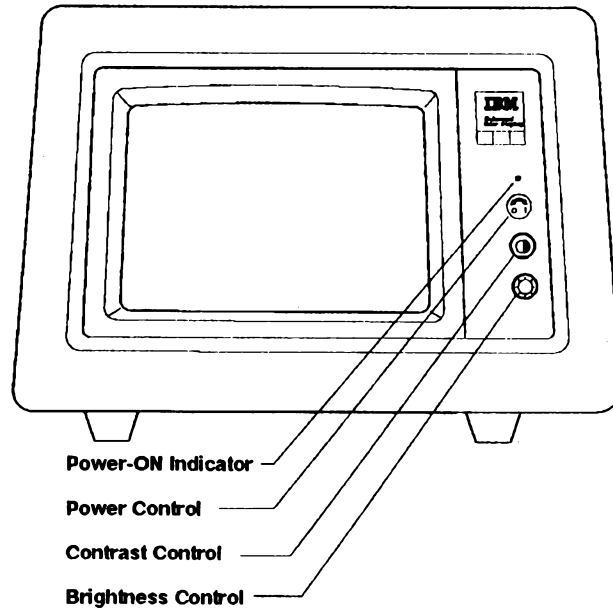

AS06A048

IS THE DISPLAY POWER-ON INDICATOR LIGHTED?

- YES** Go to "Step 122. IBM 5154 Personal Computer Enhanced Color Display" on page 2-62.
- NO** CONTINUE to next page.

Step 121. IBM 5154 Personal Computer Enhanced Color Display

Check that the display is securely plugged into the wall outlet and that power is available at the outlet. Use a lamp to check the outlet.

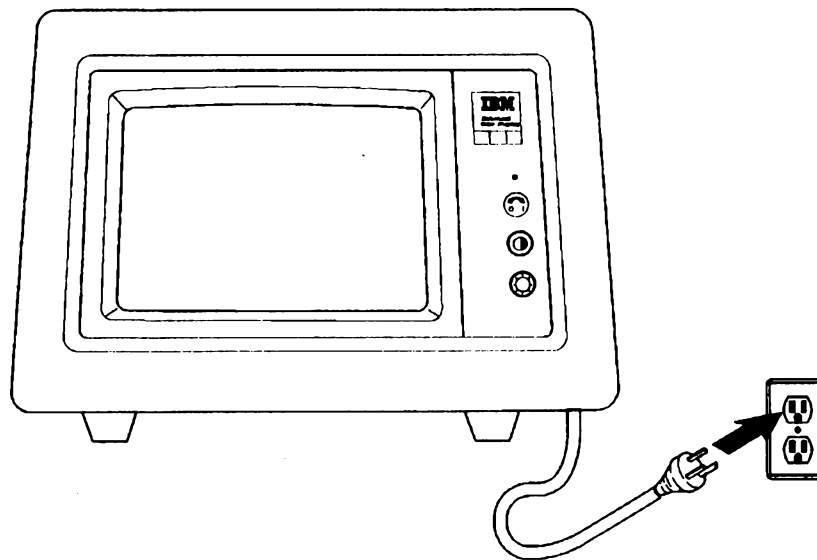

A1ZAF021

DID YOU FIND THE PROBLEM?

YES STOP, you have found the problem.

NO Go to "Step 124. IBM 5154 Personal Computer Enhanced Color Display" on page 2-64.

Step 122. IBM 5154 Personal Computer Enhanced Color Display

1. Turn off the system unit.
2. Turn the Brightness control fully clockwise.
3. Wait about 1 minute.

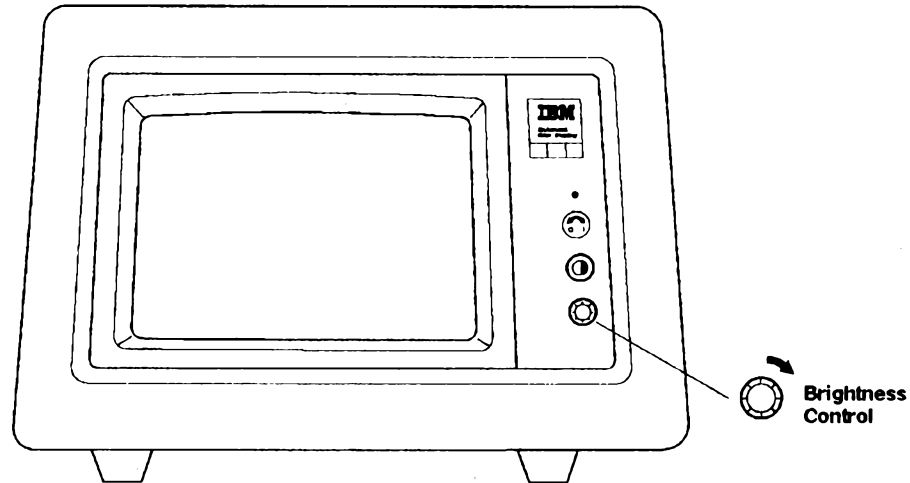

A1ZAF023

DOES THE SCREEN HAVE A LIGHTED BACKGROUND?

- YES** CONTINUE to next page.
- NO** Go to "Step 124. IBM 5154 Personal Computer Enhanced Color Display" on page 2-64.

Step 123. IBM 5154 Personal Computer Enhanced Color Display

Turn the Brightness control fully counterclockwise.

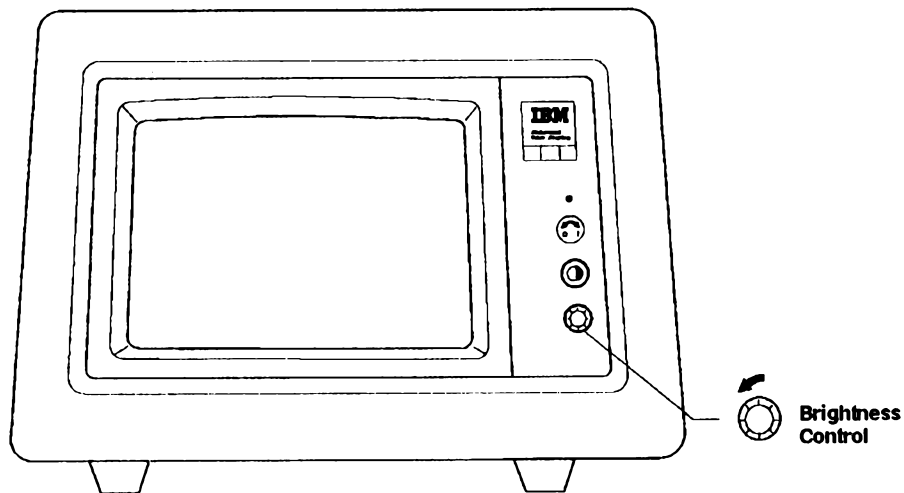

A1ZAF024

IS THE SCREEN DARK?

- YES** Go to "Step 125. IBM 5154 Personal Computer Enhanced Color Display" on page 2-65.
- NO** CONTINUE to next page.

Step 124. IBM 5154 Personal Computer Enhanced Color Display

1. Get a Problem Summary Form from Appendix B of this manual.
2. Write the Service Request Number **26-580** on item 4 of the form.
3. Have the display serviced.

Appendix B. Problem Summary Form

Please complete the following information before calling IBM for service.
Save the complete form for your service representative.

1. Describe the problem:

2. Write all messages related to the problem here:

3. Write the two-digit display number here:

4. Write the Service Request Number here:

26-580 - - - - -

26-580 - - - - -

Appendix B. Problem Summary Form B-1

AIZAF025

STOP. You have found the problem.

Step 125. IBM 5154 Personal Computer Enhanced Color Display

1. Turn on the system unit.
2. Wait about 4 minutes or until operating instructions display.
3. Set the Brightness and Contrast controls to the desired levels.



Too Dim



Too Wide



Too Narrow

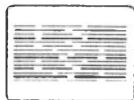

Too Short



Too Small



Tilted



Changes Size When
Brightness Control
Turned

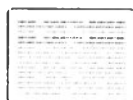

Out of Focus

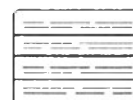

Rolling

AJZB214

DOES YOUR DISPLAY SCREEN RESEMBLE ANY OF THESE?

YES CONTINUE to next page.

NO Go to "Step 127. IBM 5154 Personal Computer Enhanced Color Display" on page 2-67.

Step 126. IBM 5154 Personal Computer Enhanced Color Display

1. Get a Problem Summary Form from Appendix B of this manual.
2. Write the Service Request Number **26-580-410** on item 4 of the form.
3. Have the display and system unit serviced.

Appendix B. Problem Summary Form

Please complete the following information before calling IBM for service.
Save the complete form for your service representative.

1. Describe the problem:

2. Write all messages related to the problem here:

3. Write the two-digit display number here:

4. Write the Service Request Number here:

26-580-410 - - - - -

26-580-410 - - - - -

Appendix B. Problem Summary Form B-1

AIZAF026

STOP. You have found the problem.

Step 127. IBM 5154 Personal Computer Enhanced Color Display

1. Get a Problem Summary Form from Appendix B of this manual.
2. Write the Service Request Number **16-410-580** on item 4 of the form.
3. Have the system unit and display serviced.

Appendix B. Problem Summary Form

Please complete the following information before calling IBM for service.
Save the complete form for your service representative.

1. Describe the problem:

2. Write all messages related to the problem here:

3. Write the two-digit display number here:

4. Write the Service Request Number here:

16-410-580 - - - - -

16-410-580 - - - - -

Appendix B. Problem Summary Form B-1

AIZAF027

STOP. You have found the problem.

Step 130. IBM 6153 Advanced Monochrome Graphics Display

Turn on the **Raster Test Control** by turning the Brightness and Raster Test control fully clockwise until it clicks.

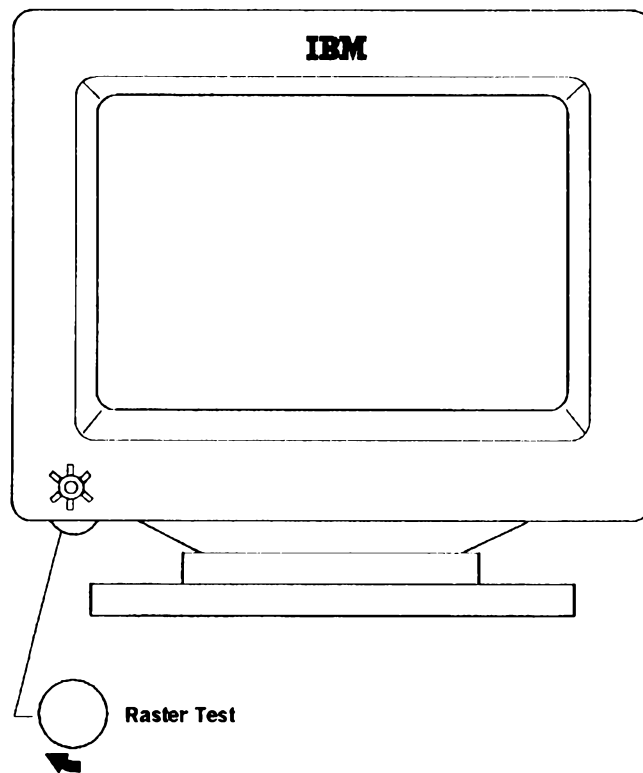

A1ZAF028

DOES THE SCREEN HAVE A LIGHTED BACKGROUND?

YES CONTINUE to next page.

NO Go to "Step 132. IBM 6153 Advanced Monochrome Graphics Display" on page 2-70.

Step 131. IBM 6153 Advanced Monochrome Graphics Display

Try to set the brightness to the desired level.

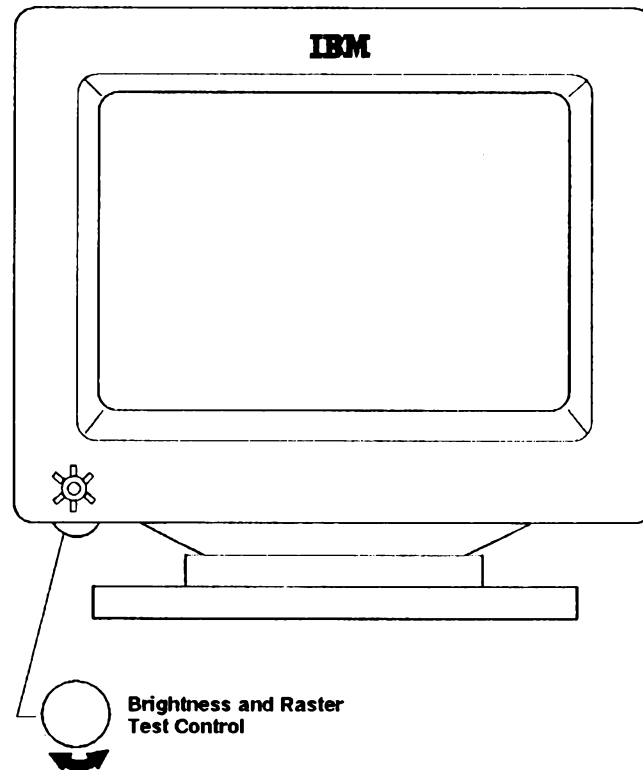

AS06A053

IS THERE A PROBLEM WITH THE BRIGHTNESS?

- YES** Go to "Step 137. IBM 6153 Advanced Monochrome Graphics Display" on page 2-75.
- NO** Go to "Step 134. IBM 6153 Advanced Monochrome Graphics Display" on page 2-72.

Step 132. IBM 6153 Advanced Monochrome Graphics Display

Check that the display power cable is securely plugged into the system unit.

See the *User Setup Guide* for cover removal.

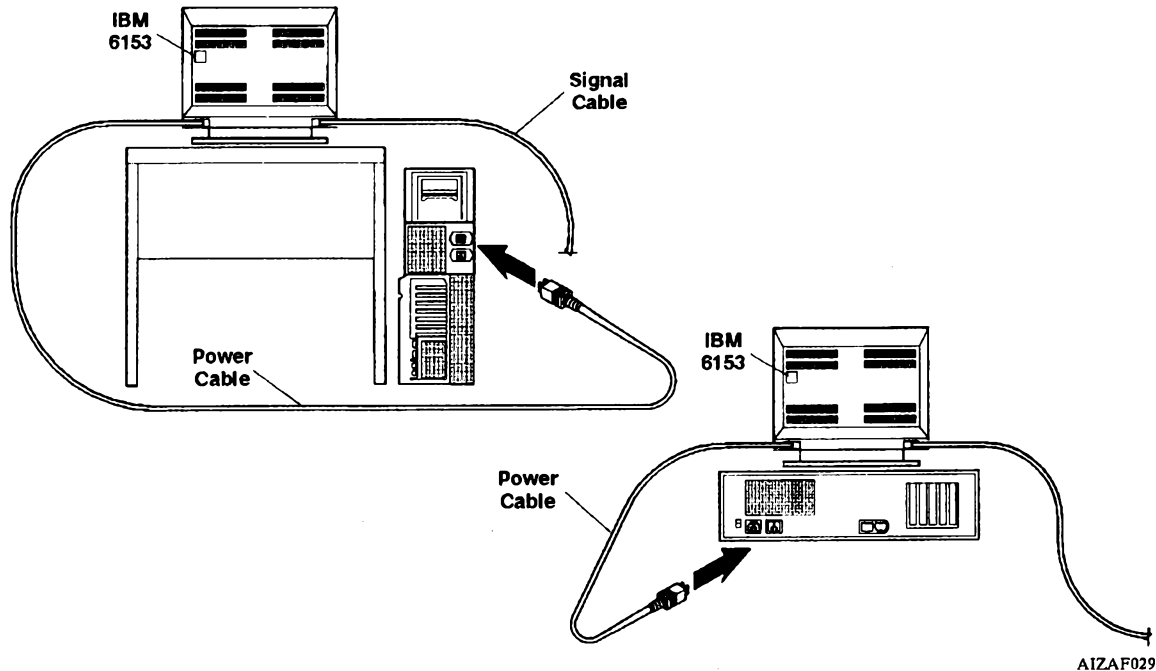

IS THE POWER CABLE SECURELY PLUGGED INTO THE SYSTEM UNIT?

YES CONTINUE to next page.

NO STOP. You have found the problem.

Step 133. IBM 6153 Advanced Monochrome Graphics Display

1. Get a Problem Summary Form from Appendix B of this manual.
2. Write the Service Request Number 26-600 on item 4 of the form.
3. Have the display serviced.

Appendix B. Problem Summary Form

Please complete the following information before calling IBM for service.
Save the complete form for your service representative.

1. Describe the problem:

2. Write all messages related to the problem here:

3. Write the two-digit display number here:

4. Write the Service Request Number here:

26-600- - - - -

26-600- - - - -

Appendix B. Problem Summary Form B-1

AIZAF030

STOP. You have found the problem.

Step 134. IBM 6153 Advanced Monochrome Graphics Display

Compare your display screen with those shown below.

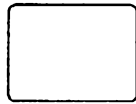

Too Dim

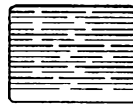

Too Wide



Too Narrow

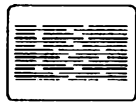

Too Short

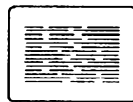

Too Small

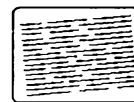

Tilted

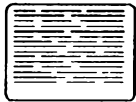

**Changes Size When
Brightness Control
Turned**



Out of Focus

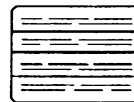

Rolling

AJZB214

DOES YOUR DISPLAY SCREEN RESEMBLE ANY OF THESE?

YES Go to "Step 137. IBM 6153 Advanced Monochrome Graphics Display" on page 2-75.

NO CONTINUE to next page.

Step 135. IBM 6153 Advanced Monochrome Graphics Display

Check that the display signal cable is securely plugged into the system unit.

See *User Setup Guide* for cover removal.

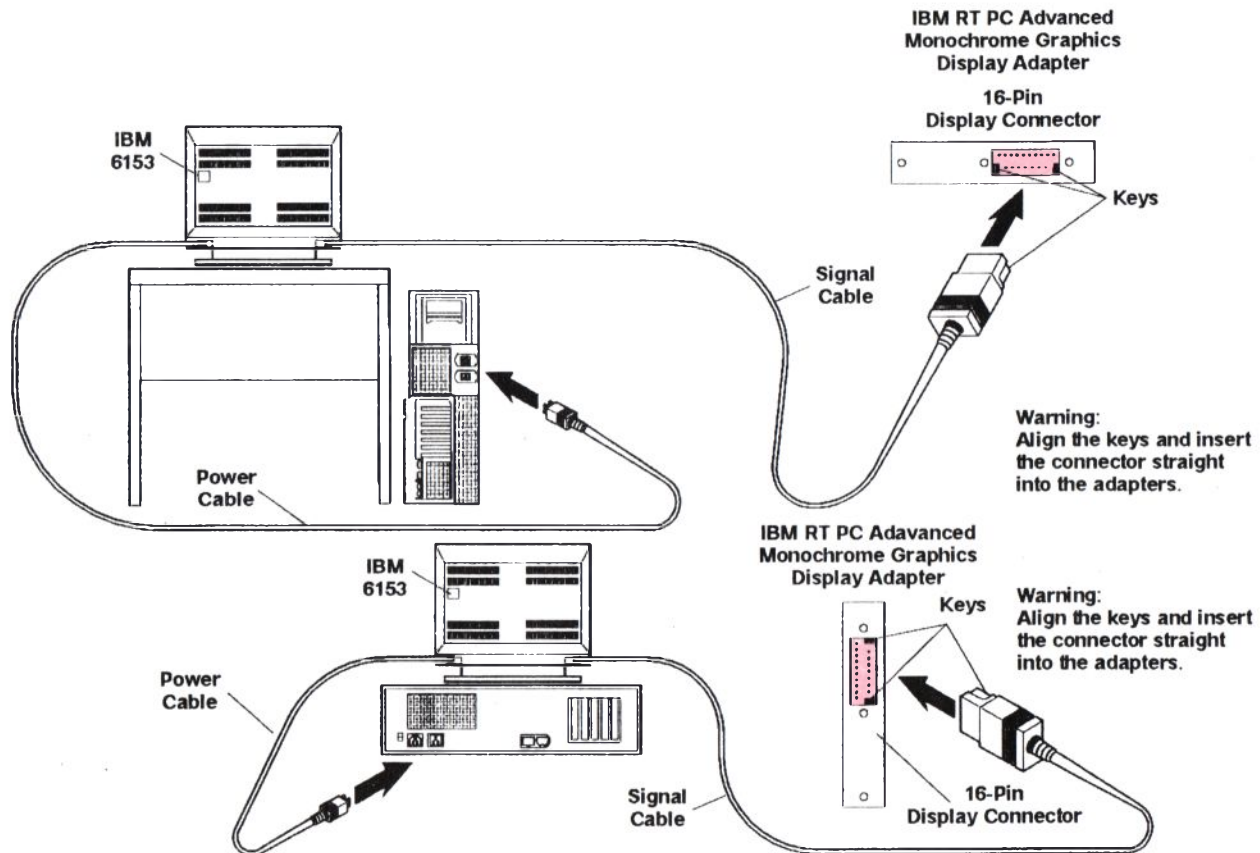

AIZAF031

IS THE SIGNAL CABLE SECURELY PLUGGED INTO THE SYSTEM UNIT?

YES CONTINUE to next page.

NO STOP. You have found the problem.

Step 136. IBM 6153 Advanced Monochrome Graphics Display

1. Get a Problem Summary Form from Appendix B of this manual.
2. Write the Service Request Number **16-430-600** on item 4 of the form.
3. Have the system unit and display serviced.

Appendix B. Problem Summary Form

Please complete the following information before calling IBM for service.
Save the complete form for your service representative.

1. Describe the problem:

2. Write all messages related to the problem here:

3. Write the two-digit display number here:

4. Write the Service Request Number here:

16-430-600 - - - - -

16-430-600 - - - - -

Appendix B. Problem Summary Form B-1

AIZAF032

STOP. You have found the problem.

Step 137. IBM 6153 Advanced Monochrome Graphics Display

1. Get a Problem Summary Form from Appendix B of this manual.
2. Write the Service Request Number **26-600-430** on item 4 of the form.
3. Have the display and system unit serviced.

Appendix B. Problem Summary Form

Please complete the following information before calling IBM for service.
Save the complete form for your service representative.

1. Describe the problem:

2. Write all messages related to the problem here:

3. Write the two-digit display number here:

4. Write the Service Request Number here:

26-600-430 - - - - -

26-600-430 - - - - -

Appendix B. Problem Summary Form B-1

AIZAF033

STOP. You have found the problem.

Step 140. IBM 6154 Advanced Color Graphics Display

Check that the display is turned on.

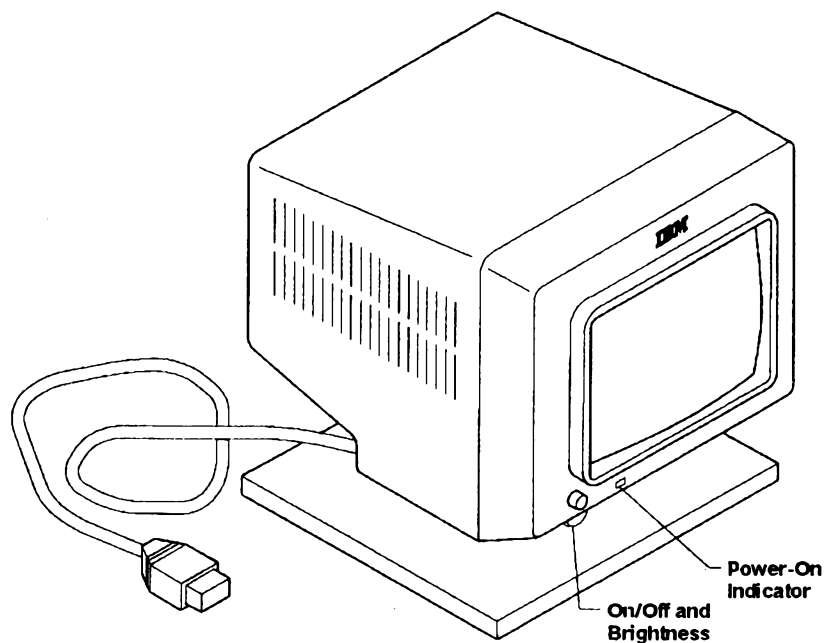

AS06A054

IS THE DISPLAY POWER-ON INDICATOR LIGHTED?

YES CONTINUE to next page.

NO Go to "Step 143. IBM 6154 Advanced Color Graphics Display" on page 2-79.

Step 141. IBM 6154 Advanced Color Graphics Display

1. Turn off the system unit.
2. Turn the On/Off and Brightness control fully clockwise.
3. Wait about 1 minute.

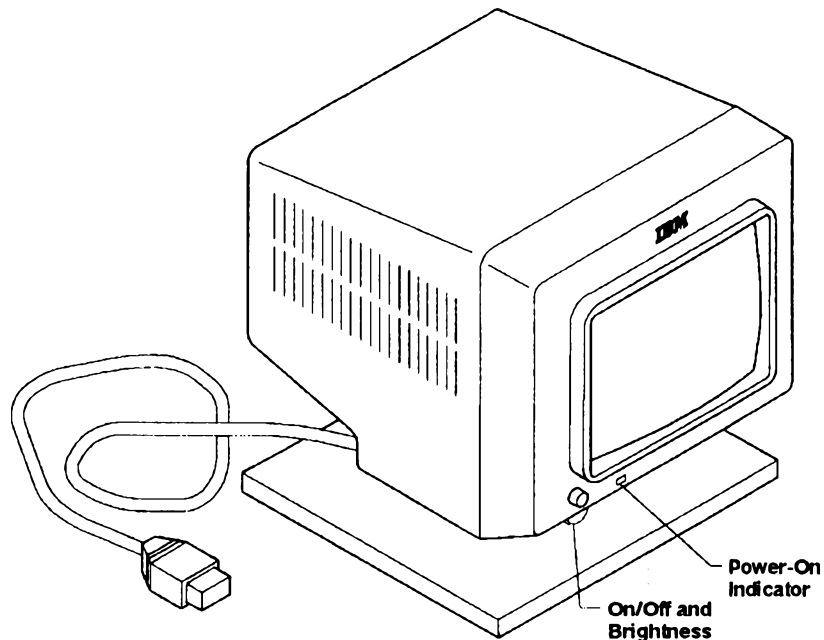

AS06A054

DOES THE SCREEN HAVE A LIGHTED BACKGROUND?

YES CONTINUE to next page.

NO Go to "Step 144. IBM 6154 Advanced Color Graphics Display" on page 2-80.

Step 142. IBM 6154 Advanced Color Graphics Display

1. Turn on the system unit.
2. Wait about 4 minutes.
3. Try to set the On/Off and Brightness control to the desired level.

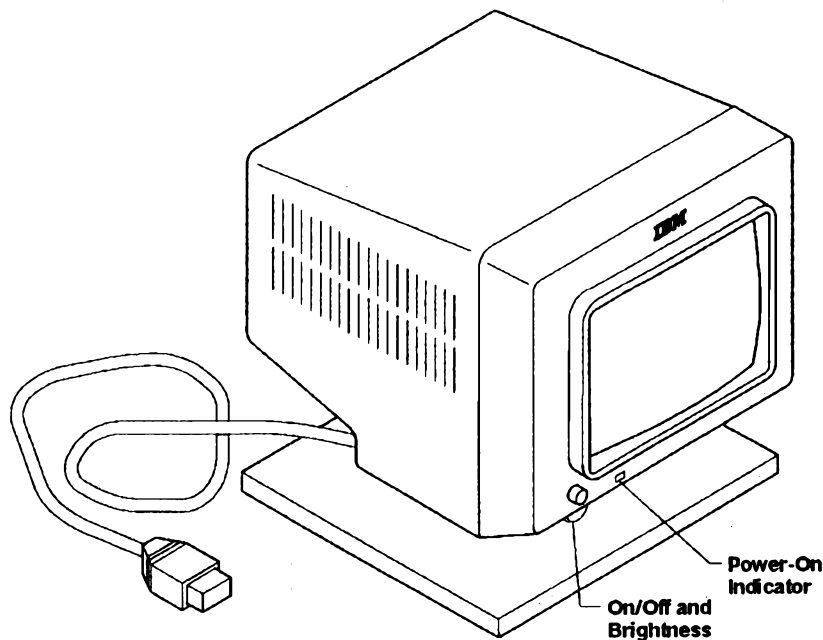

AS06A054

IS THERE A PROBLEM WITH THE BRIGHTNESS?

- YES** Go to "Step 148. IBM 6154 Advanced Color Graphics Display" on page 2-84.
- NO** Go to "Step 145. IBM 6154 Advanced Color Graphics Display" on page 2-81.

Step 143. IBM 6154 Advanced Color Graphics Display

Check that the display power cable is securely plugged into the system unit.

See *User Setup Guide* for cover removal.

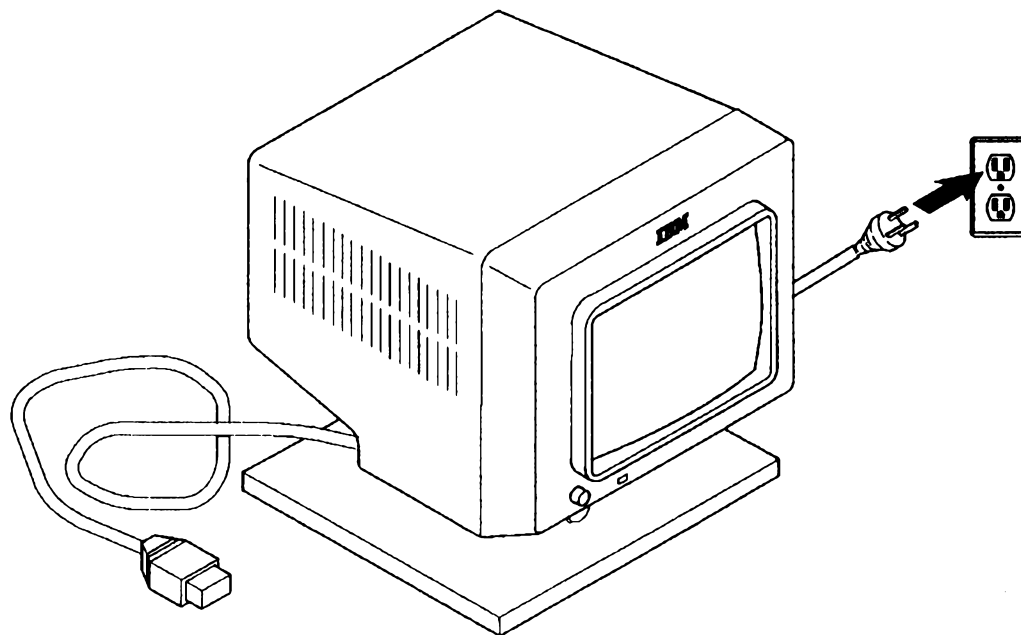

A1ZAF034

IS THE POWER CABLE SECURELY PLUGGED IN?

YES CONTINUE to next page.

NO STOP. You have found the problem.

Step 144. IBM 6154 Advanced Color Graphics Display

1. Get a Problem Summary Form from Appendix B of this manual.
2. Write the Service Request Number **26-590** on item 4 of the form.
3. Have the display serviced.

Appendix B. Problem Summary Form

Please complete the following information before calling IBM for service.
Save the complete form for your service representative.

1. Describe the problem:

2. Write all messages related to the problem here:

3. Write the two-digit display number here:

4. Write the Service Request Number here:

26-590 - - - - -

26-590 - - - - -

Appendix B. Problem Summary Form B-1

AIZAF035

STOP. You have found the problem.

Step 145. IBM 6154 Advanced Color Graphics Display

Compare your display screen with those shown below.



Too Dim



Too Wide



Too Narrow

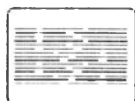

Too Short



Too Small



Tilted



**Changes Size When
Brightness Control
Turned**

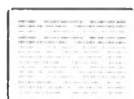

Out of Focus



Rolling

AJZB214

DOES YOUR DISPLAY SCREEN RESEMBLE ANY OF THESE?

YES Go to "Step 148. IBM 6154 Advanced Color Graphics Display" on page 2-84.

NO CONTINUE to next page.

Step 146. IBM 6154 Advanced Color Graphics Display

Check that the display signal cable is securely plugged into the system unit.

See *User Setup Guide* for cover removal.

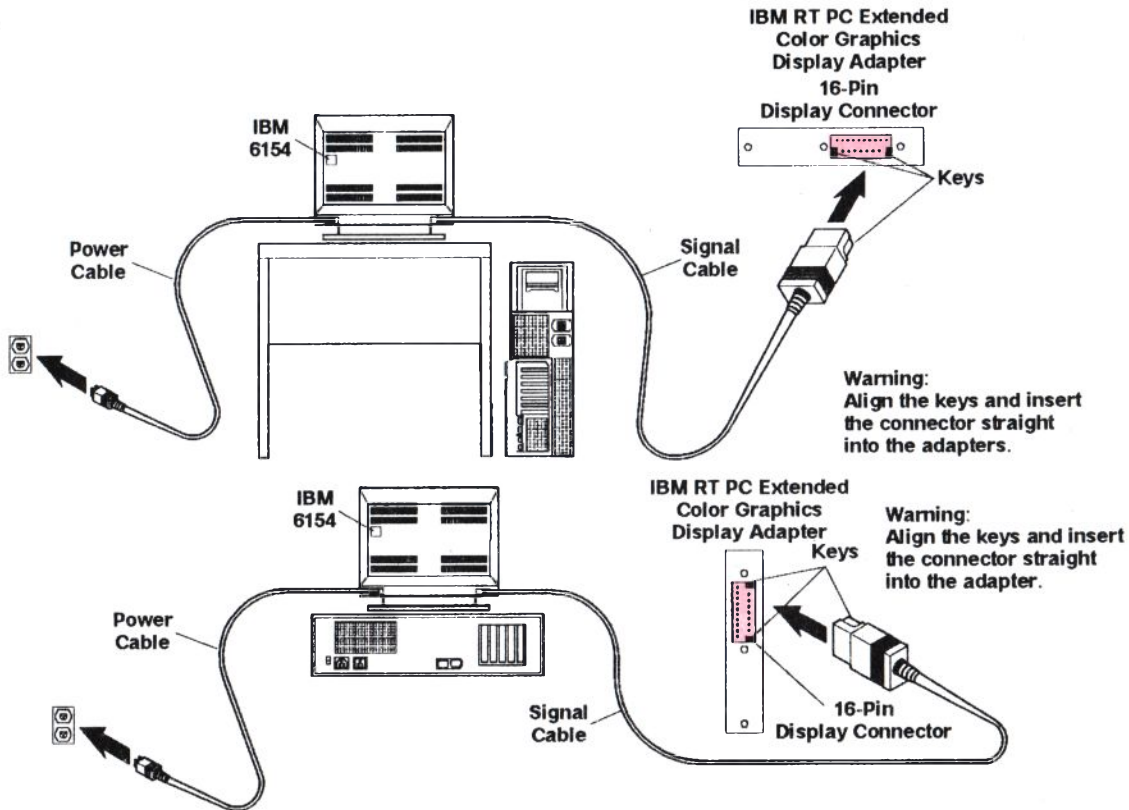

AIZAF036

IS THE SIGNAL CABLE SECURELY PLUGGED IN?

YES CONTINUE to next page.

NO STOP. You have found the problem.

Step 147. IBM 6154 Advanced Color Graphics Display

1. Get a Problem Summary Form from Appendix B of this manual.
2. Write the Service Request Number **16-450-590** on item 4 of the form.
3. Have the system unit serviced.

Appendix B. Problem Summary Form

Please complete the following information before calling IBM for service.
Save the complete form for your service representative.

1. Describe the problem:

2. Write all messages related to the problem here:

3. Write the two-digit display number here:

4. Write the Service Request Number here:

16-450-590 - - - - -

16-450-590 - - - - -

Appendix B. Problem Summary Form B-1

AIZAF037

STOP. You have found the problem.

Step 148. IBM 6154 Advanced Color Graphics Display

1. Get a Problem Summary Form from Appendix B of this manual.
2. Write the Service Request Number **26-590-450** on item 4 of the form.
3. Have the display and system unit serviced.

Appendix B. Problem Summary Form

Please complete the following information before calling IBM for service.
Save the complete form for your service representative.

1. Describe the problem:

2. Write all messages related to the problem here:

26-590-450-____-____

3. Write the two-digit display number here:

4. Write the Service Request Number here:

26-590-450-____-____

Appendix B. Problem Summary Form B-1

AIZAF038

STOP. You have found the problem.

Step 150. IBM 6155 Extended Monochrome Graphics Display

Check that the display power switch is on.

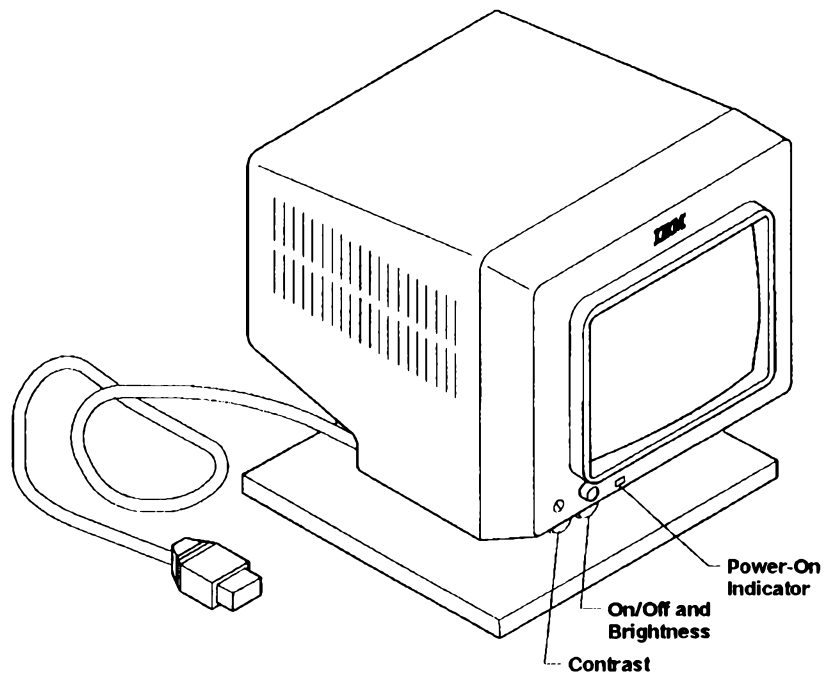

AS06A055

IS THE DISPLAY POWER-ON INDICATOR LIGHTED?

YES CONTINUE to next page.

NO Go to "Step 153. IBM 6155 Extended Monochrome Graphics Display" on page 2-88.

Step 151. IBM 6155 Extended Monochrome Graphics Display

1. Turn off the system unit.
2. Turn the Brightness and Contrast controls fully clockwise.
3. Wait about 1 minute.

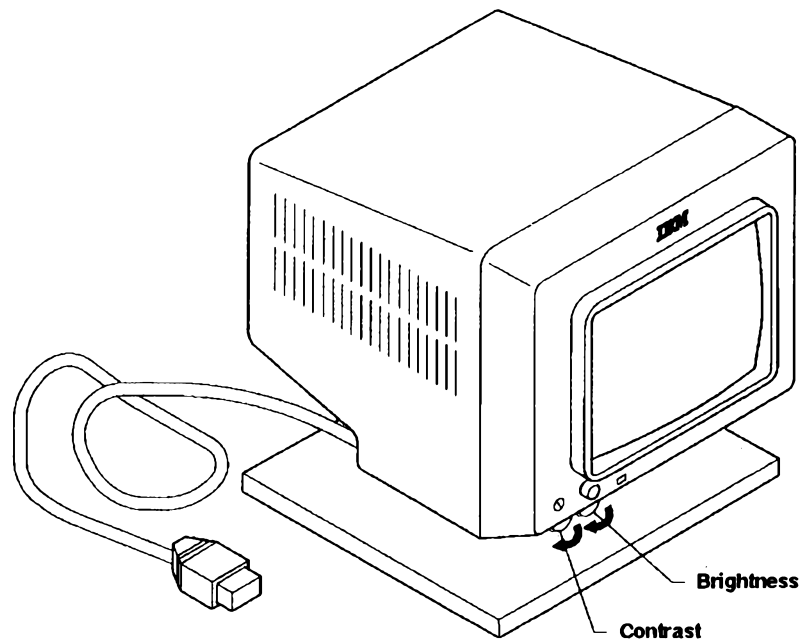

A1ZAF039

DOES THE SCREEN HAVE A LIGHTED BACKGROUND?

- YES** CONTINUE to next page.
- NO** Go to "Step 154. IBM 6155 Extended Monochrome Graphics Display" on page 2-89.

Step 152. IBM 6155 Extended Monochrome Graphics Display

1. Turn on the system unit.
2. Wait about 4 minutes.
3. Try to set the brightness and contrast to the desired level.

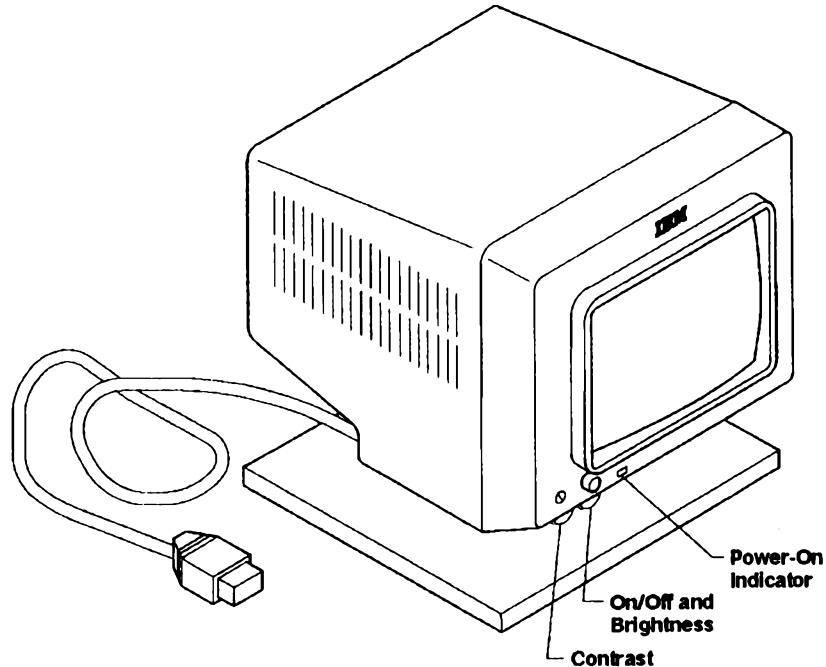

AS06A055

IS THERE A PROBLEM WITH THE BRIGHTNESS OR CONTRAST?

YES Go to "Step 158. IBM 6155 Extended Monochrome Graphics Display" on page 2-93.

NO Go to "Step 155. IBM 6155 Extended Monochrome Graphics Display" on page 2-90.

Step 153. IBM 6155 Extended Monochrome Graphics Display

Check that the display is plugged into the wall outlet and that power is available at the outlet. Use a lamp to check the outlet.

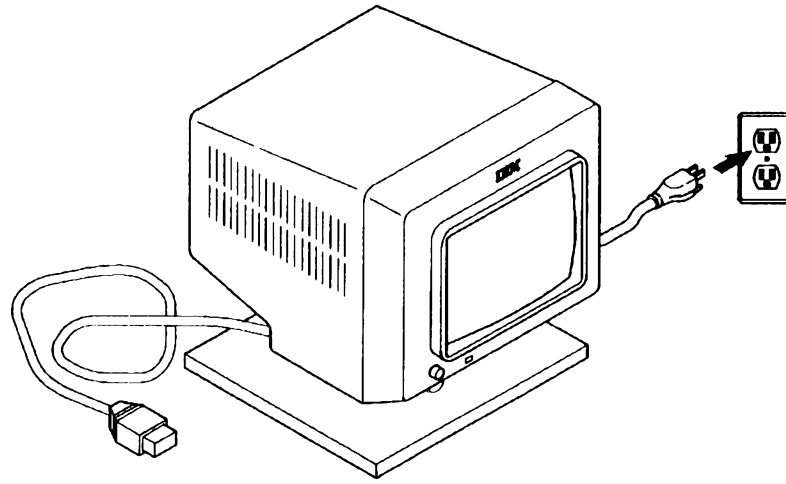

AIZAF040

IS THE POWER CABLE SECURELY PLUGGED IN?

YES CONTINUE to next page.

NO STOP. You have found the problem.

Step 154. IBM 6155 Extended Monochrome Graphics Display

1. Get a Problem Summary Form from Appendix B of this manual.
2. Write the Service Request Number 26-620 on item 4 of the form.
3. Have the display serviced.

Appendix B. Problem Summary Form

Please complete the following information before calling IBM for service.
Save the complete form for your service representative.

1. Describe the problem:

2. Write all messages related to the problem here:

3. Write the two-digit display number here:

4. Write the Service Request Number here:

26-620- - - - -

26-620- - - - -

Appendix B. Problem Summary Form B-1

AIZAF041

STOP. You have found the problem.

Step 155. IBM 6155 Extended Monochrome Graphics Display

Compare your display screen with those shown below.

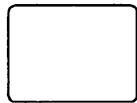

Too Dim



Too Wide



Too Narrow

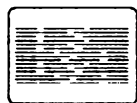

Too Short

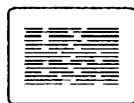

Too Small



Tilted



**Changes Size When
Brightness Control
Turned**

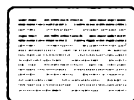

Out of Focus

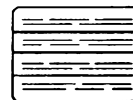

Rolling

AJZB214

DOES YOUR DISPLAY SCREEN RESEMBLE ANY OF THESE?

YES Go to "Step 158. IBM 6155 Extended Monochrome Graphics Display" on page 2-93.

NO CONTINUE to next page.

Step 156. IBM 6155 Extended Monochrome Graphics Display

Check that the display signal cable is securely plugged into the system unit.

See *IBM RT PC User Setup Guide* for cover removal.

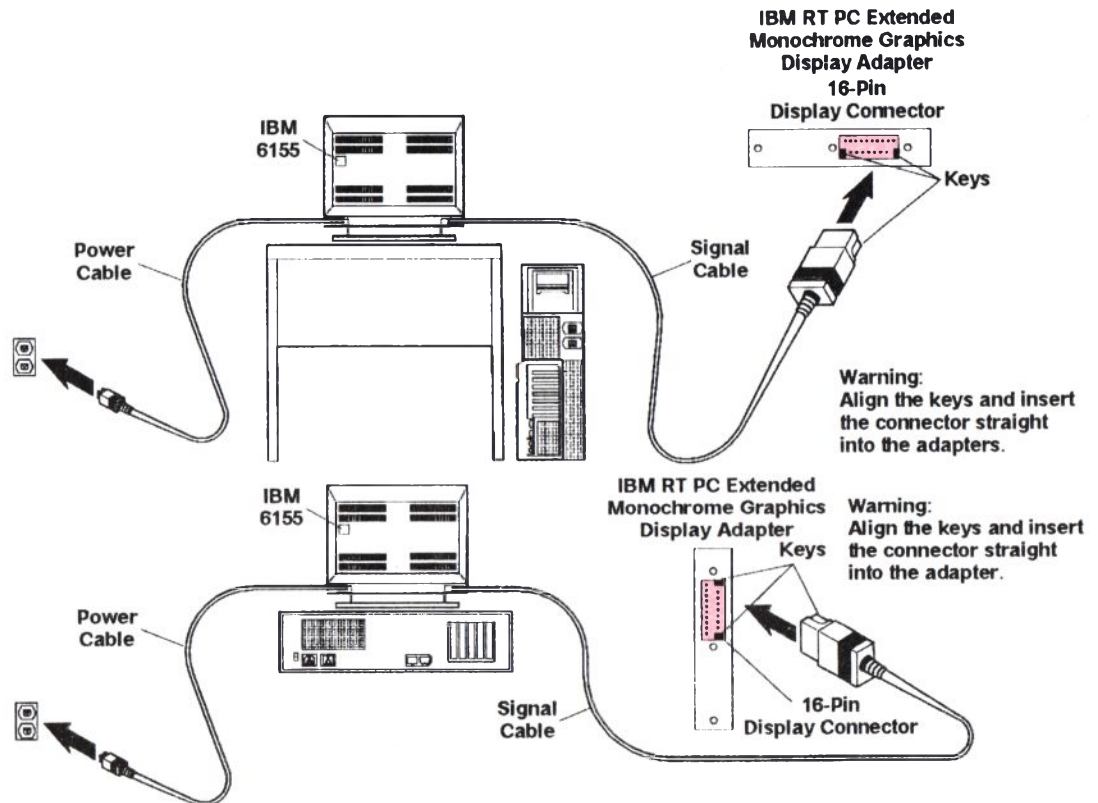

A1ZAF042

IS THE SIGNAL CABLE SECURELY PLUGGED IN?

YES CONTINUE to next page.

NO STOP. You have found the problem.

Step 157. IBM 6155 Extended Monochrome Graphics Display

1. Get a Problem Summary Form from Appendix B of this manual.
2. Write the Service Request Number **16-470-620** on item 4 of the form.
3. Have the system unit serviced.

Appendix B. Problem Summary Form

Please complete the following information before calling IBM for service.
Save the complete form for your service representative.

1. Describe the problem:

2. Write all messages related to the problem here:

3. Write the two-digit display number here:

4. Write the Service Request Number here:

16-470-620 - - - - -

16-470-620 - - - - -

Appendix B. Problem Summary Form B-1

AIZAF043

STOP. You have found the problem.

Step 158. IBM 6155 Extended Monochrome Graphics Display

1. Get a Problem Summary Form from Appendix B of this manual.
2. Write the Service Request Number **26-620-470** on item 4 of this form.
3. Have the display and system unit serviced.

Appendix B. Problem Summary Form

Please complete the following information before calling IBM for service.
Save the complete form for your service representative.

1. Describe the problem:

2. Write all messages related to the problem here:

3. Write the two-digit display number here:

4. Write the Service Request Number here:

26-620-470 - - - - -

26-620-470 - - - - -

Appendix B. Problem Summary Form B-1

AIZAF044

STOP. You have found the problem.

Step 160. IBM 5081 Graphics Display

Check that the display Power switch is on.

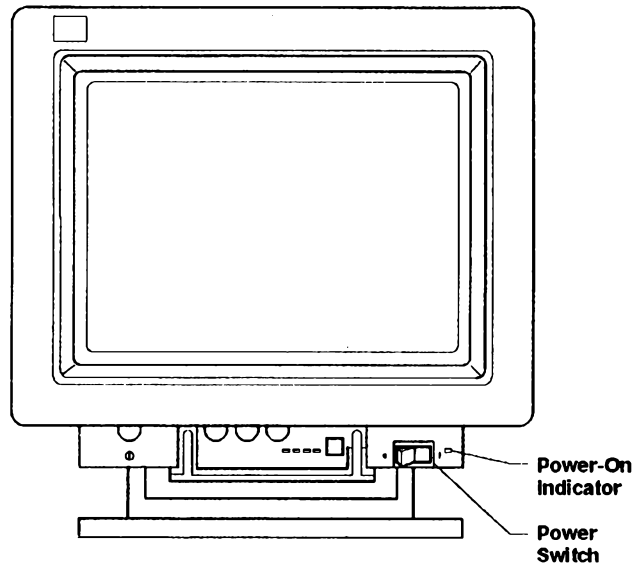

AS06A058

IS THE DISPLAY POWER-ON INDICATOR LIGHTED?

- YES** Go to "Step 162. IBM 5081 Graphics Display" on page 2-96.
- NO** CONTINUE to next page.

Step 161. IBM 5081 Graphics Display

Check that the display is plugged into the wall outlet and that power is available at the outlet. Use a lamp to check the outlet.

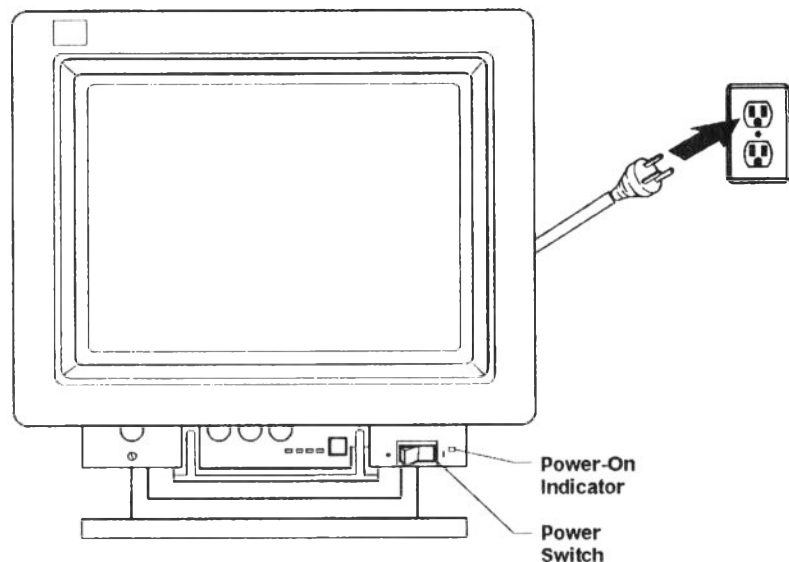

AIZAF045

IS THE POWER CABLE SECURELY PLUGGED IN?

- YES** Go to "Step 169. IBM 5081 Graphics Display" on page 2-103.
- NO** STOP. You have found the problem.

Step 162. IBM 5081 Graphics Display

1. Pull down the customer access door on the 5081 display.
2. Look at the four red failure indicators.

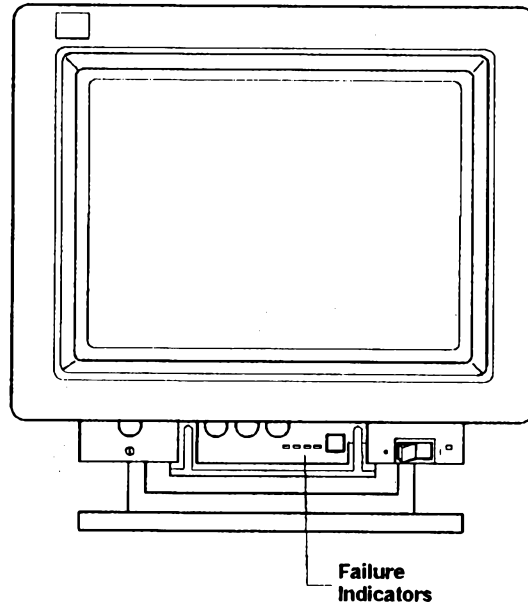

AIZAF049

ARE ANY OF THE FOUR FAILURE INDICATORS LIGHTED?

- YES** Go to "Step 169. IBM 5081 Graphics Display" on page 2-103.
- NO** CONTINUE to next page.

Step 163. IBM 5081 Graphics Display

1. Turn the Brightness control fully clockwise.
2. Press and hold the Brightness Override push button.

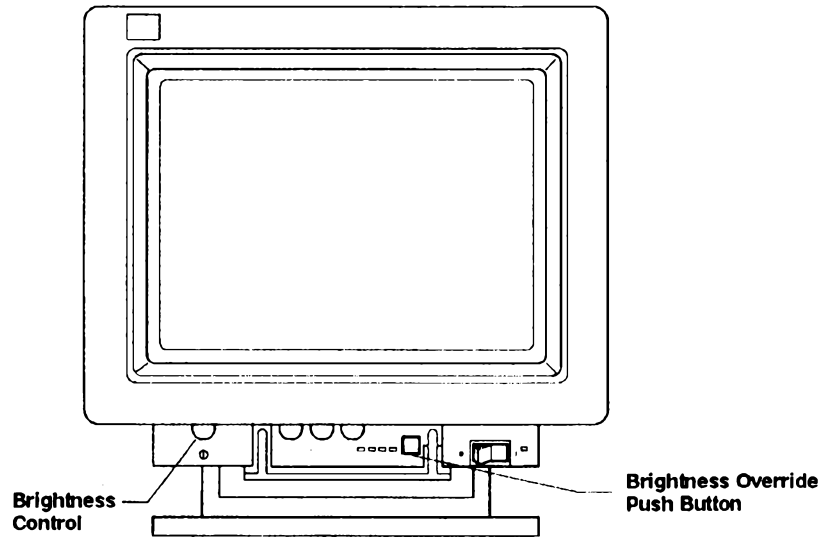

A1ZAF048

DOES THE SCREEN HAVE A LIGHTED BACKGROUND?

Release the push button.

YES CONTINUE to next page.

NO Go to "Step 169. IBM 5081 Graphics Display" on page 2-103.

Step 164. IBM 5081 Graphics Display

Look at the 5081 display.

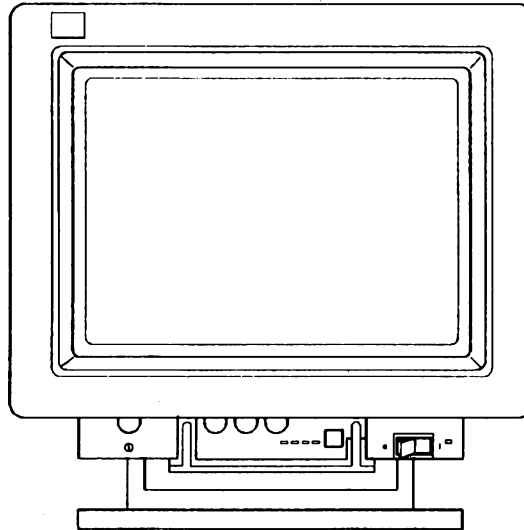

AIZAF046

**DOES THE SCREEN HAVE TEXT, RASTER, OR LIGHTED
BACKGROUND?**

YES CONTINUE to next page.

NO Go to "Step 168. IBM 5081 Graphics Display" on
page 2-102.

Step 165. IBM 5081 Graphics Display

Try to set the Brightness control to the desired level.

Note: Your model may have the Brightness control in a different location than the one shown.

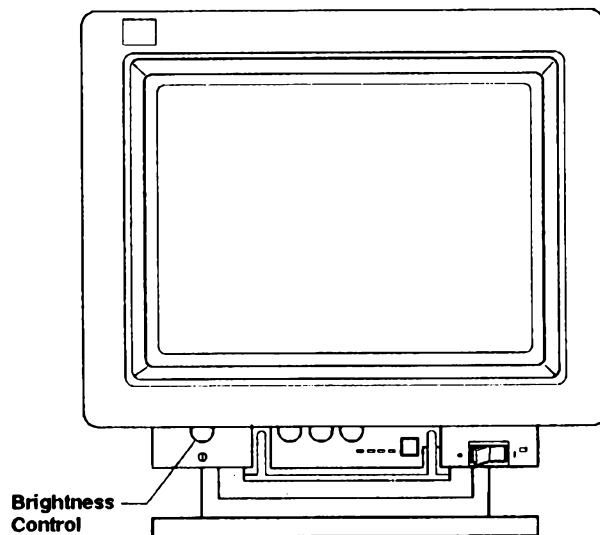

A1ZAF047

WERE YOU ABLE TO ADJUST THE BRIGHTNESS TO THE DESIRED LEVEL?

YES CONTINUE to next page.

NO Go to "Step 169. IBM 5081 Graphics Display" on page 2-103.

Step 166. IBM 5081 Graphics Display

Compare your display screen with those shown below.



Too Dim



Too Wide



Too Narrow

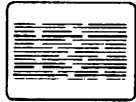

Too Short

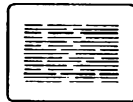

Too Small

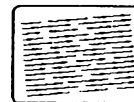

Tilted



**Changes Size When
Brightness Control
Turned**

AJZB253

DOES YOUR DISPLAY SCREEN RESEMBLE ANY OF THESE?

YES CONTINUE to next page.

NO Go to "Step 168. IBM 5081 Graphics Display" on page 2-102.

Step 167. IBM 5081 Graphics Display

1. Get a Problem Summary Form from Appendix B of this manual.
2. Write the Service Request Number **16-610-4B0** on item 4 of this form.
3. Have the display and system unit serviced.

Appendix B. Problem Summary Form

Please complete the following information before calling IBM for service.
Save the complete form for your service representative.

1. Describe the problem:

2. Write all messages related to the problem here:

3. Write the two-digit display number here:

4. Write the Service Request Number here:

16-610-4B0 - - - - -

16-610-4B0 - - - - -

Appendix B. Problem Summary Form B-1

AIZAF050

STOP. You have found the problem.

Step 168. IBM 5081 Graphics Display

1. Get a Problem Summary Form from Appendix B of this manual.
2. Write the Service Request Number **16-4B0-4A0-610** on item 4 of this form.
3. Have the system unit and display serviced.

Appendix B. Problem Summary Form

Please complete the following information before calling IBM for service.
Save the complete form for your service representative.

1. Describe the problem:

2. Write all messages related to the problem here:

3. Write the two-digit display number here:

4. Write the Service Request Number here:

16-4B0-4A0-610-----

16-4B0-4A0-610-----

Appendix B. Problem Summary Form B-1

AIZAF051

STOP. You have found the problem.

Step 169. IBM 5081 Graphics Display

1. Get a Problem Summary Form from Appendix B of this manual.
2. Write the Service Request Number **16-610** on item 4 of this form.
3. Have the 5081 display serviced.

Appendix B. Problem Summary Form

Please complete the following information before calling IBM for service.
Save the complete form for your service representative.

1. Describe the problem:

2. Write all messages related to the problem here:

3. Write the two-digit display number here:

4. Write the Service Request Number here:

16-610- - - - -

16-610- - - - -

Appendix B. Problem Summary Form B-1

AIZAF052

STOP. You have found the problem.

Step 200. System Attached to 5085

IBM 5085 front panel is shown below.

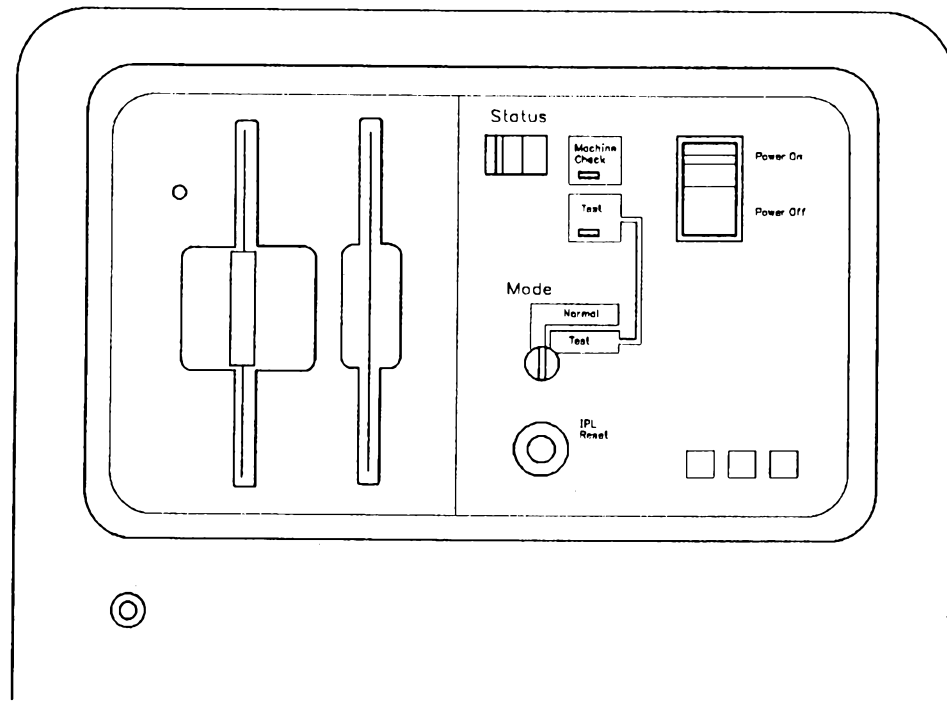

A1ZAF060

IS YOUR SYSTEM ATTACHED TO A 5085?

- YES** Go to "Step 202. Power On at 5085" on page 2-106.
- NO** CONTINUE to next page.

Step 201. System Not Attached to 5085

1. Get a Problem Summary Form from Appendix B of this manual.
2. Write the Service Request Number **32-780** on item 4 of the form.
3. Have the keyboard serviced.

Appendix B. Problem Summary Form

Please complete the following information before calling IBM for service.
Save the complete form for your service representative.

1. Describe the problem:

2. Write all messages related to the problem here:

3. Write the two-digit display number here:

4. Write the Service Request Number here:

32-780 - - - - -

32-780 - - - - -

Appendix B. Problem Summary Form B-1

AIZA F053

STOP. You have found the problem.

Step 202. Power On at 5085

Check that the 5085 Power On/Off switch is on.

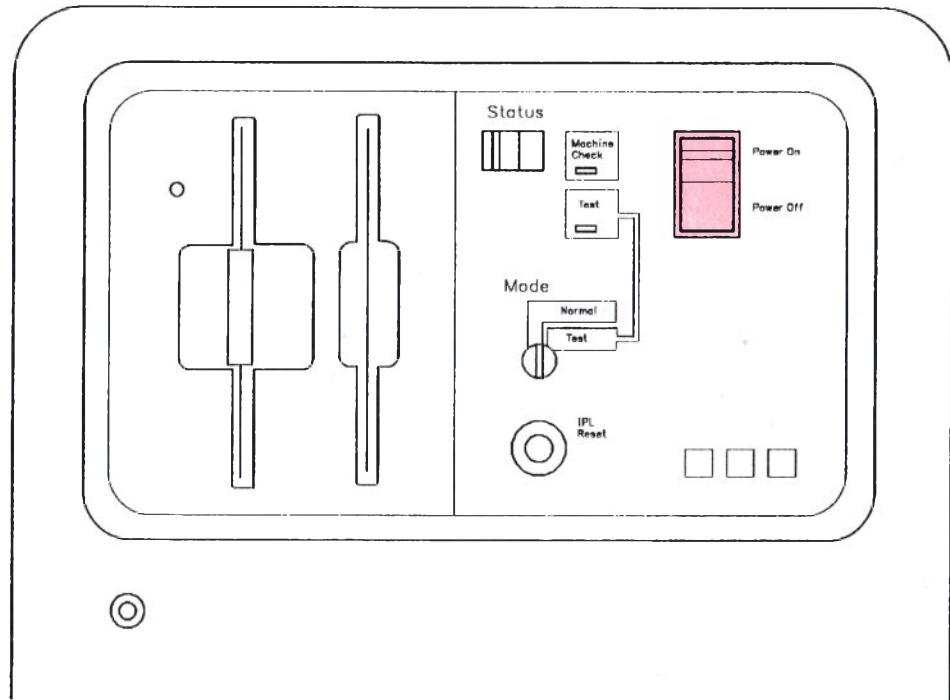

A1ZAF060

IS THE 5085 POWER ON?

- YES** CONTINUE to next page.
- NO** Turn on the 5085 and go to "Step 3. Loading Diagnostics" on page 2-11 to start problem determination procedures again.

Step 203. Keyboard Connection

Check the keyboard connection to the Peripheral Connector Assembly (PCA).

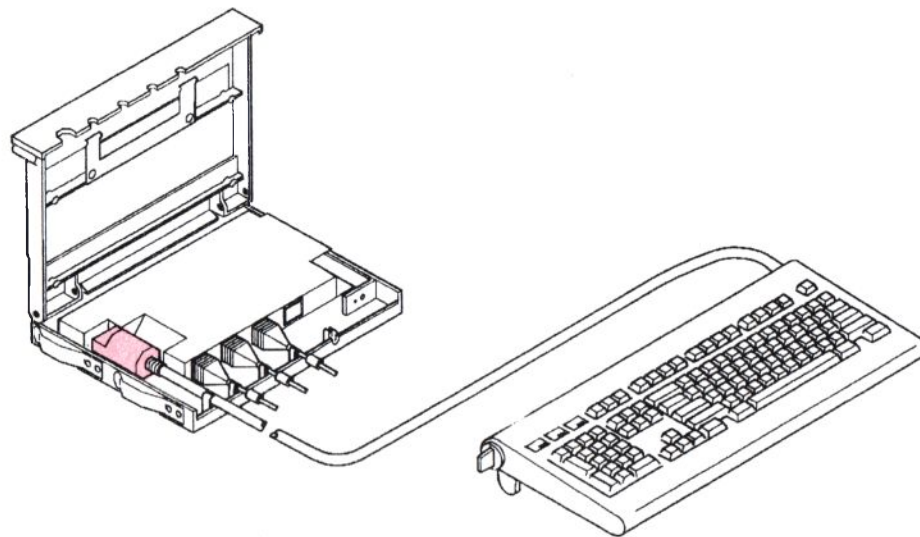

AJZB222

IS THE KEYBOARD CORRECTLY ATTACHED TO THE PCA?

- YES** CONTINUE to the next page.
- NO** Connect the keyboard to the PCA. STOP, you have completed these procedures.

Step 204. Y Cable Connection

Be sure the Y cable is properly connected between the Peripheral Connector Assembly (PCA) and the system unit M (mouse) and KBD (keyboard) connectors.

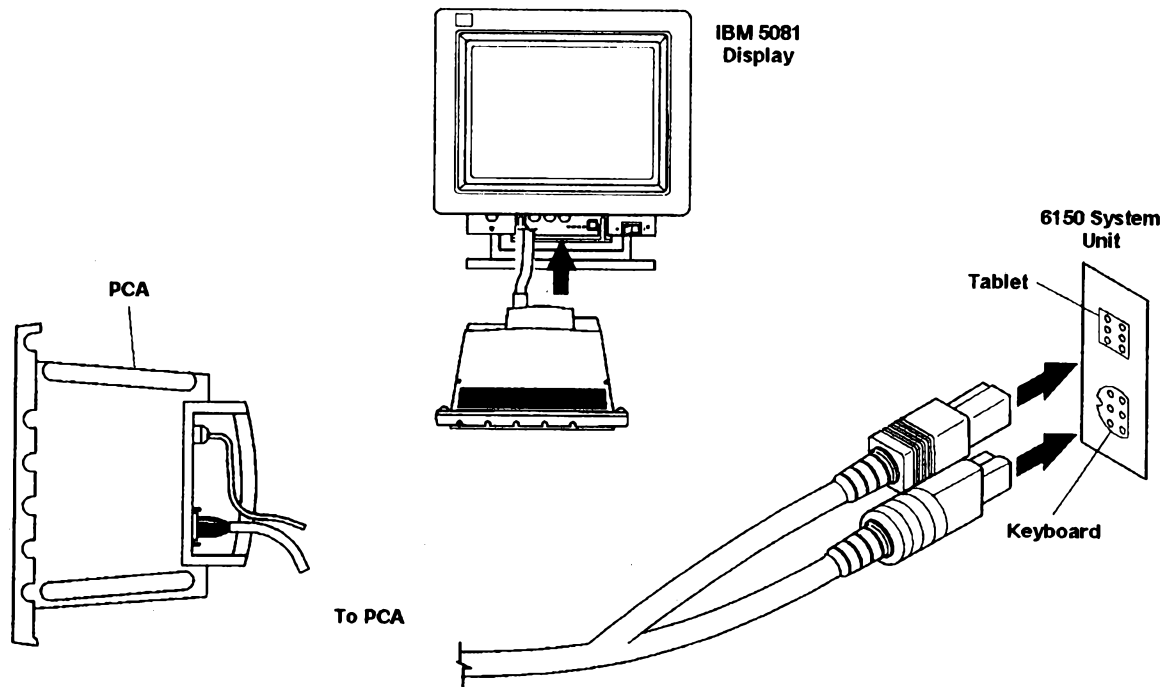

IS THE CABLE CORRECTLY ATTACHED?

- YES** Go to the Problem Determination Guide for the 5085.
- NO** Connect the Y cable to the PCA and the 6150 System Unit. STOP, you have completed these procedures.

AIZA F054

Section 3. Utilities

CONTENTS

| | |
|--|------|
| About This Section | 3-3 |
| Loading the Utilities | 3-4 |
| Loading the Diagnostic Diskettes | 3-5 |
| Function Selection | 3-7 |
| Utility Selection | 3-8 |
| Show Installed Options Utility | 3-9 |
| Show and Change Diagnostic Test List Utility | 3-10 |
| Fixed-Disk Utilities | 3-11 |
| Communication Utilities | 3-12 |
| Diagnostic Diskette Copy Utility | 3-13 |
| IBM 9332 Utilities | 3-14 |

About This Section

This section consists of a group of tests and routines you use to format the fixed disks, exercise the communication interface, and update or look at the system configuration. When you select a utility, the instructions for its use appear on the display screen.

This section is divided into seven parts:

- Loading the Utilities
- Show Installed Options Utility
- Show and Change Diagnostic Test List Utility
- Fixed-Disk Utilities
- Communication Utilities
- Diagnostic Diskette Copy Utility
- IBM 9332 Utilities.

Loading the Utilities

Loading the utilities is similar to loading the diagnostic routines. Once you have decided which utility to use, follow the steps in this section to load the utility.

This section presents a brief description of each utility.

Loading the Diagnostic Diskettes

1. Get the Diagnostics 1 (DIAG-1) diskette from the back of this manual.
2. Remove the write-protect tab, if one is present, from the diskette.
3. Turn off the system unit.
4. Wait about 1 minute.
5. Turn on the system unit and immediately insert the diskette into the diskette drive in location A and close the drive.

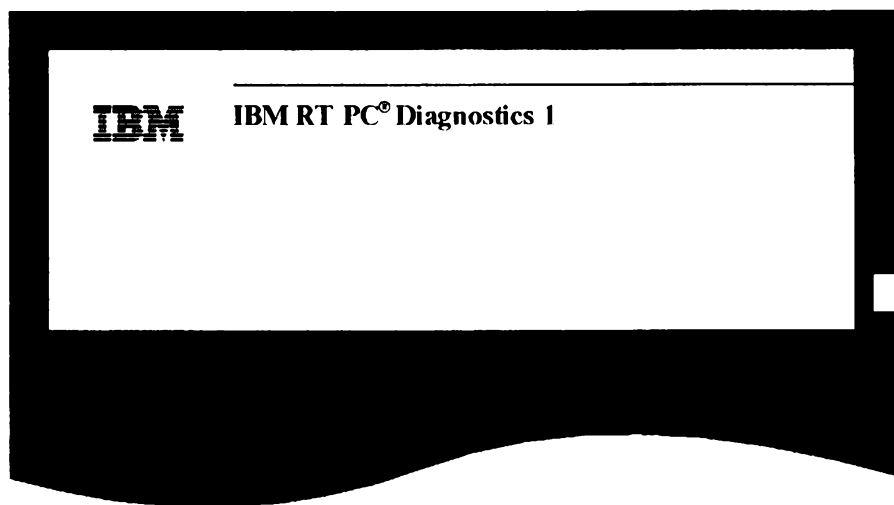

AIZAF001

CONTINUE.

-
6. Wait until the **DIAGNOSTIC OPERATING INSTRUCTIONS** screen is displayed.

Note: A 94 in the two-digit display indicates that the display is not supported by the diagnostics. Refer to the documentation that came with your display and follow those procedures.

7. Read the screen.
8. Press **Enter**.

DIAGNOSTIC OPERATING INSTRUCTIONS

This diskette contains diagnostics and utilities for your system. You should use these procedures whenever you are having problems with your system which have not been corrected by any software application procedures available.

In general, the procedures will run automatically. However, sometimes you will be required to select options, tell the system when to continue, and do simple tasks and exchange diskettes.

Several keys are used to control the procedures:

- The Enter key continues the procedure or performs an action.

CONTINUE.

Function Selection

After reading the DIAGNOSTIC OPERATING INSTRUCTIONS screen and pressing **Enter**, the FUNCTION SELECTION menu is displayed.

1. Type **2**.
2. Press **Enter**.

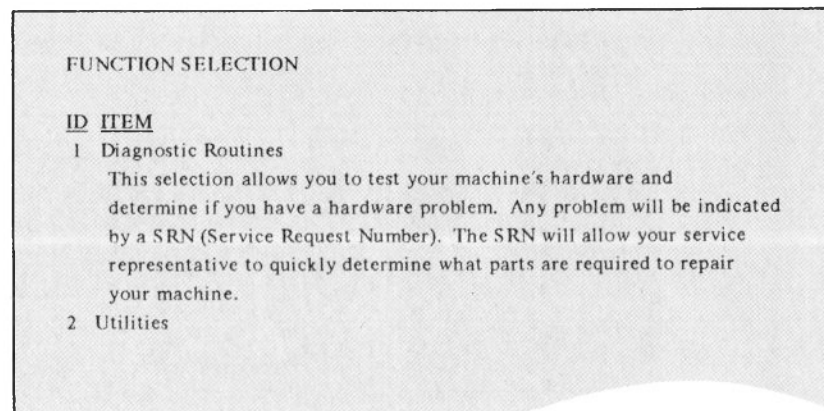

CONTINUE.

Utility Selection

The menu displayed is the UTILITY SELECTION menu. A brief description of each utility is shown on the menu. For a more detailed description, see the utility descriptions in this section.

1. From the UTILITY SELECTION menu, find the utility you want to run. Then type its ID number.
2. Press **Enter**.
3. Read and follow the instructions as they appear on the display screen.

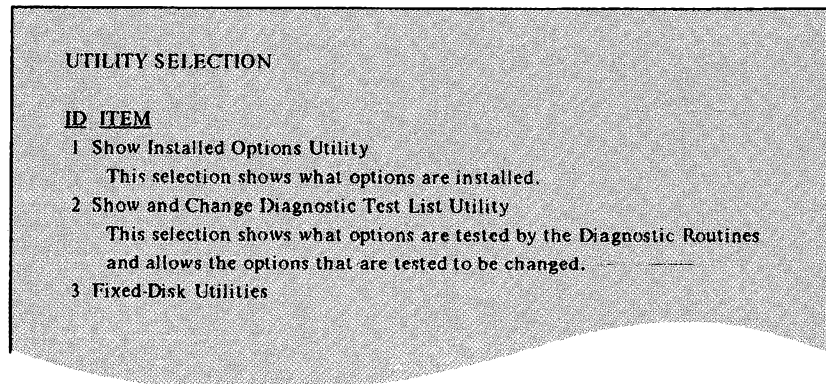

Descriptions of the various RT PC utilities can be found in the following pages.

Show Installed Options Utility

The Show Installed Options Utility displays the Configuration List built by the presence tests.

The utility is used to check the configuration of the system.

INSTALLED OPTIONS LIST

The following options are installed on your machine.

Show and Change Diagnostic Test List Utility

The Show and Change Diagnostic Test List Utility displays the Diagnostic Test List. This utility allows you to add or delete an adapter or device from the list.

Note: The option must be installed in the machine before it can be added to the test list.

DIAGNOSTIC TEST LIST

The following options will be tested by the Diagnostic Routines.

Fixed-Disk Utilities

Use the Format Fixed-Disk Utility when intermittent read or write errors occur.

This test erases all data on the fixed disk and reformats the fixed disk. Before using the test, backup all data on the disk.

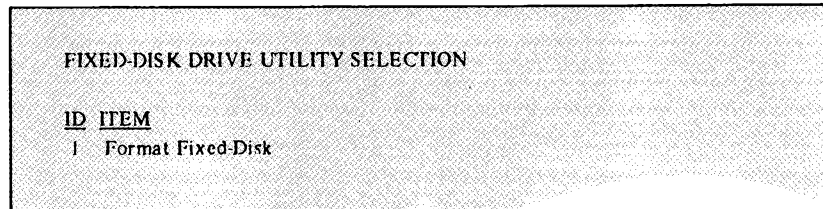

Communication Utilities

The Communication Utilities contain the following exercise:

Utilities for use with Ethernet¹.

The Utilities for use with Ethernet is used to exercise the Baseband Adapter and parts of the Ethernet Network. The utility will work with a wrap plug or with any valid Ethernet Network.

¹ Ethernet is a registered trademark of Xerox Corporation.

Diagnostic Diskette Copy Utility

The Diagnostic Diskette Copy Utility enables the user to copy diagnostic diskettes. The utility does the following:

- Instructs the user to insert a target diskette.
- Warns the user that data on the target diskette will be destroyed.
- Formats the target diskette.
- Instructs the user to insert a source diagnostic diskette.
- Copies an image copy of the source diskette to the target diskette.

Note: The copy procedure may require the user to change diskettes several times during the copy procedure.

IBM 9332 Utilities

The IBM 9332 Utilities provide the following:

- A means of down loading microcode to the IBM 9332 from a diskette.
- A means of displaying and altering the Vital Product Data on the IBM 9332.
- A means of formatting the IBM 9332. This utility erases all data and formats the file.

Appendix A. Locations and Examples

Comparison drawings for use in locating controls and determining display problems are found in this appendix. Instructions for removing and replacing a defective battery are also found in this appendix.

Diagnostic Function Keys

The following list describes the keys used and their function when running diagnostics:

- Enter** Continues the procedure or performs an action.
- End** Stops a test or an action.
- F10** Returns to the previous menu and cancels any changes.
- Escape** Resets the procedures and returns to the Diagnostic Operating Instructions.
- Page Down** Lets you see information below that shown on the screen.
- Page Up** Lets you see information above that shown on the screen.
- Backspace** Lets you correct errors.

Types of Displays

**IBM Personal Computer Display
(IBM 5151)**

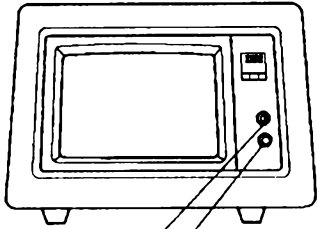

Contrast Control
Brightness Control

**IBM 6153 Advanced
Monochrome Display
(IBM 6153)**

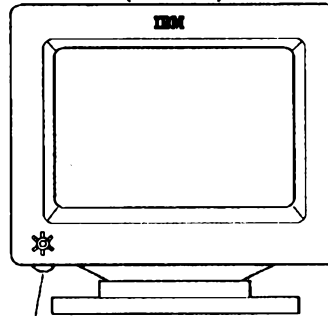

Brightness and Raster
Test Control

**IBM Personal Computer Enhanced
Color Display (IBM 5154)**

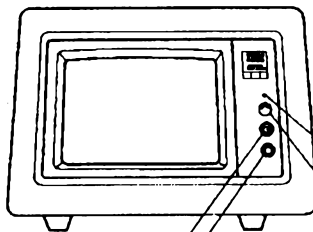

Contrast Control
Brightness Control

Power-On
Indicator
On/Off

AIZAF055

IBM 6154 Advanced Color Graphics Display

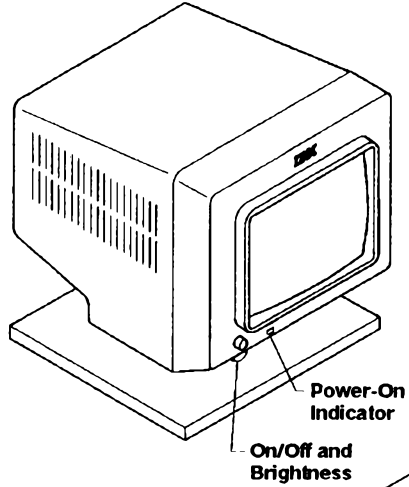

IBM 5081 Color Graphics Display

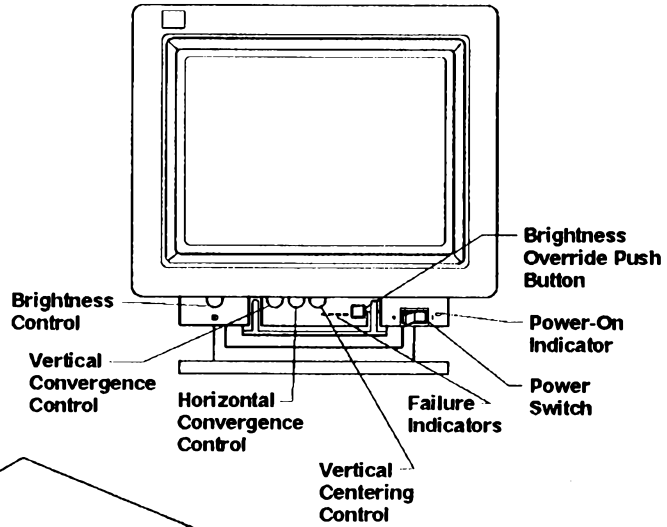

IBM 6155 Extended Monochrome Graphics Display

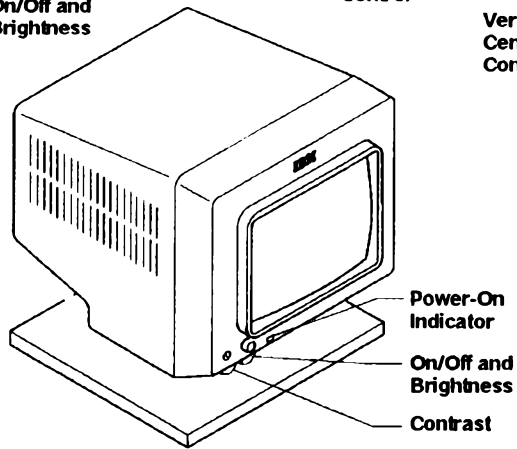

A1ZAF056

Display Test Patterns

IBM Personal Computer Display Test Patterns

Test Pattern 1

Note: The test pattern is displayed on lines 3 to 23. Lines 1, 2, 24, and 25 are not part of the test pattern.

☺☹♥♦♣♠•◻◼◽◾◿◸◹◺◻◼◽◾◿◸◹◺♂♀♫♬♭♮♯▶◀↑↓↔↔↔▲▼
!"#\$%&'()*+,-./0123456789:;<=>?
ⒶⒷⒸⒹⒺⒻⒼⒽⒾⓂⓃⓄⓅⓆⓇⓈⓉⓊⓋⓌⓍⓎⓏⓐⓑⓓⓔⓕⓖⓗⓙⓛⓜⓝⓞⓟⓠⓡⓢⓣⓤⓥⓦⓧⓨⓩ⓪⓫⓬⓭⓮⓯⓰⓱⓲⓳⓴⓵⓶⓷⓸⓹⓺⓻⓼⓽⓾⓿
ÇüéàâäåçêëèíîïËÄÊæÆðöòóùÿÖÜελϕρτ
áíóúñÑ&@¿¡¢£¼½;«»⌚⌛⌜⌝⌞⌟⌠⌡⌢⌣⌤⌥⌦⌧⌨〈〉⌫⌬⌭⌮⌯⌰⌱⌲⌳⌴⌵⌶⌷⌸⌹⌺⌻⌼⌽⌾⌿
ⓁⓂⓃⓄⓅⓆⓇⓈⓉⓊⓋⓌⓍⓎⓏⓐⓑⓓⓔⓕⓖⓗⓙⓛⓜⓝⓞⓟⓠⓡⓢⓣⓤⓥⓦⓧⓨⓩ⓪⓫⓬⓭⓮⓯⓰⓱⓲⓳⓴⓵⓶⓷⓸⓹⓺⓻⓼⓽⓾⓿

AJZBF218

Test Pattern 2

Note: The test pattern is displayed on lines 3 to 23. Lines 1, 2, 24, and 25 are not part of the test pattern.

```
!"#$%&'()*+,-./0123456789:;<=>?@ABCDEFGHIJKLMNOpqrstuvwxyz[ ]^_`abcdefghijklmnop  
!"#$%&'()*+,-./0123456789:;<=>?@ABCDEFGHIJKLMNOpqrstuvwxyz[ ]^_`abcdefghijklmnop  
!"#$%&'()*+,-./0123456789:;<=>?@ABCDEFGHIJKLMNOpqrstuvwxyz[ ]^_`abcdefghijklmnop  
!"#$%&'()*+,-./0123456789:;<=>?@ABCDEFGHIJKLMNOpqrstuvwxyz[ ]^_`abcdefghijklmnop  
!"#$%&'()*+,-./0123456789:;<=>?@ABCDEFGHIJKLMNOpqrstuvwxyz[ ]^_`abcdefghijklmnop  
!"#$%&'()*+,-./0123456789:;<=>?@ABCDEFGHIJKLMNOpqrstuvwxyz[ ]^_`abcdefghijklmnop  
!"#$%&'()*+,-./0123456789:;<=>?@ABCDEFGHIJKLMNOpqrstuvwxyz[ ]^_`abcdefghijklmnop  
!"#$%&'()*+,-./0123456789:;<=>?@ABCDEFGHIJKLMNOpqrstuvwxyz[ ]^_`abcdefghijklmnop  
!"#$%&'()*+,-./0123456789:;<=>?@ABCDEFGHIJKLMNOpqrstuvwxyz[ ]^_`abcdefghijklmnop  
!"#$%&'()*+,-./0123456789:;<=>?@ABCDEFGHIJKLMNOpqrstuvwxyz[ ]^_`abcdefghijklmnop  
!"#$%&'()*+,-./0123456789:;<=>?@ABCDEFGHIJKLMNOpqrstuvwxyz[ ]^_`abcdefghijklmnop  
!"#$%&'()*+,-./0123456789:;<=>?@ABCDEFGHIJKLMNOpqrstuvwxyz[ ]^_`abcdefghijklmnop  
!"#$%&'()*+,-./0123456789:;<=>?@ABCDEFGHIJKLMNOpqrstuvwxyz[ ]^_`abcdefghijklmnop  
!"#$%&'()*+,-./0123456789:;<=>?@ABCDEFGHIJKLMNOpqrstuvwxyz[ ]^_`abcdefghijklmnop  
!"#$%&'()*+,-./0123456789:;<=>?@ABCDEFGHIJKLMNOpqrstuvwxyz[ ]^_`abcdefghijklmnop  
!"#$%&'()*+,-./0123456789:;<=>?@ABCDEFGHIJKLMNOpqrstuvwxyz[ ]^_`abcdefghijklmnop  
!"#$%&'()*+,-./0123456789:;<=>?@ABCDEFGHIJKLMNOpqrstuvwxyz[ ]^_`abcdefghijklmnop  
!"#$%&'()*+,-./0123456789:;<=>?@ABCDEFGHIJKLMNOpqrstuvwxyz[ ]^_`abcdefghijklmnop  
!"#$%&'()*+,-./0123456789:;<=>?@ABCDEFGHIJKLMNOpqrstuvwxyz[ ]^_`abcdefghijklmnop  
!"#$%&'()*+,-./0123456789:;<=>?@ABCDEFGHIJKLMNOpqrstuvwxyz[ ]^_`abcdefghijklmnop
```

AJZF219

IBM 5081 Color Graphics Display Test Patterns

The color bar pattern used on a color display requires at least four video pixel planes. Left to right, the color bars are green, yellow, red, magenta, blue, cyan, black, and white.

Compare each color on your screen, as described above. If any color is missing, you have a megapel graphics display problem.

Test Pattern 1

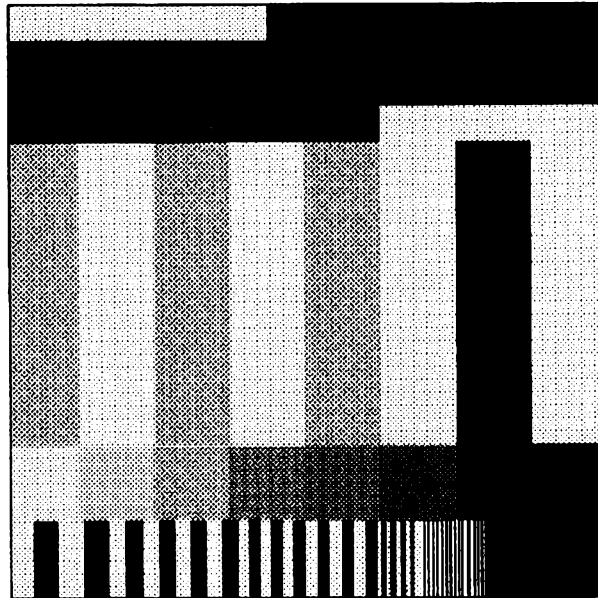

AJZBF215

Test Pattern 2

This crosshatch (grid) test pattern is used to check convergence and alignment. Adjust the vertical convergence, horizontal convergence, and vertical centering controls to correct a crosshatch (grid) pattern that is distorted.

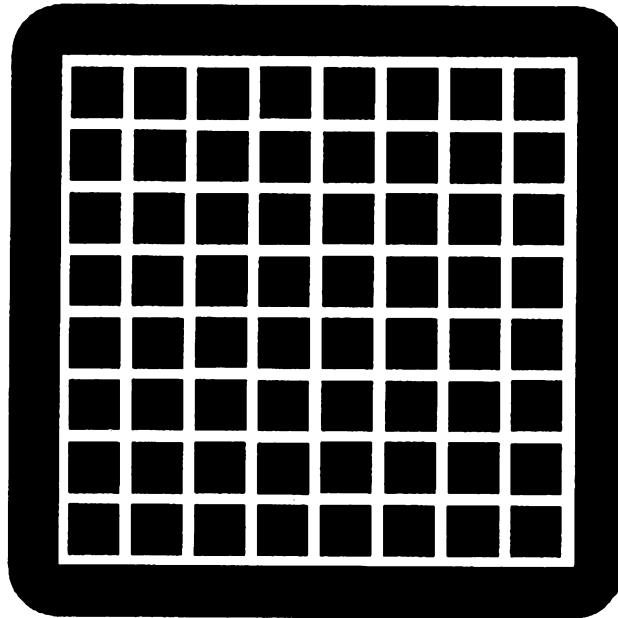

AJZB216

Battery Removal and Replacement

The following pages provide the steps necessary to remove and replace the battery in the IBM 6150 and IBM 6151 System Units.

IBM 6151 System Unit Battery Removal

DANGER

Fire, explosion, and severe burn hazard. Do not recharge, disassemble, heat above 100° C, solder directly to the cell, incinerate, or expose cell contents to water. Keep away from children. Replace with IBM Part #6299201 only or a battery that has been specifically classified by Underwriters Laboratories, Inc. for use with the IBM 6151 and is so marked to indicate such classification. Use of another battery may present a risk of fire or explosion.

For translations of this danger notice refer to "Safety Translations" on page iii.

1. Turn off the system.
2. Remove the system unit covers. See *Options Installation*.
3. Disconnect the battery cable from the system board.
4. Slide the battery up out of the holder.

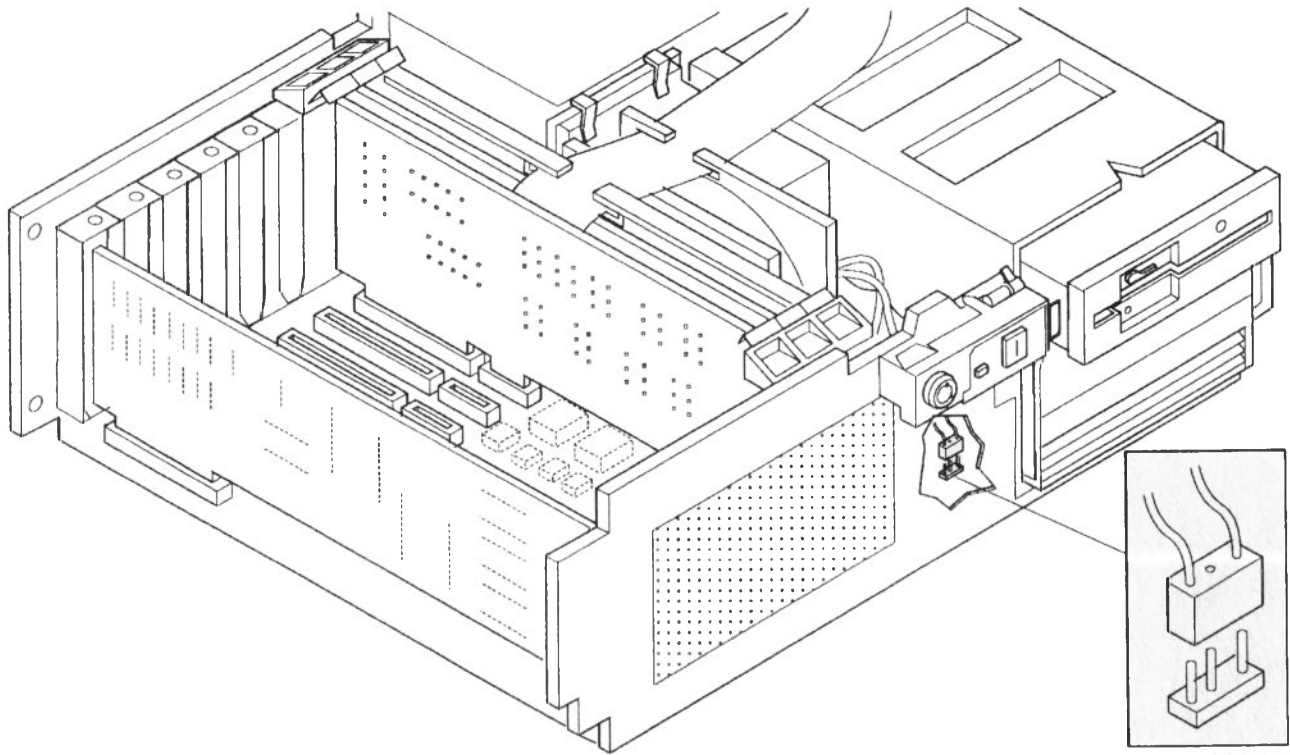

AJZBF221

IBM 6151 System Unit Battery Replacement

DANGER

Fire, explosion, and severe burn hazard. Do not recharge, disassemble, heat above 100° C, solder directly to the cell, incinerate, or expose cell contents to water. Keep away from children. Replace with IBM Part #6299201 only or a battery that has been specifically classified by Underwriters Laboratories, Inc. for use with the IBM 6151 and is so marked to indicate such classification. Use of another battery may present a risk of fire or explosion.

For translations of this danger notice refer to "Safety Translations" on page iii.

1. Align the battery with the holder and slide the battery down into position.
2. Connect the battery cable to the system board.
3. Replace the system unit covers. See *Options Installation*.

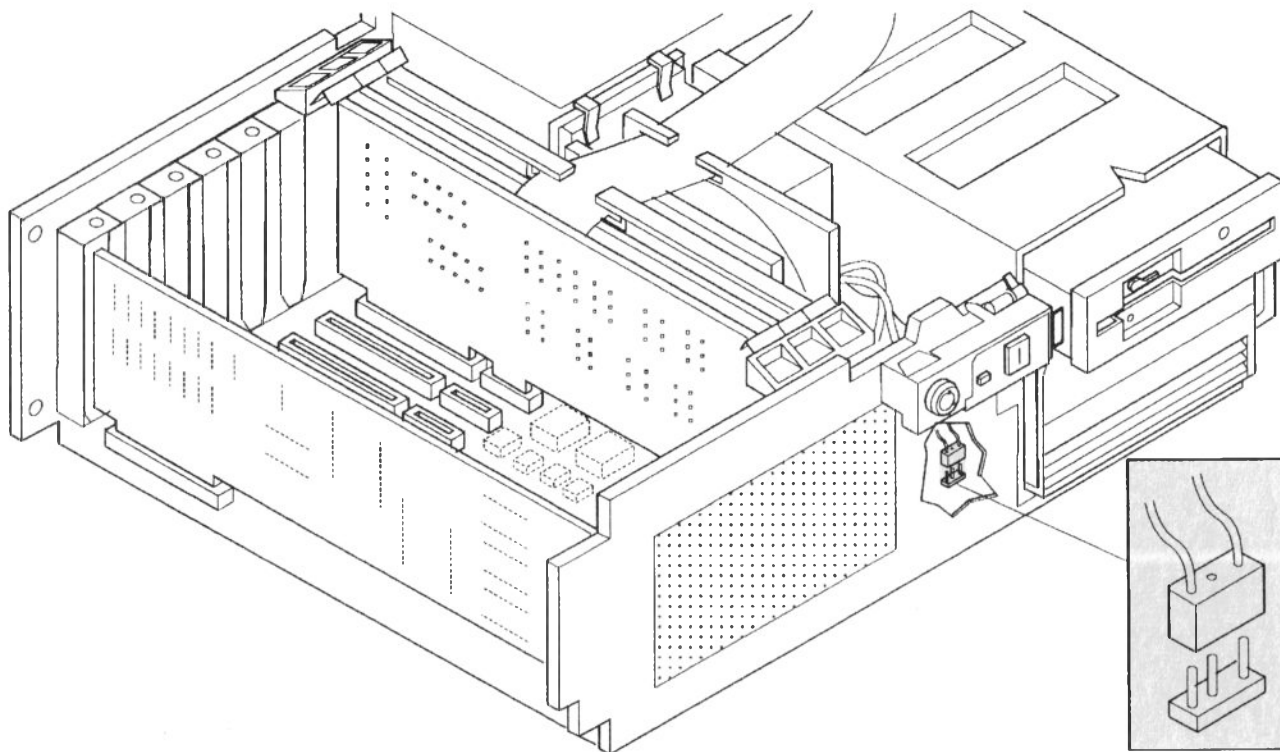

AJZBF221

IBM 6150 System Unit Battery Removal

DANGER

Fire, explosion, and severe burn hazard. Do not recharge, disassemble, heat above 100° C, solder directly to the cell, incinerate, or expose cell contents to water. Keep away from children. Replace with IBM Part #6299201 only or a battery that has been specifically classified by Underwriters Laboratories, Inc. for use with the IBM 6150 and is so marked to indicate such classification. Use of another battery may present a risk of fire or explosion.

For translations of this danger notice refer to "Safety Translations" on page iii.

1. Turn off the system.
2. Remove the front cover. See *Options Installation*.
3. Disconnect the battery cable from the operator panel board.
4. Open the battery box and remove the battery.

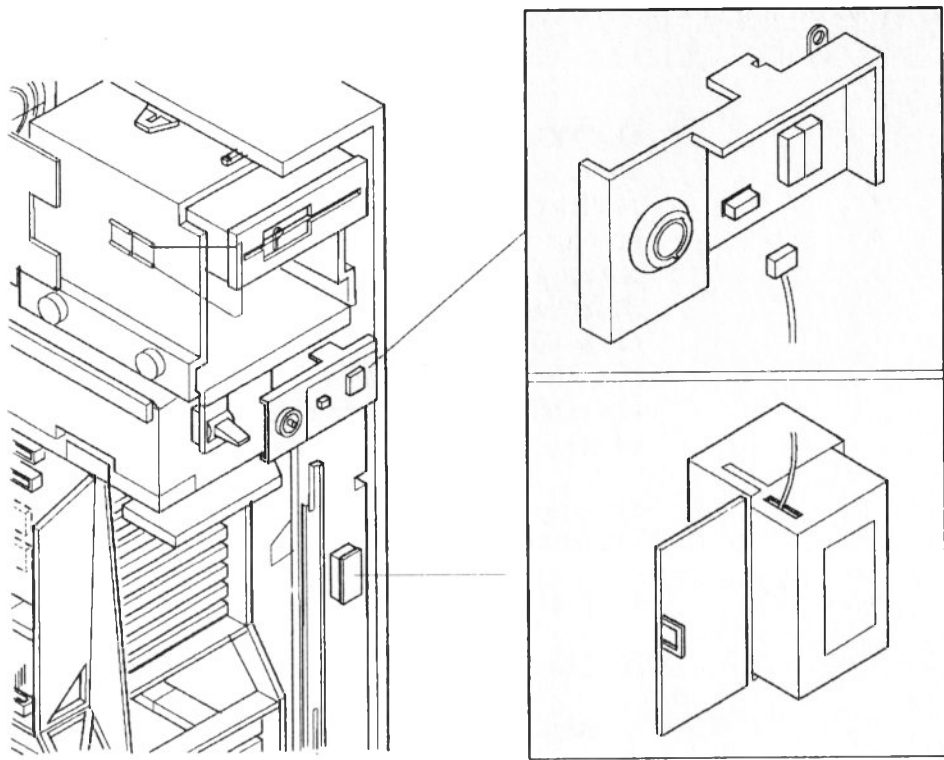

AJ ZBF220

IBM 6150 System Unit Battery Replacement

DANGER

Fire, explosion, and severe burn hazard. Do not recharge, disassemble, heat above 100° C, solder directly to the cell, incinerate, or expose cell contents to water. Keep away from children. Replace with IBM Part #6299201 only or a battery that has been specifically classified by Underwriters Laboratories, Inc. for use with the IBM 6150 and is so marked to indicate such classification. Use of another battery may present a risk of fire or explosion.

For translations of this danger notice refer to "Safety Translations" on page iii.

1. Place the battery in the battery box and close it.
2. Connect the battery cable to the operator panel board.
3. Replace the front cover. See *Options Installation*.

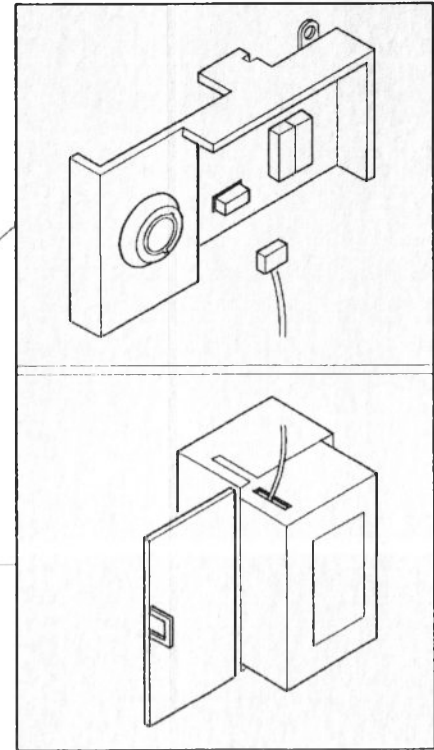
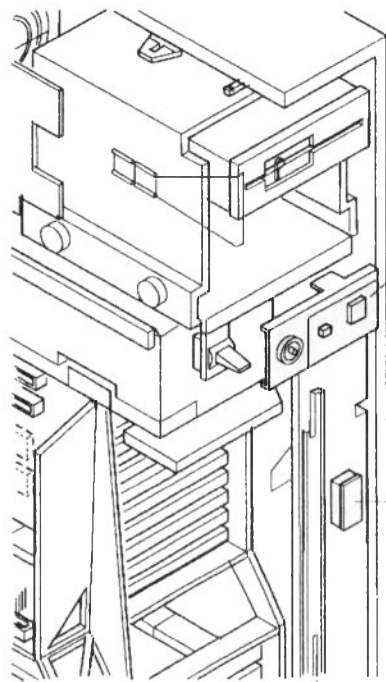

AJZBF220

)

)

)

Appendix B. Problem Summary Form

Please complete the following information before calling IBM for service. Save the completed form for your service representative.

1. Describe the problem:

2. Write all messages related to the problem here:

3. Write the two-digit display number here:

4. Write the Service Request Number here:



)

)

)

Appendix B. Problem Summary Form

Please complete the following information before calling IBM for service. Save the completed form for your service representative.

1. Describe the problem:

2. Write all messages related to the problem here:

3. Write the two-digit display number here:

— —

4. Write the Service Request Number here:

— — — — —

Appendix B. Problem Summary Form

Please complete the following information before calling IBM for service. Save the completed form for your service representative.

1. Describe the problem:

2. Write all messages related to the problem here:

3. Write the two-digit display number here:

— —

4. Write the Service Request Number here:

— — — — —

)

)

)

Appendix B. Problem Summary Form

Please complete the following information before calling IBM for service. Save the completed form for your service representative.

1. Describe the problem:

2. Write all messages related to the problem here:

3. Write the two-digit display number here:

4. Write the Service Request Number here:

)

)

)

Appendix B. Problem Summary Form

Please complete the following information before calling IBM for service. Save the completed form for your service representative.

1. Describe the problem:

2. Write all messages related to the problem here:

3. Write the two-digit display number here:

— —

4. Write the Service Request Number here:

— — — — —

)

)

)

Appendix B. Problem Summary Form

Please complete the following information before calling IBM for service. Save the completed form for your service representative.

1. Describe the problem:

2. Write all messages related to the problem here:

3. Write the two-digit display number here:

— —

4. Write the Service Request Number here:

— — — — —

Glossary

adapter. A printed circuit card that modifies the system unit to allow it to operate in a particular way.

application. A particular task, such as inventory control or accounts receivable.

ASCII. American National Standard Code for Information Exchange

asynchronous transmission. In data communications, a method of transmission in which the bits included in a character or block of characters occur during a specific time interval. However, the start of each character or block of characters can occur at any time during this interval. Contrast with synchronous transmission.

color display. A display device capable of displaying more than two colors and the shades produced via the two colors, as opposed to a monochrome display.

command. A request to perform an operation or execute a program. When parameters, arguments, flags, or other operands are associated with a command, the resulting character string is a single command.

configuration. The group of machines, devices, and programs that make up a computer system.

configure. To describe (to the system) the devices, optional features, and program products installed on a system.

connector. An electrical part used to join two other electrical parts.

cursor. (1) A movable symbol (such as an underline) on a display, used to indicate to the operator where the next typed character will be placed or where the next action will be directed.

customize. To describe (to the system) the devices, programs, users, and user defaults for a particular data processing system.

default. A value, attribute, or option that is used when no alternative is specified by the operator.

default value. A value stored in the system that is used when no other value is specified.

device. An electrical or electronic machine that is designed for a specific purpose and that attaches to your computer, for example, a printer, plotter, disk drive, and so forth.

diagnostic. Pertaining to the detection and isolation of an error.

diagnostic aid. A tool (procedure, program, reference manual) used to detect and isolate a device or program malfunction or error.

diagnostic routine. A computer program that recognizes, locates, and explains either a fault in equipment or a mistake in a computer program.

disk. A storage device made of one or more flat, circular plates with magnetic surfaces on which information can be stored.

disk drive. The mechanism used to read and write information on a disk.

diskette. A thin, flexible magnetic plate that is permanently sealed in a protective cover. The diskette is used to store information copied from the disk.

diskette drive. The mechanism used to read and write information on diskettes.

display screen. The part of the display device that displays information visually on a luminescent screen by use of controlled electron beams.

feature. A programming or hardware option, usually available at an extra cost.

fixed-disk. A storage device made of one or more flat, circular plates with magnetic surfaces on which information can be stored.

format. (1) A defined arrangement of such things as characters, fields, and lines, usually used for displays, printouts,

or files. (2) The pattern that determines how data is recorded.

formatted diskette. A diskette on which control information for a particular computer system has been written but which may or may not contain any data.

hardware. The equipment, as opposed to the programming, of a computer system.

initial program load (IPL). The process of loading the system programs and preparing the system to run jobs.

keyboard. An input device consisting of various keys allowing the user to input data, control cursor and pointer locations, and to control the user/workstation dialogue.

keylock feature. A security feature in which a lock and key can be used to restrict the use of the display station.

label. The name in the disk or diskette volume table of contents that identifies a file.

load. (1) To move data or programs into storage. (2) To place a diskette into a diskette drive. (3) To insert paper into a printer.

memory. A device or part of a device that can retain data.

menu. A displayed list of items from which an operator can select tasks.

monochrome display. A display device that has only one color.

mouse. A small user input device externally attached to the system unit.

plotter. A printing device externally attached with cables to the system unit, used to print two-dimensional graphs and charts.

plug. A device that connects the wires of an electrical circuit to an electrical source. The plug is designed to be inserted into a jack.

port. A part of the system unit or remote controller to which cables for external devices (display stations, terminals, printers) are attached. The port is an access point for data entry or exit.

POST. See *power-on self-test*.

power-on light. A light on the operator panel that indicates that the DC power in the system unit is okay.

power-on self-test (POST). An internal diagnostic program activated each time the system is turned on.

printer. A device externally attached to the system unit, used to print system output on paper.

problem determination. The process of identifying why the system is not working. Often this process identifies programs, equipment, data communications facilities, or user errors as the source of the problem.

problem determination procedure. A prescribed sequence of steps aimed at

recovery from, or circumvention of, problem conditions.

prompt (n.). A displayed request for information or operator action.

recovery procedure. (1) An action performed by the operator when an error message appears on the display screen. Usually, this action permits the program to continue or permits the operator to run the next job. (2) The method of returning the system to the point where a major system error occurred and running the recent critical jobs again.

routine. A set of statements in a program causing the system to perform an operation or a series of related operations.

run. To cause a program, utility, or other machine function to be performed.

service request number. A group of numbers used by service technicians to determine the failing area of the system.

software. Programs.

SRN. Service request number.

system. The computer and its associated devices and programs.

system unit. The part of the system that contains the processing unit, the disk drives, and the diskette drives.

system user. A person who uses a computer system.

terminal. In data communications, a device, usually equipped with a keyboard and a display, capable of sending and receiving information over communications lines.

two-digit display. Two seven-segment light-emitting diodes (LEDs) on the operator panel used to track the progress of power-on self-tests (POSTs).

utility. A service; in programming, a program that performs a common service function.

Volume ID (Vol ID). A series of characters recorded on the diskette used

to identify the diskette to the user and to the system.

work station. A device at which an individual may transmit information to, or receive information from, a computer for the purpose of performing a task (for example, a display station or printer).

wrap test. A test that checks attachment or controller circuitry without testing the device itself.

write-protect notch. The notch in a diskette that allows the diskette drive to write on it. When it is covered, the diskette is said to be write-protected since the diskette drive is physically prohibited from the write operation.



The IBM RT PC
Hardware Reference Family

Reader's Comment Form

**IBM RT PC Problem
Determination Guide**

SA23-2604-0

Your comments assist us in improving our products. IBM may use and distribute any of the information you supply in any way it believes appropriate without incurring any obligation whatever. You may, of course, continue to use the information you supply.

For prompt resolution to questions regarding set up, operation, program support, and new program literature, contact the authorized IBM dealer in your area.

Comments:

Book Title

Order No.

Book Evaluation Form

Your comments can help us produce better books. You may use this form to communicate your comments about this book, its organization, or subject matter, with the understanding that IBM may use or distribute whatever information you supply in any way it believes appropriate without incurring any obligation to you. Please take a few minutes to evaluate this book as soon as you become familiar with it. Circle Y (Yes) or N (No) for each question that applies and give us any information that may improve this book.

Y N Is the purpose of this book clear?

Y N Is the table of contents helpful?

Y N Is the index complete?

Y N Are the chapter titles and other headings meaningful?

Y N Is the information organized appropriately?

Y N Is the information accurate?

Y N Is the information complete?

Y N Is only necessary information included?

Y N Does the book refer you to the appropriate places for more information?

Y N Are terms defined clearly?

Y N Are terms used consistently?

Y N Are the abbreviations and acronyms understandable?

Y N Are the examples clear?

Y N Are examples provided where they are needed?

Y N Are the illustrations clear?

Y N Is the format of the book (shape, size, color) effective?

Other Comments

What could we do to make this book or the entire set of books for this system easier to use?

Optional Information

Your name _____
 Company name _____
 Street address _____
 City, State, ZIP _____

No postage necessary if mailed in the U.S.A.

(

(

(

)

)

)

()

)

()

(

(

(

© IBM Corp. 1985, 1986, 1988
All rights reserved.

International Business
Machines Corporation
11400 Burnet Road
Austin, Texas 78758

Printed in Italy

SA23-2604-0
P/N 22F9828





**IBM RT
AIX Operating System
Problem Determination Guide**

SA23-2603-1
22F9874

)

)

)

IBM

**IBM RT
AIX Operating System
Problem Determination Guide**

Third Edition (July 1988)

This is a major revision of and obsoletes the first edition of *IBM RT PC AIX Operating System Problem Determination Guide*.

This edition applies to all subsequent releases until otherwise indicated in new editions or technical newsletters. Changes are made periodically to the information herein; these changes will be incorporated in new editions of this publication.

References in this publication to IBM products, programs, or services do not imply that IBM intends to make these available in all countries in which IBM operates. Any reference to an IBM licensed program in this publication is not intended to state or imply that only IBM's licensed program may be used. Any functionally equivalent program may be used instead.

International Business Machines Corporation provides this manual "as is," without warranty of any kind, either express or implied, including, but not limited to, the implied warranties of merchantability and fitness for a particular purpose. IBM may make improvements and/or changes in the product(s) and/or the program(s) described in this manual at any time.

Products are not stocked at the address given below. Requests for copies of this product and for technical information about the system should be made to your authorized RT dealer or IBM representative.

A reader's comment form is provided at the back of this publication. If the form has been removed, address comments to IBM Corporation, Department 997, 11400 Burnet Road, Austin, Texas 78758. IBM may use or distribute whatever information you supply in any way it believes appropriate without incurring any obligation to you.

AIX is a trademark of International Business Machines Corporation.

IBM is a registered trademark of International Business Machines Corporation.

RT is a registered trademark of International Business Machines Corporation.

© Copyright International Business Machines Corporation 1985, 1988

About This Book

Purpose

Use this book to do software problem determination on the IBM RT[®] system. If the AIX[™] Operating System is not installed and working, the tools provided in this book cannot be used. When you suspect a software problem, use this book to find the failure.

Audience

The audience for this book is the user who has some understanding of the RT system and is having software problems with the RT system programs.

How to Use This Book

Section 1, “Software Problems” provides helpful information to aid in finding the source of software problems. Descriptions of the software error codes displayed on the system’s two-digit display and the cause and recovery actions are also found in this section.

Section 2, “Dump Utilities” describes the steps needed to dump the system memory and provides instructions for using the dump formatter.

RT is a registered trademark of International Business Machines Corporation.

AIX is a trademark of International Business Machines Corporation.

Section 3, “Error Log Analysis” describes the commands for using the error log report.

Section 4, “The Trace Utility” describes the commands and steps used in setting up the trace profile, starting and stopping trace, and producing a trace report.

A Reader’s Comment Form and Book Evaluation Form are provided at the back of this book. Use the Reader’s Comment Form at any time to give IBM information that may improve the book. After you become familiar with the book, use the Book Evaluation Form to give IBM specific feedback about the book.

Related Publications

- *IBM RT Problem Determination Guide* provides instructions for running diagnostic routines to locate and identify hardware problems. A problem determination guide for software and three high-capacity (1.2MB) diskettes containing the IBM RT diagnostic routines are included.
- *IBM RT Usability Services Guide* shows how to create and print text files, work with directories, start application programs, and do other basic tasks with the Usability Services. (Packaged with *Usability Services Reference*)
- *IBM RT AIX Operating System Commands Reference* lists and describes the AIX Operating System commands.
- *IBM RT Messages Reference* lists messages displayed by the IBM RT and explains how to respond to the messages.
- *IBM RT AIX Operating System Technical Reference* is a four-volume set.

System Calls and Subroutines, describes the system calls and subroutines that a C programmer uses to write programs for the AIX Operating System.

Files and Extensions, contains information about the extensions to the kernel and base operating system, including file formats, special files, and GSL subroutines.

VRM Programming Support, describes the VRM programming environment, including the internal VRM routines, VRM floating-point support, use of the VRM debugger, and the supervisor call instructions that form the Virtual Machine Interface.

VRM Device Support, describes device IPL and configuration, minidisk management, the virtual terminal and block I/O subsystems, as well as the interfaces to VRM device driver and data link control components. This volume also describes the programming conventions for developing your own VRM code and installing it on the system. (Available optionally)

-
- *IBM RT Bibliography and Master Index* provides brief descriptive overviews of the books and tutorial program that support the IBM RT hardware and the AIX Operating System. In addition, this book contains an index to the RT and AIX Operating System library.

Ordering Additional Copies of This Book

To order additional copies of this publication, use one of the following sources:

- To order from your IBM representative, use Order Number SBOF-1825 for all RT systems except model T-25.
- To order from your IBM dealer, use Part Number 22F9815 for all RT systems except model T-25.
- To order from your IBM representative, use Order Number SBOF-1805 for RT system model T-25.

Contents

| | |
|---|------------|
| Section 1. Software Problems | 1-1 |
| About This Section | 1-3 |
| Section 2. The Dump Utilities | 2-1 |
| About This Section | 2-3 |
| Dump Formatter | 2-18 |
| Section 3. Error Log Analysis | 3-1 |
| About This Section | 3-3 |
| Error Log Report Types | 3-4 |
| Error Log Command Format | 3-5 |
| Section 4. The Trace Utility | 4-1 |
| Using the Trace Utility | 4-2 |
| The Trace Profile | 4-3 |
| Creating the Trace Report | 4-6 |
| Section 5. Blinking Two-Digit Display Messages ... | 5-1 |
| About This Section | 5-3 |
| Errors Found at IPL | 5-4 |
| Errors Found During VRM Install | 5-14 |
| Appendix A. The VRM Maintenance Facility (VMF) | A-1 |
| About This Appendix | A-3 |
| VRM Maintenance Facility (VMF) Overview | A-4 |
| Appendix B. Error Log Entries | B-1 |
| About This Appendix | B-3 |
| Appendix C. Abend Codes | C-1 |
| About This Appendix | C-3 |
| Glossary | X-1 |

Section 1. Software Problems

(

(

(

CONTENTS

| | |
|---|-----|
| About This Section | 1-3 |
| Step 1. Determining Software Problems | 1-4 |
| Step 2. Message Displayed | 1-6 |
| Step 3. Failing Program Undetermined | 1-7 |
| VRM and AIX Operating System Dumps | 1-7 |
| Trace | 1-7 |

About This Section

This software problem section describes the tools available for use in software problem determination. These tools will help find the cause of the problem but will not fix the problem. Once you have located the failing program, use your normal problem reporting procedures.

Step 1. Determining Software Problems

If you suspect a program has a software problem, you can do several things to determine if the problem is really software.)

The Symptom Index is a list of system problems or symptoms. The section or step related to the symptom is contained in the action column of the Symptom Index.

1. Find the failure or symptom that most closely resembles your system failure.

Note: If a program has been working correctly for some time and you have made no changes, the system hardware may be failing. To check the hardware, see *IBM RT Problem Determination Guide*.

2. Follow the instructions in the Action column.
3. Follow the instructions given in the steps to complete the problem determination procedures.)

| Symptoms | Actions |
|---|---|
| c6 is alternately displayed with a two-digit abend code in the two-digit display during normal operation. | Go to "Step 2. VRM Dump (System Started)" on page 2-5. |
| XX is blinking in the two-digit display. (XX any two digits.) | Go to Section 5, "Blinking Two-Digit Display Messages" on page 5-1. |
| A message is displayed for the failure. | Go to "Step 2. Message Displayed" on page 1-6. |
| A message directed you to dump the system memory. | Go to "Step 1. Dump Utilities" on page 2-4. |
| Incorrect system operation with no message (incorrect output, unexplained system actions). | Go to "Step 1. Summary Error Log" on page 3-6. |
| System is on but appears inactive (loop, no keyboard response). | Go to "Step 9. System Appears to be Hung" on page 2-14. |
| Failing program undetermined | Go to "Step 3. Failing Program Undetermined" on page 1-7. |

Step 2. Message Displayed

If you have a message:

1. Read the message carefully
2. Do the recovery action, if any is given.

Once you have responded to the message:

3. Try the operation again.

If the program still fails:

4. Go to “Step 1. Summary Error Log” on page 3-6 to view the error log.

The error log provides a record of errors and system events and if possible, the most likely cause of the failure.

Step 3. Failing Program Undetermined

If you are unable to find the failing program in the error log, you may need to gather additional information. This information may consist of one or more of the following:

VRM and AIX Operating System Dumps

The dump utilities provide the commands needed to dump the contents of memory. Go to “Step 1. Dump Utilities” on page 2-4 for instructions on starting the dumps and for instructions on producing the dump reports.

Trace

The trace utility enables you to record certain system actions while a program that is suspected of having a problem is running. Go to Section 4, “The Trace Utility” on page 4-1 for instructions on starting and stopping trace and for instructions on producing a trace report.

Section 2. The Dump Utilities

CONTENTS

| | |
|---|------|
| About This Section | 2-3 |
| Step 1. Dump Utilities | 2-4 |
| Step 2. VRM Dump (System Started) | 2-5 |
| Step 3. VRM Dump (User Started) | 2-7 |
| Step 4. VRM Dump (User Started From VRM Debugger) | 2-9 |
| Step 5. Kernel Dump (System Started) | 2-10 |
| Step 6. Kernel Dump (User Started) | 2-11 |
| Step 7. Kernel Dump (Copy to Diskette) | 2-12 |
| Step 8. Core File | 2-13 |
| Step 9. System Appears to be Hung | 2-14 |
| Step 10. Full Image Dump | 2-15 |
| Dump Utility Messages | 2-17 |
| Dump Formatter | 2-18 |

About This Section

This section contains instructions for using the VRM, Kernel, and Full Image dump utilities to copy the contents of memory at the time of a program failure. The core file and the crash utility are also described.

The data collected by these utilities is intended to help you, or the person servicing the system, determine the cause of the failure.

Step 1. Dump Utilities

Use the following procedure to determine where to go in this Chapter. Find the dump condition in the table and go to the associated step.

| Dump Conditions | Actions |
|---|--|
| A c6 and an abend code are alternately displayed in the two-digit display. | Go to "Step 2. VRM Dump (System Started)" on page 2-5. |
| You want to start the VRM Dump. | Go to "Step 3. VRM Dump (User Started)" on page 2-7. |
| Dump is started from VRM debugger. | Go to "Step 4. VRM Dump (User Started From VRM Debugger)" on page 2-9. |
| A PANIC message was displayed on the screen. | Go to "Step 5. Kernel Dump (System Started)" on page 2-10. |
| You want to start the Kernel dump. | Go to "Step 6. Kernel Dump (User Started)" on page 2-11. |
| A core file was created. | Go "Step 8. Core File" on page 2-13. |
| System appears to be hung (no work can be done, no response from commands or interrupt keys). | Go to "Step 9. System Appears to be Hung" on page 2-14. |
| You are instructed to take a Full Image dump. | Go to "Step 10. Full Image Dump" on page 2-15. |

Step 2. VRM Dump (System Started)

The **c6** and an abend code alternately displayed in the two-digit display is a prompt to load the dump diskette. The abend codes are described in Appendix C of this book. Blinking error codes that can occur during IPL (without the **c6**) are described in Chapter 5.

Note: The dump diskette can be any formatted high-capacity diskette. A dump diskette should have been created and placed in the back of this manual when the AIX Operating System was installed.

1. Remove the dump diskette from the back of this manual.
2. Insert the dump diskette into the diskette drive in location **A**. (The top drive if there are two.)
3. Close the diskette drive door.
4. Press **CTRL-ALT-numpad8**. (Use the left **ALT** key.)

A **c8** appears in the two-digit display while the system verifies the diskette is usable. If the diskette is not usable, a **c5** appears. In this case you should remove the bad diskette and insert another.

If the diskette is good, **c9** in the two-digit display indicates the dump is running. The dump takes approximately 5 minutes to complete.

CONTINUE to next page.

When the dump is complete, **c0** is displayed in the two-digit display. For any other messages displayed, see “Dump Utility Messages” on page 2-17.

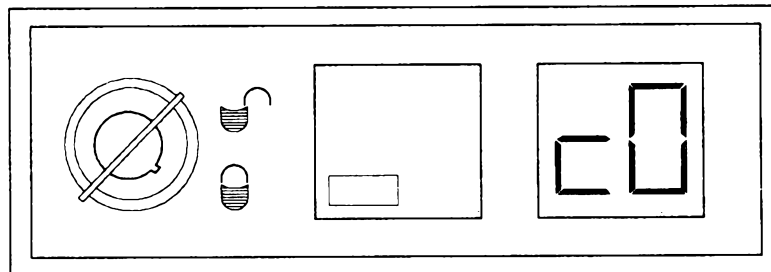

AJZB240

IS “c0” DISPLAYED?

YES Press **CTRL-ALT-Pause** to restart the operating system. Go to “Dump Formatter” on page 2-18 and format the dump diskette.

NO There may be a hardware problem. Go to *IBM RT Problem Determination Guide* and follow the procedures for problem determination.

If no problem is found before the “Diagnostic Selection” menu is displayed, run “System Checkout.”

Step 3. VRM Dump (User Started)

If you want to start the dump utility, follow these steps.

1. Remove the dump diskette from the back of this manual.

Note: The dump diskette may be any formatted high-capacity diskette. A dump diskette should have been created and placed in the back of this manual when the AIX Operating System was installed.

2. Press **CTRL-ALT-numpad8**. (Use the left **ALT** key.)

A **c6** alternating with abend code 00 is displayed in the two-digit display.

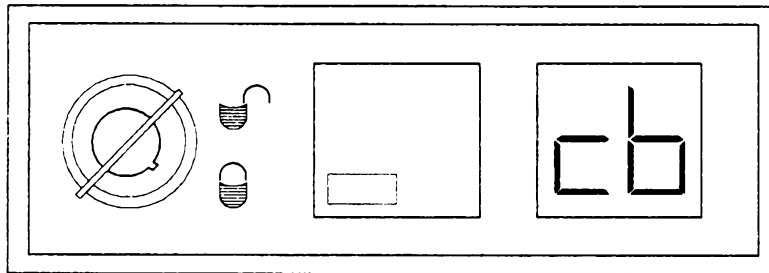

AJZB239

CONTINUE to next page.

-
3. Insert the dump diskette into the diskette drive in location A .
(The top drive if there are two.)
 4. Press the **CTRL-ALT-numpad8** keys again. (Use the left **ALT** key.)

A **c8** appears in the two-digit while the system verifies the diskette is usable. If the diskette is not usable, a **c5** appears. In this case you should remove the bad diskette and insert another.

If the diskette is good, **c9** in the two-digit display indicates the dump is running. The dump takes approximately 5 minutes to complete.

When the dump is complete, **c0** is displayed in the two-digit display. For any other messages displayed, see "Dump Utility Messages" on page 2-17.

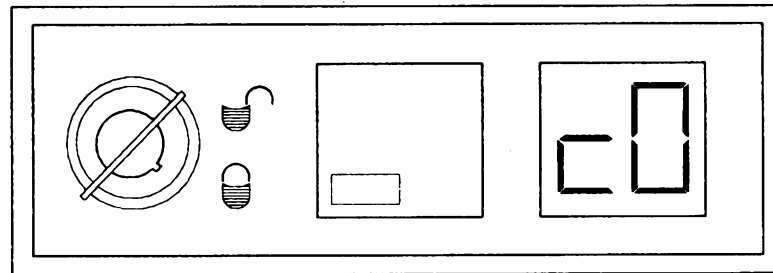

AJZB240

IS "c0" DISPLAYED?

YES Press **CTRL-ALT-Pause** to restart the operating system. Go to "Dump Formatter" on page 2-18 and format the dump diskette.

NO There may be a hardware problem. Go to *IBM RT Problem Determination Guide* and follow the procedures for problem determination.

If no problem is found before the "Diagnostic Selection" menu is displayed, run "System Checkout."

Step 4. VRM Dump (User Started From VRM Debugger)

Use the following instructions to start a dump from the debugger.

1. Read the debugger message generated from the crash.
2. Enter the command:

```
show
```

3. Read any dump or PANIC messages on the screen.
4. Hit any key to return to the debugger.
5. Enter the command:

```
quit dump
```

A **c6** and an abend code alternately is displayed in the two-digit display. The abend codes are described in *IBM RT Messages Reference* under 032-1xx, where xx is the abend code. Blinking error codes that can occur during IPL (without the **c6**) are described in Chapter 5 of this book.

Go to “Step 2. VRM Dump (System Started)” on page 2-5 and follow the instruction to complete the dump.

Step 5. Kernel Dump (System Started)

When an error is so severe that the operating system cannot continue, a PANIC message is displayed. For most PANIC messages, a Kernel dump, sometimes called a virtual machine dump, is written on the dump minidisk on the hardfile.

Refer to *IBM RT Messages Reference* for more information about the specific PANIC message.

When the dump is complete, this message is displayed:

dump succeeded, xxxx blocks

Note: Use the crash utility to look at the dump.

Go to “Step 7. Kernel Dump (Copy to Diskette)” on page 2-12.

Step 6. Kernel Dump (User Started)

If you want to start the Kernel dump utility:

1. Press the **CTRL-ALT-END** keys.
2. When the dump is written on the dump minidisk on the hardfile, this message is displayed:

dump succeeded, xxxx blocks

Note: The crash utility can be used to look at the dump.

CONTINUE to next page.

Step 7. Kernel Dump (Copy to Diskette)

To submit Kernel dump information, the dump must be copied to diskettes. Follow these instructions to copy the information from the dump minidisk on the hardfile to diskettes.

Note: The following procedure attempts to dump */dev/hd4* to one or more diskettes and */usr/adm/ras/errfile.0* and */usr/adm/ras/errfile.1* to another diskette. Do not be concerned if any of the three do not exist or cannot be reached.

1. Insert the **Install/Maintenance** diskette into drive 0 and IPL. The "System Management" panel appears on the screen.
2. Select option 3. "Start the Standalone Shell". A # prompt appears on the screen.
3. Remove the **Install/Maintenance** diskette from drive 0.
4. Insert a formatted, high-capacity diskette into drive 0.
5. Type `errdmp` and press **ENTER**
6. Remove the first diskette and insert additional diskettes when prompted.
7. Remove the final diskette and IPL as normal.

Use your normal problem reporting procedures to submit the dump information.

STOP, you have completed these procedures.

Step 8. Core File

A core file is the result of a terminated process when various errors occur. Common errors are: memory violation, illegal instructions, and bus errors. The core file is written in the process's working directory.

To examine the core file, use the **sdb** command. The **t** subcommand of the **sdb** command provides the name and address of the last function that was running in the program that ended abnormally. For more information on the **sdb** command, see *AIX Operating System Commands Reference*.

Note: If the program that core dumped is part of an LPP, copy the core file on a diskette in a backup format and submit the dump through your normal problem reporting procedures.

STOP, you have completed these procedures.

Step 9. System Appears to be Hung

A system is considered hung when no work can be done or no response is received from commands or interrupt keys.

When this condition occurs:

1. Press **CTRL-ALT-END** to copy the virtual machine to the dump minidisk. See “Step 7. Kernel Dump (Copy to Diskette)” on page 2-12 for more information.
2. Press **CTRL-ALT-numpad8** to copy the VRM to a dump diskette. See “Step 3. VRM Dump (User Started)” on page 2-7 for more information.
3. IPL the system.
4. Submit the dump information through your normal problem reporting procedures.

STOP, you have completed these procedures.

Step 10. Full Image Dump

This step dumps all of your system's real memory and requires multiple (up to four) diskettes. A full image dump takes more time than a VRM dump and you cannot use the dump formatter to inspect the information on the diskettes. Therefore, you should not use this step unless you have been directed to do so by a support person servicing your system. Otherwise, use the VRM dump procedures described in steps 2 and 3 of this chapter.

You can start a full image dump yourself, or you can take a full image dump in place of a system-started VRM dump. In either case, have enough formatted diskettes available for your system:

- Two diskettes for a 2mb system.
- Three diskettes for a 3mb system.
- Four diskettes for a 4mb system.
- Sixteen diskettes for a 16mb system.

Number the diskettes in the sequence you will use them. 1 for the first diskette, 2 for the second diskette, and so on.

If you want to take a system-started full image dump, go to item 2 in the following procedure.

If you want to start the full image dump, do the following:

1. Press **CTRL-ALT-numpad7**. (Use the left **ALT** key.)

A **c6** alternating with abend code 00 is displayed in the two-digit display.

2. (Start here for a system initiated full image dump.) Insert diskette 1 into the diskette drive in location A. (The top drive if there are two.)

3. Press **CTRL-ALT-numpad7**. (Use the left **ALT** key.)

A **c8** appears in the two-digit while the system verifies the diskette is usable. If the diskette is not usable, a **c5** appears. In this case you should remove the bad diskette and insert another.

If the diskette is good, **c9** in the two-digit display indicates the dump is running. Each diskette takes approximately 5 minutes to complete.

When a diskette is full, **c7** is displayed in the two-digit display. When that happens, remove the full diskette from the diskette drive and insert the next higher numbered diskette. A **c8** appears while the diskette is inspected and **c9** appears when the dump continues.

When the dump is complete, **c0** is displayed in the two-digit display. For any other messages displayed, see "Dump Utility Messages" on page 2-17.

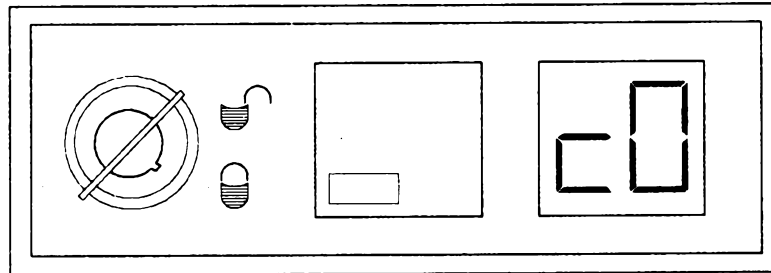

AJZB240

Is "c0" DISPLAYED?

YES Submit the dump diskettes to the person that requested the full image dump. You have now completed these procedures.

NO There may be a hardware problem. Go to *IBM RT Problem Determination Guide* and follow the procedures for problem determination.

If no problem is found before the "Diagnostic Selection" menu is displayed, run "System Checkout."

Dump Utility Messages

The messages for the dump utility are displayed on the two-digit display. These messages tell you when the dump is complete, when a dump diskette is needed, and if there is a problem found while running the dump utility.

The messages and descriptions are:

- c0** The dump utility completed.
- c4** There is a problem with the dump or with the diskette device driver. Make sure you are using a formatted diskette. If the dump does not run, go to *IBM RT Problem Determination Guide* and test the diskette drive.
- c5** The diskette is damaged. Insert another diskette in diskette drive A.
- c6** The system is requesting a VRM dump. Press the key sequence to start the VRM dump, or press CTRL-ALT-PAUSE to restart the system.

The characters c6 flash alternatively with a number *xx*. If this number is from 01 to 27, look at message 032-*1xx* in the messages book. For example, if **25** flashes on the system unit, look at message 032-125.

- c7** The dump diskette is full. Insert another dump diskette in diskette drive A.
- c8** The system is checking the dump diskette for damage.
- c9** The dump utility is running.

Dump Formatter

The Dump Formatter is used to format the information contained on the dump diskette into a readable form. The information can be directed to the display, the printer, or to a file.

If the dump program finds a problem, the dump formatter gives header information describing the problem.

The dump formatter can run in batch or interactive mode. For a complete description of the **dumpfmt** command see *IBM RT AIX Operating System Commands Reference*.

1. To run the dump formatter and produce only the header information, type the command:

```
dumpfmt -h
```

2. Press **ENTER**.
3. Report the problem to your service representative if you have not already done so. The header information may be required.

This screen is an example of the dump header:

```
Mon June 17 09:30:32 1985

Failing Component:  cccccc
Module Start Address:  xxxxxxxx
Module Offset Address:  xxxxxxxx
CID = nnnnnnnn Name = yyyyyy
ABEND Code = zzzzzzzz
```

Section 3. Error Log Analysis

CONTENTS

| | |
|---------------------------------|------|
| About This Section | 3-3 |
| Error Log Report Types | 3-4 |
| Error Log Command Format | 3-5 |
| Step 1. Summary Error Log | 3-6 |
| Step 2. Summary Error Log | 3-7 |
| Step 3. Summary Error Log | 3-9 |
| Step 4. Detail Error Log | 3-10 |

About This Section

The error log is used to help find the failing area of the system. The failures may be hardware or software. This error log is useful in finding problems when the failures are intermittent. If the Diagnostic Routines are unable to find a suspected hardware problem, the error log may have recorded the error.

Error Log Report Types

Two types of error log reports can be produced: a summary report and a detail report.

The summary report contains one-line descriptions of system activities and errors. You can specify which error types you are looking for (such as diskette, display, or program errors), and the time the errors occurred.

The detail report displays all the information available for the error. Just as in the summary report, you can specify which error types you want to see.

Error Log Command Format

To generate an error log report, enter a command in the form:

errpt flags filenames

Note: Flags and filenames are optional parameters.

Filenames specifies the error log files. The **errpt** command accepts the following flags:

- s** *date* Ignore all records logged earlier than *date*. *Date* must be in the form *MMddhhmmyy*.
- e** *date* Ignore all records logged later than *date*.
- a** Produce a detailed report.
- n** *nodename* Include only error entries from *nodename* in the report.
- v** *vmid* Include only error entries from this system name (*vmid*) in the report.
- d** *list* Limit the report to the types of error record specified in *list*. For the values that can appear in *list*, see **errpt** in *IBM RT AIX Operating System Commands Reference*.

Step 1. Summary Error Log

Notes:

1. The following command examples are issued from the AIX shell command line.
2. If you are using Usability Services, you may want to run an error log using Usability Services. For more information on running an error log from Usability Services, see *IBM RT Usability Services Reference*.

CONTINUE to next page.

Step 2. Summary Error Log

All of the following steps assume you are using the AIX Shell. If you are not, see the notes on the preceding page.

To display a summary error log report:

1. Type the command:

```
errpt -s MMdd0000yy
```

The *MMddhhmmyy* is the date and time of the suspected error and must be entered in the following format. To look at all errors for a starting day, enter **0000** for the time.

| | |
|-------------------|---|
| 0525000085 | Using this example date the system will |
| | produce an error log report for errors |
| | occurring after May 25, 1985 at |
| year | 12:00 a.m. |
| | |
| minute | |
| | |
| hour | |
| | |
| day | |
| | |
| month | |

2. Press **ENTER**.

CONTINUE to next page.

ERROR LOG REPORT

Error log: /usr/adm/ras/errfile

| Date/Time | Class | Subclass | Type | Device | Cause |
|---------------------|--------------|------------|----------|--------|----------|
| Fri Aug 16 9:28:34 | IPL/Shutdown | Soft IPL | Info | | Info |
| Mon Aug 19 11:15:22 | IPL/Shutdown | Manual IPL | Info | | Info |
| Mon Aug 19 14:07:02 | Hardware | Diskette | Perm | DSKT | Hardware |
| Tue Aug 20 17:15:45 | Hardware | Diskette | Counters | DSKT | Info |

IS THE ERROR LOG REPORT DISPLAYED?

YES CONTINUE to next page.

NO Enter the command again. If the report still does not display, the error log file may not exist.

STOP, you have completed these procedures.

Step 3. Summary Error Log

The Error Log screen is divided into six areas: Date/Time, Class, Subclass, Type, Device, and Cause.

Look at the Date/Time column first.

| ERROR LOG REPORT | | | | | |
|---------------------------------|--------------|------------|----------|--------|----------|
| Error log: /usr/adm/ras/errfile | | | | | |
| Date/Time | Class | Subclass | Type | Device | Cause |
| Fri Aug 16 9:28:34 | IPL/Shutdown | Soft IPL | Info | | Info |
| Mon Aug 19 11:15:22 | IPL/Shutdown | Manual IPL | Info | | Info |
| Mon Aug 19 14:07:02 | Hardware | Diskette | Perm | DSKT | Hardware |
| Tue Aug 20 17:15:45 | Hardware | Diskette | Counters | DSKT | Info |

IS THERE A DATE AND TIME THAT CLOSELY MATCHES YOUR TIME OF ERROR?

YES CONTINUE to next page.

NO No entries were found in the error log.

STOP, you have completed these procedures.

Step 4. Detail Error Log

Display a detail error log report using the date and time of the suspected error.

1. Type the command:

```
errpt -a -s MMddhhmmyy
```

EXAMPLE

```
errpt -a -s 0525143585
```

A detail report for the error starting on May 25, 1985, at 2:35 p.m. will be displayed.

2. Press **ENTER**.

If there are more errors near the time you suspect the error occurred, look at the detail reports for those times also.

| ERROR LOG REPORT | | | | | | |
|---------------------------------|--------------|------------|----------|--------|----------|--|
| Error log: /usr/adm/ras/errfile | | | | | | |
| Date/Time | Class | Subclass | Type | Device | Cause | |
| Fri Aug 16 9:28:34 | IPL/Shutdown | Soft IPL | Info | | Info | |
| Mon Aug 19 11:15:22 | IPL/Shutdown | Manual IPL | Info | | Info | |
| Mon Aug 19 14:07:02 | Hardware | Diskette | Perm | DSKT | Hardware | |
| Tue Aug 20 17:15:45 | Hardware | Diskette | Counters | DSKT | Info | |

CONTINUE to next page.

```

                                ERROR LOG REPORT

Error Log: /usr/adm/ras/errfile

Date/Time          Class      Subclass   Type   Device  Cause
Mon Aug 19 13:03:52 Software  Appl Prog  Perm           Software

Program Error      Module_ID = cccccc      RC = xxxxxxxx

D01 = xxxxxxxx  D02 = xxxxxxxx  D03 = xxxxxxxx  D04 = xxxxxxxx
D05 = xxxxxxxx  D06 = xxxxxxxx  D07 = xxxxxxxx  D08 = xxxxxxxx
D09 = xxxxxxxx  D10 = xxxxxxxx  D11 = xxxxxxxx  D12 = xxxxxxxx
D13 = xxxxxxxx  D14 = xxxxxxxx  D15 = xxxxxxxx  D16 = xxxxxxxx

```

IS A DETAIL ERROR REPORT SHOWN?

- YES** For hardware errors, read and follow the instruction in the detail report.
- For software errors, use your normal problem reporting procedures.
- NO** Enter the command again. If command still fails, report the problem.

Section 4. The Trace Utility

(

(

(

Using the Trace Utility

This trace utility is used to track the system events when a program is running. By tracing, or tracking these events, a report can be made explaining the system's performance and actions.

This utility is run in background mode while using a program, to trace the steps and actions of the program. By using the trace, a possible problem with a program may be found.

The Trace Profile

Before you can start the trace, you must select the *trace profile* and the events you wish to trace. The trace profile is a file that contains the areas that can be traced and is provided with the system. Events are selected by using the system editor to change the file.

To edit the system trace profile:

1. Type the command:

```
e /etc/trcprofile
```

The trace profile is now displayed. See the following page for a sample trace profile.

2. Remove the asterisk (*) from the first column of the events you want to trace.
3. If the event has a data field, enter that information also.
4. File the profile.
5. Go to “Step 1. Starting the Trace” on page 4-5 to start the trace.

* SYSTEM TRACE PROFILE

- * To set trace on for an event class, remove the comment mark (*) from the first column of the line containing the event you wish to trace.
- * Add a comment mark (*) in the first column of lines containing event types you wish to stop tracing.

***** Event

* Type Description

***** Applications

***** UNIX Extensions

* 36 Config

***** UNIX System Calls

* 60 Shared Memory

* 61 Messages

* 62 Semaphores

* 63 Signals

* 64 Time

* 65 File System

* 66 File Handling

* 67 Directory Handling

* 68 Process

***** VRM Components

* 110 Async

* 112 Async Interrupts

* 113 Virtual Terminal Manager

* 114 Keyboard Interrupts

* 115 Locator Interrupts

* 150 User-Defined Events

Step 1. Starting the Trace

After the setup of the trace profile has been completed, you can start the trace.

1. Type the command:

```
trace&
```

2. Press **ENTER**.

The trace is on, now run the program you want to trace.

Step 2. Stopping the Trace

Once you have traced the information,

1. Type the following command to stop the trace:

```
trcstop
```

2. Press **ENTER**.

Creating the Trace Report

The trace report program is used to make a readable copy of the trace information. The output can be sent to a file, the display, or a printer.

To produce the report:

1. Type the command and if needed, the options:

```
trcrpt
```

The options are:

-s *date* Starting date/time desired in the formatted file.
Date/time format is *MMddhhmmyy*.

-e *date* Ending date/time desired in the formatted file.
Date/time format is *MMddhhmmyy*.

2. Press ENTER.

The display on the following page is an example of a trace report.

TRACE LOG REPORT

File: /usr/adm/ras/trcfile

Wed Feb 6 15:07:19 1985

System: Sys01

Node: Self

Version: 0

Machine: xxxx

| TIME | SEQ | PID | IODN | IOCN | TYPE | HOOK | DATA |
|-------------|------|-------|------|------|---------|---------|------------------|
| 09:01:20.57 | 0001 | 00015 | | | Process | alarm | seconds = 585 |
| 09:01:20.58 | 0002 | 00015 | | | Process | fork | newpid = 29 |
| 09:01:20.58 | 0003 | 00029 | | | Process | sgetpid | |
| 09:01:20.58 | 0004 | 00029 | | | Process | exec | errno = 0 |
| 09:01:20.59 | 0005 | 00029 | | | Process | exit | status = 0 |
| 09:01:21.00 | 0006 | 00015 | | | Time | time | time = 476562057 |

Summary of event counts.

Event 0: 2 Event 68: 43

Event 64: 16

Total number of events: 3

Section 5. Blinking Two-Digit Display Messages

CONTENTS

| | |
|---------------------------------------|------|
| About This Section | 5-3 |
| Errors Found at IPL | 5-4 |
| Errors Found During VRM Install | 5-14 |

About This Section

This section describes the messages that can appear on the two-digit display during IPL and while the VRM install process is running. The cause and recovery procedures are given for each message. Only blinking two-digit messages are described in this section. If a two-digit message is displayed that does not blink, see the *IBM RT Problem Determination Guide* to describe the hardware displays.

Errors Found at IPL

The error numbers found in this section are errors that are found by the loadlist processor during system IPL. Some of the errors are non-fatal. When a non-fatal error is sensed, the error number blinks for about ten seconds, and then the IPL continues.

For fatal errors, (errors that completely halt the IPL) the error number continues to blink until you IPL the system again.

Most of the errors found in this section are caused by programming errors. Examples of programming errors are: an error in a module that the loadlist processor loaded or executed, or an error in the loadlist processor code itself.

Since the user has the ability to install other software on the VRM minidisk, it is sometimes difficult to tell if the error occurred in IBM code, or in the user's code, if changes have been made to the VRM minidisk. For all errors that indicate a change may have been made to the VRM, the user should again install the VRM from his IBM-supplied diskette.

Once the VRM is installed again, IPL the system. If the problem still appears, use your normal problem reporting procedures.

02 Read error.

Cause: A read error occurred on the IPL device (either disk or diskette) during execution.

Action: If you were using a diskette to IPL, try again with a backup diskette. If you were using the disk to IPL, install the Virtual Resource Manager (VRM) again, then IPL the system. If error condition still exists, go to *IBM RT Problem Determination Guide* and follow the procedures for problem determination. If no problem is found before the "Diagnostic Selection" menu is displayed, run "System Checkout."

03 Not enough memory to load a module.

Cause: There was not enough free space in memory to load a module. If you have changed the VRM minidisk by adding code, then it is possible that an added routine is writing over the internal data fields of the loadlist processor.

If the VRM minidisk has not been changed, there may not be enough contiguous memory to load the system.

Action: If the VRM minidisk has been changed, install the VRM again. If error condition still exists, go to *IBM RT Problem Determination Guide* and follow the procedures for problem determination. If no problem is found before the "Diagnostic Selection" menu is displayed, run "System Checkout."

04 Not enough space for the Define Device Area (DDA).

Cause: There was not enough memory to allocate space for the DDA. See error **03** for possible causes and actions.

05 Not enough space for the Module Index Table (MIT).

Cause: The MIT contains an entry for each file that is loaded or mapped. Either there was not enough memory to allocate space for the MIT (see error **03** for more information), or there are more than 128 files in the loadlist (the files in the directory *ldlist*).

Action: If the number of files is over 128, the number must be decreased by removing files or changing permission bits, or installing the VRM again.

06 Not enough space for the Disk Table of Contents (DTC).

Cause: The DTC contains a list of disk addresses (or diskette addresses if the IPL was from diskette) for all modules that are loaded (permission bits = 440 or 410) or mapped (permission bits = 040). Either there was not enough memory to allocate space for the DTC (see error **03** for more information), or the amount of space reserved for the DTC was not large enough to contain all the disk addresses for all of the loaded or mapped modules.

Action: If additional code has been added to the VRM minidisk, it may be necessary to remove or change the permission bits for some of the loaded or mapped files until there is enough space in the DTC for all the disk addresses.

When IPL is from disk, each DTC disk address represents a 2,048 byte block on the disk. There is space in the DTC for 2,048 disk addresses. When IPL is from diskette, each DTC diskette address represents a 512 byte block on the diskette. There is space in the DTC for 8,192 diskette addresses.

If problems still exist it maybe necessary to install the VRM again.

07 Not enough space for the match list.

Cause: There was not enough memory to allocate space for the match list. See error **03** for possible causes and actions for this.

08 Relocation symbol type not supported (non-fatal)

Cause: One of the modules being processed by the loadlist processor has a relocation symbol type that is not supported. The *VRM Programming Support* describes the rules that must be followed for files with different permission bits in the loadlist and information on the TOC object module format.

The loadlist processor skips the module not supported and continues processing after displaying the error.

Action: If the VRM minidisk has been changed by adding code, find the failing module and remove it from the loadlist.

09 File type not supported (non-fatal)

Cause: The loadlist (directory name is *ldlist*) contains a file that has a file type other than the regular file or directory file. The loadlist processor skips this file and continues processing after displaying the error.

Action: If the VRM minidisk has been changed by adding additional code, remove the file in the loadlist that has an invalid file type.

10 Invalid device

Cause: The information contained in the POST Control Block for the IPL device does not contain a valid value. Since loadable POST routines that execute during IPL have access to the POST Control Block, any of these modules could have written the invalid value to this area of the POST Control Block.

Action: If the VRM minidisk has been changed by adding additional code, the invalid module must be found and removed, or install the original VRM to correct the problem.

11 Invalid index for address from inode.

Cause: This error may occur if the RT file system contained on the VRM minidisk (or VRM diskette) has been corrupted.

Action: If this error occurs when you IPL from the VRM minidisk, install the VRM again. If this error occurs when you IPL from diskette, use the backup diskette to IPL.

12 Inode out of range.

Cause: See error 11 for cause and action.

13 Address out of range.

Cause: See error 11 for cause and action.

14 File not found.

Cause: All files processed by the loadlist processor must be under a directory name *ldlist*. A directory file name *ldlist* was not found.

Action: If the VRM minidisk has been changed so that the directory name *ldlist* has been renamed or removed, correct the problem or install the original VRM again.

15 No freeblock header space.

Cause: The loadlist processor found an error in its internal data fields while trying to deallocate space.

Action: If the VRM minidisk has been changed by adding additional code, find and remove the module that is writing in the loadlist processor internal data fields, or install the original VRM again.

16 Freeing free space.

Cause: The loadlist processor is trying to deallocate space that is already free. This error can occur if an executed module writes over the internal data fields of the loadlist processor.

Action: See error 15 for recovery procedures.

17 Address already allocated.

Cause: The loadlist processor is trying to allocate space that has already been allocated for another module. Most modules that are loaded into memory by the loadlist processor are relocatable. Relocatable modules have an origin of X'60' (the origin of a module is information located in the TOC header of the module), and can be loaded into any free space in memory. If a module has a origin other than X'60', then an attempt

is made to load the module into memory at the address represented by the origin. If the module cannot be loaded because the required space is not free, the above error occurs.

Action: If the VRM minidisk has been changed by adding additional code, find and remove the failing module, or install the original VRM again.

18 Origin not on a word boundary.

Cause: A module that was to be loaded into memory by the loadlist processor has an origin that is not on a word boundary. All modules that are to be loaded are required to have an origin located on a word boundary.

Action: If the VRM minidisk has been changed by adding additional code, find and remove the module with the invalid origin, or install the original VRM again.

19 Invalid file name.

Cause: A file in the loadlist has a file name that is invalid. The *VRM Programming Support* describes the naming conventions for files processed by the loadlist processor.

Action: If the VRM minidisk has been changed by adding additional code, remove or rename the module with the invalid file name, or install the original VRM again.

20 Invalid IOCN in the file name (non-fatal)

Cause: The field containing the four character IOCN value is invalid for some file name in the loadlist. This field must contain a hexadecimal value from X'0001' to X'0400' for any module that has an IOCN. This field must be X'0000' for any module that does not have an IOCN.

The *VRM Programming Support* describes more information on the naming conventions for modules in the loadlist. The loadlist processor will skip this module and continue processing after displaying the error.

Action: If the VRM minidisk has been changed by adding additional, remove or rename the module with the invalid file name.

21 Invalid IOCN in the DDS (non-fatal).

Cause: A module that has been executed by the loadlist processor (permission bits = 700) has returned an entry for the Define Device Area (DDA) that has an invalid value for the IOCN in the Define Device Structure (DDS).

The loadlist processor will continue processing after displaying the error.

Action: If the VRM minidisk has been changed by adding additional code, remove the module that returned the invalid DDA entry.

22 Invalid length field in the DDA entry (non-fatal)

Cause: A module that has been executed by the loadlist processor (permission bits = 700) has returned an entry for the Define Device Area (DDA) that has an invalid value in the length field. The length must be greater than 0 and less than or equal to 2048 bytes. The loadlist processor will continue processing after display the error.

Action: See error 21 for recovery.

23 Execution of loaded program failed (non-fatal)

Cause: A module that has been executed by the loadlist processor (permission bits = 700) has returned an error code to the loadlist processor that indicates that execution of the program failed. The loadlist processor continues processing after displaying the error.

Action: If the VRM minidisk has been changed by adding additional code, find the module that returned the error and remove it.

24 No entry point was found.

Cause: The loadlist processor did not find any module with entry point X'1000'. This should be the VRM nucleus module (permission bits = 450). This is the module the loadlist processor passes control to and must be present.

Action: If the VRM minidisk has been changed by adding additional code, the VRM nucleus may have been deleted or replaced. Make sure a module exists in the loadlist that can receive control from the loadlist processor, or install the original VRM again.

25

Bad load module (non-fatal).

Cause: A module that was to be loaded by the loadlist processor has invalid information in the TOC header. This module will not be loaded, and the loadlist processor will continue processing after displaying the error.

Action: If the VRM minidisk has been changed by adding additional code, find the module that caused the error and remove it.

99

Machine or program check error.

Cause: Either a hardware problem has caused a machine check, or a coding problem has caused a program check.

Action: If the VRM minidisk has been changed by adding additional code, the problem may have been caused by the code. Install the original VRM again.

If error condition still exists, go to *IBM RT Problem Determination Guide* and follow the procedures for problem determination. If no problem is found before the "Diagnostic Selection" menu is displayed, run "System Checkout."

If installing the VRM again does not correct the problem and no hardware problems are found, use your normal problem reporting procedures.

Errors Found During VRM Install

The errors described in this section are those found during the VRM install process. All of the errors are fatal except for number 45 (base device missing) and the numbers continue to blink until you re-IPL the system or take the appropriate action specified.

45 Base device missing.

Cause: There is not a functional adapter present for any of the display lposts that ran, or the keyboard is missing.

Action: Insert a "device diskette" for a display adapter that is present. Or install an adapter for one of the display lposts. Or plug in a keyboard.

46 VRM install error.

Cause: Internal problem in the VRM install code.

Action: Contact your local service representative.

47 VTCP command error

Cause: The **Inst.Batch** file on the "device diskette" has a VTCP command that is invalid.

Action: Contact the supplier of the "device diskette."

48 **Define code failure.**

Cause: A define code SVC was attempted for a file on the VTCP command line in the **Inst.Batch** file. The SVC failed and the code was not defined into the system.

Action: Contact the supplier of the "device diskette."

49 **No space for file.**

Cause: This is probably a logic error and installing more memory will not solve the problem.

Action: Contact the supplier of the "device diskette."

50 **CP define device failed.**

Cause: A define device SVC was attempted on the control program specified on the VTCP command line in the **Inst.Batch** file. The SVC failed and the control program was not added into the system.

Action: Contact the supplier of the "device diskette."

51 **CP attach device failed.**

Cause: An attach device SVC was attempted on the control program specified on the VTCP command line in the **Inst.Batch** file. The SVC failed and the control program was not attached to the virtual machine.

Action: Contact the supplier of the "device diskette."

52 Device driver define device failed.

Cause: A define device SVC was attempted on the device driver specified on the VTCP command line in the **Inst.Batch** file. The SVC failed and the device driver was not added into the system.

Action: Contact the supplier of the "device diskette."

53 VTRM define device failed.

Cause: A define device SVC was attempted on the VTRM. The SVC failed and the VTRM was not added into the system. The VTRM DDS used was that supplied by the control program.

Action: Contact the supplier of the "device diskette."

54 The VTMP could not be bound to its display.

Cause: The virtual display driver could not be linked to the virtual terminal.

Action: Contact the supplier of the "device diskette."

55 Read error.

Cause: A read error occurred during the VRM install process.

Action: Try a backup diskette if you have one or contact the supplier of the diskette.

Appendix A. The VRM Maintenance Facility (VMF)

CONTENTS

| | |
|---|------|
| About This Appendix | A-3 |
| VRM Maintenance Facility (VMF) Overview | A-4 |
| Command Format | A-5 |
| Help Text | A-7 |
| Messages | A-8 |
| The Batch Facility | A-8 |
| Commands | A-9 |
| amd | A-9 |
| cd | A-10 |
| chmod | A-11 |
| cpy | A-11 |
| crmd | A-12 |
| debug | A-14 |
| dlmd | A-15 |
| dosread | A-15 |
| echo | A-17 |
| exec | A-18 |
| flick | A-18 |
| format | A-19 |
| hd | A-20 |
| hdf | A-20 |
| hfck | A-21 |
| help | A-22 |
| inst | A-22 |
| instf | A-23 |
| li | A-23 |
| mc | A-24 |
| mkfs | A-25 |
| pause | A-26 |
| pf | A-26 |
| pwd | A-27 |
| qi | A-27 |
| quit | A-28 |
| qvm | A-28 |
| remark | A-28 |
| rm | A-29 |
| search | A-29 |
| setattr | A-30 |
| vfy | A-31 |
| vm | A-31 |

About This Appendix

This appendix contains a description of the VRM Maintenance Facility (VMF) and its uses as a tool, and also a brief description of each of the commands that are available in the tool.

VRM Maintenance Facility (VMF) Overview

VMF is a standalone tool you can use to display and modify data on direct access storage — both fixed disk and diskette. The primary purpose of the tool is to help diagnose problems with the fixed disk when the problem has made the system inoperable. You can, however, also use VMF as a standalone tool to install VRM software or its associated device drivers. VMF runs as a diskette based, standalone, virtual machine. VMF is available on the VRM install diskette as an option on the install menu. To use VMF, select the Maintenance Facility on the Install menu and then enter VMF commands on the command line.

The following is a list of the commands that make up the tool:

| | |
|----------------|--|
| amd | Alter disk or diskette data |
| cd | Change (or establish) the default device and directory for VMF |
| chmod | Change access permissions of an AIX file |
| cpy | Copy using relative sectors |
| crmd | Create a minidisk |
| debug | Invoke the VRM Debugger |
| dlmd | Delete a minidisk |
| dosread | Copy a file from a DOS diskette to an AIX file system |
| echo | Turn command echo on or off in batch mode |
| exec | Execute commands from a batch file |
| fck | Repair file system free block list |
| format | Initialize the track format on a disk |
| hd | Display data on a fixed disk or diskette |
| hdf | Display the contents of an AIX file |
| help | Display a list of VMF commands |
| hfck | Check fixed disk for bad blocks |
| inst | Copy a DOS file to a minidisk |
| instf | Copy an AIX file to a minidisk |
| li | List the names in an AIX file system directory |
| mc | Copy an entire minidisk to another minidisk |
| mkfs | Make an AIX file system |
| pause | Wait for the user to press a key in batch mode |
| pf | Patch a file in an AIX file system |
| pwd | Determine the present working directory |
| qi | List the minidisk IODN's on the system fixed disks |

| | |
|----------------|--|
| quit | Terminate the VMF |
| qvm | Display virtual machine information |
| remark | Make a batch file comment |
| rm | Delete a file from a file system |
| search | Search for a character string |
| setattr | Set minidisk attributes |
| vfy | Verify (compare) data on different devices |
| vm | IPL a virtual machine. |

Command Format

You enter all VMF commands on the display command line (line 24). The basic command format is:

command *parm1* *parm2* ...

where **command** is the command itself and *parm1* and *parm2* are parameters. The number and types of parameters vary between the commands. The maximum number of parameters for any VMF command is 15 and the maximum length of the command with parameters and flags is 80 characters (the display line length). Flags are also available for some commands. Flags are optional and are preceded by the - (dash) character. A flag changes the way the command functions. For example, the **-p** flag on the **hd** command causes the output to appear on the printer rather than the display.

Parameters

The following are descriptions of the most common parameters you supply for the commands:

iodn

This is an input/output device number for a fixed disk, a diskette, or a minidisk:

- Fixed disk *iodn* values are 1, 2, and 3.
- Diskette *iodn* values are 4 and 5.
- Minidisk *iodn* values are in the range 16384 through 32767.

minidisk_ID

This is a minidisk identifier and can be either the minidisk iodn or the minidisk name. For example, **hd0** is the name for the minidisk containing the AIX root file system and **hd6** is the name for the minidisk containing the VRM file system.

devaddr

This is the device address and can be:

- A device iodn (fixed disk or diskette)
- A minidisk iodn
- A minidisk name.

dosname

This is a PC/DOS file name. DOS directories are not supported.

AIXname

This is an AIX file identifier and must contain a complete file system pathname beginning with the device and the directory on the device (**/hd0/usr** for example).

You can however, use the VMF **cd** command to save keystrokes by establishing a current default device and directory for VMF. For example, if you want to access AIX file **myfile** in directory **usr/bin** on the **hd0** minidisk, the complete *AIXname* is **/hd0/usr/bin/myfile**. If you had used the **cd** command and established **/hd0/usr/bin** as the current default device and directory for VMF, you could merely specify **myfile** for the *AIXname* parameter.

If VMF finds a / (slash) as the first character of *AIXname*, it assumes it to be a complete path name beginning with the *devaddr* (such as **/hd0**). If VMF does not find a / as the first character (such as **myfile**), and you have used the **cd** command to establish a default device and directory path for VMF, the name entered on the command line is appended to the default. If you have not established a default, the name entered is appended to / (slash). If you have established a current device and directory for VMF and you want to access an AIX file on another minidisk, you either have to supply the full file

identifier for the other minidisk or use the `cd` command and establish a new default.

VMF does not support mounting of file systems onto the system **root** directory.

sec#

This is a sector number (decimal). The first sector number on a device is 0.

Syntax

The following characters that appear in some of the commands have the following special meaning:

- The characters `< >` surrounding a parameter indicate the parameter is optional. For example, `<parm2>` indicates that *parm2* is an optional parameter. A condition such as `<parm2 <parm3> >` means that *parm2* and *parm3* are both optional but you can only supply *parm3* if you have also supplied *parm2*.
- The `|` character is the logical **or** symbol and means you can use one of two or more parameters but not more than one. For example, `parm1 | parm2` means you can choose either *parm1* or *parm2* but not both.

You must enter characters as they are shown in the following descriptions and in the help text available on the display. All characters in the commands and parameters are case-sensitive except for DOS file names.

Help Text

This publication contains a brief description of each command. Help text for each command is available on the display when VMF is active. The help text also provides a description of each command and how to use it. To display the help text, enter the command name and a `?` on the command line. For example,

`d1md ?`

displays the help text for the delete minidisk command.

Messages

VMF issues the following three types of messages:

- General syntax errors
- Specific user errors
- Messages on behalf of the VRM.

For syntax errors, VMF displays a short message that shows the correct syntax.

For specific user errors, VMF displays a message that identifies the parameter in error.

When VMF issues an SVC for the operator and an error occurs, pertinent information about the error is displayed.

The Batch Facility

The VMF batch facility allows you to run VMF commands from a prepared list in a file. All VMF commands are valid in batch mode and in addition, the following commands are specifically for the batch facility:

| | |
|---------------|--|
| echo | Turn command echoing on and off, or display a message. |
| exec | Run a batch file. |
| pause | Wait for the operator to press the Enter key. |
| remark | Allow a comment in a batch file. |

Batch Files

A batch file is a text file on a DOS diskette that contains VMF commands. When you run a batch file, you must leave the diskette in the drive until all of the commands have completed. You need an operating system such as AIX or PC DOS to create a batch file.

Batch Variables

You can supply the batch file up to 10 variables on the **exec** command. The variables are sequentially assigned the symbols %0 through %9 beginning with the batch file name. For example, if you enter

```
exec listit /hd0/usr/bin
```

on the command line, then symbol %0 is assigned the variable **listit** and symbol %1 is assigned the variable **/hd0/usr/bin**. If the batch file named **listit** contains

```
li %1
```

then the **li** command displays the contents of directory **/usr/bin** on minidisk **hd0**.

Commands

The following are descriptions of the VMF commands. A description of each command is available on the system when VMF is active by entering *command ?* on the command line.

amd

Use **amd** to modify data on fixed disks, diskettes, and minidisks.

Format:

```
amd devaddr block# offset w1 w2 . . .
```

Parameters:

devaddr

This is the device address.

block#

This is the block number (the first block number is 0).

offset

This is the hexadecimal offset into *block#*.

w1 w2 ...

These are the 4-byte words of data to be placed starting at *offset*. You can enter each word of data without leading zeros. Each word must be separated by one or more blanks.

cd

Use **cd** to establish or change the current default device and directory for VMF in order to save keystrokes when using the VMF commands.

Format:

cd *path*

Parameters:

path

This becomes the current default device and directory for VMF.

Example:

If you specify

`cd /hd0/usr/bin`

then **/hd0/usr/bin** becomes the VMF default path name prefix each time you supply *AIXname* (such as **myfile**) without a

leading / (slash). In this case, the complete *AIXname* becomes */hd0/usr/bin/myfile*.

chmod

Use **chmod** to change the read/write permission bits in a file inode.

Format:

chmod *OOO AIXname*

Parameters:

OOO

This is the octal representation of the 9 permission bits.

AIXname

This is the path name of the file to change.

cpy

Use **cpy** to copy blocks of data. If you copy from one minidisk to another, they must have the same logical block size.

Format:

cpy *devaddr1 block#1 devaddr2 block#2 #blocks*

Parameters:

devaddr1

This is the source device for the block data.

devaddr2

This is the target device for the block data. *devaddr2* can be the same as *devaddr1*.

block#1

This is the beginning sector number on the source device.

block#2

This is the beginning block number on the target device.

#blocks

This is the number of blocks of data to transfer.

crmd

Use **crmd** to create a minidisk on a fixed disk.

Format:

crmd *iodn blksz #blks -dreald -nname -ssec# -aattr*

Flags:

-d

This option lets you specify the fixed disk to contain the new minidisk. If this option is not specified, the default is the first available space starting with fixed disk **hdisk0** (*iodn* 1). If you specify 0 for *reald*, it acts the same as the default.

-n

This option lets you specify the minidisk name up to a maximum of 4 characters. If you do not use this option you access the minidisk by *iodn* in subsequent operations.

-s

Use this option to specify the starting sector number for the new minidisk on the real device. This option should only be used when the **-d** flag is also specified.

-a

This option lets you specify the attributes for the new minidisk.

Parameters:

iodn

This is the iodn for the new minidisk.

blksz

This is a multiplier digit in the range of 1 through 16 that specifies a block size as a multiple of 512 bytes. For example, if you specified 1, the block size would be 512; if you specified 2, the block size would be 1024.

#blks

This is the size of the minidisk in blocks.

reald

This is the iodn of the device to contain the new minidisk.

name

This is the name of the new minidisk. The maximum number of characters is 4.

sec#

This is the starting sector number for the new minidisk on the device specified in *reald*.

attr

This is a character string containing the attributes for the new minidisk. The string can contain one or more of the characters **p**, **n**, **v**, **l**, **m**, or **h**. The characters have the following meaning:

p

This specifies the page space attribute.

n

This specifies the no bad block relocation attribute.

v

This specifies the write verify attribute for this minidisk.

l, m, h

This specifies the low, medium or high starting position for the new minidisk on the real device. These attributes are ignored if the -s option is specified.

debug

Use **debug** to invoke the VRM Debugger when the specified virtual machine is next dispatched. **debug** can only be used when VMF is IPL'ed directly from the fixed disk. See "instf" on page A-23 for a description of how to install VMF on the fixed disk.

Format:

debug <*vmid*>

Parameters:

vmid

This is the id, in the range 1 through 255, of the virtual machine to be debugged.

Example:

If you want to debug virtual machine 2 you enter

```
debug 2
```

The VRM Debugger is invoked when VM 2 is dispatched. It is not invoked immediately. When you get control in the debugger, it is the VM 2 environment.

dlmd

Use **dlmd** to delete a minidisk.

Format:

dlmd *minidisk_id* <*reald*>

Parameters:

minidisk_id

This is the iodn or name of the minidisk being deleted.

reald

This is the fixed disk IODN on which the minidisk resides. If you have more than one minidisk with the same name on different minidisks, you should specify this parameter.

dosread

Use **dosread** to copy a file from a DOS diskette to an AIX file system on a minidisk.

Format:

dosread *dosname* *AIXname* -**m***OOO* -**i***name*

Flags:

-m

Use this option to provide the permission bits for the new AIX file.

-i

Use this option to insert the new AIX file after the specified name in the target directory.

Parameters:

dosname

This is the name of the DOS file being copied including the diskette drive name (such as **b:**) if other than the first.

AIXname

This is the path name of the AIX file being created.

OOO

This is the octal representation of the 9 permission bits for the new AIX file.

name

The new AIX file is to be inserted after this name in the target directory.

Example:

If you enter

```
dosread vrmnuc /hd6/ldlist/vrmbase/vrmnuc.0001.00 -ilvrmnc.0000.00
```

on the command line, DOS file **vrmnuc** is copied from the first diskette drive to the filesystem on the **hd6** minidisk. The file is named **vrmnuc.0001.00** and it is placed after the name **lvrmnc.0000.00** in directory **/ldlist/vrmbase**.

If you enter

```
dosread b:myfile /hd0/usr/myusr/myfile -m444 -i..
```

on the command line, DOS file **myfile** is copied from the second (drive **b**) diskette drive to the filesystem on the **hd0** minidisk. The file is named **myfile** and it is placed after the **..** entry in directory **/usr/myusr**. The 9 access permission bits for the new AIX file are octal 444.

echo

Use this batch facility command to turn command echoing on or off, or to display a message on the display. When echoing is on, each command in the file is displayed on the screen as it starts to run.

Format:

echo <ON | OFF | *string*>

Parameters:

ON

Turn command echoing on. This is the default.

OFF

Turn command echoing off.

string

Display this string of data on the screen.

Example:

The following is a batch file fragment that shows how you might use the **echo** command:

```
echo off
echo Insert diskette into drive 5
pause
.
.
.
```

exec

Use this batch facility command to run the commands in a VMF batch file. This command is usually entered on the command line, however, you can use this command in a batch file to transfer control to another file and start running the commands contained there. Control does not return to the original file.

Format:

exec *dosname* < *var1 var2 . . . var9*>

Parameters:

dosname

This is the name of the batch file containing the VMF commands.

var1 . . . var9

These are optional variables to be passed to the commands in the batch file *dosname*.

flck

Use the flck command to repair a file system free block list. This is useful when a file system has no available free blocks because the command may make more space available.

Format:

flck *minidisk_id*

Parameters:

minidisk_id

This identifies the minidisk containing the file system to repair.

format

Use the **format** command to initialize the track format of a new disk. This command is used only for disks that have not been initialized for the RT-PC.

Format:

format *iodn*

Parameters:

iodn

This identifies the drive to format. It can be a 1, 2 or 3 that corresponds to drives in slot C, D or E respectively.

VMF attempts to determine if the disk has any previous initialization data. If it does, it uses this data when re-formatting. If the disk was un-initialized, VMF presents a menu that allows specification of drive data. The parameters required are:

- Number of cylinders
- Number of heads
- Number of sectors
- Precompensation cylinder
- Average seek speed (actuator speed).

VMF hangs after a successful format. A re-IPL of the Install program initializes the new drive in the system. It is strongly recommended that you run the RT-PC diagnostics Format option on the drive before you put data on the drive. This stresses the drive in an attempt to find any defective tracks.

Note: This command destroys all information that resides on the disk including defect lists, directories and user data.

hd

Use **hd** to display data residing on a fixed disk or diskette.

Format:

hd *devaddr sec#1 sec#2 -p*

Flags:

-p

Use this option to send the data to the printer instead of the display.

Parameters:

devaddr

This specifies the device that contains the data.

sec#1

This specifies the first sector of data to be displayed.

sec#2

This specifies the last sector of data to be displayed.

hdf

Use **hdf** to display the contents of an AIX file.

Format:

hdf *AIXname <fromoffset <tooffset>> -p*

Flags:

-p

This option sends the data to the printer instead of the display.

Parameters:

AIXname

This is the path name of the AIX file.

fromoffset

This optional parameter specifies the offset (hexadecimal) from the beginning of the file to start displaying data. If this parameter is not specified, the default is 0.

tooffset

This optional parameter (if *fromoffset* is specified) provides the offset (hexadecimal) from the beginning of the file to quit displaying data. If not specified, 128 bytes are displayed.

hfck

Use the hfck command to check a fixed disk bad block relocation area for bad blocks detected by the system during a read operation. This function may be able to relocate these bad blocks successfully. This is useful when a file system has no available free blocks because the command may make more space available. This command is available only when VMF is diskette based. VMF hangs after this command completes and a message is displayed telling you to restart the system.

Format:

hfck *reald* | * -v

Parameters:

reald

This identifies the fixed disk input/output device number to repair. If '*' is specified, all fixed disks are checked.

Flags:

-v

When this option is specified, VMF determines the file names in which unrelocated bad blocks reside.)

help

Use the **help** command without parameters to display the complete list of VMF commands. To get help for a particular command, enter the command name followed by a ? (question mark).

Format:

help

inst

Use the **inst** command to copy a DOS file to a minidisk. The file is copied sequentially starting at sector 0 of the minidisk. The previous contents of the minidisk are destroyed.)

Format:

inst *dosname minidisk_id*

Parameters:

dosname

This is the name of the DOS file to be transferred and must contain the diskette drive identifier (such as **b:**) if other than the first drive.

minidisk_id

This identifies the minidisk to receive the file.)

instf

Use the **instf** command to copy an AIX file to a minidisk. The file is copied sequentially starting at sector 0 of the minidisk. The previous contents of the minidisk are destroyed.

Format:

instf *AIXname minidisk_id*

Parameters:

AIXname

This is an AIX file identifier and must contain a complete file system pathname beginning with the device and the directory on the device (**/hd0/usr** for example).

minidisk_id

This identifies the minidisk to receive the file.

You can use this command to install VMF directly on a minidisk. To do so, make sure the VRM Install diskette is in the top drive and then issue the following commands:

```
crmd iodn 550 -nvmf
instf /4/ldlist/vrinst.0050.00 vmf
```

and then use the **setattr** command to make VMF an auto-IPL minidisk.

li

Use **li** to display the contents of an AIX directory. The entries are displayed in the order they physically exist in the directory.

Format:

li <*AIXname*> **-p**

Flags:

-p This flag sends the output to the printer instead of the display.

Parameters:

AIXname
This is the path name of the directory to be listed. If not specified, the current directory is displayed.

mc

Use **mc** to copy the entire contents of one minidisk to another. Both minidisks must have the same block size but they can differ in size. The data is truncated if the target minidisk is smaller than the source minidisk. In this case, an informational message is issued but the copy proceeds. If the target is larger than the source, the extra space is unchanged.

Format:

mc minidisk_id1 minidisk_id2

Parameters:

minidisk_id1
This is the source minidisk.

minidisk_id2
This is the target minidisk.

mkfs

Use **mkfs** to create an AIX file system on a minidisk or diskette.

Format:

```
mkfs minidisk_id | diskette_iodn <#blocks> <#iblocks>
```

Parameters:

minidisk_id

This identifies the target if it is a minidisk.

diskette_iodn

This identifies the target if it is a diskette.

#blocks

This is the size of the new file system (the default is 540):

Minidisk — This is the number of 2K blocks for the file system. Because there is an underlying 512-byte sector size, this number should not be larger than the number of sectors on the minidisk divided by 4.

Diskette — For a diskette, this is the number of 512-byte blocks for the file system.

#iblocks

This is the number of logical blocks in the I list (the default is 5):

Minidisk — This is the number of 2K blocks in the I list.

Diskette — This is the number of 512-byte blocks in the I list.

pause

Use this batch facility command to wait until the operator presses the **Enter** key. When the batch facility encounters this command in a batch file, it displays the message Press Enter to continue and then waits for the keystroke. There are no parameters for this command.

Format:

pause

pf

Use **pf** to change data in an AIX file.

Format:

pf *AIXname offset olddata newdata newdata . . .*

Parameters:

AIXname

This is the path name of the file being changed.

offset

This is the hexadecimal offset from the beginning of the file to start changing data. This offset must be on a word boundary (divisible by 4).

olddata

This is the first word of data currently stored at *offset* in the file. You do not have to supply leading zeros. If *olddata* does not match the word of data at *offset*, VMF does not change the file.

newdata . . .

These are the words of data to be placed in the file beginning at *offset*. Note that only the first word is verified.

pwd

Use this command to determine the present working directory.

Format:

pwd

qi

Use **qi** to display a list of minidisks defined on the fixed disks. If you do not specify one or more minidisk IDs, all the minidisks are listed. If you specify 0 for one of the minidisk IDs, you get a list of all fixed disk free space.

Format:

qi <*minidisk_id1 minidisk_id2 . . .*> **-p**

Flags:

-p

This flag sends the output to the printer instead of the display.

Parameters:

minidisk_id

This is the ID of the minidisks to be listed. The default is all minidisks.

quit

Use this command to terminate the VMF.

Format:

quit

qvm

Use the **qvm** command to display information about the virtual machines running in the system. The command displays the VMID and IPL IODN for the VMID requested on the command line.

Format:

qvm *<vmid>*

Parameters:

vmid

This is a virtual machine identifier for which you want information. If not specified, information on all virtual machines running in the system is displayed.

remark

Use **remark** to put comments in batch files. The comment is treated as a null command.

Format:

remark *comment*

Parameters:

comment

This is any comment that fits on one line.

rm

Use **rm** to remove a file from an AIX file system. You can remove files and directories. However, the directories must be empty. An error message is the result if you attempt to remove a directory that is not empty.

Format:

rm *AIXname*

Parameters:

AIXname

This is the path name of the AIX file or directory to be removed.

search

Use the **search** command to search for a character string on an AIX minidisk or in an AIX file.

Format:

search *AIXname* | *minidisk_iodn* *string* **-v**

Flags:

-v

You may use this option when searching an entire minidisk for a string. Additional information is given for each occurrence of the string on the minidisk.

Parameters:

AIXname

This is an AIX file identifier and must contain a complete file system pathname beginning with the device and the directory on the device (**/hd0/usr** for example).

minidisk_iodn

This is a minidisk, input/output device number. Specify a minidisk IODN when you want to search an entire minidisk for occurrences of a string. Minidisk names cannot be used because minidisk names and AIX names are ambiguous.

string

This is the search argument. The search command searches for ascii strings or hexadecimal strings. Ascii strings are specified by starting and ending the string argument with a single quote character. To search for a single quote, put two single quote characters together in the string. For example you would specify

```
search . . . 'don't'
```

to search for the word don't. String arguments that do not begin with a single quote character must be valid hexadecimal numbers.

setattr

Use this command to set on or set off minidisk attributes as defined in the *VRM Technical Reference Manual*.

Format:

```
setattr minidisk_id
```

Parameters:

minidisk_id

This identifies the minidisk.

This command results in two menus each of which has a numbered list of minidisk attributes. Use the first menu to set on desired attributes; use the second menu to set off desired attributes. If you press **Enter** for either menu without entering any attribute numbers, no attributes are changed for that menu.

vfy

Use **vfy** to verify that two areas of data are identical. If the areas are on different minidisks, the minidisks must have the same logical block size.

Format:

```
vfy devaddr1 sec#1 devaddr2 sec#2 #sectors -p
```

Flags:

-p Send messages to the printer instead of the display.

Parameters:

devaddr1 devaddr2
This identifies the devices that contain the data. These parameters can be the same.

sec#1
This is the starting sector number on *devaddr1*.

sec#2
This is the starting sector number on *devaddr2*.

#sectors
This is the number of sectors to verify.

vm

Use **vm** to IPL a virtual machine.

Format:

```
vm minidisk_id <vmid>
```

Parameters:

minidisk_id

This identifies the minidisk containing the virtual machine.)

vmid

This is an optional parameter that specifies a VM number for the machine being IPLed. If omitted, the next available VMID is used.)

Appendix B. Error Log Entries

(

(

(

CONTENTS

| | |
|---|------|
| About This Appendix | B-3 |
| Error Log Entry Types | B-3 |
| Subclass = 02 Abnormal Termination (ABEND) | B-6 |
| Subclass = 03 AIX Program Error | B-7 |
| Subclass = 04 AIX Device Driver Program Error | B-7 |
| Subclass = 07 VRM Component Program Error | B-9 |
| Subclass = 08 Application Program Error | B-24 |

About This Appendix

This appendix lists some of the software entries that you could receive. There is no action you can take with most of the possible error log entries except to report the problem. However, it is thought that with the entries listed here, you might have caused the problem with your program or your operation and you might be able take action to further diagnose and solve the problem. Because of the nature of software problems, none of the actions (when one is offered) are guaranteed, and the list is not guaranteed to be complete. And just because an entry is listed here, it doesn't guarantee the problem was caused by you or your program and not by the system software.

Error Log Entry Types

Figure B-1 on page B-4 is a list of the different error log types.

| Class | Type | Subclass | Mask | Subclass Type |
|-------|----------|---------------|------|---------------------------------|
| 01 | Hardware | all | all | |
| 02 | Software | 01 | | ROMP program check |
| | | 02 | | ABEND |
| | | | 01 | Dump taken |
| | | | 02 | No dump taken |
| | | 03 | | AIX Program Error |
| | | | 03 | AIX kernel |
| | | 04 | | AIX device driver program error |
| | | | 01 | Base LAN device driver |
| | | | 02 | 5080 peripherals |
| | | | 03 | SSLA device driver |
| | | 05 | | AIX device driver program error |
| | | 06 | | VRM base program error |
| | | | 01 | VRM attach |
| | | 07 | | VRM component program error |
| | | | 02 | Virtual terminal manager |
| | | | 03 | PC/AT coprocessor driver |
| | | | 04 | 5080 display driver |
| | | | 05 | 5080 peripherals device driver |
| | | | 06 | Generic block I/O device driver |
| | | 08 | | Applications |
| | | | 01 | Error log analysis |
| | | | 02 | Interactive workstations |
| | | | 03 | Base LAN |
| | | | 04 | Coprocessor control program |
| | | | 05 | SRC Server Support |
| | | 09 through 0F | | Customer Applications |

Figure B-1 (Part 1 of 2). Error Log Entry Types

| | | | |
|----|--------------------------------|-----|------------------------|
| 03 | IPL/Shutdown | 01 | Manual IPL |
| | | 02 | Soft IPL |
| | | 03 | Auto IPL |
| | | 04 | Shutdown |
| | | 05 | Maintenance shutdown |
| | | 06 | Multi-user shutdown |
| 04 | General System Condition | 01 | Degraded configuration |
| | | 02 | Set date/time |
| | | 03 | Server no start |
| | | 04 | Cause codes |
| | | 05 | LPOST results |
| 06 | User defined | All | |

Figure B-1 (Part 2 of 2). Error Log Entry Types

The following are descriptions of some error log entries. Some of the descriptions provide actions you can take in an attempt to eliminate or further diagnose the problem. An attempt has been made to list only the error log entries that can be caused by external actions or application programming. If a description found here is not helpful in resolving the problem, or if there is no description here for an entry you feel is pertinent to your problem, then document the problem and submit it to your service person.

All of the entries are software and are listed by subclass and mask. Within each mask category, the entries are distinguished by module and by return code.

Subclass = 02 Abnormal Termination (ABEND)

Mask = 00 VRM ABEND Message

A machine check has occurred.

A ROMP machine check occurred that was probably caused by a hardware failure. See *Hardware Technical Reference* for definitions of machine check status.

An IAR protection exception has occurred.

An attempt was made to execute an instruction in unauthorized memory.

A page fault occurred that could not be processed by the VRM.

A page fault occurred but the VRM was not in an appropriate state to process it. The most common cause is a page fault in an interrupt handler.

All paging space is in use.

The paging space is full. Use the VRM installation utility to increase the size of the paging space minidisk.

The VRM does not have enough real memory to continue.

A process or virtual machine tried to pin too much memory.

The VRM has encountered initialization data that is not valid.

Invalid data was passed to the VRM by the loadlist processor or one of the loadable posts.

The VRM is unable to allocate a system control block.

Either too many control blocks are in use or no more real memory is available.

An I/O channel error has occurred.
This error is probably caused by a bad device on the bus.

Subclass = 03 AIX Program Error

Mask = 03 AIX Kernel

The AIX kernel issues messages that are displayed on the console. These messages appear in the error log and are documented in *Messages Reference*.

Subclass = 04 AIX Device Driver Program Error

Mask = 01 Base LAN Device Driver

RC = (errno) vec_init call

There are no more interrupt sublevels available for the device. Too many devices are using the same interrupt level.

If you created some of your own devices, move some of the devices to another interrupt level and restart the machine. See *AIX Operating System Technical Reference* under Creating Device Drivers for information about the **vec_init** call.

RC = 16 ATTACH SVC

The ATTACH SVC failed.

See *VRM Programming Support* for an explanation of the return code. Possible reasons and actions to take:

-
- The device was not installed properly. Reinstall the Base PC Network Services program and try again.
 - Another device in Kernel has attached to the adapter card. Only one attach is allowed per virtual machine.

RC = 16 DETACH SVC

The DETACH SVC failed.

See *VRM Programming Support* for information about return codes. You may have to shut down and restart the machine in order to put the network device in a known state.

RC = 256 SIO - ncb command = 05

An invalid **ncb** command was issued in the **ncb** passed to the device.

Verify that the program using the **ncb** is using a valid **ncb** command value. Use the trace facility to determine what command value was passed.

RC = 257 SIO - ncb command = B0

An invalid parameter was passed to VRM in the Start I/O SVC call.

If the error persists, reinstall the Base PC Network Services program to replace the required files.

RC = 258 SIO - ncb command = 35

An attempt was made to cancel an **ncb** command that is not valid to cancel.

If the error occurred in your program, verify that the program only tries to cancel **ncb** commands that are valid as described in *Base PC Network Services*. If the error occurred in the AIX kernel cleanup routine, ensure that

your program does not close the device with outstanding **ncb's** issued.

RC = 259 SIO - ncb command = B0

There were insufficient resources on the adapter card when the **ncb** was issued.

Issue the **ncb** again because the resources may now be free. If the condition persists, verify that the number of **ncb's** allowed for the adapter card is sufficient for the number of users for the card and **ncb's** issued. Use the **devices** command to check the current value and change it if necessary.

RC = 260 SIO - ncb command = 30

An **ncb** was issued while the adapter card was being reset.

Verify that other users or programs on the RT PC do not issue **ncb reset** commands. This command clears the adapter status, name tables, and session tables. The trace facility may show the **reset** command occurring and may help in locating the program that issued the reset. The program running should be restarted.

Subclass = 07 VRM Component Program Error

Mask = 02 VRM component - Keyboard, Locator, and Sound Device Driver

Module_ID = KDDMAIN RC = 03 D01 = 01

The main entry point was called for a **DEFINE DEVICE** request with an invalid IODN.

Module_ID = KDDMAIN RC = 03 D01 = 02

The main entry point was called for an **initialization** request with an invalid IODN.

Module_ID = KDDMAIN RC = 03 D01 = 03
The main entry point was called for a **terminate device** request with an invalid device ID.

Module_ID = KDDMAIN RC = 02 D01 = 04
The main entry point was called with an invalid operation type.

Module_ID = KDDMAIN RC = 01 D01 = 05
The keyboard initialization routine called **_CHANGE** and received a non-zero return code.

Module_ID = KDDMAIN RC = 01 D01 = 06
The keyboard initialization routine called **_CHANGE** and received a non-zero return code.

Module_ID = KDDMAIN RC = 04 D01 = 07
The keyboard initialization encountered a DDS specifying that the device was not working at the time of the LPOST.

Module_ID = KDDMAIN RC = 01 D01 = 08
The locator initialization routine called **_CHANGE** and received a non-zero return code.

Module_ID = KDDMAIN RC = 01 D01 = 09
The locator initialization routine called **_CHANGE** and received a non-zero return code.

Module_ID = KDDMAIN RC = 04 D01 = 10
The locator initialization encountered a DDS specifying that the device was not working at the time of the LPOST.

Module_ID = KDDMAIN RC = 01 D01 = 11
The sound initialization routine called
_CHANGE and received a non-zero return
code.

Module_ID = KDDINTR RC = 01 D01 = 01
The second level interrupt handler entry point
called _DEQUE for the keyboard device driver
queue for an empty click buffer and received a
non-zero return code.

Module_ID = KDDINTR RC = 01 D01 = 02
The second level interrupt handler entry point
called _DEQUE for the sound device driver
queue for an empty volume buffer and received
a non-zero return code.

Module_ID = KDDINTR RC = 01 D01 = 03
The second level interrupt handler entry point
called _DEQUE for the keyboard device driver
queue for an empty keyboard buffer and
received a non-zero return code.

Module_ID = KDDINTR RC = 01 D01 = 04
The second level interrupt handler entry point
called _DEQUE for the locator device driver
queue for an empty locator buffer and received
a non-zero return code.

Module_ID = KDDINTR RC = 01 D01 = 05
The second level interrupt handler entry point
called _DEQUE for the sound device driver
queue for an empty sound buffer and received a
non-zero return code.

Module_ID = KDDINTR RC = 01 D01 = 06
The second level interrupt handler entry point
called _ENQ for the keyboard device driver
queue for sending a keystroke and received a
non-zero return code.

Module_ID = KDDINTR RC = 01 D01 = 07
The second level interrupt handler entry point called **_ENQ** for the locator device driver queue for sending mouse data and received a non-zero return code.)

Module_ID = KDDINTR RC = 01 D01 = 08
The second level interrupt handler entry point called **_ENQ** for the locator device driver queue for sending mouse data and received a non-zero return code.

Module_ID = KDDINTR RC = 01 D01 = 09
The second level interrupt handler entry point called **_DEQUE** for the keyboard device driver queue for the keyboard buffer and received a non-zero return code.

Module_ID = KDDINTR RC = 01 D01 = 10
The second level interrupt handler entry point called **_DEQUE** for the locator device driver queue for the locator buffer and received a non-zero return code.)

Module_ID = KDDINTR RC = 01 D01 = 11
The second level interrupt handler entry point called **_ENQ** for the locator device driver queue for sending tablet data and received a non-zero return code.

Module_ID = KDDINTR RC = 01 D01 = 12
The second level interrupt handler entry point called **_ENQ** for the locator device driver queue for sending tablet data and received non-zero return code.

Module_ID = KDDIOIN RC = 01 D01 = 01
The keyboard I/O initiate entry point called **_DEQUE** for the keyboard device driver queue for a **DETACH** request and received a non-zero return code.)

Module_ID = KDDIOIN RC = 01 D01 = 03

The keyboard I/O initiate entry point called
_DEQUE for the keyboard device driver queue
for the ACT VT command and received a
non-zero return code.

Module_ID = KDDIOINL RC = 01 D01 = 01

The locator I/O initiate entry point called
_DEQUE for the locator device driver queue
for a DETACH request and received a non-zero
return code.

Module_ID = KDDIOINL RC = 01 D01 = 02

The locator I/O initiate entry point called
_DEQUE for the locator device driver queue
for an ACT VT request and received a non-zero
return code.

Module_ID = KDDIOINL RC = 01 D01 = 03

The locator I/O initiate entry point called
_ENQ for the locator device driver queue for
an ACT VT request and received a non-zero
return code.

Module_ID = KDDIOINS RC = 01 D01 = 01

The sound I/O initiate entry point called
_DEQUE for the sound device driver queue for
a DETACH request and received a non-zero
return code.

Module_ID = KDDIOINS RC = 01 D01 = 02

The sound I/O initiate entry point called
_DEQUE for the sound device driver queue for
a sound request with no hardware commands
and received a non-zero return code.

Mask = 02 VRM component - Virtual Terminal Mode Processor

Module_ID = VTMMAIN RC = 0 D01 = 07
The virtual terminal mode processor received a queue element that it does not recognize.)

Module_ID = VTMOUO RC = 6521
The length of the VTD header plus the minor data is greater than the total VTD length.

Module_ID = VTMOUO RC = 6522
The virtual mode processor received an invalid major type in the VTD header.

Module_ID = VTMOUO RC = 6523
Some of the data within the VTD block is not valid.

Module_ID = VTMOUO RC = 6524
The virtual mode processor received an invalid minor type in the VTD header.)

Module_ID = VTMOUO RC = 6527
The 4-byte length in the VTD header is larger than X'00FFFFFF'.

Module_ID = VTMOUO RC = 6528
The 4-byte length field is less than X'06'.

Module_ID = VTMOUO RC = 6532
This error occurred during a request to change thresholds and a tablet is present instead of a mouse, or during a request to change dead zones and a mouse is present instead of a tablet.

Module_ID = VTMOUO RC = 6533
During a change fonts command, some of the requested fonts do not exist.)

Module_ID = VTMOUO RC = 6534
During a change fonts command, the requested fonts have different sizes.

Module_ID = VTMOU RC = 6537

This error occurred during a request to change indicators and the LPFKs are not attached, or during a request to change granularities and the dials are not attached.

Module_ID = VTMOU RC = 6544

The received VTD command is not valid in the current operating mode of the virtual terminal mode processor.

Module_ID = VTMOU RC = 6546

The terminal ID passed via the change display or the change font command is not valid.

Module_ID = VTMSTS RC = 6563

This error occurred when set keyboard map tried to change a key to a function with a function ID greater than X'1FF' or to an unsupported ID.

Module_ID = VTMSTS RC = 6564

This error occurred when set keyboard map tried to re-map one of the screen manager designated keys.

Module_ID = VTMSTS RC = 6566

This error occurred when set keyboard map tried to re-map a key with an invalid position code.

Module_ID = VTMSTS RC = 6567

This error occurred because the KSR buffer definition header is too small.

Module_ID = VTMSTS RC = 6568

This error occurred because the keyboard buffer is too small.

Module_ID = VTMQRY RC = 6522

This error occurred because the virtual terminal mode processor received a query SVC with an invalid major type.

Module_ID = VTMQRY RC = 6524

This error occurred because the virtual terminal mode processor received a query SVC with an invalid minor type.

Module_ID = VTMQRY RC = 6538

This error occurred because the queried device is not configured.

Module_ID = VTMQRY RC = 6539

This error occurred because the queried device has not been selected.

Module_ID = VTMQRY RC = 6548

This error occurred because the query ASCII codes SVC designated an area with invalid coordinates.

Module_ID = VTMQRY RC = 6580

This error occurred because either the query response buffer is not large enough for all the queried data, or because invalid parameters exist in the query SVC command.

Module_ID = VTMQRY RC = 6581

This error occurred when the queried data overflowed the response buffer. The partial data remains in the query response buffer.

Module_ID = VTMQRY RC = 6583

This error occurred when the query real device was issued for an invalid device ID.

Module_ID = VTMUPD RC = 6549 D01 = 03

This error occurred because the virtual terminal mode processor received an **ERASE**

LINE, FIELD, or AREA command with an invalid parameter.

Module_ID = VTMUPD RC = 6549 D01 = 04

This error occurred because the virtual terminal mode processor received an **ERASE DISPLAY** command with an invalid parameter.

Module_ID = VTMUPD RC = 6549 D01 = 05

This error occurred because the virtual terminal mode processor received a **SET MODE** or **RESET MODE** control sequence with an invalid parameter.

Module_ID = VTMUPD RC = 6549 D01 = 06

This error occurred because the virtual terminal mode processor received a **SET GRAPHIC RENDITION** control sequence with an invalid parameter.

Module_ID = VTMUPD RC = 6549 D01 = 07

This error occurred because the virtual terminal mode processor received a **SET CHARACTERSET** control sequence with invalid parameters.

Module_ID = VTMUPD RC = 6550

This error occurred because the virtual terminal mode processor detected an unsupported escape sequence.

Mask = 02 VRM component - Virtual Terminal Resource Manager

Module_ID = VTRUTLPF RC = 01

The resource controller tried to add a font to the font table in the resource structure and the IOCN for the font is unknown to the VRM.

Module_ID = VTRUTLPF RC = 02

The resource controller tried to add a font to the font table in the resource structure and

either the font module symbol is not exported with the correct name or the font structure is incorrect.

Module_ID = VTRUTLPF RC = 03

The resource controller tried to add a font to the font table in the resource structure and the ID of the storage segment containing the font was unknown to the VRM.

Module_ID = VTRUTLBC RC = 04

The resource controller tried to bind the common device utilities to the virtual terminal mode processor and either one or more functions are not imported with the correct names or the parameter lists do not match.

Module_ID = VTRUTLNP RC = 05

The resource controller tried to derive requisite information for an input device and the IODN identifying the device driver is unknown to the VRM.

Module_ID = VTRUTLNP RC = 06

The resource controller tried to derive requisite information for an input device and received an unexpected VRM service return code. The return code is in D02.

Module_ID = VTRUTLNP RC = 07

The resource controller tried to derive requisite information for an input device and the IOCN of the device driver (derived from the define device structure of the device) is unknown to the VRM.

Module_ID = VTRUTLNP RC = 08

The resource controller tried to derive requisite information for an input device and either the IOCN of the device driver exported a structure different from that expected by the resource controller, or the names mismatch.

Module_ID = VTRUTLNP RC = 09

The resource controller tried to derive requisite information for an input device and either the IOCN of the device driver exported a structure different from that expected by the screen manager, or the names mismatch.

Module_ID = VTRUTLND RC = 10

The resource controller tried to derive requisite information to enter a display into the real screen table of the resource structure and the IODN identifying the device driver is unknown to the VRM.

Module_ID = VTRUTLND RC = 11

The resource controller tried to derive requisite information to enter a display into the real screen table of the resource structure and the IOCN of the device driver (derived from the define device structure of the device) is unknown to the VRM.

Module_ID = VTRUTLND RC = 12

The resource controller tried to derive requisite information to enter a display into the real screen table of the resource structure and either the VDD expected a structure different from the one received, or the names mismatch.

Module_ID = VTRUTLND RC = 13

The resource controller tried to derive requisite information to enter a display into the real screen table of the resource structure and received an unexpected return code from -COPY.

Module_ID = VTRUTLND RC = 26

The resource controller tried to derive requisite information to enter a display into the real screen table of the resource structure and either the VDD does not have all of the required entry points, or the names mismatch.

Module_ID = VTRUTLND RC = 27

The resource controller tried to derive requisite information to enter a display into the real screen table of the resource structure and the attempt failed. That error was previously logged. This error occurred when the resource controller received an unexpected return code from **_COPY** while recovering resources from the previous error. The return code is in D02.

Module_ID = VTRRCICI RC = 34

During initialization, the resource controller tried to copy the module ID for various VTM components and received an unexpected VRM service return code from **_COPY**. The return code is in D02.

Module_ID = VTRRCIPR RC = 36

During initialization, the resource controller tried to set up the keyboard device and found that no keyboard is supplied in the resource controller define device structure.

Module_ID = VTRRCIPR RC = 37

During initialization, the resource controller tried to set up a display and found that none are supplied in the resource controller define device structure.

Module_ID = VTRRCIPR RC = 38

During initialization, the resource controller tried to set up a display and found that no fonts are available for that display.

Module_ID = VTRRCIPR RC = 39

During initialization, the resource controller tried to get the device ID of the sound device but the sound device driver IODN is unknown to the VRM.

Module_ID = VTRRCICS RC = 40

During initialization, the resource controller tried to bind the screen manager to the common device utilities and found that either the screen manager expected an entry point different than the one the resource controller exports or that the names mismatch.

Module_ID = VTRVTSV RC = 62

The resource controller tried to get the module ID of the replacement for the standard virtual terminal mode processor but the IOCN is unknown to the VRM.

Module_ID = VTTGADD RC = 14

An unexpected return code was received from `_ENQ` while attempting to update the valuator dial granularities with the requesting virtual terminal active.

Module_ID = VTTGADD RC = 15

An unexpected return code was received from `_ENQ` while attempting to update the LPFK key settings with the requesting

Module_ID = VTTSELD RC = 02

An error occurred during a `_BIND` of the virtual display driver to the the virtual terminal mode processor. It was caused by one of the following:

- One or more functions or structures are not imported with the correct names.
- The parameter lists do not match.
- The structure declarations do not match.

Module_ID = VTTSELD RC = 03

An error occurred during a `_BIND` of the virtual display driver. This error usually indicates that the parameter list declarations for the imported and exported symbol do not

match. This error can cause unpredictable results.

Module_ID = VTTSELD or VTTQRD RC = 05

The size of the define device structure for the requested real display device is larger than the implementation limit for these modules.

Module_ID = VTTSELD or VTTQRD RC = 06

An error occurred while obtaining the define device structure. The return code from `_QRYDS` is in D03.

Module_ID = VTTSLED RC = 08

An unexpected return code was received from `_ENQ` while attempting to update the keyboard LEDs. The return code is in D03.

Module_ID = VTTSELI RC = 09

An unexpected return code was received from `_ENQ` while updating the keyboard mode. The return code is in D03.

Module_ID = VTTSELI RC = 10

An unexpected return code was received from `_ENQ` while updating the locator thresholds. The return code is in D03.

Module_ID = VTTSELD RC = 11

This error occurred while binding virtual terminal manager component modules to each other. The error is usually caused by one of the following:

- One or more functions or structures do not match.
- The structure declarations do not match.
- The parameter lists do not match.

Module_ID = VTTSELD RC = 12

An unexpected return code was received from `_COPY` while copying the code module for the

virtual device driver. The return code is in D04.

Mask = 03 PC/AT Coprocessor Driver

Module_ID = CPDSLIH RC=0

I/O Channel Check – 286 was BUS MASTER – This channel check is usually caused by a parity error on the 512K bus memory card that could indicate a bad module on the board.

A temporary solution is to remove the bus memory card and run the Coprocessor using ROMP system memory.

Module_ID = PCCDMUL8 RC=-1 _STDMA

Nonzero return code from _STDMA – This error indicates that an invalid address or word count was written to the DMA controller by the application running on the Coprocessor.

Attempt to determine what the DMA operation in the application is doing and correct the invalid address or word count.

Module_ID = PCCVMAIN RC=-1 _MAPSYS

Mapping of system memory failed for relocated video buffer or queue – This error indicates there was insufficient memory available for the MAPSYS operation.

You should be able to request less memory for the Coprocessor when the PCSTART command is issued. For example, 512K instead of 640K.

Module_ID = PCCVMAIN RC=-1 _PINPG

Pin page range failed – This indicates that there was insufficient memory available for the PINPGS operation.

You should request less memory for the Coprocessor when the PCSTART command is issued. For example, 512K instead of 640K.

Subclass = 08 Application Program Error

Mask = 02 Interactive Workstation

Module_ID = ATE RC=1

The **send** routine logs this error during a pacing file transfer if no pacing character has been received for 30 seconds.

Verify that the pacing protocol and pacing character at the remote site match those at your site. Then restart the file transfer.

Module_ID = ATE RC=2

The **send** routine logs this error at the start of a pacing file transfer if no pacing character is received for 100 seconds. The receiving site must transmit a specified pacing character to indicate that it is ready to receive.

Verify that both the local and remote sites are using the character pacing protocol and that the character chosen for pacing is the same for both sites. Then restart the file transfer.

Module_ID = ATE RC=3

The **receive** routine logs this error during an **XMODEM** file transfer after nine transmission errors on the same sector have occurred.

If you are using a telephone connection, terminate the current session and try again in a few minutes to get a new, less noisy line.

Module_ID = ATE RC=4

The **send** routine logs this error during an **XMODEM** file transfer when it has attempted to send a sector nine times, but the receiving site has not acknowledged receipt of the data.

Verify that both sites are using the **XMODEM** file transfer protocol. Restart the remote site and be sure that it is ready to receive. Select **send** and try the file transfer again.

Module_ID = ATE RC=5

The **send** routine logs this error during an **XMODEM** file transfer when it has attempted to send an EOT (end of transmission) nine times but the receiving site has not acknowledged receipt of the EOT.

See if the file has been received on the remote end. If it has, no further action is necessary. If it has not, restart the remote site and then select **send** and try the file transfer again.

Module_ID = 6 RC=6

The **send** routine logs this error when beginning an **XMODEM** file transfer if no start character is received for 100 seconds. The receiving site must transmit a specified start character to indicate that it is ready to receive.

Verify that both the local and remote sites are using the **XMODEM** protocol and that the receiving site is ready to receive. Then restart the file transfer.

Module_ID = ATE RC=7

The **receive** routine logs this error when no data arrives in 30 seconds for a pacing file transfer or 100 seconds for an **XMODEM** file transfer.

Verify that both the local and remote sites are using the same file transfer protocol and that the remote site is set up to send. Then select receive and try the file transfer again.

Module-ID = ATE RC=8

The session has been disconnected because the system can no longer detect a carrier signal.

A break in the connection may have occurred because of one of the following:

- The telephone line has problems.
- The remote system went out of operation.
- One of the modems became disconnected.
- A wire has come loose.

Attempt to reestablish the connection.

Module-ID = ATE RC=9

The receive routine logs this error during and XMODEM file transfer when the checksum value it calculates for the sector just received does not match the checksum value calculated and sent by the remote site. This error usually occurs because of noise on the transmission line.

No action is necessary. The sector is automatically requested again up to nine times. If the errors prevent the file transfer from continuing and you are using a telephone connection, try terminating the current session and establishing a new connection that may be less noisy.

Module-ID = ATE RC=10

The receive routine logs this error during an XMODEM file transfer when the same sector is received twice.

No action is necessary. The duplicate sector is automatically discarded and file transfer continues.

Module_ID = ATE RC=11

The **receive** routine logs this error during an **XMODEM** file transfer when it receives a sector number that is not the expected sector number.

No action is necessary. The expected sector is automatically requested again and file transfer continues.

Module_ID = ATE RC=12

The **receive** routine logs this error during an **XMODEM** file transfer when the sector number and the sector number complement sent by the remote site do not match.

No action is necessary. The sector is automatically requested again and file transfer continues.

Mask = 03 Base Local Area Network (LAN)

Module_ID = pcrctl RC=2 OPEN

The **OPEN** system call to the network device failed.

The error may be because the device, **/dev/network**, does not exist. Reinstall the Base PC network program and try again. See *AIX Operating System Technical Reference* for the **OPEN** system call.

Module_ID = pcrctl RC=2 IOCTL

The **IOCTL** system call to the network device failed.

Restart the RT PC. See *AIX Operating System Technical Reference* for the **IOCTL** command.

)

)

)

Appendix C. Abend Codes

(

(

(

CONTENTS

About This Appendix C-3

About This Appendix

This appendix lists some of the abend codes that you could receive. The abend code alternately displayed in the two-digit display is a prompt to load the dump diskette.

-
- 01 A level-2 hardware interrupt has occurred.**
- Cause:** A Processor and Memory Management Card interrupt occurred. The VRM does not handle this type of interrupt.
- Action:** Request a VRM dump, or restart the system.
- 02 A machine check has occurred.**
- Cause:** A Processor and Memory Management Card machine check error occurred.
- Action:** Request a VRM dump, or restart the system.
- 03 The VRM received an SVC that was not issued by a Virtual Machine.**
- Cause:** Only a virtual machine can issue an SVC command.
- Action:** Request a VRM dump, or restart the system.
- 04 An unidentified program check occurred.**
- Cause:** This was probably a hardware error. A Processor and Memory Management Card program check occurred, and the program check status register did not contain a valid cause for the error.
- Action:** Request a VRM dump, or restart the system.

05 A trap instruction was encountered.

Cause: A virtual machine was running when a trap instruction was issued.

Action: Request a VRM dump, or restart the system.

06 A data protection exception has occurred.

Cause: A data exception program check indicated that a protection exception occurred.

Action: Request a VRM dump, or restart the system.

07 An unidentified data exception has occurred.

Cause: This was probably a hardware error. The VRM did not recognize the cause of the data exception.

Action: Request a VRM dump, or restart the system.

08 An unidentified IAR exception has occurred.

Cause: This was probably a hardware error. The VRM could not determine the cause of the IAR exception program check.

Action: Request a VRM dump, or restart the system.

09 An IAR protection exception has occurred.

Cause: An IAR exception protection check indicated a protection exception.

Action: Request a VRM dump, or restart the system.

-
- 10** **A privileged operation exception has occurred.**
Cause: A privileged operation program check was detected, but a virtual machine was not running.
Action: Request a VRM dump, or restart the system.
- 11** **An illegal operation exception has occurred.**
Cause: An illegal operation program check occurred, but a virtual machine was not running.
Action: Request a VRM dump, or restart the system.
- 12** **A page fault occurred before the VRM was fully operational.**
Cause: The VRM's virtual memory manager was not initialized and a page fault occurred.
Action: Request a VRM dump, or restart the system.
- 13** **A page fault occurred that could not be processed by the VRM.**
Cause: A page fault occurred when a Processor and Memory Management Card was disabled for interrupts, when the dispatcher could not change processes, or when device driver code was running.
Action: Request a VRM dump, or restart the system.

14 A floating point exception has occurred.

Cause: A floating point exception occurred while the VRM was running.

Action: Request a VRM dump, or restart the system.

15 The VRM encountered an unresolved reference.

Cause: An internal process attempted to reference or branch to an unknown name.

Action: Request a VRM dump, or restart the system.

16 The VRM has encountered a stack overflow.

Cause: An internal process or SVC routine overflowed its stack area.

Action: Request a VRM dump, or restart the system.

17 All paging space is in use.

Cause: The virtual memory manager did not have enough disk paging space to continue operation.

Action: Re-install the VRM and specify a larger paging space minidisk.

18 The VRM tried to reference an address that is not valid.

Cause: An internal routine took a page fault for an invalid address.

Action: Request a VRM dump, or restart the system.

19 The VRM encountered a permanent I/O error in the paging space.

Cause: The virtual memory manager received a permanent I/O error in the disk paging space.

Action: Request a VRM dump, or restart the system.

20 The VRM does not have enough real memory to continue.

Cause: The virtual memory manager could not continue operation, probably because a component has pinned too many pages.

Action: Request a VRM dump, or restart the system.

21 The VRM minidisk cannot be accessed.

Cause: You performed an IPL on a minidisk that was not a valid VRM minidisk. The VRM might have been installed incorrectly.

Action: Re-install the VRM. If this message persists, dump the contents of memory onto a formatted dump diskette, or restart the system.

22 The VRM cannot find the paging space minidisk.

Cause: The virtual memory manager could not locate a valid paging minidisk. The VRM may have been installed incorrectly.

Action: Re-install the VRM. If this message persists, request a VRM dump, or restart the system.

-
- 23 The VRM has received initialization data that is not valid.**
- Cause:** The VRM initialization routine detected an invalid load module or an invalid DDS in the data passed to it from the IPL program. The VRM may have been installed incorrectly.
- Action:** Re-install the VRM. If this message persists, request a VRM dump, or restart the system.
- 24 The VRM is unable to allocate a system control block.**
- Cause:** The VRM tried to allocate a system control block and failed. A device driver may have enqueued an excessive number of virtual interrupts to the user of a device.
- Action:** Request a VRM dump, or restart the system.
- 25 The Virtual Resource Manager could not find a fixed disk device driver.**
- Cause:** The VRM tried to locate a fixed-disk device driver and failed.
- Action:** Request a VRM dump, or restart the system.
- 26 An I/O channel error has occurred.**
- Cause:** An internal process is incorrectly accessing hardware.
- Action:** Request a VRM dump, or restart the system.

27

An I/O error occurred while accessing cylinder 0 of a fixed disk.

Cause: The VRM tried to access data (such as the bad block map or minidisk directory) on cylinder 0 of a fixed disk and experienced an I/O error. This is probably a fixed-disk hardware or formatting problem.

Action: Run diagnostics on the fixed disk. See *Problem Determination Guide* for details.

Glossary

application. A particular task, such as inventory control or accounts receivable.

batch processing. A processing method in which a program or programs process records with little or no operator action. This is a background process. Contrast with *interactive processing*.

command. A request to perform an operation or execute a program. When parameters, arguments, flags, or other operands are associated with a command, the resulting character string is a single command.

configure. To describe (to the system) the devices, optional features, and program products installed on a system.

crash. An unexpected interruption of computer service, usually due to a serious hardware or software malfunction.

cursor. (1) A movable symbol (such as an underline) on a display, used to indicate to the operator where the next typed character will be placed or where the next action will be directed.

customize. To describe (to the system) the devices, programs, users, and user defaults for a particular data processing system.

debug. (1) To detect, locate, and correct mistakes in a program. (2) To find the cause of problems detected in software.

device. An electrical or electronic machine that is designed for a specific purpose and that attaches to your computer, for example, a printer, plotter, disk drive, and so forth.

diagnostic. Pertaining to the detection and isolation of an error.

diagnostic aid. A tool (procedure, program, reference manual) used to detect and isolate a device or program malfunction or error.

diagnostic routine. A computer program that recognizes, locates, and explains either a fault in equipment or a mistake in a computer program.

disk. A storage device made of one or more flat, circular plates with magnetic surfaces on which information can be stored.

disk drive. The mechanism used to read and write information on disk.

diskette. A thin, flexible magnetic plate that is permanently sealed in a protective cover. The diskette is used to store information copied from the disk.

diskette drive. The mechanism used to read and write information on diskettes.

display screen. The part of the display device that displays information visually on a luminescent screen by use of controlled electron beams.

dump. (1) To copy the contents of all or part of storage, usually to an output device. (2) Data that has been dumped.

edit. (1) To modify the form or format of data.

editor. A program used to enter and modify programs, text, and other types of documents.

feature. A programming or hardware option, usually available at an extra cost.

fixed disk. See disk drive.

foreground. A mode of program execution in which the shell waits for the program specified on the command line to complete before returning your prompt.

format. (1) A defined arrangement of such things as characters, fields, and lines, usually used for displays, printouts, or files. (2) The pattern which determines how data is recorded.

formatted diskette. A diskette on which control information for a particular computer system has been written but which may or may not contain any data.

hardware. The equipment, as opposed to the programming, of a computer system.

history file. A file containing a log of system actions and operator responses.

initial program load (IPL). The process of loading the system programs and preparing the system to run jobs.

label. The name in the disk or diskette volume table of contents that identifies a file.

licensed program product (LPP). Software programs that remain the property of the manufacturer, for which customers pay a license fee.

load. (1) To move data or programs into storage. (2) To place a diskette into a diskette drive. (3) To insert paper into a printer.

log. To record; for example, to log all messages on the system printer.

memory. A device or part of a device that can retain data.

menu. A displayed list of items from which an operator can select tasks.

problem determination. The process of identifying why the system is not working. Often this process identifies programs, equipment, data communications facilities, or user errors as the source of the problem.

problem determination procedure. A prescribed sequence of steps aimed at recovery from, or circumvention of, problem conditions.

profile. (1) A file containing customized settings for a system or user (2) Data describing the significant features of a user, program, or device.

prompt (n.). A displayed request for information or operator action.

recovery procedure. (1) An action performed by the operator when an error message appears on the display screen. Usually, this action permits the program to continue or permits the operator to run the next job. (2) The method of returning the system to the point where a major system error occurred and running the recent critical jobs again.

routine. A set of statements in a program causing the system to perform an operation or a series of related operations.

run. To cause a program, utility, or other machine function to be performed.

setup. (1) The process or act of preparing and adjusting a machine or device for its assigned work. (2) The way in which the system unit and the external devices are arranged.

shell. See *shell program*.

shell program. A program that accepts and interprets commands for the operating system (there is an AIX shell program and a DOS shell program).

software. Programs.

system. The computer and its associated devices and programs.

system dump. A printout of storage from all active programs (and their associated data) whenever an error stops the system. Contrast with *task dump*.

system profile. A file containing the default values used in system operations.

system user. A person who uses a computer system.

task. A basic unit of work to be performed. Examples are a user task, a server task, and a processor task.

task dump. A printout of storage from a program that failed (and its associated data). Contrast with *system dump*.

trace. To record data that provides a history of events occurring in the system.

two-digit display. Two seven-segment light-emitting diodes (LEDs) on the operator panel used to track the progress of power-on self-tests (POSTs).

utility. A service; in programming, a program that performs a common service function.

Volume ID (Vol ID). A series of characters recorded on the diskette used to identify the diskette to the user and to the system.



)

)

)

Book Title _____

Order No. _____

Book Evaluation Form

Your comments can help us produce better books. You may use this form to communicate your comments about this book, its organization, or subject matter, with the understanding that IBM may use or distribute whatever information you supply in any way it believes appropriate without incurring any obligation to you. Please take a few minutes to evaluate this book as soon as you become familiar with it. Circle Y (Yes) or N (No) for each question that applies and give us any information that may improve this book.

Y N Is the purpose of this book clear?

Y N Is the table of contents helpful?

Y N Is the index complete?

Y N Are the chapter titles and other headings meaningful?

Y N Is the information organized appropriately?

Y N Is the information accurate?

Y N Is the information complete?

Y N Is only necessary information included?

Y N Does the book refer you to the appropriate places for more information?

Y N Are terms defined clearly?

Y N Are terms used consistently?

Y N Are the abbreviations and acronyms understandable?

Y N Are the examples clear?

Y N Are examples provided where they are needed?

Y N Are the illustrations clear?

Y N Is the format of the book (shape, size, color) effective?

Other Comments

What could we do to make this book or the entire set of books for this system easier to use?

Optional Information

Your name _____

Company name _____

Street address _____

City, State, ZIP _____

Tape

Please Do Not Staple

Tape

Cut or Fold Along Line

Fold and Tape

Fold and Tape

International Business Machines Corporation
Department 997, Building 998
11400 Burnet Rd.
Austin, Texas 78758-3493

POSTAGE WILL BE PAID BY ADDRESSEE

FIRST CLASS PERMIT NO. 40 ARMONK, NEW YORK

BUSINESS REPLY MAIL

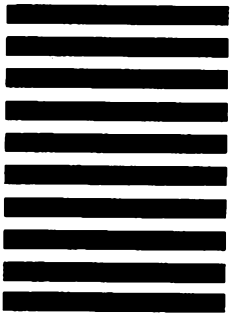

NO POSTAGE
NECESSARY
IF MAILED
IN THE
UNITED STATES



The IBM RT
Hardware Reference Family

Reader's Comment Form

**IBM RT AIX Operating
System Problem
Determination Guide**

SA23-2603-1

Your comments assist us in improving our products. IBM may use and distribute any of the information you supply in any way it believes appropriate without incurring any obligation whatever. You may, of course, continue to use the information you supply.

For prompt resolution to questions regarding set up, operation, program support, and new program literature, contact your IBM representative, authorized IBM RT dealer, or authorized IBM RT remarketer.

Comments:

Tape

Please Do Not Staple

Tape

Cut or Fold Along Line

Fold and Tape

Fold and Tape

International Business Machines Corporation
Department 997, Building 998
11400 Burnet Rd.
Austin, Texas 78758-3493

POSTAGE WILL BE PAID BY ADDRESSEE

FIRST CLASS PERMIT NO. 40 ARMONK, NEW YORK

BUSINESS REPLY MAIL

NO POSTAGE
NECESSARY
IF MAILED
IN THE
UNITED STATES



(

(

(

© IBM Corp. 1988
All rights reserved.

International Business
Machines Corporation
11400 Burnet Road
Austin, Texas 78758

Stampato da
IBM Italia S.p.A.
Vimercate

22F9874

SA23-2603-1

IBM®

()

()

()