

Systems

**Advanced Function
for Communications
System Summary**

IBM

Preface

This manual provides summary information about IBM Advanced Function for Communications, a selection of equipment and programs that provide compatible components as a basis for a data communications network. Its objective is to give readers a general understanding of Advanced Function for Communications concepts and the interrelationships of its components. System concepts are discussed briefly, and short descriptions of equipment components are included.

Chapter 1 discusses system concepts and program components; Chapter 2 describes IBM equipment (except for the System/370 host processor) that may be a part of a Systems Network Architecture (SNA) network.

The reader of this manual is assumed to have a basic knowledge of data communications systems. Introductory material for those who do not have this background information is contained in *IBM Introduction to Data*

Communications Systems, SR20-4461. Other useful background information is contained in the following publications:

IBM System/370 System Summary, GA22-7001 (Sections 4 and 5)

Data Processing Glossary, GC20-1699

IBM Supplemental Bibliography – Teleprocessing/Data Collection, GA24-3089.

Further information on SNA (Systems Network Architecture) appears in the following publications:

Systems Network Architecture General Information (to be renamed “Technical Overview”), GA27-3102.

IBM Synchronous Data Link Control General Information, GA27-3093.

Second Edition (July 1975)

This is a major revision of, and obsoletes, GA27-3099-0 and Technical Newsletter GN27-3146. This edition adds information about the IBM 3760 and IBM System/32, and makes technical and editorial changes throughout. This edition should be reviewed in its entirety.

Changes are periodically made to the information herein; before using this publication in connection with the operation of IBM systems, consult the latest *IBM SRL Bibliography Supplement – Teleprocessing and Data Collection*, GA24-3089, and associated Technical Newsletters, for the editions that are applicable and current.

Requests for copies of IBM publications should be made to your IBM representative or to the IBM branch office serving your locality.

This manual has been prepared by the IBM Systems Communications Division, Publication Center, Department E01, P.O. Box 12195, Research Triangle Park, North Carolina 27709. A form for readers' comments is provided at the back of this publication. If the form has been removed, comments may be sent to the above address. Comments become the property of IBM.

CONTENTS

Chapter 1. Advanced Function for Communications

Concepts	1-1
Systems Network Architecture	1-1
Design	1-1
Distribution of Network Functions	1-1
Advantages of Distributed Function	1-3
Components of the System	1-3
VTAM (Virtual Telecommunications Access Method)	1-3
TCAM through VTAM	1-3
Role of Controllers and the Network Control Program/VS (NCP/VS)	1-4
Synchronous Data Link Control (SDLC)	1-4
Additional Programming Support	1-4

Chapter 2. Systems Network Architecture (SNA) Equipment.

Communications Controllers	2-1
3704 Models A1-A4	2-1
Physical Equipment	2-1
Programming Support	2-2
3705 Models A1-A2, B1-B4, C1-C6, and D1-D8	2-3
Physical Equipment	2-3
Programming Support	2-3
Remote Terminals and Terminal Systems	2-4
IBM 3270 Information Display System	2-4
3271 Control Unit	2-5
3275 Display Station	2-5
3277 Display Station	2-5
3284, 3286, and 3288 Printers	2-5
Optional System Features	2-5
IBM 3600 Finance Communication System	2-6
3601 Finance Communication Controller	2-6
3603 Terminal Attachment Unit	2-6
3604 Keyboard Display	2-6
3606 Financial Services Terminal	2-6
3608 Printing Financial Services Terminal	2-6
3610 Document Printer	2-6
3611 Passbook Printer	2-7

3612 Passbook and Document Printer	2-7
3614 Consumer Transaction Facility	2-7
3618 Administrative Line Printer	2-7
IBM 3650 Retail Store System	2-10
3651 Model 50 Store Controller	2-10
3653 Point of Sale Terminal	2-10
3657 Ticket Unit	2-10
3659 Remote Communications Unit	2-10
3275 Model 3 Display Station	2-10
3284 Model 3 Printer	2-10
IBM 3660 Supermarket System	2-12
3651 Model 60 Store Controller (Scanning System)	2-12
3661 Store Controller (Key-Entry System)	2-12
3663 Supermarket Terminal	2-12
3666 Checkout Scanner	2-12
3669 Store Communications Unit	2-12
IBM 3767 Communication Terminal	2-14
Basic Capabilities	2-14
Special Features	2-14
IBM 3770 Data Communication System	2-15
3770 System Terminals	2-15
Attachable Units	2-16
Additional System Features	2-16
IBM 3790 Communication System (general-purpose configurations)	2-17
3791 Controller	2-17
3792 Auxiliary Control Unit	2-18
3793 Keyboard-Printer	2-18
3277 Display Station	2-18
Line Printer Feature	2-18
IBM 3790 Communication System/Data Entry Configuration	2-19
3791 Controller	2-19
3760 Dual Key Entry Station	2-19
IBM System/32	2-20
Abbreviations	A-1

ILLUSTRATIONS

Figure	Title	Page	Figure	Title	Page
1-1	Systems Network Architecture	1-2	2-5	Components of the IBM 3650 Retail Store System	2-11
1-2	Concepts of Function Distribution	1-2	2-6	Components of the IBM 3660 Supermarket System	2-13
1-3	IBM 3790 Communication System in an SNA Network	1-3	2-7	IBM 3767 Communication Terminal with Magnetic Stripe Reader and Forms Tractor	2-14
2-1	IBM 3704 Communications Controller	2-1	2-8	IBM 3770 Data Communication System	2-16
2-2	IBM 3705 Communications Controller	2-3	2-9	IBM 3790 Communication System	2-17
2-3	IBM 3270 Information Display System	2-4	2-10	IBM 3760 Dual Key Entry Station	2-19
2-4	Components of the IBM 3600 Finance Communication System (Part 1 of 2)	2-8	2-11	IBM System/32	2-21
2-4	Components of the IBM 3600 Finance Communication System (Part 2 of 2)	2-9			

Teleprocessing systems are essential to the vitality of industry today. However, most teleprocessing systems are extremely complex. They require thorough and careful planning, precise implementation, and are often so delicately balanced that an improvement in equipment or facilities is unavoidably accompanied by other costly alterations. In the present teleprocessing system environment, a change to an effectively performing system must be considered cautiously. A system environment that is more amenable to growth and change is needed.

SYSTEMS NETWORK ARCHITECTURE

IBM now provides Advanced Function for Communications, through Systems Network Architecture, with these objectives:

- To provide a consistent and comprehensive structure for teleprocessing system design
- To enhance teleprocessing systems for industry's data-handling requirements.
- To extend system functions conveniently and effectively to the user
- To minimize the effects of system changes
- To minimize the user's involvement in details of system operation
- To provide a teleprocessing environment that is hospitable to both general-purpose and special-purpose terminals
- To accommodate ordinary terminals or complex terminal subsystems, equally

The Systems Network Architecture (SNA) features a functional hierarchy, new technologies, and compatible programming systems.

DESIGN

Systems Network Architecture (Figure 1-1) is an integrated structure of equipment and programs that has these characteristics:

- Data transmission and any associated errors are handled by IBM equipment and programs. The accuracy of every received transmission is checked.
- The user can format data for use by the application programs and the terminals. Device dependency is minimized.

- Terminals and other network resources are shared by application programs. This reduces the need for dedicated lines and dedicated terminals.
- Functional capabilities can be dispersed. This moves processing power closer to the terminal user.

The choice of Advanced Function for Communications allows a user to emphasize system applications; elements of SNA take care of network management. Terminal control functions are handled alike in SNA, so different terminal types can be multidropped from the same communications line (if the transmission rates and modems are compatible). These terminals and the line are then shared among application programs. The impact on the system when terminals are added, removed, or changed is minor.

The 3704 or 3705 Communications Controller takes care of line control; this frees the host System/370 from the frequent attention that must be given to that function. Synchronous data link control (SDLC) facilitates two-way message flow; this duplex transmission capability makes possible the efficient use of duplex communications facilities.

Distribution of Network Functions

Distributed function allows many network responsibilities to be moved from the host to other network components. Modern circuit technologies (notably LSI—large scale integration) make possible a variety of functions in the terminal controllers and in the terminals.

Figure 1-2 illustrates a possible distribution of functions in SNA:

- The application program in the host System/370 processes system transactions; VTAM (virtual telecommunications access method) allocates network resources.
- The NCP/VS (network control program/virtual storage) in the 3704/3705 Communications Controller(s) manages the network.
- A terminal controller manages terminals, formats data, and processes local transactions.
- New types of terminals and terminal controllers provide additional functions.

A programmable terminal controller, such as the IBM 3791 Controller in Figure 1-3, can direct the flow of messages through the terminal subsystem, or it can process messages from the terminals, locally, when the host's participation is not required.

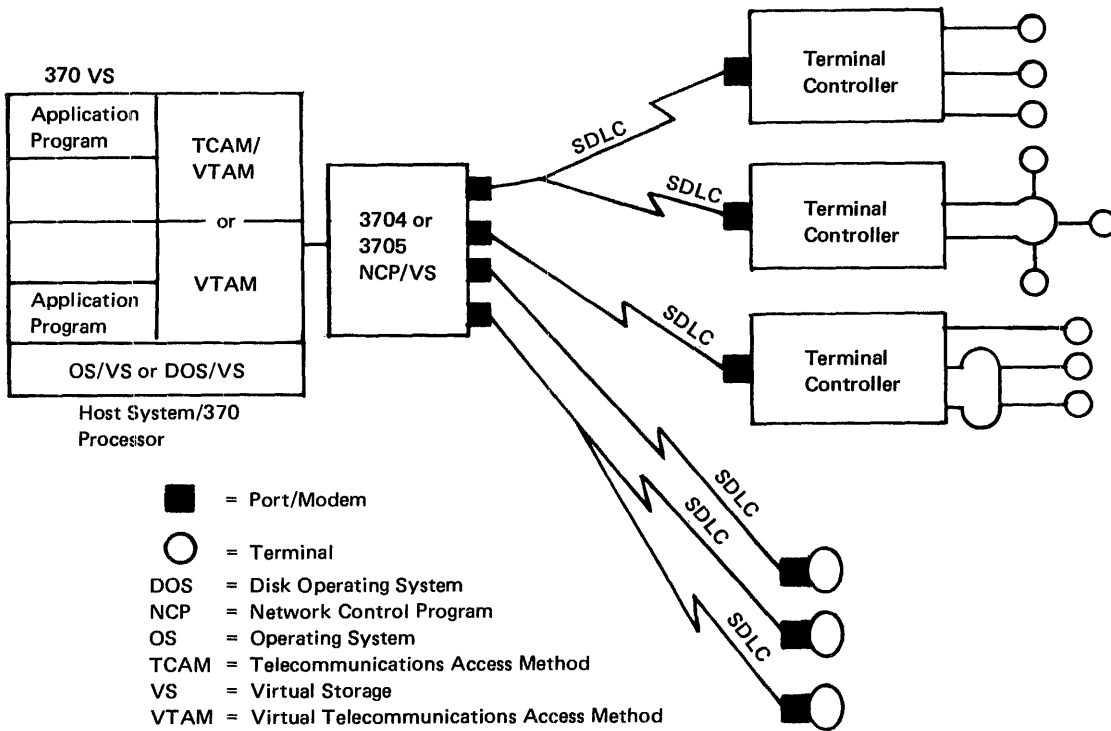

Figure 1-1. Systems Network Architecture

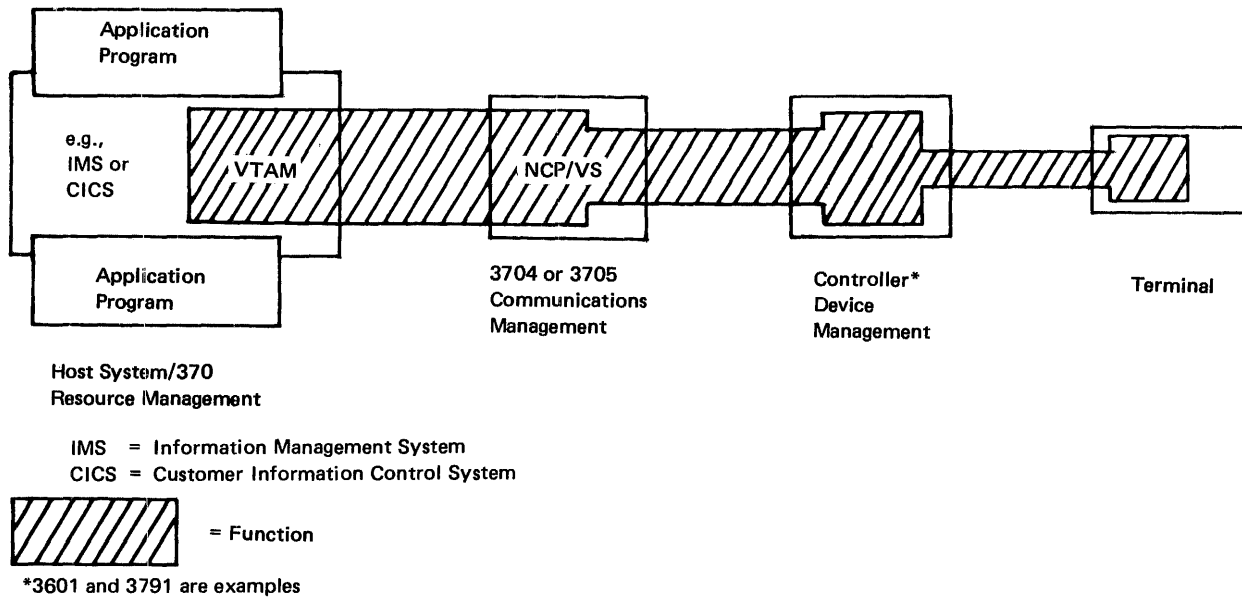

Figure 1-2. Concept of Function Distribution

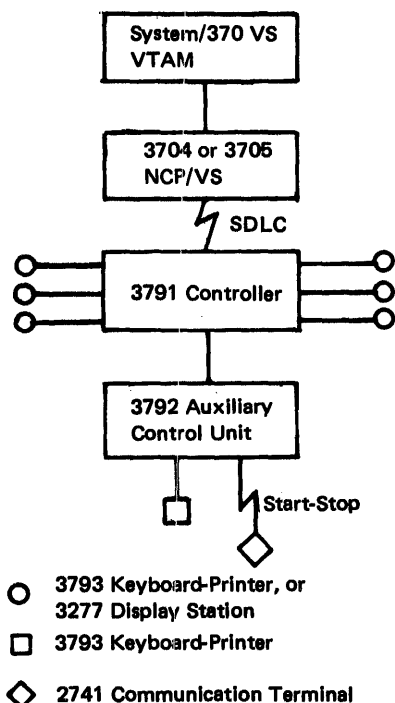

Figure 1-3. IBM 3790 Communication System in an SNA Network

When messages such as data base inquiries require host participation, the terminal controller adds network information to the outgoing inquiry message. The message is then conveyed to the application program in the host, via NCP/VS and VTAM. The application program sends its response to the originating terminal through NCP/VS and the programmable terminal controller.

Network and control information is added or deleted at the appropriate points in the network, for proper control of processing, routing, and transmission error checking.

Advantages of Distributed Function

Distributed function is characterized by transaction processing within the network, which relieves the host System/370 of many trivial requests. It also avoids the use of network resources to send to the host a transaction that can be processed closer to the terminal. Transmission error recovery is an example of distributed function; the 3704 or 3705 Communications Controller and the terminal controllers perform recovery from message errors that occur within their respective areas of control.

If a system problem isolates a terminal or terminal subsystem, the remote unit(s) may continue to operate in off-line mode, storing original or processed data for later transmission to the host.

Systems Network Architecture (SNA) promotes network resource sharing, and offers the ability to distribute function.

COMPONENTS OF THE SYSTEM

The basic components of the SNA (Systems Network Architecture) are:

- System/370 host processor
- VS operating system (OS/VS1, OS/VS2, or DOS/VS)
- VTAM, TCAM through VTAM, or Extended Telecommunications Modules (CICS/DOS/VS)
- 3704 or 3705 Communications Controller(s) with the Network Control Program/VS (NCP/VS)
- Synchronous data link control (SDLC)
- A selection of terminal controllers and terminals

In SNA, all communications controllers in a network are supervised by the resource manager for the entire network (VTAM, for example). Each 3704 or 3705 Communications Controller in the network, with its own NCP/VS, is the traffic manager for its portion of the network.

VTAM (Virtual Telecommunications Access Method)

The Virtual Telecommunications Access Method (VTAM) directs the transmission of data between host application programs and attached terminals. VTAM frees application programs to communicate readily with terminals; it reconciles the characteristics of the network between them. VTAM "owns" all of the network components, allocating their use to meet the needs of application programs.

To support communications between application programs and terminals, VTAM:

- Connects, disconnects, and controls access between the application programs and all of the terminals in the network. The terminals may be locally or remotely attached, and remote units may be terminals or terminal subsystems using SDLC line control.
- Controls the transfer of data between application programs and terminals. The application programs need not be aware of the line control discipline or of the method of terminal attachment.
- Allocates the terminals, and the network paths to them, for use by application programs. Although a terminal may be allocated at one time to a specific application, the communications controllers and communications lines are shared among concurrently active application programs. Different terminals multidropped on one line may concurrently communicate with different application programs.

TCAM Through VTAM

When queued control is required, application programs can use TCAM as an interagent between the application programs and VTAM. TCAM (Telecommunications Access Method) provides general control over transaction activity;

for example, data can be directed to an inactive system component and held in a queue until that component is activated and connected. VTAM provides the direct control described earlier.

Role of Controllers and the Network Control Program/VS (NCP/VS)

Some of the network management responsibilities can be allocated, by system design, to the communications controllers or to terminal controllers. The NCP/VS operates in the 3704 or 3705 Communications Controller to manage the portion of the network that is attached to it by the communications lines.

The main function of NCP/VS is to route data through the network. The NCP/VS also furnishes such communications management services as: line control, insertion and deletion of line control information, dynamic buffering of data, and recovery from message errors. In addition, NCP/VS can perform some data manipulation, such as message-editing and date- and time-stamping.

A terminal controller may be responsible for presenting data in the proper form at the correct terminal. Families of terminals and controllers are available for specific industries and applications, such as the IBM 3600 Finance Communication System, the IBM 3650 Retail Store System, and the IBM 3660 Supermarket System. Others, such as the 3270 Information Display System, the 3767 Communication Terminal, the 3770 Data Communication System, and the 3790 Communication System, are available for multipurpose applications.

Through commands sent from VTAM, the NCP/VS assumes most of the responsibility for controlling communications lines. These VTAM commands:

- Invite the NCP/VS to send data from the terminals to VTAM
- Enable VTAM to send data through the NCP/VS to terminals in the network.

Network management is centralized, but functions are located to optimize network performance.

Synchronous Data Link Control (SDLC)

SDLC is the serial-by-bit data link control discipline for SNA (Systems Network Architecture). SDLC is designed for efficient control between communicating elements of the network. One transmission can carry data as well as confirmation of earlier transmissions; the accuracy of each received transmission is checked. Information data transparency is inherent in SDLC; it can convey any 8-bit character code, as well as non-coded information, with no restrictions because of data link control. The design of SDLC accommodates either duplex operation (simultaneous two-way transmission of information data or control data) or half-duplex operation (one way at a time).

Additional Programming Support

Advanced Function for Communications supports remote job entry under POWER/VS (DOS/VS), RES (OS/VS1), and JES2 (OS/VS2). Releases of DOS/VS, OS/VS1, and OS/VS2 that support SNA are also supported while they are executing under VM/370.

The following units and systems can be attached to an IBM System/370 as SNA components. (As an aid to migration into SNA operation, some units and systems offer switch-controlled BSC or start-stop operation with the SNA version.)

For a list of publications about IBM teleprocessing equipment, refer to *IBM Supplemental Bibliography—Teleprocessing/Data Collection*, GA24-3089. Refer to the appropriate publication for specific information about any of the following products:

Communications Controllers

IBM 3704 Communications Controller
IBM 3705 Communications Controller

Remote Terminals and Terminal Systems

IBM 3270 Information Display System
IBM 3600 Finance Communication System
IBM 3650 Retail Store System
IBM 3660 Supermarket System
IBM 3767 Communication Terminal
IBM 3770 Data Communication System
IBM 3790 Communication System
IBM 3790 Communication System/Data Entry Configuration
IBM System/32

COMMUNICATIONS CONTROLLERS

3704 Models A1-A4

Physical Equipment

The IBM 3704 Communications Controller (Figure 2-1) is a modular programmable unit that provides expanded teleprocessing capabilities for IBM System/370 users. Designed to be an evolutionary replacement for the IBM 2701 Data Adapter Unit and the 2702 and 2703 Transmission Control Units, the 3704 can have attached as many as 32 communications lines, with a mix of synchronous and asynchronous lines.

The 3704 consists of a single module that contains a control function, a control panel, a channel adapter for attachment to a System/370 CPU (two CPUs, with special feature), a communications scanner, and the required line attachment hardware for communications lines. This hardware permits the 3704 to communicate with a variety of teleprocessing devices.

This communications controller operates over common-carrier or equivalent customer-owned communications

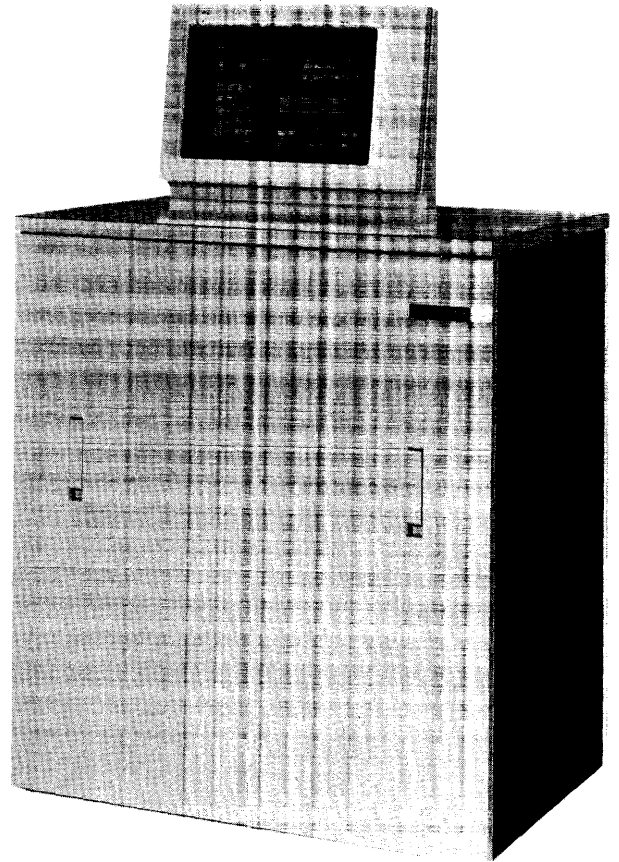

Figure 2-1. IBM 3704 Communications Controller

facilities at from 45.5 bps to 50,000 bps. It is available in four models, representing various combinations of line and channel attachment hardware, with storage capacities of from 16K bytes to 64K bytes, in 16K-byte increments.

The 3704, with appropriate programming and the remote support feature, is able to operate as a remote network concentrator, collecting data from low-speed terminals and sending it at high speed to a System/370 CPU. Thus, the 3704 provides a high degree of flexibility in matching the requirements of a teleprocessing network.

Prior to the 3704, many functions now being executed in the 3704 were performed by access methods in a CPU. When these teleprocessing functions are executed in the 3704, the CPU is freed to do more message processing and batch processing work.

Programming Support

Programming support for the 3704 includes a basic version and a virtual storage (VS) version of both the network control program and the emulation program, as well as system support programs. When executing either version of the network control program, the 3704 requires only a single System/370 subchannel address, regardless of the number of communications lines attached. This represents a significant advantage over the 2701, 2702, and 2703 transmission controls, which require a separate subchannel address for each line.

Network Control Program: The basic and VS versions of the network control program, both of which are executed in the 3704, assume a major portion of line management and buffering responsibility. Characters are decoded and assembled into messages before being released to the CPU, thus conserving System/370 CPU resources. Both basic and VS versions can support controls, terminals, and lines (up to 32) attached to a 3704, and perform such functions as:

- Communications line control
- Character checking
- Block checking
- Character buffering
- Polling
- Error recovery procedures.

Both versions also perform multiplexer functions such as converting outgoing message characters to serial bit stream (or vice versa for incoming characters), recognizing control characters within message text, and checking for transmission errors.

The *Partitioned Emulation Programming Extension*, a feature of the network control program/VS, allows the program to operate some lines in network control mode while operating other lines in emulation mode.

Emulation Program: The basic and VS versions of the emulation program, both of which are executed in the 3704, allow the 3704 to emulate most programs written for the 2701, 2702, and 2703, without modification. In addition, both versions provide an easy conversion path from the 2701, 2702 or 2703 to the 3704. With either version, the 3704 can have as many as 32 lines attached.

System Support Programs: These programs, which are executed in a CPU, generate control programs, load them into controller storage, and also dump controller storage.

3705 Models A1-A2, B1-B4, C1-C6, and D1-D8

Physical Equipment

The IBM 3705 Communications Controller (Figure 2-2) is a modular programmable control unit that can have as many as 352 communications lines attached and which requires only a single System/370 CPU channel. It operates in asynchronous mode at from 45.5 bps to 4,800 bps, and in synchronous mode at from 600 bps to 50,000 bps.

The 3705 consists of from one to four modules that contain a control function, storage, a control panel, one or two channel adapters for attachment to a System/370 CPU, (two CPUs, with channel adapter switching features), from one to four communications scanners, and the required line attachment hardware for communications lines. This hardware permits the 3705 to communicate with a variety of teleprocessing devices.

The channel switching feature for multiprocessing systems helps increase the availability of virtual multiprocessor systems such as System/370 Models 158 MP and 168 MP. With channel switching, a 3705 equipped with one channel adapter can operate concurrently with two CPUs of a multiprocessor system.

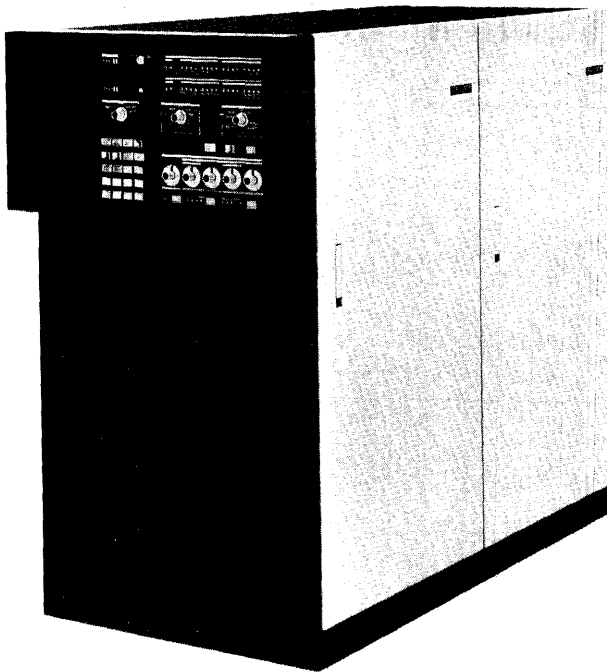

Figure 2-2. IBM 3705 Communications Controller

The 3705 is available in several models, representing various combinations of line and channel attachment hardware, and having storage capacities of from 16K to 240K bytes, in 32K-byte increments.

The 3705, with appropriate programming and the remote support feature, is able to operate as a remote network concentrator, collecting data from low-speed terminals and sending it, at high speed, to the CPU. Thus the activity of the 3705 can be closely matched to the requirements of a teleprocessing network.

Because teleprocessing functions generally require the highest priority in a data processing system, demanding a considerable amount of time and storage space, having these functions executed in the 3705 frees the CPU to do more message processing and batch processing work.

Programming Support

Programming support for the 3705 includes a basic version and a virtual storage (VS) version of both the network control program and the emulation program, as well as system support programs. When executing either version of the network control program, the 3705 requires only a single System/370 subchannel address, regardless of the number of communications lines attached.

Network Control Program: The basic and VS versions of the network control program are both executed in the 3705. Both versions control terminals and lines (up to 352) attached to the 3705 and perform such functions as polling and addressing stations, adding and deleting framing characters around message text, and executing error-recovery procedures. Both versions also perform multiplexer functions such as converting outgoing message characters to serial bit streams (or vice versa for incoming characters), recognizing control characters within message text, and checking for transmission errors.

The *Partitioned Emulation Programming Extension*, a feature of the network control program/VS, allows the program to operate some lines in network control mode while operating other lines in emulation mode.

Emulation Program: The basic and VS versions of the emulation program, both of which are executed in the 3705, allow the 3705 to emulate most programs written for the 2701, 2702, and 2703, without modification. In addition, both versions provide an easy conversion path from the 2701, 2702, or 2703 to the 3705. With either version, the 3705 can have as many as 255 lines attached.

System Support Programs: These programs, which are executed in a CPU, generate control programs and load them into controller storage, and also dump controller storage.

REMOTE TERMINALS AND TERMINAL SYSTEMS

IBM 3270 Information Display System

The IBM 3270 Information Display System (Figure 2-3) consists of display stations, printers, and control units that provide alphanumeric display capability for inquiry, data entry, source recording, transaction processing, and manual input applications. Attached remotely, the 3270 system provides a selection of line speeds up to 7,200 bps.

The 3270 system may be a single device or it may consist of subsystems having up to 32 devices each. The system can include 480- or 1,920-character display stations and 40- or 66-character-per-second or 120 line-per-minute printers. Line control for remote attachment may be binary synchronous communication (BSC) or synchronous data link control (SDLC). An existing 3270 system using BSC can be modified for SDLC operation with SNA.

A remote 3270 system is made up of combinations of the following units:

- 3271 Model 1 or 2 Control Unit (BSC), or Model 11 or 12 (SDLC)
- 3275 Model 1 or 2 Display Station (BSC), or Model 11 or 12 (SDLC)
- 3277 Model 1 or 2 Display Station
- 3284 Model 1, 2, or 3 Printer
- 3286 Model 1 or 2 Printer
- 3288 Model 2 Line Printer

Basically, Model 1 or 11 devices have a 480-character buffer; Model 2 or 12 devices have a 1,920-character buffer. The EBCDIC character set is basic; ASCII is optional on some devices.



Figure 2-3. IBM 3270 Information Display System

3271 Control Unit

The IBM 3271 Control Unit allows the remote attachment of a 3270 system to a System/370. Such a 3270 system can include IBM 3277 Display Stations and IBM 3284, 3286, and 3288 printers. (Remotely attached 3275 Display Stations are stand-alone and are not connected through a 3271.)

The 3271 Model 1 or 11 has a 480-character buffer, and can have Model 1 devices attached; the 3271 Model 2 or 12 has a 1,920-character buffer and can have Model 1 or 2 devices attached. At least one 3277 must be attached to a 3271. If the 3271 is a Model 2 or 12, the mandatory 3277 must be a Model 2.

The 3271 provides for the attachment of up to 32 separate devices. Base transmission rates for 3271 Model 1 or 2 are 2,000 and 2,400 bps; 1,200, 4,800, or 7,200 bps rates are available as options. Base transmission rates for 3271 Model 11 or 12 are 2,000, 2,400, 4,800, or 7,200 bps; 1,200 bps is available as an option.

3275 Display Station

The IBM 3275 is a remotely attached, stand-alone display station; it provides control and display of alphanumeric information on a CRT screen. The 3275 Model 1 or 11 displays up to 480 characters in 12 lines of up to 40 characters each; Model 2 or 12 displays up to 1,920 characters in 24 lines of up to 80 characters each. Basic features of all models include: dual brightness, protected data, compacted data, non-display, and character addressing.

The 3275 does not require a control unit, and is appropriate for locations requiring a single display device. A 3284 Model 3 Printer can be attached to the 3275, to provide printed copy of computer messages.

3277 Display Station

The IBM 3277 Display Station permits an operator to use the keyboard and/or light pen to display and manipulate alphanumeric data on the CRT screen. The 3277 Model 1 displays up to 480 characters in 12 lines of up to 40 characters each; Model 2 displays up to 1,920 characters in 24 lines of up to 80 characters each. The character set includes 36 alphanumeric and 27 special characters.

Individual fields of data on the screen can be program-defined for protected or unprotected storage, alphanumeric or numeric displays, non-displays, and normal or brightened character intensity. Program definition may also allow or disallow selector light-pen detection.

3284, 3286, and 3288 Printers

The IBM 3284 Printer has a 40-characters-per-second printing rate. Model 1 has a 480-character buffer; Model 2 has a 1,920-character buffer. Model 3 has no buffer and is used solely as an attachment to the 3275.

The IBM 3286 Printer has a 66-characters-per-second printing rate. Model 1 has a 480-character buffer, and Model 2 has a 1,920-character buffer.

The IBM 3288 Model 2 Line Printer attaches to a 3271-2 or 12 Control Unit. The print rate is 120 lines per minute.

Optional System Features

Optional features include:

Keylock, which provides key-operated security control of the display image

Selector Light Pen, which provides the selection of parts of a display image for further processing

Copy, which allows copying from one display to another display or to a printer (basic on Models 11 and 12)

Audible Alarm, which sounds when a character is entered into the next-to-last position on the screen

Operator Identification Card Reader, which reads encoded information from a magnetically striped plastic card, to identify the operator

Keyboard, which provides selection of input from data entry, typewriter, or operator console keyboards.

(Typewriter and operator-console keyboards are available with or without function keys.)

1200 bps Integrated Modem, which provides connection of a 3275 to nonswitched lines.

IBM 3600 Finance Communication System

The IBM 3600 Finance Communication System (Figure 2-4) consists of a programmable controller and a selection of compact terminals and associated devices. The 3600 system can be connected to a System/370 via SNA (Systems Network Architecture) and can be configured to accommodate the requirements of a variety of users. Bank tellers, for example, can use it to debit or credit checking and savings accounts, to post interest, or to record loan payments; management can use it to maintain a record of cash flow through an institution; customers can use it for self-service banking at any hour.

The Financial Services Terminals may be used to perform a set of payment process operations under control of the controller program. The terminals can be installed at any merchant location, either at the controller location or at remote locations.

Components of the system include:

- 3601 Finance Communication Controller
- 3603 Terminal Attachment Unit
- 3604 Models 1, 2, 3, and 4 Keyboard Display
- 3606 Financial Services Terminal
- 3608 Printing Financial Services Terminal
- 3610 Models 1, 2, and 3 Document Printer
- 3611 Models 1 and 2 Passbook Printer
- 3612 Models 1, 2, and 3 Passbook and Document Printer
- 3614 Models 1 and 2 Consumer Transaction Facility
- 3618 Administrative Line Printer

3601 Finance Communication Controller

The IBM 3601 Finance Communication Controller, a device with as much as 56K bytes of programmable storage, can supervise the 3600 system's terminals and associated devices, and can control data transmission between the 3600 system and a central System/370. The 3601 uses synchronous data link control (SDLC) for improved communications efficiency and has a removable diskette for storing user data and programs as well as controller data.

Special features for the 3601 include an optional integrated 1,200-bps modem.

3603 Terminal Attachment Unit

The IBM 3603 Terminal Attachment Unit connects the 3601 and remote terminal subloops to the switched or non-switched telecommunication lines that join them. In non-switched applications, the 3603 contains a Switched Network Backup Facility that can be used to bypass a malfunctioning line segment.

3604 Keyboard Display

The IBM 3604 Keyboard Display, a compact interactive terminal, can be used for a variety of applications, including deposit and withdrawal transactions, customer account inquiry, and calculation verification. The display allows a visual check of the keyed data before it is transmitted or printed and it can provide operation guidance messages for training or for complex or infrequent transactions.

The 3604 can have one of four keyboards--numeric, alpha-numeric, expanded numeric, or expanded alphanumeric. The keys and three indicator lights are defined by the financial institution's application programs in the 3601 controller. Models 1 and 2 can display 240 characters (6 lines of 40 characters each), Model 3 can display 480 characters (12 lines of 40 characters), and Model 4 can display 1,024 characters (16 lines of 64 characters).

Special features for the 3604 include a magnetic stripe reader or an encoder/reader. The reader can read data such as a teller's security code or a customer's account number from a magnetic stripe on a customer's card or passbook. The encoder/reader can encode information on a passbook stripe, as well as read it.

3606 Financial Services Terminal

The IBM 3606 Financial Services Terminal is used by sales personnel at the point of sale to authorize or complete payments for goods and services. It provides a keyboard for the entry of credit and payment inquiries, and a display screen for verification of keyed data and for display of output messages. This terminal also incorporates a reader for magnetic stripe cards.

3608 Printing Financial Services Terminal

The IBM 3608 Printing Financial Services Terminal has all the features of the 3606 terminal and also incorporates a printer that is used to print sales slips, receipts, or records, as determined by the card plan agency or financial institution.

3610 Document Printer

The IBM 3610 Document Printer is used for printing tasks such as document validations, checks, statements, low-volume reports, printouts for error tracking, and audit trails. When a 3610 is combined with a 3604, the combination forms an administrative or teller work station.

Using a 64-character set, the 3610 prints at a rate of 15 characters per second, printing 10 characters per inch on lines up to 80 characters long, with vertical spacing of five or six lines per inch.

The 3610 is available in three models. All three can print on cut-form documents. In addition, the Model 2 can print on journal rolls, and the Model 3 can print on continuous forms.

Special features for the 3610 include a 96-character set that allows printing at a rate of up to 30 characters per second, and a feature that permits a 3610 to be shared by two tellers.

3611 Passbook Printer

The IBM 3611 Passbook Printer prints one or more lines of up to 100 characters each on a passbook, a pad of cut forms (Model 1), or single cut forms (Model 2). With the basic 64-character set, printing is at 15 characters per second, 12 characters to the inch. Line spacing is either five or six lines per inch.

The top cover of the 3611 is designed to support a 3604 Model 1 or 2 Keyboard Display.

Special features available for the 3611 include a 96-character set that prints at 30 characters per second, and a shared printer with operator identifier keys so that two tellers can use one 3611 printer.

3612 Passbook and Document Printer

The IBM 3612 Passbook and Document Printer has two printing mechanisms: one for passbooks, and the other for cut-form documents. When a 3612 is combined with a 3604, the combination forms a full-function teller work station for handling a wide range of transactions.

A basic 3612 has a 64-character set and prints 15 characters per second. The passbook mechanism prints information on horizontal- or vertical-fold passbooks, 12 characters per inch on a 100-character line; the document or cut-form mechanism prints 10 characters per inch on an 80-character line. Vertical spacing for both mechanisms is either five or six lines per inch.

The 3612 is available in three models, all of which can print on passbooks or on cut-form documents. The Model 2 can also print on journal rolls, and the Model 3 can also print on continuous forms.

Special features for the 3612 include a 96-character set that allows printing at a rate of up to 30 characters per second and a feature that permits sharing of the printer by two tellers.

3614 Consumer Transaction Facility

The IBM 3614 Consumer Transaction Facility, an online banking terminal, allows customers self-service access to their accounts. Using a 3614, a customer can withdraw cash from his account, make deposits, check his account's status, and perform other transactions programmed by the financial institution. An optional depository feature allows a customer to make deposits or pay certain bills; the optional transaction statement printer gives the customer a printed record of these transactions.

Two models are available; Model 1 is for inside use, as in a lobby, and Model 2 is for outside use, mounted in a wall. The Model 2 allows a 3600 system to be available on a 24-hour basis.

To use a 3614, a customer needs a special identification card and an identification number. When the card is inserted, the customer can use the display and keyboard to direct the transaction. The 44-character display tells the customer how to use the system and how to correct operation errors, and supplies him with requested information about his account, but no one else's. The 3614 can retain stolen cards and can signal an alarm system when it is tampered with.

3618 Administrative Line Printer

The IBM 3618 Administrative Line Printer, a compact medium-speed device, can handle a variety of items, such as trial balances, exception notices, customer statements, transaction journals, and management reports.

The basic 3618 prints 10 characters per inch on lines up to 80 characters in length with vertical spacing of six lines per inch on pin-fed continuous-form paper. The 3618 printing rate depends upon the character set used, line length, and attachment mode.

Special features for the 3618 include an expanded print line and dual independent forms feed. The former expands the print line to 132 characters; the latter provides two independently indexed pinfeed mechanisms for different-size forms.

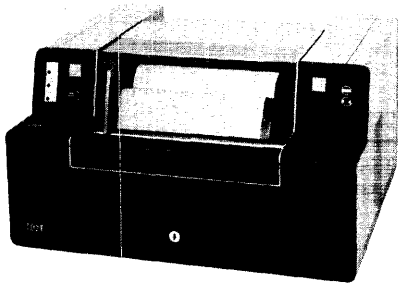

IBM 3610 Document Printer

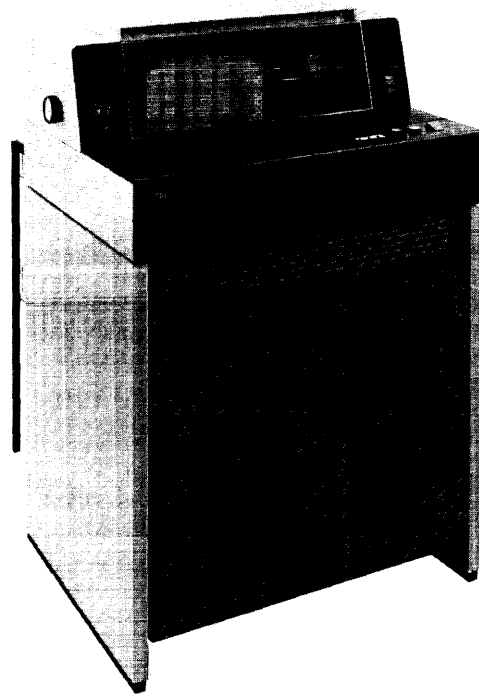

IBM 3618 Administrative Line Printer

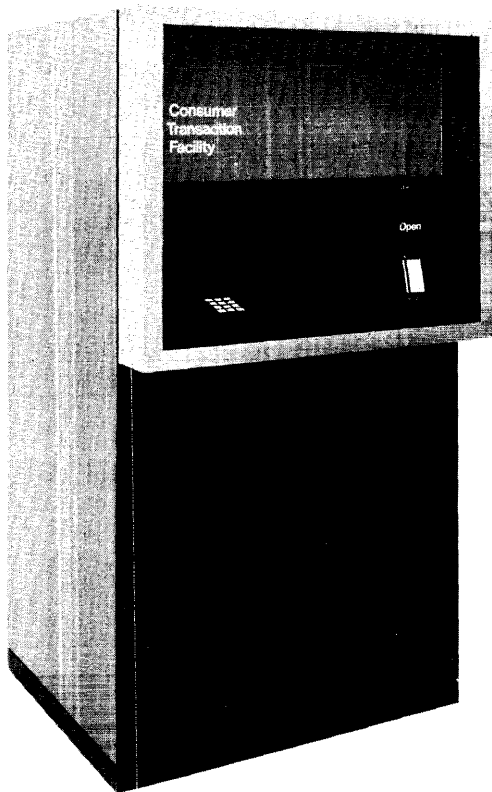

IBM 3614 Consumer Transaction Facility

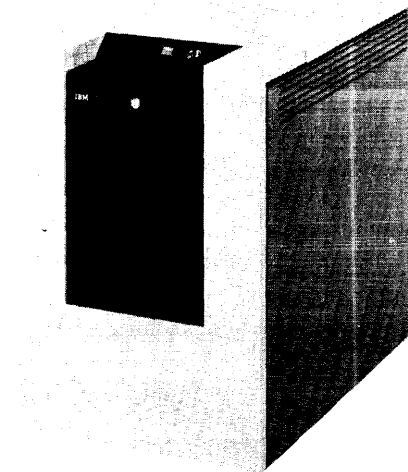

IBM 3601 Finance Communication Controller

Figure 2-4. Components of IBM 3600 Finance Communication System (Part 1 of 2)

IBM 3612 Passbook and Document Printer



IBM 3604 Model 1 Keyboard Display

A typical Teller Work Station



IBM 3606 Financial Services Terminal



IBM 3608 Printing Financial Services Terminal

Figure 2-4. Components of the IBM 3600 Finance Communication System (Part 2 of 2)

IBM 3650 Retail Store System

The IBM 3650 Retail Store System (Figure 2-5) is a comprehensive system that can handle point-of-sale transactions, data entry and inquiry, report printing, and merchandise receiving and marking.

Online connection to a System/370 via SNA (System Network Architecture) enables the 3650 system to operate on an interactive or batch basis with central System/370 applications.

Components of the 3650 system include:

- 3651 Model 50 Store Controller
- 3653 Point of Sale Terminal
- 3657 Ticket Unit
- 3659 Remote Communications Unit
- 3275 Model 3 Display Station
- 3284 Model 3 Printer
- 3784 Model 1 Line Printer

3651 Model 50 Store Controller

The IBM 3651 Model 50 Store Controller is the controlling link between point-of-sale operations, receiving-marking, credit authorization, store management, and a central System/370. The 3651 collects data from the various parts of the system; performs edit, logic, and arithmetic operations; and then stores and/or forwards the data to its destination in the system. It communicates with the various terminals on an interactive basis through a store loop, processes inquiries against various files, and communicates with System/370 on a batch or interactive basis. The basic transmission rate between the 3651 Model 50 and System/370 is 2,400 bps, over leased or switched networks.

The 3651-50 provides for point-of-sale functions and basic terminal support. The functions include basic sales and logging support, negative in-store credit check, support of the I/O devices, and facility for user program execution.

The 3651-50 uses synchronous data link control (SDLC) for improved communication efficiency and has both control storage and integrated disk storage. The disk storage has a capacity of 5 million bytes, with optional expansion to 9.3 million bytes.

3653 Point of Sale Terminal

The IBM 3653 Point of Sale Terminal has a keyboard, a three-station printer, an operator guidance panel, a transaction display, and a cash drawer with a removable till.

The keyboard is the normal input device for recording customer transactions. An optional wand reader permits a 3653 to read magnetically encoded tickets, credit cards, and employee badges. The three-station printer allows a 3653 to issue cash receipts or print on inserted documents, and maintain a journal of transactions.

The operator guidance panel has 18 short descriptive messages which are backlit, one at a time or in combination, as needed, to provide operators with step-by-step instructions.

The transaction display is a composite of an eight-position numeric display plus the symbols:

\$, . -

and five backlit captions. It shows numeric data as it is being keyed and/or calculated. The display gives the operator visual verification of output.

The Functional Expansion special feature provides the 3653 terminal with additional flexibility in handling various types of transactions.

3657 Ticket Unit

The IBM 3657 Ticket Unit is an online, high-speed, batch ticket encoder that can also batch-read 2-inch tickets. Tickets are 1-inch wide by 1, 2, or 3 inches long, and have a 1/4-inch-wide magnetic stripe. The 3657 encodes this stripe with up to 19 (1-inch), 40 (2-inch), or 60 (3-inch) characters of data, readable by the 3657 batch-read function (2-inch tickets) or by the wand available for the 3653. The 3657 also prints up to 22, 42, or 64 characters (respectively) of visually readable data, in two lines, on the tickets.

3659 Remote Communications Unit

The IBM 3659 Remote Communications Unit, a 2,400-bps signal converter, provides store-loop capability to retail establishments that are remote from a 3651. The 3659 connects to private line communications facilities for data transmission, and to the store loop for retail store operations.

3275 Model 3 Display Station

The IBM 3275 Model 3 Display Station is a 1,920-character alphanumeric display station with a keyboard. The 3275 can be used for a variety of operations, such as entering purchase orders, controlling and checking merchandise received, controlling ticket production and price changes, and making inquiries to a 3651 or to System/370 files (through the 3651 Model 50) for many other inventory, credit, and management control functions needed to operate a retail store efficiently.

3284 Model 3 Printer

An IBM 3284 Model 3 Printer can be attached to a 3275-3. This printer prints such items as store reports, due-in orders, and receiving lists.

3784 Model 1 Line Printer

An IBM 3784 Model 1 Line Printer can be attached to the 3651 Model 50 controller for the printing of reports and so forth. It is an engraved-font printer equipped with an interchangeable print belt, a variable-width forms tractor, and paper jam detection. The print line length is 132 positions; maximum printing rate is 155 lpm (lines per minute) with a 48-character set, 120 lpm with a 64-character set, or 80 lpm with a 94-character set.

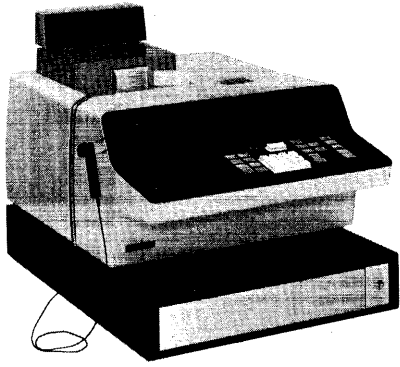

IBM 3653 Point of Sale Terminal

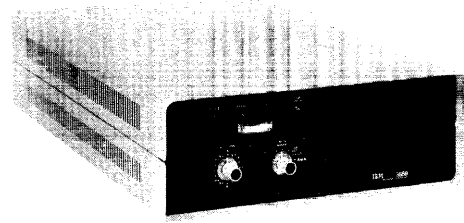

IBM 3659 Remote Communications Unit

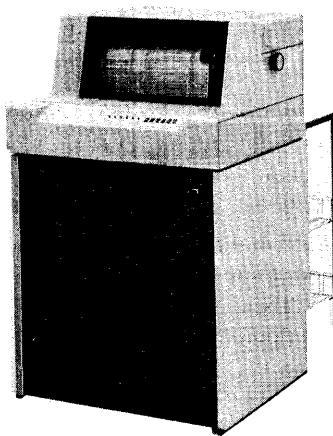

IBM 3784 Model 1 Line Printer

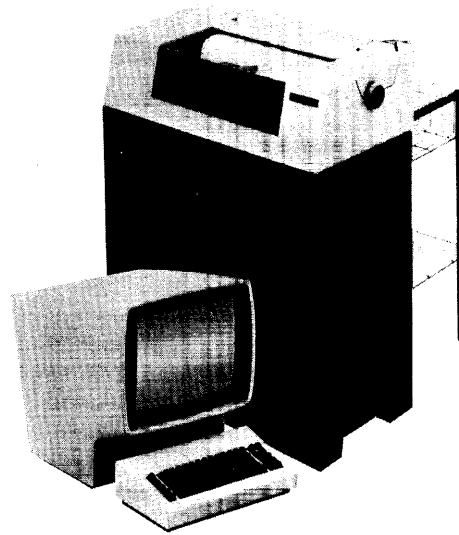

IBM 3275 Model 3
Display Station

IBM 3284
Model 3 Printer

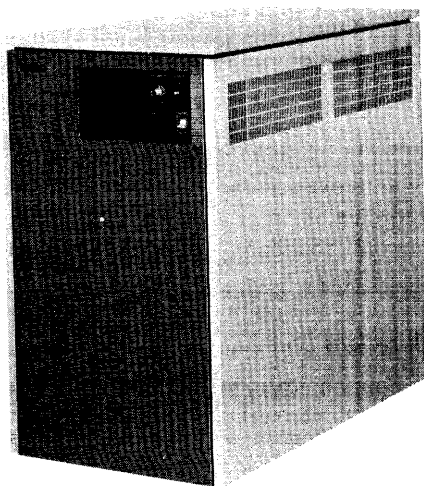

IBM 3651 Model 50 Store Controller

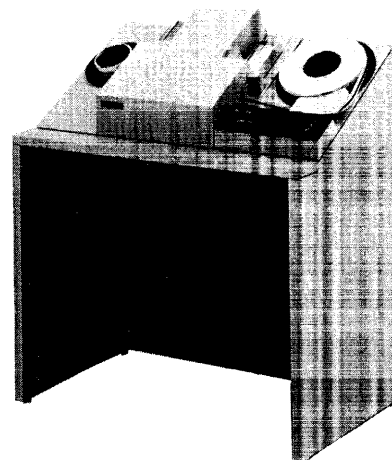

IBM 3657 Ticket Unit

Figure 2-5. Components of the IBM 3650 Retail Store System

IBM 3660 Supermarket System

The IBM 3660 Supermarket System (Figure 2-6) is designed to perform normal checkout operations and to meet the data collection and dissemination needs of the supermarket industry. It equips a supermarket to speed customer checkout, increase personnel productivity, and improve store efficiency. Two systems are available: the 3660 Scanning System (with or without scanner) and the smaller 3660 Key-Entry System (without scanner).

While performing checkout operations, the 3660 system accumulates data from customer checkout and various store operations; these can be transmitted via the switched communications network to a remote IBM System/370 processor for analysis and report generation. These reports may provide information required for ordering, allocating shelf space, analyzing sales, scheduling labor, and managing store and customer relations.

Components of the 3660 system include:

- 3651 Model 60 Store Controller (Scanning System)
- 3661 Store Controller (Key-Entry System)
- 3663 Model 1 or Model 2 Supermarket Terminal
- 3666 Checkout Scanner
- 3669 Store Communications Unit

3651 Model 60 Store Controller (Scanning System)

The IBM 3651 Model 60 Store Controller controls the operation of all terminals in a supermarket and is the communications link between the store and the System/370, on a batched basis. It has two-way telecommunications, logic, and computational capabilities; it can, in addition (as backup), control the terminals in another supermarket. This unit can contain data for:

- Up to 22,000 item records, with the item code, item code description, pricing data (single or multiprice, mix or match), department number, status for tax, stamps, and so on.
- Up to 24,000 check verification records for positive or negative control.
- Up to 200 operator records, with a user-assigned password and list of store support procedures.
- Item movement data for predesignated items sold during a defined period.
- Accounting data, such as the total transaction dollars for each operator and store office.
- Productivity records, by station, showing activity in 15-minute periods.

3661 Store Controller (Key-Entry System)

The IBM 3661 Store Controller controls the operation of 3663 terminals and is the communications link between one store and the System/370, on a batched basis. It has two-way telecommunications, logic, and computational capabilities. This unit can contain data for:

- Up to 250 item records (1,275 with additional 8K bytes of storage), with the item code, pricing data (single or multiprice, mix or match), department name and number, status for tax, stamps, and so on.
- Check verification records for negative audit.
- Operator records, with a user-assigned password and list of store support procedures.
- Item movement data for predesignated items sold during a defined period.
- Accounting data, such as the total transaction dollars for each operator and store office.
- Productivity records, by station, showing activity in one-hour periods.

3663 Supermarket Terminal

The IBM 3663 Supermarket Terminal provides the input and output facilities required for a supermarket checkout station. It replaces and extends the function of a supermarket cash register. There are three buffers in each terminal; while the checkout operator is entering data into one buffer area, another buffer is used for transmitting, and the third buffer is available to receive information. Up to twenty-four 3663 terminal stations can be attached to a 3651 Model 60 Store Controller; up to twelve 3663s can be attached to a 3661 Store Controller.

3666 Checkout Scanner

The IBM 3666 Checkout Scanner is an optical recognition device designed to “read” the Universal Product Code symbol on an item as it is passed across the scanner slot in the checkstand. An item symbol is read at a rate of up to 100 inches per second as it is moved across the scanner window. The scanner equips a supermarket to improve checker productivity, improve accuracy, and furnish input for the automatic recording of item movement data. The 3666 scanner attaches only to a 3651 Model 60 Store Controller, via a 3663 terminal.

3669 Store Communications Unit

The IBM 3669 Store Communications Unit provides communications for the 3660 Supermarket System (Scanning System) with an IBM System/370 (and with a predesignated supermarket when a backup operation is performed). Data is transmitted over common-carrier switched communications facilities at 2,400 bps. The 3669 is equipped for automatic answering.

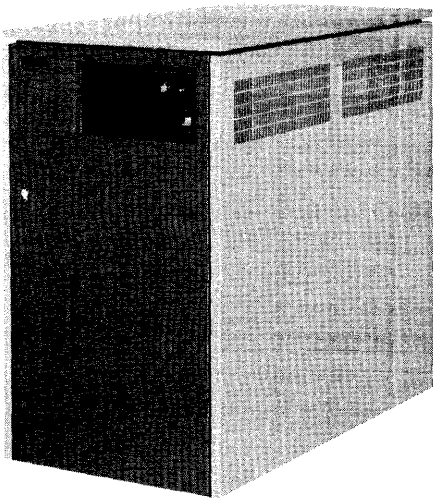

IBM 3651 Model 60 Store Controller (Scanning System)

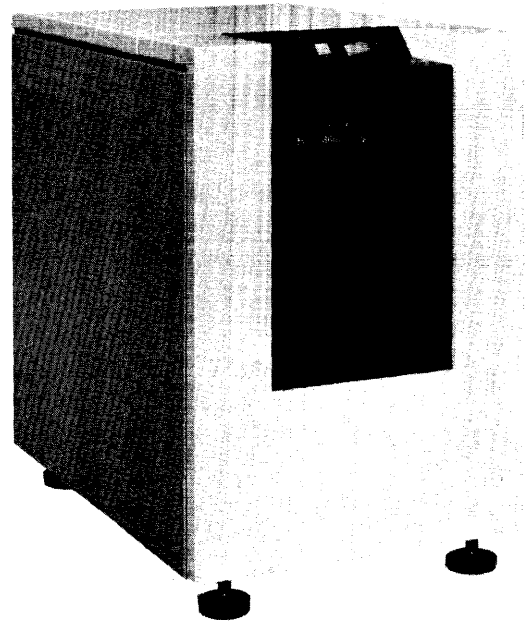

IBM 3661 Store Controller (Key-Entry System)

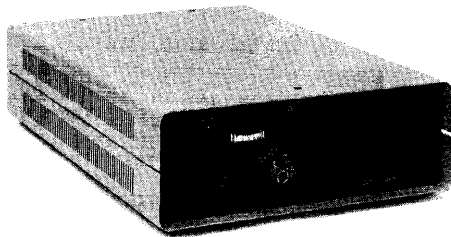

IBM 3669 Store Communications Unit

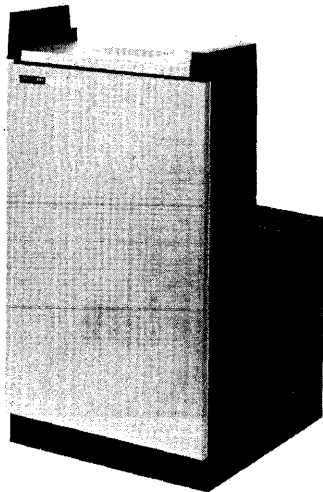

IBM 3666 Checkout Scanner

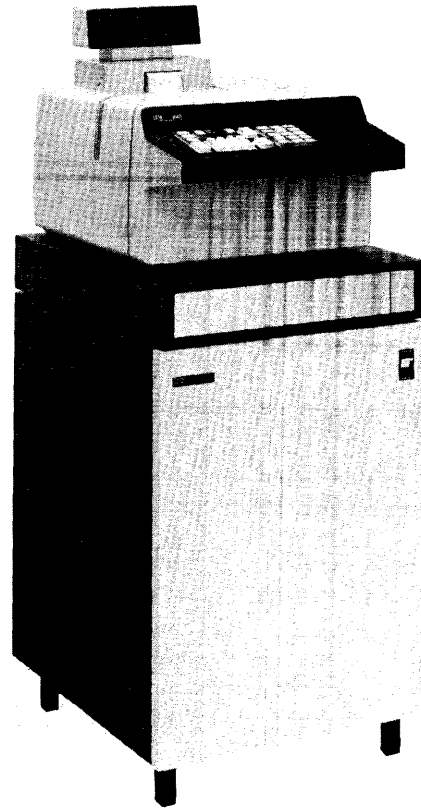

IBM 3663 Model 1 Supermarket Terminal (Integrated Station & Control Segment)

Figure 2-6. Components of the IBM 3660 Supermarket System

IBM 3767 Communication Terminal

The IBM 3767 Communication Terminal (Figure 2-7) is a compact, movable, desk-top terminal that furnishes access to a remote IBM System/370 via SNA (Systems Network Architecture). The 3767 provides a migration path for transition from Start-Stop to SDLC (SNA) line control by offering special Start-Stop features for use with 2741, 2740-1, or 2740-2 support provided by System/360 or System/370. If a Start-Stop feature is installed, a switch allows selection between Start-Stop and SDLC line control, for connection to a corresponding Start-Stop or SDLC multiplexer port.

Some of the online uses of the 3767 are:

- Computer programming
- Data entry
- Data base inquiry and update.

When it is not communicating with a System/360 or System/370, the 3767 may be used for offline secretarial typing.

The IBM 3767 is available in three models, with characteristics as follows:

	Printing Rate	Buffer Size
3767-1	40cps average	512 bytes optional
3767-2	80cps maximum	512 bytes basic
3767-3	120cps maximum	512 bytes basic

Buffer expansion special features for up to 1024 bytes are available for all three models.

Basic Capabilities

- Horizontal forms control
- Bidirectional printing
- Automatic test capability
- Batched or interactive communication
- Buffer edit (single line)
- Visual print verification
- SDLC line control
- Friction-feed of single-part continuous forms (3767-1 or 3767-2) or up to four-part cut forms.

Special Features

Start-Stop line control (choice of one):

- 2741 (3767-1 or 3767-2)
- 2740-1 point-to-point (3767-1 or 3767-2)
- 2740-1 station control (3767-1 or 3767-2)
- 2740-2

- Magnetic stripe reader (SDLC only)
- Integrated modem or EIA/CCITT line interface
- Acoustic coupler
- Calculate-Scientific
- Buffer expansion with full buffer edit
- Variable-width forms tractor (required for 3767-3)
- Security key lock
- Vertical forms control
- Alternate character set

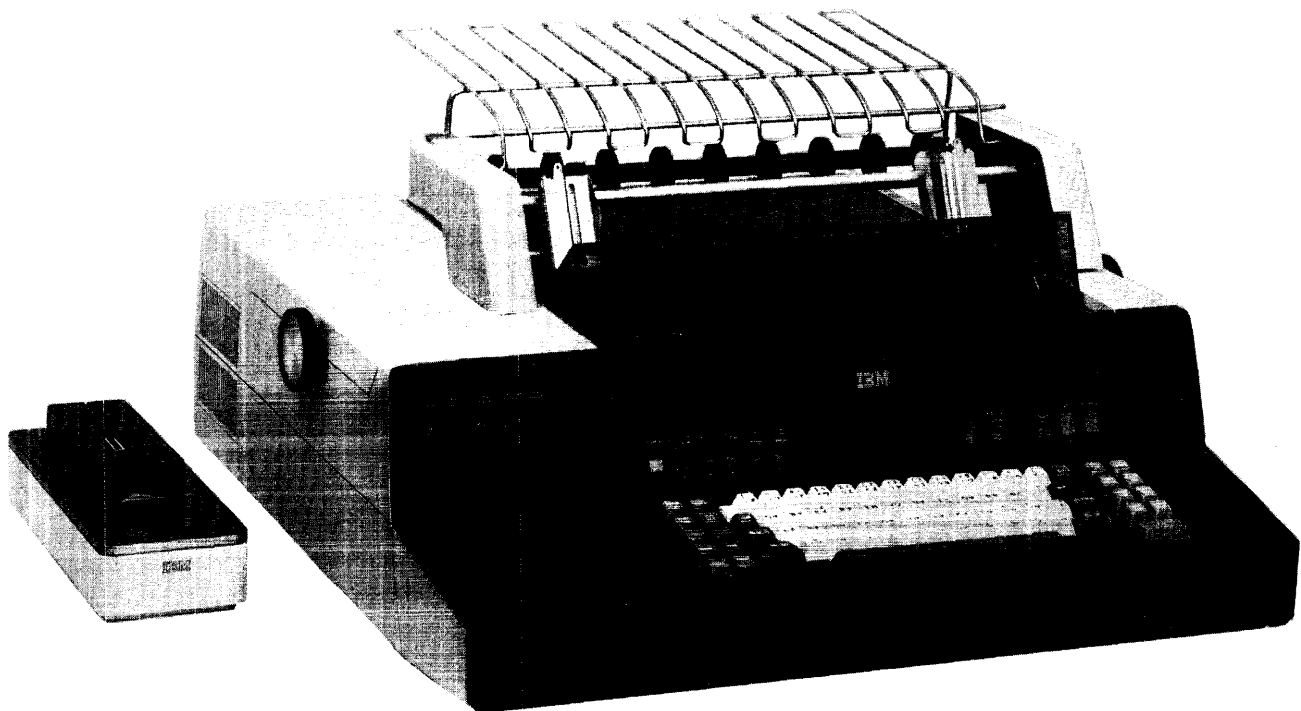

Figure 2-7. IBM 3767 Communication Terminal with Magnetic Stripe Reader and Forms Tractor

IBM 3770 Data Communication System

The IBM 3770 Data Communication System (Figure 2-8) is a family of communication terminals that offers keyboard- and-printer combinations, with a selection of I/O equipment and communication features that provides to SNA (Systems Network Architecture) a variety of multiple purpose terminal configurations.

Configuration options allow:

- Online batch operations for:
 - Line to diskette
 - Line to printer
 - Line to card punch
 - Card reader to line
 - Diskette to line
- Online interactive operation for:
 - Keyboard to line
 - Line to printer
- Offline operation for:
 - Keyboard to: diskette, card punch, or printer
 - Diskette to: diskette, card punch, or printer
 - Card reader to: diskette, card punch or printer

3770 System Terminals

The IBM 3770 Data Communication System offers the following selection of fixed-function terminals:

IBM 3771 Communication Terminal — A keyboard-printer console that prints serially by character, using a wire-matrix print head. It has 132 print positions per line and prints bidirectionally, at an average rate of 40 characters per second (Model 1) or a maximum rate of 80 (Model 2) or 120 (Model 3) characters per second.

Special features allow the addition of one card reader or card punch, operating at 50 cards per minute. The card punch can be equipped with a card read feature (to provide single-path read and punch) and a card-print feature.

IBM 3773 Communication Terminal — A keyboard-printer console having the same printing characteristics as the 3771. A customer-removable diskette is a part of its basic equipment. Up to 948 data records of up to 256 bytes each can be stored on each diskette.

IBM 3774 Communication Terminal — A keyboard-printer console, with Models 1 and 2 having the same printing characteristics as the 3771 Models 2 and 3, respectively. Additional I/O equipment may be attached, by special features, to provide: one or two magnetic diskettes, one 3784 Line Printer, one 2502 or 3501 Card Reader, and one 3521 Card Punch. The card punch operates at 50 cards per minute; a card reader may be selected for 50, 150, or 300 cards per minute.

IBM 3775 Model 1 Communication Terminal — A keyboard-printer console that prints a line at a time, with 132 print positions per line, from characters engraved on a revolving print belt. Basic equipment includes: an interchangeable print belt, a variable-width forms tractor, and paper jam detection. Maximum printing rate is 80 lines per minute with a print belt having a 94-character set, or 120 lines per minute with a 64-character set.

Another printer cannot be added to the 3775; otherwise, additional I/O equipment is the same as that available for the 3774.

IBM 3776 Communication Terminal — A keyboard line-printer console for medium-speed remote job entry. The keyboard is used for operator control of the terminal or for communication with the host system.

The printer prints a line at a time, with 132 print positions per line. Basic printer equipment includes: an interchangeable print belt, a variable-width forms tractor, and paper jam detection. For Model 1, maximum printing rate is 160 lines per minute with a print belt having a 94-character set, 230 lines per minute with a 64-character set, or 300 lines per minute with a 48-character set. Model 2 printing rate is 230 lines per minute with a 94-character set, 300 with a 64-character set, or 400 with a 48-character set.

Additional I/O equipment is the same as that available for the 3775. The Dual Data Path function allows concurrent on-line and off-line operations.

The IBM 3770 Data Communication System also offers programmable-function terminals (having the same selections of printing rates and many of the I/O features corresponding to the fixed-function terminals), as follows: IBM 3773 Models P1, P2, and P3 Communication Terminal, IBM 3774 Models P1 and P2 Communication Terminal, and IBM 3775 Model P1 Communication Terminal. In addition, a 480-character display is available for the 3774-P1 or -P2 and for the 3775-P1; a 10-key numeric keypad feature is available on all programmable models. Programmable functions include:

- Validation of entered data (range check, self-check, alpha/numeric check, length check)
- Logical and arithmetic operations (add, subtract, multiply, divide, compare)
- Storage-to-storage, table lookup, and storage compare operations
- Format and edit operations (picture, justify, fill, case)
- Direct access to data on diskettes

Programs for 3770 programmable terminals are user-written, assembled and validated by the host System/370 VS, and transmitted to the 3770 terminal for storage and subsequent use at the terminal.

All 3770 Data Communication System terminals offer:

- Communication features for operation over switched facilities at rates of up to 2,400 bps (up to 4,800 bps in the USA and Canada), or over non switched facilities at rates of up to 9,600 bps
- Synchronous data link control (SDLC)
- Dual 256-byte buffering with buffer edit
- Electronic horizontal and vertical print forms control
- Automatic answering on switched communications facilities
- Terminal identification

Attachable Units

Input and output devices attachable to one or more 3770 terminals are:

- IBM 2502 Card Reader — Reads 80-column cards at 150 cards per minute (Model A1) or 300 cards per minute (Model A2). Special features permit interchangeable feeding for 51- or 80-column cards, or for 66- or 80-column cards, and/or optical mark reading.
- IBM 3501 Card Reader — Reads 80-column cards at 50 cards per minute (maximum). This small, compact unit is suitable for desk-top use.
- IBM 3521 Card Punch — Punches 80-column cards at 50 cards per minute (maximum). Special features permit card-read/punch-check functions and/or card printing.
- IBM 3782 Card Attachment Unit — Provides facilities and mounting for attaching the 2502 or the 3521 to a 3770 terminal.

IBM 3784 Line Printer — Provides the second-printer function when it is attached to the 3774 Models 1 or 2. It is an engraved-font printer equipped with an interchangeable print belt, a variable-width forms tractor, and paper-jam detection; print line length is 132 positions. The maximum printing rate is 80 lines per minute using a print belt with a 94-character set; 120 lines per minute with a 64-character set; or 155 lines per minute with a 48-character set.

Additional System Features

All 3770 terminals can use SNA for communication with an IBM System/370.

The 3774 and 3775 with magnetic diskette, and the 3773, can create or read a diskette in basic interchange mode. Refer to *IBM Diskette General Information Manual*, GA21-9182, for additional information.

A special feature available for all 3770 terminals permits BSC communications with an IBM System/360 or System/370 operating under BTAM or VTAM and DOS/VS, or under BTAM, TCAM, or VTAM and OS/VS1 or OS/VS2. The 3770 terminals use 2770 (also 3780 for 3776 terminal) programming support when they operate in BSC mode. Connection may be via a 3704 or 3705 Communication Controller or a 2701 Data Adapter Unit attached to a channel of System/360 or System/370, or via an Integrated Communication Adapter on System/360 or System/370.



Figure 2-8. IBM 3770 Data Communication System

IBM 3790 Communication System (general-purpose configurations)

The IBM 3790 Communication System (general-purpose configurations, Figure 2-9) is an operator-oriented communication system that consists of an IBM 3791 Controller and its attached operator terminals and auxiliary control units. The operator terminals can be keyboard-printers, display stations, or a mixture of these devices. The IBM 3792 Auxiliary Control Units allow for additional operator terminals in the system, some of which can be remote from the 3790 site. In addition, a line printer is available as a special feature for the 3791 Controller or the 3792 Auxiliary Control Unit.

The 3791 Controller communicates, via communication lines or local channel attachment, with a central IBM System/370 via SNA (Systems Network Architecture). Functions performed by the 3790 system are specified by programs that are sent to the 3791 Controller from the System/370. These programs allow the 3790 system to operate without supervision from, or interaction with, the System/370, except when data or programs are being exchanged between systems.

Multiple 3790 systems can form a communications network that links remote and/or local 3790 systems with the host system.

Components of the 3790 system include:

- 3791 Models 1A, 1B, 2A, and 2B Controller
- 3792 Auxiliary Control Unit
- 3793 Keyboard-Printer
- 3277 Models 1 and 2 Display Station
- 2741 Communication Terminal

3791 Controller

The IBM 3791 Controller can concurrently service up to sixteen 3790 programs, do line printing, and provide communications with a System/370. The controller contains:

- Control storage for supporting features, functions, and operator terminals
- Diskette storage for packed transmission data, for backup of application data sets, and for batch exchange of data.
- Disk storage for 3790 programs, transaction records, and application data sets. Depending upon the model, the 3791 can have up to 26.9 million bytes of disk storage available for programs and data sets.



Figure 2-9. IBM 3790 Communication System

Communication with the System/370 is by non switched or switched communications facilities, or by a byte multiplexer channel. For switched lines, automatic or manual dialing and automatic answering are supported at the 3704 or 3705; manual dial and manual or auto-answer are supported at the 3791. A 1,200 bps integrated modem is available, or an external 1,200 or 2,400 bps modem may be attached.

3792 Auxiliary Control Unit

The IBM 3792 Auxiliary Control Unit, which may be located up to 2,000 feet from the 3791 Controller, provides:

- The capability for attaching up to four 3793 Keyboard-Printers

- A line printer as a special feature

- Special features for communicating with 2741 Communication Terminals

- A security keylock special feature that controls power to the 3792.

3793 Keyboard-Printer

The IBM 3793 Keyboard-Printer is a data entry operator terminal that can be attached to the 3791 or to the 3792, to provide printed output. The 3793 has a friction-feed platen, with a pinfeed platen available as a special feature. A maximum print line has 130 positions at 10 characters per inch; line spacing is six lines per inch.

The 3793 keyboard includes control keys, operator guidance indicators, and system indicators. Included in the normal office typewriter keyboard is a 10-key configuration of dual-function keys that can be used for entering numeric data. A special feature provides a power-line keylock for security.

3277 Display Station

The IBM 3277 Display Station can display on its CRT screen up to 480 characters in 12 lines of 40 characters each (Model 1), or up to 1,920 characters in 24 lines of 80 characters each. The last line on either model is reserved for controller use. Basic features of both models include: a 63-character set, editing features, dual brightness control, and protection of data. The keyboard for a 3277 attached to a 3790 system may be the typewriter style, data entry style, or data entry with keypunch layout.

Line Printer Feature

The Line Printer available as a special feature on the 3791 or 3792 prints continuous forms, with line spacing of six lines per inch. The print line is 80 characters (10 characters per inch), expandable to 132 characters. The maximum printing rate is 155 lines per minute, using a 98-character set.

IBM 3790 Communication System/Data Entry Configuration

This application of the IBM 3790 Communication System is designed for preparing and entering substantial batches of data records into a data processing system. The configuration of this system consists of up to twelve IBM 3760 Dual Key Entry Stations (a maximum of 24 operator positions) attached to an IBM 3791 Controller, with a disk storage capacity of up to 9.3 million bytes.

In the first phase of preparation, source data is entered and verified at the IBM 3760 Dual Key Entry Station. Various checks and edits are available to promote data accuracy and system productivity. The source data is stored locally in the 3791 Controller. In the second phase, data is transmitted to a host computer, either via a byte multiplexer channel or a teleprocessing data link.

IBM 3791 Controller

See "IBM 3790 Communication System (general-purpose configurations)", earlier.

IBM 3760 Dual Key Entry Station

The IBM 3760 Dual Key Entry Station (Figure 2-10) comprises two models. Model 1 connects to a power source and to the 3791 Controller. One or two 3760 Model 2s may be physically attached to a Model 1, providing a four- or six-operator stations. Model 1 and Model 2 units are otherwise functionally identical, each having a recessed keyboard and a display screen.

The keyboard is a common type (similar to the keyboard of the IBM 129 Card Data Recorder, for example) and contains both traditional and new function keys. Several function keys are typamatic; that is, the function is repeated as long as the key is held. The keyboard graphics are available in several languages.

The flat display screen is located to the left of the keyboard, directly above the source material desk. On the screen, up to 199 characters of entered data can be displayed simultaneously. The data displayed may be divided into a number of fields, having different checks and edits assigned in advance. A number of fields can be predefined as constants, thus providing a 'fill-in-the-blanks' prompting frame.



Figure 2-10. IBM 3760 Dual Key Entry Station (Four-operator Station)

IBM System/32

The IBM System/32 (Figure 2-11) is a desk-size, operator-controlled, general-purpose computing system designed for use as a data processing tool in a wide variety of industries. It comprises the IBM 5320 System Unit, which features keyboard data entry and disk processing. Components of the 5320 include: a keyboard, a processing unit, disk storage, a diskette drive, a display screen, and printing capability.

The keyboard has the familiar typewriter layout, with a dual-defined top row of keys that provides 24 command keys. A 10-key proof keyboard and system function keys are included.

The processing unit features MOSFET (metal-oxide-semiconductor-field-effect-transistor) main storage of 16K bytes capacity (featurable to 24K or 32K), and uses EBCDIC internal coding.

The disk storage has a capacity of 5.0 or 9.1 million bytes, depending upon the system model (see table). Access time averages less than 73.0 milliseconds in either size; the data transfer rate for either is 889K bytes per second.

The diskette drive uses standard IBM Diskettes; it reads at a rate of up to 3400 128-byte records per minute; it

writes and verifies at a rate of up to 1800 128-byte records per minute. Diskette storage is used for reading data that was entered at a 3741 or 3742 Data Station, for storage of information from the larger, non-removable disk storage, for data interchange with other devices that read IBM Diskettes, and for program distribution.

The display screen provides operator guidance and output; it uses a 64-character set and displays up to six lines of 40 characters each.

The printing speed and method of printing depend on the system model (see table). Printing is done either serially or by line; speeds range from 40 characters per second to 155 lines per minute.

Depending upon appropriate attachments and control programs, System/32 communicates with System/370 either through synchronous data link control (SDLC) via a 3704 or 3705 Communications Controller, or through binary synchronous communications (BSC) via a 2701 Data Adapter Unit or a 3704 or 3705 Communications Controller. Communication is under stored-program control at speeds up to 7200 bps on a nonswitched point-to-point or multipoint line, or up to 4800 bps on switched communications facilities.

System/32 Model	Printing Speed	Disk Storage Capacity	Main Storage Capacity
A12	40 cps (serial)	5,053,440 bytes	16,384 bytes
A13	40 cps (serial)	9,169,920 bytes	16,384 bytes
A22	80 cps (serial)	5,053,440 bytes	16,384 bytes
A23	80 cps (serial)	9,169,920 bytes	16,384 bytes
B12	50 lpm (by line)	5,053,440 bytes	16,384 bytes
B13	50 lpm (by line)	9,169,920 bytes	16,384 bytes
B22	100 lpm (by line)	5,053,440 bytes	16,384 bytes
B23	100 lpm (by line)	9,169,920 bytes	16,384 bytes
B32	155 lpm (by line)	5,053,440 bytes	16,384 bytes
B33	155 lpm (by line)	9,169,920 bytes	16,384 bytes

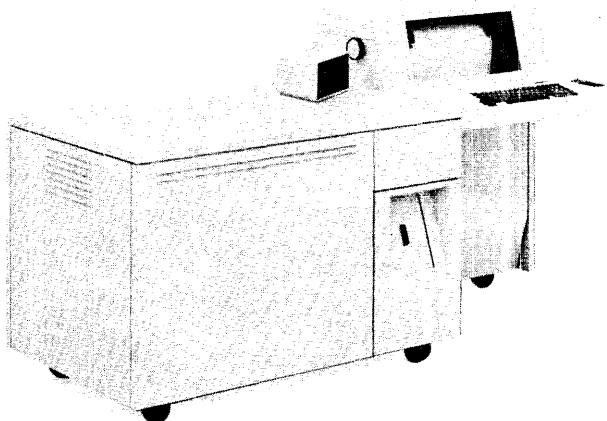

Figure 2-11. IBM System/32

Abbreviations

bps	bits per second
CICS	Customer Information Control System
cps	characters per second
CPU	central processing unit
CRT	cathode ray tube
DOS	Disk Operating System
IMS	Information Management System
I/O	input and/or output
JES	Job Entry Subsystem
lpm	lines per minute
LSI	large scale integration
MP	multiprocessor
NCP	Network Control Program
OS	Operating System
RES	Remote Entry System
SDLC	synchronous data link control
SNA	Systems Network Architecture
TCAM	Telecommunications Access Method
UPC	Universal Product Code
VM	Virtual Machine
VS	Virtual Storage
VTAM	Virtual Telecommunications Access Method

Advanced Function
for Communications
System Summary

**READER'S
COMMENT
FORM**

Order No. GA27-3099-1

Your views about this publication may help improve its usefulness; this form will be sent to the author's department for appropriate action. Using this form to request system assistance or additional publications will delay response, however. For more direct handling of such request, please contact your IBM representative or the IBM Branch Office serving your locality.

Possible topics for comment are:

Clarity Accuracy Completeness Organization Index Figures Examples Legibility

Cut or Fold Along This Line

What is your occupation? _____

Number of latest Technical Newsletter (if any) concerning this publication: _____

Please indicate in the space below if you wish a reply.

Thank you for your cooperation. No postage stamp necessary if mailed in the U.S.A. (Elsewhere, an IBM office or representative will be happy to forward your comments.)

--- Cut or Fold Along Line ---

Your comments, please

This manual is part of a library that serves as a reference source for systems analysts, programmers, and operators of IBM systems. Your comments on the other side of this form will be carefully reviewed by the persons responsible for writing and publishing this material. All comments and suggestions become the property of IBM.

Fold

Fold

First Class
Permit 40
Armonk
New York

Business Reply Mail
No postage stamp necessary if mailed in the U.S.A.

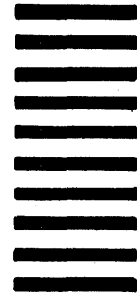

Postage will be paid by:

International Business Machines Corporation
Dept. E01
P.O. Box 12195
Research Triangle Park
North Carolina 27709

Fold

Fold

Advanced Function for Communications System Summary (File No. GENL-09) Printed in U.S.A. GA27-3099-1



**International Business Machines Corporation
Data Processing Division
1133 Westchester Avenue, White Plains, New York 10604
(U.S.A. only)**

**IBM World Trade Corporation
821 United Nations Plaza, New York, New York 10017
(International)**