

GC30-3081-1
File No. S370/4300-50

Program Product

**Network Logical
Data Manager
General Information**

Program Number 5668-971

IBM

GC30-3081-1
File No. S370/4300-50

Program Product

**Network Logical
Data Manager
General Information**

Program Number 5668-971

The IBM logo, consisting of the letters 'IBM' in a bold, sans-serif font, where each letter is formed by a series of horizontal bars of varying lengths, creating a striped effect.

Second Edition (June 1982)

This edition applies to the Network Logical Data Manager (NLDM) Program Product 5668-971, and to all subsequent releases and modifications unless otherwise indicated in new editions or Technical Newsletters. Changes are made periodically to the information herein; before using this publication in connection with the operation of IBM systems, consult the latest *IBM System/370 and 4300 Processors Bibliography*, GC20-0001, for the editions that are applicable and current.

Any reference to an IBM program product in this document is not intended to state or imply that only IBM's program product may be used. Any functionally equivalent program may be used instead.

It is possible that this material may contain reference to, or information about, IBM products (machines and programs), programming, or services that are not announced in your country. Such references or information must not be construed to mean that IBM intends to announce such IBM products, programming, or services in your country.

Publications are not stocked at the address given below; requests for IBM publications should be made to your IBM representative or to the IBM branch office serving your locality.

A form for reader's comments is provided at the back of this publication. If the form has been removed, comments may be addressed to IBM Corporation, Information Development, Department E02, PO Box 12195, Research Triangle Park, North Carolina U.S.A. 27709. IBM may use or distribute any of the information you supply in any way it believes appropriate without incurring any obligation whatever. You may, of course, continue to use the information you supply.

Preface

This manual describes the functions and use of the Network Logical Data Manager (NLDM) program product. It explains the relationship of NLDM to other network components and provides an example of how NLDM is used in network problem determination. It contains planning information, including hardware, software, and storage requirements. It also contains a list of related publications and a program summary.

This manual is intended primarily for installation managers and planners and for anyone who requires an overview of NLDM.

This manual consists of the following chapters:

- Chapter 1 contains a general overview of NLDM and describes the relationship of NLDM to other network components.
- Chapter 2 describes NLDM functions and the data collected by NLDM.
- Chapter 3 describes how NLDM is used and contains a scenario showing how NLDM may be used in problem determination.
- Chapter 4 describes hardware, software, and storage requirements for NLDM, includes performance considerations, and lists related publications.
- Chapter 5 contains a program summary of NLDM.

A glossary containing definitions of NLDM terms and abbreviations precedes the Index to this manual.

Systems Network Architecture (SNA) terms are used in this manual. Readers unfamiliar with SNA should refer to *Systems Network Architecture Concepts and Products*, GC30-3072.

This page intentionally left blank.

Contents

Chapter 1. Introduction	1
Chapter 2. Functions and Data	3
Functions	3
Initialization	3
Collecting Session Data	3
Activating and Deactivating Session Traces	4
Displaying Session Data	5
Session Data	6
Session Awareness Data	6
NAU Lists	6
Most Recent Sessions List	6
Session Configuration	6
Session Trace Data	6
Session Activation Parameters	6
Access Method PIU Data	7
NCP Data	7
VSAM Data Base	7
Chapter 3. Usage and Operation	9
Usage	9
Operation	10
Starting Session Traces	10
Stopping Session Traces	10
Displaying Session Data	10
NLDM Commands	11
NLDM Panels	12
Examples of Session Tracing	13
Tracing in a Single-Domain Network	13
Tracing in a Multiple-Domain Network	14
Scenario	16
Chapter 4. Planning for NLDM	19
Hardware Requirements	19
Software Requirements	19
Storage Requirements	20
NLDM Storage Requirements	20
ACF/VTAM Storage Requirements	20
ACF/TCAM Storage Requirements	20
Access Method PIU Buffers	20
Performance Considerations	21
Processor Utilization in the 158 Model 3	21
Processor Utilization in the 3033U	22
Processor Utilization in the 3081	22
Initialization Requirement	23
Publications	23
NLDM Publications	23
NCCF Publications	23
Systems Network Architecture Publications	24
Other Publications	24
Chapter 5. NLDM: Summary	25
Testing Period	25
License	25
Program Services	25
Warranty	25
Availability of Licensed Program	25
Glossary	27
Index	29

Figures

1. NLDM Environment	2
2. Resources That Can Have Sessions Traced	4
3. NLDM Panels	12
4. Session Tracing in a Single-Domain Network	13
5. Session Tracing in a Multiple-Domain Network	15
6. Sample Network Storage Requirements	20
7. Session History Panel	31
8. Session Configuration Panel	31
9. PIU Data Panel	31
10. NCP Data Panel	31

Summary of Amendments

This revision (GC30-3081-1) includes performance considerations and various technical and editorial changes.

This page intentionally left blank.

Chapter 1. Introduction

The Network Logical Data Manager (NLDM) program product collects and correlates data related to SNA sessions between network addressable units (NAUs) and provides users with online access to the collected data. It allows a user at a central control point to identify network problems and helps to identify undetected errors such as unresponsive terminals, lost path information units (PIUs), buffer errors, and resource status errors.

NLDM collects data relating to SNA sessions in both single-domain and multiple-domain networks and maintains the collected session data on a session basis. In addition, NLDM collects data relating to the data flows for certain non-SNA terminals not supported by the Network Terminal Option (NTO).

NLDM collects session data from the SNA access method (ACF/VTAM or ACF/TCAM) and from the network control program (ACF/NCP). The session data includes information about session activation and deactivation, the session partners, the physical configuration associated with the session, access method PIU data, and network control program (NCP) data.

NLDM runs as an application program under Network Communications Control Facility (NCCF) and can coexist with the Network Problem Determination Application (NPDA) program product and with the IBM 3600 Threshold Analysis and Remote Access Feature. Any user logged onto NCCF can access NLDM.

NLDM uses system functions provided by NCCF to communicate with the SNA access method and with the VSAM data base in which the collected session data is stored. Refer to the *NCCF General Information* manual for more information about NCCF functions.

The environment under which NLDM operates is shown in Figure 1 on page 2.

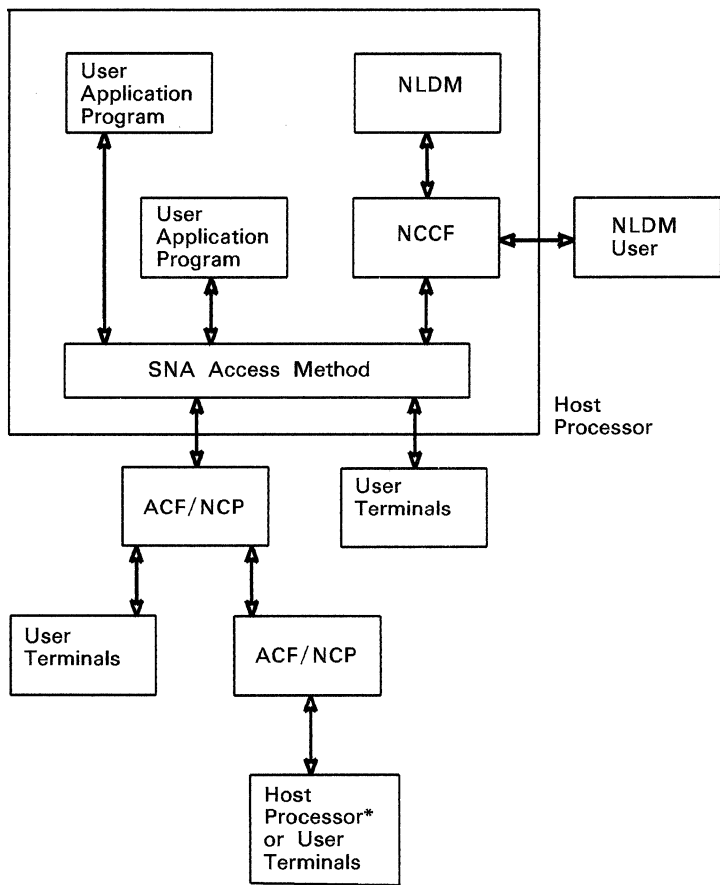

*The NLDM program product must be initialized in the host processor.

Figure 1. NLDM Environment

Chapter 2. Functions and Data

This chapter describes the functions performed by NLDM, the two kinds of session data collected and displayed by NLDM, and the data base used for storing the session data.

Functions

After it is initialized, NLDM collects session data, activates and deactivates session traces, and displays session data.

Initialization

NLDM is initialized whenever NCCF is initialized. Initialization consists of building internal control blocks, opening the NLDM VSAM data base, establishing communications with the access method, starting collection of session awareness data, and using the start-up parameters specified by the customer in an NCCF parameter definition data set, such as starting session trace or specifying the amount of data to be kept for each session trace started.

Collecting Session Data

The data collected by NLDM comes from SNA sessions involving logical units (LUs), physical units (PUs), or system services control points (SSCPs), and from data flows to or from non-SNA terminals not supported by NTO, which NLDM treats as LUs. (Non-SNA terminals supported by NTO appear to the host to be SNA resources; NLDM collects session data from SNA sessions involving those terminals.)

NLDM can collect two types of data about a session. One type of session data collected is session awareness data. Session awareness data includes the session type, the names of the session partners, and information about the session activation status. Session awareness data is collected for all sessions.

The second type of session data collected by NLDM is known as session trace data. Session trace data consists of session activation parameters, access method path information unit (PIU) data, and NCP data. Session trace data is collected only for sessions involving a resource for which a session trace has been started.

Collected session data is stored in buffers. Whenever a session ends, the associated session data is transferred from the buffers to the VSAM data base. A user may also request that data pertaining to an active session be transferred to the data base.

Figure 2 on page 4 shows the types of resources for which NLDM can collect session data.

	Session Awareness Data	Session Trace Data	
		PIU Data and Session Activation Parameters	NCP Data
Channel-attached SNA terminals	×	×	
Channel-attached non-SNA terminals (ACF/TCAM only)	×	×	
NCP-attached SNA terminals	×	×	×
NCP-attached BSC and start/stop terminals (ACF/TCAM only, except for BSC 3270s)	×	×	×
NTO terminals (including BSC and start/stop terminals other than 3270)	×	×	
Host LUs associated with user application programs	×	×	

Figure 2. Resources That Can Have Sessions Traced

Activating and Deactivating Session Traces

NLDM begins collecting session trace data only after a session trace is started. A trace may be started during or after NLDM initialization.

Session traces are started at NLDM initialization for resources specified in the NCCF parameter definition data set; resources that can be specified in that data set are all LUs, all SSCPs, or all LUs and SSCPs.

After NLDM is initialized, the user may start session traces for all network resources or for specific network resources. In a multiple-domain network, a user in one domain may start a session trace for a resource in another domain if NLDM has been initialized in that domain. Session trace data is collected for a session involving two resources in the same domain when a session trace is started for either session partner. In a multiple-domain network, all session trace data for a cross-domain session is collected only when session traces are started in both domains.

After NLDM is initialized, the user may stop session traces for all network resources or for specific network resources.

Displaying Session Data

NLDM allows the user to display the collected session data using a series of panels. If the user wants to display information about an active session, NLDM retrieves the session data from main storage. If the user wants to display information about a previously active session, NLDM gets the session data from the VSAM data base.

Session awareness data is displayed in the following ways:

- NAU lists
- A list of the most recent sessions for an NAU
- Session configuration

Session trace data is displayed in the following ways:

- Session activation parameters
- Access method PIU data
- NCP data

Session Data

NLDM can collect and display two types of session data: session awareness data and session trace data. The following topics describe the data collected and displayed by NLDM.

Session Awareness Data

Session awareness data is collected by NLDM whenever a session begins or ends. It includes information from the access method about the session activation status, the session type, and the session partners for LU-LU, SSCP-LU, SSCP-PU, or SSCP-SSCP sessions. It includes information about the activation status for non-SNA terminals not supported by NTO.

Session awareness data is displayed in the form of NAU lists, lists of most recent sessions for specific NAUs, and session configuration diagrams.

NAU Lists

The user may display lists of all network addressable units (NAUs) known to NLDM. Lists can be displayed showing the NAU names of all secondary logical units (SLUs), all primary logical units (PLUs), all LUs, all PUs, or all SSCPs. An NAU list indicates which NAUs are involved in active sessions.

Most Recent Sessions List

The user can display a list of the most recent sessions in which a specific NAU was a partner. The list is in reverse chronological order and if a session is currently active, it is the first entry in the list. The information displayed includes the name, type, and domain of each session partner. The session activation and deactivation times are shown for sessions that have ended; the session activation time is shown for an active session.

Session Configuration

The user may display the physical configuration of the part of the network in which the primary or secondary end of a specific session is located. The configuration includes the network names of the resources shown. Also displayed are the names and addresses of the session partners and the name of the domain from which the data is being viewed.

Session Trace Data

Session trace data is collected by NLDM whenever a session trace is started. Session trace data consists of session activation parameters, access method PIU data, and NCP data.

Session Activation Parameters

The user can display the parameters used for session activation if a trace is started for a session before the session is activated and if the session is successfully activated. Session activation parameters are those parameters included in the SNA command used to activate the session (Bind Session, Activate Physical Unit, Activate Logical Unit, or Activate CDRM). The session activation parameters can be displayed in either hexadecimal or text representation.

Access Method PIU Data

The user may display access method PIU data for all sessions for which NLDM collects session data. PIU data includes the transmission header (TH), the request/response header (RH), and the first 11 bytes of the request unit (RU). PIU data may be displayed in either hexadecimal or text representation.

NCP Data

The user may display NCP data for sessions involving NCP-attached resources. Except for SSCP-LU sessions, NCP data consists of the last 4 PIU sequence numbers and selected fields from control blocks that relate to the specific resource involved in the session. For SSCP-LU sessions, NCP data consists of control block information only.

VSAM Data Base

NLDM stores collected session data in a VSAM data base. The user specifies the name and size of the data base during the installation of NLDM. Session data associated with an active session is kept in main storage. When the session ends, the session data is copied from main storage into the VSAM data base. The user may also request that the data be transferred from main storage to the data base while the session is still active.

This page intentionally left blank.

Chapter 3. Usage and Operation

This chapter shows ways NLDM may be used and briefly describes the operation of NLDM. It also summarizes the commands and the panels, shows examples of session tracing, and includes a problem-determination scenario.

Usage

NLDM may be used in several ways, depending on the needs of a particular system or installation.

NLDM can be used to help identify the first occurrence of a problem. To be sure that NLDM is collecting session data when a problem first occurs, you must initialize NLDM before activating the network and you must begin trace of all sessions at initialization.

To use NLDM to help identify a subsequent occurrence of a problem, you may (1) initialize NLDM before activating the network and then begin traces of sessions involving specific or all resources, or (2) activate the network before initializing NLDM and then begin traces of sessions involving specific or all resources.

Note: If NLDM is initialized after the network is activated, session trace data can be collected only for sessions that are activated (or reactivated) after NLDM initialization; for such sessions, NCP data is not collected. If NLDM is initialized after the network is activated and all sessions are to be traced, the NCP or NCPs must be restarted.

Operation

This topic briefly describes the operation of NLDM after it has been initialized. Operating NLDM consists of starting and stopping session traces and displaying session data.

Starting Session Traces

Session traces may be started for some sessions as part of NLDM initialization. After NLDM is initialized, any user logged onto NCCF may start a session trace for any resource shown in Figure 2 on page 4. To collect session trace data for a session involving session partners in the same domain, the user starts a session trace for either session partner. To collect all session trace data for a session involving session partners in different domains, the user starts session traces in both domains.

A user may start a session trace either before or after the network is activated, depending on the intended use of NLDM. See “Usage” on page 9 for more information about using NLDM.

Stopping Session Traces

After NLDM is initialized, any user logged onto NCCF may use NLDM commands to stop session traces of sessions involving specific or all resources.

Displaying Session Data

After NLDM is initialized, any user logged onto NCCF may display the collected session data using the NLDM panels. The panel sequence begins with lists of session partner names listed by session type and progresses to a list of the most recent sessions for a specific NAU. The user may then display configuration information or session trace data for a specific session and can choose to display some information in hexadecimal representation.

Whenever desired, the user can end the NLDM panel sequence and return to NCCF.

NLDM Commands

The following list describes the NLDM commands. Some NLDM commands are assigned to program function (PF) keys.

Command	Description
BACK	Displays the previous page of a multiple-page panel.
BOTTOM	Displays the last page of a multiple-page panel.
COPY	Prints at a hard-copy device a copy of the current panel or a copy of the current page for a multiple-page panel
DISKEEP	Displays settings for the amount of session trace data to be kept.
END	Stops the NLDM panel sequence and returns the user to NCCF.
FORCE	Causes session data to be recorded in the data base.
FORWARD	Displays the next page of a multiple-page panel.
HELP	Explains the NLDM commands.
KEEP	Changes the amount of session trace data to be kept.
LIST	Displays a list of NAU names known to NLDM.
MENU	Displays the NLDM menu.
RETURN	Displays the panel that was displayed prior the the current panel.
SDOMAIN	Determines the NCCF domain for which session data is to be displayed.
SESS	Displays the session list for a specific NAU.
SET HEX	Causes certain panels to be displayed in hexadecimal representation.
TITLE	Displays the first page of a multiple-page panel.
TRACE	Starts or stops a session trace. Displays a list of resource names for which session traces have been started; if session tracing was started for all resources, displays a list of resource names for which session traces have been stopped.

NLDM Panels

The following chart shows the relationships between the panels and how a user moves from one panel to another. Some panels may be accessed directly by using the NLDM command shown.

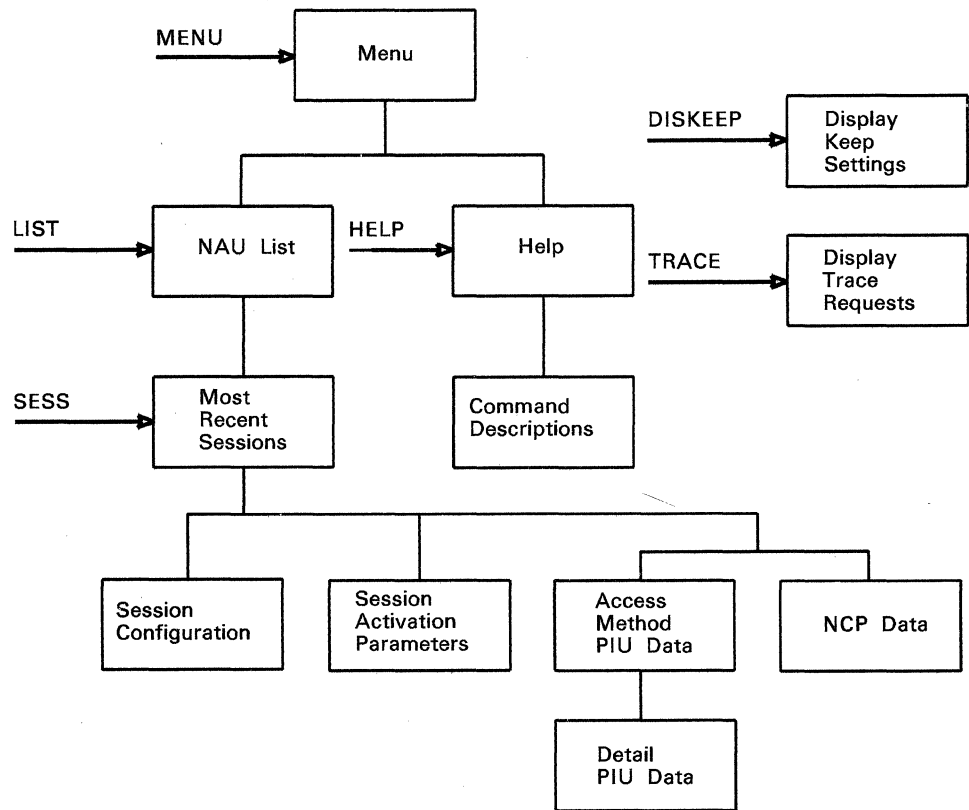

Figure 3. NLDM Panels

Examples of Session Tracing

NLDM collects session data for sessions in both single-domain networks and multiple-domain networks. The following examples show what types of session trace data are available depending on the sessions established and the resources for which session traces have been started.

Tracing in a Single-Domain Network

The following diagram shows a sample single-domain network.

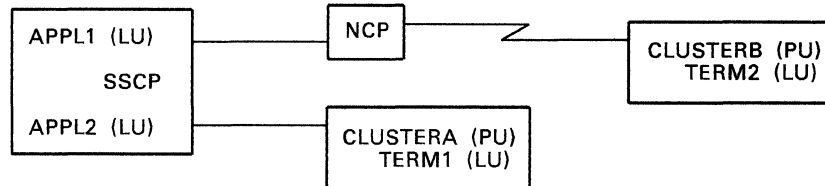

The following table indicates what session trace data is available depending on the sessions established and the resources for which session traces have been started. Not all sessions and resources for which session traces may be started are shown.

		Sessions									
		LU-LU			SSCP-LU				SSCP-PU		
		APPL1- APPL2	APPL1- TERM1	APPL1- TERM2	SSCP- APPL1	SSCP- APPL2	SSCP- TERM1	SSCP- TERM2	SSCP- CLUSTERA	SSCP- CLUSTERB	SSCP- NCP
Resource for Which Session Trace Is Started	APPL1	P	P	PN	p ¹	-	-	-	-	-	-
	APPL2	P	-	-	-	p ¹	-	-	-	-	-
	TERM1	-	P	-	-	-	P	-	-	-	-
	TERM2	-	-	PN	-	-	-	PN ²	-	-	-
	CLUSTERA	-	-	-	-	-	-	-	P	-	-
	CLUSTERB	-	-	-	-	-	-	-	-	PN	-
	NCP	-	-	-	-	-	-	-	-	-	PN
	ALL	P	P	PN	p ¹	p ¹	P	PN ²	P	PN	PN

¹ ACF/VTAM only

² NCP control block information only

Legend

P = PIU data and session activation parameters

N = NCP data

Figure 4. Session Tracing in a Single-Domain Network

Tracing in a Multiple-Domain Network

The following diagram shows a sample multiple-domain network.

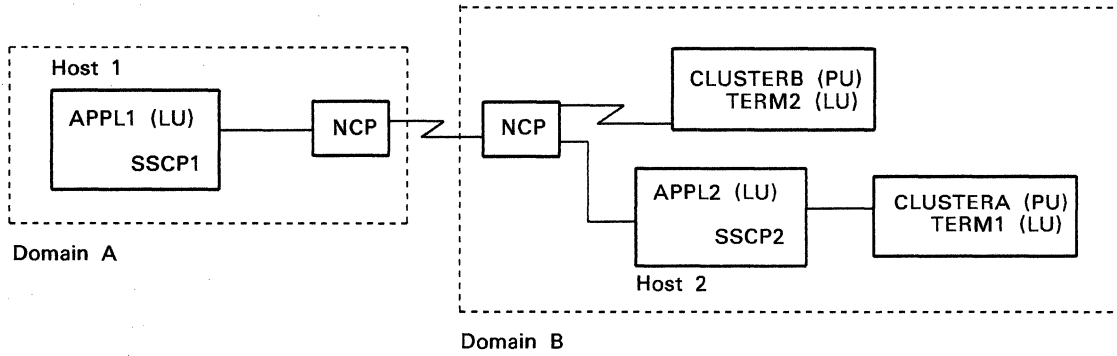

The following table indicates what session trace data is available depending on the sessions established, the resources for which session traces have been started, and the host at which the session trace was started. Not all sessions and resources for which session traces may be started are shown.

		Sessions							
		LU-LU			SSCP-LU				SSCP-SSCP
		APPL1- APPL2	APPL1- TERM1	APPL1- TERM2	SSCP1- APPL1	SSCP2- APPL2	SSCP2- TERM1	SSCP2- TERM2	SSCP1- SSCP2
Resource for Which Session Trace Is started at Host 1	APPL1	P	P	P	P ¹	-	-	-	-
	TERM1	-	P	-	-	-	-	-	-
	TERM2	-	-	P	-	-	-	-	-
	SSCP1	-	-	-	P ¹	-	-	-	P
	SSCP2	-	-	-	-	-	-	-	P
	ALL	P	P	P	P ¹	-	-	-	P
Resource for Which Session Trace Is started at Host 2	APPL1	P	P	N	-	-	-	-	-
	TERM1	-	P	-	-	-	P	-	-
	TERM2	-	-	N	-	-	-	PN ²	-
	SSCP1	-	-	-	-	-	-	-	P
	SSCP2	-	-	-	-	P ¹	P	PN ²	P
	ALL	P	P	N	-	P ¹	P	PN ²	P

¹ ACF/VTAM only

² NCP control block information only

Legend

P = PIU data and session activation parameters

N = NCP data

Figure 5. Session Tracing in a Multiple-Domain Network

Scenario

This topic provides an overview of the scenario described in the *NLDM Installation and Operation* manual. The scenario shows how NLDM can be used to determine the source of a problem.

In this scenario, the symptom of the problem is an unresponsive user terminal, that is, the terminal user cannot send messages to or receive messages from the host. The user terminal is an NCP-attached BSC 3270 terminal. The conditions for this scenario are as follows:

- The access method, NCCF, and NLDM have been initialized.
- The network is active.
- Session traces were started for the user terminal, which is identified as T620101, and the host application identified as SNAMH101.
- T620101 has started a session with SNAMH101.
- T620101 has quit responding and the terminal user has reported the problem to the network operator.

Two persons are involved in the scenario, a network operator and a diagnostician. The operator makes sure that all parts of the network are operating. The diagnostician has an understanding of Systems Network Architecture and diagnoses problems when some part of the network is not operating. In some installations, the operator and the diagnostician may be the same person.

The panels referred to in the scenario are shown on a foldout page at the back of the manual. The steps in the scenario are as follows:

1. The network operator starts the NLDM panel sequence and issues the command **SESS T620101** to display the session history panel (Figure 7). There, the operator finds information about the most recent session associated with the unresponsive terminal (T620101).
2. The operator issues **SC** to display the session configuration for the unresponsive terminal (Figure 8). The operator uses the configuration information to identify the logical names of hardware components that may be causing the unresponsive terminal condition. The operator checks for hardware errors, and if no hardware errors are detected for the identified hardware components, the operator continues using NLDM for problem determination.
3. The operator issues **PT** to display the PIU data for the primary LU (SNAMH101) and **ST** to display the NCP data for the secondary LU (T620101) that was collected just before the terminal quit responding (Figures 9 and 10). Displaying the data causes the most recent data to be retrieved from the access method and the NCP and brought into main storage so that the operator can then store the data in the NLDM VSAM data base.
4. The operator issues the **FORCE** command, which causes the session data to be copied from main storage into the data base, and then the operator reports the problem to the diagnostician.

5. The diagnostician continues problem determination using the PIU data panel (Figure 9), which displays the data stored in the data base by the operator. The diagnostician determines that the last session data collected for the session was a PIU sent by the primary LU (SNAMH101) to the secondary LU (T620101) requesting a definite response.
6. The diagnostician then uses information on the NCP data panel (Figure 10), also stored by the operator in the data base, to determine that the last sequence number was transmitted by the host and that the last sequence number received from the NCP was for the Signal Command. The diagnostician also determines from the NCP data that the NCP was waiting for a data response and that there are no outstanding pacing requests.
7. The diagnostician concludes that the secondary LU (T620101) did not transmit a response to the PIU and that the unexpected SIGNAL command sent to the host caused the host to lose synchronization with the terminal. As a result, the diagnostician calls for service on the terminal.

This page intentionally left blank.

Chapter 4. Planning for NLDM

This chapter discusses how to plan for the installation of NLDM and describes the hardware, software, and storage requirements. It also includes performance considerations, describes an initialization requirement, and lists related publications.

Hardware Requirements

A System/370, 30xx, or 4300 processor or the equivalent supported by ACF/TCAM or ACF/VTAM running with OS/VS2 MVS Release 3.8, or later, is required for NLDM.

An NLDM user may access the NLDM program product through any terminal supported by NCCF. If an IBM 3279 Display Station Model 2A or 3A is used, the NLDM panels are displayed in base colors. If an IBM 3279 Display Station Model 2B or 3B is used, the NLDM panels are displayed in 7 colors.

Software Requirements

Network Communications Control Facility (NCCF) Release 2 with the appropriate PTF running on OS/VS2 MVS Release 3.8, or later, is a prerequisite for NLDM. Refer to the *NCCF General Information* manual for additional dependencies and prerequisites. NLDM runs as an application program under NCCF.

NLDM must be used with one of the following access methods:

- ACF/TCAM Version 2 Release 4
- ACF/VTAM Version 1 Release 3 with the appropriate PTF or ACF/VTAM Version 2 with the appropriate PTF

To collect NCP data, NLDM must be used with the network control program ACF/NCP Version 2.

Storage Requirements

The following topics describe the storage requirements for NLDM, ACF/TCAM, and ACF/VTAM.

NLDM Storage Requirements

The NLDM virtual and disk storage requirements depend on the number and kinds of sessions traced and the amount of session data kept for each session traced. The storage requirements for a sample network with 500 NAUs are shown in the following chart. The sample network has about 1000 sessions, of which about one-half are LU-LU sessions. Figures shown in the chart are based on keeping 10 PIUs and data for the 10 most recent occurrences of a session for each session being traced.

	Virtual Storage	Disk (3330) Storage
No sessions traced	.7 M	38 CYL
All sessions involving the SSCP traced	1.2 M	95 CYL
All sessions involving an LU traced	1.6 M	153 CYL
All sessions traced	1.7 M	210 CYL

Figure 6. Sample Network Storage Requirements

ACF/VTAM Storage Requirements

To run with NLDM, ACF/VTAM requires at least 2 PIU buffers in the fixed common storage area (CSA). Each buffer must be at least 2048 bytes. See "Access Method PIU Buffers."

ACF/TCAM Storage Requirements

To run with NLDM, ACF/TCAM requires additional virtual storage of 3208 bytes plus storage for 2 PIU buffers. See "Access Method PIU Buffers."

Access Method PIU Buffers

The size of the access method PIU buffers ranges from 2K to 32K and is specified by the user at NLDM initialization. See the *NLDM Installation and Operation* manual for more information.

Performance Considerations

This topic includes charts showing the expected increase in processor utilization when NLDM is running in the following processors: the 158 Model 3, the 3033U, and the 3081.

The expected increase in processor utilization is based on the transaction rate of the processor and the number of major LUs associated with the processor. A transaction consists of a request from a user terminal and the corresponding response. Major LUs are the LUs responsible for 80% of the total session activity associated with a particular processor.

The following charts show the transaction rates and numbers of major LUs that result in 5%, 10%, and 15% increases in processor utilization when NLDM is running. The increases shown are based on running NLDM with all sessions being traced.

To determine the expected increase in processor utilization, find the transaction rate and the number of major LUs on the appropriate chart. If, for example, out of 1000 active LUs associated with a 3033U processor, 500 LUs are responsible for 80% of the session activity, the number of major LUs is 500. If the transaction rate for that processor is 5 transactions per second, then the expected increase in processor utilization with NLDM running is less than 5%. See "Processor Utilization in the 3033U" on page 22.

Processor Utilization in the 158 Model 3

This chart shows the 5%, 10%, and 15% increases in processor utilization with NLDM in the 158 Model 3.

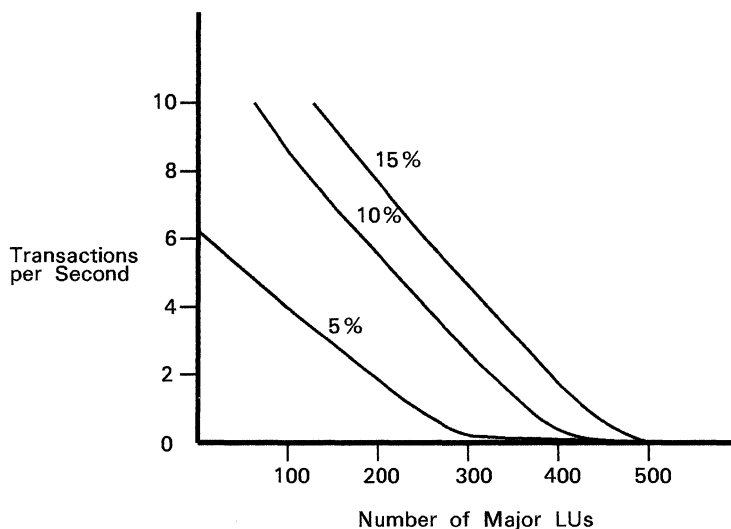

Processor Utilization in the 3033U

This chart shows the 5%, 10%, and 15% increases in processor utilization with NLDM in the 3033U.

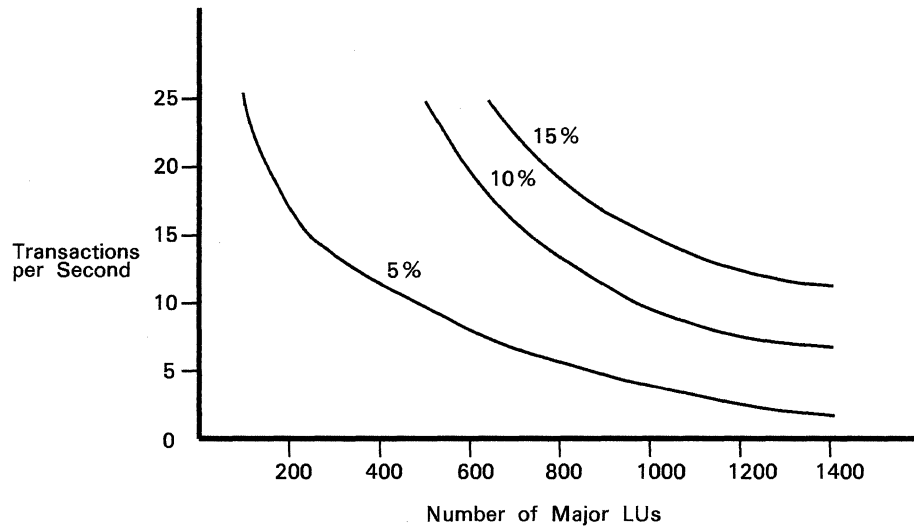

Processor Utilization in the 3081

This chart shows the 5%, 10%, and 15% increases in processor utilization with NLDM in the 3081.

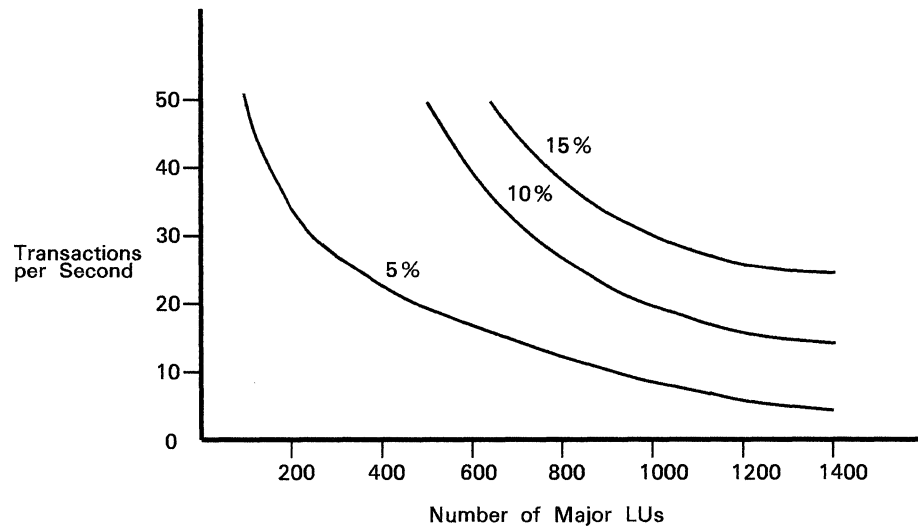

Initialization Requirement

Do not use the access method to automatically activate network resources to be used in sessions that are to be traced by NLDM. Instead, start the access method without automatically activating resources and then use the CLIST capability of NCCF to activate the network resources for which session traces are to be started.

Publications

Other publications that may be helpful when you are planning for NLDM are listed in the following topics.

NLDM Publications

The following publications provide additional information about NLDM:

- *Network Logical Data Manager Installation and Operation* describes how to install and use NLDM.
- *Network Logical Data Manager Diagnosis* describes what to do if you have a problem with NLDM.
- *Network Logical Data Manager Licensed Program Specifications*, GC30-9555, describes the Specified Operating Environment for NLDM.

NCCF Publications

The following publications provide information about the Network Communications Control Facility (NCCF) program product:

- *Network Communications Control Facility General Information*, GC27-0429
- *Network Communications Control Facility Terminal Use*, SC27-0432
- *Network Communications Control Facility Installation*, SC27-0430
- *Network Communications Control Facility Customization*, SC27-0433
- *Network Communications Control Facility Messages*, SC27-0431
- *Network Communications Control Facility Logic*, LY38-3010

Systems Network Architecture Publications

The following publications contain information about Systems Network Architecture (SNA):

- *Systems Network Architecture Concepts and Products*, GC30-3072
- *Systems Network Architecture Reference Summary*, GA27-3136
- *Systems Network Architecture Format and Protocol Reference Manual: Architectural Logic*, SC30-3112

Other Publications

The following publications contain general information about ACF/TCAM, ACF/VTAM, and ACF/NCP:

- *ACF/TCAM, Version 2 General Information: Introduction*, GC30-3057
- *ACF/VTAM General Information: Introduction*, GC27-0462 (for ACF/VTAM Version 1 Release 3)
- *ACF/VTAM Version 2 General Information*, GC27-0608
- *ACF/NCP/SSP for the IBM 3705 General Information*, GC30-3058

Chapter 5. NLDM: Summary

Testing Period

The basic license testing period is one month (30 days for World Trade). There is no testing period for the Distributed Systems License Option (DSLO).

License

A separate license is required for each machine on which the licensed program materials will be used, except as otherwise provided by IBM. For DSLO licenses, central service, including the IBM Support Center, will be provided only through the customer location designated for the basic license.

Program Services

Central Service, including the IBM Support Center, will be available until discontinued by IBM upon 12 months' written notice.

Local Licensed Program Support will be available until discontinued by IBM upon 12 months' written notice.

Local Licensed Program Support will be provided under the terms and conditions of the Agreement for Local Licensed Program Support for IBM Licensed Programs at the Monthly Licensed Program Support Charge, Monthly Additional Licensed Program Support Charge, or will be provided at the applicable hourly rate.

Local Licensed Program Support will be provided by IBM Field Engineering for DPD and by IBM Customer Engineering for E/ME/A and A/FE.

Warranty

NLDM is warranted to conform to its Licensed Program Specifications when shipped to the customer if properly used in the Specified Operating Environment.

Licensed Program Specifications may be updated from time to time and such updates may constitute a change in specifications.

Following the discontinuance of all program services, this program will be distributed on an "As Is" basis without warranty of any kind, either express or implied.

Availability of Licensed Program

The estimated availability date from PID (Program Information Department) is 8/27/82. Estimated availability at EPL (European Program Library) and other WT area Program Libraries is one month later.

This page intentionally left blank.

Glossary

This glossary defines important NLDM abbreviations and terms. It includes terms and definitions from the *IBM Vocabulary for Data Processing, Telecommunications, and Office Systems* manual, GC20-1699. Definitions from the *American National Dictionary for Information Processing* are identified by an asterisk (*). Definitions from draft proposals and working papers under development by the International Standards Organization, Technical Committee 97, Subcommittee 1 are identified by the symbol "(TC97)."

ACF/NCP. Advanced Communications Function for the Network Control Program.

ACF/TCAM. Advanced Communications Function for the Telecommunications Access Method.

ACF/VTAM. Advanced Communications Function for the Virtual Telecommunications Access Method.

Advanced Communications Function for the Network Control Program (ACF/NCP). A program product that provides communication controller support for single-domain and multiple-domain networks.

Advanced Communications Function for the Telecommunications Access Method (ACF/TCAM). A program product that provides single-domain network capability, and optionally, multiple-domain capability. ACF/TCAM runs under MVS and OS/VS1 and provides message queuing.

Advanced Communications Function for the Virtual Telecommunications Access Method (ACF/VTAM). A program product that provides single-domain network capability, and optionally, multiple-domain capability. ACF/VTAM runs under MVS, OS/VS1, and VSE and supports direct control application programs and subsystems such as VM/VCNA, VM/VSPC, and VSE/POWER.

command. A request from a terminal for the performance of an operation or the execution of a particular program.

domain. In SNA, a system services control point (SSCP) and the physical units (PUs), logical units (LUs), links, link stations, and all the associated resources that the SSCP has the ability to control by means of activation requests and deactivation requests.

logical unit (LU). In SNA, a port through which an end user accesses the SNA network in order to communicate with another end user and through which the end user accesses the functions provided by system services control points (SSCPs). An LU can support at least two sessions—one with an SSCP and one with another LU—and may be capable of supporting many sessions with other logical units.

LU. Logical unit.

multiple-domain network. In SNA, a network with more than one system services control point (SSCP).

NAU. Network addressable unit.

NCCF. Network Communications Control Facility.

NCP. Network control program.

network. (1) (TC97) An interconnected group of nodes. (2) In data processing, a user-application network. See user-application network.

network addressable unit (NAU). In SNA, a logical unit, a physical unit, or a systems services control point; it is the origin or the destination of information transmitted by the path control network.

Network Communications Control Facility (NCCF). An IBM program product consisting of a base for command processors that can monitor, control, and improve the operation of a network.

network control program (NCP). A program, generated by the user from a library of IBM-supplied modules, that controls the operation of the communication controller.

Network Logical Data Manager (NLDM). A program product that helps the user at a central control point to identify network problems relating to sessions by means of interactive display techniques.

network operator. A person or program responsible for controlling the operation of all or part of a network.

Network Problem Determination Application (NPDA). A program product that assists the user in identifying network problems from a central control point using interactive display techniques.

Network Terminal Option (NTO). An IBM program product that extends the capabilities of the ACF/NCP to support a select group of non-SNA devices.

NLDM. Network Logical Data Manager.

NPDA. Network Problem Determination Application.

NTO. Network Terminal Option.

*** operator.** A person who operates a machine. See network operator.

page. The portion of a panel that is shown on a display surface at one time.

panel. In computer graphics, a predefined display image that defines the locations and characteristics of display fields on a display surface.

path information unit (PIU). In SNA, a message consisting of a transmission header (TH) alone or of a TH followed by a basic information unit (BIU) or a BIU segment.

physical unit (PU). In SNA, the component that manages and monitors the resources (such as attached links and adjacent link stations) of a node, as requested by an SSCP via an SSCP-SSCP session.

PIU. Path information unit.

PLU. Primary logical unit.

primary logical unit (PLU). In SNA, the logical unit (LU) that contains the primary half-session for a particular LU-LU session.

problem determination. The process of identifying the source of a problem; for example, a program component, a machine failure, telecommunication facilities, user or contractor-installed programs or equipment, an environment failure such as a power loss, or a user error.

PU. Physical unit.

resource. Any facility of the computing system or operating system required by a job or task, and including main storage, input/output devices, the processing unit, data sets, and control or processing programs.

secondary logical unit (SLU). In SNA, the logical unit (LU) that contains the secondary half-session for a particular LU-LU session.

session. In SNA, a logical connection between two network addressable units (NAUs) that can be activated, tailored to provide various protocols, and deactivated, as requested. The session activation request and response can determine options for such things as the rate and concurrency of data exchange, the control of contention and error recovery, and the characteristics of the data stream. Sessions compete for network resources such as the links within the path control network. For routing purposes, each session is identified by the network or local addresses of the session partners.

session awareness data. Data relating to sessions that is collected by NLDM and that includes the session type, the names of session partners, and information about the session activation status. It is collected for LU-LU, SSCP-LU, SSCP-PU, and SSCP-SSCP sessions and for non-SNA terminals not supported by NTO.

session data. Data relating to sessions that is collected by NLDM and that consists of session awareness data and session trace data.

session partner. In SNA, one of the two network addressable units (NAUs) having an active session.

session trace. In NLDM, the function that collects session trace data for sessions involving specified resource types or involving a specific resource.

session trace data. Data relating to sessions that is collected by NLDM whenever a session trace is started and that consists of session activation parameters, access method PIU data, and NCP data.

single-domain network. In SNA, a network with one system services control point (SSCP).

SLU. Secondary logical unit

SNA. Systems Network Architecture.

SSCP. System services control point.

system services control point (SSCP). In SNA, a focal point within an SNA network for managing the configuration, coordinating network operator and problem determination requests, and providing directory support and other session services for end users of the network. Multiple SSCPs, cooperating as peers, can divide the network into domains of control, with each SSCP having a hierarchical control relationship to the physical units and logical units within its domain.

Systems Network Architecture (SNA). The description of the logical structure, formats, protocols, and operational sequences for transmitting information units through and controlling the configuration and operation of networks.

user. Anyone who requires the services of a computing system.

user-application network. (TC97) A configuration of data processing products, such as processors, controllers, and terminals, established and operated by users for the purpose of data processing or information exchange, which may use services offered by communication common carriers or telecommunication Administrations.

VSAM. Virtual storage access method.

virtual storage access method (VSAM). An access method for direct or sequential processing of fixed and variable-length records on direct access devices. The records in a VSAM data set or file can be organized in logical sequence by a key field (key sequence), in the physical sequence in which they are written on the data set or file (entry-sequence), or by relative-record number.

Index

A

- access method
 - initialization requirement 23
 - PIU buffer 20
 - publications 24
 - software requirement 19
 - source of session data 1, 16
 - storage requirements 20
- activation
 - of network 9, 23
 - parameters 3, 6
 - status 6

C

- CLIST capability of NCCF 23
- collection of data
 - about 1, 3
 - session awareness data 3, 6
 - session trace data 3, 4, 6, 9, 10
- color panels 19, 31
- commands 11, 12
- components, network, relationship to NLDM 1, 2, 19
- cross-domain sessions, tracing of 4, 10

D

- data base, VSAM 1, 3, 5, 7, 16
- data collection
 - about 1, 3
 - session awareness data 3, 6
 - session trace data 3, 4, 6, 9, 10
- data set, parameter definition 3, 4
- diagnostician's role 16
- displaying session data
 - for active session 5, 16
 - for previously active session 5
 - panel sequence 10

E

- environment for NLDM 2

F

- functions 1, 3-5

H

- hardware requirements 19
- hexadecimal representation 7

I

- initialization
 - NCCF 3

- NLDM 3, 9
- initialization requirement 23

L

- license 25

M

- major LU, description of 21
- most recent sessions list 5, 6
- multiple-domain network
 - definition 27
 - tracing in 14-15

N

- NCP data
 - about 3, 5
 - collected in a sample network 13, 15
 - description of 7
 - panel 31
 - when not collected 9
- network
 - multiple-domain 14, 27
 - sample with NLDM storage requirements 20
 - single-domain 13, 28
- network addressable unit (NAU) list 5, 6
- Network Communications Control Facility (NCCF)
 - CLIST capability 23
 - definition 27
 - initialization of 3
 - parameter definition data set 3, 4
 - publications 23
 - software requirement 1, 19
- network control program (NCP)
 - publications 24
 - restart 9
 - software requirement 19
 - source of session data 1, 16
- network operator's role 16
- Network Problem Determination Application (NPDA) 1, 27
- Network Terminal Option (NTO) 1, 4, 6, 27
- NLDM
 - definition 27
 - environment 2
 - functions 3-5
 - panels 12, 31
 - performance 21-22
 - publications 23
- non-SNA terminals
 - not supported by NTO 1, 3, 6
 - supported by NTO 3
 - that can have sessions traced 3, 4

O

- operator's role 16

P

- page of panel 11, 27
- panels
 - chart of 12
 - color 19, 31
 - definition 27
 - for scenario 31
 - sequence 10, 12
- parameter definition data set 3, 4
- parameters
 - session activation 6
 - start-up 1
- performance 21-22
- PIU buffer, access method 20
- PIU data
 - about 3, 5
 - collected in a sample network 13, 15
 - description of 7
 - panel 31
- PIU sequence numbers 7
- processor utilization 21
- program function (PF) keys 11
- program service 25
- publications, related 23-24

R

- relationship of NLDM to network components 1, 2, 19
- request unit (RU) 7
- request/response header (RH) 7
- requirements
 - at initialization 23
 - hardware 19
 - software 19
 - storage 20
- resources that can have sessions traced 3, 4
- restart NCP 9
- roles of network operator and diagnostician 16

S

- scenario
 - description of 16-17
 - panels 31
- sequence numbers, PIU 7
- session awareness data
 - collection of 3, 6
 - definition 28
 - description of 6
 - how displayed 5
- session configuration
 - about 5, 6
 - panel 31
- session data
 - collection of 1, 3, 4, 6, 9, 10
 - definition 28
 - display of 5, 10, 16
 - session awareness data 3, 5, 6
 - session trace data 3, 5, 6, 9, 10
 - storage of 1, 3, 7, 16, 17

- session history panel 31
- session parameters 5, 6
- session partner information 6
- session trace 3, 4, 10, 28
- session trace data
 - collection of 3, 4, 6, 9, 10
 - definition 28
 - description of 6
 - how displayed 5
- session tracing
 - multiple-domain network 14-15
 - single-domain network 13
- sessions traced by NLDM 6
- single-domain network
 - definition 28
 - tracing in 13
- software requirements 19
- start-up parameters 3
- starting session traces 4, 10
- status, activation 6
- stopping session traces 4, 10
- storage of session data 1, 3, 7, 16, 17
- storage requirements 20
- Systems Network Architecture (SNA)
 - definition 28
 - publications 24
 - required knowledge for diagnostician 16

T

- tracing supported by NLDM
 - cross-domain sessions 4, 10
 - kind of data collected 1, 3
 - non-SNA terminals 1, 3, 6
 - resources that can have sessions traced 3, 4
 - sessions 6
- transaction 21
- transmission header (TH) 7

U

- use of NLDM
 - determining 9
 - example of 16-17

V

- VSAM data base 1, 3, 5, 7, 17

W

- warranty 25

Numerals

- 3279 Display Stations Model 2A, 2B, 3A, or 3B 19
- 3600 Threshold Analysis and Remote Access Feature 1

Network Logical
Data Manager
General Information

READER'S
COMMENT
FORM

Order No. GC30-3081-1

This manual is part of a library that serves as a reference source for systems analysts, programmers, and operators of IBM systems. You may use this form to communicate your comments about this publication, its organization, or subject matter, with the understanding that IBM may use or distribute whatever information you supply in any way it believes appropriate without incurring any obligation to you.

Your comments will be sent to the author's department for whatever review and action, if any, are deemed appropriate. Comments may be written in your own language; English is not required.

Note: Copies of IBM publications are not stocked at the location to which this form is addressed. Please direct any requests for copies of publications, or for assistance in using your IBM system, to your IBM representative or to the IBM branch office serving your locality.

Possible topics for comment are:

Clarity Accuracy Completeness Organization Coding Retrieval Legibility

If you wish a reply, give your name, company, mailing address, and date:

What is your occupation? _____

Number of latest Newsletter associated with this publication: _____

Thank you for your cooperation. No postage stamp necessary if mailed in the U.S.A. (Elsewhere, an IBM office or representative will be happy to forward your comments or you may mail directly to the address in the Edition Notice on the back of the title page.)

Cut
Along
This
Line

Reader's Comment Form

Please Do Not Staple

Fold and Tape

Fold and Tape

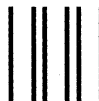

No Postage
Necessary
If Mailed
In The
United States

BUSINESS REPLY MAIL
FIRST CLASS PERMIT NO. 40 ARMONK, N. Y.

POSTAGE WILL BE PAID BY ADDRESSEE

International Business Machines Corporation
Dept. E02
P. O. Box 12195
Research Triangle Park
North Carolina 27709

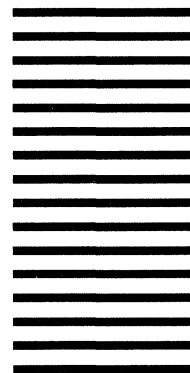

Fold and Tape

Please Do Not Staple

Fold and Tape



Cut
Along
This
Line

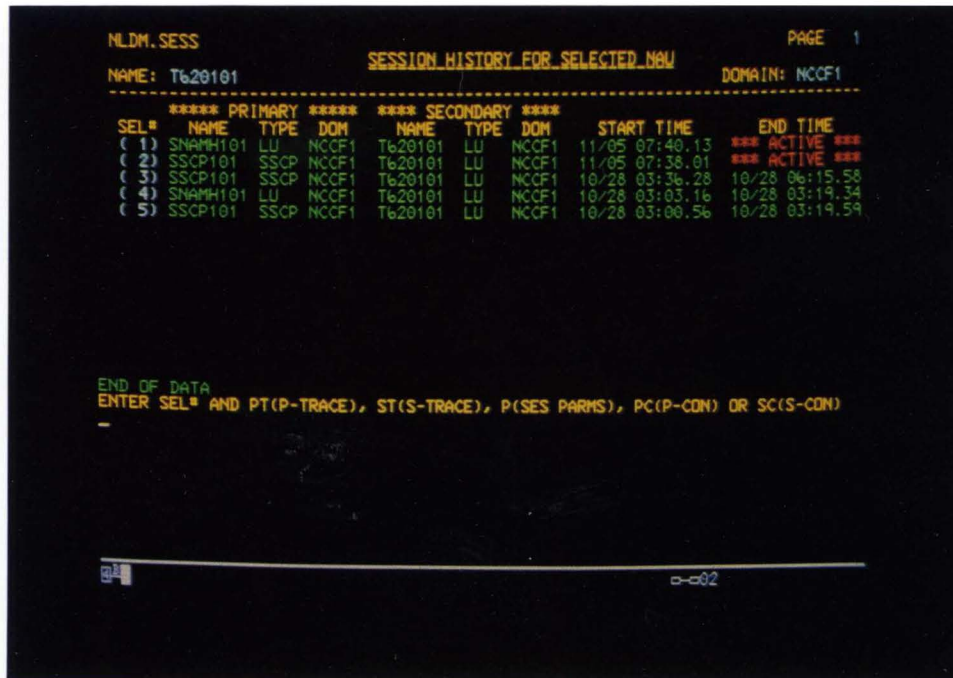

Figure 7. Session History Panel

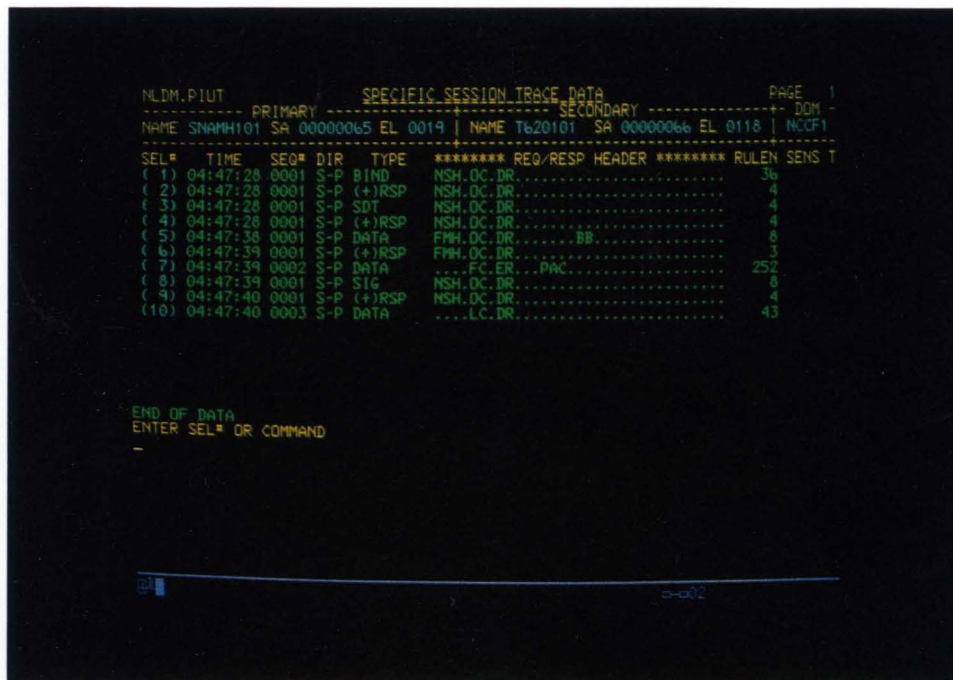

Figure 9. PIU Data Panel

Network Logical Data Manager General Information (File No. S370/4300-50) Printed in U.S.A. GC30-3081-1

