

**Systems**

**IBM 3270  
Information Display System  
Installation Manual –  
Physical Planning**



## Federal Communications Commission (FCC) Statement

**Warning:** This equipment generates, uses, and can radiate radio frequency energy and if not installed and used in accordance with the instructions manual, may cause interference to radio communications. It has been tested and found to comply with the limits for a Class A computing device pursuant to Subpart J of Part 15 of FCC Rules, which are designed to provide reasonable protection against such interference when operated in a commercial environment. Operation of this equipment in a residential area is likely to cause interference in which case the user at his own expense will be required to take whatever measures may be required to correct the interference.

### IBM Statement

This warning is also applicable to all attaching units produced for use in the USA that have been manufactured after December 31, 1980. A notice of compliance has been affixed within the customer access area of all affected units.

### Sixth Edition (December 1980)

This is a major revision of, and obsoletes, GA27-2787-4. Major technical changes have been made throughout, and this publication should be reviewed in its entirety. Significant changes or additions to the specifications contained in this publication will be reported in subsequent revisions or Technical Newsletters. Before using this publication in connection with the installation and operation of IBM equipment, refer to the *IBM System/360 Bibliography*, GC20-0366, and *IBM System/370 and 4300 Processors Bibliography*, GC20-0001, for editions that are applicable and current.

It is possible that this material may contain reference to, or information about, IBM products (machines and programs), programming, or services that are not announced in your country. Such references or information must not be construed to mean that IBM intends to announce such IBM products, programming, or services in your country.

Requests for copies of IBM publications should be made to your IBM representative or to the IBM branch office serving your locality. Some of the devices, options, and features listed in this publication may not be available in every locale. Consult your local IBM Marketing Representative for information about product availability.

A form is provided at the back of this publication for readers' comments. If the form has been removed, comments may be addressed to IBM Corporation, Department 52Q, Neighborhood Road, Kingston, N.Y. 12401. IBM may use or distribute any of the information you supply in any way it believes appropriate without incurring any obligation whatever. You may, of course, continue to use the information you supply.

## Preface

This manual contains information that is intended to guide customers in planning the physical installation of terminals and control units of the IBM 3270 Information Display System. Included are scheduling information, floor-planning information, electrical and environmental requirements, and cabling information.

This manual is arranged in the following order:

*Chapter 1. Introduction* – Provides general information about the various units that make up the 3270 Information Display System. A preinstallation schedule and customer floor-planning guide are also discussed.

*Chapter 2. Operator Work-Space Considerations* – Contains information relating to work station design layouts and the environmental considerations to be observed when planning an installation.

*Chapter 3. Site Preparation* – Explains the requirements for site preparation, including electrical requirements, cabling, and the elimination of electrical/magnetic interference.

*Chapter 4. System Configuration and Cabling* – Contains cabling schematics for local and remote configurations as well as detailed information on cables required for each configuration.

*Chapter 5. Machine Specifications* – Contains detailed specifications of each unit in the 3270 Information Display System.

*Chapter 6. Communication System Cabling* – Contains information pertaining to coaxial cable installations, including specifications for cables and connectors that the customer may elect to fabricate.

This manual also includes the following appendixes: Appendix A contains U.S. and Canada Power Plug Types; Appendix B contains Power Cable Lengths; Appendix C contains World Trade Power Plug Types; Appendix D contains Power Cord Specifications; Appendix E contains the U.S. Lightning Damage Probability Map; Appendix F contains Connector Specifications for attaching Non-IBM Modems; Appendix G contains 3270 Specification Summary (Metric Units); Appendix H contains 3270 Specification Summary (English Units); Appendix J contains Cables and Connectors Attaching Non-IBM Devices; Appendix K contains a Wire Conversion Table; Appendix L contains an Inch-to-Millimeters Conversion Table; Appendix M contains Voltage Limitations; Appendix N contains an Installation Checklist; and Appendix O lists Abbreviations and Definitions.

In planning the installation, the customer should make any arrangements deemed necessary for the services of professional consultants. The installation must meet local and national code requirements.

The following publications should be used in conjunction with this manual:

*IBM 3270 Information Display System: Component Description*, GA27-2749

*IBM 3270 Information Display System: Planning and Setup Guide*, GA27-2827

*Assembly of Coaxial Cable and Accessories for Attachment to IBM Products*, GA27-2805

*IBM System/370 Installation Manual – Physical Planning*, GC22-7004 (WT19-0004)



# Contents

<b>Chapter 1. Introduction</b>	<b>1-1</b>
3270 System Units	1-1
Preinstallation Planning	1-1
Schedule of Customer Responsibilities	1-1
Six Months before Delivery	1-1
Four Months before Delivery	1-1
Three Months before Delivery	1-2
One Month to One Week before Delivery	1-2
At Time of Delivery	1-2
Product and Environmental Safety	1-2
Customer Responsibility	1-2
Data Security	1-2
Floor Planning	1-2
Templates	1-3
<b>Chapter 2. Operator Work Space Considerations</b>	<b>2-1</b>
General Considerations	2-1
Data or Text Entry Work Stations	2-1
Interactive Work Stations	2-3
Multiple Work Stations	2-3
Selected Dimensions	2-3
Visual Considerations	2-5
Ambient Lighting	2-5
Eye Fatigue	2-5
<b>Chapter 3. Site Preparation</b>	<b>3-1</b>
Temperature and Humidity	3-1
Electrical Requirements	3-1
Voltage and Frequency	3-1
Power Cords and Receptacles	3-1
Branch Circuits and Grounding	3-1
Lightning Protection	3-2
Power Lines	3-2
Communication Lines	3-2
Signal Lines	3-2
Electromagnetic Compatibility	3-2
Electrostatic Discharge	3-2
<b>Chapter 4. System Configurations and Cabling</b>	<b>4-1</b>
Local Attachment	4-1
Host System Channel Priority	4-2
Input/Output Priority Sequence	4-2
Device Wait (Critical) Time	4-2
3270 Information Display System Cabling Schematics (Local)	4-3
3272 Control Unit	4-3
3274 Control Unit Models 1A, 1B, 1D, 21A, 21B, 21D, 31A and 31D (Local) Cabling Schematic	4-4
Remote Attachment	4-6
Communication Facilities	4-7
Major Elements	4-7
3270 Information Display System Cabling Schematics (Remote)	4-8
3271 Control Unit	4-8
3275 Display Station	4-8
Cables for Non-IBM Modems	4-9
3274 Control Unit Models 1C, 21C, and 31C (Remote) Cabling Schematic	4-10
3274 Control Unit Model 51C (Remote) Cabling Schematic	4-12
3276 Control Unit Display Station Models 1, 2, 3, 4, 11, 12, 13, and 14 (Remote) Cabling Schematic	4-14
<b>Chapter 5. Machine Specifications</b>	<b>5-1</b>
Metric Conversions	5-1
Symbols	5-1
3262 Printer Models 3 and 13 (Customer Setup Designated)	5-2
3271 Control Unit Models 1, 2, 11, and 12	5-4
3272 Control Unit Models 1 and 2	5-6
3274 Control Unit Models 1A, 1B, 1C, 1D, 21A, 21B, 21C, 21D, 31A, 31C and 31D Models 1C, 21C, and 31C (Customer Setup Designated)	5-8
3274 Control Unit Model 51C (Customer Setup Designated)	5-10
3275 Display Station Models 1, 2, 11, and 12	5-12
3276 Control Unit Display Station Models 1, 2, 3, 4, 11, 12, 13, and 14 (Customer Setup Designated)	5-14
3277 Display Station Model 1	5-16
3277 Display Station Model 2	5-18
3278 Display Station Models 1, 2, 3, 4, and 5 (Customer Setup Designated)	5-20
3279 Color Display Station Models 2A, 3A, 2B, and 3B (Customer Setup Designated)	5-22
3284 Printer Models 1, 2, and 3	5-24
3286 Printer Models 1 and 2	5-24
3287 Printer Models 1, 1C, 2, and 2C (Customer Setup Designated)	5-26
3288 Line Printer Model 2	5-28
3289 Line Printer Models 1 and 2 (Customer Setup Designated)	5-30
<b>Chapter 6. Communication System Cabling</b>	<b>6-1</b>
Conversion of 2260 Display Cables	6-1
System Cabling	6-1
IBM-Supplied Cables	6-1
Customer-Supplied Cables	6-1
Optional Customer Fabrication of Cables	6-1
Cable Installation – General	6-1
Cable Runs (Indoors)	6-1
Shield Commoning	6-2
Identification and Labeling of Device Cabling (Coaxial)	6-2
Control Unit End	6-2
Device End	6-2
Cable Runs (Outdoors)	6-2
Coaxial Cable Separation Guide	6-2
Completion Tests of Cabling	6-2
National Electrical Code Classification	6-3
UL Listing	6-3
Coaxial Cable Installation	6-3
Indoors	6-3
Outdoors	6-3
Substitute Cabling	6-3
Lightning Protection	6-3
Low Lightning Exposure Areas	6-3
Aerial Installation	6-3
Buried Installation	6-3
Medium Lightning Exposure Areas	6-4
Aerial Installation	6-4
Buried Installation	6-4
High Lightning Exposure Areas	6-4
Aerial Installation	6-4
Buried Installation	6-4
Station Lightning Protectors	6-6

Cable Specifications 6-8  
Coaxial Cables (h and l) 6-8  
Cable h (Indoor) 6-8  
Cable l (Outdoor) 6-8  
Coaxial Cable Splicing 6-8  
3270 IDS Cabling Summary 6-8

Appendix A. U.S. and Canada Power Plug Types A-1

Appendix B. Power Cable Lengths B-1

Appendix C. World Trade Power Plug Types C-1

Appendix D. Power Cord Specifications D-1

Appendix E. Continental U.S. Lightning Damage Probability  
Map E-1

Appendix F. Connector Specifications for Attaching Non-IBM  
Modems F-1

Appendix G. 3270 Specification Summary (Metric Units) G-1

Appendix H. 3270 Specification Summary (English Units) H-1

Appendix J. Cables and Connectors for Attaching Non-IBM  
Devices J-1  
EIA/CCITT Cable TEST/OPERATE Switch J-3

Appendix K. Wire Conversion Table K-1

Appendix L. Inch-to-Millimeter Conversion Table L-1

Appendix M. Voltage Limitations M-1

Appendix N. Installation Checklist N-1

Appendix O. Abbreviations and Definitions O-1

## Figures

Figure 2-1. Data or Text Entry Work Station 2-1  
Figure 2-2. Dimensions of Data or Text Entry Work Station 2-2  
Figure 2-3. Interactive Work Station 2-3  
Figure 2-4. Dimensions of Interactive Work Station 2-4  
Figure 2-5. Dual Work Station Arrangement 2-5  
Figure 2-6. Clearances for Seated Operator 2-6  
Figure 3-1. Temperature and Humidity Requirements 3-1  
Figure 4-1. Locally Attached 3270 Information Display  
System 4-1  
Figure 4-2. 3272 and 3274 Priority Considerations 4-2  
Figure 4-3. Remotely Attached 3270 Information Display  
System 4-6  
Figure 5-1. Symbols Used in Plan Views 5-1  
Figure 6-1. Low Lightning Exposure Area -- Aerial  
Installation 6-3  
Figure 6-2. Medium Lightning Exposure Area -- Aerial  
Installation 6-4

Figure 6-3. Medium Lightning Exposure Area -- Buried  
Installation 6-5  
Figure 6-4. High Lightning Exposure Area -- Aerial  
Installation 6-5  
Figure 6-5. Station Protector Summary 6-7  
Figure 6-6. Summary of IBM Part Numbers for Cables and  
Accessories 6-9  
Figure 6-7. Bulk Cable Specifications for Indoor (h) and Outdoor  
Coaxial Cable (l) 6-10  
Figure 6-8. Cable Adapter for Joining Coaxial Cables 6-11  
Figure 6-9. 3270 IDS Cabling Summary 6-12  
Figure A-1. Power Plugs Supplied in the U.S. and  
Canada A-1  
Figure A-2. Descriptions of Plugs and Receptacles A-1  
Figure A-3. NFMA Configurations A-2  
Figure C-1. Power Plug Usage Chart C-2  
Figure C-2. Power Plug Diagrams C-3

## Chapter 1. Introduction

The information presented in this manual is intended to assist management personnel, system planners, installation planners, and installation personnel in performing the physical planning and installation procedures required to install an IBM 3270 Information Display System (IDS) at a customer's facility.

In general, the manual describes the site preparation activities that should be performed at a customer's facility prior to, during, and after delivery of a 3270 Information Display System to the customer. Further, the planning and installation data presented in this manual covers the whole spectrum of system configurations that are available to the customer: large clusters, small clusters, or a mixture of both types, operating in a local or remote environment.

Installation planning as described in this manual is divided into the following phases of activity: preinstallation planning, site preparation, work space and unit allocation, overall system design layout, cabling layout for local or remote system configurations, unit-to-unit cable routing, and installation of the cabling attaching all units.

### 3270 System Units

Listed below are the individual units that make up the 3270 Information Display System:

- IBM 3262 Line Printer Models 3 and 13
- IBM 3271 Control Unit Models 1, 2, 11, and 12
- IBM 3272 Control Unit Models 1 and 2
- IBM 3274 Control Unit Models 1A, 1B, 1C, 1D, and 21A, 21B, 21C, 21D, 31A, 31C, 31D, and 51C
- IBM 3275 Display Station Models 1, 2, 11, and 12
- IBM 3276 Control Unit Display Station Models 1, 2, 3, 4, 11, 12, 13, and 14
- IBM 3277 Display Station Models 1 and 2
- IBM 3278 Display Station Models 1, 2, 3, 4, and 5
- IBM 3279 Color Display Station Models 2A, 2B, 3A, and 3B
- IBM 3284 Printer Models 1, 2, and 3
- IBM 3286 Printer Models 1 and 2
- IBM 3287 Printer Models 1, 2, 1C, and 2C
- IBM 3288 Line Printer Model 2
- IBM 3289 Line Printer Models 1 and 2

### Preinstallation Planning

The following general schedule is a guideline for customized planning at individual locations. Adherence to this schedule will ensure that the site is ready on the planned installation date.

Since the 3262, 3274 Models 1C, 21C, 31C, 51C, 3276, 3278, 3279, 3287, and 3289 machines are designated Customer Setup (CSU) machines, additional information is provided to enable both the customer and the IBM Marketing Representative to develop a comprehensive plan for the setup of customer setup machines. This information is contained in the *IBM 3270 Information Display System: 3274 Control Unit Planning, Setup, and Customizing Guide, GA27-2827*, and the *IBM 3270 Information Display System: 3276 Control Unit Display Station Planning and Setup Guide, GA18-2041*. Delays in the installation may result if the information in these publications and the schedule in the following paragraphs are not used.

### Schedule of Customer Responsibilities

#### *Six Months before Delivery*

- Review specifications for cables that the customer must supply and begin to gather procurement source information if cables are not to be ordered from IBM.
- Determine which cables to be obtained from IBM are available only in preassembled form and plan accordingly.
- Complete all structural, mechanical, and electrical design specifications.
- Verify that common carrier facilities can be installed and operational by the planned installation date.
- Obtain review by the IBM Marketing Representative for the final terminal installation plan.
- Submit invitations for bids to outside contractors as required.

#### *Four Months before Delivery*

- Have a source for cables and accessories that the customer must supply and ensure that they will be supplied on schedule.
- Submit order for cables to be obtained from IBM. (Remember that some cables are supplied with the unit and no order is required.)

### *Three Months before Delivery*

- Begin alterations to building.

### *One Month to One Week before Delivery*

- Review checklist provided in Appendix N to ensure adequate preparation.

### *At Time of Delivery*

- Place units in proper locations.
- Place units in proper location before removing external packaging material, to prevent damage to the units. Some machines are shipped on pallets which are slightly larger than the machines. These units may not go through openings (doors) to the final machine location unless removed from such pallets. Should it be necessary to remove the pallet, be careful not to damage the legs or other supports of the machine while moving the machine to its proper location.
- Remove external packaging material.
- Check order; report any discrepancies to IBM.
- Install any units designated for customer setup.

### **Product and Environmental Safety**

Safety is a major consideration in the design of IBM products. Environmental safety is the responsibility of the customer. The customer should take care regarding the placement of 3270 units within his installation. *Stacking of units is not recommended* since this creates an unsafe condition that can produce adverse effects upon the operating environment specified for each 3270 unit, and, more important, can present a potential safety hazard to service personnel. The following safety factors should also be considered:

- Emergency disconnection of power to the branch circuits serving the equipment.
- Clearances for both operating and service personnel (see the machine specification pages in Chapter 5 for recommended clearances); access clearance for each individual machine must also be considered (clearances in back of a unit are of little value if an access path is not provided).
- Grounding of branch circuits as indicated under “Branch Circuits and Grounding” in Chapter 3.
- Lightning protection as indicated in Chapter 3 for power lines and in Chapter 6 for signal lines.

### **Customer Responsibility**

The customer is responsible for all site preparation, including:

- Following the “Schedule of Customer Responsibilities” cited previously.
- Doing floor planning, discussed below.
- Obtaining, installing, and maintaining customer-supplied cables.
- Providing on-site maintenance facilities when required.
- Arranging to install any necessary communication facilities (common carrier, Postal Telephone and Telegraph, or private) and attaching IBM cabling to these facilities.

In addition, the customer must complete the setup installation, and must check out all customer-setup 3270 units. For the customer setup units (3274 Models 1C, 21C, 31C, 51C, 3276, 3278, 3279, 3262, 3287, and 3289), the customer must follow the setup instructions in *IBM 3270 Information Display System: 3274 Control Unit Planning, Setup, and Customizing Guide*, GA27-2827, and *IBM 3270 Information Display System: 3276 Control Unit Display Station Planning and Setup Guide*, GA18-2041. The procedures must be followed whenever a unit is delivered or relocated.

IBM’s Marketing Representative will assist customer personnel in understanding the requirements in this manual and will assist with the physical installation plans.

### **Data Security**

The transmission of data between units is subject to unauthorized access. The customer should take whatever precautions are necessary to protect vital information. Data encryption features or devices are available that can protect data from being understood if it is received accidentally or without authorization. These features or devices are effective, but only between the transmitting unit and the receiving unit. Because the encryption features or devices are associated with the 3276 Control Unit Display Station or the 3274 Control Unit, the transmission of information between the attached displays or printers and the control unit is unprotected and a possible source of unauthorized access.

### **Floor Planning**

For each location, a detailed floor plan, showing terminal placement, should be prepared for efficient work flow, operator comfort and safety, and adequate service clearances.



When planning work-station display layouts, a review of Chapter 2, "Operator Work Space Considerations," is recommended.

The floor plan should be reviewed by customer management and, when required, by the IBM Installation Planning Representative before cabling is ordered.

The following items should be considered:

- Service clearances as shown in planned views.
- Operator clearances
- Functional clearances
- Access clearances
- The lengths of power cords and the location of the electrical outlets with proper phase, voltage, and amperage.
- The lengths of the cables that connect units of the system to the communication channel terminations; the common carrier or PTT representative must be consulted regarding the location of the communication channel termination and the type of connection proposed.
- Where a device may interface with more than one control unit or vice versa, all cabling paths must be planned, for example, 3278 and 3279 display units with Feature Code 1720 permit switching operational

control of that display unit between two different control units. Therefore, a separate coaxial cable run is necessary between the display unit and each control unit.

- The path of the cables exiting from the unit:
  - The protection of these cables
  - The hazard these cables create by lying on the floor
- The availability of telephones with outside lines near control units, to aid problem determination.
- Electrostatic discharge (see "Electrostatic Discharge" in Chapter 3).
- High electromagnetic field strength (see "Electromagnetic Compatibility" in Chapter 3).

### **Templates**

To assist the customer's installation planning team in preparing a floor plan, IBM provides transparent templates of the units. The *IBM 3270 Information Display System Physical Planning Template, GX27-2990*, is in U.S. customary units and is drawn to a scale of 1/4 inch = 1 foot (1:48). The *IBM 3270 Information Display System Physical Planning Template, GX27-2999*, is in metric units and is drawn to a scale of 10 mm = 0.5 m or 1/4 inch = 1 ft (1:50). The templates can be obtained from the IBM Marketing Representative.



## Chapter 2. Operator Work Space Considerations

Work-station layout and environmental considerations have an effect on work efficiency and employee comfort. This is particularly true for tasks that require the operator to be at the terminal for extended periods. This chapter is not a complete work-environment design guide; it highlights factors that affect accommodation of a 3270 IDS terminal as part of a work station and performance of visual tasks.

Recommendations in this section are based on human body measurements and extensive observations. The recommended work-space dimensions are based on an adult female height of 1650 mm (64.8 inches) and an adult male height of 1780 mm (70.2 inches) and will accommodate most users of approximately these heights. Of course, some of these work-space dimensions are unsuitable in other geographical areas because population body measurements differ significantly.

### General Considerations

When an operator is at a work station more or less continuously, work-space dimensions, equipment orientation, and conveniences become important.

Where possible, allowances should be considered for individual differences, such as very tall or short operators, those with bifocals, the left-handed, and the handicapped. Adjustable chairs, keyboard wells, and footstools are some of the common ways of obtaining adjustments. Also, the operator should be able to customize the work station by re-orienting the keyboard and display-positioning the source documents, reference items, and other job articles. Storage space for personal items should also be considered.

Putting more space or sound baffles, or both, between work stations is a common measure to control noise or voice interference. Where work stations are close, it may be desirable to reduce visual distractions with, for example, low dividers between stations.

One objective in work-station design is to be able to position the keyboard at a preferred height. Typically, the height should be such that forearms are (or are nearly) horizontal.

The choice of a work-station arrangement depends upon factors such as available space, facilities, traffic, and the intended application. Depending upon customer requirements, standard furniture may be used; some modifications to standard furniture may be warranted, or custom work stations may be designed.

Two types of work stations commonly in use are discussed in the following paragraphs: data or text entry stations and interactive (inquiry/update) stations.

### Data or Text Entry Work Stations

For data or text entry work stations, the major consideration is that the operator's primary task is to key in large amounts of data from source documents. The operator seldom needs to mark or alter the source documents. Usually they are assembled in batches, or pages in the case of text, and handled that way by the operator.

Visual attention is centered on the source document; the keyboard is operated by touch rather than guided visually. Typically, at the data entry work station the display is secondary in importance to either the source document or keyboard. Occasionally, the operator may look at the display to verify an item or to inspect status indicators. The same may apply to text entry.

A data or text entry work station is shown in Figure 2-1. Recommended dimensions are given in Figure 2-2. The work station shown is not provided by IBM. Some latitude is provided for adjustments in positioning the items.

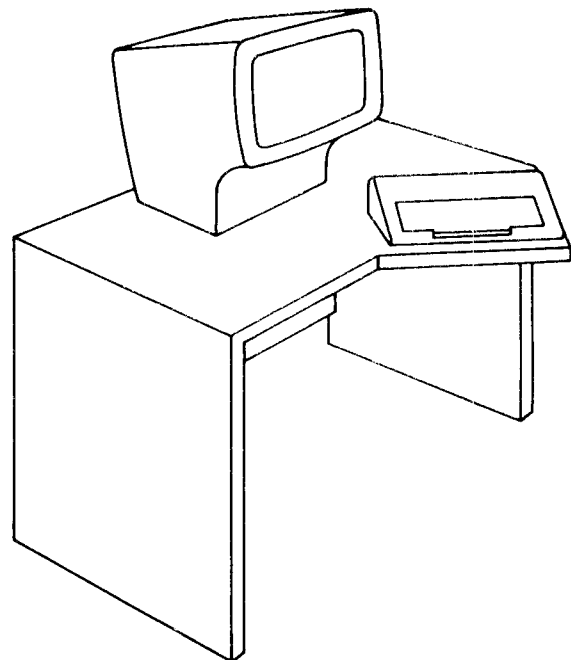

Keyboard may be located on the left side if so desired. Provisions must be made for both signal and power cabling. See plan view of applicable unit.

Figure 2-1. Data or Text Entry Work Station

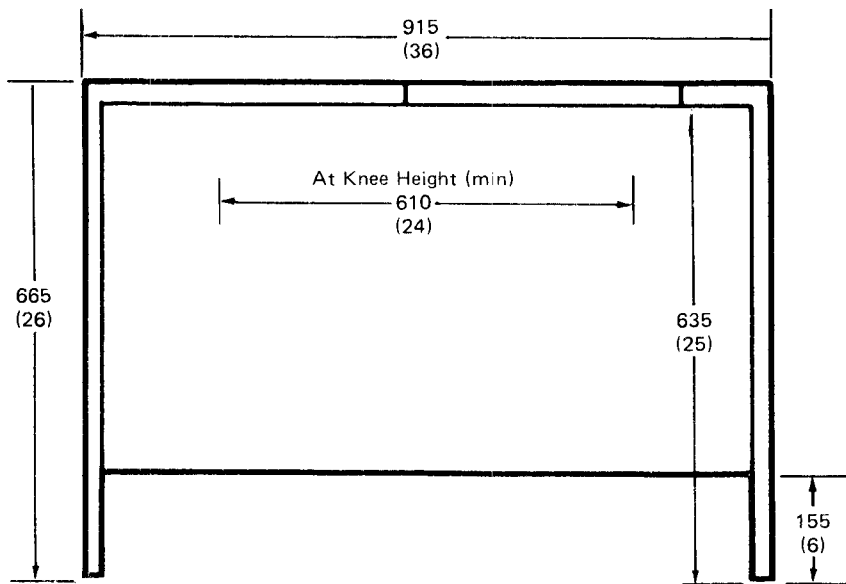
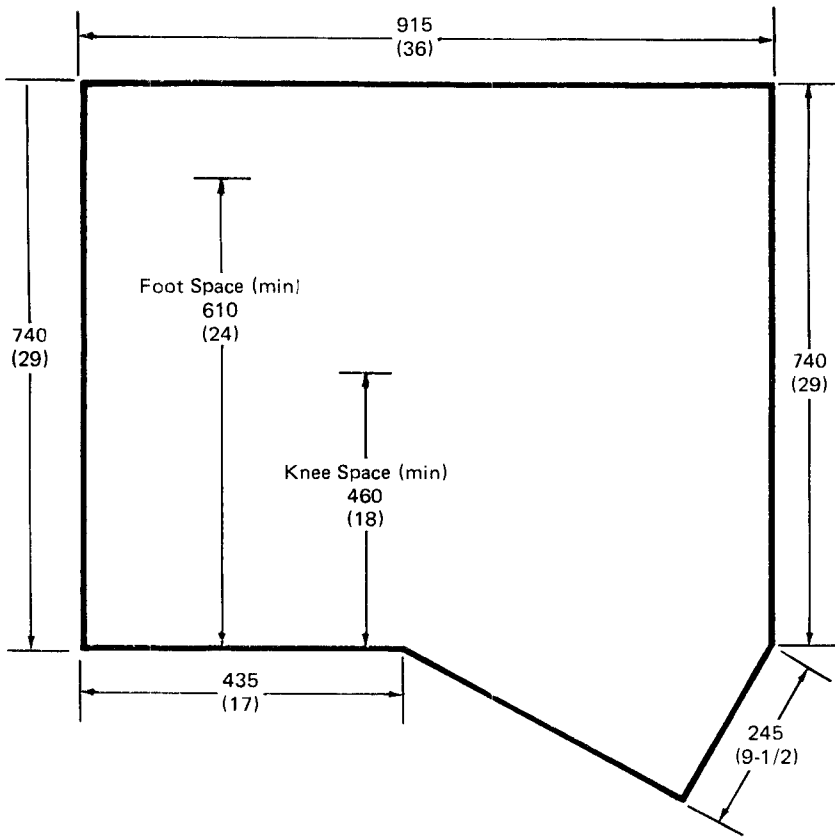

Note: Dimensions are shown in millimeters, with inches in parentheses.

Figure 2-2. Dimensions of Data or Text Entry Work Station

Fan-folded paper panels, 381 mm X 280 mm (15 inches X 11 inches), a common computer printer size, will fit alongside the terminal when opened to 560 mm (22 inches). The interactive work station (shown in Figure 2-3) may also be used for data entry tasks, but it is not as efficient for this purpose as the data or text entry work station.

### Interactive Work Stations

When a task primarily involves an interaction between the operator, display, and keyboard, the interactive station shown in Figure 2-3 is preferable. Recommended dimensions are given in Figure 2-4. In this class of applications, keying rates may be slow and are often visually guided. The operator, typically, is interested in information that is called up by a few keystrokes. That information may be modified by a few more keystrokes, orally transferred to a requesting party, or reponded to by some decision-making process.

Other than width, the dimensions for this type of work station should not change much from those for data or text entry. At an interactive station, the minimum width depends on the amount of other equipment, reference material, forms, etc., required for performing a specific set of tasks. In any case, the width of this type of work station

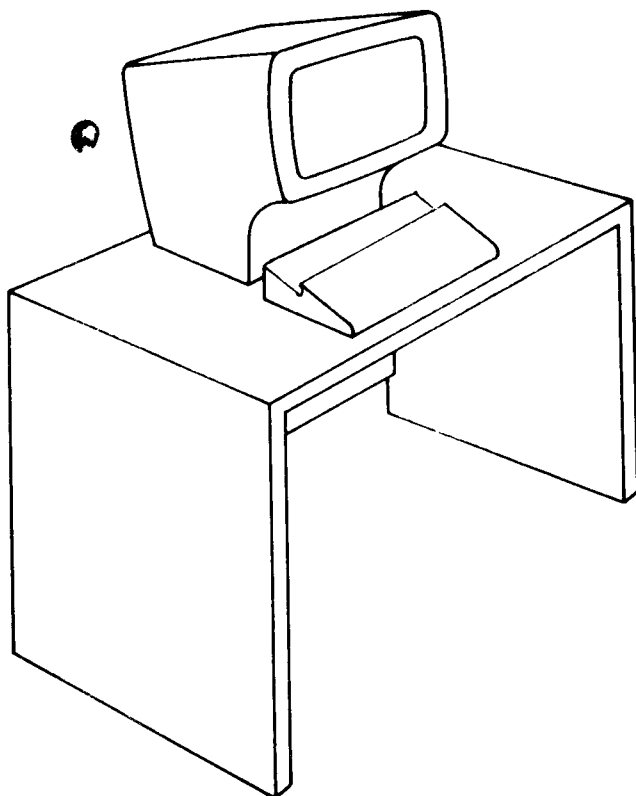

Figure 2-3. Interactive Work Station

should not be less than 715 mm (28 inches), particularly if work stations are to be placed side by side. Fan-folded computer printer paper can be accommodated here too.

### Multiple Work Stations

If the amount of floor space is particularly critical, structures that support more than one work station should be considered. Maximum compactness, with some loss of flexibility, may be obtained by designing a continuous structure that can support several individual work stations. No less than 715 mm (28 inches) of width should be allotted each work position. Figure 2-5 shows a dual work station arrangement on a 762 mm X 1524 mm (30-inch X 60-inch) surface, a commonly available size.

### Selected Dimensions

The following are recommended dimensions or positions for planning work station layouts.

Keyboard home row height from floor:

740 mm (29 inches) maximum for sustained professional keying

815 mm (32 inches) maximum for other keying (intermittent, hunt-and-peck)

Operator spacing:

715 mm (28 inches) minimum center-to-center between stations

1220 mm to 1524 mm (48 inches to 60 inches) preferred

Leg clearance, minimum:

Width: 610 mm (24 inches)

Depth: 460 mm (18 inches)

Height: 635 mm (25 inches)

Toe clearance for standing:

105 mm (4 inches) minimum

See-over height (top of display unit to floor):

Standing operator: 1397 mm (55 inches) maximum

Seated operator: 1120 mm (44 inches) maximum

Writing surface:

410 mm (16 inches) deep by 305 mm (12 inches) wide, minimum

Allow 30 mm (1 inch) spacing between multiple sets of documents

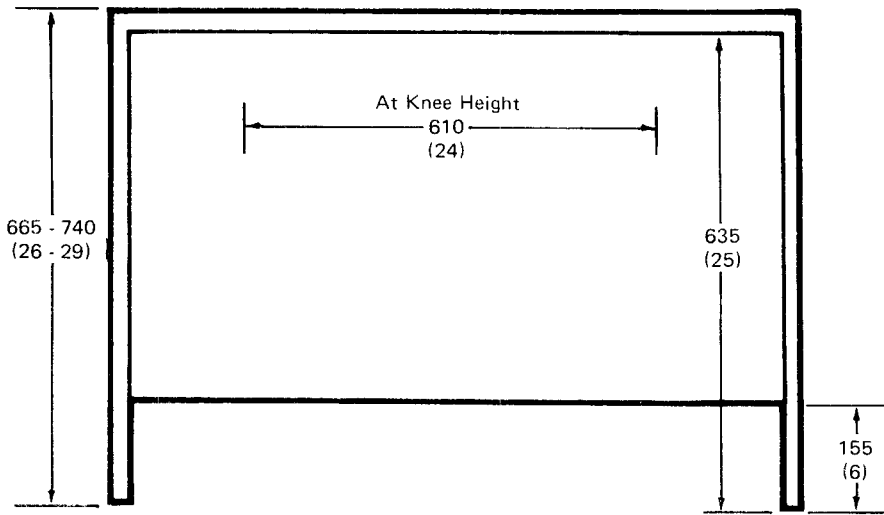
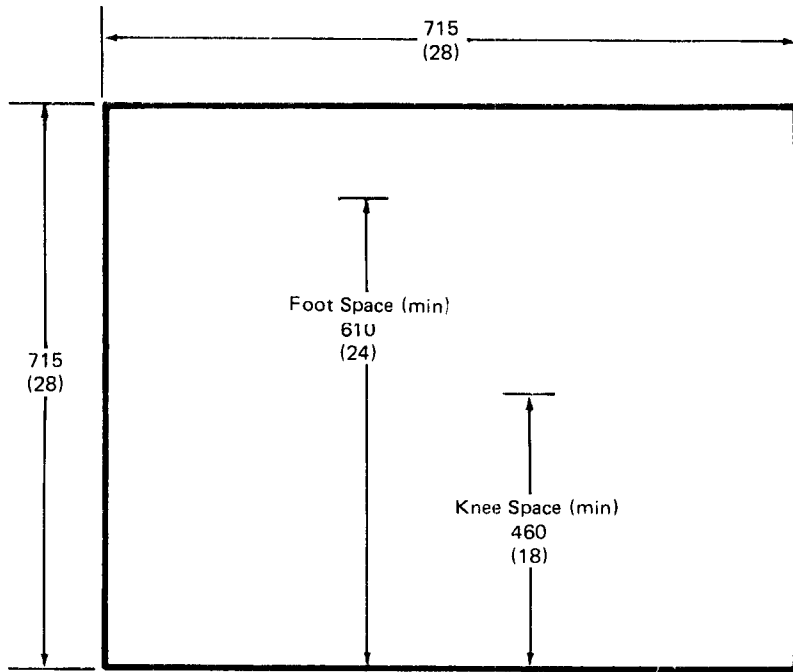

Note: Dimensions are shown in millimeters, with inches in parentheses.

Figure 2-4. Dimensions of Interactive Work Station

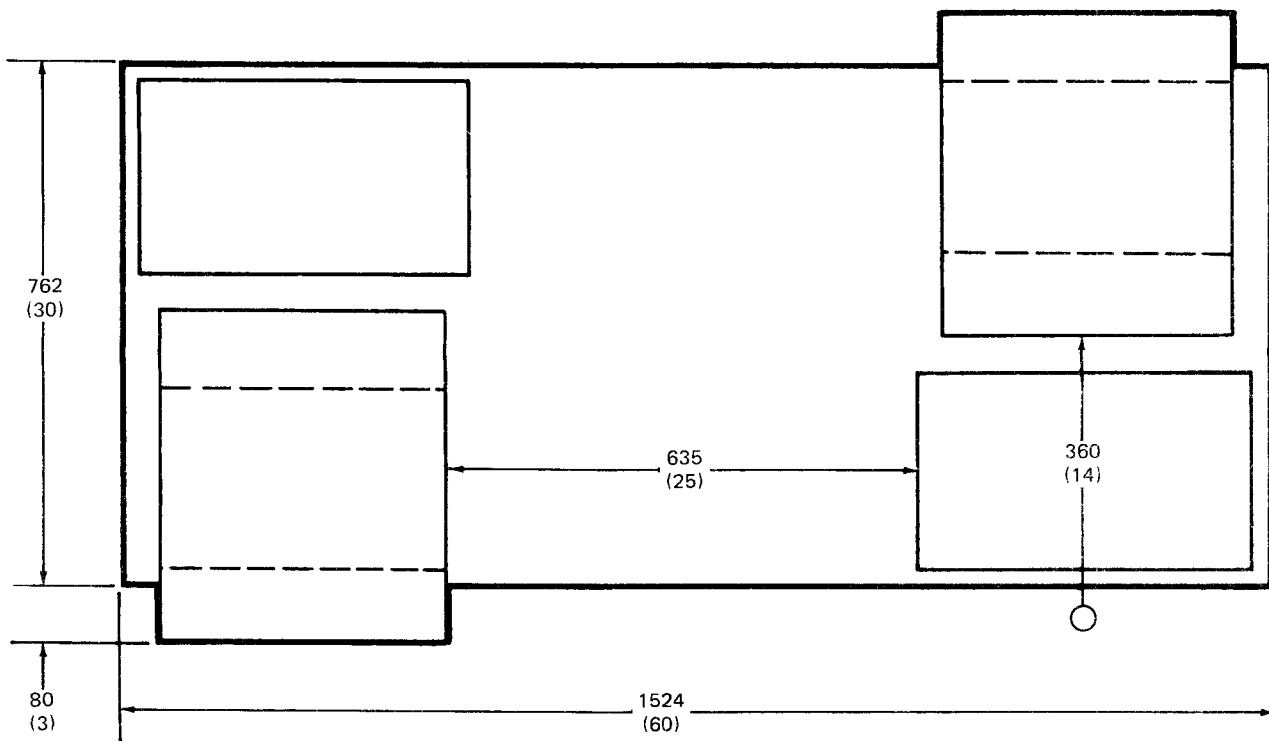

Note: Dimensions are shown in millimeters, with inches in parentheses.

Figure 2-5. Dual Work Station Arrangement

Source and reference material:

- To left of keyboard for data or text entry tasks
- To right of keyboard for tasks that require writing
- Telephone equipment to be left of keyboard, usually.

Desk-to-desk, desk-to-wall: see Figure 2-6.

### Visual Considerations

The system displays can be viewed comfortably by most persons over a range of distances, typically 330 mm to 510 mm (13 inches to 20 inches). The limits in any given case depend on the individual's eyesight, his visual environment the work station layout, and features of the reference or source material. Viewing distances greater than 610 mm (24 inches) should not be used without careful consideration.

#### *Ambient Lighting*

Filters are provided for the 3270 IDS display screens to enhance contrast and to reduce reflections from ambient lighting. The 3277 display filter is a customer option at no cost; the 3276 Control Unit/Display Station and the 3278 and 3279 displays have a built-in reflective filter.

Moderate lighting of only 540-810 lumens/meter<sup>2</sup> (50-75 footcandles) is indicated for most tasks requiring displays. It is usually helpful if lighting is reasonably balanced.

Although there are positive aspects to having windows in the display area, natural lighting may pose problems with almost any display because of its variability from less than "room ambient" to well over 100,000 lumens/meter<sup>2</sup> (9,300 footcandles). It is often helpful to orient the display screen at right angles to windows to avoid direct sunlight on the screen and to avoid sunlight in the operator's field of view when using the display.

#### *Eye Fatigue*

Eye discomfort has any number of causes which are often difficult to isolate. Discomfort may be symptomatic of bodily fatigue, a stressful visual environment, or a specific eye defect. Causes of eye discomfort and complaints are the same as in other clerical situations. Broadly speaking, the primary causes are found in attitudes, state of health, work organization factors, postural factors, the visual environment, and eye deficiencies. Often these factors interact. Those planning an installation of display terminals ought to be mindful of the common checkpoints

for minimizing visual fatigue where a display is used. Stated as qualitative rules, these points are:

- Provide adequate illumination for any visual task.
- Minimize differences in the viewing distances to the several objects, including the display, that are to be focused upon during the task.
- Provide objects that are well defined (having minimum blur, good contrast, and medium, legible size and shape).
- Minimize wide differences in brightness among work station areas; for example, desk top and walls or windows, documents, and desk tops.
- Eliminate glare sources.
- Reduce wide differences in brightness among objects; for example, document and display, documents used concurrently.
- Keep display brightness as low as possible while providing good legibility.

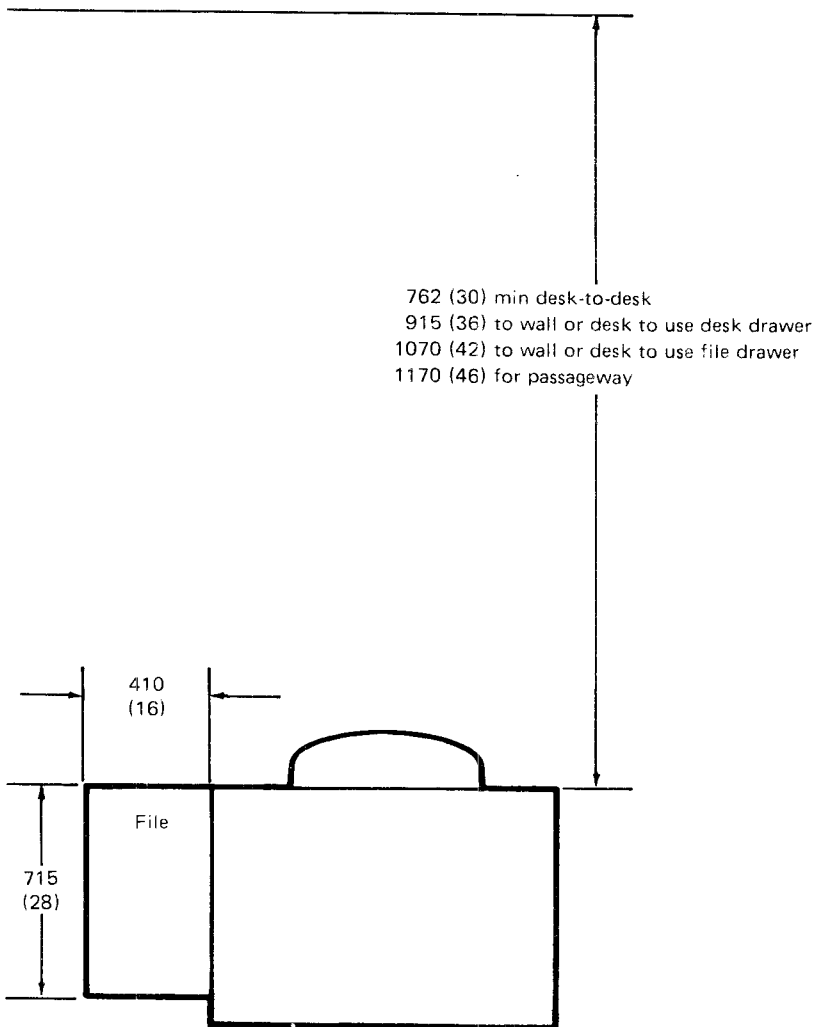

Figure 2-6. Clearances for Seated Operator



## Chapter 3. Site Preparation

### Temperature and Humidity

Hardware environmental requirements for temperature and humidity are shown in Figure 3-1. Some individual units require special consideration and may have restrictive requirements. Refer to the machine specification pages in Chapter 5 for individual requirements. Humidity limits may not be the same for the machine as for various supply products such as forms and cards. The limits of the supplies should be known because they are usually more restrictive. High or low humidity levels may cause improper feeding of paper. Before use, forms should be pre-conditioned not less than 48 hours in the environment of the printer. In some locations, airborne particles, vapors, or gases may subject units to contamination. If local conditions exist where contamination is suspected, contact the IBM Installation Planning Representative during the early planning stages or before relocating units.

<b>Environment Operating:</b>	
Temperature	10.0° to 40.6°C* (50° to 105° F)
Rel Humidity	8% to 80%
Max Wet Bulb	26.7°C** (80° F)
<b>Environment Non-Operating:</b>	
Temperature	10.0° to 51.7°C* (50° to 125° F)
Rel Humidity	8% to 80%
Max Wet Bulb	26.7°C** (80° F)
<b>Environment Storage:</b>	
Temperature	0.6° to 60.0°C (33° to 140° F)
Rel Humidity	5% to 80%
Max Wet Bulb	29.4°C (85° F)
<b>Environment Shipping:</b>	
Temperature	-40.0° to 60.0°C (-40° to 140° F)
Rel Humidity	5% to 100% (including condensation, excluding rain)
Max Wet Bulb	29.4°C (85° F)

\* The upper limit of air temperature should be derated 0.6° C (1° F) per 76 m (250 feet) of elevation above 914 m (3000 feet).

\*\* The upper limit of wet bulb temperature should be derated 0.6° C (1° F) per 30.5 m (100 feet) of elevation above 305 m (1000 feet).

Figure 3-1. Temperature and Humidity Requirements

### Electrical Requirements

#### *Voltage and Frequency*

The units of the 3270 Information Display System operate at 50 or 60 Hz. The allowable frequency variation is +0.5 Hz. The machine specification pages in Chapter 5 list the single-phase voltage at which the individual units operate. The allowable voltage variations are shown in Appendix M.

$$\text{Maximum Continuous Load in Amperes} = \frac{\text{kVA} \times 1000}{V}$$

#### *Power Cords and Receptacles*

Each unit has a three-wire power cord that includes an equipment ground wire (green or green and yellow). For use in the U.S., Canada, and Japan, the power cords have plugs attached. Appendix A identifies the plugs supplied in the U.S. and Canada. Appendix C identifies the plugs supplied in Japan. For each E/ME/A or A/FE country, except Canada and Japan, units are shipped without power plugs except for the 3262, 3274, 3276, 3278, 3287, and 3289 units (customer setup units). The power cords for these units are supplied with a plug as indicated in Appendix C.

#### *Branch Circuits and Grounding*

The individual branch circuits should have suitable circuit protection in accordance with national and local electrical codes. Each protector should be labeled to identify the branch circuit it is controlling.

The power cords are equipped with a green or green and yellow wire. This conductor must be carried back to earth or another suitable building ground. A dedicated insulated wire conductor is recommended for this purpose; however, a continuous metal conductor may be used if it has a permanent and continuous low impedance path to ground to ensure electrical continuity.

The Hot/Neutral polarity of the power receptacles should be checked and corrected, if necessary, by an electrician prior to machine installation.

## ***Lightning Protection***

### **Power Lines**

The customer should install lightning protection on his secondary power source when:

- The utility company installs lightning protectors on the primary power source.
- The area is subject to electrical storms or equivalent type power surges.

### **Communication Lines**

The customer should ensure that lightning protection is provided on the common carrier lines.

### **Signal Lines**

Refer to “Lightning Protection” in Chapter 6.

The customer is responsible for selecting the lightning protector and installing it properly.

## **Electromagnetic Compatibility**

In some instances, the site chosen for an installation may have ambient electromagnetic fields. These fields can result from nearby radio-frequency sources, such as transmitting antennas (AM, FM, television and two-way radios), radar installations, industrial equipment (radio-frequency induction heaters, arc welders, and insulation testers). Three-phase power distribution lines can generate magnetic fields that may cause display problems. As a precautionary measure, keep displays as far away as possible from such power distribution lines, preferably never closer than 1 m (3.3 feet), and from other sources of magnetic interference.

Other sources of interference include transformers (including those installed within other units), distributions panel, rotating machinery, and electric floor heating. To identify

the location of such sources of interference, check with your building engineer.

Before positioning units or cabling, an installation planning review may be appropriate to assess the environment and to determine whether any special installation or product considerations are required to assure normal system operation and maintenance. Consult with your IBM Installation Planning Representative.

## **Electrostatic Discharge**

Electrostatic charges can be built up on people and furniture as a result of:

- Movement of personnel, carts, or furniture in contact with floor covering
- Personnel in contact with furniture coverings, like seat covers

Discharge of these static charges to the metal parts of the unit or to the furniture on which it is situated may cause interference with the operation of the electronic equipment. These discharges may also cause personnel discomfort.

Major factors that contribute to this problem include:

- High-resistance floor surface material
- Carpeting without anti-static properties
- Plastic seat covering
- Very low humidity (usually less than 20%)
- Metal frame furniture

If any of the above factors apply, review the facility with your IBM Installation Planning Representative.

## Chapter 4. System Configurations and Cabling

### Local Attachment

Local (direct) attachment (Figure 4-1) of an IBM 3272 Control Unit or IBM 3274 Control Unit Models 1A, 1B, 1D, 21A, 21B, 21D, 31A, or 31D to a host system is through a selector, multiplexer, or block multiplexer channel; the control units attach via one of the eight control unit positions on the channel interface.

A 3272 can be attached to IBM S/360 Models 25, 30, 40, 50, 65, 67 (in 65 mode), 75, 85, and 195 or IBM S/370 Models 115 through 195 or 3031, 3032, and 3033 Processors.

A 3274 Model 1A, 21A, or 31A (SNA version) can be attached to IBM S/370 Models 115 through 168MP and 3031, 3032, and 3033 Processors.

A 3274 Model 1B or 21B (3272 version) can be attached to IBM S/360 Models 30, 40, 50, 65, 75, and 195 or IBM S/370 Models 115 through 195 or 3031, 3032, and 3033 Processors.

A 3274 Model 1D, 21D, or 31D (3272 version) can only be attached to IBM S/370 Models 115 through 195 or to 3031, 3032, and 3033 Processors.

At least one display station of the same model as the control unit with a keyboard special feature must be attached in each display system.

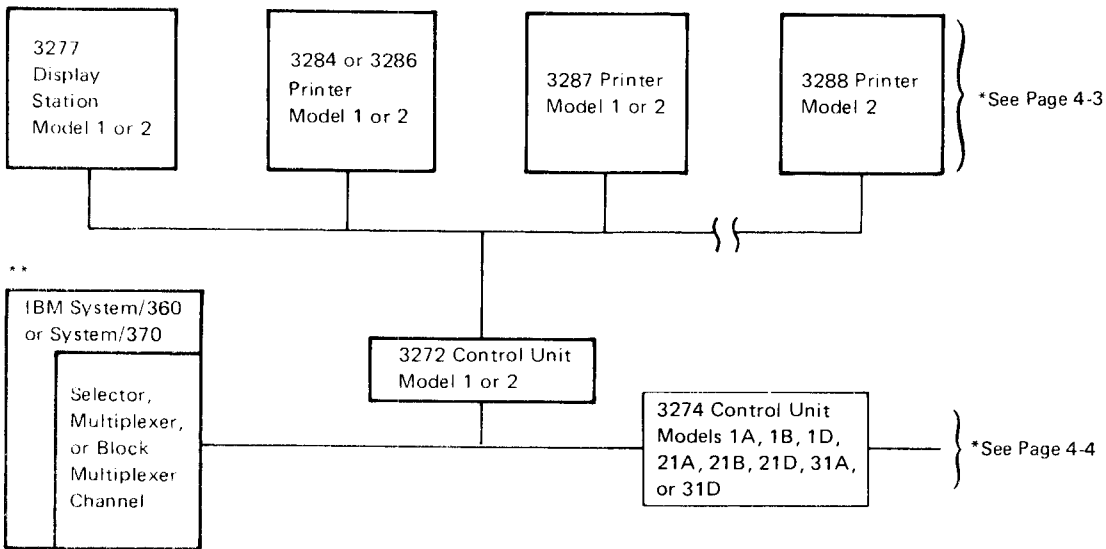

*\*Up to 32 devices can be attached to one control unit. A Model 1 control unit can only have these device models attached: 3284-1, 3286-1, 3277-1, 3287-1, and 3287-2. A Model 2 control unit can have any model device attached. However, the 3288-2 printer can only be attached to a Model 2 control unit.*

*\*\*Contact your IBM Sales Representative for possible systems that these control units can attach to.*

Figure 4-1. Locally Attached 3270 Information Display System

## Host System Channel Priority

### Input/Output Priority Sequence

Channel capabilities are affected by the sequence in which I/O devices are attached to the channel. This sequence is called priority. This is most pronounced on the byte multiplexer channel. For assigning priorities, the devices are divided into three classes:

- Class 1: Devices subject to overrun
- Class 2: Devices that require channel service in synchronization with their mechanical operations
- Class 3: Devices that do not require channel service to be in synchronization with their operations

The 3272 and 3274 Control Units do not require channel service in synchronization with their operation. Figure 4-2 shows the device priority considerations.

Device	Class	Byte Multiplexer Channel Critical Time	Block Multiplexer and Selector Channel Burst Mode Data Rate (per second)
3274	3	70 microseconds	650,000 characters
3274-1A	3	No critical time	100,000 characters instantaneous
3274-1B 3274-21B	3	No critical time	400,000 characters instantaneous read
3274-1B 3274-31B	3	No critical time	650,000 characters instantaneous write

Figure 4-2. 3272 and 3274 Priority Considerations

### Device Wait (Critical) Time

After a multiplex-mode device requests channel service, it has a fixed length of time that it can wait for service. If the channel provides service within this length of time, the device operates satisfactorily. If, however, the channel does not service the device within the device's wait time, one of two things happens: If the device is not subject to overrun, it continues waiting; if it is subject to overrun, it loses data and subsequently causes an I/O interruption condition. Neither unit (3272 or 3274) is subject to overrun; both continue to wait. However, the 3272 unit must have a response within 70 microseconds, or approximately 2 milliseconds of the data byte used in the read/write operation is lost. The time lost does not affect channel time out (32 microseconds), but it does have a major impact on data throughput.

## 3270 Information Display System Cabling Schematics (Local)

### 3272 Control Unit

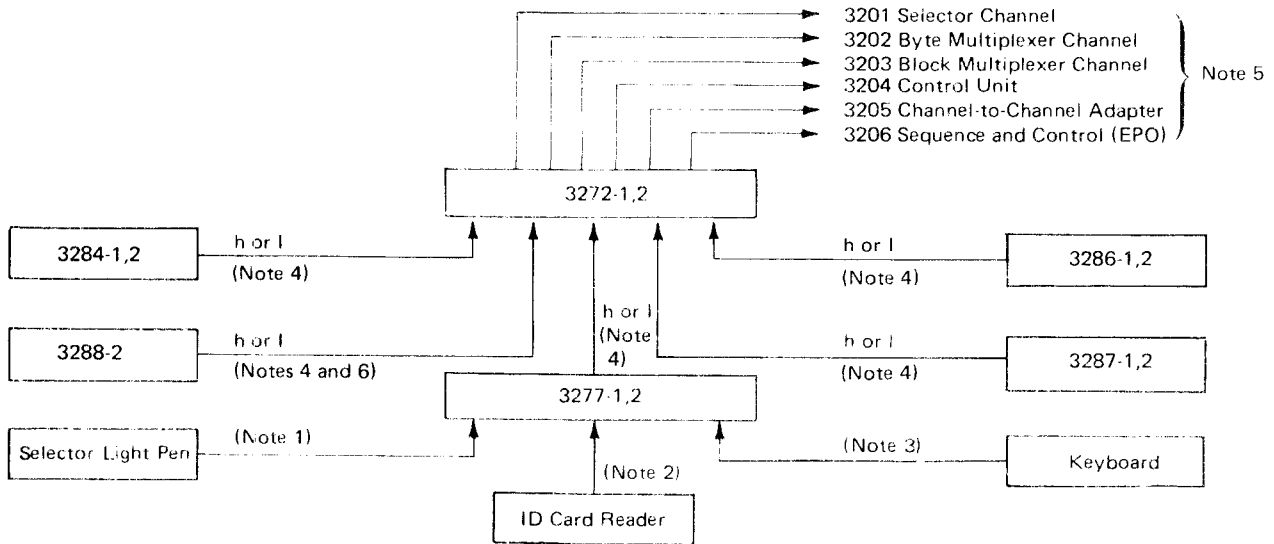

Cable Group No.	No. of Cables	From	To	Max Length m (ft)	Notes
h or l	1	3277, 3284, 3286, 3287, 3288	3272	610 (2,000)	4
3201	2	3272	Selector Channel	-	5
3202	2	3272	Byte Multiplexer Channel	-	5
3203	2	3272	Block Multiplexer Channel	-	5
3204	2	3272	Control Unit	-	5
3205	2	3272	Channel-to-Channel Adapter	-	5
3206	1	3272	Sequence and control (EPO)	46 (150)	

#### Notes:

1. A combined cable length of 1.2 m (4 feet) supplied with Selector Light Pen: 0.46 m (1-1/2 feet) from 3277 to holder; 0.76 m (2-1/2 feet) from holder to Selector Light Pen
2. Fixed cable length of 0.76 m (2-1/2 feet) supplied with ID card reader
3. Fixed cable length of 0.76 m (2-1/2 feet) supplied with keyboard
4. Customer-supplied, -installed, and -maintained. See "Cable Specifications" in Chapter 6 for ordering information and specifications.
5. Total cable length of 610 m (2,000 feet) is available to attach all control units, unless modified by cabling schematics of individual processing units or control units. Refer to IBM System/370 Installation Manual--Physical Planning, GC22-7004, or IBM System/370 World Trade Installation Manual--Physical Planning, GC19-0004, for specific channel cabling information.
6. The 3288-2 is used only with the 3272-2.

3274 Control Unit Models 1A, 1B, 1D, 21A, 21B, 21D, 31A, and 31D (Local) Cabling Schematic

(Notes 5, 7)

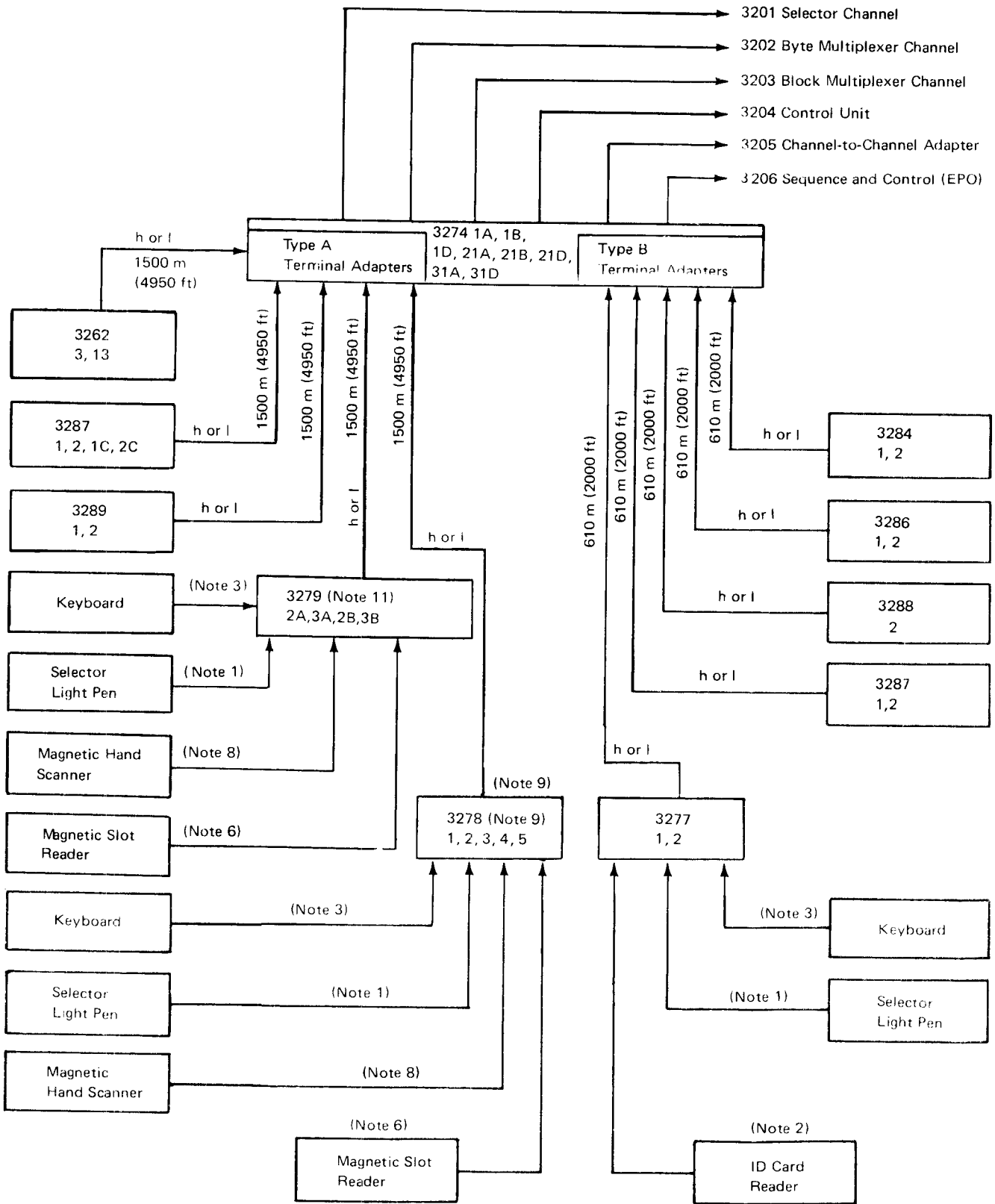

Refer to Notes on following page.

Cable Group No.	No. of Cables	From	To	Max Length m (ft)	Notes
h or l	1	3277, 3284, 3286, 3288, 3287 (Type B)	3274	610 (2000)	4
h or l	1	3278, 3279, 3262, 3287, 3289 (Type A)	3274	1500 (4920)	4
3201	2	3274	Selector Channel	61 (200)	5, 7
3202	2	3274	Byte Multiplexer Channel	61 (200)	5, 7
3203	2	3274	Block Multiplexer Channel	61 (200)	5, 7
3204	2	3274	Control Unit	61 (200)	5, 7
3205	2	3274	Channel-to-Channel Adapter	61 (200)	5, 7
3206	1	3274	Sequence and Control (EPO)	46 (150)	

**Notes:**

1. Fixed cable length of 1.22 m (4 feet) supplied with selector light pen.
2. Fixed cable length of 0.76 m (2-1/2 feet) supplied with ID card reader.
3. Fixed cable length of 0.91 m (3 feet) supplied with keyboard; optional feature: 1.67 m (5-1/2 feet).
4. Customer-supplied, -installed, and -maintained. See "Cable Specifications" in Chapter 6 for ordering information and specifications.
5. Total cable length of 61 m (200 feet) is available to attach all control units, unless modified by cabling schematics of individual processing units or control units. Refer to IBM System/370 Installation Manual--Physical Planning, GC22-7004, or IBM System/370 World Trade Installation Manual--Physical Planning, GC19-0004, for specific channel cabling information.
6. A free-standing magnetic slot reader may be plugged into a 3278 or 3279 unit: The units are equipped with a 1.5-m (5 feet) cable for attachment to a stub cable in the 3278. To extend the distance at which the slot reader may be used, two extension cables may be ordered via MES. They are:
  - 6-m (19.7 feet) extension cable PN 4832986
  - 12-m (39.4 feet) extension cable PN 4832987

The maximum distance the slot reader may be extended is 13.5 m (44.3 feet); thus, both extension cables may not be used together. In addition, no cables other than those described above may be used.
7. The local attachment for the 3274 Control Unit must be ordered by cable order. The same cables used for the 3272 Control Unit are used for the 3274 Control Unit.
8. A magnetic hand scanner is available for use with a 3278 Display Station or a 3279 Color Display Station when they are attached to a 3274 Control Unit. The scanners are equipped with a 1.5 m (5 feet) cable for attachment to a stub cable in the 3278. To extend the distance at which the scanner may be used, two extension cables may be ordered via MES. They are:
  - 6-m (19.7 feet) extension cable PN 4832986
  - 12-m (39.4 feet) extension cable PN 4832987

The maximum distance the scanner may be extended is 13.5 m (44.3 feet); thus, both extension cables may not be used together. In addition, no cables other than those described above may be used.
9. A 3278 Model 5 attaches to a 3274 Models 1A, 1D, 21A, 21D, 31A, and 31D.
10. The 3274 Model 1B does not support the 3279 Color Display Station Model 2B or 3B.

## Remote Attachment

Remote attachment (Figure 4-3) of an IBM 3271, 3274, or 3276 Control Unit or 3275 Display Station to a host system is through communication lines and modems to a transmission control unit, an integrated communications adapter, or a communications controller cabled locally to a system channel.

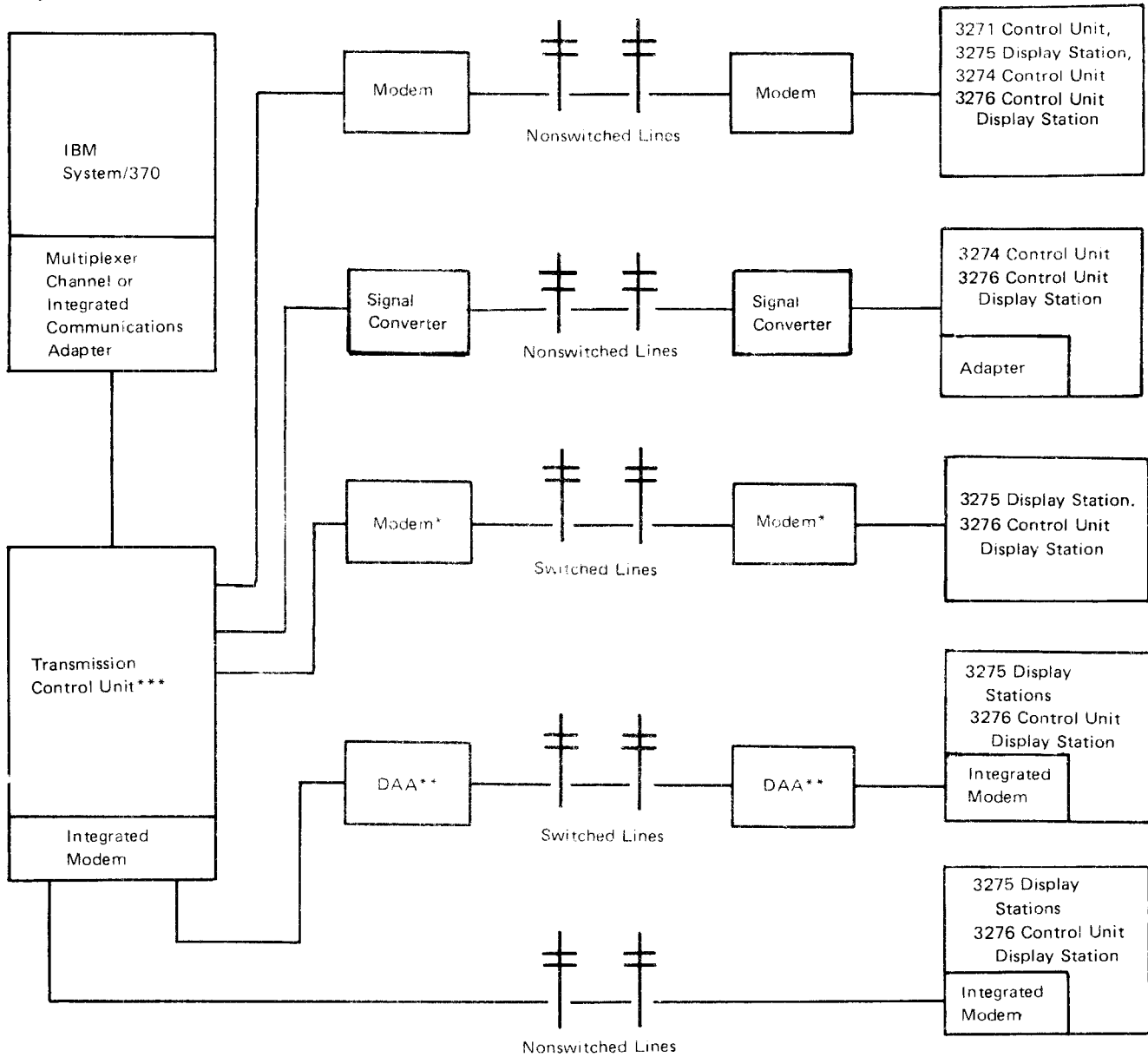

**Note:** The 3270 IDS meets the voltage signal and impedance levels of EIA standard RS/232-C, CCITT V-28, and CCITT V.35 and is designed to function with devices that comply with these standards.

\*IBM modems on switched lines require data couplers or FCC-certified equivalents.

\*\*DAA = Data-access arrangement. Data coupler type CDT or CBS, or FCC-certified equivalent required.

\*\*\*Contact your IBM Sales Representative for other control units that may be applicable.

Figure 4-3. Remotely Attached 3270 Information Display System



## ***Communication Facilities***

### **Major Elements**

The major elements of each data communication link between remotely located sites (see Figure 4-3) are:

- A communication channel
- Modems or signal converters
- Interconnecting cables

The customer must arrange for installation of communication equipment and services. These facilities must be available at the time the IBM equipment is scheduled to be installed.

**Communication Channel.** A communication channel is usually supplied by a common carrier, or in World Trade countries by the Postal Telephone and Telegraph (PTT). A channel can consist of wire, radio waves, or both. At each site, the common carrier provides the connector that terminates the channel.

**Modems or Signal Converters.** A modem or signal converter is installed at each end of each communication channel; for example, at the transmission control unit and the 3270 system. The modem or signal converter is the interface between the communication channel and the data terminal equipment.

**Modems.** A modem modulates and demodulates the signals carried on the communication channel. At a transmitting site, the modem modulates the communication channel signal with data bits. At a receiving

site, the modem demodulates the transmitted signals back to data bits.

A modem can be a stand-alone (external) unit or it can be integrated. An integrated modem device is incorporated as a feature within a unit. In some countries, communication regulations mandate the use of PTT modems for certain types of communication services. In these cases, consult your IBM Sales Representative to determine which modems are compatible.

**Signal Converters.** A signal converter is similar to a modem in that it converts data bits to signals suitable for transmission over the communication channel. However, data is transmitted over the communication channel as digital signals. An adapter is required in the 3270 system for proper interface to the signal converter. The applicable networks for signal converters are:

- AT&T nonswitched Dataphone\* digital data service network (US only)
- NTT nonswitched (DCC) X.21 network (Japan only)
- NTT switched (DDX) X.21 network (Japan only)
- CCITT V.35 Interface

**Interconnecting Cables:** The cables are used to connect the following pieces of equipment:

- The system unit that interfaces with the communication channel
- The modem or signal converter
- The connector that terminates the communication channel

---

\*Trademark of American Telephone & Telegraph Co.

## 3270 Information Display System Cabling Schematics (Remote)

### 3271 Control Unit

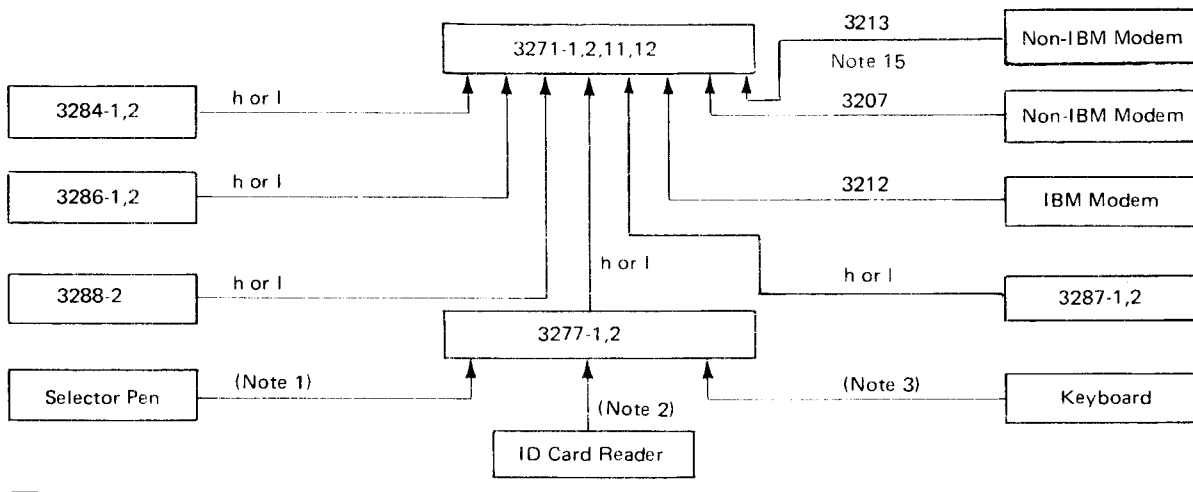

### 3275 Display Station

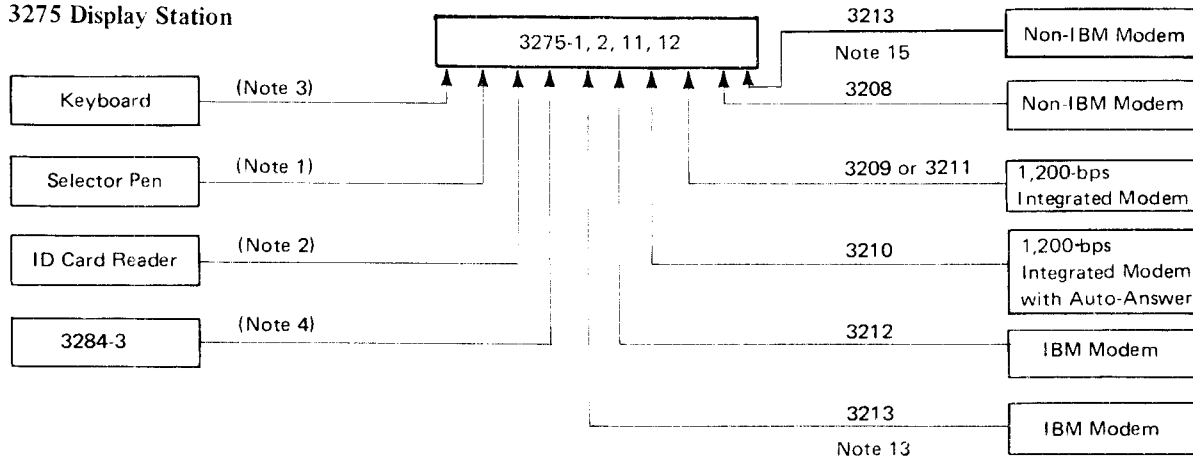

Cable Group No.	No. of Cables	From	To	Max Length m (ft)	Notes
h or 1	1	3277, 3284, 3286, 3287, 3288	3271	610 (2000)	5
3207	1	External Modem	3271	12 (40)	6, 7, 14
3208	1	External Modem	3275	12 (40)	6, 7, 14
3209	1	Nonswitched or Switched Lines	3275	12 (40)	6, 8, 9
3210	1	Switched Lines	3275	12 (40)	6, 10, 11
3211*	1	Switched or Nonswitched Lines	3275	12 (40)	6, 8
3212	1	External Modem	3271, 3275	12 (40)	12
3213	1	External Modem	3271, 3275	12 (40)	13, 15

Refer to Notes on the following page.

\*World Trade countries only except Japan.

**Notes:**

1. Fixed cable length of 0.46 m (1-1/2 feet) supplied with selector pen.
2. Fixed cable length of 0.76 m (2-1/2 feet) supplied with ID card reader.
3. Fixed cable length of 0.76 m (2-1/2 feet) supplied with keyboard.
4. Fixed cable length of 3 m (10 feet) supplied with 3284.
5. Customer-supplied, -installed, and -maintained; maximum length not to exceed 610 m (2000 feet). See "Cable Specifications" in Chapter 6 for ordering information and specifications.
6. See Appendix J, "Cables and Connectors for Attaching Non-IBM Devices".
7. For switched or nonswitched lines.
8. For switched lines without auto-answer or nonswitched lines (SF 5500).
9. Fixed cable length of 203 mm (8 inches) supplied with NTT-D1 service (Japan only).
10. For switched lines (SF 5501).
11. It is the customer's responsibility to have this cable connected to the communication facility.
12. One cable group number 3212 required for each IBM modem attached. The following listing shows attaching unit and modem types:

To Unit	Modem
3271	3872
	3874
	3875
	3976-3
	3977-3
	4872-1,3
3275	3976-3
	3977-2
	4872-1,3

13. A 3275 requires one group number 3213 to attach one IBM 3872, 3874, or 3875.
14. For direct attachment to the host system, use cable group 3207 for the 3271 and cable group 3208 for the 3275. The cable will be attached to a cable from a unit in the host system. The maximum combined length of the two cables is 12.2 m (40 ft) unless the line set or adapter of the other unit permits a greater length; for example, a 3704/3705 with line set (FC 4716) permits a total combined length of 30.4 m (100 ft).
15. A 3271 or 3275 requires one cable group number 3213 to attach one non-IBM modem in World Trade countries only, except Japan. Protective ground and signal ground are connected by this cable.

**Cables for Non-IBM Modems**

Appendix F contains specifications for connectors that attach non-IBM devices. Appendix J shows the cables and connectors that attach to non-IBM devices.

3274 Control Unit Models 1C, 21C and 31C  
 (Remote) Cabling Schematic

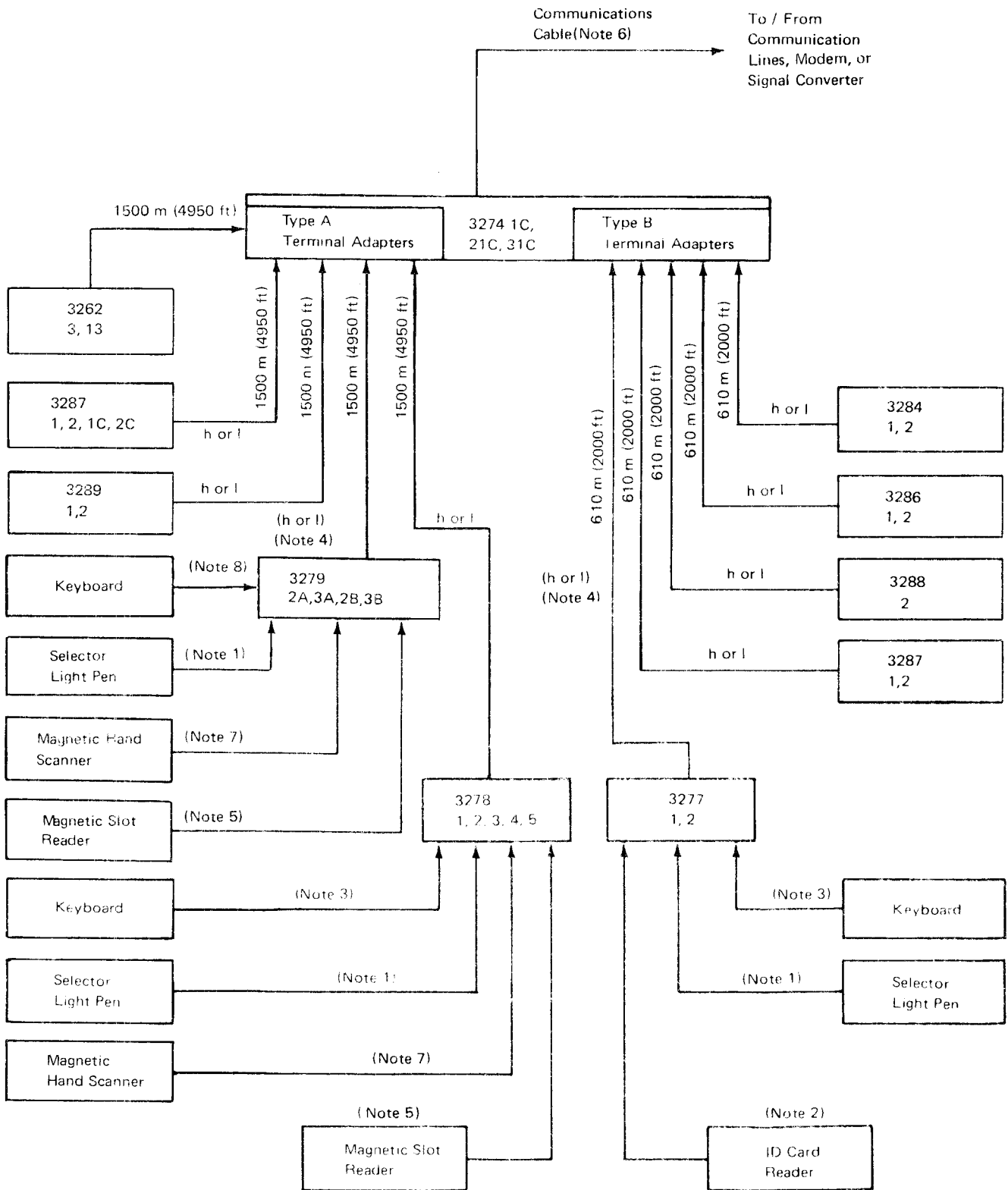

Refer to Notes on following page.

Cable Group No.	No. of Cables	From	To	Max Length m (ft)	Notes
h or l	1	3277, 3284, 3286, 3287, 3288	3274 (Type B)	610 (2000)	4
h or l	1	3278, 3279, 3262, 3287, 3289	3274 (Type A)	1500 (4920)	4
		3274 1C, 3274 21C, 3274 31C	Modem / Signal Converter/ Communication Line	12.2 (40)	6

**Notes:**

1. Fixed cable length of 1.22 m (4 feet) supplied with selector light pen.
2. Fixed cable length of 0.76 m (2-1/2 feet) supplied with ID card reader.
3. Fixed cable length of 0.76 m (2-1/2 feet) supplied with keyboard; optional feature: 1.67 m (5-1/2 feet).
4. Customer-supplied, -installed, and -maintained. See "Cable Specifications" in Chapter 6 for ordering information and specifications.
5. A free-standing magnetic slot reader may be plugged into a 3278 or 3279 unit. This unit is equipped with a 1.5-m (5 feet) cable for attachment to a stub cable in the 3278/3279. To extend the distance at which the slot reader may be used, two extension cables may be ordered via MES. They are:
  - 6-m (19.7 feet) extension cable PN 4832986
  - 12-m (39.4 feet) extension cable PN 4832987

The maximum distance the slot reader may be extended is 13.5 m (44.3 feet); thus, both extension cables may not be used together. In addition, no cables other than those described above may be used.
6. IBM supplies the cable that connects the 3274 Control Unit to the external modem, signal converter, or communication lines with the unit. This cable is customer-installed. Unless a different length is specified, IBM supplies a 6.1-m (20 feet) cable. If a cable length other than 6.1 m (20 feet) is needed, a 3.05-m (10 feet), 9.1-m (30 feet), and 12.1-m (40 feet) cable may be specified. See Appendix J for cables and connectors attaching to non-IBM devices. See the IBM Marketing Representative if further information is required.
7. A magnetic hand scanner is available for use with a 3278/3279 Display Station attached to a 3274 Control Unit. The scanners are equipped with a 1.5-m (5 feet) cable for attachment to a stub cable in the 3278. To extend the distance at which the scanner may be used, two extension cables may be ordered via MES. They are:
  - 6-m (19.7 feet) extension cable PN 4832986
  - 12-m (39.4 feet) extension cable PN 4832987

The maximum distance the scanner may be extended is 13.5 m (44.3 feet); thus, both extension cables may not be used together. In addition, no cables other than those described above may be used.
8. Fixed cable length of 0.91 m (3 feet) supplied with keyboard.

**3274 Control Unit Model 51C (Remote)  
Cabling Schematic**

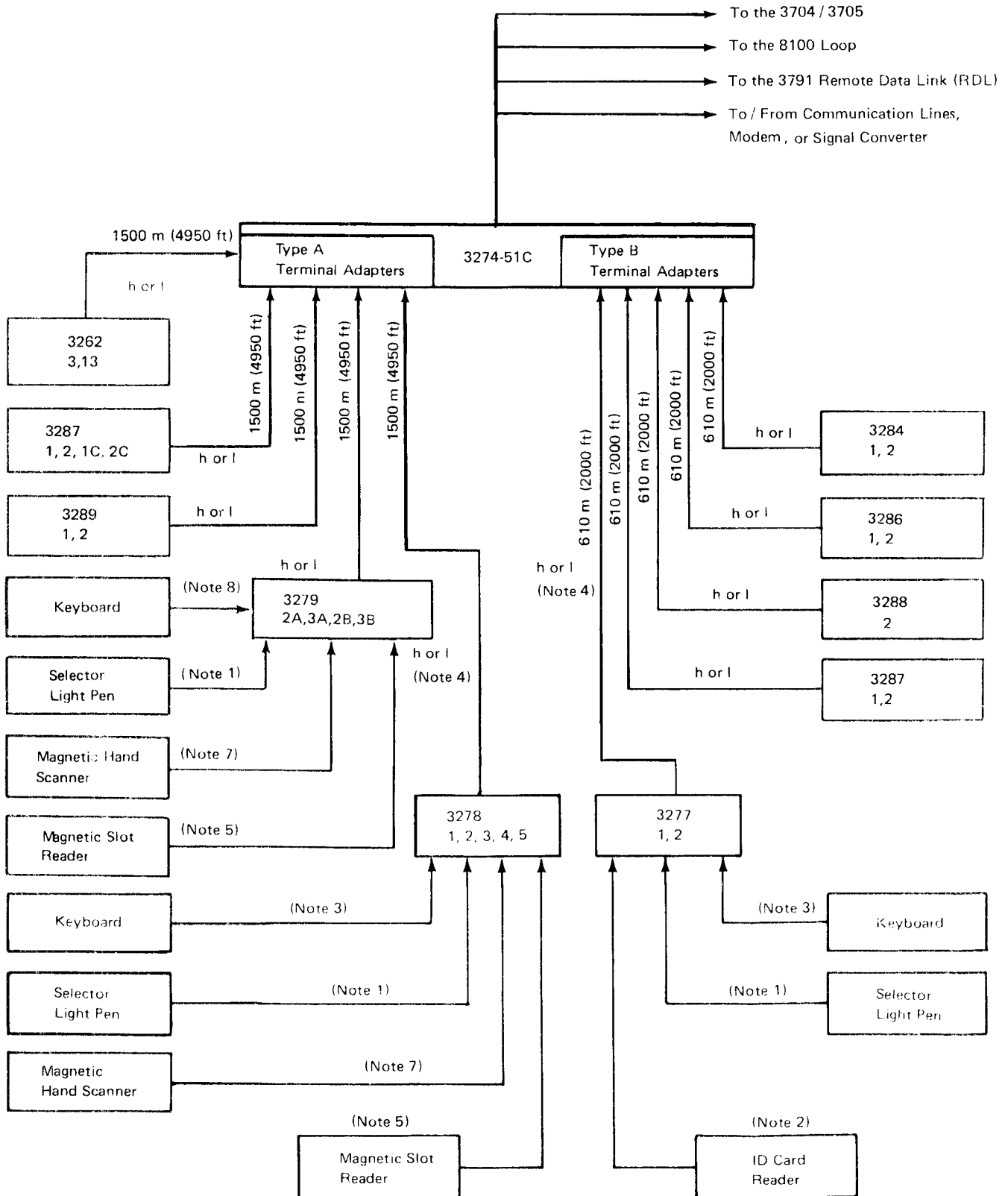

Refer to Notes on the following page.

Cable Group No.	No. of Cables	From	To	Max Length m (ft)	Notes
h or l	1	3277, 3284, 3286, 3287, 3288	3274 (Type B)	610 (2000)	4
h or l	1	3278, 3279, 3262, 3287, 3289	3274 (Type A)	1500 (4920)	4
		3274-51C	Modem / Signal Converter/ Communication Line	12.2 (40)	6
	1	3274-51C	Loop Attachment	12.2 (40)	6

**Notes:**

1. Fixed cable length of 1.22 m (4 feet) supplied with selector light pen.
2. Fixed cable length of 0.76 m (2-1/2 feet) supplied with ID card reader.
3. Fixed cable length of 0.76 m (2-1/2 feet) supplied with keyboard; optional feature: (3278 only).
4. Customer-supplied, -installed, and -maintained. See "Cable Specifications" in Chapter 6 for ordering information and specifications.
5. A free-standing magnetic slot reader may be plugged into 3278 or 3279 units. This unit is equipped with a 1.5-m (5 feet) cable for attachment to a stub cable in the 3278. To extend the distance at which the slot reader may be used, two extension cables may be ordered via MES. They are:
  - 6-m (19.7 feet) extension cable PN 4832986
  - 12-m (39.4 feet) extension cable PN 4832987

The maximum distance the slot reader may be extended is 13.5 m (44.3 feet); thus, both extension cables may not be used together. In addition, no cables other than those described above may be used.
6. IBM supplies the cable that connects the 3274 Control Unit to the external modem, signal converter, or communication lines with the unit. This cable is customer-installed. Unless a different length is specified, IBM supplies a 6.1-m (20 feet) cable. If a cable length other than 6.1 m (20 feet) is needed, a 3.05-m (10 feet), 9.1-m (30 feet), and 12.1-m (40 feet) cable may be specified. See Appendix J for cables and connectors attaching to non-IBM devices. See the IBM Marketing Representative if further information is required.
7. A magnetic hand scanner is available for use with a 3278 Display Station or 3279 Color Display Station when they are attached to a 3274 Control Unit. The scanners are equipped with a 1.5-m (5 feet) cable for attachment to a stub cable in the 3278 or the 3279. To extend the distance at which the scanner may be used, two extension cables may be ordered via MES. They are:
  - 6-m (19.7 feet) extension cable PN 4832986
  - 12-m (39.4 feet) extension cable PN 4832987

The maximum distance the scanner may be extended is 13.5 m (44.3 feet); thus, both extension cables may not be used together. In addition, no cables other than those described above may be used.
8. Fixed cable length of 0.91 m (3 feet) supplied with keyboard.

**3276 Control Unit Display Station Models 1, 2, 3, 4, 11,  
12, 13, and 14 (Remote) Cabling Schematic**

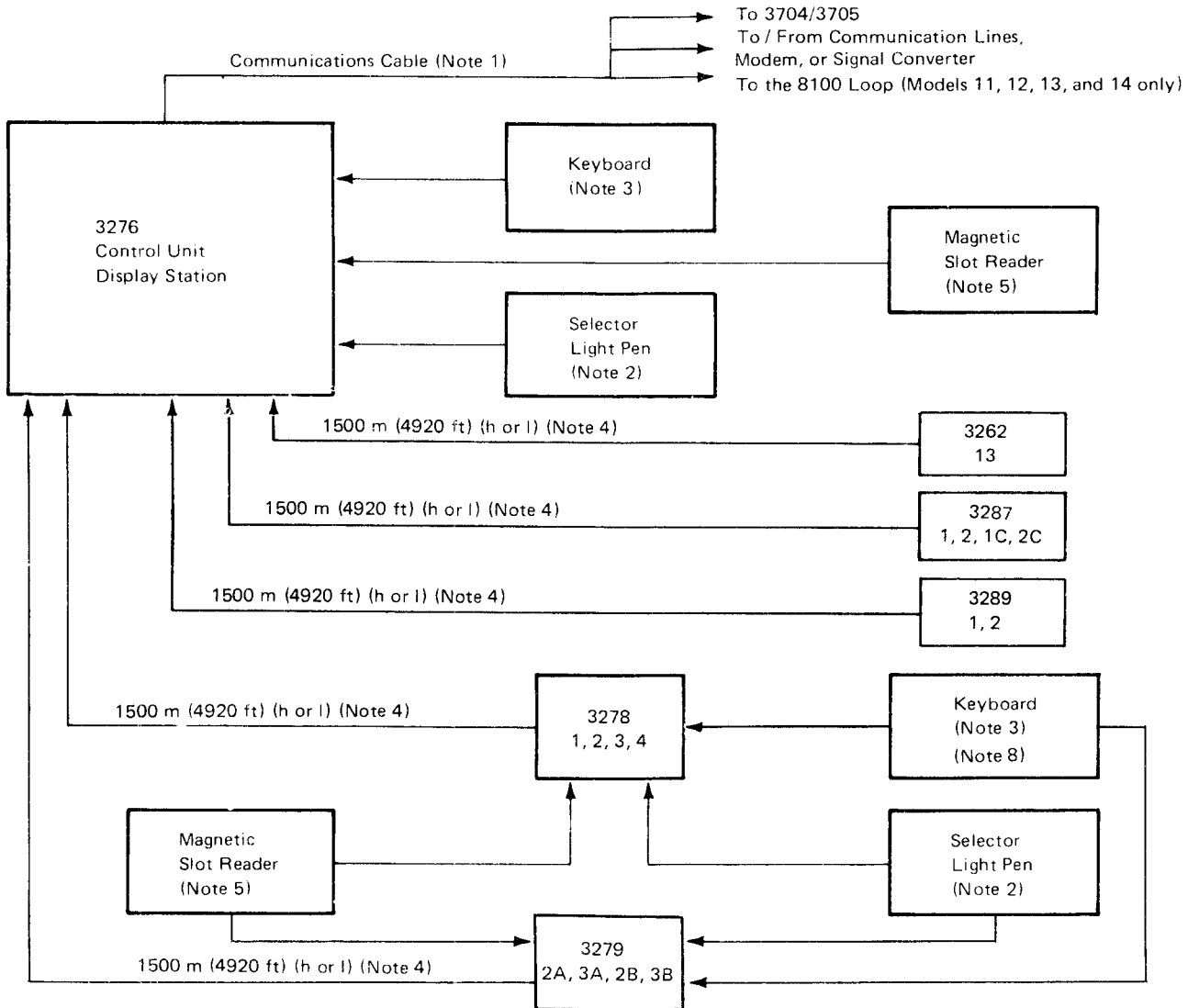

**Notes:**

1. With the 3276 Control Unit Display Station, IBM supplies the cable that connects the 3276 unit to the modem, the signal converter, the Communication Lines, or to the 8100 Loop. The Specify feature will determine the type of cable supplied. See Appendix J for cable terminations. Unless a different cable is specified for attachment to communication lines or to modems, IBM supplies a 6.1-m (20 ft) cable; included with this cable is a 0.38-m (15-in.) test cable. If a cable length other than 6.1 m (20 ft) is needed, 3.05-m (10 ft), 9.1-m (30 ft), and 12.1-m (40 ft) cables may be specified. See your IBM Marketing Representative. See the IBM 3270 Information Display System Planning, Setup, and Customizing Guide, GA27-2827, for details. This communication cable may attach directly to a cable from the 3704/3705. The total maximum length of both cables (3276 and 3704/3705 cables) should not exceed 30.5 m (100 ft). Unless a different cable is specified for attachment to the 8100 Loop, IBM supplies a 1.8-m (6 ft) cable. A 4.2-m (14 ft) cable may be specified.
2. With the Selector Light Pen, IBM supplies a 1.22-m (4 ft) cable that connects the pen to a 3276, 3278, or a 3279 unit. This cable is connected to the Selector Light Pen and the Display Station prior to delivery.
3. With each keyboard, IBM supplies a 0.76-m (2.5 ft) cable that is hardwired into the keyboard. When installing the keyboard, the customer plugs the other end of the cable into the 3276 or 3278 unit. An Optional Special Feature permits a 1.67-m (5-1/2 ft) cable.
4. The coaxial cable (h or l) is supplied, installed, and maintained by the customer. Cable h is for indoor use, and cable l is for both outdoor and indoor use.
5. A free-standing magnetic slot reader may be attached into a 3276, 3278, or a 3279 unit. The MSR is equipped with a 1.5-m (5 ft) cable for attachment to a stub cable in all units.
6. 3279 Models 2A and 2B can be attached to all 3276 models except Model 1.
7. 3279 Models 3A and 3B can be attached to all 3276 models except Models 1 and 2.
8. Fixed cable length of 0.91 m (3 feet) supplied with 3279 keyboard.



## Chapter 5. Machine Specifications











This chapter provides the machine specifications for each major component in the 3270 Information Display System.

### Metric Conversions

In this manual, English units converted into metric units are rounded to the nearest 5 millimeters, or to the nearest 1/4 inch, where decimals are used.

### Symbols

Figure 5-1 shows the symbols that are used in the plan views.

	Cable Entry and Exit Area in Base of Unit		Optional Equipment Outline
	Power Cord Exit		Service Area Boundary
	Air Intake Area		Casters
	Swinging Gate		Leveling Pads or Glides
	Standard Equipment Outline		Nonraised Floor Cable Exit*

\*For table- or counter-top terminals, the space between the bottom of the terminal and the table or counter surface permits signal cable and power cords to enter and exit from any direction. Thus, cutouts in table or counter are not necessary.

Figure 5-1. Symbols Used in Plan Views

# IBM 3262 Printer Models 3 and 13 (Customer Setup Designated)

## Plan View

Scale: 10 mm = 0.25 m

(Dimensions are shown in millimeters, with inches in parentheses.)

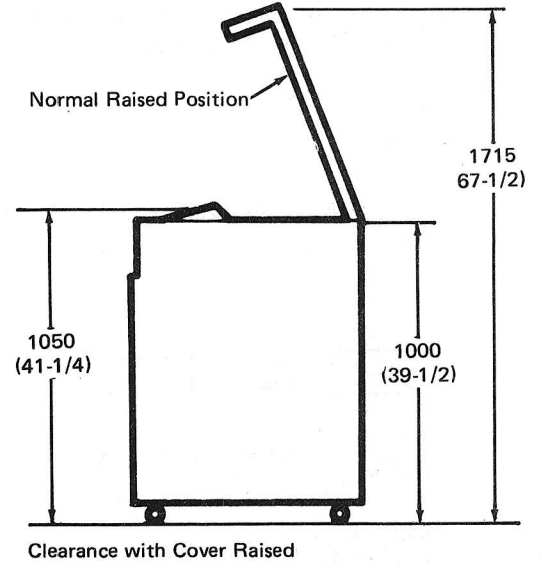
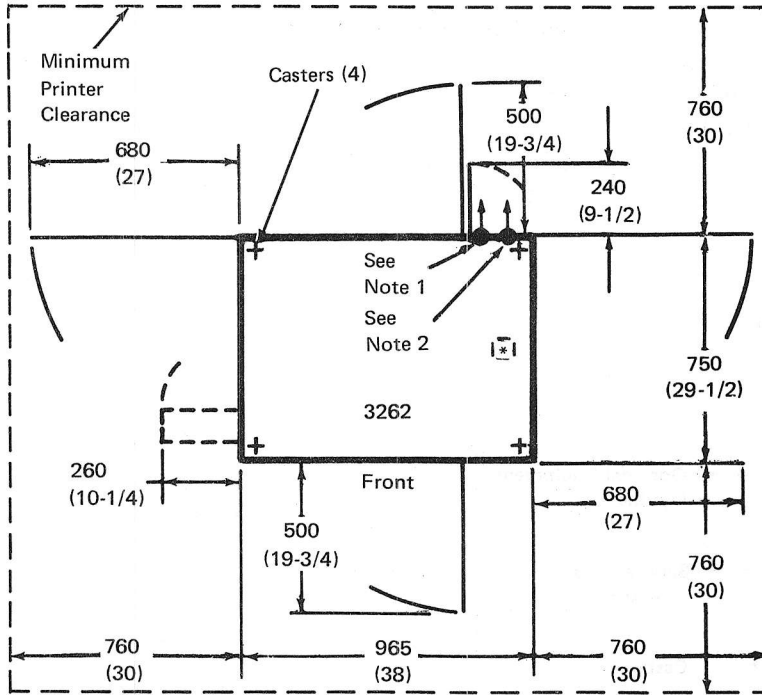

### Notes:

1. Signal cable connector location.\*
  2. Power cable location.\*
- \* Both cables can be routed through a single 64-mm (2-1/2-in.) hole in raised floor. Recommended location for the hole is centered between the front and back of the machine, and 100 mm (4 in.) from the right side.

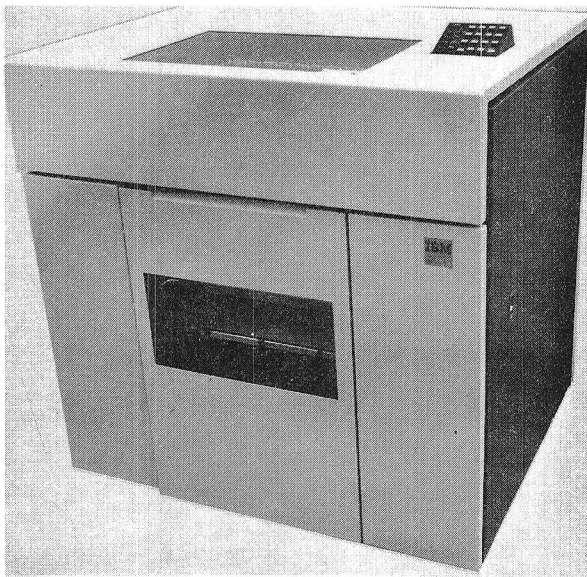

**Specifications**

**Dimensions:**

	<b>F</b>	<b>S</b>	<b>H</b>
mm	965	750	1000
(Inches)	(38)	(29-1/2)	(39-1/2)

**Service Clearances:**

	<b>F</b>	<b>L</b>	<b>R</b>	<b>Rt</b>	<b>H (cover raised)</b>
mm	760	760	760	760	1715
(Inches)	(30)	(30)	(30)	(30)	(67-1/2)

**Weight:** 245 kg (540 lb)

**Heat Output:** 1100 Watts (3750 BTU/hr)

**Power Requirements:**

kVa	1.2
Phase	1
Voltage	See chart below.

**Power Cord Style:** See Appendix D.

**Power Cord Length:** See Appendix B.

**Plug Type:** See Appendix A (U.S. and Canada).  
See Appendix C (A/FE and E/ME/A).

**Voltages That Can Be Specified**

	<b>60 Hz</b>				<b>50 Hz</b>					
	<b>100</b>	<b>110</b>	<b>120</b>	<b>127</b>	<b>100</b>	<b>110</b>	<b>200</b>	<b>220</b>	<b>230</b>	<b>240</b>
IBM (United States/Canada)			X							
IBM World Trade Americas/Far East	X	X	X	X	X	X	X	X	X	X
IBM World Trade Europe/Middle East/Africa			X <sup>1</sup>					X		X

1. Saudi Arabia only.

**Note:** Branch circuit requires a delayed-action fuse or circuit breaker with a high-surge tolerance for transformer and motor (high-magnetic) applications.

# 3271 Control Unit Models 1, 2, 11, and 12

## Plan View

Scale: 40 mm = 1 m

(Dimensions are shown in millimeters, with inches in parentheses.)

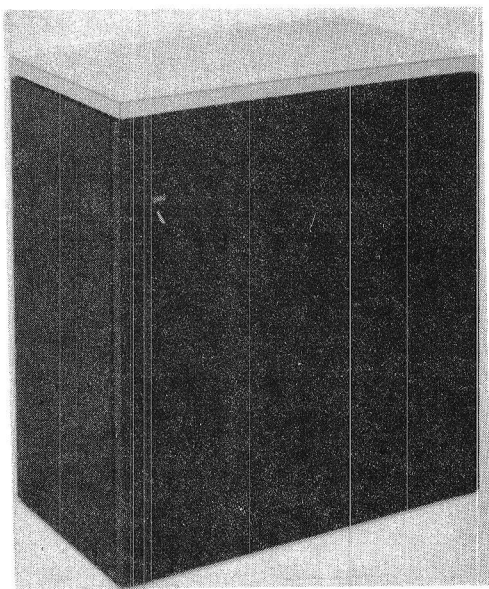
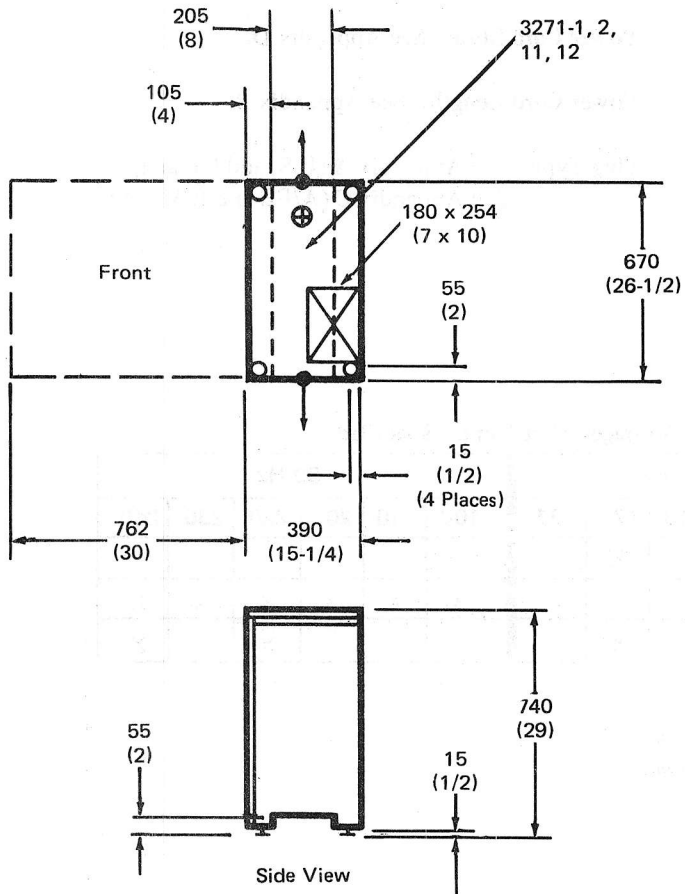

**Specifications**

*Models 1 and 2    Models 11 and 12*

**Dimensions:**

	<b>F</b>	<b>S</b>	<b>H</b>
mm	670	390	740
(Inches)	(26-1/2)	(15-1/4)	(29)

**Service Clearances:**

	<b>F</b>	<b>R</b>	<b>Rt</b>	<b>L</b>
mm	762	0	0	0
(Inches)	(30)	(0)	(0)	(0)

**Weight:** 44 kg (98 lb)

*Models 1 and 2    Models 11 and 12*

**Heat Output:**

Watts	176	186
(BTU/hr)	(595)	(630)

**Airflow:** Convection only    Convection only

**Power Requirements:**

kVA	0.18	0.20
Phases	1	1
Voltage	See chart below.	

**Power Cord:** See Appendix D.

**Power Cord Length:** See Appendix B.

**Plug Type:** See Appendix A (U.S. and Canada).  
See Appendix C (A/FE and E/ME/A).

**Voltages That Can Be Specified**

	60 Hz					50 Hz					
	100	115/120	200	208	230	100	110	123.5	200	220	235
IBM (United States/Canada)		X		X	X						
IBM World Trade Americas/Far East	X	X	X			X	X	X	X		
IBM World Trade Europe/Middle East/Africa		X <sup>1</sup>								X	X

1. Saudi Arabia only.

# 3272 Control Unit Models 1 and 2

## Plan View

Scale: 40 mm = 1 m

(Dimensions are shown in millimeters, with inches in parentheses.)

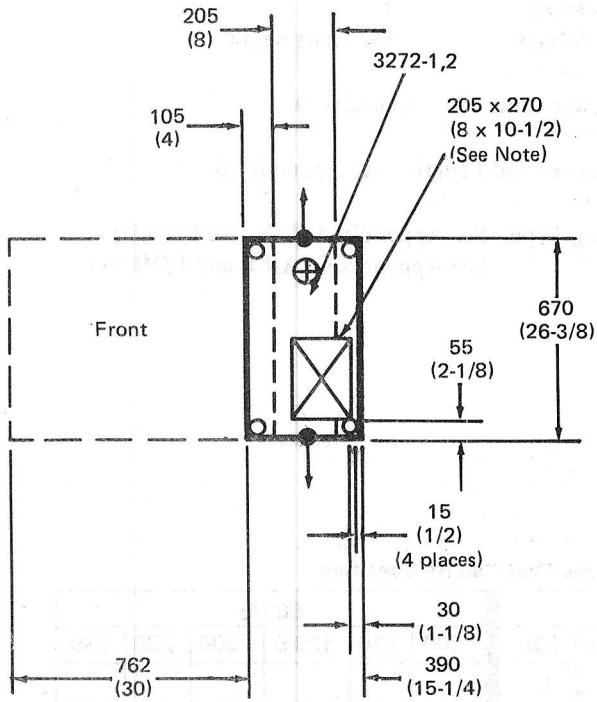

Note: Hole opening in the floor should not exceed 15 mm x 220 mm (5-3/4" x 8-1/2"). Maximum width from molding is 20 mm (3/4").

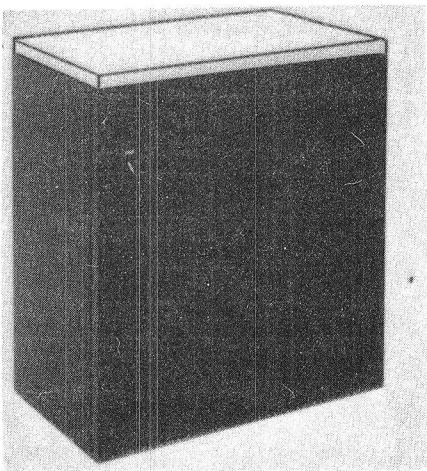
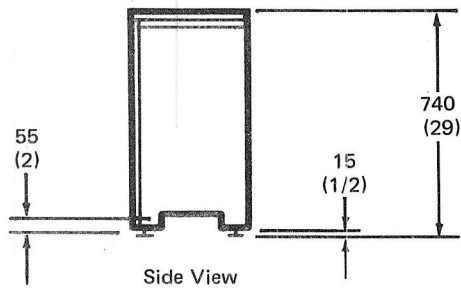

**Specifications**

**Dimensions:**

	F	S	H
mm	670	390	740
(Inches)	(26-1/2)	(15-1/4)	(29)

**Service Clearances:**

	F	R	Rt	L
mm	762	0	0	0
(Inches)	(30)	(0)	(0)	(0)

**Weight:** 43 kg (95 lb)

**Heat Output:** 176 Watts (595 BTU/hr)

**Airflow:** Convection only

**Power Requirements:**

kVA	0.18
Phases	1
Voltage	See chart below.

**Power Cord:** See Appendix D.

**Power Cord Length:** See Appendix B.

**Plug Type:** See Appendix A (U.S. and Canada).  
See Appendix C (A/FE and E/ME/A).

**Voltages That Can Be Specified**

	60 Hz					50 Hz					
	100	115/ 120	200	208	230	100	110	123.5	200	220	235
IBM (United States/Canada)				X	X						
IBM World Trade Americas/Far East	X	X	X			X	X	X	X		
IBM World Trade Europe/Middle East/Africa			X <sup>1</sup>							X	X

1. Saudi Arabia only.

**3274 Control Unit Models 1A, 1B, 1C, 1D, 21A, 21B, 21C, 21D, 31A, 31B, 31C, and 31D**  
 (Models 1C, 21C and 31C Customer Setup Designated)

**Plan View**

Scale: 40 mm = 1 m  
 (Dimensions are shown in millimeters, with inches in parentheses.)

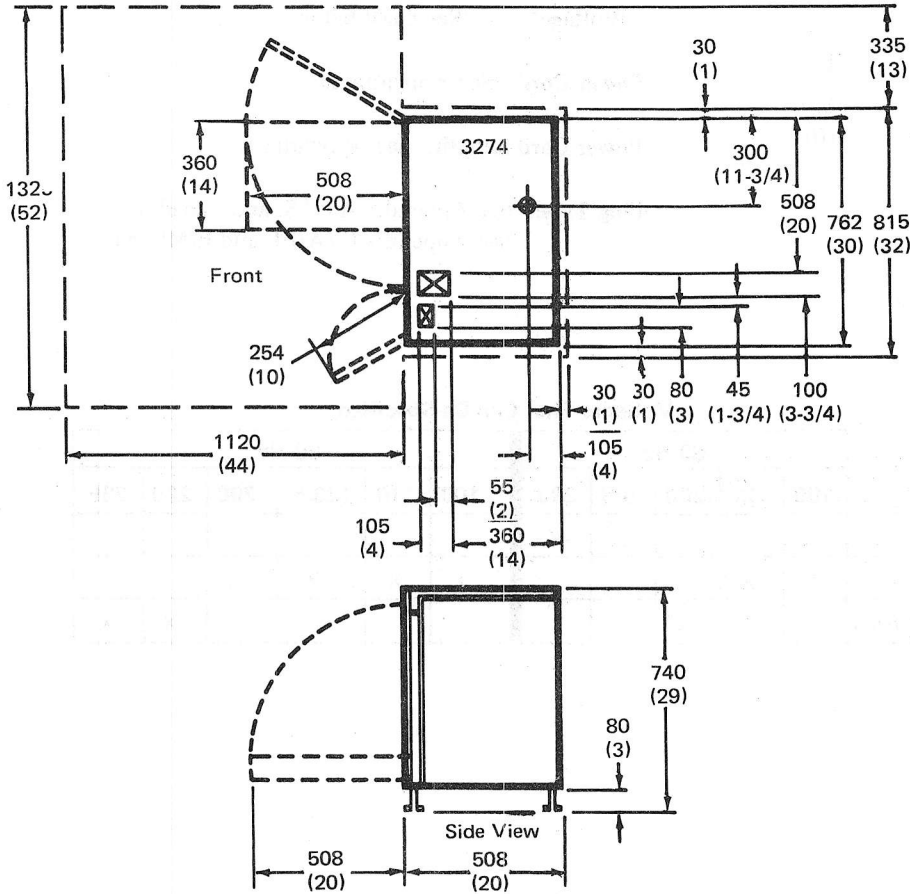

**3274 Control Unit Functional Clearances:**

	mm	(Inches)	
Front	0	(0)	Dimensions are minimum requirements for functional operation of the machine. These dimensions allow sufficient air flow to provide cooling.
Rear	30	(1)	
Left	30	(1)	
Right	30	(1)	
Top	0	(0)	
Bottom	The feet provide space between the bottom of the unit and the supporting surface to allow airflow for cooling. Care should be taken that papers, books, etc., do not impede the air flow in this space.		

*Note: If unit is installed with minimum clearance, service access must be provided.*



**Specifications**

**Dimensions:**

	F	S	H
mm	762	508	740
(Inches)	(30)	(20)	(29)

**Service Clearances:**

	F	L	R	Rt	T
mm	1120	30	30	30	0
(Inches)	(44)	(1)	(1)	(1)	(0)

**Weight:** 75 kg (165 lb)

**Heat Output:** 407 Watts (1382 BTU/hr)

**Airflow:** 2 m<sup>3</sup>/min (70 CFM) forced air

**Power Requirements:**

kVA	0.45
Phases	1
Voltage	See chart below.

**Power Cord:** See Appendix D.

**Power Cord Length:** See Appendix B.

**Plug Type:** See Appendix A (U.S. and Canada).  
See Appendix C (A/FE and E/ME/A).

**Voltages That Can Be Specified**

	60 Hz								50 Hz					
	100	110	120	127	200	208	220	240	100	110	200	220	230	240
IBM (United States/Canada)			X <sup>1</sup>			X		X						
IBM World Trade Americas/Far East	X	X	X	X	X	X	X	X	X	X	X	X	X	X
IBM World Trade Europe/Middle East/Africa			X <sup>2</sup>									X		X

1. Model 1C only.
2. Saudi Arabia only.

## 3274 Control Unit Model 51C (Customer Setup Designated)

### Plan View

Scale: 40 mm = 1 m

(Dimensions are shown in millimeters, with inches in parentheses.)

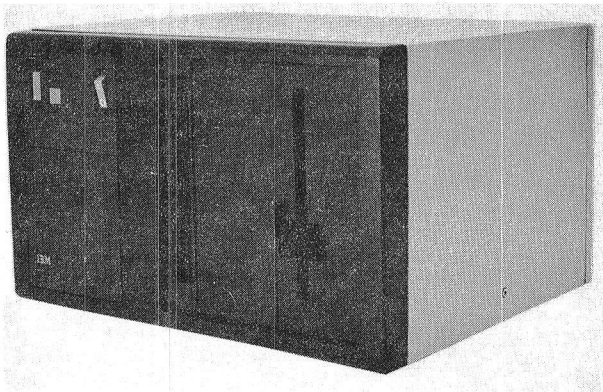
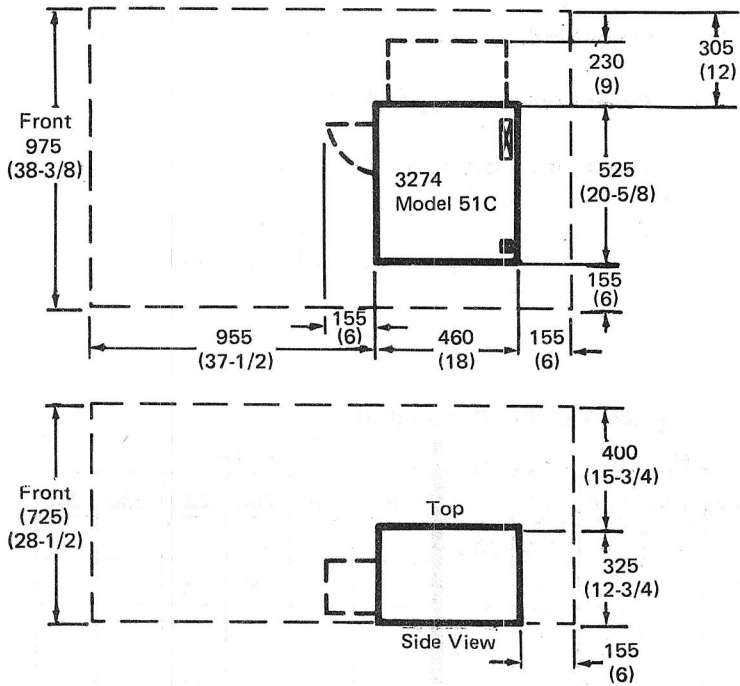

### 3274-51C Control Unit Functional Clearances

	mm	(Inches)	
Front	30	(1)	Dimensions are minimum requirements for functional operation of the machine. These dimensions allow sufficient air flow to provide cooling.
Rear	155	(6)	
Left	30	(1)	
Right	30	(1)	
Top	30	(1)	

**Note:** *If the unit is installed with minimum clearance, service access must be provided.*

**Specifications**

**Dimensions:**

	<b>F</b>	<b>S</b>	<b>H</b>
mm	535	460	335
(Inches)	(21)	(18)	(13)

**Service Clearances:**

	<b>F</b>	<b>L</b>	<b>R</b>	<b>Rt</b>	<b>T</b>
mm	30	30	155	30	30
(Inches)	(1)	(1)	(6)	(1)	(1)

**Weight:** \*29.6 – 40.9 kg\* (65 – 90 lbs)

**Heat Output:** 234 Watts (800 BTU/hr)

**Airflow:** 1.7 m<sup>3</sup>/min (60 CFM) forced air

**Power Requirements:**

kVA	0.36
Phases	1
Voltage	See chart below.

**Power Cord:** See Appendix D.

**Power Cord Length:** See Appendix B.

**Plug Type:** See Appendix A (U.S. and Canada).  
See Appendix C (A/FE and E/ME/A).

\*Depends upon internal storage.

**Voltages That Can Be Specified**

	<b>60 Hz</b>								<b>50 Hz</b>					
	<b>100</b>	<b>110</b>	<b>120</b>	<b>127</b>	<b>200</b>	<b>208</b>	<b>220</b>	<b>240</b>	<b>100</b>	<b>110</b>	<b>200</b>	<b>220</b>	<b>230</b>	<b>240</b>
IBM (United States/Canada)			X											
IBM World Trade Americas/Far East	X	X	X	X	X	X	X	X	X	X	X	X	X	X
IBM World Trade Europe/Middle East/Africa			X <sup>1</sup>									X		X

1. Saudi Arabia only.

## 3275 Display Station Models 1, 2, 11, and 12

### Plan View

Scale: 40 mm = 1 m

(Dimensions are shown in millimeters, with inches in parentheses.)

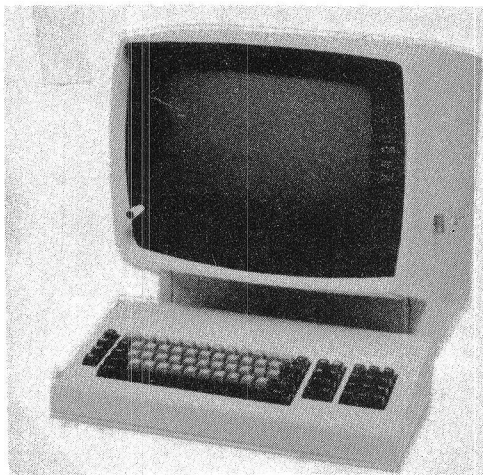
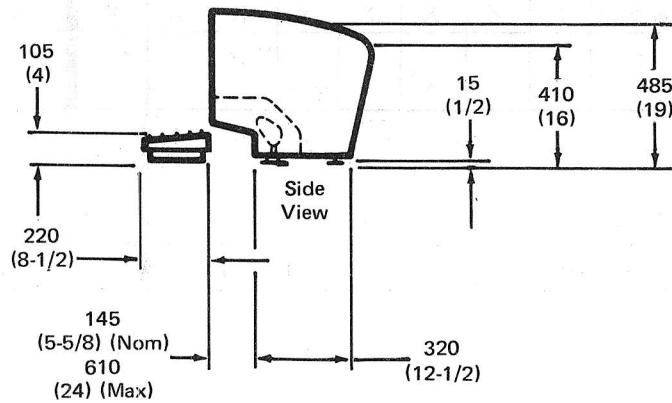
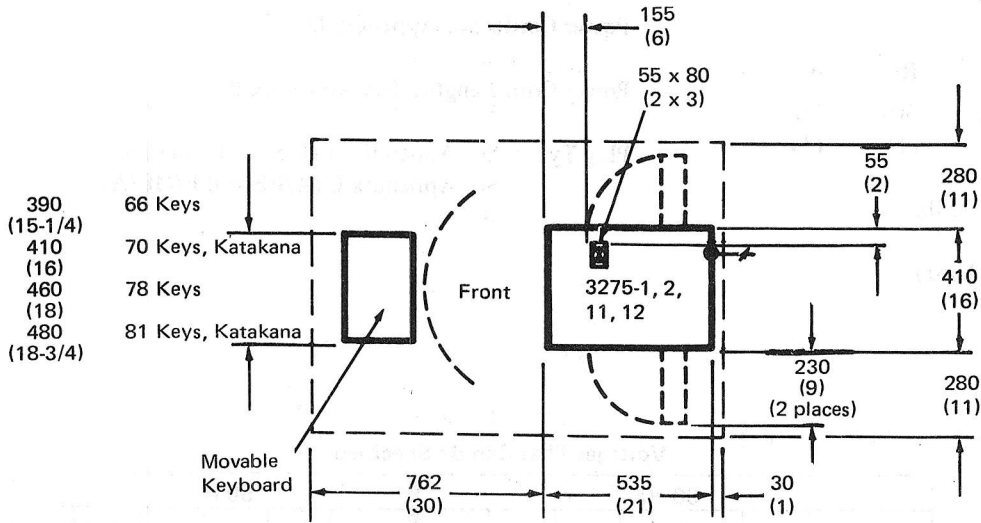

### Display Unit Functional Clearances

	mm	(Inches)	
Front	0	(0)	Dimensions are minimum requirements for functional operation of the machine. These dimensions allow sufficient airflow to provide convection cooling.
Rear	30	(1)	
Right	80	(3)	
Left	80	(3)	
Top	155	(6)	
Bottom	Unit should be installed in a manner which would guarantee adequate airflow into the underside of the unit to provide convection cooling.		

**Note:** If unit is installed with minimum clearance, service access must be provided.

**Specifications**

**Dimensions:**

	F	S (Note 1)	H
mm	410	535	485
(Inches)	(16)	(21)	(19)

**Service Clearances:**

	F (Note 2)	R	Rt	L
mm	762	30	280	280
(Inches)	(30)	(1)	(11)	(11)

**Weight:** 43 kg (95 lb) (Note 3)

	Models 1 and 2	Models 11 and 12
<b>Heat Output:</b>		
kcal/hr	207 Watts	236 Watts
BTU/hr)	(700)	(800)

**Airflow:** Convection only      Convection only

Models 1 and 2      Models 11 and 12

**Power Requirements:**

kVA	0.24	0.28
Phases	1	1
Voltage	See chart below.	

**Notes:**

The 3275 is installed on a customer-supplied desk or table. Refer to Chapter 2 for operator work space considerations.

1. This dimension does not include keyboard. See plan view.
2. Keyboard feature adds 220 mm (8-1/2 inches) to front of display and can be moved up to 610 mm (24 inches) away from power front of display.
3. Keyboard feature adds about 5 kg (10 lb).

**Power Cord:** See Appendix D.

**Power Cord Length:** See Appendix B.

**Plug Type:** See Appendix A (U.S. and Canada).  
See Appendix C (A/FE and E/ME/A).

**Voltages That Can Be Specified**

	60 Hz					50 Hz					
	100	115/120	200	208	230	100	110	123.5	200	220	235
IBM (United States/Canada)		X									
IBM World Trade Americas/Far East	X	X				X	X	X			
IBM World Trade Europe/Middle East/Africa		X <sup>1</sup>								X	X

1. Saudi Arabia only.

# 3276 Control Unit Display Station Models 1, 2, 3, 4, 11, 12, 13, and 14 (Customer Setup Designated)

## Plan View

Scale: 40 mm = 1 m  
(Dimensions are shown in millimeters, with inches in parentheses.)

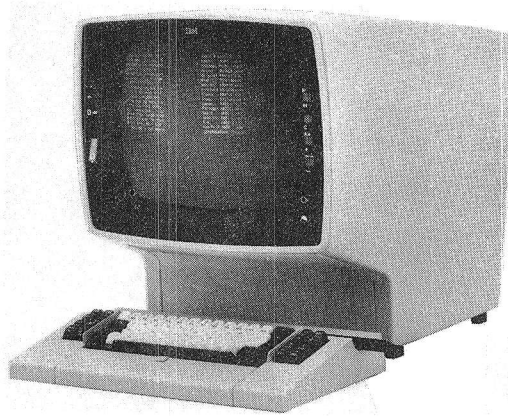
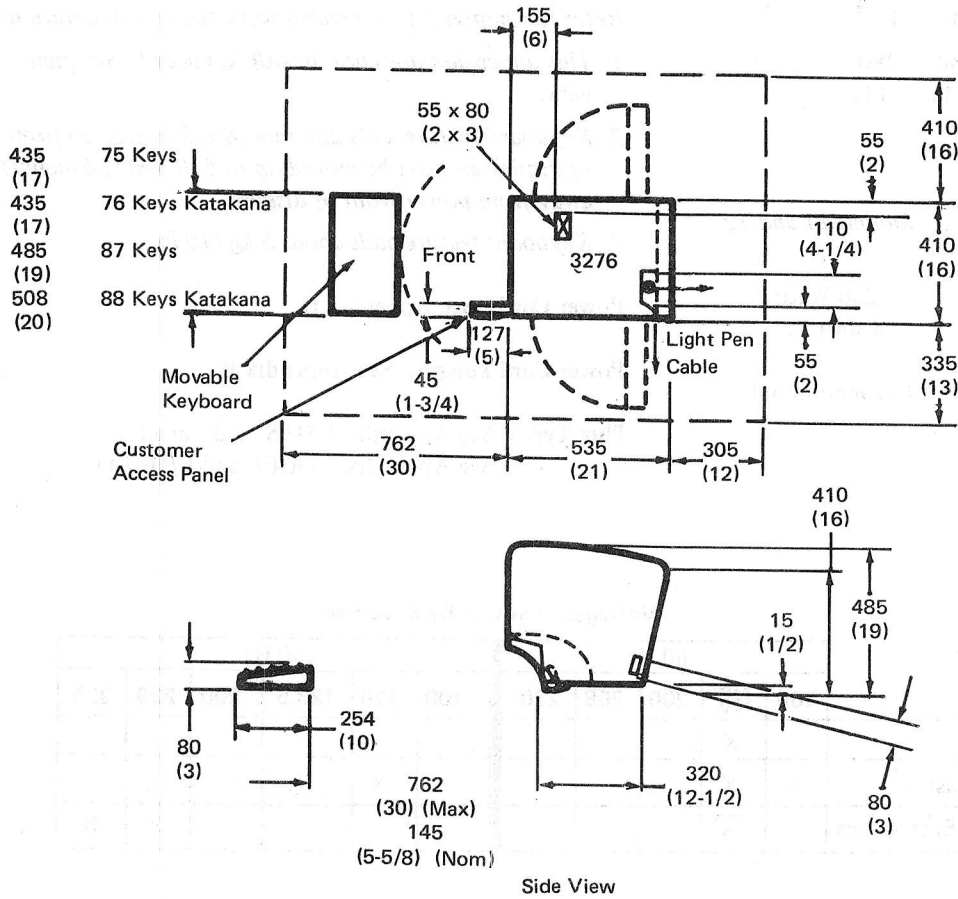

## Display Unit Functional Clearances

	mm	(Inches)	
Front	0	(0)	Dimensions are minimum requirements for functional operation of the machine. These dimensions allow sufficient airflow to provide cooling.
Rear	30	(1)	
Right	80	(3)	
Left	80	(3)	
Top	155	(6)	
Bottom	The feet provide space between the bottom of the unit and the supporting surface to allow airflow for cooling. Care should be taken that paper, books, etc., do not impede the airflow in this space.		

**Note:** *If unit is installed with minimum clearance, service access must be provided.*

**Specifications**

**Dimensions:**

	F	S (Note 1)	H (Note 2)
mm	410	535	485
(Inches)	(16)	(21)	(19)

**Service Clearances:**

	F (Note 3)	L	R	Rt	T
mm	762	410	305	335	155
(Inches)	(30)	(16)	(12)	(13)	(6)

**Weight (Note 4):** 45 kg (100 lb)

**Heat Output:** 227 Watts (770 BTU/hr)

**Airflow:** 0.57 m<sup>3</sup>/min (20 CFM) forced air

**Power Requirements:**

kVA	0.26
Phase	1
Voltage	See chart below.

**Notes:**

1. This dimension does not include keyboard. See plan view.
2. The 3276 is installed on a customer-supplied desk or table. Refer to Chapter 2 for operator work space considerations.
3. Keyboard feature adds 254 mm (10 inches) to front of display and can be moved up to 762 mm (30 inches) away from lower front of display.
4. Keyboard feature adds about 6 kg (13 lb).

**Power Cord:** See Appendix D.

**Power Cord Length:** See Appendix B.

**Plug Type:** See Appendix A (U.S. and Canada).  
See Appendix C (A/FE and E/ME/A).

Voltages That Can Be Specified

	60 Hz				50 Hz					
	100	110	120	127	100	110	200	220	230	240
IBM (United States/Canada)			X							
IBM World Trade Americas/Far East	X	X	X	X	X	X	X	X	X	X
IBM World Trade Europe/Middle East/Africa			X <sup>1</sup>					X		X

1. Saudi Arabia only.





## Specifications

### Dimensions:

	F	S (Note 1)	H
mm	370	410	430
(Inches)	(14-1/2)	(16)	(17)

### Service Clearances:

	F (Note 2)	R	Rt	L
mm	762	55	254	254
(Inches)	(30)	(2)	(10)	(10)

**Weight:** 27 kg (60 lb) (Note 3)

**Heat Output:** 155 Watts (525 BTU/hr)

**Airflow:** Convection only

### Power Requirements:

kVA	0.17 (0.18 for 220V)
Phases	1
Voltage	See chart below.

### Notes:

The 3277 is installed on a customer-supplied desk or table. Refer to Chapter 2 for operator space considerations.

1. This dimension does not include keyboard. See plan view.
2. Keyboard feature adds 220 mm (8-1/2 inches) to front of display and can be moved up to 535 mm (21 inches) away from lower front of display.
3. Keyboard feature adds about 5 kg (10 lb).

**Power Cord:** See Appendix D.

**Power Cord Length:** See Appendix B.

**Plug Type:** See Appendix A (U.S. and Canada).  
See Appendix C (A/FE and E/ME/A).

Voltages That Can Be Specified

	60 Hz					50 Hz					
	100	115/ 120	200	208	230	100	110	123.5	200	220	235
IBM (United States/Canada)		X									
IBM World Trade Americas/Far East	X	X				X	X	X		X	X
IBM World Trade Europe/Middle East/Africa		X <sup>1</sup>								X	X

1. Saudi Arabia only.

# 3277 Display Station Model 2

## Plan View

Scale: 40 mm = 1 m  
 (Dimensions are shown in millimeters, with inches in parentheses.)

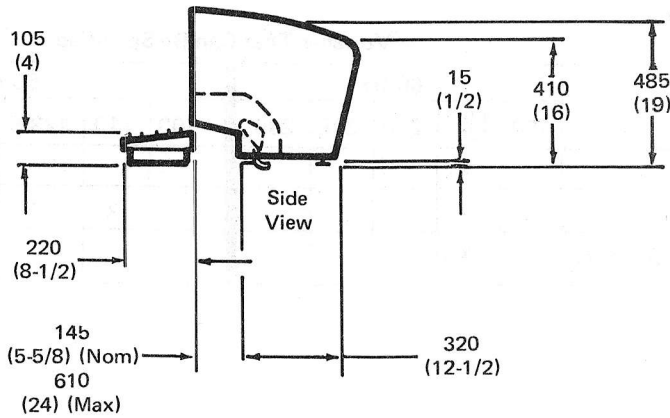
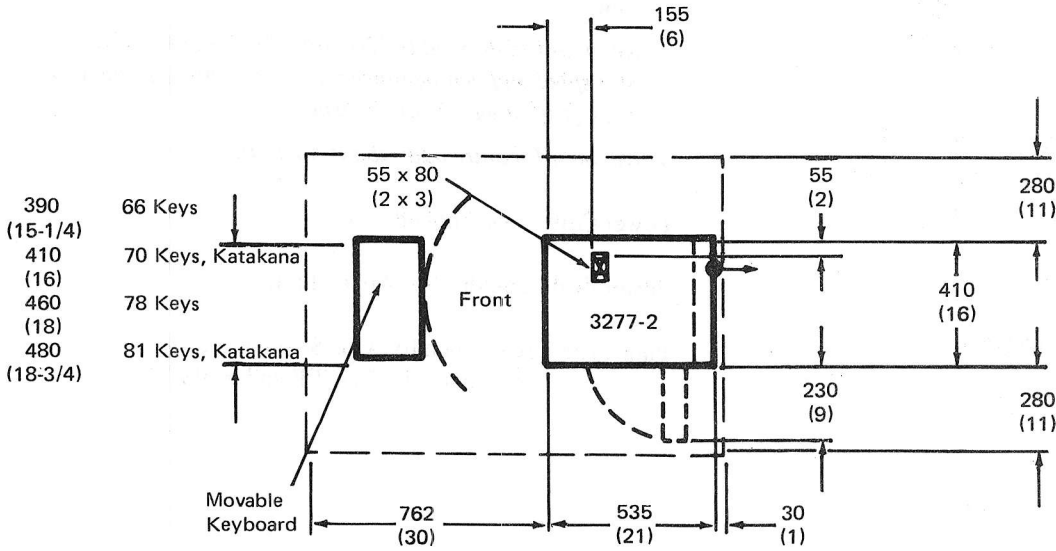

### Display Unit Functional Clearances

	mm	(Inches)	
Front	0	(0)	Dimensions are minimum requirements for functional operation of the machine. These dimensions allow sufficient airflow to provide convection cooling.
Rear	30	(1)	
Right	80	(3)	
Left	80	(3)	
Top	155	(6)	
Bottom	Unit should be installed in a manner which would guarantee adequate airflow into the underside of the unit to provide convection cooling.		

**Note:** If unit is installed with minimum clearance, service access must be provided.

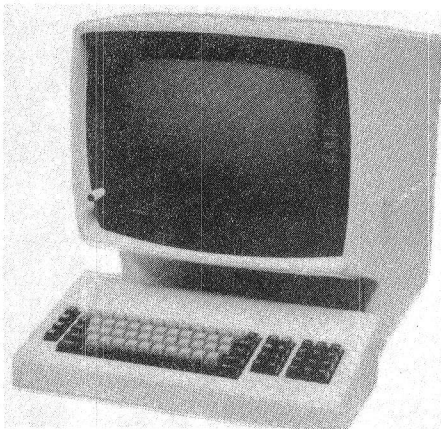

**Specifications**

**Dimensions:**

	F	S (Note 1)	H
mm	410	535	485
(Inches)	(16)	(21)	(19)

**Service Clearances:**

	F (Note 2)	R	Rt	L
mm	762	30	280	280
(Inches)	(30)	(1)	(11)	(11)

**Weight:** 39 kg (85 lb) (Note 3)

**Heat Output:** 155 Watts (525 BTU/hr)

**Airflow:** Convection only

**Power Requirements:**

kVA	0.17
Phases	1
Voltage	See chart below.

**Notes:**

The 3277 is installed on a customer-supplied desk or table. Refer to Chapter 2 for operator work space considerations.

1. This dimension does not include keyboard. See plan view.
2. Keyboard feature adds 220 mm (8-1/2 inches) to front of display and can be moved up to 610 mm (24 inches) away from lower front of display.
3. Keyboard feature adds about 5 kg (10 lb).

**Power Cord:** See Appendix D.

**Power Cord Length:** See Appendix B.

**Plug Type:** See Appendix A (U.S. and Canada).  
See Appendix C (A/FE and E/ME/A).

**Voltages That Can Be Specified**

	60 Hz					50 Hz					
	100	115/120	200	208	230	100	110	123.5	200	220	235
IBM (United States/Canada)		X									
IBM World Trade Americas/Far East	X	X				X	X	X		X	X
IBM World Trade Europe/Middle East/Africa		X <sup>1</sup>								X	X

1. Saudi Arabia only.

# 3278 Display Station Models 1, 2, 3, 4, and 5 (Customer Setup Designated)

## Plan View

Scale: 40 mm = 1 m

(Dimensions are shown in millimeters, with inches in parentheses.)

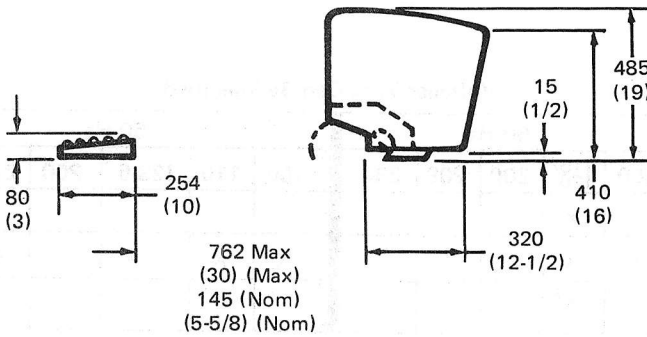
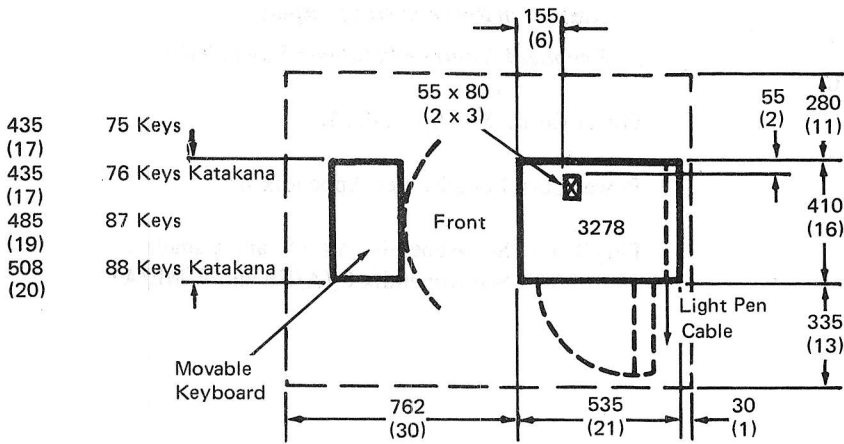

Side View

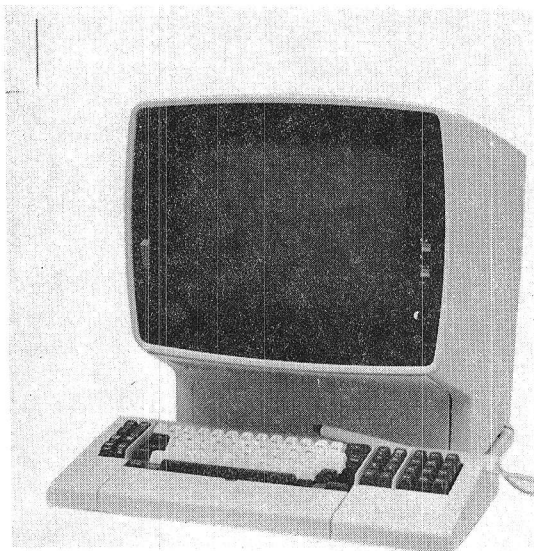

## Display Unit Functional Clearances

	mm	(Inches)	
Front	0	(0)	Dimensions are minimum requirements for functional operation of the machine. These dimensions allow sufficient airflow to provide cooling.
Rear	30	(1)	
Right	80	(3)	
Left	80	(3)	
Top	155	(6)	
Bottom	The feet provide space between the bottom of the unit and the supporting surface to allow airflow for cooling. Care should be taken that paper, books, etc., do not impede the airflow in this space.		

**Note:** If unit is installed with minimum clearance, service access must be provided.

**Specifications**

**Dimensions:**

	F	S (Note 1)	H (Note 2)
mm	410	535	485
(Inches)	(16)	(21)	(19)

**Service Clearances:**

	F (Note 3)	L	R	Rt	T
mm	762	280	30	335	155
(Inches)	(30)	(11)	(1)	(13)	(6)

**Weight (Note 4):** 36.3 kg (80 lb)

**Heat Output:** 125 Watts (420 BTU/hr)

**Airflow:** Natural convection

**Power Requirements:**

kVA	0.16
Phase	1
Voltage	See chart below.

**Notes:**

1. This dimension does not include keyboard. See plan view.
2. The 3278 is installed on a customer-supplied desk or table. Refer to Chapter 2 for operator work space considerations.
3. Keyboard feature adds 254 mm (10 inches) to front of display and can be moved up to 762 mm (30 inches) away from lower front of display.
4. Keyboard feature adds about 6 kg (13 lb).

**Power Cord:** See Appendix D.

**Power Cord Length:** See Appendix B.

**Plug Type:** See Appendix A (U.S. and Canada).  
See Appendix C (A/FE and E/ME/A).

**Voltages That Can Be Specified**

	60 Hz				50 Hz					
	100	110	120	127	100	110	200	220	230	240
IBM (United States/Canada)			X							
IBM World Trade Americas/Far East	X	X	X	X	X	X	X	X	X	X
IBM World Trade Europe/Middle East/Africa			X <sup>1</sup>					X		X

1. Saudi Arabia only.

# 3279 Color Display Station Models 2A, 3A, 2B, and 3B (Customer Setup Designated)

## Plan View

Scale: 40 mm = 1 m

(Dimensions are shown in millimeters, with inches in parentheses.)

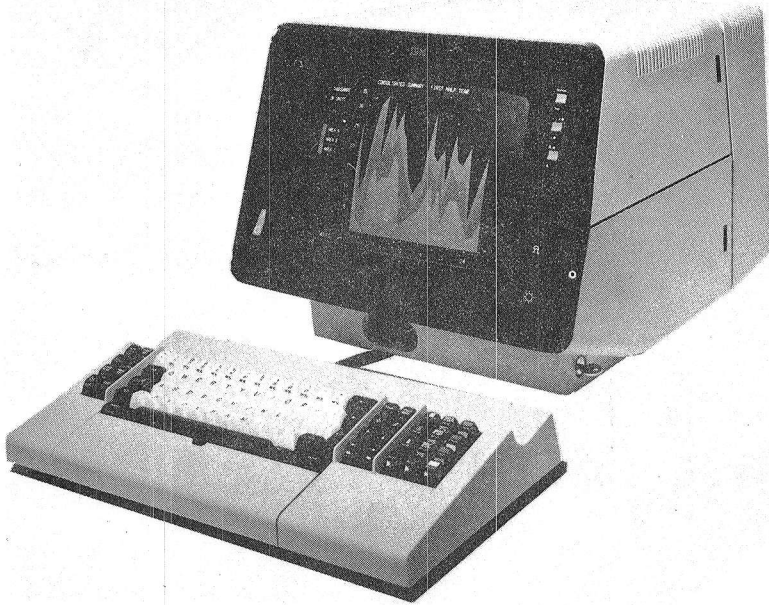
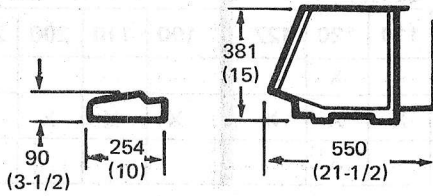
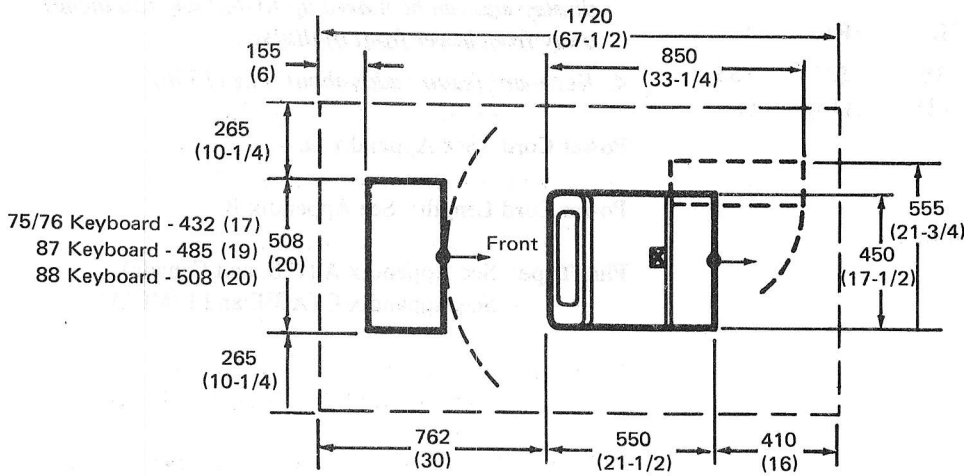

**Specifications**

**Dimensions:**

	F	S (Note 1)	H (Note 2)
mm	450	550	381
(Inches)	(17-1/2)	(21-1/2)	(15)

**Service Clearances:**

	F (Note 3)	L	R	Rt
mm	762	305	410	30
(Inches)	(30)	(12)	(16)	(1)

**Weight (Note 4):** 27 kg (58 lbs)

**Heat Output:** 243 Watts (825 BTU/hr)

**Airflow:** Natural convection

**Power Requirements:**

kVA	0.30
Phase	1
Voltage	See chart below.

**Notes:**

1. This dimension does not include keyboard. See plan view.
2. The 3279 is installed on a customer-supplied desk or table. Refer to Chapter 2 for operator work space considerations.
3. Keyboard feature adds 254 mm (10 inches) to front of display and can be moved up to 530 mm (21 inches) away from lower front of display.
4. Keyboard feature adds about:
  - 4.5 kg (10 lb) for 75/76 keyboard
  - 5.6 kg (12.5 lb) for 87 keyboard
  - 5.9 kg (13 lb) for 88 keyboard

**Power Cord:** See Appendix D.

**Power Cord Length:** See Appendix B.

**Plug Type:** See Appendix A (U.S. and Canada).  
See Appendix C (A/FE and E/ME/A).

**Keyboards:** Each 3279 unit must be equipped with a keyboard.

**Nominal Operating Voltages**

	100V to 127V 50 or 60 Hz	200V to 240V 50 or 60 Hz
IBM (United States/Canada)	X	
IBM World Trade Americas/Far East	X	X
IBM World Trade Europe/Middle East/Africa	X <sup>1</sup>	X

1. Saudi Arabia only.

3284 Printer Models 1, 2, and 3

3286 Printer Models 1 and 2

Plan View

Scale: 40 mm = 1 m  
 (Dimensions are shown in millimeters, with inches in parentheses.)

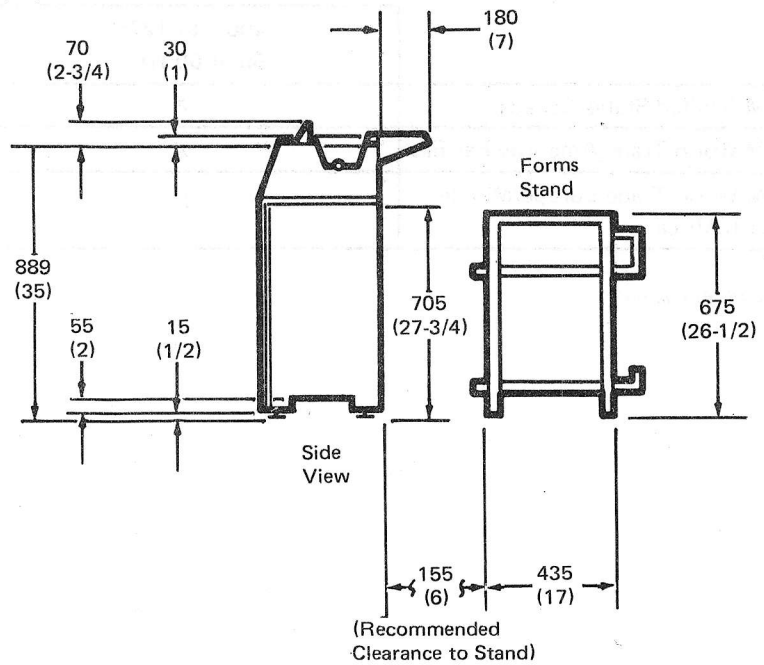
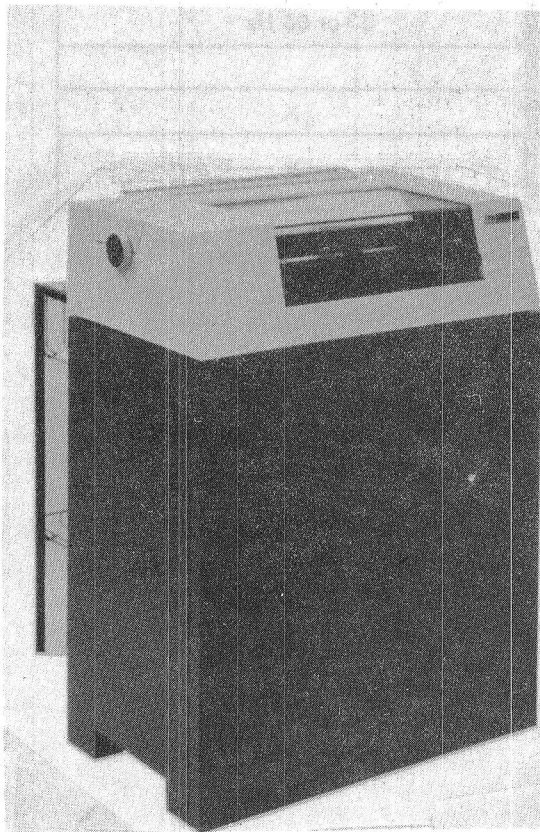
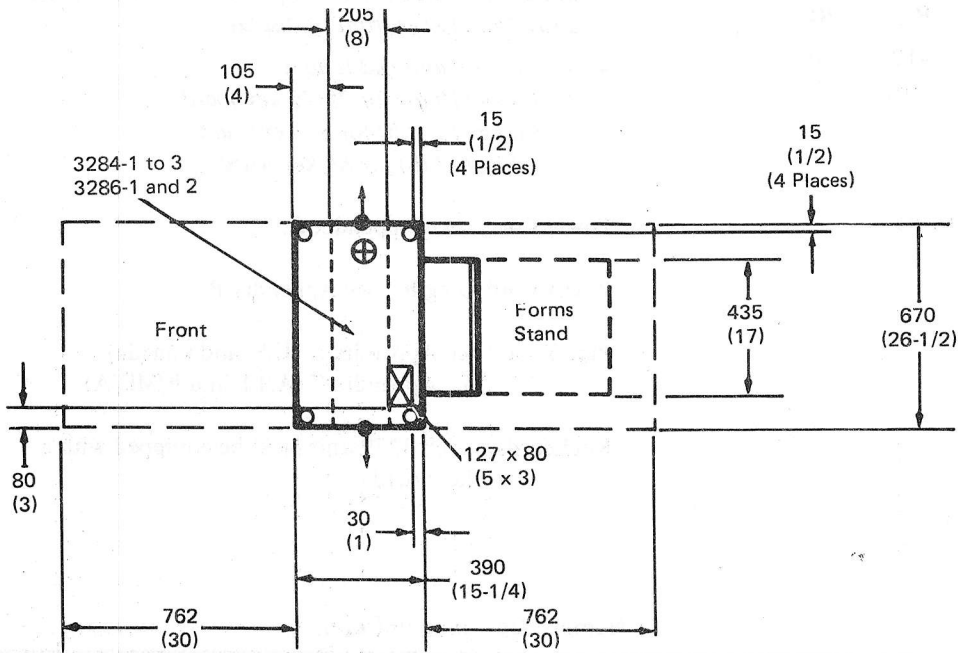



**Specifications**

**Dimensions:**

	<b>F</b>	<b>S</b>	<b>H</b>
mm	670	390	960
(Inches)	(26-3/8)	(15-1/4)	(37-3/4)

**Service Clearances:**

	<b>F</b>	<b>R</b>	<b>Rt</b>	<b>L</b>
mm	762	762	0	0
(Inches)	(30)	(30)	(0)	(0)

**Weight:** 61 kg (135 lb)

**Heat Output:** 227 Watts (770 BTU/hr)

**Airflow:** Convection only

**Power Requirements:**

kVA	0.26
Phases	1
Voltage	See chart below.

**Power Cord:** See Appendix D.

**Power Cord Length:** See Appendix B.

**Plug Type:** See Appendix A (U.S. and Canada).  
See Appendix C (A/FE and E/ME/A).

**Voltages That Can Be Specified**

	<b>60 Hz</b>					<b>50 Hz</b>					
	<b>100</b>	<b>115/ 120</b>	<b>200</b>	<b>208</b>	<b>230</b>	<b>100</b>	<b>110</b>	<b>123.5</b>	<b>200</b>	<b>220</b>	<b>235</b>
IBM (United States/Canada)		X									
IBM World Trade Americas/Far East	X	X				X	X	X			
IBM World Trade Europe/Middle East/Africa		X <sup>1</sup>								X	X

<sup>1</sup> Saudi Arabia only.

# 3287 Printer Models 1, 2, 1C, and 2C (Customer Setup Designated)

## Plan View

Scale: 40 mm = 1 m  
(Dimensions are shown in millimeters, with inches in parentheses.)

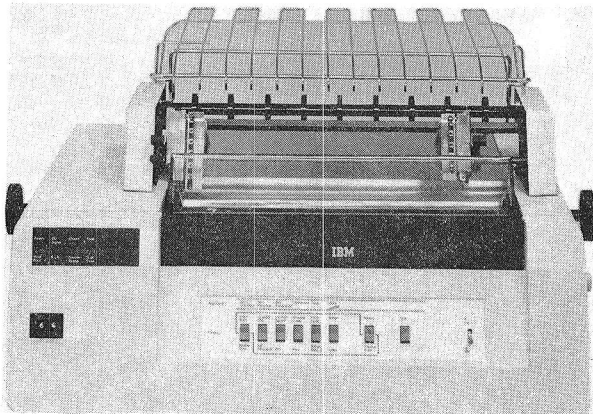
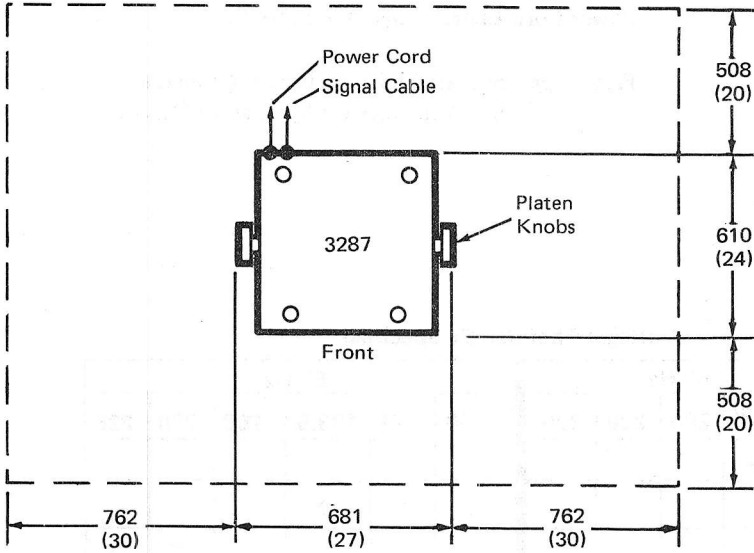

**Specifications**

**Dimensions:**

	F	S	H (Note 1)
mm	690	610	280
(Inches)	(27)	(24)	(11)

**Service Clearances (Note 2):**

	F	L	R	Rt	T
mm	508	762	508	762	1016
(Inches)	(20)	(30)	(20)	(30)	(40)

**Weight:** 39 kg (87 lb)

**Heat Output:** 220 Watts (750 BTU/hr)

**Airflow:** 1.5 m<sup>3</sup>/min (55 CFM) Standard  
 3 m<sup>3</sup>/min (105 CFM) with  
 Blower Feature #9030 when  
 operating above 32.2°C (90°F)

**Power Requirements:**

kVA	0.26
Phase	1
Voltage	See chart below.

**Notes:**

1. Height is 360 mm (14 inches) with forms tractor.
2. Height is 280 mm (11 inches) with friction feed device.
3. Side is 585 mm (23 inches) with forms tractor; and 610 mm (24 inches) with friction feed device.
4. Width is 690 mm (27 inches) with platen (knob-to-knob).
5. 1016-mm (40 inches) clearance above the table (measured from the table) is needed for logic gate which swings up from the top of the unit.
6. The 762 mm (30 inches) on each side are needed for:  
 Right -- To adjust line space emitter timing.  
 Left -- To service page length control switch and power transformer.
7. The distance between the 3287 and the display terminals should be no less than 762 mm (30 inches).

**Power Cord:** See Appendix D.

**Power Cord Length:** See Appendix B.

**Plug Type:** See Appendix A (U.S. and Canada).  
 See Appendix C (A/FE and E/ME/A).

**Voltages That Can Be Specified**

	60 Hz				50 Hz					
	100	110	120	127	100	110	200	220	230	240
IBM (United States/Canada)			X							
IBM World Trade Americas/Far East	X	X	X	X	X	X	X	X	X	X
IBM World Trade Europe/Middle East/Africa			X <sup>1</sup>					X		X

<sup>1</sup> Saudi Arabia only.

# 3288 Line Printer Model 2

## Plan View

Scale: 40 mm = 1 m  
 (Dimensions are shown in millimeters, with inches in parentheses.)

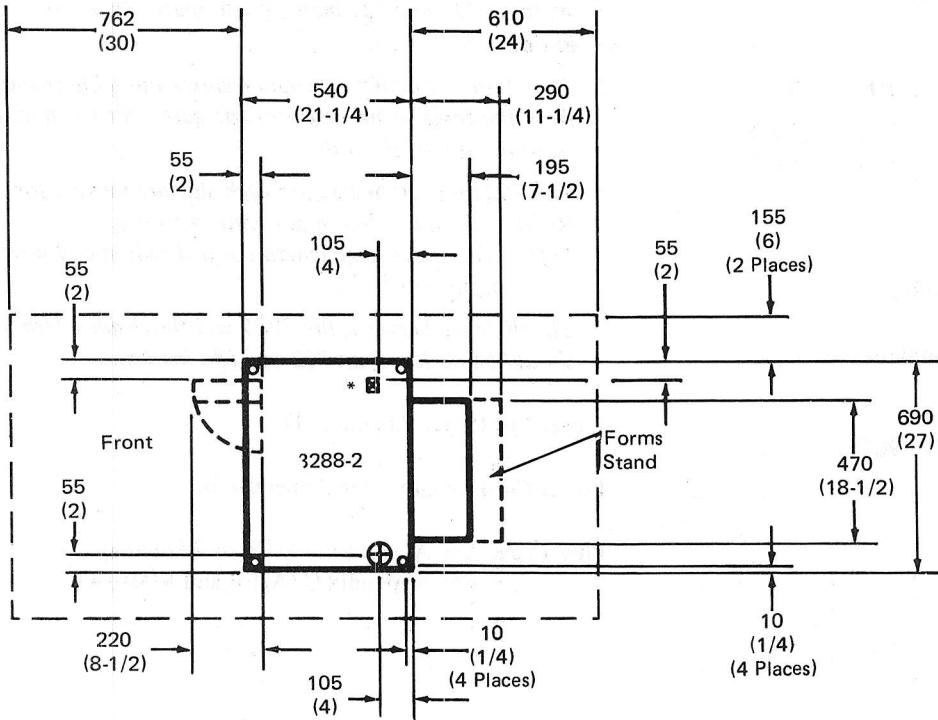

\*Cable entry/exit for coaxial cable.  
 Approximate dimensions 15 mm x 15 mm (1/2" x 1/2")

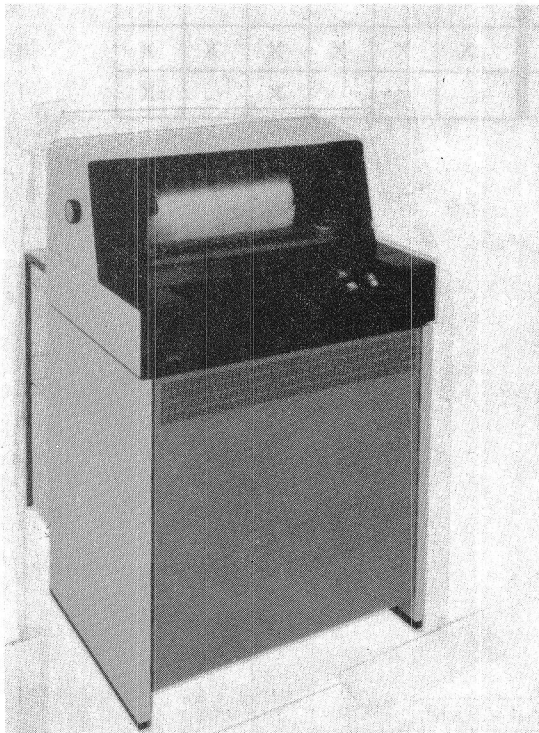
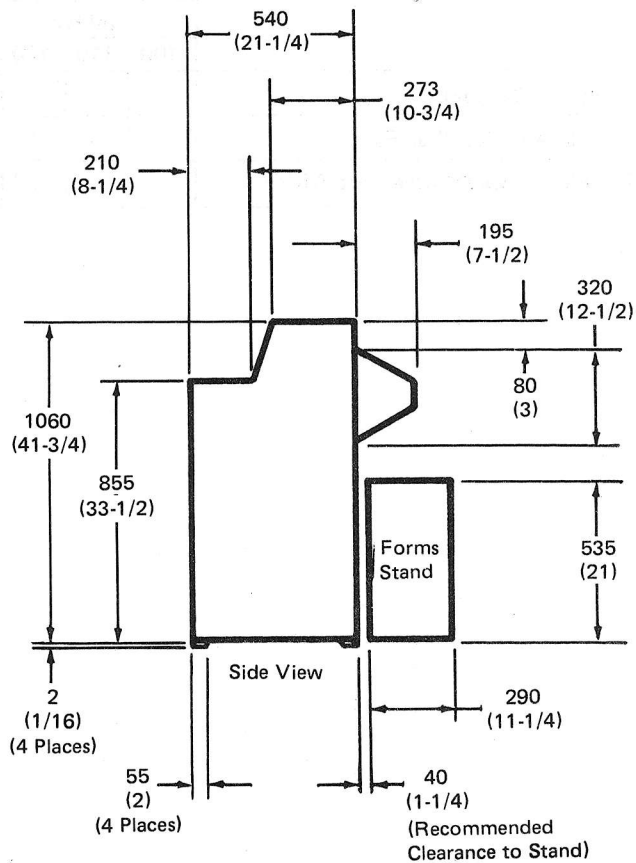

**Specifications**

**Airflow:** 39 cfm (1.1 m<sup>3</sup>/min)

**Dimensions:**

	<b>F</b>	<b>S</b>	<b>H</b>
mm	690	540	1060
(Inches)	(27)	(21-1/4)	(41-3/4)

**Power Requirements:**

kVA	0.60
Phases	1
Voltage	See chart below.

**Service Clearances:**

	<b>F</b>	<b>R</b>	<b>Rt</b>	<b>L</b>
mm	762	610	155	155
(Inches)	(30)	(24)	(6)	(6)

**Power Cord:** See Appendix D.

**Power Cord Length:** See Appendix B.

**Plug Type:** See Appendix A (U.S. and Canada).  
See Appendix C (A/FE and E/ME/A).

**Weight:** 127 kg (280 lb)

**Heat Output:** 566 Watts (1,926 BTU/hr)

**Voltages That Can Be Specified**

	<b>60 Hz</b>					<b>50 Hz</b>					
	<b>100</b>	<b>115/120</b>	<b>200</b>	<b>208</b>	<b>230</b>	<b>100</b>	<b>110</b>	<b>123.5</b>	<b>200</b>	<b>220</b>	<b>235</b>
IBM (United States/Canada)		X									
IBM World Trade Americas/Far East	X	X				X	X	X			
IBM World Trade Europe/Middle East/Africa		X <sup>1</sup>									X

1. Saudi Arabia only.

## 3289 Line Printer Models 1 and 2 (Customer Setup Designated)

### Plan View

Scale: 40 mm = 1 m

(Dimensions are shown in millimeters, with inches in parentheses.)

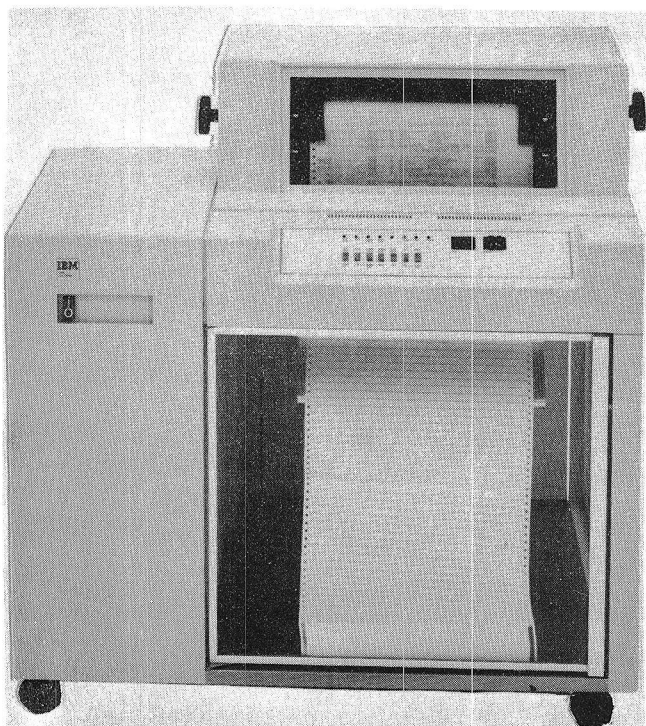
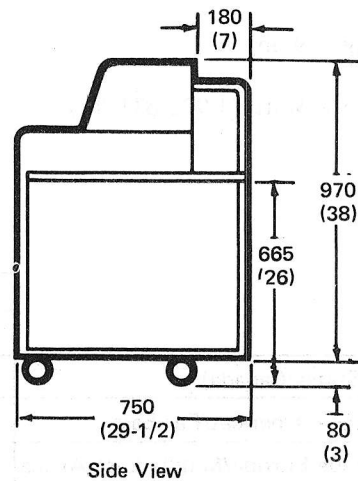
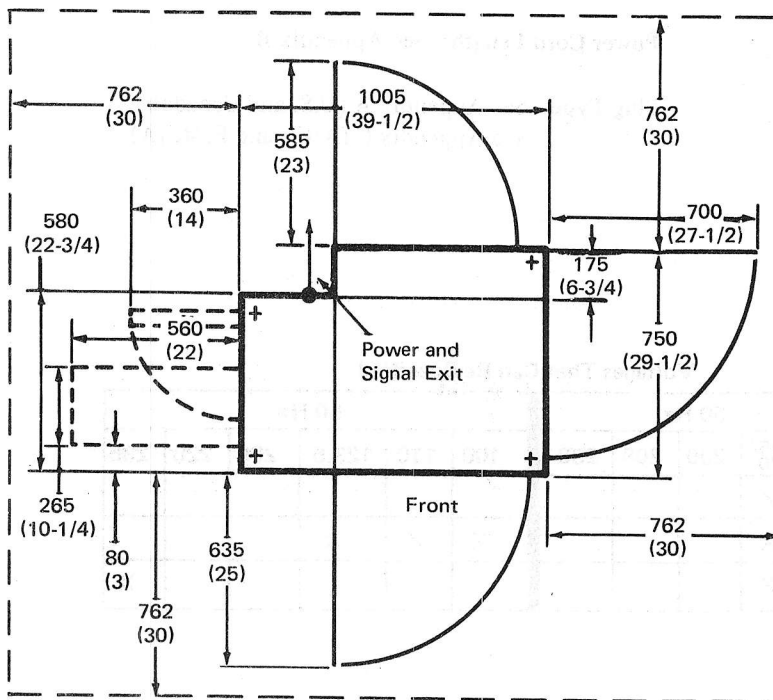

## Specifications

### Dimensions:

	F	S	H
mm	1005	750	1045
(Inches)	(39-1/2)	(29-1/2)	(41)

### Service Clearances:

	F	R	L	Rt
mm	762	762	762	762
(Inches)	(30)	(30)	(30)	(30)

Weight: 200 kg (440 lb)

Heat Output: 412 Watts (1400 BTU/hr)

Airflow: Convection

### Power Requirements:

kVA	0.6
Phase	1
Voltage	See chart below.

## Environment

**Note:** For optimum paper stacking, a temperature range of 15.6°–37.8°C (60°–100°F) and a relative humidity range of 36%–62% is recommended.

Voltages That Can Be Specified

	60 Hz				50 Hz					
	100	110	120	127	100	110	200	220	230	240
IBM (United States/Canada)			X							
IBM World Trade Americas/Far East	X	X	X	X	X	X	X	X	X	X
IBM World Trade Europe/Middle East/Africa			X <sup>1</sup>					X		X

1. Saudi Arabia only.

A space-saving technique for a congested environment is illustrated below. Casters on the 3289 Printer facilitate movement for access. Cable slack must be provided to achieve the results illustrated. Note that, in the center illustration, a 350 mm (13.5 in.) space is still available in front of the unit.

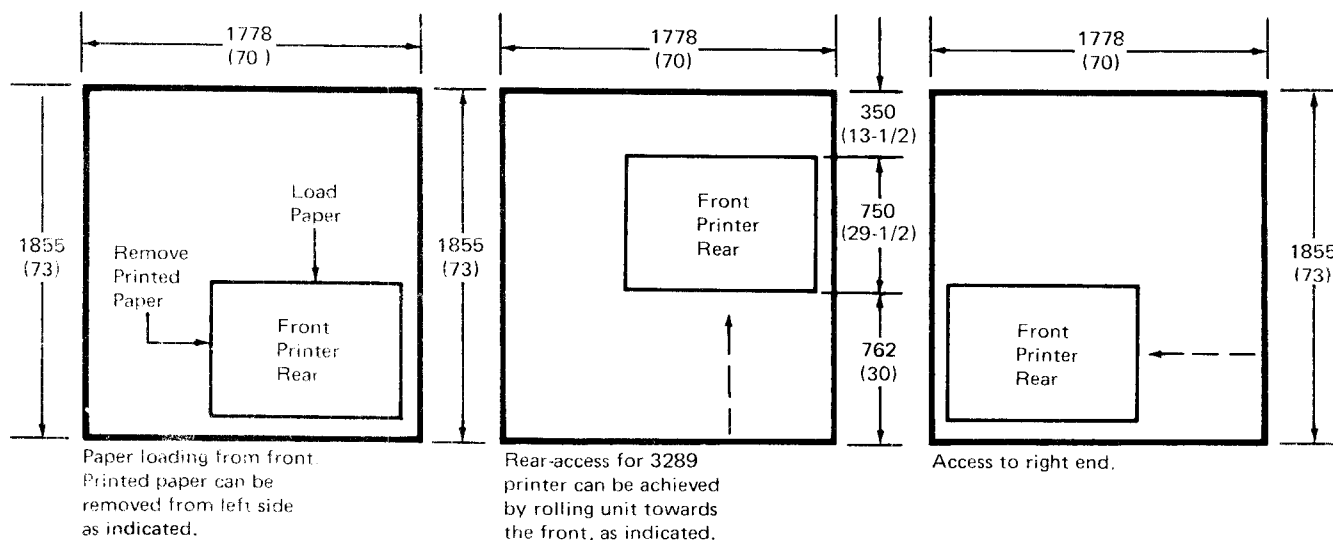





## Chapter 6. Communication System Cabling

This chapter provides cabling information for the IBM 3270 Information Display System. IBM-supplied cables (other than those automatically supplied with the unit) are cross-referenced between figures by cable group number; customer-supplied cables, by a letter designation. This section also provides information on coaxial cable installation, specifications for cables and connectors for the customer who elects to fabricate these cables, and IBM part numbers for the customer who elects to purchase the customer-supplied cables from IBM.

### Conversion of 2260 Display Cables

If the customer has previously installed 2260 cables, they may be used for 3270 installations. For conversion of 2260 cables to single coaxial cables, refer to *Assembly of Coaxial Cable and Accessories for Attachment to IBM Products*, GA27-2805.

### System Cabling

Cabling for the system includes communication cables, power cables, and signal cables (coaxial). Some of these cables are supplied by IBM; others must be supplied by the customer, who has the option of fabricating them or purchasing them, preassembled, from IBM. A preassembled cable is one that is cut to the specified length, with the connectors installed on it.

#### *IBM-Supplied Cables*

There are two types of IBM-supplied cables and two ways to order:

- For cables automatically supplied with units, determine the type and length (if variable) at the time you order the unit, and include the cables in the unit order.
- Identify cables that must be ordered separately by a cable group number and a variable length (within limits). The IBM representative will order these cables by a cable order. The length must be specified on the cable order.

IBM-supplied cables are always equipped with the connectors necessary for attachment. Refer to Appendix F and Appendix J.

#### *Customer-Supplied Cables*

Customer-supplied cables are referred to by a letter designation (*h* or *l*) which appears in place of the cable group number used for IBM-supplied cables. The customer is responsible for obtaining, installing, and maintaining these

cables. IBM part numbers are provided in this manual (see Figure 6-6) so that these cables may be ordered from IBM using a Miscellaneous Equipment Specification (MES) form. The lengths must be specified. These part numbers are for preassembled cables.

#### *Optional Customer Fabrication of Cables*

The customer may elect to fabricate customer-supplied cables. Specifications for bulk cable and descriptions of IBM-approved connectors are provided in this section.

Customers who choose to fabricate coaxial cables should order *Assembly of Coaxial Cable and Accessories for Attachment to IBM Products*, GA27-2805.

When ordering bulk cable from IBM or other source, the customer should indicate the continuous unit-to-unit cable lengths to the cable suppliers so that unplanned cutting may be avoided. If joining of coaxial cable ends is required, the adapter described under "Coaxial Cable Splicing" should be used.

### Cable Installation—General

The following paragraphs provide general information about cable installation, labeling, and completion testing.

#### *Cable Runs (Indoors)*

Communication cabling and signal cables should be separated from normal electrical wiring (100/240 V - 50/60 Hz) in accordance with the *Coaxial Cable Separation Guide* (page 6-2). Unshielded high-power or high-energy sources may require a larger separation.

Some low-frequency pocket paging systems are sensitive to the low-level signals used in the 3270 IDS. To prevent interference, communication cables should not be routed close to existing systems.

When an installation of a paging system is being planned in a facility with an IBM system already installed, review the plan with your IBM Installation Planning Representative to assure compatible operation of the paging system.

Cabling runs may be run in the same conduit as telephone lines without adverse effect.

The cable adapter terminating conductor or shield of the coaxial cable should not be grounded while the system is in operation.

### **Shield Commoning**

Shields of different coaxial cable runs must not be commoned. This could result in ground loops in the cable which could cause erratic operation within the system. If more than one cable terminates in the same location and a panel board is desired to terminate the cable runs, the panel board must be of nonconductive material.

### **Identification and Labeling of Device Cabling (Coaxial)**

Device coaxial cables are those cables that attach to a device at one end (printer or display unit) and to a control unit (3271, 3272, 3274, 3276) at the other.

#### **Control Unit End**

Label cables to indicate panel (where applicable) and port number of the control unit to which the cables will be attached. Since the output information emanates from a specific port, each device must be attached to its proper port. Labeling the cables as indicated should prevent the unit from being improperly connected should the cables ever be removed from the unit.

#### **Device End**

No labeling is necessary if there is only one device at a specific location. If more than one device is present at the same location, each device and its assigned number should be indicated on the cable. Refer to the *IBM 3270 Information Display System Planning and Site Preparation Guide (GA27-2827)* for details associated with the 3274/3276 units.

### **Cable Runs (Outdoors)**

Conductors on poles should be located below the light and power conductors and shall not be attached to a cross arm carrying light or power conductors. The coaxial cable is not self-supporting and requires a messenger for support. In areas subject to sleet and snow, support may be needed more than every 3.05 m (10 ft). Proper lead-in clearances must be provided. Lead-in or aerial-drop cables from a pole or other support, including the point of initial contact with a building, shall be kept away from electric light or power circuits, so as to avoid the possibility of accidental contact.

### **Coaxial Cable Separation Guide**

The following distances are a guide for voltages up to 440 volts; for voltages higher than 440 volts, contact your IBM Installation Planning Representative.

The minimum distance between coaxial cable and fluorescent, neon, or incandescent lighting fixtures is 0.127 m (5 in.). The coaxial cable may be routed adjacent to lighting circuit wiring (120 V) for distances of up to 150 m (500 ft).

The minimum distance between coaxial cable and unshielded power lines or electrical equipment depends upon the power of the equipment:

2 kVA or below:	0.127 m (5 in.)
2 - 5 kVA:	0.305 m (12 in.)
Over 5 kVA:	0.610 m (24 in.)

The minimum distance between coaxial cable and unshielded power lines or electrical equipment with the coaxial cable enclosed in a grounded metallic conduit:

2 kVA or below:	0.635 m (2.5 in.)
2 - 5 kVA:	0.152 m (6 in.)
Over 5 kVA:	0.305 m (12 in.)

The minimum distance between coaxial cable and power lines in grounded metallic conduit:

2 kVA or below:	0.635 m (2.5 in.)
2 - 5 kVA:	0.152 m (6 in.)
Over 5 kVA:	0.305 m (12 in.)

The minimum distance between coaxial cable enclosed in grounded metallic conduit and power lines enclosed in grounded metallic conduit:

2 kVA or below:	0.305 m (1.2 in.)
2 - 5 kVA:	0.65 m (3 in.)
Over 5 kVA:	0.152 m (6 in.)

Some governing factors that should be known before asking for guidance over 440 volts are:

- Voltage and amperage of the power lines and the unbalance of three-phase lines.
- Shield, if any, and type of shielding.
- Distance of power lines above ground (since coaxial cables should be below power lines), which determines if sufficient distance is available.
- Type of power lines (for example, multigrounded neutral-balanced three-phase).
- Length of parallel run of the two types of cable.

Cabling that is part of the system, even though it is a customer responsibility, may be purchased from IBM.

### **Completion Tests of Cabling**

Contacts for installation of cabling should stipulate completion tests to ensure that there are no faults, high-resistance connections, or circuit imbalances. Tests for the following faults should be included:

- Open circuits in individual conductors or shields. The combined resistance of the center conductor and the cable shield of the coaxial cable is approximately 47 ohms per 300 m (1000 ft) of cable (center conductor and shield shorted at remote end).
- Short circuits between conductors and shield.
- Grounding of either the conductor or shield to a grounded object.

## National Electrical Code Classification

The signal power on the coaxial cable, when the system is operating, is within the limits of Article 725 for Class 2 and 3 circuits of the National Electrical Code.

## UL Listing

Signal cabling purchased from IBM is listed with the Underwriters Laboratory.

## Coaxial Cable Installation

This section of the manual presents information relating to the installation of coaxial cables.

### Indoors

Coaxial cable (IBM PN 323921) is approved for indoor installation only. Because this cable is not self-supporting, it must be supported at least every 3 m (10 ft).

### Outdoors

Coaxial cable (IBM PN 5252750) is modified for outdoor use. This cable is suitable for both indoor and outdoor installation. It is also suitable for above-ground installation as well as direct burial (provided that adequate precautions are taken to protect the cable from damage in the trench and that it is buried well below the frost line to prevent upheaval). Since this cable is not self-supporting, it must be supported from a messenger when installed overhead at least every 3 m (10 ft). In areas subject to sleet or snow, additional support may be required.

### Substitute Cabling

Substitute cabling for either indoor coaxial cable (IBM PN 323921) or outdoor coaxial cable (IBM PN 5252750) must meet both physical and electrical specifications. See Figure 6-7.

**Note:** All cables labeled RG62A<sub>U</sub> may not meet the specifications of Figure 6-7. The use of cables that do not meet these requirements may cause system malfunction.

## Lightning Protection

Because some areas are more susceptible than others to lightning activity, the precautions taken vary with each installation. The following paragraphs present suggested outdoor cable installation methods for areas with varying degrees of exposure to lightning. In all cases, station protectors are required at both ends of the cable as described under "Station Lightning Protectors."

Appendix E contains the REA Lightning Damage Probability Map for the Continental United States, which can serve as a guide for "low," "medium," and "high" lightning areas. This map was developed by the U.S. Department of Agriculture Rural Electrification Administration, Washington, D.C. 20250. It is intended only as a *broad guideline* for determining the type of installation to be used. The map does not take into account terrain features and other local conditions that can affect exposure. Good engineering judgment and a knowledge of local conditions are essential.

### Low Lightning Exposure Areas

#### Aerial Installation

Since the coaxial cable is not self-supporting, it must be attached to the messenger (support) wire, not to exceed a maximum distance of 3 m (10 ft). Ground the messenger wire at both ends and in accordance with the instructions under "Station Lightning Protectors." See Figure 6-1.

#### Buried Installation

Bury the cable well below the frost line to prevent upheaval.

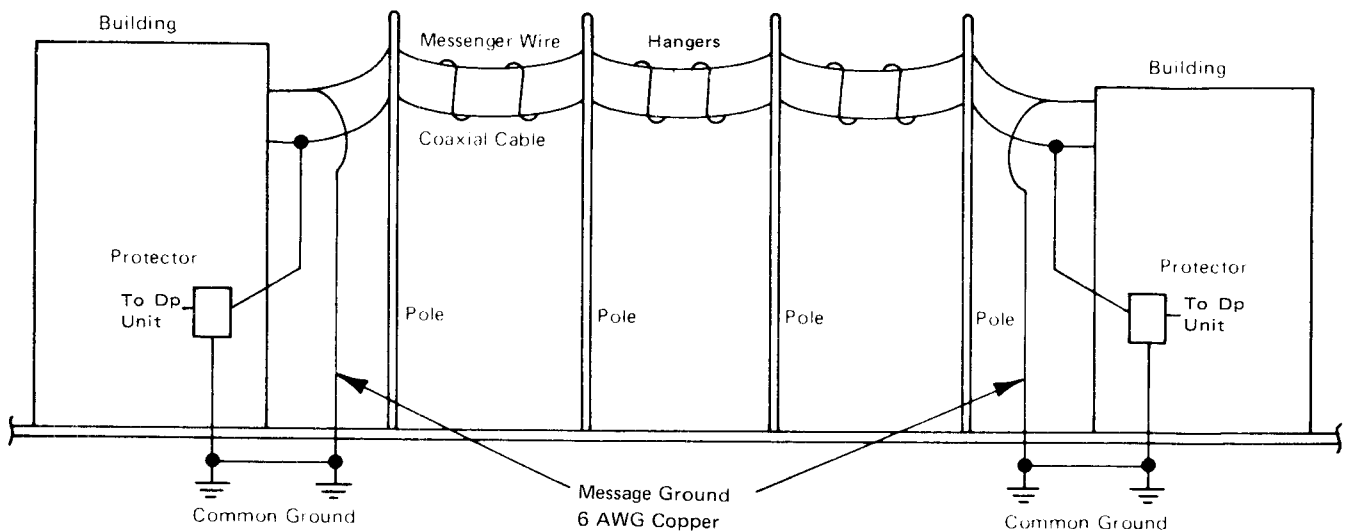

Figure 6-1. Low Lightning Exposure Area – Aerial Installation

## Medium Lightning Exposure Areas

### Aerial Installation

Install the coaxial cable and supporting messenger wire at least 1 m (39 in.) below a shield\* line. Both the shield line and the messenger wire must be grounded at each pole and at each end with 13.3 mm<sup>2</sup> (0.02 in.<sup>2</sup>) (6 AWG) copper wire. The ground resistance at each pole should not exceed 10 ohms if possible. A grounding rod driven into the earth a minimum of 2.7 m (9 ft) is the minimum requirement. Both ends of the messenger wire and shield line should be grounded in accordance with the instructions under "Station Lightning Protectors." See Figure 6-2.

### Buried Installation

Provide adequate protection and bury the cable with two shield wires installed above the coaxial cable. The horizontal spacing between the shield wires should be between 0.46 m (1 1/2 ft) and 0.61 m (2 ft). The two shield wires should be approximately 0.61 m (2 ft) above the cable and buried below the frost line. The shield wire should be 13.3 mm<sup>2</sup> (0.02 in.<sup>2</sup>) (6 AWG) (or larger) copper wire. The cable should be centered between the two shield wires as shown in Figure 6-3.

## High Lightning Exposure Areas

### Aerial Installation

The recommendations for aerial installation in Medium Lightning Exposure areas also apply to High Lightning Exposure areas. When ground resistivity is high, run a parallel buried ground wire (counterpoise) below the frost line. In addition, provide pole protection wires on each nonmetallic pole. Fasten a 13.3 mm<sup>2</sup> (0.02 in.<sup>2</sup>) (6 AWG) (or larger) copper wire to the pole from top to bottom.

This wire can also act as the grounding wire for the shield line and messenger wire. The counterpoise, if used, should have all pole grounds attached to it and be commoned to the grounding system used for the building. See Figure 6-4.

### Buried Installation

Run the cable in a metal conduit buried below the frost line. Generally, routing buried or aerial cables through the highest points of the local terrain, which are subject to increased lightning activity, should be avoided.

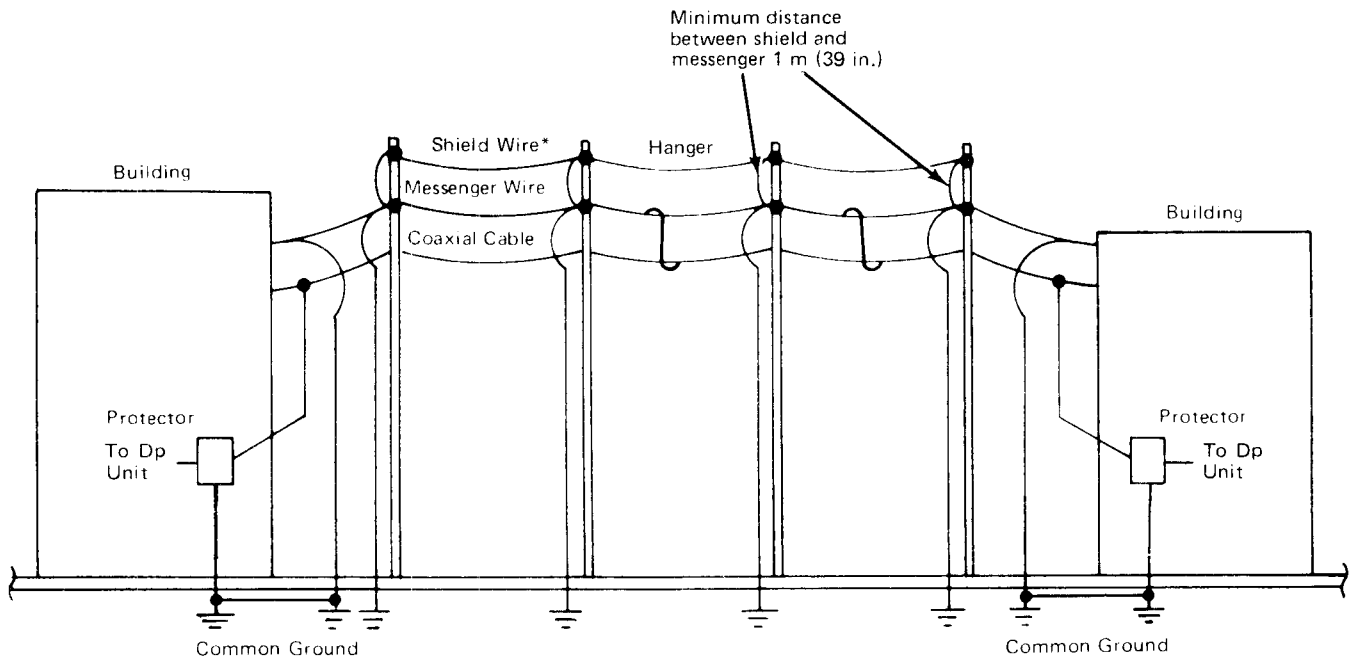

\*Power lines can provide shielding. When the cable is run jointly with the power line, the messenger wire should be bonded to the multiground neutral (MGN). The MGN can be used in lieu of an earth-driven grounding rod. Bond all ground points to the power company multiground neutral.

Figure 6-2. Medium Lightning Exposure Area – Aerial Installation

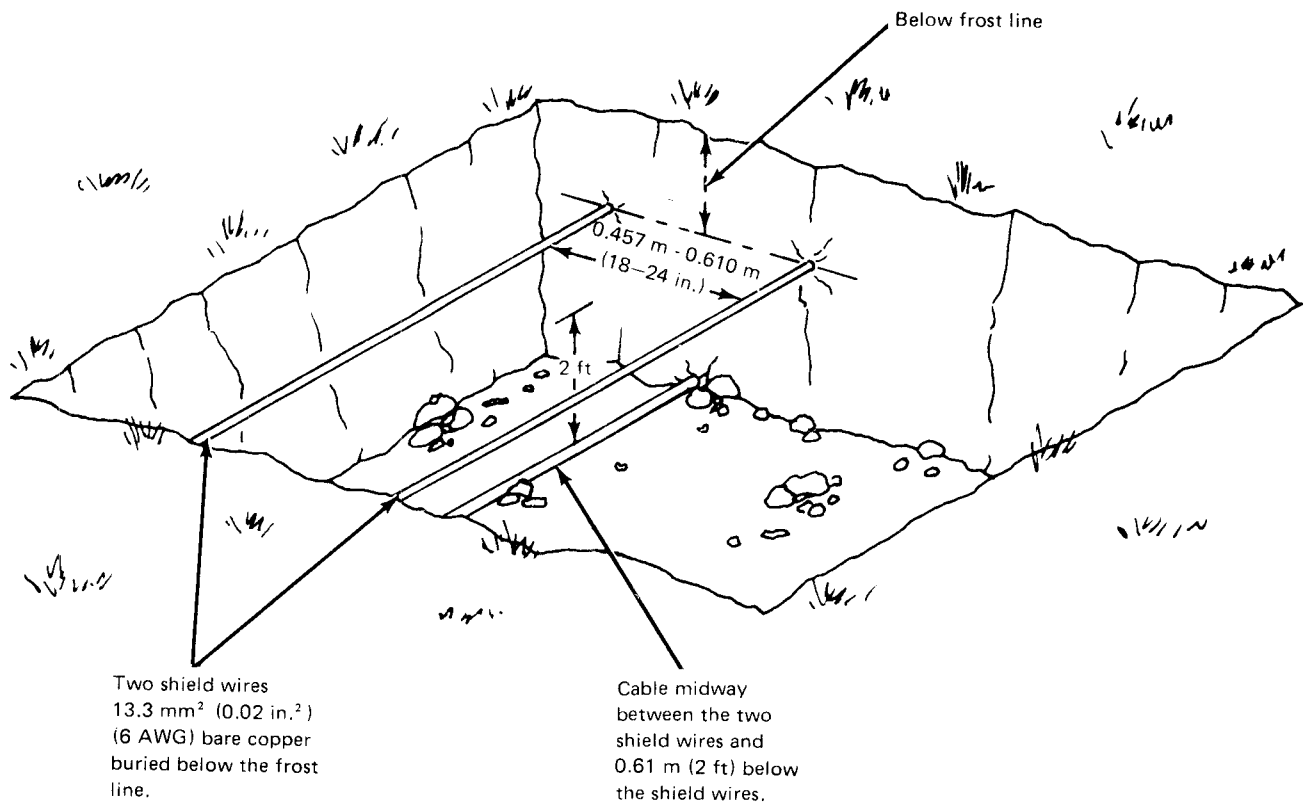
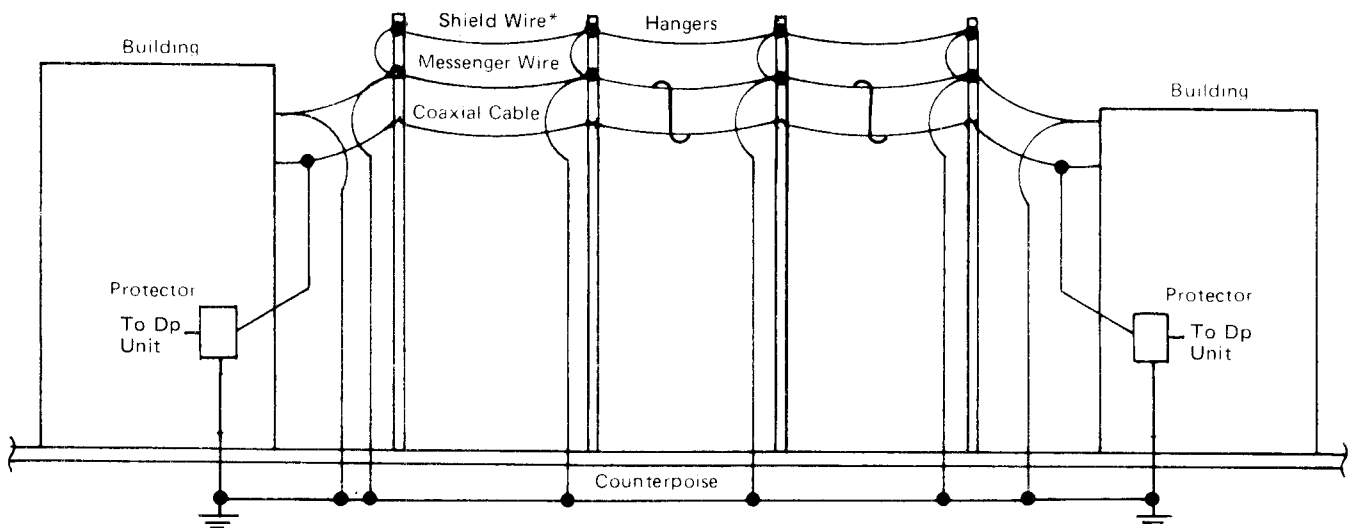

Figure 6-3. Medium Lightning Exposure Area – Buried Installation



\*Power lines can provide shielding. When the cable is run jointly with the power line, the messenger wire should be bonded to the multiground neutral (MGN). The MGN can be used in lieu of an earth-driven grounding rod. Bond all ground points to the power company multiground neutral.

Figure 6-4. High Lightning Exposure Area – Aerial Installation

## Station Lightning Protectors

To help protect personnel and minimize damage to IBM equipment from sudden surges of lightning energy, a station protector should be attached to the shield at each end of each coaxial cable that is routed outdoors. This is true for both overhead and buried cable runs. The station protector procured from IBM must be installed indoors. (The protector is designed for inside installation only.) The protector should be installed at the point at which the cable enters or exits the building and as close to suitable ground as practical. The protector must be grounded. The minimum recommended gauge of the grounding conductor is  $3.31 \text{ mm}^2$  ( $0.005 \text{ in.}^2$ ) (12 AWG). The grounding conductor should be routed to the grounding electrode in as straight a line as practical and should not exceed 3.05 m (10 feet) in length. Longer runs will require proportionately larger diameter ground wires.

The following are the various types of grounding electrodes in the preferred sequence:

1. Public metallic water pipe system (any metallic water pipe system will suffice, if at least 3.05 m (10 feet) is in moist earth).
2. Power service conduit, service-equipment enclosure or building steel (usually when a metallic water pipe system is not available; the grounding system used by the power utility is the best available ground).
3. Other grounding electrodes approved by local/national codes, that is, N.E.C. 800-31.
4. The grounding rod electrode, the least preferable since rods driven in other than good, moist earth (in water table) have been known to have a resistance of several hundred ohms.

All grounds should be commoned at one location (National Fire Protection Code). Common grounding is recognized as the most effective method of preventing side flashes resulting from a lightning discharge. The conductors used for bonding and interconnecting these grounds should be at least  $13.3 \text{ mm}^2$  ( $0.02 \text{ in.}^2$ ) (6 AWG) copper wire (lightning protection code NFPA-78).

Lighting protectors should not be installed in areas where unauthorized personnel may come in contact with them. They should not be installed, have maintenance performed, be connected or disconnected, or be handled in any way during periods of lightning activity; neither should the coaxial cable that runs from the protector to the terminal. The protectors should be installed so that access for maintenance and replacement of the elements is facilitated. The area of the building at which the cables enter or leave must neither contain combustible material nor be considered a hazardous area.

Surge protectors vary in initial cost, cost of maintenance, stability, useful life, and fail-safe protection. The customer should decide what type of protector best meets his needs. *Rural Electrification Administration Telephone Engineering and Construction Manual*, Section 823, Issue #2, dated January 1976, because of reliability and lower maintenance costs, recommends the use of gas type protectors in the following situations:

1. On all high-priority circuits of any type where continuity of service is important and only the minimum outage time can be tolerated (such as fire alarm circuits, interoffice of EAS trunk circuits, and data circuits).
2. On all carrier circuits where lightning incidence is significant.
3. For all subscriber station protectors in areas with a record of high station protection maintenance costs with carbon blocks or plant or equipment damage due to lightning surges or power fault current-induced surges.
4. For all main frame protectors in unattended central offices located in areas with a record of high protector maintenance or equipment failures caused by lightning or power fault current-induced surges.

At the present time, only the gas tube type protector is available from IBM for the above-stated reasons.

The following protector and attachment kits (see Figure 6-5) may be ordered from IBM on a miscellaneous equipment specification (MES) form:

- *Protector Kit* -- IBM PN 1830818; contains two gas element station protectors, one for each end of the cable run.
- *Attachment Kit* -- IBM PN 1833106; contains the parts necessary for attaching a station protector to two coaxial cable ends. An attachment kit is needed for each coaxial cable.

Each station protector can handle two coaxial cables. Therefore, if two cables are routed between the same two points, only one station protector kit is required, but two attachment kits are necessary. Refer to *Assembly of Coaxial Cable and Accessories for Attachment to IBM Products*, GA27-2805, for details on method of attachment. Gas element IBM PN 5252899 (Reliable Electric #1304 FSR) can be used to replace former IBM PN 5252772 (Reliable Electric #1304) by simply unscrewing the carbon element and screwing in the gas element. Care should be taken not to spill the contents in the process.

IBM PN	Part Description	Quantity	Commercial Source
1830818	Kit for gas element station protectors	1	IBM
Includes the following: 5252895	Station Protector	2	Reliable Electric Co.* R-123 FSR
5252899	Gas Protector Unit (Replaceable item for the gas element station protector)	4	Reliable Electric Co.* 1304-FSR
1833106	Kit for attaching the station protectors	1	IBM
Includes the following: 5252764	Adapter BNC Bulkhead UG-492A/U	2	Amphenol Corporation* 31-220
1833107	Jumper Assembly	2	IBM
	The following parts make up 1833107:		
	Ring Terminal 12.7 mm (0.500 in.) Stud-Wire Range 14–16 AWG	1	Electrical Supplier
	Ring Terminal #10 Stud Wire Range 14–16 AWG	1	Electrical Supplier
	Wire-Green/Yellow 14 AWG 50.8 mm (2 in.)	1	Electrical Supplier

*\*Or other equivalent customer-selected source.*

**Note:** *The Gas Protector Unit (PN 5252899) can recover repeatedly from momentary transient voltages. Sustained high current will cause the arrester to permanently ground the circuit. When this occurs, the Gas Protector Unit Must be replaced.*

**Figure 6-5. Station Protector Summary**

## Cable Specifications

This section provides bulk cable specifications and descriptions of IBM-approved connectors for the customer who elects to fabricate these cables. IBM part numbers are also provided for the customer who wishes to purchase bulk cable, connectors, or preassembled cables from IBM. See Figure 6-6 for a summary of IBM part numbers for cables and accessories.

### *Coaxial Cables (h and l)*

These cables must be procured, installed, and maintained by the customer. Cable *h* is for indoor installation only; cable *l* is for outdoor installation, although it is approved for indoor use as well.

#### *Cable h (Indoor)*

Refer to Figure 6-7 for bulk cable specifications for cable *h* (IBM PN 323921). Cables may be purchased from IBM or from a customer-selected source. Bulk cables may be ordered from IBM by specifying IBM PN 323921 and the length on a Miscellaneous Equipment Specifications (MES) form. Preassembled cables may be purchased from IBM by specifying IBM PN 2577672 and the length on the MES form.

For fabricating cables, two BNC-type connectors are needed: IBM PN 1836444 or equivalent. These two connectors can be ordered in a kit from IBM by specifying “Connector Group (indoor type), IBM PN 1836418” on the MES form. Instructions for assembling BNC-type connectors on bulk cable are given in *Assembly of Coaxial Cable and Accessories for Attachment to IBM Products*, GA27-2805.

#### *Cable l (Outdoor)*

Refer to Figure 6-7 for bulk cable specifications for Cable *l* (IBM PN 5252750). This cable is suitable for indoor and

outdoor installation and for burial. The cable may be purchased from IBM or from a source selected by the customer.

Bulk cable may be ordered from IBM by specifying IBM PN 5252750 and the length on an MES form. Preassembled cables may be purchased from IBM by specifying IBM part 1833108 and the length on the MES form.

For fabricating cables, two BNC-type connectors are needed, IBM PN 1836447 or equivalent outdoor type. These two connectors may be obtained in a kit from IBM by specifying “Connector Group (outdoor type), IBM PN 1836419” in the MES form. Instructions for assembling BNC-type connectors on bulk cable are given in *Assembly of Coaxial Cable and Accessories for Attachment to IBM Products*, GA27-2805.

### *Coaxial Cable Splicing*

Do not cut and splice cables; instead, use a quick-disconnect adapter, IBM PN 5252643, or commercial adapter, Amphenol Corp. part UG-914/U. A maximum of 13 connections is allowed in any given cable run. The adapter and the attached cable connectors must be covered with 127 mm (5 inches) of shrink tubing, 19.05 mm (0.75 inch) expanded diameter, to prevent accidental grounding of splice (Figure 6-8). This adapter and connecting jacks should be weathertight for applications requiring this type of installation.

## 3270 IDS Cabling Summary

Listed in Figure 6-9 is a summary of all the varied cable types that are required for unit installation in either a local or remote 3270 Information Display System configuration.



Units From To		Cable Group	Type	IBM Preassembled Cable Assembly	Bulk Cable No.	Connector Group <sup>1,2,3</sup>	Length <sup>4</sup> (Meters)	Length <sup>4</sup> (Feet)
3271 or 3272	3277	h	indoor	2577672	323921	1836418	610	2000
		l	outdoor	1833108	5252750	1836419	610	2000
	3284	h	indoor	2577672	323921	1836418	610	2000
		l	outdoor	1833108	5252750	1836419	610	2000
	3286	h	indoor	2577672	323921	1836418	610	2000
l		outdoor	1833108	5252750	1836419	610	2000	
3287	h	indoor	2577672	323921	1836418	610	2000	
	l	outdoor	1833108	5252750	1836419	610	2000	
3288	h	indoor	2577672	323921	1836418	610	2000	
	l	outdoor	1833108	5252750	1836419	610	2000	
3276	3278	h	indoor	2577672	323921	1836418	1500	4920
		l	outdoor	1833108	5252750	1836419	1500	4920
	3279	h	indoor	2577672	323921	1836418	1500	4920
3287	h	indoor	2577672	323921	1836418	1500	4920	
	l	outdoor	1833108	5252750	1836419	1500	4920	
3274	3262	h	indoor	2577672	323921	1836418	1500	4920
		l	outdoor	1833108	5252750	1836419	1500	4920
	3277	h	indoor	2577672	323921	1836418	610	2000
		l	outdoor	1833108	5252750	1836419	610	2000
	3278	h	indoor	2577672	323921	1836418	1500	4920
		l	outdoor	1833108	5252750	1836419	1500	4920
	3279	h	indoor	2577672	323921	1836418	1500	4920
		l	outdoor	1833108	5252750	1836419	1500	4920
	3284	h	indoor	2577672	323921	1836418	610	2000
		l	outdoor	1833108	5252750	1836419	610	2000
3286	h	indoor	2577672	323921	1836418	610	2000	
	l	outdoor	1833108	5252750	1836419	610	2000	
3287	h	indoor	2577672	323921	1836418	610/1500	2000/4920	
	l	outdoor	1833108	5252750	1836419	610/1500	2000/4920	
3288	h	indoor	2577672	323921	1836418	610	2000	
	l	outdoor	1833108	5252750	1836419	610	2000	
3289	h	indoor	2577672	323921	1836418	1500	4920	
	l	outdoor	1833108	5252750	1836419	1500	4920	

**Notes:**

1. IBM connector kit 1836418 contains two BNC connectors (IBM 1836444).
2. IBM connector kit 1836419 contains two BNC connectors (IBM 1836447).
3. See Assembly of Coaxial Cable and Accessories for Attachment to IBM Products, GA27-2805, when assembling connectors to coaxial cables.
4. Devices attached to Type B Terminal Adapters may have a maximum cable length of 610 m (2000 feet); those attaching to Type A Terminal Adapters may have a maximum cable length of 1500 m (4920 feet). Refer back to pages 4-4 and 4-10.

Figure 6-6. Summary of IBM Part Numbers for Cables and Accessories

IBM Part Number		321921	5252750
Cable Type (Notes 1, 2)		Indoor (h)	Outdoor (l)
Jacket	Material	PVC	PVC
	Wall Thickness	0.79 mm (0.031 in.)	1.02 mm (0.040 in.)
	Outside Diameter	6.15 mm (0.242 in.)	6.6 mm (0.260 in.)
Physical	Polyester Vapor Barrier	No	Yes
	Temperature Rating	60° C (140°)	
	Voltage Rating	30 Volts maximum	
	Wire Size	22 AWG – 0.325 mm <sup>2</sup>	
	Type	Solid	
Conductor	Material	Copper Covered Steel	
	Conductivity	40%	
	DC Resistance (max)	440 ohms/304.8 m (1000 ft)	
Shield	Material	Copper	
	Wire Size	34 AWG – 0.020 mm <sup>2</sup>	
	Coverage (min)	90%	
	Ends	7	
	Carriers	6	
Picks	8.2 + 10%/25.4 mm (1 in.)		
Electrical	Capacitance	14.5 pF/304.8 mm (1 ft)	
	Impedance	93 ± 5 ohms	
	Attenuation (max)	8.0 db/30.5 mm (100 ft)	
	Velocity or Propagation	80%	
UL	Style Number	1478	
Insulation		Polyethylene	

**Notes:**

1. Jacket of outdoor cable must meet minimum requirements for underground feeder and branch circuit cable and must be weatherproof; sunlight resistant per UL Subject 493.
2. Commercial cable designated RG 624/U or M17/030/RG062, meeting the requirements of the above specification, is a suitable substitute. (All cables labeled 62A/U may not meet this specification and are not suitable substitutes.)

Figure 6-7. Bulk Cable Specifications for Indoor (h) and Outdoor (l) Coaxial Cables

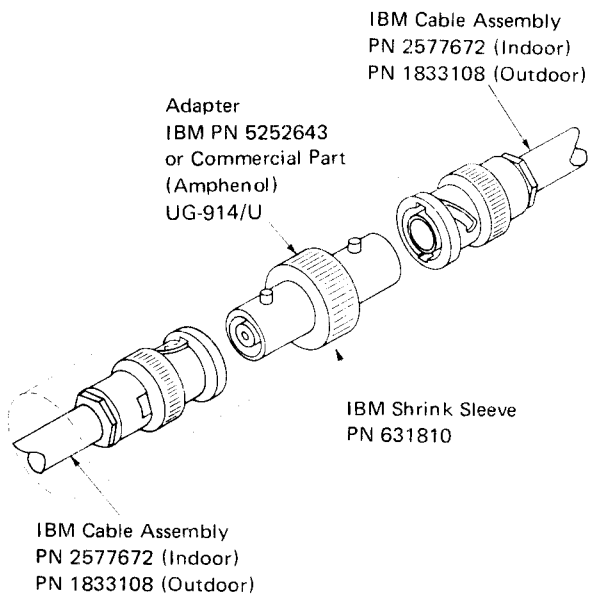

Figure 6-8. Cable Adapter for Joining Coaxial Cables

3270 Unit	Cable Type	Cable Group	Comment
3271	Teleprocessing	3207, 3208, 3209, 3210, 3211, 3212, 3213	Ordered by cable order. Installed by IBM.
	Signal (Coaxial)	h or l	Procured and installed by customer. Maximum length 610 m (2000 ft).
3272	Local Channel Attachment	3201, 3202, 3203, 3204, 3205	Ordered by cable order.
	Sequence and Control (EPO)	3206	Required with LCA cables. Ordered by cable order.
	Signal (Coaxial)	h or l	Procured and installed by customer. Maximum length 610 m (2000 ft).
3274 1A, 1B 1D, 21A 21B, 21D 31A, 31D	Local Channel Attachment	3201, 3202, 3203, 3204, 3205	Ordered by cable order. installed by IBM.
	Sequence and Control (EPO)	3206	Required with LCA cables. Ordered by cable order.
	Signal (Coaxial)	h or l	Procured and installed by customer. Maximum length to Type A terminals is 1500 m (4920 ft). Maximum length to Type B terminals is 610 m (2000 ft).
3275	Teleprocessing	3207, 3208, 3209, 3210, 3211, 3212, 3213	Ordered by cable order. Installed by IBM.
3274-1C 3274-21C 3274-31C 3274-51C 3276	Teleprocessing	Not applicable	Supplied with unit. Installed by customer.
	Signal (Coaxial)	h or l	Procured and installed by customer. Maximum length to Type A terminals is 1500 m (4920 ft). Maximum length to Type B terminals is 610 m (2000 ft).
3277 3284* 3286 3288	Signal (Coaxial)	h or l	Procured and installed by customer. Maximum length is 610 m (2000 ft).
3278 3279	Signal (Coaxial)	h or l	Procured and installed by customer. Maximum length is 1500 m (4920 ft).
3287	Signal (Coaxial)	h or l	Procured and installed by customer. Maximum length to 3274/3276 Type A adapter is 1500 m (4920 ft). Maximum length to 3271, 3272 or 3274 Type B adapter is 610 m (2000 ft).
3289	Signal (Coaxial)	h or l	Procured and installed by customer. Maximum length is 1500 m (4920 ft).

Figure 6-9. 3270 IDS Cabling Summary

## Appendix A. U.S. and Canada Power Plug Types

IBM supplies power cords with attached plugs for the United States and Canada. See Figures A-1, A-2, and A-3. The customer must provide the corresponding power outlet receptacles.

Plug Type	3262	3271	3272	3274 1A, 1B 1D, 21A 21B 21D, 31A 31D	3274 1C 21C 31C	3274 51C	3275	3276	3277	3278	3279	3284	3286	3287	3288	3289	Reference Figures
A			X*														A-2, A-3
A2				X*													A-2, A-3
A3	X																A-2, A-3
H		X			X	X	X	X	X	X	X	X	X	X	X	X	A-2, A-3
J	X	X			X	X	X	X	X	X	X	X	X	X	X	X	A-2, A-3
K		X	X	X	X												A-2, A-3
L		X	X	X	X												A-2, A-3



\* A waterproof plug may be ordered for the 3272 by specifying RPQ8K0295; for the 3274 Models by Feature Code 8801.

Figure A-1. Power Plugs Supplied in the U. S. and Canada

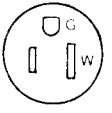

Provided by IBM				Provided by Customer						
Plug Type	Plug Cap Types			IBM Reference	Service Rating				Inline Connector	Receptacle
	Water-proof	Non-lock	Lock		Volts	Amps	Phase	Wires		
A	3720			Russell-Stoll	208/ 240	20	1	3	3913	3743
A2	3720 U-2			Russell-Stoll	208/ 240	15	1	3	3913 U-2	3743 U-2
A3	3720 U-1			Russell-Stoll	120	20	1	3	3913 U-1	3743 U-1
H		5-15P		NEMA	120	15	1	3	5-15R	5-15R
J			L5-15P	NEMA	120	15	1	3	L5-15R	L5-15R
K		6-15P		NEMA	208/ 240	15	1	3	6-15R	6-15R
L			L6-15P	NEMA	208/ 240	15	1	3	L6-15R	L6-15R

Figure A-2. Descriptions of Plugs and Receptacles

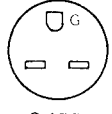
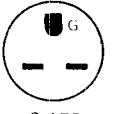
### Nonlocking Plugs and Receptacles

15 Amperes		
	Receptacle	Plug
Type	H	H
125V	 5-15R	 5-15P
Type	K	K
250V	 6-15R	 6-15P

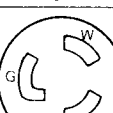
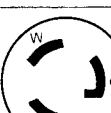
### Locking Type Plugs and Receptacles

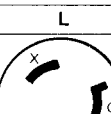
15 Amperes		
	Receptacle	Plug
Type	J	J
125V	 L5-15R	 L5-15P
Type	L	L
250V	 L6-15R	 L6-15P

### Waterproof Plugs and Receptacles







Type	20 Amperes		15 Amperes	
	Receptacle	Plug	Receptacle	Plug
250V	 3913 / 3743	 3720	 3913 U-2 / 3743 U-2	 3720 U-2
120V	 3913 U-1 / 3743 U-1	 3720 U-1		

Figure A-3. NEMA Configurations

## Appendix B. Power Cable Lengths

Unit	Cable Length
3262	4.3 m (14 ft)* 1.8 m (6 ft)*
3271	1.8 m (6 ft) 2.8 m (9 ft)*
3272	1.8 m (6 ft) 2.8 m (9 ft)*
3274	1.8 m (6 ft) 4.3 m (14 ft)*
3275	1.8 m (6 ft) 2.3 m (7.5 ft)*
3276	1.8 m (6 ft) 2.8 m (9 ft)* 3.7 m (12 ft) 4.5 m (15 ft)
3277	1.8 m (6 ft) 2.3 m (7.5 ft)*
3278	1.8 m (6 ft) 2.8 m (9 ft)* 3.7 m (12 ft) 4.5 m (15 ft)
3279	1.8 m (6 ft) 2.8 m (9 ft)* 4.5 m (15 ft)
3284	1.8 m (6 ft) 2.8 m (9 ft)*
3286	1.8 m (6 ft) 2.8 m (9 ft)*
3287	1.8 m (6 ft) 2.8 m (9 ft)* 3.7 m (12 ft) 4.5 m (15 ft)
3288	1.8 m (6 ft) 2.8 m (9 ft)*
3289	1.8 m (6 ft) 2.8 m (9 ft)* 3.7 m (12 ft) 4.5 m (15 ft)

\*Standard Cable

### Notes:

1. For the 3262, 3276, 3278, 3279, 3287, and 3289, only the 2.8-m (9 ft) and the 4.5-m (15 ft) cords are available in E/ME/A countries.
2. For the 3276, 3278, and 3279 only the 2.8-m (9 ft) and 4.5-m (15 ft) cords are available in A/FE countries except Canada.
3. For the 3279, the 1.8-m (6 ft) cord is available in the U.S. only.
4. For the 3274, only the 4.3-m (14 ft) cord is available in A/FE and E/ME/A countries.





## Appendix C. World Trade Power Plug Types

For a World Trade country, IBM supplies the power cord with attached plug that corresponds to the power outlet receptacle that is most used in that country. The plug that the 3270 System units will have is listed in the Power Plug Usage Chart (Figure C-1). The alphabetic designations in the chart refer to the illustrations in the Power Plug and Receptacle Diagrams (Figure C-2).

### Installation of a Power Plug





Because different plugs are used in different countries it is difficult to cover all plug installations in one procedure. However, three things must be considered:

1. That the shield of the power cord always have a good electrical connection to the grounding terminal in the plug.
2. That steps be taken to assure that the grounding wire and/or the drain (shield) wire cannot come in contact (touch) the other (hot) wires.
3. That the grounding wire (green–green/yellow) be properly attached to the grounding terminal in the plug.

Country	Voltage Range		Country	Voltage Range	
	125V	250V		125V	250V
Algeria		A	Jamaica	E	
Argentina		B	Japan	E D	
Australia		B	Malaysia		A
Austria		C	Mexico	E	
Bahamas	E		Netherlands		C
Barbados	E		Netherlands Antilles	E	
Belgium		A	New Zealand		B
Bermuda	E		Nicaragua	E	
Bolivia	E		Norway		C
Brazil	E	B	Panama	E	
Bulgaria		C	Paraguay		B
Chile		B	Peru	E	
Colombia		B	Philippines	E	
Costa Rica	E		Poland		C
Denmark		G	Portugal		C
Dominican Rep	E		Rumania		C
Ecuador	E		Saudi Arabia	M	
El Salvador	E		South Africa		J
Finland		C	Spain		C
France		A	Sweden		C
Germany		C	Switzerland		K
Guatemala	E		Taiwan	E	
Honduras	E		Thailand	E	
Hungary		A	United Kingdom		L
Icelando		C	Uruguay		B
Indonesia		C	Venezuela		B
Iran		C	Yugoslavia		A
Ireland		L			
Israel		H			
Italy		N			

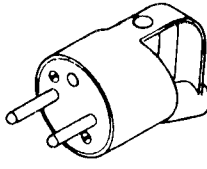
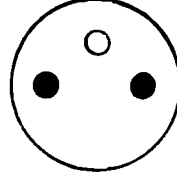
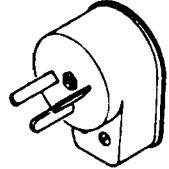
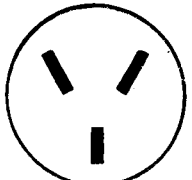
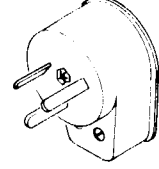
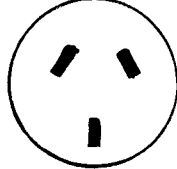
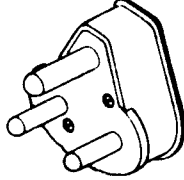
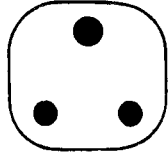
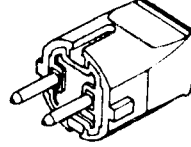
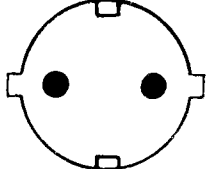
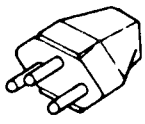
- Other Asian and Latin American countries not listed will be shipped cords with plug **E** attached.
- Other Europe, Middle East and African countries not listed will be shipped cords with plug **C** attached.

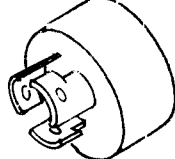
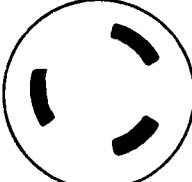
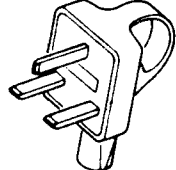
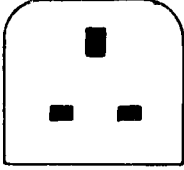
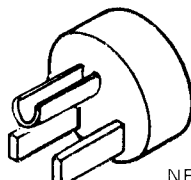
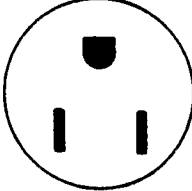
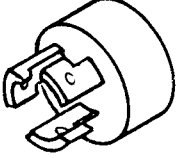
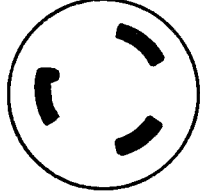
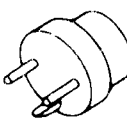
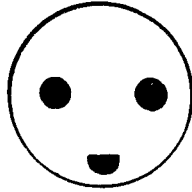
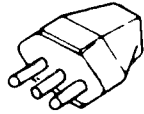
Figure C-1. Power Plug Usage Chart

Plug Three-Dimensional View	Plug Pin Side View	Plug Three-Dimensional View	Plug Pin Side View
<b>A</b> 250V 16A 		<b>H</b> 250V 10A 	
<b>B</b> 250V 10A 		<b>J</b> 250V 13A 	
<b>C</b> 250V 16A 		<b>K</b> 250V 10A 	
<b>D</b> 125V 15A Locking 		<b>L</b> 250V 13A 	
<b>E</b> 125V 15A NEMA 5-15P 		<b>M</b> 125V 15A Locking NEMA L5-15P 	
<b>G</b> 250V 10A 		<b>N</b> 250V 16A 	

Note: All power plugs except **M** and **D** are nonlocking.

Figure C-2. Power Plug Diagrams



## Appendix D. Power Cord Specifications

Cables				Conductors			
Unit	Nominal	O.D.	No. of Shields	Quantity	Nominal	O.D.	AWG No.
	Inches	mm			Inches	mm <sup>2</sup>	
3262	0.620	16	0	3	0.90	3.30	12
3271	0.350	9	1	3	0.048	0.90	18
3272	0.350	9	0	3	0.048	0.90	18
3274	0.350	9	1	3	0.048	0.90	18
3275	0.350	9	1	3	0.048	0.90	18
3276	0.350	9	1	3	0.048	0.90	18
3277	0.350	9	1	3	0.048	0.90	18
3278	0.350	9	1	3	0.048	0.90	18
3279	0.350	9	1	3	0.048	0.90	18
3284	0.350	9	0	3	0.048	0.90	18
3286	0.350	9	0	3	0.048	0.90	18
3287	0.350	9	1	3	0.048	0.90	18
3288	0.350	9	0	3	0.048	0.90	18
3289	0.380	9.7	1	3	0.060	1.32	16
3289	0.520	13	1	3	0.071	1.94	14



# Appendix E. Continental U.S. Lightning Damage Probability Map

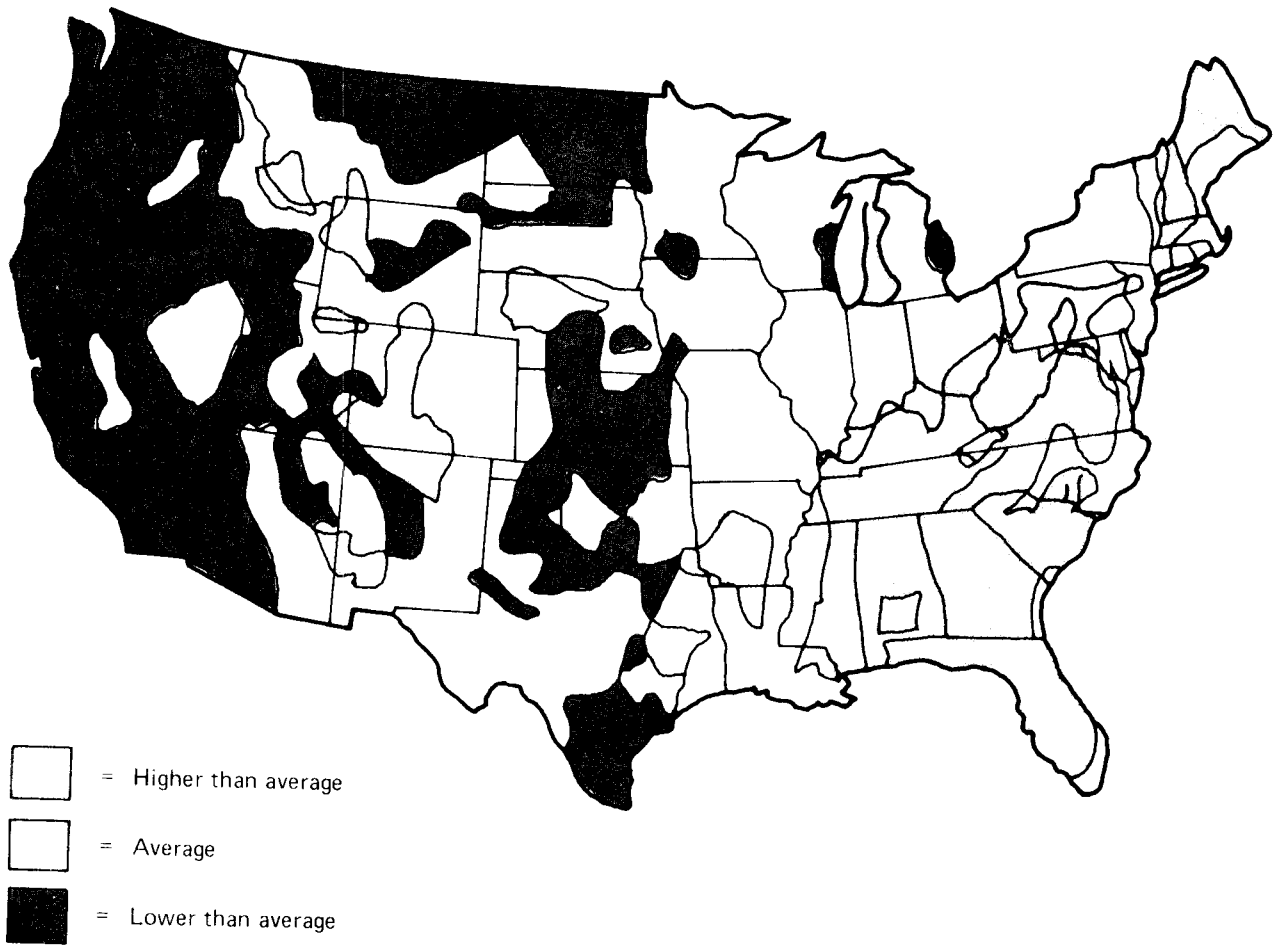

Lightning Damage Probability Map





# Appendix F. Connector Specifications for Attaching Non-IBM Modems

*Note: Dimensions are shown in millimeters, with inches in parentheses.*

## Type 283B Plug

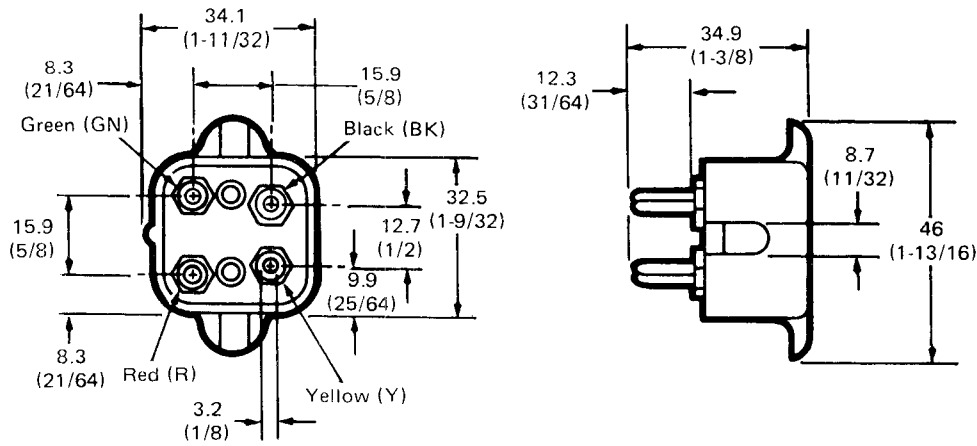

## Line Termination Jacks

Common Carrier Provided:  
Type 404B or 549A Surface Mount, or  
Type 493A Flush Mount (or Equivalent)

Common Carrier Provided:  
Type 404B or 549A Surface Mount, or  
Type 493A Flush Mount (or Equivalent)

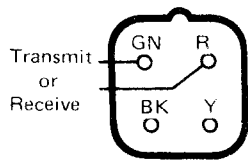

2-Wire Termination Jack

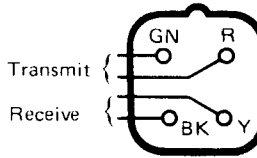

4-Wire Termination Jack

## 25-Pin EIA/CCITT Female Connector

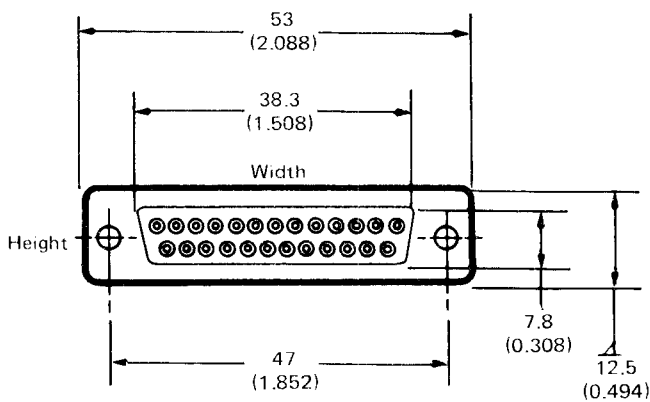

**Note:** Cable connectors are protected by a hood and strain relief assembly, with the following overall dimensions: 55.9 mm (2.2 inches) wide by 19.8 mm (0.78 inch) high.

15-Pin DTE Pin Connector

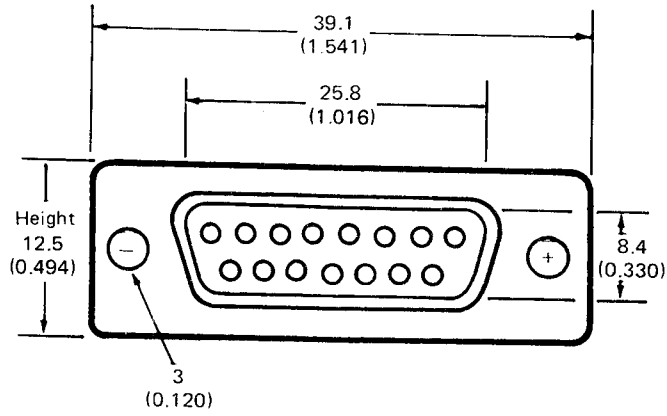

Loop Station Connector Plug

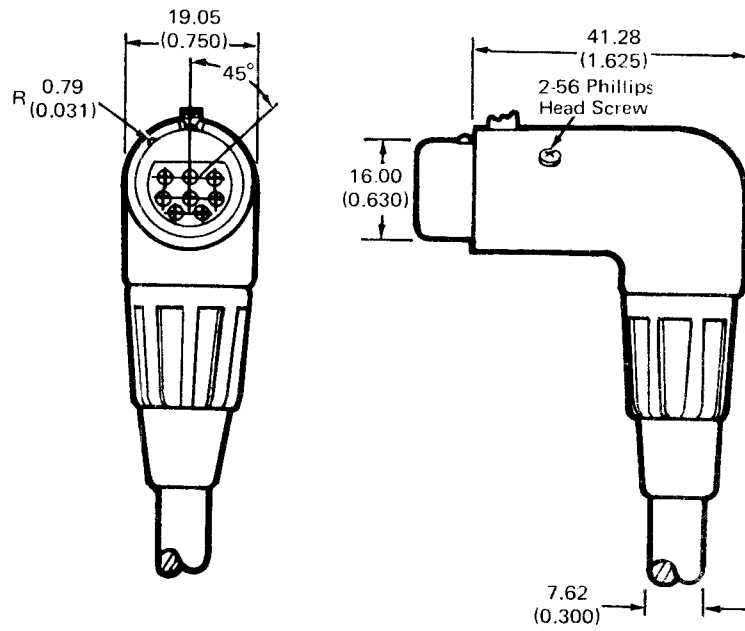

## Appendix G. 3270 Specification Summary (Metric Units)

Type	Model	Description	Electrical		Environmental		Dimensions (mm)			Service Clearances (mm)				Notes
			kVA	Watts	Cooling (Note 4)	Weight (kg)	Front	Side	Height	F	R	Rt	L	
3262	1, 13	Printer	1.2	1100	●	245	965	750	1000	760	760	760	760	1,2,3
3271	1, 2	Control Unit	0.18	176	—	44	670	390	740	762	0	0	0	1,2,3
3271	11, 12	Control Unit	0.20	186	—	44	670	390	740	762	0	0	0	1,2,3
3272	1, 2	Control Unit	0.18	176	—	43	670	390	740	762	0	0	0	1,2,3
3274	Note 6	Control Unit	0.45	407	●	75	762	508	740	1120	30	30	30	1,2,3
3274	51C	Control Unit	0.36	234	—	29.6-40.9	535	460	335	955	155	155	305	1,2,3
3275	1, 2	Display Station	0.24	287	—	43	410	535	485	762	30	280	280	1,2,3
3275	11, 12	Display Station	0.28	236	—	43	410	535	485	762	30	280	280	1,2,3
3276	All Models	Display Station Control Unit	0.260	227	●	45	410	535	485	762	305	335	410	1,2,3
3277	1	Display Station	0.17	155	—	27	370	410	430	762	55	254	254	1,2,3
3277	2	Display Station	0.17	155	—	39	410	535	485	762	30	280	280	1,2,3
3278	1,2,3,4,5	Display Station	0.16	125	—	36	410	535	485	762	30	335	280	1,2,3
3279	2A, 2B 3A, 3B	Color Display Station	0.30	243	—	27	450	550	381	762	410	30	305	1,2,3
3284	1, 2, 3	Printer	0.26	227	—	61	670	390	960	762	762	0	0	1,2,3
3286	1, 2	Printer	0.26	227	—	61	670	390	960	762	762	0	0	1,2,3
3287	1, 2	Printer	0.26	250	●	39	690	610	280	508	508	762	762	1,2,3,5
3288	2	Line Printer	0.60	566	●	127	690	540	1060	762	762	155	155	1,2,3
3289	1, 2	Line Printer	0.60	412	—	200	1005	750	1045	762	762	762	762	1,2,3

### Notes:

- Parameters not shown may be found in Chapter 5, Machine Specifications.
- These units can withstand a transient-voltage condition of plus 15% or minus 18% of nominal, if the input voltage returns to within a steady-state tolerance of plus 10% or minus 8% of the normal rated voltage within 30 cycles.
- See Appendix B for power cable lengths, Appendix C for power plug types, and Appendix D for power cord specifications.
- Type of cooling:
  - Convection
  - Forced Air
- Maximum dimensions are shown. See specification pages (Chapter 5).
- Models 1A, 1B, 1C, 1D, 21A, 21B, 21C, 21D, 31A, 31C, 31D



## Appendix H. 3270 Specification Summary (English Units)

Type	Model	Description	Electrical		Environmental		Weight (lb)	Dimensions (inches)			Service Clearances (inches)				Notes
			kVA	BTU/hr	Cooling (Note 4)	Front		Side	Height	F	R	Rt	L		
3262	1, 13	Printer	1.2	3,750	●	540	38	29-1/2	39-1/2	30	30	30	30	1, 2, 3	
3271	1, 2	Control Unit	0.18	595	—	98	26-3/8	15-1/4	29	30	0	0	0	1, 2, 3	
3271	11, 12	Control Unit	0.20	630	—	98	26-3/8	15-1/4	29	30	0	0	0	1, 2, 3	
3272	1, 2	Control Unit	0.18	595	—	95	26-3/8	15-1/4	29	30	0	0	0	1, 2, 3	
3274	Note 6	Control Unit	0.45	1,382	●	165	30	20	28.9	40	1	1	1	1, 2, 3	
3274	51C	Control Unit	0.36	800	—	65-90	20-5/8	18	12.8	37.4	5.9	5.9	11.8	1, 2, 3	
3275	1, 2	Display Station	0.24	700	—	95	16	21	19	30	1	11	11	1, 2, 3	
3275	11, 12	Display Station	0.28	800	—	95	16	21	19	30	1	11	11	1, 2, 3	
3276	All Models	Display Station	0.26	770	●	100	16	21	19	30	12	13	16	1, 2, 3	
3277	1	Display Station	0.17	525	—	60	14-1/2	16	16-7/8	30	2	10	10	1, 2, 3	
3277	2	Display Station	0.17	525	—	85	16	21	19	30	1	11	11	1, 2, 3	
3278	1,2,3,4,5	Display Station	0.16	420	—	80	16	21	19	30	1	13	11	1, 2, 3	
3279	2A, 2B 3A, 3B	Color Display Station	0.30	825	—	58	17-1/2	21-1/2	15	30	16	1	12	1, 2, 3	
3284	1, 2, 3	Printer	0.26	770	—	135	26-3/8	15-3/4	37-3/4	30	38	0	0	1, 2, 3	
3286	1, 2	Printer	0.26	770	—	135	26-3/8	15-1/4	37-3/4	30	38	0	0	1, 2, 3	
3287	1, 2, 1C, 2C	Printer	0.26	853	●	87	27	24	11	20	20	30	30	1, 2, 3, 5	
3288	2	Line Printer	0.60	1,926	●	280	27	21-1/4	41-5/8	30	30	6	6	1, 2, 3	
3289	1, 2	Line Printer	0.60	1,400	—	440	39-1/2	29-1/2	41	30	30	30	30	1, 2, 3	

### Notes:

- Parameters not shown may be found in Chapter 5, Machine Specifications.
- These units can withstand a transient-voltage condition of plus 15% or minus 18% of nominal, if the input voltage returns to within a steady-state tolerance of plus 10% or minus 8% of the normal rated voltage within 30 cycles.
- See Appendix B for power cable lengths, Appendix C for power plug types and Appendix D for power cord specifications.
- Type of cooling:
  - Convection
  - Forced Air
- Maximum dimensions are shown. See specification pages (Chapter 5).
- Models 1A, 1B, 1C, 1D, 21A, 21B, 21C, 21D, 31A, 31C, 31D



## Appendix J. Cables and Connectors for Attaching Non-IBM Devices

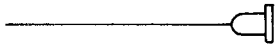
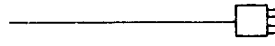
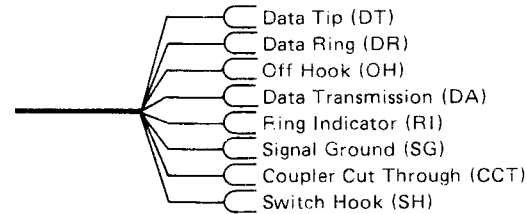
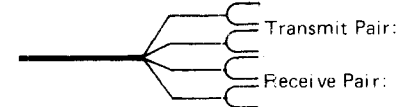
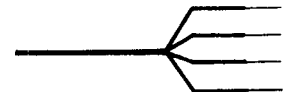

### Cables to Non-IBM Devices

Cable Group	Machine	Feature Code	Non-IBM Termination	Notes
3207 3213 3208 3213 NA* NA* NA* NA* NA*	3271 3271 3275 3275 3274-1C** 3274-21C** 3274-31C** 3274-51C** 3276**	None None None None 3701 3701 3701 3701 3701	 Short test cables required for certain countries between this cable and the modem will have the same connector.**	One EIA RS 232C connector or one CCITT connector (25-pin). Standard termination. (All countries)
NA* NA* NA* NA* NA*	3274-1C 3274-21C 3274-31C 3274-51C 3276	5650 or 5651 5650 or 5651 5650 or 5651 5650 or 5651 5650 or 5651		15-pin connector for digital service attachment to AT&T channel service unit. (U.S. and Canada)
NA* 3209 NA*	3274-51C 3275 3276	5500 or 5502 5500 5500 or 5502		WE-283B Plug: Customer provides 404B Surface Mount, 493A Flush Mount Jacks. Termination for: <ul style="list-style-type: none"> <li>● DAA CDT (or equivalent) switched.</li> <li>● Nonswitched for U.S., Canada, and Japan.</li> </ul>
NA* 3210 NA*	3274-51C 3275 3276	5501 5501 5501		Four Pair No. 6 Spade Lugs. Standard termination for: <ul style="list-style-type: none"> <li>● DAA CBS auto-answer switched network (U.S. and Canada).</li> </ul>
3211	3275	5500		Four No. 8 Spade Lugs. Standard termination for World Trade (only) nonswitched.
NTT-D1 Service	3271 3274-1C 3274-21C 3274-31C 3274-51C 3275 3276	2943 2943 2943 2943 2943 2943 2943		Skinned and tinned. (Japan only).

\* Cable supplied with unit when feature code is ordered; therefore, no cable group number is required or assigned.

\*\* This 3274/3276 EIA/CITT cable for attachment to a modem or direct attachment to a 3704, 3705, or 8100 Processor, incorporates a TEST/OPERATE wrap-test switch in the modem connector plug. A special adapter cable may be needed because of the space and access requirements of the TEST/OPERATE switch. An adapter cable is automatically shipped with the communications cable for U.K. Datel modems when Specify Code 2835 is ordered. In other cases where the adapter cable is needed, it can be obtained from an IBM field representative.

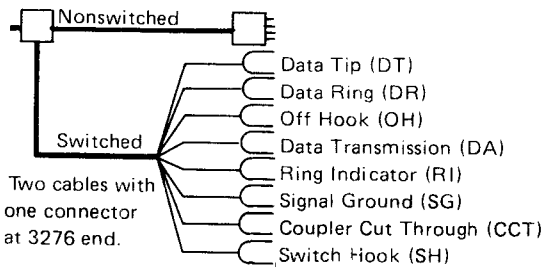
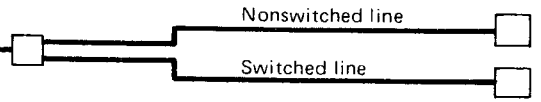
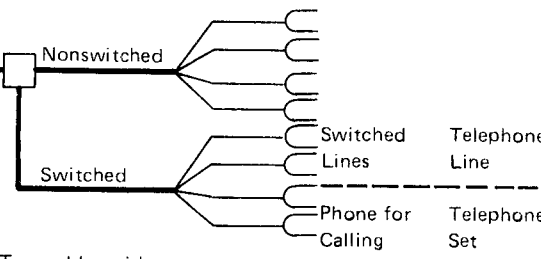
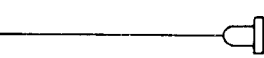
## Cables to Non-IBM Devices (Cont)

Cable Group	Machine	Feature Code	Non-IBM Termination	Notes
NA* NA*	3274-51C 3276	5508 5508	 <p>Two cables with one connector at 3276 end.</p>	Termination for: <ul style="list-style-type: none"> <li>• Nonswitched lines with SNBU auto-answer (U.S. and Canada).</li> </ul>
NA* NA*	3274-51C 3276	5507 5507	 <p>Two cables with a common connector.</p>	Termination for: <ul style="list-style-type: none"> <li>• Nonswitched line with SNBU manual-answer (U.S. and Canada)</li> </ul>
NA* NA*	3274-51C 3276	5501 or 5508 5501 or 5508	 <p>Two cables with a common connector.</p>	Termination for: <ul style="list-style-type: none"> <li>• Switched network auto-answer</li> <li>• Nonswitched lines -- SNBU (World Trade except Canada)</li> </ul>
NA* NA* NA*	3274-1C 21C, 31C 3274-51C 3276 11,12,13,14	5655 or 5656 5655 or 5655 5655 or 5656		One EIA 422 connector or one CCITT connector (25-pin) for X.21 Adapter Switched/Non-Switched Networks. Standard termination. (All countries)
NA* NA*	3274-1C 21C, 31C 3274-51C	1550 1550		One ISO 2593 Connector (34-pins) for CCITT V.35 Interface feature

\*Cable supplied with unit when feature code is ordered; therefore, no cable group number is required or assigned.

**Note:** When the 3274 or 3276 is directly attached (without modems) to a 37Q4, 3705, or 8100 Processor, the total combined communications cable length must not exceed 12.2 meters (40 feet).



# EIA/CCITT Cable TEST/OPERATE Switch

Note: Dimensions are shown in millimeters, with inches in parentheses.

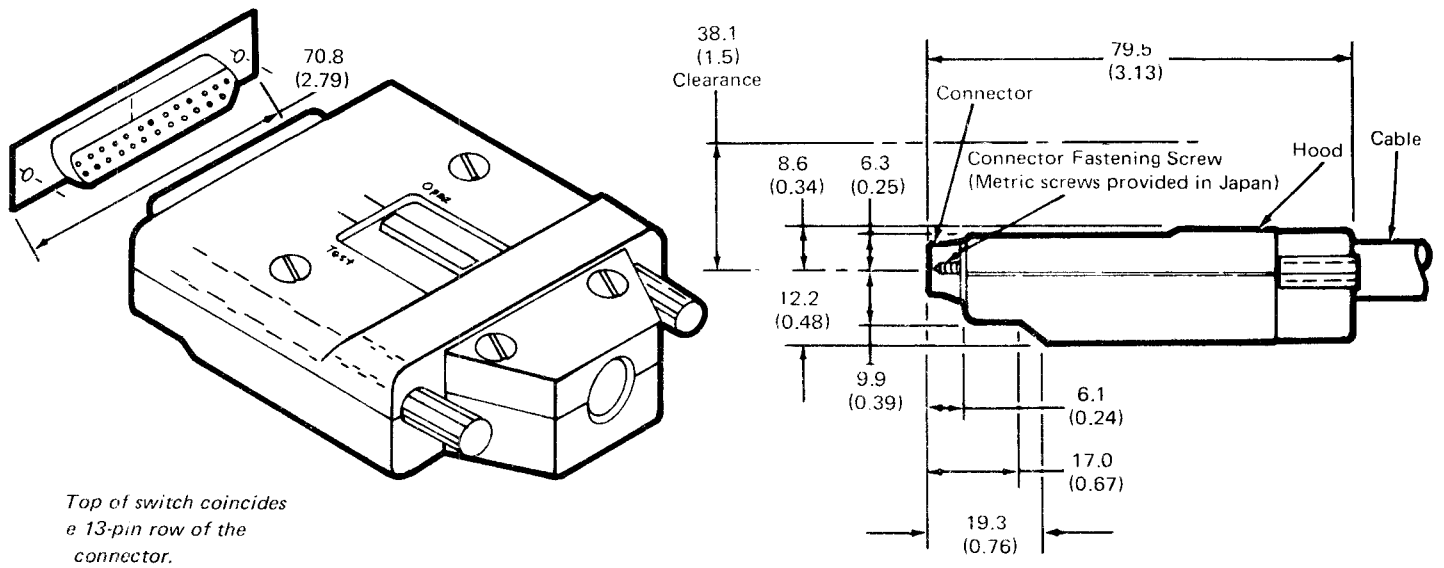



## Appendix K. Wire Conversion Table (Solid Wire)

AWG No.	Nominal Diameter (inch)	Calculated Area (sq. in.)	Nominal Diameter (mm)	Calculated Area (mm <sup>2</sup> )
12	0.0808	0.005128	2.052	3.307
13	0.0720	0.004072	1.829	2.627
14	0.0641	0.003227	1.628	2.082
15	0.0571	0.002561	1.450	1.651
16	0.0508	0.002027	1.290	1.307
17	0.0453	0.001612	1.151	1.040
18	0.0403	0.001276	1.024	0.824
19	0.0359	0.001012	0.912	0.653
20	0.0320	0.000804	0.813	0.519
21	0.0285	0.000638	0.724	0.412
22	0.0253	0.000503	0.643	0.325
23	0.0226	0.0004012	0.574	0.259
24	0.0201	0.0003173	0.511	0.205



## Appendix L. Inch-to-Millimeter Conversion Table

in.	mm	in.	mm	in.	mm	in.	mm	in.	mm
1/16	1.6	22	559	49	1245	76	1930	103	2616
1/8	3.2	22-1/2	572	49-1/2	1257	76-1/2	1943	103-1/2	2629
3/16	4.7	23	584	50	1270	77	1956	104	2641
1/4	6.4	23-1/2	597	50-1/2	1283	77-1/2	1969	104-1/2	2654
5/16	7.9	24	610	51	1295	78	1981	105	2667
3/8	9.5	24-1/2	622	51-1/2	1308	78-1/2	1994	105-1/2	2679
7/16	11	25	635	52	1321	79	2007	106	2692
1/2	12.7	25-1/2	648	52-1/2	1334	79-1/2	2019	106-1/2	2705
9/16	14.3	26	660	53	1346	80	2032	107	2718
5/8	15.9	26-1/2	673	53-1/2	1359	80-1/2	2045	107-1/2	2730
3/4	19.1	27	686	54	1372	81	2057	108	2743
7/8	22.3	27-1/2	698	54-1/2	1384	81-1/2	2070	108-1/2	2756
1	25.4	28	711	55	1397	82	2083	109	2768
1-1/2	38.1	28-1/2	724	55-1/2	1410	82-1/2	2096	109-1/2	2781
2	50.8	29	737	56	1423	83	2108	110	2794
2-1/2	63.5	29-1/2	749	56-1/2	1435	83-1/2	2121	110-1/2	2806
3	76.2	30	762	57	1448	84	2134	111	2819
3-1/2	88.9	30-1/2	775	57-1/2	1461	84-1/2	2146	111-1/2	2832
4	102	31	787	58	1473	85	2159	112	2845
4-1/2	114	31-1/2	801	58-1/2	1486	85-1/2	2172	112-1/2	2857
5	127	32	813	59	1499	86	2184	113	2870
5-1/2	140	32-1/2	826	59-1/2	1511	86-1/2	2197	113-1/2	2883
6	152	33	838	60	1524	87	2210	114	2895
6 1/2	165	33-1/2	851	60-1/2	1537	87-1/2	2223	114-1/2	2908
7	178	34	864	61	1549	88	2235	115	2921
7-1/2	191	34-1/2	876	61-1/2	1562	88-1/2	2248	115-1/2	2933
8	203	35	889	62	1575	89	2261	116	2946
8 1/2	216	35-1/2	902	62-1/2	1588	89-1/2	2273	116-1/2	2959
9	229	36	914	63	1600	90	2286	117	2972
9-1/2	241	36-1/2	927	63-1/2	1613	90-1/2	2299	117-1/2	2984
10	254	37	940	64	1626	91	2311	118	2997
10-1/2	267	37-1/2	953	64-1/2	1638	91-1/2	2324	118-1/2	3010
11	279	38	965	65	1651	92	2337	119	3022
11-1/2	292	38-1/2	978	65-1/2	1664	92-1/2	2350	119-1/2	3035
12	305	39	991	66	1676	93	2362	120	3048
12-1/2	318	39-1/2	1003	66-1/2	1689	93-1/2	2375	120-1/2	3060
13	330	40	1016	67	1702	94	2388	121	3073
13-1/2	343	40-1/2	1029	67-1/2	1715	94-1/2	2400	121-1/2	3086
14	356	41	1041	68	1727	95	2413	122	3099
14-1/2	368	41-1/2	1054	68-1/2	1740	95-1/2	2426	122-1/2	3111
15	381	42	1067	69	1753	96	2438	123	3124
15-1/2	394	42-1/2	1080	69-1/2	1765	96-1/2	2451	123-1/2	3137
16	406	43	1092	70	1778	97	2464	124	3149
16 1/2	419	43-1/2	1105	70-1/2	1791	97-1/2	2477	124-1/2	3162
17	432	44	1118	71	1803	98	2489	125	3175
17-1/2	445	44-1/2	1130	71-1/2	1816	98-1/2	2502	125-1/2	3187
18	457	45	1143	72	1828	99	2515	126	3200
18-1/2	470	45-1/2	1156	72-1/2	1841	99-1/2	2527	126-1/2	3213
19	483	46	1168	73	1854	100	2540	127	3226
19-1/2	495	46-1/2	1181	73-1/2	1867	100-1/2	2553	127-1/2	3238
20	508	47	1194	74	1880	101	2565	128	3251
20-1/2	521	47-1/2	1207	74-1/2	1892	101-1/2	2578	128-1/2	3264
21	533	48	1219	75	1905	102	2591	129	3276
21-1/2	546	48-1/2	1232	75-1/2	1918	102-1/2	2604	129-1/2	3289



## Appendix M. Voltage Limitations

	<b>Nom</b>	<b>Min</b>	<b>Max</b>
<b>A/FE 50 Hz</b>	100	90	110
	110	96.5	119
	123.5	111	136
	200	180	220
	220	193	238
	230	202	249
	235	210	259
	240	210	259
<b>A/FE 60 Hz</b>	100	90	110
	110	96.5	119
	115	104	127
	120	104	127
	127	111	137
	200	180	220
	208	180	220
	220	193	238
	230	207	252
240	208	254	
<b>E/ME/A 50 Hz</b>	110	96.5	119
	120	104	127
	123.5	111	136
	220	193	238
	235	210	259
	240	210	259
<b>U.S. &amp; Canada 60 Hz</b>	115	104	127
	120	104	127
	208	180	220
	230	207	252
	240	208	254





# Appendix N. Installation Checklist

Following is a suggested checklist to be used by the customer one week to one month before delivery of system components.

Task	Done	Requires Attention
All building alterations completed		
Unit area large enough per plan view (adequate clearance, including height clearance)	_____	_____
Adequate lighting in unit area (50-75 footcandles for displays)	_____	_____
Good furniture design		
Operator work station considering:		
Height of counters	_____	_____
Knee space	_____	_____
Acoustics, etc.	_____	_____
Electrostatic impact:		
Plastic seat covering	_____	_____
Metal frame furniture	_____	_____
Carpeting (anti-static)	_____	_____
Floor resistance	_____	_____
Raised floor cutouts (if applicable)	_____	_____
Power Receptacles		
Within cord length of machine	_____	_____
Proper configuration	_____	_____
Adequately grounded	_____	_____
Environment		
Electromagnetic (no problem from)		
Transmitting antennas	_____	_____
Industrial equipment (induction heaters, arc welders, etc.)	_____	_____
Three-phase power distribution lines	_____	_____
Electrostatic (no problem anticipated)		
Humidity	_____	_____
Floor surfaces	_____	_____
Furniture	_____	_____
Gaseous (noncontaminating)	_____	_____
Particulate (noncontaminating)	_____	_____
Storage space (forms, cards, tapes, etc.)		
Sufficient	_____	_____
Proper	_____	_____
Common carrier facilities		
Proper connections	_____	_____
Wrap test hood acceptable	_____	_____
Correct service	_____	_____
Within length of the cable	_____	_____
Neat and safe installation	_____	_____
Lightning protection (provided by the common carrier)	_____	_____
Device Considerations		
Proper cable (meets electrical and physical specifications)	_____	_____
Cable is tested	_____	_____
Properly labeled to assure proper attachment	_____	_____
Neat and safe installation		
No stumbling hazards	_____	_____
No potential of damage to cables from personnel or equipment traffic	_____	_____
Lightning protection		
Installed in a safe place and according to codes	_____	_____
Grounded per recommendations in this manual	_____	_____
Accessible for maintenance	_____	_____
Not readily accessible to other personnel	_____	_____



## Appendix O. Abbreviations and Definitions

ambient	environment	MES	Miscellaneous Equipment Specification
A/FE	Americas/Far East	MGN	Multiground Neutral
avg	average	MHz	megahertz, one million cycles per second
AWG	American Wire Gauge	min	minimum or minute
bps	bits per second	mm	millimeter
BTU	British Thermal Unit	modem	modulator-demodulator, device that modulates and demodulates signals transmitted over communication facilities
C	Celsius		
CCITT	Consultant Committee of International Telephone and Telegraph		
cfm	cubic feet per minute	NEC	National Electrical Code
cm	centimeter	NEMA	National Electrical Manufacturers' Association
cont	continuous	No.	number
CSU	Customer setup	NTT	Nippon Telephone and Telegraph
DAA	data-access arrangement		
db	decibel	OD	outside diameter
dielectric	nonconductor of direct electric current	ohm	the practical meter-kilogram-second unit of electric resistance equal to the resistance of a circuit in which a potential difference of 1 volt produces a current of 1 ampere
DTE	Data Terminal Equipment		
EAS	Extended Area Service	pF	picofarad
EIA	Electronic Industry Association	PTT	Postal Telephone and Telegraph
E/ME/A	Europe/Middle East/Africa	PVC	polyvinyl chloride
EPO	Emergency Power Off		
F	Fahrenheit/front	R	rear
ft	feet	REA	Rural Electrification Administration
h	coaxial cable type for indoor installation	Rel	relative
H	height	rms	root-mean-square
Hz	hertz, unit of frequency equal to one cycle per second	RT	right
ID	identification	S	side
IDS	Information Display System	secs	second
in.	inch	service clearance	minimum space required to allow working room for the machine operator and/or the customer engineer for servicing the unit
kcal/hr	kilocalories per hour	SF	special feature/specify feature
kg	kilogram	SNA	Systems Network Architecture
kVA	kilovolt ampere		
l	coaxial cable type for indoor or outdoor installations	UL	Underwriters Laboratory
L	left	U.S.	United States
lb	pound	WE	Western Electric
lumens/m <sup>2</sup>	lumens per square meter	WT	World Trade
m	meters		
max	maximum		



**International Business Machines Corporation**

**Data Processing Division**

**1133 Westchester Avenue, White Plains, N.Y. 10604**

**IBM World Trade Americas/Far East Corporation**

**Town of Mount Pleasant, Route 9, North Tarrytown, N.Y., U.S.A. 10591**

**IBM World Trade Europe/Middle East/Africa Corporation**

**360 Hamilton Avenue, White Plains, N.Y., U.S.A. 10601**

3270 Information Display System  
Installation Manual—  
Physical Planning

READER'S  
COMMENT  
FORM

Order No. GA27-2787-5

This manual is part of a library that serves as a reference source for systems analysts, programmers, and operators of IBM systems. This form may be used to communicate your views about this publication. They will be sent to the author's department for whatever review and action, if any, is deemed appropriate. Comments may be written in your own language; use of English is not required.

IBM may use or distribute any of the information you supply in any way it believes appropriate without incurring any obligation whatever. You may, of course, continue to use the information you supply.

Note: Copies of IBM publications are not stocked at the location to which this form is addressed. Please direct any requests for copies of publications, or for assistance in using your IBM system, to your IBM representative or to the IBM branch office serving your locality.

How did you use this publication?

- |                          |                                     |                          |                        |
|--------------------------|-------------------------------------|--------------------------|------------------------|
| <input type="checkbox"/> | As an introduction                  | <input type="checkbox"/> | As a text (student)    |
| <input type="checkbox"/> | As a reference manual               | <input type="checkbox"/> | As a text (instructor) |
| <input type="checkbox"/> | For another purpose (explain) _____ |                          |                        |

Is there anything you especially like or dislike about the organization, presentation, or writing in this manual? Helpful comments include general usefulness of the book; possible additions, deletions, and clarifications; specific errors and omissions.

Page Number:

Comment:

What is your occupation? \_\_\_\_\_

Newsletter number of latest Technical Newsletter (if any) concerning this publication: \_\_\_\_\_

If you wish a reply, give your name and address:

IBM branch office serving you

Thank you for your cooperation. No postage stamp necessary if mailed in the U.S.A. (Elsewhere, an IBM office or representative will be happy to forward your comments or you may mail directly to the address in the Edition Notice on the back of the title page.)

Note: Staples can cause problems with automated mail sorting equipment.  
Please use pressure sensitive or other gummed tape to seal this form.

Reader's Comment Form

IBM 3270 Information Display System Installation Manual—Physical Planning (File No. 3360/S370/S3/4300/8100-15) Printed in U.S.A. GA27-2787-5

Fold and tape

Please Do Not Staple

Fold and tape



NO POSTAGE  
NECESSARY  
IF MAILED  
IN THE  
UNITED STATES

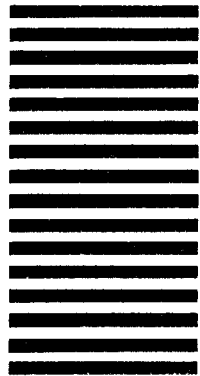

**BUSINESS REPLY MAIL**  
FIRST CLASS PERMIT NO. 40 ARMONK, N.Y.

POSTAGE WILL BE PAID BY ADDRESSEE:

International Business Machines Corporation  
Department 52Q  
Neighborhood Road  
Kingston, New York 12401

Fold and tape

Please Do Not Staple

Fold and tape



International Business Machines Corporation  
Data Processing Division

1133 Westchester Avenue, White Plains, N.Y. 10604

IBM World Trade Americas/Far East Corporation  
Town of Mount Pleasant, Route 9, North Tarrytown, N.Y., U.S.A. 10591

IBM World Trade Europe/Middle East/Africa Corporation  
360 Hamilton Avenue, White Plains, N.Y., U.S.A. 10601

3270 Information Display System  
Installation Manual—  
Physical Planning

READER'S  
COMMENT  
FORM

Order No. GA27-2787-5

This manual is part of a library that serves as a reference source for systems analysts, programmers, and operators of IBM systems. This form may be used to communicate your views about this publication. They will be sent to the author's department for whatever review and action, if any, is deemed appropriate. Comments may be written in your own language; use of English is not required.

IBM may use or distribute any of the information you supply in any way it believes appropriate without incurring any obligation whatever. You may, of course, continue to use the information you supply.

*Note: Copies of IBM publications are not stocked at the location to which this form is addressed. Please direct any requests for copies of publications, or for assistance in using your IBM system, to your IBM representative or to the IBM branch office serving your locality.*

How did you use this publication?

- |                          |                                     |                          |                        |
|--------------------------|-------------------------------------|--------------------------|------------------------|
| <input type="checkbox"/> | As an introduction                  | <input type="checkbox"/> | As a text (student)    |
| <input type="checkbox"/> | As a reference manual               | <input type="checkbox"/> | As a text (instructor) |
| <input type="checkbox"/> | For another purpose (explain) _____ |                          |                        |

Is there anything you especially like or dislike about the organization, presentation, or writing in this manual? Helpful comments include general usefulness of the book; possible additions, deletions, and clarifications; specific errors and omissions.

Page Number:

Comment:

Note: Staples can cause problems with automated mail sorting equipment.  
Please use pressure sensitive or other gummed tape to seal this form.

What is your occupation? \_\_\_\_\_

Newsletter number of latest Technical Newsletter (if any) concerning this publication: \_\_\_\_\_

If you wish a reply, give your name and address:

IBM branch office serving you

Thank you for your cooperation. No postage stamp necessary if mailed in the U.S.A. (Elsewhere, an IBM office or representative will be happy to forward your comments or you may mail directly to the address in the Edition Notice on the back of the title page.)

Reader's Comment Form

IBM 3270 Information Display System Installation Manual—Physical Planning (File No. S360/S370/S34300/8100-15) Printed in U.S.A. GA27-2787-5

Cut or Fold Along Line

Fold and tape

Please Do Not Staple

Fold and tape



NO POSTAGE  
NECESSARY  
IF MAILED  
IN THE  
UNITED STATES



**BUSINESS REPLY MAIL**  
FIRST CLASS PERMIT NO. 40 ARMONK, N.Y.

POSTAGE WILL BE PAID BY ADDRESSEE:

International Business Machines Corporation  
Department 52Q  
Neighborhood Road  
Kingston, New York 12401

Fold and tape

Please Do Not Staple

Fold and tape



International Business Machines Corporation  
Data Processing Division

1133 Westchester Avenue, White Plains, N.Y. 10604

IBM World Trade Americas/Far East Corporation  
Town of Mount Pleasant, Route 9, North Tarrytown, N.Y., U.S.A. 10591

IBM World Trade Europe/Middle East/Africa Corporation  
360 Hamilton Avenue, White Plains, N.Y., U.S.A. 10601